

Picking the Target

POPULAR MECHANICS

MAGAZINE

WRITTEN BY YOU CAN UNDERSTAND IT

SEPT.
25 CENTS
30c IN CANADA

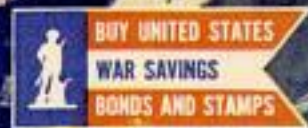

SEE PAGE 14

BUY
WAR BONDS
TODAY
Keep America
Free

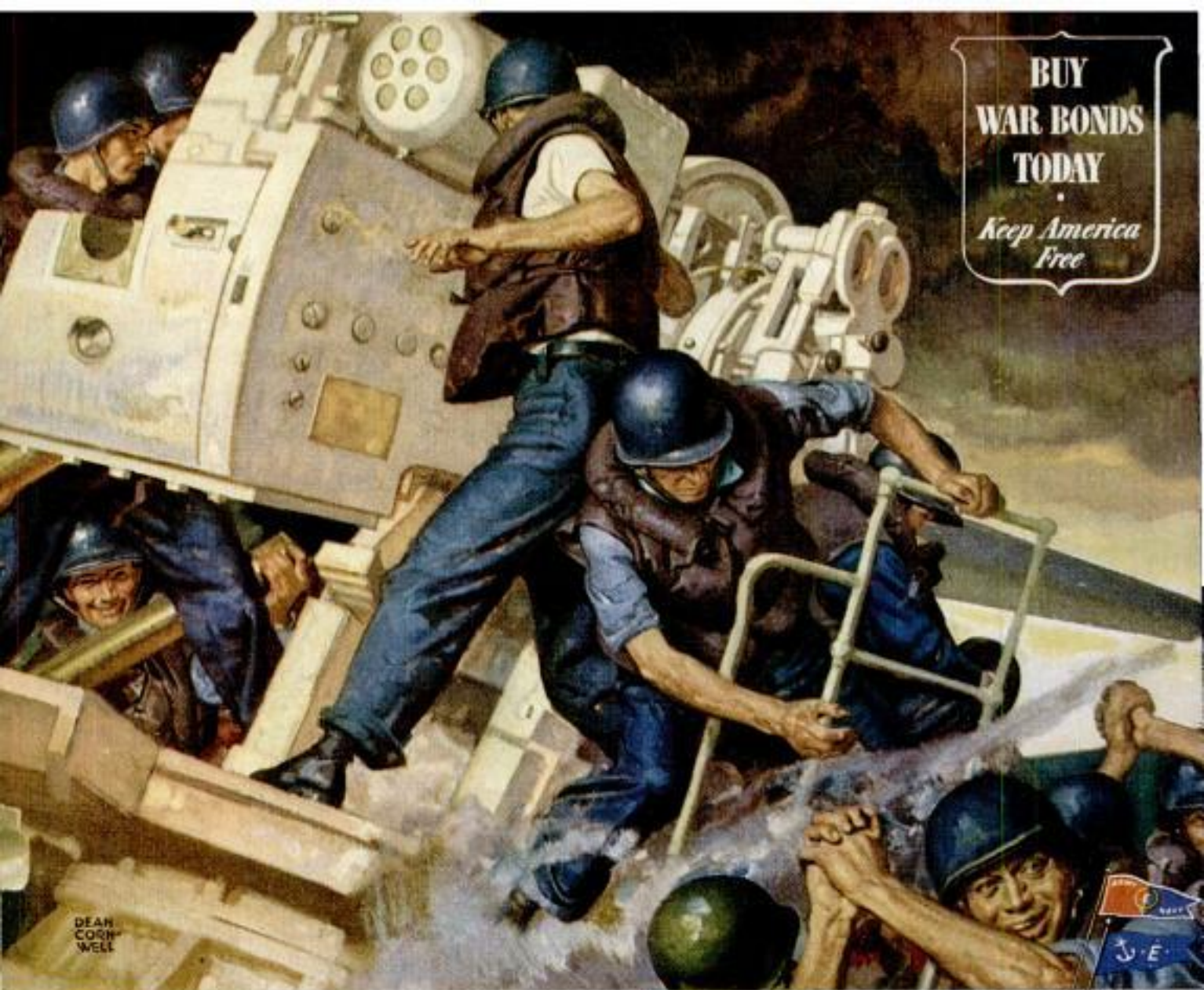

DEAN
CORN
WELL

Finish Fight *by Fisher*

The Army-Navy "E" flies above four Fisher Body plants for excellence in aircraft production and from two others for tank production, while the Navy "E," with four stars, is flown by still another Fisher Body plant for its naval ordnance work.

IT'S a hard-hitting brute—this dual-purpose 5-inch gun. It's the kind of fighting tool needed to smother enemy fire power, to give our men a life-saving advantage when the going gets tough.

We cannot take credit for *all* of it. This big 5-incher was designed by the U. S. Navy, and its production is a tribute to the cooperation of thousands of workers and several companies.

But as we see it come down the Fisher assembly lines, we get a thrill of pride out of the work we have done on it. It's proof that Fisher craftsmanship has once more been pointed right, has once more registered a hit on the production target.

Whether it's bombers, fighting planes, tanks,

anti-aircraft guns, delicate flight instruments or other armament to be built—Fisher craftsmen are on the job till they get it ironed out. That goes for some very rugged problems put up to us by the men who do the shooting. And in this fight to the finish, we intend to stay right in the middle of such things until the final bell rings.

Every Sunday Afternoon
GENERAL MOTORS SYMPHONY OF THE AIR
NBC Network



armament
BOXY BY

Fisher

DIVISION OF GENERAL MOTORS

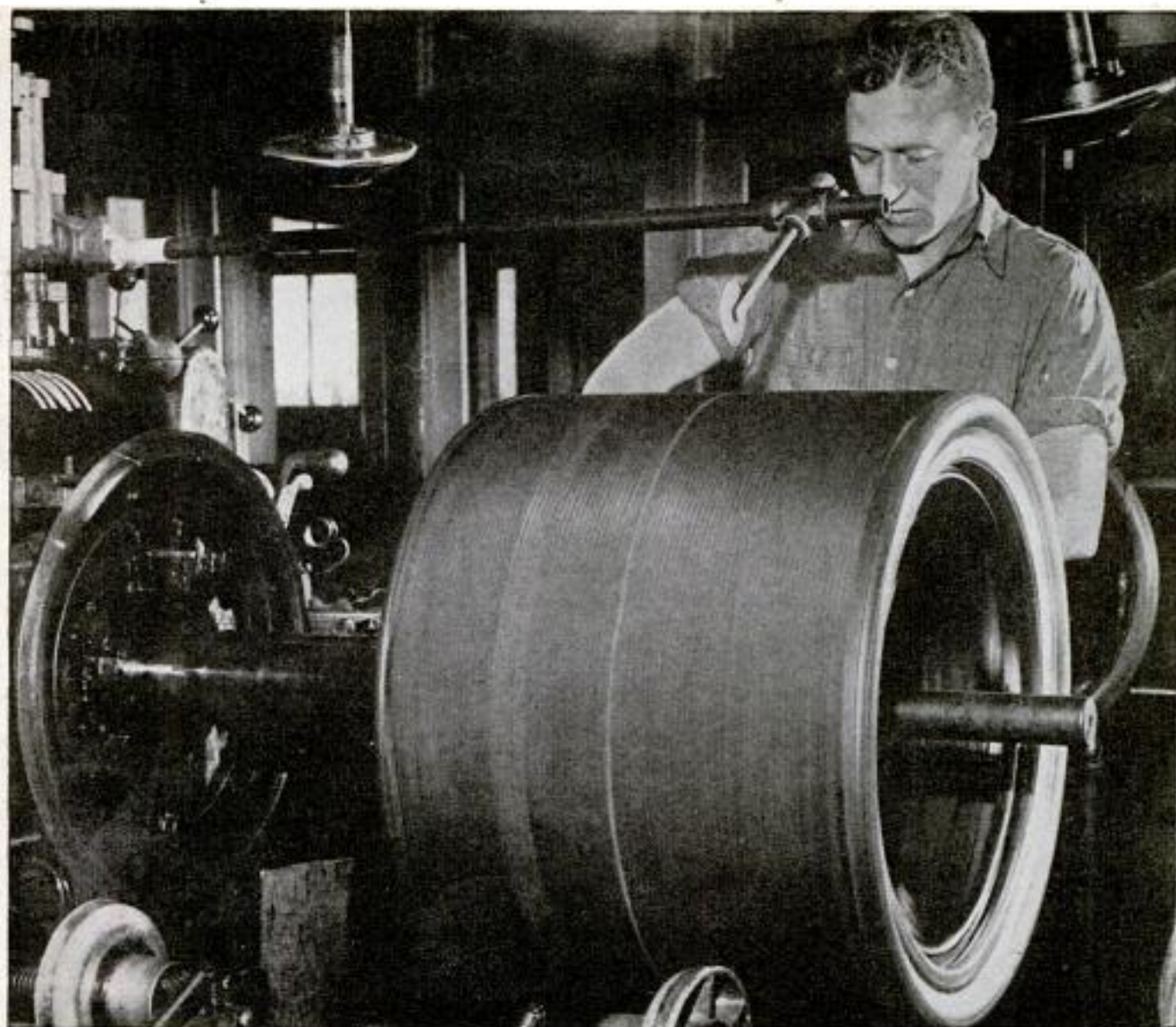

The tack we put in every tire

Synthetic rubber used to rub itself the wrong way, until the chemists found the answer

A TIRE IS BUILT like a layer cake. First, one layer of rubber-coated cord, then another on top of it. The picture above shows a man building up the layers. That's an actual tire he's working on, before it's shaped and molded.

If the layers didn't stick together tight, the tire-builder would have a bad time of it. Production would slow down. Tire failures would increase.

Natural rubber has plenty of adhesiveness, or "tack." Synthetic rubber hasn't. So B. F. Goodrich engineers began to search for something that would give synthetic rubber more "tack."

The answer was found in a cement made from natural rubber. It is

applied to both sides of each layer and the underside of the tread.

But this *natural* rubber (2% or less) in the new synthetic Silvertowns insures against lagging production, frequent failure.

By making and selling thousands of tires made with more than 50% synthetic long before the war, B. F. Goodrich engineers were able to get a three-year head start in compounding synthetic rubber—knowledge that today is invaluable to American car owners.

These tires totaled more than 80,000,000 miles. They were the first containing any synthetic rubber ever sold to American car owners. Many are still in use. Today's B. F. Goodrich tires for pas-

senger cars are all-synthetic (98%) and are almost as good as pre-war tires. Truck tires aren't as good, especially in intercity service with overloads, but are improving daily.

Few can buy right now, but if you're one of those who *can* buy tires today, go to a B. F. Goodrich dealer or Silvertown store. You'll get tires backed by years of experience with synthetic rubber in all kinds of products—tires backed by this 80,000,000-mile road test. *The B. F. Goodrich Company, Akron, O.*

In war or peace
B.F. Goodrich
FIRST IN RUBBER

SEPTEMBER, 1944

J1RQ-4S7-8UFN

Copyrighted material 1A

A Camera Fan is MADE . . . not born!



Most beautiful picture ever made? Bob's mother insists it is because it's the first snapshot he ever made. . . . and he made it of her! It was taken with a Universal, one that Bob bought out of his allowance.



Mother was embarrassed when Bob graduated to candid shots like this. Made with a Universal, of course. For even then Universal called the field with a candid-type camera priced so low even youngsters could afford it.



Here's the last one he took of his mother before entering the Navy. Also made with a Universal, the Mercury he got when he graduated from college. Bob carries this picture with him everywhere.



Bob's using Universal Navy binoculars now—for Universal's at war too, making military optical instruments instead of cameras. But Bob took his Mercury with him. He's made some great shots in his spare time.



The war will end . . . and a home and family of his own will redouble Bob's interest in photography. And what photography! Universal's wartime achievements will result in a great new series of cameras.



He'll get fast action shots yet his camera will be simple . . . thanks to Universal's pioneering of new methods in mass-producing precision optical instruments. *Expect YOUR next camera to be a Universal!*

Remember: One picture from home is worth a thousand words to a Serviceman



UNIVERSAL CAMERA CORP.

NEW YORK • CHICAGO • HOLLYWOOD

Peacetime Manufacturers of Mercury, Cinémaster, Corsair Cameras and Photographic Equipment

Popular Mechanics Magazine

Registered in U. S. Patent Office and Canada

H. H. WINDSOR, Founder

H. H. WINDSOR, Jr., Editor and Publisher

September, 1944

Vol. 82, No. 3

Next Month

REAR Admiral Clark H. Woodward says our conquest of Saipan was the greatest victory the Allies have won in the Pacific. Those are big words if you think back to the battles of Midway, the Coral Sea, Guadalcanal, Tarawa—to mention a few. In an authoritative article next month, Admiral Woodward tells why the possession of Saipan and neutralization of the Marianas is the "Springboard for Victory" over Japan. He also traces the advance of our fleet at blitz tempo to the Jap's inner defense area 4,000 miles west of Pearl Harbor. The article tells how the Japs might have staved off invasion of strategic outposts.

Twin-Threat Man

AFTER the pilot of a Navy dive bomber or torpedo plane has hit a Jap target, the Zeros attack in swarms as he heads for home. The pilot's fixed guns in the wings fire only straight ahead, and his chances for getting back would be slim without his twin-threat man in the rear turret. An October feature, "Twin-Threat Man in a Dive Bomber," tells the dramatic role of the Navy's radio-gunners in bringing the planes safe home.

Aerial Detectives

IF YOU think the air you breathe is ordinary stuff, you should talk to the men who are solving the mysteries of high speed flying. One problem is to find a way to keep a high altitude pilot from becoming overheated by cold air coming into the cockpit for ventilation. Slowing of air causes compression and heat. Don't miss "Secrets of Super Speed" next month.

IN THIS ISSUE

"The Rocket's Red Glare"	1
The Line Is Busy	8
Power for Our Western Empire	18
Picking the Target	28
Highballing 500 Trains a Day	33
High-Chair Bombardiers	40
Chemical Magic on the Farm	44
First Aid for Wounded Warships	50
Sound Tricks of the Movies	56
Heroes of the Tin Cans	65
Smoke—the Lifesaver	72
Battle Over—Batter Up!	76
Rescue From the Sky	82

Where-to-Buy-It Index—Page 8A

Cameramen Under Enemy Fire

REMEMBER the Tarawa picture of marines examining a captured Jap stronghold in the midst of battle with dead Japs strewn grotesquely about? And the pictures of our men moving onto the beaches of Normandy under machine gun fire? Those invasion photos were received in the U. S. just 36 hours after the battle started. Cameramen, in uniform and out, are risking their lives every day in combat. They ride in the first waves of landing craft onto enemy beaches. Meet these heroic front line photographers in the first installment of a two-part feature in the October issue.

Television After V-Day

AN OFFICIAL of one of the largest radio companies in America predicts that in the decade after the war some 25 million television sets will be sold in this country. It may take a few years for the industry to get up steam, but when it does you will have televised movies on a 15 by 20-foot screen in your theater or home. Engineers also predict pictures in color 10 years after victory. For a glimpse into the future read "Television After V-Day" next month.

Published monthly by POPULAR MECHANICS COMPANY, 200 East Ontario Street, Chicago (11), Ill., U. S. A. Single copy in the United States, 25 cents; subscription rates in United States and possessions, and countries of the Pan-American Postal Union, 1 year, \$2.50; 2 years, \$4.50; 3 years, \$6.00. Single copy in Canada, 30 cents; subscription rates, 1 year, \$3.00; 2 years, \$5.50; 3 years, \$7.50. To all other countries add \$1.00 a year over United States prices for overseas postage. If you plan to move, notify us at least 60 days in advance so you will not miss an issue. Give both old and new addresses. Entered as Second Class Matter, September 15, 1903, at the Post Office at Chicago, Illinois, under Act of March 3, 1879. Entered as Second Class Matter at Post Office Dept. Canada. Copyright 1944, by Popular Mechanics Company, Copyright under International Copyright Union. All rights reserved under Pan American Copyright Union. Printed in the United States of America



A ship is a world

To her crew a warship means everything—home, food, protection, life. She's a world in herself, wherever she sails on the seven seas. She must stand alone—she must meet the strains and stresses of the sea, the weather and the war. The safety of the ship—the lives of men—depend upon the enduring qualities built in by skill, experience and integrity. That is why, here at Defoe, men and women put heart and pride into the construction of every Destroyer Escort and LCI (L) Landing Craft launched. The vital responsibilities of the shipbuilder's art will tolerate only craftsmen who build well. For these reasons whatever Defoe produces after the war will have the advantages of staunch dependability . . . of better quality and value for peacetime America.

DEFOE SHIPBUILDING COMPANY, BAY CITY, MICHIGAN

Defoe



*Four White Star Renewal Citations
now decorate the Navy "E" Award
won by Defoe workers.*

INVEST IN INVASION
—BUY WAR BONDS

SHIPS FOR VICTORY
SERVANTS FOR PEACE



MEET YOUR NEW NEIGHBOR...

You would enjoy a visit to Greenland. . . A land of unusual beauty and the midnight sun. The people there are friendly, pleasant and honest, awakening with ever-increasing speed to the features of the civilization we enjoy. . . Greenland is a World Neighbor and the incidents that were once of only local importance are now of international concern. The best and easiest way to have a ringside seat to the history making events of *any* country is with shortwave radio, because with it you can tune anywhere in the world almost instantaneously. . . Your postwar Hallicrafters Radio will be a superb instrument—the world's best shortwave receiver. The result of over eighty million dollars of war research and manufacturing development, you will be able to tune in on any World Neighbor simply by turning a dial.

THE HALLICRAFTERS COMPANY, CHICAGO 16, U.S.A. • Builders of the Famous SCR-299



HALLICRAFTERS RADIOS are serving on all battlefronts and are establishing an enviable reputation for reception, transmission and dependability. Ask any radio technician—anywhere in the world—what radio gets the message thru! Victorious Allied Armies all over the world attest to the excellence of Hallicrafters Radios.

BUY A WAR BOND TODAY!

hallicrafters RADIO





The "Rambler" Roars into Rangoon

This morning you're flying with the crew of the famous "Rangoon Rambler" . . .

Crouched in the glassed-in nose beside you, Lt. Guy Spotts, the navigator, studies a map spread across his knees, checks off landmarks as they slide past underneath. Suddenly he peers ahead . . . speaks into his throat-microphone: "Pilot from navigator. There she is, Rote. We can see the target now. Alter course to three-three-zero."

"Roger!" Capt. Raymond Rote, the pilot, eases the big B-24 around and straightens out on his new course.

Then you see it . . . a splash of flame against the green horizon . . . the great, gold-domed Shwe Dagon Pagoda that towers over Rangoon. You're getting close . . . and the crew gets set. Lt. Robert Currie, the bombardier, fiddles with the knobs on his bombsight. Capt. Gordon Wilson, co-pilot, gives the instruments a last-minute check.

Now you're over the target . . . a flock of pot-bellied Jap cargo ships squatting there in the river's bend. The "Rambler" lurches and bucks as she ducks through bursts of ack-ack and goes into her bombing run.

Your heart pounds hard. Then Currie comes in on the intercom . . . cool as if he were ordering cokes at the Assam Officers Club: "Pilot from bombardier. Bombs away! Let's get out of here, pal!"

Looking back and below, you watch the formation's bombs bullseye the target. A freighter goes up in a blast of fire and black smoke. The ship beside it explodes.

Flames break out from a third. And a fourth. Currie and the other bombardiers were "on the beam" today.

Rote banks the Lib around steep, and you high-tail for home. You're congratulating yourself when . . . "Fighters at four o'clock—high!" somebody yells. You look up and see a formation of Japs sweeping out of the sun.

Now it's the gunners' turn. And between squirts of their big, twin-50's they keep up a running pep-talk:

"There goes his wing down! He's coming in! This one's my meat, Salley!"

"Hey, skipper—kick her over a little. I want a good shot at this guy."

And two Japs spiral down in flames, and the rest decide to quit. That's all for today. You look around at the crew, relaxing now, shooting the breeze, adding up the score. You think of the ribbons each man has won for flights like this.

And it makes your chest puff out with pride to be flying with guys like these . . . to be wearing the wings of the AAF—the "greatest team in the world!"

U. S. ARMY RECRUITING SERVICE



THE "RANGOON RAMBLERS": Standing: Sgt. Ferdinand Knechtel, gunner; Capt. Raymond Rote; Capt. Gordon Wilson; Lt. Guy Spotts; Lt. Robert Currie; Sgt. Joseph Willis, gunner. Seated: Sgt. John Craigie, Sgt. Carl Paak, Sgt. Adolph Scolavino, Sgt. Edward Salley, gunners.

MEN OF 17...



If you want to fly on the "greatest team in the world," an AAF air combat crew . . . go to your nearest AAF Examining Board . . . see if you can qualify for the Air Corps Enlisted Reserve. If you qualify, you will receive this insignia . . . but will not be called for training until you are 18 or over.

When called, you will be given further tests to determine the type of training you will receive. If you are trained as a gunner or technician gunner, you will go into actual combat as a non-commissioned officer. If your aptitudes are

outstandingly high, you may be trained as a bombardier, navigator or pilot; and graduate from training as a Flight Officer or Second Lieutenant.

But whatever your job on an AAF air combat crew, you will be the best-trained flier in any army on earth.

For pre-aviation training, see your local Civil Air Patrol officers. Also see your High School principal or adviser about recommended courses in the Air Service Division of the High School Victory Corps. Ask about the opportunities for college training through the Army Specialized Training Reserve Program.

For information on Naval Aviation Cadet Training, apply at nearest Office of Naval Officer Procurement. This advertisement has the approval of the Joint Army Navy Personnel Board.



FLY AND FIGHT WITH THE

GREATEST TEAM IN THE WORLD



WHITE COLLAR or OVERALLS—



Which will YOU wear after the war?

HUNDREDS of thousands of white collar workers have put on war overalls for the duration. Millions of both white collar and overall workers have put on uniforms. Hosts of home women are patriotically taking jobs.

After the war, millions will be coming back from army, navy and air force to civilian jobs; great war materials factories will be re-converting to civilian production; old peace-time functions of business will be springing up—where will you fit in the situation?

If you are wise, you will look ahead and prepare. You will not wait on chance. You will analyze the probable conditions in peace employment, decide where your likes and aptitudes fit best, and get ready. You will decide whether your best opportunities lie in production or office or store. You will determine whether you wish to work for someone else or develop a business of your own. You will train now to be above the average and, therefore, surer to get the opportunity you want after the armistice.

Nor will you wait very long. Nobody knows when this war will end or how soon this problem will hit you in the face.

major fields of commerce and industry, and we have gathered a wealth of information about job opportunities and requirements. That information is at your service.

We Can Help You Prepare

And when you have decided what field of work offers most to you for a life career, we can help you prepare for it—quickly, economically, thoroughly, in your spare time and without any interference with your present work—if it is in the list below. A 48-page booklet on the field of your choice, discussing the field and our training for it, has been prepared to help answer your questions. The coupon below or your letter will bring it to you, without cost or obligation.

Do not delay. Whether the war lasts six months or three years, now is the time to make sure your preparation for postwar success shall not be “too little and too late.”

La Salle Extension University A Correspondence Institution

DEPT. 964-R

417 S. Dearborn St., CHICAGO 5

I want to pick my career for after the war and get ready for it now. Send me your free booklet on the field I have checked below and full information about your training in that field.

- | | |
|---|--|
| <input type="checkbox"/> Foremanship | <input type="checkbox"/> Industrial Management |
| <input type="checkbox"/> Bookkeeping | <input type="checkbox"/> Accounting |
| <input type="checkbox"/> Business Law | <input type="checkbox"/> Law: LL.B. Degree |
| <input type="checkbox"/> Executive Management | <input type="checkbox"/> Traffic Management |
| <input type="checkbox"/> Salesmanship | <input type="checkbox"/> Business Correspondence |
| <input type="checkbox"/> Business English | <input type="checkbox"/> Stenotypy |

Name.....Age.....

Present Job.....

Address.....

We Can Help You Decide

If you have some question either about postwar opportunities or about your own fitness for some particular one, probably we can help you. In our 36 years, over one million adults have enrolled for our training, we have built training courses for many

PYROIL

... adds life to your car



PREVENTS CORROSION AND RUST

by protecting cylinder and piston surfaces.



REDUCES WEAR

by improving effectiveness of lubrication.



PREVENTS SLUDGES AND GUMS



REDUCES CARBON FORMATION



... Ask your station attendant to add one pint of Pyroil to your crankcase—and one ounce to your gasoline tank for each 5 gallons of gasoline.

Manufactured and Guaranteed by Pyroil Company, W. V. Kidder, Founder, 59 Pyroil Building, LaCrosse, Wisconsin.

YOUR GUARANTEE—30 YEARS' ACCEPTANCE BY FOREMOST AUTHORITIES — RACE DRIVERS — EXPLORERS — ENGINEERS

Keep Buying Bonds

PYROIL COMPANY

59 Pyroil Bldg., LA CROSSE, WISCONSIN

I want my car to last and run properly. Please tell me more about Pyroil and how it can accomplish this for me.

Name

Address

City or Town..... State.....

WHERE-TO-BUY-IT INDEX

Where no name and address appear directly under an item, the product is not believed by us to be commercially available

Gyro-compass guides assault boats.....	6
Chains on tanks explode mines.....	6
"Sea Mule" is powerful tug.....	7
Guns in packages under plane wings.....	7
Marine steers ship with foot.....	16
Mold-ladle unit makes soft hammer.....	16
Johnson Tool Co., 65 Massoit Ave., East Providence 14, R. I.	
Pocket-size electric meter.....	16
Triplett Electrical Instrument Co., Bluffton, Ohio	
Barbless spring hooks fish.....	16
Inventor: Andrew Binkowski, 910 Chicago Ave., Lansing, Mich.	
Two-way radio for trains.....	17
Telescope lift goes up 85 feet.....	17
Economy Engineering Co., 2843 W. Van Buren, Chicago 12, Ill.	
Mobile power station for bombed cities.....	26
Nazi one-man sub.....	27
Electronic machine measures hides.....	27
Boxes joined to make barge.....	32
Cold electrodes speed welding.....	32
Prostrod Products, Detroit, Mich.	
Thermit melts bridge supports.....	38
Subsoil plow leaves stubble.....	38
3,000-horsepower plane engine.....	39
"Mars" flies biggest mail load.....	39
Army's plywood storm boat.....	39
Helicopter flies inside building.....	43
Workshop dial solves problems.....	43
Greenlee Tool Co., 2136 12th St., Rockford, Ill.	
Model planes train gunners.....	48
Acroboat to hit 60 knots.....	49
Mobile airfield tower.....	49
Quack grass found to be useful.....	49
Flying boat takes off from desert.....	54
Trailers with track treads.....	54
Radio records depth of river.....	54
Motor-driven chain-type saw.....	55
Henry Disston & Sons, Inc., Tacony, Philadelphia, Pa.	
Rabbits test penicillin.....	55
Sound waves measure yarn.....	55
Pre-heater for plastic molds.....	61
Magnetic sweeper for factories.....	61
Stearns Magnetic Mfg Co., Milwaukee 4, Wis.	
Magnifier for micrometer scale.....	61
Stebur Research Lab., 711 W. Lake, Minneapolis 8, Minn.	
The world's worst road.....	62
Torches direct planes to field.....	64
Blood clotter aids brain surgery.....	64
New plastic withstands boiling.....	64
German "butterfly" bomb.....	64
Unsinkable steel life raft.....	70
Back yard dive bomber rides cable.....	70
Small plane loaded on large one.....	71
Tanks tested in "dust bowl".....	71
New gun shoots 20,000 feet high.....	75
"Flying Flossie" tests catapults.....	75
Nurses train for overseas duty.....	80
Jeep runs on rails or road.....	81
Chemists find synthetic quinine.....	81
Fire signal warns tank driver.....	81
Globe gives life raft's position.....	87
Inventor: F. H. Hagner, San Antonio, Tex.	
Hand operated grease gun.....	87
Balcrank, Inc., Cincinnati 9, Ohio	
Gift items made of Plexiglas.....	88
Vargish Co., 220 Fourth Ave., New York 3, N. Y.	
First stainless-steel cargo plane.....	88
Record blanks for home recording.....	141
Recordisc Corporation, 395 Broadway, New York City	

Craftsman and Shop Notes Index

ART AND ARTIST

Adjustable pantograph.....	121
Clay holds paint and brushes.....	122
Spacer for drawing section lines.....	123

AUTOMOTIVE

Jig holds piston in vise.....	92
Servicing the cooling system.....	105
Making a radiator grill.....	122
Easy way to remove crankcase.....	123
Waver of speedometer needle eliminated.....	129

CAMPING, HUNTING AND FISHING

Cork shield for casting plug.....	96
How to string fish.....	96
Making duck decoys.....	98
Holder for fishing plugs.....	104
Reducing wear on a tent.....	108

FARM

Padded brooder-house door protects chicks.....	130
Horseshoes used as bolster cleats.....	132
Anchoring a hog trough.....	133
Removing honey from beehive.....	139
Torch for burning weeds.....	140

HAND TOOLS

Spreader for linoleum paste.....	112
Individual handles for saw blades.....	113
Centering gauge for woodworking.....	122
Brace used as a speed wrench.....	122

Continued to page 10A



Be smart— Study Radio Now!

THIS is a *radio war*—and victory will bring a *radio world!*

That's why men with foresight and ambition are studying radio *now*—at home, in their spare time!

They know that if they're drafted, *radio training* will make them eligible for *further valuable training* with the Armed Forces—eligible for *higher rating* and *higher pay*—eligible for more *interesting assignments!*

And when they return to civil life, they'll have knowledge and background to fit

them for a well-paid, responsible job in *radio, television or electronics!*

You can study an I. C. S. Radio Course in your spare time—at low cost—starting *right now!* Mail this coupon, and we'll send you complete information on the famous I. C. S. *personalized* teaching method, which has helped thousands along the highway to success!

This information may well be worth thousands of dollars to you—yet it's yours for a 3c stamp! Mail the coupon today!

INTERNATIONAL CORRESPONDENCE SCHOOLS



BOX 5502-K, SCRANTON 9, PENNA.

Without cost or obligation, please send me booklet and full particulars about the course *before* which I have marked X:

- | | | | |
|---|--|--|--|
| <input type="checkbox"/> ELECTRONICS | <input type="checkbox"/> Highway Engineering | <input type="checkbox"/> Mold-Loft Work | <input type="checkbox"/> Business and Academic Schools |
| <input type="checkbox"/> GENERAL RADIO | <input type="checkbox"/> Lumber Dealer | <input type="checkbox"/> Patternmaking | <input type="checkbox"/> Accounting <input type="checkbox"/> Advertising |
| <input type="checkbox"/> RADIO OPERATING | <input type="checkbox"/> Sanitary Engineering | <input type="checkbox"/> Reading Shop Blueprints | <input type="checkbox"/> Arithmetic <input type="checkbox"/> Bookkeeping |
| <input type="checkbox"/> RADIO SERVICING | <input type="checkbox"/> Structural Drafting | <input type="checkbox"/> Sheet Metal Drafting | <input type="checkbox"/> Business Correspondence |
| <input type="checkbox"/> SOUND TECHNICIAN | <input type="checkbox"/> Surveying and Mapping | <input type="checkbox"/> Sheet Metal Worker | <input type="checkbox"/> Business Management |
| <input type="checkbox"/> Air Conditioning and Plumbing Schools | <input type="checkbox"/> Electrical Schools | <input type="checkbox"/> Ship Drafting <input type="checkbox"/> Ship Fitting | <input type="checkbox"/> Certified Public Accounting |
| <input type="checkbox"/> Air Conditioning | <input type="checkbox"/> Electrical Drafting | <input type="checkbox"/> Ship Practice | <input type="checkbox"/> City Letter Carrier |
| <input type="checkbox"/> Heating <input type="checkbox"/> Plumbing | <input type="checkbox"/> Electrical Engineering | <input type="checkbox"/> Steel Mill Workers | <input type="checkbox"/> College Preparatory |
| <input type="checkbox"/> Refrigeration <input type="checkbox"/> Steam Fitting | <input type="checkbox"/> Power House Electrician | <input type="checkbox"/> Tool Designing | <input type="checkbox"/> Commercial |
| <input type="checkbox"/> Chemistry Schools | <input type="checkbox"/> Practical Electrician | <input type="checkbox"/> Welding, Gas and Electric | <input type="checkbox"/> Cost Accounting |
| <input type="checkbox"/> Chemical Engineering | <input type="checkbox"/> Practical Telephony | <input type="checkbox"/> Railroad School | <input type="checkbox"/> Federal Tax |
| <input type="checkbox"/> Chemistry, Analytical | <input type="checkbox"/> Telegraph Engineering | <input type="checkbox"/> Air Brake <input type="checkbox"/> Car Inspector | <input type="checkbox"/> First Year College |
| <input type="checkbox"/> Chemistry, Industrial | <input type="checkbox"/> Internal Combustion Engines School | <input type="checkbox"/> Locomotive Engineer | <input type="checkbox"/> Foremanship |
| <input type="checkbox"/> Chemistry, Mfg. Iron & Steel | <input type="checkbox"/> Auto Technician <input type="checkbox"/> Aviation | <input type="checkbox"/> Locomotive Fireman | <input type="checkbox"/> High School |
| <input type="checkbox"/> Plastics | <input type="checkbox"/> Diesel-Electric | <input type="checkbox"/> Railroad Section Foreman | <input type="checkbox"/> Higher Mathematics |
| <input type="checkbox"/> Pulp and Paper Making | <input type="checkbox"/> Diesel Engines <input type="checkbox"/> Gas Engines | <input type="checkbox"/> Steam Engineering Schools | <input type="checkbox"/> Illustrating |
| <input type="checkbox"/> Civil, Architectural and Structural Eng'g Schools | <input type="checkbox"/> Mechanical Schools | <input type="checkbox"/> Boilermaking | <input type="checkbox"/> Motor Traffic |
| <input type="checkbox"/> Architectural Drafting | <input type="checkbox"/> Aeronautical Engineering | <input type="checkbox"/> Combustion Engineering | <input type="checkbox"/> Post Office Clerk |
| <input type="checkbox"/> Architecture | <input type="checkbox"/> Airplane Drafting | <input type="checkbox"/> Engine Running | <input type="checkbox"/> Railway Postal Clerk |
| <input type="checkbox"/> Bridges and Building Foreman | <input type="checkbox"/> Flight Engineer | <input type="checkbox"/> Marine Engines | <input type="checkbox"/> Salesmanship <input type="checkbox"/> Secretarial |
| <input type="checkbox"/> Bridge Engineering | <input type="checkbox"/> Foundry Work | <input type="checkbox"/> Steam Electric <input type="checkbox"/> Steam Engines | <input type="checkbox"/> Stenography |
| <input type="checkbox"/> Building Estimating | <input type="checkbox"/> Heat Treatment of Metals | <input type="checkbox"/> Textile School | <input type="checkbox"/> Traffic Management |
| <input type="checkbox"/> Civil Engineering | <input type="checkbox"/> Industrial Design | <input type="checkbox"/> Cotton Manufacturing | <input type="checkbox"/> Language School |
| <input type="checkbox"/> Contracting and Building | <input type="checkbox"/> Mechanical Drafting | <input type="checkbox"/> Rayon Weaving | <input type="checkbox"/> Spanish <input type="checkbox"/> French |
| | <input type="checkbox"/> Mechanical Engineering | <input type="checkbox"/> Textile Designing | <input type="checkbox"/> Good English |
| | | <input type="checkbox"/> Woolen Manufacturing | |

Name.....Age.....Home Address.....

City.....State.....Present Position.....Working Hours.....

Canadian residents send coupon to International Correspondence Schools Canadian, Ltd., Montreal, Canada.
British residents send coupon to I. C. S., 71 Kingsway, London, W. C. 2, England.

SPECIAL TUITION RATES FOR MEMBERS OF THE ARMED FORCES

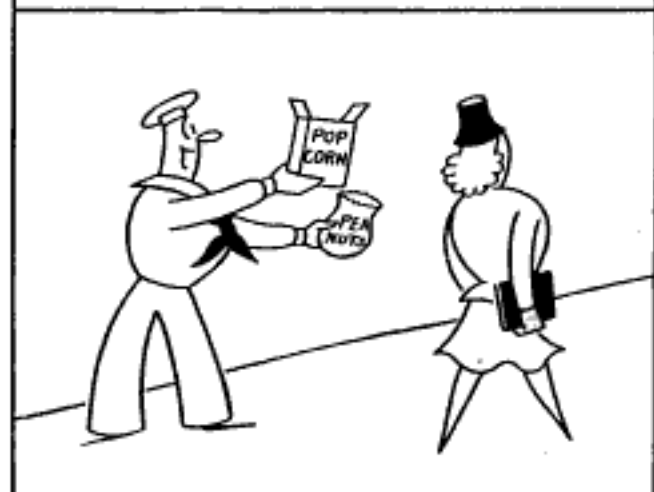
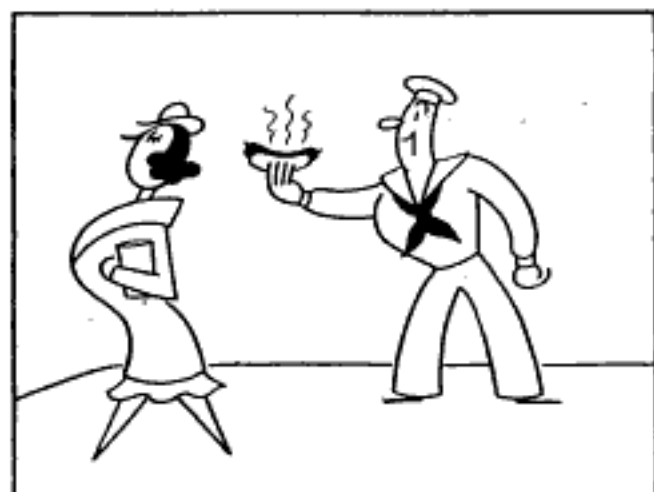

Continued from page 8A

Making a wheel puller.....	131
Tray under vise catches small parts.....	132
Test lamp made from screwdriver.....	133
Determining temperature of screwdriver.....	138

HOME IMPROVEMENTS

How to make a neat temporary stoop.....	104
Window cornice from thin stock.....	108
Cornice boards for child's room.....	109

HOUSEHOLD

Cords strung over apertures.....	89
Stovepipe joints kept from "sweating".....	92
Plate hanger made of wire.....	93
Solving home problems.....	94
Reflection shield for reading glass.....	102
Holding cloth on card table.....	104
Dummy outlet plugs protect children.....	108

LAWN AND GARDEN

Sprinkling can made from buckets.....	96
Plant duster from a tin can.....	96

OFFICE

Adjustable partition for filing cabinet.....	93
Plywood "in and out" indicator.....	140

PHOTOGRAPHY

Taking night photos.....	114
Magnifying glass helps focus enlarger.....	117
Extra prints dried in blotter roll.....	117
Shutter stickiness eliminated.....	117
Dentist's cotton rolls to wipe film.....	118
Tag on case identifies film.....	118
Tape keeps negative from slipping.....	118
Spring clip holds focusing cloth.....	118
Notebook used as negative file.....	118

POWER TOOLS

Anti-kick-back for bench saw.....	97
Improvised steady rest.....	107
Large panels drilled with press on ceiling.....	107
Center height gauge for lathe.....	123
Die holder to thread slender stock.....	139
Construction and use of tailstock turrets.....	134

RADIO AND ELECTRONICS

Hints for home recording.....	141
Dual phono unit has electronic controls (Part 2).....	142
Ultra-short-wave receiver in a tobacco tin.....	144

STORE AND SHOP

Carton flaps held open by clothespin.....	122
Measuring cable or rope on drum.....	123
Locating breaks in extension cords.....	130
Changeable price tickets on showcards.....	132
Shock absorber for pilot light.....	140
Checking copy held on printing press.....	149

WOODWORKING

Fig to split dowels.....	113
Chuck permits routing with pattern.....	139

MISCELLANEOUS

Tips to a better finish.....	91
Container aids in picking berries.....	92
Keeping ants out of lunch basket.....	92
Hinged boat seat lifts out of way.....	92
Pole and tray picnic table.....	96
Scoter steered by door-hinge pivot.....	97
Wall mirror with scrollsawed frame.....	103
Small knife made from file.....	103
Twenty-four-hour watch face.....	104
Storing long tools in drawer.....	104
Putty prevents rusting of insulator screw.....	108
Chair leg aids in attaching heel plates.....	108
How to blow glass.....	110
Pivoting bobbed runner.....	112
Grinding wheel dresser.....	119
Dry-cell carbons as commutators.....	120
Work clothes carried by trouser hanger.....	122
Notched stakes hold marking line.....	123
Poultry houses you can build.....	124
Fixture holds ladder on truck.....	132

IMPORTANT NOTICE

It is the intention of this magazine to provide its readers with information regarding the latest developments in the mechanical arts. We take no responsibility as to whether the disclosures contained in our articles are covered by patents and advise readers to investigate this subject before making, using, or selling any of the products, machines, or processes described in order to avoid possible liability for patent infringement.

AUDELS REFRIGERATION & AIR CONDITIONING GUIDE.....\$4

New from Cover to Cover—1280 Pages, Fully Illus. Covering basic principles, servicing, operation & repair of household, commercial & industrial refrigeration & air conditioning. A gold mine of essential important facts for engineers, servicemen, users.

AUDELS CARPENTERS & BUILDERS GUIDES—4 Vols.\$6

A practical illustrated trade assistant on modern construction for carpenters, joiners, builders, mechanics and all woodworkers. 4 vols., 1600 pages, 3700 illustrations, flexible covers. Pocket size. Each volume sold separately \$1.50 a vol.

AUDELS AUTOMOBILE GUIDE.....\$4

A practical quick ready reference book for auto mechanics, service men, operators & owners. Explains theory, construction & servicing of modern motor cars, trucks, buses & auto type Diesel engines. 1540 pages, fully illustrated, 55 chapters. Indexed. A standard book for mechanics. New fluid drive covered.

AUDELS DIESEL ENGINE MANUAL.\$2

A practical, concise treatise with questions and answers on the theory, operation and maintenance of modern diesel engines including General Motors 2 cycle Diesel. 384 pages, fully illus., flexible binding, pocket size. All details plainly brought out, this book is of extreme value to engineers, operators & students.

AUDELS WIRING DIAGRAMS.....\$1

210 Pages, Illustrated. Gives practical facts on wiring of electrical apparatus. It shows clearly how to wire apparatus for practically all fields of electricity. Each diagram is complete & self-explanatory. Highly Endorsed Pocket Companion.

AUDELS PLUMBERS & STEAMFITTERS GUIDES—4 Vols.\$6

A Practical Trade Assistant & Ready Reference. Explains in plain language & by clear illustrations, diagrams, charts, graphs, pictures principles of modern plumbing practice including Marine Pipe Fitting and Air Conditioning. 4 Vols.—1670 Pages—3642 Diagrams. Pocket size. Each Vol. Sold Separately \$1.50 a Vol.

AUDELS SHEETMETAL WORKERS HANDY BOOK.....\$1

Practical inside information. Fundamentals of Sheet Metal Work. 388 pages, Illustrated. 11 sections. Clearly written. Essential & important facts, figures, pointers in everyday language. Ref. Index.

AUDELS SHEETMETAL PATTERN LAYOUTS.....\$4

Developed by Experts for Sheet Metal Workers. Layout Men & Mechanics. A Practical Encyclopedia in 10 Sections, size 7 x 10 x 2—1125 Pages—350 Layouts—1600 Illustrations, 1001 Key Facts. Fully Indexed for ready reference in answering your layout problems. Covers all phases of sheet metal work including Pattern Cutting, Pattern Development & Shop Procedure.

AUDELS ANSWERS ON BLUE PRINT READING.....\$2

For Mechanics & Builders. Covers all types of blue print reading including ship & airplane. 376 pages, fully illustrated.

AUDELS NEW MACHINIST & TOOLMAKERS HANDY BOOK...\$4

Covers modern machine shop practice in all its branches. 5 practical books in 1. New from cover to cover. Tells how to set up & operate lathes, screw and milling machines, shapers, drill presses and all other machine tools. 1600 pages, fully illustrated, 5 x 8 1/2 x 2. Indexed. 5 sections. 1—Modern Machine Shop Practice. 2—Blue Print Reading & How to Draw. 3—Calculations & Mathematics for Machinists. 4—Shop Physics. 5—How to Use the Slide Rule. 60 chapters. Easy to read and understand. A shop companion that answers your questions.

AUDELS MATHEMATICS & CALCULATIONS FOR MECHANICS \$2

Mathematics for home study or reference. 700 pages, 550 illus. Practical mathematics from beginning. How to figure correctly. Easy, correct methods covering a complete review. Ill. & Indexed.

AUDELS HANDY BOOK OF PRACTICAL ELECTRICITY.....\$4

For maintenance engineers, electricians & all electrical workers. 1440 Pages, 2600 Illus. Covers important electrical information in handy form—including Marine Wiring, Radio Principles, Welding. Indexed. A Key to a practical understanding of electricity.

AUDELS RADIOMANS GUIDE.....\$4

A key to the practical understanding of radio including Frequency Modulation, Television, etc., Aircraft & Marine Radio. For radio engineers, servicemen, amateurs. 772 pages, 400 illustrations & Diagrams. Photos. Review Questions & Answers, Reference Index. Authentic, clear, concise.

AUDELS ELECTRONIC DEVICES...\$2

Tells What You Want to Know About Electric Eye, Easily Understood. Covers photo-electric cells & their applications. Amplifiers, illumination, frequencies, voltage, photocell, tubes, Ohm's Law, wiring diagrams, etc.

AUDELS WELDERS GUIDE.....\$1

A concise, practical text on operation & maintenance of all welding machines for all mechanics. Over 400 pages, illustrated. Covers all methods of electric and acetylene welding including airplane work.

AUDEL, Publishers, 49 W. 23 St., N. Y. 10

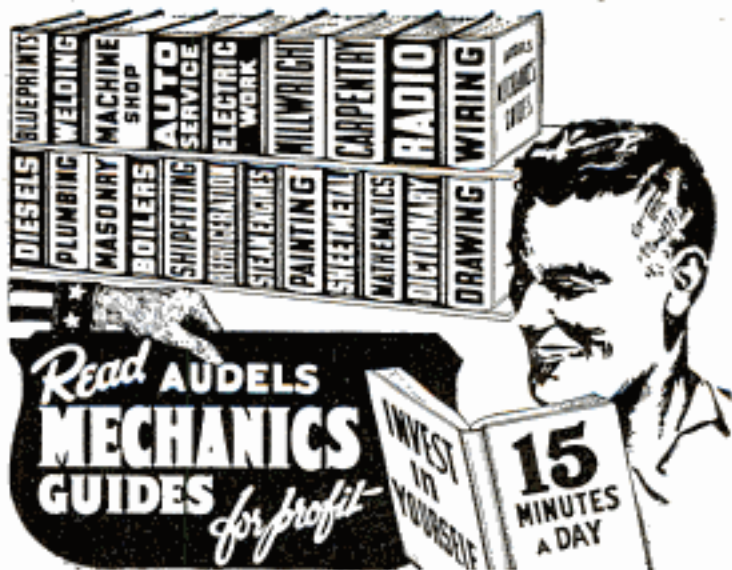

AN AUDEL GUIDE IS A GOOD FRIEND!

Use the brains and experience of others in these Guides of the Trades. Save time and money with right methods, short cuts, labor saving ideas. CHECK NOW! You can look over any Audel Guide in your home. Start the Easy Payments if satisfied.

CUT HERE MAIL ORDER

THEO. AUDEL & CO., 49 W. 23 St., New York 10, N.Y.

Please mail me for 7 days' free examination the books marked (X) below. I agree to mail \$1 in 7 days on each book or set ordered, and to further mail \$1 a month on each book or set ordered until I have paid purchase price.

If I am not satisfied with Guides I will return them.

- Audels REFRIGERATION & Air Conditioning Guide 54.
- Audels PUMPS, HYDRAULICS & AIR COMPRESSORS 4.
- Audels WELDERS GUIDE 1.
- Audels BLUE PRINT READING 2.
- Audels SHEET METAL WORKERS Handy Book 1.
- Audels SHEET METAL PATTERN LAYOUTS 4.
- Audels AIRCRAFT WORKER 1.
- Audels MATHEMATICS and CALCULATIONS 2.
- Audels MACHINISTS & TOOLMAKERS Handy Book 4.
- Audels DIESEL ENGINE MANUAL 2.
- Audels MECHANICAL Dictionary 4.
- Audels AUTOMOBILE GUIDE 4.
- Audels MARINE ENGINEERS Handy Book 4.
- Audels SHIPFITTERS Handy Book 1.
- Gueths MECHANICAL DRAWING COURSE 1.
- Rogers DRAWING and DESIGN 2.
- Audels MILLWRIGHTS and Mechanics Guide 4.
- Audels CARPENTERS and Builders Guides (4 vols.) 6.
- Audels PLUMBERS and Steamfitters Guides (4 vols.) 6.
- Audels MASONS and Builders Guides (4 vols.) 6.
- Master PAINTER and DECORATOR 2.
- Audels GARDENERS & GROWERS GUIDES (4 vols.) 6.
- Audels ENGINEERS and Mechanics Guides Nos. 1, 2, 3, 4, 5, 6, 7 and 8 complete 12.
- Audels Answers on Practical ENGINEERING 1.
- Hawkins Aids to ENGINEERS EXAMINATION 2.
- Audels WIRING DIAGRAMS 1.
- Audels Handy Book of PRACTICAL ELECTRICITY 4.
- Audels ELECTRICAL POWER CALCULATIONS 2.
- Hawkins ELECTRICAL Guides at \$1. each 10.
- Audels ELECTRONIC DEVICES 2.
- Audels ELECTRIC Dictionary 2.
- Audels RADIOMANS GUIDE 4.
- Audels NEW ELECTRIC LIBRARY at \$1.50 a Volume Vols. I, II, III, IV, V, VI, VII, VIII, IX, X, XI, XII.

Name.....

Address.....

Occupation.....

Employed by..... PM



J. E. SMITH, President
National Radio Institute
Our 30th Year of Training Men
for Success in Radio

**I WILL SEND
A SAMPLE
to PROVE I can Train You
BE A RADIO**

**Good Jobs Like These
Go To Men I Train**



\$600 Before Graduating, Kits Helped
—“From your Experimental Kits I learned how electricity worked, how to connect the three stages of a Radio together, also the practical basis for the operation of different parts of a set. I made about \$600 or \$700 before I graduated.”—S. G. PIERSON, Box 71, Dry Creek, W. Va.



\$200 a Month in Own Business
—“For several years I have been in business for myself making around \$200 a month. Business has steadily increased. I have N.R.I. to thank for my start.”—A. J. FROEHNER, 500 W. Texas Ave., Goose Creek, Texas.



Radio Service Manager of 4 Stores—“I was working in a garage when I enrolled with N.R.I. I am now Radio Service Manager for M—Furniture Co. for their 4 stores.”—JAMES E. RYAN, 119 Pebble Court, Fall River, Mass.



\$10 a Week in Spare Time—“I repaired some Radios when I was on my tenth lesson. I made \$600 in a year and a half, and have made an average of \$10 a week—just spare time.”—JOHN JERRY, 300 So. H. St., Exeter, California.



Chief Operator Broadcasting Station—“Before I completed your lessons, I obtained my Radio Broadcasting Operator's license and immediately joined Station WMPC where I am now Chief Operator.”—HOLLIS F. HAYES, 327 Madison St., Lapeer, Michigan.

*Get Into a Busy Field With
a Bright Peacetime Future*

**BIG DEMAND NOW FOR WELL TRAINED
RADIO TECHNICIANS, OPERATORS**

I will send you my Lesson “Getting Acquainted with Receiver Servicing” FREE, to show you how practical it is to train for Radio at home in spare time. It's a valuable Lesson. Study it—keep

it—use it—without obligation! And with this Lesson I'll send my 64-page, illustrated book, “Win Rich Rewards in Radio” FREE. It describes many fascinating jobs Radio offers, tells how N.R.I. gives you practical Radio experience at home with **SIX BIG KITS OF RADIO PARTS** I supply!



RADIO SERVICING (picture above) pays Technicians good money, spare or full time. **RADIO OPERATORS** (picture at right) find interesting work in U. S. Broadcasting and other types of stations.



**My Radio Course Includes
TELEVISION ★ ELECTRONICS
FREQUENCY MODULATION**

Think of the NEW jobs that Television, Frequency Modulation, Electronics, and other developments will open after the war! I will train you to be ready to cash in when Victory releases the amazing wartime developments for peacetime uses!

A TESTED WAY TO

3 Boulder Dam called the greatest engineering feat in history	19 Sep.
Boxes of welded metal joined to make barges	32 Sep.
Boxing also a sport of the armed service overseas	79 Sep.
Brain surgery aided by use of "fibrin" foam developed from blood plasma	64 Sep.
Bridge demolished by melting supports with thermit furnace	38 Sep.
Bureau of Reclamation constructed and operated 30 plants since beginning of war	25 Sep.
Burma Road (Little) "The world's Worst Road)	62-63 Sep.
Camera electrically heated for high altitude flying	30 Sep.
Carbon dioxide used in fighting electrical fires	50 Sep.
Card holder made of plexiglas	88 Sep.
Carrier telephone system helps to carry increased load on lines	9 Sep.
Catapults aircraft, tested through help of water tanks	75 Sep.
Cerex new thermoplastic that withstands sterilization	64 Sep.
Chains on tanks explode mines	6 Sep.
Chemicals	
"...Magic on the Farm"	44 Sep.
sprayed from tanks mounted under wings of planes	75 Sep.
warfare, "Smoke the Lifesaver"	72 Sep.
Cigarette holder made of plexiglas	88 Sep.
Circuit breaker remote-control on control panel in Union Tower	36 Sep.
Coast Guard "Lifetime" copper cruiser	14 Sep.
Coconut crab race staged by Marines	79 Sep.

LESSON FREE

at Home in Spare Time to

TECHNICIAN



Many Opportunities Open for Trained Radio Technicians and Operators

There's a shortage today of capable Radio Technicians and Operators. The Radio Repair Business is booming. Profits are large. After-the-war prospects are bright too. Think of the new boom in Radio Sales and Servicing that's coming when new Radios are again available—when Frequency Modulation and Electronics can be promoted—when Television starts its post-war expansion!

Broadcasting Stations, Aviation Radio, Police Radio, Loudspeaker Systems, Radio Manufacturing all offer good jobs to trained Radio men—and most of these fields have a big backlog of business that built up because of the war, plus opportunities to expand into new fields opened by wartime developments. You may never see a time again when it will be so easy to get a start in Radio!

Many Beginners Soon Make \$5, \$10 a Week EXTRA in Spare Time

The day you enroll for my Course I start sending you EXTRA MONEY JOB SHEETS that help show how to make EXTRA money fixing Radios in spare time when still learning. I send you SIX big kits of Radio parts as part of my Course. You LEARN Radio fundamentals from my illustrated, easy-to-grasp lessons—PRACTICE what you learn by building real Radio Circuits—and USE your knowledge to make EXTRA money!

Mail Coupon for FREE Lesson and Book

The opportunity war has given beginners to get started in Radio may never be repeated. So take the first step at once. Get my Lesson and 64-page illustrated book, FREE. No obligation—no salesman will call. Just mail Coupon in an envelope or pasted on a penny postal.—J. E. SMITH, President, Dept. 4JP, National Radio Institute, Washington 9, D. C.

You Build These and Other Radio Circuits with 6 Big Kits I Send



MEASURING INSTRUMENT (above) you build early in Course. Use it in practical Radio work to make EXTRA money. Vacuum tube multimeter, measures A.C., D.C. and R.F. volts, D.C. currents, resistance, receiver output.

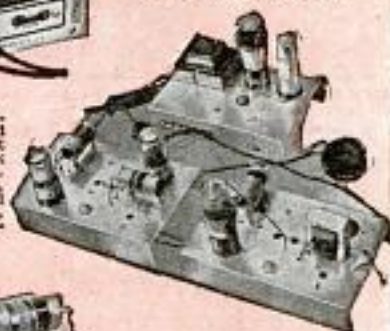

By the time you've conducted 80 sets of Experiments with Radio Parts I supply, made hundreds of measurements and adjustments, you'll have valuable PRACTICAL Radio experience for a good full or part time Radio job!



A.M. SIGNAL-GENERATOR (above) Build it yourself! Provides amplitude-modulated signals for test and experimental purposes. Gives valuable practice!

SUPERHETERODYNE CIRCUIT (above) Pre-selector, oscillator-mixer-first detector, i.f. stage, diode-detector-a.v.c. stage, audio stage. Bring in local and distant stations on this circuit you build yourself!

GOOD FOR BOTH 64 PAGE BOOK SAMPLE LESSON FREE

J. E. SMITH, President, Dept. 4JP, National Radio Institute, Washington 9, D. C.

Mail me FREE, without obligation, Sample Lesson and 64-page book, "Win Rich Rewards in Radio." (No salesman will call. Please write plainly.)

Name..... Age.....

Address.....

City..... State..... 4PR



GOOD PAY

The Mechanism of Mind



WHY YOU ARE AS YOU ARE—

and *What You Can Do About It!*

DID you ever stop to think *why* you do the things you do? Have you often—when alone—censored yourself for impulsive urges, for things said or done that did not truly represent *your real thoughts*, and which placed you at a disadvantage? Most persons are *creatures of sensation*—they react to instinctive, impelling influences which surge up within them and which they do not understand—*or know how to control*. Just as simple living things involuntarily withdraw from irritations, so likewise thousands of men and women are content to be motivated by their undirected thoughts which haphazardly rise up in their consciousness. *Today you must sell yourself* to others—bring forth your best abilities, manifest your personality, if you wish to hold a position,

make friends, or impress others with your capabilities. You must learn how to draw upon your latent talents and powers, not be bent like a reed in the wind. There are simple, natural laws and principles which—if you understand them—make all this possible.

For centuries the Rosicrucians (not a religious organization), a worldwide movement of men and women devoted to the study of life and its hidden processes, have shown thousands how to probe these mysteries of self. Renowned philosophers and scientists have been Rosicrucians—today men and women in every walk of life owe their confidence and ability to solve personal problems to the Rosicrucian private, *sensible* method of self-development. Send today for a copy of the book, "The Mastery of Life," which will be sent to you without obligation. It will tell you of the Rosicrucians *and what they can do for you*. Address: Scribe G.Q.I.

THE ROSICRUCIANS (AMORC), SAN JOSE, CALIFORNIA, U. S. A.

Copper 70% of new C.G. cruiser "Revere made of	14
Communication	
"The Line is Busy"	8
two-way radio, links train crews to yards	17
Craftsman home, aided by use of workshop dial	43 S
Dams "Power for our Western Empire"	18 Se
DDT new insecticide used by the armed forces to com- bat insect life	47 Sep.
Destroyer, destroyers	
Desron-Two, mostly widely traveled destroyer	65 Sep.
"Heroes of the Tin Cans"	65 Sep.
U. S. Borie, drawing of	67 Sep.
U.S.S. Nicholas one of 1940 Fletcher Class	68 Sep.
Dial workshop, solves problems of woodworking and tools	43 Sep.
Dive-bomber built in back-yard rides under 50-ft. cable	70 Sep.
Dog team aids work of rescue crew on snowy lake	83 Sep.
Dust-bowl man-made tests tanks	71 Sep.
Duster sprays the ground with dithane, insect killer	47 Sep.
Electrical tests made with multiple-purpose meter	16 Sep.
Electrodes icy, to speed spot welding by frosting machine	32 Sep.
Engine 3,000-h.p. most powerful for aircraft in world	39 Sep.
"Fibrin foam" substance developed from blood plasma aids brain surgery	64 Sep.
Fire-fighting	
approved system extinguishes in tanks in seconds	81 Sep.
"First Aid for Wounded Warships"	50 Sep.



INVENTORS

NOW Is the Time to PATENT and SELL Your Invention

Get
**FREE
COPY**

Now, more than ever before, is the right time to patent your invention. Why? Because manufacturers everywhere presently engaged in war production are looking ahead to the future by buying up patent rights now, so they will have new and attractive items to make and sell for civilian consumption as soon as the war is over. This is what happened during and after the last war. Hence, the smart thing for you to do is to look ahead to the future too. Protect your invention and yourself by applying for a patent now.

Patent Guide Shows What To Do

Our "Patent Guide for the Inventor" answers many important questions concerning Patents that inventors constantly ask. It tells what facts, details, drawings, sketches, etc. are necessary to apply for a Patent; how to protect your invention through dated and witnessed disclosure; how to do this AT ONCE to safeguard your rights; how Patent Office Records can be checked to determine whether the invention is probably patentable before filing fees need be paid; discusses costs involved and a practical way these can be paid as the application progresses. It tells how some inventors secured financial backing; how many simple inventions have proved large commercial successes; how Patents covering improvements also can be profitably utilized and marketed; tells countless other facts of interest.

Why You Need Expert Assistance

The Patent Laws were enacted for your benefit—to give you protection for the features of your invention which are Patentable. But these features must be legally and concisely set forth in the form of "claims." This phase of the procedure is so complex that the Patent Office advises the Inventor to engage a competent Registered Patent Attorney. We maintain a large staff—carefully trained registered patent attorneys—expert draftsmen—experienced searchers—to serve you. We have been serving inventors for more than 20 years.

Take First Step Now

With the Patent Guide you will receive also Free a "Record of Invention" form which will enable you at once to establish the date of your invention, before you file your Patent application. This step costs you nothing yet may be vital to your success. Remember—in Patent Matters, ACTION IS IMPORTANT. Delay can be costly. Mail the coupon in an envelope, or paste it on a penny postcard NOW.

CLARENCE A. O'BRIEN & HARVEY B. JACOBSON

"Worthy of your Trust"

Registered Patent Attorneys

41-J Adams Building
Washington 4, D. C.

Get This
FREE BOOK
IMMEDIATELY MAIL COUPON TODAY!



**CLARENCE A. O'BRIEN
& HARVEY B. JACOBSON**

CLARENCE A. O'BRIEN & HARVEY B. JACOBSON

Registered Patent Attorneys before the United States Patent Office
41-J Adams Building, Washington 4, D. C.

Please send me your 48-Page "Patent Guide for the Inventor" and your specially prepared "Record of Invention" form FREE. This request does not obligate me.

Name

Address

City State

(Please write or print plainly.)

SPRAYBERRY RADIO TRAINING

Gives you Both

TECHNICAL KNOWLEDGE
SKILLED HANDS



FULL RADIO SET SUPPLIED FOR SHOP PRACTICE!

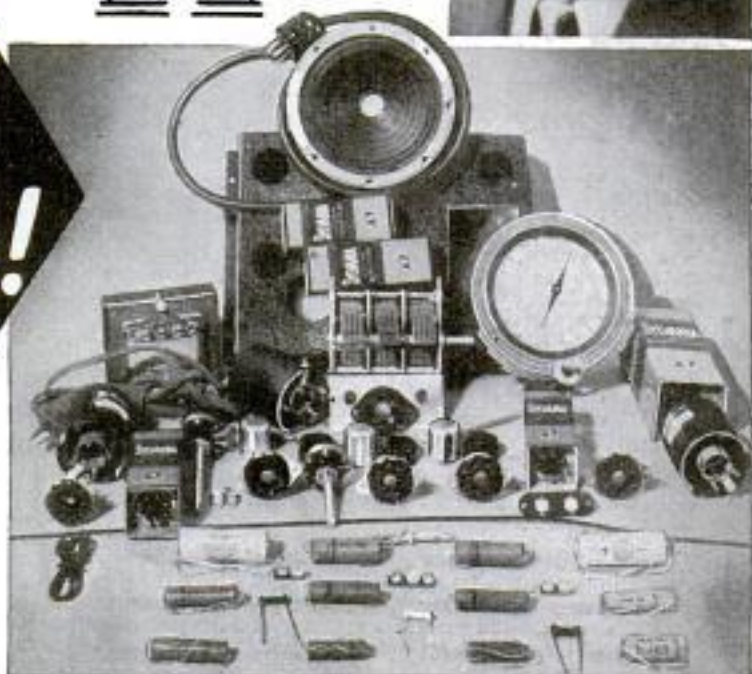

HERE'S THE ONE PRACTICAL WAY TO TRAIN FOR BIG EARNINGS AHEAD IN RADIO-ELECTRONICS & TELEVISION

JUST OUT! FREE!

"How to Read Radio Diagrams and Symbols"

... a valuable new book which explains in simple English how to read and understand any Radio Set Diagram. Provides the quick key to analyzing any Radio circuit. Includes translations of all Radio symbols. Send for this FREE book now and along with it I will send you another big FREE book describing my Radio-Electronic training.



GET FREE BOOKS

SPRAYBERRY ACADEMY OF RADIO

F. L. Sprayberry, President
Box 500R, Pueblo, Colorado.

Please rush my FREE copies of "How to MAKE MONEY in RADIO, ELECTRONICS and TELEVISION," and "HOW TO READ RADIO DIAGRAMS and SYMBOLS."

Name..... Age.....

Address.....

City..... State.....

(Mail in plain envelope or paste on penny postcard)

The offer I make you here is the opportunity of a lifetime. It's your big chance to get ready for a wonderful future in the swiftly expanding field of Radio-Electronics INCLUDING Radio, Television, Frequency Modulation and Industrial Electronics. Be wise! NOW'S the time to start. No previous experience is necessary. The Sprayberry Course starts right at the beginning of Radio. You can't get lost. It gets the various subjects across in such a clear, simple way that you understand and remember.

I'll Show You a New, Fast Way to Test Radio Sets Without Mfg. Equipment

The very same Radio Parts I supply with your course for gaining pre-experience in Radio Repair work may be adapted through an exclusive Sprayberry wiring procedure to serve for complete, fast, accurate Radio Receiver trouble-shooting. Thus under Sprayberry methods you do not have one cent of outlay for manufactured Test Equipment which is not only expensive but scarce.

Prepares You for a Business of Your Own or Good Radio Jobs... Civilian or Military

My training will give you the broad, fundamental principles so necessary as a background no matter which branch of Radio you wish to specialize in. I make it easy for you to learn Radio Set Repair and Installation Work. I teach you how to install and repair Electronic Equipment. If you enter the Army, Navy or Marines, my training will help you win higher rating and better pay.

What's My Job?—I Manufacture Weaklings into MEN!

Charles Atlas

Actual Photograph of the man who holds the title "The World's Most Perfectly Developed Man."

GIVE ME a skinny, pepless, second-rate body—and I'll cram it so full of handsome, bulging new muscle that your friends will grow bug-eyed! . . . I'll wake up that sleeping energy of yours and make it hum like a high-powered motor! Man, you'll *feel* and *look* different! You'll begin to *LIVE!*



Let Me Make YOU a NEW MAN —IN JUST 15 MINUTES A DAY!

You wouldn't believe it, but I myself used to be a 97-lb. weakling. Fellows called me "Skinny." Girls snickered and made fun of me behind my back. I was a flop. THEN I discovered my marvelous new muscle-building system—"Dynamic Tension." And it turned me into such a complete specimen of MANHOOD that today I hold the title "THE WORLD'S MOST PERFECTLY DEVELOPED MAN."

That's how I traded in my "bag of bones" for a barrel of muscle! And I felt so much better, so much on top of the world in my big, new, husky body, that I decided to devote my whole life to helping other fellows change themselves into "perfectly developed men."

What Is "Dynamic Tension"? How Does It Work?

When you look in the mirror and see a healthy, husky, strapping fellow smiling back at you—then you'll be astounded at how short a time it takes "Dynamic Tension" to GET RESULTS!

"Dynamic Tension" is the easy, NATURAL method you can practice in the privacy of your own room—JUST 15 MINUTES EACH DAY—while your scrawny shoulder muscles begin to swell, ripple . . . those spindly arms and legs of yours bulge . . . and your whole body starts to feel "alive," full of zip and go!

One Postage Stamp May Change Your Whole Life!

As I've pictured up above, I'm steadily building broad-shouldered, dynamic MEN—day by day—the country over.

2,000,000 fellows, young and old, have already gambled a postage stamp to ask for my FREE book. They wanted to read and see for themselves how I'm building up scrawny bodies, and how I'm paring down fat, flabby ones—how I'm turning them into breath-taking human dynamos of pure MANPOWER.

Take just a few seconds NOW to fill in and mail the coupon at right, and you will receive at once my FREE book—"Everlasting Health and Strength" that PROVES with actual snap-shots what "Dynamic Tension" has done for others—what it can do for YOU! Address: CHARLES ATLAS, Dept. 8J, 115 East 23rd St., New York 10, N. Y.

FREE

Mail the coupon below right now for my FREE illustrated book, "Everlasting Health and Strength." Tells all about "Dynamic Tension" methods. Crisscrossed with pictures, facts! Address me personally: CHARLES ATLAS, Dept. 8J, 115 E. 23rd St., New York 10, N. Y.



CHARLES ATLAS, Dept. 8J
115 East 23rd St., New York 10, N. Y.

I want the proof that your system of "Dynamic Tension" will help make a New Man of me—give me a healthy, husky body and big muscular development. Send me your free book, "Everlasting Health and Strength."

Name.....
(Please print or write plainly)

Address.....

City..... Zone No. (if any)..... State.....

Check here if under 16 for Booklet A.

INVENTORS

LEARN HOW TO
**PROTECT and SELL
YOUR INVENTION**

GET NEW FREE BOOK



FREE

**Invention Record
Know How Successful
Inventors Protect and
Sell Their Inventions**

Our new FREE Book is a book every inventor should have. Mail the coupon today for "How to Protect, Finance and Sell Your Invention" and learn . . .

- How to know if there is a prior U. S. patent on your invention.
- How to save steps in getting patent action.
- How to prepare your application for presentation to the Patent Office.
- How you may patent an improvement on something in use now.
- How to obtain funds to patent and promote your invention.
- How to find a buyer or backer for your invention.
- How to protect yourself in making royalty agreements.

MODERN BUSINESS WANTS INVENTIONS

Practical and novel inventions are in big demand today. The opportunity for quick money is enticing. Sales sources are many if your invention has merit. But, be *sure*—before you place your device in strange hands—that it is fully protected. A United States Patent gives you this protection. *The first step toward inventive success—always is—and always has been, the application for a U. S. Patent. There is no other way to protect your invention in accordance with the laws of this country.*

MAKE THIS RECORD NOW

If you have an invention, and wish to secure it for the future, act at once. Have it dated now and recorded in our office. We will send you this FREE Invention Record Form for the purpose. Fill out the Invention Record Form fully describing the nature of your invention. Make a sketch of its main features. Mail it to us and we will record the date it was received in our office. The earlier the date the better your chance of combating rival inventors who may lay claim to your idea later. *Don't delay a single minute in taking this important step. Your whole future may depend upon it. Mail the coupon for our FREE Invention Record Blank and New FREE Book today!*

HOW WE SERVE YOU AS REGISTERED PATENT ATTORNEYS

The U. S. Patent Office strongly recommends—unless the inventor is familiar with such matters—that he employ the services of a Registered Patent Attorney in the preparation of his Patent Application. We are Registered Patent Attorneys fully qualified to represent you at the Patent Office. We have had long experience in studying hundreds of types of inventions. This gives us the ability to judge your invention and to describe it accurately and convincingly in technical language. It gives us the perception to center arguments upon those details of your invention which, in our judgment, will be looked upon most favorably by the Patent Office Examiner.

Mail the coupon today for our new FREE Book, "How to Protect, Finance and Sell Your Invention," and our FREE Invention Record Form—maybe this step will pave the way to future security for you and your family. Act Today!

McMORROW & BERMAN
Patent Attorneys
1352 Albee Building, Washington 5, D. C.

McMORROW & BERMAN

PATENT ATTORNEYS

1352 ALBEE BUILDING, WASHINGTON 5, D. C.

Send me your new FREE book, "How to Protect, Finance and Sell Your Invention"—and "Invention Record" form at once. I understand that this request does not obligate me.

NAME

ADDRESS

CITY STATE

(Write or print name clearly)

slides areas of flat material measured by electronic set	27 Sep.
Hook barbless fish, doesn't let them get away	16 Sep.
Hosiery elasticity of measured through use of sound waves	55 Sep.
Insect fighting equipment also contained in special kits	85 Sep.
Instrument board mock-up of instruments actually used in navigation	43 Sep.
Interlocking machine of the biggest governing movements of trains in New York's Pennsylvania station	34 Sep.
"Jack-in-the-box" telescope lift raises platform 95 ft.	17 Sep.
Jeep	
shifts wheels to run on rails	81 Sep.
testing ground for combat drivers on "Little Burma Road"	62 Sep.
Kits two emergency parachute, produced by the Air Force	85 Sep.
Landing craft marine steers without steering wheel	16 Sep.
Lead melted in mold-and-ladle unit forms hammer	16 Sep.
Life raft/unsinkable carries twenty men	70 Sep.
Life raft's position given by special instrument without use of compass	87 Sep.
Locomotive	
electric, lends itself to rather high average speed	156 Sep.
100-miles-an-hour on New York-Washington route	37 Sep.
Magnetized drum on sweeper picks up dropped nails	61 Sep.
Magnifier for micrometer speeds reading of numbers	61 Sep.
Mail largest amount of flown on "Martin Mars"	39 Sep.

THEY ALL LISTEN TO ACCOUNTANTS



THERE is no field of business today which offers greater opportunities than Accounting. Changing conditions, new methods of manufacturing and merchandising, the multiplication of tax forms—all these have made Accountancy of utmost importance to management. Successful executives are fact and figure minded. *They all listen to Accountants.*

The Accounting Courses of International Correspondence Schools train men and women both in theory and in the realities of accounting practice—making a rounded education. That's why these Schools of the Successful look forward confidently to the advancement of students who complete a course.

For the person who has had elementary accounting experience, the I. C. S. Course in

Accountancy, C.P.A. Problems and Business Law is an excellent preparation for examinations leading to C.P.A. certificates. It is favored, too, by many executives who do not plan to become public accountants but who desire this training.

Other I. C. S. Accounting Courses are tailored for those interested in elementary accounting, industrial and cost accounting, and general business positions. The student who masters one of them may expect benefits in the near future as well as a worth-while position in the years to come. The coupon brings a free booklet and full information. Don't delay; mail it today.



INTERNATIONAL CORRESPONDENCE SCHOOLS BUSINESS SCHOOLS DIVISION

BOX 5503-K, SCRANTON 9, PENNA.

Without cost or obligation, please send me booklet and full particulars about the course before which I have marked X:

- | | | | |
|--|--|---|---|
| <input type="checkbox"/> Accountancy | <input type="checkbox"/> Advertising and Show-Card Lettering, Combined | <input type="checkbox"/> English and Bookkeeping | <input type="checkbox"/> Salesmanship |
| <input type="checkbox"/> Accountancy, with Elementary Accounting | <input type="checkbox"/> Advertising, Salesmanship and Show-Card Lettering | <input type="checkbox"/> Stenographic-Secretarial | <input type="checkbox"/> Petroleum Products' Salesmanship |
| <input type="checkbox"/> Accountancy, C.P.A. Problems and Business Law | <input type="checkbox"/> Direct-Mail Advertising | <input type="checkbox"/> Commercial Illustrating | <input type="checkbox"/> Salesmanship and Sales Management |
| <input type="checkbox"/> Accountancy, C.P.A. Problems and Business Law, with Elementary Accounting | <input type="checkbox"/> Retail and Department Store Advertising | <input type="checkbox"/> Caricaturing and Cartooning | <input type="checkbox"/> Service Station Salesmanship |
| <input type="checkbox"/> Bookkeeping and Cost Accounting | <input type="checkbox"/> Business Management | <input type="checkbox"/> Commercial Art | <input type="checkbox"/> Supervisory and Salesmanship |
| <input type="checkbox"/> Cost Accounting | <input type="checkbox"/> Foremanship | <input type="checkbox"/> Industrial Designing | <input type="checkbox"/> Show-Card Lettering |
| <input type="checkbox"/> Federal Tax | <input type="checkbox"/> Managing Men at Work | <input type="checkbox"/> Magazine and Book Illustrating | <input type="checkbox"/> Sign Lettering |
| <input type="checkbox"/> Junior Accountancy | <input type="checkbox"/> Commercial | <input type="checkbox"/> Newspaper Illustrating | <input type="checkbox"/> Sign Lettering and Show-Card Lettering, Combined |
| <input type="checkbox"/> Advertising | <input type="checkbox"/> Accountant-Secretarial | <input type="checkbox"/> Good English | <input type="checkbox"/> Traffic Management |
| <input type="checkbox"/> Advertising and Salesmanship, Combined | <input type="checkbox"/> Bookkeeping and Business Forms | <input type="checkbox"/> French | <input type="checkbox"/> Motor-Traffic Management |
| | <input type="checkbox"/> Business Correspondence | <input type="checkbox"/> Spanish | <input type="checkbox"/> Railroad Rate Clerk's |
| | | <input type="checkbox"/> Inventions and Their Management | |

Name..... Age..... Home Address.....

City..... State..... Present Position..... Working Hours.....

Canadian residents send coupon to International Correspondence Schools Canadian, Ltd., Montreal, Canada.

British residents send coupon to I. C. S., 71 Kingsway, London, W. C. 2, England.

SPECIAL TUITION RATES FOR MEMBERS OF THE ARMED FORCES

THESE **Free Books**
GIVE PRACTICAL POINTERS ON HOW
TO PROTECT, PATENT AND SELL YOUR
INVENTION



These two valuable books, "Patent Protection" and "When and How to Sell Your Invention" have guided many an inventor like you straight to a strong patent and SUCCESS. They tell you step by step, the proper procedure to find out if your invention can be patented . . . the steps necessary to secure a patent, and reliable, helpful suggestions on how to sell your invention. IN ADDITION . . . you'll find illustrated for your guidance . . . 115 MECHANICAL MOVEMENTS . . . just the information you may need to complete your invention.

**GET THESE FREE BOOKS AT ONCE . . .
DON'T WAIT UNTIL TOMORROW
INDUSTRY WANTS YOUR INVENTION NOW!**

Now . . . while industry and business are looking ahead to post-war markets . . . now, when they are eagerly seeking new and improved products, new and improved machines, tools and methods . . . is the RIGHT TIME TO SECURE YOUR PATENT. If you have an invention . . . BE A DO-ER! Don't take the chance of someone's beating you to it.

THE RIGHT START will save you time, money and trouble. That's why we advise you to get . . . RIGHT AWAY . . . the FREE books and the FREE important "Evidence of Invention" form that may help you establish your claim.

THIS COUPON MAY BE YOUR TICKET TO SUCCESS
...Mail It Today

VICTOR J. EVANS & Co.

Registered Patent Attorneys for Nearly 50 Years
830-K Merlín Building, Washington 6, D. C.

Please send me your books—"Patent Protection" and "When and How to Sell Your Invention"—also important "Evidence of Invention" form, without cost or obligation.

Name.....

Address.....

City and State.....

*You are Judged
by Your Speech!*

Get this
**Complete Course in
EFFECTIVE SPEECH and
BETTER ENGLISH** \$2
NOW ONLY

No matter HOW well educated you are, you will profit from a study of this remarkable 15-Chapter Course. Enlarge your vocabulary, correct pronunciation errors, develop FLUENCY and improve your command of language. You'll ENJOY this Course too—it is fascinatingly written. And it's a tremendous bargain at only \$2.00, post-paid. Order today. If not DELIGHTED, return for refund. (Sent C.O.D., plus postage, if you prefer.)



MILES KIMBALL CO., Dept 7, Oshkosh, Wisconsin

**LEARN MONEY-
MAKING CARTOONING**

IN SPARE TIME — by Easy Picture Chart Method

Same Simplified Method that has helped train creators of "Terry & Pirates," "Freckles," "Out Our Way," "Winnie Winkle," "Rog'lar Pellers," "Strange As It Seems," "The Neighbors," and many others. Earn while learning. Send 10c for Picture Chart (to test your ability), and full details. (State age.)



THE LANDON SCHOOL, Dept. 4403, Philadelphia 1, Penna.

LAW STUDY AT HOME

Legally trained men with higher positions and bigger success in business and public life. Greater opportunities now than ever before. Big corporations are headed by men with legal training. More Ability: More Prestige: More Money. We guide you step by step. You can train at home during spare time. Degree of LL. B. Successful graduates in every section of the U. S. We furnish all text material, including 14-volume Law Library. Low cost, easy terms. Get our valuable 48-page "Law Training for Leadership" and "Evidence" books FREE. Send for them NOW.

LASALLE EXTENSION UNIVERSITY, 417 South Dearborn Street
A Correspondence Institution Dept. 964-L Chicago 5, Ill.

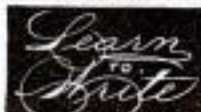

Begin today. Write now for our Free Book, "How to Become a Good Penman." It contains specimens and tells how others learned to write in spare time. Enclose 10c for your name beautifully written and a pen point suitable for shaded writing. Write today.

THE TAMELYN SCHOOL OF PENMANSHIP
7441 Ridge Building, Kansas City, Mo.

**Learn
Public
Speaking**

At home—in spare time. Many overcome "stage-fright," gain self-confidence and increase earning power, this easy way. Write for free booklet, *How to Work Wonders With Words* and requirements.

North American School, Dept. 1386
1315 Michigan Ave., Chicago 5, Ill.

RADIO

ENGINEERING, Broadcasting, Servicing, Electronics, Aviation, Marine & Police Radio taught thoroughly. 48 weeks' Engineering course equivalent to 3 years' college radio work. All expenses low. Co-educational. Catalog free.

VALPARAISO TECHNICAL INSTITUTE, Dept. D, Valparaiso, Ind.

**LEARN MONEY PAINTING
PORTRAITS**



No previous training or talent necessary. Unique Stuart System teaches you, by mail, in 11 simple, easy-to-follow lessons, to make exact charcoal and oil likenesses. Detailed guidance for your every step. Send for free book today.

STUART 121 Monument Circle, Rm. 694, Indianapolis 9, Ind.
STUDIOS, Please send me free book and outline of lessons—
Name.....
Street.....
City..... State.....

Map

electric, shows position of every train in the area	35 Sep
of the "Little Burma Road"	62-63 Sep
Mechanical brain enables operator to dial direct connection from city to city	9 Sep
Medical rolls to be dropped to Yanks	86 Sep
Meter electrical, takes multiple reading	16 Sep
Micrometer with magnifier speeds reading of numbers	61 Sep
Mobile power station to serve bombed cities	26 Sep
Mold-and-Ladle unit melts lead to form hammer	16 Sep
Money holder made of plexiglas	88 Sep
Motor-driven saw cuts big logs in five seconds	55 Sep
Movies "Sound Tricks of the Movies"	56 Sep
Nails picked up by sweeper with magnetized drum	61 Sep
Navigators in pre-flight training study model of Japanese city	31 Sep
Nozzle all-purpose, permits the water either as stream or fog	53 Sep
"Nurses' Training---And How"	80 Sep
Obstacle course part of nurses' training	80 Sep
Orange trees flourish best when provided with zinc	46 Sep
Oxygen bottles wrapped in wire don't shrapnel when hit	13 Sep
Parachutes drop food and supplies to reconnaissance units	85 Sep
Paratroopers	
protected by smoke screen	74 Sep
"Rescue from the Sky"	82 Sep

MEN! Whether You're 16 or 50..

Learn ELECTRICITY

*I'll Finance
Your Training*

Let me show you how to prepare for an
ESSENTIAL JOB NOW—in this field
that will still offer **STEADY WORK**
and **GOOD PAY AFTER THE WAR!**



A partial view of one of the Training Departments at Coyne

Learn By Doing in 90 Days

Start now to prepare for your post war future. Get into Electricity, the essential field that will continue to offer good pay and a real future after the war. Coyne trains you, NOT by correspondence but by actual shop work right on real electrical machinery. Then on my "PAY AFTER GRADUATION" PLAN YOU CAN PAY YOUR TUITION IN EASY MONTHLY PAYMENTS AFTER YOUR TRAINING PERIOD IS OVER.

In the Big Coyne Shops you have individual help by expert instructors so that you quickly and easily learn Electricity by actual work. No advanced education or previous electrical experience is needed. You are taught by the Famous Coyne "Learn-By-Doing" method which has helped hundreds of successful graduates.

Earn While Learning

If you are short of money and need part-time work to help pay for your room and board while training, my Employment Department will help you get a part-time job. When you have graduated, they will give you Lifetime Employment Service.

Learn by Doing

You work on actual equipment, you get individual training . . . all actual work . . . building real batteries . . . winding real armatures, operating real motors, dynamos and generators, wiring houses, working on real air conditioners and refrigerators, electronic controls, etc., etc.



PREPARE FOR ESSENTIAL JOBS LIKE THESE

Aircraft Electrician
Shipyard Electrician
Armature Winder
Sub-Station Operator
Auto & Aviation Ignition
Maintenance Electrician
Industrial Electronics
Air Conditioning
Electric Refrigeration
and many others

Our Employment Bureau for graduates gives FREE lifetime employment service.

MY GRADUATE EMPLOYMENT SERVICE HAS LETTERS FROM DOZENS OF FIRMS ASKING FOR COYNE TRAINED MEN FOR ESSENTIAL WORK WITH A REAL PEACE-TIME FUTURE.

READ WHAT THESE GRADUATES SAY

"I am employed as an electrician at the — Aircraft Corp. Accept my sincere thanks for helping me secure this job. You certainly help Coyne graduates in every way." — J. R. Eiker, Pa.

"I now work in the — Ordnance Plant. I don't believe a day goes by without something coming up that I had at Coyne. I make \$60 a week and will get DOUBLE that on a new job I'm expecting to get transferred to." — Wm. Ashbrook, Colo.

"Just to inform you my present employer is Uncle Sam, my pay, \$65 per week as a Navy Yard Electrician. Going to Coyne was the wisest move I ever made." — S. Walek, Mass.



H.C. Lewis

GET THE FACTS

Don't let lack of money keep you from sending in the Coupon now. My Big FREE Book is full of facts and photographs which tell you about Coyne Training. It also gives you the details of my "Pay After Graduation" Plan, Spare Time Employment Offer, Graduate Employment Service, Lifetime Scholarship and other advantages.



This modern fireproof building is occupied entirely by the Coyne Electrical School.

Men with Physical Disabilities

We also have special facilities for men who are disabled or have a physical handicap. Write us for particulars if you have a physical disability of any nature.

EXTRA TRAINING IN INDUSTRIAL ELECTRONICS

Now Included! No Extra Cost!

Send Today for this FREE Book!

H. C. LEWIS, President,
COYNE ELECTRICAL SCHOOL,
500 S. Paulina Street,
Dept. 64-72, Chicago 12, Ill.

Dear Mr. Lewis:—Without obligation send me your big free illustrated catalog, with all facts about Coyne Training and details of your "Pay-Tuition-After-Graduation" Plan, as well as the details of your extra Industrial Electronics Training you are now including.

Name.....

Address.....

City.....State.....

Mail in envelope or paste on a postcard

COYNE H. C. LEWIS, Pres.
ELECTRICAL SCHOOL
500 S. Paulina St., Dept. 64-72. Chicago, 12





SO IT NEEDS FIXING

By S. T. CHRISTENSEN
the "Fix-it Man"

WELL, I guess I'm the fellow to see, for I've repaired thousands of refrigerators (home and commercial both), vacuum cleaners, radios, washing machines, irons, fans, lamps, mangles, motors, etc. In fact, many of my customers call me their "electrical appliance doctor." And, "doctoring," I might add, has paid me a good substantial income for quite a few years. Funny, in a way, how I got started. Always liked to tinker and by experimenting around I found that most electrical appliances had many things in common. That, regardless of what the appliance was used for, or who the manufacturer was, the basic principles were much the same. From fixing my own appliances to fixing friends' and then for strangers at a fee, seems now to have been but a small step.

What to Charge?

At first, I let the owner decide the charge and, frankly, I was amazed at what I earned per hour. But then, when one figures what initial costs are involved in buying most electrical appliances, one can readily see that spending extra dollars for repairs is well worth while. Before long I was making more in my spare time repairing than from my regular job. The result . . . I went into business for myself. When war came, business boomed, for new appliances were not available.

For a while, repair parts (needed on some

jobs) were a little difficult to get. But that situation seems to have adjusted itself for many repair parts have today the high priority rating of AA2. After all, we must provide for the health and well-being of our civilian population.

The Future Offers

Friends ask me about my future. And, I think I've got a grand one. Age is no handicap in repairing. I have in my files enthusiastic letters from repairmen ranging in age from 18 to 79 years. After the war, we're bound to see hundreds of new products on the market . . . products that the average person never dreamt of. These new products and our old appliances are all going to need at some time or other "fixing." Well, I'll still be the fellow to do it. The field open for appliance repairmen is unlimited. I don't worry at all about too much competition.

If You Are Ambitious

To the contrary, I've prepared a complete course, chuck full of simple, easy to understand photos and drawings and written in the same non-technical language as this article. I know the course is good, because I have hundreds of men all over the country writing to me telling me how the course has helped swell their pockets with cash. If you too want to prepare now for your future, I suggest you read the next page and send me the handy coupon."

Parker Dam is typical of smaller irrigation projects	23 Sep.
Penicillin purity of tested with aid of rabbits	55 Sep.
Pennsylvania railroad busiest straightaway on any railroad	33 Sep.
Phone booth outdoor, serves war housing unit	10 Sep.
Phosphorous bombs when exploded make smoke screen	75 Sep.
Photography	
"Picking the Target"	28 Sep.
rapid-fire portable speedlamp shoots at 1/5000 of a second	13 Sep.
Photo-holder made of plexiglas	88 Sep.
Photo-reconnaissance played major role in invasion site	29 Sep.
Pilots fighter, trained with help of mobile control tower	49 Sep.
Pipe miles of carry captured flood waters	22 Sep.
Plant hormone enables apple and pear trees to get full crop	46 Sep.
Plastic	
molds pop out after pre-heating to order	61 Sep.
same as used in gun turrets makes gifts items	88 Sep.
Plexiglas	
used in making gift items	88 Sep.
used in making simplified celestial navigation instrument	87 Sep.
Plow subsoil, leaves protective stubble to prevent erosion	38 Sep.
Poison ivy eliminated by use of chemical	45 Sep.
Portable telephone designed for wounded veterans	9 Sep.



LEARN ELECTRICAL APPLIANCE REPAIRING

NO EXPERIENCE NEEDED

If you are at all mechanically inclined—that is to say—can hold and use tools—then you have all of the qualifications required for becoming a big money-earning home appliance repairman. It does not matter if you have not had a great deal of schooling or had no previous training along these lines. Age is no barrier . . . nor is any minor physical handicap.

Read What Other Students Say

I really believe your course the best investment a mechanically minded man can make.—*Claude E. Allen, Indianapolis, Ind.*

Your course on Appliance Servicing is the most complete and up-to-date I have heard of.—*Frank Kremen, Pottsville, Penn.*

I have received your Course in Appliance Repairing and I must say I am well pleased with same. I am only sorry I did not have said Course some years ago. I have learned so much more through this course I would not part with it.—*Charles Schwarz, Hamilton, Ohio.*

The Course in Appliance Servicing arrived a few days ago. Want to take out a few minutes of my valuable time to let you know that this is just what I have been looking for ever since I opened up my Fix-It shop. I must admit that you told the truth when you said that it contains quite a bit more information than I bargained for.—*P. J. Brett, Sebring, Ohio.*

I am a mechanic for the Western Union Telegraph Co. Three days after receiving the lessons in refrigeration I earned the exact cost of the course.—*Henry S. Lee, Washington, D. C.*

PREPARE FOR THE FUTURE

If now in war work, start your home appliance repair business in your spare time and be set with a business of your own when the war is over. You don't need elaborate fixtures or expensive equipment to be a successful repairman. Operate from your garage, basement, vacant store, etc. Work as many hours as you wish . . . the home appliance repairman is his own boss. It's a profitable occupation for on many types of repairs it is usual for a repairman to charge on the basis of \$5.00 to \$6.00 an hour! *Prepare today and make sure of tomorrow's future.*

New Course Helps All

Profusely illustrated, our new course shows you in simple, easy to understand language and drawings how to make each repair on refrigerators, vacuum cleaners, washing machines, motors, etc. Explains and gives you a working knowledge of electricity, welding, nickel plating, etc. Shows you how to build the power tools you need and how to solicit and keep business coming to you. Not a theory course but an honest to goodness course written by and used by repairmen the country over. Price of course is so low that the savings on your own household appliance repairs will quickly pay for it. Act now!

Mail Coupon for
FREE LITERATURE

CHRISTY SUPPLY CO.,
2835 N. CENTRAL AVE., DEPT. D-1303,
CHICAGO 34, ILLINOIS

Please send me all the facts about America's Fastest Growing Industry—Electrical Appliance Repairing.

Name

Address

City State

NOW-is the ideal time to get into **DRAFTING**



Learn at home from an Engineer until you have a **GOOD PAY JOB**

With industry working feverishly—the field for Draftsmen is bigger than ever. More important—draftsmen and designers must come first in changing back to peace-time production. Get into a better job with more pay and fascinating, pleasant work. Engineer Dobe will train you at home—in your spare time, to get experience on actual work, the same kind of jobs you will do in the best paid position, and train you until you are competent, experienced, holding such a position that will mean advancement and pay raises as deserved. When competent will recommend your practical work experience as references. No need for previous training to start with me—and lack of higher education should not hold you back. You can pay monthly for your practical training from an engineer; the cost is reasonable. Write today for full illustrated details and booklet. Give your age to get reply.

All working tools FURNISHED

Professional drawing instruments, all working tools, also drawing table furnished with training. Start in right Now.



GET THE FACTS TODAY!

ENGINEER DOBE, Div. 3376, Libertyville, Ill.
Please send me training facts on "Drafting and Industrial Designing". Also advertised list of positions for Draftsmen and Designers Wanted.

Name.....Age.....
Address.....
Town.....State.....

AUDELS Carpenters and Builders Guides

4 vols. \$6



Inside Trade Information for Carpenters, Builders, Joiners, Building Mechanics and all Woodworkers. These Guides give you the short-cut instructions that you want—including new methods, ideas, solutions, plans, systems and money saving suggestions. An easy progressive course for the apprentice and student. A practical daily helper and Quick Reference for the master worker. Carpenters everywhere are using these Guides as a Helping Hand to Easier Work, Better Work and Better Pay. To get this assistance for yourself, simply fill in and send the FREE COUPON below.

Inside Trade Information On:
How to use the steel square—How to file and set saws—How to build furniture—How to use a mitre box—How to use the chalk line—How to use rules and scales—How to make joints—Carpenters arithmetic—Solving mensuration problems—Estimating strength of timbers—How to set girders and sills—How to frame houses and roofs—How to estimate costs—How to build houses, barns, garages, bungalows, etc.—How to read and draw plans—Drawing up specifications—How to excavate—How to use settings 12, 13 and 17 on the steel square—How to build hoists and scaffolds—skylights—How to build stairs—How to put on interior trim—How to hang doors—How to lath—lay floors—How to paint



THEO. AUDEL & CO., 49 W. 23rd St., New York City
Mail Audels Carpenters and Builders Guides, 4 vols., on 7 days' free trial. If O.K. I will remit \$1 in 7 days, and \$1 monthly until \$6 is paid. Otherwise I will return them. No obligation unless I am satisfied.

Name.....
Address.....
Occupation.....
Reference.....PM

THIS AD IS YOU! ADDRESSED TO YOU!

That idea of yours may mean your fortune; don't pass it up! That new automotive or aircraft tool or equipment may be just what the post-war era wants. Your idea may need development; perhaps it's ready for patenting or manufacture. It makes no difference to this nationally-known organization with ample engineering, production, financial, sales and distribution facilities looking for ideas for manufacture and sale in the post-war era. If patent on your idea hasn't been applied for, have it witnessed and then write us about it completely or with a minimum of detail, as you please. But whatever you do, **DO SOMETHING** about that idea! Write in confidence NOW to

P. O. BOX 217 STA. C TOLEDO, OHIO



★ FREE COPY ★ The World Takes Wings

Get a preview of the wonderful opportunities in post-war aviation. The world's fastest growing industry offers permanent, profitable positions of leadership to those whose training and preparation qualify them. This is yours for the asking. Write at once!

WESTERN AIR COLLEGE

198 S. Myrtle Ave.

Monrovia, Calif.

LEARN WATCH REPAIRING



AT HOME. By our modern and original system of instruction you can learn every part of the **WATCH REPAIRING TRADE AT HOME.** Prepare yourself for a well-paying position or start in business after completing our course of instruction. Good watch repairers are in demand and generally earn very good salaries. For particulars apply to the Wisconsin School of Watch Repairing 524 E. Mason St., MILWAUKEE 2, WIS.

TRAIN

Your VOICE!

Results **GUARANTEED**

We build, strengthen the vocal organs—not with singing lessons—but by sound, scientifically correct silent and vocal exercises and absolutely guarantee complete satisfaction with results. Write for Voice Book, FREE. Sent to no one under 17 years old unless signed by parent.

PERFECT VOICE INSTITUTE, Studio 1256, 64 E. Lake St., Chicago, Ill.

Wonderful, new device, guides your hand; corrects your writing in a few days. Big improvement in three hours. No failures. Complete outline **FREE.** Write C. J. Ozment, Dept. 34, St. Louis, Mo

BETTER SIGHT

SIGHT-TRAINING technique improved. Everybody gets results now. WRITE: Dept. P-9 "USTI" 4057 Budlong Ave., Los Angeles 37, Calif.

Free SIGHT CHART Please send me your FREE Sight Chart with instructions.

Name.....
Address.....

WHICH OF THESE *Opportunities* INTERESTS *You* MOST?

Accounting & C. P. A.
Air Conditioning
Architecture & Building
Automotive Engineering
Aviation—Practical
Aviation Drafting & Design
Better Foremanship
Bookkeeping
Business Management
Cost Accounting for Mfg.

Diesel Engineering
Drafting & Design
Electrical Engineering
Electricity—Practical
High School Courses
Machine Shop Operations
Mechanical Engineering
Plastics Engineering
Plumbing—Practical
Private Secretary

Radio Operating & Servicing
Railway Training
Refrigeration
Sheet Metal Pattern Drafting
Shipbuilding
Shop Management
Surveying & Topographical
Drafting
Tool Making

THINK! LOOK FORWARD!

Business is making Post-war plans

Men and Women are preparing for the future

WHAT ARE YOU DOING ABOUT YOUR TOMORROWS?

● *Today*, choose the job you want—and prepare for it. Or if you are already engaged in the work you like best, start training *now* for quicker promotion. Acquire the knowledge that will help you to get ahead faster, make more money and have greater security.

Invest part of your spare time in more rapid progress. Start training now, in spare time in your own home. Be ready to grasp your opportunity and step out ahead of those who lack the ability you have attained.

American School, founded in 1897 as an educational institution *not for profit*, can help you to reach your goal just as it has helped others during the past forty-seven years. Give serious thought to the list above. Pick one or more subjects that interest you. Then check the coupon at right, add your name and address and mail it at once. The school will send you details on its training plan and outline of study prepared by specialists. There is no charge, no obligation, so send the coupon immediately.

PRACTICAL, EFFECTIVE HOME - STUDY TRAINING SINCE 1897
Take This First Easy Step

CHECK, CLIP AND MAIL COUPON NOW

AMERICAN SCHOOL, Dept. G645, Drexel at 58th, Chicago 37, Ill.
Without obligation, Please send FREE and postpaid, bulletin and details of the Subjects checked.

- | | | |
|--|---|--|
| <input type="checkbox"/> PLASTICS ENG'R | <input type="checkbox"/> Accounting and C.P.A. | <input type="checkbox"/> Drafting and Design for Men and Women |
| <input type="checkbox"/> Refrigeration | <input type="checkbox"/> Cost Accounting for Manufacturing | <input type="checkbox"/> Radio |
| <input type="checkbox"/> Architecture and Building | <input type="checkbox"/> Bookkeeping | <input type="checkbox"/> High School |
| <input type="checkbox"/> Practical Plumbing | <input type="checkbox"/> Private Secretary | <input type="checkbox"/> Air Conditioning |
| <input type="checkbox"/> Automotive Engineering | <input type="checkbox"/> Diesel Engineering | <input type="checkbox"/> Shipbuilding |
| <input type="checkbox"/> Aviation Drafting | <input type="checkbox"/> Surveying & Topographical Drafting | <input type="checkbox"/> Mechanical Eng. |
| <input type="checkbox"/> Aviation | <input type="checkbox"/> Sheet Metal Pattern Drafting | <input type="checkbox"/> Shop Management |
| <input type="checkbox"/> Business Mgmt | <input type="checkbox"/> Electrical Engineering | <input type="checkbox"/> Tool Making |
| <input type="checkbox"/> Railway Training | | <input type="checkbox"/> Better Foremanship |
| | | <input type="checkbox"/> Machine Shop Operations |

AMERICAN SCHOOL

Dept. G645, Drexel at 58th Street, Chicago 37

Name..... Occupation.....
Address..... Age.....
City..... State.....

TIRED OF WORKING FOR THE OTHER FELLOW?

TAKE the first step now, toward becoming your own boss. The COMMERCIAL TRADES INSTITUTE will help you realize your life's ambition—A Business of your Own! Today, the demand for men in the Air Conditioning and Refrigeration field far exceeds the number available. Tremendous post-war expansion will offer even greater opportunities. Begin right away—train while on your present job. Learn the fundamentals with profusely illustrated, easy-to-understand lessons—followed by actual shop and laboratory experience, under expert instructors, at no extra cost. Train for now and the future.

FOR COMPLETE DETAILS—MAIL COUPON TODAY TO SCHOOL NEAREST YOU

COMMERCIAL TRADES INSTITUTE Dept. M-1

221 N. La Salle Street, Chicago, Illinois
300 East Grove Street, Bloomington, Illinois
200 South 20th Street, Birmingham, Alabama

Please send me the free booklet "Refrigeration and Air Conditioning"—Your Guide to a SUCCESSFUL Future.

Name.....
Address.....
City.....State.....
Occupation.....

Keep that Car TICKING



Every operator and mechanic needs AUDELS AUTO GUIDE.

This book saves time, money and worry. Highly endorsed. It presents the whole subject of auto mechanics:

- 1—Basic principles
 - 2—Construction
 - 3—Operation
 - 4—Service
 - 5—Repair
- Handy Size, Easily understood.

NEW FLUID DRIVE, HYDRAULIC SHIFT AND DIESEL ENGINES FULLY COVERED

Over 1500 pages—1540 Illustrations showing inside views of modern cars, trucks and buses with instructions for all service jobs.

ASK TO SEE IT!—To Get This Assistance for Yourself Simply Fill in and Mail Coupon Today.

4 COMPLETE • PAY ONLY \$1. A MONTH ←
AUDEL Publishers, 49 West 23rd St., New York
MAIL AUDELS NEW AUTO GUIDE for free examination. If O.K. I will send you \$1 in 7 days; then remit \$1 monthly until price of \$4 is paid. Otherwise I will return it.

Name.....
Address.....
Occupation.....
Employed by..... P M



DONALD DUCK

Cartoon Home Movies

Popular and highly amusing Cartoon character. His films are always "laugh packed."

Donald Duck Features
50 Ft. 8MM... \$1.50
100 Ft. 16MM. \$3.00

Auto Mechanic..... 913-A
The Ham Actor..... 914-A
Getting The Hook..... 915-A
Squeak, Squeak..... 918-A

See At Your Photo Dealers Or Order Direct. Catalog And Price On Request. Write to—

HOLLYWOOD FILM ENTERPRISES, INC.
6060 Sunset Blvd. Dept. 115 Hollywood 28, Calif.

ACCOUNTANT

BECOME AN EXPERT

Executive Accountants and C. P. A.'s earn \$3,000 to \$10,000 a year. Thousands of firms need them. We train you directly at home in spare time for C. P. A. examinations or executive accounting positions. Previous experience unnecessary. Persons training under supervision of staff of C. P. A.'s. Placement counsel and help. Write for free book, "Accountancy, the Profession That Pays."
LASALLE Extension University, 417 So. Dearborn St.
A Correspondence Institution Dept. 964-H Chicago 5, Ill.

924 PAGE AUTHENTIC FORMULARY



10,000 Formulas, Recipes, Trade Secrets for making most any conceivable product. Prepared by experts in simple, non-technical language. Countless profitable business opportunities, supply sources. Valuable reference for home, farm or industry. \$2.00 postpaid—Canada or Foreign \$2.25. U. S. Funds. (C.O.D. orders accepted for U. S. delivery only.)

Prepare for "After-War-Business"

Especially recommended for servicemen and War Workers planning a profitable business of their own.

ADAMS BROWN COMPANY .. Dept. 10 .. Chestnut Hill 67, Massachusetts

Learn CARTOONING



FREE TRIAL LESSON! Cash in on your sense of humor—AT HOME—BY MAIL. Have fun! Make money! No experience needed to start. Write today for FREE LESSON, mailed postpaid. No obligation.
Moon Gag-Cartoon School, Dept. M, Argyle, Wisconsin.

Learn PHOTOGRAPHY at Home

Splendid opportunities. Prepare in spare time. Easy plan. No previous experience needed, common school education sufficient. Send for free booklet "Opportunities in Photography", particulars and requirements.

American School of Photography
3601 Michigan Ave., Dept. 1356, Chicago 5, Ill.

LAW

STUDY AT HOME for PERSONAL SUCCESS and LARGER EARNINGS. 35 years expert instruction—over 108,000 students enrolled. J.L.B. Degree awarded. All texts furnished. Easy payments. Send for FREE BOOK—"Law and Executive Guidance."

AMERICAN EXTENSION SCHOOL OF LAW
Dept. 25-M, 646 N. Michigan Ave., Chicago 11, Ill.

STAMMER? GET THIS FREE BOOK!

This new 128-page book, "Stammering, Its Cause and Correction," describes the Bogue Unit Method for scientific correction of stammering and stuttering—successful for 43 years. Benj. N. Bogue, Dept. 1816, Circle Tower, Indianapolis 4, Ind.

BOOKS FOUND FREE!

WHAT BOOKS DO YOU WANT?

We quote lowest market prices. No charge for locating Hard-to-Find Books. All books. OLD or NEW mailed POST-FREE.
SEARCHLIGHT BOOK CLUB, 22 East 17th St., New York City



JOKE BOOKS For Adults

The kind they like. You will be both a Riot and the Life of the Party with a set of these pocket size joke books. They are full of Entertainment, Fun and Humor. A set of six books only 50c or a special assortment of 12 books all different for \$1.00. Print name and address, send cash or stamps to:

TREASURE NOVELTY CO.,
72—5th Ave., Dept. 1209, N. Y. 11, N. Y.

Investigate the DeFOREST'S WAY TO GOOD PAY

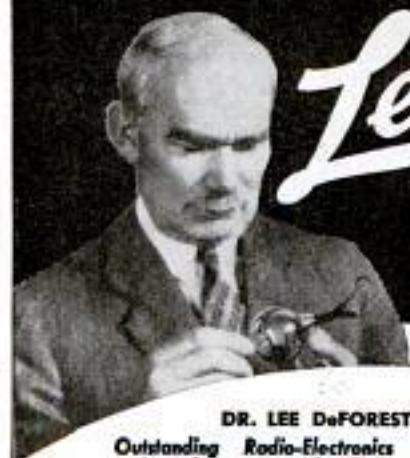

Learn

RADIO ELECTRONICS

THIS PRACTICAL, INTERESTING WAY—AT HOME!

DR. LEE DeFOREST

Outstanding Radio-Electronics authority—
under whose supervision DeForest's Training
was prepared.

"LEARN-BY-DOING" from 133 interesting HOME EXPERIMENTS

Here's a mighty interesting . . . effective way to get started toward Radio-Electronics—today's Billion-Dollar field that needs many trained men, a field that promises to be one of America's BRIGHT SOURCES OF POSTWAR OPPORTUNITY. Think of the opportunities to come in Radio and Radar manufacture, FM Radio, Sound Motion Pictures, Industrial Electronics, Broadcast Radio, Communication Radio, etc. Study the illustration to the right! With DeFOREST'S TRAINING you get the use of ALL these standard quality Radio parts and assemblies. You build and operate SIX different types of Radio Receivers—a Public Address System—a Wireless Microphone—"Electric Eye" devices—a Code Practice Oscillator—a Light Beam Transmitter—and dozens of other fascinating projects. AND THAT'S NOT ALL! DeFOREST'S TRAINING provides you with other exciting, time-tested training advantages—all fully described in our big, illustrated book, "VICTORY FOR YOU" and "KIT FOLDER" supplement. Both are yours for the asking—FREE! Fill in the coupon below—mail TODAY.



"LEARN-BY-SEEING" DeFOREST'S "A-B-C" WAY

DeForest's Training includes the use of a DeVry movie projector and 12 reels of instructive 16mm. films. These valuable ACTION movies demonstrate Radio principles in a way that's easy to grasp and remember. You SEE hidden actions taking place in Radio parts and circuits—a HOME TRAINING ADVANTAGE you get only with DeFOREST'S. You get 90 modern, loose-leaf lessons prepared under the supervision of a foremost Radio-Electronics authority—Dr. Lee DeForest, often called "THE FATHER OF RADIO AND SOUND." You get effective EMPLOYMENT SERVICE—and other advantages that can mean so much to YOU and YOUR FUTURE.

SEND FOR BIG, FREE "VICTORY" BOOK TODAY!

Send for our FREE book, "VICTORY FOR YOU!" It's packed with helpful information about (1) your opportunities TODAY and TOMORROW in Radio-Electronics—and (2) how you can make your start toward a GOOD JOB or a BUSINESS OF YOUR OWN in this vast, promising field—the proved DeFOREST'S "A-B-C" WAY. Mail the coupon TODAY!

DeFOREST'S
TRAINING INCLUDES
INSTRUCTION IN
MOTION PICTURE
SOUND EQUIPMENT
F-M RADIO
AND
TELEVISION



DeFOREST'S MOVIES HELP YOU LEARN
FASTER-EASIER

See Radio Circuits in Action—
Electrons on the March!

DeFOREST'S TRAINING, INC.

2533-41 N. Ashland Ave., Dept. Z
Chicago 14, Illinois

Please send me your "VICTORY FOR YOU!"
book and KIT FOLDER, FREE and without obligation.

Name _____ Age _____

Address _____

City _____ State _____

Check here, if under 16, for special information.





Be Your Own MUSIC Teacher

LEARN AT HOME FOR LESS THAN 7c A DAY

● Simple as A-B-C—a child can learn it. Your lessons consist of real selections, instead of tiresome exercises. Each of these delightfully easy lessons adds a new "piece" to your list. You read real notes, too—no "numbers" or trick music. Method is so thorough that some of our 750,000 students are band and orchestra LEADERS. Everything is in print and pictures. First you are told what to do. Then a picture shows you how. In a few short months you may become a good musician—the life of every party! Free Print and Picture Sample. Mail coupon for our illustrated Free Book and Print and Picture Sample. Mention your favorite instrument. U. S. School of Music, 79 Brunswick Bldg., New York 10, N. Y.

SUCCESSFUL
46TH YR.

U. S. School of Music, 79 Brunswick Bldg., New York 10, N. Y. Please send me Free Booklet and Print and Picture Sample. I would like to play (Name Instrument).

Instrument..... Have you Instrument?.....
Name.....
Address.....

ELECTRICAL BOOKS

shipped FREE

8 BIG BOOKS

FOR EXAMINATION
MODERN
ELECTRICITY
INCLUDING RADIO
AND REFRIGERATION

Here's great news for anyone interested in Electricity. NEW, up-to-date 19th Edition of Applied Electricity with new subjects fully covered, including blueprint reading, electronics, F. M. radio, fluorescent lighting. 8 Big Books FREE for examination!

NEW Edition for
Beginners and
Experts

Over 3700 pages, 2700 illustrations and 134 tables in most complete electrical work we have published. Dynamos, motors, diesel plants, power stations, transmission—everything explained for easy understanding.

BIG FIELD! Big Demand! Big Pay!

Men who understand electricity are needed now in all kinds of industries, and will be needed when war production has ended. Practically every business depends on electrical knowledge, and men who know this subject make big money. Learn easily with these new, interesting books. Send coupon for a set for FREE examination. See how they will help you to get ahead faster.

SEND NOW [A year's consulting privileges with our engineers now given to all buyers of this famous Encyclopedia of Electricity.]

AMERICAN TECHNICAL SOCIETY
Vocational Publishers Since 1898

American Technical Society, Dept. E-619, Drexel at 58th St., Chicago 37
Send for 10 days' free use, 8 volume set of New 19th Edition, Applied Electricity, including a certificate entitling me to consulting privileges for one year. I will pay the delivery charges only on the books. If I wish I may return them in 10 days and owe you nothing, but if I keep them, I will send \$2.00 after 10 days, then \$3.00 a month until the total price of only \$29.80 is paid.

NAME.....
ADDRESS.....
CITY..... STATE.....
Please attach letter stating age, occupation and name and address of employer and have at least one business man as reference. Men in service, also please give home address.

**MEN NEEDED FOR
GOOD PAY WORK**

IN
**Air Conditioning
AND
Refrigeration**

**TRAIN NOW
FOR POST-WAR**

A real opportunity for good income awaits those men who prepare NOW for an interesting and successful career in Air Conditioning and Refrigeration. Thousands of Mechanical Units need servicing right NOW; additional NEW equipment must be installed and serviced after the War.

Enter This Field For Good Earnings

Start now and learn in your spare time. Get set for bigger income possibilities. Here is a balanced plan of practical training that offers you home-study instruction and actual shop-work experience. Since 1927, U.E.I. has been training thousands of ambitious men to get better pay in this interesting, important, pleasant work. You, too, can get this "Know How" that can lead to the golden opportunities that await you after the War. This balanced instruction will not interfere with your present work. Write for FREE complete details TODAY.

UTILITIES ENGINEERING INSTITUTE
Dept. 194, 1314 W. Selden Ave., Chicago (14), Ill.

**WANTED:
IDEAS!**

Developed into the form of:
**NEW PRODUCTS • NEW
PROCESSES • INVENTIONS**

We have been retained by a number of companies desiring postwar products and processes. If your idea is acceptable an attractive contract for purchase or licensing will be arranged. Send copy of patent or drawings and description. Your information confidential. This service is free to you.

NEW PRODUCTS DIVISION
DESIGNERS FOR INDUSTRY, INC.
2915 Detroit Ave., Dept. M-7, Cleveland 13, O.

THERE'S MONEY IN CARTOONS!

RAYE BURNS will teach you HOW to CREATE ORIGINAL CARTOONS at home that you may SELL! Course consists 26 lessons and over 600 illustrations. All for Ours..... **\$2.85**

Send name and address for free details.

RAYE BURNS SCHOOL, Dept. M, Box 3583, CLEVELAND, OHIO

INDIANA TECHNICAL COLLEGE

Engineering degree in 27 months. Aeronautical, Chemical, Civil Electrical, Mechanical and Radio Engineering. Govt. approved ground school courses. Prep courses, no added cost. Large industrial center. Earn living expenses. Enter Sept. 5, Dec., March and June. Catalog, 594 E. Washington Blvd., Fort Wayne 2, Indiana.

★ SAVE WASTE PAPER ★

Short-Cut Mathematics
COMBINED WITH
Practical Mechanics Simplified

NEW 2-in-1 reading course! Now you can learn the speedy, simplified system of calculation used by draftsmen, engineers, accountants, "master minds" on the stoop. Learn easy way to multiply 4 figures by 4 figures without using old-fashioned multiplication; add long columns of figures this lightning short-cut method. Learn horsepower, slide rule, micrometer, logarithms, wood measure, puzzles, etc. Large illustrated volume complete with answers, only \$1 postpaid. Satisfaction or refund.

FREE Amsee friends with your angle-like mental powers. Complete details... mail coupon TODAY!

Nelson Co., 323 S. Wabash, Dept. 3J02, Chicago 4
Please send free details about "Short-Cut Mathematics and Practical Mechanics Simplified." No obligation.

Name.....
Address.....

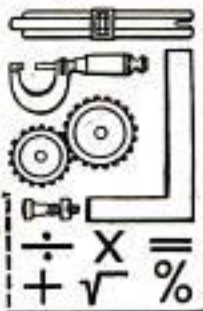

**HOW WILL YOU
FIT INTO THE
POSTWAR
WORLD?**



LEARN PLASTICS NOW!

Plastics are performing vital tasks in the war... from transparent bomber noses to synthetic rubber and Nylon parachutes... proving their real worth and demonstrating the important part they can play in the postwar period. This vast new rapidly-growing field is creating opportunities. Now is the ideal time to begin preparing yourself for a postwar career in plastics!

LEARN AT HOME—You can learn plastics in your spare time at home without interrupting your present work. The Plastics Institute has developed a thorough, easy-to-understand course of training, requiring no previous technical experience. It offers complete, authoritative training based on industry requirements.

FASCINATING COURSE—The lessons are readily grasped and practical. Every step is made clear with graphs, diagrams, pictures. Actual specimens of plastics materials are furnished. A bi-weekly bulletin, "Plastics Trends," keeps you posted on new developments.

COMPREHENSIVE—Learn the various phases of plastics from this course... materials, designing, molding, fabricating, estimating and plant management. Acquire a basic knowledge of plastics that can be invaluable in preparing you to take your place in this great new industry.

EXCLUSIVELY PLASTICS—The Plastics Institute is America's oldest and largest plastics educational organization which devotes all of its facilities exclusively to plastics. It is held in high esteem by members of the plastics industry. Many of our graduates hold responsible positions in the plastics field.

START YOUR FUTURE—TODAY! Mail the coupon below now! We will send you an interesting booklet filled with valuable information on plastics and tell you how, at small cost, you can prepare for a career in this important industry. Don't put it off! Mail today!

SPECIAL FEES FOR SERVICE MEN

Dept. PM-9 122 E. 42nd St., New York 17—Dept. PM-9 221 N. La Salle St., Chicago 1—Dept. PM-9 186 S. Alvarado St., Los Angeles 4

FREE BOOKLET
Send For It Today!



Plastics

INDUSTRIES TECHNICAL INSTITUTE

Plastics Industries Technical Institute
221 N. La Salle St., Dept. PM-9, Chicago 1

Mail in envelope or
paste on penny postcard

Gentlemen: Please send me the booklet "World of Plastics" and information on your training program. I understand there is absolutely no obligation.

Name..... Street.....

City..... Zone..... State.....

If under 17, check here for special book.

DRAFTSMEN NEEDED NOW



Industry is clamoring for more draftsmen for the job can't start until plans are drawn. Buildings, airplanes, machines, guns, tanks, bridges, all start on the drawing board, so it's no wonder that every good draftsman has a fine job. Yes, more draftsmen are needed NOW. The pay is good and the opportunities for advancement great.

Learn at Home in Spare Time

Begin now to turn spare hours into money. Be a draftsman, the connecting link between a mechanic and an engineer. Enjoy the wonderful opportunities for promotion that exist now. No experience or artistic talent is needed. You don't have to leave your present job while learning. Use spare time.

American School, Dept. DD645, Drexel Ave. at 58th St., Chicago 37, Ill.

- Gentlemen: Send me FREE information covering special training in subjects checked below. No obligation on my part.
- | | |
|--|--|
| <input type="checkbox"/> Drafting and Design for Men and Women | <input type="checkbox"/> Electrical Engineering |
| <input type="checkbox"/> Cost Accounting for Mfg. | <input type="checkbox"/> Diesel Engineering |
| <input type="checkbox"/> Architecture and Building | <input type="checkbox"/> High School Course |
| <input type="checkbox"/> Automotive Engineering | <input type="checkbox"/> Plastics |
| <input type="checkbox"/> Business Management | <input type="checkbox"/> Mechanical Engineering |
| <input type="checkbox"/> Railway Training | <input type="checkbox"/> Aviation <input type="checkbox"/> Radio |
| | <input type="checkbox"/> Shipbuilding |

Name.....
Address.....

AVIATION Career

DON'T WAIT UNTIL THE WAR IS OVER!

Since 1929 Curtiss-Wright Technical Institute has been specializing in modern, progressive training for Aeronautical Engineers and Master Aviation Mechanics (no flying involved). Prepare now for your Aviation Career. BE READY! The opportunities are great today and will be much greater in tomorrow's Age of Flight. ACT!



GRAND CENTRAL AIR TERMINAL
GLENDALE 1, CALIFORNIA
(LOS ANGELES COUNTY)

MAIL THIS COUPON TODAY!

Registrar, Curtiss-Wright Technical Institute, Grand Central Air Terminal, Glendale (1), California. Please send information and profusely illustrated catalogue on Aviation Training. FREE... without obligation... Dept. PM-9

Name..... Birth Date.....
Street.....
City..... State.....

ARE YOU HANDY WITH TOOLS? Learn to Be a Service Mechanic in REFRIGERATION and AIR-CONDITIONING—at Home!

Exceptional opportunity for men of all ages up to 60. The demand for repair and service mechanics in REFRIGERATION and AIR CONDITIONING is acute, and will continue long after the war. Our practical, thorough course trains you at home. It's easy to grasp. A common school education is enough. No previous experience is required. Learn how to start your own business with \$50 worth of tools in garage or basement. Or take a job in this big pay field. Write for Free Booklet today. No obligation whatever.

FREE Booklet

MECHANICS TRAINING SCHOOL
4701 W. Pico Dept. P-9 Los Angeles 6, Calif.

TRAIN for SUCCESS in the Poultry Business



Study at home in spare time. Earn extra while learning...

YOU CAN MAKE MORE MONEY from POULTRY. Proper management means profits ANY season, for life. Get latest scientific methods that avoid losses and mistakes. Our famous system of Home Study Training has helped thousands to success. Extra profits from the start. FREE Catalog; describes courses, methods, service. Write today to Dept. 50-P, NATIONAL POULTRY INSTITUTE, Adams Center, N. Y.

MAGIC LIQUID MAKES PHOTOS APPEAR
On Scarfs, Ties, Stationery, Etc.
Reproduce any snapshot on cloth, leather, wood, paper. Simply apply liquid. Like magic photo appears within 2 minutes in broad daylight. Harmless to negative. Won't wash off. Full colors included. Complete kit for 100 photos only \$1.25. Send no money, just name. Pay postage \$1.25 plus few cents postage on delivery. Or send cash with order and get postpaid. (Canada \$1.50 money order only.) Order today.
L & M Mfg. Co., Dept. 333-C, 229W. Breckenridge, Louisville 3, Ky.

PHOTOGRAPHY
offers OPPORTUNITIES for Today and Tomorrow

NEWS
COLOR
PORTRAIT
ADVERTISING
COMMERCIAL
MOVIE

You can qualify for fascinating work, good pay and a sound, substantial postwar future in photography. Home study or resident courses. Individual training by experts. Free booklet.
N. Y. INSTITUTE OF PHOTOGRAPHY, Dept. 40, 10 W. 33 St., New York 1, N. Y. (Founded 1910)

What Every Mason Wants

We have important Masonic books for Blue Lodge, Chapter, Commandery, Scottish Rite, and Shrine. Our Rituals Are Used the World Over. Send for free catalog of books and rituals for Masons, Odd Fellows, Knights of Pythias, Knights of Columbus, Elks, etc.
EZRA A. COOK, Publisher, P. O. Box 796, PS, Chicago 90, Ill.

MONEY MEN ALL FREE

THE PLASTEX Industry needs manufacturers on small scale and for big production of Lamp and Clock Stands, Art Goods and Novelties in Plastic and Marble imitation. Experience unnecessary. 1/2c material makes regular 10c store sellers. Rubber moulds furnished for speed production. Small investment brings good returns. Big chain store orders now being placed. Ambitious men have chance for real prosperity. Our Free booklet will interest and benefit you.
PLASTEX INDUSTRIES, Dept. P, 1665 Washington Ave., New York, N. Y.

ARE YOU A REAL ELECTRICIAN

...or merely an

ELECTRICAL WORKER?

"Sorry I can't promote You, Bill . . . but that job takes an ALL-AROUND knowledge of Electricity...not just the one operation you handle."



For a Better Electrical Job YOU Must Have All-Around Knowledge!

This is the Superintendent telling "Bill" that while he would like to give him the position of Chief Electrician it was impossible for Bill hasn't the all-around knowledge of Electricity. No! Bill's a "one operation" man and a fellow has to know all the different branches and how one branch dove-tails into all other branches.

"Bill" had been a loyal worker for over 10 years but he made the mistake many "Bills" make of assuming that length of service ALONE was all that was needed to get promotion. He didn't realize that long experience on one electrical job doesn't qualify a man for a bigger job at bigger pay. He failed to realize that there is a world of difference between an ordinary electrical worker and a REAL ELECTRICIAN.

"Bill" waited too long and "muffed" his chance. But, fortunately for "Bill" and others like him there is hope—there is a way—a simple, practical, inexpensive way to prepare for promotion in Electricity. A way that has been used by thousands—it is the PRACTICAL ADVANCED HOME STUDY WAY WITH COYNE ELECTRICAL AND RADIO BOOKS.

A few hours a week will give you quickly and surely the advanced knowledge needed TO HANDLE THAT BIGGER JOB AHEAD—and it won't cost you one penny to find out what the amazing Coyne Electrical and Radio books can do for you.

See These Sensational Books FREE!

New Practical 3 Volume Reference Set

Here's a set of electrical books written in plain language for the electrical worker who wants to get ahead. Covers everything from house wiring to D.C. and A.C. motors and equipment—over 2000 subjects. I'll send this set FREE and postpaid for examination. Look it over for 7 full days, then either return set or send \$12.55 cash or \$3.00 and \$3.00 a month until \$13.95 is paid. If you ACT NOW I'll include FREE a book of 150 Shop Prints and 1 yr. Consultation Service and technical bulletins.

SEND NO MONEY

I will ship any or all of the above books on 7 DAYS FREE TRIAL. Look them over for 7 days. If not 100% satisfied, ship them back. Other wise pay for them as indicated in coupon. If your order totals \$5.00 or more you may pay \$3 within 7 days and \$3 a month. Rush coupon.

COYNE ELECTRICAL SCHOOL
500 S. Paulina Street Dept. 64-R6 Chicago 12, Illinois

7 DAY FREE TRIAL COUPON

- H. C. Lewis, President—Coyne Electrical School
500 S. Paulina St., Dept. 64-R6, Chicago 12, Illinois
- Send me the books checked below on 7 DAYS FREE TRIAL. I'll either return them in 7 days and owe you nothing or pay for them according to the plan I select as outlined above.
- COYNE 3 VOL. REFERENCE SET; Price complete \$13.95 payments, or \$12.55 cash. BOOK of 150 shop prints included FREE. Includes one year Free Consultation Service and Technical News Bulletins.
 - COYNE TROUBLE-SHOOTING MANUAL: (1 VOL.) Price \$8.95 payments, or \$8.00 cash. Includes one year Free Consultation Service and Technical News Bulletins.
 - COYNE MANUAL OF ELECTRONICS: (1 VOL.) Price \$4.95. Includes one year Free Technical Bulletins.
 - 150 SHOP PRINTS AND MOTOR DIAGRAMS: (1 VOL.) Price \$1.95. (Free with reference set or can be bought separately.)
 - COYNE ELECTRICAL & RADIO DICTIONARY (1 VOL.) 1200 terms and definitions. Price 50c.

Name.....Age.....

Address.....

City.....Zone.....State.....

Name of Employer.....

If you wish to pay the postman the cash price when books are delivered, check here. Same 7-Day Money-Back Guarantee of Satisfaction.

Amazing 3-Vol. Set

MAIL COUPON FOR 7 DAY FREE TRIAL

THE BOOKS YOU'VE BEEN WAITING FOR!



2 OTHER NEW COYNE BOOKS Big Pay Fields—See Them FREE

Be a Master Trouble Shooter!

New GIANT Size MANUAL
New Book—just off press helps locate trouble on electrical, radio, refrigeration, Diesel and Automotive equipment. 500 easy to follow wiring diagrams. Brand New step-by-step trouble shooting program. 612 pages. Sent on 7 day FREE trial—then either return it or send \$3.00 and \$3.00 a month until \$8.95 is paid or send \$8.00 cash. Act NOW and I'll include 1 yr. FREE consultation and News Bulletins.



Learn Electronics 400 PAGES Just Off the Press

AT LAST a book for Electricians, radio men or anyone interested in PRACTICAL ELECTRONICS. Latest facts, hundreds of diagrams. Includes TROUBLE SHOOTING & INSTALLATION. Introductory price \$4.95 cash payable after 7 day FREE inspection. Order NOW and I'll include 1 yr. free bulletin service.



**"The hours
that
book
saves
me!**

**... and the
errors it
prevents!"**



BUSINESS men, secretaries, editors, and students rely upon Webster's Collegiate because it defines all the words most commonly used. Based on and abridged from WEBSTER'S NEW INTERNATIONAL DICTIONARY, Second Edition—"The Supreme Authority," and edited with the same careful scholarship, 1,300 pages; 110,000 entries; \$4.00 to \$8.75, depending on choice of bindings.

YOU MAY HAVE TO WAIT FOR YOUR COPY of WEBSTER'S COLLEGIATE. Paper rationing, plus exceptionally heavy government needs, plus an unprecedented public demand, make it impossible to supply everyone promptly. Your bookseller will do his best to provide your copy. Also ask to see:

WEBSTER'S DICTIONARY OF SYNONYMS \$4.00
WEBSTER'S BIOGRAPHICAL DICTIONARY \$6.50
G. & C. MERRIAM CO., Springfield 2, Mass.

WEBSTER'S COLLEGIATE
A Merriam-Webster

**AN INFANT INDUSTRY
... SUDDENLY MATURED
PLASTICS**

Get In at the Start—and Grow

Plastics is a new industry which the nation's war needs is forcing to quick maturity. Already Plastics are indispensable in practically every branch of the Service—Aircraft, Ordnance, Chemical, Marine, Signal Corps, etc. Opportunities? Nearly everything, from homes to clothing, from gadgets to tools, will be affected by Plastics.

Spare Time Training Now Ready

The time to get started is now. You can prepare at home, in your spare time, to take your place in an infant industry that even now is leaping into prominence. A new, practical training plan is now ready to help you realize your ambitions and build your future security. Act now. Don't delay. Mail this coupon today.

- AMERICAN SCHOOL, Dept. P645**
Drexel Ave. at 58th St., Chicago 37, Ill.
- Send me FREE information covering special training in subjects checked below. No obligation on my part.
- | | |
|---|---|
| <input type="checkbox"/> Plastics | <input type="checkbox"/> Cost Accounting for Mfg. |
| <input type="checkbox"/> Electrical Engineering | <input type="checkbox"/> Automotive Engineering |
| <input type="checkbox"/> Drafting and Design | <input type="checkbox"/> Architecture & Building |
| <input type="checkbox"/> for Men and Women | <input type="checkbox"/> Shipbuilding |
| <input type="checkbox"/> Diesel Engineering | <input type="checkbox"/> Business Management |
| <input type="checkbox"/> Mechanical Engineering | <input type="checkbox"/> High School Course |
| <input type="checkbox"/> Aviation | <input type="checkbox"/> Radio |
| | <input type="checkbox"/> Railway Training |

Name.....
Address.....

**Do You Make These
Mistakes in English?**

MANY persons say "between you and I" instead of "between you and me"—or use "who" for "whom"—or don't know whether to spell certain words with one or two "s" or "ss" or "ph" or with "ie" or "ei," etc. Every time you speak or write you show what you are. Mistakes in English reveal lack of education, refinement. Lack of language power prevents you from presenting your thoughts in the strongest way. Real command of English will help you reach ANY goal. Stop making mistakes in spelling, punctuation, pronunciation, grammar. Increase your vocabulary.



Sherwin Cody

WONDERFUL INVENTION

Only 15 minutes a day with Sherwin Cody's new invention—and you can actually SEE your English improve. It teaches by HABIT—makes it easier to do the RIGHT way. Wonderful self-correcting lessons.

FREE BOOK ON ENGLISH Lack of language power may be costing you thousands of dollars every year. See what Mr. Cody can do for you; it costs nothing to find out. Write this very minute for free book, "How You Can Master Good English in 15 Minutes a Day." It will prove a revelation. WRITE NOW, Sherwin Cody School of English, 59 Searle Bldg., Rochester 4, N. Y.

**DYKE'S
AUTO BOOK** New 20th Edition. New Material on Transmissions, Trucks, Tractors. 1488 PAGES. 4600 ILLUS. and DIAGRAMS.



Now with millions of cars needing repairs and thousands of men needed to do the work, you need the famous DYKE Auto Book more than ever before. Brand new 20th edition covers all principles, construction, repair, adjustment, testing, troubles and remedies of all cars. Covers Diesel powered cars and trucks, fundamentals of aircraft engines and passenger car specifications.

SEND NO MONEY. Write today for DYKE'S AUTO BOOK. Remit \$6 or pay postman \$6 plus postage on delivery. Money back in 5 days if not satisfied.

GOODHEART-WILLCOX CO., INC.
Dept. 16, 2009 S. Michigan Ave., Chicago, 16

WHY DON'T YOU WRITE?

Writing short stories, articles on business, shop work, gardening, home crafts, war activities, etc., will enable you to earn extra money. In your own home, on your own time, the New York Copy Desk Method teaches you how to write—the way newspaper men learn, by writing. Our unique "Writing Aptitude Test" tells whether you possess the fundamental qualities essential to successful writing. You'll enjoy this test. Write for it, without cost or obligation.

NEWSPAPER INSTITUTE OF AMERICA
SUITE 559-M, ONE PARK AVENUE, NEW YORK 16, N. Y.

**TRIAL LESSON IN
Free • DRAFTING**



More good jobs now in Drafting. Learn AT HOME in spare time for at our Chicago School. Send postcard for FREE TRIAL LESSON and see how easy to learn and get a good job.

CHICAGO TECHNICAL COLLEGE
M-295 Tech Bldg., 2030 S. Michigan Ave., 16 Chicago, Ill.

FIX TYPEWRITERS

A Simplified Practical Home Study Course. Many of our Students now have their own Business—Minor Repair for others, Repair Shops Swamped, Health or Age no handicap.



WEBER TYPEWRITER MECHANICS SCHOOL
5417 Santa Monica Blvd., Hollywood 27, Calif.



Write for my Free Book, "How to Become an Expert Penman," which shows what others have accomplished by taking my Course. Enclose 10c for one of my Favorite Pen Points and your name with a beautiful flourished bird written on a card. Write today.
T. M. TEVIS, Box 25K, Chillicothe, Mo.

**Inventions Wanted
Patented or Unpatented**

Inventions can now be safely sold without patenting expense. If you have a practical, useful idea for sale, either unpatented or patented, write **Chartered Institute of American Inventors** Dept. 4, 631 Pa. Ave., N. W. Washington, D. C.

"Meet the new foreman, Mrs. Irvin!"



• How would you like to carry home the news that you've been advanced to foreman? You've thought about it, of course. But what have you done about it?

Training is the dividing line between the man at the machine and his foreman. It outweighs long service. Promotions to supervisory rank go to the men who have equipped themselves for the step up.

Have you studied the managing of men at work? Do you have a trained man's knowledge of Wage Systems and Job Evaluation, Production Planning, Control of Materials, Control of the Quality of Manufactured Goods?

The famous Foremanship Course of the International Correspondence Schools gives you these — and much more. Don't let the other fellow "step over your head." Mailing the I. C. S. coupon has meant success for thousands of ambitious Americans. Act now to join them!



INTERNATIONAL CORRESPONDENCE SCHOOLS

BOX 5504-K, SCRANTON 9, PENNA.

Without cost or obligation, please send me booklet and full particulars about the course before which I have marked X:

- Air Conditioning and Plumbing Schools**
- Air Conditioning
- Heating Plumbing
- Refrigeration Steam Fitting
- Chemistry Schools**
- Chemical Engineering
- Chemistry, Analytical
- Chemistry, Industrial
- Chemistry, Mfg. Iron & Steel
- Plastics
- Pulp and Paper Making
- Civil, Architectural and Structural Engin'g Schools**
- Architectural Drafting
- Architecture
- Bridge and Building Foreman
- Bridge Engineering
- Building Estimating
- Civil Engineering
- Contracting and Building
- Highway Engineering
- Lumber Dealer
- Sanitary Engineering
- Structural Drafting
- Surveying and Mapping

- Electrical Schools**
- Electrical Drafting
- Electrical Engineering
- Power House Electrician
- Practical Electrician
- Practical Telephony
- Telegraph Engineering
- Internal Combustion Engines School**
- Auto Technician Aviation
- Diesel-Electric
- Diesel Engines Gas Engines
- Mechanical Schools**
- Aeronautical Engineering
- Airplane Drafting
- Flight Engineer
- Foundry Work
- Heat Treatment of Metals
- Industrial Design
- Mechanical Drafting
- Mechanical Engineering
- Mold-Loft Work
- Patternmaking
- Reading Shop Blueprints
- Sheet Metal Drafting
- Sheet Metal Worker

- Ship Drafting Ship Fitting
- Shop Practice
- Steel Mill Workers
- Tool Designing
- Welding, Gas and Electric
- Radio School**
- Electronics Radio, General
- Radio Operating
- Radio Servicing
- Railroad School**
- Air Brake Car Inspector
- Locomotive Engineer
- Locomotive Fireman
- Railroad Section Foreman
- Steam Engineering Schools**
- Boilermaking
- Combustion Engineering
- Engine Running
- Marine Engines
- Steam Electric
- Steam Engines
- Textile School**
- Cotton Manufacturing
- Rayon Weaving
- Textile Designing
- Woolen Manufacturing

- Business and Academic Schools**
- Accounting Advertising
- Arithmetic Bookkeeping
- Business Correspondence
- Business Management
- Certified Public Accounting
- City Letter Carrier
- College Preparatory
- Commercial
- Cost Accounting
- Federal Tax
- First Year College
- Foremanship
- High School
- Higher Mathematics
- Illustrating
- Motor Traffic
- Post Office Clerk
- Railway Postal Clerk
- Salesmanship Secretarial
- Stenography
- Traffic Management
- Language School**
- Spanish French
- Good English

Name..... Age..... Home Address..... Working Hours.....
 City..... State..... Present Position.....

Canadian residents send coupon to International Correspondence Schools Canadian, Ltd., Montreal, Canada.
 British residents send coupon to I. C. S., 71 Kingsway, London, W. C. S., England.

SPECIAL TUITION RATES FOR MEMBERS OF THE ARMED FORCES

9 BIG BUILDING BOOKS



SHIPPED
**FREE FOR
EXAMINATION**

Learn to draw plans, estimate, be a live-wire builder, do remodeling, take contracting jobs. These 9 practical, profusely illustrated books cover subjects that will help you to get more work and make more money. Architectural design and drawing, estimating, steel square, roof framing, construction, painting and decorating, heating, air-conditioning, concrete forms and many other subjects are included.

BETTER JOBS — BETTER PAY

Keep busy now at good pay, and be prepared for after-war building boom. Big opportunities are always for MEN WHO KNOW HOW. These books supply quick, easily understood training and handy, permanent reference information that helps solve building problems.

UP-TO-DATE EDITION

These books are the most up-to-date and complete we have ever published on these many subjects.

Coupon Brings Nine Books FREE For Examination

AMERICAN TECHNICAL SOCIETY Vocational Publishers since 1898
Dept. GG19 Drexel at 58th Street Chicago 37, Ill.

You may skip the Up-to-Date edition of your nine big books, "Building, Estimating, and Contracting" without any obligation to buy. I will pay the delivery charges only, and if fully satisfied in ten days, I will send you \$2.00, and after that only \$1.00 a month, until the total price of only \$20.00 is paid. I am not obligated in any way unless I keep the books.

Name.....

Address.....

City..... State.....

Please attach a letter stating your age, occupation, employer's name and address, and that of at least one business man as a reference. Men in service, also please give home address.

Flash! Amazing Opportunities NOW Open in these practical money-making trades watch and clock repairing



LEARN AT HOME—IN YOUR SPARETIME

Prepare for a happy future of prosperity, security...and get a big-pay job now. Fascinating, high-grade occupation. You can EARN WHILE YOU LEARN. Excellent field for part-time work at home.

COMPLETE COURSE IN HOROLOGY

Thorough self-instruction training in American and Swiss watches, clocks. Special sections on alarm clock repairs. New, practical LEARN-BY-DOING instruction method. LEARN QUICKLY, easily. No previous experience necessary. Watchmaking is basic training for aircraft instrument work, and other scientific precision jobs.

Amazing LOW PRICE • MONEY-BACK GUARANTEE
Get into this fast-growing field NOW... big opportunities... don't delay. Mail coupon below for FREE information. There's no obligation.

locksmithing and key making

COMPLETE UP-TO-DATE COURSE

How to pick locks, de-code, make master-keys, repair, install service, etc. New, self-instruction lessons for every handy man, home-owner, carpenter, mechanic, service station operator, fix-it shop, hardware dealer, gunsmith.

53 EASY ILLUSTRATED LESSONS

Bargain Price! Satisfaction guaranteed or money back. Write now... no obligation!

Free Details—Mail Coupon Today!

NELSON CO., Dept. 8J02, 321 S. Wabash Ave., Chicago 4, Ill.

Please send me—FREE and without obligation—illustrated Success-Catalog containing information about the course (or courses) I have checked below. No salesmen will call.

Watch and Clock Repairing. Locksmithing and Key Making.

NAME.....

ADDRESS.....

CITY..... STATE.....

MONEY for YOU!

INTRODUCING AMAZING AUTOFYRSTOP

Quick CASH PROFITS demonstrating AUTOFYRSTOP, remarkable new combination automatic and manual fire extinguisher and alarm. Holds unequalled records. Sells fast to defense plants, homes, schools, stores, etc. Low priced. BIG PROFITS. Experience unnecessary. Details FREE. Write: AUTOFYRSTOP CO., Dept. M-94 2035 Washington Ave., Philadelphia, Pa.



**KILLS
FIRE
BY
ITSELF**

TRI-STATE COLLEGE

B. S. Degree in 27 Months



Courses in Civil, Electrical, Mechanical, Chemical, Radio, Aeronautical Engineering; Business Administration, Accounting, Secretarial Science. TRI-STATE, distinguished for years for its 2 1/2 yr. degree courses, offers a great advantage to EX-SERVICE MEN who can COMPLETE THEIR WORK here in the SHORTEST POSSIBLE TIME. Special preparatory dept for those who lack high school or graduates who desire REFRESHER COURSES. Short diploma courses (36 weeks) in Surveying, Drafting. Living costs, tuition low. Cosmopolitan student body. Men and women. 61st year. Enter Sept., Jan., March, June. Catalog. 494 College Ave. ANGOLA, INDIANA

LEARN MEAT CUTTING At Home — In Spare Time



Get into the vital meat industry. Concise, practical Home Training based on 25 years proven instruction methods used at National's famous resident school. Prepares you for bigger pay as Meat Cutter, Supervisor, market manager or more money in your own store. Go as rapidly as your spare time permits. Diploma. Start NOW to turn your spare hours into money. Send for FREE bulletin today. No obligation.

National School of Meat Cutting, Inc., Dept. U-49, Toledo 4, Ohio

LIQUID MARBLE

Make beautiful artificial Marble slabs. Pour from liquid state. Glazed or un-glazed. Mottled, veined, snow-white, or multi-colored. Unsurpassed on kitchen or bathroom walls. Easy to make and install. PLASTIC FLOORING. Any color. Lifetime wear. Dustproof, Soundproof, Vermin-proof. Resilient to the tread. Lay out solid or in pattern design. FLEXIBLE MOLDS for plaster casting. Make your own molds for few cents each. \$1.00 in raw materials will make up to \$25.00 of finished goods. We furnish names of buyers. Write now for free information.

COMPO-TEX, BOX 786-S, ST. LOUIS (1), MO.

CARTOONING



CASH IN on Big Cartoon Market. BECOME CARTOONISTS QUICKLY with our NEW, EASY METHOD. No experience necessary. Prepared by successful cartoonists. SATISFACTION GUARANTEED. Sample LESSON PLATE and interesting literature FREE.

NATIONAL ARTISTS BUREAU
Dept. A, Box 4248 DALLAS 8, TEXAS

★ SAVE WASTE PAPER ★

REFRIGERATION

Repair and improve all refrigerators. New large manual tells how. Charts and pictures to help you. Only \$1.00, postpaid. Money back guarantee. Supreme Publications, 328 S. Jefferson St., Chicago 6, Illinois



FIBRE ARMS AND LEGS!

Light, correctly fitted, strong and comfortable. Natural appearance. Braces for all deformities. Scientific design. Fair Terms.

BUCHSTEIN-MEDCALF 610-3rd Av. S., Minneapolis, Minn.

GET INTO RADIO ELECTRONICS & TELEVISION NOW!

Hundreds of Industries Need Radio and Television Men Now and for Great Future Demands

The man trained in electronics is wanted not only in Radio and Television, but in Aviation, Transportation, Communications, ... in the designing, engineering and operation of hundreds of industries today and for years to come. Learn how great the field is for YOU... How you may GET INTO BUSINESS FOR YOURSELF. Mail the coupon now.



Send for FREE Lesson and Prove to Yourself How Quick and Easy You Get Ahead in Radio by the NEW

SHOP METHOD HOME TRAINING



Learn by Doing!

Use real Radio Equipment Furnished with your Course

Experience is the best teacher. You learn by experience with the exclusive National Shop Method of Home Training—actually build many circuits and do experiments with the big kits of standard radio parts included in your training equipment at no extra cost to you.

Build a superheterodyne receiver. Make tests and conduct experiments that show you the why and how of electronics. Build an audio oscillator, signal generators and other instruments with the parts and standards included in your course.

You gain marvelous experience by this method of learning and you have valuable equipment and instruments to use on the job. Mail the coupon and learn what this means to you.

Get ready for TELEVISION. Get your share of the RADIO SERVICE Business. Here is a sensationally improved way for you to get the right training—a thoroughly proven system whereby you study in spare time—odd hours, even minutes—and have the advantage of actual shop experience behind you.

This exclusive shop method of home training comes to you right from one of the world's greatest vocational educational centers—the resident training shops and experimental laboratories of National Schools. It is the sound, practical training based on actual experience of qualified instructors and engineers who have prepared thousands of National graduates now employed in the radio industry.

It is up-to-date—matches the progress constantly being made in modern radio, television and electronics. It is time tested. National Schools has been training men for higher pay and greater opportunity for more than a third of a century. Fill out and mail the coupon below for details.

Shop Method Training Wins Good Jobs

"My latest offer was \$5,800.00 as Radio Photo Engineer... but I'm doing well where I am now engaged. I am deeply indebted to National."

Joseph Grumich, Lake Hiawatha, New Jersey.

"Due to my training at National I was selected to instruct in the laboratory work of Navy and Marines."

R. E. Wersch, Blackfoot, Idaho

"I believe National offers the best course to be had. Keep up the good work."—O. E. Ivey, Washington, D. C.

Read what hundreds of other enthusiastic students have written about National Training. Send in your coupon today.

Train While in Service

Men in our armed services—or about to enter—get better ratings and more pay almost right from the start if they are trained in radio and electronics. The government needs experienced men in nearly all branches of the service. Then, too, you may study with National while you are still in uniform—prepare for present advancement and a sound future after the war. Thousands of men in the Army, Navy and Coast Guard have trained at National under U. S. Government sponsorship.

See for Yourself

Now, right now, is the time to grasp the great opportunity of today—a successful career for tomorrow. Get into the big money, rapid advancement, a position of importance. A BUSINESS OF YOUR OWN. The industry is crying for trained men everywhere. A rapidly expanding business—probably the greatest in industrial history—holds out the promise of a rich future—prosperous security. But to win it you must be ready. Well-trained men ONLY are wanted.

Examine the National Shop Method of Home Training carefully. Be convinced. Study the lesson we will send you FREE. No obligation of any sort. Fill out the coupon and mail it today.



GET THESE 3 BIG BOOKS FREE!

Learn for yourself just how easy this SHOP METHOD HOME TRAINING gives you the practical, down-to-earth experience you can never get from theory alone.

NATIONAL SCHOOLS

LOS ANGELES 37, CALIFORNIA EST. 1905

MAIL OPPORTUNITY COUPON FOR QUICK ACTION

National Schools, Dept. 9-PMR
 4000 South Figueroa Street, Los Angeles 37, California
 (Mail in envelope or paste on penny post card)
 Mail me FREE the three books mentioned in your ad including a sample lesson of your course. I understand no salesman will call on me.

NAME..... AGE.....
 ADDRESS.....
 CITY..... STATE.....
 Include your zone number

It's YOUR future—Make the most of it!



Start now to earn the bigger pay in electrical repair

WAS there ever such an opportunity to get started in electrical maintenance and repair—and at top-notch wages? Are you ready—with experience and ability—to cash in on it? Others are getting just the sort of background needed—quick! practical!—to handle the great variety of electrical maintenance and repair work TODAY—from this well-known electrical library. You can too!

THE LIBRARY OF ELECTRICAL MAINTENANCE AND REPAIR

5 vols., 1826 pages, 1724 illustrations

Gives you the "know-how" to tackle any wiring or motor job. Five books show you HOW—to install all types of motor and generator units—to inspect and repair motor starters and generators—to diagnose motor and generator troubles—to figure new winding for old cores—DC and AC windings—to test armature windings—test induction motors, etc., etc. One book is full of trouble-shooting charts that show quickly symptoms, causes, specific remedies, etc.

Take the first step toward improving YOUR future—Mail this coupon TODAY

No money down—special price—easy payments—FREE trial

McGraw-Hill Book Co., 330 W. 42 St., New York 18, N. Y.

Send me for ten days' free examination the Electrical Maintenance and Repair Library. If satisfactory I will send you \$1.00 in 10 days and \$2.00 monthly until the price of \$15.00 is paid. If not wanted I will return books postpaid. (To insure prompt shipment write plainly and fill in all lines.)

Name
Home Address
City and State
Position
Name of Company PM-9-44

Do you want

- .. to go to College?
- .. or to enter a Profession?
(Such as Accounting, Architecture, Nursing, Dentistry, Teaching, Social Work, Osteopathy, Beauty Culture, Optometry, Embalming, Chiropractic, Law, Medicine, etc.)
- .. or get an Office Position?

To get anywhere, you practically MUST finish High School FIRST. You can complete our simplified High School Course in SPARE time at home, as FAST as your time and abilities permit. Equivalent to resident school work—prepares you for college, pre-professional examinations, business, industry. Standard texts furnished. Diploma. Credit for H.S. subjects already completed. Single subjects if desired. Low tuition, easy terms. American School, Chicago, est. 1897—endorsed by educators. Finish your high school education NOW. Write TODAY!

High School Course at Home Many Finish in 2 Years

American School, Dept. H645, Drexel Ave. at 58th St., Chicago 37, Ill.

Gentlemen: Send me FREE information covering special training in subjects checked below. No obligation on my part.

- | | |
|--|--|
| <input type="checkbox"/> High School Course | <input type="checkbox"/> Diesel Engineering |
| <input type="checkbox"/> Cost Accounting for Mfg. | <input type="checkbox"/> Drafting and Design for men & women |
| <input type="checkbox"/> Architecture and Building | <input type="checkbox"/> Plastics |
| <input type="checkbox"/> Automotive Engineering | <input type="checkbox"/> Private Secretary |
| <input type="checkbox"/> Business Management | <input type="checkbox"/> Mechanical Engineering |
| <input type="checkbox"/> Electrical Engineering | <input type="checkbox"/> Aviation <input type="checkbox"/> Radio |
| <input type="checkbox"/> Elec. and Gas Refrigeration | <input type="checkbox"/> Salesmanship |
| <input type="checkbox"/> Air Conditioning | <input type="checkbox"/> Shipbuilding |
| <input type="checkbox"/> Railway Training | |

Name.....

Address.....

STUDY AT HOME

With A Chartered Educational Institution

Men with specialized training win higher positions, insure larger earnings, and are bigger successes in business and public life. Opportunities NOW greater than ever before. Send for our 1944 Catalog.

ARTS AND SCIENCES

Courses in Philosophy; Education; Letters; Public Health; Medical Jurisprudence; Psychology; Sociology; Physics; Chemistry; Plastics; Geology; Political Science; Theology; Business and Commerce; Accounting; Mathematics; Statistics; Agriculture.

ENGINEERING

Courses in Electrical, Civil, Mechanical, Drafting, Architectural, Steam, Aeronautical, Radio, Structural, Mining, Industrial, Highway, Petroleum, Marine, Chemical, Diesel, Automobile and Air Conditioning Engineering.

LAW

Complete Professional Law Course includes 21 Hornbook Series college grade textbooks. Courses also in Commercial Law, Patent Law and Medical Jurisprudence.

McKinley-Roosevelt Incorporated, 4610-K, Sheridan Rd., Chicago 40, Ill.

MODEL RAILROADING

THE WORLD'S MOST FASCINATING HOBBY



FREE 32-PAGE BOOKLET tells all about this absorbing hobby for skilled tradesmen, business and professional men. Give yourself hours of satisfaction and relaxation building your own scale model railroad which performs and looks like the real thing. It's easy and relatively inexpensive. Get started now. Send at once for our free booklet "Your Model Railroad."

MODEL RAILROADER MAGAZINE
DEPT. M. MILWAUKEE 3, WISCONSIN

Modern Wonder Plastic \$1.00

LUCITE KIT

Complete, supply of Lucite plastic sheets, attractive designs, instructions for cutting, shaping, bending, cementing. Make your own Lucite novelties, costume jewelry. Ideal gifts for Xmas, birthdays, etc. EARN MONEY AT HOME. Sell to your friends, \$15 to \$20 worth from \$1 Kit. Satisfaction guaranteed or money refunded. Get a supply of the Wonder Plastic NOW! Send your name and address with \$1 to Plastic Homecraft Co., 4617 West Washington Boulevard, Los Angeles 16, California.

"How to Make Money With Simple Cartoons"

A book everyone who likes to draw should have. It is free; no obligations. Simply address

CARTOONISTS' EXCHANGE
Dept. 909 Pleasant Hill, Ohio

CODE-RECEIVING SPEED



Learn to send and receive Radio Code with greater speed. Stop nervous tension. Have confidence. Be proficient. Same system used by radiotelegraph specialists. Thousands of operators needed. Rush name for FREE book.

Dept. 5-N, Box 328, Candler System Co., Denver 1, Colo., U. S. A.

MAKE MONEY

AT HOME!

Learn to color photos and miniatures in oil. No previous experience needed. Good demand. Send for free booklet, "Make Money at Home" and requirements.

NATIONAL ART SCHOOL
1315 Michigan Ave. Dept. 1356 Chicago 5



Now ANY AUTO REPAIR JOB Can Be "Duck Soup" For You!

MoToR's New AUTO REPAIR MANUAL
Shows You How to Service and Repair
ANY Part of ANY Car!

FREE 7-DAY OFFER!

NOW you can "polish off" the HARDEST jobs the EASIEST way! MoToR's AUTO REPAIR MANUAL is ready to show you how to repair anything from carburetor to rear end—with the least possible amount of time and effort!

Suppose plain-talking car engineers from every auto plant in America got together and showed you all the things you needed to know about repairing and servicing the cars they had designed and manufactured! That's really what you get in this big manual! Right at your fingertips, the main "dope"

from 150 Official Factory Shop Manuals, covering every make car built since 1935!

Easy to use, too! Quick-index leads you to right page in jiffy! Just follow simple instructions step-by-step.

SEE HOW MUCH YOU GET!

640 pages, 8½ x 11 inches, bound in sturdy covers, 200,000 service, repair, adjustment, replacement, tune-up facts on all makes and models, 1936 to 1942. More than 1000 cut-away photos, diagrams, drawings show you exactly WHAT to do and HOW to do it. Used by U. S. Army, trade and technical schools everywhere, thousands of auto servicemen.

Now YOU—without cost—can see for yourself what a wonderbook MoToR's Auto Repair Manual really is. TRY it—FREE for 7 days! Learn first-hand how it can pay for itself the first few times you use it.

SEND NO MONEY 7-Day Free Examination

Just mail coupon at right, without money! When the postman brings your book, pay him nothing. First make it show you what it's got! Unless you agree this is the greatest time-saver and work-saver you've ever seen—return book in 7 days and pay nothing. Mail coupon today! Address: MoToR Book Dept., Desk 1K, 572 Madison Ave., New York 22, N. Y.

Published by MoToR, The Leading Automotive Business Magazine. MoToR's manuals assure high standard repair work.



USED BY
U. S.
ARMY

Clear, Pictured Facts on Every Job on Every Car Built Since 1935!

Nearly 200,000 service and repair facts on all 30 makes. 640 big pages, including 50 pages of carburetor text, charts, illustrations, covering all models. Over 450 charts, tables; Tune-up Chart; Valve Measurements; Compression Pressure; Torque Wrench Reading; Starting Motor; Engine Clearances; Generator; Clutch & Brake Specifications; Front End Measurements, etc.; Engines; Electric Fuel Cooling, Lubricating Systems; Transmissions; Universals; Front Ends; Wheels; Rear Ends, etc.

Covers
All These
Makes!

American
Bantam
Auburn
Austin
Buick
Cadillac
Chevrolet
Chrysler
Cord
De Soto
Dodge
Ford
Graham
Hudson
Hupmobile
Lafayette
La Salle
Lincoln
Lincoln
Zephyr
Mercury
Nash
Overland
Oldsmobile
Packard
Pierce Arrow
Plymouth
Pontiac
Reo
Studebaker
Terraplane
Willys

Same FREE 7-Day Offer Applies on New MoToR's TRUCK REPAIR MANUAL

For mechanics, truck specialists, service stations, fleet owners. Covers EVERY job on EVERY truck made since 1936! 1400 pictures, 900 pages, 300,000 facts. Used by Armed Forces.

All types Gasoline Engines, Diesels, Henselmen, Fuel Systems, Governors, Lubrication Systems, Ignition Systems, Starters, Generators, Clutches, Transmissions, Axles, Torque Dividers, Transfer Cases, Brakes, Steering, etc.

ALSO SERVICES buses, farm and industrial tractors, contractor and road building equipment, stationary power machinery, etc. (on all parts described in Manual.) Check box in coupon at right.



MAIL COUPON NOW FOR 7-DAY FREE TRIAL

MoToR Book Dept., Desk 1K, 572 Madison Ave., New York 22, N. Y. Rush to me at once: (check box opposite book you want).

MoToR's AUTO REPAIR MANUAL (formerly "MoToR's Factory Shop Manual"). If O.K., I will remit \$1 in 7 days, \$1 monthly for 4 months, plus 35c delivery charge with final payment (\$5.35 in all). Otherwise I will return book postpaid in 7 days. (Foreign price, remit \$7 cash with order).

MoToR's TRUCK REPAIR MANUAL. (Described at left in the box.) If O.K., I will remit \$2 in 7 days, and \$2 monthly for 3 months, plus 35c delivery charges with final payment (\$8.35 in all). Otherwise I will return book postpaid in 7 days. (Foreign, remit \$11 with order).

Name _____ Age _____

Address _____

City _____ Zone No. _____ State _____
(if any)

Occupation _____

SAVE 35c! Check here if enclosing full payment (check, money order) WITH coupon. We pay 35c shipping cost.

KEY TO A PRACTICAL UNDERSTANDING OF ELECTRICITY

\$1 PER MO.

AUDELS HANDY BOOK OF ELECTRICITY

\$4 HANDY SIZE

For Engineers, Electricians, Students and all interested in Electricity. A quick, simplified, ready reference, giving complete instruction and practical information. Easy to understand. A reliable authority and a handy helper that answers your questions.

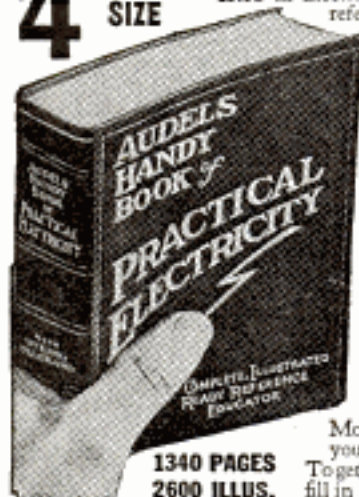

1340 PAGES
2600 ILLUS.

INSIDE TRADE INFORMATION ON

The Rules and Laws of Electricity—Maintenance of Machinery—A. C. and D. C. Motors—Armature Winding and Repair—Wiring Diagrams—House Lighting—Power Wiring—Cable Splicing—Meters—Batteries—Transformers—Elevators—Electric Cranes—Railways—Bells—Sign Flashers—Telephone—Ignition—Radio Principles—Refrigeration—Air Conditioning—Oil Burners—Air Compressors—Welding, and many Modern Applications explained so you can understand.

To get this assistance for yourself, simply fill in and mail the FREE COUPON below.

THE O. AUDEL & CO., 49 West 23rd Street, New York
Please send me "Audels Handy Book of Practical Electricity" for free examination. If satisfactory, I will send you \$1 in 7 days, then \$1 monthly until \$4 is paid. Otherwise I will return it.

Name _____
Address _____
Occupation _____
Reference _____ P M



READ FOR PROFIT!

Learn this Profitable Profession



IN 90 DAYS AT HOME

Money-Making Career Open to Men and Women, 18 to 50

Hundreds of men and women between 18 and 50 make \$10 to \$20 in a single day giving scientific Swedish Massage and Hydro-Therapy treatments. There is big demand from doctors, hospitals, sanatoriums and clubs. Graduates earn large full time incomes from these or in private practice in their own offices. Others make good money from home treatments given in spare time. Learn this interesting, money-making profession in your own home, through our home study course. Same instructors as in our nationally known resident school. You can win independence and prepare for future security by qualifying for your Diploma. Course can be completed in 3 to 4 months. Many earn while they learn. Begin your training at once.



Anatomy Charts & Booklet FREE

Enroll now and we will include, at no extra cost, many needed supplies. Fit yourself to help meet growing demand for massage now and after the war. Send the coupon at once for complete details, Anatomy Charts and 32-Page Illustrated Booklet, FREE, postpaid.

THE COLLEGE OF SWEDISH MASSAGE
Dept. 864, 100 East Ohio St., Chicago 11, Illinois
Please send me FREE and postpaid, Anatomy Charts, 32-page Booklet and complete details on Home Training.

Name _____
Address _____
City _____ State _____

INTRODUCING-New Victory Model HANDIWELD ELECTRIC ARC WELDER

RETAILS ONLY \$1.95



PLUGS INTO LIGHT SOCKET

Victory Model Handiweld Arc Welder operates from 110 volts, A.C. or D.C. current same as other arc welders higher priced; generates tremendous heat to weld all metals. Not a toy welder that uses carbons, but actually uses standard coated rods—sizes 1/16" and 3/32". However, due to Priorities a generous supply of 1/16" rods only are supplied with the welder. Guaranteed not to burn out. Repairs feeders, auto bodies, radiators, machinery parts, etc. Take Victory Model Handiweld anywhere to job, operate right from light socket. You'll find a thousand uses for this welder around your home, garage, workshop. Also in garages, factories, repair shops, tin shops, mechanics, inventors, plumbers, farmers, etc. Order a "Victory Model" Handiweld now.

SEND NO MONEY We'll rush one to you with rods, helmet, operating instructions, and all necessary parts with the exception of a large jar and a small piece of extension cord; these most everyone has. Pay postman only \$1.95 plus a few cents postage. If not delighted return Victory Model Handiweld in 5 days from receipt and money paid for it will be refunded promptly. Rush your order now.

KUMFY PRODUCTS, Dept. H-202, CINCINNATI 26, OHIO

AMAZING MONEY MAKING OPPORTUNITY LEARN WATCH REPAIRING

A lifetime profession regardless of age, sex or physical handicaps. Veterans with medical discharges—men, women, past 40—your opportunity! Lift yourself from a Futureless Job into a position paying Better than your Present work or that will permit you to establish your Own Shop. Our Watch Repairing, Jewelry Engraving Graduates wanted everywhere—positions \$50-\$75-\$100 per week. Write for details today.
K. C. SCHOOL OF WATCHMAKING, 113-A East 31st, Kans. City 8, Mo.



START YOUR OWN SHOP

Men wanted now and after the war for Plastics, Auto-Diesel, Machinist, Drafting, Refrigeration, Welding, Body & Fender, Aircraft. Earn real money or be independent in your own business. Free booklet. Specify trade. State whether interested in Home Study or Practical Shop Training.
GREER, Dept. 294, 2017 S. Wabash Ave., Chicago

Get into the BAKING BUSINESS

Bakers make good money! Now 7th Industry in wages! Nearly depression-proof. New home study Baking Course qualifies you. Common school education sufficient. If you're ambitious, write for FREE BOOK, "Opportunities in Baking."
National Baking School, 1315 Michigan, Dept. 1356, Chicago, 5, Ill.



ENJOY HEALTH BECOME A PROFESSIONAL ACROBAT!

MEN! FREE HEALTH BOOK. Print your name and address on postcard and MAIL NOW! to: EMIL KNOPP, Dept. K.M., 2154 North 52nd Street, Milwaukee 8, Wis.

★ SAVE WASTE PAPER ★



DRAW CARTOONS BIG MONEY!

EASY . . . PLEASANT WORK!
Let CHAS. H. KUHN, with 25 years actual experience in drawing a daily newspaper cartoon, teach you how to create, draw and sell your work. 52 complete lessons—one sent each week. Professional criticism on every lesson. Write today.
After Jan. 1, 1945, the price of this course will advance to \$15.00

KUHN SCHOOL OF CARTOONING
420 MURPHY BUILDING Dept. 5, INDIANAPOLIS 4, INDIANA



Learn by Mail to Mount Birds

Animals, Game-Heads, Fish, Pets, to Tan Skins

Men, Boys!

Be a **Taxidermist**. Learn at home in spare time. Easily, quickly learned. **Grand Fun**. A wonderful, profitable hobby, for expert hunters, also for amateurs, even young boys. Mount wild-game, although wild-game is not necessary. Use common, domestic specimens, squirrels, pigeons, even frogs. This famous, reliable school in business more than 55 years. **More than 300,000** delighted students. Think of that!

Hunters Save Your Trophies — Have a Home-museum Be a Taxidermy Artist

You will be **THRILLED** and **DELIGHTED**. You learn **QUICKLY**, easily **AT HOME**. Your friends will be amazed. Hunters from near and far will bring their **TROPHIES** to be mounted. You can earn fine **profits** in spare time. Many students earn \$50 to \$100 a month, in season. **Rush the coupon today**, and learn all about wonderful taxidermy. **DO IT NOW!**

Save your own hunting trophies. Have a lifelong hobby. Have a home museum that you are proud of, and that makes you popular and well-known far and wide. **BOYS**, wild-game is **not** necessary. Use common specimens, squirrels, pigeons, owls, domestic birds and animals. **It's wonderful**. Inquire today. **Kill fewer game-birds. Double your fun and pleasure.**

Fun — Fascination — Profit

And so easily learned in spare time. Wild-game is growing scarcer. Help preserve it. Shoot only a **FEW** fine ducks and other game-birds, **MOUNT THEM** for home and den, and have **MORE FUN** and **PLEASURE** than killing the legal limit every day. **Help preserve the wild-game.**

Remember you learn to mount expertly, **birds, animals, game-heads, fish, pets, to tan skins and furs**. Investigate! You will be delighted. Send for **free book today**. "Eat your trophies and have them too."

THE N.W. SCHOOL OF TAXIDERMISTRY, 3376 Elwood Bldg., Omaha 8, Nebr.

FREE BOOK!

Yes **FREE**, 44 pages, with 100 unique pictures of taxidermy work. No other book in the world like this. It will amaze and thrill you. **Ask today for your free copy. State your AGE.**

Send the Coupon!

Write name plainly in coupon or margin, or a **post card** will do. **Rush your request, as free books may be exhausted quickly. Decide now.** Don't wait a moment. **State your age.**

FREE BOOK

Northwestern School of Taxidermy, 3376 Elwood Bldg., Omaha, Neb.
Send me your free illustrated book, "How to Mount Game". Also tell me how I may learn this fascinating art easily and quickly by mail. No obligation. State your age.

Name _____ Age _____
Address _____

★ REFRIGERATION

AT YOUR FINGER TIPS with Drake's NEW Manual



By means of Drake's brand new **REFRIGERATION SERVICE MANUAL** you can get yourself a better job . . . earn more money. The latest developments in household and small commercial refrigeration become as simple as A B C when you study this remarkable book.

Written by leading authorities, and covering every problem in simple, easily understood language, this newest addition to Drake's Technical Library contains over 300 pages and 138 diagrams and illustrations. Included are the following:

- Installations
- Adjustment
- Testing
- Replacement
- Trouble Shooting
- Repair

The work covers practically every operation in field service, as performed where the equipment is installed, and also the shop operations which may be required. It includes domestic types of refrigeration, and fully and completely the commercial types in small and medium sizes, such as used in markets, milk depots, soda fountains, flower shops, etc., as well as in many air conditioning systems.

Use the coupon for your copy . . . today. Send only \$2.00. If you are not satisfied that this book is the answer to your expectations, return the book within 5 days, and your money will immediately be refunded.

OTHER IMPORTANT DRAKE BOOKS

1. **Practical Electricity and House-Wiring:** 200 pages, 227 illustrations \$1.50
2. **Spray Painting, Industrial and Commercial:** 125 illustrated pages \$1.50
3. **Carpentry Craft Problems:** 302 pages, 700 illustrations. \$2.00

DRAKE BOOKS SOLD BY ALL LEADING BOOKSELLERS

FRED'K J. DRAKE & CO., 600 W. Van Buren St., Dept. PM-9, Chicago 7, Ill.

ONLY \$2.00

4. **Plumbing Installation and Repair:** 236 pages, 153 illustrations \$1.50
5. **The Slide Rule and Logarithmic Tables:** 200 pages, illustrated \$1.50

USE THIS COUPON FOR YOUR ORDER

FRED'K J. DRAKE & CO., 600 W. Van Buren St., Dept. PM-9, Chicago 7, Ill.

O.K. Send me postpaid the Drake books I've checked. Remittance enclosed. I understand that if the books are not entirely satisfactory, I may return them within 5 days and my money will be refunded.

_____ Refrigeration Service Manual

1 2 3 4 5

Name _____

Address _____

City and State _____

_____ Check here if you want our FREE illustrated catalog.

LEARN ARC WELDING from A to Z

Prepare Yourself NOW for a BETTER POST-WAR JOB

—in the world's fastest growing industry. No matter how extensively it's being used to produce vital war materials, welding is still comparatively new and there will be a still greater demand for operators for post-war production. Train now for this highly essential war work and promising future. Write for information! Hobart Trade School, Inc., Box M-94, Troy, O.



- Lessons in Practical Arc Welding 75c
- Practical Arc Welding A Text Book \$2.00
- Practical Design for Arc Welding \$3.50

HOBART



"One of the World's Largest Builders of Arc Welders."



DRAW for MONEY Be An ARTIST!

PREPARE TODAY FOR THE FUTURE THAT LIES AHEAD

Trained Artists Are Capable of Earning \$30 - \$50 - \$75 A WEEK

Use your spare time to prepare for a profitable Art Career! Start training at home, now! It's pleasant and interesting to study Art the W. S. A. way. **COMMERCIAL ART, DESIGNING, CARTOONING**—all in ONE complete course. No previous Art experience necessary—we teach you step-by-step by our practical home study method well-known since 1914. Write today for information in **FREE BOOK, "ART FOR PLEASURE AND PROFIT"**—tells all about our course, material furnished, instruction service—and commercial opportunities for you in Art. **STATE AGE. WASHINGTON SCHOOL OF ART, Studio 129K, 1115-15th St., N. W., Washington 5, D. C.**

HUNTING & FISHING

is a monthly magazine crammed full of hunting, fishing, camping, dog and boating stories and pictures, invaluable information about guns, fishing tackle, game law changes, best places to fish and hunt—countless ideas that will add more fun to your days afield.

Special Trial Offer
Send 25c in stamps or coin and we will send you **Hunting & Fishing** for six months.

HUNTING & FISHING MAGAZINE

251 Sportsman's Bldg., Boston, Massachusetts



CLOSING OUT SALE 9 POWER TELESCOPES \$1.49 REGULAR \$2.99 SELLER



COUNT TELEGRAPH WIRES IN THE DISTANCE

We are liquidating our entire stock of 9 power, wide vision telescopes. Scientifically ground lenses. Ideal for spotting planes, boats, people, hunting, etc. Thousands sold at \$2.99—twice our present price of \$1.49 postpaid. **SEND NO MONEY.** Just pay postman \$1.49 plus few cents postage. Cash orders sent postpaid. **ACT NOW—SUPPLY LIMITED.** **VOGUE TELESCOPE CO., 7756 S. Halsted, Dept. TS-107, Chicago 20**

JIU-JITSU HOW TO BECOME REAL EXPERT

Send 10c for trial lesson and details. Age must be 15 or over.

MODERN SCHOOL JIU-JITSU, 5 W. 52 St., N. Y. C. 19

Store Route Plan PAYS BIG MONEY

SELL COUNTER CARD PRODUCTS

Build a good-paying business of your own! Call on dealers of all kinds; show nationally-advertised Aspirin, Vitamins, Cosmetics and 200 other necessities. Big 5c and 10c retail packages, high quality. Attractive counter displays sell goods fast. Free book gives amazing facts. Write! **World's Products Co., Dept. 10-Z, Spencer, Ind.**



PATENTS AND TRADE MARKS

C. A. SNOW & CO.

Registered Patent Attorneys Since 1875
Write for Free Book and "Certification of Invention" form
427 SNOW BUILDING, WASHINGTON 1, D. C.

★ SAVE WASTE PAPER ★

PATENT YOUR IDEAS SEND FOR FREE BOOK

Written by Former Member Examining Corps (1922-24) U. S. Pat. Office.

CARL MILLER, Registered Patent Attorney
Former Member Examining Corps U. S. Patent Office
Woolworth Bldg., Dept. 94-A, New York — Bond Bldg., Dept. 94-A, Washington, D. C.

BENJAMIN

H-C PELLETS ARE AVAILABLE

at dealers or direct. Cal. 22 and Cal. 177. Production of all models Benjamin Air Rifles and Benjamin Air Pistols has been suspended for the duration as our facilities are engaged in War Work. **WRITE FOR OUR ILLUSTRATED PRICE LIST OF POST WAR MODELS TODAY.**

BENJAMIN AIR RIFLE CO., 812 Marion St., St. Louis, (4) Mo.

To PROTECT YOUR INVENTION - Use this coupon, NOW

Delays are dangerous and may be very costly. My personal service assures prompt action, strict confidence, and a minimum of expense. I suggest that you send me a model or drawing, or sketch and description of your invention, and \$5.00. I will make a search and report

promptly as to its patentability and send you a copy of my 72-page booklet. Or, if you prefer to read my booklet first, mail the attached coupon at once. I will also send my "Record of Invention" form. (Over 40 years experience as a Registered Patent Attorney.)

A PERSONAL CONFIDENTIAL PATENT SERVICE

L. F. Randolph, 302-D Columbian Bldg., Washington, D. C.

Please send me at once, free of charge, your 72 page booklet and "Record of Invention" form.

Name

Address

Your Future

IN RADAR-RADIO

If you are a Radio Engineer, Layout Draftsman, Laboratory Assistant, Quality Tester, Analyser, Phaser, find out what Motorola offers you in future security, rapid advancement, recognition and salary increases. We'll send details. Write today.

Motorola GALVIN MANUFACTURING CORPORATION
4545 W. Augusta Blvd. • Chicago 51, Ill.

THIS MAN'S JOB



Pays well in good or bad times... He's a FINGER PRINT EXPERT

Learn this fascinating profession right at home!

I.A.S. has taught thousands of men and women this exciting, profitable, pleasant work. Let us teach you, too, in your own home, during spare time. You should have no doubt of the possibilities in this fine field. Think of it...

53% of all identification bureaus in America employ I. A. S.

graduates or students. This fact alone is ample evidence of the thorough, practical training given. What others have done, you too, should be able to do.

Here Is Proof That It Is NOT Difficult



Of the six finger prints at the left, two of them are alike. See if you can find the matching prints. Of course, there is much more to learn than the mere matching of finger prints, but you get the idea.

Fit Yourself Now for a Post-War Job

Instead of being just one of millions of men looking for peacetime jobs, prepare now to obtain a position that pays well from the start and offers a fine future throughout a lifetime. Send today (stating age) for our great Free Book. Use the coupon!

INSTITUTE OF APPLIED SCIENCE
Dept. 1356, 1920 Sunnyside Ave., Chicago 40, Ill.

Send for **FREE** copy of
"THE BLUE BOOK OF CRIME"

INSTITUTE OF APPLIED SCIENCE
Dept. 1356, 1920 Sunnyside Ave., Chicago 40, Ill.

Gentlemen: Without obligation, send me the "Blue Book of Crime" and complete list of Identification Bureaus employing I.A.S. students or graduates, also information regarding cost and terms. (Literature sent only to persons stating age.)

Name..... Age.....
Address.....
City..... State.....

PRINT ANY PHOTO on Paper, Cloth, Leather or Wood

SIMPLE, EASY TO USE

Magic liquid takes only 2 minutes to reproduce any snapshot you have on to stationery, handkerchiefs, ties, scarfs, etc. Won't wash off. Won't hurt negative or fabric it's used on. Personalize your belongings! An ideal gift. Complete outfit enough to transfer 100 photos—only \$1.00 postpaid. Sent C.O.D. for \$1.30.

CHRISTY PHOTO SUPPLY, Dept. 510
2835 N. Central, Chicago 34



ARTISTS MAKE MONEY

Find out your ability. Send name, age, occupation and address for Free Vocational Art Test.

ART INSTRUCTION, INC. (Formerly Federal Schools)
9134 Art Instruction Building, Minneapolis, Minnesota

ELECTRICITY MEN NEEDED

Electricians are needed everywhere. Demand is growing. Good pay now and bright future for trained men in this live, expanding vocation. Learn at home, in spare time, from old established school. Write for **FREE** Bulletin. No obligation.

AMERICAN SCHOOL

Dept. EE645 Drexel at 58th St. Chicago 37

PLASTICS

Resident engineering course, 2000 hours, Tuition \$900.00. Mold design course, 1000 hours—\$500.00. Veterans free if qualified. Chemistry course, 1000 hours—\$500.00. Study in the **HEART** of the plastics industry. (Founded 1910)

NEW YORK TECHNICAL INSTITUTE (of N. J.), 158 MARKET ST., NEWARK, N. J.

BE A PERFUME DISTRIBUTOR!

Sell reproductions of world-famous, imported perfumes and get in on the now bigger than ever year around demand for this merchandise. Eye appealing packages assure you big daily cash profits. Many millions of dollars worth of perfumes sold annually. Get started at once with us—your profits are waiting! Don't get started! Send for free details and sample TODAY! **DUCHESS D'ANDRE, Dept. 14-C, 145 No. Clark St., Chicago 2, Ill.**

MUSIC LESSONS

COMPLETE CONSERVATORY HOME STUDY COURSES

Piano, Harmony, History of Music, Advanced Composition, Voice, Public School Music, Violin, Cornet, Trumpet, Guitar, Mandolin, Saxophone, Clarinet, Dance Arranging, Ear Training and Sight Singing, Choral Conducting. The only correspondence school teaching all the courses leading to the Degree of Bachelor of Music. Ask for illustrated lessons and catalog.

Give experience..... age.....
UNIVERSITY EXTENSION CONSERVATORY Dept. U-59, Chicago 15, Ill.
1525 E. 53rd St.

Say you saw it in *Popular Mechanics!*

**WORLD'S
BEST
WANT AD
MEDIUM**

CLASSIFIED Advertisements



Advertisements in this section, 35 cents per word, each insertion, minimum 10 words, payable in advance
To be inserted under proper classification in October issue, should be in our office September 4th

October issue on sale October 1st

Popular Mechanics Magazine, 200 East Ontario Street, Chicago 11, Illinois

AUTOMOBILES—MIDGET CARS

GASOLINE Age. 360 pages. Wonderful book history automobile business in America. Start of Dodge Brothers, Ford, Nash, Durant, Chrysler, Willys, others described. Illustrations. Contains list of over 1500 American makes automobiles once manufactured. \$3.00 postpaid. Clymers, 2125 W. Pico, Los Angeles 6, Calif.

CUSTOMIZE Your automobile. Illustrated, new restyling ideas, instructions, suggestions, specific model changes by simple methods. \$1. Speed Wheel, Box 723-E, Arcadia, California.

SEE Our advertisements under Motor-cycles Classification. Clymers, 2125 W. Pico, Los Angeles 6, Calif.

AUTOMOBILE Books. "Racing photo album" 110 photos, exciting crashes, world's greatest race cars, drivers described. \$1.50. "Saga Roaring Road" 181 pages, 16 pictures. Starter Fred Wagner's early racing experiences with world famous drivers, cars described. Read about Rickenbacker, Murphy, Burman, DePalma, Ford "999", Oldfield's Benz \$2.50. Automobile racing book \$1.10. Prices include reprints, illustrations, drawings army Jeep and German BMW war motorcycles. All postpaid. Clymers, 2125 W. Pico, Los Angeles 6, Calif.

PROFESSIONAL Midget racers, motor-scooters, midget cars. Parts, plans. Handbook catalog—50 illustrations, plans—20c. Midwest, 2557 Charlestown, Toledo, Ohio.

POWER And Speed! World's most famous motor book. 110 large pages. 200 illustrations racing automobiles, motorcycles, airplanes. World's speed record chart, articles by world's famous speed kings Cobb, Evoston, Campbell, Bonneville record details, photos British racers. Describes cams, compression, valves, superchargers, international racing teams. German Auto-Union, Italian, French, British racer specifications, drawings. \$2.50 postpaid. Clymers, 2125 W. Pico, Los Angeles 6, Calif.

"TIPS On buying or selling a used car" booklet 25c. Walters, 1291 Alameda, Detroit 3, Michigan.

TIME Magazine said "Floyd Clymer's Motor Scrapbook is a 'must'". This unusual historical, education, humorous scrapbook illustrates early automobiles, motorcycles, airplanes. Read about "V-8" Chevrolet, 1906 Plymouth, Ford "2" and "3," three and five cylinder automobiles. Rambler, Maxwell, Metz, Knox, Sears, steamers, electric, foreign machines, 240 others. Motorcycle section includes Pierce "4", Merkel, Pope, Thor, Emblem, Excelsior, Henderson, Ace, Cleveland, Indian, Reading, Harley, steam and front drive motorcycles. A laugh on every one of 160 pages. Postpaid \$1.50. Clymers, 2125 W. Pico, Los Angeles 6, Calif.

INTERESTING. Educational, illustrated English "Motor" magazine on foreign automobiles. 50c postpaid. Clymers, 2125 W. Pico, Los Angeles 6, Calif.

AUTOMOBILE Racing book, fifth edition, well illustrated. Instructions on building bodies, frames, engines. Ford A and B conversions. Plans. AAA rules, specifications. Roadster racing, Indianapolis cars. \$1.00 postpaid, \$1.30 C.O.D. Ray Kuna, Dept. 47, Madisonville, Cincinnati 27, Ohio.

STEAM Automobiles! Send 25c for literature listing names 90 different makes steamers once manufactured. Illustrations, descriptions, specifications, Stanley, White, Doble, Lane, Ross steamers, boilers, engines also photos famous White Racer "Whistling Billy" and world's record holder Stanley Racer. Interesting, educational, ancient steamer history. No cars for sale. Clymers, 2125 W. Pico, Los Angeles 6, Calif.

FAREWELL To Model "T". Humorous book with cartoons, illustrations, description car, engine, chassis, first and last Model T Fords manufactured. Folder includes page on German Jet Propulsion Opel automobile. \$1.50 complete postpaid. Clymers, 2125 W. Pico, Los Angeles 6, Calif.

FREE Details of automatic gas saver with supercharge principle. Vadco Sales, 236 Eckford St., Brooklyn 23, N. Y.

SIR Malcolm Campbell's book of famous motorists! 176 pages. 42 beautiful photographs world famous racing automobiles, drivers. Campbell describes famous race tracks, his American records, European road races, his competitors. Interesting, sensational. \$3.00 postpaid. Clymers, 2125 W. Pico, Los Angeles 6, Calif.

BUILD Dashboard controlled garage door mechanism. Thoroughly tested system. Exceptionally simple, dependable. Materials inexpensive, obtainable everywhere. For overhead, swinging, sliding doors. Money back guarantee. No questions. Complete plans \$2.00. Kaytor Laboratories, Lynwood, Calif.

1944 IGNITION Supercharger \$3.50. Fast starting, mileage, pep. EG Sales Mfg. Co., 60 John St., New York.

AUTO SUPPLIES AND EQUIPMENT

WHIRLGAS Turbinator, \$3, vaporizes carburetor mixture; increases mileage and horsepower; reduces monoxide; prevents vaporlock. University and oil corporation tests. Wrench installs 15 minutes. Give auto make, year. John Hanley, 3719 Lorraine, Detroit 8, Mich.

HAVING Car trouble? Used, guaranteed auto, truck parts save money. Transmission specialists. Describe needs; immediate reply. Victory, 2439 1/2 Gunnison, Chicago 25.

1,000 MOTORISTS Needed to make gas saving test. Up to 30% savings. For trial test offer write Vacu-matic Carburetor Co., 7617-978 W. State Street, Wauwatosa, Wis.

CRANKSHAFT Refacing. Simple device. Instructions \$1.00. Free details. Richard Mfg. Co., 4544 So. St. Louis Ave., Chicago, Ill.

DUAL Mufflers. California style fit Ford V-8, Mercury. Saves gasoline, increases power, beautiful deep tone. All attachments, pipes, etc. Easy installation. \$20.00 complete. Clymers, 2125 W. Pico, Los Angeles 6, Calif.

INSERT A 4-ply rubber liner into your tire. Protect from cuts or abrasions. \$4.95. Reeder & Harris, 520 Conkey Street, Hammond, Indiana.

BURN 120 Octane—the perfect fuel in your car (not gasoline). Superb performance. Complete easily followed instructions to make your own unit. \$1.00. Earl Behling, Box 955, Inglewood, Calif.

RUN Any 6 cyl. car on 3. Chrysler roadster gets 44 miles per gal. Runs smooth, plenty power. Make and model with dollar for instructions. Jones, P.O. Box 1441, Portland, Ore.

INVENTION Uses kerosene to run motors. Circular on plans. Rush name. Houston Maupin, Tipp City 23, Ohio.

FIVE Cents worth of natural gas will run your car 25 miles. Photos, blueprints and instructions. \$1.25. Harper's Machine Shop, 218-22nd Street, Dunbar, W. Va.

ANTI-FREEZE. Noncorrosive, inexpensive. Manufacture yourself. Details for stamp. Betke, Box 699, Borger, Texas.

VACUDEX Exhauster tested on dynamometer in Institute of technology by automotive engineer, reduced back pressure materially, increased mileage, increased horsepower, with less gasoline. Easily attached in few minutes. Satisfaction guaranteed. \$3.75 postpaid. Decker Products Co., Pelham, N. Y.

AUTOMOBILE Generators. Rebuilt generators for cars or trucks. O'Keefe, 7517 Merrill, Chicago.

EXTRA Miles. Easily drive 50 miles for each gallon gas used. Equip car yourself inexpensively. New simplified diagrams and instructions \$1.00 cash or money order. Mechanic's Special, Box 54, San Bruno, Calif.

CLYMER DeLuxe chromed spotlight for automobiles, motorcycles, boats, hunters. Trigger switch, pistol grip handle, powerful beam, 32 cp., operates off any 6-8 automobile battery. Only few left, hurry. \$8.50 postpaid. Clymers, 2125 W. Pico, Los Angeles 6, Calif.

SAVE Gas. How I increased my mileage over 150% is a copyrighted article which may help you to get more mileage. Postpaid \$1.00. Copyright also offered for sale. Interested? Write. W. Orr, Box 810, Frankford, Ont., Can.

TIRED Of gas rationing, shortages, excessive carbon, ping, knock, poor mileage, high operating costs? Then get straight facts about butane, not rationed, plentiful, cannot form carbon, 120 octane, no ping, no knock, half price, plus more mileage. Butane is the perfect fuel, beware of other harmful and impractical schemes. Get complete information, sketches, list of necessary equipment, etc., by sending one dollar to Alberts, Box 492, Alhambra, Calif.

OPERATE Cars, trucks, tractors, motors, with wood or coal gas, 1/2 cost of gasoline. Extensively used in Europe. Complete detailed instructions \$1.00. W. M. Cross, Lone Rock, Wis.

PRESERVE Your tires with plastic, and puncture proof your tires. Details for stamp. Betke, Box 699, Borger, Texas.

PLATING Outfits for auto parts. Connect to a battery. No tanks used. Free particulars and proofs. Gunmetal Co., Ave. J, Decatur, Ill.

THE Lord is coming! Get guaranteed proofs free. Scheall, 262XA, Duluth, Minnesota.

AUTO TRAILERS

BUILD Your own trailer! Save money! Have every feature you want! Plans for house, sport, camp and utility trailers. Catalog describing 9 models 10c. Jim Dandy, Box 123-A, Wausau, Wisconsin.

MOTORCYCLES, BICYCLES, MOTOR-SCOOTERS AND SUPPLIES

ATTENTION: All motorcycle owners! 1944 publication of 28 pages listing complete line first grade accessories, service and trouble saving tips and charts. 25c a copy. Copy purchase price refunded on first order of \$2.00. We carry full line of all Indian part and large supply Harley-Davidson parts. New and used. Quotation on parts and service free on request. Preston Motors, Inc., Kendallville, Ind.

ELECTRIC Motorbike built from your present bicycle. \$1.00 bill brings complete instructions, drawings, specifications. Mowery, Box 994, Lancaster, Pennsylvania.

U. S. Tires \$3.25, tubes \$1.25, new front wheels \$3.00, new back wheels \$7.00. Bikes overhauled and enameled, any color \$3.00. L. S. Hilaman, R. D. 2, Rising Sun, Md.

MOTORCYCLISTS—New and used parts, accessories, all models. Catalog 10c. Henderson catalog 10c additional. Triangle, 2157 Harrison, Chicago.

BUILD Scooters, trailers, midgets, conversions. Large manual \$1.00. Illustrated circulars dime. Craftsmann Books, Box 1153-P2, Milwaukee 1, Wis.

ENGLISH "Motorcycling" Magazine. Interesting, educational, foreign motorcycles. Racing, new-old models, advertisements. 50c sample copy. Clymers, 2125 W. Pico, Los Angeles 6, Calif.

BOYS: Airspeed indicator for your bicycle. 50c. Spargo, Higganum, Conn.

PARTS. Complete motor parts list. Pistons, all sizes, chains, sprockets, for Indian, Harley, 10c. Boots, 622 East Grand, Des Moines 2, Iowa.

NEW Book just out. English Motorcycle Manual. 68 large pages complete authentic factory servicing information British war and civilian motorcycles. 140 illustrations, diagrams, drawings, engines, transmissions, Enfield, Norton, Triumph, B.S.A., Matchless, Ariel, Velocette, Burman, Lucas ignition, B.T.H. Magneto, Miller lighting sets, hydraulic forks. Wonderful book British owners, interesting, educational any motorcyclist. \$1.50 postpaid. Clymers, 2125 W. Pico, Los Angeles 6, Calif.

BOYS! All bicycle repair secrets revealed. "Bicycle Repair Manual" 65c. R. G. Klausner, Shelbyville, Ill.

WANTED—Used parts and motor for motorscooter or midget car. Garinger, 2337 Charlestown, Toledo, Ohio.

BOOK "Speed—How to Obtain It." 160 pages, illustrated, instructions, cams, balance, timing, valves, pistons, racing technique. World's greatest speed tuning book. \$1.50 postpaid. Clymers, 2125 W. Pico, Los Angeles 6, Calif.

PARTS, Accessories, pistons, chain for Harleys and Indians. McCann's P.O. Box 114, El Paso, Texas.

BOOKS! "Modern Motorcycle Mechanics and Speed Tuning." 435 pages maintenance Harley, Indian, Villiers, all British motorcycles \$2.50; with drawings, specifications, illustrations U. S. Army Jeep, German BMW war motorcycles \$3.00; "Motorcyclist's Workshop" \$1.50; "Two Stroke Motorcycles" \$1.50; "Speed—How to Obtain It" \$1.50; "Historical Motorcycling Facts" \$1.00; "Automobile Racing" \$1.10; Motorcycle instruction manual "Questions—Answers" \$1.10. All postpaid. Clymers, 2125 W. Pico, Los Angeles 6, Calif.

WANTED—Motorcycles, transmissions; scooters, small; engines of all kinds. Name your own price. Write: Midget Motors Directory, Athens, Ohio.

FLOYD Clymer's Motorcycling Manual, 144 pages, 120 illustrations. Complete information, specifications, descriptions dozens motorcycles, Engines, transmissions, carburetors, square four, two piston singles, sleeve valve engines, overhead camshafts, water cooled motorcycles, spring frames, hydraulic forks, sidecars, riding instructions. Two cycle engines and power bicycles described, illustrated. Just out \$2.00 postpaid. Clymers, 2125 W. Pico, Los Angeles 6, Calif.

MOTORCYCLE Cylinders metallized and ground to any size desired. Scored and cracked cylinders repaired. Stahl Machine Co., Tiffin, Ohio.

FLOYD Clymers Historical Motor Scrapbook \$1.50 postpaid. This is the book Time Magazine said is a "must." 160 pages. 250 early motorcycles, automobiles illustrated, described. See our advertisements under Automobiles. Clymers, 2125 W. Pico, Los Angeles 6, Calif.

MOTORCYCLE Parts, new and used. List 10c. Ballak, 811 N. 9th, St. Louis 1, Mo.

MOTORBIKE Manual. Containing motorbike and scooter plans, helpful hints and catalog section. \$1.00. Variety Enterprise Company, Dept. P.M., Box 5, Station A, Evansville, Ind.

100 MILES Gallon! Motor-scooters, motorcycles, Whizzer bicycle engines, midget automobiles, gasoline engines. No priority necessary. Catalog 10c. Clymers, 2125 W. Pico, Los Angeles 6, Calif.

MOTOR-SCOOTERS As low as \$50, motorcycles \$100, gasoline motors \$10. Unrattioned 10, 12, 14 inch balloon tires \$2 up. Mail order only. Send 25c for new catalogue just out. Midget Motors Directory, Athens, Ohio.

PLANS, Scale drawings, specifications, illustrations for building attractive motor scooter complete \$2.00; plans electrically driven bicycle \$1.50. Postpaid. Clymers, 2125 W. Pico, Los Angeles 6, Calif.

MOTORBIKE Manual. Containing plans for easy to build motorbike and scooter, and catalog section. \$1.00. Variety Enterprise Co., Dept. P.M., Box 5, Station A, Evansville, Ind.

HARLEY-DAVIDSON Parts, accessories, late models. Carl Bush, 518 Broad St., Newark, N. J.

TIRES And industrial wheels, suitable for scooters, wheelbarrows, farm equipment, etc. All sizes. Bicycles and accessories. Largest assortment in America. Send dime for list. Cycle Transport Company, 1241 So. Michigan Ave., Chicago 5, Illinois.

HARLEY-DAVIDSON 24 h.p. twin 45 motors. Perfect condition. \$85.00 and up. Latest design. Used to power farm equipment, ice sleds, midget cars, etc. Used Harley-Davidson parts. Send 25c for bulletin and 45 service manual. Knuth's, 2491 Fondulac, 6, Milwaukee, Wis.

SAVE Gasoline, build a motorbike now, send 25c for complete plans. Motorbike Service, 2108 McLean, New Albany, Ind.

AVIATION

AIR Mechanics Manual by Zweng covers aircraft and engines. Multiple choice examinations \$3.00 postpaid. Pan American Navigation Service, 12021 Ventura Blvd., North Hollywood, Calif.

PROPELLERS—Quality service, all types, sizes, special 3 blade for boats, sleds, lists free. Ford motor conversion diagrams 50c. Standard Aircraft, Ft. Worth, Tex.

CUB \$200 (Needs repainting); Curtiss Robin \$195; Fairchild \$395. Catalog over 250 listings, 25c. National Aviation, Box 1682-CS, Toledo, Ohio.

LIGHTPLANE Manuals blueprints four new designs now ready. New illustrated circulars 2 dimes. Craftsmen Books, Box 1153-P1, Milwaukee 1, Wis.

TOURING Mountains? Our altimeters tell height in feet, \$3.95, in meters \$1.95; also airplane pilot seats, sacrificed, \$1.00 each, 3 for \$2.00, gasoline level gauges \$1.95. Air Transport, Garden City, N. Y.

PIPER Cub \$225; Taylorcraft \$375; Aerocraft \$325. Send 25c for complete directory listing these and over 200 other buys, located everywhere. Used Aircraft Directory, Athens, Ohio.

AIRPLANES—Used, \$295 up. Also late models. Engines, wings, parts, machinery, books. Cheap. Send two dimes for list. Aircraft, 2300 West Flagler, Miami, Florida.

"MONGOOSE" Airplane—Dandy, live 16" wing model. Stunts, zooms, climbs. Build, fly it 2 hours. 75c by mail. Dean Model Aviation, 97 Cuthbert Street, Scotia, N. Y.

ELECTRIC FENCING

ELECTRIC Fencer, 110 v. a.c., operates 10c year. Easily built. Complete plans \$1.00. W. H. Cash, Sunnyside, Calif.

BATTERIES, GENERATORS, ETC.

EDISON Batteries. Light Power. Fifteen year life. Five year guarantee. Complete lighting plants. Free literature. See Jay Company, 321 Yonkers Avenue, Yonkers, New York.

ELECTRICAL SUPPLIES, EQUIPMENT

BEST Quality microphone cable. Single conductor, rubber-covered, 20c per foot—cash with order. Lengths 25 feet to 150 feet. Oahu Publishing Company, 804 Film Building, Cleveland 14, Ohio.

FIBRE-BAKELITE Washers, strips, small pieces, large assortment for insulation. Ideal for electricians, radio mechanics, hobby workshops. Over 1000 pieces. Satisfaction guaranteed. Special \$1.98. Order now. Hudson Trading Corp., 169 W. Hubbard, Chicago 10.

ELECTRIC Pencil: Writes-engraves all metals. \$1.00 postpaid. Beyer Mfg., 4615-H Cottage Grove, Chicago 13.

NOW—Repair your own electrical appliances with Chanite Self-welding Electrical Heating Element Flux. Instructions delivered, price \$1.00. Chanite Sales Company, 914 South Main, Fort Worth, Texas.

NEW And used electric plants, 350 watt to 40 k.w., a.c. d.c. E. F. Schmalz, 215 Wyoming Ave., Kingston, Penna.

ELECTRO-MAGNETS—Plans \$1.00. Details free. Terry, Central Station 1676, Toledo, Ohio.

REBUILT Washers, parts, wringer rolls, belts, vacuum cleaners. Servall, 1524 W. Superior St., Duluth, Minn.

SUPPLY Exhausted of 18 in. aluminum fan blades, until further notice. Ted Rise-man, 427 E. Jefferson, Springfield, Ill.

ELECTRIC Iron replacement elements \$1.50. 6 ft. cords \$1.00, with switch \$1.50. Marko Supply, 2924 Logan Blvd., Chicago 47, Ill.

NEOLITE Circuit tester checks all appliances, radios, motors, fuses, etc. 110 to 550 volts a.c. or d.c. Distinguishes a.c. from d.c. \$1.00 postpaid. Supreme Elec. Mfg., 210 Roebing St., Brooklyn 11, N. Y.

RELIGHT And use burned-out fluorescent tubes indefinitely. Easy to do. Complete information \$1.00. Research Lab., 2414-S-8th St., Council Bluffs, Ia.

ELECTRIC Soldering iron and tool marker combination \$1.00. Spot welder \$5.00. Frazee Electric, Box 5086, San Francisco 1, California.

MAKE Your own electric hammer. No gears. No coils to wind. Plans. Free details. Rush. Houston Maupin, Tipp City 19, Ohio.

REPAIR Electrical appliances, use Nichrome Flux paste. See our ad page 194. Advance Mfg. & Dist. Co.

WELDING, SOLDERING, PLATING

A.C.-D.C. Welding rods 2c each. Coated mild steel 1/16", 3/32". (Without priority.) Minimum order 100 rods f.o.f. Welders Club, AB-3432, Chicago 54.

BUILD D.C. Arcwelder without rewinding armature. Plans \$1.00 each, 25 to 600 amperes from vehicle d.c. motors. Light plant generators, automobile starter generators. Welders Club, AB-3432 Chicago 54. For Sale: Vehicle d.c. motors.

WELDERS And mechanics—protect your shirts, wear our cloth "sleeves," full length, fireproofed light weight material—sufficient for light arc welding in flat position—protection for all acetylene welders, burners and others needing protection against sparks and abrasive dust. Pair \$2.50 postpaid. "Franklin Sleeves," 42 Watson Drive, Dover 2, New Jersey.

NEW 110/220 Volt a.c. welders. Garages, farmers, shops, mills, industries. Light, heavy repair, production. Welding all metals. 110 ampere welder, \$68.00. 160 ampere, \$135.00 f.o.b. Chicago. Complete with supplies. Use immediately. Circulars, specifications, 360 amp. 220 volt a.c. welder, \$245.00. Williams Sales Company, Box 4100, Portland 8, Oregon.

SPOT Welder—Plans \$1.00. Details free. Terry, Central Station 1676, Toledo, Ohio.

NEW Model electric welder 110 volt a.c.-d.c.; will weld all metals; easy to use; full directions. Complete with power unit, flame and metallic arc attachments, carbons, fluxes, rods, mask; all for \$19.95. Used by the navy. Magic Welder Mfg. Co., 239-MP9 Canal St., New York City.

BUILD Electric welder, for \$1.00. Information free. Write "Imisco," 6347 Parnell G, Chicago 21, Ill.

ARC Welders wanted by the thousands. Learn with 316 page lessons manual. Over 500 how-to-do-it photos. \$2.00 copy. Money-back guarantee. Hobartweld, Box M-944, Troy, Ohio.

A. C. Arc welders! 125 amps. \$35. Welder for thin metals \$50. 200 amp. production welder \$100. Priority. Frazee Electric Co., Box 5086, San Francisco 1, Calif.

SLIGHTLY Used arc welders. Recommended by R.E.A. Guaranteed. Forney Mfg. Co., Fort Collins, Colo.

SUPER Welder—For home, farm, factory. Makes even beginner an expert. Improved on type used by Navy. Fully equipped with Metallic Arc and Flame Torch handles, carbons, rods, fluxes, mask, etc. Complete directions. Operates ac-dc, 110 volts. No extra wiring needed. Guaranteed. \$19.95. Save 2%, send check with order. Super Welder Manufacturing Co., Dept. A, 23 East 20 Street, New York.

WELDING, Cutting, aircraft welding and soldering equipment. Electric arc welders. Superior Oxy-Acetylene Co., Hamilton, Ohio.

MACHINERY, TOOLS AND SUPPLIES

CENTER Drill and milling vise, \$20.00. Used in many machine shops and needed in every one. Drill press turret head, three positions, will increase production 80%, \$75.00. Universal Engineering Co., Factory 2230 National Ave., San Diego 2, Cal.

LEWIS Castings, materials and blueprints are the ideal means of equipping home, school or commercial machine shops—at unbelievably low cost! Mills, shapers, vises, drill presses and many other tools are quickly and easily built from Lewis Supplies—right in your own shop. Send 10c to cover mailing of descriptive catalog listing 23 items. Lewis Machine Tool Co., Box 116, Station A, Dept. M-44, Los Angeles 31, California.

SCREWS, Nuts, bolts, washers, rivets, brackets, etc. Handy assortment for mechanics, garages, household use, workshops. Over 1000 pieces, 5 full pounds. Satisfaction guaranteed. Special \$1.98. Order now. Hudson Trading Corp., 167 W. Hubbard, Chicago 10.

H. S. Saws 3 1/2"x1 1/2" \$1.50 ea., \$15.00 doz. Plain mills 3x1 1/2"x1 1/2", \$3.00 ea., \$30.00 doz. Reconditioned H.S. cutting tools, surplus drills, reamers, etc. Any size. Lowest prices. Immediate delivery. Detroit Tool Industries, 7451 Grand River Avenue, Detroit 4, Michigan.

DRILL Grinder—Original patented precision sharpener. Grinds drills to factory accuracy. Calipers with direct reading scales. Circle cutters. New tool grinder. Lowest prices. Free literature. Factory, 811-B East 31st, Kansas City 3, Mo.

MICROMETERS New 0-1" \$5.95; 1-2" \$7.95; 2-3" \$9.95; 3-4" \$10.95. Set of 4, in handsome, durable case, \$34.50. Reading in 1/1000". Precision. Guaranteed. C.O.D. plus postage. Cash orders prepaid. Examine five days. If unsatisfactory return for full refund. Wendler Co., Dept. 12B, Fremont, Ohio.

6 INCH Used grinding wheels 50c. P.O. Box 17, Sta. A, New Haven, Conn.

TOOLS—Micrometers, channellock-vice-grip-pliers, adjustable sockets, open-box-combination sets, chests, National brands—prices. Order today. Dealers Tool Supply, Box 875, Kansas City, Mo.

MAKE Your own electric hammer. No gears. No coils to wind. Plans. Free details. Rush, Houston Maupin, Tipp City 29, Ohio.

LOW-PRICED Indicating caliper, gages holes 3/8"-8" in thousandths. Machine Supply, Newfane, Vermont.

LAWN Mower sharpener. Simple in design, build it yourself. Plans \$1.00. Winfield Hess, Dover 1, Penna.

DRILL Grinding attachment, \$5.95. Centering tool, \$3.95. Offset center punch, 3/4", 40c; 1 1/2", 50c. Zenick Company, 327 California, Burbank, California.

WANTED: Tools; equipment. Highest prices guaranteed! Justice, Box 150, Chicago 90.

SIMPLEST, Cheapest drill grinder, \$1.98 postpaid. Dealers inquiries invited. Factory, 3410 Alameda, Burbank, California.

STEEL Beam trammels for draftsmen, engineers, mechanics. Circular free. Clair Company, Box 92M, Blythebourne Station, Brooklyn, N. Y.

GRIND Drills any twist in three different drill point angles like factory, \$2.95 prepaid. Guaranteed. Factory, 1512 West Slauson, Los Angeles 44, Calif.

INDEX Heads for sale. Very inexpensive. Sixty-two different divisions. Used on small lathes, drill press, milling machines, etc. Make gears, hobbs, cutters, etc. Very accurate, and durable. Not a toy. Used by defense schools and hobbyists. Write for free folder. Long's Index Heads, 2117 East B St., Torrington, Wyo.

BOATS, OUTBOARD MOTORS, ETC.

PLASTIC Boats now! Make your own from Streamlined Jettison Tank Shell (8'x2'6"). Also streamlined outboard racers, catamarans, scooters, ice boats. While they last \$7.50. Plastic Boats, Box 187, Lake Placid, New York.

TEN Plywood boat plans 50c. Catalog boat building plans 10c. The Rudder, 15 Murray Street, New York.

BOAT Designers are highly paid professionals. Complete course by mail. Catalog. Westlawn, Montville, N. J.

MARINE Power—Easily convert any Ford motor (domestic and foreign) with Osco parts and kits. Complete catalogue 25c (coin). Osco Motors Corp., 2020 East Orleans Street, Dept. M, Philadelphia 34, Penna.

INDIAN Silver Arrow outboard motor parts. Indian Motorcycle Sales, Inc., 354 Columbus Avenue, Springfield 5, Mass.

USED Outboard motor parts. Outboard Exchange, 1194 Remsen Ave., Brooklyn, 13, N. Y.

PULL Size, cut to shape boat patterns, blueprints. 7 1/2 - 38 feet. Illustrated "Build a Boat" catalog, 10c (coin). "How to Build Boats" book, \$1.00. Cleveland Boat Blueprints Co., Station A-66, Cleveland, Ohio.

OUTBOARDS—Save 1/2. Good used parts, all makes and models. Bargains rebuild motors. Crandall Hicks Co., 959 Commonwealth, Boston, Mass.

ENGINES, MOTORS, DYNAMOS

BIG Pay jobs in welding. Complete welding lessons and reference books, 516 pages, 41 lessons, \$2.00 copy. Money-back guarantee. Hobartweld, Box 945-M, Troy, Ohio.

WINDING Data—Any motor—\$1.00. Details free. Terry, Central Station 1676, Toledo, Ohio.

AUTHORIZED By W.P.B. to sell inventory of new a.c. and d.c. midget motors—Both geared to 4 r.p.m. Shaft speed 1250 r.p.m. 110 volts. Ideal for timing devices, displays, models. Bargain price a.c. motor \$2.60. Length 3", height 2 1/2", width 2 1/2", d.c. \$3.00. Length 5 1/2", height 2 1/2", width 3". Add 25c for postage. McLaren Products Company, 114 N.W. First Street, Evansville 8, Ind.

TWIN-CYLINDER Air compressors \$16.50. Motors—various sizes. Hoffmann, 6840 Parrish, North College Hill 31, Ohio.

WINDING Data, listing 225 motors, single and three phase, \$1.00. Motor Data Co., Box 7631, Kansas City 3, Mo.

ATHLETIC EQUIPMENT, BODY BUILDING COURSES

LEARN Guerilla self-defense. Beats ju-jitsu, Circular free. Crown Books, Charlotte 4, Mich.

FEAR No man. Become a ju-jitsu expert, quickly, at home. Earn money teaching others. Secret defenses revealed. Complete 25 lesson, action photo course, \$1.00 postpaid. Dr. Malcolm Smith, 1104 Union Ave., Montreal, Canada.

BAR-BELLS, Exercise equipment. Courses. Special offers! Free booklet. Good Barbell Co., 3261-PM Watson Rd., St. Louis (9), Mo.

SUPER System of natural physical training. Free booklet. Harry Good, 3261-PM Watson Road, St. Louis (9), Mo.

SPORTING GOODS, GUNS, FISHING TACKLE, ETC.

SHOTGUN Shells: Our 12 gauge 5 and 6 chill heavy reloads are again available provided you have empties for exchange. Empties must be 12 gauge, perfect condition, no deformities. Mail in suitable carton for return delivery. Include M.O. with shipment. Shells 10c each O.P.A. established ceiling. Jim Clark Sportinggoods, 2029 W. Fondulac Ave., Milwaukee, Wis.
"REGISTERED Arrow" sets and equipment. List free. Rudolph's, Atchison, Kansas.

ARCHERY Equipment: Catalogue free. Mid-West Archery, 2309-A East 75th, Chicago 49.

AMMUNITION: Hunters: Load our Rifled Lead Slugs in your own 12-gauge shotgun shells. One dozen, with wads and complete directions for loading, including postage and packing, \$2.10. Supply limited. Order today. The Kalling Company, 8026 N. Division Road, Milwaukee 9, Wis.

"HANDARMS," "Rifles," "shotguns"—with ammunition, list 10c. Rudolph's, Atchison, Kansas.

BOY Scouts—campers, U. S. army surplus used equipment, pup tents, \$2.95; canteen with cover and cup, \$1.00; mess-kits, 75c; packs, \$1.00; cartridge belts, 50c. Complete set \$5.00. Samet Sales Co., High Point, N. C.

FISHPOLE Holder, ideal for trolling or still fishing. Drawings \$1.00. Finished \$2.75 postpaid. Harold Grabitske, 413 North Bluff St., Janesville, Wisconsin.

ARMY Officers' dark gabardine shirts \$3.50, 1/3 retail price. Can be used for sport, dress or work; please state correct size. Military Equipment & Supply Co., Inc., 199 Market, Newark, N. J.

SEND 10c for list 100 used guns. Prayseth's, Willmar, Minnesota.

"HOW To Mount Fish as a Hobby," \$1.00. Lewis Enholm, 19 Newfield St., Wollaston, Mass.

BOWS—Arrows for recreation, hunting, fishing. Beautiful archery instruction book, 90 pages, 50 illustrations, only 50c. Illustrated catalogue free. Archery Sales Service, 617 South State, Chicago.

SNOWSHOES: Immediate delivery, replacing also. Send card for sizes available. Howe Fur Company, Coopers Mills, Maine.

THE Lord is coming! Get guaranteed proofs free. Scheall, 26JXS, Duluth, Minnesota.

FIELD GLASSES, MICROSCOPES, TELESCOPES

POWERFUL Telescope lens kit—Consists 2" diameter 50" F.L. objective and 100X astronomical eyepiece, \$1.00 postpaid. With 50X terrestrial eyepiece included \$1.95. Experimenters 16 piece optical kit \$1.00. Postcard brings list outstanding optical values. Pilegor Optical Co., P-9, Sunbury, Penna.

MAGNIFIER. Powerful eye-loop magnifier. Jewelers, hobbyists, inspectors. \$1.00 postpaid. Ador, 32-A Mill St., Amityville, N. Y.

REAL 10 Power telescopes \$1.90. United 2309-G Lawrence, Toledo, Ohio.

ASTRONOMICAL Telescopes, binoculars, cameras, microscopes; bought, sold, repaired. Send 10c for list of instruments wanted. Rasmussen & Reece, 41 Market, Amsterdam, N. Y.

ASTRONOMICAL Telescopes, binoculars, cameras, microscopes; bought, sold, repaired. Send 10c for list of instruments wanted. Rasmussen & Reece, 41 Market, Amsterdam, N. Y.

MAKE Your own 100X astronomical telescope. Perfect lenses and instructions \$1.00. Instructions alone 10c. Carl Jamer, Manorville, N. Y.

MAKE Your own 50X land and sea telescope. Lenses and instructions \$1.00. Instructions alone 10c. Carl Jamer, Manorville, N. Y.

MAKE Your own compound microscope. Lenses and instructions 50X \$1.00, 100X \$1.50, 200X \$2.00. Instructions alone 10c. Carl Jamer, Manorville, N. Y.

MICROSCOPES, Telescopes, binoculars; all scientific, chemical laboratory apparatus—bought, exchanged, repaired. Exclusively our business with a background of over 17 years of courteous, satisfactory dealing. Not get-rich-quick speculators. Trial will show we know equipment; highest prices paid. Harry Ross, 68 West Broadway, New York.

MICROSCOPES—15 Years buying, selling, exchanging, repairing, accessories, research, industrial, amateur. National Scientific Instrument Co., 119 Chambers St., New York City 7.

BINOCULARS, Field glasses, watches. Buy, sell. Paul Schweer, Donnellson, Ia.

ANTIQUES, RELICS, INDIAN GOODS, CURIOS

GLASS, Antiques, relics, curios, list 5c. Guy Saulsbury, Spicer, Minn.

25 GENUINE Indian arrowheads, \$1.00. Catalog. Geo. Holder, Glenwood, Ark.

KENTUCKY Rifles, pistols, swords, daggers, powderhorns, flasks. Lists free. Antique Shop, 8 South 18th, Philadelphia 3, Penna.

INDIAN Relics, coins, novelties, minerals. Catalog 3c. Sistershop, Northbranch, Kansas.

PACIFIC Islands souvenirs. Complete hula skirt outfit, \$10.00 cash. Also free list: Shell beads necklaces, pearl-shell ornaments, woodwork, mats, etc. Enterprize, Inc., Box 51, Rarotonga, Cook Islands, South Pacific.

SWORDS, Rapiers, daggers, pistols, armor, illustrated catalog 25c. Robert Abels, 860-A Lexington Ave., New York.

INDIAN Relics, coins, bills, gems, crystals, curios, etc. Illustrated catalog 5c. 100 ancient arrowheads \$3.00. H. Daniel, Hot Springs, Ark.

MINERALS, Coins, stamps, Indian relics, pistols, old glass. Catalogue 5c. Cowboy Lemler, Las Cruces, New Mexico.

INDIAN Relics, beadwork, coins, curios, minerals, old glass. Catalog 6c. Indian Museum, Osborne, Kansas.

DOGS, PETS, BIRDS, RABBITS

ST. BERNARD Puppies. Unusual beauties. Registered. Franklin Young, R. 4, Riverhead, Long Island, New York.

BEAUTIFUL, Pure white police puppies. Ansonia Kennels, Mose, N. Dak.

RABBITS, New Zealand, reasonable. River Hill Rabbitry, Box 644, Eagle River, Wis.

RAISE Rabbits for profit. Magazine puts you in touch with markets. Copy 10c. Booklet describing twenty breeds, and magazine for three months 25c. Address American Small Stock Farmer, Dept. 3, Pearl River, N. Y.

RAISE Guinea pigs. Make money at home. Big demand. Free booklet. Taylors Guinea Pig Farm, Hapeville, Georgia.

RABBITS Wanted. Pay \$6.75 to \$10 each. Literature 10c. Hansens Rabbitry, 2744 So. State, Salt Lake City 15, Utah.

MANGE Guaranteed remedy, 2 ounces \$1.30. Leonard Laboratories, Olden, Tex.

COTTONTAIL Rabbits, jumbo frogs, fishing poles. Vol Brashears, Berryville, Arkansas.

RABBIT Skins wanted, send for high price list, shipping tags, instructions. Rabbit Products of America, 1113 So. Walnut, San Gabriel, Calif.

RAISE Money-making Angora rabbits. Wool \$9.00 pound. Plenty markets. Particulars free. White's Rabbitry, Marion, Ohio.

RABBITS—New Zealand Reds, Whites, Chins, Pigeons—White, Silver King, Race Homers. Bay Farm, 20531 E. 14th, Hayward, Calif.

MOST Beautiful fur. Small investment. Large profit. Free illustrated booklet. Willow Brook Farm, R. D. 13, Sellersville, Penna.

RAISE Your own meat—also make money raising pigeons. Booklet dime. Gebhardt Farm, Muscatine, Iowa.

RABBITS: Flemish Giants, New Zealand, Reasonably priced, Franklin Young, Riverhead, Long Island, New York.

RABBIT Hutch—Sanitary, odorless, self-cleaning! No opening doors to feed, water, supply hay. Most practical and scientific hutch made. Plans, specifications \$1.00. Angora rabbits—wool brings \$9.00 pound; catalog free. Grinsteads, Dept. 15, Edwardsville, Illinois.

MICE, Rabbits, pigs, pigeons. Information 10c. Jim Houck, Tiffin, Ohio.

SEEDS, PLANTS, NURSERY STOCK

FOR Sale: Persimmon and locust sprouts. Bob Pace, Combs, Arkansas.

GINSENG, Planting instructions free, seeds for sale. Specialty Farm, Rockford, Minn.

FARMS, FARM LANDS, REAL ESTATE

EQUIPPED 86 Acres, including 30 head stock, tools, household goods, garden, truck patch, crops time of sale, only \$2,500! County road, 3/4 mile U. S. highway, store, 4 1/2 depot high school village; 35 cultivated, some alfalfa, part-wooded pasture, 2 springs, all wire-fenced, merchantable firewood, 85 bearing fruit trees; good 5-room house, well, 40-ft. barn, good chicken houses, tenant bldgs., owner called elsewhere, real bargain, \$2,500 complete, \$1,800 down. Free catalog 7 states. United Farm Agency, 7-MP South Dearborn, Chicago 3, Ill.

WISCONSIN, Minnesota river, lake, camp sites \$35.00. 54-WM, Brainerd, Minn.

FRIENDS: Get valuable land information free. Write Mr. Armstrong, Shook, Missouri.

IOWA Farm bargain list free. Write Albert Wilson, Albia, Iowa.

OZARK Guide, Lonsdale, Arkansas. Magazine for homeseekers, sportsmen. Year, \$1.00.

STROUT'S Big fall farm catalog just out! 100 pages of bargains—from Maine to Fla., west to Texas, California and Oregon. Write today for this money-saving time-saving book. Free. Strout Realty, 235-P 4th Ave., New York 10, N. Y.

OBTAIN Free fertile South-American lands yielding four annual crops, rubber, timber. Grow sugarcane, cocoa, tropical fruits, livestock. Valuable illustrated information, 25c. Vallesp, Box 8-115, Canal, New York 13.

OPPORTUNITY, Security! Farms, lands, \$3, \$10 acre. New plan, 10c. Ozark Land Scouting Service, 408 Bellefontaine, Kansas City 1, Mo.

HACIENDA—Over square mile, fertile soil, timber on slopes, water for irrigation and power. Grow northern, subtropical crops. Auto-road to capitol six miles, airport fifteen, Pan American highway sixty. Ideal for winter or all year home. Good investment. Altitude about three thousand feet. Bargain. Other larger, one smaller. A. L. Hurst, Rosario Agency, Tegucigalpa, Honduras, Central America.

OZARK Lands for all purposes. Actual river frontages, 5 acres \$90.00 and upwards. Free list and literature. Hubbard, 216 Grossman Bldg., Kansas City, Kansas.

OZARK Farms. Large, small. Bargain prices. List free. Frank, Mountain View, Missouri.

GOOD Farm bargains, Washington, Minnesota, Montana, Idaho, Oregon, North Dakota. Dependable crops, favorable climate. Write for literature, lists describing typical farms. Specify which state. J. W. Haw, 119 Northern Pacific Ry., St. Paul, Minn.

FARM MACHINERY AND SUPPLIES

NEW Farm machinery book. Learn your farm machinery better. A time and money saver. \$1.00 postpaid. Wirtson's, West Burlington, Iowa.

ELECTRIC Fence controllers, electric fly traps, insect killers, chick brooders, lamb brooders, electric dehydrators. Gardenhour Mfg., Waynesboro, Penna.

INTERNATIONAL Electric fence far superior, more effective and reliable. Quickly pays for itself. We repair all makes of electric fences. Dealers wanted. International Electric Fence Co., 910 Van Buren St., Chicago, Illinois.

BUILD Your tractor from second-hand automobiles. Convert your horse drawn farm equipment into tractor drawn equipment. Nolan's Garage, East Wareham, Mass.

POULTRY AND FARM SUPPLIES

KNOW How to raise poultry for profit. Read Northeastern Poultryman. Every issue packed with helpful hints and practical suggestions. Latest articles on breeding, feeding, and management. Read nationally. Subscribe now. 1 year 65c; 2 years \$1.00. Northeastern Poultryman, 4M Park St., Boston 8, Mass.

RAISE Turkeys the new way. Write for free information explaining how to make up to \$3000.00 in your own back yard. Address National Turkey Institute, Dept. J, Columbus, Kansas.

PROFITABLE OCCUPATIONS

GET Into the big money! Sensational new course in "Scientific Salesmanship" turns inexperienced men into trained, money-making salesmen! Learn at home, in spare time. Moderate cost. Easy terms. Details free. Write today. Salesmanager, 29 E. 53 St., Kansas City 2, Mo.

MUSHROOMS Grown in boxes. Instructions 25c. Spawm \$1.00. Gordons, 553 William, Winnipeg, Manitoba.

TYPEWRITER Repairmen urgently needed. Earn \$40 to \$50 weekly spare time. Our easy to learn home study course teaches how to repair typewriters. Write for free information. Houston Typewriter Repair Service, P.O. Box 3357C, Houston, 12, Texas.

MONEYMAKING Plans—63 pages no ads. 25c. Victory Publications, Box 179F, Dowagiac, Mich.

PHOTOGRAPHING Without camera, making photo stamps \$1.00. Alvin, 553 William, Winnipeg, Manitoba.

MEN—Open your own electrical appliance service shop. Complete, illustrated course covering house wiring, motor repairs, household appliance repair. Free booklet. Appliance Service, 4701 West Pico, Los Angeles 6.

MECHANICALLY Inclined men—Own and operate general appliance repair shop. Complete, illustrated course shows you how. Welding, refrigeration, motor repair, how to get business, etc., all phases covered. Free literature. Christy Supply Dept. 444, 2833 N. Central Ave., Chicago.

PLASTICS. Molds, plaster casting instructions 50c. Alvin, 553 William, Winnipeg, Manitoba.

PANNING Gold for hobby or occupation. Book for beginners. Blueprints on equipment. Send name, free literature. Prospector, Box 878-K9, Oakland 4, Calif.

WELDING Pays. Learn with 1942 trade school text manual, 518 pages. Over 500 photos. \$2.00 copy. Money-back guarantee. Hobartweld, Box M-943, Troy, Ohio.

SIMPLIFIED Chemical gardening instructions 50c. Chemical \$1.00. Gordon, 553 William, Winnipeg, Manitoba.

PROFITABLE Business now—tremendous increase after peace. Details postcard. Bay State Service, 16 Bulfinch, Boston 14, Mass.

"FROG Raising" profitable—Interesting. New book tells how! Free literature. Write today! Marlboro House, 1035-P Marlborough, Detroit 15, Mich.

COMMERCIAL Rabbit raising, wool, fur and meat. For latest and most complete information read International Commercial Rabbit Journal, copy 10c, \$1.00 a year. Box 667, Salem, Ore.

GOLD-STAMPING. Exceptional post-war opportunity. Free booklet. Home City Specialties, Dept. 1273, Springfield, Massachusetts.

LEARN Refrigeration mechanics. Start your own repair shop. Complete illustrated course. Free booklet. Mechanic School, Dept. PM10, 4703 West Pico, Los Angeles 6.

LOCKSMITHING Now made easy! New course teaches you how to pick locks, fit keys, de-code, masterkey etc. Self-instruction lessons. Bargain price. Free details. Write Nelson Company, Dept. 7-02-2, Chicago 4.

ANNOUNCING New home study course in commercial baking. Good field. Nearly depression proof. Common school education sufficient. Send for free booklet "Opportunities in the Baking Industry" and requirements. National Baking School, 1315 Michigan, Dept. 343-B, Chicago.

STANDARD Rabbit Journal, Milton, Pa. 3 years \$1.00, sample dime.

EXCEPTIONAL Profits raising mink. Finest breeding stock available. Details furnished. Franklin Young, Riverhead, Long Island, New York.

\$40.00 WEEKLY. Made growing mushrooms, fresh, dried. Dominion patent 331583. Free spawm. North American, 169P Yonge, Toronto, Canada.

FREE—"Amazing New Book"—"Profits From Classified Advertising." Tells how and what to advertise. Be sure to read this book before you invest one cent in advertising. Remember—It's free! Write for your copy now. P. W. Johnson, Classified Advertising Manager, 200 East Ontario Street, Chicago, Illinois.

BOOKS, PERIODICALS, PICTURES, POSTCARDS

HARD-TO-FIND Books, out-of-print titles, first editions. Large stock of unusual items at low prices. The Bookman, Grand Rapids 2, Mich.

SPECIAL Sale of books. Technical, fiction, art, juvenile books. Write for interesting folder describing many titles. Hatch Press, 1528 Hanover, Meriden, Conn.

100,000 POST-WAR Jobs abroad—South America, China, India, Burma, Japan, Russia, Malaya. How and where to apply now. Post-war U. S. participation in world reconstruction and trade demands thousands of American-trained mechanics, salesmen, technicians, engineers, foremen, laborers and business representatives—every trade needed. Our 15,000-word, copyrighted forecast—compiled from business, professional and government sources—lists over 200 big U. S. firms with foreign interests, gives job information, salary brackets, contract tips, application letters, passport information, climatic conditions, etc.—everything needed for your immediate application. \$1.00. Return for refund in 9 days if not satisfied. Pacific Industrial Research Bureau, 203-B Studio Building, Portland 5, Oregon.

FLOWERS Fade but heart healing "Joy of Sorrow" will be forever cherished for soul stirring consolation by those with sorrowing hearts, broken spirits, disabled, soldiers and war mothers. The book to give, and to keep. Only \$1.75. Economy Sales Co., 1690 Home Ave., Akron, Ohio.

MAGAZINES—Business, vocational, diversion. Keep posted on conditions, developments and opportunities through periodicals devoted to your interests. Choose current sample copies of those you need from our list of 600 different publications covering more than 175 fields. List with prices free. Commercial Engraving Publishing Co., 34C North Ritter, Indianapolis 1, Indiana.

WHAT'S New in books? Monthly Book News, 12 months \$1.00. (Sample 25c.) Roe's, 2660K Rochester, Detroit 6, Mich.

BOOKPINDERS, 319 So. Marengo, Pasadena, Calif. Books, courses wanted and for sale.

SAVE Money by writing for our lists of special cut-rate books, many at less than 50% of original price. Pines, 144-34 70th Avenue, Flushing, New York.

GOLD Mine of information, opportunities, unusual merchandise, novelties. "swap-shop" offers. Dime brings all. A. Chervence, 1540 North Dearborn, Chicago 10.

MOVIE Stars, homes, gardens, swimming pools, etc. 18 multicolor views. Crosby, Hope, Lamour, and 13 other top stars. Complete set 25c. Also sets of 18 multicolor views of Los Angeles, Hollywood, Pasadena, San Francisco. Each set 25c. All 5 sets and free gift \$1.00. "Dandee," 330 1/2 W. 2nd St., Dept. 35, Los Angeles 12, California.

FLOYD Clymer's Historical Motor Scrapbook. \$1.50 postpaid. 250 early automobiles illustrated, described. See our advertisements classified section under automobiles, motorcycles. Clymers, 2125 W. Pico, Los Angeles 6, Calif.

BECOME Master of your own destiny—make your own "breaks"—don't trust everything to luck. Assure yourself of success and happiness. Wonder booklet tells how. \$1.00 postpaid. Literature free. Dorian Johnson, Box 313-PM, Newport, Wash.

BACK Number magazines supplied. Cavalier, 518 Carroll Street, Brooklyn, N. Y.

FREE Catalog. Unusual books. Send stamped envelope. Happiness Books, Box 206-PM-G.P.O., New York 1, N. Y.

RECEIVE \$3.00 Best-seller, monthly selection, books for \$1.00 on approval without obligation. Harry Kassin, 89 Louisa, Brooklyn, N. Y.

POST Card views, any states, 3 for 10c; Alaska, Canada, Mexico, or state and U.S.A. capitols, 7 for 25c; Panama Canal views, 3 for 10c. Box 1094, Parkersburg, W. Va.

WHAT Every Mason wants. We have Masonic books for Blue Lodge, Chapter, Commandery, Scottish Rite and Shrine. Our rituals are used the world over. Send for free catalog of books and rituals for Masons, Odd Fellows, Knight of Pythias, Knights of Columbus, Elks, etc. Ezra A. Cook, Publisher, Inc. P.O. Box 795-PS, Chicago 90, Ill.

ARTISTIC Girl pictures. Attractive models in beautiful poses. 30 to the set for \$1.00 postpaid. W. Roberts, Box 2522, Portland 3, Oregon.

150 GORGEOUS Colorado views \$1.50; 75 \$1.00. George Bryant, 3709-D High, Denver 5, Colo.

A RATIONAL View of Life—\$1.00. Benjamin Seibert, Urbana, Ohio.

DIXIE Flyer, mail order magazine, Sample 10c. Dixie, Chattanooga 7, Tenn.

MEN: Girl pictures, Sample 10c. Variety, 1242 Lilac Place, Los Angeles 28, California.

"PINUP Girls." Book of twelve beauties 50c, overseas 60c prepaid. Deluxe set 50 for \$2.00. Mathias Studio, Onancock, Va.

PIN-UPS, Gorgeous girls, full color. Sample 8x10 and 3 1/2x5 1/2 10c. Arthur Fowler, Room 1, 697 Broadway, Somerville 43, Mass.

"IF It's Wealth You Desire" achieve financial independence on your present income \$1.00. Details free. M, Box 6900, Pittsburgh 12, Penna.

BOOKFINDERS! (New, used, scarce books) supplied promptly. Send wants. Clifton, Box 2233 Capitol Station, Austin, Texas.

25 HOLLYWOOD'S Best postcards—25c. 25 beautiful homes of movie stars—25c. 25 gorgeous, colorful glamour girls—25c. "Secragraf" system (makes 1000 codes)—25c. "Postapuz" game sensation free with each! Postapuz, Box 3150, Hollywood.

HAWAIIAN Post cards. 5 beautiful cards for 25 cents. Write message, address, stamp and return for free remailing. Hawaii Shopping Service, Box 753, Honolulu, T. H.

CHINESE Physicians, secrets, 165 pages, rare illustrations, unpublished truth, secret healing arts, peculiar custom. \$1. Write Garding Lul, Box 6227, Metropolitan Station, Los Angeles, California.

ARTISTIC Girl pictures. Real models. 40 photos for \$1.00 postpaid. All different, postcard size. C. A. Scott, P.O. Box 342, Covington, Ky.

ART Color pictures. List free. Curtis, Box 1916, Denver, Colorado.

RARE, Out-of-print books located. Bookfinders, 1216N 11th Ter., Birmingham, Ala.

64 ART Cards of gorgeous beauties \$1.00. Reed Novelty, Dept. PM-5, Box 24, Queens Village 9, N. Y.

"PIN-UPS," 180 Gorgeous girl subjects! Huge bargain pack \$1.00. Clover Novelty Company, Dept. 36-DD, Hollis 7, N. Y.

GORGEOUS Full-color pin-ups, 50 different \$1.00; 160 different \$3.00. Samples 10c. Theron Fox, 1024-B Carolyn, San Jose, California.

BRIDGE To success. Prepare for tomorrow—read, study today. Consult our Book Advising Service free. Technical books of all publishers—select the best. Technicraft Book Co., P.O. B. 767A, Grand Central Annex, New York 17, N. Y.

REBINDING: We bind magazines, old books, Bibles, hymnals. Heckman Bindery, Dept. D, North Manchester, Indiana.

MAGAZINES (Back-dated) — Foreign, domestic, arts. All publishers. Bargain prices. Also books, booklets, pin-ups, subscriptions. Catalogs 10c (stamps accepted). Cicerone's, 663 First Avenue, New York 17.

SELF-EXPLAINING Bible: Illustrated circular free. Box 446-P, Minneapolis, Minn.

BOOKS. (Out-of-print, new, used) quickly supplied. Many 35c bargains. Catalogue. T. Jamkowski, 18370 Marx Ave., Detroit 3, Mich.

DRUNKENNESS Is a disease which responds to treatment. Medical skill plus human sympathy prove successful with liquor and drug cases. 60 years experience. Write for free booklet. P. M. Nelson, The Keeley Institute, Dwight, Ill.

GAMES, ENTERTAINMENT

COMEDY Written for performers! Kleinman, 25-31-B 30th Road, Long Island City 2, New York.

MAGIC TRICKS, PUZZLES, JOKER NOVELTIES

FAMOUS Magicians tricks. Sawing a woman in half, mind reading, packing box escape, spirit seance and thirty-nine other tricks fully explained and illustrated. Learn to mystify and amaze. \$1.00 postpaid. Interstate Sales, Dept. P.M., Box 1066, Fort Worth, Texas.

VANISHING Card trick. Card tossed in air vanishes with instructions. Send dime. Eastwood, Box 623, Parkersburg, W. Va.

ILLUSTRATED Book of magic, fully explains 80 startling tricks and party stunts, only \$1.00 postpaid. Big fortune telling chart included free. Brain's Book Shop, 1187 Washington Ave., Endicott, N. Y.

MAGIC Propeller! What makes it reverse? Trick toy. Mystifying! Plan 50c. W. H. Cash, Box 416, Chula Vista, Calif.

STARTLE Friends with safe exploding powder. 1001 laughs! Simple directions 10c. Lab, 3622 W. 65th, Chicago, Illinois.

AMAZING Trick of the three beans. Instructions 30c. W. H. Cash, Box 416, Chula Vista, Calif.

60 EXPERIMENTS With magnets (booklet)—50c. Terry, Central Station 1676, Toledo, Ohio.

SEND 25c For \$1.00 worth of magic tricks and our latest catalog. Ball Square Company, 697 Broadway, Somerville 44, Mass.

MYSTIFY Your friends. Amazing Chinese ring illusion. Send 25c. Box 18, Lefferts Station, Brooklyn, N. Y.

DOLLARS Apparently made out of dimes! It's easy! Sent postpaid for quarter. Western Trading Post, 1355 Cedar Ave., San Bernardino, Calif.

INTRODUCTORY Offer. Guaranteed dollar value, four tricks 25c. Windsor Magic Mart, 2443 E. 75th St., Chicago 49, Ill.

DOMESTIC And foreign novelties, cards, books, etc. Thirty-six different samples and wholesale prices sent for two dollars. Big profits. Blue Moon Specialty Co., Dept. 6, Washington at Walnut St., Ravenswood, W. Va.

SHOOTING Of Dan McGrew! More fun entertaining and mystifying friends with easy, yet baffling card illusion. No sleight of hand. Only 25c. Evans, P.O. Box 951, San Jose, California.

VENTRILLOQUISM, Complete instructions only \$1. Lesueur, 77 Wellesey, Toronto, Canada.

500 TRICKS You can do! Douglas' famous catalog of 500 tricks, now only 10c. America's fastest service on magic for pocket, parlor, stage, professional, amateur. Douglas Magic Shop, Box 274, Dallas, Texas.

QUALITY Magic since 1907—3 new catalogs available, 25c each. Book catalog and lists free. Thayer's Studio of Magic, P.O. Box 1785, Wilshire-Labrea Station, Los Angeles 26, Calif.

ENTERTAIN. Mystify with popular magic. Four secret tricks and catalog 10c. Borinstein, P-7520 Cornell, Chicago.

NEW! Simplified card tricks! Amazing self-working bafflers 50c postpaid. James W. Roundtree, 529 Elliott St., River Rouge, Michigan.

BE A magician. Large professional magic catalogue of latest tricks 25c. Ireland, C-109 North Dearborn, Chicago 2.

MAGIC Tricks, puzzles, books, cards, punch boards. Catalog 10c. Specialty, Box 671, St. Louis 1, Mo.

WORLD'S Largest professional magic shop keeps you in touch with latest tricks. To receive mailings send 25c for 1943 catalog. Holden, 220 W. 42nd St., New York.

NEW Vanishing key and catalog 25c. Sterling Magic, 345 John R, Detroit, Mich.

HOLLYWOOD Special! Magicians button, catalogue, ghost illusion and free trick for 25c. Magic House of Charles, Box 888, Hollywood, California.

EARN Money in any crowd. Call names of strangers, tell unspoken questions. Professional course mind reading, spirit writing, etc. \$1. Henderson, Box 241, San Bernardino, Calif.

COINS, TOKENS, CURRENCY

OLD Money wanted. Will pay \$100.00 for 1894 dime, S. mint, \$50.00 for 1913 Liberty head nickel (not buffalo). Big premiums paid for all rare coins. Send 4c for large coin folder. May mean much profit to you. Numismatic Co., Dept. 20, Fort Worth, Texas.

WE Buy Indian pennies, Lincoln pennies, and old rare coins. Highest prices paid. Indian pennies worth up to \$15.00 each. Lincoln pennies up to \$2.00 each. Other rare coins \$5.00 to \$2000.00 each. Send 10c today for new 1944 price catalogue of all wanted U. S. coins. American Rare Coin Co., Dept. 1, Transportation Bldg., Chicago.

I PAY Highest market prices for United States coins. Send 10c for catalogue. H. M. Lindstrom, Downers Grove, Ill.

WILL Pay \$10.00 each for certain Lincoln pennies! Indianheads \$50.00; dimes \$1,000.00. Catalogue 10c. Federal Coin Exchange, 8-PM, Columbus, Ohio.

CENTS. Large uncirculated or extra fine wanted. Give price first letter. James Peck, 1342 Carlotta, Berkeley 3, California.

FOREIGN Coin and lists 10c. Oddehon, Box 482, St. Louis, Mo.

25 DIFFERENT Indian head cents \$1.00. 12 wooden nickels \$1.00. Bargain lists 3c. Bebee Coin Company, 1180 East 63rd Street, Chicago 37, Illinois.

50,000 COINS, Medals, paper money. Lists free. Nagy, 8 South 18th, Philadelphia 3, Penna.

10 INDIAN Head cents, different dates, also price lists, 40c. Schultz, 1053 Richmond, Cincinnati, Ohio.

25 DIFFERENT Indian cents \$1.10; 12 wooden nickels \$1.00. Large retail catalogue 10c. Bebee Coin Company, Chicago 37.

GET Profit and pleasure in collecting old coins. Send 10c for 56-page illustrated coin catalog. You'll be delighted with it. Send for it now. B. Max Mehl, 370 Mehl Bldg., Fort Worth, Texas. Largest rare coin establishment in U. S. Established 44 years.

COMMEMORATIVE 1/2 — Texas, Kentucky, York, Elgin, Cleveland. \$1.50 ea. Illustrated catalogue 10c. Norman Schultz, Salt Lake City, Utah.

FREE! Foreign coin, banknote and coin collectors illustrated catalog to approval service applicants. Send 3c postage. Tatham Coinco, Springfield-125, Mass.

I MAY Have just the scarce U. S. coins you want. Send me list. "Meet me by mail." William H. Kenworthy, Waterville, Maine.

HOBBIES AND COLLECTIONS

INTERESTING — Assortment twelve pieces Hawaiian lava and coral—approximate sizes—walnut to lemon—colors. Money order \$1.50 postpaid. Address Hawaiian Souvenirs, P.O. Box 456, Honolulu, T. H.

CIGARETTE Cards bought. Highest prices paid. Don Van Brakle, Port Henry, N. Y.

HOBBY Catalogue 5c. Chameleon 25c; twenty miniature glass animals \$1.95. Quivira Specialties, Winfield, Kansas.

FOUR Pound package rough, good quality Washington petrified wood, postpaid, two dollars. Chas. Simpson, Twin Squirrel Hobby House, Quincy, Wash.

SPECIAL Offer! Real stage money. Large assortment—only 25c. Maniss Photo Co., Colorado City, Texas.

UNUSED—150 Different match covers \$1.00 or 60—50c. Tomasek, 316 Nuttall, Riverside, Illinois.

COLLECTORS—Rare samples of gemstone Beryllium. Sample 50c. 3 for \$1.00. Clarence Niebuhr, 2416 Center Street, Bakersfield, California.

ANTIQUE And modern Chinese art creations still available. Interesting list 10c. Pewitt, 605 Clayton, San Francisco 17.

100 JEWELRY Stones removed from rings, etc.—from \$2.00 to \$2.40. Lowe's, Box 311, St. Louis 1, Mo.

NEW—15 Different match covers 10c. Box 202, Rochester 1, N. Y.

WANTED: Old cigarette cards. Write Charles Bray, East Bangor, Penna.

SWAP Directory. Trades for everyone. Ferris, 317A So. Hartford, Bremerton, Wash.

UNUSED Match book covers. 100 all different \$1.00. 35 Royal Flash covers \$1.00. Free list. Charles Edelman, 1311C East 84, Cleveland 3, Ohio.

STAMP COLLECTING

POSITIVELY Greatest free offer—Latest Scott's International \$5.00 Stamp Album—covering entire world, contains 36,000 illustrated, descriptive spaces. Scott's 1944 Standard \$5.00 Catalogues "Philately's Encyclopedia" — absolutely free to applicants for foreign approvals becoming customers. Plymouth, A-9, Bell, California.

VATICAN City, Eritrea, Falkland Islands, Mauritius, Nyassaland, Selangor, African airmail, Kenya, Tanganyika, South America, Asia, British Colonies. Many others. Swell packet, 5c to approval applicants only. Kenwood Stamp Co., 321-M Burchett, Glendale 3, California.

100 U. S. Commemoratives, obsoletes, etc., 10c. Howell, 1198 Webster, Hamilton, Ohio.

100 ALL Different stamps—10c to approval applicants. A. Freeland, Guilford, Conn.

10 TRIANGLES Free. Mozambique airmail-commemoratives. Request details! Reuter, 611-C West 40th, Los Angeles 37.

EUROPE—40 Years old—15 different 10c. Eisea, Bowling Green, Ohio.

BEDRIDDEN—Collected since 1895. Dollar brings \$2.00 wholesale value fine United States or foreign—want cheaper or higher catalogued ones? Six lots \$5.00. Sample dollar value—53c. Circulars 3c. Filatelist Kline, Kent, Ohio.

100 DIFFERENT 10c With approvals. Jacobsen, 59 Nagle Ave., New York 34, N. Y.

EXOTIC Solomons, gorgeous Gilberts, etc.—3c with approvals! Saxon, Valley Stream, N. Y.

WASHINGTON Bicentennial set 10c. United States-foreign approvals. Yokama, Box 1327, San Antonio 6, Texas.

FREE Packet with lists. Write Mayfield, Route Three, Chattanooga 9, Tenn.

UNITED STATES approvals. Choice selections. Low prices. Box 488, Minneapolis.

1000 WELL Mixed U. S. 25c. Monjar, 1750 Fairmount, Cincinnati, Ohio.

15 DIFFERENT Danzig, 10c to approval applicants. E. C. Brown, 1378 Grant, Lincoln Park, Mich.

MEDIUM And cheap approvals 10% bonus. Calaveras Stamp Co., Floresville, Texas.

BAVARIAN Railway, 14 values, 5c. Approvals. Rex, 39 Blackstone, Bangor, Me.

\$2.40 **BRITISH** Guiana 1895, 5c with approvals. Windsor Stamps, 1435 East 67 Place, Chicago 37.

DIFFERENT U. S. commemoratives: 50 mint \$2.00; 100 used \$1.00. Tate, 5619 Annunciation, 15, New Orleans.

UNUSUAL Packet 10c approval applicants. Smalley, 1406 Welch, Houston 6, Texas.

50 DIFFERENT U. S., many commemoratives, 5c. Gerhardt, 2804 Rio Grande, Austin, Texas.

FREE! Approval applicants select 10c worth free—your choice. Excel, Box 1315, Chicago 80.

200 DIFFERENT Chile, Paraguay, \$1.20 check. Jorge Darrigrande, Puentealto, Chile.

FINE Approvals, freshly mounted. Fast, personal service. Tell me what countries you prefer and I'll send their stamps. Skinner, 345 East Ocean, Long Beach 2, Calif.

FREE—Latin America, 50 different including airmails, pictorials, commemoratives. This interesting packet absolutely free to serious approval applicants. Wm. Thiem, Cape Vincent, N. Y.

25 DIFF. Finland 8c with 1/2, 1/2, 1c approvals. Carroll's, 745A W. 45th, Los Angeles 37, Calif.

FREE Your choice of any 10 stamps from our first U. S. approval selection. List included. Cosmopolitan Stamp Company, Dept. M-9, 1457 Broadway, New York City.

NEW ISSUES—Complete sets "Cav-Lee Approvals." 511 North Second Street, Dep't 4, Phoenix, Arizona.

BEAUTIFUL New Zealand! Mint chamber commerce complete set 75c while they last! Traffic Station, Box 0, Minneapolis, Minn.

BULGARIA, Ceylon, Jamaica, Venezuela assortment—5c. Collectors outfit including album—75c. Liberty Stamp Co., Dept. P, Kirkwood 22, Mo.

AUSTRALIA "MacArthur", Canal Zone, Curacao! Others from Antipodes, Caribbean, Africa, Asia. Given for 3c with splendid approvals. Reo Stamps, 2371 So. Howell, Milwaukee 7, Wis.

EUROPEANS, British and French Colonials, South and Central America on approval. Henry Zimmer, 722 Culver Road, Rochester 9, N. Y.

SPAIN, 50 Different, 10c with approval selection. Paul Rawden, Box 2920, Westville, New Haven, Conn.

60 DIFFERENT U. S. commemoratives including famous Americans, Columbian, army, navy, hinges, approvals, all 25c. Ray Bovard, 309 East 3rd Ave., Cheyenne, Wyo.

FIGHTING Yugoslavia, 25 different to approval applicants. Charles Mangils, 19413A 111th Road, St. Albans, N. Y.

EXCHANGE Your duplicates with collectors everywhere. 3c stamp brings particulars. Kurtz, Box 1051, Allentown, Pennsylvania.

AFGHANISTAN, Fiume, Manchukuo, etc. 3c to approval applicants. Vail Stampco, Box 251, Jamaica, N. Y.

STAMPS From forty countries, including Malta, 10c. No approvals. Eisen, Bowling Green, Ohio.

1c TO 10c Foreign approvals. Beaumont Stamp Exchange, 2667 McPaddin, Beaumont, Texas.

GENERAL Collectors: Inexpensive approvals. Returns postpaid. Maddever, 520 Vanderbilt, Niagara Falls, N. Y.

APPROVALS—Better grade U. S. only. Reasonable prices. Box 483, Minneapolis.

10 **TRIANGLES**—Mozambique airmail-commemoratives, 10c. Approvals. Reuter, 611-B West 40th, Los Angeles 37.

DEALERS—Wholesale list. Postage 3c. Frank, 5631 Queensberry, Baltimore 19, Md.

BRITISH Colonies packet, only 3c to approval applicants. Smith, 237-A 8th Avenue, Roselle, N. J.

MALTA Set war printing 10c with approvals. Vargo Stamps, Racine, Wisconsin.

33 DIFFERENT Russian pictorials, commemoratives \$1.00. Approvals. Brandan, 1912-3rd Ave. So., Minneapolis, Minn.

COMMEMS.—75 Different fine U. S. commemoratives—50c. Sage Stamp Co., Osage, Iowa.

SMOKY Mountain sheet 8c. Western, British Colonials. Approvals. Guy Preese, R.R. 6, South Bend, Ind.

UNITED STATES! 100 face different 50 cents. Thiese, 10526 Anzac, Los Angeles 2, Calif.

SURPRISE Mint set, 10c. Fine approvals. Norien Stamps, 1417 East 34 Street, Brooklyn, N. Y.

72 DIFFERENT U. S. with U. S. or foreign approvals. References. Album Service, Soledad, Calif.

POUND Unpicked U. S. and foreign mixture containing thousands stamps \$1.00. 5 lbs. only \$4.50. Longacre Shop, 100 West 42nd, New York City.

60 DIFFERENT Coronation souvenir stamps 5c. Approvals. Dobres, 4108 Garrison Boulevard, Baltimore 15, Maryland.

50 DIFFERENT United States 5c! Approvals. Fort Stamp Company, Defiance, Ohio.

EXPORTERS Envelope mixture, censored, airmails, commemoratives, 107 envelopes \$3.10. Lava, 1824P Davidson, New York 53.

"**THE BEST**"—United States and Philippine Island approvals. Largest varieties. America's lowest selling prices. Stamp Company, Allen, Albany 3, New York.

50 DIFFERENT United States, including 378, 384, 398, only 20c. Allram, 815 So. Hill, Room 303, Los Angeles 14, California.

100 DIFFERENT—Commemoratives, airmails, triangles, diamonds, 10c. Approvals. Kostillo, Benwood, W. Va.

FREE—Packet, dictionary. With approvals. Stamps, R. 3, Marion, Ill.

NAVAL Covers, price list free. Werve, Box 951, Saginaw, Mich.

U. S. Collection, all different, 50—10c; 75—25c; 100—45c; 125—95c; 200—\$1.75; 300—\$5.00; 500—\$12.00. No approvals, unless requested. S. C. Engel Co., 38 Park Row, New York 7, New York.

100 DIFFERENT Airmails \$1, 200 \$3. Paltra, 2664 Grand Concourse, New York 58.

FINE French set 5c with approvals. H. Laguerre, Camden, New York.

50 DIFFERENT Stamps old issues, commemoratives, etc., 10c. Rea, 931 E. 11 St., Kansas City 6, Mo.

S.P.A. Miniature sheet 5c. Approvals. Bargain lists. Gaydos, Kenosha, Wis.

U. S. Colonials, airmails, commemoratives. Fine stamps on approval. Reasonable prices. Riedell, Greensburg, Penna.

LOOK! Large pictorial approvals. Kolodny, 111 Bridge, Dept. PM9, Roselle Park, New Jersey.

FREE! High quality packet of world wide stamps given to every approval applicant sending 3c for postage. Thomas Wathne, Fernhill Station, Tacoma, Wash.

BOOKS For stamp collectors. List free. Helpful Book League, 15 East 40th St., New York, N. Y.

OPPORTUNITY! Gorgeous lot with triangles, diamonds, giants, midgets, flags, airmails, and railroad stamps. Also Seychelles, Djibouti, Mongolia, Angola, New Caledonia, etc. Everything only 10c to approval applicants. Evden 2, Box 396, Niagara Falls, N. Y.

FREE! Choice set to approval buyers. "Ace." Box 344, Johnson City, N. Y.

UNITED STATES No. 209, No. 214, No. 226, No. 304, No. 306, No. 552 (mint), No. 627, No. CE2, No. P1. Send 25c. Approvals accompany. Whiton-Stamps, Norwalk, Conn.

PHILATELIC Shopping News (bargains) year 25c. 2660-E Rochester, Detroit 6, Mich.

STOCK Book to hold over 400 stamps. 20c, 6—\$1.00. Nu-Way, 205 East Broadway, New York City 2.

100 DIFFERENT Stamps \$1.00. Kansas Stamp Company, Box 422, Hutchinson, Kansas.

APPROVALS—Fine quality, attractive prices. Siegler, 1616 Mount Eagle, Alexandria, Virginia.

OUR Better customers earn stamp dividends. Details with first approvals. Armstrong, 40 Jeanette, Younstown, Ohio.

FIFTY All different covers only \$1.00. Box 334, Middleboro, Mass.

FREE! \$1.00 And \$5.00 dues! Complete set free to serious collectors with unusual moderately priced approvals. Send 3c postage. Forest D. Wilson, 711 North A Street, Tampa 6, Florida.

10 **CHOICE** Mint British Colonials 25c. Approvals sent. DuShay, Prescott Street, Meriden, Conn.

150 DIFFERENT—10c Approvals. Batson's, 3125 Normount, Baltimore 16-P, Maryland.

PACKAGE "Fighting French" 5c with approvals. Walton, Porter Road, Nashville 6, Tenn.

118 DIFFERENT Stamps including commemoratives, charities, airmail sets, etc., only 3c to approval buyers. We buy collections. Badger Stamp Co., Milwaukee 3, Wis.

U. S. Christmas seals—29 different years, singles \$1, blocks \$4. Want lists solicited. Thomas L. Parsons, Cookeville, Tennessee.

500 **UNITED STATES** for 10c! 500 United States—absolutely unpicked and unsorted—just as received from church missions. Many varieties, including large commemoratives, airmails, high denominations up to \$5.00! Stampdom's biggest package of fun—and you might find something really valuable! Price only 10c to serious approval service applicants. Money back if not delighted. Illustrated bargain lists with each order. Mystic Stamp Company, Department 80, Camden, New York.

COMBAT Unit war insignia evaluated stamps, 50 different 25c; 200 different \$1.00. VerHalen Publications, 6060 Sunset, Hollywood 28, California.

EXTRAORDINARY Pictorial collection:—Nigeria, Bermuda, Dutch Indies, Martinique, Newfoundland, Philippines, Southern Rhodesia, Porto Rico, Wurttemberg, Victoria, Wallis and Futuna, Senegal, Ceylon, Ivory Coast. Everything only 5c. Imperial Company, Box 311, Yonkers 1, New York.

FREE! The Stamp Finder! Send today for the big new edition, fully illustrated, enabling you instantly to identify all difficult stamps! Also fine packet strange, fascinating stamps from Bosnia-Herzegovina, Monaco, Patiala, Cyprus, etc., including maps, ships, animals and strange scenes. All free to approval applicants including 3c postage. Garcelon Stamp Company, Box 900, Calais, Maine.

EXCHANGE—Send 100 different U. S. or foreign with 25c coin and return stamped envelope. We will send you 125 others. Sweeney, Box 95, Watertown, N. Y.

FREE—Pick 25c worth of stamps from our first U. S. approval selection. Special illustrated lists included. S. C. Engel Co., 38 Park Row, New York 7, N. Y.

GUATEMALA 25 Different only 10c to approval applicants. RP Johnson, Box 267, Morgan Hill, California.

PACKETS All different. 100 Mexico, 50c; 100 Canada, 50c; 100 Persia, \$1.00; 60 Turkey, 75c; 50 India, 50c. Eco Stamps, 6 E. Lake, Chicago 1.

ARTCRAFT Engraved new issue cover service. Illustrated price list, 3c. John C. Sidenius, E. Rutherford, N. J.

1000 **MIXED** U. S. old and new 25c. 2 lbs. \$1.00. Weatherby, Medina, Ohio.

WANTED Collections and accumulations. Honest prices paid. Doak's, Fresno, Ohio.

U. S. Mixture, 5 lbs. \$1.75. U. S. price list. Send postage. Stanley Gibbons, 38-P Park Row, New York.

PENNY Approvals, that satisfy. Neil Gronberg, Box 5441-P, Philadelphia 43, Penna.

FOUR Foreign flag stamps free if you will send us the names and addresses of three juvenile or beginner stamp collectors. Enclose stamp for mailing. Stamp Premiums, Inc., Flatiron Bldg., Fort Worth, Texas.

BRAZIL 378 Holy Year mint 8c with 1/2, 1/2, 1c approvals. Carroll's, 745A W. 45th, Los Angeles 37, Calif.

FREE! Complete "United States" stamp catalog with 1,000 illustrations! Send 10c to cover mailing. Harris & Co., 137 Transit Building, Boston, Mass.

60 DIFFERENT United States 10c. Pricelist free. Seidenberg, Cassopolis, Mich.

1000 GRABBAGS 15c Each. 8 different \$1. Special bags, Free French included 25c. Zandy, 630 Dingaman, Reading, Pa.

SPOT Cash paid for stamp collections. PKelgwin Company, Vineland, N. J.

SMOKY Mountain commemorative sheet, largest U. S. stamp issued, and 33 U. S. including commemoratives, airmail, revenues, etc. Catalogs 75c—To approval applicants for 5c. Curhan Stamp Company, Gloucester, Mass.

19th CENTURY U. S. commems. Civil War revenues, battleship \$5 and \$10 stamps free to U. S. approval applicants. Metropolitan Stamps, 198-C Broadway, New York.

FREE! Canadian sets, royal visit, George VI, George V, coronation, jubilee, others, to approval applicants. Ensign, Box 118-M, South Orange, N. J.

COMPLETE Mint commemorative set from Manchukuo, plus attractive Brunel pictorial—everything just 3c to approval applicants. Viking, 130 (Z) Clinton St., Brooklyn, N. Y.

WEEKLY Stamp Magazine, 26 weeks, 25c. Stamp Journal, Kalamazoo, Mich.

DANDY United States approvals. Write immediately. Sullivan, Endicott Arcade, St. Paul, Minnesota.

FREE! Western Hemisphere packet. Postage 3c. Owens, 806 Welsh, Bay City, Michigan.

FREE! British Empire packet. Postage 3c. Williams, 606 Archer, Bay City, Mich.

FREE! Pony Express set (facsimiles). Postage 3c. Roberts, 406 Building, Bay City, Michigan.

CANADA 100 Different 25c—approvals all countries. Lists. Victoria Stamp Co., London, 4, Canada.

FREE! Leeward Is., Cayman Is., Turks and Caicos plus 60 different mint Geo. VI coronation poster stamps, to approval applicants sending 3c postage. Tatham Stampco, Springfield-30, Mass.

WOW! \$10.00 Worth of fun for only 10c! 500 foreign stamps, unsorted and unpicked (mostly on bits of paper) just as received from the church missions and other sources. Africa, So. America, Australia, China, Philippines, Dutch Indies, and other countries are represented. Includes a few commemoratives, airmails, and stamps cataloging up to 25c or more each! The biggest package of fun in stampdom—and you might find something really valuable! Price only 10c to serious approval applicants! Money back if not delighted. Jamestown Stamp Co., Dept. No. 22, Jamestown, New York.

VICTORY Packet free—Includes stamps from Tanganyika, British Cayman Islands, animal, scarce babyhead, coronation, early Victorian, airmail, map stamps, with big catalogue—all free. Send 5c for postage. Gray Stamp Company, Dept. PM, Toronto, Canada.

55 DIFFERENT United States 5c with approvals. Bockman, Box 145-M, Maplewood, N. J.

STAMPS Sent on approval, outstanding quality, low prices. Fred Herzberg, 168 Oak, Elmhurst, Ill.

UNITED States approvals complete coverage, fine quality, attractive prices. Seminole Stamps, Box 436, Coconut Grove, Florida.

MEXICO Census commemorative set free with approvals. Pladon Stamps, 1717-M Idaho, Toledo, Ohio.

3,000 U. S. Foreign \$2: Approvals: Griest: 409 Oak, Davenport, Iowa.

FREE, Complete Cuba tobacco set with approvals. Seminole, Glenburnie-1, Md.

CAMERAS AND PHOTO SUPPLIES

"BIG Bertha" telephoto camera easily made. Trifling cost. Objects mile away photograph close up. Ultra sharp picture. Telephoto lens and instructions \$2.00. Instructions alone 10c. Carl Jamer, Box 114, Manerville, N. Y.

BOX Camera shutters repaired. Horton, 81 Campbell, West Haven, Conn.

OIL Coloring photographs a fascinating hobby or profitable business. Learn at home. Easy simplified method. Previous experience unnecessary. Send for free information and requirements. National Art School, 1315 Michigan, Dept. 3446, Chicago 5.

ADJUSTABLE Electronic timer, turns printer, enlarger, on and off. Detailed construction plans 25c. Gould, 1042 Union, Brooklyn, N. Y.

WAR Bargains used cameras. Lists, description 25c. Used Camera Directory, 3111 West Tuscarawas, Canton 3, Ohio.

DON'T Cut your 35 mm. film strips. Store the rolls in Maraflex—neat dust-proof fibre boxes with hinged lids and sections for 25 rolls. Complete with index. Two boxes \$1.00 postpaid. Marathon Photo Supply Co., Box 415-A, Wausau, Wisconsin.

ENLARGERS—Build your own. Kit of parts, \$6.00. Free particulars. Crescent Engineering, Box 251-P, South Pasadena, California.

HAVE You a camera? Send ten cents for recent number of our big magazine, showing how to make better pictures and earn money. American Photography, 116 Camera House, Boston, Mass.

MAKE Money in photography. Learn quickly at home. Easy plan. Previous experience unnecessary. Common school education sufficient. Booklet and requirements free. American School of Photography, 1315 Michigan, Dept. 3432, Chicago 5.

CASH! Spot cash for cameras, lenses, binoculars, movie or still, sound projectors. Send full description by mail, or wire for prompt cash offer. Over 30 years of dependability insures honorable dealings. Bass Camera Company, 179 West Madison Street, Chicago, Illinois.

BASS Says: War time proves Bass leadership. Amazing selection of finest still cameras—Leica, Contax, Korelle, Reflex, Argus, new and used still available. Write for quotations. Satisfaction guaranteed or your money refunded. Bass buys 'em, sells 'em, trades 'em. Bass Camera Company, Dept. AG, 179 W. Madison St., Chicago, Illinois.

PHOTO FINISHING

NO Delay! Pictures returned immediately. Eight exposure rolls developed with two prints each or one enlargement each negative—only 25c coin. Special! Coupon on beautiful 8x10 enlargement given each 25c order. Details and film mailers free on request. Moen Photo Service, 452 Moen Bldg., LaCrosse, Wis.

SENSATIONAL Introductory offer! Send snapshot or negative, this ad and 3c. We'll send you a beautiful 7"x5" enlargement! Or, Kodak roll developed with 16 guaranteed deckle-edge Velox fadeproof prints or 8 double-size prints, 25c! Special! From your negatives, 16 regular-size or 8 double-size reprints, 25c! Candid rolls—36 exp. 35mm. developed, vaporated, enlarged to 3x4, \$1.00! 18 exp. 60c. Reprints, 3x4, 3c each. We have new, perfect 35mm. film. Low prices. Free mailers, details on request. American Studios, Dept. 413, LaCrosse, Wis.

FREE! Send negative, this ad for beautiful 4x6 enlargement. (Stamp appreciated). 16 sparkling prints, 2 Hollywood enlargements from roll or negatives 25c. Lifetone Studios, Dept. A-939, Des Moines, Iowa.

6-8 EXPOSURE Film. Film developed and printed, 5x7 enlargement free, 25c. Reprints 3c. Hubold Studio, 1414 W. Minnehaha, 4, St. Paul, Minn.

ENLARGEMENTS: Eight 5x7 from negative \$1.00. Six 5x7 from photo \$1.00. Robert Renshaw, 222 Jeffrey St., Chester, Penna.

PROFESSIONAL Enlargements made of your favorite picture on double weight portrait paper, 5x7, 25c; 8x10, 50c. Send negative and coin to Highland Studio, Box 134, Sioux Falls, South Dakota.

BEAUTIFUL 8x10 Silk finish "Canvas Texture" enlargement 50c. Lang, 1334 Thorndale, Chicago.

16 BEAUTIFUL Deckle-edged prints and enlarging coupon with each roll developed 25c. Owiphotop pm, Weatherford, Okla.

FILM Developed, 8 album size enlargements or 16 sparkling prints, 25c; 8 snappy 4x6 enlargements, 30c. Reprints each: Contact prints, 2c; album enlargements, 3c; 4x6 enlargements, 4c. Crystal Studios, 159-F, Rushford, Minn.

BILLFOLD Photos made from any portrait, snap 60c. Lang, 1334 Thorndale, Chicago.

REPRINTS 16 For 25c, 40 for 50c. Queen City Service, Dept. 8, Box 7, Niagara Square Station, Buffalo, N. Y.

8x10 SILK Sepia enlargement any negative 25c. Universal Photos, 1301 S. Avers, Chicago.

6-8 EXPOSURE Rolls developed and enlarged mammoth size 30c. Reprints 3c. Thrifty Photos, Box 46, South Gate, Calif.

SPECIAL Offer 8x10 professional enlargement from your photo or negative expertly finished. Price 69c. Immediate delivery guaranteed. Bradford Studios, 7016A So. Halsted St., Chicago 21, Illinois.

BIGGEST \$1.00 Value in 35 mm. finishing today. 36 exposure fine grain 3 1/4x4 1/2 enlargements; deckled, embossed margin and date. Eighteen exposures 75c; 16 exposure splits 55c; 36 exposure reloads 50c. Special: return this ad with \$2.00 and we will send five 36 exposure reloads. Free mailers. 8 exposure rolls in beautiful, deckled contact finish with embossed wide margin, 25c. Mailbag Film Service, Box 5440A, Chicago 80.

12 BEAUTIFUL Enlargements—from roll or negatives—only 25c! Six 5x7 enlargements, 25c; six 8x10's, 50c—from negative. Free—send negative for one free enlargement, mailers, literature! Immediate service guaranteed. Photo Research Laboratories, Blackstone 11, Mass.

PHOTOSTAMPS \$1.25 A hundred. Postcards 15 for \$1.00. Any photo. Lang, 1334 Thorndale, Chicago.

WITH Every 6 or 8 exposure roll, two full sets of prints, 25c. Skyland Studios, Box 411, Dept. "M," Asheville, N. C.

BEAUTIFUL Oil colored enlargements. Your negatives: 8x10, \$2.00; 11x14, \$2.50. From photo 50c extra. Specify colors. Haynescraft, 802 20th, Washington 6, D. C.

SPECIAL Reprint service. Order duplicates of your favorite negatives now, while these low prices prevail. All prints from size 127 to 123. 16 reprints for 25c; 50 reprints 75c; 100 reprints \$1.00. Send only snapshot negatives. Satisfaction guaranteed. Cut-Rate Reprint Service, Box 833-K, LaCrosse, Wisconsin.

YOUR Favorite kodak pictures enlarged, size 5x7, 10c; three for quarter, coin. Send best negatives (film) today. Address Gephert Studios, Dept. 82, Des Moines, Iowa.

PHOTOGRAPHY For pleasure and profit. Prepare at home. Common school education sufficient. Write for information and requirements. American School of Photography, 1315 Michigan, Dept. 3451, Chicago 5.

TROUP'S Photo Service, Troup Building, Toccoa, Georgia. 6 or 8 exposure roll film developed and printed 25c.

8 BEAUTIFUL Enlarged prints (nearly postcard size) or 16 regular prints 25c. 35mm. rolls enlarged 3 1/4x4 1/2, \$1.00. Burton Studios, 59-M, Roscoe, New York.

BEAUTIFUL 4x6 Pictures 3 1/2c each, from 116 and 120 negatives. 3 1/4x4 1/2 from all other sizes. All work guaranteed. Overnight service. Roll developed and 8 pictures 30c. Roll 12 pictures 45c. Roll 16 pictures 60c. Enlargements on double weight portrait paper 5x7—30c, 8x10—50c. Copies made from any picture 75c. Pacific Photo Service, Box 666, San Francisco, Calif.

VELOX Deckle reprints 2c. Rolls developed, two deckle edged prints each negative, 25c. Two 5x7 enlargements 25c. Summers Studio, Unionville, Mo.

EVERY Picture an enlargement! 8 sparkling deckle-edge enlargements and roll developed 25c coin; 116 size or smaller; enlarge reprints 3c. Enlarge Photo, Box 791D, Boston, Mass.

8x10 SILK Finish enlargement—25c plus stamp. Irving Studio, 4006A Irving Park, Chicago 41, Ill.

MOTION PICTURES AND SOUND EQUIPMENT

INVASION Subjects free! Enroll with original movie guild. Free subjects every month. Extra premiums given applications, information dime refundable. Silver Screen, Box 351, Morristown, New Jersey.

CAMERA Films—100 ft. 16mm. \$2.69; panchromatic Weston 84, \$4.85; 25 ft. double 88 Weston 24, \$1.89; prices include processing. Movie accessories, chemicals, bulk films. Free circulars. Promader General, Davenport, Iowa.

GUARANTEED Fresh movie film! Three spools double 8mm., \$3.45! Six spools single 8mm. for Univex cameras, \$3.50! Dalite loading! Processing free! (Limit six each type). Will ship c.o.d. Eso-S Pictures, 4038 Broadway, Kansas City 2, Missouri.

100' 16MM. Used sound film, \$1.00 postpaid. List of complete subjects upon request. We buy, sell, trade. Blackhawk Films, Dept. PM15, Davenport, Iowa.

I PURCHASE All makes of obsolete 35mm. motion picture mechanisms. Dunston, 306-33 St., Norfolk, Virginia.

SILENT 35mm. Films! Features! Shorts! Demsey, 1613 Stewart, Youngstown, Ohio.

SALE. 30x40 Tripod screens, \$8.95. Beaded. Also film rentals. Dayton Film Rental, 2227 Hepburn, Dayton, Ohio.

"D DAY" Invasion plus Allies Take Rome, 8 and 16mm. westerns, comics, dramas, 3c stamp. Excel Home Movies, 634 Acklin, Toledo 10, Ohio.

8MM. Films exchanged. Prompt service. Waits, Box 941-M, Akron 9, Ohio.

STRICTLY Confidential—We have large assortment of subjects you'll want. New catalog with generous sample dime. Trans-American Sales, Morristown, New Jersey.

COMEDIES. Glamour, sample, dime. Zientek, 1129 Monroe Circle, Baltimore 25, Maryland.

PRETTY Girl movie special! "Screen Up Girls," 8mm., \$1.00; 16mm., \$2.00, prepaid. Lists, sample, dime. Jenkins, 392, Elmira, N. Y.

\$1 BRINGS "Surprise" assortment 8mm. colorful titles! Guaranteed. LeMoine Films, Nevada, Missouri.

STARTLING New discovery, make your own movie screen. Free literature. Snow White Screen Company, Danville, Illinois.

MOVIE Camera film, 100' 16mm. \$2.25, 3 rolls \$6.00. 25' double 8mm. \$1.25. Machine developing included. Ambassador, 479-A Quincy Street, Brooklyn, N. Y.

NEW And used 8mm., 16mm. Discounts. Sample 10c. Free lists. Paramount Film Service, Monmouth, Illinois.

SPECIAL Buy! Ansco twin-8mm. Hypan movie films, three rolls, \$6.00! Three rolls 888 Panchromatic twin-8mm., \$6.50! Standard Sales, Box 154, Dept. PM, Kansas City 10, Missouri.

"THE World's Greatest Passion Play." 8mm. 16mm. and 35mm. Specify silent or sound. Rent or purchase. Hemenway Film Co., 33-P Melrose St., Boston 16, Mass.

FREE. Projector film catalog; samples 10c. Goodwill Company, Jackson, Tenn.

GORGEOUS Glamour girls—"Lorelei" and "Barong Girls" two glittering films. 8mm. 50 ft. \$2.00, 16mm. 100 ft. \$4.00 each. Travel, comedy and news reels. Screens, splicers, reels, equipment. List for 3c stamp. Audet, Box 6520, Philadelphia 38, Penna.

SPECIAL Movie film, 8mm., 25 feet double-Weston 8, \$2.00. Super double X, Pan indoor 60, outdoor 100, 16 mm.—\$6.50. Super X Pan indoor 24, outdoor 50, \$5.75. Pan Weston 12, \$5.00, 16 mm. 100 feet Weston 6, \$4.00. Free developing. Exhibitors Film Exchange, 630 9th Ave., New York 19, N. Y.

35MM. Sound films reasonable. Send stamps for lists. Mertz Films, Springfield, Illinois.

RENTAL 16mm. Talking features \$4.95, shorts 75c. 8mm.-16mm. silent, large reel 40c. Movie accessories. Free catalogs. National Cinema, 71 Dey Street, New York City.

8MM-16MM. Home movies bought, sold, exchanged. Free bargain lists. Multiprices, 171 Euclid, Bridgeport 4, Conn.

SEND Stamp for 16mm., 8mm. catalogue. Sterling's, 679 Northampton, Easton, Pennsylvania.

LEARN Movie projection, management. Free catalog. Give age. Theatre Institute, Elmira, N. Y.

BETTERPIX Outdoor safety film, 100 feet 16mm., \$2.50. 25 feet double 8mm., \$1.25. Free developing. Finished subjects sold, exchanged. Sound library. Better Films, 742 New Lots, Brooklyn 7, N. Y.

I BUY. Sell, swap, rent s.o.f. 8 and 16mm. films. List free. Harvey Iris, Box 539, Brockton, Mass.

BASS Says: Leadership in the cine field is apparent in war times. Here ready—your choice of 8 mm. and 16 mm. apparatus. Write for quotations. Your old equipment is worth real money in trade—describe please. Or we buy for cash and pay immediately on receipt. Write to headquarters. Bass buys 'em, sells 'em, trades 'em. Satisfaction guaranteed or your money refunded. Bass Camera Company, Dept. A, 179 W. Madison St., Chicago, Illinois.

35MM.-16MM. Sound projectors bought and sold, list for dime. Anchor, 482, Ithaca, N. Y.

MUSIC AND MUSICAL INSTRUMENTS

PIANISTS—(Also organists). Quickly improve technique, sightreading, accuracy, memorizing, playing through mental-muscular co-ordination. Free booklet. Broadwell Studios, Dept. 44-I, Covina, Calif.

ATTENTION Song lovers. Four new beautiful songs, words and music for piano and guitar for only \$1.00 if sent with order prepaid or send order and pay postman \$1.00 plus few cents postage on arrival. Al E. Phares, Box 762, Dunsmuir, Calif.

LEARN Piano in 5 lessons by ear. Play any song—Easiest method known. Amazing results—Complete course \$2. ABC Piano Method, Dept. M9, Mt. Vernon, N. Y., Box 145.

LEARN To sing beautifully. New modern inexpensive voice culture course. Literature free. Ferris, 317M Hartford, Bremerton, Wash.

PRIVATE Party wants an accordion for cash. Richard, 44 N. Albany, Chicago.

SONGWRITERS: You can arrange your songs for orchestras. 20 modern lessons \$2.00. Money back guarantee. Brokel College, 64-P East Jackson, Chicago.

CASH For used musical instruments. Emory T. Evans, Westminster, Md.

PLAY Hot! Play by ear. Compose. Harmony, Chords, New system. Endorsed by famous musicians. Price \$1.00. Driscoll-Cherry Studios, Leadmine, Wis.

RADIO Singing pays big money. Complete course by Russell Brooks, former Wayne King soloist, only \$3.00. Money back guarantee. Buddy DiVito, with Harry James, trained here. Brokel College, 64-PM East Jackson, Chicago.

SONGWRITERS! Amazing, convincing offer. Hibbler, C5, 2157 N. Avera, Chicago.

POEMS Wanted for musical setting. Send poem for immediate consideration. Five Star Music Masters, 630 Beacon Building, Boston.

BAND and orchestra instruments, new and reconditioned. List free. Rudolph's, Atchison, Kansas.

NEW Songs and lyrics wanted for popular radio program and professional promotion. Free examination. Transradio Music, Inc., Dept. F, 1650 Broadway, New York. (Affiliate of B.M.I.)

OUTSTANDING Songwriting service. Roscoe Barnhart, 1329 48th, Des Moines, Iowa.

MUSIC Arranged. Songs published. Frank Wildt, Music Publisher, Lancaster, Pennsylvania.

SONGWRITERS Professional plan. Edward Madden, 1300 Lodi, Syracuse, N. Y.

SONGS Published. Examination and melodies free. National Songwriters, 6603 Sunset, Hollywood.

PIANOGRAMS Teaches piano playing quickly, easily, inexpensively. Results guaranteed. Literature free. Ferris, 317P Hartford, Bremerton, Wash.

MUSIC Printing, publishing, composing, arranging. Complete service. Lowest rates. Auto-Litho Co., Jensen, Fla.

RECORDING Discs 1/2c. Easily made. Excellent quality. Special equipment unnecessary. Material available everywhere. Instructions, including sample disc, \$1.00. Kaytor Laboratories, Lynwood, Calif.

ACCORDIONS—All sizes and makes. Special discount. Free catalog. American Accordion Co., 31 S. Cicero, Chicago.

HARMONICA Magic. Easy new system eliminates notes. Self instruction method includes 75 songs. Send \$1.00. Money back if not satisfied. Harmonica Magic, Box 3870 Merchandise Mart, Chicago 54.

SONG Poems set to music. Royalty publication. Hollywood Song Guild, Box 2230, Hollywood 28, Calif.

DO You want to publish your song? Printing, arranging, melodies. Mid-West Music Press, 4737 Broadway, Chicago 40.

SONGWRITERS Are offered rare opportunity to collaborate with hit composers on percentage basis through phonograph record manufacturer. Submit poems for approval. Recola Recordings, Hollywood 28, Calif.

GUT Strings at 50% savings direct from manufacturer. Quality Aristocrat gut. Factory-fresh, sweet-toned. Dollar bargains: 8 E's for \$1 or 15c each—6 A's for \$1 or 20c each—4 D's for \$1 or 30c each. Violin E also used for ukulele 1st and 4th, banjo 1st, guitar E. Violin E used for ukulele 2nd and 3rd, banjo 2nd, guitar B. Violin D used for banjo 3rd, guitar G. We pay postage. No order less than \$1. Moneyback guarantee. No Canadian orders. H. E. Wills Co., 1047 W. 47th St., Dept. B-401, Chicago 9, Illinois.

LEARN To play piano—Fastest, easiest, most successful method. Results guaranteed. Literature free. Pittman, Dept. P, Box 1653, Las Vegas, Nevada.

SONGWRITERS—Free booklet "Getting Ahead in Songwriting." Write today. Song Service, 331-C West 46th, New York.

LEARN Piano. One hour. Free literature. Ferris, 317A So. Hartford, Bremerton, Wash.

COMPLETE Song writer course \$1.00. Frank Hartman, Cabin John, Md.

SING Beautifully. Modern voice culture. Literature free. Ferris, 317A So. Hartford, Bremerton, Wash.

SONG Poems wanted. Free examination. McNeil, Master of Music, 510-PM South Alexandria, Los Angeles, Calif.

ACCORDIONS. New and used at wholesale prices. Save up to \$100.00. Buy direct from factory. Del Principe, 307 So. Wabash, Chicago.

SONGWRITERS Wanted; prices, details, free book. Variety, 2 Salem, Ind.

LEARN Popular piano! Play hit songs in boogie-swing style. Pianists, send dime for sample arrangement. Home-study folder free. Christensen Studios, 751 Kimball Hall, Chicago 4, Ill.

WRITE Songs. Big money and reputation. Write for information. J. Gordon Pub Co., 201 N. Hoyle Ave., Chicago.

BEFORE Sending your poem to be set to music "know your composer." Free booklet. Al. Moquin, 2110 Beachwood Dr., Hollywood 28, Calif.

SONGWRITERS—Send poem for immediate examination and free rhyming dictionary. Richard Brothers, 24 Woods Building, Chicago.

SONG Poems wanted; Write for free instructive booklet, outlining opportunities. United Music Corporation, Dept. 14, Salem, Indiana.

WANTED! Lyrics, melodies for songs. We arrange, publish, sell. Superior Song Studios, Passaic, N. J.

RADIOS AND SUPPLIES

WANTED: Wiring diagram and parts list for radio control circuit for model ships. Send particulars to: Charles King, 30 Cushing Street, Providence, Rhode Island.

RADIO That works without batteries, or electricity! Selective crystal kit, \$3.00. Also superhet kits, and other radio parts. Price list, 10c. Melvin Okin, 915 Bryant Ave., Bronx, New York 59, N. Y.

LEARN Radio code; make simple, inexpensive practice outfit, send 50c for complete plans and large self instruction manual. Eticus, Box 712, Pittsburgh, Penna.

MAKE Simple, tubeless, batteryless, distance-getting crystal radios, crystal and illustrated instructions. 25c postpaid. Allen, P-427, Clinton, Missouri.

6 TO 30 Volt radio tubes repaired, 50 cents each. 50% repairable. Pierce, 201-W Washington, McAlester, Okla.

FIXED Crystal detectors, headphones, novelties. Send stamp for list. Berent's, 4300 Hampton Blvd., Norfolk, Virginia.

BUILD Microphones, phonographs. (Crystal). Instructions 25c. Crystals \$2.50. Microphone or phonograph pickup kit \$5.00. R. H. Lab, 3928 Dumaine, New Orleans, La.

REVISED Plans 18 long distance crystal sets, including "Radiobuilder"—25c. Laboratories, 363-C Hampton, Hayward, Calif.

RADIO Repairing simplified, large 8 1/2" x 11" manual, only 25c. Supreme Publications, 328 South Jefferson, Chicago 6.

SACRIFICING 1920-1935 Parts stock. Everything new, usable, standard. Over \$25.00 list—\$5.00. Collect express. Send cash. Circular 3c. Hurry. Kladag, Kent, Ohio.

RAIDO Repairmen—Display our scientific service system card. Details free. Box 1532, Des Moines, Iowa.

RADIO Tubes, parts, condensers. Free bargain lists. Potter, 1314 McGee, Kansas City, Mo.

BUILD Improved extra loud crystal radio. Complete details, 20c. Joseph Amrose, R-4, Hungary Road, Richmond, Va.

PREPARE Now for tremendous opportunities in new fields of radio after the war. Training for federal licenses. Write for particulars. American Radio Institute, 52 East 23 Street, New York 10.

RADIO Service men and experimenters send for our giant radio catalogue. Save dollars. United Radio Co. (1000M), Newark, N. J.

BUSINESS OPPORTUNITIES

LEARN Auto painting. Earn \$100 per week working for yourself. 2,000,000 autos must be painted each year at \$50 to \$100 each. Complete up to date 5,000 word copyrighted instructions for \$100. Terms. Clinton C. Davidson, 636 "C" Street, San Diego 1, California.

AFTER The war what? We have the answer for you now! Sholes Co., M-2, 45 Astor Place, New York 3, N. Y.

UPHOLSTERING. Men-women learn at home. Get started now. Illustrated instruction \$1.00 prepaid. Upholstering Institute, Dept. 224, Lombard, Illinois.

MAKE \$8-\$15 Daily. Own permanent business. No capital. New invention—Revolutionary clothesline hangers eliminates clothespins, pulleys. Nothing like it. Made easily, quickly with home tools. Materials cost 10c. Retail \$1.00 up. Sells when shown. Enormous non-competitive market now and postwar among homes, hotels, apartment buildings, institutions, agents, retail stores. Simple drawings, complete work-sales instructions sent postpaid \$1.00. Rice, Inventor, 125 N. Erie, Toledo 2, Ohio.

START Home business making statuary, plaques, art goods, novelties, souvenirs, concrete pottery, garden furniture, artificial marble flooring, liquid marble. Make your own flexible molds. Amazing profits. Valuable folder free. Creative Publishers, (PMS), Glencoe, Illinois.

10 TRIPLE-SHAVE Double-edge razor blades in classy letter style package. 1st class mail anywhere 3c. Send 30c one package or \$1.00 four packages prepaid. Agents wanted. Novelty Supply & Mfg. Co., Fremont, Ohio.

START Your own business on our capital. Always your own boss. Hundreds average \$3,000 to \$5,000 annual sales year after year. We supply stocks, equipment on credit, 200 home necessities. Selling experience unnecessary to start. Wonderful opportunity to own pleasant, profitable business backed by world wide industry. Write Rawleigh Co., Dept. I-U-PPMB, Freeport, Ill.

OWN A mail-order paper products business. Sell envelopes, tags, labels, boxes, by mail, wholesale. Tremendous demand. Steady profits. No capital necessary. Write Omaha Envelope Service, Dept. 31, 4721 California, Omaha 3, Nebr.

INSTALL "Dashboard controlled garage door equipment." Additional information under "Automobiles."

YOUR Own profitable business started at home or office. Complete particulars free. Redmont Company, P.O. Box 9264, Los Angeles 5, California.

OPERATE Profitable credit and collection agency business; earn \$5000-\$10000 upwards annually; interesting literature free. Write Educational Extension Service, Department 101, Wilshire-Labrae Station, Los Angeles.

START "Soap Factory" at home. No machinery. Amazing opportunity. Literature free. Kemico, SM-9, Park Ridge, Ill.

MANUFACTURERS Names \$6.00 per 100, all classifications, Jackson, 1108 East 42nd Place, Chicago.

FOR Well paying position, with peace time future, prepare now. Details free. Lone Star Service, 1708 First Ave., Dallas 10, Texas.

BIG Paying mail order business right at home. Tremendous profits. Experience unnecessary. Particulars free. United Profit Builders, 305 West 8th St., Los Angeles 14, Calif.

START Home Mailorder Business. New course tells how. Literature free. Kemico, 179, Park Ridge, Ill.

ELECTRIC Clocks are every where you go. buildings, homes, parking-lots, factories. Repairs increasing. Our easy to learn course with pictures and drawings teach you how to repair these clocks. Electronic Supply Co., Dept. A, P.O. Box 2350, Houston 1, Texas.

OPPORTUNITIES Galore in Progressive Mail Trade 10c. Lyle Moore, 2834 Harris Pl., Norwood 12, Ohio.

SELL Exclusive books of instruction by mail. 80% profit. No bookstore competition. Snappy circulars ready. Rush name! Financial Education, 431F, 728 15th, Denver 2, Colo.

BE Your own boss, manufacture products, sell through agents, by mail. Big profits. Source supply, formulas furnished. Centry, 3692 Rivard, Detroit, Mich.

MAMMOTH Mail; magazines, opportunities galore. Year's service with dollar bringing plans, ads, etc., all 25c. Directory, 319 So. Marengo, Pasadena, Calif.

OPPORTUNITIES. Big mails. Your name listed, 25c. Wilson, 106 Penn. Dowagiac, Mich.

READY To go mail business 25c. One small ad gets you going. Send 25c for Quarters Galore, Rennolett, 830 - 9 St., Rock Island, Ill.

MONEY Making opportunities. Leading mailorder magazine, 10c. Sign, Farmington, Missouri.

SELL By mail. Books, novelties, bargains. Big profits. Particulars free. Myatt's Mail Service, Box 192, Pittsboro, N. C.

SELL Books and courses by mail in your spare time. Siddall, Atascadero, Calif.

CO-PUBLISH Real magazine. \$1.00 starts. Details 5c. Renick, Holland, New York.

WIN Business success and wealth. Avoid mistakes. Get experienced business advice. 20 years experience in sales, advertising, manufacturing, purchasing, engineering and finance. Write, Drake, P.O. Box 1135, Columbus, Ohio.

ACT Now! Limited time only. More than 125 plans to start your own business in spare time. Many of these plans sold for more than the collection. Book of plans, wholesale sources, and sales methods only \$3.98 postpaid. P. de Beaumont, Distributor, 106A Geo. Legare, Navy Yard, S. E. C.

PROFITABLE Business plans and ideas. 25c. Details free. Spada Enterprises, 10 Lexington St., Wethersfield 9, Conn.

START Mailorder bookshop—Everything furnished; publisher cooperation. 25c brings booklet, exclusive setup, samples, exciting ideas. General Publications, Ossining, N. Y.

PATENTED Battery and cable saver. Used by largest companies. Attractive offer for distributors. Kittrell Co., Waterloo, Iowa.

MAKE Your Own Flexible Molds. Statuary, Art Goods, Novelties, Artificial Marble Flooring, Liquid Marble. Literature free. Kemico, 9-M, Park Ridge, Ill.

MAKE Candy. Own profitable business. A. Barnes, 1416 North Mosley, Wichita, Kans.

GUARANTEED Powerful mailorder letters, literature, campaigns, planned, written. Astounding results reported! Pinkie Advertising, 1201 1/2 South Ogden, Los Angeles, Calif.

MAKE Insect spray. Materials, information. Kaplan, 13 South Eden, Baltimore 31.

MAILORDER Dealers wanted for General Eisenhower's life story, just published! Southern, Waynesboro 1, Georgia.

SPARE Time mail selling is your opportunity. Postal brings details. Henderson Supply Co., Liberty, Missouri.

PLASTIC! Make money today. Exceptional profits. Send \$1.25 for our kit containing instructions and ready-cut material to make sparkling cigarette box of genuine Lucite. Plastic Center, 3132 West 11th St., Dept. M, Los Angeles 6, Calif.

MECHANICALLY Inclined men—Own and operate general appliance repair shop. Complete, illustrated course shows you how. Welding, refrigeration, motor repair, how to get business, etc., all phases covered. Free literature. Christy Supply, Dept. 144, 2435 N. Central Ave., Chicago.

PLASTICS Made without equipment. 10c lb. Perfect castings. Formula 50c. Baker, 225 Symington Ave., Toronto, Canada.

DOLLAR Making tips, book of new ideas, plans, formulas. Trade secrets. 25c postpaid. Joseph Royer, 171 How Street, Haverhill, Mass.

TREMENDOUS Profits mailing ready-made literature. Dozens moneymaking necessities. Boundless opportunity 10c. Generalprint, Columbia St., Newark 5, N. J.

BUILD Miracle homes, Yours, Others. Enjoy prosperity. Particulars. Chamberlain Co., Fitzsimons Building, Pittsburgh, Penna.

LEARN The secrets of wealth. Write F. Jorgenson, 2727 E 4th St., Superior, Wis.

A BUSINESS Of your own. Start immediately. Full or spare time, home or office, anywhere. Little or no investment. Postal brings details. Victory Publications, 301 West 145 St., New York 31, N. Y. Dept. 5.

MAIL Order business course shows you how to make money, spare or fulltime. Teaches professional mail order technique—not penny-snatching schemes. New success-catalog free! Write Nelson Company, Dept. 4-02, Chicago 4.

MAKE Colored-glazed concrete pottery, cemetery products, tiles, novelties. Basement waterproofing. Other projects. Booklet, colorplate 10c. National Potteries, Fergus Falls, Minnesota.

OPPORTUNITY Knocking. Your last chance of how to make money by mail. Send 3 cents for full particulars, Kabbani, 1137 E. 8th St., Jacksonville 6, Florida.

MADE \$24,000; Used "schemes" from "Schemer" Magazine. Alliance, Ohio. 47th year, \$1.00; 3 months, 25c.

SELL By mail. Modern course shows how. Free consultation with noted author. Details free. J. G. Schroeder, Box 504-P, Anaheim, Calif.

FIVE Big mailorder magazines 20c. Lewis Company, 828-M Carpenter, Oak Park, Ill.

LEARN Mold making and statuary casting. Factory method. Seminole Art Co., 111 1/2 W. Grand, Oklahoma City, Okla.

TWELVE Easy ways to get into business for yourself, small capital, 25c. Details free. M. Box 6900, Pittsburgh 12, Penna.

GROW Drug plants and grow rich. Box 423, Kellogg, Idaho.

LIFETIME Business, steady income repairing sewing machines. Book instructions \$1.00. Connan, 114 S. E. 74, Portland 16, Oregon.

"KNOCKOUT Plan." Send dime for starter. A.M.I.A.T., Box 982, Baltimore 3, Md.

BIG Opportunities in Latin America with U. S. firms and pay. Develop your own hacienda or business idea on side. Send \$1.00 for information and big list of American firms doing business in beautiful Latin America. Latin American Research Bureau, 305 W. 8 St., Los Angeles 14, Calif.

300 TESTED Moneymakers, 68 page book, over 40,000 words, 20c postpaid, business secrets, formulas, wholesale supply sources galore, no ads, meat only. Dulco, 324 Pitt, Pittsburgh 21, Penna.

BACKYARD Moneymakers. Unique. Some good for a fortune. Details free. M. Box 6900, Pittsburgh 12, Penna.

VITAMINS, Minerals, wholesale! Your labels! Metabasic, 9128M, Station 8, Los Angeles 5.

DOLLARS Daily in profitable business of your own. Start small, grow large with National Mail Sales Service. Information free. Tannehill, 745 North Central Ave., Chicago, Illinois.

PROFITABLE Home-office work. Magazine, literature, 25c. Alliance, 23, Abilene, Texas.

NEW Ever-repeating profit plan. Particulars free. Lynch, 402-M Hazlett, Baltimore 29, Md.

"MONEY By Mail" brings proven, tested money makers to start your own business. Sample copy 25c. I. D. Burkett, Pansey, Alabama.

BE Independent, start profitable home business. Write Power, 603 W. Cross, Ypsilanti, Mich.

ADVERTISE in Progressive Mail Trade for big positive, powerful results. Best paper for checks, inquiries, orders! Lowest rates. Pewitt Publications, 605 Clayton, San Francisco, California.

BUSINESSMEN! New method saves bookkeeping expense. Details free. Anderson Sales, 101 Park Avenue, New York 17.

DEALERS, Collectors, hobbyists, individuals, list your articles for sale, exchange, or to buy with us. No obligation, no fees, we have the market for anything. Exchange Bureau, Box 363, Jamaica 1, Long Island, N. Y.

INDIA! Country of four hundred millions. Vast field. Wanted agencies for any marketable goods. Can export any Indian manufactured goods. Jhaveri & Co., Jhaveri Building, Porbandar, India.

FOR Cash without canvassing, write Poulsen & Company, Zion, Illinois.

LEARN Refrigeration mechanics. Start your own repair shop. Complete illustrated course. Free booklet. Mechanics School, Dept. PM11, 4703 West Pico, Los Angeles 6.

HOW And where to obtain free membership in the famous National Mail Order Guild. Details free. June, 101-S Beech, Holyoke, Mass.

FORGET Canvassing! Home business, profits immense. Amazing details. 3c. Service (5) Drawer 339, Butte, Montana.

SIX New and complete post card plans for starting your own profitable business. Gordian Publishers, Box 23, Pawtucket, R. I.

BIG Mail. Latest moneymaking propositions. 10c. Arsenau, 717 Third Ave., East Duluth, Minn.

GOLD Ahead: The book of cures for lean purses. It is absolutely practical! It really works. An inspiring self help for real financial success. \$2.50 cash postpaid. Evans D. Larson, Box 345, Longview, Washington.

VITAMINS—Our high quality, low priced formula packed (in small lots) under your own private label. Big profit selling stores, agents, and consumers. Samples, prices, and literature free. The Gibson Company, Harlan, Iowa.

MONEYMAKING Opportunities, steady income. Write. Meeks Publishing Co., Box 792, Weed, California.

FREE Literature explains profitable home mailorder. **Cutler Publications**, Reading, Penna.

YOU Can make fancy profits selling flavoring extracts. Make your own. Send two dollars for each formula. Your Service, Box 643, Warren, Ohio.

RUBBERFORM—Plastic; waterproof elastic flexible mold making liquid. Sample pint with instructions \$1.25 postpaid. Gallon \$7.00. **Plastic Products**, 1410-13, Belmont, Chicago.

KARAKUL Sheep are profitable. Write: **Addis Kelley**, Maywood, Calif.

HOW And where to obtain capital. Fully explained, particulars free. **Star Service**, Wapakoneta, Ohio.

LIQUID Marble; snow-white, multi-colored. Glazed. Unglazed. Composition flooring. Lifetime wear. Any color. No priorities. Flexible molds. Plaster casting. Get into the big money now. Full information given free. Write **Compo-Tex**, Box 786-R, St. Louis, Mo.

COLOR Concrete with chemicals. Big money making Hollywood style pottery, birdbaths, without moulds, washing-wells, stucco-rock, benches. Marbling, cement water-paints. 10c brings sample, literature, pictures. **Hollywood Cement-Craft**, 8527 Wonderland, Hollywood 45, California.

AGENTS—To mail our literature. Good profits. Home business. **Maywood**, 1133 Broadway, New York.

ADVERTISE In Progressive Mail Trade, famous for famous results. There's a reason why advertisers stay in year after year. Best puller. Lowest rates. **Pewitt Publications**, 605 Clayton, San Francisco 17, Calif.

FREE Subscription to "The Mail Order News" (Somerville, N. J.) Oldest mail trade journal in America. Offer limited. Drop postal today.

WEBER Typewriter Mechanics School. Simplified homestudy-repairing increasing. **Hollywood 27**, California.

"HOW To Make Simple Molds and Plaster Plaques". Profit in popular novelties! Booklet 25c. **Plastercraft**, 1406 E. 43rd St., Cleveland 3, Ohio.

INCORPORATE Your business. Delaware laws. Many advantages, free details. **Tax Research Bureau, Inc.**, Delaware Trust Building, Wilmington, Delaware.

GET Into mail selling. Prepare for future. Start sideline business now. Splendid opportunities. Interesting, profitable propositions immediately available. **Progressive Magazine** tells how! Free details and premium offer. **Sheboygan Publishing Co.**, Sheboygan, Wisconsin.

CHARTERS: Delaware; best, cheapest; free forms. **Colonial Charter Co.**, Wilmington, Del.

DRUNKENNESS is a disease which responds to treatment. Medical skill plus human sympathy prove successful with liquor and drug cases. 60 years experience. Write for free booklet. **P. M. Neilson**, The Keeley Institute, Dwight, Ill.

127 WAYS To make money, in home or office, business of your own. Full particulars free. **Elite Co.**, 214 Grand St., New York.

BRUSH Plating outfits connect to a battery. No tanks necessary. Good paying business at home plating autoparts, bathroom fixtures, bicycles, reflectors, silvering mirrors. No shop or experience required. Outfits furnished. Free booklet. **Gunmetal Co.**, Ave. H, Decatur, Ill.

EXTRA Income—Plenty mail selling opportunities. Write **Katz**, 4234 N. Kimball, Chicago.

5 MOST Read mail order magazines 20c. **Armand Cartier**, 695A North, Pittsfield, Mass.

LIQUID Marble—Colorful, glazed! Mold, brush, spray! Composition floors, rubber-lastic molds. Particulars free. **Marbleizing Service**, Edwardsville, Illinois.

MONEYMAKING OPPORTUNITIES

THOUSANDS Of alarm clocks need repairing. Jewelry stores swamped. Our simplified course teaches you how to repair these clocks. Necessary tools and supplies furnished with course. **Alarm Clock Repair Service**, Dept. B, P.O. Box 1983, Houston, Texas.

GAIN Financial independence from a city lot or a five acre plot. A new book "Security Acres" shows you how. Send for free particulars today. **A. J. Shutt**, SA-1, P.O. Box 269, New Castle, Indiana.

HELP Win the war first! Then man, you'll like silvering mirrors, reflectors! Making sparkling chipped glass nameplates. Outfit prices. **Sprinkle, Plater**, 1983, Marion, Indiana.

MECHANICALLY Inclined men—Own and operate general appliance repair shop. Complete, illustrated course shows you how. Welding, refrigeration, motor repair, how to get business, etc., all phases covered. Free literature. **Christy Supply Dept.** 1144, 2835 N. Central Ave., Chicago.

MOLDMAKING—Plaster Casting. Complete formulas—fully illustrated. \$1.00. **Ideal Service, RM-9**, Park Ridge, Ill.

GROW Dwarfed trees few inches high for yourself or sell. Instructions 15c. **Charles McGuire**, P.O. Box 628, Dept. G, Seattle 11, Wash.

EASILY Made gasoline gas machines as well as other types (septic, reformed gas, etc.), 5,000 word booklet \$1.00. Gas rate for heating and cooking as low as 30 cents. **Ideal Spec.**, Lakewood 5, Rhode Island.

MAIL Our pulling circulars on commission. Big steady profits. Circulars all ready for mailing, 250 for \$1.00, postpaid. Sample free. **Omaha Envelope Service**, Dept. 32, 4721 California, Omaha 3, Nebr. Established 1930.

MAKE Colorful plastic jewelry, for gifts, resale. Free details. Beginner's outfit, \$1 (refundable). **M. Hughes**, 218 Sidell, Danville, Illinois.

MAKE Money at home by mail. No experience nor huge capital necessary. **Jamek**, Box 1438, Long Beach, Calif.

MONSTER Mail, magazine, adsheets, circulars. Opportunities, 10c. **Harvey Teeple**, (PM) Decatur, Indiana.

MORE Money for you! Our book reveals how. 25c postpaid. **Branan**, 328 Washington, Sandersville, Ga.

MAMMOTH Mail! Thousand opportunities, magazines, samples. 10c. **Variety**, 6106-B 11th., Indianapolis 44, Ind.

THOUSANDS Of articles wholesale. "Supply Source Directory" 10c. **Ideal Service D-9**, Park Ridge, Ill.

GET Rich without starting capital. Dept. 50, 185 W. Godfrey, Philadelphia.

MAKE Quick cash in mail order, like I do. All new tested plans. Write **Manier**, 2623 Coyner Ave., Indianapolis, Ind.

HAVING Retired at 46 with a yearly gross income in excess of \$20,000, I am not unwilling to make available to other men and women with little education and capital the basic information that they may do even better than I. My 24 page 8 1/2" x 10 1/2" illustrated, copyrighted booklet "How to Operate Concessions, Shows and Thrill Rides on Midways" sent postage prepaid U.S.A. or Canada on receipt of \$3.00 money order. **Harry McQuiston**, P.O. Box 4624 Sellwood Station, Portland, Oregon.

MONEY By mail—Dime brings proof, giant mails. **Lee Wilson**, Niles 1, Mich.

LEADING Mailorder magazine will put money in your pockets. 10c. Plus, 4612 "G" Street, Philadelphia 20, Penna.

MONEYMAKING Mail-order opportunities awaiting you. Write **Southern Mailers**, Dryden, Virginia.

CATALOG Listing hundreds of opportunities 10c. (refundable). **Barcus**, 1001 N. 13th, Terre Haute, Indiana.

REVELATION For opportunity seekers. **F. L. T.**, Dept. 63P, Box 5766, Philadelphia.

GET Big mails, magazines, samples. Name listed. 10c. **American Directory**, 1420 Mistena, Corpus Christi, Texas.

LANDOWNERS, Is there oil? Know geological secret signs, how to get well drilled. Leases, royalty, land damages by experts. Write **Landowners Guide**, Box 64, Caddo, Oklahoma.

FOUR Books—228 exciting pages on mail order work—150 ideas, plans, methods. \$1.00 postpaid. **William C. Bradley**, Box 2778, Kansas City, Mo.

THE Novelty manufacturing business offers ambitious men in every community opportunity to start profitable business. Imports cut off—Chain stores, etc., anxious for merchandise. Start in garage or basement. No material priority. Easily learned, excellent profits—No expensive equipment needed. Particulars free. **Plas-tex Products**, 332 Balboa, San Francisco 18, California.

MAILORDER Information that can save you many dollars. Yours for stamp. **Iconoclast**, 2016-P West 23rd, Little Rock, Ark.

MAKE Plenty of money in spare time right from your own home. Sales made entirely by mail. No personal contact. **Progressive Mail Trade Magazine** tells how. Sample 10c. **Edgar W. Thomas**, Barnesville, Ohio.

MANY Mighty interesting ways to make big profits in spare time, and have lots of fun, too! Details free. **M. Habermann**, Box 1642-O Perry Sq. Station, Erie, Pa.

247 MONEYMAKING Opportunities, not trash. **Lucas**, 8704 St. Aubin, Hamtramck 12, Michigan.

REPAIR Alarm clocks, make money. Instructions \$1.00. **Sterling Products Co.**, Springfield, Ill.

INVESTIGATE—Co-Operative mail promotion service for profitable opportunities. **Russell Johnson**, Clarksfield, Minnesota.

PLASTIC Costume jewelry made at home from discarded household articles. Complete instructions sent for 50c. **Joseph Wittick**, 123 Edwin, Toronto, Canada.

SPECIAL Training—for entering successful business. You start small, grow big. We tell you what to start, what to pay, what to sell, who will buy. Ask for bulletin No. 12. It's free. **Edgar W. Thomas**, Barnesville, Ohio.

WANT To make \$5000 a year? No bunk. Write **Jones Publications**, Bethany, Okla.

BIG Profits, make and fit arch supports. Particulars. **Jul Corssen**, 2638 Geyer, St. Louis 4, Missouri.

MONEY Made easily, old age, health, education, color need not stop you. Write for details. **Bargain Specialty Company**, Box 635, Modesto, California.

LEARN Refrigeration mechanics. Start your own repair shop. Complete illustrated course. Free booklet. **Mechanics School**, Dept. PM12, 4703 West Pico, Los Angeles 8.

START Profitable business at home. 25c brings details. **Des Moines Home Service**, Box 855, Des Moines, Iowa.

62 MONEY Making plans, 68 page book. 25c. **Shaw**, 250 W. Main, Logan, Ohio.

GROW Dwarfed trees few inches high for yourself or sell. Instructions. 15c. **Charles McGuire**, P.O. Box 628, Dept. G, Seattle 11, Wash.

CASH From your back yard, basement or bedroom. No experience necessary. Send for free details. **Challenge Association**, 87 Somerset, Springfield, Mass.

START Now, build money making mail order business. Be established after the war. Write for free particulars. **Young's Industries**, Kent 13, Ohio.

MONEY At home. Your own business. "Progressive Mailtrade" Magazine (15th year), prints many small capital post war opportunities. Read by thousands; you'll like it too. Copy 10c. **Publishers**, Box 115M, Gardenville, New York.

PERFUME Instructions furnished. Start mail order or local business. Particulars free. **Dr. Abell**, Parkway Bldg., Pasadena, Calif.

BOOKKEEPERS. Earn money at home posting journal entries. **Ellis Business Service**, Cedar Grove, North Carolina.

LICK After-war layoffs! Start own business; home, office. Booklet describing "Collection of 127 Tested Plans" free. **Elite Co.**, 214 Grand St., New York.

PUBLISH Your own magazine. Hand-some 52 page format, well edited, illustrated. Cost low as \$1.00 month. Brings you prestige, profits. 10c brings sample, details. **National Ord. Nebr.**

LEARN Metascience. Remarkable drug-less healing. No manipulation. No apparatus. Unbelievable simplicity and results. Inexpensive correspondence course. Write **Metascience**, De Land, Florida.

EARN Money at home! Thousands do! "Home Worker Magazine" tells how. Sample, 25c. **Sizemore**, Box 7, 4917 North Kostner, Chicago.

FORMULAS, PLANS, ETC.

FURNISH Any formula for \$1.50. Expert scientific information. **Romola King**, 700-B North Mont Clair, Dallas, Texas.

MAKE Fast selling products. No machinery. "Chemist Approval Formulas." Literature free. **Kemico**, 15, Park Ridge, Illinois.

FORMULAS: Household cleaners, dental powders, ink powders. **Frank A. DeVoe**, Box 243, Ukiah, California.

ATHLETE Foot, relief guaranteed. Formula and compound sufficient for quart. **Quarter**, Fletcher Chemicals, 114 Callaghan Ave., San Antonio 3, Texas.

"LUMINOUS Paint" shines in dark. Easily made. 100 other formulas, plans—all 25c. Soap-making course (20 formulas) \$1.00. Resilvering mirrors, formula 20c. **Ideal Service**, 309, Park Ridge, Ill.

ANY Formula \$2.00 or money back. Case **Kowal**, Chemist, 1846 Cullerton, Chicago.

ICELESS Ice! Colder; cleaner; cheaper. Instructions, 25c. **Duffy**, G-33, Covington, Ky.

NEED A chemist? Formulas, Research, Professional service, Consulting Scientific Company, Box 389, Swarthmore, Penna.

FORMULAS—Latest, best, Analysis, Literature free, Belfort, Engineering Building, Chicago.

AUTHENTIC Formulary, 924 page illustrated book. Prepared by experts, 10,000 practical tested formulas, recipes, secrets, instructions for easily making most any product. Countless profitable business opportunities. Valuable reference for home, industry. \$2.00 post paid (c.o.d. U. S. only), Foreign \$2.35. Adams Brown Company, Dept. 11, Chestnut Hill 67, Massachusetts.

REAL Manufacturing formulas. Lists free. Cummings, Chemist, Gordon Ave., Syracuse, N. Y.

CHEMISTRY

THE House of Winn, the home of supplies for amateur chemists. See Winn's New Idea chemical kits and apparatus cut-outs for home experimenting. Send 10c for retail catalog. Established 1931. John H. Winn, Dept. 509, 124 West 23 St., New York.

FREE Chemical catalogue. Enclose 3c postage. Greenwood, 398 Broadway, New York.

FREE Catalog: Chemistry, mineralogy, biology, optics, Tracey Laboratories, Evanston, Illinois.

CHEMICALS, Ounce quantities, apparatus; catalog, 5c. Fleischer's Laboratories, Everett 49, Mass.

NEW 32 Page Chemical Apparatus Order Book. Complete line of chemical glassware, apparatus and chemicals. Send 10c for this book. Standard Science Supply Company, 1236 N. Paulina St., Chicago 22, Ill.

SPECTROSCOPE For quick chemical analysis \$2.50. Kutting Sons, Campbell, California.

LABORATORY Supplies at wholesale prices: Chemistry, biology, physics. Catalogue 10c. National Scientific Co., 2204 W. North Ave., Chicago. Established 1908.

CHEMISTRY Laboratory apparatus and chemicals for industrial, analytical, and private experimental laboratories. Complete chemical laboratory supply service for correspondence school students. Send 3c for free 48-page catalog of chemicals and apparatus. Dept. M-43, Biological Supply Co., 1176 Mt. Hope Ave., Rochester, New York.

HELP WANTED

SALESMANAGER. Promote national distribution by mail from own office. No investment. Take 66% gross income in advance. Write Tom Ellis, Personal, Cedar Grove, North Carolina.

AGENTS WANTED

HOSIERY Guaranteed against everything at no extra cost! Victory sheer ladies' rayon full fashioned sells for only 94c including your profit! Also guaranteed men's hosiery. Amazing opportunity to build permanent business. No experience or money required. Simply write orders. We deliver and collect. Write today for complete free outfit. Kentercraft, Dept. HH, 44 Court Street, Brooklyn, N. Y.

\$1 STARTS You in business. Sell deluxe five fold ties, 100% wool interlining. Costs you only 37 per dozen, you make 33 dozen. Send \$1.00 for special introductory offer two five fold ties. Catalog complete line free. Philip's Neckwear, 20 West 22nd St., Dept. K-3, New York 10.

BIG Profits taking subscriptions for all magazines. Agents' confidential catalog listing over 2500 periodicals and complete starting supplies free. Fines Subscription Agency, Flushing, New York.

AMBITIOUS School seniors—We want you to sell classmates the "tops" in graduation name cards. Highest commissions. Your cards free. Cardalogs going like wildfire. Hurry! Get yours today! Craft-cards, Box 235-L, Pittsburgh 30, Penna.

EXTRA Money for you. Sell 50 for \$1.00 Christmas cards and personal stationery. Mitrace value \$1.00 Christmas assortment. Other money making boxes 35c up. Up to 100% profit. Friends, neighbors buy readily. Samples on approval. Special offer. Elmira Greeting Card Co., M-161, Elmira, N. Y.

SKUNKADORA Eliminates 100% all traces of skunk odors! Nothing like it. Whirlwind seller to farmers, trappers, general stores, breeders, etc. Big profits. Send \$1.00 for sample on money back guarantee or write Sparhawk, Sparkill, New York.

"THE Seventh Name." Sensational novelty! Religious war motto. Fast 25c seller. 3 for 25c. 20 for \$1. Cash. Evans and Clark, Publishers, Wilkes-Barre, Penna.

AGENTS—Photos on stamps going like wildfire. No investment. \$2.00 seller, excellent profits. Samples, details, free. American Merchandising, PM-1, Box 1967, Montgomery, Alabama.

CHRISTMAS Cards. Make \$5.00 with every ten \$1.00 21 card assortments you sell. Also 25 for \$1.00 imprint cards. Write for samples today. Howard P. Ellis, Dept. PM, Pitman, N. J.

SCHOOL Seniors—Sell classmates America's most beautiful, distinctive graduation name cards. Positively highest commission. Largest selection. Lowest prices. Free cards and free sample kit. Printcraft, 1423 East Elm Street, Scranton 5, Penna.

CALL On friends with easy to sell personalized stationery with name in raised type. Big profits. Free samples. Merz Printery, 135 Lenox Street, Rochester 11, N. Y.

BIG Bargains for big profits. Men's used pants 25c, suits \$1.00, topcoats 75c, shoes 12 1/2c, overcoats \$1.00. Over 100 sensational values. Experience unnecessary. Free wholesale catalog. Superior, 1250BK Jefferson, Chicago.

SELL Transparent signs, greeting cards, Christmas goods! Big profits! Catalog free! Elfcoc, 436 North Wells, Chicago.

"MAIL Order Trade Directory" tells you where to buy wholesale. 25c brings 1944 edition. Box 693-PM, Canton 1, Ohio.

"SALES Totaled \$11.50 in one hour" says Miske, Cleveland, O. Make up to 300% profit distributing Kils-Em Rat bait to dealers, homes, etc. Tremendous demand. Steady repeats. Free advertising helps. Linsinger Mfg. Co., Palmesville 20, Ohio.

AT Last! Something new and sensational in Christmas cards. Amazing "Oil-ette" cards. Like costly oil paintings. Designs never before offered. Gets orders fast. Beautiful 25 for \$1 cards, name imprinted. 9 other assortments. Big profits. Samples on approval. Pure Co., 3043 Locust, Dept. 227, St. Louis, Mo.

CALL On friends with sensational personal Christmas cards—25 for \$1.00 up. Personal stationery. Also magnificent 21-card \$1.00 assortment. Profit 50c. Experience unnecessary. Samples on approval. Wallace Brown, 225 Fifth Ave., Dept. F4, New York.

\$3 FIRE Extinguisher; quick sales, wholesale or direct; liberal profits. "Fire-Killer," 109 N. Franklin, Syracuse, N. Y.

30 BIBLICAL, Patriotic multicolored tinsel wall mottoes. Guaranteed 25c seller. Postpaid \$3.00. Empire Sales, 340 So. Main, Memphis 3, Tenn.

GET Dollars by mail! 90c profit. Instructions 10c. Terrill, Bogard 2, Mo.

LARGE Profits in your own business. Used shoes 12c, pants 25c, coats 37c, underwear 20c, dresses 15c. Hundred other bargains. Catalog free. Established 1930. Publix, 558 Roosevelt, Chicago.

HANDY Hair trimmer. Sells like wild. Trims as you comb. Saves barber bills. Samples sent on trial. Kristee, 134, Akron, Ohio.

SELL New-used clothing from home, auto, store. Men's suits 99c. Leather jackets 73c. Overcoats 43c. Dresses 12c. Ladies' coats 35c. Other bargains. Catalog free. S & N, 565A Roosevelt, Chicago.

START Your own business on our capital. Always your own boss. Hundreds average \$3,000 to \$5,000 annual sales year after year. We supply stocks, equipment on credit. 200 home necessities. Selling experience unnecessary to start. Wonderful opportunity to own pleasant, profitable business backed by world wide industry. Write Rawleigh Co., Dept. I-U-PPMA, Freeport, Ill.

SEND \$1.00 For samples rose petal bead necklace, earrings, you can quickly sell hundreds of these necklaces. 100% profit. Satisfaction guaranteed. Mission, 3521 High, Oakland, California.

PROFITS Selling novelty fun cards. Samples 10c. National Specialty, Box 391-M, Cincinnati.

AGENTS, Big profits selling our hair dressing for colored people. Write us for particulars. Dawson Company, Enfield, N. C.

EARN More money—Write for free wholesale price list. Voluntary repeat sales, good commissions, unlimited opportunities. Supplies furnished. Start today! Mail card to McGregor Magazine Agency, Dept. PM4, Mount Morris, Illinois.

SELL Christmas, everyday and birthday cards. 4154g Fifth Street, Philadelphia 40.

CHRISTMAS Card agents. We undersell everybody. Box assortments—name printed. Free cards with orders. Samples—quarter (refunded). Klayer, 2219 Crane, Cincinnati, Ohio.

PRIZE Package deals—Joke cards. Prices quoted to distributors, jobbers, operators. Eagle Specialty Co., Akron, Ohio.

SENSATIONAL Self-seller. Nothing like it. Thrilling. Educational. Stores, businessmen, accountants, bookkeepers, teachers, students, everybody. Highly endorsed. Want reliable distributors. "Prewett Factory," 1241 Miramar, Los Angeles 26.

NEW, Timely, profitable! General Eisenhower's complete life story, just published! Knickerbocker, 128-32 Lexington, New York 16.

SELL New, permanent reference calendar. Shows day of week for any date in entire Gregorian System to year 4000. Always current. Take the doubts out of dates past, present, future. Send \$1.00 for 12 assorted sizes, postpaid. Braunsar's Calendars of Reference, 2717 North Darien Street, Philadelphia 33, Penna.

LUMINOUS Paint. (Shines in dark). Spectacular seller to millions. For profitable details and free sample write. Lite-Saver, 97C, Saybrook, Connecticut.

EXCELLENT Sideline for printing salesmen. Decalomania name plates in small quantities. Also, make money applying initials on automobiles. Free samples. "Ralco," X-164, Boston (15), Mass.

EXCLUSIVE Territory. Fire extinguishers. \$2.75 retail. Old concern. Firstaid, 1824 Fourth Avenue, Los Angeles 6, Calif.

REAL Live Mexican jumping beans. 20—25c. 100—85c. 500—\$2.00. 1000—\$3.00. J. J. Frank, 523P Palm, Rockford, Ill.

AGENTS. Make 150% profit on our hair products for colored people. Write today. Vitrol Hair Products, 2529 Eight Avenue, 30 New York City.

BIG Money taking orders; shirts, ties, socks, pants, jackets, sweaters, shoes, uniforms, etc. Sales equipment free. Experience unnecessary. Nimrod, 4922-AN Lincoln, Chicago.

AGENTS. Big line including food products. Fast selling premium and bargain deals. Low prices. Send card for big outfit offer with gift. Ho-Ro-Co, 2793 Dodier, St. Louis 7, Mo.

WHOLESALE Sources. 500,000 articles. Free directory. Maywoode, 1133 Broadway, New York.

PLATING Outfits for autoperators, reflectors. Connect to a battery. No tanks necessary. Free booklet and particulars. Gunmetal Co., Ave. N, Decatur, Ill.

AGENTS: Stamping names on pocket-key protectors. Sample check with your name, address, 25c. Stamping outfits, Emblem checks, check-fobs, name plates. Hart Mfg. Co., 303 Degraw St., Brooklyn, N. Y.

MAGIC Cleaner and laundry soap deal. Hotter than a firecracker. Big profits! Sample free. Bestco, 5007 Irving Park, Chicago.

PLAYING Card game. 250% profit. Sample game 25c. Box 842, Denver 1, Colo.

GOLD Lacquered window sign, letters. New styles. Absolutely beautiful. Free samples—catalogue. Atlas, 7941 Halsted, Chicago.

FREE Water and our concentrates, makes flavors, lotions, shampoos, 72 products, labels, bottles furnished. Qualco, E-20030 Russell, Detroit.

ELITE Collection contains 127 plans for starting own business; home, office. Descriptive booklet free. Elite Co., 214 Grand St., New York.

HIGH-GRADE SALESMEN

CELL-U-MOP. Amazing new invention. Cleans floors, windows, rugs, quickly. Hands never touch water. Women simply wild about it. Tremendous profits. Salesmen, crew managers, get exclusive territory for this big seller. Kautenberg Co., Dept. PM, Freeport, Ill.

SALESMEN. Represent old, established corporation. Fast-moving line of essential maintenance materials for industrials and institutions. Factory to consumer. Commissions averaging \$52.00 per sale. Splendid postwar opportunities. Write for interview, submitting full details. Monroe Company, Inc., Cleveland 6, Ohio.

SOMETHING New in fire extinguishers. Red Comet Automatic Safety Sprays. Real fire killers. Low in price. Easy for you to sell. Splendid outfit furnished free. Write to Red Comet, 704 Comet Building, Littleton, Colorado.

1,000,000 ITEMS. Wholesale, low prices. Inquire. Allied, 210 Fifth Ave., New York City 10.

ADVERTISING Book matches—World's largest "direct selling" book match factory offers advance cash earnings calling on every type of business. Men or women. Experience unnecessary. Full, part time. Low prices. High quality. Quick deliveries. Powerful patriotic display. Special designs for army camps and naval stations. Repeats. Sales kit free. Match Corporation of America, 3433 West 48th Pl., Dept. E-8, Chicago 32.

SALESMEN Wanted for new liquid poultry wormer. Sample and commission rates upon request. Our line of poultry remedies sell under a money-back guarantee. Bielefeld Products, Dept. A, New Knoxville, Ohio.

SELL Warm leather jackets to friends, neighbors. Make money spare or full time. Also rubber raincoats, 200 styles shoes. Sample outfit free. Experience unnecessary. Consolidated Shoe System, Dept. S-65, Chippewa Falls, Wis.

NATIONAL Collection System Service since 1914. Cash advance and profit interest in all lists obtained. Give qualifications. 2024 Calvert, Baltimore.

FORMER School men or men who can sell school superintendents. Classroom charts for social studies. Good commission. Quick action. National Forum, 417 South Dearborn, Chicago 5.

PRINTING Salesmen—biggest opportunity in 20 years. Stamp brings details. Mico, Box 748, Dayton 1, Ohio.

SALESMAN: Have real money-making opening. Fits into war program. Old progressive firm. Dept. "F", Box 392, Dallas, Texas.

SELL Toy guns to everybody. Parfax Company, 4199 W. 2nd St., Los Angeles 4, Calif.

BLADES—Best quality, factory prices. Details free. Ace Blades, Buffalo, N. Y.

ORANGE Concentrate direct from our Florida grove. One quart bottle makes 6 quarts delicious natural orange drink simply by mixing with 5 parts cold water. Grocery stores, food marts, roadstands, sodafountains, resorts, camps, farmers big buyers. No investment. Protected territory. Salesmen earn \$100 to \$200 repeat commission per week. Sunset Valley Orange Co., 3357 Clifton, Chicago.

EDUCATIONAL AND INSTRUCTION

WRITE Short stories at home for pleasure and profit. Fame, riches and happiness of achievement are rewards to be realized by students who acquire tested technique. Get free booklet from home study school with 50 years experience. Write today! Blackstone-Sprague, Dept. 19, 397 North Michigan, Chicago 1.

INCREASE Your income—Study magazines covering subject that interests you. Our list covers 175 fields—616 periodicals. It's free. Write today. Commercial Engraving Publishing Co., 34E North Ritter, Indianapolis 1, Indiana.

MAKE Up to \$25-\$35 a week as a trained practical nurse. Learn quickly at home, spare-time. Easy tuition payments. Earn while you learn—many earn hundreds of dollars while studying. Easy to understand lessons, endorsed by physicians. High school not required. Our 45th year. Write for free booklet and sample lesson pages. Chicago School of Nursing, Dept. K-9, Chicago.

GOOD Jobs and a sound postwar future for you in hotel and institutional field, government housing, food and recreation projects. Men and women—all ages—needed for well-paid positions that offer color, excitement, ever-new and fascinating duties. Record-breaking business in hotels, clubs, institutions means even greater opportunities. Lewis School receiving calls for managers, hostesses, executive housekeepers, purchasing agents, stewards, etc. These are not temporary jobs, but important positions in an essential business that offers splendid opportunities in war or peace, good times or bad. Previous experience proved unnecessary! No need to leave your job to qualify. A good grade school education, plus Lewis Training qualifies you, at home, in spare time. Our National Placement Bureau helps to place you and—under our amazing Certified Job Plan—actually guarantees you will "make good" when placed. Write today for free book! Lewis Hotel Training School, Room CT-368, Washington 7, D. C. (First and only school of its kind—Now in its 28th year.)

FOR A lifetime of pleasure and profit be a treecraft expert. Do all types of budding and grafting, grow different varieties of fruit on one tree and different colored flowers on dogwood and roses. Write Treecraft Publications, Box 5, South Charlestown 3, W. Va.

"HOW To Break and Train Horses"—A book every farmer and horseman should have. It is free; no obligation. Simply address Beery School of Horsemanship, Dept. 1109C, Pleasant Hill, Ohio.

SHORTHAND In 6 weeks at home. Famous Speedwriting system, no signs or symbols. Easy to learn; easy to write and transcribe. Fast preparation for a job. Surprisingly low cost. 100,000 taught by mail. Used in leading offices and civil service. Write for free booklet. Speedwriting, Dept. 1509, 274 Madison Ave., New York 16.

NEW Writers needed to re-write ideas in newspapers, magazines, and books. Splendid opportunity to "break into" fascinating writing field. May bring you up to \$5.00 per hour spare time. Experience unnecessary. Write today for free details. No obligation. Postcard will do. Comfort Press, Inc., 210-P South Seventh St., 2, St. Louis, Mo.

AUTO Body and fender work, including metal work, welding and spray painting. Look into it! One of the most profitable branches of tremendous auto industry offering chances for good job or your own business. Train in spare time. Write for free facts. Utilities Inst., Dept. 14X, 1316 W. Belden Ave., Chicago.

WELDING—Electric arc. Learn profitable trade quickly through actual practice. Individual welder instructions at bare cost of materials. Full particulars free. Valuable welding lessons book 50c. Hobart Welding School, Box M-942, Troy, Ohio.

PUBLICITY Pays dividends. Practical 10-lesson course in publicity and public relations. Free pamphlet, "Publicity Is Profitable." Streamlined Publicity Course, Dept. M, 1130 Sacramento Street, San Francisco 8, Calif.

EXCEPTIONAL Peacetime opportunity. Operate a collection agency-credit bureau. Quickly learned. Many make \$5000 yearly up. Write Cole Associates, Syracuse, N. Y.

USED Educational and Technical books bought, sold, rented. Catalog free. Educational Exchange, Henagar, Ala.

"SUREHAND" Legible shorthand never falters. Swiftest numerals. Textbook 25c. Jesse L. Cook, Bartow, Florida.

BECOME A Doctor of Metaphysics (Ms. D.) Teach secret of contentment, happiness. Solve mental worries. Free book. College of Universal Truth, 5133-C North Clark, Chicago.

LEARN Handwriting analysis for pleasure and profit. Postal brings details. Henderson Supply, Liberty, Missouri.

MOVIE Scenario course, dollar postpaid. Oriole Company, Box 942, Baltimore.

ANYONE Who can read can learn to be wealthy! Plan for your greater success? Inquire. Habermann, Box 1642-U, Perry St. Sta., Erie, Penna.

NON-RESIDENT. High school, college, professional degrees. Bulletin free. Capital City College, Washington-5, D. C.

LEARN Profitable credit and collection agency business; investigate Educational Extension Service Advertisement under Business Opportunities.

AMAZING Mind-discovery turns "ordinary" ability into "extraordinary" achievement. Dept. 62P, Box 3766, Philadelphia.

ROADMANS Guide, copyrighted book of unusual show and travel money making secrets \$1.00. Illustrated circular. R. G. dime. Craftsman Books, Box 1153-P3, Milwaukee 1, Wis.

BECOME A finance man. Particulars free. George Lenhoff, Lincoln 8, Nebr.

INVESTIGATOR Training. Phillips Secret Service, 1917-B North Kenneth, Chicago 39, Illinois.

CELESTIAL Navigation kits and worldwide planisphere. Send for descriptive folder. No charge. Addison-Wesley Press, Inc., Kendall Sq. Bldg., Cambridge 42, Mass.

TRISECTION Solution—Divide any angle into three equal parts. Ruler and compass only. Send \$1.25 for your copy of this publication now! Author invented world's only universal focus lens. Pure Science Research Associates, 120 N. Jackson, Moscow, Idaho.

3600 SWAPS in Traders Bulletin. Ads 5c word, 20c copy. Swap instruction course \$1.00. 234 W. Lake, Chicago.

SHORTHAND. Similar, faster, easier to write and read. Prepare for postwar business jobs. This shorthand system highly successful since 1932. Pocket size edition \$1.00 postpaid. Standard Printing Company, Worcester 8, Mass.

HEAT Treat booklet \$1.00. Blacksmithing, tempering 50c. Geo. P. Smith, 519 Kipling Blvd., Lansing 12, Michigan.

DRAFTING, Trigonometry, and slide rule courses. Each \$1 complete! Write Giles, Dept. PM-10, 134 South Commonwealth, Los Angeles.

TOOL Designing pays big. Home study course. Low cost. Easy terms. Free booklet. Ohio Institute of Technology, Box 183, Greenville, Ohio.

GET "Set now!" When the war-time job boom ends, only properly trained men will get and hold permanent positions with top pay. Pick air conditioning, refrigeration, heating, ventilating, welding, electricity, radio or electronics—fastest growing, most promising industries. Prepare now, train in a few months instead of years. Low tuition, liberal terms. Earn part expenses. Big book free, Milwaukee School of Engineering, Box 644, Milwaukee, Wis.

HOME Study course, drugless therapy. Free literature. Inst. of Drugless Therapy, Tama, Iowa.

LIST Of "Home Study" books free. (New, used.) Buy, sell, rent, exchange. Bargains! Dalton, Box 3363, Seattle 14, Wash.

REMEMBER Without effort. Easy five lesson memory course \$1.00. Amazing results. Money back guarantee. Postcard brings particulars. Mighty Midget Publications, Box 566A, Lincoln, Nebraska.

REFRIGERATION Mechanics. Complete home course for repair men. Booklet free. Mechanics School, Dept. PM13, 4703 West Pico, Los Angeles 6.

RADIO Engineering, broadcasting, servicing electronics, aviation, marine and police radio taught thoroughly. All expenses low. Co-educational. Catalog free. Valparaiso Technical Institute, Dept. C, Valparaiso, Ind.

GOOD "Used" self-instruction educational books on all subjects bought, sold, rented, exchanged. Satisfaction guaranteed. Complete information and 92-page illustrated bargain catalog free. Write—Nelson Company, Dept. 2-62, Chicago 4.

CARPENTERS. We teach the square in five easy lessons by mail. Our 1/4 size practice square and simplified instructions does the work. Free information, better still send quarter for practice square and partial lesson. Builders' Topics, Medical Arts Bldg., Seattle, Washington.

USED Educational books on all subjects sold, rented, also bought and exchanged. Moneyback guarantee. Write today for free catalog and details. Lee Mountain, Pisgah, Alabama.

EARN Certified Grapho-Analyst degree analyzing handwriting. Students report earnings up to \$1.00 an hour sparetime, \$75.00 weekly full time. Graduates in employment, credit agencies, police departments, courts, business and in private practice as personal problem and vocational advisors. Fully illustrated Grapho-Analyst and 3000 word illustrated lesson free. Institute, Box 1150, Joplin, Mo.

MEDICAL Laboratory technicians in great demand. We train you in your spare time, in your own home. You can practice while studying. Write for free catalogue. Imperial Technical Institute, Box 973-E, Austin, Texas.

DRUNKENNESS is a disease which responds to treatment. Medical skill plus human sympathy prove successful with liquor and drug cases. 60 years experience. Write for free booklet. P. M. Nelson, The Keeley Institute, Dwight, Ill.

LOCKSMITH Course. Lock picking, key fitting, etc. \$1.00 prepaid. Locksmith, Canadian, Texas.

SECRET Investigation. Experience unnecessary. Investigators particulars free. George Wagner, M 125 West 86th, New York.

PLAYS, STORIES, MANUSCRIPTS

AUTHORS' Unrevised manuscripts rewritten, typed for market. Tinney, 237 Centre, Dallas, Texas.

CARTOONING COMMERCIAL ART, SHOWCARD WRITING, SIGN PAINTING

WRITE Cartoon ideas. Nationally known magazine cartoonist booklet shows how. "Be Funny for Money, 25c." Ush Studios, 518P Wrightwood, Chicago 14.

SIGNWRITING—Cartooning. Inexpensive. Instruction. John Warren, N7560 Smith, Spokane, Wash.

PEN Drawings; good quality, minimum prices. Sanden, 716 21st, Bellingham, Wash.

CARTOONISTS—Sell work, 10 money making plans, 25c. Cartoon Studio, 1402 Charles, Lacrosse, Wis.

BARGAINS — Books, courses, quick landscape painting, poster art-letting, cartooning, art studies, sign painting, etc. Write today for big illustrated list free. Art Book Shop, Kimmswick 6, Mo.

REVISED Modern poster art \$2.00. Catalogue 10c. Sign, Farmington, Missouri.

LEARN How to make show cards and paint signs. All information and instructions \$1.00. Libbey Sales Service, Box 8, Irvington, N. J.

CASH For humorous ideas, Gags! Details: dime! Gerardt, Gaston, Fairmont, W. Va.

CHALK Talks. Laugh producing program, \$1.00. Catalog 10c. Balda The Cartoonist, Oshkosh, Wisconsin.

LEARN Cartooning, a complete self instruction course. Write for free lesson. Cartoon Studio, 1402 Charles, Lacrosse, Wis.

QUALITY Art work. Minimum prices. Sanden, 716 - 21st, Bellingham, Wash.

LEARN Cartooning. Gag writing. Plans, Markets. Drawing set given! Studios, 2438 W. Lincoln, Nebraska.

CARTOONING Course—30 illustrated lessons, over 500 sketches, complete \$1.00. Rex Cartoon Studio, Box 892, Pasadena, Calif.

CARTOON Advertising; also lettering, layout service. Allan K. Jensen, Audubon, Iowa.

CARTOONING Course—30 illustrated lessons, over 500 sketches, complete \$1.00. Montes Studio, Box 892, Pasadena, Calif.

POCKET Size cartoon course—22 easy lessons, over 200 sketches including figures and lettering. Prepared by nationally known artist. Mailed postpaid on receipt of 25c in coin. Snack-Pack Co., 34 E. Georgia St., Indianapolis 4, Ind.

BUSINESS SERVICE

WANT A Washington, D. C., mail address? Complete reforwarding service, \$2.00 monthly. Hawkins, (Est. 1917), 7-a Randolph Place.

MIAMI, Florida, mailing address. Letters reforwarded promptly, 25c each, 5 for \$1.00 cash (no stamps). Send postage with letters properly addressed. Hamaco Service, P.O. Box 1445 Riverside Sta., Miami 35, Fla.

WASHINGTON, D. C. We represent you here. Also receive and forward mail. Write Service Bureau, 1401 25th St. S. E.

DENVER, Colorado, mailing address, represented here. Fool friends, have fun. Letters forwarded. 25c per letter. Box 1754.

ADVERTISING AGENCIES, LETTER WRITERS, FOR ADVERTISERS

20 WORDS, 30 newspapers \$2.00. Goodall, 37 Gardner, Vallejo, California.

ADVERTISE: 24 Words, 149 newspapers \$8.50. Lists free. Advertising Bureau, 4515-C Cottage Grove, Chicago 15.

ADVERTISE Profitably: \$20.00 reaches 5,000,000 Sunday newspaper readers with 24-word ad. Newspaper, magazine, mailing-list ratebook free. Chicago Advertising Agency, 20-PA West Jackson, Chicago 4.

MAILING List, 1,300 fresh names, \$2.00. Seattle address \$1.00. Weston, Box 521, Seattle, Washington.

ADVERTISING Placed anywhere. Copywriting, salesletters, art-work, cuts, business engineering, post-war analysis and markets, foreign service. Associated Advertising, 304 First National Bank Building, Salem, Oregon.

ADVERTISING Ideas that pay. Want ads and display ads placed in out of town newspapers and magazines. Low rates. Catalog free. Baker Advertising Agency, Suers, Ankrum Agency, 189 W. Madison, Chicago.

18 WORDS in 100 weeklies \$4.32. H. J. Darnell, 730 Hays, Jackson, Tennessee.

MAIL Order operators—Get skillfully prepared copy when placing advertising. Our "lowest" line rate plus experience gives you more profits per dollar spent. Van De Mark, Times Star Tower, Cincinnati 2.

FREE—New Advertisers Rate Guide, 44 pages. Includes everything. Lowest rates. E. H. Brown Advertising Agency, Merchandise Mart, Chicago.

ADVERTISING Placed, any publication, lowest rates, complete agency service. Skilled advertising—merchandising counsel. Ratelst and booklet, entitled "Advertising Results For Sale" free. Baker Agency, 3302 Dodge, Omaha, Nebraska.

INCH Display advertisement, 50 magazines, year \$16. Wood's Popular Services, Atlantic City, (N. J.)

TYPEWRITERS, DUPLICATORS, OFFICE DEVICES

"PRINTOMATIC" Self-feeding rotary stencil post card printer, complete, \$9.50. All makes duplicator supplies. Literature free. Pittsburgh Typewriter Supply, 336-B Fourth Avenue, Pittsburgh 22, Penna.

RUBBER STAMPS, OFFICE SUPPLIES

ONE Line 20c, 2—35c, 3—50c, 4—65c. Stamp Works, Auburn, Nebraska.

NAME—Address (2 lines) self-inking pocket stamps \$1.00, postpaid. Press, Warm Springs, Ga.

GIRLS Red lips rubber stamp with pad \$1.00. Mary Struble, Cupertino, Calif.

PRICES Sent on request. Ideal Rubber Stamp Company, Box 83, Grandriver Sta., Detroit 8, Mich.

KNOB Handle, cushioned, 2 lines 30c, 3—40c. Stamp Works, Centerport, N. Y.

3 LINES 30c; Cushioned, indexed, 35c. Signatures \$1.50. Stamprite, Wauwatosa, Wis.

PRINTING OUTFITS AND SUPPLIES

PRINTERS Big money makers. Samples 3c. Murico, Box 748, Dayton 1, Ohio.

PRESSES, Cutters, type, paper, supplies, bargain lists 3c. Levenson, Box 918, New York 8.

PRINTING Presses \$35.00. Send 25c for listings. Valco, 1518 Chestnut, St. Louis, Mo.

BARGAINS — Presses, type, supplies. Send stamp, 8 Walden, Cambridge, Mass.

INEXPENSIVE Home-made printing press. Details free. Novelty Shop, Downs-ville, Louisiana.

PRINTING Equipment, type and supplies. Send stamp for details or dime for complete illustrated supply book. Kelsey Inc., X-11, Meriden, Conn.

PRINT At home, 10c will bring a complete catalog of presses, type and supplies. P. Peiffer & Company, 6 Columbia St., Newark, N. J.

USED Presses, type, supplies. Lists 3c. Turnbaugh Service, Loysville, Penna.

PRINTING, MULTIGRAPHING, MIMEOGRAPHING, GUMMED LABELS

250 LETTERHEADS And envelopes, \$2.75 postpaid. Samples, complete multigraphed letters. William Smith, 3008 87 Street, Jackson Heights, N. Y.

STATIONERY—100 Sheets 6x7, 50 envelopes, printed, \$1.00 postpaid. Greensboro Press, Greensboro, Vermont.

LETTERHEADS, Envelopes or billheads 500, \$2.85; 1000, \$3.85. Free samples, quotations. Wilson Studios, 1728 Monroe, Madison 5, Wisconsin.

\$2.00 POSTPAID: 150 8½x11 Good bond letterheads and 150 6¼ envelopes, 500 of each \$5.75 postpaid. Mero Products, Box 344, Punxsutawney, Penna.

100 LETTERHEADS, 100 Envelopes to match, beautiful Rippelone \$1.25. Clarion Press, Richland, Iowa.

50 CALLING Cards 25c, 2 lines. Franklin, 5415-D South Natoma, Chicago 38.

400 LETTERHEADS \$1.25. Samples free. Mango Print, 555 South 20th, Newark 3, N. J.

DISTINCTIVE Printing: 500 8½x11 bond letterheads or 500 6¼ envelopes, \$2.75 prepaid. Neat work. Fast service. Victor Chicke, Harvey, Illinois.

CALENDARS—Post cards—of dogs, pigeons, canaries, printed stationery. M. Nicodemus, 2156 Berteau Ave., Chicago 18, Ill.

PRINTING—All kinds, any quantity, quality, price, 10 day service. (Rated Dun-Bradstreet). Free list. Press, Farmington, Missouri.

150 8½x11 LETTERHEADS, 150 6¼ Envelopes \$2.00 prepaid. Gago Print Shop, P1544, Muskogee, Oklahoma.

200 8½x11 HAMMERMILL Letterheads correctly printed \$1.00 postpaid. Envelopes, business cards, shipping labels, statements same. Race Printing Company, Hudson, N. Y.

\$4.00, 1,000, LETTERHEADS, Envelopes, statements, cards, etc. Dixie, Chattanooga 7, Tenn.

5000 — 6x9 CIRCULARS, Postcards, \$10.95. Folders, letters — all printing promptly. Samples. Goodprint, Harrisonburg, Va.

100 8½x11 BOND Letterheads and 100 envelopes, postpaid \$1.00. Benneville, 907 West Roosevelt, Philadelphia 40, Penna.

LOW Price printing, quick service. Samples, estimates. Wilson Printing, Dowagiac 2, Mich.

PRINTING Cuts—engravings 10c per square inch—(minimum \$1.00). 1 column halftones \$1.00 each, postpaid. List and samples free. Superior Engraving Co., Parkersburg, W. Va.

200 8½x11 BOND Letterheads \$1.00 postpaid. Schmitt Press, 2560 Stafford, Pittsburgh 4, Penna.

1,000 6x9 CIRCULARS \$2.75 Postpaid. Bargains. Merchants Press, Taylor, Tex.

3000—6x9 CIRCULARS \$5.85 postpaid to 4th zone. Education Publishers, Pittsfield, Mass.

WE Print booklets, small periodicals, folders. Estimates free. Psychical Publishers, Remington, Indiana.

FIRST Quality printing. Reasonable. Samples. Treaster Printing, 9-44PM, Millroy, Penna.

QUALITY Printing. Lowest prices. All types of work. Send for free samples. William Leedom, 356-A Mt. Carmel Avenue, Glenside, Pennsylvania.

ENVELOPES, Letterheads, mimeographed forms, 500, \$2.00; 1000, \$3.75; 5000, \$14.95. Victory, 3708-PM Cranston, Baltimore, Md.

QUALITY Printing moderately priced. What do you need? Prices on anything. Samples. Schweikle, 334 Market Street, South Williamsport 32, Penna.

PERSONALIZED Christmas greetings, 25 for \$1.00. Eastover, Box 4092, Elizabeth Station, Charlotte 4, N. C.

LET Us help you in all your printing needs. Lowest prices. State requirements. Printing Service, 7923 South Vermont Ave., Los Angeles 44, Calif.

MIMEOGRAPHING—Any copy. Reasonable. Mailers Service, Box 606, Chicago 90, Ill.

MIMEOGRAPHING—Letters, pricelists, formulas, instructions. Lowest prices. Lem's Letter Shop, 5710 Stanton, Detroit 8.

500 3½x2¼ FOUR Line gummed stickers, 25c. Moritz Printery, Saginaw, Mich.

BETTER Grade printing reasonable. Estimates on anything. Economic Press, Leonia, N. J.

PATENT ATTORNEYS

INVENTORS—First things come first. Your first move toward securing a patent on your invention is acquiring full information on what to do. Our two books "Patent Protection" and "When and How to Sell Your Invention" contain this information and other helpful data. Get them immediately, together with our "Evidence of Invention" form. They cost you nothing, you assume no obligation. Write now to Victor J. Evans & Co., Registered Patent Attorneys, 831-K Merlin Building, Washington 6, D. C.

INVENTORS: Learn now—without obligation—how to protect and sell your invention. Write for free "Record of Invention" form and complete information for making disclosure and establishing date of your invention. We also send our free "Patent Guide for the Inventor," containing complete information about patent procedure and how to sell inventions; giving illustrations of many successful inventions; over 150 basic mechanical movements. We assure you prompt, confidential service. Delays may be dangerous. Write today for your free "Patent Guide" and "Record of Invention" form. Clarence A. O'Brien & Harvey Jacobson, Registered Patent Attorneys, 41B-J Adams Building, Washington, D. C.

INVENTORS—Industry needs your ideas now! Manufacturers are getting ready now for post-war sales and production. Factories must have products to take up the slack after war orders stop. Get our new free inventor's book today and valuable "Invention Record" form. Act now. McMorro and Berman, 134-B Albee Building, Washington, D. C.

PATENT Attorney since 1904; easy terms; reasonable. Sanders, 6439 Evans, Chicago 37, Illinois.

PATENT—Particulars and blanks, free, airmailed. Sterling Buck, Park-North Avenues, Baltimore 17, Md. Government-registered 38 years.

"INVENTOR'S Guide." 100 mechanical movements, free; advises on patenting, selling inventions. Frank W. Ledermann, 154 Nassau Street, New York.

PATENTS, Promptness assured. Wilfred E. Lawson, 1524 K Street, N.W., Washington 5, D. C.

C. A. SNOW & Co., M-427 Snow Bldg., Washington 1, D. C. Registered patent attorneys. Established 1875. Literature mailed on request.

PATENTS Obtained; selling service, information, recording forms free. Labner, World Building, New York.

L. F. RANDOLPH, 302-B Columbia Bldg., Washington, D. C. Low cost. Book and information free.

PATENTS. Protect your idea by securing free "Proof of Invention" folder. Exceptional personal service. Established 1908. E. E. Vrooman, 871 Woodard Bldg., Washington, D. C.

PATENTS—Trade marks. Preliminary advice, book and disclosure form free. Personal service. Irving L. McCathran, 315 McLachlin Bldg., Washington 1, D. C. Registered Patent Attorney.

FOR INVENTORS

INVENTORS: Learn how to sell inventions. Free booklet, "Selling Your Invention." Inventors Exchange, 635 Main, Hartford, Connecticut.

INVENTORS Models—Made to scale in plastic, wax, plaster. Send details. We send free estimates. We are trusted. Chas. Riise Co., 263 Stewart St., Reno, Nevada.

PATENT Your idea! Write immediately for two free illustrated books, "Patent Protection" and "When and How to Sell an Invention." 64 pages of valuable information for inventors. No obligation. Address: Victor J. Evans & Co., 832-K Merlin Bldg., Washington 6, D. C.

INVENTORS: Learn now—without obligation—how to protect and sell your invention. Write for free "Record of Invention" form and complete instructions for making disclosure and establishing date of your invention. We also send our new free "Patent Guide for the Inventor," containing complete information about patent procedure and how to sell inventions; giving illustrations of many successful inventions; over 150 basic mechanical movements. We assure you prompt, confidential service. Delays may be dangerous. Write today for your free "Patent Guide" and "Record of Invention" form. Clarence A. O'Brien & Harvey Jacobson, Registered Patent Attorneys, 41A-J Adams Building, Washington, D. C.

WHAT Should you invent? Our free book tells you what today's inventive market wants—how to put down, patent and sell your ideas. Scores of letters in our files attest to the modern demand for inventions—our long experience as Registered Patent Attorneys will help you. Get our free book, "How to Protect, Finance and Sell Your Invention." Also special document free, "Invention Record" on which to sketch and describe your invention. Write today. No obligation. McMorrow & Berman, Patent Attorneys, 134-A Albee Building, Washington, D. C.

MANUFACTURER'S Names, addresses. State classification desired. Tupper, 18-A Lyman, Beverly, Mass.

INVENTORS: New military and commercial inventions urgently needed by manufacturers. Write for particulars. Chartered Institute, Dept. 4-A, Washington, D. C.

CASH For practical ideas and inventions. Mr. Ball, AB-9441 Pleasant, Chicago.

I SELL Patents. Established in 1900. Charles A. Scott, 713PM Garson Ave., Rochester, N. Y.

INVENTIONS WANTED

HAVE You a patent or patentable idea for a new product? If you have and it meets our requirements, responsible Eastern manufacturer will make and market it and pay you cash or liberal royalty. We are equipped to make any metal or plastic product, small to medium size. We are not interested in the ordinary, run-of-the-mill type of inventions. But if product or idea has outstanding features and can be made and sold in large volume, we are definitely interested. Company has ample capital, a resourceful engineering staff, and one of the best selling organizations in the country. Send brief description covering patent situation, market possibilities, etc., and state whether it has been offered to other manufacturers. If interested conference will be arranged through our representatives in key cities. Address: Research Dept., P.O. Box 646, Buffalo, N. Y.

HAVE Manufacturing plant and sales connections. Want new ideas. Kaydee Mfg., Long Beach, California.

PLASTIC Manufacturer will buy or manufacture on royalty basis, patented or patentable articles. Twenty years plastic experience. United Plastic Works, 8947 Exposition Blvd., Los Angeles 34, Calif.

WANTED—Patented or unpatented ideas for postwar manufacture. Submit plans and proposition. Sierra Mfg. Co., 610 So. Arroyo Pky., Pasadena 2, Calif.

ENTERPRISING Concern wants postwar products; extremely well set up, equipped shop; can manufacture, finance, handle sales. Write Barco Machine Products Company, 1975 East 65th Street, Cleveland, Ohio.

CASH For inventions, patented, unpatented. Mr. Ball, A-9441 Pleasant, Chicago.

MANUFACTURER Wants sensible mechanical device or idea with quick sales possibilities in low-priced field. Write Matt, 1412-D Great Northern Building, Chicago 4.

INVENTIONS Wanted—Extensive sales service. Seymour, 218 Aurora, Easton, Md.

INVENTORS—Reach purchasing manufacturers direct; patented, unpatented inventions. Booklet, references, free. Invention Reporter, 5B-11236 So. Fairfield, Chicago.

ALL Kinds. We have facilities and finances to make and sell your ideas, both mechanical and chemical. Send model, sample, details and wishes. General Sales & Supply Company, 110 East Main St., Madison 3, Wisconsin.

INVENTORS! Have you good, patentable ideas? Write—Mr. Metzler, 11 West 42nd, New York.

INVENTORS: Have you a sound, practical invention for sale, patented or unpatented? If so, write Chartered Institute of American Inventors, Dept. 4-D, Washington, D. C.

PATENTS FOR SALE

SEVEN Inventions combined in one. Traffic signal, fire, police, etc., patented. No reasonable offer refused. J. Massey, 1500 W. 69 Street, Los Angeles 44, Calif.

BOWLING Ball cleaning and polishing machine. Patent 2339573. Knipp, Long Beach, Calif.

PATENT: Sell or royalty. Novelty punch knife designed on sound principle. Excellent defense weapon. Poster, 2574 Ida, Omaha 11, Nebr.

SELL Outright. Patented gadget removes Spanish moss from trees, telegraph, telephone and electric light wires. I. Scudder, 9201 Hudson Boulevard, North Bergen, N. J.

POSTWAR Priming will pay us! Investigate. Plastic compounds dispenser delivers uniformly, continuously. T. Passen, Franklin Mine, Mich.

PATENT Pending railway signal device. Simple, effective. Serves badly needed purpose, low cost field, royalty basis. Ellis Mitchell, Ellard, Virginia.

MANUFACTURING

BRONZE Bushings from half inch up. Immediate delivery. 35 cents pound plus carriage. Heinlein Brass Foundry, 1448 South Third, Columbus 7, Ohio.

MODELS—Small lot manufacturing. Metals, plastics, etc. Milburn, Burlington, Kentucky.

HOME CRAFTSMEN

DELIGHTFUL All wood cart. For Christmas or sale. Simple, Sturdy, Plans 25c. Studio, Box 136, Jericho, L. I.

THE Shebel Piler files all saws. Send for circular. A. P. Shebel, T30 S. 2nd St., Milwaukee 4, Wis.

28 LAWN Ornament patterns 25c. Other patterns: 15"-20" high; Dutch girl; Dutch boy, pirate, bull terrier, Mexican girl, Mexican boy, dwarf, penguin, flower girl, 10c each; 3 for 25c. 25 novelty patterns 30c. All 82 full size patterns \$1.00 postpaid. Strother, Box 383-FZ, Belington, W. Va.

EXTRA Cash. Build and sell toy electric cannons. Loads like real cannon. Accurately shoots steel shells by magnetic propulsion, 110 volts. Power tools unnecessary. Drawings, instructions, photograph \$1.00. Details free. Hamilton, 650-A South 20th Street, Newark 3, New Jersey.

PATTERNS For fast selling toys. Ten for \$1.00. Homer Gabert, Eau Claire, Wis.

CONVERT Craftsman (or similar) drill-press to unlimited reach capacity. Nothing to buy. Instructions \$1.00. Reich, 661, Huntington, W. Va.

BLUEPRINTS—Photo cell 25c, dehydrator \$1.00. Stamp for list, Mets, 7039 Frankstown Ave., Pittsburgh, Penna.

MAKE Saleable "brass" electric lanterns from tin cans and glass jars. Drawings and directions 4 models \$1.00. Worthycraft, 43 Lovell Road, Melrose, Mass.

CELLULOSE—Beautiful assortment. Mottles, opaques, onyx, pearls. Used by ring makers everywhere. One pound assortment—pieces approximately 30 sq. in. each. Price \$1.00. Craft Service, 337 University Ave., Rochester, N. Y.

DESIGN Smart leather ornaments. Kit—7 pieces colored leather, 18 patterns, \$1.00. Beginners kit 25c. Vogue Leathers, Box 6, Fairfield 3, Iowa.

TOYS—Bulldozer, power shovel, and earthmover of new design in wood. Make toys for your home town of scrap lumber with hand or power tools. Prints showing construction and detail \$1.00. Earthmover Toys, E. Lansing, Michigan.

DO Shell craft at home. Fascinating, profitable. Beginners kit \$1.00. "Temple," Box 533 Station A, St. Petersburg, Fla.

CATALOG: Large line decal transfers. Patterns for jig sawing. New designs easy to make novelty furniture, lawn ornaments, silhouettes, letters and numerals, 100 crafts and hobbies illustrated booklets. Tools. Other lines. 500 articles finely illustrated. Write Wo-Met Shop, Ashburn, Georgia.

RENOVATE Your own venetian blinds. Get new tape, cord, hardware. Venetian Blind Supply Co., 1612 Farwell, Chicago 26.

PLYWOOD—Beautiful non priority aircraft stock. Thickness 1/32" through 1/2"; large, small panels. Fir, gum, birch, mahogany. Reasonable! Lists free! Carmen-Bronson, 160-B East Fourth Street, Mount Vernon, N. Y.

PLANS For 30 original toys in wood. \$1.00. W. S. Hess, Dover 1, Penna.

GUARANTEED Precision pantographs. \$2.00 postpaid. Enlarges drawings automatically. Eliminates squares. Details dime. Pantographs, Munising, Mich.

MODELS AND MODEL SUPPLIES

RAILWAY Models, complete line, informative catalog HO and O gauge, 79 pages, 15c. Walthers, 247 Erie, Milwaukee, Wisconsin.

SEE Our advertisement on page 36A of this issue. Model Railroader Magazine, Milwaukee 3, Wis.

SHIP Models and yacht supplies complete. Large 64 page catalogue 25c. Bill Wild's 510 East 11 St., New York City.

CATALOG 50 Engines, model railroad supplies, 25c refunded. Simonsen Model Supply, A-3054 North Greenview, Chicago 13.

PLANES, Boats, hundreds of hobby items. Catalog 6c. America's Hobby Center, Dept. B94, 40 E. 21 St., New York 10, N. Y.

WE Develop your ideas, build models, necessary tools and dies for quantity production, have fully equipped plant and engineering dept. Will finance if necessary. Logan Elec Spec. Co., 214 S. Loomis, Chicago 7, Ill.

MODEL Steam engines, boilers. Circular M 10c. Anton Bohaboy, 2297 Price St., Rahway, New Jersey.

SHIP Model kits and fittings. Complete line Fisher model yacht equipment. All Boucher, Fisher, Marine Model and Ideal kits, fittings and blueprints at standard prices. Most complete stock in New England. James Bliss & Co., Inc., 230 State Street, Boston, Massachusetts.

MAKE IT YOURSELF

BARBECUE Plans. Build your own "vertical" barbecue with our four sheet master set of plans; 49 detail drawings, complete instructions, easy to build, inexpensive, \$1.00 postpaid. Allen Seiby Associates, 1836-A Chase Ave., Chicago 28, Ill.

BUILD Your own rechargeable batteries. Instructions \$1.00. Rosengren, Hyannis, Mass.

ELECTRIC Alarm from old spring clock. Easily built. Complete plan \$1.00. W. H. Cash, Box 416, Chula Vista, Calif.

BUILD A proven long life regular size storage flash light battery easy. No technical knowledge needed. Material secured anywhere cheap. No priorities. Recharge from car battery, little current used. Instructions one dollar. B. Wayland, Red Bluff, Calif.

BUILD It yourself. Automatic overhead garage doors operated from drivers seat. Used auto parts and other material available everywhere cheap. Use 1/4 h.p. motor. Tried and tested. Be first in your neighborhood to build one. Complete plans \$1.00. McIntosh Projects, 2479 Coolidge Ave., Oakland 1, Calif.

FLUORESCENT Lights. How to make your own 20 watt lights for less than \$1.00 each. Complete, guaranteed, detailed instructions \$1.00 M.O. or war stamp. Specialty Sales, Box 1085, Muncie, Ind.

WATCHES, OLD GOLD, JEWELRY, ETC.

GUARANTEED Men's reconditioned Swiss wrist watches. Look and run like new. Reasonably priced. Free particulars. Hamilton and Company, 407A North Broadway, St. Louis, Missouri.

GOLD \$35.00 Ounce—Mail old gold teeth, diamonds, jewelry, watches—receive cash by return mail. Satisfaction guaranteed. Free information. Dr. Weisberg's Gold Refining Company, 1300-Q Hennepin, Minneapolis, Minn.

LADIES' Beautiful diamond rings \$7.98, tax inc. Size 5 to 7 1/2. Velvet lined box. Murrays, 2654 Downing St., Denver, Colo.

WATCH Repairing easy learned by our home study course. Watch repairers are in demand and are among the highest paid craftsmen today. Write for free information. Houston Chronometer & Watch Co., P.O. Box 5367C, Houston 12, Texas.

1000 ALARM Clocks wanted. Any kind or condition. Highest prices paid for old watches. Alarm Clock Repair Service, P.O. Box 1983, Dept. M, Houston, Texas.

WANTED: Watches, diamonds, jewelry. Highest prices guaranteed! Justice, Box 150, Chicago 90.

WATCH And clock repairing—complete practical course in modern horology. 66 illustrated self-instruction lessons. Just out! Low price. Information free. Write—Nelson Company, Dept. 8-02-2, Chicago 4.

OPALS. Sample packet \$5.00. Catalogue free. Norman Seward, Melbourne, Australia.

WATCHES, Materials, tools, jewelry, diamonds—bought—sold. Catalogue. Gales, Box 1000, Chicago.

TOBACCO, SMOKERS' SUPPLIES

SAVE 50% On cigarettes. Send for free catalog trial offer. Sidney Ram, 59 West Monroe, M-64, Chicago 3, Illinois.

RAZORS, BLADES, SHARPENING

100 DOUBLE-EDGE Blue surgical steel razor blades \$1.50 prepaid. Fully guaranteed. St. Moritz Blade Co., 321 Broadway, Dept. H, New York 7.

AGENTS—Patented "Slant-Stroke" razor and 10 "All American" blades in attractive box. \$3.00 dozen. American Sales, 1133 Broadway, New York City.

FOR SALE—MISCELLANEOUS

ARMY Airplane seats. Plywood. 600 f.o.b. \$200.00. Professional Products, Madisonville, Cincinnati.

SELF-WINDING Extension reels equipped with 16 feet No. 18 electric cord. Suitable for factory or garage. These reels manufactured by Vacuum Cleaner Corporation of America on special order. Closing out at \$2.25 each postpaid. Radio Reel Co., 1116 Rust Building, Tacoma 2, Wash.

WANTED—MISCELLANEOUS

WANT Coin operated machines—all kinds. Describe. Adair Company, Box 1667, Oak Park, Illinois.

GOLD Coins wanted. Will pay 50% above face value. Ralph Shaw, 707 So. Broadway, Los Angeles, California.

WANT To buy: Old time music boxes. North Side News, Sheboygan, Wis.

WE Have buyers-traders everywhere for anything you wish to sell-trade. List 20c. Swappers Guide, 610 St. Joseph, 12, Evansville, Indiana.

WE Buy "anything"! Highest prices guaranteed! Justice, Box 150, Chicago 90.

MERCURY (Quicksilver)—Cadmium, bismuth, tungsten, molybdenum, cobalt, vanadium. Write for quotations stating quantity. You'll receive guaranteed prices. Metallurgical Products Co., 35th and Moore Sts., Philadelphia, Penna. Established 1908.

WATCHES Wanted—Broken or usable—all kinds, even ingersolls. Highest prices paid for jewelry, rings, spectacles, alarm clocks, razors, cigarette lighters, gold teeth, etc. Cash mailed promptly. Lowe's, Holland Bldg., St. Louis 1, Mo.

PERSONAL

SEE Your name in newspaper headlines. Startle your friends. Fun galore. Free details. Write Horne, Box 372L, Back Bay Annex, Boston 17, Mass.

PERSONALIZED Pencils—Individual or firm name imprinted gold. Economical for school and office. Dozen 50c, 3 dozen \$1.00, gross \$3.60 cash, delivered. Pencil Market, 611 - 15th St., Knoxville 16, Tenn.

SLEEPING. Swimming or hunting you need Sleep-Rite Protectors, soft waxen earstoppers. Users coast to coast say—"great," "wonderful," "real blessing." Guaranteed package 10c. Free "sleep" literature. Raymond Dow, 15 Park Row (1215 S), New York 7.

SECURITY Acres, a living from the land, a city lot, or a five acre plot. Information free. Clark System, Ellwood City, Penna.

BOXING Expertly taught! Authoritative book, formerly \$1.00—Special 45c, 3 for \$1.25 postpaid! Sold for advertising, not profit! Majestic Sales, Box 242, Kansas City 17, Kansas.

BUY Vitamins, half price. Vitamin guide free. Richardson, Wyoming, Penna.

ESTATE Records and investigations. Heirs, others located. Chaffee, 308 Washington, Chicago 6.

HAIR Falling? Dandruff? Write Trichologist, 137 Lewis St., Phillipsburg, N. J.

MEN! Women! Look neat, save money. "Comb-trim" hair—head, arms, legs. Kiddies, too! 60c. Guaranteed. Park Sales, 235 Congress, Bridgeport 4, Conn.

LAST Will and Testament of Adolph Hitler, 3 copies 25c. Walter Arnold, 122 N. Dearborn St., Philadelphia, Penna.

YOUR New York mail address. Receive and forward your business or personal mail \$1 monthly. New York City Mailing Service, 501 West 145 St., New York 31, N. Y., Dept. 5.

FOOTPAIN? Use Sulfon, 16 footbaths \$1. Ruko, 8409 Talbot, Kew Gardens, N. Y.

DEVELOP Mindpower, concentration, memory. Unfailing book \$1.00. Booklovers, 28 Cassius Street, New Haven, Conn.

PSORIASIS Sufferers: Pixacol has brought relief when everything else failed. Use only as directed. Apply externally, dries quickly, convenient. Try regular \$1 bottle without investing a cent! Write: Pixacol, Box 3583, Cleveland, Ohio.

WANT Someone located U. S., Canada? Write Chaffee, 308 Washington, Chicago 6.

BURNING Feet—stinging callouses quickly relieved. Literature free. Lumco Products, Kimball, Neb.

PSORIASIS. Write for some real facts. Stamp. Groff, Box 502, Norristown, Penna.

BEAT Rationing! Make your shoes last longer! Simple directions \$1.00. Free particulars. Grey's, Box 1151c, Vero Beach, Florida.

TATTOOING Outfits, designs, colors. Write today. Zeis Studio, 728 Lesley, Rockford, Illinois.

GIRL Photos, beautiful models, only \$1.00 for group. "Little Eve," Box 211, Terre Haute, Indiana.

PENMANSHIP Corrector—Corrects your penmanship—few hours. Write, Ozment, 9, St. Louis, Mo.

BUY Vitamins direct. Save. Postcard. Matoska Products, White Bear Lake, Minn.

MEXICAN Legal matters reliably handled. A. Munoz, 246, Juarez, Mexico.

LIVE Longer, feel better, enjoy life. Free information. Fairchild Company, Mt. Vernon, Ohio.

DRUNKENNESS is a disease which responds to treatment. Medical skill plus human sympathy prove successful with liquor and drug cases. 60 years experience. Write for free booklet. P. M. Nelson. The Keeley Institute, Dwight, Ill.

MISCELLANEOUS

PORTRAIT Reproductions of all 31 American presidents, facsimile of Independence Declaration, ready to frame and New York souvenir book, 100 fascinating photos, only \$1. Free with order: 3 N. Y. view cards. Pretend you are in N. Y. Write cards, return, I'll mail. (Letters mailed 10c, other cities 15c.) Dealer price for photos, etc. free. Haller, 446 N. Y. Ave., Brooklyn 25, N. Y. Write. Any day. Any year.

MAGAZINES Covering 175 vocations—616 different periodicals. Learn more—earn more. Literature free. Commercial Engraving Publishing Co., 34D North Ritter, Indianapolis 1, Indiana.

REFRIGERATION Principle outlined. Trouble shooting instructions. Learn to repair any refrigerator. \$1.00 postpaid. Robert Gray, 908 East Main, Houma, Louisiana.

MAKE Your friends laugh with this comic "powder room" catalog. Robust but inoffensive humor. Mail to men and women in service. Fun at parties. Unique as Christmas cards. In amusing envelope. 25c each; 8 with comical place cards \$1; wholesale, 50 for \$3; postpaid in States if cash or stamps with order. Highlights, 1808 West 99th, Chicago 43, Illinois.

YOUR Photos copied: coloroidal. J. Black, 1249 S. Grand, Los Angeles.

ATTENTION. Gas station operators! Driveway "service signals" available. Free literature. Knipp, Long Beach, Calif.

BOYS—Girls, earn extra money easily, bonus. Write Victory, Box 179b, Dowagiac, Mich.

AZTEC Feather birds greeting cards, dozen \$2.50, samples 25c; jumping beans, dozen 25c, hundred \$1.00. Mexican Products, 126 N. Main, Tulsa 3, Oklahoma.

BIG Mail for you. Latest moneymaking offers, opportunities, catalogs, magazines. Name listed in directory 10c. Ideal Service, 109-M, Park Ridge, Ill.

INK Powder 25c (pint). Park Sales, 235 Congress, Bridgeport 4, Conn.

POCKET Shoe cloth 5c postpaid. Essential Products Co., Williamsburg 1, Mo.

HULA Skirts—Largest supply U. S. \$1.75—\$7.50. Write for catalog. Oahu Publishing Company, 892 Film Building, Cleveland 14, Ohio.

GUATEMALAN Carved mahogany plates. Beautiful handloomed Mexican tablecloths. Details free. Francis T. Coleman, Anthony, New Mexico.

GIGANTIC Mails, magazines, catalogs, samples, listing 10c. Waddell's, 309 East 75th, New York 21.

PRETEND You are in Boston. Three historic post-card views 25c. You write message, address and return. We mail from Boston. Letter service 15c. Wilson, Box 69, Dover, Mass.

BURIED Treasure and lost mines—300 locations in United States. Information free. Treasure Trove, Box 346-P, Springdale, Ark.

FOOL Your friends. Pretend you are in San Francisco. 3 post-cards sent 25c (20—\$1.00). You write message, address, return. I remain in San Francisco. Letters mailed 15c. Your friends will think you're traveling. Ira Smith, 153 Liberty St., San Francisco 10, Calif.

PEOPLE Have been buying Steach Clamps since 1940. Why not write for free booklet? Steach Clamp Co., 423 Sprague St., Dedham, Mass.

SQUARE Dance instructions, calls, 25 sets, \$1.00. Rayburn, Lonsdale, Arkansas.

FREE—Illustrated movie photo catalogue, listing movie stars, bathing suit poses, candid photos, band leaders, vocalists, etc. Send ten cents to cover handling and mailing which will be refunded with order. Irving P. Klaw, 309 East 14 St., New York City 3.

AMAZING 248-Year calendar, 1752-2000, 25c coin. Christensen, Box 1346, Salt Lake City.

HAWAIIAN Scenic postcards fool your friends. We send three for 25c. You write messages, addresses, return. We mail from Hawaii to Mainland. Letters 20c. Selsler, 2312 Kaala Ave., Honolulu 5, Territory Hawaii.

FLORIDA Cocoanuts for souvenirs. Only \$1.35 each. No stamps. Tropical Service, Box 85, Little River Sta., Miami, Fla.

BIGGEST Money in tattooing now! No experience required. Complete instructions with outfits. Send for free literature. Tatuco, 651 South State, Chicago.

RECEIVE Mails, magazines, samples. Your name in numerous mailing lists 10c. Howard, 396 Broadway, New York.

PORTRAIT Sketch from your photo in pen, pencil or litho crayon \$1.00. Oil \$5.00. Comic sketch \$1.00. Stewack, Lock Box 35, Downers Grove, Ill.

ALARM Clock stopped? Fix it yourself—anybody can—many have—simple. Illustrated directions show how. 25c. Magill, Germantown Manor, Philadelphia 19, Pa.

COMPLETE Character analysis, based on the Bible \$1.00. Holice Britt White, Ph.D., 1445 San Felipe Crts., Houston, Texas.

BOYS—Girls, write for free gift. David Berg, 659 Churchill, Bridgeport 29, Conn.

GOOD "Used" self-instruction educational books on all subjects bought, sold, rented, exchanged. Satisfaction guaranteed. Complete information and 92-page illustrated bargain catalog free. Write—Nelson Company, Dept. 2-02-3, Chicago 4.

KILL Roaches, bedbugs, moths instantly guaranteed, makes one gallon, \$1.00. Pamat's, 227 Woodbine, Brooklyn 21, N. Y.

THE Lord is coming! Get guaranteed proofs free. Scheall, 293-X, Duluth, Minnesota.

MEDICAL Laboratory technicians in great demand. We train you in your spare time, in your own home. You can practice while studying. Write for free catalogue. Imperial Technical Institute, Box 973-J, Austin, Texas.

PREVENT SMALL FIRES. LARGE FIRES.



A recent frightful increase in fire hazards has stepped up the demand for fire protection equipment to a new high. FYR-FYTERS have a very high rating in the fire equipment field, while the demand exceeds the supply just now. This backlog of business will necessitate a greatly increased sales force for our coming sales program expansion. If you want a postwar selling job, write us today. Tell us about yourself in confidence. We may have just the money-making opportunity you are seeking.

THE FYR-FYTER CO.
Dept. 90 Dayton 2, Ohio

Fyr-Fyter

ALARM CLOCKS

THOUSANDS OF ALARM CLOCKS NEED REPAIRING. Cash in on this flood of work. Jewelry stores swamped. Watchmakers too busy repairing watches. Easy to learn course with illustrations, pictures, tools and necessary material furnished with course.

Write for free information.
ALARM CLOCK REPAIR SERVICE
P. O. Box 1983 Houston 1, Texas

RADIO MADE EASY

Repair any radio. Learn quickly. New large manual tells how. Hints, pictures, diagrams to help you. Size: 8-1/2x11 in. **25¢**

Supreme Publications, 328 S. Jefferson St., Chicago 6, ILL.

A SIMPLIFIED ART ANATOMY OF THE HUMAN FIGURE
ONLY 51 POSTPAID

by Charles Carlson. The book they're talking about! One of the most informative books of its kind for both student and professional artists. Charts, notes, and over 350 drawings show detailed studies of every part of the body, posed and in action.

HOUSE OF LITTLE BOOKS, 156-160 Fifth Ave., New York

PLASTICS DESIGN ENGINEERING

Wartime applications have proved the peacetime possibilities of PLASTICS. Get ready now for this big postwar opportunity. Prepare yourself for a highly paid position in Plastics Industrial Engineering. Complete home training course now available. Send name and state age.

OHIO INSTITUTE OF TECHNOLOGY, Box P-181, Greenville, Ohio

Make BIG MONEY in Coming REAL ESTATE BOOM!

PREPARE NOW for a big pay, permanent job or your own 6-Profit business in the predicted post-war real estate boom! Salaries up to \$2,500.00 to \$10,000.00 a year in property management, brokerage, appraisal, loans, insurance, building. Dignified, pleasant work. Many make fortunes in real estate. Thousands of trained men, women required yearly by real estate firms, insurance companies, banks, Federal agencies, etc. Coming real estate boom means even bigger demand for workers, greater earnings, larger profits. Rush post-card or coupon for FREE 32-Page QUIZ BOOK and full details on Modern Real Estate Practice—first and only complete, popular-priced home training and reference library in this entire field. **Hurry!**

JOB SEEKERS! REALTORS! OWNERS! BUILDERS! INVESTORS!

RUSH COUPON OR POST-CARD FOR 32-Page FREE BOOK!

LANE BOOKS, INC.
100 E. Ohio St., Dept. B-9, Chicago 11, Illinois
Send me FREE, POSTPAID and WITHOUT OBLIGATION, your 32-Page QUIZ BOOK and complete details on Modern Real Estate Practice.

Name _____
Home Address _____

"I'll show YOU how to make yourself COMMANDO-TOUGH ... in double-quick time"



...OR IT WON'T COST YOU A CENT!"
says *George F. Jowett*

WORLD'S GREATEST BODY BUILDER

Let me prove to YOU that you can put inches of dynamic muscles on your arms! Add inches to your chest! Broaden your shoulders and power-pack the rest of your body, I can do for you what I've done for thousands the world over, including many officers and men now in the U.S. and British Armed Forces!

GIVE ME 10 MINUTES A DAY!
I'll Show You My Secrets Of Body Building

I'll help you learn the "Progressive Power Method" through which I rebuilt myself from a physical wreck to the holder of more strength records than any other living athlete or teacher! No matter how skinny or flabby you are, you can learn my methods right in your own home. Through my proved secrets I show you how to develop your power, inside and out, until YOU are fully satisfied that you are the man you want to be. "The Jowett System," says R. F. Kelly, Physical Director of the YMCA, Atlantic City, "is the greatest in the world!"

If you want a physique that will inspire respect from men, and admiration from women... **ACT LIKE A HE-MAN!** Decide at once! The famous book, "Nerves of Steel—Muscles Like Iron" will be included FREE! Priced for the strength fan! Full of photos of marvelous power-bodied men who will show you what Jowett has done for them and how he can do the same for you. Reach out... Grasp this Special Offer today!

PROVE TO YOURSELF IN ONE NIGHT!

Send only 25c for test Course, "Molding a Mighty Arm." Read it the evening it arrives—learn from experience the thrill you can give your muscles!

SEND FOR THESE FIVE FAMOUS COURSES IN BOOK FORM ONLY 25c EACH or ALL 5 for \$1.00

This Book Free!



BOOK WITH PHOTOS OF FAMOUS STRONG MEN FREE MAIL COUPON NOW

Jowett Institute of Physical Culture
230 Fifth Avenue, Dept. 479, New York 1, N.Y.

George F. Jowett: Your proposition looks good to me. Send by return mail, prepaid, the courses checked below for which I enclose (). Include FREE book of PHOTOS.

George F. Jowett Champion of Champions

All 5 courses for... \$1 Molding Mighty Legs 25c
 Molding a Mighty Arm 25c Molding a Mighty Grip 25c
 Molding a Mighty Back 25c Molding a Mighty Chest 25c
 Send all 5 C.O.D. (\$1 plus postage.) No orders less than \$1 sent C.O.D.

NAME _____ Age _____
(Print name)

ADDRESS _____

★ SAVE WASTE PAPER ★

SHEET METAL INFORMATION

SIZE 7" x 10" x 2"
1125 PAGES



ON LAYOUTS

NOW READY!

A practical, illustrated Encyclopedia covering all phases of Sheet Metal Work including Pattern Cutting, Pattern Development, and Shop Procedure—Developed by experts for Sheet Metal Workers, Layout Men, Mechanics, and Students.

1001 KEY FACTS AT YOUR FINGER ENDS

10 Big Sections, 350 Layouts, 1600 illust. FULLY INDEXED FOR READY REFERENCE in answering your layout problems. Easy to read and understand. Well printed in clear type. Flexible covers.

\$4 COMPLETE • PAY ONLY \$1 A MO. To get this assistance for yourself simply fill in and mail order today.

AUDEL Publishers, 49 West 23rd St., New York
Mail AUDEL'S SHEET METAL PATTERN LAYOUTS BOOK. Price \$4 on 7 Days Free Trial. If O. K. I will remit \$1 in 7 days and \$1 monthly until \$4 is paid. Otherwise I will return it.

NAME _____
ADDRESS _____
OCCUPATION _____
REFERENCE _____

It's Easy to Master

REFRIGERATION

and AIR CONDITIONING

SERVICING

—with diversified equipment, good instructors, well-planned lessons. Use the facilities that have trained over 30,000 students for good-paying positions in leading technical fields. Complete refrigeration course in 3 months designed especially for the man who wants to have a business of his own. Six month course includes Air Conditioning. Moderate tuition—send coupon NOW.

President Oscar Warwath, P. 544, North Broadway and East State, Milwaukee, Wisconsin

Please send Free Booklet—and give me complete information on—

() REFRIGERATION SERVICING..... 3 months

() REFRIGERATION & AIR CONDITIONING..... 6 months

() TECHNICIAN'S COURSE..... 1 year

also Electronic—Arc Welding—Aircraft Welding—Drafting—Electrical Engineering (B.S. Degree).

Name.....Address.....

City and State.....Age.....P.M.

Milwaukee School of Engineering

WANTED

**IDEAS, INVENTIONS,
HIGH-PRECISION PRODUCTS
FOR POST-WAR MANUFACTURE**

This Company, with 2 modern factories, and 1,400 employees, at present engaged in the most exacting type of high-precision war production, wants new inventions or products requiring high-precision and skill for post-war production. Consider outright purchase or royalty basis.

Write New Products Division, Dept. PM 9

THE MB MANUFACTURING CO.
NEW HAVEN, CONN.

"730 SHAVES FROM 1 BLADE"

AMAZING NEW BLADE SHARPENER



New sharpener for all makes of double-edge razor blades performs miracles! "Not necessary to change blades," writes one user. Another says, "Have used 1 blade over 730 times." RAZOROLL really sharpens blades because it strokes an leather. Gives keen, smooth shaving edges. No guess-work. Blade held at correct angle and proper pressure—automatically. Just turn crank to sharpen blade. No gears. Well made. Handsome, compact, sturdy. Weighs few ounces. Will last years. Makes ideal gift.



Only \$1.00

SEND NO MONEY! Write today. Pay postman only \$1 plus few cents postage. Use RAZOROLL for 6 days and if you're not delighted with smooth, velvet shaves you get, return RAZOROLL and we'll return your dollar. Hurry—order today. RAZOROLL COMPANY
620 North Michigan Avenue, Dept. 509, Chicago 11, Illinois

★ SAVE WASTE PAPER ★

SYN-FLO LIQUID-PLASTIC

YOU APPLY WITH A BRUSH

This is really it! A brilliant white plastic coating to beautify walls of bathrooms, kitchens—anywhere. A post-war scientific discovery. A true plastic, yet you apply it with a brush; when dry, your walls are coated with a long-wearing, high-gloss film of white plastic that will not scratch.

★ NO BRUSH MARKS
★ NON-YELLOWING

SYNFLO is made of some ingredients as modern plastic articles. It dries to a tough finish that can be scrubbed or washed like porcelain. The finish of the future—ready TODAY!

Money Back Guarantee
No. 1 for walls, woodwork; No. 2 for furniture. Pure white! Or can be tinted. \$5.95 for gal. with Special Thinner, express prepaid. Willship COD if desired.

**ORDER NOW
FREE ILLUSTRATED
CIRCULAR**

5⁹⁵ PER GALLON

SUPERIOR PAINT AND VARNISH WORKS
2256 NORTH ELSTON AVENUE · CHICAGO 14

Learn AIRCRAFT DESIGNING & ENGINEERING from RYAN

New Home Study Method Fits You For Bigger Pay in Aviation

The aircraft industry needs trained draftsmen and engineers NOW—and for the big TOMORROW in Aviation. Ryan's new Home Study Method offering you "direct-from-industry" training in Aeronautical Drafting and Engineering will prepare you during your spare time for a top-paying job and a future. It's a safe bet that many of the pleasure and commercial airplanes after the war will be created by Ryan Trained Draftsmen and Engineers. Course is easy to understand. No higher education or special experience necessary. Pay as you learn. Send coupon today for FREE 24-page book... "New Horizons of Opportunity." To save time, send coupon air mail.

Free! This Interesting 24-page Illustrated Book, Full Information and Costs

RYAN Aeronautical Institute
429 Lindbergh Field, San Diego 1, Calif.

Please send me, without any obligation on my part, your FREE 24-page illustrated book, "New Horizons of Opportunity," and full information on R.A.I., including cost of training and job opportunities.

Name _____ Age _____
Street _____
City _____ State _____

STOP RADIO STATIC



The ALL WAVE radio filter is guaranteed to help you get perfect radio reception. Eliminates all hums, clicks, crackles, etc., caused by electric razors, vacuum cleaners, motors and other electrical appliances. The ALL WAVE is a scientific and compact radio filter that can be used on any make electric radio. To connect, just put your radio plug thru the ALL WAVE's slotted opening and into any wall outlet. 15 DAY FREE TRIAL. Sent C.O.D. for \$1.50 plus postage. Cash orders sent postpaid. Rush order—supply limited. Vogue Eliminator Co., 7759 S. Halsted, Dept. AW-602, Chicago 20, Ill.

TELEVISION

Residence school. 36 weeks. Tuition \$495.00. Free tuition to VETERANS. You build a television set to keep it. Learn in the HEART of the television industry. Founded 1910. Pioneers in television education.

NEW YORK TECHNICAL INSTITUTE (of N. J.)
158 Market Street, Newark, N. J.

FUN AND PROFIT FROM YOUR HOME WORKSHOP



New 1945 "WHAT TO MAKE" is now ready. One of these books is issued each year and is a reprint of articles which have been published in our "Craftsman" Department. Hundreds of ideas that can be used around your home workshop in one handy, 224-page volume. Get book from your News Dealer or send 50c to

POPULAR MECHANICS PRESS
Dept. 568 200 E. Ontario Chicago 11

Correspondence Courses in RADIO and ELECTRICAL ENGINEERING

LOW AS \$25

ELECTRICAL ENGINEERING. Get good grasp of wide electrical field. Modern. Very understandable. Theory made easy.

RADIO ENGINEERING. Extra fine course in radio, public address, photo-electric work. Trains you to be super-service man, real vacuum tube technician. Tuition ONLY \$25 either course. Deferred payment plan. Servicemen needed badly. Write for free copies of school catalog, student magazines, etc.

FREE LINCOLN ENGINEERING SCHOOL, Box 61—P 69 LINCOLN, NEBR. (Formerly of Washington, D. C.)

★ **SAVE WASTE PAPER** ★

There's always room and BIG PAY in POWER!

War or peace, keeping the wheels of industry and the nation's utilities turning is a basic job—one there's always room, and big money, in for the expert. Take the short-cut way to a better-paying power plant job. Do as thousands of others have, to their definite gain—spend a short time daily and systematically reading and using these books.



The Library of POWER PLANT PRACTICE

6 volumes — 2,477 pages, 2,404 illustrations

These six books cover the subjects of power plant practice completely and in every detail from the foundations and coal passing to the very tops of plant smoke stacks. They give you knowledge of boilers, steam engines, steam turbines, pumps, boiler-feed apparatus, and other equipment—their construction and performance—how to select them—how to test and maintain them—how to improve efficiency and economy in operating them. Descriptions, instructions, data, questions, problems and answers, more than 2,000 detailed diagrams and illustrations—make clear why as well as how to do the work.

Free Examination—Special Price—Easy Terms

SEND THIS MCGRAW-HILL COUPON

MCGRAW-HILL BOOK CO., 330 W. 42nd St., N. Y. 18

Send me for ten days' examination the Library of Power Plant Practice. If satisfactory I will send you \$2.00 in 10 days and \$2.00 monthly until the price of \$16.00 is paid. If not wanted I will return the books postpaid. (To insure prompt shipment write plainly and fill in all lines.)

Name _____
Home Address _____
City and State _____
Position _____
Name of Company _____ PSM-9-44

SIGNS EASILY AND EXPERTLY PAINTED WITH LETTER PATTERNS

AND SHOWCARDS MANY SIZES & STYLES WHITE FOR FOLDER!

JOHN F. RAHN
1330 31 N. Central Ave. CHICAGO 51, ILL.

BROOKLYN YMCA TRADE SCHOOL

YMCA Making Plastic Molds

Learn this newest trade for post-war jobs or defense work.

Full Shop equipment. Unexcelled instruction. Fireproof dormitories. Also 2-yr. day Pre-Engineering courses.

Check your interests on coupon to receive free literature.

- Making Plastic Molds
- Aviation Mechanic
- Machinist
- Mechanical Pre-Engineering
- Diesel Pre-Engineering
- Mechanical Drafting
- Auto Mechanic
- Refrigeration
- Television and Radio Mechanic
- Architectural Drafting
- Armature Winding
- Welding
- Tool and Die Making
- Oil Burner
- Talking Pictures
- Diesel Engines
- Electrical

MAIL COUPON

1117 Bedford Ave., Dept. P.M. Brooklyn, New York City, N. Y.

Name _____
Address _____

So-Lo SAVES RUBBER

AND MOST ANYTHING MADE OF LEATHER AND CLOTH

- Spreads Like Butter
- Dries Hard Overnight
- Flexible—Non-Skid
- Waterproof—Won't Come Off



Longer Life for TIRES

Easy to fix cuts, bruises, worn spots in tires at home. Keeps out grit and water. Add hundreds of miles wear to your tires with SO-LO.

Re-Sole Your Own SHOES

Easy—at home. Spread on So-Lo like butter. Wears like leather. Use it for all footwear, children's and grownups'. Also use So-Lo for raincoats, boots, etc. Guaranteed to SAVE!



1,001 Repairs in the Home, Auto, Farm, Factory and Shop



FOR ONLY **1¢** EACH



So-Lo

AT ANY HARDWARE AND 10c STORE

"The Book They're Talking About"

For the amateur and professional artist. Contains over 350 illustrations, charts and notes, giving detailed study of every part of the body. **POSED and IN ACTION.** Price Only **\$1**
 CANADA, \$1.25 ENRIGHT CO., Dept. 40-A, P.O. Box 45, FOREST HILLS, NEW YORK

In Every Shop

Men Who Can Lead are paid well..

Lincoln Extension Institute offers instructions for shop leadership. The course combines the essentials of shop engineering with the development of personal power thru knowledge and handling of the human factors present in every industry. Men with this training are invariably marked for promotion and bigger pay. More about this important training is told in "Getting Ahead in Industry," a booklet which will be mailed upon request. Address Mr. Louis S. Vosburgh, LINCOLN EXTENSION INSTITUTE, INC. West 75th St. at Detroit, Cleveland, Ohio



You Can fix ALARM CLOCKS

New, practical home course. Just out. Makes interesting hobby—profitable too. Save money by doing your own repairing at home. Easy if you know how. Price now only \$1.00. Details FREE. Send postcard.

THIES JEWELRY STORE, Genoa 3, Illinois

LAW

STUDY AT HOME for PERSONAL SUCCESS and LARGER EARNING. 35 years expert instruction—over 108,000 students enrolled. L.L.B. Degree awarded. All texts furnished. Easy payments. Send for FREE BOOK—"Law and Executive Guidance."

AMERICAN EXTENSION SCHOOL OF LAW, Dept. 48-M, 646 N. Michigan Ave., Chicago 11, Ill.



AUTO BOOKS SENT FREE

ON APPROVAL. Just mail the coupon and we'll send you a complete set of Six Big Auto Books, 20th Edition. Whether you are a mechanic or helper, expert or apprentice, auto owner or driver, take immediate advantage of this FREE EXAMINATION OFFER.

MAKE GOOD MONEY NOW HOLD A PERMANENT JOB

America's autos must be kept in service, now and after the war. Men with "know how" are in demand, at big pay. These books will help you get and hold an important job, or give you a chance to go into business for yourself now or later. Any man who half tries to improve himself can learn auto servicing and repairing by this quick reference method. Use the JIFFY INDEX to find easily understood answer to any auto problem. These wonder books prepared by eleven of America's great automobile engineers. Many hundreds of valuable illustrations. Send the coupon TODAY.

A year's consulting privileges with our engineers now given with these books without extra charge. Vocational Publishers Since 1898

AMERICAN TECHNICAL SOCIETY, Dept. A619, 585 N. Dearborn Ave., Chicago 37, Ill.

I would like to examine your Six-Volume Set of Auto Books. I will pay the delivery charges only, but if I choose I may return them express collect. If after 10 days use I prefer to keep them, I will send you \$2 and pay the balance at the rate of only \$3 a month until \$24.80 has been paid. Please include consulting service as offered above.

Name

Address

City

State

Please attach letter stating age, occupation and address of employer and of at least one business man as reference. Men in service, also please give home address.



IS YOUR INVENTION ON THE POST WAR CALENDAR?

If you have a metal product, patented or patent pending, or an invention beyond the idea stage on which you can furnish clear sketches and written description, write us fully about it. We may have an interest in common. Your rights will be scrupulously respected.



152 W. SLAUSON
LOS ANGELES 3
CALIFORNIA

NATIONAL
MACHINE
PRODUCTS

PRECISION
CRAFTSMEN

★ SAVE WASTE PAPER ★



RADIO *Made Easy*

Learn to repair radios quickly. Simplified explanations, 288 diagrams and pictures, thousands of practical hints to help you. Covers every radio topic. New edition. For home study. 19 large lessons, only \$2.98, complete. Satisfaction guaranteed or money back.

SUPREME PUBLICATIONS 328 S. Jefferson St. Chicago 6, ILL.

Pays HOSPITAL BILLS for Whole Family

**Costs 3c a Day for Adults
Only 1½c a Day for Children**

It's here! The new Family Hospital and Surgical Expense Policy you need and want! One policy insures whole family—mother, father, children, anyone from 3 months to 65 years. No medical examination. Pays up to \$510.00 hospital and surgical bills for EACH and EVERY person insured. Pays up to \$100.00 doctor's fees for operations. Pays up to \$50.00 for operating room, medicines, ambulance, etc. Covers sicknesses, accidents, operations, childbirth, female disorders, and many other disabilities not covered by other policies. You select your own doctor and hospital. This full-coverage Family Hospital and Surgical Policy issued DIRECT to you at special family rates by big, strong company with over \$3,000,000.00 in assets. Investigate! SEND NO MONEY, but mail the coupon below quick for full details—sent FREE. No agent will call on you. Act today!

STERLING INSURANCE CO.
4776 Sterling Bldg., Chicago 11, Ill.
Send me your FREE INSPECTION Offer of **LOW-COST**
Family Hospitalization Plan.

NAME.....
ADDRESS.....
CITY..... STATE.....

FREE!



The famous 64-page, fact-packed book that has stimulated thousands of men!

"Forging Ahead in Business" is a practical, thoughtfully-written book with "punch" and common sense on every page. It carries a message of vital importance to every man who wants to make more money, get a better job and improve his station in life.

Partial Contents:

- Law of Success
- Highway of Achievement
- Forging a Career
- Making Decisions
- Organized Knowledge
- Failure and Success

Noted Contributors

Among the prominent men who have contributed to the Institute's training plan, which is described in "Forging Ahead in Business," are: Thomas J. Watson, President, International Business Machines Corp.; Clifton Slusser, Vice President, Goodyear Tire & Rubber Co.; Frederick W. Pickard, Vice President and Director, E. I. du Pont de Nemours & Co.

Simply return the coupon below, and your FREE copy of "Forging Ahead in Business" will be mailed to you.

MAIL COUPON TODAY

ALEXANDER HAMILTON INSTITUTE
Dept. 173, 71 West 23rd Street, New York 10, N. Y.
In Canada: 54 Wellington Street, West, Toronto 1, Ont.
Please mail me, without cost, a copy of the 64-page book—"FORGING AHEAD IN BUSINESS."

Name.....
Firm Name.....
Business Address.....
Position.....
Home Address.....

Listen to this Record!

SPEAK SPANISH

FRENCH, GERMAN, OR ITALIAN

Big opportunities awaiting Americans who speak Spanish. Learn as a child learns—"by listening" to these brand-new CORTINA recordings.

Only 15 Minutes a Day

Cortinaphone Method famous for 60 years. THOUSANDS have found it the most fascinating, most satisfactory method. Here is the quick, easy way to learn Spanish for PLEASURE AND BUSINESS. INVESTIGATE!

Sent on 5 Days Approval



"The Cortinaphone Short-Cut"—tells just what you want to know. Interesting. Get it!

Write Today—NOW!

CORTINA Academy (Language Specialists for 60 Yrs.)
Suite 649, 105 W. 40th St., New York 18, N. Y.

Please send me—without obligation—your free booklet. I am interested in (mark):

SPANISH French Italian German

Name

Address

BE A PLASTICS FABRICATOR

You can fabricate beautiful, modern, practical plastics gift items at home—for fun or for profits.

EASY. No special tools or training necessary. Easy, fascinating, clean, profitable.

WE SUPPLY PLASTICS. Choose items you want from our catalog. We send you crystal-clear Lucite or Plexiglas, cut to size, ready to assemble.

YOUR OWN BUSINESS. With a little experience, you can make these articles to sell at a good profit. Start your own profitable plastics busi-

ness! Earn big money!

SELL FAST. There is a big demand for beautiful, practical gift items. Sell directly to stores. Take advance orders.

CHRISTMAS GIFTS. Ideal for Christmas giving or selling—but start now!

GET CATALOG. Start yourself on this fascinating hobby or career now. Mail the coupon today for details and our catalog of many items.

Dept. PM-9, 2850 W. Ave. 35, Los Angeles 41, Calif.

PLASTICS FABRICATORS

Dept. PM-9, 2850 W. Ave. 35,
Los Angeles 41, Calif.

Please send me your catalog and complete details on how I can be a plastics fabricator, no obligation.

Name.....
Address.....
City.....Zone.....St.....

FREE CATALOG

YOU CAN EASILY MAKE Telescopes — Magnifiers — Photographic Gadgets and HUNDREDS of EXPERIMENTS with LOW COST LENSES

Big 10 Page Project and Idea Booklet with all sets—describes successful developments—points the way to new experiments.

ALL LENSES NEW, finely ground and polished, edges very slightly chipped—**A SALVAGE BARGAIN!**

Set No. 305-H "The Gadgeteer's Delight" 35 Lenses for \$5.00 Postpaid. Contains all the lenses in the above set plus twenty more expensive lenses increasing your field of experiment and gadget making. All our lenses are neatly packed and marked.

Set No. 310-H "The Experimenter's Dream" 60 Lenses and New Complete 50 Page Booklet—\$10.00 Postpaid. Contains all the lenses in the above sets plus 25 others that makes this a sensational buy. The variety of lenses in this set will enable you to conduct countless experiments and build a wide variety of optical equipment.

50 Page Illustrated Idea Booklet "Fun With Chipped Edge Lenses" Only \$1.00. The Complete Hand Book describing a wide variety of exciting experiments.

END OF WAR BARGAINS

A sensational war surplus bargain in **TANK PRISMS.** Prices slashed to dispose of these quickly. A 90-45-45 degree prism manufactured for use in U. S. Government tank periscopes. Huge size . . . 5 3/4" long, 2 1/2" wide! Finely ground, polished, slightly chipped. Stock No. 3004-H . . . **SILVERED TANK PRISM. Price \$2.00 each postpaid.** Use two to make a periscope.

Stock No. 3005-H . . . **PLAIN TANK PRISM, Price \$2.00 each postpaid.** This one is excellent for projecting all the colors of the spectrum . . . a beautiful sight. Individuals, colleges, high schools, researchers, everyone should buy these at once. The most sensational bargain we have ever been able to offer.

Make Your Own RIFLESCOPE. Complete set 5 matched Achromatic Lenses, originally produced for U. S. Navy gunscopes—3 1/2" Power. Order No. 2000-H . . . **\$11.00 Postpaid.**

16MM. Achromatic Projecting Lenses. Set No. 4002-H . . . consists of 2 cemented achromats, 18.5 MM. diameter with effective focal length of 2". Originally mfd. for U. S. Government . . . **\$4.00 Postpaid.**

EDMUND SALVAGE CO.

27 W. Clinton Ave., Dept. 11, P. O. Audubon, N. J.



New 1945 SHOP NOTES Now Ready FOR EVERY MAN WHO USES TOOLS

One of these books is issued each year and is a reprint of articles published in our Shop Notes Department. It contains cream of experience of years, of hundreds of our country's most successful mechanics. Get a copy from your News Dealer, or send 50c to

POPULAR MECHANICS PRESS
Dept. 565 200 E. Ontario Chicago 11, Ill.

FORTY POWER TOOLS

You Can Build at Low Cost

Now a NEW EDITION
FEATURING TOOLS MADE OF WOOD

Power tools for your home workshop—at a cost anyone can afford. Make them yourself—lathes, drill presses, sanding machines, shaper, circular, hand, and scroll saws and other power tools—from old auto, sewing machine, and other discarded parts that cost very little. Get the new edition, "Forty Power Tools You Can Make", and follow simple instructions, diagrams and photographs. Make yourself up to date, efficient machines that will do a good job for you and save you time, hard work, and many dollars.

Send \$1.25 for "Forty Power Tools You Can Make" today or order on postal card and pay postman on delivery anywhere in U. S. A. Your money back if not satisfied.

POPULAR MECHANICS PRESS, Dept. 567, 200 E. Ontario, Chicago, 11

THIS GREAT BOOK

HOW TO BREAK and TRAIN HORSES FREE!

Every farmer, every lover of horseflesh should have a copy of it. This amazing book tells how to know horses—how to break them—how to train them—how to make money as a master horseman. Write for it today—FREE, together with my special offer of a course in Animal Breeding without cost to you. If you are interested in Gaiting and Riding the saddle horse, check here Do it today—now. You'll never regret it.

BEERY SCHOOL OF HORSEMANSHIP
Dept. 1109 • Pleasant Hill, Ohio

LEARN MOVIE THEATRE MANAGEMENT

The Motion Picture Theatre Business offers big opportunities for trained men. Free catalog. Give age. Established 17 years.

THEATRE SCHOOL, 370 Washington Street, Elmira, New York

PREPARE NOW FOR A BIG PAY POSTWAR JOB

With The "COACHMASTER"

A helpful "coaching aid" of priceless value that prepares you for civil service and better job examinations. Packed with simplified guidance instructions for home study and reference. A stepping stone to postwar security.

ORDER NOW— Send \$1 for the COACHMASTER'S GUIDE BOOK, postpaid. Money back if not satisfied with its job aid value.

COACHMASTER, Dept. CM-9, Hutchinson, Kansas

Lovely **DALE EVANS** Says:

"IT'S EASY TO LEARN DANCING!"

DALE EVANS, Republic star of "Yellow Rose of Texas"

DANCE IN 5 DAYS . . . OR NO COST!

LEARN NEWEST STEPS—INCLUDING RHUMBA, SAMBA, CONGA and JITTERBUG, FOX TROT and WALTZ.

Let dancing open the door to Romance and Happiness for you! This sensational new book helps you learn the latest steps, quickly, easily. A revolutionary book that offers a shortcut to dancing. **MAKE THIS TEST!** Send today for Betty Lee's amazing book—it's packed full of diagrams and tells in simple language how to do the Jitterbug, Rhumba, Conga, Samba and other exciting new dances

—also the ever-popular Waltz, Fox Trot, and many old-time favorites. **SEND NO MONEY!** Act now, and we'll send you as a gift, 2 additional books FREE of any extra charge, "Tip Top Tapping," and "Swing Steps." And remember—if not satisfied with results in 5 days you may return the book and your money will be refunded.

PIONEER PUBLICATIONS, INC.
1790 Broadway, Dept. 949H
New York 19, N. Y.

Send me by return mail, in plain wrapper "Dancing," by Betty Lee, and include 2 free books.

Ship C.O.D. I will pay on arrival, plus postage.

I enclose \$1.98. Ship postage prepaid.

If in 5 days I do not learn to dance, I may return book and you will refund purchase price.

Name.....
Address.....
City.....State.....

TWO BOOKS FREE

MEN whether you are **16 OR UP TO 50**

Come to **COYNE** for a great future in

RADIO-ELECTRONICS

"Learn-by-Doing" on Real Radio Apparatus!



Prepare for a great Peace time future and a good job in Radio-Electronics now. Coyne "LEARN BY DOING" training covers latest developments in this field. Prepare quickly, easily. Fascinating well paid work in maintenance, installation and servicing Radio-Electronic equipment.

TELEVISION

If you have an all-around Radio-Electronic training, there are great opportunities for you. Tremendous expansion in Radio-Electronics, Frequency Modulation and Television predicted after the war—a world of new opportunities. Get ready for a Peace time future and a good job NOW with practical Coyne Radio Training.

Many Branches if You Have All-around Training

Why be satisfied with a narrow, no-future line when by putting in a short time in my Shops, you can qualify for unlimited opportunities in RADIO-ELECTRONICS, today's fast-growing field! These pictures show only a few of the big jobs for trained Radio-Electronics Men.

I'LL FINANCE YOUR TRAINING!

Don't let lack of money hold you back. You can GET TRAINING first—then pay your tuition IN EASY MONTHLY PAYMENTS STARTING 60 DAYS AFTER YOUR TRAINING PERIOD IS OVER. I also help you get part-time work to help pay living expenses while training if you need it, and give you Lifetime Job Service as a Coyne graduate.

SEND FOR FREE BOOK

Fully illustrated with big pictures of my Shops—facts about your future. Mail coupon now. No obligation. No salesman will call. Act today!

H. C. LEWIS, Pres., RADIO DIV. COYNE ELECTRICAL SCHOOL
500 S. Paulina St., Dept. 64-3H, Chicago 12

We also have facilities for men with physical disabilities—write for particulars.

H. C. LEWIS, Pres., RADIO DIV. COYNE ELECTRICAL SCHOOL
500 S. Paulina St., Dept. 64-3H, Chicago 12, Illinois.

Send FREE BOOK, "Your Future in Radio-Electronics" and details of easy "Pay-After-Graduation" plan.

NAME.....AGE.....

ADDRESS.....

CITY.....STATE.....

★ SAVE WASTE PAPER ★

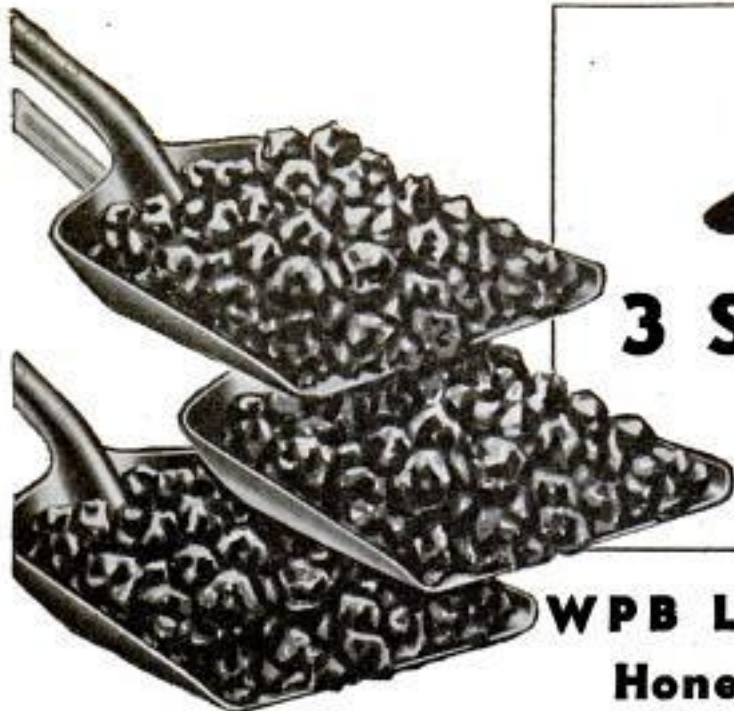

Save 3 SHOVELS FULL A DAY!

WPB LIFTS PRIORITIES ON Honeywell "Electric Janitor" DAMPER CONTROLS

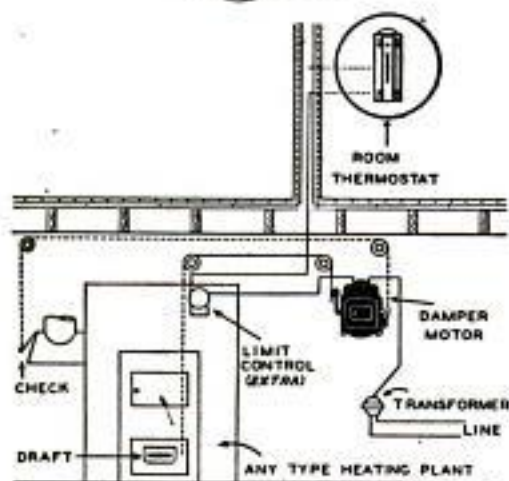

TO SAVE COAL next winter, materials have been released for the manufacture of Minneapolis-Honeywell damper controls for hand-fired heating plants.

Honeywell's damper control is called the "Electric Janitor" because it regulates your heat automatically. Just set the Honeywell thermostat at the temperature you want and the Electric Janitor will do the rest. It can save you from 10 to 30% of your coal bill, give you 24 hour comfort and save you many steps.

The Electric Janitor comes in a complete package with everything needed for quick installation. It requires no changes in your present heating system and can be installed in a few hours with ordinary house tools.

Only a limited number of controls have been released. So go to your heating dealer without delay and place your order for installation before Fall. If your dealer doesn't have an Electric Janitor in stock, he can obtain it from his jobber.

ELECTRIC JANITOR PACKAGE

Includes Honeywell thermostat, electric damper motor, transformer, chain, pulleys, cable and all accessories needed to install.

\$23⁰⁰
PLUS INSTALLATION

LIMIT CONTROL EXTRA



Damper Motor



Honeywell
"Heat-leveling"
Thermostat

MINNEAPOLIS
Honeywell
TEMPERATURE CONTROLS

Makers of the famous M-H Electronic Autopilot, used on AAF four-engined bombers

POPULAR MECHANICS

Popular Mechanics Magazine

REGISTERED IN U. S. PATENT OFFICE AND CANADA

WRITTEN SO YOU CAN UNDERSTAND IT

Vol. 82

M. S. S. SEPTEMBER, 1944

0339

No. 3



"The ROCKET'S
RED GLARE"

British Official photo

Loading rocket projectiles under wing of an R.A.F. Typhoon on an air field in Normandy, shortly after D-Day

THE war of the rockets burst into full flame with the invasion of Nazi Europe.

In the last days of the "softening up," fleets of rocket-toting planes swarmed over the Norman coast and wiped out all enemy radio installations. Thus deprived of listening posts, the Germans failed to detect the approach of airborne troops.

On D-Day unlovely little barges bobbed in the sea just off the invasion beach, and from their decks erupted lovely orange shafts that arched into the shore defenses with devastating effect. These were the LCR's—landing craft, rockets—one of the newest of the new breed of landing vessels, their decks bristling with row on row of rocket projectors.

Through the surf and up the beaches waddled rugged amphibious "Ducks" spouting rockets from multibarreled guns. Bazookas made the Yankee infantryman a walking tankbuster. British and American fighter planes carrying four rockets under each wing went hunting for tank formations or singled out Nazi command posts for heat treatment, and within a week after D-Day Typhoons and Beaufighters, Swordfish and Hurricanes and rocket-mounting Mustangs and Thunderbolts were working over the enemy from fields on French soil.

And it was about that moment that the German rockets began soaring across the Channel to bury their 2,200-pound explo-

SEPTEMBER, 1944

rocket weapons made by:
Diamond Match Co. 1



The carrier-borne Grumman Avenger above carries racks for four rockets under each wing

sive noses in London and the ports of southern England. They are not really rockets; rather flying torpedoes, or jet-propelled miniature planes carrying a terrific wallop and traveling as far as 150 miles. Their distance of travel can be controlled by the amount of fuel or the rate of its expenditure; their general direction by takeoff from fixed ramps aimed toward the target, plus an automatic gyropilot pre-set to continue the robot in its initial direction. This does not, however, prevent deflection by the wind.

However, the flying bomb is quite incapable of hitting a specific military target at any distance. At first it was thought to be radio-controlled, like the

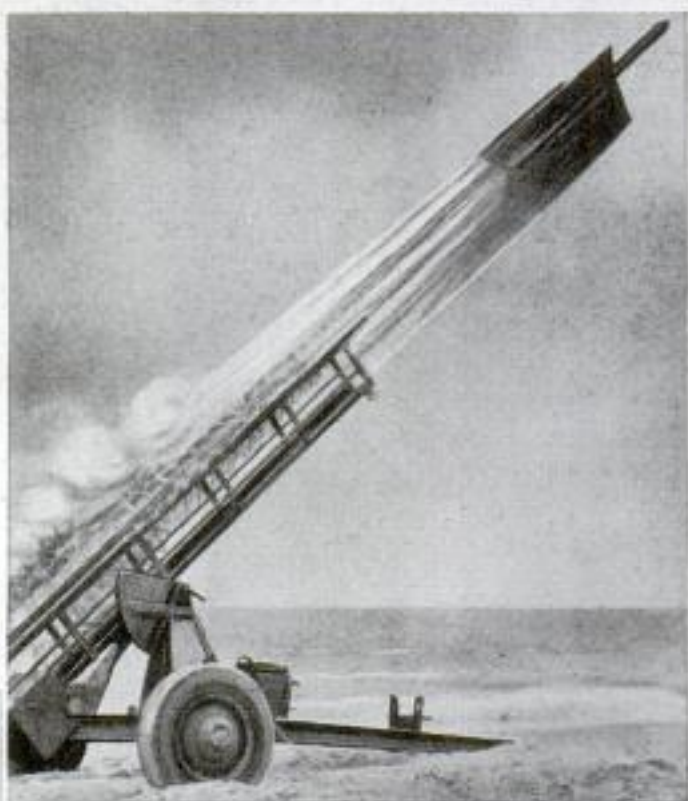

Antiaircraft gunners practice by firing at rockets, launched from wheeled projectors (left and above) at a seaside range

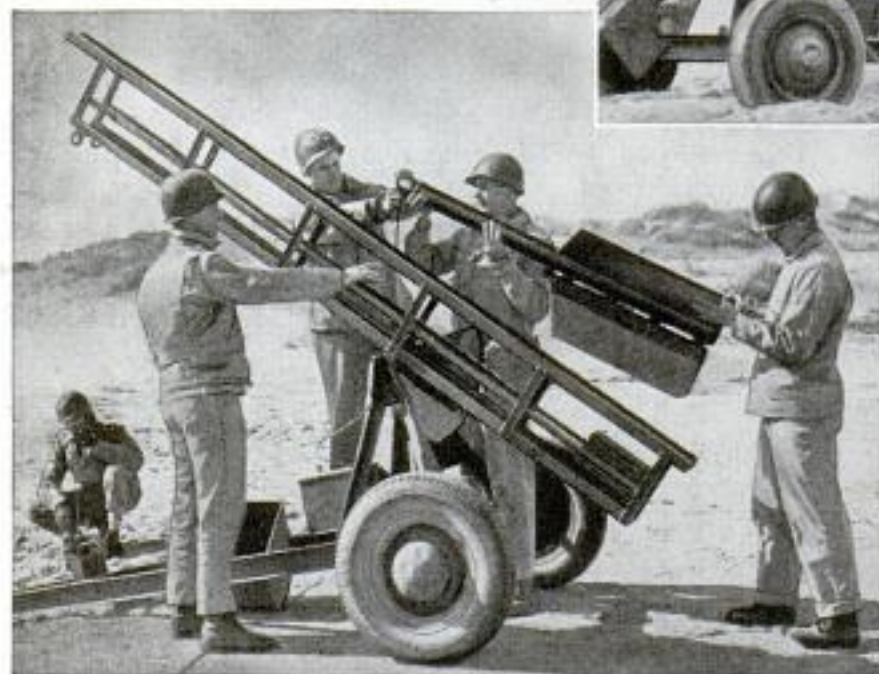

glider bombs used by the Nazis against Mediterranean shipping last year. These were launched from parent planes and guided by radio to their targets. When the Allies discovered how to "jam" their controls and sometimes sent the gliders chasing their own parents back across the sky, the Ger-

mans dropped that idea like a hot plate.

Two gyroscopes control the course of the robot, one governing its altitude and the other lateral guidance. Horribly effective in an indiscriminate way—against a large city target such as London—the flying torpedo probably has no effect on the war's outcome. Its local destructive blast is immense, and in its first 21 days of employment it killed on the average one person per 2,200-pound bomb: 2,750 bombs took 2,752 lives, and injured some 8,000 persons. Compared with the pinpointing of military objectives by Allied bomber and rocket planes, the robot is a nuisance of small strategic value. It has caused multiple tragedies and property loss, and has diverted numbers of anti-aircraft guns and fighter planes to defense. And it has served as a pilotless pinch-hitter for the German Luftwaffe at a moment when German bombers are virtually nonexistent and German fighters a vanishing race.

The fuselage of the flying torpedo is 21 feet 10 inches long and 2 feet 8 inches wide; its overall length including the jet propeller mounted above the tail is 25 feet 4.25 inches, and its wing span 16 feet. A larger robot is on the rumor list.

The Germans have also introduced recently their copy of the American ba-

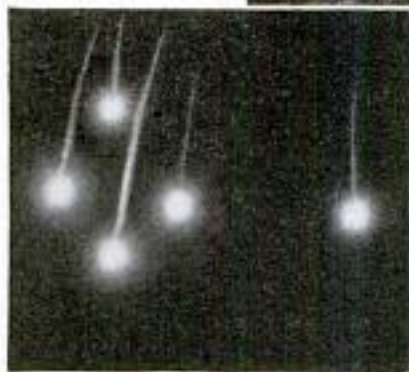

Grenade launcher above is sending up a rocket signal used for communications at front; note the five-starred signal. Below, an artist's conception of the winged bomb launched by the Germans against England
British Official photo

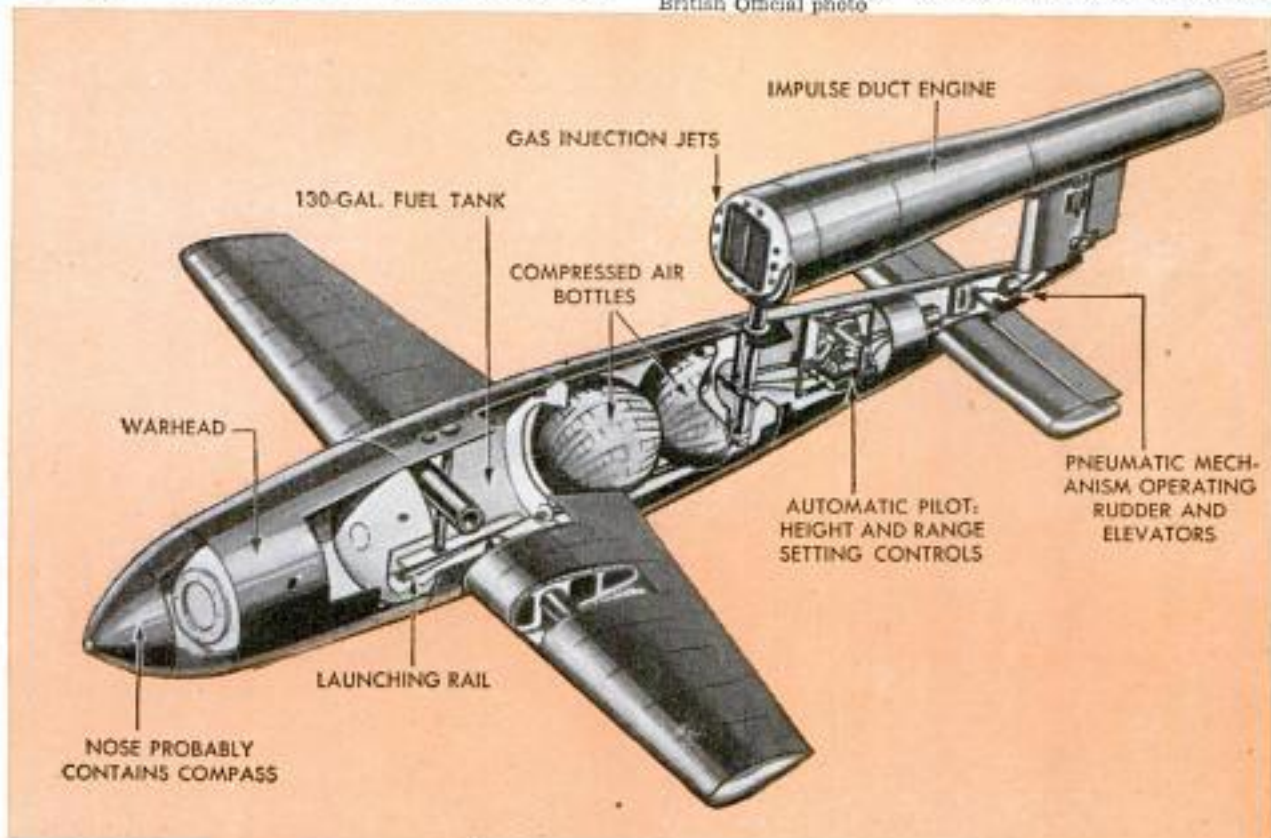



British Official photo

Erecting multiple-barreled rocket guns to fight off planes over England

zooka. First reports indicate it is a one-man "waterpipe" gun firing an 88-millimeter shell that has a terrific wallop at 50-yards range, but lacks accuracy and loses impetus beyond that.

Our own bazooka has been dubbed the "shoulder 75" by Nazis who scrambled out of tanks and pillboxes hands first when the rocket burst through their armor. It will

from Russian warplanes.

This famous pair, the Katusha and the bazooka, became the parents of a sky rocket—the flying bazooka. A lightweight weapon like the Yankee bazooka, that has such a powerful blast effect coupled with light weight and absence of recoil, would be an ideal air weapon, and the U. S. Army Air Force and Navy both began develop-

penetrate brick walls and shatter rock, smash through the toughest enemy tank the Allies have encountered, and on one occasion a Yankee colonel saw a doughboy blast the turret right off a German tank with a single bazooka rocket from 75 yards away, and the turret sailed 40 feet through the air.

The Russians were probably the first to splash the rocket's red glare in the face of the Nazis at Stalingrad. There the now famous "Katusha" sent a shower of rockets at a single target in a withering salvo. It was very quickly adapted for launching

Antiaircraft rockets flash up from a battery of projectors to meet the Luftwaffe during a Nazi bomb raid

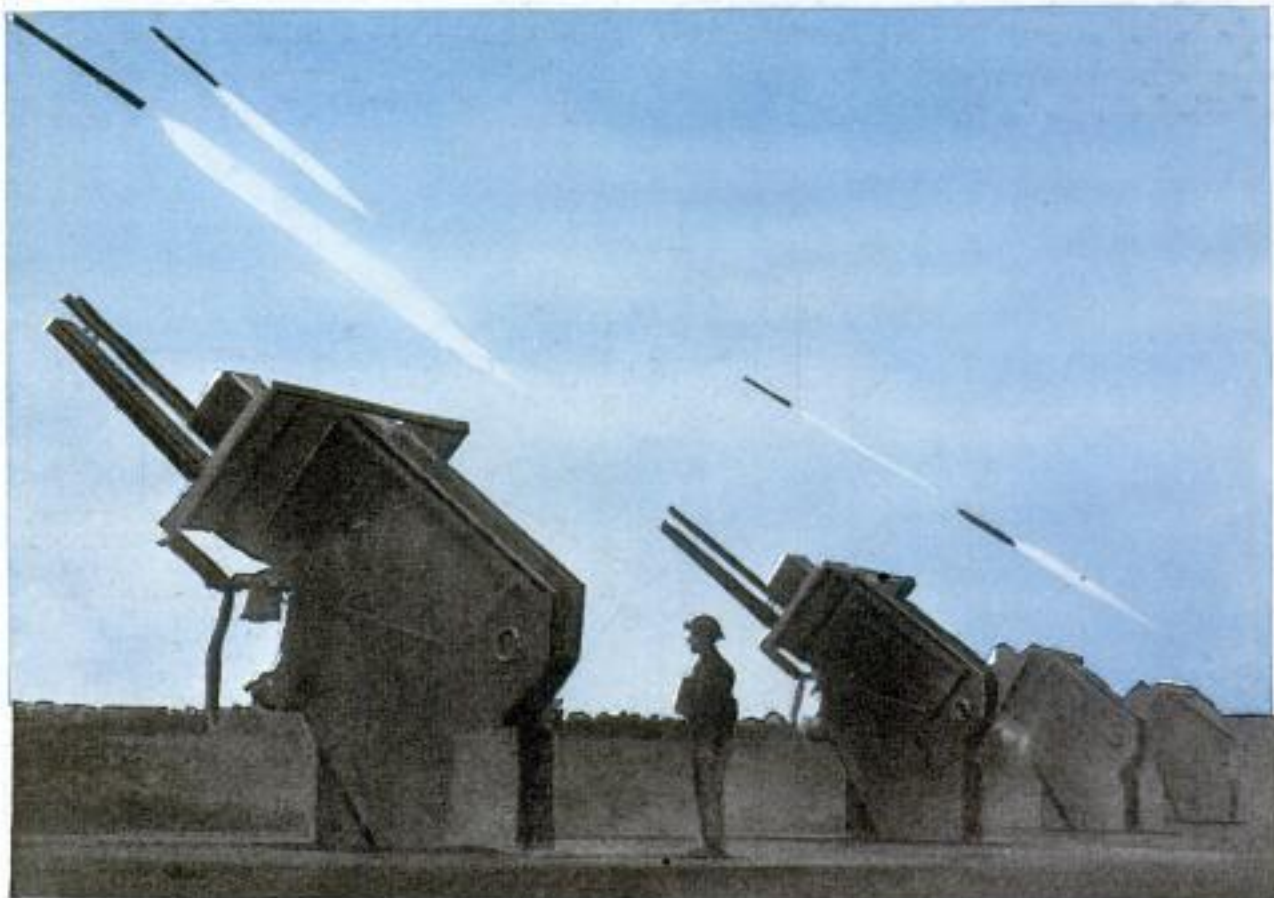

ing rockets for their own purposes.

The flying bazooka made one of its first appearances when a fleet of P-39 Airacobras swept down from the clouds over Rabaul and sank 40 Jap barges with their high-explosive rockets. After that successful mission the Air Force announced that rocket racks had been installed under the wings of all five of our Army fighters—the P-38 Lightning, the Airacobra, the P-40 Warhawk, P-47 Thunderbolt and Mustang.

The rocket lacks something of the accuracy of



Gen. Sir Oliver Leese, British Eighth Army commander, sights a captured rocket antitank gun—German version of the bazooka—on the Italian front

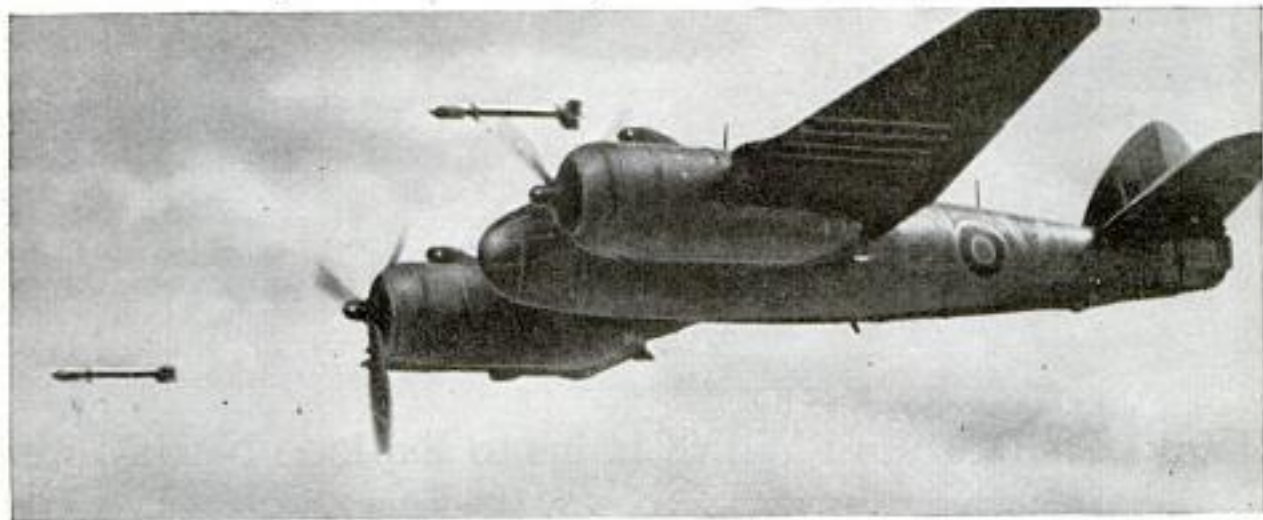

the machine gun and rifle, but that discrepancy is made up by increasing skill of the fighter plane pilot in sighting his plane on the target. On the credit side is the rocket's terrific power, which has the effect of a 105-millimeter shell without entailing the immense weight of the 105 gun and its mount. The simple rocket tubes are mounted under the airplane's wing in pairs, four projectors on each wing; they can be fired singly, in pairs or in a simultaneous salvo of eight. A particular advantage of the flying bazooka is its lack of recoil. It is a rath-

Continued to page 160

Above, a Beaufighter of the R.A.F. Coastal Command lets go two rockets in an attack on a German convoy at sea. Below, U. S. Ordnance officers examine abandoned German rocket gun in which booby traps were planted



*Sperry Gyro Comp., U.S.A. Bldg.
30 Rockefeller Plaza
N.Y.C.*

0321

Gyro-Compass Guided Assault Boats to France

Hundreds of non-magnetic, lightweight gyro-compasses which make use of elec-

Mr. John Warren & Mitt

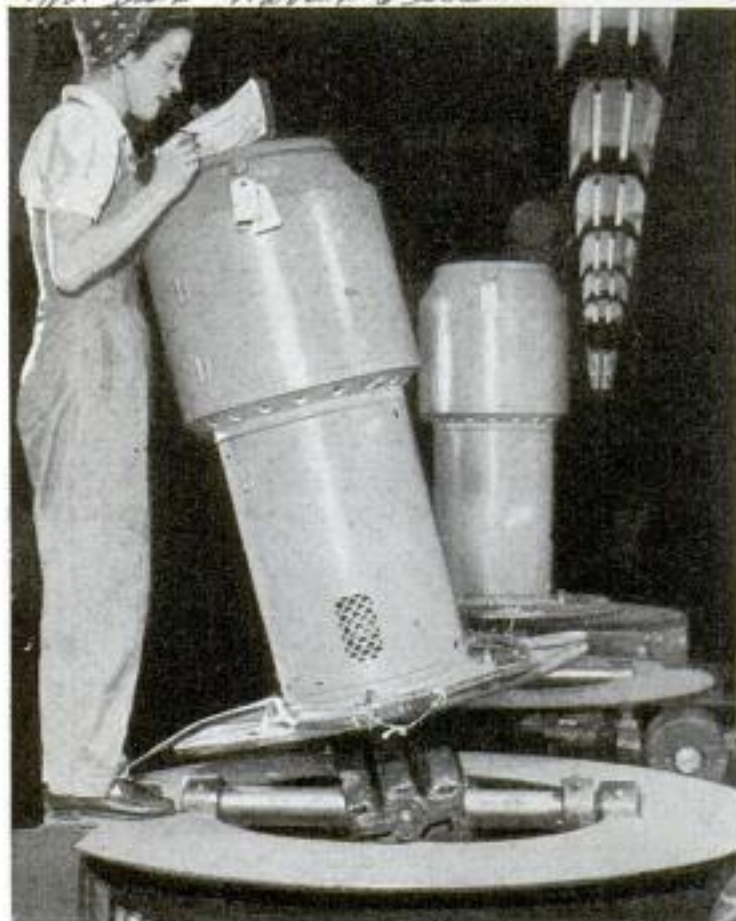

tronics were produced by the Sperry Gyro-compass Company as a preparation for the invasion of France. The Navy asked for a gyro-compass light in weight and yet rugged enough to operate on small boats during amphibious warfare, which must proceed on a fixed timetable despite hazardous coastlines, heavy surf and impaired visibility. It also had to be non-magnetic so it wouldn't be affected by electrical machinery or by cargoes of tanks, guns, trucks, and jeeps. To meet these requirements Sperry engineers designed a compass which stands at normal height but is only 19 inches in diameter. Except for the voltage regulator and the repeaters, all items of equipment are contained within the binnacle. To cope with space limitations on small vessels, the binnacle can be split into upper and lower halves and placed in different locations on the ship. The top half, which has the rotor and mechanism that actually does the job, may be installed at the steering station and the bottom half, with the control panel, amplifier panel, filter and motor generator, can be located where more space is available.

0380

Tanks Flail Ground With Chains to Explode Nazi Mines

"Flail tanks" which explode enemy mines by beating the ground with chains are being used by the British Army. Across the front of the tank is fitted a steel cylinder

to which are attached a number of lengths of chain several feet long. As the tank moves forward the cylinder revolves rapidly and the chains are whirled around, lashing the ground to set off anti-personnel or antitank mines and clear a path the width of the tank. A late model of the "flail tank"—called the "Crab"—drives its chains by the engine itself instead of by an independent motor as on the "Scorpion," an earlier model which destroyed 100 percent of the mines in its path in North Africa.



Above, "flail tank" beating the ground in search of mines. Right, British tank showing revolving drum for whirling chains mounted in front. One of these tanks destroyed 47 Nazi mines without damaging itself



*Lilbo, Neal & Battle (Adm.)
 Chamber of Commerce Bldg.
 Atlanta 9, Ga.*

0349

"Sea Mules" Herd Landing Craft and Big Ships



U.S. Navy

Hailed as "virtually unsinkable" in its operations in the English channel during the invasion, the Ingalls Sea Mule is a small but powerful marine tug which is expected to revolutionize the handling of vessels in harbors and inland waterways. The Sea Mule, which was shipped across in a "knocked down" condition and reassembled at invasion ports, was used to tow or push barges across the channel. The craft is so maneuverable it has been dubbed the "harbor jeep." Since the invasion, a larger type of Sea Mule, the strongest tug of its size, has been launched at the Ingalls Iron Works Company, Birmingham, Ala. The tug is 42 feet long and 15 feet wide with a draft of 7½ feet. Each of her two propellers receives 250 horsepower from twin Chrysler marine engines. Although the Mule usually takes a crew of three, one man can handle her in light traffic.



Photos from: *Ingalls Iron Works, Inc.
 50 Parkville Plaza
 N. W. 77, N. Y.*

Gun 'Packages' Under Wings Add Punch to Navy Planes

0330

U.S. Navy

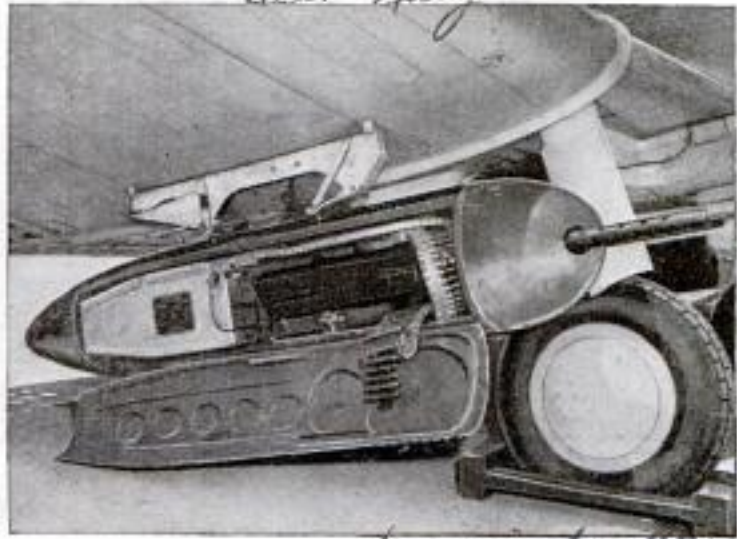

"Gun packages" are hung under the wings of certain Navy planes, increasing the firepower of some craft 100 percent. The guns are placed in self-contained cases which are attached to the wings by sway braces, the same as those used for bombs, so that the plane may carry bombs, auxiliary gasoline tanks or guns without substantial alterations. Although the gun packages are not intended to be dropped after the ammunition is exhausted, they may be jettisoned when a quick get-away is necessary. Each package weighs over 350 pounds and is longer than a 2,000-pound block buster.

SEPTEMBER, 1944

*Designed by:
 Capt. John W. Luyck, Civil En-7
 Training Corp., U.S.N., Washington, D.C.*

Copyrighted material

Mr. Allen Warren G. Mease
7 Park Ave.
N. Y. 16, N. Y.

0418

THE LINE IS BUSY



Telephone workers are being recognized as the Signal Corps of the home front army, maintaining production and morale. It takes some 500,000 of these workers—440,000 in the Bell System alone—toiling in shifts around the clock to keep our 26,000,000 or more telephone bells ringing out with sad music for our enemies. About 225,000 of the total are operators, and 68 percent are women.

Their production job is indicated by the 12,000 phone calls required to make a big bomber, 60,000 to build a cargo ship, and 87,000 "hello's" to complete a destroyer.

What the telephone means to the morale of homesick servicemen, or wounded veterans, is shown by the fact that the peak days for phone use are Christmas, Thanksgiving, and Mother's Day. Traffic on these days—

Telephone "minute man" making emergency repairs after storm. Below, workers on B-29 bomber use world's shortest phone line

THE next time you reach for the telephone just remember that Americans are doing the same thing at the outstanding rate of 106,000,000 times per business day. This adds up around 35,000,000,000 calls a year.

Never in the history of this nation or any other have the wires hummed with so much conversation, a great part of it connected with the war. It appears that the harder we fight and the more we produce, the more we use the telephone. So the present incredible rate of telephone use might be taken as a sure indication that Victory's on the wire.

Telephone conversations for the year will show an increase of 2,500,000,000 over the last year before our entry into the war. And the boost would be higher, except for people who are beginning to understand that the telephone, like a gun or a tank, is an instrument of war—slugging it out 24 hours a day.



particularly long distance—is now greater than the former record set on Dec. 7, 1941.

The greatest pinch has come in long distance. Toll and long distance calls are up about 300,000,000 a year since we entered the war. Long distance calls have multiplied as much in the last three years as in the previous 36 over the Bell System.

One reason this company has been able to carry the increased load despite shortages in equipment and labor is the increased use of the modern carrier telephone system. This makes a dozen telephone conversations grow where one sprouted before. Complicated terminal apparatus separates the various messages and sends them speeding by different frequencies over a single pair of wires to a distant point where other equipment changes them back to their original voice frequency.

Another device engineered by the Bell Telephone Laboratories is a mechanical brain which enables an operator to dial a direct connection from city to city. Called "the Number Four Toll Switching System," it was inaugurated in Philadelphia, where switchboards, which look like adding machines, are in use. By this system an operator can employ mechanical devices to find an idle long distance circuit, hold the circuit, signal the central office in a distant town and finally ring the telephone of the called party without the help of the operator in the called party's town.

Another mechanical robot went to work in the Los Angeles area. Subscribers dial nearby toll calls and the machine prepares a printed ticket, fixing the cost and charging it to the proper number.

Extremely important, too, was the war-

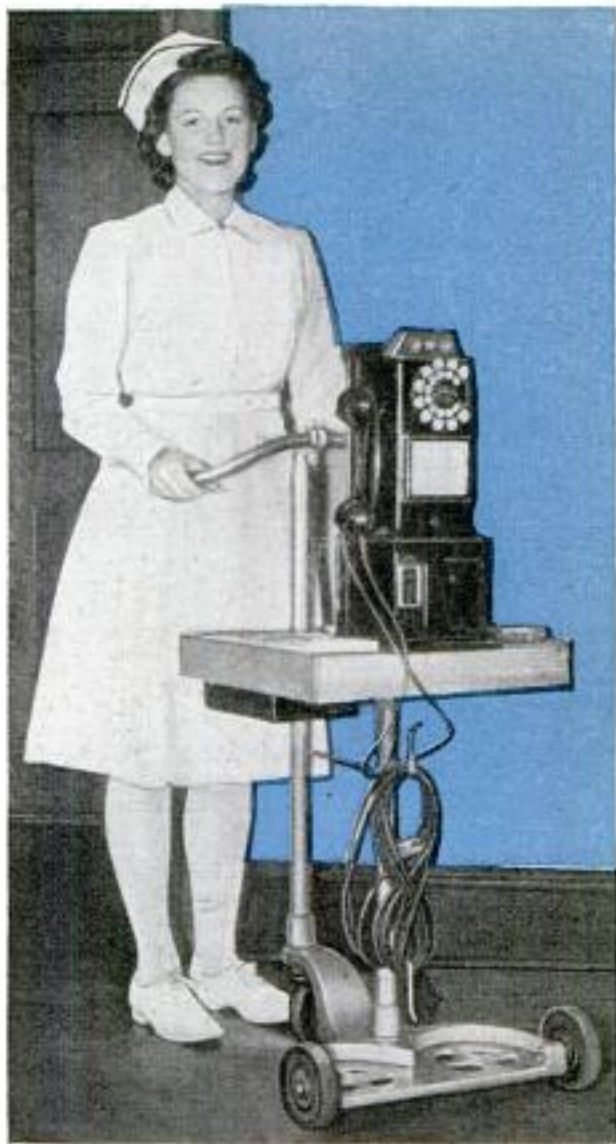

Designed for wounded veterans, portable telephone with long cord is rolled to bedside. Below, a long distance toll board—calls have jumped 300 million

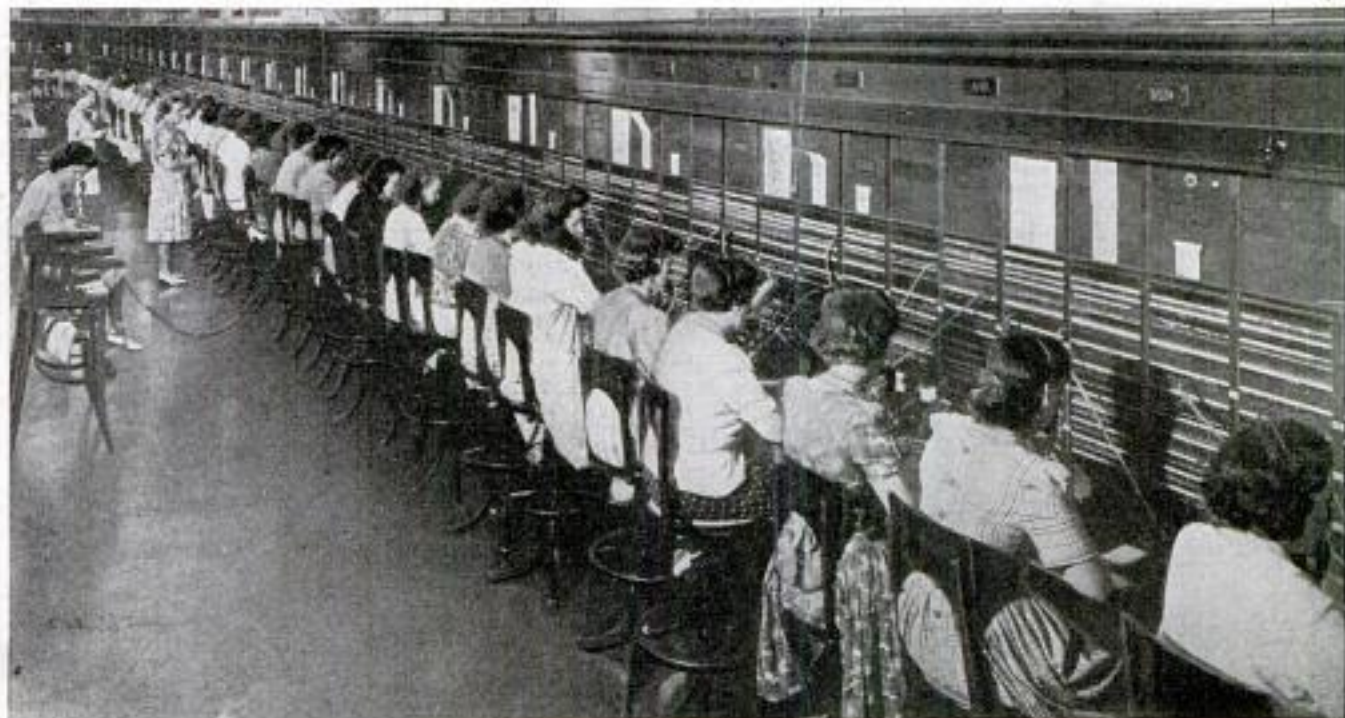

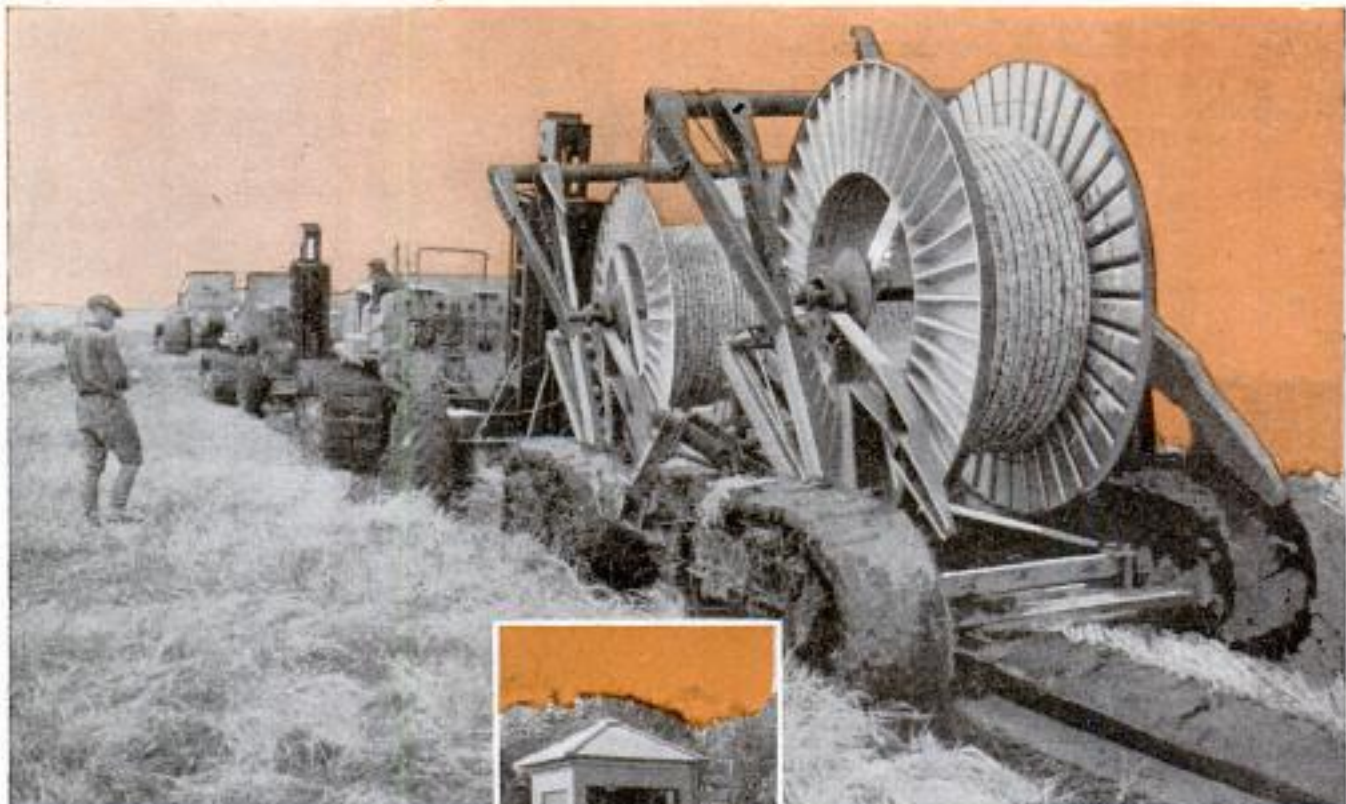

Home front war machine (above) plowing under a section of transcontinental cable which carries several messages over one pair of wires. Right, outdoor phone booth serves war housing unit. Below, motor-driven reel takes down copper wires so they can be used again

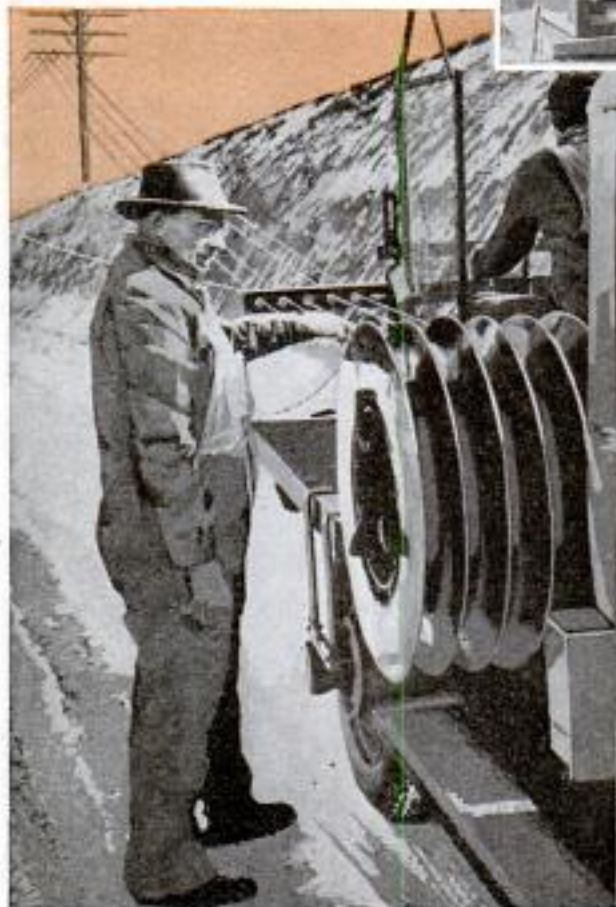

time completion of cable connections between Omaha and Sacramento, Atlanta and Terre Haute and between Dallas and San Antonio.

Just as vital, perhaps, is the high-spirited morale of telephone employees who have scored by hard work, economies, short cuts and new ideas.

When the sudden burst of war activity, particularly at night, upset traffic on basic long distance lines, traffic control bureaus became more vital than ever.

A large part of this night volume originated at military establishments where G. I. Joes were calling the folks at home. Thus, a special night layout was devised to provide more circuits needed at certain places. Its job is controlling these night circuits and regular circuits, too, and providing a quick picture of the shifting situation at any time.

In a typical bureau, a girl posts a colored code symbol beside the name of a city. The codes indicate the load on the circuits, how calls are being routed and other pertinent information.

Most remarkable is the manner in which service has been maintained without large, new supplies of copper wire and telephone instruments, both of which are now serving the men in uniform in far-off places.

Wire is an item, indeed. About 100,000,000 miles of it connects the more than 70,000 cities and towns in the United States. Yet, new copper requirements of the Bell Sys-



tem were reduced from a peak rate of 92,000 tons a year to an estimated 6,000 tons in 1943. About 10,000 tons of Bell System copper were salvaged and returned to the national copper pool, more than offsetting the new copper used. The entire system's requirements for bare copper line wire were being met by reusing wire removed from poles.

By employment of a special type of truck with a motor-driven reel, wire is being carefully taken down from a telephone line no longer needed, so that it can be saved and used again.

Another ingenious device fixed on a hand pole permits aerial drop wires to be coated with asphalt by one man without lowering them from their supports. The painting treatment is a means of retarding deterioration of these wires which connect the subscriber's premises, and of reducing the peaks of trouble during prolonged periods of wet weather.

Exposed aerial lead-covered cables are removed by a machine which lowers them carefully to prevent breaking, coats them with asphalt, wraps them in felt and then buries them in a trench.

A metal-saving "victory" joint is used in splicing lead-covered telephone cables.



Cable-wrapping and burying technique is speeded with a two-wheel guide which prevents sharp bends. Left, the lineman tying wire to glass insulator is symbol of 24-hour maintenance service—only five percent of the Bell System's outside wires are open like these. Below, adding-machine type of switchboard locates idle circuits.

Bell System photos





From this telephone center for the armed forces in Times Square, New York, calls go to every state in nation

Compared with the old-style joint, it requires 40 percent less solder. Since the solder used for wiping joints consists of nearly one-third tin, the new technique saves about 110,000 pounds yearly in the amount of tin used for repair and maintenance.



Dummy switchboards, made principally of a photograph, save strategic materials and permit regular switchboard positions to be used for providing telephone service. These simulated switchboards are made of heavy cardboard over which a photograph of an actual switchboard has been pasted.

New, also, are outdoor telephone booths, first installed in wartime housing developments where telephone facilities are unavailable to serve ordinary needs. They are used in other spots where special demands had to be met, such as in trailer camps, public parks, gasoline stations and military posts.

The Bell System companies have done everything possible to provide special service for men in uniform, especially to wounded veterans. A variety of hospital bedside, plug-in telephone hook-ups have been provided. Even telephone booths big enough for wheel chairs have been installed.

According to a telephone official, some of the men back from the battle zones were almost in dread of calling their mothers. "How do

Posting colored code symbol beside name of city aids routing long distance calls

I tell her I only have one leg?" was one anxious question. And others had heard of the experience of a buddy in the next bed. A call home. A mother's answer. A "Hello, mom." A click, then a thud. "It's better," they advised, "to call your father or your sister

first; they can take it better." In war-time government projects alone, the Bell System has placed 20,000,000,000 feet of wire. The biggest private switchboard in the world is where you might expect it to be—in the War Department. The shortest telephone line in the world is



in the busy, noisy Boeing B-29 airplane plant where workmen talk over the telephone although only a foot apart. They are separated by a wall of metal.

Flood, fire and storm have made preparedness a telephone habit. Safeguarding war telephone communications has heightened this function. Lines are patrolled. Stand-by engines are kept on hand to provide emergency power. Nearly two-thirds of the wire network is underground. In fact, 95 percent of all outside wire is either underground or in overhead cable. Long distance cables are under gas pressure which sets off automatic alarms when trouble develops. If lines are broken, essential calls can be switched over alternate routes. Emergency switchboards move by plane.

Some of the adventures of the telephone men in the field are thrilling.

A wire chief near a northeastern Air Transport Command base got a hurry up call. A crew laying steel landing mats had driven three-foot spikes through a cable, knocking out the control tower radio transmitter by which planes were brought in.

"There are eight planes in the air," the telephone man was informed. "The ceiling is 100 feet. It's pouring rain. Either you get us two circuits in a hurry or there will be a lot of blood spilled when the planes run out of gas!"

While the planes droned above in the murky sky, the wire-chief started two men with wire, one from the control tower and another from a connection three-quarters of a mile away. They met the wire chief in the middle of a swamp. Stripping off their raincoats, they made a tent, completed a dry splice and restored service in time to permit the control tower to land the planes.

One telephone man achieved a lot of attention while installing a phone in a War Department office in Washington. He had been working 40 hours and, lured by the soft rug under an ornate desk, he had fallen asleep.

A guard who found him snoozing there hours later was positive he had captured a spy. It happened that he had picked one of the most important spots in the world—the office of General Marshall.

Oxygen Bottles Wrapped in Wire Don't "Shrapnel" When Hit

To prevent them from "shrapneling" when hit by flak, oxygen and carbon-dioxide cylinders used for breathing and fire-fighting purposes on Allied planes are wrapped with steel wire. A bullet striking a wrapped cylinder leaves only a clean hole, while an untreated cylinder would explode. The process was developed by Walter Kidde and Company.

SEPTEMBER, 1944

88 West St.
Syracuse, N. Y.

Rapid-Fire Portable Speedlamp Shoots at 1/5000 of a Second



Something a press photographer dreams about—a portable speed-lamp unit capable of taking pictures at a speed of 1/5,000th of a second—has been released to the armed forces by Eastman Kodak Company. The unit is ideal for covering indoor sports events where extremely fast and dramatic action must be caught. The speedlamp can make 200 consecutive flashes when the battery is employed, or an indefinite number when operating with alternating current. The light output is good enough to produce a fully timed negative of an average subject at 15 feet with high speed film exposed at f/11. The flash length of 1/5,000th of a second is far above that of any mechanical shutter. The 18-pound power unit is supplied with a shoulder strap. The company announced that delivery to persons with high priorities may be made after all government requirements are filled.

Photographer, N. Y.

Flexible Putty Fills Wing Dents To Reduce "Skin Friction"

Hailed as an important step toward the absolute minimum of "skin friction," or perfect wing-surface smoothness, a flexible, high-adhesion aircraft putty has been developed to fill dents and cracks between riveted aluminum sheets forming airplane wings. So important is wing-surface smoothness in fast fighter planes that it has been seriously suggested they be wiped free of dust and other small particles before each takeoff. The new putty has a buttery consistency and stays in place, maintains the desired surface contour because it has no tendency to flow, and does not sag.

Report of 2-28-44 aircraft putty

G. I. du Pont & Company
Wilmington, Delaware

0145

0389

"LIFETIME" COPPER CRUISER



Almost as thin-skinned as cardboard, a swanky, rakish cabin cruiser, the "Revere," has survived 30 months of rugged Coast Guard patrol work and may revolutionize the design of pleasure boats. Its 45-foot hull (below, under construction) consists of an alloy which is 70 percent copper and 30 percent nickel and is only 80/1,000 of an inch thick. Erected as a buoyant shell and lacking most of the conventional inner supports, the boat has resisted the ravages of salt water



Above, two-way radio designed to use 10 crystal-controlled waves, is one of the many luxuries on the \$50,000 boat, built by Revere Copper and Brass, Incorporated, for tests by the Coast Guard. Below, plan of interior arrangement

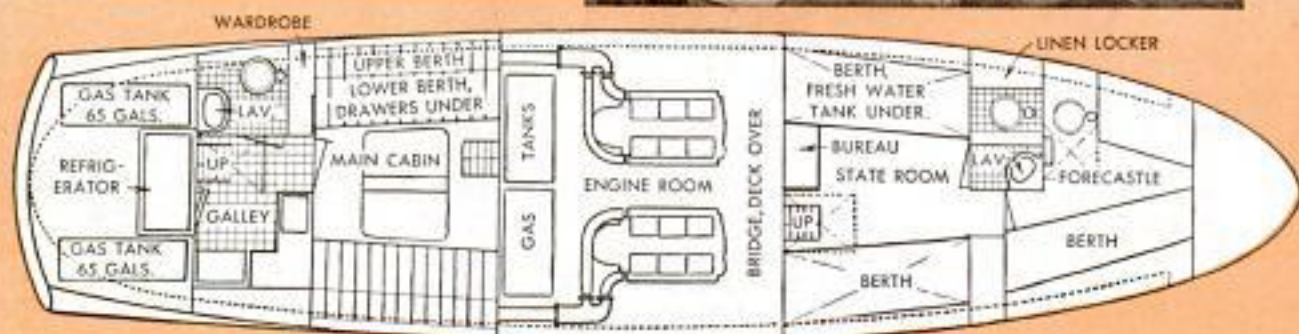



Above, part of the forward deck section of the craft, which is fireproof, worm-proof, leakproof and resists corrosion



Above, unusual galley layout showing its many corrosion-resistant fixtures. The shell design gives the boat roominess and facilities ordinarily found only in a large yacht

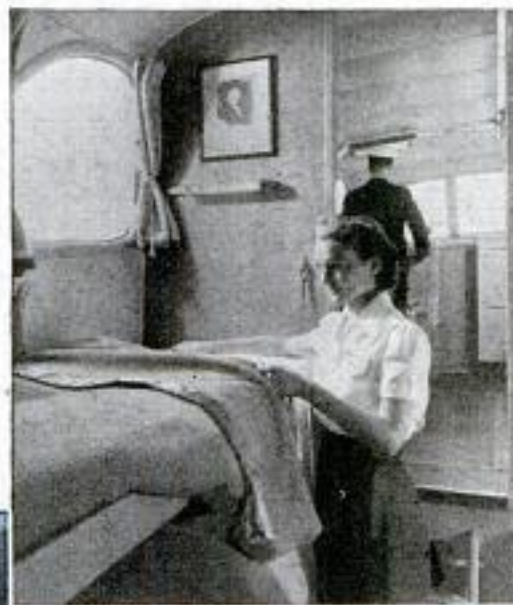

Left, double stateroom with drawer space under bunks and fluorescent lighting. Note the head room and the volume of daylight possible in the cabin. Insulation insures quiet

Below, the "Revere" purrs up the Hudson River. Manufacturing of cupro-nickel cabin cruisers will be started on a mass scale for civilians as soon as priorities are lifted



Marine Standing on Rudder Steers Helm-less Ship

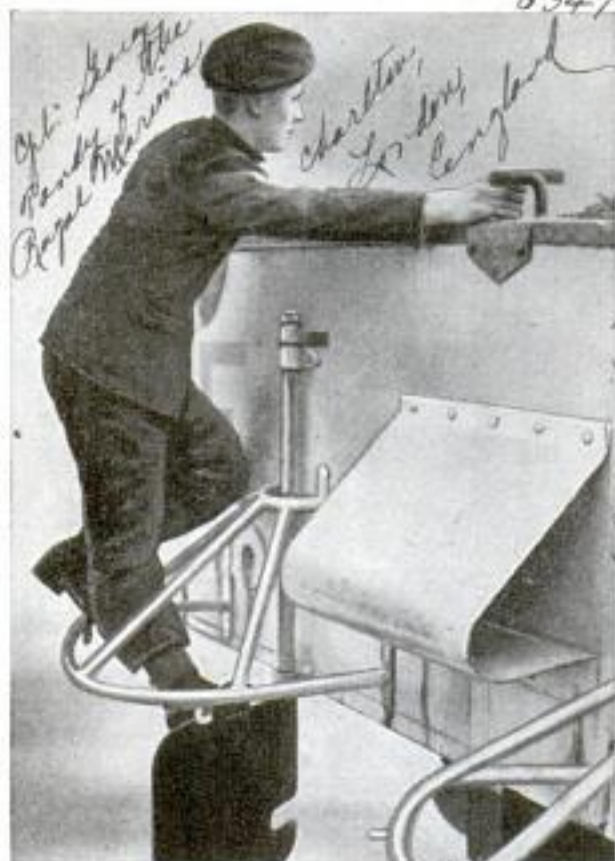

On D-Day Corp. George Tandy of the Royal Marines found himself running a landing craft assault boat in the English channel with no steering wheel and a shattered engine room telegraph. They had been torn away when the boat ran afoul of the hook which lowered it into the water from its parent craft. So he slipped over the square stern, placed one foot on the rudder guard rail, and controlled the rudder with the other. In this precarious position he steered the craft seven miles to the Normandy shore and seven miles back again to her parent ship.

Mold-and-Ladle Unit Melts Lead To Form a Soft Hammer

By means of a combination mold and ladle, it is easy to make soft lead hammers

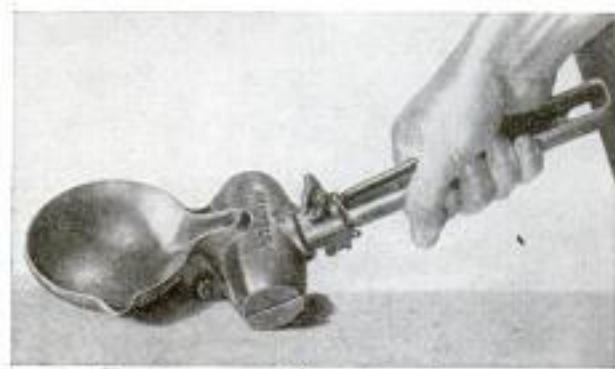

which are used to work on material without marring. The lead is placed in the ladle, which is then closed and held over the fire until the lead melts. By depressing the handle to a horizontal position, the molten lead flows into the mold and around the hammer handle to form the head.

Pocket-Sized Electrical Meter Takes Multiple Reading

Electrical tests of many types can be made with a multiple-purpose meter which is so small and compact it slips into the pocket easily. The tiny unit answers all volt, ohm and milliammeter requirements and includes additional features of larger and more costly equipment. The meter is equipped with self-contained batteries which slide out for replacement.



Barbless Spring Hooks Fish So They Don't Get Away



To keep both the little and big ones from getting away, a barbless fish hook has been made of fine steel wire with a spring in the center. The hook has two prongs. The larger one is baited by the angler and the two ends are clasped together. When the fish grabs the hook, the spring is released and the hooks catch the fish on both sides of its mouth. Fish are not harmed by the barbless hook and undersized ones can be removed and thrown back into the water.

To learn where to buy commercial products described in these pages, see the index.

*Surv Oak Freight Yards.
Surv Oak, Ill.*

Train's Two-Way Radio Links Crew to Yards

0.308



Above, engineer and fireman in locomotive receive orders from yardmaster (right) via a radio telephone instrument to switch some more freight cars

Two-way radio communication in high frequencies between locomotive engineer and dispatcher has been inaugurated in the Rock Island railroad's freight yards near Chicago. The installation of transmitters and receivers, which operate at 10 watts in the 40 megacycle band of frequencies,

permits conversation between switch engine crews and yard masters. The station has an operating radius of 25 miles. The railroad plans to install additional high-frequency systems for communication between engines and cabooses of trains, and yards and dispatcher.

0153

"Jack-in-the-Box" Telescope Lift Raises Platform 95 Feet

For reaching high ceilings and walls in cleaning and service work, an electric "jack-in-the-box" lift telescopes up to 95 feet. In some models the platform can be lowered to six feet so that the lift can be moved through doorways and transported in elevators. Capacities of the lifts range up to 500 pounds, which makes it possible for two men and much equipment to be carried. The men on the platform have full travel control by means of an electric pushbutton system. Dual controls are located on the frame near the ground and include a safety stop button. The lift is portable, the platform railing being folded down when it is not in use.



Platform lift at maximum extended height of 95 ft. is shown at far right, in comparison to lift as it is before being elevated. When lift at Rockefeller Center is not being used it can be stored in the basement. Unextended, it may be carried through a doorway 5 feet wide, 6 feet, 10 inches high



SEPTEMBER, 1944

*Ceroney Engineering Co.
2643 W. Van Buren St.
Chicago 12, Ill.*

Copyrighted material

Mr. Wayne Whittaker

0107

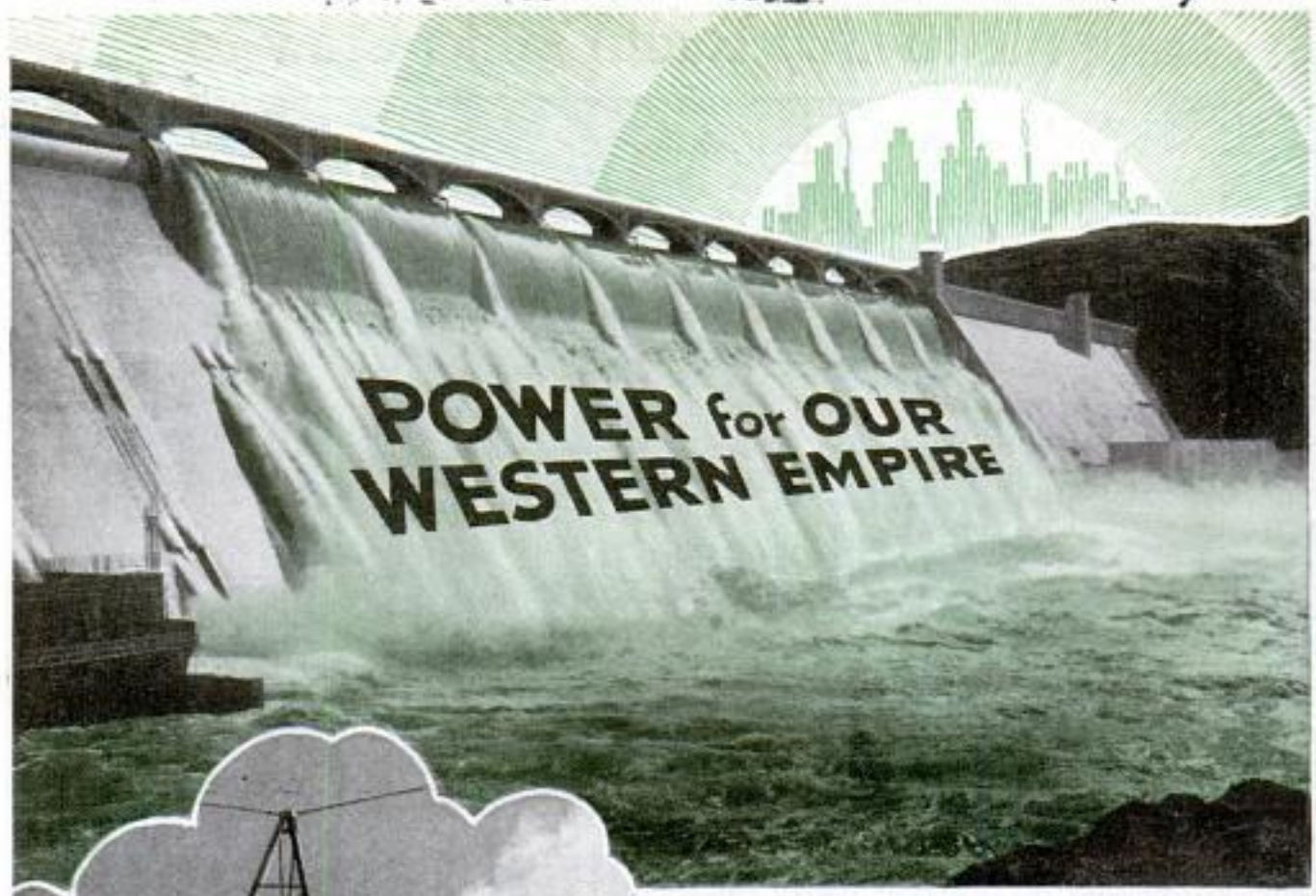

POWER for OUR WESTERN EMPIRE

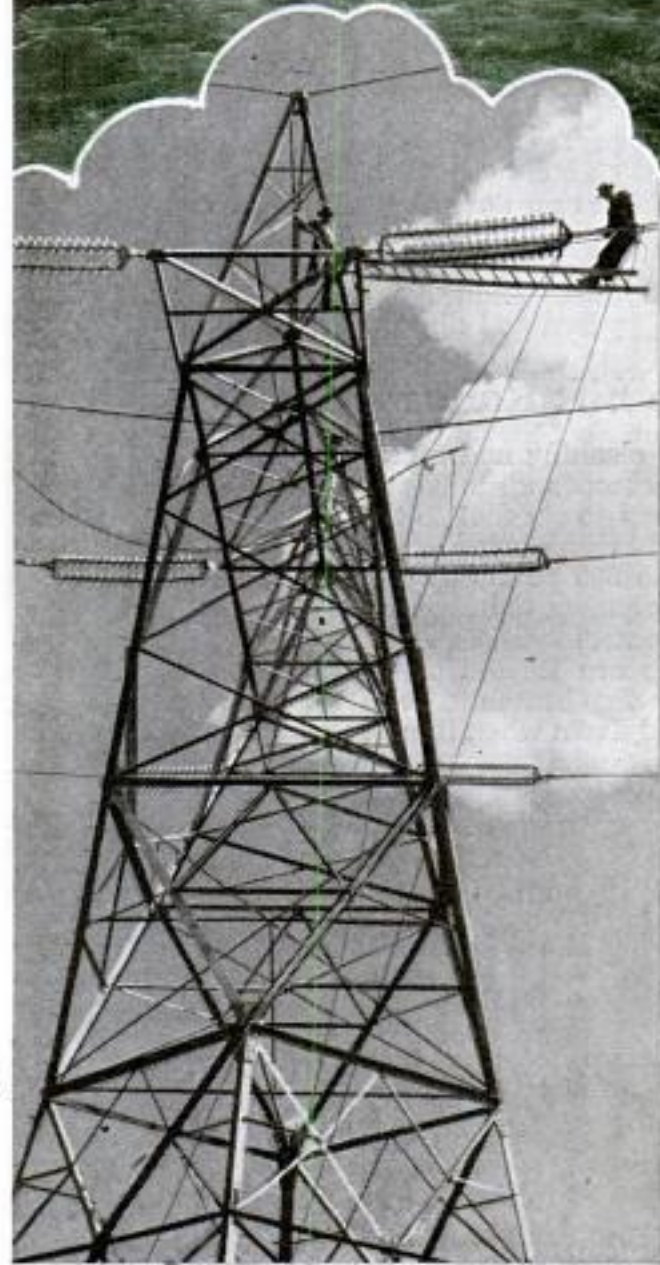

Grand Coulee—potent source of power for war or peace. Left, symbol of a new empire

By Wayne Whittaker

WHEN the whistles blow and the bells ring and G. I. Joe comes marching home, he's going to look Uncle Sam straight in the eye and say:

"Well, I won the biggest war in history for you. Now what have you got for me?"

If you think Uncle Sam is going to be caught napping and have to mumble something under his whiskers about a dole ticket or an apple stand, just guess again. His answer, right from the shoulder, will be:

"Roll up your sleeves, Joe. We've got a vast western empire that is yours for the taking."

Big talk? Sure it is. Biggest in the history of the U.S.A. It concerns a new empire of 20 million acres that would permit the West to double its present population. This big talk is backed up by facts, scale models, blueprints and something far more tangible—four million acres of rich reclaimed land that once supported a sickly growth of sagebrush and cactus.

Much of the credit for transforming dry but fertile areas into garden spots lush with grain, fruit and vegetables,

goes to the Bureau of Reclamation of the Interior Department. If you think that bureau shies away from a big job all you have to do is take a look at Boulder dam, called the greatest engineering feat in history, or Grand Coulee, giant of them all, or recently-completed Shasta, or any one of a score of projects that have been harnessing runaway rivers for irrigation, power, flood control and municipal water.

The immediate postwar program of the bureau, as outlined by Harold L. Ickes, Secretary of the Interior, would provide irrigation service for 16 million acres within three years. It will take more than half a million men at construction sites and in factories to do the job and supply the materials. This new service will add



Concrete tube with steel ribs will carry waters to reclaim arid tract in San Joaquin Valley, part of a project to create 2,000,000-acre garden spot. Below, Boulder dam holds record for million-kilowatt capacity





Huge penstock on Shasta dam is prepared for painting. At left, sheep on Grand Coulee

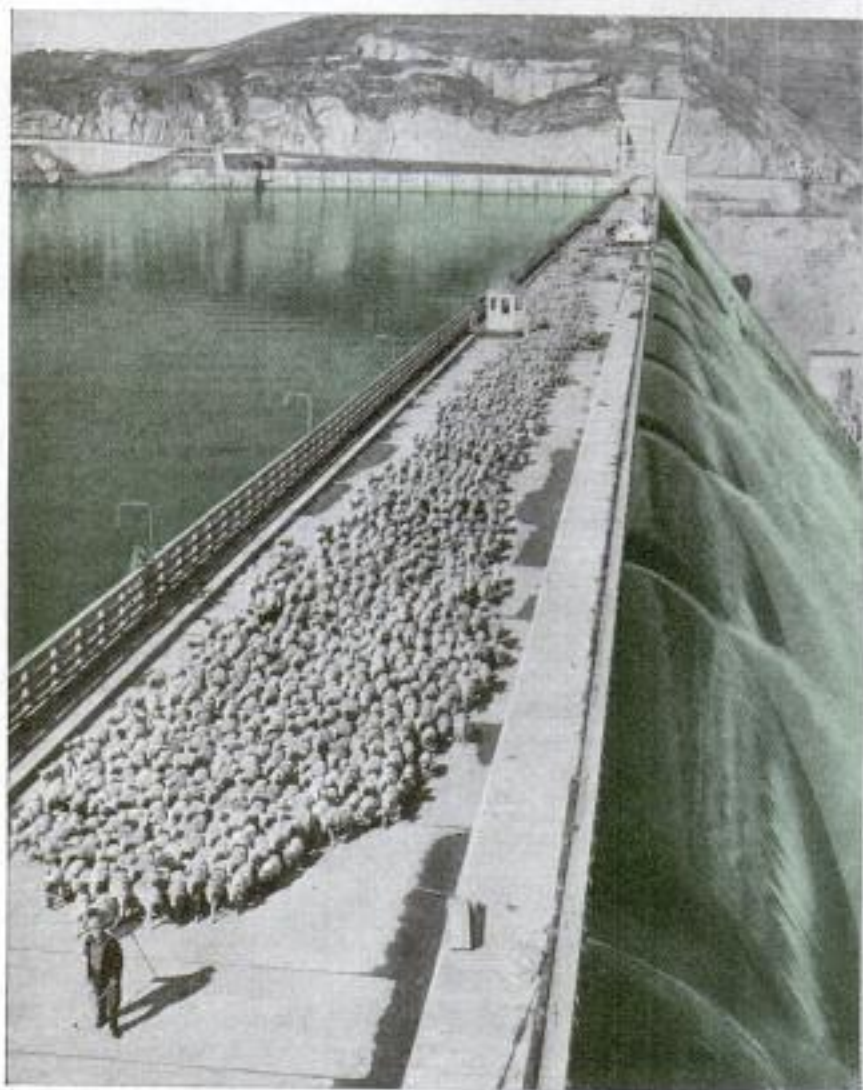

150,000 highly productive farms to the wealth of the nation and give security to as many more farms now harassed by drought or flood. New cities and industries will spring up across the lands dotted by dams, reservoirs and power plants, and criss-crossed with canals and irrigation ditches.

The new empire is scattered over the western third of the United States. Its development will see the completion of great projects interrupted by the war in the Pacific Northwest, central California, and in the Southwest. Additional projects now in the planning stage will get under way, if Congress approves, on both sides of the Continental Divide and in the Great Plains region where rivers go on a rampage in spring and dry up in midsummer.

No crystal ball is need-

ed to reveal what the bureau's irrigation and hydro-electric power program means to the nation in time of war or peace. All you have to do is glance at the record of three great projects in various stages of development. They are the Columbia River Basin project in Washington to be irrigated from Grand Coulee dam, Central Valley project in California, and the Colorado-Big Thompson project. These developments, part of a

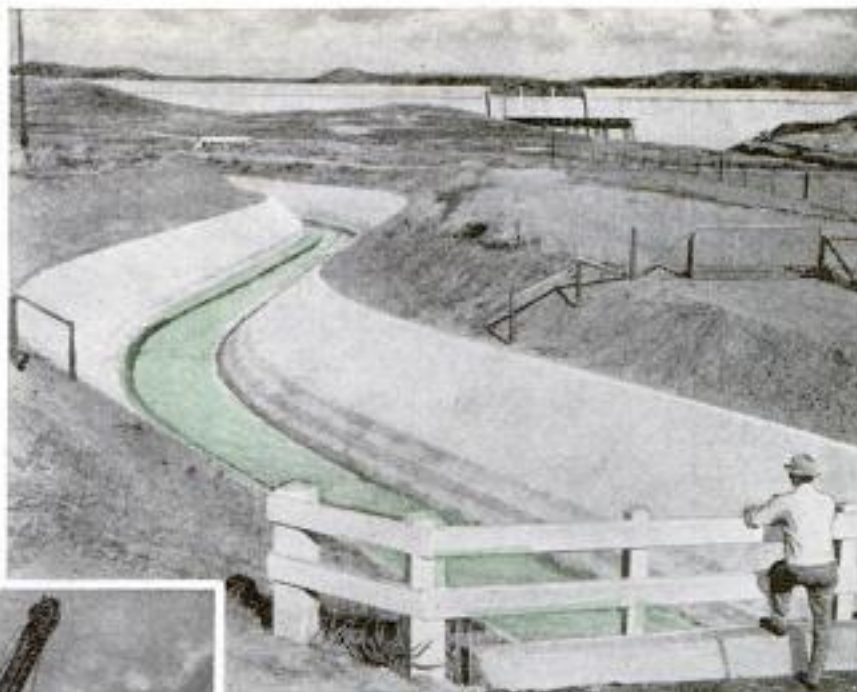

Concrete canal is fed from reservoir of Friant dam in background. Left, digging part of 37-mile canal



went into service two months before Pearl Harbor.

With war plants bobbing up like mushrooms, a power shortage appeared imminent in the summer of 1942 despite the three big generators then in operation. To fill the gap, two 75,000-kilowatt generators were transferred to Grand Coulee from Shasta dam in California where the powerhouse had not been completed. These generators were rushed into operation in eight months instead of the usual 30 months required for the construction and installation of regular Grand Coulee units.

Recently, Grand Coulee's record-breaking expansion was climaxed with the in-

long-time plan to insure peacetime prosperity, are vital cogs in America's war machine today.

When new war industries in the Pacific Northwest were threatened with a power famine, the government ordered full speed ahead on the completion of Grand Coulee dam on the Columbia River. The first of the six 108,000-kilowatt generators now in operation



Row crop irrigation in Arizona field makes crops boom

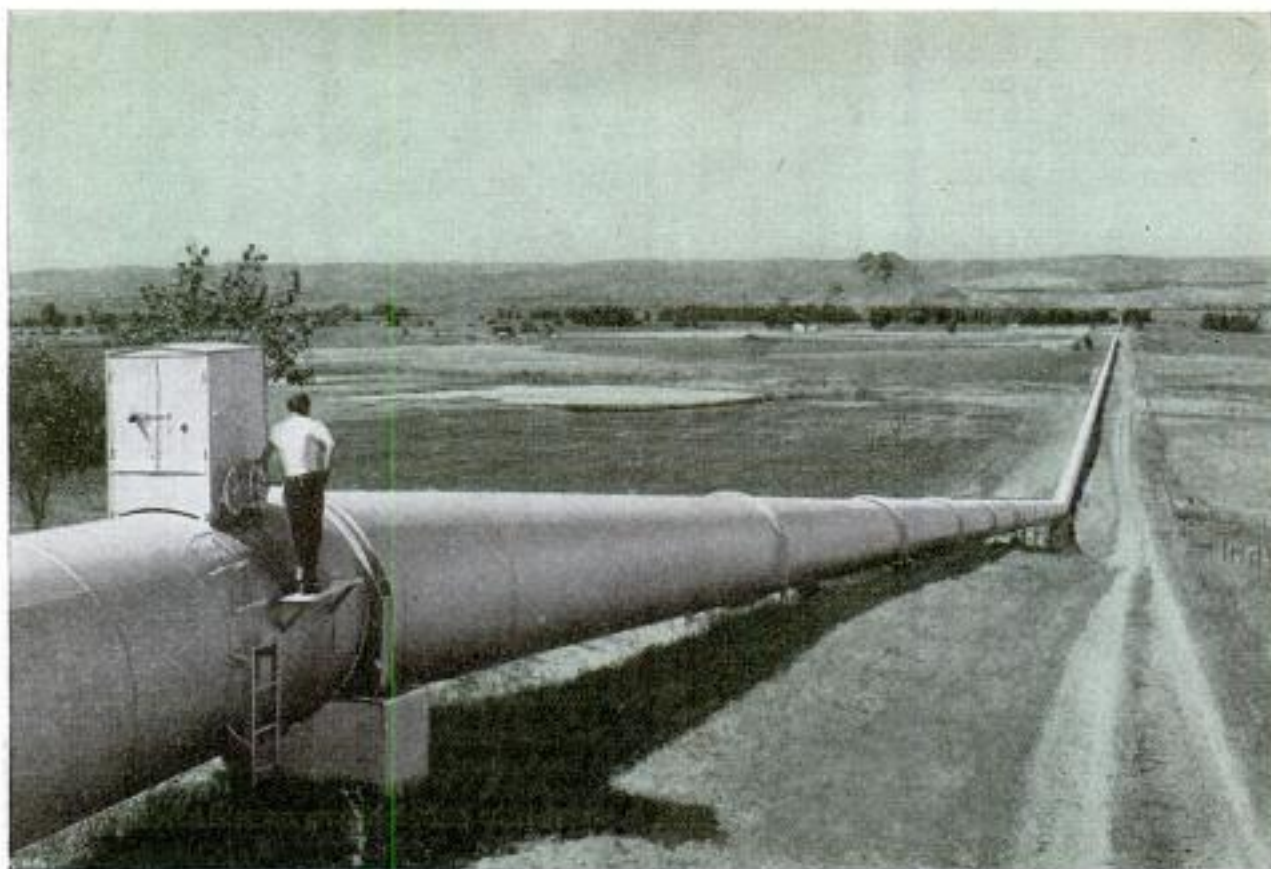

Miles of pipe like this will carry captured flood waters to help reclaim 16,000,000 acres in the Bureau of Reclamation's postwar program. Below, erecting link in 100-mile transmission line to carry Shasta dam power to industries

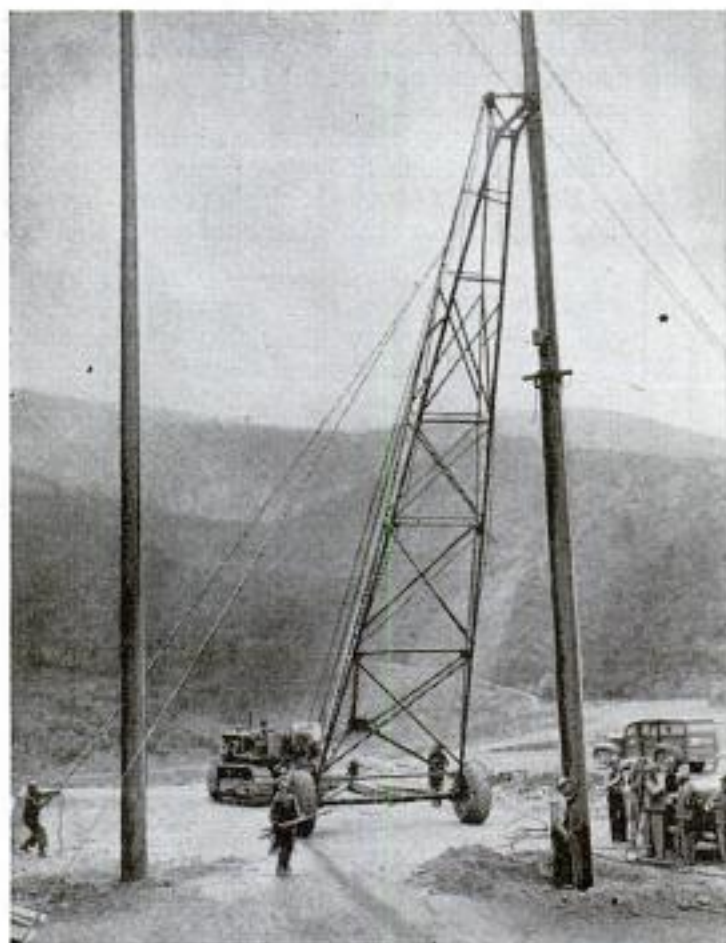

stallation of the 10th generator. This increased the plant's capacity to more than 800,000 kilowatts—third largest in the world. Ninety-eight percent of the power produced at Grand Coulee goes to war industries and military establishments, according to Harry W. Bashore, commissioner of reclamation.

"No other power system in the United States, public or private, is contributing so much of its output to winning the war," Bashore said.

In the Grand Coulee plant is the most modern speed regulating equipment in the world. Its generators operate literally like clockwork, for they are synchronized with a high-gear master clock. Four times a day, this master clock is checked with the naval observatory's time signal by radio.

Downstream from Grand Coulee is the Bonneville dam, built by the U. S. Army Corps of Engineers. The Grand Coulee-Bonneville power pool keeps northwest war industries humming at peak production. Among these industries are five important aluminum plants producing 6,000,000 pounds of that precious metal a year, or about one-third of the national total. The aluminum from these plants in 1944 would build 30,000 bombers.

Hydro-electric power now pouring into war plants will be just as potent in postwar factories which will create a balanced economy in a rich agricultural district.

Another section of the new empire, farther down the coast, is the 500-mile arid valley of central California. When the Bureau of Reclamation Central Valley project is completed, the famed California Chamber of Commerce will really have something to sing about — irrigation water for a 2,000,000-acre garden spot available for intensive cultivation the year around.

Guardians of this area are giant Shasta dam, second in size only to Grand Coulee, and Friant dam. Shasta, two-thirds of a mile long and higher than the Washington Monument, rises to the north of the valley and controls the waters of the Sacramento River. Friant acts as monitor of the San Joaquin River which flows from the south. Di-

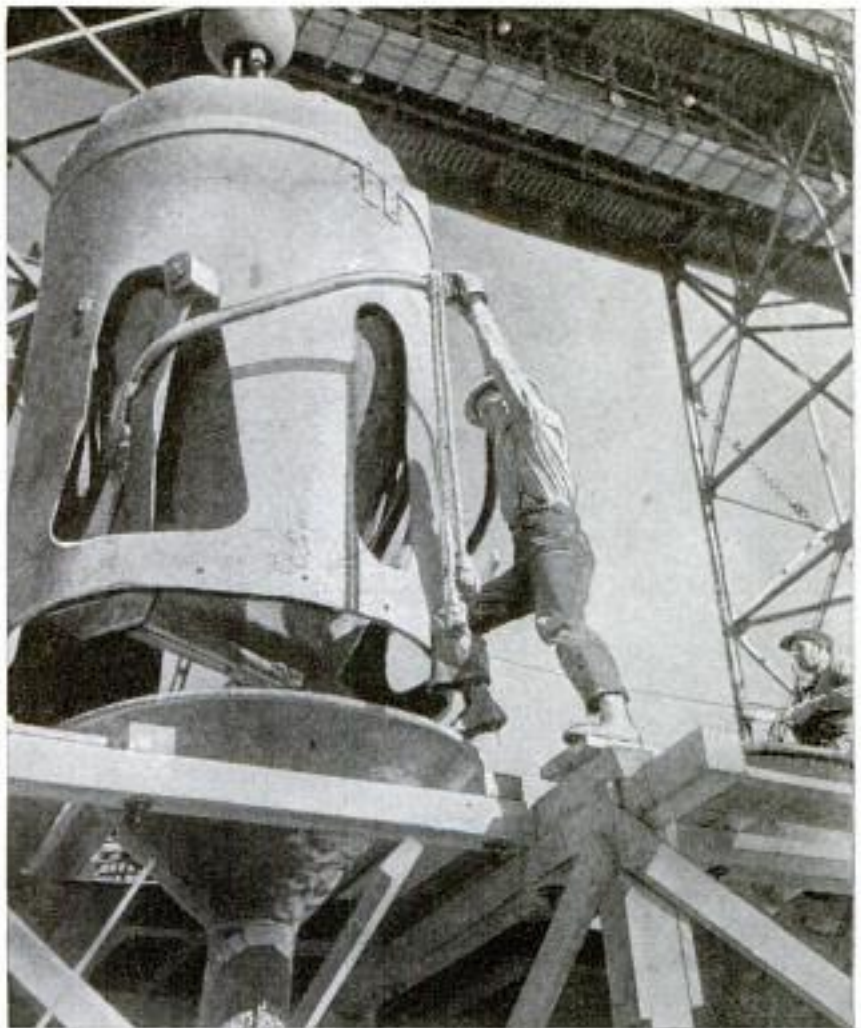

Dam builders perform the "impossible" by using chute to place concrete in areas out of reach of regular bucket. Below, Parker dam, looking up stream from the Arizona side, is typical of smaller irrigation projects

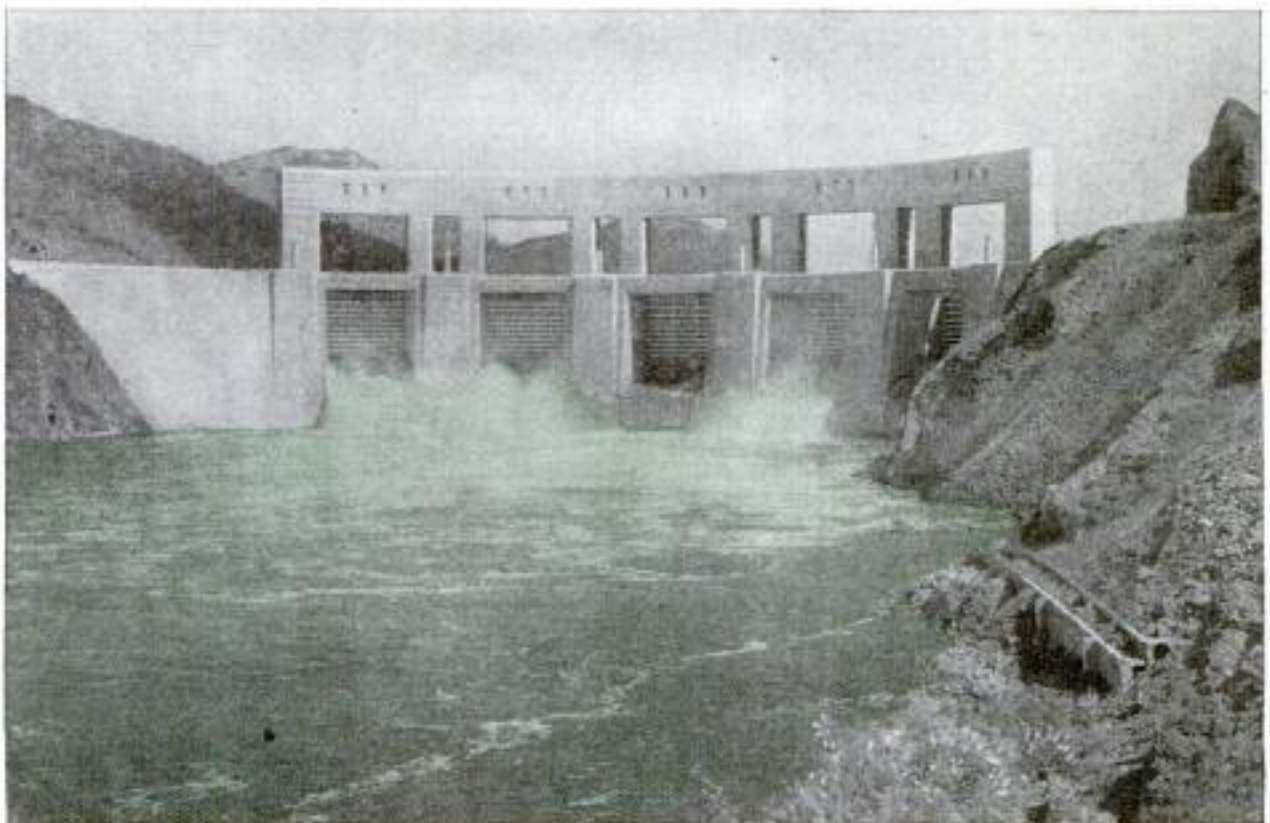

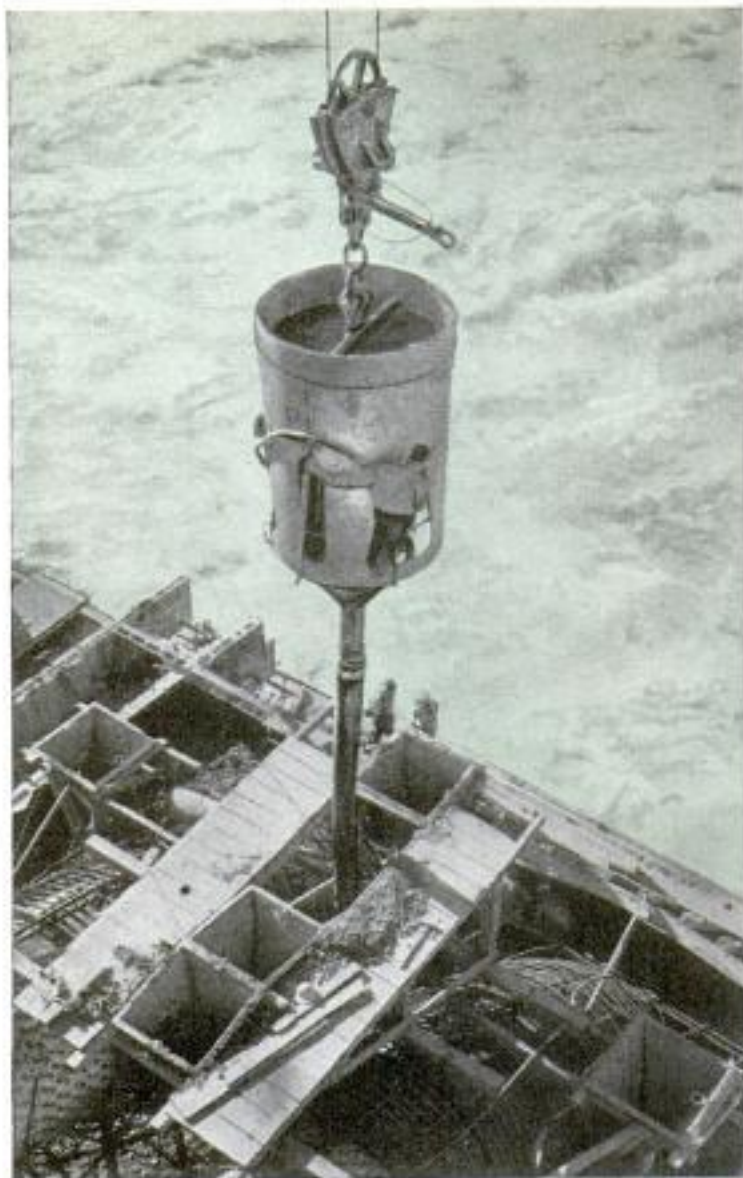

Aside from the bread-and-butter features of the reclamation projects, they are providing new playgrounds for postwar vacationers. The big reservoirs form beautiful inland lakes, paradise for fishermen and inland sailors.

Another pillar of the new empire is Boulder dam which spans that portion of the once-rampant Colorado River forming the boundary between Arizona and Nevada. Lake Mead, the tremendous reservoir backed up by the dam, holds enough water to supply every man, woman and child in the U. S. with 80,000 gallons each. The captured flood water, which once played havoc with the lives and property of 100,000 persons, will be used to irrigate 2,000,000 acres. It solves the water problem of 13 cities, including Los Angeles. It also creates more than 500 million kilowatt-hours of electric energy a month. This power has helped produce tons of metal in the world's largest magnesium plant, and enabled airplane factories and other war industries to break production rec-

Placing concrete in the dam structure with "elephant trunk" bucket. Below, water and sandblast are used between "pours"

version of water into the Madera and Friant-Kern canals will reclaim a great tract in the southern San Joaquin Valley.

The era of the simple project that merely turned some water out on arid land and did nothing more is finished, according to Michael W. Straus, First Assistant Secretary of the Interior. He points to the multiple benefits of the various projects, of which Shasta dam is a shining example. Its great reservoir, backing up 35 miles, not only provides water for irrigation and power plants, but creates a mountain lake within Shasta National Forest. It also provides year-around navigation on the Sacramento River, helps to eliminate floods, and provides water for homes and industries. One phase of the Central Valley project is devoted to the control of salinity around San Francisco Bay.

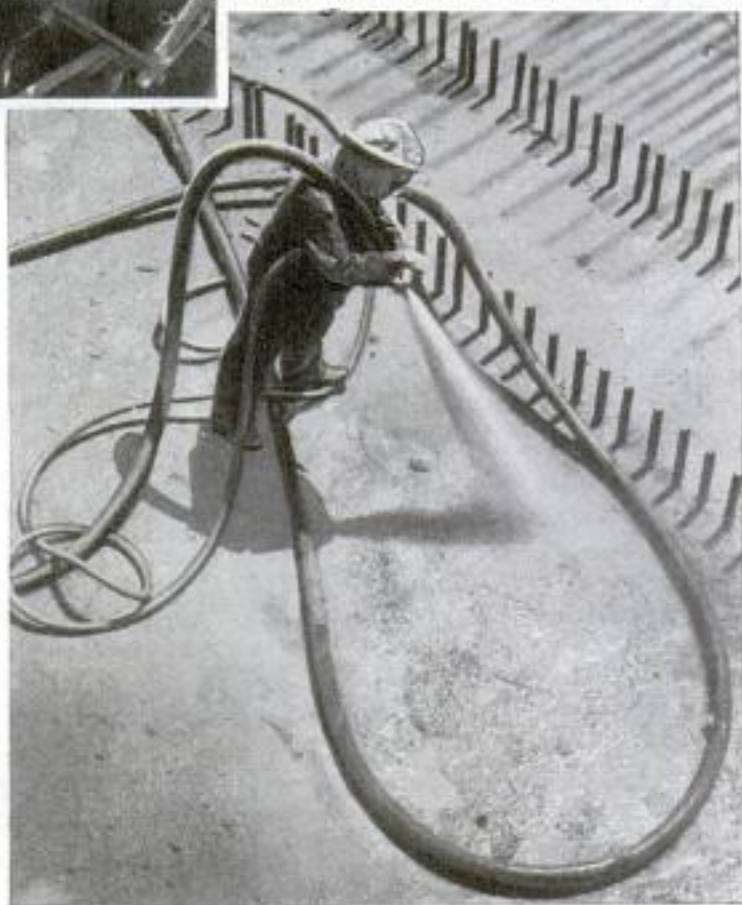

ords. Boulder dam's generators recently operated at a capacity of more than a million kilowatts, the first power plant in the world to have that distinction.

Since we entered the war, the power output of the 30 plants constructed and operated by the Bureau of Reclamation has been more than doubled. Capacity of the plants this year is expected to exceed 2,400,000 kilowatts. With a 1943 capacity of 2,000,000 kilowatts, the output was nearly 12 billion kilowatt-hours. This was about as much electrical energy as was produced by all the power plants in the U. S. when we entered the first World War. To produce 12 billion kilowatt-hours by steam, would have required 7,860,000 tons of coal or 1,350,000,000 gallons of fuel oil!

Supplying war plants with hydro-electric power is only part of the picture. Lands reclaimed by the Bureau of Reclamation are helping feed a fighting nation and its allies. Crops valued above \$350,000,000 were grown on these lands last year, and the amount will be greater in 1944.

If the bureau's record during the last decade is any indication of what the future holds, there is little doubt where the power is coming from to build additions to our western empire. Rivers like the Missouri, Arkansas, Rio Grande and others, wait to be chained and converted into empire builders.

Six regional offices of the Bureau of Reclamation are ready to start the program rolling when our victorious G. I. Joes come marching home shouting: "Where do we go from here?"

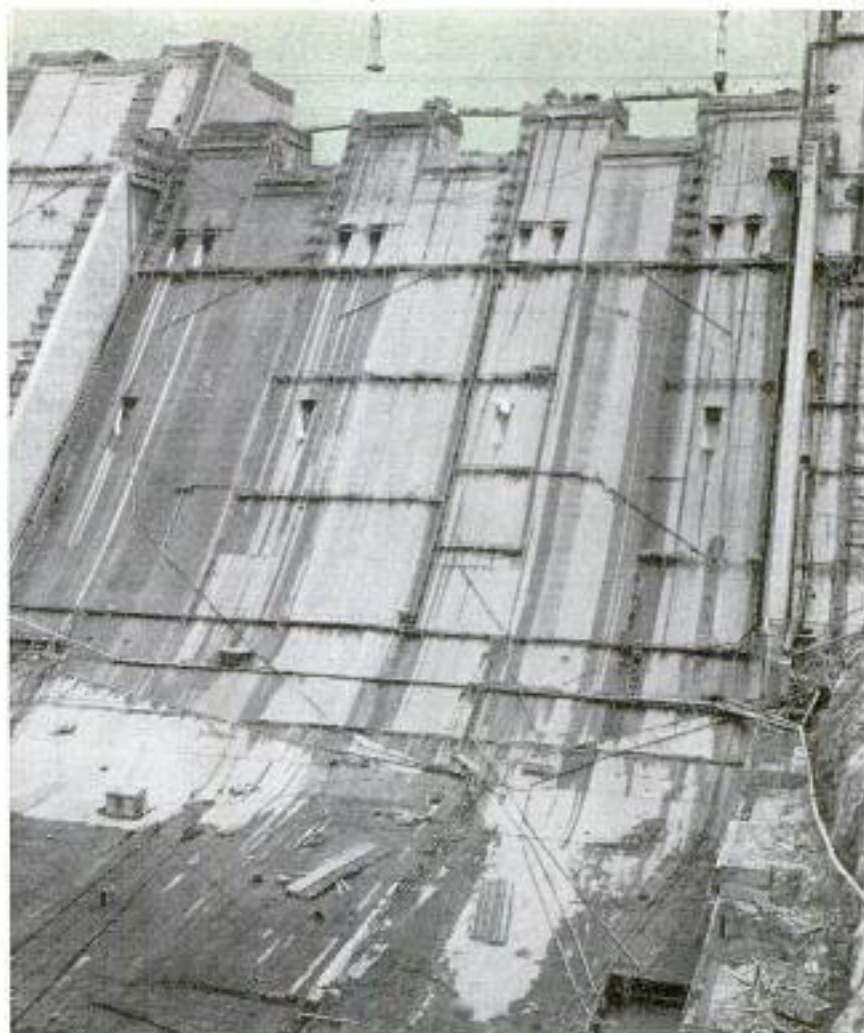

Higher than the Washington Monument is the spillway of Shasta dam on Sacramento river. Below, giant 84-inch needle valve in Friant dam controls flow of San Joaquin waters into new Madera irrigation canal

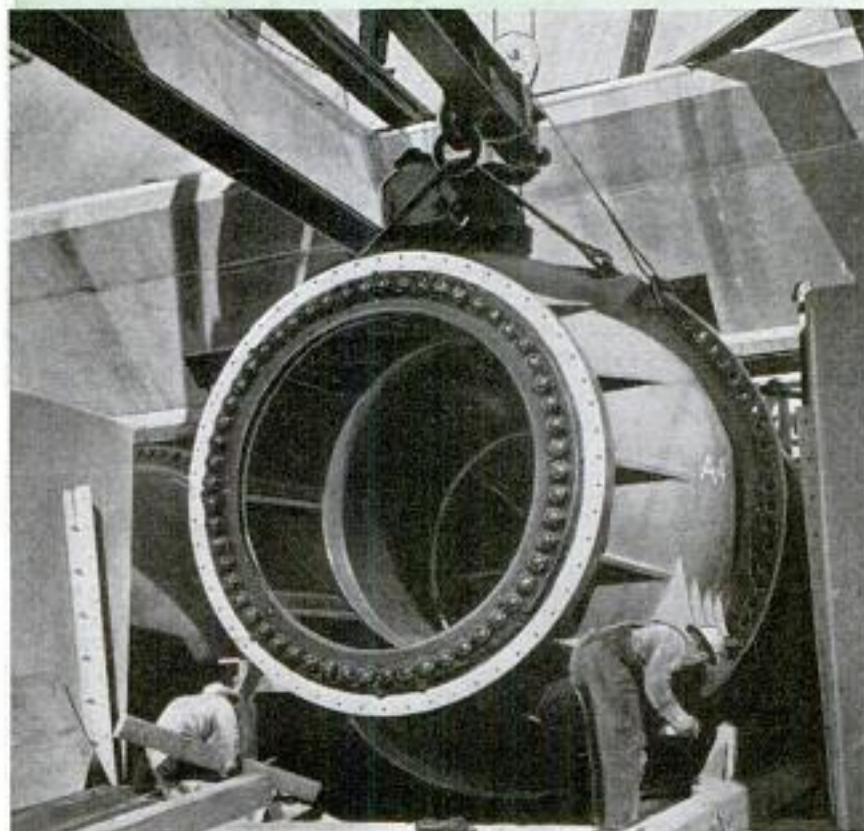

Mobile Power Station to Serve Bombed Cities

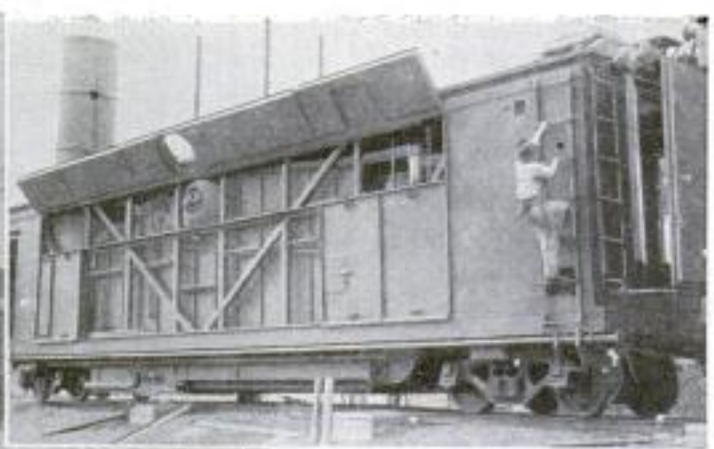
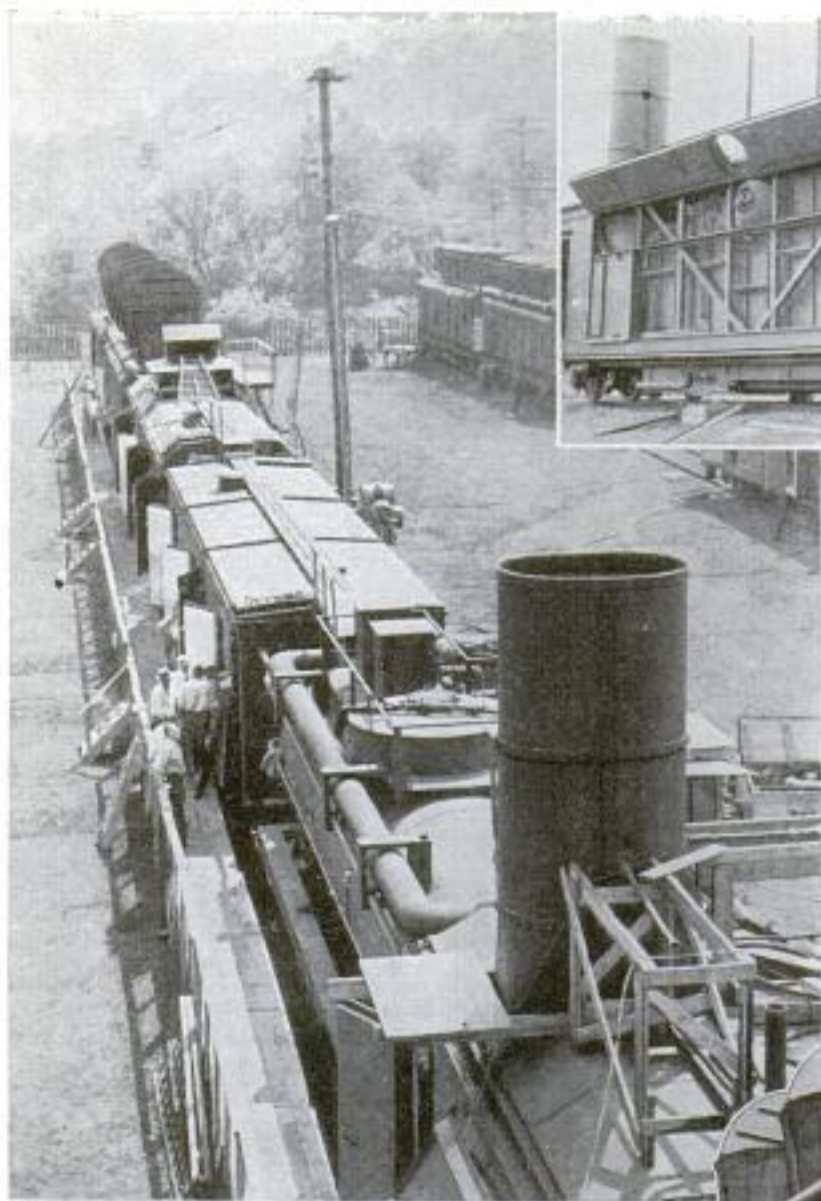

Above, final assembly work on the boiler car of one of the 5,000 kilowatt trains. Each train, consisting of eight cars, is ready to follow on heels of an advancing army, stop at the coal stockpile of a wrecked power station and feed current to factories and homes. All the trains can operate in temperatures from 40 degrees below zero to 95 above. After the war they will be available for disaster emergencies



To restore current to bombed cities re-taken from the Axis, the Allies are using 10 Westinghouse trains, each carrying a complete electric power station. The stack in the foreground (above) is on one of two boiler cars which generate enough steam to run a Liberty ship. Right, condenser car about to be tested. Below, sketch of two condenser cars which shoot out 800,000 cubic feet of air a minute. Cutaway of car at right shows position of fans

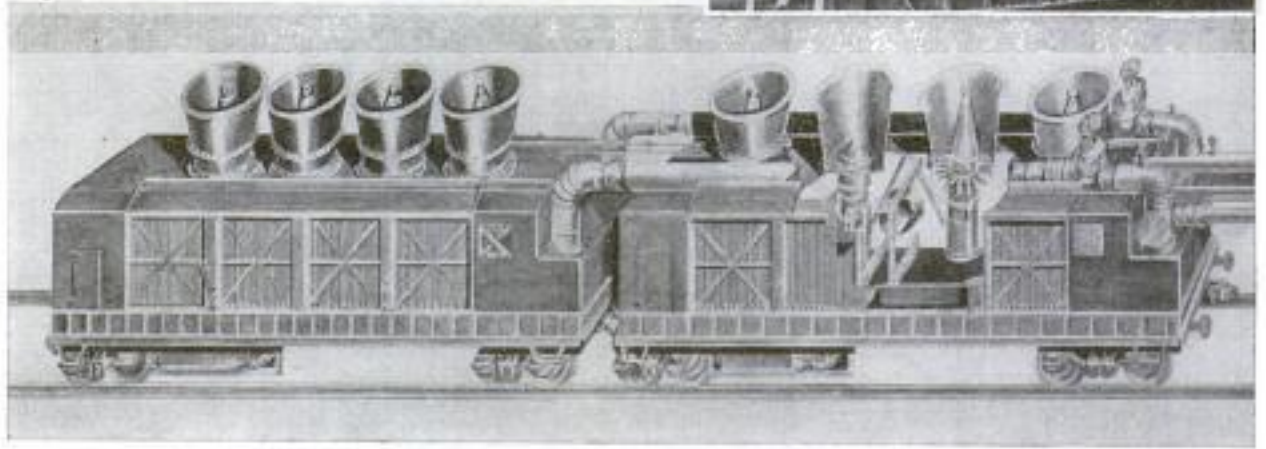

Westinghouse Electric & Mfg. Co. Pittsburgh, Pa.

"Suicide Pilot" of Tiny Nazi Sub Fires Torpedo

That the Nazis have used one-man submarines to launch suicidal torpedo attacks was disclosed when a 12-foot submarine containing a 17 year old sailor was washed ashore on the Anzio beachhead. These craft, which are driven by electric batteries,



Above, radio-controlled tank captured from the Nazis is loaded on trailer. Left, a German "human torpedo" manned by a 17-year-old sailor is washed up on the shore



of the German midget submarines have been failures, several exploding within sight of their objective. Apparently the Germans have had more success with their radio-controlled tank, also 12 feet long, whose driver takes it as far as he dares, then gets out and directs the tank and its 1,000 pounds of explosives to the target by radio. The tank was first used against the Allies at Anzio.

approach their targets silently at slow speeds and release a propeller-driven torpedo. Unlike the two-man British "human torpedoes," which have had success, most

as he dares, then gets out and directs the tank and its 1,000 pounds of explosives to the target by radio. The tank was first used against the Allies at Anzio.

Electronic Set Measures Hides And Textile Pattern Layouts

Industrial plants are using an electronic machine which measures the areas of flat sections of material, such as the size of leather hides in the leather industry and pattern layouts in the textile business. Other possibilities are the measuring of the area of ink on printed matter and the surface enclosed by pin pricks of perforated layouts and outlines. The machine is a two-part cabinet. The bottom cabinet contains photoelectric equipment that scans the pieces of hide traveling on rollers through a long narrow slot. As the light beam travels along the slot, it moves part of the distance before it strikes the skin, then crosses the skin and finishes the stroke out of contact with the leather. These operations are repeated on the return stroke. Since the rate of movements of the beam and the rate of feed of the skin are known, the area of the skin can be quickly calculated by finding the total time interval that the beam is on the skin.

Paper Also Fights—Save It!



Signal Corps photo

Here's another cogent reason for saving paper. Last year the U. S. Army bought \$70,000,000 worth of paper, and one fighting item on the list was paper cases for artillery shells. Some idea of the expenditure of shells in an area of concentrated artillery fire is gained from this picture of a dump in Italy where containers are salvaged from a Fifth Army battleground. You can help ease the shortage of a vital material by saving all your waste paper for your salvage committee

0258
0-344
"Submarine" May-1944

Stockton Profile George Lang 27
Lowell, Mass.

Mr. Wayne
W. Miller

PICKING *the* TARGET



An Air Force officer picks a target on the English Channel coast as plans for bombing mission are laid



Looking up through camera doors (right) of an O-47 plane you face the big camera of an aerial observer. Below, 52-pound flash bombs for night photography

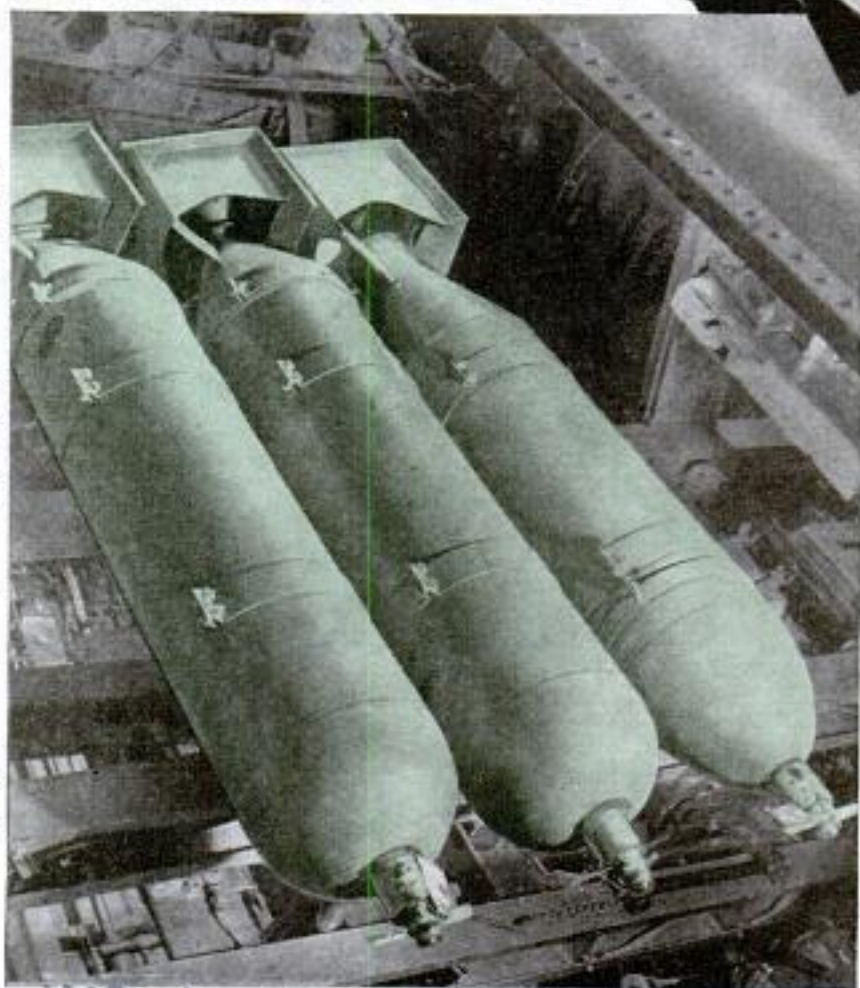

"BUT HOW did they know it was there?" Millions of Americans ask the question after reading some exciting account of a successful mission by Allied bombers against some highly strategic target.

How did they know the Germans were making radar equipment in the old Zeppelin works at Friedrichshafen? How did they know the camouflaged plant at Huls was producing synthetic rubber? Who told them the battleship Tirpitz was at anchor in the Alten Fjord? How did they happen to catch 200 Jap planes on the ground at Wewak and 19 ships in the harbor at Truk? How did they know when the German submarine pens at Vegesak had been re-

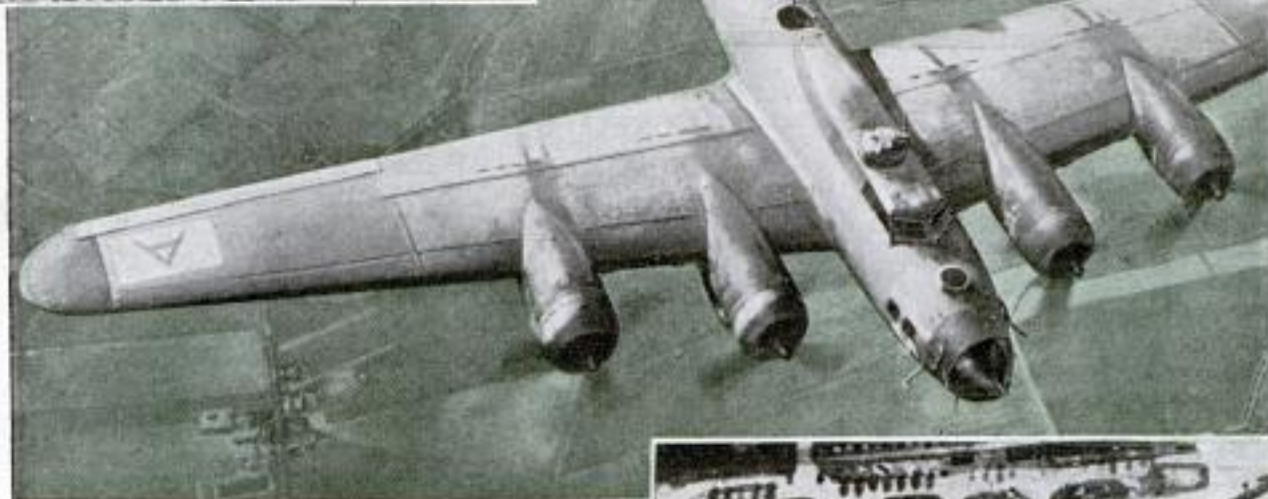

Reconnaissance photos at upper left and below show Nazi signal corps depot at St. Cyr before and after a bomb raid. Upper right, a B-17 blasts Marienburg

built to a point where they were worth plastering again?

The answer is photo-reconnaissance. It is also the source of about 80 percent of the information we have about what the enemy is doing, where he is doing it, and how we are going to stop him. Reconnaissance pilots fly alone in unarmed planes to get the photographs. They steal the enemy's secrets at 300 miles an hour, at altitudes from 300 to 30,000 feet.

In planning the invasion of Europe, millions of aerial photographs were taken, including more than half a million pictures of German coastal fortifications alone. These photographs, taken over a six-month period, revealed amazing details of defenses and terrain. Expert aerial photo-interpreters can estimate ground elevation of only a few feet from pictures taken at 30,000 feet. Color photography makes camouflage stand out like a beacon.

Photo-reconnaissance played a major role in the selection of the invasion site between Le Havre and Cherbourg. Thousands of photographs of northern France revealed the location of important military



U. S. Army Air Force photo
Loading photoflash bombs, with which night pictures from four miles up can be made. They light the earth on darkest night with noon brilliance

highways, railroad yards, bridges, hidden hangars and camouflaged airstrips, gun installations, mine fields, ammunition dumps, and likely places for the concentration of troops. On these targets, 13,000 tons of bombs were dropped in the four days preceding the invasion.

Although the men who take 99 percent of the pictures of enemy positions carry cameras instead of guns, and must act as their own navigators and radio operators, no one ever called them "suicide" pilots. They are experts at faking and must be the despair of German radar operators, for they never seem to arrive where they are headed. This frequent changing of course, all carefully planned, baffles the methodical German who cannot figure out whether the target is to be Berlin or Hamburg. Consequently, Messerschmitts and Focke-Wulfs are forever trying to intercept our reconnaissance pilots "where they ain't."

But there is flak to dodge at 30,000 and even 40,000 feet, and when the pilots "dice" an area at 300 feet

Camemen rig up an electrically heated camera for high altitude
AAF Materiel Command photo



there is the danger of small arms fire. For day missions, U. S. reconnaissance units fly stripped-down Lightning P-38's which can outrun enemy fighters. The stripping consists of replacing 900 pounds of guns and firing mechanism with 500 pounds of photographic equipment, saves weight and increases speed and range.

Two-camera and three-camera installations are used on the P-38's. The former takes overlapping pictures by shooting straight down, and the tri-metrogon method provides three different views, taken simultaneously, which give a horizon-to-horizon picture.

At 20,000 feet, tri-metrogon cameras photograph a 40-mile area, and planes traveling 200 miles an hour can "shoot" 8,000 square miles per hour. At 30,000 feet,

telephoto cameras can record areas six miles square with prints so sharp it is possible to tell the difference between light and medium tanks and detect barbed wire. The accuracy of the telephoto cameras is so fabulous that the pilots jokingly insist a second-day beard is visible in a picture taken from six miles up.

The cameras work automatically, and after the pilot has determined the proper position all he has to do is press a button. If he wants a series of shots he holds the button down and the cameras take several pictures a second.

Photographs are taken at night with magnesium flash bombs, which provide a billion candle power at the peak of the flash, illuminating the target area for miles.

Four-engined bombers are sometimes equipped for photographic missions. Liberators, carrying six cameras instead of bombs, have been used over Europe and the South Pacific. Photos taken from Liberators helped trap the Jap ships at Truk. These planes carry standard armor and ten .50 caliber machine guns.

Often, when a pilot has complet-

Continued to page 148



From his flying "greenhouse" a student at Aerial Observation School trains his camera on a target. Below, bombardiers and navigators in pre-flight training study model of Japanese city; they must learn to identify enemy cities, planes and ships

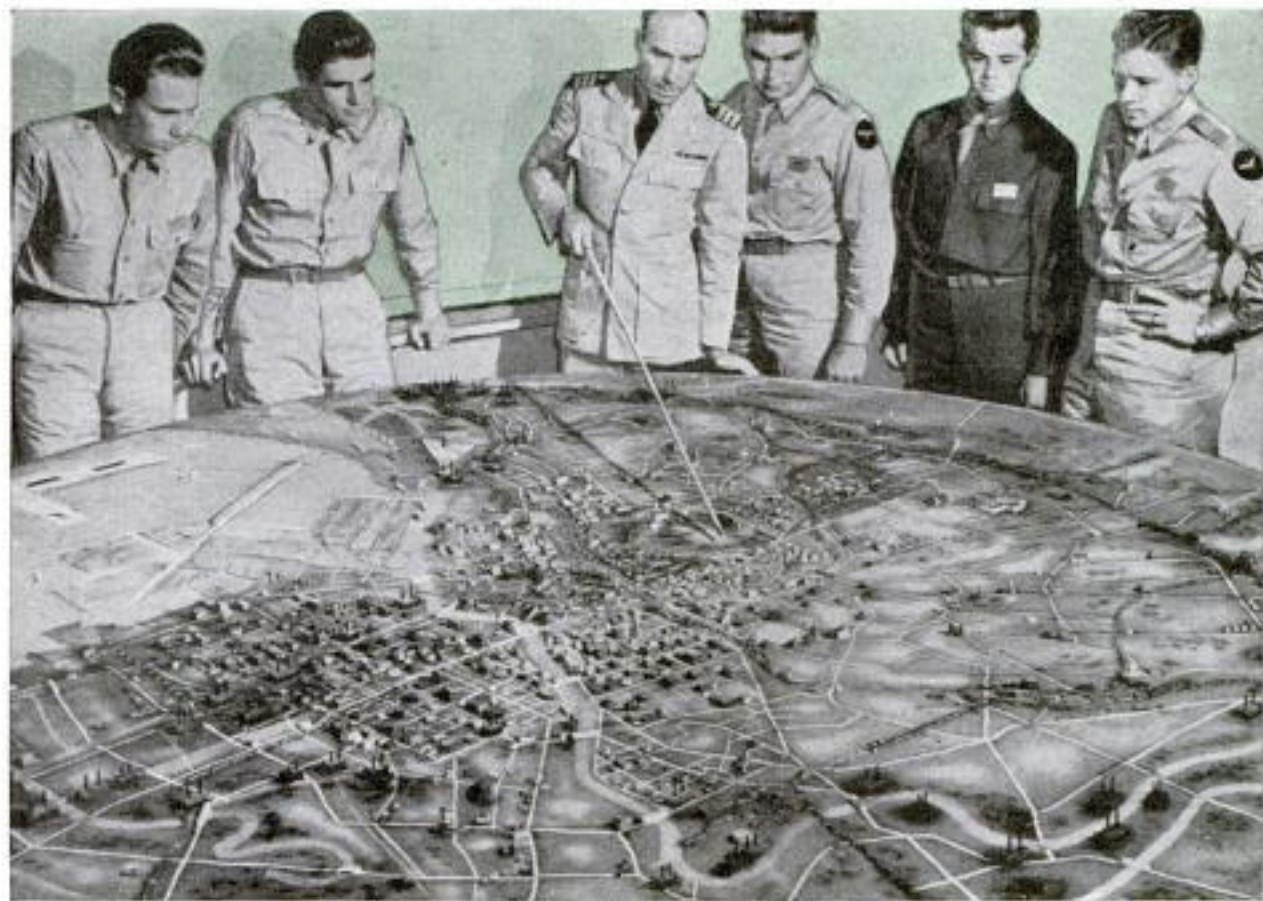

*Home Newsreleases Inc. 0915
+61 - C. Wright Ave. N. Y. N. Y.*

Boxes Joined as Barge Float Allies to Beaches

Hollow boxes of welded metal joined together to make self-propelled barges bridged the last few hundred yards between ships and beaches when Allied troops stormed the Normandy coastline.

The pontoon gear, known as the "Rhino Ferry," can be put together aboard ship and loaded with men, vehicles and supplies as soon as it is lowered into the water. Having less draft than landing craft, the barges are ideal for the long shallow beaches of Europe; they also were used in the invasions of Attu, Africa, Sicily and Italy. Two outboard motors at both ends of the stern can push the barge along at a little more than four knots. The pontoons are built in two sizes—five by seven by five feet deep, and seven by seven by five. Filled with water, the barges can be used as piers and docks.

U. S. Navy --- called "Rhino Ferry"

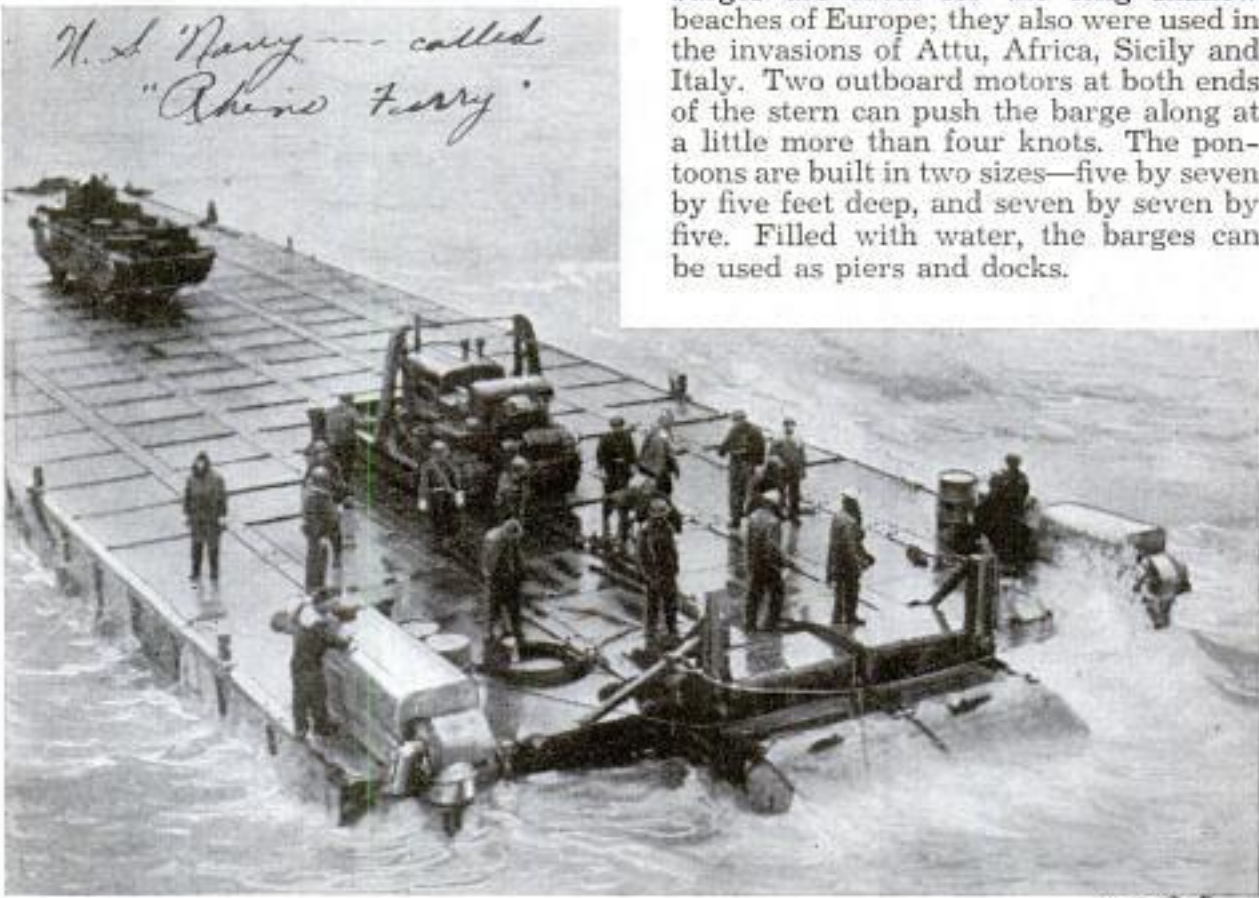

0283

Icy Electrodes to Speed Welding Put Frost on Machine

By pumping a stream of "super-cooled" liquid into and then out of copper electrodes in a welding machine, spot welding of thin sections is speeded up and the quality of the work is improved. Refrigerating

of the electrodes, which are specially designed for the purpose, keeps them from heating up to such an extent that they alloy with the aluminum being welded, thus preventing a clean strong weld and requiring a halt in production until they are cleaned. The liquid is maintained at any desired temperature in a special refrigerating unit. A replaceable cap, cold forged from electrolytically pure copper and fitted to the end of an electrode, makes it possible to bring the cooled liquid down to within a fraction of an inch of the point where the welding is actually taking place, which is where the heat can do the most damage. Use of these caps makes it unnecessary to replace the entire electrode. As a result, even when welding at high speeds, welding machines now are often covered with frost.

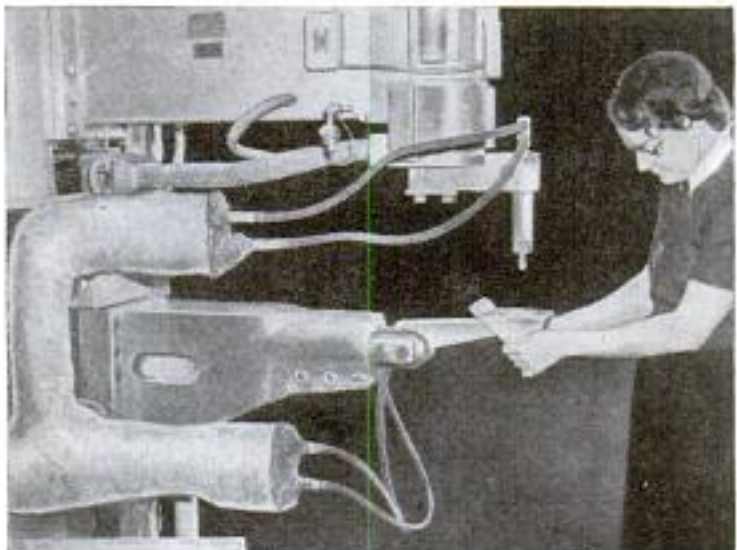

Photo courtesy of Frostrade Products

Cont: Deane & Co. Bond Bldg. Detroit, Mich.

*7/4/48: Frostrade Products
19929 C. Peter
Detroit 3, Mich.*

HIGH BALLING 500 TRAINS *a* DAY

By
Roderick M. Grant

FROM their gallery seats in Union Tower at Rahway, N. J., the Pennsylvania Railroad's block operator and leverman watch over an endless passing parade through the bottleneck that is no bottleneck.

Beneath their windows lies probably the busiest straightaway on any railroad. Just west of Union Tower the rails from New Jersey seaside towns merge into the main line that leads into New York from Philadelphia, Washington, Harrisburg and the west and south. A few miles east of Rahway the freight lines diverge to fan out in sprawling yards along the waterfront; farther on, at Newark, the main trunk heads eastward to the Pennsylvania



One of 88 Pennsylvania passenger trains a day between the two cities leaves the Broad Street Station in Philadelphia for New York. Below, the power director in New York City routes 11,000-volt current to wires





The engineer overlooks the streamlined nose of GG-1 passenger locomotive

Station in Manhattan while another offshoot forks down to Jersey City.

But here at Union Tower traffic is at its thickest. All told, the Pennsylvania carries roughly 11 percent of all America's railway freight tonnage and 18 percent of all the passengers. And a large and solid

chunk of this filters through the high-speed bottleneck at Rahway.

It is no rarity to find all the lamps lit on the frosted-glass panel before the block operator, indicating a "full house"—a train on each of the six tracks within the ten-mile section governed by Union Tower. In morning and evening rush hours there are even moments when all six tracks beneath the window are loaded, and the block operator has a busy few seconds to jot down on his log the engine number, train number, the time and track of each passing train.

The two men in the tower have full responsibility over trains in their section. Behind the block operator stands the leverman at the long bank of levers controlling the interlocked switches and signals governing the route of each train. Movements on the middle pair of the six tracks can be made in either direction, so that at peak hours three tracks west of

Train directors, yardmasters, block operators and levermen supervise and operate this interlocking machine, one of the biggest, governing movements of trains in New York's Pennsylvania Station



Union and four tracks east are available for traffic in one direction, either east or west. Colored arrows on the electric track map above the interlocker indicate direction of traffic flow on the inner tracks at the moment. Dots of light across the animated map show the position of every train in the area.

Railroading is a forward passing game. Union Tower has no dispatcher, but is in touch with division dispatchers by telephone. The Union block operator receives a New York-bound train from the tower at Metuchen, six miles west; clears the train to Elmora Tower, and so on until it is delivered to the big interlocking which controls movements in Pennsylvania Station.

Hours before an overnight sleeper filters past Union Tower to the threshold of New York, the Pennsylvania Station dispatcher reads a train consist coming by Teletype. It reports train No. 60, with engine 4877, left Harrisburg at 5:35 a.m. The consist lists baggage car 6139, five Pullman cars by name—"Night Mantle, Imperial Pass, City of Johnstown," etc.—diner 4423, nine more sleepers; then the train crew listed by name. From this consist the Pennsylvania Station block operator knows the length of the train and routes it to the station platform of proper length. Every tower from Harrisburg to New York relays train and engine numbers and passing time.

Five hundred trains a day highball past Union Tower. Four hundred passenger trains carrying suburbanites and transcontinental travelers, troops, and thousands commuting on hourly

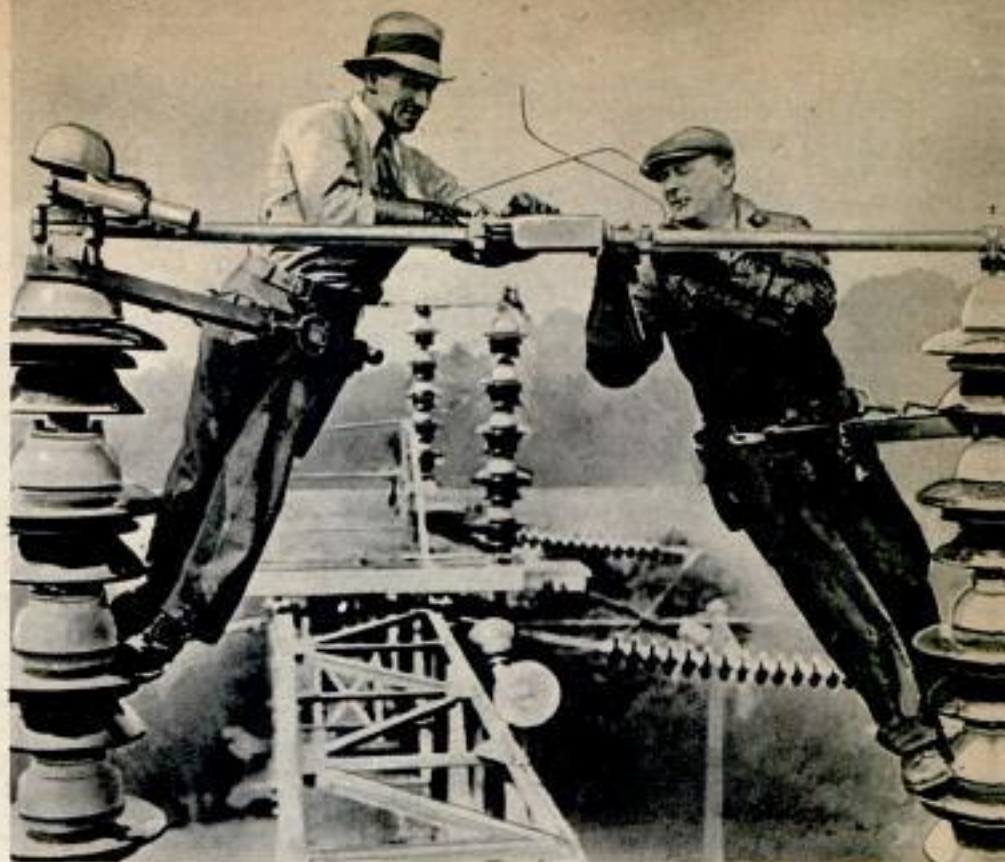

Electricians adjust a 132,000-volt transmission line switch at a power sub-station. Below, an armed guard stands by during wartime at the approaches to a five-track lift bridge at a busy gateway to New York City

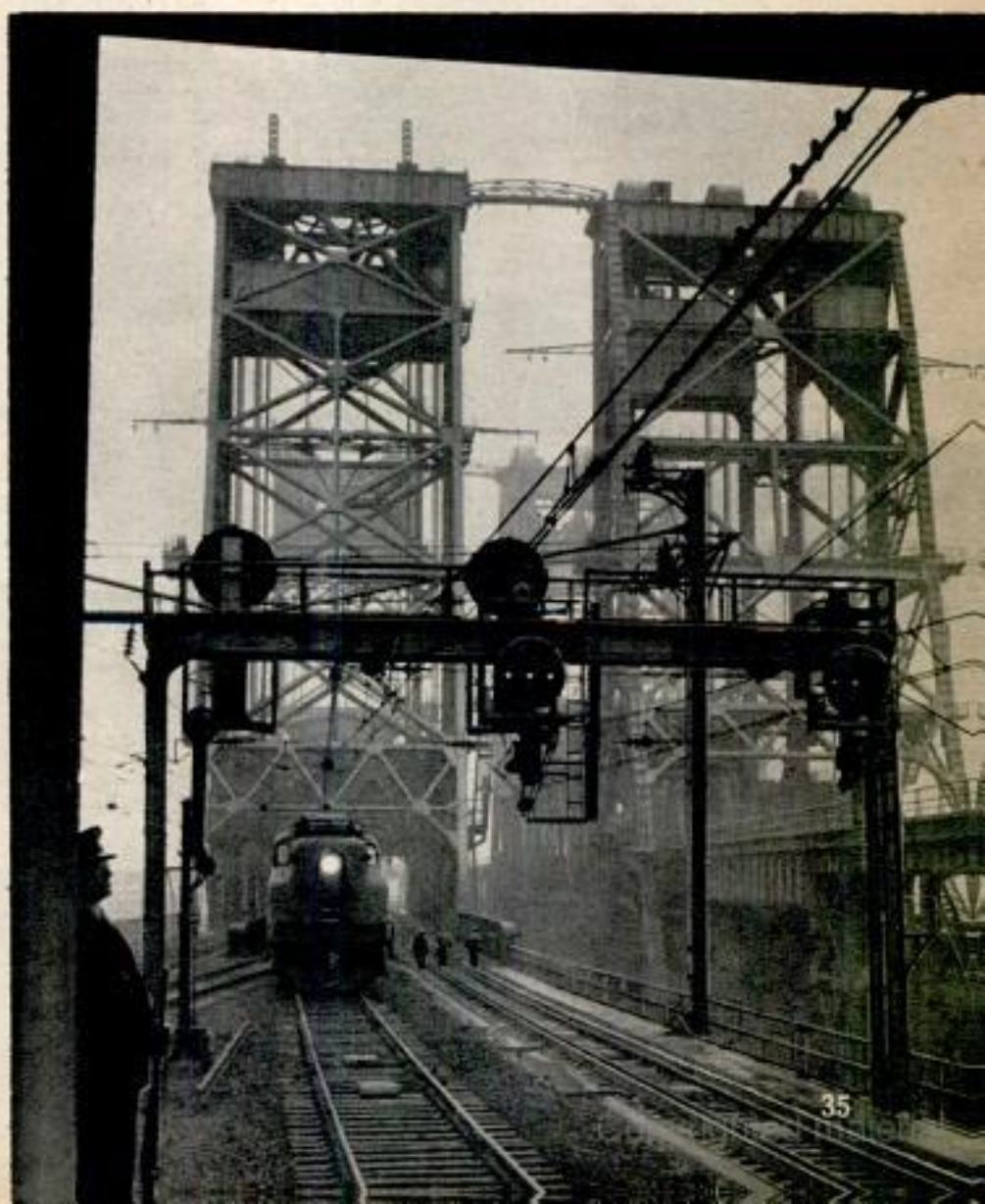



Operating the remote-control circuit breaker on control panel in Union Tower at Rahway, N. J., for nearby power station

trains between the nation's capital and the largest city. Fifty freight trains westbound, and 50 more headed eastward with war materiel for army docks, with coal and oil and merchandise, with perishables to be put aboard car floats and ferried across the river to the markets of lower Manhattan.

A train every three minutes all day, on

the average. More dense than that in rush hours. And among the fleet of streamlined electric locomotives the towermen notice a sprinkling of steam engines, some pulling freights, others troop trains headed for the port of embarkation. They look a bit anachronistic steaming along beneath the network of 11,000-volt wires that stretch from Long Island City to Harrisburg, Pa., and Washington, D. C.—2,677 miles of track representing 41 per cent of the electrically operated standard railroad trackage in America. The transmission lines carry 132,000 volts, stepped down to 11,000 volts a.c. at the pantograph. So heavy has wartime traffic become that at the last peak, in November, 1943, 88 steam locomotives supplemented the fleet of electric "horses."

By the end of 1943 the Pennsylvania had a pool of electric engines with a total of 1,100,000 kilowatt capacity, ranging from half-pint switch locomotives and suburban motor cars to the mile-a-minute freighters and 4,620-horsepower "GG-1" passenger streamliners whose twelve drive wheels can pull a steel train at better than 100 miles an hour. Last November the electric fleet drew out of the wires a record peak load of 235,000 kilowatts through its heavi-

Block operator and leverman in Union Tower are perpetually busy. There's a train every three minutes here



est hour. The flow of power mounts astronomically. Last January the Pennsylvania used 70,188,000 kilowatt hours in the New York area, 69,416,000 more in the Philadelphia - Washington-Harrisburg zones. In a year the figure would add up to 1,675,000,000 kilowatt hours.

Philadelphia being the capital of the line, the railroad's load dispatcher officiates from there over the entire electric system.

If a GG-1 develops a

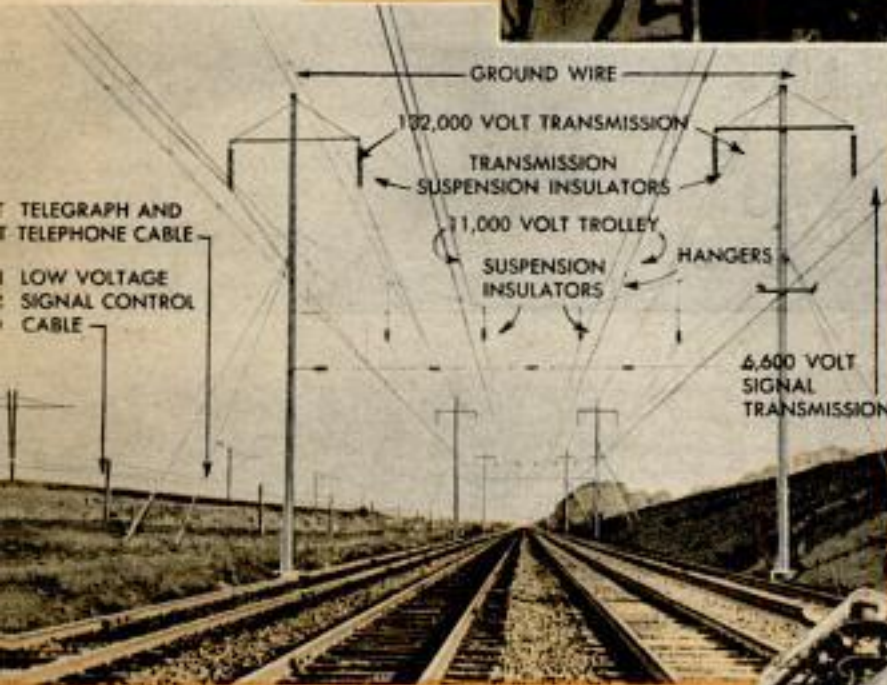

Wayside signals are duplicated in cab of fast passenger locomotives

short circuit near Rahway, high speed breakers instantly kill the trolley feeding the engine. The block operator at Union Tower who controls the sub-station at Rahway, gets the New Jersey area power director on the telephone, advising him of the trouble. The power director is in complete charge of trol-

Continued to page 156

Above, the Pennsylvania's catenary trolley system. Below, a 100-miles-an-hour locomotive on the New York-Washington route



bridge at place of Interlake Snow Cap.
in So. Chicago.

0105

Thermit Topples Bridge by Melting Its Supports

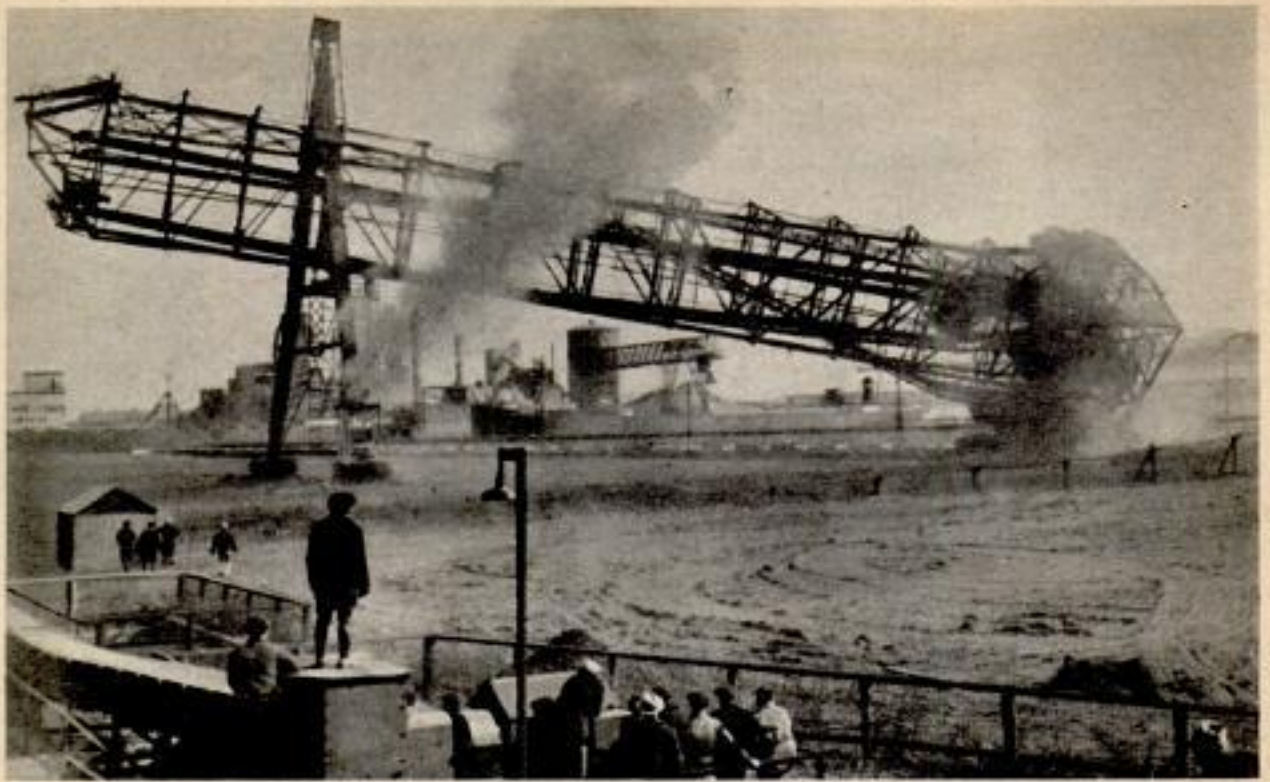

To wreck a huge traveling coal and ore bridge in Chicago recently, a thermit furnace was built around four of its eight supports. Ignited by electricity, the burning metal compound reached 6,000 degrees in

10 seconds and the piers melted, toppling the 20-year-old structure which was 300 feet long, 80 feet high, and 30 feet wide. It was one of the swiftest demolition jobs Chicago has ever known.

079

Subsoil Plow Leaves Protective Stubble to Prevent Erosion

To guard against the eroding effects of wind and rain, a new subsurface plow loosens the soil and at the same time leaves a protective blanket of stubble on top. Instead of turning over a barren furrow,

blades of this plow merely loosen the soil a few inches below the surface. Implements adapted to the work, which are manufactured by several companies, range from one or two blades to an eight-foot,

five-blade machine. Sub-surface plowing, developed from experiments conducted at the University of Nebraska in cooperation with the U. S. Soil Conservation Service, boosts crop yields in dry regions by increasing the seepage of rain water through the stubble into the soil. This type of tillage, also known as stubble mulch farming, has proved effective in many grain and orchard regions.

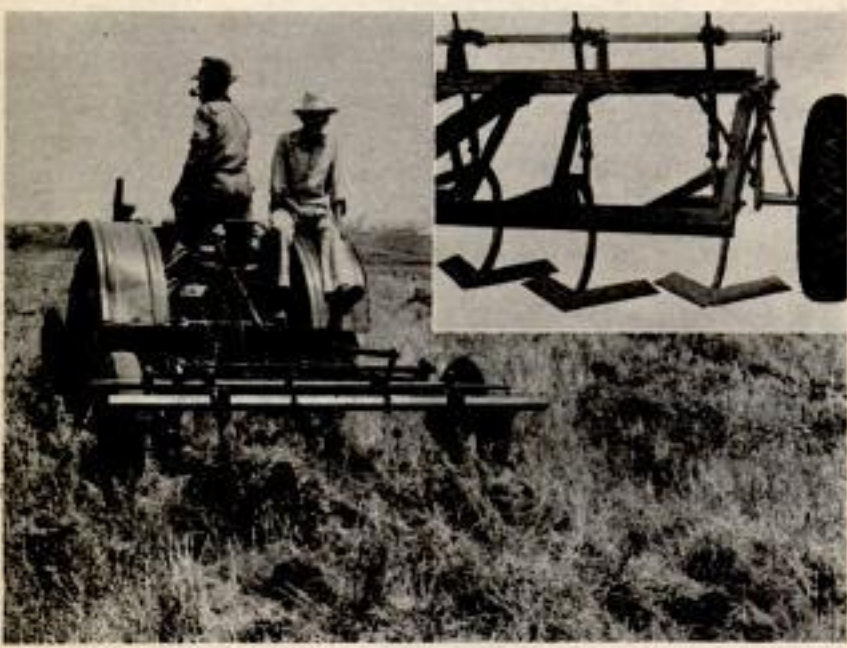

Orchard trees planted in clay soils loosened by small dynamite charges sometimes bear fruit a year or two earlier.

Mr. J. C. Dwyer, Acting Chief
U. S. Dept. of Agriculture
Soil Conservation Service
Washington 25, D. C.

Allison Division 0302
General Motors Corp.
Indianapolis, Indiana

3,000-Horsepower Engine Is Tops for Planes

American fighter planes will attain even greater speeds and climb more rapidly with the new Allison 3,000-horsepower engine. This 24-cylinder, liquid-cooled power plant is the most powerful aircraft engine in the world. It has twice the piston displacement of the present standard Allison 12-cylinder engine used in the Lockheed Lightning, Mustang P-51, the Invader A-36, Warhawk and Airacobra. Although the weight of the standard engine was already less than one pound per horsepower, the new model has further decreased the weight per horsepower. The cylinders are arranged in four banks of six each, giving the engine an over-all design of a "W" compared to the "V" design of the 12-cylinder engine. Simplified design of the new

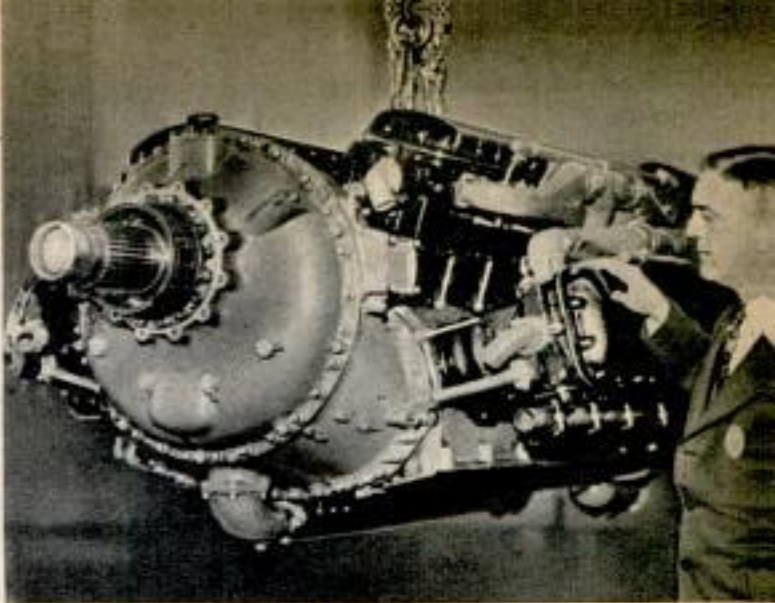

engine makes it possible to rush mass production, for 97 percent of the parts are interchangeable with those of the standard model. The engine is designed for installation on multi-engine aircraft as well as fighters, according to Allison engineers.

"Mars" Flies Biggest Mail From Hawaii to California



Twenty-five thousand pounds of letters—a record airmail load—recently was flown from Hawaii to Alameda, Calif., in the Martin "Mars" flying boat. At an average of 1/2 ounce per letter, the load amounted to 800,000 pieces of mail which, at prevailing rates, would carry \$160,000 in postage. While the load set a new record for airmail, it was 10,000 pounds short of the all-time record payload of 35,000 pounds carried by the "Mars" on its first war mission.

0270
The Standard Mailing Co.
Baltimore 3, Md.

Army's Plywood Storm Boat Hits Beach Like Toboggan

Designed to spearhead a river crossing by assault troops, a "storm boat" used by the army engineers is made entirely of plywood and powered by a 50 horsepower motor capable of 20 to 23 miles per hour. The craft carries eight fully equipped riflemen and a crew of two. It makes a difficult target for the enemy because of its low lines and great maneuverability. If the shore is low and shelving, the boat may be beached head-on at full speed, which often toboggans it high and dry. Once it hits the beach, its passengers, who have been lying prone, leap out, rifle in hand, ready for action, and the boat scoots back to its embarkation point to ferry supplies. The "storm boat" is 16 feet, nine inches long, by six feet, six inches wide.



HIGH CHAIR BOMBARDIERS



Bombardier cadets at Midland Army Air Field in Texas begin a bombing run on fixed targets. Below, a low seat in "highchair" trainer teaches bombing from low altitude

By Lt. Col. Howard E. Watkins

Director of Training, Army Air Forces Bombardier School, Midland Army Air Field, Midland, Texas



THE bombardier in the greenhouse is crouching over his bombsight. As he peers through the eyepiece, he sees the target, a gasoline refinery, below and ahead. His fingers deftly adjust the delicate controls. He centers the target on the cross hairs. He makes a final check on level, range, course, drift.

"Bombs away," he says over the interphone. "OK to turn." Seconds later, a series of flashes on the target shows his aim has been good.

The bombardier walks away. He hasn't even left the training hangar.

That's one phase of "synthetic bombing." The apparatus on which he "flew" his mission is a "projection trainer," one of a number of devices, many of them developed by members of our own staff at Midland Army Air Field, which are saving millions of dollars throughout the Army Air Forces Training Command. What is more important, they make it possible to give a cadet a more thorough foundation in both theory and practice of bombing.

Synthetic bombing is not a substitution for the real thing. Student bombardiers still drop hundreds of practice bombs on targets, from fifteen-foot

square pyramids of clay to an 817-foot full-scale model of the Nazi battleship "Von Tirpitz."

But now, in addition to actual flying missions, the tyro bombardiers spend hours on mechanical training aids which simulate everything encountered in the air except flak and enemy fighters. These training aids are particularly valuable in the preliminary stages. A student can drop several times as many "synthetic bombs"



Hunched over bombsight, the cadet follows target on film until he has it on crosshairs of sight. Flashes on target tell whether he has hit it. Below, diagram of projection trainer

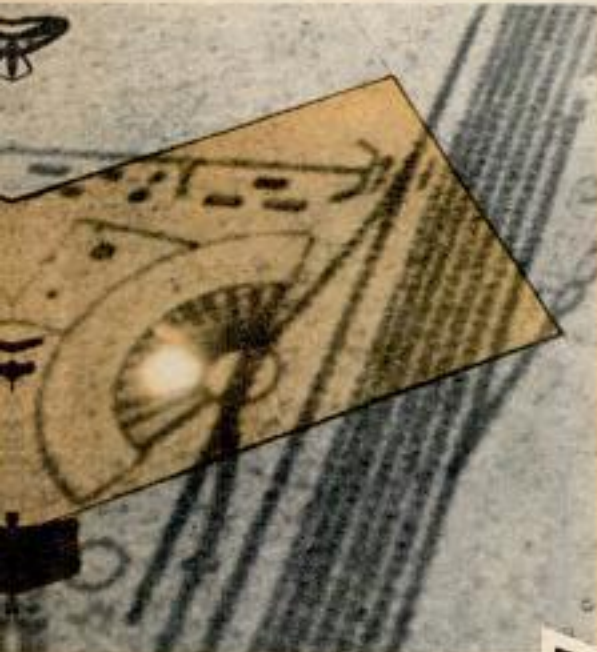

Above, target (railway yard) as it moves toward bombsight of trainer. Below, image projected through hole to ceiling is mirrored to screen

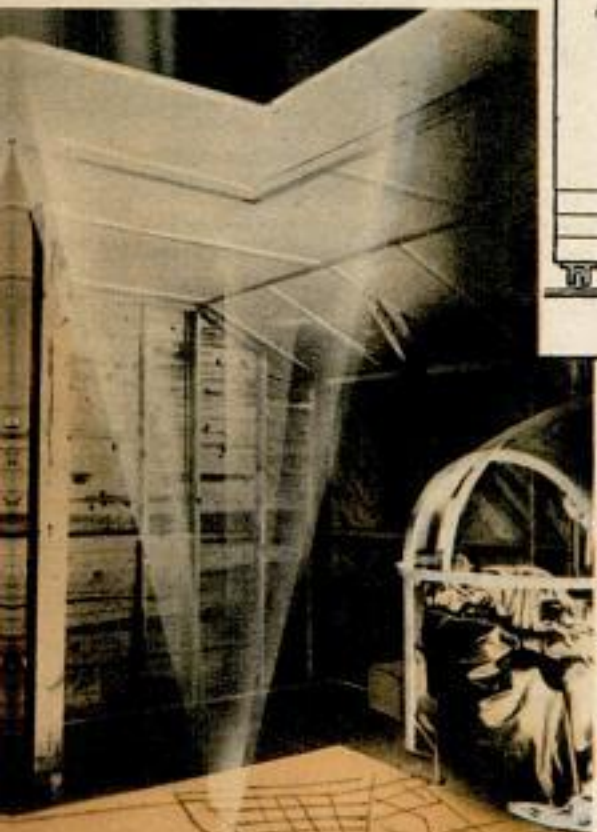
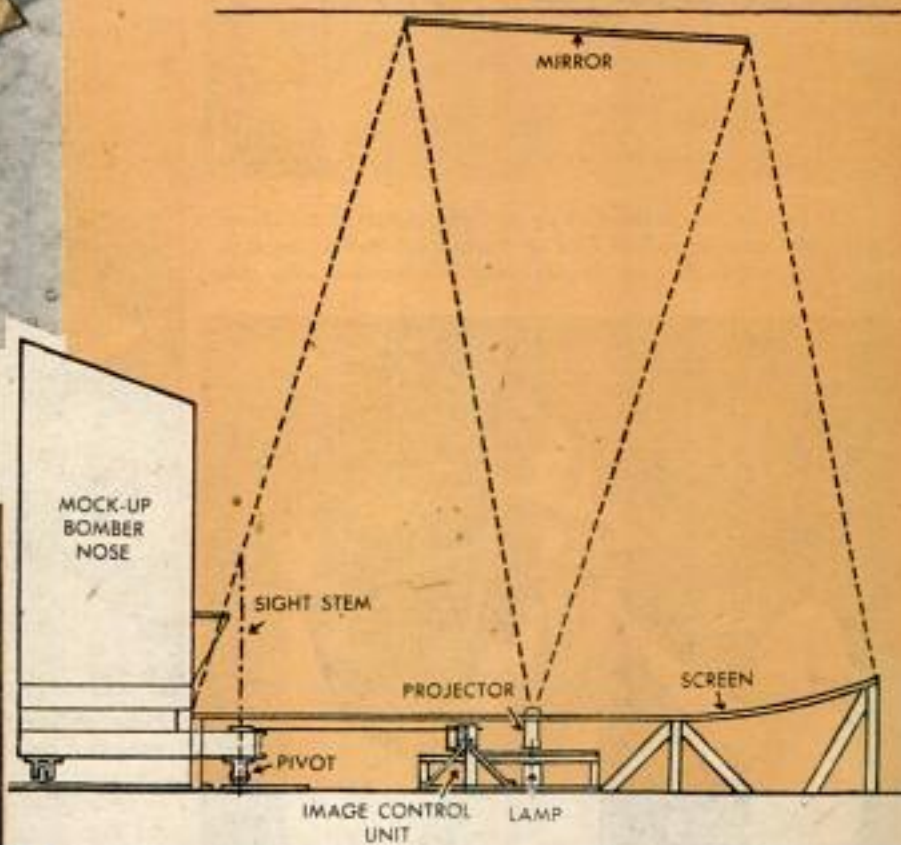

as actual missiles in a given time. His instructor can demonstrate procedure and results, and each mistake can be analyzed. When an error is discovered, the student can concentrate on correcting that error.

In those first difficult weeks, when a student couldn't drop a bomb close enough to scare the crows off the target anyhow, he acquires the fundamentals right in the hangar. Synthetic bombing requires no pilot, no aerial crew or ground crew. It doesn't even require bombs.

The projection trainer was perfected by our special projects section. Major Edward McKaba,



On the Navitrainer's bug or "wintruder" is charted the course student flies on "mission." Below, mockup of bomber's nose familiarizes bombardier with post

in charge, conceived and developed the trainer with the assistance of his staff. Its principal feature is the projection of a moving slide, showing a section of terrain, onto a horizontal screen in front of the bombardier. The movement makes it appear as if the bombardier were flying over the target.

The cadet sits in a mock-up of a bombardier's compartment and sights an actual bombsight. The controls of the sight are connected with the projector so that movement of the slide will change accordingly. For instance, if the cadet sees the target to the left and sets his controls for the proper course, the slide will move in a direction to bring the target toward the



Motor-driven mockups of navigation instruments are operated by instructor as students work out problems

bombsight. Effect of wind drift can be added by a simple adjustment. The bomber nose mock-up is set on a pivot so that it will point in the proper direction as course is changed. A light flashes on the target to indicate the location of bomb hits.

The standby of synthetic bombing training is the "high chair" trainer, a self-propelled scaffold ten feet high, on wheels. The cadet sits on a platform atop the scaffold and, with a real bombsight, sights at a moving target "bug" on the hangar floor. The bomb release trips a clock which causes a plumb bob to drop onto the target after the proper interval has elapsed to



allow for assumed altitude. A sheet of paper, with the bull's-eye marked by an X, is placed on the target "bug." Carbon paper falls across the target as the plumb bob drops, making a record of hits. Containing a small electric motor, the target bug can be propelled at varying speeds and angles to simulate a moving target, wind drift, or both.

Cadets start with runs of about 75 seconds. After they have started flying, they continue workouts on the trainer, but solve more difficult problems. Time of the runs is shortened to 20 or 30 seconds.

A lower seat, two feet above floor level, is used for instruction in low-altitude bombing. As a further improvement on the high chair trainer, there has been installed in each trainer a modification of the Automatic Pilot, which permits the bombardier to take over control of his "ship," in so far as course runs and drift are concerned, exactly as on a real mission.

With the introduction of a course in dead-reckoning navigation, there arose the necessity for training devices. One is the Navitrainer, used in teaching bombardier-navigators the use of navigation instruments before they make actual flights. The Navitrainer simulates the exact conditions of flight, but a mission takes 40 minutes to an hour and a half, instead of three to five hours for an actual flight. It is in two units, one a movable "bug," about four feet in diameter, the other the cab that houses the navigator's "office."

The bug is called the "wintroducer," short for "wind introducer," because adjustments in the bug will vary the direction of the wind in the problem. Mounted on the wintroducer is a huge reproduction of the mercator, on which the take-off point and destination are marked before the student enters the cab. An over-sized pencil plots on the mercator the actual course the student works out as he "flies" his mission. When he has finished he may see just how far he may have varied from the course set.

The cab is driven by a motor that moves it 30 to 36 inches an hour, to correspond to the speed of the plane. On the control panel are an air speed indicator, altimeter and temperature gauge. Also mounted in the cab are a drift meter and an aperiodic compass. The navigation student must also have with him in the Navitrainer a Weems aircraft plotter, an E6B computer, dividers, mercator plotting sheet, a log, a handful of pencils—and a clear head.

Another navigation training aid recently developed is the Classroom Instrument Board, a mock-up of the instruments actually used in navigation. Each instrument is motor-driven and controlled from a port-

Continued to page 158



Helicopter Flies Inside Building To Show Precision Control

Aviation made its bow as an indoor sport recently at an armory in Buffalo, N. Y., when a test pilot demonstrated the Bell helicopter before representatives of the Army and Civil Air Patrol. The craft took off, performed maneuvers in a restricted space and landed. The stunt was staged to show the stability and precision control of the Bell helicopter. *Test pilot: Ralph W. Carlson*

*0264
August 12
Army*

Workshop Dial Solves Problems On Woodworking and Tools

To aid the home craftsman in a variety of problems, a varnished cardboard calculator offers charts of closely related woodworking data. By merely adjusting the dial, a craftsman can convert linear to board feet, determine slope per foot in degrees, and find comparative hardness, weights, shrinkage, warping and ease of working of the various woods. Bit sizes for head, body and thread of standard screws, nail specifications, and tips on tool sharpening are included on the calculator, which is an accurate protractor as well. The chart is six inches in diameter.

*0247
Kumbe Tool Co.
2136 12th St. S.E.
Brookfield, Ill.*

COMPARATIVE EASE OF WORKING WITH HAND TOOLS	
BEAR	White - Ash - Oak
YELLOW BIRCH	Oak - Elm - Mahogany
CHERRY	Maple - Walnut - Pine
WALNUT	White Pine - Fir
DO, SPRUCE	Red Pine - Cedar
SOFTWOOD	White Pine - Fir
GREENISH PINE	White Pine - Fir
BILLAR PINE	White Pine - Fir
WHITE PINE	White Pine - Fir
RED PINE	White Pine - Fir
REDWOOD	White Pine - Fir
SANDWOOD	White Pine - Fir
WEST LARCH	White Pine - Fir
YELLOW PINE	White Pine - Fir
EAST SPRUCE	White Pine - Fir
ENGLISH SPIN	White Pine - Fir
ITALY SPIN	White Pine - Fir
BARCELONA	White Pine - Fir
DO, YELLOW PINE	White Pine - Fir
STRONG	White Pine - Fir
TUPLO	White Pine - Fir
WALNUT	White Pine - Fir

H—High M—Medium L—Low

CHARACTERISTICS OF WOODS

CHEMICAL MAGIC *on the* FARM

*Mr. Thomas C.
Hawson, Jr.
3872 Franklin
Ave. Los
Angeles 27, Calif.*



Top, spraying citrus grove with a multiple-nozzle boom. Left, dusting truck in action. Chemical dust is blown into trees through narrow openings at rear (see below) at 70-miles-an-hour initial speed



IF AN actor should be asked to represent agricultural chemistry in a play he might very properly dress himself in the costume of a magician. His magic wand could be the applicator of a power spray.

He would have to perform some amazing tricks to astonish an audience of farmers, for the things that he has been up to lately have already taken their breath away.

Agricultural chemistry has been going into their fields and weeding their crops. It has been making fruit stick to the trees until ripe. It has been preventing plant diseases, removing pests, and supplying mineral foods to plants and trees that need them. It has been putting trees to sleep during warm winters, insuring good crops the next season. It even has the promise of making more blossoms per plant grow to maturity. Some of this magic is done with colored

POPULAR MECHANICS

Copyrighted material

dusts, but more often with liquid sprays.

Weeding a crop by means of a chemical spray sounds ridiculous, for how could a chemical recognize the weeds and kill them, yet not harm the crop? Research men reasoned that a plant with broad leaves would absorb more spray than would a plant with narrow leaves, hence it might be possible to kill broadleaved weeds in a crop of narrowleaved plants.

They were right. One of the first crops on which they worked was onions. Leafy weeds absorbed the poison and died while the same spray rolled harmlessly off the onion shoots. Light petroleum oils are the basis of several such weed-killing sprays. Stove oil spray is an effective weed killer in carrots. Heavier oils kill both weeds and crop, lighter oils are not effective. The oil spray is applied when the feathery carrot plants are about an inch tall. Broadleaved weeds are killed by it; the young carrots continue to grow. Similar sprays are used for eliminating weeds in grain crops. Mustard plants in a field of barley die out when sprayed, morning glories in grain are killed without harming the crop.



A high-spray outfit working through a walnut orchard, spraying against codling moth

Driver of chemical dusting truck wears a respirator as he starts the dust blower

A spray treatment with DuPont "Ammate" weed killer eliminates poison ivy quickly



Research on selective weed killers has hardly started. Eventually it may be possible to get rid of weeds in any crop by means of sprays. There is some indication that the leaves of some vegetables are most receptive to moisture at a certain time of day; possibly it will be found that weeds can be singled out and killed by spraying the fields at the time of day when the crop itself is relatively immune.

Ammonium sulfamate, developed by Du Pont, is one new herbicide that has some selectivity against weeds in lawns and that





High-pressure jet protects shade trees in a Benton Harbor, Mich., park. Below, this spray rig forces vapor through nozzles at right, then propeller blows the spray into the trees

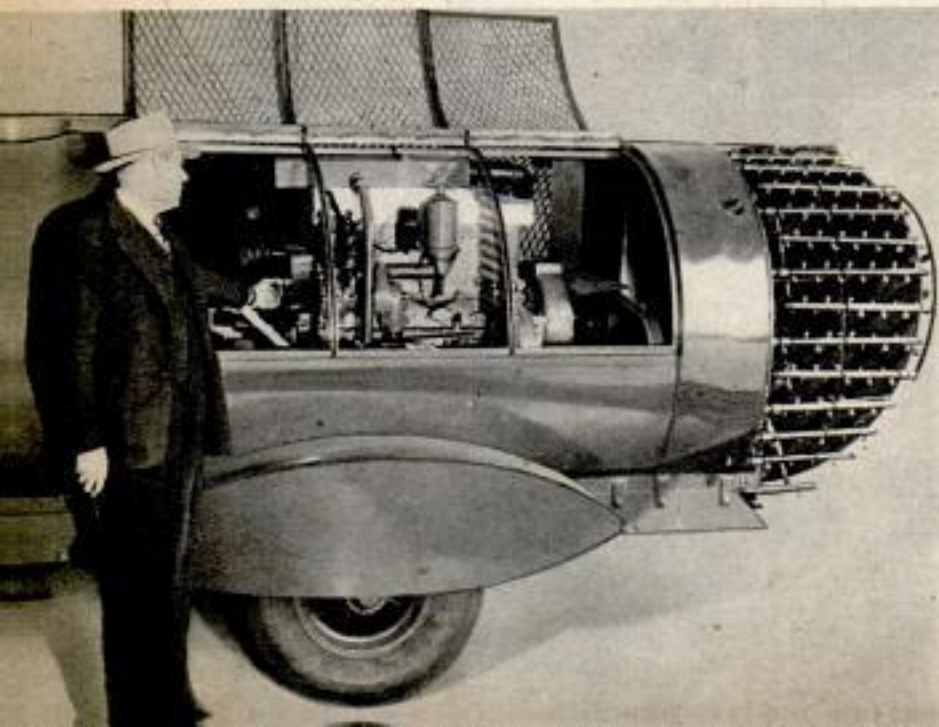

is outstandingly lethal against certain woody perennials including poison oak, ivy, and sumac. These scourges as well as goldenrod, chokeberry, and ragweed are easily eradicated by spraying them with ammonium sulfamate. Its residue is not poisonous to animals, or humans. "Ammate" is a salt and does its work by absorption by the plant's leaves. It kills woody perennials without the need of grubbing them out.

Orchards would yield bigger crops if it were not for the percentage of fruit that falls before maturity. Today apple and pear orchardists are getting full crops by spraying with a Du Pont synthetic plant hormone which retards dissolution of the abscission zone in the stem. Instead of dropping, the fruit remains on the tree and develops desirable size and color. Elimination of premature drop in cherries, plums, peaches, grapes, and certain vegetables by means of similar sprays is also being investigated.

Research, too, is being directed toward making more blossoms "stick" to their branches. Tomatoes, for instance, bloom profusely and yet many blossoms drop off instead of maturing into fruit. Development of a hormone spray that would reduce the percentage of blossom drop seems promising.

In southern areas, peach trees refuse to go to sleep during unduly warm winters, then fail to produce fruit the next season. On some occasions such warm weather has been fought by planting cakes of ice around the bases of the trees to help keep the sap from rising. Today peach orchardists use a spray that brings on dormancy, helping the trees to bloom the next spring.

Spraying, too, is the method by which some crops are provided with minerals not obtained from the soil. California orange trees flourish best when provided with traces of zinc; accordingly, small amounts of zinc are sprayed on the trees, to be absorbed by the leaves.

Chemical sprays and dusts perform their most important work as pest killers and disease inhibitors. Chewing insects such as codling moths, cabbage worms, potato beetles, and boll weevils are controlled by arsenical and fluorine

compounds, nicotine, or rotenone. Sucking insects and mites including various scales, aphids, flea and leaf hoppers, and plant bugs, are fought with contact insecticides that include various oils and rotenone or pyrethrum dusts and sprays. Plant diseases, caused by fungi, consist of blights, spots, mildews, and canker afflictions. The best way to fight these is by spraying with a fungicide.

A spray rig for an orchard may consist of a heavy-duty truck that carries a tank holding several hundred gallons of liquid, a pump that has a capacity of 60 gallons per minute at up to 600 pounds pressure per square inch, plus a hydraulically operated tower that can be raised 30 feet, from which spray is applied to the treetops.

Apples and pears may require as many as eight sprays in a year; the cost of pest control spraying in citrus runs about \$50 per acre per year. Without such sprays few crops could be grown to maturity. Many orchards would be killed in two seasons if the insects had a free hand. Still, oils and pest poisons in the long run affect the fertility of soil and are non-beneficial to the plants and trees.

Today spray men are excited over the possibilities of the new insecticide known as DDT, used by the armed forces to combat lice, fleas, flies, mosquitoes, and practically all harmful insect life. This insecticide apparently has no bad effect on soils and plant life.

Agricultural pest control men are experimenting with it in the hope that one or two applications per year will act against practically all the pests that now attack valuable crops.

SEPTEMBER, 1944

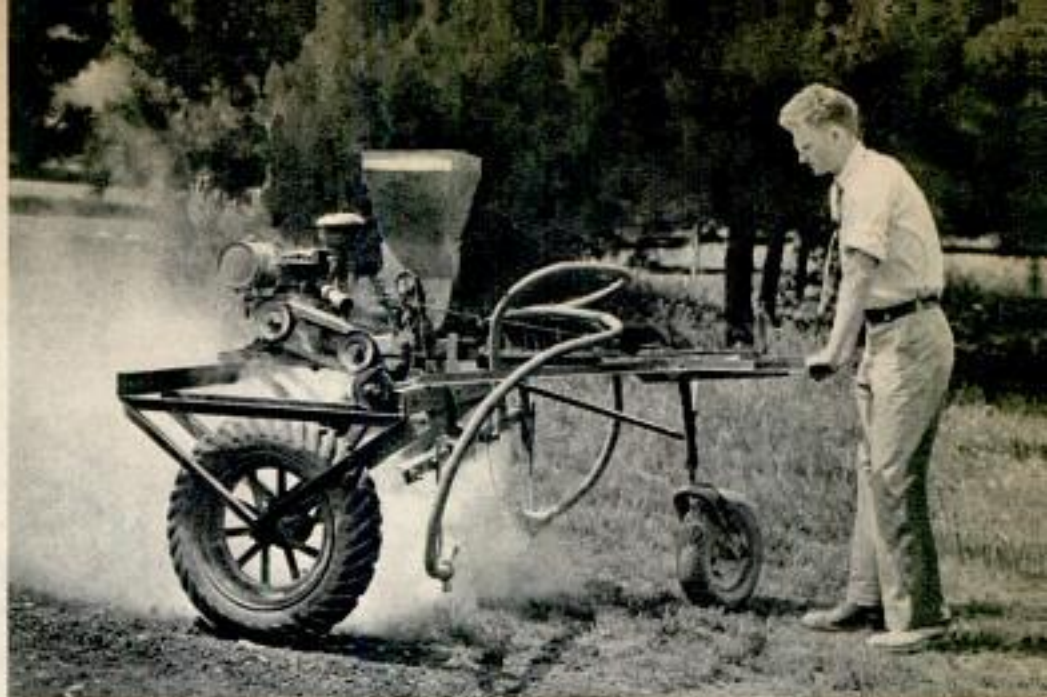

This small power-operated duster sprays the ground with dithane, insect and fungus killer. Plants absorbing dithane become deadly to insects

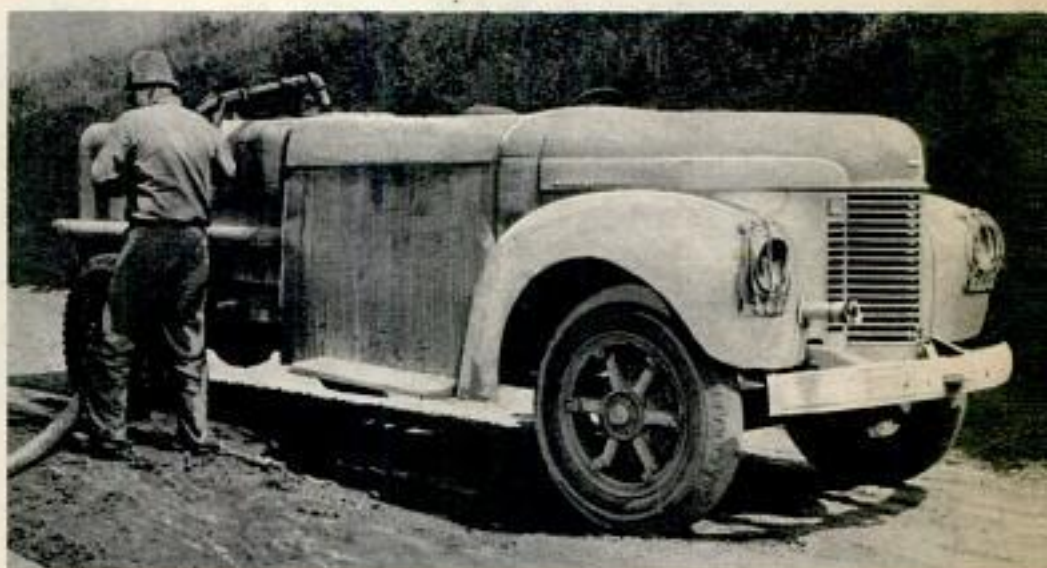

Supply truck (above) takes on water to be pumped into tanks of spray rigs working through adjacent orchard. Below, sprays carrying traces of zinc help supply that mineral to orange trees showing zinc deficiency



0309

From model planes for hobbyists the American Junior Aircraft Co. of Portland, Ore., turned to target planes for the Army, and delivers as many as 5,000 models a week—a lot for any factory! Left, a radio-controlled model. Below, whip-control plane hits 90 miles an hour in two seconds

1166 N.E. 31st Ave.

MODEL PLANES STUNT for GUNNERS



Jim Walker, company president, flies two "fireballs" with trigger-operated speed control and elevator control

Besides radio and sonic-controlled craft and manually flown scale models of fighters, catapult planes are built for aerial gunnery targets; their wings unfold at top of 300-foot rise, then the bullets fly



100-Ton Aeroboat Will Skim Water at 60 Knots

Plans for building a giant aeroboat which would skim the waves at 60 knots have been drawn by Ivan Troeng, engineer of Stockholm, Sweden. According to the design, only one-tenth of the ship rests on water, while the remainder is supported by air. The giant will weigh 100 tons and its two 3,500-horsepower engines will drive air propellers. Troeng has successfully tested a 16-foot model, which reached a speed of 50 knots with a 60 horsepower engine driving a water propeller.

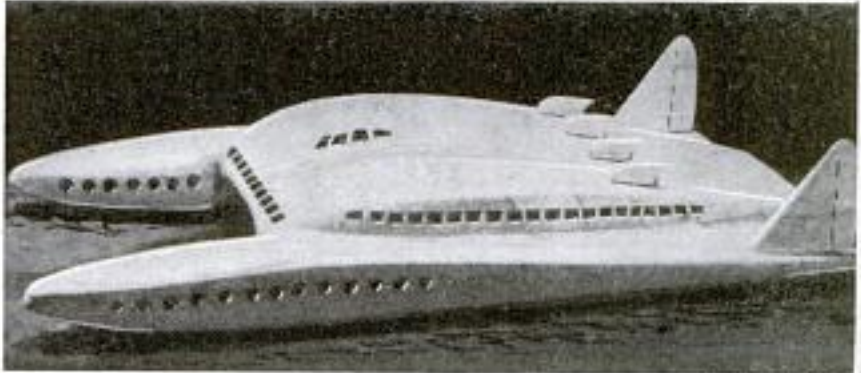

Above, right, the designer in his 16-foot aeroboat. Lower right, model of the 100-ton ship which he plans to build

Instructor in Mobile Glass Tower Advises Fighter Pilots

Transition from slow training ships to speedy fighter planes is made easier for pilots at Foster Field, Texas, with a mobile control tower. This glass-enclosed cupola mounted on an army truck chassis is as complete as a stationary tower. Instructors in the tower keep a sharp eye on student pilots during takeoffs and landings. If a plane's flaps or landing gear are not being manipulated properly, the instructor uses the tower-to-pilot radio to help the student correct his mistakes. As the mobile unit has its own generating plant driven by a small gasoline engine, it can be used at auxiliary fields where power is unavailable.

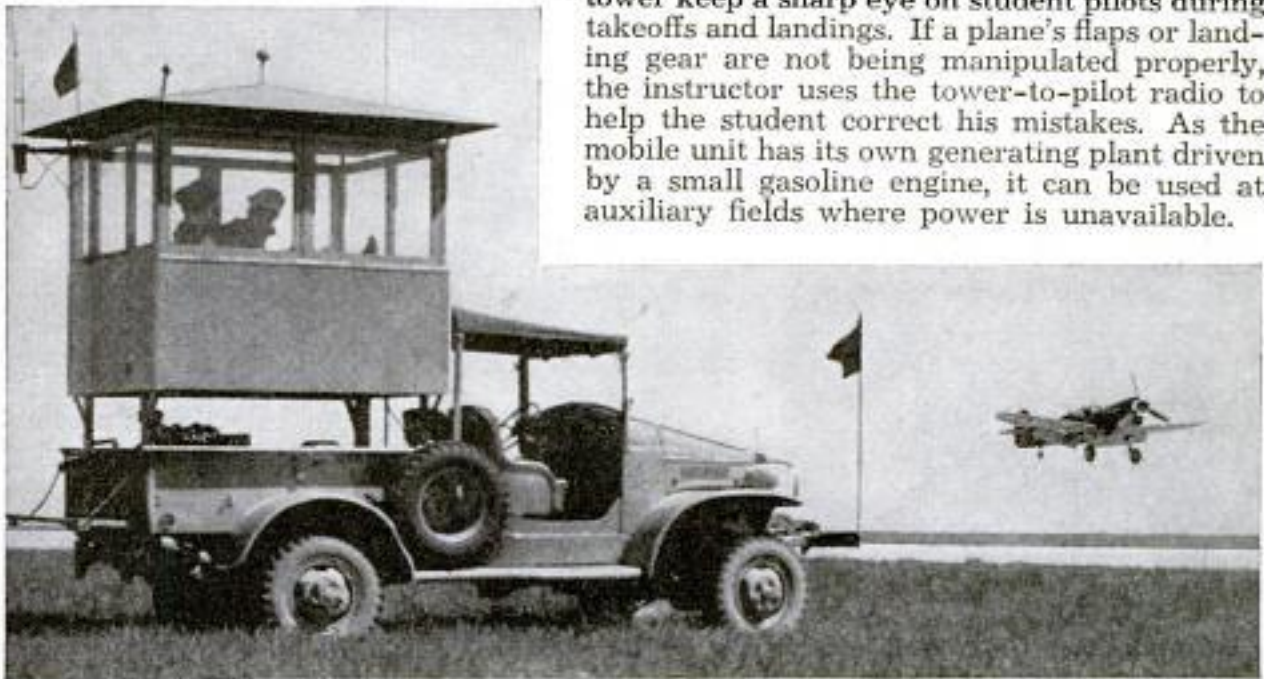

Pest Weed Finally Makes Itself Useful by Holding Down Airfield Turf

Quack grass, a coarse weed whose complicated root system is a pest to fancy lawn owners, will be used extensively in areas where a tenacious turf is required, agricultural authorities predict. Recently two practical uses have been found for it:

keeping down the dust on airfields and holding down railroad embankments. In addition, increased study of its qualities indicate that it probably will be used at army camps, on athletic fields, on the banks of streams and on uncultivated hillsides.

*The Jay L. March Co. (Incl.)
Cooper Hill
Marion, Ohio.*



FIRST AID *for* WOUNDED WARSHIPS

Its bow blown off in battle, the cruiser New Orleans reached port with a temporary bow. Below, damage control men fight electrical fires with carbon dioxide

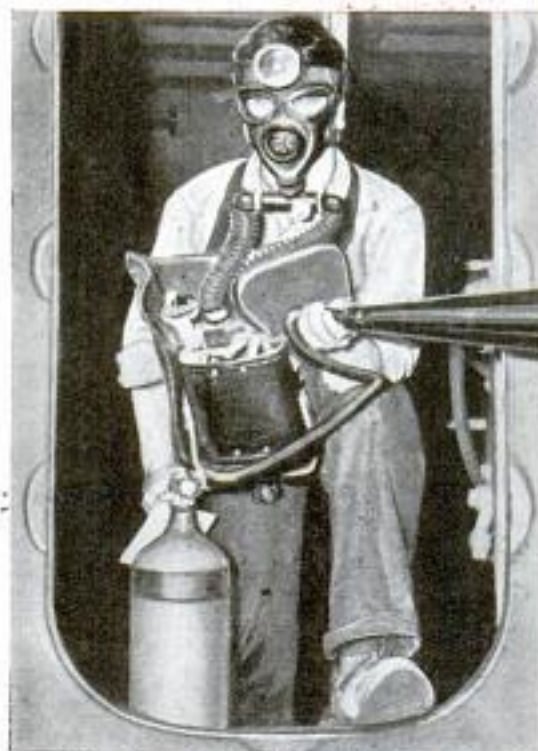

AN AMERICAN warship in action is manned by two crews of fighters. One crew fires the guns and runs the ship. The task of the other crew is to minimize and repair battle damage, helping the ship to stay in the fight. Damage control men work right alongside the gun crews, putting out fires that enemy shells have started, repairing damaged piping and machinery, and keeping the ship afloat if she is badly hit.

A bomb that plunges through the armor of a turret and explodes inside not only kills the gun crew, it may touch off a chain of events that destroys the ship. Flaming powder and ammunition in the turret may break through to an ammunition hoist, starting a fire in a main magazine that blows up the ship.

Such a bomb plunged through the top of a

turret on the U.S.S. "Savannah" during an engagement off Italy. Flames were leaping from the hole a couple of seconds after the explosion but the fire didn't get a chance to spread. A damage control party made its way to the turret top at once and poured heavy streams of water into the flames. The "Savannah" continued to fight, with one turret out of action.

The destructive power of modern naval weapons is terrific. In a quarter of an hour during the Battle of Guadalcanal, for instance, one American destroyer was sunk, one was blown up, another was dead in the water, and two were damaged. An American cruiser was in flames, two others had been badly holed, and a fourth cruiser was damaged so badly she had to leave the action. All of this happened in the length of time you may take to glance over a newspaper.

In spite of this wholesale destruction it was an American victory, for our side sank 18 Jap ships and forced the rest to flee. Our losses might have

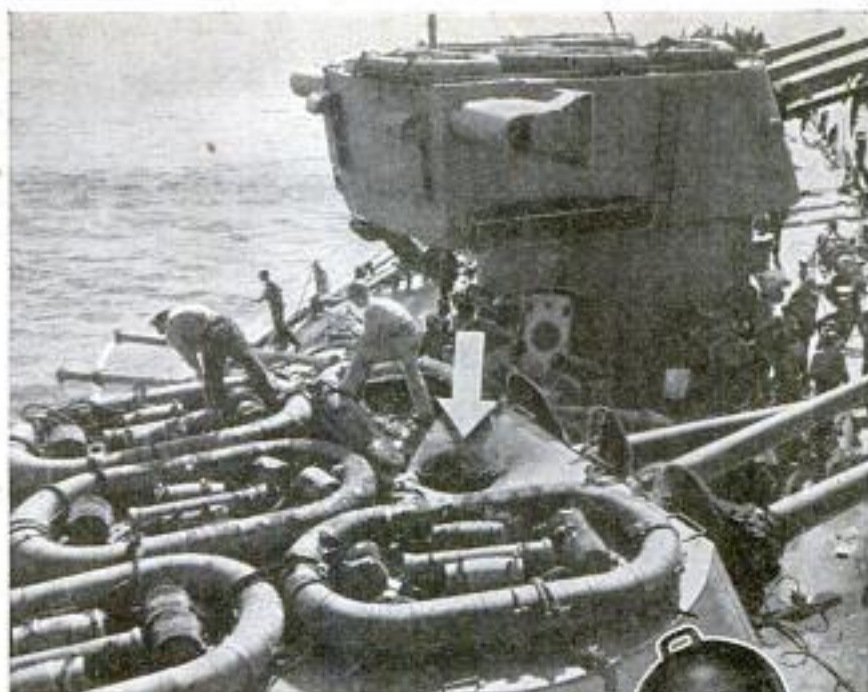

Arrow points to hole where German bomb pierced cruiser's turret. Right, this tool cuts hole in steel bulkhead or cuts cable with exploding cartridge



Damage control men quelling petroleum fire with water spray
U. S. Navy photos





Top, Navy school teaches technique of plugging a small hole in ship's side

Replica of a section of warship is used to train men for fire fighting

Below, sailors mop up water below-decks with pumps and canvas bags

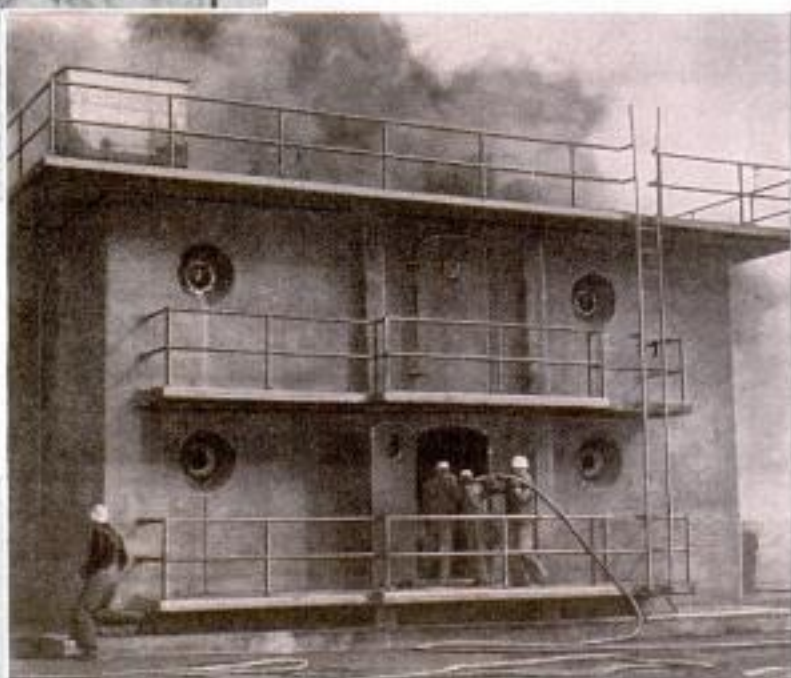

been greater and the damage to the Japs much less except for our damage control technique that kept "as many men at as many guns for as long as possible."

The essence of damage control is speed in combatting each emergency. A bomb or shell that bursts open a tank of high test gasoline and sets it afire can start a conflagration that destroys the ship if the fire isn't attacked at once and successfully extinguished. A torpedo that blows open a ship's side can start a series of events that ends in the ship's destruction five minutes or five hours later unless effective measures are started at once. This doesn't mean, of course,

that damage control parties can overcome every wound the ship suffers; it simply means that some ships that might have been lost are still in action because damage control parties saved them.

The quantities of gasoline, fuel oil, powder and ammunition, as well as clothing, bedding, and personal effects make practically every part of a warship vulnerable to fire. Damage control men are warned to expect a fire from every hit. During one battle an American cruiser had 25 fires raging during a half hour. Each fire was separately confined and quelled and the ship continued in action.

The Navy fire fighter has at hand for extinguishing fires, water, steam, fog, foam and carbon di-

oxide equipment. The water is provided by a fire main which is a piping system that delivers water pumped from the sea to fire plugs and sprinkler systems. A secondary water supply is provided by portable handybilly pumps, in the event of failure of the principal supply or the need of additional water. The special Navy all-purpose nozzle permits the application of water either as a solid stream or fog. As fog, water possesses its greatest heat-absorbing ability. It dilutes combustible vapors, reduces temperatures and as it turns to steam, extinguishes the fire. The screen of fog, produced at the nozzle, protects the fire fighter and enables him to approach the fire safely.

In extinguishing gasoline and oil fires, foam is the principal agent, with water fog as a coolant and a protective screen for the operating personnel.

In fires involving electrical equipment CO_2 is used as the principal medium of extinguishment, as it is not injurious to electrical equipment and is not a conductor of electricity. Water fog is also used as a protective screen where necessary to make entry. Electrical equipment is de-energized as soon as possible to remove the primary cause of the fire. Water fog is a non-conductor of electricity up to 5,000 volts.

War vessels are compartmented so that only a portion of the hull is flooded when a torpedo blows a hole in the side below the water level. Damage control men aren't satisfied with simply strengthening the bulkheads of a flooded compartment when the compartment is holed. They do this with fire-resistant timbers, cutting them to size and shoring up the bulkheads, then they try to patch up the hole itself. The tons of water in the compartment not only slow the ship's speed but decrease her buoyancy, giving her less margin of safety in

Continued to page 150



Seamen at a Navy damage-control school wear self-contained oxygen breathing apparatus while rehearsing their work. Below, recruits learn to close small holes in a ship's hull by means of a mattress, held in place with wooden planks and shoring



Flying Boat Takes Off From Desert on Wheels

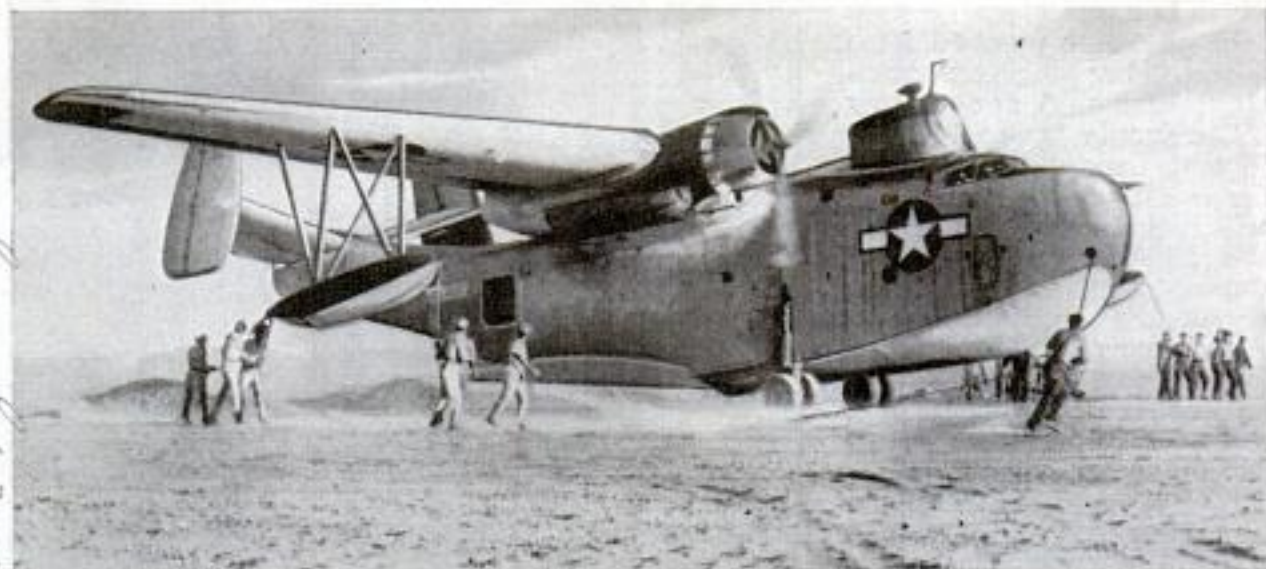

What is believed to be the first take-off ever made by a giant flying boat from a dry field was accomplished recently by a Martin Mariner in southern Arizona. The 26-ton Navy craft had been forced to land

on an arid lake when a motor failed. To get it back in the air, a ground crew attached double-tired wheels to the sides of the airship, which permitted the pilot to handle it like a land plane.

0272

Trailers Set on Track Treads Haul Bombs Over Mud



Better than rubber tires, or even sure-footed pack animals, trailers equipped with track treads are able to forge a path through the deep mud and rough terrain surrounding Aleutian bases. Pulled by

Caterpillar tractors, they are hitched in pairs, tandem fashion, to haul bombs for convenient transfer to the bays of long range bombers. They also carry material for airport runway construction.

0259

Radio System Signals Depth of River at Robot Gauge Stations in Water

By means of a robot radio system, increases in the levels of the Salt and Verde Rivers are recorded automatically in the office of the chief hydrographer of the Salt River Valley Water Users' Association in Phoenix, Ariz. The radio signals are sent by gauges installed in both streams, via 25-watt transmitters. When the "telemark" coder, a combination coding device and

time switch, is in operation, a motor-driven contact arm sweeps across it to produce signals which represent the gauge height of the river at the moment, together with the station's call letters. Before the radio was installed the Phoenix office had to depend on telephone calls, which frequently were not possible during stormy seasons, when the river level data was most needed.

54 by Leopold & Stevens Co. Phoenix, Arizona

flown by: Lt. A. W. Pittsford
USNR, of High Desert, N.C.

Caterpillar Tractor Co
Phoenix, Ill.

Henry Deaton + Sons, Inc.
4435 Pennsylvania Ave.
Philadelphia, Pa. 0220

Motor-Driven Saw Cuts Big Log in Five Seconds

Powered by a two-cylinder engine built on the same principles as an outboard motor, a chain-type saw can cut through a 15-inch log in five seconds. The motor, which has 10 horsepower and runs on a mixture of gasoline and oil, is the first air-cooled, alternate two cycle ever built. The cutting chain rides on a rotating sprocket and an automatic device keeps it at the correct tension. The saw, which weighs 100 pounds and can be carried anywhere a man can walk, is used extensively by army construction workers overseas.

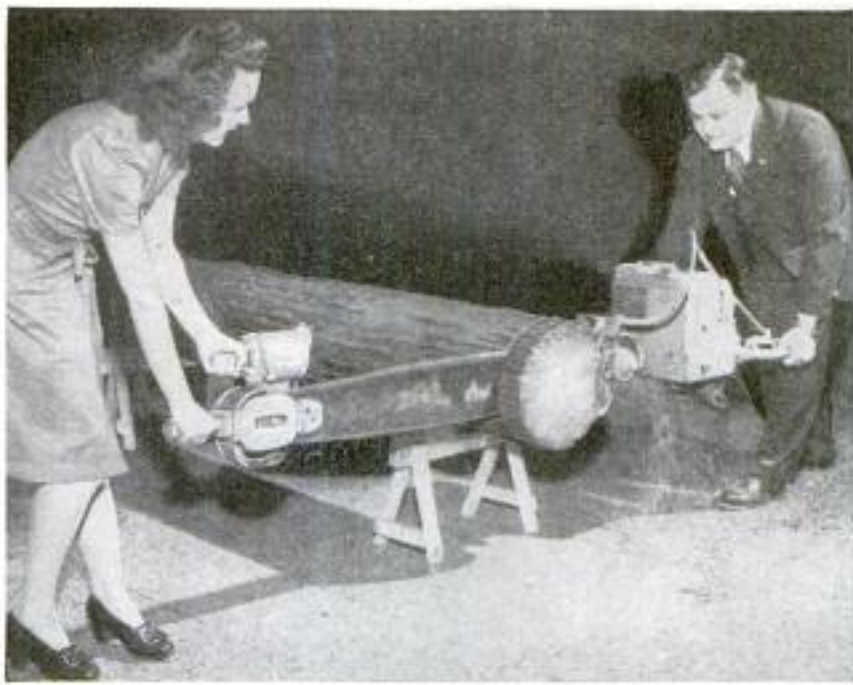

"Stable" of Rabbits in Stanchions Test Purity of Penicillin

Lined up in stanchions in a new chemical laboratory at Terre Haute, Ind., some 750

New Zealand white rabbits are doing an important bit of work for the good health of the human race.

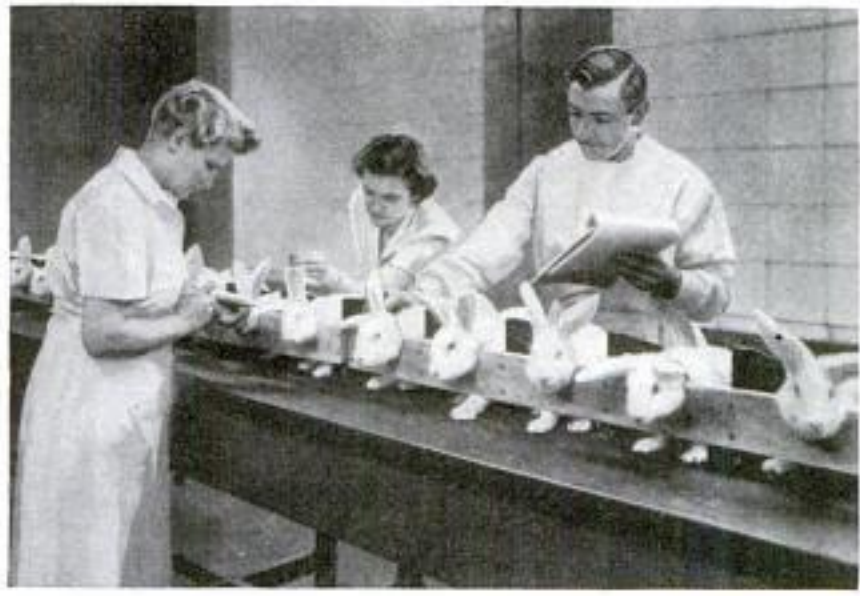

They are used to test the purity of the new drug, penicillin, now in mass production at this plant of the Commercial Solvents Corporation as well as many other drug manufacturers. The pyrogen test is one of the last operations before shipment of penicillin. A measured quantity of the drug is injected into a vein in the rabbit's ear. If the animal's temperature rises abnormally within four hours, some fever-producing agent is present and the lot is rejected.

0240
Pure White
Indians

High "Whistle" of Steel Bar Measures Yarn to Test Elasticity of Hose

Sound waves, which are performing many odd jobs in industry, are now used to measure the elasticity in women's hosiery yarns. The exact degree of elasticity must be known for the proper adjustment of looms or knitting machines. Two scientists in the rayon technical division of the Du Pont Company developed a method for gauging the elasticity of fiber or film by determining how fast sound passes through the material. The test fiber is attached to one end of a bar of steel. When a radio tube

oscillator is turned on, the steel bar vibrates, emitting a note which is higher than the whistle range of man or piccolo. The test material vibrates like a violin string, and the wave length of these vibrations is measured to calculate the velocity of sound through the material. This gives a more accurate measurement of the elasticity than the old method of hanging a weight on the yarn. This test has been used on linen, rayon, nylon, wool and various types of Cellophane.

W. Livingston 98, Del.

SOUND TRICKS of the MOVIES

TTRUE to life and death in other respects, the battle movie that you may see at the theater tonight deliberately soft-pedals the noises of war.

Medium-caliber gunfire is reproduced at a tenth or a twentieth of its actual intensity. The nearby explosion of a heavy bomb may be only a thousandth as loud in the theater as in reality.

It's a good thing that this is so. Sound technicians could rebuild theater equipment to reproduce explosions and gunfire at closer to their actual volumes but the result would be a theaterful of shell-shocked spectators. The difference between sound and concussion is simply a matter of degree.

Not long ago some sound experts were using a recording of artillery fire to test a new high-powered amplifier in an empty auditorium. The first shot that was "fired"

Skate wheels rolling on an iron strap simulate sound of elevated railway. Below, exterior stage representing a carrier's deck

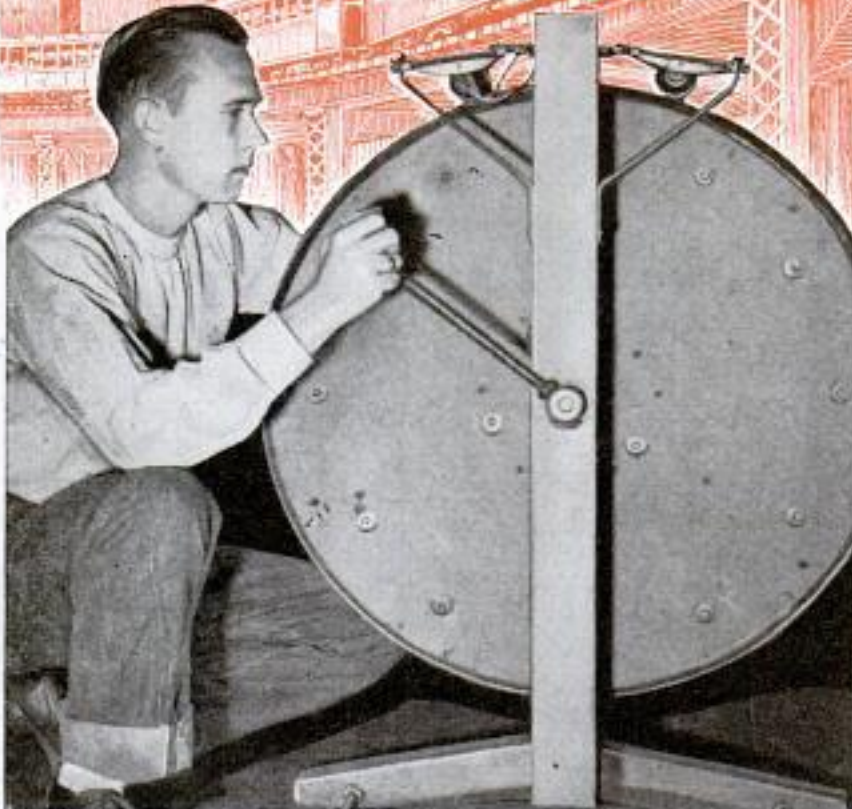

Mr. Levinson

Sound effects

by the amplifier brought an end to the test, for the echo or concussion wave that bounced back from the rear wall was so strong that it smashed the speaker.

Preparing battle noises for the movies is a lot more complicated than just holding up a microphone to catch the sounds that are desired. In assembling the sound track for "A Wing and a Prayer," Ed Hanson of Twentieth Century-Fox put a sound crew on board an aircraft carrier to pick up the noises of take-offs and landings, the bellowing of the bull horn, and the other carrier noises. Then, when the sound track was developed and previewed, Hanson found as usual that some of the



The sharp clap of two wooden bars sounds like a slap in the face on sound film. Realistic woodpecker (left) makes his own noise for film when the cord is pulled



sounds reproduced perfectly while others would need to be doctored before they would be recognizable in a theater.

Conversation on an airplane's intercommunication system, for instance, is not very intelligible to people who are not used to listening to this flat mechanical talk. Such conversations, as well as speeches that are transmitted by a pilot's throat microphone, must be improved in the sound laboratory so that audiences can understand them.

Synthetic wind and synthetic

Shooting action and sound on "flight deck" built for the film "A Wing and a Prayer"

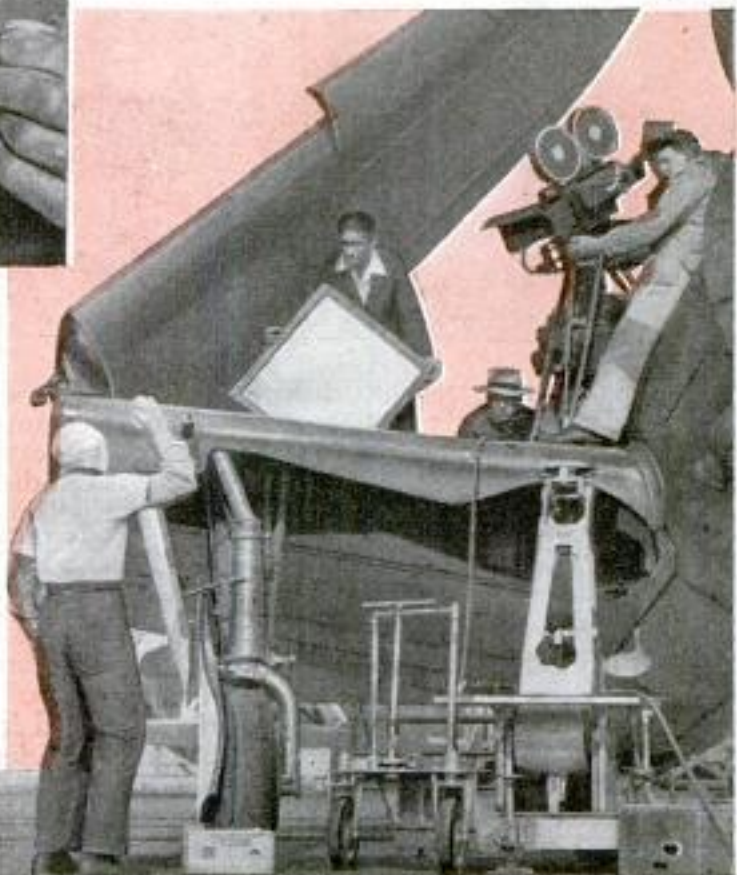

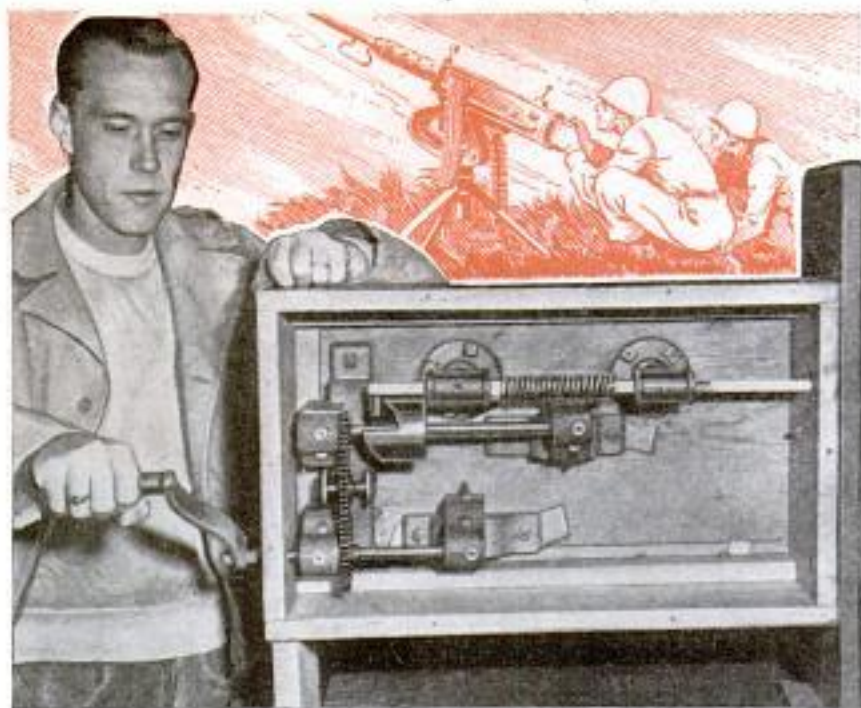

Turning the crank (above) slams the metal rod against a sounding board at right end of box. The result, to the movie audience, is the chatter of a machine gun. Below, the truck in which sound is recorded on film



thunder are two good examples of how Hollywood manufactures sounds that the microphone has trouble in picking up. The difficulty in recording wind is that wind pressure merely pushes against the diaphragm of a microphone, making a sound that goes "blub blub blub." It's much better to record the whines and screams of compressed air that escapes through small orifices in a tin can. A machine that whirls wooden rods around until they whistle in the air can also be used to produce sounds that imitate anything from a gentle zephyr to a full gale.

In the pioneer days of sound Ed Hanson tried for months to get a realistic recording of heavy thunder. The results were pretty thin until he encountered a storm in Arizona. Hanson's equipment was in the bottom of a canyon

Wooden posts slapping floor of box produce sound of marching men

and it picked up a good reproduction of the thunder claps that roared and echoed back and forth between the canyon walls. The studio used portions of that sound track for years, whenever thunder sounds were needed. It was good, but not as good as modern movie thunder that is created by bending and shaking large panels of sheet metal. These crack and roar perfectly for the microphone.

Most kinds of gunfire reproduce quite well on the sound tracks. But the sharp tap-tap-tap of machine gun fire and the thundering roar of naval guns that you hear while watching such action on the screen are not always recorded at the time the camera films the scenes. It is often simpler and technically better for the sound men to obtain these



effects elsewhere or to manufacture them as needed.

When a sound crew is on location, possibly at an air base where it has been sent to record the characteristic noises of a P-38 in flight, the men also pick up any other sounds that might be needed in the future. They tune in as a B-17 starts its engines, or they catch the heavy drone of a big bomber formation overhead. All such sounds are added to the studio's sound library. This consists of thousands of feet of recordings of thousands of different sounds.

Thus when specific battle noises are needed the first place to look for them is in the sound library. But just the right kind of machine gun fire, for example, may not be on file. Then it's up to J. D. Delfino, the studio's sound effects man, to produce it. Delfino builds a wooden box with a hardwood sounding board at one end. A metal rod slams against this board when a crank is turned, imitating perfectly the heavy explosions of a machine gun. Turn the handle once and you get a single shot; keep turning it and you produce a burst of firing noise. To produce the effect of a Jap automatic weapon, a thinner sounding board is used. This gives a higher pitched note.

Recently the studio men were turning out the battle noises of two different wars at the same time. One group was busy on "A Wing and a Prayer" while another



Sets of steam whistles and electric bells are mounted in studio
Preparing to film scene as pilot leaves sinking plane for raft

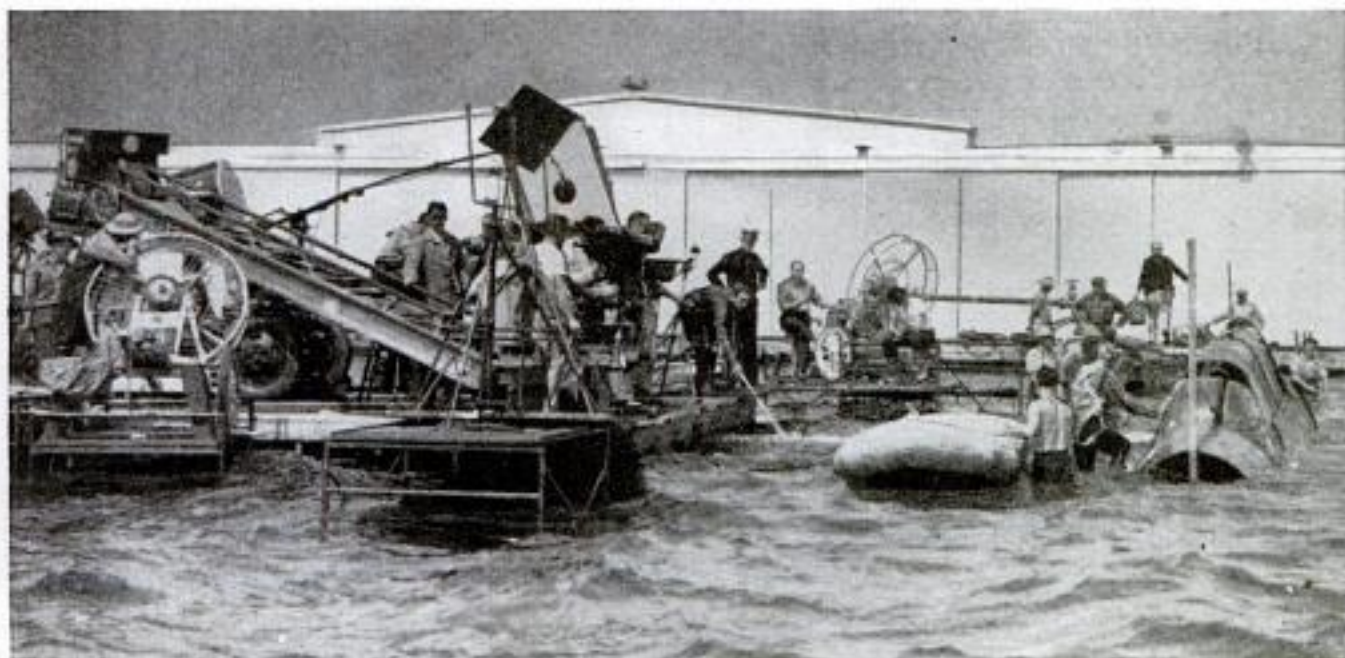

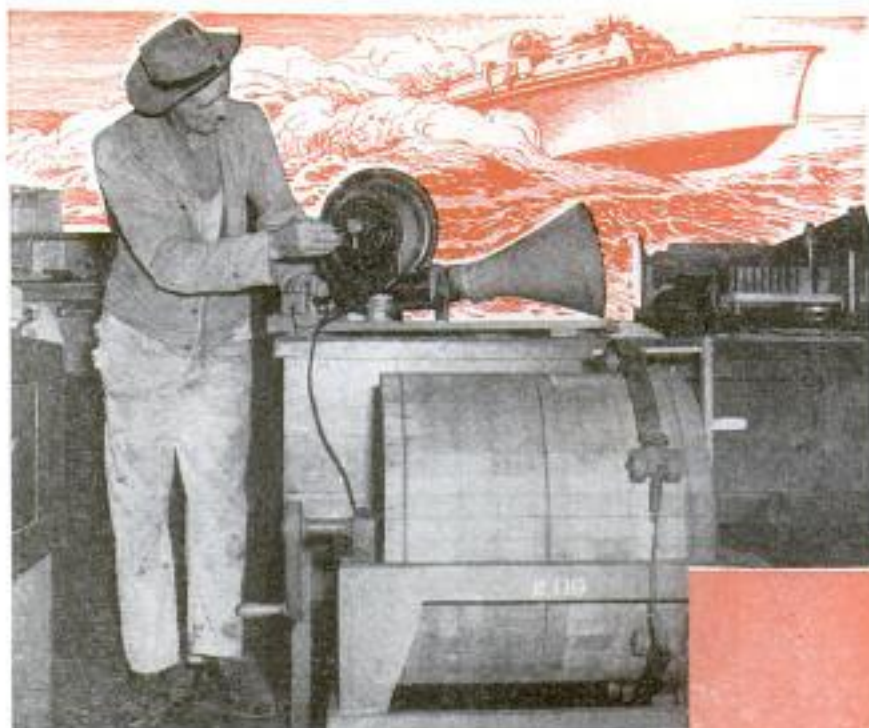

Adjusting blower for sound effect. Barrel simulates the rumble of torpedo boat's exhaust when crank is turned

was living in the past, putting together the sound effects for battle scenes of the first World War. These are being used in "Wilson," the story of the life and time of President Wilson.

A bazooka sounds like a sky rocket when it is fired. Delfino expects to imitate this new type of projectile with compressed air when the need arises. Compressed air, too, probably will produce just the effect desired when the noise of a jet-propulsion airplane is to be simulated.

Delfino's department at Twentieth Century-Fox resembles a maniac's museum. It's filled with a weird collection of impractical-looking devices built from boxes, barrels,

lengths of rubber tubing, and assorted junk. Each machine produces a particular sound. Turn the handle of one and the rumble of an elevated train is heard. Operate the plunger of a second and the chuff-chuff of a tugboat's exhaust is produced. To get the effect of a ship's hawser straining against a bollard you move a friction lever that presses against a leather collar, making a realistic creaking and groaning.



Above, preparing to install directional microphone in place of conventional "mike" on boom. Left, building replica of Jap machine gun for a movie

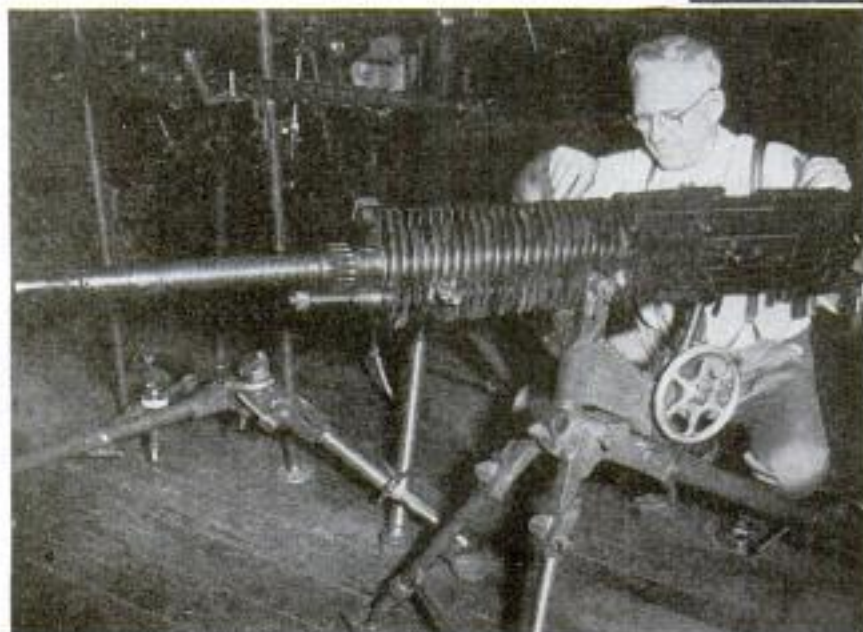

Delfino has created some 3,000 mechanical sound makers, all different, and he's never been stumped. In his department, too, are hundreds of domestic and foreign musical instruments, horns, chimes and whistles.

Part of the sound man's job is to produce silence on occasion. Musical instruments such as a bugle or piano are deliberately muted before they are

played upon in front of the camera. It's best to record the notes in a special acoustical recording room and then dub in the music on the sound track, matching the sound to the action on the film.

The studio's sound library, incidentally, has a large collection of the cries and noises of many wild and domestic animals. But the studio doesn't turn to Delfino when it needs an animal cry that isn't in its files, nor do the sound men head for the nearest zoo. Among Hollywood's odd professions is that of animal imitator. The studio merely calls in an expert who can bark, howl, or growl as needed. Practically all the screams, baby talk, and childish cries that are used in the movies are also produced by these adults.

In producing a war picture the movie makers create explosions and shell bursts in full size for the camera, yet the noise that is to accompany these explosions is often recorded in miniature. A bomb that apparently blows up a gun position right in front of the camera would wreck the camera and sound equipment as well, if the bomb were real. Movie explosions are created by firing buried charges that harm no one. These explosions don't always make a convincing noise, however, so the sound men make recordings of the explosions of small cartridges and charges that sound just right, close up. In the laboratory they can build up the volume of the miniature explosions to an intensity that suits the action of the picture.

Even most of the news reels of the war have had their sound added this way. Most actual battlefront films are made with 16 millimeter cameras unaccompanied by sound. The synthetic sounds that are added when the small film is enlarged to 35 millimeters for projection in the theaters are just as realistic as if made on the spot.

Plastic Molds Pop Out of Unit After Pre-Heating to Order

Like an automatic toaster, an RCA electronic power generator pops up plastic preforms for moldings after pre-heating them to order. The cabinet-like heater, which is rolled from one molding press to another, can prepare preforms for moldings weighing up to one pound. It includes an automatic timer which is set to the number of seconds required to heat a particular weight and shape of material.

Radio Corp. of America
SEPTEMBER, 1944

G. C. A. Victor Div.
Couders, N. J.

Sweeper With Magnetized Drum Picks Up Dropped Nails

Dropped nails, screws, washers, and other metallic objects can be picked off the floors of industrial plants by a magnetic floor sweeper operated like a lawn mower. Its revolving drum is permanently magnetized and requires no cumbersome energizing cables that trail and entangle the operator. The drum is 18 inches wide.



0 222
Stearns Magnetic Mfg. Co.
Milwaukee 47 Wis.

Magnifier for Micrometer Scale Speeds Reading of Numbers

Micrometers are quickly and accurately read without the usual eye strain with a transparent plastic magnifier that covers the scale. With the magnifier, tool and die makers and inspectors find it easy to split the divisions of the ordinary micrometer into tenths. The magnifier not only reduces errors in reading the scale, but protects the micrometer from dirt. It is available to fit all standard micrometers.



0 277
Labor Research Lab.
711 W. Lake
Menard, 8, Missouri

"Business Week"
5/20/44

. . . The **WORLD'S WORST**



The "Little Burma Road," a trucker's nightmare 11½ miles long, is a rugged testing ground for jeep combat drivers at Camp Walters, Tex. To get cars over bridgeless streams, they must be hauled over on a suspension line (above) or wrapped in big tarpaulins and floated over (upper left)



Motive power for a floating jeep (above) is supplied by G. I.'s paddling with shovels. Below, jeep is driven along sharp incline



*Little Buena Rd.
Driver Training Course
Camp Waltham, Texas*

0294

ROAD ..



Right, jeep gets stuck in mud, one of the 28 obstacles driver must overcome to prove himself



Signal Corps photos

Below, map of the road, which was bulldozed out of rough terrain and then left to the mercy of the weather. In lower part, note the small, steep hills, which include two down grades of 45 and 75 percent and two up-grades of 45 percent. In extreme lower left-hand corner is a "corduroy" section—300 feet of railroad ties. Other obstacles are tank trap road blocks, blind curves, shelled area with holes four feet deep and desert area

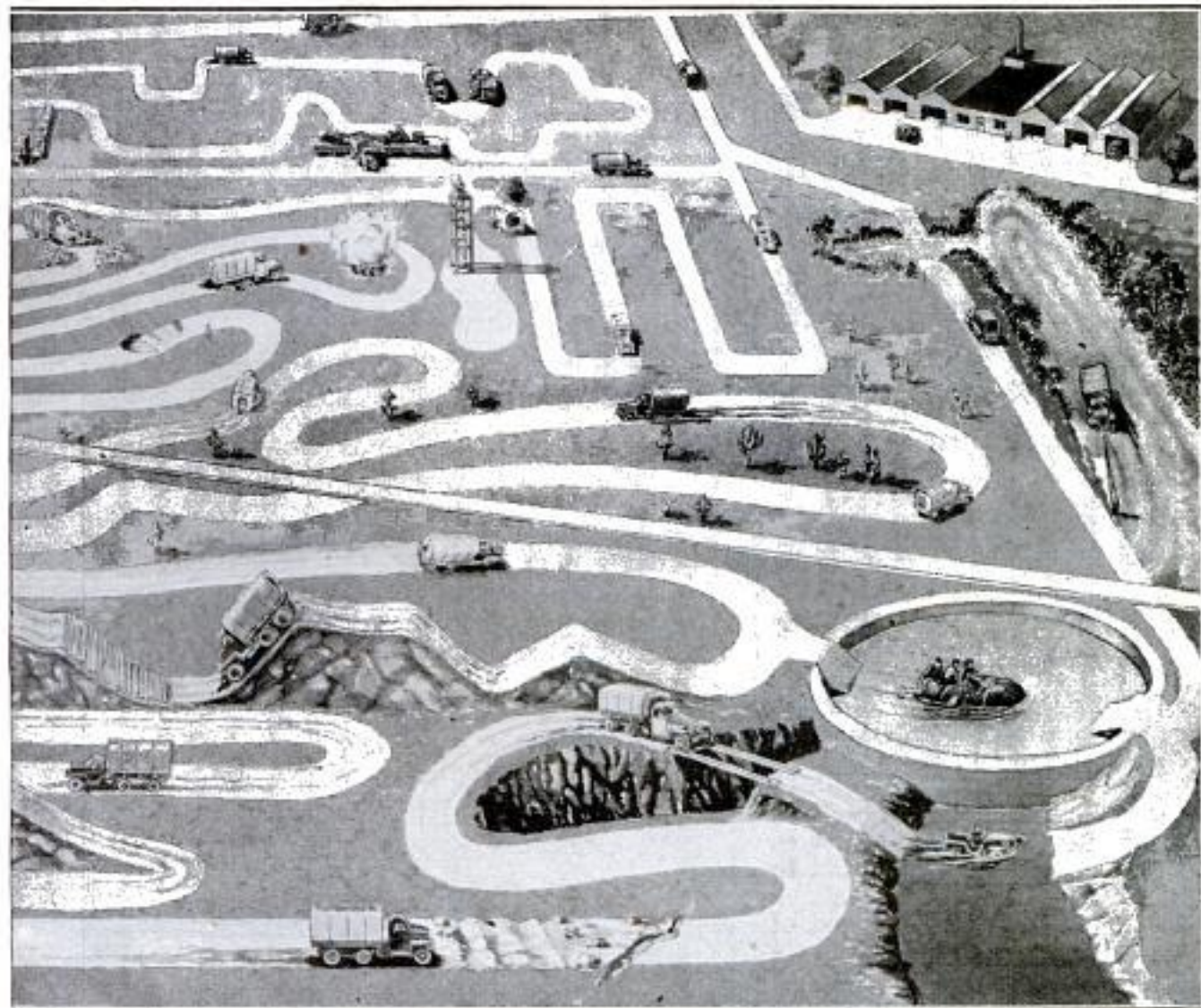

Torch Signal for Night Raiders Directs Bombers to Stations



Traffic cops of the R.A.F. use electric torches to direct bombers to their dispersal stations after night raids over Germany. Just like the signalmen on the decks of aircraft carriers, the R.A.F. torch swingers have a special wigwag code. While the torches convey vital information to bomber crews, they don't give any secrets away to an enemy alert to radio waves. The signals are also useful when radio equipment on the planes has been knocked out of commission in combat.

Clotter Made Out of Blood Aids Brain Surgery

Made from the blood of volunteer donors, a spongy substance called "fibrin foam" quickly stops bleeding. It shortens the time previously required for brain and nerve operations, according to Army neuro-surgeons who acclaim it as one of the great medical discoveries of the war. Fibrin foam, which is rapidly absorbed by tissue, can be applied in sizes ranging from that of pinhead to golf ball. The larger applications are for implanting in the bed of removed tumors. Another development from blood plasma, is "fibrin film," which is being ap-

praised by the Army. It is a thin, tough material designed as a substitute for the "envelope" which surrounds the brain. Both "fibrins" are products of the department of physical chemistry at Harvard University.

Plastic Survives Boiling Without Losing Shape

"Cerex," a new thermoplastic which withstands sterilization, has been developed by the Monsanto Chemical Company. The plastic, which holds its shape and strength in boiling water and yet can be molded by the fastest, most economical methods, is used widely in radar, radio and other military electronic equipment where there is a demand for lightweight substances which have electrical and heat-resisting properties.

German "Butterfly" Bomb Scatters Explosives

Among the surprise weapons of the Germans is an anti-personnel bomb which Allied soldiers dubbed the "butterfly." It is dropped from a plane and opens after dropping a predetermined distance to scatter many small bombs in the path of advancing troops. The small bombs are of the delayed-action type. They often explode a day or two after they are dropped.

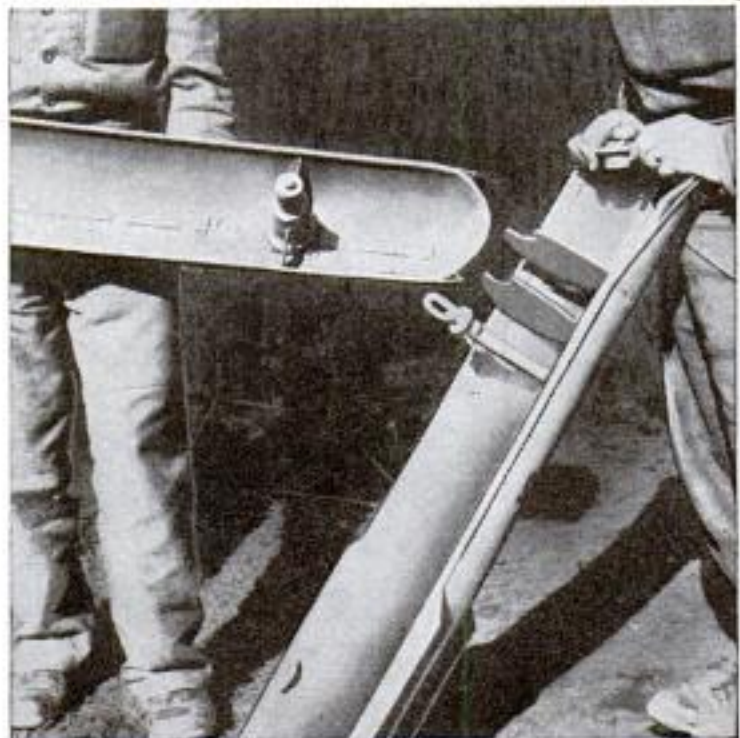

developed by: Dept. of Physical Chemistry, Harvard Univ.

all done in Mo.

0185

0301

0169

0187

penel

Mr. G. W. Moody, 1362 N. Beethoven St., Chicago 19, Ill. 0231

HEROES of the TIN CANS

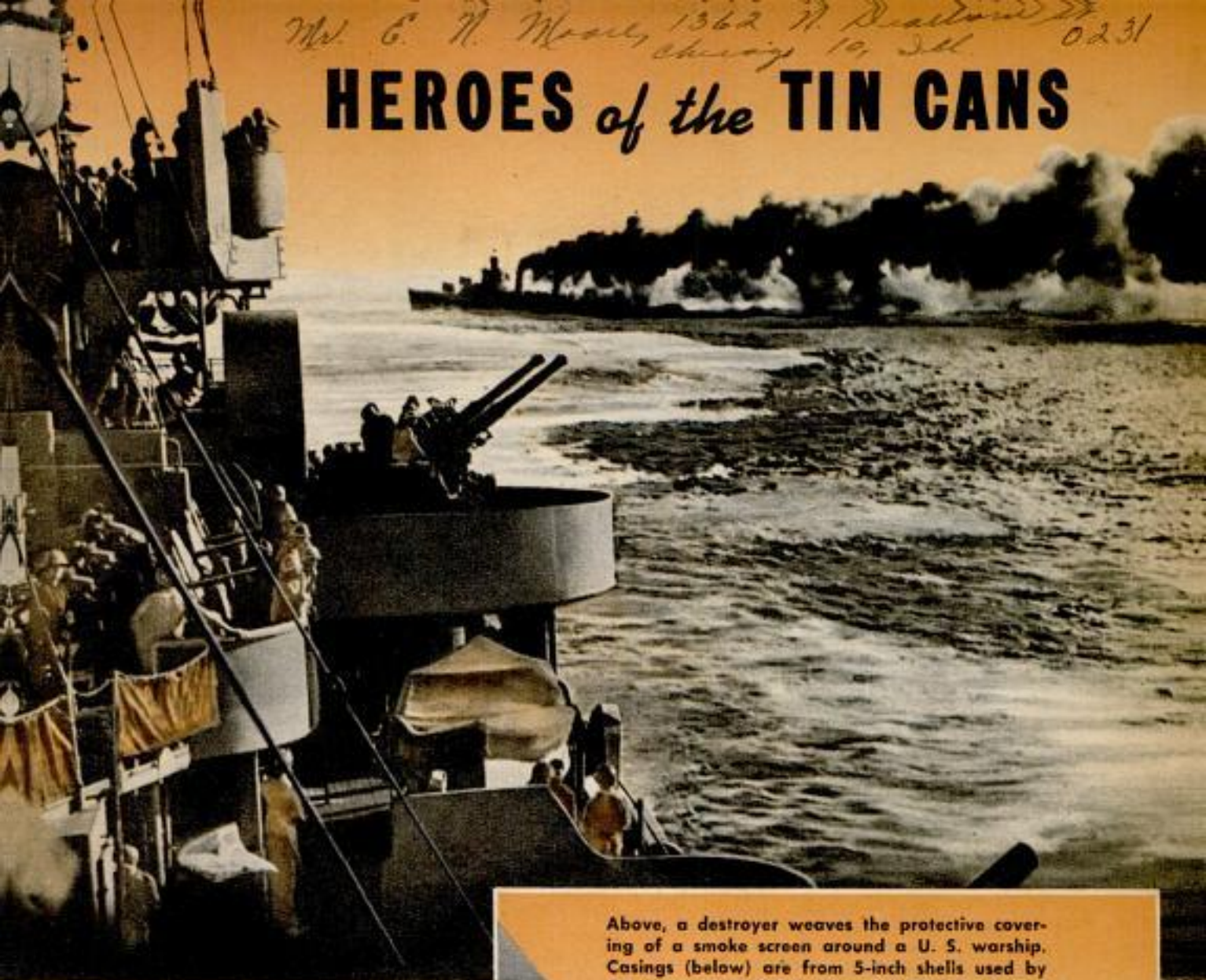

Above, a destroyer weaves the protective covering of a smoke screen around a U. S. warship. Casings (below) are from 5-inch shells used by the destroyer to sink a submarine the night before

THE officers and men of Desron-Two had nineteen Navy Crosses, two Distinguished Service Medals, thirteen Silver Star medals, two Navy and Marine medals and 56 letters of commendation for outstanding service in action.

Desron-Two—official name of the Navy's Destroyer Squadron Two—had been literally everywhere in the war against the Japs. Its list of battles was impressive—Makin, Lae, Salamaua, Tulagi, Coral Sea, Midway, Santa Cruz, Guadalcanal. Its deeds in action were heroic—for example, most of the men rescued from three aircraft carriers sunk in the Pacific, the Lexington, the Yorktown and the Hornet, owe their lives to ships of Desron-Two.

Twelve destroyers comprised Desron-Two when it was organized in mid-1940. Five of them—the Sims, Hammann, Benham, O'Brien and Walke—were sunk





Above, destroyer knifing into a fairly rough sea. Note the ack-ack guns, depth charges and life raft on crowded superstructure

Below, U. S. aircraft carrier with escort destroyer. An important job of the "tin cans" is guarding "flat tops" and darting in to pick up the survivors if a ship or plane goes down



by the enemy in the Pacific. Yet not a single ship screened by this squadron had been lost through submarine action.

Yes, it looked very much like Desron-Two was about due for a Presidential Unit Citation, highest honor that can be bestowed on any unit of the fighting forces.

But when the citation was not awarded, the men of Desron-Two were neither surprised nor disappointed. For they knew, as did Admiral Chester W. Nimitz, commander-in-chief of the Pacific fleet, that their achievements had not surpassed the accom-

plishments of other destroyers and destroyer squadrons. They knew what Admiral Nimitz was talking about in quoting from the section of the General Order creating the unit citation, which reads:

"Recommendations will be confined to cases wherein the unit performs services in action above and beyond the high standard expected of our forces and is considered outstanding as compared to services of other comparable units engaged in the same or similar actions."

The work of Desron-Two can be regarded as typical of all destroyer action.

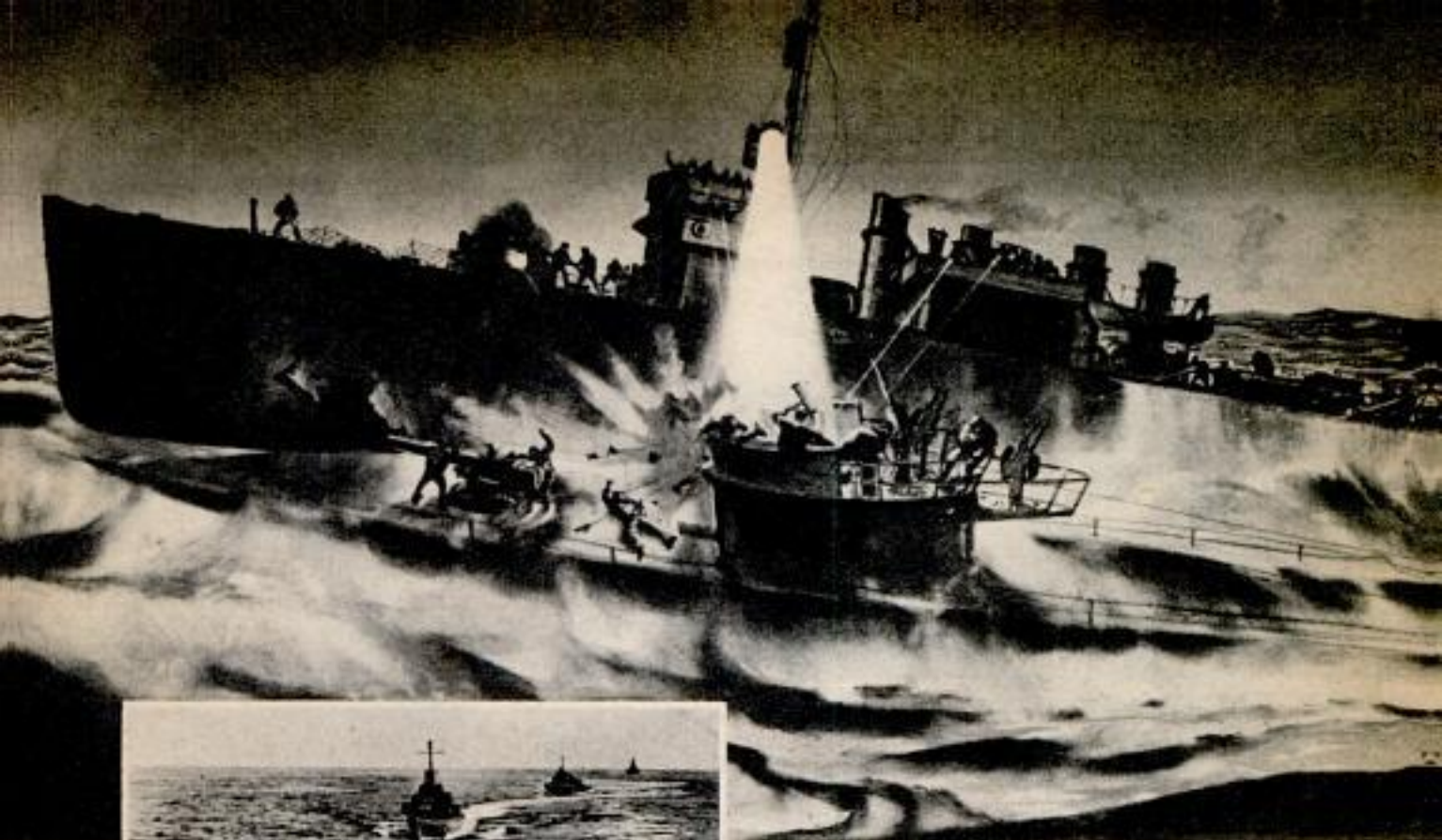

Above is a drawing which shows the U. S. destroyer Borie ramming and strafing a submarine. Searchlight shows German hit by shell case thrown by Navy gunner. Left, "tin cans" follow "flat top"

ute combat that saw the destroyer Chevalier sink after a hit by a torpedo. But despite great honors won by destroyer officers and men, and the notable part destroyers have played in almost every United Nations campaign where sea operations were involved, their activities, more often than not, are unheralded or overshadowed in the news by the operations of larger ships. On any basis of calculation, however, destroyers can be given a top-ranking role whether it be in convoy, in screen-

There are individual destroyers, of course, that have made headlines on many occasions. One of these is the O'Bannon which did receive a Presidential Unit Citation for a single ship as a result of a long battle record that culminated off Jap-held Vella Lavella when the O'Bannon, with two other destroyers, engaged a force of nine Jap ships, sank three and routed the others in a fierce 30-min-

Gun crew on deck after destroyer firing in night action





armor, weight being sacrificed for speed and great maneuverability. It has been estimated that the life of a destroyer in battle is only eleven minutes and the end of the Hammann in the battle of Midway when it was struck by torpedoes aimed at the carrier Yorktown came in just five minutes with a greater loss of life than was suffered by the entire air personnel participating in that historic engagement.

This "thin skin," however is not always dan-

Above, crew fires 20 mm. burst from destroyer escorting an Allied convoy. Right, destroyer guns are aimed skyward to protect perilous landing of American Fifth Army on the beach at Salerno, Italy

ing or escort work, in battle action, in anti-submarine operations, in bombardment of land installations, or in rescue tasks from the arctic to the tropics and from one hemisphere to other.

In Navy parlance, destroyers are called "tin cans," because of the lightness of the destroyer's protective



Below, the U.S.S. Nicholas, one of the 1940 Fletcher Class destroyers whose particulars were kept a secret from the public



gerous, for the destroyer's swiftness and agility is a great advantage in eluding enemy fire and darting in and out to deal quick and devastating blows. On one occasion, when the Japs held four remaining atolls in the Marshalls, the pilot of a Corsair fighter plane was shot down close to a shore where enemy guns were in action. A destroyer at once slipped in and picked up the airmen, all the while dueling shot for shot with the land batteries with the ship's quick-firing 5-inch guns. Though some of the firing was at close range, the "tin can" completed its mission with minor damage from two hits.

Rolling, pitching and plunging, even through heavy seas with breath-taking speed, U. S. destroyers can unleash terrific firepower.

Continued to page 152



Above, message secured to a line from a U. S. Coast Guard cutter is hauled aboard a destroyer. Below, wounded airman rescued by a destroyer is swung aboard an aircraft carrier by breeches buoy



Unsinkable Steel Life Raft Carries Twenty Men

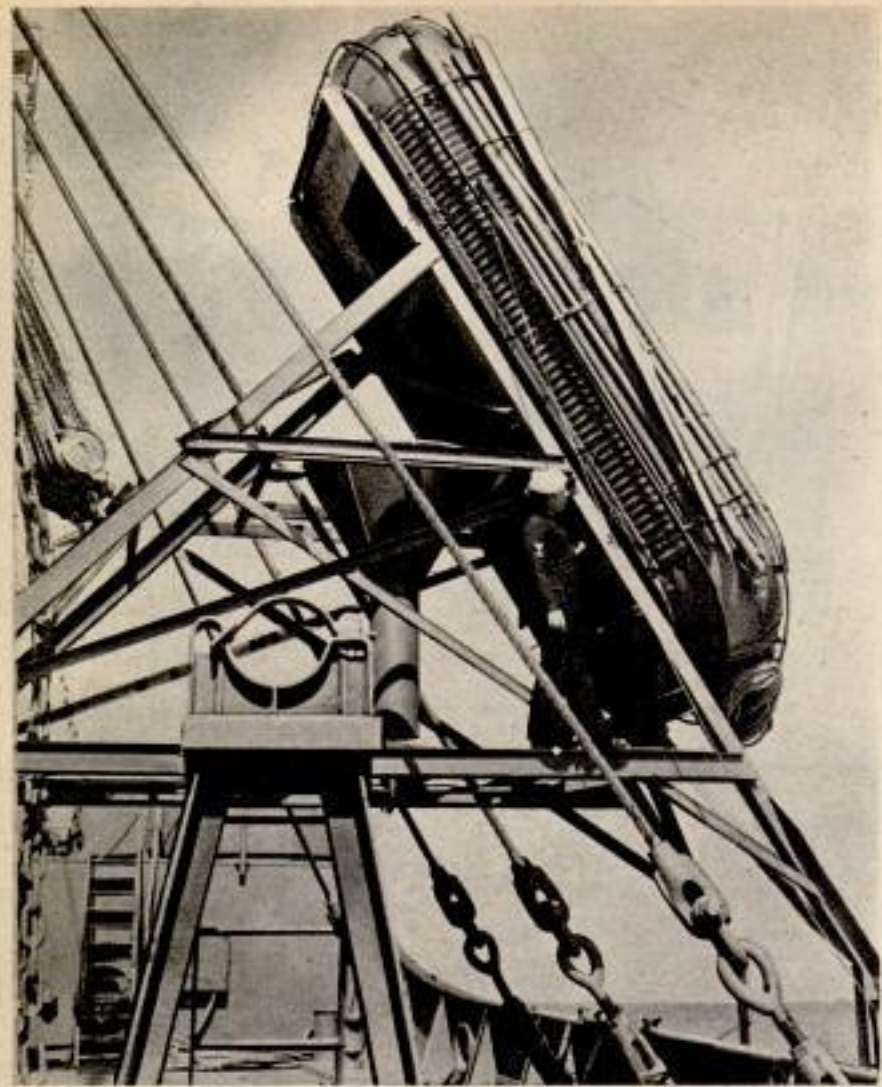

Made of 16-gauge cold rolled steel, a life raft used on Victory ships can carry 20 men and is unsinkable. In addition, it can load a half ton of supplies and equipment, including mast, oars, sails, food, blankets, fishing kits, sea anchor, storm oil, Bible, and playing cards. No matter how the raft hits the water, in being launched, it floats topside up, since both sides are exactly alike. It is 16 feet, 2 inches long with an 8-foot beam, and has a bow to aid sailing or rowing. Its outer shell containing 19 airtight compartments is three feet in diameter and has so much buoyancy it draws only 6½ inches of water under maximum load. Empty, the raft weighs 2,425 pounds.

Left, launching the life raft, which always lands topside up, no matter how it hits the water. Both sides are identical

Back Yard "Dive Bomber" Rides Under 50-Foot Cable

With bits of scrap and plenty of ingenuity, an English aircraft worker built a "dive bomber" in his back yard. It "flies" 50 feet. The plane, which holds several children, is suspended from a cable with a pulley arrangement. After the "bombing run" the plane is pulled back up the cable with a rope. Phonograph motors turn the propellers to add to the realism.

in England



Children riding the "back yard bomber" on one of its routine flights

☛ A new automatic high-speed sprinkler system protecting the rocket powder factories of the Hercules Powder company has extinguished fires one-fifth of a second after they started.

"Flying Whale" Carries "Jonah" to Repair Base



Just as Jonah was once swallowed by the whale, a small plane of the Air Service Command was drawn into the cavernous mouth of a large experimental all-wood cargo plane at Fullerton, Calif., recently for

transportation to a repair base. The small plane had been grounded, with a cracked cylinder head. This was the first time the A. S. C. loaded one plane into another for flight purposes.

Wind and Sand Pelt Tanks in Man-Made "Dust Bowl"

Full-sized tanks, trucks and other military vehicles are subjected to artificially produced sandstorms in a "dust bowl" installed in a Studebaker Corporation laboratory to test the life of mechanical parts under desert conditions. Through a series of air induction jets and miniature wind-

mills, almost any wind velocity and dust intensity can be churned up in the laboratory, believed to be the largest of its kind in the world. Since engineers can enter the dust chamber only when wearing respirators and cumbersome protective clothing, the "driver" sits in a sealed booth before

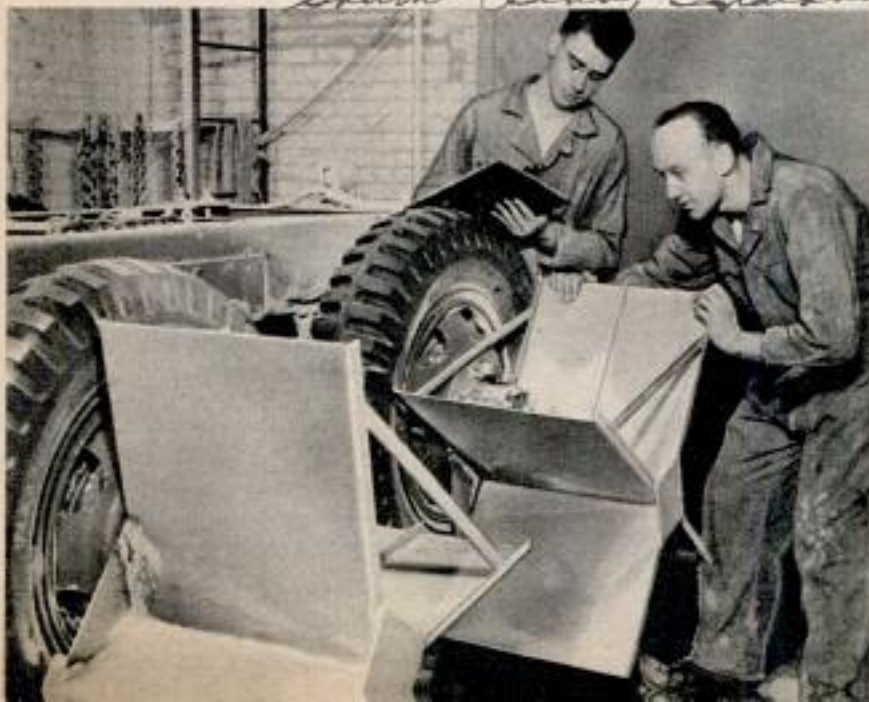

a window and operates the vehicle by remote control, stopping, starting and steering according to an experimental procedure. One test calls for the wheels of the vehicle, mounted off the floor, to be brought to 35 miles per hour for five minutes, then braked to a stop. Driving over rough terrain is simulated by eccentric weighting of the wheels so that they bob up and down. Wheels are fitted with huge paddles to cause a maximum whirling of dust.

SMOKE *the* LIFESAVER

*Major Gary O. Gilmore, C. W. S.
Information Branch
Chemical Warfare Service,
Army Service Forces
Washington 25, D. C.*



Chemical warfare troops lay a smoke screen before fording a stream on maneuvers in New Caledonia

ENEMY gunners find it about four times as hard to hit the target when smoke gets in their eyes. That's why an ingenious variety of smoke prepared by the Chemical Warfare Service is considered a big factor in reducing American casualties on the fighting fronts.

Adapted for offense as well as defense, our smoke pots and fog machines have covered air attacks, prevented bombings,

shielded river crossings, blinded enemy artillerymen, mystified axis machine gunners and protected our infantry advances. Although the employment of artificial smoke in battle dates back to the days of Caesar and Pompey, who used it in landing operations, its skillful use in enormous quantities is "a startling development of this war," in the opinion of Maj. Gen. William N. Porter, chief of the CWS of the United States Army.

It was 5:50 o'clock one afternoon last November when the sound of a low-flying aircraft sent the port of Naples in "condition red." The order went out, "make smoke!" At 6 o'clock the plane was identified as friendly, and the order came, "cease smoke!" Within that brief ten minutes the whole city had been blanketed under clouds of artificial haze. By coincidence, a German bomber formation was approaching, little realizing that the city was already invisible

Left, loading smoke liquid from 55-gallon drums by gravity feed into smoke tanks in New Guinea



from the air. At 6:06 these German formations were identified and the order was repeated, "make smoke!" The man-made mists over Naples were promptly strengthened.

The German aircraft made a rendezvous while flare-laying planes went over the port to mark the targets. One flare-layer circled over the harbor, searching for his targets in the blinding smoke. The plane was heavily engaged by ack-ack. As the flyer weaved and bobbed in desperation, the bombers waiting for their targets to be illuminated



Above, chemical warfare service company starts a smoke screen with a 4.2 chemical mortar or "goon gun" which fires white phosphorus smoke and some high explosive

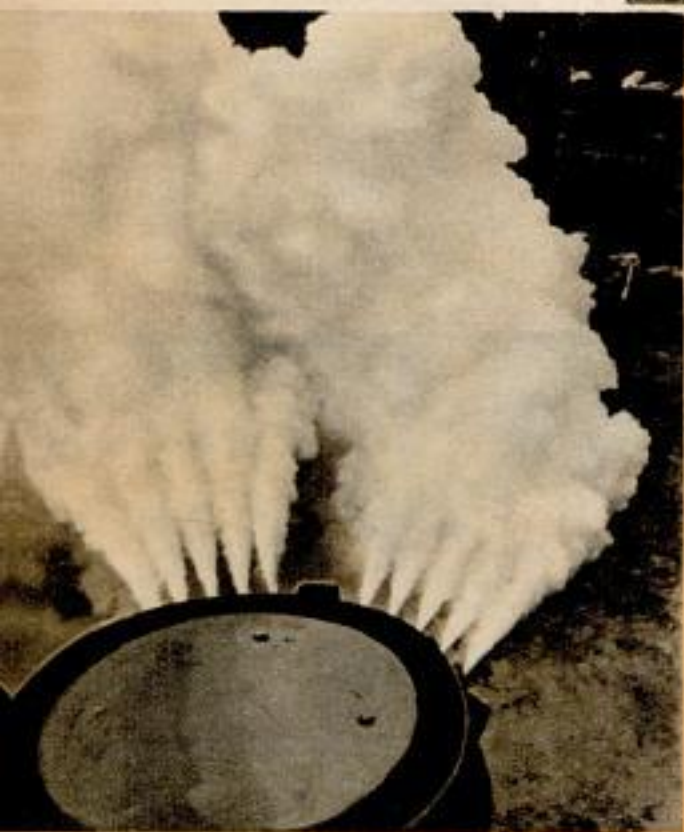

Above, smoke issuing from a "fog machine." Right, under cover of smoke pots burning in foreground troops and equipment push ashore from a landing craft during an air alert on the Salerno beach

finally made a half-hearted attack. They dropped their bombs at random, and most of them fell into the sea. By the time the flares had been released, the German bombers were disappearing over the horizon. It was a wash-out raid, made ineffective by Chemical Warfare Service smoke generator companies equipped with fog machines and smoke pots.

On another occasion in Italy a CWS unit with each of its chemical mortars, or "goon guns" lobbing a 25-pound shell every 15 seconds, established a screen nearly 1,000 feet high, for three miles along the Volturno river, to blind the enemy. This screen was maintained for 18 hours while Combat Engineers spanned the stream with





Above, how a plane releases sulphurtrioxide smoke from a belly tank. It can provide a 400-foot wall to screen paratroopers

bridges. At other points the supporting Chemical unit threw up screens into which the Nazis poured bullets and shells, confident that the bridge-builders were toiling behind the clouds. The Nazis were wrong. In this particular operation the screens were decoys and the engineers, working several hundred yards away, finished the bridge unnoticed.

Even the humble smoke pot has furnished spectacular assistance. One day last January troops and equipment were streaming along the highways at the foot

Right, a 5-gallon smoke pot for amphibious war. Below, smoke laid by planes covers mass landing of paratroopers

of Mount Trocchio near Cassino. German artillery on the mountain had direct observation of the area and began pumping shells into the road. It was imperative that these supplies be kept moving up to the front. Members of a chemical battalion set out hundreds of smoke pots around the shelled area, producing a huge screen six miles long and two miles high under which the key highways disappeared from view. The Nazi gunners, blinded, fired more than a thousand shells into the area, but because of the protective cover there was practically no damage, and traffic proceeded with little interruption.

One of the most spectacular smoke operations occurred in the Markham River Valley, near Lae, New Guinea. Japanese ground crews at their Nadzab airstrip were surprised on September 5, 1943, as seven Boston bombers appeared over the mountain crests, each carrying two M-10 smoke tanks under each wing. There were faint pops as the glass

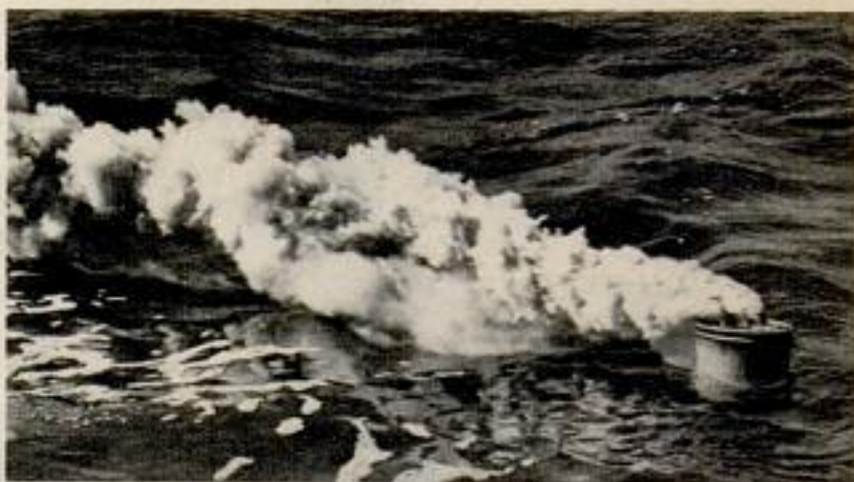

outlets of the smoke tanks were blown open by detonators and, as the bombers dropped into the valley, smoke billowed from the aerial tanks, settled rapidly to the ground, then rose to form walls 400 feet high and 4,000 feet long. Under cover of these cloud walls, low-flying transports, which had followed the smoke planes, disgorged more than a thousand paratroopers. By the time the smoke had dispersed, the parachute soldiers had organized for a successful attack on the airfield.

Japanese shipping in Simpson Harbor at Rabaul, New Britain, was attacked on November 2, 1943, under cover of aerial smoke. Jap anti-aircraft gunners looked up to see formations of American bombers roar in over the harbor and split into two separate flights. They saw the bomb bays open and 100 pound phosphorus bombs fall from the planes. Laid in long, neat rows along either side of the harbor, the smoke bombs "walked" through the AA positions. Within seconds the phosphorus had reacted with the air to produce two dense smoke walls, each three-quarters of a mile long, to mark off the harbor.

An instant later, succeeding waves of bombers appeared through a small opening in the screen and streamed low over the vulnerable ships. Blinded by this man-made fog, the Jap anti-aircraft was unable to fire accurately, and the mission was successfully completed.

Military use of smoke is two-fold: Area screening over cities, harbors and vital installations to prevent accurate bombing, and wall-like screening across battle fronts to blind enemy observation.

The CWS makes smoke in four ways: (1) Burning-type munitions, such as smoke pots, using heat to vaporize chemical mixtures. (2) Exploding bombs, shells, and grenades scattering white phosphorus, which reacts on exposure to the air to form dense white smoke. (3) Liquid smoke chemicals sprayed from tanks mounted under wings of planes. (4) Steam mixed with oil spray produced by fog machines, such as the mechanical smoke generator.

The M1 mechanical smoke generator, which screened Naples, is the Army's biggest smoke producer. Resembling a Gay Nineties fire engine, it consists of fuel tanks and a boiler mounted on a trailer for towing and is operated by a two-man crew. With suitable wind one generator can, within ten minutes, screen a square mile.

Vital ports in the North African and Central Mediterranean areas have been protected by these machines ever since the American smoke-makers arrived in Oran in November, 1942. The port of Algiers has had continuous smoke protection since that

Continued to page 154



Gun Shoots Four Miles Higher To Break Ack-Ack Record

Capable of hurling a projectile 20,000 feet higher than any other known anti-aircraft weapon, the army's "stratosphere gun" is one of its most formidable new pieces of artillery. The 120 mm., 4.7 inch gun, which dwarfs other army equipment, is operated by six men.

"Flying Flossie" Tossed Into Air To Test Aircraft Catapults 0256

"Flying Flossie," a steel water tank on wheels, may be a strange looking piece of equipment to be operating with the Royal Navy but she has an important job. Several times every day "Flossie" is hurled into the air to test new aircraft catapults of British battleships. If a catapult proves to be defective, no tragedy results because "Flossie" is built to absorb hard knocks.



BATTLE OVER --- BATTER UP!

By Paul Healy

WHEN the bedraggled Marines disembarked on the small Pacific island for their period of rest, they looked tired, gaunt and lifeless. The memory of killing hung like a pall. But after a refreshing plunge into the sea, they scoured the beach until two of them discovered a coconut. Instead of eating it, they began to toss it—soon the battle-weary platoons were racing up and down the shore in an exciting game of touchball!

Seabee (above) slams out a hit in game on Guadalcanal

Left, crewman dives from the cat-walk of a U. S. flat-top
U. S. Navy photo

The incident is typical of the ingenious ways in which American servicemen relax at the front. As youths who had hardened their muscles and developed a competitive spirit on neighborhood sandlots and in country fields, they know the value of rough and tumble recreation. Once they lay aside their weapons for a ball and bat (or reasonably accurate facsimiles), trot onto whatever will serve as a playing field, and begin to "rib" their opponents, the strain of combat is temporarily forgotten, even though they may be within earshot of enemy gunfire.

In one manner or another almost all the native

Below, Marine raider battalion puts on tug o' war during field day exercises staged to amuse and relax the veterans overseas
U. S. Marine Corps photo

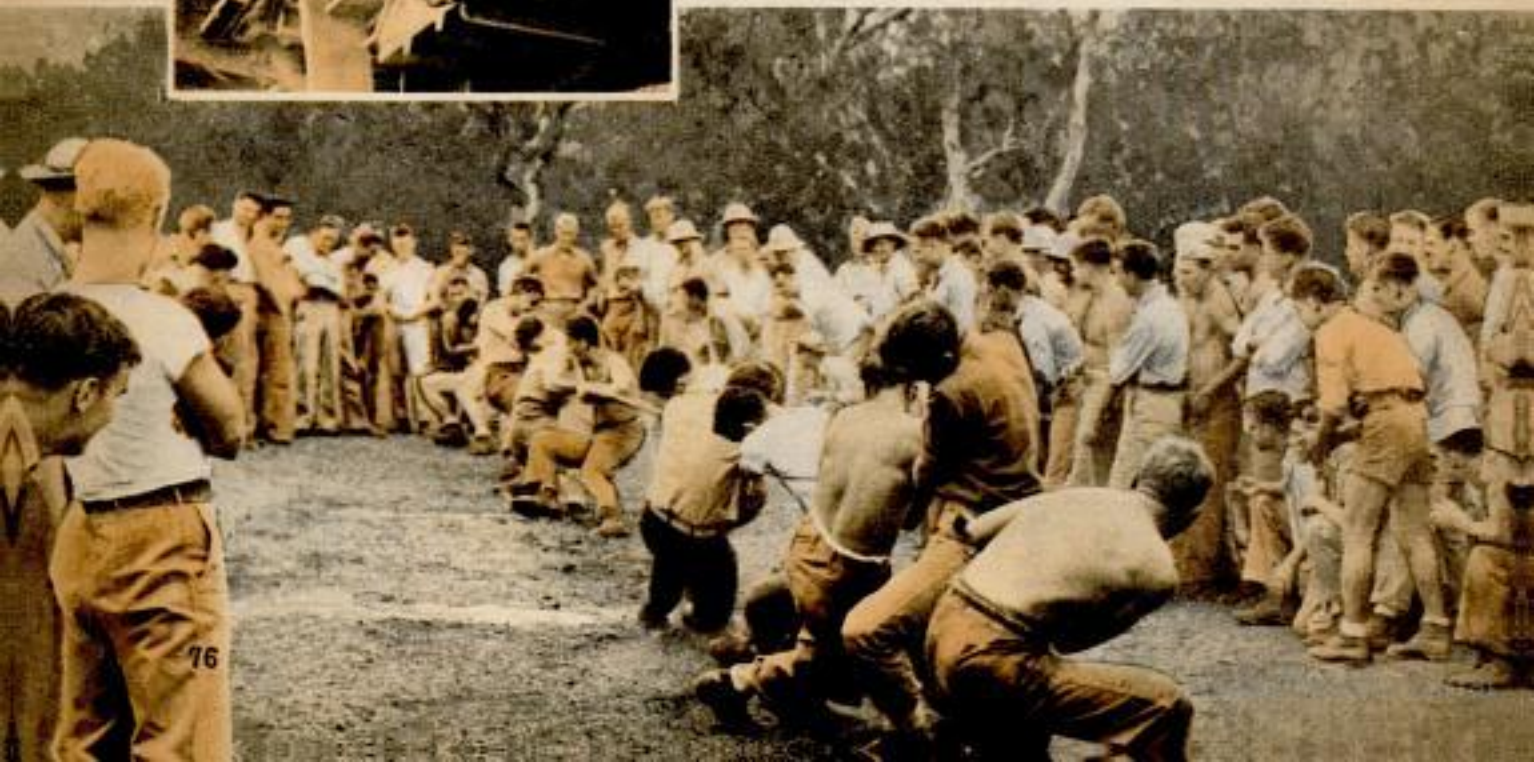
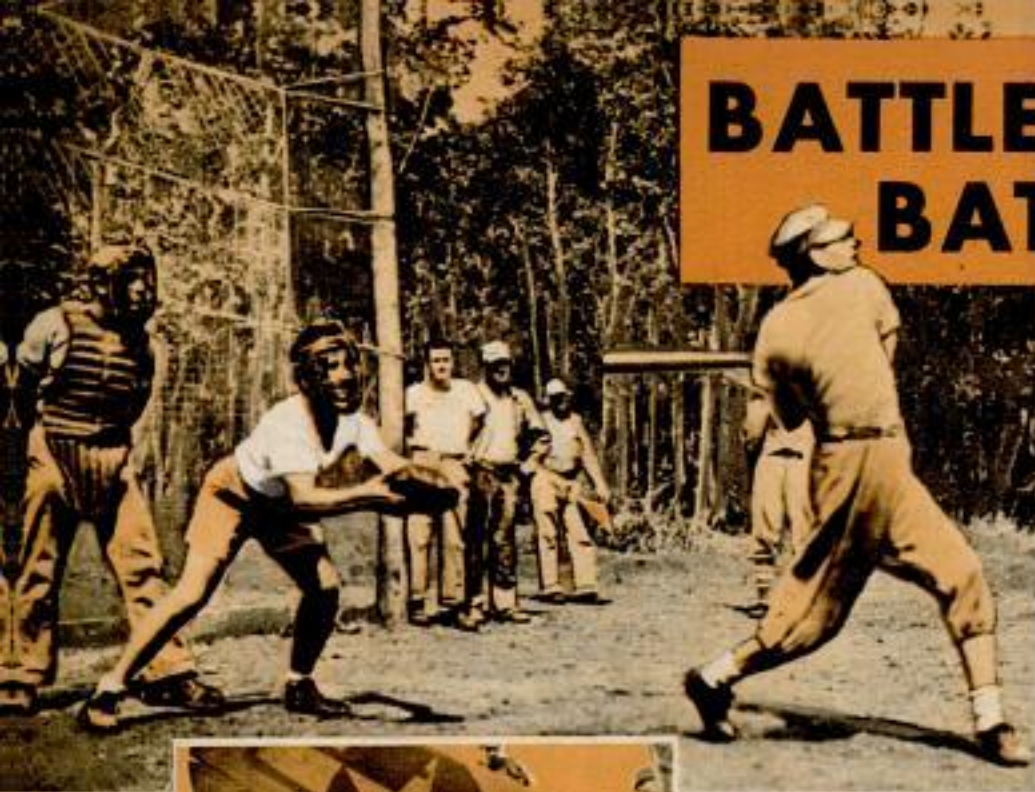

American sports are staged overseas. Last spring 600 marine veterans on Bougainville organized a softball tournament. With the help of the army engineers and the Seabees, 21 first class diamonds were hacked out of the jungle or built in reclaimed swampland, complete with scraped infields, grass outfields and wire backstops.

One group of Seabees laid out a sporty nine-hole golf course right in the jungle, fashioned their own clubs, and organized tournaments.

Apparently, no obstacles are too great and no playing fields are too preposterous for our sports-hungry soldiers, sailors and marines. In New Guinea, for example, the only way soldiers could play "golf" was to use darts instead of clubs and balls in the jungle "fairway." The 18 discs which represented holes were distributed on various trees. Heavy darts, thrown from 50 feet, represented the driver and brassie. The light dart was used for approaches and putts. This battalion also carved out of the undergrowth what they claimed



Above "Austus Tussle," a new game played by the Marines

Right, Marine completing 30-foot climb up rope obstacle

Below, flat-top crew relaxes after invasion of Kwajalein

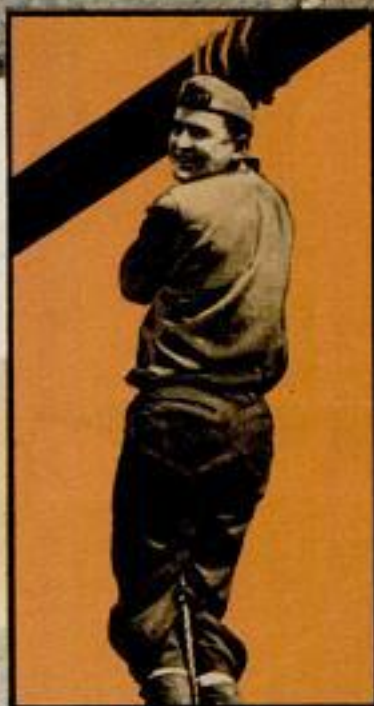



Above, Marines practice football "somewhere in the Pacific"



was the only bowling alley on any fighting front.

When a lease-lend convoy was marooned at Archangel one summer, baseball bats, playing fields and even a catcher's mitt were improvised on the spot, and a White Sea league of four teams, one from each ship, was organized by Navy men and merchant marine sailors.

Often Yankee ingenuity adapts itself to strange lands by making up new games or changing old ones. Take "underleg," one of the recreational phenomena of World War II. It is a modified baseball, in which the "batter" throws the ball as far from the fielders as possible. He must reach first base before the ball is returned.

New sports devised by the marine corps are "Canteen Canter" and "Austus Tussle." The former is a variation of the old sack race. The contestants, carrying cups filled to the brim with water, try to cover a 50-yard course dotted with holes, logs and other debris with the least water spilled.

"Austus Tussle" is a mixture of Australian and American football.

Tropical Marine basketball court (left) is sand and ball is made of rubber to keep it from getting soggy. Below, Marine ball players perform conditioning exercises

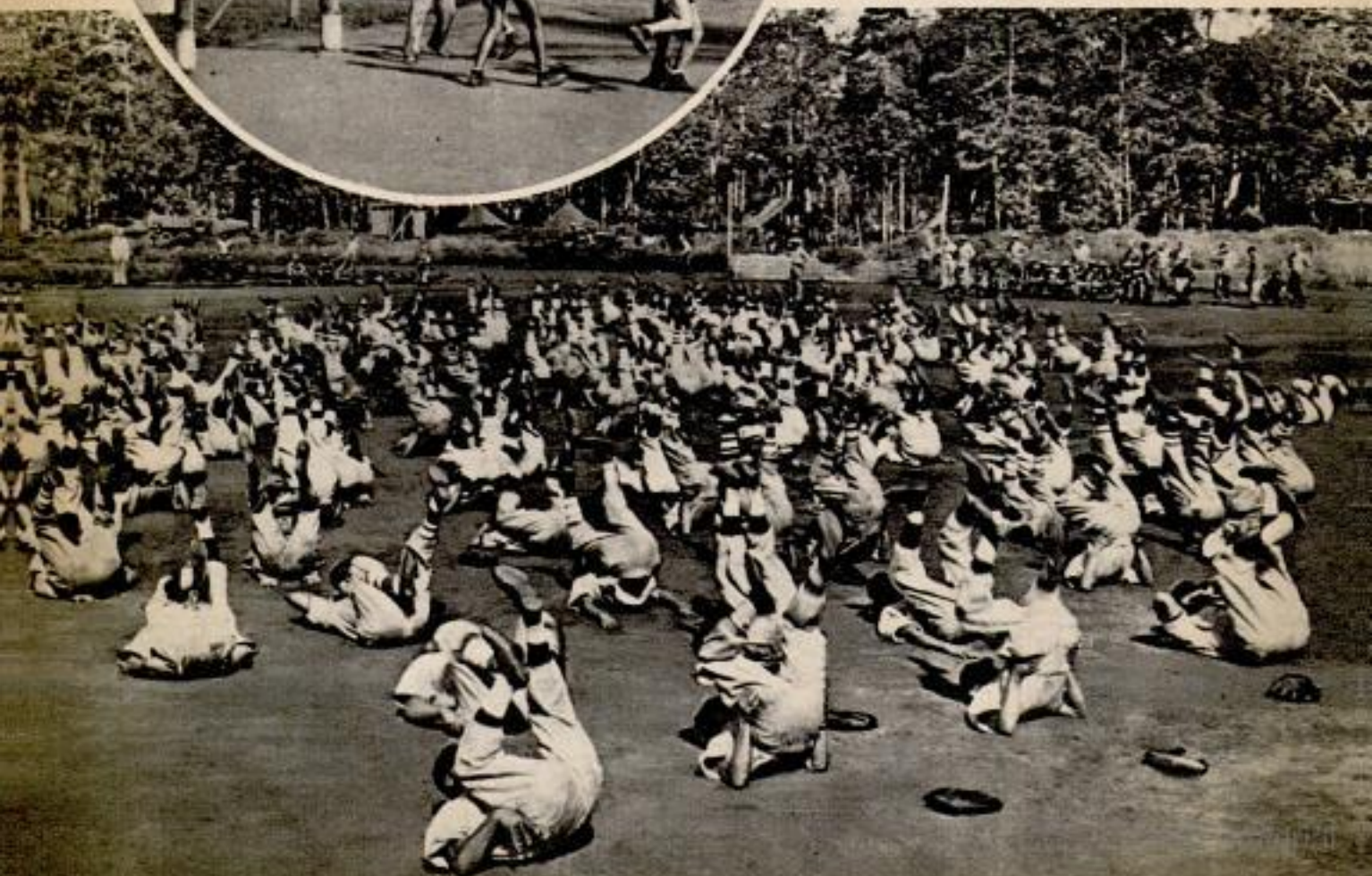



Above, Air Force private is k.o.'d by Marine. Upper right, wild steer bucks off Marine during rodeo at a Pacific base. Right, Marines stage coconut crab race

On an oval field 150 to 200 yards by 100 to 170 yards, the object is to throw or kick the football through the goal posts at opposite ends of the field. There are 18 players on each side, all eligible to throw or receive passes. When a player catches the ball, he is eligible to be played on, and in "Austus Tussle" anything goes.

While resting up from the terrific battle of Tarawa, marines staged an old-fashioned barbecue and rodeo, roping and riding broncos.

On an LSD (landing ship, dock) marines returning from combat swam in the cavernous well deck which was partly flooded so that amphibious tractors could be driven aboard. After the water was pumped out, the Leathernecks started a softball game. Later handball enthusiasts played against the bulkhead and all the way back to the base this open-to-the-sky deck was the center of sports activity.

Many high-ranking officers share the American fighter's passion for athletics. Maj. Gen. Claire L. Chennault, head of the 14th Army Air Force in China, is highly respected as a softball pitcher. Soldiers who saw Lt. Gen. Mark Clark approaching them in the midst of a baseball game in North Africa were delighted to hear him demanding a turn at bat.

So effective as morale-boosters are competitive sports that Adm. Chester Nimitz declared the recreation center organized in the South Pacific by Lt. Comdr. Jimmy Crowley, former Fordham University football coach, to be worth five battleships.

Carrier men race while walking on their hands



NURSES' TRAINING --- AND HOW!



If the troop ship on which they go overseas should be torpedoed, climbing down a cargo net will be old-stuff to the nurses

*Major G. Venter
Public Relations
P.O. 7, Westbury
Fort Devens,
Mass.*

Army photos. 1st Service Command

Up and over! U. S. Army nurses clear a three-foot water hazard on the obstacle course at Fort Devens, Mass. Basic training for nurses is rugged, but fits them for overseas duty

There's fun to be had as well as aching muscles by swinging on ropes (right) across pit

Below, crawling through tunnels on all fours may help these nurses dodge bullets at front

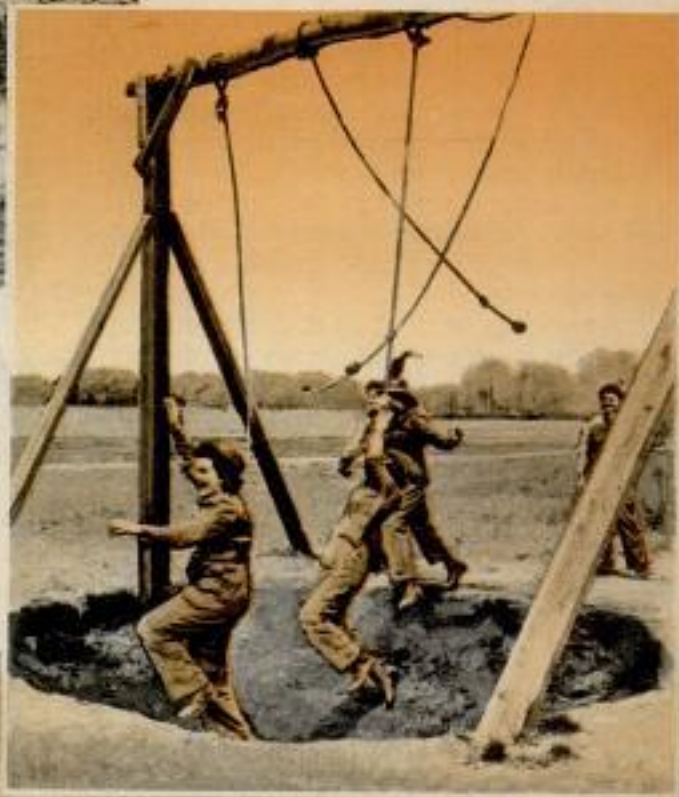

'Casey Jones' Jeep Shifts Wheels to Run on Rails

Built to bounce over the roughest kind of terrain, the versatile army jeep has been adapted to skim down the railroad track. A "Casey Jones" model was devised by Maj. H. G. A. Mauldin, of the Royal Engineers, who equipped the vehicle with two sets of interchangeable wheels—four of them with tires and four a variation of flanged trolley wheels. A special clamp holds the front wheels straight for rail travel, at which time the tires are carried in racks. The jeep is used for track inspection and other jobs.



0195

Chemists Find Synthetic Quinine After 100-Year Search

After a search of 100 years, a synthetic method of producing quinine, the anti-malarial drug, has been found by Dr. Robert B. Woodward, of Harvard, and Dr. William E. Doering, of Columbia University. The climax to their laboratory experiments came when they were able to create quinotoxine, a chemical which originally had been produced from quinine by Pasteur.

The scientists followed the method found by Rabe, a German chemist, for reconvert- ing quinotoxine into quinine. Natural quinine is extracted from the bark of the cinchona tree, which grows in Java and Latin America. Medical authorities hope the synthesizing of quinine will lead to the development of a prophylactic which can not only fight malaria but prevent it.

Polaroid Corp., Cambridge 39, Mass.

Fire Signal Warns Tank Driver to Kill Blaze With Gas

Flames in United States Army tanks can be extinguished in seconds through an im-

proved fire-fighting system. A detector

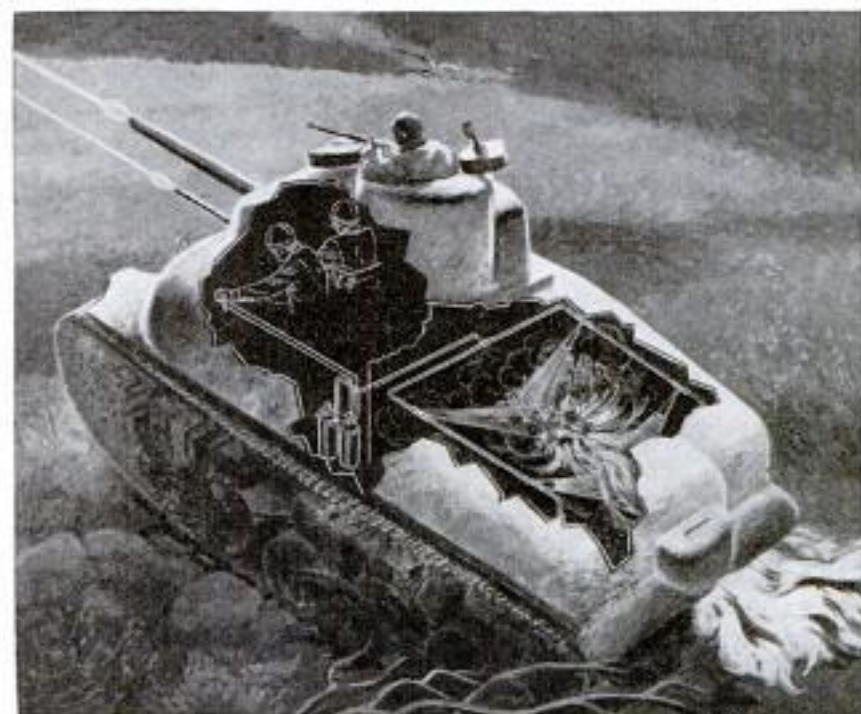

whereupon the driver pulls a lever, instantly flooding the engine compartment with a blanket of blaze-smothering carbon dioxide gas. The detector contains two organic filaments, each of which holds open an electric switch. Close approach to flame destroys the filaments and thereby closes the circuit, which flashes the fire signal. Formerly used only in aircraft, the system was adapted to combat the highly flammable vapors of the high-test fuels in war vehicles. The system works whether the tank is on its side, back or right side up, and regardless of the jolting.

*Mfg: Walter Dillinger Co.
88 West St.
N. Y., N. Y.*

0238

0207

*Cont: Spence-Gammell Co.
40 E. 34th St.
N. Y. 16, N. Y.*

RESCUE

From that point on, the rescuers faced few difficulties. The whites—including a Royal Canadian Mounted Police constable, the trading post manager and his wife, and a clerk—were evacuated by the plane, and the Eskimos were brought supplies.

Key to this successful rescue, as in many others equally spectacular, was the parachute. Without it, aerial rescue operations would often be impossible in remote regions where airmen are forced down or travelers stranded. In the Fort Ross rescue, an attempt to land the plane without expert guidance of the officer dropped by parachute might have ended in disaster.

The parachute is the cornerstone of rapidly ex-

Jumper lowers rope from 'chute. Below, huge messages tell story



FOUR hundred miles north of the Arctic Circle—at Fort Ross, Hudson Bay Eskimo trading post and farthest north of Canadian settlements—four white persons, one a woman, and 50 natives were marooned.

Eight days' food remained. Their supply ship, *Nascopie*, had failed to break through the ice to the northern tip of Boothia Peninsula on Bellot Strait, three miles from Hazard Bay where the post is situated. The Royal Canadian Air Force had no rescue plane available.

Only one hope remained—the U. S. Army Air Force, to which a rescue appeal was made.

Day and night, the stranded group watched the skies for help. At last a plane was sighted. But it did not land, for ice conditions were hazardous, even for a ski-equipped craft. Instead, by parachute, came 2,000 pounds of welcome supplies—and a U. S. Air Force officer. It was the officer's task to test the ice and select a suitable landing place, then to direct the plane from the ground. Next day, a safe runway was laid out on the ice and marked with bags of coal.

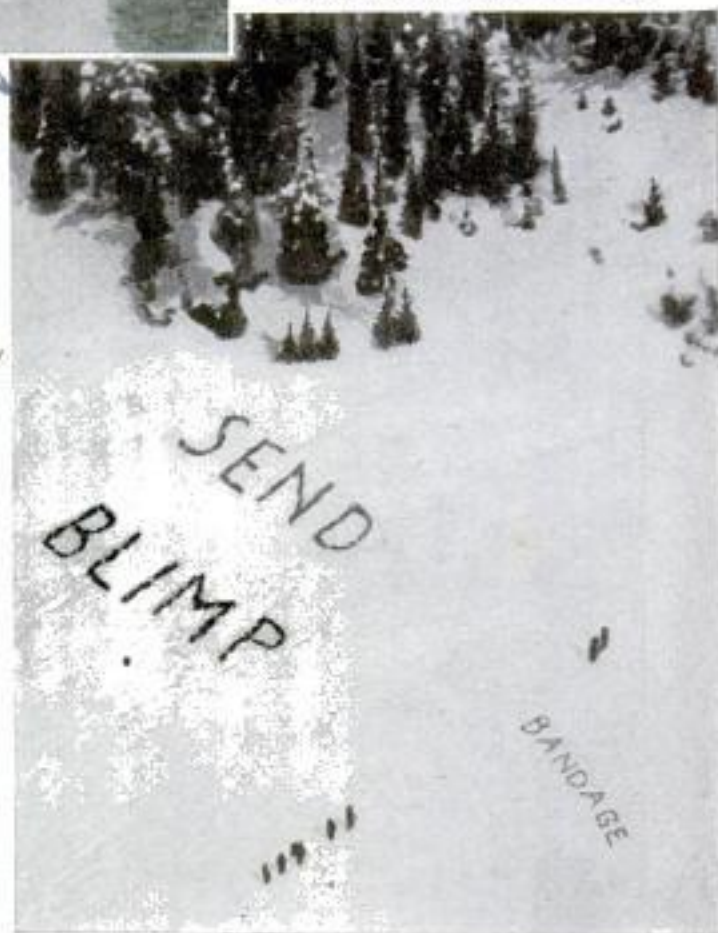

*Mr. G. W. Mason
1362 N. Dearborn St.
Chicago 19, Ill.*

0 156

from the SKY...



AAF rescue squadron applies first aid to "crash victim." Right, ready to go aloft is "para-rescuer" of Coast Guard

panding aerial rescue programs now extending to all branches of military and civilian aviation, and even to such organizations as the U. S. Forest Service. These programs will be a vital adjunct to postwar aviation when global air lines extend over Arctic wastes, little traveled seas and vast areas untouched by civilization.

Because of its widespread experience in training and employing "smoke jumpers" in fighting forest fires, the U. S. Forest Service of the Department of Agriculture has taken the lead in parachute rescue activities, and the Forest Serv-



Dog team aids work of rescue crew training on snowy lake



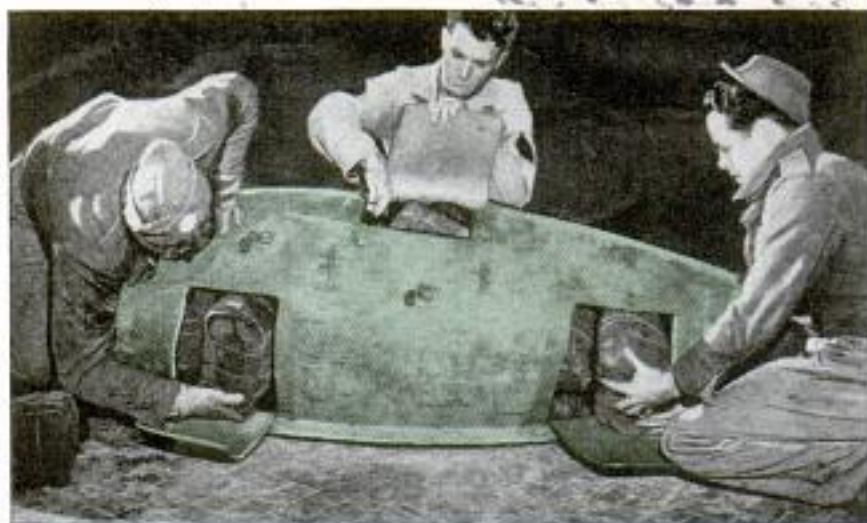

Loading rations into auxiliary gas tanks to be dropped to paratroopers at advanced post. Tank is carried (below) on bomb rack under the wing



ice station at Seeley Lake, near Missoula, Mont., has become the major center for trainees.

The Forest Service "smoke jumper" methods of parachuting fully equipped men to remote areas were confined originally to work in mountainous and timbered regions during the summer when fire hazards are greatest. It has been found, however, that the same methods were easily adapted to the problem of dropping men and supplies, summer or winter, on any kind of terrain. A series of rigid tests confirmed the effectiveness of the system in winter with minor changes in equipment and technique.

The Forest Service works closely with the Emergency Rescue Branch of the Air Force in training personnel. In addition, the Coast Guard has trained representatives at Seeley Lake, and has established "Para-Rescuer"

Trainees lift cover of sled used to move injured flyers

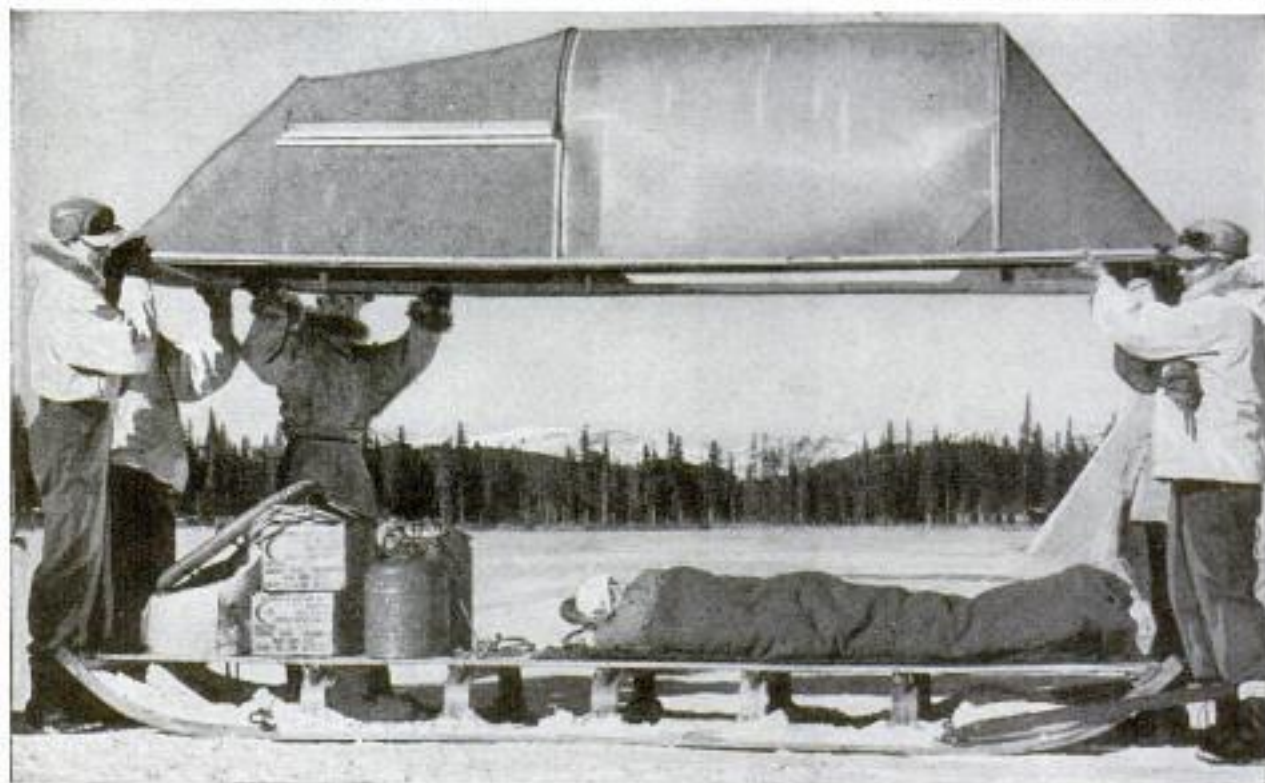

units, the first of which was assigned to duty at Ketchikan, Alaska. The Aeronautics Observation School at Edmonton, Alberta, has sent men to Seeley Lake for training and upon completion of their courses they give instruction to their co-workers in Canada. The same procedure has been followed by the Canadian Pacific Airways. The Army and Coast Guard have sent medical men for parachute rescue training, and the Forest Service has supplemented the 'chute work with courses in woodcraft.

Dropping food and supplies by parachute to stranded airmen and travelers has been done for years, but the technique has been improved. Results include greater accuracy in landing supplies and a careful selection of articles most needed by marooned persons in northern timberland, tropical jungles, Arctic regions, deserts and on the ocean. Two types of crash rescue kits have been developed by the Army Air Force and Forest Service. These include food and medical supplies, camp and trail equipment, radio communication kit, and other items.

The Air Force has produced two emergency parachute kits, one for jungle, and the other for Alaskan use. These include compass, matches, emergency rations, mosquito headnet, gloves, cooking kit, iodine, three-bladed knife, fish line and hooks, camphor gum, insect repellent, quinine, signal flare, machete, sharpening stone and first-aid kit. Particular attention has been paid to insect fighting equipment in Alaskan kits, as well as tropical, because in the summer there are 10



Army transport (above) shows how food and supplies can be dropped by 'chute to reconnaissance units. Below, jumping tower for rescue trainees simulates sudden shock of opening parachute

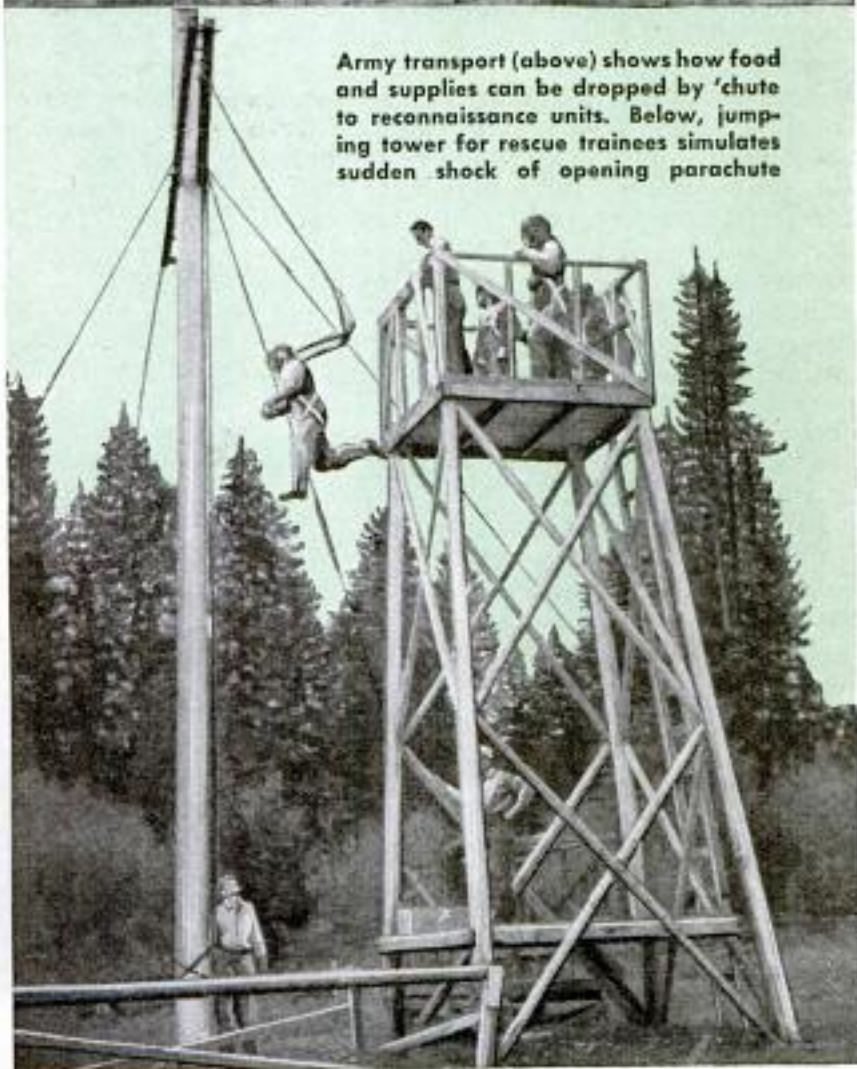



Yanks load medical rolls in plane ready to be dropped to advanced units

times as many mosquitoes per square mile over two-thirds of the land north of the tree line as in any equal area in the tropics.

A high percentage of air crews forced down at sea or in remote spots have been rescued by squadrons of the Emergency Rescue Branch of the Army Air Forces. In most of these rescues, parachutes were used in dropping supplies or personnel. Rescue squadrons have been activated in every theater of operations where AAF personnel are stationed. Medical men, navigators, radio technicians and persons familiar with the territory make up the squadrons, and all of them are thoroughly trained in the use of parachutes. The squads are reported to be excellent morale builders.

In the main, parachute rescue squads function as determiners of damage and injury resulting from plane crashes, and with the aid of medical jumping officers, provide first aid and emergency medical attention until ground crews are able to penetrate to the scene of the crash. Most rescue work involves injured men who not only need attention on the spot, but as-

Learning to manipulate rope to escape parachute in tree



sistance in traveling back to civilization. Therefore, special emphasis has been placed on first-aid training of jumpers and jumper training for physicians and surgeons.

Special training also is given in the use of parachute cloth itself, either by rescuers or by men marooned in spots after supplies are dropped. Several types of tents may be constructed of parachute cloth, or it may be used as head or body covering. Holes dug in the ground and lined with the cloth will collect rainwater. The tents can be used as fish nets—spread across narrow portions of small streams to trap fish as they swim downstream. On the desert,

spiral gaiters of parachute cloth keep sand out of shoes. Instructions for using the parachute are dropped with supplies.

At Seeley Lake, Mont., the Forest Service has a standard course for training jumpers for rescue work as well as for fighting forest fires. This is divided into two phases, ground training and jumper training.

The ground training occupies a minimum of six days prior to jumper training. A daily portion of the ground training is devoted to physical conditioning on an obsta-

cle course patterned after courses in use in armed service camps. Special attention is given to strengthening arm, leg and back muscles to withstand the rigors of landing and maneuvering the parachute canopy during descent.

Preliminary jump training is done from 25-foot towers. The men are fully equipped, and are stopped in their fall before they reach the ground by means of an overhead boom. This is to simulate the shock of the opening of the 'chute and to overcome the natural antipathy of the trainee to jumping from high objects.

The next training step is called "let-down" training. The trainee is fully dressed in jumping suit and is equipped with harness and chest pack. To the snaps on the shoulders of the harness a single-tree is attached by short lift webs and the single-tree is connected by block and tackle to a cable suspension line 30 feet in the air between two upright poles. The trainee is first hoisted a few feet off the ground and given instruction in the let-down procedure devised to permit jumpers to descend from high trees, using a 75-foot rope which is threaded through the harness and attached to the lift webs of the single-tree.

Considerable of the ground training time is spent in instructing jumpers in safe methods of climbing trees to retrieve their 'chutes without damage. The trainees are made thoroughly familiar with two types of radios used by jumpers. One is a compact, ultra-high-frequency set used for communication between jumpers on the ground and the plane overhead. The other is a medium frequency set for contact with bases up to 75 miles away.

Jumpers also are trained in the use of colored signal panels and code signals.

Advanced jumper training consists of from seven to twelve actual jumps. The first two are devoted to orientation of the men, and after that the instruction includes steering the 'chute, slipping the 'chute to lose altitude, stopping oscillation and other related actions during descent. The first six jumps are made on a cleared area, the rest into timber.

During the training, the more capable men are selected for spotter training to enable them to select jumping spots, determine wind drift with miniature drift chutes, and to time the jumps correctly to compensate for wind and other conditions. For jumps, the planes are slowed to around 70 miles per hour.

Forest Service parachute crews this year are made up largely of conscientious objectors who have volunteered for the work. Coast Guardsmen and other service personnel in training have responded to calls and jumped to fight forest fires.

Inventor: F. H. Wagner
San Antonio, Texas
Globe Gives Life Raft's Position Without Sextant or Compass



Made entirely of Plexiglas and weighing only one pound, a simplified celestial navigation instrument for use on life rafts recently was submitted to the armed forces. The globular device, which will float on water and is visible from a distance of 25 feet at night, combines a sextant for use during the day with a quick means of determining true north, sun time, latitude and great circle courses and direction. Exact reproduction of the movements of all celestial bodies used in navigation just as they are seen from any point on the earth's surface is possible with the instrument. On a life raft, it is said, it would eliminate the need for a nautical almanac, sextant, compass, and involved calculations.

Photo by: Nathan & Shaver Co. 22 Washington St., Philadelphia, Pa.

Hand Gun With 5-Ton Pressure Greases Frozen Bearings

By developing a pressure of 10,000 pounds, a streamlined, hand-operated grease gun easily and quickly forces its lubricant through the toughest frozen bearings. The gun, which dispenses light or heavy grease under all climatic conditions, has a capacity of 18 ounces.



Balkcrank
Balcrank, Inc.
Ann Arbor, Mich.

Vargan X Co.
210 Seventh Ave.
N. Y. 3, N. Y. 0233

Plastic Gift Items Made of Gun Blister Material



The same transparent plastic used as a blister for observation domes, gun turrets and bomber noses, is being fashioned into a variety of glistening accessories for civilians. Among the gift items made of Plexiglas are a pack holder to prevent cigarettes from crushing, a card holder to keep playing cards fresh and undamaged; a paper-

thin money holder; a two-way pocket photo-holder; and a photo-frame. The featherweight material is not only stain-proof and shatterproof but also may be sawed and carved like wood, or machined, drilled and threaded like soft metal. Until recently transparent plastics had been largely restricted to government use.

Navy's Stainless Steel Air Giant Loads Cars on Belly Ramp ⁰²⁴⁶

Radically different in appearance, the Conestoga is the first cargo plane made entirely of stainless steel and the first Navy plane designed primarily for cargo carrying. Manufactured by the E. G. Budd Company of Philadelphia, it can be con-

verted into a troop carrier with 24 seats and a flying ambulance equipped with one vehicle and eight stretchers, or 24 stretchers. Paratroops can be launched simultaneously through exit doors on both sides of the fuselage, while troop supplies may be dropped through a unique hatch in the rear of the belly, below the upswept tail, which is 31 feet, nine inches above the ground. The hatch also drops down to form a ramp over which cargo may be moved. For safety in the event of a crash the two-man crew sits above the level of the cargo in the knob-like nose that slopes down to a slimmer mid-section. Powered by two 1,200 horsepower radial engines, the Conestoga can carry 10,400 pounds. It is 68 feet long with a 100-foot wingspread, a cruising speed of 165 miles per hour and a range of 1,700 miles. With auxiliary fuel tanks this may be extended to 2,500 miles.

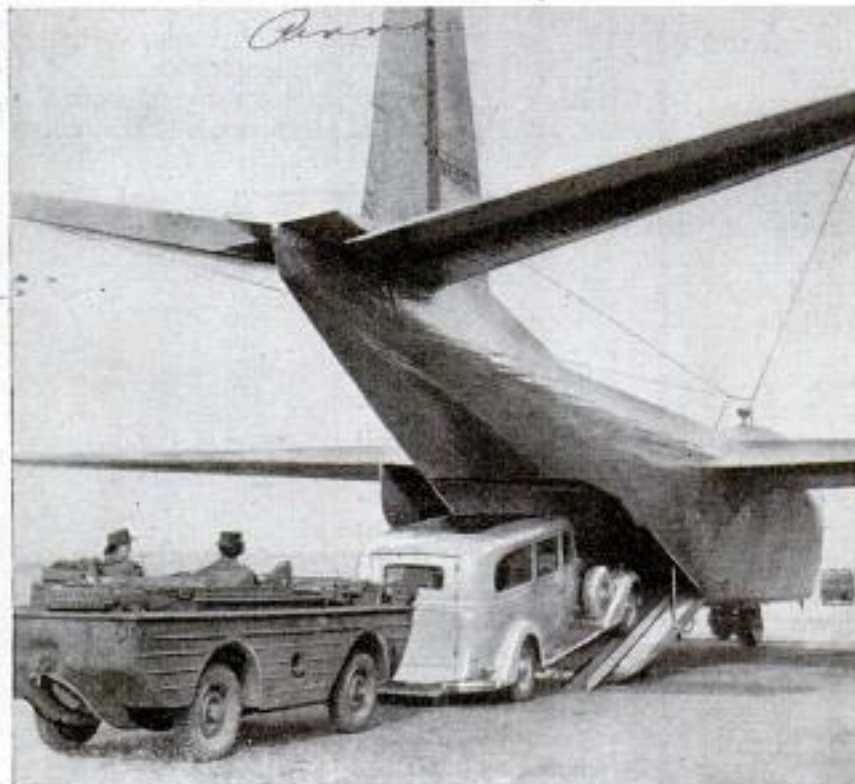



Bookends

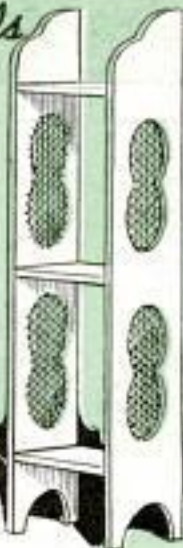

Shelves

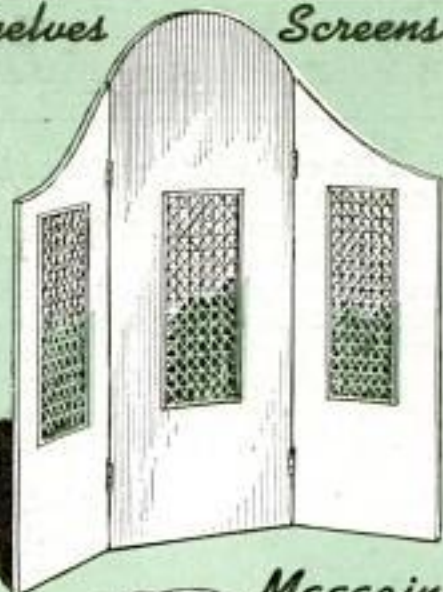

Screens

APERTURES

strung with cord

By Charles and Bertram Brownold

FRUIT and bread boxes, clothes hampers and other utility receptacles that require ventilation can be improved in appearance if you string cord across the apertures in much the same way that tennis rackets are strung. The effect will be even more unusual if you use cords of different colors or of varying thicknesses. Other articles such as book ends, wall shelves, screens, magazine racks, waste baskets, etc., also can be decorated by strung apertures even though the openings are purely ornamental and not for ventilation.

In all cases, take care in locating accurately the small holes for stringing the cord, as carelessness in this detail will result in lines that are not parallel, and the symmetry of the design will be impaired. Holes around square or rectangular apertures are equidistant, but this



Magazine racks

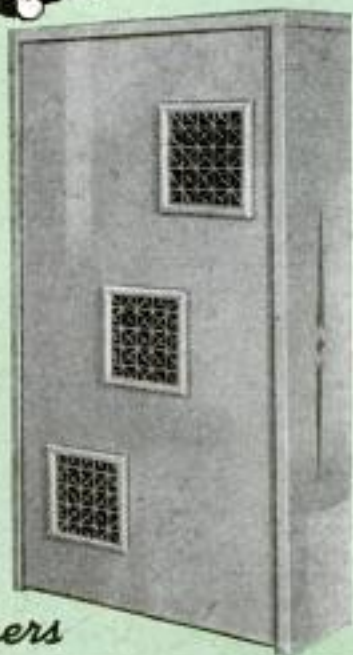

Hampers



① SAW OUT THE OPENINGS ② DRILL HOLES FOR CORD

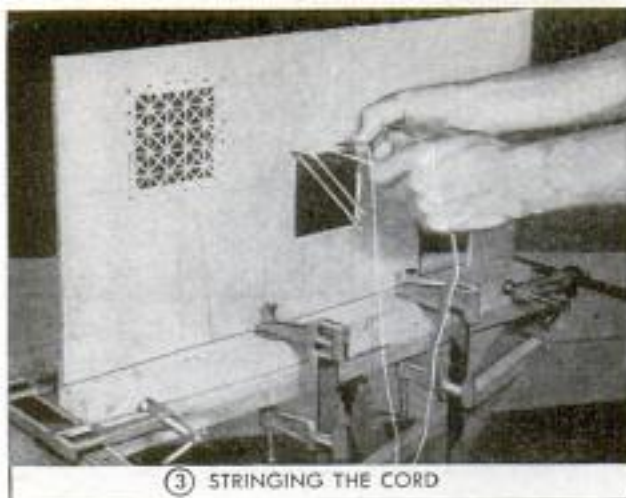

③ STRINGING THE CORD

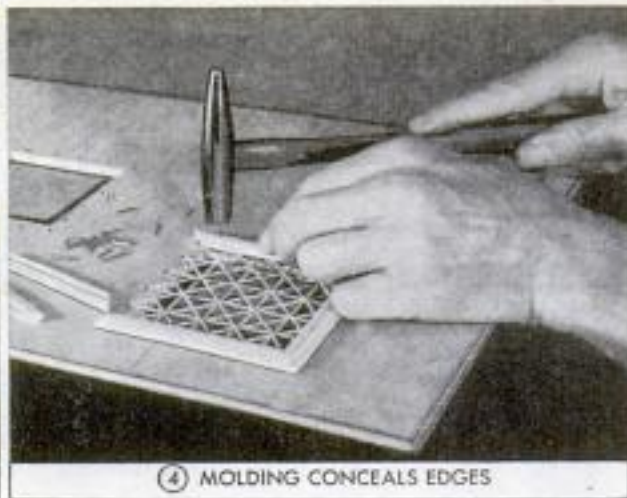

④ MOLDING CONCEALS EDGES

is not the case with circular or oval apertures even though the parallel cords are the same distance apart. To guard against mistakes in hole spacing lay out the pattern of the aperture and the holes on a piece of paper, testing the accuracy of the layout by drawing lines from point to point to represent the cord. Then tape the pattern on the work and, with a sharp awl, punch through the paper to locate the holes to be drilled.

After locating the pattern in this way, cut out the opening and drill the holes as in Figs. 1 and 2. They should be spaced about $\frac{1}{4}$ in. from the edges of the aperture. Then, by measuring the distance from point to point, along the lines to be strung, compute the length of cord you will need for the whole job. If this precaution is not

taken you may run short of cord before the opening is completely strung, which necessitates undoing the cord and starting all over, as knots in the cord spoil the appearance of the weaving. By using two upholsterer's needles you can work from both ends of the cord and thus avoid pulling the entire length through each hole. As you proceed, pull the cord tight and keep it from loosening by forcing small wooden pegs into the holes so that both hands are free, as in Fig. 3, shifting the pegs as the work proceeds, and discarding them after the stringing has been finished and you have knotted the ends. The small holes and the knotted ends of the cord can be hidden by molding, as in Fig. 4, which is rabbeted or shimmed up with splints to a height sufficient to cover the cord.

This Sewing Kit Can Be Kept Handy Between Book Ends

This kit can be kept in a bookcase, between book ends or any other place where

it will keep your sewing accessories handy at all times. It is made from a block of wood which is cut out in the center and fitted with a front and back of plywood or other suitable material, the front being hinged to form a lid. The edges of the block are shaped to resemble the pages of a book. If desired, the front and back can be covered with cloth, imitation leather or other suitable material to make the appearance more authentic. Short dowels hold spools of thread, and thimbles, scissors, etc., are slipped over corks, which are screwed to the bottom of the kit inside the recessed block. — Herman R. Wallin, New York City.

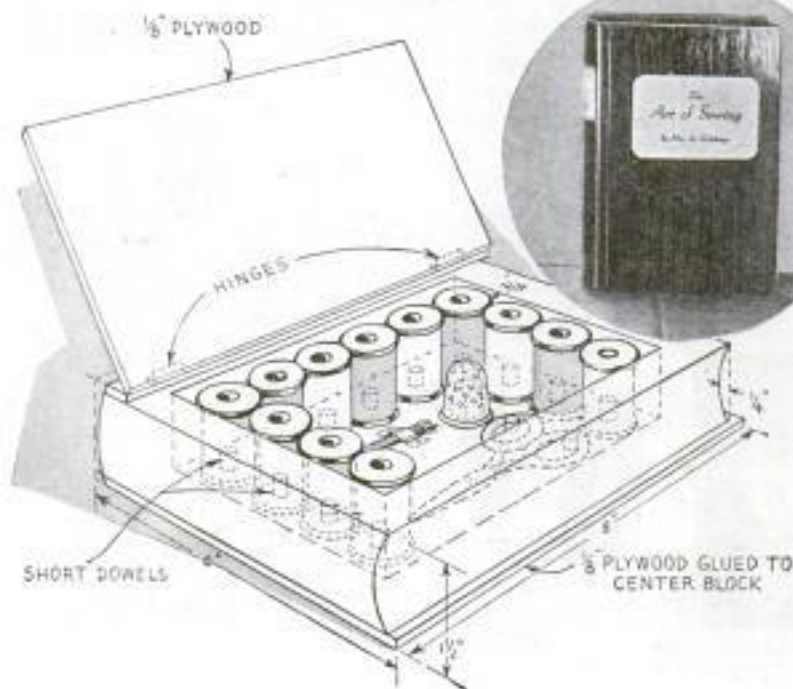

Tips on a BETTER FINISH

LITTLE TRICKS THAT
HELP IN APPLYING A
PERFECT VARNISH



DON'T use varnish directly from the can. **DO** pour what you'll need in a separate cup and discard left-overs



DON'T apply succeeding coats of varnish without first testing hardness. **DO** apply succeeding coats when the varnish resists impression of thumbnail

DON'T apply varnish if chilled—it will be sticky and hard to brush. **DO** warm it by setting the can in hot water (70-90°) and it will level nicely

DON'T rub down coats with fresh sandpaper. **DO** scuff it first by rubbing together to knock off the sharp grits

However careful, dirt specks will get in the finish. These are easily lifted from the wet varnish with a clean sliver of wood tipped with a small ball of burnt varnish to which the specks will cling when touched lightly. Don't wait until the varnish is tacky but remove specks as you go. Burnt varnish consists of varnish, 1 part, melted rosin, 6 parts, well mixed. In use, a drop or two is rolled into a small ball between moistened fingers and placed on a stick. As the specks are lifted from the varnish they are kneaded into the ball



To pick up final traces of dust, the expert uses a "tack rag," which is a cloth moistened with varnish and kept in an airtight can. To make one, dip a cotton handkerchief in warm water, wring out lightly, sprinkle with turpentine and cover with varnish. Wring out until nearly dry

Jig to Hold Auto Piston in Vise While Installing New Rings



Motorists and others who do their own repair work and do not have equipment for holding pistons while working on them will find this simple jig handy for holding a piston in a vise. The jig consists of a piece of flat iron drilled in the center to take a hook bolt. In use, the bolt is hooked over the wrist pin and the nut tightened to pull the flat iron piece tightly against the bottom of the piston, after which the iron is gripped in the vise to hold the piston solidly in a handy working position.

Picking of Berries Simplified With This Container



You can save time when picking berries by using this container, which is suspended from your hand, thus making it unnecessary to reach your hand in and out of the briars to put the berries in a basket or bucket. The container is merely a tin can with one end removed and fitted with a wire bail bent to the shape shown. The bail slips over the hand as indicated, one side

being longer than the other so that the can will hang in a vertical position when the hand is held in a natural position for picking berries.

—William C. Turtle, Portland, Ore.

Ants Kept Out of Lunch Basket

To prevent ants from getting into your picnic lunch basket, invert a bowl in a pie tin, fill the tin with water and set the lunch basket on the bowl. The water forms a moat which ants are unable to cross.



Tar Seepage at Stovepipe Joints Prevented by Extra Damper

A tar-like substance which often seeps through the joints of stovepipe can be eliminated by placing an opening in the smoke pipe directly above the draft damper, which should be near the stove, and fitting the opening with a sliding or flap door. If this extra hole is opened whenever the draft damper is closed, the gases in the pipe will be kept in circulation and will not condense inside.

—J. B. Temple, Toronto, Canada.

Hinged Boat Seat Lifts Out of Way For Loading and Cleaning

The annoyance of climbing back and forth over the seat of your boat when loading, bailing or cleaning, may be overcome by hinging the seat plank at one end. A long turnbuckle pivoted to the supporting cleat will hold the seat vertically when elevated.

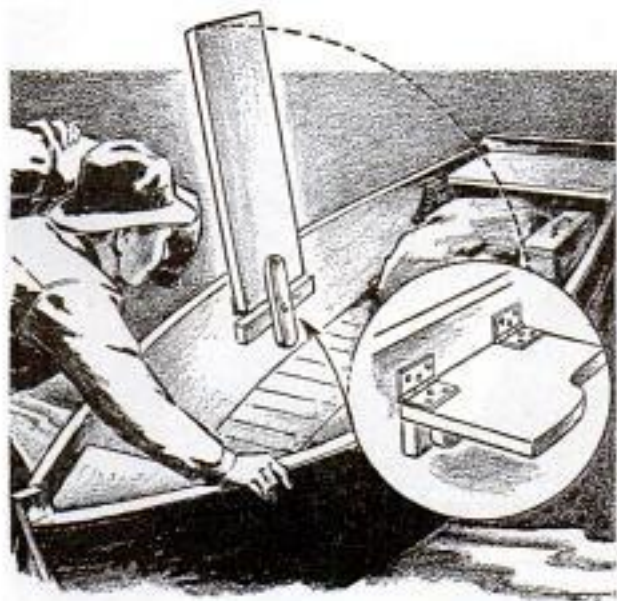

Concealed Wire Hanger Holds Plate on Wall.

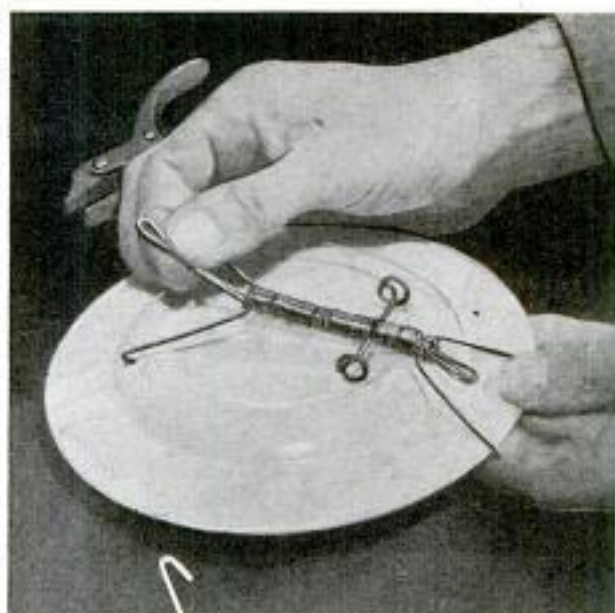
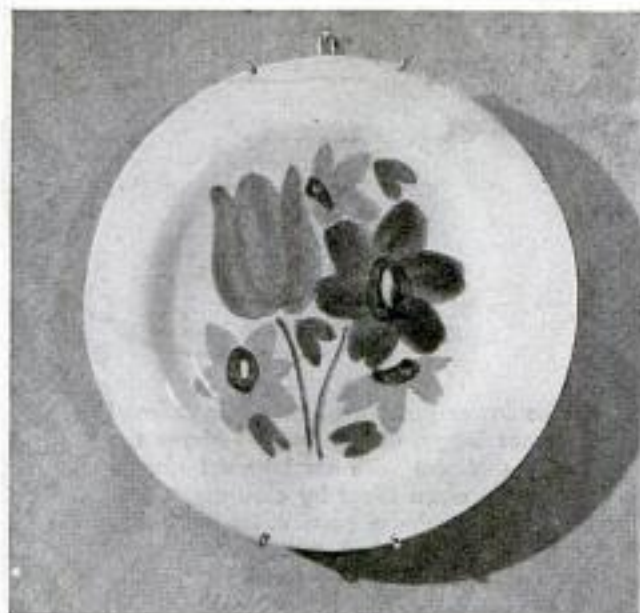

A hanger that will hold a decorative dinner plate steady on the wall and will not be noticed can be made by bending double two short pieces of wire to form the looped-end pieces shown, and turning back the ends into a V with the tips hooked to fit over the rim of the plate. A 2-in. length of $\frac{3}{16}$ -in. coil spring is slipped over the loops. It may be necessary to spread the spring to fit over the doubled wire. Screen-door spring may be suitable in some cases, or a spring of narrower diameter made by winding piano wire around a $\frac{3}{16}$ -in. bolt or drill rod. Then a piece of wire is inserted through the spring and a loop formed in each end as a stabilizer to hold the plate parallel to the wall.

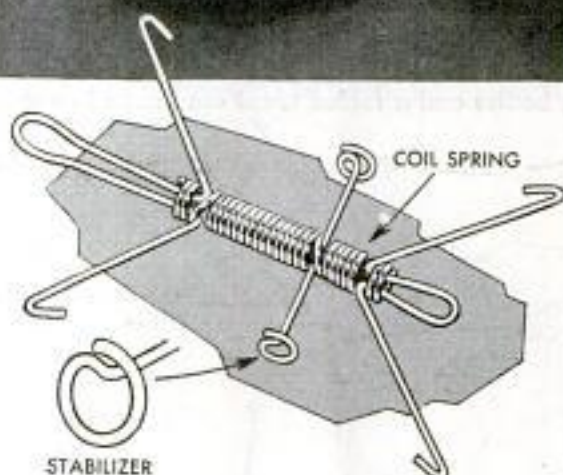

Adjustable Partitions for Drawers of Homemade Cabinet

After making a large filing cabinet having several drawers, the partitions or take-ups for the drawers, which I was unable to purchase, were made of wood as shown.

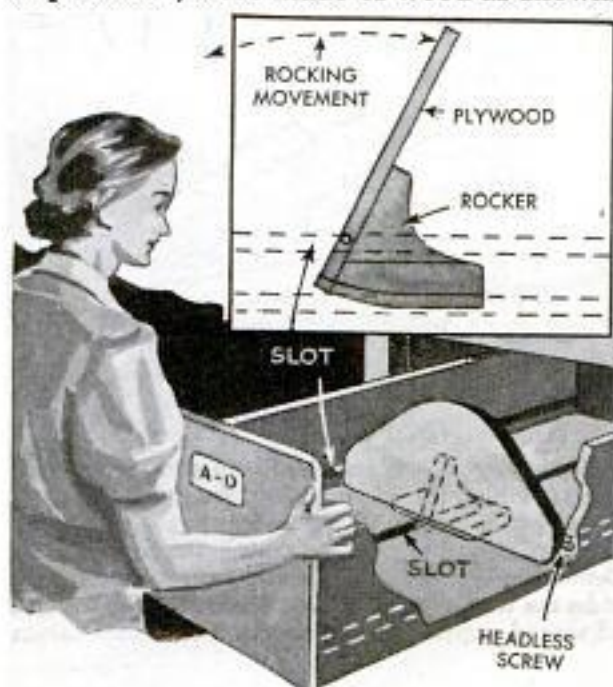

Each partition consisted of a piece of plywood having a rocker screwed to its back as indicated, the rocker working in a slot in the drawer bottom. Headless screws projecting from the ends of the plywood slide in grooves in the drawer sides. With this arrangement, pressure of the filed papers against the front of the partition tilts it backward, in which position the rocker causes the screws to press against the upper surfaces of the slots and thus keep the assembly from moving. The greater the pressure the greater the binding effect of the screws. The partition is adjusted by tilting it forward and then moving it as desired. The partition can be inverted or removed by laying it face down and twisting it sideways to engage or disengage the headless screws in the side slots.

—F. H. Peterson, Monroe, La.

Never allow weeds to ripen or remain in your garden in the fall. If you do, the seeds will drop to the ground during the winter, and more weeds will grow in the spring than would ordinarily.

Solving HOME



Baby sweaters keep their shape after washing if nursing bottles and a folded towel are inserted as shown

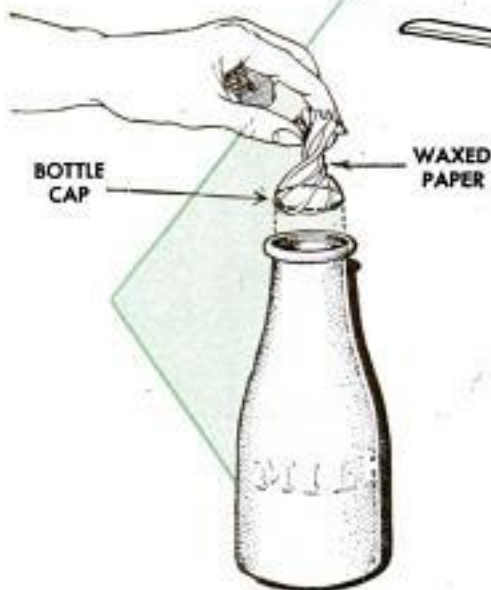

It is easy to remove a bottle cap repeatedly if you wrap a piece of waxed paper on the cap to serve as a handle



If the lower portion of salad in a bowl becomes soggy, simply keep it above the excess moisture with an inverted saucer. Below: To clean silver by electrolysis, put it in an aluminum pan; cover with hot salt water (salt, two tps. to a quart). Keep heated just below the boiling point

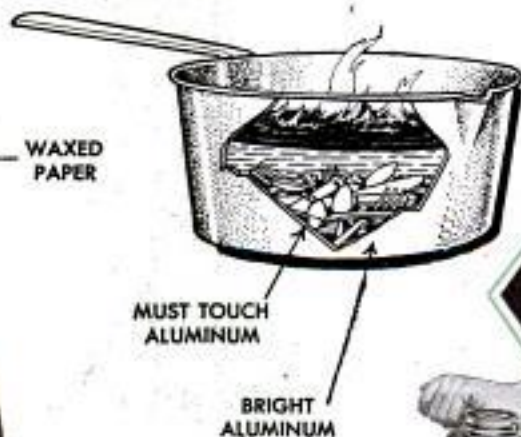

STRAP OR BELTING
1" X 14"

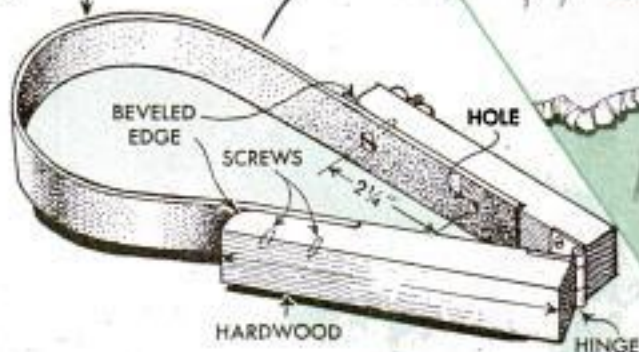

Above: This holder grips a fruit jar firmly and safely while you are screwing on the lid. It is made from an old belt or strap about 14 in. long, mortised in and screwed to hardwood handles, hinged together as shown. The beveled ends of the handles prevent excessive wear. Left: An emergency stopper on the flush-type sink drain can be had by using a piece of waxed paper or a disk from an ice-cream carton

PROBLEMS

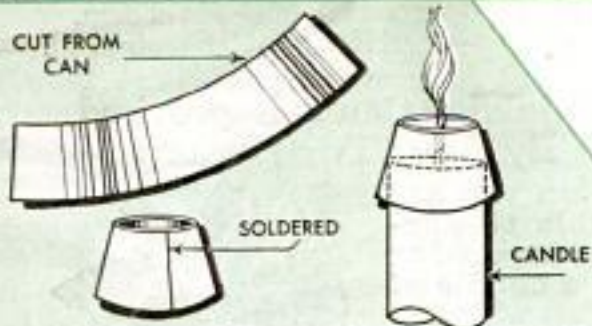

Candles will burn longer and wax will not run down the sides if you use this shield cut from a tin can. Right: A warped clean-out door on a furnace or boiler is made draft-tight by holding an asbestos sheet at the opening and closing the door on it

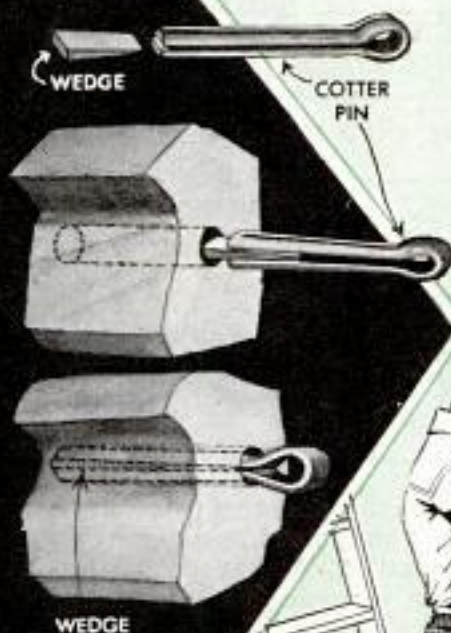

Left: To make a cotter pin hold securely in cement, drill a hole to take the pin and then slip a small steel wedge between the legs before inserting the pin. Driving down the pin will cause the wedge to spread the legs when it hits the bottom of the hole. Right: Odds and ends of soap can be used to make suds in a laundry tub by placing them in a perforated can on the hot faucet



The marring of table tops or other polished surfaces by ash trays can be prevented by two crisscrossed strips of tape placed on the bottom of each tray



One home owner, not having had opportunity to apply numbered tacks to his storm windows, simply identified the windows by writing on them with soap before storage. This is removed when washing the windows before replacing them



Plywood Trays Pivoted on Stake To Form Picnic Table



Picnickers can gather around this compact tray assembly, spread the leaves and thus provide a handy table. The entire unit can be taken apart in a moment and stacked in a small space in the car when lunch is over. The leg is a hardwood stake about 3 ft. long, which is driven into the ground. A wooden collar supports the trays as they are slipped over the stake.

Cork Shields Casting-Plug Hooks While Carried in Pocket

To shield the barbs on your treble-hooked casting plug so that you can carry it in your pocket when wading in mid-

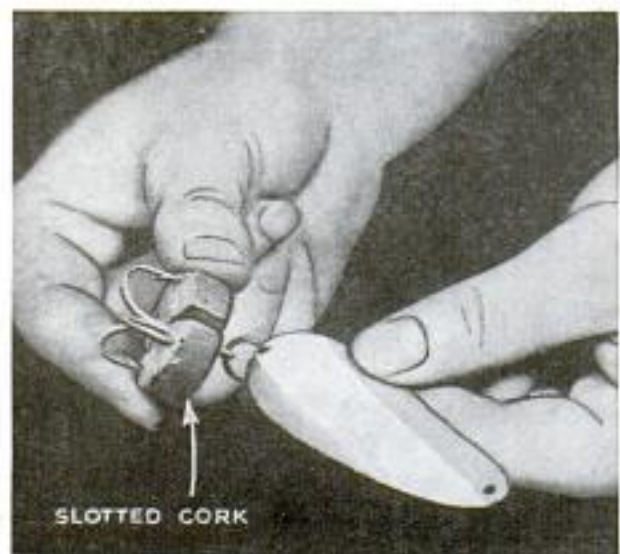

SLOTTED CORK

stream, and to keep the hooks from tangling when carried in the kit, notch a piece of cork, slip it over the casting plug shank and press it down on the hooks as shown.

—Paul Reed, Indianapolis, Ind.

Sprinkling Can Is Improvised By Using Two Buckets

When you are unable to purchase a sprinkling can, a couple of buckets will serve as a substitute, provided one will fit inside the other. An old leaky bucket will do for the inside one. Punch several holes in its bottom, fill the good one with water and set the old one inside. When it fills with water lift it out and hold it over the plants to be sprinkled.—P. B. Read, Chicago.



Don't Drown Fish on a Stringer



If you have had trouble with fish dying on a stringer, it is possible they were drowned by stringing them through the gills. On some kinds of fish this prevents normal operation of the mouth and gills and the fish soon die. To avoid this, run the stringer through the fish's lips as indicated. When this is done, the fish can operate his gills and mouth in the normal way.

Plant Duster From a Tin Can

A handy and efficient plant duster can be made by punching a series of $\frac{1}{16}$ -in. holes in the lid and around the rim of an ordinary friction-lid can of 1-qt. size. Filled with insecticide to within 2 or 3 in. of the top and shaken over a plant, the can forces the dust downward and outward, thus assuring good coverage of the foliage. Be sure that the lid fits tightly so that it will not come off when shaking the can.



Scooter Steering Post Pivots on a Door Hinge

A door hinge provides a simplified steering pivot easy to install on any type of homemade scooter, whether you use roller-skate or other wheels

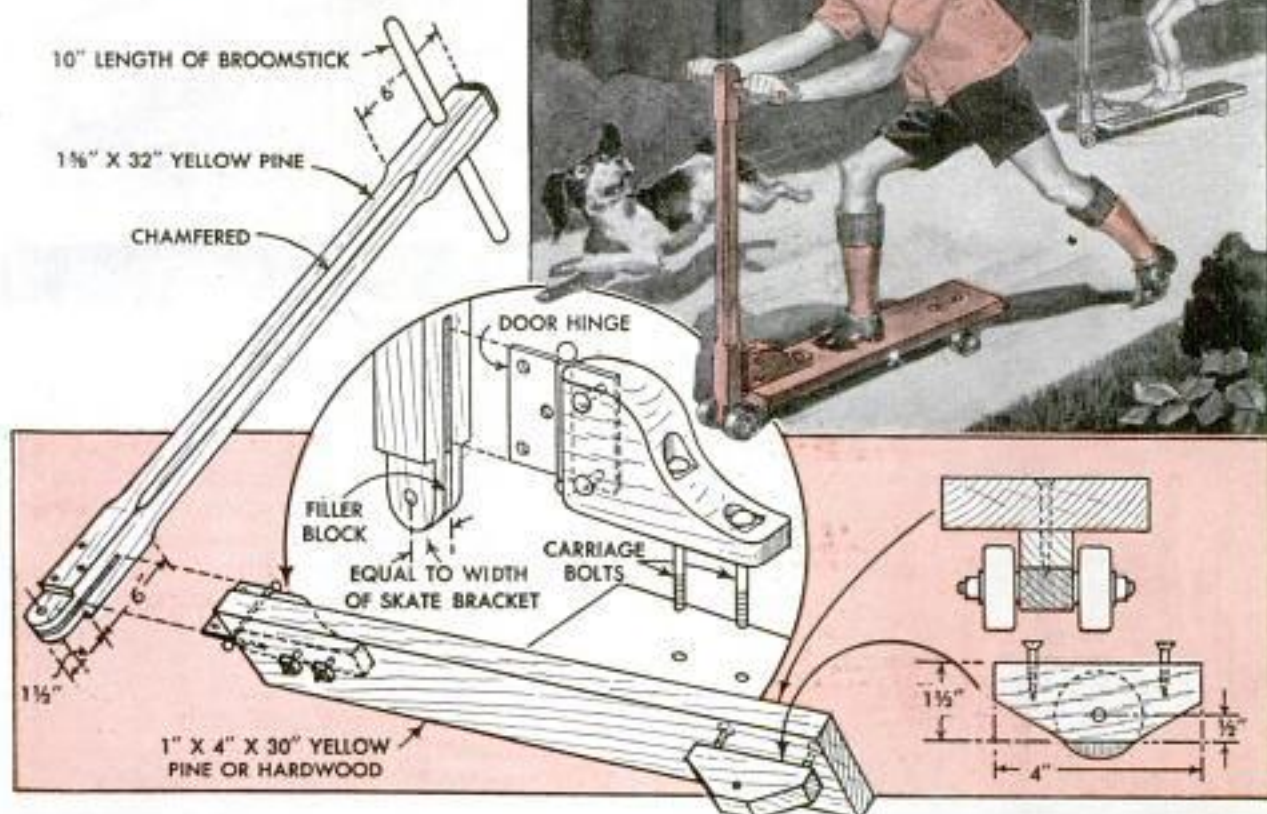
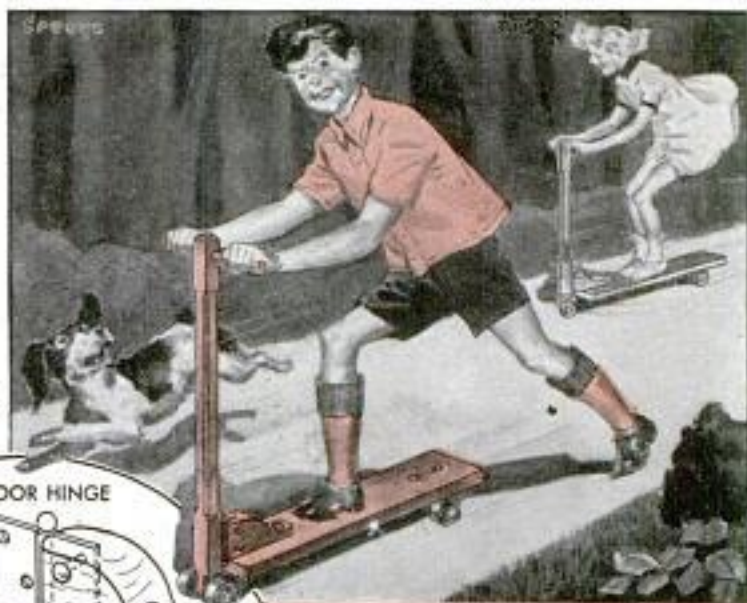

This skate-wheel scooter, unlike the usual homemade type, has the steering post pivoted. A block of 2-in. stock supports the steering post, both block and post being slotted to take a heavy butt-type hinge, which is held in place with stove bolts. The lower end of the steering post and the rear-axle block, both of hardwood, are the same width as the axle supports on

the skates, thus making it an easy matter to slip the skate-wheel axles through the holes and attach the wheels. A filler block is used to close the lower end of the slot in the steering post. For the handle, a 10-in. length of broomstick is inserted in a hole drilled in the steering post and a wood screw is driven in to secure it.

—Harold Gluck, New York City.

Spike Foot on Saw Fence Prevents "Kick Back" of Work

To avoid any possibility of narrow strips of wood being thrown toward him when ripping on his bench saw, one worker installed a spike foot on the fence. The spike, which is shaped as shown, is pivoted through a hole in the fence and is held by a cotter key. In this way, the spike does not interfere with feeding work, but effectively prevents it from being kicked back should it catch on the saw accidentally.

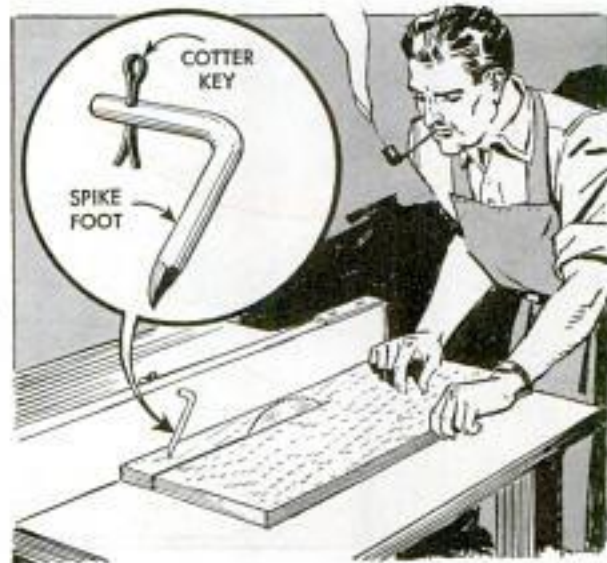

CASH FOR YOUR IDEAS

We pay cash for ideas showing simpler and better ways to do daily tasks, shortcuts in shop work, darkroom aids, household hints, auto kinks, etc. Send a good photo or sketch and a concise but full explanation of your idea to the Homecraft Editor, Popular Mechanics, 200 East Ontario St., Chicago.



MAKE YOUR

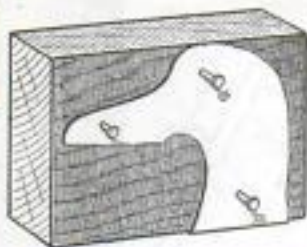

① CARDBOARD PATTERN

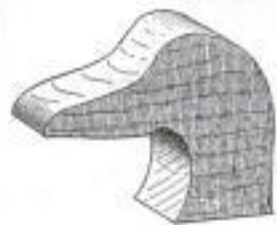

② SAWED TO OUTLINE

By W. C. Lamme

MAKING wood duck decoys is just another of those craft jobs which may seem difficult, but actually are very easy to do. Likely the most difficult part is carving the head, but if you cut and shape it separately and then attach it to the body, the work will be easier and you will have a better job.

Figs. 1 and 2 show the first steps. The pattern is drawn from Fig. 4 by laying off the profile of the head full size on heavy cardboard or $\frac{1}{4}$ -in. wood. Then, after sawing out the pattern, tack it to a white-pine block 5 in. long, $1\frac{3}{4}$ in. thick and 3 in. wide. A similar length of ordinary 2 by 4-in. stock is just the right thickness and width. Don't use any pieces that are knotty, cross-grained, or full of pitch. Band-saw the head to the shape shown in Fig. 2 or remove the waste in straight cuts with a handsaw. Now, after sharpening a small blade of your pocket knife to a razor-keen edge you're ready for the carving, Fig. 12. Start the cut at the edge of the wood. You will see that by starting on the original edge anywhere and making a cut you produce two other edges which in turn are cut

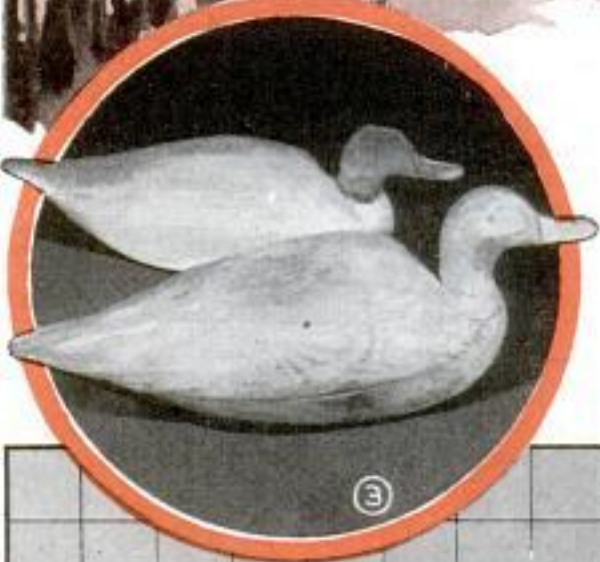

③

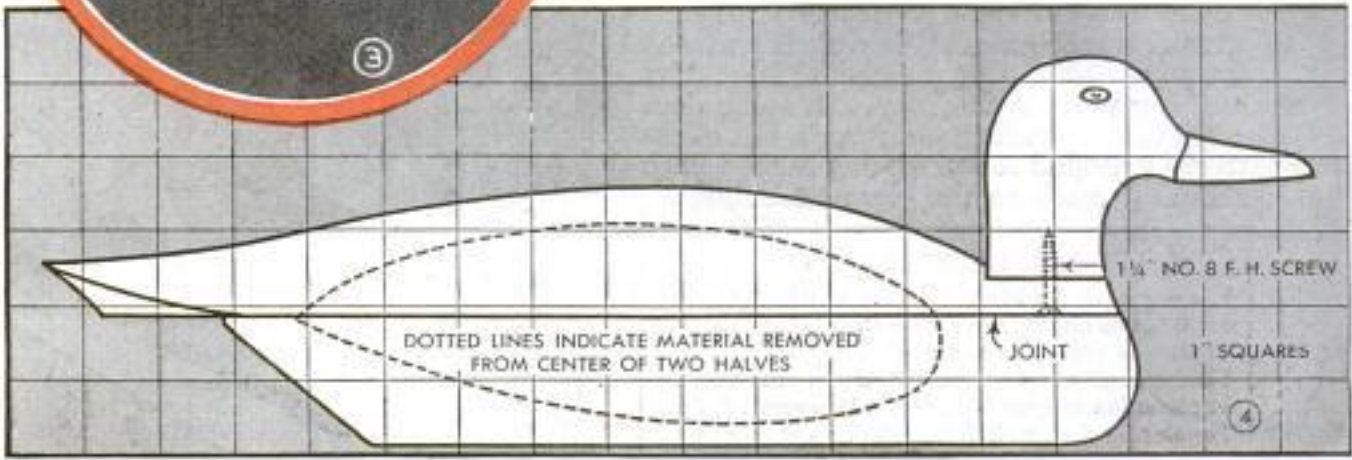

OWN DECOYS

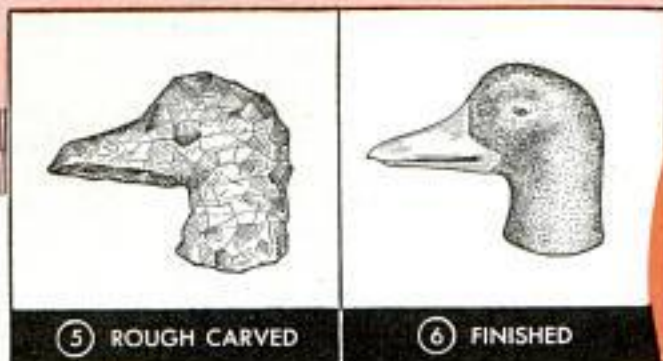

down. That's the trick in carving such a shape as this. Be careful to prevent splitting at the top of the head and along the bill where the grain is straight. Make short, scalloped cuts to avoid lifting long chips. At the upper curve of the neck near the back of the head, and under the head in front, the job may be a little difficult. Merely bring these areas to a rough round shape and leave the rest to the wood rasp. After you have rounded over the corners until the curves meet at the center of the flat surfaces, and have trimmed the top of the bill to an inverted, flattened V-shape you will have the head rough carved to the stage shown in Fig. 5. Now, you start work on the body, since the head can be finished as you see it in Fig. 6 only after the body is made. Taking Figs. 4, 8 and 10 as the side, front and top views of the contours, you can make the body in either of two ways: Build it up "sandwich" fashion like the hull of a ship model from a number of pieces of stock, or make it from two pieces of 1 3/4-in. stock with a hollowed center as in Fig. 13. The latter method is the best and quickest. Note from Figs. 4 and 8 that there are two pieces, the top one 14 1/2 in. long and the lower about 12 1/4 in. long. Ordinary 2 by 8-in. selected pine

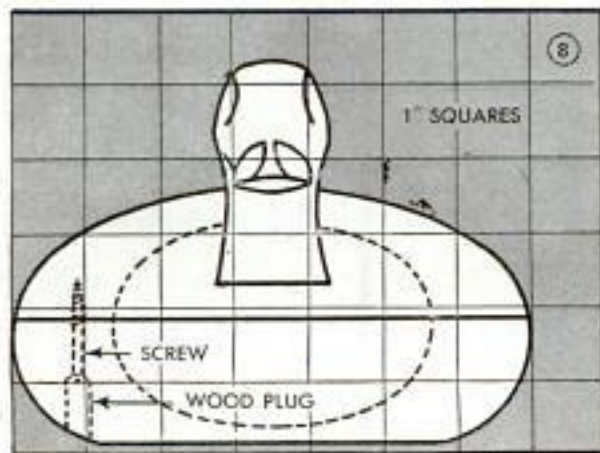
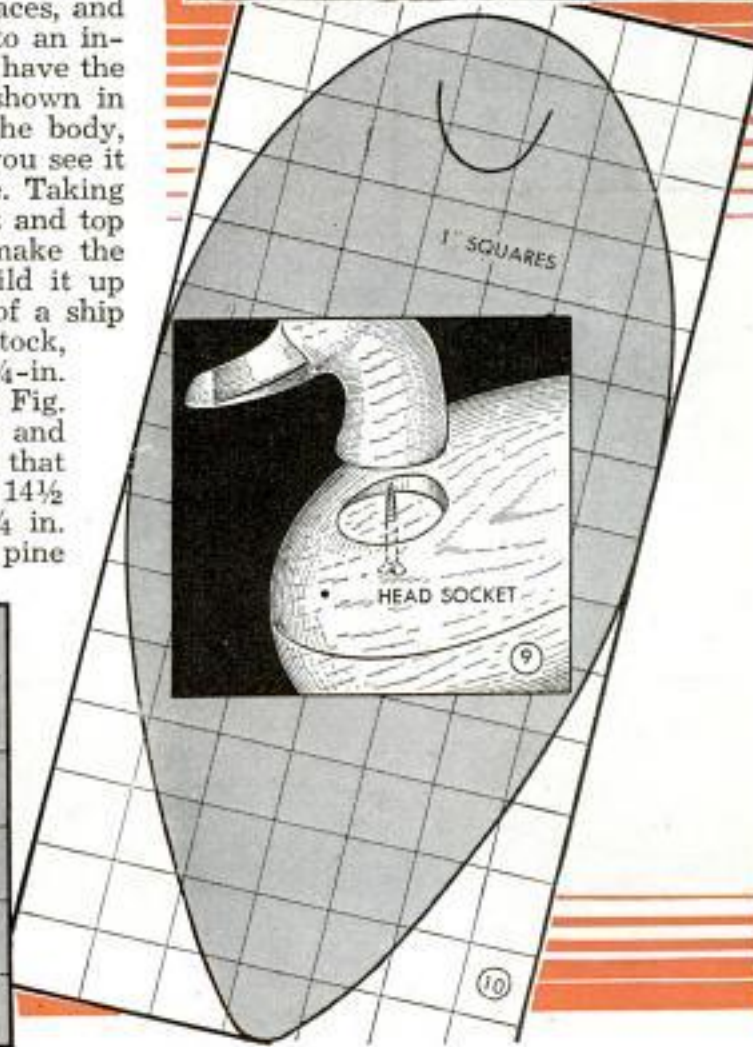

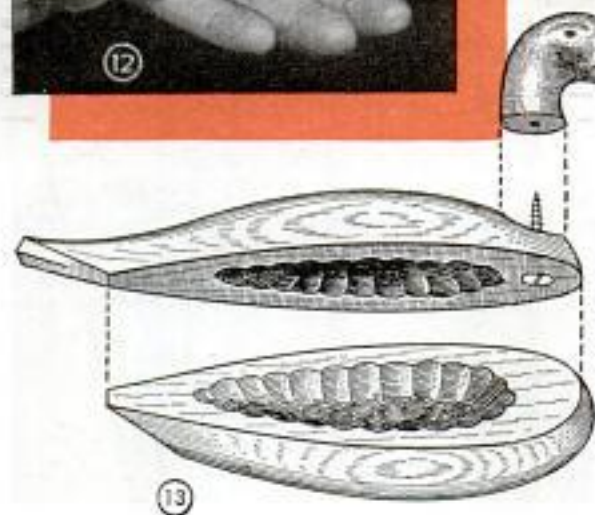
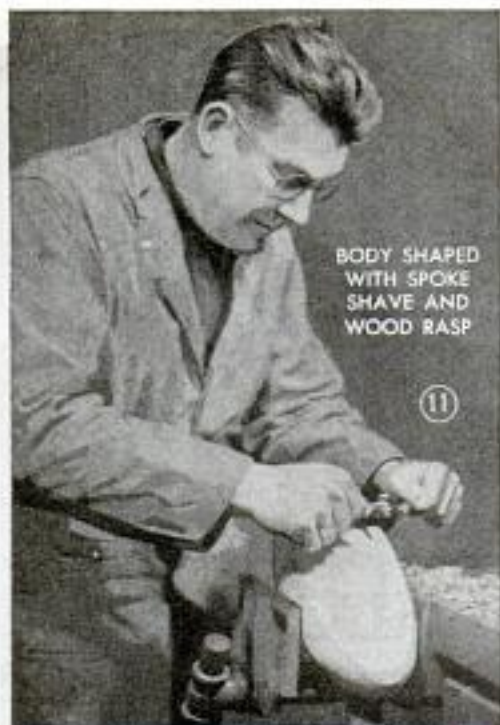

or fir stock is just right. Both top and bottom pieces are sawed to the shape shown in Fig. 10 except, of course, the lower piece is shorter, and one end is cut at an angle as in Fig. 4. Dotted lines in Figs. 4 and 8 indicate approximately the amount of waste to be removed from the halves. This is done with a gouge as in Fig. 7. If desired, you can make cardboard templates from Figs. 4 and 8 to aid in shaping the body curves. The whole job amounts to little more than rounding the curved edges with a spoke shave as in Fig. 11, but here's a point to remember: If you are making a number of decoys, Fig. 3, it's a good idea to bring them all to a finished stage, make a trial assembly of each, and then weigh them individually. In this way you can disassemble and trim out more waste from the centers to bring them all to a uniform weight. This is quite important in the full-bodied decoy.

The head is attached with a single screw as in Figs. 4 and 16, but before attaching, a socket must be formed for the neck, as indicated in Fig. 9. Be sure that the head is no higher in relation to the body than indicated in Fig. 4 as a head raised high is an attitude of alarm in live birds. Once the head is attached, assemble and finish the body surfaces with a wood rasp. Then disassemble, coat the joints with waterproof resin glue, drive home the body screws and fill the holes with plugs as in Fig. 8. No need to sand the surfaces; it is better to leave them rough in the "rasp" finish. Figs. 15 and 19 show one quick method of making a passable eye. Ready-made glass eyes can be used if desired. Practically speaking, the eyes are not at all essential.

Fig. 14 gives a fairly simple color key for painting the body in simulation of a mallard drake. A good job will take time and care. If available, use japan colors over the gray ground coat. Otherwise use ordinary outside oil paints and, when these are thoroughly dry, finish with a coat of flat varnish to dull the gloss. If done carefully, this procedure results in a very natural appearing job. However, many practical and experienced wildfowl hunters consider the attempt to simulate the natural plumage colors in intricate detail as unnecessary. They prefer that their decoys be painted only in monotone variations of gray and brown, which makes it possible to use the same decoys on a number of the common

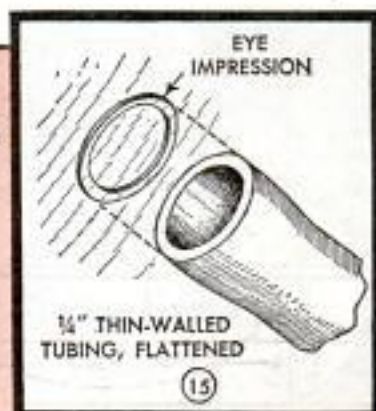
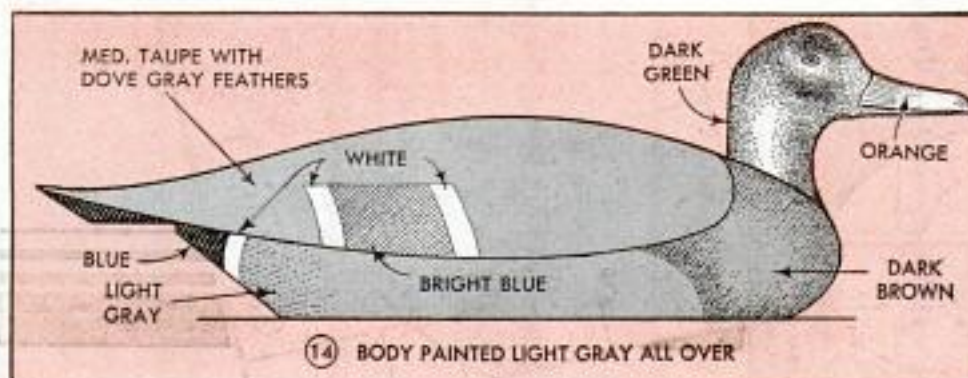

species. For this purpose the head and neck can be colored a dark green and the breast a brown which is blended into a medium gray for the balance of the body. The simulation of wing feathers is made with a lighter gray. When you blend the wet paint colors, Fig. 21, keep the excess wiped from the brush with a cloth. This particular decoy is really a "composite" simulation, larger than some common species, somewhat smaller than others, but experiment has shown it to be effective, durable, and most important, it rides rough water well. To finish, turn a small screw eye into the bottom about 4 in. back of the breast curve to provide for attaching an anchor.

Profile or silhouette decoys are simple to make. They are effective lures and have the advantage of being light and easy to transport and set out. Figs. 17 and 23 show one type of silhouette which is loose-doweled to a base or float. To make the body, lay off a pattern, less $\frac{1}{2}$ in. from the height, from Fig. 4, and for the base a pattern from Fig. 10. Transfer outlines to $\frac{3}{4}$ -in. stock and saw in the usual way. Some makers use $1\frac{1}{8}$ -in. stock for the base. Dowels are glued in only one of the members so that the parts can be separated and carried flat. Fig. 18 shows another version, a folding affair which is exceptionally handy. Slots are cut in one end of each arm to take silhouettes band or scrollsawed from $\frac{3}{4}$ -in. stock. Again use the profile in Fig. 4, but add about $\frac{1}{2}$ in. to the height of the body. Use $2\frac{1}{4}$ -in. bolts with wing nuts to provide adjustment in the arms and hold the silhouettes.

Next comes the silhouette goose decoy, a "collapsible" affair with folding head and leg. A 21-in. length cut from a $\frac{3}{4}$ by 8-in. board and band or scrollsawed to pattern serves for the body. Head, neck, and leg are separate pieces attached to the body

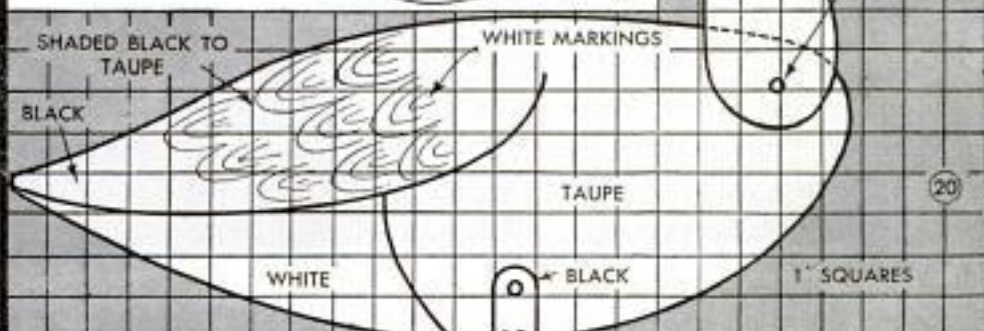
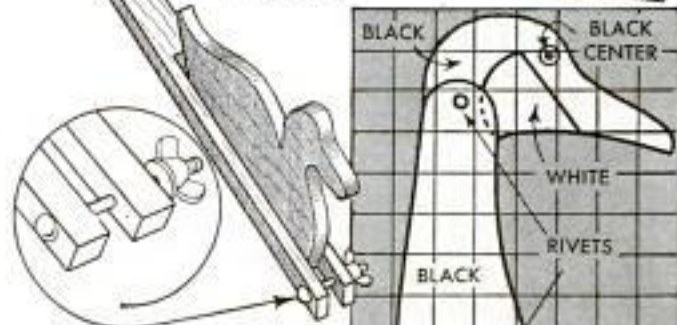
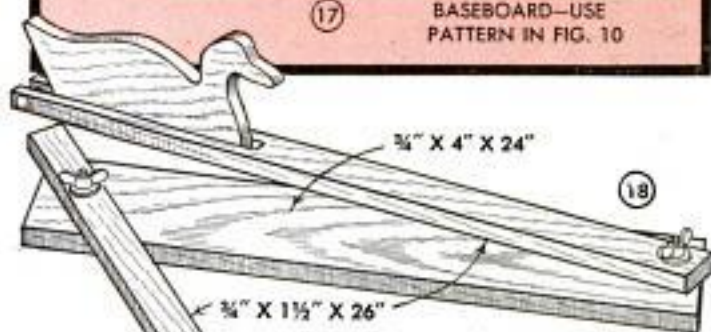
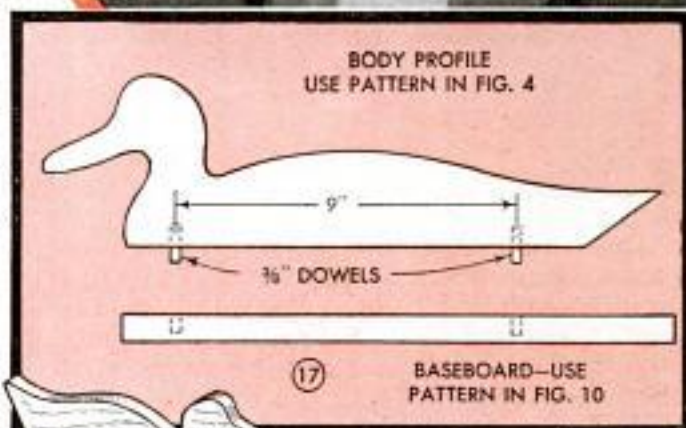

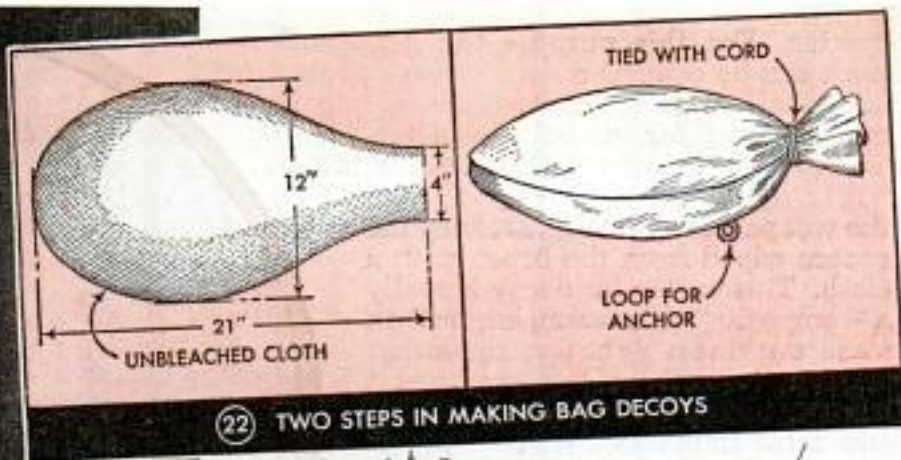

23 SILHOUETTE DECOY



24 BAG DECOY

with rivets. Use $\frac{1}{2}$ -in. stock for these parts. Colored areas are indicated in Fig. 20. The silhouette duck decoys, Figs. 17 and 18, are best painted a medium gray all over with a green head and brown breast, the latter color blended into the gray. To make representative eyes on both the duck and goose silhouettes, first paint a small area an orange color where the eye is to be. When dry, draw a $\frac{3}{16}$ -in. circle with india ink. Bring the head color up to the inked line and paint a black center as indicated in Fig. 20. The eye on the goose decoy is somewhat larger. Both are "conventional" eyes but they will serve the purpose. Remember, if you use oil paints for either of these jobs to finish with a coat of flat varnish to kill the gloss.

Last comes the bag decoy and that's literally what it is. A crude affair to be sure, but very effective; in fact it is quite widely used by experienced hunters. To make it, cut two pieces from unbleached cotton cloth (some use light canvas) to the size indicated in Fig. 22. These are sewed together with a double seam, then reversed, and the resulting bag stuffed, the open end being tied with a stout cord. Sew a loop to the underside for attaching an anchor. Ordinarily, the material known as kapok is best for filling, but lacking this, cedar shavings or upholsterers' curled hair will do. Most of the materials used for treating canvas will serve very well for waterproofing the cloth. Two coats of linseed oil will serve nicely for this purpose. Coloring the cloth body can be done in the

same way as described for the full-bodied wood decoy, using oil paints or japan colors. With a spring clothespin for a bill, Fig. 24 shows about what you get, unimpressive perhaps in a closeup, but from a "duck's-eye" view quite effective.

Reading Glass Fitted With Shield To Avoid Reflections

Reflections that sometimes make a reading glass difficult to use can be avoided by shielding the glass. A small ice-cream container will serve excellently for this purpose. Remove the lid and bottom from the container and cut a small hole in the side to take the handle. Unscrew the handle, put the glass inside the container and screw on the handle through the hole.

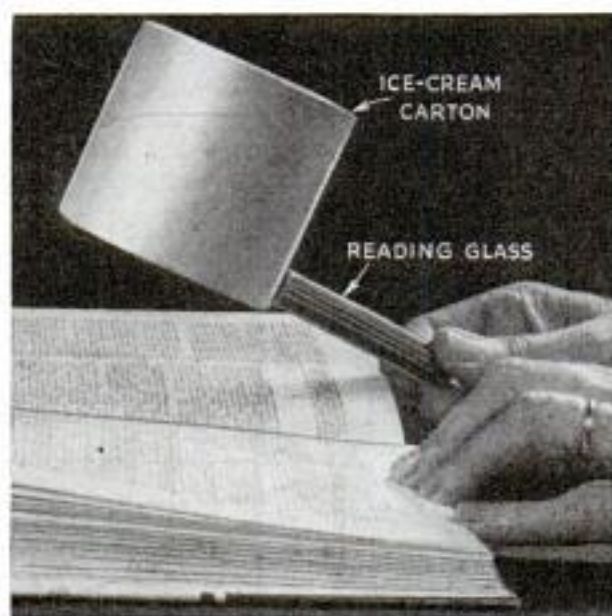

Scrollsawed Frame Renews the Old Wall Mirror

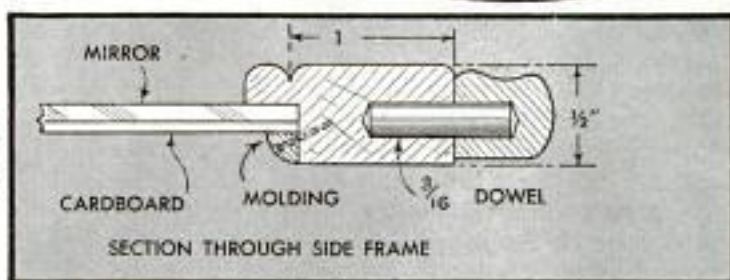
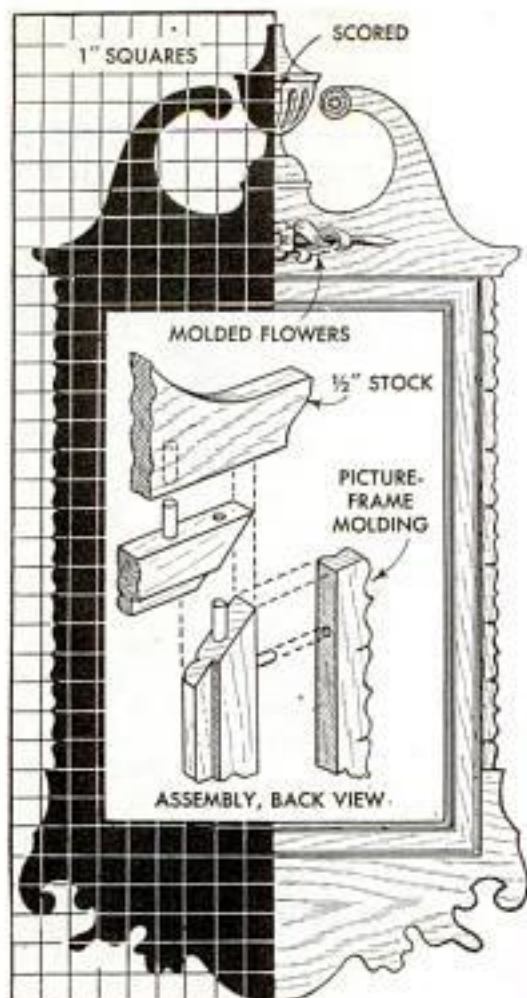

There's no need to discard an old mirror that has an outmoded frame, as you can provide a new scrollsawed frame of period design similar to the one illustrated. If the old frame is straight you need add only the scrollsawed plywood pieces at the top and bottom, and ornamental strips at the sides, which may be cut from a discarded picture's

frame. If you make up a new frame, miter the joints and fasten them together with dowels and glue as shown in the lower detail. The urn is scored with a gouge or router, and the ornamental molded flowers are glued on. Stain and wax may be applied as a finish or the frame may be painted in harmonizing colors.

Knife Made From Old File Has Turned Handle and Cap

You will find many uses for this little knife, the blade of which is shielded when not in use. The knife is especially useful around a desk or sewing machine and, if desired, it can be carried in your pocket or in a lady's purse. The blade is made from a small file, the tang of which is ground down and driven into a small turned handle. A ferrule for the latter can be made from an empty cartridge. A cap or shield is made by boring out a hardwood block to slip over the blade and part of the handle, and then turning it to shape.

Garage doors will not freeze shut if old crankcase oil is applied along the frame and door edges with a paintbrush as this keeps moisture from seeping in.

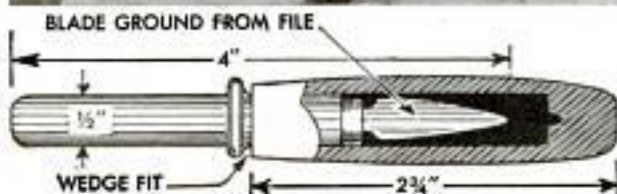

Neat Temporary Stoop of Brick And Concrete Is Inexpensive



Home owners who plan to raise their houses to install new foundations often find it a problem to make a suitable temporary stoop for outside doors. An attractive stoop can be made without great cost, adding to the appearance of the home as well as the safety of its members. Six or eight concrete blocks, about 6 by 8 by 36 in. provide a rim for a stoop one step high. The rim is filled with sand, tamped down well, and surfaced with brick, flagstone, or irregular thin concrete slabs. This stoop can be removed easily when the house is raised.

—Michael Ligocki, Gary, Ind.

Adapting a Watch to Show Time In 24-Hour Periods



To make your watch dial show a day of 24 hours rather than one of two 12-hour periods, and thus correspond to the system used by the military forces, remove the cover glass, pry off both the hour and minute hands carefully and with a pencil compass scribe two circles beneath the ring of numerals, as shown. Then, directly under figure 1, draw in the numerals beginning with 13 and ending with 24 under the 12-hour mark. To make these figures easily readable, they should be inked in before re-

placing the hands and cover glass. By using a 24-hour dial you will be able to tell by simple subtraction how many hours and minutes intervene between any two designated periods of the day.

—A. E. Rohmer, Washington, D. C.

Hole in Drawer Permits Storage Of Long Articles

Long tools, such as trammel arms, straightedges, scales and many other similar articles, can be stored in a bench drawer that is normally too small to accommodate them by boring a hole or sawing a slit in the back so that the tool ends can project. This system can be used in all drawers that do not take up the entire depth of the cabinet or bench in which they are made. Wooden supports screwed to the side of the drawer hold the tools near the top where they can be reached without disturbing other contents.

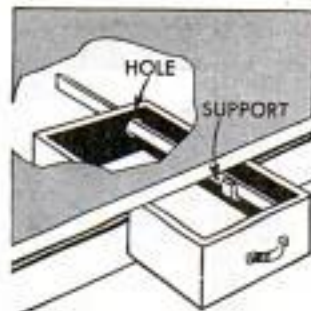

Easy Way to Hold Tablecloth On a Picnic Table



When a card table is pressed into service as an outdoor picnic table, or when it is used as an auxiliary table inside where the cloth might slip off, a rubber band on each leg will keep the cloth in place. Just gather each corner of the cloth against the leg and slip a band over both the leg and the cloth.

Fishing Plugs Kept Handy in Boat With Bamboo Holder

In order to keep his fishing plugs handy for instant selection, one fisherman transfers them from his tackle box to a notched trough of bamboo, tacked to one side of the boat. In this way, several plugs can be kept in order.

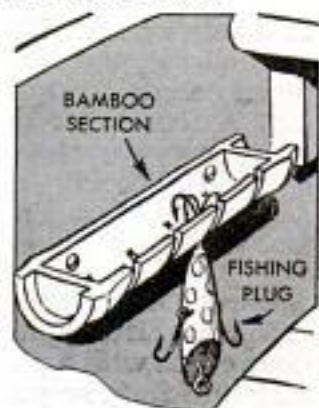

Servicing Your **COOLING SYSTEM** *before Winter*

POOR gasoline mileage, burned bearings and valves, and scored pistons are some of the troubles that can be caused by a faulty cooling system. As all oils thin out under heat, a car motor that runs too hot has to operate on lubricants that lack film thickness essential for complete protection. On the other hand, a motor that runs cold is likely to be damaged because of excessive oil dilution. Besides this, a cooling system that allows the motor to overheat must be filled often, Fig. 1, which is both wasteful and costly when anti-freeze solutions are used.

Often, the cause of an inefficient cooling system lies in the thermostat. This should be closed when the motor is cold, but fully open when the coolant reaches a temperature somewhere between 160 and 180 degrees Fahr. It is easy to test the thermostat, which is located either in the upper hose or in the cylinder head close to where the hose attaches. In either case, the hose must be removed, Fig. 2, to get at the thermostat, which then can be removed and tested in a pan of heated water as in Fig. 3, using a thermometer to check the water temperature. A thermostat for use with alcohol should be open completely at 160 degrees and for permanent anti-freeze it should be open at 180 degrees. If the thermostat opens too soon, the motor does not warm up quickly and operates too cool. Opening too late may cause overheating.

Another cause of inefficiency in a cooling system is loose and worn fan belts, Fig. 4, and misalignment between the belt pulleys, which causes early failure of the belt, Fig. 5. When a motor runs too cold, unburned gasoline works down into the crankcase and dilutes the oil, resulting in



① FAULTY COOLING SYSTEMS NEED WATER OFTEN



② DISCONNECT UPPER HOSE TO REMOVE THERMOSTAT

③ TESTING THERMOSTAT IN HOT WATER

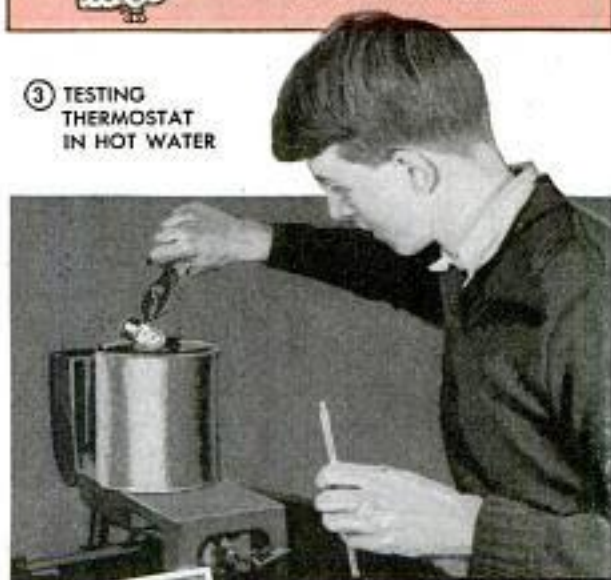

⑥ BURNED VALVES



⑤ MISALIGNED FAN BELT



④ RENEW WORN FAN BELT

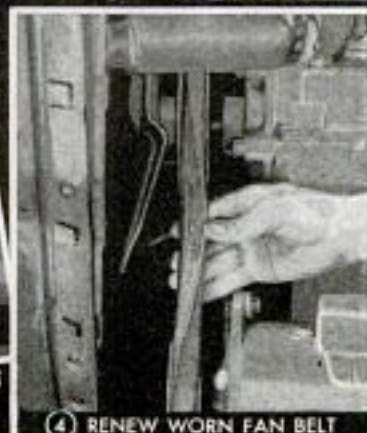



9 APPLYING CEMENT TO GASKET

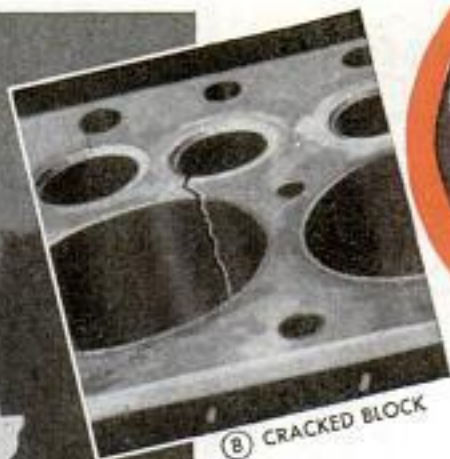

8 CRACKED BLOCK



7 RUINED PISTONS

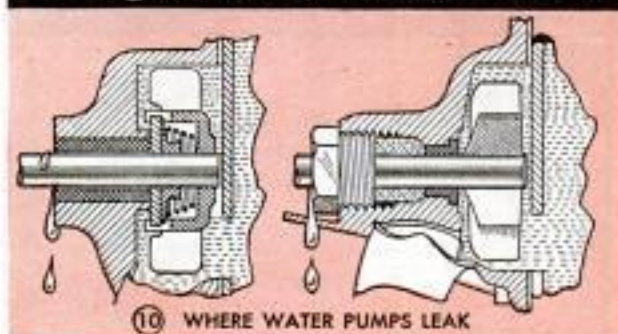

10 WHERE WATER PUMPS LEAK

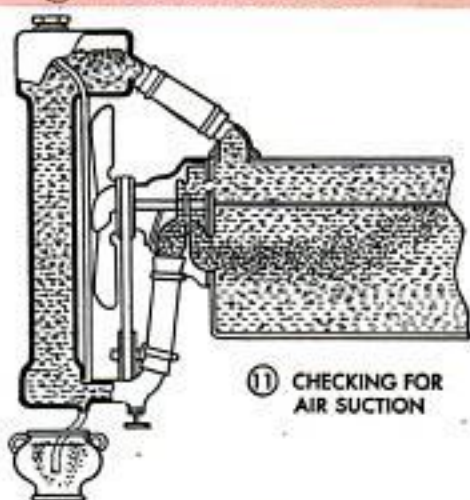

11 CHECKING FOR AIR SUCTION



12 HOSE AND FAN BELT REMOVED BEFORE CHECKING FOR EXHAUST-GAS LEAKAGE

excessive wear and corrosion of vital parts such as pistons, wrist pins and bearings. On the other hand, distortion of metals from overheating, and reduction in the thickness of the oil film from high temperatures can be the cause of burned valves, Fig. 6, stuck piston rings and scored pistons, Fig. 7, and sometimes cracked blocks as in Fig. 8.

Still another common cause of trouble in a cooling system is a leaky water pump or lower hose connection. Fig. 10 shows where water pumps usually leak. But even more serious is the leakage of air into the cooling system. Constant introduction of air as a result of water-pump suction so aerates the coolant that it will increase in bulk, with the result that some will be lost through the overflow pipe. Another action resulting from the presence of air in the coolant is the extremely high rate of rusting in the cylinder block. To test for air leakage, be sure that the coolant level in the radiator is at normal height with sufficient room for expansion, and then place the radiator cap in position so that it is air tight. With a rubber tube attached to the lower end of the overflow pipe and placed in a jar of water, you are ready to test for air leakage as in Fig. 11. The motor should be operated at a rather fast speed until it is warmed up to proper operating temperature. Then, with no change in speed, see if air bubbles continue to rise in the jar of water. This indicates conclusively that an air leak exists. With the equipment attached, necessary corrections should be made on the water pump or loose connections until the trouble has been eliminated.

Another cause of corrosion is the seepage of exhaust gas from the combustion chamber into the coolant. To test for this condition, remove the fan belt and the upper hose as in Fig. 12 and adjust the water level in the cooling system so that it is just visible at the upper outlet from the motor. The thermostat should be removed. Then, by idling the motor and suddenly "gunning" it for very brief intervals, bubbles can be seen rising through the cooling



13 LEAKY RADIATOR

liquid if there is an exhaust leak. Introducing a little oil into the carburetor to cause smoky exhaust will make the presence of exhaust gas in the coolant more conspicuous. While the leakage of exhaust into the cooling system is bad because of its highly corrosive effect, the loss of coolant into the engine, probably through the same leak, is also extremely destructive. In cases of this kind, new cylinder-head gaskets, if available, should be installed or the old ones, if in good condition, should be made tight with the use of gasket cement, Fig. 9. A common cause of leakage is unequal tension of the cylinder head bolts.

It's a simple matter for any car owner to service his own cooling system twice a year. Use of any of the well known radiator cleaning compounds, as in Fig. 14, is a



14 IT'S EASY TO USE COOLING-SYSTEM CLEANERS

wise precaution. Be sure to follow the manufacturer's directions as to use. After the compound has remained in the system the specified time, remove the hose connections and allow the liquid to gush out for the greatest cleansing effect. Then flush out gently with a garden hose. Merely opening the petcock does not provide a sufficiently fast flow to carry away the foreign matter loosened by the cleaner. Looking closely at the radiator of any car that is a year or two old, it is not unusual to see white blotches on the fins as in Fig. 13. These blotches are lime deposits, each blotch indicating the presence of a leak in the core. Accordingly, when a cleaning agent is used in a radiator that has white blotches on it, it is not unlikely that leaks develop as a result of using the cleaner, although it did not cause the leaks. They were there previously, and were merely clogged with rust and lime.

Lathe Follower and Tool Holder Used as a Steady Rest

When a lathe steady rest is not available, one can be improvised for certain kinds of work by using a follower in connection with the tool holder as shown. The latter is reversed in the tool post and placed so that it serves as the third work support, thus the follower and holder combined form a steady rest. Such a rest is most useful when using drills and other tools that can be supported by the tailstock.

One basement shop owner, requiring a drill press for drilling large panels, solved the problem by mounting a bench drill press on the ceiling; a level table mounted below the head gave all necessary working space.

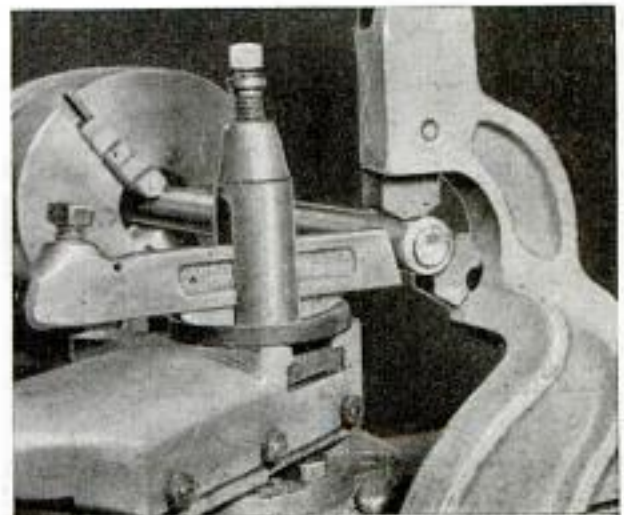

Dummy Plugs in Wall Outlets Protect Small Children

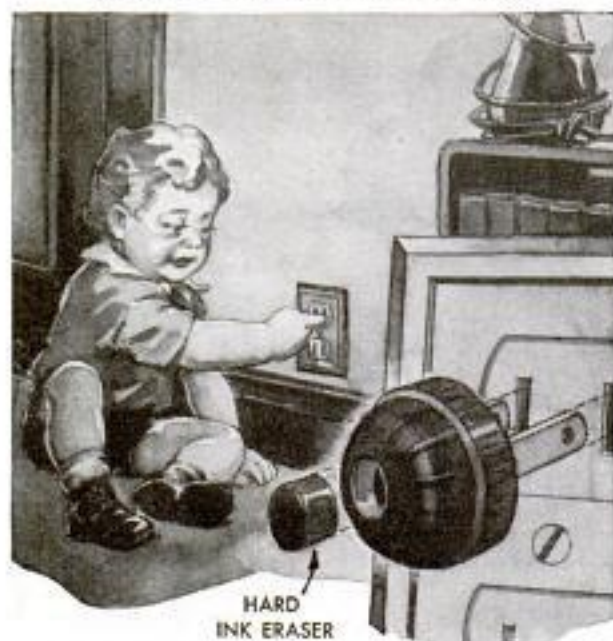

Small children who persist in playing with electric wall outlets, poking their fingers or metal objects into the slots, can be discouraged from such a dangerous habit by covering the outlets with tight-fitting dummy plugs. The ordinary cord plug can be used for this purpose by detaching the wires, inserting it into the socket and stuffing the opening with a tight-fitting plug made from a hard ink eraser. The eraser should be cut off flush with the face of the plug. When you want to use the outlet the dummy plug can be removed and a plug with wires inserted in its place.

Simple Precautions for Reducing Wear on Your Tent

Campers can prevent excessive wear on their tents, especially at the corners and top peak, which bear the greatest strain when the tent sways in a high wind, by

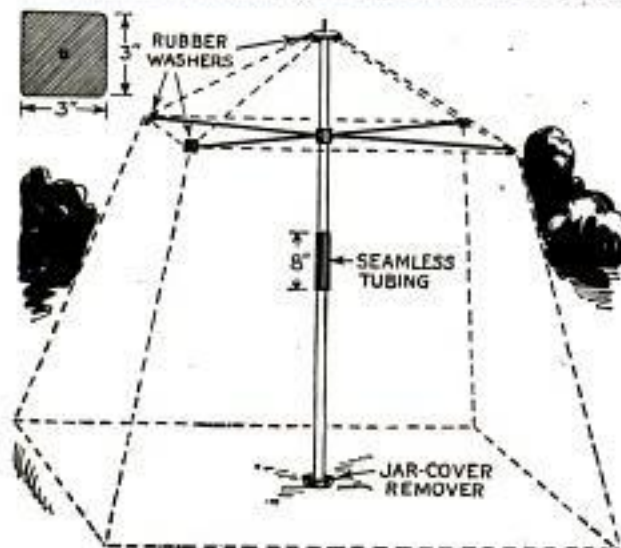

cutting 3-in. squares from an old inner tube and placing them over the ends of the center pole and spider before inserting them through the grommets in the canvas. And some of the wind sway will be reduced by substituting an 8-in. length of steel tubing for the tin sleeve sometimes used to connect the two pieces of the center pole. A jar-cover remover set under the center pole, and caster cups placed under the legs of a steel cot used in a tent will protect the flooring.

Long Window Cornice Rabbeted To Give Daintiness and Rigidity

Thick stock can be used for window cornice boards without looking bulky by rabbeting the wood along the lower edge to reduce its thickness. As the thickness of the wood at the top cannot be seen when the cornice is hung, it will appear from a distance to be of thin wood, thus giving a more pleasing appearance without sacrificing rigidity.



Putty Protects Insulator Screw



When putting up screw-type insulators, one electrician places a small amount of putty around the base of the screw as indicated. When the insulator is screwed in place the putty spreads out between the porcelain and wood, forming a watertight joint that protects the screw against rust.

When the insulator is screwed in place the putty spreads out between the porcelain and wood, forming a watertight joint that protects the screw against rust.

Chair Leg Is Used as a Shoe Last When Attaching Heel Cleats

A chair leg is handy when attaching the metal cleats to prevent excessive wear in one spot on the heel of a shoe. The chair is merely turned upside down and the shoe placed over the leg as shown.



CORNICE BOARDS for Children's Rooms



It's Fun to BLOW



By Alexander Maxwell

THOUGH it takes long practice to fashion the artistic glass ornaments you see in novelty shops, anyone can learn in a short time to turn out simple pieces such as the vases, flowers and fishes shown in Fig. 4. These are made from ordinary soft glass tubing like that used in high-school chemistry classes and shown in the upper detail of Fig. 2. To succeed in making even these elementary objects, you must observe a few basic precautions. Glass is blown while it is red hot. At this heat it has the consistency of thick sirup. To



GLASS

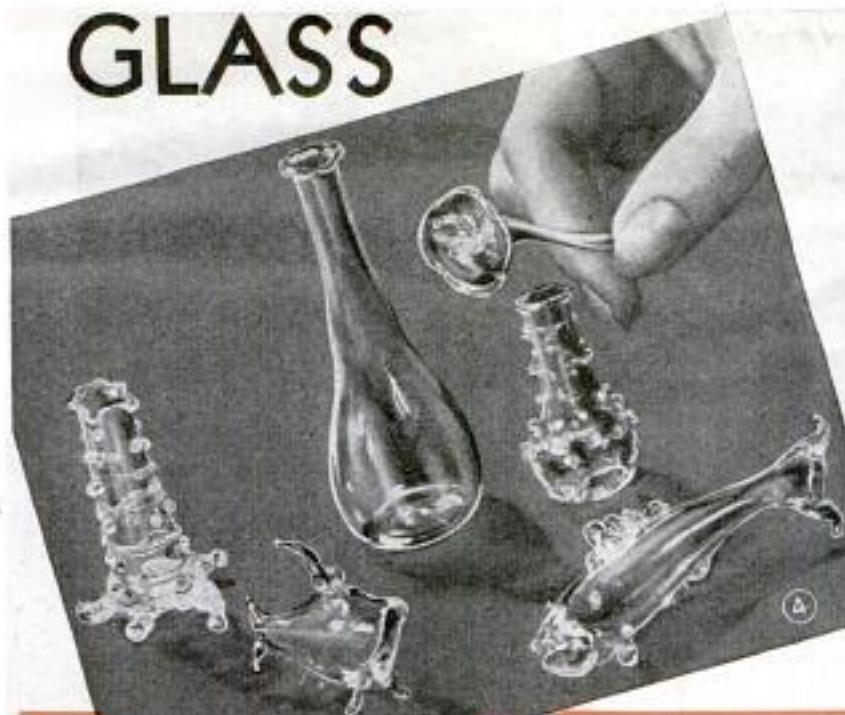

keep it from dripping, therefore, you must keep rotating the tube and blowing into it, otherwise it will sag or wrinkle from lack of sustaining pressure. Furthermore, the room in which you work must be free of drafts, for a sudden puff of cool air coming in contact with the hot glass will shatter your work in a moment.

You will need a few tools and some equipment, illustrated in Fig. 2, for heating, shaping and gripping the work. Most of these may be purchased from chemical supply houses. An ordinary gas plate, Fig. 1, may be used instead of a Bunsen burner,

shown in Figs. 5 and 7. The gas plate, however, is especially suited for heavier work, while the burner generally is preferred for more delicate heating. Graphite rods, which must first be heated, are used to form lips, flares and indentations on the work, and a graphite slab—also preheated—is used to form a flat bottom or base on the glass, the latter being pressed against it. The slab is moved by means of tongs. Work is held between the tines of the neck grabber while applying finishing touches, such as the tails on the fishes shown in Fig. 6. The tines are stationary and so cannot press in against the fragile glass. With the file you cut off the formed object or cut

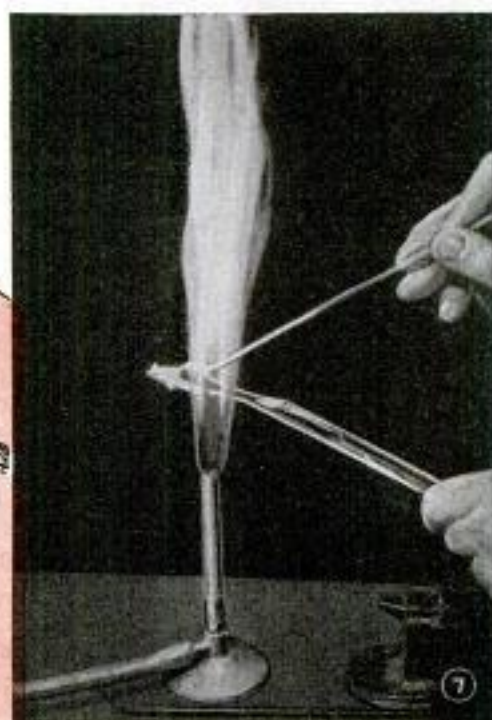
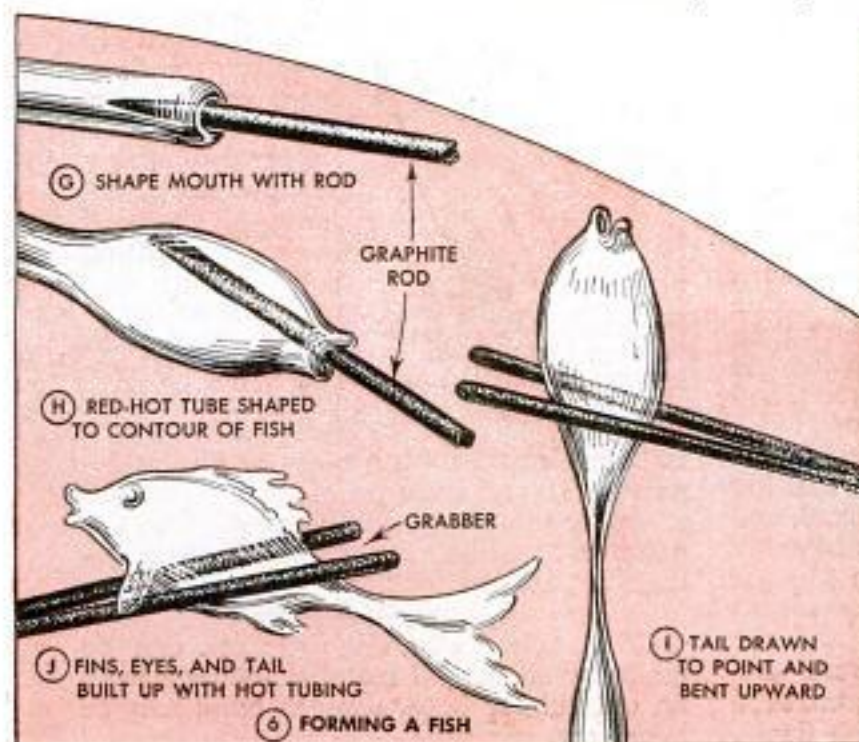

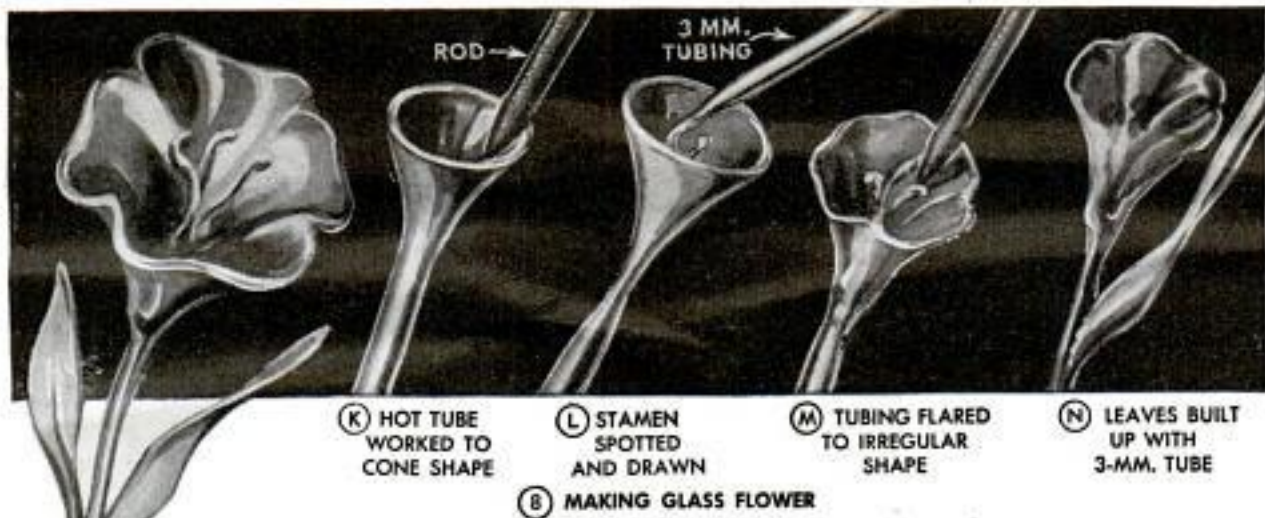

small pieces from cold tubing. For the first project it is better to make something simple, such as the vase shown in steps A to F of Fig. 3. To start, grease your lips with petroleum jelly to prevent them from adhering to the glass. Then take a length of 3-mm. tubing, seal the end by heating it in the flame (A) and, placing the other end between your lips, gradually blow out a bubble with a steady pressure while rotating the tube (B). The bubble should not be larger than five times the tube's diameter. To prevent the glass from wrinkling, keep up the pressure until it hardens. If the bubble is not large enough, reheat the tube and blow it up again, but do not keep it in the heat long this time or the bubble will collapse. The base is formed by pressing the bubble gently on the heated graphite slab (C) while blowing lightly to keep up the pressure. To "hobnail" (D), keep the partly finished vase in the flame, gently press the red hot point of a 3-mm. tube against it as shown in Fig. 7, and then pull it away, leaving a drop of melted glass on the vase. The drops must be completely fused with the vase, however, otherwise they will break off in cooling. Decorations can be applied in like manner by touching a white-hot tube to the work in the flame. The melting tube will flow out in a fine line as the work is rotated. The neck then can be cut off with the wheel of an electric hand grinder (E), or the edge of a file, and the lips or flares formed at the end with the point of a heated graphite rod (F).

The same general rules apply to making the fish shown in details G to J, Fig. 6, and the flowers, Fig. 8, except that no blowing is necessary. Instead, the molten glass is formed with the rods, and the appendages—fins, tail and eyes of the fish, and the stamens and leaves of the flowers—are fused on by touching a melting 3-mm. tube to the work while it is held in the flame,

as the "hobnails" were added to the vase.

In general, do not remove any piece from the heat longer than necessary for a brief inspection, and watch carefully for indications of sagging. After the general shape has been formed, never reheat to more than a dull pink or the piece will begin to flow and so lose its shape. In pieces such as the fish and flowers that are not blown to shape, the sagging of a part cannot be prevented since there is no internal air pressure to keep them inflated. However, a gracefully drooping leaf or the bending of a fin may suggest the natural action of flowers and fish and need not be corrected. When the object is finished, lay it on the hot slab, put a tin can or other cover over it while it cools, and leave it for at least an hour.

Linoleum-Paste Spreader Made From Hard-Pressed Board



If a suitable spreader for linoleum paste is not available, one can be made from a piece of tempered, hard-pressed board by cutting teeth along one edge. After forming the teeth with a thin file or a knife, they are all worked down to a

uniform length with a piece of fine sandpaper. Being waterproof and strong, a spreader of this type will not stick to the paste and will be very effective in spreading the paste uniformly.

Good substitute hose washers can be made by slicing off suitable sections from an old rubber hose, using a band saw or hack saw.

Jig Permits Splitting Dowels Without Spiraling

With this jig it's easy to saw wood dowels or metal tubing exactly in half lengthwise without spiraling. To make the jig, drill a hole across the width of a piece of suitable stock, from edge to edge, making the hole the same diameter as that of the dowels. Then make a cut from one edge of the board exactly through the center of the hole, running the cut halfway across the board as shown in the detail. At the end of the cut fit a sheet-metal splitter of the same thickness as the saw cut. A second band-saw cut, made from the edge of the board directly through the center of the hole and perpendicular to the first saw cut, is useful for inserting a wood wedge by which the size of the hole may be adjusted.

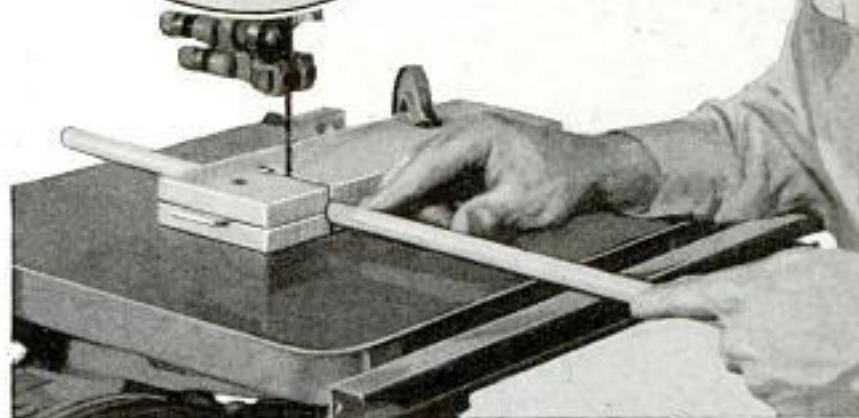
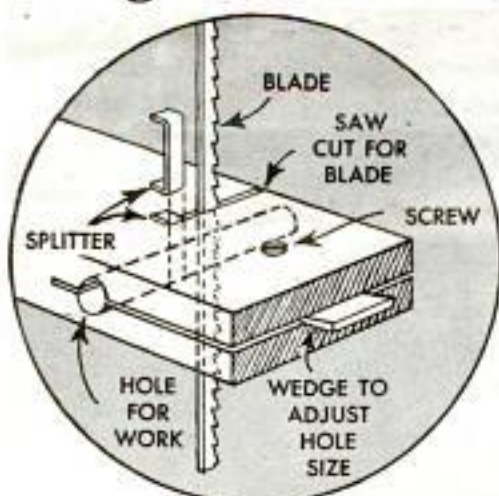

Bobsled Runner Pivoted to Avoid Digging Into Snowdrifts

In building a bobsled, particular attention must be given the design and construction of the runners, for if these are pivoted far enough back, they will tend to ride over the bumps and snowdrifts instead of digging into them. The runner illustrated here is pivoted approximately one-third the distance from the back, and each runner pivots independently like "knee-

action" automobile wheels. Note that the tip is slightly above the pivot point. The profile is cut according to the pattern in any size desired, the measurements given here being those of proportions, not inches or feet. For runners use ash or other hardwood 2 in. thick. Fasten a length of $\frac{1}{8}$ -in. flat iron along the bottom edge with flat-head screws.

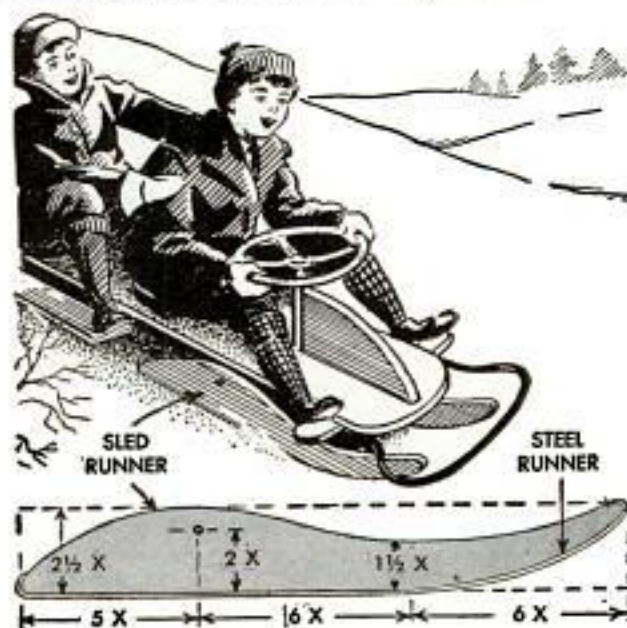

Separate Handles for Saw Blades Encourage Their Correct Use

A workman who has only one handle for a nest of saw blades is likely to use one blade for all jobs rather than change saw handles. To avoid doing this, a handle should be provided for each blade. The handles are cut easily to the desired shape from hardwood and can be reinforced by driving a nail into the end of each as indicated. It is still better to bore a pilot hole and drive in a long slender screw, taking care not to split the wood.

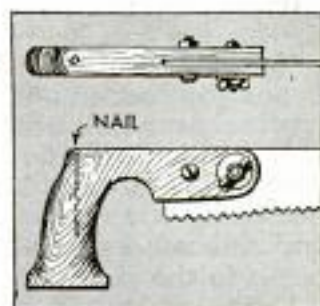

TAKING PHOTOS AT NIGHT

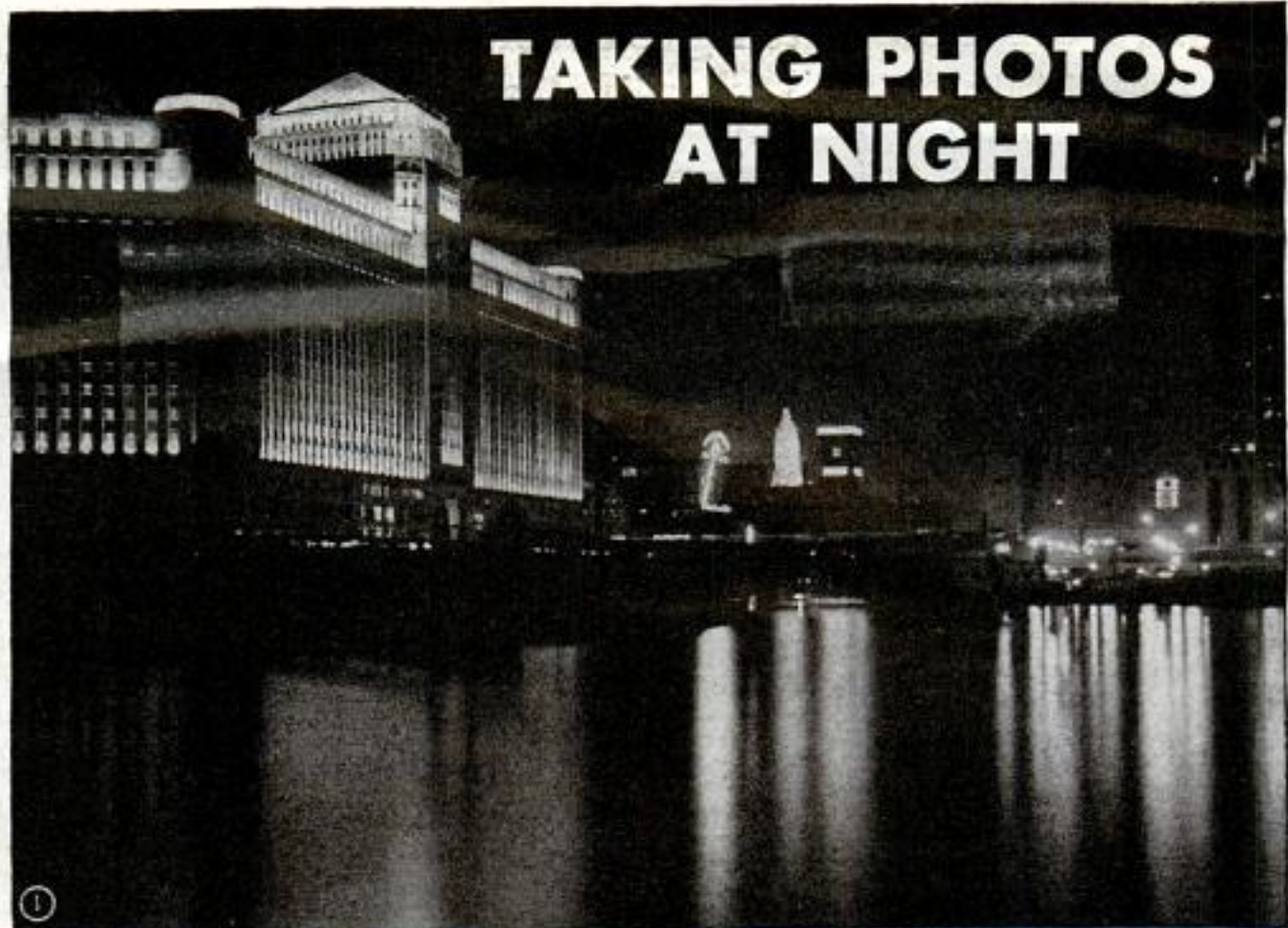

By Fred G. Korth

ONE of the easiest ways for a beginner to make interesting pictures is by night photography. While a few experiments with your type of film may be needed to determine correct exposure, it is probable that you will get some good results from the start. Roll film or film-pack is preferred to cut film or plates because the film base is much thinner and therefore less halation of the highlight areas in the picture can be expected. So-called "double-coated" film is best; it has the fast emulsion on top and a much slower one underneath. Seldom will the highlights be strong enough to spread in the thin film base or be reflected by the rear surface of the film and still cause a lot of exposure blackening to the slow second emulsion.

Exposure meters are not of much help as they do not react to the weak light available at night and therefore you will just have to guess. Modern film emulsions have quite a latitude allowing for errors in exposure one way or another. That's why it may be



sufficient to make three shots in the beginning, if you vary the duration of exposure considerably. For time exposure, it is absolutely necessary to have a sturdy tripod or some other object on which the camera can be supported solidly.

Assume that you are to take a scene in the city somewhat like those shown in Figs. 1 and 3. There are some floodlighted buildings, some windows are lighted, street lights are illuminated and there is light from automobiles. Your estimate may be an exposure of 30 sec. at F 8. To make sure of getting the picture you make two more exposures, one for 8 sec. and the other for 2 min. with the same lens opening. After normal development of the film you will be able to judge



which of three time exposures came closest to being correct.

A floodlighted statue like the one shown in Fig. 2 requires a different sort of calculation. In most instances lights are placed a good distance away, and statues are not illuminated brilliantly. However, you must give the subject sufficient exposure so that it will appear light against the dark buildings, sky and other dark background. Offhand, you can allow an exposure ten times that required for Figs. 1 and 3. Speaking of sky, avoid including the moon or some bright stars, as these may cause short white streaks in time exposures, owing to the rotation of the earth. Fig. 4 likewise requires a long exposure because a courtyard such as shown here usually is illuminated by lamps of rather low wattage.

Fig. 5 is typical of the interesting opportunities that present themselves. The shot was made while it actually was snowing. A lens hood of ample size kept the snow flakes from getting on the



lens, and the focusing cloth was wrapped around the camera to keep it from getting wet. The exposure was 15 min. at F 8 with an ordinary street lamp as the only source of illumination standing 60 ft. to the left outside the picture. Whenever a lamp is not included in the negative area it is unlikely that overexposure is objectionable; a slight overexposure will help to bring out shadow details of dark objects.

Entirely opposite conditions are encountered in taking a shot like the one

shown in Fig. 6. Hundreds of people assembled for some special occasion are milling around a brilliantly illuminated fountain. Obviously you don't want a blur of humanity in motion. Therefore you open up your lens diaphragm as far as possible, use the fastest film available, and take a chance with a short exposure and subsequent strong development of the negative. In such cases you will have to forget about shadow details.

So far the illustrations have shown subjects as they are found at night. There are, however, possibilities of using other sources of light to help bring out seemingly hopeless subjects that do not have any illumination from the outside. Fig. 7 shows a factory. There were lighted lamps inside the building. A straight time exposure would have given an impression of the window areas only and the important outline of the plant would have been lost. So daylight was brought to the rescue. This sort of thing requires nothing but patience, and it is



bound to work every time: Put the camera on a very substantial tripod and make a short exposure some time before sunset. If $\frac{1}{2}$ sec. would give a bright picture, give it $\frac{1}{10}$ sec. for a night effect. Then wait until total darkness, avoiding any slight movement of the camera, and take a time exposure of say 10 min. to get the lights and windows. In Fig. 7 the weak light in the sky section of the first exposure blends nicely with the bright lights in the windows obtained with the second exposure. In winter when such waiting might be somewhat uncomfortable you can use a photoflash lamp. The home in Fig. 8 was first prepared by turning on all lights in rooms facing the camera. While the shutter was



open for the short time exposure, the writer walked to the right and to the left and shot a photoflash lamp at the house from each side. The lights were held as high above the ground as possible in order to get at least a faint image of the roof.

Stand Supports Magnifying Glass Used to Focus Enlarger

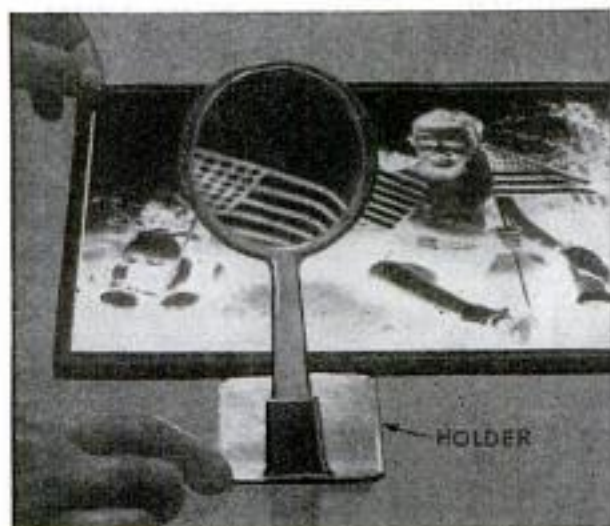

When a magnifying glass is used to inspect a projected image from an enlarger as an aid in getting sharper enlargements, time lost in focusing the glass continuously during the inspection can be saved if the glass is supported in a holder as shown. A dime-store reading glass will do, and once it is adjusted in the holder to suit the focal length of the lens, inspecting an image is just a matter of setting the holder on the enlarging easel and looking through the glass, thus leaving your hands free to adjust the enlarger. The holder is shaped from thin sheet metal to provide a base and a socket is formed to take the reading-glass handle.

—Howard Rozelle, San Diego, Calif.

Capacity of Blotter Roll Easily Increased to Dry Several Extra Prints

When a blotter roll is filled to its usual capacity, several extra prints may be dried at the same time by inserting a few blotters between the cardboard roll and the linen backing paper. Extra prints are placed between the blotters and the linen paper.

Eliminating Shutter Stickiness

A drop or two of carbon tetrachloride between the leaves of the shutter diaphragm will help to eliminate shutter stickiness. Even if it is necessary to repeat the process once or twice to allow the solvent to work in thoroughly, it will not harm the shutter.

—Dr. R. R. Voorhees, Pueblo, Colo.

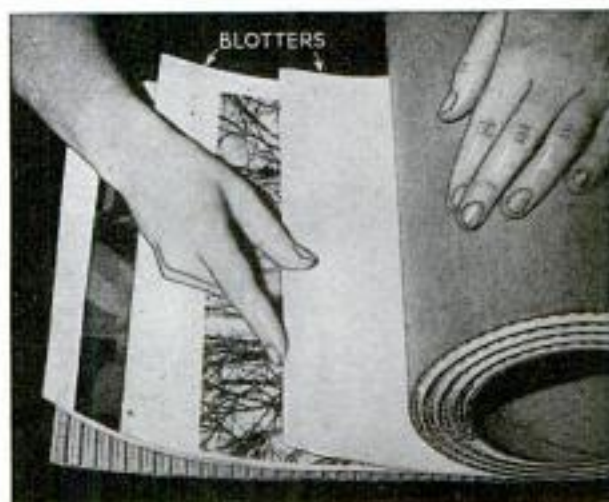

Films Squeegeed Before Drying With Dentist's Cotton Rolls



You can improvise efficient squeegees from dentist's cotton rolls for wiping excess moisture from film before drying it. These come in several diameters, but for this purpose the $\frac{1}{2}$ -in. size is most desirable. Since the cotton rolls are inexpensive, you can use new ones for each film.

Shipping Tag Identifies Film Loaded in Camera

Cut down and snapped over the fastener of the camera carrying case, a shipping tag is handy to carry necessary information regarding the type of film and the date it was loaded into the camera. Other data such as type of lighting, exposure, etc., can



be jotted down on the tag and placed in the film container until development. Absence of a tag can be used to indicate that the camera is empty.

Negatives Held Firmly by Tape On Printer or Enlarger Masks

Negatives are much easier to manage in a printing frame or enlarger when a strip of cellulose or other tape is placed along one of the inside edges of the negative mask. To hold the negative in place, one edge of it is slipped under the portion of the tape, which is kept from sticking to the film by a strip of plain paper.—Richard R. Busch, Chicago.



Focusing Cloth Held by Clips Will Not Slip Off



A focusing cloth will not slip from the camera if it is held in place by two or three spring-type paper clips as shown. Spring clothespins or other available types of clasps also would serve the purpose equally well if you are unable to obtain paper clips.

Envelopes Attached to Notebook Provide Negative File

A simple but effective negative file is made by cutting off the flaps of ordinary envelopes and taping the envelopes to the covers of a stenographer's notebook from which the used pages have been removed. With each envelope suitably classified, negatives are easily located.





SHOP NOTES

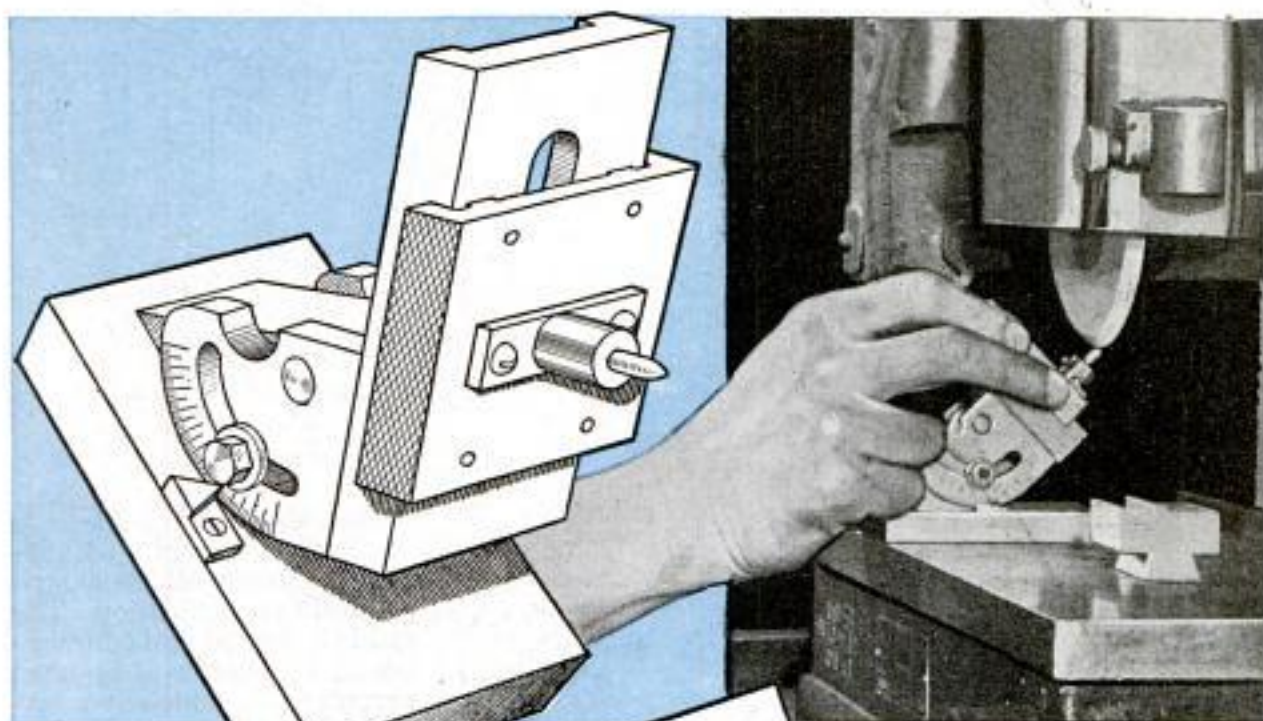

Accurate

WHEEL DRESSER

Cuts Bevels

By
Charles F. Brien

FOR surface-grinder work in the small shop not equipped with an adequate wheel-dressing jig, this one, especially designed for bevel dressing, can be made up by any machinist or tool maker. It will be of help whenever it is easier to dress the wheel than to hold the work at an angle. Previous to making the one shown here, the writer spent considerable time in dressing the wheel by hand, using a parallel strapped to an angle block, and sliding the diamond up and down on the parallel by hand, but this resulted in broken wheels and involved accident hazard.

The swivel or protractor of this dresser can be set and locked securely at any predetermined angle, and the diamond can be put in any of three different positions, after

which the dresser is properly mounted in correct relation to the wheel. Moving the knurled slide up and down by hand raises and lowers the diamond without endangering the operator's fingers.

All the parts, except as otherwise specified, are made of cold-rolled steel. Start by making the base. This is drilled and counterbored for two socket-head screws, which are used to fasten the base and swivel support together securely. The base is fitted with a protractor indicator shown in the circular inset, which is fastened permanently to the base with a flat-head machine screw. The swivel support is drilled and tapped to take the screws that fasten it to the base as well as two locking screws on opposite sides, which serve to tighten the swivel at any position. These fit 90-degree, 1/4-in. slots in the swivel. Although shown on one side only, a slot must be made in each side of the swivel. The lower

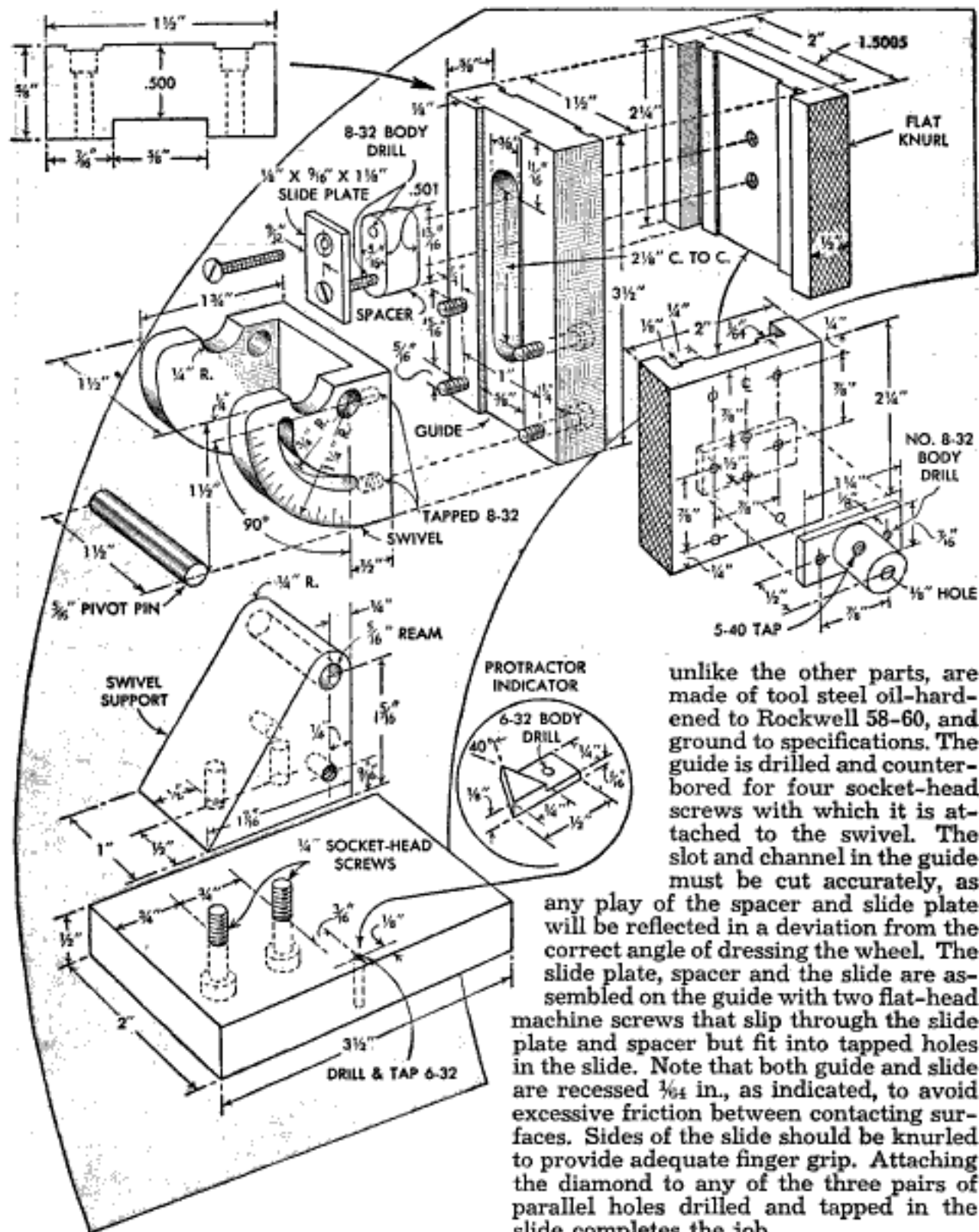

Pantograph Is Easily Adjusted for Copy Work

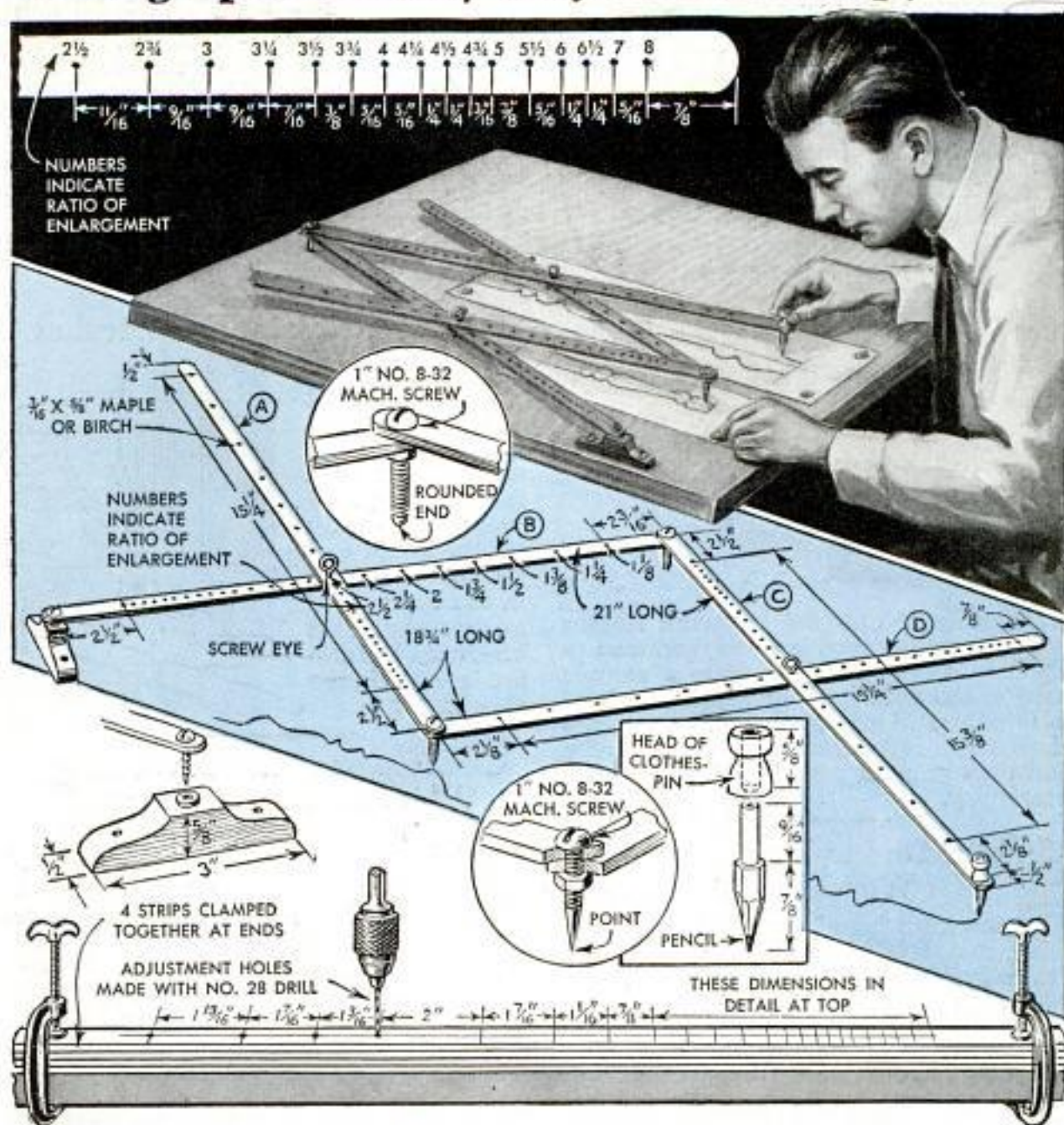

Suitable for copying maps and diagrams and for making enlargements of woodwork patterns, this pantograph can be made from four strips of birch or maple pivoted together by brass machine screws. The holes for the pencil, tracing point, pivot block and the round-end pivot screw are drilled $\frac{1}{2}$ in. from the ends of the strips. The adjustment-screw holes are spaced identically on all four strips, except that the first holes in strips A and B are measured $2\frac{1}{2}$ in. from the center of the large holes at the end for the bolt pivoting strip B to the block and for the tracing point in strip A; and $2\frac{3}{8}$ in. from the center of the large hole for the pencil in strip C and from the center of the hole for the tracing point in strip D. Also, notice that the strips are joined

so that the ends of strips A and C in which the holes are closely spaced are connected to strips D and B at the ends where the holes are widely spaced. After marking the beginning of the enlargement scale, all strips may be clamped together and drilled at the same time. Since the accuracy of the instrument depends upon the correctness of the hole spacing, care should be taken to lay out the intervals precisely, for the pantograph will exaggerate even a small divergence from exact measurement which, though this may not be important to most copy work, will materially affect the accuracy of scale drawings.

☐ A small fly sprayer is handy for applying antiseptic to cuts and sores on animals.

Workman's Folded Work Clothes Carried With Trouser Hanger



Difficulty of carrying his work clothes to and from his shop led one workman to devise a carrying handle from a trouser hanger, the wire hook of which was bent to form a good grip as shown. In use, the clothes are rolled into a suitable bundle and then gripped with the hanger in the usual way.

Simple Tool to Locate Centers Of Wood Turnings

Fitting work from $\frac{3}{8}$ to 2 in. in diameter, this center-marking tool can be made by anyone, and is a timesaver for the woodworker where exact location of the centers

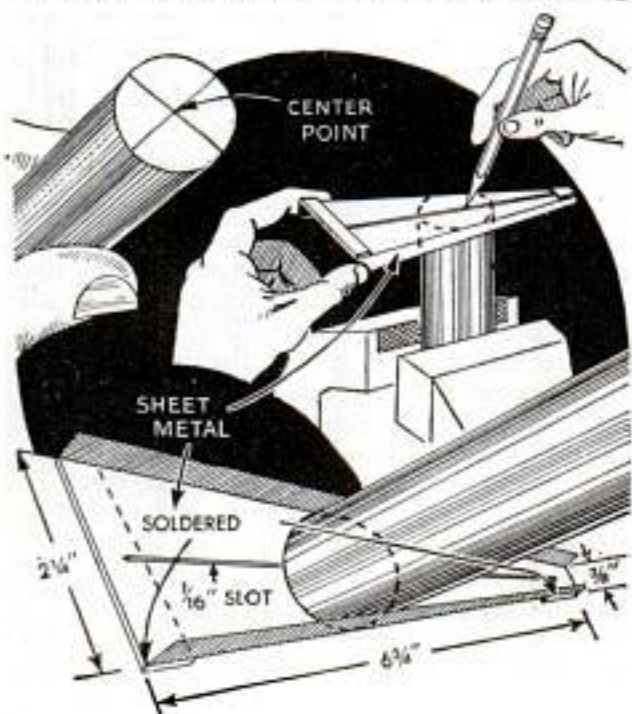

is not critical. The tool is made of sheet metal as indicated and can be almost any size desired, although the size given will be suitable in most cases. In use, the tool is placed over the end of the work and adjusted so that the sides are a snug fit against the work, after which a line is made across the end of the work with a lead pencil in the tool slot. Then the tool is turned to bring the slot at right angles to the penciled line and another mark is made. The intersection of the two pencil lines is the center of the work.

Clay Holds Paint and Brushes On Window Ledge

To hold paint and brushes on a window ledge, one sign painter uses modeling clay. By pressing the clay on the ledge and setting the can on it, the can is held securely. The brush handles also are inserted in the clay, as shown.



Clothespins Hold Cover Flaps While Cartons Are Packed

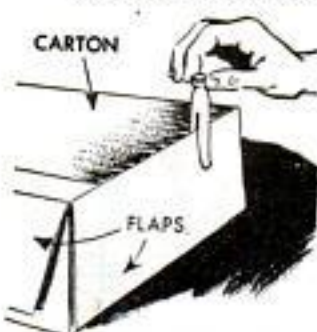

A good way to keep the cover flaps folded down while packing cardboard cartons is to place ordinary clothespins over the folded edges. This method eliminates the use of projecting

arms sometimes installed on packing benches for this purpose.

—Harry Radzinsky, Great Neck, L. I.

Speed Wrench for Socket Screws

An ordinary carpenter's brace can be used as a speed wrench for tightening or loosening hollow head cap screws. Just cut off the short arm of the regular wrench included with every box of screws and use it in the brace chuck.

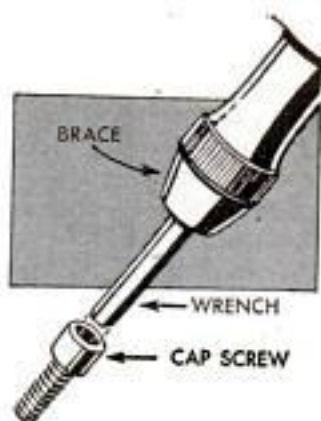

Piston-Base Height Gauge Centers Lathe Tool



When the cutting edge of the tool bit must be set at exactly lathe-center height in certain operations such as thread cutting, taper turning and parting, this height gauge will save time. The gauge can be made from the top of a discarded auto pis-

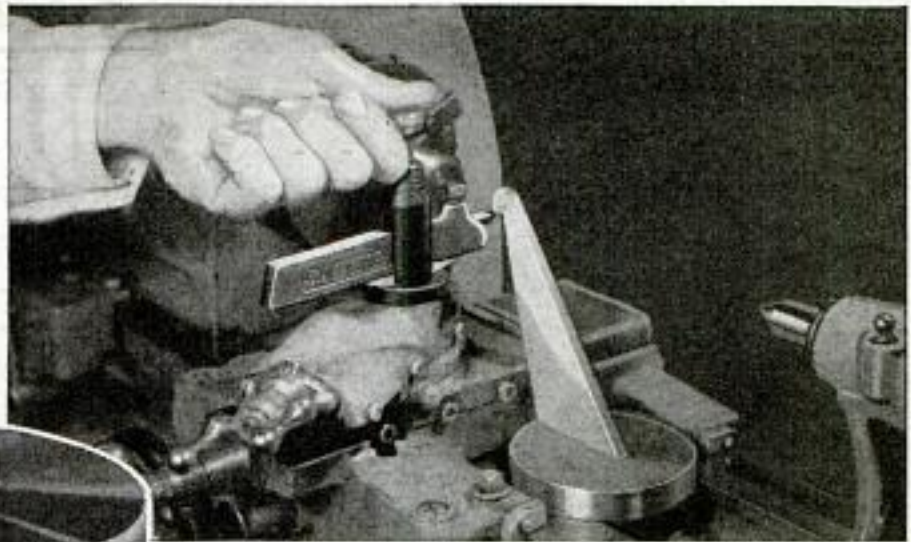

ton and a small piece of $\frac{1}{4}$ -in. flat stock cut to the shape shown. Turn the piston head absolutely flat at top and bottom and fasten the vertical part to the base with two 10-32 screws. The overhanging tip of the gauge should be made to indicate the exact lathe-center height when the gauge is placed on the lathe ways.

—C. W. Woodson, East Aurora, N. Y.

Determining Length of Rope Wound Tightly on Drums

When it is necessary to determine the length of rope, cable or similar materials wound tightly on drums where the drums are either full or where part of the material has been removed, here is an easy way to do it: Measure the depth of the material H , on the drum and to this add the diam-

eter S , of the drum. Multiply this sum by the depth H . Then, multiply the product by the inside length L , of the drum. Next, divide this product by the square of the diameter D , of the rope, cable or other material on the drum, all of the above measurements being in inches, and then multiply the quotient by .262 which will give the approximate length in feet of the material on the drum.

—W. F. Schaphorst, Newark, N. J.



Excavator's Line Held Securely On Stakes Without Tying It

Annoyed by frequently tying and untying his marking line to take up the slack, one mason sawed cross slots in the corner stakes and threaded the line through them. In this way, the line could be held securely without tying it. Also, this arrangement made it possible to tighten each section of the line between the stakes without the preceding section loosening.

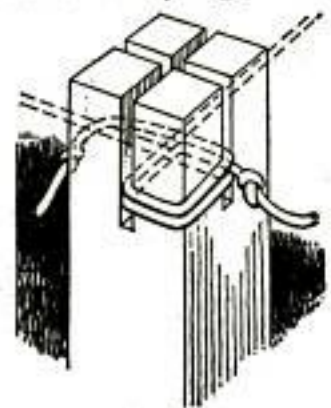



POULTRY

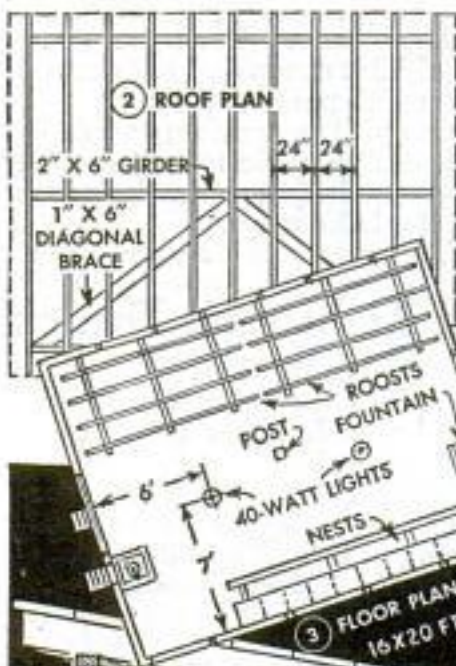
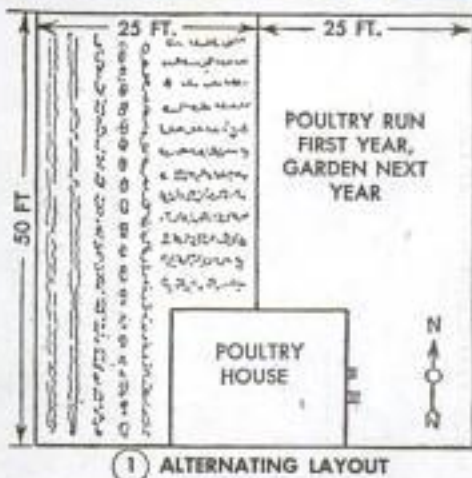

SUCCESSFUL poultry raising requires first-class housing, which means ample space, dry floors, plenty of sunshine, good ventilation without drafts, and protection from the elements. About 3 sq. ft. of floor space should be allowed for White Leghorns, and 4 sq. ft. for the heavier meat breeds, such as Rhode Island Reds and Plymouth Rocks. The outdoor pens should allow at least 7 sq. ft. of space per bird. A desirable arrangement for a pen is to have two runs, alternating these for use as a garden in successive years. Fig. 1 illustrates a layout for 100 birds on a 50-ft. plot with one house and two pens. Where space permits, the flock can be doubled or tripled if sections are added to the original house and pens.

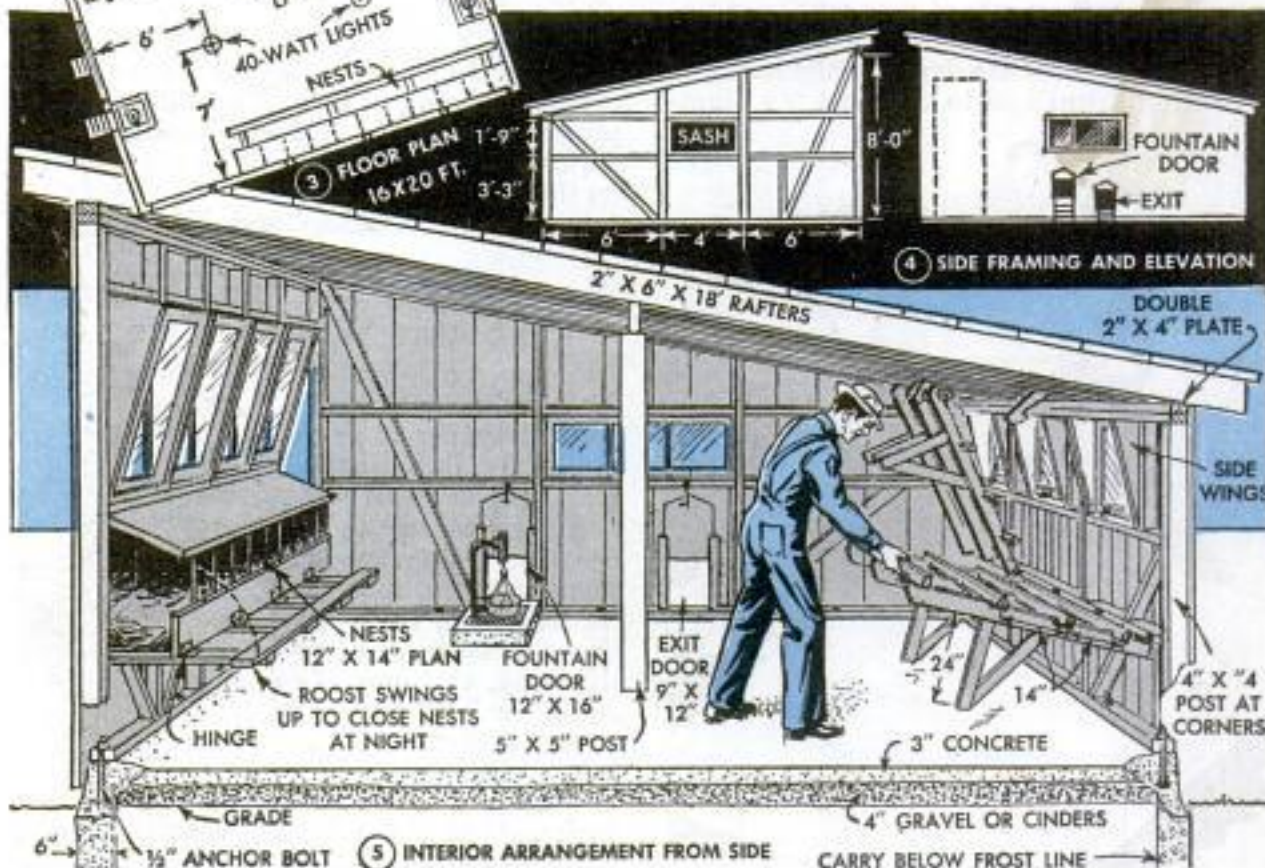

HOUSES You Can Build

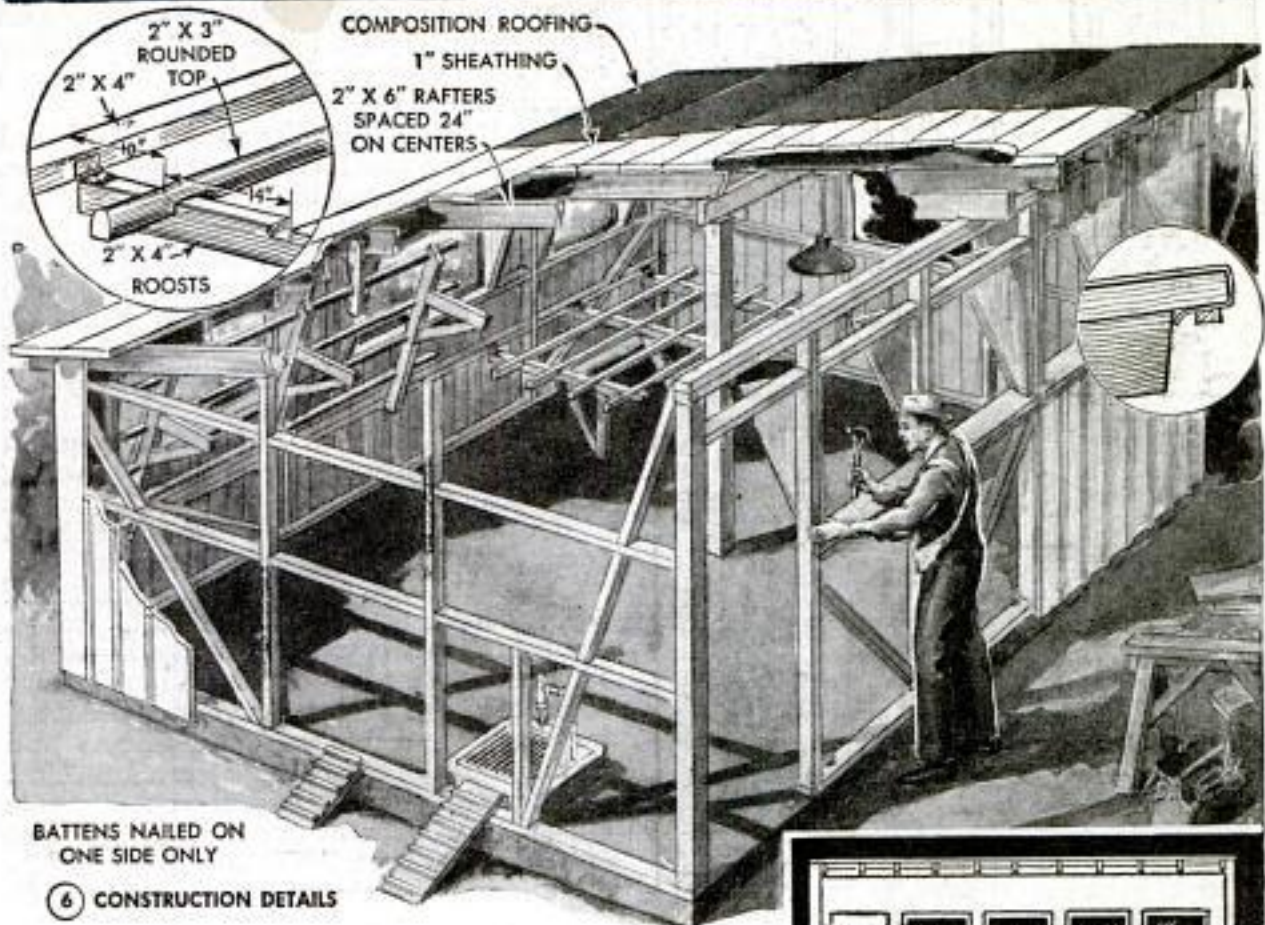

BATTENS NAILED ON ONE SIDE ONLY

6 CONSTRUCTION DETAILS

The floor plan shown in Fig. 3 is arranged to combine the best features of those recommended by successful poultry raisers, agricultural schools and government farm bureaus. This house is designed for White Leghorns. For larger fowl, increase the length to 24 ft. The elevations in Figs. 4 and 7 show the ample lighting arrangements, with windows on all sides and a single door conveniently in front. Board-and-batten construction does not require as much framing as horizontal sheathing. Note that diagonal braces are used generously, as this is very important in a light structure. One common fault of the average "hen house" is its slant away from the prevailing wind, due to not having "sway braces." Even the rafters should have diagonal braces as in Fig. 2. These are 1-in. boards and prevent a twisting effect in high winds. The sectional view in Fig. 5 gives a good idea of the construction. Concrete is the best material for a floor as it does not rot, is rat-proof and more easily cleaned than boards, which tend to splinter. If a wooden floor must be used, build it at least 18 in. above grade so that vermin cannot make nests beneath, and dogs can get under to discourage rodents.

Footings are carried below grade and cinders or gravel are used as fill between them to a depth of 4 in., after which concrete is poured over this to a depth of 3 in. The footings should extend below the frost line, and 1/2-in. anchor bolts spaced 4 ft. apart

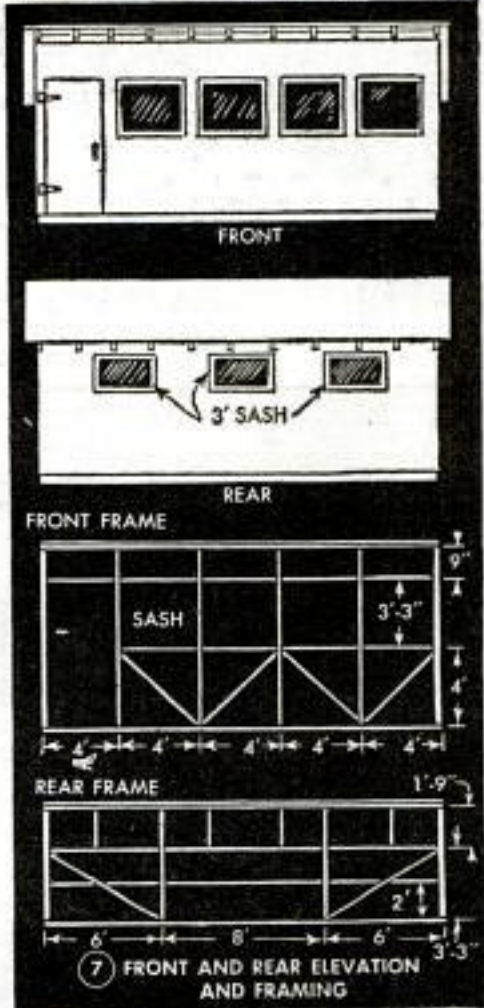

7 FRONT AND REAR ELEVATION AND FRAMING

265 22 54 Journalist work

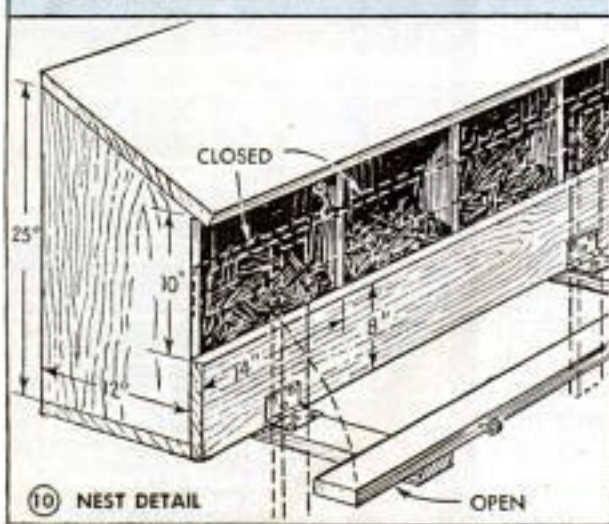
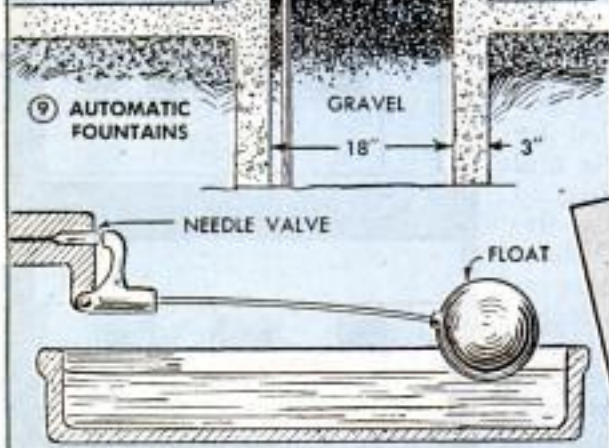
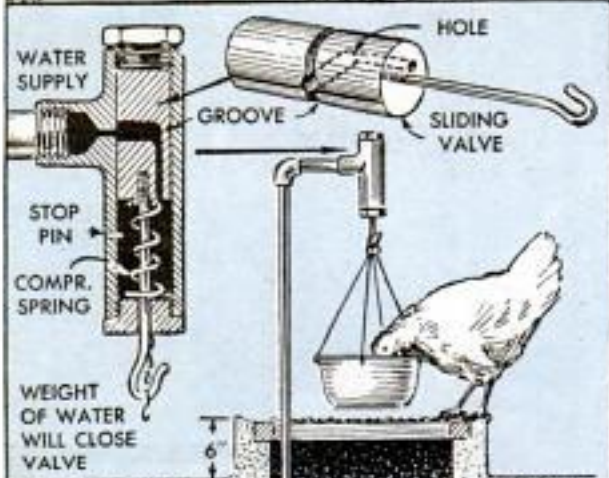
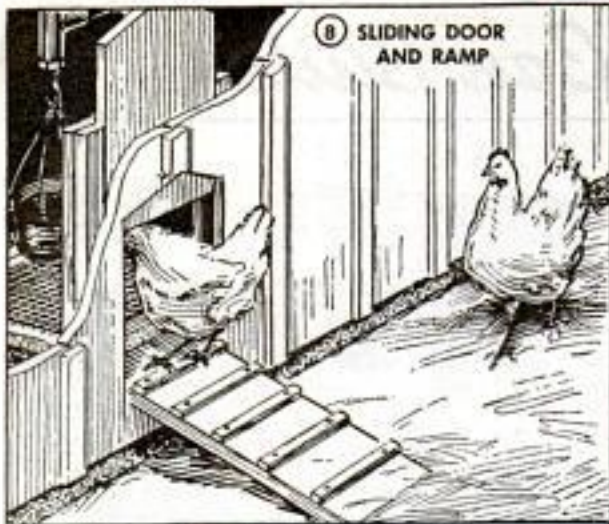

should be embedded in the wet concrete to anchor the sills. Studs are toenailed to them and horizontal members and plates are installed as indicated in Figs. 4 and 7. The siding boards then should be nailed on the framing, space being left for window and door openings, before the rafters are installed.

Note in Fig. 5 that the sash are designed to tilt inward and have wings on each side. This forces the ventilation upward, away from nests and roosts, and also affords some protection for the glass-substitute which will last longer than if exposed directly to the force of a heavy downpour. Nests are arranged along the front wall just below the sash, and have a hinged perch which is swung up at night to keep the birds from getting into the nests. Roosts are arranged to swing up out of the way when cleaning the floor. A single center post supports a girder under the rafters. Houses only 12 ft. or less in depth do not require this.

General assembly and arrangement of the structure are shown in Fig. 6. Roosts are built in two units for easy handling. Their construction is shown in the circular detail of Fig. 6. Although not indicated, the framing should be sheathed inside as well as outside where the nests are installed. When putting battens over the siding joints outside, nail each at one side of the joint only, doing this on the side facing prevailing winds. The siding boards will shrink

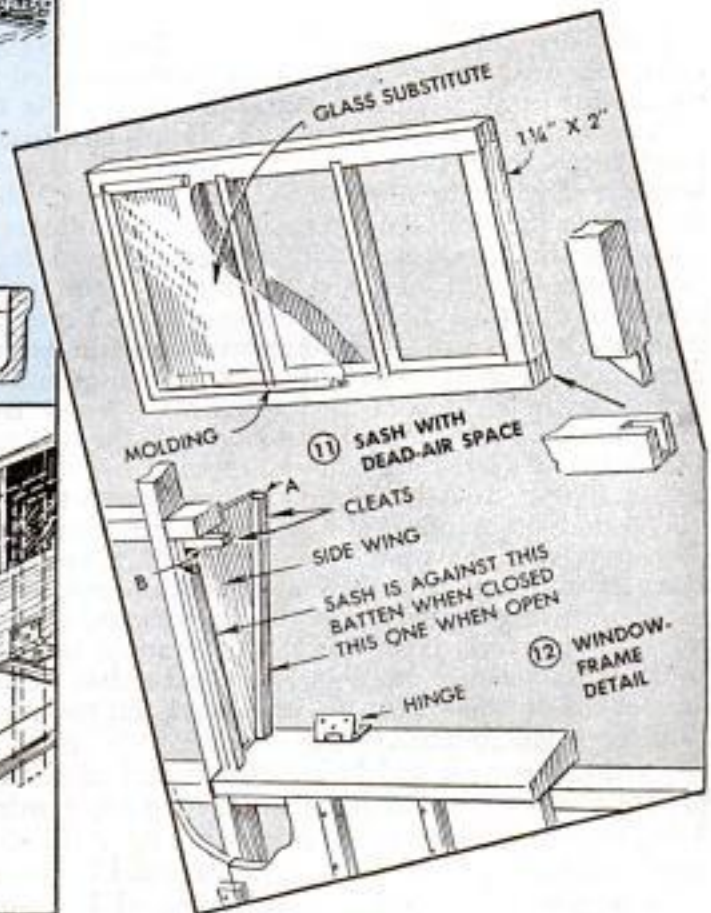

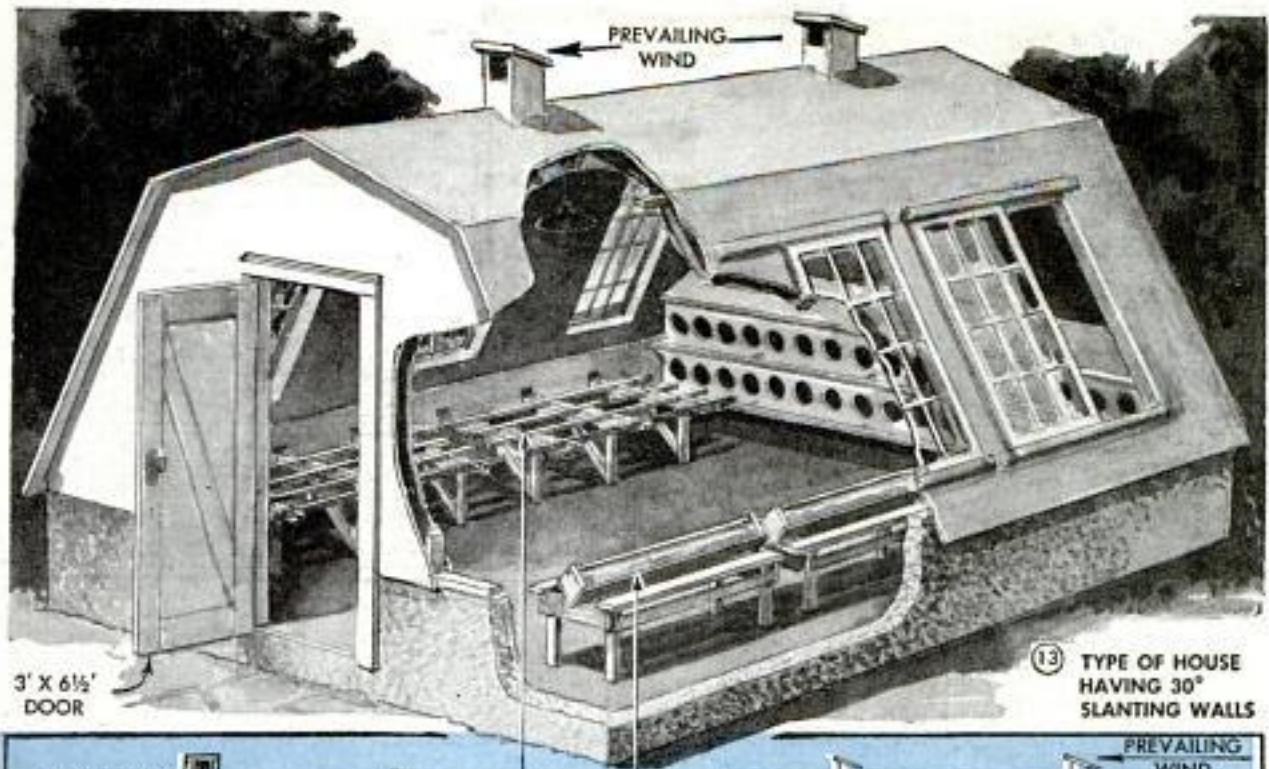

in dry weather and battens are absolutely necessary. If they were nailed on both sides of the joints shrinking of the boards would split them.

Fig. 8 shows a section through the exit door, which is similar to the one for the fountain. The latter, by the way, is housed inside for use in bad weather and to protect it against freezing. To prevent water spilling on the floor and to keep out litter, the fountain is placed over a raised, gravel-filled well, which is fitted with a lift-out frame of hardware cloth. An automatic fountain can be made as shown in the upper detail of Fig. 9, in which a plunger valve is forced up by a compression spring when the level in the water pan becomes low. This is a machine job and should be made of brass or bronze which does not rust. A more common type of valve having a float, is shown in the lower detail.

Nest construction is shown in Fig. 10.

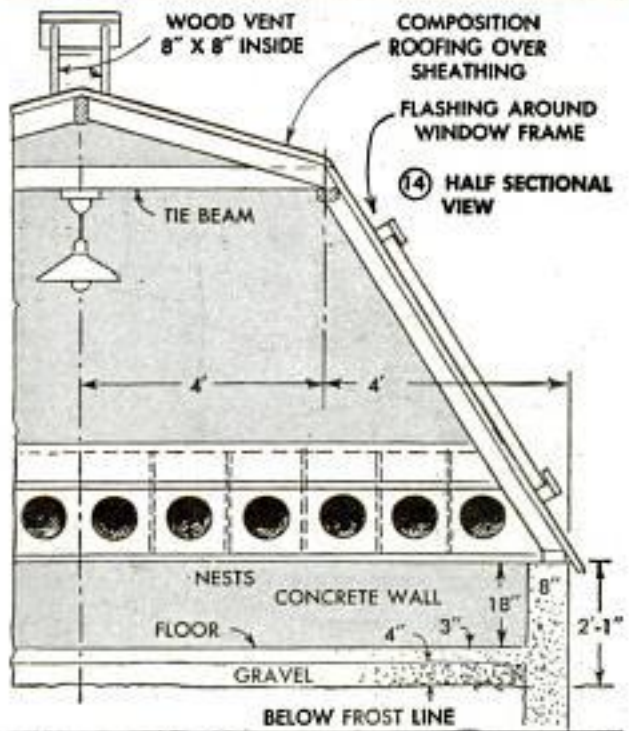

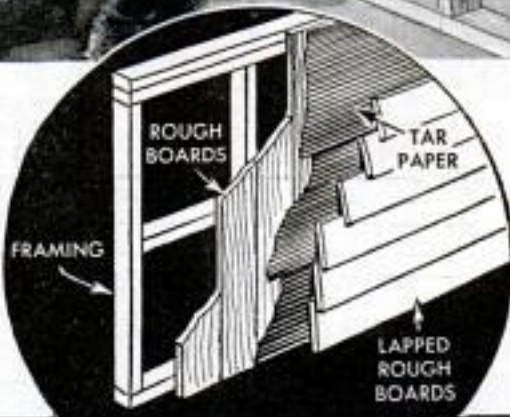
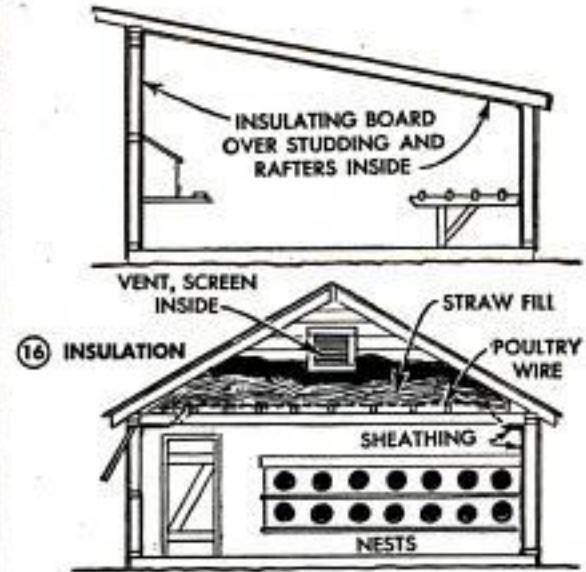

There should be one nest to each five birds, or twenty for the hundred in this unit. Another arrangement of nests is shown in Fig. 18 in which the hens enter along a "catwalk" at the rear. The advantage of this arrangement is that the nests are dark, which reduces the possibility of hens eating the eggs.

Side wings for the window sash are shown in Fig. 12. The sash should be hinged at the bottom and fitted with a crescent catch at the top to draw it snugly against the cleat B. When open, they rest against cleat A. The sash are made as in Fig. 11, with mortised corners and a glass substitute on both sides to provide a dead-air space for good insulation without appreciably detracting from the light. Real glass, incidentally, does not retain warmth at night, nor does it pass as much of the health-giving ultra-violet rays as does glass substitute.

Another type of house is illustrated in Figs. 13 and 14, in which the side walls incline at 30 degrees from the vertical, thus permitting light to enter the windows for a longer period than if they were vertical. In this case glass substitute should not be used in the sash, which slide sideways in rails to give more ventilation than afforded by the wooden ventilators on top. Arrangement of the floor plan is similar to that of the preceding design, and construction of the floor is the same except that concrete walls are carried up 18 in. all around. Sides as well as roof are covered with composition roofing, and care must be taken to install flashing around all window frames to render them rainproof. Various types of roofs can be used on poultry houses as shown in Fig. 15. The combination and gable roofs, A and B, are desirable for large structures, but are too deep for the shed roof design described first. The

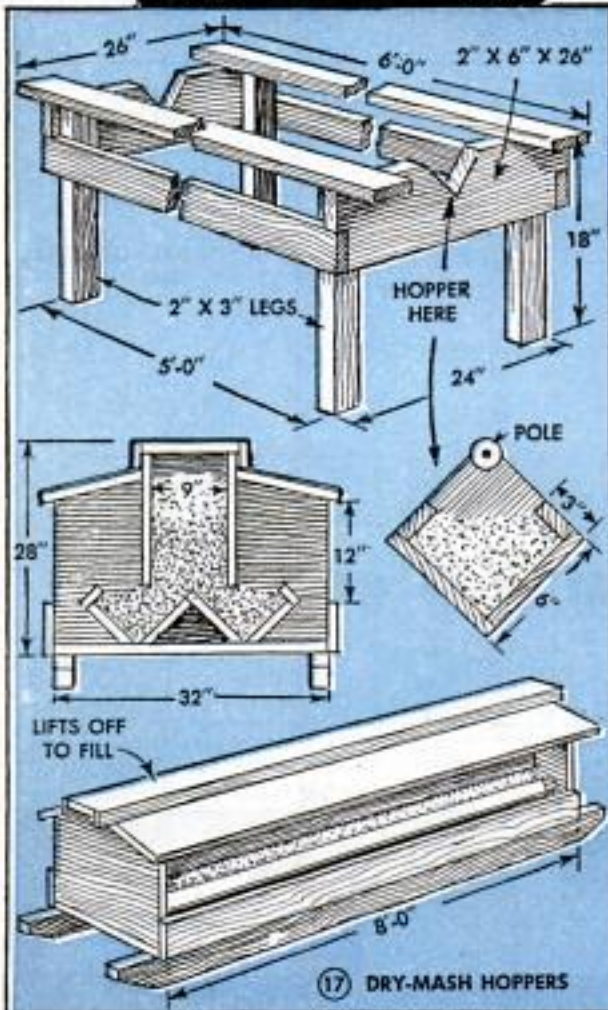

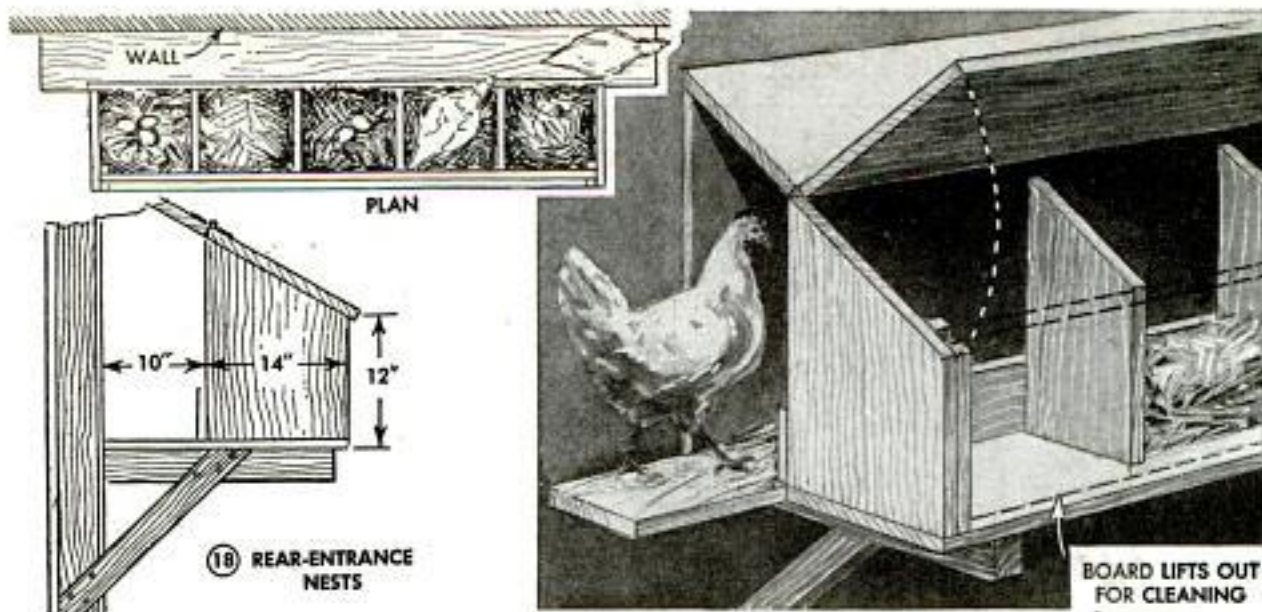

monitor and semi-monitor types, C and D, allow for top ventilation as well as added light through swing-in sash.

Two methods of insulation are illustrated in Fig. 16. Simplest is to line walls and ceiling with insulation board. In cold climates this is important, and in all cases, insulation should be installed behind and above the roosts to prevent chill at night, or moisture condensing on the walls.

Some poultrymen install a droppings board under the roosts, with poultry wire to keep the chickens away from the droppings. The roosts are arranged to swing up as in Fig. 19 to facilitate cleaning. A vent at the eaves is provided by a flap between the rafters and above the plate as indicated in the circular detail of Fig. 19. For growing fowl or young chicks, a "sun room" is made having sides of poultry netting and a hardware-cloth floor just above the ground as in Fig. 20. In the outdoor runs, posts are placed 8 ft. apart and 24 in. deep, with ends creosoted and the wire about 3 in. below grade as in Fig. 21, but deeper if troubled with skunks or other burrowing animals. However, do not put a rail across the tops of the posts as the full grown fowl, especially White Leghorns, will fly up to it. Floor space required for various numbers of hens is given in Fig. 22. Bear in mind that this is about the minimum; allow more if you have the area and the material available.

Dry-mash hopper design is important where a large number of fowl are kept, because when improperly constructed, a considerable waste will result. Two approved types are shown in Fig. 17, each being made of wood. Poultrymen, specializing in egg production, recommend having ample hoppers filled at all times for best results. As much as 24 ft. of hopper length per 100 birds is not too much.

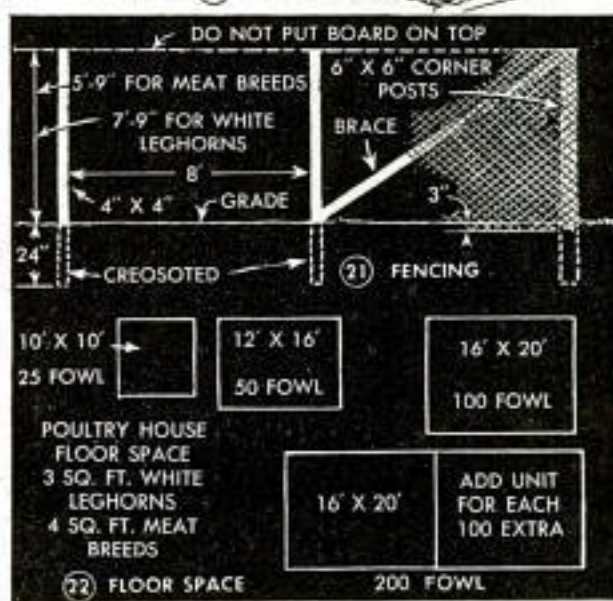
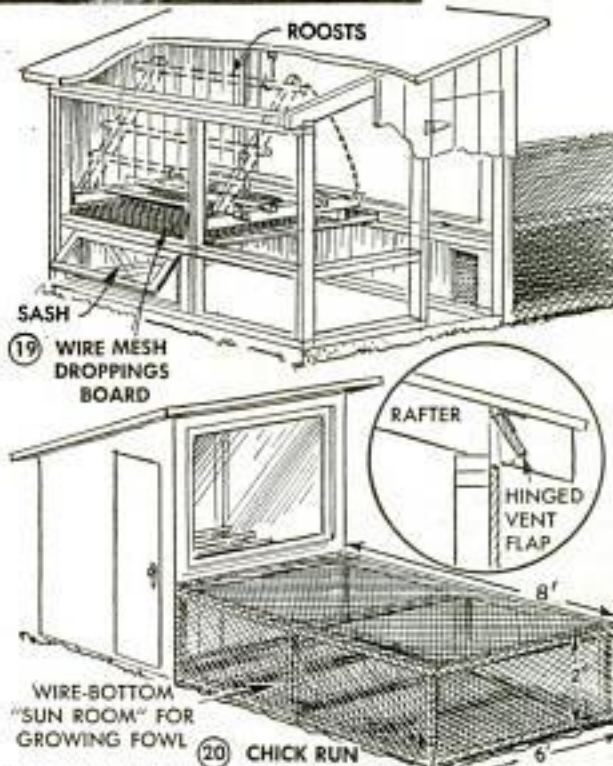

Slender Stock Threaded in Lathe Using This Die Holder

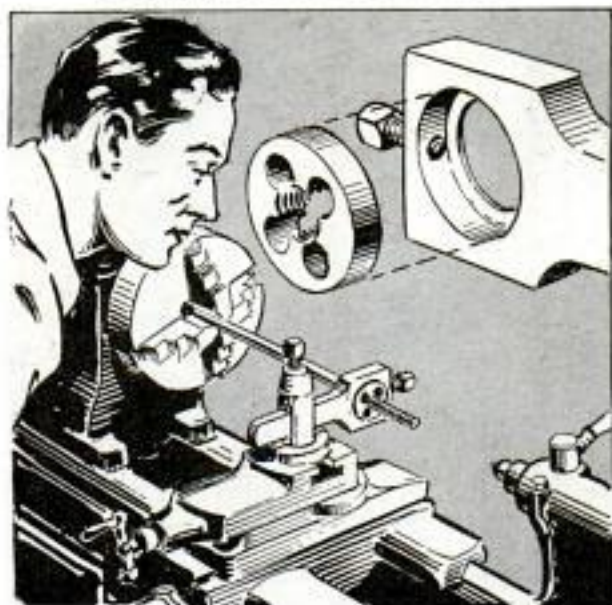

Long slender rods may be threaded more accurately on a lathe with less danger of damaging them if a die holder like the one shown is used. It consists of a handle long enough to clamp in the tool holder and a head reamed as shown to take standard button dies, which are held by a setscrew. When clamped in the tool holder, the cutter is lined up by centering with the tail-stock center and is squared with the lathe by pressing flush against the face plate. To start the threading, push the die up to the work until the first few threads have been cut and the die begins to pull the carriage. For removal, if the lathe does not reverse, the setscrew can be loosened and the die twirled off the rod.

—Russell Rosendahl, Muskegon, Mich.

Brooder-House Door Padded To Protect Small Chicks

To keep chicks in his brooder-house from being injured under the edge of the door when it was opened, one poultryman

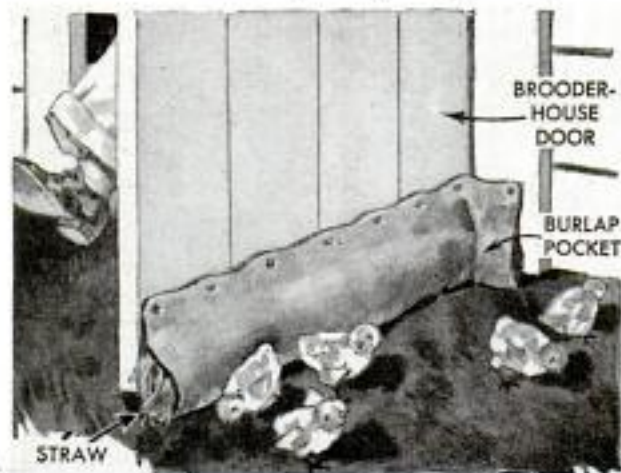

tacked a folded piece of burlap to the bottom edge of the door and filled it with straw to provide a cushion. When the door is opened, the cushion brushes the chicks harmlessly out of the way.

High-Tension Current Locates Breaks in Extension Cords

In one shipyard where a great number of extension cords were used, the wires inside the cord often were broken without leaving any indication of the break in the insulation or covering. Thus it was difficult to locate the break by the usual means and many hours were lost in repairing the cords. To save this time, the cords were connected to a 7,500-volt luminous-sign transformer with a secondary capacity rating of 60 milliamps as shown, using a lamp at the end of the cord to complete the electrical circuit. In passing through the cord, the high-tension current will jump the break in the wire, heating it and causing

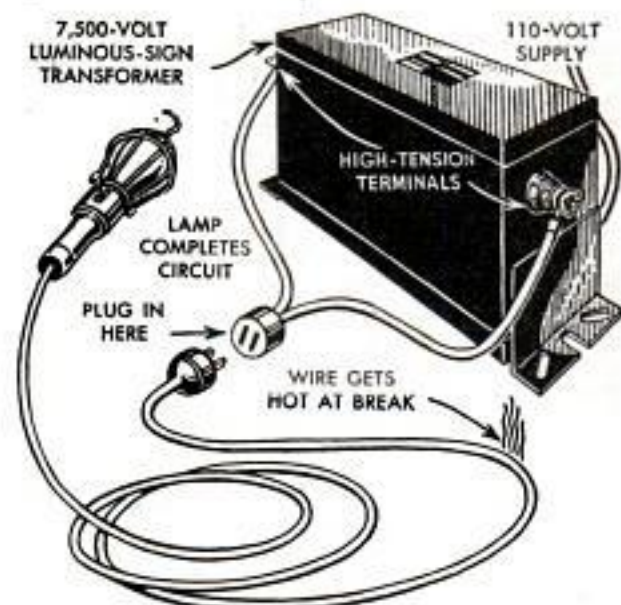

the insulation to become warm at the break, which can be located by running the hand over the cord. If the current is left on for two or three minutes, the wire will become hot enough to burn through the insulation and thus automatically locate the break in the cord.

—C. W. Furnberg, Portland, Ore.

WRITE FOR POPULAR MECHANICS!

Readers are paid cash for ideas printed on these pages. You too, may know of a simpler, faster or better way to do some daily chore about the home, farm, office, shop or garage; an aid to amateur photographers, model makers, workshop fans, car owners, hobbyists, etc. Just send a short but complete description plus a sketch or photo to the Homecraft Editor of Popular Mechanics. Checks sent promptly for accepted ideas.

You can make this WHEEL PULLER



For removing wheels, gears, pulleys, etc., a small wheel puller like the one shown in Fig. 3 is just the thing. Fig. 7 shows the sizes and shapes of the various parts and Fig. 1 shows how the yoke can be shaped in a lathe and then drilled and tapped as in Fig. 2 for the pressure screw. The arms or side clamps are shaped with a hack saw and file or on a grinder, or you can even use a disk sander as in Fig. 6. After assembling the arms and yoke, the pressure screw is turned to size as in Fig. 4, leaving a head at one end to take the handle, after which the screw is threaded as in Fig. 5. The lower end is turned to a 60-degree angle and a hole is drilled through the screw head to take a handle, which is fitted with endpieces to hold it in place.

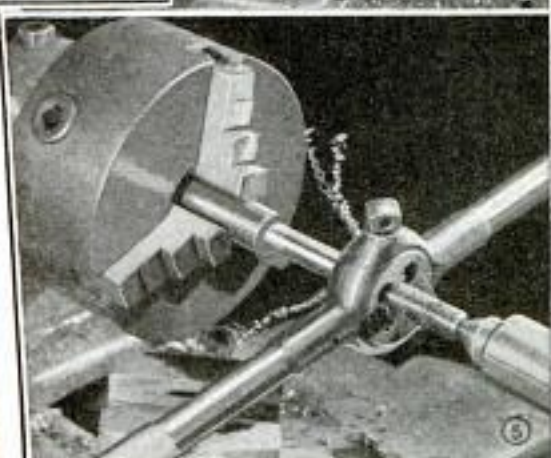
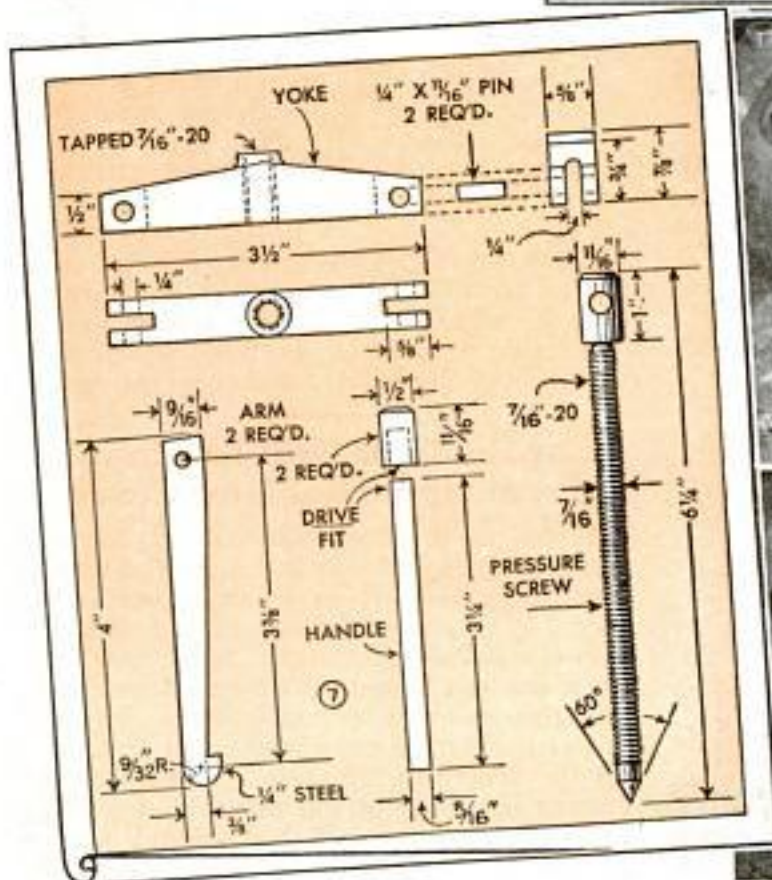
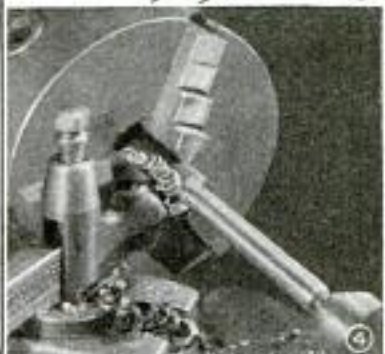

Swinging Tray Under Bench Vise Prevents Loss of Small Parts



Small parts, such as screws, nuts, etc., that are dropped accidentally when working on a carburetor or other mechanism clamped in a vise, will not be lost if a tray is mounted under the vise to catch them. The tray can be made of wood or sheet metal and is pivoted to the underside of the bench by means of a bolt and wing nut, the bolt being located in one corner of the tray. When not in use the tray can be swung under the bench out of the way.

Ladder Supported at End of Truck For Painting and Cleaning Work

Although professional painters and the workmen of street departments of many cities have trucks with specially built bodies for use in cleaning and painting street lamps and similar work, it is easy to

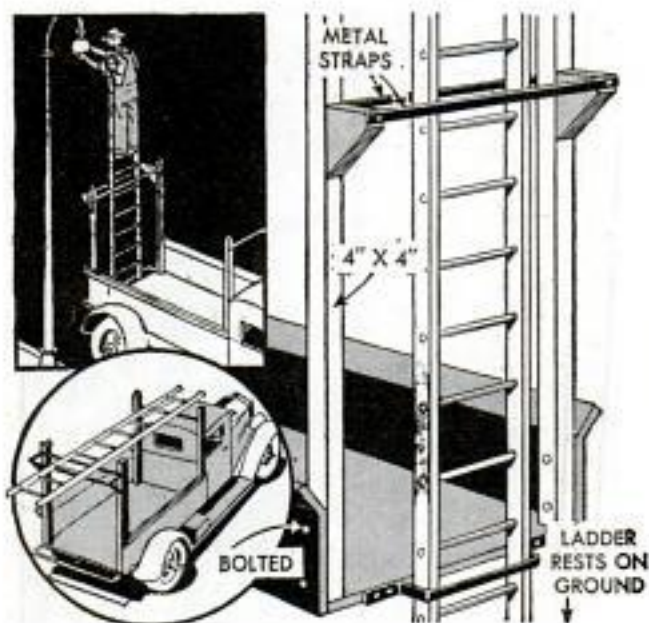

improvise suitable equipment for such work where the special-type trucks are not available. The equipment shown for cleaning and painting street lamps is a good example. Here the body of a regular truck is fitted with four posts for carrying ladders and the rear two posts are equipped to support a ladder in a vertical position, the lower end of the ladder resting on the ground. When not in use, the posts can be removed by taking out two bolts in each one.

Price Tickets Easy to Change On This Show Card

Merchants who use show cards can save time and expense, where prices change frequently, by using the method shown. Tabs are cut in the card so that price tickets can be slipped under them.



Horseshoes Used as Bolster Cleats For Box on Farm Wagon

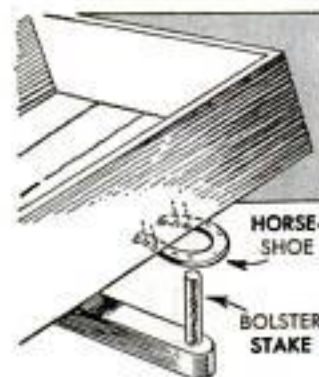

Cleats nailed across the bottom of a farm-wagon box to keep it from sliding back and forth on the bolsters of the running gear often are unsatisfactory because they rot quickly or because they allow the box to

bounce out of position when driving over rough ground. To avoid this, one farmer uses horseshoes, which are nailed to the underside of the box so that they project to slip over the bolster stakes as indicated.

Car Radiator Grill Fashioned From Home Radiator Cover

If you need a replacement for your car radiator grill and one is not available, the type of grill used to cover an ordinary home or office radiator can be fashioned into one suitable for a car. Select a design open enough to permit free passage of air and thin enough to bend easily. Form a pattern of heavy wrapping paper to transfer the design to the metal. You can make curves by forming the metal and joining the seams with small sheet-metal screws or bolts through holes bored in the grill,

fastened to pieces of heavy gauge galvanized metal underneath. The grill may be chrome plated, but if this is impossible a covering of paint front and back will do.

Handy Test Lamp for Checking Circuits in a Car

Here's a lamp that is just the thing for testing electrical circuits in a car. The sharp pointed prod can be pushed into insulated wires or cables to trace a hot wire, and is especially

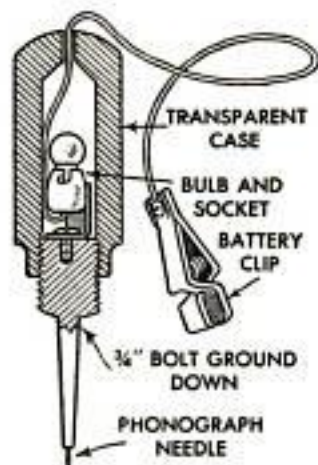

handy to get into hard-to-reach places. To make the lamp, drill out the plastic handle of an old screwdriver to take the bulb and bracket of a small dash lamp. Tap the hole to take a bolt that has been ground down to the shape indicated. Then sweat-solder a phonograph needle

to the pointed end of the bolt and solder or rivet the lamp socket to the other end. Connect a lead wire to the socket and run it out through a small hole in the upper end of the handle. Put a battery clip on the end of the wire. In use, ground the lamp by slipping the clip over the frame or a bolt head in the car. When the lamp lights it can be seen through the handle.

Crankcase of Car Removed Easily When Front End Is Raised

The next time you have to remove the crankcase from a model-A or V-8 Ford, put a jack under the front bumper brackets and raise the car until the wheels just start to clear the floor. This will allow the radius rods to lower enough to slip out the crankcase without having to remove them.

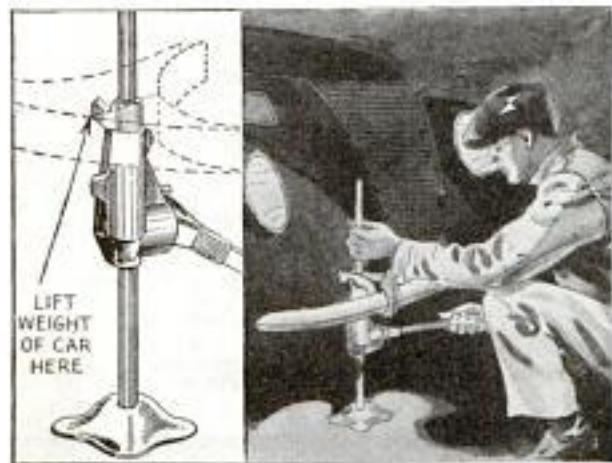

This Spacer Gauges Section Lines Indicating Steel or Cast Iron

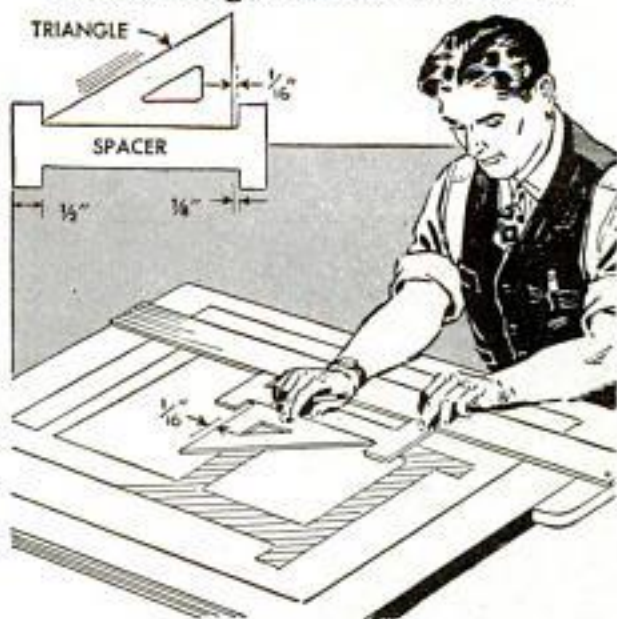

With this spacer, draftsmen will save much of the time they formerly spent in drawing shading lines to indicate steel and cast iron. The spacer is a piece of $\frac{1}{10}$ -in. hardwood with a section cut out on each side, one to measure $\frac{1}{16}$ in. longer than the triangle base and the other $\frac{1}{8}$ in. longer. For spacing lines to indicate cast iron, the triangle is placed in the cutout with the apex touching one side of the spacer, after which a line is drawn and the triangle moved over so that the base butts against the other side. The lines drawn on the hypotenuse will then be spaced exactly $\frac{1}{16}$ in. apart. Similarly, in designating steel, the spacer is reversed and the triangle base set $\frac{1}{8}$ in. from the arm.

—Richard F. Crooker, Worcester, Mass.

Anchoring Trough on Concrete

To anchor a hog trough on a concrete feeding floor so that it could not be moved or tipped over by the animals, yet be released easily for emptying or cleaning, one farmer anchored it as shown. A pipe stake was set

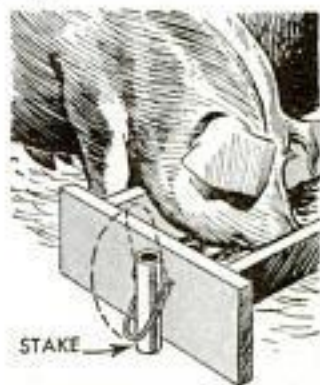

in the concrete at each end of the trough, which was fitted with wire loops to drop down over the stakes. If the loops are long enough to come within an inch of the floor, when they are in position over the stakes, there will be little possibility of the pigs rooting them off the stakes.

—G. E. Hendrickson, Argyle, Wis.

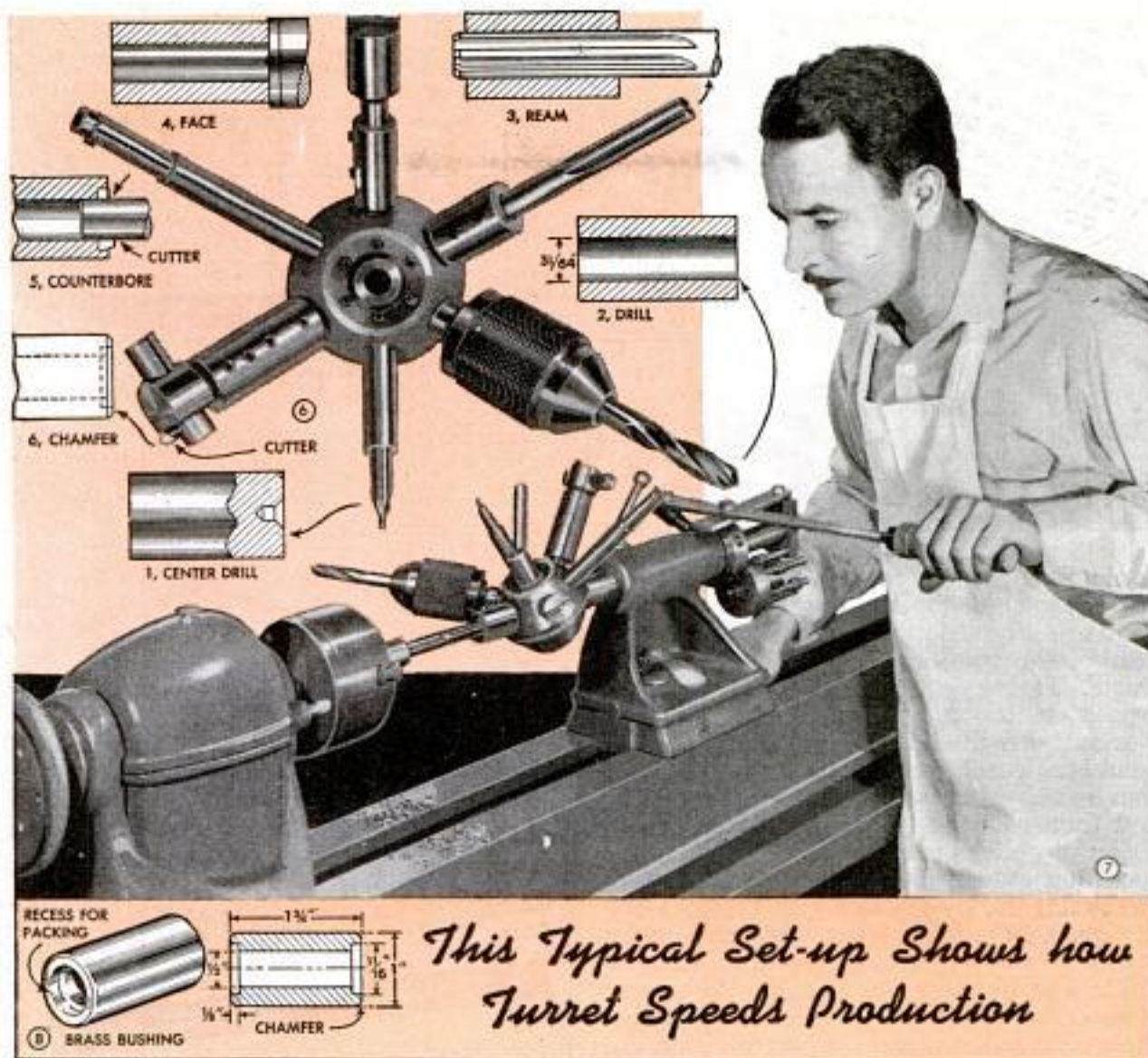

of the turret controls the depth of feed for each tool. Construction of the turret is shown in Figs. 4 and 5. Starting out, you make the ram or tailstock spindle first, making the larger diameter of this the same as the regular tailstock ram on your lathe. A new tail nut, threaded to fit the lathe and bored $\frac{1}{4}$ in. less than the full diameter of the ram, Fig. 2, is next, followed by the tool-head and stop-rod index plates. The rear of the lower portion of the tool head is flattened to furnish a neater and more substantial joint with the ram spindle. The flattening job can be done by routing and grinding on a drill press with the work held at the required angle in a vise (or the drill table is tilted). In the same working position, the hole for the ram thread is drilled and the tap started, as shown in Fig. 3. The tool head is finished complete except for the tool holes; the drilling of these should be the last operation and is done by a reversal of the process which the turret will later do on actual work. Fig. 1 shows the operation. It can be seen that absolute accuracy is assured.

The stop-rod device consists of two plates. One of these carries the six stop rods, and the other is fastened to the rear face of the tail nut, as can be seen in Fig. 5. The position of the two flat-head machine screws used for mounting should be figured closely, as the hole for the index pin will be drilled between them later. Actual indexing of both stop rods and the tool head is controlled by a hardened steel pin under spring pressure, which engages in conical recesses in the tool-head top and index plate. The feed mechanism is a simple arrangement of levers, permitting a feed of about $3\frac{1}{2}$ in. The short lever should be positioned to ride on the tail nut, which supplies a support. The endpiece of the ram is held in place by a setscrew, and is drilled to slide over the uppermost stop rod.

Typical setups: A typical setup using the six-position turret is shown in Figs. 6 and 7. Fig. 8 shows the job—a plain brass bushing with recessed ends to take packing rings. Preparatory to turning, the 1-in. bar stock used is sawed to length, allowing about $\frac{1}{16}$ in. for trimming. Then the work

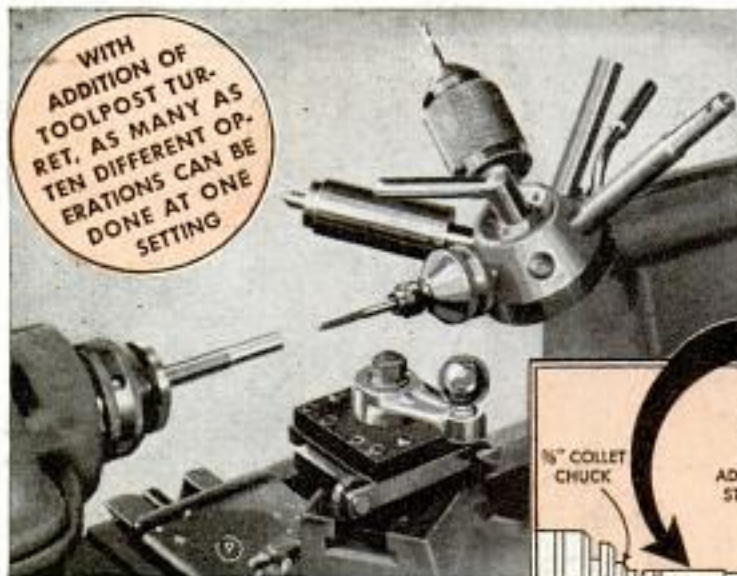

is chucked in a three-jaw chuck, and the various tools in the turret head are brought into play in succession to complete the required shape. Turret positions 4, 5 and 6 repeat on the opposite end of the work after rechucking. The turret head is released for each new station by releasing the clamp handle and then rotating the tool head until the index pin clicks into position. The corresponding stop rod is indexed with a flip of the fingers.

Figs. 9, 10 and 11 picture another simple setup. In this case, the job is an aluminum guide post as shown in Fig. 10. Bar stock is used and is fed in suitable long lengths through a collet chuck, turret position A, controlling the advance of each new piece. Other operations follow in rotation, as can be seen in Fig. 11. It will be noted that four of the operations in this setup are worked from a four-position tool post turret. Placement of this device for the various cuts should be controlled by swinging stop links clamped to the lathe bed and cross slide.

Determining tool lengths: An important part of any turret setup is the determination of suitable working tool lengths. If the setup is made by fit-and-try methods, one or more tools may be found to be too long or too short to permit working. A chart similar to the one shown in Fig. 12 should be made up for each new job. This sample applies to the job shown in Fig. 11. Columns 1, 2 and 3 of this are self explanatory. Column 4 is obtained by subtracting the feed needed by each tool from the maximum feed. Thus, if the maximum feed is $3\frac{1}{2}$ in. and the feed required for turret position No. 2 is $\frac{3}{4}$ in., the figure opposite No. 2 station on the chart will be $2\frac{3}{4}$ in. Column 5 shows a heavy box in which is marked the length of the longest tool used



OPERATIONS IN MAKING THIS PIECE

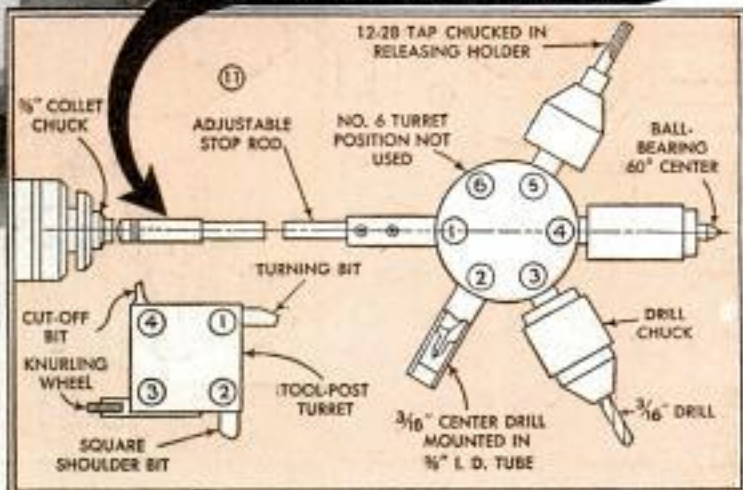

Turret Position	Job	Feed Needed	Max. Feed Less Feed Needed	Tool Length
1	Stop Rod	0"		
2	Center Drill	$\frac{3}{4}$ "	$3\frac{1}{2}$ "	$2\frac{3}{4}$ " to 6"
3	Tap Drill	$\frac{3}{8}$ "	$2\frac{1}{2}$ "	$3\frac{1}{4}$ " to 6"
4	Tail Center	$\frac{3}{8}$ "	$2\frac{1}{2}$ "	6"
5	Tap	$\frac{3}{8}$ "	$3\frac{1}{2}$ "	$2\frac{3}{4}$ " to 6"
6	Open		$2\frac{3}{4}$ "	$3\frac{1}{4}$ " to 6"

12 CHECK CHART TO DETERMINE TOOL LENGTHS

in the setup, as measured from the face of the turret to the end of the tool. From this figure (6 in. in this case) are subtracted the figures in column 4. The result in each instance is the shortest possible length of each tool, and the bushing or other holding device used for the tool, should be made or arranged so that the total length of the tool comes between the minimum and maximum length. Altogether, this sounds a bit complicated, but you will find it quite simple and a real timesaver in making setups. Obviously, if fittings already available show short on two or more turret positions, it is advantageous to reduce the length of the longest tool. In actual work, this usually will be a drill or reamer held in a chuck, and shortening can be done by rechucking the drill or reamer in a solid bushing.

Four-position turret: The four-position turret is a simple device with less scope than the six-position turret, but nevertheless a good accessory. As shown in Figs. 13 and 14, it is fitted with a Morse taper shank and is mounted and worked in the

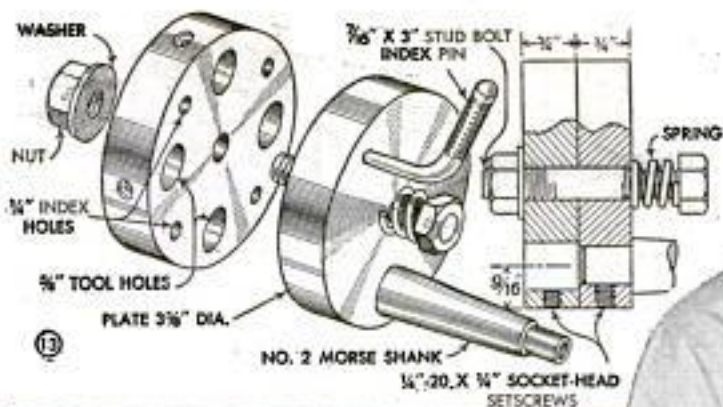

FOUR-POSITION TURRET IS EASY TO MAKE

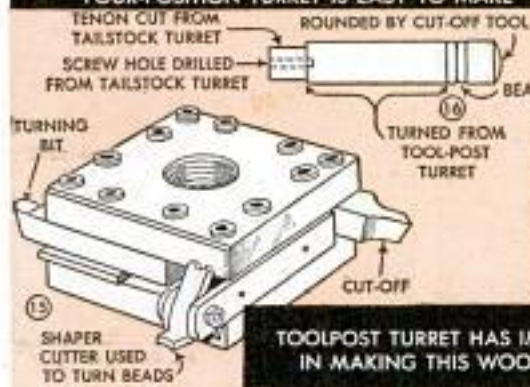

TOOLPOST TURRET HAS IMPORTANT PART IN MAKING THIS WOODEN HANDLE

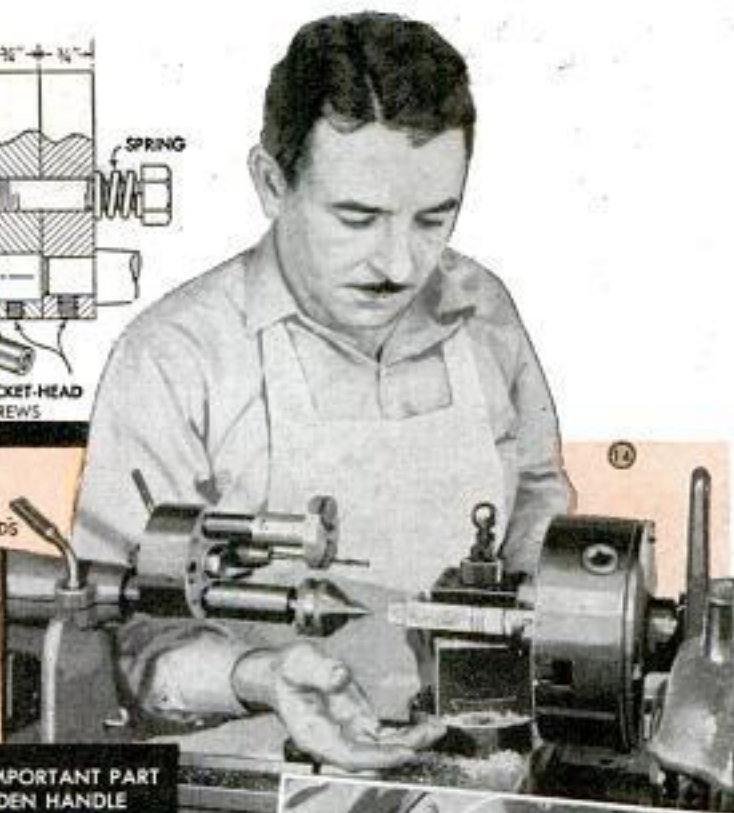

regular lathe tailstock. However, it is apparent that the same turret could be used with the same feed mechanism previously described for the six-position turret. In making this turret, the center hole for the stud is drilled first, after which the two plates can be mounted on the stud and turned, Fig. 17. The index holes are made by first drilling a hole at any point in the back plate and then moving it a quarter turn to drill each of the four holes in the front plate, Fig. 18. As in the six-position turret, drilling of tool holes comes last, with the head setup and indexed in the same position as it will take in actual work, Fig. 19.

A sample job with this turret is shown in Figs. 13, 15 and 16. The 3/4-in. dowel stock used is fed through the lathe headstock spindle. After drilling and tenoning the work from the tailstock turret, the toolpost turret is brought into action, the work meanwhile being supported by a spinning center mounted in the turret.

Duplex semi-turret: The duplex semi-turret is a two-position tool holder, simple and practical for such jobs as drill-and-ream, drill-and-counterbore, drill-and-tap, etc. The one shown in Fig. 21, is made from a 1/2-in. 90-degree pipe elbow, which is machined flat in the lathe, as shown in Fig. 22. The sample operation with this turret, as pictured in Fig. 20, is a simple drill-tap and cut-off job on a brass rod. The method of tapping is worth noting. The tap is held in a bushing made to fit an inexpensive type of ball-bearing spinning center. By holding the spinning center stationary by hand, the tap can be fed into the work by pushing the tailstock. After cutting to depth, the spinning center is released, allowing the tap to spin with the work. Then

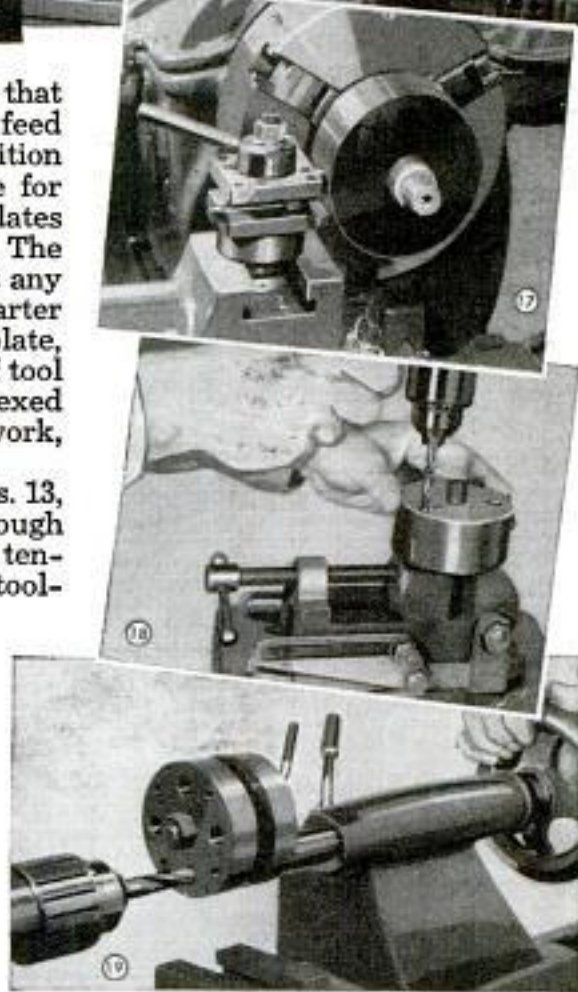

the spindle is reversed to back the tap out of the hole. This method is practical on brass and aluminum; steel, too, when the tap is not over 1/4 in. diameter. With a suitable bushing holder, the same setup can be used for small dies.

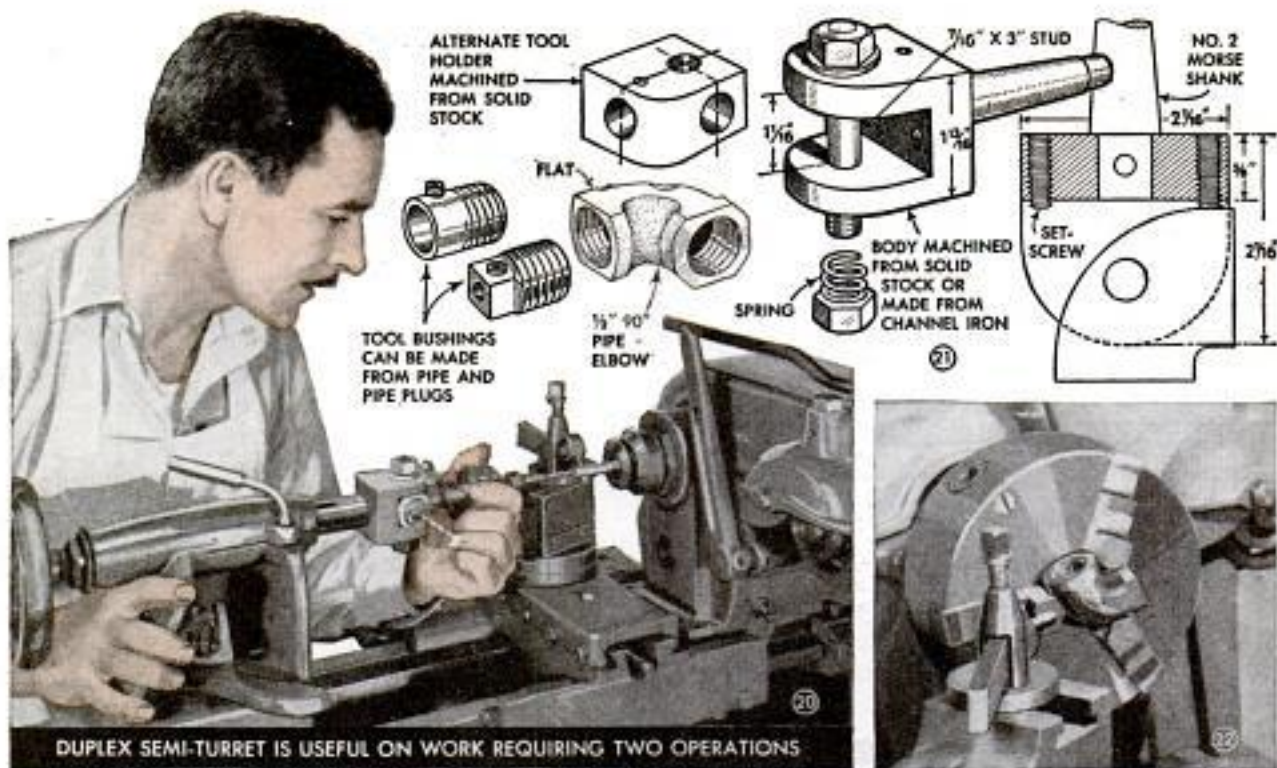

DUPLEX SEMI-TURRET IS USEFUL ON WORK REQUIRING TWO OPERATIONS

<i>Turret Tooling</i>	
SUGGESTIONS FOR VARIOUS JOBS	
JOB	TOOL OR METHOD
DRILL	USE DRILL CHUCK OR MAKE BUSHING TO FIT
REAM	REAMER CAN BE HELD SAME AS DRILL, BUT FLOATING TYPE OF HOLDER SHOWN IS BETTER
BORE	BAR OR SOLID CUTTER ADJUSTABLE HOLDER
COUNTER-BORE	USE STANDARD COUNTER-BORES. BUSH TO FIT HOLES IN TURRET
FACE	MAKE OR BUY TWO-BLADE CUTTERHEAD. END MILLS CAN ALSO BE USED
TURN	SIMPLEST SET-UP IS TO DO ALL TURNING FROM TOOL-POST TURRET. HOWEVER, A PLAIN TURNER FOR USE IN TAILSTOCK TURRET OFTEN CAN BE USED TO ADVANTAGE BUSHING
CENTER SUPPORT	USE 60° PLAIN OR BALL-BEARING CENTER PLAIN B. BEARING
MILL	THREE AND FOUR-FLUTE HOLLOW MILLS ARE EXCELLENT FOR END-TURNING TO DIAMETER
THREAD	LIGHT WORK CAN BE DONE BY MOUNTING TAP OR DIE IN BALL-BEARING CENTER AS SHOWN IN FIG. 20 AND EXPLAINED IN TEXT. FOR HEAVIER CUTS, A HOLDER WITH BUILT-IN RELEASING CLUTCH SHOULD BE USED BUSHING

Turret tooling: Tooling up for any particular job is largely a matter of head-scratching, more or less simplified by the variety of standard tools you have on hand. While it is possible to buy over 200 types of special turret tools covering every conceivable type of operation, the money involved is not usually justified on short-run work. Most setups with the light-duty turrets described are standard lathe items or fittings that can be made readily. The chart at the left covers several standard operations as done with simple tools, and it will be found that most jobs come within this list. The less expensive turret tools, which may be purchased if desired, include a floating reamer holder, an adjustable reamer holder (rigid type with adjustment for exact centering), a plain turner and a facing tool. Releasing tap-and-die holders, which spin with the work when feed pressure is removed, are not too expensive and are a worthwhile investment when considerable threading is to be done. Most expensive and most versatile of the commoner turret tools is the box tool (not shown) used for turning to diameter, chamfering, forming, etc. Except on continuous production, it is more economical to substitute turning from the tool-post turret for all cuts commonly done with box tools on heavy turret lathes.

When heating a soldering iron in a gas or charcoal furnace, it is easy to determine from a distance when the iron is ready for use if you observe the color of the flame, which will be a bright green when the iron is hot enough to flow solder.

Handy Torch Used to Fire Weeds And Piles of Brush

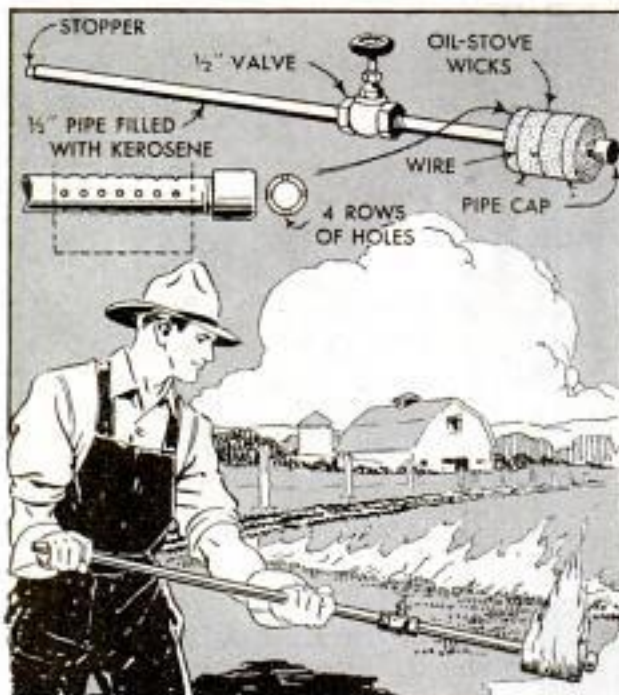

One farmer who fires brush piles and burns dead grass and weeds from his pastures uses this torch for starting the fires. The torch consists of a length of $\frac{1}{2}$ -in. pipe, which is fitted with a valve and capped at one end. Four rows of small holes are drilled near this end, and several wicks from an old oil stove are wrapped over the holes where they are held with wire. The part of the pipe between the valve and the other end is filled with kerosene, which is retained by a cork stopper. In use, the valve is opened to wet the wicks with kerosene. After the wicks have been ignited, the flame is controlled by the valve. The torch is extinguished by smothering the flame.—James Vick, Church Road, Va.

Shock Absorber for Pilot Light

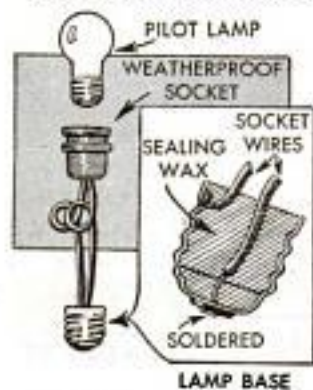

The life of a pilot light, mounted on machinery subject to vibration, can be lengthened if the vibration is prevented from being transmitted to it. This can be done by mounting the lamp as shown. A weatherproof socket is connected to an attachment plug by means of two wires, which then are coiled to act as a flexible shock absorber. Where the lamps used are of such size that no sockets or attachment plugs are available, a substitute may be made as shown

in the lower detail. A socket of the proper size to fit the pilot lamp, with wires attached, is connected to a discarded lamp base by soldering the wires to the metal shell and to the metal center contact, and filling the base with melted sealing wax.

—Thomas Trail, Baltimore, Md.

Glass Plate on Job-Press Table Keeps Checking Copy at Hand

The make-ready of a job on a platen printing press often requires reference to an original copy, which may become badly soiled in handling or even become lost before the work is completed.



To avoid this possible trouble, one printer put a piece of glass on the press table and kept the copy under it. Also, the glass permits easy checking with the original copy on long runs of color printing where several runs are required to complete the job.

Employees' Arrival and Departure Recorded on Plywood Indicator



This indicator board shows at a glance at what time any salesman or other member of the personnel left the office and when he is expected to return. Mounted at a convenient angle is a piece of plywood ruled into columns, the first column to be used for the employees' names and the others for the hours of the working day. In each of these hour columns holes are drilled, each hole representing a 15-min. interval from 0 to 45 minutes. A golf tee or other suitable peg is then inserted in the hole corresponding to the 15-min. period during which an employee left the office, and another such peg, colored differently, is placed in the hole which indicates the period in which he is expected to return.



Radio

HINTS FOR HOME RECORDING

HOME recordings, or "snapshots in sound" as some prefer to call them, make permanent records of your baby's first words, birthday greetings and "letters" of spoken words to mail to distant friends and relatives. Similar recordings are made in teaching music and speech.

Owners of home recording apparatus, and phono-radio combinations with built-in record-making facilities sometimes encounter difficulties through lack of proper instruction, as they usually depend on short demonstrations given when they purchased the instrument.

The blanks, or "recordises," come in various sizes and thicknesses, coated and ready for cutting. A magnetic recording head is shown in Fig. 1; the armature is suspended in rubber with a stiff bearing at the bottom and a flexible damping block at top. Motion is imparted to the stylus as the armature vibrates in response to the alternating current in the coil. It is a delicate cutting tool and must be adjusted correctly. See that the stylus is inserted all the way into the cutting head with the flat side of the shank facing the thumbscrew. The cutting face of the stylus must be perpendicular to the disk, Fig. 2. Figs. 3, 4 and 5 illustrate and explain typical troubles.



FIG. 3

Bent or misshapen recording blanks sometimes produce a "skip" pattern when the recording head is unable to cut a "low" area after bouncing upward over a "high" portion of the blank

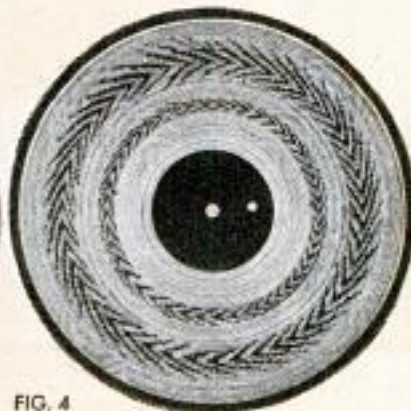

FIG. 4

Vibrations in the recording machine produce a "moire" pattern. Other common causes may be hum in the amplifier, dirt in the cutting mechanism, worn drive-wheels or overloaded motors

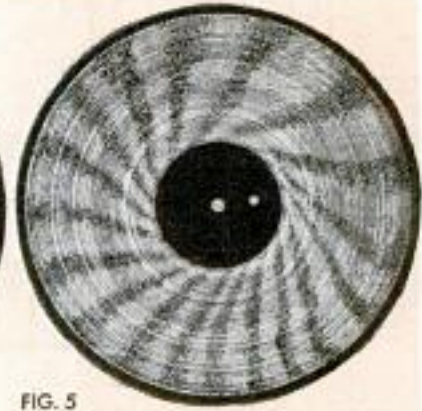

FIG. 5

Another "imperfect" pattern to watch for is the "spoke" design. Usually caused by overloaded motors or vibrations due to worn drive gear

DUAL PHONO UNIT

Part II



CONTINUING with the construction details for the amplifier section of this electronic dual phono unit and public address system, please note that the tube sockets are recessed by the same method that was employed to mount the rectifier tube in the power unit diagram Fig. 2 that appeared in the August issue. By means of this arrangement it is only necessary to remove the hoods from the pilot lamps in order to close the case. A short length of rubber tubing placed over the center pins prevents the turntables from falling.

The amplifier consists of a 6SJ7 tube as a pre-amplifier feeding into a 6P5 triode, and its output is paralleled with the output of both triode sections of the 6Y7-G tube. The input grids to the 6Y7-G are used for each individual pickup. The output of the 3 paralleled triodes is then coupled to the 6AD7 tube in a phase inverter stage, which,

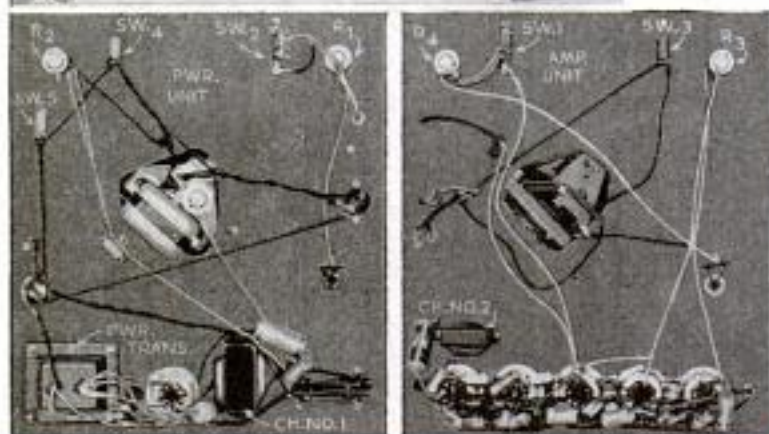

Fixed Resistors			
2-250M ohm	1/2 watt carbon	R5, R6	
1-1.5 megohm	"	"	R7
1-3,000 ohm	"	"	R8
1-1,500	"	"	R9
3-25M	"	"	R10, R11, R12
1-50M	"	"	R13
1-330M	"	"	414
1-120M	"	"	R15
1-150M	"	"	R16
1-470M	"	"	R17
1-3 megohm	"	"	R19
1-400 ohm	5-watt wire-wound	R-18	

Note - M = thousand

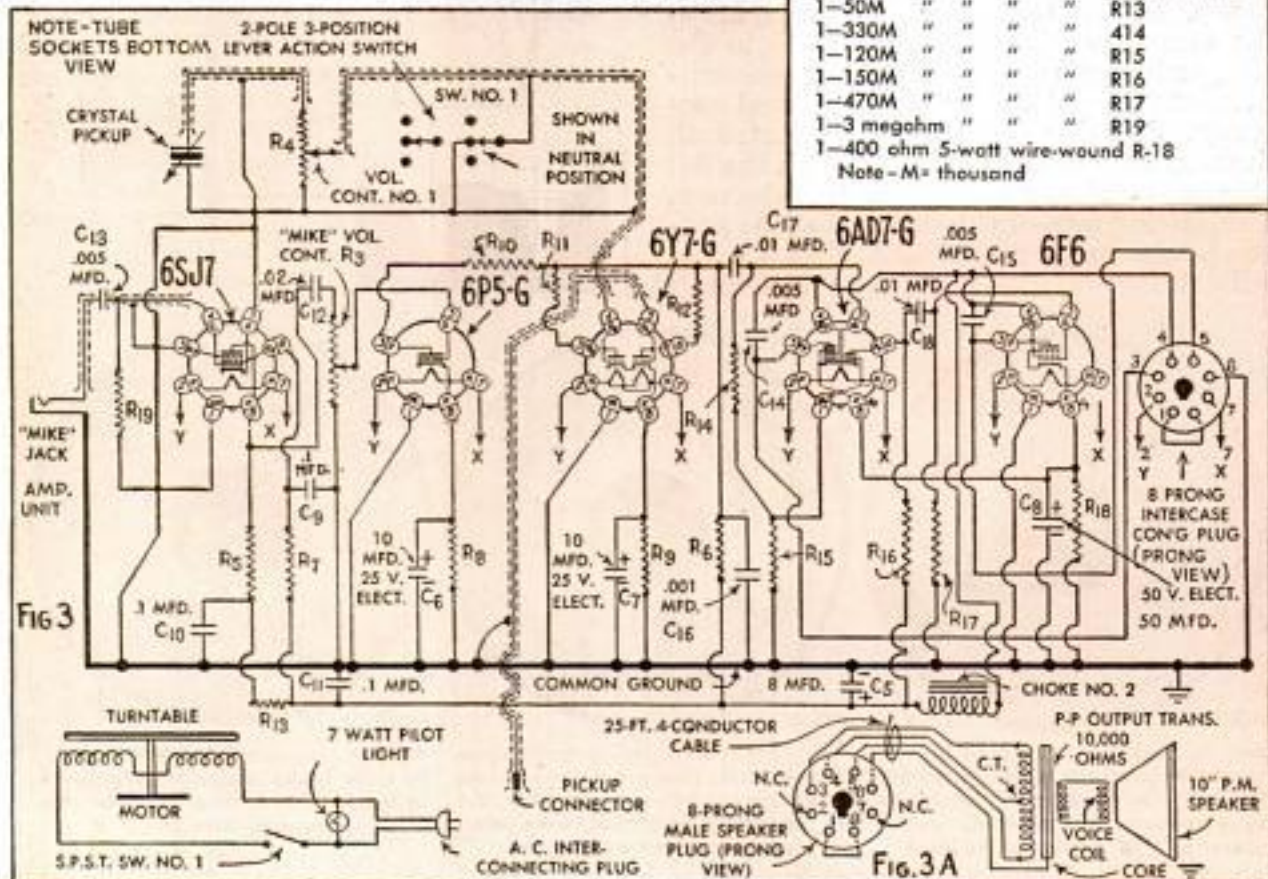

HAS ELECTRONIC CONTROLS

with the 6F6, provides the push-pull output stage. Students will note in Fig. 3 that the phase inverter triode is part of the 6AD7 tube, the other portion being equivalent to a 6F6 output pentode.

Pictorial wiring diagram Fig. 4 shows all amplifier controls and wiring details. The Amphenol socket mounting shells are all connected together at common ground and substitute for a metal chassis. Choke No. 2 is a common 300-ohm type; all unmarked condensers are 600-volt tubular paper types. Detailed student material list R-327 is available from Popular Mechanics radio department, upon receipt of postage. By referring to all diagrams it will be noted that the interconnecting sockets are interchangeable; the a.c. line circuit cannot be completed until both the speaker and amplifier are plugged in for proper load.

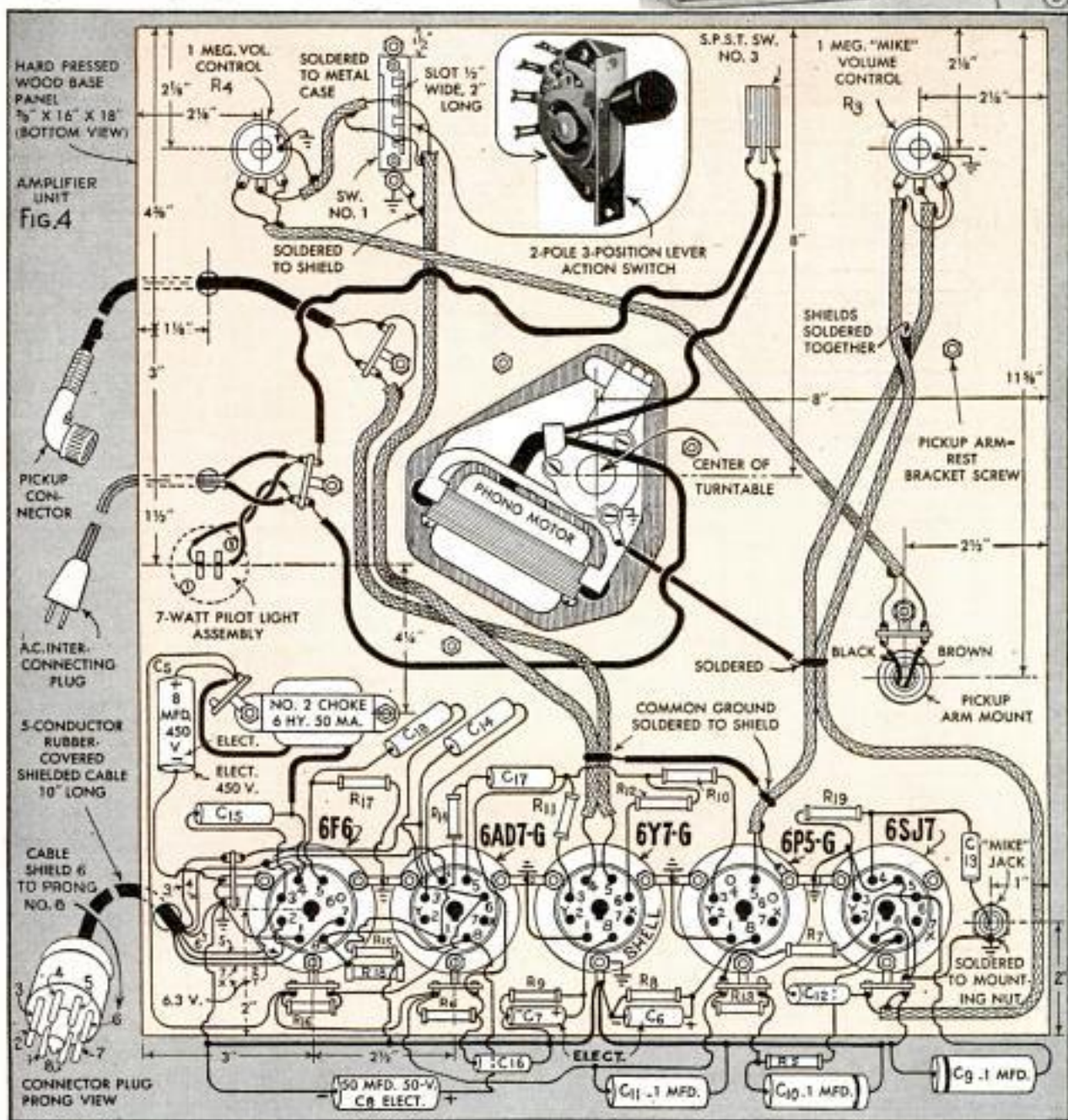
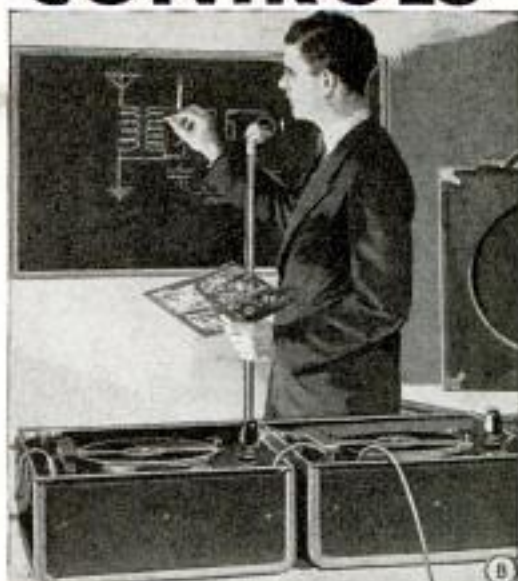

Ultra-Short-Wave Receiver in a Tobacco Tin

By L. B. Robbins



DESIGNED for those who like to construct miniature radio apparatus from odds and ends of parts, this tiny 2½-meter receiver is housed in a 1½-ounce tobacco tin, and is useful in WERS activities.

Two 1½-volt "penlite" cells are connected in parallel for the A-battery and these are easily renewed by means of a simple clip arrangement illustrated in Figs. 2 and 3. The most important part of the chassis is detailed in Fig. 1. This piece of flat metal is shaped to make a close sliding fit.

Pictorial wiring diagram Fig. 3 shows all parts and wiring in a "cutaway" view. The positive A contact strip with clips is cemented to the fiber strip which in turn is cemented to the inside of the lid. Coil L₁ turns and spacing must be determined by test to gain the spot in the 2½-meter band between 112 and 116 megacycles where the tuning condenser C₁ is effective with a 4-ft. antenna. Tuning is done by means of a fiber "screwdriver." The schematic circuit diagram appears in Fig. 3-A and Fig. 5 and the completed assembly is shown in Fig. 4. Any miniature tube that will operate at ultra-high frequencies may be used. Assemble and wire the parts flat on the bench first and make all tests before mounting the chassis in the can. A hearing aid type B-battery can be employed. The r.f. choke is a 2 mh. type; the coil tap point near plate end being determined by trial. Grounds may be soldered to the can by pushing the wire through holes and soldering outside.

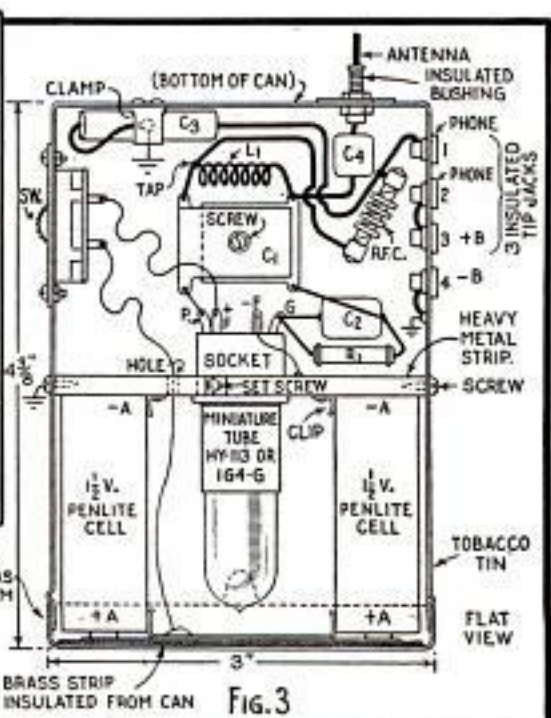
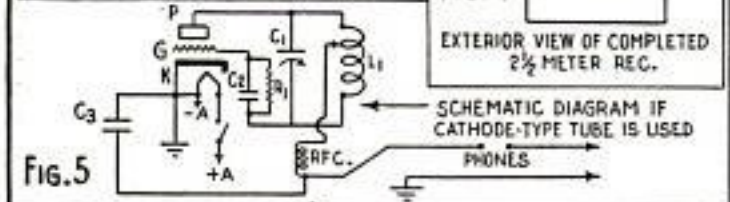
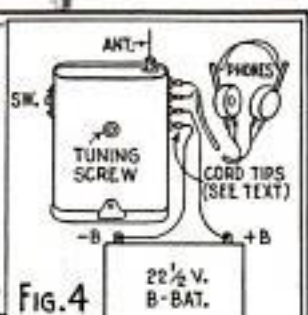
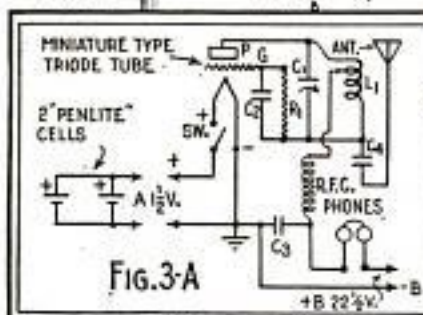
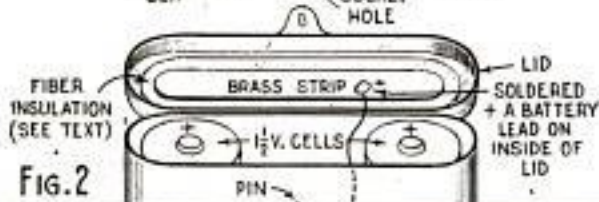
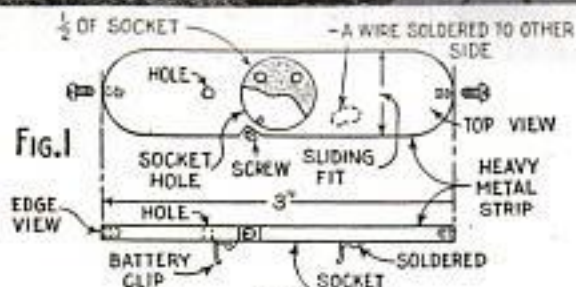

- C₁ = 3-30 MMFD. TRIMMER CONDENSER
- C₂ = 50 MMFD. MIDGET MICA CONDENSER
- C₃ = .01 MFD. PAPER CONDENSER 300 V.
- C₄ = 50 MMFD. MIDGET MICA CONDENSER
- R₁ = 5 MEG. RESISTOR, ¼ WATT
- R.F.C. = UHF. R.F. CHOKE OR OHMITE TYPE Z-O
- SW. = SLIDE SWITCH
- L₁ = 3-4 TURNS NO. 16 WIRE SPACE WOUND ON 15" FORM

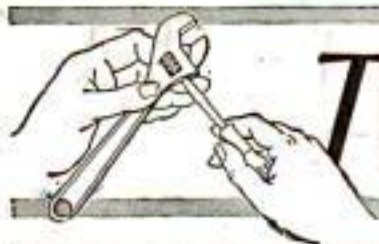

TOOL NOTES

Maintenance
and Repair
Suggestions to
Prolong Tool Life

No. 18 PICKING THE PROPER TOOL FOR THE JOB

With Hacksaws, the question of picking the proper type concerns the blade more than the frame. However, reasonable judgment should be exercised in choosing a saw for a specific job.

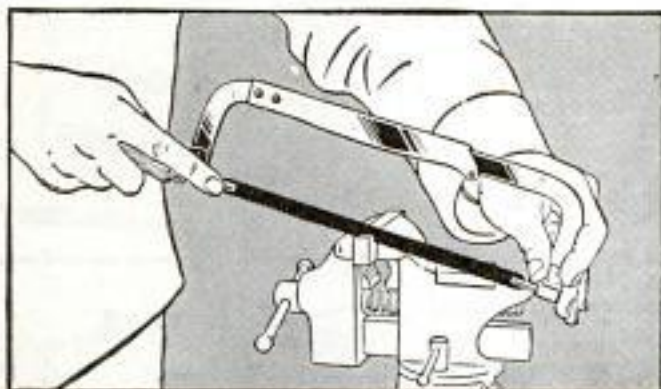

Crescent's No. 1042, for example, is relatively light and is intended for average rather than heavy duty service. Depth of cut is another matter to be considered. The frame above cuts only to a 2-1/2" depth, which might not be sufficient for the job at hand.

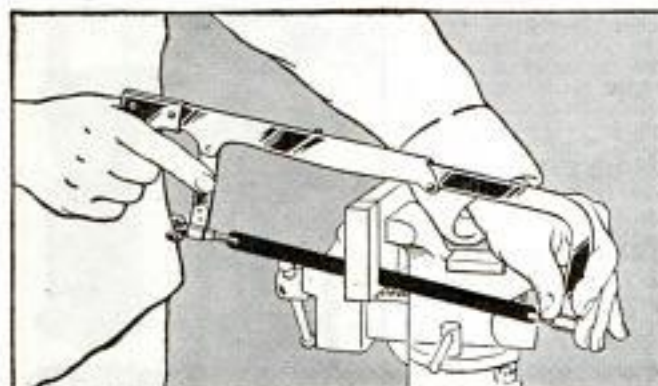

Crescent's No. 1047, with its heavy rigid frame, on the other hand is designed for the hardest work imaginable. Its 3-1/4" depth of cut is sufficient for the job illustrated and its big, comfortable, pistol-grip handle enables the operator to put more power in the cutting stroke.



Blades are made with a varying number of teeth per inch, ranging from 14 to 32. Selection of the blade should be based upon material to be cut. Blades with 18 teeth per inch are the best for general use, but there is no such thing as an "all-purpose" blade.

USE 14 TEETH PER INCH	IRON SOFT STEEL RAILS
USE 18 TEETH PER INCH	TOOL STEEL IRON PIPE LIGHT ANGLE
USE 24 TEETH PER INCH	COPPER BRASS MEDIUM TUBING SHEET METAL
USE 32 TEETH PER INCH	THIN TUBING THIN SHEET METAL

Select your blade according to the above chart. Never permit a condition wherein the teeth "straddle" the work. Use a blade of finer pitch or change the angle between blade and work so at least two teeth are always engaged. Have work securely held when sawing.



MAIL THE COUPON TODAY!
This is No. 18, in Crescent's TOOL NOTES Series. These informative advertisements provide practical information for users of hand tools.

Crescent Tool Co., Jamestown, N. Y. H-6

Please send your "Tool Notes" Series
 for Bulletins for 3-ring binder

Name _____

Address _____

City _____ State _____

CRESCENT TOOLS

Give Wings to Work

CRESCENT TOOL COMPANY, JAMESTOWN, N. Y.

EXTRA

THE *Delta*gram

EXTRA

SEPTEMBER 1, 1944

MILWAUKEE, WISCONSIN

200 PRIZES GIVEN AWAY FREE IN DELTA POST-WAR SHOP PLANNING CONTEST!

You Have a Chance to Win

Here are the Rules Be sure to read them!

1 The contest is open to any person of any age (male or female) residing in the United States or Canada, except employees of The Delta Manufacturing Co., dealers and distributors of Delta products and their employees, employees of Delta's advertising agency, and members of the immediate families of any of the above.

2 Entries are to consist of a floor plan or layout of the entrant's proposed post-war homecraft shop showing position of power tools, workbenches, and other major equipment, together with a statement giving the following information:

- Reasons for adopting layout and equipment shown in floor plan.
- List of power equipment now owned.
- List of power equipment planned for purchase after the war, the prices you would pay, and name of store where purchase would be made.
- List of hand tools and other accessories now owned.
- General type of work to be done in the shop.

3 Entries will be judged on their suitability to the type of work to be done, efficiency and ingenuity of arrangement, and use of space available. Neatness and clearness will count, but not costliness or elaborateness of the proposed shop, or elaborateness of the presentation.

4 All entries must be postmarked not later than midnight Tuesday, October 31, 1944. They are to be mailed to Contest Editor, The Delta Mfg. Co., 681K E. Vienna Ave., Milwaukee 1, Wis. Entries become the property of The Delta Mfg. Co. to be used as they see fit, and none can be returned.

5 Decision of the judges will be final. In case of ties, duplicate prizes will be awarded.

6 Contestants are limited to one entry. If more than one entry is submitted by a contestant, only the first one received will be considered.

7 Final judging will be done by:
William Bachrach, Regional Coordinator of Engineering, Science and Management, War Training.
E. R. Haan, Technical Editor, Popular Mechanics.
Harry Walton, Home and Workshop Editor, Popular Science.

★ **1st Prize** ★
Your choice of \$1,000.00 in Delta Equipment—(retail value) Enough to have a complete Delta-equipped homecraft shop you can really be proud of!

★ **2nd Prize** ★
Your choice of \$500.00 in Delta Equipment—(retail value)

★ **3rd Prize** ★
Your choice of \$250.00 in Delta Equipment—(retail value)

★ **4th to 8th Prizes** ★
Your choice of \$75.00 in Delta Equipment—(retail value)

★ **9th to 20th Prizes** ★
\$10.00 worth of Delta Accessories and/or Supplies!—(retail value)
(Merchandise certificates will be awarded to winners entitling them to prizes when materials required for making Delta equipment are released by the government.)

★ **21st to 40th Prizes** ★
Set of 27 Deltacraft Project Books and Manuals! \$4.50 value!

★ **41st to 60th Prizes** ★
Set of 6 Delta Tool Manuals — Value \$1.50!

★ **61st to 200th Prizes** ★
1 Year's Subscription to The Delta-gram!
Value 50¢.

Here are the Prizes!

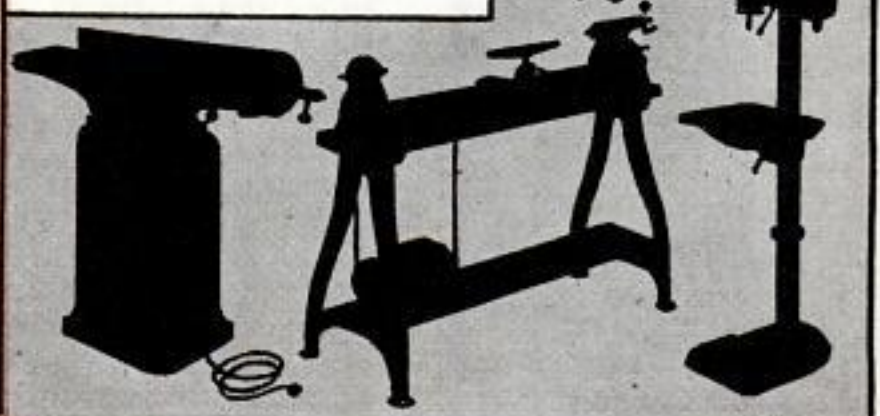

★ **1st Prize** ★

\$1,000⁰⁰ in Delta Equipment
(Retail value)

for a Homecraft Shop!

**Nothing to buy! No entry fee!
You don't have to be an expert to win!**

Think of the thrill of winning \$1,000.00 worth of famous Delta equipment (post-war delivery)! Or one of the many other valuable prizes in this big contest!

And think of the fun, the healthful recreation you and your family can get from these tools, as you create things of beauty and utility out of wood and metal and fascinating new plastics!

Here's How to Get It!

All you have to do is to put down on paper your idea of a practical homecraft shop. Maybe it's that shop you've been dreaming about — or perhaps it's an improvement on the one you now have.

Whatever it is, simply send us a sketch of the floor plan (don't worry, we don't expect a mechanical engineer's finished drawing)—together with a statement covering the points given in the rules shown here.

Well Worth Trying For!

You haven't anything to lose by entering this contest — except the little time and trouble you take to get your entry ready. But you do have a lot to gain!

Delta homecraft power tools — made by the largest manufacturer of power tools for the homecraft shop — are truly fine tools. They're *accurate*—they're *dependable* — they're *safe*.

It's Up to You!

Now, whether *you* win these dandy Delta prizes—or whether someone else wins them — depends solely on *you*. Certainly you can't win, if you don't enter the contest. But you *do* have a chance, if you do send us your plan.

So read the rules now. Then, get a head-start on the others by going right ahead preparing your entry.



Some Helpful Tips that may make YOU one of the winners

To start you off on the right foot, we're going to tip you off here to some of the things the judges will look for. The judges, incidentally, are recognized authorities, not connected with The Delta Manufacturing Company. They will have the final say-so on the winners.

Check off the items as you include them in your plan. That way, you won't forget anything.

- Include a floor plan or layout of your proposed post-war homecraft shop, showing location and position of the power tools you would use. Indicate the size of area it would cover.
- List the power tools you think should be part of a complete homecraft shop.
- List the Delta power tools that you would like to get after the war. Give the name of the store where you would be likely to make such purchase.
- List the power tools — if any—that you now own.
- Are any of the following materials difficult to obtain in your locality during normal times? Wood? Paint? Finishes? Hardware? Plastics?
- What kind of tool racks, paint racks, storage bins for nails, screws, etc., would you recommend? How about lumber storage?
- Do you prefer to work in wood? Metal? Plastics? Or combination of all?

The above are simply suggestions. Include any other material that you think can help put you among the winners.

BUILDING AIR POWER WITH ELBOW GREASE



Photo courtesy Republic Aviation Corp.—
Special-file operation on edge of casing.

THE mass-production of airplane, tank, truck and engine parts by automatic-machine operations excites wonder. But it still takes human skill, good hand tools and plenty of "elbow grease" to "put things together." Knowing the *right* tool for each job is of first importance in any mechanical "I.Q."

Files . . . there are *several thousand* kinds, cuts and sizes. Yet, to keep up with the new materials and production problems of this skilled-mechanics era, Nicholson still finds needs for files of new design or characteristics.

FREE BOOK, "FILE PHILOSOPHY"—for production and purchasing heads, foremen, key mechanics.

NICHOLSON FILE CO., 22 Acorn St., Providence 1, R.I., U.S.A.
(Also Canadian Plant, Port Hope, Ont.)

NICHOLSON FILES FOR EVERY PURPOSE

NICHOLSON
U.S.A.
MADE IN U.S.A.

Picking the Target

Continued from page 31

ed a mission and has film left he takes a few extra shots while zigzagging home. That was how the synthetic rubber plant at Huls was discovered. The photographs showed a large camouflaged factory using great quantities of coal and oil. The interpreters guessed the plant was making Buna rubber. This was confirmed by study of the type of plant required along with a study of the layout of the factory at Huls.

The photo-interpreters went so far as to select vital points within this strategic target, such as the boiler house. One expert even determined the amount of pressure in the boiler from enlarged photographs. When the crews of Flying Fortresses were briefed for this target, they were shown detailed photographs with the boiler house as the prime target. When pinpoint bombing struck, its accuracy was proved by steam that shot a mile into the air.

Photo-reconnaissance units in England have a long list of targets which they photograph at varying intervals. These include more than 400 air fields, two other synthetic rubber plants besides the one at Huls, 29 submarine building yards, numerous aircraft factories and scores of others. Pictures of the flight strips adjoining aircraft plants have given our combat pilots their first views of every new model introduced by the enemy. Also high on the photo-reconnaissance priority list are radar stations and radar manufacturing plants. The radio detection factory at Friedrichshafen was bombed after an enlarged photograph showed 250 pairs of the basket-type apparatus lined up in the open beside the plant.

One of the toughest jobs handled by U. S. photo-reconnaissance pilots was to "shoot" 100,000 square miles of territory in the South Pacific. Until this was done, the only available maps were more than 50 years old. The new maps have pointed the way for both island-to-island and leap-frogging tactics, and the aerial photos have made Jap defenses an open book.

When headquarters wants pictures in a hurry they are developed on the planes in a few minutes and dropped in containers with sponge rubber shock absorbers.

High ranking officers such as Generals Eisenhower, Spaatz, and Doolittle, have repeatedly heaped praise on photo-reconnaissance units. Every pilot, although he flies without guns, is said to be directly responsible for destroying at least 10 enemy planes. That should make them aces in any man's war.

INSIGNE OF THE CORPS OF ENGINEERS



WHERE PERFORMANCE REALLY COUNTS...



Dependable

... CHAMPION SPARK PLUGS ARE IN THE VANGUARD!

When the Corps of Engineers take hold, things move. Masters, of every type of engine-driven vehicle and power equipment, dependability is the measure of everything they use. That's why Champion Spark Plugs are on active duty with the Engineers, as they are with every branch of our armed forces on land, water and in the air; for dependability



has been Champion's hallmark for more than thirty years. When you need new spark plugs, demand dependable Champions. Remember, too, that all spark plugs should be inspected, tested and cleaned at regular intervals for maximum engine efficiency and economy.

Champion Spark Plug Company,
Toledo 1, Ohio.



TO SAVE
GASOLINE
—KEEP SPARK
PLUGS CLEAN

BUY MORE AND MORE WAR BONDS UNTIL THE DAY OF VICTORY

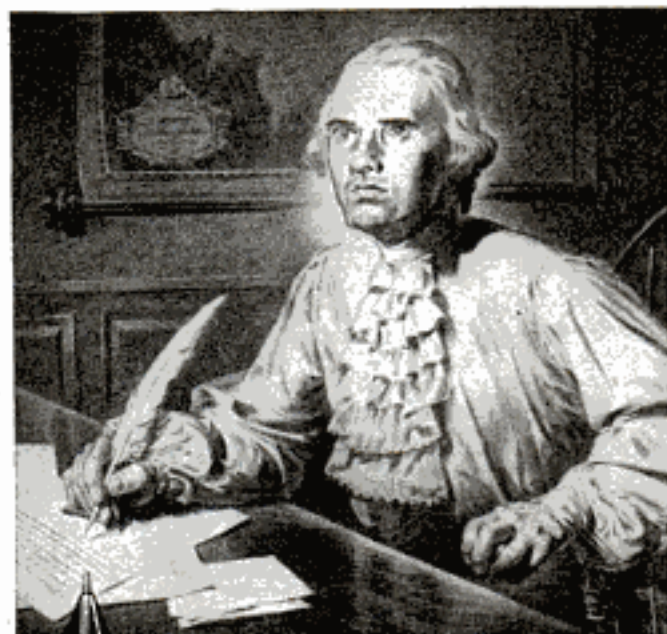

THE PASSION of great purpose

With white heat in his mind, and the passion of great purpose . . . Thomas Jefferson in 1776 drafted the Declaration of Independence . . . using goose quills for pens.

Today no man needs pointed feathers or any other antique implement for writing. Because in Inkograph he has an indomitable pen to pace his swiftest thought . . . with a point that pressure will not injure . . . fast acting, reliable, adapted to any hand—dependable for years.

Inkographs are preferred by men in service. So if your dealer doesn't have one, keep trying!

The name Inkograph on the barrel identifies the genuine. Sorry, no mail orders—only dealers can supply you.

Use any pen to sign up for more
WAR BONDS!

INK-O-GRAPH²

Inkograph Co., Inc., 200 Hudson St., N. Y. C. 13

First Aid for Wounded Warships

Continued from page 53

case of additional damage. Men go down into the flooded compartment in shallow water diving outfits. They locate the hole in the hull, place mattresses over it, and secure the mattresses in place with timbers. Then the water is pumped out, sometimes by a submersible electric pump.

One of the handiest tools the damage control men have is a new portable jack-of-all-trades device called a velocity power tool. This machine will punch a hole in steel plate, pound down the head of a rivet in one blow, cut steel rope, splice the ends of steel rope, and do a variety of other jobs. It looks like an overgrown rivet gun and is loaded with an explosive cartridge. A special head for the job in hand is fitted to the tool and then the cartridge is fired, forcing the head to punch a hole or do other work. This power tool works in air or water.

Large warships have a "damage control central" to which damage is reported and from which assistance is dispatched. In addition, damage control parties are stationed at different points in a ship.

During a night battle against the Japs, the U.S.S. New Orleans was shaken by a terrific explosion. Down below, damage control men began to make their way forward along a passageway, when suddenly they found themselves staring out at the stars. One hundred and sixty-four feet of the ship's bow had been blown away when the magazine exploded. The ship's compartmentation kept her afloat and the engines were still able to turn over. After rigging a temporary bow of palmetto logs at a nearby island the New Orleans made her way to Sydney and thence to a United States naval yard where she was fitted with a new bow. Since then she has engaged in several operations against the enemy.

Time after time the Jap radio has announced the sinkings of portions of American naval task forces. "A Yankee battleship and two cruisers were sunk in yesterday's engagement," the Japs boast, believing every word of it. Their aviators had told them that the battleship was on fire and that each of the two other ships had taken a torpedo.

But more often than they know, the Japs are wrong. Damage control men had fought the fires, isolated and pumped out flooded compartments, and had made it possible for the ships to be worked back to repair bases. A few days or a few months later the same vessels were back in action. Perry's old slogan "Don't Give Up the Ship!" has taken on a new meaning.

Tough

BUT

OH SO GENTLE



Want a new car? Well, you can't get one. So you'd better take good care of the one you already have.

Wear-wise car owners watch the engine. They know that oil-pumping is a sign of worn-out piston rings—that neglect can lead to serious trouble.

Millions have learned that Hastings Steel-Vent piston rings stop oil-pumping, check cylinder wear, restore engine performance and gasoline mileage.

When your motor specialist recommends new piston rings, it will pay you to install Hastings Steel-Vents.

HASTINGS MANUFACTURING COMPANY • HASTINGS, MICHIGAN

Hastings Mfg. of Canada, Ltd., Toronto

★ *It's a privilege to buy War Bonds*

HASTINGS STEEL-VENT



PISTON RINGS

TOUGH on oil-pumping • **GENTLE** on cylinder walls

Will Your Car Outlast the War?

As a special wartime service to owners of **ALL MAKES** of cars, General Motors offers a new edition of *The Automobile User's Guide*, containing 196 practical suggestions on such subjects as *how to get better gasoline economy, how to prolong tire life, how to keep your car in the best operating condition, how to preserve exterior finish, etc.*



You can get your **FREE COPY** from any General Motors dealer or by using the coupon below.



Customer Research Dept., Room 1763
GENERAL MOTORS, DETROIT 2, MICH.

Please send **FREE COPY** of new 64-page
"AUTOMOBILE USER'S GUIDE"

Name
please print

Address
please print

City State

Make & Model
of Car Owned

Heroes of the Tin Cans

Continued from page 69

Main guns of destroyers are four- and five-inch, and all the newer ships have the Navy's new quick-firing five-inch weapons that are effective, horizontally, up to a range of ten miles, and vertically against planes, to five or six miles in the air.

Though every inch of space on a destroyer deck is at a premium, it must be made to accommodate from four to 16 torpedo tubes. Most effective at close range, torpedo action really comes into its own in battles such as that in Macassar Straits.

The night was dark and misty when a large Jap convoy was caught in the straits. The ships were massed, made to order for destroyer attack. And four destroyers, aided by planes and subs, did attack, knifing up and down, guns and torpedo tubes going full blast. At least four large transports were sunk, two medium transports possibly sunk, two transports damaged.

Thrilling chapters in destroyer history have been written when submarines were the only foe. One of these was in the Atlantic when the Borie went down after a terrific death struggle with two subs, part of which was fought at such close range that one member of the Borie crew, a fireman, David Southwick, knocked a German off the sub's deck with his sheath knife.

The Borie was one of the overage destroyers which have staged so remarkable a comeback after nearly 20 years on "Red Lead Row" with their bottoms painted with red lead paint and their machinery painted with preservative. Most of these vessels were built in the first world war, and now are doing duty as troop transports, minelayers, minesweepers, seaplane tenders and convoy escorts. The Dallas, the Cole, the Bernadou and the McFarland have been cited on at least two occasions—the landing of troops in the face of enemy fire in French Morocco, and the delivering of badly needed supplies to Guadalcanal.

Casualties among overage destroyers have been heavy. Ten of them have been lost in the Pacific, and another, formerly the Buchanan but later the British HMS Campbelltown after the 50-destroyer trade with Britain, lies in the harbor at St. Nazaire, France, where she was deliberately blown up to make the dock gates of this German-held sub-base useless.

The destroyer Ward fired the first shot against the Japs at Pearl Harbor when she sank an enemy submarine, the Greer was the first U. S. warship attacked by a sub in the Atlantic, and the Reuben James was the first sunk by a German torpedo.

AUTO-LITE SPARK PLUGS

IN SERVICE ON EVERY FRONT



"Pears like them Army fellers is buildin' a bridge . . . wonder what fer?"

PLAY IT SAFE...GET A "PLUG-CHEK"

To find out, quickly and accurately, whether your plugs are wasting gas coupons for you, drive in to your local Auto-Lite Spark Plug Dealer. Ask him for Auto-Lite's famous "Plug-Chek"—the scientific inspection service that helps spot the plugs that waste gas. You may find all that is needed is cleaning or regapping your present plugs. But if new ones are necessary, install Auto-Lites, the spark plug that's ignition engineered.

THE ELECTRIC AUTO-LITE COMPANY
TOLEDO, 1 • Merchandising Division • OHIO
BACK THE ATTACK—BUY WAR BONDS

Tune In
AUTO-LITE'S
GREAT RADIO SHOW
**"EVERYTHING
FOR THE BOYS"**

Featuring men and women at
the fighting fronts
Tuesday Night—NBC Network



"A Thing of Beauty
AND A
(SMOKING) Joy Forever!"

Just as fine embroidery deserves fine linen, so fine pipe craftsmanship deserves fine briar!

There is no substitute for imported briar from the Mediterranean region. So that's the material we give the master pipe-makers of LHS to work with—that and solid rubber bits, sterling silver bands, and years of pipe-making "know how".

LHS

STERNCREST

STERLING

Some things
haven't changed!

\$5

Smooth and Antique-Finish . . . many handsome models, each one numbered, registered and guaranteed by LHS.



No. 12
Golf Model

LHS

STERNCREST 14K

We select briar of rare grain and beauty, circle it with solid gold, and offer the Sterncrest 14K to the ultra-discriminating who want to own, and \$7.50 give, the ultimate in pipes.

All good pipe dealers carry LHS famous pipes

L. & H. STERN, INC., Stern Bldg., Brooklyn 1, N.Y.

Makers of LHS Ultra-line \$10 and Purex Pipes \$3.50, \$1.50

YOU WILL UNDERSTAND—Thousands of LHS pipes are now going to the armed services. If you can't always locate the LHS model you want, remember, any LHS is "Perfection in a Pipe."

Put this in your pipe and smoke it.

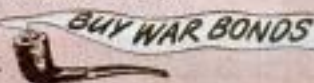

Smoke the Lifesaver

Continued from page 75

date. During this period no shipping was sunk and no serious damage ever accomplished by enemy bombers.

Such screens are generally created by the coordinated operation of one or more CWS smoke generator companies. As a rule, smoke pots are placed by the hundreds in an inner ring around the most vital areas to provide instantaneous screening. In an outer ring around the city are mobile mechanical generators which move back and forth to fill in any rifts in the screen.

Canned smoke comes in several forms. The M1 HC smoke pot, filled with hexachlorethane, weighs about 11 pounds and burns about six minutes, giving off dense clouds of white smoke. The HC M4 floating smoke pot, a larger version, is dropped from naval vessels. A five-gallon steel pail filled with hexachlorethane, the M4 burns for 10 to 15 minutes. The CWS has also just standardized a new 30-pound HC smoke pot which burns for 20 minutes. Smoke pots also have been used to mark off beachheads for landing forces, indicating to Naval artillery where not to fire.

Although primarily an antipersonnel weapon, the M15 white phosphorus grenade can also be used for laying small smoke screens. The M47 white phosphorus bomb weighing 100 pounds, used at Rabaul, presents a triple threat since the phosphorus acts as an incendiary, produces smoke and also harasses the enemy with flaming fragments which sear and cling to all persons within the bursting area.

Shells filled with white phosphorus smoke agent, a non-toxic chemical, are issued to the field artillery both for marking targets and for laying screens. The most effective is the versatile 4.2-inch chemical mortar, which can fire 20 rounds a minute at ranges up to two and a half miles.

The first historical reference to wartime use of smoke was the miracle whereby the Israelites were protected on their march from Egypt to the Promised Land. After the civil wars of the Roman empire, little was heard of smoke until 1632, when Gustavus covered his crossing of the Lech in face of Tilly by a smoke screen created from burning wet straw. The first use of smoke in the first world war probably was the burning of a haystack that enabled a British company to withdraw from the La Basse canal defense in October, 1914. By 1916, smoke shells were in use. Not until the battles of Arras, in 1917, were the art of accurate projection of smoke shells and their great value appreciated.

FIGHTING EDGE

U. S. Army pilots have flown more Allison-powered fighter planes into battle than planes powered by any other engine.

★ Pilots like Allison *reliability* to get there and back—*durability* to stand up under more fighting hours—*economy* to extend range—*smoothness* to reduce pilot fatigue. ★ This numerical superiority and these Allison qualities have added much to America's fighting edge. Thousands of enemy planes have been downed by pilots flying Allison-powered fighters.

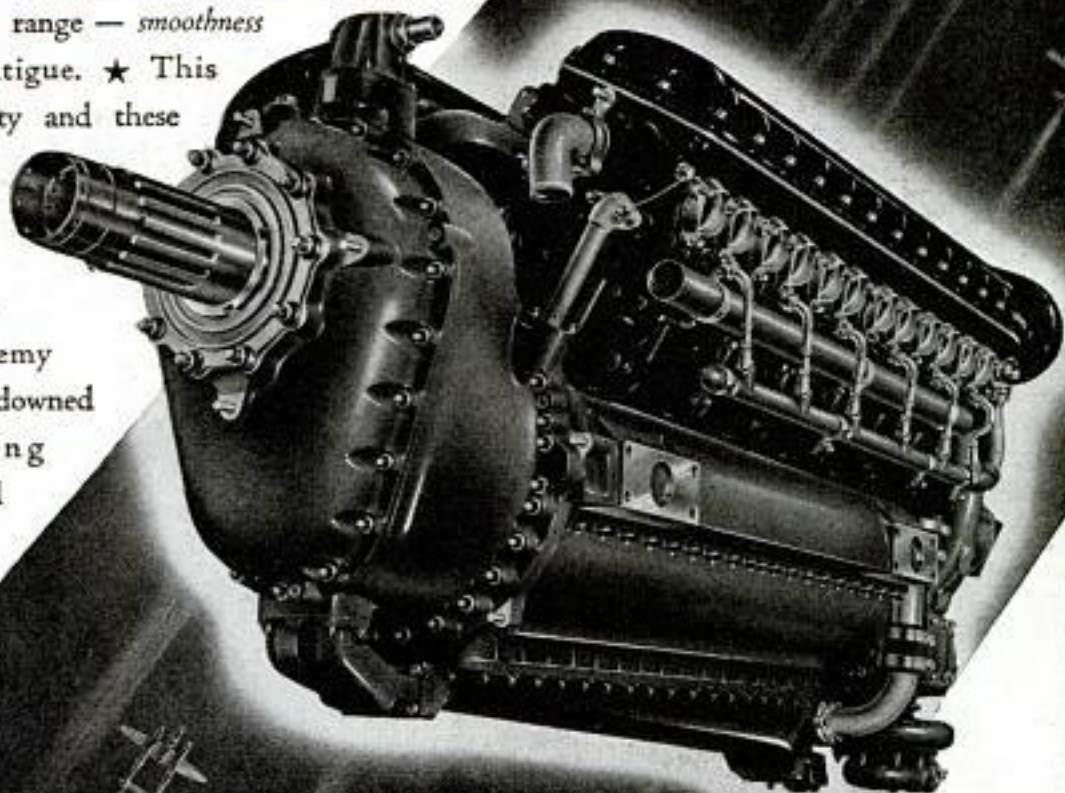

POWERED BY ALLISON

P-38—Lightning

P-39—Airacobra

P-40—Warhawk

A-36 and P-51—Mustang

P-63—Kingcobra

Allison has already furnished more than 50,000 engines for use in these planes.

LIQUID-COOLED AIRCRAFT ENGINES

Allison

DIVISION OF

Indianapolis, Indiana

Every Sunday Afternoon

GENERAL MOTORS SYMPHONY OF THE AIR—NBC Network



**KEEP AMERICA STRONG
BUY MORE WAR BONDS**

Nowhere is reliable performance more indispensable than with America's buses. So, there is a tip for you in the way the bus transportation industry cares for spark plugs. All plugs are thoroughly cleaned and accurately adjusted every 3,000-5,000 miles. When plugs are finally worn out, new ones are installed promptly,—and thousands of them are AC Spark Plugs.

Follow this same system with your own spark plugs, and you will not only enjoy the utmost in plug reliability but also conserve urgently needed materials and fuel for our fighting men.



BRING YOUR FIGHTING MAN HOME SOONER
BUY ANOTHER WAR BOND

Highballing 500 Trains a Day

Continued from page 37

ley and substations in his area. However, the power director must obtain permission from the load dispatcher at Philadelphia before opening any transmission lines.

Across the street from Pennsylvania Station in New York the power director presides over the station from which direct current is supplied to the 11,000-volt, 25-cycle overhead catenary wires. Before him is an illuminated map of the circuits, trouble showing up instantly with lights indicating circuit breakers in operation.

The ability of the electric locomotive to accelerate rapidly and to maintain a uniform high speed uphill and down by utilizing the overload capacity of the motors on the upgrades has enabled the Pennsylvania to cut 45 minutes from its fastest schedules between Washington and New York.

Having no power plant to carry, the electric locomotive can be maintained in fewer hours than steam or Diesel. On the Pennsylvania, electric locomotives run about 25 percent more annual mileage than steam engines on similar service. Winter brings problems of wires sagging with ice and pantographs dragged down by ice outweighing their springs. When ice is forming, they send out a 12-car train with all 12 pantographs up to scrape sleet from the wires, and they are trying electric heaters on pantographs to keep ice from forming.

J. V. B. Duer, assistant to the vice president in charge of operations, reports that passenger schedules were shortened on the average, about an hour and freight schedules two hours by electrification, with little or no increase in maximum speeds.

"With freight trains," he says, "two things affect the improvement of schedule. First, the electric locomotive is a more reliable motive power unit, and freight trains can be run among passenger trains with greater assurance of non-interference with passenger trains. Second, the electric locomotive lends itself to a rather high average speed in momentum operation of trains. Although it loses some speed going uphill, it passes over the top at a higher speed than a steam locomotive does, because it uses excess power available in the trolley and overload capacity available in the motors to arrive at the top of the hill at a higher speed than if it carried its generating equipment." But he adds that advantages of electrical operations occur only where they are applied, in fast movement of a large number of heavy trains, and in tunnels and terminal operations.

Continued to page 158

Ingenious New Technical Methods

Presented in the hope that they will
prove interesting and useful to you.

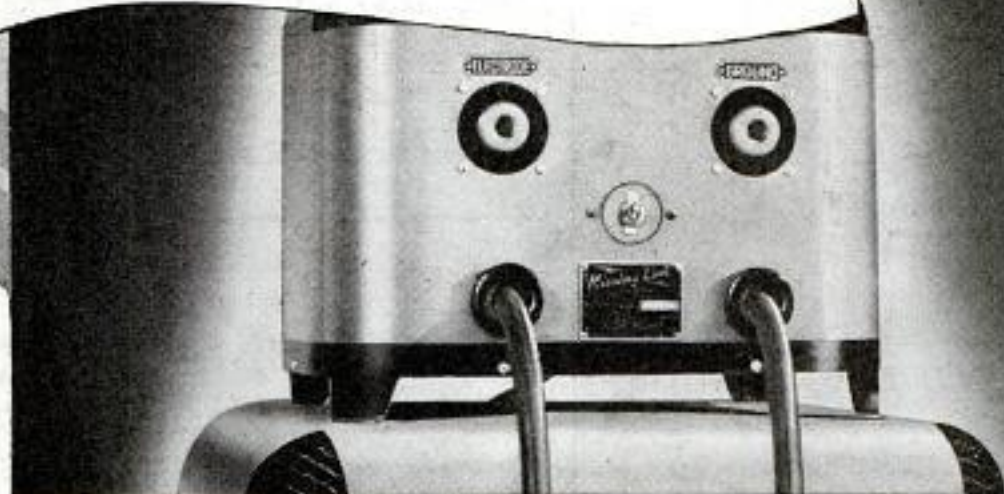

Revolutionary Hy-cycle Automatic Arc Pro- vides Complete Control of Arc and Heat

At last, a development that automatically starts the arc before the welding electrode actually comes in contact with the work! Eliminating the "pecking" or "scratching" that so often creates tension and operator fatigue. Its many advantages contribute largely to saving time and labor because an operator can be trained in far less time than usual, and higher speeds can be obtained. This hy-cycle automatic arc unit, called "Missing Link," permits the operator to weld with any welding rod, bare steel or alloy. Rods that could not be used before can be burned with ease—such as bare mild steel, dust coated, reverse polarity, aluminum, bronze, stainless steel, etc., AC or DC.

One of its most important advantages is welding light gauge. Light gauge requires low heat—making many jobs almost impossible for ordinary methods. Since the "Missing Link" starts automatically on as low as one ampere of heat, the welding of light gauge sheet can be done with surprising speed with no time out for "pecking" and "sticking."

You all know that our fighting men need the finest quality materials that we here at home can produce. That goes for Wrigley's Spearmint Gum, too. Although our stock pile of quality raw materials is getting lower and lower we are maintaining our standards of quality. Naturally, we are forced to limit production. So we are giving priority where it is needed most—and where you want us to—our fighting men and women overseas only. Because chewing gum is essential to them—they are getting all of our limited production of Wrigley's Spearmint Gum.

You can get complete information from Mid-States Equipment Company, 2429 South Michigan Avenue, Chicago 16, Illinois.



Simplifies welding vertical
and overhead

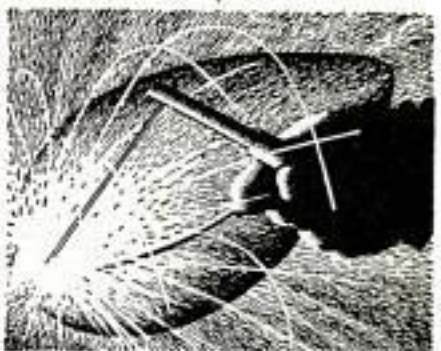

Makes it easy to weld light
gauge work

Y-136

Act now to avoid a *Frigid Family*



...INSULATE YOUR ATTIC WITH BALSAM-WOOL



Will another winter of shivers and shakes afflict your family? Will cold wave warnings again make you shudder? Not if you insulate your attic—now—with Balsam-Wool Attic Insulation! It's the simple, practical, inexpensive way to keep more comfortable—while you save up to 20% in fuel.

Balsam-Wool Attic Insulation is so easy to apply! It's laid like a rug in your attic—no fuss or muss. Windproof, moistureproof and fire resistant, it gives lifetime service, saving money on your fuel bills year after year. In fact, Balsam-Wool is so good that it's sold under a *money-back guarantee* of complete satisfaction! Mail the coupon or see your **lumber dealer** about applying Balsam-Wool before it's too late—don't let a possible insulation shortage cheat you out of comfort!

Balsam-Wool

SEALED ATTIC INSULATION

Balsam-Wool... Products of Weyerhaeuser... Nu-Wool

WOOD CONVERSION COMPANY
Dept. 210-9 First National Bank Bldg.
St. Paul 1, Minnesota

Gentlemen: I want to know more about Balsam-Wool Double-Value Attic Insulation.

To assist us in giving you special information, please check: I am a home owner
renter architect contractor
student postwar planner

Name.....

Address.....

City.....State.....



A plume of white comes into view far down the track below Union Tower.

"Troop train," remarks the block operator as he jots down an entry on his log a minute later. Boys in khaki peer from the troop sleepers. The towerman observes:

"G. I.'s on their way."

The bay window of Union Tower looks down on a kaleidoscopic view of the war. American railroads carried more carloads of freight to the ports in March than any other month in history. The towerman got an eyeful of the invasion in the continuous preview rolling past... boxcars and Pullmans, flatcars laden with tanks and boats, alligators and enormous crates... 500 trains a day highballing through, 7,000 cars of freight moving at almost passenger train speed. And this is just one of the railroads feeding the world's busiest port and the Yanks overseas.

High Chair Bombardiers

Continued from page 43

able electric control panel, which may be set at the instructor's desk. The altimeter is driven at 1,000 feet per minute and the compass, airspeed meter and temperature gauge are driven at speeds which permit accurate setting on each. Quick and smooth changes in altitude, temperature, heading, and airspeed may be accomplished by a flick of the finger. An entire classroom may be flown on all headings and at a wide range of altitude, airspeed and temperature. Each student is made to set his watch accurately and can then be taken over a rapid flight in which he is kept hopping in order to keep up with his log entries.

It also has considerable value in altitude and computation training for bombardier students. The flight data such as barometric pressure, target, and runway elevation are furnished on a simulated flight board. The class may be flown to a desired indicated altitude and the instruments set for any desired conditions. Making use of bombing tables and computers, the student is required to compute correctly the true altitude above target, true airspeed, trail, and disc speed.

A remarkable series of training aids has been developed by Lieut. Joseph Chopp. One of them is a working model of the Norden bombsight—about 15 feet long and five feet high. The huge sight can be dismantled and put back together again. Separate models show different portions of the sight. Full-size mock-ups acquaint students with the bombardier compartments of the principal types of combat planes.

Continued to page 160



“... but this one's my favorite”

“I knew you'd want to look at *this* one. Most everybody does. I'll bet my Savage Model 99 has been out of the rack a hundred times.

“I've done a lot of big game hunting in my day and I expect to do a lot more after the war. I've handled a flock of guns, too, but this Savage is my favorite. Talk about streamlining and balance! Just handle it. This rifle is chambered for the famous Savage .300 cartridge—one of the most powerful ever developed for light, fast, lever action rifles. But, in the Savage Model 99, you have the choice of several other calibers. For example, there's the Savage .250-3000 ... one of the first of the high

velocity, flat trajectory type cartridges. It really reaches out for long range shots on coyotes, mountain goats and other medium-size game.

“So here's a tip ... when the time comes ... pick a Savage Model 99. Then you'll know why it's my favorite.”

SAVAGE ARMS CORPORATION
Plants in Utica, N. Y. and Chicopee Falls,
Mass. • Manufacturer of Savage, Stevens
and Fox Sporting Arms.

SAVAGE

Huge quantities of military arms have been produced by Savage. This same capacity for precision manufacturing in quantity will make future Savage Sporting Arms your first choice.



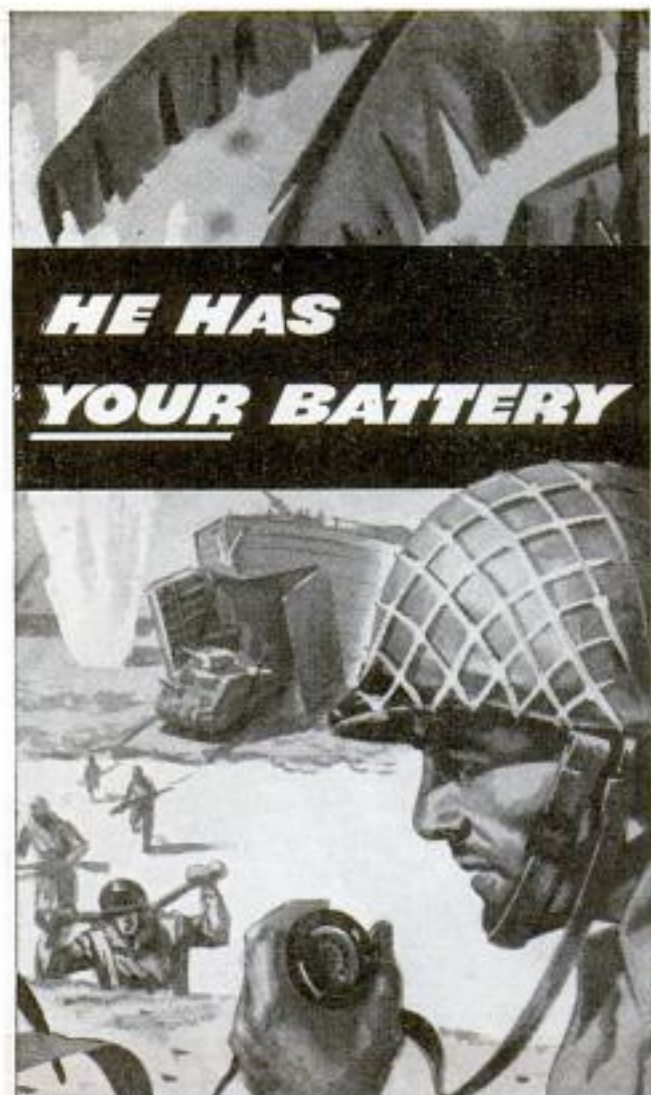

**HE HAS
YOUR BATTERY**

His message must get through! Lack of a "Walkie-Talkie" battery might mean death . . . not for one man but for thousands! The very dry cells that normally go into your batteries now supply the vital voltage for "Walkie-Talkies." That means limited supplies "over here," so use your available Burgess Batteries sparingly . . . handle them carefully as eggs. For Free Battery Hints — Write Dept. E-1, Burgess Battery Company, Freeport, Ill.



BURGESS BATTERIES

IN THE NATION'S SERVICE
On the Fighting Front
On the Home Front

Mock-ups of bomb racks, with empty bombs ranging from 17-pound anti-personnel missiles to 2,000-pound blockbusters, are used to teach problems of loading.

Another innovation is the sonic system for scoring bomb hits on the target ranges. Four microphones set in a square pattern each 500 feet from the target's center, are wired to a recorder several thousand feet away. By recording the time of arrival of the sound at each microphone an indication of the bomb's position is obtained. For instance, the sound wave from a bomb hit in the center of the target will reach all four microphones at the same instant. An off-center hit will activate the nearest microphone first and the others in order of distance from the explosion. This record is applied to a hyperbolic board on which the position of the point may be plotted.

This unit lies inoperative until a bomb impact shakes the ground. This ground or seismic wave is picked up by buried geophones and starts the recorder going in time to record the sonic waves.

These are a few of many devices and techniques in use throughout the AAF Training Command to make certain that American bombardiers continue to be the world's best. The effectiveness of this "synthetic" training is being demonstrated, with real bombs, on every fighting front. Midland Army Air Field's own graduates are demonstrating it with bombs that are smashing enemy factories, sinking enemy ships, blasting a road to Victory.

"The Rocket's Red Glare"

Continued from page 5

er simple shell tube containing powder. When fired, the flow of gas issuing from its tail propels it in the sighted direction, its flight being stabilized by fins. It is therefore especially useful for low-level attacks and strafing, when the kick of a cannon slows the plane and unsteadies it.

Because of this specialty of blasting accurately at high speed and low altitudes, the rocket fighters were assigned the job of knocking out all German radio installations that had survived the pre-invasion attacks by heavy and medium bombers. The flying bazookas did the job neatly.

British Typhoon torpedo bombers carrying rockets were called on for help during the assault on Caen, when 25 Nazi tanks were massed for a counterattack. A German prisoner told his captors the Typhoons had wrecked 17 tanks beyond repair.

Grumman Avengers of the U. S. Marine Corps gave the Japs their first introduc-

Continued to page 162



Needles and nails made his first watch tools . . .

THE March wind rattled the bedroom window. But the lantern on the floor gave a steady glow to warm the boy's feet.

Then his head bent more closely to the work. He nudged the balance wheel—and life came back into the timepiece.

Watch repairing was coming easier to young Henry Ford. He had started at 14 and the first watch (today in his collection at Dearborn) had been mended with a shingle nail, a corset stay, and knitting needles. Now, after school, he was neighborhood watch repairer.

Everyone was enthusiastic

about his work, particularly because he didn't charge for it. But it wasn't money that Henry Ford was interested in. Here was an opportunity to *learn by doing!*

Years later, the watchmaker's precision learned by Henry Ford in those winter nights was to guide the building of 30 million cars and trucks. Moreover, it was Mr. Ford's knowledge of watchmaking that prompted inauguration of the assembly line. This in turn brought shorter working hours, increased wages, made life easier for millions, and is now speeding equipment to preserve our American way of living.

New cars belong to the future. But when tomorrow's Ford, Mercury and Lincoln cars arrive, they will reflect anew the watchmaker's skill, the workmanship and engineering resourcefulness that are typical of Ford Motor Company.

As in the past, they will be motorcars that are reliable and economical, smart and comfortable. And they will be priced within the means of the greatest number. For Mr. Ford has declared: "The profits we are most interested in are those the public gets from using the things that we produce. The only real profit is the public benefit."

FORD MOTOR COMPANY 

POWERFUL LIQUID

promptly soothes TORTURE of

ATHLETE'S FOOT

And
On Contact
Kills Germs
That
Cause It!



If you're discouraged about a mean, hard to relieve case of Athlete's Foot—just try *Extra Strength ZEMO*. The first applications relieve that intense itching soreness between cracked peeling toes and on contact actually *kill* the vicious germs that most commonly cause and spread Athlete's Foot.

Zemo is a Doctor's wonderful soothing yet powerfully medicated liquid backed by 35 years' success. The first trial of Zemo convinces! At all drugstores.

NOTE: Also Fine for
Tired, Sore Feet

ZEMO



MACHINISTS

Only Gerstner Chests can give your tools proper care. Free Catalog.

GERSTNER TOOL CHESTS

444 Columbia St. Dayton 7, Ohio

New Comfort for You



ELASTI-GLASS*

Belts and Braces of the Future

100% ELASTIC ALL STRETCH

Available now... in limited quantities at many dealers... smartly fashioned Elasti-Glass braces, with yielding 100% full stretching comfort in wide range of sport tones. Clip or button ends... \$1

Also Elasti-Glass "Stratton" Belt in Tan, Grey or Brown with handsome Giant Grip buckle... 100% stretching comfort... \$1.

*Elasti-Glass is an ORGANIC GLASS and although of almost living elasticity contains no silica or rubber. (Trade Mark Registered U. S. Pat. Off. Made from Vinylool Brand Resins. (Trade Mark Reg. C. & C. C. C.) Covered by U. S. Pat. No. 2,283,313.

Buchbaum & Co.

MANUFACTURERS SINCE 1888 - CHICAGO

Dealer's Note: Limited stocks on hand at our New York, Chicago, Los Angeles and Honolulu Offices.

tion to the airborne rocket in the South Pacific. Staff Sergeant Dan Bailey of Atlanta, Marine combat correspondent, rode along when the Avengers lit into a Japanese bivouac area on Bougainville.

"The Jap camp was in a clearing a mile or so inland," he reported. "From the air the native huts and tents stood out like gravy spots on a green vest. We flew toward it in a low glide. . . I caught a glimpse of brilliant red balls racing away from the plane with a loud whistling sound.

"The rockets smashed into the center of the target, throwing a purple mushroom of flame, smoke and debris more than 100 feet into the air."

In the amphibious assaults at Arawe and Cape Gloucester, New Britain, rocket-firing Ducks led the troops ashore, blistering the Jap beach defenses with a barrage from multi-barreled rocket projectors.

For the invasion of Europe, the amphibious forces took the small infantry landing craft and adapted it for bombardment. It became the Landing Craft, Rockets.

Only a small crew is needed on the LCR. The craft is navigated from an asbestos-guarded post at the stern. The forward part of the boat is lined with racks of the light rocket projectors. Once loaded, these tubes are fired by remote control from the stern.

The full broadside of these rocket boats is said to be more powerful than a salvo from the nine big 16-inch guns of the British battleships Nelson or Rodney. It is no wonder that a German prisoner on the Cherbourg peninsula said the rockets were the most terrible thing he had ever faced.

There is no doubt that developments in the last few months point to a new departure in warfare. The rocket itself is not new—witness the "rocket's red glare" when the British attacked Fort McHenry in 1814, and even earlier uses of the rocket against Napoleon at Waterloo and in an expedition against Boulogne in 1805, when the British equipped boats for salvo firing of rockets.

But today the rocket has acquired a new terror. There is speculation over giant robots that might be sent across the Atlantic, at which scientists scoff because of the inaccuracy of any long-range robot and the tons of fuel such a weapon would require. However, a huge launching site captured near Cherbourg was believed to have been ready for a monster brother of the winged robot bomb already blitzing London. The launcher might accommodate a rocket bomb carrying five tons of explosives. In the shape of today's rocket may be seen the shadow of the next and more terrible war, unless the United Nations are wise enough to prevent that tragedy.

HYCON

Hydraulic Pumps

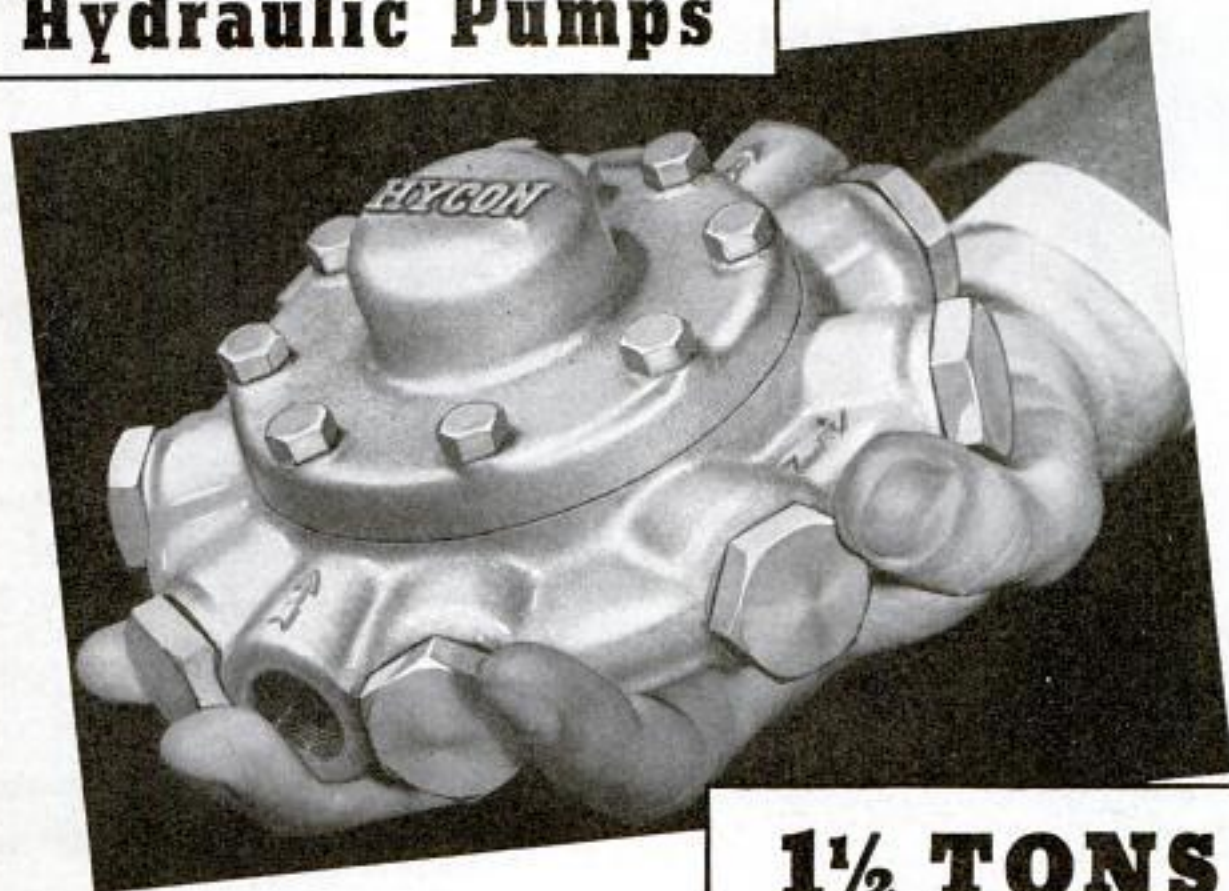

*The compact, dependable heart
of your hydraulic system*

**Testing units—Machine application
Pumps and valves for all purposes re-
quiring low volume and high pressures**

HYCON positive displacement pumps are built in two capacities
—Model K (four cylinders) and Model L (eight cylinders)

**EQUIPMENT AVAILABLE FOR
IMMEDIATE DELIVERY**

Catalogues on request

1½ TONS
of controlled pressure in
the palm of your hand

Model	Rated Capacity in G. P. M. at 1800 R. P. M.	Maximum Pressure P. S. I.	Recom- mended Motor Drive
K	.53	3000	2 H. P.
L	1.05	3000	3 H. P.

THE NEW YORK AIR BRAKE COMPANY

Hydraulic Division

420 LEXINGTON AVENUE, NEW YORK 17, N. Y.

IT'S
Fluid Power
THAT OPERATES
A TRAIN

On railroads Fluid Power is used for everything from blowing the whistle to stopping the train. And it is only with Fluid Power that all brakes can be controlled from the cab.

Fluid Power is transmitted through tubes. Brake pressure is delivered to every car without shafts, gears, belts or pulleys.

This method of providing force where it is needed has many advantages. With Fluid Power you can move tons or squash a bug on a watch crystal!

Fluid Power is easy to control. Parker Engineered Systems are performing a host of different tasks in a wide variety of industries. Applications of Fluid Power seem almost limitless.

If you need power for drive or control, it will pay you to investigate the advantages of Fluid Power. It may hold your answer to better postwar products. A Parker Engineer will be glad to give you complete details.

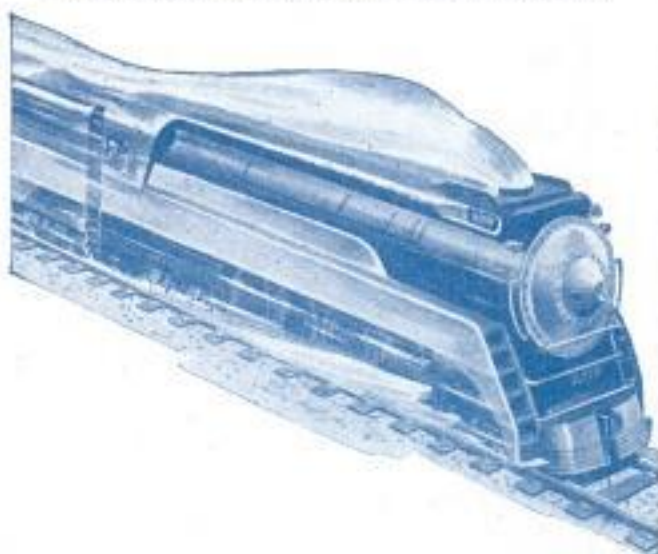

THE
PARKER
APPLIANCE COMPANY
CLEVELAND • LOS ANGELES
FLUID POWER ENGINEERING

Save Fingers
with
Steel-Grip Finger Guards



Hundreds of factories are saving time and injuries in war production by protecting workers with Steel-Grip Finger Guards. Used for handling rough or sharp articles, for buffing, grinding, sanding, polishing, punch press work and hundreds of other jobs. Protect fingers or thumb, front or back, from cuts, abrasions or blisters. Made of durable leather with elastic web back for snug, cool, comfortable fit. Easy on and off. One size fits all, men or women. Send 10c each for samples or trial order box of 50 at 83¢ each, less 10%.

OLD HICKORY
STEEL GRIP

Famous Industrial
Safeguards Since 1910

Catalog of Steel-Grip Safety
Apparel free on request

INDUSTRIAL GLOVES COMPANY

651 Garfield, Danville, Illinois
(In Canada: Safety Supply Co., Toronto)

New Designs in
FRANZITE GRIPS



Modernize Your Gun! Improve Your Score!

Most durable grips made. Positively unbreakable! For Colt, Smith & Wesson, Hi-Standard, Ortigas, Luger & Mausers in a wide choice of beautiful designs in ivory, pearl, walnut, onyx, etc. Low prices. FREE CATALOG. Dealers Wanted.

SPORTS, INC., (Mfrs.) 2850 N. Clark St., Dept. P-9, Chicago, Ill.



Kandler's Special
10 TON ARBOR PRESS

For washing machine repair, electrical and general repair shops—a big-capacity press (takes work 18"x21½") at only **\$3300 F.O.B.**

Write **KANDLER MACHINERY**
1407 WAVERLY DR., KALAMAZOO 17, MICH.

IT'S FREE Don't Miss
This NEW
BOOKLET

"The Age of Chemistry"

New 1944 Chemcraft Chemistry Booklet describes many amazing experiments you can perform; and tells of the big opportunities, both now and in the future, for boys with a knowledge of chemistry... Send Today.
THE PORTER CHEMICAL COMPANY
32 Prospect Ave., Hagerstown, Md.



PULVEX
FLEA POWDER

Kills fleas
JUST APPLY TO ONE SPOT

25¢
AND 50¢

PAINT STRIPING TOOL

Try it! See the Added Beauty

ONLY
\$1.00
POST
PAID

With this NEW TOOL (not a brush) everyone can now draw lines with paint, enamel, lacquer, etc. Used on autos, models, toys, games, imitation tile walls, cabinets, furniture, linoleum floors, signs, bulletin boards, sporting goods, house workshop projects, etc. Send only \$1.00 for complete tool for painting a 1/16" wide stripe, including adjustable guide, operating instructions, etc. C.O.D. price \$1.25.

As easy to use
as a pencil.



Patented

Extra interchangeable tips for making 1/64", 1/32", 3/64", 1/16", 3/32" and 1/8" wide stripe lines—50¢ each.

Every Painter and Craftsman Should Own One.

Send for your tool and as many additional width tips you need today. Use it. If you are not satisfied that you can do better work, add character as well as beauty to your product or project, return the tool and we'll refund your money promptly.

Paint Dealers: Write for literature, etc.
4234-B Lincoln Ave.
WENDELL MFG. CO. CHICAGO 18, ILL.

For Jungle Fighters Today— For YOU Tomorrow



This Amazing NEW "Pocket" Stove Originally Designed by Coleman

is now serving jungle fighters, ski-troopers, tank crews, rangers—gallant fighters everywhere.

It's the sport stove of tomorrow you'll never want to be without on any after-victory outdoor trip. Easy to carry as a thermos bottle—only 8½ in. high, 4½ in. in diameter. Ready in minutes for cooking, heating drinks, purifying water. **BURNS SAME FUEL USED IN YOUR CAR**—white or leaded—fuel that is available everywhere. Telescoping case makes handy utensils.

Originally designed by Coleman engineers for the armed forces, this new miracle stove will be ideal for vacation travel, picnics, backyard steak fries, hunting, fishing and camping—hundreds of uses about the home—after the war.

FREE BOOK—Write for dramatic picture story of the Coleman "Pocket" Stove on the fighting fronts.



THE COLEMAN LAMP AND STOVE CO.
Wichita, Kans. Chicago, Ill. Philadelphia, Pa.
Los Angeles, Calif. Toronto, Canada



for Outstanding
Achievement
in War Production

Coleman

"POCKET" STOVES • CAMP STOVES • LAMPS • LANTERNS • IRONS

Carhartt

QUALITY

For Wartime Wear



Carhartt Work Clothes have been famous for their full-fashioned quality fit, for over fifty years. Blue and pin stripe overalls, lace back dungarees, work caps, extra heavy brown duck overalls provide the right selection for America's hard hitting army of war workers. Heavily reinforced, lockstitched, full cut, with extra deep pockets, non-rust buttons, and made from Carhartt's famous Sanforized Master Cloth you'll find them economical and comfortable for war time wear.

Carhartt's heavy brown duck overalls are built for the toughest jobs.

HAMILTON CARHARTT OVERALL CO.

Established 1869

Detroit, Mich.
Atlanta, Ga.

Carhartt Park, Ky.
Dallas, Texas

On sale at your local dealers

Carhartt

UNION MADE WORK CLOTHES

50 Years a Friend to Organized Labor

ELECTRICITY FOR ANY JOB ANYWHERE



ONAN GASOLINE DRIVEN ELECTRIC PLANTS provide electricity in locations where it is not otherwise available, and for emergency standby service. Thousands of units are doing a winning job in the war.

Sizes from 350 to 35,000 watts. A.C. 50 to 800 cycles, 115 to 660 volts, D.C. 6 to 4000 volts. Also dual A.C. and D.C. output models. D. W. ONAN & SONS, 1097 Royalston Ave., Minneapolis 5, Minn.

ONAN

DRILL PRESS OWNERS!

HERE'S 1 TOOL WITH 5 DISTINCT USES
THE BARRON MULTI-PURPOSE
ROTARY WOOD PLANER



PLANES & SURFACES • PANELS & BEADS \$750
ROUFS & GROOVES • RABBETS • TENONS

Converts ANY drill press into a time saving, low cost planer, paneler, tenoner, etc. Surface finishes all types of tough grained and knotty surfaces to agree smoothness. Safely guaranteed harmless to drill press. Thousands now in use. SOLD ON MONEY BACK GUARANTEE. Full refund on 5 day trial. Shipped prepaid on receipt of \$7.50—or C.O.D. YOU RISK NOTHING. Free literature.

Barron Tool Co., 369 Architects Bldg., Detroit 1, Mich.

COMPLETE
STEEL TOP AUXILIARY
DRILL PRESS TABLE

Has 200 sq. in. smooth working surface. Equipped for shaper and many other important workshop uses—a real buy at \$5.95



NEW! Sell Popular
ALL WOOL
Buffalo Check Shirt

BIG PROFITS FOR YOU!



Every Outdoor man a prospect. Smartest color and style combined with warm wool comfort. Genuine ALL WOOL Buffalo Check Shirts. Full cut, patented storm cuffs. Amazingly low priced, with generous profit for you. COMPLETE LINE—Leather and wool jackets, raincoats, 200 fast selling shoe styles for men and women. Our salesmen making biggest profits in this field, using Actual Samples we furnish FREE. Write today for FREE SAMPLE OUTFIT.

MASON SHOE MFG. CO., Dept. M-43, Chippewa Falls, Wis.

AMAZING MYSTERY BUTTON



Startles Everybody.

With this Electronic Button you can make your own

Telephone—Amplifier—Detector—Transmitter.

Attach this button to piece of wire—transmit conversation to another room. Music also transmitted to distant places. Most interesting, electrical apparatus ever discovered. Besides you can perform hundreds of experiments. So try it can be ordered in dozens of places. A Free War Product. Supply Limited. Electronic Button including 5000 word instruction booklet with 50 illustrations and experiments sent postpaid only \$1.00.

Electronic Products Company, Saint Charles, Ill.

Build: STEAM ENGINE

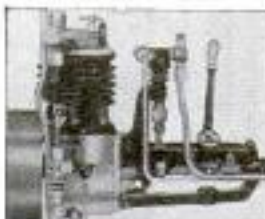

● A precision built and engineered single cylinder, 1/4" scale marine model, with clutch or reverse.

● Send \$2.50 for 14 pages scale drawings, 2 photos, instructions.

● 2 Photos and Description...\$.25

● Rough Castings Kit..... 12.50

● Horizontal Flash Boiler Drawings and Instructions 1.00

THOMPSON ENGINEERING CO. 266 NO. DIVISION BLDG., GRAND RAPIDS 2, MICH.

EMPIRE "TORPEDO" LEVELS

Available in ALUMINUM Now!

Swiss, hardest, accurate level. "Cigar-shaped" cap't. top pockets. Polished ALUMINUM, 9" long, with level, plumb and 45° vials. Light weight, strong. No. 26, only \$1.75. Limited number. Order from dealer or write direct.

EMPIRE LEVEL MFG. CO. DEPT. P-110 20 SOUTH SIXTH STREET MILWAUKEE 4, WISCONSIN

THINGS TO MAKE IN YOUR HOME WORKSHOP

16 Complete Plans — only 10c Useful, practical, easy-to-build projects — bird houses, lazy chair, etc. Includes photos, drawings.

STANLEY TOOLS

174 Elm Street, New Britain, Conn.

DO YOU

WANT a permanent business profession of your own? Then BECOME A FOOT CORRECTIONIST. Earnings in this greatly needed profession run as high as \$50-\$100 weekly after a few weeks home training—not medical or chiropody—no further capital needed, no goods to buy. 47th year. Write for free booklet.

Stephenson System of Foot Correction

28 Back Bay.

Boston, Mass.

FIRST ON MY *Want List* IS A NEW HARLEY-DAVIDSON

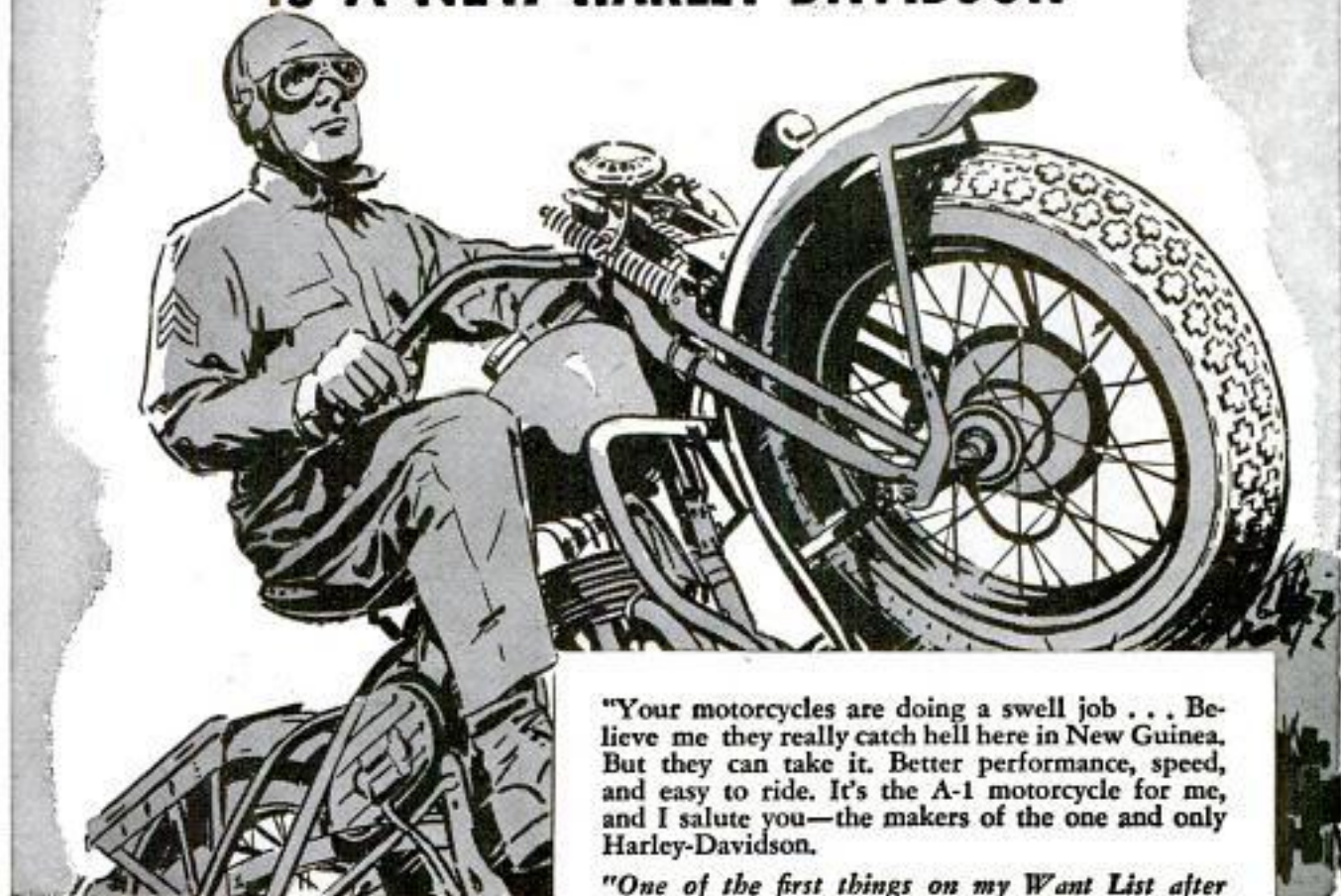

"Your motorcycles are doing a swell job . . . Believe me they really catch hell here in New Guinea. But they can take it. Better performance, speed, and easy to ride. It's the A-1 motorcycle for me, and I salute you—the makers of the one and only Harley-Davidson.

"One of the first things on my *Want List* after the war is a new Harley-Davidson. Your machines are helping to win the things the boys want."

Corp. V. A. N. — it will be swell when fellows like you are back to ride in race meets, hill-climbs, endurance runs and other exciting motorcycle events. Thousands of riders have Harley-Davidsons at the top of their *Want List* — and "BUY BONDS" is their slogan so they CAN own one.



HARLEY- DAVIDSON MOTORCYCLES

HARLEY-DAVIDSON MOTOR CO.
Dept. P, Milwaukee 1, Wisconsin

Please send at once free copy of 24-page
ENTHUSIAST MAGAZINE, filled with motor-
cycle action pictures and thrilling stories.

Name.....

Address.....

City..... State.....

Only a Smokemaster has this star feature!



The secret of Smokemaster's consistently fine smoking qualities is right in the stem. Here an ordinary pipe cleaner absorbs all moisture as fast as it forms. Keeps the entire smoke passage clear. Smoke is never drawn through rank, biting moisture... What a difference that makes in smoking pleasure!



Pat. No. 2,166,537

At leading dealers

The Armed Forces are getting a large share of Smokemaster production. If your dealer is temporarily out of Smokemasters, place your order so he can supply you as soon as he gets another shipment.

Smokemaster Custom-made \$7.50

Smokemaster Standard \$1.00

BRIARCRAFT, Inc.

347 FIFTH AVENUE, NEW YORK 16, N. Y.

★ SAVE WASTE PAPER ★

SAVE THAT MOTOR!

Give electric tools longer life with Heavy Body 3-IN-ONE Oil! Right for electric refrigerators and washing machines, too. Lubricates, cleans, polishes, prevents rust. At Hardware, Drug, Grocery, 10¢ Stores.



HEAVY BODY

"3-IN-ONE" OIL

INVENTORS, SCHOOLS, CRAFTSMEN BRONZE FOUNDRY



is again available in limited quantity without priority. Orders filled in sequence as received. INVENTORS—SCHOOLS—CRAFTSMEN use FOUNDRYETTE for making castings quickly for new inventions, for instruction, and general purpose. Order now for early delivery. Three sizes are available capable of making bronze castings of 1½, 3, and 6 pounds weight, aluminum, copper, brass, etc., \$17.50, \$24.00, \$34.50, f.o.b. Kansas City. Domestic gas supply and 110 volt AC or DC energy required for operation. Write for circular.

KANSAS CITY SPECIALTIES CO.
Box 6022, Dept. P-46 Kansas City, Mo.

2 TOOLS IN ONE COMPASS-DIVIDER

QUALITY STEEL—PRECISION TOOL for every home workman. Replaceable guide points, scribing needle and standard pencil—rightly holds at ¼ to 7 inch openings. Indispensable for linoleum, tile, sheet metal and workshop use. 10-day MONEY BACK GUARANTEE. Send cash or money order (no C.O.D.'s). We pay postage.

WALTER E. SELCK & CO.
223 W. HUBBARD ST., DEPT. 6, CHICAGO 10, ILL.



NEW OTTAWA SAW

BIG FREE BOOK

World's Fastest 6 H.P. EASY TO MOVE



Fells trees. Saws big logs, small logs, limbs. Pulley for belt work. Easy to handle, weighs less than lower powered units. FULLY GUARANTEED. Cuts in on fuel storage. Turn wood lots into cash.

OTTAWA MFG. CO. 927 PINE ST. OTTAWA, KANS.

WYTEFACE

TRADE MARK

STEEL MEASURING TAPES



K+E TRADE MARK

KEUFFEL & ESSER CO.

HOBOKEN, N. J.

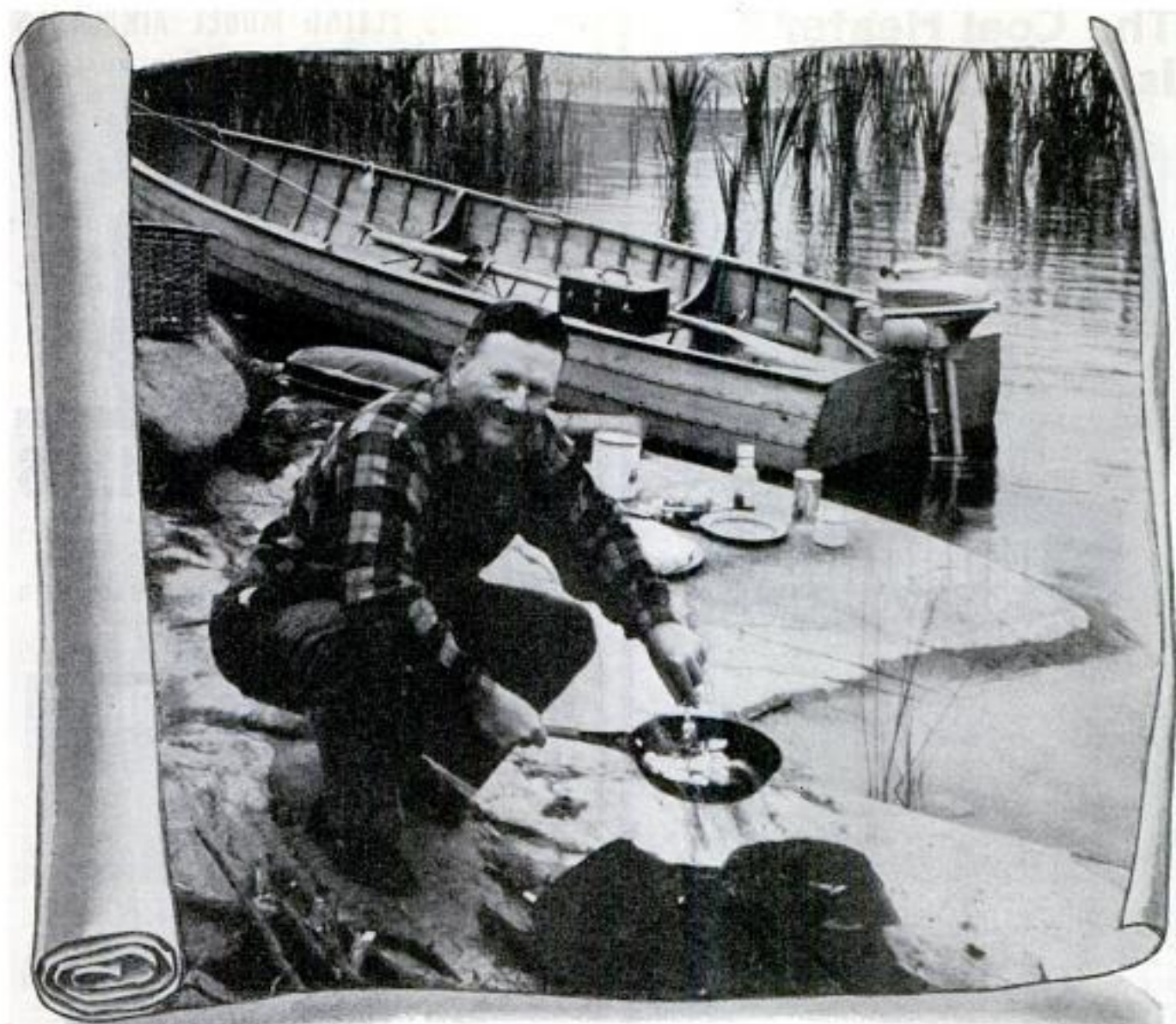

The Postwar Plans of Mr. G. I. Joe

Most of his plans are pretty simple, but more vivid and convincing than the best drawn blueprint of a postwar miracle. Some of them look a lot like the picture above. The same old water and rocks, reeds and pines. Plenty of good fishing and savory slabs of just-caught bass sizzling and browning in the pan. And finally the welcome old chow call . . . "Come and get it".

V-mail from a host of "planners" indicate that a sparkling new Evinrude will be an important part of the picture. On battle fronts around the world the boys have watched Evinrudes deliver the kind of performance they respect . . . and want more of when they get back. Our plans are to provide it for them . . . to the very top of their expectations!

EVINRUDE MOTORS, Milwaukee 9, Wisconsin



*Every Dollar You Invest Helps Speed
Victory . . . Buy More War Bonds*

EVINRUDE



OUTBOARD MOTORS

The Coal Heater That Is Amazing America!



Model 520

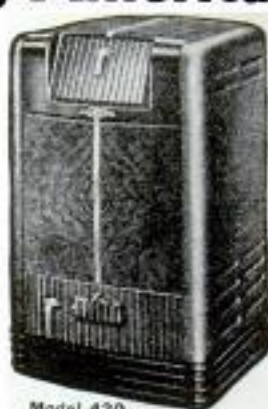

Model 420

WARM MORNING
1944 MODELS



U.S. Pat. Nos. 225527 and 127471, and Can. Pat. No. 401088. Name Reg. in U.S. and Can. Pat. Off.

ONLY HEATER of its kind in the world! . . . the heater with remarkable, patented interior construction principles that have brought new, modern heating comfort to hundreds of thousands of users.

Be Sure to Get the Genuine! Look for the name, spelled **W-A-R-M M-O-R-N-I-N-G** . . . the original and genuine! Semi-automatic, magazine feed. Holds 100 lbs. coal. Burns any kind of coal, coke or briquets. You need start a fire but once a year. Requires less attention than most furnaces. Heats all day and all night without refueling. Equipped with automatic draft control.

SEE YOUR DEALER TODAY — Have him demonstrate all the remarkable features of **WARM MORNING**. (K-60)

Locke Stove Co., 114 W. 11th, Kansas City 6, Mo.

SOLDIERS, SAILORS & WAR WORKERS



Your Watch with a Broken Crystal Is Useless
— Exposed to Damage from Glass and Dust.

PROTECT YOUR WATCH—Avoid costly repairs—Go to any jeweler—ask for a **G-S FLEXO CRYSTAL 100% BREAK-PROOF**—Any size—Any shape. Can be fitted while you wait. Mfgs. of military water-proof watches, gauges, instruments now use **G-S FLEXO CRYSTALS**—100% BREAK-PROOF.

Inquiries invited from manufacturers.

GERMANOW-SIMON MACHINE COMPANY, Rochester, N.Y.

AUTHENTIC FLYING MODEL AIRPLANES Sensational Time-Saving Construction!

Enjoy the thrill of building and flying a model built on a tube. 45 fine kits to choose from—15 cents to \$3.00. Big 32 inch wing span kits—fighters and bombers—only 50 cents. All kits include cement.

★ **Joe Ott** **OTT-O-FORMER AND OTT-O-TUBE CONSTRUCTION** ★
AIRPLANE KITS
★ **At Your Dealer** ★
JOE OTT MANUFACTURING CO.
415 West Superior Street - CHICAGO, IO



BALL BEARINGS

Set in flawless steel rings, assuring precision operation due to friction-free rotation. All Standard makes—New Departure, S. K. F., Norma-Hoffman, Fafrir, etc. We can supply promptly any quantity needed from our large stock of the MOST POPULAR SIZES. And you SAVE 50 to 60% on the Manufacturer's List. All Ball BEARINGS FULLY GUARANTEED.

Write TODAY for Bulletin B
M-E-T EXCHANGE, Dept. PM, 323 Canal St., New York 13, N. Y.

WOOD WORKERS
AMAZING BOOK FOR YOU
Harold Hunt wants to send revised No. 14 catalog. 124 pages of woodworking ideas. UNEQUALED BARGAINS in imported and American woods, supplies. Those already holding this catalog—send for revised sheets.
CRAFTSMAN WOOD SERVICE CO.
2729 S. Mary St., Dept. A-49, Chicago 8, Ill.

only 10¢

TRAILER AXLES, HITCHES, AND PARTS

• If you are interested in purchasing trailer axles, hitches, and other trailer parts, contact us promptly. Complete house trailer blue prints, \$1.00. Write for free literature.
HAMMER BLOW TOOL COMPANY, Dept. 109, WAUSAU, WIS.

10c NEW BOOK OF LATHE AND DRILL PRESS SET-UPS
Practical, unusual uses, contains 49 illustrations. Post-Send 10c to cover handling and postage. Paid **JACOBS MFG. CO.** 154 Jacobs Rd. Hartford 1, Conn.

BLOWERS EXHAUST FANS Furnaces, coal, oil, gas. One & two burner. Controls and repairs for stoves, oil & gas burners. **ELECTRIC DAMPER CONTROL FOR COAL FURNACES \$16.00** Stockers for apartments & stores. Sump pumps, plumbing and heating equipment. Automatic gas water heaters. **GAS RANGES \$29.00**. Gas & oil circulating heaters. **PEERLESS SALES**, Dept. M. C. V. Sta. Box 122, Lincoln, 8 Neb.

Say you saw it in *Popular Mechanics!*

SHAW and Peppy-Pal GARDEN TRACTORS

• 1 to 9 H.P. Circulars on request. War limits production—We supply repairs for all SHAW Tractors sold in our 40 years in business.

BUILD YOUR OWN RIDING TRACTOR—"WAR HORSE"

using old auto parts, powered by 2 H.P. or larger air-cooled engine; or walking type Garden Tractor 1/2 to 3 H.P. or convert truck or auto into Farm Tractor. Each with steel or rubber tires; will plow, cultivate. Plans for building, in few hours, any one of above, postpaid for \$1.00 (state which wanted) or all 3 for \$2.00. Money Back Guaranteed!

SHAW MFG. CO., 4509 Front St. Galesburg, Kansas
6686 North 4th St., Columbus, Ohio



The "FIGHTINGEST" Radio in the Armed Services

THE men who do the fighting like the Motorola-built Handie-Talkie. They say without qualification... "It's fine... just like having a house telephone at your fingertips. We're never alone. We feel safer, stronger, because we're always in touch with our command post! Yes, sir, the Handie-Talkie is the 'fightingest' 2-way radio in this war!"

Now and as long as there is an enemy gun pointed at an American fighter, the business of Motorola Electronics Engineers will be *Communications for Victory*. They look forward eagerly to the time when their added knowledge and skills may be once more applied to the business of designing and producing Motorola Radios and Television for your greater listening pleasure.

The men and women who make Motorola military radio have won their fourth Army-Navy "E" award for "production beyond expectations". That, in their opinion, is the best way for us on the home front to express our gratitude for the courage and self-sacrifice of our men and women on the fighting fronts.



GALVIN MFG. CORPORATION • CHICAGO 51

F-M RADIO ★ PHONOGRAPHS ★ RADAR ★ TELEVISION ★ F-M POLICE RADIO ★ MILITARY RADIO COMMUNICATIONS
SEPTEMBER, 1944

"HANDIE-TALKIE"
another
Motorola Radio
FIRST!

*Have You Bought
That Extra War Bond?*

Motorola
Radio

ARE YOU AN OLD MAN AT QUITTING TIME?



Do you think it's all right for you to feel so *jagged out* at quitting time? Do you *know why* you're so tired? With many men it's the *unsuspected* strain and "drag" on delicate, hidden cords that *saps energy* . . . and in many cases these strains can be relieved comfortably with the help of a Bauer & Black Suspensory.

READ THIS FREE ILLUSTRATED BOOK!

It shows and tells how men in all sorts of occupations claim they've found the answer to "QUITTING TIME FATIGUE" . . . *why they say they feel years younger . . . more active . . . more alive . . . all through the day!*

**DON'T FEEL "BUSHED" ANOTHER DAY
SEND THE COUPON NOW!**



BAUER & BLACK

Suspensories

Division of The Kendall Company

Dept. S-309
2500 South Dearborn St., Chicago 16, Ill.
Maybe I'm missing something. Send me your booklet on suspensories . . . quick.

Name.....
Address.....
City..... State.....

END TOOL RUST WORRIES



RIG—Universal stops rust when others fail. Used by Mfrs.—Labs. Unexcelled for TOOLS, dies, hinges, locks, chrome, battery terminals or anything that rusts! Also good for guns. Tube 50c. 1 lb. \$1.50. Write **RIG, 5646 LAKE PARK AVE., CHICAGO 37, ILL.**

MENDS EVERYTHING

Dishes, glassware, furniture, luggage and toys.



**DU PONT
DUCO CEMENT**

Fuse Puller — Circuit Tester



For Home or Factory

TESTS 110-250 VOLTS

When motors stop and lights go out, this tool quickly **LOCATES DEAD CIRCUITS** and safely removes blown Fuse. The Star Test Pocket Plier is made of a Transparent Plastic having in one of the legs a small lamp in series with a resistance and can be used to test 110 to 250 volts circuit. The Plier will pull fuses from 10 to 100 Amperes. Thousands of Electricians find this tool handler than Test Lamps. Price \$2.75 each without Leads, \$1.50 additional for Leads, plus 10c postage. Can be obtained from General Electric or Westinghouse Stores or directly from us. Order NOW. **STAR PLIER CO., 233 Canal St., New York 13, N. Y.**

- ACHROMATIC LENSES
- ASTRONOMICAL OBJECTIVES
- OPTICAL FLATS, 1/2 WAVE
- ALUMINIZED DIAGONALS, 1/2 WAVE
- FRONT SURFACE MIRRORS, 1/2 WAVE

Send for prices and details.

MAYFLOR PRODUCTS CORP., KATONAH, N. Y.

New OTTAWA WOOD SAW



For Tractors

—Makes wood sawing fast and easy. Can cut enough wood to pay for itself quickly. Easily moved while attached. Big heavy blade. **FREE details.**

LOW PRICE

OTTAWA MFG. CO.
W927 Oak Ave., Ottawa, Kans.

FREE TO HOME CRAFTSMEN



A FULL YEAR'S SUBSCRIPTION TO CONSTANTINE'S Chips & Chats

An interesting bi-monthly publication for Craftsmen. Exchange ideas from all over America. Publishes photos of your projects. Lists current supply of materials and tools still available. Contains helpful ideas in every issue. Free with Constantine's Master Manual which costs only 25c. coin or stamps, and which is included on first order of \$1.50 or more. **Send today.**
ALBERT CONSTANTINE & SON, INC.
725V East 135th St. New York 54, New York

WINDOW SIGN LETTERS

For Store Fronts and Office Windows. Anyone can put them on. Free Samples. Imitation Gold and Silver. **METALLIC LETTER CO., 430 N. Clark St., Chicago 10**



AUTO ENGINE SPEED CONTROL GOVERNORS

Give constant or changeable speed to any auto or truck engine, when used for power. Guaranteed. Instructions. Oil ring bearing \$13.00. Ball bearing \$19.50. Prepaid. Also additional carburetor butterflies. In Montreal, 7546 Wiseman St. Latin Amer. East Asiatic Co.

Agents wanted: Parts Dealers, Garages, Wreckers, Implement Dealers. Free circulars.

CANDEE, 2641 S. Hill • Los Angeles-7

THE **HOW AND WHY** OF

WILLIAMS
DROP-FORGED TOOLS

INTERNAL THREADING WITH WILLIAMS' BORING TOOLS

● Internal Threading on an engine lathe involves practically the same operations as external threading (described in another Williams Data Sheet) except for the tool used and its application to the work. Three types of Williams' Boring Tools are used extensively for internal threading. Instructions for the use of the three types illustrated are identical, and represent our recommended practice.

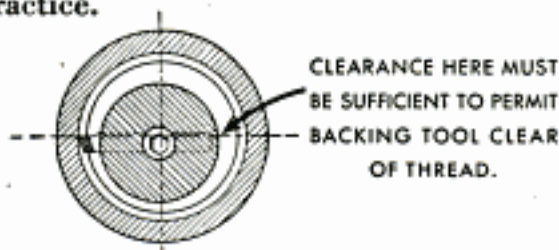

Since threading cutters are not regularly furnished with Williams' Boring Tools, the first essential is to provide a cutter bit ground to the proper angle, 60° for American National Threads. For internal threading more front clearance is required to prevent the heel of the tool from rubbing than is required for external threading.

The top of the cutter bit should be set at exact center as shown above, and a bar of

the largest practical diameter used in order to provide maximum rigidity. For right hand threading, the Compound Rest is rotated counter-clockwise (feed crank swung to right) and accurately set at 29°. Now mount the tool so that the bar is parallel to the lathe centers and align the cutter bit accurately with a center gage with the point of the bit to the wall nearest the operator.

With the work chucked or held on a face plate, right hand threading is done from the outer edge of the bore toward the headstock. Left hand threading is done from left to right, with the lead screw direction reversed.

Using the Compound Rest Screw (not the Carriage Cross Feed) feed into the work .002" to .004". Repeat until desired depth is attained, finishing off with depth of cut reduced to .001" on the final pass.

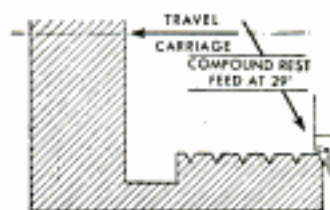

Action of the Thread Cutting Tool, with Compound Rest set at angle of 29°, is shown at left. Left side of Tool removes main chip which curls

clear better than when Tool is fed in at 90° angle. Right side of Tool merely shaves the thread smooth and helps produce a good finish.



WILLIAMS' ADJUSTABLE BORING-TOOL POST

4 sizes for bars 1/2" to 2-1/4". Height of bar easily adjusted with knurled ring.



WILLIAMS' LIGHT BORING-TOOL HOLDER

3 sizes for bars 1/8" to 7/16" diameter, and square cutters 1/4" to 3/8".



WILLIAMS' BORING-TOOL HOLDER

5 sizes for bars 3/16" to 1-1/8". Each takes many sizes of bars.



Williams' Boring Bars, and Cutters, Plain and Sleeve type, are also sold separately. 9 sizes, 1/2" x 7-5/8" to 2-1/4" x 34".

FREE DATA SHEETS

J. H. WILLIAMS & CO., BUFFALO 7, N. Y.
ON USE OF SHOP AND HAND TOOLS

Your name and address in the margin below will bring 12 Tool Holder Data Sheets (punched for 3-ring binder) and a list of our complete Data Sheet series. Mail to above address, Dept. PM-944.

JUST OFF THE PRESS!

**SPIEGELS BIG FALL
AND WINTER CATALOG**

SEND FOR YOUR COPY TODAY!



This big 632-page catalog is now for the first time divided into 5 complete stores:

- A Fashion-Right Store for Women
- A Complete Department Store for Children
- A Men's Wear and Sporting Goods Store
- A Style-Conscious Home Furnishings Store
- A Complete Hardware—Farm—Auto Store

Here at Spiegels you have three convenient ways to buy—Cash, 30-Day Charge or Time Payments. This new catalog gives full details of these three plans.

As you undoubtedly know, there is an extreme shortage of paper and for this reason the number of catalogs we were able to print for this coming season has been limited. This makes it most important that we send catalogs only to substantial people who are interested in shopping at Spiegels.

For this reason, we are asking you to fill out the few questions on the Catalog Request Coupon. Your answers will be kept strictly confidential.

CHICAGO **SPIEGEL** ILLINOIS

CATALOG REQUEST COUPON

Please answer questions below and mail to SPIEGEL INC., 1061 W. 35th ST., CHICAGO 9, ILLINOIS, to get your copy of the new big SPIEGEL Fall and Winter Catalog. If married, answers must apply to husband.

1. What kind of work do you do? _____

2. Date hired by present employer? _____ 3. What are your present WEEKLY earnings? \$ _____
(Month) (Year)

4. Do you own your home? _____ Rent? _____ Room at home? _____ Room outside? _____

Name _____

Address _____

City _____ State _____

20-49

HERE'S

**COMPASS
N-E-W-S**

BUY BONDS
OFTEN AND
KEEP THEM

Sherrill's amazing new developments in compass design for military use will be yours at popular prices for autos, boats and planes at war's end.

**SHERRILL
RESEARCH CORP.**
PERU, INDIANA

DIXON'S GRAPHITE SLIPSTIK

No more sticking, squeaking doors, windows, drawers! Rub-on, fast lasting SLIPSTIK. A-1 lubricant... for bicycle chains, fire-arm actions, miscellaneous shop uses.



JOSEPH DIXON CRUCIBLE CO., JERSEY CITY 3, N. J.

Burpee's LARKSPUR
GIANT

Plant Seeds This Fall for biggest, best Larkspur next spring. To try, we'll send a 15c-Packet Burpee's Giant Double Larkspur seeds free with directions. All colors mixed. Easy to grow, needs no special care—large double florets, closely set, spikes 8 to 4 ft. tall. Write today—send stamp for postage.

W. ATLEE BURPEE CO.
273 Burpee Bldg., Philadelphia 32, Pa.
(or) 273 Burpee Bldg., Clinton, Iowa

Burpee's Seed Catalog Free

All Colors
**SEEDS
FREE**

110-VOLTS AC from DIRECT CURRENT

with KATO KONVERTERS. Furnish standard 110-v AC from 32, 110, or 220-v. DC. Good deliveries on sizes 350 through 1500 watts on priority orders. Good deliveries on 5, 7½, 15 & 25 KW AC generators. Mfr's of motor generators, frequency changers and high frequency generators.



KATO ENGINEERING CO.
42 Elm Street, MANKATO, MINN., USA

★ SAVE WASTE PAPER ★

BUILD YOUR OWN ARC-WELDER

For Light or Heavy Work
No rewinding necessary—use coils take 1 hour old auto generators. Works on 110 or 220 A.C. Has 20 different beats. Complete plans and BIG Catalog 35c.

LEJAY MFG. CO. 3347 LeJay Bldg. Minneapolis, Minn.



Monuments

\$13.00 Up. Guaranteed Genuine Marble & Granite. Deal direct with Us by mail. Save. Write for Free catalog today.

U. S. MARBLE & GRANITE CO. Oneco, Fla.

Freight Paid Anywhere in U.S.A.

ANYONE CAN DO THIS IF THEY HAVE OUR CHART

Blue Print 27" x 36" shows how to find length of any rafter; find any angle in degrees, frame any polygon 3 to 16 sides, read board foot and brace tables, octagon scale, rafter tables and many other uses. Can be scaled down for model work as well as full scale framing. Also Chart changing pitches to degrees for use with Radial Saws. Send 50c in Coin or M.O. No Checks or Stamps. **MASON & PARRISH ENGINEERS**, 2106-B N. Burdick St., Dept. D, Kalamazoo 61, Mich.

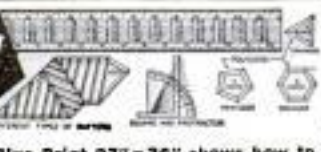

SPECIAL OFFER FOR AGENTS

NOW! "A New Look of Youth" in Zenith's RADIONIC HEARING AID with the New *Neutral-Color* Earphone and Cord

Standard Equipment, No Extra Cost! Now, to Zenith's famous precision quality, years of research have added another great advance: an entirely new standard of smartness and style.

With the exclusive new Zenith NEUTRAL-COLOR Earphone and Cord, even the most sensitive-minded person can wear an aid with new confidence and poise. For what modern styling did for eye-glasses, this smart Zenith ensemble does for the hearing aid: gives it a new "look of youth." The visible parts are *scarcely noticeable*—they complement any complexion.

Try it yourself, and see the proof! Discover, too, the remarkable performance and economy that have won for Zenith an amazing popularity among hearing aids! No "high-pressure" methods . . . your own ears will decide. Visit your Zenith dispenser. Or mail coupon below for complete information.

How Can \$40 Buy This Fine Precision Quality? Because mass production makes possible far greater precision than small production, and at the same time it cuts costs. This is simply Zenith history repeating itself. Zenith portable radios once sold for \$200. Mass production made them better, and lowered the price to \$29! Zenith's leadership in PRECISION MASS PRODUCTION is the reason you enjoy Zenith's *best quality* in a hearing aid at \$40!



**Gone is the Old
"Black Button and Cord"**

Note how Zenith's NEW NEUTRAL-COLOR EARPHONE is scarcely noticeable by comparison with "black button." Complements any complexion. Feather-light, comfortable, made of long-wearing plastic.

New TRANSLUCENT PLASTIC CORD, too, looks well with any apparel. Washable . . . perspiration-proof . . . kink-proof. Will not fray. Also gives less friction or clothing noise than the old type fabric covered cord.



THE NEW

\$40

COMPLETE,
READY TO WEAR

Accepted by American
Medical Association
Council on Physical
Therapy

COPYRIGHT 1944.
ZENITH RADIO CORP.



ZENITH RADIONIC HEARING AID

BY THE MAKERS OF

ZENITH
RADIO

RADIONIC PRODUCTS EXCLUSIVELY—
WORLD'S LEADING MANUFACTURER
All Production Now for War or Rehabilitation

CANADIANS! The New Zenith Radionic Hearing Aid is now available in Canada—direct by mail only—at \$40 complete (Canadian currency) with no additional charge for transportation, duties or taxes! For particulars write our Canadian distributor, Dept. PM-9, Zenith Radio Corporation of Canada, Ltd., Guaranty Trust Building, Windsor, Ontario.

PASTE ON PENNY POST CARD AND MAIL

ZENITH RADIO CORPORATION, Dept. PM-9
P. O. Box 6940A, Chicago 1, Illinois

Please send me your Free descriptive booklet on the New Zenith Radionic Hearing Aid.

Name _____

Address _____

City _____ State _____

Physicians check for special literature.

REPAIR TILE

THE EASY *Centraz* WAY

Centraz TILE POINT



Repairs cracks over bathtubs, around kitchen sinks, pipes and plumbing fixtures. Dries Pure White. Pint 35¢

(40¢ West of Rockies)

WATERPROOF ADHESIVE

Sets loose tile and linoleum. Prevents screws, bolts and pipe joints from working loose. ¼ Pint... 25¢

(30¢ West of Rockies)



For Sale at Your Hardware and Paint Dealer

CHRISTY COMPANY, Inc.

1417 Pine Street

St. Louis 3, Mo.

MAKE BIG MONEY SAWING WOOD NOW!

350 Cuts a Minute



OTTAWA ONE-MAN TRACTOR SAW

Turn wood lots into cash; help save other fuels to win the war. Use Ottawa—fastest cutting; easiest way. Cuts large and small logs, fells trees. Thousands in use. Built to last with special heavy stiff saw blade. Positive safety clutch control, driven from any power take-off. OTTAWA MFG. CO., D927, Forest Ave., Ottawa, Kansas

FREE BOOK and Price List

Build These Big 36" Industrial Training CLEVELAND MODELS



Learn Theory, Design, Construction, Flight, Quickly, Easily, Inexpensively

AAP Pilot Lt. A. A. Z. writes: "For a thorough course in aerodynamics, you can't find a more painless method than building CLEVELAND Models."

- 36" Whirlwind (illus.)
- 36" Spitfire
- 36" Warhawk
- 36" Mustang
- 36" Messer, ME-109
- 36" Airacobra
- 36" Piper Cub
- 36" Lightning
- 36" Typhoon
- 36" Hurricane

\$150

Each Kit only

Build the Biggest \$1.00 Plane in the U. S.

Catalog 5c none free

Build This Huge 84" Super Condor Scorer, only \$100



\$100

Go to your dealer. If ordering direct include 20c extra (pack-post)

CLEVELAND MODEL & SUPPLY CO., 4598DS Lorain Ave., Cleveland 2, Ohio

SOILLESS GROWTH of Plants

The Story of Botanical Wonders

A NEW SCIENCE OFFERING NEW CAREERS

FASCINATING • GET STORY OF SOILLESS GROWTH, ILLUSTR. ALSO 10-Gal. Chemicals Silica Sand Pad. All Only..... 60c

Send to UTILITY CHEMICALS 7524 S. Racine Avenue, CHICAGO 26, ILLINOIS



BUILD WITH CEMENT COMPOSITION

strongly reinforced with cheap wood. Several formulas. Modern stream-lined roof, walls and gutters in use. How to build a house 22x24, three rooms, as low as \$100 for materials, garage, \$20, 20x50 poultry house, \$50. Farm buildings for a few dollars. Home-made equipment to make wall-high building blocks with inside and outside finish. Also roof, wall and floor tile in color, and durable wallboard of wood-ash. Lumber saving. Long lasting. No painting. Make doors and windows. Sectional cabins, 100 motor-cars, sheet. Mixer and saw easily made from an old auto. 40 War-time plans. Earn \$10 a day. Guaranteed. Illustrated instructions. \$1.00.

MAKE FURNITURE OF COMPOSITION cement, sawdust, asbestos, paper. Home-made chests. Some past scrap wood and metal. Illustrated instructions to make tables, cabinets, chests, racks, shelves, lacated sinks, lawn novelties and toys. Over 400 per cent profit. 50c.

HOW TO MAKE 50 ACCURATE WOODWORKING MACHINES, tools, electric wood cutters and many other things from old auto parts and washing machine motors. Illustrated, 50c.

HOME MFG. ENTERPRISES, 50 selected home shop projects, 50c.

Special: All of the books described above, \$2.00 postpaid. No C.O.D.

HOME INDUSTRIES, 1318 South 16th Ave., Dept. PM, Omaha 5, Nebr.

Say you saw it in Popular Mechanics!



SELL ELECTRIC FENCE

The New HIBALL FENCE RETAILS KIT is the best yet. Sell \$195 dealers or direct. Salesmen make up to \$188.64 per gross. Good territory open. 2 Samples, \$3.00.

LEJAY MFG. CO. 2947 Lejay Bldg., Minneapolis, Minn.



KRW ARBOR PRESSES BENCH TYPE AND HYDRAULIC

NEEDED IN EVERY SHOP—SAVE TIME AND MONEY—DO BETTER WORK, QUICKER.

No shop is complete without a small arbor press. Pressing and squeezing operations can be done better and faster on a KRW Arbor Press. Stop using vise and sledge hammer methods—they generally deliver spoiled work in the end. KRW Factory-To-You Prices give you greater value for your money. Order today.

KRW Bench Type Arbor Presses, 3 sizes

- No. 37-P ½ Ton, \$18.25*
- No. 37-O 1 Ton, \$23.00*
- No. 37-N 3 Ton, \$33.00*

*Prices F.O.B. Arendse, N. Y. Slightly higher west of Rockies. Stand illustrated extra.



KRW Hydraulic Presses are built in 25, 50, 60 and 75 ton sizes. Prices start at \$198.00*.

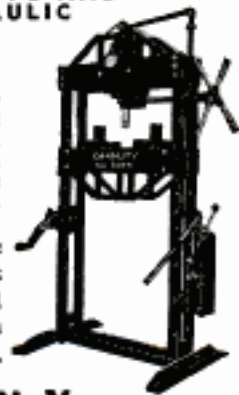

K. R. WILSON, 17 Lock St., BUFFALO 2, N. Y.

Builders of Shop Equipment for Ford Dealers Since 1916

SCREWBALL IDEAS ON BATTERY CARE



Quagmire Thistledown puts his hope in dope. Somebody sold him a magic fluid that's supposed to put new life in tired batteries. Sorry, Quagmire, but it won't work. Throw away that magic "soup" and follow suggestions below:

THE WISE WAY IS PERIODIC RECHARGES!

DON'T wait until your battery goes dead. If your driving is restricted by rationing, drive in to your Exide Dealer for an occasional FREE CHECK UP! When necessary, he'll advise a periodic recharge. At little cost, periodic recharges will keep your battery strong and postpone the day when you'll need a new one. When you *must* buy, get a dependable, long-lasting Exide. Buy to Last—Save to Win.

THE ELECTRIC STORAGE BATTERY CO.
Philadelphia 32
Exide Batteries of Canada, Limited, Toronto

EXIDES ARE USED IN MORE THAN 100
APPLICATIONS BY OUR ARMED FORCES



- 1 Don't buy *anything* you can do without.
 - 2 When you **MUST** buy, insist on dependable, long-lasting merchandise.
 - 3 Take care of the things you have. *Make them last!*
- These conservation rules save materials for war production, help curb inflation, give you more money to invest in War Bonds.

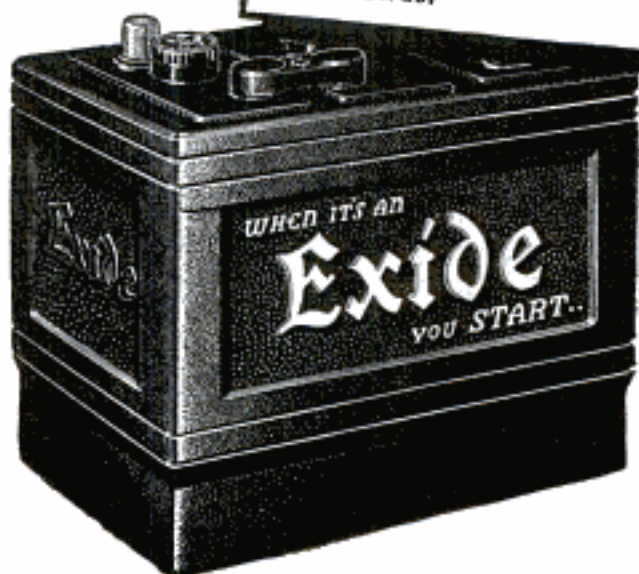

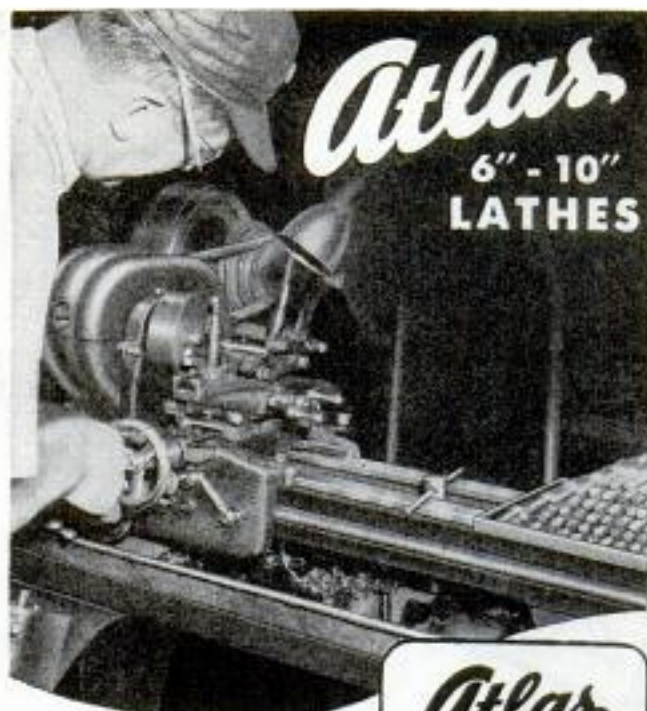

Atlas

6" - 10"
LATHES

WHEN YOU WANT A LATHE

Precision-proven by the rigors of vital war production, Atlas lathes are the ideal all-around machine tools for commercial or private shops. Only MRO or higher priority orders can be entered now. But when war needs are filled, be sure to see the versatile, low-cost Atlas tools in action before you buy! Send for latest catalogs.

ATLAS PRESS COMPANY

943 N. Pitcher St.
KALAMAZOO
13D, MICH.



BUY WAR BONDS

Atlas 4 TOOL TEAM for SMALL PARTS MACHINING



DRILL PRESSES



MILLING
MACHINES



SHAPERS



LATHES

5 lbs. HANDY ASSORTMENT \$1.98

FOR MECHANICS—GARAGES
—WORKSHOPS—HOME USE

SCREWS • NUTS • BOLTS • WASHERS •
RIVETS • SPRINGS • BRACKETS • MISC.

MORE THAN 1,000 PIECES

5 full pounds—a veritable treasure chest of fastening devices for every practical use. Satisfaction guaranteed. Order now **\$1.98**

SPECIAL—2 assortments, over 2,000 pieces, for \$3.69.

HUDSON TRADING CORPORATION

The House of Handy Assortments

165 West Hubbard St., Chicago 10, Ill.

FREE!

Handy List of Special Assortments—fiber, bakelite, rubber and felt parts; radio jugs, clips and connectors; springs; self-tapping screws, etc.



END DAMP AIR with DRI-AIR

PROTECT your valuable equipment, tools, foods and furnishings from damage! End dampness in your home or workshop with amazing **DRI-AIR**. Makes Dry Rooms Healthful, Pleasant

Place **DRI-AIR** Unit in any room, basement, storeroom or closet. **DRI-AIR** Chemical absorbs extra moisture from the air. Keeps rooms dry. Prevents mould and mildew. **DRI-AIR** kills musty odors; stops rust; keeps furniture and woodwork from warping. Complete **DeLuxe DRI-AIR** including 10 lbs. Chemical, \$5.50 f. o. b. Chicago. Ask your dealer or order direct.



TAMMS SILICA COMPANY
228-LY N. LA SALLE STREET, CHICAGO 1, ILL.

RUST-PROOF ANYTHING IN 2 MINUTES!

An invisible coating of this easy-to-apply oil will do just that.

★ FIENDOIL ★

Cleans . . . Protects . . . 35c 2-oz. Bottle at Dealers

McCambridge & McCambridge Co.
Baltimore 23, Md.

LAW STUDY AT HOME for PERSONAL SUCCESS and LARGER EARNINGS. 35 years expert instruction—over 108,000 students enrolled. LL.B. Degree awarded. All texts furnished. Easy payments. Send for FREE BOOK—"Law and Executive Guidance."
AMERICAN EXTENSION SCHOOL OF LAW
Dept. 45-M, 646 N. Michigan Ave., Chicago 11, Ill.



MEN

This Horseshoe Ring, Handmade, Hand-engraved, inlaid with simulated pearl, is a **KNOCKOUT!** Shoe and shank of everlasting Monel Metal is

GUARANTEED 20 YEARS

Supply is limited . . . act now! SEND NO MONEY with order, just name and ring size. Pay on arrival, 20% tax included, ONLY \$3.98, NOT one cent extra for anything! Return in five days for refund if not delighted. Address:

AMERICAN JEWELRY CO., Dept. 333-H, Wheeling, W. Va.

POPULAR MECHANICS

★ SAVE WASTE PAPER ★



American fighters make sure our big guns are hitting enemy installations. Artillery fire control crew receive directional data from observers and pass it on to gun crews.

Telephones

keep Long Toms

on target

War needs the plants and manpower that would normally be making telephone instruments, wires, cables and switchboards for civilian use. That's why there are many people waiting for telephone service.

It will be some time before equipment is available to give service to all who want it. But we shall continue to do everything we can to make that time as short as possible.



BELL TELEPHONE SYSTEM

Please give the service men first call on Long Distance from 7 to 10 each night. That's the best time for most of them to call home.

Amazing Handy ADDING MACHINE

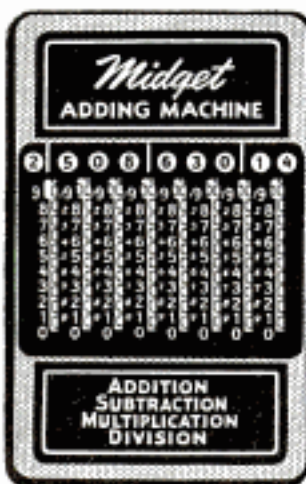

Can Be Carried
in Vest Pocket

ONLY

\$2.50

POSTPAID

**ABSOLUTELY
ACCURATE**

Yet Weighs Only 5 Ounces

- Handles Totals up to \$10,000,000.00.
- Totals appear instantly—as fast as you put the figures down.
- Can be used to subtract, multiply and divide, as well as add.
- Metal construction for years of service.

Haven't you often wished for a handy little device like this . . . that you could take with you ANYWHERE . . . on the road, in the office, at home or in the shop? You can get one now . . . Business man, student, housewife—everyone finds this handy, guaranteed-accurate little machine useful . . . ORDER YOURS TODAY.

SEND NO MONEY

Just send name and address. Then pay postman \$2.50 plus postal charges on delivery. Or send \$2.50 with order and we pay all charges—saving you about 50 cents at the new postal rates.

LEE SPECIALTY CO., Dept. PM-4,
Box 3620, Mdse. Mart, Chicago 54, Ill.

MAIL COUPON TODAY

LEE'S SPECIALTY CO., Dept. PM-4,
Box 3620 Mdse. Mart, Chicago 54, Ill.

Please send me one of your MIDGET ADDING MACHINES.

I am enclosing \$2.50 Send C.O.D. plus postage

NAME

ADDRESS

CITY & STATE

★ SAVE WASTE PAPER ★

**CHASE THREADS
TRUE &
STRAIGHT**

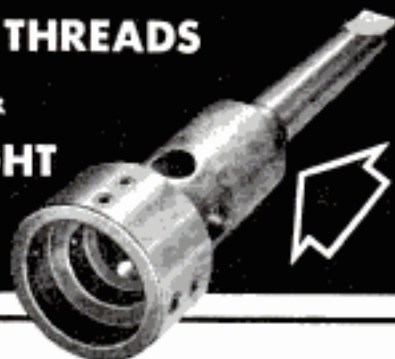

The RIEGER DIE HOLDER has steps for 1" and 1 1/2" O. D. button dies. Use it in lathe or drill press to chase threads up to 5/8" x 3". The quick, accurate way to thread one piece or a quantity. Needed in every machine shop. Standard model has No. 2 Morse taper shank. Ask for literature.

THE RIEGER MFG. CO.

Dept. PM-9

MIAMISBURG, OHIO

**TAPE WORMS
ROUND WORMS
(Ascarids)
HOOK WORMS
WHIP WORMS**



...you can free your dog of all these worms

with **PULVEX**

COMBINATION
TREATMENT **WORM CAPSULES**

Used by leading breeders. At leading pet, drug, department stores, 50c a package (double size, 75c). Packed two ways: for puppies, for dogs.

GENUINE U.S. BARGAINS



O. D. WOOL BLANKETS (USED) . . . \$2.95
USED GOT MOSQUITO NETS . . . 1.25
U. S. ARMY PUP TENTS (USED) . . . 3.00
Slightly Used Army Caisson Wheels with
Axles, 56" high, weight per pair with Axle,
322 lbs. \$37.50

Thousands of Other Bargains in Military, Outdoor
& Sport Goods for Hunter, Farmer, Scout. Send 10¢
for 32-page catalog returned with first order.

A and N SUPPLY CO.
4724 LESTER ST. RICHMOND, VA.

UTICA TOOLS



Ask Your Dealer



UTICA DROP FORGE & TOOL CORP.
★ UTICA, N. Y. ★

POPULAR MECHANICS

Copyrighted material

HERE'S

BEEN A

BIG CHANGE



THE old-fashioned phonograph played sweet music in its day. But with the advent of the radio, home entertainment took on a new significance.

The most significant change in tapered roller bearings in recent years is Tyson's extra rolls—actually thirty percent more

around the raceway. That's important. For it's the rolls that carry the load.

Today users of heavy-duty equipment are amazed at the sustained efficiency of these Tyson "All-Rolls" Bearings under most exacting operating conditions.

The big name in bearings today is . . . TYSON!



TYSON BEARING CORPORATION • MASSILLON, OHIO.

COUNT THE ROLLS - THE ROLLS COUNT

Tyson
TODAY'S HEAVY-DUTY BEARING



★ BUY MORE WAR BONDS ★

**GLAMORIZE
AND WINTERPROOF YOUR HOME WITH**

PLASTI-COTE



**AMAZING LIQUID
PLASTIC PAINT**

**ONE
COAT
COVERS**

EXTERIOR

THE PAINT OF TOMORROW—TODAY! Imagine cosying and beautifying your home, inside and out, with a film of real plastic, tough, tenacious, deeply beautiful... which neither sun, rain, fumes, or smoke affects. That's PLASTI-COTE, the amazingly durable plastic paint, which anybody can apply.

EXTERIOR—One Coat Covers clapboard, shingle, stucco, brick, plasterboard, concrete, metal. Fills cracks and imperfections. Leaves no brush marks. Does not chip, chalk, or peel.

INTERIOR—Gloss, semi-gloss or flat, for walls and woodwork, even old wallpaper. Washes like tile. Cannot be thinned with water.

MONEY BACK GUARANTEE

Use 25% of this resin-based liquid plastic paint. If not delighted, return remainder and receive full refund. Order for cash, post-paid; or C. O. D. plus small express charge. Colors: White, Ivory, Cream, Buff, Dusty Rose, Peach, Grey, Blue, Brown, Black, and Green, 3 shades. A gallon covers 300 square feet.



INTERIOR

\$5.95

**PER
GAL.**



Say Good-Bye to Wax and Polish Slavery—Use PLASTI-CLEAR FLOOR FINISH
Banishes waxing and polishing. Resists alcohol, cigarette burns, boiling water—even lye. Ideal for wood, concrete, linoleum, tile. Non-skid. 10 colors and clear. Per Gal. \$6.75.

Cosify Your Damp Basement with PLASTI-BASE WATERPROOF FINISH
Seals and beautifies brick, concrete, masonry, mortar. Stops seepage and moisture. No costly undercoats necessary. Make your basement dry, colorful playroom. 6 colors. Gal. \$7.50.

DEALER INQUIRIES INVITED

CELLO-NU PRODUCTS

333 N. MICHIGAN AVE., DEPT. 2, CHICAGO 1, ILL.

★ SAVE WASTE PAPER ★

HONES!
and stropps
RAZOR BLADES



**More shaves,
better shaves
from every blade**

Allegro—that's the name of this clever device from Switzerland—and it will give you a brand new idea of shaving comfort. For Allegro will put a perfect, professional cutting edge on a double-edge blade in 30 seconds. First it *hones* on a regular honing stone; then it *stropps*. Just snap the blade in place and stroke back and forth.

Strongly built for years of service. \$6.50 at leading cutlery stores. If not available locally, we send post-paid on receipt of \$6.50.

Graf & Schmidt, Inc., Dept. 19, 381 4th Ave., New York 16, N. Y.

15 LENSES

Plus 50 PAGE Idea Booklet to Help You...

(All Lenses New—Edges very slightly chipped)
... make your own telescopes, low power microscope, magnifiers, dummy camera, photo cells, rifle scope, detachable reflex viewfinder for 35-mm. camera, telephoto lens, photographic gadgets, for experimental optics, copying and ultra-closeup shots and hundreds of other exciting experiments.

EDMUND SALVAGE COMPANY
27 W. Clinton Avenue, P. O. Audubon, New Jersey

Set 602-H
Only

\$2.60

Postpaid

**FREE! LATEST, MOST
COMPLETE RADIO
PARTS CATALOG**



**EVERYTHING in RADIO and
ELECTRONICS for War Training,
Maintenance or Repair**



**New R-F Resonance and
Coil Winding CALCULATOR**

Easy to use! For fast accurate determination of resonance factors and coil winding data. No. 37-955. Postpaid, only 25c.



RADIO'S FINEST BOOK VALUES

Specially prepared to aid radio training in schools and industry. Full of valuable data. Send for all six!

- Radio Formulas and Data Book No. 37-752... 10c
- Dictionary of Radio Terms No. 37-751... 10c
- Radio Circuit Handbook No. 37-753... 10c
- Radio Builders' Handbook No. 37-750... 10c
- Simplified Radio Servicing No. 37-755... 10c
- Radio Data Handbook No. 37-754... 25c
- All Six Books No. 37-799... 75c

ALLIED RADIO CORP.
833 W. Jackson, Dept. 5-J-4, Chicago 7

ALLIED RADIO

POPULAR MECHANICS

FOR MEN
WHO REALLY
KNOW PIPES

Royalton CROWN

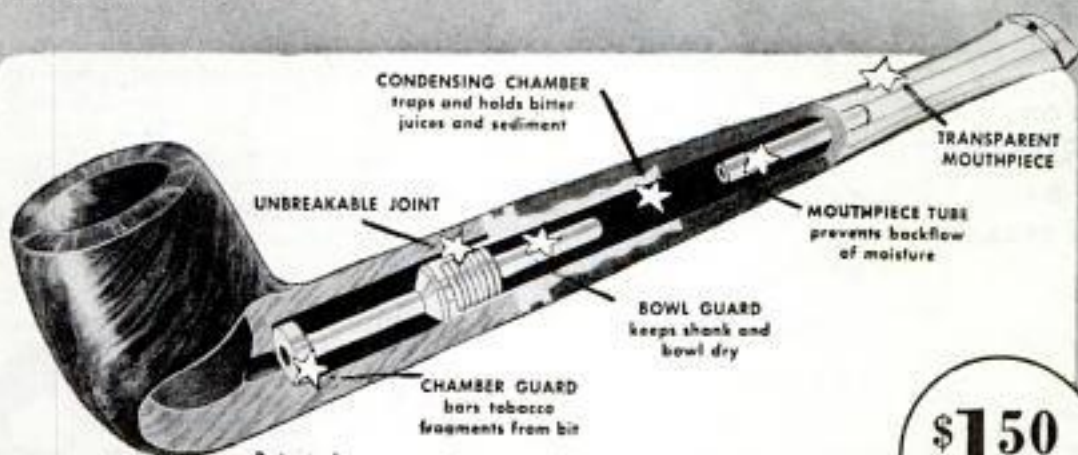

\$1.50

Selected Briar

You'll see the difference—You'll taste the difference—when you smoke a Royalton CROWN... Its patented safeguards eliminate every pipe-gripe... Its many inbuilt features add up to a guarantee of a clean, dry pipe—assurance of constant, unadulterated smoking contentment.

HENRY LEONARD & THOMAS, INC., OZONE PARK, N.Y.

IF YOU WANT TO MAKE
"Good Pictures"

USE YOUR CAMERA—SEND 25c

For this 56-page book, it will help solve many of your problems. Write to Argus, Inc., Ann Arbor, Michigan, Dept. K.



argus — ann arbor
incorporated — michigan

ON SWITCHBOARDS...
PANEL EQUIPMENT

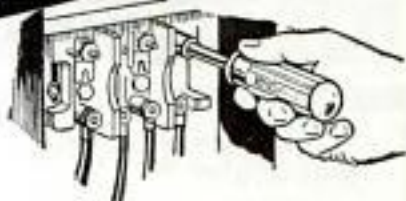

Make Easy Work
of Nuts in Tight Places with
XceLite Hollow Shaft Nut Drivers

A real expeditor of jobs on radio panels, telephone and power switchboards. The hollow shaft slips over protruding studs; accurately machined socket accommodates two nuts. Genuine shock-proof XceLite handle. Shafts insulated if desired. Seven sizes, from $\frac{1}{8}$ " to $\frac{5}{8}$ " (nut sizes). Priorities required—sales restricted. Ask your hardware, radio or mill supply dealer or write Dept. J.

PARK METALWARE CO., INC.
ORCHARD PARK • NEW YORK



XCELITE

BACK THE ATTACK—KEEP THE WAR BONDS YOU BUY

BEFORE STARTING DIRTY WORK

Rub on
"PRO-TEK"
like a
cold cream



When
through work,
grime and paint
wash right off



It acts like an
invisible glove



DU PONT
PRO-TEK
REG. U. S. PAT. OFF.
HAND PROTECTIVE CREAM

BURN YOUR NAME ON TOOLS WITH THE ARKOGRAF

PROTECT YOUR TOOLS FROM THEFT

Write with electricity any name or design on the handle and fasten tools and instruments, or any metal, like writing on paper with pen or pencil. Thousands used by mechanics, garages, machine shops. Complete outfit \$1.50—Prepaid Anywhere. Interesting illustrated circular free. Write today. ARKOGRAF PEN CO., 3927 S.E. Stark, Portland 15, Ore.

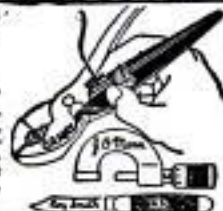

IT'S YOUR PATRIOTIC DUTY TO KILL RATS!

Rats causing terrific damage and spreading disease

Rats are destroying millions of dollars worth of precious food, property and are spreading disease. An easy and quick way to kill rats is with K-R-O.

K-R-O is made from *red squill*—a raticide recommended by the U. S. Dept. of Agriculture because it effectively kills rats. Safe to use around livestock or poultry.

Ask for K-R-O at your druggist's or feed dealer. K-R-O Co., Springfield, Ohio.

K-R-O
KILLS RATS ONLY



MAKE MONEY CASTING AT HOME FREE FACTS SENT



Make hundreds of Plastic Casts, quick, easy. Sell output to stores, novelty shops, etc. Enormous profits. No experience. Very little capital needed. Start in basement, garage or workshop. Complete, simple instructions anyone can follow. Start now while merchants are begging for merchandise to sell. Rush.

PLASTIC ARTS STUDIOS, R. R. 4, Dept. 29, Muncie, Ind

Now She Shops "Cash And Carry" Without Painful Backache

Many sufferers relieve nagging backache quickly, once they discover that the real cause of their trouble may be tired kidneys.

The kidneys are Nature's chief way of taking the excess acids and waste out of the blood. They help most people pass about 3 pints a day.

When disorder of kidney function permits poisonous matter to remain in your blood, it may cause nagging backache, rheumatic pains, leg pains, loss of pep and energy, getting up nights, swelling, puffiness under the eyes, headaches and dizziness.

Don't wait! Ask your druggist for Doan's Pills, used successfully by millions for over 40 years. They give happy relief and will help the 15 miles of kidney tubes flush out poisonous waste from your blood. Get Doan's Pills.



You'll Get **MORE GOOD WELDS** per Hour with a **HOBART Arc Welder**

- ▶ "Simplified" DUAL CONTROL
- ▶ REMOTE CONTROL
- ▶ POLARITY CONTROL
- ▶ IN-BUILT EXCITER & COOL OPERATION

LOOK AT THESE EXCLUSIVE FEATURES... that make HOBART the outstanding welding machine buy for more quality welding per hour and continuous operation without shutdowns.

IT'S SIMPLIFIED... for ease in operation, yet built to give years of dependable service on all types of welding jobs.

HOBART BROTHERS CO.
BOX M-941 Troy, Ohio

Write Today for Catalog and Special HOBART PLAN For Immediate Deliveries, proper Priority necessary.



HOBART "One of the World's Largest Builders of Arc Welders and Equipment."

More Speed

for every hand tool operation . . . Snap-ons deliver it . . . with less effort, greater accuracy and utmost safety! In hundreds of plants engaged in critical war production, Snap-ons are standard tool equipment . . . the choice of better mechanics throughout industry. 3,000 modern Snap-on tools provide a wide selection for production, assembly and maintenance operations. Snap-on offers direct-to-user tool service through 37 factory branches in key production centers.

SNAP-ON TOOLS CORPORATION
8062-1 28th Ave., Kenosha, Wis.



The tremendous holding power of Weldwood Glue is due to the strength of the *bond* it makes between woods. It actually *welds* them together.

You'll find Weldwood Glue remarkably simple to mix and use, too. Just mix the fine powder with ordinary tap water, spread with brush or stick, and the job's done. Clamps can be removed and the job can be light-worked in a few hours.

Your hardware store or lumber dealer has handy packages of Weldwood Glue in 10c, 25c, 50c and 85c (1 lb.) sizes. Get a can today or send 25c and your dealer's name for a trial 3½ oz. sample. Supply limited, due to Uncle Sam's war needs.

UNITED STATES PLYWOOD CORPORATION
Weldwood Glue Dept., 106, 55 West 44th St., New York 18, N. Y.

Weldwood Glue has everything:

1. Tremendous strength.
2. Waterproof, bacteria- and rot-proof.
3. Quick and easy to use. No heating. No waiting.
4. Economical.
5. Applied cold, quick setting.
6. Stain-free.



"Makes the glue line the **SAFETY line**"

WELDWOOD
PLASTIC RESIN
WATERPROOF GLUE

» MARXMAN »

FOR MEN OF ACTION



MARXMAN PIPES ease the tension... the strain of battle, the breakneck pace in the office and factory. Men of action everywhere depend on MARXMAN PIPES to relax... to lighten the load!

Enjoy the smoothness, the mellowness, the cool and satisfying sweetness of a MARXMAN. Every pipe is bench-made by expert craftsmen from thoroughly aged, selected briars. There's a MARXMAN PIPE for every taste—all the popular styles and also many exclusive shapes. Look for «MARXMAN» on the next pipe you buy.

MOROCCO
Featherweight at
\$250



MEL-O BRIAR
Famous Pipes at
\$350



SUPER BRIAR
Rare Grains at
\$500

AT FINE STORES—EVERYWHERE

» MARXMAN »

27 W. 24th Street, New York City

★ SAVE WASTE PAPER ★

HOLD-E-ZEE

AUTOMATIC GRIP SCREWDRIVERS

Hold-E-Zees do the job better, faster. They excel wherever screwdrivers are used. Gripper instantly released by spring action, sliding up out of way when not in use. *High-quality materials throughout.*

Upton Bros., Inc.
86 Exchange St.
Rochester 4,
N. Y.



At
Leading
Dealers Everywhere

BARGAIN SALE!



*Genuine
Guaranteed
SWISS WATCHES
WITH JEWELLED
MOVEMENTS*

Yes, even these days there are bargains in hard-to-get jewelry! Distinctive, new and handsome — renowned for accurate time-keeping. Modernistically styled—finer quality. Built by Swiss craftsmen, noted for their outstanding excellence in materials and workmanship. Smart adjustable band sets off attractive chrome case to excellent advantage. You'll be thrilled with its splendid beauty. Precision GUARANTEED Swiss Four Jewel Pin Lever movement. Easy to read dial. Beautiful gift box included.



LOWER
THAN
CEILING
PRICES

Send No Money—Wear at Our Risk
Written Guarantee With Every Watch

Satisfaction guaranteed or money back. Price of men's sturdy, dependable wrist watch only \$13.25. Price of Ladies exquisite dainty wrist watch only \$14.75. Simply send name, address, and tell us which watch is wanted. Pay postman C. O. D. plus a few cents postage and 10% Federal Tax. The supply is limited, so order today. Immediate delivery.

International Diamond Co., 2521 Indiana Ave., Dept. JR1, Chicago 16, Ill.

do you WORRY?

Why worry and suffer any longer if we can help you? Try a Brooks Patented Air Cushion. This marvelous appliance for most forms of reducible rupture helps hold nearly every rupture securely and gently—day and night—at work and at play. Thousands made happy. Light, neat-fitting. No hard pads or stiff springs to chafe or gouge. Made for men, women and children. Durable, cheap. **Sent on trial** to prove it. Never sold in stores. Beware of imitations. Write for Free Book on Rupture, no-risk trial order plan, and proof of results. All Correspondence Confidential.



Brooks Company, 158-D State St., Marshall, Mich.

WAR WORKERS-WIN "PRODUCTION AWARDS"

Dremel Moto-Tools are used on hundreds of jobs, in thousands of war plants, because they are such great time and labor savers.

Kit No. 1 with 23 high grade accessories and Model 1 Moto-Tool in hard-wood case \$17.50

Kit No. 2, same as above with Master Model Moto-Tool \$23.50

Sharpening tools . . . cleaning dies, castings, cores and welding points . . . grinding, polishing, burring and finishing . . . these are but a few of Moto-Tool's many capabilities. Only Moto-Tool has all these features—27,000 r.p.m. (assures better work and lengthens life of cutters); shockproof (bakelite) case; oil-less (oil-sealed) bearings; fan-cooled motor. Order Moto-Tools and accessories at your dealer, or direct on 10-day trial. Money-back guarantee. If you need a Moto-Tool in your work, ask your employer for priority. Catalog FREE.

DREMEL MFG. CO., Dept. T114-J, Racine, Wis.

—Suggest—
MOTO-TOOLS

TO SAVE TIME—
CUT COSTS AND
SPEED PRODUCTION





How to enjoy starched collar neatness & soft collar comfort

The answer is SPIFFY—the invisible collar stay with the self-adjusting springs. Smooths away wrinkles and collar curl—holds down the points—keeps a fellow looking neat, smart and trim the whole day long.



19 Million Sold To Servicemen!

It's a "Must" with the boys in khaki... they're easy to mail. Why not send two or three to *your* man in the service.

Every man should have three or four—25c and more at men's stores everywhere.

SPIFFY COLLAR STAYS

CREST SPECIALTY CO., 663 W. Washington St., Chicago 6, Ill.

Mortite

YEAR AROUND PLUGGER-UPPER

A pliable Plastic that plugs holes in and around screens, casements, drain-boards, sinks, bathtubs, etc. Stops rattles.

In winter weatherstrips windows.

MANY USES IN THE HOME

Keeps out dust and dirt, mosquitoes, flies, ants and other insects.

Easy to apply. Unrolls like ribbon. Adheres to any clean, dry surface. Just press into place and it stays put. Does not shrink, crack or chip.

About 80 feet to a roll. At your Dealer's or \$1.25 postpaid.

Send for Circular

J. W. MORTELL CO.

522 Burch St.

Kankakee, Ill.



ANYONE, ANYTIME CAN MAKE PHOTO-COPIES QUICKLY

The most **USEFUL** copying method ever perfected



A-PE-CO
PHOTO-COPPER
\$55.
COPIES UP TO
18" x 22"

The accuracy, ease and speed with which A-PE-CO photo-copies are made by anyone, are creating hundreds of new users. This modern, versatile, low-cost method makes photo-exact copies of anything written, printed, drawn or photographed. Experience proves that A-PE-CO quickly pays for itself.

LEGALLY ACCEPTED PHOTO-COPIES OF

- Letters
- Records
- Blueprints
- Shop Orders
- Pictures
- Receipts
- Drawings
- Documents

Same-size copies of anything up to 18" x 22". Eliminates errors. Saves steno-copying, tracing, proofreading. No camera, focusing, film or moving parts. Any employee quickly becomes expert. Lowest investment in equipment. Use on any desk or table. You need A-PE-CO. Let us show you how you can use it to expedite office and shop copying. Immediate delivery. See why thousands are in satisfactory use. Send for A-PE-CO folder—today.

AMERICAN PHOTOCOPY EQUIPMENT CO.

2849 No. Clark St. Dept. GF-94 Chicago 14, Illinois

Representatives in Principal Cities

In Canada: Railway and Power Engineering Corp., Ltd.

FIGHT WITH WAR BONDS

The Sharper the Knife, the Better the Plane!

New! No. 83 X-ACTO deluxe all metal knife chest. The finest in knife sets complete with 3 solid aluminum handles and 12 interchangeable blades, in handy wooden chest. Price \$5.00 complete. Other knives and sets from 50c to \$1.50.

RE-BLADE IN
30 SECONDS



Every modeller knows the difference between a sharp or dull knife. And the great difference between X-ACTO and other knives is that X-ACTO, with blades made of fine surgical steel is always sharp. For when the cutting edge dulls, with a twist of the wrist a new blade is inserted.

But even more than that, each of the eight different blades in X-ACTO Kits is designed for specific cutting jobs. Each is a "specialist" in its own right.

Only with X-ACTO, the reliable blade knife, can you derive the greater satisfaction from your hobbies that comes from using the right knife with the right blade, that are always sharp, that always cut with precision.

For better results... order your X-ACTO set today!

Write for 32 page Handbook "How to Build Solid Scale Model Warplanes" —10 cents



On sale at Hobby and Model Dealers, Hardware and Dept. Stores or order direct from
X-ACTO CRESCENT PRODUCTS CO.
440 Fourth Ave., New York 14, N. Y.

X-acto

EVERKEEN knife

★ SAVE WASTE PAPER ★

STOKER EMPTIES OWN ASH!

A remarkable stoker already used by thousands of home owners—fits into any furnace or boiler. Manufactured since 1934. So automatic it takes the coal from your present coal bin through a pipe to the furnace, going around corners if necessary. Keeps house at even temperature, empties its own ash in sealed containers, no coal to shovel, no clinkers to dig, only bituminous stoker of its kind on the market. Send for full information NOW!

POCAHONTAS FUEL COMPANY INCORPORATED
344 EAST 131st STREET • CLEVELAND 8, OHIO

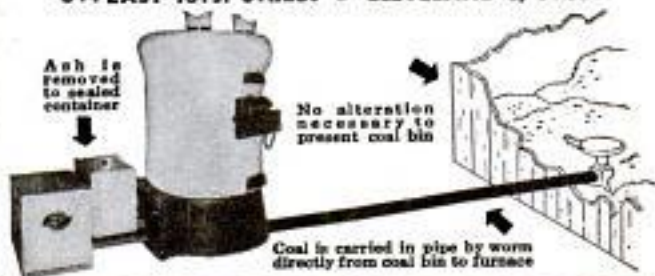

RADIO CABINETS—SPEAKER BAFFLES—BLANKS

Large selection for MANUFACTURERS, DEALERS, SERVICE MEN & EXPERIMENTERS. Beautiful all wood cabinets. WRITE for FREE catalog & prices.
L. Vaughan Cabinet Co., 3810 Clark, Chicago 13, Ill.

MASCOT SLIDE RULE

● Fits the pocket. Quickly solves any problem in multiplication, division, proportion. Gives the square, the square root, logarithm and reciprocals of all numbers. Trig scales give sines and tangents of numbers. Fine black graduations on white celluloid. Complete with instructions. Price in fabricoid case \$1.00, in leather case \$1.25. Money back if not satisfied. Special offer to agents and dealers.



MONITOR SLIDE RULE—6" Dia.

Made in white Vinylite. Same scales as Mascot Slide Rule. Complete with instructions. Without case, \$2.95. Leatherette case, 75c addn'l.

TAVELLA SALES CO., 19-M West Broadway, New York 7, N. Y.

SAW TO THE LINE —and Save Your Breath



only
\$1.00
POST
PAID

Money Back If
Not Satisfied

HOME Craftsmen—here is a unique device that automatically keeps your sawing line clear of saw dust as you work, without constant stooping and blowing away of saw dust with your breath.

Clerline is a simple, lightweight unit that quickly and easily attaches to your saw handle. Each stroke of the saw causes a jet of air to be directed at the sawing line, clearing away dust—the same as is done by power sawing equipment. Nothing to get out of order. Lasts a lifetime. Will not affect the balance of your saw.

Get a Clerline now—send only \$1.00 and one will be mailed to you postpaid. Try it—if you are not entirely satisfied, return it and the purchase price will be cheerfully refunded.

CLERLINE Dept. PM Weedsport, N. Y.

WHEN YOU GO FISHIN' - TAKE A FRIEND!

THERE are lots of folks (who've never fished) who need the solace and relaxation of a fisherman's day on the water. Give them a taste of this healthful, healing sport. Share your fun... When you go fishin', take a friend!

It goes without saying, of course, that you'll have more fishin' time—and more fun all around—if the third party on your trip is a Sea-Horse. The Sea-Horse is a born fishin' friend. JOHNSON MOTORS, 400 Pershing Road, Waukegan, Illinois.

DEALERSHIPS: All of today's Sea-Horses are for the armed services and essential needs. But if you are interested in selling and servicing outboard motors after the war, write us now—no matter what your location may be.



**There Is
No Substitute For
Experience**



**DO YOUR DUTY—
BUY WAR BONDS**

JOHNSON SEA-HORSES for DEPENDABILITY

That's YOU Driving Again!

* Certainly, after the war! And you'll have the new HULL COMPASS to guide you to the mountains, the seashores, remote picnic spots. Styled to tomorrow and improved in performance by wartime engineering.



HULL MFG. CO., P.O. Box 246-D9, Warren, Ohio



Read about Motorcycling—write

INDIAN MOTORCYCLE COMPANY, SPRINGFIELD, MASS.

Indian

BUY WAR BONDS NOW

★ ★ TO BUY AN INDIAN LATER ★ ★

Start a SAW REPAIR BUSINESS!

MAKE A GOOD LIVING IN YOUR OWN BUSINESS—sharpening saws with the Foley Automatic Saw Filer. It makes old saws cut like new again. All hand saws, also band saws and cross-cut circular saws can be filed on this ONE machine.

THERE ARE HUNDREDS OF SAWS TO BE FILED in your own neighborhood, used by farmers, carpenters, homes, schools, factories, etc. W. L. Tarrant writes: "I left my old job last September and in 10 months have filed 2,159 saws. We have a lovely business worked up and cannot keep up with the work."

SEND FOR FREE PLAN

Shows how to start this steady cash business. No experience needed, no eye-strain, no canvassing. You can get a Foley Saw Filer now—no special priority required. Send coupon today.



FOLEY Automatic SAW FILER

FOLEY MANUFACTURING CO.
916-4 Foley Bldg., Minneapolis 13, Minnesota
Send Free Plan on Saw Filing business, no obligation

Name _____

Address _____

REED MICROMETERS 1", 2" and 3" READING to 1/10000"

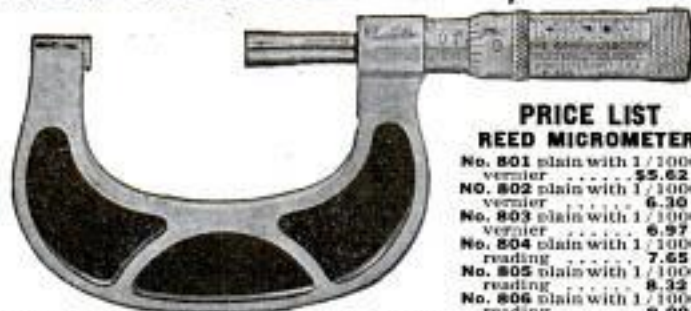

**PRICE LIST
REED MICROMETERS**

No. 801 plain with 1/10000" vernier	\$5.62 net
No. 802 plain with 1/10000" vernier	6.30 net
No. 803 plain with 1/10000" vernier	6.97 net
No. 804 plain with 1/1000" reading	7.65 net
No. 805 plain with 1/1000" reading	8.32 net
No. 806 plain with 1/1000" reading	9.00 net

Illustrated is Reed No. 802 1 to 2" micrometer, graduated to 1/10000". Here is a fine all around micrometer for general shop use with extremely high quality workmanship. Other sizes listed have same type frame, construction.

SHOP AGENTS WANTED. We have a very interesting proposition for individual mechanics who want to earn extra money as shop agents selling Reed Micrometers, Tool Chests, Dial Indicators & other Machinists' Tools. Write for full details today.

Add 10¢ for postage.
Write for new free eight-page folder "MEASURE TO 1/10000" AT NO EXTRA COST."

You can now obtain Reed Micrometers immediately without priority. This precision tool has been made in the U.S.A. for over thirty years. Fully guaranteed, must pass rigid tests for accuracy.

We now furnish Reed Micrometers in the 1", 2" and 3" sizes with a vernier reading to 1/10000" AT NO EXTRA COST. Compare our net prices shown below. Tolerances are closer. More and more blueprints call for tenths of thousandths and every good mechanic needs a 1", 2" and 3" micrometer graduated to 1/10000". Here is your opportunity to purchase these tools at today's low prices. Send your order to us for quick delivery.

GEORGE SCHERR CO., INC., 200A Lafayette St., New York 12, N. Y.

Complete \$20

ENGINES IN STOCK



The G. H. Q. miniature gasoline engine that really operates is still available. Over 100,000 sold to date. 1/5 H. P. Complete with flywheel and propeller, fuel, 15 accessories and full instructions. Fully bench tested and ready to run. Power for all models. \$20 complete. Send only \$1.00—Shipped Collect C.O.D. same day. Send 25c for illustrated Catalog of hundreds of hobby items and airplane identification chart.

GHQ MOTORS, Dept. BV94, P. O. Box 203, Madison Sq. Sta., New York 10, N. Y.

★ SAVE WASTE PAPER ★

AMMCO 7" SHAPER

"A Precision Machine of a Thousand Uses"

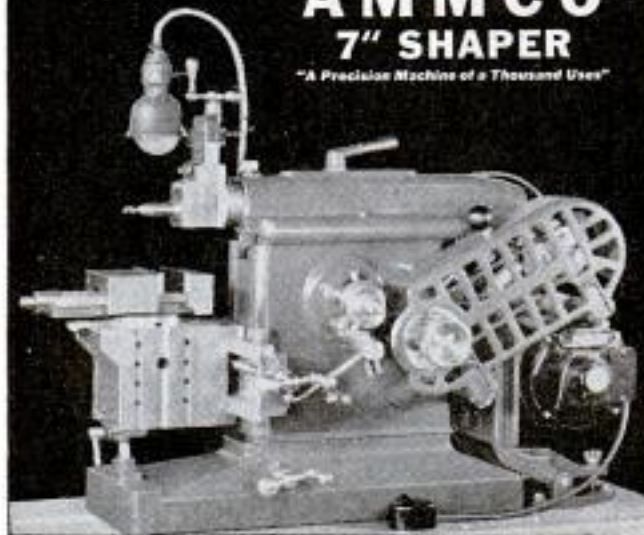

A wide variety of jobs can be done accurately, quickly, easily, and economically on the AMMCO Shaper (7" stroke).

Construction incorporates many features you would expect to find only in larger, more expensive machines... For example: WAYS of ram, tool head, and front face of the main frame are of the "VEE" type, hand scraped to insure accuracy and long life. Available for stationary installation or as portable unit.

Write today for specifications and prices

AMMCO

2140 Commonwealth Ave. North Chicago, Ill.

ARMY and NAVY BARGAINS

U.S. Army Pup Tents (used) . . . \$3.25
O. D. Wool Blankets (used) . . . \$2.50
Army Cots . . . \$2.95

Hundreds of other Bargains in Military, Outdoor and Sport goods for Scout, Farmer, Factory and Outdoor Workers. Send now for FREE PRICE LIST. Money Back Guarantee with all purchases.

MILITARY MAIL ORDER CO., S. E. Cor. 7th and Spruce St., PHILA. 6, PA.

Make Your PAINT BRUSHES LAST!

How easy—with Dic-A-Doo Paint Brush Bath! Keeps new brushes soft, springy, flexible, ready for the next job. Restores old brushes to useful work. All the hard, caked paint dissolves. . . Buy 5¢ package, 10¢ box, at Paint Stores, Hardware Stores, Five and Ten Cent Stores. The Patent Cereals Co., Geneva, N. Y., makers of Dic-A-Doo Paint Cleaners.

DIC-A-DOO PAINT BRUSH BATH



"Better hole up—a guy just got my uncle with a 30-30 Marlin!"



Seal Windows and Doors—
Cut Heat Losses



KALK-KORD

Seals Cracks Quickly,
Easily, Without Tools!

Kalk-Kord, the original non-hardening caulking compound in soft rope-like form, enables you to seal window and door frames against cold and dirt, fills cracks in wood or plaster anywhere, inside and out.

You simply press Kalk-Kord in place with fingers alone, no guns or other tools needed. It is non-oxidizing and will not

check, crack, or harden. Kalk-Kord seals tightly and it stays tight.

Use Kalk-Kord now. Lower your heating bills and avoid soiled walls and drapes due to drafts. Use it also to seal unsightly cracks or nail holes in woodwork or plaster. Kalk-Kord is waterproof and can be painted over immediately if desired.

Kalk-Kord is packed in convenient rolls, ready for use. It is neat and clean to work with, cannot stain. Users everywhere are enthusiastic about Kalk-Kord. Try it yourself, now.

Buy Kalk-Kord at your nearest SEARS, ROEBUCK retail store or order from Sears by mail.

PRESSTITE ENGINEERING COMPANY
3978 Chouteau Avenue St. Louis 10, Missouri



AC
FUEL PUMPS

You have enjoyed such good service and long life from your AC Fuel Pump because of the quality that is built in, from design to finished pump.

You will continue that performance and quality if you insist on an AC when you need a new, or a rebuilt, fuel pump.

BUY WAR BONDS • BRING VICTORY QUICKER



SEE FOR YOURSELF

WHAT "Graf-Flox" IS

★ Now you can SEE why Burd "Graf-Flox" Piston Rings will give new life and add thousands of miles to the motor of your car or truck. Independent research laboratory photos* graphically show: 1. That Burd electric furnace iron has uniformly distributed natural graphite, scientifically controlled for maximum inherent self-lubrication. 2. That the troublesome abrasive metal particles always remaining on ring surface after grinding have been removed. This is done by an exclusive "Graf-Flox" method. 3. That another "Graf-Flox" process has applied penetrating colloidal graphite to further assure self-lubrication. These are the reasons why Burd "Graf-Flox" Piston Rings are instant seating—need no run-in . . . non-abrasive—do not scuff . . . self-lubricating—do not score, seize or stick in grooves . . . why they are piling up engine re-ring, re-bore and re-claim performance records. Mail coupon for Burd "Graf-Flox" Handy Handbook and Car Economy Record Book. Sent free.



* Microphoto shows uneven grain structure . . . poorly distributed natural carbon in ordinary cupola-iron rings. Note metal particles on ring surface which loosen in cylinders and cause trouble.

* Photomicrograph reveals Burd electric furnace iron has uniform distribution of natural graphite . . . controlled tensile strength . . . abrasive particles removed . . . deep deposit of colloidal graphite applied.



BURD PISTON RING CO., ROCKFORD, ILL.



BURD "Graf-Flox" PISTON RINGS

THIS COUPON BRINGS 2 FREE BOOKS

BURD PISTON RING CO., DEPT. PM
Rockford, Ill.
Gentlemen:

Please send me your Handy Handbook on how to keep my car in good working order. Also Car Economy Record Book to keep mileage costs and gas coupons safely.

Name

Address

City State



THE BOND with a PEDIGREE



Chicago **FV**

A thousand test formulas—hundreds of bonds of various kinds—fifty years experience making bonds for the world's best grinding wheels—this is the Pedigree behind the new FV Bond.

FOR THAT PERFECT FINISH—Chicago Wheels made with FV Bond hold their shapes even when run at high speed—produce a satin-like finish that is so accurate it passes any surface analyzer test hands down.

Chicago Mounted Wheels are tough, long lived, dependable. Over 300 sizes, styles and grains.

Chicago Grinding Wheels—Only sizes up to 3" in diameter for the duration, with full WPB approval.



Handee Tool of 1001 Uses and Hi-Power Grinders are still available to all who have priorities.

Send for Free Catalog

CHICAGO WHEEL & MFG. CO.

1101 W. Monroe St., Dept. PM, Chicago 7, Ill.

POCKET ADDING MACHINE

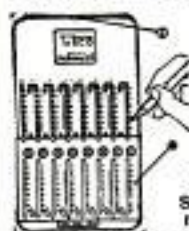

STURDY STEEL construction for lifetime use. Adds, subtracts, adds multiplication. Capacity 999,999.99. A real machine—guaranteed 5 years. Thousands of satisfied users. Send name and address. We ship immediately. On delivery, pay postman \$2.50 (plus C.O.D. and postage charges). If you send \$2.50 with order, we pay postage. Leatherette case 25c additional. Your money back after 10 days trial if not satisfied.

Free Trial \$2.50
Send no money

TAVELLA SALES CO., 19-MA West Broadway, New York 7, N. Y.

GUARANTEED VIBRATORS—\$100 EACH

Rebuilt Radio For very prompt delivery, enclose remittance and return postage. We rebuild any make or kind of vibrator. Send your old vibrator to **BEST VIBRATOR CO., P. Box 5802 Cleveland 1, Ohio**

TIGHTEN LOOSE PLATES

WITH **GUM-TITE** PLASTIC RELINER



FREE Gum-Tite CLEANER & APPLIER with every tube of . . . **MIRACLE ACTING GUM-TITE**

LASTS 4 to 6 MONTHS

Keeps Food Out . . . Smooths Gums . . . Easy to Use . . . Fits Eastern Teeth

Makes eating a pleasure. Your teeth won't slip, come loose, drop down. Now you can bite into tough meat, chew seasonal Gum-Tite is the original plastic reliner. Not a powder or a paste! No whitening! No embarrassment!

Rush order TODAY! Postage FREE in Cook is included with order. One Tube costs \$1.00 (3 for \$2.50). In addition you'll get FREE our marvelous Gum-Tite Cleaner. 100% Satisfaction or DOUBLE YOUR MONEY BACK! Write to AGOR PRODUCTS COMPANY, Dept. No. P3M-1 454 Broadway, Chicago 40, Ill.

AGOR PRODUCTS COMPANY, 454 Broadway, Chicago 40, Ill.

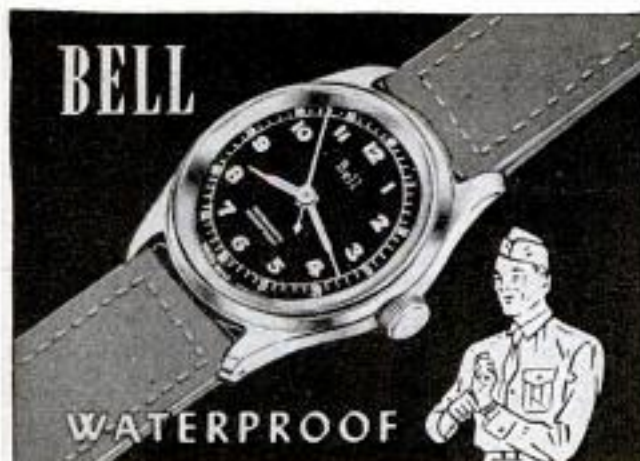

Waterproof, shockproof, anti-magnetic, radium dial and hands, unbreakable crystal, precision tested, sweep second hand.

- No. IE 121 — 15 jewels, stainless steel back \$39.75
- No. IE 212 — 17 jewels, stainless steel back \$42.50
- No. IE 330 — 17 jewels, all stainless steel case \$59.75

POSTPAID FED. TAX INCL. • MAIL ORDERS PROMPTLY FILLED

Write for Free Illustrated Booklet "IE"

BELL WATCH COMPANY

Time-Life Bldg., Rockefeller Center, New York 20, N. Y.

NEW! IDEAL NAVY GIFTS!

Grand "Sweetheart" Combination Gift!

... the pin for HER ... the ring for HIM

No. 3121—Men's heavy ring in 10K Solid Gold, only \$16.50, in Sterling Silver, \$7.50. Lady's pin (No. 5411) in solid sterling, 24K gold plate anchor, \$3.00. Pictures actual size. Prices include postage and Federal Tax. Satisfaction guaranteed. Send for free circular of Navy Jewelry.



HERFF-JONES-CHICAGO, Inc., Dept. PM, 32 W. Randolph, Chicago 1, Ill.

Miniature Mask for DUST and HAY FEVER

Hay fever sufferers wear to keep from breathing pollen. Handy as a pair of glasses! For best protection keep mouth closed and breathe thru nose. Guards against nuisance dusts, lint, coal, cement, grain dust, plant pollens, etc. Wear when sweeping, dusting, cleaning furnace, sanding, grinding, paint spraying. DUPOR No. 1 weighs 1 oz. Has 9 sq. in. filter. Folder FREE!



Order Today \$1.00 POST PAID

H. S. COVER, Dept. PM, South Bend, Ind.
"GOLDEN JUBILEE YEAR, 1894-1944"

Now Ready! NEW! FREE! CATALOG RADIO AND ELECTRONIC COMPONENTS AND EQUIPMENT

... last-minute listings ... hundreds of items ... for schools, government and military services, war plants, laboratories, etc. MAIL COUPON TODAY.

LAFAYETTE RADIO CORP.
901 W. JACKSON BLDG., CHICAGO 7, ILL., DEPT. P-9

Please send me a FREE copy of the new Lafayette Radio Corporation Catalog No. 94.

NAME
ADDRESS
CITY STATE

SEPTEMBER, 1944

RIY (Repair it Yourself) Endorses SMOOTH-ON



Have you joined the RIY? Almost every householder today is a member. And when leaks, cracks, loose parts threaten the life of household equipment which is now practically impossible to replace, Smooth-On No. 1 Iron Repair Cement supplies RIY first aid. Lasting aid, too. For Smooth-On—so easy to apply, no heat required—has PROVEN its satisfactory results through 50 years on the market.

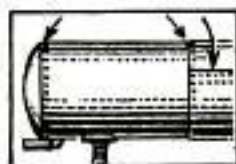
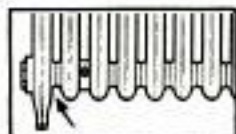

When leaks or cracks appear in heating or plumbing systems, when screws, bolts, handles, casters, hinges, etc., refuse to stay tight, reach for your can of Smooth-On—and be sure to have one always on hand for emergencies. Obtainable in 1 3/4 oz., 7 oz. and larger containers from your hardware store or if necessary, from us.

FREE 40-Page Repair Handbook



40-page, pocket size, conveniently indexed Smooth-On Handbook shows practical, tested, short-cut ways by which YOU can repair about every type of home equipment—Send the coupon.

Smooth-On Mfg. Co., Dept. 37
570 Communipaw Ave., Jersey City 4, N. J.
Please mail me my Repair Handbook

Name
Address
9-44

Free

Do it with SMOOTH-ON

★ SAVE WASTE PAPER ★

YOUR AFTER-WAR TA-PAT-CO



EASY TO PACK

You'll find your new after-war Ta-Pat-Co lighter, warmer, more compact, easy to carry, easy to pack. In making hundreds of thousands of sleeping bags for the armed forces, we have added a lot of "know how" to the sixty years of experience we had before the war.

Your sporting goods dealer will have the new Ta-Pat-Co for you after the war... and it's worth waiting for!

THE AMERICAN PAD & TEXTILE CO.
GREENFIELD, OHIO

*In Peace and in War, the Leading Manufacturer of Life-Save
Equipment and Sleeping Bags*



A GENUINE HIDE GLUE READY-TO-USE

No mixing or heating means no chilled joints.

AT YOUR HARDWARE DEALER

or send 30 cents for 1/4 pint to The Franklin Glue Co., Columbus 3, Ohio



in every battle... doing
vital jobs... unflinching

that's
why
there
are just
a few
left for
essential
jobs at
home



BRIGHT STAR BATTERY CO. CLIFTON, NEW JERSEY



The Needle with the Plastic "Silencer"



ELECTRIC HEATING APPLIANCE ELEMENTS REPAIRED...

Use NICHROCITE PASTE

Simply overlap ends, apply Nichrocite Paste and turn on current. Used by large utility companies. Trial order, \$1.00; 4 oz., \$2.50; 1 pound, \$8.00.
Advance Mfg. & Dist. Co., Box 861 Minneapolis, Minn.

COLOR CONCRETE WITH CHEMICALS

A business of your own. Big money making Hollywood style pottery and birdhouses without moulds. Wishing-wells, stucco-rock, benches. Marbling and cement water-paints. 10c brings sample, literature, pictures.
Hollywood Cement-Craft, 8529 Wonderland Ave., Hollywood 46, California

Wonder-Tone NOISE ELIMINATOR

Just attach to your radio (long, short wave) and enjoy reception free from distracting noises. Send No-Money Pay Postman 60c plus postage or send 60c and we'll send postpaid. Return in 5 days for refund if not delighted.

WONDER-TONE COMPANY, Dept. 44, 7078 N. Clark St., Chicago 26, Ill.



BRUSH PLATING OUTFITS

for autoparts, reflectors, faucets, bicycles.
No tanks necessary. Free particulars.

GUNMETAL CO., AVE. M, DECATUR, ILLINOIS



Titan Slide Rule

6" diameter. Easily read, clearly marked single index scales. Gives logarithms, reciprocals, squares, square roots, sines, and tangents. Continuous circular calibrations cannot go "off-scale." Invaluable in multiplication, division, proportion, conversion, all mathematical problems. Made of durable heavy pure white Vyn-lite. Complete with instructions, \$2.95. Leatherette case 75c additional. Money-back guarantee.

PRECISION INSTRUMENT CO.

Box 654, Dept. B

Church St. Annex

New York 7, N. Y.

America's Number One Manufacturer of Warm Air Heating Plants Announces

A NEW KIND OF FURNACE DESTINED TO SWEEP AMERICA!

**COSTS LESS!...MORE EFFICIENT!...AMAZINGLY COMPACT!
ALREADY PROVED IN THOUSANDS OF HOMES!**

FLOOR-LEVEL AIR DRAWN OFF HERE—QUICKLY WARMED—MEANS WARM FLOORS.

AIR INTAKE CHAMBER SPREADS AIR INTO HEATING CHAMBER.

AIR IS WARMED AND CIRCULATED 3 TO 5 TIMES AN HOUR IN AN AVERAGE 5-ROOM HOUSE.

STREAMLINED BOTTOM MAKES AIR "FLY" 35% FASTER THROUGH THE FURNACE!

80% OPEN REGISTER SPEEDS WARMTH TO EVERY CORNER OF YOUR HOME.

COMPLETELY AUTOMATIC! NO DIRT, ASHES, SHOVELING OR WORK.

NEEDS NO BASEMENT—NO DUCTS. AIR-FLOW PRINCIPLE GIVES BETTER COMFORT.

GET THE WHOLE STORY OF THIS "HEAT OF TOMORROW" FROM THIS FREE BOOK!

FREE!
The "INSIDE STORY" about this and other "magic" heat plants.

IT'S CALLED A "FLOOR FURNACE"—BECAUSE IT IS SET IN THE FLOOR!

Here is some of the practical Coleman heat-magic you can have after the war. New "warm-floor" comfort—automatic effortless ease—surprisingly low fuel cost. One of a group of advanced heating plants, perfected by Coleman engineering genius. Gas, oil, butane models will be available.

A book of solid facts about the different type of heating that will be available when production is resumed. Mail coupon for your copy, to Coleman Lamp and Stove Co., Dept. PO-613, Wichita 1, Kansas.



**THE "HOT" NAME
IN HOME HEATING**



Coleman

THE COLEMAN LAMP AND STOVE COMPANY
WICHITA 1 • CHICAGO 11 • PHILADELPHIA 8 • LOS ANGELES 54

THE COLEMAN LAMP & STOVE CO.,
Dept. PO-613, Wichita 1, Kansas.

Without obligation, send me your FREE illustrated book,
"The Inside Story of Tomorrow's Home Heating."

Name _____

Address _____

Town _____ State _____

LIMITED QUANTITIES

Electric Stoves
1-Burner and
2-Burner



Carpet Sweepers
Electric Vacuum
Cleaners

Electric Steam Irons
Automatic Electric Irons
Electric Irons



Electric Roasters All Sizes
Electric Waffle Bakers
Electric Hair Dryers

Infra-Red
Health Lamps



Schick Electric
Shavers
and Others



RADIOS, A.C. & D.C.
Table & Console Models



Electric
Food and Cream
Mixers



Electric Sandwich
Toasters

Electric Toasters
Electric Broilers
Automatic
Pop-Up Toasters



Electric Room Heaters
with or without Wire Guard

Electric Fans, All Sizes

Electric Wire, All Sizes

Heater Elements

Iron Elements

Cooker Elements



Silverware for Home Use
Silverware for Restaurant Use

Write or phone for prices

JOSEPH WINKLER & CO.

667-671 N. CLARK ST. CHICAGO 10, ILL.

SHELDON

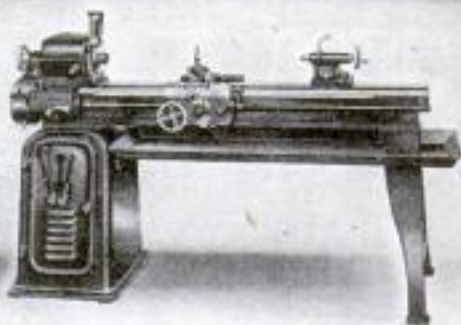

A Complete Line of 10", 11" and 12" PRECISION LATHES

Quality Lathes built to industrial
machine tool standards. Used by
Army, Navy, and Marines. Manual
50c. Catalog free.

SHELDON MACHINE CO., Inc.
4286 N. Knox Ave., Chicago 41, USA

The Care
and Operation
of a Lathe

★ SAVE WASTE PAPER ★



Balance 4" x 5" Base. With either 56.00
Metric or Avoirdupois Weights ...

Catalog with 3000 Illustrations of Laboratory
Apparatus sent for 75 cents. Catalog listing 10,000
chemicals, drugs, minerals, etc., and 1700 scientific
books sent for 25 cents.

LABORATORY MATERIALS CO.,
2321 Vincennes Ave., Chicago, Ill.

Now for EVERY WORK SHOP!

NEW Invention Electroplates by BRUSH

Easy to Plate CHROMIUM GOLD, SILVER, NICKEL, COPPER

... For Pleasure and Profit!

If you have a workshop—at home or in business—you need this new Warner Electroplater. At the stroke of an electrified brush, you can electroplate models and projects—you can replate worn articles, faucets, tools, fixtures, silverware, etc. with a durable, sparkling coat of metal... Gold, Silver, Chromium, Nickel, Copper or Cadmium. Method is easy, simple, quick. Everything furnished—equipment complete, ready for use. By doing a bit of work for others, your machine can pay for itself within a week. So make your shop complete by getting a Warner Electroplater right away. Send today for FREE SAMPLE and illustrated literature. ACT AT ONCE! Mail Coupon.

WARNER ELECTRIC CO., DEPT. 317
360 North Michigan, Chicago 1, Illinois

FREE Details & Sample!

WARNER ELECTRIC CO., 360 N. Michigan, Chicago 1, Dept. 317
Gentlemen: Send Free Sample and Details to:

Name _____

Address _____

City _____ State _____

SAVES VALUABLE TIME AND MONEY

NOW a *DYNAMIC* **HEAVY DUTY INDUSTRIAL WELDER**

WORKS OFF
110 VOLT
ELECTRIC
LIGHT
CIRCUIT



**AMAZINGLY SIMPLE
AND EASY TO OPERATE**

This portable **DYNAMIC WELDER** easily carried right to the job—plugs into any convenient, properly wired 110 volt light circuit.

**WORKS ON IRON, STEEL,
BRASS, BRONZE AND
OTHER METALS**

Has eight metallic and carbon arc welding heat stages. Does work you would think only possible with a larger, more expensive machine.

DESIGNED TO DO HIGH-GRADE WELDING INEXPENSIVELY

Maintenance men, farmers, mechanics, machine shops, foundries, auto, general repair and job welding shops using the **DYNAMIC WELDER** find it so indispensable and useful that they cannot afford to be without it. If inexperienced you can easily learn to do a variety of high-grade welding jobs by following the practical simplified operating and welding instructions furnished.

GET DETAILS on our 10-DAY TRIAL OFFER

Once you see a **DYNAMIC** in operation you won't want to be without it. Its simplicity will amaze you. In a year the **DYNAMIC** only costs you about 6c a day. Comes complete, ready to operate, with helmet, rods, cables, electrode holder and operating instructions, etc. Nothing else to buy. Write today for free priority assistance and particulars on how to qualify for one of these amazingly low-priced welders. Act now while they are still available.

READ WHAT USERS SAY

Repair Shop Owner says, "It will do more than you say."

"I want to say I operate a repair garage and am more than satisfied with the welder. It will do more than you say."
C. F. Butler, Ohio

It's the Greatest Portable Outfit

"Now I am equipped for all kinds of welding and before I go further I must say it's the greatest portable outfit for welding any man could ever wish to own. I wouldn't sell mine for the cost of plenty welders I have seen which were very high in cost but not in convenience. You may put me on file as a booster of your wonderful welding product."
W. J. E. St. John, N. B., Canada

Better Than I Expected

"I have done quite a little welding with my welder and will frankly say it is better than I expected. The price, convenience, and variety of work that can be done with the Dynamic are the attractive points."
W. K. P., Portland, Ore.

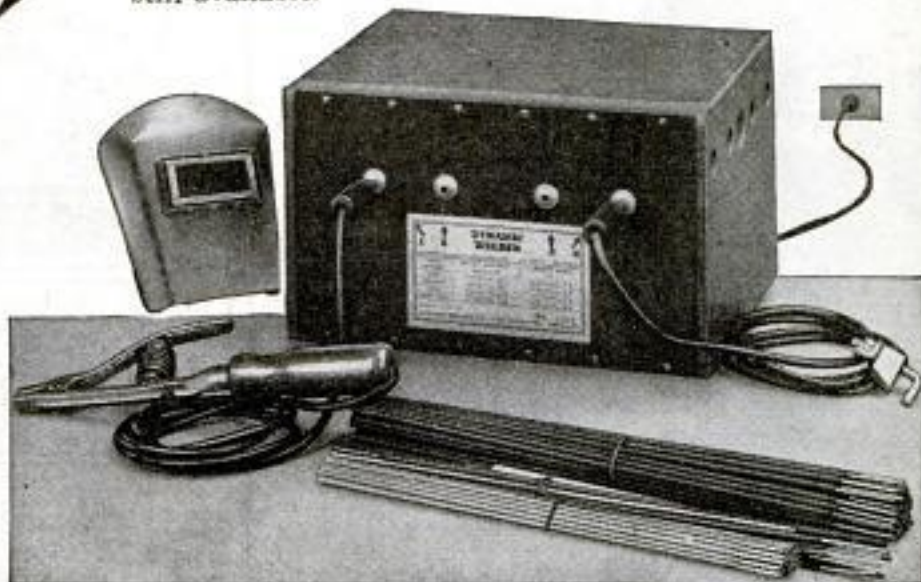

DYNAMIC WELDER CO.

13 EAST 23rd STREET **BG**
CHICAGO 16, ILL.

For FUN AND PROFIT

GET THIS
BOOK OF OVER
100 ITEMS
WORTH \$12.35 IF PLANS
BOUGHT INDIVIDUALLY

Only
\$1.50



AMAZINGLY SIMPLE PLANS for PRACTICAL PROJECTS

You will have no trouble in working out the plans detailed in the LeJay Manual and you will get a lot of enjoyment from them. Whether or not you are mechanically inclined, the projects in these plans will appeal to you for their usefulness and practicality. They will save you money and make money for you, too, in jobs and repairs for neighbors and friends, because the plans embody all kinds of electrical devices.

NO EXPENSIVE TOOLS or MATERIAL NEEDED

The tools you have around the house are all you need for these projects and most of the necessary material can be found around garages, workshops and scrap yards. Being able to make your own welder helps a lot in doing other jobs, and the LeJay Manual shows you how easy it is to do this. Also, how to make:

- 200 Amp. Generator Welders
- Large Transformer Welders
- Gunsmith's Carbon Welder
- 6, 12, 32, 110-Volt Motors
- Electric Outboard Motor
- Wind-driven Light Plant
- Electric Fences
- Electric Drills
- Bench Grinders
- Electric Scooter
- Armature Rewinding
- Insect Electrocutors
- Electric Bicycle Pusher, etc.

SEND NO MONEY—BUT

Send a postcard with your name and address and a request to send the LeJay Manual C.O.D. and the postman will deliver it at your door. If you are not entirely satisfied after 3 days perusal, send it back and we will refund the \$1.50. Bear in mind, however, that C.O.D. fees have been considerably increased, so if you prefer to save this expense, send \$1.50 now, under the same guarantee. In Canada, \$1.75.



**3 DAY
TRIAL**

LEJAY MFG. CO
47 LeJAY BUILDING
MINNEAPOLIS - 8 - MINN.

LOOK AT THIS TOOL BOX

ALL STEEL
4 Cantilever
TRAYS



Built
Like a
Battleship

NO
PRIORITY
NEEDED

ONLY
\$7.95
PREPAID

THOUSANDS PURCHASED BY THE
U. S. AIR CORPS AND ARMY ENGINEERS

Amazing value in this Super-De Luxe Tool Box Kit. Limited supply for civilian use. Has 4 roomy cantilever trays with handy opening action on attached hinges. Note divided compartments for screws, nuts, bolts, small tools, etc.—each tray easily accessible. Sturdily built of 18-gauge steel for years of service. Closed size 18" x 10" x 13". Cover lids close in hip roof design for handy carrying. Has metal snap locks and stout steel handle. Olive drab baked enamel wrinkle finish with matching trays.

RUSH YOUR ORDER Just send \$1 deposit and pay balance of \$6.95, plus express charges on delivery. Or enclose \$7.95 with order for prepaid delivery. You save express charges and recently increased C.O.D. fee. If not delighted return in 5 days for refund. No risk!

ANDREW A ROBE WAREHOUSE 1716 S. Michigan Ave. Dept. 12, Chicago, Ill.

Fix Scratches, Dents, Nicks the Professional Way!



Get This Handy Kit!

Repair damaged furniture surfaces with new practical kit. Enables anyone to do fast, easy touch-up jobs like a professional cabinet finisher. Makes furniture and cabinets look new. Every home and shop needs this remarkable kit. Pays for itself over and over!

Amazing Results—Easy to Use

Kit includes 23 different items—scratch removers for slight scratches, assorted shades of shellac sticks for deep nicks, bottles of light and dark stains, shading lacquer, alcohol lamp with feet, stainless steel scrubbers, touch-up brushes, scratch sticks, steel wool, sandpapers, rubbing liquid. Packed in handy leatherette finish case. Send for it today. Best investment of lifetime. Fully guaranteed. Detailed instructions supplied.

\$3.95

Postpaid

AMERICAN HOUSEHOLD BUREAU
Dept. F, 520 N. Michigan Ave., Chicago, Ill.

Say you saw it in POPULAR MECHANICS



WORLD'S LOWEST PRICED ADDING MACHINE

Best Pocket Size
FREE TRIAL
IDEAL FOR BUSINESS OR
PERSONAL USE. GUARANTEED
ACCURATE. TOTAL COST
SEND NO
MONEY
Not a toy. Operates with only a finger
lick. Adds, subtracts, multiplies, di-
vides. Counts up to ten million. Pays
for itself over and over. Ideal gift—
for Business, Income Tax and School use. MONEY BACK GUARANTEED.
Send name and address. Pay postman only \$2.00 plus
postage. (Send full cash if outside U. S.) Money back
in 10 days if not delighted. AGENTS WRITE.

CALCULATOR MACHINE COMPANY (Mrs.)
DEPT. 157, P. O. BOX 1118 CHICAGO, ILLINOIS



Motorists! up to

30% EXTRA MILEAGE

from **EACH GAS STAMP** with a

VACU-MATIC

CARBURETOR *Control*



➔ You can't change gas rationing, but you can make sure that each precious gallon of gasoline is providing you with the maximum mileage of which your car is capable. Now you can get added mileage . . . plus quicker starting and more power! Make this trial test. Install a Vacu-Matic on your car and get up to 30% extra mileage on a money-back guarantee.

AUTOMATIC SUPER-CHARGE PRINCIPLE

• Vacu-Matic is entirely different! It operates on the supercharge principle by automatically adding a charge of extra oxygen drawn free from the outer air, into the heart of the gas mixture. It is entirely automatic and allows the motor to "breathe" at the correct time, opening and closing *automatically*.

PROVEN BY TEST

• In addition to establishing new mileage records on cars in all sections of the country, the Vacu-Matic has proven itself on thousands of road tests and on dynamometer tests which duplicate road conditions and record accurate mileage and horsepower increases. Thousands of motorists now enjoy extra mileage—improved performance with Vacu-Matic.

FITS ALL CARS

• Vacu-Matic is constructed of six parts assembled and fused into one unit, adjusted and sealed at the factory. Nothing to regulate. Any motorist can install in ten minutes. The trial offer coupon will bring all the facts. Mail it today!

AGENTS TRIAL OFFER ➔

• Vacu-Matic offers a splendid opportunity for unusual sales and profits. Every car, truck, tractor and motorcycle owner a prospect. Valuable territories now open. You can obtain one for your own car if you help us introduce it to a friend. Just check and mail the coupon today.

Send this Coupon Today

THE VACU-MATIC COMPANY
7617-974 W. State St., Wauwatosa 13, Wis.

Please send full particulars about VACU-MATIC, also how I may obtain one for trial on my car. This does not obligate me in any way.

Name

Address

City

State

Check here if interested in Agency Proposition.

PRECISION

— AS VITAL IN WAR AS IN PEACE

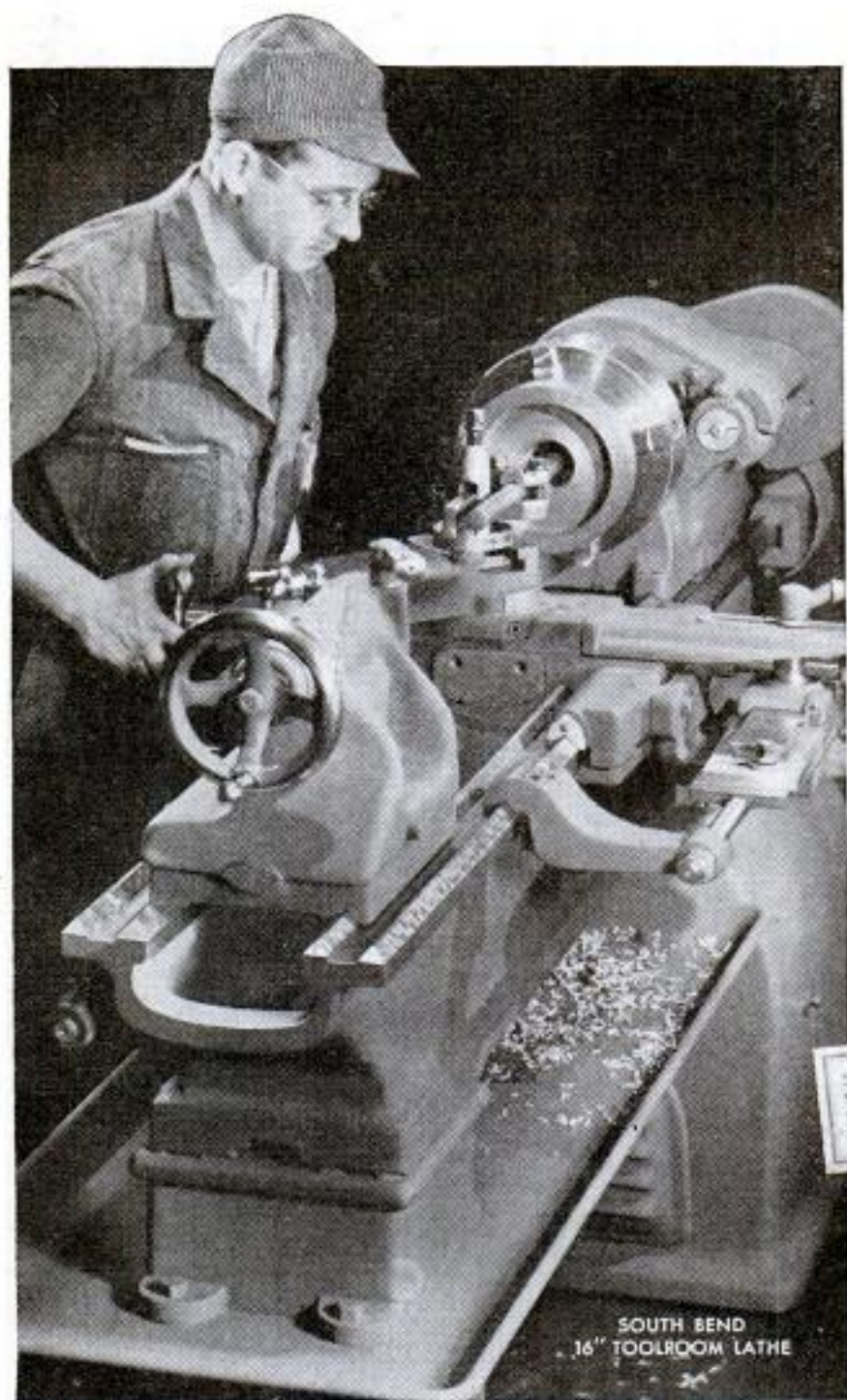

SOUTH BEND
16" TOOLROOM LATHE

In every theater of war South Bend Lathes are holding to their pre-war traditions for dependable precision. In the mobile machine shops of our mechanized forces they duplicate factory tolerances on intricate parts needed for emergency repairs on guns, tanks, trucks and other essential equipment. On board many of the Navy's fighting ships, where high precision is an absolute requirement, they are also depended upon for the maintenance and repair of mechanical equipment. In the repair bases of the Air Forces, they play an equally important part in keeping planes in service.

In all classes of war service these lathes are doing fine precision work—not only with the armed forces but also in industry where dependable accuracy is as vital as speed and versatility in meeting war's urgent production schedules.

When civilian production is resumed, South Bend precision will again prove as indispensable to peacetime industry as it is now for exacting war work. Embodying the improvements developed to meet war production requirements, South Bend Engine Lathes, Toolroom Lathes, and Precision Turret Lathes will be available.

POST-WAR PRIORITY PLAN



To those who cannot qualify for a war-time priority, South Bend Lathe Works offers a practical Post-War Priority Plan. You can place your order now for any South Bend Lathe. No deposit or down payment is required. We ask only that the order be placed in good faith. When civilian production is resumed, orders will be filled in the sequence established by the numbers of the Post-War Priority Certificates. Should conditions necessitate, the order may be cancelled at any time. Write now for details of this plan—and our Catalog No. 100-C.

BUY WAR BONDS... SAVE FOR LATHES

SOUTH BEND LATHE WORKS

LATHE BUILDERS FOR 37 YEARS • SOUTH BEND 22, INDIANA

PRINTED BY POPULAR MECHANICS COMPANY, CHICAGO, ILL., U. S. A.

POPULAR MECHANICS material

LIGHTER MOMENTS with **fresh Eveready Batteries**



"Your bawth is drawn, m'Lord!"

IF YOU ARE finding it difficult to buy "Eveready" flashlight batteries this is the reason. Nearly all we make are going to the Armed Forces and to essential war industries. This leaves very few of these long-life, dependable flashlight batteries for civilian consumers.

Back up our hard hitting Infantry boys with War Bonds. Buy all you can afford.

FRESH BATTERIES LAST LONGER . . . Look for the date line →



EVEREADY

TRADE-MARK

The registered trade-mark "Eveready" distinguishes products of National Carbon Company, Inc.

"Attaboy, Joe...
light up a Camel
and look natural!"

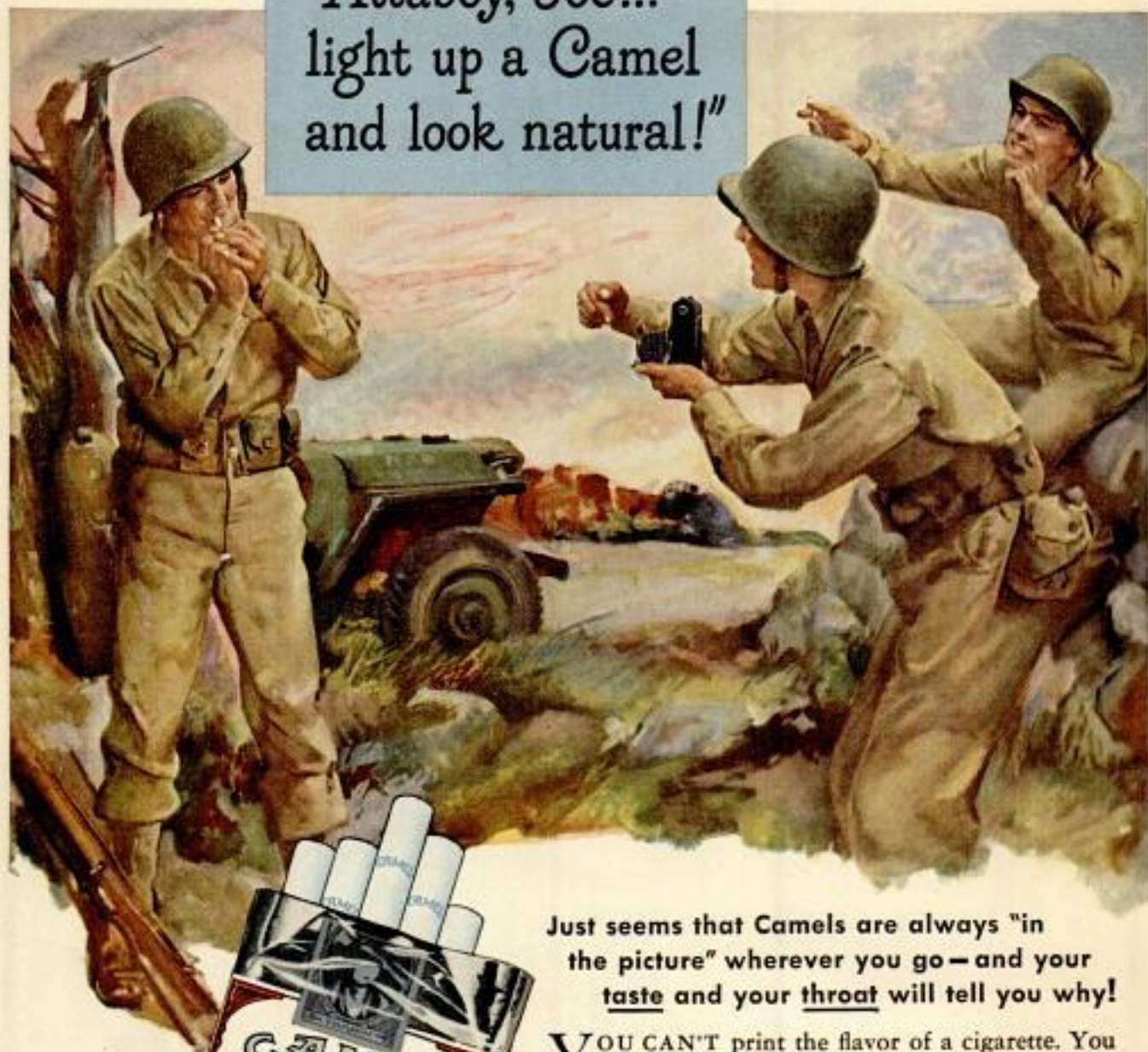

BUY
WAR BONDS
STAMPS

R. J. Reynolds
Tobacco Co.,
Winston-Salem,
N. C.



Just seems that Camels are always "in the picture" wherever you go — and your taste and your throat will tell you why!

YOU CAN'T print the flavor of a cigarette. You can't snap it with a camera, paint it with a brush. Only *your own* taste can tell you which cigarette you like best. And only *your own* throat can decide which cigarette "likes you" best. Give your taste a chance to judge the rich, full, mellow flavor of Camel's superb blend of costlier tobaccos. Give your throat a chance to experience Camel's mildness, coolness, and kindness.

Try Camels on your own T-Zone, T for taste, T for throat, the true proving ground for a cigarette.



Camels — *First in the Service*

With men in the Army, Navy, Marine Corps, and Coast Guard,
the favorite cigarette is Camel. (Based on actual sales records.)