

Fire from the Sky



POPULAR MECHANICS MAGAZINE

REGD. TRADE MARK GREAT BRITAIN 1942

AUG.
25 CENTS
30c IN CANADA

SEE PAGE 14



**BUY UNITED STATES
WAR SAVINGS
BONDS AND STAMPS**



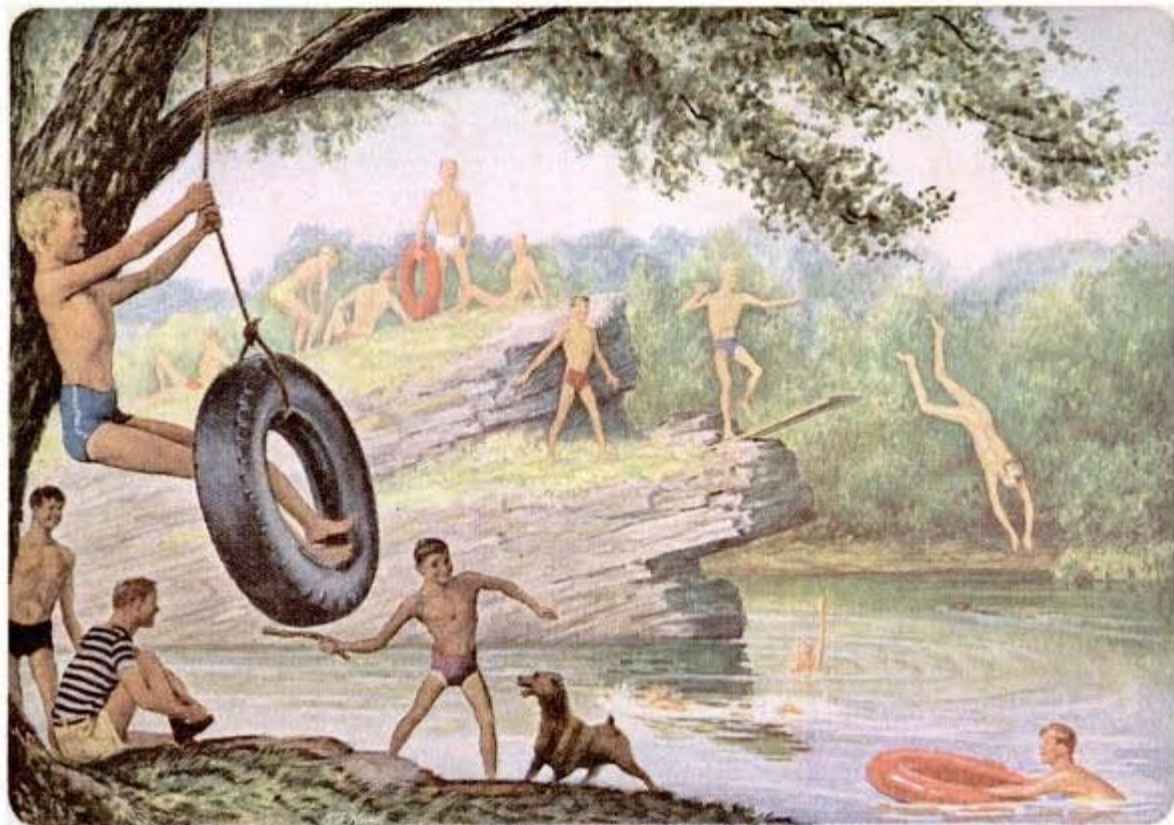

Remember when . . .
your good tires wound up at the old swimmin' hole?

THAT OLD CASING made a dandy swing, so what if it *did* have a few thousand miles left in it?

The tubes that bobbed so merrily in the water could still hold air. But that didn't matter, either! For in those days, rubber was plentiful.

What wouldn't a lot of us give for those same tires and tubes today! Many of them, no doubt, were almost as good as the ones on which we'll probably have to ride for many long months to come.

The rubber crisis is not over—and until it is over it is squarely up to you to get every possible mile from your present tires. Rule No. 1: *Keep air pressure up to 32 and speed down to 35.* Rule No. 2: *Have your tires recapped as soon as they're smooth.* (Recapping is *not* rationed.) The rest is

just careful driving and watchful attention.

Making those tires of yours last is more than just a matter of keeping your own car in shape for your own use. It's joining up with other good Americans from coast to coast to help win the great Battle of Rubber—and keep America's wartime transportation rolling until the war is won.

★ ★ ★

Whenever you see a "Seiberling Tire" sign, you can be sure that it marks the establishment of an INDEPENDENT business man—a man who has had the courage and initiative to go into business "on his own"—and thus CREATE JOBS FOR OTHERS. He could do this because, here in America, we believe in "Free Enterprise"; we believe that the greatness of this country in the future, as in the past, must depend in large measure upon the opportunities it offers for the independent business man to grow and prosper. Seiberling Tires always have been and will continue to be sold by INDEPENDENT dealers only!

SEIBERLING *Experts in Rubber*



Wartime manufacturers of Bullet-Sealed Tubes and Military Tires for our armed forces • Bullet-Sealing Gasoline Tanks • Rubber Floats, Boats and Pontons • Rubber Parts for Gas Masks, Airplanes and Tanks. Also makers of Tires and Tubes for passenger cars and trucks • Sealed Air Tubes • Rubber Heels, Soles and Mechanical Goods.



MEET YOUR NEW NEIGHBOR . . .

Holland is a tiny nation, proud and independent. In time of peace, it was thought of as a land of dikes and windmills, of tulip beds and pleasant, industrious people. . . . But, there will be much to learn about Holland, its love for freedom and its implacable fight against tyranny and oppression . . . There will be much to learn about every nation of our world, important things for understanding and tolerance that will mean a better peace. . . . One of the finest means of studying our World Neighbors is shortwave radio. With it, you can reach any nation almost instantaneously to know the history and politics of that nation even while they are happening. . . . Look to Hallicrafters, when Peace is won, for the world's best short wave receivers—the results of over fifty million dollars worth of war research and developments in Radio.



HALLICRAFTERS RADIOS are the Radioman's Radio. Designed and built for experts, they are the world's finest shortwave receivers. Victorious Allied Armies all over the world will attest to their excellence. **THE HALLICRAFTERS COMPANY, CHICAGO 16, ILLINOIS, U. S. A.**

BUY A WAR BOND TODAY!

hallicrafters RADIO



This One



HN4G-UHE-XA7D

AUGUST, 1944

1A



LONG DISTANCE calls
increased more in the
last 36 months than in
the preceding 36 years.

Bearing up well

He's carrying quite a load but he's doing all right. And he's mighty grateful for your help — especially when Long Distance circuits are crowded.

Then the Long Distance operator may say — “Please limit your call to 5 minutes.” Saving telephone time is important in wartime.

BELL TELEPHONE SYSTEM



Popular Mechanics Magazine

Registered in U. S. Patent Office and Canada

H. H. WINDSOR, Founder

H. H. WINDSOR, Jr., Editor and Publisher

Next Month

MATA HARI of this war is the photo-reconnaissance pilot, stealing Jap and Nazi military secrets from the air at 300 miles an hour—and more. It was “rec” that found the battleship Tirpitz in a Norwegian fiord, that spotted the 200 Jap planes ready for harvest at Wewak and spied out the German radio-location factory in the old Zeppelin works at Friedrichshaven. “Picking the Target,” a feature in the September issue, tells the role of the flying spies in mapping France for the Invasion Command and grabbing closeups of the beaches from 300 feet above the Nazi coastal batteries.

500 Trains a Day

THE towermen in the Pennsylvania Railroad’s “Union Tower” at Rahway, N. J., have gallery seats looking down on the busiest traffic thoroughfare on any railroad. Five hundred trains a day highball past this point on their way into and out of New York, and there are moments when all six electrified tracks are loaded and the operator is plenty busy logging engine numbers. Pay a visit to this tower—read “Highballing 500 Trains a Day” in the next issue.

Rescue From the Sky

MAROONED at a trading post 400 miles north of the Arctic Circle, four white persons and 50 Eskimos faced starvation. Ice had stopped their supply ship; the U. S. Army Air Force was their last hope. Help came quickly—a ton of supplies parachuting out of the sky, then a rescue plane. A September story tells of this new Emergency Rescue service.

August, 1944

Vol. 82, No. 2

IN THIS ISSUE

How the Invasion Was Planned	1
Meet the B-29!	8
The Shape of Things to Come	18
Gateway to War	27
Our Animal Allies	33
Fire From the Sky	40
Topsy-Turvy Farming	44
Torture Tests for Tin Fish	50
Calling Signals for the Army	56
Going Up!	65
Air Made to Order	72
Fighting Below the Waterline	76
Cameras at Work	82

Where-to-Buy-It Index—Page 8A

Power for Our Western Empire

THERE is a vast empire coming into being—an empire of 20 million acres that will be ripe for development when G. I. Joe comes home in search of a career. The basis of that empire is power: networks of electric lines from Boulder Dam and Grand Coulee, Shasta and others to power new industries across the west. Power, too, in irrigation: the Department of the Interior proposes to turn 16 million acres of desert into 150,000 productive farms in the three years after the war. A feature in the September issue introduces you to America’s coming empire.

Heroes of the Tin Cans

THE life of a destroyer in battle is figured at just 11 minutes. Some live longer. The U.S.S. O’Bannon won a Presidential Citation for an epic career culminating in a battle off Vella Lavella, where the O’Bannon and two other destroyers fought nine Jap ships for 30 terrible minutes, sank three and routed the rest. Follow the Yankee destroyers into battle around the world—read the story of the “Heroes of the Tin Cans” in next month’s issue.

Published monthly by POPULAR MECHANICS COMPANY, 200 East Ontario Street, Chicago (11), Ill., U. S. A. Single copy in the United States, 25 cents; subscription rates in United States and possessions, and countries of the Pan-American Postal Union, \$2.50 a year. Single copy in Canada, 30 cents; subscription rates, \$3.00 a year. To all other countries add \$1.00 a year over United States prices for overseas postage. If you plan to move, notify us at least 60 days in advance so you will not miss an issue. Give both old and new addresses. Entered as Second Class Matter, September 15, 1903, at the Post Office at Chicago, Illinois, under Act of March 3, 1879. Entered as Second Class Matter at Post Office Dept. Canada. Copyright 1944, by Popular Mechanics Company, Copyright under International Copyright Union. All rights reserved under Pan American Copyright Union. Printed in the United States of America

Want to move 35 Tons?

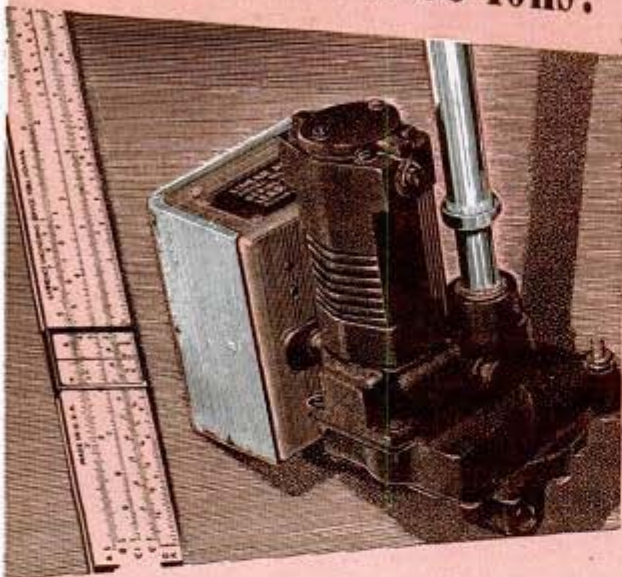

WE wouldn't tell you how fast America's fighting planes go. That's a military secret. But we've all read it's well over 300 miles an hour.

We've read too how they hit 700 or 800 miles an hour in dives. And how paint was peeled by the air pressure.

Did you ever stop to think that the plane's flaps and controls have to work surely, smoothly and dependably against pressures like that?

It's done by such mechanisms as you see in the picture.

They are called Lear Actuators.

They are powerful. Some can push up to 75,000 pounds.

They are light. That's a "must" in aircraft.

They are small. They have to fit in available space.

A good many preconceived notions had to go by the board to meet all these requirements. For example, the little electric motor that runs them is full of revolutionary engineering refinements.

Every man and every minute we have now can't make all the motors and actuators that we would like to deliver for Uncle Sam's aircraft.

But the day is coming when they will have different jobs to do. New jobs on peacetime products—perhaps like steering ocean liners, or parking cars, or things we've never thought of.

That is one reason for this advertisement. We want to know who can use an actuator or a motor like these.

Another reason is, we want you to know that there is available the kind of thinking and engineering which have produced these and some 250 other Lear products.



Ingenious New Technical Methods

Presented in the hope that they will
prove interesting and useful to you.



**HAND
GROUND**



**MACHINE
GROUND**

New Precision Step Drill Grinder Simplifies Production and Maintenance of Step Drills

The quality of a step drill produced by common methods depends almost entirely on the skill and attention of the individual tool maker. However, with the development of the precision step drill grinder, the human element has been entirely eliminated, the characteristics of the step being completely controlled by the grinding machine without adjustments during the course of grinding. This automatic feature insures absolute uniformity, regardless of quantity, and permits large-volume production of step drills.

The apparent advantages gained through the use of the step drill grinder are: Permits mass production of drills ground to exact specifications, entirely independent of the human element. Maintenance, too, is no longer an obstacle as step drills produced by this method are quickly sharpened by the same uniform machine-controlled operation. With the step drill grinder step drills can now be made from standard drills. These advantages result in a wider application of step drills which provide a definite saving of machine tools, man-hours and cost; this in turn results in greater production.

You know there are plenty of benefits in chewing gum, too. That's why all of the Wrigley's Spearmint we're able to make from our available stocks is going overseas to our fighting men and women. You know what a lift it's been on the job and we wish we could supply everybody, because we have pride, too, in our workmanship and productivity. But there just aren't enough available top quality raw materials right now to do it. When we can produce it in sufficient quantity, it will be back to you with the same fine flavor and chewing satisfaction... Wrigley's Spearmint has never been changed!

*You can get complete information from Spiral Mfg.
Corp., 5022 North Kedzie Avenue, Chicago 25, Illinois.*

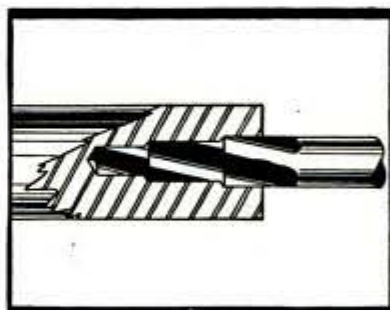

The above illustration shows mechanical design which requires a hole having diameters diminishing in steps. This is an operation for step drills which has often been neglected due to difficulty in obtaining and maintaining step drills.



Step drills produced by our method are quickly sharpened by the same uniform, machine-controlled method.

Y-128



When lint collects upon a suit,
Or threads on dresses stick,
Some Texcel Tape-rolled inside out-
Will pick it off-but quick!

And when this calendar was hung
No hole was left to gape,
For neither nail nor tack was used.
What was? Why, Texcel Tape!



So many things about a house
This Texcel Tape can do -
From wrapping up to fastening down
In place of strings or glue.



For Texcel is an improved tape
Whose "stick-ums" bonded on.
It won't come off, it won't dry out
Before the judgment dawn.



Since all the Texcel Tape that's made
Is being used for war,
Buy Bonds and Stamps 'til Victory
Returns it to your store.

Made by
Industrial Tape Corporation
A Division of
Johnson & Johnson
New Brunswick, N.J.

Texcel Tape

CELLOPHANE TAPE - STICKS WITH A TOUCH

YES, Mr. (or Miss) Bookkeeper, you can become an accountant and make real money.

And you don't need to take the long drudgery way of learning on the job—day by day—a little now and a little then.

Instead you can take a shorter cut to accountancy success—a shorter cut that will give you accountancy training and fit you for more money and a better job in a comparatively short time.

The demand for accountants is great. You need only scan the "Help Wanted" columns to prove this for yourself. And while the demand is increasing, the shortage of capable accountants is becoming more acute.

Taxes—Social Security, the Withholding Tax, Victory Tax—changes in plant structure, the many and varied reports heads of business must have to know the status of their companies quickly and accurately, the many and varied reports which have to be made to government, rapid turnover of labor—

All these and many more factors make the demand for competent accountants far exceed the supply—and promotion comes fast to the able man who knows the whys and wherefores of accountancy.

Under the LaSalle Problem Method you can acquire a thorough knowledge of Accountancy—you can master its fundamental principles and become expert in the application of those principles. You learn by doing—and without losing any time from your present work.

You train directly under the supervision of a competent staff of Certified Public Accountants—and you can train as quickly or as slowly as you choose.

Our 48-page booklet, "Accountancy, the Profession That Pays," is FREE. It explains how we train you from the ground up—or from where you are now—according to your needs. The cost is low—terms easy.

Send the coupon now. Don't lay it aside and say you'll send it later. It can be the means of your success—perhaps more money and a better job than you ever dreamed. At least it's worth investigating. So send it now.

Name _____ Age _____

Position _____

Address _____

City and State _____



"I'm TIRED of being just a Bookkeeper

**I'm going to be an Accountant
—and make REAL money"**

LASALLE
EXTENSION UNIVERSITY

A Correspondence Institution

Dept. 864-H

Chicago 15, Ill.

I'd like to prepare for a good accounting job. Send me your free booklet and full details about your training.



PYROIL

users believe
in an ounce
of prevention



An ounce of prevention has always been better than a pound of cure. When it comes to your automobile, today, that ounce of prevention is especially important—because there just isn't any cure for a worn out car. The extra miles you might have had with Pyroil care—are gone forever.

Drive your car to your service station and ask for Pyroil—a pint in your crankcase—and an ounce in your gas tank with every 5 gallons of gasoline. Then you'll have proven protection against corrosion, excess cylinder wear, rust, carbon formations, gums and sludges.

Manufactured and Guaranteed by Pyroil Company, W. V. Kidder, Founder, 58 Pyroil Building, LaCrosse, Wisconsin.

PYROIL Adds Life to Your Car

PYROIL COMPANY

58 Pyroil Building, LaCrosse, Wisconsin

I want my car to last and run properly. Please tell me more about Pyroil and how it can accomplish this for me.

Name

Address

City or Town

State

WHERE-TO-BUY-IT INDEX

Where no name and address appear directly under an item, the product is not believed by us to be commercially available

Detector locates lost radium.....	16
List of inventions needed.....	16
Clamp speeds planing or sawing.....	16
Stech Clamp Co., 423 Sprague St., Dedham, Mass.	
Helicopter rescues downed flyer.....	17
Flashlight pictures made from plane.....	17
"Teardrop" cockpit on fighter plane.....	17
Wheeled stepladder aids tunnel maintenance.....	26
Warplanes set speed records.....	26
Measles preventive for soldiers.....	26
Japs use odd costume for bayonet drill.....	26
X-rays diagnose plane damage.....	32
Quick-releasing clamp for car battery.....	32
Paul Henry Co., 2037 S. La Cienega Blvd., Los Angeles, Calif.	
Crossbow draws quartz filaments.....	32
Eight-engine, 55-seat plane.....	38
Dusting brush with rubber bulb.....	38
Willoughbys, 110 W. 32nd St., New York	
Coating for glass or wood conducts electricity.....	38
E. I. du Pont de Nemours & Co., Wilmington, Del.	
Army glider carries loaded truck.....	39
Stabilizing device on helicopter.....	39
Cooling fan for plane engine.....	39
Propeller-driven water scooter.....	43
Red ends on shafts warn workers.....	43
Army "knapsack" for gasoline.....	47
Penicillin to be released to civilians.....	47
Models teach workers safety rules.....	48
Trainer shoots ink to mark hits.....	49
Vest-pocket gasoline heater.....	49
Cow treated with oxygen.....	54
Hose clamp tightens like belt.....	54
Aircraft Standard Parts Co., 1711 19th Ave., Rockford, Ill.	
Robot monitors warn flyers.....	54
Spotters wear mine markers on helmets.....	54
"Aircraft carrier" on wheels.....	55
Train riders measured for seat.....	60
Planes drop tanks to set fires.....	60
Hand blinker trains air crew.....	60
Rotating stage for television.....	61
Sleeping bag has 20-ft. zipper.....	61
The All-American gun.....	62
75-foot desert bus.....	64
Snow plow guided by hand.....	64
Gravelly Motor Plow Co., Dunbar, W. Va.	
Gasoline engine fueled like Diesel.....	64
Two planes joined together.....	70
Hearts transplanted in frogs.....	70
"Shears" on tractor cut trees.....	70
Floral appliques for wall.....	71
Trimz Co., 1012 Spaulding Ave., Chicago	
Remover for blackout paint.....	71
Turco Prod., Inc., 6135 S. Central Ave., Los Angeles, Calif.	
Foot pedal operates vise.....	75
Van Products Co., Erie Trust Bldg., Erie, Pa.	
Glucose sustains men on life rafts.....	75
New wind tunnel.....	80
Gun launches plane with blank shell.....	81
Village moved on barges.....	81
Tractor has square wheels.....	87
Phone dial for blind.....	87
N. A. DeStefano, 219 Aronde Rd., San Carlos, Calif.	
Radio mast of tubular plywood.....	88
Maryland Engin'ring Co., 1326 Reisterstown Rd., Pikesville, Md.	
Brain controls bomber engine's "breathing".....	88
Ten-barreled Nazi mortar.....	88
Panoramic adapter used with communications receiver.....	141
Hallicrafters, Inc., 2611 Indiana Ave., Chicago	
Locking type tube clamps.....	144
The Birtcher Corp., 5087 Huntington Drive, Los Angeles, Calif.	
Replacement type dry electrolytic condensers.....	144
The Sprague Company, North Adams, Mass.	
Vest pocket slide rule.....	144
Tuvella Sales Company, 25 West Broadway, New York City	
Tab-type wire markers.....	144
William Brand and Co., 276 Fourth Ave., New York City	
Soldering iron with groove for holding melted solder.....	144
Dual Remote Control Co., Inc. Wayne, Mich.	
Belt-type tool holder for radio workers.....	144
E. F. Hillegas Mfg. Co., 516 Allen Ave., Glendale, Calif.	

Craftsman and Shop Notes Index

ART AND ARTIST

Drawing board extension supports T-square.....	104
Rod prevents soiling work on drawing board.....	120
Sturdy drawing desk.....	121
Symbols on rubber stamps save time.....	130

AUTOMOTIVE

Wallet on sun visor holds papers.....	92
Repair for leaky muffler.....	96
Holding robe on car seat.....	113
Shield protects tires against sun.....	117
Tire data kept in hub caps.....	120
Dolly aids in changing heavy truck tires.....	139
Clean screen stops bearing leak.....	139
Determining firing order of motor.....	140
Rivets reduce size of plug wrench.....	140

BOATS AND BOATING

Food chopper is good calking tool.....	92
Boat bailed automatically.....	110
Anchor holder for short moves.....	112
Servicing your outboard.....	113

Continued to page 10A

INTERNATIONAL CORRESPONDENCE SCHOOLS

OFFER YOU LOW-COST

SPECIAL TRAINING

FOR SUCCESS IN MODERN BUSINESS AND INDUSTRY

TECHNICAL COURSES

Air Conditioning Schools

Air Conditioning
Heating
Plumbing
Refrigeration
Steam Fitting

Chemistry Schools

Chemical Engineering
Chemistry, Analytical
Chemistry, Industrial
Chemistry,
Mfg. Iron and Steel
Pulp and Paper Making

Civil, Architectural and Structural Engineering Schools

Architecture
Architectural Drafting
Bridge and Building
Foreman
Bridge Engineering
Building Estimating
Civil Engineering
Concrete Engineering
Contracting and Building
Highway Engineering
Retail Lumberman
Structural Drafting
Structural Engineering
Surveying and Mapping

Electrical Schools

Electrical Engineering
Electric Wiring
Gas and Electric Welding
Industrial Electrician
Lighting Technician

Power House
Practical Telephony
Radio, General
Radio Operating
Radio Servicing
Telegraph Engineering

Internal Combustion Engines Schools

Automobile Technician
Aviation
Diesel-Electric
Diesel Engines
Gas Engines

Mechanical Schools

Airplane Drafting
Foundry Work
Heat Treatment of Metals
Inventing and Patenting
Machine Shop Practice
Mechanical Drafting
Mechanical Engineering
Metal Pattern Drafting
Mold Loft Work
Reading Shop Blueprints
Sheet Metal Worker
Ship Drafting
Ship Fitting
Shop Practice
Steel Mill Workers
Tool Designing
Wood Pattern Making

Railroad Courses

Air Brake
Car Inspector
Locomotive Engineer
Locomotive Fireman
Railroad Car Repairer
Railroad Section Foreman

Steam Engineering Schools

Boiler Making
Combustion Engineering
Engine Running
Marine Engines
Petroleum Refining Plant

Steam Electric
Steam Engines

Textile Schools

Cotton Manufacturing
Textile Designing
Woolen Manufacturing

BUSINESS and ACADEMIC COURSES

Academic Schools

Arithmetic
College Preparatory
First Year College
High School
Higher Mathematics
Illustrating

Business Schools

Accounting
Advertising
Bookkeeping
Business Correspondence
Business Management
Cert. Pub. Accounting
Commercial

Cost Accounting
Foremanship
Salesmanship
Secretarial
Stenography
Traffic Management

Civil Service Schools

City Letter Carrier
Post Office Clerk
Railway Postal Clerk

Language Schools

French
Good English
Spanish

If you can read and write,
and are willing to study,

WE CAN TEACH YOU!

• *Special service and attention are always given to the student who may need extra help in order to understand.*

REASONABLE TERMS
MAY BE ARRANGED



The successful man DOES today what the failure INTENDS to do tomorrow. Mail this coupon NOW!

Special Tuition Rates for Members of the Armed Forces

INTERNATIONAL CORRESPONDENCE SCHOOLS

BOX 5699-J, SCRANTON 9, PENNA.

Please send complete information on following subject:

(Write above Technical, Business or General Educational Subject in which you are interested.)

Name _____ Age _____

Address _____

City _____ State _____

Employed by _____

Present Position _____

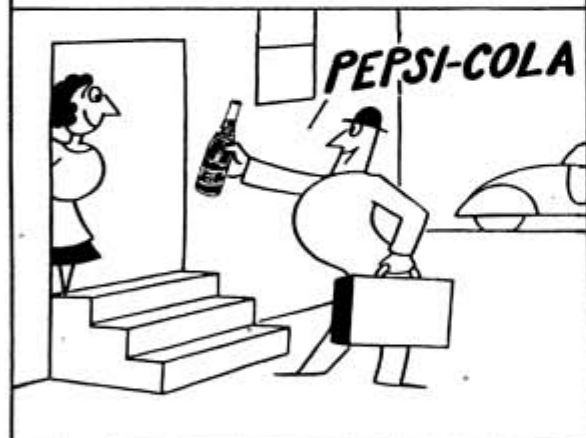
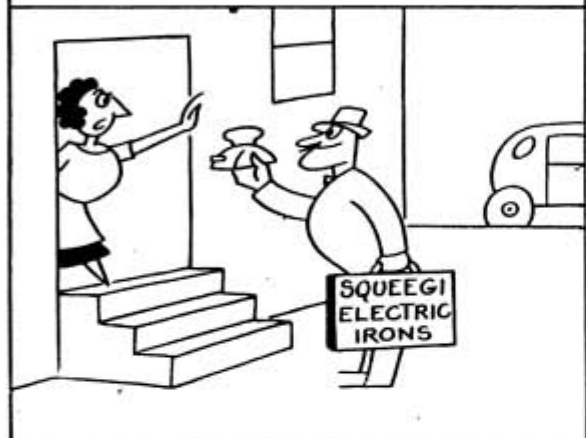

O. SOGLOW

Continued from page 8A

CAMPING, HUNTING AND FISHING

Making an Indian Ti-Pi.....106
Camp stove folds into small bundle.....112

FARM

Preventing hens from roosting on nests.....130
Cone on plant duster assures better coverage.....140

HAND TOOLS

Making a strop-hone.....105
Paper guide to bore straight holes.....120
Pipe used as emergency star drill.....124
Marking gauge used as compass.....124
Adjustable metal-slotting saw.....125
Improvised level.....129
Knife sharpener burrs edges of sheet metal.....130
Easy-to-make depth gauge.....131
Convenient mounting for bench vise.....140

HOME IMPROVEMENTS

New faces for old doors.....89
Laundry-tub faucets made from pipe fittings.....91

HOUSEHOLD

Wooden rack holds dish mops.....91
Emergency elastic from old inner tube.....91
Solving home problems.....94
Keeping corks from sticking.....96
Curing sticking doors and windows.....97
Keeping electrical servants happy.....98
Preventing garbage can from tipping.....104
Extra drawer in closet under stairs.....120
Mending holes in aluminum ware.....120
Labeling canning jars.....124

LAWN AND GARDEN

Blanching cauliflower heads.....104
Producing blue hydrangeas.....110
Hose nozzle to aerate fish pool.....112
Tying ears protects corn from birds.....112
Melons ripened uniformly.....140

PHOTOGRAPHY

Deckle edges on enlargements.....118
Making sure lens cap is removed.....118
Gelatin filter used behind lens.....118
Making faulty flash bulbs work.....118
Method of embossing prints.....118
Adjustable darkroom light.....119
Weighing papers used on photo scales.....119

POWER TOOLS

Angle drilling on the drill press.....96
Scroll saw sands small parts.....117
Dual tool-post grinder.....126
Grinding lathe-chuck jaws.....129
Head clamp for drill press.....130
The automatic screw machine.....132

RADIO AND ELECTRONICS

Panoramic receiver the "electronic detective".....141
Dual phono unit has self-contained amplifier (Part I).....142
Drill chart for radio workers.....144
Seven-point switch from an old tube socket.....144
Replacing "burned out" sections in electrolytic condenser.....144

STORE AND SHOP

Sectional pipe roller to move heavy crates.....104
Cigar boxes used as card files.....110
Price tags for watermelons.....124
Printing-press gauge pins easily improvised.....124
Sealed-beam bench light.....125
Knife to open cartons.....129
Adjustable head for soldering iron.....130

TOYS, GAMES AND NOVELTIES

Bow bazooka.....93
Model train track from tin cans.....97
"Marine Mustang" for fun at the beach.....105
Game of "Bomber".....117

WOODWORKING

Corrugated fasteners hold split turning.....104
Neat way to curve thick stock.....110

MISCELLANEOUS

Broom makes nonslip surface on sidewalk.....96
Nails keep abrasive powder from clogging shaker.....96
Anchoring umbrella at the beach.....110
Blotter protects matches from perspiration.....110
All-wood stroller.....111
Cleaner for oilcan spout.....124
Salvaging warped timbers.....129
Preventing loss of identification badge.....130
Pilot light for aquarium heater.....131

IMPORTANT NOTICE

It is the intention of this magazine to provide its readers with information regarding the latest developments in the mechanical arts. We take no responsibility as to whether the disclosures contained in our articles are covered by patents and advise readers to investigate this subject before making, using, or selling any of the products, machines, or processes described in order to avoid possible liability for patent infringement.

AUDELS AIRCRAFT WORKER . . . \$1

Answers Your Questions on 1—Aircraft Materials, Terms, Parts, 2—Blueprints, Working Drawings, 3—Mathematics, How to Figure, 4—Layout & Bending, 5—Tools & Machines, 6—Riveting, Spot Welding & Hints, 7—Fabrication, Angles, etc. 8—Assembly, Fuselage, Wing & Final—How to Use Tools, 9—Tables & Data, Symbols, Army & Navy Specifications, etc. 240 Pages illus.

AUDELS SHEETMETAL

PATTERN LAYOUTS . . . \$4

Developed by Experts for Sheet Metal Workers, Layout Men & Mechanics. A Practical Encyclopedia in 10 Sections, size 7 x 10 x 2—1125 Pages—350 Layouts—1600 Illustrations. 1001 Key Facts. Fully indexed for ready reference in answering your layout problems. Covers all phases of sheet metal work including Pattern Cutting, Pattern Development & Shop Procedure.

AUDELS SHEETMETAL WORKERS

HANDY BOOK . . . \$1

Practical inside information. Fundamentals of Sheet Metal Work. 388 pages. Illustrated. 11 sections. Clearly written. Essential & important facts, figures, pointers in everyday language. Ref. Index.

AUDELS WELDERS GUIDE . . . \$1

A concise, practical text on operation & maintenance of all welding machines for all mechanics. Over 400 pages, illustrated. Covers all methods of electric and acetylene welding including airplane work.

AUDELS ANSWERS ON

BLUE PRINT READING . . . \$2

For Mechanics & Builders. Covers all types of blue print reading including ship & airplane. 376 pages, fully illustrated.

AUDELS NEW MACHINIST &

TOOLMAKERS HANDY BOOK . . \$4

Covers modern machine shop practice in all its branches. 5 practical books in 1. New from cover to cover. Tells how to set up & operate lathes, screw and milling machines, shapers, drill presses and all other machine tools. 1600 pages, fully illustrated. 5 x 8 1/2 x 2. Indexed. 5 sections. 1—Modern Machine Shop Practice. 2—Blue Print Reading & How to Draw. 3—Calculations & Mathematics for Machinists. 4—Shop Physics. 5—How to Use the Slide Rule. 60 chapters. Easy to read and understand. A shop companion that answers your questions.

AUDELS MATHEMATICS &

CALCULATIONS FOR MECHANICS \$2

Mathematics for home study or reference. 700 pages, 550 illus. Practical mathematics from beginning. How to figure correctly. Easy, correct methods covering a complete review. Ill. & Indexed.

AUDELS AUTOMOBILE GUIDE . . . \$4

A practical quick ready reference book for auto mechanics, service men, operators & owners. Explains theory, construction & servicing of modern motor cars, trucks, buses & auto type Diesel engines. 1540 pages, fully illustrated. 55 chapters. Indexed. A standard book for mechanics. New fluid drive covered.

AUDELS DIESEL ENGINE MANUAL \$2

A practical, concise treatise with questions and answers on the theory, operation and maintenance of modern diesel engines including General Motors 2 cycle Diesel. 384 pages, fully illus., flexible binding, pocket size. All details plainly brought out, this book is of extreme value to engineers, operators & students.

AUDELS RADIOMANS GUIDE . . . \$4

A key to the practical understanding of radio including Frequency Modulation, Television, etc., Aircraft & Marine Radio. For radio engineers, servicemen, amateurs. 772 pages. 400 Illustrations & Diagrams. Photos. Review Questions & Answers, Reference Index. Authentic, clear, concise.

AUDELS HANDY BOOK OF

PRACTICAL ELECTRICITY . . . \$4

For maintenance engineers, electricians & all electrical workers. 1440 Pages, 2600 illus. Covers important electrical information in handy form—including Marine Wiring, Radio Principles, Welding. Indexed. A Key to a practical understanding of electricity.

AUDELS CARPENTERS & BUILDERS

GUIDES—4 Vols. \$6

A practical illustrated trade assistant on modern construction for carpenters, joiners, builders, mechanics and all woodworkers. 4 vols., 1600 pages, 3700 illustrations, flexible covers. Each volume pocket size. Sold separately \$1.50 a vol.

AUDELS PLUMBERS & STEAMFITTERS

GUIDES—4 Vols. \$6

A Practical Trade Assistant & Ready Reference. Explains in plain language & by clear illustrations, diagrams, charts, graphs, pictures principles of modern plumbing practice including Marine Pipe Fitting and Air Conditioning. 4 Vols.—1670 Pages—3642 Diagrams. Each Vol. Pocket Size. Sold Separately \$1.50 a Vol.

AUDELS WIRING DIAGRAMS . . . \$1

210 Pages. Illustrated. Gives practical facts on wiring of electrical apparatus. It explains clearly in simple language how to wire apparatus for practically all fields of electricity. Each diagram is complete & self-explanatory. Highly Endorsed Pocket Companion.

AUDELS ELECTRONIC DEVICES . . \$2

Tells What You Want to Know About Electric Eye. Easily Understood. Covers photo-electric cells & their applications. Amplifiers, illumination, frequencies, voltage, photocells, tubes, Ohm's Law, wiring diagrams, etc.

AUDELS, Publishers, 49 W. 23 St., N. Y. 10

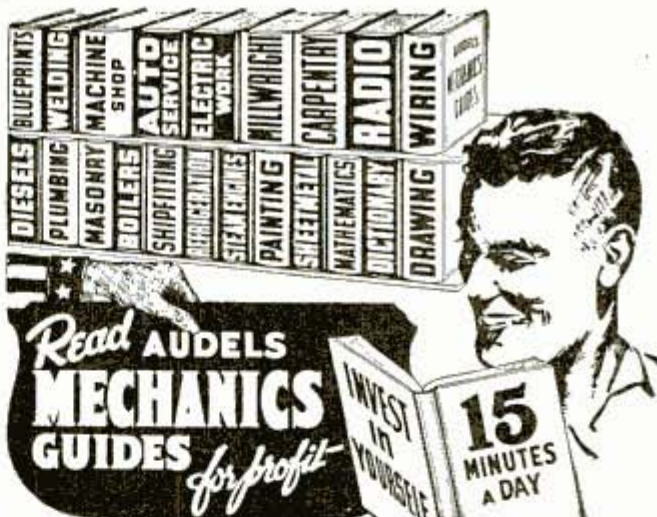

AN AUDEL GUIDE IS A GOOD FRIEND!

Use the brains and experience of others in these Guides of the Trades. Save time and money with right methods, short cuts, labor saving ideas. CHECK NOW! You can look over any Audel Guide in your home. Start the Easy Payments if satisfied.

CUT HERE MAIL ORDER

THEO. AUDEL & CO., 49 W. 23rd St., New York 10

Please mail me for 7 days' free examination the books marked (X) below. I agree to mail \$1 in 7 days on each book or set ordered, and to further mail \$1 a month on each book or set ordered until I have paid purchase price.

If I am not satisfied with Guides I will return them.

- Audel's PUMPS, HYDRAULICS & AIR COMPRESSORS \$4.
- Audel's WELDERS GUIDE 1.
- Audel's BLUE PRINT READING 2.
- Audel's SHEET METAL WORKERS Handy Book 1.
- Audel's SHEET METAL PATTERN LAYOUTS 4.
- Audel's AIRCRAFT WORKER 1.
- Audel's MATHEMATICS and CALCULATIONS 2.
- Audel's MACHINISTS & TOOLMAKERS Handy Book 4.
- Audel's DIESEL ENGINE MANUAL 2.
- Audel's MECHANICAL Dictionary 4.
- Audel's AUTO GUIDE 4.
- Audel's MARINE ENGINEERS HANDY BOOK 4.
- Audel's SHIPFITTERS Handy Book 1.
- Audel's MARINE Engineers Guide 3.
- Gueths MECHANICAL DRAWING COURSE 1.
- Rogers Mechanical DRAWING and Design 2.
- Audel's MILLWRIGHTS and Mechanics Guide 4.
- Audel's CARPENTERS and Builders Guides (4 vols.) 6.
- Audel's PLUMBERS and Steamfitters Guides (4 vols.) 6.
- Audel's MASONS and Builders Guides (4 vols.) 6.
- Master PAINTER and DECORATOR 2.
- Audel's GARDENERS & GROWERS GUIDES (4 vols.) 6.
- Audel's ENGINEERS and Mechanics Guides 12.
- Nos. 1, 2, 3, 4, 5, 6, 7 and 8 complete 12.
- Audel's Answers on PRACTICAL ENGINEERING 1.
- Audel's Answers on REFRIGERATION 2.
- Hawkins Aids to ENGINEERS EXAMINATION 2.
- Rogers MACHINIST GUIDE 2.
- Audel's WIRING DIAGRAMS 1.
- Audel's Handy Book of PRACTICAL ELECTRICITY 4.
- Audel's ELECTRICAL POWER CALCULATIONS 2.
- Hawkins ELECTRICAL Guides at \$1. each 10.
- Audel's ELECTRONIC DEVICES 2.
- Audel's ELECTRIC Dictionary 2.
- Audel's RADIOMANS GUIDE 4.
- Audel's NEW ELECTRIC LIBRARY at \$1.50 a Volume 4.
- Vols. I, II, III, IV, V, VI, VII, VIII, IX, X, XI, XII.

Name _____
 Address _____
 Occupation _____
 Employed by _____ P M



You, too, can fly a
**PIPER
CUB!**

...and here's a new booklet
that tells you how
...plus a lot more

You'll want to fly when Victory is won—and it's easy to learn in a Piper Cub! There is no deep, dark mystery to flying, as you will learn in the new booklet "Piper Cub . . . In War and In Peace," which tells you the basic principles of flight.

In addition, it includes an interesting history of the light airplane, it covers the wartime and peacetime uses of Piper Cubs and tells what the coming air age will mean to you. You'll enjoy this new 32-page, aviation booklet beautifully illustrated in full color.

Just send 10c for your copy to cover postage-handling. Piper Aircraft Corporation, Dept. PM84, Lock Haven, Penna.

PIPER *Cub*
POINTS THE WAY TO WINGS FOR ALL AMERICANS



LEARN

SPANISH

FRENCH, ITALIAN, GERMAN

quickly, easily, correctly, inexpensively, by

**LANGUAGE-PHONE
METHOD**

BUSINESS MEN, professionals, engineers, Army and Navy personnel—all advance rapidly knowing Spanish, French, Italian or German. Original standard *Language-Phone Method* gives you the actual voice instruction of an expert native teacher right in your own home. It's as easy and pleasant as listening to music. Write for full details and easy terms. Play records on your own phonograph. Satisfaction guaranteed or money refunded.

**FREE BOOKLET AND
DEMONSTRATION**

FREE ILLUSTRATED BOOKLET. Write today for your copy of an interesting 16-page, illustrated booklet which answers every question about Language-Phone, easy payment terms, and 7 days' free trial offer.

7 DAYS' FREE TRIAL. Try Language-Phone in your home a week before deciding. A small deposit brings you the entire course.

FREE DEMONSTRATION. Come to our New York office for free demonstration, daily except Saturday.

FUNK & WAGNALLS COMPANY

Dept. 77, 354 Fourth Avenue, New York 10, N. Y.

**LEARN MONEY-
MAKING CARTOONING**

IN SPARE TIME — by Easy Picture Chart Method



Same Simplified Method that has helped train creators of "Terry & Pirates," "Freddie," "Out Our Way," "Winnie Winkle," "Reg'lar Fellers," "Strange As It Seems," "The Neighbors," and many others. Earn while learning. Send 10c for Picture Chart (to test your ability), and full details. (State age.)

THE LONDON SCHOOL, 4468 National Bldg., Cleveland 14, Ohio

PLAY GUITAR
LIKE THE
COWBOYS
DO... **8 1/2** \$
A LESSON



Just out—very latest guaranteed, simple, easy method. Play cowboy songs the Western way in a few minutes by ear. Surprise and amaze your friends. Be in big demand at parties, camps, public entertainments, on the radio, etc. 12 Complete Lessons.

SEND NO MONEY. only \$1.00 plus postage, or send \$1.00 and get EXTRA SONGS all postpaid. (Canada, \$1.35 money order only.) Nothing else to buy. Positive money back guarantee. Rush order today.

WESTERN RANGER STUDIOS, Dept. 158, Hutchinson, Kans.

Short-Cut Mathematics
COMBINED WITH
Practical Mechanics Simplified

NEW 2-in-1 reading course! Now you can learn the speedy, simplified system of calculation used by draftsmen, engineers, accountants, "master minds" on the stage. Learn easy way to multiply 4 figures by 4 figures without using old-fashioned multiplication; add long columns of figures the lightning short-cut method. Learn horsepower, slide rule, micrometer, logarithms, wood measure, puzzles, etc., etc. Large illustrated volume complete with answers, only \$1 postpaid. Satisfaction or refund. Amaze friends with your magic-like mental power.

FREE

Complete details... mail coupon TODAY!

Nelson Co., 321 S. Wabash, Dept. 3H02, Chicago 4

Please send free details about "Short-Cut Mathematics and Practical Mechanics Simplified." No obligation.

Name

Address

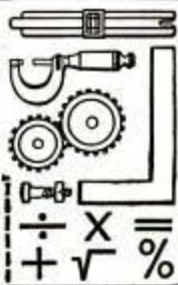

I Will Train You at Home For

Good Jobs Now Open in RADIO



Here's your opportunity to get a good job in a busy field with a bright peacetime future! Today there is a shortage of trained Radio Technicians and Operators. So mail the Coupon for a FREE copy of my 64-page, illustrated book, "Win Rich Rewards in Radio." It describes many fascinating types of Radio jobs, tells how N.R.I. trains you at home in spare time—how you get **practical** experience building and testing Radio Circuits with **SIX BIG KITS OF RADIO PARTS** I send!

Big Demand Now for Well Trained Radio Technicians, Operators

Keeping old Radios working is booming the Radio Repair business. Profits are large, after-the-war prospects are bright, too. Think of the **new boom** in Radio Sales and Servicing that's coming when new Radios are again available—when Frequency Modulation and Electronics can be promoted—when Television starts its postwar expansion! Broadcasting Stations, Aviation Radio, Police Radio, Loudspeaker Systems, Radio Manufacturing all offer good jobs now to qualified Radio men—and most of these fields have a **big backlog** of business that is building up during the war, plus opportunities to expand into new fields opened by wartime developments. You may never again see a time when it will be so easy to get a start in Radio!

Many Beginners Soon Make \$5, \$10 a Week EXTRA in Spare Time

The day you enroll for my Course I start sending you **EXTRA MONEY JOB SHEETS** that help show how to make **EXTRA** money fixing Radios in spare time while still learning. I send you **SIX big kits** of Radio parts as part of my Course. You **LEARN** Radio fundamentals from my illustrated, easy-to-grasp lessons—**PRACTICE** what you learn by building real Radio Circuits—and **USE** your knowledge to make **EXTRA** money!

Find Out What N.R.I. Can Do For You

MAIL THE COUPON for your **FREE** copy of my 64-page book. It's packed with facts—things you never knew about opportunities in Broadcasting, Radio Servicing, Aviation Radio, other Radio fields. Read the details about my Course—"50-50 Training Method"—6 Experimental Kits—**EXTRA MONEY JOB SHEETS**. See the fascinating jobs Radio offers and how you can train at home. Read many letters from men I trained telling what they are doing, earning. No obligation. **Just MAIL COUPON** in an envelope or pasted on a penny postal!—**J. E. SMITH, President, Dept. 4HP, National Radio Institute, Washington 9, D. C.**

Our 30th Year of Training Men for Success in Radio.

Radio Jobs Like These Go to Men I Trained

\$200 a Month in Own Business—"For several years I have been in business for myself making around \$200 a month. I have N.R.I. to thank for my start." **J. A. FROEINER, 300 W. Texas Ave., Goose Creek, Texas.**



\$10 a Week in Spare Time—"I repaired some Radios when I was on my tenth lesson. I made \$600 in a year and a half, and have made an average of \$10 a week—just spare time." **JOHN JERRY, 300 South H. St., Exeter, Calif.**



Communication Station Operator—"Am with the Civil Aeronautics Administration at the Sureport Airways Communication station. Have a lifetime position, with pension after retirement." **JESSE N. ROBERTS, Box 1076, Sureport, La.**



Chief Operator Broadcasting Station—"Before I completed your lessons, I obtained my Radio Broadcast Operator's license and immediately joined Station WMPG where I am now Chief Operator." **HOLLIS F. HAYES, 327 Madison St., Laneer, Mich.**

YOU Build These and Other Radio Circuits with 6 Big Kits I Send!



Superheterodyne Circuit. Preselector, oscillator-mixer, first detector, i.f. stage, diode detector-a.v.c. stage, audio stage. Bring in local and distant stations on this circuit which you build!



Measuring Instrument you build early in Course. Use it in practical Radio work to make **EXTRA** money. Vacuum tube multimeter, measures A.C., D.C. and R.F. volts, D.C. currents, resistance, receiver output.



A.M. Signal-Generator. Build it yourself! Provides amplitude-modulated signals for test and experimental purposes. Gives valuable practice!



MAIL THIS NOW

**J. E. SMITH, President, Dept. 4HP
National Radio Institute,
Washington 9, D. C.**

Mail me **FREE**, without obligation, your 64-page book: "Win Rich Rewards in Radio." (No salesman will call. Please write plainly.)

Age.....

Name

Address

City..... State.....

**My Radio Course Includes Training in
TELEVISION • ELECTRONICS • FREQUENCY MODULATION**

**SECRETS ENTRUSTED
TO A FEW**



**The Unpublished
Facts of Life**

THERE are some things that can not be generally told—*things you ought to know*. Great truths are dangerous to some—but factors for *personal power and accomplishment* in the hands of those who understand them. Behind the tales of the miracles and mysteries of the ancients, lie centuries of their secret probing into nature's laws—their amazing discoveries of the *hidden processes of man's mind*, and the *mastery of life's problems*. Once shrouded in mystery to avoid their destruction by mass fear and ignorance, these facts remain a useful heritage for the thousands of men and women who privately use them in their homes today.

THIS FREE BOOK

The Rosicrucians (not a religious organization), an age-old brotherhood of learning, have preserved this secret wisdom in their archives for centuries. *They now invite you to share the practical helpfulness of their teachings*. Write today for a free copy of the book, "The Mastery of Life." Within its pages may lie a new life of opportunity for you. Address Scribe Q.J.H.

**The ROSICRUCIANS
(AMORC)**

San Jose

California, U.S.A.

DRAW for MONEY

Be An ARTIST!

**PREPARE TODAY FOR THE
FUTURE THAT LIES AHEAD**
Trained Artists Are Capable of
Earning \$30-\$50-\$75 A WEEK

Use your spare time to prepare for a profitable Art Career! Start training at home, now!



It's pleasant and interesting to study Art the W. S. A. way. **COMMERCIAL ART, DESIGNING, CARTOONING**—all in ONE complete course. No previous Art experience necessary—we teach you step-by-step by our practical home study method well-known since 1914. Write today for information in **FREE BOOK, "ART FOR PLEASURE AND PROFIT"**—tells all about our course, material furnished, service—and commercial opportunities for you in Art State age. **WASHINGTON SCHOOL OF ART**
Studio 128K, 1115-15th St., N. W., Washington 5, D. C.

**924 PAGE AUTHENTIC
FORMULARY**



10,000 Formulas, Recipes, Trade Secrets for making most any conceivable product. Prepared by experts in simple, non-technical language. Countless profitable business opportunities. Valuable reference for manufacturers or students. \$2.00 postpaid; Canada or foreign, \$2.35, U. S. Funds. (C.O.D. orders accepted for U. S. delivery only.)

Prepare for "After-War-Business"

Especially recommended for servicemen returning to civilian life
ADAMS BROWN COMPANY . . Dept. 10 . . Chestnut Hill 67, Massachusetts

LAW STUDY AT HOME

Legally trained men win higher positions and bigger success in business and public life. Greater opportunities now than ever before. Big corporations are headed by men with legal training.

More Ability: More Prestige: More Money

We guide you step by step. You can train at home during spare time. Degree of L. B. Successful graduates in every section of the U. S. We furnish all text material, including 14-volume Law Library. Low cost, easy terms. Get our valuable 48-page "Law Training for Leadership" and "Business" books FREE—send for them NOW.
LaSalle Extension University, Dept. 864-L Chicago
A Correspondence Institution

Free • DRAFTING



More good jobs now in Drafting. Learn AT HOME in spare time (or at our Chicago School). Send postcard for **FREE TRIAL LESSON** and see how easy to learn and get a good job.

CHICAGO TECHNICAL COLLEGE
K-205 Tech Bldg., 2000 S. Michigan Ave., 16 Chicago, Ill.



Wonderful, new device, guides your hand; corrects your writing in a few days. Big improvement in three hours. No failures. **Complete outline FREE**. Write C. J. Ozment, Dept. 34, St. Louis, Mo.

Get into the BAKING BUSINESS

Bakers make good money! Now 7th Industry in wages! Nearly depression-proof. New home study Baking Course qualifies you. Common school education sufficient. If you're ambitious, write for **FREE BOOK, "Opportunities in Baking."**
National Baking School, 1315 Michigan, Dept. 135-C, Chicago



MUSIC LESSONS

COMPLETE CONSERVATORY HOME STUDY COURSES

Piano, Harmony, History of Music, Advanced Composition, Voice, Public School Music, Violin, Cornet, Trumpet, Guitar, Mandolin, Saxophone, Clarinet, Dance Band Arranging, Ear Training and Sight Singing, Choral Conducting. The only correspondence school teaching all the courses leading to the Degree of Bachelor of Music. Ask for illustrated lessons and catalog.

Give experience age
UNIVERSITY EXTENSION CONSERVATORY 1525 E. 53rd St.
Dept. U-53, Chicago 15, Ill.

INVENTORS

NOW Is the Time to PATENT and SELL Your Invention

Now, more than ever before, is the right time to patent your invention. Why? Because manufacturers everywhere presently engaged in war production are looking ahead to the future by buying up patent rights now, so they will have new and attractive items to make and sell for civilian consumption as soon as the war is over. This is what happened during and after the last war. Hence, the smart thing for you to do is to look ahead to the future too. Protect your invention by applying for a patent now, so you will be in position to cash in on an outright sale, or on the royalties your invention will bring.

Get
**FREE
COPY**

Patent Guide Shows What To Do

Our "Patent Guide for the Inventor" answers many important questions concerning Patents that inventors constantly ask. It tells what facts, details, drawings, sketches, etc. are necessary to apply for a Patent; how to protect your invention through dated and witnessed disclosure; how to do this AT ONCE to safeguard your rights; how Patent Office Records can be checked to determine whether the invention is probably patentable before filing fees need be paid; discusses costs involved and a practical way these can be paid as the application progresses. It tells how some inventors secured financial backing; how many simple inventions have proved large commercial successes; how Patents covering improvements also can be profitably utilized and marketed; tells countless other facts of interest.

Why You Need Expert Assistance

The Patent Laws were enacted for your benefit—to give you protection for the features of your invention which are Patentable. But these features must be legally and concisely set forth in the form of "claims." This phase of the procedure is so complex that the Patent Office advises the Inventor to engage a competent Registered Patent Attorney. We maintain a large staff—carefully trained registered patent attorneys—expert draftsmen—experienced searchers—to serve you. We have been serving inventors for more than 20 years.

Take First Step Now

With the Patent Guide you will receive also Free a "Record of Invention" form which will enable you at once to establish the date of your invention, before you file your Patent application. This step costs you nothing yet may be vital to your success. Remember—in Patent Matters, ACTION is IMPORTANT. Delay can be costly. Mail the coupon in an envelope, or paste it on a penny postcard NOW.

CLARENCE A. O'BRIEN & HARVEY B. JACOBSON

"Worthy of your Trust"

Registered Patent Attorneys

41-H Adams Building
Washington 4, D. C.

Get This
FREE BOOK

IMMEDIATELY MAIL COUPON TODAY!



**CLARENCE A. O'BRIEN
& HARVEY B. JACOBSON**

CLARENCE A. O'BRIEN & HARVEY B. JACOBSON
Registered Patent Attorneys before the United States Patent Office
41-H Adams Building, Washington 4, D. C.

Please send me your 48-Page "Patent Guide for the Inventor" and your specially prepared "Record of Invention" form FREE. This request does not obligate me.

Name _____

Address _____

City _____ State _____

(Please write or print plainly.)

LEARN ELECTRICITY

12 WEEKS SHOP TRAINING
ACTUAL WORK ON MOTORS, GENERATORS, ENGINES ETC.

PREPARE FOR A GOOD PEACE-TIME JOB ... THAT IS ESSENTIAL NOW!



Mail coupon today for details of my famous Coyne "Learn by Doing" method of practical shop training that prepares you for a good war-time job with a real future after the war—in Electricity, the big-pay field. Serve your country now by getting a training and at the same time you will be helping yourself by preparing for a peacetime future. Age or lack of money need not hold you back.

I'LL FINANCE YOUR TRAINING

Get training first; then take 12 months to complete small monthly tuition payments starting 60 days after your training period is over.

"LEARN-BY-DOING" AT COYNE

Coyne Training is practical training, easy to grasp... you learn quickly by doing actual jobs on real electrical machinery in my shops. Not by correspondence—you are trained right here in my big Chicago training shops. You don't need previous experience or advanced education. Expert instructors guide you every step of the way.



NOW! INDUSTRIAL ELECTRONICS INCLUDED AT NO EXTRA COST

Now I am including with my regular electrical training, extra training in Industrial Electronics, at no added tuition cost. You can remain at Coyne after finishing your Electrical training, and take this extra training for extra opportunities now and after Victory.



Earn While Learning—Job Help When Trained

If you need part-time work to help with living expenses while at Coyne, we'll help you get it. After graduation you will be given FREE JOB SERVICE for your lifetime.

MEN with physical disabilities. We also have facilities for you. Ask for details!

MEN! WHETHER YOU ARE 16 OR UP TO 50—GET MY STORY

My FREE BOOK will interest any fellow who wants to get ahead even though he may have but very little money... Fill in the coupon today and mail it to me and you'll get my big FREE Catalog and all the facts.



H. C. LEWIS, President
COYNE ELECTRICAL SCHOOL
500 S. PAULINA ST. CHICAGO 12, ILL.

H. C. LEWIS, President, Coyne Electrical School
500 S. Paulina Street, Dept. C4-72, Chicago 12, Ill.
Send me, without obligation, your Big Free Book. Tell me about the extra INDUSTRIAL-ELECTRONICS TRAINING included with Coyne Electrical Training and give details of "Pay-Tuition-After-Graduation" Offer.

NAME.....
ADDRESS.....
CITY..... STATE.....

Do You Make Mistakes in English?

EVERY time you speak or write you show just what you are. Mistakes in English reveal you as a person who lacks education and refinement. Lack of language power prevents you from presenting your thoughts in the strongest possible way. No matter what you do, real command of English will help you to your goal. Stop making mistakes in spelling, punctuation, pronunciation. Increase your vocabulary.



WONDERFUL INVENTION

Only 15 minutes a day with Sherwin Cody's new invention—and you can actually SEE your English improve. It teaches by HABIT—makes it easier to do the RIGHT way. Wonderful self-correcting lessons include spelling, punctuation, grammar and expression.

FREE BOOK ON ENGLISH Lack of language power may easily be costing you thousands of dollars every year. See what Mr. Cody can do for you; it costs nothing to find out. Mail a postal card or letter this very minute for free book. "How You Can Master Good English in 15 Minutes a Day." It will prove a revelation to you. WRITE NOW. Address:

Sherwin Cody School of English, 58 Searle Bldg., Rochester 4, N. Y.



DRAW CARTOONS BIG MONEY!

EASY... PLEASANT WORK!

Let CHAS. H. KUHN, with 25 years actual experience in drawing a daily newspaper cartoon, teach you how to create, draw and sell your work. 52 complete lessons—one sent each week. Professional criticism on every lesson. Write today. After Jan. 1, 1945, the price of this course will advance to \$15.00

KUHN SCHOOL OF CARTOONING
420 MURPHY BUILDING Dept. S. INDIANAPOLIS 4, INDIANA

TRAIN

Your VOICE!

Results GUARANTEED

We build, strengthen the vocal organs—not with singing lessons—but by sound, scientifically correct silent and vocal exercises and absolutely guarantee complete satisfaction with results. Write for Voice Book, FREE. Sent to no one under 17 years old unless signed by parent.

PERFECT VOICE INSTITUTE. Studio 135-C, 64 E. Lake St., Chicago, Ill.

What Every Mason Wants

We have important Masonic books for Blue Lodge, Chapter, Commandery, Scottish Rite, and Shrine. Our Rituals Are Used the World Over. Send for free catalog of books and rituals for Masons, Odd Fellows, Knights of Pythias, Knights of Columbus, Elks, etc.

EZRA A. COOK, Publisher, P. O. Box 796, PAT, Chicago 90, Ill.

LAW

STUDY AT HOME for PERSONAL SUCCESS and LARGER EARNINGS. 35 years expert instruction—over 108,000 students enrolled. LL.B. Degree awarded. All texts furnished. Easy payments. Send for FREE BOOK—"Law and Executive Guidance."

AMERICAN EXTENSION SCHOOL OF LAW
Dept. 44-M, 646 N. Michigan Ave., Chicago 11, Ill.

STAMMERER?

This new 128-page book, "Stammering, Its Cause and Correction," describes the Bogue Unit Method for scientific correction of stammering and stuttering—successful for 43 years. Benj. N. Bogue, Dept. 1815, Circle Tower, Indianapolis 4, Ind.

GET THIS FREE BOOK!

MONEY FOR MEN ALL DATA FREE

THE PLASTEX Industry needs manufacturers on small scale and for big production of Lamp and Clock Stands, Art Goods and Novelties in Plastex and Marble Imitation. Experience unnecessary. 1/2¢ material makes regular 1¢c store sellers. Rubber moulds furnished for speed production. Small investment brings good returns. Big chain store orders now being placed. Ambitious men have chance for real prosperity. Our Free booklet will interest and benefit you.

PLASTEX INDUSTRIES, Dept. P, 1085 Washington Ave., New York, N. Y.

HOW JOE'S BODY BROUGHT HIM FAME INSTEAD OF SHAME

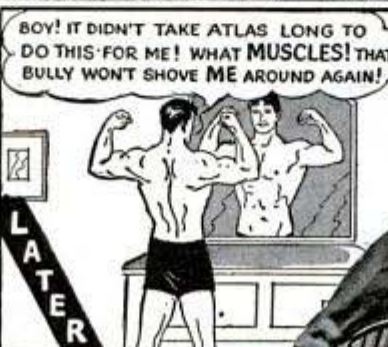

Charles Atlas

—actual photo of the man who holds the title, "The World's Most Perfectly Developed Man."

I Can Make YOU A New Man, Too in Only 15 Minutes A Day!

If YOU, like Joe, have a body that others can "push around"—if you're ashamed to strip for sports or a swim—then give me just 15 minutes a day! I'll PROVE you can have a body you'll be proud of, packed with red-blooded vitality! "Dynamic Tension." That's the secret! That's how I changed myself from a spindleshanked, scrawny weakling to winner of the title, "World's Most Perfectly Developed Man."

"Dynamic Tension" Does It!

Using "Dynamic Tension" only 15 minutes a day, in the privacy of your own room, you quickly begin to put on muscle, increase your chest measurements, broaden your back, fill out your arms and legs. Before you know it, this easy, NATURAL method will make you a finer speci-

men of REAL MANHOOD than you ever dreamed you could be! You'll be a New Man!

FREE BOOK

Thousands of fellows have used my marvelous system. Read what they say—see how they looked before and after—in my book, "Everlasting Health And Strength."

Send NOW for this book—FREE. It tells all about "Dynamic Tension," shows you actual photos of men I've turned from puny weaklings into Atlas Champions. It tells how I can do the same for YOU. Don't put it off! Address me personally: Charles Atlas, Dept. 8H, 115 East 23rd St., New York 10, N. Y.



**CHARLES ATLAS, Dept. 8H,
115 East 23rd St., New York 10, N. Y.**

I want the proof that your system of "Dynamic Tension" will help make a New Man of me—give me a healthy, husky body and big muscular development. Send me your free book, "Everlasting Health and Strength"

Name.....
(Please print or write plainly)

Address.....

City.....State.....

Check here if under 16 for Booklet A

INVENTORS

LEARN HOW TO
**PROTECT and SELL
YOUR INVENTION**

GET NEW **FREE BOOK**



FREE

**Invention Record
Know How Successful
Inventors Protect and
Sell Their Inventions**

Our new **FREE Book** is a book every inventor should have. Mail the coupon today for "How to Protect, Finance and Sell Your Invention" and learn . . .

- How to know if there is a prior U. S. patent on your invention.
- How to save steps in getting patent action.
- How to prepare your application for presentation to the Patent Office.
- How you may patent an improvement on something in use now.
- How to obtain funds to patent and promote your invention.
- How to find a buyer or backer for your invention.
- How to protect yourself in making royalty agreements.

MODERN BUSINESS WANTS INVENTIONS

Practical and novel inventions are in big demand today. The opportunity for quick money is enticing. Sales sources are many if your invention has merit. But, be *sure*—before you place your device in strange hands—that it is fully protected. A United States Patent gives you this protection. *The first step toward inventive success—always is—and always has been, the application for a U. S. Patent. There is no other way to protect your invention in accordance with the laws of this country.*

MAKE THIS RECORD NOW

If you have an invention, and wish to secure it for the future, act at once. Have it dated now and recorded in our office. We will send you this **FREE Invention Record Form** for the purpose. Fill out the Invention Record Form fully describing the nature of your invention. Make a sketch of its main features. Mail it to us and we will record the date it was received in our office. The earlier the date the better your chance of combating rival inventors who may lay claim to your idea later. *Don't delay a single minute in taking this important step. Your whole future may depend upon it. Mail the coupon for our FREE Invention Record Blank and New FREE Book today!*

HOW WE SERVE YOU AS REGISTERED PATENT ATTORNEYS

The U. S. Patent Office strongly recommends—unless the inventor is familiar with such matters—that he employ the services of a Registered Patent Attorney in the preparation of his Patent Application. We are Registered Patent Attorneys fully qualified to represent you at the Patent Office. We have had long experience in studying hundreds of types of inventions. This gives us the ability to judge your invention and to describe it accurately and convincingly in technical language. It gives us the perception to center arguments upon those details of your invention which, in our judgment, will be looked upon most favorably by the Patent Office Examiner.

Mail the coupon today for our new **FREE Book**, "How to Protect, Finance and Sell Your Invention," and our **FREE Invention Record Form**—maybe this step will pave the way to future security for you and your family. Act Today!

McMORROW & BERMAN
Patent Attorneys

1351 Albee Building, Washington 5, D. C.

McMORROW & BERMAN

PATENT ATTORNEYS

1351 ALBEE BUILDING, WASHINGTON 5, D. C.

Send me your new **FREE book**, "How to Protect, Finance and Sell Your Invention"—and "Invention Record" form at once. I understand that this request does not obligate me.

NAME

ADDRESS

CITY..... STATE.....

(Write or print name clearly)

THERE is a definite I.C.S. type. The records of 100,000 current students . . . nearly 5 million students since 1891 . . . supply the outlines. Here's how the typical enrollee shapes up at the time of beginning his studies:

He is an adult. In wartime he is in the Armed Forces or in vital production. But war or peace, good times or bad times, he is an employed man. Circumstances have prevented his attending a college but he is ambitious, intelligent, determined to acquire the specialized training that will help him in his present job and prepare him for a better one.

Does the description fit *you*? Then you'll be interested in what I.C.S. helps these students to achieve. In a single 30-day period we have received as many as 635 student letters reporting advancement in salary and position. In a period of 120 days we have received 1,920 such reports.

Graduates include the presidents, board chairmen, chief engineers or chief chemists of some of the largest steel, airplane, chemical, railroad and electrical equipment companies in the country. Thousands of others have registered substantial successes in their chosen fields. Here's the kind of coupon they signed and mailed.

are you the
I. C. S.
type of man?



INTERNATIONAL CORRESPONDENCE SCHOOLS



BOX 5501-K, SCRANTON 9, PENNA.

Without cost or obligation, please send me booklet and full particulars about the course *before* which I have marked X:

- | | | | |
|---|--|--|---|
| <p>Air Conditioning and Plumbing Schools</p> <p><input type="checkbox"/> Air Conditioning
<input type="checkbox"/> Heating <input type="checkbox"/> Plumbing
<input type="checkbox"/> Refrigeration <input type="checkbox"/> Steam Fitting</p> <p>Chemistry Schools</p> <p><input type="checkbox"/> Chemical Engineering
<input type="checkbox"/> Chemistry, Analytical
<input type="checkbox"/> Chemistry, Industrial
<input type="checkbox"/> Chemistry, Mfg. Iron & Steel
<input type="checkbox"/> Plastics
<input type="checkbox"/> Pulp and Paper Making</p> <p>Civil, Architectural and Structural Engin'g Schools</p> <p><input type="checkbox"/> Architectural Drafting
<input type="checkbox"/> Architecture
<input type="checkbox"/> Bridge and Building Foreman
<input type="checkbox"/> Bridge Engineering
<input type="checkbox"/> Building Estimating
<input type="checkbox"/> Civil Engineering
<input type="checkbox"/> Contracting and Building
<input type="checkbox"/> Highway Engineering
<input type="checkbox"/> Lumber Dealer
<input type="checkbox"/> Sanitary Engineering
<input type="checkbox"/> Structural Drafting
<input type="checkbox"/> Surveying and Mapping</p> | <p>Electrical Schools</p> <p><input type="checkbox"/> Electrical Drafting
<input type="checkbox"/> Electrical Engineering
<input type="checkbox"/> Power House Electrician
<input type="checkbox"/> Practical Electrician
<input type="checkbox"/> Practical Telegraphy
<input type="checkbox"/> Telegraph Engineering</p> <p>Internal Combustion Engines School</p> <p><input type="checkbox"/> Auto Technician <input type="checkbox"/> Aviation
<input type="checkbox"/> Diesel-Electric
<input type="checkbox"/> Diesel Engines <input type="checkbox"/> Gas Engines</p> <p>Mechanical Schools</p> <p><input type="checkbox"/> Aeronautical Engineering
<input type="checkbox"/> Airplane Drafting
<input type="checkbox"/> Flight Engineer
<input type="checkbox"/> Foundry Work
<input type="checkbox"/> Heat Treatment of Metals
<input type="checkbox"/> Industrial Design
<input type="checkbox"/> Mechanical Drafting
<input type="checkbox"/> Mechanical Engineering
<input type="checkbox"/> Mold-Loft Work
<input type="checkbox"/> Patternmaking
<input type="checkbox"/> Reading Shop Blueprints
<input type="checkbox"/> Sheet Metal Drafting
<input type="checkbox"/> Sheet Metal Worker</p> | <p><input type="checkbox"/> Ship Drafting <input type="checkbox"/> Ship Fitting
<input type="checkbox"/> Shop Practice
<input type="checkbox"/> Steel Mill Workers
<input type="checkbox"/> Tool Designing
<input type="checkbox"/> Welding, Gas and Electric</p> <p>Radio School</p> <p><input type="checkbox"/> Electronics <input type="checkbox"/> Radio, General
<input type="checkbox"/> Radio Operating
<input type="checkbox"/> Radio Servicing</p> <p>Railroad School</p> <p><input type="checkbox"/> Air Brake <input type="checkbox"/> Car Inspector
<input type="checkbox"/> Locomotive Engineer
<input type="checkbox"/> Locomotive Fireman
<input type="checkbox"/> Railroad Section Foreman</p> <p>Steam Engineering Schools</p> <p><input type="checkbox"/> Boilermaking
<input type="checkbox"/> Combustion Engineering
<input type="checkbox"/> Engine Running
<input type="checkbox"/> Marine Engines
<input type="checkbox"/> Steam Electric
<input type="checkbox"/> Steam Engines</p> <p>Textile School</p> <p><input type="checkbox"/> Cotton Manufacturing
<input type="checkbox"/> Rayon Weaving
<input type="checkbox"/> Textile Designing
<input type="checkbox"/> Woolen Manufacturing</p> | <p>Business and Academic Schools</p> <p><input type="checkbox"/> Accounting <input type="checkbox"/> Advertising
<input type="checkbox"/> Arithmetic <input type="checkbox"/> Bookkeeping
<input type="checkbox"/> Business Correspondence
<input type="checkbox"/> Business Management
<input type="checkbox"/> Certified Public Accounting
<input type="checkbox"/> City Letter Carrier
<input type="checkbox"/> College Preparatory
<input type="checkbox"/> Commercial
<input type="checkbox"/> Cost Accounting
<input type="checkbox"/> Federal Tax
<input type="checkbox"/> First Year College
<input type="checkbox"/> Foremanship
<input type="checkbox"/> High School
<input type="checkbox"/> Higher Mathematics
<input type="checkbox"/> Illustrating
<input type="checkbox"/> Motor Traffic
<input type="checkbox"/> Post Office Clerk
<input type="checkbox"/> Railway Postal Clerk
<input type="checkbox"/> Salesmanship <input type="checkbox"/> Secretarial
<input type="checkbox"/> Stenography
<input type="checkbox"/> Traffic Management</p> <p>Language School</p> <p><input type="checkbox"/> Spanish <input type="checkbox"/> French
<input type="checkbox"/> Good English</p> |
|---|--|--|---|

Name.....Age.....Home Address.....

City.....State.....Present Position.....Working Hours.....

Canadian residents send coupon to International Correspondence Schools Canadian, Ltd., Montreal, Canada.
British residents send coupon to I. C. S., 71 Kingsway, London, W. C. 2, England.

SPECIAL TUITION RATES FOR MEMBERS OF THE ARMED FORCES

INVENTORS

YOU'VE NEVER HAD A GREATER

Opportunity!

GET THESE BOOKS—THEY'RE FREE—THEY TELL YOU WHAT TO DO

Many Patents...If Secured Now...Have 3-Fold Chance to Become Profitable

Do you realize the value of your labor-saving or time-saving device . . . your improvement on a machine . . . your gadget that does some job better or does a job automatically that has never been done before? Man—then think this over!

NOW is the time to have your application prepared and prosecuted because American manufacturers are planning their coming peacetime production while they are out-producing the Axis. Thus—if your invention will help win the war, your Government may adopt it. Or—one or more war goods manufacturers may use it. Then—when peace comes—many opportunities may present themselves. Even if your invention is for peacetime use only—DON'T WAIT. Cash in on the present wave of "Postwar" Thinking. **WHATEVER YOUR INVENTION—THERE IS NO BETTER TIME THAN THE PRESENT TO DO SOMETHING ABOUT IT.**

HOW WE CAN HELP YOU

A thoroughly trained staff here at Victor J. Evans & Co., competently takes care of all the details for you . . . a procedure followed by many inventors. The experience of this staff is your assurance that your patent application will be prepared in the proper manner and speedily pushed to a conclusion. We've served men like you for nearly fifty years.

GET THESE BOOKS—THEY'RE FREE—THEY TELL YOU WHAT TO DO

These two big books—"Patent Protection" and "When and How to Sell Your Invention" have helped many inventors to success. They can help you! Sixty-four pages of valuable information and guidance, well illustrated. Show details of 115 Mechanical movements. They may be just what you need to complete your invention.

Use the coupon NOW—while it's fresh in your mind. We'll rush the books to you with free "Evidence of Invention" form that will help you establish your claim.



SUCCESS COMES TO THOSE WHO ACT!

SEND THIS COUPON TODAY—

VICTOR J. EVANS & Co.

Registered Patent Attorneys for Nearly 50 years
830-J MERLIN BUILDING • WASHINGTON-6, D. C.

Please send me your books "Patent Protection" and "When and How to Sell your Invention"—also important "Evidence of Invention" form, without cost or obligation.

Name

Address

City and State

★ SAVE WASTE PAPER ★

MICKEY MOUSE CARTOON HOME MOVIES

Always Packed With Laughs

Show Mickey, as the BIG FEATURE and include a Donald Duck—3 Monkeys—Oswald Rabbit cartoon.

Get These Features
200 ft. 16MM. \$6.00
100 ft. 8MM. \$3.00

MICKEY'S
Wild Party 1403-B
Wild Dream 1405-B
Princess Charming 1407-B
Air Raid 1414-B

See at Your Dealers or Order Direct. Write for Catalog and Prices To

HOLLYWOOD FILM ENTERPRISES, INC.
6060 Sunset Blvd. Dept. 115 Hollywood 28, Calif.



LIQUID MARBLE

Make beautiful artificial Marble slabs. Pour from liquid state. Glazed or un-glazed. Mottled, veined, snow-white, or multi-colored. Unsurpassed on kitchen or bathroom walls. Easy to make and install. **PLASTIC FLOORING.** Any color. Lifetime wear. Dustproof, Soundproof, Vermin-proof. Resilient to the tread. Lay out solid or in pattern design. **FLEXIBLE MOLDS** for plaster casting. Make your own molds for few cents each. \$1.00 in raw materials will make up to \$25.00 of finished goods. We furnish names of buyers. Write now for free information. **COMPO-TEX, BOX 786-S, ST. LOUIS (1), MO.**

LEARN WATCH REPAIRING



AT HOME. By our modern and original system of instruction you can learn every part of the **WATCH REPAIRING TRADE AT HOME.** Prepare yourself for a well-paying position or start in business after completing our course of instruction. Good watch repairers are in demand and generally earn very good salaries. For particulars apply to the **Wisconsin School of Watch Repairing 524 E. Mason St., MILWAUKEE 2, WIS.**

AUDELS NEW MACHINISTS HANDYBOOK NOW READY!



Prepare!

A KEY TO SHOP PRACTICE
For Every Machinist, Toolmaker, Machine Operator, Draughtsman, Metal Worker, Mechanic or Student. Covers Shop Practice in All Branches.

A READY REFERENCE
Tells How to Operate and Set Up Lathes, Screw and Milling Machines, Shapers, Drill Presses and All Machine Tools.

5 PRACTICAL BOOKS IN ONE!
60 FULLY ILLUSTRATED CHAPTERS
Covering: 1—Modern Machining Shop Practice. 2—Blue Print Reading and How to Draw. 3—Calculations & Mathematics for Machinists. 4—Shop Physics. 5—How to Use Slide Rule.

Get This Information for Yourself. Mail Coupon Today. No Obligation Unless Satisfied. **ASK TO SEE IT.**

1600 PAGES FULLY ILLUSTRATED \$4 COMPLETE • PAY ONLY \$1 MO.

THEO. AUDEL & CO., 49 WEST 23rd STREET, NEW YORK
Mail AUDELS MACHINISTS & TOOLMAKERS HANDY BOOK. Price \$4 on 7 Days Free Trial. If O. K. I will remit \$1 in 7 days and \$1 monthly until \$4 is paid. Otherwise I will return it.

Name

Address

Occupation

Reference

ELECTRICIANS... RADIO MEN See These Great Pay Boosters FREE!

I'LL SEND YOU MY
FAMOUS REFERENCE BOOKS ON
7 DAYS FREE TRIAL



H. C. Lewis Pres. Coyne Electrical School

FREE WITH SET



Here's a great triple-header **EXTRA VALUE** I'll give you **FREE** with the 3-volume set if you act at once: (1) Big book of 150 shop prints, motor and radio diagrams and how to read them; (2) One-year consultation service by mail on your technical problems; (3) Subscription to **Technical News Bulletins** — ALL **FREE** with the Reference Set.

AMAZING 3 VOLUME REFERENCE SET

Yes! . . . Truly amazing! These 3 up-to-the-minute volumes actually contain more material than many sets selling for 2 or 3 times the price. Covers entire field of electricity and radio—motors, generators, auto and aviation electricity, air conditioning, refrigeration and hundreds of other subjects, complete, thorough, authoritative. Equally valuable for beginner or old timer—for home study or on-the-job problems. **See these books at my risk!** Send coupon below—keep set 7 days! Then either return it or send \$3 and \$3 a month until \$13.95 is paid. Cash price \$12.55 saves you 10% if sent within 7 days after books reach you.

TROUBLE-SHOOTING MANUAL

At last, the thoroughly practical Manual long needed by men in **ELECTRICITY, RADIO and REFRIGERATION**. Nothing else like it. Saves you time—helps win advancement and bigger pay. Really 4 **GREAT BOOKS** IN ONE, 600 page volume. (1) New step-by-step Trouble-Shooting course. (2) 500 Shop Prints. (3) Electrical-Radio Dictionary. (4) Spare-time job suggestions. Examine 7 days at my risk and then return it or send \$3 and \$3 a month until \$8.95 is paid. Cash price \$8.00 saves you 10%.

ELECTRONICS—New—Authoritative

Get ready for big things to come with my sensational new Electronics Manual—**ONLY BOOK OF ITS KIND!** A gold-mine of up-to-the-minute facts, graphic illustrations and easy-to-understand diagrams. Describes each type of tube—its uses, installation, servicing for electric devices. Get up-to-date on this new development that experts say will revolutionize post-war industry. **Special introductory price \$4.95 (Cash or C.O.D.)**

ELECTRICAL DICTIONARY

Simply, exactly defines over 1100 electrical and radio terms—contains many useful electrical and radio diagrams. A great help to beginner or veteran. Only 50c postpaid.

SEND NO MONEY:

I will ship any or all of the above books on 7 DAYS FREE TRIAL. Look them over for 7 days. If not 100% satisfied, ship them back. Otherwise pay for them as indicated in coupon. If your order totals \$5.00 or more you may pay \$3.00 within 7 days and \$3.00 a month. Rush coupon.

COYNE ELECTRICAL SCHOOL
Dept. C4-3R6
500 S. Paulina St. Chicago 12

TROUBLESHOOTING MANUAL

612 Big Pages, Hundreds of pictures and diagrams. New 1944 edition.

PRACTICAL ELECTRONICS

New! Latest miracle of science is made easy to understand. Only book of its kind now on sale!

ELECTRICAL DICTIONARY

Over 1100 Electrical and radio terms defined and illustrated. Needed by every electrical worker or student.

FREE TRIAL COUPON - NO MONEY DOWN

- COYNE 3 VOL. REFERENCE SET: Price complete \$13.95 payments, or \$12.55 cash. BOOK of 150 shop prints included **FREE**. Includes one year Free Consultation Service and Technical News Bulletins.
- COYNE TROUBLE-SHOOTING MANUAL: (1 VOL.) Price \$8.95 payments, or \$8.00 cash. Includes one year Free Consultation Service and Technical News Bulletins.
- COYNE MANUAL OF ELECTRONICS: (1 VOL.) Price \$4.95. Includes one year Free Technical Bulletins.
- 150 SHOP PRINTS AND MOTOR DIAGRAMS: (1 VOL.) Price \$1.95. (Free with reference set or can be bought separately.)
- COYNE ELECTRICAL & RADIO DICTIONARY (1 VOL.) 1200 Terms and Definitions. Price 50c.

If you wish to pay the postman the cash price when books are delivered, check here. Same 7-Day Money-Back Guarantee of Satisfaction.

H. C. Lewis, President—Coyne Electrical School
500 S. Paulina St., Dept. C4-3R6, Chicago 12, Illinois

Send me the books checked at the left on 7 DAYS FREE TRIAL. I'll either return them in 7 days and owe you nothing or pay for them according to the plan I select as outlined above.

Name..... Age.....

Address.....

City..... Zone.... State.....

Name of Employer.....

GAIN MORE SKILL with THESE BOOKS

Choose books you want. Encircle title numbers in coupon. Mail coupon WITHOUT MONEY. When books arrive, examine 5 DAYS FREE. Unless delighted, return without obligation. Otherwise, send only \$1.25, plus postage, for each book you keep.

Only
\$1.25
EACH

1. BOWLING FOR ALL



Joe Falcaro and Murray Goodman — World's Undeclared Match Games Bowling Champion (Falcaro) teaches beginners, experts, all ages! Principles, delivery, direction, speed, strikes, spares, "Do's and Don'ts." Rules and Tournaments, Action photos.

2. JIU-JITSU



Frederick P. Lowell — How to overpower a physically stronger aggressor. Photographs and text first teach eight jiu-jitsu muscle-building exercises. Then 61 lessons are "acted out" in 150 clear photographs!

3. SWIMMING



R. J. H. Kiphuth—Yale's famous coach shows how to be a strong, easy swimmer. Pre-water exercises; breast-stroke, back-stroke, free-style. Drawings, 94 photos. Advice on teams.

4. BOXING



Edwin L. Haislet—Not only WHICH techniques to learn, but WHEN and HOW to learn and use them. Easy-to-understand text, clear drawings explain position, hitting, blocks, foot-work, training, etc.

5. PHYSICAL CONDITIONING



Stafford and Duncan—How to get in condition for football, baseball, basketball, etc., "toughen up" for any emergency. 436 drawings, plus simple directions, show you 34 interesting exercises.

6. WRESTLING



E. C. Gallagher—152 half-page photos of wrestling champions—with clear, explanatory text. Standing, bringing to mat, holds, escapes, falls. Author is champ-producing wrestling coach of Oklahoma A. & M.

5 DAY FREE EXAMINATION COUPON

A. S. BARNES AND COMPANY

Dept. 28, 67 W. 44th St., New York 18, N. Y.

Send — for Free Examination — books whose title-numbers I encircle below. Unless delighted, I may return them in 5 days without obligation. Otherwise, I will send you \$1.25, plus postage, for each book I keep.

1 2 3 4 5 6

Name _____

Address _____

City _____ Zone No. _____ State _____
(if any)

SAVE POSTAGE! Check if enclosing full payment with coupon. Then WE pay postage. Same 5-day return privilege.

★ SAVE WASTE PAPER ★

Learn AIRCRAFT DESIGNING & ENGINEERING



LET RYAN TRAIN YOU FOR A LIFETIME CAREER IN AVIATION

The aircraft industry needs trained draftsmen and engineers NOW. Ryan's new Home Study Method offering you "direct-from-the-industry" training in Aeronautical Engineering will prepare you during your spare time for a top-paying job and a future. Course is easy to understand. No experience necessary. Pay as you learn. Write today for FREE 24-page book. . . "New Horizons of Opportunity." Give age.

HOME STUDY
AFFILIATE OF
RYAN SCHOOL
OF AERONAUTICS

RYAN AERONAUTICAL INSTITUTE
428 Lindbergh Field, San Diego 1, Calif.

DYKE'S AUTO BOOK



New 20th Edition. New Material on Transmissions, Trucks, Tractors. 1488 PAGES. 4600 ILLUS. and DIAGRAMS.

Now with millions of cars needing repairs and thousands of men needed to do the work, you need the famous DYKE Auto Book more than ever before. Brand new 20th edition covers all principles, construction, repair, adjustment, testing, troubles and remedies of all cars. Covers Diesel powered cars and trucks, fundamentals of aircraft engines and passenger car specifications.

SEND NO MONEY. Write today for DYKE'S AUTO BOOK. Remit \$6 or pay postman \$6 plus postage on delivery. Money back in 5 days if not satisfied.

GOODHEART-WILLCOX CO., INC.
Dept. 1-C, 2009 S. Michigan Ave., Chicago, 16

WHY DON'T YOU WRITE?

Writing short stories, articles on business, homemaking, gardening, children, war activities, etc., will enable you to earn extra money. In your own home, on your own time, the New York Copy Desk Method teaches you how to write—the way newspaper men learn, by writing. Our unique "Writing Aptitude Test" tells whether you possess the fundamental qualities essential to successful writing. You'll enjoy this test. Write for it, without cost or obligation.

NEWSPAPER INSTITUTE OF AMERICA
SUITE 559-L, ONE PARK AVENUE, NEW YORK 16, N. Y.

Inventions Wanted Patented or Unpatented

Inventions can now be safely sold without patenting expense. If you have a practical, useful idea for sale, either unpatented or patented, write

Chartered Institute of American Inventors
Dept. 4, 631 Pa. Ave., N. W. Washington, D. C.

ANY BOOK IN PRINT!

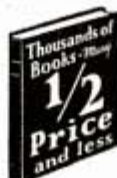

Delivered at your door. We pay postage. Standard authors, new books, popular editions, fiction, reference, medical, mechanical, children's books, etc. —all at guaranteed savings. Send card now for Clarkson's 1944 Catalog.

FREE Write for our great illustrated book catalog. A short course in literature. The buying guide of 300,000 book lovers. **FREE** if you write **NOW—TODAY!**

CLARKSON PUBLISHING COMPANY
Dept. 28 1253 S. Wabash Ave. Chicago, Ill.

EARN MONEY PAINTING PORTRAITS



• No previous training or talent necessary. Unique Stuart System teaches you, by mail, in 11 simple, easy-to-follow lessons, to make exact charcoal and oil likenesses. Detailed guidance for your every step. Send for free book **today**.

STUART STUDIOS, 121 Monument Circle, Rm. 684, Indianapolis 9, Ind.

Please send me free book and outline of lessons.

Name _____

Street _____

City _____ State _____

POPULAR MECHANICS

GET INTO RADIO ELECTRONICS & TELEVISION NOW!

Hundreds of Industries Need Radio and Television Men Now and for Great Future Demands

The man trained in electronics is wanted not only in Radio and Television, but in Aviation, Transportation, Communications, ... in the designing, engineering and operation of hundreds of industries today and for years to come. Learn how great the field is for YOU... How you may GET INTO BUSINESS FOR YOURSELF. Mail the coupon now.



Send for FREE Lesson and Prove to Yourself How Quick and Easy You Get Ahead in Radio by the NEW

SHOP METHOD HOME TRAINING



Learn by Doing!
Use real Radio Equipment Furnished with your Course



Experience is the best teacher. You learn by experience with the exclusive National Shop Method of Home Training—actually

build many circuits and do experiments with the big kits of standard radio parts included in your training equipment at no extra cost to you.

Build a superheterodyne receiver. Make tests and conduct experiments that show you the why and how of electronics. Build an audio oscillator, signal generators and other instruments with the parts and supplies included in your course.



You gain marvelous experience by this method of learning and you have valuable equipment and instruments to use on the job. Mail the coupon and learn what this means to you.

Get ready for TELEVISION. Get your share of the RADIO SERVICE Business. Here is a sensationally improved way for you to get the right training—a thoroughly proved system whereby you study in spare time—odd hours, even minutes—and have the advantage of actual shop experience behind you.

This exclusive shop method of home training comes to you right from one of the world's greatest vocational educational centers—the resident training shops and experimental laboratories of National Schools. It is the sound, practical training based on actual experience of qualified instructors and engineers who have prepared thousands of National graduates now employed in the radio industry.

It is up-to-date—matches the progress constantly being made in modern radio, television and electronics. It is time tested. National Schools has been training men for higher pay and greater opportunity for more than a third of a century. Fill out and mail the coupon below for details.

Shop Method Training Wins Good Jobs



Joseph Grumtch, Lake Hiawatha, New Jersey.

"My latest offer was \$5,800.00 as Radio Photo Engineer... but I'm doing well where I am now engaged. I am deeply indebted to National."

"Due to my training at National, I was selected to instruct in the laboratory work of Navy and Marines."



"I believe National offers the best course to be had. Keep up the good work."—D. R. Ivey, Washington, D. C.

Read what hundreds of other enthusiastic students have written about National Training. Send in your coupon today.

Train While in Service



Men in our armed services—or about to enter—get better ratings and more pay almost right from the start if they are trained in radio and electronics. The government needs experienced men in nearly all branches of the service. Then, too, you may study with National while you are still in uniform—prepare for present advancement and future after the war.

Thousands of men in the Army, Navy and Coast Guard have trained at National under U. S. Government sponsorship.

See for Yourself

Now, right now, is the time to grasp the great opportunity of today—a successful career for tomorrow. Get into the big money, rapid advancement, a position of importance. A BUSINESS OF YOUR OWN. The industry is crying for trained men everywhere. A rapidly expanding business—probably the greatest in industrial history—holds out the promise of a rich future—prosperous security. But to win it you must be ready. Well-trained men ONLY are wanted.

Examine the National Shop Method of Home Training carefully. Be convinced. Study the lesson we will send you FREE. No obligation of any sort. Fill out the coupon and mail it today.



GET THESE 3 BIG BOOKS FREE!

Learn for yourself just how easy this SHOP METHOD HOME TRAINING gives you the practical, down-to-earth experience you can never get from theory alone.

NATIONAL SCHOOLS

LOS ANGELES 37, CALIFORNIA EST. 1905

MAIL OPPORTUNITY COUPON FOR QUICK ACTION

National Schools, Dept. 8-PMR
4000 South Figueroa Street, Los Angeles 37, California

(Mail in envelope or paste on penny post card)

Mail me FREE the three books mentioned in your ad including a sample lesson of your course. I understand no salesman will call on me.

NAME..... AGE.....

ADDRESS.....

CITY..... STATE.....

Include your zone number

America's War Made Industry—

ELECTRICAL APPLIANCE REPAIRING



OFFERS BIG MONEY—INDEPENDENCE

The restrictions on the manufacture of electrical home appliances has greatly increased the need for and earnings of skilled home appliance repairmen. Always a good business, today **ELECTRICAL APPLIANCE REPAIRING** is one of the most profitable occupations that the average mechanically inclined man can turn to. On many types of repairs it is usual for a repairman to charge on the basis of \$5.00 to \$6.00 an hour! Work as many hours as you wish—a home appliance repairman is his own boss. Operate from your garage, basement, vacant store, etc.

NO SPECIAL SKILL NEEDED!

If you are mechanically inclined—can hold and use tools—you too can be a big money-earning home appliance repairman. Age is no barrier—nor are minor physical handicaps. Learn how to repair refrigerators, vacuum cleaners, washing machines, motors, ranges, etc., etc. Our course is written in simple, easy to understand language, profusely illustrated with drawings and photography showing you step by step what troubles to look for and how to repair them. Explains and gives you a working knowledge of electricity, welding, nickel plating, etc. Shows you how to build power tools you may need and how to solicit and keep business coming to you. Not a complicated "theory course" but an honest to goodness course written and used by repairmen the country over. Price of course is so low that the savings on your own household appliance repairs will quickly pay for it. Prepare NOW for a real future.

Mail Coupon for FREE LITERATURE

CHRISTY SUPPLY CO.
2835 N. Central Ave., Dept. D-1203
Chicago 34, Illinois

Please send me all the facts about America's Fastest Growing Industry—Electrical Appliance Repairing.

Name.....
Address.....
City.....State.....

Say you saw it in *Popular Mechanics!*

What Can You Read In This



FINGER PRINT?

Study it carefully. There is a secret hidden in it, just as there is in every finger print. For 28 years we have been training men to become Finger Print experts. Over 53% of all American Identification Bureaus employ I.A.S. trained men. Get into this steady-employment, good pay profession. Learn at home. Small cost. Fine opportunities.

"THE BLUE BOOK OF CRIME"

FREE This thrilling book tells all about many famous crime cases and how you can qualify for one of the fine positions in the Identification field. Write for it, stating your age.

INSTITUTE OF APPLIED SCIENCE

Dept. 135-C, 1920 Sunnyside Ave., Chicago 40, Ill.

THERE'S MONEY IN CARTOONS!

RAYE BURNS will teach you HOW to CREATE ORIGINAL CARTOONS at home that you may SELL! Course contains 26 lessons and over 600 illustrations. All for Only..... **\$2.85**

Send name and address for free details.
RAYE BURNS SCHOOL, Dept. M, Box 3583, CLEVELAND 3, OHIO

FIX TYPEWRITERS

A Simplified Practical Homestudy Course. Many of our Students now have their own Business—Many Repair for others. Repair Shops Swamped. Health or Age no handicap.
WEBER TYPEWRITER MECHANICS SCHOOL
5417 Santa Monica Blvd., Hollywood 27, Calif.



Begin today. Write now for our Free Book, "How to Become a Good Penman." It contains specimens and tells how others learned to write in spare time. Enclose 10c for your name beautifully written and a pen point suitable for shaded writing. Write today.

THE TAMBLYN SCHOOL OF PENMANSHIP
Y441 Ridge Building, Kansas City, Mo.

BETTER SIGHT

SIGHT-TRAINING technique improved. Everybody gets results now. WRITE: Dept. P-8 "USTI" 4057 Budlong Ave., Los Angeles 37, Calif.



Please send me your FREE Sight Chart with instructions.

Name.....
Address.....

WHICH OF THESE *Opportunities* INTERESTS *You* MOST?

Accounting & C. P. A.
Air Conditioning
Architecture & Building
Automotive Engineering
Aviation—Practical
Aviation Drafting & Design
Better Foremanship
Bookkeeping
Business Management
Cost Accounting for Mfg.

Diesel Engineering
Drafting & Design
Electrical Engineering
Electricity—Practical
High School Courses
Machine Shop Operations
Mechanical Engineering
Plastics Engineering
Plumbing—Practical
Private Secretary

Radio Operating & Servicing
Railway Training
Refrigeration
Sheet Metal Pattern Drafting
Shipbuilding
Shop Management
Surveying & Topographical
Drafting
Tool Making

THINK! LOOK FORWARD!

Business is making Post-war plans

Men and Women are preparing for the future

WHAT ARE YOU DOING ABOUT YOUR TOMORROWS?

● *Today*, choose the job you want—and prepare for it. Or if you are already engaged in the work you like best, start training *now* for quicker promotion. Acquire the knowledge that will help you to get ahead faster, make more money and have greater security.

Invest part of your spare time in more rapid progress. Start training now, in spare time in your own home. Be ready to grasp your opportunity and step out ahead of those who lack the ability you have attained.

American School, founded in 1897 as an educational institution *not for profit*, can help you to reach your goal just as it has helped others during the past forty-seven years. Give serious thought to the list above. Pick one or more subjects that interest you. Then check the coupon at right, add your name and address and mail it at once. The school will send you details on its training plan and outline of study prepared by specialists. There is no charge, no obligation, so send the coupon immediately.

PRACTICAL, EFFECTIVE HOME - STUDY TRAINING SINCE 1897

Take This First Easy Step

CHECK, CLIP AND MAIL COUPON NOW

AMERICAN SCHOOL, Dept. GC45, Drexel at 58th, Chicago 37, Ill.
Without obligation. Please send FREE and postpaid, bulletin and details of the Subjects checked.

- | | | |
|--|---|--|
| <input type="checkbox"/> PLASTICS ENG'R | <input type="checkbox"/> Accounting and C.P.A. | <input type="checkbox"/> Drafting and Design for Men and Women |
| <input type="checkbox"/> Refrigeration | <input type="checkbox"/> Cost Accounting for Manufacturing | <input type="checkbox"/> Radio |
| <input type="checkbox"/> Architecture and Building | <input type="checkbox"/> Bookkeeping | <input type="checkbox"/> High School |
| <input type="checkbox"/> Practical Plumbing | <input type="checkbox"/> Private Secretary | <input type="checkbox"/> Air Conditioning |
| <input type="checkbox"/> Automotive Engineering | <input type="checkbox"/> Diesel Engineering | <input type="checkbox"/> Shipbuilding |
| <input type="checkbox"/> Aviation Drafting | <input type="checkbox"/> Surveying & Topographical Drafting | <input type="checkbox"/> Mechanical Eng. |
| <input type="checkbox"/> Aviation | <input type="checkbox"/> Sheet Metal Pattern Drafting | <input type="checkbox"/> Shop Management |
| <input type="checkbox"/> Business Mgmt | <input type="checkbox"/> Electrical Engineering | <input type="checkbox"/> Tool Making |
| <input type="checkbox"/> Railway Training | | <input type="checkbox"/> Better Foremanship |
| | | <input type="checkbox"/> Machine Shop Operations |

Name..... Occupation.....
Address..... Age.....
City..... State.....

AMERICAN SCHOOL

Dept. GC45, Drexel at 58th Street, Chicago 37

DRAFTSMEN NEEDED

Now



Industry is clamoring for more draftsmen for the job can't start until plans are drawn. Buildings, airplanes, machines, guns, tanks, bridges, all start on the drafting board, so it's no wonder that every good draftsman has a fine job. Yes, more draftsmen are needed NOW. The pay is good and the opportunities for advancement great.

Learn at Home in Spare Time

Begin now to turn spare hours into money. Be a draftsman, the connecting link between a mechanic and an engineer. Enjoy the wonderful opportunities for promotion that exist now. No experience or artistic talent is needed. You don't have to leave your present job while learning. Use spare time.

American School, Dept. DDC45, Drexel Ave. at 58th St., Chicago 37, Ill.

Gentlemen: Send me FREE information covering special training in subjects checked below. No obligation on my part.

- | | |
|--|--|
| <input type="checkbox"/> Drafting and Design for Men and Women | <input type="checkbox"/> Electrical Engineering |
| <input type="checkbox"/> Cost Accounting for Mfg. | <input type="checkbox"/> Diesel Engineering |
| <input type="checkbox"/> Architecture and Building | <input type="checkbox"/> High School Course |
| <input type="checkbox"/> Automotive Engineering | <input type="checkbox"/> Plastics |
| <input type="checkbox"/> Business Management | <input type="checkbox"/> Mechanical Engineering |
| <input type="checkbox"/> Railway Training | <input type="checkbox"/> Aviation <input type="checkbox"/> Radio |
| | <input type="checkbox"/> Shipbuilding |

Name.....

Address.....

Keep that "TICKING" Car

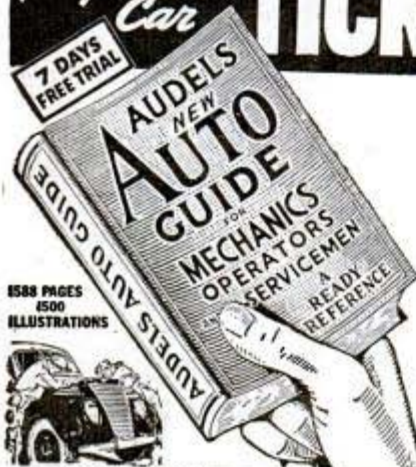

Every operator and mechanic needs AUDELS AUTO GUIDE.

This book saves time, money and worry. Highly endorsed. It presents the whole subject of auto mechanics:

- 1—Basic principles
 - 2—Construction
 - 3—Operation
 - 4—Service
 - 5—Repair
- Handy Size. Easily understood.

NEW FLUID DRIVE, HYDRAULIC SHIFT AND DIESEL ENGINES FULLY COVERED

Over 1500 pages—1540 illustrations showing inside views of modern cars, trucks and buses with instructions for all service jobs.

\$4 ASK TO SEE IT!—To Get This Assistance for Yourself Simply Fill in and Mail Coupon Today.

COMPLETE • PAY ONLY \$1. A MONTH ←

AUDEL Publishers, 49 West 23rd St., New York
 MAIL AUDELS NEW AUTO GUIDE for free examination. If O. K. I will send you \$1 in 7 days; then remit \$1 monthly until price of \$4 is paid. Otherwise I will return it.

Name.....

Address.....

Occupation.....

Employed by..... P.M.

STUDY AT HOME

With A Chartered Educational Institution

Men with specialized training win higher positions, insure larger earnings, and are bigger successes in business and public life. Opportunities NOW greater than ever before. Send for our 1944 Catalog.

ARTS AND SCIENCES

Courses in Philosophy; Education; Letters; Public Health; Medical Jurisprudence; Psychology; Sociology; Physics; Chemistry; Plastics; Geology; Political Science; Theology; Business and Commerce; Accounting; Mathematics; Statistics; Agriculture.

ENGINEERING

Courses in Electrical, Civil, Mechanical, Drafting, Architectural, Steam, Aeronautical, Radio, Structural, Mining, Industrial, Highway, Petroleum, Marine, Chemical, Diesel, Automobile and Air Conditioning Engineering.

LAW

Complete Professional Law Course includes 21 Hornbook Series college grade textbooks. Courses also in Commercial Law, Patent Law and Medical Jurisprudence.

McKinley-Roosevelt Incorporated, 4610-K, Sheridan Rd., Chicago 40, Ill.

CARTOONING



CASH IN on Big Cartoon Market. BECOME CARTOONISTS QUICKLY with our NEW, EASY METHOD. No experience necessary. Prepared by successful cartoonists. SATISFACTION GUARANTEED. Sample LESSON PLATE and interesting literature FREE.

NATIONAL ARTISTS BUREAU

Dept. A, Box 4248

DALLAS 8, TEXAS



JOKE BOOKS For Adults

The kind they like. You will be both a Riot and the Life of the Party with a set of these pocket size joke books. They are full of Entertainment, Fun and Humor. A set of six books only 50c or a special assortment of 12 books all different for \$1.00. Print name and address, send cash or stamps to:

TREASURE NOVELTY CO.,

72—5th Ave., Dept. 1208, N. Y. 11, N. Y.

Learn PHOTOGRAPHY at Home

Splendid opportunities. Prepare in spare time. Easy plan. No previous experience needed, common school education sufficient. Send for free booklet "Opportunities in Photography", particulars and requirements.

American School of Photography
 3601 Michigan Ave., Dept. 135C, Chicago 5, Ill.



Write for my Free Book, "How to Become an Expert Penman," which shows what others have accomplished by taking my Course. Enclose 10c for one of my Favorite Pen Points and your name with a beautiful flourished bird written on a card. Write today.

T. M. TEVIS, Box 25K, Chillicothe, Mo.

PLASTICS

Resident engineering course. 2000 hours. 50 weeks. Tuition \$900.00. Board and room jobs available. Located in the HEART of the Plastics Industry. Founded 1910. Pioneers in Plastics education. State approved.

NEW YORK TECHNICAL INSTITUTE (of N. J.), 151 MARKET ST., NEWARK, N. J.

HELPFUL BOOKS ON ANY SUBJECT

Lists of helpful books for business, trade, hobby or self improvement. Handbooks, \$1. books and HOW TO BOOKS: HOW TO WRITE BETTER LETTERS \$1. IT IS FUN TO DRAW \$1. 20-20 MINUTE LESSONS IN BOOKKEEPING \$1.50. Lists of latest books on any subject free.

HELPFUL BOOK LEAGUE, 15 East 40th St., New York 16, N. Y.

Store Route Plan PAYS BIG MONEY

SELL COUNTER CARD PRODUCTS

Build a good-paying business of your own; Call on dealers of all kinds; show nationally-advertised Aspirin, Vitamins, Cosmetics and 200 other necessities. Big 5c and 10c retail packages, high quality. Attractive counter displays sell goods fast. Free book gives amazing facts. Write!

World's Products Co., Dept. 10-Y, Spencer, Ind.





DeFOREST'S prepares you for a wide range of interesting, good pay jobs in the fascinating Radio-Electronics Industry.

For Good Jobs TODAY...
TOMORROW...LEARN

RADIO ELECTRONICS

DeFOREST'S A-B-C WAY

THE fast-moving Opportunity Field of Radio-Electronics needs many trained men! Let us show you how to get ready to take advantage of the breaks—the good jobs—the satisfying pay checks of today, and the bright postwar opportunities of tomorrow. Write for DeFOREST'S big, free book—"VICTORY FOR YOU!"

You see how you may cash-in on a field that includes F. M. Radio, Communication Radio, Electronics, Broadcast Radio, Motion Picture Sound, Radio Sales and Service, or a Radio business of your own.

You see how DeFOREST'S has helped many get their start in Radio-Electronics—helped them to good pay jobs in essential industries—helped others to preferred military classifications with higher ratings and better pay. Helped others to full and part time sales and service businesses of their own. Mail the coupon NOW—TODAY! See how DeFOREST'S can help YOU get started toward this fascinating work by means of its effective "A-B-C" Training Method—in your spare time, at home.

A YOU GET INTERESTING, PRACTICAL LOOSE-LEAF LESSONS

DeFOREST'S TRAINING includes 90 modern, well illustrated loose-leaf lessons, prepared under the supervision of one of the world's foremost Radio authorities, Dr. Lee DeForest—inventor of the Audion tube which helped make modern Radio possible.

B YOU WORK AT HOME WITH THIS PRACTICAL EQUIPMENT

You "learn-by-doing" with eight big kits of standard Radio parts and assemblies—working out 133 interesting experiments to gain valuable experience at home. You experiment with Light Beam Transmission. You build and operate an Aviation Band Radio Receiver, Wireless Microphone, 5-tube Super-heterodyne Receiver, an intriguing "Electric-Eye" device—and many other projects.



C YOU SHOW MOVIES AT HOME

You use a genuine DeVRY 16mm Motion Picture Projector and Films to help you learn Radio faster...easier. Hidden Radio-Electronic action comes to life! You see Electricity in motion—*Electrons on the march!*

DeFOREST'S also provides an effective EMPLOYMENT SERVICE which has long-established contacts with employers with whom we have placed many trained radio men. Act now! Mail the coupon! See how you may get ready to cash-in on both today's and postwar's promising future in the broad and exciting field of Radio-Electronics.

READ WHAT THESE DeFOREST MEN SAY!

"Let me say that since being on this job I have many times expressed the fact that I wouldn't take a lot of money for the training I had from your organization. It has helped me immensely."—Richard Strouhal, Oklahoma.

"I have obtained employment with theMfg. Company. You may be interested to know they speak very highly of DeForest's students and state they have had excellent results with your men whom they have employed."—Clifford Taylor, Mass.

"As a result of DeForest's Training, I am doing very well. If my income doesn't range between \$50.00 and \$75.00 per week, I figure something is wrong."—Lyle Rielly, Wis.

DeFOREST'S TRAINING INCLUDES INSTRUCTION IN MOTION PICTURE SOUND EQUIPMENT F-M RADIO AND TELEVISION



DeFOREST'S TRAINING INC., Chicago, Ill

DeFOREST'S TRAINING, INC.
2533-41 N. Ashland Ave., Dept. X
Chicago 14, Illinois

Please send me your "VICTORY FOR YOU" book and KIT FOLDER, FREE and without obligation.

Name.....Age.....

Address.....

City.....State.....

Check here, if under 16, for Special Information.

Mail the Coupon TODAY!

The set of books that makes



MASTER MACHINISTS and leads to bigger pay!

This big home-study and reference course gives you the practical facts on machines and methods you need to advance in machine shop work. Take advantage of the other man's experience as found in books, to solve your problems, increase your efficiency, with

The AMERICAN MACHINISTS' LIBRARY

6 volumes—2368 pages—2516 illustrations

(A combined home-study course and reference library)

This library of machine shop practice was written for practical men. It gives you the best methods for every kind of machine shop work. It fully explains lathes, drills, and other machine tools and their operation, automatic screw machines, speeds and feeds, gear design and production, jigs and fixtures, punch and die work, metal surfacing, etc., etc. Plainly written—completely illustrated—the best kind of help to the machine shop man who wants to advance himself.

No money down—special price—easy payments.

EXAMINATION COUPON

McGraw-Hill Book Co., 330 W. 42nd St., N. Y. 18

Send me for ten days' examination the American Machinists' Library. If satisfactory I will send you \$1.50 in 10 days and \$3.00 monthly until the price of \$19.50 is paid. If not wanted, I will return the books postpaid. (To insure prompt shipment write plainly and fill in all lines.)

Name

Home Address

City and State

Position

Name of Company

PM-544

AUDELS Carpenters and Builders Guides 4 vols. \$6



Inside Trade Information for Carpenters, Builders, Joiners, Building Mechanics and all Woodworkers. These Guides give you the short-cut instructions that you want—including new methods, ideas, solutions, plans, systems and money saving suggestions. An easy progressive course for the apprentice and student. A practical daily helper and Quick Reference for the master worker. Carpenters everywhere are using these Guides as a Helping Hand to Easier Work, Better Work and Better Pay. To get this assistance for yourself, simply fill in and mail the FREE COUPON below.

How to use the steel square—How to file and set saws—How to build furniture—How to use a mitre box—How to use the chalk line—How to use rules and scales—How to make joints—Carpenters arithmetic—Solving mensuration problems—Estimating strength of timbers—How to set girders and sills—How to frame houses and roofs—How to estimate costs—How to build houses, barns, garages, bungalows, etc.—How to read and draw plans—Drawing up specifications—How to excavate—How to use settings 12, 13 and 17 on the steel square—How to build hoists and scaffolds—skylights—How to build stairs—How to put on interior trim—How to hang doors—How to lay floor—How to paint



THEO. AUDEL & CO., 49 W. 23rd St., New York City

Mail Audels Carpenters and Builders Guides, 4 vols., on 7 days' free trial. If O.K. I will remit \$1 in 7 days, and \$1 monthly until \$6 is paid. Otherwise I will return them. No obligation unless I am satisfied.

Name

Address

Occupation

Reference

ARE YOU HANDY WITH TOOLS?

Learn to Be a Service Mechanic in

REFRIGERATION and AIR-CONDITIONING—at Home!

Exceptional opportunity for men of all ages up to 60. The demand for repair and service mechanics in REFRIGERATION and AIR CONDITIONING is acute, and will continue long after the war. Our practical, thorough course trains you at home. It's easy to grasp. A common school education is enough. No previous experience is required. Learn how to start your own business with \$50 worth of tools in garage or basement. Or take a job in this big pay field. Write for Free Booklet today. No obligation whatever.

FREE Booklet

MECHANICS TRAINING SCHOOL

4701 W. Pico Dept. P-8 Los Angeles 6, Calif.

TRAIN for SUCCESS in the Poultry Business



YOU CAN MAKE

MORE MONEY from POU-TRY. Proper management means profits ANY season, for life. Get latest scientific methods that avoid losses and mistakes. Our famous system of Home Study Training has helped thousands to success. Extra profits from the start. FREE Catalog; describes courses, methods, service. Write today to Dept. 50-O, NATIONAL POULTRY INSTITUTE, Adams Center, N. Y.

Study at home in spare time. Earn extra while learning.



Nationwide opportunities, sound postwar career waiting. Photographers needed by newspapers, advertisers, in business, industry, science. N.Y.I. graduates also winning promotion. Higher pay in Armed Forces. Qualify at America's largest, oldest school. Resident or home study courses. FREE catalog gives details. N. Y. INSTITUTE OF PHOTOGRAPHY, Dept. 49, 10 W. 33 St., New York 1, N. Y.

ARTISTS MAKE MONEY

Find out your ability. Send name, age, occupation and address for Free Vocational Art Test.

ART INSTRUCTION, INC. (Formerly Federal Schools) 8134 Art Instruction Building, Minneapolis, Minnesota

RADIO MADE EASY

Repair and improve all radios. New simplified manual tells how. Hints, pictures, diagrams to help you. Size: 8 1/2 x 11 in. Supreme Publications, 328 S. Jefferson St., Chicago 6, ILL. 25¢

HOME STUDY OR PRACTICAL SHOP TRAINING

Men wanted to learn following big pay trades: Auto-Diesel, Machinist, Plastics, Drafting, Refrigeration, Welding, Body and Fender, Aircraft. Established 1902. 41,000 graduates. Free booklet. Specify trade. State whether interested in Home Study or Practical Shop Training. GREER SHOP TRAINING, Dept. 184, 2017 S. Wabash Ave., Chicago, 16

Learn Public Speaking

At home—in spare time. Many overcome "stage-fright," gain self-confidence and increase earning power, this easy way. Write for free booklet, *How to Work Wonders With Words* and requirements. North American School, Dept. 135C, 1315 Michigan Ave., Chicago 5, Ill.

MAKE THIS SUIT YOURS NEW PLAN



Earn CASH Showing to Friends!

Write at once if you want this fine made-to-measure suit! You can get it by taking a few orders from friends, and earn up to \$10.00, \$12.00 in a day. Your personal suit helps you take more orders with Pioneer latest style, made-to-measure guaranteed suits at amazingly low prices. Also complete line of Ladies' Tailored Suits. No experience, no money needed. Write today for FREE SAMPLES—telling about yourself—age, etc. No obligation—act now! PIONEER TAILORING COMPANY Congress & Throop Sts., Dept. H-2116, Chicago 7, Ill.

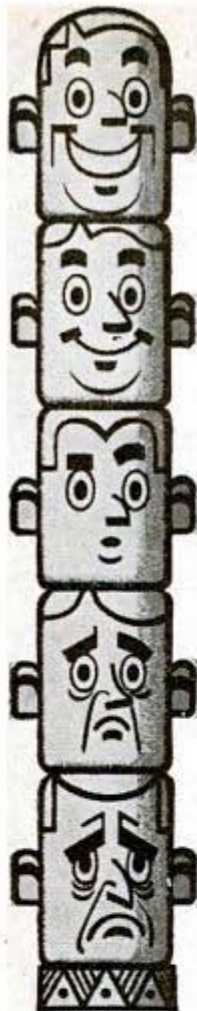

THE TOP MEN in Industrial Posts often are I. C. S. graduates

THE men holding the top industrial jobs didn't get there by wishful thinking. They had ambition and intelligence . . . and they applied them to obtaining essential *training*. Many enrolled with the International Correspondence Schools, famous for 53 years as a training system for industry and commerce.

When a committee of ranking U. S. scientists voted Modern Pioneer medals to the outstanding inventors of the past 25 years, 59 of the award winners

stated over their own signatures that they had studied I. C. S. technical courses.

Successful I. C. S. graduates are numbered by the thousands and they include presidents, production managers, chief engineers, head chemists of some of the greatest airplane, railroad, steel, chemical and electric companies in the nation.

You have ambition and intelligence. I. C. S. has the training you need to get to the top. Mail the coupon today.

INTERNATIONAL CORRESPONDENCE SCHOOLS



BOX 5700-J, SCRANTON 9, PENNA.

Without cost or obligation, please send me booklet and full particulars about the course *before* which I have marked X:

Air Conditioning and Plumbing Schools
 Air Conditioning
 Heating Plumbing
 Refrigeration Steam Fitting

Chemistry Schools
 Chemical Engineering
 Chemistry, Analytical
 Chemistry, Industrial
 Chemistry, Mfg. Iron & Steel
 Plastics
 Pulp and Paper Making

Civil, Architectural and Structural Engin'g Schools
 Architectural Drafting
 Architecture
 Bridge and Building Foreman
 Bridge Engineering
 Building Estimating
 Civil Engineering
 Contracting and Building
 Highway Engineering
 Lumber Dealer
 Sanitary Engineering
 Structural Drafting
 Surveying and Mapping

Electrical Schools
 Electrical Drafting
 Electrical Engineering
 Power House Electrician
 Practical Electrician
 Practical Telephony
 Telegraph Engineering

Internal Combustion Engines School
 Auto Technician Aviation
 Diesel-Electric
 Diesel Engines Gas Engines

Mechanical Schools
 Aeronautical Engineering
 Airplane Drafting
 Flight Engineer
 Foundry Work
 Heat Treatment of Metals
 Industrial Design
 Mechanical Drafting
 Mechanical Engineering
 Mold-Loft Work
 Patternmaking
 Reading Shop Blueprints
 Sheet Metal Drafting
 Sheet Metal Worker

Ship Drafting Ship Fitting
 Shop Practice
 Steel Mill Workers
 Tool Designing
 Welding, Gas and Electric

Radio School
 Electronics Radio, General
 Radio Operating
 Radio Servicing]

Railroad School
 Air Brake Car Inspector
 Locomotive Engineer
 Locomotive Fireman
 Railroad Section Foreman

Steam Engineering Schools
 Boilermaking
 Combustion Engineering
 Engine Running
 Marine Engines
 Steam Electric
 Steam Engines

Textile School
 Cotton Manufacturing
 Rayon Weaving
 Textile Designing
 Woolen Manufacturing

Business and Academic Schools
 Accounting Advertising
 Arithmetic Bookkeeping
 Business Correspondence
 Business Management
 Certified Public Accounting
 City Letter Carrier
 College Preparatory
 Commercial
 Cost Accounting
 Federal Tax
 First Year College
 Foremanship
 High School
 Higher Mathematics
 Illustrating
 Motor Traffic
 Post Office Clerk
 Railway Postal Clerk
 Salesmanship Secretarial
 Stenography
 Traffic Management

Language School
 Spanish French
 Good English

Name.....Age.....Home Address.....Working

City.....State.....Present Position.....Hours.....

Canadian residents send coupon to International Correspondence Schools Canadian, Ltd., Montreal, Canada.
 British residents send coupon to I. C. S., 71 Kingsway, London, W. C. 2, England.

SPECIAL TUITION RATES FOR MEMBERS OF THE ARMED FORCES



AUTO

BOOKS SENT FREE

ON APPROVAL. Just mail the coupon and we'll send you a complete set of Six Auto Books, 20th Edition. Whether you are a mechanic or helper, expert or apprentice, auto owner or driver, take immediate advantage of this FREE EXAMINATION OFFER.

MAKE GOOD MONEY NOW HOLD A PERMANENT JOB

America's autos must be kept in service, now and after the war. Men with "know how" are in demand, at big pay. These books will help you get and hold an important job, or give you a chance to go into business for yourself now or later. Any man who hauls tires to improve himself can learn auto servicing and repairing by this quick reference method. Use the JIFFY INDEX to find easily understood answer to any auto problem. These wonder books prepared by eleven of America's great automobile engineers. Many hundreds of valuable illustrations. Send the coupon TODAY.

A year's consulting privileges with our engineers now given with these books without extra charge.
Vocational Publishers Since 1898

CAN YOU FIX IT?

These wonder books tell step by step HOW to make difficult repairs and adjustments, how to keep a car at maximum efficiency, including latest improvements in car design and operation. Engine troubles and how to correct them well covered.

6 BIG VOLUMES
2800 pages, 2000 illustrations, wiring diagrams, etc., including Diesel engines. Beautiful modernistic, washable cloth binding.

AMERICAN TECHNICAL SOCIETY, Dept. AC19
Drexel Ave. at 58th St., Chicago 37, Ill.

I would like to examine your Six-Volume Set of Auto Books. I will pay the delivery charges only, but if I choose I may return them express collect. If after 10 days use I prefer to keep them, I will send you \$2 and pay the balance at the rate of only \$3 a month until \$24.80 has been paid. Please include consulting service as offered above.

Name
Address
City State

Please attach letter stating age, occupation and address of employer and of at least one business man as reference. Men in service, also please give home address.

AVIATION

Career

DON'T WAIT UNTIL THE WAR IS OVER!

Since 1929 Curtiss-Wright Technical Institute has been specializing in modern, progressive training for Aeronautical Engineers and Master Aviation Mechanics (no flying involved). Prepare now for your Aviation Career. BE READY! The opportunities are great today and will be much greater in tomorrow's Age of Flight. ACT!



CURTISS  **WRIGHT**
TECHNICAL **INSTITUTE**

GRAND CENTRAL AIR TERMINAL
GLENDALE 1, CALIFORNIA
(LOS ANGELES COUNTY)

MAIL THIS COUPON TODAY!

Registrar, Curtiss-Wright Technical Institute, Grand Central Air Terminal, Glendale (1), California. Please send information and profusely illustrated catalogue on Aviation Training. FREE ... without obligation ... Dept. PM-8

Name Birth Date
Street
City State

Men Needed for Good Pay Work in

AIR CONDITIONING and REFRIGERATION

Train NOW for Post-War . . .

You can enter this field easily and quickly—and prepare yourself for an attractive income! Thousands of Air Conditioning and Refrigeration Units are in need of servicing. Additional NEW equipment will be sold after the War. Get ahead in this work that offers excellent wages and opportunity. Let U.E.I. show you how to prepare for this interesting work as it has for thousands of successful U.E.I. trained men in the past 17 years. Investigate this home-study training that's balanced with actual shop work. Get this training without interference with your present job. Write today for FREE complete details.

UTILITIES ENGINEERING INSTITUTE, Dept. 184
1314 W. Belden Ave., Chicago (14), Ill.

BE A PERFUME DISTRIBUTOR!

Sell reproductions of world-famous, imported perfumes and get in on the now bigger than ever year around demand for this merchandise. Eye appealing packages assure you big daily cash profits. Many millions of dollars worth of perfumes sold annually. Get started at once with us—your profits are waiting! But get started! Send for free details and sample TODAY! **DUCHESS D'ANDRE**, Dept. 14-B, 145 No. Clark St., Chicago 2, Ill.

WANTED: IDEAS!

Developed into the form of:
NEW PRODUCTS • NEW PROCESSES • INVENTIONS

We have been retained by a number of companies desiring postwar products and processes. If your idea is acceptable an attractive contract for purchase or licensing will be arranged. Send copy of patent or drawings and description. Your information confidential. This service is free to you.

 **NEW PRODUCTS DIVISION**
DESIGNERS FOR INDUSTRY, INC.
2915 Detroit Ave., Dept. M-7, Cleveland 13, O.

BOOKS FOUND FREE!

WHAT BOOKS DO YOU WANT?

We quote lowest market prices. No charge for locating Hard-to-Find Books. All books. OLD or NEW mailed POST-FREE. **SEARCHLIGHT BOOK CLUB**, 22 East 17th St., New York City



WIN OR LOSE FOR FUN

Each BOOK OF FUN contains a combination of amusement ideas, including 12 games of chance and 12 quiz and forfeit questions. 10 books have a total of 210 feature plays. It's fun! You'll want more! A knockout for parties at home or at work. Popular with servicemen as a gift. May be used in campaign fund raising, etc. Handy pocket size.

10 BOOKS FOR \$1.00
ONLY
All Orders Filled Promptly

CLIP COUPON • FILL OUT • MAIL TODAY!

GAY GAMES, INC. MUNCIE, INDIANA

Please Send Me 10 BOOKS OF FUN . . . I Enclose \$1.00

Name
Address
City State

Will PLASTICS? Revolutionize Industry

WILL PLASTICS revolutionize industry... change our mode of living... or perform miracles? We do not believe they will. If, however, your business or employment has to do with products of metal, wood, leather, paper, fabric, ceramics, or coating material, you cannot afford to ignore the importance of plastics in your post-war planning.

Plastics are suitable for many new applications, but the intelligent use of plastics can only be determined by knowing their advantages and limitations.

Plastics Institute offers a comprehensive, up-to-date source of information through its Home Study Course in plastics... composed of forty-four lesson assignments, complete with detailed, modern illustrations and samples of plastics materials... prepared and conducted by recognized plastics authorities. This course takes you step by step through all phases of plastics, from sources and properties of materials to commercial applications in finished products... through mold design and molding, fabricating, laminating, testing and plant operation.

For complete information, mail the coupon for your copy of the FREE booklet, the "World of Plastics." It tells you about plastics in war and peace, the Plastics Institute Home Study Course, and the Executive Reference Set.

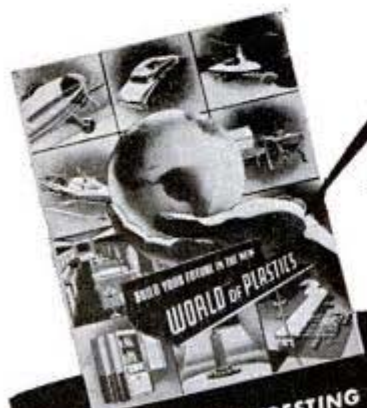

GET THIS INTERESTING
BOOK "WORLD OF
PLASTICS" SENT FREE!
Get Full Details Now.

Plastics INDUSTRIES TECHNICAL INSTITUTE

Department PM-8
122 E. 42nd St.
New York 17, New York

Department PM-8
221 N. La Salle St.
Chicago 1, Ill.

Department PM-8
186 S. Alvarado St.
Los Angeles 4, Calif.

MAIL COUPON FOR FREE BOOK

Plastics Industries Technical Institute *Mail in envelope or
221 N. La Salle St., Dept. PM-8, Chicago 1. paste on penny postcard.*
Gentlemen: Please send me the booklet "World of Plastics" and infor-
mation on your training program. I understand there is absolutely no
obligation.

NAME..... AGE.....
STREET.....
CITY.....ZONE.....STATE.....

Dept. PM-8

LEARN AIR CONDITIONING and REFRIGERATION



★
TRAIN
where the
ARMY
TRAINED

Now—for the first time the complete facilities of the **COMMERCIAL TRADES INSTITUTE**, which has been training men of the U. S. Army, are available to civilians. The most up-to-date, complete course of training in Air Conditioning and Refrigeration offered today. Learn right where you are, in your present job, with simple, easy-to-follow, profusely illustrated lessons. Receive actual shop and laboratory training under refrigeration men whose experience totals over 300 man years. Today's amazing opportunities will be even greater after the war. Train now. Be ready for a well paying position or a business of your own.

★
**FOR COMPLETE DETAILS—MAIL COUPON TODAY
TO SCHOOL NEAREST YOU**

COMMERCIAL TRADES INSTITUTE, Dept. M
221 No. LaSalle Street, Chicago, Ill.
200 So. 20th Street, Birmingham, Alabama
300 East Grove Street, Bloomington, Ill.

Please send me the free booklet "Refrigeration and Air Conditioning"—Your Guide to a SUCCESSFUL Future.

Name.....
Address.....
City..... State.....
Occupation.....

Do you want

- .. to go to College?
- .. or to enter a Profession?

(Such as Accounting, Architecture, Nursing, Dentistry, Teaching, Social Work, Osteopathy, Beauty Culture, Optometry, Embalming, Chiroprody, Law, Medicine, etc.)

- .. or get an Office Position?

To get anywhere, you practically **MUST** finish High School **FIRST**. You can complete our simplified High School Course in **SPARE** time at home, as **FAST** as your time and abilities permit. Equivalent to resident school work—prepares you for college, pre-professional examinations, business, industry. Standard texts furnished. Diploma. Credit for H.S. subjects already completed. Single subjects if desired. Low tuition, easy terms. American School, Chicago, est. 1897—endorsed by educators. Finish your high school education **NOW**. Write **TODAY!**

High School Course at Home Many Finish in 2 Years

American School, Dept. HC45, Drexel Ave. at 58th St., Chicago 37, Ill.

Gentlemen: Send me **FREE** information covering special training in subjects checked below. No obligation on my part.

- | | |
|--|--|
| <input type="checkbox"/> High School Course | <input type="checkbox"/> Diesel Engineering |
| <input type="checkbox"/> Cost Accounting for Mfg. | <input type="checkbox"/> Drafting and Design for men & women |
| <input type="checkbox"/> Architecture and Building | <input type="checkbox"/> Plastics |
| <input type="checkbox"/> Automotive Engineering | <input type="checkbox"/> Private Secretary |
| <input type="checkbox"/> Business Management | <input type="checkbox"/> Mechanical Engineering |
| <input type="checkbox"/> Electrical Engineering | <input type="checkbox"/> Aviation <input type="checkbox"/> Radio |
| <input type="checkbox"/> Elec. and Gas Refrigeration | <input type="checkbox"/> Salesmanship |
| <input type="checkbox"/> Air Conditioning | <input type="checkbox"/> Shipbuilding |
| <input type="checkbox"/> Railway Training | |

Name.....

Address.....

HOW TO WRITE FOR MONEY

If you **REALLY** want to write for **CASH** you **CAN!** Jack Woodford's new complete book "HOW TO WRITE FOR MONEY" gives YOU in 20 fact-packed chapters the **AUTHENTIC** "know-how" in simple, logical, time-

tested and proven **EASY-TO-FOLLOW** directions. Jack Woodford is author of 38 published **NOVELS** (crime, romance, sex, satire), 4 **NON-FICTION** books, over 2000 **STORIES**, 500 feature **ARTICLES**, 30 **HOLLYWOOD MOVIES** (Warners, M.G.M., Columbia). No other professional writer in the **WORLD** has had as many first novels dedicated to him as Jack Woodford. **WHY?** Because for 14 years Woodford has made a hobby of helping the beginning writer to **SELL!** If **ANYBODY** knows the answers, angles, inside dope, short-cuts and trade-secrets of all professional writers **WOODFORD** is **THAT MAN!** Turn rejection slips into **paychecks**. **DO NOT BELIEVE YOU CANNOT WRITE. YOU CAN!** NEVER have editors, publishers, producers, been so desperate for **NEW NAMES**. This is **YOUR** opportunity. **WOODFORD** shows you **HOW!** At Mr. Woodford's own request this brand new publication will be delivered to your door for \$1.50 **ONLY**, plus 15c packing and shipping charges. **ORDER TODAY!** Send \$1.65 in cash, check, or money order to—

MARCEL RODD BOOK PUBLICATIONS, Order Dept. A-2
6535 Hollywood Boulevard Hollywood 28, Calif.



CODE-SENDING-RECEIVING-SPEED

Learn to send and receive Radio Code with greater speed. Stop nervous tension. Have confidence. Be proficient. Same system used by radiotelegraph specialists. Thousands of operators needed. Rush name for **FREE** book.

CANDLER SYSTEM CO., Dept. 5-J, Box 522, Denver 1, Colo., U. S. A.

PRINT ANY PHOTO on Paper, Cloth, Leather or Wood

SIMPLE, EASY TO USE

Magic liquid takes only 2 minutes to reproduce any snapshot you have on to stationery, handkerchiefs, ties, scarfs, etc. Won't wash off. Won't hurt negative or fabric it's used on. Personalize your belongings! An ideal gift. Complete outfit enough to transfer 100 photos—only \$1.00 postpaid. Sent C.O.D. for \$1.30.

CHRISTY PHOTO SUPPLY, Dept. 410
2835 N. Central, Chicago 34



RADIO ENGINEERING, Broadcasting, Servicing, Electronics, Aviation, Marine & Police Radio taught thoroughly. 48 weeks' Engineering course equivalent to 3 years' college radio work. All expenses low. Co-educational. Catalog free.
VALPARAISO TECHNICAL INSTITUTE, Dept. D, Valparaiso, Ind.

GET INTO PLASTICS

START YOUR OWN BUSINESS SMALL CAPITAL—WORK AT HOME

● Be your own boss. Get into new plastics business today. Start in your own home. Small capital needed. As you increase your knowledge and skill, you grow with this big industry. This opportunity is yours today, so get started now in what may mean a big paying Plastics business of your own.

● Now for the first time you can start by preparing in your own spare time — in your own home. This new plan gives you the sound fundamental knowledge you need to be a success in Plastics. Included are actual working projects and plastics materials to teach you, in your own home, how to do fabrication, shaping, forming, finishing, cementing, mold making, casting, etc. *Mail coupon for free information.*

PLASTICS TECH., 739 BOYLSTON ST., BOSTON 15, MASS.

NAME..... AGE.....

ADDRESS..... P.O. ZONE.....

CITY..... STATE.....

Now YOU Can Lick Any AUTO REPAIR JOB!

IN LESS TIME—WITH LESS WORK



**FREE
7-DAY OFFER**

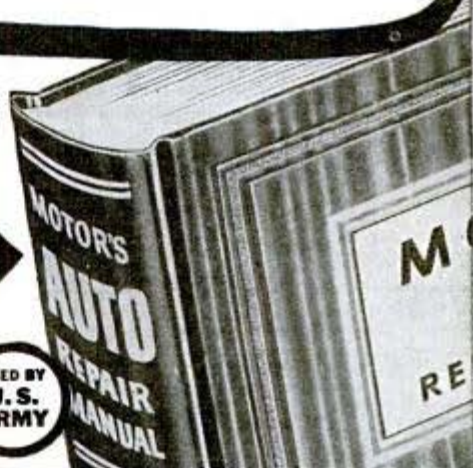

MoToR's New Auto REPAIR MANUAL
shows you how to service and
repair ANY part of ANY car!

No auto repair job is too tough when you've got MoToR's AUTO REPAIR MANUAL! You can repair anything from carburetor to rear end—quickly, easily, right! Just look up make, model, and the job in the quick index—and go to work! Clear, illustrated instructions lead you step by step.

To make such an amazing book possible, the engineer-editors of MoToR Magazine collected and "broke down" 150 official factory shop manuals for you, spotted all the vital repair information you need, dove-tailed it all together into ONE handy, easy-to-understand book.

No Other Manual Like It!

This BIG book—640 pages, 8½ x 11 inches, bound in sturdy covers—brings you nearly 200,000 service, repair, adjustment, replacement, tune-up facts on every car built from 1935 to 1942. More than 1000 cut-away photos, dia-

grams, drawings show you exactly WHAT to do and HOW to do it! Used by the U. S. Army, trade and technical schools everywhere, thousands of auto servicemen.

Now YOU—without cost—can see for yourself what a wonderbook MoToR's Auto Repair Manual really is. TRY it—FREE for 7 days! Learn first-hand how it can pay for itself the first few times you use it.

USED BY
U.S.
ARMY

SEND NO MONEY
7-Day Free Examination

Just mail coupon below—without money! When the postman brings your book, pay him nothing. First make it show you what it's got! Unless you agree this is the greatest time-saver and work-saver you've ever seen—return book in 7 days and pay nothing. Mail coupon today! Address: MoToR Book Department, Desk 1J, 572 Madison Ave., New York 22, New York.

**Clear, Pictured Facts on Every Job
on Every Car Built Since 1935!**

Nearly 200,000 service and repair facts on all these makes:

American	Ford	Oldsmobile
Bantam	Graham	Overland
Auburn	Hudson	Packard
Austin	Hupmobile	Pierce
Buick	Lafayette	Arrow
Cadillac	La Salle	Plymouth
Chevrolet	Lincoln	Pontiac
Chrysler	Lincoln	Reo
Cord	Zephyr	Studebaker
De Soto	Mercury	Terraplane
Dodge	Nash	Willys

640 large pages; including 50 pages of carburetor text, charts, illustrations, covering all models. Over 450 charts, tables, Tune-up Chart; Valve Measurements; Compression Pressure; Torque Wrench Reading; Starting Motor; Engine Clearances; Generator; Clutch & Brake Specifications; Front End Measurements, etc., Engines; Electric, Fuel, Cooling, Lubricating Systems; Transmissions; Universals; Front Ends; Wheels; Rear Ends, etc.

**Same FREE 7-Day Offer Applies on New
MoToR'S TRUCK REPAIR MANUAL**

For mechanics, truck specialists, service stations, fleet owners. Covers EVERY job on EVERY truck made since 1936! 1400 pictures, 900 pages, 300,000 facts. Used by Armed Forces. Warranted to contain every essential fact you need to know. Sturdy binding, size 8½ x 11.

Covers all types Gasoline Engines; Diesels and Hesselmans. Fuel Systems, Governors, Lubrication Systems, Ignition Systems, Starters, Generators, Clutches, Transmissions, Axles, Torque Dividers, Transfer Cases, Brakes, Steering, etc. etc.

Offered on same FREE 7-Day examination as Auto Repair Manual. Check box in coupon at right.



MoToR

Published by MoToR, The Leading Automotive Business Magazine. MoToR's manuals assure high standards of repair work.

MAIL COUPON NOW FOR 7-DAY FREE TRIAL

MoToR Book Dept., Desk 1J, 572 Madison Ave., New York 22, N.Y.

Rush to me at once: (check box opposite book you want).
 MoToR's AUTO REPAIR MANUAL. (formerly "MoToR's Factory Shop Manual"). If O.K., I will remit \$1 in 7 days, and \$1 monthly for 4 months, plus 35c delivery charge with final payment (\$5.35 in all). Otherwise I will return book postpaid in 7 days. (Foreign price, remit \$7 cash with order).

MoToR's TRUCK REPAIR MANUAL (Described at left in the box.) If O.K., I will remit \$2 in 7 days, and \$2 monthly for 3 months, plus 35c delivery charges with final payment (\$8.35 in all). Otherwise I will return book postpaid in 7 days. (Foreign price, remit \$11 cash with order).

Name..... Age.....

Address.....

City..... Zone No. State.....

Occupation.....

SAVE 35c! Check here if enclosing full payment (check, money-order) WITH coupon. We pay 35c shipping costs.

QUICK WAY TO LEARN MUSIC

—play any instrument

GET A REAL thrill out of music! Play the musical instrument you like best. Start right in with simple tunes. No tedious, old-fashioned drills and exercises.

It's easy! Everything is in print and picture. You see every position and move. Thousands have been amazed at their progress in just a few short weeks. Now they're sought-after guests for every party! Don't miss out on the popularity that is rightfully yours!

Mail coupon today for free illustrated Booklet and Print and Picture sample that show how easily and quickly you can learn music at home. Just check instrument that interests you in coupon below. U. S. School of Music, 78 Brunswick Bldg., New York 10, N. Y.



SUCCESSFUL 46TH YR.

FREE PRINT and PICTURE SAMPLE

U. S. School of Music, 78 Brunswick Bldg., New York 10, N. Y. Please send me Free Booklet and Print and Picture Sample. I would like to play instrument checked below. (Do you have instrument.....)

Piano	Accordion	Trumpet	Ukulele
Guitar	Saxophone	Tenor Banjo	Clarinet
Violin	Mandolin	Cornet	Other Instrument

Name (Please Print)

Street

City State

Say you saw it in Popular Mechanics!

AN INFANT INDUSTRY ... SUDDENLY MATURED PLASTICS

Get In at the Start—and Grow

Plastics is a new industry which the nation's war needs is forcing to quick maturity. Already Plastics are indispensable in practically every branch of the Service—Aircraft, Ordnance, Chemical, Marine, Signal Corps, etc. Opportunities? Nearly everything, from homes to clothing, from gadgets to tools, will be affected by Plastics.

Spare Time Training Now Ready

The time to get started is now. You can prepare at home, in your spare time, to take your place in an infant industry that even now is leaping into prominence. A new, practical training plan is now ready to help you realize your ambitions and build your future security. Act now. Don't delay. Mail this coupon today.

AMERICAN SCHOOL, Dept. PC45
Drexel Ave. at 58th St., Chicago 37, Ill.

Send me FREE information covering special training in subjects checked below. No obligation on my part.

- | | |
|---|---|
| <input type="checkbox"/> Plastics | <input type="checkbox"/> Cost Accounting for Mfg. |
| <input type="checkbox"/> Electrical Engineering | <input type="checkbox"/> Automotive Engineering |
| <input type="checkbox"/> Drafting and Design | <input type="checkbox"/> Architecture & Building |
| <input type="checkbox"/> For Men and Women | <input type="checkbox"/> Shipbuilding |
| <input type="checkbox"/> Diesel Engineering | <input type="checkbox"/> Business Management |
| <input type="checkbox"/> Mechanical Engineering | <input type="checkbox"/> High School Course |
| <input type="checkbox"/> Aviation | <input type="checkbox"/> Radio |
| | <input type="checkbox"/> Railway Training |

Name

Address

INTRODUCING-New Victory Model HANDIWELD ELECTRIC ARC WELDER

RETAILS ONLY \$1.95

FULLY GUARANTEED



PLUGS INTO LIGHT SOCKET

Victory Model Handiweld Arc Welder operates from 110 volts, A.C. or D.C. current same as other arc welders higher priced; generates tremendous heat to weld all metals. Not a toy welder that uses carbons, but actually uses standard coated rods—sizes 1/16" and 3/32". However, due to Priorities a generous supply of 1/16" rods only are supplied with the welder. Guaranteed not to burn out. Repairs fenders, auto bodies, radiators, machinery parts, etc. Take Victory Model Handiweld anywhere to job, operate right from light socket. You'll find a thousand uses for this welder around

your home, garage, workshop. Also in garages, factories, repair shops, tin shops, mechanics, inventors, plumbers, farmers, etc. Order a "Victory Model" Handiweld now.

SEND NO MONEY We'll rush one to you with rods, helmet, operating instructions, and all necessary parts with the exception of a large jar and a small piece of extension cord; these most everyone has. Pay postman only \$1.95 plus a few cents postage. If not delighted return Victory Model Handiweld in 5 days from receipt and money paid for it will be refunded promptly. **KUMFY PRODUCTS, Dept. G-202, CINCINNATI 26, OHIO**

A SIMPLIFIED ART ANATOMY OF THE HUMAN FIGURE



ONLY \$1 POSTPAID The book they're talking about! One of the most informative books of its kind for both student and professional artists. Charts, notes, and over 350 drawings show detailed studies of every part of the body, posed and in action. **HOUSE OF LITTLE BOOKS, 158-160 Fifth Ave., New York**

KEY TO A PRACTICAL UNDERSTANDING OF ELECTRICITY

\$1 PER MO.

• AUDEL'S HANDY BOOK OF ELECTRICITY

\$4 HANDY SIZE

For Engineers, Electricians, Students and all interested in Electricity. A quick, simplified, ready reference, giving complete instruction and practical information. Easy to understand. A reliable authority and a handy helper that answers your questions.

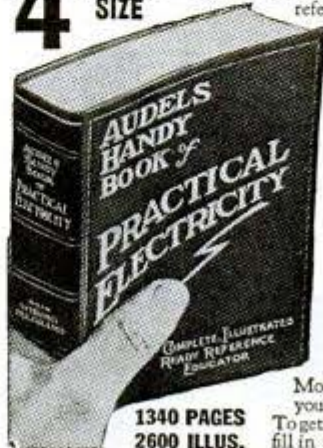

• INSIDE TRADE INFORMATION ON

The Rules and Laws of Electricity—Maintenance of Machinery—A. C. and D. C. Motors—Armature Winding and Repair—Wiring Diagrams—House Lighting—Power Wiring—Cable Splicing—Meters—Batteries—Transformers—Elevators—Electric Cranes—Railways—Bells—Sign Flashers—Telephone—Ignition—Radio Principles—Refrigeration—Air Conditioning—Oil Burners—Air Compressors—Welding, and many Modern Applications explained so you can understand.

1340 PAGES To get this assistance for yourself, simply
2600 ILLUS. fill in and mail the FREE COUPON below.

THEO. AUDEL & CO., 49 West 23rd Street, New York
Please send me "Au-del's Handy Book of Practical Electricity" for free examination. If satisfactory, I will send you \$1 in 7 days, then \$1 monthly until \$4 is paid. Otherwise I will return it.



READ FOR PROFIT!

Name _____
Address _____
Occupation _____
Reference _____ PM

POPULAR MECHANICS

Learn by Mail to Mount Birds

Animals, Game-Heads, Fish, Pets, to Tan Skins



Men, Boys!

Be a Taxidermist. Learn at home in spare time. Easily, quickly learned. Grand Fun. A wonderful, profitable hobby, for expert hunters, also for amateurs, even young boys. Mount wild-game, although wild-game is not necessary. Use common, domestic specimens, squirrels, pigeons, even frogs. This famous, reliable school in business more than 35 years. More than 300,000 delighted students. Think of that!

Hunters Save Your Trophies — Have a Home-museum Be a Taxidermy Artist

You will be THRILLED and DELIGHTED. You learn QUICKLY, easily AT HOME. Your friends will be amazed. Hunters from near and far will bring their TROPHIES to be mounted. You can earn fine profits in spare time. Many students earn \$80 to \$100 a month, in season. Rush the coupon today, and learn all about wonderful taxidermy. DO IT NOW!

Save your own hunting trophies. Have a lifelong hobby. Have a home museum that you are proud of, and that makes you popular and well-known far and wide. BOYS, wild-game is not necessary. Use common specimens, squirrels, pigeons, owls, domestic birds and animals. It's wonderful. Inquire today. Kill fewer game-birds. Double your fun and pleasure.

Fun — Fascination — Profit

And so easily learned in spare time. Wild-game is growing scarcer. Help preserve it. Shoot only a FEW fine ducks and other game-birds, MOUNT THEM for home and den, and have MORE FUN and PLEASURE than killing the legal limit every day. Help preserve the wild-game.

Remember you learn to mount expertly, birds, animals, game-heads, fish, pets, to tan skins and furs. Investigate! You will be delighted. Send for free book today. "Eat your trophies and have them too."

THE N. W. SCHOOL OF TAXIDERM, 337-C Elwood Bldg., Omaha 8, Nebr.

FREE BOOK!

Yes FREE, 44 pages, with 100 unique pictures of taxidermy work. No other book in the world like this. It will amaze and thrill you. Ask today for your free copy. State your AGE.

Send the Coupon!

Write name plainly in coupon or margin, or a post card will do. Rush your request, as free books may be exhausted quickly. Decide now. Don't wait a moment. State your age.

FREE BOOK

Northwestern School of Taxidermy, 337-C Elwood Bldg., Omaha, Neb. Send me your free illustrated book, "How to Mount Game". Also tell me how I may learn this fascinating art easily and quickly by mail. No obligation. State your age.

Name _____ Age _____
Address _____



NEW PRODUCTS—NEW IDEAS

● A large manufacturer now engaged exclusively in defense work, wants large production items for post-war development.

We can furnish Engineering, Financing, Manufacturing, Selling.

Many sound products or ideas never get past the model stage, due to a lack of one or more of the above essentials. Why not contact a strong company able to supply all of the above facilities within the one organization. If your proposition meets the requirements of soundness and practicability, we would like to discuss it

with you. Before sending your drawings to us or anyone else, protect yourself by having copies of them witnessed and the originals retained in your possession. The date of witnessing should be kept confidential by you, as this is the date on which you can prove priority.

AERO SUPPLY MFG. CO., INC., Corry, Pa.

★ JOHN BROWN SCHOOLS ★

JOHN BROWN UNIVERSITY—
Academic, Vocational and Bible
College

"America's first university of vocational specialization." 5000 watt radio station, airfield. All industries of small city used in laboratory training.

★ ★ ★

Siloam Springs, Ark.
JOHN BROWN ACADEMY
High School. Academic, Vocational.

San Diego, Calif.
BROWN MILITARY ACADEMY
Junior School through Junior College, separate units on beautiful campus. Highest official War Dept. rating.

Sulphur Springs, Ark.
BROWN MILITARY ACADEMY OF THE OZARKS
Junior School and Junior High School.

Glendora, Calif.
BROWN SCHOOL FOR GIRLS
Junior School and High School.
"In the beauty spot of the West."

Non-Profit — accredited — definitely evangelical. Address individual school or
JOHN E BROWN, LL. D., Pres
SILOAM SPRINGS, ARK.

**DESIGNERS, ENGINEERS
DRAFTSMEN, METALSMITHS—**

NEW—100 clear and concise welding design ideas gleaned from practical experience of others. Every idea clearly shown by drawings—easy to understand and apply. If you are interested in welded design, you can't be without this book, nothing else like it, \$3:50 Postpaid, 5 days approval.

**HOBART
BROTHERS COMPANY**

Hobart Bros. Co., Box M-84, Troy, Ohio

Design FOR ARC WELDING

will save you many times its cost on your next redesign projects. Order now, \$3.50 (Postpaid)

512 Pages, 516 Illustrations. Complete manual and text book on Welding Postpaid - \$2.00



"One of the World's Largest Builders of ARC WELDING Equipment."

Flash! Amazing Opportunities NOW Open in these practical money-making trades watch and clock repairing



LEARN AT HOME—IN YOUR SPARETIME

Prepare for a happy future of prosperity, security... and get a big-pay job now. Fascinating, high-grade occupation. You can EARN WHILE YOU LEARN. Excellent field for part-time work at home.

COMPLETE COURSE in HOROLOGY

Thorough self-instruction training in American and Swiss watches, clocks. Special sections on alarm clock repairs. New, practical LEARN-BY-DOING instruction method. Learn QUICKLY, easily. No previous experience necessary. Watchmaking is basic training for aircraft instrument work, and other scientific precision jobs.

Amazing LOW PRICE • MONEY-BACK GUARANTEE
Get into this fast-growing field NOW... big opportunities... don't delay. Mail coupon below for FREE information. There's no obligation.

locksmithing and key making

COMPLETE UP-TO-DATE COURSE

How to pick locks, de-code, make master-keys, repair, install service, etc. New, self-instruction lessons for every handy man, homeowner, carpenter, mechanic, service station operator, fix-it shop, hardware dealer, gunsmith.

53 EASY ILLUSTRATED LESSONS
Bargain Price! Satisfaction guaranteed or money back. Write now... no obligation!

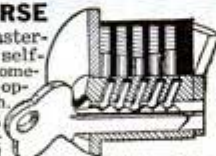

Free Details—Mail Coupon Today!

NELSON CO., Dept. 8H02, 321 S. Wabash Ave., Chicago 4, Ill.
Please send me—FREE and without obligation—illustrated Success-Catalog containing information about the course (or courses) I have checked below. No salesman will call.

Watch and Clock Repairing. Locksmithing and Key Making.

NAME.....

ADDRESS.....

CITY.....

STATE.....

BENJAMIN



H-C PELLETS ARE AVAILABLE

at dealers or direct, Cal. 22 and Cal. 177. Production of all models Benjamin Air Rifles and Benjamin Air Pistols has been suspended for the duration as our facilities are engaged in War Work. WRITE FOR OUR ILLUSTRATED PRICE LIST OF POST WAR MODELS TODAY.

BENJAMIN AIR RIFLE CO., 812 Marion St., St. Louis, (4) Mo.

To PROTECT YOUR INVENTION—Use this coupon, NOW

Delays are dangerous and may be very costly. My personal service assures prompt action, strict confidence, and a minimum of expense. I suggest that you send me a model or drawing, or sketch and description of your invention, and \$5.00. I will make a search and report

promptly as to its patentability and send you a copy of my 72-page booklet. Or, if you prefer to read my booklet first, mail the attached coupon at once. I will also send my "Record of Invention" form. (Over 40 years experience as a Registered Patent Attorney.)

L. F. Randolph, 302-D Columbian Bldg., Washington, D. C.

Please send me at once, free of charge, your 72 page booklet and "Record of Invention" form.

Name.....

Address.....

A PERSONAL CONFIDENTIAL PATENT SERVICE—

★ FREE COPY ★ The World Takes Wings

Get a preview of the wonderful opportunities in post-war aviation. The world's fastest growing industry offers permanent, profitable positions of leadership to those whose training and preparation qualify them. This is yours for the asking. Write at once!

WESTERN AIR COLLEGE

198 S. Myrtle Ave.

Monrovia, Calif.

Learn TOOL DESIGN

Opportunity for rapid advancement in this great, giant industry is now offered to qualifying students. Learn to be a machine or tool designer in spare time with our thorough home study course. Students are given up-to-the-minute, practical instructions. Many now making \$100 to \$125 a week. This rapidly expanding industry is calling for more machine and tool designers than available. Rush name for full free facts on machine or tool design. State age. Penny postal will do—but hurry.

OHIO INSTITUTE OF TECHNOLOGY, Box 176, Greenville, Ohio

MAKE MONEY AT HOME!

Learn to color photos and miniatures in oil. No previous experience needed. Good demand. Send for free booklet, "Make Money at Home" and requirements.

NATIONAL ART SCHOOL
1315 Michigan Ave. Dept. 135C Chicago 5

PATENTS AND TRADE MARKS

C. A. SNOW & CO.

Registered Patent Attorneys Since 1875
Write for Free Book and "Certification of Invention" form
427 SNOW BUILDING, WASHINGTON 1, D. C.

PATENTS Protect Your Idea: By

securing FREE my "PROOF OF INVENTION" folder. Exceptional Personal Service. Excellent References. Established 1906.
E. E. VROOMAN, 871 Woodward Bldg., WASH., D. C.

PATENT YOUR IDEAS

SEND FOR FREE BOOK NOW TO OBTAIN A PATENT!

Written by Former Member Examining Corps (1922-24) U. S. Pat. Office.
CARL MILLER, Registered Patent Attorney
Former Member Examining Corps U. S. Patent Office
Woolworth Bldg., Dept. 84-A, New York—Bond Bldg., Dept. 84-A, Washington, D. C.

★ SAVE WASTE PAPER ★

FOR POST WAR SUCCESS— PREPARE NOW!

Post war adjustment and job competition will offer unusual opportunity to the man or woman who has prepared for them. Sales, Accounting and Management people will be in demand. You can get ready now—in your spare time, at moderate cost—by home study. Free 48 page booklets tell you how. Check your subject below, write name and address in margin, mail this ad today.

- | | |
|---------------------------------------|--|
| <input type="checkbox"/> Accounting | <input type="checkbox"/> Business Management |
| <input type="checkbox"/> Salesmanship | <input type="checkbox"/> Traffic Management |
| <input type="checkbox"/> Law: L.L.B. | <input type="checkbox"/> Industrial Management |
| <input type="checkbox"/> Foremanship | <input type="checkbox"/> Stenotypy |

LA SALLE EXTENSION UNIVERSITY
A Correspondence Institution
Dept. 864-R CHICAGO, 15

POST-WAR PRODUCTS WANTED

We are interested in new products saleable in the aircraft, automotive, railroad, agricultural and construction fields, whose principal parts may be forged, cast or pressed from metals. Will consider developed or partly developed ideas. Correspondence invited with inventors, designers, engineers and patent attorneys, which will be treated in strictest confidence.

Established over 60 years, we have capable engineering and experimental staffs. Prompt attention. Write RESEARCH ENGINEER, J. H. WILLIAMS & CO., BUFFALO 7, N.Y.

REFRIGERATION

Repair and improve all refrigerators. Large manual tells how. Charts and pictures to help you. Price only \$1.00, postpaid. Money back guarantee. SUPREME PUBLICATIONS, 328 S. Jefferson St., Chicago 6, ILL.

★ SAVE WASTE PAPER ★

9 BIG BUILDING BOOKS



SHIPPED
FREE FOR
EXAMINATION

Learn to draw plans, estimate, be a live-wire builder, do remodeling, take contracting jobs. These 9 practical, profusely illustrated books cover subjects that will help you to get more work and make more money. Architectural design and drawing, estimating, steel square, roof framing, construction, painting and decorating, heating, air-conditioning, concrete forms and many other subjects are included.

BETTER JOBS — BETTER PAY

Keep busy now at good pay, and be prepared for after-war building boom. Big opportunities are always for MEN WHO KNOW HOW. These books supply quick, easily understood training and handy, permanent reference information that helps solve building problems.

UP-TO-DATE EDITION

These books are the most up-to-date and complete we have ever published on these many subjects.

Coupon Brings Nine Books FREE For Examination

AMERICAN TECHNICAL SOCIETY Vocational Publishers since 1898
Dept. GC19 Drexel at 58th Street Chicago 37, Ill.

You may ship me the Up-to-Date edition of your nine big books, "Building, Estimating, and Contracting" without any obligation to buy. I will pay the delivery charges only, and if fully satisfied in ten days, I will send you \$2.00, and after that only \$3.00 a month, until the total price of only \$29.00 is paid. I am not obligated in any way unless I keep the books.

Name.....

Address.....

City..... State.....

Please attach a letter stating your age, occupation, employer's name and address, and that of at least one business man as a reference. Men in service, also please give home address.

HERE'S THE ONE WAY TO REALLY LEARN RADIO-ELECTRONICS and TELEVISION



FULL RADIO SET
SUPPLIED for PRACTICE

GET READY for BIG EARNINGS AHEAD

The offer I make you here is the opportunity of a lifetime. It's your big chance to get ready for a wonderful future in the swiftly expanding field of Radio-Electronics INCLUDING Radio, Television, Frequency Modulation, and Industrial Electronics. Be wise! NOW is the time to start. No previous experience is needed. I supply you with Radio Parts which you use to gain pre-experience in Repair work. These same Parts are used for testing and for Signal Tracing, etc.



PREPARES YOU for a
BUSINESS of YOUR OWN

... or Good Radio Jobs, Civilian or Military

The Sprayberry course starts right at the beginning of Radio. It gets the various subjects across in a clear, simple way. I make it easy for you to learn Radio Set Repair and Installation Work... by practical, proved, time-tested methods. I teach you how to install and repair Electronic Equipment. Soon you'll be qualified for a good paying job in one of the nation's Radio plants doing war work OR, if you enter the Army, Navy, or Marines, my training will help you win higher rating and better pay.



READ WHAT GRADUATE SAYS

"Wins Out in Army Test"

"Since I completed your elegant Course in Radio I have been drafted into the Army and put into the Signal Corps. I had to compete to get the job I now hold and as a result of my training with you, I made the best grade and got the job. The point I am driving at is if it hadn't been for your thorough course in Radio I would probably be peeling potatoes now. I recommend your training to all because it is written in language that the average layman can understand." — A R C H PLUMMER, JR., Fort Meade, Md.

Grasp This Opportunity!



GET BIG
FREE
BOOK

MAIL COUPON

SPRAYBERRY ACADEMY OF RADIO

F. L. Sprayberry, President
Box 500RH, Pueblo, Colorado.

Please rush my FREE copy of "HOW TO MAKE MONEY in RADIO, ELECTRONICS and TELEVISION."

Name..... Age.....

Address.....

City..... State.....

(Mail in plain envelope or paste on penny postcard)

**WORLD'S
BEST
WANT AD
MEDIUM**

CLASSIFIED Advertisements



Advertisements in this section, 35 cents per word, each insertion, minimum 10 words, payable in advance
To be inserted under proper classification in September issue, should be in our office August 4th
September issue on sale September 1st

Popular Mechanics Magazine, 200 East Ontario Street, Chicago 11, Illinois

AUTOMOBILES—MIDGET CARS

TIME Magazine, May 29, page 55. Review: "To Americans for whom an automobile is a 20th century work of art, and its evolution a nostalgic memory, Floyd Clymer's Scrapbook is a 'must.' Floyd Clymer's Historical Motor Scrapbook! 160 pages photographs, specifications, descriptions 250 early automobiles, motorcycles—including Chevrolet V-8, friction driven Plymouth, Ford "2" and "6", 3 cylinder Elmore, revolving engine automobile, Studebaker electric, Pope, Knox, Oldsmobile, Thomas, Sears, Maytag, Maxwell, Hupmobile, Mitchell, Rambler, Orient, Wayne, Brush, Peerless, Lambert, E-M-F, Flanders, Reo, Lozier, Selden-Ford patent litigation details, Lincoln truck, Overland, Marmon, electrics, foreign cars, others. Interesting, educational, historical, humorous ancient motor history includes motorcycle section, \$1.50 postpaid. Clymers, 2125 W. Pico, Los Angeles 6, Calif.

BUILD Dashboard controlled garage door mechanism. Thoroughly tested system. Exceptionally simple, dependable. Materials inexpensive, obtainable everywhere. For overhead, swinging, sliding doors. Complete plans \$1.00. Kaytor Laboratories, Lynwood, Calif.

AUTOMOBILE Books. "Racing photo album" 110 photos, exciting crashes, world's greatest race cars, drivers described. \$1.50. "Saga Roaring Road" 181 pages, 16 pictures. Starter Fred Wagner's early racing experiences with world famous drivers, cars described, read about Rickenbacker, Murphy, Burman, DePalma, Ford "999", Oldfield, Benz \$2.50. Automobile racing book \$1.10. Prices include reprints, illustrations, drawings army Jeep and German BMW war motorcycles. All postpaid. Clymers, 2125 W. Pico, Los Angeles 6, Calif.

PROFESSIONAL Midget racers, motor-scooters, midget cars. Parts, plans. Handbook catalog—50 illustrations, plans—20c. Midwest, 2557 Charlestown, Toledo, Ohio.

STEAM Automobiles! Send 25c for literature listing ninety different makes steamers once manufactured, illustrations, descriptions, specifications, Stanley White, Locomobile, Ross, Grout, Lane, Doble, others. No cars for sale. Clymers, 2125 W. Pico, Los Angeles 6, Calif.

SEND \$1.00 For large photographic cuts showing racing cars and boats, speed equipment, etc. sheet for Fords all models Chevrolet, Willys and other standard engines. Robert M. Roof, R & R Mfg. Co., Box 546, Anderson, Indiana.

AUTOMOBILE Racing Pictorial. Photographs 236 world famous drivers, officials, personalities. \$1.00 postpaid. Clymers, 2125 W. Pico, Los Angeles 6, Calif.

POWER And Speed! World's most famous motor book. 110 large pages. 200 illustrations racing automobiles, motorcycles, airplanes. World's speed record chart, articles by world's famous speed kings Cobb, Eyrston, Campbell, Bonneville record details, photos, British racers. Describes cams, compression, valves, superchargers, International racing teams, German Auto-Union, Italian, French, British racer specifications, drawings. \$2.50 postpaid. Clymers, 2125 W. Pico, Los Angeles 6, Calif.

AUTOMOBILE Racing book, fifth edition, well illustrated. Instructions on building bodies, frames, engines. Ford A and B conversions. AAA rules, specifications. Roadster racing, Indianapolis cars. \$1.00 postpaid, \$1.30 C.O.D. Ray Kuns, Dept. 47, Madisonville, Cincinnati 27, Ohio.

ENGLISH Automobile publication "Motor." Interesting illustrations, descriptions, comments British automobiles. Published weekly. \$10 yearly. \$5.50 six months. Sample copy 50c postpaid. Clymers, 2125 W. Pico, Los Angeles 6, Calif.

1944 **IGNITION** Supercharger \$3.50. Fast starting, mileage, pep. EG Sales Mfg. Co., 60 John St., New York.

AUTO SUPPLIES AND EQUIPMENT

WHIRLGAS Turbinator, \$3, spins and vaporizes carburetor mixture entering motor. Increases mileage and horsepower; reduces deadly monoxide. University and oil corporation tests. Wrench installs 15 minutes. Give auto make, year. John Hanley, 5719 Loraine, Detroit 8, Mich.

AUTO Parts, both new and used. If you need a part, new or used, for a car or truck 1928 to 1942, you can get it from Trainor's, 7232 to 42 Stony Island Ave., Chicago, Illinois.

CLYMER DeLuxe chromed spotlight for automobiles, motorcycles, boats, hunters. Trigger switch, pistol grip handle, powerful beam, 32 cp., operates off any 6-8 automobile battery. Only few left, hurry. \$8.50 postpaid. Clymers, 2125 W. Pico, Los Angeles 6, Calif.

1,000 **MOTORISTS** Needed to make gas saving test. Up to 30% savings. For trial test offer write Vacu-matic Carburetor Co., 7617-966 W. State Street, Wauwatosa, Wis.

EXTRA Miles. Easily drive 50 miles for each gallon gas used. Equip car yourself inexpensively. New simplified diagrams and instructions \$1.00 cash or money order. Mechanic's Special, Box 54, San Bruno, Calif.

DUAL Mufflers. California style fit Ford V-8, Mercury. Saves gasoline, increases power, beautiful deep tone. All attachments, pipes, etc. Easy installation. \$20.00 complete. Clymer's, 2125 W. Pico, Los Angeles 6, Calif.

FIVE Cents worth of natural gas will run your car 25 miles. Blueprints and plans \$1.25. Harpers Machine Shop, 218-22nd Street, Dunbar, W. Va.

SAVE Gas. How I increased my mileage over 150% is a copyrighted article which may help you to get more mileage. Postpaid \$1.00. Copyright also offered for sale. Interested? Write W. Orr, Box 810, Frankford, Ont., Can.

GAS-SAVER, New. Year of car and 3c stamp. Anderson Vapo-Carburetor Co., Box 265, H. C. Sta., San Diego, Calif.

TIRED Of gas rationing, shortages, excessive carbon, ping, knock, poor mileage, high operating costs? Then get straight facts about butane, not rationed, plentiful, cannot form carbon, 120 octane, no ping, no knock, half price, plus more mileage. Butane is the perfect fuel, beware of other harmful and impractical schemes. Get complete information, sketches, list of necessary equipment, etc., by sending one dollar to Alberts, Box 492, Alhambra, Calif.

BUILD Your own unit to burn 120 octane fuels in your car. Perfect performance. Complete details \$1.00. Behco, Box 55, Hyde Park Station, Los Angeles, Calif.

INVENTION Uses kerosene to run motors. Circular on plans. Rush name. Houston Maupin, Tipp City 9, Ohio.

AUTOMOBILE Generators. Rebuilt generators for cars or trucks. O'Keefe, 7517 Merrill, Chicago.

SAVE! Used, guaranteed parts all cars; transmission specialists. Describe needs fully! Immediate reply. Victory, 2439-1/2 Gunnison, Chicago 25.

PORTABLE Folding stove. Vest pocket size. Condensed tablets supply quick, clean, safe heat. Campers, vacationers, service men. Quickly heats coffee, soups, canned foods. Weights ten ounces. Stove complete with 39 heat tablets \$1.50 postpaid. Clymers, 2125 W. Pico, Los Angeles 6, Calif.

OPERATE Cars, trucks, tractors, motors, with wood or coal gas, 1/2 cost of gasoline. Extensively used in Europe. Complete detailed instructions \$1.00. W. M. Cross, Lone Rock, Wis.

PRESERVE Your tires with plastic, and puncture proof your tires. Details for stamp. Betke, Box 699, Borger, Texas.

PLATING Outfits for auto parts. Connect to a battery. No tanks used. Free particulars and proofs. Gunmetal Co., Ave. J, Decatur, Ill.

THE Lord is coming! Get guaranteed proofs free. Scheall, 263XA, Duluth, Minnesota.

AUTO TRAILERS

BUILD Your own trailer! Save money! Have every feature you want! Plans for house, sport, camp and utility trailers. Catalog describing 11 models 10c. Jim Dandy, Box 125-A, Wausau, Wisconsin.

MOTORCYCLES, BICYCLES, MOTOR-SCOOTERS AND SUPPLIES

MOTORCYCLISTS — New and used parts, accessories, all models. Catalog 10c. Henderson catalog 10c additional. Triangle, 2157 Harrison, Chicago.

TIME Magazine, May 29, page 55. Review: "To Americans for whom an automobile is a 20th century work of art, and its evolution a nostalgic memory, Floyd Clymer's Scrapbook is a 'must.' Floyd Clymer's Historical Motor Scrapbook! Just out, 160 pages, photographs, specifications, descriptions 250 early motorcycles, automobiles, including Pierce "4", Merkel, Pope, Yale, Thomas, Harley, Indian, Marsh, Reading, Thor, steam motorcycle, Ace, Cleveland, Dayton, Minneapolis, front wheel driven motorcycles and scooters. British, German, French, Swedish makes. Auto section includes Chevrolet V-8, friction driven Plymouth, Ford "2" and "6", revolving engine car, steamers, electrics, Brush, Pope, Maxwell, Studebaker electric, Sears, Knox, Maytag, Hupmobile, Orient, Rambler, others. Interesting, educational, humorous ancient motoring history. \$1.50 postpaid. Clymers, 2125 W. Pico, Los Angeles 6, Calif.

BUILD Electric bicycle. No chains, gears, welding. Relay controlled. Plans \$1. Klaus, 1369 Missouri, Pittsburgh 6, Penna.

MOTORSCOOTERS \$40 Up; motorcycles \$30 up; motors \$4 up. Unrationed tires, parts cheap. Send 25c for war-time bargain catalogue. Midget Motors Directory, Athens, Ohio.

NEW Book just out. English Motorcycle Manual. 68 large pages complete authentic factory servicing information British war and civilian motorcycles. 140 illustrations, diagrams, drawings, engines, transmissions, Enfield, Norton, Triumph, B.S.A., Matchless, Ariel, Velocette, Burman, Lucas Ignition, B.T.H. Magneto, Miller lighting sets, hydraulic forks. Wonderful book British owners. Interesting, educational any motorcyclist. \$1.50 postpaid. Clymers, 2125 W. Pico, Los Angeles 6, Calif.

MOTORBIKE Manual. Containing plans for easy to build motorbike and scooter, and catalog section. \$1.00. Variety Enterprise Co., Dept. PM, Box 5, Station A, Evansville, Ind.

"MOTORCYCLES — How to Manage Them," 260 pages, 175 illustrations, drawings. Read it, become a better motorcyclist. Expertly written. \$1.50 postpaid. Clymers, 2125 W. Pico, Los Angeles 6, Calif.

BOOK "Speed—How to Obtain It." 160 pages, illustrated, instructions, cams, balance, timing, valves, pistons, racing technique. World's greatest speed tuning book. \$1.50 postpaid. Clymers, 2125 W. Pico, Los Angeles 6, Calif.

BRIGGS-STRAITON, Lauson, Maytag, Johnson, Evinrude motors. Bought, sold, or listed free. Write full description, condition and price f.o.b. your freight station. Don Woodcock, Midland, Michigan.

HARLEY-DAVIDSON Parts, accessories, late models. Carl Bush, 518 Broad St., Newark, N. J.

100 MILES Gallon! Motor-scooters, motorcycles, Whizzer bicycle engines, midget automobiles, gasoline engines. No priority necessary. Catalog 10c. Clymers, 2125 W. Pico, Los Angeles 6, Calif.

TIRES And industrial wheels, suitable for scooters, wheelbarrows, farm equipment, etc. All sizes. Bicycles and accessories. Largest assortment in America. Send dime for list. Cycle Transport Company, 1241 So. Michigan Ave., Chicago 5, Illinois.

FLOYD Clymer's Motorcycling Manual, 144 pages, 120 illustrations. Complete information, specifications, descriptions dozens motorcycles. Engines, transmissions, carburetors, square four, two piston singles, sleeve valve engines, overhead camshafts, water cooled motorcycles, spring frames, hydraulic forks, sidecars, riding instructions. Two cycle engines and power bicycles described, illustrated. Just out \$2.00 postpaid. Clymers, 2125 W. Pico, Los Angeles 6, Calif.

PARTS, Accessories, pistons, chain for Harleys and Indians. McCann's, 2104 Texas Street, El Paso, Texas.

PLANS, Scale drawings, specifications, illustrations for building attractive motor scooter complete \$2.00; plans electrically driven bicycle \$1.50. Postpaid, Clymers, 2125 W. Pico, Los Angeles 6, Calif.

HARLEY-DAVIDSON 24 h.p. twin 45 motors. Perfect condition. \$85.00 and up. Latest design. Used to power farm equipment, ice sleds, midget cars, etc. Used Harley-Davidson parts. Send 25c for bulletin and 45 service manual. Knuth's, 2491 Fondulac, 6, Milwaukee, Wis.

ENGLISH Magazine "Motorcycling" published weekly. Interesting specifications, illustrations, description British motorcycles. Racing, past and future models discussed. \$10 yearly, six months \$5.50. Sample copy postpaid 50c. Clymers, 2125 W. Pico, Los Angeles 6, Calif.

SAVE Gasoline, build a motorbike now, send 25c for complete plans. Motorbike Service, 2108 McLean, New Albany, Ind.

BOYS: "All bicycle repair secrets revealed." Bicycle repair manual, 65c. R. G. Klausner, Shelbyville, Ill.

BOOKS: "Modern Motorcycle Mechanics and Speed Tuning," 435 pages maintenance Harley, Indian, Villiers, all British motorcycles \$2.50; with drawings, specifications, illustrations U. S. Army Jeep, German BMW war motorcycles \$3.00; "Motorcyclist's Workshop" \$1.50; "Two Stroke Motorcycles" \$1.50; "Motorcycles—How Manage Them" \$1.50; "Speed—How to Obtain It" \$1.50; "Historical Motorcycling Facts" \$1.00; "Automobile Racing" \$1.10; Motorcycle instruction manual "question-answers" \$1.10. All postpaid. Clymers, 2125 W. Pico, Los Angeles 6, Calif.

AVIATION

A & E Mechanics Manual prepares for "multiple choice" examinations. \$3.00 postpaid or C.O.D. Aviation Publishers, Box 503, Studio City, California.

"MONGOOSE" Airplane—Dandy, live 16" wing model. Stunts, zooms, climbs. Build, fly it 2 hours. 75c by mail. Dean Model Aviation, 97 Outhbert Street, Scotia, N. Y.

AIRCRAFT Altimeter 8000 meters \$1.95. Revolution indicators 0-2400 r.p.m. \$3.95. Pitch bank indicator, electrically illuminated \$2.95. Bosch hand cranking magnetos worth \$50.00 sacrificed \$4.95. All brand new, guaranteed. Air Transport, Garden City, N. Y.

BIPLANES, Used as is \$295. Wings, engines, parts, cheap. Send stamp. Aircraft, 2300 West Flagler, Miami, Florida.

CURTIS Robin \$245; Aeronca \$375; Taylorcraft, damaged landing gear \$375. Send 25c for new summer directory of over 200 listings. Used Aircraft Directory, Athens, Ohio.

AIRCRAFT Mechanics and students, get these 3 "must" books. Wood, fabric and doping, sheet metal work, airplane inspection guide. all 3 for \$1.95. Air Transport Equipment, Garden City, N. Y.

NEW Lightplane manual. Sportplane manual, lightplane blueprints, etc. Circulars 20c. Craftsman Books, Box 1153PM, Milwaukee 1, Wis.

AERO Fact book. Just out. Complete history of flying from 1783 to 1944. Seven hundred most important dates in aviation history with what happened and who did it. Names, descriptions, warplanes of leading nations. Origins of planes and companies. Airplane production figures. Hundreds of other facts. Most accurate and complete ever compiled. Only \$1.00 postpaid. White Publications, Dept. A, Postoffice Box 106, Los Angeles.

ELECTRIC FENCING

CLOSE Out. Electric fence kits. Guaranteed. Positive, safe, sure. Complete \$1.95 prepaid. Send check. Circular free. Alf Equipment Company, Kent, Wash.

ELECTRIC Fencer, 110 v. a.c., operates 10c year. Easily built. Complete plans \$1.00. W. H. Cash, Sunnyside, Calif.

ELECTRIC Fencers \$3.75. All makes repaired. Wholesale Fence, Hales Corners, Wisconsin.

BATTERIES, GENERATORS, ETC.

EDISON Batteries. Light. Power. Fifteen year life. Five year guarantee. Complete lighting plants. Free literature. See Jay Company, 321 Yonkers Avenue, Yonkers, New York.

ELECTRICAL SUPPLIES, EQUIPMENT

THE Latest manual on multispeed three phase induction motors. \$2.00. Satisfaction guaranteed. Electric Generator Mfg. Co., 1333 No. Dale St., St. Paul 3, Minn.

ELECTRICAL Appliance repair. Open your own shop. Learn house wiring; electric motors, vacuum cleaners, washers, etc. Complete illustrated course shows how. Free booklet. Pacific School, Dept. AP83, 4703 West Pico, Los Angeles 6.

NEW And used electric light plants. All sizes from 350 watts and up. E. P. Schmatz, 215 Wyoming Ave., Kingston, Penna.

RECHARGEABLE Flashlite batteries and chargers. 342 N. 16th St., Phoenix, Arizona.

ELECTRO-MAGNETS, Plans for building. \$1.00. Terry, Central Station 1676, Toledo 3, Ohio.

PROPELLERS For exhaust and attic fans. 1/4 h.p. \$2.50, 1/6 h.p. \$2.40. Dealers wanted. Banks Propellers, R.F.D. 7, Ft. Worth, Texas.

RELIGHT And use burned-out fluorescent tubes indefinitely. Easy to do. Complete information \$1.00. Research Lab., 2414-S-8th St., Council Bluffs, Ia.

CLOSING Out, half price, selfwinding extension reels equipped with 16 feet No. 18 electric cord assuring needed length at all times. Suitable factory or garage. Only \$2.25 each postpaid. Radio Reel Co., 1116 Rust Building, Tacoma 2, Wash.

ELECTRIC Fans—Correctly balanced 16" aluminum blades, 1/2" bore, \$3.00; heavy guard, \$2.00. Use 1/4-1/2 h.p. electric motor and make your own fans. Ted Rise-man, 427 E. Jefferson, Springfield, Ill.

ELECTRIC Pencil: Writes-engraves all metals. \$1.00 postpaid. Beyer Mfg., 4515-H Cottage Grove, Chicago 15.

WELDING, SOLDERING, PLATING

WELDING Equipment (new—used) bought, sold. Write Phillip Wilson, 1341-A "E" Street, Napa, Calif.

ELECTRIC Welder guaranteed 6 months penetrates 16 gauge metal or money back. \$6.45 complete. 110 volts a.c.-d.c. Victory welder, complete less jar, small wire \$1.95. Essay Mfg. Co., H. N. Quincy 69, Mass.

ARC Welders wanted by the thousands. Learn with 516 page lessons manual. Over 500 how-to-do-it photos. \$2.00 copy. Money-back guarantee. Hobartweld, Box M-844, Troy, Ohio.

NEW 110 Volt a.c.-d.c. arc welder. No priority. \$1.50. Uses 1/16, 3/32 rod. Frazee Electric, Box 5086, San Francisco 1.

BUILD D.C. arcwelder without rewinding armature. Plans \$1.00 each. 25 to 600 amperes from automotive d.c. motors, light plant generators, automobile starter-generators. Welders Club, AB-3432, Chicago 54.

A. C. Arc welders! 125 amps. \$35. Welder for thin metals \$50. 200 amp. production welder \$100. Priority. Frazee Electric Co., Box 5086, San Francisco 1, Calif.

NEW Model electric welder 110 volt a.c.-d.c.; will weld all metals; easy to use; full directions. Complete with power unit, flame and metallic arc attachments, carbons, fluxes, rods, mask; all for \$19.95. Used by the navy. Magic Welder Mfg. Co., 239-MP7 Canal St., New York City.

SLIGHTLY Used arc welders. Recommended by R.E.A. Guaranteed. Forney Mfg. Co., Fort Collins, Colo.

ALL Purpose electric welder uses 110/220 volts a.c. Continuous output 20 to 160 amperes. Handles 1/16" to 3/16" electrodes. Light or heavy production, maintenance, repairs. Vernier type controls. Farms, garages, shops, factories. Fully guaranteed. Headshield, electrode holder, cables, electrodes, instructions, ready to use, \$135.00 f.o.b. Chicago. Other sizes, accessories, supplies. Circulars. Williams Sales Company, Box 4100, Portland 8, Ore.

SUPER Welder—For home, farm, factory. Makes even beginner an expert. Improved on type used by Navy. Fully equipped with Metallic Arc and Flame Torch handles, carbons, rods, fluxes, mask, etc. Complete directions. Operates ac-dc, 110 volts. No extra wiring needed. Guaranteed. \$19.95. Save 2%, send check with order. Super Welder Manufacturing Co., Dept. A, 23 East 20 Street, New York.

WELDING, Cutting, aircraft welding and soldering equipment. Electric arc welders. Superior Oxy-Acetylene Co., Hamilton, Ohio.

MACHINERY, TOOLS, SUPPLIES

DRILL Grinding attachment, \$5.95. Centering tool, \$3.95. Offset center punch, 3/8" 40c; 1/2" 60c. Zenick Company, 327 California, Burbank, California.

HARDWARE, Tools, vee belts, pattern and model maker supplies, gas engine castings, unbreakable handle screwdrivers, send 10c for 4" size, free catalog. Tark and Sons, 6304 W. Patterson Ave., Chicago 34.

FOR Sale: Hand milling machine, lathes, milling vice, tools. Albert Turcotte, R.F.D. 4, Norwich, Conn.

WANTED: Tools; equipment. Highest prices guaranteed! Justice, Box 150, Chicago 90.

SIMPLEST, Cheapest drill grinder, \$1.98 postpaid. Dealers inquiries invited. Factory, 3410 Alameda, Burbank, California.

ADVERTISING Service for your surplus power tools and equipment. Special! 25c (coin). Includes your ad and copy of "American Trader." Box 1091, Sarasota, Florida.

MARK Tools permanently, quickly, easily. Will mail instructions, materials, except acid (obtainable drug stores). Fifty cents. Ed Coe, Whitewater, Wisconsin.

DRILL Grinder—The original patented precision sharpener. Use with any bench grinder—No special fittings. Grinds drills to factory accuracy. \$9.15. Calipers, with direct reading scale, 4" inside \$2.00, outside \$1.75. 6" steel scale with magnifying lens \$3.00. Circle cutters for steel, plastic, etc. \$3.50. New tool grinder \$34.50. Free literature. Factory, 811-B East 31st, Kansas City 3, Mo.

LEWIS Castings, materials and blueprints are the ideal means of equipping home, school or commercial machine shops—at unbelievably low cost! Mills, shapers, vises, drill presses and many other tools are quickly and easily built from Lewis Supplies—right in your own shop. Send 10c to cover mailing of descriptive catalog listing 23 items. Lewis Machine Tool Co., Box 116, Station A, Dept. M-42, Los Angeles 31, California.

STEEL Beam trammels for draftsmen, engineers, mechanics. Circular free. Clair Company, Box 92M, Blythebourne Station, Brooklyn, N. Y.

GRIND Drills any twist in three different drill point angles like factory. \$2.95 prepaid. Guaranteed. Factory, 1512 West Slauson, Los Angeles 44, Calif.

INDEX Heads for sale. Very inexpensive. Sixty-two different divisions. Used on small lathes, drill press, milling machines, etc. Make gears, hobbs, cutters, etc. Very accurate, and durable. Not a toy. Used by defense schools and hobbiests. Write for free folder. Long's Index Heads, 2117 East B St., Torrington, Wyo.

CONCRETE Building block machines and molds. Easy payments. Catalog free. Concrete Machine Co., 5129 South Compton Ave., St. Louis 11, Mo.

BOATS, OUTBOARD MOTORS, ETC.

COLLAPSIBLE Boats. Handy portable inflatable rubber boats carrying from one to seven men, in both new and used condition, priced at \$9.95 to \$99.50, depending upon size and condition. Write for particulars. Karl Ort, Dept. PM, York, Penna.

INBOARD marine motors. State requirements. Charles F. Stokes, Coldwater, Michigan.

TEN Plywood boat plans 50c. Catalog boat building plans 10c. The Rudder, 13 Murray Street, New York.

BOAT Designers are highly paid professionals. Complete course by mail. Catalog. Westlawn, Montville, N. J.

MARINE Power—Easily convert any Ford motor (domestic and foreign) with Osco parts and kits. Complete catalogue 25c (coin). Osco Motors Corp., 2020 East Orleans Street, Dept. M, Philadelphia 34, Penna.

INDIAN Silver Arrow outboard motor parts. Indian Motorcycle Sales, Inc., 354 Columbus Avenue, Springfield 5, Mass.

USED Outboard motor parts. Outboard Exchange, 1194 Remsen Ave., Brooklyn, 12, N. Y.

FULL Size, cut to shape boat patterns, blueprints, 7½ - 38 feet. Illustrated "Build a Boat" catalog, 10c (coin). "How to Build Boats" book, \$1.00. Cleveland Boat Blueprints Co., Station A-66, Cleveland, Ohio.

OUTBOARDS - Save ½. Good used parts, all makes and models. Bargains rebuilt motors. Crandall Hicks Co., 959 Commonwealth, Boston, Mass.

ENGINES, MOTORS, DYNAMOS

YOUR Maytag gasoline motor can be completely rebuilt like new for approximately \$10.00 plus transportation. (Only Maytag motors with starting pedal attached to motor.) Maytag Service Co., Washington, Penna.

BIG Pay jobs in welding. Complete welding lessons and reference books, 516 pages, 41 lessons, \$2.00 copy. Money-back guarantee. Hobartweld, Box 845-M, Troy, Ohio.

MOTOR Winding plans, any motor, \$1.00. Terry, Central Station 1676, Toledo 3, Ohio.

AUTHORIZED By W.P.B. to sell inventory of new a.c. and d.c. midge motors—Both geared to 4 r.p.m. Shaft speed 1250 r.p.m. 110 volts. Ideal for timing devices, displays, models. Bargain price a.c. motor \$2.00. Length 3" height 2½" width 2½" d.c. \$3.00. Length 5½" height 2½" width 3". Add 25c for postage. McLaren Products Company, 114 N.W. First Street, Evansville 8, Ind.

WINDING Data, listing 225 motors, single and three phase, \$1.00. Motor Data Co., Box 7631, Kansas City 3, Mo.

ATHLETIC EQUIPMENT—BODY BUILDING COURSES

BAR-BELLS, Exercise equipment. Courses. Special offers! Free booklet. Good Barbell Co., 3261-PM Watson Rd., St. Louis (9), Mo.

SUPER System of natural physical training. Free booklet. Harry Good, 3261-PM Watson Road, St. Louis (9), Mo.

SPORTING GOODS, GUNS, FISHING TACKLE, ETC.

BOY Scouts, campers, U. S. army surplus used equipment. Pup tents \$1.95, mess-kits 75c. Canteens with cover and cup \$1. Cartridge belts 50c. Complete set \$5. Samet Sales Co., High Point, N. C.

"OH Boy how they bite!" Newest discovery, luminous bait, glows for hours in darkest, deepest waters. One month's supply sent prepaid, \$1.00. Please state, salt water or fresh. Art-Glo, Wickford, Rhode Island.

"HANDARMS" "Rifles," "shotguns"—with ammunition, list 10c. Commando sheath knives, free circular. Rudolph's, Atchison, Kansas.

"PLAN For plenty" ammunition. Gun-ammunition list 25c. Frank Farish, Vicksburg, Mississippi.

LIVELY Red worms 200—\$1.00; 1,000—\$4.00 postpaid. Harry Dean, Rt. 2, Milford, Mich.

NETS And seines to order. Don Cowart, Clark Ridge, Ark.

ARCHERY, "Registered Arrow" sets and equipment. List 10c. Rudolph's, Atchison, Kansas.

GOLFERS: Apply a professional appearing paint job to old golf balls (cost for equipment and materials about one cent for two balls). Directions for putting on dots and filling in of lettering—one dollar bill. Archie Vaillancourt, 45 Ruth Street, Pontiac, Michigan.

ARCHERY Equipment: Catalogue free. Mid-West Archery, 2209-A East 75th, Chicago 49.

EXPERT Gunsmithing, repairs, chrome plating, barrels shortened. Estimates furnished. Kenfix Company, 406 Morgan, Tampa, Florida.

SEND 10c For list 100 used guns. Frayseth's, Willmar, Minnesota.

"HOW To Mount Fish as a Hobby." \$1.00. Lewis Enholm, 19 Newfield St., Wollaston, Mass.

BOWS—Arrows for recreation, hunting, fishing. Beautiful archery instruction book, 90 pages, 50 illustrations, only 50c. Illustrated catalogue free. Archery Sales Service, 617 South State, Chicago.

SNOWSHOES: Immediate delivery, replacing also. Send card for sizes available. Howe Fur Company, Coopers Mills, Maine.

THE Lord is coming! Get guaranteed proofs free. Scheall, 263XS, Duluth, Minnesota.

HANDGUNS Wanted for war effort. 25, 32, 38, 45 calibers. Send gun now for inspection. Anchor, 482, Ithaca, N. Y.

FIELD GLASSES, MICROSCOPES, TELESCOPES

POWERFUL Telescope lens kit—Consists 3" diameter 75" focus objective—50X and 100X astronomical eyepiece. Build six foot refracting telescope. Guaranteed show moon's craters, rings Saturn, moons Jupiter, double stars, etc. While they last \$1.95 postpaid. With 50X terrestrial eyepiece \$2.95. Also experimenters 16 piece optical kit—includes 12 assorted lenses combining into numerous optical hook-ups \$1.00. Stamp brings literature, telescope construction plans, test chart for measuring definition—power—field any telescope or binoculars. Pfeigor Optical Co., P-8, Sunbury, Penna.

MAKE Your own 100X astronomical telescope. Perfect lenses and instructions \$1.00. Instructions alone 10c. Carl Jamer, Manorville, N. Y.

MAKE Your own 50X land and sea telescope. Lenses and instructions \$1.00. Instructions alone 10c. Carl Jamer, Manorville, N. Y.

MAKE Your own compound microscope. Lenses and instructions 50X \$1.00, 100X \$1.50, 200X \$2.00. Instructions alone 10c. Carl Jamer, Manorville, N. Y.

REAL 10 Power telescopes \$1.90. United, 2309 Lawrence, Toledo, Ohio.

MICROSCOPES, Telescopes, binoculars; all scientific, chemical laboratory apparatus—bought, exchanged, repaired. Exclusively our business with a background of over 17 years of courteous, satisfactory dealing. Not get-rich-quick speculators. Trial will show we know equipment; highest prices paid. Harry Ross, 68 West Broadway, New York.

ASTRONOMICAL Telescopes, binoculars, cameras, microscopes; bought, sold, repaired. Send 10c for list of instruments wanted. Rasmusen & Reece, 41 Market, Amsterdam, N. Y.

MICROSCOPES—15 Years buying, selling, exchanging, repairing, accessories, research, industrial, amateur. National Scientific Instrument Co., 119 Chambers St., New York City 7.

BINOCULARS, Field glasses, watches. Buy, sell. Paul Schiew, Donnellson, Ia.

ANTIQUES, RELICS, INDIAN GOODS, CURIOS

ANCIENT Stone tomahawk 50c. 100 ancient arrowheads \$3.00. 10 tiny perfect bird arrowheads \$1.00. Flint knife 50c. List free. Lear's, Glenwood, Arkansas.

PACIFIC Islands souvenirs. Complete hula skirt outfit, \$10.00 cash. Also free list: Shell beads necklaces, pearl-shell ornaments, woodwork, mats, etc. Enterprise, Inc., Box 51, Rarotonga, Cook Islands, South Pacific.

SWORDS, Rapiers, daggers, pistols, armor, illustrated catalog 25c. Robert Abels, 860-A Lexington Ave., New York.

MINERALS, Coins, stamps, Indian relics, pistols, old glass. Catalogue 5c. Cowboy Lemley, Las Cruces, New Mexico.

INDIAN Relics, coins, bills, gems, crystals, curios, etc. Illustrated catalog 5c. 100 ancient arrowheads \$3.00. H. Daniel, Hot Springs, Ark.

INDIAN Relics, beadwork, coins, curios, minerals, old glass. Catalog 5c. Indian Museum, Osborne, Kansas.

DOGS, PETS, BIRDS, RABBITS

RAISE Guinea pigs. Make money at home. Big demand. Free booklet. Taylors Guinea Pig Farm, Hapeville, Georgia.

RAISE Money-making Angora rabbits. Wool \$9.00 pound. Plenty markets. Particulars free. White's Rabbitry, Marion, Ohio.

PEDIGREED Racing homers, finest champion stock. King Loft, Hayward, Calif.

RABBIT Skins wanted. High prices. Complete instructions on request. Rabbit Products of America, 1113 So. Walnut, San Gabriel, Calif.

RABBITS—New Zealand Reds, Whites, Chins, Pigeons—White, Silver King, Race Homers. Bay Farm, 20531 E. 14th, Hayward, Calif.

MOST Beautiful fur. Small investment. Large profit. Free illustrated booklet. Willow Brook Farm, R. D. 15, Sellersville, Penna.

RAISE Your own meat—also make money raising pigeons. Booklet dime. Gebhardt Farm, Muscatine, Iowa.

RABBIT Hutch—Sanitary, odorless, self-cleaning! No opening doors to feed, water, supply hay. Most practical and scientific hutch made. Plans, specifications \$1.00. Angora rabbits—wool brings \$9.00 pound; catalog free. Grinsteads, Dept. 15, Edwardsville, Illinois.

MICE, Rabbits, pigs, pigeons. Information 10c. Jim Houck, Tiffin, Ohio.

RABBITS: Flemish Giants, New Zealand. Reasonably priced. Franklin Young, Riverhead, Long Island, New York.

RAISE Rabbits for profit. Magazine puts you in touch with markets. Copy 10c, Booklet describing twenty breeds, and magazine for three months 25c. Address Small Stock Farmer, Dept. 3, Pearl River, N. Y.

FARMS, FARM LANDS, REAL ESTATE

FOUR Acres on northwoods lake. Hunting, fishing, trapping. \$315. \$15 down. \$15 per month. Walter Risberg, Hayward, Wis.

WISCONSIN, Minnesota lake frontage \$7 acre. Dept. 54-E, Brainerd, Minn.

157-ACRE Farm, including garden, crops time of sale, 6 cows, 2 sows, 8 shoats, 19 wool goats, 10 kids, 90 hens, horse, mule, farming tools, only \$2,500! High school bus, RFD road, 6 miles town; 60 cultivated, mostly all pasture now, good grass, dependable springs, woven wire, 50 apple-trees, 50 fruit trees; good 4-room house, spring water, 36-ft. fair barn, 3 poultry bldgs.; real bargain \$2,500 complete \$1,500 down, quick possession! Write for free catalog. United Farm Agency, 7-MP South Dearborn, Chicago 3, Ill.

BEAUTIFUL Farms, lands, \$5 \$10, etc. Don't buy blind! New plan. 25c. Ozark Land Scouting Service, 408 Bellefontaine, Kansas City 1, Mo.

OZARK Land; \$3 acre; terms. Williams Realty, Mt. Vernon, Ill.

FARM Catalog mailed free. Hundreds of bargains. New York, Connecticut, New Jersey and 21 other states Maine to Fla., west to Texas, California and Oregon. Strout Realty, 255-P 4th Ave., New York City 10.

SECURITY Acres, a living from the land, a city lot, or a five acre plot. Information free. Clark System, Ellwood City, Penna.

IOWA Farm bargain list free. Write Albert Wilson, Albia, Iowa.

REYBURN'S Ozark Guide, Lonsdale, Arkansas. For homeseekers, sportsmen, year, \$1.00.

OBTAIN Free fertile South-American lands yielding four annual crops. Others \$1 acre. 25c brings valuable illustrated information. Vailles, 311 Church Street, New York 13.

GOVERNMENT Land \$1.00 acre up. Information all states 25 cents. National Tax Service, 1037A Majestic Bldg., Detroit.

HACIENDA—Over square mile, fertile soil, timber on slopes, water for irrigation and power. Grow northern subtropical crops. Auto-road to capitol six miles, airport fifteen. Pan American highway sixty. Ideal for winter or all year home. Good investment. Altitude about three thousand feet. Bargain. Other larger, one smaller. A. L. Hurst, Rosario Agency, Tegucigalpa, Honduras, Central America.

LAND—Missouri, Illinois, \$3 to \$25 acre. Terms. Williams Realty, Mt. Vernon, Ill.

OZARK Lands for all purposes. Actual river frontages. 5 acres \$90.00 and upwards. Free list and literature. Hubbard, 216 Grossman Bldg., Kansas City, Kansas.

OZARK Farms. Large, small Bargain prices. List free. Frank, Mountain View, Missouri.

FLORIDA Farms, groves, near Orlando, Tampa, other places. Deal direct with owner. Richardson, Wyoming, Penna.

GOOD Farm bargains. Washington, Minnesota, Montana, Idaho, Oregon, North Dakota. Dependable crops, favorable climate. Write for literature, lists describing typical farms. Specify what state. J. W. Haw, 119 Northern Pacific Ry., St. Paul, Minn.

FARM MACHINERY AND SUPPLIES

ELECTRIC Fence controllers, electric fly traps, insect killers, chick brooders, lamb brooders, electric dehydrators. Gardenhour Mfg., Waynesboro, Penna.

INTERNATIONAL Electric fence far superior, more effective and reliable. Quickly pays for itself. We repair all makes of electric fences. Dealers wanted. International Electric Fence Co., 910 Van Buren St., Chicago, Illinois.

BUILD Your tractor from second-hand automobiles. Convert your horse drawn farm equipment into tractor drawn equipment. Nolan's Garage, East Wareham, Mass.

POULTRY AND FARM SUPPLIES

RAISE Turkeys the new way. Write for free information explaining how to make up to \$3000.00 in your own back yard. Address National Turkey Institute, Dept. 3, Columbus, Kansas.

POULTRY Shipping coops—New design, strong construction. Write: Burbank Seed Company, Department P, 20 Free Street, Portland, Maine.

PROFITABLE OCCUPATIONS

MAKE, Sell, shell novelties. Shells for beginners, instructions, sample \$3.00. "Temple," Box 533, Station A, St. Petersburg, Fla.

ELECTRICAL Appliance repair. Open your own shop. Learn house wiring; electric motors, vacuum cleaners, washers, etc. Complete illustrated course shows how. Free booklet. Pacific School, Dept. AF81, 4703 West Pico, Los Angeles 6.

MUSHROOMS Grown in boxes. Instructions 25c. Spawn \$1.00. Gordons, 553 William, Winnipeg, Canada.

SENSATIONAL New book tells how to create income in your back yard. Details free. Challenge, 87P Somerset, Springfield 8, Mass.

WELDING Pays. Learn with 1942 trade school text manual. 518 pages. Over 500 photos. \$2.00 copy. Money-back guarantee. Hobartweld, Box M-843, Troy, Ohio.

MECHANICALLY Inclined men—Own and operate general appliance repair shop. Complete, illustrated course shows you how. Welding, refrigeration, motor repair, how to get business, etc., all phases covered. Free literature. Christy Supply Dept. 443, 2835 N. Central Ave., Chicago.

GOLD-STAMPING. Exceptional post-war opportunity. Free booklet. Home City Specialties, Dept. 1273, Springfield, Massachusetts.

LEARN Refrigeration mechanics. Start your own repair shop. Complete illustrated course. Free booklet. Mechanics School, Dept. PM10, 4703 West Pico, Los Angeles 6.

LOCKSMITHING Now made easy! New course teaches you how to pick locks, fit keys, de-code, masterkey, etc. Self-instruction lessons. Bargain price. Free details. Write Nelson Company, Dept. 7-02-2, Chicago 4.

ANNOUNCING New home study course in commercial baking. Good field. Nearly depression proof. Common school education sufficient. Send for free booklet "Opportunities in the Baking Industry" and requirements. National Baking School, 1315 Michigan, Dept. 343-B, Chicago.

"FROG Raising" profitable—Interesting. New book tells how! Free literature. Write today! Marlboro House, 1035-P Marlborough, Detroit 15, Mich.

STANDARD Rabbit Journal, Milton, Pa. 3 years \$1.00, sample dime.

EXCEPTIONAL Profits raising mink. Finest breeding stock available. Details furnished. Franklin Young, Riverhead, Long Island, New York.

\$40.00 WEEKLY. Made growing mushrooms, fresh, dried. Dominion patent 331583. Free spawn. North American, 169P Yonge, Toronto, Canada.

BOOKS, PERIODICALS, PICTURES, POSTCARDS

POST Card views, any states, 3 for 10c; Alaska, Canada, Mexico or state and U.S.A. capitols, 7 for 25c; Panama Canals views 3 for 10c. Box 1064, Parkersburg, W. Va.

SMALL Books. Good reading. Bible study, 10c each, 3 for 25c. Stamps accepted. Pfeiffer, 1421 W. Adams, Chicago.

FLOWERS Fade, but heart-healing, soul-stirring "Joy of Sorrow" inspires perpetual fortitude. Those in trouble, wounded and waiting war mothers will cherish it forever. \$1.75. Economy Sales, 1690 Home Ave., Akron, Ohio.

WHAT Every Mason wants. We have Masonic books for Blue Lodge, Chapter, Commandery, Scottish Rite and Shrine. Our rituals are used the world over. Send for free catalog of books and rituals for Masons, Odd Fellows, Knight of Pythias, Knights of Columbus, Elks, etc. Ezra A. Cook, Publisher, Inc., P.O. Box 796-PAT, Chicago 90, Ill.

SAVE Money by writing for our lists of special cut-rate books, many at less than 50% of original price. Pines, 144-34 70th Avenue, Flushing, New York.

IMPORTANT Literature free write to Vital Foundation, 465 Lorimer, Brooklyn 6, N. Y.

MAGAZINES—Keep posted on what is happening in your line of business, trade or profession through publications devoted to these interests. Choose current sample copies of those you need from our list of 600 different periodicals covering more than 175 fields. List with prices free. Commercial Engraving Publishing Co., 34C North Ritter, Indianapolis 1, Indiana.

GOLD Mine of information, opportunities, tips, unusual merchandise, novelties, "swap shop" page. Dime brings all. Chervence, 1540 North State, Chicago 10.

"MISTAKES God Did Not Make." two dimes. Kenko, 1912 E. Pacific, Philadelphia, Penna.

15 SCENES Of life in South Seas, has 11 actual 3 1/2 x 5 close-up photos of native girls attired only in grass skirts. Taken in the wilds of New Guinea by a "Seabee" now serving there. \$1.00 postpaid. Mrs. Beatrice Bachand, 7 Potter Place, North Adams, Mass.

HAWAIIAN Post cards, 5 beautiful cards for 25 cents. Write message, address, stamp and return for free remailing. Hawaii Shopping Service, Box 753, Honolulu, T. H.

BOOKFINDERS, 319 So. Marengo, Pasadena, Calif. Courses, books wanted and for sale.

BOOK Bargains catalogs free. Sterling, K-71 West 85th, New York.

BOOKFINDERS' (New - used - scarce books) secured promptly. Send wants. Clifton, Box 2233 Capitol Station, Austin, Texas.

CHINESE Physicians, secrets, 165 pages, rare illustrations, unpublished truth, secret healing arts, peculiar custom. \$1. Write Garding Lui, Box 6227, Metropolitan Station, Los Angeles, California.

ARTISTIC Girl pictures. Real models. 40 photos for \$1.00 postpaid. All different. postcard size. C. A. Scott, P.O. Box 342, Covington, Ky.

BOOKS For trade, hobbies, business and personal. Lists free. Furgal, Box 331, Prescott, Ariz.

FREE—100 Page catalog of new and used college and home study text and reference books at a saving. Est. 1902. College Book Co., Dept. M, Columbus, Ohio.

GLAMOROUS Pin-ups wholesale. 3 1/4 x 5 1/4 to 8 x 10. Dozen samples 25c. Richardson, Wyoming, Penna.

ART Color pictures. List free. Curtis, Box 1916, Denver, Colorado.

"IF It's Wealth You Desire." Fortune building principles, practiced by ancient Babylonians. Literally a book of gold. \$1.00. Ross Nichols, P.O. Box 831, Pine Bluff, Arkansas.

RARE, Out-of-print books located. Bookfinders, 1210N 11th Ter., Birmingham, Ala.

MAGAZINE Subscription agents wanted. Catalog listing 5000 magazines, supplies free. New York Circulation Service, 30 Church, New York 7.

PIN-UPS. Beautiful girl models, over 200 selections. Send \$1.00 for big package. Ball Square Company, 210 5th Ave., New York City.

PICTURE Best cards produced from your photograph. Ideal for camps, hotels, advertising purposes. 4154a Fifth Street, Philadelphia 40.

PIN-UPS Gorgeous girls, full color. Sample 8x10 and 3 1/2 x 5 1/2 10c. Arthur Fowler, Room 1, 697 Broadway, Somerville 43, Mass.

64 ART Cards of gorgeous beauties \$1.00. Reed Novelty, Dept. PM-5, Box 24, Queens Village 9, N. Y.

"PIN-UPS" 180 Gorgeous girl subjects! Huge bargain pack \$1.00. Clover Novelty Company, Dept. 36-DD, Hollis 7, N. Y.

GORGEOUS Full-color pin-ups, 50 different \$1.00; 160 different \$3.00. Samples 10c. Theron Fox, 1024-B Carolyn, San Jose, California.

BEAUTIFUL Hollywood, Los Angeles, colored view cards. Assorted 12 cards 50c. Surprise friends with cards from California. You address, stamp cards, we mail. Letters remailed 25c. Monthly service \$2.00. Dandee Distributors, 320 1/2 W. 2nd St., Los Angeles 12, Calif.

108 GORGEOUS Colorado views \$1.25. George Bryant, 3709-D High, Denver 5, Colo.

CALIFORNIA View cards: Missions, beaches, orange groves, big trees, capital, palm lined aves., Devil's Garden, etc. 18 views 25c with facts and map about California. "Dandee," 320 1/2 W. 2nd St., Los Angeles 12, Calif.

INVASION! 15 Actual invasion scenes. U. S. armed forces worldwide battlefronts. Reproductions latest available official pictures. Contained neat mailing packet, 2 1/2 x 3 1/2 inches, 25c each; 5 for \$1; 11 for \$2, postpaid. (War savings stamps accepted.) Lloyd, 1411-C NW 17th, Oklahoma City 6.

BRIDGE To success. Prepare for tomorrow—read, study today. Consult our Book Advising Service free. Technical books of all publishers—select the best. Technicraft Book Co., P. O. B. 767A, Grand Central Annex, New York 17, N. Y.

A RATIONAL View of life—\$1.00. Benjamin Seibert, Urbana, Ohio.

BOOKS, Technical, occult. Catalogues free. Cass Book Mart, 1231-33 Cass, Detroit 26, Michigan.

"SUPERSTITIONS" New book just out, very interesting and mystifying, many origins, enjoyed by those in armed service! Sent for \$1.00 postpaid. Samans' Superstitions, Box 1313, Terre Haute, Ind.

REBINDING: We bind magazines, old books, Bibles, hymnals. Heckman Bindery, Dept. D, North Manchester, Indiana.

MAGAZINES (Back-dated) — Foreign, domestic, arts. All publishers. Bargain prices. Also books, booklets, pin-ups, subscriptions. Catalogs 10c (stamps accepted). Ciccone's, 863 First Avenue, New York 17.

SELF-EXPLAINING Bible: Illustrated circular free. Box 446-P, Minneapolis, Minn.

BOOKS, (Out-of-print, new, used) quickly supplied. Many 35c bargains. Catalogue. T. Jankowski, 18870 Marx Ave., Detroit 3, Mich.

DRUNKENNESS Is a disease which responds to treatment. Medical skill plus human sympathy prove successful with liquor and drug cases. 60 years experience. Write for free booklet. P. M. Nelson, The Keeley Institute, Dwight, Ill.

GAMES, ENTERTAINMENT

COMEDY Written for performers! Kleinman, 25-31-B 30th Road, Long Island City 2, New York.

POCKET Checker board. Unusual, interesting. Sent postpaid only 25c. Harold Welch Jr., 780 Sufield, Birmingham, Michigan.

MAGIC TRICKS, PUZZLES, JOKER NOVELTIES

SHOOTING Of Dan McGrew! More fun entertaining and mystifying friends with easy, yet baffling card illusion. No sleight of hand. Only 25c. Evans, P.O. Box 951, San Jose, California.

ANSWER Questions. Call names, birth-dates. Professional master mindreading act. (no assistant). Self contained. Use anywhere. \$1.00. Magical Enterprises, Levering, Mich.

FREE Novelty with big illustrated list of magic, novelties, also other literature 10c. Elton Johnson, 2406 Anson Road, Dallas 9, Texas.

MYSTERIOUS Tumbling blocks, pocket coin trick. 35c guaranteed. Dreisbach, 617 North Saint Elmo, Allentown, Penna.

JUGGLING. Complete line of props and books. Montandon Magic, Box 711, Tulsa 1, Okla.

AMAZING. Make small objects of solid steel float like wood. Write Treecraft Publications, Box 5, South Charleston 3, W. Va.

DEAD Japs—Finger trick, realistic, mystifying. \$1.00. Raysol Products (1), Poplar Bluff, Missouri.

VANISHING Card trick. Card tossed in air vanishes. Dime brings one. Eastwood, Box 623, Parkersburg, W. Va.

JOKERS Novelties, puzzles. Illustrated lists 3c stamp. Tug-o-Luck, Lehighstone, Penna.

800 MAGIC Tricks, books and secrets now in stock. New 1944 lists free. Magic Store, Minneapolis 2, Minn.

QUALITY Magic since 1907. Four new catalogs ready, twenty-five cents each. Book catalog and lists free. Thayers, Box 1785, Wilshire-La Brea Station, Los Angeles 16, Calif.

DOLLARS Apparently made out of dimes! It's easy! Sent postpaid for quarter. Chandler, 1355 Cedar Ave., San Bernardino, Calif.

TRICKY Match box, it turns around! It stands up! and it opens, most weird, uncanny magic novelty trick, complete, ready to do. 25c. Magic Shop, 2463-M, Kensington Ave., Philadelphia, Penna.

SEND 25c For \$1.00 worth of magic tricks and our latest catalog. Ball Square Company, 697 Broadway, Somerville 44, Mass.

VENTRILOQUISM, Complete instructions only \$1. Lesueur, 77 Wellesley, Toronto, Canada.

LEARN Ventriloquism, 3c stamp brings particulars. Smith, 801 Bigelow, Peoria, Illinois.

500 TRICKS You can do! Douglas' famous catalog of 500 tricks, now only 10c. America's fastest service on magic for pocket, parlor, stage, professional, amateur. Douglas Magic Shop, Box 274, Dallas, Texas.

QUALITY Magic since 1907—3 new catalogs available, 25c each. Book catalog and lists free. Thayer's Studio of Magic, P.O. Box 1785, Wilshire-Labrea Station, Los Angeles 36, Calif.

MAGICIANS' Headquarters. 216-page catalog, pocket, parlor, professional tricks. 25c. Kanter's, M-1311 Walnut, Philadelphia 7.

ENTERTAIN. Mystify with popular magic. Four secret tricks and catalog 10c. Borinstein, P-7520 Cornell, Chicago.

NEW! Simplified card tricks! Amazing self-working bafflers 50c postpaid. James W. Roundtree, 529 Elliott St., River Rouge, Michigan.

BE A magician. Large professional magic catalogue of latest tricks 25c. Ireland, C-109 North Dearborn, Chicago 2.

MAGIC Tricks, puzzles, books, cards, punch boards. Catalog 10c. Specialty, Box 671, St. Louis 1, Mo.

WORD'S Largest professional magic shop keeps you in touch with latest tricks. To receive mailings send 25c for 1943 catalog. Holden, 220 W. 42nd St., New York.

NEW Vanishing key and catalog 25c. Sterling Magic, 345 John R., Detroit, Mich.

HOLLYWOOD Special! Magicians button, catalogue, ghost illusion and free trick for 25c. Magic House of Charles, Box 888, Hollywood, California.

EARN Money in any crowd. Call names of strangers, tell unspoken questions. Professional course, mind reading, spirit writing, etc., \$1. Henderson, Box 341, San Bernardino, Calif.

COINS, TOKENS, CURRENCY

DOLLAR Assortments paper money. Every item different. "7 Russian"; "7 Poland"; "9 Austria-Hungary"; "15 Germany"; any lot \$1.00. See former ads. All-Nation, 157-HP West Lake, Chicago 1, Ill.

10 INDIAN Head cents, different dates, also price lists, 40c. Schultz, 1053 Richmond, Cincinnati, Ohio.

OLD Money wanted. Do you know that coin collectors pay up to \$100.00 for certain U. S. cents? And high premiums for all rare coins? We buy all kinds. Send 4c for large coin folder. May mean much profit to you. Numismatic Co., Dept. 20, Fort Worth, Texas.

25 DIFFERENT Indian cents \$1.10; 12 wooden nickels \$1.00. Large retail catalogue 10c. Bebee Coin Company, Chicago 37.

RARE U. S. coins. List 10c. Sandys, 753 Gardena, Long Beach 4, Calif.

WILL Pay \$10.00 each for certain Lincoln pennies! Indianheads \$50.00; dimes \$1,000.00. Catalogue 10c. Federal Coin Exchange, 7-PM, Columbus, Ohio.

COLLECTION Indianheads, every year from 1879 through 1909, with album, \$2.00. Catalog U. S. coins, 10c. Catalog foreign coins, 10c. Ben's Coin Company, 72 West Washington, Chicago 2, Ill.

30 DIFFERENT Foreign coins \$1; 100 different \$4; 50 mixed Indian cents \$1. Lists. Gold coins bought, sold. Delmonte, 725 West 172, New York 32.

GET Profit and pleasure in collecting old coins. Send 10c for 56-page illustrated coin catalog. You'll be delighted with it. Send for it now. B. Max Mehl, 370 Mehl Bldg., Fort Worth, Texas. Largest rare coin establishment in U. S. Established 44 years.

COMMEMORATIVE 3 1/2 — Texas, Kentucky, York, Elgin, Cleveland. \$1.50 ea. Illustrated catalogue 10c. Norman Shultz, Salt Lake City, Utah.

FREE! Foreign coin, banknote and coin collectors illustrated catalog to approval service applicants. Send 3c postage. Tatham Coinco, Springfield-125, Mass.

I MAY Have just the scarce U. S. coins you want. Send me list. "Meet me by mail." William H. Kenworthy, Waterville, Maine.

HOBBIES AND COLLECTIONS

EMBROIDERED Service insignia. Sample and price lists 10c. Hobbyguld, M-35 West 32nd St., New York.

100 JEWELRY Stones removed from rings, etc.—from \$2.00 to \$2.40. Lowe's, Box 311, St. Louis 1, Mo.

NEW—15 Different match covers 10c. Box 202, Rochester 1, N. Y.

COLLECTORS! Get our assortment of real stage money. Only 25c. Manisa Photo Co., Colorado City, Texas.

WANTED: Old cigarette cards. Write Charles Bray, East Bangor, Penna.

JOIN The National Hob-c Club, 243 Westfield St., Rochester 11, N. Y.

COLLECTOR Wants old or curious firearms. Fred Braucher, 345 Lisbon St., Canfield, Ohio.

TWENTY Different cactus plants postpaid, \$1.00. Eulalia Turner, Azusa, Calif.

SWAP Directory. Trades for everyone. Ferris, 317A So. Hartford, Bremerton, Wash.

UNUSED Match book covers. 100 all different \$1.00. 35 Royal Flash covers \$1.00. Free list. Charles Edelman, 1311C East 84, Cleveland 3, Ohio.

COLLECTORS! Exchange duplicates. Stamp brings particulars. Box 2166, Denver 1, Colorado.

STAMP COLLECTING

500 UNITED States for 10c! 500 United States—absolutely unpicked and unsorted—just as received from church missions. Many varieties, including large commemoratives, airmails, high denominations up to \$5.00! Stampdom's biggest package of fun—and you might find something really valuable! Price only 10c to serious approval service applicants. Money back if not delighted. Illustrated bargain lists with each order. Mystic Stamp Company, Department 80, Camden, New York.

BEAUTIFUL Newfoundland! Mint sets 25c, 50c, 75c, \$1.00. Complete inc air and 48c stamp only \$3.00. Also finest United States. Traffic Sta., Box O, Minneapolis, Minn.

SPECIAL Album free. The United States flag series for twelve overrun nations is the most unique, remarkable, impressive, and beautiful set of stamps ever issued. It fairly cries for a special album worthy of it, such as we have published. It's a very fine album of 34 pages. Cover designed by a famous artist. Arrangement artistic and practical, telling the history of each honored nation.—It is free to sincere approval applicants. Just send 10c for mailing expenses, and state whether you desire approvals of the United States or foreign stamps or both. Approval Headquarters, Globus Stamp Company, 268 Fourth Ave., New York City 10, Dent. 291.

10 LARGE Australian commemoratives, picturing animals, soldiers, monuments and historical events. Includes a King George V jubilee. All 5c with approvals. Sam Shock, 70B Washington Rd., Asheville, N. C.

COMBAT Unit war insignia evaluated stamps, 50 different 25c; 200 different \$1.00. VerHalén Publications, 6060 Sunset, Hollywood 28, California.

EXTRAORDINARY Pictorial collection:—Nigeria, Bermuda, Dutch Indies, Martinique, Newfoundland, Philippines, Southern Rhodesia, Porto Rico, Wurtemberg, Victoria, Wallis and Futuna, Senegal, Ceylon, Ivory Coast. Everything only 5c. Imperial Company, Box 311, Yonkers 1, New York.

FINE Approvals, freshly mounted. Fast, personal service. Tell me what countries you prefer and I'll send their stamps. Skinner, 345 East Ocean, Long Beach 2, Calif.

ALASKA Embossed air mail cover with photo stamp. Attractive. Unique. Send 15c stamps or coin. Arctic Cachet Company, Box 118, Ketchikan, Alaska.

FREE Your choice of any 10 stamps from our first U. S. approval selection. List included. Cosmopolitan Stamp Company, Dept. M-8, 1457 Broadway, New York City.

FREE! The Stamp Finder! Send today for the big new edition, fully illustrated, enabling you instantly to identify all difficult stamps! Also fine packet strange, fascinating stamps from Bosnia-Herzegovina, Monaco, Patials, Cyprus, etc., including maps, ships, animals and strange scenes. All free to approval applicants including 3c postage. Garcelon Stamp Company, Box 900, Calais, Maine.

EXCHANGE—Send 100 different U. S. or foreign with 25c coin and return stamped envelope. We will send you 125 others. Sweeney, Box 95, Watertown, N. Y.

FREE—Pick 25c worth of stamps from our first U. S. approval selection. Special illustrated lists included. S. C. Engel Co., 38 Park Row, New York 7, N. Y.

GUATEMALA 25 Different only 10c to approval applicants. EP Johnson, Box 267, Morgan Hill, California.

FREE—New Union South Africa war set to approval applicants. Charles Cleaveland, 806 North Humphrey, Oak Park, Ill.

10 TRIANGLES—Mozambique airmail-commemoratives, 10c. Approvals. Reuter, 611-B West 40th, Los Angeles 37.

FREE! \$1.00 And \$5.00 dues. Complete set free to serious collectors with unusual approvals. Send 3c postage. Forest D. Wilson, 711 North A Street, Tampa 6, Florida.

COLORFUL Oceanic set 3c with approvals. Sullivan's, Fairport, New York.

FOUR Mozambique triangles, unused, 10c with approvals. Vargo Stamps, Racine, Wisconsin.

1c TO 10c Foreign approvals. Beaumont Stamp Exchange, 2667 McFaddin, Beaumont, Texas.

UNITED States exclusively! Attractively priced approvals. Return postage paid. Tropical, 720 N.W. 61st Street, Miami-38A, Florida.

165 DIFFERENT. Mint predominating, 10c. Approvals. Best, Box 139, Bangor, Maine.

PACKETS All different. 100 Mexico, 50c; 100 Canada, 50c; 100 Persia, \$1.00; 60 Turkey, 75c; 50 India, 50c. Eco Stamps, 6 E. Lake, Chicago 1.

STOCKBOOK To hold over 400 stamps, 20c, 6—\$1.00. Nu-Way, 205 East Broadway, New York City 2.

50 DIFFERENT Precancels 3c, with approvals. Knopp, Box 1381, Bristol, Conn.

20,000 VARIETIES 1c, 5c each! Davison, Box 31A, Wollaston, Mass.

62 DIFFERENT U. S. coils, 2 Panama Pacific, catalogue \$1.50, only 20c. Aliram, 815 So. Hill, Room 303, Los Angeles 14, Calif.

AGENTS Wanted, sell stamps, no investment. William Waugh, 2140 N. N.W., Washington 7, D. C.

ARTCRAFT Engraved new issue cover service, illustrated price list, 3c. John C. Sidenius, E. Rutherford, N. J.

PHILATELIC Shopping News, year 25c. Stamporium, 2660 Rochester, Detroit 6, Mich.

1000 MIXED U. S. old and new 25c. 2 lbs. \$1.00. Weatherby, Medina, Ohio.

U. S. Precancels, 500, \$1.00. Canada precancels 500, \$1.00. Gibbons, 106 N. Walnut St., East Orange, N. J.

WANTED Collections and accumulations. Honest prices paid. Doak's, Fresno, Ohio.

INTERESTING Packet free with foreign approvals. Farley Stamps, Pennington Gap, Virginia.

PRESIDENTS—U. S. \$2—\$5, both 60c applicants approvals. Dudley Hoskins, Gonzales, Texas.

U. S. Mixture, 5 lbs. \$1.75. U. S. price list. Send postage. Stanley Gibbons, 38-Park Row, New York.

STAMPS—Old issues, approvals, attractive prices. F. Buckmaster, 505 Auditorium Boulevard, Daytona Beach, Florida.

1000 WELL Mixed U. S. 25c. Monjar, 1750 Fairmount, Cincinnati, Ohio.

100 DIFFERENT U. S. postage 40c. Ray Taylor, 2509 Rice Blvd., Houston, Texas.

FREE! Choice set from our approvals. Liberty Stamps, 262 South 12th, Philadelphia 7, Penna.

BETTER Approvals—"United States" only, reasonable. Box 488, Minneapolis, Minnesota.

POUND Unpicked U. S. and foreign mixture containing thousands stamps \$1.00. Longacre Shop, 102 West 42nd, New York City.

NICARAGUA Airmail set 5c. Approvals sent. Yokums, Box 1327, San Antonio 6, Texas.

SUFERB Approvals, net prices. Stamps 1/3 to 1/8 catalogue. P. G. Beals, 170A Tremont St., Boston, Mass.

ECUADOR—Five large flags—postage 15c. Airmails 15c. Both 25c. Approvals. Buchanan, 307 East 23rd, New York 10.

ARMY Navy set complete 10c. Nice approvals. Kress, Box 144A, Hanover, Penna.

SPECTACULAR Approval service for collectors using International Junior or Modern albums. Loewy, Arcadia, Calif.

PENNY Approvals, that satisfy. Neil Gronberg, Box 5441-P, Philadelphia 43, Penna.

FOUR Foreign flag stamps free if you will send us the names and addresses of three juvenile or beginner stamp collectors. Enclose stamp for mailing. Stamp Premiums, Inc., Flatiron Bldg., Fort Worth, Texas.

TWELVE U. S. flag stamps complete, 50c. Six 1941 airmails complete, 80c. Catalog U. S. stamps, 10c. Catalog foreign stamps in sets, 10c. Ben's Stamp Company, 72 West Washington, Chicago 2, Ill.

PITCAIRN Islands! 1/2d, 1d, 1 1/2d mint. These colorful mutiny on the bounty stamps for only 10c to applicants for my medium and low priced approvals. William E. Thiem, Dept. S, P.O. Box 319, Cape Vincent, New York.

BRAZIL 378 Holy Year mint 8c with 1/4, 1/2, 1c approvals. Carroll's, 7454 W. 45th, Los Angeles 37, Calif.

60 DIFFERENT United States 10c. Pricelist free. Seidenberg, Cassopolis, Mich.

127 DIFFERENT Stamps including Free Fighting French, Haiti, Johore, Cochon, only 10c to approval applicants. Reich Stamp Co., 4647 Kenmore, Chicago, Dept. M8.

1000 GRABBAGS 15c Each. 8 different \$1. Special bags, Free French included 25c. Zandy, 630 Bingham, Reading, Pa.

"THE Best"—United States and Philippine Islands approvals. Largest varieties. Lowest selling prices in America. Stamp Company, Albany 3, New York.

FREE! Complete "United States" stamp catalog with 1,000 illustrations! Send 10c to cover mailing. Harris & Co., 137 Transit Building, Boston, Mass.

BRITISH Colonies packet, only 3c to approval applicants. Smith, 237-A 8th Avenue, Roselle, N. J.

SPOT Cash paid for stamp collections. PKeigwin Company, Vineland, N. J.

SMOKY Mountain commemorative sheet, largest U. S. stamp issued, and 33 U. S. including commemoratives, airmail, reprints, etc. Catalogs 75c—To approval applicants for 5c. Curhan Stamp Company, Gloucester, Mass.

19th CENTURY U. S. commems. Civil War revenues, battleship \$5 and \$10 stamps free to U. S. approval applicants. Metropolitan Stamps, 198-C Broadway, New York.

FREE! Canadian sets, royal visit, George VI, George V, coronation, jubilee, others, to approval applicants. Ensign, Box 118-M, South Orange, N. J.

COMPLETE Mint commemorative set from Manchukuo, plus attractive Brunei pictorial—everything just 3c to approval applicants. Viking, 130 (Z) Clinton St., Brooklyn, N. Y.

WEEKLY Stamp Magazine, 26 weeks, 25c. Stamp Journal, Kalamazoo, Mich.

DANDY United States approvals. Write immediately. Sullivan, Endicott Arcade, St. Paul, Minnesota.

FREE! Western Hemisphere packet. Postage 3c. Owens, 806 Welsh, Bay City, Michigan.

FREE! British Empire packet. Postage 3c. Williams, 606 Archer, Bay City, Mich.

FREE! Pony Express set (facsimiles). Postage 3c. Roberts, 406 Building, Bay City, Michigan.

CANADA 100 Different 25c—approvals all countries. Lists. Victoria Stamp Co., London, 4, Canada.

FREE! Leeward Is., Cayman Is., Turks and Caicos plus 60 different mint Geo. VI coronation poster stamps, to approval service applicants sending 3c postage. Tatham Stampco, Springfield-30, Mass.

WOW! \$10.00 Worth of fun for only 10c! 500 foreign stamps, unsorted and unpicked (mostly on bits of paper) just as received from the church missions and other sources. Africa, So. America, Australia, China, Philippines, Dutch Indies, and other countries are represented. Includes a few commemoratives, airmails, and stamps cataloging up to 25c or more each! The biggest package of fun in stampdom—and you might find something really valuable! Price only 10c to serious approval applicants! Money back if not delighted. Jamestown Stamp Co., Dept. No. 22, Jamestown, New York.

VICTORY Packet free—Includes stamps from Tanganyika, British Cayman Islands, animal, scarce babyhead, coronation, early Victorian, airmail, map stamps, with big catalogue—all free. Send 5c for postage. Gray Stamp Company, Dept. PM, Toronto, Canada.

55 DIFFERENT United States 5c with approvals. Bookman, Box 145-M, Maplewood, N. J.

STAMPS Sent on approval, outstanding quality, low prices. Fred Herzberg, 168 Oak, Elmhurst, Ill.

UNITED States approvals complete coverage, fine quality, attractive prices. Seminole Stamps, Box 436, Coconut Grove, Florida.

MEXICO Census commemorative set free with approvals. Pladon Stamps, 1717-M Idaho, Toledo, Ohio.

3,000 U. S. Foreign \$2: Approvals: Griest: 409 Oak, Davenport, Iowa.

FREE, Complete Cuba tobacco set with approvals. Seminole, Glenburnie-1, Md.

CAMERAS AND PHOTO SUPPLIES

OIL Color photographs for pleasure and profit. Easy, step by step method only \$1.00. Send today. Wm. Greener, St. Johns, Michigan.

YOU Can color your own photographs and snapshots. It's great fun. It's profitable. Manufacturers of the world-famous Peerless Self-Blending Water Colors—sold from coast to coast, are offering a beginners set of colors, with book of complete instructions, for twenty-five cents. Only one set to a customer. Send coin or money order; no stamps. Address, Peerless Color Laboratories, Rochester 9, N. Y.

35MM. Projectors, cameras, films, sound, silent; screens. Free lists. Mogull's, 64 West 48th Street, New York City.

DON'T Cut your 35 mm. film strips. Store the rolls in Marafiles—neat dust-proof fibre boxes with hinged lids and sections for 25 rolls. Complete with index. Two boxes \$1.00 postpaid. Marathon Photo Supply Co., Box 415-A, Wausau, Wisconsin.

WILL Buy any movie or still camera regardless of size or condition, describe fully. W. K. Crosson, 4515 Grand River Ave., Detroit 8, Mich.

ENLARGERS—Build your own. Kit of parts, \$6.00. Free particulars. Crescent Engineering, Box 251-P, South Pasadena, California.

HAVE You a camera? Send ten cents for recent number of our big magazine, showing how to make better pictures and earn money. American Photography, 116 Camera House, Boston, Mass.

MAKE Money in photography. Learn quickly at home. Easy plan. Previous experience unnecessary. Common school education sufficient. Booklet and requirements free. American School of Photography, 1315 Michigan, Dept. 3432, Chicago 5.

OIL Coloring photographs a fascinating hobby or profitable business. Learn at home. Easy simplified method. Previous experience unnecessary. Send for free information and requirements. National Art School, 1315 Michigan, Dept. 3444, Chicago 5.

CASH! Spot cash for cameras, lenses, binoculars, movie or still, sound projectors. Send full description by mail, or wire for prompt cash offer. Over 30 years of dependability insures honorable dealings. Bass Camera Company, 179 West Madison Street, Chicago, Illinois.

BASS Says: War time proves Bass leadership. Amazing selection of finest still cameras—Leica, Contax, Korelle reflex, Argus, new and used still available. Write for quotations. Satisfaction guaranteed or your money refunded. Bass buys 'em, sells 'em, trades 'em. Bass Camera Company, Dept. AG, 179 W. Madison St., Chicago, Illinois.

PHOTO FINISHING

NO Delay! Pictures returned immediately. Eight exposure roll developed with two prints each negative, or one enlargement each only 25c coin. Send order today, or write for free film mailers, premium offers, etc. Moen Photo Service, 452 Moen Bldg., LaCrosse, Wis.

ROLL Developed and printed 25c. 25 reprints 50c. Skrudland, 6444-D Diversey, Chicago.

ABSOLUTE Satisfaction guaranteed. Roll developed—16 prints and three free enlargement coupons, 25c. Reprints 3c each. Beautiful colored 8x10 enlargement free with 100 reprints. Dick's Photo, Louisville, Ky.

PICTURES "Permanitized" in transparent plastic! Amazing new process preserves forever your prized snap-shots, etc., bill-fold size, for loved ones in service to carry. Waterproof, non-soiling, crack-proof. Miniature plastic-permanitized picture of Niagara Falls and full details free. Mail-Back Photo Service, Box 505, Buffalo, New York.

1 ROLL 35mm. developed, printed free. Send this ad. Sky-Line Photo Service, Box 450, St. Louis, Mo.

ENLARGEMENTS: Eight 5x7 from negative \$1.00. Six 5x7 from photo \$1.00. Robert Renshaw, 222 Jeffrey St., Chester, Penna.

STATIONERY Carrying a lifelike photograph of you! Makes your letters seem like a personal visit. Just send \$1.25 with photo, snapshot, or negative, name to be imprinted, for special box. Photo returned. Only \$1.00 without name. National Photo Art, Dept. 678, Janesville, Wis.

6-8 EXPOSURE Rolls developed and enlarged mammoth size 39c. Reprints 3c. Thrifty Photos, Box 46, South Gate, Calif.

CHOICE Film offers—Roll developed, 8 beautiful enlarged prints (deckled if desired); or 16 brilliant "Lifetime" prints; or 8 sparkling prints plus 2 fade-proof enlargements. Pre-war quality and price—25c. Fast service. Quality guaranteed. Free mailers. Credit for unprintable negatives. Dept. 53, May Studios, LaCrosse, Wis.

BIGGEST \$1.00 Value in 35 mm. finishing today. 36 exposure fine grain 3 1/2x4 1/2 enlargements; deckled, embossed margin and date. Eighteen exposures 75c; 16 exposure splits 55c; 36 exposure reloads 50c. Special: return this ad with \$2.00 and we will send five 36 exposure reloads. Free mailers. 8 exposure rolls in beautiful, deckled contact finish with embossed wide margin, 25c. Mailbag Film Service, Box 5440A, Chicago 80.

12 BEAUTIFUL Enlargements—from roll or negatives—only 25c! Six 5x7 enlargements, 25c; six 8x10's, 50c—from negative. Free—send negative for one free enlargement, mailers, literature! Immediate service guaranteed. Photo Research Laboratories, Blackstone 11, Mass.

FREE! Send negative, this ad for beautiful 4x6 enlargement. (Stamp appreciated). 16 sparkling prints, 2 Hollywood enlargements from roll or negatives 25c. Lifetime Studios, Dept. A-839, Des Moines, Iowa.

SPECIAL Offer 8x10 professional enlargement from your photo or negative expertly finished. Price 69c. Immediate delivery guaranteed. Bradford Studios, 7016A So. Halsted St., Chicago 21, Illinois.

AT Last! Roll developed, all your snapshots hand colored as beautiful as actual color photography, 35c. Hand colored reprints 4c each—12 for 45c. National Photo Art, Janesville 15, Wisconsin.

PHOTOSTAMPS \$1.25 A hundred. Postcards 15 for \$1.00. Any photo. Lang, 1334 Thorndale, Chicago.

WITH Every 6 or 8 exposure roll, two full sets of prints, 25c. Skyland Studios, Box 411, Dept. "M," Asheville, N. C.

REPRINTS 16 For 25c. 40 for 50c. Queen City Service, Box 7, Niagara Square Station, Dept. 8, Buffalo, N. Y.

BEAUTIFUL 8x10 Enlargement from your photo or negative 45 cents. Originals returned unharmed. Quick service. Photo Lab., 3122 N. Clark St., Chicago 14, Ill.

BEAUTIFUL Oil colored enlargements. Your negatives: 8x10, \$2.00; 11x14, \$2.50. From photo 50c extra. Specify colors. Haynescraft, 802 20th, Washington 6, D. C.

SPECIAL Reprint service. Order duplicates of your favorite negatives now, while these low prices prevail. All prints from size 127 to 122. 16 reprints for 25c; 50 reprints 75c; 100 reprints \$1.00. Send only snapshot negatives. Satisfaction guaranteed. Cut-Rate Reprint Service, Box 833-K, LaCrosse, Wisconsin.

YOUR Favorite kodak pictures enlarged, size 5x7, 10c; three for quarter, coin. Send best negatives (film) today. Address Gepbert Studios, Dept. 82, Des Moines, Iowa.

IMMEDIATE Service. Pictures returned same day order received. Smashing low pre-war prices! Sixteen guaranteed deckled-edge Velox prints from roll, 25c. Or one colored or two plain enlargements free with 8 deckled-edge prints, 25c. 16 reprints from negatives 25c. Candid roll developed, magic-eye timed, vapo-rated and enlarged to 3x4 on deckled-edge Velox paper—36 exp. 35mm. \$1.00; 18 exp. 60c; 16 exp. No. 127 50c; 8 exp. Bantam 25c. Reprints 3x4, 3c each. We have new, perfect 35mm. film. Low prices. Free mailers, details on request. American Studios, Dept. PM-1, LaCrosse, Wis.

PHOTOGRAPHY For pleasure and profit. Prepare at home. Common school education sufficient. Write for information and requirements. American School of Photography, 1315 Michigan, Dept. 3451, Chicago 5.

TROUP'S Photo Service. Troup Building, Toccoa, Georgia. 6 or 8 exposure roll film developed and printed 25c.

16 BEAUTIFUL Oversize deckled prints and two enlargements with first order 25c. Owlphoto M1, Weatherford, Oklahoma.

8 BEAUTIFUL Enlarged prints (nearly postcard size) or 16 regular prints 25c. 35mm. rolls enlarged 3 1/4 x 4 1/2, \$1.00. Burton Studios, 55-M. Roscoe, New York.

35MM. Argus, Leica, etc. (except "Mercury") 36 exposure rolls, fine grain developed (Eastman DK-20) and beautifully enlarged to 3 1/4 x 4 1/2 glossy prints, 90c. Cartridge reloaded, 35c. 12 exposure rolls, 55c. reloaded 20c. 24-hour service. Satisfaction guaranteed. Free mailing bags, sample print. Technifinish Laboratory, 38-42 Scio St., Rochester 4, N. Y.

BEAUTIFUL 4x6 Pictures 3 1/2c each, from 116 and 120 negatives, 3 1/4 x 4 1/2 from all other sizes. All work guaranteed. Overnight service. Roll developed and 8 pictures 30c. Roll 12 pictures 45c. Roll 16 pictures 60c. Enlargements on double weight portrait paper 5x7-30c, 8x10-50c. Copies made from any picture 75c. Pacific Photo Service, Box 666, San Francisco, Calif.

VELOX Deckle reprints 2c. Rolls developed, two deckle edged prints each negative, 25c. Two 5x7 enlargements 25c. Summers Studio, Unionville, Mo.

EVERY Picture an enlargement! 8 sparkling deckle-edge enlargements and roll developed 25c coin; 116 size or smaller; enlarge reprints 3c. Enlarge Photo, Box 791D, Boston, Mass.

THREE Prints each good negative, 6 to 8 exposure rolls, 30c. 12, 16, 18 exposure rolls, 50c. Reprints, 3c. Fred D. Eastman, Boe, Iowa.

8x10 SILK Finish enlargement—25c plus stamp. Irving Studio, 4006A Irving Park, Chicago 41, Ill.

ENLARGEMENTS: Eight 5x7 from negative \$1.00. Six 5x7 from photo \$1.00. Robert Renshaw, 222 Jeffrey St., Chester, Penna.

ROLL Developed and 8 beautiful enlargements 2 to 6 times larger. Deckle edge—high gloss. Any 8 exposure roll 25c coin. 12 ex. 35c—16 ex. 50c—36 ex. \$1.00. Reprint enlargements 3c each. Alden Photos, 94-3 Astor Sta., Boston, Mass.

PERSONALIZE Your stationery with cute photostats \$2.25 per hundred. Send photo, Jimmies Photo Service, P.O. Box 667, Dept. 1, Greenfield, Mass.

MOTION PICTURES AND SOUND EQUIPMENT

100' 16MM. Used sound film, \$1.00 postpaid. List of complete subjects upon request. We buy, sell, trade. Blackhawk Films, Dept. PM14, Davenport, Iowa.

SPECIAL Music film, 8mm., 25 feet double-Weston 8, \$2.00. Super double X, Pan indoor 60, outdoor 100, 16 mm.—\$6.50. Super X Pan indoor 24, outdoor 50, \$5.75. Pan Weston 12, \$5.00. 16 mm. 100 feet Weston 6, \$4.00. Free developing. Exhibitors Film Exchange, 630 9th Ave., New York 19, N. Y.

GLAMOUR Special. (Until Aug. 15). "Starlet Revue," "Sarong Girls," "Beauty Brevities," "Lorelei," each, 8mm., 50 ft., \$1.50 instead of \$2.00. 16mm., 100 ft., \$3.00 instead of \$4.00. Complete lists, glamour sample, dime. Jenkins, 392-F, Elmira, N. Y. Kodachrome 8-16mm. subjects too.

MAIL Portrait, amazing personal movie animated cartoon. Fred Amster Cine-Art Animation Service, Mt. Rainier, Md.

8MM-16MM. Films. Free catalogue (sample film 10c). Parkway Exchange, 1593 Union Street, Brooklyn, New York.

BRAND New 16mm. sound films \$14.95. Gordon Conner, Port Clinton, Ohio.

STARTLING Discovery. Movie screen coating. Free literature. Snow White Screen Company, Danville, Illinois.

35MM. Sound films reasonable. Send stamps for lists. Mertz Films, Springfield, Illinois.

TAKE Movies in color. 100' 16mm. \$3.50—100' black and white \$2.25. 25' double 8mm. \$1.25, developing included. Bulk double 8mm. Ambassador, 479-A Quincy Street, Brooklyn, N. Y.

TRANS American gives free film subjects every month, why not investigate? Dime brings complete 1944 catalog, generous sample with complete sensational literature. Trans American Sales, Morristown, New Jersey.

8MM-16MM. Silent-sound films. Complete rental library. All latest subjects. Free catalogue, (sample film 10c). Garden Film, 317 West 50th, New York 19.

SILENT 35mm. Films! New comedies! Demsey, 1613 Stewart, Youngstown, Ohio.

MOVIE Projectors. Bought and sold. United, 2309 Lawrence, Toledo, Ohio.

RENTAL 16mm. Talking features \$4.95, shorts 75c. 8mm.-16mm. silent, large reel 40c. Movie accessories. Free catalogs. National Cinema, 71 Dey Street, New York City.

GLAMOUR Girls, catalog, sample, dime. Zientek, 1129 Monroe Circle, Baltimore 25, Maryland.

FREE. New movie catalog; sample films, 10c. Goodwill Company, Jackson, Tenn.

ANSKO Twin-8mm. movie film! SSS Panchromatic, \$2.69 per roll! Hypan, \$2.48 per roll! Will ship c.o.d. (Limit six rolls per customer.) Standard Sales, Box 154, Kansas City 10, Missouri.

GUARANTEED Fresh movie film! Three spools double 8mm., \$3.45! Six spools Univex, \$3.50! Daltie loading! Processing free! (Limit six each type.) Will ship c.o.d. Eso-S, 4038 Broadway, Kansas City 2, Missouri.

CAMERA Films—100 ft. 16mm. \$2.50; panchromatic Weston 64, \$4.85; 25 ft. double 88 Weston 24, \$1.89; prices include processing. Movie accessories, chemicals, bulk films. Free circulars. Promader Genera, Davenport, Iowa.

CAMERA Film, 100 ft., 16mm., processing included, \$2.50. The Film Exchange, 147 West 42nd Street, New York 18.

8MM-16MM. Home movies bought, sold, exchanged. Free bargain lists. Multiprices, 171 Euclid, Bridgeport 4, Conn.

SEND Stamp for 16mm., 8mm. catalogue. Sterling's, 679 Northampton, Easton, Pennsylvania.

SELLING Out 8-16mm. comedies, cartoons, etc. Camera films. We buy, trade. Catalogue stamp. Camera Man, 542P 5th Ave., New York.

16MM. Sound OWI film rented, list dime. Anchor, 482, Ithaca, N. Y.

"THE World's Greatest Passion Play." 8mm. 16mm. and 35mm. Specify silent or sound. Rent or purchase, include stamp. Hemenway Film Co., 33-F Melrose St., Boston 16, Mass.

LEARN Movie projection, management. Free catalog. Give age. Theatre Institute, Elmira, N. Y.

BETTERPIX Outdoor safety film, 100 feet 16mm., \$2.50. 25 feet double 8mm., \$1.25. Free developing. Finished subjects sold, exchanged. Sound library. Better Films, 742 New Lots, Brooklyn 7, N. Y.

I BUY, Sell, swap, rent s.o.f. 8 and 16mm. films. List free. Harvey Iris, Box 539, Brockton, Mass.

BASS Says: Leadership in the cine field is apparent in war times. Here ready—your choice of 8 mm. and 16 mm. apparatus. Write for quotations. Your old equipment is worth real money in trade—describe please. Or we buy for cash and pay immediately on receipt. Write to headquarters. Bass buys 'em, sells 'em, trades 'em. Satisfaction guaranteed or your money refunded. Bass Camera Company, Dept. A, 179 W. Madison St., Chicago, Illinois.

\$1 BRINGS "Surprise" assortment 8mm. colorful titles! Guaranteed. LeMoine Films, Nevada, Missouri.

35MM-16MM. Sound projectors bought and sold, list for dime. Anchor, 482, Ithaca, N. Y.

MUSIC AND MUSICAL INSTRUMENTS

PIANISTS—(Also organists). Quickly improve technic, sightreading, accuracy, memorizing, playing through mental-muscular co-ordination. Free booklet. Broadwell Studios, Dept. 44-H, Covina, Calif.

LEARN To play piano—Fastest, easiest, most successful method. Results guaranteed. Literature free. Pittman, Dept. P, Box 1653, Las Vegas, Nevada.

POPULAR Piano in 12 lessons guaranteed. Kelly School, 1781 Oak St.—17, San Francisco, Calif.

ATTENTION Song lovers. Four new beautiful songs, words and music for piano and guitar for only \$1.00 if sent with order postpaid or send order and pay postman \$1.00 plus few cents postage on arrival. Al. E. Phores, Box 782, Dunsmuir, Calif.

RADIO Singing pays big money. Complete course by Russell Brooks, former Wayne King soloist, only \$3.00. Money back guarantee. Brokel College, 64-PM East Jackson, Chicago.

SONGS Published—Liberal plan. Barnhart Publications, 1320 48th, Des Moines, Iowa.

MUSIC Arranged to songs. Frank Wildt, Music Publisher, Lancaster, Pennsylvania.

"DON'T Cry Now"—Hillbilly song-hit 35c your dealer or direct. Male quartet included. Neptune Music Publisher, P.O. Box 508, Annapolis, Maryland.

POEMS Wanted for musical setting. Send poem for immediate consideration. Five Star Music Masters, 630 Beacon Building, Boston.

ACCORDIONS—All makes and sizes. Wholesale prices. Request catalog. We also buy accordions. American Accordion Company, 31 S. Cicero, Chicago.

BAND And orchestra instruments, new and reconditioned, list 10c. Rudolph's, Atchison, Kansas.

SONGWRITERS—Free booklet "Getting Ahead in Songwriting." Write today. Song Service, 331-C West 46th, New York.

SONGWRITERS! B.M.I. Publisher with established radio program seeks new songs, poems! What have you? Professional's sincere examination free! High fidelity recordings made. Transradio Music, Inc., 1650-N Broadway, New York.

SONGWRITERS: You can arrange your songs for orchestras. 20 modern lessons \$2.00. Money back guarantee. Brokel College, 64-P East Jackson, Chicago.

SONGWRITERS—We have connections to exploit good songs. Don't send any material; write for details. McGinty Music Co., 2285 N.W. 2nd Street, Miami 35, Fla.

LEARN Piano. One hour. Free literature. Ferris, 317A So. Hartford, Brementon, Wash.

DO YOU want to publish your song? Information free. Mid-West Music Press, 4737 Broadway, Chicago 40, Ill.

COMPLETE Song writer course \$1.00. Frank Hartman, Cabin John, Md.

SING Beautifully. Modern voice culture. Literature free. Ferris, 317A So. Hartford, Brementon, Wash.

HAWAIIAN Music, six 35c selections \$1. (Steel guitar or piano.) Golden Gate Publications, 1724 Telegraph, Oakland 12, California.

ACCORDIONS. New and used at wholesale prices. Save up to \$100.00. Buy direct from factory. Del Principe, 307 So. Wabash, Chicago.

SONGWRITERS Wanted; prices, details, free book. Variety, 2 Salem, Ind.

SONGWRITERS — Professional offer. Edward Madden, 1300 Lodi, Syracuse, N. Y.

SONGS Wanted: Poems set to music. Free publishing. Royalties. Hollywood Song Guild, Box 2230, Hollywood 28, Calif.

SONGWRITERS! Amazing outstanding proposition. Hibbler, C5, 2157 N. Avera Chicago.

LEARN Popular piano! Write Magic Key, 111-A Broadway, Glendale 4, Calif.

LEARN Popular piano! Play hit songs in boogie-swing style. Pianists, send dime for sample arrangement. Home-study folder free. Christensen Studios, 751 Kimball Hall, Chicago 4, Ill.

SONG Poems wanted. Free examination. McNeil, Master of Music, 510-PM South Alexandria, Los Angeles, Calif.

WRITE Songs. Big money and reputation. Write for information. J. Gordon Pub Co., 201 N. Hoyne Ave., Chicago.

BEFORE Sending your poem to be set to music "know your composer." Free booklet. Al. Moquin, 2110 Beachwood Dr., Hollywood 28, Calif.

SONGWRITERS—Send poem for immediate examination and free rhyming dictionary. Richard Brothers, 24 Woods Building, Chicago.

SONG Poems wanted: Write for free instructive booklet, outlining opportunities. United Music Corporation, Dept. 14, Salem, Indiana.

WANTED! Lyrics, melodies for songs. We arrange, publish, sell. Superior Song Studios, Passaic, N. J.

GOOD Music composed to good words. Music printing. Reginald Belfer, Chatham, New Jersey. Established 1910.

RADIOS, SUPPLIES, INSTRUCTION

RADIO Tubes, parts, condensers. Free bargain lists. Potter, 1314 McGee, Kansas City, Mo.

RADIO Repairing simplified, large 8 1/2" x 11" manual, only 25c. Supreme Publications, 328 South Jefferson, Chicago 6.

REVISED Plans 18 long distance crystal sets, including "Radiobuilder"—25c. Laboratories, 363-C Hampton, Hayward, Calif.

BRAND New five tube a.c.-d.c. superhet kits! Crystal kits, and other radio parts! Complete price list, 10c. Melvin Okin, 915 Bryant Ave., Bronx, New York, N. Y.

BUILD Microphones, phonographs (crystal). Instructions 25c. Microphone or phonograph pickup kit \$5.00. R. H. Laboratory, 3928 Dumaine, New Orleans, La.

CRYSTAL Radio experimenters, write immediately. Leslie Hulet, Lakewood, New Jersey.

MAKE Simple, tubeless, batteryless, distance-getting crystal radios. Crystal and illustrated instructions, 25c postpaid. Allen, PM427, Clinton, Mo.

FOR Sale — Oscillators \$39.50. Volt ohmeters \$39.50. Speakers, all sizes. Wire. Tubes, the hard to get parts. Freck Radio & Supply Company, Asheville, N. C.

BUILD Improved extra loud crystal radio. Complete details, 20c. Joseph Amorse, R-4, Hungary Road, Richmond, Va.

PREPARE Now for tremendous opportunities in new fields of radio after the war. Training for federal licenses. Write for particulars. American Radio Institute, 52 East 23 Street, New York 10.

RADIO Service men and experimenters send for our giant radio catalogue. Save dollars. United Radio Co. (1000M), Newark, N. J.

HELPFUL Radio books. Up-to-date list free. Popular Mechanics Press, (C-43), 200 E. Ontario, Chicago.

BUSINESS OPPORTUNITIES

IMPORTANT And profitable! Territories are yet open. Make your post war plans now if you want a good, profitable business of your own. Be your own boss and have earnings in keeping with your efforts. Even though you may be otherwise occupied at the present time, you owe it to yourself to investigate the wonderful opportunity that can be yours. Write for full details on "Post War Opportunities." No obligation. The C. I. Togstad Company, Dept. PW-3, Kokomo, Ind.

START Home business making statuary, plaques, art goods, novelties, souvenirs, concrete pottery, garden furniture, artificial marble flooring, liquid marble. Make your own flexible molds. Amazing profits. Valuable folder free. Creative Publishers, (PMS), Glencoe, Illinois.

TOOL Designing pays big. Home study course. Low cost. Easy terms. Free booklet. Ohio Institute of Technology, Box 179, Greenville, Ohio.

LEARN Mailorder business. Make money at home. Amazing new course. Write now so you can understand it. Free details. Belfort, 225 Engineering Building, Chicago 6, Ill.

START Your own business on our capital. Always your own boss. Hundreds average \$3,000 to \$5,000 annual sales year after year. We supply stocks, equipment on credit, 200 home necessities. Selling experience unnecessary to start. Wonderful opportunity to own pleasant, profitable business, backed by world wide industry. Write Rawleigh Co., Dept. H-U-PPMB, Freeport, Ill.

MAKE Your own Flexible Molds. Statuary, Art Goods, Novelties, Artificial Marble Flooring, Liquid Marble. Literature free. Kemico, 8-M, Park Ridge, Ill.

PLEASURE And profit making recording discs costing 1/2c each. Excellent quality. Special equipment unnecessary. Material available everywhere. Instructions, including sample disc, 50c. Kaytor Laboratories, Lynwood, Calif.

MAKE Things glow in the dark. No experience required. Artificial flowers, radio dials, light switches, greeting cards, religious items, toys. Send \$1.00 for generous one oz. bottle and agents offer. Shine-In-Dark, 324 W. Madison, Chicago 6, Ill.

OWN A mail-order paper products business. Sell envelopes, tags, labels, boxes, by mail, wholesale. Tremendous demand. Steady profits. No capital necessary. Write Omaha Envelope Service, Dept. 28, 4721 California, Omaha 3, Nebr.

ELECTRICAL Appliance repair. Open your own shop. Learn house wiring; electric motors, vacuum cleaners, washers, etc. Complete illustrated course shows how. Free booklet. Pacific School, Dept. AP82, 4703 West Pico, Los Angeles 6.

YOUR Own profitable business started at home or office. Little or no investment. Guaranteed. Spare or full time. Experience unnecessary. Complete particulars free. Redmont Company, P.O. Box 9264, Los Angeles 5, California.

HOME Service Company rug and upholstery cleaning outfit complete. Brand new, 40% discount. Heidelberg, 148 North Prentiss, Jackson, Mississippi.

PLASTIC! Make money today. Exceptional profits. Send \$1.25 for our kit containing instructions and ready-cut material to make sparkling cigarette box of genuine Lucite. Plastic Center, 3132 West 11th St., Los Angeles 6, California.

NEW Ever-repeating profit plan. Particulars free. Lynch, 402-D Hazlett, Baltimore 29, Md.

UPHOLSTERING. Rebuilding furniture pays. Easy to learn. Pleasant work. Do your own upholstery. Start upholstery business. Big illustrated course only \$1.00. Order today, or write. Upholstering Institute, Dept. 221, Lombard, Illinois.

INDIA! Country of four hundred millions. Vast field. Wanted agencies for any marketable goods. Can export any Indian manufactured goods. Jhaveri & Co., Jhaveri Building, Forbandar, India.

MECHANICALLY Inclined men — Own and operate general appliance repair shop. Complete, illustrated course shows you how. Welding, refrigeration, motor repair, how to get business, etc., all phases covered. Free literature. Christy Supply, Dept. 143, 2835 N. Central Ave., Chicago.

GUARANTEED Powerful mailorder letters, literature campaigns, planned, written! Big, positive results! Investigate! Finkel-Advertising, 1201 1/2 South Ogden, Los Angeles, California.

LEARN Credit and collection agency business; earn \$50-\$150 weekly upwards; interesting literature free. Write Educational Extension Service, Department 101, Wishire-Labrae Station, Los Angeles.

ELECTRIC Clocks are every where you go, buildings, homes, parking-lots, factories. Repairs increasing. Our easy to learn course with pictures and drawings teach you how to repair these clocks. Electronic Supply Co., Dept. A, P.O. Box 1983, Houston 1, Texas.

SELL By mail. Make big money. Be established after the war. Details free. Write quick. United Profit Builders, 305-A West 8th St., Los Angeles 14, Calif.

START "Soap Factory" at home. No machinery. Amazing opportunity. Literature free. Kemico, SM-8, Park Ridge, Ill.

FOR Cash without canvassing, write Poulsen & Company, Zion, Illinois.

SELL By mail. Modern course shows how. Free consultation with noted author. Details free. J. G. Schroeder, Box-P, Anaheim, Calif.

OPPORTUNITIES Galore in Progressive Mail Trade 10c. Lyle Moore, 2854 Harris Place, Norwood 12, Ohio.

BUILD A profitable business. Details free. Spada Enterprises, 10 Lexington St., Wethersfield 9, Conn.

MEN—Women—Plan for post war conditions; booklet describing collection of 127 money-making plans free. Morrill, Box 847, Portsmouth, N. H.

SHOESTRING Start leads to success. Investigate leading mail order magazine. Sample 10c. "Plus," 4612 "G" Street, Philadelphia, Penna.

300 TESTED Money-makers, 68 page book, over 40,000 words, 25c postpaid. Business secrets, formulas, wholesale supply sources, galore, no ads, meat only. Branan, 328 Washington, Sandersville, Ga.

PROFITABLE Home business, sensational new course. Flexible mold making, novelty casting. No priorities. Valuable folder free. Plastic Arts Studio, Route 3, Muncie, Ind.

START Wholesale distributing business. Complete mail sales campaign literature free. Rotex, 216C Degraw, Brooklyn, N. Y.

PLASTIC Engineering pays big. Home study course. Low cost. Easy terms. Free booklet. Ohio Institute of Technology, Box P-172, Greenville, Ohio.

LEARN Refrigeration mechanics. Start your own repair shop. Complete illustrated course. Free booklet. Mechanics School, Dept. PM11, 4703 West Pico, Los Angeles 6.

MONEYMAKING Opportunities, business secrets, plans, tips, formulas. Mack, Box 1278-H, San Francisco 1.

SELL Books and courses by mail in your spare time. Siddall, Atascadero, Calif.

HOW And where to obtain free membership in the famous National Mail Order Guild. Details free. June, 101-S Beech, Holyoke, Mass.

PAYING Mail business. Stamp brings profit. General Publications, Ossining 1, N. Y.

EARN Money in your backyard. Free details. George Gundrum, LeRoy, Mich.

"CASH In now on the latest craze"—Planchette Ouija Boards are taking the country by storm. People by the thousands are asking the ouija board to reveal the mysteries of the future. It is a thrilling fascinating game. Send \$1.49 for sample and wholesale price list. Planchette Co., 128 No. Wells, Chicago 6, Illinois.

INSTALL "Dashboard controlled garage door equipment." Additional information under "Automobiles."

FORGET Canvassing! Home business, profits immense. Amazing details. 3c. Service (5) Drawer 339, Butte, Montana.

"If It's wealth you desire"—Read Amazing Tales of Babylon. Inspirational. Helpful. \$1.00 guidebook to greater earnings. Listen, Box 9816, Station S, Los Angeles, Calif.

MAKE Furniture polish at home in your sparetime. Sells on sight to stores, agents, friends, etc. Get in on this live-wire, send 50c for instructions and formulas today. Neil Bique, Gages Lake, Libertyville, Ill.

SIX New and complete post card plans for starting your own profitable business. Gordin Publishers, Box 23, Pawtucket, R. I.

4 MAILORDER Magazines, 3 months each—25c. Profitable plan included free. Commodore, Box 101-D, Forest Park, Ill.

MAMMOTH Mail; magazines, opportunities galore. Year's service with dollar bringing plans, ads, etc. All 25c. Directory, 319 So. Marengo, Pasadena, Calif.

AFTER The war what? We have the answer for you now! Shoes Co., M-1, 45 Astor Place, New York 3, N. Y.

FIVE Big mailorder magazines 20c. Lewis Company, 828-M Carpenter, Oak Park, Ill.

DOLLARS. Make money! Sell formulas for 7 invisible inks by mail! Formulas and instructions 25c. Three secret codes free with order! Far-Go Co., B-1546, Uniontown, Penna.

WANTED—Mail order dealers, beginners, read my new letter—Mail Selling Is Money Business. Boom beginning now. Rush name. Houston Maupin, Tipp City 16, Ohio.

LIFETIME Opportunity. 2,400% profit. Details stamp. Dickie, Oklahoma City 4, Oklahoma.

MONEY Cleaning, repairing alarm clocks. Instructions \$1.00. Sterling Products Co., Springfield, Ill.

BIG Mail. Latest money-making propositions. 10c. Arseneau, 717 Third Ave., East, Duluth, Minn.

GUARANTEED Income! Grind lawn mowers. \$2.00 capital! Mowers, Janesville, Wis.

PLASTICS. Made at home, without equipment. Perfect castings, formula 50c. Baker, 225 Symington Ave., Toronto, Can.

OPERATE Your own "health conditioning club!" Dynamic but simple techniques. No manipulation. No apparatus. Meta-bic System, Drawer 9128M, Station 8, Los Angeles.

CO-PUBLISH Real magazine, details 3c. Sample 10c. Renick, Holland, N. Y.

"KNOCKOUT Plan." Send dime for starter. Affiliated, Box 982, Baltimore 3, Md.

GOLD Ahead: The book of cures for lean purses. It is absolutely practical! It really works. An inspiring self help for real financial success. \$2.50 cash postpaid. Evans D. Larson, Box 545, Longview, Washington.

VITAMINS—Our high quality, low priced formula packed (in small lots) under your own private label. Big profit selling stores, agents, and consumers. Samples, prices, and literature free. The Gibson Company, Harlan, Iowa.

"MAIL Order Trade Directory"—1944 edition; wholesale reference guide to reliable supply sources and services. Only 25c. Box 693, Canton 1, Ohio.

10 TRIPLE-SHAVE Double-edge razor blades in classy letter style package. 1st class mail anywhere 3c. Send 30c one package or \$1.00 four packages prepaid. Agents wanted. Novelty Supply & Mfg. Co., Fremont, Ohio.

MONEYMAKING Opportunities, steady income. Write, Meeks Publishing Co., Box 792, Weed, California.

FREE Literature explains profitable home mailorder. Cutler Publications, Reading, Penna.

START Your postwar planning now. Go into business for yourself at home in spare time. We can help you. Details free. L. T. Alexander, Dept. 131, 430 W. 9th, Dallas 8, Texas.

YOU Can make fancy profits selling flavoring extracts. Make your own. Send two dollars for each formula. Your Service, Box 643, Warren, Ohio.

RUBBERFORM— Plastic; waterproof elastic flexible mold making liquid. Sample pint with instructions \$1.25 postpaid. Galton \$7.00. Plastic Products, 1410-13, Belmont, Chicago.

AFTER The war then what? Go in business, sell by mail, big profit, fully guaranteed. Dr. G. Anthony, 210 5th Ave., New York.

VALUABLE Advice in advance on how to make money by mail. Details free. Unusual Book Mart, 242 North Park, Decatur, Illinois.

KARAKUL Sheep are profitable. Write: Addis Kelley, Maywood, Calif.

HOW And where to obtain capital. Fully explained, particulars free. Star Service, Wapakoneta, Ohio.

LIQUID Marble; snow-white, multi-colored. Glazed. Unglazed. Composition flooring. Lifetime wear. Any color. No priorities. Flexible molds. Plaster casting. Get into the big money now. Full information given free. Write Compo-Tex, Box 786-R, St. Louis, Mo.

BUILD Miracle homes. Yours. Others. Enjoy prosperity. Particulars, Chamberlain Co., Fitzsimons Building, Pittsburgh, Penna.

YOU Too can learn how to make, mold or cast real plastics. Send stamped envelope Box 498, Gainesville, Texas.

COLOR Concrete with chemicals. Big money making Hollywood style pottery, birdbaths, without moulds. Wishing-wells, stucco-rock, benches. Marbling, cement water-paints. 10c brings sample, literature, pictures. Hollywood Cement-Craft, 8527 Wonderland, Hollywood 46, California.

AGENTS—To mail our literature. Good profits. Home business. Maywood, 1133 Broadway, New York.

ADVERTISE In Progressive Mail Trade, famous for famous results. There's a reason why advertisers stay in year after year. Best puller. Lowest rates. Pewitt Publications, 605 Clayton, San Francisco 17, Calif.

"HOW To Make Money With Hobbies"—Mail order work, handicraft, stamps, or dozens of other hobbies. 60 pages of exciting experiences, ideas, plans \$1. Free circulars of many unusual books and plans. The Hatch Press, 526 Hanover St., Dept. PM, Meriden, Connecticut.

FREE Subscription to "The Mail Order News" (Somerville, N. J.) Oldest mail trade journal in America. Offer limited. Drop postal today.

WEBER Typewriter Mechanics School. Simplified homestudy-repairing increasing. Hollywood 27, California.

"HOW To Make Simple Molds and Plaster Plaques." Profit in popular novelties! Booklet 25c. Plastercraft, 1406 E. 43rd St., Cleveland 3, Ohio.

INCORPORATE Your business. Delaware laws. Many advantages, free details. Tax Research Bureau, Inc., Delaware Trust Building, Wilmington, Delaware.

GET Into mail selling. Prepare for future. Start sideline business now. Splendid opportunities. Interesting, profitable propositions immediately available. Progressive Magazine tells how! Free details and premium offer. Sheboygan Publishing Co., Sheboygan, Wisconsin.

CHARTERS: Delaware: best, cheapest; free forms. Colonial Charter Co., Wilmington, Del.

DRUNKENNESS Is a disease which responds to treatment. Medical skill plus human sympathy prove successful with liquor and drug cases. 60 years experience. Write for free booklet. P. M. Nelson, The Keeley Institute, Dwight, Ill.

127 WAYS To make money, in home or office, business of your own. Full particulars free. Elite Co., 214 Grand St., New York.

TWENTY DOLLARS daily, selling automobile products (samples). Kay, 129 W. Third, Los Angeles 13, California.

BRUSH Plating outfits connect to a battery. No tanks necessary. Good paying business at home plating autoparts, bathroom fixtures, bicycles, reflectors, silvering mirrors. No shop or experience required. Outfits furnished. Free booklet. Gunmetal Co., Ave. H, Decatur, Ill.

EXTRA Income—Plenty mail selling opportunities. Write Katz, 4254 N. Kimball, Chicago.

5 MOST Read mail order magazines 20c. Armand Cartier, 695A North, Pittsfield, Mass.

LIQUID Marble—Colorful, glazed! Mold, brush, spray! Composition floors, rubber-lastic molds. Particulars free. Marbleizing Service, Edwardsville, Illinois.

HELPLEFUL Books on hundreds of subjects. Catalog free. Popular Mechanics Press, (C-43), 200 E. Ontario, Chicago.

MONEYMAKING OPPORTUNITIES

PLASTIC Costume jewelry made at home from easily obtainable materials. Send 50c for our instructions telling how completely. Joseph Wittick, 123 Edwin, Toronto, Canada.

HOME Money-making plans. Particulars—Inspirations, 411 Garland, Takoma Park, Maryland.

MECHANICALLY Inclined men—Own and operate general appliance repair shop. Complete, illustrated course shows you how. Welding, refrigeration, motor repair, how to get business, etc., all phases covered. Free literature. Christy Supply Dept. 1143, 2835 N. Central Ave., Chicago.

BIG Profits, make and fit arch supports. Particulars. Jul Corssen, 2638 Geyer, St. Louis 4, Missouri.

SELL Envelopes by mail. Big profits. Omaha Envelope Service, Dept. 29, 4721 California, Omaha 3, Nebr.

THOUSANDS Of articles wholesale. "Supply Source Directory" 10c. Ideal Service D-8, Park Ridge, Ill.

MONEY Made easily, old age, health, education, color need not stop you. Write for details. Bargain Specialty Company, Box 635, Modesto, California.

247 GOOD Genuine money-making opportunities. Not trash. Lucas, 8704 St. Aubin, Hamtramck 12, Michigan.

LEARN Refrigeration mechanics. Start your own repair shop. Complete illustrated course. Free booklet. Mechanics School, Dept. PM12, 4703 West Pico, Los Angeles 6.

START Profitable business at home. 25c brings details. Des Moines Home Service, Box 855, Des Moines, Iowa.

HELP Win the war first! Then man, you'll like silvering mirrors, reflectors! Making sparkling chipped glass nameplates. Outfit prices. Sprinkle, Plater, V60, Marion, Indiana.

MOLDMAKING—Plaster Casting. Complete formulas—fully illustrated. 25c. Ideal Service, RM-8, Park Ridge, Ill.

62 MONEY Making plans, 68 page book, 25c. Shaw, 250 W. Main, Logan, Ohio.

GROW Dwarfed trees few inches high for yourself or sell. Instructions. 15c. Charles McGuire, P.O. Box 628, Dept. G, Seattle 11, Wash.

GIANT Mails, opportunities galore, big mail trade magazine, adsheets, circulars, three months 25c. Harvey Teeple, Decatur, Indiana.

EARN Money evenings, copying and duplicating comic cartoons for advertisers. Adservice, Argyle, Wisconsin.

MAKE Beautiful vases from discarded jars. Something new, different. Sell on sight. Instructions \$1.00. Lindall, 6316 Richard, Tampa 6, Florida.

MONEYMAKING Mailorder opportunities awaiting you. Write Lawson, 1011-A Harwick, Willow Run, Mich.

CASH From your back yard, basement or bedroom. No experience necessary. Send for free details. Challenge Association, 87 Somerset, Springfield, Mass.

GET Your mail order start by joining The National Mail Order Guild. They tell you all the facts—what sells by mail—who buys by mail and how to reach them. They help you every step of the way. Send for full information. No obligation. A. J. Shutt, P.O. Box 269, New Castle, Indiana.

SECURITY Acres, how to make a living from city lot or 5 acres. Postpaid \$1.00. Sign, Farmington, Missouri.

60 PIECE Mammoth mail. Thousand opportunities magazines. 10c. Variety Mailers, 1116-N, Capitol, Indianapolis 4, Ind.

MIND-STIMULATOR Creates new, money-making opportunities. FLT, Ph. D., Dept. 44PM, 185 Godfrey, Philadelphia 20.

ATTENTION Men, handmade silver and leather goods repeat faster. Ten dollar deposit required on samples, returnable. Palmer Products, Box 643, Asheville, N. C.

START Now, build money making mail order business. Be established after the war. Write for free particulars. Young's Industries, Kent 15, Ohio.

MONEY At home. Your own business. "Progressive Mailtrade" Magazine (15th year), prints many small capital post war opportunities. Read by thousands; you'll like it too. Copy 10c. Publishers, Box 115M, Gardenville, New York.

THOUSANDS Of alarm clocks need repairing. Jewelry stores swamped. Our simplified course teaches you how to repair these clocks. Necessary tools and supplies furnished with course. Alarm Clock Repair Service, Dept. B, P.O. Box 1983, Houston, Texas.

PERFUME Instructions furnished. Start mail order or local business. Particulars free. Dr. Abell, Parkway Bldg., Pasadena, Calif.

BOOKKEEPERS. Earn money at home posting journal entries. Ellis Business Service, Cedar Grove, North Carolina.

LICK After-war layoffs! Start own business; home, office. Booklet describing "Collection of 127 Tested Plans" free. Elite Co., 214 Grand St., New York.

PUBLISH Your own magazine. Hand-some 52 page format, well edited, illustrated. Cost low as \$1.00 month. Brings you prestige, profits. 10c brings sample, details. National, Ord, Nebr.

LEARN Metascience. Remarkable drugless healing. No manipulation. No apparatus. Unbelievable simplicity and results. Inexpensive correspondence course. Write Metascience, De Land, Florida.

EARN Money at home! Thousands do! "Home Worker Magazine" tells how. Sample, 25c. Sizemore, Box 7, 4917 North Kostner, Chicago.

FORMULAS, PLANS, ETC.

HAVE You a technical problem? Do you need reliable technical information for your home, work, or to develop profitable ideas. For \$3.00 you can have the advice of a research chemist with extensive practical and industrial experience. Each problem given individual attention. M. Gardner, 2830 West Liberty Ave., Pittsburgh 16, Penna.

INSECT Spray formula, \$1.00. Mix two simple ingredients sold in every neighborhood. Makes full gallon at one-fourth cost. Absolutely harmless to humans. Stainless. No kerosene or gasoline. Same type as sold in stores. R. C. Lind, P.O. Box 4506, Houston, Texas.

EXCELLENT. Brushless shaving, women's skin, cream, \$5.00. Grabard, 33 Hilltop Acres, Yonkers 4, New York.

MAKE Fast selling products. No machinery. "Chemist Approval Formulas." Literature free. Kemico, 15, Park Ridge, Illinois.

FORMULAS — Latest, best. Analysis. Literature free. Belfort, Engineering Building, Chicago.

"LUMINOUS Paint" shines in dark. Easily made. 100 other formulas, plans—all 25c. Soap-making course (20 formulas) \$1.00. Resilvering mirrors, formula 20c. Ideal Service, 308, Park Ridge, Ill.

MAKE Artificial honey; formula, including 10 others 50c. Lush, 504 Woodside Ave., Bridgeport, Conn.

MAKE Big money. 6 new secrets for \$1.00. Itching feet remedy, bug-a-boo, "kill-em-all," rid of rats, how to make your own cola drink. Recharge flashlight batteries and reclean used motor oil like new. Industrial Research, 17 Madison St., Boston 19, Mass.

ICELESS Ice! Colder; cleaner; cheaper. Instructions, 25c. Duffy, D-53, Covington, Ky.

ANY Formula or refund. Send \$2.00. Case Kowal, Chemist, 1846 Cullerton, Chicago.

AUTHENTIC Formulary, 924 page illustrated book. Prepared by experts. 10,000 practical tested formulas, recipes, secrets, instructions for easily making most any product. Countless profitable business opportunities. Valuable reference for home, industry. \$2.00 post paid (c.o.d. U. S. only). Foreign \$2.35. Adams Brown Company, Dept. 11, Chestnut Hill 67, Massachusetts.

7,000 FORMULAS 25c Each. 25,000 American mfrs. addresses, 10c each. Frank A. DeVoe, Box 243, Ukiah, Calif.

REAL Manufacturing formulas. Lists free. Cummings, Chemist, Gordon Ave., Syracuse, N. Y.

CHEMISTRY

THE House of Winn, the home of supplies for amateur chemists. See Winn's New Idea chemical kits and apparatus outfits for home experimenting. Send 10c for retail catalog. Established 1931. John H. Winn, Dept. 508, 124 West 23 St., New York.

LABORATORY Supplies at wholesale prices: Chemistry, biology, physics. Catalogue 10c. National Scientific Co., 2204 W. North Ave., Chicago. Established 1908.

CHEMISTRY Laboratory apparatus and chemicals for industrial, analytical, and private experimental laboratories. Complete chemical laboratory supply service for correspondence school students. Send 3c for free 48-page catalog of chemicals and apparatus. Dept. M-43, Biological Supply Co., 1176 Mt. Hope Ave., Rochester, New York.

COLCHICINE — Creates new mutant plants—Experiments magazine and booklet 25c. Questok, 277 Washington, Newton 58, Mass.

SPECTROSCOPE For quick chemical analysis \$2.50. Kutting Sons, Campbell, California.

FREE Catalog: Chemistry, mineralogy, biology, optics. Tracey Laboratories, Evanston, Illinois.

HELP WANTED

EARN Profits in spare time by recommending technical books to fellow workers. Write for details to E. M. Kask, 330 W. 42nd Street, New York 18, New York.

AGENTS WANTED

WINNING The name "Clever Hostess" or become our representative in your home town for "Crystals of Color." Pure U. S. certified food colors. Not sold in stores. Liberal commissions. Package of assorted shades for testing will be mailed for twenty-five cents; coin or money order. Peerless Color Laboratories, Rochester 9, N. Y. Bank references. Established 1902.

TAKE Orders for new sensational plastic lifetime reproductions of any photo or negative. Amazingly beautiful. Big earning opportunity. Part or full time. Get details quickly. Quaker Photo, 914 Walnut St., Philadelphia 7, Penna.

HOSIERY Guaranteed against everything at no extra cost! Victory sheer ladies' rayon full fashioned sells for only 94c including your profit! Also guaranteed men's hosiery. Amazing opportunity to build permanent business. No experience or money required. Simply write orders. We deliver and collect. Write today for complete free outfit. Kentcraft, Dept. GH, 44 Court Street, Brooklyn, N. Y.

EXTRA Money for you. Sell 50 for \$1.00 Christmas cards and personal stationery. Miracle value \$1.00 Christmas assortment. Other money making boxes 35c up. Up to 100% profit. Friends, neighbors buy readily. Samples on approval. Special offer. Elmira Greeting Card Co., M-137, Elmira, N. Y.

CALL On friends with sensational personal Christmas cards—50 for \$1.00 up. Personal stationery. Also magnificent 21-card \$1.00 assortment. Profit 50c. Experience unnecessary. Samples on approval. Wallace Brown, 225 Fifth Ave., Dept. G-4, New York.

BIRTHDAY, Everyday and patriotic greeting cards. 4154g Fifth Street, Philadelphia 40.

EXCELLENT Sideline for printing salesmen. Decalcomania name plates in small quantities. Also, make money applying initials on automobiles. Free samples. "Raico," X-164, Boston (18), Mass.

MEDICINE Men. Write today for prices on our tonics, herbs, liniments, ointments, tablets, soap, vitamins liquid or tablets, anything and everything you need at lower prices. Celtona Medicine Co., 1016 Central Ave., Cincinnati 2, Ohio, Dept. F.M.

AGENTS—300% Profit selling gold color window letters; stores and offices. Free samples. Metallic Letter Co., 438-B North Clark, Chicago 10.

EXCLUSIVE Territory. Fire extinguishers. \$2.75 retail. Old concern. Firstaid, 1824 Fourth Avenue, Los Angeles 6, Calif.

EVERYDAY Cards. Make \$5.00 with every ten \$1.00 assortments you sell. Also victory cards and everyday wrappings. Unusual demand. Write for samples today. Howard P. Ellis, Dept. PM, Pitman, N. J.

FLUORESCENT Lighting starters—Underwriters Labs. approved. Buy direct. You sell wholesale and retail. Request sample and prices. Electronix Products Co., Box 58, Pawtucket, R. I.

AT Last! Something new and sensational in Christmas cards. Amazing "Oilette" cards. Like costly oil paintings. Designs never before offered. Gets orders fast. Beautiful 25 for \$1 cards, name imprinted. 9 other assortments. Big profits. Samples on approval. Puro Co., 3043 Locust, Dept. 226, St. Louis, Mo.

CHRISTMAS Card representatives! We have it! Most sensational new line ever designed. Clever, individualized, useful! Agents cleaning up! Sample kits going fast! Drop postal for yours today! No obligation! Craftcards, Box 235-X, Pittsburgh 30, Pennsylvania.

BIG Profits taking subscriptions for all magazines. Agents' confidential catalog listing over 2500 periodicals and complete starting supplies free. Pines Subscription Agency, Flushing, New York.

REAL Live Mexican jumping beans. 20—25c, 100—85c, 500—\$2.00, 1000—\$3.00. J. J. Frank, 525P Palm, Rockford, Ill.

START Your own business on our capital. Always your own boss. Hundreds average \$3,000 to \$5,000 annual sales year after year. We supply stocks, equipment on credit. 200 home necessities. Selling experience unnecessary to start. Wonderful opportunity to own pleasant, profitable business backed by world wide industry. Write Rawleigh Co., Dept. H-U-PPMA, Freeport, Ill.

PENCILS, Carbon paper and typewriter ribbons repeat. Complete line for office and advertising. 25% commission. We carry accounts. Universal Graphite Pencil Co., Clinton, N. J.

LUMINOUS Paint, (Shines in dark). Profitable seller to thousands of homes, stores, offices and factories. Rush name for free sample to Lite-Saver, 97C, Saybrook, Connecticut.

BIG Bargains for big profits. Men's used pants 25c, suits \$1.00, topcoats 75c, shoes 12½c. Over 100 sensational values. Experience unnecessary. Free wholesale catalog. Superior, 1250-AR Jefferson, Chicago.

PROFITS Selling novelty fun cards. Samples 10c. National Specialties, Box 301-M, Cincinnati.

AGENTS. Make 150% profit on our hair products for colored people. Write today. Vitool Hair Products, 2529 Eight Avenue, 30 New York City.

SELL Personal stationery, printing, greeting cards, and patriotic specialties to friends and service men. Ipeco, 1511 Chicago Street, Omaha, Nebraska.

BIG Money taking orders; shirts, ties, Sox, pants, jackets, sweaters, shoes, uniforms, etc. Sales equipment free. Experience unnecessary. Nimrod, 4922-AN Lincoln, Chicago.

AGENTS. Big line including food products. Fast selling premium and bargain deals. Low prices. Send card for big outfit offer with gift. Ho-Ro-Co, 2793 Dodier, St. Louis 7, Mo.

CHRISTMAS Cards. Earn \$2 an hour. Take orders galore from friends. 25 exquisite folders with name \$1. Free samples. Others to \$2.50. America's fastest selling 21 Christmas folder box. Costs 50c. Sells \$1. Request samples today. Sunshine Art, Dept. E, 115 Fulton St., New York City.

WHOLESALE Sources. 500,000 articles. Free directory. Maywoode, 1133 Broadway, New York.

PLATING Outfits for autotaps, reflectors. Connect to a battery. No tanks necessary. Free booklet and particulars. Gunmetal Co., Ave. N. Decatur, Ill.

AGENTS: Stamping names on pocket-key protectors. Sample check with your name, address, 25c. Stamping outfits. Emblem checks, check-fobs, name plates. Hart Mfg. Co., 303 Degraw St., Brooklyn, N. Y.

MAGIC Cleaner and laundry soap deal. Hotter than a firecracker. Big profits! Sample free. Bestco, 5007 Irving Park, Chicago.

PLAYING Card game. 250% profit. Sample game 25c. Box 842, Denver 1, Colo.

GOLD Lacquered window sign, letters. New styles. Absolutely beautiful. Free samples—catalogue. Atlas, 7941 Halsted, Chicago.

FREE Water and our concentrates, makes flavors, lollipops, shampoos, 72 products, labels, bottles furnished. Qualco, E-20030 Russell, Detroit.

ELITE Collection contains 127 plans for starting own business; home, office. Descriptive booklet free. Elite Co., 214 Grand St., New York.

HIGH-GRADE SALESMEN

SELL Warm leather jackets to friends, neighbors. Make money spare or full time. Also rubber raincoats, 200 styles shoes. Sample outfit free. Experience unnecessary. Consolidated Shoe System, Dept. S-74, Chippewa Falls, Wis.

SAMPLES Native handicrafts \$3.30. Barrington Smith Company, Halfwaytree-10, Jamaica, B.W.I.

EXTRA Cash: Easy sample demonstration sells home owners new zoya base preservative for beauty, durable protection, shingle roofs, sidewalks. Write today, Box 5672, Dept. D, Cleveland, Ohio.

LOCAL Salesman for exclusive rights, representing company manufacturing new, patented, fast moving toy building block, selling to drug stores and department stores. Notch Block Company, 2014 N. Charles St., Baltimore 18, Maryland.

SALESMAN: Have real money-making opening. Fits into war program. Old progressive firm. Dept. "F," Box 392, Dallas, Texas.

SEASONABLE Sideline for traveling salesman. Business already established. No samples to carry. State territory covered. Hurry. Fair Supply House, New London, Ohio.

FORMER School men or men who can sell school superintendents. Classroom charts for social studies. Good commission. Quick action. National Forum, 417-B South Dearborn, Chicago 5.

INDUSTRIAL Salesmen, sell bandage that needs no adhesive tape! War plants big users. Testimonial letters prove increased production. Big commission. Modern Necessities Company, 737 W. Randolph St., Chicago 6, Ill.

SELL Toy guns to everybody. Parflex Company, 4189 W. 2nd St., Los Angeles 4, Calif.

BLADES—Best quality, factory prices. Details free. Ace Blades, Buffalo, N. Y.

JOBBERs. Dealers, sell long profits merchandise. Imprints available. Write Adams Exchange, 150-P West 124th Street, New York 27, N. Y.

ORANGE Concentrate direct from our Florida grove. One quart bottle makes 6 quarts delicious natural orange drink simply by mixing with 5 parts cold water. Grocery stores, food marts, roadstands, sodafountains, resorts, camps, farmers big buyers. No investment. Protected territory. Salesmen earn \$100 to \$200 repeat commission per week. Sunset Valley Orange Co., 3357 Clifton, Chicago.

EDUCATIONAL AND INSTRUCTION

MAKE Up to \$25-\$35 week as a trained practical nurse. Learn quickly at home, spare time. Easy tuition payments. Earn while you learn—many earn hundreds of dollars while studying. Easy to understand lessons endorsed by physicians. High school not required. Our 45th year. Write for free booklet and sample lesson pages. Chicago School of Nursing, Dept. TK-8, Chicago.

WELDING—Electric arc. Learn profitable trade quickly through actual practice. Individual welder instructions at bare cost of materials. Full particulars free. Valuable welding lessons book 50c. Hobart Welding School, Box M-842, Troy, Ohio.

"HOW To Break and Train Horses"—A book every farmer and horseman should have. It is free, no obligation. Simply address: Beery School of Horsemanship, Dept. 1108, Pleasant Hill, Ohio.

WHY Don't you write? Writing short stories, articles, etc., will enable you to earn extra money. In your spare time we teach you to write the way newspaper men learn—by writing. Free "Writing Aptitude Test" tells whether you possess the fundamental qualities essential to successful writing. Write today! Newspaper Institute of America, Suite 570-L, One Park Avenue, New York 16, N. Y.

WRITERS: Send for free circular P-74, with unified sales plan for placing your work. Otis Adelbert Kline, Literary Agent, Established 1923, 507 Fifth Avenue, New York 17.

MEMORIZE The Morse Code in a few simple short cuts. No need to spend weeks in tiresome memorizing and repetition. Telegraph key and buzzer not essential. Our method will teach you in one fourth the time. Study for amateur or commercial radio now. Big opportunities after the war. Knowledge of Morse Code will be a must. Only 10 cents per lesson. Send \$1.00 for 10 lessons to Rapid Fire Code Course, Box 4484, Washington 17, D. C.

LIST Of "Home Study" books free. (New, used.) Buy, sell, rent, exchange. Bargains! Dalton, Box 3363, Seattle 14, Wash.

REMEMBER Without effort. Easy five lesson memory course \$1.00. Amazing results. Money back guarantee. Postcard brings particulars. Mighty Midget Publications, Box 566A, Lincoln, Nebraska.

EXCEPTIONAL Peacetime opportunity. Operate a collection agency—credit bureau. Quickly learned. Many make \$5000 yearly up. Write Cole Associates, Syracuse, N. Y.

PLASTIC Engineering pays big. Home study course. Low cost. Easy terms. Free booklet. Ohio Institute of Technology, Box 171, Greenville, Ohio.

HEAT Treat booklet \$1.00. Blacksmith tempering 50c. Smith, Box 202, East Lansing, Michigan.

LEARN How to make show cards and paint signs. All information and instructions \$1.00. Libbey Sales Service, Box 8, Irvington, N. J.

REFRIGERATION Mechanics. Complete home course for repair men. Booklet free. Mechanics School, Dept. PM13, 4703 West Pico, Los Angeles 6.

INVESTIGATOR Training. Phillips Secret Service, 1917-B North Kenneth, Chicago 39 Illinois.

ASSOCIATION Of American Writers, 319 So. Marengo, Pasadena, Calif. Membership \$3.00 includes year's subscription to "Arrival" beautiful certificate, press card, auto sticker, many benefits. Join now. (Sample "Arrival" 25c.)

COACHMASTER Presents post war job plan. Simplified method of preparing for examinations; civil service and other tests that lead to better jobs. Manuscript of priceless value gives information in simple plain language. \$1.00 post paid. Money back guarantee. Rush order today. Coachmaster, Dept. 90, Hutchinson, Kansas.

CELESTIAL Navigation kits and world-wide planisphere. Send for descriptive folder. No charge. Addison-Wesley Press, Inc., Kendall Sq. Bldg., Cambridge 42, Mass.

"DAILY Key notes for key production men" 65c each. Barmore, 242 South Holyoke, Wichita 8, Kansas.

RADIO Engineering, broadcasting, servicing electronics, aviation, marine and police radio taught thoroughly. All expenses low. Co-educational. Catalog free. Valparaiso Technical Institute, Dept. C, Valparaiso, Ind.

GOOD "Used" self-instruction educational books on all subjects bought, sold, rented, exchanged. Satisfaction guaranteed. Complete information and 92-page illustrated bargain catalog free. Write—Nelson Company, Dept. 2-02, Chicago 4.

LEARN To draw nudes. Over 350 illustrations, charts and notes giving detailed study of every part of the human body. Send for Art Anatomy of the Human Figure by Charles Carlson. Only \$1.00. Ball Square Company, 210 Fifth Ave., Suite 1102, New York City.

CARPENTERS. We teach the square in five easy lessons by mail. Our 1/4 size practice square and simplified instructions does the work. Free information, better still send quarter for practice square and partial lesson. Builders' Topics, Medical Arts Bldg., Seattle, Washington.

HOME Study course, drugless therapy. Free literature. Inst. of Drugless Therapy, Tama, Iowa.

BECOME A Doctor of Metaphysics (Ms. D.) Teach secret of contentment, happiness. Solve mental worries. Free book. College of Universal Truth, 5651-C North Asland, Chicago.

NEW Writers needed to re-write ideas in newspapers, magazines, and books. Splendid opportunity to "break into" fascinating writing field. May bring you up to \$5.00 per hour spare time. Experience unnecessary. Write today for free details. No obligation. Postcard will do. Comfort Writer's Service, 210-P South Seventh St., St. Louis, Mo.

USED Educational books on all subjects sold, rented, also bought and exchanged. Money-back guarantee. Write today for free catalog and details. Lee Mountain, Pisgah, Alabama.

EARN Certified Grapho-Analyst degree analyzing handwriting. Students report earnings up to \$1.00 an hour spare time. \$75.00 weekly full time. Graduates in employment, credit agencies, police departments, courts, business and in private practice as personal problem and vocational advisors. Fully illustrated Grapho-Analyst and 3000 word illustrated lesson free. Institute, Box 1150, Joplin, Mo.

MEDICAL Laboratory technicians in great demand. We train you in your spare time, in your own home. You can practice while studying. Write for free catalogue. Imperial Technical Institute, Box 973-E, Austin, Texas.

DRUNKENNESS Is a disease which responds to treatment. Medical skill plus human sympathy prove successful with liquor and drug cases. 60 years experience. Write for free booklet. P. M. Nelson, The Keeley Institute, Dwight, Ill.

LOCKSMITH Course. Lock picking, key fitting, etc. \$1.00 prepaid. Locksmith, Canadian, Texas.

SECRET Investigation. Experience unnecessary. Investigators particulars free. George Wagner, M 125 West 86th, New York.

HUNDREDS Of helpful books. Catalog free. Popular Mechanics Press, (C-43), 200 E. Ontario, Chicago.

PLAYS, STORIES, MANUSCRIPTS

STORIES, Novels rewritten from authors' unrevised manuscript. Flawless typing. Submission to editors if desired. Tinney, 237 Centre, Dallas, Texas.

BUSINESS SERVICE

DESIGNING Of patents, products, jigs, fixtures, etc. Drafting according to your sketches. Neat and accurate work. VanLierop, 3819 St. Clair, Detroit 14.

USE Our Washington, D. C., office for your business, personal mail. Complete receiving, forwarding service. \$2.00 monthly. Hawkins, 7-pm4 Randolph Place.

RECEIVING And re-forwarding mail. For further particulars write to Dunn Mail System, 216 West 60th Street, Box 42, New York 23, N. Y.

CALIFORNIA Address. Mail forwarding and receiving service \$2.00 month. Letters mailed 10c each. View cards 3-25c mailed free. Chandler, 1355 Cedar Ave., San Bernardino, California.

CARTOONING, COMMERCIAL ART, SHOWCARD WRITING, SIGN PAINTING

CARTOONING. Signwriting pays! Either course, 8x11, thoroughly illustrated. \$1.00. Details free. John Warren, N7509 Smith, Spokane, Wash.

ILLUSTRATED Cartoon course. 15 lessons 75c. Money making plans 25c. 60 showcard patterns 10c. Cartoon markets 10c. Cartoon Studios, 1402 Charles, LaCrosse, Wis.

BEST Complete cartoon course with artists kit—\$2.00. Membership Cartoonists Association free. Cartoon Publishers, West Springfield, Mass.

QUALITY Art work. Minimum prices. Sanden, 716-21 St., Bellingham, Wash.

REVISED Modern poster art \$2.00, catalogue 10c. Sign, Farmington, Missouri.

POCKET Size cartoon course—22 easy lessons, over 200 sketches including figures and lettering. Prepared by nationally known artist. Mailed postpaid on receipt of 25c in coin. Snack-Pack Co., 34 E. Georgia St., Indianapolis 4, Ind.

CHALK Talks. Laugh producing program. \$1.00. Catalog 10c. Balda The Cartoonist, Oshkosh, Wisconsin.

CARTOONING Course:—30 illustrated lessons, over 500 sketches, complete \$1.00. Montes Studio, Box 892, Pasadena, Calif.

ADVERTISING AGENCIES, LETTER WRITERS, FOR ADVERTISERS

ADVERTISING Ideas that pay. Want ads and display ads placed in out of town newspapers and magazines. Low rates. Catalog free. Baker Advertising Agency, Sucrs. Ankrum Agency, 189 W. Madison, Chicago.

MAILING List, 1,300 fresh names, month old, \$2.00. Weston, Box 521, Seattle, Washington.

18 WORDS In 100 weeklies \$4.32. H. J. Darnell, 730 Hays, Jackson, Tennessee.

ADVERTISING Placed everywhere lowest rates. Reliable guidance on publications, expert assistance on ads without charge. Newspaper, magazine, mailing-list ratebook free. Chicago Advertising Agency, 29-P West Jackson, Chicago 4.

MAILING List, 1,300 fresh names, \$2.00. Weston, Box 521, Seattle, Washington.

MAILING Lists book buyers guaranteed, 350—\$1.00. Sterling Publications, A-71 West 85th, New York.

24 WORDS 30 Newspapers \$2.00. Goodall, 37 Gardner, Vallejo, California.

MAIL Order operators—Get skillfully prepared copy when placing advertising. Our "lowest" line rate plus experience gives you more profits per dollar spent. Van De Mark, Times Star Tower, Cincinnati 2.

ADVERTISE Your business in my papers and magazines. Low prices. Guaranteed large circulation. Dr. G. Anthony, 210 5th Ave., New York.

ADVERTISE; 24 Words, 149 newspapers \$6.50. Lists free. Advertising Bureau, 4515-C Cottage Grove, Chicago 15.

FREE—New Advertisers Rate Guide. 44 pages. Includes everything. Lowest rates. E. H. Brown Advertising Agency, Merchandise Mart, Chicago.

FREE—"Amazing New Book"—"Profits From Classified Advertising." Tells how and what to advertise. Be sure to read this book before you invest one cent in advertising. Remember—it's free! Write for your copy now. F. W. Johnson, Classified Advertising Manager, 200 East Ontario Street, Chicago, Illinois.

ADVERTISING Placed, any publication, lowest rates, complete agency service. Skilled advertising—merchandising counsel. Ratelst and booklet, entitled "Advertising Results For Sale" free. Baker Agency, 3302 Dodge, Omaha, Nebraska.

INCH Display advertisement, 50 magazines, year \$16. Wood's Popular Services, Atlantic City, (N. J.)

TYPEWRITERS, DUPLICATORS, OFFICE DEVICES

DUPLICATE Letters, forms, price lists, menus, 1001 other jobs perfectly on Redigraph. Low priced. All supplies included. Lasts for years. Immediate shipment. Redigraph, 15 E. Third St., Dept. 98, Cincinnati 2.

TYPEWRITERS. Duplicators, etc. Bought and sold. Write DixieGraph, King, N. Car.

PRINT-O-MATIC \$9.50. Handy postal printer \$8.50, used mimeograph \$25. All makes office machines bought and sold. Write Schubert, Box 9818, Los Angeles 77, California.

"PRINTOMATIC" Self-feeding rotary stencil post card printer, complete, \$9.50. All makes duplicator supplies. Literature free. Pittsburgh Typewriter Supply, 336-R Fourth Avenue, Pittsburgh 22, Penna.

RUBBER STAMPS, OFFICE SUPPLIES

3 LINES, Cushioned, indexed, knob handle, 50c. Guaranteed. Ideal, Box 83, Grand River Sta., Detroit 8, Mich.

ONE Line 15c, 2-25c, 3-35c. Stamp Works, Auburn, Nebr.

3 LINES 30c; Cushioned, indexed, 35c. Signatures \$1.50. Stamprite, Wauwatosa, Wis.

PRINTING, MULTIGRAPHING, MIMEOGRAPHING, GUMMED LABELS

1000 Raised Letter Business Cards \$2.50. Mimeographed letters on Hammermill white paper, 250—\$1.50; 500—\$2.50; 1000—\$4.50; postpaid. Aronson & Co., 180 W. Washington, Chicago.

YOUR Name, address on de luxe cushion mount rubber stamp, \$1.00, pad 25c. Name and address neatly printed on 500 gummed stickers 3/4x2" 30c coin (no stamps). Write plain. Edgewood Press, Box A-1, Edgewood, Maryland.

QUALITY Printing moderately priced. What do you need? Prices on anything. Samples, Schweikle, 334 Market Street, South Williamsport 32, Penna.

BEAUTIFUL Personal postals, your name and address, 50-35c, 100-65c. Other sensational personal stationery values. Samples free. D-MCO, 2308N South 9th Avenue, Maywood, Illinois.

4-PAGE 6x9 Book paper folders, Thousand \$11.25. Reporter, Chelsea, Oklahoma.

100 8 1/2x11 LETTERHEADS And 100 6 1/4 envelopes \$1.00 postpaid. Benneville, 907 West Roosevelt, Philadelphia 40, Penna.

\$2.00 POSTPAID: 150 8 1/2x11 Good bond letterheads and 150 6 1/4 envelopes. 500 of each \$5.75 postpaid. Mero Products, Box 344, Punxsutawney, Penna.

100 8 1/2x11 LETTERHEADS, 100 8 1/2x5 1/2 Half letterheads, 200 6 1/4 envelopes, \$2.00 postpaid. Gago Print Shop, P1544, Muskogee, Oklahoma.

DISTINCTIVE Personal stationery. Samples free. Treaster Printing, 8-44PM, Milroy, Pennsylvania.

500 BUSINESS Cards printed \$1.00 postpaid. Arcraft Printers, 97-02 Roosevelt Ave., Corona, N. Y.

OFFSET And letterpress printing. Send specifications or sample for estimate. 4154p Fifth Street, Philadelphia 40.

BEST Printing! Letterhead or envelopes. 200—\$1.25; 500—\$2.50; 1000—\$3.85. Apress, Box 391, Charlotte 1, N. C.

MIMEOGRAPHING—Any copy. Reasonable. Mailers Service, Box 606, Chicago 90, Ill.

ACTION Post cards! 500—\$3.00; 1000—\$4.50, ppd. Bay, 1607 So. Sherman, Bay City, Michigan.

ANYTHING Printed, reasonable. Samples. State requirements. Excelsior Printers, Weatherford, Texas.

100 3-LINE Gummed stickers 10c. E. Gustafson, Pawling, New York.

400 LETTERHEADS Printed \$1.25. Mango, 555 So. 20th, Newark 3, N. J.

MIMEOGRAPHING. Low prices. Write. Power, 923 W. Vine, Kalamazoo, Michigan.

250 8 1/2x11 LETTERHEADS Or 6 1/4 envelopes, \$1.25; both, \$2.25. Lung, Huntertown, Indiana.

25 PRINTED Noteheads and envelopes, 35c postpaid, 100 each, \$1.00. Commodore, 101-D, Forest Park, Illinois.

LETTERHEADS \$3.00 Thousand, note-heads \$2.50 thousand, billheads \$2.50 thousand, envelopes \$3.10 thousand, business cards \$1.80 thousand, two-color gummed name and address labels 25c hundred, other prices equally low. Samples free. Independent Print, 1511 Chicago Street, Omaha, Nebraska.

PERSONAL Stationery, 200 sheets, 100 envelopes \$1.00. Mario Giglio, Dept. 19, 441 Ferry, Pontiac, Michigan.

MIMEOGRAPHING—Letters, pricelists, formulas, instructions. Lowest prices. Lem's Letter Shop, 5710 Stanton, Detroit 8.

100 LETTERHEADS and envelopes \$1.00. Comic cards packet 25c. Dickover Press, 5233 Cleveland, Kansas City 4, Missouri.

500 3x2 1/4 FOUR Line gummed stickers. 25c. Moritz Printery, Saginaw, Mich.

BETTER Grade printing reasonable. Estimates on anything. Economic Press, Leonia, N. J.

PRINTING OUTFITS AND SUPPLIES

PRESSES, Type, 25c lb. Supplies, paper, bargain list 3c. Box 918, New York 8.

INEXPENSIVE Home-made printing press. Details free. Novelty Shop, Downsville, Louisiana.

PRINTING Equipment, type and supplies. Send stamp for details or dime for complete illustrated supply book. Kelsey Inc., X-11, Meriden, Conn.

PRINT At home. 10c will bring a complete catalog of presses, type and supplies. P. Peiffer & Company, 6 Columbia St., Newark, N. J.

USED Presses, type, supplies. Lists 3c. Turnbaugh Service, Loysville, Penna.

PATENT ATTORNEYS

INVENTORS—First things come first. Your first move toward securing a patent on your invention is acquiring full information on what to do. Our two books "Patent Protection" and "When and How to Sell Your Invention" contain this information and other helpful data. Get them immediately, together with our "Evidence of Invention" form. They cost you nothing, you assume no obligation. Write now to Victor J. Evans & Co., Registered Patent Attorneys, 831-J Merlin Building, Washington 6, D. C.

"INVENTOR'S Guide", 100 mechanical movements, free; advises on patenting, selling inventions. Frank W. Ledermann, 154 Nassau Street, New York.

PATENTS. Promptness assured. Wilfred E. Lawson, 1524 K Street, N.W., Washington 5, D. C.

INVENTORS—Before disclosing your invention to anyone send for form "Evidence of Conception"; "Schedule of Government and Attorneys' Fees" and instructions. Sent free. Lancaster, Allwine & Rommel, 411 Bowen Building, Washington 5, D. C.

INVENTORS: Learn now—without obligation—how to protect and sell your invention. Write for free "Record of Invention" form and complete instructions for making disclosure and establishing date of your invention. We also send our new free "Patent Guide for the Inventor," containing complete information about patent procedure and how to sell inventions; giving illustrations of many successful inventions; over 150 basic mechanical movements. We assure you prompt, confidential service. Delays may be dangerous. Write today for your free "Patent Guide" and "Record of Invention" form. Clarence A. O'Brien & Harvey Jacobson, Registered Patent Attorneys, 41B-H Adams Building, Washington, D. C.

C. A. SNOW & Co., M-427 Snow Bldg., Washington 1, D. C. Registered patent attorneys. Established 1875. Literature mailed on request.

PATENTS Obtained; selling service, information, recording forms free. Labiner, World Building, New York.

L. F. RANDOLPH, 302-B Columbian Bldg., Washington, D. C. Low cost. Book and information free.

PATENTS. Protect your idea by securing free "Proof of Invention" folder. Exceptional personal service. Established 1906. E. E. Vrooman, 871 Woodard Bldg., Washington, D. C.

PATENTS—Trade marks. Preliminary advice, book and disclosure form free. Personal service. Irving L. McCathran, 315 McLachlen Bldg., Washington 1, D. C. Registered Patent Attorney.

SELL Your patent through a small classified ad in Popular Mechanics. Many inventors have found buyers in this way. Ask me for proof—I'll gladly send it to you. P. W. Johnson, Manager Classified Advertising, 200 E. Ontario St., Chicago.

FOR INVENTORS

INVENTORS: Learn now—without obligation—how to protect and sell your invention. Write for free "Record of Invention" form and complete instructions for making disclosure and establishing date of your invention. We also send our new free "Patent Guide for the Inventor," containing complete information about patent procedure and how to sell inventions; giving illustrations of many successful inventions; over 150 basic mechanical movements. We assure you prompt, confidential service. Delays may be dangerous. Write today for your free "Patent Guide" and "Record of Invention" form. Clarence A. O'Brien & Harvey Jacobson, Registered Patent Attorneys, 41A-H Adams Building, Washington, D. C.

INVENTORS. Industry needs your ideas now! Two reasons—1. Manufacturers are getting ready now for post war sales and production. 2. Right now, manufacturers are seeking products their expanded facilities can handle; factories must have products to take up the slack after war orders stop. Your chance comes with patent protection now—delay may endanger your chance. Get our new free Inventor's Book today and valuable "Invention Record" form. This request does not obligate you. Act now. Write today. McMorro & Berman, Patent Attorneys, 1349 Albee Bldg., Washington 5, D. C.

PATENT Your idea! Write immediately for two free illustrated books, "Patent Protection" and "When and How to Sell an Invention," 64 pages of valuable information for inventors. No obligation. Address: Victor J. Evans & Co., 832-J Merlin Bldg., Washington 6, D. C.

WHAT Should you invent? Our free book tells you what today's inventive market wants—how to put down, patent and sell your ideas. Scores of letters in our files attest to the modern demand for inventions—our long experience as Registered Patent Attorneys will help you. Get our free book, "How to Protect, Finance and Sell Your Invention." Also special document free, "Invention Record" on which to sketch and describe your invention. Write today. No obligation. McMorro & Berman, Patent Attorneys, 1349 Albee Building, Washington, D. C.

MANUFACTURER'S Names, addresses. State classification desired. Tupper, 18-A Lyman, Beverly, Mass.

INVENTORS: New military and commercial inventions urgently needed by manufacturers. Write for particulars. Chartered Institute, Dept. 4-A, Washington, D. C.

INVENTORS. Learn how we sell your invention. Free booklet, "Selling Your Invention" tells all about it. Inventors Exchange, 635 Main, Hartford, Conn.

CASH For practical ideas and inventions. Mr. Ball, AB-9441 Pleasant, Chicago.

I SELL Patents. Established in 1900. Charles A. Scott, 773PM Garson Ave., Rochester, N. Y.

INVENTIONS WANTED

WANTED—Patented or unpatented ideas for postwar manufacture. Submit plans and proposition. Sierra Mfg. Co., 610 So. Arroyo Pky., Pasadena 2, Calif.

MANUFACTURER Wants sensible mechanical device or idea with quick sales possibilities in low-priced field. Write Matt, 1412-D Great Northern Building, Chicago 4.

POPULAR Wooden farm item. Simple manufacture. Box 511, Aurora, Illinois.

INVENTIONS Wanted—Extensive sales service. Seymour, 218 Aurora, Easton, Md.

CASH For postwar product ideas, patented or unpatented, urgently needed. Write Industrial Engineering, 1155 South Kenmore, Los Angeles, California.

INVENTORS—Reach purchasing manufacturers direct; patented, unpatented inventions. Booklet, references, free. Invention Reporter, 5B-11236 So. Fairfield, Chicago.

CASH For inventions, patented, unpatented. Mr. Ball, A-9441 Pleasant, Chicago.

ALL Kinds. We have facilities and finances to make and sell your ideas, both mechanical and chemical. Send model, sample, details and wishes. General Sales & Supply Company, 110 East Main St., Madison 3, Wisconsin.

INVENTORS! Have you good, patentable ideas? Write—Mr. Metzler, 11 West 42nd, New York.

INVENTORS: Have you a sound, practical invention for sale, patented or unpatented? If so, write Chartered Institute of American Inventors, Dept. 4-D, Washington, D. C.

PATENTS FOR SALE

IMPROVED End adjustable wrench with locking device. Tested, very efficient, durable and simple. Fred P. Richardson, Kikikitat, Wash.

REASONABLE, Patented 1943, new improved ash tray. Inventor William Powers, 26367 Annapolis Road, Dearborn, Michigan.

I HAVE Several excellent inventions for postwar production. Royalty basis. Inventor, Box 334, Hudson, New York.

POSTWAR Priming will pay us! Investigate. Plastic compounds dispenser delivers uniformly, continuously. T. Pasanen, Franklin Mine, Mich.

SALES Proven wood novelty has been sold to large department and chain stores. M. Jarnagin, 14924 Aubrey, Detroit 23, Mich.

PATENTED Well sprung ball bearing hopper sports shoe, potential craze. Westmaas, Kitty, British Guiana.

MANUFACTURING

MODELS—Small lot manufacturing. Metals, plastics, etc. Milburn, Burlington, Kentucky.

MODELS AND MODEL SUPPLIES

PLANES, Boats, hundreds of hobby items. Catalog 6c. America's Hobby Center, Dept. B84, 40 E. 21 St., New York 10, N. Y.

SHIP Models and yacht supplies complete. Large 64 page catalogue 20c. Bill Wild's, 510 East 11 St., New York City.

SHIP Model kits and fittings. Complete line Fisher model yacht equipment. All Boucher, Fisher, Marine Model and Ideal kits, fittings and blueprints at standard prices. Most complete stock in New England. James Bliss & Co., Inc., 220 State Street, Boston, Massachusetts.

HOME CRAFTSMEN

CELLULOID—Beautiful assortment. Motives, opaques, onyx, pearls. Used by ring makers everywhere. One pound assortment—pieces approximately 30 sq. in. each. Price \$1.00. Craft Service, 337 University Ave., Rochester, N. Y.

JEWELRY—Novelties made from shells. Lamps from novelties. Instructions with orders. Dixie Sales, Sebring, Fla.

WHITTLES—Softwood subjects, 10 patterns, instructions, 25c. Cartoon Studios, 1402 Charles, LaCrosse, Wis.

DESIGN Smart leather ornaments. 7 piece leather kit, 18 patterns, \$1.00. Beginners kit, 25c. Vogue Leathers, Box 6, Fairfield 3, Iowa.

ELECTRIC Cannon, toy. No explosives. 110 volts. Build from scrap. Drawings, instructions, photograph 50c. Details, photograph 10c. Hamilton, 850-A South 20th Street, Newark 3, New Jersey.

28 LAWN Ornament patterns 25c. Other patterns; 15"-20" high; Dutch girl; Dutch boy, pirate, bull terrier, Mexican girl, Mexican boy, dwarf, penguin, flower girl, 10c each; 3 for 25c. 25 novelty patterns 30c. All 62 full size patterns \$1.00 postpaid. Strother, Box 383-FU, Belington, W. Va.

GUARANTEED Precision pantographs, \$2.00 postpaid. Enlarges drawings automatically. Eliminates squares. Details dime. Pantographs, Munising, Mich.

PLYWOOD—Beautiful non-priority aircraft stock. Thicknesses 1/32" through 1/4"; large, small panels. Fir, gum, birch, mahogany, walnut. Reasonable! Lists free! C. Bronson, 160 East 4th St., Mount Vernon, N. Y.

MAKE IT YOURSELF

FLUORESCENT Lights. How to make your own 20 watt lights for less than \$1.00 each. Complete, guaranteed, detailed instructions \$1.00 M.O. or war stamp. Specialty Sales, Box 1086, Muncie, Ind.

SPEED Victory—Build own dehydrator. Plans information, 25c coin. Christensen, Box 1346, Salt Lake City 11.

MAKE Your own fruit and vegetable dryer. Simple illustrated plans, complete with guaranteed electric heating unit \$1.00 prepaid. Limited supply available. Alf Equipment Company, Kent, Wash.

WATCHES, OLD GOLD, JEWELRY, ETC.

MEXICAN Curios; beautiful hand made lapel pin, three fifty. Bracelet, ten dollars, money order. Includes wholesale prices. Marin Aguilar, San Juan Letran 123, Mexico City.

ALARM Clocks—Easily repaired at home with our instructions—50c. Thies Jewelry, Genoa, Illinois.

WANTED: Watches, diamonds, jewelry. Highest prices guaranteed! Justice, Box 150, Chicago 90.

WATCH And clock repairing—complete practical course in modern horology. 66 illustrated self-instruction lessons. Just out! Low price. Information free. Write—Nelson Company, Dept. 8-02-2, Chicago 4.

OPALS. Sample packet \$5.00. Catalogue free. Norman Seward, Melbourne, Australia.

WATCHES. Materials, tools, jewelry, diamonds—bought—solid. Catalogue. Gales, Box 1000, Chicago.

TOBACCO, SMOKERS' SUPPLIES

BARGAIN Barrel smoking tobacco. Blended from \$5, \$4 and \$3 mixtures. Only \$1.75 per pound. Send for free catalog trial offer. Sidney Ram, 59 West Monroe, K-64, Chicago 3, Illinois.

FREE To pipe smokers—For a new pipe smoking thrill, write us your brand of tobacco and get free package mild, tasty, natural-flavored "Green River." Pete Moberly, Box 967, Owensboro, Kentucky.

CIGARS—Trial box 50, \$4.00. Hand made clear Havana, \$5.25 and \$6.00. Add 25c mailing. Zibar, Roselle, New Jersey.

50 LONG Filler cigars \$5.40. George Bacalles, Corning, N. Y.

LORD Carlton English smoking mixture. 1/2 pound, \$1.50. You'll like it. Independent Cigar Stores, Montreal, Canada.

RAZORS, BLADES, SHARPENING

100 DOUBLE-EDGE Blue surgical steel razor blades \$1.50 prepaid. Fully guaranteed. St. Moritz Blade Co., 321 Broadway, Dept. G, New York 7.

AGENTS—Patented "Slant-Stroke" razor and 10 "All American" blades in attractive box. \$3.00 dozen. American Sales, 1133 Broadway, New York City.

SURVEYING INSTRUMENTS

GUARANTEED Factory rebuilt transits and levels for sale (cash or terms) or rent (with purchase option). We will repair, trade, or buy old instruments. Ship prepaid for estimate and valuation. For complete information, write for list M910. Warren-Knight Co., (Manufacturers of Transits and Levels), 136 N. 12th St., Philadelphia 7, Penna.

FOR SALE—MISCELLANEOUS

LIVE Bull frogs, worms, crawfish, snakes. Bob Pace, Combs, Ark.

REPAINTED Golf balls. 4 for \$1.00. J. Oncher, 2 Trinity, Amsterdam, N. Y.

WANTED—MISCELLANEOUS

WANT Camera Lucida such as used by artist. Marston Woodbury, 861-20th Ave. N. St. Petersburg, Florida.

USED Safes and filing cabinets wanted immediately. \$2.00 bonus paid for leads, anywhere, anytime. Empire State Safe Company, 220 P Centre Street, New York 13, N. Y.

CAST Iron products wanted. Have facilities for making castings, light machine work and assembling. Cimpro, Grafton, Wis.

WE Buy "anything"! Highest prices guaranteed! Justice, Box 150, Chicago 90.

1000 ALARM Clocks wanted. Any kind or condition. Highest prices paid for old watches. Alarm Clock Repair Service, P.O. Box 1983, Dept. M, Houston, Texas.

GOT Anything to sell or trade? We have the buyers and swappers. List 20c. Swappers Guide, 610 St. Joseph, Evansville, Indiana.

WANTED—Party to help develop valuable inventions, best references given and required. Summerville, 6810 F, Seat Pleasant, Md.

SWAP Buy, sell items wanted for western trading post. Your ad sent all over U.S.A.—free! Write today. Send no money. 1355 Cedar Ave., San Bernardino, California.

MERCURY (Quicksilver)—Cadmium, bismuth, tungsten, molybdenum, cobalt, vanadium. Write for quotations stating quantity. You'll receive guaranteed prices. Metallurgical Products Co., 35th and Moore Sts., Philadelphia, Penna. Established 1909.

DOBE Drafting course used, state condition and price. Dewar, 630 Elizabeth, Dearborn, Michigan.

WHAT Have you to sell? Livewire salesman with Chicago office calling on department, hardware and furniture stores in several mid-western states. Write Consolidated, 1943 N. California, Chicago.

WATCHES Wanted—Broken or usable—all kinds, even Ingersolls. Highest prices paid for jewelry, rings, spectacles, alarm clocks, razors, cigarette lighters, gold teeth, etc. Cash mailed promptly. Lowe's, Holland Bldg., St. Louis 1, Mo.

PERSONAL

POST Card brings information. Wonderful photographic novelty. Inexpensive! Majestic Sales, Box 242, Kansas City 17, Kansas.

BIRTH Certificates. Any state, five dollars. Universal Personal Record Service, 703 So. Alameda, Corpus Christi, Texas.

MENTAL Baffling 52 cards face down instantly display card chosen. \$1.00. Scientific fortune telling, 150 pages, 50 illustrations \$1.00. Waterman, 601 Laurel, San Mateo, California.

DISCOVER Your best abilities through scientific aptitude tests. Information 10c. Testing Service, 202-M Commercial Building, Rockford, Ill.

RECORDS: Birth, adoption, marriage, death, estate. Belated birth registration assistance. Persons located. Chaffee, 308 Washington, Chicago 6.

DANIEL M. Williamson—Everything straight. Please write now, return September school. Family.

IF It's wealth you desire, send postcard for details. Max Haberman, P.O. Box 1642-C Perry Sq. Sta., Erie, Penna.

TATTOOING Outfits, designs, colors. Write today. Zeis Studio, 728 Lesley, Rockford, Illinois.

PSORIASIS Sufferers: Pixacol has brought relief when everything else failed. Use only as directed. Apply externally, dries quickly, convenient. Try regular \$1 bottle without investing a cent! Write: Pixacol, Box 3583, Cleveland, Ohio.

HOW To get what you want. Psychology method. Unfailing book. \$1.00. Book-lovers Publishing Co., 28 Cassius Street, New Haven, Conn.

RUPTURED?—Improved appliance holds up—in. Free trial. Earles Company, Flint, Michigan.

ECZEMA Sufferers, "Sirsolve" has brought relief when everything else has failed. Try it and see. 2 ounces \$1.30 postpaid. Address—Leonard Laboratories, Olden, Texas, Box 7.

PSORIASIS. Dry eczema! Rush name for amazing facts. Special no risk offer. Carter-Howell Laboratory, 457 Schenectady Avenue, Dept. L-3, Brooklyn 3, N. Y.

GIRL Photos, beautiful models, only \$1.00 for group. "Little Eve," Box 211, Terre Haute, Indiana.

HANDWRITING Analyzed. Complete analysis of personality, character of writer. Amazing. 50c. Analax, 2407 So. La Brea, Los Angeles 16, Calif.

PENMANSHIP Corrector—Corrects your penmanship—few hours. Write, Ozment, 9, St. Louis, Mo.

BUY Vitamins direct. Save. Postcard. Matoska Products, White Bear Lake, Minn.

MISFIT In your job? We can help you. Information. Occupational Advisory Service, Box 1154A, Paterson, N. J.

MEXICAN Legal matters reliably handled. A. Munoz, 240, Juarez, Mexico.

HAIR Falling? Dandruff? Write Trichologist, 137 Lewis St., Phillipsburg, N. J.

LIVE Longer, feel better, enjoy life. Free information, Fairchild Company, Mt. Vernon, Ohio.

DRUNKENNESS Is a disease which responds to treatment. Medical skill plus human sympathy prove successful with liquor and drug cases. 60 years experience. Write for free booklet. P. M. Nelson. The Keeley Institute, Dwight, Ill.

MISCELLANEOUS

INK—Make it yourself. Simply dissolve powder in water. Quart package 50c. Blue black, royal blue, washable blue, red, purple or green. Mention color when ordering. Eagle Ink Company, 66-18 99th Street, Forest Hills, New York.

ROACH Proof. Use "Permancure." The easy way. Non-poison. \$5.00. Satisfaction guaranteed. Old Colony Wax, Davenport, Iowa.

COLLECT Old accounts. My system works. Details free. Wright Service, Imler, Penna.

DON'T Wait until the rush begins! Plan now. Build your own home yourself and save 1/3 to 1/2. Let us tell you how. Write today! No obligation. Address: William H. Jackson, A.B., 1713 Howard Street, Port Huron, Michigan.

GUATEMALAN Carved mahogany plates. Beautiful handloomed Mexican tablecloths. Details free. Frances T. Coleman, Anthony, New Mexico.

BIG Mail for you. Latest moneymaking offers, opportunities, catalogs, magazines. Name listed in directory 10c. Ideal Service, 108-M, Park Ridge, Ill.

YOUR Photos copied; coloroidal. J. Black, 1249 S. Grand, Los Angeles.

NOW You can make your own Plasto-plate printing cuts. Simple, easy process. Adaservice, Argyle, Wisconsin.

YOUR House number neatly made. Only 35 cents p.p. Brandt Supply, 2310 22 Ave., So. Minneapolis, Minn.

WALLPAPER Removing simplified with garden hose attachment, 50c. Mystic Manufacturing Co., 255 McCormick Place, Cincinnati, Ohio.

ALASKA Scenes in Kodachrome slides. 75c each. Free list. Alaska Film Company, Box 81, Ketchikan, Alaska.

MONTREAL Business man will act as Canadian representative. Well organized office. Competent staff. Bank references. Would be interested in buying photo-stamp and phoning outfit. Trotter, 1658 E. Mount Royal, Montreal, Canada.

CALENDAR—248 Year. (1752-2000). Easily understood. 25c coin. Invaluable to students. Christensen, Box 1346, Salt Lake City 11, Utah.

DETAILED Instruction on birth certificates, citizenship, naturalization. Write for information. Civic Letter Service, 936 So. Alvarado, Los Angeles 6, Calif.

GIANT U. S. flags—8x12 ft., sewed stars and stripes. Beautiful, guaranteed. Postpaid \$10.00. Byrnes Flag Supplies, Robinson 20, Ill.

WORK Any cross-word puzzle. Amazing short-cuts. Specially prepared book. Send 50 cents. Pascoe Products, 4814 Brady, Houston, Texas.

FUNNY Cartoon drawn to your idea. \$1.00 postpaid. Verret, Raceland, La.

RECEIVE Mails, magazines, samples. Your name in numerous mailing lists 10c. Howard, 396 Broadway, New York.

108 LETTERLAFPS 25c. Artists 82-29 60th Road, Elmhurst, N. Y.

COMPLETE Character analysis, based on the Bible \$1.00. Holice Britt White, Ph.D., 1445 San Felipe Crts., Houston, Texas.

SUPERMAIL And sample "Traveling Salesman"—10c. Diehl Boundary, York, Pennsylvania.

BOYS—Girls, write for free gift. David Berg, 659 Churchhill, Bridgeport 29, Conn.

MEXICAN Jumping beans. Dozen 25c, hundred \$1.00. Mexicanproducts Co., 126 N. Main, Tulsa 3, Oklahoma.

SKUNKADORA—Destroys skunk odors instantly. Simply amazes everybody. New discovery that's sold on moneyback guarantee. No competition. Sells fast—pays tremendous profit. Write immediately. Sparhawk Laboratory, Sparkill, N. Y.

GET Humorous Alaska license to hunt Japs. Send 25c. A remarkable novelty. Alaska Sportsman, Ketchikan, Alaska.

GOOD "Used" self-instruction educational books on all subjects bought, sold, rented, exchanged. Satisfaction guaranteed. Complete information and 92-page illustrated bargain catalog free. Write—Nelson Company, Dept. 2-02-3, Chicago 4.

KILL Roaches, bedbugs, moths instantly guaranteed. makes one gallon, \$1.00. Pamat's, 227 Woodbine, Brooklyn 21, N. Y.

HAVE Fun. Tell anyone's age and amount of loose change in his pocket. Complete instructions 10c. Carl Bohman, Saratoga Springs, N. Y.

ATTENTION To manufacturers: New inventions. Models can be obtained with every invention. Steach, 423 Sprague St., Dedham, Mass.

FREE Descriptive list rare, unusual, exciting books. Not sold in stores. Gard Sales Co., Box 46, Arlington, Virginia.

TRICK Chalk stunts. Catalog 10c. Balda The Cartoonist, Oshkosh, Wis.

THE Lord is coming! Get guaranteed proofs free. Scheall, 263-X, Duluth, Minnesota.

MEDICAL Laboratory technicians in great demand. We train you in your spare time, in your own home. You can practice while studying. Write for free catalogue. Imperial Technical Institute, Box 973-J, Austin, Texas.

It's Fun to Draw

A COMPLETE SELF-INSTRUCTION COURSE AND REFERENCE BOOK
with over 1000 "How-to-do-it" SKETCHES AND DRAWINGS
9 Sections—a \$9 Value All for only \$1.00



ANYONE WHO HAS LEARNED TO WRITE

can learn to draw! This helpful book removes the mysticism that has surrounded art. By reducing the elements of drawing to its simple steps, it teaches THE BEGINNER to draw, and then to advance into more difficult subjects.

The illustrations show the 9 BRANCHES OF PRACTICAL ART which this book covers. No previous knowledge on your part is expected. Within a few days you will be drawing with an ease and enjoyment you never thought possible. For the professional artist, it is a REFERENCE BOOK and veritable mine of information.

This book guides you from the first stroke on paper to selling the finished art. Includes specific instruction on: Still Life, Anatomy, Human Figure, Faces, Portraits, Cartooning, Advertising, Lettering, Commercial Art, Illustrations, etc. Teaches you to draw: hands, feet, heads, bodies, ears, noses, mouths, eyes;—how to express: laughter, anger, terror, grief, etc.;—how to attain: balance, composition, symmetry, shading, action, movement. Also how to letter with 37 COMPLETE ALPHABETS. And how to draw cartoons, caricatures and comic drawings. Includes glossary, etc.

To make it generally available, we have set the special price of \$1. If not delighted, money back. Merely mail the coupon.

MAIL COUPON

KNICKERBOCKER PUB. CO.

Dept. D-702, 120 Greenwich St., New York 6, N. Y.

Rush me a copy of "It's Fun to Draw." If it hasn't opened up new paths of fun and artistic ability for me, I may return it and it won't cost me a single penny.

I enclose \$1.00 in full payment.
 Send C.O.D. I'll pay postman \$1.00 plus 3% C.O.D., postage and money order fees.

Name
Address
City State

Merely mail the coupon below. When your copy of "It's Fun to Draw" arrives—read and test it for 3 days. If, after this examination, it hasn't opened up new paths of fun and artistic ability for you—return it, and it won't cost you a single penny. If you decide to keep it, the FULL PRICE is only \$1.00.

You take absolutely no risk—so mail coupon NOW!

EXAMINE IT FREE!

★ REFRIGERATION

AT YOUR FINGER TIPS with Drake's NEW Manual

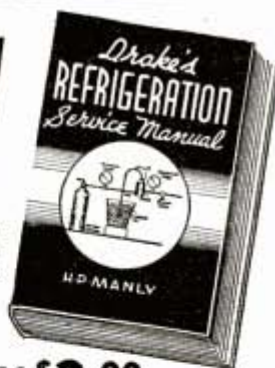

By means of Drake's brand new REFRIGERATION SERVICE MANUAL you can get yourself a better job . . . earn more money. The latest developments in household and small commercial refrigeration become as simple as A B C when you study this remarkable book.

Written by leading authorities, and covering every problem in simple, easily understood language, this newest addition to Drake's Technical Library contains over 300 pages and 138 diagrams and illustrations. Included are the following:

- Installations
- Adjustment
- Testing
- Replacement
- Trouble Shooting
- Repair

The work covers practically every operation in field service, as performed where the equipment is installed, and also the shop operations which may be required. It includes domestic types of refrigeration, and fully and completely the commercial types in small and medium sizes, such as used in markets, milk depots, soda fountains, flower shops, etc., as well as in many air conditioning systems.

Use the coupon for your copy . . . today. Send only \$2.00. If you are not satisfied that this book is the answer to your expectations, return the book within 5 days, and your money will immediately be refunded.

OTHER IMPORTANT DRAKE BOOKS

1. Practical Electricity and House-Wiring: 200 pages, 227 illustrations \$1.50
2. Carpentry Craft Problems: 302 pages, 700 illustrations . . . \$2.00
3. Plumbing Installation and Repair: 236 pages, 153 illustrations . . . \$1.50
4. Cyclopaedia of Radio and Electronics: 1,000 pages, 1,178 illustrations, 130 tables, 150 graphs \$5.00
5. The Slide Rule and Logarithmic Tables: 200 pages, illustrated . . \$1.50
6. Spray Painting, Industrial and Commercial: 125 illustrated pages \$1.50

ONLY \$2.00

DRAKE BOOKS SOLD BY ALL LEADING BOOKSELLERS

FRED'K J. DRAKE & CO., 600 W. Van Buren St., Dept. PM-8, Chicago 7, Ill.

USE THIS COUPON FOR YOUR ORDER

FRED'K J. DRAKE & CO., 600 W. Van Buren St., Dept. PM-8, Chicago 7, Ill.

O.K. Send me postpaid the Drake books I've checked. Remittance enclosed. I understand that if the books are not entirely satisfactory, I may return them within 5 days and my money will be refunded.

Refrigeration Service Manual
1 2 3 4 5 6

Name

Address

City and State

Check here if you want our FREE illustrated catalog.

"I'll show YOU how to make yourself COMMANDO-TOUGH

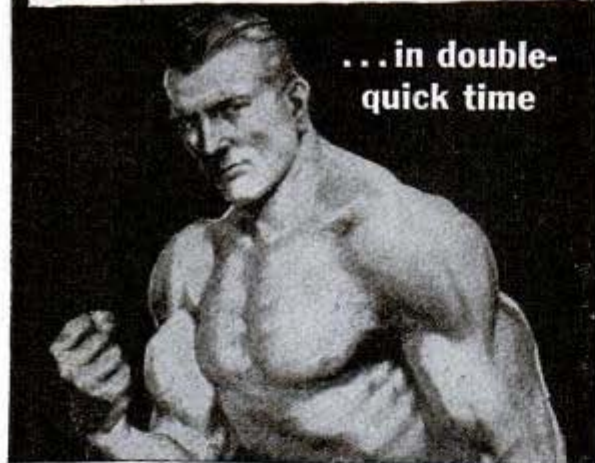

...in double-quick time

...OR IT WON'T COST YOU A CENT!"

says *George F. Jowett*

WORLD'S GREATEST BODY BUILDER

Let me prove to YOU that you can put inches of dynamic muscles on your arms! Add inches to your chest! Broaden your shoulders and power-pack the rest of your body. I can do for you what I've done for thousands the world over, including many officers and men now in the U.S. and British Armed Forces!

GIVE ME 10 MINUTES A DAY!

I'll Show You My Secrets Of Body Building

I'll help you learn the "Progressive Power Method" through which I rebuilt myself from a physical wreck to the holder of more strength records than any other living athlete or teacher! No matter how skinny or flabby you are, you can learn my methods right in your own home. Through my proved secrets I show you how to develop your power, inside and out, until YOU are fully satisfied that you are the man you want to be. "The Jowett System," says R. F. Kelly, Physical Director of the YMCA, Atlantic City, "is the greatest in the world!"

If you want a physique that will inspire respect from men, and admiration from women... ACT LIKE A HE-MAN! Decide at once! The famous book, "Nerves of Steel—Muscles Like Iron" will be included FREE! Priceless for the strength fan! Full of photos of marvelous power-bodied men who will show you what Jowett has done for them and how he can do the same for you. Reach out... Grasp this Special Offer today!

Jowett Institute of Physical Culture
230 Fifth Avenue
Dept. 478
New York 1, N.Y.

PROVE TO YOURSELF IN ONE NIGHT!

Send only 25c for test Course, "Molding a Mighty Arm." Read it the evening it arrives—learn from experience the thrill you can give your muscles!

SEND FOR THESE FIVE FAMOUS COURSES IN BOOK FORM

ONLY 25c EACH
or ALL 5 for \$1.00

This
Book
Free!



BOOK WITH PHOTOS OF FAMOUS STRONG MEN
MAIL COUPON NOW

FREE



Jowett Institute of Physical Culture
230 Fifth Avenue, Dept. 478, New York 1, N.Y.

George F. Jowett: Your proposition looks good to me. Send by return mail, prepaid, the courses checked below, for which I enclose (). Include FREE book of PHOTOS.

George F. Jowett
Champion of
Champions

- | | |
|--|---|
| <input type="checkbox"/> All 5 courses for... \$1 | <input type="checkbox"/> Molding Mighty Legs 25c |
| <input type="checkbox"/> Molding a Mighty Arm 25c | <input type="checkbox"/> Molding a Mighty Grip 25c |
| <input type="checkbox"/> Molding a Mighty Back 25c | <input type="checkbox"/> Molding a Mighty Chest 25c |
| <input type="checkbox"/> Send all 5 C.O.D. (\$1 plus postage.) No orders less than \$1 sent C.O.D. | |

NAME Age

(Print name)

ADDRESS

● THIS AD IS ADDRESSED TO YOU!

That idea of yours may mean your fortune; don't pass it up! That new automotive or aircraft tool or equipment may be just what the post-war era wants. Your idea may need development; perhaps it's ready for patenting or manufacture. It makes no difference to this nationally-known organization with ample engineering, production, financial, sales and distribution facilities looking for ideas for manufacture and sale in the post-war era. If patent on your idea hasn't been applied for, have it witnessed and then write us about it completely or with a minimum of detail, as you please. But whatever you do, DO SOMETHING about that idea! Write in confidence NOW to

P. O. BOX 217 STA. C TOLEDO, OHIO

Correspondence Courses in
RADIO and ELECTRICAL ENGINEERING

LOW AS
\$25



ELECTRICAL ENGINEERING. Get good grasp of wide electrical field. Modern. Very understandable. Theory made easy.
RADIO ENGINEERING. Extra fine course in radio, public address, photo-electric work. Trains you to be super-service man, reel vacuum tube technician. Tuition ONLY \$25, either course. Deferred payment plan. Servicemen needed badly.
Write for free copies of school catalogs, student magazines, etc.

FREE LINCOLN ENGINEERING SCHOOL, Box 61—P 68
LINCOLN, NEBR. (Formerly of Washington, D. C.)

Learn this Profitable Profession



IN 90 DAYS
AT HOME

Money-Making Career Open to Men and Women, 18 to 50

Hundreds of men and women between 18 and 50 make \$10 to \$20 in a single day giving scientific Swedish Massage and Hydro-Therapy treatments. There is big demand from doctors, hospitals, sanatoriums and clubs. Graduates earn large full time incomes from these or in private practice in their own offices. Others make good money from home treatments given in spare time. Learn this interesting, money-making profession in your own home, through our home study course. Same instructors as in our nationally known resident school. You can win independence and prepare for future security by qualifying for your Diploma. Course can be completed in 3 to 4 months. Many earn while they learn. Begin your training at once.



Anatomy Charts & Booklet FREE

Enroll now and we will include, at no extra cost, many needed supplies. Fit yourself to help meet growing demand for massage now and after the war. Send the coupon at once for complete details, Anatomy Charts and 32-Page Illustrated Booklet, FREE, postpaid.

THE COLLEGE OF SWEDISH MASSAGE
Dept. C64, 100 East Ohio St., Chicago 11, Illinois

Please send me FREE and postpaid, Anatomy Charts, 32-page Booklet and complete details on Home Training.

Name.....

Address.....

City..... State.....

AMAZE
your friends



with
MAGIC
10 TRICKS

Full
EQUIPMENT for



**10 HAIR-RAISING
TRICKS**

A \$5.00 VALUE
NOW ONLY \$2
POST PAID



MYSTIFY friends! Gain popularity! It's easy with this Magic outfit. Furnished with all the secret equipment and instructions. Your friends will gasp with astonishment when you make things disappear and reappear. The tricks we send you are similar to those used by many professional magicians.

FREE Book of Magic

With your order. Contains \$1,000 worth of magical secrets—102 startling tricks. All yours if you order now!

How to Order

Send name and address with \$2.00 money order or cash. (Foreign \$2.50). No C.O.D.'s. Immediate shipment guaranteed.

A Splendid Gift for Servicemen

D. ROBBINS & CO., Dept. P-8
152 West 42nd St., New York 18, N. Y.



**YOU GET
EQUIPMENT
FOR THESE
10 TRICKS**

1. **MAGIC FRAME**
—card selected by a spectator is instantly made to appear in the Magic Frame.
2. **CHAN'S LAUNDRY TICKET**
—a strip of paper with Chinese characters is torn into small pieces, then restored!
3. **YOGI BEADS**
—string of beads mysteriously removed by magician.
4. **MAGIC RULER**
—an amazing solid thru solid effect!
5. **E-Z MONEY VANISHER**
—coins, bills, small articles appear or disappear.
6. **FOOLED AGAIN**
—a comedy card trick that fools all!
7. **RED DEVILS**
—dice astonishingly appear after vanishing.
8. **MYSTIC YAGS**
—a new trick that fools even the wisest ones!
9. **MAGIC RATTLE BARS**
—mix and challenge - no one but you can do it.
10. **AGAINST GRAVITY!**
—glasses stick to board upside down!

So-Lo SAVES RUBBER

AND MOST ANYTHING MADE OF LEATHER AND CLOTH

- Spreads Like Butter
- Dries Hard Overnight
- Flexible—Non-Skid
- Waterproof—Won't Come Off

Longer Life for TIRES



Easy to fix cuts, bruises, worn spots in tires at home. Keeps out grit and water. Add hundreds of miles wear to your tires with SO-LO.

Re-Sole Your Own SHOES



Easy—at home. Spread on So-Lo like butter. Wears like leather. Use it for all footwear, children's and grownups'. Also use So-Lo for raincoats, boots, etc. Guaranteed to SAVE!

1,001 Repairs in the Home; Auto, Farm, Factory and Shop



Mend It with So-Lo
FOR ONLY **1¢** EACH



So-Lo AT ANY HARDWARE AND 10c STORE

I'll Train You IN DRAFTING

until you have a **GOOD PAY JOB**



All working tools FURNISHED

Professional drawing instruments, all working tools, also drawing table furnished with training. Start in right now.



With industry working feverishly—the field for Draftsmen is bigger than ever. More important—draftsmen and designers must come first in changing back to peace-time production. Get into a better job with more pay and fascinating, pleasant work. Engineer Dobe will train you at home—in your spare time, to get experience on actual work, the same kind of jobs you will do in the best paid position, and train you until you are competent, experienced, holding such a position that will mean advancement and pay raises as deserved. When competent will recommend your practical work experience as references. No need for previous training to start with me—and lack of higher education should not hold you back. You can pay monthly for your practical training from an engineer; the cost is reasonable. Write today for full illustrated details and booklet. Give your age to get reply.

GET THE FACTS NOW!

ENGINEER DOBE, Div. C-337, Libertyville, Ill.
Please send me training facts on "Drafting and Industrial Designing". Also advertised list of positions for Draftsmen and Designers Wanted.

Name Age.....
Address
Town State.....



Know Electricity as Experts Know It—and Get an Expert's Pay!

What about your future? Who is safe today? Surely not the man who is contented to stand still! Know your job thoroughly—prepare yourself for jobs ahead. To do just this thousands of men have used

The Croft Library of Practical Electricity

The Croft Library is a complete electrical educator. It is founded on practice—on 20 years of shirt-sleeve experience—on work as it is actually done. It is jammed from cover to cover with the kind of hard-headed facts you want. Written so that the beginner can easily understand it, yet so sound and thorough, that it is the daily guide of 50,000 highly paid electrical workers and engineers. Croft tells you the things you need to know about motors, generators, armatures, commutators, transformers, circuits, switchboards, distribution systems—electrical machinery of every type—wiring for light and power—wiring of subbed buildings—underwriters and municipal requirements—illumination in its every phase—the most improved methods of lighting—lamps and lamp effects, etc.—how to do a complete job, from planning it, to completion.

No money down—easy payments

Fill in and mail the coupon attached and we will send you the entire set of seven volumes for ten days' examination on approval. We take all the risk—you assume no obligation. If you decide to keep the books, send \$3.00 in ten days and the balance at the rate of \$3.00 a month. Send the coupon NOW and see the books for yourself.

EXAMINATION COUPON

MCGRAW-HILL BOOK CO., 330 W. 42nd St., N. Y. 18

Send me for ten days' examination on approval the Croft Library of Practical Electricity, 7 vols. If satisfactory I will send you \$3.00 in 10 days and \$3.00 monthly until the price of \$18.00 is paid. If not wanted, I will return the books postpaid. (To insure prompt shipment write plainly and fill in all lines.)

Name.....
 Home Address.....
 City and State.....
 Position.....
 Name of Company..... PM-8-44

How to Get a BIG PAY Real Estate JOB



- PROPERTY MANAGER
- BROKER • APPRAISER
- LOANS • INSURANCE
- YOUR OWN BUSINESS

Thousands of trained men and women are required each year by real estate firms, insurance companies, banks, Federal agencies for property management, brokerage, appraisal, real estate loans and insurance work. Dignified, pleasant work with plenty of opportunities to advance. Salaries up to \$2500.00 to \$10,000.00 a year. Many make fortunes selling real estate on commission. Not one but 6 big sources for profit in real estate.

YOUR OWN BUSINESS. Coming real estate boom means even bigger demand for workers, greater earnings, larger profits. Take advantage of tested methods and valuable instruction material as given by author as Director of special real estate courses at Columbia, Yale, Chicago, Tulane, Southern California, other universities and real estate boards—now in convenient book form for the first time! Send coupon for 7 days' FREE examination.

Modern Real Estate Practice

5 Volume Library for Home Study and Reference Ready

First and only complete library and home training course in this big field. For real estate people, beginners, property owners, builders. Shows how to manage income property, how to sell real estate, 26 ways to get prospects, short cuts to appraising property values, handling loans and insurance, methods for finding largest to smallest real estate office. Residential, commercial, industrial, farm property. Complete information on securing tenants, holding tenants, listing systems, real estate maintenance, purchasing, collections, management budget, inspection reports, showing property, sales aids, closing the deal, creative selling, market analysis, real estate law, leases, taxation, financing, community planning, growth and decline of neighborhoods, how cities grow, speculative building, farm management, etc. Mail coupon now—SEE this remarkable library—the only one of its kind.

FREE 7 DAYS' EXAMINATION

LANE BOOKS, 100 E. Ohio St., Dept. B-8, Chicago 11, Illinois

Send me for 7 days' examination, the Modern Real Estate Practice Library, also Free Home Study Guide. If satisfactory, I will send you \$3.00 in 7 days, then \$3.00 a month until the price of \$24.00 is paid. If not wanted, I will return the books postpaid. (Save 10% . . . send cash price of \$21.60 with order if preferred . . . you save \$2.40. Same return privilege.)

NAME.....
 HOME ADDRESS.....
 Please attach letter stating age, occupation, employer's name and address and that of at least one business man as reference.

HOME STUDY GUIDE Included FREE!



A POST-WAR OPPORTUNITY
for MEN SERVING THE WAR EFFORT

Our company will have a number of Dealerships open for the sale of our Fire Extinguishers in the Post-War period. At the present time we are registering the names and addresses of men who are looking ahead with the idea of entering the Selling Field. These men whom we select for Dealership will have the opportunity to get in on the "ground floor" and build up a Profitable and Permanent Business. Register your name by writing us today.



INDIANA TECHNICAL COLLEGE

Engineering degree in 27 months. Aeronautical, Chemical, Civil Electrical, Mechanical and Radio Engineering. Govt. approved ground school courses. Prep courses, no added cost. Large industrial center. Earn living expenses. Enter Sept. 5, Dec., March and June. Catalog, 584 E. Washington Blvd., Fort Wayne 2, Indiana.

ENJOY HEALTH BECOME A PROFESSIONAL ACROBAT!

for FREE HEALTH BOOK. Men! Print your name and address on postcard and MAIL NOW! to . . . EMIL KNOFF, Dept. J.M., 2154 North 52nd Street, Milwaukee 8, Wis.

★ SAVE WASTE PAPER ★

Lovely DALE EVANS Says:

"IT'S EASY TO LEARN DANCING!"

DALE EVANS, Republic star of "Yellow Rose of Texas"

DANCE IN 5 DAYS . . . OR NO COST!

LEARN NEWEST STEPS—INCLUDING RHUMBA, SAMBA, CONGA and JITTERBUG, FOX TROT and WALTZ.

Let dancing open the door to Romance and Happiness for you! This sensational new book helps you learn the latest steps, quickly, easily. A revolutionary book that offers a shortcut to dancing. **MAKE THIS TEST!** Send today for Betty Lee's amazing book—it's packed full of diagrams and tells in simple language how to do the Jitterbug, Rhumba, Conga, Samba and other exciting new dances —also the ever-popular Waltz, Fox Trot, and many old-time favorites. **SEND NO MONEY!** Act now, and we'll send you as a gift, 2 additional books FREE of any extra charge, "Tip Top Tapping," and "Swing Steps." And remember—if not satisfied with results in 5 days you may return the book and your money will be refunded.

PIONEER PUBLICATIONS, INC. 1790 Broadway, Dept. 948H New York 19, N. Y.

Send me by return mail, in plain wrapper "Dancing," by Betty Lee, and include 2 free books.

Ship C.O.D. I will pay on arrival, plus postage.

I enclose \$1.98. Ship postage prepaid. If in 5 days I do not learn to dance, I may return book and you will refund purchase price.

Name.....
 Address.....
 City..... State.....

NOW YOU CAN SAVE ON PATENT EXPENSES

until such time when your new item has been proven out to have commercial value. Whether you have a gadget, a drawing, a formula, or design, write for our booklet. It will show you how for \$15 the conception date will be fully protected. Many of the foremost inventors of the country are using our guaranteed method which gives a surety bond inclusive of microfilm reproduction. WRITE US TODAY! MICROSTAT CORPORATION OF NEW ENGLAND P. O. Box 308, NORWALK, CONNECTICUT

LAW

STUDY AT HOME for PERSONAL SUCCESS and LARGER EARNINGS. 35 years expert instruction—over 108,000 students enrolled. LL.B. Degree awarded. All texts furnished. Easy payments. Send for FREE BOOK—"Law and Executive Guidance." AMERICAN EXTENSION SCHOOL OF LAW Dept. 44-M, 646 N. Michigan Ave., Chicago 11, Ill.

MAGIC LIQUID MAKES PHOTOS APPEAR

On Scarfs, Ties, Stationery, Etc.

Reproduce any snapshot on cloth, leather, wood, paper. Simply apply liquid. Like magic photo appears within 2 minutes in broad daylight. Harmless to negative. Won't wash off. Full colors included. Complete kit for 100 photos only \$1.29. Send no money, just name. Pay postman \$1.29 plus few cents postage on delivery. Or send cash with order and get postpaid. (Canada \$1.50 money order only.) Order today. L & M Mfg. Co., Dept. 333-B, 229 W. Breckenridge, Louisville 3, Ky.



★ SAVE WASTE PAPER ★



Bernarr Macfadden, founder and originator of Physical Culture Magazine—now again on sale in a new format at all newsstands.

LET

Bernarr Macfadden

HELP YOU

SAVE YOUR HAIR!

No Magic Tonics—No Cure-All
Just Plain Common Sense

Is your hair beginning to thin, fall out, turn gray? Don't resign yourself to being bald, unattractive, old looking, until you have read Bernarr Macfadden's "Hair Culture". Recommending no cure-alls, no magic salves, but merely applying principles of healthy living, this 210 page book is chock full of down-to-earth common sense based upon an intimate knowledge of the natural bodily functions.

Forty years ago, Bernarr Macfadden started to become bald but today his wavy handsome head of hair is the envy of men and women, half his age. Learn from his experience. Get his book on hair culture today. This may be just the advice you have been waiting for. Clip the coupon now!

SEND NO MONEY

Merely pay the postman \$2.00, plus \$30 for postage and handling charges. Or, if you send your check or money order for \$2.00 with the coupon, we will pay postage and handling charges for you.

SOLD WITH A MONEY-BACK GUARANTEE

Macfadden Foundation, Dept. 738
535 Fifth Avenue, New York 17, N.Y.
Please send me "Hair Culture". [] I will pay the postman \$2.00 plus \$30 postage and handling charges. [] I enclose \$2.00 (check or money order).

Name
Address
City State

MEN whether you are 16 OR UP TO 50

Come to COYNE for a great future in



RADIO-ELECTRONICS

"Learn-by-Doing" on Real Radio Apparatus!

Prepare for a great Peace time future and a good job in Radio-Electronics now. Coyne "LEARN BY DOING" training covers latest developments in this field. Prepare quickly, easily. Fascinating well paid work in maintenance, installation and servicing Radio-Electronic equipment.

TELEVISION

If you have an all-around Radio-Electronic training, there are great opportunities for you.

Tremendous expansion in Radio-Electronics, Frequency Modulation and Television predicted after the war—a world of new opportunities. Get ready for a Peace time future and a good job NOW with practical Coyne Radio Training.

Many Branches if You Have All-around Training

Why be satisfied with a narrow, no-future line when by putting in a short time in my Shops, you can qualify for unlimited opportunities in RADIO-ELECTRONICS, today's fast-growing field! These pictures show only a few of the big jobs for trained Radio-Electronics Men.

I'LL FINANCE YOUR TRAINING!

Don't let lack of money hold you back. You can GET TRAINING first—then pay your tuition IN EASY MONTHLY PAYMENTS STARTING 60 DAYS AFTER YOUR TRAINING PERIOD IS OVER. I also help you get part-time work to help pay living expenses while training if you need it, and give you Lifetime Job Service as a Coyne graduate.

SEND FOR FREE BOOK

Fully illustrated with big pictures of my Shops—facts about your future. Mail coupon now. No obligation. No salesman will call. Act today!

H. C. LEWIS, Pres., RADIO DIV. COYNE ELECTRICAL SCHOOL
500 S. Paulina St., Dept. C4-3H Chicago 12

We also have facilities for men with physical disabilities—write for particulars.



H. C. LEWIS, Pres., RADIO DIV. COYNE ELECTRICAL SCHOOL
500 S. Paulina St., Dept. C4-3H, Chicago 12, Illinois.
Send FREE BOOK, "Your Future in Radio-Electronics" and details of easy "Pay-After-Graduation" plan.

NAME AGE
ADDRESS
CITY STATE

INSPECTION PROBLEMS?

Here's how Controlled Lighting saves time on tough inspection jobs



G-E REFLECTOR LAMP

REFLECTING MIRROR

To look inside a 75 mm. shell was difficult...until G-E lighting engineers helped work out a faster, more accurate inspection method. A standard G-E reflector lamp with a mirror arrangement "turns shells inside out"—makes sure there's no grease, dirt or pitting. It's a typical example of inspection methods that use controlled lighting...and it's another instance where G-E engineers have helped to gain faster, better inspection methods.



1 Brightness contrast patterns are useful for the inspection of chatter in polished metallic surfaces. Reflections reveal defects of unevenness and other irregularities.

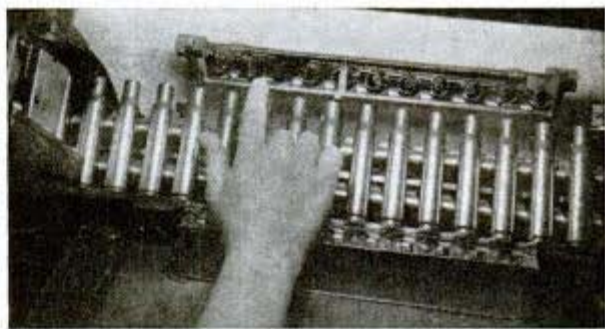

2 An inspection unit developed specifically for cartridge case inspection. It makes use of reflected light from mirrors, showing the interior and primer cup end of the cases.



In these special applications—or in standard installations—be sure you get the utmost in lighting quality. Look for the famous G-E monogram on all the bulbs you buy.

* * *

Send For New G-E Booklet That Gives The Facts On Lighting For Inspection. Write to General Electric Co., Div. 166-PM-H, Nela Park, Cleveland 12, Ohio.

"TO MAKE G-E LAMPS STAY BRIGHTER LONGER"
The Constant Aim of G-E LAMP RESEARCH

KEEP BUYING WAR BONDS—KEEP THE WAR BONDS YOU BUY

G-E MAZDA LAMPS
GENERAL ELECTRIC



Hear the General Electric radio programs: "The G-E All-Girl Orchestra," Sunday 10 p. m. EWT, NBC; "The World Today" news every weekday, 6:45 p. m. EWT, CBS.

Popular Mechanics Magazine

REGISTERED IN U. S. PATENT OFFICE AND CANADA

WRITTEN SO YOU CAN UNDERSTAND IT

0323

Vol. 82

AUGUST, 1944

No. 2

HOW THE INVASION WAS PLANNED



Signal Corps photo
U. S. assault troops with
full packs wade through
gap in Nazi's West Wall

Mrs. Whittaker

IN SPEAKING of the greatest military assault in history—the invasion of France by the Allied forces—Prime Minister Churchill said:

“Everything proceeded according to plan. And what a plan!”

The magnitude of that plan, worked out by persons Herr Hitler once called “military idiots,” staggers the imagination. It embraced the air, ground and sea forces of this nation and our allies. It hurdled problems of supply and transport, of pre-invasion training, of production and improvement of weapons, of photo-reconnaissance and mapping on a scale that makes the battle plans of Napoleon look like a game of checkers. More than 125,000,000 maps alone, just to mention one item, were used in perfecting the master invasion plan.

The success of that plan was demonstrat-

ed to a stunned enemy and a surprised world on D-Day. Four thousand ships carried the magnificently equipped troops across the English Channel under protection of a powerful naval force including 12 battleships, and thousands of aircraft.

Parachute and airborne divisions, spearheading the invasion, filled the sky over Normandy. As a climax to the “combined operations” attack on German coastal defenses, Allied planes dropped 11,000 tons of bombs in the eight hours preceding the landing and big naval guns pounded the coast before the troops went ashore. In 10

AUGUST, 1944

*Hartup Aircraft, Inc.
Lanthorne, Calif.*

1



Beachhead on D-Day—troops in ducks, half-tracks and afoot advance on German positions. Note file on hill

minutes, 600 naval guns fired 2,000 tons of shells at Nazi batteries.

Behind the invasion plan were lessons learned the hard way on the beaches of Dunkirk, Dieppe, North Africa, Sicily, Salerno, Anzio, Attu and Kwajalein.

After the general timing for the invasion was set at Teheran, the exact site for the landing was decided upon. This remained a closely guarded secret until H-Hour on D-Day. The low sandy beaches of Normandy between Le Havre and Cherbourg were selected not only for their proximity to great bases and supply depots in England, but because the region was suitable for amphibious operations and the defenses were within easy range of our aircraft.

The Norman coast, however, was just about the center of Hitler's famous West Wall. German boasts about the invulnerability of this West Wall acted as a boomerang, for they inspired the most careful reconnaissance in military history.

What happened to this

P-61 night fighter "Black Widow," was among the new weapons ready for the invasion push

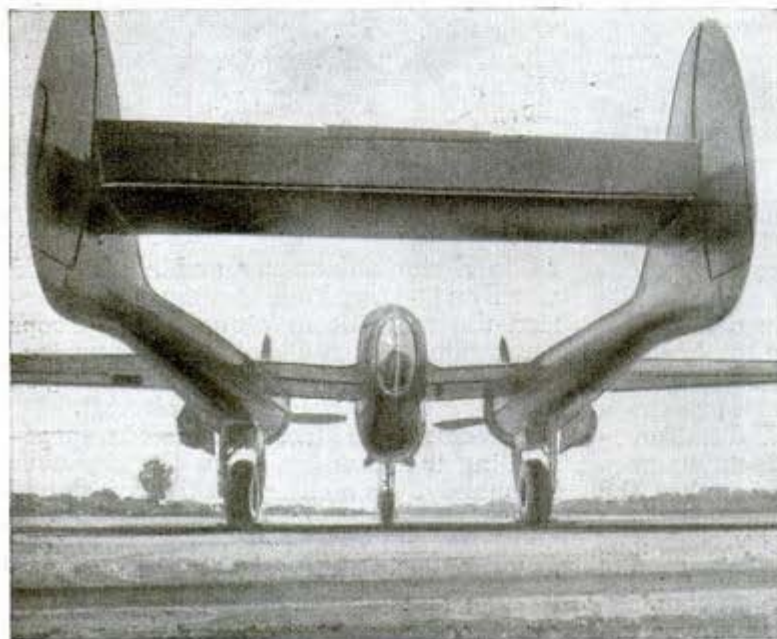



Yanks crowd a Navy LCI as craft nears invasion coast. Below, firing eight-inch siege gun with 18-mile range

West Wall on D-Day? The answer forms a revealing chapter in the invasion plan. For months our troops had been storming a replica of that West Wall set up along the coast of England.

From information obtained from Commando and Ranger raids on the French coast, from the French underground, from photo-reconnaissance, from scouting parties in small boats and midget submarines came a complete picture of German coastal defenses. The only thing missing was the secret rocket weapon which the Nazis threatened would blow England to bits.

The Nazi shore defenses consisted of a ring of tubular steel scaffolding built under water 150 yards out from the high

Amphibious "ducks" practicing invasion maneuvers





Barrage balloons over invasion armada add to aerial cover; top, studying captured Nazi layout of beach

water line, and behind this a double apron of wire fence, concrete antitank barriers in zigzag arrangement with protruding steel prongs (called "horned scullies" by our troops), and another double apron of wire fence. On the beach above the high water line was a three-foot barbed wire fence, a mine field, an intricate deep wire obstacle, an antitank ditch, concrete antitank wall, and "dragon's teeth"—concrete blocks to stop tanks. Behind this maze of beach de-

fenses were pillboxes; farther back, heavy artillery. With the mined waters off shore—which were cleared by minesweepers during the early hours of D-Day—this composed the coastal sector of Hitler's West Wall.

A duplicate of these defenses was built by American and Royal engineers at a pre-invasion training base. When the assault divisions of engineers and infantry arrived in the first landing barges, they knew how

U. S. cruiser *Augusta* nearing rifle range of French coast dwarfs landing boats carrying assault troops
U. S. Navy photo



to blast a gap through these barriers. After the engineers had cleared a path for the assault infantry to advance on the pillboxes, the first heavy equipment to come ashore was the bulldozers.

These bulldozers with armored cabs roll off the barges pulling sleds with steel mats to build roads across the soft sand. If a tank or piece of heavy artillery is hit by an enemy shell, or a truck bogs down, the bulldozers push them out of the way and the supplies move on. Some of the bulldozers



With hands lifted in surrender, Nazis come over crest of hill in France



Troops firing behind enemy beach obstacles at Nazi pillboxes. Below, abandoned German robot tank found in a dugout near the shore; remotely-controlled tank is loaded with explosives



were carried ashore from LST's and other landing craft on the Navy's new "Rhino Ferry," a self-propelled barge of light welded steel pontoons. These pontoons, one of scores of innovations developed for the invasion, can also be put together to form floating wharves and causeways.

Airborne divisions were used on a scale that dwarfed the German landings at Crete and our own in Sicily. An airborne division is made up of a regiment of paratroop infantry, two glider regiments and miscellaneous units, such as engineers, quartermaster, signal corps, medical and others. One paratroop innovation in Normandy was the dropping of dummies which confused the Germans as to where the real landings were to be made. Adding injury to in-



Tank destroyer affords shelter from snipers at Normandy beach on D-Day

sult, some of the dummies were filled with explosives.

The spearheading paratroopers, all with particular jobs to perform and special targets to attack, cleared strips for the "one-mission" gliders to land men and equipment. Some gliders carried light tanks. The glider regiments quickly built landing strips for the troop transports. The location of these airstrips was selected months in advance from aerial photos. The calculations from these photos are so accurate that the number of cubic yards of earth to be moved can be closely estimated. This careful planning was one reason five airstrips were completed a few days after D-Day. This was an important factor in the rapid advance and the joining up of airborne and seaborne infantry to consolidate

positions along 60 miles of coast.

While troops were training and great piles of material were accumulating in England, our air fleets were carrying out a plan for strategic bombing of enemy targets. On their "priority" list were submarine pens, aircraft, munitions and armament plants, oil refineries, synthetic rubber factories and all industries producing goods for the Nazi machine. The Luftwaffe's wings were pinned back in the air and on the ground, according to plan. The result was that on D-Day Allied Supreme Headquarters could estimate the Germans had a maximum of 1,750 fighters

and 500 bombers to combat the 7,500 Allied planes operating with the invasion forces. The plan worked so well that the weakened Luftwaffe left the sky to the Allies on D-Day.

The air attack wound up with a 50-day assault on enemy transportation extending several hundred miles inland from Holland to the Bay of Biscay. Ninth Air Force fighter bombers and rocket-firing R.A.F. Typhoon fighters threw enemy transportation and communications into chaos. American Mustangs, Lightnings and Thunderbolts added "strafe bombing" and "glide bombing" to the familiar technique of dive bombing. In strafe bombing, the fighters come in low and plant delayed-action bombs before pulling up to almost 90 degrees. In glide bombing, the angle of de-

U. S. airborne troops, spearheading invasion forces, leap from glider after landing behind enemy lines

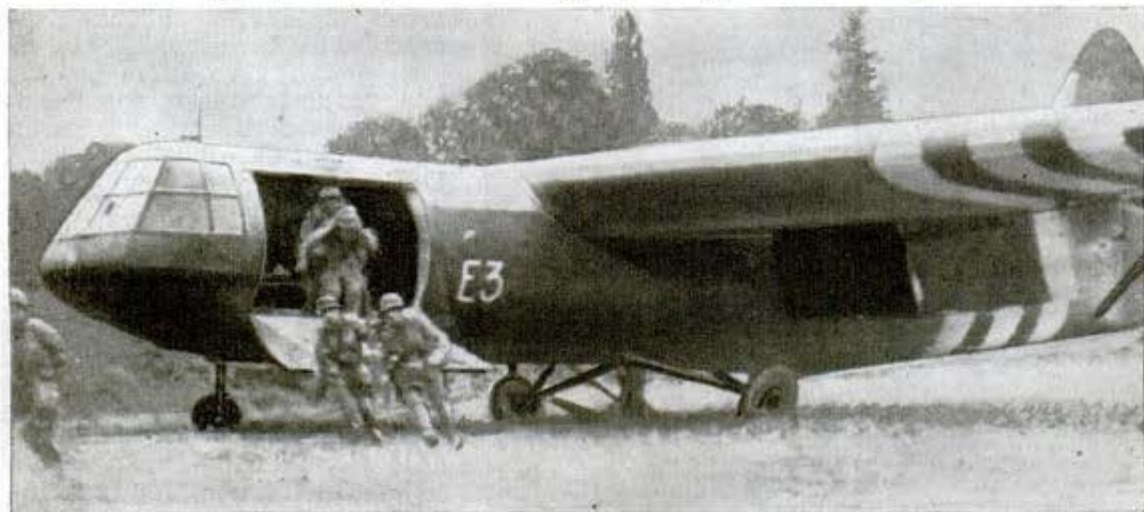

scent is more gradual than in dive bombing and the ascent much sharper. At 400 to 500 miles an hour, the planes are too fast to be tracked by Nazi flak batteries.

The region around Caen was marked on the master invasion plan as the focal point for pre-invasion bombing, but care had to be taken not to tip our hand in advance of D-Day. Twenty-one days before D-Day airfields and communication centers were bombed within 130 miles of Caen.

The next step was a concentrated assault on coastal batteries, set in 30 inches of concrete, along the invasion site. This attack was carried out on the eve of D-Day and repeated 30 minutes before H-Hour. Night and day fighters were used, in the final assault joined by 1,350 Flying Fortresses and Liberators. The 11,000 tons of bombs mentioned earlier, were dropped in this final phase.

During the actual landing, fighters covered every beach operation. American Thunderbolts flew high cover, British Spitfires flew low. Night bombers laid smoke screens. Other planes protected the convoy across 70 miles of channel.

One of the greatest problems for the invasion planners was the shipping of gigantic stores of fighting equipment and supplies to England, assembling the equipment and distributing it to coastal depots. Every one of the thousands of men landed in France required about 10 ship tons of overall equipment, and an additional ship ton every 30 days. The number of separate items needed was about a million. Some of these million items had to be accumulated in millions, resulting in astronomical totals. These supplies, ranging from M-4 tanks, 240-mm. howitzers and flame throwers, to bazookas, razor blades, and carrier pigeon feed, were moved by ships on a rigid timetable.

For two years these supplies flowed steadily to depots scattered over England. The Army Service units—ordnance, engineers, signal, medical, transportation, quartermaster and others—built up stock piles so large there was no chance of putting many under cover. Fields were blanketed with guns, rocket weapons, amphibious vehicles such as the famous "duck," trucks, half tracks, bulldozers, ambulances. The only protection from enemy eyes at these open-air depots was camouflage and the

Continued to page 160

Sliding Platform to Launch Ship Is Floated Out From Under

0190

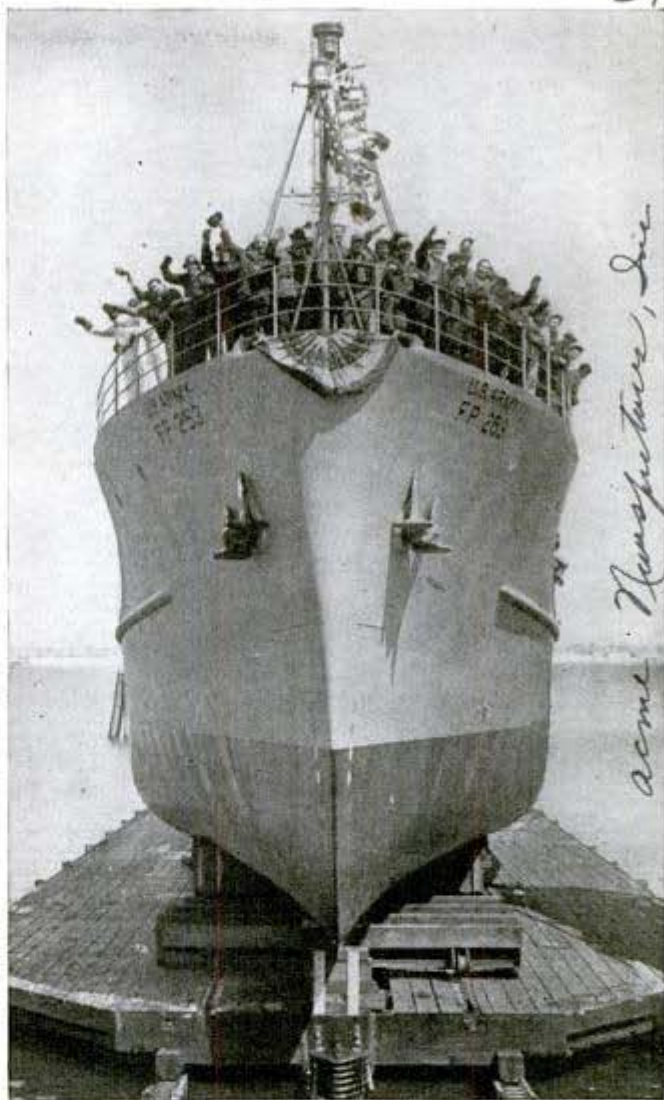

acme Transportation, Inc.

Among wartime innovations for ushering a ship from the ways to the waves is a sliding platform which holds the craft erect. The platform, used recently to launch a vessel built for the Army Transportation Corps, is released by cables. After ship and platform are in the water, the latter is floated out from under the vessel.

Fighter Plane Gets Steel Teeth For "Buzz Saw" Attack

0217

Fighter pilots could literally bite off the wings, tails and other exposed parts of enemy planes in combat with a recently patented sawtooth blade. The inventors proposed to line the saw with sharp steel teeth and attach it beneath the fuselage. The blade is hinged at the forward end and is retractable.

Boeing Aircraft Co.
Seattle, Wash.



Meet the B-29!

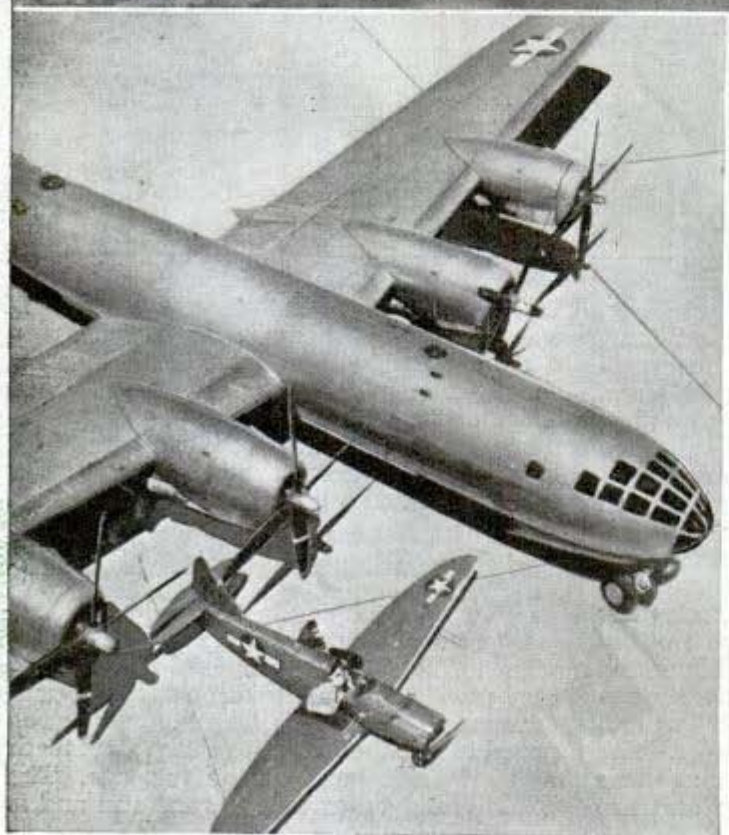

By Wayne Whittaker

AFTER several years of suspense the "wraps" are off the most whispered about bomber in the world and America's ex-military secret No. 1.

The job of keeping a veil of secrecy around the Boeing Aircraft Company's Superfortress, the B-29, might be compared with trying to hide Vesuvius under a circus tent. Recently, the giant four-engined ship, half again as large as a Flying Fortress, opened a new chapter in aerial warfare with the bombing of The Imperial Iron and Steel Works at Yawata.

The B-29 can fly higher, faster, farther, and carry a heavier bomb load than any

Beside Boeing's B-29, target plane (Culver Kaydet) looks like a model

POPULAR MECHANICS

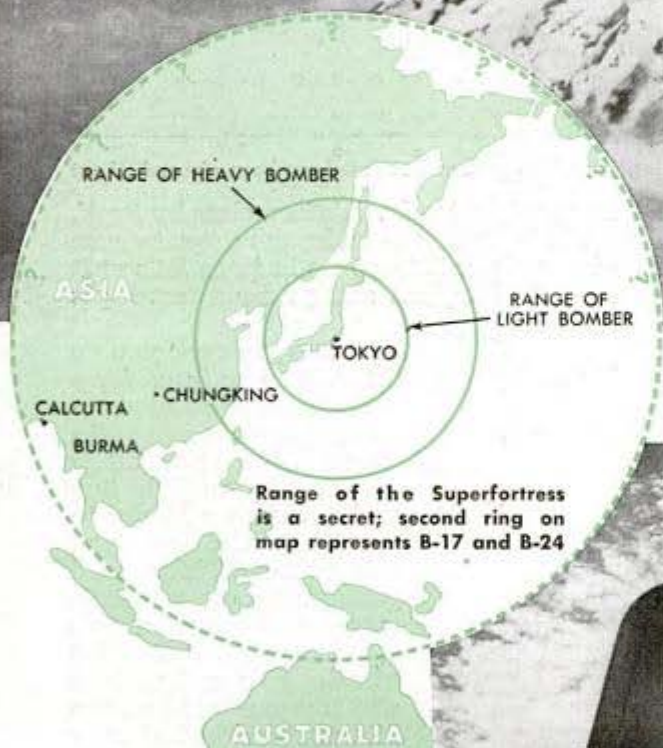

Long-nosed queen of the AAF has the greatest range and bomb load, and can fly higher than any other bomber. Below, tail resembles B-17

other bomber in the world. It can blast enemy fighters out of the sky with a 20-mm. cannon and .50-caliber machine guns in power turrets.

This super bomber, destined to become a familiar sight over enemy territory, is still a stranger to most Americans. Outwardly, except for size and elongated nose,



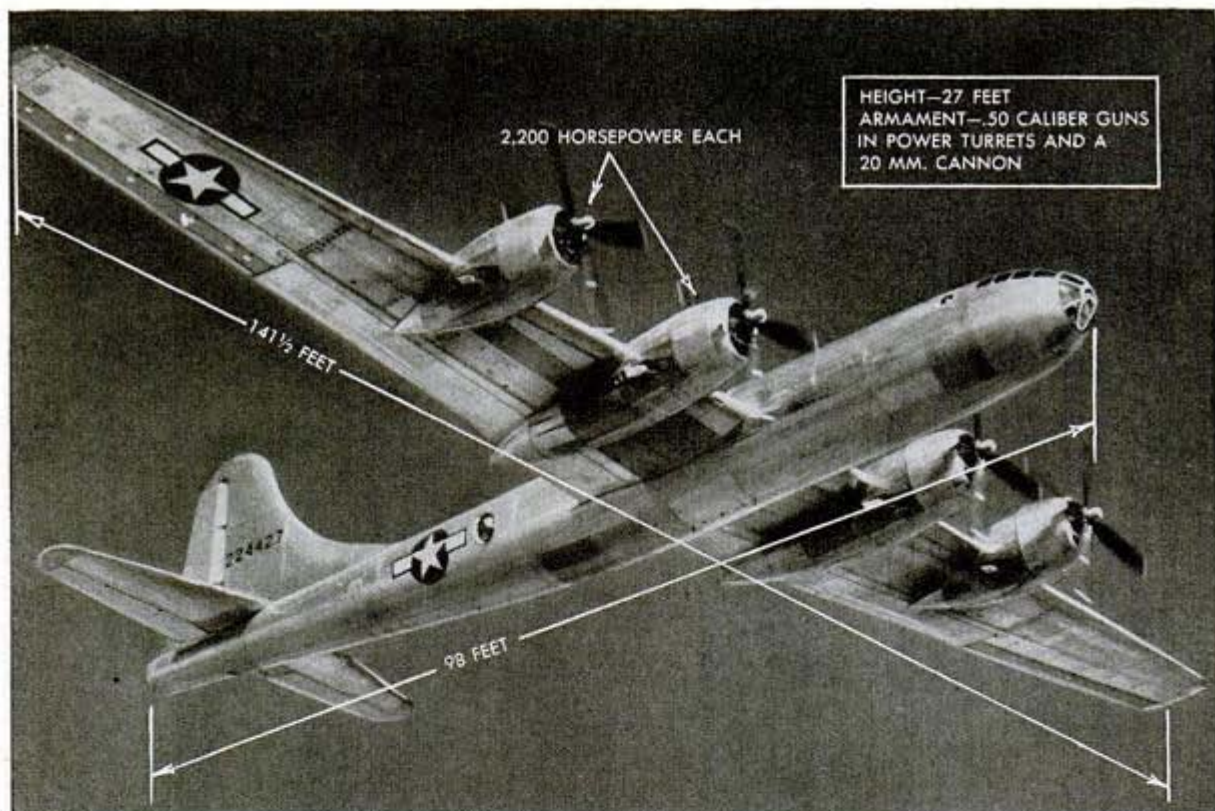

Wings appear to be attached almost at center of fuselage; machine guns and cannon have been airbrushed out

it resembles a Flying Fortress. The nose section, a distinctive feature, projects so far ahead of the wings they appear to be almost at the center of the fuselage. Makers of the B-29 stress that this is an entirely new plane, not an improved model of the Flying Fortress as the name, Superfor-

ress, might imply. It's in a class by itself.

The best way to make the acquaintance of any plane is to go up in it, so let's visit the Wichita plant and go for a test flight on the B-29.

After signing the Army waivers, you go to the flight service shop to be fitted for a

Excellent visibility for gunners is provided at the sighting positions



parachute and receive instructions on how to pull a rip cord. Then you follow the crew to the flight line and crawl up a ladder to a hatch in the forward compartment. You and your parachute sit down at the radio operator's station and the pilot hands you a headset which you plug in on the interphone. The test crew consists of pilot, co-pilot, flight engineer, and an observer in the rear.

The whistling and bop-bop of the interphone is soon interrupted with a voice saying: "Testing . . . testing." Then, after an interval: "All clear."

The four 2,200-horsepower Wright air-cooled engines are started. The plane taxis down the run-

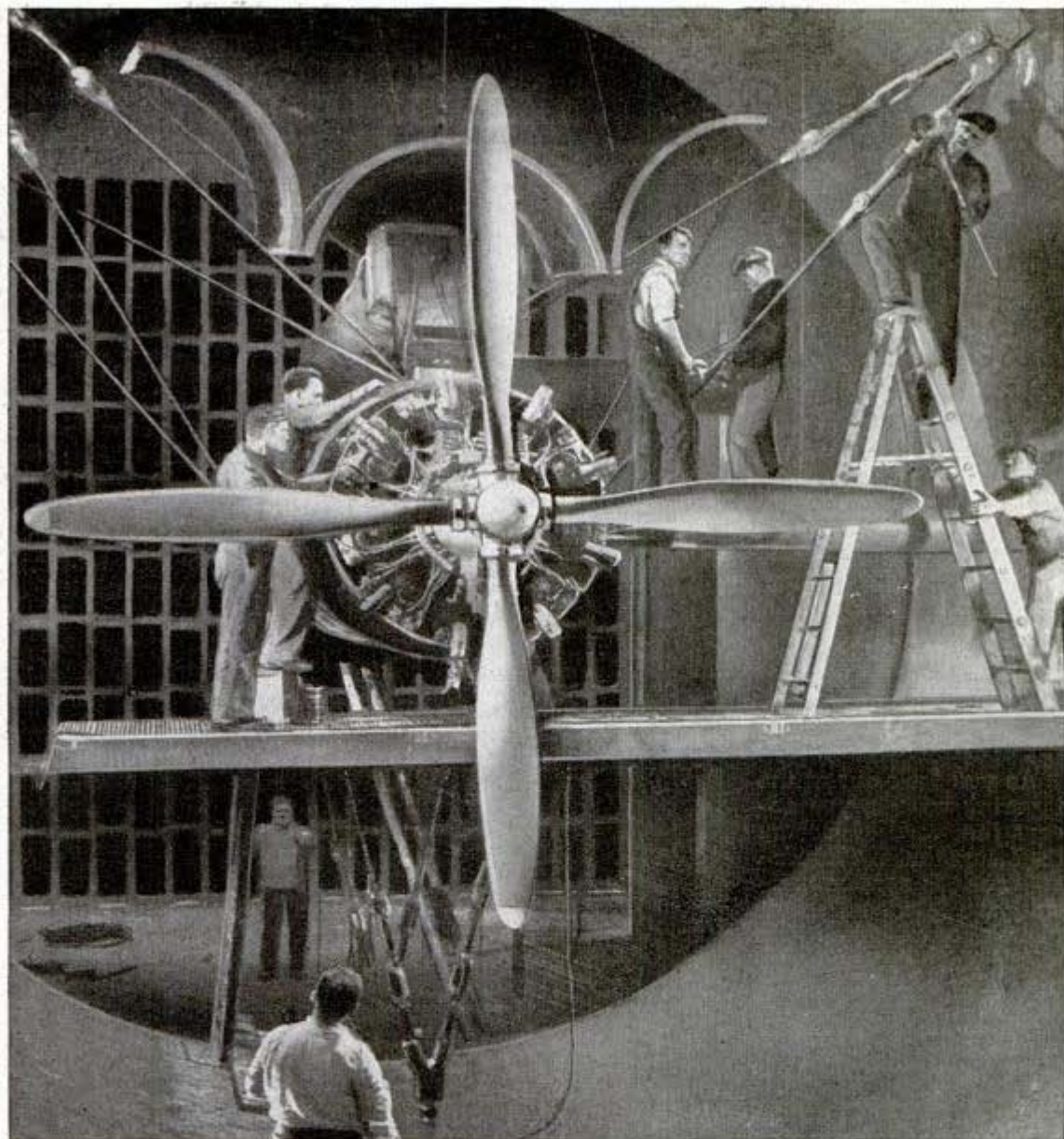

Testing the B-29's 2,200 horsepower Wright engine in Dodge Chicago plant which is turning out thousands

way and swings about. You follow the takeoff on the interphone.

"Wing flaps are 25 degrees . . . engineer to co-pilot over . . . like to make a quick check of the plugs before we take off . . . Roger . . . engineer to co-pilot over . . . will we take off with full turbo . . . yeah, pretty hot day . . . engineer ready for takeoff . . . observer ready in the rear."

The plane moves forward with a surge of power, and as you peer ahead through the bombardier's bay the runway leaps toward you. Then, on the interphone:

"Right gears are up . . . left gears are up . . . everything normal at the engineer's stand . . . cut the putt-putt."

The "putt-putt" is an auxiliary power plant which supplies power to operate the

brakes and flaps when taxiing, taking off or landing.

The bomber, which weighs perhaps twice as much as the 30-ton Flying Fortress, is off the ground in a jiffy and seems to climb with the ease of a fighter plane.

You climb up in the navigator's seat and view the plane and the world below from the bubble where he "shoots" the sun. The Superfortress has a wing span of more than 141 feet and is nearly 100 feet long. Overall height is more than 27 feet. In comparison, the Flying Fortress has a wing span of 103 feet, a length of 75 feet, and height of 19 feet. The 16½-foot four-bladed propellers of the B-29 are the largest ever installed on any aircraft, and the 8,800 horsepower of the engines is nearly twice that of a B-17.

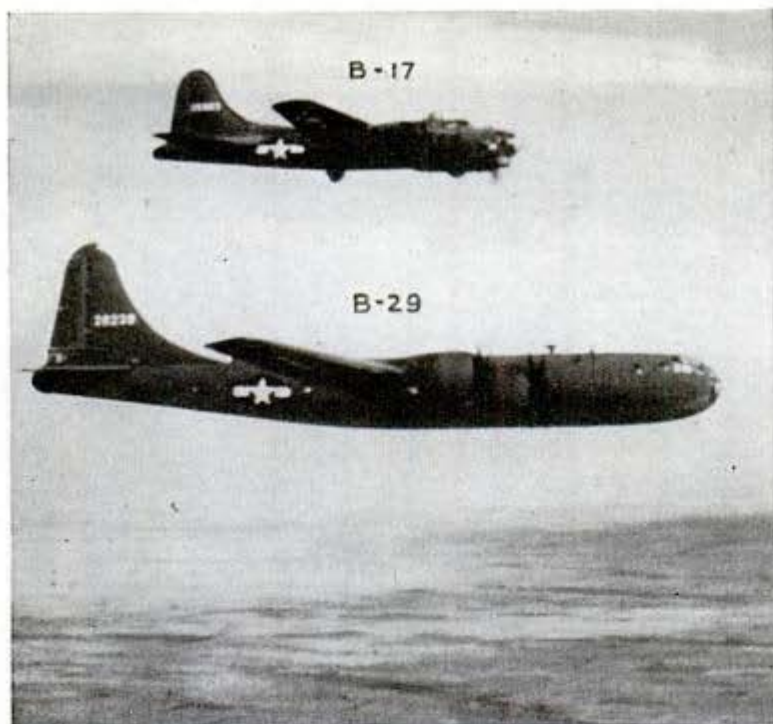

Superfortress (B-29) is half again as large as Flying Fortress (B-17). Below, mechanic on wing of superbomber grooms 2,200 horses for sky ride

As you look out at the tapering wings, you accept the word of Boeing engineers that the Superfortress is aerodynamically the "cleanest" large plane ever designed. The wing, which is completely new, has an ingenious flap to reduce the speed of landings and distance of takeoffs. This gives the B-29 the same landing speed as a B-17. The flaps are extended 25 degrees at takeoff, rolling back and down to increase the wing area by 19 percent.

The B-29 is almost entirely electrically operated. Every piece of equipment with the exception of the hydraulic braking system is activated either by an electric motor or cables; there are 150 electric motors on the ship. The control surfaces are "directly" operated by the pilot, which is said to make the plane handle more like a pursuit ship than a bomber.

You move forward to the bombardier's seat,

straddle the automatic pilot, and look down through the crystal-clear nose to the peaceful farms of Kansas. You try to imagine the bombardier's sensation with an enemy fighter rushing in headon with guns blazing, or in the face of enemy flak. Then you climb up by the pilot and crouch on the hatch cover. The cold metal testifies the air outside is plenty cold.

E. M. "Allie" Allison, chief test pilot for Boeing, says the plane "flies like a dream."

The cruising speed, maximum speed, ceiling, range, placement of armament and number of guns, and bomb load, are still military secrets. Everything about this "perfect" bomber has been dictated by lessons



learned in combat. The Air Force sets the speed at "well over 300 miles an hour," ceiling at "well over 30,000 feet," the range "very long" and the bomb load "very heavy." The range for ferrying the B-29's is greatly increased with auxiliary tanks.

Some conception of the plane's capabilities may be gleaned from the announced fact that it will fly higher, farther and with greater bomb load than any other bomber. It is common knowledge that B-17's have operated above 40,000 feet; that the B-17 with bomb racks under the wings will carry some 10 tons of explosives, and that it can fly from England to Berlin and back.

Test Pilot Allison suddenly reveals that the plane you are on has only been off the ground once before, and then for only 35 minutes.

"But we were pretty sure it would hold together," he says. "We've really tested these babies."

And he isn't kidding. No plane in history has received the tests given the B-29 which made its first flight Sept. 21, 1942. The supercharger for the engines, alone, required more than 5,000 hours of tests. No single supercharger had enough capacity to supply the 18-cylinder radial engines. The result is a twin installation. The plane's great weight also necessitated development of the first dual nose wheel for its "tricycle" landing gear. The aerodynamic perfection of the retracting gear is indicated by the fact that when the gear is down the drag on the ship is doubled.

Five huge plants taking part in the mass production of the Superfortresses include the Boeing factories in Seattle, Renton, Wash., and Wichita; the Glenn L. Martin plant in Omaha, Neb., and the Bell Aircraft Company plant in Marietta, Ga. The Fisher Body Division of General Motors will play a major part in turning out sub-assemblies. The engines are built by the Wright Aeronautical Corporation and the Dodge division of the Chrysler Corporation.

You clap your headset on for the landing. "Observer to engineer . . . how about getting putt-putt started . . . Roger . . . right landing gear down . . . left landing gear down . . . wing flaps are 25 degrees . . . fuel boost is off . . . engineer ready for landing . . . wing flaps are full down."

And the biggest bomber in the world comes in for a perfect landing. The full story of the B-29, which cannot be told yet, will be written across enemy skies. But you can take the word of Gen. H. H. Arnold, commander of the U. S. Army Air Forces, that the B-29 is "superb."

Basket Built Inside Stroller For Shopping Trips

By using a combination stroller and market basket, a mother in San Francisco solved the problem of how to shop while keeping track of small children. The vehicle is a pushcart which has seats for two children installed



0 224
 John Stanton of Home Transporters, Inc.
 814 Mission St., San Francisco, Calif.

in front of a large built-in compartment for carrying parcels. It is narrow enough to travel in store lanes and includes a safety belt for keeping the children in their seats. The cart weighs only 16 pounds but can load 300 pounds.

Synthetic Rubber Gets New Life From Reclaim Formula

Millions of pounds of used tires, tubes, treads, motor supports and other articles made of synthetic rubber are being salvaged as the result of the discovery of a reclamation formula by United States Rubber Company research men. Scientists had been searching for the method ever since they found that the reclaim formula for natural rubber failed to make the synthetic material plastic enough for re-use. The processing is being done on the same machinery which was used to reclaim natural rubber and the reclaimed synthetic material is converted back into the same items for which it was originally made.

Rockefeller Center
 N. Y., N. Y.

*Capt. Col. W. M. Brail, Air Corps,
Laurinburg-Maxton Army Air Base,*

GLIDER PARADE

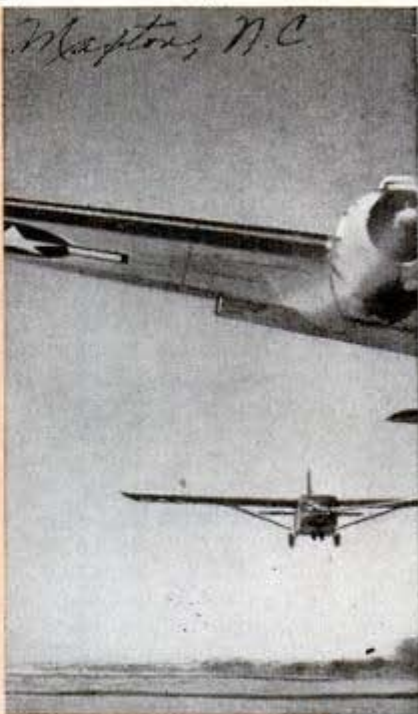

At start of mission men rush to gliders with equipment, while tow truck crew (foreground) gets ready to pull ships behind tow planes

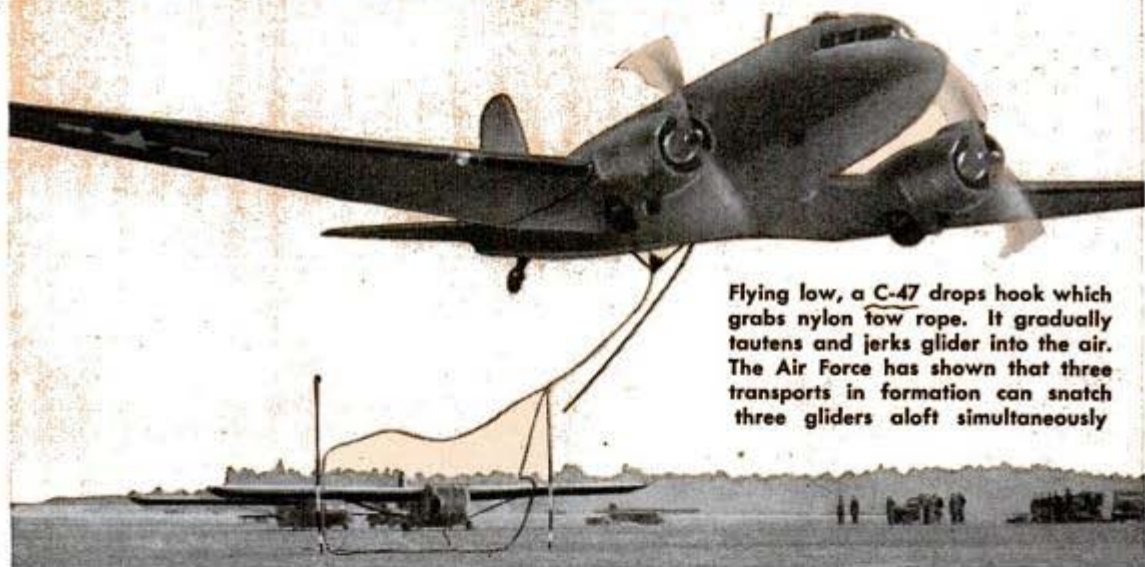

Flying low, a C-47 drops hook which grabs nylon tow rope. It gradually tautens and jerks glider into the air. The Air Force has shown that three transports in formation can snatch three gliders aloft simultaneously

Below is the double tow arrangement. One glider flies slightly higher and to the rear of the other, preventing collisions in the air. Gliders can carry 75 mm. howitzers, 37 mm. anti-tank guns and tractors to tow them

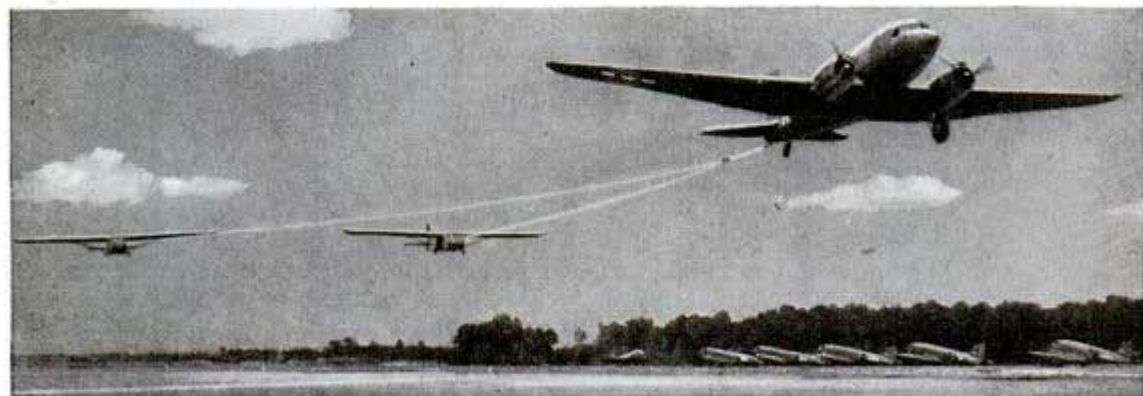



Above, C-54 transport hauls a CG-13 glider. Great, weird-looking glider fleets flew more than 30,000 miles in April in the day and night invasion rehearsal. In the second day of the real invasion, a 50-mile-long train of gliders crossed into France

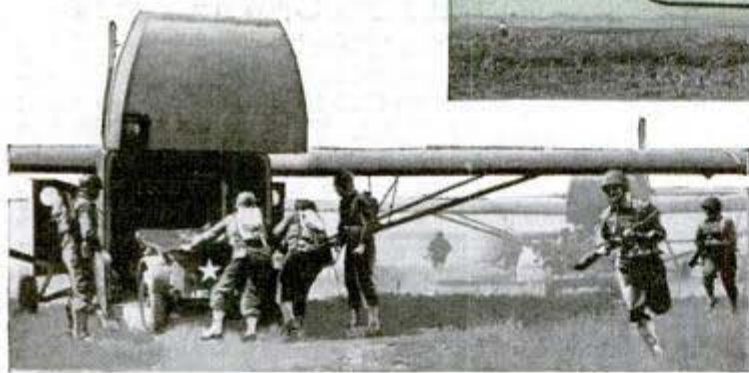
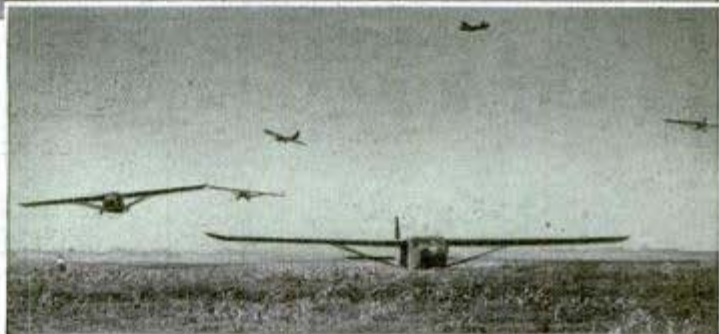

Above, gliders descend in "follow-the-leader" style and park compactly

Left, as soon as glider lands men go into action. Some set out on foot, others roll a jeep through the nose

Below, glider occupants board raft as others tie buoys under the wings



Lost Radium Found in Hour By Electric Detector



Schubert, N. Y.

Robert W. Mayer

Operated on much the same principle as a mine detector used by sappers at the front, an instrument to recover priceless capsules of radium has been developed by the General Electric X-Ray Corporation. The detector is connected with earphones, and the location of radium is revealed by a sound like radio static. Recently, the instrument located a stolen \$10,000 radium capsule beneath a bench in a locker room of a Buffalo factory in less than an hour.

0310

Here's List of Inventions Needed To Help Uncle Sam Fight

There's still a vast amount of unfinished business for inventors who want to help win an American victory. How valuable Yankee inventiveness has proved thus far is evident in the long list of weapons and devices turned over to the military services by the National Inventors Council—among them the bazooka's electric firing device, a method of hauling tanks out of ditches, a signaling mirror for lost aviators, multiple uses of milkweed floss.

Now the Council is posing another long list of inventions wanted, and asking ama-

teur and professional inventors alike to get busy. Here are a few of the needs: A life vest that will inflate automatically and turn the man on his back when thrown overboard unconscious by concussion. An optical method of distinguishing between artificial and natural green. A simple gauge for measuring positive and negative phases of explosion blast. Some way to control fires in tanks until personnel can be evacuated. A quickly erected tramway for unloading ships. Protection against flame throwers. A lightweight, inexpensive material other than synthetic rubber which will hold air or carbon dioxide. Methods of removing or destroying obstacles to landing operations. A way to reduce glare from glass surfaces by durable coatings applicable in the field. Protection against land mines for vehicles. Clothing that will guard against white phosphorus. Methods of generating and dissipating fogs. Location and destruction of hidden pillboxes. A gas mask with a transmitter that will carry the wearer's voice clearly. Colored smokes and odorless toxic agents.

While many of these are beyond the capacity of the amateur inventor, thousands of simpler ideas—whether they apply to war problems or not—are wanted urgently by the National Inventors Council.

0265

Clamp Speeds Planing or Sawing With Firm Grip on Board

Taking the "jitter" out of a board being planed or sawed is the job of a metal U-shaped clamp that can be screwed to work bench or plank. Thumbscrews hold the board firmly in place and a sheet metal guard protects the wood. When planing, two thumbscrews hold the board and a third acts as a stop to prevent it from sliding under pressure. The clamp is also handy for sharpening saws. The saw is placed between two thin boards and put into the clamp.



Bedham, Mass.

*Dept. of Commerce
Washington, D.C.*

POPULAR MECHANICS
*Mr. Alexander Mack
423-425 Sprague St.*

Helicopter Alights on Sea to "Rescue" Aviator

0204

Fitted with pontoons to land on water, helicopters may play an important part in rescuing men adrift in life rafts. In a recent demonstration conducted by Coast Guardsmen, a "wounded" flyer was rescued from a raft. The helicopter alighted on the water close to the raft and the "injured" man climbed into a stretcher basket attached to the craft. This eliminates much of the rough handling which is unavoidable in other methods of rescue. Helicopters are also used by the Coast Guard for patrol duty.



Photocell Trips Camera Shutter as a Flash Bomb Bursts

0155

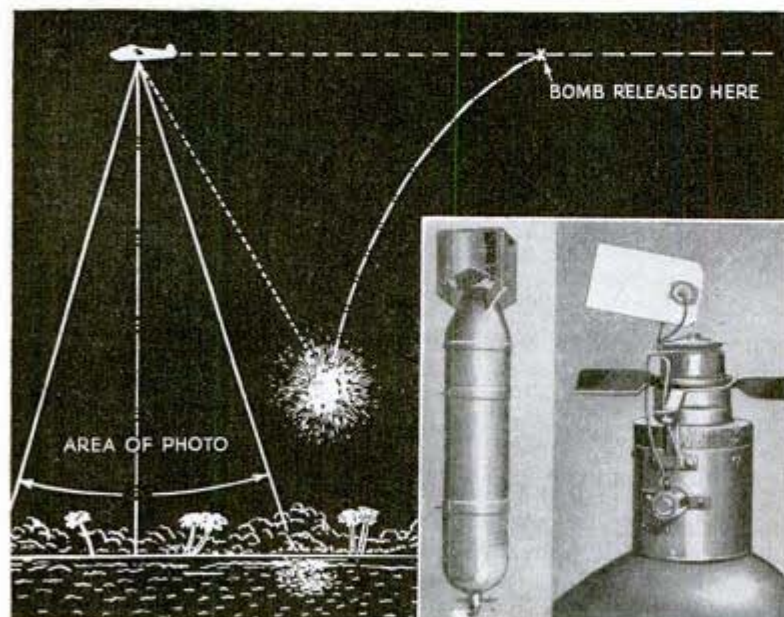

Aerial photography at night has been improved and simplified with the aid of a photo-flash bomb which utilizes the same principle as the news cameraman's flash light. A fuse is set to explode the flash bomb at a point behind the plane. This in turn actuates a photoelectric cell which opens and closes the camera shutter. .Dropped in train, these bombs cause a sequence of pictures which can be combined into a mosaic. The flash does not show up in the picture except when reflected from water. The bomb contains 25 pounds of flash-light powder.

*of A. Army Air Force
Wright Field, Ohio*

"Teardrop" Cockpit on Fighter Gives Pilot All-Around View

Pilots of North American P-51 fighter planes, top ranking pursuit ships in speed, range and ceiling, are assured 360-degree visibility with a transparent "teardrop" cockpit. This may give a pilot the split second of advantage in combat that often means life or death. The new cockpit cover is also an aid to night flying, for it can be rolled back to give an unhindered view and eliminate light reflections.



0221

The **SHAPE** of **THINGS**

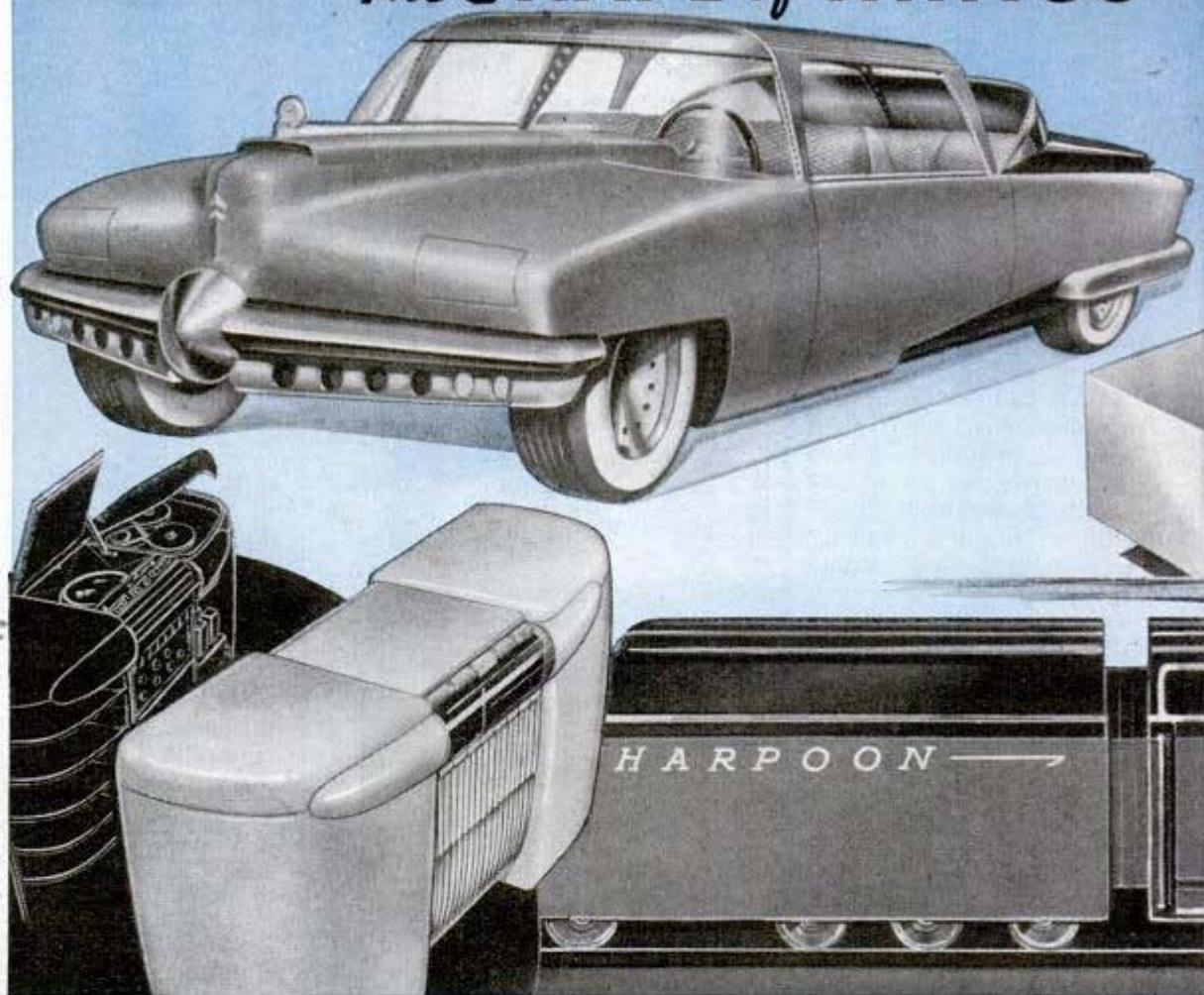

At top is one of Raymond Loewy's conceptions of the automobile of the future. Below, at left, radio-television set designed in plastics cabinet by Sundberg and Ferar, including a magnetic-wire phonograph

580 7th Ave.
N. Y., 19 N. Y.

By Roderick M. Grant

*Stephenson Bldg.
Detroit, Mich.*

LIFE will never be the same again. The techniques and materials conceived under the impulse of war must inevitably bring vast changes in our ways of living, greater comforts and greater efficiency.

Home has never been an efficient thing. You pour more than half your fuel up the chimney and through the walls and windows. You furnish the house with lush carpets and overstuffed furniture that erupt clouds of dust at every movement. Paint and wallpaper perennially wither and fade. Summer dampness mildews, winter heat dismembers furniture. You tramp numberless miles from refrigerator to stove to dining table and back again.

Your automobile was an enormity of chrome to be traded in at the first hint of a rust spot. It was heavy, it drank gasoline like a lord, it had blind spots, but it was

pretty and fast. You traveled in railroad cars probably twice as heavy as they need be, behind locomotives that delivered the goods effectively despite a technically inefficient power plant.

This is not to say that your p.f.c. will come home to a pink plastic house with dustfree air conditioning and a rear-engine-car traveling 50 miles on a gallon of 150-octane gas. But this is a promise that evolution of better living will begin when the war ends, for it has begun already on the drawing boards of American designers who are shaping the future for our builders and manufacturers.

When designers' dreams come down to earth, of course, economic considerations will dictate their form. Practicality ruled, for example, in the designing of a functional utility unit for the home, conceived by

to COME ...



Raymond Loewy's radio-television set with remote control (inset); helicopter by George W. Walker

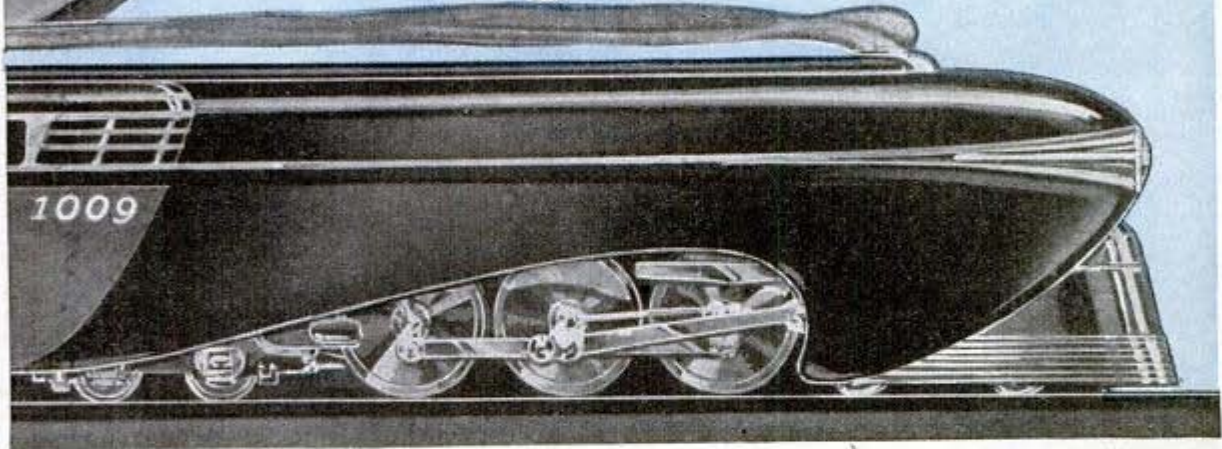
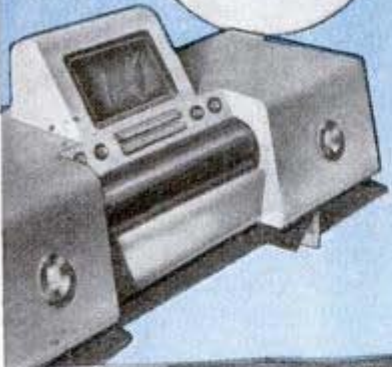

340 N. Milwaukee St.
Milwaukee 2, Wis.

Sundberg-Ferar of Detroit for the Virginia Lincoln Corporation. In this unit, the newly-developed low pressure molding technique of forming large pieces of resin-impregnated fibrous materials is used to form bathroom and kitchen fixtures integral with standardized interchangeable wall sections. All plumbing, wiring and electrical ducts are built in, and quickly connected by flexible connections to gas, electric, sewage and plumbing outlets built into the foundation.

Morgan, Va.

Notice "harpoon" shape of steam locomotive designed by Brooks Stevens. Below, engineers of Servel, Inc., study models of household equipment

The kitchen has a built-in refrigerator with drawers instead of doors; a flick of the fin-

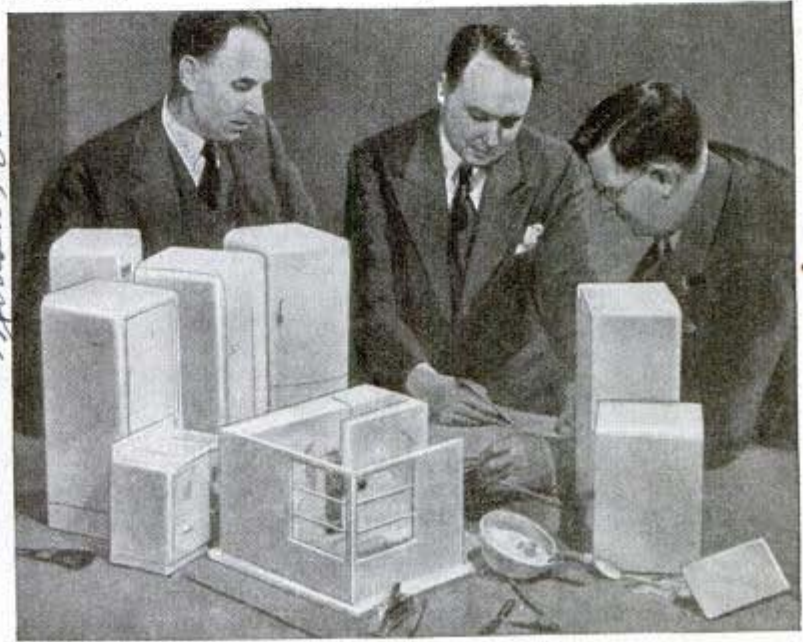

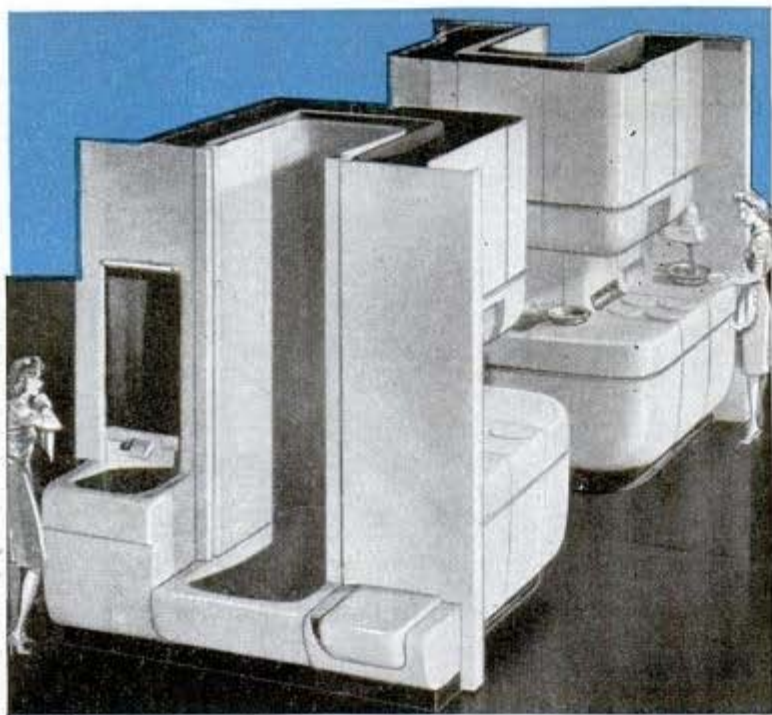

Tub and shower of bathroom (Sundberg & Ferar) fit into "U" of kitchen unit. Below, highway "livestock train" sketched for Timken-Detroit Axle Co.

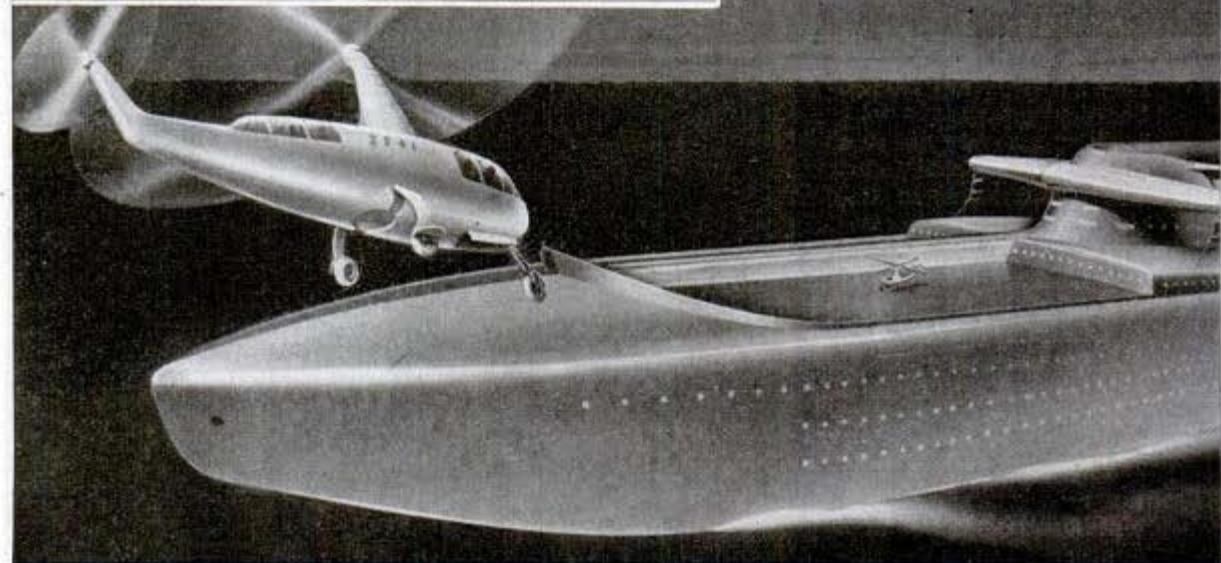
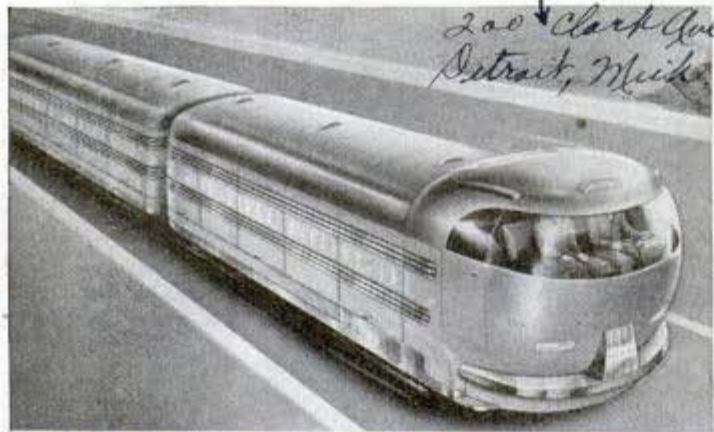

ger releases the catch and the transparent-front drawer rolls forward on a slightly inclined track. The sink, recessed into the wall, includes a plastic shower head for rinsing dishes, its hose automatically drawn up on a hidden reel when released. A compartment at the left of the sink contains air-conditioning and heating units and the hot water supply.

On the other side of the unit is the bathroom, with built-in fixtures conveniently arranged, and fluorescent lighting.

Many a home owner will go shopping for new heating plants after the war, and there will be new heating "packages" of diminutive size and high efficiency. Already there is promised a heat-control system, built by

Minneapolis-Honeywell Regulator Co., which will permit sectional regulation so that the living room can be maintained at 72 degrees, the bedroom at 65, the garage and attic at 50 or any desired level. This heat regulator, already used in large public buildings, can be installed in many existing home heating systems after

Turbo-electric liner with helicopter on deck, conceived by Raymond Loewy

the war to modulate the flow of heat to each room or section as required, wasting not a degree where it is not needed.

The home planners of the Owens-Illinois Glass company include in their preview a plastic refrigerator with an icewater tap, ice cube ejector, deep freeze unit, ultraviolet lamp to sterilize food, and a circular central section

The four-place family plane at right is an artist's suggestion of an Aeronca plane of the future

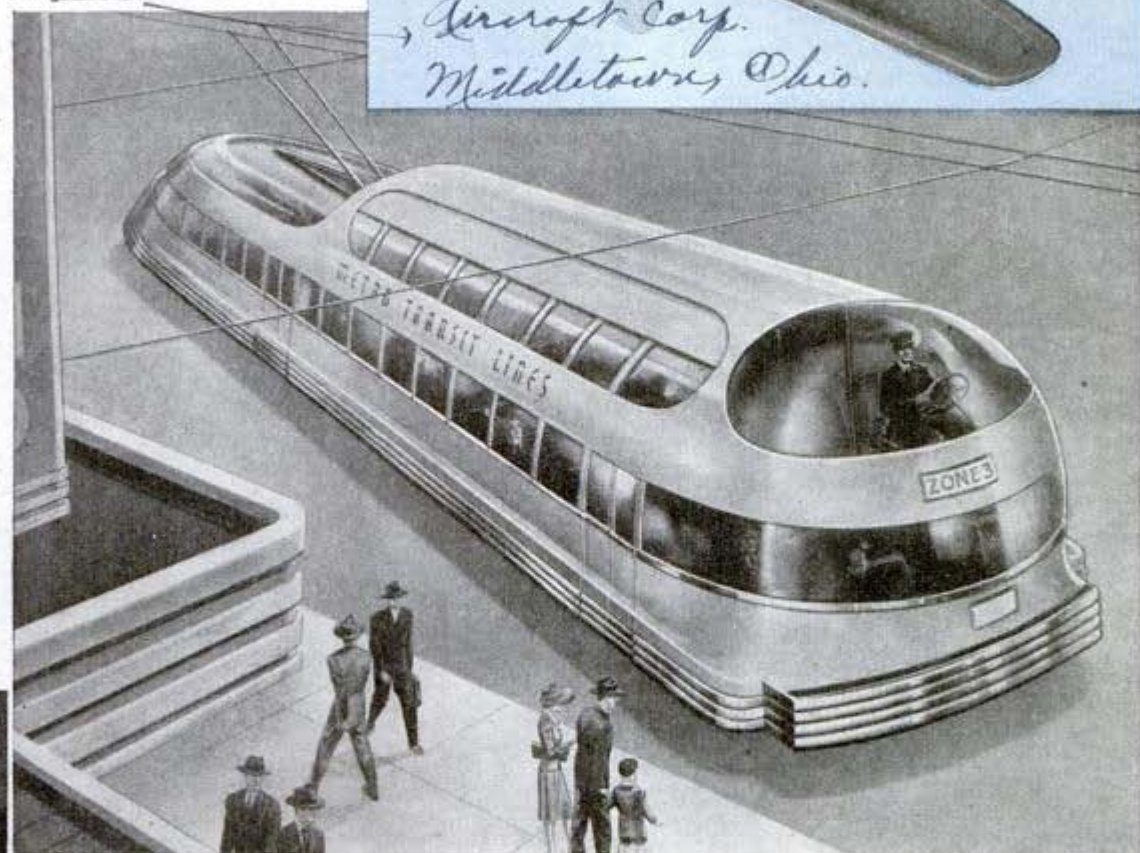
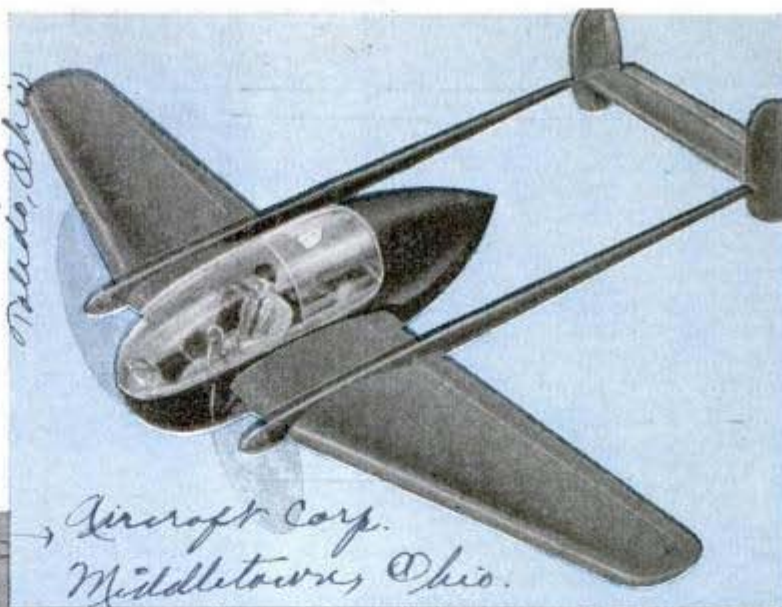

Timken-Detroit Axle Co.

This twin-deck trackless trolley with the driver upstairs, and with a sky-view "roll-back" roof, is proposed by one industrial engineer

with revolving shelves. They also suggest an electric eye that will see you coming and open the swinging door as you carry a tray of dishes from diningroom to kitchen . . . a waste pulverizer that chews up table scraps and old bottles . . . a cordless electric iron . . . windows that open at touch of a pushbutton.

Westinghouse looks forward to completely air-conditioned homes with dust and dirt collected from the air electrostatically by home-size Precipitrons . . . lockers to quick-freeze foods from your post-victory garden . . . automatic washing machines with electric driers and ironers.

It is pretty generally agreed that the next automobiles

built will be modified 1942 models. It is the car after the next that our designers are planning. George W. Walker, Raymond Loewy, Brooks Stevens, Sundberg and Ferar all have their versions of the streamline sedans of the future, some of them rear-engine models, nearly all emphasizing visibility through plastic windows and at least partly transparent roofs, and a minimum of corner-post obstructions. Family-size helicopters are also on the drawing boards, and Raymond Loewy as consultant engineer for the Greyhound Corporation has sketched a huge helicopter-bus which would have terminals on the roof of motor bus stations.

From the Timken-Detroit Axle company comes a whole album suggesting the "shape of things to come" from the truck and bus builders when their energies are no longer absorbed in building tanks and aircraft and military trucks. These "vehicles of tomorrow" sketched for the company by Lurelle Guild range from a twin-deck trackless trolley with a sky-view, roll-back roof to an earth-moving dump truck with an off-

set cab at one side, steering-driving axles at both ends permitting the truck to be driven in either direction without turning around, and dumping its load both fore and aft. Timken-Detroit also visualizes delivery trucks with merchandise display panels in the sides, airport trucks carrying plastic containers loaded with packaged goods for air cargo shipment, and huge tractor-trailer combinations specially designed for hauling livestock, milk, oil, passengers, produce.

"The day of the 'all-purpose' truck is gone," the Timken-Detroit company points out. "Just as livestock differs from household goods, so should the trucks and trailers that carry each be designed for its particular kind of load. . .

"From the crucible of war have come great technical advances. . . Fuels that get more power from new engines. Lighter but stronger metals that reduce over-all weight, yet serve better the purposes of safety.

"All this is on the side of vastly improved performance, longer life, greatly reduced

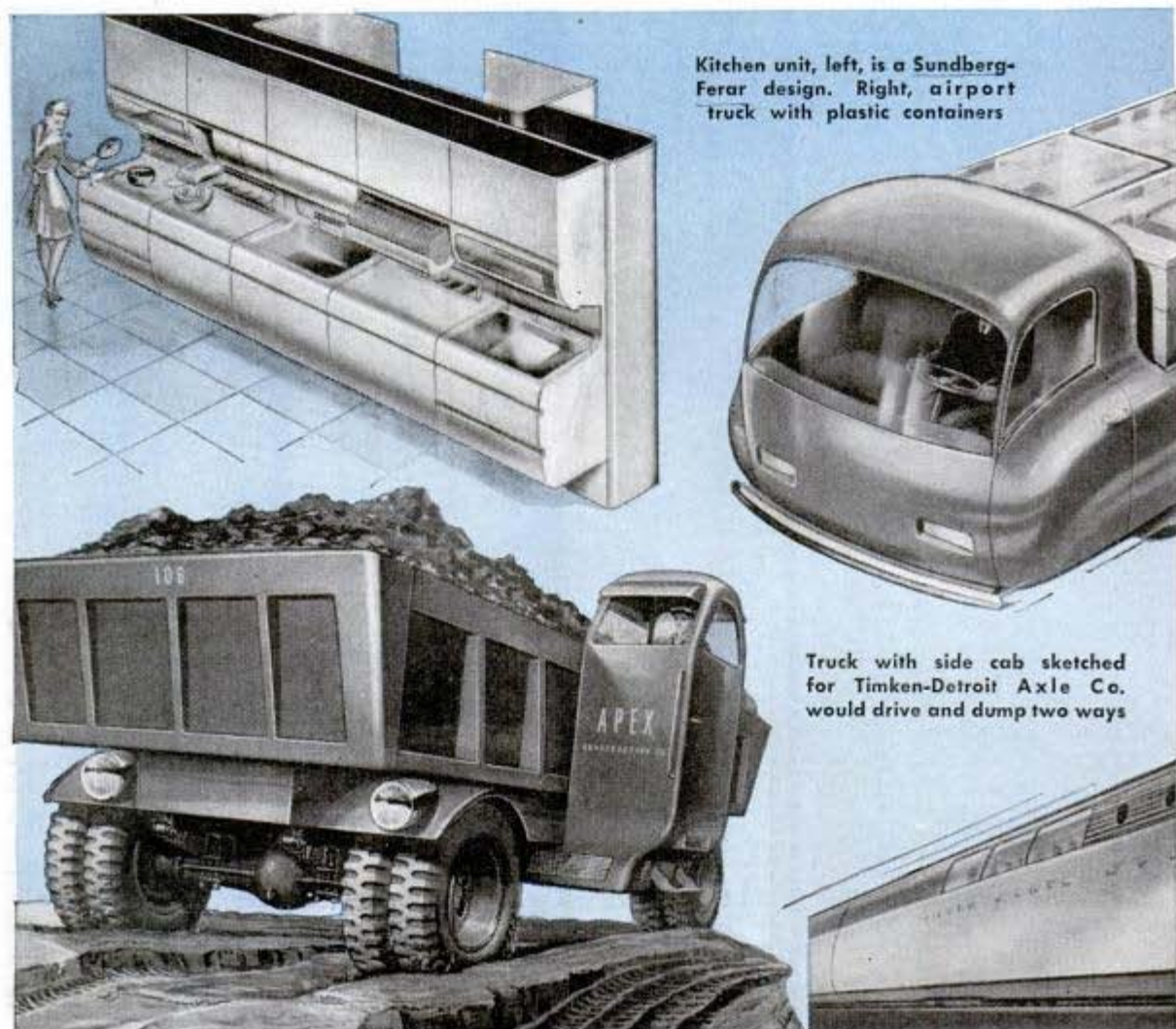

Kitchen unit, left, is a Sundberg-Ferar design. Right, airport truck with plastic containers

Truck with side cab sketched for Timken-Detroit Axle Co. would drive and dump two ways

operating and maintenance cost. And already on the drawing boards of designers are the sketches of bodies that will increase carrying capacity, reduce 'drag,' promote safety, facilitate loading and contribute greatly to the comfort of all who drive or ride."

Surveys have indicated that more than 1,000,000 families will undertake home improvements shortly after the war, 1,000,000 new homes per year will be built, and there is a vast market accumulating for new automobiles, radios, television and FM, refrigerators, washing machines and so on and on.

As Norman Bel Geddes and company, industrial

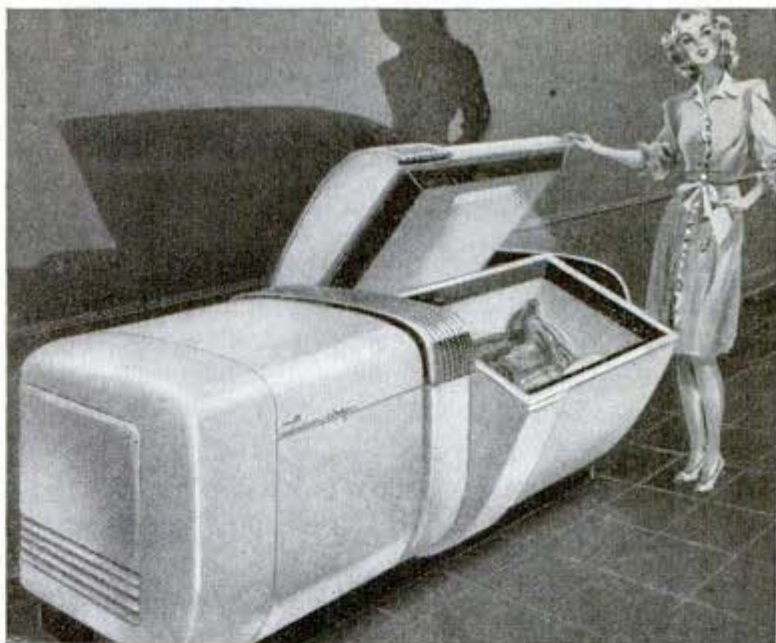

The home freezer unit is a Brooks Stevens design. The same artist borrowed from automotive styling in prophetic sketches of lightplane, below

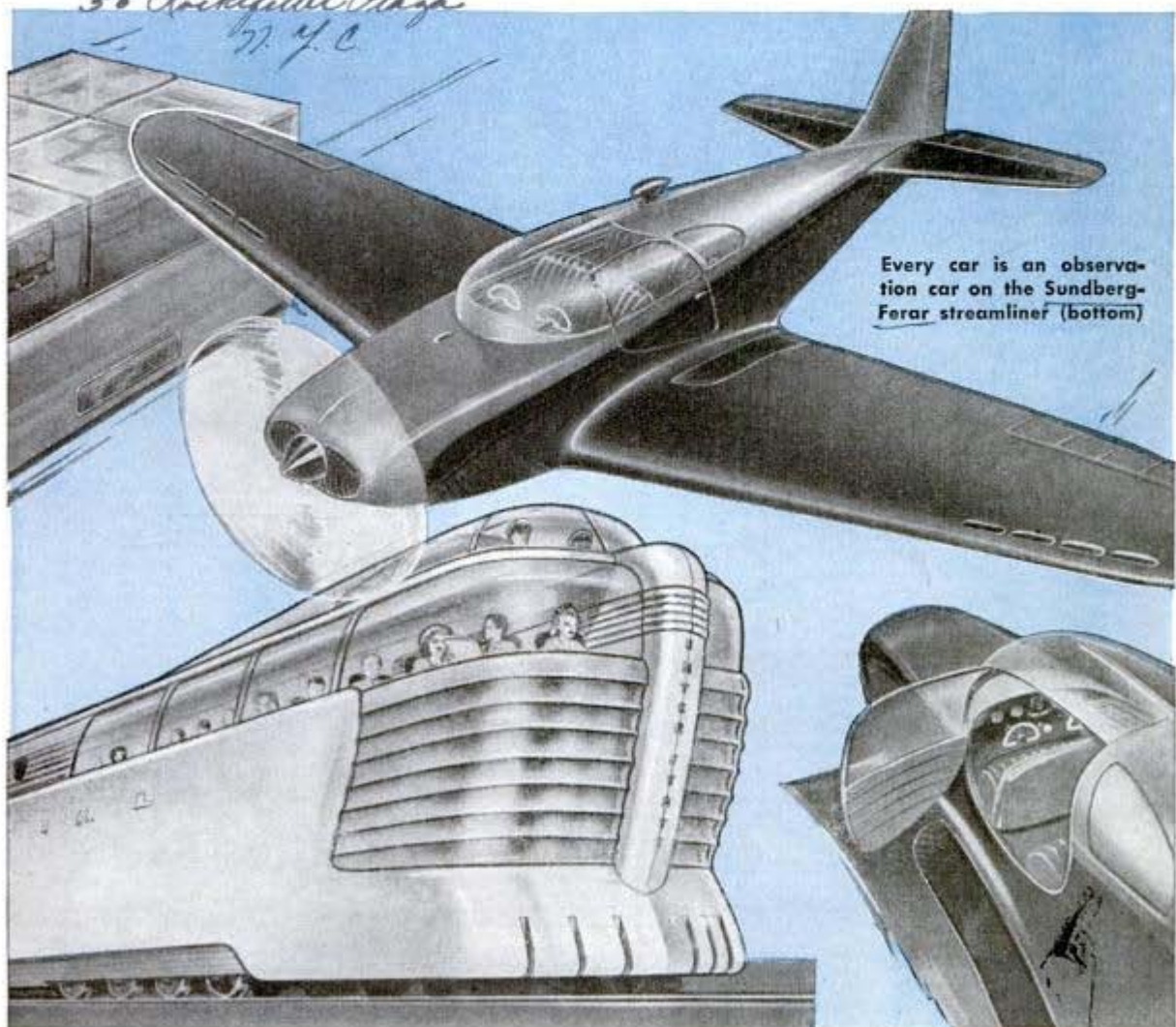

Every car is an observation car on the Sundberg-Ferar streamliner (bottom)



Timken-Detroit Axle Co.

Tomorrow's light delivery truck may have changeable merchandise showcase

designers, have said: "The destruction and obsolescence of equipment and traditional ideas prompted by the war is a Godsend to us all. It offers the opportunity to start over, with the knowledge and experience of the past and the confidence that we can do for peace what we did for war. We should no longer be handicapped by dated ideas and methods."

Furniture and textiles are bound to undergo changes as molded plywoods and plastics and synthetic fibers have their first chance at peacetime competition. Many of the postwar automobile plans propose woven plastics for seat coverings.

Sundberg and Ferar have suggested a plastic chair designed for comfort, its body molded by the "heatronic" method with large presses. Instead of "clumsy steel springs," the designers propose a preformed sponge-rubber cushion and a zipper fastening the upholstery of woven extruded plastic to the chair. The back and legs would be transparent, and the chair would be shaped to support the body at every point.

Brooks Stevens, whose postwar ideas range from a streamline locomotive to a refrigerator

with a transparent-plastic corner window, offers a novel suggestion of molded plastic tableware. Modern plastics, he points out, offer an infinite variety of form and color possibilities, and since it is no

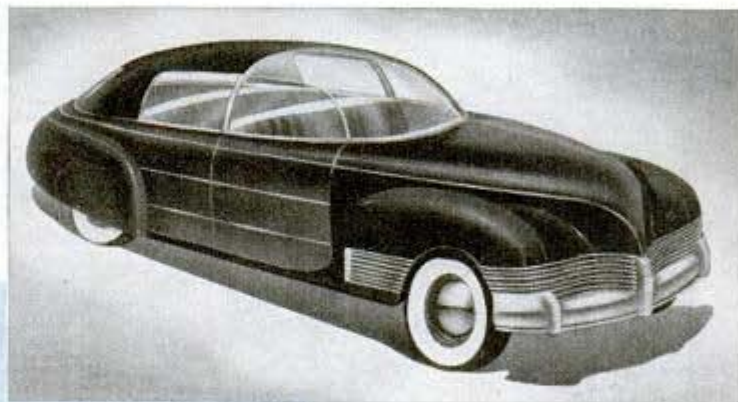

Sedan is a George W. Walker design; below, bus by Sundberg-Ferar

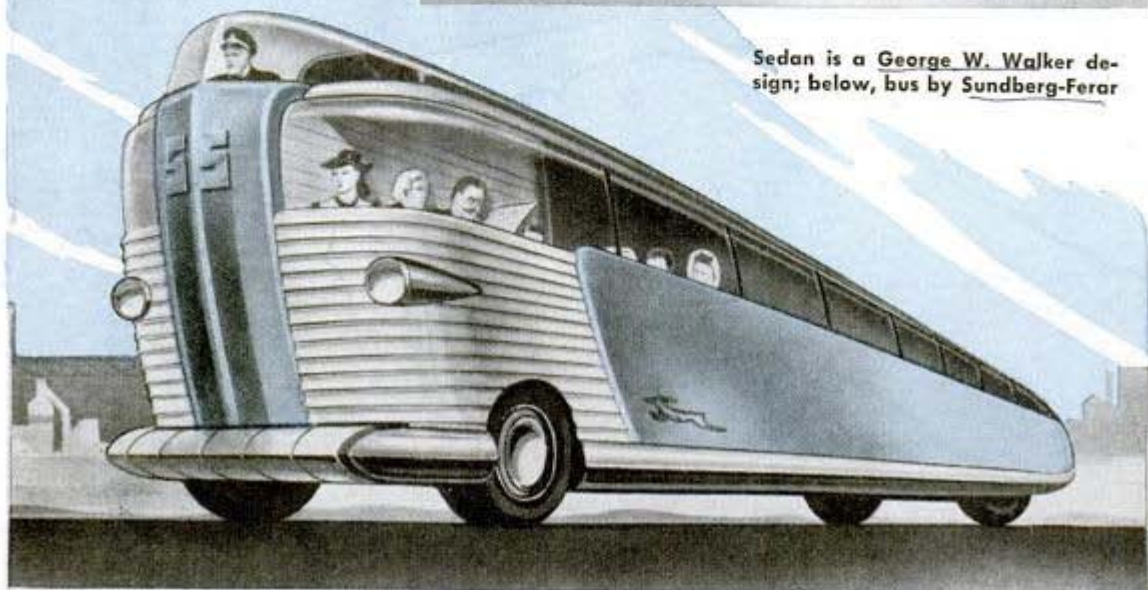



Raymond Loewy styled this proposed helicopter bus, seating 14 passengers, for the Greyhound Corporation

longer necessary to adhere to the traditional round plate form inherited from the pottery wheel, he has molded plates with a modern motif, a straight edge on one side.

Changes in home equipment must be evolutionary, not revolutionary. Old houses have always been the principal market for new appliances, and designers must stay close to tradition to fit the new stove or refrigerator into the old house.

Sundberg and Ferar point out that "universal application of plastics" is a myth.

"Two prime factors will retard the spread of this versatile material into many fields," they say: "dimensional stability and impact strength. Both must be greatly increased, and plastics in general must be greatly reduced in cost if their use is not to be limited to gadgets and ornaments.

"There are, however, three recent developments in the plastic field which do show promise for the future if the cost of production can be made compatible with peacetime economics. One is heatronic molding permitting faster cycles and larger pieces; the

George W. Walker, automotive designer, calls the drawing at right "Highways of Tomorrow"

second is the development of a relatively hard and thermostable transparent allyl resin still in the experimental stage; the third is low-pressure molding in which resin-impregnated cloth, paper or plywood can be formed by heat and low pressures."

Money is no object in war. Thus much of the pioneering research that will eventuate in the new products and processes of peace has already been charged off. But money is the dictator in peacetime industry. The innovations in store for your new way of living will come gradually as the dreams of the designers prove marketable and economical and sound.

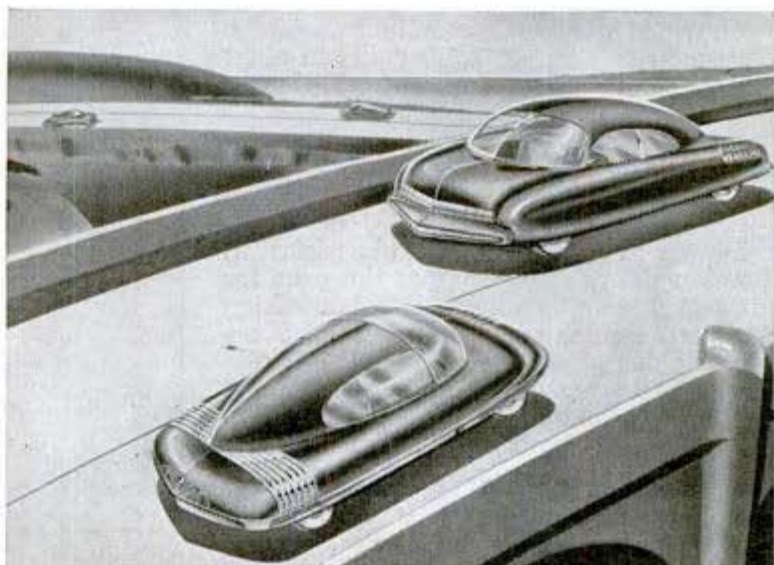

0184

Stepladder Mounted on Tricycle Speeds Tunnel Maintenance

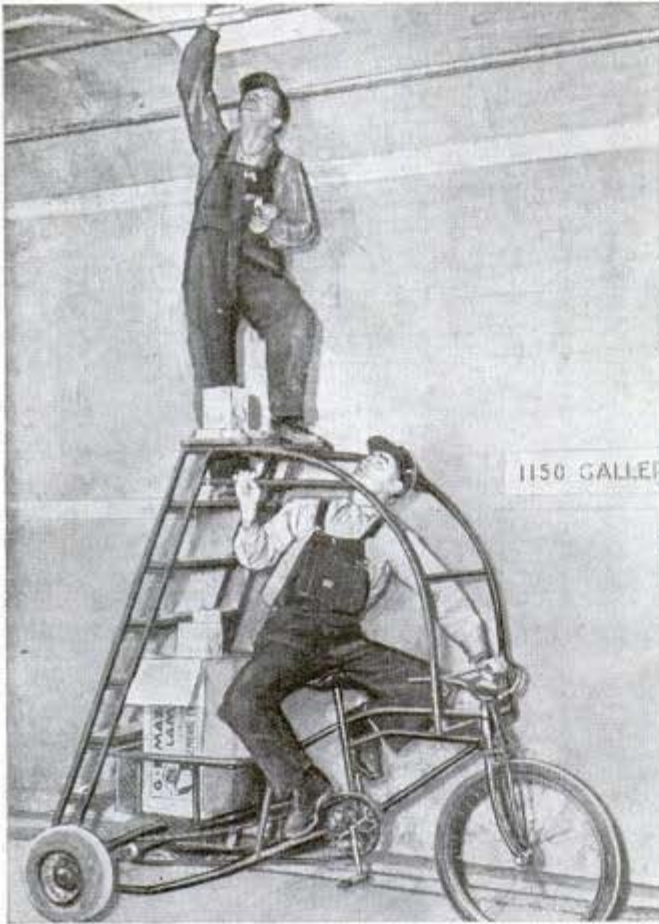

Two-man crew servicing lights in tunnels of Grand Coulee dam

Burned-out light globes in the miles of tunnels inside Grand Coulee dam are quickly replaced by a two-man crew that travels on a special tricycle. Mounted on the tricycle is a stepladder and platform from which it is easy to reach light sockets. Two men service the 2,800 lights in eight and one-half miles of tunnels, replacing about 400 burned-out globes each week.

0262

Warplanes Set Speed Records Cross-Country and Atlantic

Dinner in Los Angeles and breakfast in London the next morning is the pace for air travel recently set by record-breaking U.S. and British warplanes. A P-51 Mustang fighter plane broke the cross-continental speed record by traveling from Los Angeles to New York in 6 hours, 31 minutes and 30 seconds. This included a stop of 6 minutes and 25 seconds in Kansas City for refueling. The Mustang, which averaged 390 miles per hour in flight, beat the Los Angeles-Washington record of the

Wing Comdr. J. De L. Woodrige
 Constellation by 26½ minutes. A new trans-Atlantic speed record was set by an R.A.F. Mosquito bomber by flying the 2,200 miles from Labrador to England in six hours and 46 minutes. A previous record of eight hours and 56 minutes for the same route was held by a Liberator bomber. The Mosquito averaged 325.12 miles an hour on the trip.

0260

Army Measles Preventive Made of Blood Plasma

Large supplies of gamma globulin, which contains the antibodies developed in the blood to fight measles, are now available to United States Army soldiers. The globulin is obtained by the War Department from Red Cross blood plasma, since most adults have had the disease.

0206

"Man in the Iron Mask" Is Jap at Bayonet Drill

Enemy equipment captured by the United States Army on Kwajalein Island indicates that the Japanese soldier dresses up like one of King Arthur's knights before practicing bayonet fighting. The captured uniform included an iron mask, a barrel-like chest guard, and pads to protect the head and loins similar to those worn in medieval times.



Soldier models bayonet drill togs captured from Japs

Col. Clair Peterson & Lt. Col. Jack Carter - A. G. F. - Mustang

POPULAR MECHANICS
 Sgt. John W. Jones, Jr.
 Springfield, Ohio.

Mr. Steinson, Jr.
3872 Franklin Ave.
Los Angeles 29, Calif.

0249

GATEWAY to WAR

DURING the first few months of the war more military supplies moved through the port facilities of San Francisco Bay than all other ports of the United States combined. Now, with the Pacific push gathering impetus, the outward flow of troop transports, ammunition ships, and war vessels of every description from the Golden Gate is at a peak again.

San Francisco Bay has been called the "heart and strategic center of offensive operations in the Pacific." It is all that and more. Here are the headquarters of the Western Sea Frontier, the Western Defense Command, and the Fourth Air Force. Exposed to possi-



Millions of tons of Army cargo pass under San Francisco Bay bridge en route to war

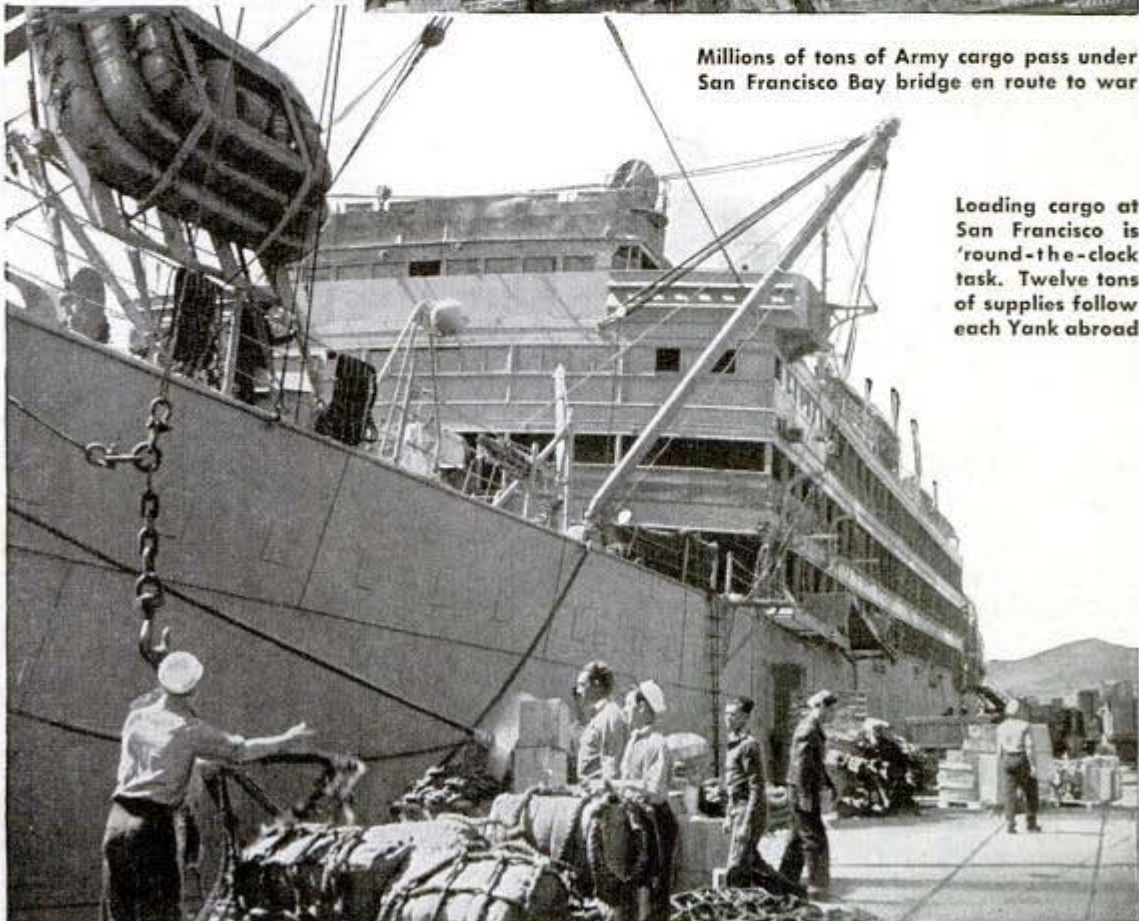

Loading cargo at San Francisco is 'round-the-clock' task. Twelve tons of supplies follow each Yank abroad

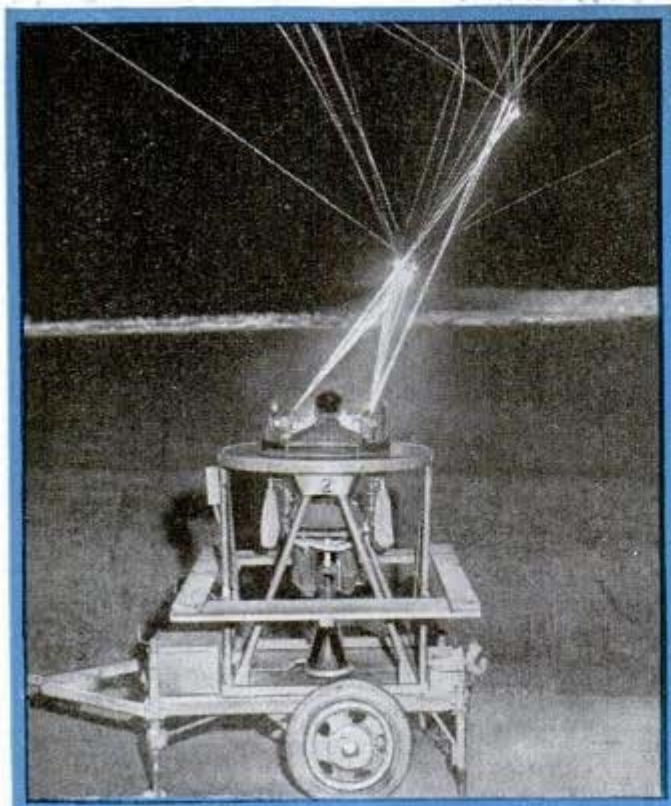

Official U. S. Navy photo
Night practice with tracers on naval range at San Francisco.
Below, men load scout cars for movement to embarkation port

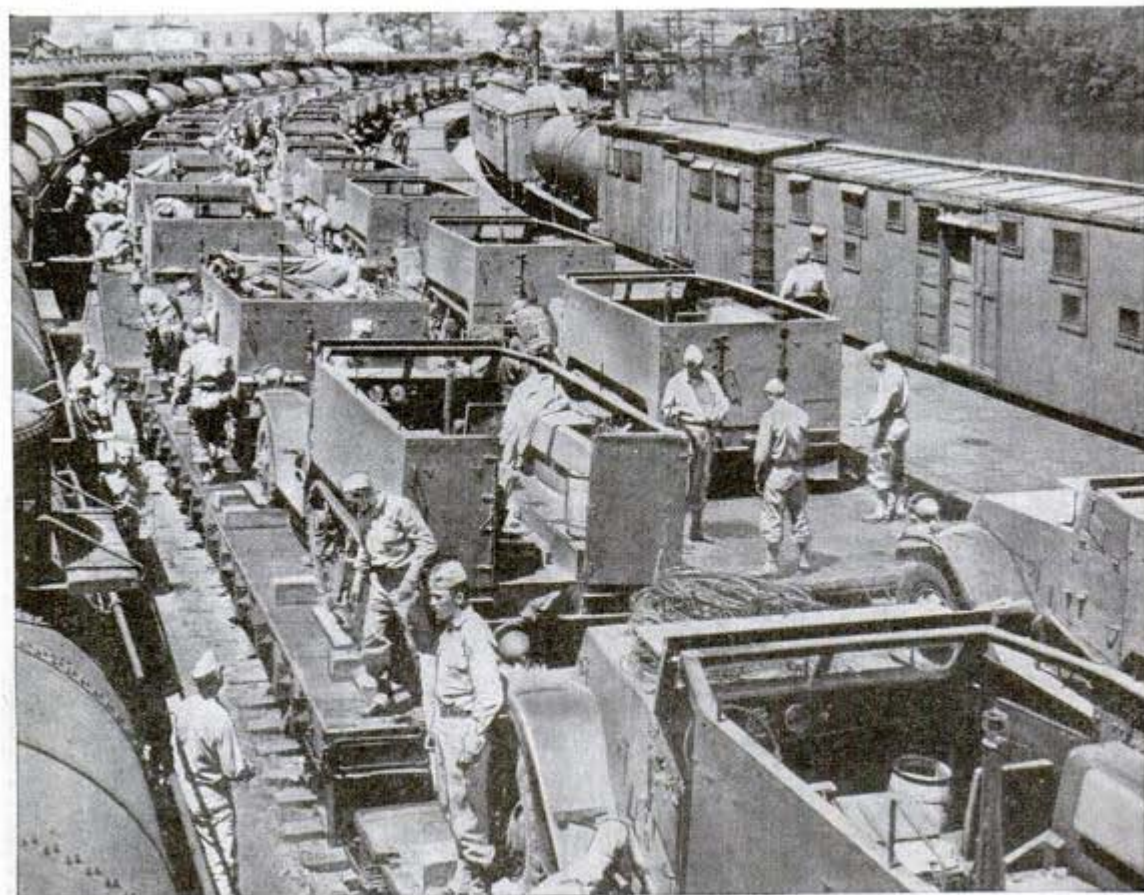

ble enemy attack, it is well guarded ashore by the Army and well protected offshore by the Navy. Practically every civilian activity in the area is connected with waging war. Wartime increase in population is greatest among the metropolitan areas and 100,000 new housing units have not been enough to fill the need.

Not all details of wartime activity can be told, although it has been announced that one of the world's greatest arsenals is located on the bay and that the nation's greatest naval base and supply depot are likewise in the area. One fourth of the country's ships, involving contracts of more than three billion dollars awarded during the last four years, are being built by Bay yards. Liberty ships were launched by one yard at the rate of one per day during a recent one-month period.

The activity at Mare Island Navy Yard is typical of the whole Bay region. Mare Island is not only building surface ships and submarines, it repairs warships that have received battle damage and assembles destroyer escorts

that are shipped from prefabrication points as far away as Denver. LCT's, sometimes jocularly called "Large Cattle Trucks" by their crews instead of "Landing Craft—Tanks," and other small ships and craft are also assembled at Mare Island.

During the last two years this Navy yard trebled in size and now employs nearly 50,000 workers. To get this number of people to and from their jobs requires 280 buses that travel more than the distance around the world each day. Cafeterias in the yard serve 11,000 hot meals daily and twice that number of lunches from mobile canteens.

On top of all its other activities, San Francisco Bay is the site of the San Francisco Port of Embarkation. A port of embarkation is an installation of the Transport Corps, Army Service Forces, and com-

prises a port where ships are assembled and where troops and supplies are received from interior zones for transshipment overseas. Embarkation facilities include huge Army installations, vast commercial



Relaying orders at the control tower of naval air station along the bay

Floating crane at Mare Island Navy Yard lifts a finished LCT off the ways and places vessel in the water

Navy photo

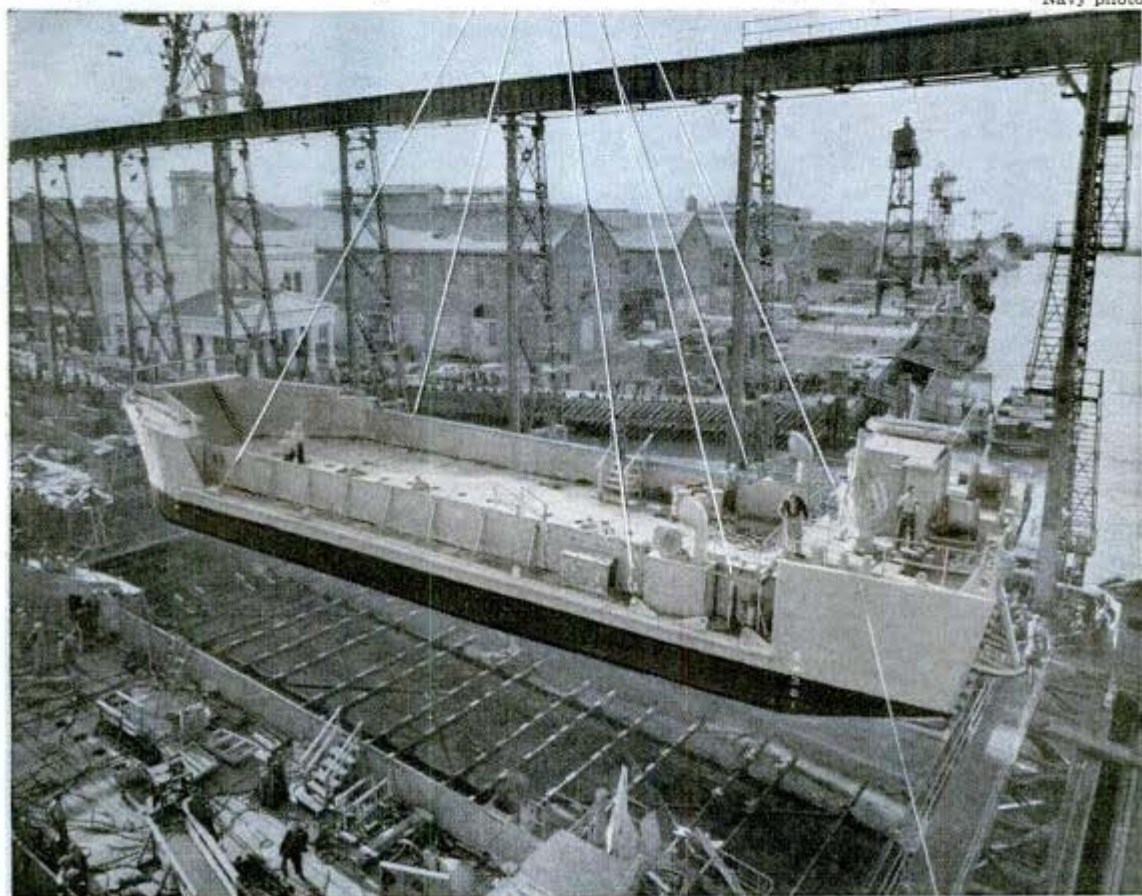



Inspecting spare gun tubes awaiting shipment abroad

waterfront terminals, motor inspection bases where vehicles receive final servicing before being shipped, Army post offices for handling incoming and outgoing overseas mail, and miles of docking space. It is the home base of the troops overseas.

A modern army requires prodigious amounts of equipment and supplies. An infantry division may use 542 tons of ammunition alone in one day. At least 15 Liberty ships and troop ships are needed to transport an armored division and this division in action may consume thousands of gallons of gasoline per hour. Up to 12 ship tons of equipment accompanies each man who goes overseas and nearly another one and a half ship tons of food, clothing, and supplies must be shipped out

every month to keep him in combat.

During the last war nearly half of all the supplies used by the A.E.F. were obtained abroad. This time, not only are the requirements much higher per man, but practically all such supplies must be shipped from the United States. More than 25 million tons of Army cargo had moved overseas from all three coasts by the beginning



War freight moving across mountains on Southern Pacific train will find space reserved for it at dock warehouse. Below, lifting 1,000-pound aerial bomb on spark-proof truck at arsenal on bay



of 1944, more than two and a half times as much cargo as was shipped abroad during World War I. In addition to all this are the enormous quantities of supplies that go to our Allies.

Moving such vast amounts of goods is an unparalleled task. Originating possibly on Kansas farms, in Texas oil fields, and in Michigan motor plants, all the supplies must be funneled through the ports of embarkation. During



Navy gunners practicing with twin-mounted 40 mm. anti-aircraft guns on beach overlooking Pacific Ocean, and near busy port of embarkation

the last war, transportation of war goods bogged down. Loaded freight cars blockaded the rails leading to the main ports and at one time 200,000 loaded cars were strung out, stalled, from east coast ports all the way back to Chicago.

No such congestion has occurred this time, due to the planning of the Transportation Corps. Freight is not started toward a port until it is known that space will be available. En route the loaded cars pass through military regulating stations where the

movement of individual cars may be expedited, delayed, or diverted according to the latest schedules from the ports. Possibly a ship that is due to load cargo two weeks hence is torpedoed on its way to port; at the regulating station the freight that was destined for that ship is diverted to another port or is held back until another ship will be available. The regulating stations are located as far inland as the Rocky Mountains.

If it turns out that shipping space is not available at the last minute or when there is an urgent change in priorities, freight arriving at a port is sent to a holding and reconsignment point located within an overnight's run of the port. These points are reser-

Continued to page 158



Trainload of fighting tanks moves toward the Pacific "Gateway to War"

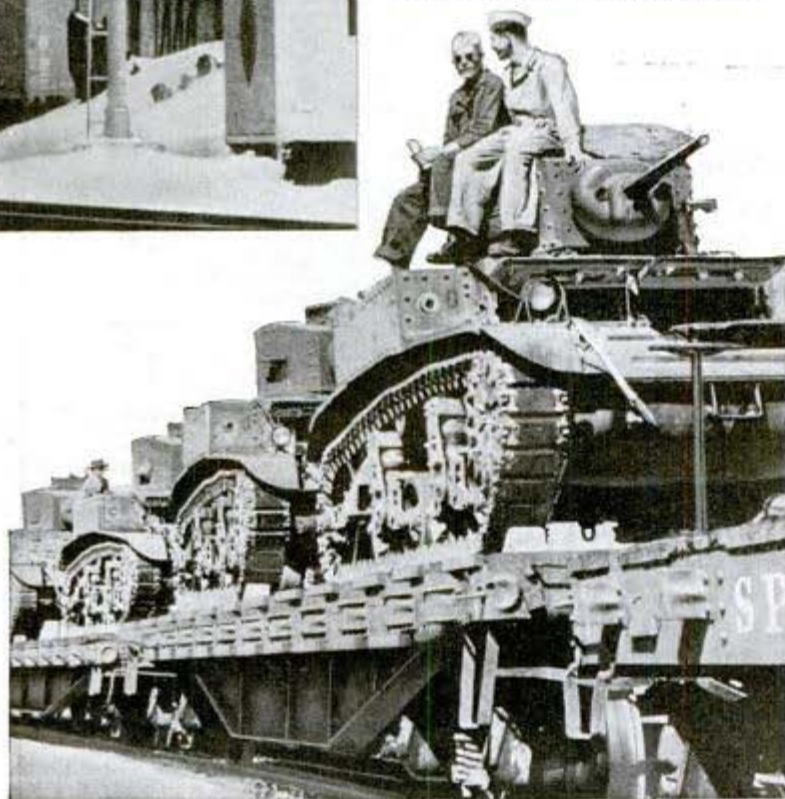

X-Rays Diagnose Damage ⁰²¹⁹ At Aircraft "Hospital"

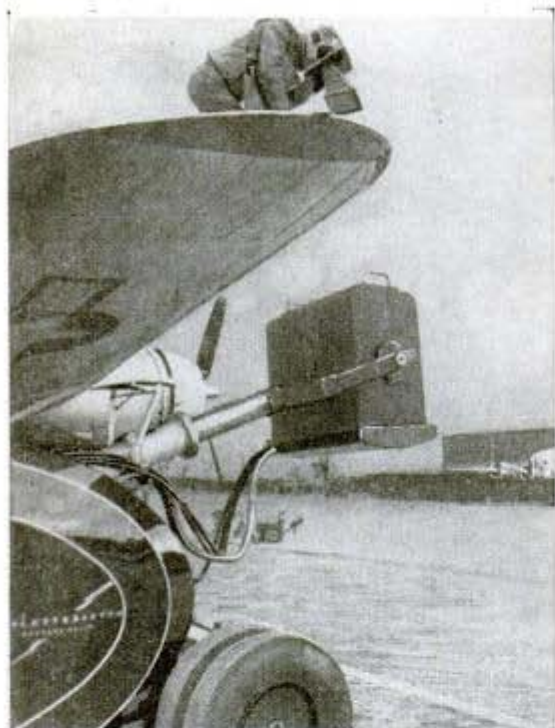

When a bomber or fighter plane limps home with a damaged part, it is immediately sent for treatment to one of the many airplane "hospitals" scattered throughout England and northern Ireland. There the "injuries" are X-rayed and all the ship's wants are looked after. Technically, the "hospitals" are Base Air Depots of the Air Service Command and their job is to supply the Air Force with anything it needs.

Car Battery Is Changed in Jiffy ⁰²¹³ With Quick-Releasing Clamp

Automobile batteries are removed with ease and speed when held in place by a cam-action clamp. Instead of bothering with the conventional wing nuts, all a mechanic has to do is release the cam lever and lift the battery out. The clamp is easily fastened to battery boxes on cars, trucks

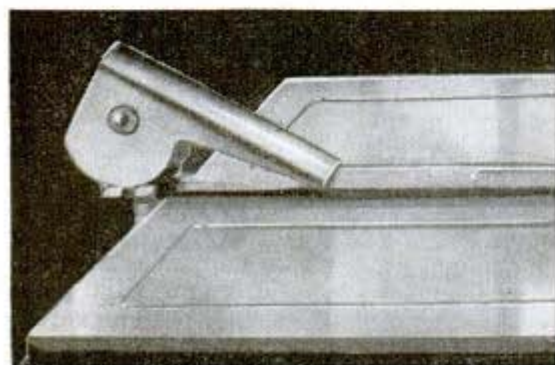

32. *The Paul Henry Co.
2037 S. La. Brea Blvd.
Los Angeles 34, Calif.*

or busses, and holds a battery firmly in place. It is said to eliminate the need of safety wiring.

Science Puts Crossbow to Work ⁰¹⁸⁹ Drawing Quartz Filaments

Adapting Robin Hood's favorite weapon to scientific purposes, Westinghouse research engineers shoot an arrow from a crossbow to draw out delicate quartz filaments used to measure the magnifying power of an electron microscope. The engineer places the steel bow in firing position on a wooden stock and attaches the arrow to a small, cylindrical piece of quartz. With the hot flame of an oxy-hydrogen torch he heats the quartz until it is just about to melt, then pulls the trigger. The arrow darts from the bow at high speed, trailing gossamer-like threads of quartz so fine that it would take 60 to match the thickness of a human hair. The filaments are 1/30,000 inch in diameter.

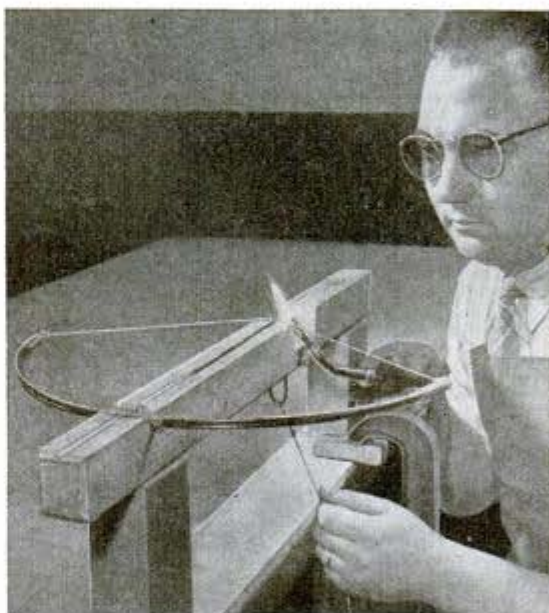

*Westinghouse Electric & Mfg. Co.
Pittsburgh, Pa.*

Save That Paper!

It may be only a petty annoyance to you, this shortage of paper. But to the war industries that need it, and to the Yankees overseas, a paper famine can be serious.

With your cooperation there need be no shortage. Yesterday's newspaper is of no value to you. But yesterday's newspaper, that empty candy box, the batch of advertisements you tossed in the wastebasket, the carton that brought today's groceries—these are the makings of the paperboard boxes that carry ammunition and field rations to the boys doing the fighting for you.

Save every scrap of paper for salvage. Waste-paper dealers, your favorite charity or the local salvage committee will tell you what to do with it.

By Paul Healy

IF THE domesticated members of the animal kingdom were to go on a sit-down strike, they might justifiably be accused of sabotage—even in this highly mechanized war. Allied commanders would wonder how to move equipment over mountain trails and through jungle swamps, how to communicate with one another without radio, how to scent a hidden enemy. Since the Axis would be similarly handicapped, opposing forces in certain theaters might be unable to come to grips.

Fortunately, however, animals still support man's war efforts faithfully and well, even though their tasks have been increasingly taken over by machines since Hannibal overcame the Romans with elephants, oxen and horses. There are crises when all the inventions of science are useless and man must call upon a dog, horse, mule, pigeon, camel or elephant for help. And nine times out of 10 he can count on heroics which neither he nor his machines could surpass.

Consider Caesar, a German shepherd trained as a Marine Corps "devil dog." Caesar landed on Bougainville with the first assault wave. On the first day, as

OUR ANIMAL ALLIES

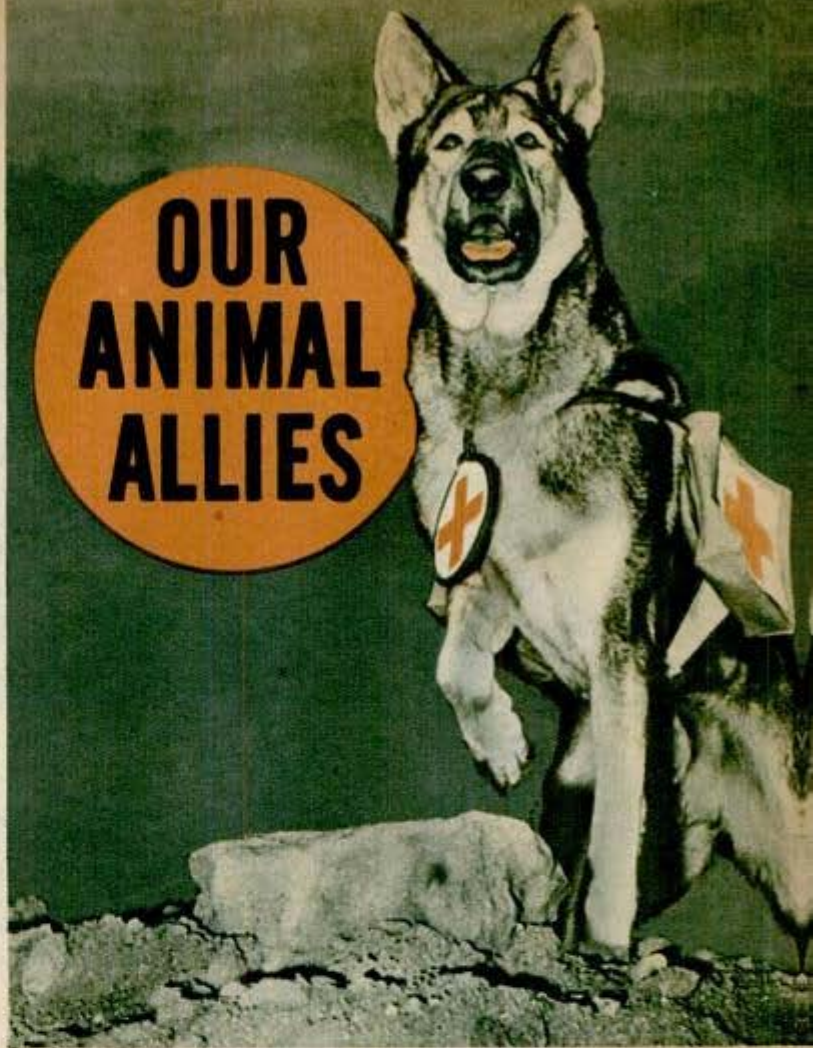

Rin Tin Tin III (above) is one of thousands of "mercy dogs" trained for Red Cross work by U. S. Army. Below, mule bearing pack litter for field artillery unit stationed in New Guinea

Capt. Herman Jammiche



*History
John W.
Madison*



Above, Army sled dogs hauling machine gun and operator. Left, a pigeon being released with a message



the only means of communication between Company M and the battalion post, he carried messages and captured Jap papers in nine round trips totaling 31 miles, two of the trips under fire. Once when Caesar and his master were advancing toward the enemy lines, with the dog "pointing" camouflaged snipers and pillboxes, his sensitive ears detected the click of a hand grenade several yards ahead. Caesar darted forward and sprang, catching the Jap's throwing arm in mid-air. The grenade dropped and exploded, killing the Jap and wounding Caesar in the hip and side.

Several other Marine canines also won distinction on Bougainville, such as Andy, a Dobermann Pinscher, who led Company M to the Jap road block a few hundred yards inland. His ears located a machine gun nest where 15 Japs were annihilated.

On the steep, rocky slopes of Italy (below) horses replaced trucks in packing supplies and equipment





On practice maneuvers Dalmatian war dog (above) locates "wounded soldier." Soon he will return leading first aid unit. Below, paratrooper rehearses sending message by homing pigeon as soon as he has landed in enemy territory

Lt. Col. Alan Shapley officially described the work of the War Dog Platoon of 24 canines and 55 men as "an unqualified success." True to training, not one dog barked on Bougainville.

Duke, a German shepherd who could scent a Jap three quarters of a mile away when the wind was right, became the Sergeant York of the dog world during some of the hottest fighting of the South Pacific. On New Guinea he was credited with flushing 50 Jap snipers. At Cape Gloucester he uncovered 80 Japs, of which 60 were killed, the rest captured.

Fiercest of the dogs used in this war were the "anti-tank" animals trained by the Russians. On the Kalinin front packs of dogs charged advancing Nazi tanks, leaping against their sides to deposit bombs carried in their muzzles, and then streaked back to escape the explosion. Nine heavy tanks and two armored cars were reported destroyed on one of these fantastic forays, but the trick later was abandoned because of the large number of canine casualties it entailed.

The modern war dog is a refined descendant of the blood-thirsty mastiffs loosed against the foe in medieval times. He is a sentry standing watch outside war plants and military posts and along the beaches with the Coast



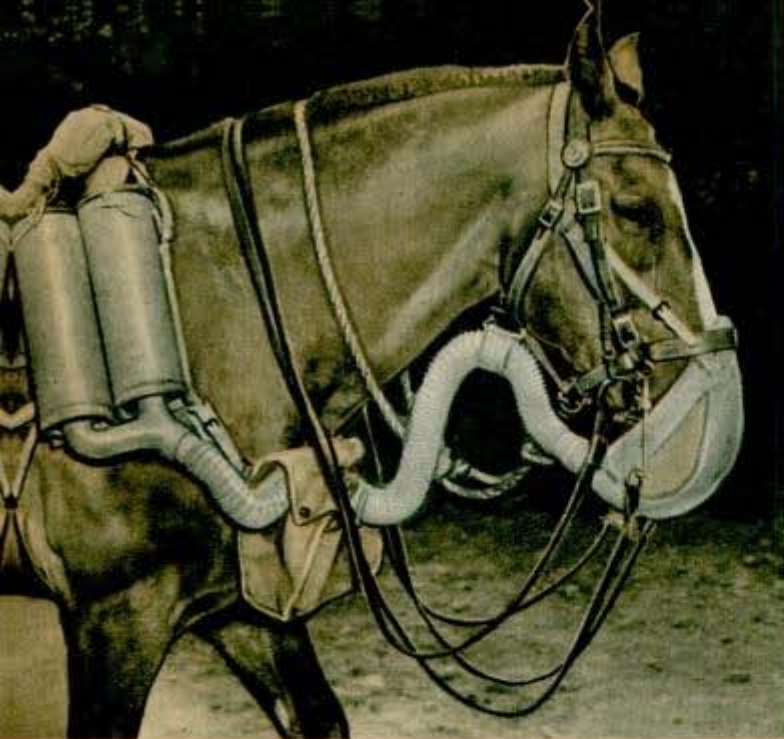

Cavalry mount (above) learns to wear gas mask. Note double canister. Below, "Sarah," a duck, is mascot of an RAF squadron



Guard; like Caesar, Duke and Andy, he is a messenger and a spotter and occasionally he carries supplies and strings telephone wires; he pulls sledges and ammunition carts in Newfoundland and Alaska; and in No Man's Land he guides first aid units to the wounded. In combat he is directed by the "silent whistle" which is pitched too high to be audible to human ears.

It has been a long time since generals rode white chargers and mounted troops dominated a battle. Nevertheless, the loyal, hard-working horse still plays a vital, if less spectacular, wartime role. Right after the German Army made the mechanized division famous in the Low countries in the spring of 1940, the Wehrmacht turned up with 800,000 military horses, some of which accompanied the infantry into territory won by the panzers, thus saving fuel and rubber. Japan is said to have used 300,000 horses against China and 75,000 more in the big Pacific offensive of 1942.

Our War Department stepped up horse purchases from 2,000 annually to 23,000 in 1941 and sent an SOS for soldiers to attend a school for horseshoers and saddlers at Fort Riley, Kas. Many artillery officers had always admitted the horse is indispensable for moving supplies off roads and

Below, a placid camel rests after hauling a supply wagon "somewhere in India"



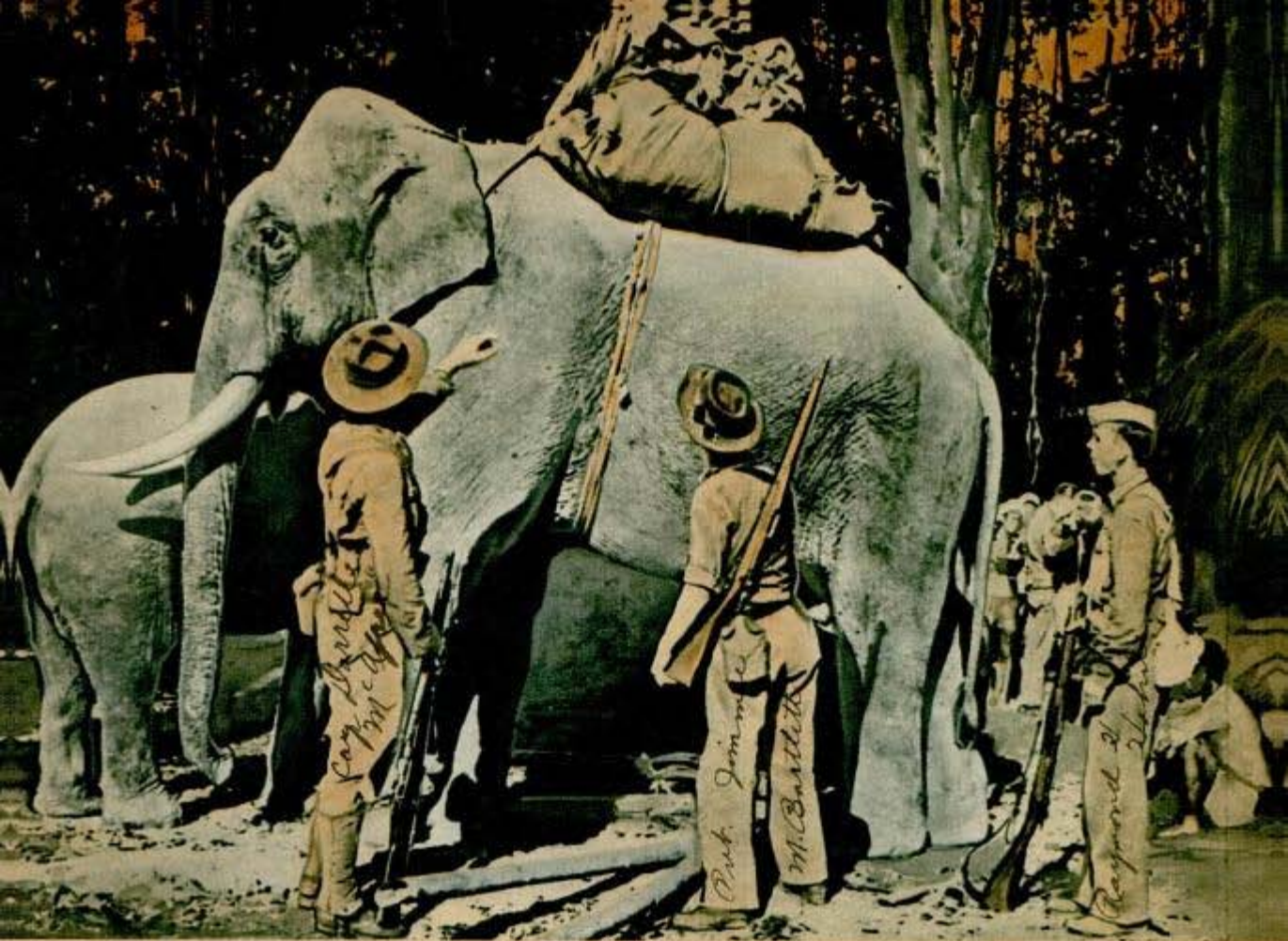

Above, an Indian elephant carries bedding for U. S. troops. Below, sentry dog bares fangs outside camp

through darkness, rain and mud. Their opinion was proved time after time in the Philippines and in the mountains of Italy, where motor vehicles frequently became stalled or wrecked.

Our horse cavalry is not used as dramatically as the Russian Cossacks and Guardsmen, who struck the bewildered Germans swiftly from behind their own lines, killing and capturing almost entire infantry regiments. Because trained horses are adept at swimming rivers and hiding in ditches and woods, United States Army horse cavalry is considered valuable for scouting purposes in uneven country. Capt. Alvin T. Netterblad, who led a mechanized cavalry reconnaissance troop in Italy, said he often longed for horses on the devious mountain paths.

Many a patriotic horse is doing his bit by releasing a jeep for combat duty. In June, 1942, the army announced it was replacing 1,500 trucks and cars with animal drawn vehicles at camps in this country. In addition, coast guard sailors have been mounted on horses so they could cover more shore territory where saboteurs would be likely to land.

Stubborn, sure-footed mules made the headlines last March when they were

Continued to page 154



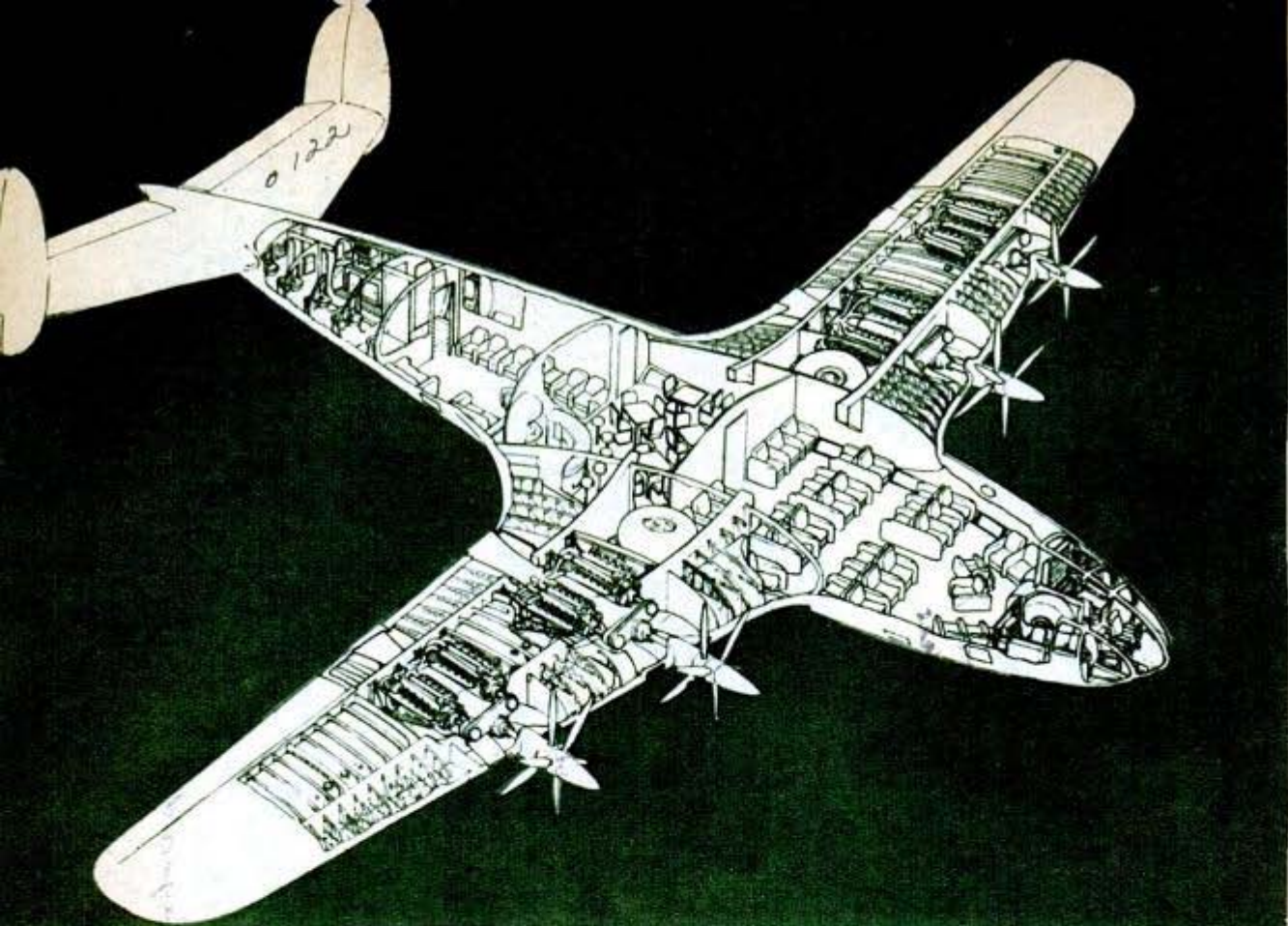

Eight-Engine, 55-Seat Plane to Have a 3,450-Mile Range

Plans for a postwar commercial airliner which will have eight engines and seats for 50 passengers and a crew of five have been drawn by a British designer, F. G. Miles. The plane is expected to attain a speed of 350 miles per hour and have a range of 3,450 miles. Payload for its maximum

range is set at 16,430 pounds. The design calls for Rolls-Royce motors producing 14,000 horsepower at 425 miles per hour at 16,000 feet, or, on a weak mixture, 10,000 horsepower at 380 miles per hour at 18,000 feet. According to the British Information Services, a scale model has been tested.



Rubber Bulb on Dusting Brush ⁰¹⁰² Blows Specks Off Lenses

Designed to remove the tiny specks which cannot be seen by the naked eye, a rubber blower bulb has been attached to a camel's-hair brush for use in cleaning lenses and film apertures of cine cameras and projectors. The blower roots out the infinitesimal particles from the lens or aperture when the bulb is squeezed, and the brush whisks them away. ⁰¹¹⁷

Silver Coat Conducts Electricity On Glass or Wood Surface

Applying a ceramic type composition containing silver powder to glass, wood and other non-conductive materials gives the surface high electrical conductivity and low electrical resistance. The new composition, which is used in condensers and other units in electrical circuits, is applied by brushing, dipping, or spraying.



Army Glider Can Carry a Fully-Loaded Truck

Although it costs only one-tenth as much as a transport plane, the YCG-13, newest glider of the army air forces troop carrier command, can carry almost as much as our heaviest bombers, and it is said to be ca-

pable of transporting more men and supplies in less time. The craft, which can land on its wheels or skids, is big enough to take aboard an entire medium truck, loaded with equipment.

Stabilizing Device on Helicopter Keeps Rotor Horizontal



Regardless of the angle of the craft, a stabilizing device on the new Bell Aircraft helicopter keeps its rotor in a horizontal plane. The stabilizer, which is said to increase simplicity of controls, is placed between the mast and the rotor. The helicopter is powered by a 160-horsepower air-cooled engine mounted vertically behind the pilot's compartment, and uses a two-bladed rotor. Span of the rotor is 33 feet. On the tail is a conventional anti-torque propeller. Bell engineers believe their machine has hurdled three longtime obstacles in the development of helicopters—instability, excessive vibration, and difficulty of control.

0236
Bell Aircraft Corp.
Buffalo, N.Y.

Cooling Fan Behind Propellers Steps Up Rate of Climb 20 Percent

War planes can climb into the stratosphere 20 percent faster with a cooling fan mounted behind the propellers, according to tests conducted by the Wright Aeronautical Corp. The many-bladed fan developed by Wright engineers helps to eliminate the drag of earlier cooling methods. It is also said to add to the cruising speed and high altitude performance of war planes. Tests indicate that on twin-engined cargo planes the new cooling device can increase pay load 10,000 pounds. The fan fits just inside the engine cowling and forces air over the engine's cooling fins.

AUGUST, 1944

Paterson, N.J.

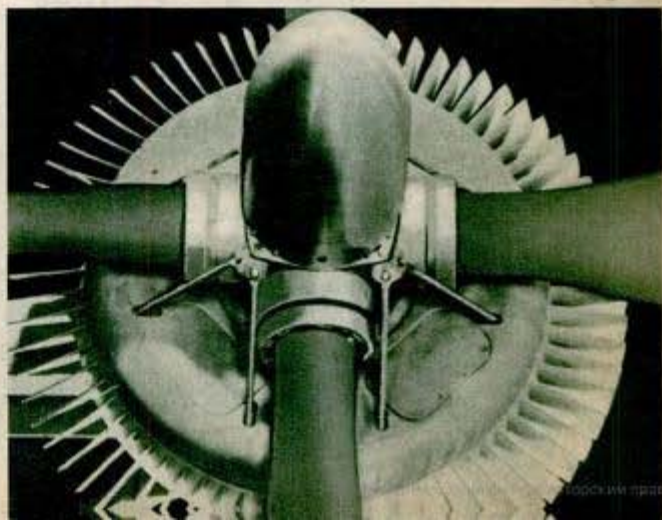

0183

FIRE from the SKY



Above, fire bombs hurtle from B-17's to sow flames in Germany. Below, putting incendiary jelly in bombs

MATCHSTICKS are raining on Germany—matchsticks by the millions, matchsticks that leave a path of seared and ruined destruction, matchsticks whose flaring flame cannot be extinguished by any means known to man, matchsticks that are playing an important part in the Allied program of destroying the military might of the Axis.

These are real matchsticks, for they are used effectively and terribly to set fires, raging infernoes that raze enemy installations. They are known technically as incendiary bombs. Scientifically designed to burst into flame upon contact with almost any object, they range in size from two and four-pounders up to mighty 500-pound bombs which the experts declare will defy all efforts to extinguish them.

A bombing fleet can carry hundreds of thousands of the smaller incendiaries, a single large aircraft has a capacity of about 1,500. In a recent raid on Berlin's battered war plants, Allied aircraft dropped close to 350,000 fire-setting bombs. On that mission, the incendiaries made up almost the entire load of the air fleet, 98 percent, to be exact. In many situations, the incendiary



now pays greater dividends per pound of weight carried in bomb racks than does the high-explosive bomb, even the famed four and six-ton "block busters." As a result, the use of fire bombs has increased. When the war began, incendiaries formed only five percent of bomb loads carried by Allied aircraft; today the percentage is above 60 and is increasing steadily.

Production of fire bombs now ranges into the hundreds of millions, with seven principal types



Machine operator (above) corking the vents in magnesium incendiary bombs

of these bombs being employed against German and Japanese targets. For the most part, incendiaries are of the magnesium, thermate (Army version of thermit), phosphorus and oil varieties, largest being the extinguishing-defier, the 500-pound "block burner."

Of the seven types, the

Left, a demonstration of fire bombs. Below, a phosphorus bomb bursts, scattering particles

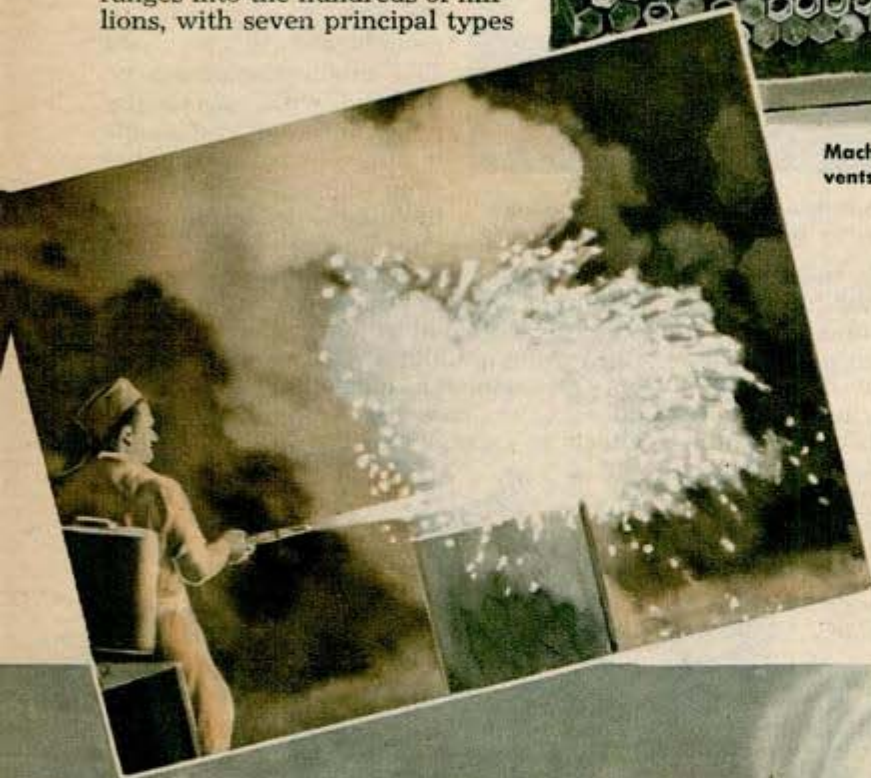



A stick of oil incendiary bombs falls toward the rail and communication center of Munster, Germany, as B-17's bomb bay doors open

magnesium bombs weigh two to four pounds each; usually released in clusters, they disperse to fall individually, like a handful of sparks dropping onto the carpet. They resemble giant metal firecrackers, but have a far more destructive nature than firecrackers. Although only one out of a dozen can be expected to land on something that will catch fire, their wide coverage—through the scattering effect—can start hundreds of small fires at the same time, vastly multiplying the difficulties of enemy fire-fighters.

Designed for use particularly against targets difficult to ignite, the four-pound thermate

Right, a cluster of 500 fire bombs. Bomb printing press (below) speeds up labeling by doing away with stencils

bomb burns three or four minutes at 3,400 degrees. This intense heat melts the bomb's steel tube and releases molten metal to contact and run across the target, setting fires as it spreads. This also is dropped in clusters.

Incendiaries depending upon jellied oil for their capacity to spread flaming destruction are made up in three sizes, six pounds, 100 pounds and 500 pounds. The smallest explodes on impact with spectacular effect, bursting and shooting burning oil and rubber from its tail 25 yards in all directions. It is dropped in clusters.

The 100-pounder is a thin-walled shell weighing only 20 pounds when empty. It contains jellied oil which scatters in fiercely burning chunks over an area about 40 yards in diameter. Particles of the flaming oil cling to materials touched and resist efforts to extinguish. The M76, "goop" or

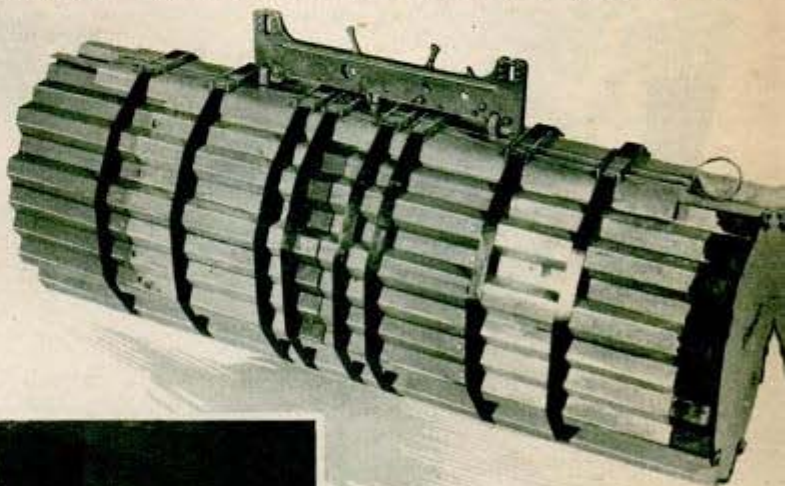

PT bomb is the third, and largest—the 500-pounder—and contains a mixture of jellied oil, finely powdered scrap-magnesium and other ingredients. Experts claim that there is no known means of extinguishing it.

A 30-pound white phosphorus bomb, which contains 12 pounds of the agent, is somewhat similar to a fat cigar with a small propeller and a large steel fin. The phosphorus scat-

ters its clinging, burning particles over an area up to 100 yards in diameter. Suspended vertically in the bomb bay of an aircraft, the bomb falls free when released by the bombardier. Its propeller spins for several revolutions and then drops off, freeing the bomb fuse for action. This incendiary packs a powerful punch, but is lightweight and therefore must be dropped from relatively low altitudes to insure accuracy.

Clusters of fire bombs, upon being released from the bomb bay, break open automatically and spread packaged flame through space. Each cluster contains up to 128 of the four-pounders, resulting in a bomb that may weigh up to 500 pounds.

One of the latest developments in incendiaries is the aimable cluster, which has a nose and a tail as though it were a single bomb. This permits the lightweight bomb to be aimed with precision. At the proper altitude, a time fuse explodes a primacord charge and opens up the cluster.

Chemical Warfare Service, in addition to developing and manufacturing fire bombs, is responsible for testing the bombs as they come off production lines. At skip-bombing ranges fire bombs are dropped from low altitudes to strike a concrete mat almost horizontally and ricochet against a thick concrete wall.

The now famous Doolittle raid on Tokyo came at a time when the magnesium supply was very low in the United States, so the Chemical Warfare Service rushed into production a quantity of thermate bombs for this mission. Their effectiveness is attested by reports of the starting of hundreds of separate fires in the Japanese capital, fires which raged for many hours and destroyed vital enemy installations. Since that time, use of incendiaries has increased steadily and in one raid on Germany's shipyards at Kiel the fire bombs were employed, effectively and exclusively.

In the Steaua Roma company area of the Ploesti oil fields, the tanks were wiped out during the historic August, 1943, attack; every plane on that mission carried some fire bombs. Fifty-six tons of fire rained from the skies on Hamburg in the July 26, 1943, raid, while Schweinfurt felt the force of 80 tons on October 14, 1943, in the attack that virtually eliminated German roller bearing plants from further war activity.

The tremendous production of incendiaries by the Chemical Warfare Service indicates that some fire bombs are dropped in practically every attack. With the recent development of "block-burners," such as the 500-pound "goop," the trail of fire can be expected to leap with ever increasing momentum through enemy installations. There's fire in the skies over Germany—and Japan.



Propeller-Driven Water Scooter Hits 45 Miles Per Hour

Designed to look like a wingless seaplane, a propeller-driven water scooter built by Herman Koplin, an employee of the Glenn L. Martin Co. at Baltimore, can travel 45 miles per hour. The boat's body, which resembles the front half of an airplane fuselage, has a cockpit and is mounted on twin pontoons that can be exchanged for skis in the winter. The craft is powered by a 27-horsepower, 4-cylinder, air-cooled motor and has two rudders, one on the rear of each float connected through pulleys to a control wheel in the cockpit. The gasoline tank holds eight gallons—enough for three hours.

*Baltimore, Md.
in A-30 and PB M
planes, Production Dept.*

Shaft Ends Turn in Red Spirals To Warn Passing Workers

Daubing the ends of revolving shafts with red paint is one of the many steps taken to reduce the number of casualties by the Air Service Command of the Army Air Forces in Oklahoma City, Okla. Shaft ends painted in this manner rotate in red spirals as a warning to passing workers to beware of danger.



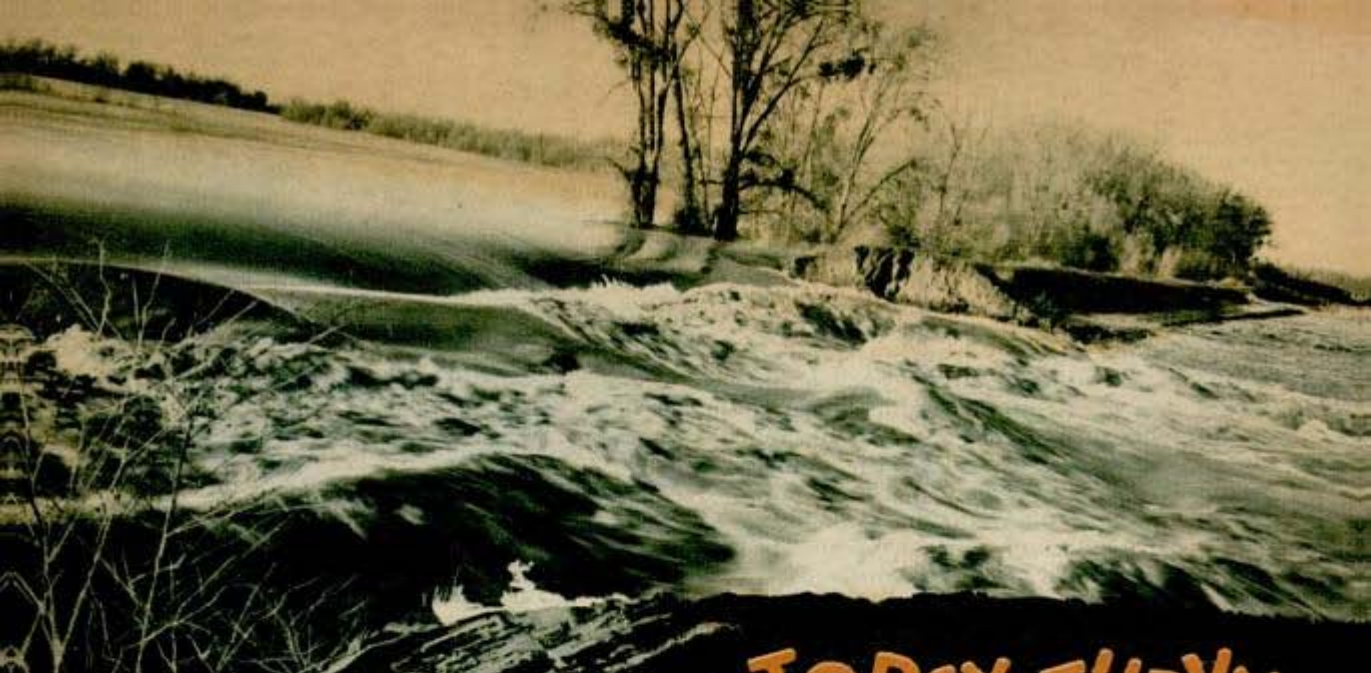

Spring flood waters of the Sacramento break through levee in California's inland delta

TOPSY-TURVY FARMING



Houses on spongy peat soil are jacked up to keep floors level. Below, triple wheels on truck prevent sinking; all vehicles are specially equipped

AMERICA'S queerest farming region is below sea level and consists of ground that will burn if a fire is built on it and that will float downstream if its river banks are undercut.

"This Ground Will Burn" is the warning sign that cautions you against discarding lighted cigarettes. A crop can go up in smoke once a fire starts in the rich peat soil. Landowners sometimes take advantage of the inflammability of their ground to eradicate weed seeds and pests. They set the earth afire and burn off an inch or two of the surface, then flood the field to quench the fire.

That's one odd feature of the topsy-turvy farming practiced in California's inland delta at the confluence of the Sacramento and San Joaquin rivers, 50 miles inland from San Francisco Bay. Delta soil, one of the richest in the world, consists of silt and solid peat which in some spots is 40 feet deep. The region reaches from Sacramento to beyond Stockton. The delta was once a vast swamp or tule marsh, inundated by river waters and subjected to the rise and fall of ocean tides backing up the waters of the Sacramento.

During gold rush days a few

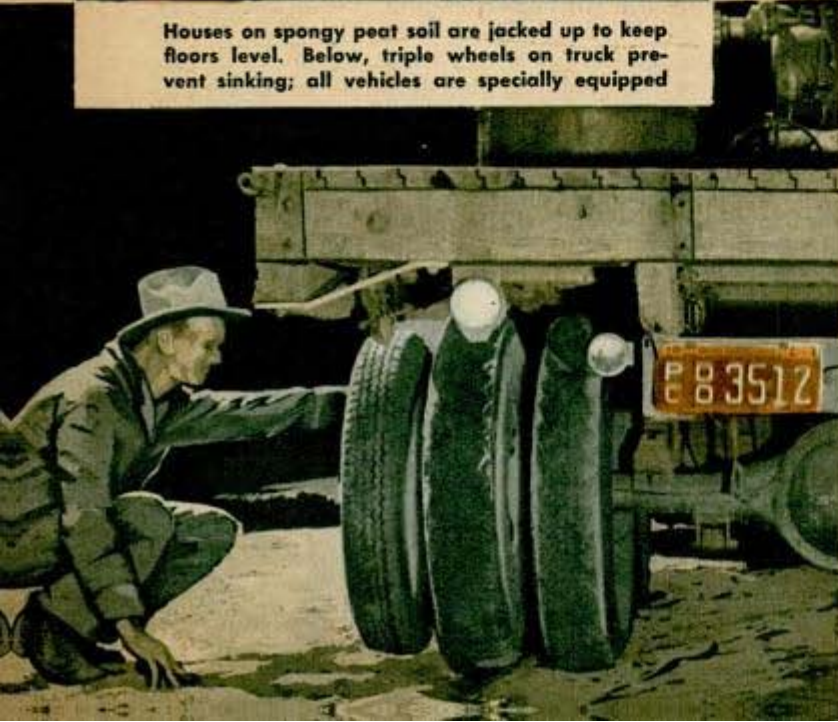

Mr. Johnson 0210

Swamp-type tracks with wide wood paddles attached support tractor on the loose soil

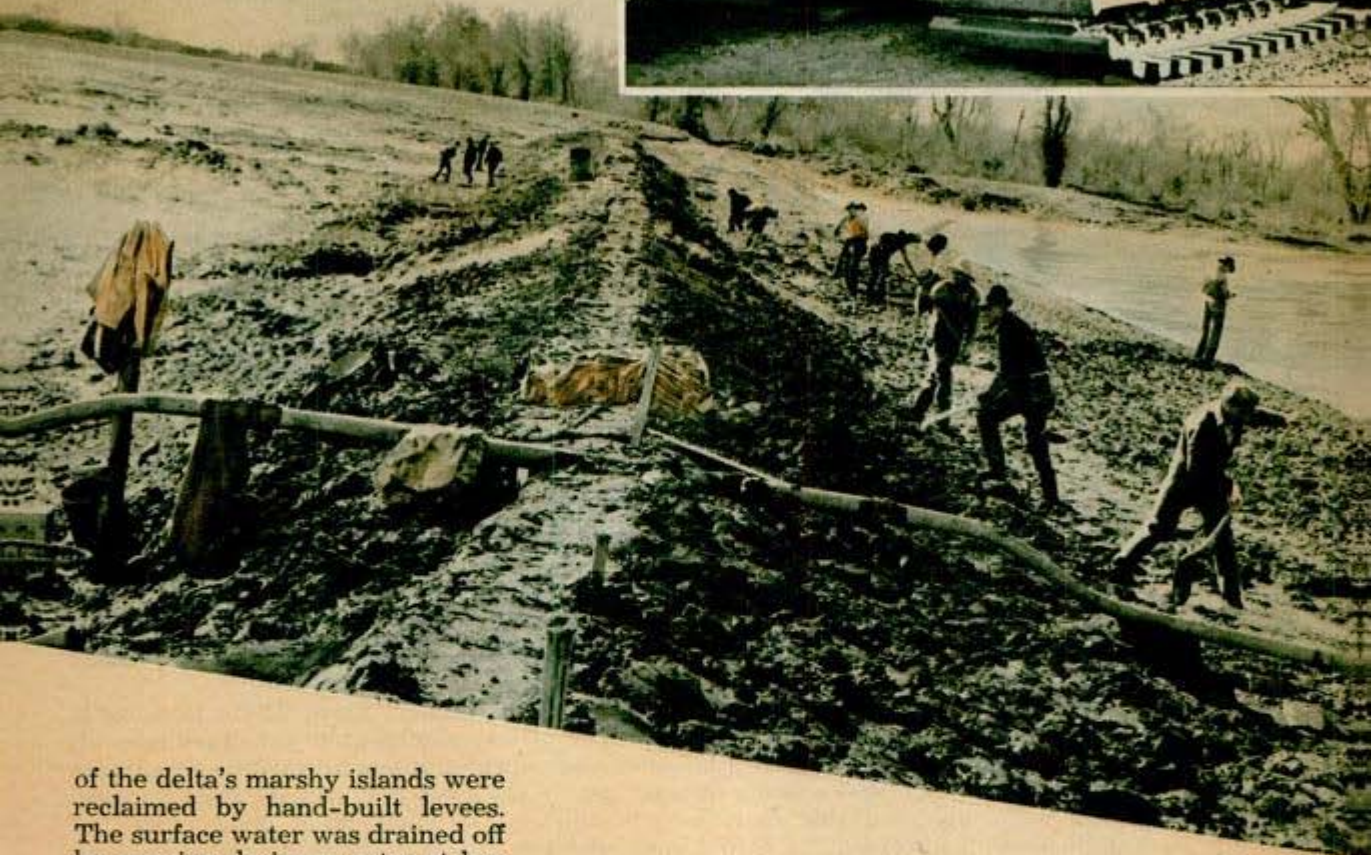

of the delta's marshy islands were reclaimed by hand-built levees. The surface water was drained off by opening drainage gates at low tide, also pumping by steam plants. Crops flourished so well that today 114 walled islands have been created, encompassing half a million acres of farmland that produce close to 50 million dollars worth of agricultural products per year. Some of the crops are grown on land that is 10 feet below the level of the water in the adjoining channels. Boats were the only means of transportation along the 550 miles of waterways until a decade or so ago. Now many of the islands contain paved roads and are connected by bridges. Free ferry service connects the others.

Erecting emergency crest on levee to hold back flood waters. Below, chemical weeding rig sprays poison that kills broad-leaf weeds and drains harmlessly off narrow leaves of grain

In the early days, delta farming was a continuous battle against fire and flood. Accidental fires in the dried soil did great damage,





This chunk of peat ground was set on fire with match. Farmers burn soil to destroy weed seeds. Sign (right) is familiar sight

necessitating flooding and re-pumping. Even controlled firing against weeds and pests has its drawbacks, for periodic burning of the surface has reduced the original levels of some islands by as much as five feet.

The first dikes that were raised were of light peat soil and when these were undercut by river currents a whole section of levee would float away downstream. When draglines were invented this machinery was used to drag up heavier silt to form more permanent levees. Seasonal combinations of high tides and high rivers are still an occasional threat to the islands, and

dredging and dike building is carried on much of the time.

Peat soil is a spongy mass of fibrous material. You sink in it over your ankles when you walk across it. Automobiles on the stabilized roads shake the ground like minor earthquakes. Trucks are equipped with three rear wheels on each side for support, with double wheels in front. In the days of horses, draft animals were shod with wide wooden shoes.

The modern track-laying tractor was invented in the delta region because of the need for buoyancy on the soft ground, and our modern earthmoving equipment like-



wise got its start here. Delta farming is completely mechanized yet practically all mechanical equipment must be rebuilt for use in the area. An ordinary tractor would sink out of sight on a boggy patch of ground. Tractors must be equipped with extra-wide swamp-type tracks, over which wooden paddles are sometimes attached.

Because of the costs of drainage and levee maintenance it is most economical to farm delta lands in large acreages. This has permitted research that might not be profitable for owners of small farms. Thus the delta was one of the first areas to adopt chemical weeding. Broadleaf weeds that are a nuisance in narrow leaf crops, such as onions or grain are killed by chemical poisons that are absorbed by the weeds and drain off harmlessly from the narrow leaves of the crop itself.

Houses, barns, and sheds in the delta are all built above ground on short stilts. A house on an ordinary foundation would soon settle

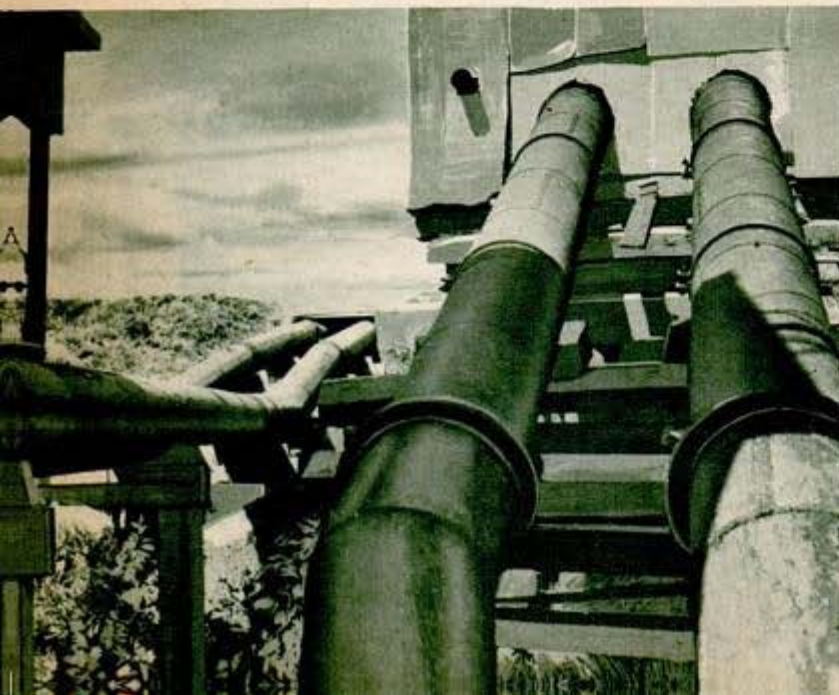

Pipelines carry drainage waters from island up over levee into waterway beyond

out of plumb. Placing a house on stilts makes it easier to jack it for re-alignment.

Leaf lettuce grows three feet tall in the delta peat; watermelons grow so big that you can't get them through the door of an automobile, and pea vines put out pods that are a foot long. But the lettuce is no good, the watermelons aren't fit to eat, and there are no peas in the giant pods. These surface crops simply "blow up" and have no nourishment.

On the other hand, the delta lands produce several times the national average of potatoes per acre; sugar beets grow at the rate of 35 tons per acre, and the delta is the source of most of the asparagus grown in the United States. Root crops, corn, grains, and alfalfa flourish.

Delta farmers don't care whether it rains or not for they get all the water they want merely by opening flood gates or operating siphons that reach over the levees into the waterways. Irrigation ditches spread the water through the fields. Of more concern is the problem of excess water. Deep and narrow drainage ditches traverse the fields and conduct ground waters to central sumps where automatic float-controlled electric pumps discharge the water across the levees. This double system of water regulation permits close control of the water table in the ground. Ground moisture is raised or lowered at will to fit the needs of the different crops and the different stages of growth. In the delta, irrigation is mainly a matter of controlled drainage.

Being below sea level, the delta would be flooded by salty ocean water if it were not for the constant down-flow of river water. When the rivers are low, not enough fresh water comes down stream to prevent the ingress of salt water which is unfit for irrigation. The California state division of water resources measures the snowfall in the mountains each spring and estimates the month-by-month runoff. This is then interpreted into stream flow, which gives a prediction as to the time and amount of any salt water invasion. Warned ahead of time that sea water can be expected in the delta region during October, the farmers double their usual September irrigation to carry the crops through the following month in which they will not irrigate at all.

Demands for fresh river water upstream have lowered the flow of the Sacramento and the San Joaquin in recent years, allowing salt water to creep farther inland during periods of low river water. This condition threatened to make much of the delta unfit for agriculture, but now control dams have been built upstream. These hold back the spring flood waters and the excess is released during months of low water, insuring a safe minimum flow at all times.

0109
**Army "Knapsack" for Gas
Holds Seven Gallons**



Developed for carrying aviation gasoline over jungle trails or into zones where trucks cannot travel, is a water-resistant canvas bag which holds seven gallons. It has a strong, rubber-like plastic impregnated lining which withstands internal pressure and offers good resistance to heat and cold. The bag can be dropped and tossed around with less danger of bursting seams than with a metal container. Empty bags lie flat and require a minimum of shipping and storage space. When filled, the container weighs 50 pounds.

*Kimberly Clark Corp.
Dunsmuir, Calif.*

0180
**Penicillin Released to Civilians
Will Cost \$35 Per Patient**

In the near future, penicillin, the wonder drug which cures cases resistant to sulfa treatment, will be available to civilians according to Robert D. Coghill of the fermentation division of the Department of Agriculture. This is made possible by new methods which speed the growth of the mold from which the drug is derived. The estimated cost of penicillin for treating a severe case of blood poisoning is \$35. Twenty-one million dollar fermentation plants are now being erected in this country and Canada. Although the peak production of these plants will total only nine pounds of pure penicillin a day, this is sufficient to treat about 250,000 cases a month.

MODELS TEACH SAFETY



and demonstrated at safety meetings. As a note of comic relief, one model gets across a lesson on carelessness in which a workman and a bucket have a multiple catastrophe. The models were built by R. V. Milligan, safety inspector at Edgar Thomson Works, Carnegie-Illinois Steel Corporation. Mr. Milligan has found that in teaching safety rules, these equipment models combine many of the best instruction features of such single aids as charts, posters, graphs, movies—or even the real equipment itself.

With a flick of the controls on model crane, safety instructor shows foremen of steel mill how an accident occurred. Model has movable parts and is equipped with various types of safety devices. Below, model enacts comic scene to drive safety lesson home. First, descending bucket strikes "man" on head as he is climbing ladder; he falls as a foreman comes out of the door knocking the ladder on top of him

Courtesy U. S. Steel News

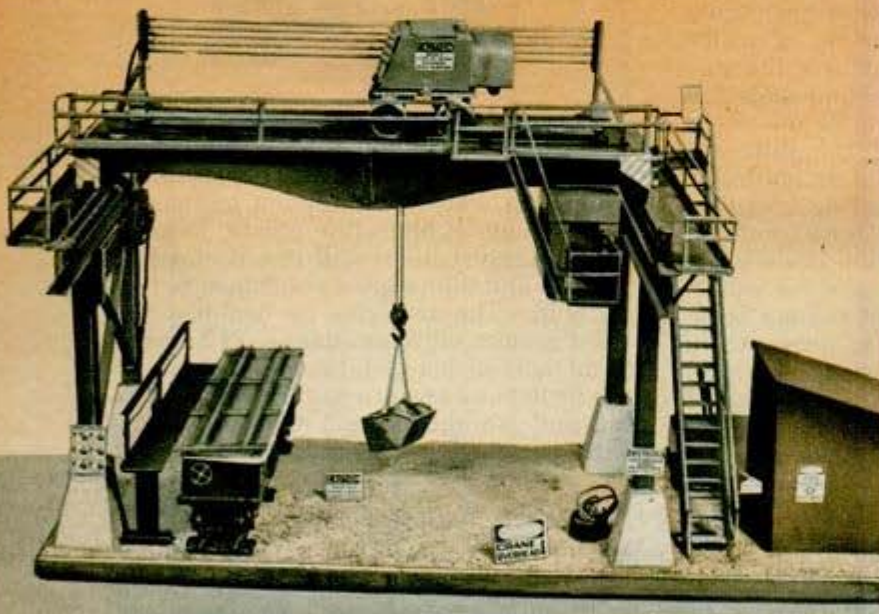

MODELS of equipment used in a steel plant, including a pint-size crane with movable parts, add realism to safety instruction by pointing out dangerous practices and re-enacting accidents. The overhead electric traveling crane has a hoist and bridge trolley which function like a real crane with the added help of a magnet. It is completely equipped with safety features including guards on moving parts, fire extinguishers painted the proper color, workable limit switch, warning signs and hand rails. When a new device is perfected, it is added to the model

48 *Edgar Thomson Works,
Carnegie-Illinois Steel Corp.
Carnegie Bldg., Pittsburgh 30,
Pa.*



"Bull's-Eye" Trainer Shoots Ink to Mark Hits

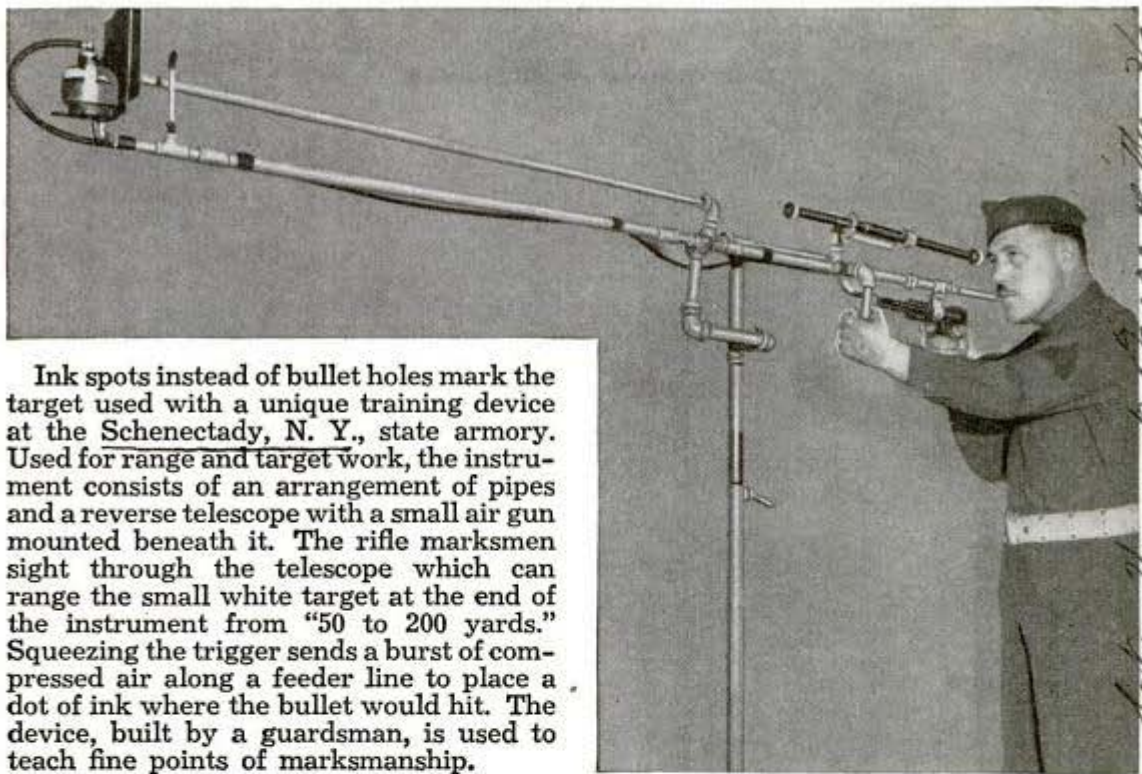

Ink spots instead of bullet holes mark the target used with a unique training device at the Schenectady, N. Y., state armory. Used for range and target work, the instrument consists of an arrangement of pipes and a reverse telescope with a small air gun mounted beneath it. The rifle marksmen sight through the telescope which can range the small white target at the end of the instrument from "50 to 200 yards." Squeezing the trigger sends a burst of compressed air along a feeder line to place a dot of ink where the bullet would hit. The device, built by a guardsman, is used to teach fine points of marksmanship.

Sgt. Raymond Lawrence of the 1st. Det. 1st. Bn. 2nd Reg., N.Y. Guard

"Vest Pocket" Gasoline Furnace Heats 20-Room House

Although it weighs only 21 pounds, a "vest pocket" furnace now used by the armed forces can generate enough energy

to heat a 20-room house. About the size of an office waste basket, it uses the spiral accelerating flow design, is hermetically sealed and has a small combustion chamber. The gasoline-burning edition is being employed to dry soldiers' laundry, heat hospital tents, dry parachutes, de-ice planes and keep the ground warm while workmen dig tunnels. Engineers of the Stewart-Warner Corporation, which manufactures the heater, do not consider gasoline a good fuel for household use but believe the principles they have developed are applicable to the burning of fuel oil or manufactured or natural gas. They point out that the heater is so light it could be hung from the rafters of a house, or put in some other out-of-the-way spot, thus affording greater space for living. Smaller units, perhaps eight inches in diameter and nine inches high, could be supplied one to a room with individual thermostat controls.



Division at Watertown Chicago, Ill.

☐ To learn where to buy commercial products described in these pages, see the index.

TORTURE TESTS for TIN FISH



Flying boat drops aerial torpedo on Navy testing range; notice second "tin fish" under wing. Navy jeep (right) is used to tow torpedoes from repair shop. Below, dismantling "fish" after test

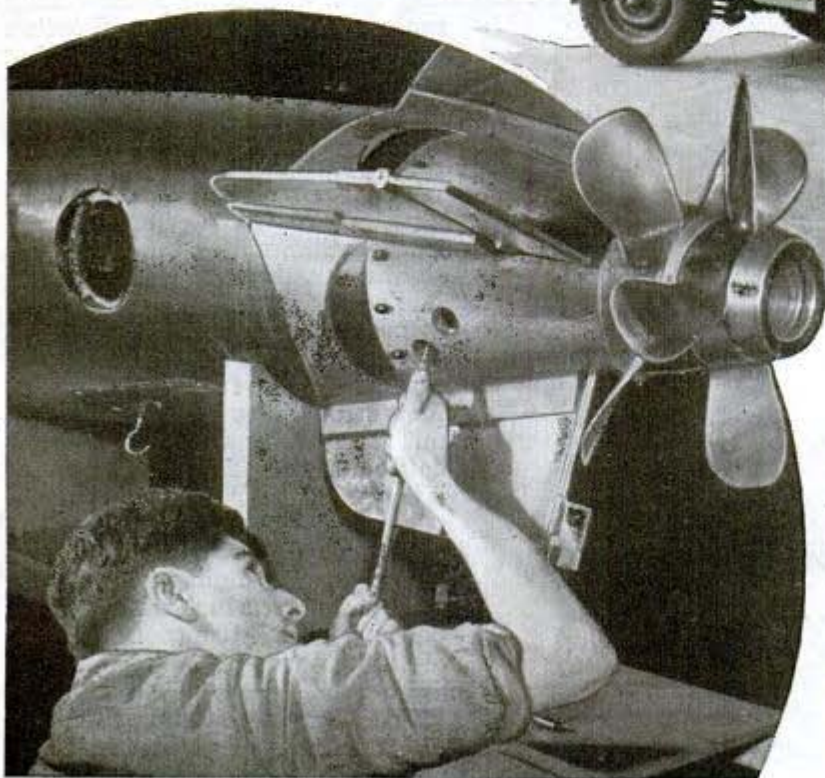

sportsmen criss-cross the waters of the adjacent bay, sound and nearby Atlantic Ocean in their fishing cruisers with rod, reel and line awaiting a strike. Civilians are strictly barred from the area.

Instead, wind-tanned Navy personnel give torture tests to lethal and intricate metal fish to make reasonably certain that torpedoes discharged by surface vessels or planes will run

"hot, straight and normal" to blast the day-lights out of enemy ships.

The trim little fishing cruisers and launches are still there, chasing these modern fish-of-war. But in addition, speeding planes, barges, machine shops, deep-sea divers and a great assembly of scientific instruments and Navy experts have a part in the fishing expeditions.

Few machines of war, regardless of their delicate adjustment, are more carefully put together than torpedoes. These cigar-like steel tubes, together with their complex interior mechanisms, are really midget automatic submarines. The mechanical magic of torpedoes enables them to control the depth at which they travel, their speed and direction, even shifting their course and moving around pre-determined curves.

Like submarines, they have propellers

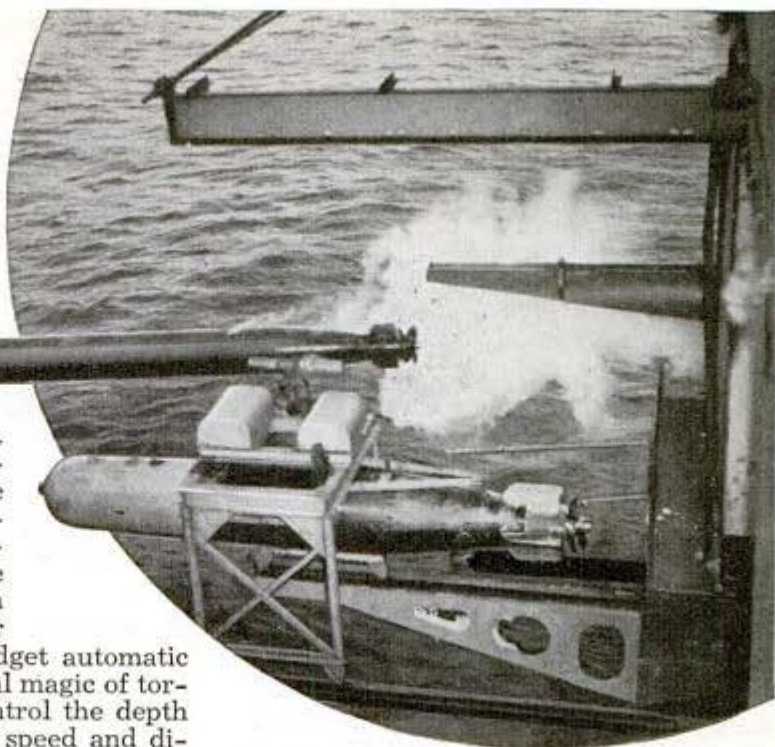

Firing long destroyer-type torpedo from barge while aerial type beneath it awaits drop-test. Below, retrieving buoyant torpedo which will rise to surface from 18,000 feet after discharging water from head
U. S. Navy photos

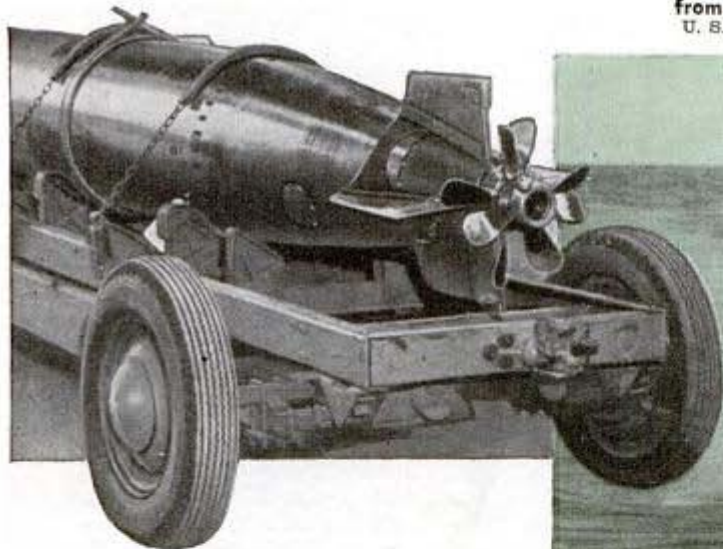

and self-contained, self-regulated power plants. They are able to travel five miles at speeds around 50 miles per hour. Instead of firing a torpedo, the torpedoes fire themselves on contact with the target. Instead of carrying about 100 pounds of explosive, like a 16-inch shell weighing 2,000 pounds, they tote over 500 pounds of death-dealing TNT.

With all of the necessary devices tightly packed into their shells to make room for the big



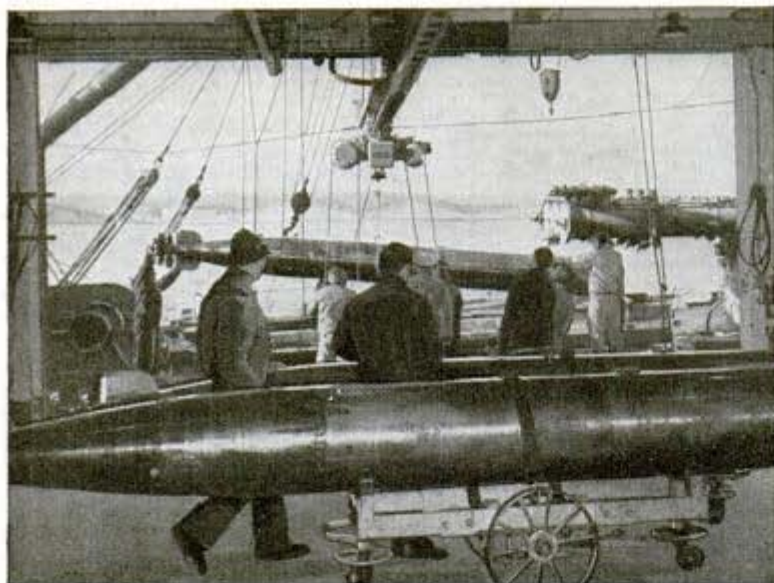

Loading the day's "catch" aboard Navy YTT after trial runs on range

explosive charge, even the finest workmanship and most rigid inspection are not sufficient to guarantee that, when the big moment comes, the tin fish will act precisely according to specifications.

So, when a torpedo has passed factory inspection, it is likely to be routed by way of New York City and along the length of Long Island to the tip, where the city's sportsmen once sought game fish.

Here, along with a number of others which appear to be duplicates, the torpedo is unloaded at what used to be the Long Island Railroad Station. It is now the

Right, torpedo has just been fired from tube on barge, full view of which is shown below. Note retriever boats left of craft

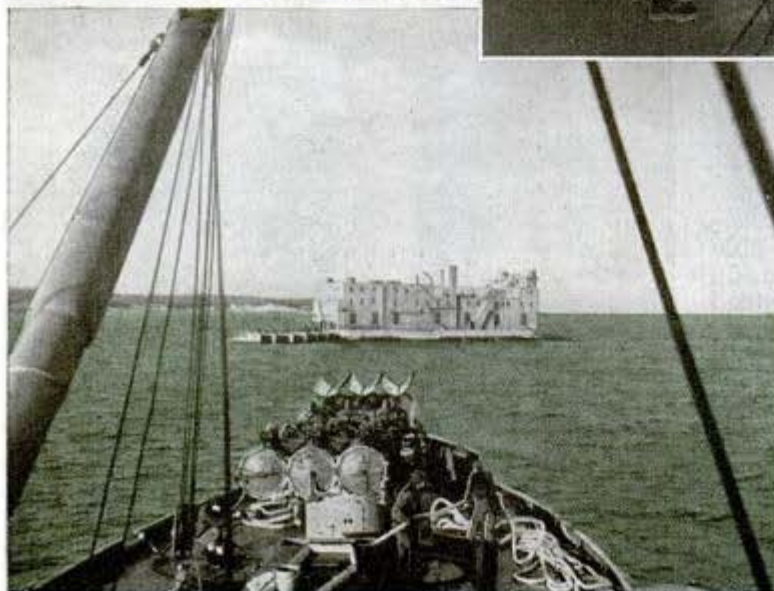

main gate house of the closely guarded area reserved for firing trials of tin fish.

The torpedo is trucked past a seven-story building used as officers' quarters, past the former fishermen's clubhouse built like a French chateau which now houses enlisted personnel and eventually to a pier. Here it is loaded onto a ship which takes it a few hundred yards out into Fort Pond Bay, where it is placed aboard what the Navy has named a YTT.

This 1,500-ton craft looks like a four-deck houseboat except that it has a number of torpedo

tubes extending from a deck. It holds hundreds of torpedoes at one time and is the center of activity at the U. S. Naval Torpedo Testing Range.

While it is awaiting its test run, the tor-

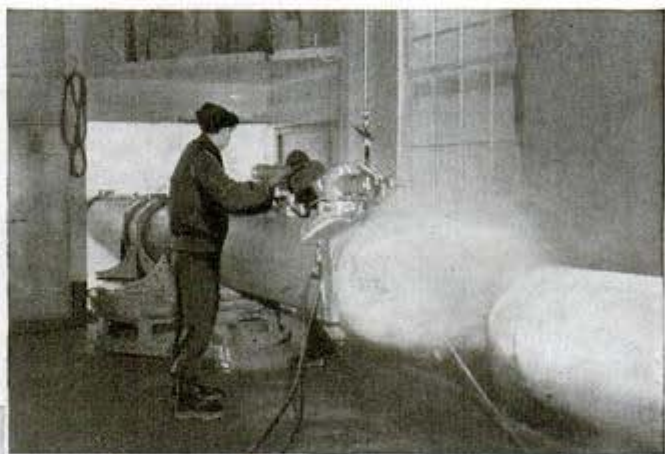

pedo gets a thorough check-up. If the weather is cold, an anti-freeze solution is poured into its mechanism. At this stage, the torpedo is not equipped with its war head, the front section containing TNT. Instead, all are fitted with exercise heads, filled with water. If the weather is bad on the day scheduled for testing, the test is abandoned because high waves cause the tin fish to act up and a test under such conditions would be

useless. There is never a dull moment on the range while firing is in progress. Target rafts are aligned for thousands of yards along the range and men in small boats clock the torpedoes as they flash by. A high-powered launch shoots away from the YTT each time a "fish" hits the water, accompanying it for the first few hundred yards, ready to follow if it goes astray.

Planes roar overhead. Their job is to track the "fish" and guide the retriever boats to the spot where the spent torpedo surfaces.

In the observation tower of the YTT a keen watch is kept. Radio-telephone contact with the small boats permits keeping a check on the torpedo down every foot of the course. With these engines of destruction costing about \$10,000 each, no chance is taken on losing one. Some go ashore, and men instantly go after them. Some sink, and the spot is marked so divers can retrieve them. More than a dozen divers work at the station.

Most "fish" cut a jug-handle curve before straightening out. The wake is clearly apparent.

Continued to page 148

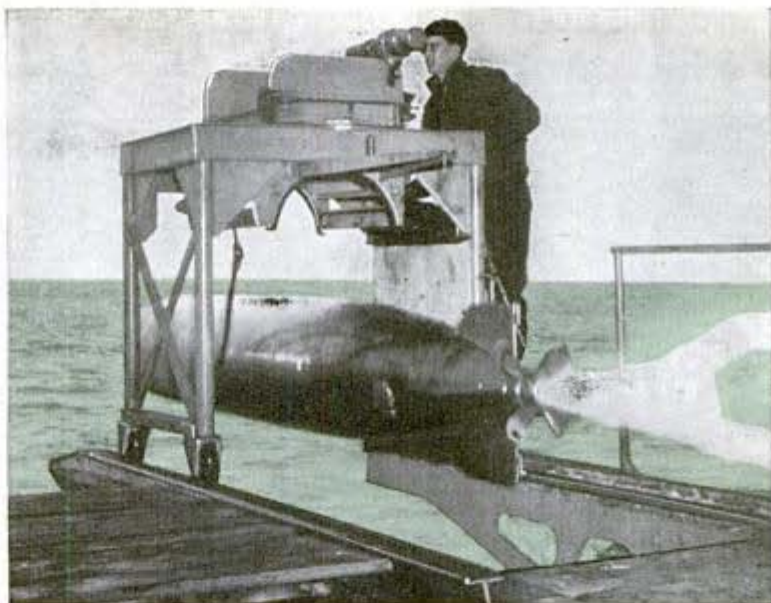

Aerial-type torpedo starts test run with short drop from barge. One out of every five is also dropped from plane for double check on lot

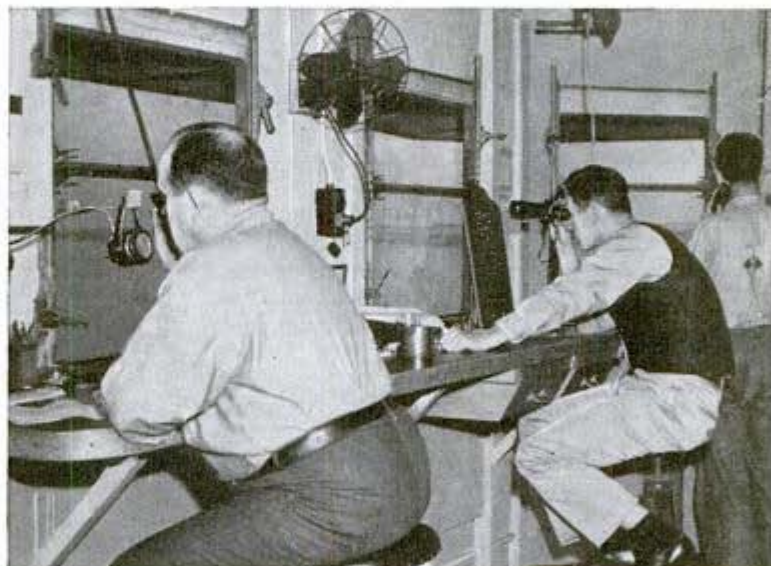

In observation tower on barge, officer at left orders firing and man at right follows torpedoes with glasses as they speed down the range. Below, torpedoes ride odd conveyance along pier to boat



0129

Cow Is Cured of Pneumonia With Aid of Oxygen Tent

Dr. Francis M. Groot Palmer, Mass.



When a cow in Massachusetts failed to respond to food and developed a temperature of 106, a veterinarian diagnosed the illness as pneumonia and administered intravenous treatment of sulfa drugs. In 24 hours the cow showed no improvement, had difficulty in breathing and was unable to stand so the doctor devised an oxygen tent and put the animal's head in it. After oxygen was supplied for two days and sulfa drugs were administered at a rate of 1,080 grams daily, recovery resulted. This is believed to be the first time in which a cow was treated in that manner.

Daily Radio Mfg. Corp.

worm thumb-screw is turned, the band is rapidly drawn through its housing to tighten the clamp. According to the manufacturer, the clamp does not require a lock wire to prevent its being loosened by vibration, since the beltlike action holds under extreme jolting.

067

Robot Monitors Warn Flyers If Radio Courses Shift

Warning signals from an automatic monitor are helping to prevent accidents which might result from the sudden shifting of radio courses being followed by transport planes throughout the United States. The monitor receiver is installed by the Civil Aeronautics Administration 1,200 feet from the radio range station, directly on the radio course, and connected by telephone line to an indicator panel in the airport control room. If any radio course deviates as little as 3 degrees from its normal setting, due to terrain or atmospheric conditions, the monitor sends an electrical impulse which flashes a red light and sounds a siren to warn the airport control crew. At the same time the airport monitor automatically dials the range transmitter which sends warning signals to all pilots.

Daily M. N.

0140

Spotters Wear Mine Markers On Their Steel Helmets

Mine spotters have created a new hat fashion by wearing their markers piled on top of their steel helmets while they range ahead of the army, seeking out the locations of enemy mines. Whenever they locate an explosive, they place a marker on the spot and the sappers, following the spotters, remove or demolish the mine.

0177

Hose Clamp Tightens Like Belt To Keep Joint Leakproof



To effect a leak-proof joint, a hose clamp equipped with worm-and-worm gear action tightens like a belt. The tightening band is a spring steel strip perforated to correspond with the teeth of a worm gear. When the



"Aircraft Carrier" on Wheels Trains Airmen

Jane Buerge of AAF Service School

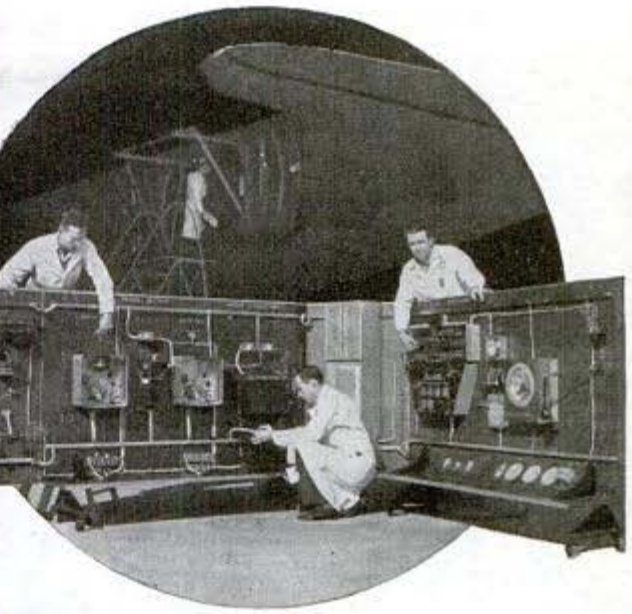

All intricate parts of the Douglas C-54 cargo ship from radio apparatus (above) to "Silent Joe" the automatic pilot (below) are carried in big boxes aboard two truck-towed trailers to help train maintenance mechanics, pilots, engineering officers and the flight crews at air depots



Checking electrical panels which are hinged to form square box to fit easily into trailer. The panels are on casters so they can be rolled into a hangar or classrooms

Left, trailer unit ready to "take-off" from Douglas Santa Monica plant. With unit go experts on engines, electrical equipment, radio, all parts of C-54

C. P. Pearson



Capt. Charles McKeenan

Prize exhibit is model of Skymaster in Plexiglas. The switches operate lights at all the stations throughout ship

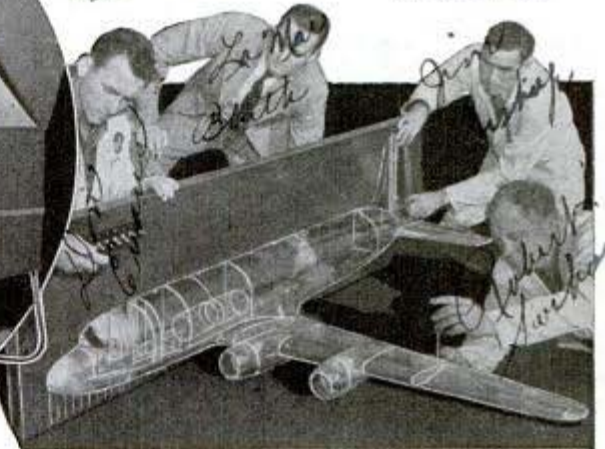

CALLING SIGNALS *for the* ARMY

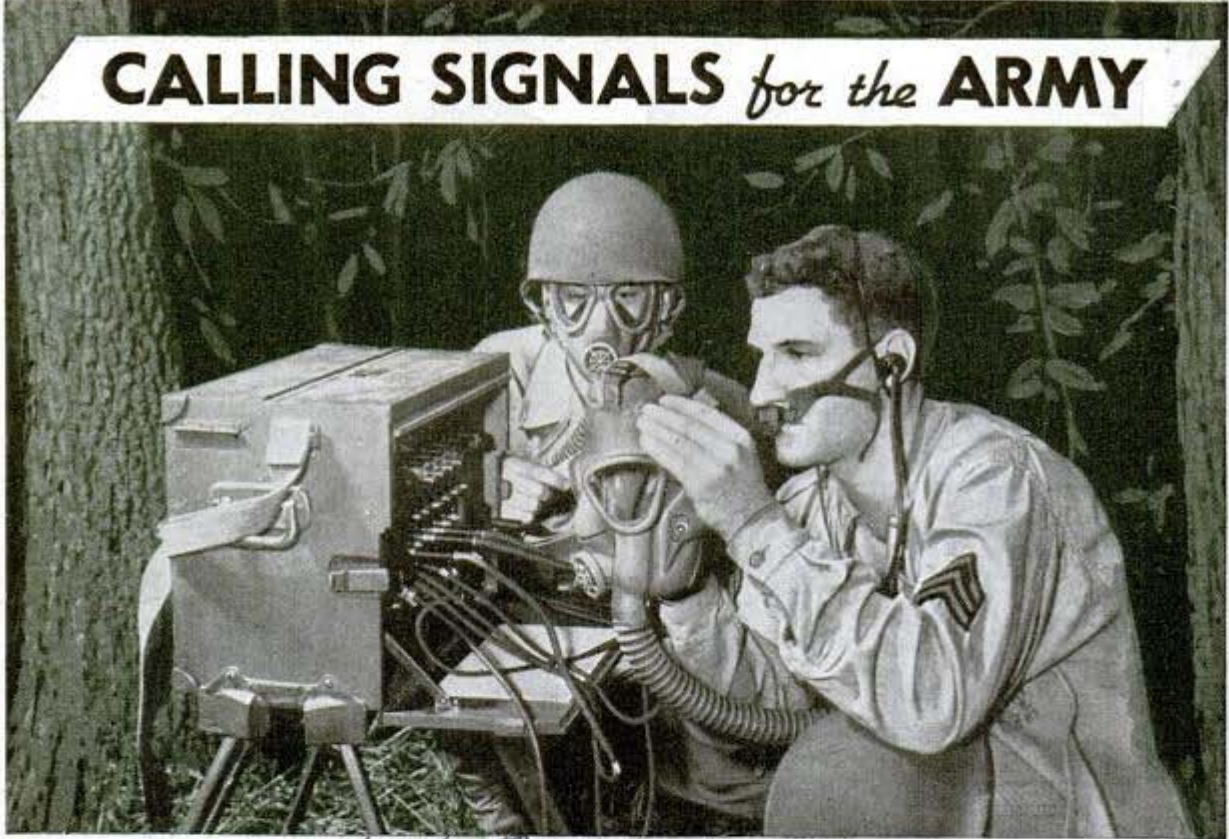

Courtesy Electro-Voice Mfg. Co. *South Bend, Indiana*

The "lip" microphone used by Army Ground Forces shuts out din of battle. It weighs less than two ounces. Below, Signal Corps men on trailer are erecting a telephone line overseas

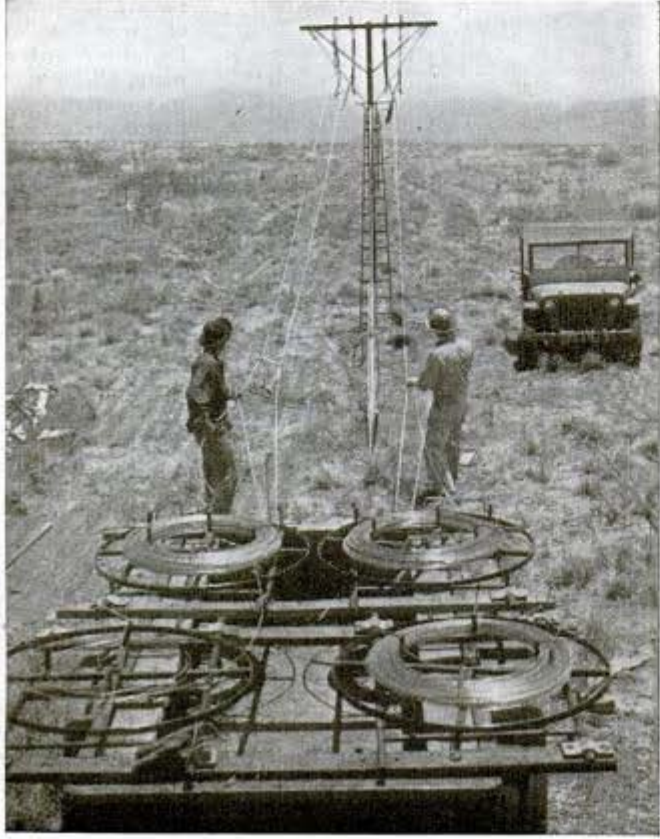

THE most far-flung communication system in the world is one that relatively few people know anything about. Ten million words of traffic are transmitted over it every day. It employs every known method of communication from submarine cables to carrier pigeons and from radio to semaphore flags. It pries into the Arctic, crosses the equator, and circles the world.

Called "A Com," it is the Army Communications System by which America's global war is run. Heart of the system is the Army Signal Center in Washington, D. C., and heart of the system's radio network is Station WAR, consisting of a number of radio transmitters near Washington.

These transmitters, beamed to other stations across the oceans, are of up to 40 kilowatts in power and are all remotely controlled by high-frequency radio circuits from the Signal Center. Voice, hand-keyed code, radio teletype, radiotype that handles 100 words per minute, and radio telephoto pictures are transmitted over them. Without such a system of high-speed communication our

global military operations would bog down and disintegrate.

Lesser stations are located in each military theater of operations and these in turn are the focal points of subsidiary radio and land wire networks. At the outer fringes of these webs the chain of communication reaches soldiers on the battle line. These men are in touch with their command posts by walkie-talkie or by handie-talkie radio sets.

Operating this great communication system is only one of the multitude

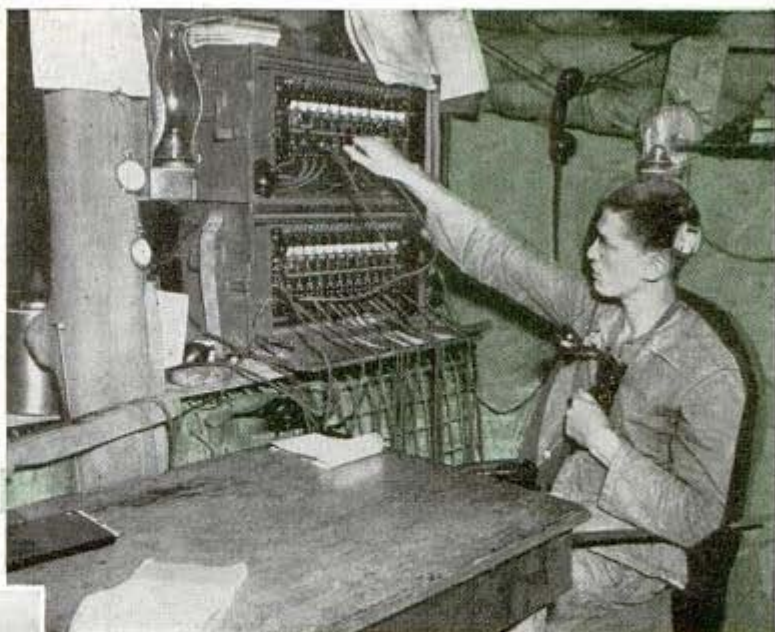

This telephone exchange in New Guinea is housed in a dugout and protected by sand bags. Left, scouts use radio to report to GHQ



of tasks performed by the Signal Corps. Members of the signal companies are among the first men ashore in an amphibious landing. Wire layers work right up to the front lines during battle, keeping communications open with the rear. Specially trained groups of signal men work with the cavalry, armored ground forces, and mountain troops. Signal radio intelligence men intercept enemy radio messages and by means of direction finders determine the locations of enemy stations so that they can be destroyed. Signal pigeon companies provide birds for carrying



Dogs transport carrier pigeons to front lines





Radio direction finder locates enemy transmitters for bombing

messages; other companies set up and operate the great trunks that connect busy military areas, while still other specialists repair battle damage to equipment.

An amphibious operation in particular is one that demands split second co-ordination between all elements. The only way to provide this is with hundreds of miles of telephone wire and with innumerable radio circuits. Amphibious two-and-a-half ton trucks carrying complete radio stations are

Under cover of smoke screen, Ranger uses handie-talkie to communicate with ship during beach operation



among the vehicles that reach shore early in such a landing. Wire for telephone circuits follows right behind, and jeeps or motorcycles for message carriers are also on "priority" during the landing.

The Signal Corps provides two-way radio sets for the cars of military police. It develops and supplies equipment for the Air Forces. It provides radiosonde apparatus for army weathermen, land mine detectors for the engineers, and has specialists who study captured enemy communication apparatus for possible ideas that we could use ourselves.

In this connection it is interesting to know that most German radio sets are well and ruggedly built but are poorly waterproofed. German broadcast receivers usually bear the warning: "Use of this radio for foreign station reception is a crime against the national safety. By order of Der Fuehrer such use will be punished by severest penalty. SOLDIERS, BEWARE!"

Jap radios are either direct copies of American sets or are of inferior construction. B batteries, tubes, and other units carry both American and Jap symbols for identification and the imitation even apes the colors used by manufacturers for distinguishing their products. Fabricated frames that are easily damaged or twisted, distorting the calibration, are used in place of castings.

More than 100,000 items ranging from

midget tubes to big mobile broadcasting stations are used by the Signal Corps or are distributed by it to the troops and the Air Forces. Even such incongruous items as porcelain eggs, poison gas, and blonde hair that has never been permanently waved are included in the Signal Corps inventory. The porcelain eggs are used to fool mature pigeons into laying real eggs to maintain the supply of message-carrying birds, while poison gas in tiny cylinders is included in each shipment of pigeon feed that is sent abroad. The gas, slowly escaping, kills vermin in the feed. Blonde hair has its use as the humidity indicator in radiosonde types of weather stations.

Practically all Army short and medium range voice radios are frequency modulated, this being a reason why you can pick up little Army traffic on your all-wave amplitude modulation receiver. FM was adopted because such circuits are difficult to jam, are least affected by man-made or natural static, have greater fidelity, and require less power. Experience of the military suggests that after the war, many commercial broadcast stations will switch over to FM. Some present broadcast receivers can be adapted to receiving such programs by means of a special tuner, while other home broadcast receivers will need to be replaced.

Army radio equipment is ruggedly built, for lives and battles could be lost if part of a set fails in a crisis. Early during re-armament a Signal Corps officer put a commercial police radio in a tank and took it for a ride. The radio shook to pieces and went out of operation within a mile, before the tank had a chance to fire its guns. The specially built radios used in tanks are able to operate perfectly

Continued to page 150

AUGUST, 1944



Signal Corps men using sturdy high-powered mobile transmitter



*Halliburton Co.
2611 Indiana St.
Chicago 16, Ill.*

Above, mobile radio station operated by gasoline-driven generator on trailer. Below, Signal Corps sets up army wire circuits in Italian ruins



0143

Train Riders Are Measured To Find Perfect Seat



Above, chair which measured thousands of passengers

To find the ideal seat dimensions for postwar coaches, the Boston & Maine railroad recently set up a test chair in Boston's North Station concourse for the purpose of measuring 3,000 adult passengers. Working with the Department of Anthropology at Harvard University, the railroad will measure for correct seat height, seat length, elbow height, hip breadth, back height, and shoulder breadth. Results of the test will be made available to all railroads.

0203

Planes Drop Self-Igniting Tanks To Set Enemy Fields Afire

Incendiary belly tanks jettisoned by fighter-plane pilots to set the enemy's fields afire now carry detonators which ignite them when they reach the target. Formerly, after the planes descended to grass-skimming altitude and dropped their tanks filled with gasoline and crude oil, they had to circle around and ignite them with incendiary bullets or small-caliber cannon shell. Another flame-thrower designed to frighten the Japs, who are said to have a special fear of fire weapons, holds

a fuel which includes a type of solid incendiary particles that make denser snow-flakes of fire within the general sheet of flame. These continue to burn after the rest of the flame has gone out. To rout an entrenched enemy the army sometimes puts white phosphorus in shells, bombs, mortar-missiles and hand grenades so that fragments of the flaming stuff fall in an arc-like shower, dropping vertically into slit trenches and fox holes and disabling their occupants with flesh burns.

0167

Hand Blinker Trains Air Crew To Signal Like Sailors

Cardboard blinker devices with shutters like those in regular Navy blinkers are used to train aviation cadets. This insures plane-to-plane or plane-to-ground communication should radios be destroyed by enemy action or when radio silence is necessary so position will not be revealed. The training blinker is operated with the pressure of a finger on the cardboard to simulate dots and dashes. The International Morse Code is printed on the back of each blinker which enables cadets to send messages before they have learned the entire code.

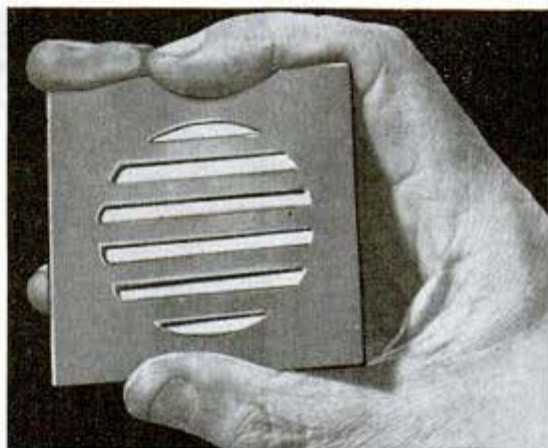

Army Air Force photo
Top, pressure operates shutter; bottom, reverse side

The Austin Co.

16112 Cleveland Ave., Cleveland, Ohio 0186

Rotating Stage for Television Has Four Sets

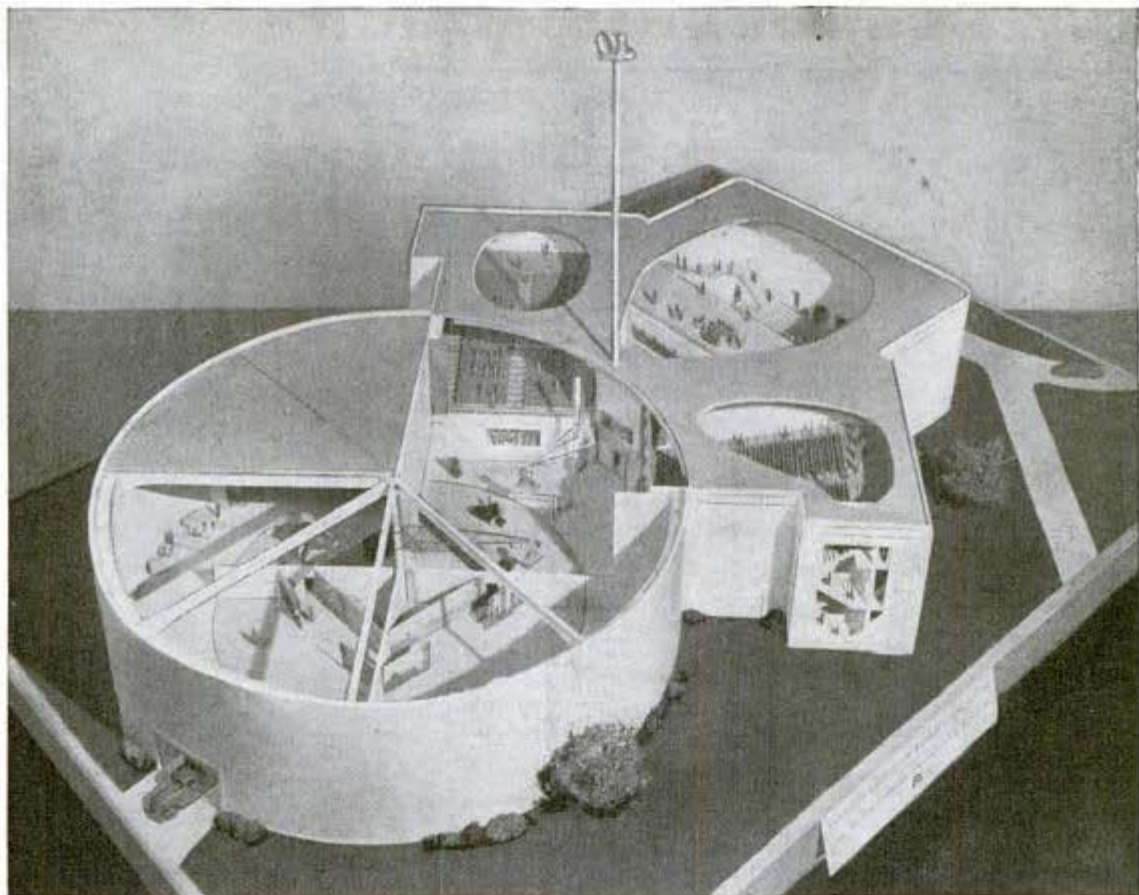

To provide for rapid change of scene without interference with telecasting, a working model of a postwar television studio exhibited recently includes a circular rotating stage with four sets. The auditorium part of the theater is divided into three sectors. The center part is occupied by the cameras, which are placed so they

can take the scene from any angle and all ranges. Flanking this are the sectors occupied by the studio audience. Soundproof curtains can cut either sector off from the stage at the end of a scene if it is desirable, so members of the audience could file out without disturbing the performers. Both sectors could also be used at once.

Army Sleeping Bag for Wounded Has a 20-Footer Zipper ⁰¹³⁸

To keep the wounded warm while evacuating them in cold climates or at high altitudes, a special army sleeping bag is equipped with two mattresses closed by means of a slide fastener more than 20 feet long—one of the longest zippers ever manufactured. In all, there are 10 separate zippers to permit access to the patient at any point on his body without entirely exposing him. Another slide fastener with three sliders permits opening the bag down the front.

Among 115,287 predatory animals destroyed last year in 29 states were 103,981 coyotes.



AUGUST, 1944

Army Quartermaster Corp. 61

The ALL-AMERICAN GUN

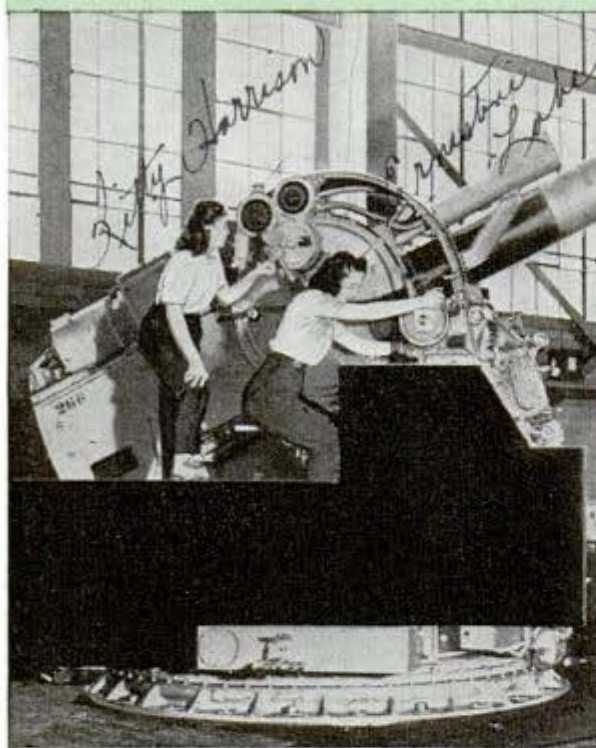

The Japs call it a giant machine gun, and our Navy men say it will do anything but shoot straight down. It is the Navy's 5-inch gun. Although many Allied weapons were developed by the best ordnance experts of several nations, this gun was produced by American designers for American ships and built solely in American arsenals. It is the main armament on destroyers and is also used on aircraft carriers and other important ships. Above, gun mount checkers making final inspection at naval ordnance plant



Five-inch guns guard flight deck of veteran U.S.S. Ranger, first Navy vessel designed as a carrier

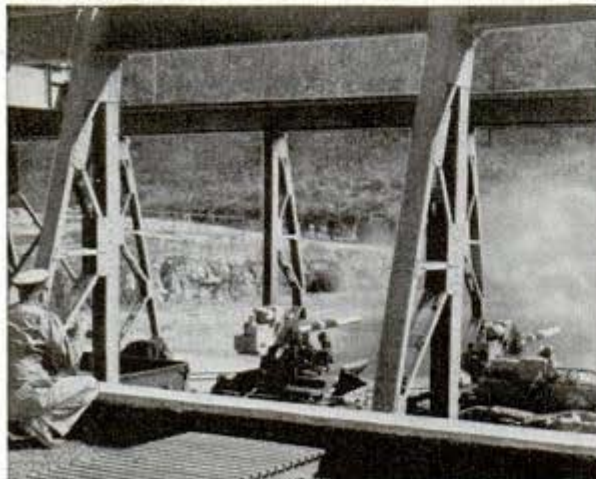

Three 5-inch guns belch smoke during test at proving ground at Louisville Naval Ordnance Plant. New light cruiser tries out its guns (right) on target towed by vessel which is just a dot on the horizon



Mr. G. N. Moore
1362 N. Dearborn St.; Chicago 10, Ill.



Direct hits by 5-inchers at Tarawa exploded Jap oil dump in cloud of black smoke. Gun is power-driven and fires 12 50-pound projectiles per minute. Upper right, target of armor plate throws up beacon as it repels shell during double purpose test at the Navy Ordnance Proving Ground, Dahlgren, Va. The horizontal range is 10 miles, ceiling six

Right, Marine gunners man 5-incher as antiaircraft weapon during actual combat aboard carrier. Gun has latest fire control and can be automatically or manually controlled. Power of projectile is so great that near hits, controlled by time fuses, knock out planes. Below, putting a mirror-like finish on barrel which is precisioned to 10,000th of inch



75-Foot Air-Conditioned Bus Crosses Desert

0182



Equipped with 12 gears, a monster **RAF** bus travels between Habbaniya, Iraq and Damascus, carrying 40 passengers with luggage. The vehicle, which weighs 30 tons, is 75 feet long and 11 feet wide and its wheels stand 4 feet, 2 inches high. Completely air-conditioned, it has a kitchen, toilet and taps which give ice water.

Bus, resembling a rubber-tired Pullman being drawn by truck, dwarfs sedan of conventional size beside it

Power Plow Guided by Hand Cleans 4-Foot Lane of Snow

Powered by a five-horsepower, gasoline-driven motor, a snow plow guided by hand can clean any standard-width driveway in two quick sweeps. Its 48-inch blade is completely reversible as to angle without

changing a bolt, and it can be set straight for bull-dozing jobs. Resting on a pair of rubber-tired wheels, the plow is two feet high and can easily handle snow 14 inches deep, according to the manufacturer.



Engine Fueled Like Diesel Eliminates Throttle Lag

Fuel is delivered directly to the cylinders of a gasoline engine instead of in vaporized form with a new injection method. Advantages of the system, developed by the American Bosch Corporation, Springfield, Mass., include smoother power delivery and the elimination of time lag on the throttle, higher efficiency with low-grade gasolines, and reduction of fire hazard. With this system, fuel is delivered uniformly to every cylinder and the smooth flow of power is said to increase mileage per gallon. Diesel engines are fueled much the same way. While present production is earmarked for military uses, the development is expected to have a wide effect on all kinds of gasoline-powered transportation after the war.

Gravel Motor Plow & Cultivator Co., Durham, N. C.



GOING UP!

Mr. Stinson

UP IN Alaska it sometimes gets so cold that an ordinary gasoline-fired air heater spits icicles. Aircraft mechanics who are trying to warm an engine on the ground put three of the heaters in a row so that the warmed but still chilly air from the first heater passes through the others, picking up heat from each.

At high altitudes the cabin heater of an airplane labors against even lower temperatures. In fact, the air may be so thin and cold that the fuel used in the heater won't even ignite.

Thirty-five thousand feet, roughly, is the present practical ceiling at which men can exist, aircraft can fly, and equipment can operate. Greater altitudes have been reached, of course, but this is the generally accepted ceiling. Man wants to fly higher, say at 10 miles above the earth, and science is developing ways and means to make that possible.

AUGUST, 1944

Dressed in experimental high-altitude clothing, a gunner is tested for mental and physical reaction to telephoned commands in cold chamber. Below, on the comfortable side of the new Douglas stratosphere room an engineer operates altitude controls on main panel

025-

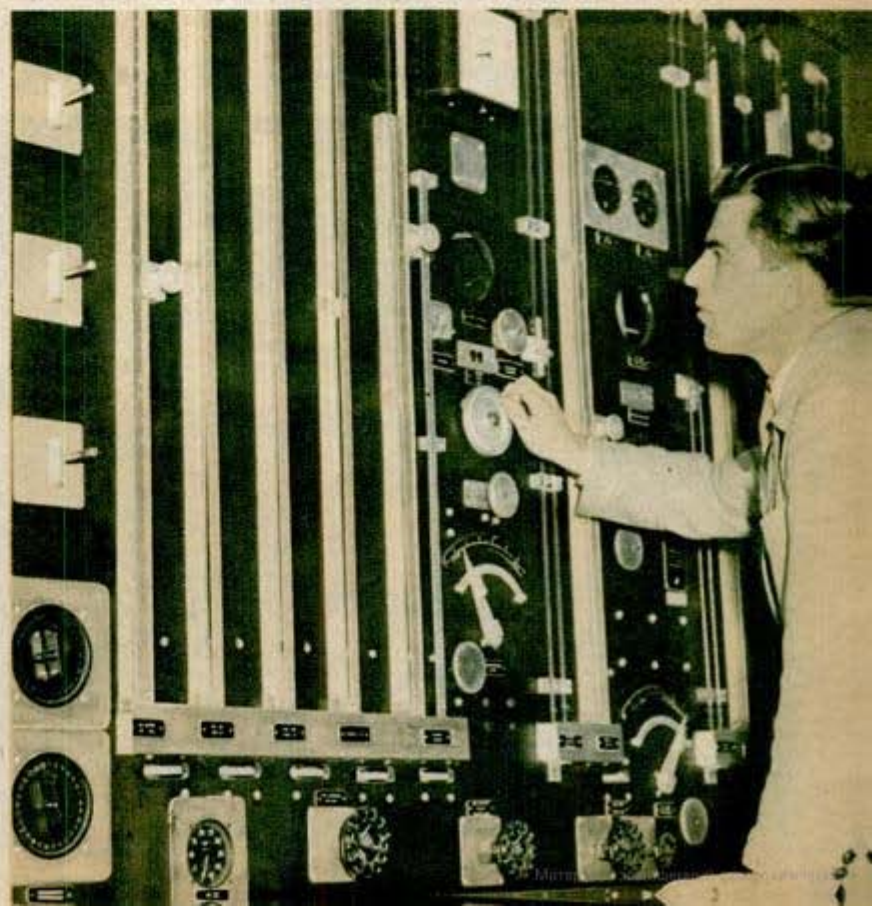



The stupefying effect of oxygen want and low pressure at high altitude is shown by flyer who could not finish sentence "I feel well"

Supercharging a cabin heater so that it will provide warmth in the stratosphere is one item. Furnishing adequate atmospheric pressure for the men is another. Even while breathing pure oxygen every flyer has his individual "ceiling" some-

dropped to a little less than one pound per square inch, comparable with that of the atmosphere at 65,000 feet.

In this frigid partial vacuum the Douglas engineers create a gale of thin wind by means of an external air circulation sys-

where in the neighborhood of 40,000 feet. Above that point the air is so thin that his blood doesn't absorb enough of the oxygen he inhales. Each breath must be taken by conscious effort instead of being an automatic reflex. But what is the best way to provide a denser atmosphere under military conditions? Should the whole cabin be supercharged or would it be simpler for each man to wear a helmet and suit inflated to comfortable pressure? Researchers are studying the problem.

Engine carburetion is equally important. At the Douglas Aircraft Company in California improved carburetor induction systems are being studied in a new big altitude chamber in which the low pressures and temperatures of the stratosphere can be duplicated. Inside the insulated steel cylinder, 10 by 40 feet in dimensions, temperatures as low as 130 degrees below zero can be attained while the air pressure is

From this switchboard, electricity of various cycles or voltages, a.c. or d.c., is fed to Douglas laboratories

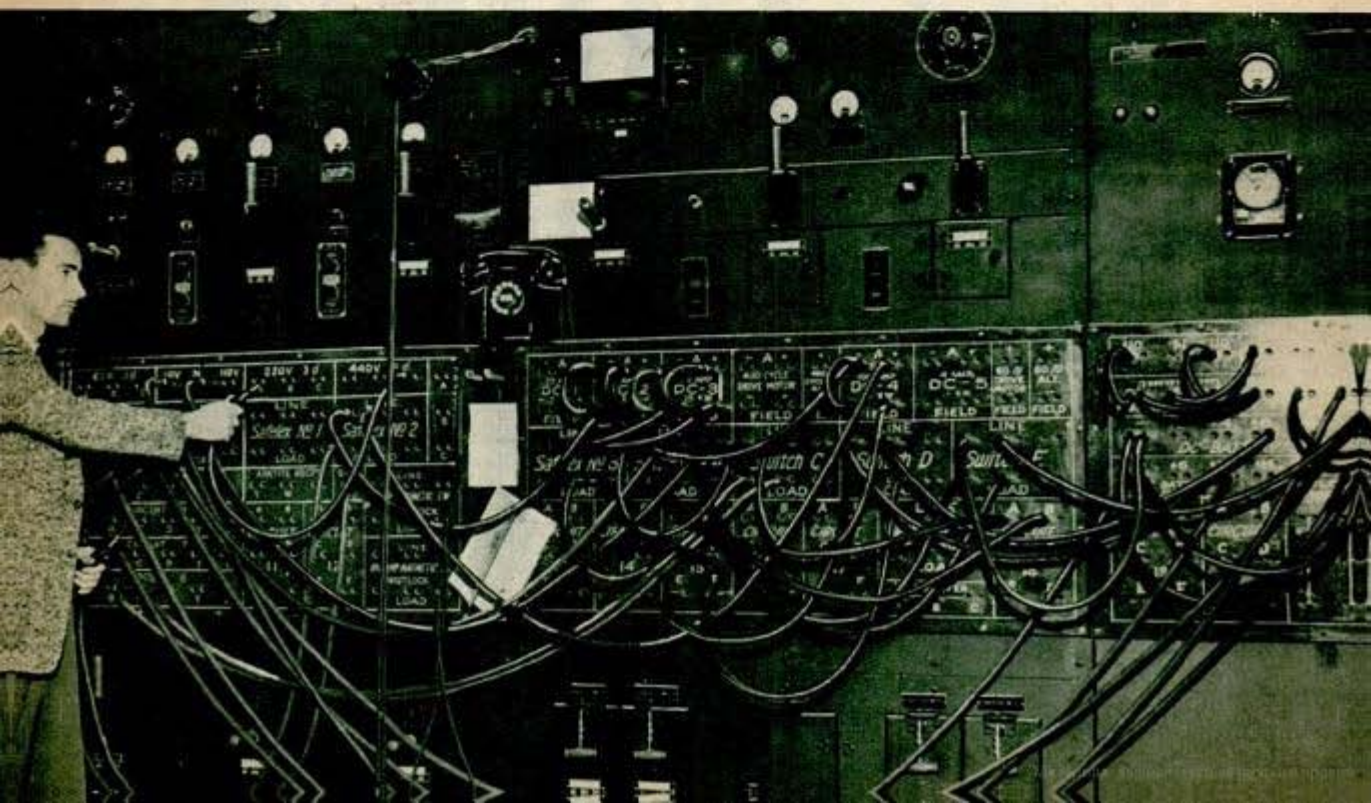

tem. Just like the altitude chamber to which it is connected, this system is sealed and insulated against sea level conditions. The system even has special refrigeration to remove the small amount of heat that is built up in the thin air by the action of the fan blades that keep it in motion.

This strato-chamber makes it possible not only to expose carburetors and other aircraft equipment to the conditions found at high altitude, but to operate them just as if they were in an airplane moving through the thin air. Thus the complete air induction system may be studied while air and fuel are passing through it.

Another kind of stratosphere investigation has to do with guns. In Pennsylvania the York Corporation is building a double-roomed altitude chamber so that even ar-



Above, passing hot air gun through hatch in two-foot thick wall of cold room; inside temperature may be as low as 130 degrees below zero. At left, test board with 144 contacts for quick check of bomber's wiring circuits. On panel below are gauges for testing strains at 78 different points of airplane structure

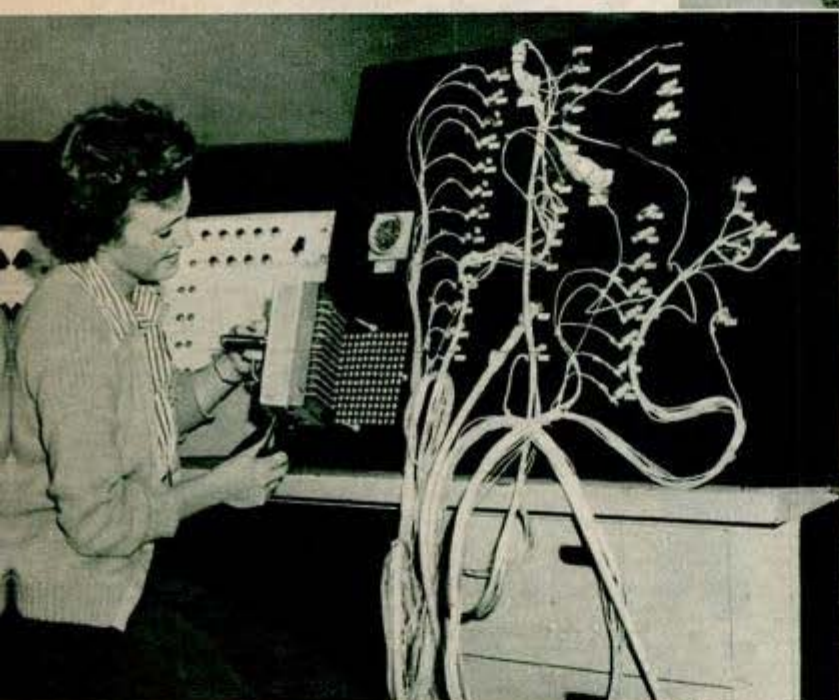

tillery may be taken up to a simulated altitude of 50,000 feet. With an atmospheric pressure of 1.68 pounds per square inch and with the temperature touching 70 degrees below zero, shells from a 75-mm. cannon will be fired into a concrete backstop.

So vital has altitude research become that at Douglas two small strato-chambers in addition to the new big chamber are in operation. A great cold room in which the temperature may be reduced to 130 degrees below zero, and smaller insulated boxes inside of which the temperature can range from 160 degrees above zero to 130 degrees below, are also used. Seventy-five percent of the parts that go into Douglas combat and cargo planes have been tested in these facilities.





Testing an airplane radio with the help of dummy antennas in the radio laboratory, above. Two smaller altitude chambers at the Douglas factory are engaged in research, testing and improving the myriad materials and parts that make up modern aircraft. In one area, engineers are rolling a nose wheel down an incline, causing it to hit the ground with an impact similar to that of a hard landing. Electric strain gauges and a motion picture camera record the

sulted when the extreme cold of high altitude caused embrittlement of sealing compounds used in the tanks. New compounds that retain their elasticity at low temperatures solved that one.

Altitude investigation is only part of the research program at Douglas. More than 500 scientists, test engineers, and technicians under the direction of J. R. Goldstein are engaged in research, testing and improving the myriad materials and parts that make up modern aircraft. In one area, engineers are rolling a nose wheel down an incline, causing it to hit the ground with an impact similar to that of a hard landing. Electric strain gauges and a motion picture camera record the

Such studies revealed why the steel cables of an airplane's control system seemed to grow long and slack at high altitudes, why the double glass of cockpit windows bulged and gave distorted vision high above the earth, and why fuel tanks sometimes leaked at an airplane's ceiling. Control systems became slack because the steel in the cables shrunk less at low temperatures than did the aluminum of the fuselage, it was learned. Metals whose coefficients of contraction approach that of aluminum are now available as cables, providing positive control at all altitudes. The reason why the double windows bulged was because the dense air of sea level, trapped between the panes, expanded when the exterior pressures went down. Now the windows are vented or a pressure-equalizing device is used. Leaking fuel tanks re-

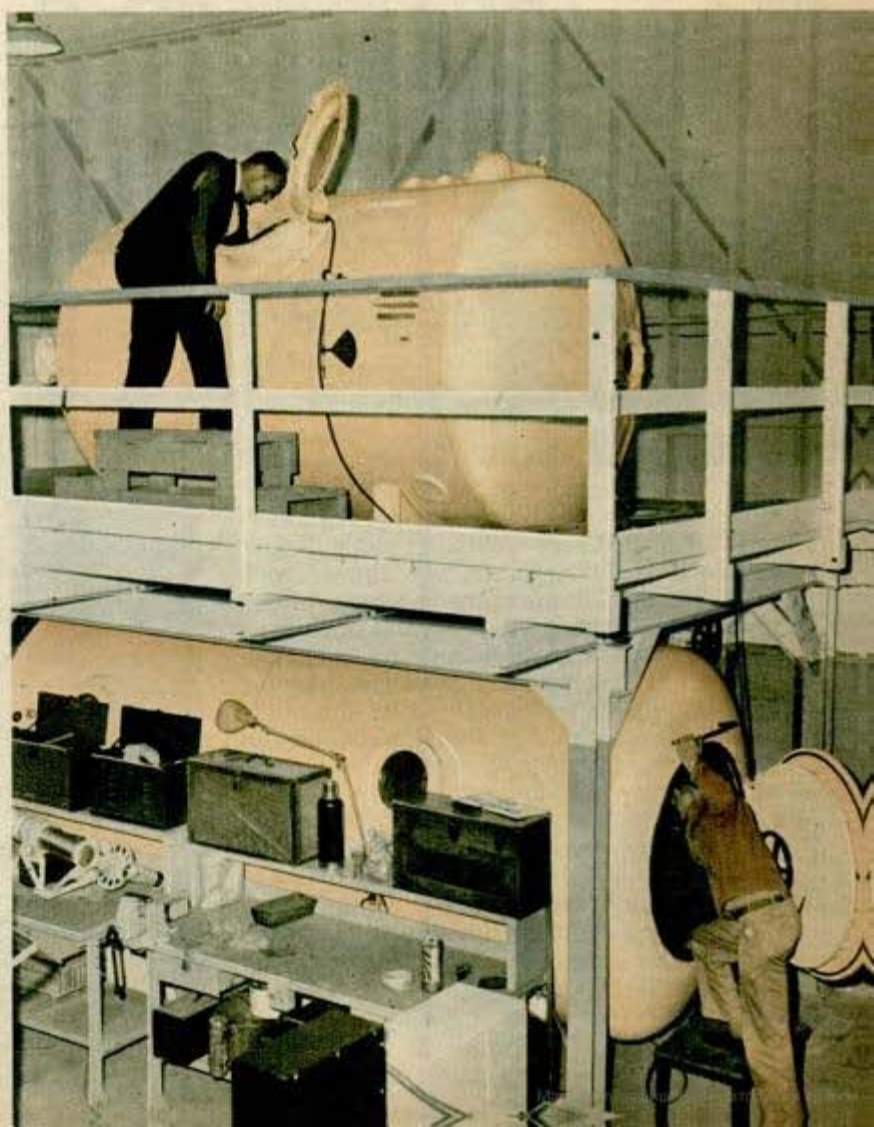

effect of the shock on the tire, wheel, and landing gear structure. Nearby, a new design of wing is being weighted down with tons of shot bags so that its deflections under different loads can be learned and its point of failure established. In an adjacent hydraulics laboratory a group is designing the hydraulic pressure system that will be used to operate a new wheel brake. In the radio lab a transmitter is being tuned on the bench so that no adjusting or shielding will be required when it is placed in an airplane.

Down in "Research Hollow" adjacent to the main Douglas plant, other investigations are being made. A maze of transparent plastic tubing, under a shed, duplicate of an airplane's fuel system, allows a group of fuel engineers to watch gasoline flow through the lines in response to the opening and closing of valves.

Vibration is an ever-present gremlin in aircraft. The constant shaking may weaken metal, rubber, or plastic to the breaking point. Parts in question are placed in mechanical vibrators that shake them for days or weeks at a time, then the parts are tested for strength. Whole portions of an airplane's structure, such as a huge engine nacelle with wing stubs at each side, complete to engine and propeller, are vibrated in a gale, hour after hour, in simulation of actual flight.

Year after year, such research enables our aircraft to fly faster, farther, higher, carry greater loads more safely, and last longer than ever before.

AUGUST, 1944

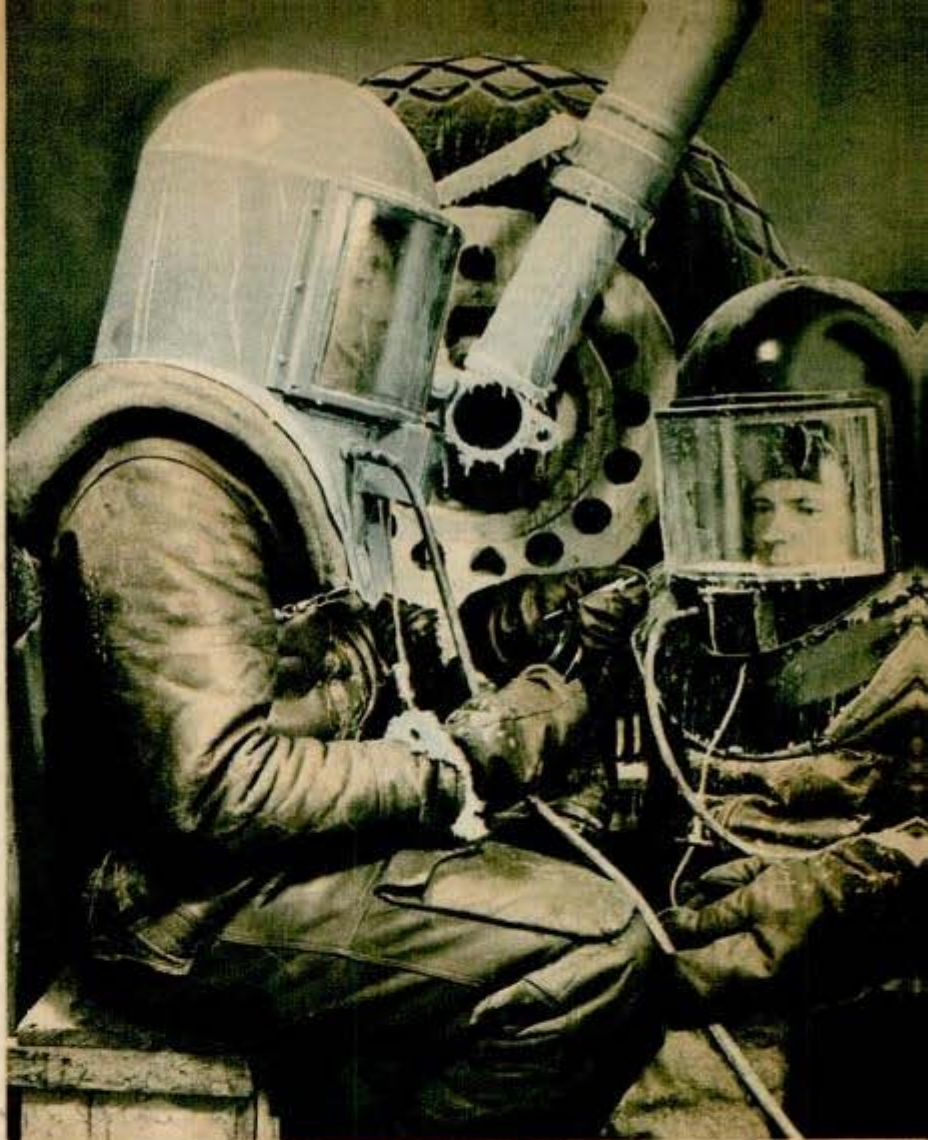

Landing gear in scene above has been undergoing a low-temperature test, and the technicians have to take it too. Below, a research technician emerges from Douglas "refrigerator" after a low-pressure instrument test

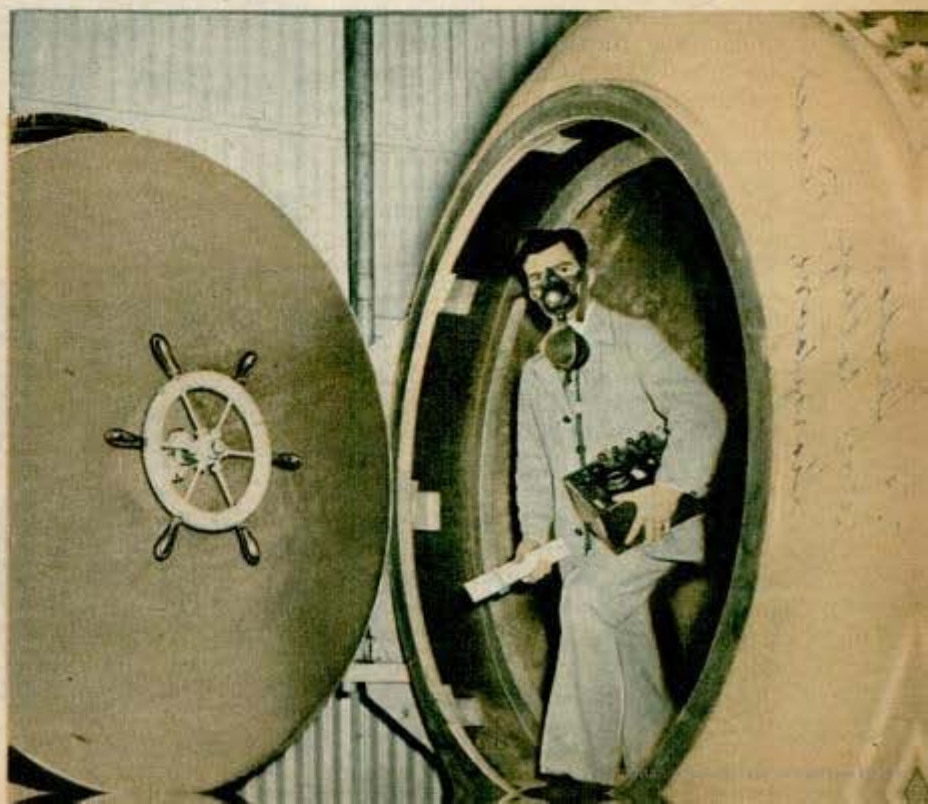

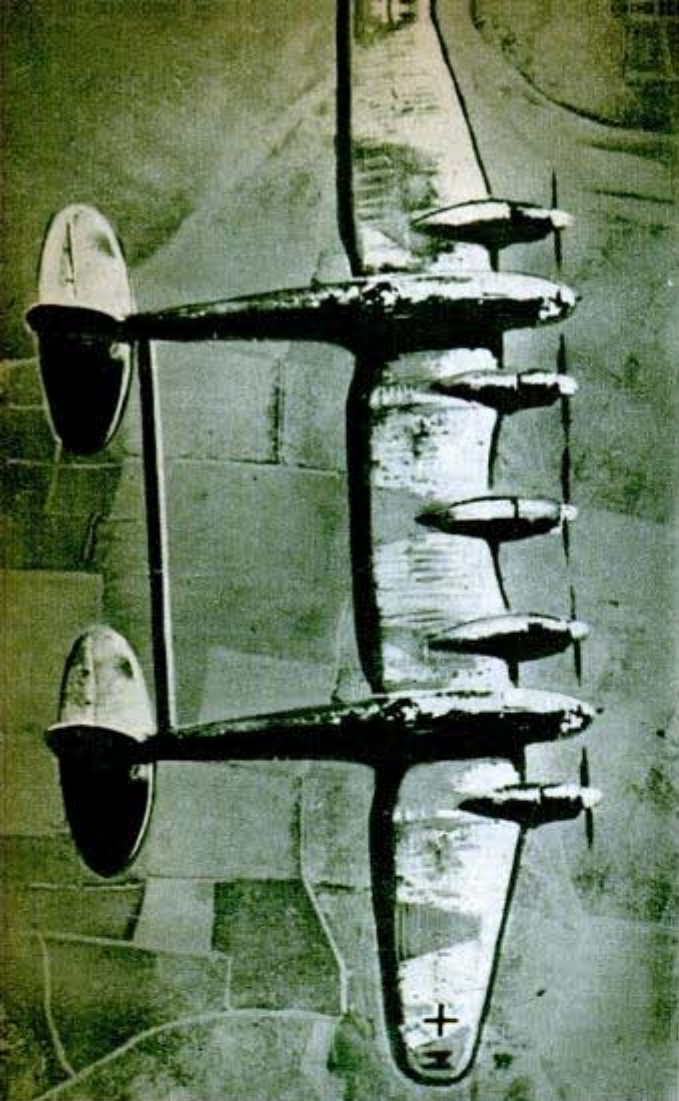

0104

Two Heinkels Joined Together Become Nazi Glider Tug

When a Mosquito Intruder pilot recently shot down a German glider tug, called the "Siamese Twin" plane by the Allies, he said he could scarcely believe his eyes. It was a freakish looking craft consisting of two twin-engined Heinkels joined together at the wing tips with an extra engine at the joint. To give an idea of what it looks like, a composite photograph of two Heinkels attached at the wing tips was made, with a fifth motor sketched in.

0188

Hearts Transplanted in Frogs Keep Pumping for 130 Days

By developing a method of rapidly sewing up blood vessels, a Russian scientist has successfully transplanted hearts in frogs. Some have lived for 130 days in the laboratories of the Gorky Medical Institute in Moscow. Electrocardiograms reveal no change in the muscle action of the transplanted organs and the frogs which were operated on behaved in a normal manner. The Russian scientist, Prof. N. P. Sinitsin, placed a second heart beside the animal's own in earlier experiments. Frogs with two hearts lived about 30 days. Later, frogs' hearts were completely replaced. Despite the success of the experiments, Prof. Sinitsin said the problem of transplantation of organs is still far from solved.

P. Sinitsin

Gorky Medical Institute, Moscow

0263

Mechanical "Lumberjack" Cuts 22-Inch Trees

Two huge blades which operate on the same principle as hedge shears are attached to a Caterpillar tractor to turn it into a mechanical lumberjack. The shears snip off a 17-inch pine or 22-inch elm in less than two minutes, and are said to do the work of 200 men. To cut a tree, the blades encircle the trunk, then close, and the tractor backs away. Patented by Kirk Knight, Jr., formerly of Bartlett, Texas, the machine was used for clearing ground on a dam project. Although production of the tree-shears was halted by the war, it is believed they might ease the manpower shortage in the woods and ultimately the paper shortage by cutting timber for pulp.



O.P. Bradlow
1507 College Texas
Chapel Hill, Texas

See the index to find where to buy articles described in this magazine. Say You Saw It in Popular Mechanics.



Cut and Pasted "Wallflowers" Brighten Room

With a basin of water, a clean cloth and a yardstick, ready-pasted and cut floral appliques can be applied quickly to any plain, painted or papered surface. The decorations, available in six patterns of varied colors, include Victorian Floral for the living room, Lotus Pool for the bathroom, and English Ivy for kitchen, dinette, or sun room. Each pattern comes in seven pieces consisting of a centerpiece and six sections which can be arranged in bouquets, garlands or sprays. Before dipping them in water, they can be pinned to the wall for a trial effect and the top outlines marked with a pencil. As the paste does not set for several minutes, the inex-

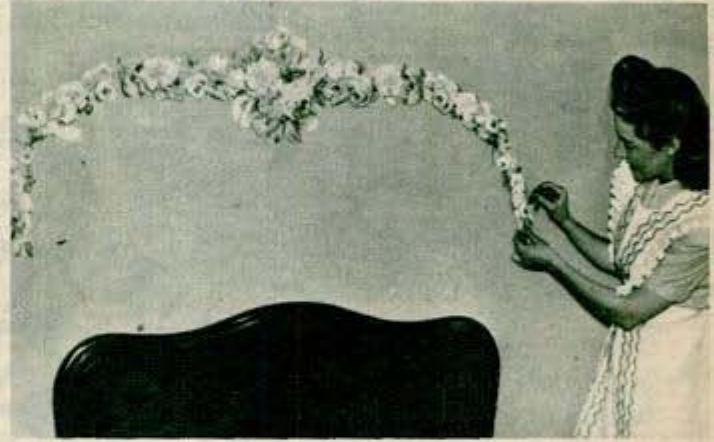

*Pring Co., Inc.
1012 S. Spaulding Ave.
Chicago 24, Ill.*

perienced home decorator can take his time. Cut-outs from the patterns may be used as accessory notes on screens, wastebaskets, or dresser drawers.

Paint Stripped From Windows by Coating With Solution

0103

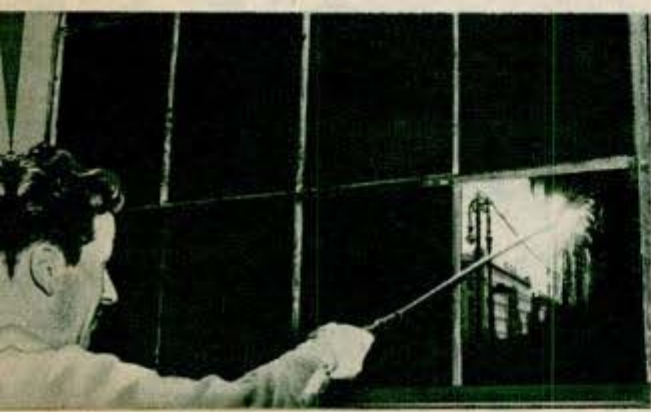

With the threat of enemy air raids steadily being minimized in the United States, a paint-stripping solution has been devised for those who want to remove blackout paint from windows and lights. Of heavy consistency, the paint remover can be brushed or sprayed on the windows without running over to adjacent surfaces. The stripper penetrates both asphaltic and non-asphaltic paints, and is said to loosen paint even on such surfaces as light bulbs, where the paint has been baked.

*Duro Products, Inc.
6135 S. Central Ave.
Los Angeles, Calif.*

Lt. G. B. Jones
4611 S. 31st Rd.

AIR MADE

on earth right here in America, so is it theoretically possible to reproduce America's climate anywhere else in the world. Perhaps, in the coming years of peace, tourists to the dank islands of the South Pacific, where American bravery is driving back the Jap barbarians, may be able to put up at night, in temperate comfort, at an inn kept air-conditioned by some enterprising promoter of the tourist trade.

Air-conditioning is a double-barreled science; it aims at controlling the temperature and at clean-

Soldiers (left) "march" through different "climates" in army laboratory. Below, air conditioning keeps dust off these glass prisms used in making a war instrument



IMAGINE a smokeless Pittsburgh, or Gary, or Birmingham; smelter stacks in mountain communities without any trace of soot or fumes; homes where dust, or insects, or allergy-inducing pollens are unknown; temperate zone comfort at the equator. . .

These are some of the fancies conjured up by the developments in the science of air-conditioning which in two short decades has grown to occupy an indispensable spot in industry, and a position of high promise for the years after the war.

Just as it is now possible, in testing chambers, to reproduce any climate



Column 23 7/28/49
7 Arlington
Arlington, Va.

TO ORDER

ing the air itself. Though first conceived of as an aid to comfort, air conditioning is now recognized as an asset to health and bodily efficiency. Modern air conditioning is a far cry from early installations that were scarcely more than refrigerating units and frequently did not provide proper humidity, to say nothing of cleanliness.

If you ask an air-conditioning expert, "Can you condition the air in my home"—or office, or factory—like as not

Top, welding fumes and dust particles being drawn through hoses are removed by portable air cleaner. Right, a flip of the dial can cool this room in summer or heat it in spring or fall. Below, gears are cut in shop where the temperature remains constant for seven days

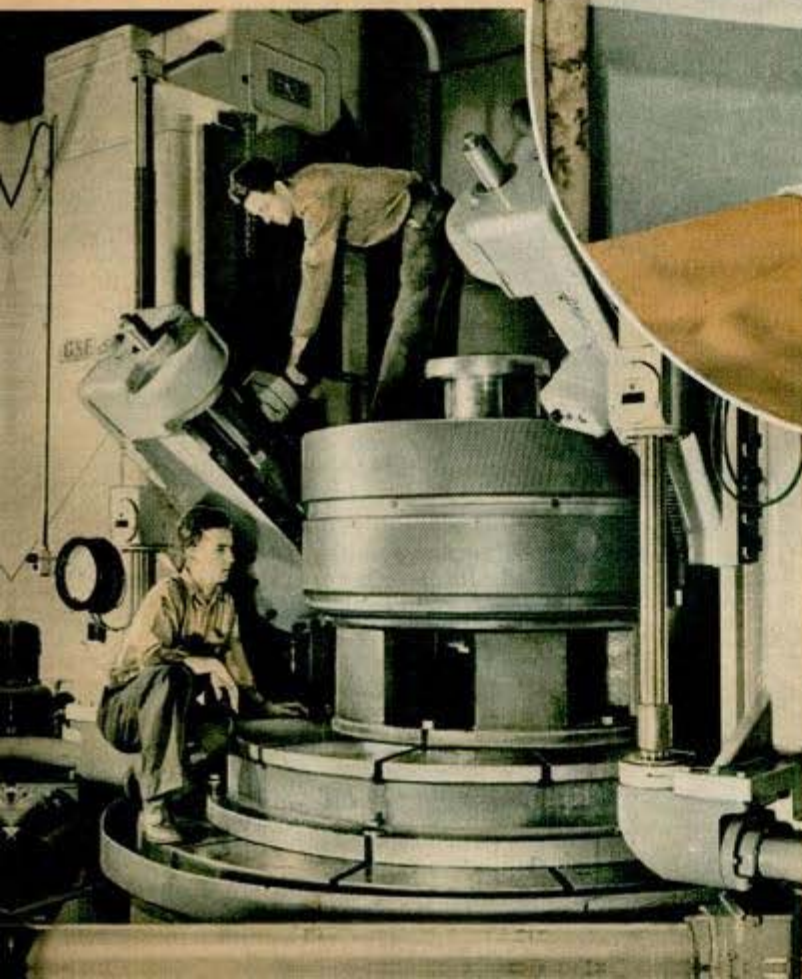

you'd get the answer: "Condition it for what?" So flexible are modern units that almost any variety of inside climate can be conjured up at will.

Clothing manufacturers, for instance, must protect their furs and woolens from insects, yet prevent mold or mildew. Ideally, the temperature for the clothing should be 35 to 40 degrees, and the humidity high enough to prevent dry-



Navy parachutes hung in air-conditioned room to keep grit and moisture from damaging the fabric
 Official U. S. Navy photo

ing of the fur skin. But this is not cold enough to kill moths, while the humidity is just right for them. With air-conditioning, periodic "shock treatments" are applied to the entire storage chamber. The temperature is rapidly lowered to 15 degrees, which kills the moths, then quickly raised to 50 degrees, to hatch out any re-

maining eggs, then again lowered to the killing temperature, and finally brought back to normal storage temperature. This same "shock cycle" is being employed to safeguard military clothing for high-altitude flying.

The tendency of silks to absorb moisture from the air, which changes their physical properties, makes air-conditioning essential in the making and storing of parachutes. Silks also tend to crack along the creases, when folded for any length of time, so the 'chutes are suspended, unfurled, from high ceilings, so that every square inch of the material would be subject to the ravages of excessive moisture were not the humidity properly controlled. Proper air-conditioning guarantees this control.

Not many Americans will go in for orchid-growing, but a great many might profit from the experiences of orchid growers in air conditioning. Theorizing that mold and bacteria ride "pick-a-back" on particles of dust, one firm installed an electrostatic air cleaner in its planting room, and anticipated an increase in the percentage of flowers from the orchid seeds, which take from 7 to 10 years to produce full blossoms.

But it isn't only the temperamental orchid that suffers from polluted air. Complete industrialization of the Western World has made soot almost the normal "diet" of the human lung. The average resident of an industrial city may take into his lungs each day a teaspoonful of dirt made up of particles so small they are usually invisible.

One analysis of this universal contamination showed the pollution to include 45 percent smoke carbons, or soot; 40 percent silicious matter, or windblown dirt; and the balance coal dust, fibrous matter, and other miscellaneous filth. In terms of excess laundering, dry cleaning, painting, metalworking and lighting costs, this air-borne pollution may cost merchants of a city, as well as householders, from 5 to 30 million dollars a year.

For more than a century it has been known that passing smoke through an electrical field simply makes the smoke disappear; Sir Oliver Lodge first applied this principle to the stack of a lead smelter in 1884; the Cottrell system was the first attempt to commercialize an electrostatic cleaner.

One such modern electrostatic cleaner is



High voltage electricity in these cells "electrocutes" dirt, dust and smoke, the enemies of precision work. The cells can clean 45,000 cubic feet of air a minute

Van Products Co.
Eric Trust Bldg.
Greene, Pa.

Foot Pedal Operates Vise With Air Pressure

0230

the Westinghouse "Precipitron." It simply electrocutes dust particles. Fine tungsten wires are suspended in the leading edge of a cell, and at the outer sides of these is a grounded rod. Current of 13,000 volts, d.c., is applied between wire and rod, creating a strong electrostatic field, through which, as the air passes, every particle of foreign matter receives a positive charge. In the cell's collector are parallel plates, charged with 6,000 volts, and since unlike charges attract, the positively charged particles of soot, dust and the like are hurled to the negative plates, grounded and held, while the clean air passes on.

Such an air-cleaner has almost as many uses as there are industries. It keeps dust motes out of rooms where delicate radio, navigation, or fire-control instruments are being assembled; a spot of dust on parts of such instruments, or excessive moisture, might mean a miss for an American battlewagon, or for a Yank bomber; it might mean a navigating error that would bring death to the entire crew of an airplane.

Air-conditioning equipment of the Carrier Co. is being used in laboratories developing microfilm, where the tiniest particle of dust might obscure a whole word on the film. In welding operations, the "misting" caused by the heat of the torch, and the accumulation of fumes, are prevented by use of a welding fume remover, which sucks off the air from the operation, precipitates the tiny particles, then whisks clean air back into the operator's room.

Dust is a hazard to both men and machinery. With men, it can cause dread silicosis, asthma, or allergic skin troubles; with equipment, it can discolor plastics, foul lubricants, erode cylinder walls, cause short circuits or fires in electrical equipment, or even violent dust explosions.

Fine dust discharged from a 300-foot stack, can travel 276 miles before sinking to the ground, and the finer the dust, in some cases, the greater its possible damage to the lungs.

The air-conditioning of hospital operating rooms has become almost a "must," for a supply of clean, dust-free air minimizes the danger of infection, and the same equipment also whisks away the fumes of anaesthetics that might otherwise decrease the efficiency of medical teams. Such equipment is being installed in portable operating chambers and laboratories for the military services in the field.

The nerve center of any airport, its radio control tower, is almost always completely unprotected from the sun, and with glassed-in walls to assure a clear view of the runways for the operator, charged with dispatching the landing and departing

Continued to page 152

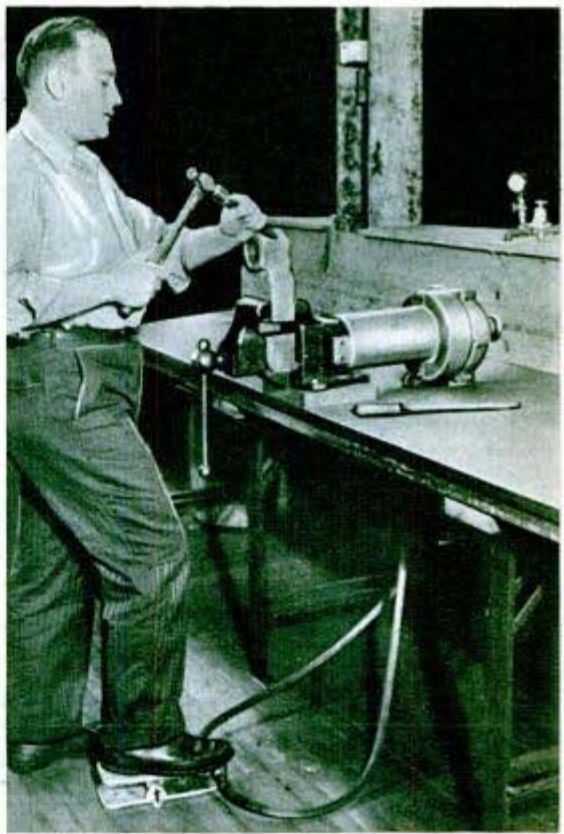

With a power unit that uses air to do the work of straining muscles, an ordinary bench vise is converted to a speedy machine tool. Slight pressure of the toe on a foot pedal closes the jaws of the vise under pressure up to two and a half tons, and heel pressure on the pedal opens the jaws as easily. The hands of the worker are free. Air control is provided by a cylinder attached to the body of the vise, and a pressure regulator permits handling of delicate parts as well as heavy pieces. The operator is protected by a safety stop. This unit is adaptable to 4-inch or 4½-inch vises.

0225

Glucose Substitutes for Water On Life Rafts Adrift

Castaways on rubber life rafts would stay alive longer if they had a supply of glucose, a common sugar which serves as both food and drink, according to studies made by Dr. James Gamble, of Harvard University. Dr. Gamble said that for every 100 grams of glucose eaten the body retains 140 grams of water which otherwise is excreted. In the experiments the glucose consumed as a partial substitute for water kept the men cheerful and physically active, while those who took no sugar were gloomy and dispirited.

1943 Bureau of
Aeronautics

21

FIGHTING BELOW THE WATER LINE

By Thomas E. Stimson, Jr.

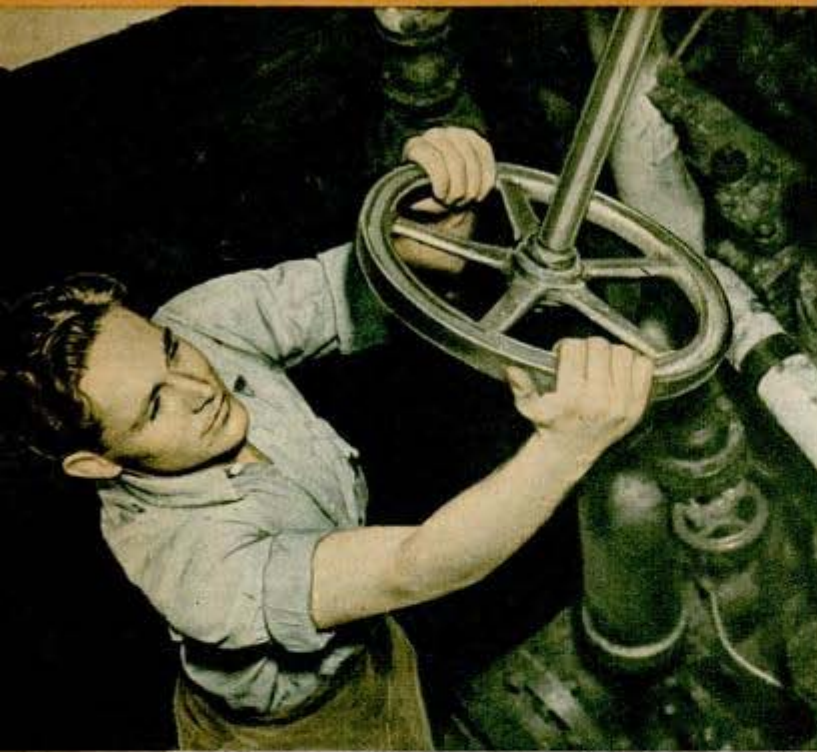

Sailor closing overhead valve in a warship's engine room. Below, port between engine rooms is closed during battle to make compartments watertight, and orders are given by phone

A WARSHIP is no better than the "black gang" that mans its engines, and its chances of victory in a sea fight depend to a great degree on the coolness and resourcefulness of these men who fight from below the water line.

From their battle stations the firemen and engineers have the double duty of operating the engines and, in case of damage, making emergency repairs so that the ship can continue to fight.

Not only does their power plant propel the ship itself but from it comes the energy that raises ammunition from the magazines, moves the deck turrets, and helps load and fire the guns. The black gang provides power for the steering engines, it keeps pressure on the fire mains and operates the ship's pumps, and it even distills fresh water from the sea for drinking purposes and for the boilers. Without these men the ship is helpless.

Ordinarily the power plant consists of several firerooms in which steam is manufactured, and several engine rooms in which this steam operates turbines that are geared to the propeller shafts. Cross connections make it possible to pipe steam from any fire room to any engine room, enabling the ship to keep moving even though part of the plant is knocked out. Similarly, the turbo-generators that create electricity are scattered through the engine spaces. Even if some of them go out of action, power to operate the ship's auxiliaries can be obtained from generators at other locations.

This technical strategy plus the heroism of engineers and firemen in repairing battle damage at the risk and at the cost of their lives is a reason why our ships are often able to continue to fight after be-



ing seriously hurt and why a crippled ship can often make its way to port for repairs.

When a ship goes into action the bridge is apt to ring for full speed on all engines. This signal is received by the throttleman in each engine room. He in turn rings up on his fire-room indicator an order for more steam. Then over the telephone that connects him with the bridge he learns the exact speed that must be made. "Make turns for twenty-eight



Above, yeoman relaying orders to engine room from the bridge. Damage control man (left) wears self-containing breathing mask and carries hose with spray nozzle



knots." He spins open his throttle wheel, admitting more steam to the high pressure turbine and increasing the rotation of the propeller shaft. The usual engine room noises increase in intensity and the big reduction gears begin to emit a scream that beats in the ears.

In the firerooms, meanwhile, the water tenders have ordered more burners lighted in the boilers to increase the amount of heat and so provide more steam. Blower speeds are built up to draw in more air for combustion. Here, too, the noise increases. The roar of the blowers and the rush of air through the boiler registers make even shouted conversation difficult. At slow speeds the firerooms are the hottest places on a ship and the temperature in front of the boilers may approach 120 degrees, but the temperature drops when the speed is stepped up. The increased flow of air reduces the heat.

Some firerooms operate at greater than atmospheric pressure to provide forced

The U.S.S. North Carolina, new battleship whose underwater power plant is protected by armor and blisters
U. S. Navy photo



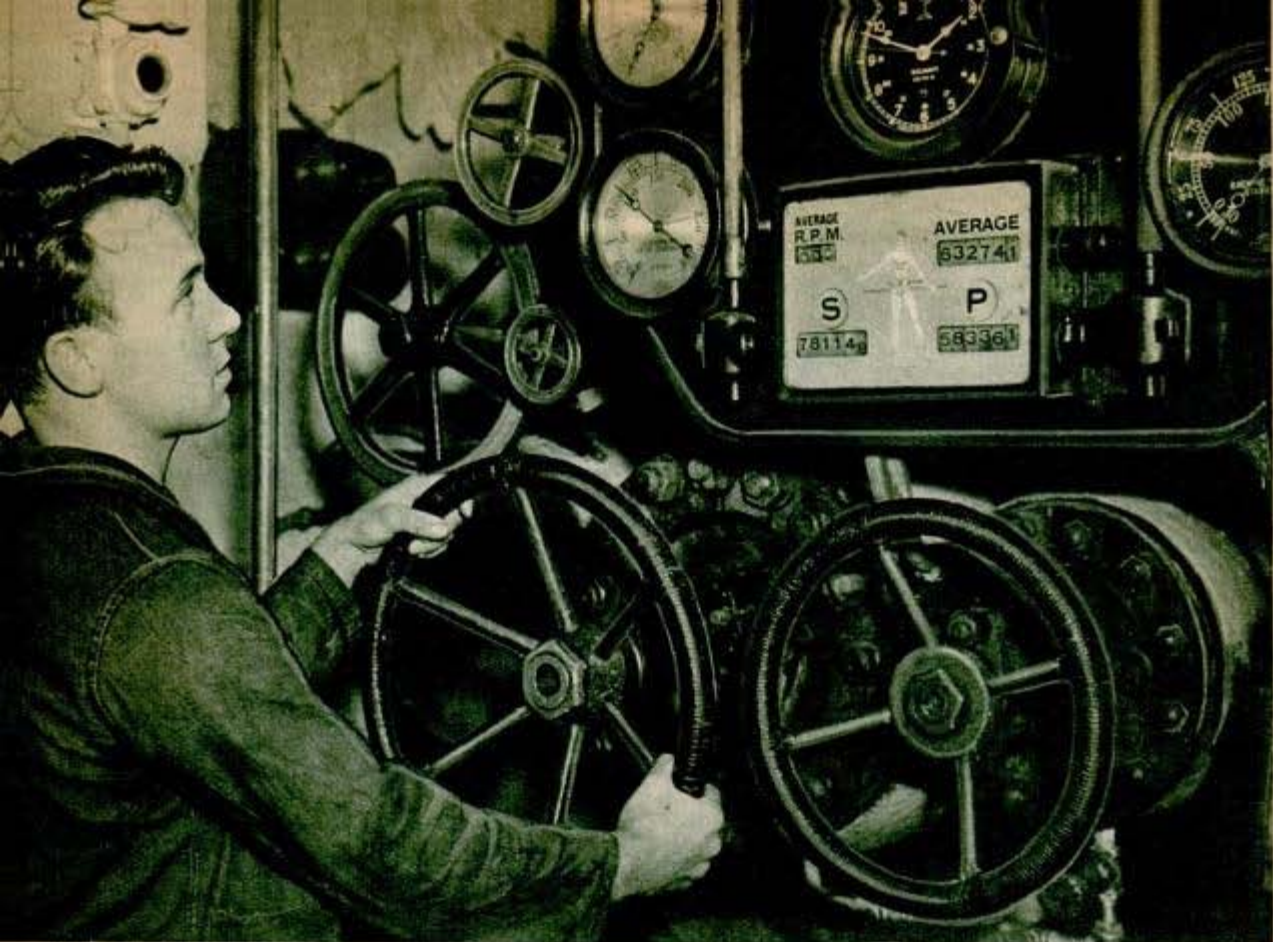

A throttleman, above, at controls of the turbines that drive a destroyer. Below, a fireman adjusting registers of express-type boilers in the fireroom

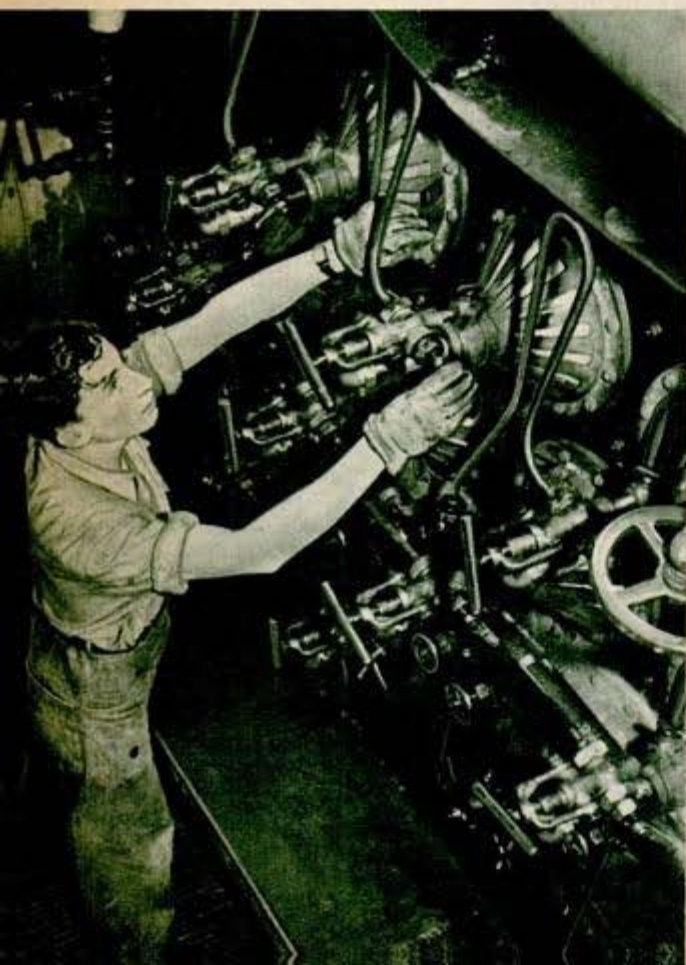

draft. These must be entered through an air lock, closing one door or hatch behind you before opening the second to avoid reducing the air pressure.

In such firerooms the water tender motions his men to stand clear of the boiler fronts when the ship goes into action. The firing of a big gun on deck can cause a flareback, drawing flames out of the boilers and badly burning anyone who stands in front of them. Such a flareback results from the partial vacuum that is created momentarily on deck when a gun is fired, starving the blowers of the air they are sending down. Too, the concussion wave from the gun's explosion blocks the gases that are rising in the stack, contributing to the flareback. The exploding of an enemy shell or bomb on deck can also pull the flames out from the boilers, and the piercing of the fireroom by a shell is bound to do so.

All sorts of damage can be caused by the punishment that a ship takes in action. The snapping of a fuel line can flood the bilges with oil, paving the way for a disastrous fire. A leak in a fuel tank, allowing water to mix with the oil, puts the boiler out of action when the water reaches the burners. The tank must be shut off, the lines and burners cleaned out, and a switch made to another tank.

The water that the boilers heat into steam is much more pure than ordinary

drinking water. Even a slight contamination can slow down the ship. It doesn't take long, if salt water mixes with the boiler water, for the salt to make its way to the turbines and collect on the blades, locking them and putting the engine out of action.

A leak in one of the lines that carry superheated steam at high pressure can be a bad casualty. The deadly vapor may kill every man in the compartment at one breath. Nothing can be done until one or two damage control men, dressed in asbestos suits and breathing their own self-contained oxygen supplies, descend into the compartment and shut down the leaking steam line.

One of the many epics of the black gangs in this war occurred while the Japs still held a foothold in the Aleutians. In the North Pacific an American force of four destroyers, a light cruiser, and a heavy cruiser was jumped by a Jap force that consisted of six destroyers, two light cruisers, and two heavy cruisers. By all the rules of war our ships were doomed.

During the three and a half hour gunnery duel the American heavy cruiser was hit hard several times and it was her engineroom gang that kept her in the fight. One shell pierced an oil tank, letting loose a flood of fuel oil and ice cold sea water that began to fill an engineroom. The men stuffed rags and their own clothes into the cracks of the leaking bulkhead without effect. The engine was shut down and the

Continued to page 154

High pressure turbine (below) in the engineroom where the "black gang" sweats it out in battle

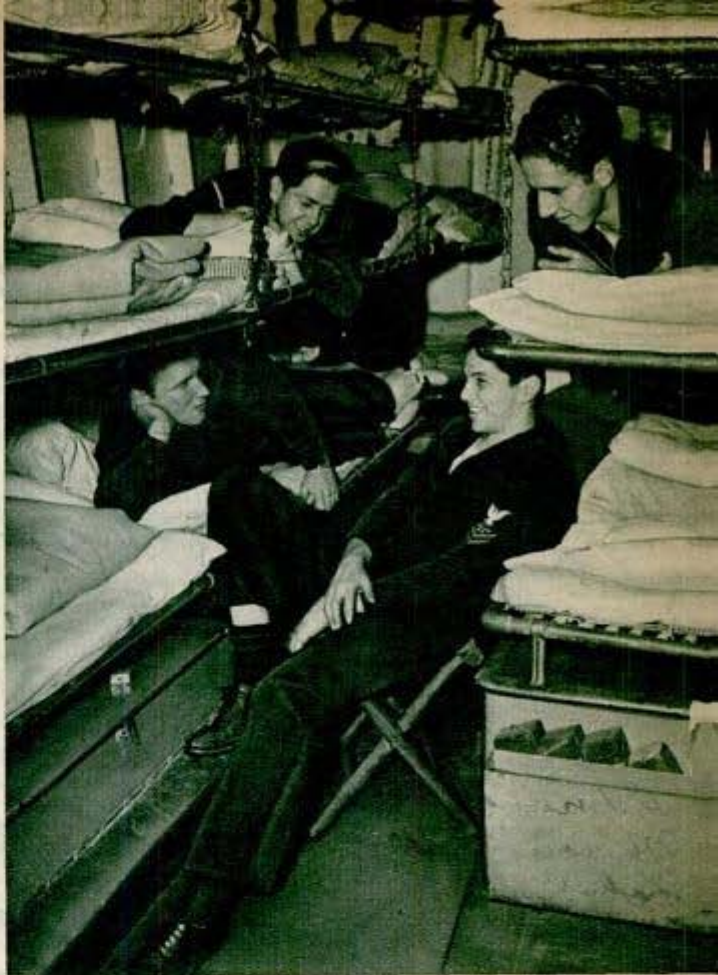

Young destroyer men (above), off watch, relax in their crowded quarters. Below, damage control man puts on asbestos suit before beginning his task



HARNESSING the HURRICANE

Aircraft models can "fly" 700 miles per hour—almost the speed of sound—when engineers turn on the giant 16-blade fan (left) in the Boeing Aircraft Company's new wind tunnel. The "hurricane" stirred up by the fan, powered by an 18,000 horsepower motor, runs the 450-foot rectangular course in less than two seconds. Models up to 12 feet in width can be tested

Seattle, Wash.

*Edmund T. Allen
Memorial Aeronautical
Labs.*

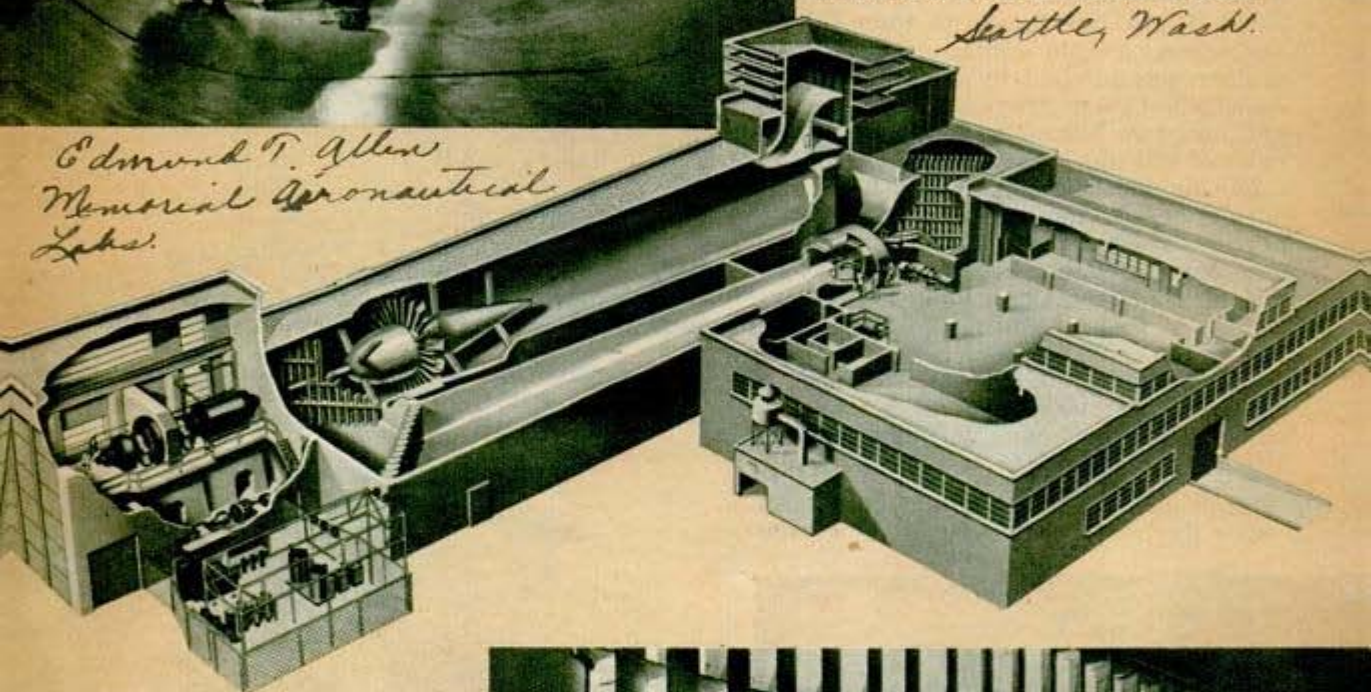

Cutaway shows power substation, engine room, the tunnel bore, air interchanger tower and operations room. Conical shaped fairing extending from hub of fan prevents turbulence. Test model can be seen in narrow "throat" of tunnel



High banks of vanes (right) guide wind smoothly around four corners of the tunnel. The vanes not only serve to "turn" the air, but also cool it during high speed operation. They are hollow and enclose sprays of cold water

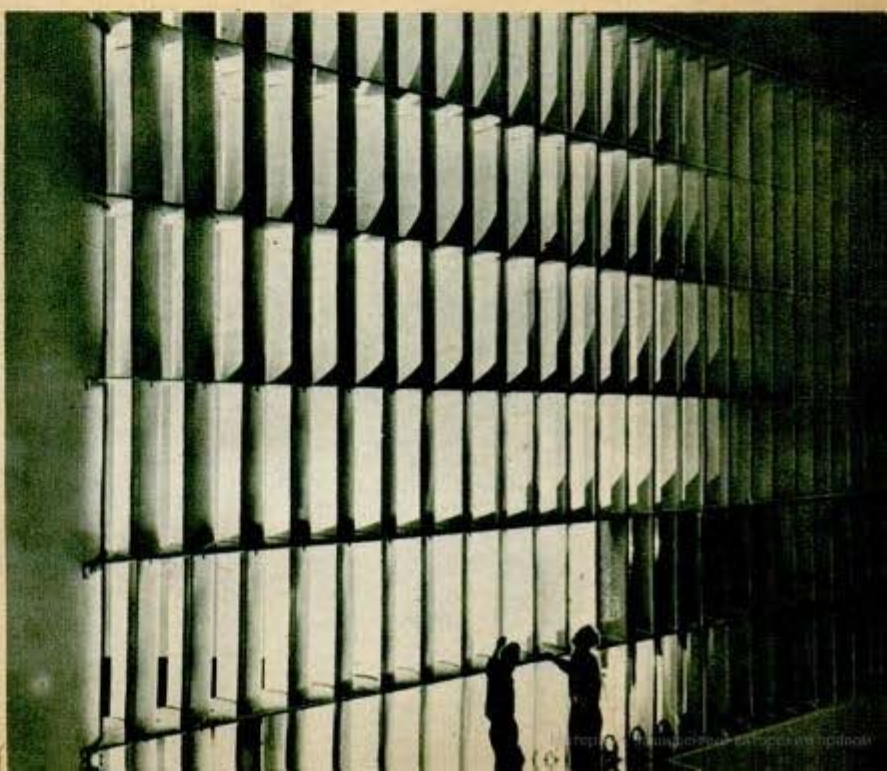

Gun Launches Plane With Blank Shell

Firing a blank shell, a catapult gun half as large as a man provides the power to launch scout planes from the deck of a battleship or cruiser. When a shell containing black powder is fired in the gun, the rapidly expanding gases rush into a bomb-shaped expan-



Clifford Frew



Above, shell is put in catapult gun to test breech. Left, officer watches as workman tries an inspection gauge on line of catapult guns in a plant

sion chamber and operate a large piston, just as gasoline vapors explode to push the piston in an automobile engine. The piston yanks a small cart along the catapult track at high speed, and the scout plane, sitting on the cart, is projected into the air.

0130

"Village" Loaded on 12 Barges Floats Down Ohio River

Thirty fully equipped homes loaded on a string of 12 barges were pushed by a tug down the Ohio river from Pt. Pleasant, W. Va., to Uniontown, Ky., where they were unloaded for Camp Breckenridge, Ky. Because the river rose, then fell, then

rose again, it took three weeks to load the tow. The houses were 24 feet wide, 56 feet long, and 15 feet high. Two barges lashed together made a separate unit, which had room enough for five houses. The tow was made up of six of these units.

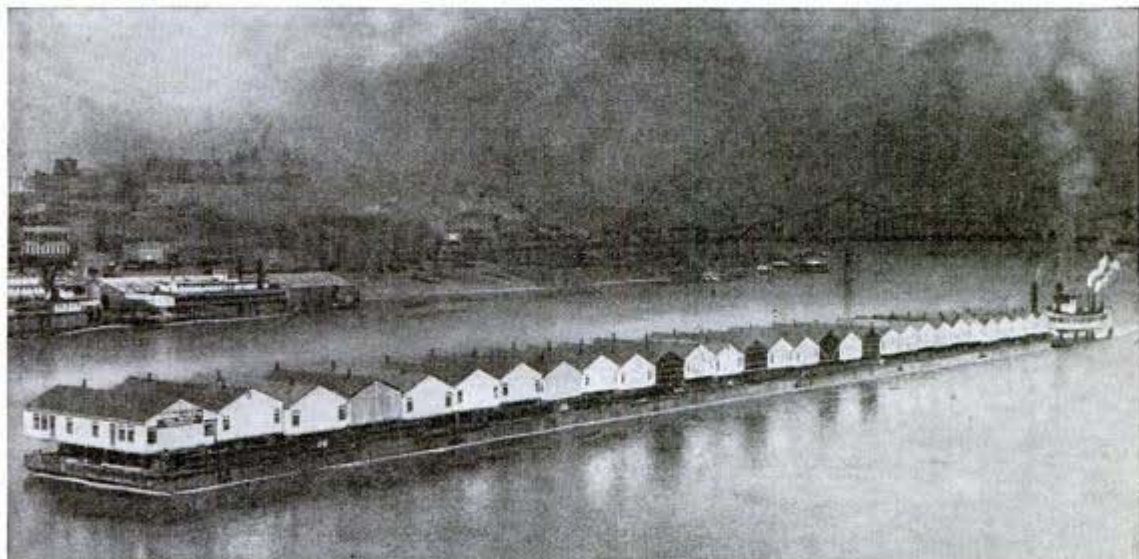

The houses, looking like a couple of blocks uprooted from a small town, are pushed down the Ohio river

CAMERAS *at* WORK

THE little black box that you used to record junior's first step has been promoted to one of the prime tools of industry and science.

A six-ton camera that, for all its enormity, is still a first cousin of your pushbutton miniature, is on the day and night shifts at Boeing turning out patterns for big bombers. In another industrial theater the drop-lets of fuel sprayed from a Diesel engine injector perform for ten-millionths of a second before the critical eye of an engineer's camera.

Before an audience of



Studebaker engineer attaches "muff" to movie camera to overcome poor shutter action in sub-zero. Its heating coils are shown at right. Below, a cameraman at a Bell Aircraft plant rides the nose of an Airacobra like a cowboy to make a technical shot for the engineers; assistant holds light

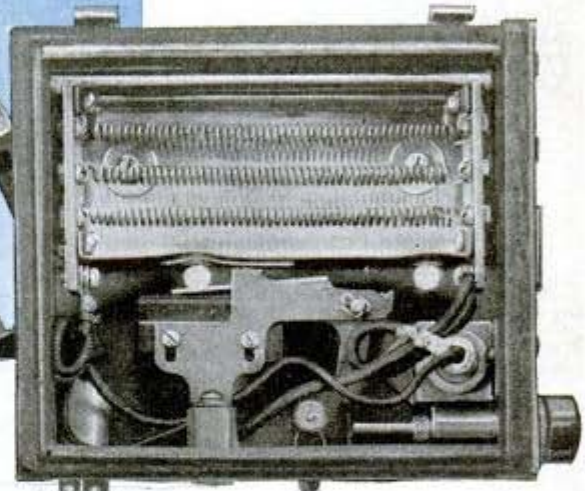

medical scientists a human eye looms up to fill a seven-foot projection screen, and the sutures used in a delicate operation appear the size of a ship's hawsers. Factory workers watch on another screen the sequence of photographs training them in the most efficient method of packing aircraft parts.

If you have been irritated at times by the shortage of film and supplies for your pocket camera, you will be comforted by the knowledge that photography in its multiple phases—visual training, research, micrography, photo-tem-

Mr. Grant

*Bell Aircraft Co.
2049 Chalmers Ave.
Buffalo, N.Y.*



plate work, motion study and vibration analysis, down to simple things like V-mail and "passport" photos for war workers—has developed tremendously in technique and in importance during the war. Without the camera as its "seeing eye," American industry that has astonished the world and itself by its production pace would have been as handicapped as the blind.

The home of the Airacobra is a typical example of industry's dependence on photography. Neither the largest nor the least important photolaboratory, Bell Aircraft's studio turns out 10,000 photographic prints a week, and the number has been as high as 13,245.

Visual training is one of the most important functions. Thousands of "green" workers had to be trained in a brief period. The plant photographer caught the sequence of a process on 35-millimeter film, enlarged the prints, and the supervisor placed the pictures before the new employee. It was easier to learn how to install the hood over the pilot's cockpit from pic-

Developing and enlarging prints on the night shift at the Bell Aircraft photo darkroom. Below, a metallographic expert at Schenectady plant of General Electric Company photographs metal sample



Mrs. Constance Brodie 83



Analysis of metals is an important phase of research; above, G. E. worker studies specimen in eyepiece of camera-microscope. Below, studying molecular structure with an electron diffraction camera

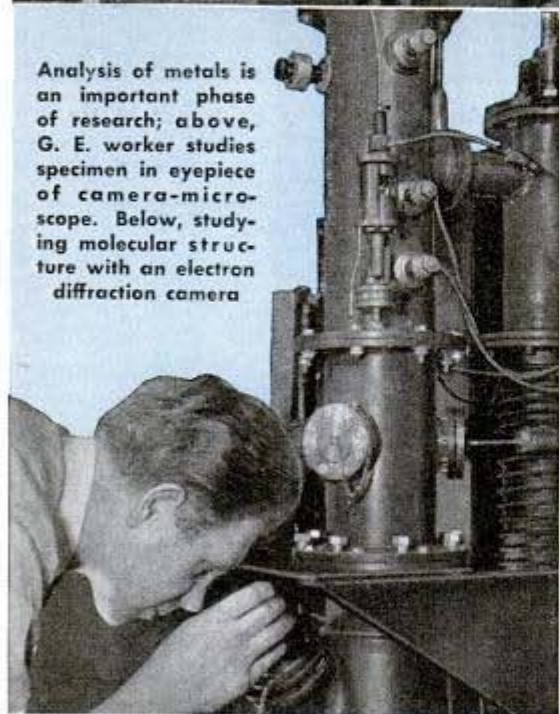

Westinghouse photo

tures than from hours of lectures or textbook study.

Bell's movie division has produced at least 30 sound films illustrating production and maintenance and flight of the P-39. Various other sections of the laboratory handle employee identification pictures, X-ray photography, micrography, publicity pictures, record photographs on microfilm and so on. Company records are also copied on paper

negatives, which permit quick contact printing and save film.

Microfilm recording has become almost an industry in itself. Many large companies, libraries and government offices have adopted the miniature film to save a vast amount of warehouse space devoted to valuable documents. General Electric puts accounting records on film, recording as many as 8,000 filing cards on a roll of microfilm the size of a package of cigarettes. In Los Angeles the 33,000 400-page volumes of maps, records and deeds accumulated in the county recorder's office

A Westinghouse engineer uses polarized-light camera to picture inside of plastic models of turbine parts



since 1852 have been transferred to more than 85 miles of micro-film which occupy only three percent of the storage space required by the original documents. Over 7,000,000 exposures were made during the transfer.

High-speed motion pictures and stop-motion "stills" have become vital laboratory instruments. One of the newest cameras, developed by the Bell Telephone laboratories, is capable of exposing 8,000 movie frames per second, using 8-millimeter film, or 4,000 frames on 16-millimeter film. Projected at the normal 16 frames per second, this 8,000-frame movie magnifies time by 500 to 1. At top speed the film travels through the camera at 70 miles an hour, expo-



Above, laboratory staff at Bell Aircraft plans a studio picture. At left, Boeing's template chief compares his pocket camera with six-ton camera for making templates

sure time per frame being as rapid as $1/30,000$ of a second.

Henry M. Lester of New York, a specialist in the high-speed art, is a regular consultant on industrial problems involving vibration and high-velocity machine operations, and photographs surgical operations and kindred work for the medical profession. He tells of taking a half day to set up a truckload of equipment; then making the complete exposure in $1\frac{1}{2}$ second. He made a photographic study of an airplane propeller, set in motion by sonic vibrations, and revealed "fishtail" vibrations along the blade, enabling the aeronautical designers to correct the trouble.

The Hercules Powder Company uses millionth-of-a-second pictures to analyze what happens when a high explosive detonates. Wright Aeronautical engineers focus the speed cameras through a quartz window to observe what happens inside an airplane engine cylinder.

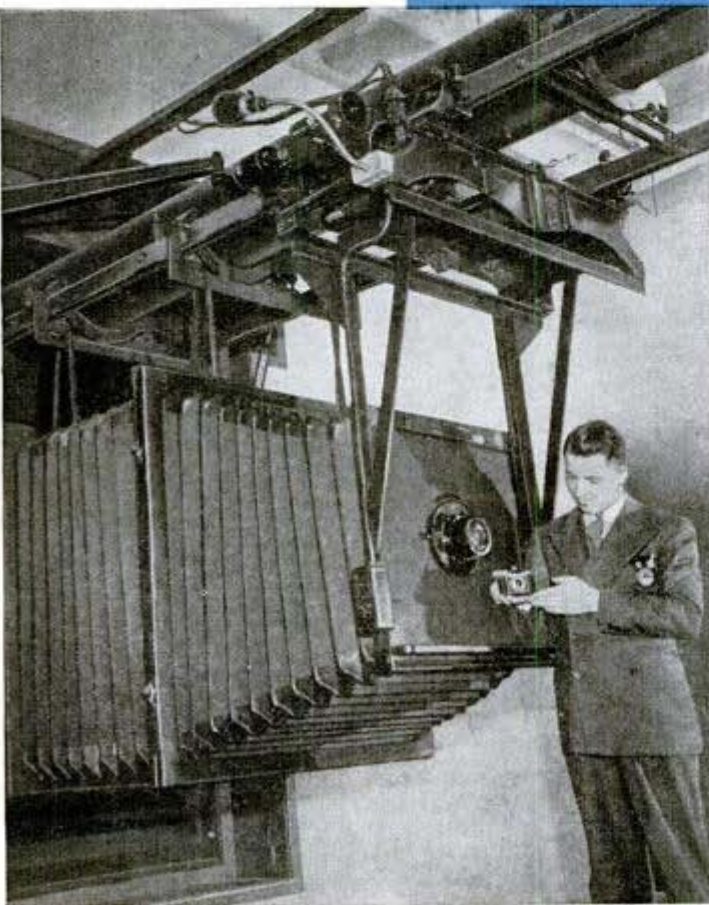

AUGUST, 1944

*Boeing Aircraft Co.
Seattle 14, Wash.*

85



Special hand bracket (top and right) holding photofloods and 35-millimeter camera, was designed by Bell Aircraft for use on visual training picture assignments. Below, North American Aviation uses X-ray to activate fluorescent coating on metal template in this housing. Metal glows except where lines are scribed

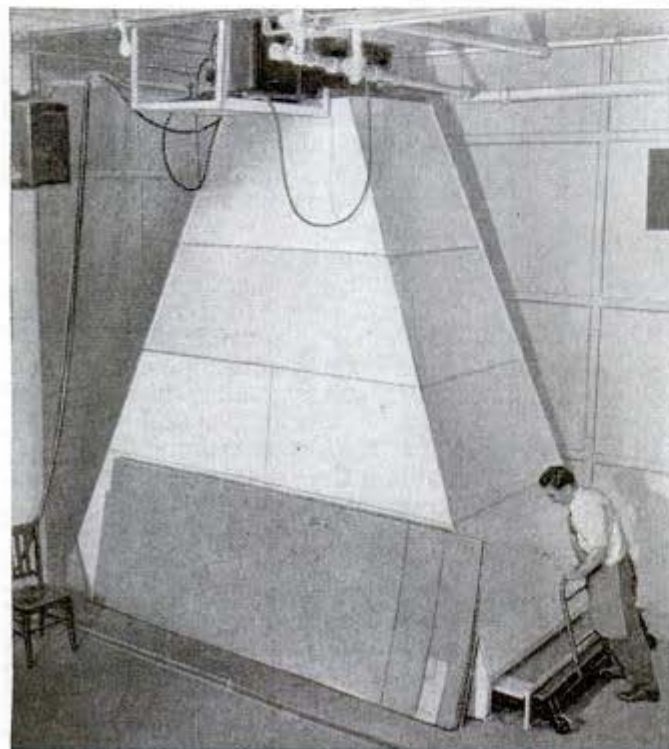
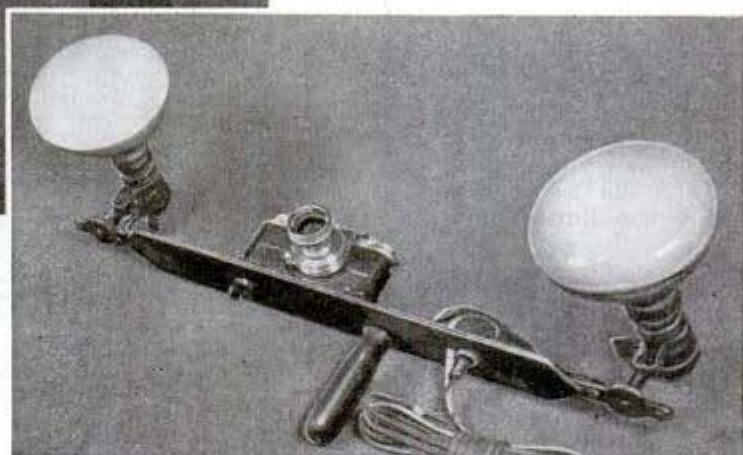

General Electric's contribution to speed photography is a portable lamp which throws a millionth-second light of sufficient intensity to "stop" for the camera a wheel rotating at 70,000 r.p.m. Its tiny mercury lamp, about as big as a wooden match, will burn only one full second—but it's good for 1,000,000 exposures and at that rate would last the average newspaper photographer 500 years.

With the Edgerton stroboscopic lamp, which flashes on and off hundreds of thousands of times per second, a fascinating study is being made of the buzzing wing beats of tiny fruit flies, in order to determine photographically the effect of drugs and other phys-

iological stimuli on these insects.

One of the greatest time-saving achievements of the industrial camera is the photo-template process, most dramatically seen in the big aircraft plants. Every airplane part requires a full-size pattern or template, and the Boeing Flying Fortress, for example, has some 30,000 parts. Before the photo-template method arrived, each template was laboriously laid out by hand from a conventional blueprint—some requiring 200 hours of individual work. Today the photographic process produces for Boeing in 48 man hours what formerly cost 12,000 man hours. Hundreds of copies of the template can be made from one photographic negative.

Boeing's engineers lay out their original drawing on a sheet of thin steel, the drawing being the exact dimensions of the part to be produced. This master layout is

placed on a huge easel in the photo template darkroom and photographed by the \$20,000, six-ton "big berth" camera. The glass negative, about one-fifth the size of the original drawing, is then used—with the big camera now as enlarger—to print full-sized templates on photosensitized steel plates. Some of these templates weigh as much as 300 pounds and must be hoisted by power crane from the easel to the 360-gallon developing tanks.

At the North American Aviation plant, the metal template is treated with a fluorescent lacquer, the master design is imposed with a scribing tool, and then under an X-ray lamp the drawing stands out as black lines against the fluorescent surface. A negative is made from this plate.

Photography has become the most effective of teachers. Inexperienced workers build ships in the Norfolk Navy Yard by following simple pictures instead of blueprints. After the first destroyer escort was built, photographers assembled about 200 pictures of every section of the ship and these were posted in their proper places in every subsequent "D.E." built, to guide the unskilled workman.

General Electric made high-speed movies of metal boring and cutting tools in action to learn correct cutting angles, and teach students proper technique. Many an arc welder learned his art from General Electric's full-color sound movie, "The Inside of Arc Welding."

A wartime innovation which makes possible motion picture "shooting" in sub-zero weather resulted from trouble encountered by Studebaker engineers in testing military equipment in the Canadian Rockies. Movies of the tests proved jerky because of poor shutter action when the cold contracted the camera's metal parts. Studebaker researchers designed a jacket to fit over the camera slide cover, enclosing heater coils fed by a battery and controlled by a thermostat. The camera functions efficiently now at 45 below zero.

Infrared photography, metallography, X-ray studies are all vital phases of industrial research, only now coming into full use. Color film is just a decade old, and is already indispensable. When the end of the war brings secrets into the open, there will be revelations of new color films and new uses of them. One company is understood to have under development a method of producing natural color pictures from black-and-white negatives.

Picture magazines have helped to teach industry that one picture is the equal of 10,000 words. Let the shipyard worker or manufacturer or research scientist ask a question—the camera will give him the answer.

AUGUST, 1944

Tractor With "Square Wheels" Offers Better Grip on Earth



To achieve a better grip on the earth, a tractor shown at a demonstration of labor-saving machinery by the Washington State College Extension Service was equipped with treads which squared off its wheels. Its inventor, R. N. Riblet, of Spokane, Wash., said the wheels offer exceptional traction and make the tractor bumpless.

Braille Marks on Phone Dial Help the Blind Make Calls 0216

To help the blind patients at the Letterman General Hospital in San Francisco, Calif., in overcoming their handicap, a Braille telephone set has been devised. The phone has a portable dial mounted on a Bakelite encasement with the Braille alphabet and Braille markings for numerals on its face and back.



*N. A. De Stefano
219 Grindel Rd.
San Carlos, Calif.*

Radio Mast of Tubular Plywood Speeds Assembly at Front

Portable radio masts of tubular plywood are set up quickly at captured airfields to establish ground-to-plane communication. The lightweight masts, 50- or 75-foot models, consist of four sections four inches in diameter and a top piece which are joined by sleeve couplings. They were designed by the Signal Corps for easy "packaging" in cargo planes. A three-man crew can put the sections together, raise the mast

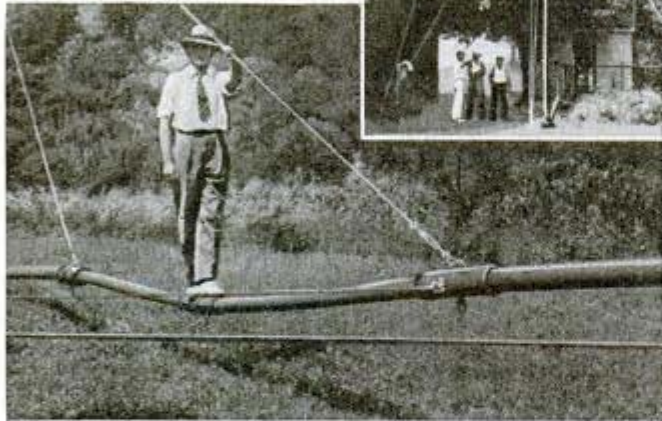
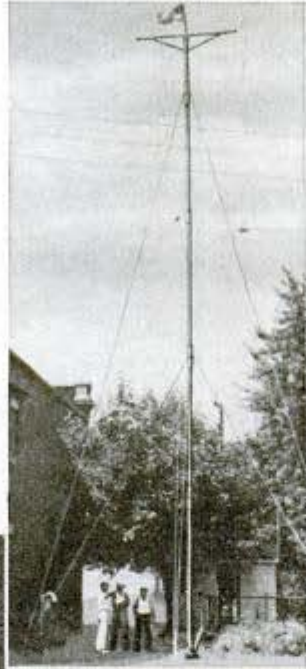

Lightweight mast supports man's weight; wires hold it erect

by a boom, and have a radio in operation in 30 minutes. The base end is set in a hinged metal socket fixed to the ground by long spikes. Guy wires help hold the mast erect. Formerly, heavy masts of solid wood or metal were used which were cumbersome to handle. The plywood masts have been widely used since proving their worth in the African invasion.

0154

Bomber Engines 'Breathe' Under 'Brain's' Control

Long a secret, the Electronic Turbo Regulator was presented to the public recently as the instrument by which the Army Air Force controls the "breathing" of heavy bomber engines in high altitudes. The mechanism relieves the pilot of watching for over-speeding of the supercharger, which could prove fatal, and insures maximum safe power out-

put and efficiency. Employing the same basic circuits as the autopilot, its principle is to compress the rarefied air of the upper atmosphere and feed this to the carburetor under a pressure sufficient to obtain the high power output required of aircraft engines. It operates from a single knob control on the cockpit throttle column. This adjustment controls all four engines at the same time, assuring equal manifold pressure and providing a simplified control of air speed on bombing runs. The control system operates continuously, making minute adjustments in waste gas position as the airplane gains or loses altitude or speed, or moves into hot or cold fronts where air pressures vary. The Turbo Regulator also includes a governor, directly connected to the turbine, which automatically prevents the supercharger from overspeeding by setting up an electrical high limit, thus preventing the system from demanding more from the supercharger than it is capable of delivering safely.

0126

10-Barreled Nazi Mortars Toss Heavy Barrage

One of the many heavy weapons the German Army has rushed to the eastern front to try to slow the Russian advance is a motorized, 10-barreled mortar. Pictures from neutral sources which show several of these guns in action seem to indicate the Nazi gunners can fire 10 shells at a clip.



A 10-barreled mortar about to be fired on the Russian front

Maryland Engineering Co.
1326
Pikesville, Md.
Manneapolis Honeywell
Regulator Co., Minneapolis, Minn.

5 New Faces on Old Doors



WITH little labor and expense, anyone can improve the appearance of a plain entrance door. For a modern stucco or frame house, imitation shutters form wings for the door and a trellis for vines as in Fig. 1.

1. The sides, slats and top are made from 1 by 2-in. stock, and the bottom panels are 1 by 10-in. stock as in Fig. 6.

6. Width and color are gained for the door of a frame house by topping it with a triangular strip of 1-in. stock and providing two wings of 8-in. boards as in Fig. 2. Three brackets to hold flowerpots on the wings are made as shown in Fig. 8. An appropriate doorway for the seaside home is shown in Fig. 3. Right-angle



①

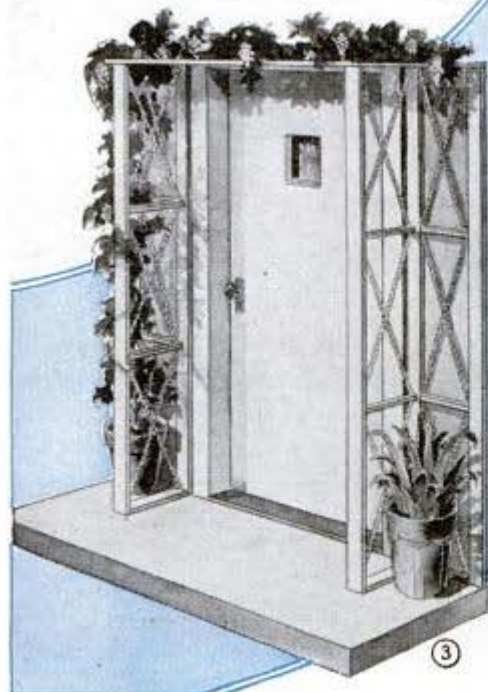

③



②



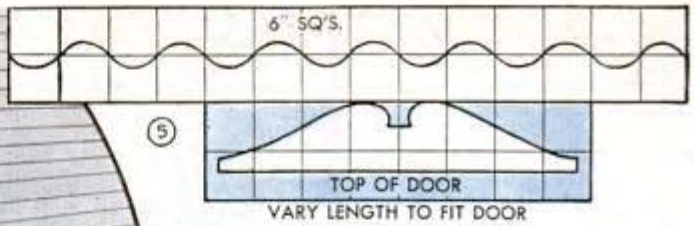
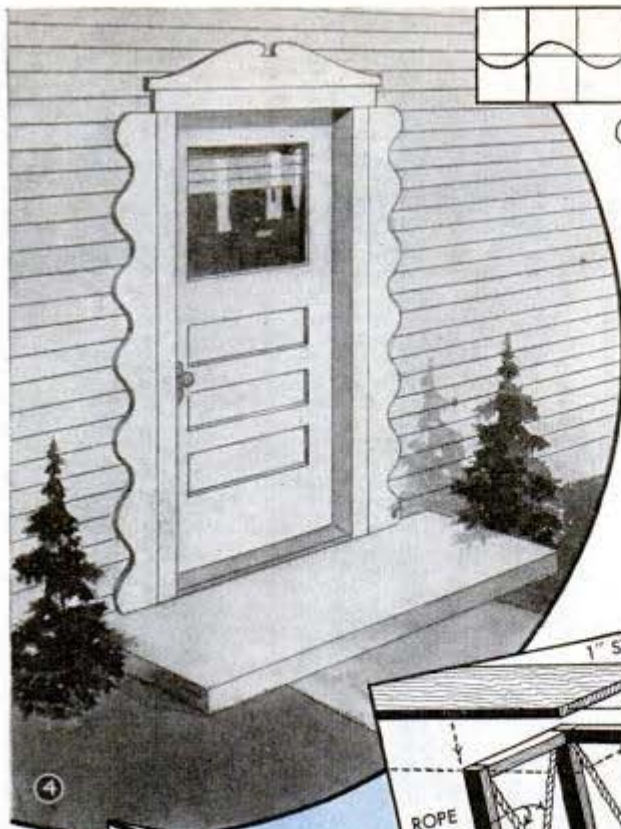

wings topped by a shelf-like roof of 1-in. boards form the framework, which is laced with rope as in Fig. 7. Two scalloped wings of 1 by 12-in. stock, Figs. 4 and 5, make the door of an older style home look considerably larger. A grill of 1 by 2-in. stock like the one in Fig. 10 will add a novel touch to any door. House numbers of wood, Fig. 9, look well with this decoration when painted a color to contrast with that of the house.

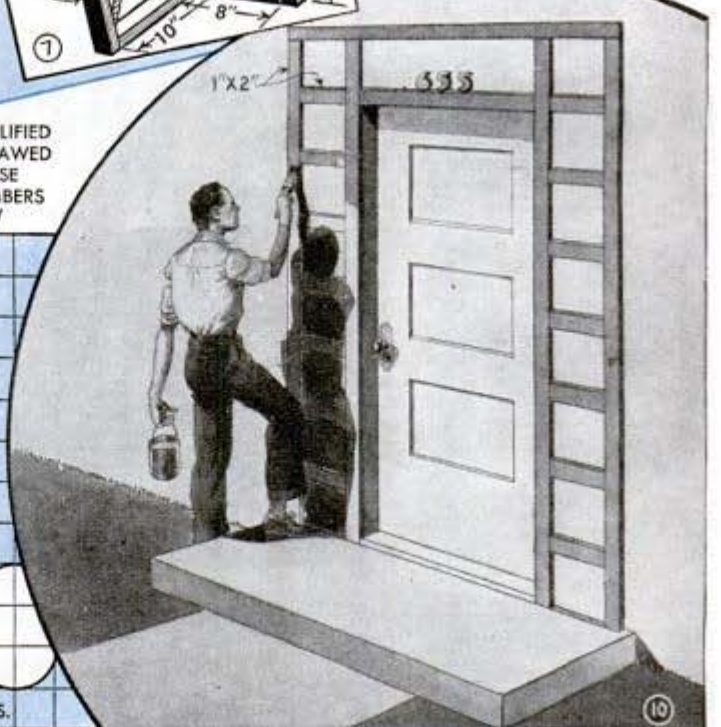
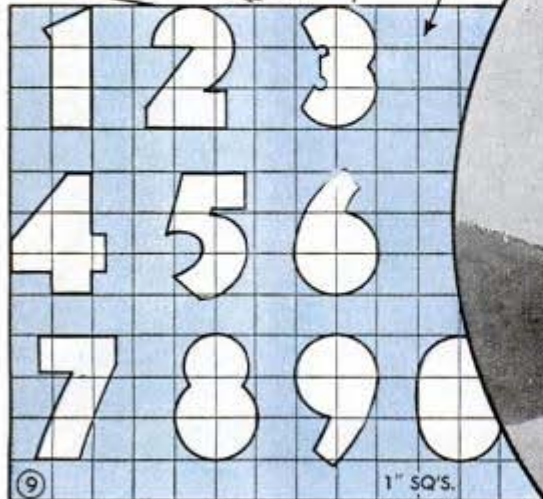
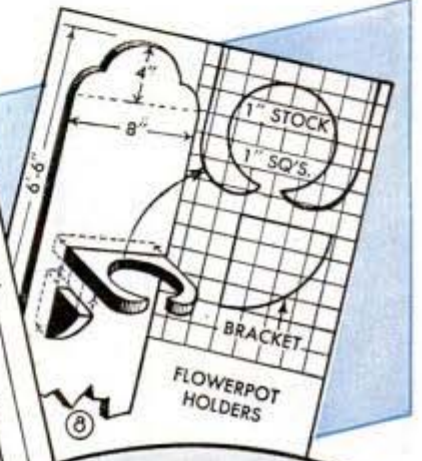
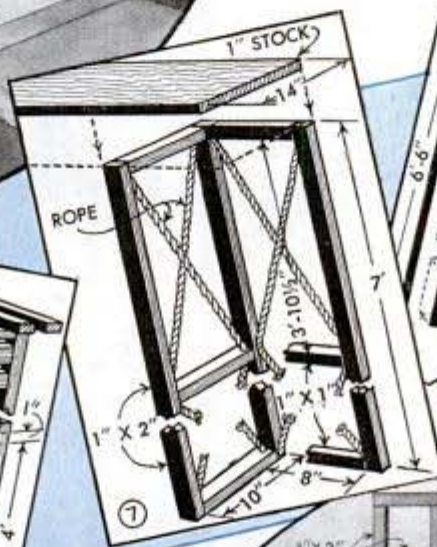
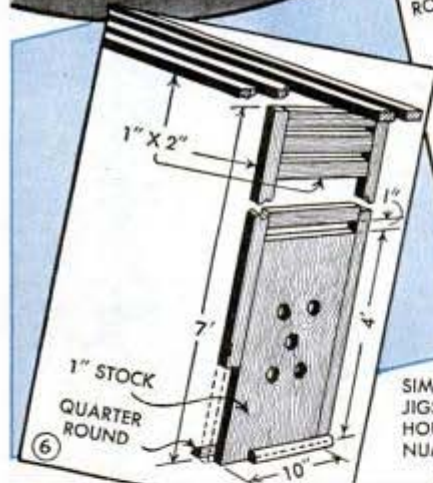

Sailor Kitchen Rack Holds Dish Mops Handy

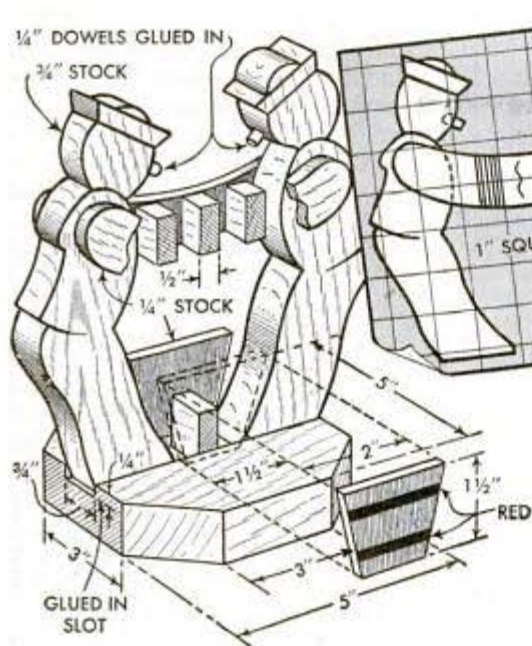

These gay sailors will keep your dish mops ready for instant use and hold them vertical so that they will dry quickly. The figures are traced on $\frac{3}{4}$ -in. stock and jigsawed. A blind hole is drilled in each to take a short piece of $\frac{1}{4}$ -in. dowel for a nose. Arms are sawed from $\frac{1}{4}$ -in. plywood and are fastened with brads or small screws to the figures, which are glued into a

groove in the base. To hold the mops, four filler blocks each 1 in. long are cut from a $\frac{3}{4}$ by $\frac{1}{2}$ -in. strip and bradded in place, after which the bucket sides are attached and the color applied. The suits are blue with white sleeve stripes, caps are white, noses red, and the bucket striped as shown while other portions are merely varnished.

—R. L. Fairall, La Crescenta, Calif.

Swing-Spout Faucet for Laundry Made From Pipe Fittings

If you are unable to purchase a faucet for your laundry tubs, one can be made

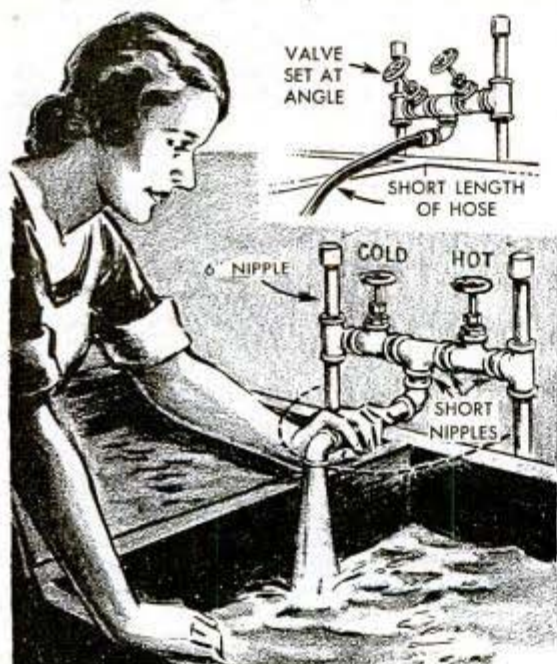

from pipe fittings consisting of two valves, five close or short nipples, two 3 or 4-in. nipples and caps to form the air cushions, and two elbows and a 6 or 8-in. nipple to form the swing spout. If the vertical water pipes leading to the tubs are spaced too close together for this assembly, they can be spaced farther apart by offsetting one of them below the tubs with a couple of elbows and a short nipple. Although not shown, it will be necessary to use a union on one of the vertical water pipes for final assembly after the faucet has been installed. If vertical water pipes are too close to a wall for convenient operation of the valves, the valves can be set at an angle as shown in the upper detail. Also, instead of a spout, a length of hose can be used.

One housewife makes emergency elastic by cutting spirally around the end of an old inner tube until she has the desired length of narrow rubber strip, the ends of which are joined by pasting strong cloth over them and sewing through the cloth and rubber.

Boat Seams Are Calked Easily With Food-Chopping Knife



If you have had difficulty in finding a tool for pressing oakum into the seams of a boat when calking it, try a single-blade food chopping knife of the type shown. You will find the knife ideal for the purpose, and the rocking motion that can be imparted to the curved blade enables you to press oakum deeply and firmly into the joint.

Wallet Riveted to Auto Sun Visor Is Handy for Cards and Papers

You'll always have a safe place to carry gas and repair receipts, license papers, etc., that must be kept with the car if you rivet a wallet to one of the sun visors so that the wallet is out of sight when the visor is raised up. A wallet that has a currency pocket fitted with a slide fastener is best.

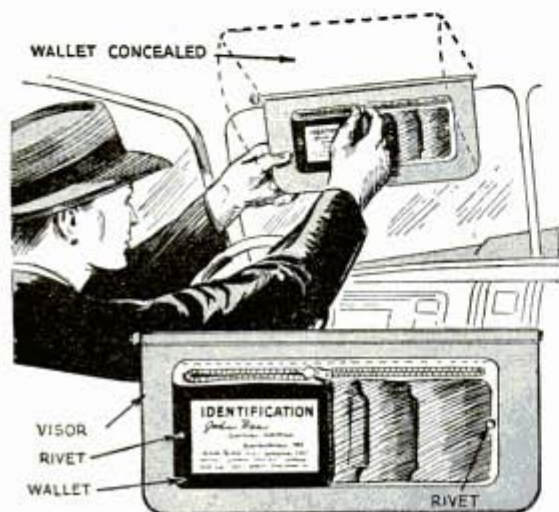

Fun With This Bow Bazooka

Patterned after the army's famous bazooka, this play gun will make it easy for backyard soldiers to neutralize enemy pillboxes. The gun fires a hardwood projectile that has a detonating pin in the nose to explode harmless caps when striking solid objectives. The propelling force is an ordinary hickory bow mounted on the barrel. General dimensions of the gun are given in Fig. 1. A larger bow may be used with a longer barrel. The barrel is made in two halves, preferably of white pine or redwood, which are light in weight and easily worked. Saw cuts are made as shown, the waste removed with a gouge and the groove trued up with a template as in Fig. 2. Then the halves are glued together and the outside turned in a lathe or trimmed down with a plane and drawshave. Assembly details are given in Fig. 3. Note that the barrel is slotted as far forward as the bow bracket for the plunger-yoke arms to slide in, and the end is closed with a breech plug. A loading slot is cut in the barrel to receive the rocket. Aiming sights consist of a flat-iron ring and a screw with the head ground off, the latter being screwed in or out of the barrel to obtain sight adjustment. The bow is set at a slight angle in the bracket that holds it on the gun as indicated in Fig. 3, the bracket being a wooden block bored to slip over the barrel and grooved to take the bow as indicated in Fig. 4. Note that the upper edge of the barrel also is grooved to take the lower edge of the bow, and that a retaining pin secures the bow in the bracket. Two small coil compression springs absorb the shock of the plunger yoke at the end of its stroke. Fig. 5 shows the plunger assembly, which consists of an iron plate with half-round blocks of wood to center it in the barrel, a lip being bent down at the rear edge to engage the trigger. This is made as in Fig. 8. It moves in a slot in the pistol grip and is held in the forward or cocked position by a flat spring. The rocket body is shaped from a block of hardwood as in Fig. 6. The detonating pin is a $\frac{1}{4}$ -in. bolt. Fig. 7 gives a general idea of the size and assembly of the breech mechanism. Before firing and when placed in the barrel, the bolt of the rocket should be pushed back gently against the cap so that the force of the bow will not fire it prematurely when the trigger is pulled.

BOW BAZOOKA

fires harmless "explosive" rockets

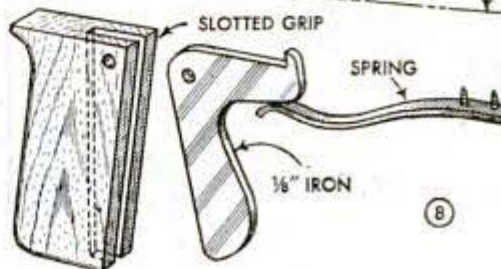
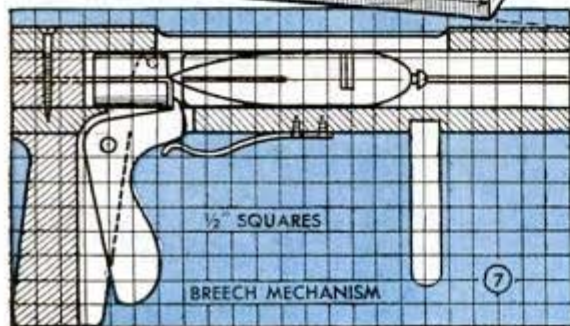
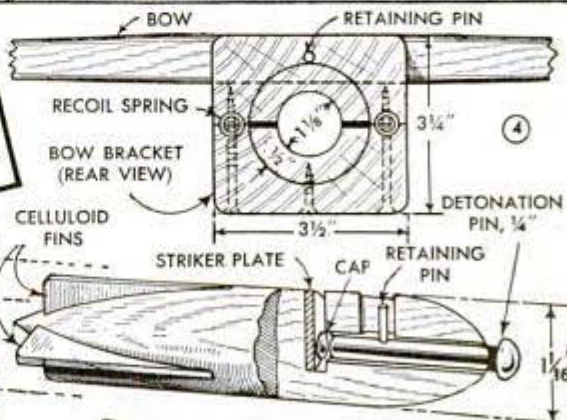
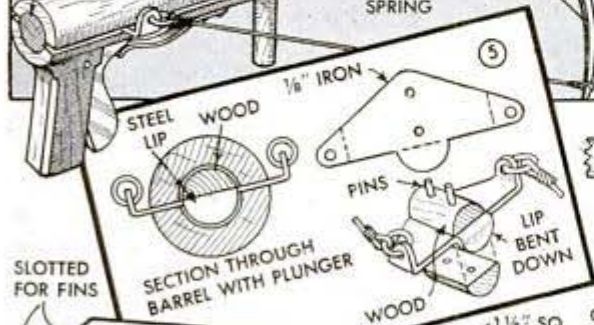
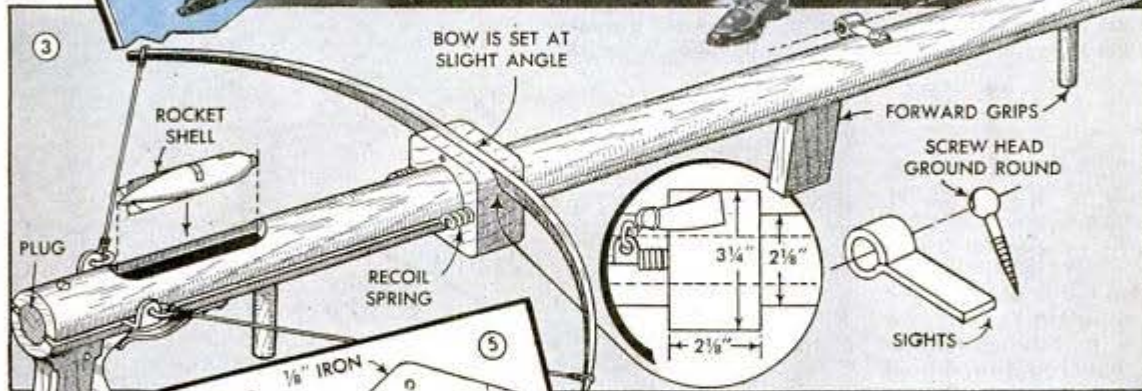
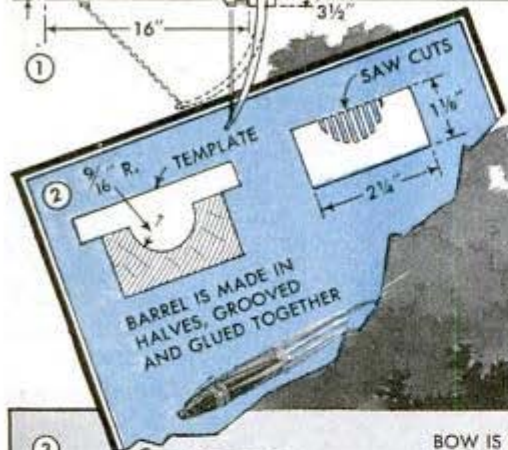
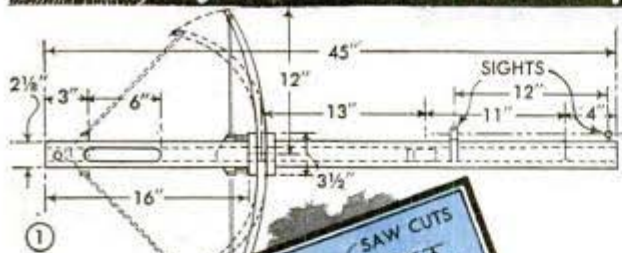

Solving HOME



PHONOGRAPH SPRING

An excellent rack for supporting jars of fruits or vegetables in a canning kettle is provided by an old phonograph spring with its coils opened up about $\frac{1}{2}$ in. apart

Below: If the cover of a paper ice-cream carton is hard to pull off, cut through the rim with a knife and it will come apart



ICE CREAM CARTON

Right: A miniature double boiler which is handy for melting chocolate or other foods can be improvised by placing a small measuring cup in one of larger size. Below: You can save time in rinsing rice by measuring the desired quantity into a large strainer and dipping this into a bowl of water

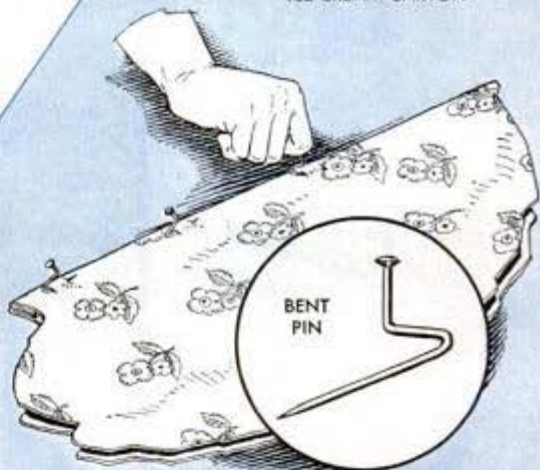

BENT PIN

Above: Basting pins are easier to use if they are bent as shown. Below: When it is necessary to keep valuables at hand during the night, they will be safe in a pocket stitched to the pillow as shown. You can close the pocket with a slide fastener

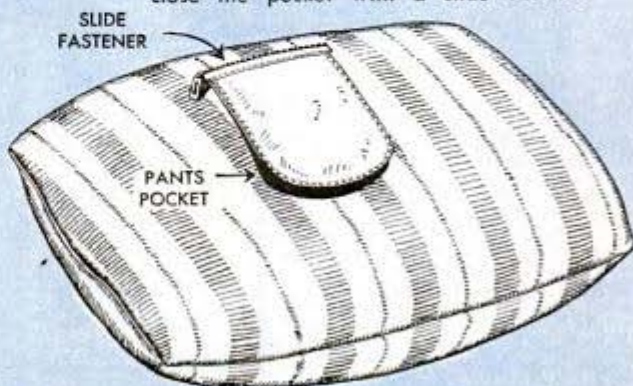

SLIDE FASTENER

PANTS POCKET

PROBLEMS

Below: Used in mousetraps as bait, modeling clay is effective, is not easily stolen and will last longer than ordinary bait

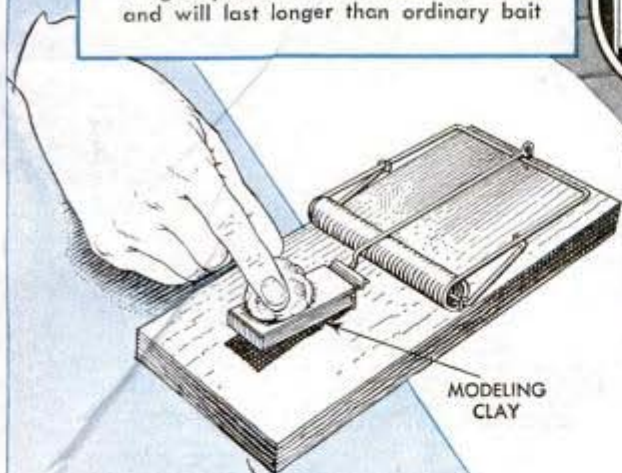

MODELING CLAY



A child unable to reach a doorknob can open the door if one end of a fabric strap is fastened to the door shank as shown, so that pulling the strap will turn the knob

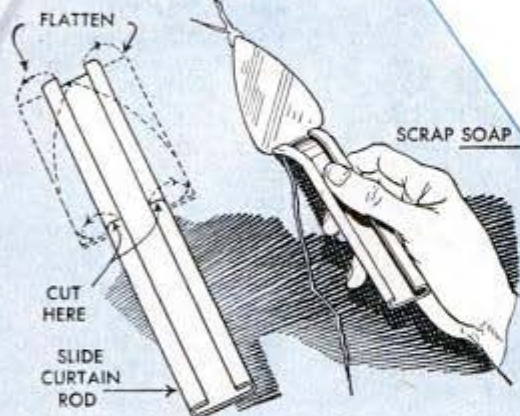

SCRAP SOAP

Above: A good trowel for small odd jobs about the house can be made by cutting and bending a piece of curtain rod as shown. Below: Storage space for extra table extension boards is provided by brackets screwed below the table



Left: Scraps of leftover soap will make good liquid soap if they are broken up and placed in a bottle filled with water. A shaker top dispenses this liquid soap quickly and easily. Below: Stains on silver are avoided and taking of medicine is much more sanitary if paper spoons are kept in the medicine cabinet for the purpose

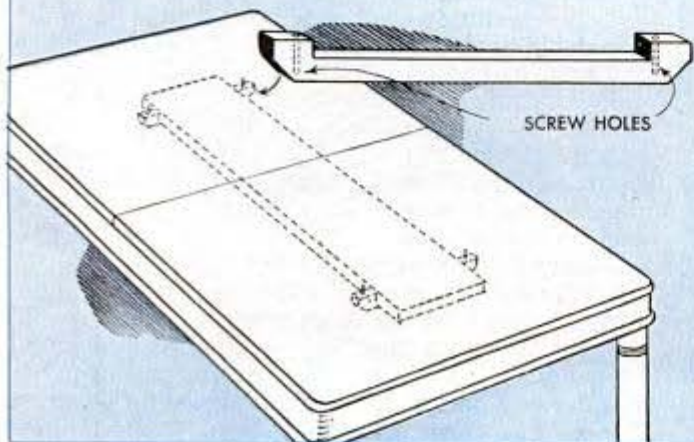

SCREW HOLES



Nonslip Surface Put on Sidewalk With Altered Push Broom



When a sidewalk is laid at a fairly steep angle it is advisable to roughen the surface to help prevent slipping when the walk is wet. To do this we use an old push broom from which alternate sets of bristles have been removed. By running the broom back and forth over the concrete before it sets, a number of shallow grooves are produced.

—Otto M. Kohler, Jr., Wheaton, Ill.

Precision Angle-Drilling Machine From Your Drill Press

Owners of small home workshop drill presses can use them as precision angle-drilling machines by fitting the tables with a scale as shown. Of course, the scale must be calibrated accurately for each machine. Celluloid or metal can be used for the scale. Celluloid is the easiest to work and if used, it should be cemented to the table, first cementing cardboard to the table and

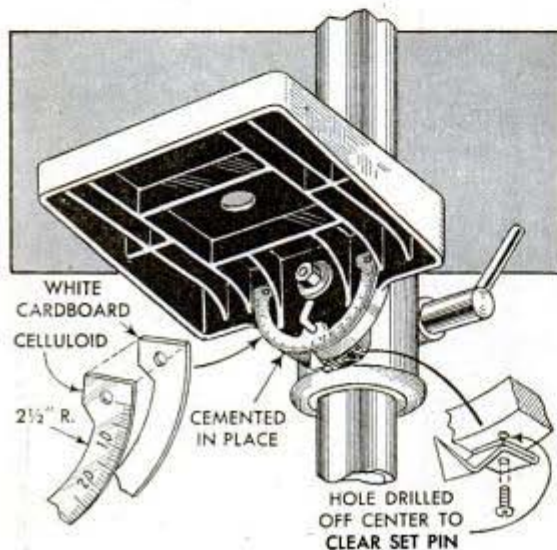

then the celluloid to the cardboard. If riveted, the celluloid is likely to buckle between the rivets and be inaccurate. Metal can be riveted to the table. After scoring the calibrations in the surface of the scale, coat it with India ink and immediately wipe off, leaving the ink in the scores.

—Carl W. Bertsch, Philadelphia, Pa.

Corks Prevented From Sticking In Glue or Sirup Bottles

Sticking of corks in glue or sirup bottles or other sticky liquids may be prevented by any of these methods: Dip the cork in melted paraffin, and the wax coating will keep it from sticking. Cover the cork with waxed paper. Or replace the cork with a stopper cut from a candle and tapered to fit.

—Mrs. Hal Geihm, Aurora, Ill.

Nails Keep Abrasive Powder From Clogging in Shaker

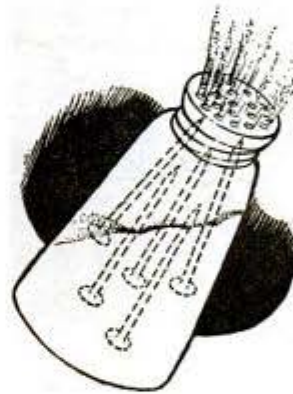

If you employ a saltshaker to apply abrasives or other powder to any surface, you can speed the action and prevent clogging by dropping several small nails into the shaker with the points toward the cap. These will strike the shaker holes from time to

time and serve to keep them from clogging.

Simple Way to Repair a Muffler

Silencing motor operation and protecting motorists against deadly carbon monoxide gas does not necessarily mean installing a new muffler, although this is preferable where the parts are available. An easy and rather permanent repair can be made with

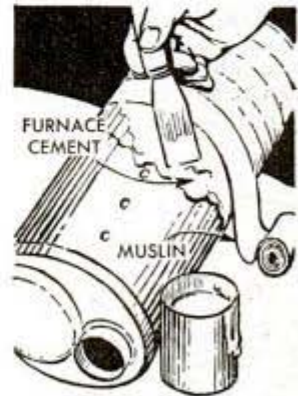

ordinary furnace cement and strips of muslin. By coating the muffler thickly with the cement and binding it in place with the cloth similar to the way high-pressure steam pipes are wrapped, the life of the muffler can be extended almost indefinitely.—C. E. Packer, Chicago.

Model Train Track Is Formed From Tin Cans

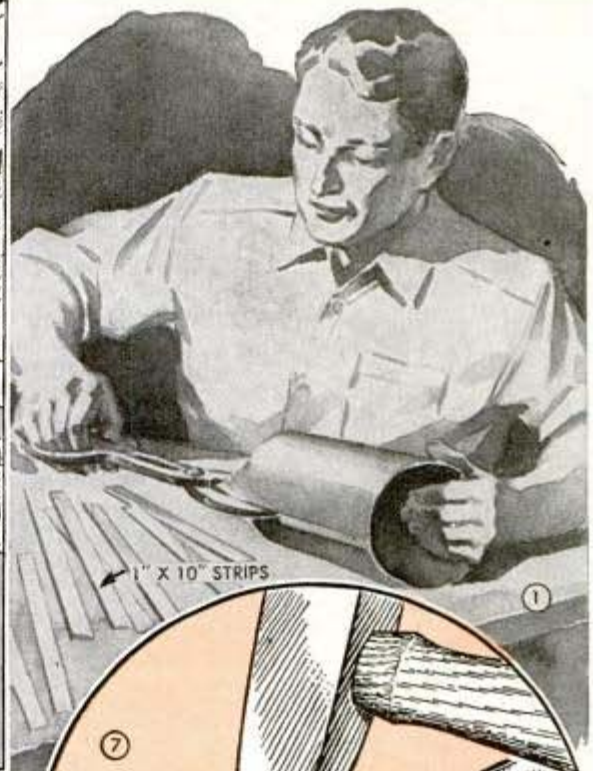
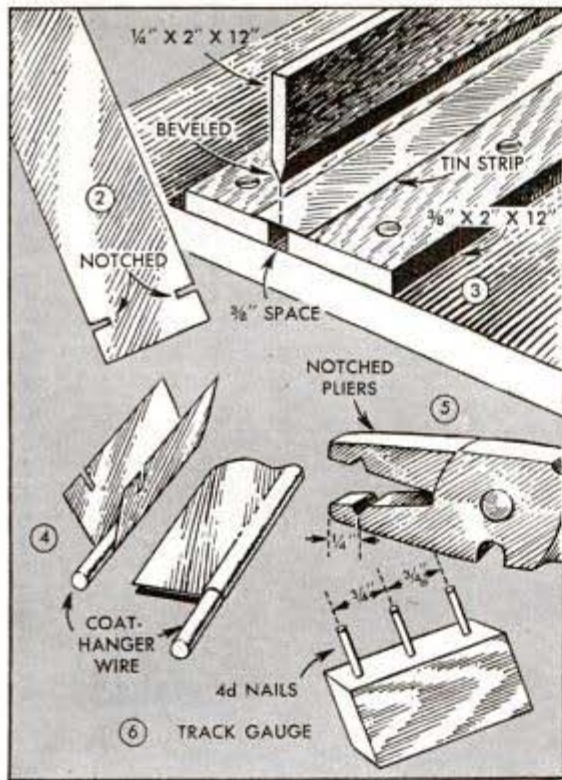

You can make both straight and curved track for either "0" or "00" gauge toy trains from strips of metal cut from No. 2½ or larger tin cans. For straight track, 1 by 10-in. strips are needed, as in Fig. 1, but for curved track, the length should be ¾ in. longer for the outside and ¾ in. shorter for the inside rails. For sections of straight track, each strip should be notched ¼ in. from the ends, as in Fig. 2, to facilitate tacking them to ties. Curved rails must have an extra notch at the center. Each strip is creased by being placed over a ⅜-in. space between two pieces of hardwood screwed to a baseboard, and pressed down by a narrow strip beveled at one edge, as in Fig. 3. Next, a 12-in. length of coat-hanger wire is placed in the crease, as in Fig. 4, and a pair of notched pliers used to force the metal tightly around the wire as in Fig. 5. Long-nosed pliers with the ends ground down and notches cut ¼ in. from the ends are best. While still gripping the track with the pliers, spread apart the double edge with a screw driver and tap down the sides with a small hammer to form the rail flanges, using the end of the pliers as an anvil, as shown in Fig. 7. The wire core can now be removed and the rails spaced by the track gauge detailed in Fig. 6, and fastened to the ties by No. 3 carpet tacks. Any scrap wood can be used for making the ties, which are ½ by ½ by

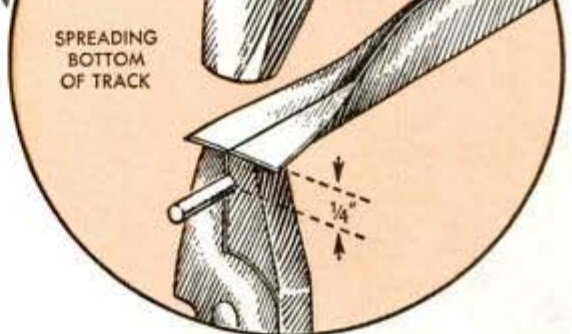

2 in. in size. Straight track sections have ties at the end only, and curved sections have a tie at the center also. Curved rails are bent to the desired arc before being attached to ties. After tacking down the rails, cut 1½-in. lengths of galvanized wire and insert these pieces into the ends of the rails to join track sections, and close the ends slightly with pliers to make a snug fit on the wire pins.

—B. S. Skinner, Decatur, Ga.

Curing Sticking Windows

Sticking of doors and windows often can be remedied by placing a two-by-four about two feet long edgewise against the jamb and pounding it a few times with a hammer. This moves the jamb enough to allow the door or window to swing freely.

—R. K. Fowler, Redding, Calif.

Keeping ELECTRICAL SERVANTS

THE average American home runs smoothly by virtue of a host of electrical servants. Although numerous, these servants readily classify themselves into three big families: (1) The Lighters, such as a floor lamp or any type of lamp bulb, (2) The Heaters, including toasters, irons, percolators, waffle irons, etc., (3) The Runners, covering all motorized devices such as refrigerators, washers, mixers and vacuum cleaners. It will be apparent that although mechanical construction may vary, certain ills of any one group affect all items in that group, thereby greatly simplifying the needed "know how" to make necessary repairs.

Cords and plugs: Cords and plugs are basic and apply to all electrical equipment. Most persons know how to make necessary repairs, but the few ideas pictured on this page may serve as a "refresher" course. Silk-cov-

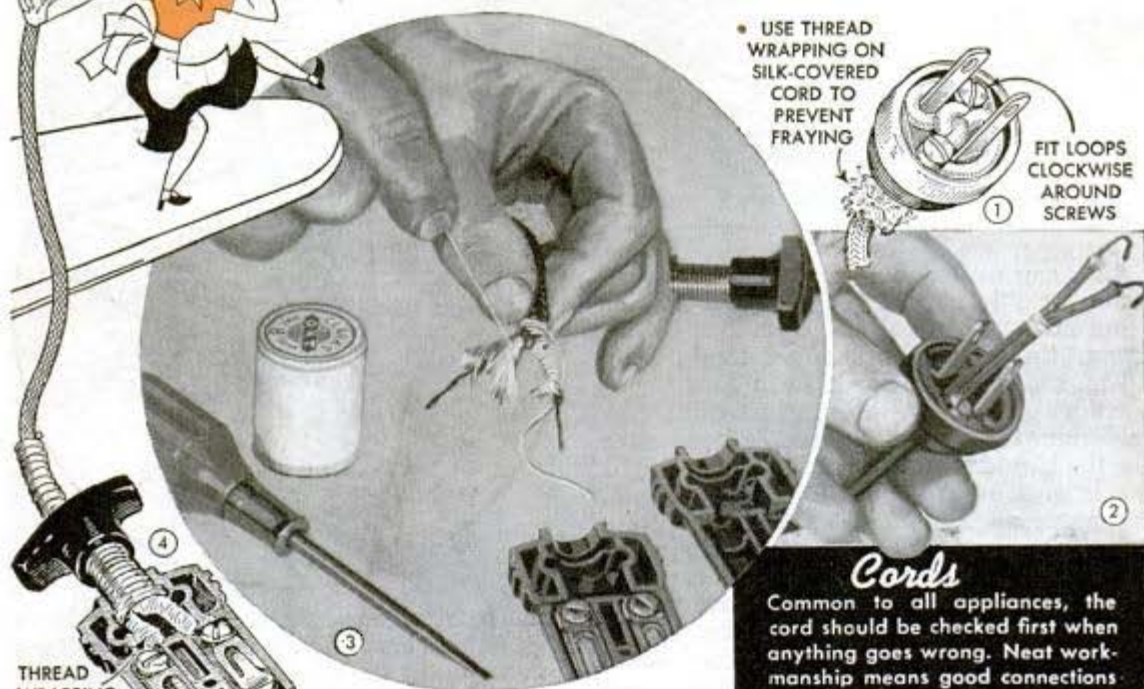

• USE THREAD WRAPPING ON SILK-COVERED CORD TO PREVENT FRAYING

FIT LOOPS CLOCKWISE AROUND SCREWS

Cords

Common to all appliances, the cord should be checked first when anything goes wrong. Neat workmanship means good connections.

THREAD WRAPPING

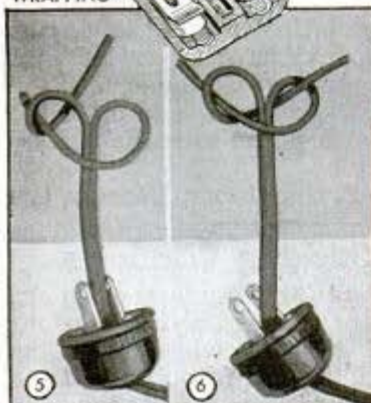

UNDERWRITERS' KNOT PREVENTS PULL ON PLUG CONNECTIONS

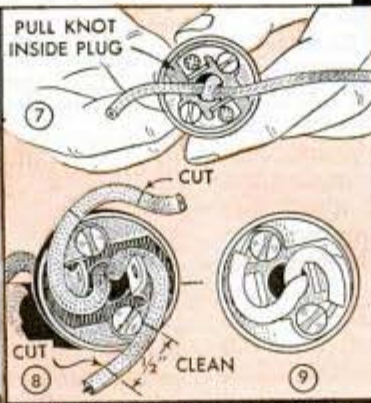

WRAP WIRES AROUND PRONGS TO DETERMINE WHERE TO CUT AND CLEAN

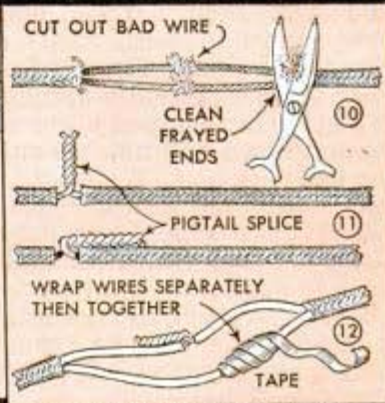

PROMPT ATTENTION TO FRAYED CORD WILL AVOID SHORT-CIRCUIT

HAPPY

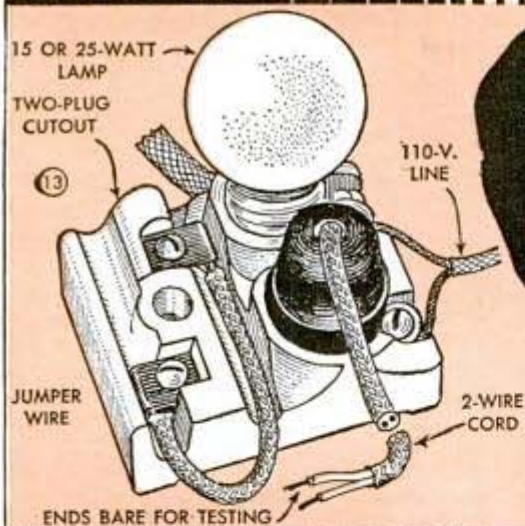

ered cords and asbestos-insulated cords should always be wrapped with thread when making plug connections to prevent fraying, as shown in Figs. 1, 2 and 3. The insulation should be intact right up to the point of contact, Fig. 4. The underwriter's knot for plugs as shown in Figs. 5 and 6 takes the strain of pulling on the cord and prevents strain on the connections. It is especially good with the popular parallel-wire rubber cord. Steps in making plug connections after tying the knot are shown in Figs. 7 and 8. The best practice is to leave the wire long and the insulation intact until actual fitting. Fig. 8 shows where to cut and clean. Fig. 9 shows a plug properly connected—the wire is pulled around the prongs and fitted clockwise under the screw heads. A frayed weak spot in a cord should be spliced promptly instead of waiting until the wire or fuse burns out due to a short circuit. The common splice joint is best made with pigtail splices, as shown in Figs. 10, 11 and 12. Each joint is wrapped separately with friction tape; then the two wires are wrapped together.

Circuit tester

Best method of checking circuits in any appliance is to use the simple circuit tester shown—costs little and is useful on dozens of jobs

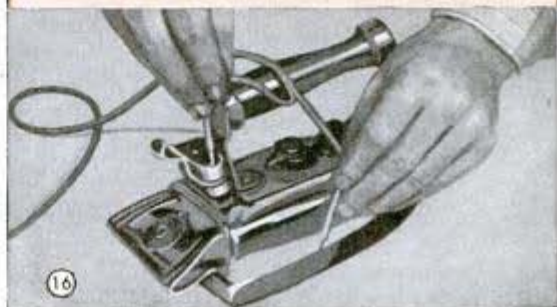
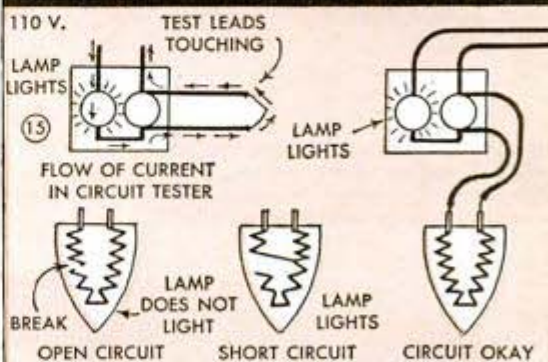



Irons

Usual fault is break in heating element, which can be repaired by splicing or arc-welding the severed ends

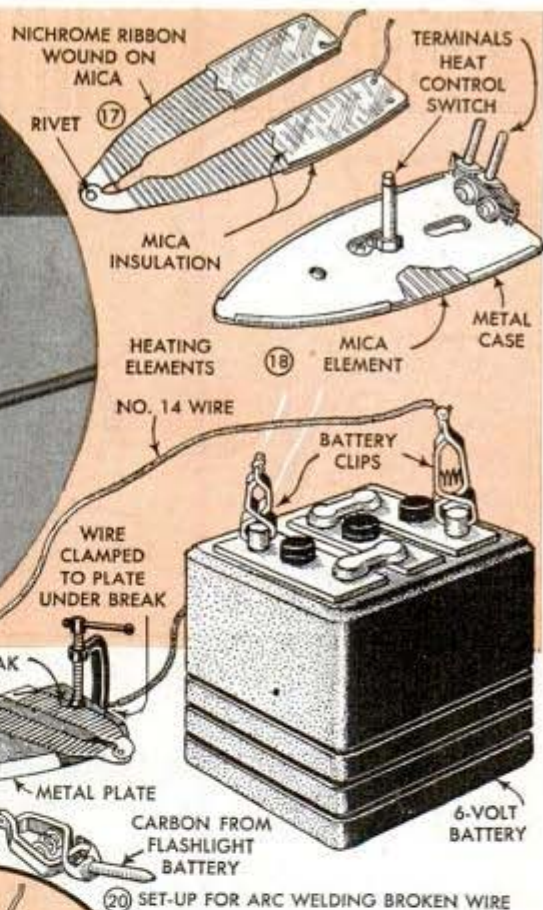

22 LAMP SHOULD LIGHT WHEN TEST LEADS ARE TOUCHED TO SWITCH TERMINALS



23 DEFECTIVE SWITCH CAN BE DISCARDED. ELEMENT WILL WORK WHEN WIRES ARE SPICED

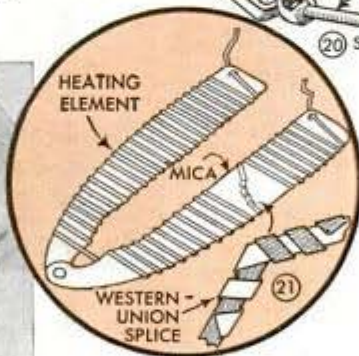

Circuit tester: While breaks in an electrical circuit usually can be traced visually, it is quicker and better to use a circuit tester. This is made up as shown in Fig. 13 and costs less than fifty cents. How it works is shown in Fig. 15—if you touch the two test leads together you make a complete

circuit, causing the lamp to light. Likewise if you apply the test leads to any circuit, such as a flatiron, as shown in Figs. 14 and 15, the lamp will light if the circuit in the iron is not broken. Also, it should be noted that the lamp will light if a short circuit exists, Fig. 15, but positively cannot light when the circuit is broken. The current passed by the bare wires of the circuit tester is limited to the size of the bulb used, and is not sufficient to actually heat the iron, run a motor, or do anything else which the straight 110-volt line would do. This doesn't mean that you shouldn't be careful—play safe and treat the two test leads as "hot."

Checking electric iron: Using the circuit tester, apply the leads to the prong terminals, as shown in Fig. 14. If the heating element is all right, the lamp will light. Apply one lead to the prong terminal and the other to the sole plate, Fig. 16. The lamp should not light. If it does the circuit is grounded, that is, some part of the wiring is bare of insulation and



The vacuum cleaner

Check cord first, especially at point where it enters handle. Universal type motor will give good service if kept oiled. Brushes should be inspected periodically and replaced when they become too short

touching the sole plate or cover. No light across the terminals shows that the circuit is broken. In this case, remove the handle, cover, and any other parts necessary to expose the heating element. The most common type of heating element is ribbon Nichrome wire wrapped on mica and insulated on either side with mica, as shown in Fig. 17. Better grade elements are covered with a metal case, Fig. 18, and it is necessary to pry off the case. Still other elements are built right into the sole plate in a solid mold; this type is not repairable except by obtaining a new replacement part.

Patching Nichrome wire: A break in the Nichrome ribbon or wire can be patched by twisting the two ends together, as shown in Fig. 21. A better method is to fuse the broken ends together with a small makeshift arc-welding outfit, as in Figs. 19 and 20. In use, the pointed carbon should be touched to the break delicately and only for an instant. You will get a flash of white hot wire and the two ends will fuse together. Prolonged contact generates too much heat and burns the wire completely. No flux is needed although borax can be used if desired. Sometimes the break is within a few turns of the post terminals, and in this case it is practical simply to unwind the broken section and make a new connection.

Electric-iron switch: If the iron has a heat-control switch, test it across the terminals, as shown in Fig. 22, to determine if the fault is in the heating element or the switch. If the switch is defective and a replacement not available, the iron can be made usable by twisting or welding the two ends together, as indicated in Fig. 23. There is little that can be done with a defective switch; make certain, however, that the thermostatic disk is not jammed open (saucer shape). Try mild pressure with your fingers in manipulating the disk—it should have a curved bell shape when the iron is cold.

Other heater-type appliances: Apply the same general tests as described. Always



24 CLEAN COMMUTATOR WITH FINE (8-0) SANDPAPER



25 INSPECT BRUSHES AND FIT NEW ONES IF NEEDED

check the cord first (use test lamp and run current through both wires separately), and then proceed systematically until the fault is discovered. Some appliances, such as inexpensive toasters, can be checked visually since the heating element is in full view. Breaks in round Nichrome wire can be spliced much the same as described for ribbon wire. In all cases, press the splice flat and make it as tight as possible—any slight amount of arcing from a loose joint will immediately burn the wire.

Vacuum cleaners: With so many different makes and styles, about the only thing vacuum cleaners have in common is the motor. This is usually a series-wound universal type, a high-speed motor suitable for sweepers, mixers, fans and other light duty applications. If the motor goes bad, the first check point should be the brushes. These can be removed by unscrewing the caps which hold them in place, as shown in Fig. 25. Replace the brushes if they are worn too short. Test the spring tension to make sure that the springs keep the

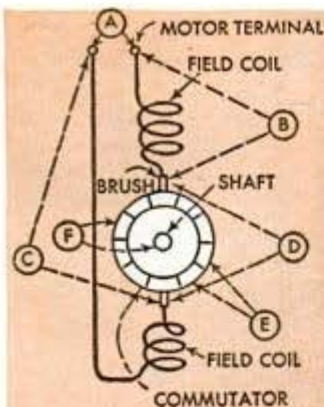

TEST LAMP SHOULD LIGHT AT ALL POINTS SHOWN EXCEPT (F)

26 UNIVERSAL-MOTOR CIRCUIT



27

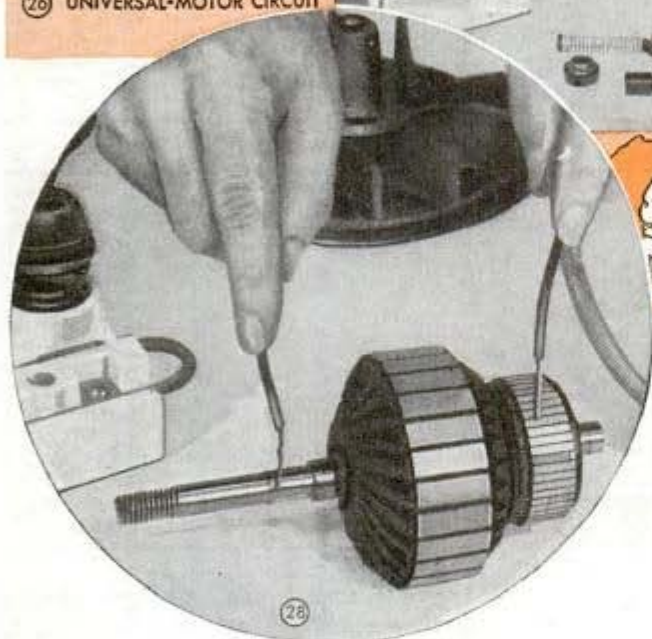

28



Universal motors

Wiring of this motor is quite simple and easily checked with a test lamp for broken circuits

brushes in contact with the commutator, (part against which the brushes bear). When replacing old brushes, be sure to fit them properly to the curve of the commutator. If new brushes are fitted, break them in by slipping a piece of fine sandpaper under a brush with the sand facing the end of the brush, then swing the rotor back and forth until the brush is ground to fit. Clean the commutator with gasoline, or sand it bright with fine (8/0) sandpaper, as shown in Fig. 24. If the commutator is grooved, the rotor should be removed to permit turning the commutator down smooth on the lathe. Other than motor failure, the most common causes of trouble are dirt and lint tightly wound around the motor shaft or the belt-driven brush, lack of oil, and poor bearings.

Universal motors: When checking a vacuum cleaner's universal motor with the test lamp, remove the motor from the

cleaner. Fig. 26 shows the simple circuit of a universal motor. In testing across the lettered points, a light shows that the circuit is continuous. Fig. 27 illustrates test B. A light shows that this field coil is continuous, but although the wiring is intact, the insulation may be burned off. Test D checks the coils of the rotor or armature. If no light is obtained, test each adjacent pair of commutator segments all around, as at E. Each pair should light; no light indicates that the coil is burned out between these two segments. This condition will cause considerable sparking at the commutator, also the motor will be dead if it stops with the dead coil in contact with the brush. A repair job can be done by "jumping" the segments together by soldering a copper wire across the ends. If the test lamp lights when making test F also shown in Fig. 28, insulation has been scraped or burned from armature coil or coils, and the wire is touching the shaft causing a "ground."

When the test lamp does not light when it should, careful inspection should be made of the circuit being tested. Unless the motor is burned out, breaks usually will be found at the ends of the wires and can be repaired. When it is definitely determined that the motor is burned out, it should be junked or turned over to a service shop for rewinding.

D-I-Y-5
+ D-I-Y 13

Home Repairs

Proper care will make them last longer



Electric iron

Polish bottom with very fine steel wool. Rub frequently with waxed paper. Always plug in at outlet; keep the iron plug in place. If arcing occurs at plug, take plug apart and squeeze contacts lightly with pliers. Keep cord in good condition



Toaster

Have a long bristle brush handy for wiping out crumbs. Never immerse toaster in water—clean only with damp cloth. Breaks in heating element can be repaired the same as described for irons (see text). Never use a fork to remove toast

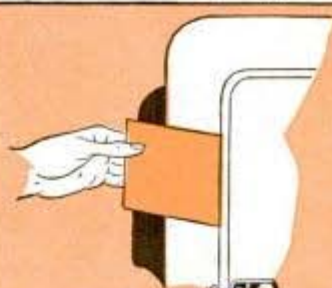

Refrigerator

Replace door seal if it does not hold sheet of paper with door closed. Keep condenser clean by brushing or vacuum cleaner attachment—dirt and dust make motor run overtime. Allow room at back and over top so that refrigerator can breathe



Coffee maker

Never dip electric parts in water. Percolator has fuse in bottom to prevent overheating if it boils dry—remove with screwdriver and replace if needed. Glass vacuum coffee maker should be cleaned once a week with baking soda in water just as if you were making coffee



Motors

Oil regularly and keep clean so that motor can breathe. See that pulleys are properly aligned and tight on shaft. Be very careful not to stall split phase motors. If motor is universal type, check brushes regularly and clean commutator. Use proper size fuse to protect motor



Washing machine

Don't overload. Always clean after using and release pressure on wringer rolls. If stored in cold place, give it time to warm up in warm location to soften grease in gear case. Be sure that all moving parts are well lubricated. Check periodically for loose bolts and screws

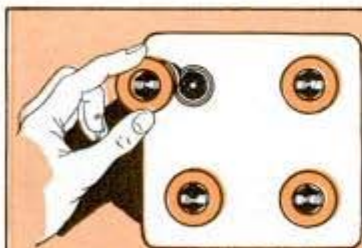

Fuses

Under average conditions, circuits with lights should not have fuses larger than 15 amperes. Convenience outlets take 20 ampere fuses. Large fuses are no protection—the house wiring itself will burn up before the fuse blows. When installing new fuses, play safe—pull the switch



Cords and plugs

If plug does not make contact at outlet, bend prongs slightly outward. Avoid overloading outlets—the maximum load on any one circuit should not exceed 1400 watts. Keep all cords free of kinks. Hang cords on round peg when not in use—don't throw them in a drawer



Lamps

Keep lamp bulbs clean for maximum illumination. Use one large bulb instead of several small ones—a 100-watt lamp gives 50% more light than four 25-watt lamps. Do not use fuses larger than 15 amperes when there are lamps on the circuit. Use proper type of shade

Block Extension Aligns T-Square At Bottom of Drawing Board



Use of a T-square very near the bottom of the drawing board is facilitated by this triangular extension, which is fitted onto the bottom of the board and held in place with dowel pins. The square then may be held firmly against the extension where otherwise it would have no support. The extension can be removed easily whenever desired.

Sectional Pipe Roller Turns Boxes And Heavy Crates Easily

The difficulty of turning a heavy crate that is being moved on an ordinary pipe roller may be overcome by cutting the pipe in short sections and slipping these over an axle of smaller pipe, using pipe caps at

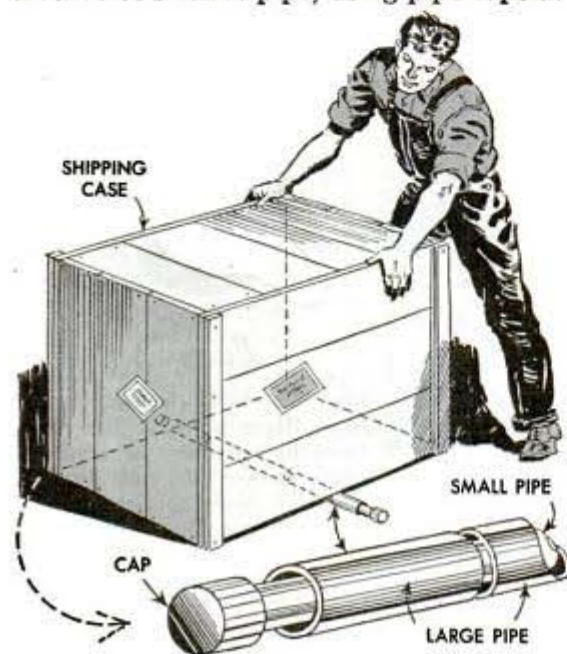

the ends to hold them in place. Thus in the turning, the sections may rotate independently and thereby give a differential action to the roller.

Garbage Can "Screwed" to Wall

To prevent a garbage can from being tipped over by small animals, attach it to a wall or post by means of a round-head screw as indicated. Drill a hole in the side of the can to take the screw head, then file out a section above the hole to form a keyhole opening. This will permit easy release of the can when it is to be emptied.



—Ken Murray, Baltimore, Md.

Corrugated Fasteners Save Time In "Gluing" Split Turnings

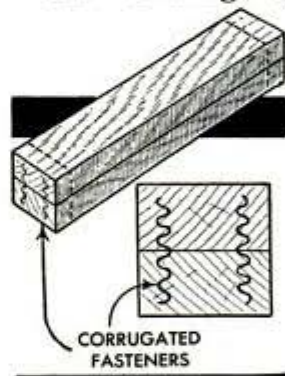

There's no waiting for glue to dry when you use corrugated fasteners instead of glue paper to hold split turnings together. Here the stock is cut extra long to provide sufficient waste at the ends so that the fasteners will not interfere with the

turning. Two fasteners driven flush in each end of the work will hold it firmly together.

Easy Way to Blanch Cauliflower

Here's an old gardener's tip to blanch cauliflower heads so they will be tender and evenly colored. To do this, run a length of twine between two stakes so that it may be looped once around the gathered outer leaves of each plant, thus enclosing the heads and sheltering them from the rays of the sun. This should be done when the heads are about 1½ to 2 in. in diameter.

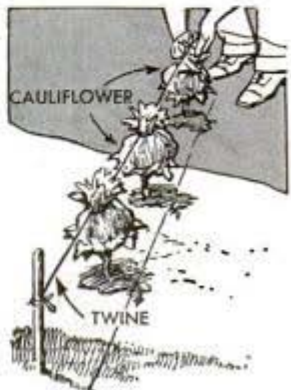

Put to Sea on a Galloping "Marine Mustang"

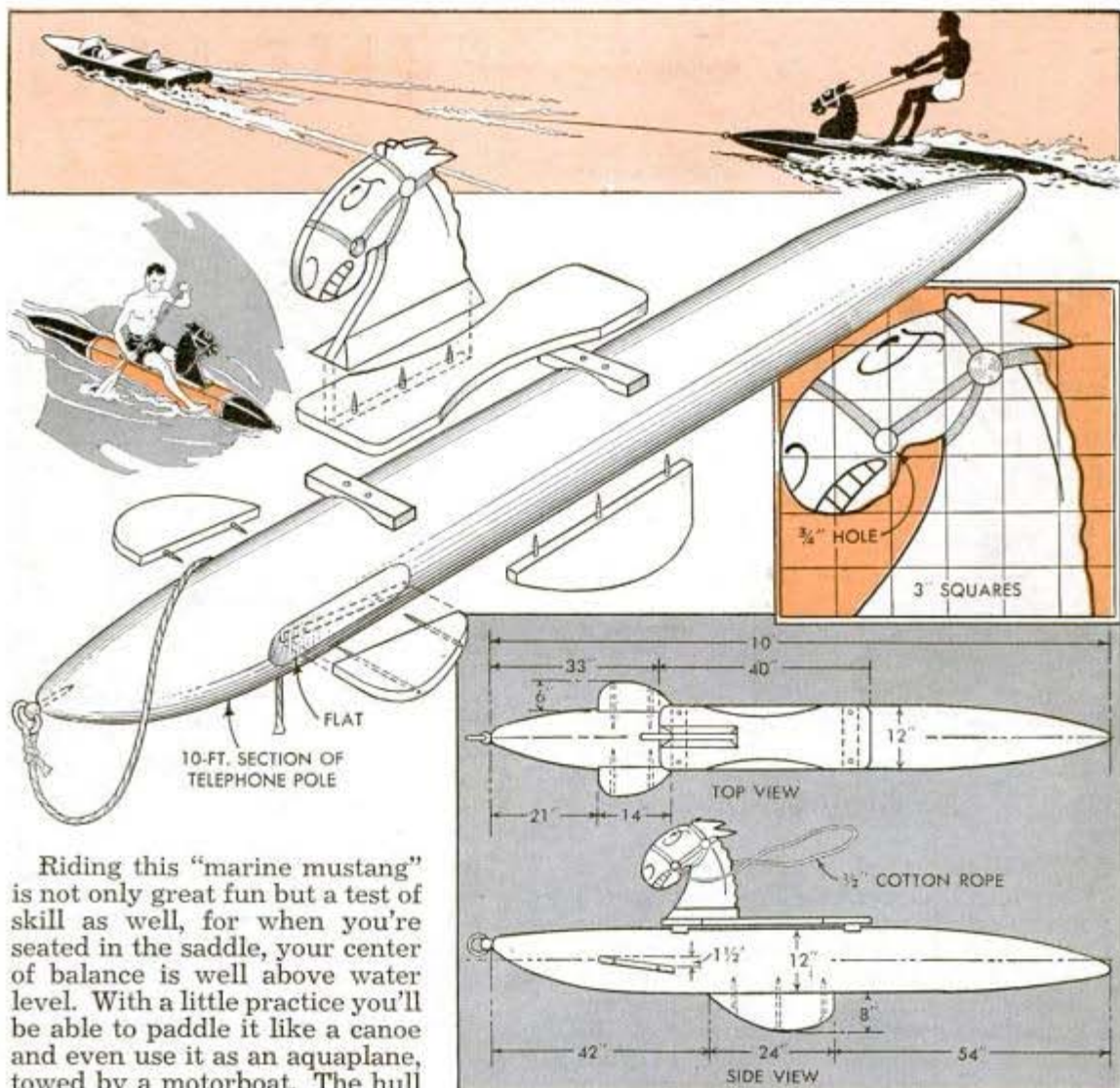

Riding this "marine mustang" is not only great fun but a test of skill as well, for when you're seated in the saddle, your center of balance is well above water level. With a little practice you'll be able to paddle it like a canoe and even use it as an aquaplane, towed by a motorboat. The hull or float is a 10-ft. section of discarded telephone pole. With adz, draw-shave and plane the ends are streamlined as indicated and a towing ring is installed in the tip. Two cleats are mortised into the top for deck supports, and a pair of planing fins of $\frac{3}{4}$ -in. stock attached at an angle on

the sides by long lag screws. The keel is secured in the same manner. The head is scrollsawed from pieces of $\frac{3}{4}$ -in. material held together by long dowels or $\frac{1}{4}$ -in. bolts running across the grain to prevent splitting, and braced with triangular cleats.

Honing on Leather Gives Woodworking Tools Keen Edges

An excellent leather hone to get keen edges on woodworking tools can be made from scraps of dry oak-tanned sole leather, obtained from a shoe-repair shop. Cut the pieces roughly to $\frac{5}{8}$ by $2\frac{1}{2}$ in. and assemble enough of them to make up a block 5 to 8 in. long. After the smooth (hair) side has been trimmed or sanded, all surfaces are coated with a good grade of hot hide glue and clamped together under moderate pressure. When the glue has dried, smooth both sides of the block on garnet cloth,

scrape the surfaces slightly to remove clinging grit grains and apply several coats of saddle soap to both sides; soak for an hour in neat's-foot oil. One side of the hone should be treated with a cream-thick mixture of finest silicon carbide or aluminum oxide, flour and lard oil, well rubbed in. Leave the other side plain or rub it with jewelers' rouge. Use the hone exactly as you would an oilstone except that you stop the tool from its edge instead of against it.

Camp Comforts INDIAN



①

Meaning of ti-pi
Ti—to dwell
Pi—used for

Blackfoot design on ti-pi
A—White circles represent stars, and medium blue background the sky
B—Cross means night moth symbolizing sleep bringer
C—Green band stands for good road
D—Black mountains
E—Light blue puff balls

By Gray Wolf

WITH this ti-pi, (Indian word from which is derived the English "tepee") you can satisfy your yen for the primitive and still be dry and warm. In addition, a ti-pi is easier than a tent to transport, the covering and some small rope being about all that is necessary, as the rest of the equipment needed is available at your campsite. Size of the ti-pi depends on your requirements. For two people, the 10-ft. Blackfoot design shown is ample. Fig. 1 explains the various symbols in the design.

In making a ti-pi, first cut out the cover according to the pattern in Fig. 2. If possible, the cover should be cut from one piece of canvas without seams. Notice that the shape is not quite a complete half circle, the center point being located between the smoke flaps. Be sure to cut 6 in. outside of the inner line to allow for a bottom hem. This is sewed all around and grommets inserted at 18 to 24 in. intervals to take pegging ropes as in Fig. 4. Or, a rope can be sewed in the hem and loops brought out as shown, in which case the openings for the loops must be stitched to prevent tearing. Next, corresponding holes for breast pins are made and reinforced along the straight edges of the cover between the smoke flaps and the door opening, and also below the door, Figs. 2 and 5. In

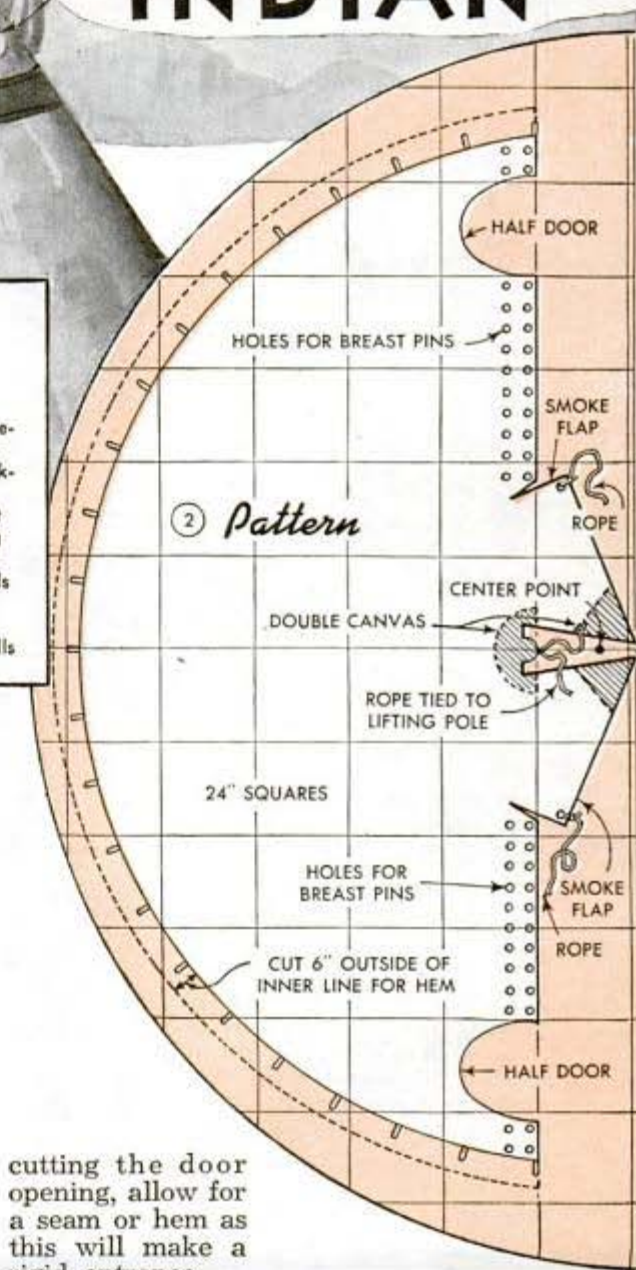

cutting the door opening, allow for a seam or hem as this will make a rigid entrance.

At the top of the ti-pi another reinforcement of double canvas is made as indicated by the shaded portions in Fig. 2, and a rope sewn in between the two pieces for tying the cover to the lifting pole. Ropes tied through grommets in the lower points of the smoke flaps should reach to the ground, as they serve to tie the smoke flaps snugly in rainy weather. This completes the cover except for its decorations. Of course, these are not necessary, but for sake of realism they are well worthwhile. Many pictures are available on authentic ti-pi designs.

in a Real TI-PI

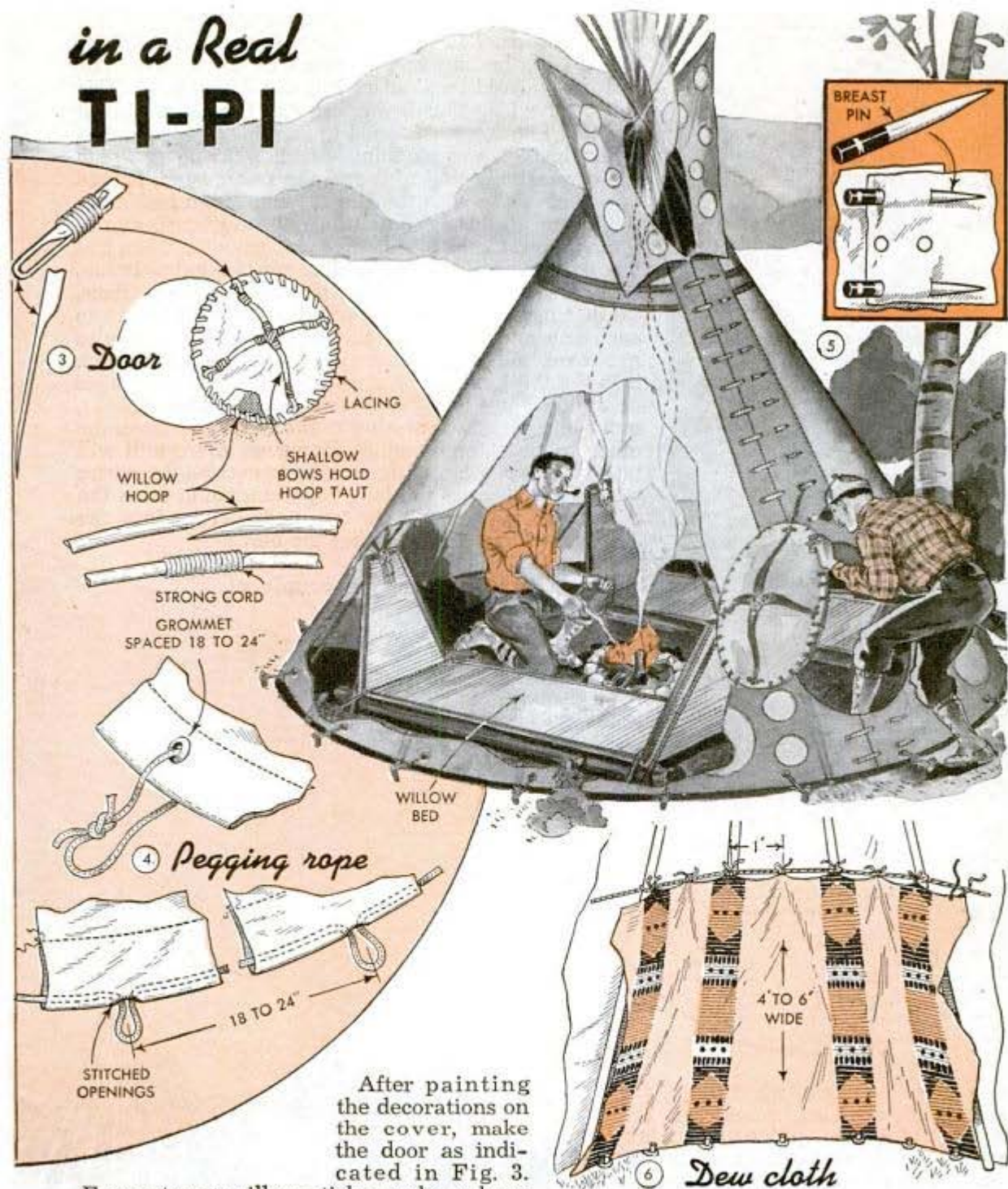

3 **Door**

WILLOW HOOP

SHALLOW BOWS HOLD HOOP TAUT

LACING

STRONG CORD
GROMMET
SPACED 18 TO 24"

WILLOW BED

4 **Pegging rope**

STITCHED OPENINGS

18 TO 24"

BREAST PIN

5

6 **Dew cloth**

4" TO 6" WIDE

From strong willow sticks, make a hoop about 6 in. larger than the opening, beveling the two ends to overlap, after which you lash them together with strong cord as shown. The cross bars for the door should be long enough to form shallow bows. Lace the door covering to the hoop, and at each quarter of the circle pass the cord through the looped end of a cross bar, allowing one end to extend to permit hanging the door to a breast pin. Tie the cross bars together at the center.

For added comfort, a lodge lining or dew

cloth as Indians call it, should be used. Make this from light canvas in several sections as in Fig. 6. Tie the top edge to a rope which is looped around each pole and peg the bottom edge to the ground. The sections should overlap. The lining serves several purposes: Extending from the pole on one side of the door around the ti-pi to the pole on the other side, it serves as a flue, causing the air that enters under the side of the ti-pi to rise between the canvas side and the lining, thus providing a draft



a tripod with equal distances between the poles. Fig. 7 shows the order in which other poles are set up, their upper ends resting in the crotch of the tripod. The last pole should be stout as it is the lifting pole. This is placed under the ti-pi cover and the tie strings at the top, Fig. 2, are fastened to it. Then the canvas is folded back, the whole thing is set in place, after which the canvas is brought around the framework, lapped over and closed with the breast pins. From inside the ti-pi, you gradually move the poles outward, one at a time, until the canvas is tight and smooth. Then peg the bottom to the ground. Put up the lodge lining, build a round stone fireplace and set the smoke flaps. To do this, insert slender poles into pockets sewed to each flap and then raise the flaps, crossing the poles as shown in Fig. 1. If the wind blows the smoke back into the ti-pi, move the flaps around in one direction or another until the draft is right. In case of rain, move one pole clear around to the front and move the other to close the opening. However, there still will be a small opening left for smoke to escape. In severe windy weather, tie the long rope extending from the top of the tripod poles to two pegs driven into the ground inside the ti-pi, using the clove hitch as in Fig. 10.

Although unnecessary, a couple of

Erecting ti-pi

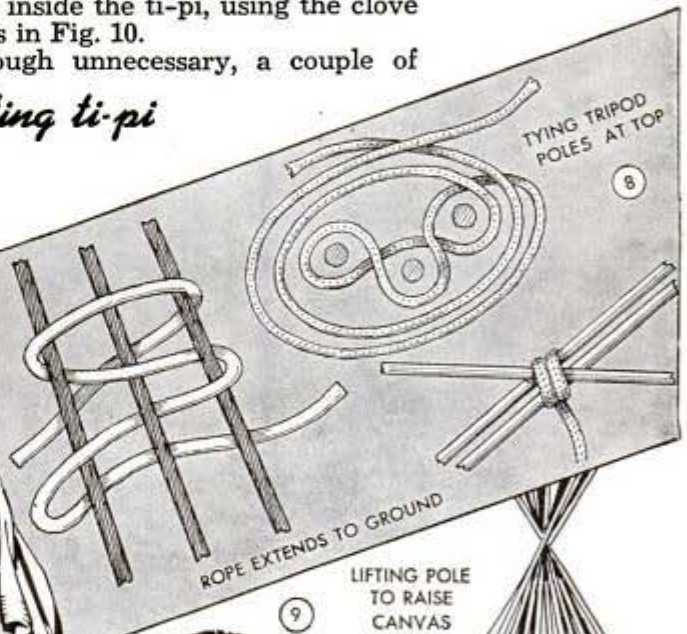
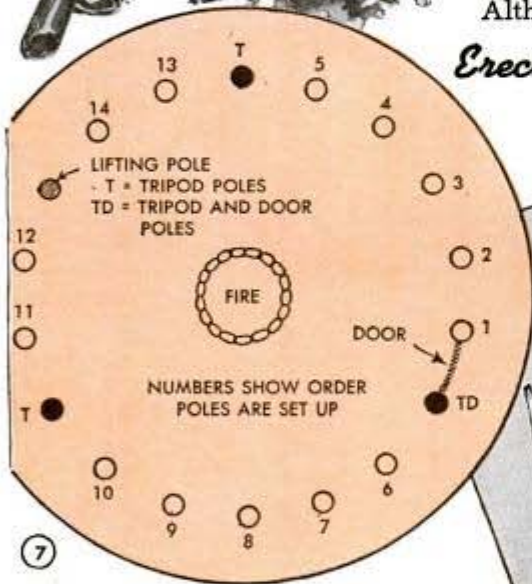

to carry the smoke up through the smoke flaps. Also, when you are seated inside the ti-pi the updraft is above your head. In case of rain, the lining prevents water that may run down the poles from dripping on you.

To set up the ti-pi, use sixteen slender poles 3 to 3½ in. thick at the base and about 3 ft. longer than the height of the ti-pi. Select three of the best ones, spread out the cover and lay two poles along the center and one on the edge. Tie them securely together where they cross, using the method shown in Fig. 8. Allow the rope to extend far enough to reach the ground when the ti-pi is raised. Now, lift the poles, Fig. 9, and spread them to make



willow beds made as shown in Figs. 11 to 16 inclusive will make sleeping more comfortable. Arrangement of beds and fire-place inside the ti-pi is shown in Fig. 5. To construct a bed, first make a framework to the dimensions given in Fig. 13 by driving pegs into the ground and tying strong cords between and across them. Next, cut and peel a number of willow twigs, making the longest ones 32 in. for the horizontal portion of the bed, slowly graduating the twigs in length to form the backrests. Drill or burn holes through the twigs 1 in. from each end. Next, place the twigs on the frame and lash them to the outer cords as in Fig. 14,

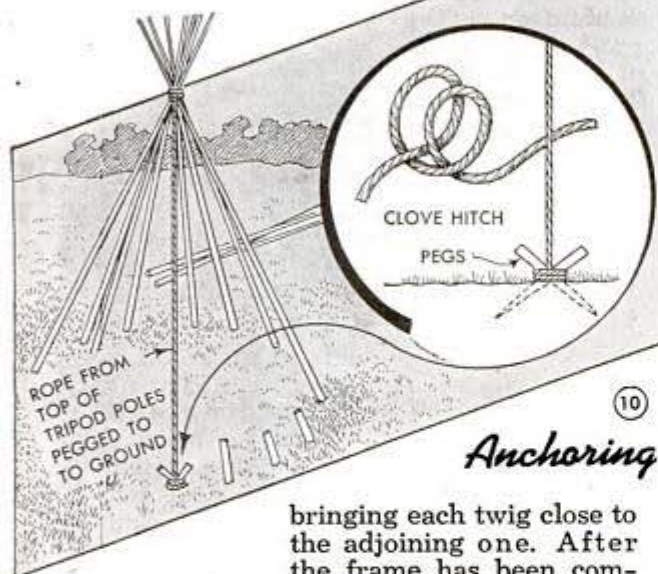

Anchoring

bringing each twig close to the adjoining one. After the frame has been completed, it is a good idea to bind the edges with strips of colored cloth by folding it over the ends as in Fig. 12 and stitching between the twigs. If greater stability is desired, weave $\frac{1}{2}$ -in. webbing through the center of the bed as indicated in Fig. 15.

To set up the bed, select two logs and peg them to the ground as in Fig. 11. Place the bed on them and hold the backrests in place by two tripods. To hold the bed firmly, a cord should pass over the bed and be tied to a peg on each side as in the circular detail of Fig. 11. In damp weather set the bed on logs and forks as in Fig. 16. Select strong logs or poles that will support your weight without sagging in the center and lay them in the crotch ends of strong stakes driven into the ground to project at a uniform height.

A sleeping bag on one of these beds will enable you to sleep comfortably. However, if you have no sleeping bag, a long sack made of white duck and filled with beech leaves will provide a good mattress. When not in use as a mattress, the sack provides a good container for your bed.

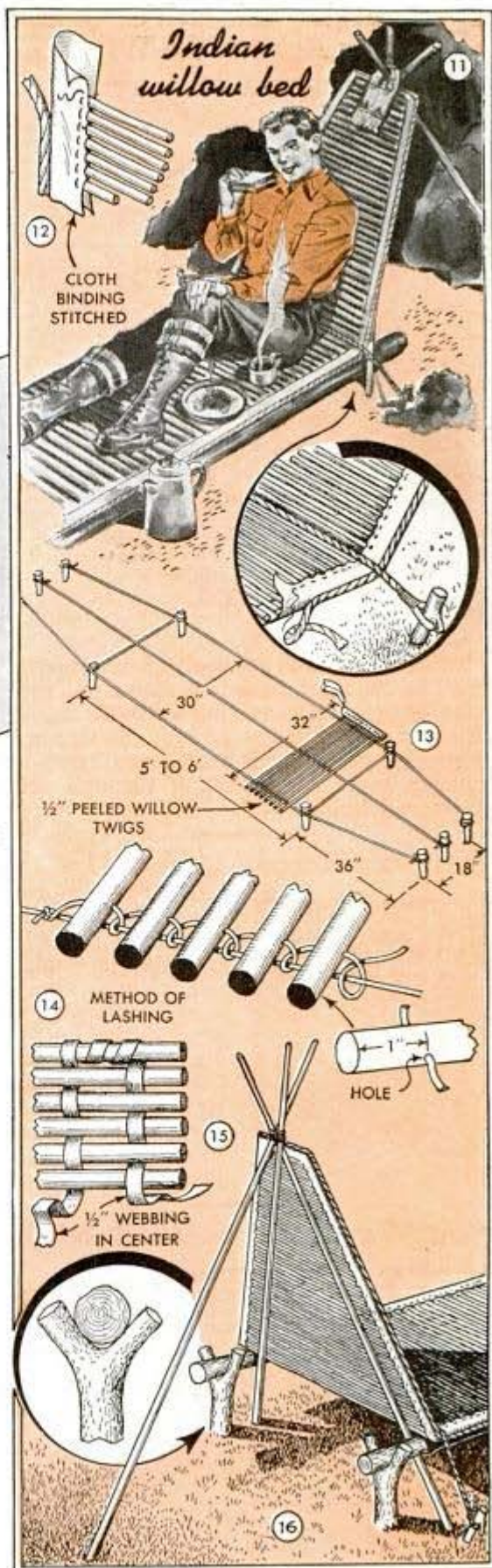

Anchoring Large Beach Umbrella Firmly Against the Wind



To keep a beach umbrella from rolling away in the wind, anchor it with a few can lids tied to the ribs and buried in the sand. The lids are punched through the centers to receive stout cords which are knotted to keep them from pulling through the punctured holes.

Blotter Keeps Matches Dry

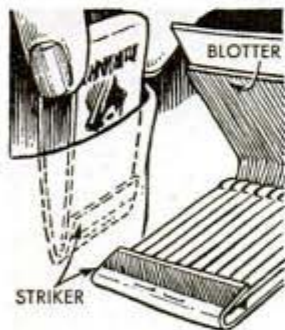

Workers or sportsmen who carry book matches in pockets where they may be ruined by perspiration will find a piece of blotting paper helpful. Placed around the matches it will keep them dry.

Neat Way to Curve Thick Stock

Easier than kerfing, here's a way you can bend thick stock in a continuous strip around corners, such as when adding set-in bases to cabinets, chests, etc. First, the corner is fitted with a built-up block as shown. Then the

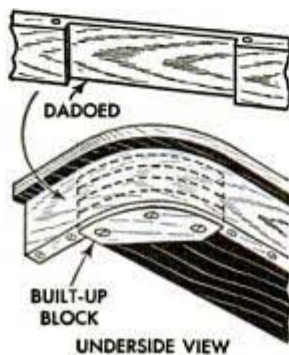

strip to be curved is cut down in thickness at the point where it is to be bent, or a distance equal to the perimeter of the block. The radius determines the amount the work must be cut down, the smaller the radius, the thinner the thickness. Cut in this way, and with one end of the strip screwed to the cabinet, the strip can be curved around nicely without splitting.

Blue Hydrangeas Are Produced By Alum at Roots

Blue hydrangeas are produced by a Wisconsin flower grower by inserting a lump of alum among the roots of the ordinary white type. The color to which the blossoms turn after this treatment is a novelty.

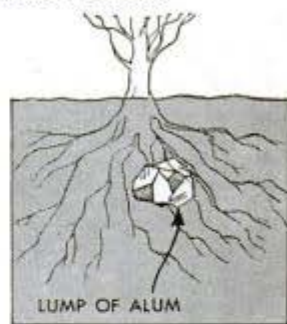

Seepage Water Drawn From Boat Through Suction Tube



A flexible or bent metal tube with a funnel slipped in the end can be used to draw seepage water from the bottom of a boat automatically. When the boat is in motion with one end of the tube touching the floorboards and the funnel end dragging through the water, suction pulls the water out.

Blocks Adapt Box as Card File

Wooden cigar boxes and similar boxes can be converted into durable and attractive 3 by 5-in. card index files. Wood blocks rounded at the top are inserted along the sides of the box to reduce the inside width of the box to 5 in., the length of the cards. Imprinted lettering on the box, if objectionable, may be removed with rough sandpaper. The card file will hold several times the number of cards contained in small file boxes.

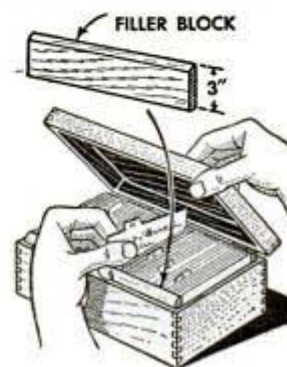

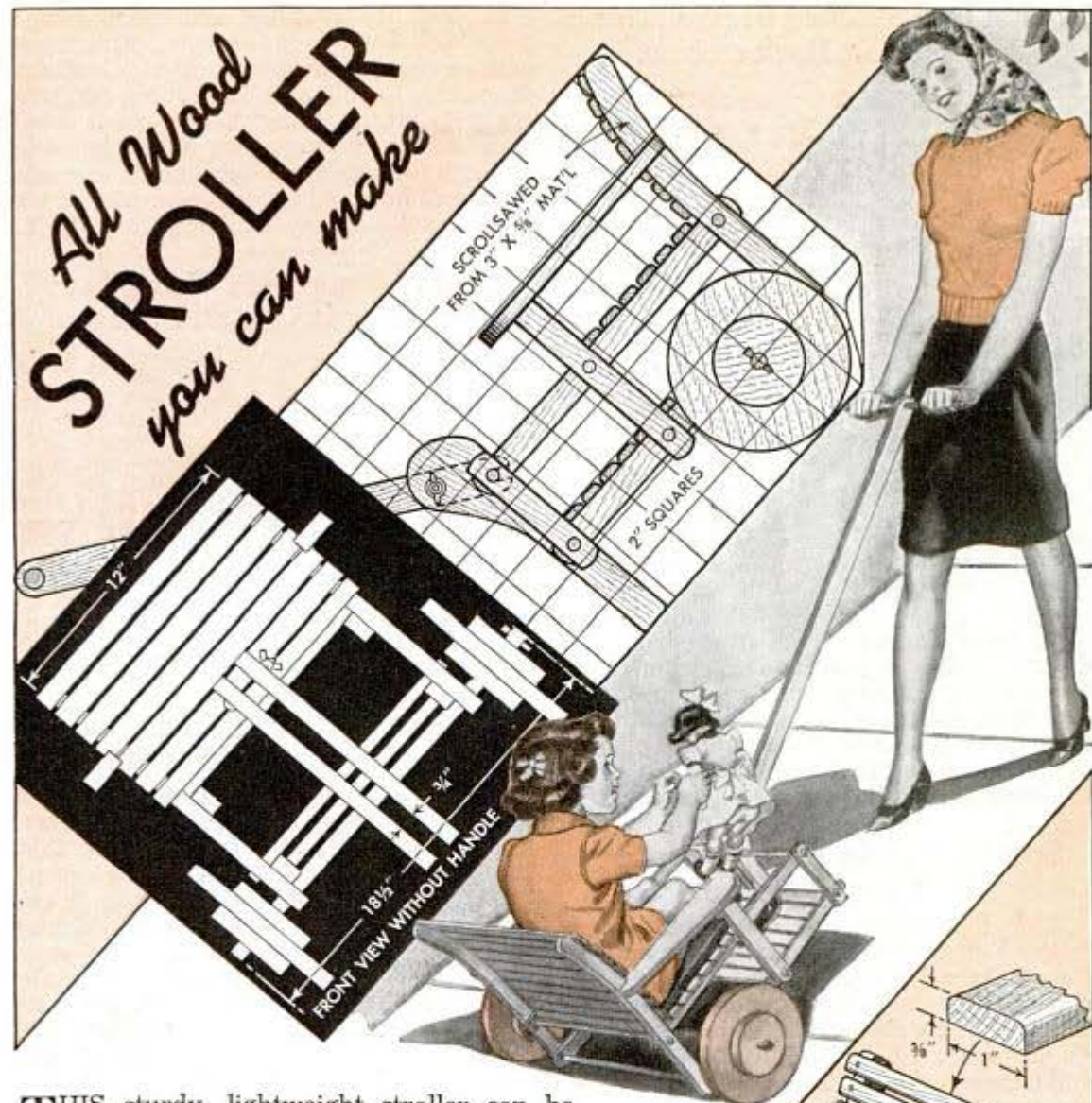

THIS sturdy, lightweight stroller can be used on shopping trips as well as in the home as a chair for the baby. Space under the seat is floored for carrying packages, and the notched handle is retained by a removable wing nut. The axle is a $\frac{3}{4}$ -in. dowel lubricated with graphite, and the frame is joined from side to side by $\frac{5}{8}$ -in. dowels. The grain in the wheels and hubs should run at right angles for maximum strength. Glue and screws at all dowel joints will add rigidity to the vehicle. Oak stain and spar varnish will protect the stroller from the weather as well as add to its finished appearance.

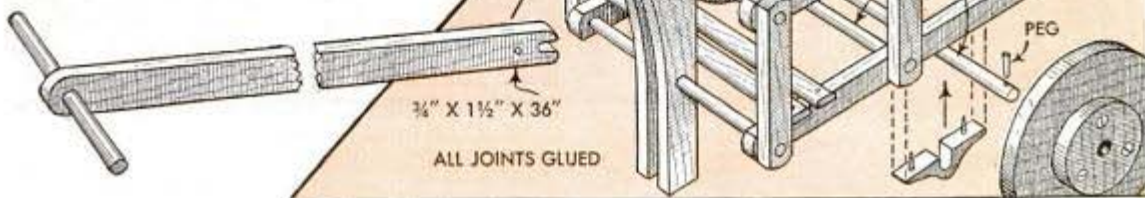

Pocket End Stitched in Auto Robe Holds It on Back of Seat



POCKET END
STITCHED IN
AUTO ROBE

To keep an auto robe from dropping down or sliding from side to side when used as a seat cover, fold one end over and stitch it at the sides to make a pocket about 6 or 8 in. deep. The robe then may be placed over the seat so that the pocket fits over the back to hold it securely in place.

Special Nozzle Aerates Water In Your Fish Pool

With this nozzle you can aerate your fishpool at the time fresh water is added, thus making it unnecessary to completely change the water at frequent intervals. The nozzle consists of an 18-in. length of $\frac{3}{4}$ -in. pipe, an 8-in. length of $\frac{3}{8}$ -in. pipe and a hose coupling. To assemble the nozzle, insert the small pipe inside the coupling, slip the large pipe over it and rivet the assembly together as indicated. Then,

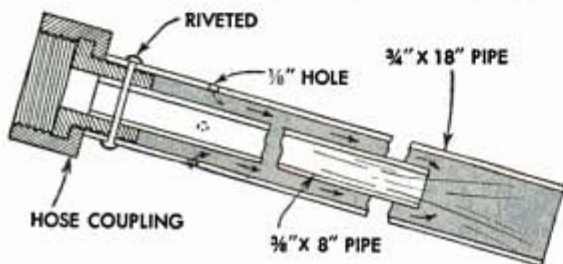

1 in. from the coupling end of the larger pipe, drill four $\frac{1}{8}$ -in. holes, spacing them equally in a row around it. In use, connect the nozzle to your hose, insert the end into the pool water almost to the small holes and turn on the pressure. Water rushing through the nozzle will pull air in through the small holes and mix it with the water in the pool.—J. Hobert, Hempstead, N. Y.

Simple Homemade Camp Stove Bundles Into Small Package

A portable camp stove can be made by inserting four iron rods through a short length of pipe and then bending them as indicated. The rods may be spread apart to support a utensil over a fire, or folded for carrying.



Birds Are Unable to Damage Corn When Ears Are Tied at the Top



You can protect your sweet corn from birds that peck the ears at the ends by tying the tops of the husks with thread or cord when the kernels start to develop. The birds, unable to tear the ear open from the side, cannot reach the kernels.

Holder Supports Anchor of Boat To Change Fishing Location

Instead of pulling the anchor into the boat every time he wanted to move a short distance to a new location, one fisherman uses this simple holder to support the anchor a few inches off the lake bottom. The holder is merely a hinge screwed to the inside surface of the boat so that one half of it hangs over the side, the end of the hinge being slotted to take the anchor chain.

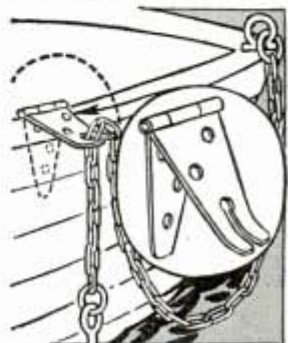

Servicing Your OUTBOARD

HAVE you ever noticed some fisherman fruitlessly cranking his outboard motor with an occasional "spit and sputter" the only reward for his labor? Such hard starting generally can be avoided if you use the recommended gas-and-oil mixture and if the motor is properly serviced from time to time to keep it in tip-top condition.

Ignition: Housed under the flywheel, Fig. 13, the ignition system of a modern outboard motor is surprisingly dependable, but it does require attention. At least once each season the flywheel should be removed and the entire magneto cleaned and adjusted. On many motors the nut that tightens the flywheel also serves as a flywheel puller, Fig. 1. A shoulder on the nut contacts the starting-ropes plate, and after the nut is loosened, a turn or two forces the flywheel from the tapered end of the crankshaft. All electrical connections should be checked for tightness. A loose condenser should be tightened, Fig. 2, as this may cause hard starting. Ignition points should be faced true on an oil stone and set to factory specifications. In the absence of such information, adjust the points to open .018 to .020 in., Fig. 3. Lubrication consists of a tiny bit of light oil applied with a toothpick to the pin that supports the movable contact point, and just a touch



① REMOVING NUT THAT TIGHTENS FLYWHEEL



② TIGHTENING THE CONDENSER



④ IGNITION WIRE SOLDERED



③ SPACING IGNITION POINTS



⑥ CORK FLOAT TO BE RECOATED



⑦ RESOLDER LOOSE METAL FLOAT

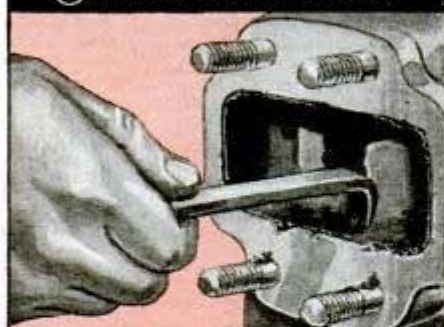

⑧ SCRAPING EXHAUST PORT CLEAN



⑨ CHECK RING-GROOVE CLEARANCE

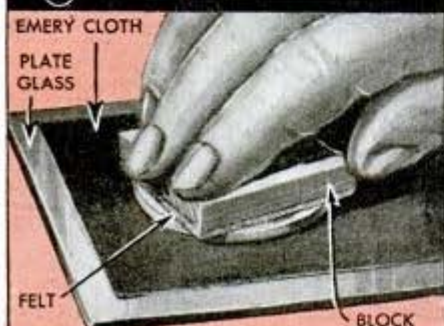

⑩ PISTON RINGS LAPPED



⑤ SHELLACKING GASKET



of hard grease applied to the cam which is an integral part of the crankshaft. If starting has been difficult, it is a good idea to take the flywheel to an authorized outboard-motor service shop and have the magnet recharged.

After several seasons of use, constant flexing of the high-tension wires, as a result of advancing and retarding the spark, may cause insulation cracks which lead to loss of spark. If available, new wires should be installed as in Fig. 4. In soldering electrical connections always use non-corrosive flux—never acid flux! When testing the spark of an outboard magneto it is important that the ignition wires be held not more than $\frac{3}{8}$ in. from some metal part of the motor to which the spark may jump. Cranking the magneto with the wires hanging in space invites a breakdown in the insulation of the coil.

Carburetors: Sometimes the shellac coating on cork floats gradually deteriorates, allowing fine particles to loosen and clog the carburetor. Then the float also loses its proper buoyancy and cannot control the gas flow. The permanent cure for this condition is to remove the float and allow it to dry thoroughly. After this, any loose particles should be sanded off and the entire float given two thin coats of shellac, Fig. 6. Also, it is not unusual to find floats disconnected from the arm, with the result that the carburetor shuts off all fuel, and operation becomes impossible. As this type of carburetor has a metal float, the cure is to solder the float back onto the arm, Fig. 7. Any metal float that has a leak should be pierced with a needle opposite the leak, so that all the liquid and fumes can be blown out. Then the hole and original leak should be soldered, using as little solder as possible to avoid reducing the buoyancy of the unit.

Compression: Although everyone realizes the importance of compression in the combustion chambers, the necessity of compression in the crankcase of a two-cycle outboard motor often is overlooked. Without this compression, the fuel charge is not delivered effectively to the cylinders. A simple check for crankcase compression is to remove all the spark plugs and then crank the motor. You should be able to feel very slight compression in the crankcase and to hear a definite "popping" sound.

11 NEW PISTONS SHOULD BE CHECKED CAREFULLY FOR FIT

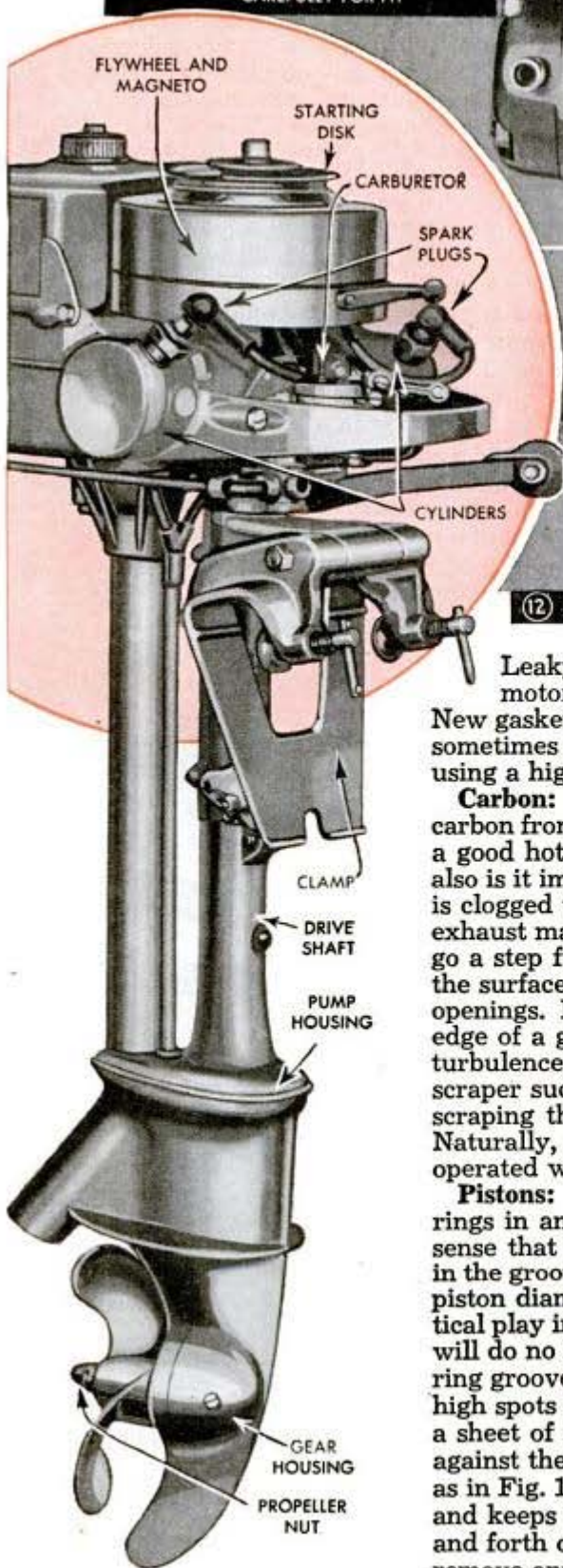

13 ARRANGEMENT OF PARTS ON TYPICAL OUTBOARD MOTOR

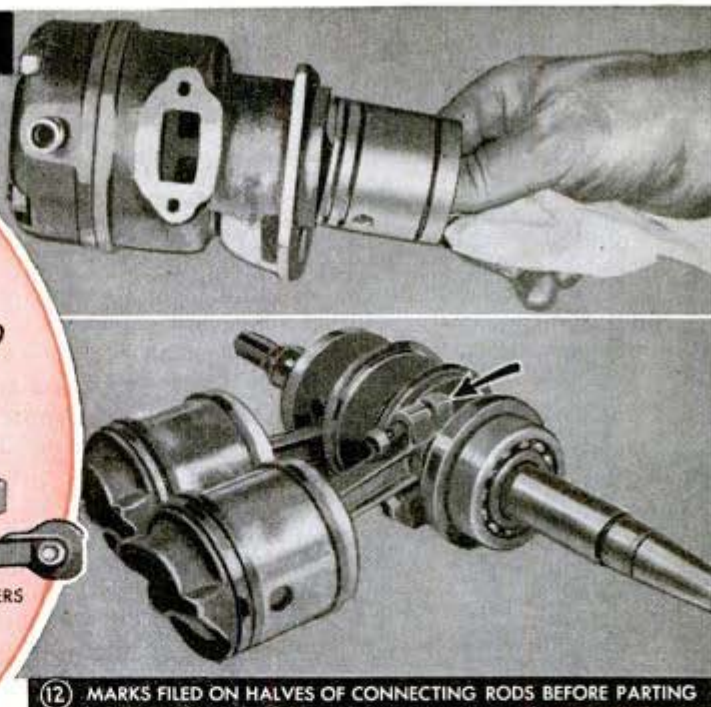

12 MARKS FILED ON HALVES OF CONNECTING RODS BEFORE PARTING

Leaky gaskets, loose bearings or shaft glands in some motors can totally destroy crankcase compression. New gaskets should be installed, or if these are unavailable, sometimes the old ones can be made compression tight by using a high grade gasket cement as in Fig. 5.

Carbon: One of the most essential services is removing carbon from the exhaust system, Fig. 8. As one cannot build a good hot fire in a furnace that is clogged with ashes, so also is it impossible to get good operation from a motor that is clogged up with carbon. It is not difficult to remove the exhaust manifold and scrape the exhaust ports. Some even go a step further and streamline the passages by polishing the surfaces in the exhaust opening as well as in the intake openings. In streamlining the gas passages be sure that the edge of a gasket does not project into a passage and cause turbulence, thereby restricting the flow. Frequently a hand scraper such as is used for fitting bearings proves useful in scraping the edge of port or piston for perfect alignment. Naturally, care must be taken to see that the motor is not operated with any metal particles left in the cylinder.

Pistons: Contrary to popular opinion, the pistons and rings in an outboard motor do not need to be tight in the sense that they butt closely at the ends or fit very snugly in the grooves. An end gap of .004 to .005 in. for each inch of piston diameter generally will prove satisfactory, and vertical play in the grooves of as much as .004 or .006 in., Fig. 9, will do no harm provided the rings are not warped and the ring grooves are not rough. Lapping piston rings to remove high spots is done on a piece of plate glass on which is held a sheet of fine emery cloth. The ring is pressed uniformly against the cloth by a small block of wood padded with felt as in Fig. 10. The felt assures uniform pressure on the ring and keeps the block from slipping. Working the ring back and forth over the fine emery in a figure-eight pattern will remove any high spots. Obviously this operation should be done only to the amount required to get a true surface.

Prior to removing any part from a motor, it is well to mark the part on an unfinished surface so that there will

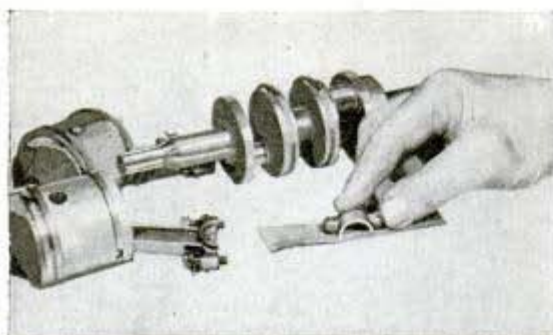

14 DRESSING CAP ON CONNECTING ROD

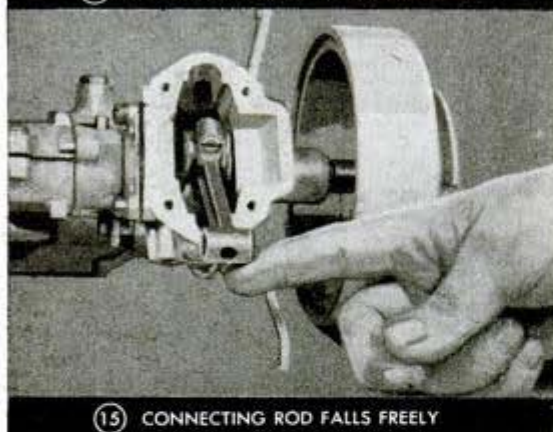

15 CONNECTING ROD FALLS FREELY

be no question about returning it to its original location. As indicated in Fig. 12, this is especially true when removing connecting-rod bearings which should be marked lightly with a file or sharp center-punch before being taken from the shaft.

Should it be necessary to install new pistons, be sure they have proper clearance, Fig. 11. Since fitting a piston too tight can cause serious trouble, installation of new pistons should be left to outboard mechanics. While in automotive service a "rule-of-thumb" way of checking pistons is to figure on .001 in. of clearance for each inch of piston diameter, the average clearance for outboard work will be more nearly .0015 in. for each inch of piston diameter. Finally, after the rings and pistons have been fitted, the owner who wants peak performance follows the example of outboard racing drivers and laps in the pistons and rings with a creamy paste consisting of a soft abrasive window-cleaning powder and light engine oil. This paste is dripped in through the port while the motor is being cranked with power applied generally by a heavy-duty electric drill or a lathe, continuing to run the motor in this way until all surfaces have a fine finish and there is no drag anywhere. Then, the entire motor is dismantled, after which all traces of the abrasive are washed out thoroughly with gasoline.

Connecting rods: Fitting connecting rods is something that the mechanically inclined owner can do himself, and when there is unusual clatter in a motor it may suggest that the bearings should be tightened. Rod adjustment can be done by facing the bearing halves as seen in Fig. 14. Too tight a fit must be avoided. While no noticeable play should be present in the rod when properly fitted, still there must be absolutely no drag, and the rod must fall freely of its own weight when checked on the tip of the finger as in Fig. 15. One thing that certainly will damage a motor results when the lock ring at the end of the wrist pin works loose. Continued operation after this has developed will be certain to ruin the piston and cylinder. Consequently, when working on any motor, it is most important to see that the ring, Fig. 16, is securely snapped into position. When operating a motor that has an unusual noise it should be checked immediately or it may be damaged beyond repair. If your outboard develops a sing-



16 LOCK RING OF PISTON PIN SET IN POSITION



17 CHECK THREADS OF PROPELLER SHAFT

ing sound, by all means check the lubricant in the lower housing or you may soon have a set of junk gears.

Propeller: And while on the subject of servicing the lower end of the motor, it sometimes happens that forcing the propeller nut on too tightly injures the threads on the propeller shaft, Fig. 17. When this has happened, it may be possible to clean them up a bit by using a three-corner file.

Game of "Bomber" Calls for Careful Planning

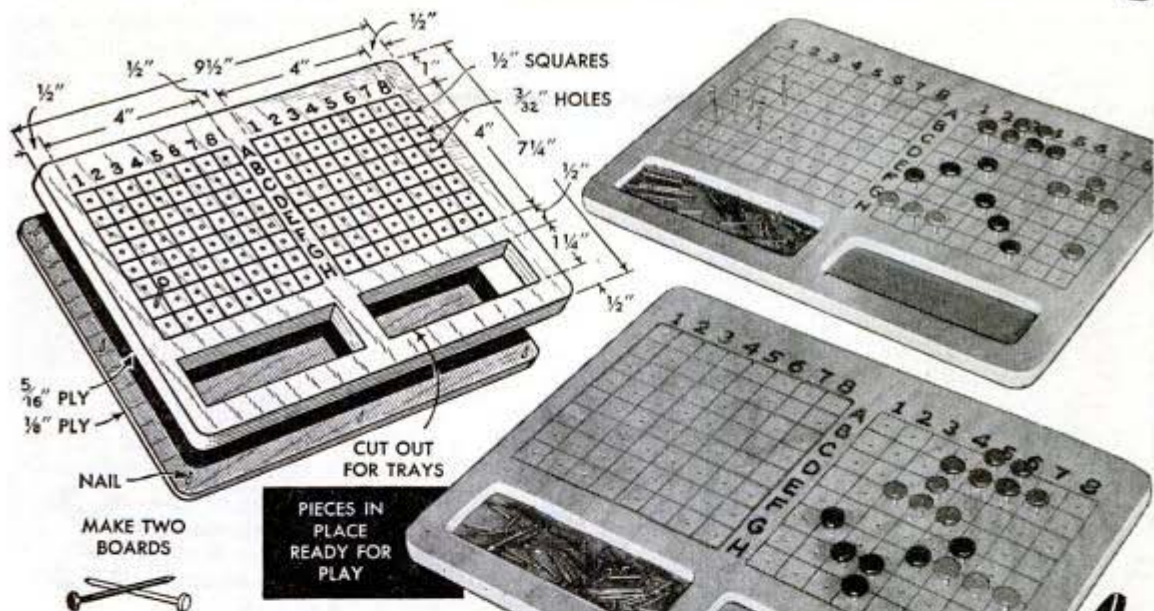

If you like a pastime with a touch of war atmosphere, try "Bomber," a game for two players, each having a board. Arrange the pieces on the right hand side and use the left to keep account of your opponent's attack. By this means you can quickly grasp the general pattern of his offensive and shift your pieces out of range. To start the game, call out a number such as D-5. If your opponent has part of his force in that square, he announces a hit; if not, a miss. If you score a hit, he must remove that piece from his board. If you hit "Blabbermouth" your opponent must

PIECE	SHAPE	COLOR
1 CRUISER		GREEN
1 SUB		BROWN
1 BATTLESHIP		GRAY
2 PLANES		1 BLACK 1 RED

tell the position of any piece you name and remove it from the board. "Blabbermouth" is then placed in a new position. The pieces can be made from upholstering nails with the heads painted as specified. Each board requires twenty 1-in. brads painted red to serve as markers for hits, and unpainted brads to designate misses.

"BLABBERMOUTH" IS THE TRAITOR WHO TELLS WHERE YOUR FORCES ARE

Tires of Parked Car Shielded Against Exposure to Sun

One worker who had to park his car where the tires would be exposed to the sun's rays, which rapidly deteriorate rub-

ber, protected them with shields. These were nothing more than pieces of heavy cardboard cut to a suitable size and slipped up under the fenders. When not in use, the shields were carried inside the car trunk.

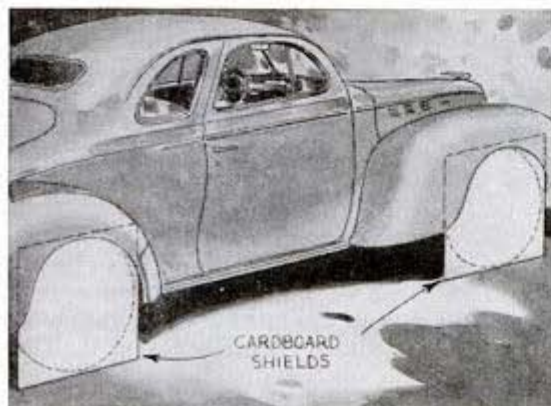

Scroll Saw Sands Irregular Work

Sanding small irregular or curved pieces is much easier if the job is done with a strip of abrasive paper substituted for the blade in a scrollsaw. If sandpaper without fiber backing is used, two strips of the paper should be glued together back-to-back for strength. Metal objects may be finished in the same way if emery cloth is used in the scroll saw.

—W. Piland, Portsmouth, Va.

Deckle Edges on Enlargements Made With Blotting Paper

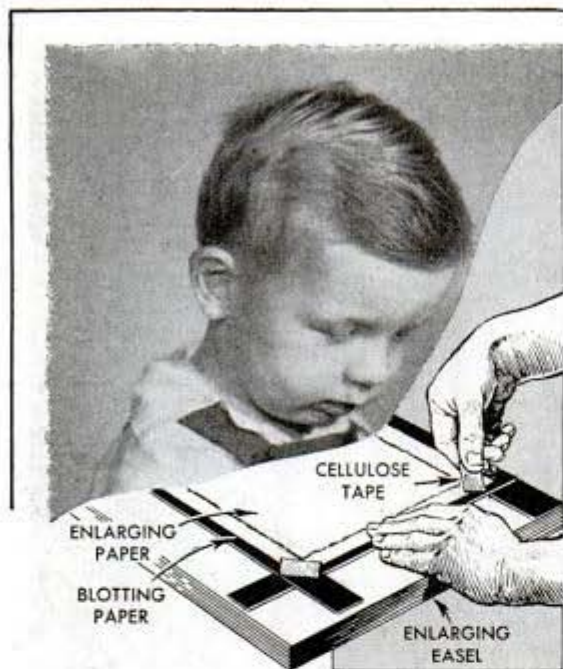

It's easy to make attractive deckle edges on your enlargements if you tear strips of blotting paper and fasten them to the masking arms of your enlarging easel as shown. Blotting paper is recommended since it tears with a good feathery edge. If the blotting paper is scored about half way through with a sharp knife, it will tear easily along a straight line.

L. Robert Luttrell, Chicago.

Lens Cover Will Be Removed If Hooked to Carrying Strap

A popular type of 8-mm. movie camera is supplied with a rubber lens cap so designed that when the cap is removed from the front of the lens it cannot be lost or misplaced accidentally. To avoid any possibility of forgetting to remove the cap be-



fore using the camera, it is a good idea to loop the camera carrying handle across the rubber band that connects the cap to the lens base as shown. In this way, the cap will be removed when the carrying strap is used to hold the camera during exposure.

—Roland Swedlund, Buffalo, N. Y.

Gelatin Filters Used Behind Lens In Ground-Glass Cameras

Inexpensive gelatin filters can be used with ground glass cameras by placing the filters inside the bellows behind the lens. Framed with cardboard or tape, the filters will fit snugly into the folds of the bellows. Of course, care should be taken to remove the filter before folding the camera.

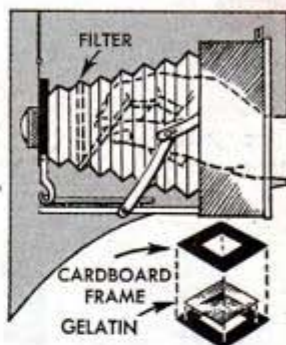

—H. Klein, Pittsburgh, Pa.

Faulty Photoflash Bulb Repaired By Jarring It on Hand

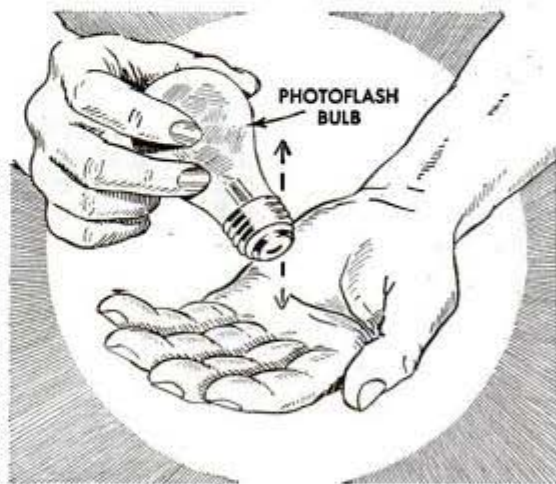

Don't throw away a photo-flash bulb simply because it doesn't go off when it should. Often you will find that "banging" the screw base part of the bulb against the palm of the hand will bring the foil into contact with lead-in terminals and the bulb will thus function as it should.

—Don Mario, Providence, R. I.

For embossing prints, place the photograph to be embossed on a plywood square or whatever you use to make the indentations and run your print roller over it. The roller will not be harmed for its original purpose by the slightly uneven surface.

Darkroom Lamp Provides Variable Light Control

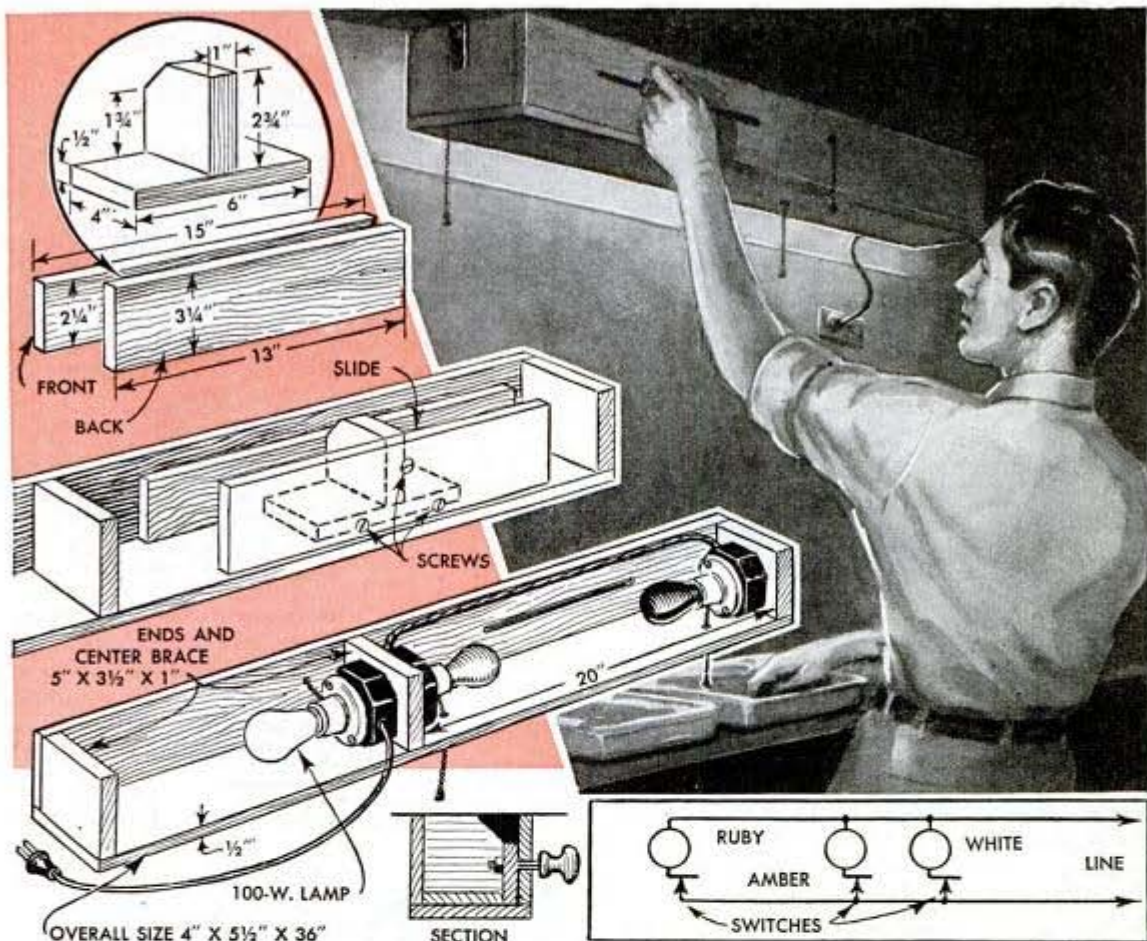

In this darkroom lamp, the intensity of illumination from the amber and ruby lights is controlled by a sliding compartment operated from the front of the housing. Illumination is indirect, permitting a greater allowable brilliance without fogging the work than would be possible with direct light. A 100-watt bulb also is provided to give general illumination over the darkroom bench. Note that all three lamps are controlled individually by pull-chain sockets. Chains for the amber and ruby

lights extend through the bottom of the housing, while the chain for the white light extends through the front for easy identification. Before assembling the housing, mount and wire two sockets on the center partition and one on the endpiece. The sliding compartment is placed in position with the 15 by 2¼-in. side against the inside of the front. Install a knob through a slot in the front, taking care to attach it so that there is no binding.

—J. C. Coombs, Evanston, Ill.

Weighing Papers Used on Scales Fitted With Wire Frame

Photographic chemicals can be weighed more conveniently if heavy wire frames are soldered to the prongs of the pan holders. This will enable you to use folded weighing papers more easily. These are merely squares of paper folded twice diagonally. With this method a fresh sheet of paper can be used for each chemical, avoiding the accidental mixing of two chemicals. Chemical powders pour more easily from the papers, which also "center" better on the scales, making for greater accuracy.

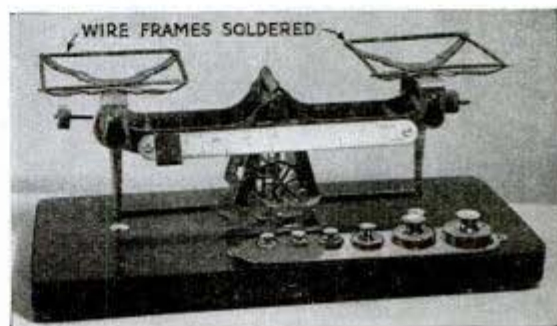

Rod Shield on Drawing Board Prevents Soiling Long Work



On many drafting jobs it is necessary to use large sheets of paper that hang over one end of the drawing board. In such cases the worker often has to stand in an awkward position to keep from soiling the overhanging paper. To prevent this and to make his working position more restful, one draftsman uses a shield at the front of his board. The shield is an iron rod bent to shape and inserted into holes drilled into the edge of the board as indicated.

Utilizing Waste Space in Closet Built Over Stairway

If you have a closet built over a stairway leading to the basement or to an upper floor, and the stair ceiling runs at an angle through the lower part of the closet, a drawer can be built in to utilize the waste



space between the stair ceiling and the raised floor in the closet. You will find many uses for such a drawer, such as a clothes hamper, a place to store extra bedding, etc.

—Kenneth Matthews, Baltimore, Md.

Guide to Bore Straight Holes With a Brace and Bit

Having a number of wooden rollers, in the ends of which I wished to bore holes with a brace and bit, I used a paper guide like the one shown to help assure that the holes would be straight. The guide consisted of a sheet of paper wrapped around



the end of the roller to project a few inches beyond its end. With this arrangement, I could keep the drill centered in the paper cylinder fairly accurately by merely sighting down over the brace.

—A. H. Waychoff, Phoenix, Ariz.

Data on Tires Kept in Hub Cap



One motorist who keeps a record of his tire purchases, repairs, etc., prints this data on paper disks, which are cemented to the inside surface of the hub caps. As most caps fit tightly enough to exclude dust and water under ordinary conditions, the data is safe and always at hand for reference whenever desired.

Mending Aluminum Ware With Ball-Peen Hammer

You can repair tiny holes in aluminum ware easily by placing the worn part over a small anvil or the head of a bolt held in a vise and hammering on the outside of the hole with the ball of a small ball-peen hammer. Aluminum is malleable enough so that this treatment will close the hole and also bend the worn portion of the bottom slightly so that it no longer takes the wear. This method is much simpler than reaming out the hole and mending with the bolt-and-washer system.



SHOP NOTES



DRAWING DESK *has all conveniences*

By Frank Hegemeyer

DRAFTSMEN will find this drawing desk sturdy and convenient. The drawing board can be adjusted to eighteen different positions, and vanishing points are established by means of movable side arms, as illustrated in Fig. 1. Also, there is a built-in compartment with opal glass and lights for tracing, shown in Fig. 2, and three roomy compartments for storing full-size blueprints and other bulky material, besides a drawer to hold equipment.

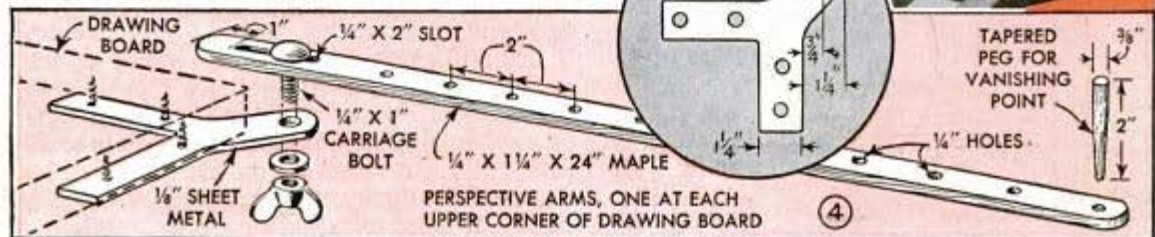

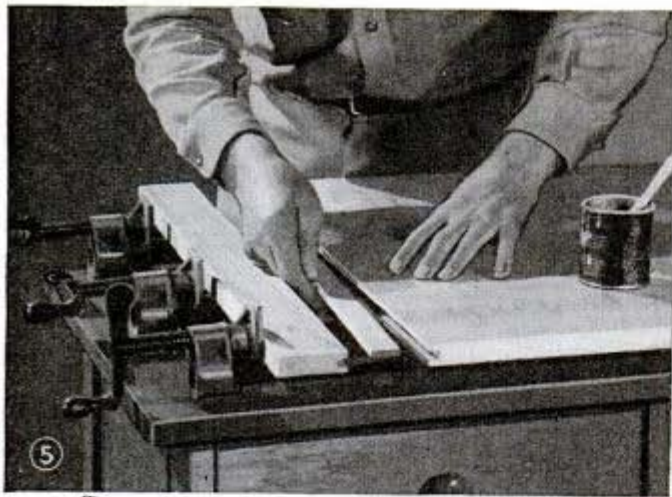

A drawing board of the proper size can be purchased, or one can be made by joining six pieces of basswood or sugar pine with the heart and sap sides alternating to minimize warping. The ends should be grooved for a maple spline, and all pieces glued together as in Fig. 5. After the board has been surfaced smooth, a coat of boiled linseed oil should be applied to both sides and edges. Tapered pegs, which serve as vanishing points, fit into holes

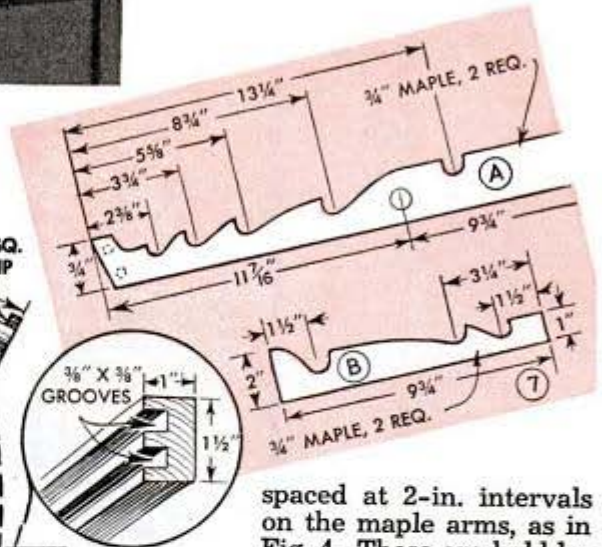
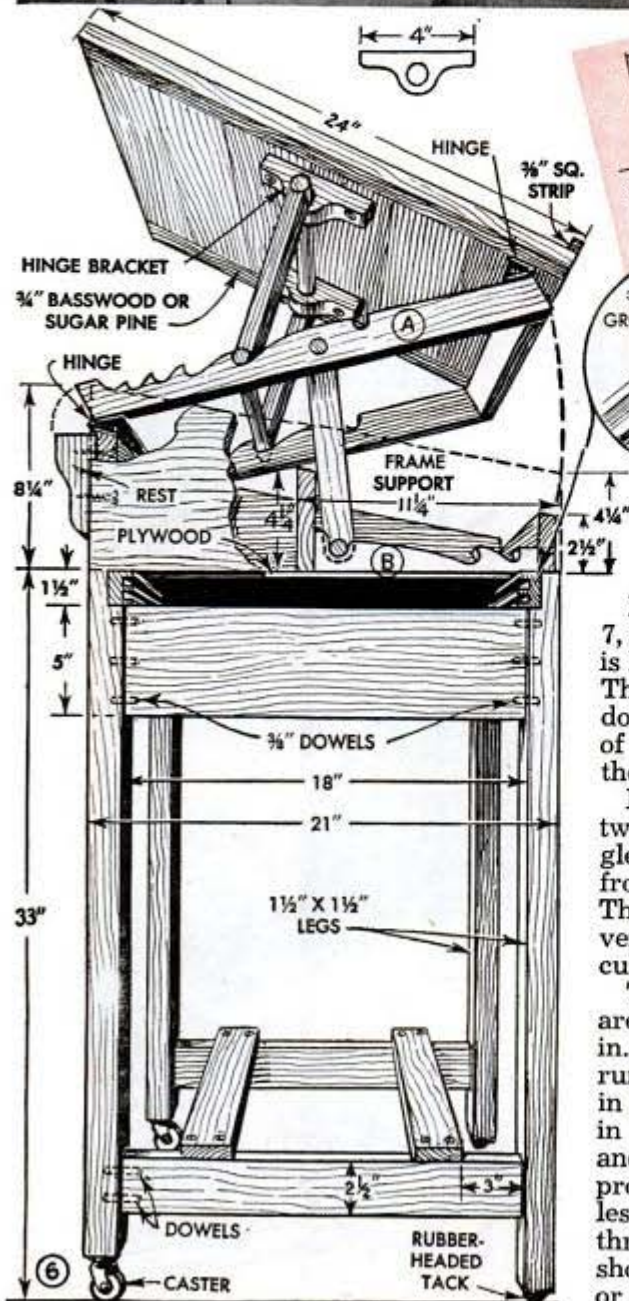

spaced at 2-in. intervals on the maple arms, as in Fig. 4. These are held by $\frac{1}{8}$ -in., sheet-metal brackets screwed to the upper corners of the board, as shown in Figs. 3 and 4.

Pieces A and B, indicated in Figs. 6 and 7, are of maple. Fig. 9 shows how the dowel is held by hinge brackets, one at each end. These are fastened to the board when the dowel is in the $2\frac{3}{8}$ -in. notch to give a tilt of 20 degrees. The other notches increase the tilt of the board by 10 degrees each.

For the light box, two porcelain sockets, two 40-watt frosted tubular lamps, a toggle switch, some lampcord and a piece of frosted or opal glass 8 by 10 in. are needed. The inside should be painted white, and vent holes are provided to permit air circulation, as illustrated in Fig. 12.

The front, back and ends of the top part are rabbeted on the bottom edge for a $\frac{1}{4}$ -in. plywood bottom, and grooved maple runners are inserted in the notched legs as in Fig. 6, to hold the sliding panels shown in Fig. 10. Fig. 11 shows how the upper and lower rails are mortised together to provide sturdy support for the desk. Unless otherwise specified, $\frac{3}{4}$ -in. pine is used throughout, and all joints are doweled as shown. The desk can be painted or stained, or it can be shellacked and varnished.

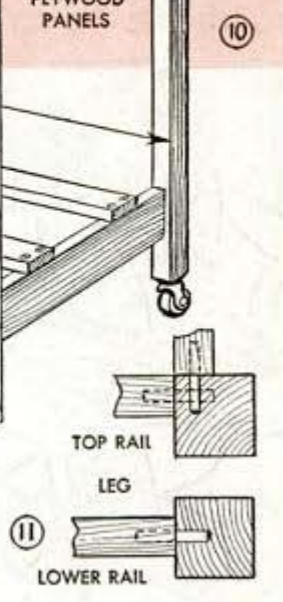
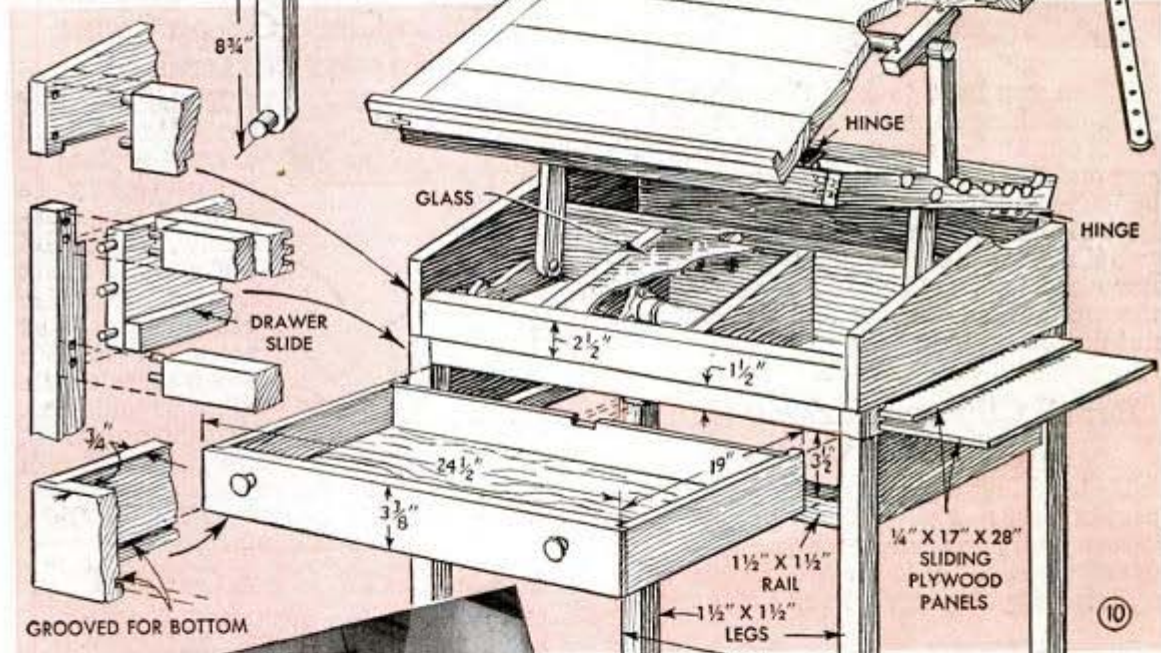
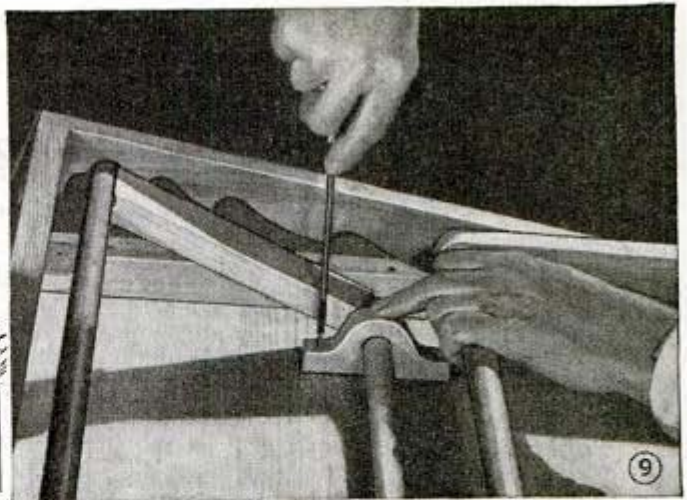
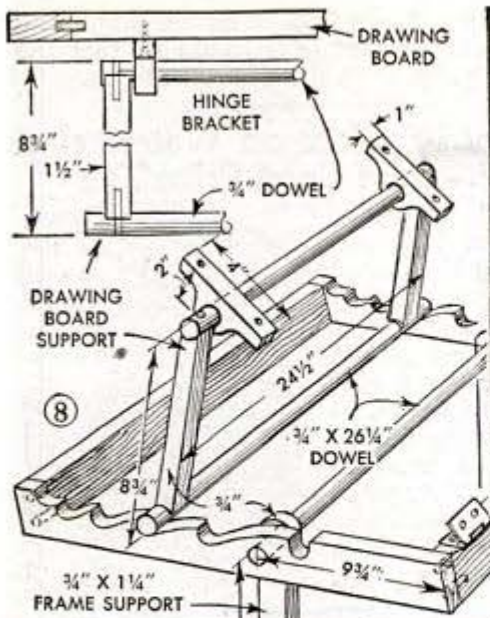

Beveled Pipe Used as Star Drill When Boring Through Wall



When you have to drill through a brick wall and there is no star drill at hand, just bevel one end of a piece of pipe of suitable size and use it as a drill. Of course, it may be necessary to sharpen the pipe frequently, but this can be done in a moment or two if a grinder is at hand. If possible, follow a mortar joint between the bricks and the work will be easier and the drill will not dull so quickly.

Pencil Clip on Marking Gauge To Use It as Compass

By bradding a pencil clip to the movable part of your marking gauge it can be used as a compass and thus make it unnecessary to carry two tools. The clip is formed from a piece of spring steel. In use, the scratch

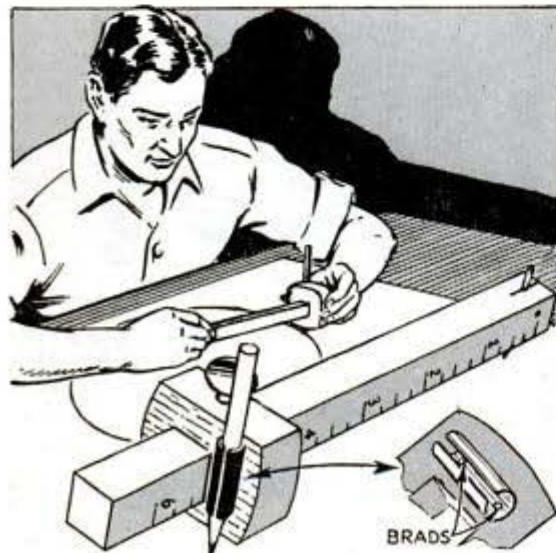

pin of the gauge is used as the pivot, and the movable part is adjusted so that the pencil point is at the desired radius.

Scraped Surface on Watermelon Provides Good Price Tag

In stores where watermelons are sold by the pound and therefore may have a number of different prices, just scrape a spot on each melon to expose the white surface underneath. This provides a good background on which to print the price.

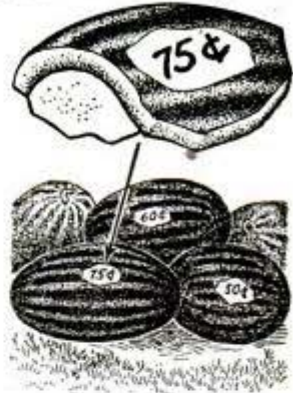

Wire to Clean Oilcan Spout Always at Hand



If the spout of an oilcan used around a piece of machinery is clogged frequently by grease and dirt and there isn't a wire handy for cleaning it, just wrap a short piece of wire around the spout as indicated.

In this position, the wire will always be at hand and will not interfere with use of the can.

—John L. Dougheny, Toledo, Ohio.

Making Your Own Gauge Pins

Gauge pins for a platen printing press can be made from ordinary banding iron such as is used to reinforce wooden packing cases and boxes. Short lengths of the iron are cut and shaped at the ends as indicated, after which they are inserted in slits cut in the drawsheet where they are held by drops of sealing wax. A "shoofly" cut in the drawsheet in front of each pin will aid in sliding card stock against the pins.—Geo. T. Clayton, Los Angeles, Calif.

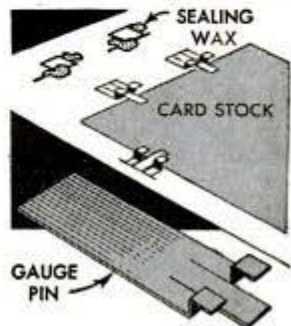

Wax crayons are excellent for labeling canning jars if used while the jars are hot.

Sealed-Beam Lamp Directs Light on Workbench

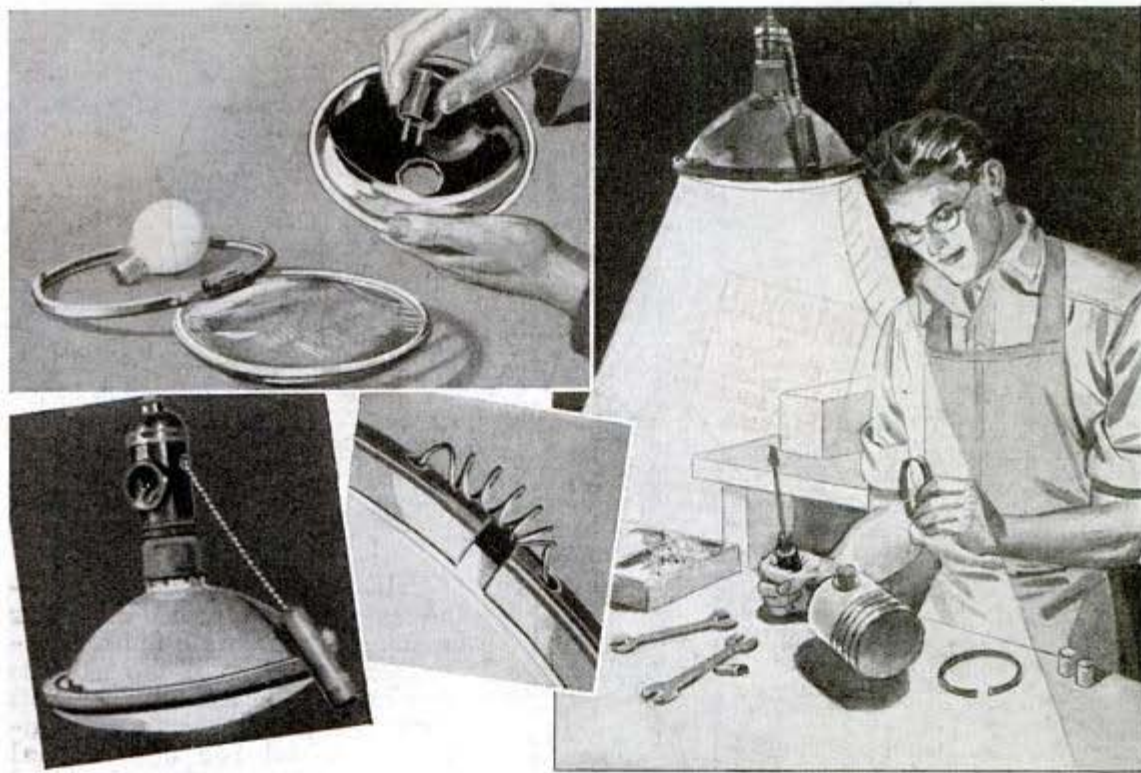

For a few cents you can convert a discarded sealed-beam automobile headlight, usually available without charge at garages, into a tarnish-proof workbench light that will concentrate its full brilliance where you want it—right on the work. Use a sealed-beam light of the kind that has a metal reflector. First cut through the soft alloy seal with a hacksaw, remove the glass cover and drive out the old bulb with a punch. The bulb opening can be enlarged easily to fit a plug-in receptacle by cutting back with tinner's shears at $\frac{1}{4}$ -in. inter-

vals and bending the intervening strips with a pair of pliers to break them off. Then the opening can be expanded smoothly by forcing the reflector over the tapered neck of a soda-pop bottle. After inserting the lamp bulb, drill a small hole in each end of the seal, replace the gasket and cover, pull the ends together and attach a piece of wire or a small coil spring to hold them tight. As the lamp has a tendency to concentrate the light in one spot, it should be mounted on an arm pivoted horizontally to direct the light where needed.

Adjustable Slotting Saw Used on Wide Range of Work

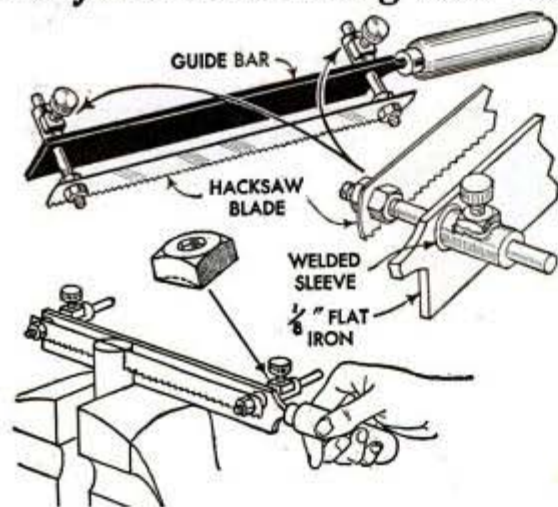

This saw will help assure accuracy and will save you time, especially when slotting a number of duplicate pieces. The saw consists of a hacksaw blade attached to a frame, which serves as a guide bar and from which the saw blade can be spaced as desired. The frame is merely a piece of flat iron cut down at one end to form a tang to take a handle and drilled near each end to receive headless bolts. These are locked to the hacksaw blade by means of nuts on each side of it, and slip through the holes in the frame into sleeves welded to the frame where they are held by thumb-screws. The latter are turned into nuts welded over holes drilled through the sides of the sleeves.



DUAL TOOL-POST GRINDER

By James Brown

THE tool post grinder is necessary in lathe work whenever a superfine, accurate finish is required, especially if the work is too hard to be turned. The unit described here carries a 4-in. diameter wheel for cylindrical grinding, Fig. 6, and can be fitted with an insert spindle for internal work, Fig. 1. Speeds of approximately 4600 and 7000 r.p.m. are provided, the higher speed being used only for internal work.

Construction is started by turning the bearing housing and spindle as in Figs. 2 and 3. The spindle

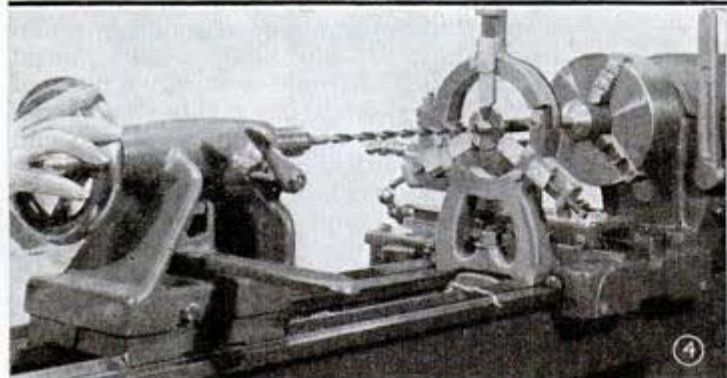
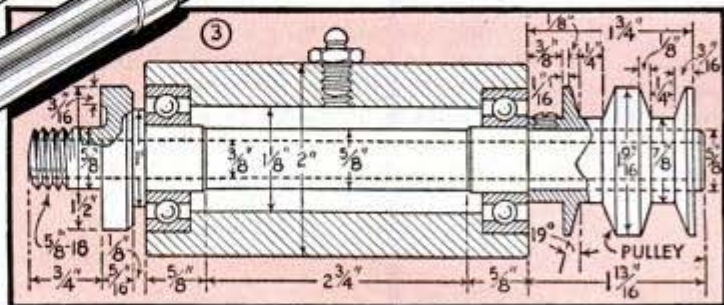
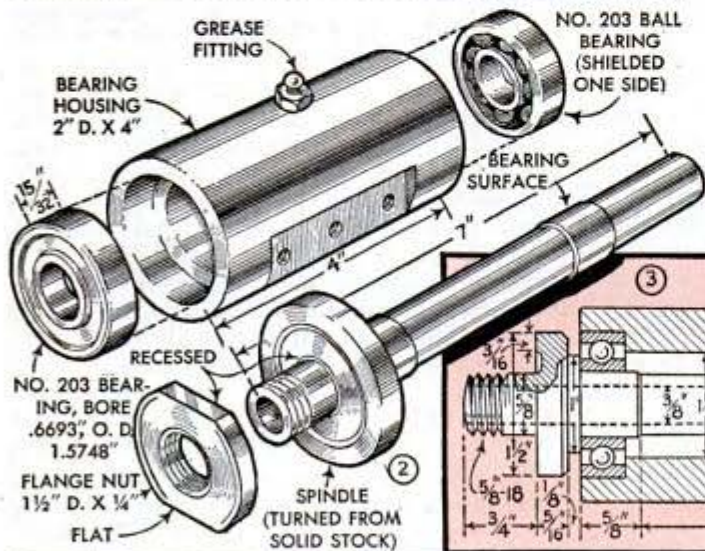



has a $\frac{3}{8}$ -in. hole from end to end, which should be reamed for a distance of about 2 in. from the flanged end in order to provide an accurate seat for the insert spindle. The hole should be drilled almost through from the flanged end as shown in photo Fig. 4, after which the work is reversed and drilled from the opposite end. A slight misfit is permissible since the insert spindle can be turned to fit. The important point is to have both ends accurately centered. For external turning, the bearing housing is mounted in a three-jaw chuck, after which a center rest is used and the center hole and outer bearing seat is turned to size. Without

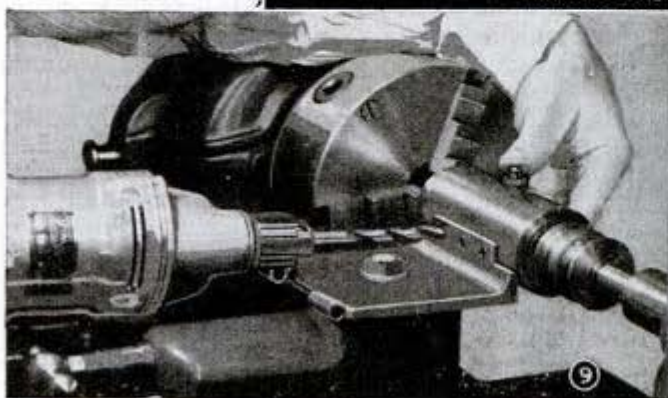
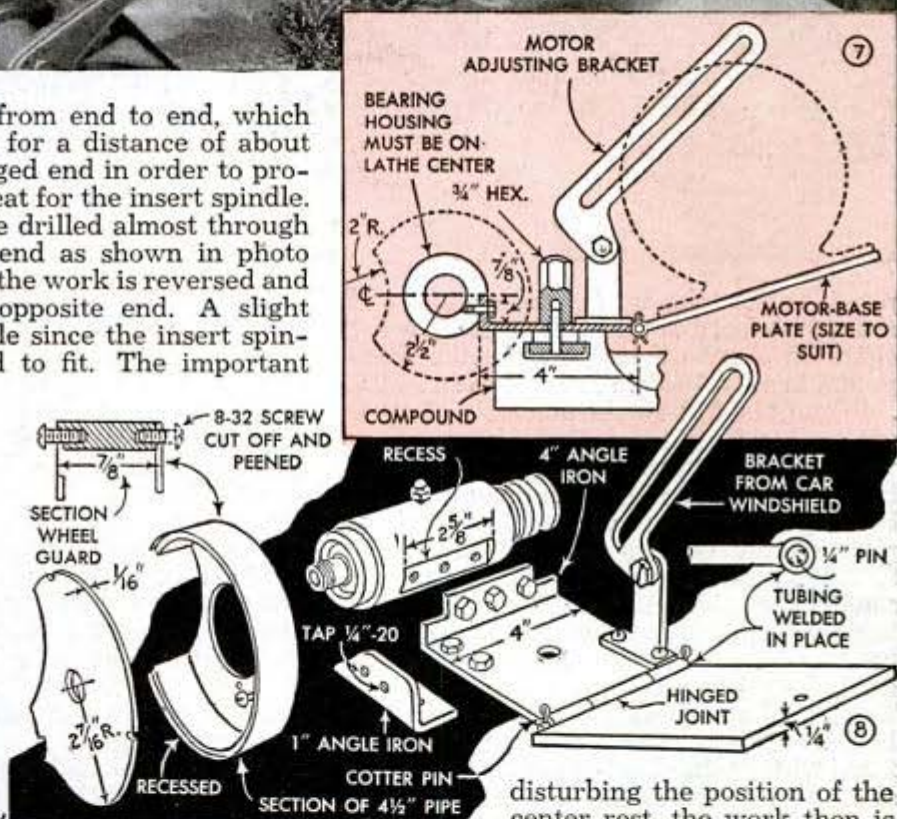

disturbing the position of the center rest, the work then is reversed for turning the bearing seat at the opposite end. Great care should be exercised in turning all bearing surfaces as the bearings must be a snug, press fit both inside the housing and around the spindle. Ball bearings recommended are No. 203 light duty, with shields on one side. These are standard size in any make and usually can be obtained at automotive supply houses. Bronze bearings may be substituted if desired. The drive pulley

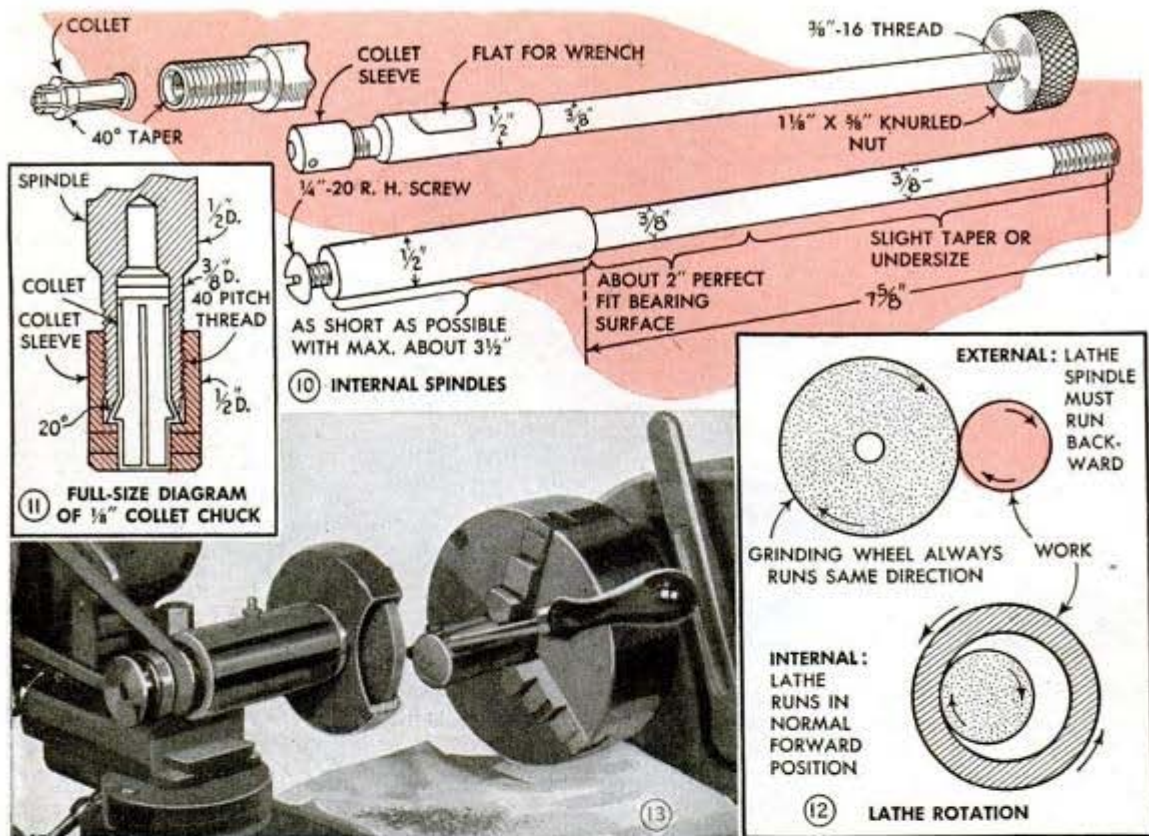

provides the take-up for the spindle and should be faced smooth. Belt grooves are cut with a cut-off tool, setting the compound to cut a 19-degree angle as in Fig. 5.

Figs. 7 and 8 show the assembly of other parts. It is apparent that the grinding wheel must come on the lathe centerline, hence care is necessary in mounting the bearing housing to the angle-iron base plate. Actual setting-up, as shown in Fig. 9, will locate the recess exactly, and the same set-up should be used for spot-drilling the tapped holes. The recess itself can be cut with a milling attachment, or can be ground straight across on a bench grinder. The grinding-wheel guard uses a short length of 4½-in. pipe as a frame, this being fitted with ¼-in. sheet-iron disks on either side. The guard is mounted to the 1-in. angle as shown in Fig. 8, using two, ¼-20 round-head machine screws, the heads of which are ground down to about ⅜ in. thick.

The motor should be no less than ¼ hp. Naturally, you will want the motor as small and compact as possible, but at the same time you need power. A standard ¼-hp. motor, while a bit on the bulky side, is perhaps the best from a performance viewpoint. Drive pulleys should be 4 and 6 in. The belt has a ⅜-in. face, 38-degree vee, with a circumference of about 25 in. The motor-adjusting bracket shown was obtained from an old model car; it works on

a machine screw threaded into the top motor end bell hole.

Insert spindles for internal grinding can be made up in any of a number of styles, the two shown in Fig. 10 being typical. The top spindle takes wheels with ⅜-in. shanks, and the bottom spindle requires wheels with ¼-in. hole. The collet chuck is perhaps the most useful since it utilizes the same grinding wheels used in the popular hand grinders. The collet and collet sleeve also can be obtained from the hand grinder. Fig. 11 shows this chuck full size. The same pattern, but in a larger size to take standard wheels with ¼-in. shanks, would make an excellent mounting for heavy internal grinding.

In using the tool-post grinder for external grinding on cylinders, the lathe spindle must be reversed, that is, it must run backward. This is accomplished with a standard reversing switch, which should be standard equipment on every lathe. When the job is internal grinding, the lathe runs in normal forward position, Fig. 12. Proper dressing of the wheel, preferably with a diamond dresser, is essential for clean smooth work. Dressing should be done mechanically, not freehand. A simple mounting for a diamond dresser is shown in Fig. 13. A somewhat similar mounting can be made for a square or round stick dresser, which can be used satisfactorily if a diamond is not available.

Safety Knife to Open Cartons

Workmen who have to open cardboard cartons frequently will find this knife handy, as it can be closed and carried safely in the pocket.

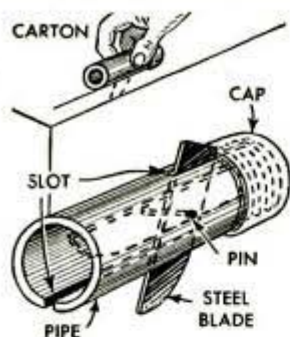

The knife consists of a steel blade pivoted inside a short piece of pipe as indicated, the pipe being slotted on opposite sides at the ends to receive the blade. In fitting the blade, pivot it so that the upper end projects just slightly when the blade is in the cutting position. In this way, two or three turns of the pipe cap at the end will permit the blade to swing inside the pipe where it stays until it is swung out and the cap tightened to lock it in the opened position.

Jig Aids in Grinding Jaws Of Universal Chuck

Truing up sprung jaws of a three-jaw chuck by grinding is a fairly easy job if a jig like the one shown is used to hold the jaws in alignment. However, be sure that it is the jaws that are sprung and not the scroll. First, drill three holes in a piece of plate metal, spacing the holes equally to fit over the outer ends of the jaws. Then bore out the center of the plate between the holes as indicated. Next, place the jig over the jaws and tighten them against the lower sides of the holes, which produces the same effect as tightening them against a piece of work. Now, with a grinder and wheel of suitable size mounted correctly on the lathe carriage as indicated, feed the wheel against the jaws by inserting it into the large center hole in the jig.

—Will D. Candee, Los Angeles, Calif.

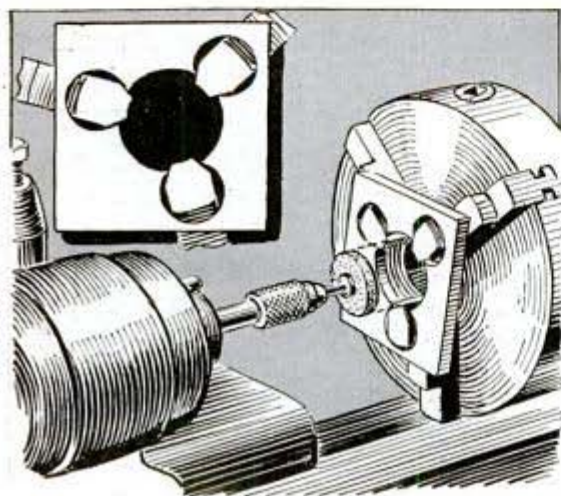

AUGUST, 1944

One Straight Double Stud Made From Two Warped Pieces



Badly warped studs and other small timbers often can be salvaged by nailing two of the warped ones together and using them where double studs are required. Place the warped pieces one on top of the other with the concave surfaces facing opposite directions. Then, drive a large nail at one end and have a second worker spring the warped ends together as other nails are driven. In most cases a timber thus formed will remain fairly straight.

—Frank Beatty, Chicago

Level Improvised on Straightedge

Needing a level on a job where none was available, one workman improvised one by using a plumb bob and a straightedge. A block 16 in. long was nailed exactly at right angles to the straightedge as indicated and the plumb bob was suspended from a screw eye at the upper end of the block. After marking the exact center of the block near the lower end, it was easy to tell when an object was level by bringing the line of the plumb bob directly over the mark on the block.

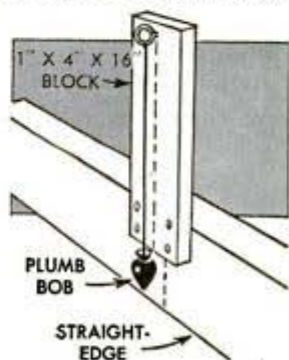

129

Auto-Muffler Clamp Is Handy On Drill-Press Column

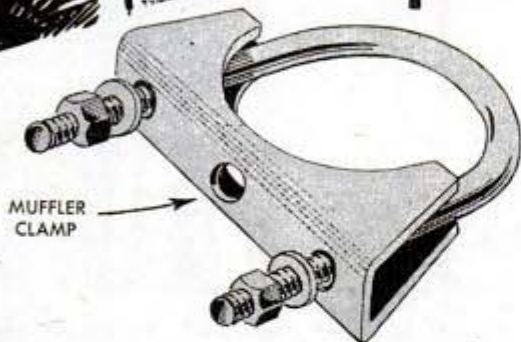

After trying unsuccessfully to purchase a clamp for my drill press to hold the head when swinging it out of the way, I found that a clamp of the type used on auto mufflers was ideal for this purpose. I use these clamps under the drill-press head and also under the table. In this way, I can swing either the head or table around out of the way without disturbing their vertical adjustment.—R. Boettinger, Englewood, N. J.

Artists' Symbol Stamps Save Time When Making Blueprints

Draftsmen who make up drawings of electrical circuits and do similar work can save time and assure accuracy by using

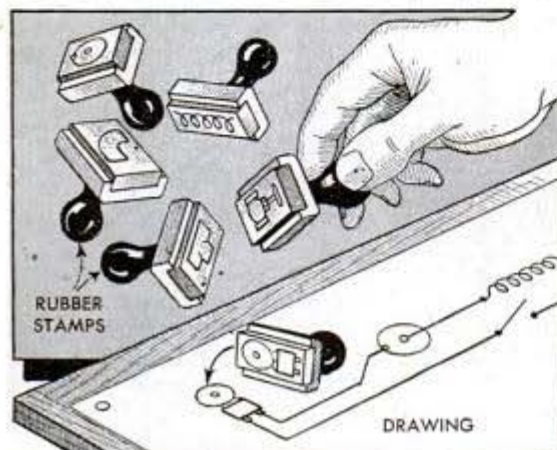

rubber stamps of the most common symbols used in their work. In this way, they can stamp the symbols in the desired locations on the drawing and then connect them with lines to complete the circuit or other drawing that is being made.

Knife Sharpener Removes Burrs From Edges of Sheet Metal

Used by the employes of a large aircraft company, an ordinary knife sharpener has been found very satisfactory for removing burrs from the edges of sheet metal. Besides performing an efficient job, the sharpener saves time by burring both edges in one operation.



Loss of Identification Badge Avoided With Nail Polish



The clasps on some identification badges are so easily disengaged that they are frequently lost. In such cases, a drop of cellulose cement or clear fingernail polish applied to the clasp as indicated will prevent this trouble. The cement dries quickly to a

hard film and can be peeled off easily when necessary to change the badge from one garment to another.

—Ken Murray, Baltimore, Md.

Hens Prevented From Roosting On Edges of Nests

If your chickens have a habit of roosting on the edges of the nests, the trouble can be stopped easily. Just notch the edge of the front retaining board. This will make it difficult for the chickens to perch on it and they will give up the habit.

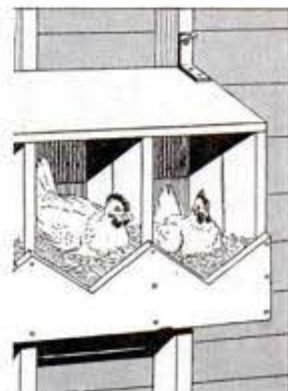

This Accurate Depth Gauge Is Easy to Make

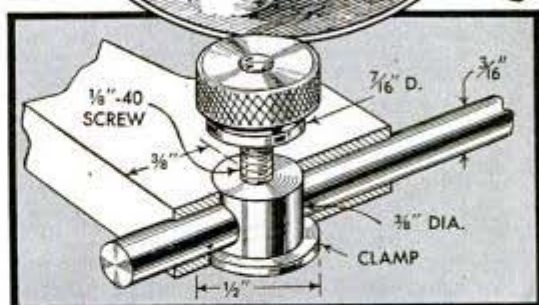
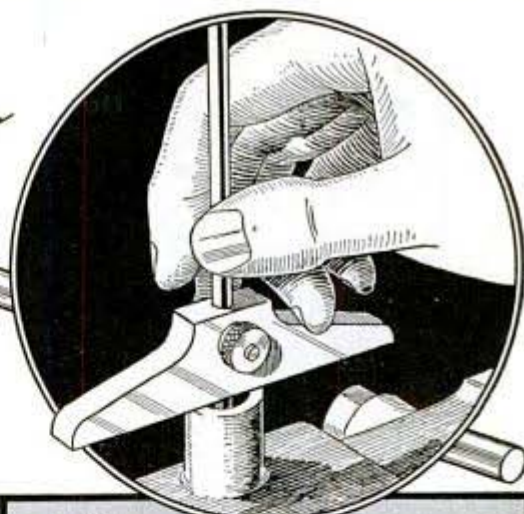
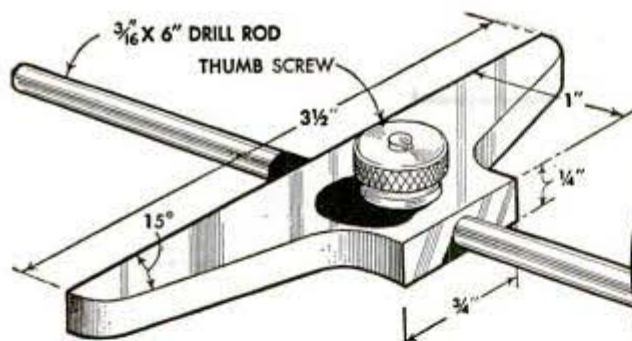

With this simple depth gauge you can set the spindle accurately and tighten it in place without nicking its polished surface or disturbing the setting, just by turning the knurled thumbnut which pulls up the flanged clamp against the spindle to hold it. After scribing the outline of the beam on a piece of cold-rolled steel, chuck the latter in a lathe and drill a $\frac{3}{8}$ -in. hole $\frac{1}{2}$ in. from the top, and counterbore it to a $\frac{1}{2}$ -in. diameter and a depth of $\frac{1}{32}$ in. for the clamp flange. Next, from a piece of drill rod, turn the clamp with a $\frac{1}{32}$ by $\frac{1}{2}$ -in. flange, and a projecting shaft $\frac{1}{8}$ by $\frac{5}{16}$ in. to form the bolt, and thread it as shown. The thumbnut is similarly turned to size, drilled and tapped for the clamp screw, knurled and cut off. Then the clamp is inserted in the beam with a thin piece of paper placed under the flange to allow for clearance, the hole for the spindle is laid out carefully on the beam end and drilled through both beam and clamp. When the

paper is removed from behind the flange there will be a clearance of several thousandths of an inch to allow the clamp to be pulled up tightly against the spindle when the nut is tightened and thus grip the spindle securely without marring it.

—C. W. Woodson, East Aurora, N. Y.

Aquarium Heater and Thermostat Checked by Pilot Light

If you have lost tropical fish due to failure of the heater or thermostat, you'll appreciate the value of using a pilot light in

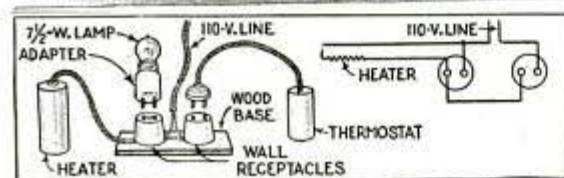
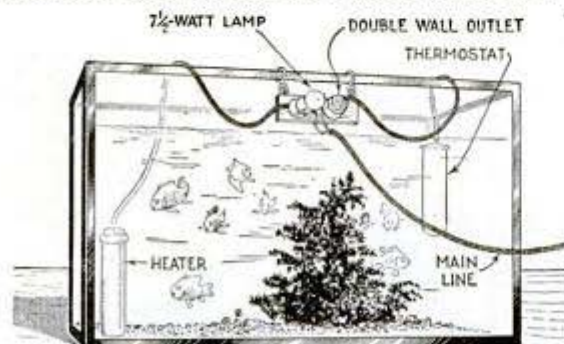

the line to determine at a glance when the heater and thermostat are operating correctly. Get a small lamp and a plug-in adapter socket, and two porcelain receptacles of the screw-on type. Wire these to your 110-volt circuit and aquarium heater as indicated in the lower right-hand detail, and attach the assembly to a wooden, plastic or fiber base. The thermostat cord is provided with a plug to slip into the right-hand receptacle and the socket holding the pilot lamp is plugged into the other receptacle, after which the assembly can be hung from the edge of the aquarium on the outside as shown. The lamp will light when the heater is working. If the lamp and heater do not function as often as necessary to keep the water at the proper temperature, the thermostat should be checked as it may be defective or may require adjustment. If the light is on continuously, the thermostat may be working correctly but the heater is not functioning.

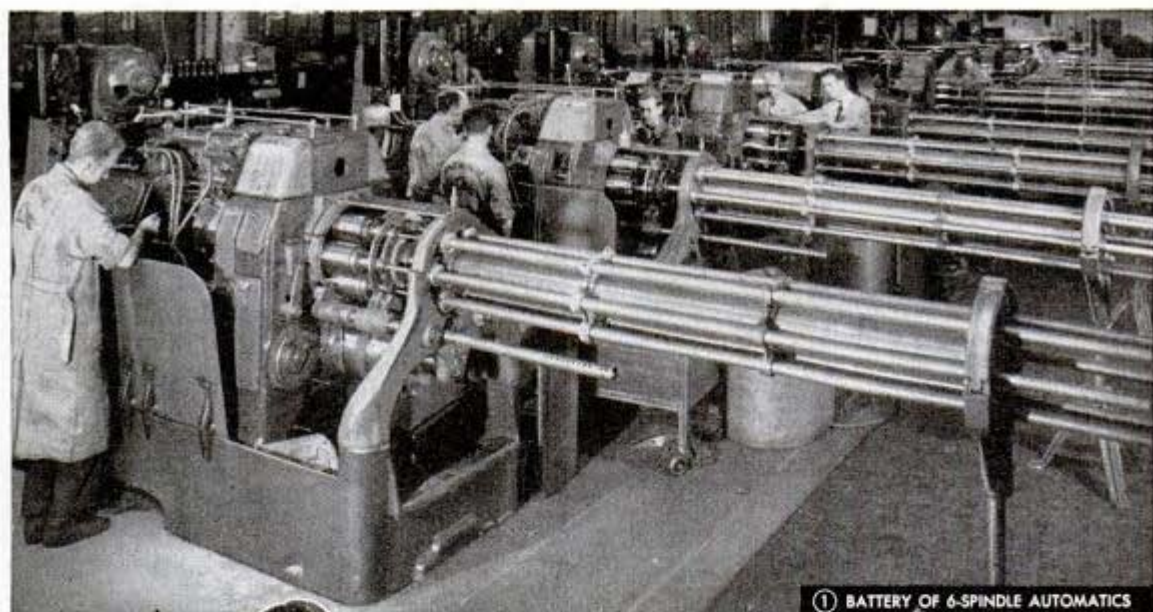

① BATTERY OF 6-SPINDLE AUTOMATICS

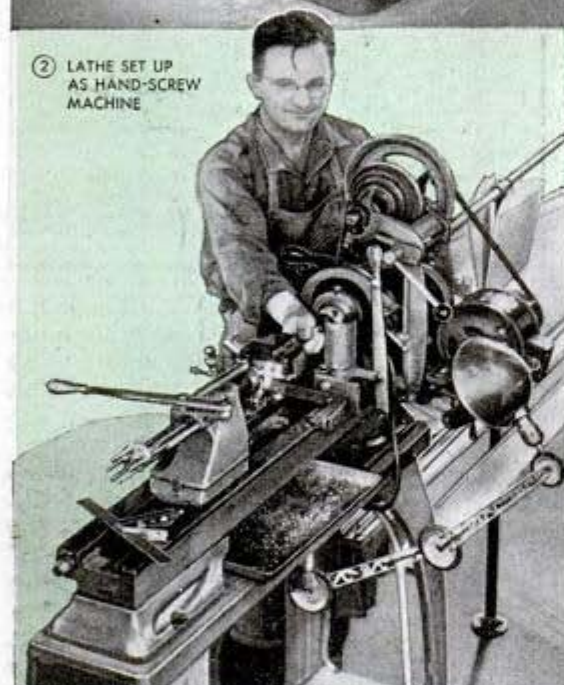

② LATHE SET UP AS HAND-SCREW MACHINE

THE automatic screw machine, originally nothing more than an automatic turret lathe, was first used, as its name implies, for making screws. However, after numerous improvements, this machine has become a complex multiple-spindle lathe used for producing amazing quantities of small turned parts of various sizes and shapes with a high degree of uniform accuracy and at a minimum cost. While some simple parts shown in Fig. 6, which require only a few operations, can be produced at the rate of 6,000 an hour, other parts requiring more operations may take 3 or 4 minutes to produce each.

Material from which the parts are made may be standard round, square or hexagon bar stock. The blank stock is automatically fed to the cutting tools which perform various operations on each piece in sequence. Speeds and feeds of the cutting tools to obtain economical operation



③ ONE-SPINDLE AUTOMATIC

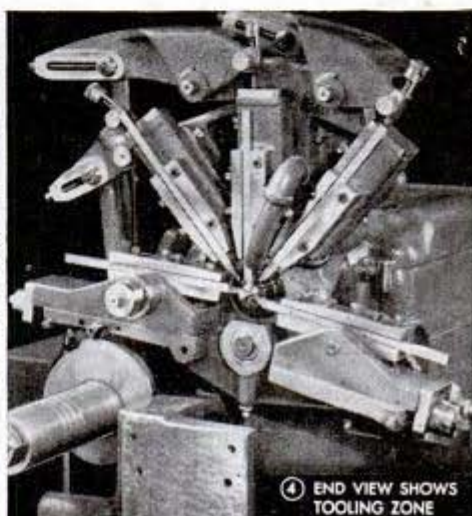

④ END VIEW SHOWS TOOLING ZONE

"Briefing" the AUTOMATIC SCREW MACHINE

By H. J. Chamberland

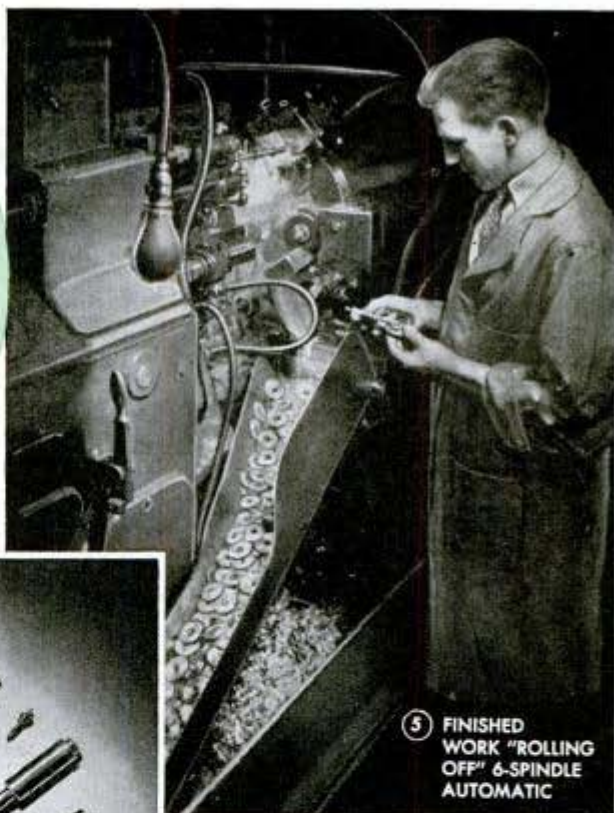

5 FINISHED WORK "ROLLING OFF" 6-SPINDLE AUTOMATIC

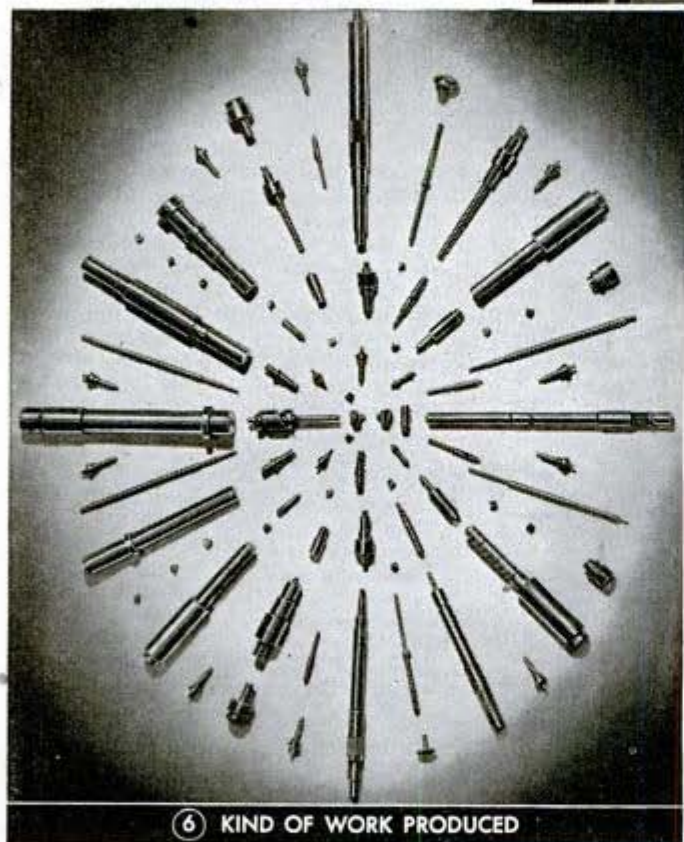

6 KIND OF WORK PRODUCED

also are varied automatically. Each spindle of a multiple-spindle screw machine holds a bar of stock and the cutting tools are fed forward against stock held in opposing spindles. After finishing its cut, each tool returns to its starting position and the work-spindle carrier or head rotates so that each bar of stock is brought to the next cutting position. After turning, drilling, reaming, counterboring, threading and other operations are performed, the finished piece is cut off. So, on an eight-spindle screw machine a piece of finished work is dropped off with each change of

indexing of the spindle carrier—or eight pieces in a complete rotation. Fig. 1 shows a battery of six-spindle automatics while Fig. 5 shows how finished parts "roll off" such a machine in prodigious quantities. Generally the parts are produced with an average tolerance of from three to five one-thousandths inch, but for high-precision work it is possible to work within limits of two to five ten-thousandths inch.

Turret-fitted lathe: Fig. 2 shows a small engine lathe equipped with a turret, which is the forerunner of the present screw machine. This setup differs from a regular turret lathe in that bar stock for the former is inserted through the headstock and is gripped securely by means of a spring collet. Regular turret-lathe work applies to the machining of blanks already cut off from large-diameter stock, or else forgings or castings, which are held in jaw chucks, chucking devices and on faceplates.

Single-spindle automatic: This machine, Fig. 3, is the stepping stone between the original turret-fitted lathe and the multiple-spindle automatic. The end view, Fig. 4, shows five positions for tools to machine externally. When drilling, reaming, screw-cutting and tapping attachments are re-

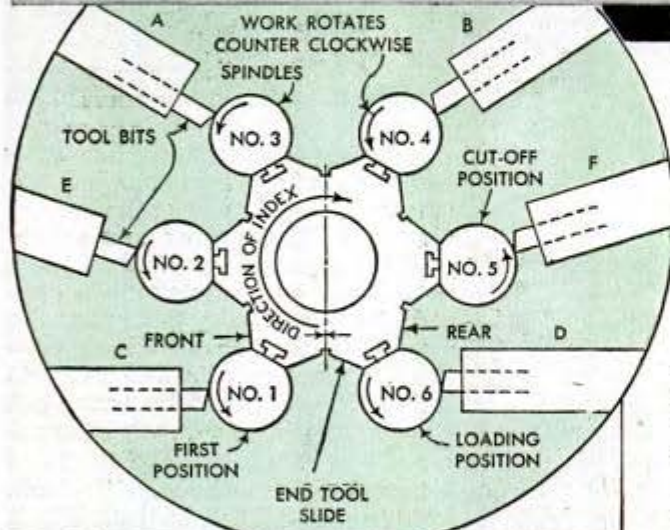
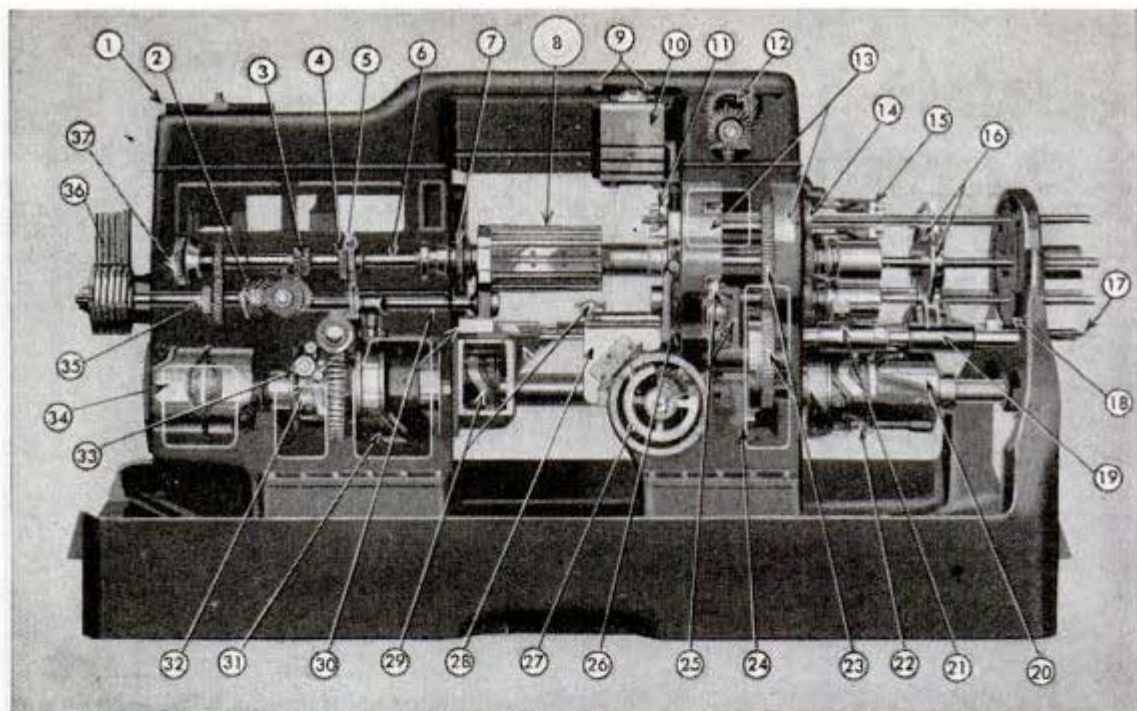

7 DETAILS OF 6-SPINDLE AUTOMATIC

- | | |
|---|---|
| 1—Motor plate | 21—Chucking slide |
| 2—Oil pump drive | 22—Chucking drum |
| 3—Threading sprockets (or gears) | 23—Indexing gears for spindle carrier |
| 4—High speed drilling drive | 24—Indexing arm for spindle carrier |
| 5—Feed clutch lever | 25—Lacking pin and lever for spindle carrier |
| 6—Spindle drive shaft | 26—Side slide stop bracket and stop screws |
| 7—Idler gear for high speed drilling attachment | 27—Lower side slide drums |
| 8—End tool slide | 28—Lower side slides |
| 9—Upper side slide drums | 29—Drum operated sliding stock feed stop |
| 10—Upper side slides | 30—End tool slide pusher and guide |
| 11—Spindle collet and pusher | 31—End tool slide drum |
| 12—Intermediate side slide drum drive gears | 32—Drum for high speed clutch, threading clutch and brake |
| 13—Spindle carrier | 33—Worm wheel drive shaft brake |
| 14—Spindle gears | 34—Threading slide drums |
| 15—Finger holder mechanism | 35—Range gears |
| 16—Stock feeding ring and aligning disc | 36—Main drive |
| 17—Stock feeding spring | 37—Spindle speed and feed change gears |
| 18—Stock reel index | |
| 19—Stock feeding slide | |
| 20—Stock feeding drum | |

8 END VIEW OF SPINDLE-CARRIER ASSEMBLY

quired they are bolted to the vertical section of the bed. While this type of machine is limited to small-diameter bars, the machining and stock-feeding cycle is fully automatic, each individual tool being timed to take a particular cut. Once the machine has been set up to requirements, all the operator has to do is to insert the stock.

Arrangement and operation of multiple-spindle automatics: The number of spindles (4, 6 or 8) on an automatic screw machine limits the diameter of bars that the machine will accommodate. A 4-spindle machine takes bar stock $\frac{7}{8}$ to $4\frac{3}{4}$ in. in diameter, a 6-spindle takes $\frac{9}{16}$ to $3\frac{1}{2}$ in., and an 8-spindle $1\frac{5}{8}$ to $2\frac{5}{8}$ in. The machines shown in Fig. 1 are 6-spindle units which are most generally used. In study-

ing Fig. 7, which shows the rear view of a six-spindle screw machine, note particularly the location of the end-tool slide, 8. Its relation to the side tooling zone is shown in Fig. 8. A and B are upper side tool slides, C and D are lowers and E and F are intermediates. Tool slides A, E and C function from the front side of the machine

while B, F and D function from the rear. The spindle locations are referred to as working positions and are indicated numerically from 1 to 6 in Fig. 8. Spindles revolve to the left or counterclockwise as viewed from the rear end of the machine. They are driven by gears on each spindle from a central gear on the drive shaft which runs the entire length of the machine, passing through the spindle carrier and its stem.

Bars are loaded into each spindle after indexing the above assembly to No. 1 position. Automatic feeding takes place at the No. 6 position. Then the spindle carrier indexes by steps to bring the bar of stock in each spindle successively into line with the various tools held on the end and side toolslides. The indexing occurs when all cutting tools have been withdrawn from the work.

Drilling, reaming, counterboring, screw-cutting and tapping operations, including all customary turning operations, are done from the end tool slide. Provisions are made for the use of die heads and collapsing taps. High-speed drilling attachments also are used regularly and in this case some of the spindles are idled by means of a stopping mechanism. Slotting and cross-milling are operations frequently executed in these machines. All peripheral speeds, timing, depth of cut and amount of feed for each cutting tool are dependent on a network of gear combinations and cams

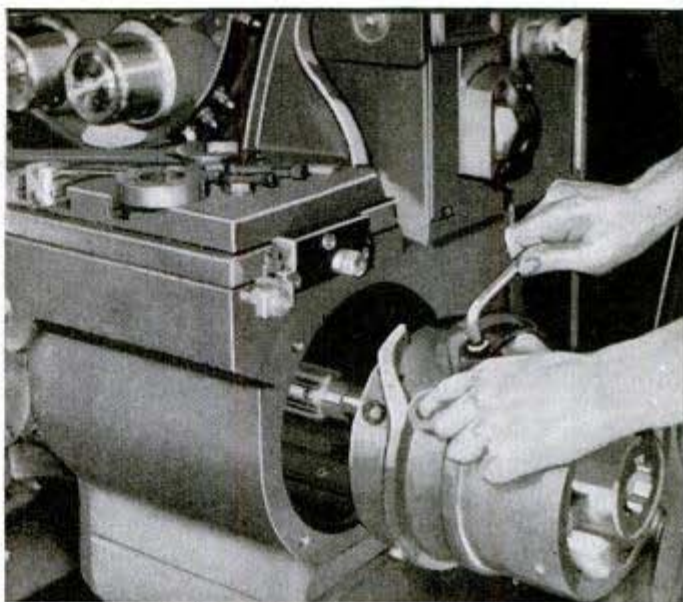

9 ADJUSTING CAM OF SIDE SLIDE

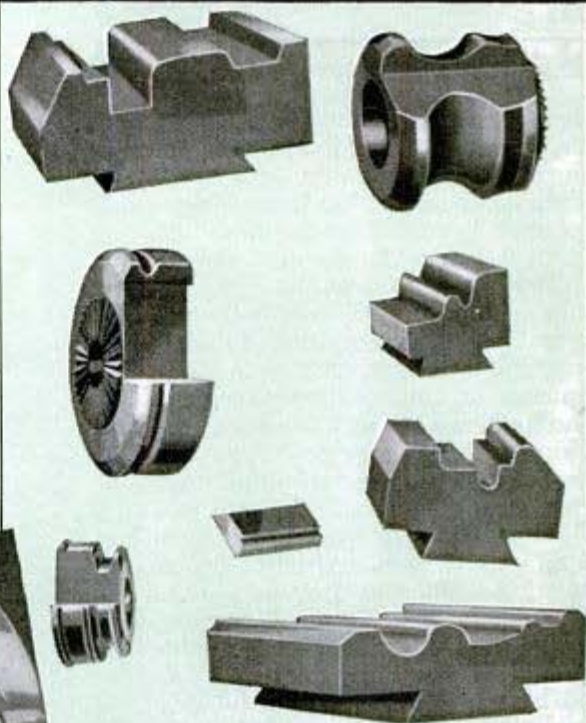

10 DOVETAIL AND CIRCULAR FORMING TOOLS



12 TOOL OUTLINE GROUND IN PLAIN SURFACE

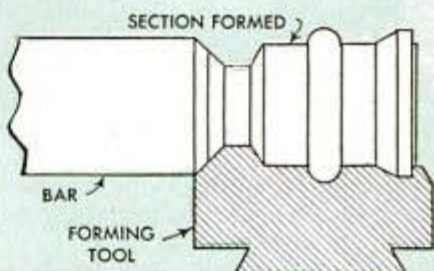

11 HOW FORMING TOOL FUNCTIONS

13 SHARPENING CIRCULAR TOOL ON HORIZONTAL DIAMOND DISK



14 COLORED TIPS IDENTIFY TOOLS

distributed all over the machine. For example, refer to Fig. 9 where the drum related to the rear lower slide has been pulled from the pilot shaft to adjust the cam that will control that particular cutting tool.

Tooling requirements: One advantage of a multiple-spindle automatic is the possibility of dividing long cuts between two or more operations, thus reducing the time the tools are at work for each machining cycle. For example, one tool can be placed behind another in the same T-slot of the end tool slide to perform operations on long work such as drilling and turning at the same time and in the same spindle position. When the design of a piece involves numerous operations, they can be divided between the end and the side tool slides, and may include both roughing and finishing tools in successive positions so they work on different bars simultaneously.

All types of lathe cutting tools are used in screw machines with no change in grinding requirements. However, with multiple-spindle production, dovetail and circular forming tools predominate as they reproduce an external outline which would otherwise require several cuts with different tools. Typical examples of dovetail and circular tools are shown in Fig. 10. Fig. 11 shows how these

forming tools function, the one shown being a dovetail tool. A roughing and a finishing tool are used frequently simultaneously to avoid retarding other cuts of the cycle. As forming tools are intended for quantity production, a master tool is made first and the working tools are duplicated as needed. In some cases, as shown in Fig. 12, the outline of a dovetail tool is produced by grinding on a straight surface after the tool has been otherwise machined and hardened. This applies to a form where the deepest section is less than $\frac{3}{16}$ in. Fig. 13 shows the cutting edge of a carbide-tipped circular forming tool being sharpened on a diamond-impregnated, horizontally-operated disk. A large number of carbide-tipped cutting tools like the one shown in Fig. 14 are used with screw machines. There are various grades of tips to suit different cuts and materials, and as a safeguard against using the wrong tool, tips are available in different colors. After brazing the tip to the body, the color shown in A is painted on the body at B to assure selecting the proper tool once the color on the tip is ground off.

15 TYPES OF TOOL HOLDERS AND ACCESSORIES

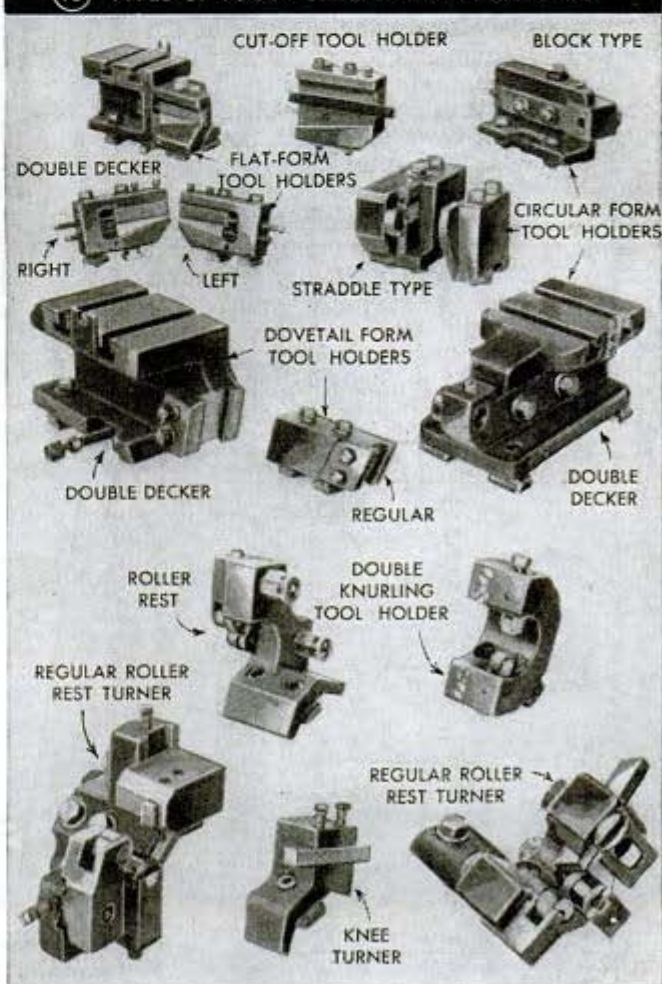

Forming tools require an assortment of tool holders such as shown in Fig. 15.

Setting up a six-spindle automatic: Where batteries of these machines are operated, a number of units are assigned to a set-up man especially trained for this work only after years of operating experience. A good set-up man is a combination toolmaker and machinist who is versatile in tool and machine construction. In most screw-machine shops it is customary for the engineering department to

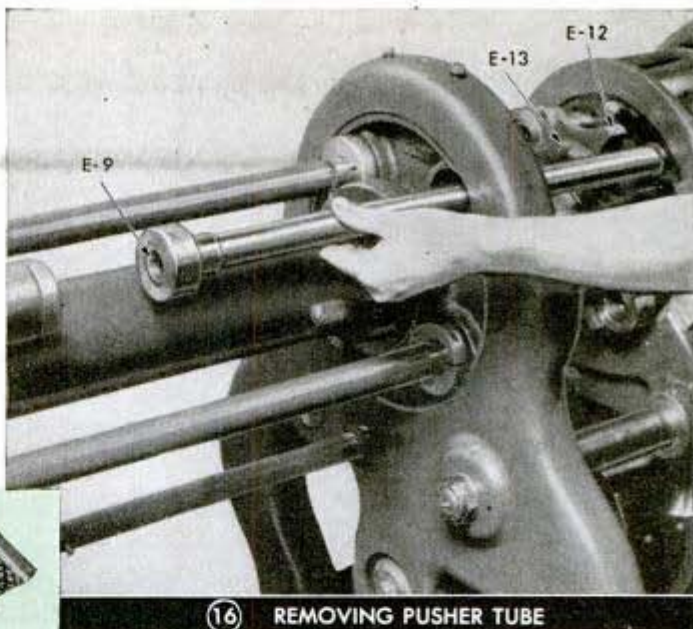

provide a drawing of each part to be machined and its dimensions. Also specified are the spindle speed for the job in revolutions and surface feet per minute, the related gearing, feed change gears, cam adjustments besides all tool holders, cutting tools and other requisites with their respective position in the tooling zone. This information is of great assistance not only to the set-up man, but also to the operator.

The primary step is to fit and adjust the six collets and pushers that automatically grip and feed the bars. Rather than use plain collets it is most economical to select a master type collet as shown in detail A of Fig. 17, in which case it is only necessary to change pads and the same collet can serve for various sizes of bar stock. As collets only chuck the work, master pushers shown in detail B advance the bar after each index and at the 6th or "loading" position. Pushers, often called feeding fingers, grip the bar just enough to carry it the required distance. To fit pushers or the pusher pads only, pusher tubes are removed one at a time by rotating guard disk E-13 of Fig. 16. E-12 is an aligning disk and E-9

is a spool bushing which is used on the end of all pusher tubes.

To change collets, each spindle must be indexed to the 1st position. The finger holder is released with the hand chucking lever H in Fig. 18, and the nut collar C-12 is screwed off to pull the tube through the spindle nose far enough to remove the collet thereon and substitute one of required size. The next step consists of installing all spindle-speed and feed-change gears as specified in the instruction sheet. The cam T on the stock-feeding drum D-4 is set to regulate the advance of each bar at the 6th position. E-12 is the aligning disk and E-13 the guard disk also shown in Fig. 16. Fig. 19 shows how the stock-feeding slide is located on the high point of the cam T of Fig. 18. The high point of the cam is put in line with roller E-10 of Fig. 19. This is accomplished by loosening screw E-11 and pushing the aligning disk E-12 and the stock-feeding ring E-2 forward. Then the various side-slide and end-slide cams are adjusted according to instructions. The speed at which the cams revolve and their contour govern the timing and depth of cut for each position. Fig. 20 shows setting the cam on the end tool slide drum.

As previously stated and shown in Fig. 8, loading is done at the 6th position. This is where each bar is advanced by a pusher. The first side and end cuts therefore take place at this position and the second cuts are made at the 1st position, and so on. Once the cycle is in order and the machining is being started at the 6th position, a completed piece is cut off the bar at the 5th position although it was actually completed at the 4th position. Fifteen or twenty simultaneous operations often occur



(18) COLLET ADJUSTMENT MECHANISM

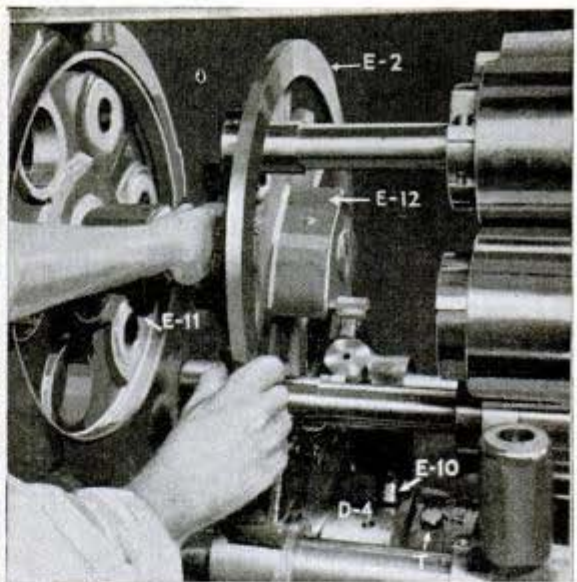

(19) LOCATING STOCK-FEEDING SLIDE

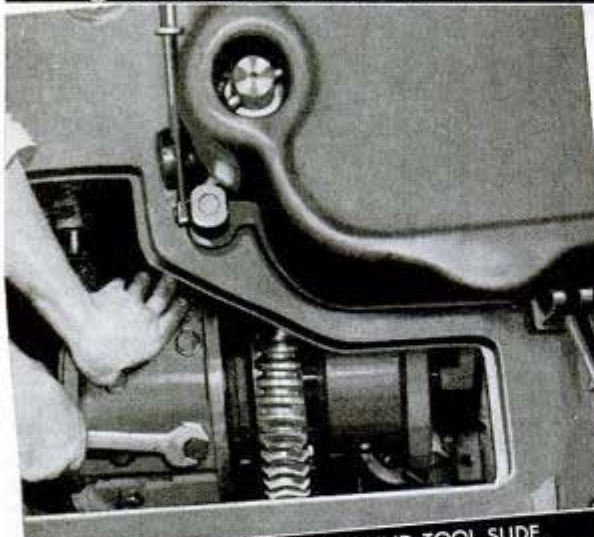

(20) ADJUSTING CAM ON END TOOL SLIDE

during the cycle which might consume but a few seconds. As a typical example, take the part shown in Fig. 21. This item required 45 pieces of tooling such as collets, pushers, spool bushings, cutting tools, rests and tool holders. It was produced at the rate of 336 pieces an hour. At the 6th position, the part is rough-formed at A and spot-drilled at B. At the 1st position it is finish-formed at E, faced at C and partly drilled at D; at the 2nd position it is drilled through at F. At the 3rd position, shaving tool G smooths the cuts A and E while a combination counterbore-reamer H goes to work. In the 4th position the part is being tapped (I) about $\frac{1}{4}$ in. deep and in the 5th position it is cut off (J). With screw-machine production, it is important that both the work and cutting tools be kept flooded with high quality coolants.

(21) TOOLING SEQUENCE

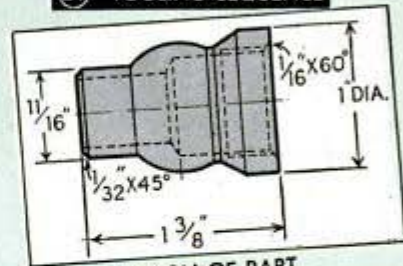

DESIGN OF PART

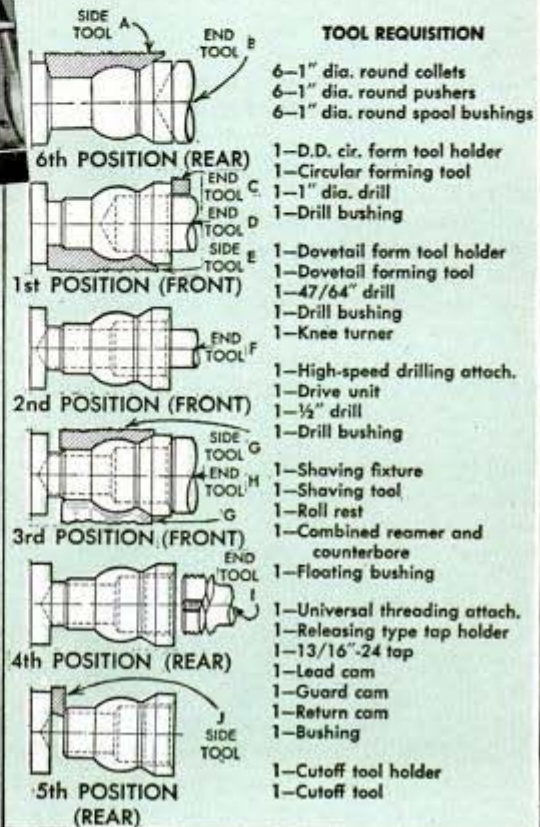

Jointed Soldering Iron Handy in Tight Places

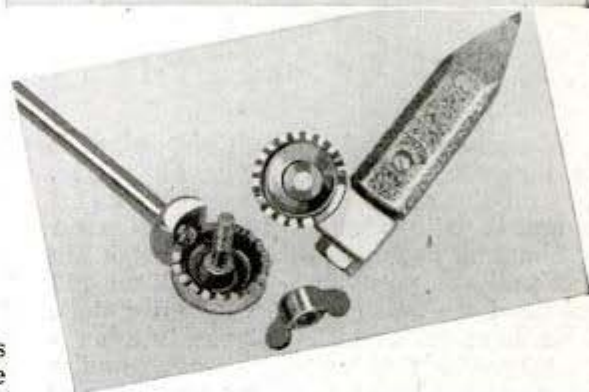
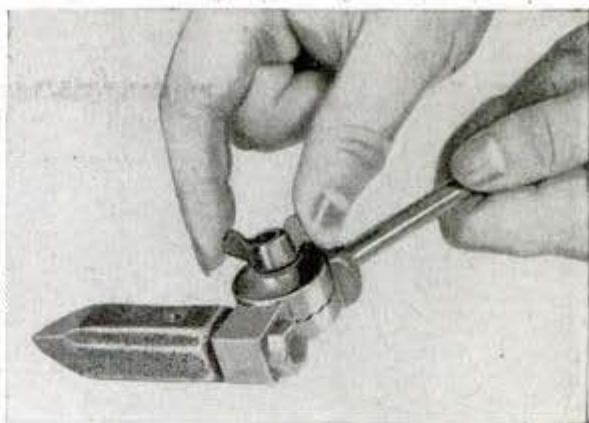
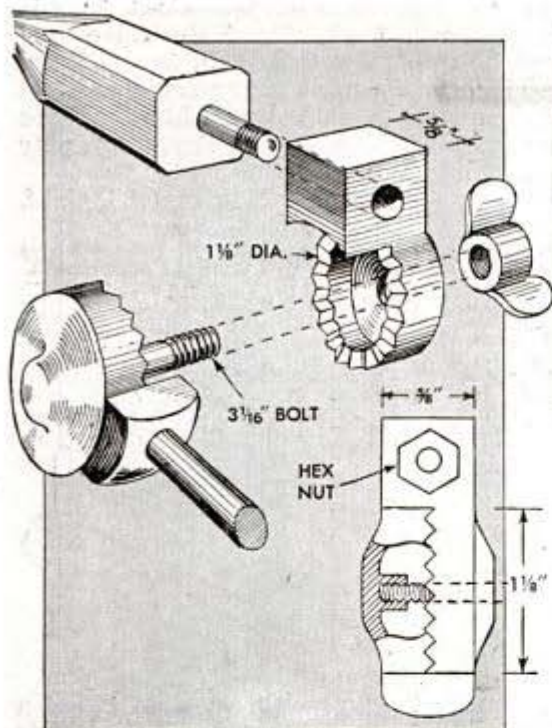

To solder those hard-to-reach places where space is limited, tinner's will save much time and effort by using an iron with an adjustable head like the one illustrated. The swivel joint from an old bridge lamp is just the thing for this purpose. Saw through the shaft of the iron and thread the head end to take a retaining nut. The other end of the shaft should be threaded to fit the swivel where it was screwed to

the lamp frame. If you can't get the serrated parts, you can use ordinary shafting and depend on friction between the contacting flat surfaces to hold the parts together firmly. If the flat surfaces are roughened with a file, they will grip better.

-F. T. Brown, Chicago.

Dolly Saves Heavy Lifting When Changing Truck Tires

Noticing that mechanics in garages often used a dolly to aid in changing heavy truck tires, one driver adapted the idea to help when changing a tire on the road. The spare tire was carried on the dolly, which worked on a track between the body sills as indicated in the upper detail. Although not shown, two bolts through the track and dolly held the latter in place. With this arrangement, the spare tire is merely pulled out with the dolly, after which the latter is used as shown to remove the flat tire and put on the spare.

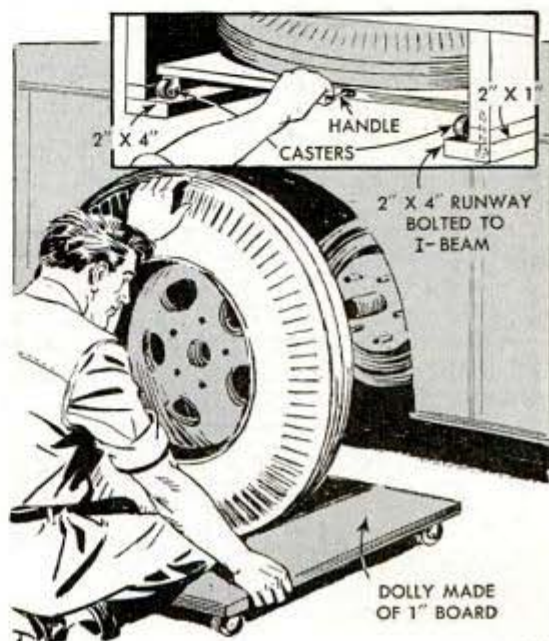

Clean Screen Stops Bearing Leak

Common cause of V-8 main bearing leaks is the breather-cap screen, which often plugs up with dirt, causing pressure in the crankcase that may make leakage in front or rear main bearings. To avoid this difficulty keep the screen well cleaned, and if it has rusted, replace it.

How to Mount Your Bench Vise To Make It More Useful

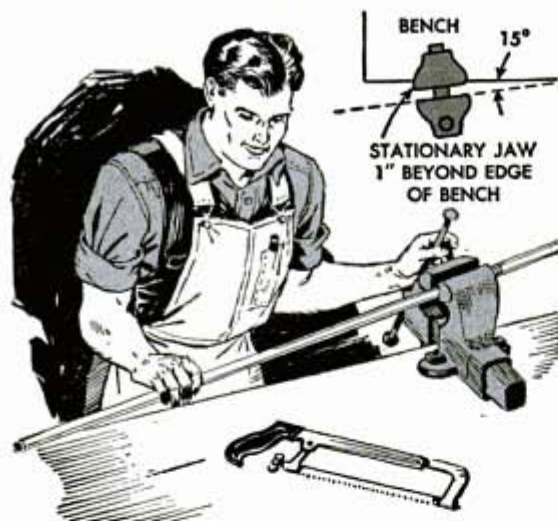

When you mount a bench vise, place it so that the stationary jaw extends 1 in. beyond the edges of the bench, and also mount it so that the jaws are at an angle of about 15 degrees to the bench edge. In this position, you can stand work on end on the floor and still grip it in the vise. Also, long work can be gripped in a horizontal position with one end resting on the bench. This keeps the long overhanging end of the work from dropping to the floor every time the vise is released to readjust the work.

—S. C. Moore, Niagara Falls, Ont., Can.

Melons Set on Dirt Mounds Have Uniform Color



One farmer avoids decay and uneven ripening of melons or squash by placing them on mounds of earth while they are still green. This exposes the greatest area of the melon to the sun and air, and leaves but a small

space in contact with the soil. Also, the mounded soil dries out quickly after a rain so that the melon is not resting on the wet ground which may cause it to rot.

Correct Firing Order of Motor Determined With Oil

A few drops of oil in the spark-plug sockets, after loosening the plugs, makes it easy to determine the firing order of any motor. When the motor is cranked slowly,

the oil will bubble in the sockets as each piston comes up on the compression stroke, at the top of which the plug fires. This is much easier than taking off the valve cover, when no reference book is available, and is certainly much easier than a random trial-and-error method, considering there are many combinations for the firing order of an internal combustion motor.

—Marceille Conklin, Ojai, Calif.

Oversize Socket Wrench 'Padded' For Use on Small Work

I recently had a set of spark plugs to install and the only wrench available was slightly large. To make the wrench fit the plugs, I drilled holes through the flat sides and put in split rivets and flattened them.

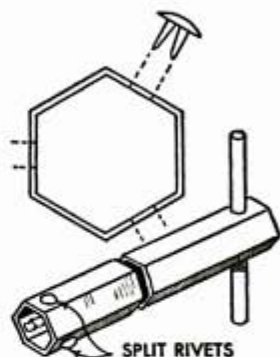

This made the wrench a little small, but a few strokes with a file reduced the rivets so it would fit. If the wrench is needed for larger plugs the rivets can be removed easily.—Hollis D. Hatch, Wollaston, Mass.

Plant Duster Fitted With Cone Assures Better Coverage

To assure better coverage of plants and to avoid waste of dusting materials, one farmer fitted a paper cone to the nozzle of his dusting gun as shown. The cone must be large enough to fit part way down over the plant so that the dust is confined and not permitted to spread in the wind.





Panoramic Receiver the "Electronic Detective"

By Cyrus T. Read, W9AA

ONE of the many important wartime duties of the cathode-ray tube is the detection of illegal transmitters operated by enemy agents. Used in an adapter unit connected to a Hallicrafters type SX-28 communications receiver, this tube makes visible a 100-kilo-cycle section of the radio frequency spectrum and permits the operator of a monitoring station to observe simultaneously all transmissions in that portion of the wave band. Weak signals from illegal stations that could easily be missed in the noise and "static" of normal loudspeaker reception are plainly visible on the cathode ray tube screen.

Racked as shown in photo (A) the panoramic adapter unit (B) is mounted above the receiver; a small part of the output of the receiver's first detector is fed into the input of the adapter through a coupling resistor. Connections are quite simple, as shown in rear view photo (C). The signal to which the receiver is tuned appears as a glowing inverted "V" in the center of the cathode ray tube's screen. In addition, all other signals up to 50 kilocycles on either side appear as illustrated in the inset sketch of the tube screen. As the receiver is tuned, the signals move across the screen so that the station being received always appears in the center, or zero, position.

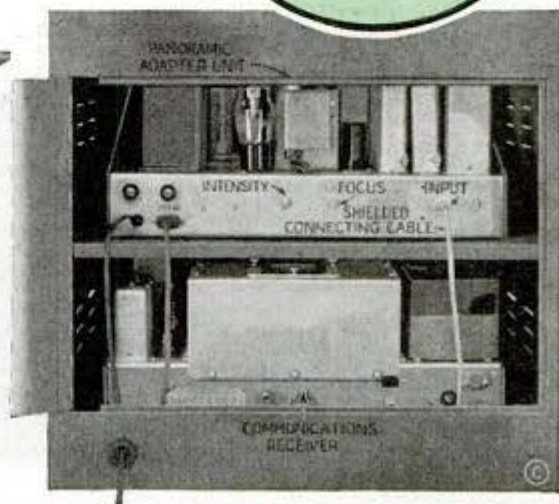
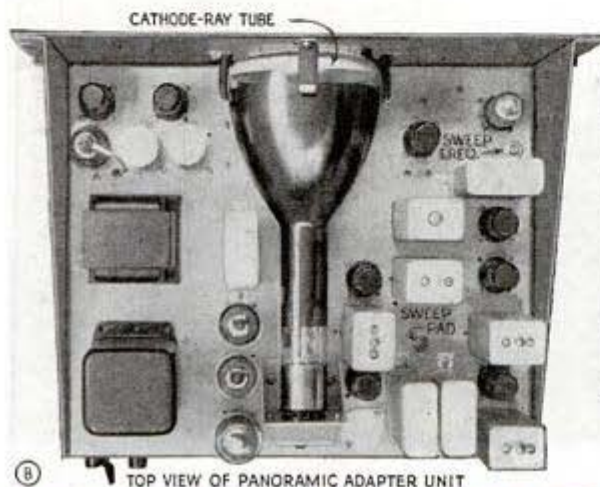
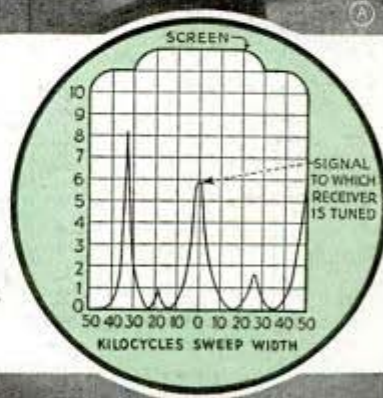

DUAL PHONO UNIT HAS

By Arthur I. Rattray—Part I



MOST home movie makers have at some time or other desired to have an appropriate musical background for their pictures, and also a means for describing the scenes being presented. The dual record player illustrated meets all of these requirements and includes electronic controls for fading the records and microphone in and out. Two-pole, 3-position switches are employed for dubbing in sound-effect records, and hooded pilot lights are provided.

In one split case there are two phono turntables with their respective pickups, a high-gain amplifier with push-pull audio; three channels for electronic mixing; two phono channels and one "mike" channel. Both sections of the case fold together into one compact unit; the P.M. speaker and its connecting cable fit into another portable case. The materials except the large case and a few accessories, such as the 35c "night lamps," came from a well stocked radio experimenter's junk box. The phono motors and turntables were salvaged from old record players. Each motor has its own switch (SW3 and SW4), and SW5 is the master switch. The "mike" channel has very high gain and its volume can be varied without dis-

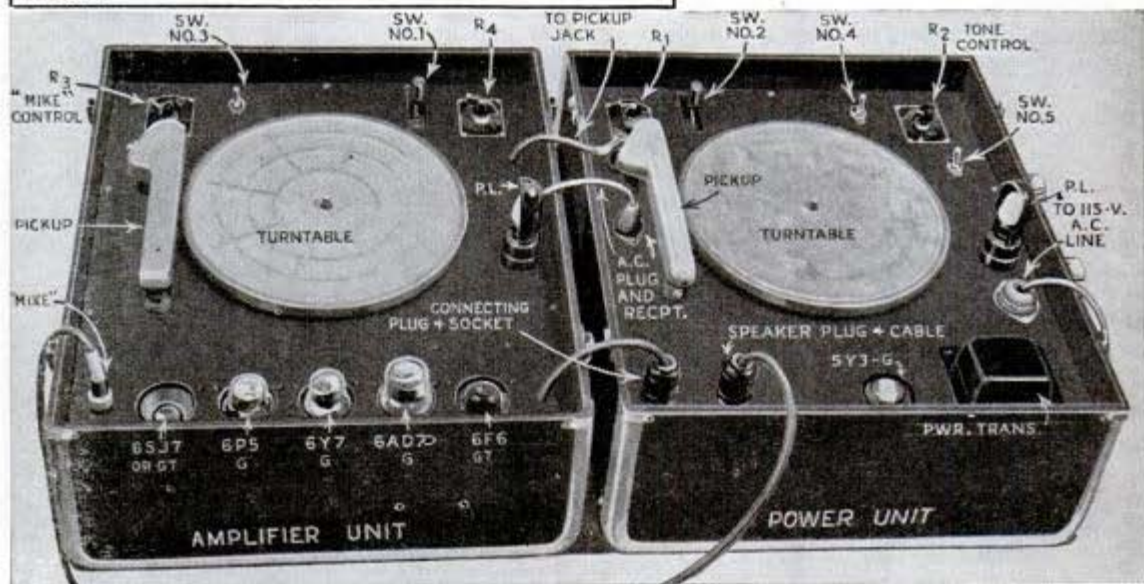
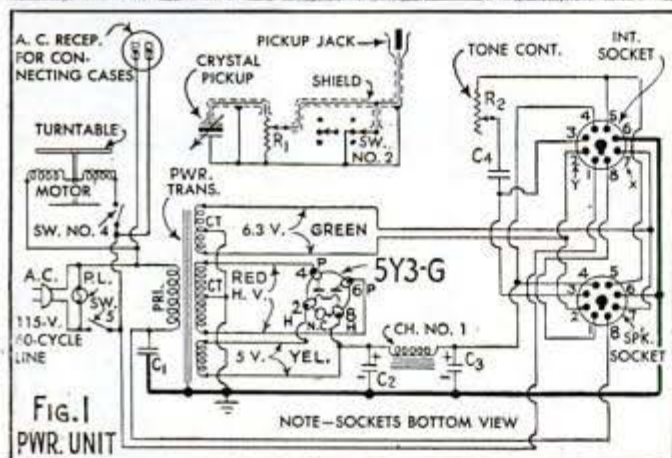

SELF-CONTAINED AMPLIFIER

turbing the volume of the phono channels.

Although not designed for radio beginners, there is nothing particularly difficult about the construction. The schematic circuit diagram for the power unit section appears in Fig. 1. Pictorially presented in the underside view Fig. 2, all wiring is clearly shown. The power transformer is a common broadcast receiver type; 600-volt center-tapped secondary at 120 ma.; 5-volts at 3 ma.; and 6.3 volts at 5 ma. Choke No. 1 is a common filter type (8 henries, 120 ma., 250 ohms.) Outside measurements of each case section are: 16½ in. wide, 18½ in. long and 6¾ in. deep. Wood cleats support the panels 1½ in. below tops.

(To be continued)

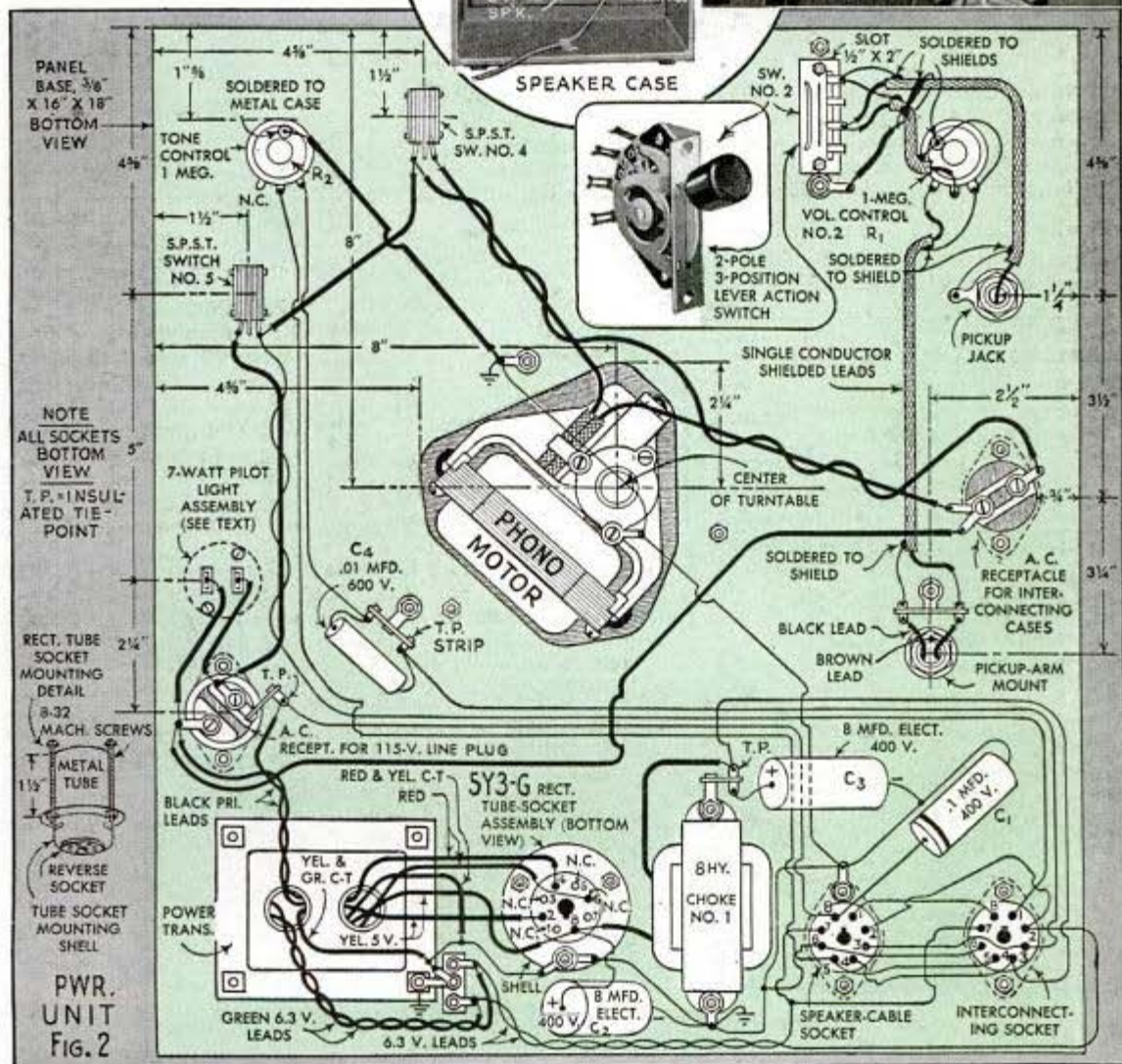
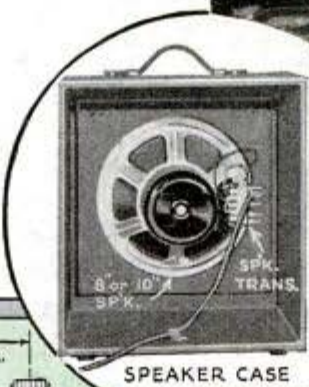

Helpful RADIO SUGGESTIONS



(A) Handy drill chart tells at a glance exactly which drill size to use for clearing certain sizes of machine screws used in radio repair work; also for correct size holes to permit tapping in steel or brass. Use next larger size drill for tapping Bakelite or similar composition materials. Drills kept in a numbered stand are always ready for use

DRILL CHART FOR RADIO USE			
Drill Number	Diameter Inches	Clears Screw	Correct for Tapping Steel or Brass
2	.221	12/24	—
10	.193	10/32	—
16	.177	—	12/24
18	.169	8/32	—
21	.159	—	10/32
25	.149	—	10/24
28	.140	6/32	—
29	.136	—	8/32
33	.113	4/36	—
35	.110	—	6/32
39	.100	3/48	—
42	.093	—	4/36
45	.082	—	3/48

(B) When only one section of a multi-section electrolytic condenser "burns out" do not discard the entire unit, simply replace the defective section with a compact single unit "Atom" type dry electrolytic condenser of the same capacity and voltage rating. Mount and connect as shown in sketch; new positive lead "C" replaces defective section "A"

(C) Electric soldering iron has a machined well and groove which can be filled with solder thus freeing one hand to hold work

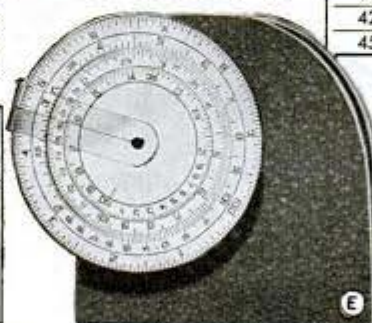
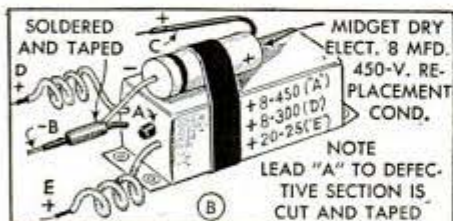

(G) Tab-type wire markers for identifying very fine wires or small diameter radio conductors; (H) Stainless steel tube clamps mount on chassis for locking radio tubes securely in mobile radio apparatus subject to extreme vibration stresses



(D) Leather tool holder for radio workers belt, has numerous pockets; (F) Seven-point switch made from an octal tube socket, may be used in crystal receivers or test sets to substitute for tap switches

(E) Vest-pocket slide rule for quickly solving problems in multiplication, division and proportion

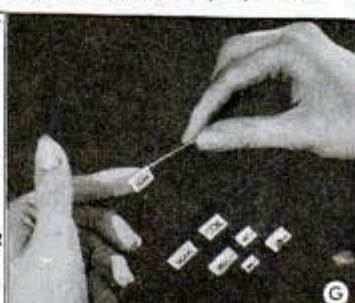
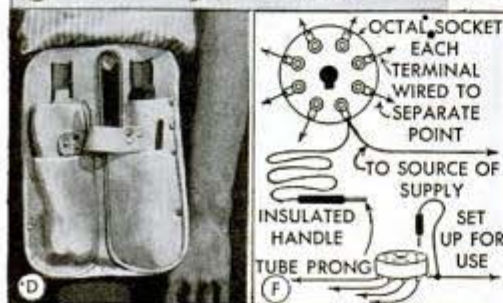

Here's how your car

FEELS...



... after

MARFAK

chassis

lubrication!

You're in clover in more ways than one with a MARFAK chassis lubrication job. Your car loses that old lopy feeling, takes on velvety smoothness and new handling ease. And it's efficiently protected against wear by tough, long-lasting MARFAK that has been applied by *chart* not by chance. Every point of wear, every point of adjustment gets a going over . . . from control arms to rear shackles. Ask your Texaco Dealer to give your car that "MARFAK feeling" — now!

THE TEXAS COMPANY

Let us
MARFAK
your car



TUNE IN the TEXACO STAR THEATRE every Sunday night. See your local newspaper for time and station.

AUGUST, 1944

145

STRIKING POWER

More than 50,000 Allison engines have been built for the use of Allied fighting pilots around the globe. ★ These skilled pilots using fighting planes powered by these engines have established a lopsided "box score" in our favor. ★ That is testimony to the striking power of good men armed with good American fighting equipment. ★ It is also an indication of aircraft engine performance you will be glad to have in the planes you use after final victory.

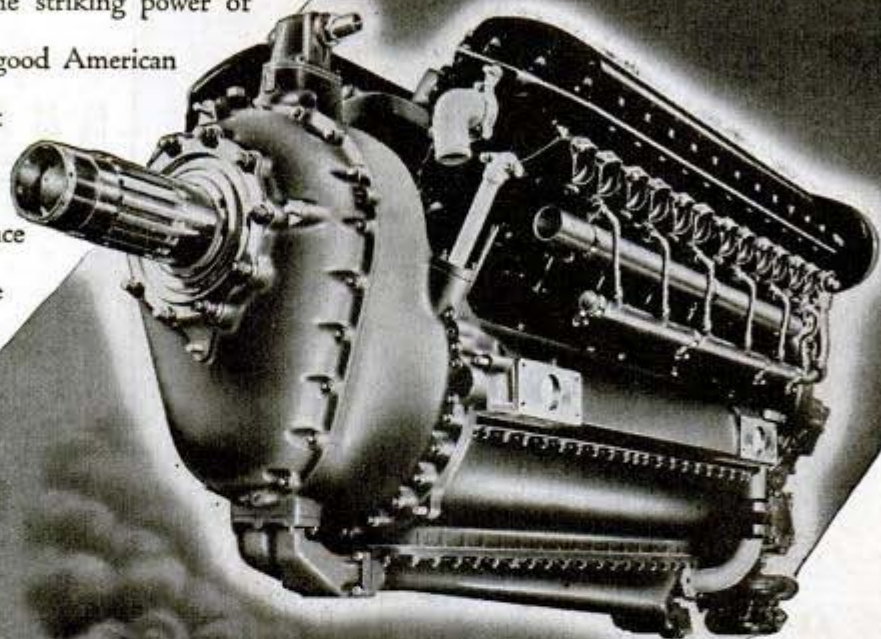

POWERED BY ALLISON

P-38—Lightning

P-39—Airacobra

P-40—Warhawk

A-36 and P-51—Mustang

The more-than-50,000 Allison engines built for the U. S. Army Air Forces power the above planes.

LIQUID-COOLED AIRCRAFT ENGINES

Allison

DIVISION OF

Indianapolis, Indiana

Every Sunday Afternoon



**KEEP AMERICA STRONG
BUY MORE WAR BONDS**

GENERAL MOTORS SYMPHONY OF THE AIR — NBC Network



THIS AMAZING FLASHLIGHT BATTERY STAYS FRESH FOR YEARS

Power Is There - When You Need It!

Many flashlight batteries go dead just lying around in a flashlight. But not Ray-O-Vac LEAKPROOF Batteries! With LEAKPROOF'S patented sealed-in-steel construction, the power won't leak out—it's there when it's needed for years and years. And it protects your flashlight from corrosion damage.

**RAY-O-VAC LEAKPROOF BATTERIES ARE
NOW GOING 100% TO OUR ARMED FORCES**

FLASHLIGHTS



BATTERIES

BUY WAR BONDS



BUY WAR STAMPS

RAY-O-VAC COMPANY, MADISON 4, WISCONSIN
OTHER FACTORIES AT CLINTON, MASSACHUSETTS • LANCASTER, OHIO • SIOUX CITY, IOWA

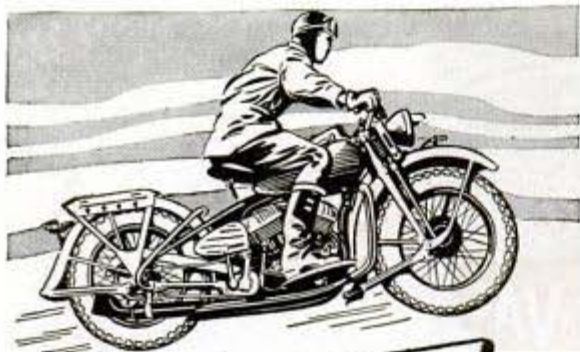

"I REMAIN, AN OLD HARLEY-DAVIDSON BUG"

IT'S the way F/O George B., ends his letter that explains how Harley-Davidsons and motorcycling get under a fellow's skin:

"Am an American in the Canadian Air Force — served over three years as a bomber pilot in the African, Sicilian and Italian shin-dig, and am now back in England as an instructor. Have ridden Harley-Davidsons more than twenty years — they are the best. I firmly believe motorcycling experience helps a lot toward being a good pilot. There's a marked similarity in the way both machines handle. I still yearn for my Harley-Davidson which used to keep me in good physical shape. I will have saved more than enough to buy a new Harley-Davidson after this fracas is over. I remain, an old Harley-Davidson bug."

That tells the story, men. Once a Harley-Davidson owner, you'll always want one. **BUY WAR BONDS NOW** — own a new, war-proved Harley-Davidson after Victory!

HARLEY-DAVIDSON MOTOR CO.
Department P, Milwaukee 1, Wisconsin



Write for free copy of **ENTHUSIAST MAGAZINE** filled with motorcycle pictures and stories.



HARLEY-DAVIDSON MOTORCYCLES

Torture Tests for Tin Fish

Continued from page 53

The water boils and bubbles, and puffs of smoke break the surface for the first few yards of the run.

Some torpedoes, improperly adjusted, are surface runners. If they get off the beam, they are dangerous. Only recently one smashed through the side of a range boat.

When the torpedoes are brought in by the retriever boats, they are hoisted back aboard the YTT and the exercise heads are taken off. Then the torpedo is sent to the huge overhaul shop, a windowless one-story structure. Several hundred torpedoes may be here at one time, some fresh from the factories being loaded with alcohol, water and compressed air preparatory to firing, some being examined and adjusted after firing, others awaiting shipment. One room in the shop is devoted to the gyroscope, the automatic helmsman which directs the torpedo.

So effectively do these steering devices work that few torpedoes are lost. Recently, however, a fishing vessel operating off Long Island not far from the testing range brought up a "tin fish" in its nets.

In this case, the special balancing mechanism in the practice head probably failed to work. These water-filled heads are so fitted that when the "tin fish" has finished its trial run, the water is discharged, lightening the nose of the torpedo so that it rises to the surface from 10,000 to 18,000 feet. The yellow noses are easily spotted.

Two types of torpedoes are tested at Montauk, one for use by surface vessels such as destroyers and the other for planes. Every "tin fish" sent to Montauk is fired at least once from the YTT. The long, destroyer-type cylinders are shot from tubes. The stubby aerial torpedoes are simply dropped into the water. In addition to the primary drop-test, one in every five of the aerial "fish" is also dropped from a plane, thus affording a double check on each lot.

If they don't stay on the line or travel at the right speed or remain at the right depth or go the correct distance, they are overhauled and tested again and again.

One celebrated "tin fish" was fired 23 times. On 22 tries something was wrong with it. It dived, it surfaced, it ran left, it ran right. Twenty-two times it was taken down and readjusted. On the 23rd test it ran "hot, straight and normal." With the men at the range breathing a collective sigh of relief, it was shipped out to the fleet. The good word came back later. The 24th time it hit the water it sank a Jap ship.



FLUID POWER ENGINEERING

by Parker

FLUID POWER. Confine fluid in a closed system, apply power at one end, and you deliver power instantly at the other end.

That is Fluid Power—based on hydraulics—the 1944 way to get work done. Any kind of work—hard or easy, brutal or delicate. Precisely-timed work or remote-controlled work.

You can step Fluid Power up or step it down—to lift a tank or wind a watch. You can make it fit the job. You can flow it around corners and into tight places. You can regulate it, by valves, within precise limits.

TRANSMITTING FLUID POWER. Fluid Power is transmitted through tubes; it needs no shafts, gears, pulleys or belts.

Tubes themselves are simple devices, easy to cut, bend, join or put in place.

But when a system of tubes is used to transmit Fluid Power, it calls for wrinkle-free bends, leak proof fittings, precise operating valves, flow without obstruction. It gets to be an engineering job.

FLUID POWER ENGINEERING. That's been Parker's business for twenty years—designing Fluid Power tubing systems, engineering them, building valves and fittings, and making fabricating tools. Often we do the fabricating, too.

War demands have made industry more and more aware of the great number of things Fluid Power can do. For us, that has been the basis of a healthy growth in experience and knowledge, and the variety of our products.

Today, you'll find Parker-engineered Fluid Power systems in refrigerators and bombers, in chemical plants and locomotives—everywhere in industry.

LOOKING AHEAD. With at least one eye on the future, wouldn't you like to talk this through now with a Parker engineer? No matter what you make, or what kind of machines you operate, you are likely to find some interesting possibilities in the Fluid Power idea.

An interesting booklet, giving you more facts about Fluid Power, will be sent on request. Address Parker Appliance Co., 17325 Euclid Ave., Cleveland 12, Ohio.

THE
PARKER
 APPLIANCE COMPANY
 CLEVELAND • LOS ANGELES
FLUID POWER ENGINEERING

Tool Tips by **STANLEY**

HAND PLANING

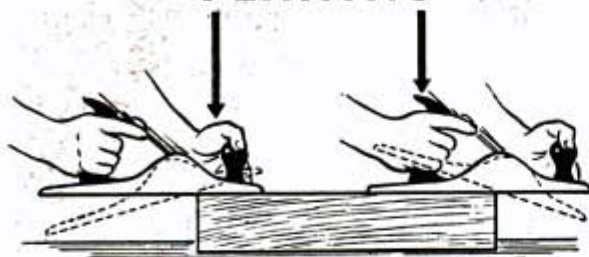

To cut a long, straight edge or surface, push the plane *with the grain* — in the uphill direction of the fibres. *Keep the plane straight* by pressing down on the knob at beginning of stroke and on handle at end of stroke.

It is easier to plane a long straight edge with a long plane than a short one. A long plane bridges the low parts and does not cut them till the high spots are removed.

DOZENS OF PROVED METHODS ARE COVERED IN THE STANLEY TOOL GUIDE

More than 200 illustrations, with practical instructions covering the use of boring tools, doweling jig, spoke shaves, scrapers, planes, marking gauge, and other commonly-used hand tools are included in this one book. Send for your copy today, 25c postpaid.



*A Big Value
for only 25¢*

STANLEY TOOLS
184 Elm St., New Britain, Conn.

Enclosed find 25c. Please send me the Stanley Tool Guide, postpaid.

Name.....

Address.....

City..... State.....

Calling Signals for the Army

Continued from page 59

during the shock of combat after the tank has been driven for possibly thousands of miles. Frequencies for calling other tanks, the artillery, and command posts are selected by pushbuttons. All such sets are dust and water proof and are designed to operate under high temperature and high humidity conditions. Tankers and airmen wear throat microphones that pick up the vibration of their vocal cords while excluding exterior noise and reverberation. A two-ounce "lip mike" that straps under the nose and covers the mouth is also used.

Mobile, long-range radio stations provide the backbone of communication in the field. Contained in a 1½-ton truck that tows its own motor-generator on a trailer, such stations are operating today in the frigid north and in the equatorial jungles. Parked in a field, a flat top antenna is installed that gives such a station a range of up to 2,300 miles under good conditions.

Besides handling the Army's communication, the Signal Corps takes its picture. Combat photographers attached to the Signal Corps accompany troops into battle, carrying rifles in addition to still cameras or movie outfits. Some of their pictures have technical value, some are transmitted by radio back to the United States for use by magazines and newspapers. In their own domestic motion picture studios, the Signal Corps creates instructional films that are used in the training of new troops.

Another Signal Corps duty is technical operation of the Signal Photo Mail Service, the familiar air-borne V-mail, the volume of which is in the neighborhood of 23 million letters per month.

One job that Signal Corps men were handed and broke records in accomplishing was that of building a 2,060-mile phone line along the Alaska military highway. The line consists of two circuits that are expanded by carrier systems to provide seven talking channels and 14 teletypewriter channels. In building subsidiary lines in Alaska the communication men had to drop their reels of telephone wire by airplane onto a glacier, that being the only practical way to deliver it to the spot. In other places they found that their telephone poles wouldn't stay in the ground. The annual thaw pushed the poles up six inches to a foot. This was solved by setting three poles as a tripod.

That was just one more job for the Signal Corps men, the soldiers who live up to their motto that commands "Get the message through."

Young Horsepower for old cars

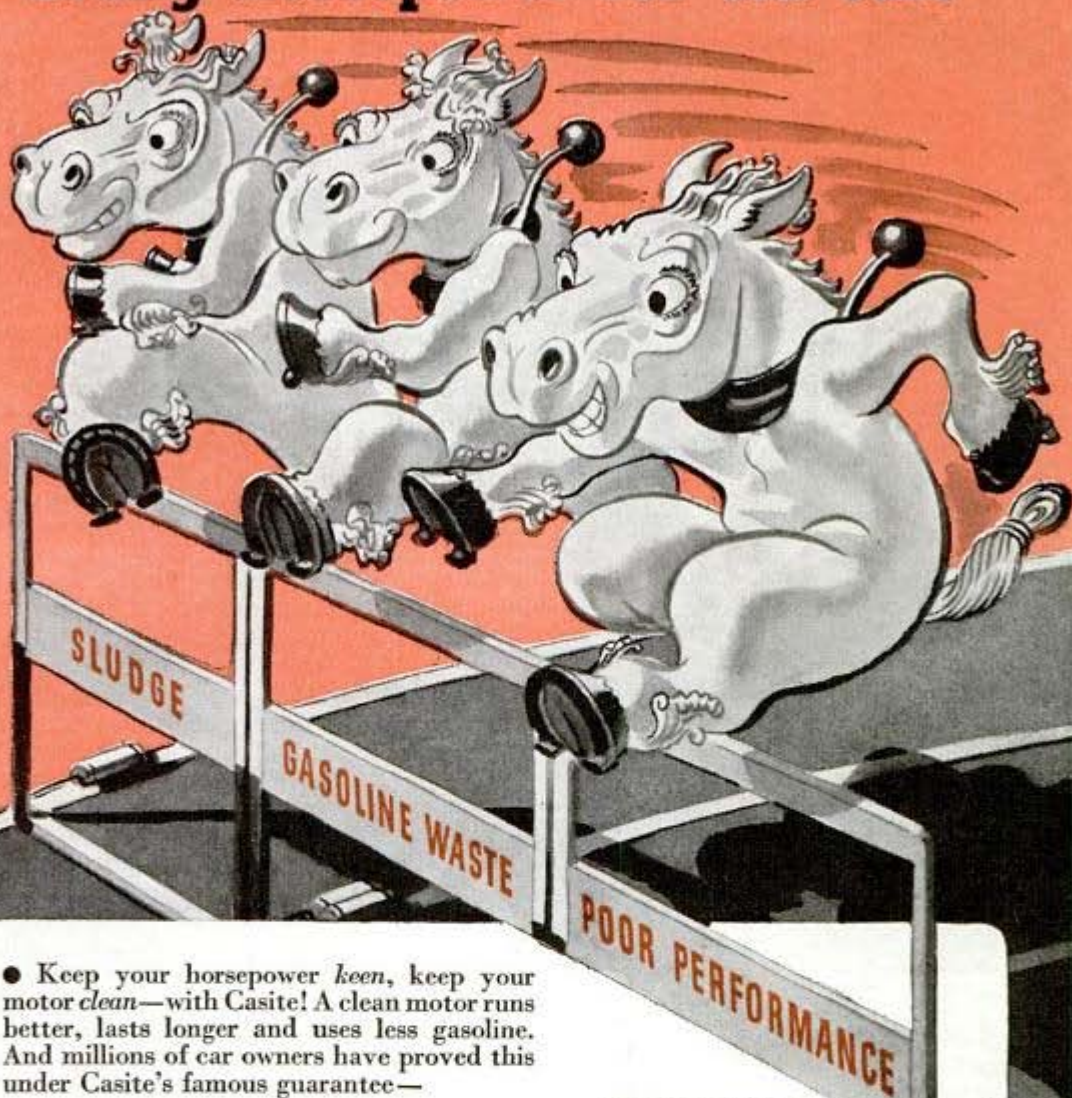

● Keep your horsepower *keen*, keep your motor *clean*—with Casite! A clean motor runs better, lasts longer and uses less gasoline. And millions of car owners have proved this under Casite's famous guarantee—

BETTER AND SMOOTHER PERFORMANCE OR DOUBLE YOUR MONEY BACK

You are invited to buy and test Casite on the unconditional promise that it must improve your performance noticeably or **DOUBLE YOUR MONEY BACK**.

It's as simple as that! So why not try Casite today? It is sold by service stations, garages and car dealers from coast to coast, and costs only 65¢ a pint.

THE CASITE CORPORATION, HASTINGS, MICH.

GUARANTEE

Add Casite to crankcase and run through carburetor according to instructions, then drive your car 100 miles or for 60 days, whichever is first. If not convinced that Casite gives you better and smoother performance, you get double your money back by filling out guarantee certificate and mailing it to The Casite Corporation, Hastings, Michigan. Maximum refund is \$1.30 per pint, twice the nationally advertised price of Casite.



CLEANS OUT MOTORS • KEEPS MOTORS CLEAN

DRAWFILING A GUN BARREL FOR DRAWING A SHARP BEAD



"Striking" a rifle barrel, to give it precision streamlining, aids the sharpshooter's eye. And the expert gunsmith knows just how to do it. He **drawfiles** the barrel—usually with a smooth-cut Mill file—to remove undulations left by the lathe-turning operation.

Only the most carefully designed, accurately cut and uniformly hardened files are good enough for such exacting work. That's the kind Nicholson manufacture is noted for. *The right file for the job and Twelve perfect files in every dozen* have become such Nicholson truisms that Nicholson and Black Diamond brands are widely the choice of mechanics who need the best in files for the work they do. **FREE BOOK—"File Philosophy"—48 pages.**

Nicholson File Co., 22 Acorn St., Providence 1, R. I., U. S. A.
(Also Canadian Plant, Port Hope, Ont.)

NICHOLSON
FILES FOR EVERY
PURPOSE

NICHOLSON
U.S.A.
MADE IN U.S.A.

Air Made to Order

Continued from page 75

planes. Temperatures within such chambers would become unbearable were it not for air-conditioning, and the efficiency of the tower man, and of the field, would be impaired.

In rooms where powder is being handled, in the loading of bombs or shells, exact control of the humidity is essential, for a variation might alter the burning rate of the powder when it is actually used. Consistent accuracy in battle demands that the powder all burn at the same rate, or shells will go wild, and bombs fail to explode at the proper time.

In the eerie navigation trainer used by the Army Air Forces, a simulated star-studded heavens gives the crewmen practice in reading the 12 navigational stars, which are in reality pinpoints of light spaced exactly as the stars would appear in the night sky. A variation of as little as two degrees in the chamber would give a false sextant reading, so Carrier air-conditioning units keep the temperature at an exact 72 degrees.

Air conditioning makes possible the phenomenal record of Yankee submarines. It is an essential tool of this metallurgical war, from the mines to the battlegrounds. One spectacular improvement affects the production of steel. It has long been recognized that particles of foreign matter in the blast air for steel-mill furnaces may affect the quality of the steel produced. With control of the blast air, all foreign matter may be removed, and uniformity of the steel assured.

These industrial installations of air-conditioning equipment are potent home-front weapons, but more than that, they point the way toward increased comfort and better health for all after the war. Already there are portable installations for any window that will clean and humidify the air, and warm it or cool it.

Similar installations to be attached to central heating units are also the subject of vast improvements, based on wartime experience. The old-fashioned idea of a steam-heated, dry-as-dust apartment, with its threat to health, should be replaced in postwar homes by air supplies tailored to the comfort of each member of the family.

It is safe to say that, with the inevitable boom in housing after the war, air-conditioning will be one of the most potent of all job-producing industries. Even the automobile industry might install air-conditioners in cars, at least for the luxury trade. It is feasible now.

WHY USE A NUT?

A nut draws things together and holds them tight. It permits taking apart and refastening.

If a nut loosens by itself, it fails in its job. A good nut must always hold.

That is the unusual virtue of the Elastic Stop Nut. Where an ordinary nut lets go, this one grips fast. It locks anywhere on the bolt. It can't wiggle or turn of its own accord—even under severe vibration.

But you can take it off and put it back on time and time again. It still locks. And it never mars the bolt.

The reason is the elastic collar in the top. When the nut is turned on, this collar squeezes between the bolt threads and hugs tight.

This provides security. That is why Elastic Stop Nuts are used by billions in America's airplanes. There are more of these nuts used than all other lock nuts combined.

After a while you'll see these nuts with the Esna red collar on the things you buy. And count on it—whether it's a new car, refrigerator, radio or what not, it will be stronger, safer, quieter and longer lasting because of Elastic Stop Nuts.



The Railway Express Agency uses a great many Elastic Stop Nuts on its fleet of 15,000 trucks. It uses them on many of the chassis and truck bodies as illustrated above, because once drawn up tight, they hold fast. No periodic taking up — no loose, squeaky or rattling trucks on the road, even in the face of day-in, day-out going and stopping on all kinds of roads.

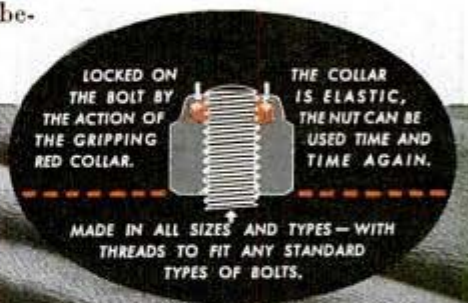

LOCKED ON THE BOLT BY THE ACTION OF THE GRIPPING RED COLLAR.

THE COLLAR IS ELASTIC, THE NUT CAN BE USED TIME AND TIME AGAIN.

MADE IN ALL SIZES AND TYPES—WITH THREADS TO FIT ANY STANDARD TYPES OF BOLTS.



ESNA
TRADE MARK OF
ELASTIC STOP NUT CORPORATION OF AMERICA
ELASTIC STOP NUTS
Lock fast to make things last
UNION, NEW JERSEY AND LINCOLN, NEBRASKA

SAVE THAT SAW!



A saw that's dull makes muscles ache!
Get it *fixed* for goodness sake!



Take it to your hardware store—
Saving tools helps win the war!



Where you see this window sign . . .
You'll get work that's extra fine!



Later on, you can *insist on*
A brand new saw made by **DISSTON!**



HENRY DISSTON & SONS, INC.
811 Tacony, Phila. 35, Pa., U.S.A.

DISSTON

GOOD ADVICE ON TOOLS *Free!*

The Disston Saw, Tool and File Manual tells how to use and care for tools. **FREE** at your Hardware Store, or write us for a copy.



Fighting Below the Water Line

Continued from page 79

water and oil rose to the men's shoulders before the pumps began to win. With the compartment still partly flooded, the men got the turbine back in operation.

Some of the water, however, was working into other punctured fuel tanks all the time the pumps were trying to get rid of it. This water was picked up by the fuel lines and carried to the boilers. The burners sputtered and went out. Five minutes later the big cruiser was dead in the water. She was an easy target for the Japs so one destroyer laid a smoke screen around her and the other three raced toward the enemy in a desperate torpedo attack, to gain a little time. A little time was all the cruiser's black gang needed. Three minutes after she had come to a stop they had cleaned the contaminated oil from the fuel lines and burners of one boiler and steam was being raised. A couple of minutes later she was under way again and back in the fight, firing broadsides. That action plus the oncoming destroyers was too much for the stronger Jap force and they turned and ran.

That's the story of one fight. There have been scores of instances in the last couple of years like it, in which the men in the bowels of our warships saved their ships and won our battles.

Our Animal Allies

Continued from page 37

flown into Burma in American-manned gliders to help operate supply lines. A total of 1,600 were used on the Burma front during the monsoon season in 1942 and there were only 12 casualties among them. One string of mules was credited with keeping a supply line open for several Allied battalions isolated when the heavy rains came. When the Americans began using mules on the yard-wide foot trails in the mountains of Italy, the Germans began a systematic slaughter of all the mules they could find. Despite much talk about snowmobiles, mountain-climbing jeeps and caterpillars, mules also have been relied upon to furnish supplies in the high country where the ski troops practice.

One of the few United States army mules who has been able to distinguish himself by an individual exploit is Mehitabel, who kicked in the head of a German soldier. Mehitabel, lost between the lines in North Africa and searching for a human friend, resented it when the German prodded her

Continued to page 156

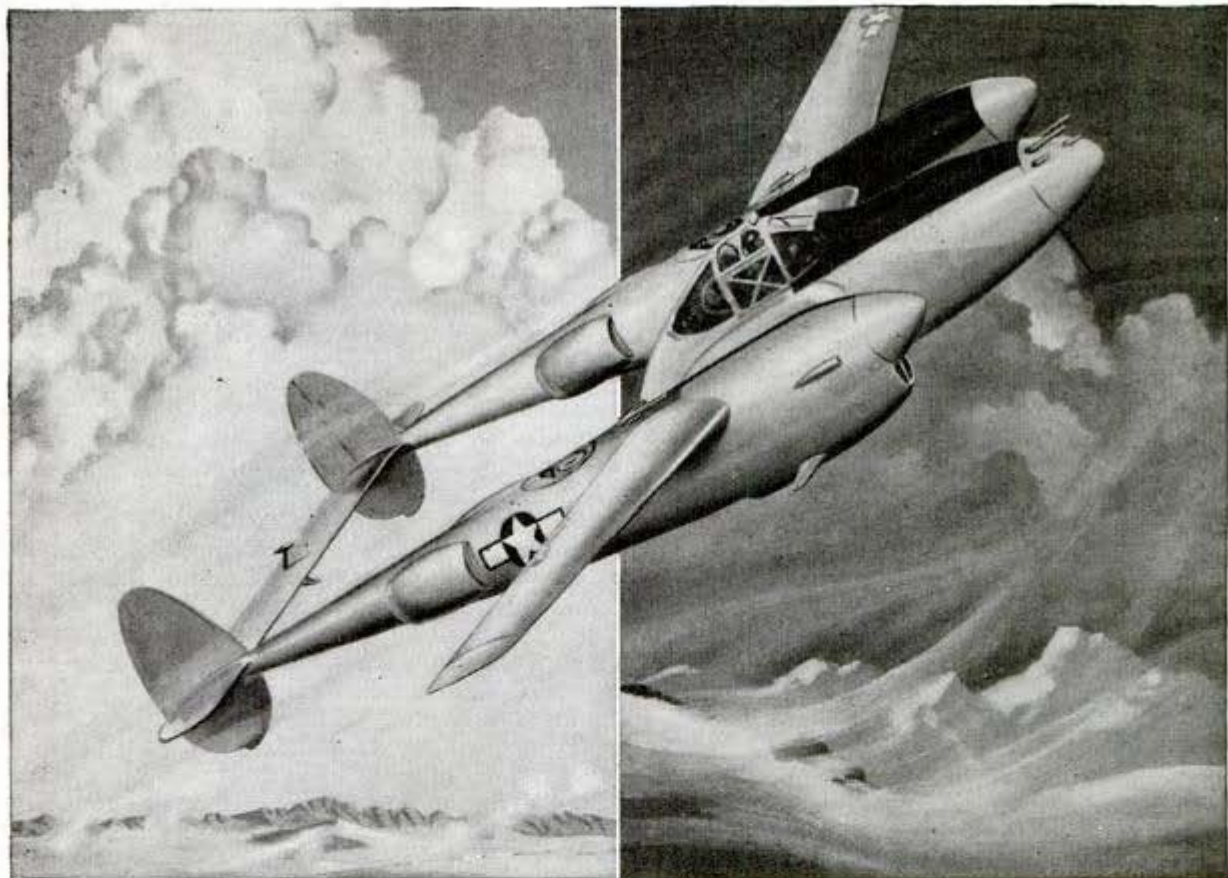

FROM JUNGLE HEAT TO ARCTIC COLD

Finger-Tip Control for the P-38 Passes Toughest Endurance Test!

The Hycon "Stratopower" pump—standard equipment on the Lockheed P-38—has passed the grueling hydraulic test at the blistering heat of 160 degrees and at the bitter cold of 65 below zero. It stood up under 550 continuous hours of operation—the equivalent of about 200,000 non-stop flying miles—and still had the staying qualities to repeat the test.

A remarkable record, yes! But not surprising. For the "Stratopower" pump passes the acid test of active combat every day in every extreme of climate. Lockheed engineers, by installing aileron boosters actuated by this unique pump, have doubled this great plane's maneuverability and enabled it to fight better and higher—eight miles up in the stratosphere.

Until victory, our entire production of "Stratopower" pumps is reserved for fighting planes. And, to fill the tremendous demand, every available facility is being utilized at peak capacity.

LET'S ALL BACK THE ATTACK — BUY MORE WAR BONDS

THE NEW YORK AIR BRAKE COMPANY

Hydraulic Division

420 LEXINGTON AVENUE, NEW YORK 17, N. Y.

For Industry's Postwar Uses

The compact high-pressure Hycon "Stratopower" pump, furnishing variable volume up to 3000 pounds per square inch—when no longer restricted by wartime needs—will do a great many hydraulic jobs better.

Out of the incredible demands of the war will come miracles of technological improvement to help rebuild a shattered world. More goods must be produced faster and cheaper. New machines will be created and old machines modernized. Hycon high-pressure hydraulic power units are ready with their contribution to this task.

If you have a problem of actuation in your postwar plan, or the modernization of your present equipment, Hycon will help to solve it. High-pressure (3000 pounds per square inch) pumps and valves, or assembled complete power units, are available for your requirements.

For Tomorrow Infinitely variable
pressure controls at YOUR fingertips



HYCON * * *

REGISTERED TRADE MARK

Stratopower Pump

Patented — Manufactured only by The New York Air Brake Company

When Army tanks, jeeps, trucks, "Ducks," combat cars go into action, spark plugs must do their job—and keep doing it. To assure this unfailing performance, the Army takes great pains to check and clean its spark plugs,—millions of which are AC's.

As a "home-front soldier," you should take equal care of your spark plugs. All plugs should be cleaned and adjusted every 3,000 miles. That assures longer life, maintenance of engine power, better gas economy. Only when badly worn, should spark plugs be replaced. When you replace with new AC's, utmost reliability is certain.

Give your spark plugs this care and you will get the most from them—and also conserve materials, gasoline, and oil for our fighting men.



CLEAN PLUGS
SAVE UP TO
ONE GALLON
OF GASOLINE
IN TEN

AC
SPARK PLUGS

BUY THAT EXTRA WAR BOND THIS MONTH

irritably with his bayonet. Today Mehitabel is a government pensioner wearing a wound stripe.

For 2,000 years homing pigeons have been influencing the tide of battle and World War II is no exception. Among the pigeon heroes is "Yank," who brought back the news of the recapture of Gafsa by our troops in North Africa, making the 20 mile trip in one hour and 15 minutes. Then there is the "G. I. Joe" who flew 20 miles in 20 minutes to avert a possible bombing disaster in Italy. His message told headquarters that British troops had just entered Colvi Vecchia, the target of a flight of allied bombers about to take off.

"Lady Astor," a little pigeon WAC released from the front line in North Africa one day, was shot en route but managed to crash-land the next morning at the home loft, 70 miles away, still bearing the piece of paper strapped to her leg.

Today almost every combat branch uses pigeons, including the paratroops, tank crews, mechanized troops and infantry units, being transported in mobile trailer lofts, each accommodating 50 pigeons.

Lord Mountbatten's staff knew just what was happening on the beaches during the Commando raid at Dieppe because the pigeon couriers didn't fail. Officers aboard ships far out in the Mediterranean likewise were kept informed during the invasion of Africa. In both instances it would have been easy for the enemy to pick up radio broadcasts.

Signal Corps pigeons have tremendous feats to their credit. One was found capable of covering 500 miles in a day; another made a 2,100-mile flight through stormy weather across most of the United States. A new trick was added to pigeons' accomplishments in this war: they learned how to take off from airplanes flying between 300 and 400 miles per hour. Some of them instinctively performed a "dead drop" until they were clear of the ship, while others needed paper bags to cloak their wings until they were out of harm's way.

The services of the lumbering elephant and the homely camel are more specialized but equally indispensable. In 1941 the Indian Army elephant was drafted to replace the railroad from Rangoon to the Burma Road and keep open the life line to China. Today elephants are the light cranes, bulldozers, and mobile winches of the troops who face the Japanese on the India-Burma frontier. Laboring with the engineers, these animated mountains drive piles by stomping on them and haul heavy loads of timber through almost impassable jungles.

Continued to page 158

SCREWBALL IDEAS ON BATTERY CARE

#5



Marmaduke Daffy thinks he's charging his battery by driving down to the corner store each evening. Fact is, his starter and lights use up more "juice" on these short trips than his generator can replace. Better walk, Marmaduke. You're wasting gas and tires.

...THE WISE WAY IS PERIODIC RECHARGES!

RESTRICTED driving is bad news for batteries. Many cars aren't being driven enough to keep the battery properly charged. But you needn't let your battery weaken and "die".

Take it to your Exide Dealer for periodic recharges. That way, you can avoid starting trouble and postpone the day when you'll need a new battery. When you *must* buy, get a dependable, long-lasting Exide. Buy to Last—Save to Win.

THE ELECTRIC STORAGE BATTERY CO.
Philadelphia 32

Exide Batteries of Canada, Limited, Toronto

EXIDES ARE USED IN MORE THAN 100 APPLICATIONS BY OUR ARMED FORCES



- 1 Don't buy *anything* you can do without.
 - 2 If you **MUST** buy, insist on dependable, long-lasting merchandise.
 - 3 Take care of the things you have. Make them *last!*
- These conservation rules save materials for war production, help curb inflation, give you more money to invest in War Bonds.





*"Mighty" IS
THE WORD FOR
"Dyno-Mite"*

Here are little giants of the tool world — "Dyno-Mite" . . . world's smallest (users call them "finest") production tools. Perfectly balanced for easy handling, the streamlined drill packs surprising power. Weighing only 2½ pounds it is easily handled by women, yet it will operate in steel at speeds to tax the staying power of any operator.

And "Dyno-Mite" electric screw drivers and nut runners (illustrated), weighing only 3½ pounds, give greater load capacity and high efficiency with almost a total absence of vibration. The new "Adjustomatic" Selective Torque Clutch allows for instant adjustment from the outside of the tool and transmits power with velvet smoothness. Write for further details.



MILLERS FALLS CO. Greenfield, Mass., U. S. A.

The pack camel, despite his halitosis and yellow teeth, is much in demand when it comes to hauling material to build desert airfields or conserving precious gasoline and tires. He has plodded patiently for the Allies in North Africa, Burma, India, China and southern Russia. Camels traverse the deep sand where ambulances and even mules founder.

Animals also serve the war effort as mascots. Warriors make pets of anything that walks, crawls, or wiggles, and this war has produced some unusual ones. Perhaps the most famous is Siwash, a duck who landed on Tarawa with a marine artillery unit and proceeded to rout a Jap rooster and pig. Eta, a monkey, was one of the most intelligent. Adopted by the 9th Air Force in the Middle East, Eta learned to pull the handle marked "salvo" on B-24 bombers.

Gateway to War

Continued from page 31

voirs for the runoff of cargo and comprise a final control by which a deluge of cargo or a scarcity of it at the port itself can be avoided. A holding and reconsignment point contains some three million square feet of warehouse and open storage space, up to 30 miles of trackage, and requires a staff of 1,000 employees.

At the port itself, ships are loaded in one of three ways depending on their destinations. Combat loading, for a ship that is to carry troops and equipment directly to a scene of action, means that the first pieces of equipment that will leave the ship are loaded last, on top, where they will be instantly available. Combat loading permits the troops to go ashore fighting.

Another arrangement is convoy loading. In this type of loading a full cargo is put into the ship with certain priority items on top. Organizational loading, the third method, is the same as ordinary commercial loading in which a ship is loaded to make best use of its cargo spaces.

Upon departure from port a schedule is laid out so that if any particular ship is lost at sea, its cargo can be duplicated without delay and loaded on another vessel.

The other function of a port of embarkation is the orderly movement of troops from their training camps to the ships. For this purpose huge camps known as staging areas have been established close to the ports. Here the combat units are made up at full strength, final physical examinations are conducted, training deficiencies are corrected and rehearsals of the type of fighting that they will encounter in their

Continued to page 160

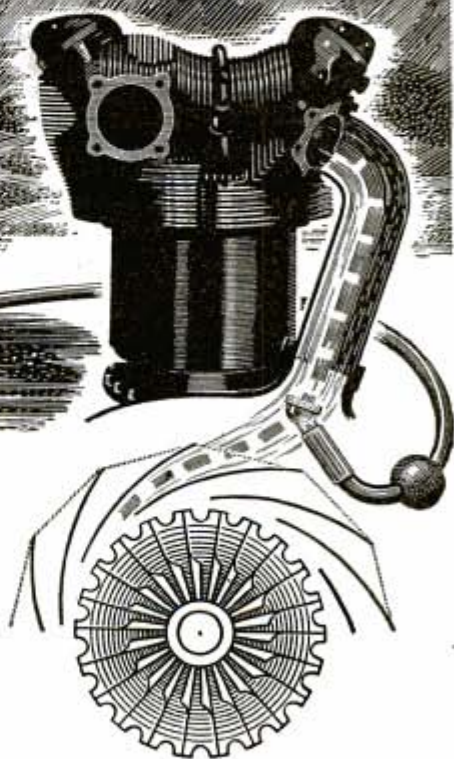
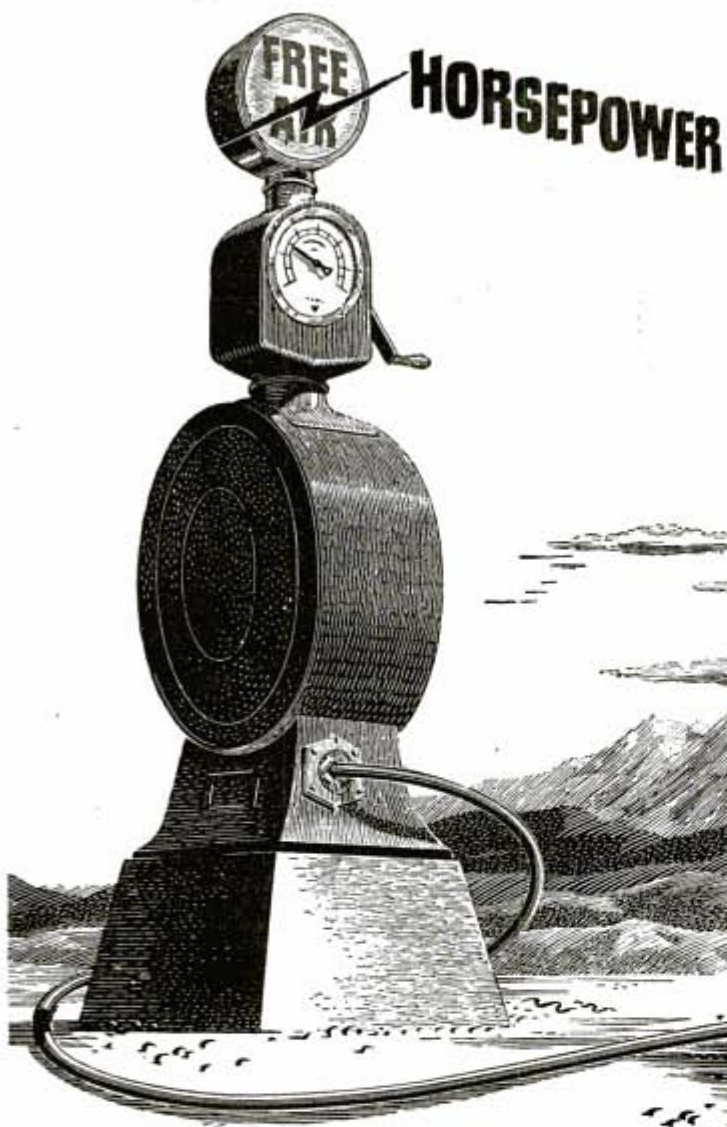

An aircraft engine supercharger is not a mysterious device; it is simply an air pump. By compressing more air into a cylinder, more fuel may be burned during each power stroke—which in turn means greater output. At sea level or altitude, whether turbo or gear driven, a supercharger's sole purpose is to increase engine horsepower.

Although it takes power to pump air with a supercharger, the result is a dividend of free horsepower far exceeding the investment. Flight at high altitude is impossible unless the rarefied air is first compressed, while in a Cyclone 9 at take-off, 100 HP spent to drive the supercharger rewards the engine with 500 additional horsepower at the crankshaft.

★ ★ ★

Superchargers, like Cyclones, pay their way.

A supercharger supplies combustion air at greater density, permitting increased engine power.

Cyclones and Whirlwinds · Light · Compact · Powerful

WRIGHT Aircraft Engines

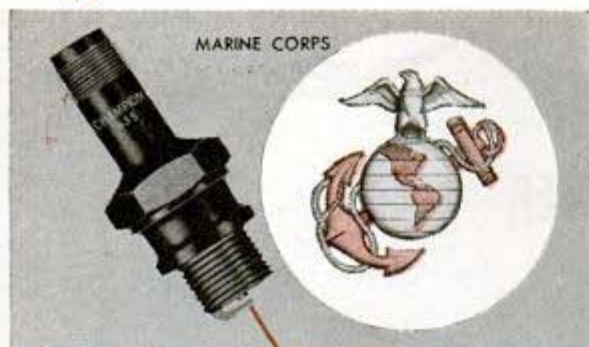

**WHERE DEPENDABILITY REALLY COUNTS
COUNT ON DEPENDABLE
CHAMPION SPARK PLUGS**

Our government makes no compromise with absolute dependability in any product used by our armed forces. The fact that Champion Spark Plugs are on active duty on every front, on land, water and in the air is dramatic evidence of the traditional dependability which has been their outstanding characteristic for over thirty years. Many exclusive and patented features account for their superior performance in every type of engine.



LET'S ALL BACK THE ATTACK—BUY WAR BONDS

theater of the war are held. Shortages in equipment and supplies are made up. When a soldier reaches a staging area he virtually becomes a military secret. It is his last stop ashore before he sails.

Some time ago Japan complained bitterly over the radio about the seemingly endless flow of men and equipment that America was dispatching across the Pacific, north, west, and south. That was before the Pacific push really got started!

How the Invasion Was Planned

Continued from page 7

fact that daytime flying was too unhealthy for the enemy over England. One Yank protested that if we didn't stop piling up equipment, the island would surely tip.

One of the most effective new weapons in the invasion was a 50-pound rocket projectile that can be fired from ground positions, from barges, or airplanes, and can be loaded with explosives or chemicals for laying smoke.

The supply line extended back across convoy lanes, through U. S. embarkation ports, to depots in this country with 245,000,000 square feet of storage space. The process of moving supplies to England was gauged by the general timetable, radioed requisitions from supply officers in England, and the availability of ships. In one month, about 1,500,000 ship tons of cargo were shipped from New York alone.

When the convoys left U. S. ports, supply officers notified British ports of the contents, not only of the ships but of certain holds in the ships. In this way, supply officers in England earmarked items for the various depots so the goods could keep moving. Some of the high-priority cargo was moved by air as D-Day approached. Our commanding officers insisted on "amphibious packing" of goods so that they would remain intact after a dunking.

Continued to page 162

**Model Builders
Attention!**

	V	V-2	V-3
Hex	1/2"	3/8"	5/16"
Thread	3/8"-24	1/4"-32	1/4"-32
Thread Length	7/32	7/32	5/32
Weight, Grams	8	3 1/2	2 1/2

Actual Size V-Plug

Champion spark plugs for model gas engines give the same dependable performance as regular Champions. Silliment sealed. Sillimanite insulator. Alloy needlepoint electrodes for easy starting. One piece construction.

CHAMPION

SPARK PLUG COMPANY • TOLEDO 1, OHIO

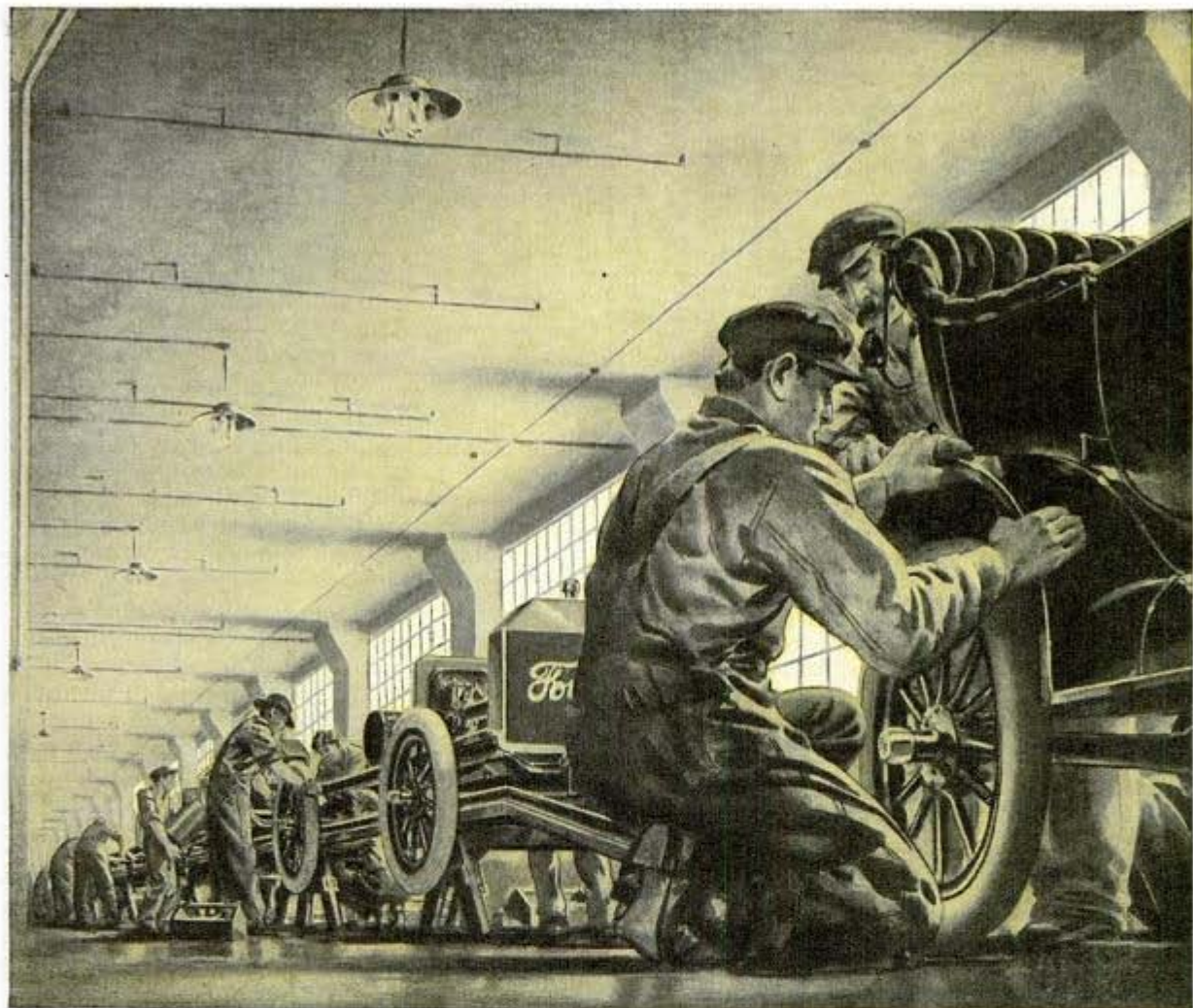

There and then . . . the assembly line was born

EARLY in 1913, Henry Ford had his technicians try a new production idea which had come to him as he inspected a watch factory. Instead of having a single group of men make the entire assembly on each flywheel magneto, the unit was moved from one worker to another. The result was a 50% saving in time!

"Why not test this idea on the whole chassis?" Mr. Ford next suggested. So now, along elevated greased rails, each chassis was being pushed by hand as workers added the various parts in sequence. *There and then, the assembly line was born!*

A chain-driven line was soon operating. And the 14 hours once required for a chassis assembly were cut to 1 hour, 33 minutes.

Before 1913 ended, over 100,000 Ford cars had been built, breaking all records for the industry.

This achievement meant more than a saving in time, more than creating new methods for all industry. To Mr. Ford and his associates, this was another step to make life easier for millions.

From the first, the assembly line technique of production eased working conditions. Along with other modern advances, it helped to increase the life span of work-

ers. At Ford, it soon made possible the 8-hour day. And with unskilled labor in many places earning as little as \$1 a day, Ford basic pay was raised to \$5.

The assembly line also brought price reductions on Ford cars, placing them within reach of more people. Sharing production savings with the public is fundamental with Ford.

Today, in the creation of equipment vital to victory, Ford men continue their search for better ways of doing things. What they are learning is bound to be reflected in the improved Ford transportation of tomorrow.

FORD MOTOR COMPANY 

FACTORY WORKERS warned about ATHLETE'S FOOT

With
Itching
Between
Cracked
Peeling Toes!



If you're discouraged about a stubborn, hard to relieve case of Athlete's Foot (very catching)—just try *Extra Strength ZEMO*—a Doctor's invisible medicated liquid backed by 35 years' success.

First applications of ZEMO promptly relieve your distress and on contact actually kill those vicious germs that most commonly cause and spread Athlete's Foot. Use Zemo freely—soon your discomfort should disappear. Stainless—so clean to use! Get today. Any drugstore.

NOTE: For real stubborn cases buy Extra Strength

ZEMO



PATTERN MAKERS

Gerstner Chests always please the particular men of your trade. Free Catalog.

GERSTNER TOOL CHESTS

444 Columbia St. Dayton 7, Ohio

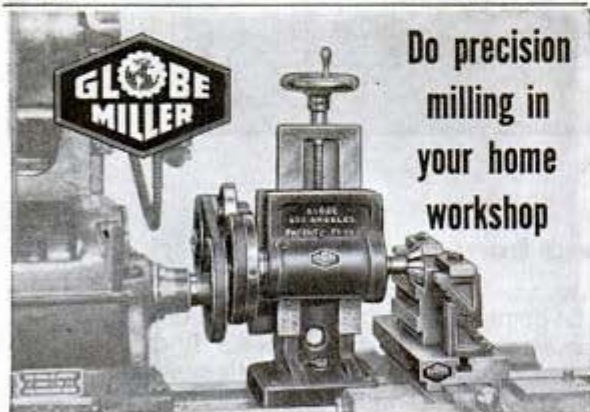

Do precision
milling in
your home
workshop

Globe Miller attaches to standard lathe in 3 minutes, does all precision milling operations, but costs only a fraction as much as milling machine. With headstock as power source, it uses all lathe speeds and feeds, and increases lathe swing 5 to 10 inches.



DIVIDING HEAD



MILLING VISE

Accessories: Precision-made arbors, end mill holders, step blocks, dogs, chuck adapters, work holding fixtures and other machine tool accessories available.

Write for Free Literature

GLOBE PRODUCTS MFG. CO.

3380 Robertson Boulevard, Los Angeles 34, California

Aviation gasoline and fuel for tanks and trucks by the millions of gallons was stored. About 60 percent of the deadweight tonnage moved to front lines is gasoline and oil. Fuel must be transported in oil drums until tankers can get close enough to shore to connect with portable pipelines. These lightweight pipelines, used with great success in Tunisia, will ease the problem of oil supply for our army in Europe. They are far more difficult for the enemy to see than a tank truck, and a 100-pound bomb must strike within four feet to wreck the pipe. Even then it can be quickly repaired; a thousand feet can be laid in two hours.

While the Army was piling up supplies, transporting and training a huge invasion force, the Navy was constructing amphibious bases along the British coast. Navy and Army units practiced the loading and unloading of combat teams and equipment from dozens of types of landing craft.

All the time preparations moved ahead on a grand scale, Allied Supreme Headquarters maintained the strictest secrecy as to when and where the invasion army would strike. There were map rooms where even generals had to show special passes.

Although the Germans could not guess the place, they probably figured they could accurately set the time of day in accordance with the tides. Here they were fooled, for our invasion planners set the time four hours before high tide. Thus, most of the enemy shore batteries that had not been knocked out by our aircraft were caught napping. This plan was carried out even though General Eisenhower had to postpone the hour of attack 24 hours awaiting favorable weather.

As D-Day neared, the troops were briefed for their exact mission and reshuffled from battalions and companies into "craft loads," ready to move at a moment's notice. After briefing, the invasion camps were "sealed" and the men were forbidden communication with unbriefed troops or civilians. These final security measures prevented any leaks as to the hour and place of attack after briefing thousands of men.

When H-Hour came and the Navy and air crews moved the Allied forces across the channel, it was the culmination of the most minutely planned combined operation on record. The invasion forces were composed of inter-dependent units, a weak link in any one of which would have meant disaster. In the master plan, the air forces, ground troops, airborne divisions, and naval units were welded together to form the most powerful force ever hurled against an enemy shore.

They planned it that way.

There's
been a
big change



THE GAME is the same—but look at the clothes! The principle of the tapered roller bearing hasn't changed, either—but Tyson has developed an *All-Rolls* design which has vastly improved bearing efficiency.

When Tyson found a way to add *thirty*

percent more rollers around the raceway, they set a new pace for bearing strength and rigidity. They increased load capacity. In many cases, they *doubled* bearing life.

The big name in bearings today is . . . TYSON!



TYSON BEARING CORPORATION • MASSILLON, OHIO

COUNT THE ROLLS - THE ROLLS COUNT



Tyson
TODAY'S HEAVY-DUTY BEARING

★ KEEP ON BUYING WAR BONDS ★



EXCLUSIVE! NEW!
YOURS FOR ONLY 10¢

Facts at your fingertips!...for anyone who works with wood! Just set the dial...quickly convert linear feet to board feet...determine slope per foot in degrees... comparative hardness, weights, shrinkage, warping, ease of working of various woods. There's more, too: bit sizes for head, body and thread of standard screws... nail specifications... tool sharpening tips... an accurate protractor. 6" in diameter... easy reading... heavy varnished cardboard... fits your tool kit. Special wartime offer by the makers of famous GREENLEE TOOLS— send today—a tool (not a toy) for a dime!



Send for yours now!

GREENLEE TOOL COMPANY, 2108 COLUMBIA AVENUE
 ROCKFORD • ILLINOIS

Enclosed is 10c. Send your "Handy Calculator" by return mail.

Name _____
 Address _____
 City _____ State _____

★ SAVE WASTE PAPER ★



Read about Motorcycling
 write INDIAN MOTORCYCLE CO.
 Springfield, Mass.

Indian MOTORCYCLES

RUST-PROOF ANYTHING IN 2 MINUTES!

An invisible coating of this easy-to-apply oil will do just that.

★ FIENDOIL ★

Cleans . . . Protects . . . 35c 2-oz. Bottle at Dealers
 McCambridge & McCambridge Co.
 Baltimore

GET MORE POWER FROM YOUR OUTBOARD



Start easier, get more speed, power. Use TIME-SAVER Lapping Compound when you refit bearings. Gives closer fit, better compression. 24 years successful use. Used by leading outboard mfrs. Get-acquainted sample and instructions, 25c; economy size \$1.00, postpaid. Satisfaction guaranteed or money refunded.

TIMESAVER—1115-D Post St., Seattle 1, Wash.

- ACHROMATIC LENSES
- ASTRONOMICAL OBJECTIVES
- OPTICAL FLATS, 1/2 WAVE
- LUMINIZED DIAGONALS, 1/2 WAVE
- FRONT SURFACE MIRRORS, 1/2 WAVE

Send for prices and details.

MAYFLOR PRODUCTS CORP., KATONAH, N. Y.

STOP LEAKS IN BASEMENT WALLS, FLOORS

Stop-it



Stop those leaks! End that seepage through cracks in basement walls and floors. Use **STOP-IT**—amazing quick-setting waterproof material. **INSTANTLY** seals dripping cracks and openings. For interior and exterior use.

EASY TO USE Simply mix with water and apply on cracks. Sets hard and permanent. At amazing low cost, you can turn that damp, musty basement into a delightful playroom. Get **STOP-IT** at your dealer or write direct.



TAMMS SILICA COMPANY
 228-EV N. La Salle St. - Chicago 1, Ill.

FREE BOOKLET
 Send for free "Household Hints in War-Time." Tells how to save money, conserve food, clothing, fuel.

AGAIN, ZENITH MAKES HEARING AID HISTORY!

Brings New Smartness and Style at No Extra Cost with the

New Neutral-Color Earphone and Cord

ZENITH made hearing aid history by bringing fine precision *quality* within reach of all. Now Zenith follows through—makes history again—brings you, in its complete production, an entirely new standard of hearing aid *smartness and style!*

After years of research—Zenith now does for the hearing aid what modern styling did for eyeglasses! Now America's hard of hearing can wear an aid with visible parts that are *scarcely noticeable*, because they blend with any complexion.

This smart new Zenith ensemble brings an attractive new "look of youth" to the hearing aid. You'll notice it immediately when you look at yourself in the mirror. Now, no one need feel self-conscious about wearing a hearing aid.

See the proof of this today. And *bear* the proof of excellence in performance that has made America swing *overwhelmingly* to the New Zenith Radionic Hearing Aid. Visit the Zenith-franchised dispenser nearest you. Or, for complete information by mail, use the convenient coupon below.



THE NEW ZENITH RADIONIC HEARING AID



THE NEW EARPHONE

- Smart, modern, scarcely noticeable! Pleasingly neutral in color so that it blends with any complexion.
- Sturdily constructed of beautiful, long-wearing plastic.
- Comfortable to wear because it's feather-light in weight.



THE NEW CORD

- Translucent plastic—looks well with any apparel. Greatly reduces friction or clothing noise.
- Slender, light in weight, more comfortable, lasts longer.
- Perspiration-proof . . . water-proof . . . kink-proof . . . washable. Will not fray, wipes clean with damp cloth.



Accepted by American Medical Association Council on Physical Therapy



GOOD NEWS FOR CANADIANS

The New Zenith Radionic Hearing Aid is now available in Canada—*direct by mail only*—at \$40 complete (Canadian currency) with no additional charge for transportation, duties or taxes! For particulars write our Canadian distributor, Dept. PM-8, Zenith Radio Corporation of Canada, Ltd., Guaranty Trust Bldg., Windsor, Ont.

COPYRIGHT 1944, ZENITH RADIO CORP.

\$40 COMPLETE, READY TO WEAR
With New Neutral-Color Earphone and Cord—Crystal Microphone—Radionic Tubes—Batteries—One Quality, Zenith's Best.

BY THE MAKERS OF



Mail Coupon for Free Descriptive Booklet

Zenith Radio Corporation, Dept. PM-8
P. O. Box 6940A, Chicago 1, Illinois
Please send me your Free descriptive booklet on the New Zenith Radionic Hearing Aid.

Name _____

Address _____

City _____ State _____

Physicians check here for literature.

ZENITH RADIO CORPORATION, CHICAGO, ILLINOIS

DON'T MARRY

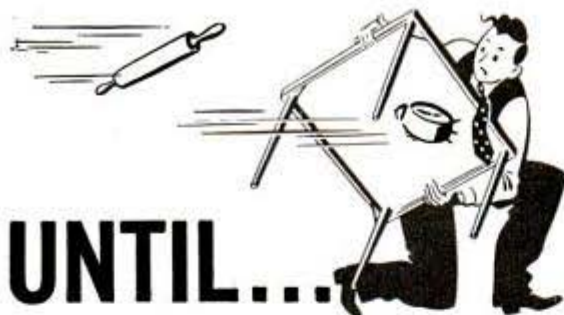

UNTIL...

you find out the meaning of your sweetheart's name

You'll be surprised at the meanings of some people's names. Let us send you a free book which tells you the meanings of over 900 names for men and women (with the origin of each).

We would like to send you this fascinating, color-illustrated booklet free . . . because it will help you to remember the "Ethyl" name and what it means:

"ETHYL is a trade mark name. It stands for antiknock fluid made only by the Ethyl Corporation. Oil companies put Ethyl fluid into gasoline to prevent knocking."

ENTIRELY FREE. NO OBLIGATION. MAIL COUPON NOW.



"WHAT'S IN A NAME?"

Dept. PM 19, Box 53, New York 8, N. Y.

Please send me a free copy of "What's in a Name?"

Name (PLEASE PRINT)

Address

City & State



ELECTRICITY FOR ANY JOB ANYWHERE



ONAN GASOLINE DRIVEN ELECTRIC PLANTS provide electricity in locations where it is not otherwise available, and for emergency standby service. Thousands of units are doing a winning job in the war.

Sizes from 350 to 35,000 watts. A.C. 50 to 800 cycles, 115 to 560 volts, D.C. 6 to 4000 volts. Also dual A.C. and D.C. output models. D. W. ONAN & SONS, 1096 Royalston Ave., Minneapolis 5, Minn. Details gladly furnished

ONAN

★ SAVE WASTE PAPER ★

MAKE BIG MONEY SAWING WOOD NOW!

350 Cuts a Minute



OTTAWA ONE-MAN TRACTOR SAW

Turn wood lots into cash; help save other fuels to win the war. Use Ottawa—fastest cutting; easiest way. Cuts large and small logs, fells trees. Thousands in use. Built to last with special heavy stiff saw blade. Positive safety clutch control, driven from any power take-off.

OTTAWA MFG. CO., D827, Forest Ave., Ottawa, Kansas

FREE BOOK and Price List



PULVEX FLEA POWDER

Kills fleas
JUST APPLY TO ONE SPOT

25¢ AND 50¢

WOOD WORKERS

AMAZING BOOK FOR YOU

Harold Hunt wants to send revised No. 14 catalog. 124 pages of woodworking ideas. UNEQUALLED BARGAINS in imported and American woods, supplies. Those already holding this catalog—send for revised sheets.

CRAFTSMAN WOOD SERVICE CO. 2729 S. Mary St., Dept. A-48, Chicago 8, Ill.

only 10¢

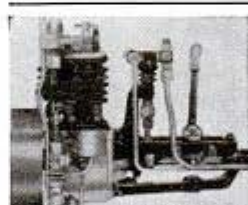

Build: STEAM ENGINE

● A precision built and engineered single cylinder, 1/4" scale marine model, with clutch or reverse.

● Send \$2.50 for 14 pages scale drawings, 2 photos, instructions.

● 2 Photos and Description...\$.25

● Rough Castings Kit.....12.50

● Horizontal Flash Boiler Drawings and Instructions 1.00

THOMPSON ENGINEERING CO. 206 NO. DIVISION BLDG., GRAND RAPIDS 2, MICH.

BUILD AN ARC WELDER FROM OLD GENERATOR

For Light or Heavy Work. 30-200 amperes. Complete PLANS 35c. Send today and we'll include FREE our Big NEW Catalog.

LEJAY MANUFACTURING CO. 1347 LeJay Bldg., Minneapolis, Minn.



TRAILER BUILDERS' PARTS CATALOG

We'll save you money on everything. Largest and most complete trailer builders' supply house in the United States. Member TRAILER COACH MFRS.' ASSOC. Send 10c for parts catalog. NATIONAL TRAILER EQUIPMENT CO. 719 N. Seventh St. Milwaukee 3, Wis.

GRAY HAIR VITAMIN NOW \$1.95

No dyes—No drugs—Hair grew out in Natural Color in almost nine out of ten test cases just taking one tablet Calcium Pantothenate Vitamin each day.

Why pay \$3.50 to \$5.00 for the famous "Gray Hair Vitamin"? SEND NO MONEY. Just send name and address. We will ship 100 10-mg. tablets (100 days' supply) genuine standard quality Calcium Pantothenate Vitamin C.O.D. for \$1.95 plus few cents postage. Guaranteed same quality as used in National Tests or money back. HYGEA VITAMIN CO., 2017 S. Michigan Ave., Dpt. 98, Chicago, Ill.



**WHAT A BARGAIN!
PAGE AFTER PAGE OF
PLANS, PICTURES, PROJECTS
— FOR MORE FUN IN
YOUR HOMECRAFT
SHOP!**

6 Big Issues of THE *Delta*gram

—the popular, plan-packed
homecrafters' magazine —
for only **50¢!**

DELTA-CRAFT BOOKS .. a complete education in modern shop practical

Group "A"
\$150

Operating Manuals for Better Results with Power Tools. Set of six books. Shows how to get the most out of your lathe, drill press, circular saw and jointer, band saw and scroll saw, abrasive tools, shaper.

Classified Designs . . . A Whole Book on Each Subject. Set of nine books containing hundreds of plans for chairs, lamps, garden furniture, tables, novelties, toys, games, foot-stools, magazine racks, etc.

Group "B"
\$150

Group "C" [COMBINATION OF ALL BOOKS IN "A" and "B"] \$300

Group "D"
\$240

Practical Projects — Set of nine books containing most popular projects from Delta-Craft publications — plus all manuals in Group "A".

Group "E"
85¢

Set of 3 Books—"How to Plan a Home Workshop" "Making Money with Delta Tools" "Practical Finishing Methods."

Order Now!



Money-saving, money-making ideas on what to make and how to make it — in every issue of The Deltagram . . .

Think of it! Only 50¢ for a whole year's subscription to the magazine that novices and expert craftsmen everywhere read to get helpful tips — designs — news — plans — while they're still brand new!

Here's some of the best knowledge available on home-craft subjects — sent to you six times a year by the makers of famous Delta Power Tools.

Practical in Every Detail! The Deltagram leaves nothing to guesswork. Every plan, every shop tip, every design is detailed . . . specific. Instructions are step-by-step — complete and understandable, so that even the beginner can follow them easily, without costly waste of time and materials.

65 Tested Plans, 3/4¢ Each! Each season the Deltagram — only 50¢ for a whole year —

contains about 65 different, shop-tested plans . . . so each plan costs you about 3/4¢.

Certainly inexpensive, isn't it? Especially for knowledge that helps you get more enjoyment from your shop, by helping you produce finer, professional-looking work that wins admiration — and doing it more easily, more quickly, more safely.

Get Your Subscription In! New subscriptions start with the September-October issue . . . so make sure you get every one. Fill out the coupon . . . enclose 50 cents in check, stamps, or money order . . . and mail today!

HM-13

If your subscription to THE DELTAGRAME expires soon . . . RENEW IT NOW so that you won't miss a single issue!

Tear out and mail today!

Deltacraft Publications, THE DELTA MANUFACTURING CO. 681H E. Vienna Ave., Milwaukee 1, Wisconsin

Please send the material checked below. Money order, stamps, or check for.....(total cost) is enclosed.

- The Deltagram — year's subscription.....50¢
(My old subscription expires (date).....)
- Group "A" — 6 Operating Manuals.....\$1.50
- Group "B" — 9 Classified Design Books..... 1.50
- Group "C" — Combination of "A" and "B"..... 3.00
- Group "D" — 6 Manuals and 9 Project Books..... 2.40
- Group "E" — Set of 3 books......85¢

Name.....

Address.....

City..... (.....) State.....

REPAIR TILE

THE EASY *Centraz* WAY

Centraz TILE POINT

Repairs cracks between tile work and bathtub or sink—also where tile abuts door and window trim.

Pint.....35¢
(40¢ West of Rockies)



WATERPROOF ADHESIVE

Sets loose tile, linoleum and miscellaneous veneers to plaster, brick, wood, concrete, etc. ¼ Pint....25¢

(30¢ West of Rockies)



For Sale at Your Hardware and Paint Dealer

CHRISTY COMPANY, Inc.

1417 Pine Street

St. Louis 3, Mo.

AMMCO 7" SHAPER

"A Precision Machine of a Thousand Uses"

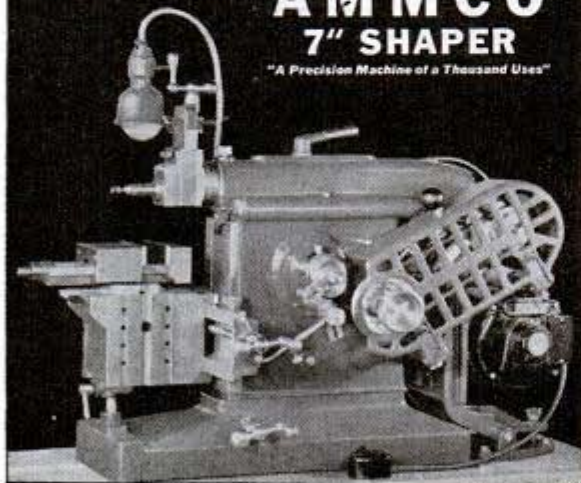

A wide variety of jobs can be done accurately, quickly, easily, and economically on the AMMCO Shaper (7" stroke).

Construction incorporates many features you would expect to find only in larger, more expensive machines... For example: WAYS of ram, tool head, and front face of the main frame are of the "VEE" type, hand scraped to insure accuracy and long life. Available for stationary installation or as portable unit.

Write today for specifications and prices

AMMCO

2140 Commonwealth Ave. North Chicago, Ill.

ONE JOB PAYS FOR THIS NEW SPINDLE STOP

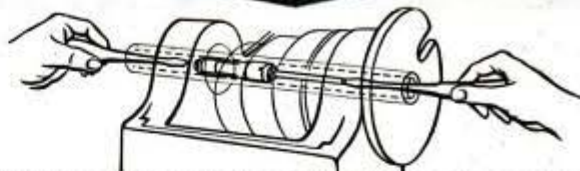

Here's a quick set-up for positioning repeat operations in the lathe. You tighten the Rieger Spindle Stop in the hole of the headstock spindle with two screwdrivers. Won't scar or burr walls. Automatically limits entrance of work pieces... saves measuring each piece in a run... assures accuracy. In short, the Rieger Spindle Stop enables you to put your lathe on a production basis for repeat operations. Regular model fits ¾" holes. Ready for immediate delivery. Ask for complete information.

THE RIEGER MFG. CO.

Department PM-8

MIAMISBURG, OHIO

POCKET ADDING MACHINE

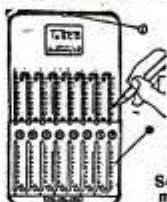

STURDY STEEL construction for lifetime use. Adds, subtracts, aids multiplication. Capacity 999,999.99. A real machine—guaranteed 5 years. Thousands of satisfied users. Send name and address. We ship immediately. On delivery, pay postman \$2.50 (plus C.O.D. and postage charges). If you send \$2.50 with order, we pay postage. Leatherette case 25c additional. Your money back after 10 days trial if not satisfied.

Free Trial \$2.50

Send no money

TAVELLA SALES CO., 19-KA West Broadway, New York 7, N. Y.

ONE-MAN SAWMILL LESS THAN \$135.00

Easy To Turn Trees Into Money

Makes Lumber, ties, shingles, crates, lath, studding, siding.



Belsaw Models in 10, 14 and 20 feet sawing lengths. Patented Mechanical Feed, accurate set works and positive dogs. Use tractor or old auto engine for low cost power. Thousands used for commercial sawing. Pays for itself quickly. Send post card today for VITEE booklet, "How To Make Lumber" and Catalog of Woodworking Equipment. BELSAW MACHINERY CO. Dept. 1811-G, 3542 Main Street, Kansas City 2, Mo.

CRESCENT TOOLS

Give Wings to Work

ASK YOUR HARDWARE DEALER

HELP MAKE THE OLD THINGS DO!

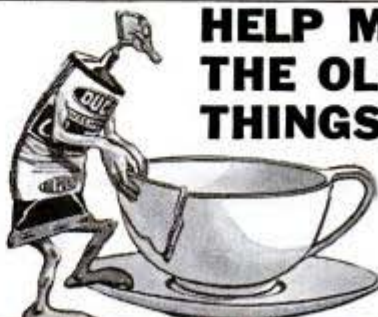

Mends dishes, glassware, furniture, toys and luggage.



DU PONT DUCO CEMENT

REG. U. S. PAT. OFF.

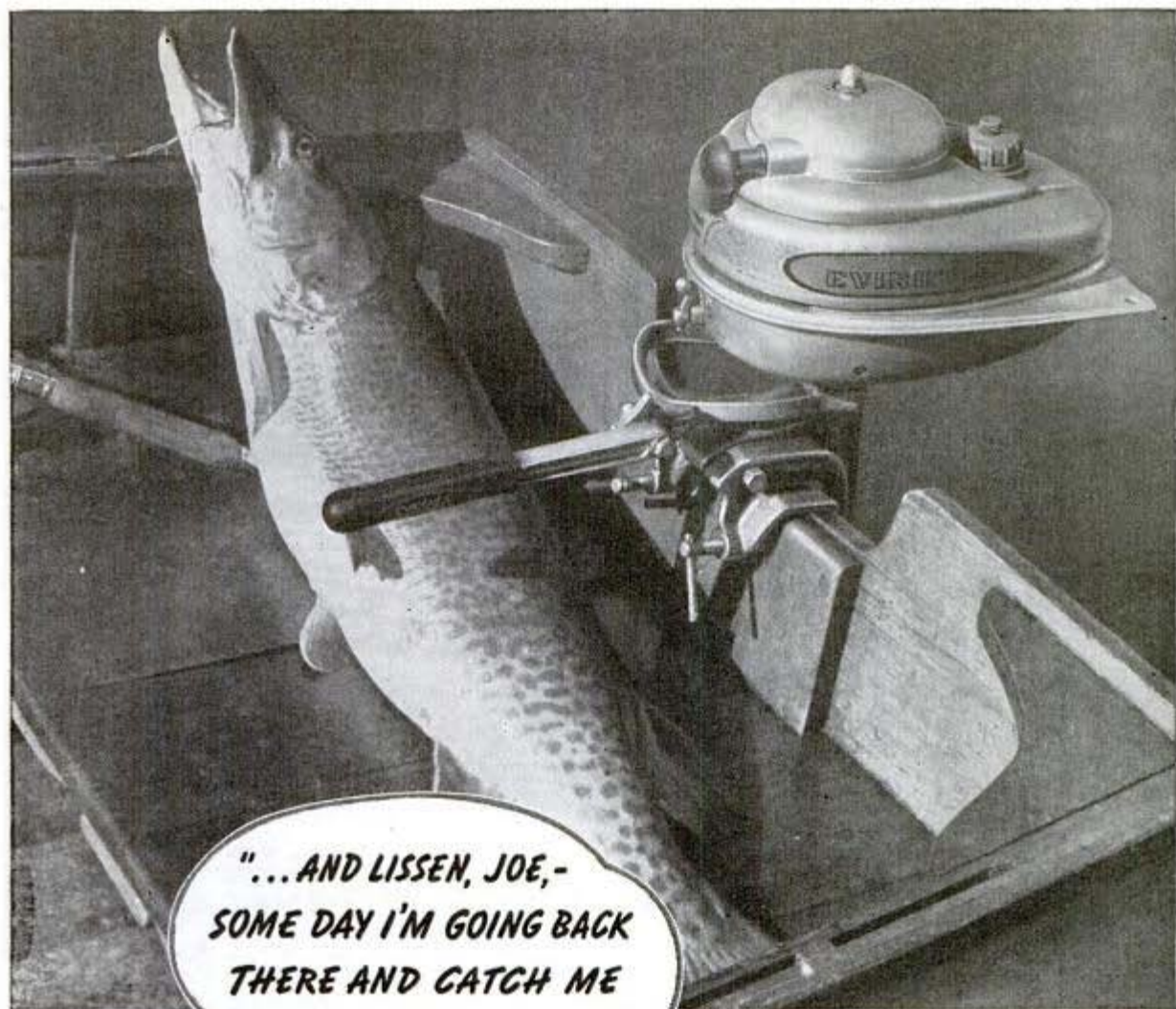

"... AND LISSEN, JOE,-
SOME DAY I'M GOING BACK
THERE AND CATCH ME
ALL HIS BROTHERS!"



More power to all the G. I. Joes who brag about the wallopers they caught . . . and the still bigger ones they'll catch in happy days to come. The boys talk a heap of fishing, we're told. Maybe those big Evinrudes that serve with them help sharpen old fishing memories — and appetites!

One of those great Storm Boat Evinrudes would make at least a dozen fast, smooth, rugged fishing motors . . . the kind they'll want when they get back. And we'll do our darndest to please them!

FREE! Send for this special issue of the "Evinrude News". A pictorial magazine that covers outboards in war and peace — profusely illustrated with photos showing Evinrudes serving the Army and Navy, and pictures of happy peacetime uses to follow! Write today for your copy! EVINRUDE MOTORS, 5076 North 27th Street, Milwaukee 9, Wisconsin.



EVINRUDE



OUTBOARD MOTORS

★ EVERY DOLLAR YOU INVEST HELPS SPEED VICTORY . . . BUY MORE WAR BONDS

Does a busy day
make an OLD MAN
out of you?



● Maybe you're *missing* something, mister . . . maybe you *could* end that "old man" feeling *this* simple, scientific way . . . with a Bauer & Black self-adjusting Suspensory. Men everywhere in all walks of life, active or quiet, heavy or light . . . say the firm, comfortable, flexible support of a Suspensory makes them *feel years younger* . . . *less tired* . . . *all the time*.

Mail Coupon for FREE BOOK



This free illustrated book tells you how men claim to have found new vigor . . . helped to banish quitting-time fatigue . . . how they *stay* fit and energetic all day long . . . every day. Send for your free copy today.

BAUER & BLACK

Suspensories

Division of The Kendall Company

Dept. S308,
2500 S. Dearborn St., Chicago 16, Ill.

Please send me your booklet about Suspensories.

Name _____

Address _____

City _____ State _____

My Occupation is Active Not Active

★ SAVE WASTE PAPER ★



10c NEW BOOK OF LATHE AND DRILL PRESS SET-UPS
Practical, unusual uses, contains 49 illustrations.
Post- Send 10c to cover handling and postage.
Paid JACOBS MFG. CO. 154 Jacobs Rd. Hartford 1, Conn.



Mitchell NORTH AMERICAN B-25
U.S.A.A.F. Bomber
SIMPLIFIED OTT-O-FORMER AND OTT-O-TUBE KIT

40 KITS TO CHOOSE FROM
75c to \$3.00. • At Your Dealer Now

FOUR NEW WAR PLANE MODELS!

Easy to Build — Extra Big Value

Just released! New models of some of the world's fightingest ships. All Ott-O-Tube construction, with sensational time-saving torque tube and ready-cut parts.

- N. A. MITCHELL B-25
40 Inch, \$1.50
 - THUNDERBOLT P-47
40 Inch, \$1.50
 - TYPHOON (British)
32 Inch 50c
 - HELLDIVER SB2C1
32 Inch 50c
- By mail, minimum order
\$1.00. Postage 15c

Joe Ott
AIRPLANE KITS
OTT-O-FORMER
AND OTT-O-TUBE
CONSTRUCTION
JOE OTT MANUFACTURING CO.
415 West Superior Street - CHICAGO, ILL.

SYNGRO

Torpedoes the Axis!

Synero Electric Jig Saws are busy torpedoing the Axis in the shape of SYNCRO-machined parts for submarines, bombers, tanks, guns, etc. Meanwhile Synero research guarantees better Synero Saws for you after Victory!

SYNGRO WORLDS SAFEST SAWS



SYNGRO DEVICES, INC.
3265 Bermuda Ave.
Ferndale 20, Michigan



NEW! Sell Popular
ALL WOOL
Buffalo Check Shirt -

BIG PROFITS FOR YOU!



Every Outdoor man a prospect. Smartest color and style combined with warm, snug comfort. Genuine ALL WOOL Buffalo Check Shirts, Full cut, patented storm cuffs. Amazingly low priced, with generous profit for you.

COMPLETE LINE—Leather and wool jackets, raincoats, 200 fast selling shoe styles for men and women. Our salesmen making biggest profits in this field, using Actual Samples we furnish FREE. Write today for FREE SAMPLE OUTFIT.

MASON SHOE MFG. CO., Dept. M-42, Chippewa Falls, Wis.

110-VOLTS AC from DIRECT CURRENT

with KATO KONVERTERS. Furnish standard 110-v AC from 32, 110, or 220-v. DC. Good deliveries on sizes 250 through 1500 watts on priority orders. Good deliveries on 5, 7½, 15 & 25 KW AC generators. Mfr's of motor generators, frequency changers and high frequency generators.

KATO ENGINEERING CO.
41 Elm Street, MANKATO, MINN., USA



OTTAWA LOG SAW Write for FREE BOOK

PUT THIS OTTAWA to work for you. MAKE MONEY! Wood is valuable. Does more than 10 men. Easily operated. Falls trees—and saws limbs. Use 6-hp. engine for other work.
OTTAWA MFG. CO.
827 Wood St. Ottawa, Kans.



A Ship Must Fight ★ ★ ★

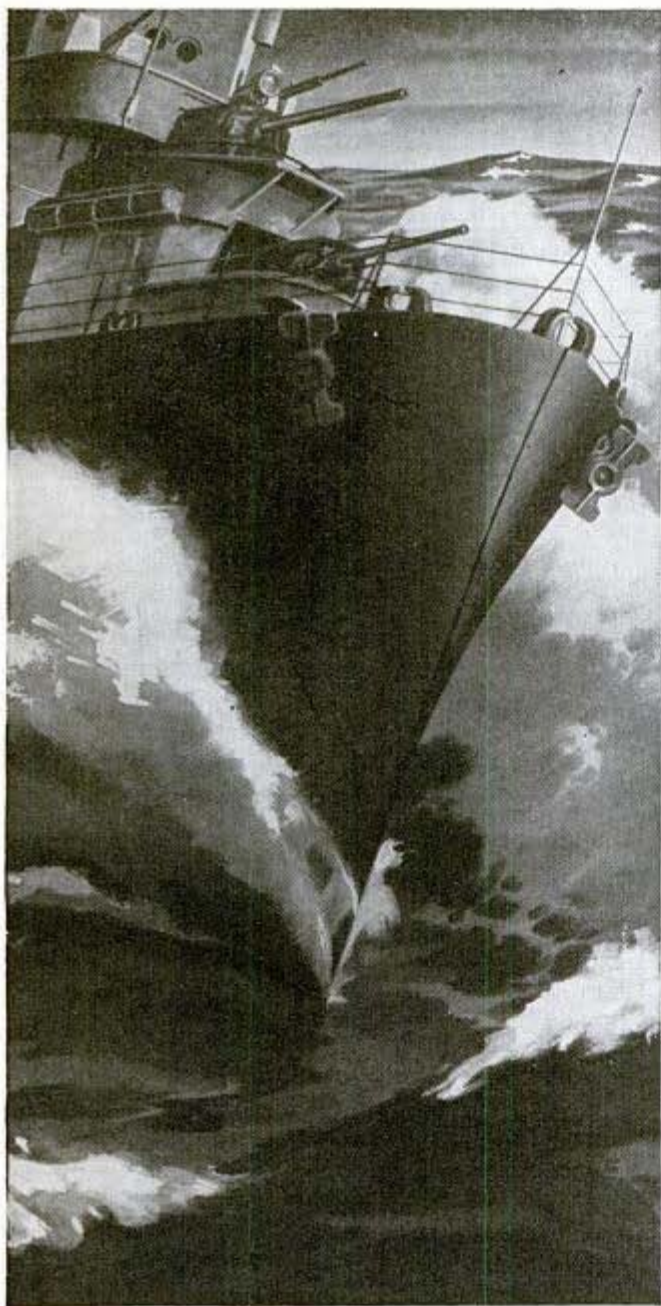

the Weather

★ ★ **the Sea**

★ ★ **and the War**

★ Before the christening champagne is dry on her bow, a warship begins a life-long battle. For she is born to defy sea and weather as well as the blows of war!

The stresses and strains she must withstand present problems that require the skill and craftsmanship of experienced shipbuilders. Her fate and the lives of her crew are staked upon the ability and integrity contributed by these men as she grows upon the ways.

Here at Defoe, we put heart and pride into every Destroyer Escort or LCI (L) Landing Craft launched. And whatever this organization may manufacture after the war will have these ingredients of sturdy, dependable quality. The standards of fine craftsmanship and teamwork developed here in war work will find peacetime expression in better products and values for America!

DEFOE SHIPBUILDING COMPANY, BAY CITY, MICHIGAN

Defoe

*Four White Star Renewal Citations
now decorate the Navy "E" Award
won by Defoe workers.*

INVEST IN INVASION
—BUY WAR BONDS

SHIPS FOR VICTORY
SERVANTS FOR PEACE



MAKE TIME with "YANKEE" TOOLS!

Do the tools you buy make your work easier, faster, more efficient? Do they save you time, money, trouble? Will they stand the pressure of hard work, earning their keep by long, dependable service? They will, indeed, if they are "Yankee" Fine Mechanics'

Tools, the choice of true craftsmen everywhere, for more than half a century. There's only one trouble with "Yankee" Tools today, but that's a trouble that will be corrected quickly by Victory: Supply can't keep up with demand . . . for "Yankee" Tools, you see, are at work for war. So remember the built-in ingenuity of "Yankee" Screw Drivers, Drills, Vises, Bit-Braces, and Tap Wrenches. They've been designed to make time! And making time, above, is "Yankee" Spiral Screw Driver No. 130A—a size for every purpose.

"YANKEE" TOOLS

make good mechanics better

North Bros. Mfg. Co., Phila. 33, U.S.A.

Established 1880

Makers, also, of "Yankee-Handyman" Tools

BURN YOUR NAME ON TOOLS

WITH THE ARKOGRAF

PROTECT YOUR TOOLS FROM THEFT

Write with electricity any name or design on the hardest and finest tools and instruments or any metal, like writing on paper with pen or pencil. Thousands used by mechanics, garages, machine shops.

Complete Outfit \$3.50—Prepaid Anywhere
Interesting illustrated circular free. Write today.
ARKOGRAF PEN CO., 3927 S.E. Stark, Portland 15, Ore.



★ SAVE WASTE PAPER ★



KRW ARBOR PRESSES BENCH TYPE AND HYDRAULIC

NEEDED IN EVERY SHOP—SAVE TIME AND MONEY—DO BETTER WORK, QUICKER.

No shop is complete without a small arbor press. Pressing and squeezing operations can be done better and faster on a KRW Arbor Press. Stop using vise and sledge hammer methods—they generally deliver spoiled work in the end. KRW Factory-To-You Prices give you greater value for your money. Order today.

KRW Bench Type Arbor Presses, 3 sizes

No. 37-P ½ Ton, \$13.25*
No. 37-O 1 Ton, \$23.00*
No. 37-N 3 Ton, \$33.00*

*Prices F.O.B. Arcade, N. Y. Slightly higher west of Rockies. Stand illustrated extra.



KRW Hydraulic Presses are built in 25, 50, 60 and 75 ton sizes. Prices start at \$198.00*.



K. R. WILSON, 17 Lock St., BUFFALO 2, N. Y.

Builders of Shop Equipment for Ford Dealers Since 1916

DRILL PRESS OWNERS!

HERE'S 1 TOOL WITH 5 DISTINCT USES
THE BARRON MULTI-PURPOSE
ROTARY WOOD PLANER



PLANES & SURFACES • PANELS & BEADS \$750
ROUTS & GROOVES • RABBETS • TENONS COMPLETE

Converts ANY drill press into a time saving, low cost planer, paneler, tenoner, etc. Surface finishes all types of tough grained and knotty surfaces to agate smoothness. Safe! Guaranteed harmless to drill press. Thousands now in use. SOLD ON MONEY BACK GUARANTEE. Full refund on 5 day trial. Shipped prepaid on receipt of \$7.50—or C.O.D. YOU RISK NOTHING. Free literature.

STEEL TOP AUXILIARY DRILL PRESS TABLE

Has 300 sq. in. smooth working surface. Equipped for shaper and many other important workshop uses—a real buy at \$5.95



Barron Tool Co., 369 Architects Bldg., Detroit 1, Mich.

INVENTORS, SCHOOLS, CRAFTSMEN BRONZE FOUNDRY



is again available in limited quantity without priority. Orders filled in sequence as received. INVENTORS—SCHOOLS—CRAFTSMEN use FOUNDRYETTE for making castings quickly for new inventions, for instruction, and general purpose. Order now for early delivery. Three sizes are available capable of making bronze castings of 1½, 3, and 6 pounds weight, aluminum, copper, brass, etc., \$17.50, \$24.00, \$34.50, f.o.b. Kansas City. Domestic gas supply and 110 volt AC or DC energy required for operation. Write for circular.

KANSAS CITY SPECIALTIES CO.

Box 6022, Dept. P-45

Kansas City, Mo.



BALL BEARINGS

Set in flawless steel rings, assuring precision operation due to friction-free rotation. All Standard makes—New Departure, S. K. F., Norms-Hoffman, Fafnir, etc. We can supply promptly any quantity needed from our large stock of the MOST POPULAR SIZES. And you SAVE 50 to 60% on Manufacturer's List. All Ball BEARINGS FULLY GUARANTEED

Write TODAY for Bulletin B

M-E-T EXCHANGE, Dept. PM, 323 Canal St., New York 13, N. Y.

BRUSH PLATING OUTFITS

for autoparts, reflectors, faucets, bicycles.

No tanks necessary. Free particulars.

GUNMETAL CO., AVE. M., DECATUR, ILLINOIS



GENUINE U.S. BARGAINS

O. D. WOOL BLANKETS (USED) . . . \$2.95
USED COY MOSQUITO NETS . . . 1.25
U. S. ARMY PUP TENTS (USED) . . . 3.00
Slightly Used Army Caisson Wheels with Axles, 56" high, weight per pair with Axle, 322 lbs. \$37.50

Thousands of Other Bargains in Military, Outdoor & Sport Goods for Hunter, Farmer, Scout Send 10¢ for 32-page catalog returned with first order.

A and N SUPPLY CO.

4724 LESTER ST.

RICHMOND, VA.

How to learn to shoot

... under the nationwide pre-induction training program sponsored by the National Rifle Association Washington, D. C.

TAKE ADVANTAGE of this government-approved program intended to train the maximum number of our citizens in the use of small arms.

Here is invaluable training for all prospective service men, defense units, guards and others—

Less than 2% of all men inducted into the armed services knew anything about rifled firearms

Shocking but true! Don't be in this class. Familiarity with firearms constitutes a real service to our country now and will stand you in good stead the greater part of your life.

WRITE TODAY for the free booklet "The Guidebook to Rifle Marksmanship," also other literature which tells you how you may get pre-induction rifle training.

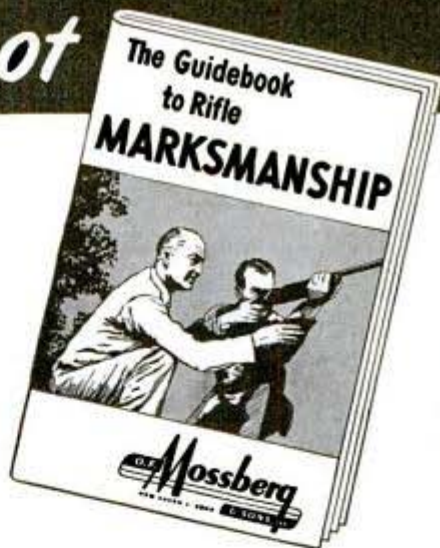

O.F. Mossberg
& SONS, INC.

4658 St. John St., New Haven 5, Conn.

Today 100% in war work. In normal times, manufacturers of .22 cal. RIFLES, SHOTGUNS, TELESCOPE SIGHTS, TARGO GUNS & EQUIPMENT

*A Little Breather Now and Then
Is a "Must" for Busy Men!*

If you're lucky enough to own an outboard motor, use it. Put it to work to keep you fit for your war-time job.

And share your fun. *When you go fishin', take a friend.* Take one who has never fished before and give his heart the kind of lift that only fishermen know. You'll both be better for it.

You'll have more fishin' time, of course—and more fun all around—if the third party on your trip is a Sea-Horse.

The Sea-Horse is a born fishin' friend.

DEALERSHIPS: All of today's Sea-Horses are for the armed services and essential needs. But if you are interested in selling and servicing outboard motors after the war, write us now—no matter what your location may be.

JOHNSON MOTORS
400 Pershing Road, Waukegan, Illinois



**Johnson Sea-Horses
for Dependability**

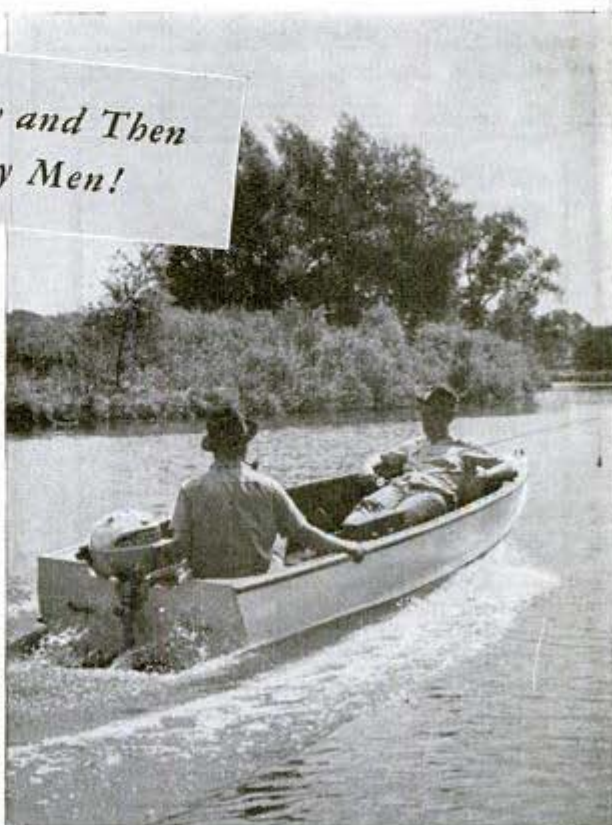

THERE IS NO SUBSTITUTE FOR EXPERIENCE

What a Tool Box

Built to U. S. Navy Specifications



NO PRIORITY NEEDED!

What a Tool Kit! Not since Pearl Harbor has there been anything like it available! There wouldn't be now except that a limited quantity has been released for civilian use. Built to U. S. Navy specifications. And built like a battleship—so well made that a 250 lb. man can sit on it without damage. Made of 18-gauge sheet steel, heavily reinforced at corners with buttresses. Handsomely finished with baked enamel. Carrying handles, heavy and sturdy enough to support any weight, no matter how much you load up this case. Cover lids fastened with two genuine continuous piano hinges, guaranteed never to buckle or break away. Tray divided into three compartments, convenient for small tools, screws, nuts, bolts, and other small parts, has a sturdy cross-bar handle made of tube steel. Kit measures 21x8½x7 inches over all. Don't confuse this tool box with the ordinary sleazy cases generally offered at this low price. This is a de luxe case built to last for life-time, and so guaranteed by us and the maker. But hurry your order! At the low price of \$5.95, our supply won't last long. **SEND NO MONEY.** Pay postman only \$5.95 plus postage on arrival. Satisfaction or your money back.

ILLINOIS MERCHANDISE MART, Dept. 2105-A
 300 N. DEARBORN STREET, CHICAGO 10, ILL. **ORDER NOW!**
 Please send me a Tool Box as illustrated, complete with tray. I am to pay Postman only \$5.95 C. O. D., plus postage on arrival. It is understood that if I am not 100% satisfied I will return within 10 days for a full refund.

Name _____
 Address _____
 City _____ State _____

**TAPE WORMS
 ROUND WORMS
 (Ascarids)
 HOOK WORMS
 WHIP WORMS**



...you can free your dog of all these worms

with **PULVEX**
COMBINATION WORM CAPSULES

Used by leading breeders. At leading pet, drug, department stores, 50c a package (double size, 75c). Packed two ways: for puppies, for dogs.

END DAMP AIR with DRI-AIR

PROTECT your valuable equipment, tools, foods and furnishings from damage! End dampness in your home or workshop with amazing **DRI-AIR**. **Makes Dry Rooms Healthful, Pleasant** Place **DRI-AIR** Unit in any room, basement, storeroom or closet. **DRI-AIR Chemical** absorbs extra moisture from the air. Keeps rooms dry. Prevents mould and mildew. **DRI-AIR** kills musty odors; stops rust; keeps furniture and woodwork from warping. Complete **DeLuxe DRI-AIR**



including 10 lbs. Chemical, \$5.50 f.o.b. Chicago. Ask your dealer or order direct. Send for FREE BOOK-LET, "Household Hints in Wartime." Write today! **TAMMS SILICA COMPANY**
 228-BD N. LASALLE STREET, CHICAGO 1, ILL.

SAVE TIME AND TROUBLE WHEN YOU REFIT BEARINGS



Refit con-rod or other bearings in ¼ the usual time. Use **TIMESAVER** Lapping Compound; 24 years successful use by leading firms. Quicker and easier. Makes bearings fit better, last longer, have perfect oil clearance over entire surface. Get acquainted with and instructions, 25c; economy size, \$1.00, postpaid. Satisfaction guaranteed or your money refunded.

TIMESAVER—1115-F POST ST., SEATTLE 1, WASH.

MASCOT SLIDE RULE



● Fits the pocket. Quickly solves any problem in multiplication, division, proportion. Gives the square, the square root, logarithm and reciprocals of all numbers. Trig scales give sines and tangents of numbers. Fine black graduations on white celluloid. Complete with instructions. Price in fabricoid case \$1.00, in leather case \$1.25. Money back if not satisfied. Special offer to agents and dealers.

MONITOR SLIDE RULE—6" Dia.
 Made in white Vinylite. Same scales as Mascot Slide Rule. Complete with instructions. Without case, \$2.95. Leatherette case, 75c add'n'l.
TAVELLA SALES CO., 19-K West Broadway, New York 7, N. Y.



Kandler's Special 10 TON ARBOR PRESS

For washing machine repair, electrical and general repair shops—a big-capacity press (takes work 18"x21½") at only **\$3300** F.O.B.

Write **KANDLER MACHINERY**
 1407 WAVERLY DR., KALAMAZOO 17, MICH.



COOLING BUILD YOUR OWN

Plans for Coolers & Blowers. Exhaust. Electric Cellar Drainer Pumps. Pressure Switches. Plumbing and Heating supplies. Fan & Damper controls. Thermostats. Gas Stoves. Water Heaters. Electric Fans. Furnaces. Stoves for apartments. Free literature. **PEERLESS SALES, Box 122 C. V. 4th., Lincoln, Neb.**



BUILD THESE PROJECTS

For garden or lawn. Easy to build. Easy to sell. Detailed blueprints Model B-25 Dutch Windmill 50c; Model OM-60 Old Mill 55c. Lawn Figure Patterns—Sunbonnet Girl, Dutch Boy, Tulip Girl, Holland Pair, 35c each, all 4—\$1.00. Catalog illustrating many models, send 10c today.

CRAFTSMAN'S MODEL CO., Dept. P-78, 2030 N. 41st St., Milwaukee, Wis.

★ SAVE WASTE PAPER ★

ENGINES IN STOCK

Complete \$20



The G. H. Q. miniature gasoline engine that really operates is still available. Over 100,000 sold to date. 1/5 H. P. Complete with flywheel and propeller, fuel, 15 accessories and full instructions. Fully bench tested and ready to run. Power for all models. \$20 complete. Send only \$1.00—Shipped Collect C.O.D. same day. Send 25c for illustrated Catalog of hundreds of hobby items and airplane identification chart.

GHQ MOTORS, Dept. BV84, P. O. Box 203, Madison Sq. Sta., New York 10, N. Y.



BEST SELLER SENT FREE

to men who smoke pipes

John Middleton's Walnut pipe-tobacco has been custom-made for the carriage-trade since the days of sailing-ships. This mild, fragrant, friendly, naturally aromatic tobacco is the largest seller in its price-field. We'll send you an ample sample of this best seller, with a free copy of the gaily illustrated, easy-to-read booklet, "The Choice of Experience." Just jot your name and address on a postcard, and mail it to John Middleton, 1201 Walnut (Tobacco) St., Philadelphia 7, Pa. Better do it now before you forget.



YOUR Guide after VICTORY

* HULL AUTO COMPASS will direct your car faithfully, too. After the war, dealers will have the improved new model, battle-tested, scientifically engineered.



Assure Victory
—BUY BONDS

HULL MFG. CO., P. O. Box 245-DS, WARREN, OHIO

Miniature Mask for DUST and HAY FEVER

Hay fever sufferers wear to keep from breathing pollen. Handy as a pair of glasses! For best protection keep mouth closed and breathe thru nose. Guards against nuisance dusts, lint, coal, cement, grain dust, plant pollens, etc. Wear when sweeping, dusting, cleaning furnace, sanding, grinding, paint spraying. DUPOR No. 1 weighs 1 oz. Has 9 sq. in. filter. Felder FREE!



Order Today \$1.00
POST PAID

H. S. COVER, Dept. PM, South Bend, Ind.
"GOLDEN JUBILEE YEAR, 1894-1944"

DO YOU

WANT a permanent business profession of your own? Then BECOME A FOOT CORRECTIONIST. Earnings in this greatly needed profession run as high as \$50-\$100 weekly after a few weeks home training—not medical or chiropody—no further capital needed, no goods to buy. 47th year. Write for free booklet.

Stephenson System of Foot Correction
28 Back Bay, Boston, Mass.

SHAW and "Peppy-Pal" "DU-ALL" GARDEN TRACTORS

• 1 to 9 H.P. Circulars on request. War limits production—We supply repairs for all SHAW Tractors sold in our 40 years in business.

BUILD YOUR OWN RIDING TRACTOR—"WAR HORSE"

using old auto parts, powered by 2 H.P. or larger air-cooled engine; or walking type Garden Tractor 1/2 to 3 H.P. or convert truck or auto into Farm Tractor. Each with steel or rubber tires; will plow, cultivate. Plans for building, in few hours, any one of above, postpaid for \$1.00 (state which wanted) or all 3 for \$2.00. Money Back Guaranteed!

SHAW MFG. CO., 4508 Front St.
Galesburg, Kansas
668G North 4th St., Columbus, Ohio



Avoid another winter of... "Cold Comfort"



—INSULATE NOW WITH BALSAM-WOOL ATTIC INSULATION



Did your teeth chatter in chilly rooms last winter? Then this year avoid shivers in your home—and stay far more comfortable—by applying Balsam-Wool Insulation in your attic, NOW. Balsam-Wool pays for itself in fuel savings—often reducing fuel bills as much as 20%.

Balsam-Wool gives you year-round benefits. It keeps your house cooler in summer, and it prevents heat leakage in winter. This original, blanket-type insulation has proved its value in hundreds of thousands of homes. It is windproof, moistureproofed and fire resistant... designed for permanence.

MONEY-BACK GUARANTEE—Because it is a superior product, Balsam-Wool is sold under a money-back guarantee of complete satisfaction! Don't wait—see your lumber dealer now about buying Balsam-Wool on easy monthly payments. Or, mail the coupon for complete information.

Balsam-Wool

SEALED ATTIC INSULATION

Balsam-Wool... Products of Weyerhaeuser... Nu-Wood

WOOD CONVERSION COMPANY
Dept. 210-B, First National Bank Bldg.
St. Paul 1, Minnesota

Gentlemen: I want to know more about Balsam-Wool Double-Value Attic Insulation.

To assist us in giving you special information, please check: I am a home owner
renter architect contractor
student

Name.....
Address.....
City.....State.....



Some things haven't changed!

... Long a symbol of constancy—THE NORTH STAR
Long the perfect pipe material—MEDITERRANEAN BRIAR



\$5

Antique and Smooth Finish. Sterling Silver Band. Solid Rubber Bir. Every pipe numbered, registered and guaranteed by LHS

Made of GENUINE IMPORTED BRIAR

AT ALL GOOD DEALERS

NEW LHS STERNCREST 14K

Of briar specially selected for beauty of grain. 14K solid gold band. Truly, "Perfection in a Pipe". \$7.50

L & H STERN, Inc., Stern Bldg., Brooklyn 1, N.Y.

Makers of LHS Ultra-fine \$10 Certified Purex \$3.50

SORRY—So many LHS pipes are going to the armed services, that your dealer may not always be able to supply you with just the model you want.

FIELD "STOVE" and HEATABS \$1.00

COMPACT "STOVE" and HEATABS \$2.00

Speaker HEATABS

HOUSEWIVES, WARWORKERS, SPORTSMEN . . .
Everybody NEEDS HEATABS

You've longed for them . . . hoped for them . . . and now you can GET them! Speaker HEATABS with either of the "pocket stoves" shown here, FRY, HEAT or BOIL foods and liquids, indoors or outdoors. Heatab "Compact Cookit," when closed, resembles cigarette case or lady's compact. Carry it in your pocket, purse or car glove compartment. Just the thing for picnics, campfires, hunting and fishing trips. Many uses at home, factory or office . . . for doctors, nurses, scouts . . . for emergency heat and light. Used extensively by our armed forces. Send the "FIELD STOVE" or Deluxe "COMPACT COOKIT" and HEATABS to your friends or relatives in Service . . . Help them have their meals hot, just like mother used to!

FIELD STOVE and HEATABS, \$1.00 . . . Deluxe COMPACT COOKIT & HEATABS, \$2.00, Postpaid.

J. W. SPEAKER CORPORATION
3057 N. Weil St. Dept. PM, Milwaukee 12, Wis.

NO SMOKE
NO SOOT
NO ASH
NO POISON FUMES

all HEAT!

FRY FIELD "STOVE"
HEAT COMPACT "STOVE"
BOIL

ORDER BY MAIL
IF YOUR DEALER
CAN'T SUPPLY YOU

Speaker HEATABS TABLETS OF concentrated HEAT



Free Fall Catalog

Ready August 7

Showing Hunting Footwear, Clothing, and forty-three other leather and canvas specialties of our own manufacture for campers and hunters.

L. L. Bean, Inc.
Freeport 102, Me.

15 LENSES

Plus 50 PAGE Idea Booklet to Help You . . .

(All Lenses New—Edges very slightly chipped) . . . make your own telescopes, low power microscope, magnifiers, dummy camera, photo cells, rifle scope, detachable reflex viewfinder for 35-mm. camera, telephoto lens, photographic gadgets, for experimental optics, copying and ultra-closeup shots and hundreds of other exciting experiments.

EDMUND SALVAGE COMPANY
27 W. Clinton Avenue, P.O. Audubon, New Jersey

Set 602-H
Only
\$2.60
Postpaid

The Dennison Handy Helper says:

It Took Time to Make It.
Use Care—Don't Break It

AND INSURE CARE IN HANDLING WITH

Dennison CAUTION LABELS

At Stationery Departments Everywhere



BUILD MODERN STREAM-LINE



Three-room house 22x24 as low as \$100, big garage \$20, poultry house 20x30, \$50, for materials. Cement composition. New easy way to apply. Ten formulas. 100 money-saving ideas. No painting. Long lasting. Insulating. Farm buildings for a few dollars. Sectional cabins. Make doors and windows. Home-made equipment to make building blocks, panels, floor, wall and roof tiles in colors with molds, wooden forms, or trowel. Make durable wall-board of sawdust at little or no cost. Also furniture. Mixer and circular saw from old auto easily made. Guaranteed. Illustrated book of instructions. \$1.00, with 40 War-time plans. Earn \$10.00 a day. HOME INDUSTRIES, 1318 So. 30th Ave., Dept. PM, Omaha 5, Nebr.

TRAILER AXLES, HITCHES, AND PARTS

● If you are interested in purchasing trailer axles, hitches, and other trailer parts, contact us promptly. Complete house trailer blue prints, \$1.00. Write for free literature.



HAMMER BLOW TOOL COMPANY, Dept. 108, WAUSAU, WIS.

★ SAVE WASTE PAPER ★

RATIONED MOTORISTS

Now Get **EXTRA GASOLINE MILEAGE**



Now you can get up to 30% extra gasoline mileage with a Vacu-matic on your car. Quicker pick-up, smoother running, added power and precious gasoline savings guaranteed.

Automatic Supercharge Principle
Vacu-matic is entirely different! Operates on the Supercharge principle. Saves gas. Automatically provides a better gas mixture. Guaranteed to give up to 30% extra gas mileage, more power and better performance.

FITS ALL CARS
Constructed of six parts, fused into a single unit. Adjusted and sealed at the factory. Very quickly installed by anyone.

AGENTS TRIAL OFFER

Every car, truck, tractor a prospect. Send name, address on postcard for big money making offer and how you get yours for introducing.

Vacu-matic Co., 7617-963 W. State St., Wauwatosa 13, Wis.

PRELUDE to a PERFECT FINISH



Finish must now be measured in micro inches. That's where the new Chicago **FV BOND** Wheels excel. They give a precision smoothness so intensified that it passes any surface analyzer test.



FV BOND is available in all types of Chicago Mounted and Small Grinding Wheels—in all abrasives, grain and grade combinations. It is the result of research and experiment on hundreds of aircraft jobs.

Chicago Mounted Wheels are tough, long lived, dependable. Over 300 sizes, styles and grains.

Chicago Grinding Wheels—Only sizes up to 3" diameter for the duration, with W P B approval.

Handee Tool of 1001 Uses and Hi-Power Grinders are still available to all who have priorities.

Send for Free Catalog

CHICAGO WHEEL & MFG. CO.

1101 W. Monroe St., Dept. PM, Chicago 7, Ill.



New Designs in **FRANZITE GRIPS**

Modernize Your Gun! Improve Your Score! Most durable grips made. Positively unbreakable! For Colt, Smith & Wesson, Hi-Standard, Ortgies, Luger & Mausers in a wide choice of beautiful designs in ivory, pearl, walnut, onyx, etc. Low prices. **FREE CATALOG.** Dealers Wanted.

SPORTS, INC., (Mrs.) 2850 N. Clark St., Dept. P-8, Chicago, Ill.

COLOR CONCRETE WITH CHEMICALS

A business of your own. Big money making Hollywood style pottery and birdbaths without moulds. Wishing-wells, stucco-rock, benches. Marbling and cement water-paints. 10c brings sample, literature, pictures. **Hollywood CementCraft, 8529 Wonderland Ave., Hollywood 46, California**

Wonder-Tone NOISE ELIMINATOR

Just attach to your radio (long, short wave) and enjoy reception free from distracting noises. Send-No-Money Pay Postman 60c plus postage or send 60c and we'll send postpaid. Return in 5 days for refund if not delighted.

WONDER-TONE COMPANY, Dept. 43, 7078 N. Clark St., Chicago 26, Ill.

TOMBSTONES \$13.69

Interested! Write us now for Free Catalog. Made of best Marble & Granite. Service direct to you by mail. Why wait. **U. S. MARBLE & GRANITE CO., Oneco, Fla.**

ARTIFICIAL ARMS-LEGS

WRITE FOR FREE BOOK showing how **CARNES ARTIFICIAL** arms, legs have **PUT THOUSANDS BACK ON THE PAYROLL.** Every limb made to fit individual amputation. World-wide recognition of merit since 1904. **BOOK SENT FREE**—advise whether interested in leg or arm—no obligation, send for it now.

CARNES ARTIFICIAL LIMB CORP. Dealers and Representatives Everywhere
908-S East 12th Kansas City, Mo.

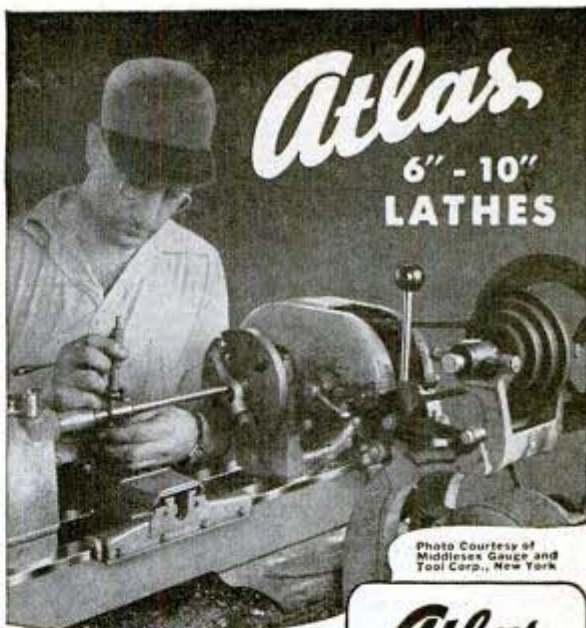

Photo Courtesy of Middlesex Gauge and Tool Corp., New York

COMPACT and CAPABLE

The performance record of Atlas lathes in thousands of war plants forecasts a new kind of production engineering for peace. Today, these compact, capable machines deliver precision work formerly entrusted only to larger, far more expensive equipment. Tomorrow, the same precision and efficiency will help meet new production problems.

If your postwar plans include machine tools for business or home pleasure, see an *Atlas in action!* Available now only on war or MRO orders. Send for new, free catalogs.

ATLAS PRESS COMPANY

843 N. Pitcher St.
KALAMAZOO
13D, MICH.



Atlas 4 TOOL TEAM for SMALL PARTS MACHINING



DRILL PRESSES



MILLING MACHINES



SHAPERS



LATHES

ANYONE, ANYTIME CAN MAKE PHOTO-COPIES QUICKLY

The most
USEFUL
copying method
ever perfected



A-PE-CO
PHOTO-COPYER
\$55.
COPIES UP TO
18" x 22"

The accuracy, ease and speed with which A-PE-CO photo-copies are made by anyone, are creating hundreds of new users. This modern, versatile, low-cost method makes photo-exact copies of anything written, printed, drawn or photographed. Experience proves that A-PE-CO quickly pays for itself.

LEGALLY ACCEPTED PHOTO-COPIES OF

- Letters
- Records
- Blueprints
- Shop Orders
- Pictures
- Receipts
- Drawings
- Documents

Same-size copies of anything up to 18" x 22". Eliminates errors. Saves steno-copying, tracing, proofreading. No camera, focusing, film or moving parts. Any employee quickly becomes expert. Lowest investment in equipment. Use on any desk or table. You need A-PE-CO. Let us show you how you can use it to expedite office and shop copying. Immediate delivery. See why thousands are in satisfactory use. Send for A-PE-CO folder—today.

AMERICAN PHOTOCOPY EQUIPMENT CO.

2849 No. Clark St. Dept. GF-84 Chicago 14, Illinois
Representatives in Principal Cities
In Canada: Railway and Power Engineering Corp., Ltd.

FIGHT WITH WAR BONDS

FREE PLAN!

Shows how to Start a Good War-Time Business with a Big Future

There are hundreds of saws in your community that need sharpening repeatedly, used by home owners, carpenters, farmers, schools, factories, mills, etc. Our FREE PLAN shows how to get this business. With a Foley Automatic Saw Filer you can file saws faster and better than the best hand filer and earn up to \$2 or \$3 an hour. No eyestrain. One machine files ALL saws—hand, band, circular. No special priority application required—delivery guaranteed. Get into



SAW-FILING

now,—there is plenty of business during wartime, and be all set for the big building boom which is sure to come when the War is over. Send coupon today for FREE PLAN—no obligation, no salesman will call.

FOLEY MFG. CO., 816-4 FOLEY BLDG., MINNEAPOLIS 13, MINN.

Please send FREE PLAN on saw filing business.

NAME
ADDRESS

PAY-RAISING — EXTRA MONEY BOOKS

Use these books to prepare for a better job—bigger pay—to start a profitable spare time or full time business of your own, improve your home, start a hobby. Popular Mechanics specializes in supplying outstanding self-help books on many subjects.

- How to Remodel a House Nothing is omitted. \$4.75
- Painting, Furniture Finishing & Repairing New self-help book for craftsmen, home owners\$1.50
- Shop Notes for 1944 Now ready. For every man who uses tools... .50c
- Shop Notes Library 5 vols.—1944, 43, 42, 41, 40 (no dup. mat.) \$2.50
- Refrigerated Locker Manual Plant operation, quick freeze, etc.\$3.00
- How to Read Blueprints \$1.50
- Welding, Brazing & Soldering How to build own equipment and use it effectively\$1.25
- Garden Book Build own trellises, lawn furniture, fire-places, ornaments, etc. \$1.00
- Forty Power Tools Build own saw, drill, iron, sander, etc. from scraps—save money\$1.25
- Rewinding & Servicing Electric Motors (No. 75)25c
- Running & Milling Machine (new)\$1.50
- Turn Scrap Into Money Convert old auto generators into motors, welders, etc.\$1.00
- Motorcycle Speed & How to Obtain It\$1.50
- House Wiring (No. 89) All information needed to do complete job. .25c
- Modern Refrigeration Electric, gas. Be service expert\$5.00
- Dyke's Auto Ency. (includes Diesels, airplane engines) Now 20th Ed. World's greatest book for mechanics\$6.00
- Sheet Metal Work Self instruction in all phases\$2.50
- Tool & Saw Sharpening (No. 92)25c
- Armature Winding Construction, winding, repairing AC & DC Motors, generators ... \$2.00
- Build Your Own Boat Describes 17 popular boats—powerboats, sailboats, plywood outboard, etc. 192 pages \$1.50
- Forging Practice\$1.50
- Toys You Can Make of Wood\$2.50
- Carpentry Learn modern methods\$2.00
- Foundry Work\$2.00
- What to Make for 1944 New 224 page book of handicraft projects... .50c
- What to Make Library 5 vols.—1944, 43, 42, 41, 40 (no dup. mat.) \$2.50
- Blueprint Reading For building trades...\$1.25
- Pattern Making Wood, metal\$2.00
- Action Toys (No. 66) Plans for 21 easy-to-make toys25c
- The Young Craftsman over 450 things boys can make\$1.00
- Five Acres and Independence How to make money on small farm.....\$2.50

- New, Pocket Size MACHINE SHOP SERIES
- Drill Presses\$1.50
- Engine Lathes 1.50
- Shapers 1.50
- Planers 1.50
- Millers 1.50
- Turret Lathes 1.50
- A-B-C of Poultry Raising\$2.50
- How to Build Violin, Pipe Organ, Banjo-Uke ...\$1.00
- Wooden Clock Movement Full-size pattern ... 75c
- Silhouette Book 212 attractive silhouettes 50c
- Deluxe Small Homes Selection of 210 popular designs\$1.00
- Knobs, Tie Splices For everyone who uses rope\$1.25
- Plastics Latest information on manufacture and use \$3.75
- Workbenches & Tool Cabinets You Can Build (No. 47)25c
- Your Car Hundreds of simple car repairs, short cuts that will help make it last for the duration...\$1.25
- Concrete Handbook New book on using concrete around home, garden, farm\$1.50
- Oil Burner Handbook...\$1.50
- Steel Square Pocket Book Best methods of using \$1.00
- Photo Guide Construct own equipment, gadgets. Make better photos\$1.25
- Elementary Forge Practice\$2.00
- Welding, Electric...\$1.25
- Welding, Oxy-Acetylene Welding, cutting...\$1.25
- Metallurgy\$2.50
- Fluorescent Lighting New manual on construction, installation, repair\$3.00
- Shipbuilding Blueprint Reading\$3.00
- Ropp's Calculator Figuring made easy...\$1.50
- Plumbing Installation & Repair For those without previous training\$1.50
- Complete Book of Garden Magic Covers all phases of gardening\$3.00
- Wine Makers' Manual...\$1.50
- Judo, 30 Lessons in Modern Jiu-Jitsu\$1.89
- Modern Core Practices & Theories Only book published treating completely with production and use of cores in metal casting\$8.00
- Watch Repairing Simplified\$3.00
- Propagation of Plants Covers every conceivable method\$3.50
- Lessons in Ornamental Penmanship\$1.00



MAIL THIS COUPON TODAY

Check the books you want, write your name and address below, and mail this advertisement with money order or check. Outside U. S. A. include 15% additional for shipping charges. Books selected will be mailed promptly on our "money back if you're not entirely satisfied" guarantee.

Name
City State.....
Address

Mail to **POPULAR MECHANICS PRESS**
Dept. 562—200 East Ontario St., Chicago 11, Ill.

FREE! LATEST, MOST COMPLETE RADIO PARTS CATALOG



EVERYTHING in RADIO and ELECTRONICS for War Training, Maintenance or Repair



New R-F Resonance and Coil Winding CALCULATOR

Easy to use! For fast accurate determination of resonance factors and coil winding data. No. 37-955. Postpaid, only 25c.



RADIO'S FINEST BOOK VALUES

Specially prepared to aid radio training in schools and industry. Full of valuable data. Send for all six!

- Radio Formulas and Data Book No. 37-752..10c
- Dictionary of Radio Terms No. 37-751..10c
- Radio Circuit Handbook No. 37-753..10c
- Radio Builders' Handbook No. 37-750..10c
- Simplified Radio Servicing No. 37-755..10c
- Radio Data Handbook No. 37-754..25c
- All Six Books No. 37-799..75c

6 BOOKS FOR 75c

ALLIED RADIO CORP.
833 W. Jackson, Dept. 5-H-4, Chicago 7

ALLIED RADIO

ARMSTRONG TOOL HOLDERS

enabled American industry to change to war production "over night." For they are the permanent, multi-purpose tools used by 96 per cent of the machine shops and tool rooms, on lathes, planers and shapers—the tools used to make dies and jigs, to build production machines. They are the tools you will want for your own shop after the war—ARMSTRONG TOOL HOLDERS for industry, ACE Tool Holders for home work shops.



ARMSTRONG BROS. TOOL CO.

"The Tool Holder People"
358 N. Francisco Ave., Chicago, U.S.A.

MANY NEVER SUSPECT CAUSE OF BACKACHES

This Old Treatment Often Brings Happy Relief

Many sufferers relieve nagging backache quickly, once they discover that the real cause of their trouble may be tired kidneys.

The kidneys are Nature's chief way of taking the excess acids and waste out of the blood. They help most people pass about 3 pints a day.

When disorder of kidney function permits poisonous matter to remain in your blood, it may cause nagging backache, rheumatic pains, leg pains, loss of pep and energy, getting up nights, swelling, puffiness under the eyes, headaches and dizziness.

Don't wait! Ask your druggist for Doan's Pills, used successfully by millions for over 40 years. They give happy relief and will help the 15 miles of kidney tubes flush out poisonous waste from your blood. Get Doan's Pills.

AUGUST, 1944



A Few Cents' Worth of SMOOTH-ON may save A Costly Repair Bill

A LEAK in the plumbing, a crack in the boiler, a hole in the water tank—those household troubles that might cause waiting for a plumber or handyman and an expensive repair job—nowadays are more often quickly and inexpensively fixed by the householder, himself, with the aid of handy Smooth-On No. 1 Iron Repair Cement.

You'll find Smooth-On easy to use—no heat or dismantling required—and with it you can make effective, workmanlike, durable repairs to home equipment which is impossible to replace for the duration.

Keep Smooth-On handy for emergencies. It's inexpensive and on sale at your neighborhood hardware store.

40-PAGE REPAIR HANDBOOK FREE



Send coupon for this invaluable aid to home, garage and shop repairs. 170 diagrams. Tested, practical short-cut instructions. Indexed for handy reference.

MAIL THIS TODAY

Smooth-On Mfg. Co., Dept. 37
570 Communipaw Ave., Jersey City 4, N. J.
Yes—please send me the Smooth-On Handbook.

Name

Address

8-44

Free Do it with SMOOTH-ON

"I'm sorry
I invented
the pocket!"

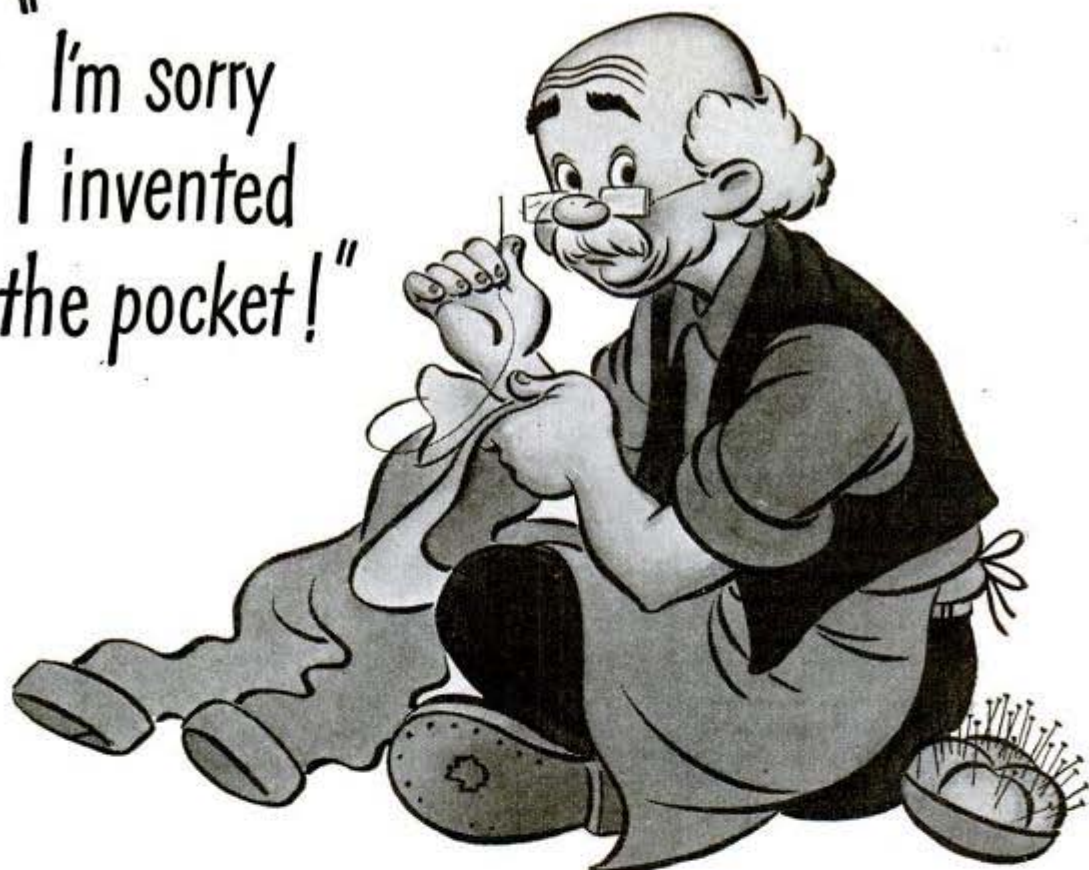

IF I HAD KNOWN that some Americans would be using pockets to hold all the extra money they're making these days, I never would have invented them.

Pockets are good places to keep hands warm.

Pockets are good places to hold keys . . . and loose change for carfare and newspapers.

But pockets are no place for *any* kind of money except actual expense money these days.

The place—the *only* place—for money above living expenses is in War Bonds.

Bonds buy bullets for soldiers.

Bonds buy security for your old age.

Bonds buy education for your kids.

Bonds buy things you'll need later—that you can't buy now.

Bonds buy peace of mind—knowing that your money is in the fight.

Reach into the pocket I invented. Take out all that extra cash. Invest it in interest-bearing War Bonds.

You'll make me very happy if you do.

You'll be happy too.

WAR BONDS to Have and to Hold



POPULAR MECHANICS MAGAZINE

This is an official U.S. Treasury advertisement—prepared under auspices of Treasury Department and War Advertising Council

Mortite

YEAR AROUND PLUGGER-UPPER

A pliable Plastic that plugs holes in and around screens, casements, drain-boards, sinks, bathtubs, etc. Stops rattles.

In winter weatherstrips windows.



MANY USES IN THE HOME

Keeps out dust and dirt, mosquitoes, flies, ants and other insects.

Easy to apply. Unrolls like ribbon. Adheres to any clean, dry surface. Just press into place and it stays put. Does not shrink, crack or chip.

About 80 feet to a roll. At your Dealer's or \$1.25 postpaid.

Send for Circular

J. W. MORTELL CO.

522 Burch St.

Kankakee, Ill.



SOILLESS GROWTH

of Plants

The Story of Botanical Wonders



A NEW SCIENCE OFFERING NEW CAREERS

FASCINATING

GET STORY OF SOILLESS GROWTH, ILLUSTR.

ALSO 10-Gal. Chemicals Silica Sand Pad. 60c All Only.....

Send to UTILITY CHEMICALS 7524 S. Racine Avenue, CHICAGO 29, ILLINOIS

Get Your Share of **U. S. WAR BONDS** ★ **STAMPS**

do you WORRY?

Why worry and suffer any longer if we can help you? Try a Brooks Patented Air Cushion. This marvelous appliance for most forms of reducible rupture helps hold nearly every rupture securely and gently—day and night—at work and at play. Thousands made happy. Light,



neat-fitting. No hard pads or stiff springs to chafe or gouge. Made for men, women and children. Durable, cheap. **Sent on trial** to prove it. Never sold in stores. Beware of imitations. Write for Free Book on Rupture, no-risk trial order plan, and proof of results. All Correspondence Confidential.

Brooks Company, 158-D State St., Marshall, Mich.

GLAMORIZE AND WINTERPROOF YOUR HOME WITH

PLASTI-COTE



AMAZING LIQUID PLASTIC PAINT

ONE COAT COVERS

EXTERIOR

THE PAINT OF TOMORROW—TODAY! Imagine cosy and beautifying your home, inside and out, with a film of real plastic, tough, tenacious, deeply beautiful... which neither sun, rain, fumes, or smoke affects. That's **PLASTI-COTE**, the amazingly durable plastic paint, which anybody can apply.

EXTERIOR—One Coat Covers clapboard, shingle, stucco, brick, plasterboard, concrete, metal. Fills cracks and imperfections. Leaves no brush marks. Does not chip, chalk, or peel.

INTERIOR—Gloss, semi-gloss or flat, for walls and woodwork, even old wallpaper. Washes like tile. Cannot be thinned with water.

MONEY BACK GUARANTEE

Use 25% of this resin-based liquid plastic paint. If not delighted, return remainder and receive full refund. Order for cash, post-paid; or C. O. D. plus small express charge. Colors: White, Ivory, Cream, Buff, Dusty Rose, Peach, Grey, Blue, Brown, Black, and Green, 3 shades. A gallon covers 300 square feet.



INTERIOR

\$5.95

PER GAL.



Say Good-Bye to Wax and Polish Slavery—Use **PLASTI-CLEAR FLOOR FINISH**

Banishes waxing and polishing. Resists alcohol, cigarette burns, boiling water—even lye. Ideal for wood, concrete, linoleum, tile. Non-skid. 10 colors and clear. Per Gal. \$6.75.

Cosify Your Damp Basement with PLASTI-BASE WATERPROOF FINISH

Seals and beautifies brick, concrete, masonry, mortar. Stops seepage and moisture. No costly undercoats necessary. Make your basement dry, colorful playroom. 6 colors. Gal. \$7.50.

DEALER INQUIRIES INVITED

CELLO-NU PRODUCTS

333 N. MICHIGAN AVE., DEPT. 2, CHICAGO 1, ILL.

Tomorrow's Miracle



New Improved
ELASTI-GLASS
Wristwatch Bands

The most comfortable wrist watch band you've ever worn. New improved double-lustrous Elasti-Glass. Long-wearing light, stretching, perspiration and waterproof. Always firm, yet buoyantly comfortable. Smart buckle.

\$1

Choice of blue or brown—for Civilian and Servicemen. Now available in limited quantities—at most dealers... \$1
*Elasti-Glass is an ORGANIC GLASS and although of almost living elasticity contains no silica or rubber. (Trade Mark Registered U. S. Pat. OS. Made from Vinylite Broad Resins. †Trade Mark Reg. C. & C. C. C.) Covered by U. S. Pat. No. 2,288,318.

Buchbaum & Co.
MANUFACTURERS SINCE 1888 CHICAGO

Dealer's Note: Limited stocks on hand at our New York, Chicago and Los Angeles Offices.

BELL



WATERPROOF

Waterproof, shockproof, anti-magnetic, radium dial and hands, unbreakable crystal, precision tested, sweep second hand.

No. JL 121 — 15 jewels, stainless steel back \$39.75

No. JL 212 — 17 jewels, stainless steel back \$42.50

No. JL 330 — 17 jewels, all stainless steel case \$59.75

POSTPAID FED. TAX INCL. MAIL ORDERS PROMPTLY FILLED

Write for Free Illustrated Booklet "JL"

BELL WATCH COMPANY

Time-Life Bldg., Rockefeller Center, New York 20, N. Y.

For Real Summer Fun, Build & Fly these
SUPER GLIDERS



4-Ft. Eaglet

Patterned after "Baby" Bowbus. Easily built. Get 2, give 1 to a friend. Kit E-5018.....

84" Super Condor Soarer

Easy to build, flies gracefully, and actually soars for hours. It's the top design for learning principles of advanced soaring flights. Biggest \$1.00 plane in U. S. Kit E-5019.....

\$100

Learn Flight Theory, Design, Construction, Building

36" Industrial Tr'ng Models

Kit T73 "Spitfire"; Kit T74 Messerschmitt ME-109; Kit T76 "Aircobra"; Kit T77 "Warhawk"; Kit T78 "Hurricane"; Kit T85 "Lightning"; Kit T91 "Mustang"; Kit T99 "Typhoon"; Kit T105 "Whitwind" (Illustrated)



Each Kit Only \$150

At your dealers, or direct. Minimum order \$1.00 (Add 20c packing post chge.) Send 5c for latest catalog of all C-D War Models.

CLEVELAND MODEL & SUPPLY CO., 4508D75 Lorain Ave., Cleveland 2, Ohio

SPARK PLUGS GUARANTEED 25,000 MILES

Federal Spark Plugs lead the field in quality and engineering. Manufactured to same S.A.E. specifications as leading brands. Porcelain is the best modern science has yet produced. Only Virgin Lake Copper Gaskets are used. For more power, speed, and pep change to Federals today. Every plug guaranteed for 25,000 miles.

Set of 6 only \$2.49; 8 only \$3.33 prepaid. Single plugs 50c each.

Remit with order. Save new increased C.O.D. fees. State make and year of car. FEDERAL SPARK PLUG MFG. CO. 1716 S. Michigan Ave. Chicago, Ill.



FUN AND PROFIT FROM YOUR HOME WORKSHOP

New 1944 "WHAT TO MAKE" is now ready. One of these books is issued each year and is a reprint of articles which have been published in our "Craftsman" Department. Hundreds of ideas that can be used around your home workshop in one handy, 224-page volume. To get book, send 50c to

POPULAR MECHANICS PRESS
Dept. 556, 200 E. Ontario, Chicago 11

**WELDING
BRAZING
and
SOLDERING**

• How to Build Your Own Equipment and Use It Effectively

COMPLETE CONSTRUCTIONAL DETAILS ON:

- Torch for Brazing Bandsaw Blades Assembled from Pipe Fittings.
- Soldering Irons for 6, 32 and 110-v. current.
- Arc Soldering Torch.
- Electric Spot Welder for Small Shop.
- Arc Welder that Handles Sheet Metal Up to 3/16 in. in Thickness.
- Portable Unit with Welding Generator Driven by Auto Motor.
- Electric-Arc Furnace to Melt Metals and Make Alloys.
- Electric Furnace for Annealing, Heat Treating, etc.
- Semi-Portable Tube Rectifier Converts a. c. to d. c.
- Small Gas-Fired Blast Furnace.
- Blast Burners from Rods and Tubes.

HELPFUL ARTICLES ON:

The Right Weld, Oxyacetylene Welding and Cutting, Stainless Steel Soldered, Brazed and Welded, Brazing Bandsaw Blades, Split-Second Soldering, When and How to Spot Weld, Heat-Treating Iron and Steel, Identifying Metal in Broken Castings. Price \$1.25

POPULAR MECHANICS PRESS

Dept. 561 • 200 E. Ontario Street, Chicago 11

POPULAR MECHANICS

in every battle...
doing vital jobs...
unfailingly...



that's
why
there
are just
a few
left for
essential
jobs at
home

BRIGHT STAR BATTERY CO., CLIFTON, NEW JERSEY

GUARANTEED Rebuilt Radio VIBRATORS—\$1.00 EACH

Send old vibrator. For very prompt delivery, enclose remittance and return postage. We rebuild any make or kind of vibrator. Send your old vibrator to

BEST VIBRATOR CO. P. Box 5802 Cleveland 1, Ohio

**SAVE MONEY ON OVERHAUL JOBS
REFIT BEARINGS
THE TIMESAVER WAY**



DON'T BORE or scrape re-poured bearings! Use **TIMESAVER** Lapping Compound. Gives closer fit, longer-lasting bearings, is quicker and easier. 24 years successful use by leading mfrs. Get-acquainted sample and instructions.

25c; economy size \$1.00, postpaid. Satisfaction guaranteed. **TIMESAVER—1115-E POST ST., SEATTLE 1, WASH.**

**Pays HOSPITAL BILLS
for Whole Family**

**Costs 3c a Day for Adults
Only 1½c a Day for Children**

It's here! The new Family Hospital and Surgical Expense Policy you need and want! One policy insures whole family—mother, father, children, anyone from 3 months to 65 years. No medical examination. Pays up to \$510.00 hospital and surgical bills for EACH and EVERY person insured. Pays up to \$100.00 doctor's fees for operations. Pays up to \$50.00 for operating room, medicines, ambulance, etc. Covers sicknesses, accidents, operations, childbirth, female disorders, and many other disabilities not covered by other policies. You select your own doctor and hospital. This full-coverage Family Hospital and Surgical Policy issued **DIRECT** to you at special family rates by big, strong company with over \$3,000,000.00 in assets. Investigate! **SEND NO MONEY**, but mail the coupon below quick for full details—sent **FREE**. No agent will call on you. Act today!

STERLING INSURANCE CO.
4775 Sterling Bldg., Chicago 11, Ill.
Send me your **FREE INSPECTION Offer of LOW-COST**
Family Hospitalization Plan.

NAME _____
ADDRESS _____
CITY _____ STATE _____

**»MARXMAN»
FOR MEN OF ACTION**



MARXMAN PIPES ease the tension...the strain of battle, the breakneck pace in the office and factory. Men of action everywhere depend on MARXMAN PIPES to relax...to lighten the load!

Enjoy the smoothness, the mellowness, the cool and satisfying sweetness of a MARXMAN. Every pipe is bench-made by expert craftsmen from thoroughly aged, selected briars. There's a MARXMAN PIPE for every taste—all the popular styles and also many exclusive shapes. Look for **-MARXMAN-** on the next pipe you buy.

MOROCCO
Featherweight at
\$250



MEL-O BRIAR
Famous Pipes at
\$350



SUPER BRIAR
Rare Grains at
\$500



AT FINE STORES—EVERYWHERE

»MARXMAN»

27 W. 24th Street, New York City

**DIXON'S GRAPHITE
SLIPSTIK**

For fast RUB-ON lasting lubrication of bicycle chains, fire arm actions, doors, drawers, window slides and everything that sticks or squeaks.

JOSEPH DIXON CRUCIBLE CO., JERSEY CITY 3, N. J.



RETAILS
15¢

UGLY BLACKHEADS OUT in SECONDS with VACUTEX BLACKHEAD EXTRACTOR \$1.00



Blackheads are ugly, offensive, embarrassing. They clog pores, mar your appearance, invite criticism. Now your blackheads can be removed in seconds, scientifically, and easily, without injuring or squeezing the skin. VACUTEX creates a gentle vacuum around the blackhead, cleans out hard-to-reach places in a jiffy. Germ laden hands never touch the skin. Simply place the direction finder over your blackhead, draw back extractor... and it's out. Release extractor and blackhead is ejected. VACUTEX does it all! Don't risk infection, order today!

**SAFE • SURE
SANITARY
DAINTY
FAST
PLEASANT**

10 DAY TRIAL COUPON

Balco Products Co., Dept. A-3208
19 West 44th St., New York 18, N. Y.

Enclosed find Ship C. O. D. I
\$1.00. Send me will pay postman
Vacutex postpaid. \$1 plus postage.

My dollar will be refunded if I am not delighted.

NAME.....
ADDRESS.....

Test-O-Lite the MODERN TROUBLE SHOOTER

← THE NEON GLOW

... LOCATES TROUBLE INSTANTLY in electric circuits, fuses, cut-outs, motors, radios, appliances. Tests everything electrical from 100 to 550 volts. Indicates hot or grounded wires. Tells AC from DC. Far superior to ordinary clumsy test bulb.

↑ PUTS "FINGER" ON THE TROUBLE SPOT -- QUICKLY

Saves precious time. Indispensable in shop or home. Has patented safety features. Vest pocket size with clip. Lifetime guarantee. List \$1.50 (Priority A7 required) Purchase through regular electrical dealers.



FUSES

MOTORS

OUTLETS

L. S. BRACH MFG. CORP.
55 Dickerson St. Newark, N. J.

Handy Order List Check and Mail! Little Library of USEFUL INFORMATION

Here at amazingly low cost is the practical help and information you have always wanted. Articles in previous issues of Popular Mechanics have been classified according to subject and are now available in these handy reprint booklets.

MAKE SELECTION NOW • POSTPAID TO YOUR HOME
5 for \$1.00 12 for \$2.00 25c Each

ELECTRICAL BOOKLETS

Rewinding & Servicing Electric Motors—75.
House Wiring—89.
Electromagnets & Solenoids—44.
Transformer Construction—41.
The Boy Electrician—43.
Soldering & Brazing—17.
Arc & Spot Welders—5.
Treasure Finders—13.

ELECTROPLATING BOOKLETS

Electroplating with Copper, Nickel, Chromium, Cadmium—86.
Plating Leather & Other Non-Metallic Objects—87.

WORKSHOP EQUIPMENT BOOKLETS

How to Use Measuring Tools—106.
Power-Driven Saws—74.
Drill Presses, Grinders—79.
Sanders—80.
Wood—Metal-Turning Lathes—81.
Filing Machine, Hacksaw, Cutoff Wheel, Shaper—82.
Lathe Tools You Can Make—101.
Workbenches—Tool Cabinets—47.
Spray Painting—94.
From Pattern to Casting—91.

BOOKLETS ON SHARPENING, USING TOOLS

Tool and Saw Sharpening—92.
Using & Sharpening Drills & Wood Bits—90.
Successful Wood Turning—32.
How to Read Blueprints—71.
Metal Turning Lathe Kinks—99.
Operating a Metal Lathe—100.
Heat Treating & Hardening—102.
Working with Glass—103.

HOME IMPROVEMENT BOOKLETS

Simple Home Improvements—104.
Building Extra Attic Rooms—23.
Attractive Basement Rooms—24.
Lower Your Fuel Cost—31.
Hanging Wallpaper—38.
Curing Leaky Basements—45.
Fitting Home Game Room—55.
Built-In Fixtures—78.
Indoor & Outdoor Fireplaces—88.
Ridding Home of Insect Pests—107.

GARDENING BOOKLETS

Backyard Gardening—39.
Lawn & Garden Novelties—72.
Trellises, Pergolas, Fences—76.
Lawn & Garden Furniture—77.
Playground Equipment—73.
Concrete Garden Furniture—6.
Bird Houses—7.
Farm & Garden Tractors—8.

CRAFT WORK—HOBBY BOOKLETS

Complete how-to-make-it instructions.
Magazine Racks—49.
Clock Cases—50.
Making Serving Trays—53.

Children's Room Furniture—51.
Book Ends—52.
Small Tables—54.
Smoking Stands—56.
Jigsawed Novelties—57.
Desks—58.
Book Cases—59.
Doll House & Doll Furniture—60.
25 Shelves You Can Make—64.
Novelties Turned on Lathe—62.
Inlay Pictures—Veneering—63.
Whittling, Wood, Soap Carving—65.
Action Toys—66.
High Flying Kites—67.
Windmills & Weather-vanes—68.
Lamps in Wood, Metal—69.
Home Work Opportunities—19.
Telescopes—20.
Metal Craft—28.
Small Looms—37.
Wood Finishing—40.
Gem Cutting—42.
Working With Plastics—61.

BOAT BUILDING BOOKLETS

Build a boat at home—you can do it

14 Ft. Outboard Runabout—2.
14 Ft. Sailing Dinghy—26.
21 Ft. Sloop—46.
Rowboats, Bicycle Boat, Small Dinghy—83.
Small Sail Boats—84.
Two Outboard Runabouts—85.
Build Your Own Canoe, Kayak, Surfboard—30.
Fast Class-E Ice Yacht—22.

AUTOMOBILE BOOKLETS

Auto Kinks and Shortcuts—10.
Building Trailers—27.
Motor-Driven Midget Car & Scooter—34.
Stop Auto Electrical Troubles—95.

PHOTOGRAPHY BOOKLETS

Save Money—make your own photo equipment

Photo Enlargers—1.
Photo Printers & Dryer—25.
Photo Darkroom Equipment—96.
Picture Projector, Trick & Table Top Photography—97.
Photo Kinks—98.

FORMULA BOOKLETS

Simple Ingredients—Make Useful Products

Cleaning Formulas—11.
Cosmetic Formulas—12.
Food Products Formulas—15.
Metal Plating & Coloring—21.
Re-Silvering Mirrors—70.

MISCELLANEOUS

Knots and Rope-work—105.
Chemical Experiments—93.
Taxidermy—9.
Log Cabins, Tourists Cottages—14.
Magic for Everybody—29.
Trapping Small Animals—33.
Training Your Dog—35.
Small Furnaces—36.

Check and mail with this coupon!

POPULAR MECHANICS PRESS, Dept. 563, 200 E. Ontario, Chicago 11

Just check the booklets you want, clip this advertisement and mail with your remittance (U. S. bills may be mailed if carefully wrapped). Ask for big FREE catalog of helpful books.

MONEY BACK GUARANTEE

Name.....

Address.....

City..... State.....

\$100 MOTOR-GENERATOR for \$17.95

MADE FOR U.S. ARMY TANKS BY WESTINGHOUSE

Make \$5.00 Per Hour

and more in spare time by developing this Westinghouse Motor-Generator into:



- 1 1/2 HP. D-C Motors
- AC-DC Motors
- Home Generator Sets
- Wind Chargers
- Arc Welders
- Hoist Motors
- Marine Power Units
- Experimental Units
- School Equipment
- Alarms and Signals
- Farm Applications

Cost over \$100.00. Brand new, 1 1/2 HP, 24-V, 3600 RPM, D-C motor direct connected to 1-K.W., 230-V, D-C Generator in same housing. Ball-bearing. Totally enclosed, 3/4" shaft (adapter 95c extra). Wt., 125 lbs. Converted into D-C motor by changing and rewinding two 1-lb. coils No. 31 wire. Instructions furnished for D-C motor only. Invest \$17.95 and get priceless experience reworking unit for other uses and make easy profits selling your developments.

Shipped Prepaid for \$17.95 (Cash) or C.O.D. on \$3.00 Deposit.
MIDLAND MOTORS, 509 S. Green St., Chicago 7, Ill.

Used by military and civilian training schools to teach fundamentals of radio

PROGRESSIVE RADIO TRAINING KITS

Include all components as well as hardware, wire, etc. Chassis and cases are punched and finished. Large, easy-to-read schematic diagrams are supplied. Ease of assembly permits units to be torn down and re-wired time and again.

Write for FREE brochure! Our Special Schools Service Division will be glad to work with you.

LAFAYETTE RADIO CORPORATION

901 W. JACKSON BLVD., CHICAGO 7, ILL., DEPT. P



ELECTRIC HEATING APPLIANCE ELEMENTS REPAIRED . .

Use NICHROCITE PASTE

Simply overlap ends, apply Nichrocite Paste and turn on current. Used by large utility companies. Trial orders, 50c or \$1.00; 4 oz., \$2.50; 1 pound, \$8.00.
Advance Mfg. & Dist. Co. Box 861 Minneapolis, Minn.

Get Your Share of **U. S. WAR BONDS** ★ **STAMPS**

After Victory



S C ELECTRIC OUTBOARD MOTORS

Plan on owning a modern S C Electric Outboard Motor. Quiet, dependable, efficient, these motors are ideal for trolling with boats up to 16 foot.



S C BOAT & LUGGAGE TRAILERS

A dual-purpose trailer for any flat, vee or round-bottom boat up to 18 foot . . . or with utility body in place, a 1000-pound luggage and equipment carrier.

S C products will be available just as soon as civilian production of such items can again be resumed.



SILVER CREEK PRECISION CORP.
SILVER CREEK, NEW YORK

Awarded the Army-Navy "E" for excellence in war production. Now building precision parts for 30 cal. Carbine and Springfield Rifles; 30 and 50 cal. Browning Machine Guns; 20 mm Oerlikon Anti-Aircraft Guns; Curtiss P-40 and P-46 Aircraft; Aircraft generators and Sterling Admiralty Engines.

SAVE WASTE PAPER

REED MICROMETERS 1", 2" and 3" READING to 1/10000"

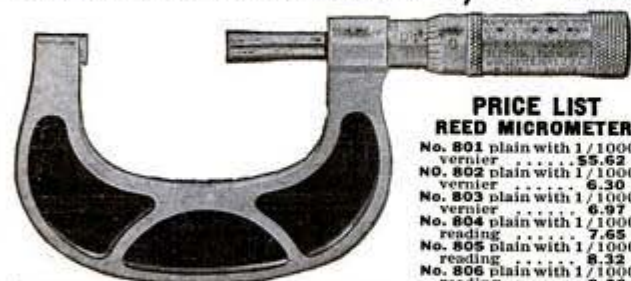

PRICE LIST

REED MICROMETERS

- No. 801 plain with 1/10000" vernier \$5.62 net
- No. 802 plain with 1/10000" vernier 6.30 net
- No. 803 plain with 1/10000" vernier 6.97 net
- No. 804 plain with 1/1000" reading 7.65 net
- No. 805 plain with 1/1000" reading 8.32 net
- No. 806 plain with 1/1000" reading 9.00 net

Add 10c for postage.
Write for new free eight-page folder "MEASURE TO 1/10000" AT NO EXTRA COST."

Illustrated is Reed No. 802 1 to 2" micrometer, graduated to 1/10000". Here is a fine all-around micrometer for general shop use with extremely high quality workmanship. Other sizes listed have same type frame, construction.

SHOP AGENTS WANTED. We have a very interesting proposition for individual mechanics who want to earn extra money as shop agents selling Reed Micrometers, Tool Chests, Dial Indicators & other Machinists' Tools. Write for full details today.

GEORGE SCHERR CO., INC., 200A Lafayette St., New York 12, N. Y.

You can now obtain Reed Micrometers immediately without priority. This precision tool has been made in the U.S.A. for over thirty years. Fully guaranteed, must pass rigid tests for accuracy.

We now furnish Reed Micrometers in the 1", 2" and 3" sizes with a vernier reading to 1/10000" AT NO EXTRA COST. Compare our net prices shown below. Tolerances are closer. More and more blueprints call for tenths of thousandths and every good mechanic needs a 1", 2" and 3" micrometer graduated to 1/10000". Here is your opportunity to purchase these tools at today's low prices. Send your order to us for quick delivery.

**We took 'em!
and they're all good**

And my Argoflex and I are two, happy, camera fans from now on. Good pictures of the whole family. What fun! And what an album when Tom comes home.

argus
Cameras and Optical Equipment

ANN ARBOR MICHIGAN

The 56-page booklet "Good Pictures" is published by Argus to help you solve many of the problems of picture taking. Send 25c to ARGUS, INCORPORATED, ANN ARBOR, MICH. DEPT. 5

AWARDED TO PLANT OPTICAL DIVISION

413 Pages
Profusely Illustrated

FIVE ACRES and Independence

A PRACTICAL GUIDE TO THE SELECTION AND MANAGEMENT OF A SMALL FARM

By M. G. Kains
B. S., M. S., formerly Special Crop Culturist of U. S. Dept. of Agriculture.

ALL OF US long some day to own a SMALL FARM, whether it be for permanent residence or as a weekend haven where we may enjoy the relaxation of rural life. With war upon us, inflation, depression, strikes, high rents, high cost of food and shortages threatening, we may find the solution in a properly operated small farm where we can eat regularly and abundantly, sleep soundly, have no money worries and live a healthy outdoor life. You don't have to own a large farm, but it is important to have practical advice from one who knows all about how to farm. There are many pitfalls which may easily be avoided. And there are many tried and proved methods which can lead to success.

We have found a practical book that starts at the beginning and takes you step by step into successful farming. This book takes nothing for granted. It tells what kind of farm to buy; how to choose it; how to finance it; what and how to plant, choose and care of livestock, poultry, bees, etc.; especially essentials of fruit and vegetable growing, fertilizers, irrigation, spraying, cultivation, harvesting, storage, sale of products and by-products. Every page is packed with proved ways to make the small farm self-supporting and profitable. Whether you have a farm now or are planning to purchase one, get this book by Mr. Kains and prepare yourself. Don't miss "Five Acres and Independence": it might change your whole life, it may bring you the independence and security you are now striving so hard to obtain!

Only \$2.50, Postpaid in U.S.A. (Outside U.S. \$2.75). Order Today

POPULAR MECHANICS PRESS Room 570 • 200 East Ontario Chicago, 11

6 FEET OF ACCURACY IN 2 INCHES OF CASE

On the job, or in the home workshop, the MASTER Streamline steel tape rule is tops in your tool-kit . . . 6-ft. of accuracy are wound compactly into a 2 in. case . . . simplifies cramped-space measuring . . . can be used as scribe, caliper, height gauge, for inside measuring, or for layout work . . . patented lever-lock holds reading stationary . . . comes with spare blade that can be quickly and easily inserted . . . ask for practical help-packed booklet "Rules for Measurement." It's FREE.

\$2.65 each complete with spare blade

MASTER
WOOD AND TAPE RULES

MASTER RULE MFG. CO., INC.
815 E. 136 St., N. Y. C., Dept. F-8

Enclosed please find \$2.65 for 6 ft. Streamline with spare blade.

Name _____
Address _____
City _____ State _____

BUILD a BOAT

FOR PLEASURE OR PROFIT DESCRIBES 17 LOW COST BOATS

Get this outstanding book and build a boat at home for your own use or to sell at a profit. You can do it. Just the boat you've always wanted—power, sail or row boat—17 different kinds and sizes.

Order BUILD A BOAT on postal card and pay only \$1.50 plus postage on delivery. Return in 5 days if not pleased and get money back. Or send \$1.60 with order. (Outside U. S. \$1.70 with order.) Order today.

POPULAR MECHANICS PRESS
Dept. 558, 200 E. Ontario, Chicago, 11

- Row Boat—12 Foot
- Dinghy—5 Foot
- Dinghy—14 Foot Sailing
- Training Ship—6 Foot
- Sea Sled—9 Foot
- Outboard—18 Foot
- Cruiser Boat—Kayak
- Bicycle Boat—Sectional
- Row Boat—5 Foot
- Dinghy—5 Foot
- Canoe—16 Foot
- Sailing—12 Foot
- Outboard—12 Foot
- Outboard—Runabout
- Outboards—Ice Yacht

Say you saw it in
POPULAR MECHANICS

WE MEND MEN BY AUTO-MATIC FIBRE-LITE ARMS & LEGS

With Soft Adjustable COMFORT SOCKETS. TRUSSES, BRACES, SOX, SUPPORTS.

Cash or Terms. Give Full Details.

WORMAN CO., 310-P, THIRD AV. SO. MINNEAPOLIS-15, MINN. U.S.A.

SIGNS EASILY AND EXPERTLY PAINTED WITH LETTER PATTERNS AND SHOWCARDS

MANLY SIZES & STYLES WRITE FOR FOLDER

JOHN F. RAHN
1330-31 N. Central Ave. CHICAGO 51, ILL.

Fuse Puller — Circuit Tester

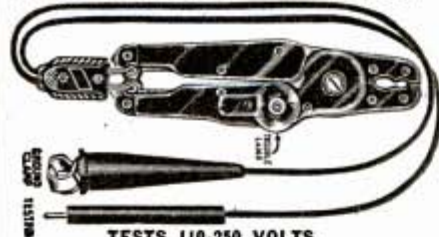

For
Home
or
Factory

TESTS 110-250 VOLTS

When motors stop and lights go out, this tool quickly **LOCATES DEAD CIRCUITS** and safely removes blown Fuse. The Star Test Pocket Plier is made of a Transparent Plastic having in one of the legs a small lamp in series with a resistance and can be used to test 110 to 250 volts circuit. The Plier will pull fuses from 10 to 100 Amperes. Thousands of Electricians find this tool handler than Test Lamps. Price \$2.75 each without Leads, \$1.50 additional for Leads, plus 10c postage. Can be obtained from General Electric or Westinghouse Stores or directly from us. Order NOW. **STAR PLIER CO., 233 Canal St., New York 13, N. Y.**

New OTTAWA WOOD SAW



For Tractors

Makes wood sawing fast and easy. Can cut enough wood to pay for itself quickly. Easily moved while attached. Big heavy blade. FREE details.

LOW
PRICE

OTTAWA MFG. CO.
W827 Oak Ave., Ottawa, Kans.

TELESCOPING MEASURING TOOLS

... Measure All Holes, Slots, Etc. — 5/16 Inch to 6 inches ... Gives You Outside Micrometer Accuracy on Inside Measurements

FINISH YOUR OWN SET OF FOUR TOOLS

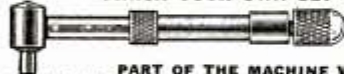

Only \$2.50 C.O.D.

PART OF THE MACHINE WORK ALREADY DONE—ONLY SIMPLE LATHE WORK NECESSARY TO COMPLETE. No special tools required—Threading, Knurling, etc., already done. Kit includes all material (part machined); simple drawings, and detailed instructions. Just mail your name and address to: **ALCO SHOP, 2628 Armstrong Avenue, Los Angeles 26, California**

★ SAVE WASTE PAPER ★

AMAZING MYSTERY BUTTON



Startles Everybody. With this Electronic Button you can make your own Telephone—Amplifier—Detectophone. Attach this button to piece of cardboard—transmit conversation to another room. Music also transmitted to distant places. Most interesting, electrical apparatus ever discovered. Enables you to perform hundreds of experiments. So tiny it can be concealed in dozens of places. A Pre-War Product. Supply Limited. Electronic Button including 5000 word instruction book with 500 illustrated experiments postpaid only \$1.00. **Electronic Products Company, Saint Charles, Ill.**

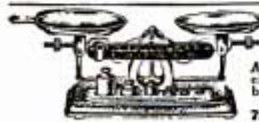

Balance 4" x 9" Base. With either 5 6.00 Metric or Avoirdupois Weights ...

Catalog with 3000 Illustrations of laboratory Apparatus sent for 75 cents. Catalog listing 10,000 chemicals, drugs, minerals, etc., and 1700 scientific books sent for 25 cents. **LABORATORY MATERIALS CO., 7321 Vincennes Ave., Chicago, Ill.**



AUTO ENGINE SPEED CONTROL GOVERNORS

Give constant or changeable speed to any auto or truck engine, when used for power. Guaranteed. Instructions. Oil ring bearing \$13.00. Ball bearing \$19.50. Prepaid. Also additional carburetor butterflies. In Montreal, 7546 Wiseman St. Latin Amer. East Asiatic Co. Agents wanted: Parts Dealers, Garages, Wreckers, Implement Dealers. Free circulars.

CANDEE, 2641 S. Hill • Los Angeles-7

BEFORE STARTING DIRTY WORK

Rub on "PRO-TEK" like a cold cream



When through work, grime and paint wash right off



It acts like an invisible glove



DU PONT
PRO-TEK
HAND PROTECTIVE CREAM

INVENTION AUTOMATICALLY FEEDS COAL & EMPTIES OWN ASH FROM FURNACE!

A remarkable stoker already used by thousands of home owners—fits into any furnace or boiler. Manufactured for over 9 years. So automatic that it takes coal from your present coal bin, going around corners if necessary, feeds it to the furnace, burns it as demanded by a thermostat located in the living quarters of your home, and empties the ash into a sealed container. There is no coal to shovel, or clinker to dig! Made in several sizes ... If you are planning to build a home in the future, choose the complete Air Conditioner, which has this automatic stoker built in. Send for full information on how you can be sure of an early delivery of a Pocahontas Automatic Stoker after the war.

WRITE TODAY!

"ORIGINAL"

POCAHONTAS FUEL COMPANY INCORPORATED
344 East 131st Street • Cleveland 8, Ohio

POCAHONTAS

BIN-FEED ASH REMOVAL STOKERS

Use it up . . .



That's the thing to do in wartime. Eat every bite of food, save every scrap of soap, make a patriotic habit of stretching all the supplies in the house so they go further.

Wear it out . . .



This year old coats, old shoes, are a badge of honor. They show you're sensible enough to know that one way to keep prices down is to wear your old things out!

Make it do . . .



Before you spend a penny in wartime, ask yourself, "Do I really need this? Or do I have something now that will do?" As you patch and darn, you keep prices down.

or do without!



When you put your money in War Bonds, in savings, in taxes, in insurance—you're helping to fight the war and build a sound, stable nation for the peace to come.

It's your money you're saving when you help keep prices down. For it's buying too much when there's too little to buy that sends prices up. And when prices go up—and keep going up—your savings, your future, are in danger.

How can you help keep prices down?

By never spending a thin dime you could turn into a War Stamp. By thinking twice—and thinking "No"—at every urge to open your purse.

By wearing old things out, making makeshifts do. Remember, it's the things you *don't* buy that keep prices down!

See that prices go no higher . . .

Be a Saver—not a Buyer!

A United States war message prepared by the War Advertising Council; approved by the Office of War Information; and contributed by this magazine in cooperation with the Magazine Publishers of America.



TUNGSTEN CARBIDE

CUTTING TOOLS

For home workshop craftsmen. Set of 6 genuine tungsten carbide tipped tools, with 2 1/4"x1/4" steel shanks. For turning, boring, facing, milling, reaming and finishing.

Set of 6, postpaid \$4.00

Complete set includes 3 tools for cutting steel and cast iron—3 for fibre, hard rubber and non-ferrous materials. Satisfaction guaranteed or money back.

KWIK-KUT TOOL CO., 13418 Fenkell, Detroit 27, Mich.



SHORT of GASOLINE?

Make your own gas! Convert Wood and water, coal or coke into motor fuel with generator easily made and attached to your car, truck or tractor. Operate at fraction of usual cost. New industry now open. Build for others at good profit. Complete instructions, over 25,000 words of new, vital knowledge, with drawings and diagrams, now available to every motor operator. The best and most valuable information obtainable. Rush \$3 for your copy of GAS GENERATORS FOR AUTOS, TRUCKS AND TRACTORS.

THE MATTHEWS MANUFACTURING CO.
DEPT. 130 CALGARY, CANADA.

WRITE FOR
OUR
TOOL DATA
SHEETS

WILLIAMS

SUPERIOR DROP-FORGED TOOLS

J. H. WILLIAMS & CO., BUFFALO, N. Y.

FIBRE ARMS AND LEGS!

Light, correctly fitted, strong and comfortable. Natural appearance. Braces for all deformities. Scientific design. Fair Terms.

BUCHSTEIN-MEDCALF

610-3rd Av. S., Minneapolis, Minn.

WINDOW SIGN LETTERS

For Store Fronts and Office Windows. Anyone can put them on. Free Samples. Imitation Gold and Silver. METALLIC LETTER CO., 430 N. Clark St., Chicago

"RATIONEER"

SAVE GAS

SPARK PLUGS

Precision engineered by "Tungsten" for present day 35 mile per hour driving. Amazing increased mileage because they burn all the gas. Thousands have been astonished—you will be, too. Change to "RATIONEER" today—stretch gas mileage. Get more power and pep from any car.

Set of 6 only \$4.14; 8 only \$5.52, prepaid. Single plugs 75c each.

Money back if not delighted. Enclose remittance, save greatly increased C.O.D. fees. State make and year of car.

TUNGSTEN SPARK PLUG MFG. CO. 1718 S. Michigan Ave. Chicago, Ill.

FOR MEN WHO Really KNOW PIPES

Royalton

FILTERWELL

- CONDENSING WELL traps and retains moisture . . .
- FILTER sucks in tars and bitter juices . . .
- "SURELOK" coupling won't loosen; holds filter in stem when bit is removed . . .

\$1

Selected
Lightweight
Briar



FILTERWELL combines exclusive pipe safeguards . . . the FILTER, easily replaced, absorbs NICO-TARS (tobacco sediment) . . . the WELL, built into the transparent bit, prevents back-flow of moisture into the mouth . . . Double assurance of a clean, ever-dry pipe and constant smoking contentment.

Henry Leonard & Thomas, Inc., Ozone Park, N. Y.



Titan Slide Rule

3/4" diameter. Easily read, clearly marked single index scales. Gives logarithms, reciprocals, squares, square roots, sines, and tangents. Continuous circular calibrations cannot go "off-scale." Invaluable in multiplication, division, proportion, conversion, all mathematical problems. Made of durable heavy pure white Vinylite. Complete with instructions, \$2.95. Leatherette case 75c additional. Money-back guarantee.

PRECISION INSTRUMENT CO.

Box 654, Dept. A Church St. Annex New York 7, N. Y.

IF YOU WANT AN ARC WELDER
...BETTER SEE HOBART USE THE COUPON!

Don't Wait!
Get Complete
DELIVERY
Information
from us NOW.

If you are on important work, you should have the advantages of "Simplified" Arc Welding to help you speed your work, cut costs, get stronger, better jobs. Hobart Welders have many advantages not found in other welders, are more suitable for your work. Let us send you catalog and details on how you can get a welder NOW. Use the coupon.

HOBART BROS. CO., Box M-841, Troy, Ohio

HOBART "Simplified" ARC WELDERS

Catalog FREE!



Am interested in a _____ amp Welder for immediate delivery.

Send items checked—no obligation.

Complete Welder Catalog

Vest Pocket Welders' Guide

Name _____

Address _____

Hobart Bros. Co., Box M-841, Troy, Ohio

"One of the World's Largest Builders of Arc Welders"



NOW a DYNAMIC HEAVY DUTY INDUSTRIAL WELDER

Saves VALUABLE TIME and MONEY!

AMAZINGLY SIMPLE & EASY TO OPERATE

This portable Dynamic Welder—easily carried right to the job—plugs into any convenient, properly wired 110 volt light circuit—works on Iron, Steel, Brass, Bronze and other metals—has eight metallic and carbon arc welding heat stages—does work you would think only possible with a larger, more expensive machine.

DESIGNED TO DO HIGH GRADE WELDING INEXPENSIVELY Maintenance Men; Farmers; Mechanics; Machine Shops; Foundries; Auto, General Repair and Job Welding Shops; using the Dynamic And it's so indispensable and useful that they cannot afford to be without it.

If inexperienced, you can easily learn to do a variety of high grade welding jobs by following the practical, simplified operating and welding instructions furnished.

DYNAMIC WELDER CO., 13 East 23rd St., BD, Chicago 16, Ill.

for Only \$23.50

COMPLETE

Once you see a Dynamic in operation you won't be without it. Its simplicity will amaze you. In a year the Dynamic only costs you about 6c a day.

Comes complete with helmet, rods, cables, electrode holder and operating instructions, etc.

Write today for free priority assistance and particulars on how to qualify for one of these amazingly low-priced welders. Act now while they are still available. Get details on our 10-day trial offer.



Beautiful "COVERED WAGON" LAMP

will supply scarce cholla cactuswood for base and wheels, also full details for making this lamp. Approx. height 12"—Only \$1.50 Postpaid

ARIZONA CACTUS SHOP 530 North Wilson Ave. Tucson, Arizona

Say you saw it in POPULAR MECHANICS

MAKE YOUR OWN POWER TOOLS at Low Cost from old Auto Parts, etc.

A New Edition Featuring TOOLS of WOOD

Now you can have a good lathe, drill press, circular and band saw and other power tools in your home workshop, at a cost of only a few dollars each. Make them yourself from old auto parts, discarded sewing machines and other odds and ends that cost little or nothing. Get this new book—"Forty Power Tools You Can Make." Costs only \$1.25 postpaid. This book gives every detail in plain language you can understand and follow. Hundreds of pictures and plans show every step to follow in making the power tools you want. Actual photographs of finished machines included. Send \$1.25 today. Money back if not satisfied.



MAKE EVERY POWER TOOL NEEDED IN YOUR HOME WORKSHOP

Some of the power tools you can make are:

2 Band Saws	2 Drill Presses
9 Sanding Machines	1 Scroll Saw
2 Circular Saws	2 Wood Turning Lathes
1 Metal Lathe	3 Grinders
1 Power Hack Saw	1 Shaper or Moulding Machine
1 Jig Shears	1 Vibrating Pencil
1 Cut-Off Wheel	and others

Information too, about pulleys, belts, motors and drive methods. Just published. No other book like it. Order today.

POPULAR MECHANICS PRESS

Dept. 559 • 200 E. Ontario Street, Chicago 11

WORLD'S LOWEST PRICED ADDING MACHINE Vest Pocket Size FREE TRIAL

IDEAL FOR BUSINESS OR PERSONAL USE. GUARANTEED ACCURATE. TOTAL COST SEND NO MONEY

Not a toy. Operates with only a finger flick. Adds, subtracts, multiplies, divides. Counts up to ten million. Pays for itself over and over. Ideal Gift—for Business, Income Tax and School use. MONEY BACK GUARANTEED. Send name and address. Pay postman only \$2.50 plus postage. (Send full cash if outside U. S.) Money back in 10 days if not delighted. AGENTS WRITE.

CALCULATOR MACHINE COMPANY (Mrs.)
DEPT. 156, P. O. BOX 1118 CHICAGO, ILLINOIS

Make Models with KEENER, safer, FASTER X-acto knives! You, too, will be an EXPERT modeler

Make Model Planes for Uncle Sam!

No other knife at any price has all the rich features that make X-ACTO the undisputed first choice of model makers. Its superkeen, surgical-steel blades (just re-blade to re-sharpen) and the scientifically shaped blades in eight styles, give the craftsman the most versatile tools of his whole outfit. With these amazing knives, you increase output and improve accuracy.

KIT NO. 62—Double set with 2 handles, 12 blades... \$2.00
KIT NO. 82—Furnished with 3 handles, 12 blades and fitted wooden chest... \$3.50

FREE— with your order 32 page Manual "How To Build Model Planes"

RE-blade to RE-sharpen



At Your Hobby Dealer's Hardware or Dept. Store

X-Acto Crescent Products Co., 440-4th Avenue, New York 16, N. Y. Send X-ACTO checked. Enclose FREE 32 page Manual "How To Build Model Planes."

Enclosed find \$..... X-ACTO desired:
 Chest No. 82—\$2.50 Set No. 62—\$2.00 No. 1 (light)—with one blade 50c No. 51—with 5 extra assorted blades \$1.00 No. 2 (heavy)—with one blade 50c.
 No. 62—with 5 extra assorted blades \$1.00.
 I will pay postman \$..... plus 41c postage

Save postage & C.O.D. fee by remitting with order. (No C.O.D.'s on orders under \$2.00)
Name
Address

SYN-FLO LIQUID-PLASTIC

YOU APPLY WITH A BRUSH

This is really it! A brilliant white plastic coating to beautify walls of bathrooms, kitchens—anywhere. A post-war scientific discovery. A true plastic, yet you apply it with a brush; when dry, your walls are coated with a long-wearing, high-gloss film of white plastic that will not scratch.

★ NO BRUSH MARKS
★ NON-YELLOWING
SYNFLO is made of same ingredients as modern plastic articles. It dries to a tough finish that can be scrubbed or washed like porcelain. The finish of the future—ready TODAY!

Money Back Guarantee
No. 1 for walls, woodwork; No. 2 for furniture. Pure white! Or can be tinted. \$5.95 for gal. with Special Thinner, express prepaid. Willship CQD if desired.

ORDER NOW
FREE ILLUSTRATED
CIRCULAR



5⁹⁵
PER
GALLON

Plastic
THAT
FLOWS

SUPERIOR PAINT AND VARNISH WORKS
2256 NORTH ELSTON AVENUE · CHICAGO 14

Now
for EVERY WORK SHOP!

NEW Invention Electroplates by BRUSH



**Easy to Plate CHROMIUM
GOLD, SILVER, NICKEL, COPPER**
... For Pleasure and Profit!

If you have a workshop—at home or in business—you need this new Warner Electroplater. At the stroke of an electrified brush, you can electroplate models and projects—you can replate worn articles, faucets, tools, fixtures, silverware, etc. with a durable, sparkling coat of metal... Gold, Silver, Chromium, Nickel, Copper or Cadmium. Method is easy, simple, quick. Everything furnished—equipment complete, ready for use. *By doing a bit of work for others, your machine can pay for itself within a week.* So make your shop complete by getting a Warner Electroplater right away. Send today for FREE SAMPLE and illustrated literature. **ACT AT ONCE! Mail Coupon.**
WARNER ELECTRIC CO., DEPT. 316
360 North Michigan, Chicago 1, Illinois

FREE Details & Sample!

WARNER ELECTRIC CO., 360 N. Michigan, Chicago 1, Dept. 316
Gentlemen: Send Free Sample and Details to:

Name _____
Address _____
City _____ State _____

THERE'S Profit & Fun in THESE PLANS

only \$1.50

OVER 100 ITEMS
-Worth \$12.35
IF PLANS BOUGHT SEPARATELY



HAVE FUN—MAKE MONEY

You can surprise yourself with the profitable things you can make from these LeJay plans. No special tools or special experience necessary, and most of your material, particularly old generators, can be found around garages, workshops and scrap yards. Make your own welder and do some paying jobs for the neighbors.

EASY TO FOLLOW PLANS

Clear illustrations and charts help you every step of the way in making such interesting things as:

- 200 Amp. Generator Welders
- Large Transformer Welders
- Gunsmith's Carbon Welder
- Workshop Spot Welder
- 6, 12, 32, 110-Volt Motors
- Electric Outboard Motor
- Wind-driven Light Plant
- Electric Fencers
- Electric Drills
- Bench Grinders
- Electric Scooter
- Armature Rewinding
- Insect Electrocutors
- Electric Bicycle Pusher, etc.

SEND NO MONEY—BUT

Send a postcard with your name and address and a request to send the LeJay Manual C.O.D. and the postman will deliver it to your door. If you are not entirely satisfied after 3 days perusal, send it back and we will refund the \$1.50. Bear in mind, however, that C.O.D. fees have been considerably increased, so if you prefer to save this expense send \$1.50 now, under same guarantee.



- WELDING GENERATORS
- TRANSFORMER WELDERS
- ARMATURE WINDING
- ELECTRIC OUTBOARD
- POWER TOOLS
- WIND PLANTS
- ELECT. GOBIKE
- MOTORS
- INSECT KILLERS
- ELECTRIC SCOOTER
- ELECTRIC FENCERS
- LIGHT GENERATORS
- TRACTOR LIGHTS

3 DAY TRIAL

LEJAY MFG. CO.
47 LEJAY BUILDING.
MINNEAPOLIS 8, MINNESOTA.

★ SAVE WASTE PAPER ★

Setting Performance Records for Precision Machining

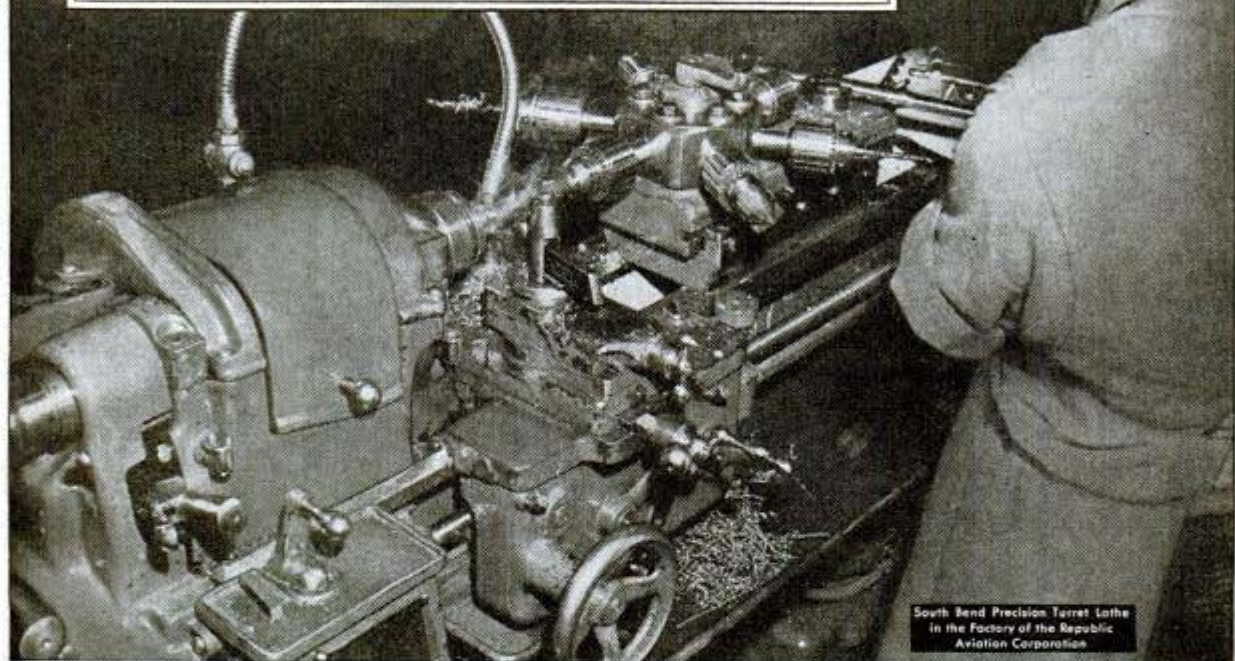

High precision and close tolerances have always been the watchwords of the aviation industry. But with the war came demands for higher speeds and better performance. This meant that even closer tolerances had to be established and maintained through the greatest production schedules in history. We are proud that providing lathes to meet the exacting requirements of warplane production is one of our important assignments. Throughout the aviation industry South Bend Lathes are setting enviable performance records for precision machining.

In all metal working industries, South Bend Lathes are giving the same dependable service that they are giving in the aviation industry.

Versatile and efficient, they are also used for emergency service work by the Armed Services. They travel with the Army in compact mobile machine shops. Many fighting ships of the Navy have one or more South Bend Lathes on board for making emergency repairs at sea. They are used by the Air Forces in repair bases here and overseas.

Now, as before Pearl Harbor, our entire factory is devoted to the production of South Bend Lathes. No other product is made by us. There has been no lowering of standards because of wartime restrictions and shortages. The use of substitute materials is negligible, limited to non-essential parts. Improvements have been accelerated. Today, South Bend Lathes are better in every way.

South Bend Engine Lathes and Toolroom Lathes are made in five sizes: 9", 10", 13", 14½", and 16" swing. Precision Turret Lathes are available in two sizes: Series 900 having ½" collet capacity, and Series 1000 having 1" collet capacity. Write for Catalog No. 100-C.

POST-WAR PRIORITY PLAN

To those who cannot qualify for a wartime priority, South Bend Lathe Works offers a practical Post-War Priority Plan. You can place your order now for any South Bend Lathe. No deposit or down payment is required. We ask only that the order be placed in good faith. When civilian production is resumed, orders will be filled in the sequence established by the numbers of the Post-War Priority Certificates. Should conditions necessitate, the order may be cancelled at any time. Write for details of this plan.

BUY WAR BONDS NOW...SAVE FOR LATHES

SOUTH BEND LATHE WORKS

LATHE BUILDERS FOR 37 YEARS • SOUTH BEND 22, INDIANA

PRINTED BY POPULAR MECHANICS COMPANY, CHICAGO, ILL., U. S. A.

LIGHTER MOMENTS with **fresh Eveready Batteries**



"I'm Sorry, Sirs!"

"Keep your eye on the Infantry—the doughboy does it!" Does the rugged, slugging job of winning the war, man to man against the enemy.

WE KNOW it's mighty disappointing to hear your dealer keep saying —"No 'Eveready' flashlight batteries yet." But our Armed Forces and vital war industries are using these dependable batteries—and they're taking nearly all we can make.

FRESH BATTERIES LAST LONGER . . . Look for the date line →



EVEREADY

TRADE-MARK

The word "Eveready" is a registered trade-mark of National Carbon Company, Inc.

CAROLE LANDIS STARRING IN THE COLUMBIA PICTURE "BY SECRET COMMAND"

*What your boy
wants most...*

Letters from home
Cigarettes that
SATISFY

Carole Landis

Back from the war zone, Carole also says...
"I saw thousands of cartons of cigarettes given
to our boys overseas and can say without res-
ervation Chesterfield is always a favorite."

Discover for yourself the meaning of Chesterfield's
5 Key-words to more Smoking Pleasure . . . **RIGHT**
COMBINATION WORLD'S BEST TOBACCOS.

IT'S CHESTERFIELD FOR MILDNESS
and
BETTER TASTE

Copyright 1944, LIGGETT & MYERS TOBACCO CO.