

Roughriders of the Deep



# POPULAR MECHANICS

## MAGAZINE

WRITTEN SO YOU CAN UNDERSTAND IT

JULY  
25 CENTS  
30c IN CANADA

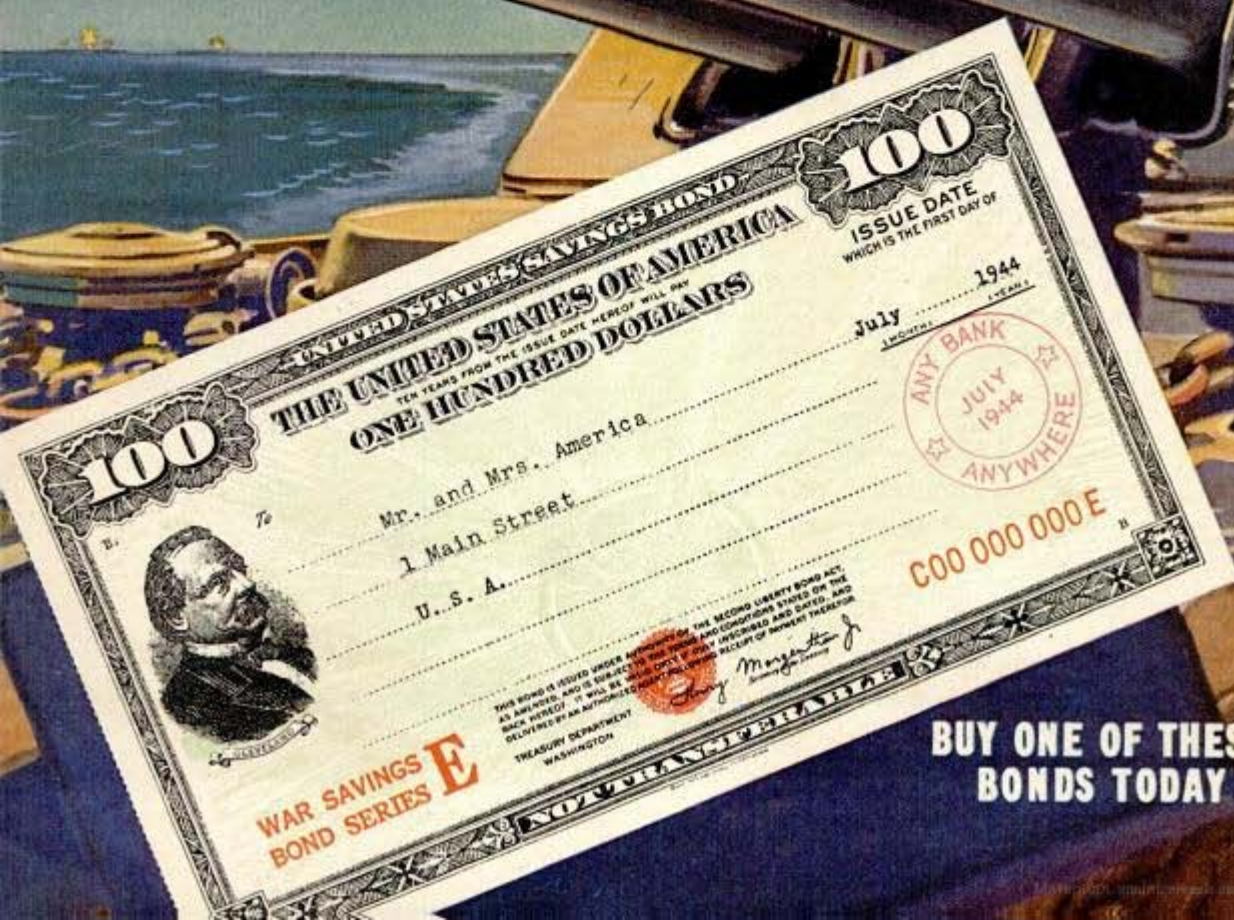

BUY ONE OF THESE BONDS TODAY

BUY  
WAR BONDS  
TODAY

Keep America  
Free



## Victory pace

by *Fisher*

The Army-Navy "E" flies above four Fisher Body plants for excellence in aircraft production and from two others for tank production, while the Navy "E," with four stars, is flown by still another Fisher Body plant for its naval ordnance work.

**G**REAT masses of heavy armament are now helping to write the prologue to victory.

Fisher Body has produced its share of this armament — tanks, anti-aircraft guns, gun-breech housings, fighting planes, bombers and delicate flying instruments.

To do this we had to disregard the normal limits of our business, and build products entirely new to us. We had to explore technical fields foreign to us. We had to enlarge our plant facilities.

Looking back on those hectic days and nights of conversion, we realize that an understanding of true craftsmanship proved

to be, literally, a lifesaver. Precision work on armament came easily to precision workmen. Long-acquired skills and crafts met demands for the most extreme accuracy.

And an important reason why Fisher Body has yet to fail at a war job is because craftsmanship has never yet failed us.

Every Sunday Afternoon  
GENERAL MOTORS SYMPHONY OF THE AIR  
NBC Network



armament  
~~BOX~~ BY

*Fisher*

D I V I S I O N O F G E N E R A L M O T O R S

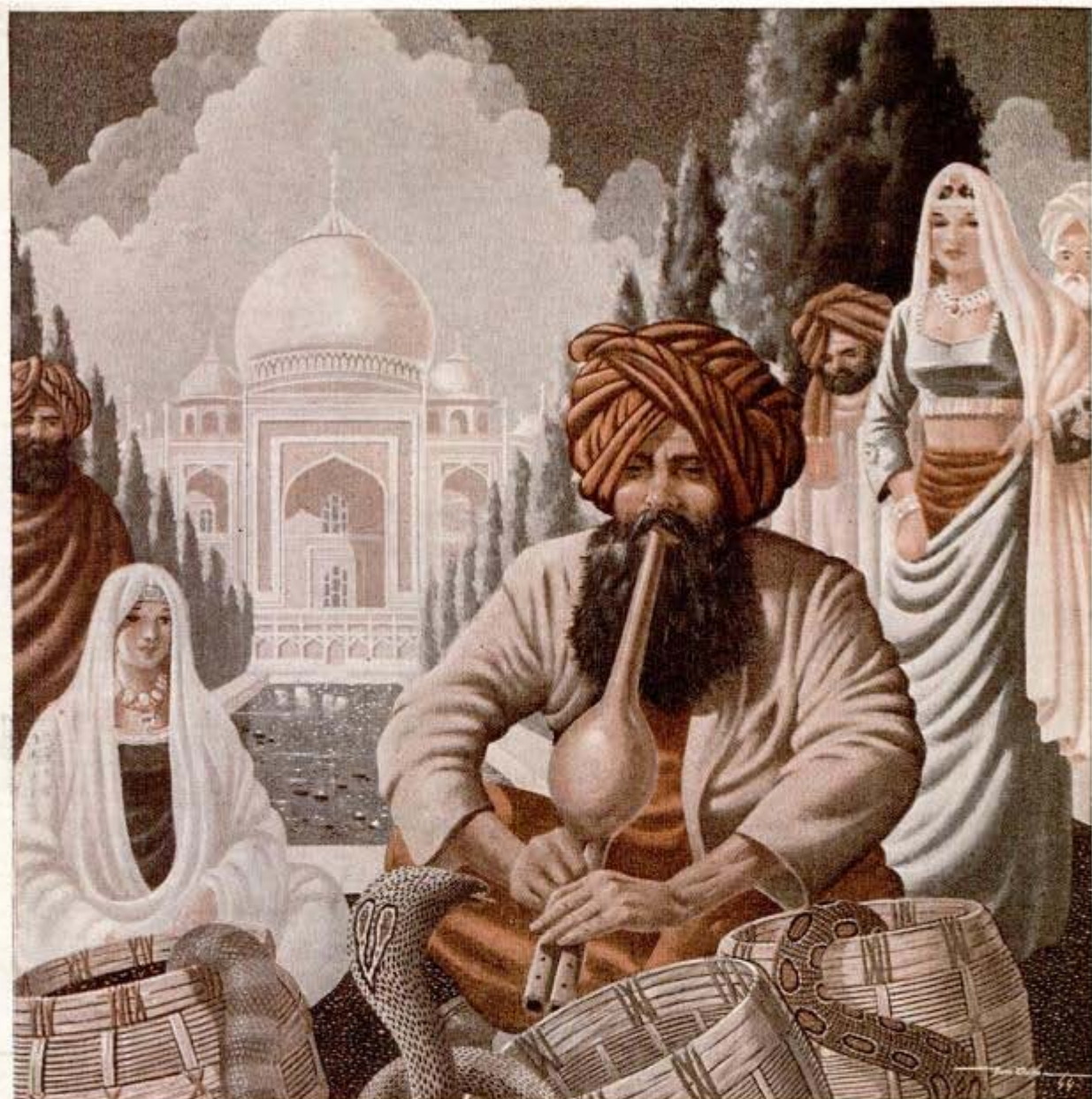

## MEET YOUR NEW NEIGHBOR...

No longer strangers are the people opposite us on a world steadily growing smaller. The ways of life in all parts of the world will be as familiar as those of your next door neighbor.

There is no doubting the importance of short wave radio in the postwar world . . . important in bringing about a better understanding between nations—aiding the progress of civilization and bringing to all peoples the *good* things in life.

Look to Hallicrafters, when the war is won, for the results of more than fifty million dollars worth of war research and developments in Radio.



For ten years Hallicrafters has been the radioman's radio. Ask any electronic technician anywhere in the world . . . yes, particularly ask an enemy radio expert . . . which receiver brings the world together. THE HALLCRAFTERS CO., MANUFACTURERS OF RADIO AND ELECTRONIC EQUIPMENT, CHICAGO 16, U. S. A. **BUY A WAR BOND TODAY!**

# hallicrafters RADIO



This One



RH8H-J11-JXFO

JULY, 1944

1A

ARMY AIR FORCES



**WHERE PERFORMANCE REALLY COUNTS...**



*... COUNT ON DEPENDABLE*  
**CHAMPION SPARK PLUGS**

The American people will always give an overwhelming vote of confidence to that which they *know* they can depend upon. That's why more motorists prefer Champions to any other spark plug—why more Champions are in daily use, than any other.



The Champion Spark Plugs in service with our armed forces in the air, on land and sea and on the home front are piling up increasing evidence that Champion dependability really means something and is something you can count upon.



**TO SAVE GASOLINE  
—KEEP SPARK PLUGS CLEAN**

**LET'S ALL BACK THE ATTACK—BUY WAR BONDS**

# Popular Mechanics Magazine

Registered in U. S. Patent Office and Canada

H. H. WINDSOR, Founder

H. H. WINDSOR, Jr., Editor and Publisher

July, 1944

Vol. 82, No. 1

## Next Month

ONE of the sportiest fishing grounds off Long Island's tip is closed to the millionaire anglers just now. It is a wartime hunting ground for tin fish. The torpedoes that are sinking Japan's fleet get their start here in a testing ground, where Navy inspectors peering through glasses watch the course of each \$10,000 tin fish as it makes its trial run from a tube or its simulated drop from a torpedo plane. Speedboats rush to retrieve each torpedo, guided sometimes by observation planes. Read about this torpedo proving ground in the August feature, "Torture Tests for Tin Fish."

## "Going Up!"

AIR FORCE mechanics in Alaska sometimes harness three gasoline-fired air heaters in tandem to produce enough warm air to start an airplane engine suffering from the arctic chill. But it's hot in Alaska compared with the cold room in Douglas Aircraft's laboratory, where the thermometer may hit 130 below zero in a test of men and instruments for service at 50,000 feet up. What goes on in the cold capsule is related in an article next month.

## Air Made to Order

IMAGINE a cool, brisk day in the New Guinea jungle or a smokeless day in Pittsburgh. It's not impossible. Postwar tourists may put up in comfortable air-conditioned inns on South Pacific isles, electrostatic air cleaners may eliminate smoke in our steel cities, and, says an article in the August issue, there's a promise of dustfree comfort for your home.

## IN THIS ISSUE

Torpedo Cowboys	1
Parlor Cars With Wings	8
Revolution on Rails	18
First Aid for Lost Flyers	28
The Iron Cavalry	33
Metal Powders Speed V-Day	40
They Get There First	44
Roughriders of the Deep	50
The World's Biggest Business	56
They Make Tomorrow's Planes Today	65
Silver Goes to Work	72
Featherweights on Wheels	76
Heroes of the "Hump"	82

Where-to-Buy-It Index—Page 8A

## The Shape of Things to Come

WHEN the tremendous pent-up desire for new homes and new automobiles, television and helicopters and just plain electric irons is loosed by the hoped-for Armistice whistles, what will American industry have to offer? Probably very little, at the moment. But the designs are on the drawing boards—and some of them you will see in an eight-page feature next month: "The Shape of Things to Come." The story tells of a molded bathroom-and-kitchen unit, functionally designed, ready to plug into foundation outlets; cordless electric irons, automatic machines that drive drudgery from the home.

## Fire From the Sky

AERIAL photographs by the "rec" pilots who follow the bomber fleets show acres of roofless buildings in Berlin. Incendiaries had done an efficient job. An August article tells of one raid in which close to 350,000 fire bombs were dropped on the Nazi capital—incendiaries formed 98 percent of the entire bomb load. Our experts say their new "matchsticks," defying all extinguishing agents, are more effective than two-ton blockbusters for destroying enemy arms factories.

Published monthly by POPULAR MECHANICS COMPANY, 200 East Ontario Street, Chicago (11), Ill., U. S. A. Single copy in the United States, 25 cents; subscription rates in United States and possessions, and countries of the Pan-American Postal Union, \$2.50 a year. Single copy in Canada, 30 cents; subscription rates, \$3.00 a year. To all other countries add \$1.00 a year over United States prices for overseas postage. If you plan to move, notify us at least 60 days in advance so you will not miss an issue. Give both old and new addresses. Entered as Second Class Matter, September 15, 1903, at the Post Office at Chicago, Illinois, under Act of March 3, 1879. Entered as Second Class Matter at Post Office Dept. Canada.

Copyright 1944, by Popular Mechanics Company, Copyright under International Copyright Union. All rights reserved under Pan American Copyright Union. Printed in the United States of America

THE **HOW AND WHY** OF

**WILLIAMS**  
DROP-FORGED TOOLS

**USE OF WILLIAMS' THREADING TOOL HOLDERS**



Thread cutting in the engine lathe is one of the most exacting lathe operations, and one which requires a thorough knowledge of change gear principles and procedure. However, the accuracy and quality of the final job depends upon the cutting tool itself. An explanation of the proper application of two types of Williams' Threading Tool Holders follows:

**EXTERNAL THREADING WITH WILLIAMS' LOCKABLE SPRING-HEAD HOLDER**



Made in 3 sizes for cutters 1/4", 5/16" and 3/8" square.

This tool is designed for both fine and coarse threading. Its Spring Head is equipped with a Locking Nut which provides the rigid backing required for heavy cuts; when loosened, the Holder becomes a Spring Tool for finishing work. Finished High Speed Steel cutters are furnished with this tool having each end ground to a "V" point forming an angle of 60°.

To set the Tool, first adjust the cutter so that only the ground portion projects beyond the holder. Now set the Holder in the Tool Post, adjusting the cutter

*Application of Threading Tool. Center Gage must be held parallel to the machine bed ways when setting tool.*

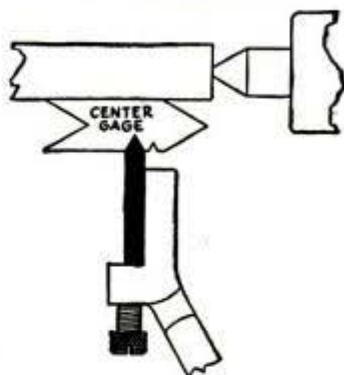

point vertically to exact center of the work. Then place a Center Gage with its back edge in contact with the work, or the Tailstock Spindle, and adjust the Tool horizontally by fitting the cutter point exactly into the 60° angle notch in the front edge of the Center Gage. (see illustration). Tighten the Tool Post Screw, using caution not to change position of the Holder. Apply cutting oil to the work generously when threading steel.

**EXTERNAL THREADING WITH WILLIAMS' FORMED-CUTTER HOLDER**



Made in 4 sizes, with formed cutters 5/16" to 5/8" thick.

The High Speed Steel Formed Cutter with which this tool is equipped is ground to an included angle of 60° and is backed off for correct clearance. In regrinding, the top edge only is ground, thus assuring a point of proper form and angle as originally supplied.

Procedure in setting this tool is the same as explained for the Spring Head Tool. In adjusting height of Tool so as to center on the work, do not use the Stop Screw on the side of Holder. This adjustment is used to compensate for metal removed from the cutting point in regrinding. The top surface of cutting point must always be horizontal when threading. (see illustration).

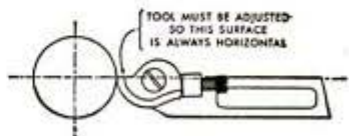

**FREE DATA SHEETS**

**J. H. WILLIAMS & CO., BUFFALO 7, N. Y.**

**ON USE OF SHOP AND HAND TOOLS**

Your name and address in the margin below will bring 12 Tool Holder Data Sheets (punched for 3-ring binder) and a list of our complete Data Sheet series. Mail to above address, Dept. PM-7.

# Handie-Talkie signals the **attack!**



**HANDIE-TALKIE IS**

**ANOTHER MOTOROLA RADIO FIRST!**

If there is glory at all in war, *all of it* goes without question to the men who do the fighting. We who on the production front turn out the weapons for Victory find ample satisfaction in the knowledge that our product *delivers* when needed.

Our fighting men feel stronger and safer because of the Handie-Talkie... the "house telephone" of the infantry company. With it, our side knows where the enemy is and what he's doing. This knowledge is often the margin of Victory—and Victory is our goal!

The Handie-Talkie is a battery powered radio receiver and transmitter no larger than a cracker box. The operator talks, giving information, and listens, receiving instructions. Officers and men in the infantry call it the "fightingest" radio set in the army! The "Handie-Talkie" was pioneered and developed exclusively by Motorola Electronics Engineers. It is a Motorola habit to be first!

**GALVIN MFG. CORPORATION**  
CHICAGO 51, ILL.



*Motorola Engineers who were famous in peacetime for radio that delivered peak performance will have pleasant surprises for you in Motorola Post-War Radio for Home and Car.*

## Motorola Radio



FM RADIO ★ PHONOGRAPHS ★ RADAR ★ TELEVISION ★ FM POLICE RADIO ★ MILITARY RADIO COMMUNICATIONS

## The World's Most Precious Cargo

No gold-laden galleon ever carried a cargo half so precious as that of the Navy's sturdy LCI (L) Landing Craft. For theirs is the task of transporting to the invasion beachheads the cream of American manhood . . . our sons, brothers and husbands whose courageous efforts are clearing the paths to Tokyo and Berlin. ☆ Defoe men and women are putting their hearts as well as their brains and brawn into these invasion vessels. Yes, and a full measure of patriotic devotion, too, plus the engineering skill and experienced craftsmanship traditional in shipbuilding. ☆ Today, Defoe's job is to build sturdy, dependable fighting ships of the Navy. But tomorrow, these same skills and abilities will be devoted to building just as fine products, at low cost, for peacetime America. Whatever Defoe creates then will reflect the same pride we take in our work these crucial days.



DEFOE SHIPBUILDING COMPANY, BAY CITY, MICHIGAN

**Defoe**

*Four White Star Renewal Citations  
now decorate the Navy "E" Award  
won by Defoe workers.*

INVEST IN INVASION  
—BUY WAR BONDS

SHIPS FOR VICTORY  
SERVANTS FOR PEACE



## To Junior Executives . . . and Department Managers:

# Are YOU stuck on a Job Plateau?



ists, men who know one job or department well. That's probably where you shone—and are still shining. You are probably good in finance, production, law, sales,

advertising, or some other specialized department.

But the top jobs—the general executive jobs call for that and a lot more than that. They demand a fair understanding of all departments, their inter-relationship and their place in the whole company scheme. They require an over-all knowledge and ability to coordinate and supervise the specialized experts.

If you are to move up from your plateau, you must somehow achieve this broader management knowledge and ability. And you can't get it from day-by-day experience—that is both too slow and incomplete.

Fortunately, you can get it conveniently, economically, and quickly. Our Business Management Training, designed for just this purpose, has given this to thousands who have thus stepped on up to better positions and pay.

A free 48-page booklet, "The Modern Executive," describes in detail this executive training. A copy is waiting for your request. Send for it today and see whether this training may be just what you need to get off your present plateau.

**ARE YOU** like millions of other good men in business? Did you move along reasonably well until you reached your present junior executive or department manager job—and then stop? Have you watched other men move by you or come in from the outside to the big positions above you?

If so, probably the fault is yours.

In the lower strata of business and industry, the call is for special-



## LASALLE EXTENSION UNIVERSITY

**A Correspondence Institution**

Dept. 764-BM

CHICAGO 15, ILL.

• Please send me—free and without obligation—your booklet, "The Modern Executive." I want to see whether your Business Management Training can help me become a more successful executive.

NAME

ADDRESS

PRESENT POSITION

AGE

**PYROIL COMPANY**  
**57 Pyroil Bldg., La Crosse, Wisconsin**

I want my car to last and run properly. Please tell me more about Pyroil and how it can accomplish this for me.

Name .....

Address .....

City .....

State .....

... *This Coupon* will bring you vital information about an easy inexpensive way to add life to your car. Pyroil, available for you at your service station, protects your car against corrosion, excess cylinder wear, rust. It reduces carbon formations and frees away gums and sludges. One pint of Pyroil in your crankcase and one ounce in your gas tank with every 5 gallons of gasoline *does it!*

Manufactured and Guaranteed by Pyroil Company, W. V. Kidder, Founder, 57 Pyroil Bldg, La Crosse, Wisconsin.



**YOUR GUARANTEE**

13 years' acceptance by foremost authorities—race drivers—explorers—engineers.

**Keep Buying Bonds**

**PYROIL**

**Adds life to your Car**

**WHERE-TO-BUY-IT INDEX**

Where no name and address appear directly under an item, the product is not believed by us to be commercially available

Collapsible rubber lifeboat .....	4
Dial counts windings of coil .....	4
Production Instrument Co., 710 W. Jackson Blvd., Chicago	
Pre-flight trainer never leaves ground .....	5
High-speed reconnaissance car .....	5
Chemical compound waterproofs soil .....	6
Hercules Powder Co., Wilmington, Del.	
Plastic ribbon replaces hair in weather instrument .....	6
Midget motor develops 30 horsepower .....	7
London's ack-ack rocket guns .....	7
German "Beetle" tank .....	7
Nazi mine in wooden box .....	7
Excursion boat converted to troop carrier .....	13
Training rifle fires needles .....	13
Trucks set records for big loads .....	17
Plywood back pack for soldier .....	17
Gunners guard coast in tiny train .....	26
Bomber uses parachutes as brakes .....	26
World's largest pin-up girl .....	27
Spreader unit for truck .....	27
Baughman Mfg. Co., 116 E. Arch St., Jerseyville, Ill.	
Air mechanics work wonders with scrap .....	32
Dummies test parachutes .....	38
Tandem jeeps double hauling power .....	38
Pop gun tester for flak weapon .....	39
Firemen carry hose on tightrope .....	39
Powder mixed with water becomes milk .....	39
Consolidated Badger Cooperative, Shawano, Wis.	
Whirling tower tests 'chutes .....	43
Invasion stock pile .....	48
Model mule trains cavalrymen .....	49
Turkish bath for bombers .....	54
Grid machine does six months' work in day .....	54
Fireproof air ducts for planes .....	54
Balloons lift sunken plane .....	55
Radio station built into truck .....	55
Grass planter digs and waters .....	61
Cement bonds metal to wood .....	61
The fleet hits the front line .....	62
Plane requires 97-man crew .....	64
Camera photographs night sky .....	64
Lever-type clamp of wood .....	70
Empire Level Mfg. Co., Milwaukee, Wis.	
Knife blade withdraws into handle .....	70
Mark Specialty Co., 406 Temple Bldg., Rochester, N. Y.	
Collapsible container for cooking .....	70
Fast-drying concrete .....	70
Seaplane can alight on land or snow .....	71
Tank buster shoots armor-piercing bomb .....	71
Film case serves as projector stand .....	75
Bell & Howell Co., 1801 Larchmont Ave., Chicago 13, Ill.	
Insulated wall saves fuel .....	75
High flying on the ground .....	80
Bombs on fighter plane felt first at front .....	81
Stapling pliers have magazine feed .....	81
Bostitch Co., 175 Division St., E. Greenwich, R. I.	
"Impossible" stunts with helicopter .....	81
U. S. Army's "briefcase" gun .....	87
Compressed air clears welder's mask of fumes .....	87
Spring clips hold flexible tubing .....	87
Packless Metal Corp., 31 Winthrop Ave., New Rochelle, N. Y.	
Magnifying glass on headband .....	88
Kiny Mfg. Corp., 146 W. 29th St., New York City	
20-sided globe reduces distortions .....	88
Like-A-Globe Co., 405 Temple St., New Haven 11, Conn.	
Long life phono needle has plastic noise-reducing shaft .....	144
Aero Needle Company, 208 E. Erie St., Chicago 11, Ill.	
Microphone control box with "busy signal" light .....	144
Executone Company, Inc., 415 Lexington Ave., New York, N. Y.	

**Craftsman and Shop Notes Index**

<b>AUTOMOTIVE</b>	
Guide for installing radiator hose .....	129
Replacing valve guides .....	132
<b>BOATS AND BOATING</b>	
Kick-katamaran .....	93
Caring for outboard motor .....	98
Pivoted footrest aids in bailing .....	106
<b>FARM</b>	
Shelter for small chicks .....	96
Tether stake for pony or goat .....	112
Repairing cracked grain scoop .....	123
<b>FURNITURE</b>	
Lightweight beverage table .....	89
Knockdown work table .....	113
<b>HAND TOOLS</b>	
Straightener for small wire .....	96
Edge-beveling with a hand plane .....	102
Leather paddle prevents hammer marks .....	104
Non-rolling tool handles .....	106
Burning out ax handle .....	106
Marking gauge to align dowel holes .....	114
Glue brushes made from sash cord .....	114
Corrugated fastener scrapes wire .....	121
Wrench is reel for plumb-bob line .....	122
Bolt and nut pull gib keys .....	122
Copper tube flanged with screw .....	123
Multi-blade screwdriver .....	129
Guide to punch holes in leather .....	132
Snap switch on soldering iron .....	133
Pliers cut off for special jobs .....	140

Continued to page 10A



# DRAFT

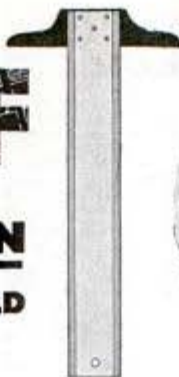

## YOUR OWN POST-WAR WORLD NOW!

AT THE drafting board you can design a rewarding future for yourself. No one else can do this for you — and the time to start on it is *now*. When the post-war time of great opportunities arrives, it isn't going to wait for any one to catch up.

The man who is drafting ships, planes, tanks and guns today is the man who will be drafting tomorrow's aircraft units, automobiles, buildings, air-conditioning systems. With the knowledge he is acquiring now, he is drawing up his personal world within the great new world.

The greater the opportunities, the fewer the places for the untrained. The International Correspondence Schools make training in

drafting — and 400 other technical and business subjects — open to all. In or out of the Armed Forces, no matter where or how you're situated, famous I. C. S. Courses are available for spare-time study at low cost.

In drafting, there's an I. C. S. Course especially designed for you whether you're a beginner ambitious to qualify as a draftsman or a draftsman who wants to become a designer and to keep on moving up from there. It's worthy of note that nearly every "big name" American in engineering and production acquired experience at the drafting board. And that many of them started by mailing the coupon you're now looking at.

### INTERNATIONAL CORRESPONDENCE SCHOOLS



BOX 5696-J, SCRANTON 9, PENNA.

Without cost or obligation, please send me booklet and full particulars about the course *before* which I have marked X:

- Airplane Drafting
- Architectural Drafting
- Electrical Drafting
- Mechanical Drafting
- Sheet Metal Drafting
- Ship Drafting
- Structural Drafting
- Air Conditioning and Plumbing Schools
- Air Conditioning
- Heating  Plumbing
- Refrigeration
- Steam Fitting
- Chemistry Schools
- Chemical Engineering
- Chemistry, Analytical
- Chemistry, Industrial
- Chem., Mfg. Iron & Steel
- Plastics
- Pulp and Paper Making
- Civil, Architectural and Structural Engineering Schools
- Architecture
- Bridge and Bldg. Foreman
- Bridge Engineering

- Building Estimating
- Civil Engineering
- Contracting and Building
- Highway Engineering
- Lumber Dealer
- Sanitary Engineering
- Surveying and Mapping
- Electrical Schools
- Electrical Engineering
- Power House Electrician
- Practical Electrician
- Practical Telephony
- Telegraph Engineering
- Internal Combustion Engines School
- Auto Technician
- Aviation  Diesel-Electric
- Diesel Engines
- Gas Engines
- Mechanical Schools
- Aeronautical Engineering
- Flight Engineer
- Foundry Work
- Heat Treatment of Metals
- Industrial Design
- Mechanical Engineering
- Mold-Loft Work
- Patternmaking

- Reading Shop Blueprints
- Sheet Metal Worker
- Ship Fitting
- Ship Practice
- Steel Mill Workers
- Tool Designing
- Welding, Gas and Electric
- Radio School
- Electronics
- Radio, General
- Radio Operating
- Radio Servicing
- Railroad School
- Air Brake  Car Inspector
- Locomotive Engineer
- Locomotive Fireman
- Railroad Section Foreman
- Steam Engineering Schools
- Boilermaking
- Combustion Engineering
- Engine Running
- Marine Engines
- Steam Electric
- Steam Engines
- Textile School
- Cotton Manufacturing
- Rayon Weaving

- Textile Designing
- Woolen Manufacturing
- Business and Academic Schools
- Accounting  Advertising
- Arithmetic  Bookkeeping
- Business Correspondence
- Business Management
- Certified Public Accounting
- City Letter Carrier
- College Preparatory
- Commercial
- Cost Accounting
- Federal Tax
- First Year College
- Foremanship
- High School
- Higher Mathematics
- Illustrating
- Motor Traffic
- Post Office Clerk
- Railway Postal Clerk
- Salesmanship
- Secretarial  Stenography
- Traffic Management
- Language School
- Spanish  French
- Good English

Name..... Age..... Home Address..... Working Hours.....

City..... State..... Present Position.....

Canadian residents send coupon to International Correspondence Schools Canadian, Ltd., Montreal, Canada.  
British residents send coupon to I. C. S., 71 Kingsway, London, W. C. 2, England.

**SPECIAL TUITION RATES FOR MEMBERS OF THE ARMED FORCES**

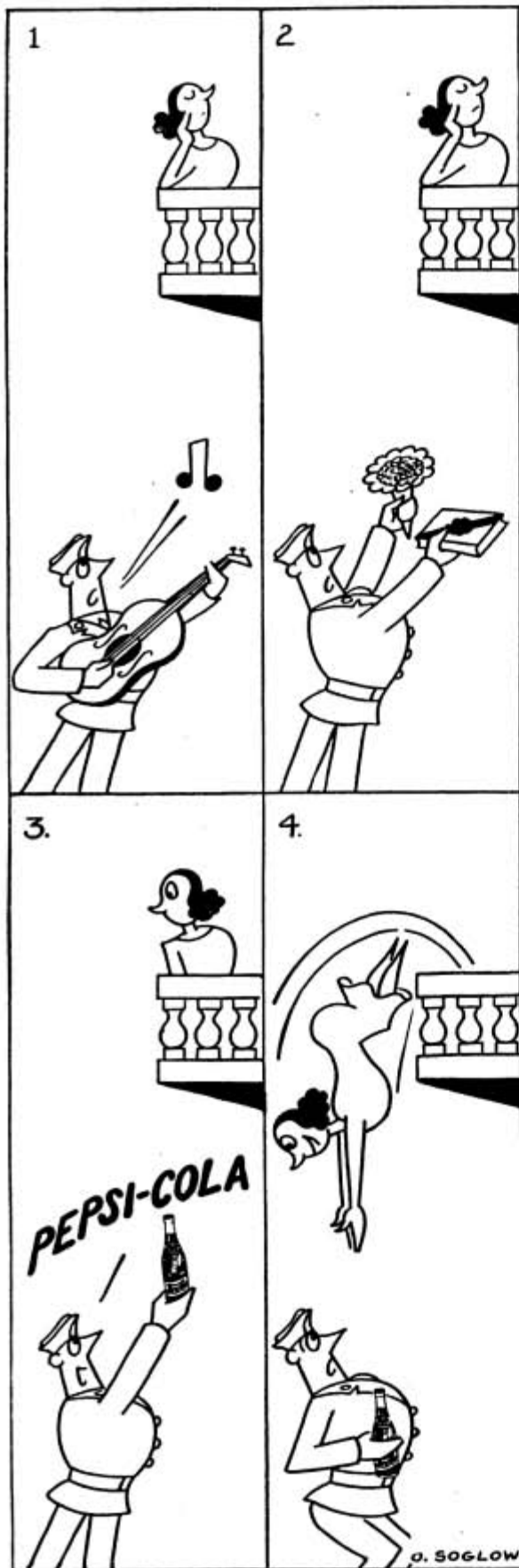

Continued from page 8A

**HOUSEHOLD**

Cutting velvet and jersey cloth.....	90
Data hidden behind sliding picture.....	91
Solving home problems.....	94
Spectacle case as shopping-bag handle.....	96
Preserving leather book covers.....	102
Baby crib shaped like a boat.....	103
Cleaning powder removes paint spots.....	104
Inexpensive wallpaper cleaner.....	107
Cleaning washing machine.....	107
Capsules picked up with rubber bulb.....	112
Folding chair converted to baby walker.....	114
Reading wattage of overhead lamp.....	114

**HUNTING, CAMPING AND FISHING**

Latch string opens tent flaps.....	92
Files carried in hat band.....	106
Preventing loss of tent-pole hinge pin.....	106
Tent wall pegged to small logs.....	112

**LAWN AND GARDEN**

Edger trims lawn neatly.....	91
Vest-pocket summer house.....	97
Seeds stored in glass jars.....	97
Depth gauge for rotary plow.....	106
Lazy Susan lawn table.....	107

**METALWORKING**

Locating dowel holes in foundry pattern.....	122
Holder for sawing small rods.....	123
Chisel for sheet metal.....	123
Heat treatment of steel.....	124

**OFFICE**

Pen made to hold extra ink.....	91
Glycerin renews stamp pad.....	91
Crochet hook opens wrappers.....	92
Emergency stamp pad.....	96
Clip holds paper basket upright.....	114

**PHOTOGRAPHY**

Photo kinks.....	117
Deckle edges made with pinking shears.....	118
Supporting camera for low shots.....	118
Regulating water for washing prints.....	118
Coffee as sepia toner.....	118
Black paint from phonograph records.....	118

**PAINT AND PAINTING**

Shellac carried in shoe-polish bottle.....	116
Mottle finish produced by dipping.....	131

**POWER TOOLS**

Tool trues up disks in lathe.....	122
Fixture to make bushings.....	123
Holding metal washers for grinding.....	130
Repairing nut on cross-feed screw.....	133

**RADIO AND ELECTRONICS**

"Don'ts" for radio set owners.....	141
"Pocket" portable has built-in loop antenna.....	142
Plastic crochet needle as service tool.....	144
"China" marking pencil for writing service data on tubes.....	144
Handles for small bench drawers from old condenser plates.....	144
Antenna window strip from copper foil building material.....	144
Pilot light bulb remover made from spring clothespin.....	144
Repairing dials and tuning knobs.....	144
Celluloid scratch-preventer shields for tuning controls.....	144

**STORE AND SHOP**

Oil drums moved on detachable casters.....	122
Tin can weights for coal trucks.....	122
Thermometer shows progress of contest.....	123
Portable display rack for window.....	130
Printing raised lettering.....	132
Detachable shop shelf.....	140

**WOODWORKING**

Nail interlocks door-jamb joint.....	104
Smooth sanding.....	119
Cutting threads in wood.....	124

**MISCELLANEOUS**

Easy way to clean a watch.....	92
Removing nails from wood trim.....	96
Three-cell flashlight converted to two.....	96
Hammer aids in wrapping cord.....	97
Ruler carried in notebook.....	103
Keys identified by color.....	103
"Raincoat" keeps bandage dry.....	104
All-purpose wood wagon.....	105
Making good concrete.....	108
Pusher handle for coaster wagon.....	112
Pennants help locate arrows.....	112
Refinishing floors.....	115
Emergency three-rail ladder.....	121
Fire pail made useless for other purpose.....	123
Drilling out tubular rivets.....	129
Spring fixture steadies T-square.....	129
Guide aids in coupling pipe.....	132
Brush for cementing shingles.....	133
Small chains made from wire.....	140

**IMPORTANT NOTICE**

It is the intention of this magazine to provide its readers with information regarding the latest developments in the mechanical arts. We take no responsibility as to whether the disclosures contained in our articles are covered by patents and advise readers to investigate this subject before making, using, or selling any of the products, machines, or processes described in order to avoid possible liability for patent infringement.

## AUDELS AIRCRAFT WORKER... \$1

Answers Your Questions on 1—Aircraft Materials, Terms, Parts, 2—Blueprints, Working Drawings, 3—Mathematics, How to Figure, 4—Layout & Bending, 5—Tools & Machines, 6—Riveting, Spot Welding & Hints, 7—Fabrication, Angles, etc. 8—Assembly, Fuselage, Wing & Final—How to Use Tools, 9—Tables & Data, Symbols, Army & Navy Specifications, etc. 240 Pages Illus.

## AUDELS SHEETMETAL PATTERN LAYOUTS... \$4

Developed by Experts for Sheet Metal Workers, Layout Men & Mechanics. A Practical Encyclopedia in 10 Sections, size 7 x 10 x 2—1125 Pages—350 Layouts—1600 Illustrations, 1001 Key Facts. Fully indexed for ready reference in answering your layout problems. Covers all phases of sheet metal work including Pattern Cutting, Pattern Development & Shop Procedure.

## AUDELS SHEETMETAL WORKERS HANDY BOOK... \$1

Practical inside information. Fundamentals of Sheet Metal Work. 388 pages. Illustrated. 11 sections. Clearly written. Essential & important facts, figures, pointers in everyday language. Ref. Index.

## AUDELS WELDERS GUIDE... \$1

A concise, practical text on operation & maintenance of all welding machines for all mechanics. Over 400 pages, illustrated. Covers all methods of electric and acetylene welding including airplane work.

## AUDELS ANSWERS ON BLUE PRINT READING... \$2

For Mechanics & Builders. Covers all types of blue print reading including ship & airplane. 376 pages, fully illustrated.

## AUDELS NEW MACHINIST & TOOLMAKERS HANDY BOOK... \$4

Covers modern machine shop practice in all its branches. 5 practical books in 1. New from cover to cover. Tells how to set up & operate lathes, screw and milling machines, shapers, drill presses and all other machine tools. 1600 pages, fully illustrated. 5 x 6 1/2 x 2. Indexed. 5 sections. 1—Modern Machine Shop Practice. 2—Blue Print Reading & How to Draw. 3—Calculations & Mathematics for Machinists. 4—Shop Physics. 5—How to Use the Slide Rule. 60 chapters. Easy to read and understand. A shop companion that answers your questions.

## AUDELS MATHEMATICS & CALCULATIONS FOR MECHANICS \$2

Mathematics for home study or reference. 700 pages, 550 illus. Practical mathematics from beginning. How to figure correctly. Easy, correct methods covering a complete review. Ill. & Indexed.

## AUDELS AUTOMOBILE GUIDE... \$4

A practical quick ready reference book for auto mechanics, service men, operators & owners. Explains theory, construction & servicing of modern motor cars, trucks, buses & auto type Diesel engines. 1540 pages, fully illustrated. 55 chapters. Indexed. A standard book for mechanics. New fluid drive covered.

## AUDELS DIESEL ENGINE MANUAL \$2

A practical, concise treatise with questions and answers on the theory, operation and maintenance of modern diesel engines including General Motors 2 cycle Diesel. 384 pages, fully illus., flexible binding, pocket size. All details plainly brought out, this book is of extreme value to engineers, operators & students.

## AUDELS RADIOMANS GUIDE... \$4

A key to the practical understanding of radio including Frequency Modulation, Television, etc., Aircraft & Marine Radio. For radio engineers, servicemen, amateurs. 772 pages. 400 Illustrations & Diagrams. Photos. Review Questions & Answers, Reference Index. Authentic, clear, concise.

## AUDELS HANDY BOOK OF PRACTICAL ELECTRICITY... \$4

For maintenance engineers, electricians & all electrical workers. 1440 Pages, 2600 illus. Covers important electrical information in handy form—including Marine Wiring, Radio Principles, Welding. Indexed. A Key to a practical understanding of electricity.

## AUDELS CARPENTERS & BUILDERS GUIDES—4 Vols. \$6

A practical illustrated trade assistant on modern construction for carpenters, joiners, builders, mechanics and all woodworkers. 4 vols., 1600 pages, 3700 illustrations, flexible covers. Each volume pocket size. Sold separately \$1.50 a vol.

## AUDELS PLUMBERS & STEAMFITTERS GUIDES—4 Vols. \$6

A Practical Trade Assistant & Ready Reference. Explains in plain language & by clear illustrations, diagrams, charts, graphs, pictures principles of modern plumbing practice including Marine Pipe Fitting and Air Conditioning. 4 Vols.—1670 Pages—3642 Diagrams. Each Vol. Pocket Size. Sold Separately \$1.50 a Vol.

## AUDELS WIRING DIAGRAMS... \$1

210 Pages. Illustrated. Gives practical facts on wiring of electrical apparatus. It explains clearly in simple language how to wire apparatus for practically all fields of electricity. Each diagram is complete & self-explanatory. Highly Endorsed Pocket Companion.

## AUDELS ELECTRONIC DEVICES... \$2

Tells What You Want to Know About Electric Eye. Easily Understood. Covers photo-electric cells & their applications. Amplifiers, illumination, frequencies, voltage, photocell, tubes, Ohm's Law, wiring diagrams, etc.

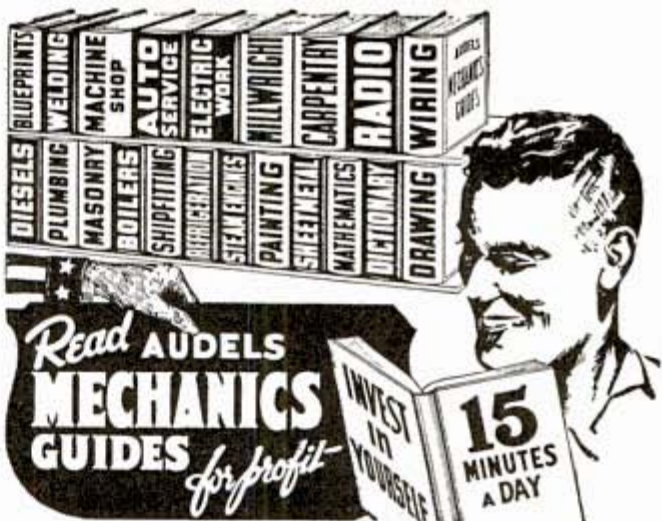

## AN AUDEL GUIDE IS A GOOD FRIEND!

Use the brains and experience of others in these Guides of the Trades. Save time and money with right methods, short cuts, labor saving ideas. CHECK NOW! You can look over any Audel Guide in your home. Start the Easy Payments if satisfied.

# CUT HERE MAIL ORDER

THEO. AUDEL & CO., 49 W. 23rd St., New York 10

Please mail me for 7 days' free examination the books marked (X) below. I agree to mail \$1 in 7 days on each book or set ordered, and to further mail \$1 a month on each book or set ordered until I have paid purchase price.

If I am not satisfied with Guides I will return them.

- Audels PUMPS, HYDRAULICS & AIR COMPRESSORS \$4. . . . . 1.
- Audels WELDERS GUIDE . . . . . 1.
- Audels BLUE PRINT READING . . . . . 2.
- Audels SHEET METAL WORKERS Handy Book . . . . . 1.
- Audels SHEET METAL PATTERN LAYOUTS . . . . . 4.
- Audels AIRCRAFT WORKER . . . . . 1.
- Audels MATHEMATICS and CALCULATIONS . . . . . 2.
- Audels MACHINISTS & TOOLMAKERS Handy Book . . . . . 4.
- Audels DIESEL ENGINE MANUAL . . . . . 2.
- Audels MECHANICAL Dictionary . . . . . 4.
- Audels AUTO GUIDE . . . . . 4.
- Audels MARINE ENGINEERS HANDY BOOK . . . . . 4.
- Audels SHIPFITTERS Handy Book . . . . . 1.
- Audels MARINE Engineers Guide . . . . . 3.
- Gueths MECHANICAL DRAWING COURSE . . . . . 1.
- Rogers Mechanical DRAWING and Design . . . . . 2.
- Audels MILLWRIGHTS and Mechanics Guide . . . . . 4.
- Audels CARPENTERS and Builders Guides (4 vols.) . . . . . 6.
- Audels PLUMBERS and Steamfitters Guides (4 vols.) . . . . . 6.
- Audels MASONS and Builders Guides (4 vols.) . . . . . 6.
- Master PAINTER and DECORATOR . . . . . 2.
- Audels GARDENERS & GROWERS GUIDES (4 vols.) . . . . . 6.
- Audels ENGINEERS and Mechanics Guides . . . . . 12.
- Nos. 1, 2, 3, 4, 5, 6, 7 and 8 complete . . . . . 12.
- Audels Answers on Practical ENGINEERING . . . . . 1.
- Audels Answers on REFRIGERATION . . . . . 2.
- Hawkins Aids to ENGINEERS EXAMINATION . . . . . 2.
- Rogers MACHINIST GUIDE . . . . . 2.
- Audels WIRING DIAGRAMS . . . . . 1.
- Audels Handy Book of PRACTICAL ELECTRICITY . . . . . 4.
- Audels ELECTRICAL POWER CALCULATIONS . . . . . 2.
- Hawkins ELECTRICAL Guides at \$1. each . . . . . 10.
- Audels ELECTRONIC DEVICES . . . . . 2.
- Audels ELECTRIC Dictionary . . . . . 2.
- Audels RADIOMANS GUIDE . . . . . 4.
- Audels NEW ELECTRIC LIBRARY at \$1.50 a Volume . . . . . 4.
- Vols. I, II, III, IV, V, VI, VII, VIII, IX, X, XI, XII.

Name.....  
 Address.....  
 Occupation.....  
 Employed by..... P M

AUDEL, Publishers, 49 W. 23 St., N. Y. 10

# In your Mind's Eye

## The Secret of MENTAL CREATING

IF you just like to dream, read no further. There comes a time when your fancies *must* be brought into light—and stand the test of every-day, hard realities. Are you one of the thousands—perhaps millions—whose thoughts never get beyond the stage of *wistful wishing*? Do you often come to from a daydream with the sigh, "If only I could bring it about—*make it real*?"

All things begin with thought—it is what follows that may take your life out of the class of those who hope and dream. Thought energy, like anything else, can be dissipated—or it can be made to produce actual effects. *If you know how to place your thoughts* you can stimulate the creative processes within your mind—through them you can assemble things and conditions of your world into a happy life of accomplishment. *Mental creating* does not depend upon a magical process. It consists of *knowing how* to marshal your thoughts into a power that draws, compels and organizes your experiences into a worth-while design of living.

### ACCEPT THIS *Free* BOOK

Let the Rosicrucians tell you how you may accomplish these things. The Rosicrucians (not a religious organization), a world-wide philosophical fraternity, have preserved for centuries the ancients' masterful knowledge of the functioning of the inner mind of man. They have taught men and women how to use this knowledge to *recreate their lives*. They offer you a free copy of the fascinating book, "The Mastery of Life." It tells how you may receive this information for study and use. Use coupon opposite.

*The* ROSICRUCIANS  
(AMORC)

SAN JOSE

CALIFORNIA

SCRIBE: O. J. B.  
The Rosicrucians (AMORC),  
San Jose, California.

Please send free copy of "The Mastery of Life,"  
and I shall read it as directed.

Name.....

Address.....

City.....



**Radio Servicing (left).** Many N.R.I. Graduates make \$50 a week running their own full time Radio repair businesses. Others hold regular jobs, make \$5, \$10 a week EXTRA fixing Radios in spare time.

**Broadcasting Stations (right)** employ N.R.I. trained men as Operators, Installation and Maintenance Men and pay well.



**Radio Operators (below)** find good jobs in Broadcasting Stations, Aviation, Police and Ship Radio.



# BE A SUCCESS ... IN RADIO!

## I WILL TRAIN YOU AT HOME



**J. E. SMITH**  
President  
National Radio  
Institute

Here's your opportunity to get a good job in a busy field with a bright peacetime future! There is a shortage today of trained Radio Technicians and Operators. So mail the Coupon for my FREE, 64-page, illustrated book, "Win Rich Rewards in Radio." It describes many fascinating types of Radio jobs, tells how N.R.I. trains you at home in spare time—how you get practical experience building and testing Radio Circuits with SIX BIG KITS OF RADIO PARTS I send!

**More Men I Trained Now Make \$50 a Week Than Ever Before**

Keeping old Radios working is booming the Radio Repair business. Profits are large. After-the-war prospects are bright too. Think of the new boom in Radio Sales and Servicing that's coming when new Radios are again available—when Frequency Modulation and Electronics can be promoted—when Television starts its postwar expansion!

Broadcasting Stations, Aviation Radio, Police Radio, Loudspeaker Systems, Radio Manufacturing all offer good jobs now to qualified Radio men—and most of these fields have a big backlog of business that has built up during the war, plus opportunities to expand into new fields opened by wartime developments. You may never see a time again when it will be so easy to get a start in Radio!

**Many Beginners Soon Make \$5, \$10 a Week EXTRA in Spare Time**

The day you enroll for my Course I start sending you EXTRA MONEY JOB SHEETS that help show how to make EXTRA money fixing Radios in spare time while still learning. I send you SIX big kits of Radio parts, as part of my Course. You LEARN Radio fundamentals from my illustrated, easy-to-grasp lessons—PRACTICE what you learn by building real Radio Circuits—PROVE what you learn by interesting tests on the circuits you build!

**Find Out What N.R.I. Can Do for You**

MAIL THE COUPON for my FREE 64-page book. It's packed with facts—things you never knew about opportunities in Broadcasting, Radio Servicing, Aviation Radio, other Radio Fields. Read the details about my Course—"50-50 Training Method"—6 Experimental Kits—Extra Money Job Sheets. See the fascinating jobs Radio offers and how you can train at home. Read many letters from men I trained, telling what they are doing, earning. No obligation. Just MAIL COUPON in an envelope or pasted on a penny postal—J. E. SMITH, President, Dept. 4GP, National Radio Institute, Washington 9, D. C.

### YOU GET 6 KITS OF RADIO PARTS!

By the time you've built this Superheterodyne and many other Radio circuits with the six big kits of Radio parts I send you will have valuable practical experience!



**Our 30th Year of Training Men for Success in Radio.**



### GOOD FOR BOTH 64 PAGE BOOK SAMPLE LESSON FREE

**MR. J. E. SMITH, President, Dept. 4GP NATIONAL RADIO INSTITUTE, Washington 9, D. C.**

Mail me FREE, without obligation, Sample Lesson and 64-page book "Win Rich Rewards in Radio." (No salesman will call. Write plainly.)

Age.....  
Name.....  
Address.....  
City..... State..... ZIP.....

### I Trained These Men

#### Chief Operator Broadcasting Station

"Before I completed your lessons, I obtained my Radio Broadcast Operator's license and immediately joined Station WAFM where I am now Chief Operator." **HOLLIS F. HAYES, 327 Madison St., Lapeer, Michigan.**



**\$200 a Month in Own Business**

"For several years I have been in business for myself making around \$200 a month. Business has steadily increased." **ARLIE J. FROEHNER, 300 W. Texas Ave., Goose Creek, Texas.**



**\$10 a Week in Spare Time**  
"I repaired some Radio sets when I was on my tenth lesson. I really don't see how you can give so much for such a small amount of money. I made \$600 in a year and a half, and I have made an average of \$10 a week—just spare time." **JOHN JERRY, 1337 Kalamath St., Denver, Colorado.**



### TELEVISION ELECTRONICS FREQUENCY MODULATION

My up-to-date Course includes training in these new developments.

### FREE RADIO LESSON

I will send you a FREE Lesson, "Getting Acquainted with Receiver Servicing," to show you how practical it is to train for Radio in spare time. It's a valuable lesson. Study it—keep it—use it—without obligation! Tells how "Superhet" Circuits work, gives hints on Receiver Servicing, Locating Defects, Repair of Loudspeaker, I. P. Transformer, Gang Tuning Condenser, etc. 81 illustrations. Get your sample lesson FREE—mail Coupon NOW!

It's YOUR future—Make the most of it!



Start now to earn the bigger pay in electrical repair

WAS there ever such an opportunity to get started in electrical maintenance and repair—and at top-notch wages? Are you ready—with experience and ability—to cash in on it? Others are getting just the sort of background needed—quick! practical!—to handle the great variety of electrical maintenance and repair work TODAY—from this well-known electrical library. You can too!

## THE LIBRARY OF ELECTRICAL MAINTENANCE AND REPAIR

5 vols., 1826 pages, 1724 illustrations

Gives you the "know-how" to tackle any wiring or motor job. Five books show you HOW—to install all types of motor and generator units—to inspect and repair motor starters and generators—to diagnose motor and generator troubles—to figure new winding for old cores—DC and AC windings—to test armature windings—test induction motors, etc., etc. One book is full of trouble-shooting charts that show quickly symptoms, causes, specific remedies, etc.

Take the first step toward improving YOUR future—Mail this coupon TODAY

No money down—special price—easy payments—FREE trial

McGraw-Hill Book Co., 330 W. 42 St., New York 18, N. Y.

Send me for ten days' free examination the Electrical Maintenance and Repair Library. If satisfactory I will send you \$1.00 in 10 days and \$2.00 monthly until the price of \$15.00 is paid. If not wanted I will return books postpaid. (To insure prompt shipment write plainly and fill in all lines.)

Name .....

Home Address .....

City and State .....

Position .....

Name of Company .....

## DRAFTSMEN NEEDED NOW



Industry is clamoring for more draftsmen for the job can't start until plans are drawn. Buildings, airplanes, machines, guns, tanks, bridges, all start on the drafting board, so it's no wonder that every good draftsman has a fine job. Yes, more draftsmen are needed NOW. The pay is good and the opportunities for advancement great.

### Learn at Home in Spare Time

Begin now to turn spare hours into money. Be a draftsman, the connecting link between a mechanic and an engineer. Enjoy the wonderful opportunities for promotion that exist now. No experience or artistic talent is needed. You don't have to leave your present job while learning. Use spare time.

American School, Dept. DDB45, Drexel Ave. at 58th St., Chicago 37, Ill.

Gentlemen: Send me FREE information covering special training in subjects checked below. No obligation on my part.

- |  |  |
|--|--|
| <input type="checkbox"/> Drafting and Design for Men and Women | <input type="checkbox"/> Electrical Engineering                  |
| <input type="checkbox"/> Cost Accounting for Mfg.              | <input type="checkbox"/> Diesel Engineering                      |
| <input type="checkbox"/> Architecture and Building             | <input type="checkbox"/> High School Course                      |
| <input type="checkbox"/> Automotive Engineering                | <input type="checkbox"/> Plastics                                |
| <input type="checkbox"/> Business Management                   | <input type="checkbox"/> Mechanical Engineering                  |
| <input type="checkbox"/> Railway Training                      | <input type="checkbox"/> Aviation <input type="checkbox"/> Radio |
|  | <input type="checkbox"/> Shipbuilding                            |

Name .....

Address .....

## "THREE MONKEYS" Cartoon Films



"High light" the HOME MOVIE show. Three leading characters make each film a feature.

50 Ft. 8MM. .... \$1.25 | 100 Ft. 16MM. .... \$2.50  
 Ship Wrecked ..... 1209-A | The Auto Race ..... 1213-A  
 High and Dizzy ..... 1210-A | Midnight Spooks ..... 1214-A

Screen also a Mickey Mouse, Oswald Rabbit and Donald Duck Cartoon for a full evening of delightful HOME entertainment.

See At Your Dealers or Order Direct  
 For Catalog and Prices, Write to—  
**HOLLYWOOD FILM ENTERPRISES, Inc.**  
 6060 Sunset Blvd. Dept. 115 Hollywood 28, Calif.

## ACCOUNTANT BECOME AN EXPERT

Executive Accountants and C. P. A.'s earn \$2,000 to \$10,000 a year. Thousands of firms need them. We train you thoroughly at home in spare time for C. P. A. examinations or executive accounting positions. Previous experience unnecessary. Personal training under supervision of staff of C. P. A.'s. Placement counsel and help. Write for free book, "Accountancy, the Profession That Pays."

LaSalle Extension University, Dept. 764-H, Chicago  
 A Correspondence Institution

## LEARN WATCH REPAIRING



AT HOME. By our modern and original system of instruction you can learn every part of the WATCH REPAIRING TRADE AT HOME. Prepare yourself for a well-paying position or start in business after completing our course of instruction. Good watch repairers are in demand and generally earn very good salaries. For particulars apply to the Wisconsin School of Watch Repairing 524 E. Mason St., MILWAUKEE 2, WIS.

**STAMMER** you owe it to yourself to send for our free book. Thousands of cases corrected. Est. 41 years. No hand swing or sing song. Millard Inst. of Normal Speech, 2303 W. Wis. Ave., Milwaukee, Wis.

## 924 PAGE AUTHENTIC FORMULARY

10,000 Formulas, Recipes, Trade Secrets for making most any conceivable product. Prepared by experts in simple, non-technical language. Countless profitable business opportunities. Valuable reference for manufacturers or students. \$2.00 postpaid; Canada or Foreign \$2.35. U.S. Funds. (C.O.D. orders accepted for U.S. delivery only.)

Prepare for "After-War-Business"

Especially recommended for servicemen returning to civilian life

ADAMS BROWN COMPANY • Dept. 10 • Chestnut WH 67, Massachusetts



Wonderful, new device, guides your hand; corrects your writing in a few days. Big improvement in three hours. No failures. Complete outline FREE. Write C. J. Ozmert, Dept. 34, St. Louis, Mo.



## DRAW CARTOONS BIG MONEY!

EASY... PLEASANT WORK!

Let CHAS. H. KUHN, with 25 years actual experience in drawing a daily newspaper cartoon, teach you how to create, draw and sell your work. 52 complete lessons—one sent each week. Professional criticism on every lesson. Write today.

**KUHN SCHOOL OF CARTOONING**  
 420 MURPHY BUILDING Dept. S. INDIANAPOLIS 4, INDIANA



# INVENTORS

## NOW Is the Time to PATENT and SELL Your Invention

Now, more than ever before, is the right time to patent your invention. Why? Because manufacturers everywhere presently engaged in war production are looking ahead to the future by buying up patent rights now, so they will have new and attractive items to make and sell for civilian consumption as soon as the war is over. This is what happened during and after the last war. Hence, the smart thing for you to do is to look ahead to the future too. Protect your invention by applying for a patent now, so you will be in position to cash in on an outright sale, or on the royalties your invention will bring.

## Patent Guide Shows What To Do

Our "Patent Guide for the Inventor" answers many important questions concerning Patents that inventors constantly ask. It tells what facts, details, drawings, sketches, etc. are necessary to apply for a Patent; how to protect your invention through dated and witnessed disclosure; how to do this AT ONCE to safeguard your rights; how Patent Office Records can be checked to determine whether the invention is probably patentable before filing fees need be paid; discusses costs involved and a practical way these can be paid as the application progresses. It tells how some inventors secured financial backing; how many simple inventions have proved large commercial successes; how Patents covering improvements also can be profitably utilized and marketed; tells countless other facts of interest.

## Why You Need Expert Assistance

The Patent Laws were enacted for your benefit—to give you protection for the features of your invention which are Patentable. But these features must be legally and concisely set forth in the form of "claims." This phase of the procedure is so complex that the Patent Office advises the Inventor to engage a competent Registered Patent Attorney. We maintain a large staff—carefully trained registered patent attorneys—expert draftsmen—experienced searchers—to serve you. We have been serving inventors for more than 20 years.

## Take First Step Now

With the Patent Guide you will receive also Free a "Record of Invention" form which will enable you at once to establish the date of your invention, before you file your Patent application. This step costs you nothing yet may be vital to your success. Remember—in Patent Matters, ACTION is IMPORTANT. Delay can be costly. Mail the coupon in an envelope, or paste it on a penny postcard NOW.

## CLARENCE A. O'BRIEN & HARVEY B. JACOBSON

*"Worthy of your Trust"*

Registered Patent Attorneys  
41-G Adams Building  
Washington 4, D. C.

Get This  
**FREE BOOK**

IMMEDIATELY MAIL COUPON TODAY!

Get  
**FREE  
COPY**



## CLARENCE A. O'BRIEN & HARVEY B. JACOBSON

CLARENCE A. O'BRIEN & HARVEY B. JACOBSON  
Registered Patent Attorneys before the United States Patent Office  
41-G Adams Building, Washington 4, D. C.

Please send me your 48-Page "Patent Guide for the Inventor" and your specially prepared "Record of Invention" form FREE. This request does not obligate me.

Name \_\_\_\_\_

Address \_\_\_\_\_

City \_\_\_\_\_ State \_\_\_\_\_

(Please write or print plainly.)

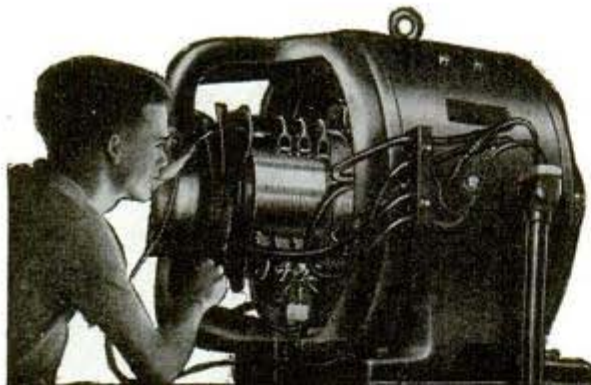

**MEN** *whether you are* **16** OR UP TO **50**  
**PREPARE FOR A GOOD WAR-TIME JOB**  
**...WITH A PEACE-TIME FUTURE!**

Trained Electrical men are needed now. It's not how young you are, or how old you are. The question is have YOU the training to hold a good war-time job today—and to insure your future after the war?

## Learn **ELECTRICITY** **IN 12 WEEKS**

**ON REAL MOTORS, GENERATORS, ETC.**

COYNE TRAINING is easy, practical. Located in Chicago, heart of vast war industries, Coyne has behind it 44 years of "know-how" in training successful men. Mail coupon now!

### "Learn-by-Doing" in the Great Coyne Shops

Get ready for a big future the quick Coyne Way—by actual work on full-size electrical equipment, not by correspondence. Learn wiring, motors power plants, switchboards, auto and aircraft electricity, etc. Be an "All-Round Electrical Man"—for big opportunities!

### Start Now—Pay Later

My "Pay-Tuition-after-Graduation" plan enables you to start right away, and pay for your tuition in easy payments when finished. If you need part-time work to help defray expenses while here, I'll help you get it.

### You Don't Need Experience or Advanced Education!

Coyne Training is simplified. Many fellows with no experience or advanced education owe their present good jobs to my easy, step-by-step methods. You'll find Coyne boosters wherever Electricity is known!

### Get My Free Book!

Let me send you my big illustrated book showing how I help you get the training you need for a good Electrical job. It's FREE—no obligation—no salesman will call. Send the coupon today!

**H. C. LEWIS, Pres.**  
**COYNE ELECTRICAL SCHOOL**  
 500 South Paulina Street,  
 Dept. 84-72, Chicago 12, Ill.



**H. C. LEWIS, President**  
**COYNE ELECTRICAL SCHOOL**  
 500 S. Paulina St., Dept. 84-72, Chicago 12  
 Send me your Free Book. Tell me about your SPECIAL INDUSTRIAL ELECTRONICS TRAINING at no extra cost, and your Pay-Tuition-after-Graduation offer.

NAME.....  
 ADDRESS.....  
 CITY.....STATE.....

**MEN WITH PHYSICAL DISABILITIES**  
 We also have facilities for you. Write for details.

### Special Offer! **INDUSTRIAL ELECTRONICS** **Now Included!**

No extra cost for valuable extra training—big field of new opportunities!



*H. C. Lewis*

## "YOU ARE UNDER ARREST!"



## There's a Thrill in Bringing a Crook to Justice Through Scientific **CRIME DETECTION**

I have taught thousands of men and women this exciting, profitable, pleasant profession. Let me teach you, too, in your own home. Prepare yourself in your leisure time to fill a responsible, steady, well-paid position in a very short time and at very small cost. What others have done, you too, can do.

### 53% of All American Identification Bureaus

**Be A FINGER PRINT Expert**

Employ students or graduates of I.A.S. This fascinating work is easy to learn and the training is inexpensive. You, too, can fit yourself to fill a responsible crime detection job with good pay and steady employment. But don't delay—get the details now. Let me show you how easily and completely I can prepare you for this fascinating work, during spare time, in your own home. You may pay as you learn. Write today for free Crime Book.

### FREE! "THE BLUE BOOK OF CRIME"

It's a thriller. Tells about some of the most interesting crimes ever perpetrated and how they were solved through the very methods taught by I.A.S. Send now—be sure to state age.

**INSTITUTE OF APPLIED SCIENCE**  
 Dept. 135-B, 1920 Sunnyside Ave., Chicago 40, Illinois



## TRI-STATE COLLEGE

### B. S. Degree in 27 Months

Distinguished for technical 2 1/2-year courses in Civil, Electrical, Mechanical, Chemical, Radio, Aeronautical Engineering; Business Administration, Accounting, and Secretarial Science.

**MEN AND WOMEN**—3 yr. high school students with good record admitted. Special Preparatory Department. Short diploma courses (26 weeks) in Surveying, Drafting, Low tuition. Low living costs. Cosmopolitan student body. 61st year. Enter June, Sept., Jan., March. Catalog. 474 College Ave. **ANGOLA, INDIANA**

## What Every Mason Wants

We have important Masonic books for Blue Lodge, Chapter, Commandery, Scottish Rite, and Shrine.

Our Rituals Are Used the World Over. Send for free catalog of books and rituals for Masons, Odd Fellows, Knights of Pythias, Knights of Columbus, Elks, etc. **EZRA A. COOK, Publisher, P. O. Box 796, PJX, Chicago 90, Ill.**

**LAW**  
**STUDY AT HOME for PERSONAL SUCCESS and LARGER EARNINGS.** 35 years expert instruction—over 108,000 students enrolled. LL.B. Degree awarded. All texts furnished. Easy payments. Send for FREE BOOK—"Law and Executive Guidance."

**AMERICAN EXTENSION SCHOOL OF LAW**  
 Dept. 43-M 646 N. Michigan Ave. Chicago 11, Ill.

## LEARN MONEY PAINTING PORTRAITS

● No previous training or talent necessary. Unique Stuart System teaches you, by mail, in 11 simple, easy-to-follow lessons, to make exact charcoal and oil likenesses. Detailed guidance for your every step. Send for free book today.

**STUART STUDIOS** 121 Monument Circle, Rm. 674, Indianapolis 9, Ind.  
 Please send me free book and outline of lessons.  
 Name.....  
 Street.....  
 City.....State.....

# HOW A 97-LB. WEAKLING

Became the **WORLD'S MOST PERFECTLY DEVELOPED MAN**

The inspiring story of **CHARLES ATLAS**

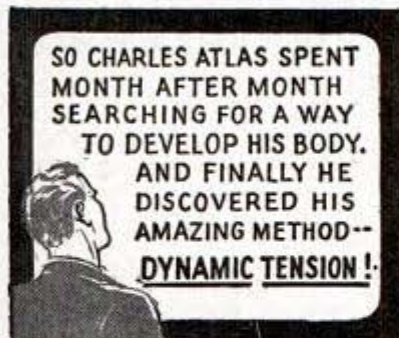

## I Can Make You a New Man, Too, In Only 15 Minutes a Day!

If you're the way I USED to be—if you are skinny and feel only half-alive—if the better jobs pass you by—if you can't make the "grade" physically in the service—if you're ashamed to strip for sports or a swim—and if you want a HE-MAN'S body—then give me just 15 minutes a day! I'll PROVE you can have a build you'll be PROUD of! "Dynamic Tension" will do it for you, too! That's how I changed my own build into such perfect proportions that famous sculptors and artists have paid me to pose for them. My body won me the title, "World's Most Perfectly Developed Man." And now I can give you solid, beautiful, USEFUL muscle wherever YOU want it!

**"Dynamic Tension" Does It!**  
In only 15 minutes a day, "Dynamic Tension" can bulge up your chest, broaden your back, fill out your arms and legs. Before you know it, this easy, NATURAL method will make you a New Man! In fact, I GUARANTEE you'll start seeing results in the first 7 days!

I give you no gadgets or contraptions to fool with. You simply utilize the UNDEVELOPED muscle-power in your own God-given body—almost unconsciously every minute of the day—walking, bending, over, etc.—to BUILD MUSCLE and VITALITY. And it's so easy—my secret, *Dynamic Tension*, does the trick!

### FREE BOOK

Thousands of fellows in every branch of the service as well as civilians have used my "Dynamic Tension" to change themselves into real HE-MEN! Read what they say—see how they looked before and after—in my book—free. Tells all about "Dynamic Tension," shows actual photos of men I've turned from puny weaklings into Atlas Champions. And I can do the same for YOU. Mail the coupon now! Address me personally: **CHARLES ATLAS, Dept. 8G, 115 East 23rd St., New York 10, N. Y.**



—actual photo of the man who holds the title, "The World's Most Perfectly Developed Man."

**CHARLES ATLAS, Dept. 8G, 115 East 23rd St., New York 10, N. Y.**

I want the proof that your system of "Dynamic Tension" will help make a new man of me—give me a healthy, husky body and big muscular development. Send me your free book, "Everlasting Health and Strength."

Name..... (Please print or write plainly)

Address.....

City..... State.....

Check here if under 16 for Booklet A

# INVENTORS

**McMORROW & BERMAN**  
**PATENT ATTORNEYS**

135-Z ALBEE BUILDING, WASHINGTON 5, D. C.  
Send me your new FREE book, "How to Protect, Finance and Sell Your Invention"—and "Invention Record" form at once. I understand that this request does not obligate me.

NAME .....

ADDRESS .....

CITY .....

STATE ..... (Write or print name clearly)

## Learn How To **PROTECT and SELL YOUR INVENTION**

*Mail Coupon  
Now!*

**GET NEW  
FREE  
BOOK**



**MODERN BUSINESS WANTS INVENTIONS** Practical and novel inventions are in big demand today. The opportunity for quick money is enticing. Sales sources are many if your invention has merit. But, be sure—before you place your device in strange hands—that it is fully protected. A United States Patent gives you this protection. *The first step toward inventive success—always is—and always has been, the application for a U. S. Patent. There is no other way to protect your invention in accordance with the laws of this country.*

**MAKE THIS RECORD NOW** If you have an invention, and wish to secure it for the future, act at once. Have it dated now and recorded in our office. We will send you this FREE Invention Record Form for the purpose. Fill out the Invention Record Form fully describing the nature of your invention. Make a sketch of its main features. Mail it to us and we will record the date it was received in our office. The earlier the date the better your chance of combating rival inventors who may lay claim to your idea later. *Don't delay a single minute in taking this important step. Your whole future may depend upon it. Mail the coupon for our FREE Invention Record Blank and New FREE Book today!*

**HOW WE SERVE YOU AS REGISTERED PATENT ATTORNEYS** The U. S. Patent Office strongly recommends—unless the inventor is familiar with such matters—that he employ the services of a Registered Patent Attorney in the preparation of his Patent Application. We are Registered Patent Attorneys fully qualified to represent you at the Patent Office. We have had long experience in studying hundreds of types of inventions. This gives us the ability to judge your invention and to describe it accurately and convincingly in technical language. It gives us the perception to center arguments upon those details of your invention which, in our judgment, will be looked upon most favorably by the Patent Office Examiner. Mail the coupon today for our new FREE Book, "How to Protect, Finance and Sell Your Invention," and our FREE Invention Record Form—maybe this step will pave the way to future security for you and your family. Act Today!

We paint no glowing road to fortune—but if you have an invention . . . if it serves a definite new need . . . if the public accepts it—we can tell you it may provide the security and benefits you are seeking.

**McMORROW & BERMAN**  
Patent Attorneys 135-Z ALBEE BUILDING • WASHINGTON 5, D. C.

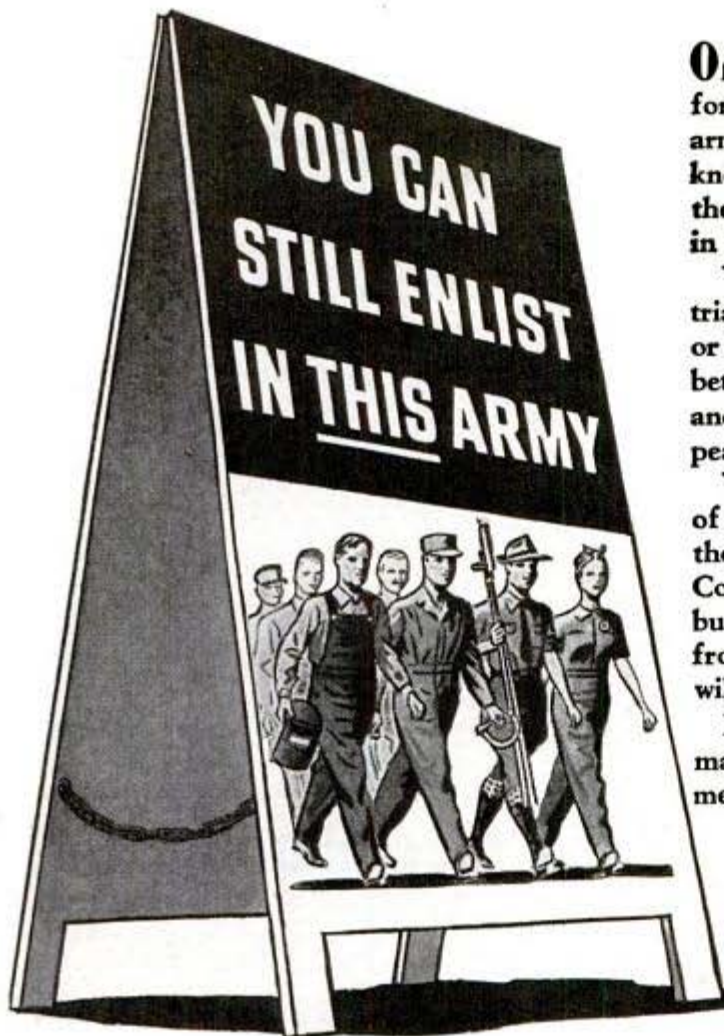

ONE great American army is still open for enlistments! It's the all-important army of *trained men* — whose *specialized* knowledge and skill are helping to win the war *today*, and will play a vital role in the victory world of *tomorrow!*

You still have time to join these "industrial rangers." Even if you're over 38 — or over 50! — training will make you a better fighter on the production front, and will fit you for a better job when peace comes.

You can get your training as thousands of business and industrial leaders got theirs — by studying a low-cost I. C. S. Course in your spare time, at home! 400 business and technical subjects to choose from — one, or a combination of several, will fit you for greater success.

Mail this coupon for complete information on I. C. S. textbooks, teaching methods and personalized instruction.

**SPECIAL TUITION RATES FOR MEMBERS OF THE ARMED FORCES**

## INTERNATIONAL CORRESPONDENCE SCHOOLS



BOX 5697-J, SCRANTON 9, PENNA.

Without cost or obligation, please send me booklet and full particulars about the course *before* which I have marked X:

- |   |   |  |   |
|---|---|--|---|
| <p><b>Air Conditioning and Plumbing Schools</b></p> <p><input type="checkbox"/> Air Conditioning<br/><input type="checkbox"/> Heating <input type="checkbox"/> Plumbing<br/><input type="checkbox"/> Refrigeration <input type="checkbox"/> Steam Fitting</p> <p><b>Chemistry Schools</b></p> <p><input type="checkbox"/> Chemical Engineering<br/><input type="checkbox"/> Chemistry, Analytical<br/><input type="checkbox"/> Chemistry, Industrial<br/><input type="checkbox"/> Chemistry, Mfg. Iron &amp; Steel<br/><input type="checkbox"/> Plastics<br/><input type="checkbox"/> Pulp and Paper Making</p> <p><b>Civil, Architectural and Structural Engin'g Schools</b></p> <p><input type="checkbox"/> Architectural Drafting<br/><input type="checkbox"/> Architecture<br/><input type="checkbox"/> Bridge and Building Foreman<br/><input type="checkbox"/> Bridge Engineering<br/><input type="checkbox"/> Building Estimating<br/><input type="checkbox"/> Civil Engineering<br/><input type="checkbox"/> Contracting and Building<br/><input type="checkbox"/> Highway Engineering<br/><input type="checkbox"/> Lumber Dealer<br/><input type="checkbox"/> Sanitary Engineering<br/><input type="checkbox"/> Structural Drafting<br/><input type="checkbox"/> Surveying and Mapping</p> | <p><b>Electrical Schools</b></p> <p><input type="checkbox"/> Electrical Drafting<br/><input type="checkbox"/> Electrical Engineering<br/><input type="checkbox"/> Power House Electrician<br/><input type="checkbox"/> Practical Electrician<br/><input type="checkbox"/> Practical Telephony<br/><input type="checkbox"/> Telegraph Engineering</p> <p><b>Internal Combustion Engines School</b></p> <p><input type="checkbox"/> Auto Technician <input type="checkbox"/> Aviation<br/><input type="checkbox"/> Diesel-Electric<br/><input type="checkbox"/> Diesel Engines <input type="checkbox"/> Gas Engines</p> <p><b>Mechanical Schools</b></p> <p><input type="checkbox"/> Aeronautical Engineering<br/><input type="checkbox"/> Airplane Drafting<br/><input type="checkbox"/> Flight Engineer<br/><input type="checkbox"/> Foundry Work<br/><input type="checkbox"/> Heat Treatment of Metals<br/><input type="checkbox"/> Industrial Design<br/><input type="checkbox"/> Mechanical Drafting<br/><input type="checkbox"/> Mechanical Engineering<br/><input type="checkbox"/> Mold-Loft Work<br/><input type="checkbox"/> Patternmaking<br/><input type="checkbox"/> Reading Shop Blueprints<br/><input type="checkbox"/> Sheet Metal Drafting<br/><input type="checkbox"/> Sheet Metal Worker</p> | <p><input type="checkbox"/> Ship Drafting <input type="checkbox"/> Ship Fitting<br/><input type="checkbox"/> Shop Practice<br/><input type="checkbox"/> Steel Mill Workers<br/><input type="checkbox"/> Tool Designing<br/><input type="checkbox"/> Welding, Gas and Electric</p> <p><b>Radio School</b></p> <p><input type="checkbox"/> Electronics <input type="checkbox"/> Radio, General<br/><input type="checkbox"/> Radio Operating<br/><input type="checkbox"/> Radio Servicing</p> <p><b>Railroad School</b></p> <p><input type="checkbox"/> Air Brake <input type="checkbox"/> Car Inspector<br/><input type="checkbox"/> Locomotive Engineer<br/><input type="checkbox"/> Locomotive Fireman<br/><input type="checkbox"/> Railroad Section Foreman</p> <p><b>Steam Engineering Schools</b></p> <p><input type="checkbox"/> Boilermaking<br/><input type="checkbox"/> Combustion Engineering<br/><input type="checkbox"/> Engine Running<br/><input type="checkbox"/> Marine Engines<br/><input type="checkbox"/> Steam Electric<br/><input type="checkbox"/> Steam Engines</p> <p><b>Textile School</b></p> <p><input type="checkbox"/> Cotton Manufacturing<br/><input type="checkbox"/> Rayon Weaving<br/><input type="checkbox"/> Textile Designing<br/><input type="checkbox"/> Woolen Manufacturing</p> | <p><b>Business and Academic Schools</b></p> <p><input type="checkbox"/> Accounting <input type="checkbox"/> Advertising<br/><input type="checkbox"/> Arithmetic <input type="checkbox"/> Bookkeeping<br/><input type="checkbox"/> Business Correspondence<br/><input type="checkbox"/> Business Management<br/><input type="checkbox"/> Certified Public Accounting<br/><input type="checkbox"/> City Letter Carrier<br/><input type="checkbox"/> College Preparatory<br/><input type="checkbox"/> Commercial<br/><input type="checkbox"/> Cost Accounting<br/><input type="checkbox"/> Federal Tax<br/><input type="checkbox"/> First Year College<br/><input type="checkbox"/> Foremanship<br/><input type="checkbox"/> High School<br/><input type="checkbox"/> Higher Mathematics<br/><input type="checkbox"/> Illustrating<br/><input type="checkbox"/> Motor Traffic<br/><input type="checkbox"/> Post Office Clerk<br/><input type="checkbox"/> Railway Postal Clerk<br/><input type="checkbox"/> Salesmanship <input type="checkbox"/> Secretarial<br/><input type="checkbox"/> Stenography<br/><input type="checkbox"/> Traffic Management</p> <p><b>Language School</b></p> <p><input type="checkbox"/> Spanish <input type="checkbox"/> French<br/><input type="checkbox"/> Good English</p> |
|---|---|--|---|

Name.....Age.....Home Address.....

City.....State.....Present Position.....Working Hours.....

Canadian residents send coupon to International Correspondence Schools Canadian, Ltd., Montreal, Canada.  
British residents send coupon to I. C. S., 71 Kingsway, London, W. C. 2, England.

**SPECIAL TUITION RATES FOR MEMBERS OF THE ARMED FORCES**

# MEN AND WOMEN!

Has your war work given you  
an idea for a patentable

# INVENTION?



An "invention" doesn't necessarily have to be a complicated, technical mass of machinery . . . most inventions are the outgrowth of an "idea" that someone had to do something better, faster or cheaper. It's possible that you've figured out a gadget . . . or an improvement on a machine . . . that will help someone do it "easier, faster, cheaper."



## MAYBE YOU CAN CASH IN ON IT!!

The only difference between you and a successful, money-making inventor may be that he went ahead and DID SOMETHING ABOUT IT! Most professional inventors turn their inventions over to a reliable Registered Patent Attorney whose trained staff is equipped to secure a strong patent for the inventor with the greatest possible speed and at a minimum of expense. When you hold a patent you have the right to exclude others from making, using or selling your invention for a period of 17 years . . . which means that no one can cash in on your invention without your permission, no manufacturer can make money on it without buying your patent or paying you a satisfactory royalty unless he wishes to risk a suit in court. Furthermore, most manufacturers refuse to consider an invention for commercialization unless the inventor has first filed for his patent. Don't let the fact that it may be a simple invention bother you . . . remember the paper clip, nothing but a twisted wire . . . but today, it is an almost indispensable piece of office equipment.

NEARLY A HALF-CENTURY of  
Patent Experience--At your Service!

NOW is the time to use your initiative! Your first step, which costs you nothing and doesn't obligate you . . . is to write TODAY . . . right now . . . for our two big books, 64 pages of facts and information, which tell just how to go about getting a patent; how to market it; what kind of sketch or model is needed; how to make a proper disclosure; 115 mechanical movements; etc. Do you want to cash in on your invention? It's UP TO YOU!



VICTOR J.  
**EVANS & Co.**

*Merlin M. Evans*

REGISTERED PATENT ATTORNEYS

MAIN OFFICE: 830-H MERLIN BLDG.  
WASHINGTON 6, D. C.

Please send me your books, "Patent Protection" and "How to Sell an Invention" without cost or obligation:

NAME .....

ADDRESS .....

CITY AND STATE .....

SAVE WASTE PAPER

## INTRODUCING-New Victory Model HANDIWELD ELECTRIC ARC WELDER



PLUGS INTO  
LIGHT SOCKET

Victory Model Handiweld Arc Welder operates from 110 volts, A.C. or D.C. current same as other arc welders; higher priced; generates tremendous heat to weld all metals. Not a toy welder that uses carbons, but actually uses standard coated rods—sizes 1/16" and 3/32". However, due to Priorities a generous supply of 1/16" rods only are supplied with the welder. Guaranteed not to burn out. Repairs fenders, auto bodies, radiators, machinery parts, etc. Take Victory Model Handiweld anywhere to job, operate right from light socket. You'll find a thousand uses for this welder around

your home, garage, workshop, repair shops, tin shops; mechanics, inventors, plumbers, farmers, etc. Order a "Victory Model" Handiweld now.

**SEND NO MONEY** We'll rush one to you with rods, helmet, op-erating instructions, and all necessary parts with the exception of a large jar and a small piece of extension cord; these most everyone has. Pay postman only \$1.95 plus a few cents postage. If not delighted return Victory Model Handiweld in 5 days from receipt and money paid for it will be refunded promptly. Rush your order now.

KUMFY PRODUCTS, Dept. F-202, CINCINNATI 26, OHIO

## Free Book MOUNT BIRDS, ANIMALS, FISH

Yes FREE. Explains Taxidermy. Tells how to learn at home by mail to mount birds, animals, heads . . . to TAN skins and furs. Great for MEN and BOYS. Fun! Also earn money in spare time. WRITE TODAY—NOW—for free book containing 100 game pictures. State AGE, N.W. School of Taxidermy, Dept. 3378, Omaha, Neb.



## THERE'S MONEY IN CARTOONS!

RAYE BURNS will teach you HOW TO CREATE ORIGINAL CARTOONS at home that you may SELL! Course contains 26 lessons and over 600 illustrations. All for Only.....

**\$2.85**

Send name and address for free details.  
RAYE BURNS SCHOOL, Dept. M, Box 1298, CLEVELAND 3, OHIO

## Correspondence Courses in RADIO and ELECTRICAL ENGINEERING

LOW AS  
**\$25**

ELECTRICAL ENGINEERING. Get good grasp of wide electrical field. Modern. Very understandable. Theory made easy. RADIO ENGINEERING. Extra fine course in radio, public address, photo-electric work. Train you to be super-service man, and vacuum tube technician. Tuition ONLY \$25, other course. Deferred payment plan. Services men needed badly.

Write for free copies of school catalogs, student magazines, etc.  
**FREE LINCOLN ENGINEERING SCHOOL, Franklin Stn., Box 61—P-87**  
(Formerly at Lincoln, Nebr.) WASHINGTON, D. C.

## Short-Cut Mathematics COMBINED WITH Practical Mechanics Simplified

NEW 2-in-1 reading course! Now you can learn the speedy, simplified system of calculation used by draftsmen, engineers, accountants, "master micks" on the stage. Learn easy way to multiply 4 figures by 4 figures without using old-fashioned multiplication; add long columns of figures the lightning short-cut method. Learn horsepower, slide rule, micrometer, barometer, wood measure, puzzles, etc., etc. Large illustrated volume complete with answers, only \$1 postpaid. Satisfaction or refund. Amaze friends with your magic-like mental powers.

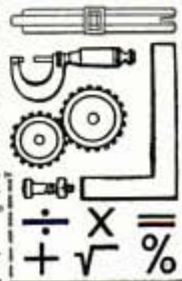

**FREE** Complete details . . . mail coupon TODAY!

Nelson Co., 321 S. Wabash, Dept. 3002, Chicago 4

Please send free details about "Short-Cut Mathematics and Practical Mechanics Simplified." No obligation.  
Name .....  
Address .....

# WHICH OF THESE *Opportunities* INTERESTS *You* MOST?

Accounting & C. P. A.  
Air Conditioning  
Architecture & Building  
Automotive Engineering  
Aviation—Practical  
Aviation Drafting & Design  
Better Foremanship  
Bookkeeping  
Business Management  
Cost Accounting for Mfg.

Diesel Engineering  
Drafting & Design  
Electrical Engineering  
Electricity—Practical  
High School Courses  
Machine Shop Operations  
Mechanical Engineering  
Plastics Engineering  
Plumbing—Practical  
Private Secretary

Radio Operating & Servicing  
Railway Training  
Refrigeration  
Sheet Metal Pattern Drafting  
Shipbuilding  
Shop Management  
Surveying & Topographical  
Drafting  
Tool Making

## THINK! LOOK FORWARD!

Business is making Post-war plans

Men and Women are preparing for the future

### WHAT ARE YOU DOING ABOUT YOUR TOMORROWS?

● *Today*, choose the job you want—and prepare for it. Or if you are already engaged in the work you like best, start training *now* for quicker promotion. Acquire the knowledge that will help you to get ahead faster, make more money and have greater security.

Invest part of your spare time in more rapid progress. Start training now, in spare time in your own home. Be ready to grasp your opportunity and step out ahead of those who lack the ability you have attained.

American School, founded in 1897 as an educational institution *not for profit*, can help you to reach your goal just as it has helped others during the past forty-seven years. Give serious thought to the list above. Pick one or more subjects that interest you. Then check the coupon at right, add your name and address and mail it at once. The school will send you details on its training plan and outline of study prepared by specialists. There is no charge, no obligation, so send the coupon immediately.

PRACTICAL, EFFECTIVE HOME - STUDY TRAINING SINCE 1897

Take This First Easy Step

**CHECK, CLIP AND MAIL COUPON NOW**

AMERICAN SCHOOL, Dept. GB45, Drexel at 58th, Chicago 37, Ill.  
*Without obligation. Please send FREE and postpaid, bulletin and details of the Subjects checked.*

- |  |   |  |
|--|---|--|
| <input type="checkbox"/> PLASTICS ENG'R                  | <input type="checkbox"/> Accounting and C.P.A.              | <input type="checkbox"/> Drafting and Design for Men and Women |
| <input type="checkbox"/> Refrigeration                   | <input type="checkbox"/> Cost Accounting for Manufacturing  | <input type="checkbox"/> Radio                                 |
| <input type="checkbox"/> Architecture and Building       | <input type="checkbox"/> Bookkeeping                        | <input type="checkbox"/> High School                           |
| <input type="checkbox"/> Practical Plumbing and Building | <input type="checkbox"/> Private Secretary                  | <input type="checkbox"/> Air Conditioning                      |
| <input type="checkbox"/> Automotive Engineering          | <input type="checkbox"/> Diesel Engineering                 | <input type="checkbox"/> Shipbuilding                          |
| <input type="checkbox"/> Aviation Drafting               | <input type="checkbox"/> Surveying & Topographical Drafting | <input type="checkbox"/> Mechanical Eng.                       |
| <input type="checkbox"/> Aviation                        | <input type="checkbox"/> Sheet Metal Pattern Drafting       | <input type="checkbox"/> Shop Management                       |
| <input type="checkbox"/> Business Mgmtment               | <input type="checkbox"/> Electrical Engineering             | <input type="checkbox"/> Tool Making                           |
| <input type="checkbox"/> Railway Training                |   | <input type="checkbox"/> Better Foremanship Operations         |
|  |   | <input type="checkbox"/> Machine Shop Operations               |

Name..... Occupation.....  
Address..... Age.....  
City..... State.....

**AMERICAN SCHOOL**

Dept. GB45, Drexel at 58th Street, Chicago 37

# AUDELS Carpenters and Builders Guides

4 vols. \$6



**Inside Trade Information** for Carpenters, Builders, Joiners, Building Mechanics and all Wood workers. These Guides give you the short-cut instructions that you want—including new methods, ideas, solutions, plans, systems and money saving suggestions. An easy progressive course for the apprentice and student. A practical daily helper and Quick Reference for the master worker. Carpenters everywhere are using these Guides as a Helping Hand to Easier Work, Better Work and Better Pay. To get this assistance for yourself, simply fill in and mail the FREE COUPON below.

### Inside Trade Information On:

How to use the steel square—How to file and set saws—How to build furniture—How to use a mitre box—How to use the chalk line—How to use rules and scales—How to make joints—Carpenters arithmetic—Solving mensuration problems—Estimating strength of timbers—How to set girders and sills—How to frame houses and roofs—How to estimate costs—How to build houses, barns, garages, bungalows, etc.—How to read and draw plans—Drawing up specifications—How to excavate—How to use settings 12, 13 and 17 on the steel square—How to build hoists and scaffolds—skylights—How to build stairs—How to put on interior trim—How to hang doors—How to lath—lay floors—How to paint



**THEO. AUDEL & CO., 49 W. 23rd St., New York City**

Mail Audels Carpenters and Builders Guides, 4 vols., on 7 days' free trial. If O.K. I will remit \$1 in 7 days, and \$1 monthly until \$6 is paid. Otherwise I will return them. No obligation unless I am satisfied.

Name .....

Address .....

Occupation .....

Reference ..... P.M.

## Flash! Amazing Opportunities NOW Open in these practical money-making trades watch and clock repairing



### LEARN AT HOME—IN YOUR SPARETIME

Prepare for a happy future of prosperity, security... and get a big-pay job now. Fascinating, high-grade occupation. You can **EARN WHILE YOU LEARN**. Excellent field for part-time work at home.

### COMPLETE COURSE in HOROLOGY

Thorough self-instruction training in American and Swiss watches, clocks. Special sections on alarm clock repairs. New, practical **LEARN-BY-DOING** instruction method. Learn **QUICKLY**, easily. No previous experience necessary. Watchmaking is basic training for aircraft instrument work, and other scientific precision jobs.

**Amazing LOW PRICE MONEY-BACK GUARANTEE** Get into this fast-growing field NOW... big opportunities... don't delay. Mail coupon below for **FREE** information. There's no obligation.

## locksmithing and key making

### COMPLETE UP-TO-DATE COURSE

How to pick locks, de-code, make master-keys, repair, install service, etc. New, self-instruction lessons for every handy man, homeowner, carpenter, mechanic, service station operator, fix-it shop, hardware dealer, gunsmith.

**53 EASY ILLUSTRATED LESSONS** Bargain Price! Satisfaction guaranteed or money back. Write now... no obligation!

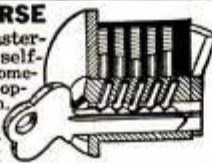

### Free Details—Mail Coupon Today!

**NELSON CO., Dept. 8G02, 321 S. Wabash Ave., Chicago 4, Ill.** Please send me—**FREE** and without obligation—illustrated Success-Catalog containing information about the course (or courses) I have checked below. No salesman will call.

Watch and Clock Repairing.  Locksmithing and Key Making.

NAME .....

ADDRESS .....

CITY .....

STATE .....

## THIS AD IS ADDRESSED TO YOU!

That idea of yours may mean your fortune; don't pass it up! That new automotive or aircraft tool or equipment may be just what the post-war era wants. Your idea may need development; perhaps it's ready for patenting or manufacture. It makes no difference to this nationally-known organization with ample engineering, production, financial, sales and distribution facilities looking for ideas for manufacture and sale in the post-war era. If patent on your idea hasn't been applied for, have it witnessed and then write us about it completely or with a minimum of detail, as you please. But whatever you do, **DO SOMETHING** about that idea! Write in confidence **NOW** to

P. O. BOX 217 STA. C TOLEDO, OHIO

## REFRIGERATION SERVICE MECHANICS COURSE AND AIR CONDITIONING

Learn at home—how to start your own repair shop on little capital. No previous experience needed. Common school education sufficient. Splendid opportunity for older men. Prepare now for after the war. **FREE** illustrated booklet.

### MECHANICS TRAINING SCHOOL

4701 W. Pico Dept. P-7 Los Angeles 6, Calif.

## CARTOONING



**CASH IN** on Big Cartoon Market. **BECOME CARTOONISTS QUICKLY** with our **NEW, EASY METHOD**. No experience necessary. Prepared by successful cartoonists. **SATISFACTION GUARANTEED**. Sample **LESSON PLATE** and interesting literature **FREE**.

**NATIONAL ARTISTS BUREAU**  
Dept. A, Box 4248 DALLAS 8, TEXAS

## PLAY GUITAR LIKE THE COWBOYS DO... 8 LESSONS



Just out—very latest guaranteed, simple, easy method. Play cowboy songs the Western way in a few minutes by ear. Surprise and amaze your friends. Be in big demand at parties, camps, public entertainments, on the radio, etc. 12 Complete Lessons.

**SEND NO MONEY** Pay postman postage, or send \$1.00 and get **EXTRA SONGS** all prepaid. (Canada, \$1.25 money order only.) Nothing else to buy. Positive money back guarantee. Rush order today.

WESTERN RANGER STUDIOS, Dept. 157, Hutchinson, Kans.

## INDIANA TECHNICAL COLLEGE

Engineering degree in 27 months. Aeronautical, Chemical, Civil Electrical, Mechanical and Radio Engineering. Govt. approved ground school courses. Prep courses, no added cost. Large industrial center. Earn living expenses. Enter Sept. 5, Dec., March and June. Catalog, 374 E. Washington Blvd., Fort Wayne 2, Indiana.

## BETTER SIGHT

**SIGHT-TRAINING** technique improved. Everybody gets results now. **WRITE:** Dept. P-7 "USTI" 4057 Budlong Ave., Los Angeles 37, Calif.



Please send me your **FREE** Sight Chart with instructions.

Name .....

Address .....



Amazing New Opportunities. Now and After Victory!

# ELECTRICIANS

-Get Ready for Better Jobs in ALL BRANCHES of ELECTRICITY...with this Easy, Practical, Pay-Raising Set of Books!



## Solves Your Electrical Problems Quickly

Whether you are an "old timer" or a beginner in the electrical field—YOU NEED THE COYNE ELECTRICAL AND RADIO REFERENCE SET.

**AUTHORITATIVE—PRACTICAL—**Prepared by experts. Used on the job by hundreds of electricians, radio men, maintenance men, etc. **EASY. COMPLETE.** Covers everything Electrical: house wiring, armature winding, AC & DC motors, generators, Radio, Automotive, Refrigeration, etc. Answers your electrical questions clearly and completely.

## Where Will YOU Be After the War?

If you hold a good job now—will it still be a good job after the war? Start preparing at once for a steady future in Electricity. Today you may be doing just one kind of electrical work. Protect your future—learn to handle MANY BRANCHES. Send for these big, handsome, pay-raising books NOW.

## COSTS YOU NOTHING to Examine Set!

I want to send this great Set—3 volumes, over 1200 pages and 2,000 pictures—to your home 7 DAYS FREE. If it's not all I claim, return it and you owe me nothing—If you keep it just send \$3 in 7 days and \$3 monthly until amazing low price of only \$13.95 is paid. Or save 10% by sending cash price, \$12.55. Act today!

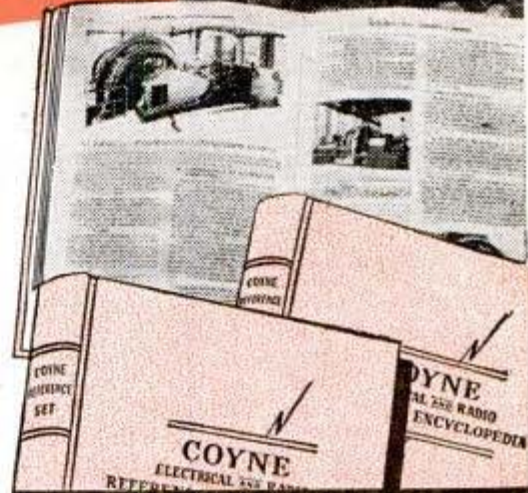

## 3 Great Extra Features...

Right now I'm including at no extra cost: 1. Big Extra Book of 150 shop prints. 2. 1 Year Consultation Service by mail. 3. Subscription to Technical News Bulletins—ALL FREE with Reference Set!

**FREE WITH SET**

## 2 OTHER NEW COYNE BOOKS Big Pay Fields - See Them Now!

### Be a Master TROUBLE SHOOTER —New Giant-Size COYNE MANUAL

Helps locate troubles on motors, appliances, radios, Refrigerators, etc. 500 easy-to-follow diagrams. NEW Step-by-Step Trouble Shooting Course. 612 big pages. A gold mine of money-making facts! Sent on 7 DAY FREE TRIAL, then return or pay \$3 and then \$3 monthly until \$8.95 is paid. Cash price \$8—you save 95c.



400 PAGE  
COYNE BOOK

### ELECTRONICS

Just off the press! For electricians, radio men and all interested in Practical Electronics. Latest facts, hundreds of pictures, diagrams. Includes INSTALLATION and TROUBLE SHOOTING in INDUSTRIAL ELECTRONICS. Introductory price \$4.95 CASH; pay after 7 DAY TRIAL—money back guarantee.



All Books Guaranteed by  
**COYNE ELECTRICAL SCHOOL**  
500 S. Paulina St., Dpt. B4-3R6, Chicago 12

## Select the Books You Want to See... on 7 DAYS FREE TRIAL

**DON'T SEND A PENNY!** Mail coupon for books you want. They'll come postage paid. Keep them 7 days. If not fully satisfied return them at my expense. This coupon is a REQUEST—not an order, until you've actually had the books 7 full days. Rush the coupon today!

## SEND NO MONEY!

H. C. Lewis, Pres. Coyne Electrical School  
500 S. Paulina St., Dept. B4-3R6, Chicago (12), Ill.

Send books checked for 7 Day Free Examination. If I keep them I'll either pay the cash price or send \$3.00 in 7 days and balance \$3.00 monthly until payment plan price is paid—if not satisfied I'll return them and owe nothing.

- Coyne Reference Set—3 Vols. and Free Extra Book \$13.95 (payments) or \$12.55 Cash.
- Trouble Shooting Manual—1 Vol. \$8.95 (payments) or \$8.00 cash.
- Electronics—1 Vol. \$4.95 Cash—Full amount in 7 Days if satisfied.

NAME.....AGE.....

ADDRESS.....

CITY.....STATE.....

If you prefer to pay postman when books come, check here  
—Same 7 Day money back guarantee.

**America's War Made Industry—**

# ELECTRICAL APPLIANCE REPAIRING



## OFFERS BIG MONEY—INDEPENDENCE

The restrictions on the manufacture of electrical home appliances has greatly increased the need for and earnings of skilled home appliance repairmen. Always a good business, today **ELECTRICAL APPLIANCE REPAIRING** is one of the most profitable occupations that the average mechanically inclined man can turn to. On many types of repairs it is usual for a repairman to charge on the basis of \$5.00 to \$6.00 an hour! Work as many hours as you wish—a home appliance repairman is his own boss. Operate from your garage, basement, vacant store, etc.

## NO SPECIAL SKILL NEEDED!

If you are mechanically inclined—can hold and use tools—you too can be a big money-earning home appliance repairman. Age is no barrier—nor are minor physical handicaps. Learn how to repair refrigerators, vacuum cleaners, washing machines, motors, ranges, etc., etc. Our course is written in simple, easy to understand language; profusely illustrated with drawings and photography showing you step by step what troubles to look for and how to repair them. Explains and gives you a working knowledge of electricity, welding, nickel plating, etc. Shows you how to build power tools you may need and how to solicit and keep business coming to you. Not a complicated "theory course" but an honest to goodness course written and used by repairmen the country over. Price of course is so low that the savings on your own household appliance repairs will quickly pay for it. Prepare NOW for a real future.

## Mail Coupon for FREE LITERATURE

**CHRISTY SUPPLY CO.**  
2835 N. Central Ave., Dept. D-1103  
Chicago 34, Illinois

Please send me all the facts about America's Fastest Growing Industry—Electrical Appliance Repairing.

Name.....

Address.....

City.....State.....

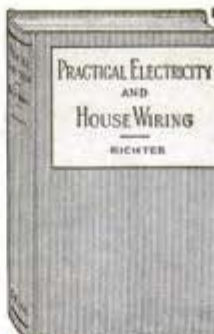

## SAVE ... do your own electrical work

This handy guidebook for the amateur and professional electrician contains material on wiring methods for homes, farms and motors; insulations, installing fixtures and switches; principles of efficient lighting, and AC and DC electricity.

- 200 informative pages
- 227 helpful illustrations

**ORDER TODAY** Pay postman \$1.50 plus C.O.D. charges. Postage prepaid if cash in ad—\$1.50 advance.

**FRED'K J. DRAKE & CO.**  
Dept. PM-7, 600 West Van Buren St.  
Chicago, Ill.  
Drake books sold by all leading booksellers

## MAGIC LIQUID MAKES PHOTOS APPEAR

On Scarfs, Ties, Stationery, Etc.

Reproduce any snapshot on cloth, leather, wood, paper. Simply apply liquid. Like magic photo appears within 2 minutes in broad daylight. Harmless to negative. Won't wash off. Full colors included. Complete kit for 100 photos only \$1.29. Send no money, just name. Pay postman \$1.29 plus few cents postage on delivery. Or send cash with order and get postpaid. (Canada \$1.50 money order only.) Order today.

L & M Mfg. Co., Dept. 333-A, 229 W. Breckenridge, Louisville 3, Ky.

## TRAIN Your VOICE!

Results **GUARANTEED**

We build, strengthen the vocal organs—not with singing lessons—but by sound, scientifically correct silent and vocal exercises and absolutely guarantee complete satisfaction with results. Write for Voice Book, FREE. Sent to no one under 17 years old unless signed by parent.

**PERFECT VOICE INSTITUTE.** Studio 135-B, 64 E. Lake St., Chicago, Ill.

## STUDY AT HOME

With A Chartered Educational Institution

**Courses in ENGINEERING:** Electrical, Civil, Mechanical, Drafting, Architectural, Steam, Aeronautical, Radio, Structural, Mining, Industrial, Highway. Petroleum, Marine, Chemical.

**Courses in ARTS AND SCIENCES:** Philosophy; Education; Letters; Public Health; Medical Jurisprudence; Psychology; Sociology; Physics; Chemistry; Geology; Pol. Science; Theology; Law; Business and Commerce; Accounting; Mathematics; Statistics; Agriculture.

McKinley-Roosevelt Incorporated, 4610-UC, Sheridan Road, Chicago, 40

## Get into the BAKING BUSINESS

Bakers make good money! No w 7th Industry in wages! Nearly depression-proof. New home study Baking Course qualifies you. Common school education sufficient. If you're ambitious, write for **FREE BOOK**, "Opportunities in Baking." National Baking School, 1315 Michigan, Dept. 135-B, Chicago

## PLASTICS ★ ★ DESIGN ENGINEERING

Wartime applications have proved the peacetime possibilities of **PLASTICS**. Get ready now for this big postwar opportunity. Prepare yourself for a highly paid position in **Plastics Industrial Engineering**. Complete home training course now available. Send name and state affn. **OHIO INSTITUTE OF TECHNOLOGY**, Box P-170, Greenville, Ohio

## STAMMER?

This new 128-page book, "Stammering, Its Cause and Correction," describes the Bogus Unit Method for scientific correction of stammering and stuttering—successful for 43 years. Benj. N. Bogus, Dept. 1814, Circle Tower, Indianapolis 4, Ind.

**GET THIS FREE BOOK!**

## REFRIGERATION

Repair and improve all refrigerators. New manual tells how. Charts and pictures to help you. Price only \$1.00, postpaid. Money back guarantee. **Supreme Publications**, 328 S. Jefferson St., Chicago 6, Illinois.

## WILL YOU WEAR THIS SUIT

and Make up to \$12 in a Day!

Let me send you a union tailored to measure suit **FREE AS A BONUS**. Just follow my easy plan and take a few orders. Make up to \$12 in a day easily. No experience—no house-to-house canvassing necessary. Big opportunity—full or spare time.

Send for samples—**FREE OF COST**. Write today for **FREE ACTUAL CLOTH SAMPLES** and "sure-fire" money-getting plans. For quick action write fully giving age, etc. Send no money. **H. J. Collin, PROGRESS TAILORING CO.**, 500 So. Throop St., Dept. G-216, Chicago 7, Ill.

**PREPARE  
NOW!  
FOR A BETTER  
FUTURE**

**GET INTO**

# **RADIO ELECTRONICS**

## **LEARN AT HOME DeFOREST'S A-B-C WAY**

This message is addressed to you men who are alert to *both today's* needs and *tomorrow's* opportunities for good jobs, good pay, and a wide variety of employment possibilities in the **BILLION DOLLAR RADIO-ELECTRONICS INDUSTRY**. Write today for DeFOREST'S BIG, FREE, ILLUSTRATED BOOK, "**VICTORY FOR YOU**". See how you may prepare quickly, easily—in your spare time at home—to make your start toward an interesting and profitable Radio-Electronics future.

### **YOU GET DeFOREST'S 3-WAY COMBINATION TRAINING—**

a simple A-B-C course of instruction—an exclusive, 3-way combination of illustrated Text, Movie Training Films, and actual Shop Work in your own home. You learn-by-SEEING—and *prove* your knowledge by DOING. You use (A) a genuine DeVRY Movie Projector and instructive Training Films to make your preparation clearer, easier. You use (B) EIGHT big Kits of "HOME LABORATORY" Radio Parts and Assemblies for working out 133 interesting experiments. You get (C) 90 well-illustrated Loose-Leaf Lessons, prepared under the personal direction of Dr. Lee DeForest, often called "*the Father of Radio*". And once you are trained, DeFOREST'S EXPERIENCED EMPLOYMENT SERVICE helps you make your start.

**"Learn-by-Seeing"  
FASTER ... EASIER  
With the Aid of  
HOME  
MOVIES**

**DeForest's Training includes instruction  
in MOTION PICTURE SOUND EQUIP-  
MENT, FM RADIO, and TELEVISION**

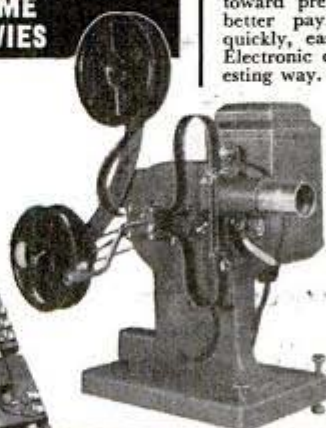

### **Free! COLORFUL DESCRIPTIVE LITERATURE**

Simply PRINT your name and address neatly on the coupon below. Mail it. Get BOTH the colorful KIT SUPPLEMENT and our BIG illustrated book, "**VICTORY FOR YOU**". Get pages of valuable information on present and future RADIO-ELECTRONICS opportunities. See how effectively DeFOREST'S can help you—in your spare time at home—to make YOUR start toward a Radio-Electronics FUTURE!

## **DeFOREST'S TRAINING INC.** CHICAGO 14, ILL. U. S. A.



### **LET THEIR EXPERIENCE GUIDE YOU**



**Dr. Leo DeForest**  
supervised the  
Preparation of  
DeForest's  
Training.

**PUT  
YOURSELF  
IN THIS  
PICTURE**



**Dr. Norman A.  
DeVry — Visual  
Education Pion-  
neer — founded  
DeForest's  
Training.**

DeFOREST'S TRAINING, INC.,  
2533-41 N. Ashland Ave., Dept. W,  
Chicago 14, Illinois.

Send me BOTH your big book, "**VICTORY FOR YOU**" and your **KIT SUPPLEMENT** —showing how I may make my start in **RADIO-ELECTRONICS** your A-B-C-simple Home Training Way. No cost! No obligation!

Name \_\_\_\_\_ Age \_\_\_\_\_  
(Please Print)  
Address \_\_\_\_\_  
City \_\_\_\_\_ State \_\_\_\_\_

Check Here, if Under 16, for Special Information.



# AUTO

## BOOKS SENT FREE

**ON APPROVAL.** Just mail the coupon and we'll send you a complete set of Six Big Auto Books, 20th Edition. Whether you are a mechanic or helper, expert or apprentice, auto owner or driver, take immediate advantage of this FREE EXAMINATION OFFER.

**MAKE GOOD MONEY NOW HOLD A PERMANENT JOB**

America's autos must be kept in service, now and after the war. Men with "know how" are in demand, at big pay. These books will help you get and hold an important job, or give you a chance to go into business for yourself now or later. Any man who half tries to improve himself can learn auto servicing and repairing by this quick reference method. Use the **JIFFY INDEX** to find easily understood answer to any auto problem. These wonder books prepared by eleven of America's great automobile engineers. Many hundreds of valuable illustrations. Send the coupon TODAY.

**[A year's consulting privileges with our engineers now given with these books without extra charge.]**

Vocational Publishers Since 1898

### CAN YOU FIX IT?

These wonder books tell step by step HOW to make difficult repairs and adjustments, how to keep a car at maximum efficiency, including latest improvements in car design and operation. Engine troubles and how to correct them well covered.

**6 BIG VOLUMES**  
2800 pages, 2000 illustrations, wiring diagrams, etc., including Diesel engines. Beautiful modernistic, washable cloth binding.

AMERICAN TECHNICAL SOCIETY, Dept. AB19  
Drexel Ave., at 58th St., Chicago 37, Ill.

I would like to examine your Six-Volume Set of Auto Books. I will pay the delivery charges only, but if I choose I may return them express collect. If after 10 days use I prefer to keep them, I will send you \$2 and pay the balance at the rate of only \$3 a month until \$24.80 has been paid. Please include consulting service as offered above.

Name .....

Address .....

City ..... State .....

Please attach letter, occupation and address of employer and of at least one business man as reference. Men in service, also please give home address.

**AUDELS NEW MACHINISTS HANDYBOOK NOW READY!**

**Prepare!**

**A KEY TO SHOP PRACTICE**  
For Every Machinist, Tool-maker, Machine Operator, Draughtsman, Metal Worker, Mechanic or Student. Covers Shop Practice in All Branches.

**A READY REFERENCE**  
Tells How to Operate and Set Up Lathes, Screw and Milling Machines, Shapers, Drill Presses and All Machine Tools.

**5 PRACTICAL BOOKS IN ONE!**  
60 FULLY ILLUSTRATED CHAPTERS  
Covering: 1—Modern Machine Shop Practice. 2—Blue Print Reading and How to Draw. 3—Calculations & Mathematics for Machinists. 4—Shop Physics. 5—How to Use Slide Rule.

Get This Information for Yourself. Mail Coupon Today. No Obligation Unless Satisfied. ASK TO SEE IT.

**\$4 COMPLETE • PAY ONLY \$1 MO.**

**1600 PAGES FULLY ILLUSTRATED**

THEO. AUDEL & CO., 49 WEST 23rd STREET, NEW YORK

Mail AUDELS MACHINISTS & TOOLMAKERS' HANDY BOOK. Price \$4 on 7 Days Free Trial. If O. K. I will remit \$1 in 7 days and \$1 monthly until \$4 is paid. Otherwise I will return it

Name .....

Address .....

Occupation .....

Reference .....

P. M.

**NEW PRACTICAL RADIO FOR WAR TRAINING**

**ONLY \$2.95 COMPLETE**

**DO RADIO WORK IMMEDIATELY**  
Begin doing practical radio work with the first chapter. Learn quickly how to test radio sets and parts. Simplified picture-clear explanations make basic radio facts easy to understand and to apply on the job. Hundreds of radio servicing tips given by experts. Repair radios for fun or profit. Get an essential radio War-Job. Prepare yourself for after-the-war opportunities in Radio.

**GET PRACTICAL RADIO TRAINING**  
This amazing, different home-study manual will teach you quickly to do radio work. At first you will learn about parts, tubes, tests, simple circuits. Later chapters cover receivers, transmitters, testers, trouble-shooting. New, up-to-date editing makes material on Electronics. Follows U. S. Office of Education outlines.

**NEW EDITION NO RISK 10-DAY EXAMINATION** — Examine the complete Practical Radio Manual for 10 days without risk or obligation. See how easy it is to learn radio this new way. Send only \$2.95, full price, and the manual will be sent postpaid. Use the lessons for 10 days if you are pleased, keep the manual — otherwise return it and receive all your money back. Order today on trial.

SUPREME PUBLICATIONS, 328 S. JEFFERSON ST., CHICAGO 6, ILL.

# LAW

## STUDY AT HOME

Legally trained men win higher positions and bigger success in business and public life. Greater opportunities never than ever before. Big corporations are headed by men with legal training.

**More Ability: More Prestige: More Money**  
We guide you step by step. You can train at home during spare time. Degree of LL. B. Successful graduates in every section of the U. S. We furnish all text material, including 14-volume Law Library, low cost, easy terms. Get our valuable 48-page "Law Training for Leadership" and "Evidence" books FREE. Send for them NOW.

LaSalle Extension University, Dept. 764-L Chicago  
A Correspondence Institution

## JOKE BOOKS For Adults

The kind they like. You will be both a Riot and the Life of the Party with a set of these pocket size joke books. They are full of Entertainment, Fun and Humor. A set of six books only 50c or a special assortment of 12 books all different for \$1.00. Print name and address, send cash or stamps to:

**TREASURE NOVELTY CO.,**  
72—5th Ave., Dept. 1207, N. Y. 11, N. Y.

## LIQUID MARBLE

Make beautiful artificial Marble slabs. Pour from liquid state. Glazed or un-glazed. Mottled, veined, snow-white, or multi-colored. Unsurpassed on kitchen or bathroom walls. Easy to make and install. **PLASTIC FLOORING.** Any color. Lifetime wear. Dustproof, Soundproof, Vermin-proof. Resilient to the tread. Lay out solid or in pattern design. **FLEXIBLE MOLDS** for plaster casting. Make your own molds for few cents each. \$1.00 in raw materials will make up to \$25.00 of finished goods. We furnish names of buyers. Write now for free information.

**COMPO-TEX, BOX 786-S, ST. LOUIS (1), MO.**

**Learn Penmanship**

Write for my Free Book, "How to Become an Expert Penman," which shows what others have accomplished by taking my Course. Enclose 10c for one of my Favorite Pen Points and your name with a beautiful fringed bird written on a card. Write today.

**T. M. TEVIS, Box 25K, Chillicothe, Mo.**

## Learn PHOTOGRAPHY at Home

Splendid opportunities. Prepare in spare time. Easy plan. No previous experience needed, common school education sufficient. Send for free booklet "Opportunities in Photography", particulars and requirements.

**American School of Photography**  
1315 Michigan Ave., Dept. 1358, Chicago 5, Ill.

## FIBRE ARMS AND LEGS!

Light, correctly fitted, strong and comfortable. Natural appearance. Braces for all deformities. Scientific design. Pair Terms.

**BUCHSTEIN-MEDCALF**  
610-3rd Av. S., Minneapolis, Minn.

## Store Route Plan PAYS BIG MONEY

**SELL COUNTER CARD PRODUCTS**  
Build a good-paying business of your own. Call on dealers of all kinds; show nationally-advertised Aspirin, Vitamins, Cosmetics and 250 other necessities. Big 5c and 10c retail packages, high quality. Attractive counter displays sell goods fast. Free book gives amazing facts. Write!

**World's Products Co., Dept. 10-X, Spencer, Ind.**

# Will PLASTICS? Revolutionize Industry

**W**ILL PLASTICS revolutionize industry... change our mode of living... or perform miracles? We do not believe they will. If, however, your business or employment has to do with products of metal, wood, leather, paper, fabric, ceramics, or coating material, you cannot afford to ignore the importance of plastics in your post-war planning.

Plastics are suitable for many new applications, but the intelligent use of plastics can only be determined by knowing their advantages and limitations.

Plastics Institute offers a comprehensive, up-to-date source of information through its Home Study Course in plastics... composed of forty-four lesson assignments, complete with detailed, modern illustrations and samples of plastics materials... prepared and conducted by recognized plastics authorities. This course takes you step by step through all phases of plastics, from sources and properties of materials to commercial applications in finished products... through mold design and molding, fabricating, laminating, testing and plant operation.

For complete information, mail the coupon for your copy of the FREE booklet, the "World of Plastics." It tells you about plastics in war and peace, the Plastics Institute Home Study Course, and the Executive Reference Set.

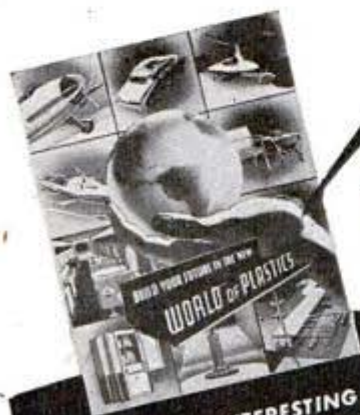

GET THIS INTERESTING  
BOOK "WORLD OF  
PLASTICS" SENT FREE!  
Get Full Details Now.

## Plastics INDUSTRIES TECHNICAL INSTITUTE

Department PM-7  
122 E. 42nd St.  
New York 17, New York

Department PM-7  
221 N. La Salle St.  
Chicago 1, Ill.

Department PM-7  
186 S. Alvarado St.  
Los Angeles 4, Calif.

### MAIL COUPON FOR FREE BOOK

Plastics Industries Technical Institute *Mail in envelope or*  
221 N. La Salle St., Dept. PM-7, Chicago 1. *paste on penny postcard.*  
Gentlemen: Please send me the booklet "World of Plastics" and information on your training program. I understand there is absolutely no obligation.

NAME..... AGE.....

STREET.....

CITY..... ZONE..... STATE.....

Dept. PM-7

The set of books that makes **MASTER MACHINISTS** and leads to bigger pay!



This big home-study and reference course gives you the practical facts on machines and methods you need to advance in machine shop work. Take advantage of the other man's experience as found in books, to solve your problems, increase your efficiency, with

**The AMERICAN MACHINISTS' LIBRARY**

6 volumes—2368 pages—2516 illustrations  
(A combined home-study course and reference library)

This library of machine shop practice was written for practical men. It gives you the best methods for every kind of machine shop work. It fully explains lathes, drills, and other machine tools and their operation, automatic screw machines, speeds and feeds, gear design and production, jigs and fixtures, punch and die work, metal surfacing, etc., etc. Plainly written—completely illustrated—the best kind of help to the machine shop man who wants to advance himself.

No money down—special price—easy payments.

**EXAMINATION COUPON**

McGRAW-HILL BOOK CO., 330 W. 42nd St., N. Y. 18

Send me for ten days' examination the American Machinists' Library. If satisfactory I will send you \$1.50 in 10 days and \$3.00 monthly until the price of \$19.50 is paid. If not wanted, I will return the books postpaid. (To insure prompt shipment write plainly and fill in all lines.)

Name .....  
Home Address .....  
City and State .....  
Position .....  
Name of Company ..... PM-7-44

SAVE WASTE PAPER

**AVIATION Career**

**DON'T WAIT UNTIL THE WAR IS OVER!**

Since 1929 Curtiss-Wright Technical Institute has been specializing in modern, progressive training for Aeronautical Engineers and Master Aviation Mechanics (no flying involved). Prepare now for your Aviation Career. BE READY! The opportunities are great today and will be much greater in tomorrow's Age of Flight. ACT!



**CURTISS TECHNICAL**



**WRIGHT INSTITUTE**

GRAND CENTRAL AIR TERMINAL  
GLENDALE 1, CALIFORNIA  
(LOS ANGELES COUNTY)

**MAIL THIS COUPON TODAY!**

Registrar, Curtiss-Wright Technical Institute, Grand Central Air Terminal, Glendale (1), California. Please send information and profusely illustrated catalogue on Aviation Training. FREE... without obligation... Dept. PM-7

Name ..... Birth Date .....  
Street .....  
City ..... State .....

**PIN-UP EYEFULS**

30 Gorgeous Gals In Full Color

Now... thrilling, glamorous, gorgeous, breath-taking girl beauties in life-like, cozy, full color pictures—PIN-UP EYEFULS for your den or barracks. Size 4x3 to 5x8.



**FREE PICTURE CATALOG**

Just send \$1 for 30 PIN-UP EYEFULS, postpaid with PICTURE CATALOG Listing (300 full-color reproductions of original paintings by well-known artists for framing) included free of extra cost. A gorgeous offering of girls, babies, floral and religious pictures for envelope Tuck-Ins and Pin-Ups.

**FRANK MATTHEWS**

111 W. Washington, Dept. 58, Chicago 2, Ill.

**FREE TRIAL LESSON IN DRAFTING**

More good jobs now in Drafting. Learn AT HOME in spare time (or at our Chicago School). Send postcard for **FREE TRIAL LESSON** and see how easy to learn and get a good job.

**CHICAGO TECHNICAL COLLEGE**  
H-205 Tech Bldg., 2000 S. Michigan Ave., 16 Chicago, Ill.

**INVENTORS! NOTICE**

● **GET GOOD ADVICE FROM A SUCCESSFUL INVENTOR.** I can save you time and money. I will tell you what to do and what not to do. I will send you my Sales Plan that sold my first invention and made me Fifteen Thousand Dollars (\$15,000.00) in royalties in a short time. This Sales Plan has sold five of my other inventions. I will send this valuable advice and sales plan for One Dollar (\$1.00). Money refunded if not satisfied. ADDRESS—SUCCESSFUL INVENTOR, P. O. Box 5212 E. Michigan Station, Indianapolis, Ind.

Keep that Car **TICKING**

7 DAYS FREE TRIAL

**AUDELS NEW AUTO GUIDE FOR MECHANICS OPERATORS A SERVICE MEN READY REFERENCE**

Every operator and mechanic needs AUDELS AUTO GUIDE.

This book saves time, money and worry. Highly endorsed. It presents the whole subject of auto mechanics:

- 1—Basic principles
- 2—Construction
- 3—Operation
- 4—Service
- 5—Repair

Handy Size, Easily understood.

NEW FLUID DRIVE, HYDRAULIC SHIFT AND DIESEL ENGINES FULLY COVERED

Over 1500 pages—1540 illustrations showing inside views of modern cars, trucks and buses with instructions for all service jobs.

ASK TO SEE IT!—To Get This Assistance for Yourself Simply Fill in and Mail Coupon Today.

**4 COMPLETE • PAY ONLY \$1. A MONTH**

**AUDEL Publishers, 49 West 23rd St., New York**  
MAIL AUDELS NEW AUTO GUIDE for free examination. If O. K. I will send you \$1 in 7 days; then remit \$1 monthly until price of \$4 is paid. Otherwise I will return it.

Name.....  
Address.....  
Occupation.....  
Employed by..... PM



## Be smart— Study Radio Now!

**T**HIS is a *radio war*—and victory will bring a *radio world!*

That's why men with foresight and ambition are studying radio *now*—at home, in their spare time!

They know that if they're drafted, *radio training* will make them eligible for *further valuable training* with the Armed Forces—eligible for *higher rating* and *higher pay*—eligible for more *interesting assignments!*

And when they return to civil life, they'll have knowledge and background to fit

them for a well-paid, responsible job in *radio, television or electronics!*

You can study an I. C. S. Radio Course in your spare time—at low cost—starting *right now!* Mail this coupon, and we'll send you complete information on the famous I. C. S. *personalized* teaching method, which has helped thousands along the highway to success!

This information may well be worth thousands of dollars to you—yet it's yours for a 3c stamp! Mail the coupon today!

### INTERNATIONAL CORRESPONDENCE SCHOOLS



BOX 5698-J, SCRANTON 9, PENNA.

Without cost or obligation, please send me booklet and full

- ELECTRONICS
- GENERAL RADIO
- RADIO OPERATING
- RADIO SERVICING
- SOUND TECHNICIAN

- Air Conditioning and Plumbing Schools
- Air Conditioning
- Heating  Plumbing
- Refrigeration  Steam Fitting

- Chemistry Schools
- Chemical Engineering
- Chemistry, Analytical
- Chemistry, Industrial
- Chemistry, Mfg. Iron & Steel
- Plastics
- Pulp and Paper Making

- Civil, Architectural and Structural Engin'g Schools
- Architectural Drafting
- Architecture
- Bridge and Building Foreman
- Bridge Engineering
- Building Estimating
- Civil Engineering
- Contracting and Building

- Highway Engineering
- Lumber Dealer
- Sanitary Engineering
- Structural Drafting
- Surveying and Mapping

- Electrical Schools
- Electrical Drafting
- Electrical Engineering
- Power House Electrician
- Practical Electrician
- Practical Telephony
- Telegraph Engineering

- Internal Combustion Engines School
- Auto Technician  Aviation
- Diesel-Electric
- Diesel Engines  Gas Engines

- Mechanical Schools
- Aeronautical Engineering
- Airplane Drafting
- Flight Engineer
- Foundry Work
- Heat Treatment of Metals
- Industrial Design
- Mechanical Drafting
- Mechanical Engineering

- Mold-Loft Work
- Patternmaking
- Reading Shop Blueprints
- Sheet Metal Drafting
- Sheet Met. Worker
- Ship Drafting  Ship Fitting
- Shop Practice
- Steel Mill Workers
- Tool Designing
- Welding, Gas and Electric

- Railroad School
- Air Brake  Car Inspector
- Locomotive Engineer
- Locomotive Fireman
- Railroad Section Foreman

- Steam Engineering Schools
- Boilermaking
- Combustion Engineering
- Engine Running
- Marine Engines
- Steam Electric  Steam Engines

- Textile School
- Cotton Manufacturing
- Rayon Weaving
- Textile Designing
- Woolen Manufacturing

#### Business and Academic Schools

- Accounting  Advertising
- Arithmetic  Bookkeeping
- Business Correspondence
- Business Management
- Certified Public Accounting
- City Letter Carrier
- College Preparatory
- Commercial
- Cost Accounting
- Federal Tax
- First Year College
- Foremanship
- High School
- Higher Mathematics
- Illustrating
- Motor Traffic
- Post Office Clerk
- Railway Postal Clerk
- Salesmanship  Secretarial
- Stenography
- Traffic Management

#### Language School

- Spanish  French
- Good English

Name.....Age.....Home Address.....

City.....State.....Present Position.....Working Hours.....

Canadian residents send coupon to International Correspondence Schools Canadian, Ltd., Montreal, Canada.

British residents send coupon to I. C. S., 71 Kingsway, London, W. C. 2, England.

**SPECIAL TUITION RATES FOR MEMBERS OF THE ARMED FORCES**



# It's Really Fun!

## LEARN MUSIC WITHOUT A TEACHER this easy way!

Learn at home by wonderful improved method. Simple as A-B-C—a child can learn it. Your lessons consist of real selections, instead of tiresome exercises. Each of these delightfully easy lessons adds a new "piece" to your list. You read real notes, too—no "numbers" or "trick music."

Method is so thorough that some of our 750,000 students are band and orchestra LEADERS. Everything is in print and pictures. First you are told what to do. Then a picture shows you how. In a few short months you may become a good musician—the life of every party!

Mail coupon today for our illustrated Free Book and Print and Picture Sample which fully explain our easy method. Mention your favorite instrument. U. S. School of Music, 77 Brunswick Bldg., New York 10, N. Y. 46th year—Established 1898.

### SUCCESSFUL 46TH YEAR

U. S. School of Music, 77 Brunswick Bldg., New York 10, N. Y. Please send me Free Booklet and Print and Picture Sample. I would like to play (Name Instrument).

Instrument..... Have you Instrument?.....

Name..... (PLEASE PRINT)

Address.....

SAVE WASTE PAPER



SHIPPED  
FREE FOR  
EXAMINATION

Learn to draw plans, estimate, be a live-wire builder, do remodeling, take contracting jobs. These 9 practical, profusely illustrated books cover subjects that will help you to get more work and make more money. Architectural design and drawing, estimating, steel square, roof framing, construction, painting and decorating, heating, air-conditioning, concrete forms and many other subjects are included.

### BETTER JOBS — BETTER PAY UP-TO-DATE EDITION

Keep busy now at good pay, and be prepared for after-war building boom. Big opportunities are always for MEN WHO KNOW HOW. These books supply quick, easily understood training and handy, permanent reference information that helps solve building problems.

### Coupon Brings Nine Books FREE For Examination

AMERICAN TECHNICAL SOCIETY Vocational Publishers since 1898  
Dept. G819 Drexel at 58th Street Chicago 37, Ill.

You may ship me the Up-to-Date edition of your nine big books, "Building, Estimating, and Contracting" without any obligation to buy. I will pay the delivery charges only, and if fully satisfied in ten days, I will send you \$2.00, and after that only \$1.00 a month, until the total price of only \$29.00 is paid. I am not obligated in any way unless I keep the books.

Name.....

Address.....

City..... State.....

Please attach a letter stating your age, occupation, employer's name and address, and that of at least one business man as a reference. Men in service, also please give home address.

## PRINT ANY PHOTO on Paper, Cloth, Leather or Wood

### SIMPLE, EASY TO USE

Magic liquid takes only 2 minutes to reproduce any snapshot you have on to stationery, handkerchiefs, ties, scarfs, etc. Won't wash off. Won't hurt negative or fabric it's used on. Personalize your belongings! An ideal gift. Complete outfit enough to transfer 100 photos—only \$1.00 postpaid. Sent C.O.D. for \$1.30.

CHRISTY PHOTO SUPPLY, Dept. 310  
2835 N. Central, Chicago 34



## —PHOTOGRAPHY—

for  
P  
R  
O  
F  
E  
S  
S  
I  
O  
N  
I  
S  
T

Whether you are interested in photography for fun or as a sound present and postwar career—get the facts as to how America's largest, best equipped school can qualify you for success. Home study or resident training. Individual instruction by experts. Free book gives details. N. Y. INSTITUTE OF PHOTOGRAPHY, Dept. 49, 10 West 33 St., New York 1, N. Y. (Founded 1910)

## Inventions Wanted Patented or Unpatented

Inventions can now be safely sold without patenting expense. If you have a practical, useful idea for sale, either unpatented or patented, write Chartered Institute of American Inventors Dept. 4, 631 Pa. Ave., N. W. Washington, D. C.

## MAKE MONEY AT HOME!

Learn to color photos and miniatures in oil. No previous experience needed. Good demand. Send for free booklet, "Make Money at Home" and requirements.

NATIONAL ART SCHOOL  
1315 Michigan Ave. Dept. 1358 Chicago 5

## PLASTICS

Learn the modern way. We are located in the heart of the Plastics Industry. School founded in 1910. Write for booklet "I". Fully accredited.

NEW YORK TECHNICAL INSTITUTE, 108-5TH AVE., NEW YORK 11, N. Y.

## FIX TYPEWRITERS

A Simplified Practical Homestead Course. Many of our Students now have their own Business—Many Repair for others. Repair Shops Swamped. Health or Age no handicap. WEISER TYPEWRITER MECHANICS SCHOOL 5417 Santa Monica Blvd., Hollywood 27, Calif.



## DRAW for MONEY

### BE AN ARTIST!

Trained Artists are Capable of Earning \$30, \$50, \$75 a week

Use Your Spare Time to Prepare for a Profitable Art Career! COMMERCIAL ART, DESIGNING and CARTOONING—all in ONE complete home study course. No previous Art experience necessary—we teach you step by step—hundreds have profited by our practical method. TWO ART OUTFITS FURNISHED. Full information in colorful, FREE BOOK, "Art for Pleasure & Profit"—tells all about our course, service, what our graduates say—and commercial opportunities for you in Art.



### FREE BOOK gives details!

WASHINGTON SCHOOL OF ART  
Studio 127 K. 1115 15th St. N.W. Wash. S. D. C.  
Send me your booklet and full particulars about your course.

Name..... AGE.....

Address.....

City..... State.....



# GET INTO RADIO



You profit by a fascinating career in Radio, Radionics, Electronics, Television.

## ELECTRONICS TELEVISION *Now!*

Shortages in trained, skilled men run into the hundreds of thousands. One of the biggest fields is RADIO, with its many fascinating branches. Wartime demands for Radio men are tremendous and will continue UNABATED after the war. That's important to you. You want training in a field that will continue to advance. National Schools offers you a time-tested method of Home Training which has helped thousands of men to more pay, and unlimited opportunity in the growing RADIO industry.

## Shop Method Home Training by a Long Established Resident School

Get Ready For Your Opportunity . . . It's Here! Radio technical men are needed everywhere; afield in action, and at home in industry! Trained men are needed in the Army, Navy and Air and Signal Corps, Government Defense Service and Civilian fields. Now, in answer to repeated demands for Trained Radio Technicians, National Schools has extended its famous Shop Methods so you can qualify right at home. You can quickly prepare to be of greatest service to your country and yourself. Yes, right at home, in your spare time. National's time-tested plan of Home Training will definitely establish you, in a

short time, so you can hold a good job in this fascinating field. Furthermore, you become equipped for an ever bigger career in the years of reconstruction after war.



### TRAIN DURING MILITARY SERVICE

Prepare for Radio Service in Army and Navy. In U. S. Gov't service you install, operate and maintain most technical equipment such as secret ultra-high frequency apparatus to locate airplanes, submarines, etc. Get promotion in rank and increased pay almost from the start.

### COMMAND ANY OF THESE JOBS

- Radio Expert
- Electronics Engineer
- Radio Broadcasting
- Studio Technician
- Television Technician
- Aviation Radio
- Ship & Harbor Radio
- Business of Your Own
- 137 Different Types
- of Jobs to Choose From

## TREMENDOUS POST WAR DEMAND

### NO PREVIOUS EXPERIENCE NEEDED!

Radio is only one of the courses you receive when you become a National Student. Electronics is brand new and open to every trained radio man. After this war it will produce new marvels that will be needed and used in every home. General Electric, Westinghouse and all great manufacturers have many new electronic inventions ready to market. National men, because of their knowledge and training in Electronics, will be in on the ground floor and among the first to cash in.

Television is a big new opportunity. National men will have the "know how" to merit jobs in this great industry.

### RADIO EQUIPMENT INCLUDED

You work with the finest equipment and materials furnished by us at no extra charge.



## NATIONAL SCHOOLS

LOS ANGELES 37, CALIFORNIA  
EST. 1905



## FREE LESSON

And OPPORTUNITY BOOK . . .

To prove that you can easily learn radio at home by National's famous "Shop Method" home training, we will send this SAMPLE LESSON without cost or obligation. With it, we will send you a big, 36 page book, "Your Future in Radio, Television and Electronics." Mail the coupon NOW.



### MAIL OPPORTUNITY COUPON FOR QUICK ACTION

National Schools, Dept. 7-PMR  
4000 S. Figueroa Street  
Los Angeles 37, Calif.

Mail in envelope or paste on penny postal

Please rush me, FREE and without any obligation on my part, Sample Lesson in Radio, Television and Electronics and full details of your "Shop Method" of home training. No salesman will call.

NAME \_\_\_\_\_ AGE \_\_\_\_\_

ADDRESS \_\_\_\_\_

CITY \_\_\_\_\_ STATE \_\_\_\_\_

INCLUDE ZONE NUMBER

# Do you want

→ ..to go to College?

→ ..or to enter a Profession?

(Such as Accounting, Architecture, Nursing, Dentistry, Teaching, Social Work, Osteopathy, Beauty Culture, Optometry, Embalming, Chiropractic, Law, Medicine, etc.)

→ ..or get an Office Position?

To get anywhere, you practically MUST finish High School FIRST. You can complete our simplified High School Course in SPARE time at home, as FAST as your time and abilities permit. Equivalent to resident school work—prepares you for college, pre-professional examinations, business, industry. Standard texts furnished. Diploma. Credit for H.S. subjects already completed. Single subjects if desired. Low tuition, easy terms. American School, Chicago, est. 1897—endorsed by educators. Finish your high school education NOW. Write TODAY!

## High School Course at Home

Many Finish in 2 Years

American School, Dept. HB45, Drexel Ave. at 58th St., Chicago 37, Ill.

Gentlemen: Send me FREE information covering special training in subjects checked below. No obligation on my part.

- |  |  |
|--|--|
| <input type="checkbox"/> High School Course          | <input type="checkbox"/> Diesel Engineering                      |
| <input type="checkbox"/> Cost Accounting for Mfg.    | <input type="checkbox"/> Drafting and Design for men & women     |
| <input type="checkbox"/> Architecture and Building   | <input type="checkbox"/> Plastics                                |
| <input type="checkbox"/> Automotive Engineering      | <input type="checkbox"/> Private Secretary                       |
| <input type="checkbox"/> Business Management         | <input type="checkbox"/> Mechanical Engineering                  |
| <input type="checkbox"/> Electrical Engineering      | <input type="checkbox"/> Aviation <input type="checkbox"/> Radio |
| <input type="checkbox"/> Elec. and Gas Refrigeration | <input type="checkbox"/> Salesmanship                            |
| <input type="checkbox"/> Air Conditioning            | <input type="checkbox"/> Shipbuilding                            |
| <input type="checkbox"/> Railway Training            |  |

Name.....

Address.....

## KEY TO A PRACTICAL UNDERSTANDING OF ELECTRICITY

\$1 PER MO.

### AUDELS HANDY BOOK OF ELECTRICITY

\$4 HANDY SIZE

For Engineers, Electricians, Students and all interested in Electricity. A quick, simplified, ready reference, giving complete instruction and practical information. Easy to understand. A reliable authority and a handy helper that answers your questions.

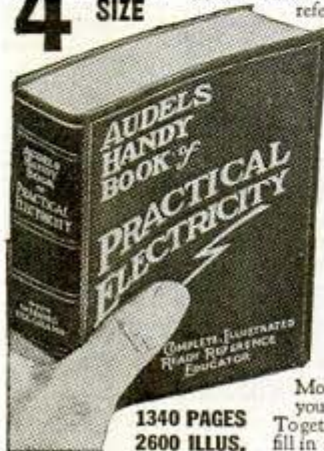

### INSIDE TRADE INFORMATION ON

The Rules and Laws of Electricity—Maintenance of Machinery—A. C. and D. C. Motors—Armature Winding and Repair—Wiring Diagrams—House Lighting—Power Wiring—Cable Splicing—Meters—Batteries—Transformers—Elevators—Electric Cranes—Railways—Bells—Sign Flashers—Telephone—Ignition—Radio Principles—Refrigeration—Air Conditioning—Oil Burners—Air Compressors—Welding, and many Modern Applications explained so you can understand.

1340 PAGES  
2600 ILLUS.

Get this assistance for yourself, simply fill in and mail the FREE COUPON below.

THEO. AUDEL & CO., 49 West 23rd Street, New York

Please send me "Audels Handy Book of Practical Electricity" for free examination. If satisfactory, I will send you \$1 in 7 days, then \$1 monthly until \$4 is paid. Otherwise I will return it.

Name.....

Address.....

Occupation.....

Reference..... PM



READ FOR PROFIT!

## MUSIC LESSONS

### COMPLETE CONSERVATORY HOME STUDY COURSES

Piano, Harmony, History of Music, Advanced Composition, Voice, Public School Music, Violin, Cornet, Trumpet, Guitar, Mandolin, Saxophone, Clarinet, Dance Band Arranging, Ear Training and Sight Singing, Choral Conducting. The only correspondence school teaching all the courses leading to the Degree of Bachelor of Music. Ask for illustrated lessons and catalog.

Give experience ..... 1525 E. 53rd St.  
UNIVERSITY EXTENSION CONSERVATORY Dept. U-50, Chicago 15, Ill

## TRAIN for SUCCESS in the Poultry Business



Study at home in spare time. Earn extra while learning.

YOU CAN MAKE MORE MONEY from POULTRY. Proper management means profits ANY season, for life. Get latest scientific methods that avoid losses and mistakes. Our famous system of Home Study Training has helped thousands to success. Extra profits from the start. FREE Catalog; describes courses, methods, service. Write today to Dept. 50-N. NATIONAL POULTRY INSTITUTE, Adams Center, N. Y.



## RADIO OPERATORS WANTED

Learn to send and receive Radio Code at home or camp, or prepare for higher proficiency and rating through easy, practical system used in training radio-telegraph specialists. Good pay, adventure, interesting work. Send for revealing 52-page FREE Book. Dept. 50, Box 928 Denver, Colo., U.S.A.

## STUDY ENGINEERING AT HOME

With A Chartered Educational Institution

Courses in ENGINEERING: Electrical, Civil, Mechanical, Drafting, Architectural, Steam, Aeronautical, Radio, Structural, Mining, Industrial, Highway, Petroleum, Marine, Chemical.

Courses in ARTS AND SCIENCES: Philosophy; Education; Letters; Public Health; Medical Jurisprudence; Psychology; Sociology; Physics; Chemistry; Geology; Pol. Science; Theology; Law; Business and Commerce; Accounting; Mathematics; Statistics; Agriculture.

McKinley-Roosevelt Incorporated, 4610-TC, Sheridan Road, Chicago, 40

## BE A PERFUME DISTRIBUTOR!

Sell reproductions of world-famous, imported perfumes and get in on the now bigger than ever year around demand for this merchandise. Eye appealing packages assure you big daily cash profits. Many millions of dollars worth of perfumes sold annually. Get started at once with us—your profits are waiting! But get started! Send for free details and sample TODAY! DUCHESS D'ANDRE, Dept. 14-A, 145 No. Clark St., Chicago 2, Ill.

A SIMPLIFIED ART ANATOMY OF THE HUMAN FIGURE ONLY \$1 POSTPAID

by Charles Carlson. The book they're talking about! One of the most informative books of its kind for both student and professional artists. Charts, notes, and over 350 drawings show detailed studies of every part of the body, posed and in action. HOUSE OF LITTLE BOOKS, 156-160 Fifth Ave., New York

LAW STUDY AT HOME for PERSONAL SUCCESS and LARGER EARNINGS. 35 years expert instruction—over 108,000 students enrolled. LL.B. Degree awarded. All texts furnished. Easy payments. Send for FREE BOOK—"Law and Executive Guidance."

AMERICAN EXTENSION SCHOOL OF LAW  
Dept. 43-M, 646 N. Michigan Ave., Chicago 11, Ill.

HOME STUDY OR PRACTICAL SHOP TRAINING Men wanted to learn following big pay trades: Auto-Diesel, Machinist, Plastics, Drafting, Refrigeration, Welding, Body and Fender, Aircraft. Established 1902. 41,000 graduates. Free booklet. Specify trade. State whether interested in Home Study or Practical Shop Training.

GREER SHOP TRAINING, Dept. 174, 2017 S. Wabash Ave., Chicago, 16

NEW PLAN SUIT FREE AS A BONUS

EARN CASH Showing to Friends!

Write at once if you want this fine made-to-measure suit! I send it FREE as a bonus for you to show friends and earn up to \$10.00, \$12.00 in a day taking orders for latest style made-to-measure guaranteed suits at amazingly low prices. Also complete line of Ladies' Tailored Suits. No experience, no money needed. Write for FREE CLOTH SAMPLES—telling about yourself—age, etc. No obligation—act now!

PIONEER TAILORING COMPANY  
Congress & Throop St., Dept. G-1116, Chicago 7, Ill.





# New Short-Cut Saves You Time and Work On ALL

## AUTO REPAIR JOBS!

TRY IT **FREE** FOR 7 DAYS!

### MoToR's New AUTO REPAIR MANUAL Cuts Repair Time in Half!

EVERY day more and more men who repair cars—in their full time or spare time—are sending for MoToR's New AUTO REPAIR MANUAL. Not because they don't know their stuff! But because this 640-page auto repair "bible" saves them so much valuable time and effort on every repair job on every car built since 1935!

With this manual at your finger tips even the toughest repair jobs take only half the time! For right here in front of you are all the facts you need for any job, "broken down" from several hundred official factory shop manuals—and simplified into easy, 1-2-3, step by step in-

structions by the engineer-editors of MoToR Magazine.

It's so downright easy to work with this handy manual! When a repair job comes your way, you just look up the make, model and job in quick-reference index. Then you spread manual open before you, follow the easy repair instructions on the big, clear 8½"x11" pages that stay flat and open.

### 200,000 FACTS — 1,000 ILLUSTRATIONS!

Packed in between sturdy covers that can "take it," are 200,000 facts about service, repair, adjustment, replacement, tune-up. Everything you need to know from carburetor to rear end, on all makes and models built from 1935 through 1942. With more than 1,000 cut-away photos, diagrams, drawings that show you exactly WHAT to do and HOW to do it!

See for YOURSELF why this book is so popular with the U S Army, Navy trade and technical schools, and with thousands of auto servicemen the country over. WITHOUT PAYING A PENNY you may try out MoToR's AUTO REPAIR MANUAL and see how it will save you time, labor, money! It's yours to examine for 7 days—Absolutely Free!

### SEND NO MONEY 7-Day Free Examination

Just mail coupon below—without money! When the postman brings your book, pay him nothing. First make it show you what it's got! Unless you agree this is the greatest time-saver and work-saver you've ever seen—return book in 7 days and pay nothing. Mail coupon today! Address: MoToR Book Dept., Desk 1H, 572 Madison Ave., New York 22, New York.



### Covers All These Makes!

- |           |              |
|-----------|--------------|
| American  | La Salle     |
| Bantam    | Lincoln      |
| Auburn    | Lincoln      |
| Austin    | Zephyr       |
| Buick     | Mercury      |
| Cadillac  | Nash         |
| Chevrolet | Overland     |
| Chrysler  | Oldsmobile   |
| Cord      | Packard      |
| De Soto   | Pierce Arrow |
| Dodge     | Plymouth     |
| Ford      | Pontiac      |
| Graham    | Reo          |
| Hudson    | Studebaker   |
| Hupmobile | Terraplane   |
| Lafayette | Willys       |

### Clear, Pictured Facts on Every Job on Every Car Built Since 1935!

Nearly 200,000 service and repair facts on all 30 makes. 640 big pages; including 50 pages of carburetor text, charts, illustrations, covering all models. Over 450 charts, tables; Tune-up Chart; Valve Measurements; Compression Pressure; Torque Wrench Reading; Starting Motor; Engine Clearances; Generator; Clutch & Brake Specifications; Front End Measurements, etc., Engines; Electric, Fuel, Cooling, Lubricating Systems; Transmissions; Universals; Front Ends; Wheels; Rear Ends, etc.

### Same FREE 7-Day Offer Applies on New MoToR's TRUCK REPAIR MANUAL

For mechanics, truck specialists, service stations, fleet owners. Covers EVERY job on EVERY truck made since 1936! 1400 pictures, 900 pages, 300,000 facts. Used by Armed Forces.

All types Gasoline Engines, Diesels, Hesselman, Fuel Systems, Governors, Lubrication Systems, Ignition Systems, Starters, Generators, Clutches, Transmissions, Axles, Torque Dividers, Transfer Cases, Brakes, Steering, etc.

ALSO SERVICES many buses, farm and industrial tractors, contractor, road building equipment, stationary power machinery, etc. (on all parts described in Manual.)

Check box in coupon at right.



Published by MoToR, The Leading Automotive Business Magazine. MoToR's manuals assure high standard repair work.

### MAIL COUPON NOW FOR 7-DAY FREE TRIAL

MoToR Book Dept., Desk 1H, 572 Madison Ave., New York 22, N.Y. Rush to me at once: (check box opposite book you want).

MoToR's AUTO REPAIR MANUAL (formerly "MoToR's Factory Shop Manual"). If O.K., I will remit \$1 in 7 days, \$1 monthly for 4 months, plus 35c delivery charge with final payment (\$5.35 in all). Otherwise I will return book postpaid in 7 days. (Foreign price, remit \$7 cash with order).

MoToR's TRUCK REPAIR MANUAL. (Described at left in the box.) If O.K., I will remit \$2 in 7 days, and \$2 monthly for 3 months, plus 35c delivery charges with final payment (\$8.35 in all). Otherwise I will return book postpaid in 7 days. (Foreign, remit \$11 with order).

Name \_\_\_\_\_ Age \_\_\_\_\_

Address \_\_\_\_\_

City \_\_\_\_\_ Zone No. \_\_\_\_\_ State \_\_\_\_\_

Occupation \_\_\_\_\_

SAVE 35c! Check here if enclosing full payment (check, money order) WITH coupon. We pay 35c shipping cost.

# Quick! Right Now Get into DRAFTING



**I'll train you until you  
have a GOOD PAY JOB**

With industry working feverishly—the field for Draftsmen is bigger than ever. More important—draftsmen and designers must come first in changing back to peace-time production. Get into a better job with more pay and fascinating, pleasant work. Engineer Dobe will train you at home—in your spare time, to get experience on actual work, the same kind of jobs you will do in the best paid position, and train you until you are competent, experienced, holding such a position that will mean advancement and pay raises as deserved. When competent will recommend your practical work experience as references. No need for previous training to start with me—and lack of higher education should not hold you back. You can pay monthly for your practical training from an engineer; the cost is reasonable. Write today for full illustrated details and booklet. *Give your age to get reply.*

## All working tools FURNISHED

Professional drawing instruments, all working tools, also drawing table furnished with training. Start in right Now.



**GET THE FACTS TODAY!**

**ENGINEER DOBE, Div. 3379, Libertyville, Ill.**  
Please send me training facts on "Drafting and Industrial Designing". Also advertised list of positions for Draftsmen and Designers Wanted.

Name.....Age.....  
Address.....  
Town.....State.....

# Learn this Profitable Profession



**IN 90 DAYS  
AT HOME**

## Money-Making Career Open to Men and Women, 18 to 50

Hundreds of men and women between 18 and 50 make \$10 to \$20 in a single day giving scientific Swedish Massage and Hydro-Therapy treatments. There is big demand from doctors, hospitals, sanatoriums and clubs. Graduates earn large full time incomes from these or in private practice in their own offices. Others make good money from home treatments given in spare time. Learn this interesting, money-making profession in your own home, through our home study course. Same instructors as in our nationally known resident school. You can win independence and prepare for future security by qualifying for your Diploma. Course can be completed in 3 to 4 months. Many earn while they learn. Begin your training at once.



## Anatomy Charts & Booklet FREE

Enroll now and we will include, at no extra cost, many needed supplies. Fit yourself to help meet growing demand for massage now and after the war. Send the coupon at once for complete details. Anatomy Charts and 32-Page Illustrated Booklet, FREE, postpaid.

**THE COLLEGE OF SWEDISH MESSAGE**  
Dept. B64, 100 East Ohio St., Chicago 11, Illinois

Please send me FREE and postpaid, Anatomy Charts, 32-page Booklet and complete details on Home Training.

Name.....  
Address.....  
City.....State.....

# Learn AIRCRAFT DESIGNING & ENGINEERING



**LET RYAN TRAIN YOU FOR A  
LIFETIME CAREER IN AVIATION**

The aircraft industry needs trained draftsmen and engineers NOW. Ryan's new Home Study Method offering you "direct-from-the-industry" training in Aeronautical Engineering will prepare you during your spare time for a top-paying job and a future. Course is easy to understand. No experience necessary. Pay as you learn. Write today for FREE 24-page book. . . . "New Horizons of Opportunity." Give age.

**HOME STUDY  
AFFILIATE OF  
RYAN SCHOOL  
OF AERONAUTICS**

**RYAN AERONAUTICAL INSTITUTE**  
427 Lindbergh Field, San Diego 1, Calif.

# MODEL RAILROADING

**THE WORLD'S MOST FASCINATING HOBBY**



**FREE 32-page booklet** tells all about this absorbing hobby for skilled tradesmen, business and professional men. Give yourself hours of satisfaction and relaxation building your own scale model railroad which performs and looks like the real thing. It's easy and relatively inexpensive. Get started now. Sent at once for our free booklet "Your Model Railroad."

**MODEL RAILROADER MAGAZINE**  
DEPT. JM MILWAUKEE 3, WISCONSIN



Begin today. Write now for our Free Book, "How to Become a Good Penman." It contains specimens and tells how others learned to write in spare time. Enclose 10c for your name beautifully written and a pen point suitable for shaded writing. Write today.

**THE TAMBLYN SCHOOL OF PENMANSHIP**  
Y441 Ridge Building, Kansas City, Mo.

★ ★ ★

# MAKE YOUR OWN POWER TOOLS at Low Cost

*from old Auto Parts, etc.*



## A New Edition Featuring TOOLS of WOOD

Now you can have a good lathe, drill press, circular and band saw and other power tools in your home workshop, at a cost of only a few dollars each. Make them yourself from old auto parts, discarded sewing machines and other odds and ends that cost little or nothing. Get this new book—"Forty Power Tools You Can Make." Costs only \$1.25 postpaid. This book gives every detail in plain language you can understand and follow. Hundreds of pictures and plans show every step to follow in making the power tools you want. Actual photographs of finished machines included. Send \$1.25 today. Money back if not satisfied.



## MAKE EVERY POWER TOOL NEEDED IN YOUR HOME WORKSHOP

- Some of the power tools you can make are:
- |                    |                              |
|--------------------|------------------------------|
| 2 Band Saws        | 2 Drill Presses              |
| 9 Sanding Machines | 1 Scroll Saw                 |
| 2 Circular Saws    | 2 Wood Turning Lathes        |
| 1 Metal Lathe      | 3 Grinders                   |
| 1 Power Hack Saw   | 1 Shaper or Moulding Machine |
| 1 Jig Shears       | 1 Vibrating Pencil           |
| 1 Cut-Off Wheel    | and others                   |

Information too, about pulleys, belts, motors and drive methods. Just published. No other book like it. Order today.

## POPULAR MECHANICS PRESS

Dept. 555 • 200 E. Ontario Street, Chicago 11



# Now-Learn Radio & Electronics

## MAKE MORE MONEY Now and After the War

### In This Fascinating Field of Big New Opportunities

Standard Texts of Instruction Used by  
U. S. Army Signal Corps —  
Now Available to Everyone —  
thru Sensational Bargain Offer!

Only  
**\$9.95**  
CASH

**FREE 5 Day Trial** in Your Own Home

win the war — You can use them to  
Uncle Sam is using these books to Help  
win Success!

### These Books Tell You— All About . . .

Radio receivers and transmitters from the antenna to the loud-speaker, circuits, tubes, what each part does; explains tubes, batteries, motors, generators, microphones, crystals, F.M. and hundreds of other subjects—everything you want to know about radio and electronics.

In 31 concise, easily-understood lessons, 5 volumes, 881 pages; 681 illustrations, diagrams and charts, plus supplementary booklets of shortcuts, definitions and charts that tie-in all your information and make it easy and understandable.

Get ready now for your golden opportunity—It's Here! Prepare yourself for quick advancement in the armed forces or to step into a better job now or after the war when competition gets tough. Here's the way to do any job quicker, easier—all the knowledge you need for top pay, a better job, spare time money or a profitable business of your own in this thrilling opportunity field. Experts are scarce and pay is high. Yes, you can now tap all the secrets of radio and electronics quickly at incredibly small cost thru these Govt. Standardized books—the identical texts used by the U. S. Army to train thousands of young men and women in the armed forces. Each book, every lesson bears the insignia of the U. S. Signal Corps. It's new, streamlined, up-to-the-minute. More than 23,000 soldiers and WACs got their training from these books in Kansas City alone—just a fraction of the thousands all over the Nation who have moved into real action jobs thru mastery of these books. Electronics is the "open sesame" to success in the world of today and tomorrow. It's now yours at a price anyone can afford to pay. Simple, easy, condensed—these books give you in hours the knowledge it used to require months to master.

### You Can Profit thru these Books—

Young men, young women, electricians, mechanics, students, radio repairmen, telephone and telegraph operators, business men—anyone who owns a radio set—will find these books invaluable. They open a new world of knowledge, skill and opportunity. Everything explained in plain, simple words—the Army way.

### Knowledge Means Mastery In the World of Today and Tomorrow

The last war was run by Telephone. This war will be won by electronics. The miracle of Radio, Electronic Communications, Walkie-Talkie, etc., as taught by these books, make it possible for our army to plan, attack, bomb, be at the right place at the right time, to get the jump on the enemy. It's an amazing achievement. Here before your eyes, are the fundamental secrets of how it's done. The achievements of electronics in industry after the war will be just as amazing. There will be rich rewards for those who prepare now and know the secrets of success.

### How This Set Was Designed

This is no mere reference set nor text designed to sell at a profit. It was compiled under government supervision to help win the war. The U. S. Army had to turn out qualified radio and electronics experts in a hurry. Old, slow training methods had to be discarded. Recognized radio authorities and educators were summoned—all existing texts examined. The best features of all were selected, revised, new short cuts originated—the combined knowledge of America's leading authorities crystallized, simplified and condensed into this MASTER TECHNICAL TEXT FOR ENLISTED MEN.

### Get These 5 Master Books

Here's the Standard 12-week Training Text used by our Army—All you need to know to be a master of radio and electronics—condensed into these 5 wonderful books. Just the knowledge you need for success. Anyone who can add, subtract, multiply and divide can master it.

### You Get 2 Valuable Handbooks FREE with this Offer

**Booklet No. 1**—tells you all you need to know about mathematics, hundreds of short-cuts and army methods of learning electronics the easiest, quickest way.

**Booklet No. 2**—shows you how to study, how to check your progress and knowledge. Gives useful charts, tables, and formulas, explanation of terms, codes, etc.

**Note**—We have only a few of these No. 2 booklets on hand. When they are gone only Booklet No. 1 will accompany the course free, so act immediately to save disappointment.

**HAASE & KISSEL**  
6321 Chestnut, Kansas City 5, Mo.

### Accept this Special Offer

Never again will this opportunity be open. We acquired the few remaining hundreds of these books when army training contracts expired in Kansas City. When they are sold, no more will be reprinted. Your opportunity to get your set at this bargain price is now. While they last you can have your set for only \$11.95 payable \$2.95 with order, balance \$3.00 monthly for 3 months or \$9.95 cash, delivered postpaid—a saving of 16-2/3 per cent. (Until now, comparable radio instruction courses have cost 10 to 30 times this amount.) It's the offer of a lifetime. Accept it NOW on our 5-Day free trial guarantee offer. Simply fill in coupon below designating your choice of payment and mail today.

### Get Into a Business of Your Own as:

- Radio Expert
  - Electronics Engineer
  - Radio Technician
  - Broadcasting Technician
  - Radio Service & Repair
  - Aviation Radioman
  - Police Radio Technician
  - Short Wave Radio Operator
  - Remote Control Man
  - Industrial Photo Cell Mfg.
- Take Your Pick of 100 Different Type Jobs.

### Examine At Our Risk

Study the books in your own home for 5 full days at our risk. Then if not delighted, if you are willing to part with your bargain at any price, simply pack them up and return them to us and your money will be refunded in full without question.

### MAIL TODAY—NOW

**Haase & Kissel**  
6321 Chestnut, Kansas City 5, Mo.

**Gentlemen:**  
Please rush the Radio Technical Training Text used in training by the U. S. Army Signal Corps. I desire shipment as specified below. I will return set within 5 days for refund if not satisfied.

- Check**
- I enclose \$9.95 in full payment. You send books postpaid.
  - Ship books C.O.D. I will pay postman \$10.39 on delivery.
  - I enclose \$2.95 and agree to pay \$3.00 per month for 3 months. Total cost \$11.95.

Name.....  
Address.....  
City..... State.....



**DESIGNERS, ENGINEERS  
DRAFTSMEN, METALSMITHS—**

NEW—100 clear and concise welding design ideas gleaned from practical experience of others. Every idea clearly shown by drawings—easy to understand and apply. If you are interested in welded design, you can't be without this book, nothing else like it. \$3:50 Postpaid, 5 days approval.

# Design FOR ARC WELDING

will save you many times its cost on your next redesign projects. Order now, \$3.50 (Postpaid)

512 Pages, 516 Illustrations. Complete manual and text book on Welding Postpaid—\$2.00



**HOBART  
BROTHERS COMPANY**

Hobart Bros. Co., Box M-74, Troy, Ohio

"One of the World's Largest Builders of ARC WELDING Equipment."

## GET INTO PLASTICS

### START YOUR OWN BUSINESS SMALL CAPITAL—WORK AT HOME

● Be your own boss. Get into new plastics business today. Start in your own home. Small capital needed. As you increase your knowledge and skill, you grow with this big industry. This opportunity is yours today, so get started now in what may mean a big paying Plastics business of your own.

● Now for the first time you can start by preparing in your own spare time — in your own home. This new plan gives you the sound fundamental knowledge you need to be a success in Plastics. Included are actual working projects and plastics materials to teach you, in your own home, how to do fabrication, shaping, forming, finishing, cementing, mold making, casting, etc. Mail coupon for free information.

PLASTICS TECH, 620 COM. AVE., BOSTON 15, MASS.

NAME ..... AGE .....

ADDRESS .....

CITY ..... STATE .....



## BUILD a BOAT

Row Boat—12 Foot  
Dinghy—8 Foot  
Training Ship—6 Foot  
Sea Sled—5 Foot  
Outboard—12 Foot  
Cruiser—18 Foot  
Bicycle Boat—Kayak  
Row Boat—Sectional  
Dinghy—Sailing  
Canoes—16 Foot  
Sailing—12 Foot  
Outboard—Runabout  
Pontoons—Ice Yacht

### FOR PLEASURE OR PROFIT DESCRIBES 17 LOW COST BOATS

Get this outstanding book and build a boat at home for your own use or to sell at a profit. You can do it. Just the boat you've always wanted—power, sail or row boat—17 different kinds and sizes.

Order BUILD A BOAT on postal card and pay only \$1.50 plus postage on delivery. Returns in 5 days if not pleased and get money back. Or send \$1.50 with order. (Outside U. S. \$1.70 with order.) Order today.

POPULAR MECHANICS PRESS  
Dept. 854, 200 E. Ontario, Chicago, 11

## Become a Real Estate Broker!

A profitable Lifetime career in any of America's Finest Professions. For complete details and free copy of pamphlet entitled "The Real Estate Brokerage Business as a Professional Career." Write J. A. STEIN, Post Office Box 1565, St. Petersburg, Florida.

THOUSANDS OF

## ALARM CLOCKS

need only proper cleaning or repairing. You can learn to do this at HOME. It's easy, but you must know how. Simplified Course only \$50c. THIES JEWELRY STORE, Genoa 8, Illinois

**PATENTS** Protect Your Idea: By securing FREE my "PROOF OF INVENTION" folder. Exceptional Personal Service. Excellent References. Established 1906. E. E. VROOMAN, 871 Woodward Bldg., WASH., D. C.

Always write your name and full address clearly when answering advertisements.

**PATENT YOUR IDEAS** HOW TO OBTAIN A PATENT  
SEND FOR FREE BOOK

Written by Former Member Examining Corps (1923-24) U. S. Pat. Office.  
CARL MILLER, Registered Patent Attorney  
Former Member Examining Corps U. S. Patent Office  
Woolworth Bldg., Dept. 74-A, New York—Bond Bldg., Dept. 74-A, Washington, D. C.

**PATENTS AND TRADE MARKS**  
**C. A. SNOW & CO.**  
Registered Patent Attorneys Since 1875  
Write for Free Book and "Certification of Invention" form  
427 SNOW BUILDING, WASHINGTON 1, D. C.

## BENJAMIN

### H-C-PELLETS ARE AVAILABLE

at dealers or direct. Cal. .22 and Cal. .177. Production of all models Benjamin Air Rifles and Benjamin Air Pistols has been suspended for the duration as our facilities are engaged in War Work. WRITE FOR OUR ILLUSTRATED PRICE LIST OF POST WAR MODELS TODAY.

BENJAMIN AIR RIFLE CO., 812 Marion St., St. Louis, (4) Mo.

## To PROTECT YOUR INVENTION—Use this coupon, NOW

Delays are dangerous and may be very costly. My personal service assures prompt action, strict confidence, and a minimum of expense. I suggest that you send me a model or drawing, or sketch and description of your invention, and \$5.00. I will make a search and report

promptly as to its patentability and send you a copy of my 72-page booklet. Or, if you prefer to read my booklet first, mail the attached coupon at once. I will also send my "Record of Invention" form. (Over 40 years experience as a Registered Patent Attorney.)

L. F. Randolph, 302-D Columbian Bldg., Washington, D. C.

Please send me at once, free of charge, your 72 page booklet and "Record of Invention" form.

Name .....

Address .....

### A PERSONAL CONFIDENTIAL PATENT SERVICE—

# WANTED: IDEAS!

Developed into the form of:  
NEW PRODUCTS • NEW  
PROCESSES • INVENTIONS

We have been retained by a number of companies desiring postwar products and processes. If your idea is acceptable an attractive contract for purchase or licensing will be arranged. Send copy of patent or drawings and description. Your information confidential. This service is free to you.



NEW PRODUCTS DIVISION  
**DESIGNERS FOR INDUSTRY, INC.**  
2915 Detroit Ave., Dept. M-7, Cleveland 13, O.

## LEARN AT HOME TO MOUNT BIRDS



Animals, Heads, Fishes, Pets; to TAN. Be a Taxidermist. Profit and FUN.

Hunters, save your valuable TROPHIES. Mount ducks, squirrels, everything. Learn to TAN for leather and furs. Wonderful HOBBY Have a HOME MUSEUM.—BIG PROFITS mounting for others. INVESTIGATE NOW.

**FREE BOOK** With 100 fine game pictures. NOW absolutely FREE. Write TODAY.

Send Postal TODAY for FREE BOOK. State AGE. N. W. SCHOOL OF TAXIDERMY, Dept. 337B, Omaha, Neb.

## LEARN MONEY-MAKING CARTOONING

IN SPARE TIME — by Easy Picture Chart Method

Same Simplified Method that has helped train creators of "Terry & Pirates," "Freckles," "Out Our Way," "Winnie Winkle," "Reg'lar Fellers," "Strange As It Seems," "The Neighbors," and many others. Earn while learning. Send 10c for Picture Chart (to test your ability), and full details. (State age.)

THE LONDON SCHOOL, 4407 National Bldg., Cleveland 14, Ohio



## AN INFANT INDUSTRY ... SUDDENLY MATURED PLASTICS

### Get In at the Start—and Grow

Plastics is a new industry which the nation's war needs is forcing to quick maturity. Already Plastics are indispensable in practically every branch of the Service—Aircraft, Ordnance, Chemical, Marine, Signal Corps, etc. Opportunities? Nearly everything, from homes to clothing, from gadgets to tools, will be affected by Plastics.

### Spare Time Training Now Ready

The time to get started is now. You can prepare at home, in your spare time, to take your place in an infant industry that even now is leaping into prominence. A new, practical training plan is now ready to help you realize your ambitions and build your future security. Act now. Don't delay. Mail this coupon today.

AMERICAN SCHOOL, Dept. PB45  
Drexel Ave. at 58th St., Chicago 37, Ill.

Send me FREE information covering special training in subjects checked below. No obligation on my part.

- |  |   |
|--|---|
| <input type="checkbox"/> Plastics                              | <input type="checkbox"/> Cost Accounting for Mfg. |
| <input type="checkbox"/> Electrical Engineering                | <input type="checkbox"/> Automotive Engineering   |
| <input type="checkbox"/> Drafting and Design for Men and Women | <input type="checkbox"/> Architecture & Building  |
| <input type="checkbox"/> Diesel Engineering                    | <input type="checkbox"/> Shipbuilding             |
| <input type="checkbox"/> Mechanical Engineering                | <input type="checkbox"/> Business Management      |
| <input type="checkbox"/> Aviation                              | <input type="checkbox"/> High School Course       |
| <input type="checkbox"/> Radio                                 | <input type="checkbox"/> Railway Training         |

Name.....  
Address.....

## HERE'S THE ONE WAY TO REALLY LEARN RADIO-ELECTRONICS and TELEVISION



FULL RADIO SET  
SUPPLIED for PRACTICE

### GET READY for BIG EARNINGS AHEAD

The offer I make you here is the opportunity of a lifetime. It's your big chance to get ready for a wonderful future in the swiftly expanding field of Radio-Electronics INCLUDING Radio, Television, Frequency Modulation, and Industrial Electronics. Be wise! NOW is the time to start. No previous experience is needed. I supply you with Radio Parts which you use to gain pre-experience in Repair work. These same Parts are used for testing and for Signal Tracing, etc.



### PREPARES YOU for a BUSINESS of YOUR OWN

... or Good Radio Jobs, Civilian or Military

The Sprayberry course starts right at the beginning of Radio. It gets the various subjects across in a clear, simple way. I make it easy for you to learn Radio Set Repair and Installation Work... by practical, proved, time-tested methods. I teach you how to install and repair Electronic Equipment. Soon you'll be qualified for a good paying job in one of the nation's Radio plants doing war work O.K. if you enter the Army, Navy, or Marines, my training will help you win higher rating and better pay.



### READ WHAT GRADUATE SAYS

"Wins Out in Army Test"

"Since I completed your elegant Course in Radio I have been drafted into the Army and put into the Signal Corps. I had to compete to get the job I now hold and as a result of my training with you, I made the best grade and got the job. The point I am driving at is if it hadn't been for your thorough course in Radio I would probably be peeling potatoes now. I recommend your training to all because it is written in language that the average layman can understand." — A R C H PLUMMER, JR., Fort Meade, Md.

Grasp This Opportunity!



GET BIG  
FREE  
BOOK

### MAIL COUPON

SPRAYBERRY ACADEMY OF RADIO

F. L. Sprayberry, President  
Box 500RG, Pueblo, Colorado.

Please rush my FREE copy of "How to MAKE MONEY in RADIO, ELECTRONICS and TELEVISION."

Name..... Age.....

Address.....

City..... State.....

(Mail in plain envelope or paste on penny postcard)

**WORLD'S  
BEST  
WANT AD  
MEDIUM**

# CLASSIFIED Advertisements



Advertisements in this section, 35 cents per word, each insertion, minimum 10 words, payable in advance  
To be inserted under proper classification in August issue, should be in our office June 20th

August issue on sale July 20th

Popular Mechanics Magazine, 200 East Ontario Street, Chicago, Illinois

## AUTOMOBILES—MIDGET CARS

**AUTOMOBILE Books.** "Racing photo album" 110 photos, exciting crashes, world's greatest race cars, drivers described, \$1.50. "Saga Roaring Road" 181 pages, 16 pictures. Starter Fred Wagner's early racing experiences with world famous drivers, cars described, read about Rickenbacker, Murphy, Burman, DePalma, Ford "999", Oldfield's Benz \$2.50. Automobile racing book \$1.10. Prices include reprints, illustrations, drawings army Jeep and German BMW war motorcycles. All postpaid. Clymers, 2125 W. Pico, Los Angeles 6, Calif.

**GARAGE Doors,** all types controlled from dashboard pushbutton. Thoroughly tested system. Amazingly simple, dependable. Materials inexpensive, obtainable everywhere. Complete "Build Yourself" plans \$1.00. Kaytor Laboratories, Lynwood, Calif.

**POWER AND Speed!** World's most famous motor book, 110 large pages, 200 illustrations racing automobiles, motorcycles, airplanes. World's speed record chart, articles by world's famous speed kings Cobb, Eyeston, Campbell, Bonneville record details, photos British racers. Describes cams, compression, valves, superchargers, international racing teams, German Auto-Union, Italian, French, British racer specifications, drawings. \$2.50 postpaid. Clymers, 2125 W. Pico, Los Angeles 6, Calif.

**AUTOMOBILE Racing book,** fifth edition, well illustrated. Instructions on building bodies, frames, engines, Ford A and B conversions. Plans AAA rules, specifications. Roadster racing, Indianapolis cars. \$1.00 postpaid, \$1.30 C.O.D. Ray Kuns, Dept. 47, Madisonville, Cincinnati 27, Ohio.

**FLOYD Clymer's Historical Motor Scrapbook!** 148 pages photographs, specifications, descriptions 250 early automobiles, motorcycles — including Chevrolet V-8, friction driven Plymouth, Ford "2" and "6", 3 cylinder Elmore, revolving engine automobile, Studebaker electric, Pope, Knox, Oldsmobile, Thomas, Sears, Maytag, Maxwell, Hupmobile, Mitchell, Rambler, Orient, Wayne, Brush, Peerless, Lambert, E-M-F, Flanders, Reo, Lozier, Selden-Ford patent litigation details, Lincoln truck, Overland, Marmon, electric, foreign cars, others. Interesting, educational, historical, humorous ancient motor history includes motorcycle section. \$1.50 postpaid. Clymers, 2125 W. Pico, Los Angeles 6, Calif.

**\$1.00 FOR Large photographic cuts** of racing cars and boats with price sheet direct from factory. R & R Mfg. Co., Box 546, Anderson, Indiana.

**1944 IGNITION Supercharger \$3.50.** Fast starting, mileage, pep. EG Sales Mfg. Co., 60 John St., New York.

**ENGLISH Automobile publication "Motor"** Interesting illustrations, descriptions, comments British automobiles. Published weekly, \$10 yearly, \$5.50 six months. Sample copy 50c postpaid. Clymers, 2125 W. Pico, Los Angeles 6, Calif.

**CUSTOMIZE Your automobile.** Illustrated, new restyling ideas, instructions, suggestions, specific model changes by simple methods. \$1. Speed Wheel, Box 723, Arcadia, California.

**STEAM Automobiles!** Send 25c for literature listing ninety different makes steamers once manufactured, illustrations, descriptions, specifications. Stanley, White, Locomobile, Ross, Grout, Lane, Doble, others. No cars for sale. Clymers, 2125 W. Pico, Los Angeles 6, Calif.

**DON'T Worry or stew over gas saving.** We save the deadly monoxide gas you burn to "drive your car longer." Start saving today. Send \$3 to Cook Equalizer, Bismarck, North Dakota.

**PROFESSIONAL Midget racers, motor-scooters, midget cars.** Parts, plans. Handbook catalog—50 illustrations, plans—20c. Midwest, 2557 Charlestown, Toledo, Ohio.

**AUTOMOBILE Racing Pictorial.** Photographs 236 world famous drivers, officials, personalities. \$1.00 postpaid. Clymers, 2125 W. Pico, Los Angeles 6, Calif.

## AUTO SUPPLIES AND EQUIPMENT

**CLYMER DeLuxe chromed spotlight** for automobiles, motorcycles, boats, hunters. Trigger switch, pistol grip handle, powerful beam, 32 cp., operates off any 6-8 automobile battery. Only few left, hurry. \$8.50 postpaid. Clymers, 2125 W. Pico, Los Angeles 6, Calif.

**WHIRLGAS Turbinator,** \$3, spins and vaporizes carburetor mixture. Increases mileage and horsepower; reduces monoxide. University and oil corporation tests. Wrench installs 15 minutes. Give auto make, year. John Hanley, 5719 Loraine, Detroit 8, Mich.

**AUTOMOBILE Generators.** Rebuilt generators for cars or trucks. O'Keefe, 7517 Merrill, Chicago.

**GASOLINE Saving device,** Chevrolet, Dodge, Plymouth, 1933-1938. Walert Company, 3429 North 10th St., Milwaukee 6, Wisconsin.

**1,000 MOTORIST'S** Needed to make gas saving test. Up to 30% savings. For free test offer write Vacu-Matic Carburetor Co., 7617-959 W. State St., Wauwatosa, Wis.

**HELP Protect your automobile** against theft. Simple, easy plan. Nothing to buy. Instructions 50c. John Ozeinovic, R. No. 1, Box 200, Lowell, Mass.

**SPECIAL: 30 Picked formulas and plans** for \$1.00. Reclaim used oil. Carbon remover. Puncture-proof your tires. Auto-top dressing. Antifreeze. Ignition supercharger. Run car on wood, coal or natural gas. Plus 20 more equally important formulas. Monroe-Methods, Box 4766-A, San Francisco 1, Calif.

**DUAL Mufflers.** California style fit Ford V-8, Mercury. Saves gasoline, increases power, beautiful deep tone. All attachments, pipes, etc. Easy installation. \$20.00 complete. Clymer's, 2125 W. Pico, Los Angeles 6, Calif.

**EXTRA Miles.** Drive 50 miles for each gal. gas used. Inexpensive to equip car yourself. Diagrams, instructions, \$1.50 cash or money order. Mechanic's Special, Box 54, San Bruno, Calif.

**NON-RATIONED!** Get formula and simple directions for mixing multi-purpose solvent cheap as gasoline. Use for pressure stove fuel, dry cleaner, high grade engine fuel. Law prohibits use in motor vehicles, boats, planes. Send \$1.00. "Organic Solvents," Box 4931, Miami, Fla.

**SAVE! Used, guaranteed parts** all cars; transmission specialists. Describe needs fully! Immediate reply. Victory, 2439-1/2 Gunnison, Chicago 25.

**THROW Gasoline** against storm. Returns, vapor. That's how Stor-Mo Vaporizer adds mileage. Build yourself, it's simple, results good. Plan 85c. J. Friesen, B-65, Winkler, Man., Can.

**GAS Tank guard** prevents siphoning. Fits all cars, 50c. George Bacalles, Corning, N. Y.

**PORTABLE Folding stove.** Vest pocket size. Condensed tablets supply quick, clean, safe heat. Campers, vacationers, service men. Quickly heats coffee, soups, canned foods. Weighs ten ounces. Stove complete with 39 heat tablets \$1.50 postpaid. Clymers, 2125 W. Pico, Los Angeles 6, Calif.

**PRESERVE Your tires** with plastic, and puncture proof your tires. Details for stamp. Betke, Box 899, Borger, Texas.

**PLATING Outfits** for auto parts. Connect to a battery. No tanks used. Free particulars and proofs. Gunmetal Co., Ave. J, Decatur, Ill.

**ATTENTION: Run your car on** ((natural or artificial gas)) without alteration to your carburetor or gasoline system. Photo, blueprints, and literature giving approximate cost, size of tank, pressure, mileage, instructions, etc. \$1.25. Harper's Machine Shop, 218 - 22nd Street, Dunbar, W. Va.

**SAVE Gas.** How I increased my mileage over 150% is a copyrighted article which may help you to get more mileage. Postpaid \$1.50. Copyright also offered for sale. Interested? Write, W. Orr, Box 810, Frankford, Ont., Can.

**OPERATE Cars, trucks, tractors, motors,** with wood or coal gas, 1/2 cost of gasoline. Extensively used in Europe. Complete detailed instructions \$1.00. W. M. Cross, Lone Rock, Wis.

**THE Lord is coming!** Get guaranteed proofs free. Scheall, 263XA, Duluth, Minnesota.

## AUTO TRAILERS

**VACATION Cottages.** Easy towing; optional gasbooster. Non-priority, individualized plan service. Archtrailer, 5133 N. 25th Pl., Arlington, Va.

**BUILD Your own trailer!** Plans \$1.00 each. House, sport, camp, utility trailers. Catalog 10c. Jim Dandy, Box 125-A, Wausau, Wisconsin.

## MOTORCYCLES, BICYCLES, MOTOR SCOOTERS AND SUPPLIES

**ENGLISH Magazine "Motorcycling"** published weekly. Interesting specifications, illustrations, description British motorcycles. Racing, past and future models discussed. \$10 yearly, six months \$5.50. Sample copy postpaid 50c. Clymers, 2125 W. Pico, Los Angeles 6, Calif.

**PARTS And service** for most motor-scooters using Lauson or Briggs and Stratton motors. 3.50 x 6 tires and tubes available with ration certificate. Send for our pamphlet describing our new centrifugal clutch which will operate on most motor scooters. American Moto Scoot Company, 1305-23 W. Carroll Avenue, Chicago 7, Ill.

**CONVERT Your bike** into an electric motorbike. Simple, practical. \$1.00 brings drawings, specifications, instructions. Mowery, Box 994, Lancaster, Penna.

**BOOKS!** "Modern Motorcycle Mechanics and Speed Tuning," 435 pages maintenance Harley, Indian, Villiers, all British motorcycles \$2.50; with drawings, specifications, illustrations U. S. Army Jeep, German BMW war motorcycles \$3.00; "Motorcyclist's Workshop" \$1.50; "Two Stroke Motorcycles" \$1.50; "Motorcycles—How Manage Them" \$1.50; "Speed—How to Obtain It" \$1.50; "Historical Motorcycling Facts" \$1.00; "Automobile Racing" \$1.10; Motorcycle instruction manual "question-answers" \$1.10. All postpaid. Clymers, 2125 W. Pico, Los Angeles 6, Calif.

**FACTORY Moto-scoot \$50;** motorcycles \$30 up; midget cars \$60 up; gasoline motors \$4 up; unrationed wheels, tires, parts cheap. Send 25c for big war-time bargain catalogue. Midget Motors Directory, Athens, Ohio.

**PARTS.** Complete motor parts list. Pistons, all sizes, chains, sprockets, for Indian, Harley, 10c. Boots, 623 East Grand, Des Moines 9, Iowa.

**BLUEPRINTS** To make your own motorbike \$2.50. O. Martin, 723 Parker Ave., Beloit, Wis.

**HARLEY-DAVIDSON Parts, accessories,** late models. Carl Bush, 518 Broad St., Newark, N. J.

**MOTORCYCLE Cylinders** metallized and ground to any size desired. Scored and cracked cylinders repaired. Stahl Machine Co., Tiffin, Ohio.

**MOTORBIKE And scooter manual.** Containing motorbike and scooter plans, supply catalog and helpful hints, \$1.00. Variety Enterprise, Box 5, Station A, Evansville, Ind.



FLOYD Clymer's Historical Motor Scrapbook! Just out. 148 pages, photographs, specifications, descriptions 250 early motorcycles, automobiles, including Pierce "4", Merkel, Pope, Yale, Thomas, Harley, Indian, Marsh, Reading, Thor, steam motorcycle, Ace, Cleveland, Dayton, Minneapolis, front wheel driven motorcycles and scooters, British, German, French, Swedish makes. Auto section includes Chevrolet V-8, friction driven Plymouth, Ford "2" and "6", revolving engine car, steamers, electric, Brush, Pope, Maxwell, Studebaker electric, Sears, Knox, Maytag, Huppmobile, Orient, Rambler, others. Interesting, educational, humorous ancient motoring history. \$1.50 postpaid. Clymers, 2125 W. Pico, Los Angeles 6, Calif.

**MOTORCYCLISTS**—New and used parts, accessories, all models. Catalog 10c. Henderson catalog 10c additional. Triangle, 2157 Harrison, Chicago.

NEW Book just out. English Motorcycle Manual. 68 large pages complete authentic factory servicing information British war and civilian motorcycles. 140 illustrations, diagrams, drawings, engines, transmissions, Enfield, Norton, Triumph, B.S.A., Matchless, Ariel, Velocette, Burman, Lucas ignition, B.T.H. Magneto, Miller lighting sets, hydraulic forks. Wonderful book British owners, interesting, educational any motorcyclist. \$1.50 postpaid. Clymers, 2125 W. Pico, Los Angeles 6, Calif.

**TIRES** And industrial wheels, suitable for scooters, wheelbarrows, farm equipment, etc. All sizes. Bicycles and accessories. Largest assortment in America. Send dime for list. Cycle Transport Company, 1241 So. Michigan Ave., Chicago 5, Illinois.

FLOYD Clymer's Motorcycling Manual. 144 pages. 120 illustrations. Complete information, specifications, descriptions dozens motorcycles. Engines, transmissions, carburetors, square four, two piston singles, sleeve valve engines, overhead camshafts, water cooled motorcycles, spring frames, hydraulic forks, sidecars, riding instructions. Two cycle engines and power bicycles described, illustrated. Just out \$2.00 postpaid. Clymers, 2125 W. Pico, Los Angeles 6, Calif.

**PARTS, Accessories, pistons, chain for Harleys and Indians.** McCann's, 2104 Texas Street, El Paso, Texas.

BOOK "Speed—How to Obtain It." 160 pages, illustrated, instructions, cams, balance, timing, valves, pistons, racing technique. World's greatest speed tuning book. \$1.50 postpaid. Clymers, 2125 W. Pico, Los Angeles 6, Calif.

**ATTENTION** Motorcycle owners. 1944 publication covering trouble saving tips on Indian and Harley Davidson motorcycles. Full line of new and used Indian parts. Large supply Harley Davidson parts new and used. Price 25c a copy. Copy price refunded on first order of \$2.00 or more. Preston Motors, Inc., Kendallville, Ind.

**"MOTORCYCLES—How to Manage Them,"** 260 pages, 175 illustrations, drawings. Read it, become a better motorcyclist. Expertly written. \$1.50 postpaid. Clymers, 2125 W. Pico, Los Angeles 6, Calif.

**HARLEY-DAVIDSON** 24 h.p. twin 45 motors. Perfect condition. \$85.00 and up. Latest design. Used to power farm equipment, ice sleds, midjet cars, etc. Used Harley-Davidson parts. Send 25c for bulletin and 45 service manual. Knuth's, 2491 Fondulac, 6, Milwaukee, Wis.

**SAVE Gasoline, build a motorbike now,** send 25c for complete plans. Motorbike Service, 2108 McLean, New Albany, Ind.

100 MILES Gallon! Motor-scooters, motorcycles, Whizzer bicycle engines, midjet automobiles, gasoline engines. No priority necessary. Catalog 10c. Clymers, 2125 W. Pico, Los Angeles 6, Calif.

**BOYS:** "All bicycle repair secrets revealed." Bicycle repair manual, 65c. R. G. Klausner, Shelbyville, Ill.

**PLANS, Seal drawings, specifications, illustrations for building attractive motor scooter complete \$2.00; plans electrically driven bicycle \$1.50. Postpaid.** Clymers, 2125 W. Pico, Los Angeles 6, Calif.

### AVIATION

**AIR Mechanics Manual** by Zweng covers aircraft and engines. Multiple choice examinations \$3.00 postpaid. Pan American Navigation Service, 12021 Ventura Blvd., North Hollywood, Calif.

**AIRPLANES, Motors, crackups, cheap.** Send 25c for big war-bargain catalogue. Used Aircraft Directory, Athens, Ohio.

**PROPELLERS** Of quality, all types, 3 blade Airliner for sleds, boats. Motor conversion diagrams 50c. Literature free. Standard Aircraft, Ft. Worth, Texas.

**AERO** Fact book. Just out. Complete history of flying from 1783 to 1944. Seven hundred most important dates in aviation history with what happened and who did it. Names, descriptions, warplanes of leading nations. Origins of planes and companies. Airplane production figures. Hundreds of other facts. Most accurate and complete ever compiled. Only \$1.00 postpaid. White Publications, Dept. A, Postoffice Box 106, Los Angeles.

NEW Lightplane manual. Sportplane manual. Lightplane blueprints, etc. Circulars 20c. Craftsman Books, Box 1153PM, Milwaukee 1, Wis.

### ELECTRIC FENCING

**ELECTRIC Fencers** \$3.50 and up. Write to: Wholesale Fence, Hales, Corners, Wis.

### BATTERIES, GENERATORS, ETC.

**EDISON Batteries.** Light. Power. Fifteen year life. Five year guarantee. Complete lighting plants. Free literature. See Jay Company, 321 Yonkers Avenue, Yonkers, New York.

### ELECTRICAL SUPPLIES, EQUIPMENT

**EXPERIMENTERS**—12 Inch neon tubes, red or blue, \$2.00; fluorescent, any color, \$3.00. Quartz ultra violet U-tubes, \$10.00. Shipped prepaid. Rayo, 2304 W. 7th Street, Los Angeles 5, Calif.

**ELECTRO-MAGNETS**—Plans for building—\$1.00. Terry Sales, Central Station 1676, Toledo, Ohio.

6 FT. Ironing cords \$1.00, with switch \$1.50, replacement elements \$1.50. Marko Supply, 2924 Logan Blvd., Chicago 47, Ill.

**ELECTRICAL Appliances repaired,** see our ad page 170. Advance Mfg. & Dist. Co.

**ELECTRICAL Appliance repair.** Open your own shop. Learn house wiring; electric motors, vacuum cleaners, washers, etc. Complete illustrated course shows how. Free booklet. Pacific School, Dept. AP83, 4703 West Pico, Los Angeles 6.

**ALL Sizes electric plants, a.c.-d.c.** 350 watts to 40 kw. E. F. Schmalz, 215 Wyoming Ave., Kingston, Penna.

**ELECTRIC Pencil:** Writes-engraves all metals. \$1.00 postpaid. Beyer Mfg., 4515-H Cottage Grove, Chicago 15.

**NOW—Repair your own electrical appliances** with Chanite Self-welding Electrical Heating Element Flux. Instructions delivered, price \$1.00. Chanite Sales Company, 914 South Main, Fort Worth, Texas.

**ELECTRIC Fans**—Correctly balanced 16" aluminum blades, 1/2" bore, \$3.00; heavy guard, \$2.00. Use 1/4-1/2 h.p. electric motor and make your own fans. Ted Rise-man, 427 E. Jefferson, Springfield, Ill.

### WELDING, SOLDERING, PLATING

**A.C. Welding rods d.c. (mild steel)** 50 pound cartons without priority. (Minimum order \$5.00.) 1/8" 10c. 5/32" 9c. 3/16" 8c pound f.o.b. Welders Club, AB-3432, Chicago 54.

**WELDERS** Make your own flux for brazing dirty, rusty castings. Write for free sample. Metallurgical Formula Service, 2218 Dellwood Ave., Jacksonville, Florida.

**A. C. Arc welders!** 125 amps. \$35. Welder for thin metals \$50. 200 amp. production welder \$100. Priority. Frazee Electric Co., Box 5086, San Francisco 1, Calif.

**NEW Model electric welder** 110 volt a.c.-d.c.; will weld all metals; easy to use; full directions. Complete with power unit, flame and metallic arc attachments, carbons, fluxes, rods, mask; all for \$19.95. Used by the navy. Magic Welder Mfg. Co., 239-MP7 Canal St., New York City.

**BUILD Large, medium or small a.c. or d.c. arcwelder.** Plans \$1.00 each. Welders Club, AB-3432, Chicago 54.

**WELDING Equipment, new, used.** Bought and sold. List equipment or "wants" free. Write Phillip Wilson, 1341-A "E-st.", Napa, Calif.

110 VOLT, 60 Cycle arc welders, 125 amps. 6 heats. \$35. Others. Frazee Electric Co., Box 5086, San Francisco, Calif.

**ARC Welders** wanted by the thousands. Learn with 516 page lessons manual. Over 500 how-to-do-it photos. \$2.00 copy. Money-back guarantee. Hobartweld, Box M-744, Troy, Ohio.

**ELECTRIC Arc welder,** costs less than \$1.00, easy to make from available scrap. Startling discovery. Guaranteed to weld. No toy. Mail \$1.00 for complete directions to make and operate, or write for further information. "International," Incorporated, 6347 Parnell Q, Chicago 21, Illinois.

**SLIGHTLY Used arc welders.** Recommended by R.E.A. Guaranteed. Forney Mfg. Co., Fort Collins, Colo.

**ALL Purpose electric welder** uses 110/220 volts a.c. Continuous output 30 to 160 amperes. Handles 1/16" to 3/16" electrodes. Light or heavy production, maintenance, repairs. Vernier type controls. Farms, garages, shops, factories. Fully guaranteed. Headshield, electrode holder, cables, electrodes, instructions, ready to use. \$135.00 f.o.b. Chicago. Other sizes, accessories, supplies. Circulars. Williams Sales Company, Box 4109, Portland 8, Ore.

**MAGIC Arc electric welder** has 999 uses. New model welds all metals, used by electricians, plumbers, garages, navy, many large industrial plants. Complete with all supplies, mask, rods, fluxes, instructions, \$19.95 postpaid. Immediate shipment. Literature. Sine Equipment, P376W, Quakertown, Penna.

**SUPER Welder**—For home, farm, factory. Makes even beginner an expert. Improved on type used by Navy. Fully equipped with Metallic Arc and Flame Torch handles, carbons, rods, fluxes, mask, etc. Complete directions. Operates ac-dc, 110 volts. No extra wiring needed. Guaranteed, \$19.95. Save 2%, send check with order. Super Welder Manufacturing Co., Dept. A, 23 East 20 Street, New York.

**WELDING, Cutting, aircraft welding and soldering equipment.** Electric arc welders. Superior Oxy-Acetylene Co., Hamilton, Ohio.

### MACHINERY, TOOLS AND SUPPLIES

**DRILL Grinder**—The original patented precision sharpener. Use with any bench grinder—No special fittings. Grinds drills to factory accuracy. \$9.15. Calipers, with direct reading scale, 4" inside \$2.00, outside \$1.75. 6" steel scale with magnifying lens \$3.00. Circle cutters for steel, plastic, etc. \$3.50. New tool grinder \$34.50. Free literature. Factory, 811-B East 31st, Kansas City 3, Mo.

**SIMPLEST, Cheapest drill grinder,** \$1.98 postpaid. Dealers inquiries invited. Factory, 3410 Alameda, Burbank, California.

**LEWIS Castings, materials and blueprints** are the ideal means of equipping home, school or commercial machine shops—at unbelievably low cost! Mills, shapers, vises, drill presses and many other tools are quickly and easily built from Lewis Supplies—right in your own shop. Send 10c to cover mailing of descriptive catalog listing 23 items. Lewis Machine Tool Co., Box 116, Station A, Dept. M-42, Los Angeles 31, California.

**PATTERN** And model maker supplies, tools, gas engine castings, unbreakable handle screwdrivers, send 10c for 4" size and free catalog. Terek and Sons, 6304 W. Patterson, Chicago.

**LAWN Mower sharpener.** Simple in design. Build it yourself. Plans \$1.00. Scott Hess, Dover 1, Penna.

**MICROMETERS** New 0-1" \$5.95; 1-2" \$7.95; 2-3" \$9.95; 3-4" \$10.95. Set of 4, in handsome, durable case, \$34.50. Reading in 1/1000". Precision. Guaranteed. C.O.D. plus postage. Cash orders prepaid. Examine five days. If unsatisfactory return for full refund. Wender Co., Dept. 12A, Fremont, Ohio.

**DRILL Grinding attachment,** \$5.95. Centering tool, \$3.95. Offset center punch, 3/4", 40c; 1/2", 60c. Zenick Company, 327 California, Burbank, California.

**GARAGE Doors** dashboard controlled. Look under "Automobiles."

**MAKE Your own electric hammer** in five hours with material obtainable without priority. Large or small. Engrave, chisel, cut metal, plastics, plywood. No coils to wind. Costs little to make your own with our instructions \$2.00. Order from this ad on money back guarantee or write for free details. Houston Maupin, Tipp City 2, Ohio.

**STEEL Beam trammels** for draftsmen, engineers, mechanics. Circular free. Clair Company, Box 92M, Blythebourne Station, Brooklyn, N. Y.

10" **STEEL Wire wheel brushes,** interchangeable centers for buffing. McCann's, 2104 Texas Street, El Paso, Texas.

**GRIND Drills** any twist in three different drill point angles like factory. \$2.95 prepaid. Guaranteed. Factory, 1512 West Slauson, Los Angeles 44, Calif.

**INDEX Heads** for sale. Very inexpensive. Sixty-two different divisions. Used on small lathes, drill presses, milling machines, etc. Make gears, hobbs, cutters, etc. Very accurate, and durable. Not a toy. Used by defense schools and hobbyists. Write for free folder. Long's Index Heads, 2117 East B St., Torrington, Wyo.

**CONCRETE** Building block machines and molds. Easy payments. Catalog free. Concrete Machine Co., 5129 South Compton Ave., St. Louis 11, Mo.

**ASSORTMENT** New, used high-speed tools. Box 493, Flint, Mich.

#### BOATS, OUTBOARD MOTORS, ETC.

**TEN Plywood boat plans** 50c. Catalog boat building plans 10c. The Rudder, 15 Murray Street, New York.

**ELECTRIC** Outboard motors can be built from available parts with our 7 page working drawings and step-by-step instructions. Price \$1.00. Silver Creek Precision Corp., 2 Mechanic St., Silver Creek, N. Y.

**BOAT** Designers are highly paid professionals. Complete course by mail. Catalog. Westlawn, Montville, N. J.

**SAIL** Your rowboat! Mast, boom, sail, \$12. Trysall, Brewster, N. Y.

**INDIAN** Silver Arrow outboard motor parts. Indian Motorcycle Sales, Inc., 354 Columbus Avenue, Springfield 5, Mass.

**MARINE** Power—Easily convert any Ford motor (domestic and foreign) with Osco parts and kits. Complete catalogue 25c (coin). Osco Motors Corp., 2020 East Orleans Street, Dept. M, Philadelphia 34, Penna.

**USED** Outboard motor parts. Outboard Exchange, 1194 Remsen Ave., Brooklyn, 12, N. Y.

**FULL** Size, cut to shape boat patterns, blueprints, 7 1/2 - 38 feet. Illustrated "Build a Boat" catalog, 10c (coin). "How to Build Boats" book, \$1.00. Cleveland Boat Blueprints Co., Station A-66, Cleveland, Ohio.

**OUTBOARDS** — Save 1/2. Good used parts, all makes and models. Bargains rebuild motors. Crandall Hicks Co., 959 Commonwealth, Boston, Mass.

#### ENGINES, MOTORS, DYNAMOS

**ELECTRIC** Motors, generators, converters, 1/4 to 5 h.p., a.c. d.c. Also soda carbonator, a.c. to d.c. rectifier battery chargers. Temps Bros. Motor Company, 609 Myrtle Avenue, Brooklyn, New York.

**BIG** Pay jobs in welding. Complete welding lessons and reference books, 516 pages, 41 lessons, \$2.00 copy. Money-back guarantee. Hobartweld, Box 745-M, Troy, Ohio.

**AUTHORIZED** By W.P.B. to sell inventory of new a.c. and d.c. midget motors—Both geared to 4 r.p.m. Shaft speed 1250 r.p.m. 110 volts. Ideal for timing devices, displays, models. Bargain price a.c. motor \$2.00. Length 3", height 2 1/2", width 2 1/2", d.c. \$3.00. Length 5 1/2", height 2 1/2", width 3". Add 25c for postage. McLaren Products Company, 114 N.W. First Street, Evansville 8, Ind.

**"SIMPLEX** Motors." Rotary and semi-rotary. Fractional h.p. sizes. For water, oil, air, steam. Pressures, 40 lbs. and up. Duplex Motors, Burlington, Iowa.

**WINDING** Data, listing 225 motors, single and three phase, \$1.00. Motor Data Co., Box 7631, Kansas City 3, Mo.

#### ATHLETIC EQUIPMENT—BODY BUILDING COURSES

**HANDBALANCING** Easily learned. Write W. Power, 923 W. Vine, Kalamazoo, Michigan.

**LEARN** Guerrilla self-defense. Beats Jiu-Jitsu. Circular free. Crown Books, Charlotte 4, Mich.

**BAR-BELLS**, Exercise equipment. Courses, Special offers! Free booklet. Good Barbell Co., 3261-PM Watson Rd., St. Louis (9), Mo.

**SUPER** System of natural physical training. Free booklet. Harry Good, 3261-PM Watson Road, St. Louis (9), Mo.

#### SPORTING GOODS, GUNS, FISHING TACKLE, ARCHERY, TRAPPING

**NETCRAFT** Kit—Make landing nets, turtle traps, live nets, hammocks. Dollar bill brings: large, medium, small shuttles (patented), gauges, illustrated instruction booklet. Smaller kit—Medium shuttle, gauge, booklet—50c. Netcraft, Dept. B, Toledo, Ohio.

**SUPERWAX** Preserves, waterproofs canvas, rope, leather. 1 1/2 pounds (gallon size), \$1.00 postpaid. Superwax, Box 1492-A, Milwaukee 1, Wisconsin.

**WILL** Pay \$27.50 per thousand of 22 shorts shells. Will buy any amount. Ship railway express c.o.d. Payment guaranteed. J. Zotter, 423 12th St., Oakland, California.

**"HANDARMS," "Rifles," "shotguns"**—sold with generous amount of ammunition. List 10c. Commando sheath knives, free circular. Rudolph's, Atchison, Kas.

**EXPERT** Gunsmithing, repairs, chrome plating, barrels shortened. Estimates furnished. Kenlix Company, 406 Morgan, Tampa, Florida.

**SEND** 10c For list 100 used guns. Prayseth's, Willmar, Minnesota.

**ARCHERY**, "Registered Arrow" sets and equipment. List 10c. Rudolph's, Atchison, Kansas.

**ARCHERY** Equipment: Catalogue free. Mid-West Archery, 2209-A East 75th, Chicago 49.

**ELEVEN** Good box traps. Complete blueprints, 30c. Wesho-Uco, Box 51, Detroit, Mich.

**"HOW** To Mount Fish as a Hobby," \$1.00. Lewis Enholm, 19 Newfield St., Wollaston, Mass.

**SNOWSHOES**: Immediate delivery, replacing also. Send card for sizes available. Howe Fur Company, Coopers Mills, Maine.

**BOWS**—Arrows for recreation, hunting, fishing. Beautiful archery instruction book, 90 pages, 50 illustrations, only 50c. Illustrated catalogue free. Archery Sales Service, 617 South State, Chicago.

**THE** Lord is coming! Get guaranteed proofs free. Scheall, 263XS, Duluth, Minnesota.

#### FIELD GLASSES, TELESCOPES, MICROSCOPES

**POWERFUL** Telescope lens kit—Consists 3" diameter 75" focus objective—50X and 100X astronomical eyepiece. Build six foot refracting telescope. Guaranteed show moon's craters, rings Saturn, moons Jupiter, double stars, etc. While they last \$1.95 postpaid. With 50X terrestrial eyepiece \$2.95. Also experimenters 16 piece optical kit—includes 12 assorted lenses combining into numerous optical hook-ups \$1.00. Stamp brings literature, telescope construction plans, test chart for measuring definition—power—field any telescope or binoculars. Pfeegor Optical Co., P-7, Sunbury, Penna.

**MAKE** Your own 100X astronomical telescope. Perfect lenses and instructions \$1.00. Carl Jamer, Manorville, N. Y.

**INSPECTOR'S** Lenses magnify and leave hands free. Magni-Focuser Binocular Eyeshade magnifies object three times actual size. Sharp focus about ten inches from forehead. Send \$8.50 for ten-day trial. Money-back guarantee. Shipped postpaid. Stanley Fluid-Lite Magnifier, bench type, \$24.50 cash. Priority required. N. L. Huebsch, Box 83, East Williston, N. Y.

**MICROSCOPES**, Telescopes, binoculars: all scientific, chemical laboratory apparatus—bought, exchanged, repaired. Exclusively our business with a background of over 17 years of courteous, satisfactory dealing. Not get-rich-quick speculators. Trial will show we know equipment; highest prices paid. Harry Ross, 68 West Broadway, New York.

**MAKE** Your own compound microscope. Lenses and instructions, 50X \$1.00, 100X \$1.50, 200X \$2.00. Carl Jamer, Manorville, N. Y.

**ASTRONOMICAL** Telescopes, binoculars, cameras, microscopes; bought, sold, repaired. Send 10c for list of instruments wanted. Rasmussen & Reece, 41 Market, Amsterdam, N. Y.

**MICROSCOPES**—15 Years buying, selling, exchanging, repairing, accessories, research, industrial, amateur. National Scientific Instrument Co., 119 Chambers St., New York City 7.

**BINOCULARS**, Field glasses, watches. Buy, sell. Paul Schweer, Donnellson, Ia.

#### ANTIQUES, RELICS, INDIAN GOODS, CURIOS

**RELICS**, Minerals, coins, miniatures. Catalog 5c. June's Antiques, Northbranch, Kansas.

**SWORDS**, Rapiers, daggers, pistols, armor, illustrated catalog 25c. Robert Abels, 860-A Lexington Ave., New York.

**MINERALS**, Coins, stamps, Indian relics, pistols, old glass. Catalogue 5c. Cowboy Lemley, Las Cruces, New Mexico.

**25** GENUINE Indian arrowheads, \$1.00. Catalog. Geo. Holder, Glenwood, Ark.

**INDIAN** Relics, coins, bills, gems, crystals, curios, etc. Illustrated catalog 5c. 100 ancient arrowheads \$3.00. H. Daniel, Hot Springs, Ark.

**INDIAN** Relics, beadwork, coins, curios, minerals, old glass. Catalog 6c. Indian Museum, Osborne, Kansas.

#### DOGS, PETS, BIRDS, RABBITS

**RABBITS**—New Zealand Reds, Whites, Chins. Pigeons—White, Silver King, Race Homers. Bay Farm, 20531 E. 14th, Hayward, Calif.

**WILD** Geese, ducks, peafowl, pigeons, rabbits, pheasants. Prices free. Jewell Game Farm, Danville, Ill.

**RAISE** Guinea pigs. Make money at home. Big demand by army, navy, laboratories. Booklet free. Taylors Guinea Pig Farm, Hapeville, Georgia.

**PEDIGREE** White New Zealand rabbits, white mice, canies, hamsters. Folder 10c. Fairfield Rabbit Farms, Caldwell, N. J.

**RABBIT** Breeding stock for sale. Free pricelist. 64-page booklet, "Profitable Rabbit-Raising," 15c per copy. Folio, "How and Where to Raise and Sell Rabbits," 10c. Small Stock Farms, 606 King, Fairfield, Ill.

**WANTED**—25,000 Meat rabbits. Will contract for entire production. Will quote present prices that we are paying for 3c stamp. Small Stock Farms, 606 King, Fairfield, Ill.

**RAISE** Your own meat—also make money raising pigeons. Booklet dime. Gebhardt Farm, Muscatine, Iowa.

**RABBIT** Hutch—Sanitary, odorless, self-cleaning! No opening doors to feed, water, supply hay. Most practical and scientific hutch made. Plans, specifications \$1.00. Angora rabbits—wool brings \$9.00 pound; catalog free. Grinsteads, Dept. 15, Edwardsville, Illinois.

**MICE**, Rabbits, pigs, pigeons. Information 10c. Jim Houck, Tiffin, Ohio.

**PUPPIES**, Also supplies, what do you need? Books colored pictures, descriptions 108 recognized breeds, 35c. Royal Kennels, Chazy, N. Y.

**RABBITS**: Flemish Giants, New Zealand, Reasonably priced. Franklin Young, Riverhead, Long Island, New York.

**MOST** Beautiful fur. Small investment. Large profit. Free illustrated booklet. Willow Brook Farm, R. D. 15, Sellersville, Penna.

**BIRD** Fanciers, American Canary Magazine Monthly, Year's subscription \$2.00. 2839-P N. Halsted St., Chicago 14, Ill.

**RAISE** Rabbits for profit. Magazine puts you in touch with markets. Copy 10c. Booklet describing twenty breeds and magazine for three months 25c. Address Small Stock Farmer, Dept. 3, Pearl River, N. Y.

**MONEY** Raising rabbits. Investigate. Folder 10c. Close Rabbitry, Tiffin, Ohio.

**RAISE** Highly profitable Angora rabbits. Multiply fast. Wool \$8.50 pound. Plenty markets. Particulars free. White's Rabbitry, Marion, Ohio.

#### FARMS, FARM LANDS, REAL ESTATE

**READY** Now—160 acres including 32 head stock, crops time of sale, only \$3,500! Gravel road, cream route, 35 cultivated, more tillable, woods pasture, 3 springs, merchantable firewood, timber, 150 pear trees; 4-room fair house, walnut shade, brooder house; taxes \$9 last year; act now, only \$3,500 equipped, \$2,000 down. Free catalog. United Farm Agency, 7-MP South Dearborn, Chicago 3, Ill.

**OZARK** Lands for all purposes. Actual river frontages. 5 acres \$90.00 and upwards. Free list and literature. Hubbard, 216 Crossman Bldg., Kansas City, Kansas.

**FARM** Catalog mailed free. Hundreds of bargains New York, Connecticut, New Jersey and 21 other states Maine to Fla., west to Texas, California and Oregon. Strout Realty, 255-P 4th Ave., New York City 10.

**OZARK** Farms, Large, small. Bargain prices. List free. Frank, Mountain View, Missouri.

**MINNESOTA'S** 10,000 Lakes calling you. 40 acres unimproved land \$300.00. Theo. Gau, Pierz, Minn.

**WISCONSIN**, Minnesota lake frontage \$7 acre. Dept. 54-A, Brainerd, Minn.

**FLORIDA** Farms, groves, near Orlando, Tampa, other places. Deal direct with owner. Richardson, Wyoming, Penna.

**OBTAIN** Free fertile South-American lands yielding four annual crops. Others \$1 acre. 25c brings valuable illustrated information. Valles, 311 Church Street, New York 13.

**SEE** The Highlands of Louisiana where winter brings no idle acres. Choice cut-over land at low prices with terms. Send for descriptive book without obligation. Long-Bell Farm Land Corporation, 896 R. A. Long Bldg., Kansas City, Mo.

**BEAUTIFUL** Ozark farms, lands. Low prices, post-war security. Don't buy blind. Our plan saves money, disappointment. Details 25c. Ozark Land Scouting Service, 408 Bellefontaine, Kansas City 1, Mo.

**GOOD Farm bargains.** Washington, Minnesota, Montana, Idaho, Oregon, North Dakota. Dependable crops, favorable climate. Write for literature, lists describing typical farms. Specify which state. J. W. Haw, 119 Northern Pacific Ry., St. Paul, Minn.

#### FARM MACHINERY AND SUPPLIES

**TRACTOR** With front cultivator made from auto and truck with less work, good traction, pulls 16 in. plow. Design \$1.00, week for refund. O. C. Lytle, R. 1, Kittanning, Penna.

**ELECTRIC Fence controllers,** electric fly traps, insect killers, chick brooders, lamb brooders, electric dehydrators. Gardenhour Mfg., Waynesboro, Penna.

**INTERNATIONAL Electric fence** far superior, more effective and reliable. Quick-ly pays for itself. We repair all makes of electric fences. Dealers wanted. International Electric Fence Co., 910 Van Buren St., Chicago, Illinois.

**BUILD Your tractor from second-hand automobiles.** Convert your horse drawn farm equipment into tractor drawn equipment. Nolan's Garage, East Wareham, Mass.

#### POULTRY, FARM SUPPLIES

**POULTRY** Shipping coops—New design, strong construction. Write: Burbank Seed Company, Department P, 20 Free Street, Portland, Maine.

**RAISE Turkeys** the new way. Write for free information explaining how to make up to \$3000.00 in your own back yard. Address National Turkey Institute, Dept. 3, Columbus, Kansas.

#### PROFITABLE OCCUPATIONS

**WELDING Pays.** Learn with 1942 trade school text manual. 516 pages. Over 500 photos. \$2.00 copy. Money-back guarantee. Hobartweld, Box M-743, Troy, Ohio.

**MECHANICALLY Inclined men**—Own and operate general appliance repair shop. Complete, illustrated course shows you how. Welding, refrigeration, motor repair, how to get business, etc., all phases covered. Free literature. Christy Supply Dept. 442, 2835 N. Central Ave., Chicago.

**LOCKSMITHING** Now made easy! New course teaches you how to pick locks, fit keys, de-code, masterkey, etc. Self-instruction lessons. Bargain price. Free details. Write Nelson Company, Dept. 7-02-2, Chicago 4.

**ANNOUNCING** New home study course in commercial baking. Good field. Nearly depression proof. Common school education sufficient. Send for free booklet "Opportunities in the Baking Industry" and requirements. National Baking School, 1315 Michigan, Dept. 343-B, Chicago.

**SELL Envelopes** by mail. Big profits. Omaha Envelope Service, Dept. 24, 4721 California, Omaha 3, Nebr.

**MUSHROOMS** Grown in boxes. Instructions 25c. Spawn \$1.00. Gordons, 553 William, Winnipeg, Manitoba.

**"FROG Raising"** profitable—Interesting. New book tells how! Free literature. Write today! Marlboro House, 1035-P, Marlborough, Detroit 15, Mich.

**LEARN Refrigeration mechanics.** Start your own repair shop. Complete illustrated course. Free booklet. Mechanics School, Dept. PM10, 4703 West Pico, Los Angeles 6.

**SIMPLIFIED** Chemical gardening, folio 50c. Gordon, 553 William, Winnipeg, Canada.

**ELECTRICAL Appliance repair.** Open your own shop. Learn home wiring; electric motors, vacuum cleaners, washers, etc. Complete illustrated course shows how. Free booklet. Pacific School, Dept. AP81, 4703 West Pico, Los Angeles 6.

**MONEY Raising frogs;** folio 50c. Alvin, 553 William, Winnipeg, Manitoba, Canada.

**STANDARD Rabbit Journal,** Milton, Pa. 3 years \$1.00, sample dime.

**EXCEPTIONAL** Profits raising mink. Finest breeding stock available. Details furnished. Franklin Young, Riverhead, Long Island, New York.

**SIGNS** Made easily. Instructions and ten sets modern alphabets; numerals, patterns. Sizes up to eight inches. All for \$1.00. Co-Operative Service, Box 638, Chicago.

**\$40.00 WEEKLY.** Made growing mushrooms, fresh, dried. Dominion patent 331583. Free spawn. North American, 169P Yonge, Toronto, Canada.

#### BOOKS, PERIODICALS, PICTURES, POSTCARDS

**INVASION**—Timely packet containing 15 pictures, size 2½x3½ inches, of actual invasion scenes U. S. armed forces on world battlefronts. Latest official pictures available; interesting for servicemen and civilians alike. Contained neat mailing packet. 25c each; 5 for \$1; 11 for \$2, postpaid. Stamps accepted. Lloyd, 1411-A NW 17th, Oklahoma City 6, Oklahoma.

**SAVE Money** by writing for our lists of special cut-rate books, many at less than 50% of original price. Pines, 144-34 70th Avenue, Flushing, New York.

**PHOTOSTAMPS** \$1.25 A hundred. Postcards 15 for \$1.00. Any photo. Lang, 1334 Thorndale, Chicago.

**MAGAZINES**—Business, vocational, diversion. Current single copies only. Choose from 600 different publications, covering agriculture, art, aviation, beverage, construction, dogs, health, hobbies, insurance, medical, music, photography, poultry, television, refrigeration, sports, watchmaking and more than 150 other fields. List with prices free. Commercial Engraving Publishing Company, 34C North Ritter, Indianapolis 1, Indiana.

**BRIDGE** To success. Prepare for tomorrow—read, study today. Consult our Book Advising Service free. Technical books of all publishers—select the best. Technicraft Book Co., P.O. B. 767A, Grand Central Annex, New York 17, N. Y.

**WHAT** Every Mason wants. We have Masonic books for Blue Lodge, Chapter, Commandery, Scottish Rite and Shrine. Our rituals are used the world over. Send for free catalog of books and rituals for Masons, Odd Fellows, Knight of Pythias, Knights of Columbus, Elks, etc. Ezra A. Cook, Publisher, Inc., P.O. Box 796-PJX, Chicago 90, Ill.

**10 DAZZLING** Hollywood "pin-up" beauties; "special award" exclusive pictures 8x10 (color cover, two-tone). Grab 'em! Turner! Sheridan! etc. Free with each order, 10 pocket size picture cards of additional Hollywood beauties. All 20 for \$1.00. (No C.O.D.'s). Hollywood Parade, Box 5P 7833, Del Valle Sta., Los Angeles.

**"SWAP Shop"** page, unusual merchandise, novelties. Literature are features of "mail merchandise mart." Dime brings it. A. Chervence, 1540 North State, Chicago 10.

**WRITER'S** Instruction books. World's largest collection. List free. Humanity Press, 220 West 42nd St., New York 18.

**BEAUTIFUL** California view cards. Assorted Hollywood, Los Angeles Missions, desert, others. 25, 50c; 50, \$1.00. Geo. Nelson, 721 Garland St., Los Angeles.

**BOOKPINDERS'** (New - used - scarce books) secured promptly. Send wants. Clifton, Box 2233 Capitol Station, Tustin, Texas.

**PHOTO Collectors.** "Beautiful Texas" scenery. Samples 50c. Chauvin, Brownsville, Texas.

**RARE** Out-of-print books located. Bookfinders, 1210N 11th Ter., Birmingham, Ala.

**BOOKS**—Tell us your wants. Chapbooks. 6 Girard, Rochester 10, N. Y.

**150 WAYS** To use soy beans. Postpaid \$1. Midwestern Laboratories CV, Lincoln, Nebr.

**25 ARTISTIC** Pictures; list books, novelties, 50c. Western Sales, Hillstreet Bldg., Los Angeles 14.

**GLAMOUR** Girl "pin-up" pictures. Size 5x7. Dozen 35c. Curtis Specialties, Box 1918, Denver, Colo.

**A RATIONAL** View of life—\$1.00. Benjamin Seibert, Urbana, Ohio.

**BOOKS.** Technical, occult. Catalogues free. Cass Book Mart, 1231-33 Cass, Detroit 26, Michigan.

**WANT** Beautiful pin-ups? Rush postcard. Warner, 114 N. Elm, Jackson, Mich.

**"PIN-UPS,"** 180 Gorgeous girl subjects! Huge bargain pack \$1.00. Clover Novelty Company, Dept. 35-DD, Hollis 7, N. Y.

**64 ART** Cards of gorgeous beauties \$1.00. Reed Novelty, Dept. PM-4, Box 24, Queens Village 9, N. Y.

**"SUPERSTITIONS."** New book just out, very interesting and mystifying, many origins, enjoyed by those in armed service! Sent for \$1.00 postpaid. Samans' Superstitions, Box 1313, Terre Haute, Ind.

**EDUCATION** In finance, not only how to make money, but how to get the most out of every dollar. Complete details free. Amity Books, 4751 N. Hopkins, Milwaukee 9, Wis.

**REBINDING:** We bind magazines, old books, Bibles, hymnals. Heckman Bindery, Dept. D, North Manchester, Indiana.

**EARN Money** in any crowd. Call names of strangers; tell unspoken questions. Professional course mind reading, spirit writing, etc. \$1.00 (postpaid). Scott, Box 31-W, Melbourne, Fla.

**"PROSPERITY** Can be lasting." Amazing new book paves the way for "live and let live world." Exciting. Interesting. Truthful. Will awaken new constructive thoughts in you. Positively nothing else like it. 25c postpaid. M. H. Redmer, 1450 W. North Ave., Chicago 22, Ill.

**SEVENTY** Can be life's prime. Send for circular and learn about "How to Stay Young." Bookmaster, Box 588-B, Stillwater, Okla.

**MAGAZINES** (Back-dated) — Foreign, domestic, arts. All publishers. Bargain prices. Also books, booklets, pin-ups, subscriptions. Catalogs 10c (stamps accepted). Cicerone's, 863 First Avenue, New York 17.

**ARTISTIC** Girl pictures. Real models, 40 photos for \$1.00 postpaid. All different, postcard size. C. A. Scott, P.O. Box 342, Covington, Ky.

**HELPFUL** Books for your trade, hobby or business. Lists on any subject free. Helpful Book League, 1239 Broadway, New York 1, N. Y.

**SELF-EXPLAINING** Bible: Illustrated circular free. Box 446-P, Minneapolis, Minn.

**BOOKS** (Out-of-print, new, used) quickly supplied. Many 35c bargains. Catalogue. T. Jankowski, 18870 Marx Ave., Detroit 3, Mich.

**DRUNKENNESS** Is a disease which responds to treatment. Medical skill plus human sympathy prove successful with liquor and drug cases. 60 years experience. Write for free booklet. P. M. Nelson, The Keeley Institute, Dwight, Ill.

#### GAMES, ENTERTAINMENT

**FASCINATING** New card game and quiz book; send us your best plays on convenient form furnished free; cash paid if published in quiz book. Game 35c, quiz book 25c or both for 50c. Sports-Kards, 380 River, Troy 1, N. Y.

#### MAGIC TRICKS, PUZZLES, JOKER NOVELTIES

**VANISHING** Key 50c. Svengal wonder automatic deck \$1.00. New magic pkg. card tricks. Lists jokes, professional magicians, trick secrets 50c. Lindhorst Magician, 612PM Pine, St. Louis.

**AMAZING** Pocket coin trick puzzle—Tumbling blocks. Fascinating. 35c guaranteed. Dreisbach, 617 N. Saint Elmo, Allentown, Penna.

**AMAZE** And mystify friends: Cut 5 point star with one cut. Folding and cutting diagram 25c. Harper's, 218-22nd Street, Dunbar, W. Va.

**SEND 25c** For \$1.00 worth of magic tricks and our latest catalog. Ball Square Company, 697 Broadway, Somerville 44, Mass.

**VENTRILOQUISM.** Complete instructions only \$1. Lesueur, 77 Wellesley, Toronto, Canada.

**ENTERTAIN** With magic for prestige, profit, pleasure. Slave rope escape and our list of mysteries starts you. 25c. Windsor Magic Mart, 2443 E. 75th St., Chicago 49, Ill.

**JOIN Magicians' Fraternity!** Monthly magazine of tricks, sample, 10c. International Magicians, Mount Morris, Illinois.

**TRICKY** Match box, it turns around! It stands up! and it opens, most weird, uncanny magic novelty trick, complete, ready to do. 25c. Magic Shop, 2463-M, Kensington Ave., Philadelphia, Penna.

**MAGIC** Trick and catalog 25c. Beebe, Box 260Y, Pontiac, Michigan.

**GREATEST** Mysteries clearly explained—or money refunded—406 pages. \$1.00. Wilkes, Oberlin, O.

**VANISHING** Card trick. Card tossed in air vanishes. With instructions. Two dimes. Eastwood, Box 623, Parkersburg, W. Va.

**LEARN** Ventriloquism, 3c stamp brings particulars. Smith, 801 Bigelow, Peoria, Illinois.

**SPECIAL** While they last. 4 magicians books, all for \$1.00. Howard's Fun Shop, 908½ Travis, Houston, Texas.

**500 TRICKS** You can do! Douglas's famous catalog of 500 tricks, now only 10c. America's fastest service on magic for pocket, parlor, stage, professional, amateur. Douglas Magic Shop, Box 274, Dallas, Texas.

MIND Reading course, \$12.50. Results guaranteed or your money promptly refunded. Sample lesson, 25c. Sample lesson teaches how to read any card from deck (no tricks); how to read words and numbers which a friend may write. Anyone can easily master this art. Telepathic Institute, 606 West King, Fairfield, Ill.

QUALITY Magic since 1907—3 new catalogs available, 25c each. Book catalog and lists free. Thayer's Studio of Magic, P.O. Box 1785, Wilshire-Labrea Station, Los Angeles 36, Calif.

MAGICIANS' Headquarters. 216-page catalog, pocket, parlor professional tricks. 25c. Kanter's, M-1311 Walnut, Philadelphia 7.

ENTERTAIN. Mystify with popular magic. Four secret tricks and catalog 10c. Bernstein, P-7520 Cornell, Chicago.

AMAZE Everyone. Answer unspoken questions. Professional "no assistant" mindreading course, \$1.00. Magical Enterprises, Box 111P, Roseville, Michigan.

NEW! Simplified card tricks! Amazing self-working bafflers 50c postpaid, James W. Roundtree, 529 Elliott St., River Rouge, Michigan.

BE A magician. Large professional magic catalogue of latest tricks 25c. Ireland, C-109 North Dearborn, Chicago 2.

MAGIC Tricks, puzzles, books, cards, punch boards. Catalog 10c. Specialty, Box 671, St. Louis 1, Mo.

WORLD'S Largest professional magic shop keeps you in touch with latest tricks. To receive mailings send 25c for 1943 catalog. Holden, 220 W. 42nd St., New York.

NEW Vanishing key and catalog 25c. Sterling Magic, 345 John R. Detroit, Mich.

HOLLYWOOD Special! Magicians button, catalogue, ghost illusion and free trick for 25c. Magic House of Charles, Box 888, Hollywood, California.

EARN Money in any crowd. Call names of strangers, tell unspoken questions. Professional course mind reading, spirit writing, etc., \$1. Henderson, Box 341, San Bernardino, Calif.

### HOBBIES AND COLLECTIONS

SEMINOLE Indian dolls over two inches 35 cents, 3 for \$1.00. Hitching Post Ranch, Hollywood, Florida.

COLLECTORS! Exchange duplicates. Stamp brings particulars. Box 2166, Denver 1, Colorado.

TWENTY Different cactus plants postpaid, \$1.00. Eulalia Turner, Azusa, Calif.

SWAP Directory. Trades for everyone. Ferris, 317A So. Hartford, Bremerton, Wash.

SPECIAL Offer! Real stage money. Large assortment—only 25c. Maniss Photo Co., Colorado City, Texas.

"POPULAR Hobbies" newspaper—year's subscription, 50c. Sample copy free. Box 710, Los Angeles 53, California.

HOBBY Catalogue 5c; reptile bulletin 5c. Stamp list free. Quivira Specialties, Winfield, Kansas.

AGATES Resembling landscapes and water scenes \$3.50 for rough slices. Few extra choice specimens at ten, fifteen and twenty dollars. Paul N. Barker, Midway, Wash.

ILLUSTRATED Hobby magazine free. Barrington Smith Co., Halfwaytree-PM, Jamaica, B. W. I.

SILK Embroidered service emblems. Sample and price list 10c. New insignia guide 10c. Hobbyguild, M-35 West 32nd, New York.

JEWELRY Stones removed from rings, etc. 100 assorted \$2.00. Lowe's, Box 311, St. Louis 1, Mo.

UNUSED Match book covers. 100 all different \$1.00. 35 Royal Flash covers \$1.00. Free list. Charles Edelman, 1311C East 84, Cleveland 3, Ohio.

NEW—15 Different match covers 10c. Box 202, Rochester 1, N. Y.

PLUME Agate slabs \$1.00 up. Bishop's Agate Shop, North Bonneville, Wash.

### COINS, TOKENS, CURRENCY

COLLECTION Indianheads, every year from 1879 through 1909, with album, \$2.00. Catalog U. S. coins, 10c. Catalog foreign coins, 10c. Ben's Coin Company, 72 West Washington, Chicago 2, Ill.

DOLLAR Assortments. Every item different. "22 paper monies;" "10 encased postage stamp money;" "30 foreign coins;" "25 Indian head cents." Any assortment \$1.00. All-Nation, 157-P West Lake, Chicago 1, Ill.

DOLLAR Size Louisiana Exposition Fund bronzed medals, issued to finance Louisiana's exhibits at Panama Pacific Exposition. Uncirculated \$1.00 ea., 3 for \$2.50 postpaid. Orleans Coin Shop, 814 Royal St., New Orleans, La.

WE Buy Indian pennies, Lincoln pennies, and old rare coins. Highest prices paid. Indian pennies worth up to \$15.00 each. Lincoln pennies up to \$2.00 each. Other rare coins \$5.00 to \$2000.00 each. Send 10c today for new 1944 price catalogue of all wanted U. S. coins. American Rare Coin Co., Dept. 1, Transportation Bldg., Chicago.

30 DIFFERENT Foreign coins \$1; 100 different \$4; 50 mixed Indian cents \$1. Lists. Gold coins bought, sold. Delmonte, 725 West 172, New York 32.

FOREIGN Coin and lists, 10c. Oddehon, Box 482, St. Louis, Mo.

21 DIFFERENT Indian head cents and Guidine Lindbergh medallion \$1.00. Gretsche, 35-09 Broadway, Long Island City, N. Y.

WILL Pay \$10.00 each for certain Lincoln pennies! Indianheads \$50.00; dimes \$1,000.00. Catalogue 10c. Federal Coin Exchange, 6-PM, Columbus, Ohio.

OLD Money wanted. Will pay fifty dollars for nickel of 1913 with Liberty head (no buffalo). We pay cash premiums for all rare coins. Send 4c for large coin folder. May mean much profit to you. Numismatic Co., Dept. 20, Fort Worth, Texas.

COINS For sale—Catalogue 3c. Federal Coin Mart, Columbus, Ohio.

SCARCE Collection contains large cent over 85 years old, flying eagle cent, white Indian cent, 2c piece, 3c piece, foreign coin, foreign bill and our latest buying and selling list. All for \$1.00. 28 different dates Indian cents \$1.00. 25 different foreign coins \$1.00. Worthy Coin Corp., 23-F Cornhill, Boston, Mass.

WALL. "Map of World." 20 foreign coins, mounting directions. Valuable coin information. One dollar. Alwick, 5437 Nagel, St. Louis 9, Mo.

10 INDIAN Head cents, different dates, also pricelists, 40c. Schultz, 1053 Richmond, Cincinnati, Ohio.

GET Profit and pleasure in collecting old coins. Send 10c for 56-page illustrated coin catalog. You'll be delighted with it. Send for it now. B. Max Mehl, 370 Mehl Bldg., Fort Worth, Texas. Largest rare coin establishment in U. S. Established 44 years.

COMMEMORATIVE \$1½ — Texas, Kentucky, York, Elgin, Cleveland, \$1.50 ea. Illustrated catalogue 10c. Norman Shultz, Salt Lake City, Utah.

FREE! Foreign coin, banknote and coin collectors illustrated catalog to approval service applicants. Send 3c postage. Taham Coinco, Springfield-125, Mass.

I MAY Have just the scarce U. S. coins you want. Send me list. "Meet me by mail." William H. Kenworthy, Waterville, Maine.

### STAMPS WANTED

FULL Market prices paid for collections, accumulations and mixtures; singles and sets; old stamps on letters. Any quantity. United States and foreign. Prompt payments. Over 30 years in business. Condor Stamp Company, 87 Nassau Street, New York City 7.

### STAMP COLLECTING

POSITIVELY Greatest free offer—Latest Scott's International \$5.00 Stamp Album—covering entire world, contains 38,000 illustrated, descriptive spaces. Scott's 1944 Standard \$5.00 Catalogues "Philately's Encyclopedia" — absolutely free to applicants for foreign approvals becoming customers. Plymouth, A-9, Bell, California.

TWELVE U. S. flag stamps complete, 50c. Six 1941 airmails complete, 80c. Catalog U. S. stamps, 10c. Catalog foreign stamps in sets, 10c. Ben's Stamp Company, 72 West Washington, Chicago 2, Ill.

STAMP Brings my large summer bargain list of penny U. S. used. Graham's, 316 Given, Lexington, Ky.

40 DIFFERENT Stamps 5c with approvals. Cornetta Brothers, 228 West 25 Street, New York, N. Y.

FINE Approvals, freshly mounted. Fast, personal service. Tell me what countries you prefer and I'll send their stamps. Skinner, 345 East Ocean, Long Beach 2, Calif.

WORLD'S Largest diamond and triangle stamps, free stamp magazine, stamps from fighting Free French, 20 stamps from 20 different countries, pictorials, airmails, big bargain 5c with approvals. Capital Stamps, Dept. 2, Little Rock, Ark.

60 DIFFERENT United States 10c. Regulars, old issues, highest values, commemoratives. Charles Stone, 3547 28th St., Astoria 1, N. Y.

WE Want to C-u-b-a customer of ours! To serious approval applicants we offer a big packet of all different Cuba stamps—from the first issue to the last!—for only five cents. Includes a scarce old stamp issued nearly 100 years ago; airmail; sinister anti-fifth columnist issue, etc. Total catalog price over \$1.50. Send that nickel today and get the surprise of your life. Garcelon Stamp Company, Box 500, Calais, Maine.

PITCAIRN Islands! ½c, 1d, 1½c mint. These colorful mutiny on the bounty stamps for only 10c to applicants for my medium and low priced approvals. William E. Thiem, Dept. S, P.O. Box 319, Cape Vincent, New York.

118 DIFFERENT Stamps including commemoratives, charities, airmail, pictorials, sets etc., only 3c with approvals. Badger Stamp Company, 228P West Wisconsin, Milwaukee 3, Wisconsin.

TO New customers—An attractive set of stamps free, with request for approvals. Calaveras Stamp Co., Floresville, Texas.

U. S. Buying lists for accumulators 10c. Also foreign stamps wanted in large quantity. Grossman, 102 West 42nd, New York.

FREE Your choice of any 10 stamps from our first U. S. approval selection. Illustrated list included. Cosmopolitan Stamp Company, Dept. M-7, 1457 Broadway, New York City.

"UNITED States only"—Fine approvals—Low prices. Box 488, Minneapolis.

10c PACKETS: 50 diff. nations at war; 50 United States; 25 Asiatic; 25 Belgium; 25 French Colonies; 50 Germany; 25 Japan; 25 Scandinavian. Liberty Stamp Co., Dept. P. Kirkwood 22, Mo.

POSTER Stamps—War insignia 50 different in color 25c; 200 different \$1.00. VerHalen Publications, 6058 Sunset, Hollywood 28, Calif.

100 U. S. stamps, mixed, extra select. Many commemoratives. Only 38 cents. Jungkind, Box 80GP, Little Rock, Ark.

STAMPS Cataloging \$4.04, price 25c. Burtis, 125 Greenwood, Trenton, N. J.

VICTORY Packet for a 25c defense stamp. Goldenrest Stamps, Box 62, Roxbury, Mass.

80 PAGE United States priced catalogue free. Postage 3c. Spencer Anderson, 65 Nassau, New York City.

FOUR Mozambique triangles 10c with approvals. Vargo Stamps, Racine, Wis.

15 DIFFERENT Danzig, 10c to approval applicants. E. C. Brown, 1376 Grant, Lincoln Park, Mich.

1c TO 10c Foreign approvals. Beaumont Stamp Exchange, 2667 McFaddin, Beaumont, Texas.

100 VICTORY Flag stamps 10 cents. Loren A. Hollenberg, Roseville, Ill.

500 U. S. Many commemoratives, airmails, higher values, older issues, 70 varieties guaranteed. 25c. Hogan's Stamps, Ashland, Wis.

A "RAM" Tank and Corvett stamp, 3c with approvals. Knopp, Box 1381, Bristol, Conn.

BARGAINS In fine approvals. Write today! International Stamp Co., Hallettsville, Texas.

BRAZIL 378 Holy Year mint 8c with ½, ½, 1c approvals. Carroll's, 745A W. 45th, Los Angeles 37, Calif.

AMAZING Pictorial packet 3c with approvals. Sullivan's, Fairport, New York.

10 TRIANGLES—Mozambique airmail-commemoratives, 10c. Approvals. Reuter, 611-B West 40th, Los Angeles 37.

1000 WELL Mixed U. S. 25c. Monjar, 1750 Fairmount, Cincinnati, Ohio.

LIST OF collectors desiring to exchange stamps, etc., 10c. Kurtz, Box 1051, Allentown, Penna.

FREE—Wright Brothers airmail. Approvals. Westco, 6002 Truro, Houston 7, Texas.

FREE—Set airmails showing RAF "Spitfire" plane. Approvals. H. Penny, Rowton, Conn.

EUROPE—40 Years old—15 different 10c. Elsea, Bowling Green, Ohio.

BELGIUM 25 Different parcel post, 3c with approvals. Fox Stamps, 153 Mineral Spring, Passaic, N. J.

OLD Scarce U. S. seconds. Approvals. Herrfelds, 551 Clinton, Newark 8, N. J.

COSTA Rica, Orchid, fish, cacao. Send 5c. Approvals. Buchanan, 307 East 23rd, New York 10.

U. S. Stamps! Wholesale! 25c, 50c, \$1.00 packets. Cary Frazier, Rome, Ga.

**PHILATELIC** (Monthly) Shopping News, year 25c. Stamporium, 2660 Rochester, Detroit 6, Mich.

**FREE** Copy hobby magazine. (Year-25c). Kaw Chief, Lawrence, Kansas.

**FREE**—30 Different U. S. with approvals. Taubers, 1755 Ocean Parkway, Brooklyn, N. Y.

200 **DIFFERENT** Foreign, 30c. Many countries. Jem Stamps, Port Jefferson, N. Y.

25 **BRITISH** Empire 5c to new approval applicants. Premiums to regular customers. Proctor, 3505 Broadway, New York.

**WASHINGTON** Bicentennial set 10c with United States approvals. Yokums, Box 1327, San Antonio 6, Texas.

**RARE** Elobey, RioDeOro, Djibouti, Danzig, 5c with approvals. Superior, 1019 Greyton, Cleveland Heights, Ohio.

4,000 **DIFFERENT** Foreign \$2. 1,000 different United States \$4. Approvals. Send money in dollar bills. Leon Garrett, Box 517, Independence, Kansas.

**DOUBLE** Your money and have fun by buying and selling stamps. \$1 brings easy-to-follow plans and wholesale source of supply. Martin, 7704 New Utrecht Ave., Brooklyn, New York.

"**LOTS** Of fun." About 500 mixed U. S. stamps on paper. Contains precancelled commemoratives, high values, airmails, etc. Absolutely unpicked. Sold as received by us from various missions. To approval applicants 15c postpaid, otherwise 25c. Potter, 1314 McGee, Kansas City 6, Mo.

60 **DIFFERENT** United States 10c. Pricelist free. Seidenberg, Cassopolis, Mich.

127 **DIFFERENT** Stamps including Free Fighting French, Haiti, Johore, Cochon, only 10c to approval applicants. Reich Stamp Co., 4647 Kenmore, Chicago, Dept. M8

125 **ALL** Different U. S. \$1.00. Old, new issues—Comms., postage, dues, famous Americans, airmails, etc. Good condition. Lightly cancelled. Guaranteed to please. Try our foreign packets 10c each, 3 for 25c. 14 packets \$1.00. All different. Bargain. Approvals sent on request. Armour Stamp Co., St. Albans, N. Y.

1000 **GRABBAGS** 15c Each. 8 different \$1. Special bags. Free French included 25c. Zandy, 630 Bingham, Reading, Pa.

"**THE** Best"—United States and Philippine Islands approvals. Largest varieties. Lowest selling prices in America. Stamp Company, Albany 3, New York.

**FREE!** Complete "United States" stamp catalog with 1,000 illustrations! Send 10c to cover mailing. Harris & Co., 137 Transit Building, Boston, Mass.

**BRITISH** Colonies packet, only 3c to approval applicants. Smith, 237-A 8th Avenue, Roselle, N. J.

**SPOT** Cash paid for stamp collections. Pkelgwin Company, Vineland, N. J.

1000 **MIXED** U. S. old and new 25c. 2 lbs. \$1.00. Weatherly, So Euclid 21, Ohio.

**SMOKY** Mountain commemorative sheet, largest U. S. stamp issued, and 33 U. S. including commemoratives, airmail, revenues, etc. Catalogs 75c—To approval applicants for 5c. Curhan Stamp Company, Gloucester, Mass.

19th **CENTURY** U. S. commems. Civil War revenues, battleship \$5 and \$10 stamps free to U. S. approval applicants. Metropolitan Stamps, 198-C Broadway, New York.

**FIND** Stamps worth fortunes! Six big items! "Queer Countries" packet: Djibouti, Qwallor, etc. Packet scarce Russia, catalog price 50c! Fine packet of 25 different British Colonies—Turks and Caicos Islands, Hyderabad, Jamaica, etc. United States \$4.00 and \$5.00 high values. Big "Far East" packet of 20 different stamps from Dutch Indies, Siam, Philippines, etc. Illustrated 32 page booklet—tells where to look for, and sell, stamps worth up to \$10,000 apiece! Everything for only 5c to approval service applicants! Mystic Stamp Company, Department 80-R, Camden, New York.

**FREE!** Canadian sets, royal visit, George VI, George V, coronation, jubilee, others, to approval applicants. Ensign, Box 118-M, South Orange, N. J.

**COMPLETE** Mint commemorative set from Manchukuo, plus attractive Brunei pictorial—everything just 3c to approval applicants. Viking, 130 (Z) Clinton St., Brooklyn, N. Y.

**WEEKLY** Stamp Magazine, 26 weeks, 25c. Stamp Journal, Kalamazoo, Mich.

**DANDY** United States approvals. Write immediately. Sullivan, Endicott Arcade, St. Paul, Minnesota.

U. S. Mixture, 5 lbs. \$1.75. Postage extra. U. S. price list, Stanley Gibbons, 38-P Park Row, New York.

**FREE!** Western Hemisphere packet. Postage 3c. Owens, 806 Welsh, Bay City, Michigan.

**FREE!** British Empire packet. Postage 3c. Williams, 608 Archer, Bay City, Mich.

**FREE!** Pony Express set (facsimiles). Postage 3c. Roberts, 406 Building, Bay City, Michigan.

**CANADA** 100 Different 25c—approvals all countries. Lists, Victoria Stamp Co., London, 4, Canada.

**FREE!** Leeward Is., Cayman Is., Turks and Caicos plus 60 different mint Geo. VI coronation poster stamps, to approval service applicants sending 3c postage. Tatham Stampco, Springfield-30, Mass.

**WOW!** \$10.00 Worth of fun for only 10c! 500 foreign stamps, unsorted and unpicked (mostly on bits of paper) just as received from the church missions and other sources. Africa, So. America, Australia, China, Philippines, Dutch Indies, and other countries are represented. Includes a few commemoratives, airmails, and stamps cataloging up to 25c or more each! The biggest package of fun in stampdom—and you might find something really valuable! Price only 10c to serious approval applicants! Money back if not delighted. Jamestown Stamp Co., Dept. No. 22, Jamestown, New York.

**VICTORY** Packet free—Includes stamps from Tanganyika, British Cayman Islands, animal, scarce babyhead, coronation, early Victorian, airmail, map stamps, with big catalogue—all free. Send 5c for postage. Gray Stamp Company, Dept. PM, Toronto, Canada.

55 **DIFFERENT** United States 5c with approvals. Bookman, Box 145-M, Maplewood, N. J.

**UNITED** States approvals complete coverage, fine quality, attractive prices. Seminole Stamps, Box 436, Coconut Grove, Florida.

**STAMPS** Sent on approval, outstanding quality, low prices. Fred Herzberg, 168 Oak, Elmhurst, Ill.

**MEXICO** Census commemorative set free with approvals. Pladon Stamps, 1717-M Idaho, Toledo, Ohio.

**BELGIUM**, 25 Different only 5c to new approval applicants. Charles Mangels, 194-13a 111th Road, St. Albans, N. Y.

3,000 U. S. Foreign \$2; Approvals: Griest, 409 Oak, Davenport, Iowa.

**FREE**, Complete Cuba tobacco set with approvals. Seminole, Glenburnie-1, Md.

#### CAMERAS, PHOTO SUPPLIES

**WILL** Buy any movie or still camera regardless of size or condition, describe fully. W. K. Crosson, 3465 Wager, Detroit, Mich.

**NATIONAL** Graflex 2—used but perfect working order with new case sunshade and filter \$83.00. Elwood 2½x2½ enlarger complete with lens 4.5 anastigmat \$38.50. Write us your needs. We buy and sell everything photographic. Barbeaus, Oswego, N. Y.

**ENLARGERS**—Build your own. Kit of parts \$6.00. Free particulars, Crescent Engineering, Box 251-P, South Pasadena, California.

**HAVE** You a camera? Send ten cents for recent number of our big magazine, showing how to make better pictures and earn money. American Photography, 116 Camera House, Boston, Mass.

**MAKE** Money in photography. Learn quickly at home. Easy plan. Previous experience unnecessary. Common school education sufficient. Booklet and requirements free. American School of Photography, 1315 Michigan, Dept. 3432, Chicago 5.

**OIL** Coloring photographs a fascinating hobby or profitable business. Learn at home. Easy simplified method. Previous experience unnecessary. Send for free information and requirements. National Art School, 1315 Michigan, Dept. 3444, Chicago 5.

**BASS** Says: War time proves Bass leadership. Amazing selection of finest still cameras—Leica, Contax, Korable reflex, Argus, new and used still available. Write for quotations. Satisfaction guaranteed or your money refunded. Bass buys 'em, sells 'em, trades 'em. Bass Camera Company, Dept. AG, 179 W. Madison St., Chicago, Illinois.

**CASH!** Spot cash for cameras, lenses, binoculars, movie or still, sound projectors. Send full description by mail, or wire for prompt cash offer. Over 30 years of dependability insures honorable dealings. Bass Camera Company, 179 West Madison Street, Chicago, Illinois.

#### PHOTO FINISHING

**NO Delay!** Pictures returned immediately. Eight exposure rolls developed with two prints each or one enlargement each negative—only 25c coin. Special! Coupon on beautiful 8x10 enlargement given each 25c order. Details and film mailers free on request. Moon Photo Service, 452 Moen Bldg., LaCrosse, Wis.

**PICTURES** "Permanitized" in transparent plastic! Amazing new process preserves forever your prized snap-shots, etc., pass-case size, for loved ones in service to carry. Waterproof, non-soiling and non-fraying. Miniature plastic-permanitized picture of Niagara Falls and full details free. Mail-Back Photo Service, Box 505, Buffalo, New York.

**ENLARGEMENTS:** Eight 5x7 from negative \$1.00. Six 5x7 from photo \$1.00. Robert Renshaw, 222 Jeffrey St., Chester, Penna.

**REPRINTS** 2c Each. 5x7 enlargements 20c. Roll developed 16 prints 25c. Free mailers. Laurent, Box 116 Eastwood, Syracuse, N. Y.

**WE** Make photo-exact copies of birth, marriage and death certificates; also drawings and valuable papers. \$2.00. Jackson Studio, Columbus, Mississippi.

**WITH** Every 6 or 8 exposure roll, two full sets of prints, 25c. Skyland Studios, Box 411, Dept. "M," Asheville, N. C.

**REPRINTS** 16 For 25c, 40 for 50c. Queen City Service, Box 7, Niagara Square Station, Dept. 8, Buffalo, N. Y.

**BEAUTIFUL** 8x10 Enlargement from your photo or negative 45 cents. Originals returned unharmed. Quick service. Photo Lab., 3122 N. Clark St., Chicago 14, Ill.

**SNAPSHOT** Reprints 2½c each, fifty or more 2c each. 6-8 exposure rolls developed, two prints each exposure 30c. Finest workmanship—fast service. Mercury Studios, A-109 North Dearborn, Chicago 2.

**BEAUTIFUL** Oil colored enlargements. Your negatives: 8x10, \$2.00; 11x14, \$2.50. From photo 50c extra. Specify colors. Haynescraft, 802 20th, Washington 6, D. C.

**CAMERA** Dollar makers. "Photo profits" 25c. Roy, 214 Wade, Cincinnati.

**FREE**—One roll developed free! Also two enlargements free! Bargain information returned immediately! Rush roll—no money! Satisfaction guaranteed. Photo-friend, Blockstone 1, Mass.

**FREE!** Send negative, this ad for beautiful 4x6 enlargement (Stamp appreciated). 16 sparkling prints, 2 Hollywood enlargements from roll or negatives 25c. Lifetime Studios, Dept. A-739, Des Moines, Iowa.

6-8 **EXPOSURE** Rolls developed and enlarged mammoth size 30c. Reprints 3c. Thrifty Photos, Box 48, South Gate, Calif.

**SPECIAL** Reprint service. Order duplicates of your favorite negatives now, while these low prices prevail. All prints from size 127 to 122. 16 reprints for 25c; 50 reprints 75c; 100 reprints \$1.00. Send only snapshot negatives. Satisfaction guaranteed. Cut-Rate Reprint Service, Box 833-K, LaCrosse, Wisconsin.

**YOUR** Favorite kodak pictures enlarged, size 5x7, 10c; three for quarter, coin. Send best negatives (film) today. Address Gelpert Studios, Dept. 82, Des Moines, Iowa.

**IMMEDIATE** Service. Pictures returned same day order received. Smashing low pre-war prices! Sixteen guaranteed deckled-edge Velox prints from roll, 25c. Or one colored or two plain enlargements free with 8 deckled-edge prints, 25c. 16 reprints from negatives 25c. Candid roll developed, magic-eye timed, vaporated and enlarged to 3x4 on deckled-edge Velox paper—36 exp. 35mm. \$1.00; 18 exp. 60c; 16 exp. No. 127 50c; 8 exp. Bantam 25c. Reprints 3x4, 3c each. We have new, perfect 35mm. film. Low prices. Free mailers, details on request. American Studios, Dept. PM-1, LaCrosse, Wis.

**PHOTOGRAPHY** For pleasure and profit. Prepare at home. Common school education sufficient. Write for information and requirements. American School of Photography, 1315 Michigan, Dept. 3451, Chicago 5.

**TROUP'S** Photo Service, Troup Building, Toccoa, Georgia. 6 or 8 exposure roll film developed and printed 25c.

16 **BEAUTIFUL** Oversize deckledged prints and two enlargements with first order 25c. Owlphoto M1, Weatherford, Oklahoma.

8 **PRINTS**, All enlarged to nearly postcard size, from your roll or negatives, 25c. Willard Studios, Box 3535A, Cleveland 18, Ohio.

**BIGGEST \$1.00 Value in 35 mm. finishing today.** 35 exposure fine grain  $3\frac{1}{4} \times 4\frac{1}{2}$  enlargements; deckled, embossed margin and date. Eighteen exposures 75c; sixteen exposure splits 55c. Free mailers. 8 exposure rolls in beautiful deckled contact finish with embossed wide margin. 25c. Mailbag Film Service, Box 5440A, Chicago 80.

**8 BEAUTIFUL Enlarged prints (nearly postcard size) or 16 regular prints 25c.** 35mm. rolls enlarged  $3\frac{1}{4} \times 4\frac{1}{2}$ , \$1.00. Burton Studios, 55-M. Roscoe, New York.

**35MM. Argus, Leica, etc. (except "Mercury")** 36 exposure rolls, fine grain developed (Eastman DK-20) and beautifully enlarged to  $3\frac{1}{4} \times 4\frac{1}{2}$  glossy prints, 90c. Cartridge reloaded, 35c. 18 exposure rolls, 55c. reload 20c. 24-hour service. Satisfaction guaranteed. Free mailing bags, sample print. Technifinish Laboratory, 38-42 Scio St., Rochester 4, N. Y.

**BEAUTIFUL  $4 \times 6$  Pictures 3 $\frac{1}{2}$ c each,** from 116 and 120 negatives.  $3\frac{1}{4} \times 4\frac{1}{2}$  from all other sizes. All work guaranteed. Overnight service. Roll developed and 8 pictures 30c. Roll 12 pictures 45c. Roll 16 pictures 60c. Enlargements on double weight portrait paper 5x7-30c, 8x10-50c. Copies made from any picture 75c. Pacific Photo Service, Box 666, San Francisco, Calif.

**VELOX Deckle reprints 2c.** Rolls developed, two deckle edged prints each negative, 25c. Two 5x7 enlargements 25c. Summers Studio, Unionville, Mo.

**EVERY Picture an enlargement!** 8 sparkling deckle-edge enlargements and roll developed 25c coin; 116 size or smaller; enlarge reprints 3c. Enlarge Photo, Box 791D, Boston, Mass.

**THREE Prints each good negative, 6 to 8 exposure rolls, 30c.** 12, 16, 18 exposure rolls, 50c. Reprints, 3c. Fred D. Eastman, Bode, Iowa.

**8x10 SILK Finish enlargement-25c plus stamp.** Irving Studio, 4006A Irving Park, Chicago 41, Ill.

**ROLL Developed and 8 beautiful enlargements 2 to 6 times larger.** Deckled edge-high gloss. Any 8 exposure roll 25c coin. 12 ex. 35c-18 ex. 50c-36 ex. 1.00. Reprint enlargements 3c each. Alden Photos, 94-3 Astor Sta., Boston, Mass.

#### MOTION PICTURES AND SOUND EQUIPMENT

**FREE 1944 Illustrated home movie film and 8-16mm. silent film rental list.** Lowest rates. Escco Film Products, 4247-49 South Kedzie Avenue, Chicago 32, Illinois.

**ANSCO Twin-8mm. movie film! SSS Panchromatic, \$2.69 per roll!** Hypan, \$2.48 per roll! Will ship c.o.d. (Limit six rolls per customer.) Standard Sales, Box 154, Kansas City 10, Missouri.

**TITLES And film editing since 1924.** Extensive film rental library, 8mm., 16mm. Silent and sound. Catalog free. Zenith Cinema Service, 3252 Poster Ave., Chicago 25, Ill.

**GUARANTEED Fresh movie film! Three spools double 8mm., \$3.45!** Six spools Univex, \$3.50! Daltle loading! Processing free! (Limit six each type.) Will ship c.o.d. Esco-S, 4038 Broadway, Kansas City 2, Missouri.

**8MM.-16MM. Films.** Free catalogue (sample film 10c). Parkway Exchange, 1893 Union Street, Brooklyn, New York.

**35MM. Sound films.** Bought, sold, exchanged. Lists. Star, Whitesville, Mass. "ERUPTION OF Mount Vesuvius." Thrilling! 8mm.-16mm. Silent-sound films. Complete rental library. All latest subjects. Free catalogue, (sample film 10c). Garden Film, 317 West 50th, New York 19.

**CAMERA Films-100 ft. 16mm. \$2.50;** panchromatic Weston 64, \$4.85; 25 ft. double 88 Weston 24, \$1.89; prices include processing. Movie accessories, chemicals, bulk films. Free circulars, Fromader Genera, Davenport, Iowa.

**SCREEN Up girls, 8mm., 25 ft., \$1.00.** 16mm., 50 ft., \$2.00. Glamour lists, sample dime. Griffin 21, Ithaca, N. Y.

**CAMERA Film, 100 ft., 16mm.,** processing included, \$2.50. The Film Exchange, 147 West 42nd Street, New York 18.

**MOVIE Films at discounts.** List 5c, P. A. system, 40 watt, \$100; 18 watt, \$40. Gordon Conner, Port Clinton, Ohio.

**BARGAINS.** 8-16mm. camera films. Library clearance. No-Wat-Ka, 257 Main, Passaic, N. J.

**35MM. Sound silent projectors, films.** Savare, Woodcliff Lake, New Jersey.

**CUSTOM Title cards, Stamp, samples.** Byrom, Jr., Wartrace, Tenn., Ri.

**KODACHROME Glamour movies!** Also many in black-white. "Beauty Brevities," "Starlet Revue," each, 8mm., 50 ft. \$2.00. (color \$7.50). 16mm., 100 ft. \$4.00 (color \$14.75). Lists, BW sample, dime. Jenkins, 392-F, Elmira, N. Y.

**8MM-16MM. Home movies** bought, sold, exchanged. Free bargain lists. Multiprices, 171 Euclid, Bridgeport 4, Conn.

**SILENT.** Sound 35mm. films. Technicolor samples 10c. Demsey, 1613 Stewart, Youngstown, Ohio.

**100' 16MM. Used sound film, \$1.00 post-paid.** List of complete subjects upon request. Blackhawk Films, Dept. PM13, Davenport, Iowa.

**16MM. Sound projectors** bought and sold, send dime for list, Anchor, 21, Ithaca, N. Y.

**8MM-16MM. Silent, sound films** for sale. Rental Services, Oakville, Connecticut.

**FREE, Projector and camera film catalog.** Samples 10c. Goodwill Company, Jackson, Tennessee.

**16MM. Sound on film OWI subjects** for rental. List for dime. Griffin, 21, Ithaca, N. Y.

**35MM. Silents-buy sound.** Hoosierland, 1734 Noble, Anderson, Ind.

**35MM. Sound film and equipment.** Sale or exchange. (Guaranteed). United Film Exchange, Norman Ave., Avon Lake, Ohio.

**EXTRAORDINARY!** New 1944 catalog just published. Newest "Five Star" Kodachrome, black, white film subjects. Sensational 8mm., 16mm. film offer included. Catalog with generous sample, dime. Trans-American Sales, Morristown, New Jersey.

**LABORATORY Direct movie film, 100' 16mm. \$2.25.** 3 rolls \$6.00. 25' double 8mm. \$1.25. Developing included. Ambassador, 479-A Quincy Street, Brooklyn, N. Y.

**SEND Stamp for 16mm., 8mm. catalogue.** Sterling's, 679 Northampton, Easton, Pennsylvania.

**"THE World's Greatest Passion Play,"** 8mm. 16mm. and 35mm. Specify silent or sound. Rent or purchase, include stamp. Hemenway Film Co., 33-F Melrose St., Boston 16, Mass.

**LEARN Movie projection, management.** Free catalog. Give age. Theatre Institute, Elmira, N. Y.

**8MM., 16MM. Rentals, silent 40c per reel;** sound features \$4.95. Free lists. National Cinema, 71 Dey St., New York.

**BETTERPIX Outdoor safety film, 100 feet 16mm., \$2.50.** 25 feet double 8mm., \$1.25. Free developing. Finished subjects sold, exchanged. Sound library. Better Films, 742 New Lots, Brooklyn 7, N. Y.

**I BUY, Sell, swap, rent s.o.f., 8 and 16mm. films.** List free. Harvey Iris, Box 539, Brockton, Mass.

**BASS Says: Leadership in the cine field** is apparent in war times. Here ready-your choice of 8 mm. and 16 mm. apparatus. Write for quotations. Your old equipment is worth real money in trade—describe please. Or we buy for cash and pay immediately on receipt. Write to headquarters. Bass buys 'em, sells 'em, trades 'em. Satisfaction guaranteed or your money refunded. Bass Camera Company, Dept. A, 179 W. Madison St., Chicago, Illinois.

**\$1 BRINGS "Surprise" assortment 8mm.** colorful titles! Guaranteed. LeMoine Films, Nevada, Missouri.

#### MUSIC AND MUSICAL INSTRUMENTS

**SING Beautifully.** Fame and fortune beckons. Self-coaching course by top-flight teacher. Marvelously simplified. Inexpensive. Literature free. Barcus Publications, 1003a North 13th Street, Terre Haute, Indiana.

**RADIO Singing pays big money.** Send \$3.00 for complete course—by Russell Brooks, former Wayne King soloist. Money back guarantee. Brokel College, 64-PM East Jackson, Chicago.

**HAWAIIAN Guitar players,** send one dollar for 10 of our diagram songs. National Guitar Club, Commercial Block, Benton Harbor, Michigan.

**POPULAR Piano in 12 lessons.** Kelly School, 1781 Oak St., San Francisco, Calif.

**BAND And orchestra instruments,** new and reconditioned, list 10c. Rudolph's, Atchison, Kansas.

**LEARN Piano in 5 lessons by ear.** Play any song—Easiest method known. Amazing results—Complete course \$2. ABC Piano Method, Dept. M7, Mt. Vernon, N. Y., Box 145.

**LEARN Piano.** One hour. Free literature. Ferris, 317A So. Hartford, Bremerton, Wash.

**ACCORDIONS—All makes and sizes.** Wholesale prices. Request catalog. We also buy accordions. American Accordion Company, 31 S. Cicero, Chicago.

**PIANISTS—(Also organists).** Quickly improve technic, sightreading, accuracy, memorizing, playing through mental-muscular co-ordination. Free booklet. Broadwell Studios, Dept. 44-G, Covina, Calif.

**HOW To sell songs.** Free details. Andy Toce, 22 Burton, Hartford 5, Conn.

**DO You want to publish your song?** Information free. Mid-West Music Press, 4737 Broadway, Chicago 40, Ill.

**SONGWRITERS—Arrange your songs** for orchestras. Modern arranging course. 20 lessons \$2.00. Money back guarantee. Brokel Collect, 64-P East Jackson, Chicago.

**POEMS Wanted for musical setting.** Send poem for immediate consideration. Five Star Music Masters, 630 Beacon Building, Boston.

**BRILLIANT Melody to your words, \$2.** Professionals, 339, Mill Valley, California.

**SONGWRITERS! B.M.I. Publisher** with established radio program seeks new songs, poems! What have you? Professional's sincere examination free! High fidelity recordings made. Transradio Music, Inc., 1650-N Broadway, New York.

**COMPLETE Song writer course \$1.00.** Frank Hartman, Cabin John, Md.

**SING Beautifully.** Modern voice culture. Literature free. Ferris, 317A So. Hartford, Bremerton, Wash.

**MUSIC Arranged to songs.** Frank Wildt, Music Publisher, Lancaster, Pennsylvania.

**HAWAIIAN, Spanish guitar music.** Wide choice. Expert advice. 23 years experience. Eddie Alkire, Easton, Penna.

**PLAY Swing piano in six weeks.** "Write send course 7 days approval or will send \$1.00." Pianow, 670-A North Kenmore, Hollywood 4, California.

**HAWAIIAN Music, six 35c selections \$1.** (Steel guitar or piano.) Golden Gate Publications, 1724 Telegraph, Oakland 12, California.

**HOTT Jazz playing offers pleasure, profits.** Amazing new course guarantees results. Alkire Publications, Easton, Penna.

**ACCORDIONS.** New and used at wholesale prices. Save up to \$100.00. Buy direct from factory. Del Principe, 307 So. Wabash, Chicago.

**SONGWRITERS Wanted; prices, details, free book.** Variety, 2 Salem, Ind.

**SONG Poems wanted.** Free booklet, full particulars. Write. Song Service, 331-O West 46th, New York.

**SONGWRITERS—Professional offer.** Edward Madden, 1300 Lodi, Syracuse, N. Y.

**GUITARISTS.** Teaching pays well. We train you. Earn while learning. Guaranteed. Alkire Publications, Easton, Penna.

**SONGS Wanted; Poems set to music.** Free publishing. Royalties. Hollywood Song Guild, Box 2230, Hollywood 28, Calif.

**SONGWRITERS! Amazing, outstanding proposition.** Hibbler, C5, 2157 N. Avers, Chicago.

**LEARN Popular piano! Write Magic Key, 111-A Broadway, Glendale 4, Calif.**

**LEARN Popular piano! Play hit songs** in boogie-swing style. Pianists, send dime for sample arrangement. Home-study folder free. Christensen Studios, 751 Kimball Hall, Chicago 4, Ill.

**SONG Poems wanted.** Free examination. McNeil, Master of Music, 510-PM South Alexandria, Los Angeles, Calif.

**OUTSTANDING Songwriting service.** Roscoe Barnhart, 1320 48th, Des Moines, Iowa.

**WRITE Songs.** Big money and reputation. Write for information. J. Gordon Pub Co., 201 N. Hoyne Ave., Chicago.

**BEFORE Sending your poem to be set** to music "know your composer." Free booklet. Al. Moquin, 2110 Beachwood Dr., Hollywood 28, Calif.

**SONGWRITERS—Send poem for immediate examination and free rhyming dictionary.** Richard Brothers, 24 Woods Building, Chicago.

**SONG Poems wanted; Write for free** instructive booklet, outlining opportunities. United Music Corporation, Dept. 14, Salem, Indiana.

**WANTED! Lyrics, melodies for songs.** We arrange, publish, sell. Superior Song Studios, Passaic, N. J.

**GOOD Music composed to good words.** Music printing. Reginald Beicher, Chatham, New Jersey. Established 1910.

**HELPFUL Books on hundreds of subjects.** Catalog free. Popular Mechanics Press, (C-43), 200 E. Ontario, Chicago.

## RADIOS, SUPPLIES, INSTRUCTION

**RECORDING** Disks 1/4c. Easily made. Material available everywhere. Instructions 35c. Kaytor Laboratories, Lynwood, Calif.

**CRYSTAL** Radio experimenters. Write Hulet, 29 East 39th St., New York.

**VOICE** Records duplicated. Save your precious serviceman's records. Duplicates made \$1.50-4 for \$5.00. Mail your original record to Radio & Appliance Service Co., 42 Crosby Road, Chestnut Hill 67, Mass. (Records returned) c.o.d.

**RADIO** Tubes, parts. Bargain lists 3c. Potter, 1314 McGee, Kansas City 6, Mo.

**RADIOS** Overhauled and rebuilt, small, large record changers, by licensed radio engineers. Ship your radio prepaid by parcel post or railway express. Radio & Appliance Service Co., 42 Crosby Road, Chestnut Hill 67, Mass.

**MAKE** Simple, tubeless, batteryless, distance getting, crystal radios. Crystal and illustrated instructions, 25c postpaid. Allen, PM427, Clinton, Mo.

**BRAND** New, six-tube, a.c.-d.c. superhet kits! Other radio parts! Complete price list, 10c. Melvin, Okin, 915 Bryant Ave., Bronx, New York.

**FOR** Sale — Oscillators \$39.50. Volt ohmmeters \$39.50. Speakers, all sizes. Wire. Tubes, the hard to get parts. Freck Radio & Supply Company, Asheville, N. C.

**REVISED** Plans 18 long distance crystal sets, including "Radiobuilder"—25c. Laboratories, 363-C Hampton, Hayward, Calif.

**BUILD** Improved extra loud crystal radio. Complete details, 20c. Joseph Amorse, R-4, Hungary Road, Richmond, Va.

**PREPARE** Now for tremendous opportunities in new fields of radio after the war. Training for federal licenses. Write for particulars. American Radio Institute, 52 East 23 Street, New York 10.

**RADIO** Service men and experimenters send for our giant radio catalogue. Save dollars. United Radio Co. (1000M), Newark, N. J.

## BUSINESS OPPORTUNITIES

**"CASHING** In on a business gold mine" is an important booklet of vital interest for those now operating a sandwich shop, drive in place, roadside inn, etc., and for those desiring to open a business of this type on a profitable basis, an extraordinary opportunity exists. Booklet free for the asking. No obligation. Haskell D. Boyer, P.O. Box 1486, Fort Worth 1, Texas.

**LEARN** Mailorder business. Make money at home. Amazing new course. Written so you can understand it. Free details. Belfort, 225 Engineering Building, Chicago 2, Ill.

**START** Home business making statuary, plaques, art goods, novelties, concrete pottery, garden furniture, artificial marble flooring, liquid marble. Make your own flexible molds. Amazing profits. Valuable folder free. Creative Publishers, (PM7), Glencoe, Illinois.

**OWN** A mail-order paper products business. Sell envelopes, tags, labels, boxes, by mail, wholesale. Tremendous demand. Steady profits. No capital necessary. Write Omaha Envelope Service, Dept. 22, 4721 California, Omaha 3, Nebr.

**VITAMINS**—Our high quality, low priced formula packed (in small lots) under your own private label. Big profit selling stores, agents, and consumers. Samples, prices, and literature free. The Gibson Company, Harlan, Iowa.

**BIG** Profits, make and fit arch supports. Particulars. Jul Corssen, 2638 Geyer, St. Louis 4, Missouri.

**I** MAKE A good living from my home by mail. You could do likewise. Postal brings details. William Dunbar, New Brunswick 1, N. J.

**START** A unique backyard industry. Make extra money. Literature free. George Gundrum, LeRoy, Michigan.

**FOUR** Books—228 exciting pages on mail order work—150 ideas, plans, methods. \$1 postpaid. Free circulars of many unusual books. Lynch Magazine-Book Agency, 402-D Hazlett Ave., Baltimore 29, Md.

**START** "Soap Factory" at home. No machinery. Amazing opportunity. Literature free. Kemcio, SM-7, Park Ridge, Ill.

**CANADIAN** Organization wants new fast selling specialties, novelties, etc. Manufacturers, dealers, large or small, anywhere, what have you to offer? Wittick Enterprises, 123 Edwin Avenue, Toronto, Ontario.

**"MAIL** Order Trade Directory"—1944 edition; wholesale reference guide to reliable supply sources and services. Only 25c. Box 693, Canton 1, Ohio.

**START** Your own business on our capital. Always your own boss. Hundreds average \$3,000 to \$5,000 annual sales year after year. We supply stocks, equipment on credit. 200 home necessities. Selling experience unnecessary to start. Wonderful opportunity to own pleasant, profitable business backed by world wide industry. Write Rawleigh Co., Dept. G-U-PPMB, Freeport, Ill.

**PLASTIC** Engineering pays big. Home study course. Low cost. Easy terms. Free booklet. Ohio Institute of Technology, Box P-164, Greenville, Ohio.

**UPHOLSTERING**; Profitable. Big demand, easy learned. Illustrated course shows how. Write. Upholstering, Lombard, Illinois.

**MECHANICALLY** Inclined men — Own and operate general appliance repair shop. Complete, illustrated course shows you how. Welding, refrigeration, motor repair, how to get business, etc., all phases covered. Free literature. Christy Supply, Dept. 142, 2835 N. Central Ave., Chicago.

**52-PAGE** Mailorder magazine and big mail, 10c. David Talbot, Green Cove Springs, Fla.

**BUILD** Your own business. Mechanics hand paste. Make it. Sell it. Formula and instructions \$1.00. Garrison, 22 Conklin Place, Dumont, N. J.

**MAKE** Your own Flexible Molds. Statuary, Art Goods, Novelties, Artificial Marble Flooring, Liquid Marble. Literature free. Kemcio, 7-M, Park Ridge, Ill.

**10 TRIPLE-SHAVE** Double-edge razor blades in classy letter style package. 1st class mail anywhere 3c. Send 30c one package or \$1.00 four packages prepaid. Agents wanted. Novelty Supply & Mfg. Co., Fremont, Ohio.

**GUARANTEED** Income! Grind lawn mowers. \$2.00 capital! Mowers, Janesville, Wis.

**BEFORE** You invest in mail selling ventures investigate our "what is your future" setup. Houston Maupin, Tipp City 9, Ohio.

**MANY** Make money by mail, you can too. Information free. Riley, 14568 Superior Rd., Cleveland 18, Ohio.

**NEW** Booklet "Getting Dollars by Mail" 10c. Terrill, Bogard 2, Mo.

**OPERATE** America's lowest price peanut vender. Write Fielding Company, 259 Pearl Street, Jackson, Mich. Stock shipments.

**SELL** By mail professionally. What, how, where? Giunta, 78-45M 81st Street, Brooklyn 27, N. Y.

**MONEYMAKING** Opportunities, steady income. Write, Meeks Publishing Co., Box 792, Weed, California.

**MAIL-ORDER** Opportunities — details free. Alexander, 3002 Rodman, Washington 8, D. C.

**YOUR** Own mail business. Pleasant, profitable. Write Reichert's, 1838 Van Buren, E. Cleveland, Ohio.

**30 PROFITABLE** Business plans. Complete 25c. Free literature. Spada Enterprises, 10 Lexington St., Wethersfield 9, Conn.

**"ALKAVITA"** Tablets. Big profits. Start: \$1.00. Details: stamp. Dickie, 23NE8, Oklahoma City 4.

**DOLLARS** Quickly earned, own boss, with full purse. Write, Julia Stout, Garden City, Mo.

**OPPORTUNITY** For machinist with some shop equipment. Frank Harris, Juneau, Alaska.

**START** Profitable home business! Free information! Rayco, Box 124, Newport News, Virginia.

**START** Mailorder bookshop—Everything furnished; publisher cooperation. 25c brings booklet, exclusive setup, samples, exciting ideas. General Publications, Ossining, New York.

**MAKE** Insecticide spray. Instructions, materials 35c. Kaplan, 13 South Eden, Baltimore.

**10 MAILORDER** Magazines, including 52-page publication 20c. Weyl, Box 202-Y, Columbus 16, Ohio.

**START** Profitable mail order business on limited capital. Modern inexpensive course shows how. Includes free consultation with noted author, a top flight mail-sales specialist. Eye opening details free. J. G. Schroeder, Box 504-p, Anaheim, Cal.

**601 MONEY** Making ways 69c. George Bryant, (R.2), Lawrenceburg, Ky.

**MAILORDER** Magazines, opportunities, giant mails 10c. Scholl, 2002 Morris Ave., Birmingham, Ala.

**MONEY** Making opportunities—Leading mailorder magazine, big mail, 10c. Sign, Farmington, Missouri.

**MAIL** Order business training insures your post-war future. Write today. Schroy System of Self-Advancement, Box 8084, Market Station, Los Angeles 21, California.

**MEN** Women plan now for war conditions. Booklet describing collection of 127 money making plans free. Morrill, Box 847, Portsmouth, N. H.

**PROFITABLE** Home business. Sensational new course. Flexible mold making, novelty casting. No priorities. Valuable folder free. Plastic Arts Studio, Route 4, Muncie, Ind.

**MAKE** Flexible molds! Cast plaques, novelties! Sample and information free! H. Tooker, 630-K Chestnut, Hamilton, O.

**CAPITAL** Seekers—Interested in raising \$25,000 or more should write to Amster Leonard, Fox Bldg., Detroit 1, Mich.

**FREE** Literature explains profitable home mailorder. Cutler Publications, Reading, Penna.

**GARAGE** Doors dashboard controlled. Look under "Automobiles."

**PLASTICS**. Made at home without equipment, 10c pound. Perfect castings and moulds—formula and instructions 50c. Fred Baker, 225 Symington Ave., Toronto, Canada.

**LEARN** Refrigeration mechanics. Start your own repair shop. Complete illustrated course. Free booklet. Mechanics School, Dept. PM11, 4703 West Pico, Los Angeles 6.

**START** Your postwar planning now. Go into business for yourself at home in spare time. We can help you. Details free. L. T. Alexander, Dept. 131, 430 W. 9th, Dallas 8, Texas.

**MAKE** Money at home. I did. You can. Details, dime, stamp. Home Service Bureau, Box 3221, Chouteau Station, St. Louis, Missouri.

**SUCCESSFUL** Debt collection methods 50c. Alvin, 553 William, Winnipeg, Man., Canada.

**GROW** Drug plants and grow rich. Box 423, Kellogg, Idaho.

**ELECTRICAL** Appliance repair. Open your own shop. Learn house wiring; electric motors, vacuum cleaners, washers, etc. Complete illustrated course shows how. Free booklet. Pacific School, Dept. AP82, 4703 West Pico, Los Angeles 6.

**YOU** Can make fancy profits selling flavoring extracts. Make your own. Send two dollars for each formula. Your Service, Box 643, Warren, Ohio.

**READY** To go mail business 25c. One small ad gets you going. Send 25c for Quarters Galore. Rennolett, 830 - 9 St., Rock Island, Ill.

**"THE** Key to Wealth," our folio (sent free) will interest you. F. A. Alsen, Box 165, Chicago 90, Ill.

**YOUR** Own business with \$25.00 capital. Stamp brings details. Varvel, Box 1311, Salt Lake City 11, Utah.

**FIRE** Extinguisher, start your own business, formula for contents, where to get container, complete instructions for advertising and selling, get everything needed in your home town. \$1.00. Box 45, Mission City, B. C. Canada.

**PLASTICS**. Molds, plaster casting, instructions 50c. Alvin, 553 William, Winnipeg, Canada.

**BUILD** Your future now. Plans and formulas, particulars. Hudson Specialty Co., 201A 48th St., Union City, N. J.

**RUBBERFORM** — Plastic; waterproof elastic flexible mold making liquid. Sample pint with instructions \$1.25 postpaid. Gallon \$7.00. Plastic Products, 1410-13, Belmont, Chicago.

**AFTER** The war then what? Go in business, sell by mail, big profit, fully guaranteed. Dr. G. Anthony, 210 5th Ave., New York.

**MAKE** Money at home. New booklet containing profit making plans for starting mail order or local business. Price 25c. Gordin Publishers, Box 23, Pawtucket, R. I.

**CO-OPERATIVE** Collection System collects bad debts for twenty cents each. "Complete Starter System" \$1.00. Co-Operative System, Box 638, Chicago.

**BETTER** Times will come your way, opportunities galore in Progressive Mail Trade. Send 10c for your copy today. Lyle P. Moore, 2854 Harris Place, Norwood 12, Ohio.

**VALUABLE** Advice in advance on how to make money by mail. Details free. Unusual Book Mart, 242 North Park, Decatur, Illinois.

**KARAKUL** Sheep are profitable. Write: Addis Kelley, Maywood, Calif.

**HOW** And where to obtain capital. Fully explained, particulars free. Star Service, Wapakoneta, Ohio.

**MAIL** Order information and guaranteed offer free. Box 467, Lowell, Mass.

**LIQUID** Marble; snow-white, multi-colored. Glazed, Unglazed. Composition flooring. Lifetime wear. Any color. No priorities. Flexible molds. Plaster casting. Get into the big money now. Full information given free. Write Compo-Tex, Box 786-R, St. Louis, Mo.

**BUILD** Miracle homes. Yours. Others. Enjoy prosperity. Particulars. Chamberlain Co., Fitzsimons Building, Pittsburgh, Penna.

**YOU** Too can learn how to make, mold or cast real plastics. Send stamped envelope Box 498, Gainesville, Texas.

**MAILORDER** Magazines, opportunities, giant mails 10c. Scholl, 2002 Morris Ave., Birmingham, Ala.

**COLOR** Concrete with chemicals. Big money making Hollywood style pottery, birdbaths, without moulds. Washing-wells, stucco-rock, benches. Marbling, cement water-paints. 10c brings sample, literature, pictures. Hollywood Cement-Craft, 8527 Wonderland, Hollywood 46, California.

**AGENTS**—To mail our literature. Good profits. Home business. Maywood, 1133 Broadway, New York.

**ADVERTISE** In Progressive Mail Trade, famous for famous results. There's a reason why advertisers stay in year after year. Best puller. Lowest rates. Pewitt Publications, 605 Clayton, San Francisco 17, Calif.

**TODAY'S** Prize winning mail order opportunity fulfills beginners hopes. Quick, economical start. Dollar getting sales literature. Popular merchandise. Write Klemco, St. Clair Shores, Michigan.

**DISTRIBUTE** Vitamin and mineral tablets and capsules. 100 different products. Low wholesale prices. Catalog. National Vitamin Company, Portland 4, Ore.

**"HOW To Make Money With Hobbies"**—Mail order work, handicraft, stamps, or dozens of other hobbies. 60 pages of exciting experiences, ideas, plans \$1. Free circulars of many unusual books and plans. The Hatch Press, 526 Hanover St., Dept. PM, Meriden, Connecticut.

**FREE** Subscription to "The Mail Order News" (Somerville, N. J.) Oldest mail trade journal in America. Offer limited. Drop postal today.

**WEBER** Typewriter Mechanics School. Simplified homestudy-repairing increasing. Hollywood 27, California.

**"HOW To Make Simple Molds and Plaster Plaques."** Profit in popular novelties! Booklet 25c. Plastercraft, 1406 E. 43rd St., Cleveland 3, Ohio.

**INCORPORATE** Your business. Delaware laws. Many advantages, free details. Tax Research Bureau, Inc., Delaware Trust Building, Wilmington, Delaware.

**GET** Into mail selling. Prepare for future. Start sideline business now. Splendid opportunities. Interesting, profitable propositions immediately available. Progressive Magazine tells how! Free details and premium offer. Sheboygan Publishing Co., Sheboygan, Wisconsin.

**CHARTERS:** Delaware; best, cheapest; free forms. Colonial Charter Co., Wilmington, Del.

**DRUNKENNESS** Is a disease which responds to treatment. Medical skill plus human sympathy prove successful with liquor and drug cases. 60 years experience. Write for free booklet. P. M. Nelson. The Keeley Institute, Dwight, Ill.

**127 WAYS** To make money, in home or office, business of your own. Full particulars free. Elite Co., 214 Grand St., New York.

**BRUSH** Plating outfits connect to a battery. No tanks necessary. Good paying business at home plating autoparts, bathroom fixtures, bicycles, reflectors, silvering mirrors. No shop or experience required. Outfits furnished. Free booklet. Gunmetal Co., Ave. H, Decatur, Ill.

**EXTRA** Income—Plenty mail selling opportunities. Write Katz, 4254 N. Kimball, Chicago.

**5 MOST** Read mail order magazines 20c. Armand Cartier, 695A North, Pittsfield, Mass.

**LIQUID** Marble—Colorful, glazed! Mold, brush, spray! Composition floors, rubber-lastic molds. Particulars free. Marbleizing Service, Edwardsville, Illinois.

## MONEYMAKING OPPORTUNITIES

**HERE'S** A moneymaker! Sell new 1944 scheme booklets by mail. Big profits. Sales literature furnished at cost. Sample booklet 25c. Details free. Climax, 1210 South Harding, Chicago 23.

**DOLLARS** Daily, in profitable m. o. business of your own. Start small, grow large with National Mail Sales Service. No penny ante scheme but a real opportunity. Information free. Tannehill, 745 N. Central Ave., Chicago, Ill.

**MOLDMAKING**—Plaster Casting. Complete formulas—fully illustrated. 25c. Ideal Service, RM-7, Park Ridge, Ill.

**BIG** Mail. Special offers. Mailorder magazine 3 months, with your name listed in big mail directory free. All 25c. Richmond, Box 21-P, Los Angeles 31.

**BIGGER** Earnings through mail selling. Palmetto Service Bureau, M, Box 124, Columbia, South Carolina.

**WAR** Workers now flooding mails with dollars. To get your share, write—Speck, 181 West Dauphin, Philadelphia 33, Penna.

**247** GENUINE Opportunities. Magazine only 10c. Lucas, 8704 St. Aubin, Hamtramck 12, Michigan.

**CO-PUBLISHERS** Wanted. Particulars free. Scholl, 2002 Morris Ave., Birmingham 3, Ala.

**HELP** Win the war first! Then man, you'll like silvering mirrors, reflectors! Making sparkling chipped glass nameplates. Outfit prices. Sprinkle, Plater, V60, Marion, Indiana.

**GIANT** Mails, opportunities galore: big mail trade magazine, adsheets, circulars, three months 25c. Harvey Teeple, Decatur, Indiana.

**START** Now, build money making mail order business. Be established after the war. Write for free particulars. Young's Industries, Kent 15, Ohio.

**MECHANICALLY** Inclined men — Own and operate general appliance repair shop. Complete, illustrated course shows you how. Welding, refrigeration, motor repair, how to get business, etc., all phases covered. Free literature. Christy Supply Dept. 1142, 2835 N. Central Ave., Chicago.

**MONEYMAKING** Mailorder opportunities awaiting you. Write Lawson, 1011 Harwick, Willow Run, Mich.

**"DOLLAR** Tips" moneymaking book plans, formulas, ideas, business secrets. 25c postpaid. Joseph Royer, 15-M How Street, Haverhill, Mass.

**INCREASE** Your income. Biggest international wholesale, export concern. Particulars free. Nerl's C°, Box 2932, Rio, Brazil, South America.

**REALTY** Business, how to buy, sell farms, properties, business, book 50c. Many other vocations. Free list. Mell Specialties, Western Springs, Ill.

**EARN** Money evenings, copying and duplicating comic cartoons for advertisers. Adservice, Argyle, Wisconsin.

**MAKE** Shaving, complexion cream with dairy cream. Formula, directions 25c. Ferris, 619 Wellington, Chicago.

**THOUSANDS** Of articles wholesale. "Supply Source Directory" 10c. Ideal Service D-7, Park Ridge, Ill.

**DOLLARS** In your daily mail. Tested sales letters that bring back the cash. Big profits. Write Logan, 315-P W. Peachtree, Lakeland, Fla.

**START** A home business in spare time. Experience not essential. Literature free. Romola King, 301 West Ninth Street, Cisco, Texas.

**FOUR** Great books. 228 exciting pages of moneymaking opportunities. 150 ideas, plans, schemes \$1.00. Pioneer, Box 404P, Yonkers 1, N. Y.

**NEED** Cash? Read "Mail Order World." Boundless opportunities! 10c. Homework Publications, 814-44th, San Francisco.

**GROW** Dwarfed trees few inches high for yourself or sell. Instructions. 15c. Charles McGuire, P.O. Box 628, Dept. G, Seattle 11, Wash.

**ATTRACTIVE** Moneymaking opportunities, magazines, 25c. Refundable. Hirsch Enterprises, Spring Valley, New York.

**"MAKING** Money with rabbits." Valuable hints. 25 cents. H. Chisholm, Exira, Iowa.

**SPECIAL** Training—for entering successful business. You start small, grow big. We tell you what to start, what to pay, what to sell, who will buy. Ask for bulletin No. 12. It's free. Edgar W. Thomas, Barnesville, Ohio.

**LEARN** Refrigeration mechanics. Start your own repair shop. Complete illustrated course. Free booklet. Mechanics School, Dept. PM12, 4703 West Pico, Los Angeles 6.

**ICE** Cream candy—Candied fruits. Sensationally delicious. Formulas 20c. LaPlant, Menominee, Michigan.

**MAKE** Up to \$25 weekly in spare time at home. Full instructions folio 25c. Universal Service, 919 N. St. Mary's St., San Antonio 2, Texas.

**"THE** Key to Wealth." our folio (sent free) will interest you. Aisen Service, Box 165, Chicago 90, Ill.

**MAGAZINES,** Circulars, opportunities 10c. Holloway, Box 237, Franklin Park, Ill.

**SURE** Income—Put up Moth Gas and TSP, nationally known items. Source, particulars, quarter. Novelty Print Shop, Dover, N. H.

**GET** Rich without starting capital. My copyrighted plan (guaranteed) has already enriched thousands. Dr. T. 185 W. Godfrey, Philadelphia.

**MONEY** At home. Your own business. "Progressive Mailtrade" Magazine (15th year), prints many small capital post war opportunities. Read by thousands; you'll like it too. Copy 10c. Publishers, Box 115M, Gardenville, New York.

**PROFITS** Without merchandise. 10000 word course. Details, stamp. Challenge, 87P Somerset, Springfield 8, Mass.

**IF** You want to trade or sell anything (regardless of what it is) send 20c coin for "Swappers Guide." It lists hundreds of swap-buy-sell opportunities all over America. Swappers Guide, 610 N. St. Joseph, Evansville 12, Indiana.

**GET** Your mail order start by joining the National Mail Order Guild. They tell you all the facts—what sells by mail—who buys by mail and how to reach them. They help you every step of the way. Send for full information. No obligation. A. J. Shutt, P.O. Box 269, New Castle, Indiana.

**CATALOG,** 300 Money making plans and books. One dime. Co-Operative Service, Box 638, Chicago.

**THOUSANDS** Of alarm clocks need repairing. Jewelry stores swamped. Our simplified course teaches you how to repair these clocks. Necessary tools and supplies furnished with course. Alarm Clock Repair Service, Dept. B. P.O. Box 1983, Houston, Texas.

**PERFUME** Instructions furnished. Start mail order or local business. Particulars free. Dr. Abell, Parkway Bldg., Pasadena, Calif.

**BOOKKEEPERS,** Earn money at home posting journal entries. Ellis Business Service, Cedar Grove, North Carolina.

**LICK** After-war layoffs! Start own business; home, office. Booklet describing "Collection of 127 Tested Plans" free. Elite Co., 214 Grand St., New York.

**PUBLISH** Your own magazine. Hand-some 52 page format, well edited, illustrated. Cost low as \$1.00 month. Brings you prestige, profits. 10c brings sample, details. National Ord. Nebr.

**LEARN** Metascience. Remarkable drugless healing. No manipulation. No apparatus. Unbelievable simplicity and results. Inexpensive correspondence course. Write Metascience, De Land, Florida.

**EARN** Money at home! Thousands do "Home Worker Magazine" tells how. Sample, 25c. Sizemore, Box 7, 4917 North Kostner, Chicago.

## CHEMISTRY

**THE** House of Winn, the home of supplies for amateur chemists. New Idea home laboratory chemical kits and apparatus outfits for home experimenting. Send 10c for retail catalog. Established 1931. John H. Winn, Dept. 507, 24 West 23 St., New York.

**270** CHEMICAL Reagents. Apparatus. Bargain! Justice, 125 West Monroe, Chicago 3.

**LABORATORY** Supplies at wholesale prices: Chemistry, biology, physics. Catalogue 10c. National Scientific Co., 2204 W. North Ave., Chicago. Established 1908.

**LABORATORY** Supplies and chemicals. Send 10c for catalog listing 5000 items at wholesale prices. Standard Science Supply Co., 1236 N. Paulina St., Chicago, Illinois.

**COLCHICINE**—Creates new mutant plants—Experiments magazine and booklet 25c. Questok, 277 Washington, Newton 58, Mass.

**CHEMISTRY** Laboratory apparatus and chemicals for industrial, analytical, and private experimental laboratories. Complete chemical laboratory supply service for correspondence school students. Send 3c for free 48-page catalog of chemicals and apparatus. Dept. M-43, Biological Supply Co., 1176 Mt. Hope Ave., Rochester, New York.



100 DIFFERENT Chemicals. One ounce or more each. Excellent opportunity for diversified laboratory stock. \$6.90. Midwest Chemical Co., 3724 Second Ave., South, Minneapolis, Minnesota.

SPECTROSCOPE For quick chemical analysis \$2.50. Kutting Sons, Campbell, California.

FREE Catalog: Chemistry, mineralogy, biology, optics. Tracey Laboratories, Evanston, Illinois.

#### FORMULAS, PLANS, ETC.

40 COSMETIC Formulas, other beauty information. 200-page book. \$1.00. Richmond Pub. Co., Box 21-P, Station A, Los Angeles.

SHOE Renew 25c. Clothes, carpet cleaner 25c. Dr. Waterman, 601 Laurel, San Mateo, California.

SPECIAL: 30 Picked formulas and plans for \$1.00. Read Monroe-Methods ad in classification (Auto Supplies and Equipment.)

"LUMINOUS Paint" shines in dark. Easily made. 100 other formulas, plans—all 25c. Soap-making course (20 formulas) \$1.00. Resilvering mirrors, formula 30c. Ideal Service, 307, Park Ridge, Ill.

ICELESS Ice! Colder; cleaner; cheaper. Instructions, 25c. Duffy, C-53, Covington, Ky.

ANY Formula \$2.00 or money back. Case Kowal, Chemist, 1846 Cullerton, Chicago.

MAKE Big money. Get these 6 money-making secrets for \$1.00. Itching feet remedy, bug-a-boo, kill 'em all, rid of rats, how to make your own cola drink. Recharge flashlight batteries and reclean used motor oil. Industrial Research, 17 Madison St., Boston 19, Mass.

MAKE Soap for home use. Start a soap factory. The quickest and cheapest way that soap can be made. \$2.00 postpaid. Lawrence Bordenlon, Ancon, Canal Zone, Panama.

THE Master formula. Mix two common ingredients and you have twelve essential products, all in one bottle. Simple instructions, description of products and formula \$1.00. H. M. Bureau, Box 4262, Edmont, Canada.

GASOLINE Gas machine plans, \$1.00. Easily made from spare piping and parts. Up to thousand cubic feet per gallon. Ideal Spec., Lakewood 5, R. I.

AUTHENTIC Formulary. 924 page illustrated book. Prepared by experts. 10,000 practical tested formulas, recipes, secrets, instructions for easily making most any product. Countless profitable business opportunities. Valuable reference for home, industry. \$2.00 post paid (c.o.d. U. S. only). Foreign \$2.35. Adams Brown Company, Dept. 11, Chestnut Hill 67, Massachusetts.

FORTY Fast seller formulas and catalog \$1.00. Co-Operative Service, Box 638, Chicago.

MAKE Fast selling products. No machinery. "Chemist Approval Formulas." Literature free. Kemico, 15, Park Ridge, Illinois.

FORMULAS—Latest, best. Analysis. Literature free. Belfort, Engineering Building, Chicago.

REAL Manufacturing formulas. Lists free. Cummings, Chemist, Gordon Ave., Syracuse, N. Y.

#### HELP WANTED

MEN, 20-45 yrs., to work on railroad rail testing service cars. Those under 38 must be draft deferred. Job entails constant traveling. Electrical-mechanical experience preferred. Also stewards; salary plus all living expenses. Those now in 100% war work not considered unless released. Write full details to Personnel Department, Sperry Products, Inc., 1505 Willow Ave., Hoboken, N. J.

#### AGENTS WANTED

SPARKLE Products polishing clothes cleans all—No messy liquid-powder—Sells fast. 25c. Free sample. Sparkle Products, Box 1605, Boston.

SELL Personal stationery, printing, greeting cards, and patriotic specialties to friends and service men. Ipcó, 1511 Chicago Street, Omaha, Nebraska.

SALESMEN—Agents wanted at army and navy bases to sell honor rolls. Very beautiful and nothing can compare with it as a keepsake. Sample \$1.00. Particulars free. Owen Carpenter, 2024 Glenn Ave., Fresno 4, Calif.

AGENTS—300% Profit selling gold color window letters; stores and offices. Free samples. Metallic Letter Co., 438-B North Clark, Chicago.

BIG Profits taking subscriptions for all magazines. Agents' confidential catalog listing over 2500 periodicals and complete starting supplies free. Pines Subscription Agency, Flushing, New York.

CALL On friends with easy to sell personalized stationery with name in raised type. Big profits. Free samples. Merz Printery, 135 Lenox Street, Rochester 11, N. Y.

EVERYDAY Cards. Make \$5.00 with every ten \$1.00 assortments you sell. Also Victory cards and everyday wrappings. Unusual demand. Write for samples today. Howard P. Ellis, Dept. PM, Pitman, N. J.

BIG Money taking orders; shirts, ties, socks, pants, jackets, sweaters, shoes, uniforms, etc. Sales equipment free. Experience unnecessary. Nimrod, 4922-AN Lincoln, Chicago.

START Your own business on our capital. Always your own boss. Hundreds average \$3,000 to \$5,000 annual sales year after year. We supply stocks, equipment on credit. 200 home necessities. Selling experience unnecessary to start. Wonderful opportunity to own pleasant, profitable business backed by world wide industry. Write Rawleigh Co., Dept. G-U-PFMA, Freeport, Ill.

AGENTS Double your money on our hair dressings for colored people. Write us. Dawson Mfg. Co., Enfield, N. C.

LITE-SAVER Is a harmless luminous paint that shines in the dark. Profitable seller to millions. Details. Ward, 97C, Saybrook, Connecticut.

AGENTS. Big line including food products. Fast selling premium and bargain deals. Low prices. Send card for big outfit offer with gift. Ho-Ro-Co, 2793 Dodier, St. Louis 7, Mo.

RELIGIOUS Motives, also 7x11 signs for restaurants, stores, etc. Sells fast at dime. Send 10 cents for samples. Frank G. Keen, 36 Elberon Ave., Hawthorne, New Jersey.

GOLDEN Magic transforms, in raised gold, any thing you write, draw or rubber stamp, fast seller. Professional size \$1.00. Agents wanted. Joseph Mail Service, Keene, N. H.

BIG Bargains for big profits. Men's used pants 25c, suits \$1.00, topcoats 75c, shoes 12½c. Over 100 sensational values. Experience unnecessary. Free wholesale catalog. Superior, 1250-AH Jefferson, Chicago.

STREAMLINER! Sensational money-making, money-saving gasoline stretcher. Goes like greased streak! Distributor's harvest now. Thermosilwks, Peoria 4, Ill.

MAKE—Sell new glass cleaner. Gallon 25c. 8 gallons \$1.00. Guaranteed. Order now. Formico Service, 314 Kiefaber, Dayton 9, Ohio.

LUMINOUS Flowers, ear rings, crucifix, pictures, etc.; glo-brite in the dark; new process; sensational sellers. Write today. Glo-Brite, 1904-PM Patterson, Chicago 13.

NEW Gift items! Every housewife and family a prospect. Sensational seller, good profit. Agents—write for details. Art Soap Co., Dept. PM, 314 W. 104th, New York 25, N. Y.

CHRISTMAS Cards. Earn \$2 an hour. Take orders galore from friends. 25 exquisite folders with name \$1. Free samples. Others to \$2.50. America's fastest selling 21 Christmas folder box. Costs 50c. Sells \$1. Request samples today. Sunshine Art, Dept. E, 115 Fulton St., New York City.

HOSIERY Guaranteed against everything at no extra cost! Victory sheer ladies' rayon full fashioned sells for only 94c including your profit! Also guaranteed men's hosiery. Amazing opportunity to build permanent business. No experience or money required. Simply write orders. We deliver and collect. Write today for complete free outfit. Kentcraft, Dept. EH, 44 Court Street, Brooklyn, N. Y.

PROFITS Selling novelty fun cards. Samples 10c. National Specialties, Box 301-M, Cincinnati.

WHOLESALE Sources. 500,000 articles. Free directory. Maywoode, 1133 Broadway, New York.

PERSONALIZED Patriotic items! Today's great sellers! Sample free! Harry T. Latz Service, Inc., 242 West 55th Street, New York 19, N. Y.

PLATING Outfits for autotamps, reflectors. Connect to a battery. No tanks necessary. Free booklet and particulars. Gunmetal Co., Ave. N. Decatur, Ill.

AGENTS: Stamping names on pocket-key protectors. Sample check with your name, address, 25c. Stamping outfits. Emblem checks, check-fobs, name plates. Hart Mfg. Co., 303 Degraw St., Brooklyn, N. Y.

MAGIC Cleaner and laundry soap deal. Hotter than a firecracker. Big profits! Sample free. Bestco, 5007 Irving Park, Chicago.

PLAYING Card game. 250% profit. Sample game 25c. Box 842, Denver 1, Colo.

EXCELLENT Sideline for printing salesmen. Decalomania name plates in small quantities. Also, make money applying initials on automobiles. Free samples. "Ralco," 1483 Washington, Boston (18), Mass.

GOLD Laquered window sign, letters. New styles. Absolutely beautiful. Free samples—catalogue. Atlas, 7941 Halsted, Chicago.

FREE Water and our concentrates, makes flavors, lotions, shampoos, 72 products, labels, bottles furnished. Qualco, E-20030 Russell, Detroit.

ELITE Collection contains 127 plans for starting own business; home, office. Descriptive booklet free. Elite Co., 214 Grand St., New York.

#### HIGH-GRADE SALESMEN

ADVERTISING Book matches—World's largest "direct selling" book match factory offers advance cash earnings calling on every type of business. Men or women. Experience unnecessary. Full part time. Low prices. High quality. Quick deliveries. Powerful patriotic display. Special designs for army camps and naval stations. Repeats. Free kit, instructions. Match Corp. of America, 3433 West 48th Pl., Dept. E-7, Chicago 32.

FORMER School men or men who can sell school superintendents. Classroom charts for social studies. Good commission. Quick action. National Forum, 417-A South Dearborn, Chicago 5.

SELL Books and courses by mail in your spare time. Siddall, Atascadero, Calif.

SELL Toy guns to everybody. Parfex Company, 4189 W. 2nd St., Los Angeles 4, Calif.

BLADES—Best quality, factory prices. Details free. Ace Blades, Buffalo, N. Y.

JOBBERS. Dealers, sell long profits merchandise. Imprints available. Write Adams Exchange, 150-P West 124th Street, New York 27, N. Y.

ORANGE Concentrate direct from our Florida grove. One quart bottle makes 6 quarts delicious natural orange drink simply by mixing with 5 parts cold water. Grocery stores, food marts, roadstands, sodafountains, resorts, camps, farmers big buyers. No investment. Protected territory. Salesmen earn \$100 to \$200 repeat commission per week. Sunset Valley Orange Co., 3357 Clifton, Chicago.

SALESMEN: Have real money making opening. Fits into war program. Old progressive firm. Dept. "F," Box 392, Dallas, Texas.

#### EDUCATIONAL AND INSTRUCTION

"DAILY Key notes for key production men" 65c each. Barmore, 242 South Holyoke, Wichita 8, Kansas.

MATHEMATICS—Announcing the greatest discovery of all time—The solution of the historic problem of angle-trisection with the ruler and compass only. This discovery will benefit you and millions of others with the application of its mathematics to all branches of science. Its author is the inventor of the world's only universal focus lens. It has a fixed focus, and reproduces, photographically, everything from the lens surface to infinity with perfect definition. It does not have the distortion of present day lenses, caused by refraction, thereby refuting the currently accepted principle of optics. If you are interested in technical progress and your own advancement, you need this mathematics. Publication now available \$1.25. Pure Science Research Associates, 120 N. Jackson, Moscow, Idaho.

MAKE Up to \$25-\$35 week as a trained practical nurse. Learn quickly at home, spare time. Easy tuition payments. Earn while you learn—many earn hundreds of dollars while studying. Easy to understand lessons, endorsed by physicians. High school not required. Our 45th year. Write for free booklet and sample lesson pages. Chicago School of Nursing, Dept. TK-7, Chicago.

LEARN To remember without effort. Easy five lesson memory course, \$1.00. Amazing results. Money back guarantee. Postcard brings particulars. Mighty Midget Publications, Box 566A, Lincoln, Nebr.

ENJOY Health! Become professional acrobat. Free health book. Write! Knoff, 2154M North 52nd Street, Milwaukee, Wis.

**GOOD Jobs and a sound postwar future for you in hotel and institutional field, government housing, food and recreation projects. Men and women—all ages—needed for well-paid positions that offer color, excitement, ever-new and fascinating duties. Record-breaking business in hotels, clubs, institutions means even greater opportunities. Lewis School receiving calls for managers, hostesses, executive housekeepers, purchasing agents, etc. These are not temporary jobs, but important positions in an essential business that offers splendid opportunities in war or peace, good times or bad. Previous experience proved unnecessary! No need to leave your job to qualify. A good grade school education, plus Lewis Training qualifies you, at home, in spare time. Our National Placement Bureau helps to place you and—under our amazing Certified Job Plan—actually guarantees you will "make good" when placed. Write today for free book! Lewis Hotel Training School, Room CR-368, Washington 7, D. C. (First and only school of its kind—Now in its 28th year.)**

**GET "Set now!"** When the war-time job boom ends, only properly trained men will get and hold permanent positions with top pay. Pick air conditioning, refrigeration, heating, ventilating, welding, electricity, radio or electronics—fastest growing, most promising industries. Prepare now, train in a few months instead of years. Low tuition, liberal terms. Earn part expenses. Big book free. Milwaukee School of Engineering, Box 644, Milwaukee, Wis.

**MATHEMATICS**, Arithmetic, algebra, geometry, trigonometry, calculus, physics, problems solved, pre-inductions, refresher courses, architect's, surveyor's engineer's licenses, Questions, answers. Mondell Institute, 230 West 41 St., New York.

**"HOW To Break and Train Horses"**—A book every farmer and horseman should have. It is free; no obligation. Simply address Beery School of Horsemanship, Dept. 1107, Pleasant Hill, Ohio.

**WELDING**—Electric arc. Learn profitable trade quickly through actual practice. Individual welder instructions at bare cost of materials. Full particulars free. Valuable welding lessons book 50c. Hobart Welding School, Box M-742, Troy, Ohio.

**LEARN The credit and collection agency business; earn \$50.00-\$150.00 weekly upwards. Interesting literature free. Write Educational Extension Service, Department 101, Wilshire-Labrae Station, Los Angeles.**

**EXCEPTIONAL Peace-time opportunity. Operate a collection agency—credit bureau. Quickly learned. Many make \$5000 yearly up. Write Cole Associates, Syracuse, N. Y.**

**"SUREHAND"** Legible shorthand is 25c. Jesse L. Cook, Bartow, Florida.

**RADIO Engineering, broadcasting, servicing electronics, aviation, marine and police radio taught thoroughly. All expenses low. Co-educational. Catalog free. Valparaiso Technical Institute, Dept. C, Valparaiso, Ind.**

**GOOD "Used" self-instruction educational books on all subjects bought, sold, rented, exchanged. Satisfaction guaranteed. Complete information and 92-page illustrated bargain catalog free. Write—Nelson Company, Dept. 2-02, Chicago 4.**

**THE New era of postwar science and prosperity approaches. Get in line for wealth, security, and happiness! Amazing details free. Lorentzian Institute, Box 832, San Jose, Calif.**

**PLASTIC Engineering pays big. Home study course. Low cost. Easy terms. Free booklet. Ohio Institute of Technology, Box P-163, Greenville, Ohio.**

**MAKE Photo stamps, instructions 50c. Alvin, 553 William, Winnipeg, Canada.**

**USED Technical and educational books bought, sold, rented. Catalog free. Educational Exchange, Henagar, Alabama.**

**FREE Manuscript reading. Also marketing. Renseb PM, 30 Church, New York City 7. (Established 1918.)**

**AMAZING Bargains! New-used encyclopedias, reference, technical, adult books. Lists free. Clifton, Box 2233, Capitol Station, Austin, Texas.**

**EARN \$50-\$100 Week. Learn drafting. Monroe Institute, PM-7, Alton, Illinois.**

**HAWAIIAN "Hula Dance," simple, illustrated book \$1.00 postpaid. Brown Specialty Service, 1711 Kilaua Avenue, Hilo, Hawaii, U.S.A.**

**INVESTIGATOR Training. Phillips Secret Service, 1917-B North Kenneth, Chicago 39, Illinois.**

**LEARN To draw nudes. Over 350 illustrations, charts and notes giving detailed study of every part of the human body. Send for Art Anatomy of the Human Figure by Charles Carlson. Only \$1.00. Ball Square Company, 210 Fifth Ave., Suite 1102, New York City.**

**REFRIGERATION Mechanics. Complete home course for repair men. Booklet free. Mechanics School, Dept. PM13, 4703 West Pico, Los Angeles 6.**

**FREE Psychological talent analysis. Streamline your future. Uncover your genius! Dr. Haynes, 802 20th, Washington 6, D. C.**

**EASY Substitute for shorthand. Learn in three lessons, 10c. Elliott School, 4426 Carrollton, New Orleans.**

**CARPENTERS**, We teach the square in five easy lessons by mail. Our 1/4 size practice square and simplified instructions does the work. Free information, better still send quarter for practice square and partial lesson. Builders' Topics, Medical Arts Bldg., Seattle, Washington.

**HOME Study course, drugless therapy. Free literature. Inst. of Drugless Therapy, Tama, Iowa.**

**BECOME A Doctor of Metaphysics (Ms. D.)** Teach secret of contentment, happiness. Solve mental worries. Free book. College of Universal Truth, 5651-C North Asland, Chicago.

**BE A doctor. Learn chiropractic. Fast growing profession. (Residence course only.) Write for catalog—Dept. A. Texas Chiropractic College, San Pedro Park, San Antonio 1, Texas.**

**STOP Radio noises!** Amazing new booklet tells how, \$1.00. Moneyback guarantee. Inquiries answered. Rowe Company, 660 Mission, San Francisco 5, California.

**NEW Writers needed to re-write ideas in newspapers, magazines, and books. Splendid opportunity to "break into" fascinating writing field. May bring you up to \$5.00 per hour spare time. Experience unnecessary. Write today for free details. No obligation. Postcard will do. Comfort Writer's Service, 210-P South Seventh St., 2, St. Louis, Mo.**

**USED Educational books on all subjects sold, rented, also bought and exchanged. Moneyback guarantee. Write today for free catalog and details. Lee Mountain, Pisgah, Alabama.**

**EARN Certified Grapho-Analyst degree analyzing handwriting. Students report earnings up to \$1.00 an hour sparetime, \$75.00 weekly full time. Graduates in employment, credit agencies, police departments, courts, business and in private practice as personal problem and vocational advisors. Fully Illustrated Grapho-Analyst and 3000 word illustrated lesson free. Institute, Box 1150, Joplin, Mo.**

**MEDICAL Laboratory technicians in great demand. We train you in your spare time, in your own home. You can practice while studying. Write for free catalogue. Imperial Technical Institute, Box 973-E, Austin, Texas.**

**DRUNKENNESS** is a disease which responds to treatment. Medical skill plus human sympathy prove successful with liquor and drug cases. 60 years experience. Write for free booklet. P. M. Nelson, The Keeley Institute, Dwight, Ill.

**LOCKSMITH Course. Lock picking, key fitting, etc. \$1.00 prepaid. Locksmith, Canadian, Texas.**

**SECRET Investigation. Experience unnecessary. Investigators particulars free. George Wagner, M 125 West 86th, New York.**

**HUNDREDS Of helpful books. Catalog free. Popular Mechanics Press, (C-43), 200 E. Ontario, Chicago.**

#### BUSINESS SERVICES

**WASHINGTON D. C.** We represent you here. Also receive and forward mail. Write Service Bureau, 1401 25th St. S.E.

**HOLLYWOOD, California**, mail address. Fool friends! Your business and personal letters, etc., reforwarded from here promptly. Monthly service \$2.00. Single letter 25c. (No stamps.) Naber, 5545 Virginia Ave., Hollywood 27, California.

**\$2.00 MONTHLY** Maintains Washington, D. C., office address. Your mail re-forwarded daily. Hawkins, 7pm3 Randolph Place.

#### PROFESSIONAL SERVICES

**HAVE You any problems requiring technical advice, literature research, unavailable publications, bibliographies, formulas, manufacturers abstracting, translations, etc.?** Consult specialist James Kanegis, 619 Eye Street, S.W., Washington 4, D. C.

#### CARTOONING, COMMERCIAL ART, SHOWCARD WRITING, SIGN PAINTING

**CARTOONING**, Signwriting pays! Either course, complete fundamentals, \$1.00. Details free. John Warren, N7509 Smith, Spokane, Wash.

**ARTISTS** Oil painting set—12 tubes oil color 1/2x4 inches, turpentine, linseed oil, brushes, palette and board \$2.69. Edwards, 818 66th Ave., Philadelphia, Pa.

**CARTOONISTS!** Learn and earn. Illustrated cartoon course—ten money making plans—60 showcard ideas—markets. \$1.00. Cartoon Studios, 1402 Charles, LaCrosse, Wis.

**POCKET Size cartoon course—22 easy lessons, over 200 sketches including figures and lettering. Prepared by nationally known artist. Mailed postpaid on receipt of 25c in coin. Snack-Pack Co., 34 E. Georgia St., Indianapolis 4, Ind.**

**CHALK Talks.** Laugh producing program. \$1.00. Catalog 10c. Balda The Cartoonist, Oaksh, Wisconsin.

**CARTOONING Course—30 illustrated lessons, over 500 sketches, complete \$1.00. Montes Studio, Box 892, Pasadena, Calif.**

**MONEY-MAKING Ideas.** Latest books. Catalog free. Popular Mechanics Press, (C-43), 200 E. Ontario, Chicago.

#### ADVERTISING AGENCIES, LETTER WRITERS, FOR ADVERTISERS

**MAIL Order operators—Get skillfully prepared copy when placing advertising. Our "lowest" line rate plus experience gives you more profits per dollar spent. Van De Mark, Times Star Tower, Cincinnati 2.**

**ADVERTISE Profitably: \$20.00 reaches 5,000,000 Sunday newspaper readers with 24-word ad. Newspaper, magazine, mailing-list ratebook free. Chicago Advertising Agency, 20-PA West Jackson, Chicago 4.**

**24 WORDS, 30 Newspapers \$2.00. Good-all, 37 Gardner, Vallejo, California.**

**ADVERTISE Your business in my papers and magazines. Low prices. Guaranteed large circulation. Dr. G. Anthony, 210 5th Ave., New York.**

**18 WORDS In 100 weeklies \$4.32. H. J. Darnell, 730 Hays, Jackson, Tennessee.**

**ADVERTISE! 24 Words, 149 newspapers \$6.50. Lists free. Advertising Bureau, 4515-C Cottage Grove, Chicago 15.**

**FREE—New Advertisers Rate Guide. 44 pages. Includes everything. Lowest rates. E. H. Brown Advertising Agency, Merchandise Mart, Chicago.**

**ADVERTISING Placed all magazines, newspapers U.S.A., Canada. Lowest rates. Free Service. 54-page catalog free. Baker Advertising Agency, A-189 W. Madison, Chicago.**

**ADVERTISING Placed, any publication, lowest rates, complete agency service. Skilled advertising—merchandising counsel. Ratelist and booklet, entitled "Advertising Results For Sale" free. Baker Agency, 3302 Dodge, Omaha, Nebraska.**

**FREE—"Amazing New Book"—"Profits From Classified Advertising." Tells how and what to advertise. Be sure to read this book before you invest one cent in advertising. Remember—it's free! Write for your copy now. F. W. Johnson, Classified Advertising Manager, 200 East Ontario Street, Chicago, Illinois.**

**INCH Display advertisement. 50 magazines, year \$16. Wood's Popular Services, Atlantic City, (N. J.)**

#### TYPEWRITERS, DUPLICATORS, OFFICE DEVICES

**PRINT-O-MATIO \$9.50.** Handy postal printer \$8.50, used mimeograph \$25. All makes office machines bought and sold. Write Schubert, Box 9818, Los Angeles 27, California.

**SAVE 50% On duplicating supplies. Send 30c for 3 sample stencils. 24 for \$1.75. One pound ink 85c. "Printomatic" duplicator \$8.50. Post card stencils \$1.00 quire. Catalogue free. Dupligraph, 5348 Barry, Chicago 41, Illinois.**

**GUARANTEED Typewriter ribbon renewer, year's supply. 50c. Hirsch Enterprises, Spring Valley, N. Y.**

**DUPLICATORS, Dictaphones, addressographs and other office machines rebuilt, guaranteed machines for sale. No priority. We offer highest cash prices for used office machines. Pruitt Office Machines, Inc., 425-PM No. LaSalle St., Chicago, Ill.**

**"PRINTOMATIC" Self-feeding rotary stencil post card printer, complete. \$9.50. All makes duplicator supplies. Literature free. Pittsburgh Typewriter Supply, 336-R Fourth Avenue, Pittsburgh 22, Penna.**

## RUBBER STAMPS, OFFICE SUPPLIES

YOUR Name, address on deluxe cushion mount rubber stamp \$1.00, pad 25c. Postpaid cash with order. Edgewood Press, Box A-5, Edgewood, Maryland.

ONE Line 15c, 2-25c, 3-35c. Stamp Works, Auburn, Nebr.

3 LINES 30c; Cushioned, indexed, 35c. Signatures \$1.50. Stamprite, Wauwatosa, Wis.

## PRINTING, MULTIGRAPHING, MIMEOGRAPHING, GUMMED LABELS

LETTERHEADS \$3.00 Thousand, noteheads \$2.50 thousand, billheads \$2.50 thousand, envelopes \$3.10 thousand, business cards \$1.80 thousand, two-color gummed name and address labels 25c hundred, other prices equally low. Samples free. Independent Print, 1511 Chicago Street, Omaha, Nebraska.

ADVERTISE With art advertising blotters. The lasting, useful, inexpensive medium. Samples. Keith Press, Elizabethtown, N. Y.

POSTPAID—1000 Embossed business cards \$1.75. Elmer Griffith, Sciotoville, Ohio.

DISTINCTIVE Personal stationery—Samples free. Treaster Printing, 7-44PM, Milroy, Penna.

DELUX Business cards from new type blue or black ink, by artisan, 250—\$2.00 or 500—\$3.00 prepaid. Get samples. Overnight service. Delux Press, 21 E. Van Buren, Chicago, Ill.

MIMEOGRAPHING—Any copy, reasonable. Mailers Service, Box 606-A, Chicago 90, Ill.

10,000 6x9 CIRCULARS Printed \$16.50. Free samples. Specialty Printers, 3111 West Tuscarawas, Canton 3, Ohio.

YOUR Name, address printed on 500 gummed stickers, 1/2x2", 30c coin (no stamps). Write plain. Edgewood Press, Box A-5, Edgewood, Maryland.

25 PRINTED Noteheads and envelopes, 35c postpaid, 100 each, \$1.00. Commodore, 101-D, Forest Park, Illinois.

BUSINESS Or personal cards 100 for 50c. Samples. Personal Card, Box 370, New Haven, Conn. Agents investigate.

100 8 1/2x11 LETTERHEADS And 100 envelopes \$1.00 postpaid. Benneville, 907 West Roosevelt, Philadelphia 40, Penna.

PERSONAL Stationery, 200 sheets, 100 envelopes \$1.00. Mario Giglio, Dept. 19, 441 Perry, Pontiac, Michigan.

1000 8 1/2x11 LETTERHEADS \$3.85 f.o.b. Samples. Apostle's, 112P Buck, Paulsboro, N. J.

5000 LOTS—6x9 Circulars, postcards, letterheads, \$11.00. Envelope slips \$4.75. Folders, labels—all printing low prices. Samples. Goodprint, Harrisonburg, Va.

LETTERHEADS—Best quality—reasonable. Samples. Regal, 1366 Belfair, Springfield, Ohio.

200 BOND Letterheads, envelopes, 89c, 2000—\$5.98. Samples. Joseph Johnson, 1382-A Fifth Ave., New York 29.

PRINTING—All kinds, any quantity, quality, price, 10 day service. (We are rated Dun-Bradstreet). Free list. Press, Farmington, Missouri.

1000 RAFFLES In books, numbered—\$3.50. Nu-Way, 205 East Broadway, New York City.

PRINTING—Excellent work, reasonable prices. Send copy for estimate. Edgewood Press, Box A-5, Edgewood, Maryland.

\$2.00 POSTPAID: 150 8 1/2x11 Good bond letterheads and 150 6 3/4 envelopes, 500 of each \$5.75 postpaid. Mero Products, Box 344, Punxsutawney, Penna.

400 LETTERHEADS Printed \$1.25. Mango, 559 South 20th, Newark 3, N. J.

MIMEOGRAPHING—Letters, pricelists, formulas, instructions. Lowest prices. Lem's Letter Shop, 5710 Stanton, Detroit 8.

100 LETTERHEADS, 100 Envelopes, \$1.25, prepaid. Excelsior Press, Hampton, Virginia.

1000 RAISED Letter process business cards, \$2.50 postpaid. Aronson & Co., 180 W. Washington, Chicago 2.

100 8 1/2x11 LETTERHEADS And 100 6 3/4 envelopes, \$1.00 postpaid. Neat work—fast service. Victor Chicke, Harvey, Ill.

100 LETTERHEADS And envelopes \$1.00. Comic cards packet 25c. Dickover Press, 5233 Cleveland, Kansas City 4, Missouri.

500 3/4x2 1/4 FOUR Line gummed stickers, 25c. Moritz Printery, Saginaw, Mich.

BETTER Grade printing reasonable. Estimates on anything. Economic Press, Leonia, N. J.

## PRINTING OUTFITS AND SUPPLIES

FOR Sale. Portable or basement commercial printing outfit, \$200.00. Send stamp for inventory. Murico, Box 748, Dayton 1, Ohio.

PRESSES. Used type, paper, supplies. Bargain list 3c. Box 918, New York 8.

PRINTING Equipment, type and supplies. Send stamp for details or dime for complete illustrated supply book. Kelsey Inc., X-11, Meriden, Conn.

PRINT At home, 10c will bring a complete catalog of presses, type and supplies. P. Peiffer & Company, 6 Columbia St., Newark, N. J.

USED Presses, type, supplies. Lists 3c. Turnbaugh Service, Loysville, Penna.

INEXPENSIVE Home-made printing press. Details free. Novelty Shop, Downsville, Louisiana.

## PATENT ATTORNEYS

INVENTORS—First things come first. Your first move toward securing a patent on your invention is acquiring full information on what to do. Our two books "Patent Protection" and "When and How to Sell Your Invention" contain this information and other helpful data. Get them immediately, together with our "Evidence of Invention" form. They cost you nothing, you assume no obligation. Write now to Victor J. Evans & Co., Registered Patent Attorneys, 831-H Merlin Building, Washington 6, D. C.

WHO Buys Inventions? Manufacturers everywhere have written us seeking new patented inventions. Present defense program offers splendid opportunity to inventors with meritorious ideas. As registered patent attorneys in Washington we have served hundreds of inventors—for full information on how to protect your invention write for free book, "How to Protect, Finance and Sell Your Invention." Also free special form "Invention Record" upon which to sketch and describe your invention. No obligation. McMorrow & Berman, Registered Patent Attorneys, 1348 Albee Building, Washington, D. C.

INVENTORS: Learn now—without obligation—how to protect and sell your invention. Secure free "Record of Invention" form with instructions for making disclosure and establishing date of your invention—and new free book "Patent Guide for the Inventor" containing complete information about patent procedure and how to sell inventions; giving illustrations of many successful inventions; over 150 basic mechanical movements. Delay may be costly. For prompt confidential service—write today to Clarence A. O'Brien & Harvey Jacobson, Registered Patent Attorneys, 41B-G Adams Building, Washington, D. C.

PATENTS. Promptness assured. Wilfred E. Lawson, 1524 K St., N.W., Washington, D. C.

C. A. SNOW & Co., M-427 Snow Bldg., Washington 1, D. C. Registered patent attorneys. Established 1875. Literature mailed on request.

PATENTS Obtained; selling service, information, recording forms free. Labiner, World Building, New York.

L. P. RANDOLPH, 302-B Columbian Bldg., Washington, D. C. Low cost. Book and information free.

"INVENTOR'S Guide." 100 mechanical movements, free; advises on patenting, selling inventions. Frank W. Ledermann, 154 Nassau Street, New York.

PATENTS. Protect your idea by securing free "Proof of Invention" folder. Exceptional personal service. Established 1906. E. E. Vrooman, 871 Woodard Bldg., Washington, D. C.

INVENTORS—Before disclosing your invention to anyone send for form "Evidence of Conception"; "Schedule of Government and Attorneys' Fees" and instructions. Sent free. Lancaster, Allwine & Rommel, 411 Bowen Building, Washington, D. C.

PATENTS—Trade marks. Preliminary advice, book and disclosure form free. Personal service. Irving L. McCathran, 315 McLachlen Bldg., Washington 1, D. C. Registered Patent Attorney.

## FOR INVENTORS

PATENT Your idea! Write immediately for two free illustrated books, "Patent Protection" and "When and How to Sell an Invention." 64 pages of valuable information for inventors. No obligation. Address: Victor J. Evans & Co., 832-H Merlin Bldg., Washington 6, D. C.

INVENTORS: New military and commercial inventions urgently needed by manufacturers. Write for particulars. Chartered Institute, Dept. 4-A, Washington, D. C.

INVENTORS: Learn now—without obligation—how to protect and sell your invention. Secure free "Record of Invention" form with instructions for making disclosure and establishing date of your invention—and free "Patent Guide for the Inventor," containing complete information about patent procedure and selling inventions; giving illustrations of many successful inventions; over 150 basic mechanical movements. Delay may be costly. For prompt, confidential service—write to Clarence A. O'Brien & Harvey Jacobson, Registered Patent Attorneys, 41A-G Adams Building, Washington, D. C.

INVENTORS. Learn how we sell your invention. Free booklet, "Selling Your Invention" tells all about it. Inventors Exchange, 635 Main, Hartford, Conn.

MANUFACTURER'S Names, addresses—any classification. Tupper, 18-A Lyman, Beverly, Mass.

CASH For practical ideas and inventions. Mr. Ball, AB-9441 Pleasant, Chicago.

SEND For "Why Some Inventors Succeed and Others Fail" and 25c mailing costs. We develop and design inventions or products to promote success. Ideal Co. Development and Patent Engineers, 10 Hicks St., Brooklyn, N. Y.

I SELL Patents. Established in 1900. Charles A. Scott, 773PM Garson Ave., Rochester, N. Y.

CASH Quickly for inventors. Our clients provide the money to promote patented or unpatented inventions. Theft proof protection document free. Torrey, 93-A Federal, Boston, Mass.

## INVENTIONS WANTED

RELIABLE. Experienced, bonded engineering service for patenting, developing, marketing, financing practical inventions. Your ideas are protected by Engineers Seal. Write Mechanical Research Company, 601 Failing Bldg., Portland 4, Ore.

WANT Inexpensive toy or specialty item. Submit model if possible. Ny-Cal, 221 West Broadway, Glendale, Calif.

CASH For postwar product ideas, patented or unpatented, urgently needed. Write Industrial Engineering, 1155 South Kenmore, Los Angeles, California.

INVENTORS—Reach purchasing manufacturers direct; patented, unpatented inventions. Booklet, references, free. Invention Reporter, 5B-11236 So. Fairfield, Chicago.

CASH For inventions, patented, unpatented. Mr. Ball, A-9441 Pleasant, Chicago.

ALL Kinds. We have facilities and finances to make and sell your ideas, both mechanical and chemical. Send model, sample, details and wishes. General Sales & Supply Company, 110 East Main St., Madison 3, Wisconsin.

INVENTORS! Have you good, patentable ideas? Write—Mr. Metzler, 11 West 42nd, New York.

INVENTORS: Have you a sound, practical invention for sale, patented or unpatented? If so, write Chartered Institute of American Inventors, Dept. 4-D, Washington, D. C.

## PATENTS FOR SALE

PLASTIC. Papier mache mfg's. new non-poison insecticides developed by government soon should be availing. Check following patents through large public library's T. M. 361,333, Des. 112,718, No. 2,187,276, No. 2,255,360, door chime and musical toy No. 2,254,488, 3 million child birth's 1943 toys will be sold. Map Co's. check T. M. 376,007, No. 2,186,204, airplane safety device No. 2,192,450, Milo Miller, 4827 Bellevue, No. 2, Kansas City, Missouri. Phone Logan 8060.

AUTOMATIC Spreader for washing cream separator disks. Specialty, 1353 N. Clark, Chicago, Ill.

STAR Back comb for sale, cash or royalty basis, fast seller now and after war. Robert Motley, 607 Burwood Ave., Dayton, Ohio.

SENSATIONAL Alarm system, simple, effective. Accurate Print Co., 64 W. Randolph, Chicago.

PATENT Pending combination salt and pepper shaker. Molded plastic. Dan Stankunas, 3933 D St., Detroit 16, Mich.

WILL Sell outright, royalty, or partnership with man of business, sales ability and finance. Combination tool, wrench, pipe wrench, inside clamp, outside clamp, hack-saw, tap wrench, trammel points, spacing punches. Every feature practical. Leon Hagstrom, 1829 Ruddiman, North Muskegon, Mich.

## MANUFACTURING

**PRODUCTS** Wanted by established manufacturer to distribute and/or manufacture. Small tool field preferable, but not necessary. Bert S. Gittins, Advertising, Milwaukee 2, Wis.

**MANUFACTURING.** Model making. Inventions solicited, good equipment. Baum's Metal Specialties, Kansas City, Mo.

**MODELS**—Small lot manufacturing. Metals, plastics, etc. Milburn, Burlington, Kentucky.

### MODELS AND MODEL SUPPLIES

**RAILWAY Models.** complete line, informative catalogs O gauge, 104 pages, 25c; HO, 48 pages 15c. Walthers, 247 Erie, Milwaukee, Wisconsin.

**PLANES.** Boats, hundreds of hobby items. Catalog 6c. America's Hobby Center, Dept. B74, 40 E. 21 St., New York 10, N. Y.

**CATALOG 50 Engines.** model railroad supplies, 25c refunded. Simonsen Model Supply, A-3054 North Greenview, Chicago 13.

**SEE Our advertisement** on page 34A of this issue. Model Railroad Magazine, Milwaukee 3, Wis.

**RAILWAY Models.** complete line, informative catalog HO-O gauges, 79 pages 15c. Walthers, 247 Erie, Milwaukee, Wis.

**MFG.** Dies, stampings and model supplies. Send 3c for catalog. Pierce Model Works, Tinley Park, Ill.

**SHIP Models** and yacht supplies complete. Large 64 page catalogue 20c. Bill Wild's, 510 East 11 St., New York City.

**MODEL Kits** and supplies, catalog 10c. Steve Patti Co., 1443 W. Forest Home Ave., Milwaukee 4, Wisconsin.

**SHIP Model kits** and fittings. Complete line Fisher model yacht equipment. All Boucher, Fisher, Marine Model and Ideal kits, fittings and blueprints at standard prices. Most complete stock in New England. James Bliss & Co., Inc., 220 State Street, Boston, Massachusetts.

### MAKE IT YOURSELF

**WATER Softener** plans and instructions for building, \$1.00. Your plumber has 70% of the material. Parts price list attached. Sweigart, 904 Grand, Des Moines 9, Iowa.

**AIR Condition** your home. Easy to build plans \$2.00. Norbert Schimke, Minnet, No. Dak.

**FIRE;** Fire; make your own extinguishers. Low cost. Easily made and used. Information free. Instructions \$1.00. Fire Control Laboratories, Dept. E, 1207 No. Main St., Pueblo, Colo.

**SEE Our display ad** page 170. Peerless Sales, Lincoln, Nebr.

### HOME CRAFTSMEN

**MONEY** In making wooden toys. Design your own car, jeep, truck, tractors, etc. We sell wheels \$4.95 per hundred, 6 for 50c postpaid. Money back guaranteed. McN Mfg. Co., 2516 South Eighth Street, Minneapolis, Minnesota.

**28 LAWN Ornament patterns** 25c. Other patterns; 15"-20" high; Dutch girl; Dutch boy, pirate, bull terrier, Mexican girl, Mexican boy, dwarf, penguin, flower girl, 10c each; 3 for 25c. 25 novelty patterns 30c. All 63 full size patterns \$1.00 postpaid. Strother, Box 383-FS, Bellington, V. Va.

**MAKE Colorful costume jewelry** for gifts, resale. Free details. Beginner's outfit, \$1 (refundable). H. Hughes, 218 Sidell, Danville, Illinois.

**ELECTRIC Cannon.** toy. No explosives. 110 volts. Build from scrap. Drawings, instructions, photograph 50c. Photograph dime. Hamilton, 650-A South 20th Street, Newark 3, N. J.

**WOODEN Wheelbarrow** easy made. Instructions 25c. (Good seller.) Wilkes, Oberlin, Ohio.

**PATTERNS,** 8 Original lawn ornament patterns, 25c. M. Stultz, 146 William St., Alexandria, Va.

**PLANS** For 24"x48" drafting table, \$1.00. W. Hess, Dover 1, Penna.

**RENOVATE** Your own Venetian blinds. Get new tape, cord or hardware. Venetian Blind Supply Co., 1612 Farwell, Chicago.

**NOVELTIES** From scrap wood, 25 patterns, 25c. Lists 5c. Lynds, Medway, Mass.

**DESIGN** Smart leather ornaments. Leather, instructions, 25c. Vogue Leathers, Box 6, Fairfield, Iowa.

**MAKE Novelties** from cypress knees, 50c up postpaid. Dixie Sales, Sebring, Fla.

**TOY Bulldozer,** earth mover, and power shovel of new design. Make from scrap lumber with hand or power tools. Make boys' toys for your home town. Prints showing construction and detail \$1.00. Earthmover Toys, East Lansing, Mich.

**THE Shebel Filer** files all saws. Send for circular. A. P. Shebel, 730 S. 2nd St., Milwaukee 4, Wis.

### WATCHES, OLD GOLD, JEWELRY, ETC.

**GUARANTEED** Men's reconditioned Swiss wrist watches. Look and run like new. Reasonably priced. Free particulars. Hamilton and Company, 407A North Broadway, St. Louis, Missouri.

**WATCH** And clock repairing—complete practical course in modern horology. 66 illustrated self-instruction lessons. Just out! Low price. Information free. Write—Nelson Company, Dept. 8-02-2, Chicago 4.

**OPALS.** Sample packet \$5.00. Catalogue free. Norman Seward, Melbourne, Australia.

**WATCHES,** Materials, tools, jewelry, diamonds—bought—sold. Catalogue. Gales, Box 1000, Chicago.

### TOBACCO, SMOKERS' SUPPLIES

**LORD Carlton** English smoking mixture.  $\frac{1}{2}$  pound, \$1.50. You'll like it. Independent Cigar Stores, Montreal, Canada.

### RAZORS, BLADES, SHARPENING

**RAZOR Blades,** double edge, 100 tissue thin blades made from watch spring steel. Sold under a money back guarantee, \$1.20 postpaid. 100 blue steel double edge blades \$1.05 postpaid. Samples for stamp. National Sales Company, Dept. 113, 4101 Buick Street, Flint 5, Mich.

**AGENTS**—Patented "Slant-Stroke" razor and 10 "All American" blades in attractive box. \$3.00 dozen. American Sales, 113 Broadway, New York City.

**100 DOUBLE Edge** blue surgical steel razor blades \$1.50 prepaid. Fully guaranteed. St. Moritz Blade Co., 321 Broadway, New York 7, N. Y.

### FOR SALE—MISCELLANEOUS

**FURNACE** Fittings, gutters, chimney stacks, ventilators, everything in sheet metal products. No priority. Western Heating Co., 635 Elati, Denver 5, Colo.

**REPAINTED** Golf balls, 4 for \$1.00. J. Oncher, 2 Trinity, Amsterdam, N. Y.

### WANTED—MISCELLANEOUS

**WATCHES** Wanted—Broken or usable—all kinds, even Ingersolls. Highest prices paid for jewelry, rings, spectacles, alarm clocks, razors, cigarette lighters, gold teeth, etc. Cash mailed promptly. Lowe's, Holland Bldg., St. Louis 1, Mo.

**WANTED:** Old automobile catalogues prior to 1925, any make, any model, also auto magazines featuring automobile show numbers. L. C. Partridge, 712 Federal St., Chicago.

**WANTED**—Direct reading micrometer caliper. Sapper, 459 Hudson, Brooklyn, N. Y.

**WANTED** Old jewelry, guns, tools, electric motors, drills, appliances, midget radios, bowling balls, portable sewing machines, antique relics, outboard motors. Full cash value mailed. Gibes Auctioneer, 5555 Greenbay Ave., Milwaukee, Wis.

**5000 WATCHES** wanted. Any kind or condition. Also old gold, discarded jewelry, etc. Mail now for highest prices. Free details. Hamilton and Company, 407A North Broadway, St. Louis, Missouri.

**AGENCY** Wanted. Articles especially suited for mail order sales. Pabsch Co., Box 603, G.P.O., New York City.

**INDIA Agency** wanted for radios, machine tools, household items, plastics, cosmetics, auto accessories, musical instruments, foods, toys, electrical, hardware goods, technical books. Excellent post-war opportunity. Manufacturers, dealers, write submitting catalogs, literature and discounts. (Bank-trade references furnished.) Sannon-Kombin Corporation, The Mall, Mussoorie, India.

**MERCURY** (Quicksilver)—Cadmium, bismuth, tungsten, molybdenum, cobalt, vanadium. Write for quotations stating quantity. You'll receive guaranteed prices. Metallurgical Products Co., 35th and Moore Sts., Philadelphia, Penna. Established 1909.

**WE Pay** you well for "anything" you wish to sell: Tools, instruments, equipment, merchandise, jewelry. Justice Jobbers, Box 150, Chicago.

**WANTED**—Old jewelry, tools, electric motors, drills, appliances, midget radios, bowling balls, portable sewing machines, antique relics, outboard motors. Full cash value mailed. Gibes Auctioneer, 5555 Greenbay Ave., Milwaukee, Wis.

### PERSONAL

**CHILD'S Bible.** Life of Jesus, 124 pages, 25c. Bobbitt, 1609 Tenth Avenue North, Nashville 8, Tenn.

**GLASSES.** Complete in your choice of frame or mounting at amazing low prices. Broken lenses duplicated. Send for free price list today. Wright Optical Company, P.O. Box 2043, St. Louis, Mo.

**SLEEP Tight**—Night workers, sailors—stop noise—get sound refreshing sleep with Sleep-Rite, soft waxen ear stoppers. Four months supply \$1.00. Trial package 10c. Satisfaction guaranteed. "Sleep booklet" free. Raymond Dow, 15 Park Row (1215L), New York 7.

**EYEGLASSES** Duplicated. Low cost. Yankee Lense Service, Box 5C, P163 West 171 St., 52 New York.

**PENMANSHIP** Corrector—Corrects your penmanship—few hours. Write, Ozment, P. O. Box 10, St. Louis, Mo.

**BUY** Vitamins direct. Save. Postcard. Matoska Products, White Bear Lake, Minn.

**MISFIT** In your job? We can help you. Information. Occupational Advisory Service, Box 1154A, Paterson, N. J.

**DISCOVER** Your best abilities through scientific aptitude tests. Information 10c. Testing Service, 206-M Commercial Building, Rockford, Illinois.

**MEXICAN** Legal matters reliably handled. A. Munoz, 240, Juarez, Mexico.

**RUPTURED?** Improved appliance holds—up—in. Free trial. Earles Company, Flint, Michigan.

**COMEDY** Written for performers! Kleinman, 25-31-B 30th Road, Long Island City 2, New York.

**PSORIASIS** Sufferers: Pixacol has brought relief when everything else failed. Use only as directed. Apply externally, dries quickly, convenient. Try regular \$1 bottle without investing a cent! Write: Pixacol, Box 1298, Cleveland, Ohio.

**WANT** Someone located? Write Bureau of Records, 308 Washington, Chicago 6.

**MEXICAN** Legal information by Mexican legal attorney, Sra. Antoneta Aguilar, Lista-de-Correos, Mexico City, Mexico, D. F.

**SPOREN** Creme for treatment and prevention of athlete's foot. Successfully used six years, money back guarantee. Cash or check, \$3.00 postpaid. Howard J. Good, 728 Summit, Toledo, Ohio.

**HAIR** Falling? Dandruff? Write Trichologist, 137 Lewis St., Phillipsburg, N. J.

**LIVE** Longer, feel better, enjoy life. Free information. Fairchild Company, Mt. Vernon, Ohio.

**DRUNKENNESS** Is a disease which responds to treatment. Medical skill plus human sympathy prove successful with liquor and drug cases. 60 years experience. Write for free booklet. P. M. Nelson, The Keeley Institute, Dwight, Ill.

**12 GOOD** Gags your friends will bite on, 50c coin. Four Oklahoma City picture cards, 25c coin. Retailed free. Letters one dime. A. Warner Service, Box 1105, Oklahoma City 1, Okla.

### MISCELLANEOUS

**HAVE** Flag ready. Celebrate coming victories. Display high-grade beautiful combination American flag and banner. Show your colors. Size six feet by four feet, prepaid to any address for \$5. American Flag and Pole Co., 50 Oak Street, Belleville, New Jersey.

**BOYS**—Girls, write for free gift. David Berg, 659 Churchill, Bridgeport 29, Conn.

**ALL** Steel folding stove with large box heat tablets. Send \$1.00, we ship postpaid. Three extra boxes fuel \$1.00. Agents proposition 10c. Radio Warehouse, 362M Wooster, Akron, Ohio.

**PENCILS**—Individual or firm name imprinted gold. Dozen 50c 3 dozen \$1.00, gross \$3.60. Pencil Market, 611 - 15th St., Knoxville, Tenn.

**ALASKA** Highway views, 2 postcards 25c, 10 for \$1.00. Surprise friends with card from Canada. You address cards, we mail. Letters remailed 25c. Corcoran, Box 301, Edmonton, Alberta, Canada.

**DEHYDRATOR**—Make your own. Plans-instructions 25c coin. Christensen, Box 1346, Salt Lake City.

**SELL** Direct or buy. Big values. Relief guaranteed. Plymouth Foot Appliance & Remedies Co., Plymouth, Ohio.

UNFINISHED Wall plaques 2½c. Molds 75c. Write. Oman, 642 Broadway, St. Paul 1, Minn.

\$2 CLOCK Attachment starts radio, lights, coffee pot automatically. Circular. Vestfold, Ardmore, Penna.

BIG Mail for you. Latest moneymaking offers, opportunities, catalogs, magazines. Name listed in directory 10c. Ideal Service, 107-M, Park Ridge, Ill.

MEDALLIONS—No foreign business. J. Black, 1249 So. Grand, Los Angeles.

HAND Engraved name cards, 6 for 25c. King, 5845 DeLancey, Philadelphia, Penna.

NOW You can make your own Plasto-plate printing cuts. Simple, easy process. Adyservice, Argyle, Wisconsin.

BRINKO Cleaner, polish. Guaranteed. 50c. Brinkley, 1520 N. Regester, Baltimore 13, Md.

MEXICAN Jumping beans. Dozen 25c. hundred \$1.00. Mexicanproducts Co., 136 N. Main, Tulsa 3, Oklahoma.

PEOPLE Have been buying Steach Clamps since 1940. Why not write for free booklet? Steach, 423 Sprague St., Dedham, Mass.

SKUNKADORA—Destroys skunk odors instantly. Simply amazes everybody. New discovery that's sold on moneyback guarantee. No competition. Sells fast—pays tremendous profit. Write immediately. Sparhawk Laboratory, Sparkill, N. Y.

GET Humorous Alaska license to hunt Japs. Send 25c. A remarkable novelty. Alaska Sportsman, Ketchikan, Alaska.

AMAZING 248-Year calendar—1752-2000. 25c coin. Easily understood. Christensen, Box 1346, Salt Lake City.

GOOD "Used" self-instruction educational books on all subjects bought, sold, rented, exchanged. Satisfaction guaranteed. Complete information and 92-page illustrated bargain catalog free. Write—Nelson Company, Dept. 2-02-3, Chicago 4.

UNUSUAL Novelties. Samples 10c. Modern. Box 2, Sta. B, New York 2.

GIGANTIC Mails, magazines, catalogs, samples, listing 10c. Waddell's, 309 East 75th, New York 21.

ASSOCIATION Of American Writers, 319 So. Marengo, Pasadena, Calif. Membership \$3.00. Includes year's subscription to "Arrival," beautiful certificate, press card, auto sticker, many benefits. Join today. (Sample "Arrival" 25c.)

KILL Roaches, bedbugs, moths instantly guaranteed, makes one gallon, \$1.00. Pamat's, 227 Woodbine, Brooklyn 21, N. Y.

FREE Catalog Jamaica novelties. Barrington Smith Company, Halfwaytree-PM, Jamaica, B. W. I.

HAVE Fun. Tell anyone's age and amount of loose change in his pocket. Complete instructions 10c. Carl Bohman, Saratoga Springs, N. Y.

ATTENTION To manufacturers: New inventions. Models can be obtained with every invention. Steach, 423 Sprague St., Dedham, Mass.

OZARK Guide, Lonsdale, Arkansas. Magazine for homeseekers, sportsmen. Year, \$1.00.

FREE Descriptive list rare, unusual, exciting books. Not sold in stores. Gard Sales Co., Box 46, Arlington, Virginia.

RECEIVE Mails, magazines, samples. Your name in numerous mailing lists 10c. Howard, 396 Broadway, New York.

GENUINE Italian spaghetti and ravioli sauce. Formula \$1.00. Goosander brand. Pio. Bendinelli, Box 41½, Stevensville, Mich.

TRICK Chalk stunts. Catalog 10c. Balda The Cartoonist, Oshkosh, Wis.

"CLASSIFIED Swap Directory" \$1.00. Get started swapping. Golden Rule, 654 N. Florence, Burbank, Calif.

MAGAZINES, Circulars, opportunities. Dime, Edward Lau, Box 1258, Honolulu 7, Hawaii.

INFORMATION. Any subject. Moderate rates. The Roxbys, 747 So. New Hampshire Ave., Los Angeles 5.

THE Lord is coming! Get guaranteed profits free. Scheall, 263-X, Duluth, Minnesota.

MEDICAL Laboratory technicians in great demand. We train you in your spare time, in your own home. You can practice while studying. Write for free catalogue. Imperial Technical Institute, Box 973-J, Austin, Texas.

FARM And garden tractors. Complete information on two tractors you can build from auto parts, etc., at small cost, 25c. Popular Mechanics Press, (C-43), 200 E. Ontario, Chicago.

MAKE Money building bird houses. Illustrated instruction book, 25c. Popular Mechanics Press, (C-43), 200 E. Ontario, Chicago.

COLLECT Old accounts. My system works. Details free. Wright Service, Imler, Penna.

HOBBY Books. Latest titles. Catalog free. Popular Mechanics Press, (C-43), 200 E. Ontario, Chicago.

## ANY BOOK IN PRINT!



Delivered at your door. We pay postage. Standard authors, new books, popular editions, fiction, reference, medical, mechanical, children's books, etc. —all at guaranteed savings. Send card now for Clarkson's 1944 Catalog.

FREE Write for our great illustrated book catalog. A short course in literature. The buying guide of 300,000 book lovers. FREE if you write NOW—TODAY!

CLARKSON PUBLISHING COMPANY  
Dept. 27 1253 S. Wabash Ave. Chicago, Ill.

# SYN-FLO LIQUID-PLASTIC

YOU APPLY WITH A BRUSH

**Plastic THAT FLOWS**

This is really it! A brilliant white plastic coating to beautify walls of bathrooms, kitchens—anywhere. A post-war scientific discovery. A true plastic, yet you apply it with a brush; when dry, your walls are coated with a long-wearing, high-gloss film of white plastic that will not scratch.

**\* NO BRUSH MARKS**  
**\* NON-YELLOWING**

SYNFLO is made of some ingredients as modern plastic articles. It dries to a tough finish that can be scrubbed or washed like porcelain. The finish of the future—ready TODAY!

**Money Back Guarantee**  
No. 1 for walls, woodwork; No. 2 for furniture. Pure white! Or can be tinted. \$5.95 for gal. with Special Thinner, express prepaid. Willship COD if desired.

**ORDER NOW**  
**FREE ILLUSTRATED CIRCULAR**

**WALLS**

**WOODWORK**

**SUPERIOR PAINT AND VARNISH WORKS**  
2256 NORTH ELSTON AVENUE · CHICAGO 14



## Every Ambitious Man in Industry Should Read this Free Booklet!

"FORGING AHEAD IN BUSINESS" contains FACTS for all thoughtful, forward-looking men; it has a message of particular interest to technical men.

This 64-page booklet, of which more than 3,000,000 copies have been circulated, outlines a definite plan of training for your future progress in industry.

Said one man who had sent for it:

"In thirty minutes this booklet gave me a clearer picture of my business future than I have ever had before."

Fill in the coupon below and this helpful manual will be sent to you by mail and without cost.

ALEXANDER HAMILTON INSTITUTE  
Dept. 146, 73 West 23rd Street, New York 10, N. Y.  
In Canada, 54 Wellington St., West, Toronto, Ont.  
Please mail me a copy of the 64-page book—"FORGING AHEAD IN BUSINESS."

Name.....  
Address.....



## Dance in 5 Days... OR NO COST!

**NEWEST STEPS—RHUMBA, SAMBA, CONGA and JITTERBUG.**

Let dancing open the door to Romance and Happiness for you! This sensational new book helps you learn the latest steps, quickly, easily. A revolutionary book that offers a shortcut to dancing. **MAKE THIS TEST!** Send today for Betty Lee's amazing book—it's packed full of diagrams and tells in simple language how to do the Jitterbug, Rhumba, Conga, Samba and other exciting new dances

—also the ever-popular Waltz, Fox Trot, and many old-time favorites. **SEND NO MONEY!** Act now, and we'll send you as a gift, 2 additional books FREE of any extra charge, "Tip Top Tapping," and "Swing Steps." And remember—if not satisfied with results in 5 days you may return the book and your money will be refunded.



**PIONEER PUBLICATIONS, INC.**  
1790 Broadway, Dept. 947H  
New York 19, N. Y.

Send me by return mail, in plain wrapper "Dancing," by Betty Lee, and include 2 free books.

Ship C.O.D. I will pay on arrival, plus postage.

I enclose \$1.98, Ship postage prepaid. If in 5 days I do not learn to dance, I may return book and you will refund purchase price.

Name.....

Address.....

City..... State.....

## HUNTING and FISHING



ones. Wherever you are, you will find Hunting & Fishing Magazine good company — a real friend and pal the whole year round.

### SPECIAL "Handshake" OFFER

We will send you Hunting & Fishing Magazine for the next SIX MONTHS, on receipt of 25c in stamps or coin (a 90c value figured at the single copy price). Mail your order today for this big bargain.

**HUNTING & FISHING MAGAZINE**

251 Sportsman's Building Boston, Mass.

## DOUBLE your FUN with ROD and GUN,

by reading Hunting & Fishing Magazine. You will enjoy every issue — crammed with thrilling, exciting stories and pictures of outdoor sport and adventure. Valuable information and advice by leading experts on firearms, ammunition, fishing tackle, boats, camping equipment, dogs, etc., will bring you better luck and success — real dope on all kinds of fish and game and where and how to get the big

## DYKE'S AUTO BOOK

**New 20th Edition. New Material on Transmissions, Trucks, Tractors. 1488 PAGES. 4600 ILLUS. and DIAGRAMS.**



Now with millions of cars needing repairs and thousands of men needed to do the work, you need the famous DYKE Auto Book more than ever before. Brand new 20th edition covers all principles, construction, repair, adjustment, testing, troubles and remedies of all cars. Covers Diesel powered cars and trucks, fundamentals of aircraft engines and passenger car specifications.

**SEND NO MONEY.** Write today for DYKE'S AUTO BOOK. Remit \$6 or pay postman \$8 plus postage on delivery. Money back in 5 days if not satisfied.

**GOODHEART-WILCOX CO., INC.**  
Dept. 1-B, 2009 S. Michigan Ave., Chicago, 16

## RADIO ENGINEERING

Broadcasting, Servicing, Electronics, Aviation, Marine & Police Radio taught thoroughly. 48 weeks' Engineering course equivalent to 3 years' college radio work. Co-educational. Catalog free.

**VALPARAISO TECHNICAL INSTITUTE, Dept. D, Valparaiso, Ind.**

## MONEY for MEN ALL DATA FREE

THE PLASTEX Industry needs manufacturers on small scale and for big production of Lamp and Clock Stands, Art Goods and Novelties in Plastex and Marble imitation. Experience unnecessary. The material makes regular 10c store sellers. Rubber moulds furnished for speed production. Small investment brings good returns. Big chain store orders now being placed. Ambitious men have chance for real prosperity. Our Free booklet will interest and benefit you.

PLASTEX INDUSTRIES, Dept. P, 1085 Washington Ave., New York, N. Y.

## Get Your Share of U. S. WAR BONDS ★ STAMPS



## PRACTICAL, PROFITABLE Low Cost BOOKS

POPULAR MECHANICS OWN PUBLICATIONS

Books for self improvement, to help you save money on repairs and alterations, for hobby enjoyment... and... way to earn extra money.

- How to Read Blueprints... \$1.50
- Forty Power Tools You Can Make (New Ed.)... \$1.25
- From old parts, scrap, etc.
- Concrete Handbook (new)... \$1.50
- Do work for yourself, others.
- Your Car. Save \$100 Yearly... \$1.25
- Simple repairs, Shortcuts.
- Build a Boat... \$1.50
- 17 popular kinds. Easy.
- Shop Notes Library (1944 Volume)... \$ .50
- 5 Volumes now \$2.50.
- Garden Book... \$1.00
- Make your own furnishings.
- Welding, Brazing, Soldering... \$1.25
- How to make and use equipment.
- What to Make (1944 Volume)..... \$ .50
- 5 volumes now \$2.50.
- Boy Mechanic..... \$2.00
- Photo Guide..... \$1.25
- Make own equipment, better pictures.
- Money Making Formulas... \$2.00
- Painting, Furniture Finishing & Repairing (new) \$1.50
- The Young Craftsman (new) Over 450 easy-projects. \$1.00

**POPULAR MECHANICS PRESS,** Dept. 553, 200 East Ontario, Chicago, 11

## IF YOU WANT AN ARC WELDER... BETTER SEE HOBART USE THE COUPON!

Catalog FREE!



**Don't Wait! Get Complete DELIVERY Information from us NOW.**

If you are on important work, you should have the advantages of "Simplified" Arc Welding to help you speed your work, cut costs, get stronger, better jobs. Hobart Welders have many advantages not found in other welders, are more suitable for your work. Let us send you catalog and details on how you can get a welder NOW. Use the coupon.

HOBART BROS. CO., Box M-741, Troy, Ohio

## HOBART "Simplified" ARC WELDERS

"One of the World's Largest Builders of Arc Welders"

Am interested in a \_\_\_\_\_ amp Welder for immediate delivery.

Send items checked—no obligation.

Complete Welder Catalog

Vest Pocket Welder's Guide

Name.....

Address.....

Hobart Bros. Co., Box M-741, Troy, Ohio

# QUICK CASH for YOU

## INTRODUCING AMAZING AUTOFYRSTOP

—the remarkable new combination automatic and manual fire extinguisher and alarm that is setting records. TREMENDOUS MARKET. Sells on 2-minute demonstration to defense plants, homes, schools, stores, etc. LOW PRICED.

**KILLS  
FIRE  
BY ITSELF**

**Big Profits.** Write for FREE facts. EXPERIENCE NOT NECESSARY. **AUTOFYRSTOP CO., Dept. M-74** 2035 Washington Ave., Philadelphia, Pa.

## Understand **ELECTRONICS** with a **HYMARX OUTLINE**

*Concise, thoro, scholarly*

Prepared by **S. SOLOWAY** of Harvard University

**PRICE \$1.50**

Student Outlines Co., 17-21 Bromfield St., Boston 8, Mass.



## SWISS MADE WATCHES

**Wear 10 Days at Our Risk!**

Swiss made watches are renowned for accurate time-keeping. This men's watch has a sturdy, finely-constructed chrome case, an open figure dial, genuine leather strap. **SEND NO MONEY!** Just pay postman for wristwatch \$8.50 plus few cents postage and 10% Federal excise tax. Wear for 10 days on our money-back if not satisfied guarantee! Rush orders today—supply is limited. **VOGUE JEWELRY CO.,** 2759 S. Halsted, Dept. MM-104, Chicago 20.

## YOUR OPPORTUNITY

Plastics — Refrigeration — Air Conditioning — Radio — Optics — Electronics — Automotive Trades — Electrical Engineering — Building & Construction, etc.

Technical Books of **All Publishers** for **Free Examination.** Ask for **FREE Catalogues of Subjects** interesting you **Today.** State your **POSITION.**

**MODERN TECHNICAL BOOK CO., Dept. M. M.**  
55 West 42nd Street New York 18, N. Y.

## LEARN **MOVIE PROJECTION THEATRE MANAGEMENT**

The Motion Picture Theatre Business offers big opportunities for trained men. Free catalog. Give age. Established 17 years.

**THEATRE SCHOOL,** 370 Washington Street, Elmira, New York

## 300 WAYS TO MAKE MONEY

**MONEY BACK GUARANTEE**

**\$1.00 VALUE**

**25¢**

**68**

**PAGES**

**40,000**

**WORDS**

In "CASH IN" you get **ALL** the real money-makers—dozens of profitable tested mail order plans, confidential business secrets, dozens of practical tested formulas, successful tested schemes—actual experiences of men who have started on a shoestring—with less than \$10 capital.

25c a copy postpaid. Send U. S. stamps, money order, or coin.

**NATIONAL PLANS INSTITUTE**  
P. O. Box 26C, Station N, New York 23, N. Y.



# So-Lo SAVES RUBBER AND MOST ANYTHING MADE OF LEATHER AND CLOTH

- Spreads Like Butter
- Dries Hard Overnight
- Flexible—Non-Skid
- Waterproof—Won't Come Off



## Longer Life for TIRES

Easy to fix cuts, bruises, worn spots in tires *at home.* Keeps out grit and water. Add hundreds of miles wear to your tires with SO-LO.

## Re-Sole Your Own SHOES

Easy—at home. Spread on So-Lo like butter. Wears like leather. Use it for all footwear, children's and grownups'. Also use So-Lo for raincoats, boots, etc. Guaranteed to **SAVE!**



## 1,001 Repairs in the Home, Auto, Farm, Factory and Shop

Mend It with  
**So-Lo**



FOR ONLY **1¢** EACH



# So-Lo

AT ANY HARDWARE  
AND 10c STORE

**MEN** *whether you are* **16 OR UP TO 50**

Come to  
**COYNE**  
for a great  
future in



# RADIO-ELECTRONICS

"Learn-by-Doing" on Real Radio Apparatus!



Prepare for a great Peace time future and a good job in Radio-Electronics now. Coyne "LEARN BY DOING" training covers latest developments in this field. Prepare quickly, easily. Fascinating well paid work in maintenance, installation and servicing Radio-Electronic equipment.



## I'LL FINANCE YOUR TRAINING!

Don't let lack of money hold you back. My plan lets you start now, pay tuition in easy monthly payments when you're trained and on the job. I help you get part-time work to help pay living expenses while training, give you Lifetime Job Service as a Coyne graduate.



### TELEVISION

If you have an all-around Radio-Electronic training, there are great opportunities for you.

Tremendous expansion in Radio, Electronics, Frequency Modulation and Television predicted after the war—a world of new opportunities. Get ready for a Peace time future and a good job NOW with practical Coyne Radio Training.



### Many Branches if You Have All-around Training

Why be satisfied with a narrow, no-future line when by putting in a short time in my Shops, you can qualify for unlimited opportunities in RADIO-ELECTRONICS, today's fast-growing field! These pictures show only a few of the big jobs for trained Radio Electronics Men.



### SEND FOR FREE BOOK

Fully illustrated with big pictures of my Shops—facts about your future. Mail coupon now. No obligation. No salesman will call. Act today!



**H. C. LEWIS, Pres., RADIO DIV. COYNE ELECTRICAL SCHOOL**

500 S. Paulina St., Dept. B4-3H, Chicago 12

We also have facilities for men with handicaps or physical disabilities—write for particulars.

H. C. LEWIS, Pres., RADIO DIV. COYNE ELECTRICAL SCHOOL, 500 S. Paulina St., Dept. B4-3H, Chicago 12, Illinois. Send FREE BOOK, "Your Future in Radio", and details of easy "Pay-After-Graduation" plan.

NAME.....

ADDRESS.....

CITY..... STATE.....

## PICTORIAL GUIDE TO MACHINE SHOP PRACTICE



NEW—JUST OUT! Useful to working apprentices and students for study of material and processes. Contains hundreds of easy-to-follow pictures and diagrams. Thoroughly illustrates right and wrong ways of performing machine shop work. Tells and SHOWS how to file, drill and grind correctly, how to use calipers, chisels, etc. Gives tips on lubrication and cutting compounds. Covers milling and angle work, and hundreds of other operations. A practical, easy-to-read book. Helps improve work and increase earnings. Highly recommended. Sent postpaid \$1.50. No obligation—send for it today! Money back in 5 days if not delighted.

EMERSON BOOKS INC., Dept. 394-C, 251 W. 19th St., N. Y. 11

## HOW TO GET A BIG PAY JOB IN Real Estate

Write for FREE BOOK!

Tremendous real estate boom predicted. Big-pay, permanent jobs or your own 6-profit business. Salaries up to \$2,500 to \$10,000 a year in property management. brokerage, appraisal, loans, insurance, building. Many make fortunes selling real estate. Thousands of trained men, women, required yearly by real estate firms, insurance companies, banks, Federal agencies. Rush post-card for 32-page QUIZ BOOK—mailed FREE with full details on new and only 5-volume library, MODERN REAL ESTATE PRACTICE! Lane Books, Dept. B-7, 100 East Ohio St., Chicago 11, Illinois.

## ARTISTS MAKE MONEY

Find out your ability. Send name, age, occupation and address for Free Vocational Art Test.

ART INSTRUCTION, INC. (Formerly Federal Schools) 7134 Art Instruction Building, Minneapolis, Minnesota

## STUDY LAW AT HOME

With A Chartered Educational Institution

Men with legal training win higher positions, larger earnings, and are bigger successes in business and public life. Opportunities NOW greater than ever before. Complete course includes 21 Hornbook series college grade textbooks. Send for 1943-44 Catalog. McKinley-Roosevelt Incorporated, 4619-LT, Sheridan Road, Chicago, 49

## BOYS Ask Dad to Get this Great Book for You!



This new book tell and shows how to make over 450 things—useful articles for the home, toys, furniture, boats, novelties, photo equipment, electrical gadgets, etc. of the more simple, easy-to-make type. Only ordinary tools are needed. No special skill required. Tell Dad to send \$1.00 to address below NOW. We'll send Dad's money back if you and he don't think it's worth double the cost.

POPULAR MECHANICS PRESS  
200 EAST ONTARIO STREET  
DEPT. 550, CHICAGO 11, ILL.

## Do you WORRY

Why worry and suffer any longer if we can help you? Try a Brooks Patented Air Cushion. This marvelous appliance for most forms of reducible rupture permits Nature to do her part—holds most ruptures securely and gently—day and night. Thousands made happy. Light, neat-fitting. No hard pads or stiff springs to chafe or gouge. Made for men, women and children. Durable, cheap. Sent on trial to prove it. Never sold in stores. Beware of imitations. Write for Free Book on Rupture, no-risk trial order plan, and proof of results. All Correspondence Confidential.



Brooks Company, 158-C State St., Marshall, Mich.

Always write your name and full address clearly when answering advertisements.



**LEARN**  
  
**SPANISH**  
 FRENCH, ITALIAN, GERMAN  
 quickly, easily, correctly, inexpensively, by  
**LANGUAGE-PHONE**  
**METHOD**

**B**USINESS MEN, professionals, engineers, Army and Navy personnel — all advance rapidly knowing Spanish, French, Italian or German. Original standard *Language-Phone Method* gives you the actual voice instruction of an expert native teacher right in your own home. It's as easy and pleasant as listening to music. Write for full details and easy terms. Play records on your own phonograph. Satisfaction guaranteed or money refunded.

**FREE BOOKLET AND DEMONSTRATION**

**FREE ILLUSTRATED BOOKLET.** Write today for your copy of an interesting 16-page, illustrated booklet which answers every question about Language-Phone, easy payment terms, and 7 days' free trial offer.

**7 DAYS' FREE TRIAL.** Try Language-Phone in your home a week before deciding. A small deposit brings you the entire course.

**FREE DEMONSTRATION.** Come to our New York office for free demonstration, daily except Saturday.

**FUNK & WAGNALLS COMPANY**  
 Dept. 68, 354 Fourth Avenue, New York 10, N. Y.

**Earns \$400 the First Year**

"So far I have written around a hundred articles, many of them stories about war activities. Last year I made around \$400, and it was the first year I really started to write. Your course is the best way to get expert instruction in professional writing."—T. Edward Karlsson, 224 East 79th St., New York, N. Y.



**Why Don't You Write?**

*It's much simpler than you think!*

**S**O many people with the "germ" of writing in them simply can't get started. They suffer from inertia. Or they set up imaginary barriers to taking the first step.

Many are convinced the field is confined to persons gifted with a genius for writing.

Few realize that the great bulk of commercial writing is done by so-called "unknowns." Not only do these thousands of men and women produce most of the fiction published, but countless articles on business affairs, home and shop crafts, war activities, gardening, local events, homemaking, etc., as well.

Such material is in constant demand. Every week thousands of checks for \$25, \$50 and \$100 go out to writers whose latent ability was perhaps no greater than yours.

**The Practical Method**

Newspaper work demonstrates that the way to learn to write is by writing! Newspaper copy desk editors waste no time on theories or ancient classics. The *story* is the thing. Every copy "cub" goes through the course of practical criticism—a training that turns out more successful authors than any other experience.

That is why Newspaper Institute of America bases its writing instruction on the Copy Desk Method. It starts and keeps you writing in your own home, on your own time. And upon the very same kind of *actual assignments* given daily to metropolitan reporters. Thus you learn by *doing*, not by studying the individual styles of model authors.

Each week your work is analyzed constructively by practical writers. Gradually they help to clarify your own distinctive style. Writing soon becomes easy, absorbing. Profitable, too, as you gain the "professional" touch that gets your material accepted by editors. Above all, you can see constant progress week by week as your faults are corrected and your writing ability grows.

**Have You Natural Ability?**

Our Writing Aptitude Test will reveal whether or not you have natural talent for writing. It will analyze your powers of observation, your imagination and dramatic instinct. You'll enjoy taking this test. There is no cost or obligation. Simply mail the coupon below, today. Newspaper Institute of America, One Park Avenue, New York 16, N. Y. (Founded 1925)

**NOTICE TO CANADIANS**

Newspaper Institute's operations in Canada have been approved by the Foreign Exchange Control Board, and to facilitate all financial transactions, a special permit has been assigned to their account with The Canadian Bank of Commerce, Montreal.

**Free** Newspaper Institute of America, One Park Avenue, New York 16, N. Y.

Send me, without cost or obligation, your *Writing Aptitude Test* and further information about writing for profit as promised in Popular Mechanics, July.

Mr. \_\_\_\_\_  
 Mrs. \_\_\_\_\_  
 Miss \_\_\_\_\_  
 Address \_\_\_\_\_  
 (All correspondence confidential. No salesman will call on you.) 72-H-814  
 Copyright 1943 Newspaper Institute of America

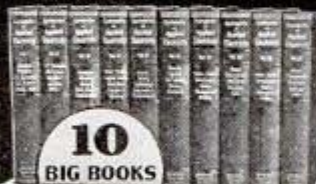
**ELECTRICAL BOOKS**  
 shipped FREE  
  
**10 BIG BOOKS**  
 FOR EXAMINATION  
**MODERN ELECTRICITY**  
 INCLUDING RADIO AND REFRIGERATION

Here's great news for anybody interested in Electricity. NEW 18th edition of Applied Electricity brought right down to date with NEW Electrical subjects fully covered, including Electrical Blueprint Reading. 10 big Volumes and all shipped FREE for examination.

**New Edition For Beginners and Experts**

Over 3000 pages—hundreds of illustrations—the most complete work of its kind we have ever published. Dynamos, motors, power stations, wiring, radars, everything electrical explained so anyone can understand it.

**BIG FIELD! Big Demand!**

**Big Pay!** Men who understand electricity are urgently needed in thousands of War Production industries. Airplanes, ship building, arms plants, machine shops—practically every industry depends on electricity and men who know this subject make big money. Pleasant, fascinating work, easy to learn and do; learn with these books. Send coupon for a set for FREE examination and see for yourself.

**SEND NOW** [ A year's consulting privileges with our engineers now given to all buyers of this famous Cyclopedia of Electricity. ]

AMERICAN TECHNICAL SOCIETY  
 Vocational Publishers since 1898

American Technical Society, Dept. EB19, Drexel at 58th St., Chicago 37  
 Send for 10 days' free use. 10 volume set of New 18th Edition, Applied Electricity, including a certificate entitling me to consulting privileges for one year. I will pay the delivery charges only on the books. If I wish I may return them in 10 days and owe you nothing, but if I keep them, I will send \$2.00 after 10 days, then \$3.00 a month until the total price of only \$29.80 is paid.

NAME \_\_\_\_\_  
 ADDRESS \_\_\_\_\_  
 CITY \_\_\_\_\_ STATE \_\_\_\_\_

Please attach letter stating age, occupation and name and address of employer and give at least one business man as reference. Men in service, also please give home address.

*There's  
been a  
big change*



**PLUS-FOURS** once brought in the low scores. And long skirts were the only acceptable dress. But all things change.

Even roller bearings have advanced. Tyson's new "All-Rolls" design is recognized as a vast improvement by users of heavy-duty equipment.

Size for size, Tyson has *thirty percent more load-carrying rollers*—for greater strength and rigidity . . . for longer life . . . for maximum efficiency.

In Army and Navy equipment—in vital industry, transportation, agriculture—the big name in bearings today is . . . **TYSON!**



TYSON BEARING CORPORATION, MASSILLON, OHIO

*COUNT THE ROLLS - THE ROLLS COUNT*



**Tyson**  
**TODAY'S HEAVY-DUTY BEARING**

★ BUY MORE WAR BONDS ★

# Popular Mechanics Magazine

REGISTERED IN U. S. PATENT OFFICE AND CANADA

WRITTEN SO YOU CAN UNDERSTAND IT

0 211

Vol. 82

JULY, 1944

No. 1



*Some Newspaper, Doc.  
461-5 of Am.*

Two British torpedo cowboys wearing divers' helmets and oxygen masks ride their weapon on the surface

**A**N ALERT lookout might have noticed a suspicious object moving slowly across the dark waters of Palermo harbor, rather like two bumps on a log.

But the Axis ships in the Sicilian port lay snug within the harbor's antisubmarine net, the tiny screw propelling the mysterious intruder churned silently and if there were sound detectors listening, they failed to pick up the throb of the British submarine's motor off in the distance.

The two "cowboys" dived their torpedo as they reached the protective net, slipped under it and head-

ed straight for the brand new cruiser, the *Ulpio Traiano*. Reaching its side undetected, they detached the warhead and fastened it to the hull of their victim. Then they remounted the after portion of the torpedo and guided it away.

Minutes later there was a terrific explosion, and the cruiser went down a flaming

wreck, dead before she had struck a single blow at the United Nations. Some distance away in the harbor there was another blast, and the 8,500-ton transport *Viminale*, lying alongside the jetty, was torn open so se-

## AUGUST ISSUE OUT JULY 20

The August issue will be on sale and will be mailed to subscribers about July 20, somewhat later than the previous publication date. Beginning September 1, your Popular Mechanics Magazine will appear regularly on the first day of the month of issue. The September issue, for example, will be out September 1



In the scene above a torpedo launched from submarine outside enemy harbor creeps quietly toward target



Above, rear man dismounts to lift net protecting harbor and let torpedo pass beneath. Photo shows how the "cowboys" act as their own periscope



verely she sank later while being towed away for repairs.

The human torpedo that made those successful attacks in January, 1943, was one of the best kept secrets of the war—at least a secret from Allied civilians. The Axis may have learned something of its operation by experience and by capture, for all six of the daring British submariners who jockeyed the three torpedoes inside Palermo harbor that night were made prisoners after two of the weapons had attained their objectives.

German and Italian navies are reported to have tried similar weapons during this war, but there is no confirmation

that they were successful. An attempt by Italians to ride an explosive mount into Gibraltar's harbor was reported, and one maritime officer reported the Nazis had tried riding their torpedoes over submarine nets.

First official announcement of the Allies' "torpedo cowboys" came when the British Admiralty recently awarded decorations to the six who reached shore safely and became prisoners at Palermo.

The torpedoes are submersible, but most of the way to the target they are ridden close to the surface, the heads of the two crewmen above water like human periscopes. Instead of the high-powered engines that drive conventional torpedoes at speeds approaching 60 miles an hour, these mounted torpedoes creep slowly and quietly under propulsion of electric motors that make no more noise than an electric fan. The warhead contains up to 500 pounds of explosives. The men wear diving suits and straddle the torpedo, behind breakwater shields. On reach-

Continued to page 162



Oxygen supply permits the men to remain under water for short period. Here the glass face mask is lifted

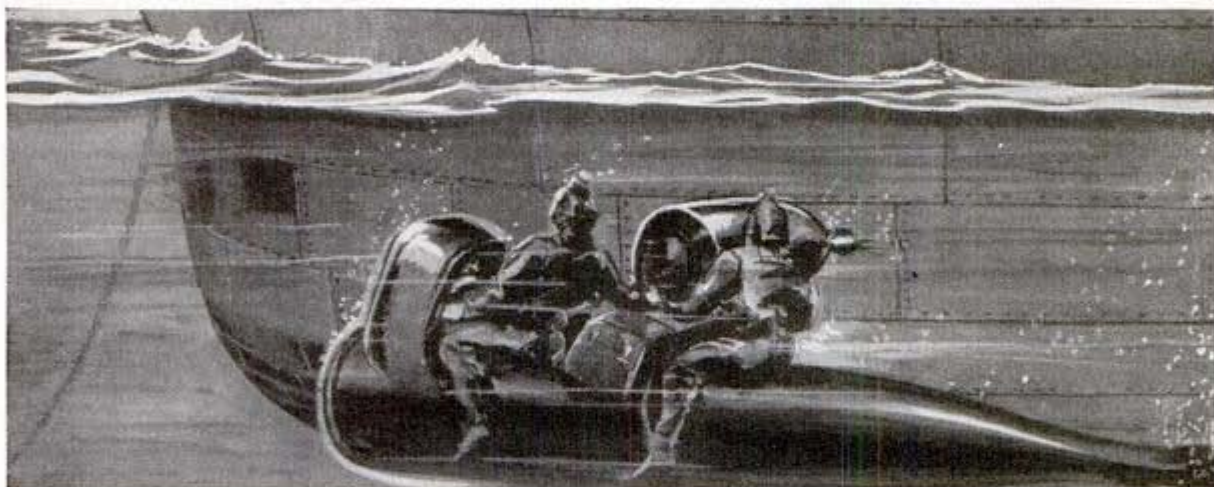

Approaching the target unseen, the men detach the warhead of the torpedo, fix it on victim's hull and set time fuse. In the interval before explosion (below) they have time to ride aft portion of torpedo to safety



# Collapsible Lifeboat Holds 25 With Provisions for 30 Days

77 886

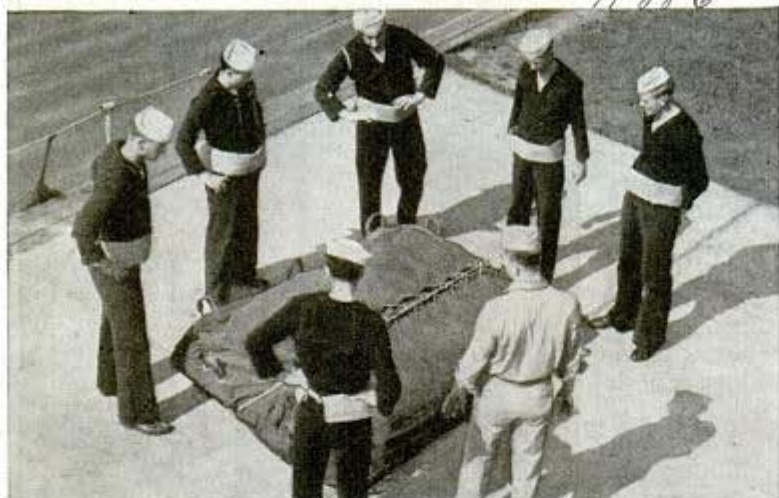

The Firestone Tire & Rubber Co.  
Akron, Ohio

hand pump is also provided to maintain pressure in the buoyancy tubes as required. Bulkheads or individual air chambers in the buoyancy tube keep the raft afloat even if it is damaged, and a complete repair kit is provided. Also, there is a removable and inflatable bottom, capable of acting as an auxiliary raft since it can also support a full complement of 25 passengers. This bottom also insulates the occupants from cold and dampness, while a weather cloth, attached to the side of the boat by ropes and wood stanchions, protects the occupants from wind and rain.

o 111

## Counter Records 9,000 Coil Turns Per Minute

Nine thousand revolutions a minute can be wound easily on coils by means of a coil winding counter operated by a flexible shaft. The shaft permits the placing of the coil and the counter close together so that both may be viewed at the same time without any strain on the operator.

Because it folds away into relatively small space, yet when inflated will hold 25 persons and provisions to keep them alive for 30 days, the world's largest rubber lifeboat, recently tested by the Coast Guard, is expected to be of increasing importance aboard ships of the United Nations. It fits into a pack 5 by 7 feet by 18 inches, or any comparable cubic dimensions, small enough to be lashed to the side of a ship's cabin and still leave sufficient room in a passageway, and can be inflated in a matter of seconds. Many such pneumatic boats could be packed aboard one transport. It consists of a buoyancy tube, 24 inches in diameter, and three inflatable cross tubes, which provide seats for the occupants and make for lateral stability. Occupants have a space 21 feet by six feet, in which are fastened six lateral six-foot seats. When inflated with compressed carbon dioxide, the 25-foot craft has a 10-foot beam. A



POPULAR MECHANICS  
Production Instrument Co.  
710 W. Jackson Blvd.  
Chicago, Ill.

# Cadets Learn to Fly in an Earthbound Trainer <sup>0100</sup>

Student flyers are making their first "flights" in an earthbound training craft that is controlled in its ground maneuvers in exactly the same manner a conventional plane is controlled. Its seven-horsepower engine can't lift the preflight trainer from the ground, but it can attain a speed of 35 miles per hour, and at 10 to 15 miles an hour the tail rises and the plane is "flown" by manipulating the rudder and control surfaces of the wings, which are in reality exaggerated ailerons. The craft is a tail-wheel type, its front wheels supporting the weight of the plane but not balancing it.



While incapable of flight with its 7-horsepower motor, this preflight trainer built by California Aero Glider Co. teaches the use of rudder and ailerons

## "Armored Greyhound" Outruns What It Can't Outshoot <sup>0142</sup>

Able to outrun anything it cannot outshoot, the army's M-8 is a six-wheeled, seven-ton, heavily armored reconnaissance car which can travel at high speed over almost any terrain and is capable of ascending a 45 percent grade. Known as an

"armored greyhound," it is equipped with a 37-mm. antitank gun and a .30-caliber machine gun, which move as a unit in the manually operated rotating turret. The four-man crew is protected by armor plate, with the driver and his assistant having protected vision through steel shutters and by indirect devices called protectoscopes. The car, a secret until recently, resembles a turtle-back in construction and its armored hull, which also serves as a chassis, presents a low silhouette to enemy eyes. The motor is cradled between two sets of power-driven axles, which make the rear end of the car a four-wheel drive. When the going gets tough, the front wheels also are engaged.



The car can be operated almost normally even if its special combat tires are punctured by enemy bullets

JULY, 1944

*Ford Motor Co.  
Chicago + St. Paul plants.*

0131

# Chemical Waterproofs Soil To Make Roads 'Mudless'

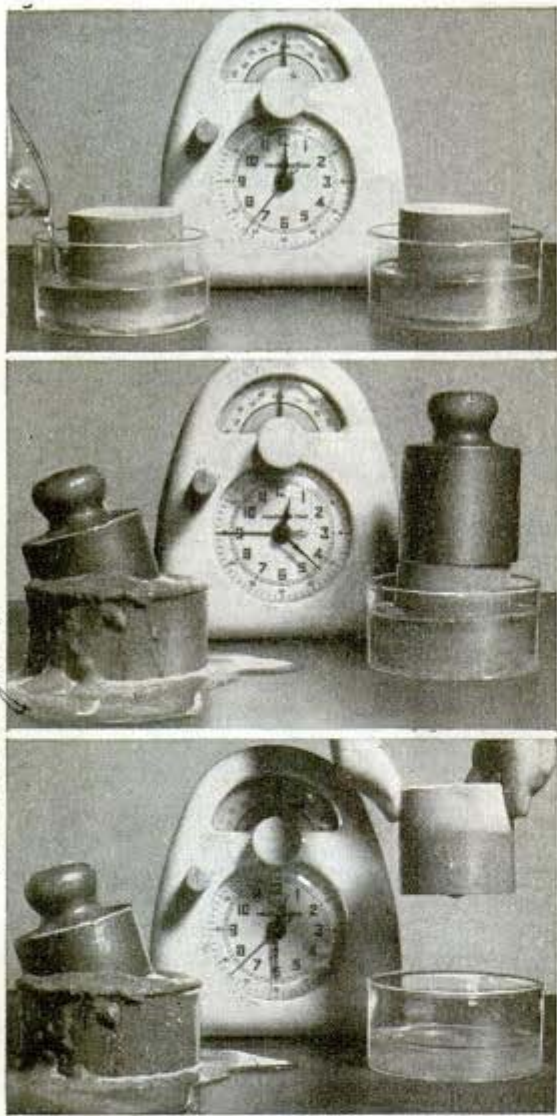

*Corulco Powder Co.  
Wilmington, Del.*

Treated core of soil at right remains solid through half-hour experiment but untreated core turns to mud

Streets and country roads may some day be "mudless" all the year around as the result of the development of a resin compound which makes the soil waterproof. The "mudproofing" is accomplished by mixing a new product called Stabinol, a patented resin compound derived from pine resin, with the top few inches of soil. This gives a surface which will remain dry for several years. Water will drain off or evaporate, rather than seep through the treated soil and turn into mud. The surface also resists the capillary rise of moisture from below. Although the treatment does not increase the load-bearing capacity of the soil, it keeps it from getting wet and thus losing its strength. It has been used successfully on roads, airplane landing

fields and other construction projects. Experiments with two dishes of soil, one treated with Stabinol and one untreated, show that twenty minutes after water is poured into the dishes, the untreated core of dirt has dissolved into mud, while the treated soil is unchanged.

0192

# Plastic Ribbon Doubles for Hair In 'Strato' Weather Instrument

Human hair used in weather instruments to gauge humidity in the substratosphere may be replaced by a plastic ribbon. The plastic element, known as the electric hygrometer strip, is used in a moisture meter developed by the Friez instrument division of Bendix Aviation Corp. It is attached to the radio sonde which is carried 10 miles into the air by free balloons. Changes in humidity produce varied electrical characteristics in the plastic. Human hair varies in length with moisture changes. The plastic ribbon is said to be more accurate.

*Baltimore, Md. Central Ave.*

0137

# Midget Motor of 30 Horsepower Does Work of 665-Pounder

Built to drive the propellers of small warplane models being tested in wind tunnels, a 57-pound projectile-like motor develops a horsepower equal to that of a 665-pound engine. The small motor with a 30 horsepower rating is only five inches in diameter and 13 inches long. It is water-cooled and has a rated speed of 6,000 revolutions a minute.

*General Electric Co. Schenectady, N.Y.*





0147

# Ack-Ack Rocket Guns Throw Hail of Shrapnel

While the Germans have been letting drop rumors about their secret rocket weapons, unpublicized rocket guns have been playing an important and a spectacular role in defending London from enemy air attacks. When German raiders sweep over the city, the rockets burst in umbrella patterns against the night sky and a sheet of shrapnel comes down from each exploding rocket like a hail storm. The guns have been used for about two years with great success against high-level as well as dive bombing.



0172

## Miniature German Tank Controlled by Cable

Although it is so small it looks like a toy, the Germans' crewless miniature tank, called the "Beetle," is said to carry 1,000 pounds of explosives. It is about six feet long and is controlled by radio or electric cable. The tank was used against the Allies in the beachhead fighting at Anzio, Italy, and on the Russian front. Red Army soldiers succeeded in stopping the mechanical pest on many occasions by sneaking around behind it and cutting its cable. Several of the vehicles were captured by the Americans in Italy.



This robot tank, looked on hopefully as a secret weapon by German staff officers, is guided toward enemy by cable or radio

0170

## Nazis Put Mine in Wooden Box To Foil Metal Detectors

To foil devices which can detect metal, the Germans planted a new type of anti-personnel mine in small wooden boxes as part of their efforts to halt the Allied advance in Italy. In examining the nonmetallic mines, sappers found the detonators were only about twice as big as a cigarette.

This harmless-looking detonator hidden in its little box could maim a soldier



*Blum L. Martin Co.  
Baltimore & Md.*



# PARLOR



GROSS WEIGHT  
OVER 80,000 POUNDS

The cozy trio affords a preview of post-war travel in the clouds aboard Consolidated Vultee's Model 39. Among transports to be converted for luxury travel is the sharklike Lockheed Constellation (above)

IT IS July 15, 1948. The telephone rings at the information desk in the New York office of a major air line.

"Any planes leaving today for Mexico City?" asks a businessman.

"The usual 10 daily flights," the clerk replies, "either local or express. The express will get you there in eight hours and 12 minutes. The local takes an hour and 14 minutes longer."

"How much is the fare?"

"One way is \$61.50; round trip \$110.70. May I refer you to the reservation desk?"

"Okay," says the businessman.

"Pleasant trip to you," says the clerk.

And it will be just that—pleasant—aboard one of the super airliners of the future. Some of these ships are now being tested for postwar service; others are in the mockup stage or on drafting boards. On these planes—tomorrow's

parlor cars with wings—the passenger will be king. The guy who once thought he was lucky to get a free stick of chewing gum and a glass of ice water will accept such luxury items as "pillow" radios in stride.

Seats for passengers will be the last word in comfort, and the berths will have extra breadth and width. All

Cutaway of JRM-1, production version of Martin Mars, shows how flying boat can "swallow" four jeeps

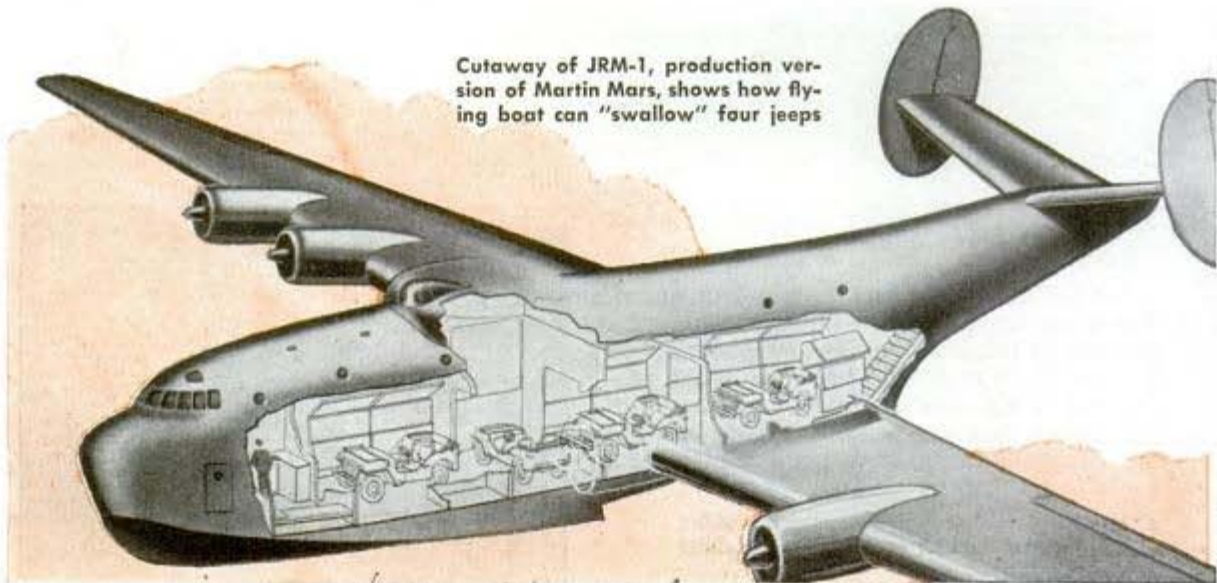

*Consolidated Vultee Aircraft Corp.  
San Diego, Calif.*

# CARS with WINGS

FOUR 2,200 H.P. ENGINES

WING SPAN 123 FEET

LANDING SPEED, 80 MILES PER HOUR; MAXIMUM CEILING, 30,000 FEET; SPEED WITH FULL LOAD, OVER 300 MILES AN HOUR; COMMERCIAL CAPACITY, 57 PASSENGERS AND CREW; MILITARY CAPACITY, 100 SOLDIERS WITH PACKS AND RIFLES

USEFUL LOAD MORE THAN 14 TONS

OVERALL LENGTH-95 FEET

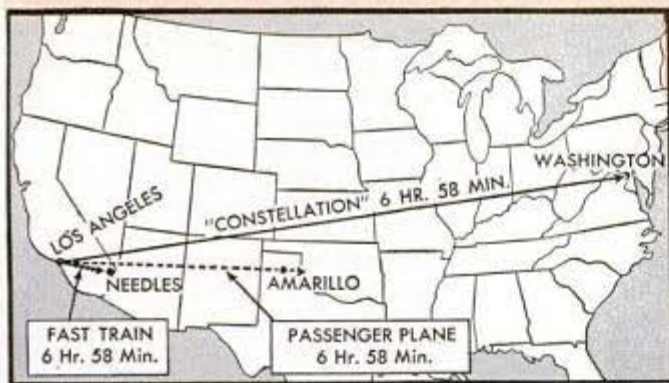

Constellation record for cross-country hop is basis for comparative distances. Right, the powder room on Model 39 mockup

cabins will be pressurized to enable flight in the silky smoothness of the stratosphere "above the weather." Instead of sitting cramped in their seats, passengers will move about with the same freedom they enjoy today on de luxe Pullman trains.

After a lot of big talk about giant transports of weird design that would carry hundreds of passengers at the speed of sound, postwar aviation planners have their feet on the ground and their eyes on actual test flights and planes on order. For example, the above conversation about a trip to Mex-



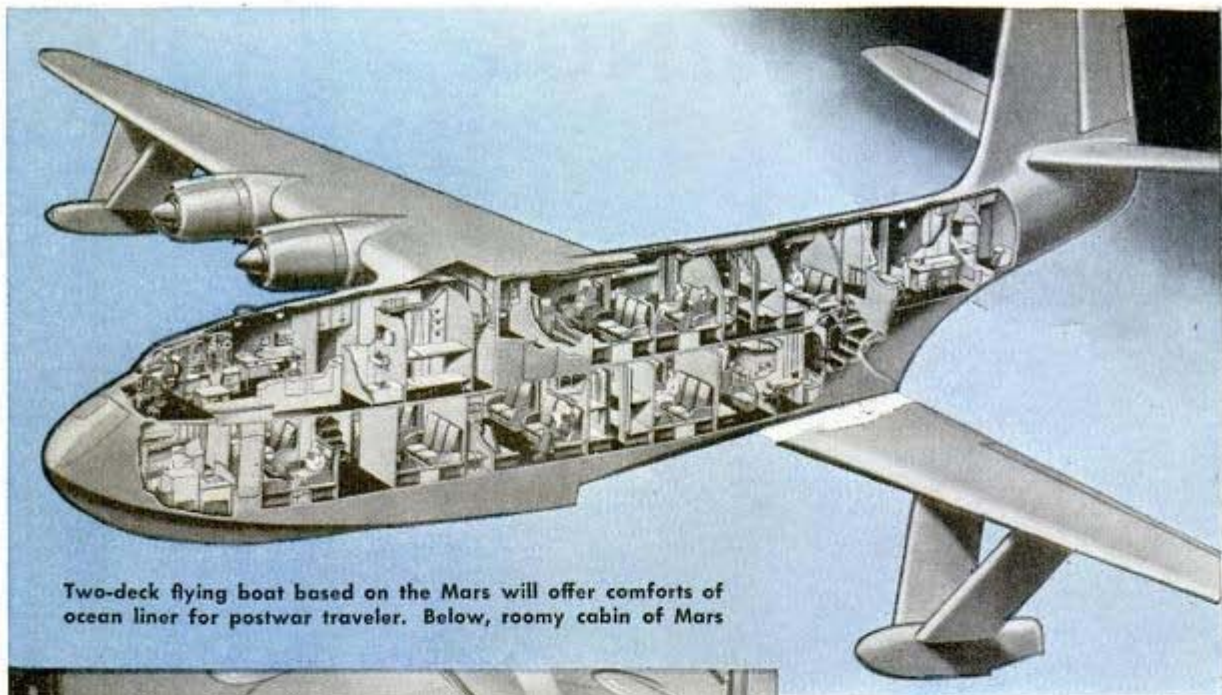

Two-deck flying boat based on the Mars will offer comforts of ocean liner for postwar traveler. Below, roomy cabin of Mars



The distance covered by the Constellation was somewhere between 2,663 and 2,292 miles, the straight-line distance between Los Angeles and Washington and the great circle route, respectively.

The previous record of seven hours and 28 minutes for a cross-country flight was made by Hughes in 1937 at an average speed of 327 miles an hour. Comparative figures, however, are unfair to the Constellation

ico City in 1948 is based on a schedule of probable world services recently released by Pan American Airways.

A better example is the record-breaking cross-continental flight recently made by Howard Hughes in the Lockheed Constellation, which was designed as a peacetime transport for Transcontinental & Western Air, Inc. This six-hour and 58-minute flight from Burbank, Calif., to Washington, D. C., demonstrated to an air-minded nation that some of the "things to come" in aviation are already here.

The four-motored Constellation with the profile of a shark averaged nearly 355 miles an hour on the trip. Fighter plane speed for a huge transport! A train leaving Burbank at the same time as the Constellation would have been pulling into Cadiz, Calif., when Hughes and his crew were stepping out of the plane at the Washington National Airport. If a regular passenger plane had attempted to race the Constellation, it would have just passed Amarillo, Texas, when the record-breaker crossed the finish line.



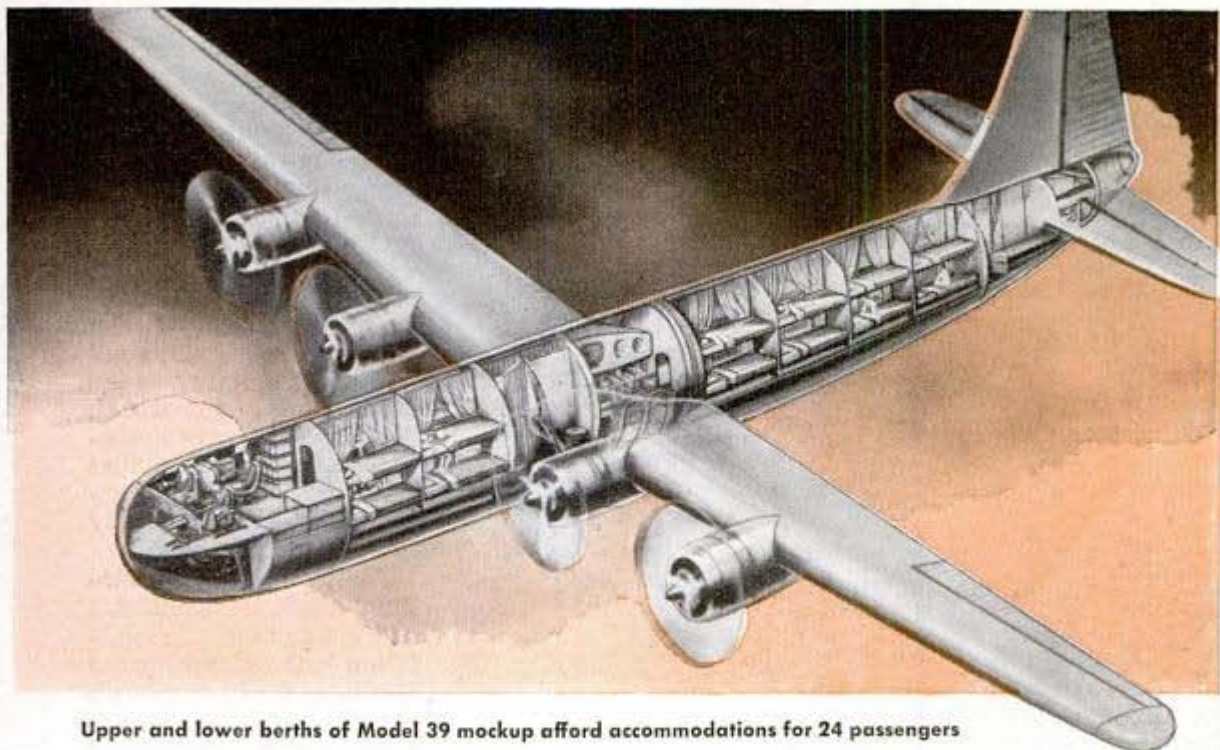

Upper and lower berths of Model 39 mockup afford accommodations for 24 passengers

for the earlier flight was made in a small specially built plane with Hughes as the sole passenger. On its record trip, the Constellation carried 17 passengers and had room for 57 if fitted as a luxury liner, or 100 soldiers as a troop transport.

Although the Constellation was flown from Burbank to Washington at heights ranging from 15,000 to 19,000 feet, its perfect circle fuselage is built to accommodate a pressure cabin which will lift its ceiling for postwar passenger flights to between 25,000 and 30,000 feet. With only three of its 2,200-horsepower air cooled Wright engines, the ship can hold an altitude of 25,000

feet, and its ceiling with two engines is 16,500 feet. Two-speed gear-driven superchargers begin operating as soon as the plane leaves the ground, instead of at the 8,000-foot level as in earlier transports.

The Constellation is one answer to the question of size for postwar transports. The wing span is 123 feet—just three feet longer than the first flight made by the Wright brothers at Kitty Hawk in 1903. The plane is 95 feet long. (The familiar 21-passenger DC-3 has a wing spread of 95 feet and is 64½ feet long.) Gross weight of the Constellation is 40 tons, and it can carry a payload of 28,000 pounds.

Lined up before the Constellation are crew and number of passengers—57—it will carry after the war  
Courtesy TWA

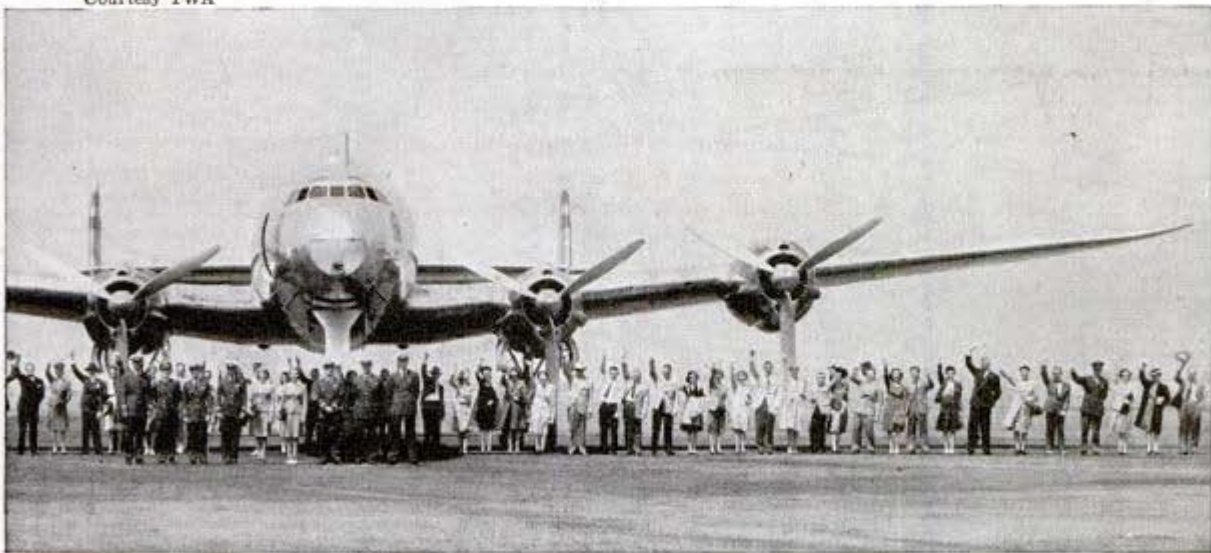



Courtesy Consolidated Vultee Aircraft Corp.

Seats on mockup of postwar airliner are converted into roomy lower berth

Despite its size, the ship's powerful engines can lift it into the air in less than 1,500 feet at sea level. This, coupled with a landing speed of 80 miles an hour, enables it to take off and land on exceedingly short runways. Maneuvering flaps, which are telescoped into the wing for speed, are extended to increase the lift on take-offs

and for landings at slow speed. These telescoping flaps are one of the reasons for the plane's ability to fly faster, farther, and with bigger loads than any other land transport in mass production.

Civilians will have to wait until the war ends to ride the Constellations, for until then they will be carrying troops and supplies for the Army to the far corners of the world. The official Army designation for the ship that has made those far corners only 24 hours away is "C-69."

Another postwar airliner about the same size as the Lockheed Constellation is the Consolidated Vultee Corporation's "Model 39." This plane is now in the test flight

stage. Its design incorporates the wing and engines of Consolidated's B-24 Liberator bomber which are attached to a new 90-foot fuselage. The wing span of the four-motored Liberator is 110 feet.

Model 39, called the "club car of the clouds," has original seating arrangements

Continued to page 160



It's a 23-foot, seven-inch climb to the top of the Lockheed Constellation's triple tail

# Excursion Boat Goes to War as a Troop Carrier <sup>0 159</sup>

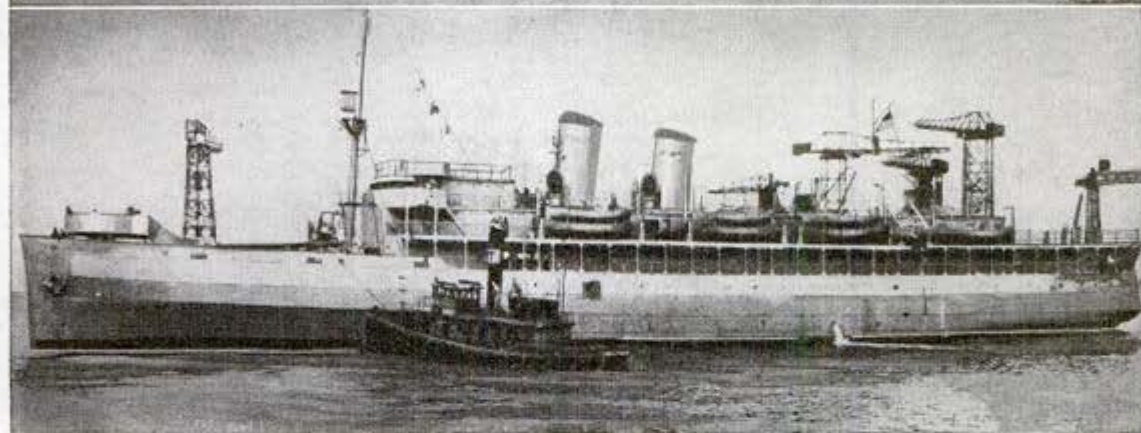
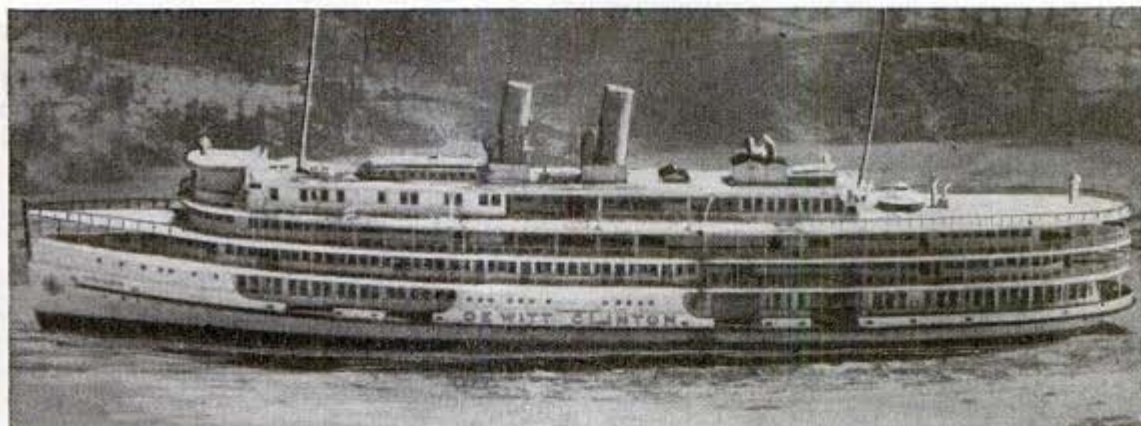

The gray steel-plated sides have streamlined the vessel which began carrying New Yorkers on cruises in 1921

Fitted out with guns and armor, as she was in 1917-18, the De Witt Clinton, a veteran Hudson river excursion steamer, is going to war as a 3,699-ton transport again. Details of her transformation and her new name have been kept secret but officials of the Bethlehem Steel Company, which handled the reconversion operations, said

that a steel superstructure had replaced her wooden decks. Originally named the Manhattan, the 320-foot ship was built in 1913 and purchased by the Navy and re-named the U.S.S. Nopatin in 1917. During the war she took 150,000 soldiers across the English Channel. After the war the Navy sold her to the Hudson River Day line.

## Rifle "Fires" Needles One Inch to Chart Trainee's Errors <sup>0 90</sup>

By using a rifle which shoots needles at a range of one inch, Canadian army instructors can determine a trainee's mistakes in handling a rifle with scientific exactness. The rifle, which looks and feels like an actual gun, is made of wood, springs and pins. Upon pressure against the trigger, it releases a small two-pronged needle rig into a scale model target graph. The upper prong punches a hole where the bullet would normally hit. The lower prong strikes at the same time and shows by its position any faults of canting, elevation or trigger pressure made by the trainee.

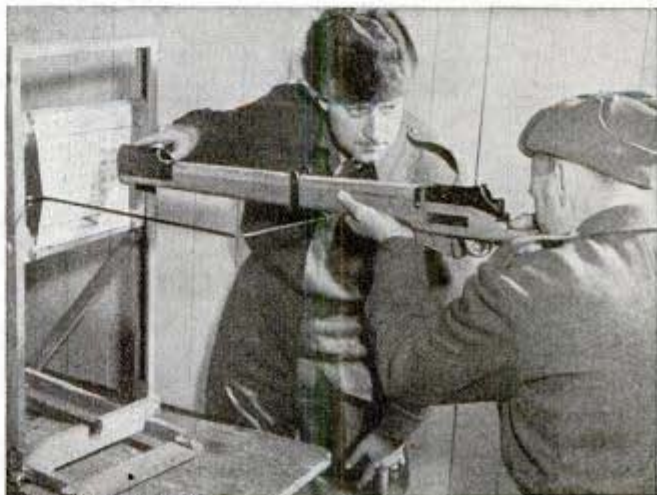

Canadian Army photo

*Curtiss-Wright Corp., Dayton, Ohio*



# IDEAS THAT



Courtesy Curtiss-Wright Corp. The "G. I. Joe's" of industry are showing ingenuity in discovering ways to increase the flow of war goods. Here are some innovations by workers: above, plastic bell cap center punch which locates the exact center of hole. Right, a polisher for interior of cylinders

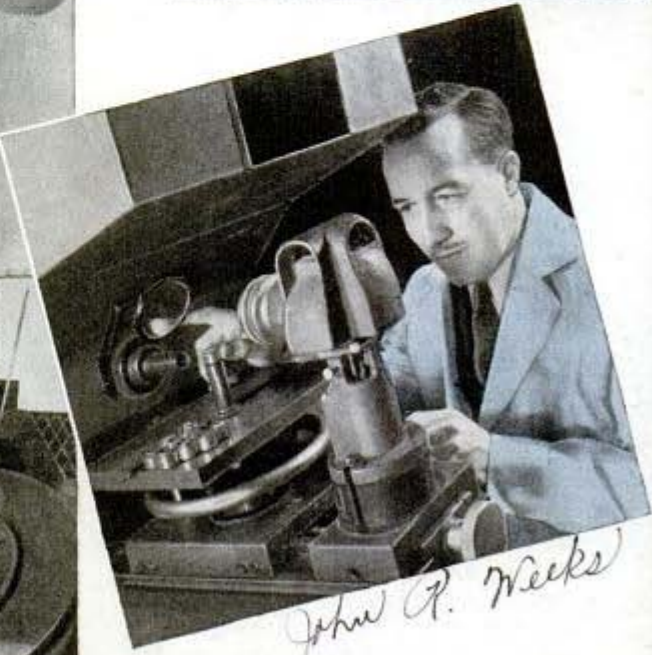

Left, foot control for rotary welding fixture was suggested by employee in Fisher Body Division of General Motors; it frees hands. Above, Westinghouse engineer with speedup optical system for inspection unit

Material, энциклопедический авторский перевод



# HIT the JACKPOT



*Theodore S. Caglinger*

Curtiss-Wright Corp.  
This non-slip bracket for mushroom rivet sets prevents damage to airplane "skin"

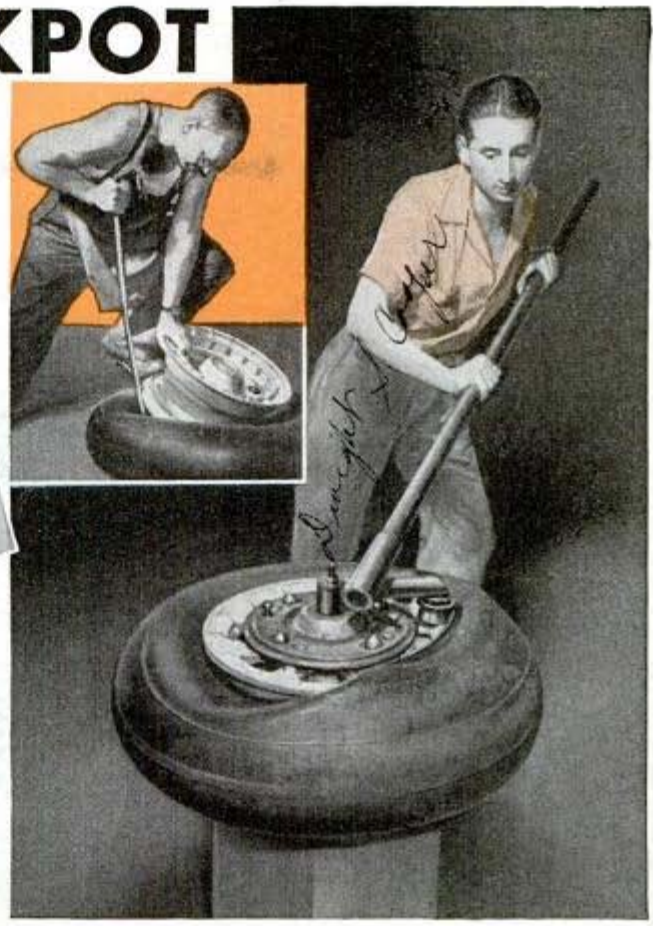

Tire mounting machine suggested by a Goodyear Tire & Rubber Co. employee saves 10,000 man hours a year on airplane maintenance. Roller-pressure principle with long lever simplifies operation and eliminates possibility of damage. This idea was released to the ordnance department. Inset shows old method



Bench clamp that requires no screws or bolts holds work rigidly and is easily removed when not needed. It was invented by a Bureau of Reclamation employee

Below, telephone on wheels slides along rail which is pivoted in center to serve two desks. It was invented by two Chevrolet officials to meet shortage

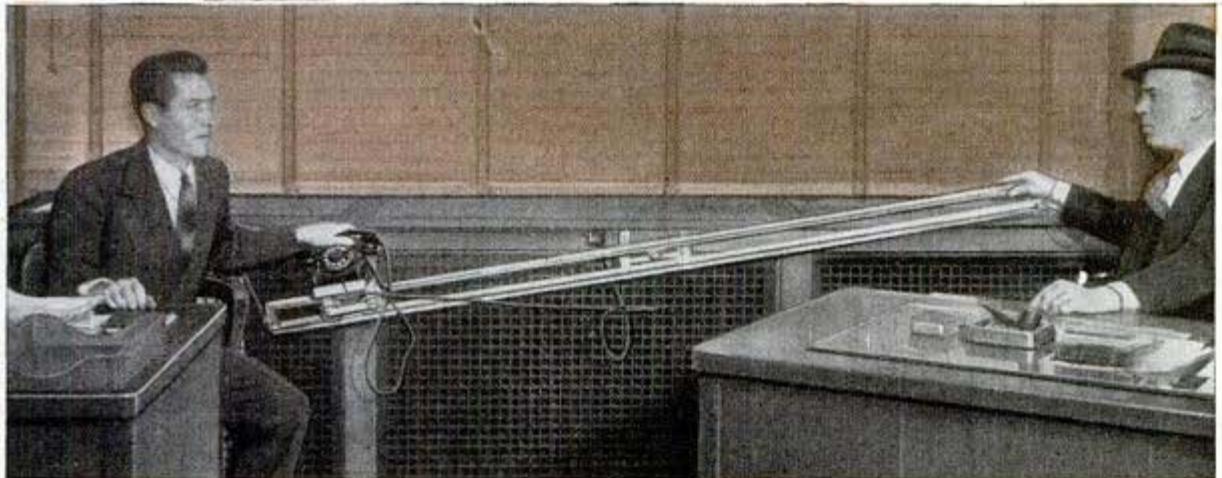

# B-25 Cannon Carrier Mounts 14 Machine Guns



America's twin-engined triple-threat bomber—the strafing, bombing and cannonading B-25 Mitchell—has 10 additional .50-caliber machine guns in its newest model, boosting the total to 14. This array of firepower in addition to the ship's famous 75-mm. nose cannon makes the B-25 the heaviest armed bomber in the world, according to its manufacturers, North American Aviation, Inc. Four machine guns protrude from the nose of the plane, and four others are fixed in a forward firing position, two on either side of the fuselage. Two waist guns and a pair of tail guns can be fired through a wide arc above or below or to the side. The tail turret is new. There are also two machine guns in the relocated upper turret which has been moved forward from the center of the fuselage. Another new B-25 has only 12 machine guns, its conventional transparent nose containing a bombardier's compartment and two guns. The 14-gun model has a metal nose. The 75-mm. cannon was re-

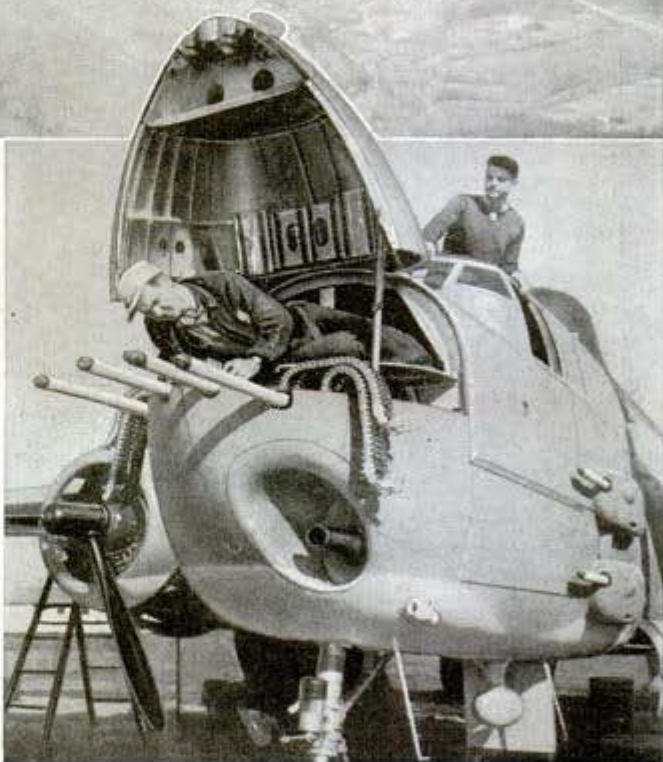

Top, the 12-gun "Mitchell" with transparent nose; below, the deadly prow of the 14-gun model has eight "fifties" and a "75"

vealed recently to be a full-length field piece that fires about the same size shell as the 75's on Sherman tanks. Both models carry heavier armor than previous types.

## Don't Waste Paper!

One of the simplest forms of patriotism you can practice is to save paper. Never in the world has there been so enormous a demand for paper and paperboard as today. Millions of tons of supplies are shipped every month to our armies and naval bases overseas, and a great proportion of the supplies must be packaged in heavy

paper boxes. You can help to ease a critical paper shortage by bundling your waste newspapers, magazines, cartons—even your old letters and greeting cards—and calling the local salvage committee, your favorite charity or any waste-paper dealer to pick them up.

**DON'T BURN PAPER! SAVE IT!**

*"I made much of it"*

*Mack International Motor Truck Corp. 27 St. 1, N. Y.*

*71 861*

# Trucks Haul Plane and Tower to Set Records

Two six-wheel Mack trucks down in Texas are carrying a couple of blue ribbons on their hoods for hauling the highest, widest and longest loads ever shipped over Texas highways. Highest and widest honors were combined in a single haul when the fuselage of a 21-passenger DC-3 transport plane was moved from Houston to Dallas. It measured 21 feet high and 24 feet wide. On narrow bridges the plane's wing sections were lifted above the railings by means of tandem gin poles mounted on the trucks. One of the trucks holds the record for the longest load—a 115-foot petroleum tower that weighed 80,000 pounds.



Rigging lifted fuselage at narrow bridges; below, 115-foot oil tower

*Hauling done by:  
Hunsaker Motor Freight  
Lines, Inc.  
Dallas, Texas*

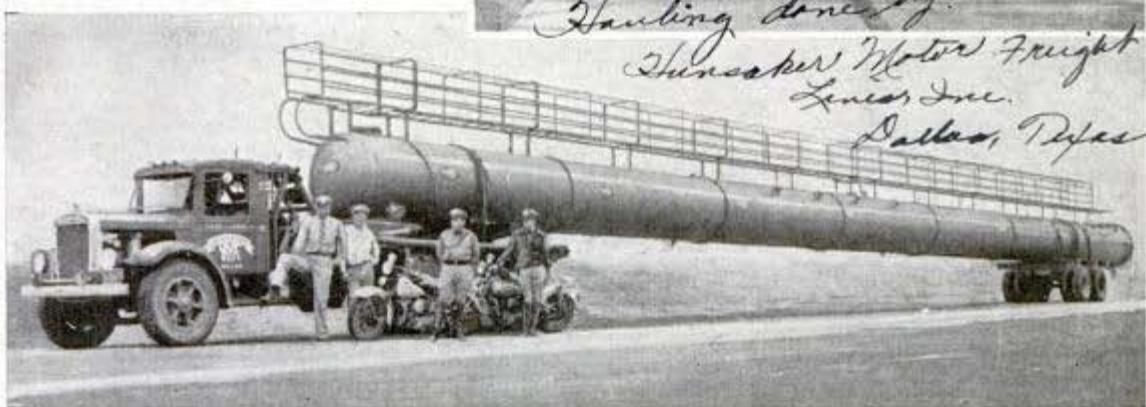

## Plywood Back Pack for Soldier Makes the Load Easier

To reduce straining and chafing of shoulder and back muscles, an improved "packboard" has been devised for the American doughboy, to carry awkward equipment

through jungle, mud or snow. The new packboard, weighing only four pounds in comparison to seven for the old style equipment, is made of plywood molded with synthetic resin glue under heat and pressure. Canvas lashed across a recess in the board cushions the carrier's back and protects it from galling and strain. The pack, carried by a shoulder harness, is used by infantry, medical corps, engineers, and signal corps for moving weapons, ammunition, radios, cans of water and gasoline, ration boxes, medical supplies, and stores beyond the point where wheeled vehicles can go.

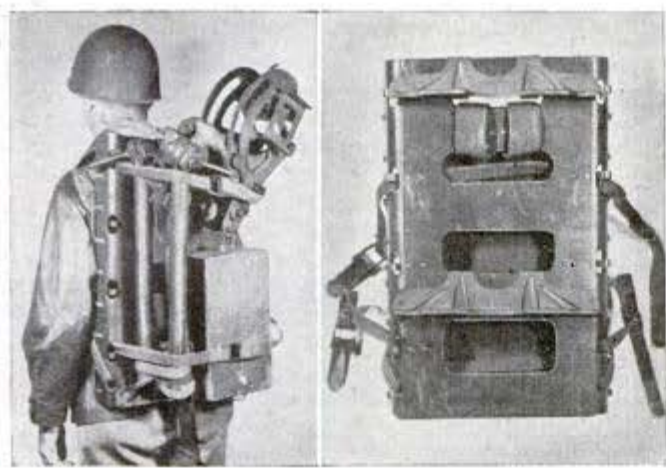

The light packboard permits soldiers to carry all types of awkward equipment easily. Its cotton shoulder harness can be slung or unslung quickly

# REVOLUTION ON RAILS



New York Central tunnel (left) near Peekskill, N. Y., was enlarged to accommodate huge war shipments. Above, inside cab of a Pennsylvania R.R. locomotive showing position light signals

wood trains drawn by Diesel-electric or gas turbine locomotives, beating 100 miles an hour and steadied by gyrostabilizers so that a night's sleep or a day's relaxation will be jerkless and joltless.

New steel and aluminum alloy freight cars—500,000 will be needed—will be as strong as present cars, but several thousand pounds lighter, enabling the postwar freight train to knock off an 80-mile-an-hour clip.

The great postwar changes depend upon the manner in which the railroads can use the increased production of aluminum, steel, copper, Diesel engines, turbines, electric drives, rubber, oil and plastics.

Right now, the railroads are emphasizing wartime efficiency and safety, using the limited materials available, but bolstering them with ingenuity and scientific investi-

**O**VER the hump in their tremendous job of moving the nation's men, machines and merchandise to their war tasks, the railroads are making the nation's 65,000,000 tons of rails in 400,000 miles of steel road sing sweetly as they roll along toward the greatest period of progress in the history of the iron horse.

Most of the people now alive will live to see railroads so different that some of the equipment now operating will be ready for the museums, many railroad men believe.

For the postwar period, they predict aluminum, stainless steel, plastics and ply-

The streamlined "Empire State Express" carries a full load these days on New York Central

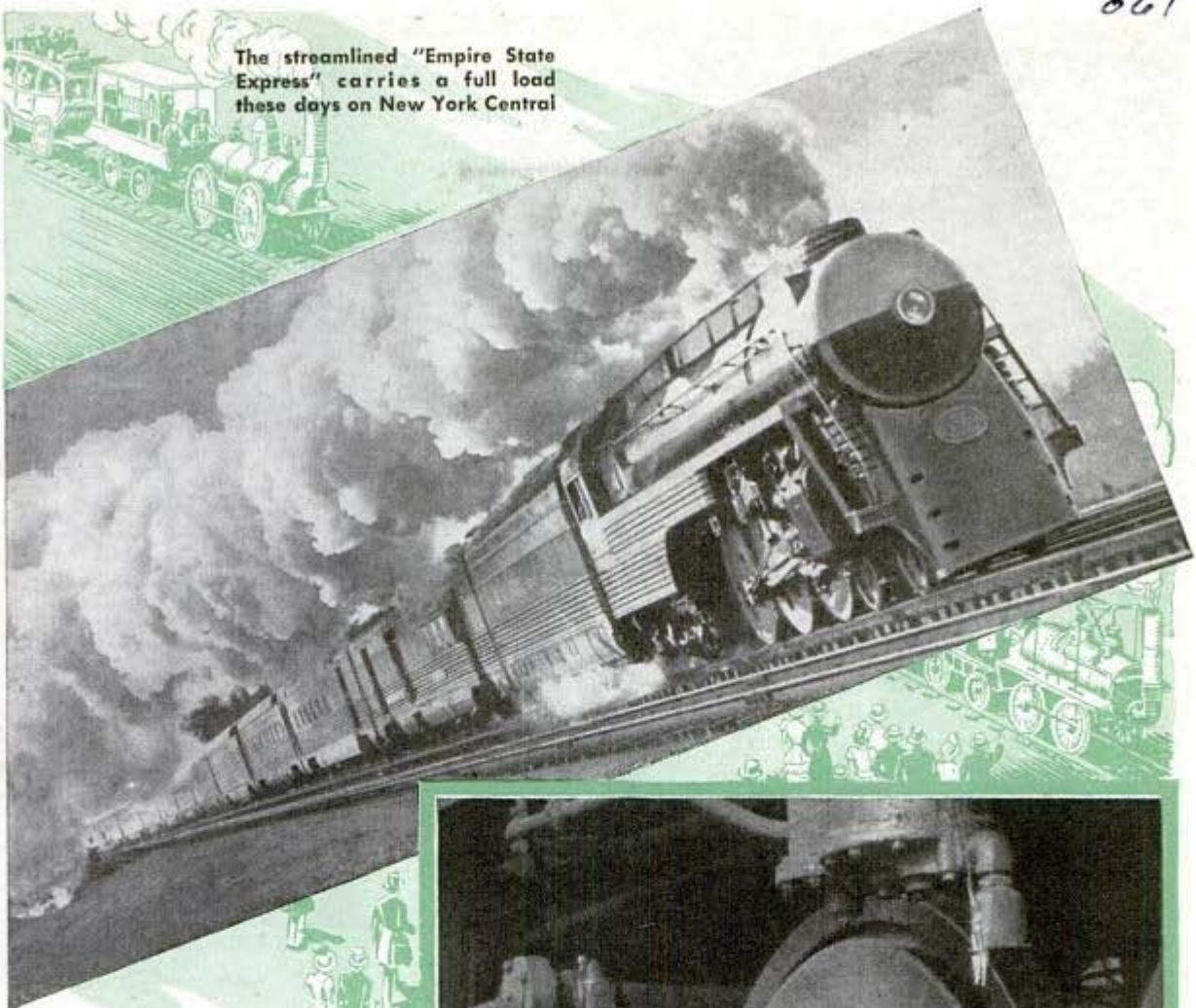

gation to maintain safe trackage, millions of miles of wire on 4,250,000 telegraph poles, 1,275,000,000 crossies, the 1,500 tunnels and the 230,000 grade crossings. One of the innovations is a new hollow axle weighing less and providing more strength than the solid axles in use since the beginning of railroading. This is saving 65 tons of steel a day or more than 20,000 tons of steel a year, enough to build 722 General Sherman tanks.

A new plant at the works of the Pittsburgh Steel Company at Altenport, Pa., produces 500 railroad axles a day.

Oiling a Long Island railroad engine; women help on jobs that were once "for men only"

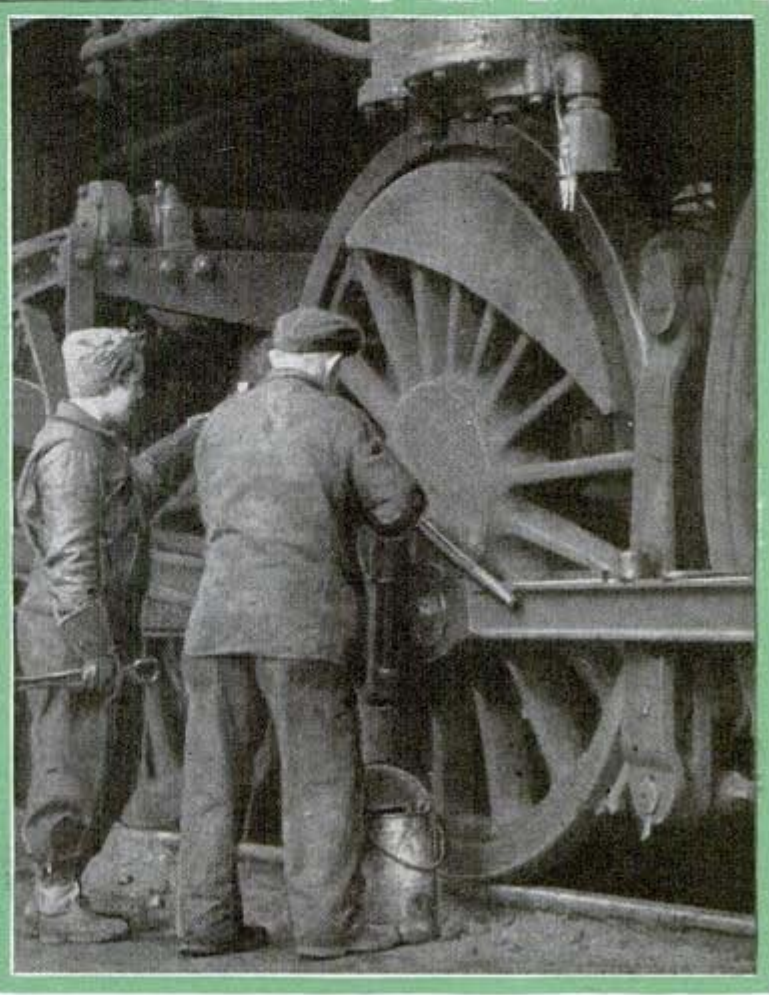

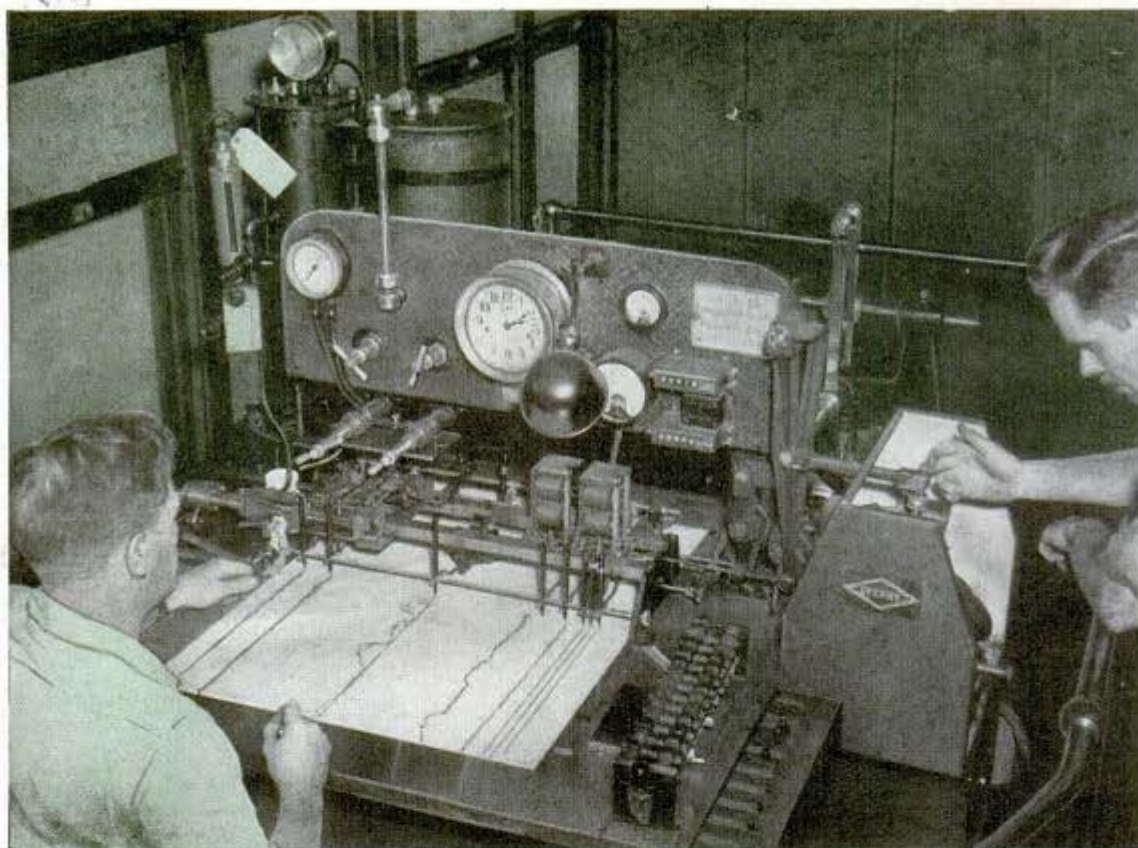

Watching the graph of rail conditions as track recorder car of Chesapeake & Ohio makes an inspection trip

Each axle for a 50-ton freight car, the type most generally in use, weighs 260 pounds less than its solid steel predecessor. With four axles being used for each car, this means a saving in weight of 1,040 pounds for each car. The raw material for the axles consists of forged seamless steel tubing.

Another example of the progressive trend is the 1,200 triple-deck-berth troop sleeping cars, the first cars in the history of the nation built exclusively for troop-carrying purposes, constructed by the

Pullman-Standard Car Manufacturing Company. War-emergency cars now, they foreshadow the lighter, more compact postwar sleeping car.

Each car accommodates thirty men. The arrangement of berths will be incorporated in one of the new types of cars the company expects to introduce on a wide scale after the war.

In daytime the cars have somewhat the appearance of European coaches. The wide triple-berth seats are grouped in sections on one side of the car with the aisle running along the other side. At night, the backs of the seats are raised to form the middle berth while the seat remains in position to form the lower berth. Upper berths are fixed and may be used at any time. Each section is equipped with racks for weapons.

The question of lightness and strength in railroad cars is being decided in a remarkable "squeeze" machine under the supervision of the Association of American Railroads.

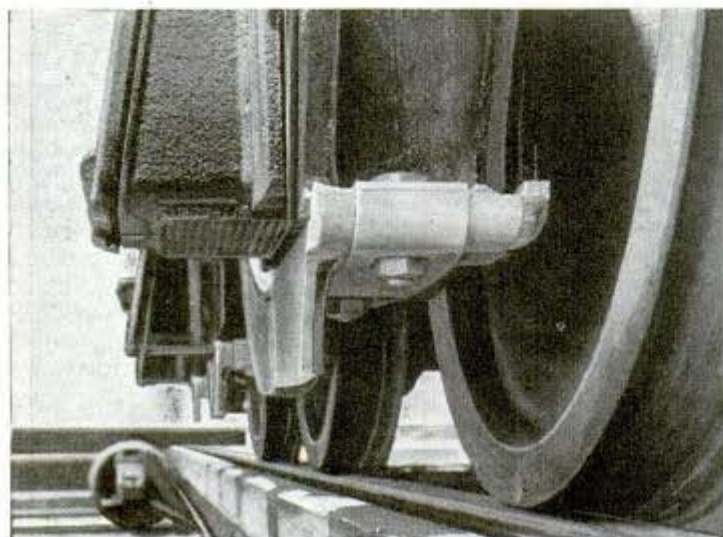

Safety guide on Southern Pacific car lets truck slide on rail if a wheel leaves the track, prevents turning off

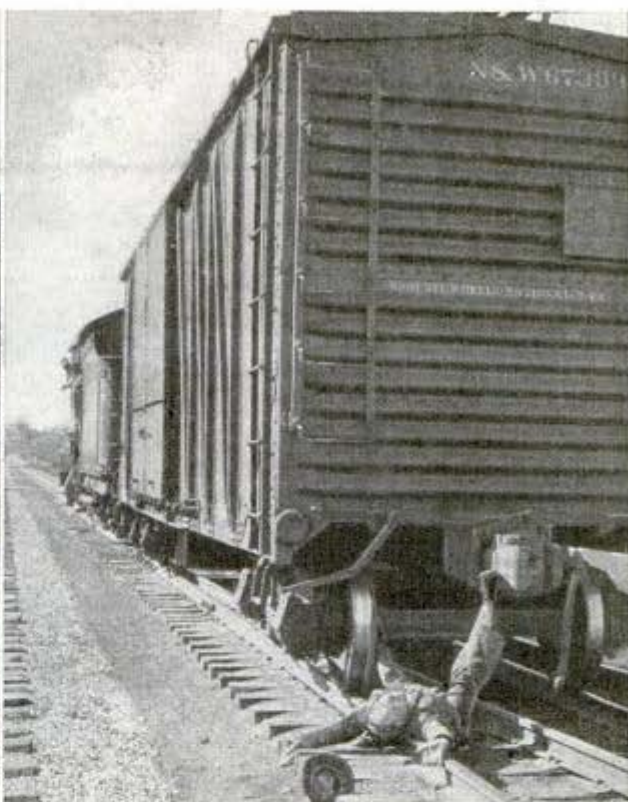
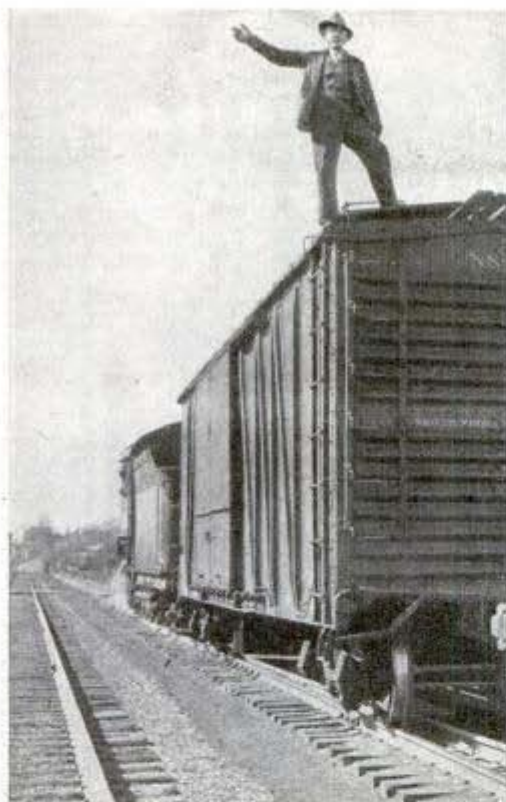

Norfolk & Western R.R. photos

Photos dramatize violation of safety rules, warn men to stand near center of moving car. New crossing sign has wigwag, bell and flashing lights

This exerts up to a million pounds of pressure by hydraulic jacks. In other tests for the same purpose—of balancing weight against strength—railroad cars have been sent crashing into each other.

The use of block signals, centralized traffic control and cab signals to accelerate heavy traffic with safety is being expanded.

Centralized traffic control, through which all train movements on a given stretch of track are controlled by one man who throws the switches and sets the signals from a central control desk, eliminates the written train order. Instead, the train crews obey signals displayed at the point where the order would ordinarily be issued.

The cab signal device brings into the cab, before the eyes of the engineman and fireman, the wayside signal indi-





handling of train orders. Carrier current apparatus superimposed on existing wires permits two, and in some cases four or more, telegraph messages or telephone conversations to be accommodated simultaneously on a single wire.

Among the recent developments in the field of electricity and electronics utilized by the railroads are radio-telegraph tugboat dispatching, telephone announcing systems in yards and stations, and yard engine telephone systems.

Left, cleaning ballast on Bessemer & Lake Erie R.R.; 5,000-horsepower electric giant below hauls New Haven freight at passenger-train speed

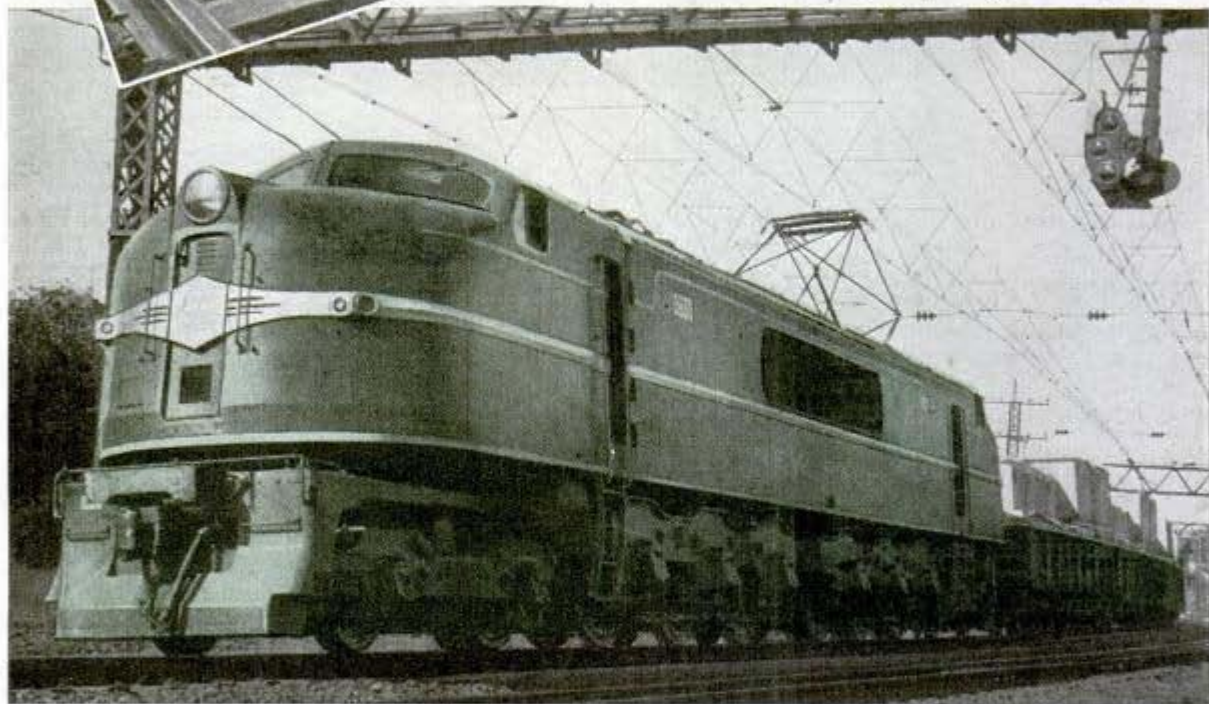

cation for the block in which the train is operating. The engine crew is also warned by a whistle when a restrictive signal is displayed.

The great increase in wartime railroad traffic and the necessity for handling the numerous details of operation on a minute-to-minute basis have brought an unprecedented load on the telegraph and telephone communication facilities. In many instances Morse telegraph has been replaced by printing telegraph service, thus increasing the message capacity of existing line circuits. Telephone train dispatching, to replace Morse telegraph, has expedited the

Each of the more than 42,600 locomotives and 2,000,000 freight cars and 38,000 passenger, baggage, mail and express cars is carefully inspected by trained, experienced inspectors after each run. Couplers, brake systems, wheels, axles, and all the other moving parts are examined carefully. Wheel journals are inspected and lubricated as required before each trip.

While trains are moving, their condition is constantly watched by all railroad men along the way. Towermen, bridge tenders, crossing gate tenders, crews of passing trains, track workers, and others watch each passing train to report anything out



of order. The crew exercises a careful watch over its own train as well, observing it on every curve. Freight trains are passed slowly over inspection pits, so that their entire under side may be examined by inspectors.

Robert Selph Henry, of the Association of American Railroads, reports that between one and two million tons of rails, enough to lay about 10,000 miles of track, are replaced each ordinary year.

The Pennsylvania Railroad and several others have installed dragging equipment

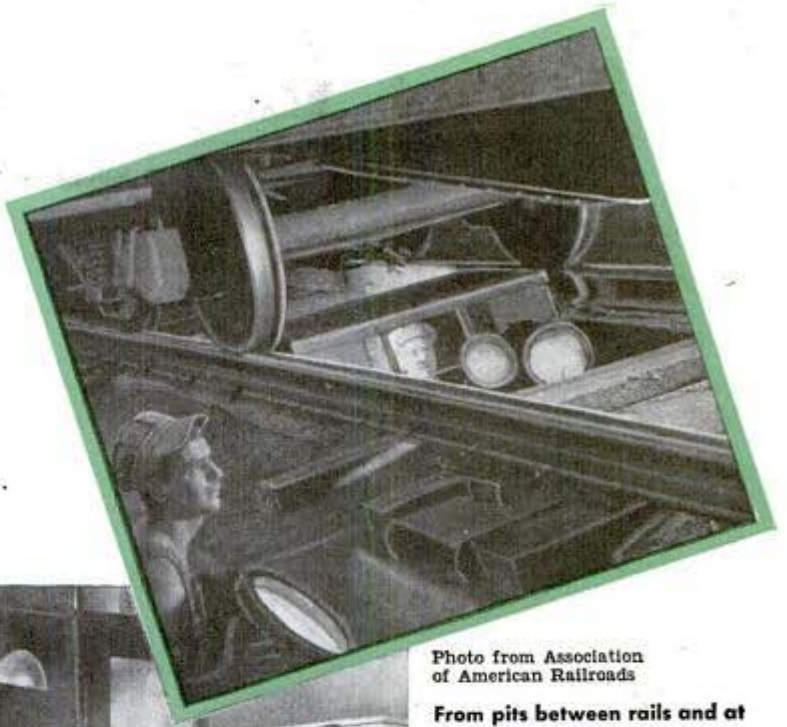
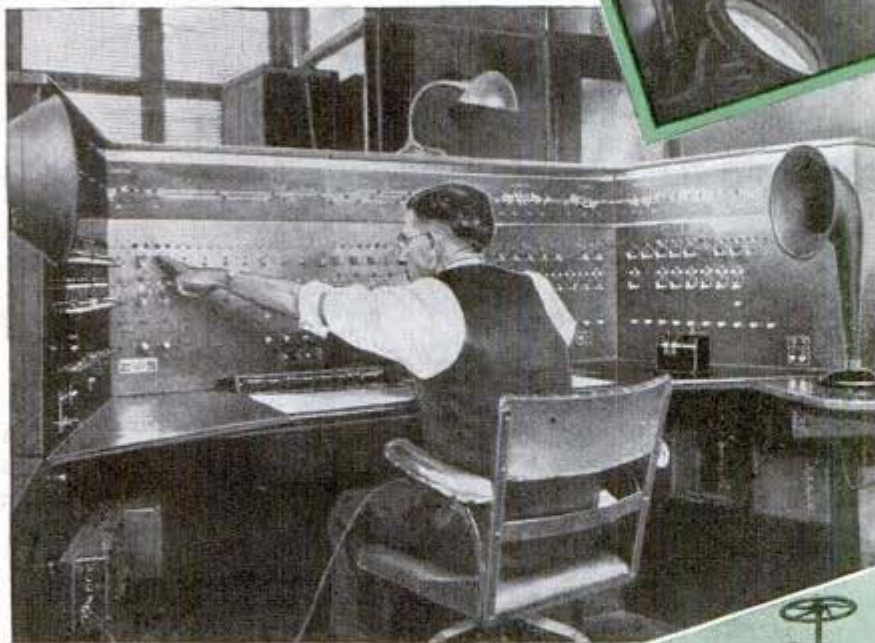

Photo from Association of American Railroads

From pits between rails and at side of track inspectors examine Pennsylvania freight cars



One man exercises "remote control" over miles of track from Centralized Traffic Control board of Baltimore & Ohio

Waiting too long to adjust a coupler may cost a hand, Norfolk & Western photo warns

Union Switch & Signal Co.

detectors at some distance ahead of interlocking switch installations where trains are switched from track to track, for the purpose of indicating the presence of any object which might be hanging from the cars between the rails, and lower than the rail surface. When a train actuates such a detector, signals are set to stop the train before it can pass over the switches.

Another improvement is high speed air brake equipment. In developing high speed passenger trains, and especially streamlined trains, the railroads and air brake manufacturers cooperated in

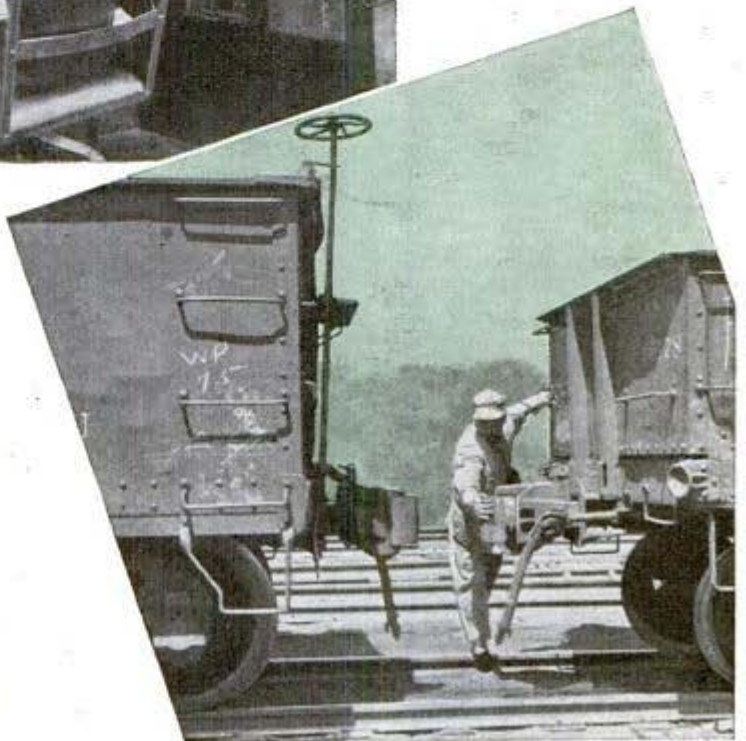

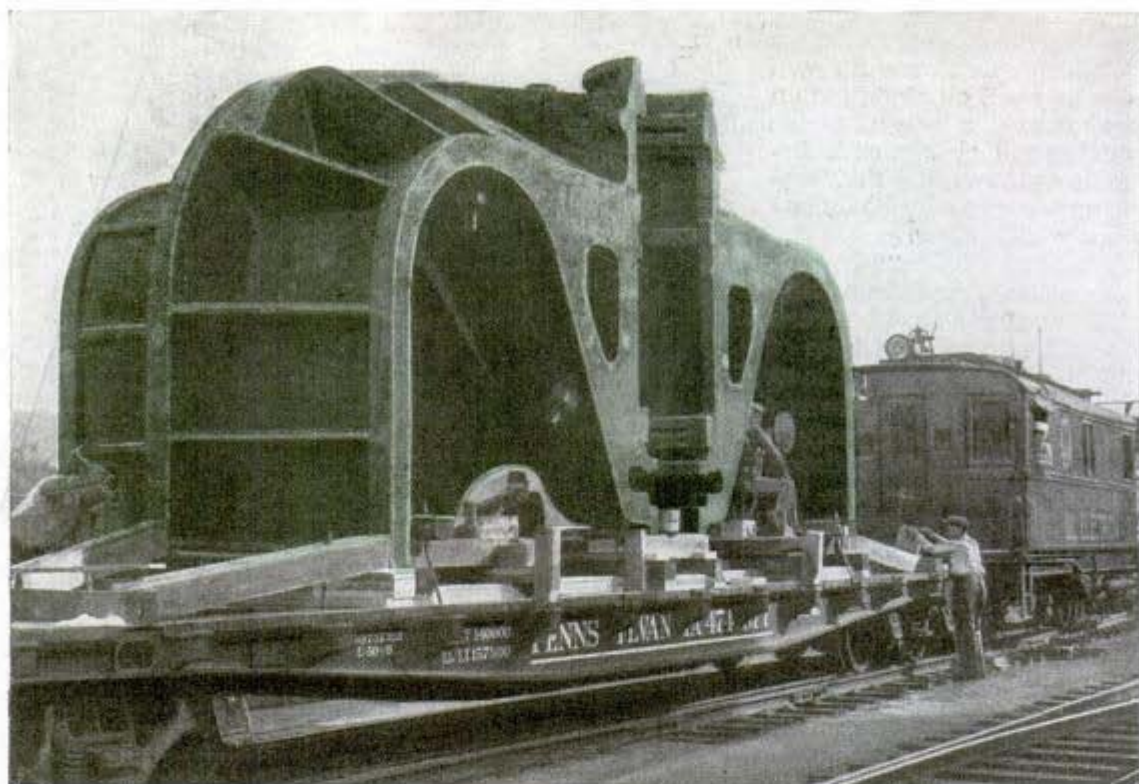

Typical of wartime railway loads is this 130,400-pound turbine base cast at Westinghouse Trafford foundry

the production of improved air brakes which insure better control of trains at all times and make it possible to bring them to a stop from high speeds within a reasonable distance. One feature of these brake systems is graduated pressure, with the maximum pressure at the beginning of the brake application and subsequent reduction to bring the train to a stop without heavy shock.

As train speeds increased, the Association of American Railroads developed an improved passenger car axle. Beginning with preliminary tests of small axles made to one-quarter size, the research progressed to the building of machines to test full sized railroad axles. With this equipment, installed in a special building at the plant of the Timken Roller Bearing Company at Canton, Ohio, high speed tests on axles of various designs and materials were carried out on a 24-hour basis for approximately two years. As a result, the Association adopted designs for new axles which have greatly increased resistance to fatigue failure due to high speed operation.

Among the improvements in signal protection for trains are "coded" track circuits which require no wires alongside the track to carry current and which can be adapted to indicate a great variety of track conditions. The coded track circuit offers a

higher degree of protection against broken rails than it is possible to obtain with the conventional non-coded direct current track circuit.

Mountain railroads are guarding their lines against slides and rock falls by fences so arranged that if they should be blocked or disturbed by a fall of rock, signals on either side of the fall would give warning.



Santa Fe switchman shows safe way to release hand brake, feet braced and one hand gripping car ladder

Electrical interlocking is being substituted on most roads for the former mechanical method of interlocking. By throwing a lever or pushing a button an entire route is set up for a movement through the maze of tracks and switches in a terminal, automatically interlocked so that no other conflicting route can be set up at the same time. With all the improvements in automatic safety equipment, there is increasing emphasis on the education of all employees in safe practices and safe thinking.

Special wartime jobs have been found for the "porcupine" cars, equipped with rods extending like spines in a fan-shaped manner, built to measure tunnel clearances. They are checking these underground and track-side clearances for huge wartime loads of guns, machinery, tanks and other vehicles. In one case a granite tunnel on the Hudson division of the New York Central was widened to permit loads from new war plants to pass through.

Continuous research is being conducted



Electric fence flashes warning if rocks fall on tracks of a mountain line

by the American railroads with special measuring devices installed under sections of track to register performance under actual traffic.

Steel rails are bent, pounded, and sliced in laboratory work supported jointly by the Association of American Railroads and the steel manufacturers. Out of research have come consistently better and stronger rails. Test machines apply far more severe continuous treatment to steel rails than received under actual operating conditions. Wheel loads up to 80,000 pounds may be applied on the rail which is moved back and forth under the test wheel.

From dawn till dark rail detector cars travel the steel roadways seeking out hidden flaws to keep the rails singing a song of safety. These cars seek out one of the greatest track hazards, the internal "transverse fissure" which occurs in rails and can, if permitted to grow unmolested, cause rails to rupture.

However, cooperative research by the railroads and rail manufacturers has eliminated this transverse fissure, which is a fatigue failure in the railhead. It was dis-

Continued to page 156



And here a Santa Fe switchman shows the wrong way to release brake, knocking it loose without holding on

# Gunners Patrol English Coast in Miniature Train

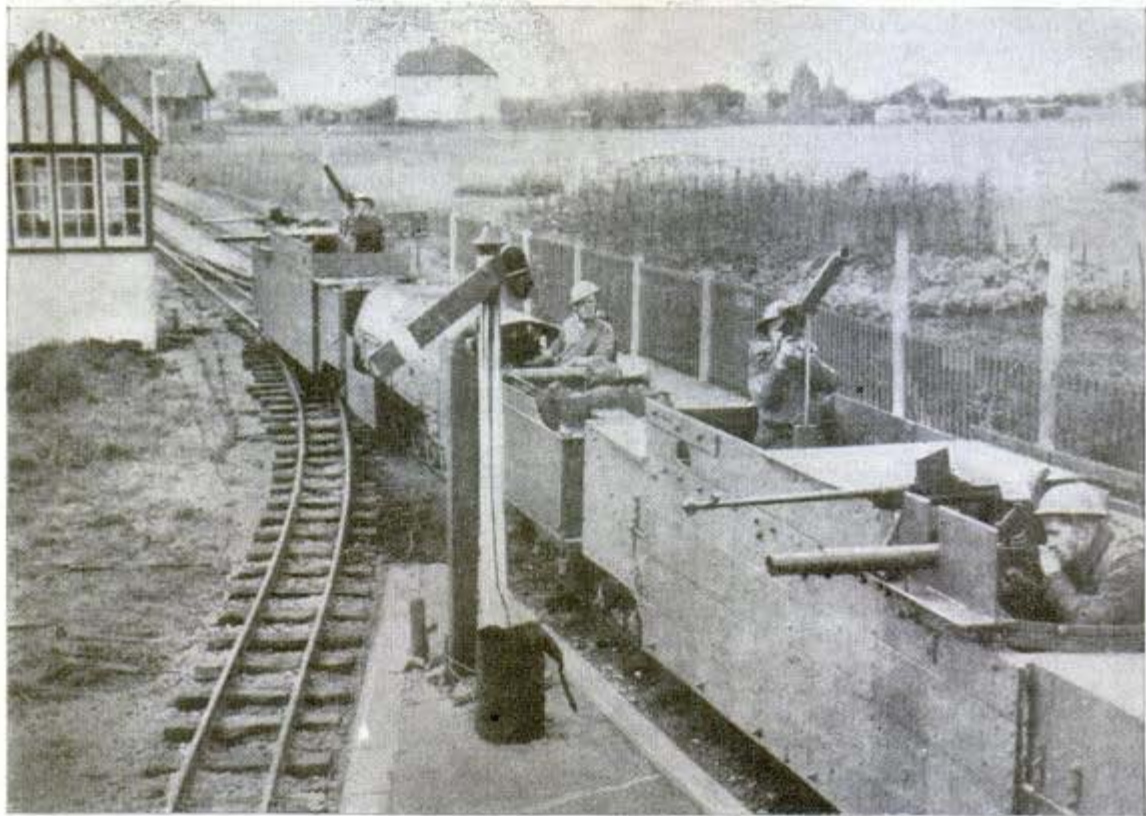

British soldiers are patrolling the Kent coastline on a miniature train formerly used by sight-seeing vacationists. But instead of riding merrily in comfortable pas-

senger cars, the soldiers sit behind grim armor-plate and heavy machine guns, ready to spit death at any enemies who try to set foot on His Majesty's soil.

## *England* Bomber Uses 'Chutes as Brakes in Emergency Landing 0 205

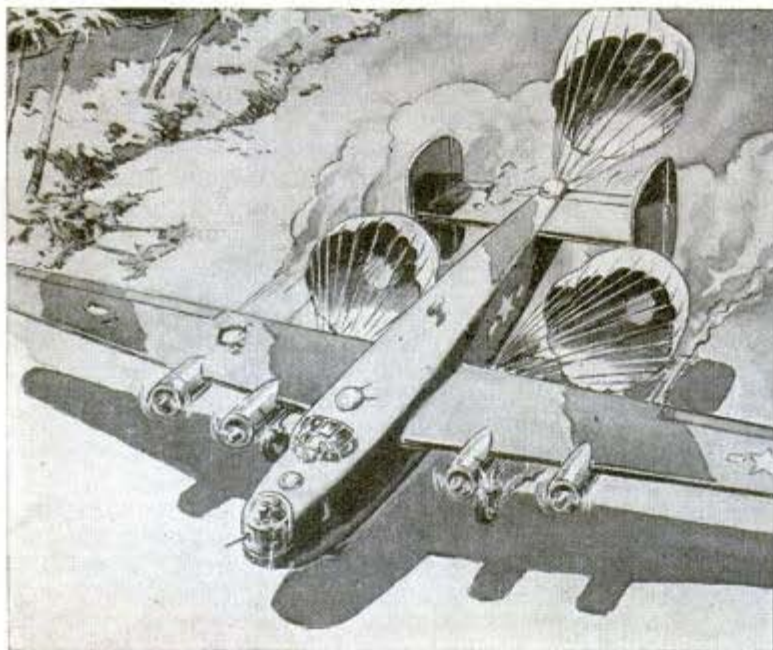

Quick thinking on the part of the crew and three handy parachutes helped land a crippled B-24 Liberator bomber on a short fighter strip on Tarawa. Jap shells had knocked out the bomber's hydraulic system which made its brakes useless. As a substitute for brakes, parachutes were attached to each of the waist gun mounts and to the fuselage bracings in the tail. The parachutes were released when the wheels touched the coral strip. They opened almost simultaneously, and the crew estimated the plane's landing speed of 140 miles an hour was reduced 30 to 40 miles an hour by the 'chutes.

Parachutes on crippled B-24 reduce landing speed about 40 miles an hour

*Plane piloted by  
1st Lt. Chas. F. Batten  
34 Campbell St., Warren, P.D.*

*Michael Todd's "Mexican Hayride"*

0196

# Huge "Pin-Up Girl" Towers Over Broadway

Crowds at 50th street and Broadway in New York City can't help noticing the world's largest "pin-up girl"—a giant reproduction of an original drawing by the artist, Varga, which decorates the Winter Garden Theater. The figure measures 157 feet long and 30 feet high, and, standing, would tower 12 stories high. If she were alive, she would wear a size 84 shoe. Her lips are wider than an archery bow.



The figure's toes and lips are so huge they make workmen look like Lilliputians



## Spreader Unit Installed in Truck Operated by Transmission From Cab

To save labor and simplify spreading of all types of materials on the ground, a spreader is installed as a complete unit under a flat bed truck. It can distribute agri-

cultural limestone, commercial fertilizers, cinders and sand, or broadcast oats and soybeans evenly and uniformly, from 20 to 40 feet wide, depending on the speed of the truck. Power is obtained by a power take-off on the truck transmission. Steel shafts with universal joints run in special bearings to convey the power. Thus, in addition to the driver, who controls the spreader from the cab, only a man to shovel the material into the hopper is needed. A steel plate lid is furnished to cover the hopper so that the truck may be used for other purposes without using the spreader.

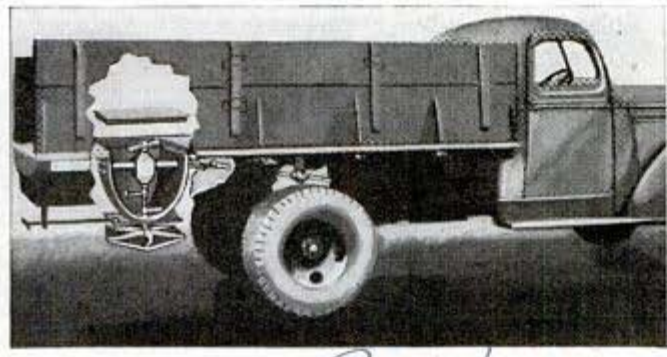

JULY, 1944

*Baughman Mfg. Co.  
116 E. Arch St.  
Joliet, Ill.*

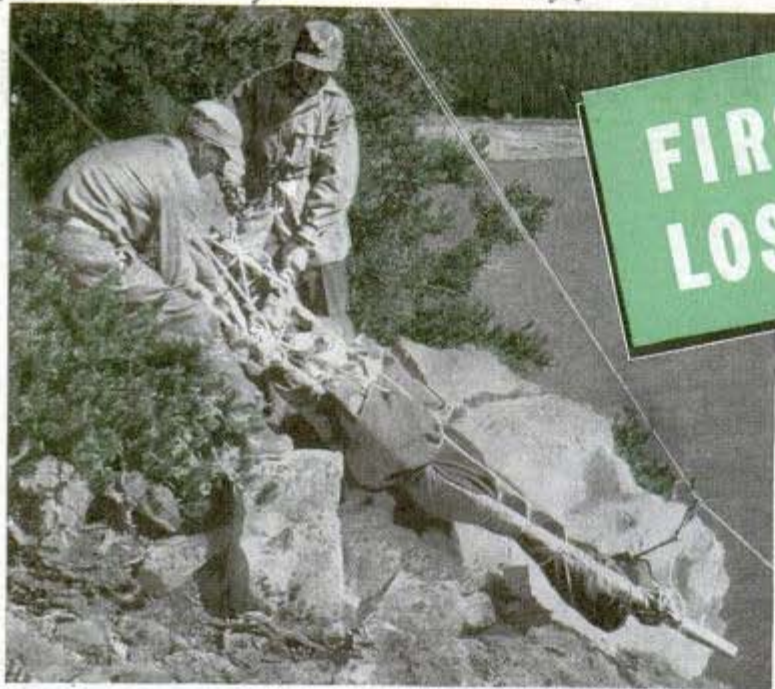

U. S. Army photos

Trainees of Search and Rescue Squadrons show how to lower injured airman from cliff to rubber lifeboat, using saplings and jackets for a litter



**E**MERGENCY—B-24 enroute from Boise to Wendover—last position reported Twin Falls 0200, last radio contact at 0400, position unknown, somewhere in mountain area—fuel exhausted, must abandon ship.”

Many such a terse message barely had time to flash back the predicament of some ill-fated ship before it was forced down to be stranded for weeks in some isolated mountain area.

A group of men have been trained at Gowen Field, Idaho, as the nucleus of a series of units whose purpose will be to rescue flyers forced down in wild mountain country. The first group was composed of a parachuting

## FIRST AID for LOST FLYERS

doctor, two officer pilots, two forestry paratroop “smoke chasers” and a sergeant. Other units are being formed at Gowen Field and other air fields in mountain areas of the United States.

The training places special emphasis on parachuting over a heavily timbered area, so that rescue personnel may learn to land and disengage themselves when falling directly into trees. For protection against head injuries, the parachutists wear football-type helmets and steel masks like those used by baseball catchers; this equipment is in addition to the usual heavy flying clothing.

Considerable time is given to the art of “spot landing” — bailing out from various altitudes



and landing as close as possible to a designated marker. The rescuers wear a reserve chute in front for emergencies in which the other chute fails to open.

Army ground personnel are trained in ways of searching for lost flyers, to coordinate with the air search-and-rescue team. The ground men must be experienced in use of skis in rugged country. It is related that once when a bombing plane went down with ten men aboard, 40 rescuers were required, since four men had to be assigned to carry each downed flyer on a stretcher—and it takes about one hour to walk one mile in rough country. Trails must be cut and special equipment used, including a caterpillar-type "snowmobile" which can proceed across deep snow.

The first test of the search-and-rescue units was held in a spot several miles from the training field where a group of soldiers were sent to enact the role of forced-down flyers. These men spread a yellow marker



Top, an Air Force weather observer in arctic. Center, inspecting wind indicator. Below, dog team takes "injured" man to base hospital from first aid tent





Pack dogs are trained to carry emergency aid to flyers downed in Arctic

cloth, a four-foot square which air crews had to spot in order to effect the rescue.

A radio report, purporting to be from the plane forced down, gave the approximate location and the rescue aircraft took up the search. Upon sighting the cloth marker, one pilot brought his plane into the wind and a "drift chute" was tossed out to determine the wind velocity. The drift chute is a 36-inch chute that, tossed free, falls at the same rate as a parachutist. Its use gives parachute jumpers an accurate estimate of how quickly they will land and how near the marker. In this test, three of the small chutes were launched

before one landed close enough to the marker to make it practical for parachutists to follow.

Then one of the 'chutists jumped, landed within 100 feet of the marker and after disengaging himself from his chute, immediately established communication with the plane by means of a "walkie-talkie" radio he carried down with him.

Next, he determined the condition of the men on the ground; finding some required medical attention, he radioed this information to the plane and the doctor parachuted down. Food and supplies were dropped, and an 85-pound medical kit for the doctor.

From that point, the rescue would be accomplished either by a plane carrying stretchers, if the area permitted landing, or by a ski and sled party.

A similar project is under way at another point, in the northeastern states near the Canadian border. It is called the Search and Rescue Division of the Army Air Forces' Air Transport Command. Obviously its job is to rescue flyers forced down on the northern run to England and its operations may carry the rescuers into the frozen lands far north of the United States.

Members of the division are trained in all phases of search and rescue work and

In this actual rescue scene Coast Guardsmen haul an injured man to a hospital after hunting an entire month for six men whose plane crashed into a mountain in an isolated section of Alaska





are ready to speed by plane and dog sled and "shanks' mare" to any remote point where a plane may have come down. While the downed flyers are instructed how to keep alive in the arctic weather, planes drop food and supplies, then medical men if necessary. A large parachute may be dropped for use as a tent to form a shelter from the winds.

Should the flyers be injured or exhausted, members of the rescue teams may jump from planes, administer to the victims and maintain contact by radio with rescuers proceeding to the scene by dog sled or on foot.

Important as these units are to the Army, the real significance of their work lies in the certainty

At right, an emergency hospital tent is pitched to treat patient before attempting to transport him to a base hospital



that the government and the air lines undoubtedly will provide means of rescuing air crews and passengers from desolate lands over which passenger aircraft will fly when peace is a fact.

Left, practicing rescue of men downed on Arctic lake; dogs carry shelters, blankets, food and first aid equipment. Below, men on snowshoes practice with sled



# Ingenuity Works Wonders With Scrap

*J. A. Brindley, Major A. C. Spantini, Operative, Asst. Chg. of Air Staff, Opatovitz, Commandante, Opatovitz*



U. S. Army Air Forces photo  
With this crude rigging device, ingenious mechanics of an Air Service Command repair squadron dismantle Jap Zero on the Buna strip. The Zero will be shipped to Port Moresby for use as training ship. Supply and maintenance of U. S. fighting planes on all fronts is the big job of the ASC with headquarters at Patterson Field, Ohio. The ASC has warehouses and depots scattered all over the world. Right, damaged tail of B-17 is speedily repaired with help of extension ladder made of scrap material and attached to jeep. In addition to G. I. mechanics, ASC employs 300,000 civilians



Northwest African ASC photo  
Steam boiler for cleaning aircraft parts was made from discarded 50-gallon gasoline drums and scraps of metal "somewhere in North Africa"

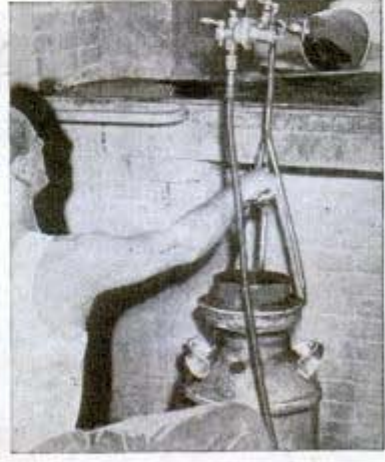

Firing oven with homemade torch before baking bread. Eight-foot flame applied for half hour leaves oven so hot it bakes bread in 90 minutes

*Mr. Jensen, Jr. 3872 Maxwell Ave. Los Angeles 21, Calif. 3/13*

# The IRON CAVALRY



"PETER TREETOP, this is Able Lunchbox. The enemy is pulling out. The enemy is taking the road east of the village. We are attacking."

Able Lunchbox listened to the reply to his radio message, put his earphones away, and stood up in his vehicle.

Up ahead, smoke was rising from fires that the enemy had set. Wary of land mines that might be planted in the dirt road, the scout car and its accompanying tanks moved off across the fields toward the village.

In an earlier war the commander of this little force would have risen in his stirrups, waved a saber, and shouted "Charge!" He and his troop are cavalymen. Today most cavalry soldiers fight from armored vehicles instead of from saddles. They communicate by radio or flags instead of by voice. They groom heavy engines and self-propelled guns instead of horses. But their duties and traditions remain the same.

Theirs is the job of finding the enemy, learning all they can about him,

Scout car commander signaling other armored cavalry units. Below, cavalry troop's anti-aircraft machine gun





Driver of self-propelled assault weapon aims a sub-machine gun

and as frequently as not, fighting him. They are the "eyes, ears, and nose" of the army. Field glasses and radio transmitters are their most important tools; the big guns on their vehicles come second. They feel out

fits 24 hours a day. Among their multitude of jobs is that of harassing the enemy and breaking through his lines, then running wild in his back area. They blast his supply roads, tear up his phone networks, and shell his supply dumps at point blank range. All the time they are noting details, gathering information, and reporting it by radio.

On the scout cars and other vehicles are short range voice sets for talking back and forth, plus heavy and rugged long range outfits that use dot-and-dash communication.

Slang sentences are often used as or-

Light observation plane, one of the armored cavalry's "eyes," climbs up out of a temporary field



ders, made up ahead of time, to baffle enemy listeners. "Peter Treetop, this is Able Lunchbox. It looks like the old gray mare." Radioed back from a scouting force, the message might mean that the enemy has withdrawn. Or, if such had been decided before the mission began, it could mean that Able Lunchbox had broken down or was disabled.

In such an event it is the duty of the men in the vehicle to destroy the crystal frequency control units of their radio sets. The radio crystals are always destroyed if there is a chance that the enemy might capture them. A set of crystals, captured last week, might be used by the enemy today to issue what seem to be bonafide orders to an American unit. With such crystals the enemy can tune a transmitter to today's frequency and issue orders calling for a withdrawal or a sortie in a useless direction. In the meantime the American cavalry command post, listening in, will break in with a message of denial. The radio operators on the vehicles must use their heads to separate friend from foe on the air. The game works both ways and enemy radio equipment that is captured by us is put to the same use, that of confusing enemy units.

As scouts and commando fighters, the armored cavalry are among the most heavily armed groups in the army. Their specialized vehicles are designed for speed and fire



Radio operator in scout car is equipped with a transmission key clamped to his leg



Scout carries own pack-back radio with antenna he can bend perpendicular. Below, command car covers convoy with smoke by circling it





Above, a closeup of a driver's compartment in a scout car. Below, an armored scout car climbing the bank of a hill. Besides being self-containing for long periods, with their own bedding, food and camouflage nets, these vehicles are among the army's best armed

power. Even the peep—jeep to the rest of the army—is often equipped with a machine gun and becomes a rolling machine gun nest. The big armored scout cars carry heavier armament. There are light tanks that operate with the cavalry and a troop includes several self-propelled assault guns as well, each carrying a machine gun and cannon.

Last year cavalymen carried revolvers as personal weapons; now many of them have been issued a new light submachine gun that is not much larger than a revolver. It has a heavy wire frame that extends to form a shoulder rest, so the gun can be aimed and used like a rifle.

An armored troop is a self-contained outfit that can operate for long periods with a minimum of supply. The men strap their bedrolls to the outsides of their tanks and self-propelled guns, live off canned rations and whatever fresh food they can capture, and use enemy fuel whenever they can to conserve their own supplies. Each vehicle carries its own camouflage net and each troop has its own pioneer and demolition section. These engineers strengthen bridges, blast trees out of the way, and during a with-



drawal cause as much wreckage as they can to hamper the enemy.

Armored cavalry is at its best in open country; it has not replaced horse cavalry for exploring precipitous and heavily wooded areas. In modern warfare an armored cavalry unit may be assigned to each big infantry unit and to each large armored group. Such outfits are attached to groups that are serving in many parts of the world. Their training is carried on right up to the day of battle even though they were ready and eager for combat on the day they left the United States.

Armored warfare has changed considerably since the Germans first put blitzkrieg tactics into use. Tanks made impressive gains early in the war, then the Russians found a way to stop them. When attacked by tanks the Russians simply opened up and let them through, then concentrated on destroying the weaker supply vehicles that were trying to follow in their wake. The tanks wound up deep in Russian territory, out of fuel. The crews had the choice of surrender or death.

Nowadays tanks are used mainly as the spearhead of an infantry attack. Foot soldiers often ride on the tanks or follow along behind them, and the armored units move ahead slowly enough for their support and

Closeup of smoke pot which produces a dense smoke cloud that lasts for more than five minutes



Under those bedding rolls are driver and commander of tank destroyer. Below, observer and radioman spy from a dead tree

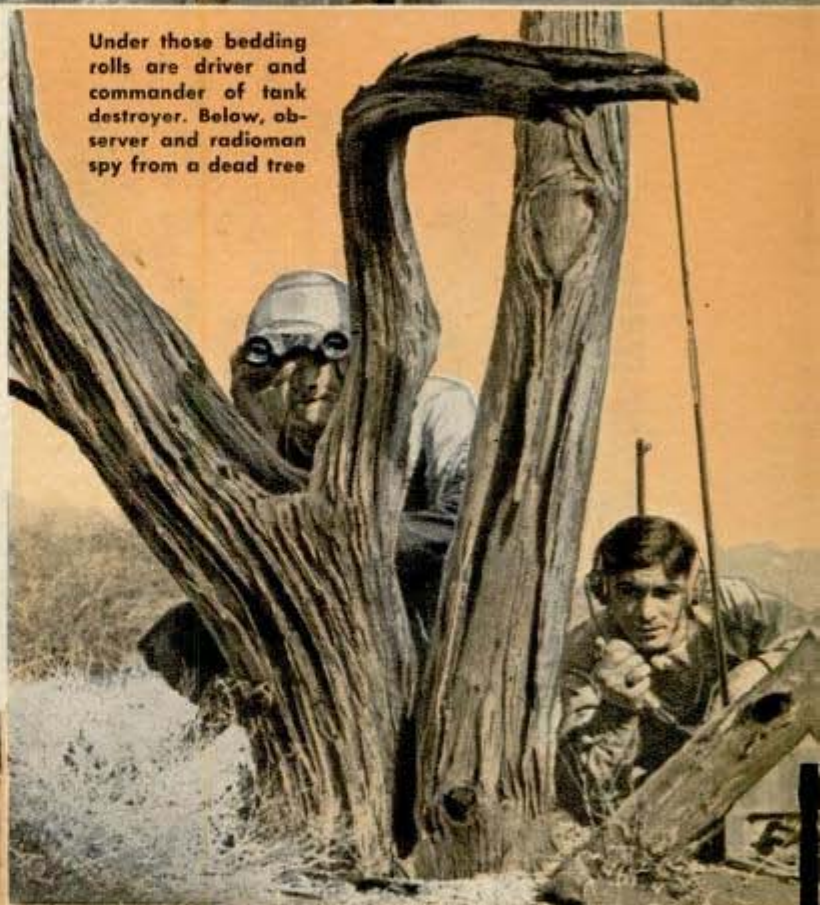

supplies to keep up. In any such combination the armored cavalry plays its part, protecting the flanks or starting a diversion. In case of a withdrawal they remain behind to protect the rear. The cavalry has taken a beating in this war, in Africa and on the continent, yet you will search a long time before you find an iron horse cavalryman who wants quieter duty.

081



### Dummies "Bail Out" In Parachute Test

Paratroopers do a lot of jumping out of airplanes but none of them has made as many leaps as the dummies used at the Stanley Switlik parachute plant in Trenton, N. J. The dummies, which correspond in weight to an average man, are strapped into parachutes and dropped from planes as a final test to see that newly made 'chutes are safe. The mechanism that drops the dummies from the plane pulls the ripcord. The plant specializes in "pocket" 'chutes which are smaller, lighter, and claimed to be safer than large ones.

Women pilots strap dummies into 'chutes before taking them "upstairs," where the 'chutes will be given final safety tests

051

### Tandem Jeeps Joined by "Magic Link" Double Their Hauling Power

Two jeeps can form a team to haul a disabled 13-ton tank or an artillery piece weighing as much as 4,000 pounds, by means of a "magic link" which hitches them back-to-front as a single pulling unit. The coupling device doubles each jeep's normal capacity to pull 1,900 pounds, enabling

them to pull in tandem a load that ordinarily would have to be moved by 2½ ton trucks. In addition, once they have placed a big gun in position, the scout cars could be unhitched easily and pressed into service at once as reconnaissance vehicles or ammunition carriers.

Willy - Overland Motors, Inc.  
Tulsa, Okla.





## "Pop Gun" Tester For Flak Weapon Uses Dummy Shell

Forty-millimeter anti-aircraft guns are tested with a machine which uses dummy ammunition and compressed air for power. This machine, developed by the Plymouth Division of the Chrysler Corporation, saves both time and valuable ammunition in testing the complicated mechanism of the gun. Flak is thrown 10,000 feet into the air by this weapon which fires 120 two-pound projectiles per minute. American improvements on the original European design of the 40 mm. gun, along with precision machining of its 1,500 parts, have made possible its mass production.

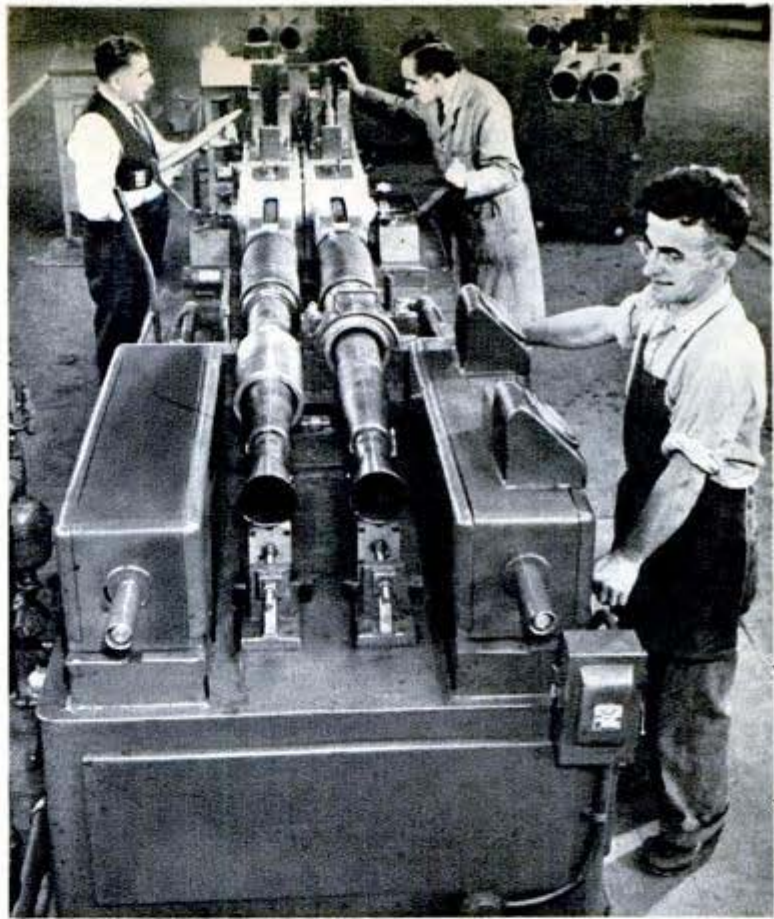

024  
Plymouth Division Chrysler  
2680 Ch. 10 Street Bldg.  
Detroit 24, Mich.

## Firemen Practice on Tightrope While Balancing Four Reels of Hose

Carrying four reels of fire hose weighing 200 pounds, East London firemen make a 40-foot tightrope crossing to help perfect

their sense of balance. In the commando course at Chigwell they also are obliged to walk a tightrope with ladders slung over their shoulders, cross a rickety wooden structure carrying a length of hose under each arm, and then dive through narrow openings into "burning" dugouts.



## Powder Mixed in Water Becomes Fluid Milk

Milk which dairy experts assert looks and tastes just like the fresh fluid variety results from mixing whole milk powder with water. When a dash of cold water is added to four and a half ounces of the whitish powder, which has all the food value of fresh milk, it dissolves instantly into a quart of milk. The powder, which sells at approximately 30 percent under retail prices for fluid milk, could rest on the pantry shelf a year without spoiling. It is made by spraying whole milk into a huge drier into which heated air is forced under pressure. As the milk and hot air meet and fall toward the bottom of the drier, the air takes the water out of the milk.

Consolidated Dairymen Corporation  
Shawano, Wis.  
59

# METAL POWDERS SPEED V-DAY

Achievements such as these in the war production program are reported by America's powdered metal industry, and they are not surprising when it is considered that this industry's swift and spectacular development has squeezed 50 years of progress into less than the last 50 months.

Parts and products made from metal powders, some of them almost as soft to the touch as a fine cosmetic, now are used throughout practically the entire range of American mechanized land, air and sea-going fighting equipment, and metallurgists agree they will be very much in evidence in peacetime manufacturing, perhaps revolutionizing many

Left, some of the parts made from powdered metal. Below, hydraulic press for powdered metal, one of largest ever built



**F**OUR thousand small metal parts turned out to exact dimensions without machining in a single minute.

Big gun mount bearings that weigh 60 to 100 pounds, yet require no smelting.

Millions of man-hours of labor, and hundreds of thousands of tons of critical materials saved annually.

New metal alloys hitherto impossible to create by conventional methods.

Below, left, powdered iron is poured into a mold or die; then powder-filled die and plunger are placed between jaws of hydraulic press, right

*Mr. C. H. Moore  
1362 N. Dearborn St.  
Chicago 10, Ill.*

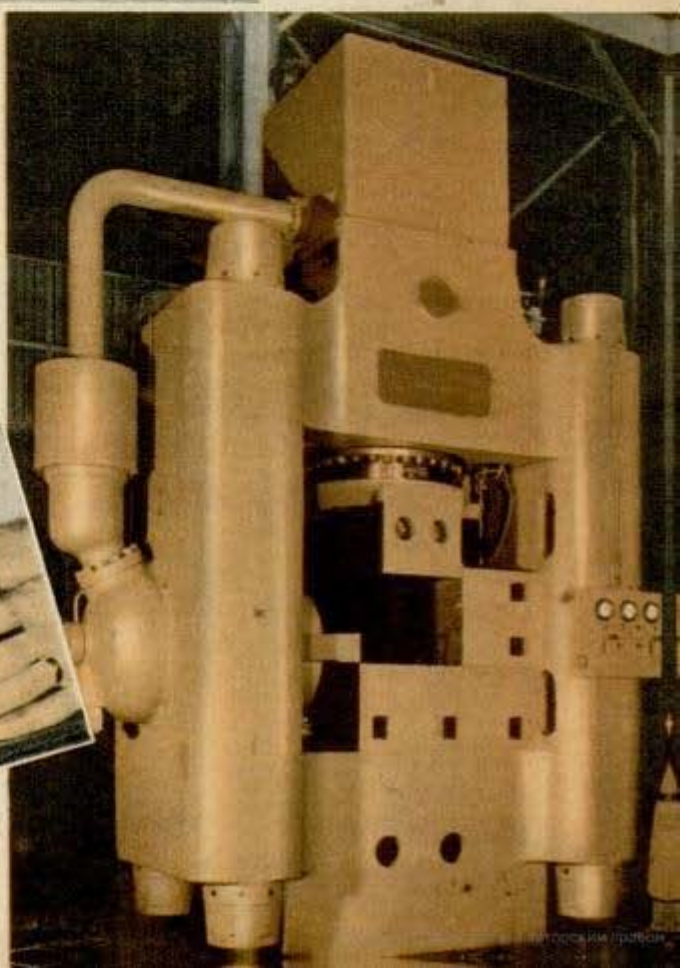

*Morane Products Div.  
General Motors Corp.  
Dayton, Ohio.*

prepare engineering and production procedures.

Flying Fortresses and B-24 Liberators each are said to have around 2,000 powdered metal parts. B-26 bombers have just under 1,000. Thousands more are used in other warplanes, in warships, tanks, trucks, ordnance equipment and the like, replacing machined parts in most instances. Today you will find electric motor parts, magnets, porous bearings and filters, gears, machine tools, abrasive wheels and disks, diamond drill bits, airplane instrument parts of light metals, brasses and bronzes, camera and clock parts, electrical contact points, and a host of others, made of powdered metal.

The principle of powdered metallurgy, which entirely by-passes the commonly known melting process, is relatively so simple that historians say it even was used by the ancients. It is in the applications of the principle that so much progress has been made since the war began.

Reduced to its elementary steps, making parts from metal powders



"Shot blaster" cleanses welding scale from breech casing for Bofors cannon

Below, weighing oil-impregnated bearing made of powdered metal. It weighs 62½ pounds



Left, above, a pile of metal powder and bronze part it becomes in seconds. Right, magnet illustrates properties of iron powder made of scrap iron



consists of placing the powder in a finely finished die or mold, and applying pressure. This is called "briquetting." Then the parts, which have a high finish but which can be crumbled with the fingers at this stage, are sintered or heat treated in atmospherically controlled furnaces at a point below the melting point. Each part retains its shape and size, but the molecules of the metal particles become fused together or interlinked under



Above, filling steel dies with powdered metal "mix" in the first briquetting operation. Below, lifting oil-impregnated powdered-metal bearings out of bath to drain excess oil back into the tank



heat and the desired strength thus is obtained. Occasionally, it is necessary to do some machining or to apply additional pressure, depending on the closeness of allowed tolerances, or other facts. In most cases, however, parts are ready for use after sintering, and are extremely accurate.

Contributing more than anything else to the growth of the powdered metal industry have been the development of new high pressures, new methods of producing large bearings and other parts, improved die-making techniques, and more scientific mixing of various metal powders to form desired alloys.

Prior to 1940, the heaviest powdered metal part rarely exceeded three pounds; today, bearings of powdered metal range up to 60 pounds and even higher, with diameters up to 30 inches. Designed and probably now in production are bearings weighing 100 pounds.

Accuracy of powdered metal dies and molds has been improved to a remarkable extent, and far more shapes and sizes now are possible than ever before. Making dies for gears has been reduced to an exact science, which explains why most powdered metal parts are so precise when they come from the sintering furnace.

The problems formerly encountered in the often complex tasks of mixing various metal powders to form alloys also have been largely overcome in the last three years. Formerly, ordinary mixing methods would not serve, since powders of heavy metals would not mix evenly with those of light metals, and certain powders would show inability to cohere.

Now it has been determined that the shape of the particles of powders has an essential bearing on how well they will stick together. Circular shapes are rarely used today, except for filters, and shapes may be angular, acicular, nodular or of other oddly assorted contours, each type serving its purpose in a certain form or for a certain article.

There are three principal methods of powdering metal now in widespread use. One is atomization, a process of liquefying and spraying under pressure, used with lead, tin, aluminum and oth-

ers with relatively low melting points. Another is reduction, the removal of oxygen, and the third is electrolysis, or decomposition by electrical means.

Making parts from metal powders eliminates some 20 machining operations, including turning, facing, drilling, boring, counterboring, milling, broaching, profiling, shaping, gear cutting, slotting, grinding, hobbing, chamfering, blanking, flattening, coining and burring. The average machining loss with standard manufacturing methods is said to vary from 20 to 80 percent. But, in making a part from powder, the weight of the powder exactly equals the weight of the finished product.

Strength is another important advantage claimed by powder metallurgists. One manufacturer reports strengths ranging up to 166,000 pounds per square inch.

Powdered metal already has solved many industrial problems, going back to the first industrial application of the process when it was applied to the production of tungsten filaments for electric lamps. Tungsten is the most suitable material for filaments because it will not melt at high temperatures caused by electric current, but this same quality makes it expensive and troublesome to melt and cast. Powdered tungsten provided a way out of this difficulty.

According to P. R. Kalischer, Westinghouse metallurgist, tungsten ore, a coarse brown powder, now is chemically treated to convert it into yellow tungstic acid, also a powder. After refining to remove water and oxygen, pure powder is obtained and this is squeezed to form it into bars two feet long and less than half an inch thick. These are baked in a hydrogen furnace and then placed in hydrogen-filled metal "bottles" while an electric current is passed through them. The material then takes on a metallic appearance, after which the bars are heated and hammered into rods which can be drawn into wires one-fifth the thickness of a human hair.

This material is stronger than the highest grade of steel used in building bridges and skyscrapers. An inch-square bar of tungsten can stand a pull of 250 tons, while the highest grade of structural steel snaps under a load of about 100 tons.

Powdered metallurgy received its most important impetus before the war with the development of "ever-lubricated" bearings. Literally billions of these have been manufactured, and applications have been found in automobiles, airplanes, refrigerators, electric clocks, sewing machines and other common products. Such bearings, being porous, become permanently lubricated after soaking the porous spaces with lubricating oil, and are especially useful in places where bearings are difficult to reach.



## Whirling Tower Tests 'Chutes Under Eye of Speed Camera

Because small errors or accidents in the fabrication of parachutes can prove so costly, a parachute manufacturer has developed a test tower and an indoor proving ground to make certain the 'chutes are safe. The test tower, a tripod with an extended cable attached to the released 'chute, mechanically reproduces every stress and strain which the billowing silk might have to undergo in actual use. Every detail of the parachute's operation, from the time it is released, is carefully observed by engineers and recorded by a high speed camera. In the indoor test the 'chute is inspected while radial tension of 20 pounds is applied on each suspension line. Then it is spread over vertical forms shaped to match the inside contours of a 'chute during shock loading, with the suspension lines anchored to the floor. The 'chute is "proof loaded" by applying pressure to a jack and increasing the stages by 500 pounds each until some part of the 'chute gives way.

*Parsons Parachute Co., Inc.  
Manchester, Conn.*

☞ See the index to find where to buy articles described in this magazine. Say You Saw It in Popular Mechanics.

# THEY GET THERE

The time is two a.m., July 9, 1943. The soldiers are glider troops spearheading the invasion of Hitler's Europe. As the big engineless machines streak down on the hostile shore there is a roar of transports overhead. Parachutes blossom in the sky bearing still more attackers. Their objectives, like those of the glider troops, are enemy strong points and roads up which reinforcements can be expected to move to block the Allied landings.

Outside a pillbox a German sentry hears the transports, sees the chutes floating to earth. He dashes frantically to the field telephone but is cut down by the guns of glider commandos. A companion manages to gasp the message: "Troop carrier planes!

By Major Vincent P. Wilber, AC

**T**HROUGH the night sky there comes a low whistling, like the singing of a telephone wire in the wind. Now a vision of great batwings momentarily against the moon, a deep bumping noise and a rumble. Suddenly out of the blackness of a Sicilian meadow near Gela materialize the forms of armed men, their faces blackened, carbines at the ready. The whistle and the shadow come again and again. The troopers multiply, band together into groups and move off into the blackness.

British War Office photo

Paratroops pour out of troop carrier planes in mass descent, above. Gliders carry jeeps and 75-mm. pack howitzers; below, airborne troops unload a big gun

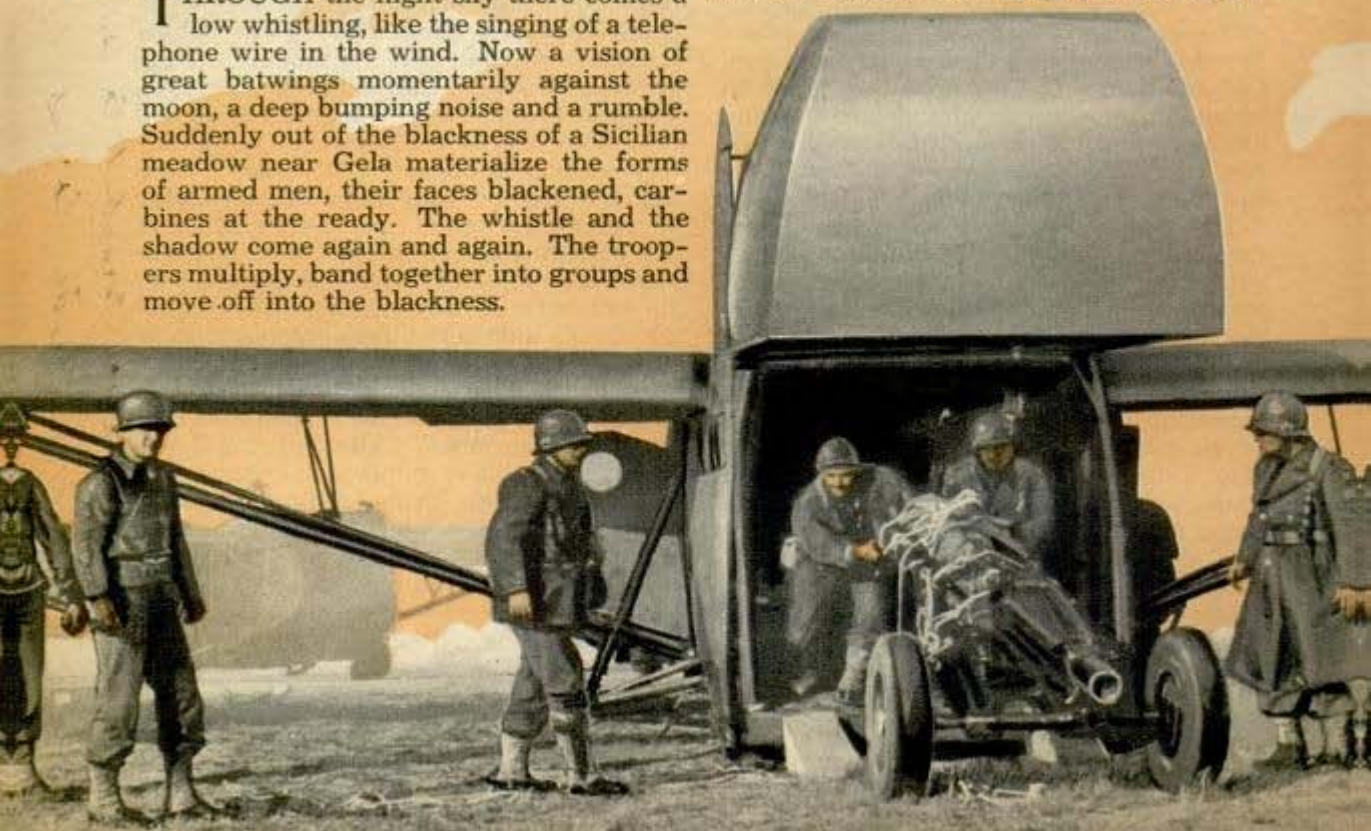

# FIRST



*Major Lizzett*  
8-5-2

Last man to land is still unbuckling chute as comrades begin attack with tommyguns



Hundreds of them Dropping paratroops and gliders on our positions! Send help!"

How well the Troop Carrier Command of the Army Air Forces and the British and American airborne troops they carried did this job is best expressed in this commendation received from General Eisenhower himself: "The record of the performance of the Command has given me great gratification. The accomplishment of its officers and men in carrying to their destination, through difficult weather, navigational obstacles and hostile fire in unarmed and unarmored aircraft the largest number of troops yet lifted by air, is a signal one. Their return to base with a loss of only two percent, and their complete readiness for operation on the following night is remarkable and shows great fortitude, superior organization



Above, a paratrooper is ready to "hit the silk" along with his outfit's famous jumping mascot, "Geronimo." At left, airborne bicycle troops go aboard an air transport



Inside a glider headed for enemy territory, soldiers equipped with tommy guns, rations, water and first aid equipment await action behind enemy lines. Below, glider is airborne before towplane leaves ground

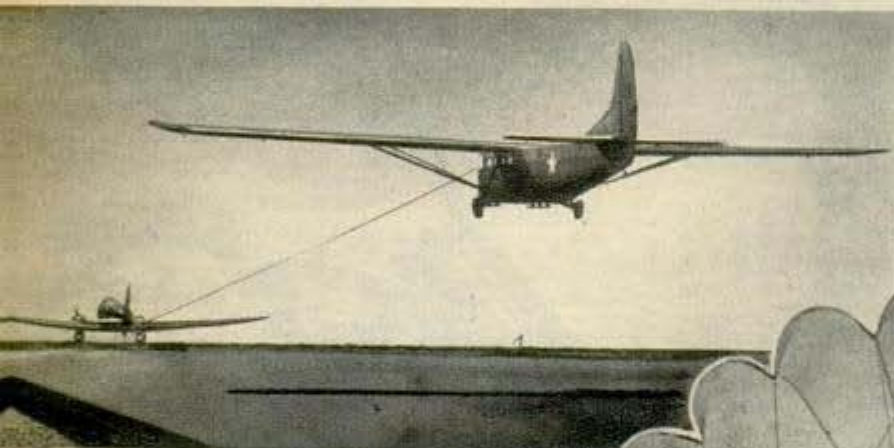

and training on the part of all concerned."

The Troop Carriers received a slightly different commendation from the enemy. According to Nazi and Italian prisoners, their high command was of the opinion that approximately twice the number of troops were descending from the skies than was actually the case, so great was the confusion.

One of the youngest organizations in the Army Air Forces is the I Troop Carrier Command, founded April 30, 1942, with headquarters at Indianapolis. It is the responsibility of this organization to train and send out to

Down in approved fashion, Marine's next move is to spill air from chute



battlefronts the Troop Carrier wings, groups and squadrons which have been eulogized as "the common carriers of death and destruction. . . Destination, the enemy's rear."

An example of the type of courage and skill with which the TCC seeks to imbue its flyers is the saga of a plane piloted the night of the Sicilian operation by Captain James R. Farris.

A few minutes before he reached the drop zone an anti-aircraft shell ripped a huge gash in the fuselage and carried away part of the vertical stabilizer. Capt. Farris continued to his objective, signaled the paratroopers to jump, then turned back for his base in North Africa. Although flying at a speed not far above the stalling point (the co-pilot later reported there was only about half a ship left) Farris managed to make it by skimming just over the waves of the Mediterranean.





The pilot of another damaged aircraft, limping back on one motor, decided to make a belly landing in the water. When he hit, the plane bounced thirty feet into the air, but he managed to get it under control and bring all hands down safely.

The I Troop Carrier Command maintains ten training bases in the United States. A Troop Carrier pilot, just out of flying school, reports first to the command's transition training center, Bergstrom Field, at Austin, Texas. Here he learns to fly the C-47 aircraft, the same plane flown by the nation's commercial transport pilots, most of whom have had hundreds of hours of air time before they can touch it. Inside the C-47 are 24 aluminum bucket seats shaped to fit 24 posteriors in parachutes. An astral dome has been added for use of the navigator in taking sights. Otherwise it is the old, reliable Douglas DC-3. In the combat theaters it is called on to haul loads that would give a CAA inspector in this country the creeps.

From transition training a TCC pilot moves on to unit training where he is assigned to a squadron preparing to go overseas. He now gets a month of practice in navigation, night flying, glider towing and close formation work. This may be at any

Continued to page 150

Parachutists march aboard planes that will ferry them to scene of action, where they will attack an airport to clear way for airborne infantry following. Below, a C-47 troop carrier converted into ambulance

*T/3 Clifford J. Gumbert, Lakewood, Ohio*



*and Lt. James Dickinson, Quartermaster*



An armorer (above) counts noses in the "bomb bank" before ground crews start loading planes. These went to Hamburg

# INVASION STOCKPILE

An avalanche of war materiel from U. S. and British plants has transformed England into an island arsenal to supply the hardest hitting invasion force in history. No roof is big enough to hide the vast array of 25 pounders with tractors above—a field piece with a punch well remembered by the Afrika Korps, and a potent weapon for invasion

*British Supermarine  
Dorchester, Dec 17, 1944  
Mr. Chipping, Ill.*



Once it was Nazi Panzer troops that roared across the boundaries of defenseless neutrals. Here Britain's motorcycle army prepares for action



Left, this bombproof shelter houses what it offers protection against—bombs. They are piled up by thousands in underground storehouses ready to be sent to bomber stations



Below, barges packed with decontamination trucks on way to U. S. ships which will carry them to invasion front—just in case Nazis use gas

# Non-Kicking "Model" Mule Helps Train Yanks

What do they do in the cavalry? Well, before they ride the men must learn the art of tying and packing equipment carried on horses and mules. The proper method of bridling, saddling and packing is taught at Camp Funston, Kas., with wooden and kick-proof mules (right). It takes skill to balance pack

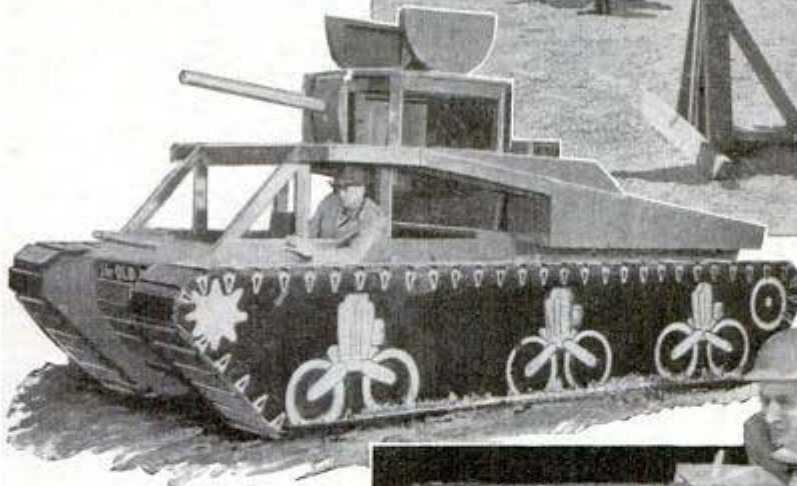
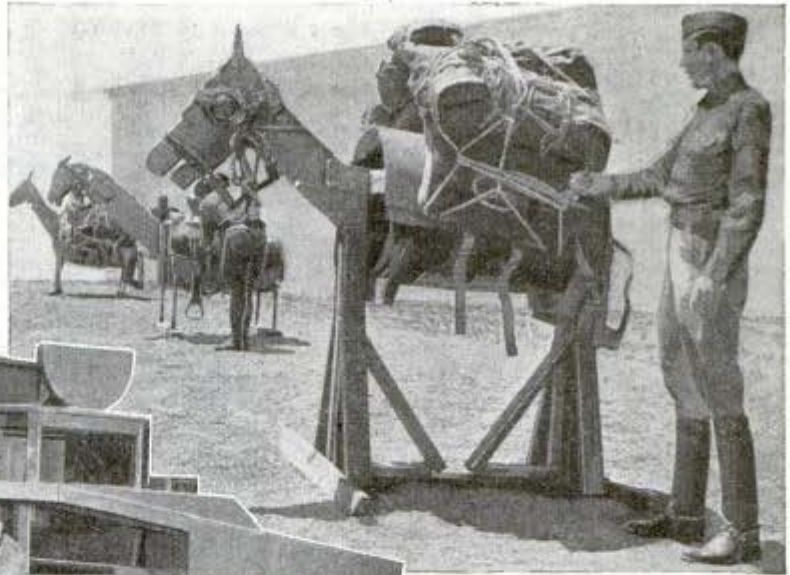

Signal Corps photos  
Wooden machine gun (below) wouldn't stop a Japanazi, but it's a handy weapon to use for "strafing" ridge during maneuvers

This tank, built of lumber from scrap pile at Camp Joseph R. Robinson, Ark., has movable guns and sides which let down. It's for training medical soldiers in removing wounded men from tanks that have been disabled in the field



Dummy guns (left and below) were used extensively during field maneuvers before America's war production caught up with its fast-growing army. The men who manned these guns have swapped them for the real thing, but the training they received with these crude models proved of value at places like Guadalcanal, Gela Beach and Attu. Today throughout the world, U. S. soldiers have the finest and most deadly equipment of any army



JULY, 1944

*Douglas Parmentier, Lt. Col., U.S. Army Chief,  
Publications Branch, Bureau of Public Relations,  
War Dept., Washington 25, D.C.*

Stimson, 3872 Franklin Ave.  
Los Angeles 27, Calif.

# ROUGHRIDERS of the DEEP

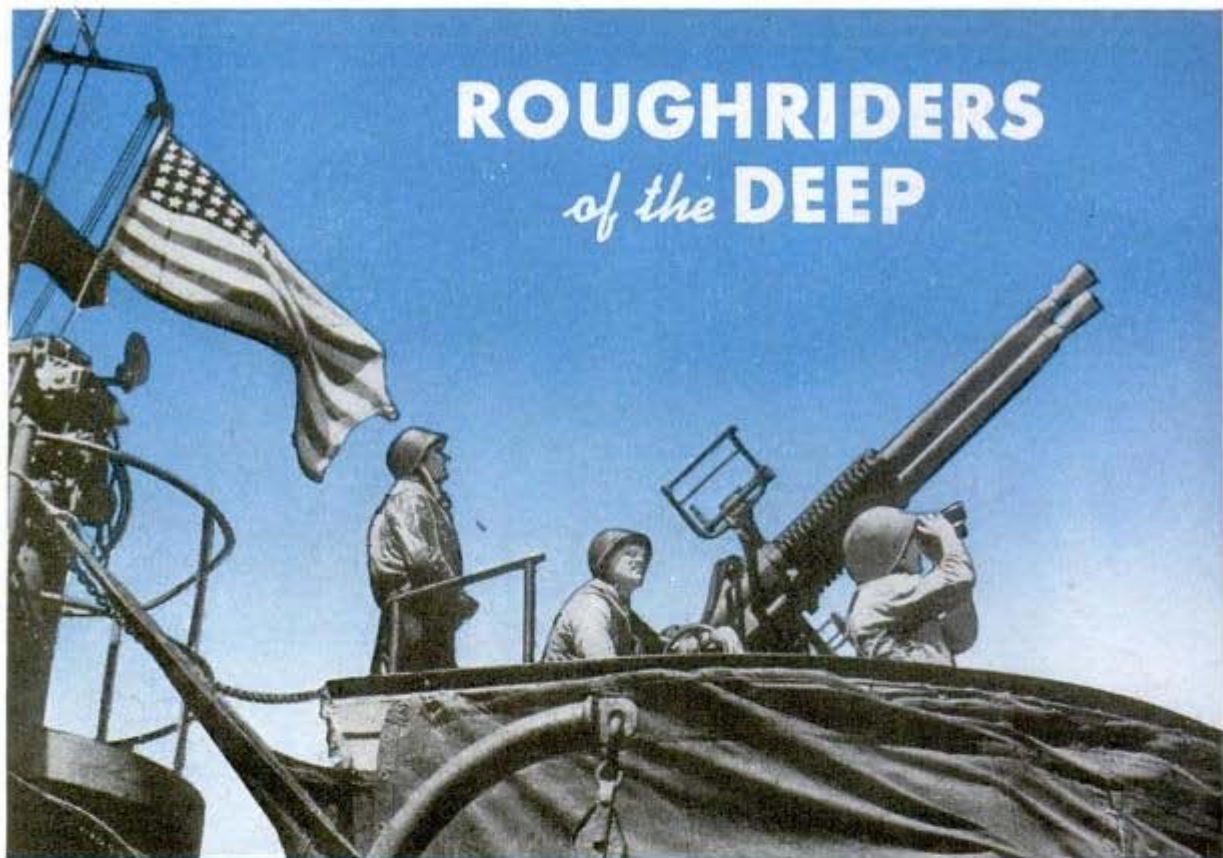

Above, ack-ack gun crew aboard a destroyer. Below, lookouts on the flying bridge wearing battle helmets, masks and warm clothes

U. S. Navy photo



By  
**Thomas E. Stimson, Jr.**

**Y**OU take a beating when it's your turn to act as lookout on a destroyer in rough weather.

The biting wind screams through the rigging overhead, it digs through the slits of your foul-weather mask and freezes your face, it picks up spray from the bow and slings it up at you on the flying bridge, 30 feet or more above the water.

The rolling motion of the ship is accentuated at that height. Possibly you are going to be seasick but not for more than an instant do you relax in your duty of searching your quadrant of horizon and sky for ships and aircraft. You would be warmer and dryer under cover but your eyes and ears are most efficient just where you are, exposed to the weather. Night and day, all the time a destroyer is at sea, four men

are on lookout. They stand two hour watches.

A destroyer is a comfortable vessel in pleasant weather and at moderate speeds but fair weather for cruising can't be picked during war. Big ships plow through heavy swells with hardly a quiver. The "cans," long and light and built for speed, pitch over them instead. They roll, too, at almost all speeds.

Often you strap yourself in your bunk to avoid being thrown out. Part of the time you make your way along deck by means of a life line, hanging on when green water comes aboard. Sometimes you eat with an arm wrapped around a stanchion, holding on to a sandwich and a mug of coffee. A plate of food on the table would tumble into your lap. The sailors who perform technical tasks on a big battleship are sometimes hardly aware that they are at sea. Destroyer men are always in intimate contact with it.

Destroyers are the smallest all-around fighting ships of the fleet and they have a multitude of duties. They screen larger warships, they hunt down and destroy submarines, and they accompany aircraft carriers to help protect them and to rescue airmen from the water. They lay smoke screens to hide ships that have been dis-



Lookout (above), dressed for stormy weather, studies the horizon with powerful binoculars mounted on swivel. Below, signalman wearing polaroid glasses operates blinker

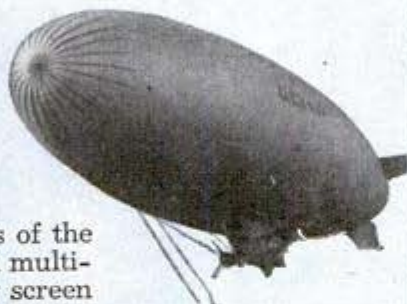

Below, crew of 20 mm. antiaircraft gun rehearses as blimp cruises in the background



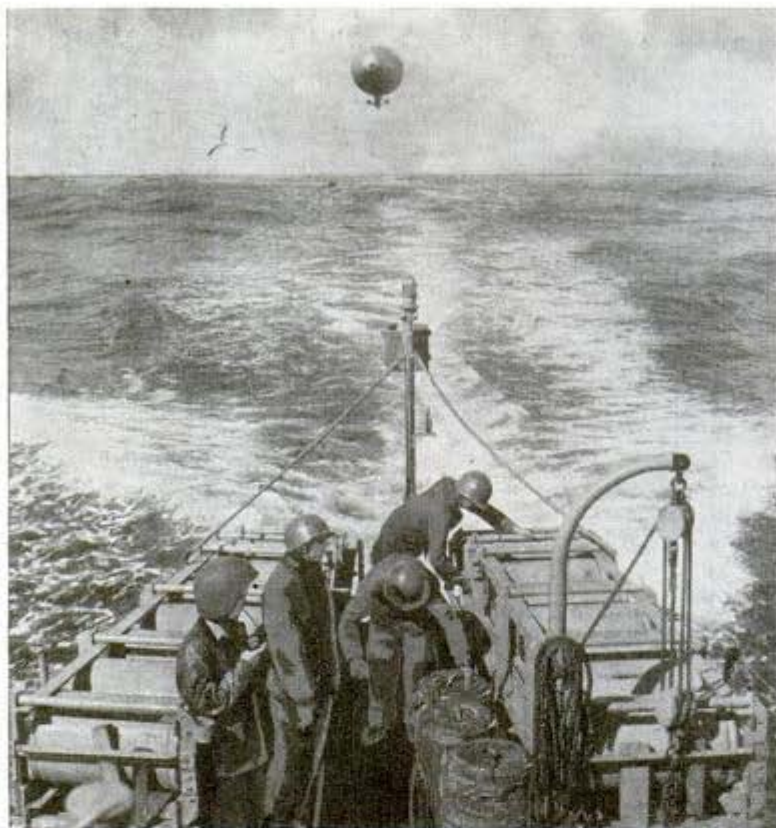

Preparing to drop depth charges near submerged enemy submarine from destroyer's stern. Armed Navy blimp stands by

abled. They perform convoy work, engage in patrol operations, use their deck guns to cover amphibious landings, and on occasion serve as small, high speed transports.

Regarded as expendable fighting units, they must be ready to sacrifice themselves unhesitatingly if they can save a larger ship by doing so.



A single heavy shell that lands in an engine room can put a destroyer out of action or sink it. On the other hand, they can sink capital ships that are many times their own size. The traditional role of destroyers in a sea fight is a high speed dash toward the enemy battle line. When they attain striking distance they wheel and launch broadsides of torpedoes from their deck tubes. The torpedoes fan out so that the targets can hardly escape no matter how they maneuver. The United States has hundreds of these deadly craft.

Their speed is their best protection, for they carry practically no armor. Even our newest destroyers that are almost big



enough to be classed as baby cruisers are lightly built. Their thin hulls bend and weave when they smash into big seas. Destroyers have long thin lines, about 10 feet of length for every foot of beam, to help give them speed. Their hulls have room for little more than their great engines, fuel for the engines, and the torpedoes, depth charges, and shells with which they fight.

Not much space remains for comfortable living quarters and during war even some of the

Torpedoes, or "tin fish," being fired from tubes of a destroyer

conveniences of peacetime are removed. The men sleep in bunks that are jammed and crowded three deep in the living spaces. On the other hand, the ship's captain has two bunks, one in his cabin and one adjoining the bridge, yet at sea the captain gets less sleep than any other member of the crew. He sleeps, when he can, wherever he will be handiest for action.

In new destroyers the crews are served chow cafeteria-style and use their mess halls as a recreation room between meals. In the destroyers that were built during the first World War, old but still very valuable fighting ships, the men eat at tables that are placed

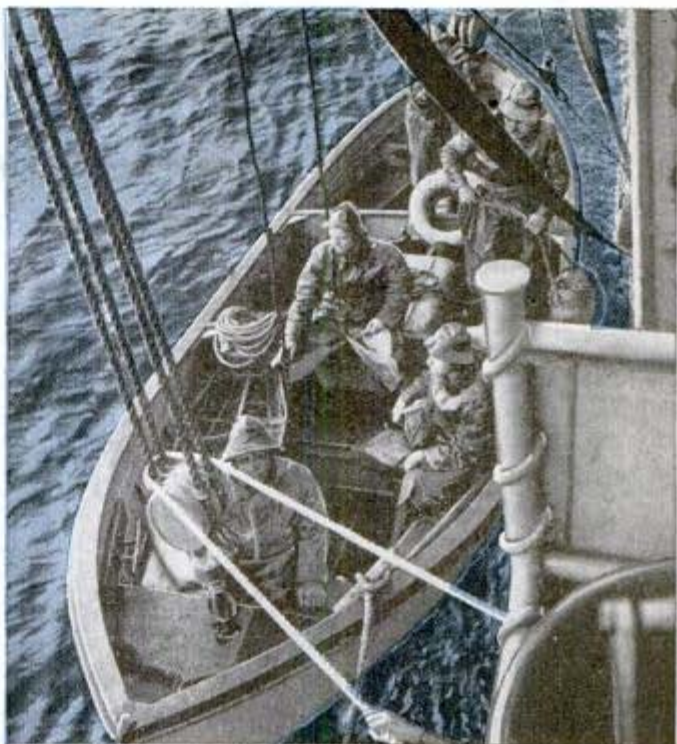

Rescue party with life preservers and medical kit go to aid of a shipwrecked sailor. Below, U.S. *Morris*, a medium-sized modern destroyer  
U. S. Navy photo



between their rows of bunks. Garbage from the galley is saved and is dumped once every few nights. Garbage that is thrown over the side too frequently might give information to the enemy as to the ship's course.

Sailors like to have and use their own personal radio broadcast receivers but the only such receiver on a warship today is in the main radio control room. Popular programs are received on it and are re-broadcast over the ship's public address system.

The public address system has other uses as well. Announcements and orders are made over it. In earlier wars, men who

Continued to page 158

A damage control detail wields fire fighting lines along the deck of a destroyer



# "Turkish Bath" for Bomber Made of Old Boiler

*Fourth Air Depot*

First glance at a novel aircraft cleaning system used in Australia would convince the visitor that he was looking at a cross between a locomotive and a bomber. The stack belongs to a steam boiler, taken from an old dairy, which is used to produce the steam to clean the plane. All planes arriving at the air depot are given steam baths to remove mud and dust which retards speed of the ships.

Getting steam up in the boiler to coax a coat or two of jungle mud from a bomber somewhere in Australia

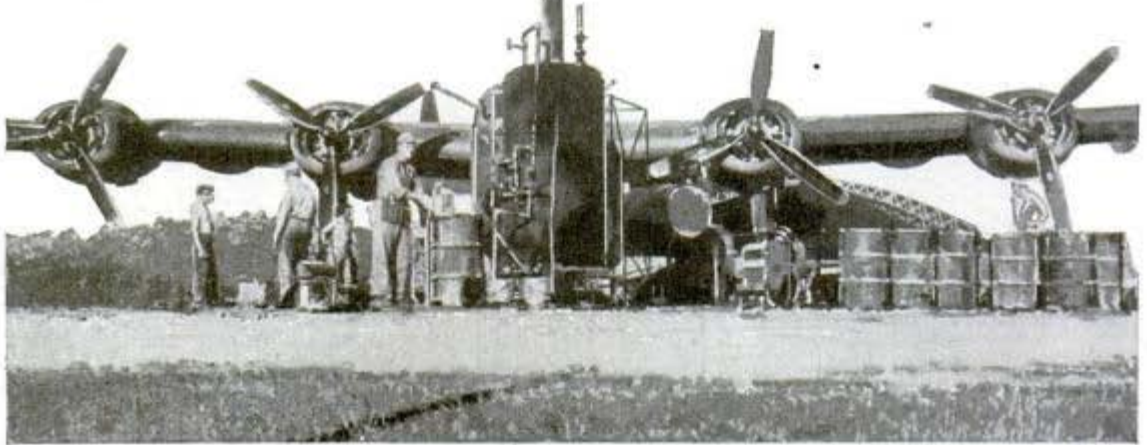

# Six Months' Work Done in Day by Huge "Grid Machine"

*0136*

Work that formerly took half a year now is done better in a single day at the Boeing

Aircraft Co., Seattle, Wash., with a large "grid machine" invented by an employee.

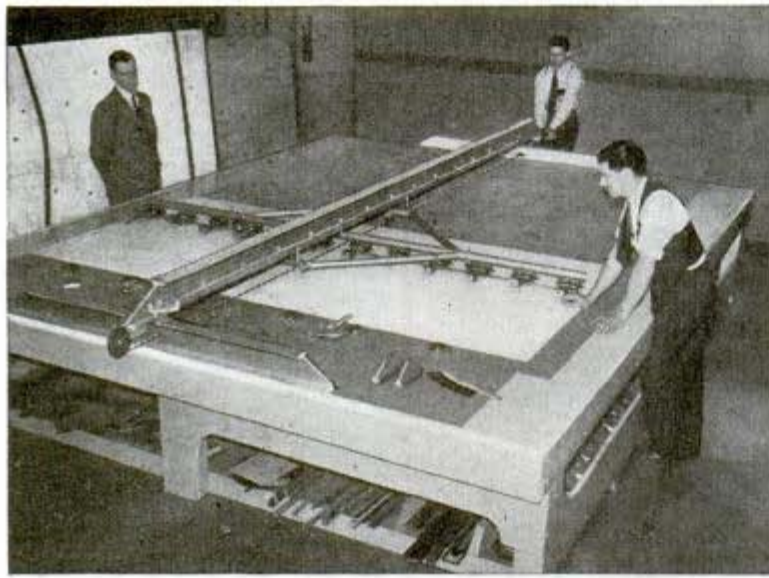

The machine, which draws 12 lines on metal at one time, saves hand drawing and makes the process of drawing straight lines on the painted surface of sheet metal more accurate. The table has a smooth steel top and a simple application of girder members keeps it rigid, allowing a cross piece boom to move across its surface with a gang of scribes which cut the lines. It is easy to slide the plate at right angles, fasten it, and repeat the process to make the grids necessary for master layout drawings.

# Fireproof Asbestos Air Ducts on Planes Save Metal and Man Hours

*0207*

Air ducts for both heat and ventilation on aircraft are made of a fireproof asbestos product that saves aluminum and other metals. The material, made of fabric, as-

bestos, and a coating of synthetic resin, eliminates welding, die casting, riveting, and intricate metal processing. This pliable fabric can be formed into intricate shapes.

*H. A. Rubber Co.  
Rockefeller Center,  
N. Y., N. Y.*



# Balloons to Lift Sunken Plane Support 6,000 Pounds Each

Navy engineers plan to salvage airplanes which have been shot down over water with an ingenious use of balloons, each of which can lift 6,000 pounds. The special balloons, developed by Navy engineers and made by the General Tire & Rubber Company, Akron, Ohio, are attached to a sunken plane while deflated. When air is forced into the balloons, they will raise the plane to the surface. Stress on the big balloons is evenly distributed by loops around the middle to which rope or cable is attached. A plane can be towed away easily after it is raised.

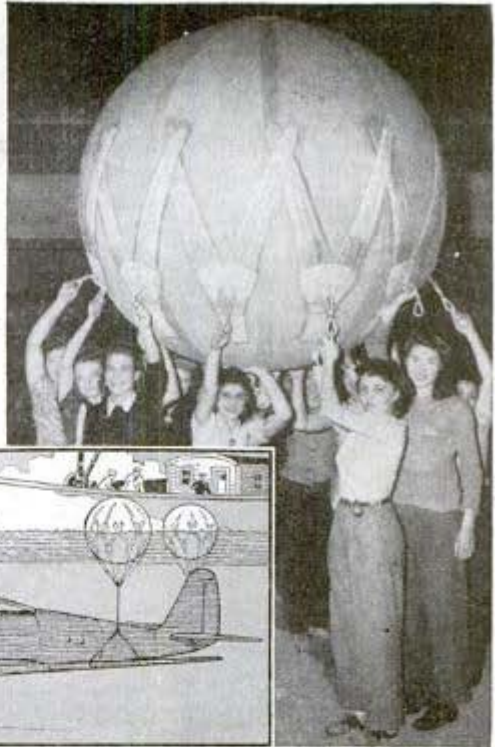

The six special balloons shown in drawing can lift 36,000 pounds of airplane to the surface. Balloon in photo could lift five times the number of girls gathered beneath it. Navy engineers developed this plan for salvaging planes

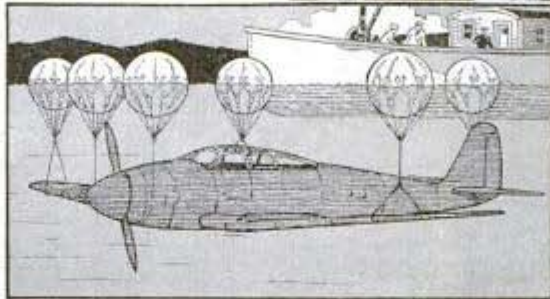

084

# Radio Station Built Into Truck Has Range of 100 Miles

Mounted on a 1½ ton army truck, the Signal Corps' SCR-299 mobile radio station has a range of at least 100 miles day or night using either voice or code transmission and traveling at full speed. The

unit consists of a short-wave transmitter of approximately 450 watts output, two standard receivers, a speech amplifier and a special antenna tuning unit to match the output of the transmitter to a 15-foot whip antenna. Power is supplied by a gasoline-driven, 117-volt, AC generator carried in a trailer behind the truck. Accessories include two field telephones with a mile of wire, a Signal Corps frequency meter, an electric heater and enough tools and spare parts to perform a major repair job anywhere. Variations of this equipment include the SCR-399 in which the same radio components are mounted in a shelter which can be used on a 2½ ton truck or placed on the ground for fixed station operation, and the special installation in a half-track which is used for air liaison communications. When operated as a fixed station where a large antenna can be used, the range is greatly increased.

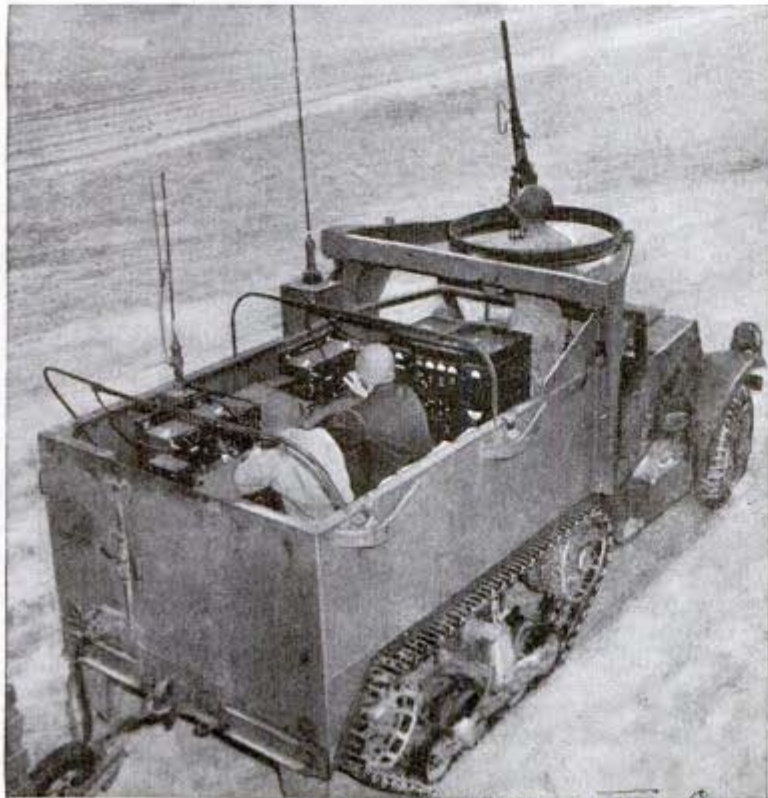

*The Halbiroft Co.  
2611 Indiana Ave.  
Chicago 16, Ill.*

# The WORLD'S BIGGEST BUSINESS

Budg. Co.  
Lanney, Ill.

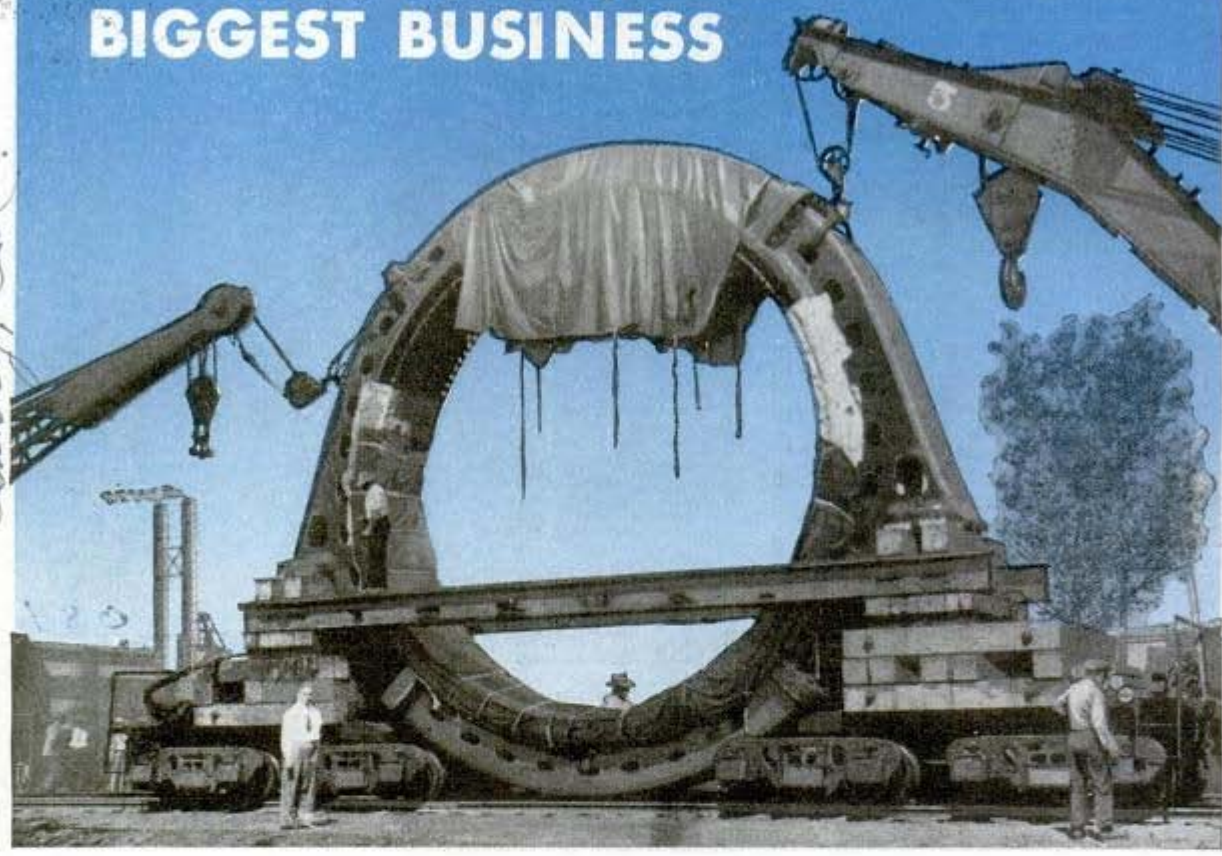

## By Roderick M. Grant

The railroads, breaking records day after day, take such loads as this in stride. Below, 130-ton American locomotive lands in England

**E**PICS happen every week in this war and are forgotten the next.

One of those epics was the incredible trek of the French under General LeClerc a thousand miles across the Libyan desert from Chad to the Mediterranean. They fought a few outposts of Italians holding the oases and freed General Montgomery's army from the threat of flanking as it advanced from El Alamein. More than men, they fought mountains and gales of sand, blistering heat and stark cold. Mostly they fought distance.

Wading through perpetual dunes, the column of trucks was nourished by Douglas DC-3 planes that flew a thousand miles to bring them fuel and supplies. It cost 20 drums of gasoline to bring a single

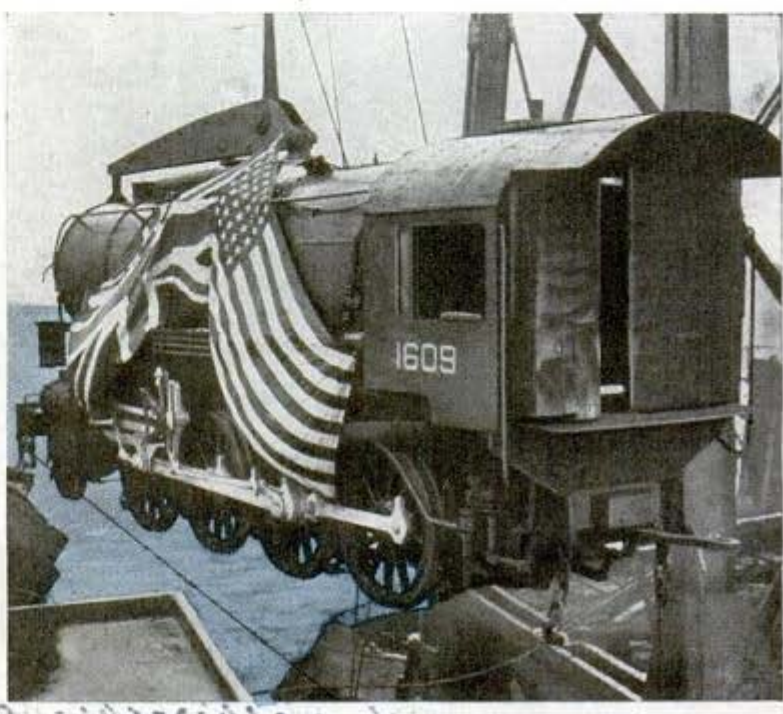

drum to the advanced base at Zouar in northern Chad. The planes that flew on 500 miles to supply the column in mid-Sahara burned 11 drums of 100-octane gas to deliver 15 drums of motor truck fuel.

The obliteration of Hamburg was another epic. In one raid alone, Flying Fortresses in 45 minutes dumped over the Nazi port 5,152,000 pounds of explosives, a year's supply to the engineers who blasted the route of the Panama Canal.

Paratroop sergeant at right takes a lesson in running a locomotive  
Signal Corps photo

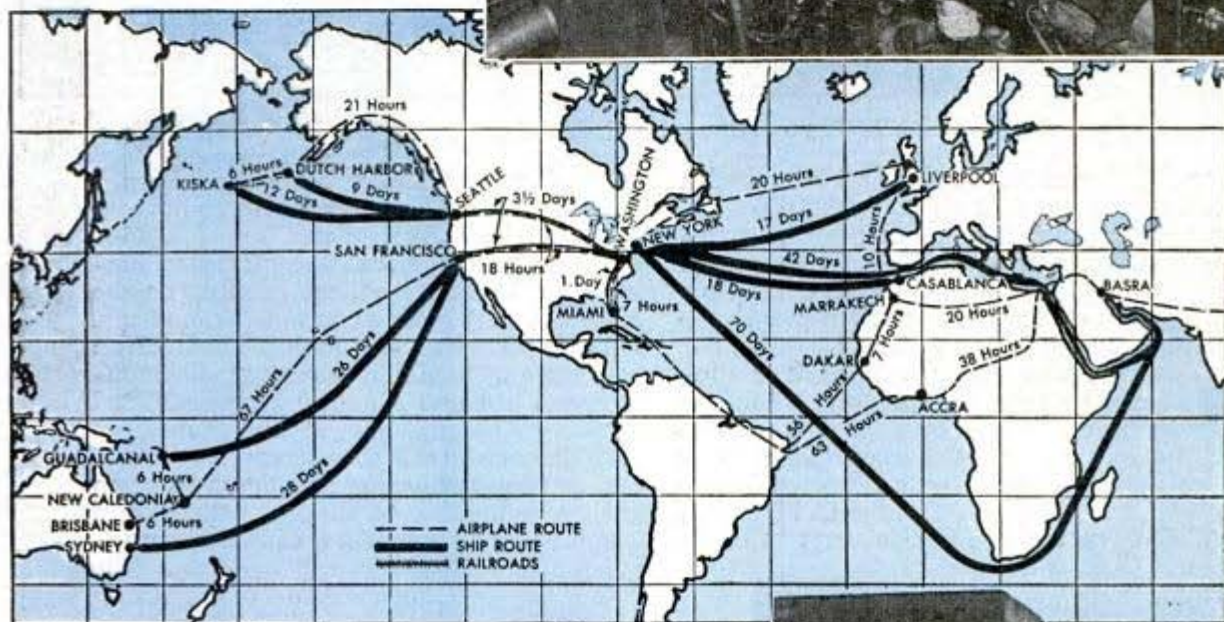

The Alaska Road was another. In February, 1942, Army Engineers got the order to plan a 1,480-mile road through uncharted wilderness. Eight months later the pioneer highway was open.

Each is an epic in itself, and together they point up the immensity of this war of logistics, of supplying armies on every continent; flying fuses from Montreal to Egypt to save Suez, piping gasoline a thousand miles from Skagway to Fairbanks, shipping millions of tons over 56,000 miles of sea routes. The world's biggest business is that of supplying

Map of U. S. Army supply routes contrasts time by ship and plane. Below, army jeep with steel wheels hauls a freight in Australia





The amphibious cargo carrier for landing operations, this "Duck" is hauling a 105-mm. howitzer up the beach

our fighting men. In the first year and a half of war we sent abroad 2,000,000 men, in addition to thousands already overseas. Initial equipment totaled  $7\frac{1}{2}$  tons per man. Maintaining that army overseas requires 82 pounds of supplies per man per day—more than a ton every month.

The man who oversees the task of supplying and transporting the army is Lt. Gen. Brehon B. Somervell, commanding general of the Army Service Forces. That he is succeeding remarkably is reflected in the official report of Gen. George C. Marshall, Chief of Staff of the U. S. Army: "We are

equipping the Chinese troops and French troops, we have been providing equipment for the British, Australians, New Zealanders and Canadians, we have furnished supplies to Latin American republics—we have been truly an arsenal of democracy. All this demands the maintenance of an elaborate system for allocation, distribution and transportation, to be coordinated with our daily normal problem of meeting the demands of our own forces.

"The requirements of logistics are seldom understood. The conflicting demands of our theater commanders, of Allied sov-

One member of crew guides tank across spanners from one flat-car to the next as a trainload of fighting machines starts for war front over the Santa Fe Ry.



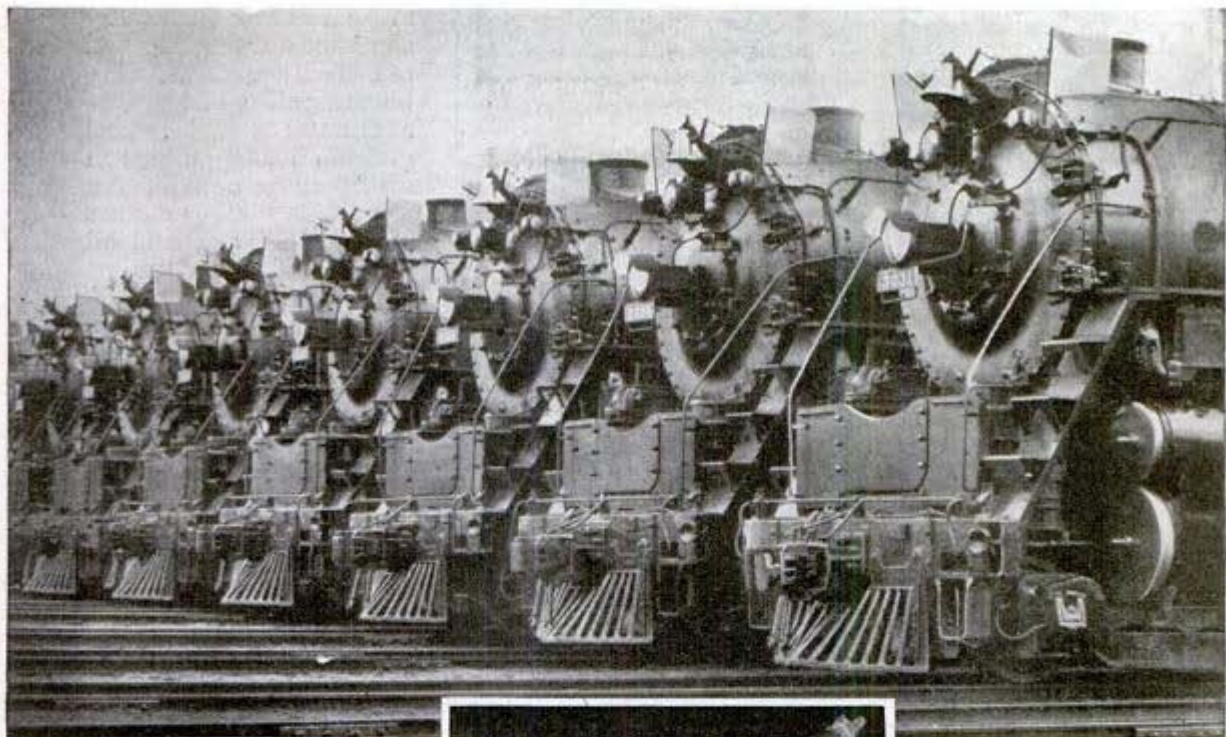

eign powers and of the home front, pose difficulties never before approximated. The necessity for a high degree of efficiency in management is evident and it has been found in the coordination of all the various supplies and administrative departments of the Army under the command and leadership of Lt. Gen. Brehon B. Somervell."

There is nothing that delineates so sharply the global quality of this war as the map of the supply routes. It is 28 days by ship from San Francisco to Sydney; 12 days from Seattle to Kiska; 17 days from New York to Liverpool; 42 to 70 days from New York to Basra. Casablanca is nearly as far from Tunis as New York from Miami. How an army and its materiel flowed across 1,000 miles of North Africa by feeble railways and poor roads, with help from transport planes and portable pipe lines, is another epic. Scores of locomotives and hundreds of freight cars



Assn. of American Railroads

With fewer but more powerful locomotives than in 1918, railroads are hauling war freight with little confusion

At left, a railroad tank car is prepared to take on a load of oil for the eastern seaboard at a station in Texas

Trainees at army motor operations school learn how to pull a truck out of a tough spot in Wyoming mountains

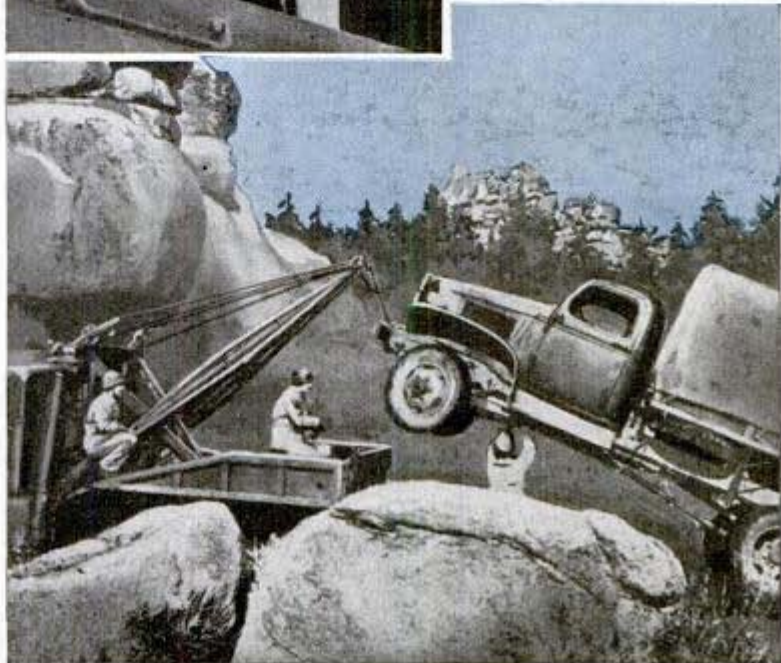

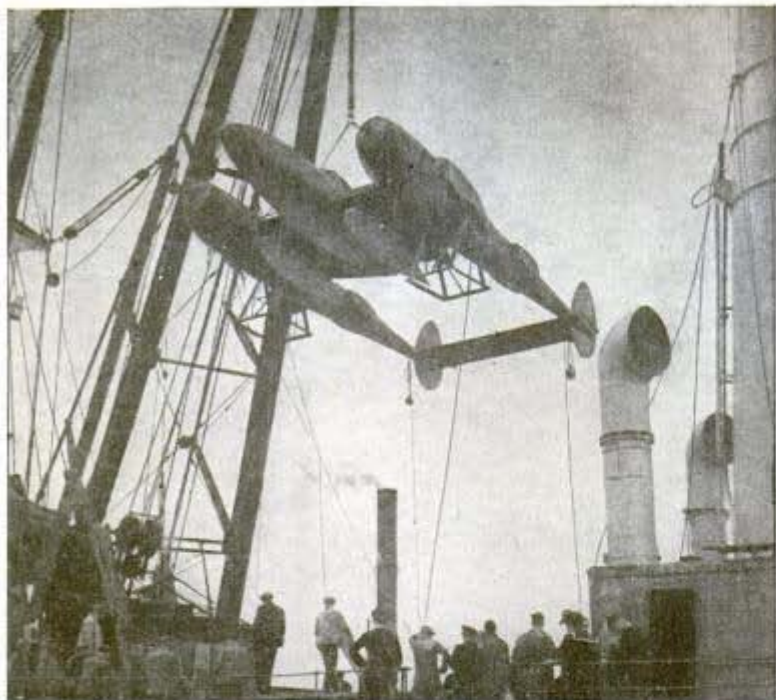

Many fighter planes hop the Atlantic "on their own." This P-38 Lockheed Lightning is being hoisted from a transport's hold at an English port

were shipped from the United States. Coal had to be shipped to run them, and loaded by hand. Trains operated in total blackout. One bit of fortune was the discovery of 20 or more "General Pershing" locomotives that had been sent to France in World War I to haul ammunition for the Yankees, and afterward sold to France. They turned up on the railroads of Algeria and Morocco and are doing business again for Uncle Sam.

Caravans of motor trucks rolled along North African roads, refueling from gasoline cars cached by the thousands. The British estimated that 70 percent of all

without a locomotive. They took apart two army trucks, installed boxcar wheel rims on their wheels, adjusted the gauge to fit the rails, and handed the army two serviceable makeshift engines.

The tonnage of stuff being moved is unbelievable. In one six-week period of heavy fighting on a single front 38,000,000 rounds of ammunition were hauled to the firing line and exploded in the Nazi's face . . . about ten shots per second, whether pistols or machine guns or blockbuster bombs. The ground forces alone had to be supplied 300 different types of ammunition.

They also had to be fed and clothed. And a half million pounds of soap was just one item on the bill of lading.

Our railroads are also rather busy. In 1943 they hauled as much freight as in the combined years 1918, peak of World War I traffic, and 1939. Passenger traffic in 1943 was well over 1918 and 1939 together. Army freight moves at a rate of 4 million tons per month, more than four times the 1918 rate; 2 million soldiers and sailors travel by rail

Self-propelled army rail car has wheels adjustable to any gauge from 30-inch Australian track to 66-inch Russian track

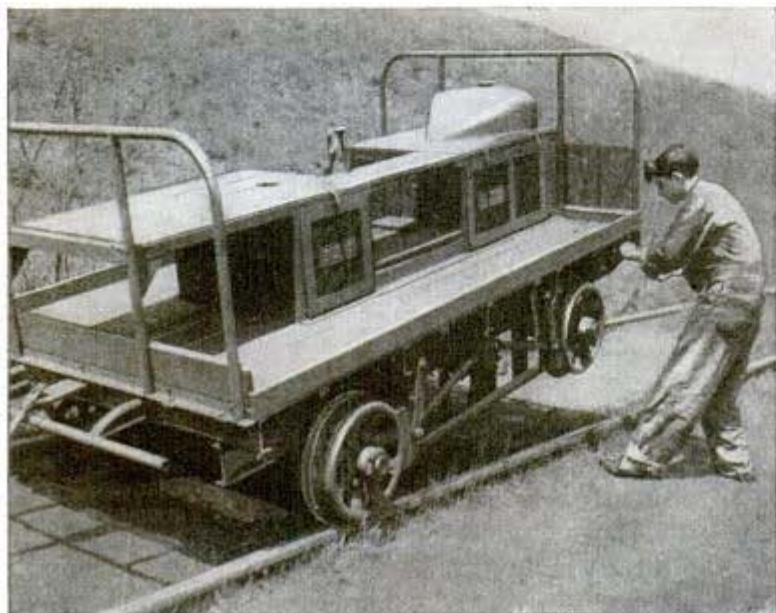

every month in organized groups, in addition to the vast number traveling on fur-loughs. Every day the railroads carry 1,500,000 passengers, haul 2,000,000 tons of coal and deliver about 40 million gallons of oil to the east. Each day they move 4,600 carloads of freight to ports, and twice that much to domestic military posts.

It probably makes Dr. Goebbels of Berlin a bit sick to eat the words he spoke about two years ago, when he prophesied that our railroads would break under the war load. He pointed out that we entered the war with 10,000 fewer locomotives, 500,000 fewer freight cars than at the start of World War I. But those freight cars, he neglected to say, average 25 percent greater capacity than in 1918, they are being loaded 10 percent nearer to capacity, they move 50 percent faster behind locomotives incomparably more powerful, and the "turn-around" has been accelerated tremendously by rapid loading and unloading.

Railroads measure their work in ton-miles—one ton carried one mile. In 1943 they reported an estimated 730 billion ton-miles, compared with 638 billion ton-miles in 1942. Railroad passenger-miles for 1943 were estimated at 85 billion compared with less than 54 billion in 1942. And for 1944 the railroads expect another rise of 6 percent in freight tonnage, 15 percent in passenger traffic.

Over in Iran, lend-lease material for the Russians is moved over an American-operated railroad carrying 10 times the traffic of the Burma Road at its best.

The problems of logistics include the supply of flour, milk, sugar, olive oil, meat, medicine and soap to the peoples of liberated Africa, Sicily, Italy. They include the problem of delivering to Russia 6,500 airplanes, 3,000 tanks, 125,000 submachine guns, 170,000 trucks and jeeps, 300,000 tons of chemicals and explosives and a vast tonnage of food and drugs. Perhaps the toughest of General Somervell's assignments is that of moving personnel, equipment, and supplies into China after transporting the materiel halfway around the globe.

World War I seems but an afternoon skirmish by contrast with this war on six continents and seven seas. By good fortune and hard work we have the world's greatest air fleet and a Navy without a peer, an incomparable system of railroads, an army and an industry rolling on wheels by the million. We are building ships faster than they are sunk and sinking submarines faster than they are built. The war of logistics, the biggest business on earth, is being won. Our fighting men are the best equipped and the best supplied.

"The end is not yet clearly in sight," says the Chief of Staff, "but victory is certain."

## Grass Planter Digs and Waters In Time-Saving Operation



Charles M. Kelly, Lt. Col., Aviation, U.S. Army

Grass can be planted in the hottest and driest months at the San Antonio, Tex., aviation cadet center, with a combination garden hose and grass planter invented there. The planter was devised to plant Bermuda grass runners on barren land, and water them all in one operation. It consists of a piece of iron pipe about the length of a broom handle and having a connection for the attachment of a garden hose. At one end of the pipe is a piece of flat metal with a slightly concave edge for pushing down sprigs of grass already dropped into holes. The end of the pipe discharges water continuously. The operator handles the instrument like a spade.

## "Rubber" Cement Bonds Metal To Thin Plywood Veneer

Plywood only 1/8 inch thick can be cemented to a metal surface by means of a new type of rubberlike adhesive developed by the Goodyear Tire and Rubber Co. A metal sheet of any thickness bonded in this fashion to a layer of wood can be bent into any shape or cut with shears or stamping press without cracking the wood or pulling it loose from the metal. Other metal units can be welded to the back of the metal sheet. The new process, which requires no critical materials and is economical, is expected to revolutionize and improve the design of building interiors, homes, furniture, airplanes, automobiles, railway cars, and ships in peacetime.

"Pliband"

*Drawing by: S. W. Clatworthy on Pages 246-247, The Sphere, London, Feb. 19, 1944*

# The FLEET HITS

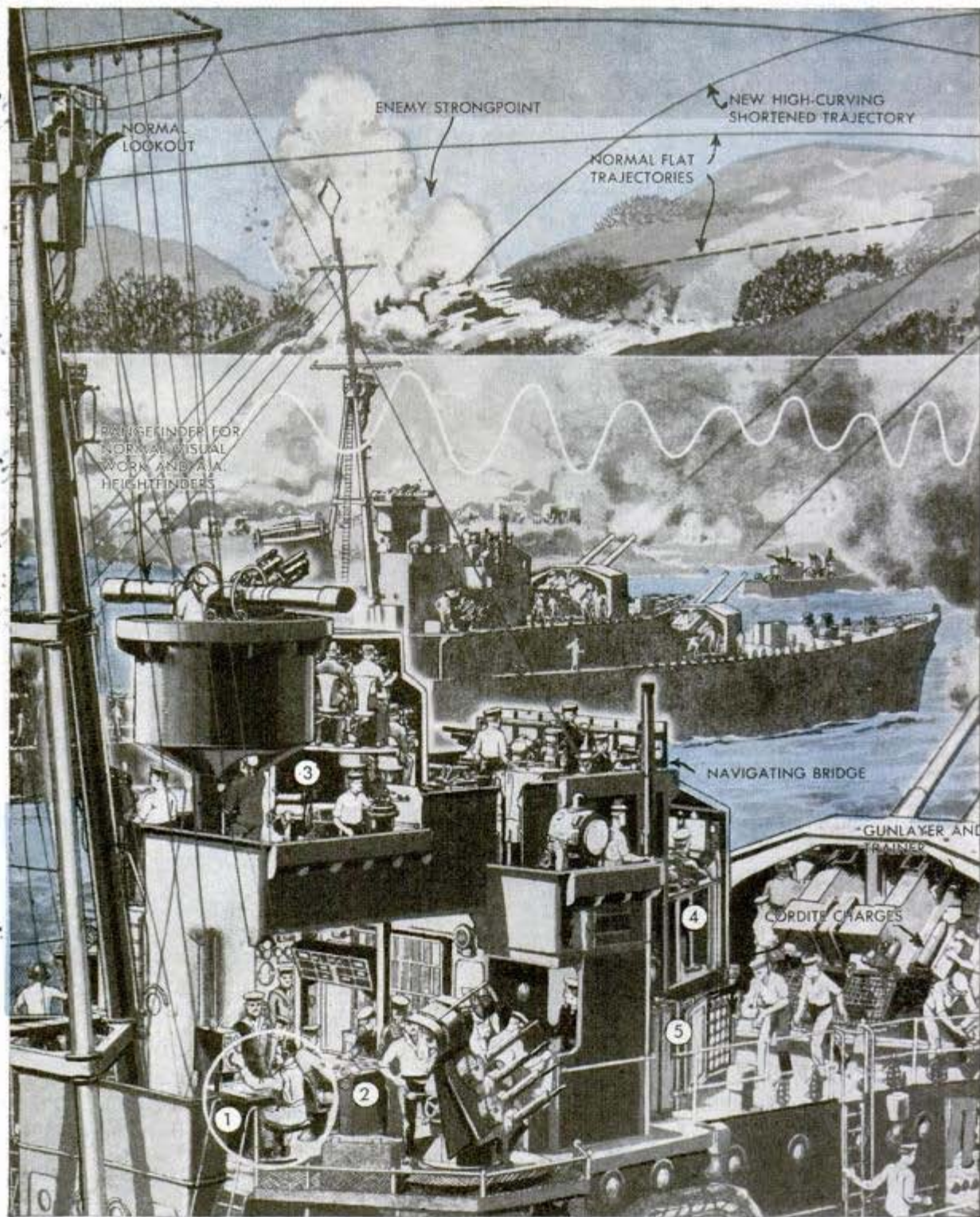

Backing up the land forces with naval gunfire is a World War II innovation highly developed by the Allied navies. Destroyers, cruisers, and even the big battleships help soften up enemy strongholds. The drawing across the top of these pages shows the naval bombardment as seen from shore. The high-

curved trajectory of the shells is adapted to bombardment of unseen targets. The lower drawing, a partly cutaway view of a destroyer, shows the action on board during an attack. Two Army artillery officers help direct the fire, a forward observation officer and a liaison officer. The observation officer is put



# the FRONT LINE

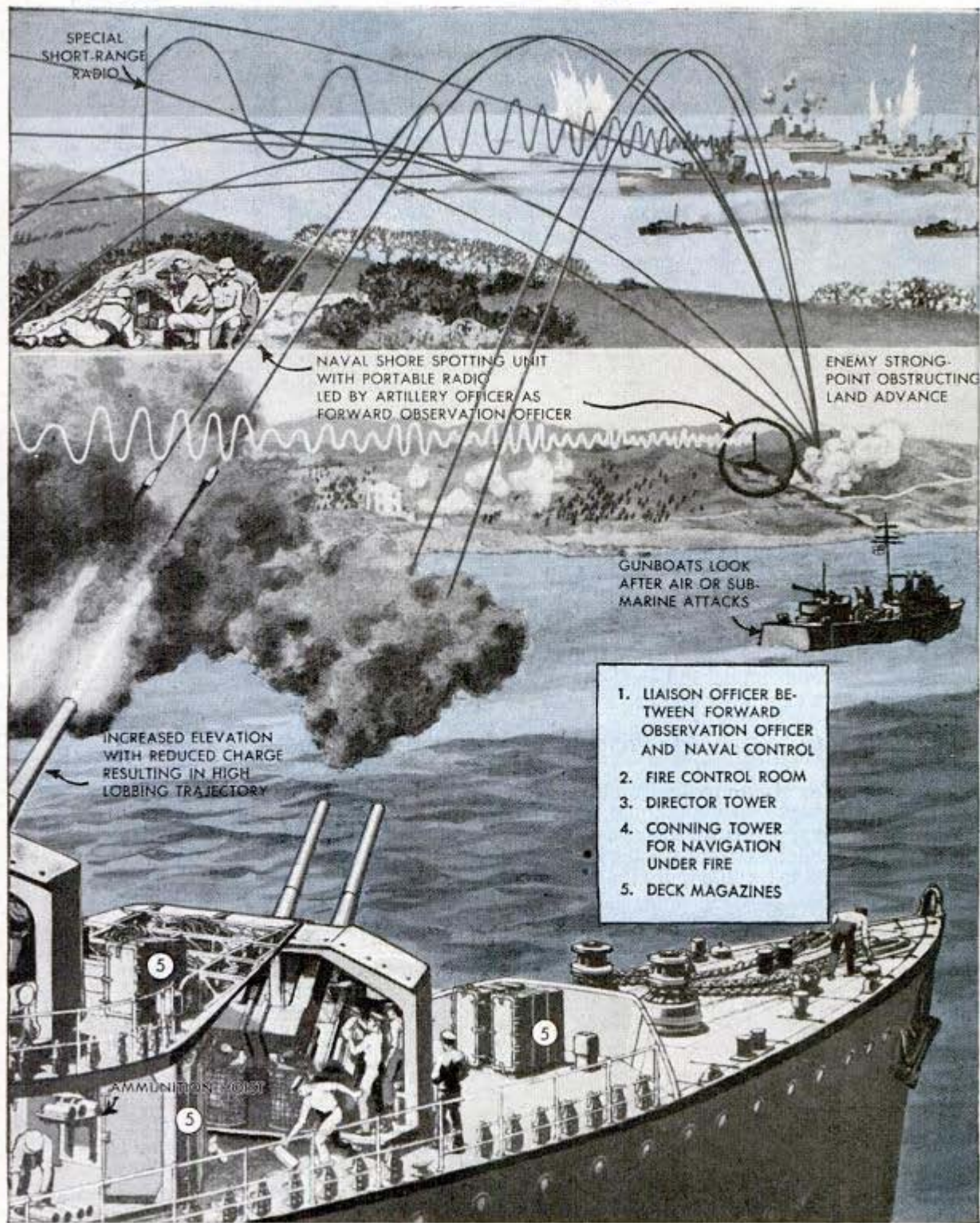

ashore by boat or parachute, or is flown over the target to direct the fire by radio and spot the results. His reports are passed along by the liaison officer to naval fire control officers. Principal change in the firing is that the charges are reduced for lobbing the regulation shells. Note how the guns are ele-

vated to give the howitzer-like trajectory. The numbered chart (inset) shows ship stations which are operated under special conditions during the bombardment. This type of shelling was used with success in Sicily, Italy, and in the South Pacific  
 Drawing copyright by S. W. Clatworthy

# Single Carrier Plane Requires 97-Man "Crew"

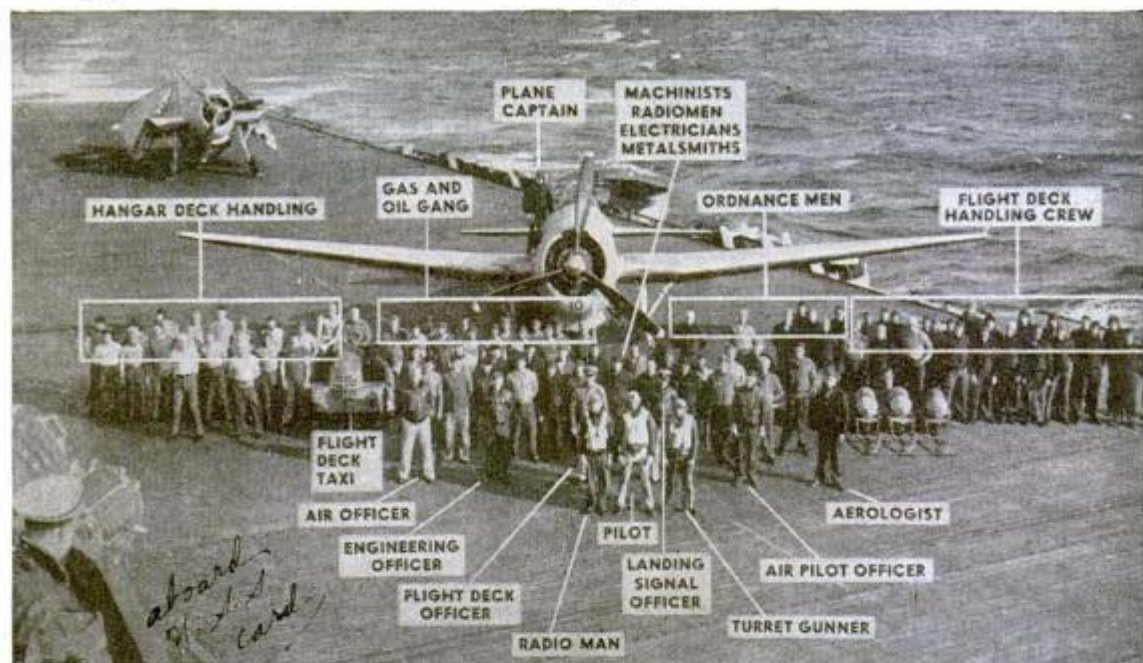

When an Avenger torpedo bomber swoops in for the kill in an attack on an enemy convoy, the men in the plane aren't the only ones responsible for the success or failure of the mission. Though they are largely unheralded in the official communiques, the men left behind on the carrier are all part of a 97-man "crew" that

is required to keep the bomber in the air. These officers and men have such varied duties as keeping the plane, its equipment and armament in repair; handling the craft both above and below decks, seeing after its power plant, directing the pilot in take-offs and landings, and helping direct the craft home from its mission.

71903

## Camera Photographs Night Sky as Aid in Aerial Mapping

Pictures of the stars are being used to determine the exact latitude and longitude of areas being mapped from the air. "Zenith cameras" which take the photos of the night sky are said to be able to fix the exact

position of a spot on the earth's surface within 40 or 50 feet, a minute margin of error considering that the earth's circumference is 131,000,000 feet. One or several "zenith cameras" are placed within the area being mapped, and the "star data" is later coordinated with the aerial pictures. The equipment includes three units, one camera to make a picture of the portion of the night sky immediately surrounding the zenith; another camera simultaneously photographing three navigation watches, set on Greenwich time, and an automatic timing unit which operates and synchronizes the other two. Pertinent information about the mission on which the camera is used is also photographed on the same plate. Having the time and the position of the stars, men who know nothing about astronomy are able, with the aid of a catalogue of stars, to establish the exact location of the point of observation.

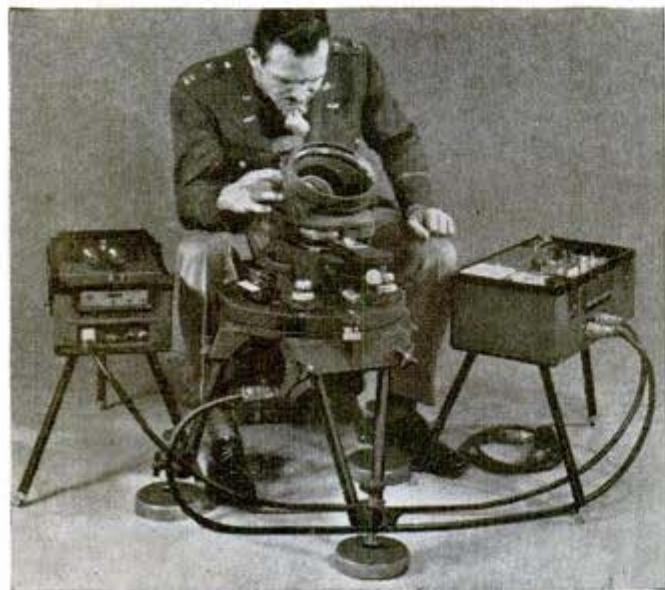

*Eastman Kodak Co.  
Rochester, N. Y.*

# THEY MAKE TOMORROW'S PLANES TODAY

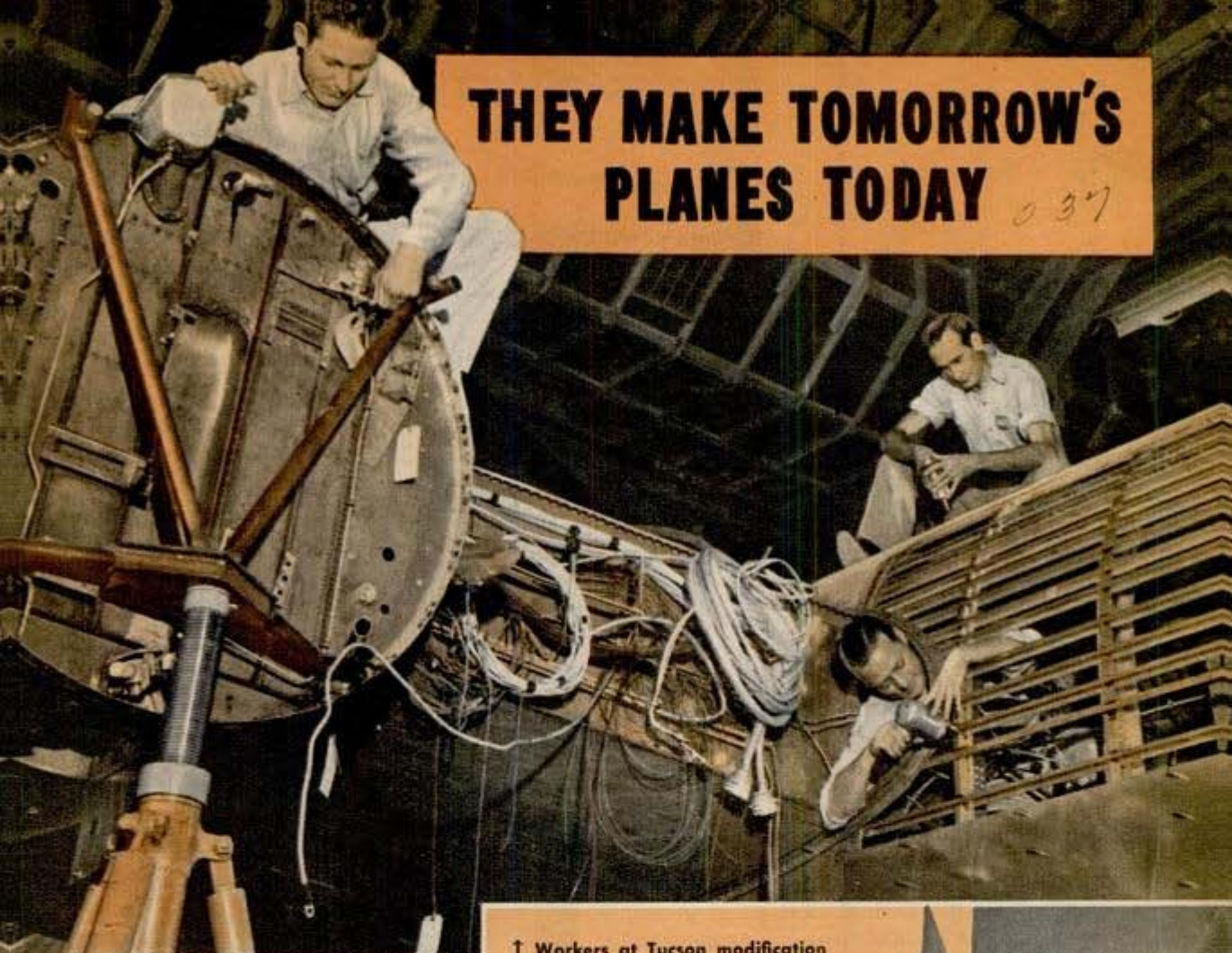

*Major John P. Leggett*

THOSE Zero pilots had it coming to them. For weeks they had been having things their own way, sneaking out of the sun and up behind Uncle Sam's big bombers to pour in a hail of machine gun bullets that knocked many a winged warship out of the Pacific skies. Back to the United States went an urgent plea for help.

Engineers went to work and quickly came out with the answer—a gun compartment to be built into the tail of the sky giants. But time was flying, and more bombers were being shot down; there was no time to wait until manufacturing plants could be re-tooled. With that in mind, Army Air Forces sped the decision to the theater—the bombers must be modified right in the field. And the next time the Zero pilots came zooming to the kill, they were met by a deadly blast from the “stinger” in the tail of each bomber.

Today such modifications rare-

↑ Workers at Tucson modification center convert the Liberator used as Prime Minister Churchill's personal plane into a transport

Until modification plants placed a tail gun (below) in B-17, Japs had a vulnerable spot for attack

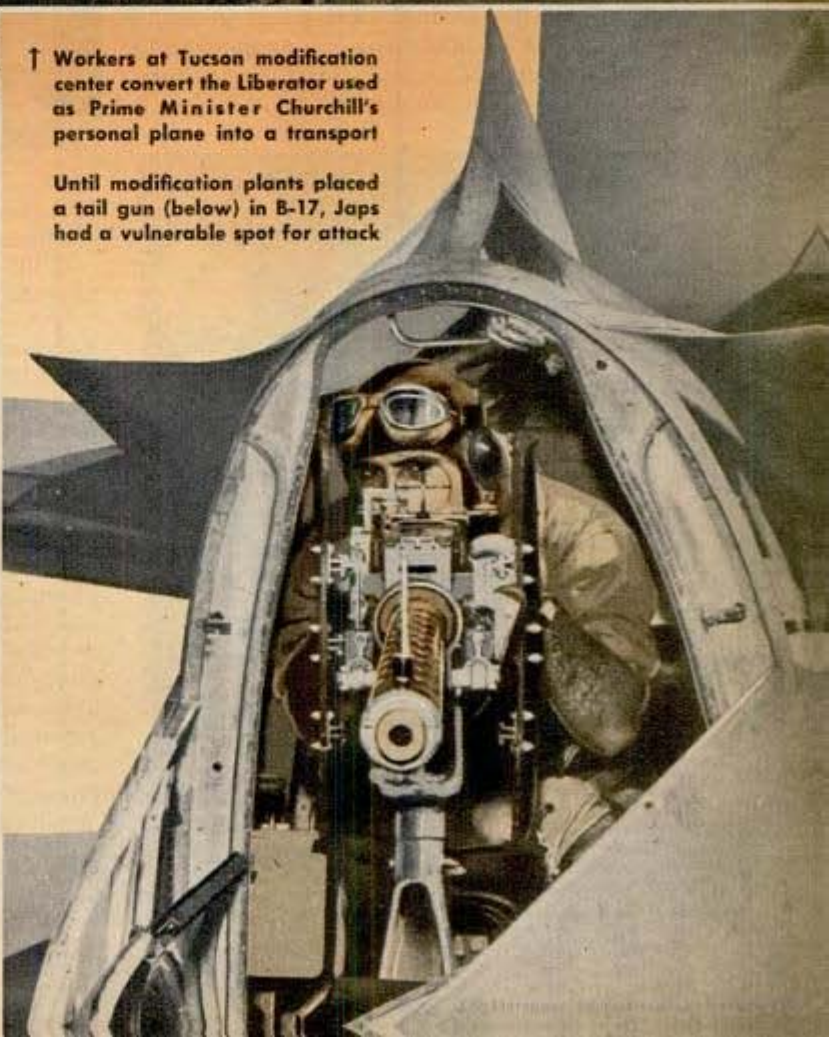



as Boeing's B-17 or Consolidated Vultee's B-24 and its transport prototype, the C-87.

Modifications on Consolidated aircraft are accomplished at a large center located at Tucson, Arizona, new planes being flown directly from the Consolidated plant at

To the front turret of the B-17 (left) a chin was added to provide more sting (below)

U. S. Army Air Force photos

ly need to be accomplished in the field. It's true that some changes are effected by mechanics in the various theaters, but major alterations are made at modification centers — huge engineering-manufacturing plants to which most new aircraft and many old ones are sent to be prepared for action in a particular area, such as the desert, or the Arctic or the tropics.

There are a number of these modification centers in the United States. In general, each will be assigned the job of modifying a certain type of aircraft, such as fighters, or a certain manufacturer's product, such

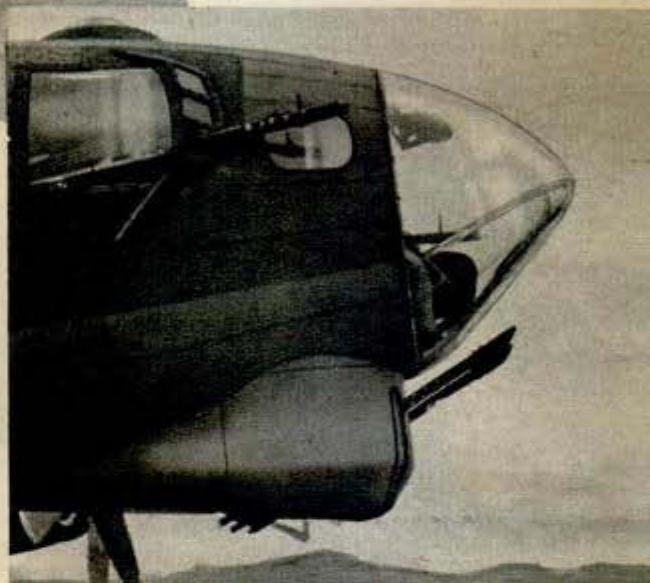

San Diego to Tucson for the necessary changes before going in any theater.

This case history illustrates how this system operates:

Two engines were dead and half of the tail section appeared to be shot away as the big bomber rolled to a stop on a field far from America's shores. Hurriedly the crew reported and a few hours later, certain portions of their report were handed to officers of the Special Projects Branch of the Materiel Center, Wright Field, Ohio. And these officers wasted no time in studying the report, which recommended certain changes in the B-24, suggestions which resulted from that last mission.

Less than a week later, some of the changes requested—incidentally by this air crew in North Africa—were being incorporated into new B-24 Liberators on the modification center at Tucson. Quick change artists, these boys at Tucson, and similar centers, for they must meet the ever

On the Tucson plant's "zipper line" workers fit de-icer boots on the leading edges of wings and stabilizers

and swiftly changing problems of the war. Shifts in enemy tactics must be met by immediate changes in Uncle Sam's equipment, without upsetting the flow of airplanes off the assembly line at the manufacturer's plants.

Instead of being just a place where aircraft may be prepared to fly in a certain area, the modification center is the means of avoiding the "freezing" of designs which volume production usually requires. This flexibility, permitting changes and additions to be made on today's airplane, rather than on a drawing board of next year's model, often results in a saving of lives, and certainly increases the fighting ability of the equipment.

Two types of operations are performed on aircraft at the Tucson center; first, alterations required to fit an airplane specially for the climatic and other conditions in which it will be operated, comprising some twenty-five percent of the center's work; and second, modifications required by the Army Air Forces and usually involving changes for improvement of the plane's defense or offense, comprising the other 75 percent of the plant's operations. The second class of modifications may be accomplished at Tucson for a few days or a few months, depending upon the time required by the Consolidated factory to adjust its assembly line procedure to permit the new change in design to be incorporated in the aircraft when first assembled.

Factory assembly lines never can take care of changes necessary for planes going to certain areas. The factory produces aircraft that may go to frozen Alaska, torrid Africa or the steaming tropics; operating conditions are different in each place. So the Tucson center must make changes.

Liberators bound for the Arctic are given special winterization treatment — carburetor heat controls, additional cabin heating, de-icing facilities and similar changes. Similarly, B-24s to be used in the desert areas receive attention that will permit the most efficient operation there. For instance, some parts of

**Armorer at modification center must keep 50-caliber guns in fighting trim**



Plexiglas sections for turrets are formed by being heat-bent over chiseled-out wooden forms above. Form at left will cover nose turret

the big bombers must be protected from the abrasive-like sand; special air cleaners are installed to sift out dust and keep it out of electrical and hydraulic equipment; special paint jobs make the bomber blend with its desert surroundings.

The Tucson plant's biggest job, preparing tomorrow's planes today, gives the Axis some of its biggest headaches. Just imagine the surprise of the first Japanese pilot who swooped up beneath the Liberator to attack what had been its unprotected belly and was met by crackling machine guns mounted in a ball turret that popped out in his face!

That turret came into being as the result of reports, telling of successful attacks by enemy aircraft on the undersides of Liberators, reaching Wright Field. There officers studied the problem day and night until they decided that a turret should be





Preparing a life raft "tub" in Tucson modification center's sub-assembly department. Plant readies planes for particular areas

provided. Because the Liberator is so low to ground when it lands, the turret had to be retractable into the bomber. Sperry developed the original turret, but it could not be installed immediately on the assembly line at Consolidated, due to the many changes necessary. So the first installations

were made at Tucson, thus avoiding the delay that would have resulted from re-tooling and re-arrangement of work routine at the factory.

Of course procedures at the modification center were not in accord with the customs and practices of engineering because operations began with nothing except layouts and sketches. It was a case of "quick and dirty tooling" and rule-of-thumb engineering at the start. But these methods were fast and scores of Liberators equipped with the turrets reached the combat area several weeks earlier than they would have if it had been necessary to wait for the factory to get set and come into production.

As fast as Consolidated bombers and transports are ferried from San Diego to the Tucson center, they are pulled by tractor from their landing point to places on the modification lines, some six in number. All these lines go through the center's three 700-foot hangars. Two of these hangars have lines which are called "zipper lines." On the zipper line, the planes are staggered so that the wing of one passes a few

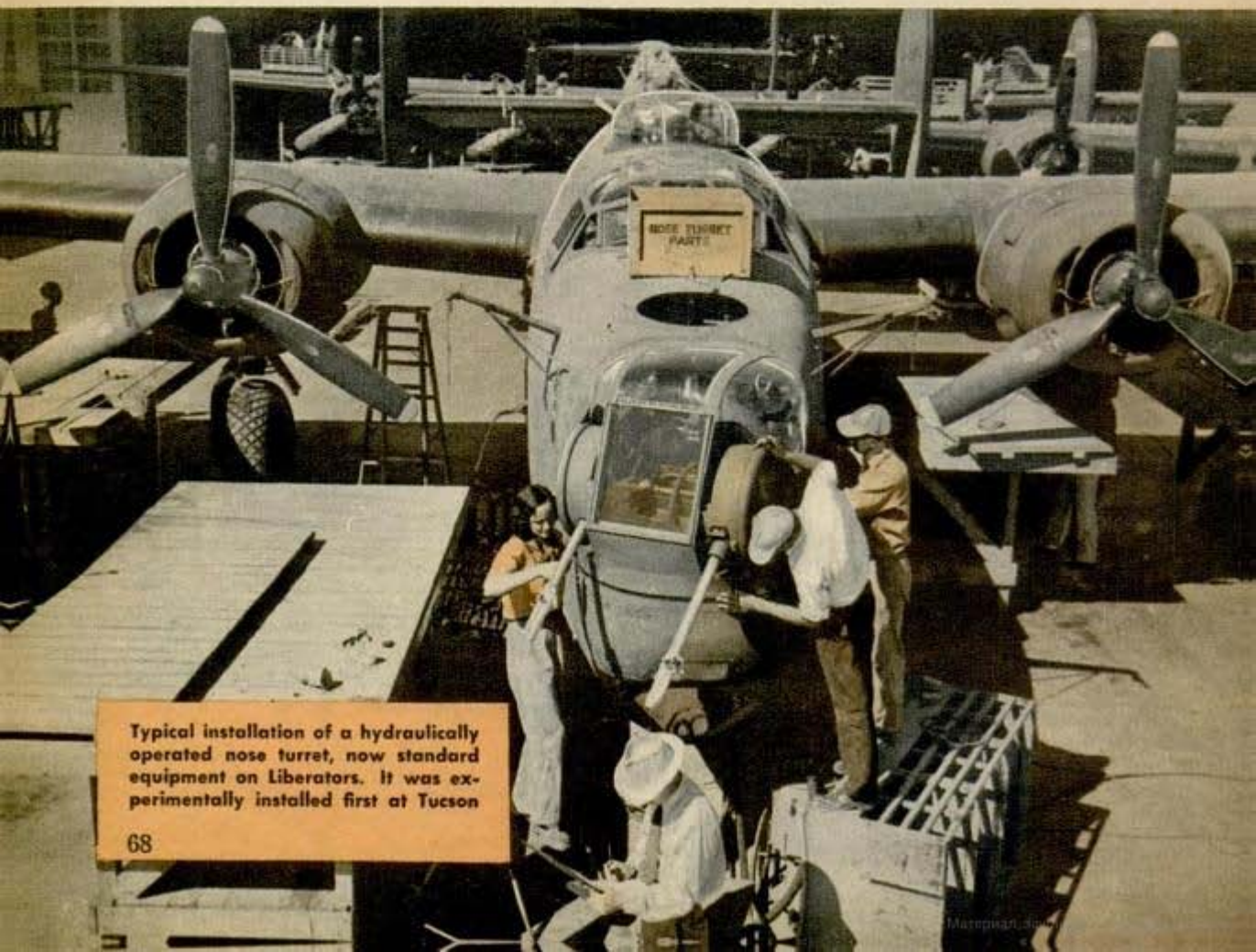

Typical installation of a hydraulically operated nose turret, now standard equipment on Liberators. It was experimentally installed first at Tucson



Flyers at left admire B-17's tail machine gun. Below, a Flying Fortress model whose design and equipment profited from modifications made after experiences in combat

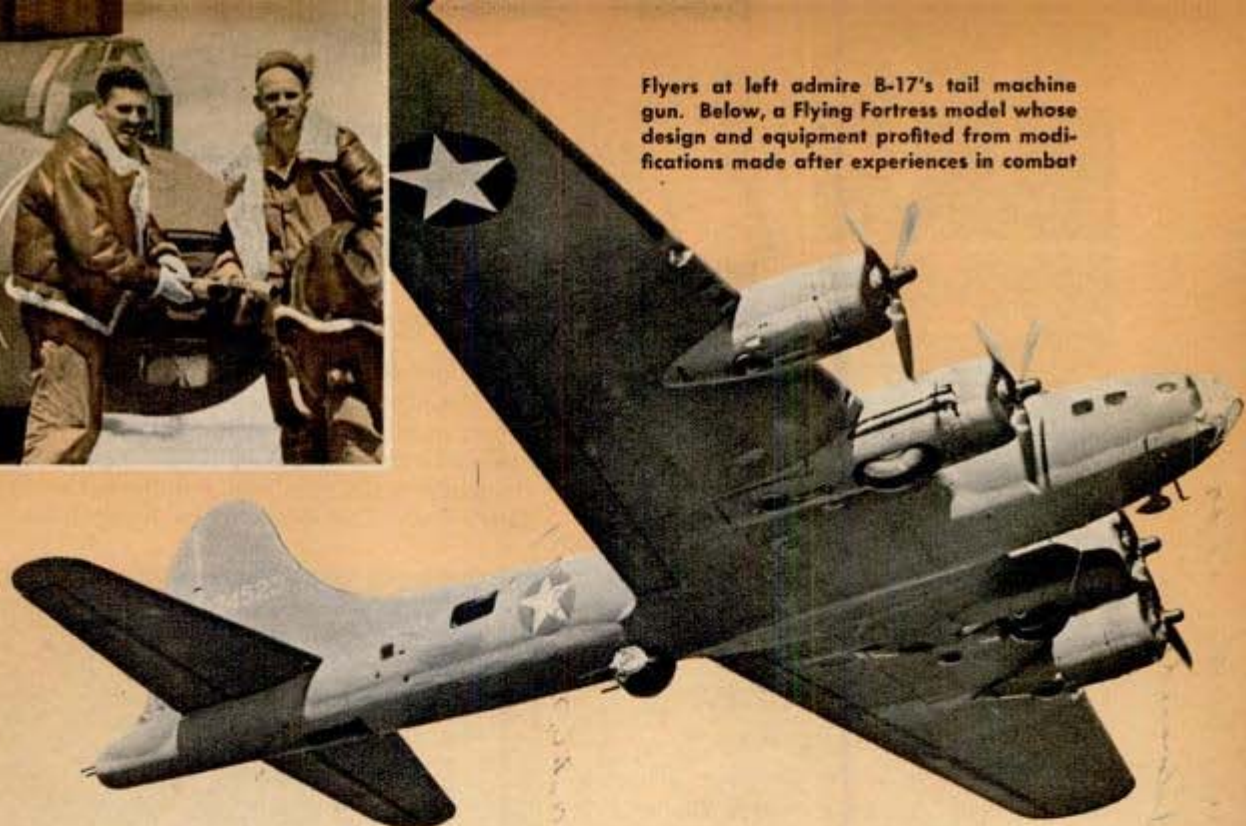

feet behind the empennage (tail assembly) of another. Each of the twelve stations on a line are manned by a crew chief and three assistants, each on a specialized job.

Virtually every job is of such a rush nature that the modification engineers have no time to prepare special tools and dies; as a result, fabrication workers necessarily become resourceful and work fast.

For example, installation of life rafts may be desirable. Stock for them may be cut with tin snips and hand-formed over maple blocks; then the holes cut in the upper part of the fuselage for the raft hous-

ings. Covers then will be fashioned and automatic release mechanism devised.

Small parts frequently are produced on small benches and tool room lathes, although a 60-ton hydraulic press also is among the center's equipment. In spite of all the tools at the Tucson plant, the workers there are proudest of such achievements as that of a man who devised a burring tool out of a dime store knife sharpener.

The modification engineer must be almost as resourceful as the mechanic at some isolated air base, and he usually is, for the job is done, and done well.

This is one of the early B-17 models which later underwent changes at modification centers rather than await the re-tooling of manufacturing plants. Thus they could be rushed back into combat zones much more quickly



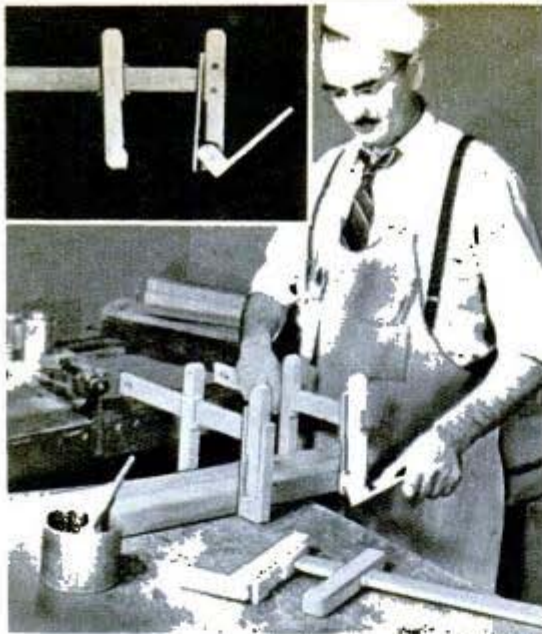

### Lever-Type Clamp of Wood Has Wide Capacity Range

Using a single action leverage principle of operation, a clamp made entirely of wood provides a quick and secure clamping action. Parts to be clamped are merely inserted between the "jaws," the sliding arm moved up into position, and the hinged lever flipped down. The clamp weighs only 12 ounces and has a capacity ranging from 1/2 to 11 inches. Its greater capacity and versatility eliminates the need for several types of clamps for different capacities.

### "Turtle" Blade on Cut-Out Knife Withdraws Into the Handle

By turning a knob on the tip of a pencil-shaped handle, the two-edged blade of a cut-out knife is withdrawn into the handle. The sharp blade can be extended for a deep

cut or the thickness of a single page. The tool is handy for cutting stencils, clipping magazines, trimming photographs, and is also used by printers. When the "turtle" blade is withdrawn into the plastic "shell," the knife can be carried clipped to a pocket like a pencil.

### Army Does Outdoor Cooking In Asbestos Container

United States army flyers and medical corps men carry a collapsible container made of lightweight, seamless asbestos fabric coated with synthetic rubber for emergency use. The bag can be hung from a

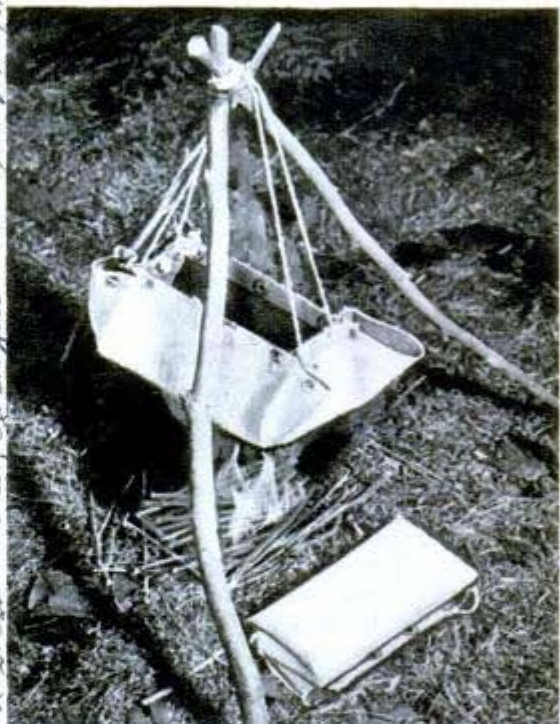

makeshift tripod over an open fire to serve for cooking purposes or for sterilizing operating instruments. After the war it is expected to be ideal camping equipment.

### Fast-Drying Concrete Cuts Cost Of Prefabricated Houses

Concrete has become a low-cost material for prefabricated houses as a result of the quick-drying treatment perfected by Grosvenor Atterbury, director of research for the Yale University department of architecture. In the new method the forms must remain in the molds only a fraction of the time required formerly, when slow-hardening in expensive molds necessitated a large investment for plant and equipment. The ensuing greatly increased output of the plants is said to reduce substantially the cost of the finished home.



*Empire Level Mfg. Co. Milwaukee, Wis.*

*M. S. Rubber Co. Philadelphia, Pa. 7, 20, 27.*

*Mark Specialty Co. 406 E. 5th St. Rochester, N.Y.*

*0101*

*038*

*0161*



*Edo Aircraft Corp. 086  
College Point, N. Y.*

## Seaplane Can Alight On Land and Snow

Pontoon gear with wheels or skids has been devised to permit seaplanes to alight on water, land or snow. One set of floats, used by medium size planes, has wheels which are electrically retracted and lowered by two switches, one



for the two bow wheels and one for the two main wheels. Main wheels retract into wells located aft of the step. Both main and bow wheels are equipped with hydraulic shock absorbers and with water rudders which are hooked to the air rudder controls by cables. The metal floats can be landed

on snow or water. Smaller floats for the light plane, instead of retractable bow wheels, have nonretractable bow skids supported by shock absorbers and fitted with nonabrasive shoes. The skids are so designed that they follow the unevenness of the ground and do not "dig in" the water.

## Lightweight "Tank Buster" Shoots Bombs That Pierce 4-Inch Armor

Light enough to be carried by infantrymen and yet powerful enough to knock out enemy tanks and pillboxes, the "Piat" (projector infantry anti-tank), a British

<sup>054</sup>  
weapon, does a job similar to that of the American bazooka gun. The Piat weighs 33 pounds, less than the old anti-tank rifle, and can be put into operation in a few seconds. It fires a 2¾ pound bomb which can pierce four-inch armor plate. A spring mechanism insures so light a recoil that the Piat can be fired from the shoulder. Infantrymen using it in that fashion, with the fore part of the weapon rested, have been trained to hit a moving tank at a range of 100 yards. It has proved effective at destroying machine gun nests up to 350 yards. The bomb explodes on impact, the propellant force being derived from the explosion of a cartridge in the tail assembly.





# SILVER GOES *to* WORK

Silver owned by U. S. Treasury Department at West Point depository being released for war use on lease-lend basis. Below, silver is in the emulsion on motion picture film, which army technician is shown splicing in a Signal Corps editing room

Signal Corps photo

**F**OR thousands of years second only to gold among the precious metals of the world, prized as a measure of wealth and a medium of exchange, silver today is doubly precious for a new and vastly different reason. It is helping win the war in the nation's factories and wherever battles are being fought.

Industrial uses of silver, now primarily in war production, have multiplied and expanded so rapidly that industrial consumption has doubled twice in the short span of four years. Even the doors of the U. S.

POPULAR MECHANICS



Mr. G. W. ...  
1362 N. Dearborn  
Chicago 10, Ill.



OWI photo  
Women learn to braze silver  
in an aircraft construction  
class at vocational school

Treasury's silver stronghold at West Point have been thrown open, figuratively, to industry, and thousands of tons of the white metal have been loaned to manufacturers for non-consuming purposes.

So valuable and vital has silver become as a war material, that there are few war industries which do not use it in one way or another, either as a substitute for copper, tin or other strategic metals, or because of its own inherent and exclusive advantages. Even as Pizarro, conqueror of Peru, once shod his horses with silver in an emergency, the United States and its allies have turned to silver to solve countless war production problems, and with outstanding success.

In 1943, something like 170,000,000 ounces of silver went into industrial use, and of this only around 10,000,000 ounces were used in the arts field, including silverware, jewelry and other nonessential products where use is curtailed. In round figures, industrial consumption in 1942 was 120,000,000 ounces; in 1941, 80,000,000 ounces, and in 1940, only 40 million ounces.

But despite this rapid increase, and with the United States alone using practically as much silver as now is being produced in the entire Western hemisphere, the government found it advisable to place enormous quantities of Treasury silver at the disposal of industry.



Eastman Kodak photo  
Rolls of 35 mm. motion picture film are stacked and ready for shipment to army units. Below, rolling a wide sheet of sterling silver at Handy & Harman plant, world's largest. Industrial use of silver has doubled twice in four years





Western Electric photo  
 Adjusting relays (in which large quantities of silver are used) in Navy telephone switchboard

In West Point vaults comparable to Uncle Sam's gold fortress at Fort Knox, Ky., are well over three billion ounces of silver. Part of this is required to back United States currency, and the remainder is known as "free silver," now available for industrial use through the Defense Plant Corporation or held for sale at 71.11 cents an ounce, the fixed price for domestically mined silver.

Of the first billion ounces (34,460 short tons) of this "free silver" released, about

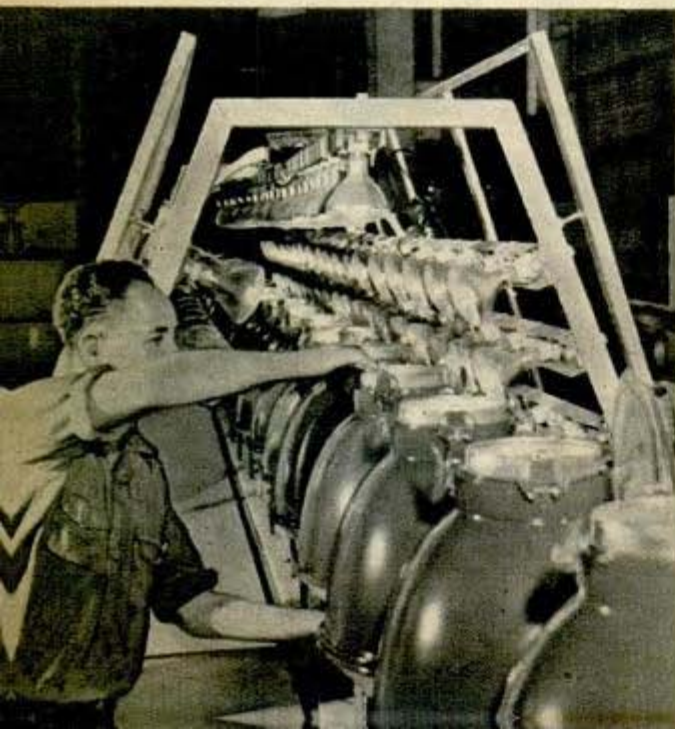

19,000 short tons were certified for industrial allocation within a year. On the loan basis, all of this Treasury-owned silver must be remelted and returned in its original bar form after the war. Thus, it cannot be alloyed, and is used principally in bus bars (primary electrical conductors), wire strip for transformers and experimental cable for overhead power transmission lines. In most cases, this silver replaces scarce copper. The big bus bars, which are cast or rolled but never drilled or sawed, are used in war plants and are kept under guard, although weight plus high voltage usually preclude theft.

Even a hasty review of wartime uses of silver makes it easy to understand why such huge quantities of the white metal are needed. Approximately one pound of silver originally is required for each airplane engine bearing. Some is reclaimed for reuse after manufacturing processes are



Above, a Gorham craftsman modeling silverware. Left, General Electric used silvered glass instead of aluminum for reflectors, saving 560,000 pounds of aluminum in the manufacture of lighting equipment

complete, but the net total finally used is around one-third of a pound per bearing.

So successful has been the use of silver in plane engines that many tank engines now have silver-alloyed bearings and even the small bearings in high-speed superchargers contain silver. No other metal has been found that is so effective in high horsepower power plants.

The Army and Navy ordnance departments are among the largest users of silver. Much of it goes into brazing alloys used in

the fabrication of shells of all types including those used in chemical warfare. The Navy now uses silver brazed connections for its non-ferrous piping in ships.

One of the nation's largest makers of electrical equipment reports that almost every motor, generator, transformer or other piece of apparatus made for the war has silver in its construction. Despite the cost of using silver, the advantages in current-carrying contacts result in an improvement in quality sufficient to justify its use, and silver brazing alloys are making joints by the million on a competitive basis with other joining methods. These alloys are used widely in airplane construction, in the making of electrical equipment and in fabricating large copper piping for marine uses. The saving of more than 50 percent is effected, in no small measure, by the use of increased silver content in alloys.

Brazing alloys, developed to a high degree of perfection through the use of silver, account for a large proportion of the wartime consumption of the precious metal. According to General Electric, one type of brazing alloy, widely used before the war, was composed mainly of copper, the remainder being silver and phosphorus. Now, alloys with copper content as low as 16 percent are in general use. A typical alloy consists of 50 percent silver, 16 percent zinc, 18 percent cadmium and only 16 percent copper.

Before the war the electric household refrigerator industry was a leader in using silver brazing, and was the largest industrial consumer. No soft solders were used on connecting lines because early use of these materials led to the production of considerable equipment which developed defects in that the solder failed in service, resulting in gas leaks. To prevent troubles from such causes most states now require silver brazed connections.

Not only does silver excel copper as a conductor of electricity, but it has many outstanding physical and chemical properties, one of which is a heat conductivity higher than any other metal. Some of the other advantages of silver in industrial use are explained by Robert H. Leach, vice-president of Handy and Harman, largest silver plant in the world, at Bridgeport, Conn., who says:

"The photographic industry has become a large consumer of silver; millions of ounces are used each year. The silver is converted into silver nitrate and as this has to be of a high degree of purity its production is confined to large companies which manufacture photographic equipment and supplies or to chemical companies

Continued to page 148

JULY, 1944

## Portable Film-Carrying Case Serves as Projector Stand

0132

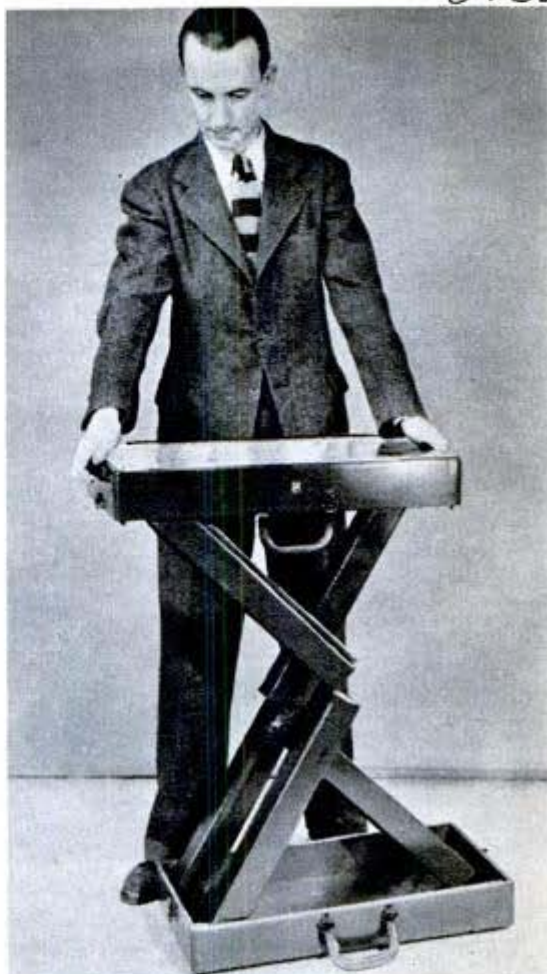

*Bed & Howell Co.  
1801 Marchmont Ave.  
Chicago 13, Ill.*

Instead of stacking books on a chair every time home movies are to be shown, amateur operators can convert a portable carrying and storage film case into a projector stand. Closed, the case is 12½ by 24¼ by 7 inches; when opened out, it stands 42 inches high with a platform 12½ by 24½ inches suitable for any size projector or as a speaker's rostrum.

0166

## Insulating Wall in Radiator Niche Saves Seven Percent of Fuel

By placing insulation behind radiators recessed into the outside walls of modern homes, as much as seven percent of the winter fuel can be saved, tests by University of Illinois engineers reveal. The tests, made in a typical brick veneer small home, showed that heat loss for each square foot of recess equals as much as that of 16 square feet of the insulated wall. The tests were made by installing in each radiator recess 1-inch rigid insulation with aluminum foil reflective surface.

*Urbana, Ill. in cooperation with  
Insulation Institute & Radiator Mfg. Co.*

# FEATHERWEIGHTS ON WHEELS

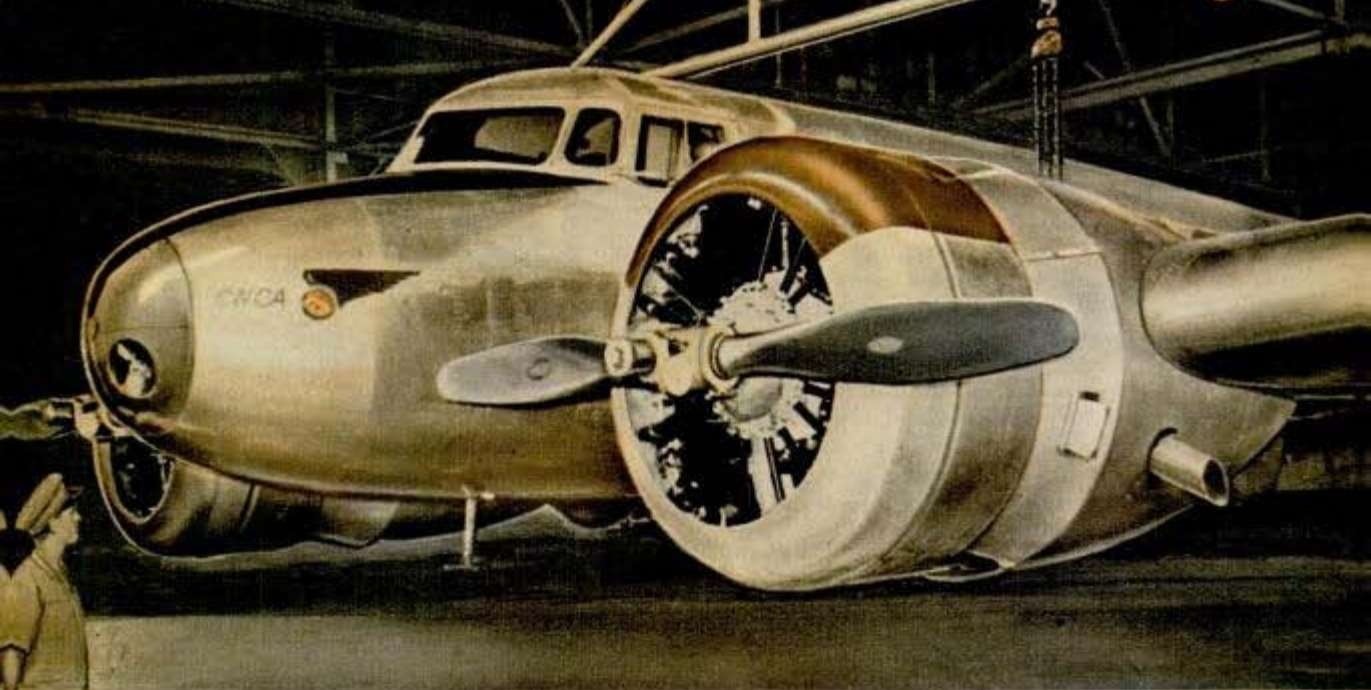

"Weighing in" a new twin-engine airplane at the factory on Fairbanks-Morse suspension scales

"ADD more lightness" will be the watchword of transportation equipment manufacturers in the postwar era.

Everything from baby carriages to locomotives will be scrutinized by engineers whose job it is to find and remove each ounce or ton of unneeded heaviness. Re-

ducing the deadweight of a vehicle improves its efficiency, cuts down fuel costs, or increases its load carrying ability.

It is estimated that if one pound is removed from the weight of a medium-sized passenger transport airplane, its payload capacity is increased by \$2,000 during its operating life. In the case of railroads, cutting half a ton from the weight of an ordinary freight car permits a saving of up to \$15 for the car per year because of the reduced hauling effort. The automobiles talked about for the future, using lightweight metals and plastics to reduce their weight, will be capable of the same speeds, comforts, and carrying capacities as present cars, yet will require smaller engines. That means more miles per gallon of fuel.

Engineers have been talking about weight control for decades but not until the war made airplane poundage a deadly serious

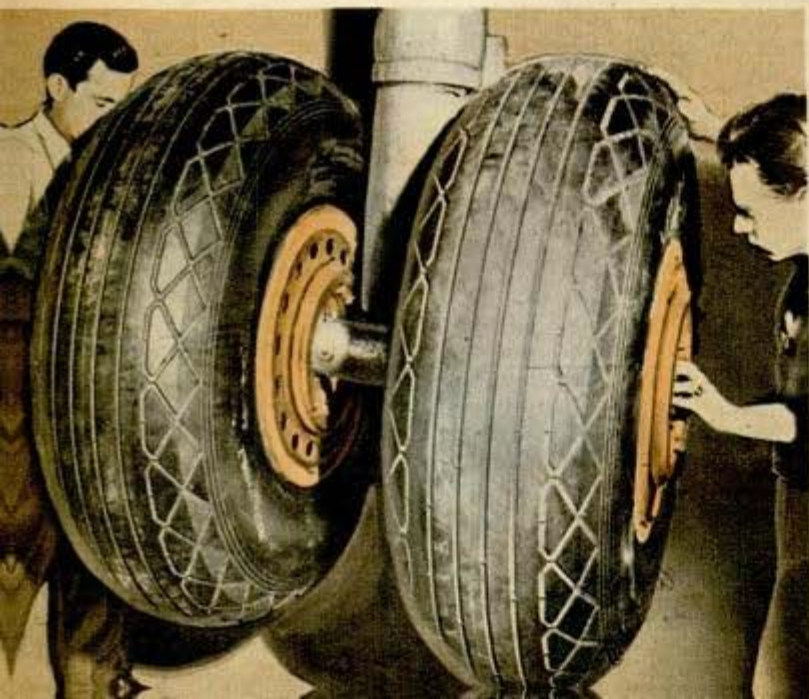

Two small landing wheels on the Constellation weigh less than one large wheel

3872 Franklin Ave. 058  
Los Angeles 27, Calif.

matter did weight engineering become a formal art. Every pound that is saved in building a military airplane may then be used in providing more armor, more bullets for its machine guns, or for greater bomb or fuel load.

Today at Lockheed Aircraft Corporation as at other large aircraft factories a staff of special industrial dieticians watches over each new design to chisel off superfluous avoirdupois without reducing the plane's flight ability. Much of the engineering knowledge gained in aviation may be applied to other kinds of transportation, and the Society of Aeronautical Weight Engineers is making its findings available to all industry.

At Lockheed, L. R. Hackney and his staff work hand in hand with the de-



This 15-foot section of "barrel" fuselage of Constellation (above) weighs only 50 pounds more than the workman

Two aircraft radio masts of magnesium on scales at left exactly balance a single identical mast of heavier alloy

The triple tail of the Constellation provides maximum stability and control with the minimum structural weight



Ref:  
Mr. L. R. Hackney, Engineering Dept.  
Lockheed Aircraft Corp.  
Burbank, Calif.





Weight engineers must determine a landplane's "water line" and length of time it will stay afloat, and specify location and size of flotation bags carried for emergency. Below, P-38's four machine guns and 20 mm. cannon present a problem of weight concentrated in nose

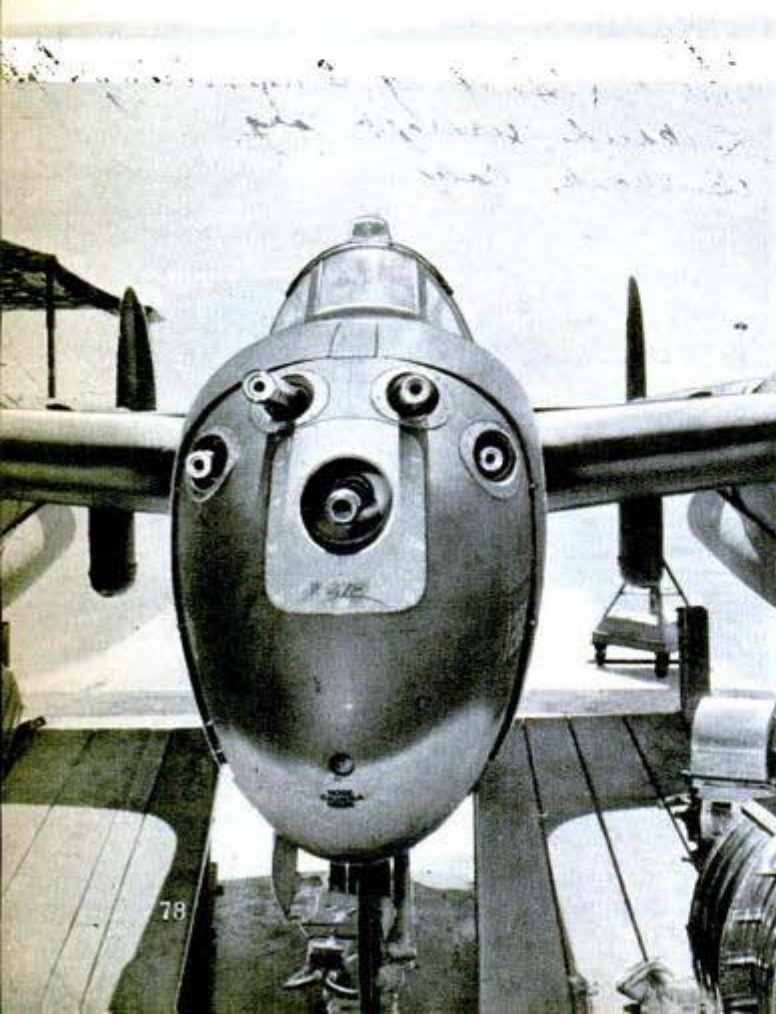

sign and stress departments, for a decision that affects weight also bears on the plane's center of gravity, its strength, and its performance. Sometimes the engineers can redesign part of a structure to save poundage, sometimes they can substitute a lightweight metal or plastic for a heavier material. Sometimes, however, they deliberately select the heavier of two materials in cases where it proves to be really the lighter when installed in the plane. An aircraft part that is made of stainless steel is much heavier than its duplicate in aluminum, for instance, yet in some applications it may add the least to the plane's empty weight, since less steel may be needed to carry the required load.

The same sense applies to equipment. Of two electric motors that can perform the same work, the heavier may be selected if it uses less current than does the other. The smaller conductors required for the reduced current may cut down the weight of the whole installation.

The importance of such details is illustrated by the big four-engined Lockheed "Constellation." Hackney and his staff were able to reduce its weight by 3,000 pounds under the original estimate of its tonnage. In effect that amount was added to the airplane's carrying capacity. Thus in a passenger transport version of the "Constellation" one and a half extra tons of cargo weight will be available.

In spite of the accomplishments of the weight engineers, airplanes today don't carry as high a percentage of useful load as they did in the past. In 1929 a tri-motored Fokker could lift a useful load amounting to 40.5 percent of its gross weight, as against the approximate 36 percent useful load of a modern transport. This loss in payload efficiency is partly because modern aircraft are of sturdier construction and partly because a great deal of equipment that adds to safety and comfort is now being carried. The old Fokker carried 75 pounds of radio equipment; the radio gear on a modern airplane weighs some 500 pounds. In all, about 220 pounds of safety and comfort equipment per passenger are carried by a modern transport.

Empty or loaded, an airplane's center of gravity and its balance are vitally important. The control of these factors is a part of weight en-



gineering. Recently a flying boat in a squadron crossing an ocean was unable to keep up with its companions although all the planes were operating at the same engine settings. The pilot of the lagging plane saw that his trim tabs indicated nose heaviness. He shifted some of his cargo to the rear. That allowed him to fly with the tabs neutral and at once the flying boat picked up speed. Recently, too, a cargo plane loaded for a trip abroad lurched into the air on the



New lightweight railroad car is suspended by pedestal coil springs. At left, set of dials responding to mockup of the hydraulic system of a plane are studied by weight engineers



and when the plane took off again it flew smoothly.

The meticulous balance required in an airplane is not so necessary in a vehicle that has four wheels on the road, but lack of correct balance explains in part the poor handling characteristics that drivers of some cars have complained of in the past. The light cars of the future, engineers predict, will be improved because of the new understanding of centers of gravity and balance that has been acquired in aviation.

In the commercial truck and bus field, lightweight aluminum or magnesium bodies promise to cut down gross weight and allow vehicles to carry the same payloads at reduced fuel expense. Torsion bar suspension, first tried out in the United States by race car drivers, is receiving attention in the truck and bus fields because of its weight-reduction possibilities. A torsion bar, one end

Continued to page 154

takeoff, flew crazily, and changed altitude unpredictably. The experienced pilot had his hands full in returning safely to the field. Under the supervision of an expert the cargo was reloaded to provide a correct center of gravity

Samples of stuffing for aircraft seats weigh alike; the larger one consists of hair and latex, the smaller one is foam rubber



Mr. C. M. ...  
N. Y., 16, N. Y. 0152

# HIGH FLYING on the GROUND

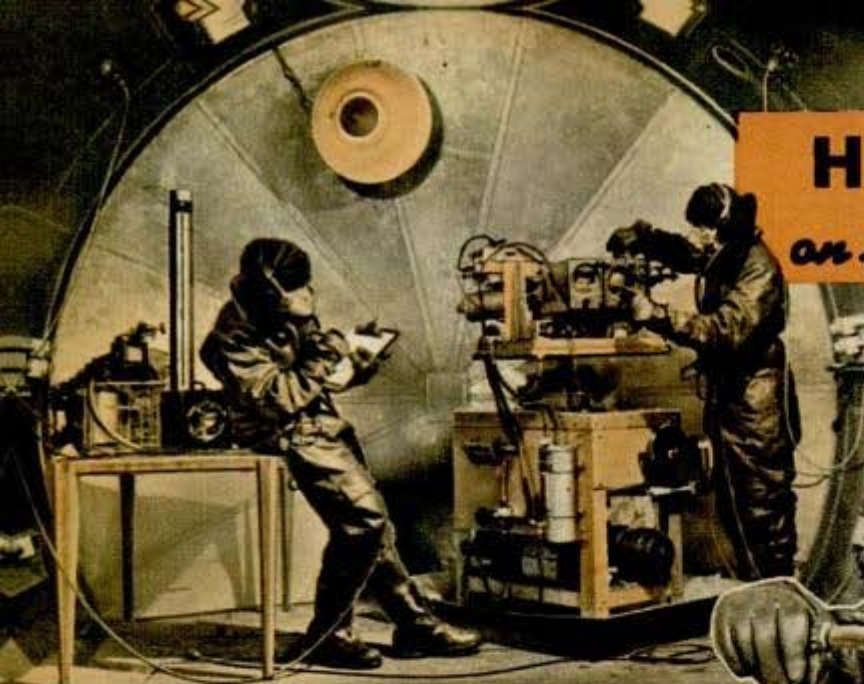

Guarding the lives of U. S. flyers who fight in the stratosphere seven and eight miles above the earth, are high altitude engineers who work in 75-below-zero chambers simulating altitude of 60,000 feet. Above, engineer checks action of a Sperry gyro-pilot. Right, exercising protects against "bends"



70  
720  
The Sperry Corp., P. O. Box 100, Rochester, N. Y., N. Y.

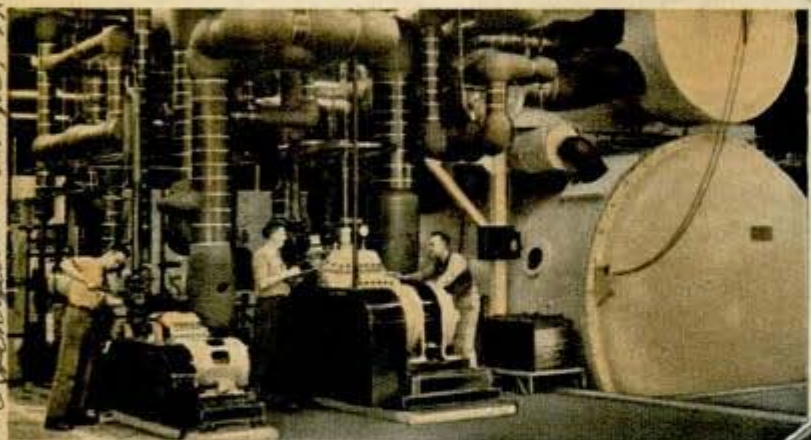

Refrigerating machinery and pumps dwarf "strato" tank in Sperry laboratory. Below, observer in sealed lock can open door quickly if anything goes wrong "upstairs." Below at right, naval officer questioning test crew inside tank



# Bombs on Fighter Plant Felt Quickest at Front

When an assembly plant for fighter planes is bombed, the effect is felt on the front line in two weeks. If raw materials are blasted, it takes 10 to 25 weeks before the enemy's fighter squadrons feel the shock. A chart made from statistics supplied to the Secretary of War by the commanding general of the Army Air Forces also shows that the bombing of plants producing unfinished parts for fighter craft is felt on the front lines in five to 10 weeks. Plants that build such planes, vital for the defense of Fortress Europe, have long been a favorite target of American and British bomber crews.

## Stapling Pliers With Magazine Feed Join Strips of Wire Netting in Jiffy

*Bostitch Co., 175 Avenue M, Newark, N. J.*



Magazine-fed pliers, which hold 60 to 70 ring staples in one loading, are used to speed the joining of strips of wire netting and fence wires. The two-pound pliers are operated like those used to set rings in hogs' noses. Magazine-feeding saves time by eliminating the hand-placing of every ring. Pressure on the handles of the tool locks the rings with a quarter-inch overlap which holds them securely in place.

## Coast Guard Asks "Impossible" Stunts Of Its Helicopter Pilot Students

After 25 hours of flight training, a helicopter pilot student is required to put his machine through a series of "impossible" stunts, Lt. Comdr. F. A. Erickson writes in the United States Coast Guard magazine. He must (1) take off sidewise and climb at a 45-degree angle; come down the same way but stop and hover before setting the ship down; (2) take off backward and fly tail-first; at 25 or 50 feet altitude, while continuing flight in same direction, swing tail around and go on nose first; (3) from 200 feet altitude make 60 degree glide and land on marked area approximately 20 feet on a side; and (4) fly around the boundary of a square, stopping in the air at each corner, without deviating more than one foot, vertically or horizontally, from true flight line. Comdr. Erickson said the training is preparing pilots for the Coast Guard's peacetime uses of helicopters in rescue and ferrying work.

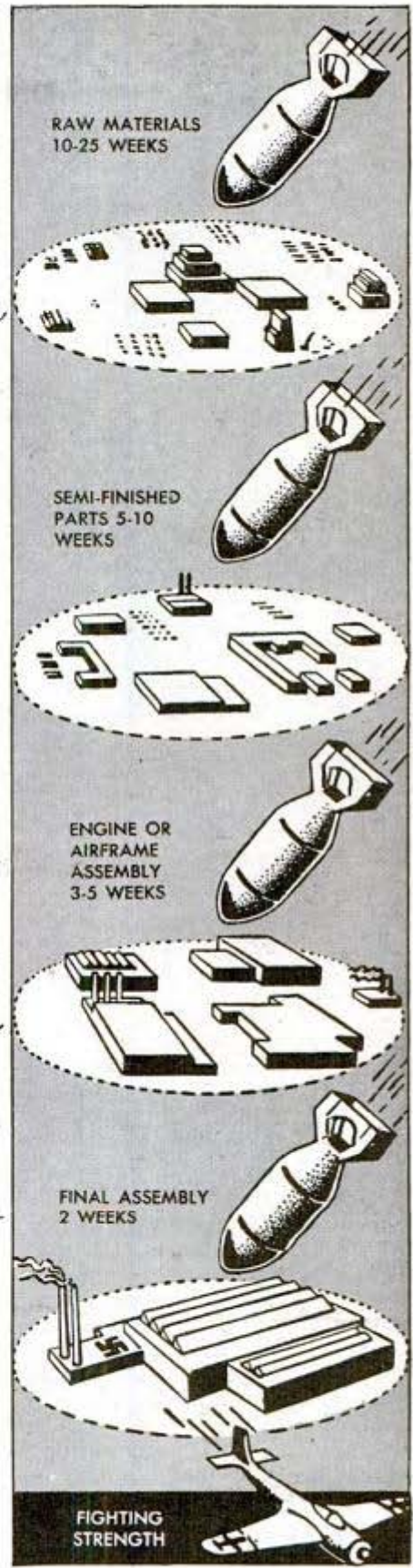

Native labor helps fill gasoline truck close by airfield

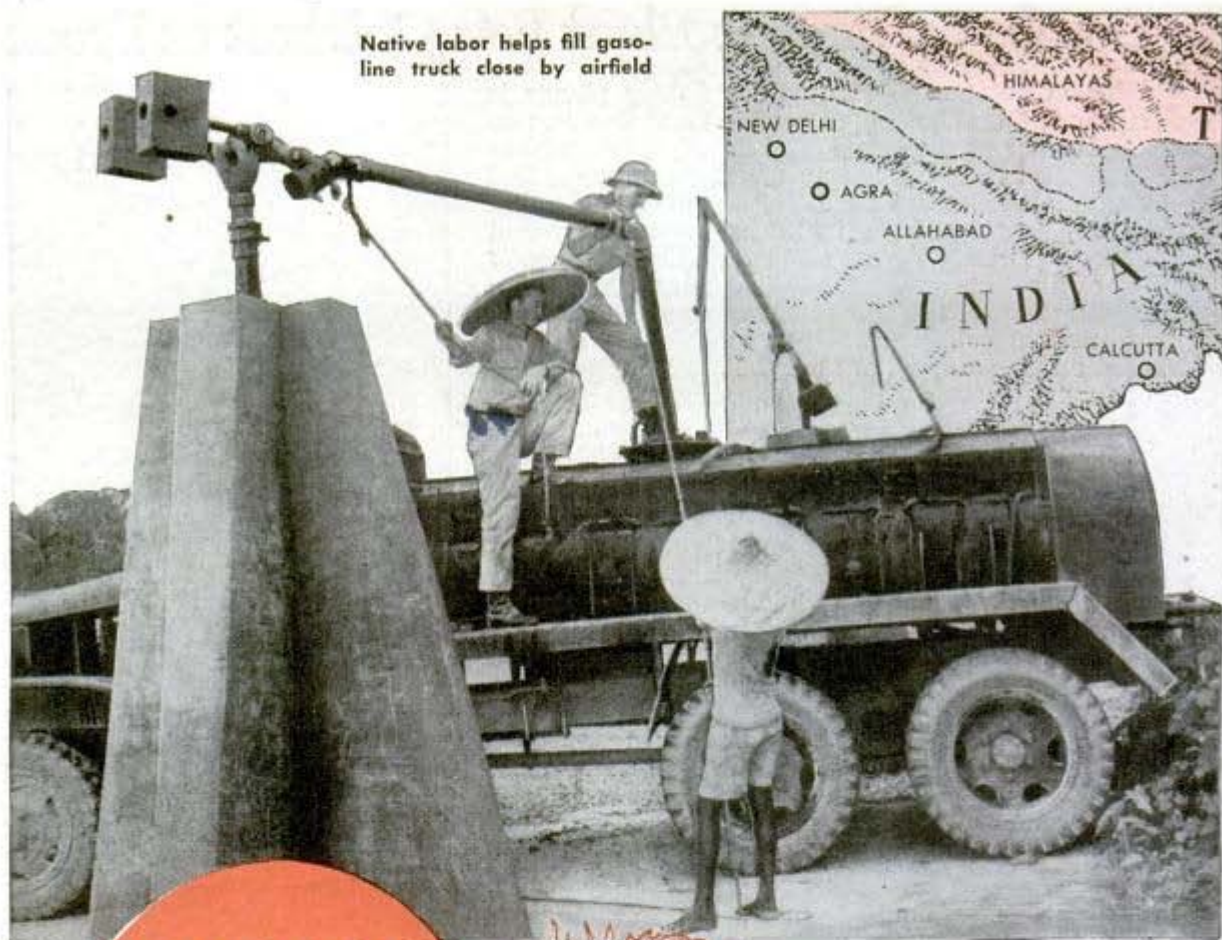

## HEROES of the "HUMP"

By Wayne Whittaker

FROM the crude loud speaker of the radio perched on a packing crate in the center of the bamboo hut came weird whistles and scratches. Eight pairs of ears belonging to the American flyers reclining behind mosquito nets on four double-deck bunks, one against each wall, were cocked toward the speaker. Alongside the two barrack bags, rifles, steel helmets and gas masks beside each bunk hung the flyers' jackets bearing the insignia of the India-China Wing of the Air Transport Command. The only light in the hut was from a lantern suspended from a pole under the thatched roof.

Soon a singsong voice from Tokyo came through the scratches on the radio:

"Yesterday Imperial Japanese bombers in great force from advanced base Myitkyina in North Burma . . . (scratch, squeak) . . . thousands of tons explosives on American airfields in Assam . . . American cargo planes all burn . . . China Wing of Air Transport Command wiped out . . . smoking ruin."

The guffaws of the men who fly the most dangerous air route in the world spread from hut to hut, from airfield to airfield in the network of bases in Assam, northeast corner of India between Tibet and Burma.

Tojo was always good for a laugh. The truth was that Jap bombers had dropped a few "eggs" on an airstrip yesterday and destroyed several cargo planes, but that was about the extent of the damage. And today—here was the joker—the commander of the "Hump" sector had sent out the largest tonnage of supplies that had ever been flown in a single day from India into China.

The amount of tonnage that went over



Air route from Assam to Kunming passes over the Burma "Hump" where peaks are hidden in fog

the Hump that day is a secret, just as it is every other day. But it can be revealed that the number of planes leaving the airfields of Assam daily for China is greater than the flights that come and go at La Guardia Field. The India-China Wing today is the biggest single air transport operation in aviation history and its monthly tonnage of military supplies is greater than was ever carried by trucks over the old Burma Road.

Since the fall of Rangoon in March, 1942, and the closing of the Burma Road, this air line has been the only supply route to Maj. Gen. Claire L. Chennault's 14th Air Force in China and the armies of Generalissimo Chiang Kai-shek. Critical cargo flown over the line includes aviation gasoline, ammunition, bombs, jeeps, trucks, artillery, small arms, airplane motors, spare parts, food and clothing. Ev-



Loading ingots of tin on a Curtiss C-46 at Chinese base for the return trip to India. Below, air view of Burma Road held by Japs

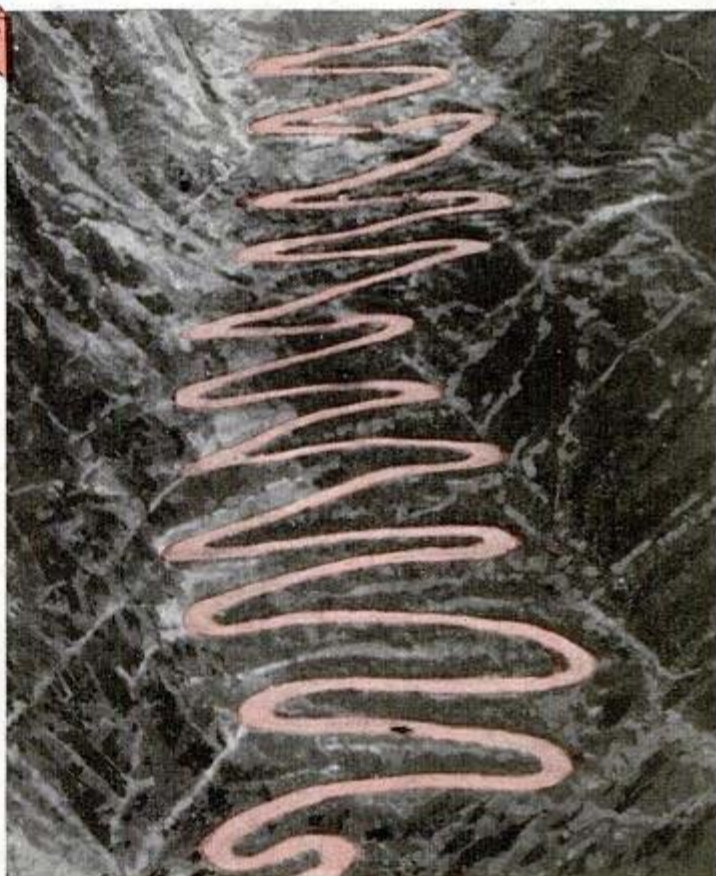

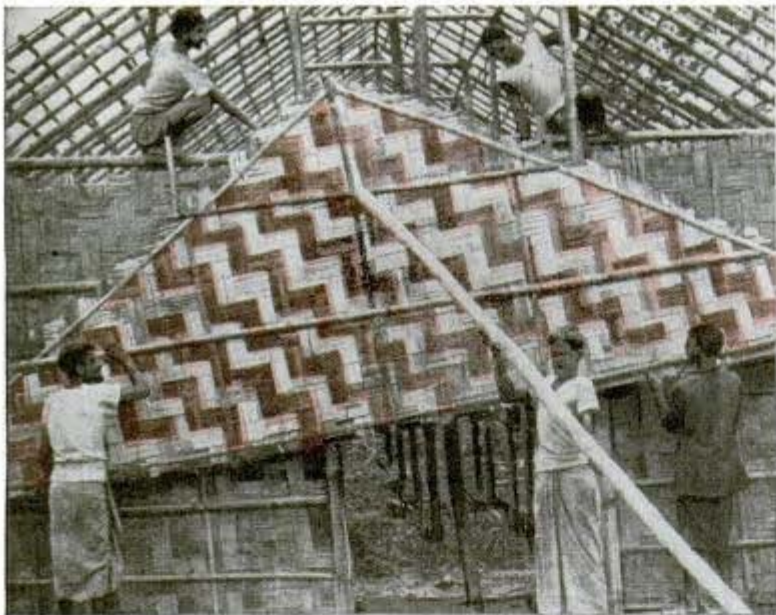

Natives erecting basha of cane strapped to bamboo poles to house Yanks



Water buffaloes help surface parking area near airstrip by pulling crude roller. Below, Chinese mechanics rebuilding C-46 at open air "factory"

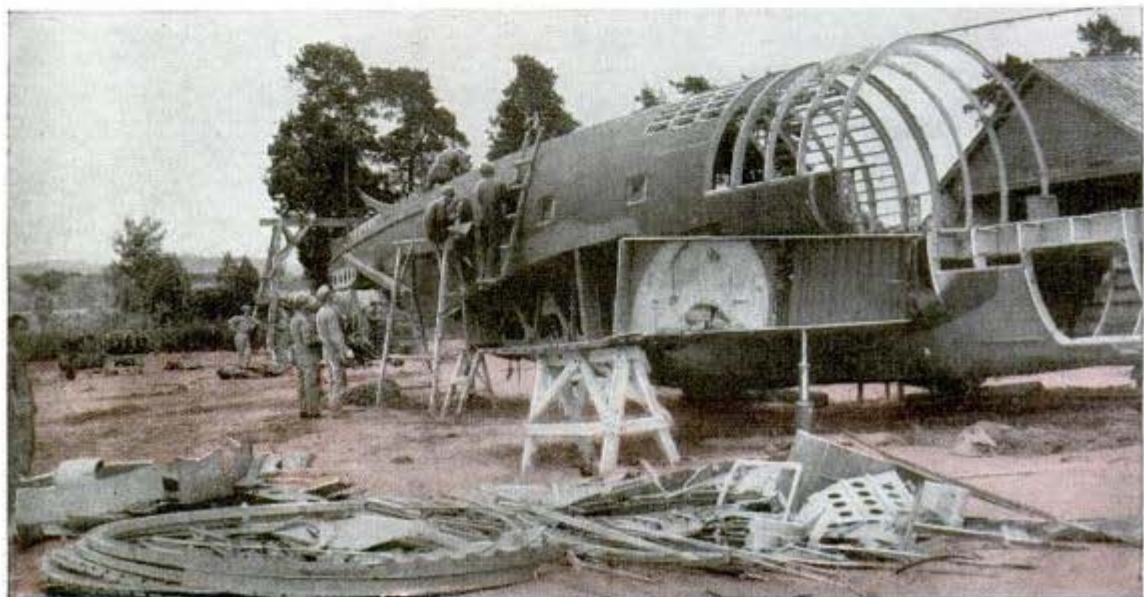

ery gallon of gasoline delivered costs about \$20, and it takes three plane loads of fuel to put one heavy American bomber into the air for one raid on Jap positions.

The Hump route from Assam to Yunnan is 500 miles long, and veteran flyers say that every mile is a gamble with death. It gets its name from the subsidiary ranges of the Himalaya Mountains that extend into Burma, jagged snow-capped little brothers of Mount Everest that protrude into the clouds and mist at 18,000 feet.

Between the peaks are valleys of lush jungle and treacherous air currents which cause a plane to drop a couple of thousand feet in a minute.

In the so-called winter months, the Assam lowlands are covered with fog through which the planes must find their way down. During the monsoon season, from March to October, there is a steady downpour of rain, and the "ceiling" during this period is seldom higher than 3,000 feet. Icing starts at 15,000 feet. Planes sometimes have to fly as high as

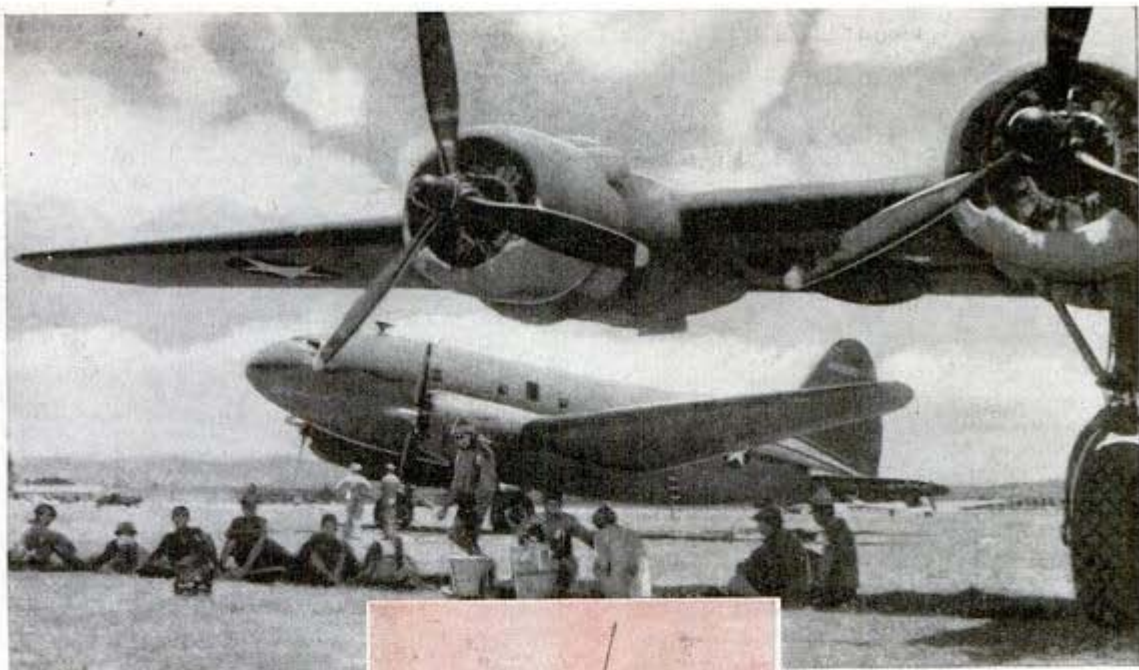

Wing of C-87 shades laborers at lunch. Right, red ball is run up pole as air warning

30,000 feet to get over the "weather." Clear weather is a hazard, too, for the big unarmed transports are then more easily spotted by the Japs. And to further complicate the pilots' problems, the mountains deflect radio beams dozens of miles.

This deflection of beams and an accompanying gale resulted in an unscheduled visit to "Shangri-La" by one of the crews. Their C-87 (converted B-24 Liberator) flew in snow and darkness for hours after losing radio contact with the base. When there was no gas left, the crew of five men bailed out and found themselves on a snowy peak in the forbidden land of Tibet. Flight Officer Harold J. McCallum later reported they were so close to the mountain when they left the plane that the parachutes barely had time to open.

Three of the men land-

Filling rice bags to drop on remote stations in the hills



ed near enough to find each other by shouting above the whine of the blizzard. At daybreak, they were joined by the fourth member of the crew. The fifth man spent three nights alone. He lived on chocolate bars and quenched his thirst with snow.

Natives led the pilots to a village where an English-speaking Bhutanese monk lived. He housed them in his mud hut and contacted the Tibetan





Early morning scene—native livestock sleeps under ships. Left, loading tin

Teamwork by crew members of the India-China Wing is as highly developed as it is on the bombers that shuttle over Europe, according to Chaplain (Major) John S. Garrenton, who recently returned after 22 months in Assam. Major Garrenton has flown over the Hump 32 times. He tells how the loyalty of one 17-year-old radio operator, a corporal, saved the life of his crew chief.

"The C-46 in which they flew was attacked by Japs who suddenly dropped out of the clouds," he said. "A burst of gun fire swept the cargo plane from nose to tail. The pilot and co-pilot were killed. The left engine was shot out and the right engine set on fire. The plane plunged from 17,000 feet in a mass of flame. Neither the young corporal nor the crew chief could jump because they were pinned to the floor of the

foreign minister who sent out a party to bring the flyers to the holy city of Lhasa. The minister arranged for a party to take the flyers by horseback to India. It took weeks to make the trip along narrow trails that wound among 25,000-foot peaks. After a short rest, the crew was back on the job.

Many of the men who have to bail out over the Hump, or survive a crash, find their way back to India. When a crew is in trouble, its position is radioed back to the base. A rescue plane flies out, locates the lost flyers and drops them supplies by parachute. If immediate medical aid is needed, a flight surgeon bails out.

Splattering mud and water, a C-87 takes off for "Hump"





burning ship by some heavy cargo that had broken loose.

"When the ship crashed in the jungle, it burst open and the two men were thrown clear. The corporal had only a few cuts and bruises, but the crew chief had a broken back and could not move. Placing water and food by the injured man, the corporal walked three days through the jungle to find help. He returned with native stretcher bearers and helped carry his chief to a village. There he sent up signals until a rescue plane was sent with a doctor who bailed out and remained with them all the way to a hospital in India."

Veterans of the Hump like to tell about the "early days" of the wing which started out with a few dilapidated DC-3's "that no respectable airline in the States would ever let leave the ground." That was in April, 1942.

The men operated from a single-strip airfield constructed by native labor in what had been a tea garden.

"That was some tea party," one pilot reminisced. "We loaded our own planes in those days. Spare parts were as scarce as mechanics. Delicate equipment that goes back to the factory in the States was ripped apart and repaired on the line. Sometimes a line chief would work 72 hours at a stretch."

An old radio was rigged up and made to serve as a communications center. There was a shortage of oxygen masks. The old DC-3's were not built for high altitude operations, but that didn't stop them. The pilots did their own navigating with 20-year-old maps and an "array" of instruments that consisted of one compass. Before the planes could take off, water buffaloes and curious natives had to be chased off the field.

Hugging the clouds to avoid Jap planes, flying down valleys to get around lofty peaks they couldn't fly over, fighting unpredictable air currents, ice or fog, this band of men kept a trickle of supplies flowing into China during the dark months of 1942. Late that year the Hump route was turned over to the Air Transport Command and things began to hum.

In February, 1943, 2,600 tons of supplies were flown into China. More pilots and better planes were added to the line, including a new Curtiss Commando (C-46). The Commando can carry three jeeps or an equivalent weight of artillery. Then came the freight-carrying Liberators with their 10-ton cargo capacities. Last fall, regular night flying was inaugurated.

Airfield after airfield was hastily constructed. Before the outside world knew what was happening, northeastern Assam

Continued to page 156

JULY, 1944

## U. S. Army's "Brief Case" Gun Is Quick-Firing Weapon



Small but deadly, the United States Army's new "brief case" machine gun is a compact weapon the Yankee soldier can sling into position quickly. The .45-caliber weapon, which is sighted from the shoulder, fires as rapidly as the trigger is pressed and pops its spent shells into the air.

## Compressed Air Fed Into Mask Guards Welders From Fumes

Protection against illness caused by fumes, a hazard faced constantly by welders, is a feature of a new mask worn at the Pullman-Standard Car Mfg. Co., in Chicago. A small hose is attached to a compressed air unit which fits inside the hood and directs the spray of air about nose and mouth. This prevents sweating and soiling of the eyes and stops fumes from being drawn into the welder's lungs.



Allen McJames 87

Packless Metal Products Corp.  
31 W. 42nd St., New York, N.Y.

### Spring Clips for Flexible Tubing Stop Vibration and Chafing

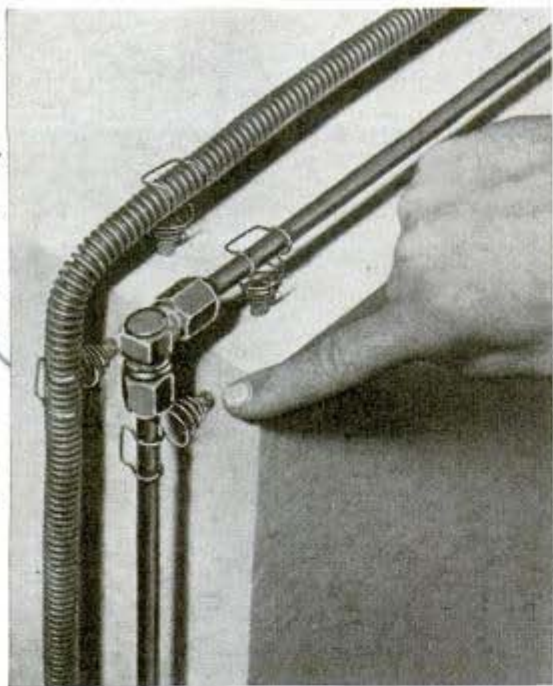

Flexible tubing and hose are held in place with fasteners consisting of a conical spring ending in a clip. They absorb the vibration by permitting the tube to move in all directions, and provide for expansion without breaking the line. They are easily mounted with a screw at the base of the spring. At corners where tubes are bent at right angles, the clips prevent chafing.

71857

Calanese Celluloid Corp.  
180 W. 42nd St., N.Y.

trial inspectors, the optical industry has devised a set of magnifying lenses which are mounted on a band worn around the head. The band includes a small extension which permits the magnifiers to be pushed up out of the line of vision when not in use, thereby conserving valuable time. The set can be worn comfortably over spectacles, if necessary.

039

### Flat Map Distortions Reduced By Forming 20-Sided Solid

Prof. Irving Fisher of Yale University has invented a world map to reduce the distortions in flat maps. Made up of 20 triangles of equal size, it can be folded into an icosahedron, a 20-sided solid resembling a globe. One advantage is that it is harder

Sikahybe, 205 W. 42nd St., New York, N.Y.

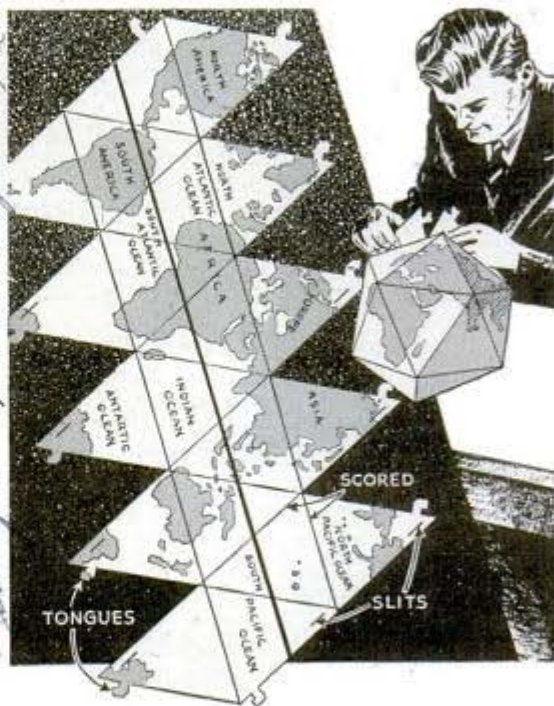

to transfer a great circle route from a globe to any flat projection than from an icosahedron to Prof. Fisher's flat projection. Flattened out, the map can assume many forms, including the grouping of the land areas in which the war is now being waged by using only six of the triangles. It is possible to arrange the map so it can be built up or flattened out merely by pulling a string. Needle and thread or slits and tongues can be used to keep the icosahedron together.

You can obtain additional information about products described in this magazine by writing to the firms listed in the Where-to-Buy-It index. Say You Saw It in Popular Mechanics.

Magnifying Glass  
916  
May 29th 1941  
N.Y.C.

### Magnifying Glass on Headband Aids Laboratory Workers

For the convenience of medical men, nurses, laboratory technicians, and indus-





# The CRAFTSMAN

*Lightweight*

## BEVERAGE TABLE

*carried with ease*

FOR A FEW cents worth of material you can make a novel refreshment table that will be an ornament to your living room as well as a useful piece of furniture. Made of light wood glued together, it may be carried easily about the house in place of the server generally used, and will stand firmly on its four legs. The tray is made of a solid piece of  $\frac{5}{8}$ -in. board cut to the size shown in Fig. 1. On this tray six pieces of  $\frac{1}{2}$ -in. stock are glued to form a railing so that beverage glasses will not slip off.

The railing pieces are fashioned to the overall dimensions shown in Fig. 3. Each end is cut at a 60-degree angle, after which the pattern is outlined carefully as shown in the light area. A piece of cardboard or tin can make a good pattern for outlining the design, as illustrated in Fig. 2. Before gluing the sections to the tray board, sandwich strips of blotting paper between the railing

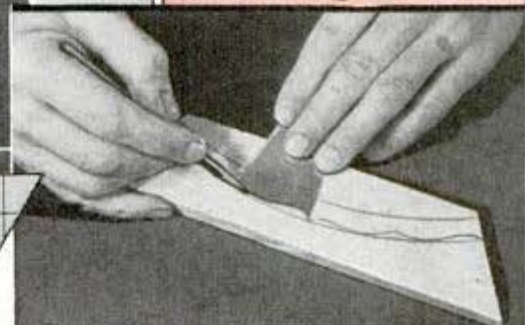
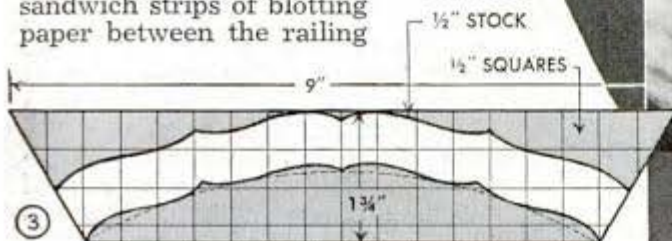
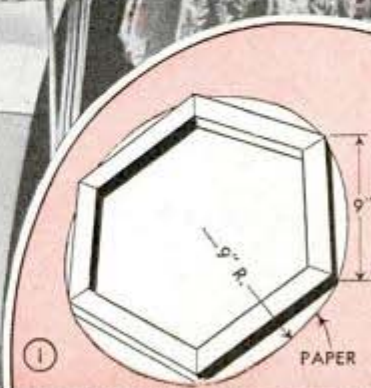

by  
*Charles and Bertram Brownold*

② *Marking railing design*

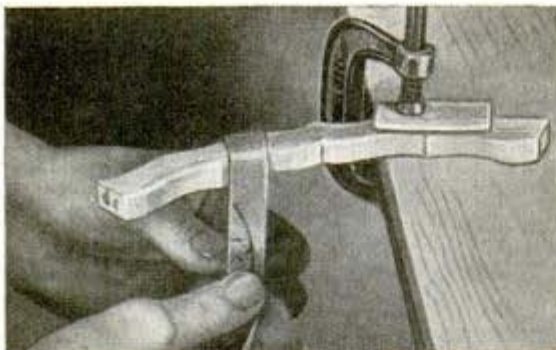

④ *Railing pieces sanded*

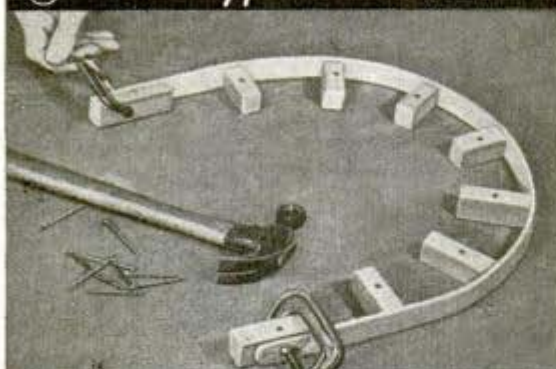

⑤ *Handle pieces clamped*

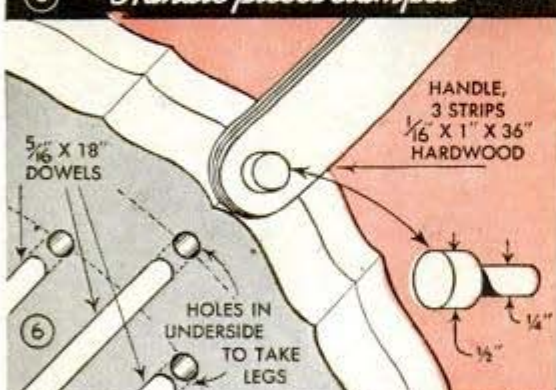

⑦ *Wrapping ends of legs*

and tray so that you can take them apart when you are ready to cut the inner line of the design on the railing sections. Now, with the railing and tray glued together over the blotting paper, cut the outer line of the design with a jigsaw, band saw or coping saw. Before separating the pieces, however, be sure to mark all parts so that later they may be reassembled in the same positions, because no matter how carefully you cut the design, there will be small discrepancies which will show up if the pieces are not replaced as they were when cut.

Sand off the blotting paper, cut the inner line of design on the railing pieces and round off the sharp edges with emery cloth as shown in Fig. 4, so that the edges will hold the finish paint or enamel. The pieces are now ready to be glued back on the tray. Another method that can be used just as well is to cut out the inner line of design on the railing sections, next glue them permanently to the tray, and then cut the outer line of design through both railing and tray.

The handle consists of three strips glued together in the jig illustrated in Fig. 5. As soon as the glue dries, the handle may be attached to the tray by wood pegs shown in Fig. 6. These are turned to shape or made by gluing pieces of 1/4-in. dowel into buttons of 1/2-in. dowel drilled to receive them. The legs are located on the tray bottom by marking off four triangles with sides 2 1/4 in. long pointing outward. Drill a blind hole at the corners of each triangle and glue in the leg dowels, as in Fig. 6. The ends of the legs are lashed together with linen fishline, Fig. 7, and then coated with varnish.

The table may be left in natural finish by sanding and varnishing, or painted to match other furniture. Beautiful effects may be achieved by antiquing the edges of the railing or by shading them slightly to set them off from the base color.

### Cutting Velvet and Jersey Cloth When Using a Pattern

When cutting velvet, jersey and similar fabrics to a pattern for making garments, avoid pinning the cloth and pattern together. If this is done, the cloth may slip ahead of the scissors when cutting it and cause the cut piece to be of inaccurate shape. Instead, lay paper weights or other small objects on the pattern and material to keep the pattern in place. Then mark the outline of the pattern on the cloth and cut the latter to shape. This eliminates slipping of the pattern. However, if the cloth is cut doubled, the two thicknesses of cloth should be pinned securely together.

—Gladys M. Burrell, Chicago.

# Lawns Trimmed Evenly by Simple, Fast Edger

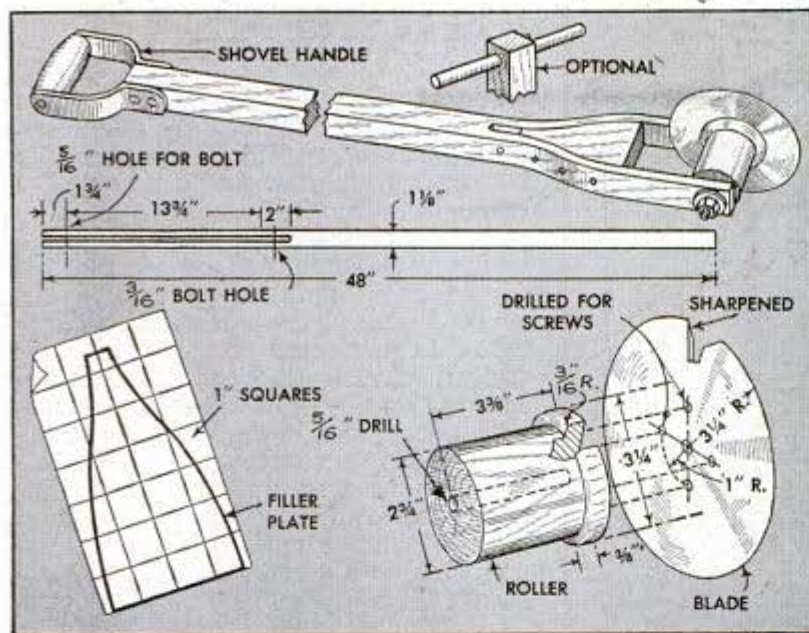

Trimming lawns at uniform depth and width is accomplished with this speedy edger featuring a spacing roller turned from a maple block. The shaft is a piece of oak or other straight-grained hardwood. First drill the bolt holes, then slit about twice saw-blade thickness. To prevent splitting the shaft, insert upper bolt before attaching filler plate. Steaming will make the tough wood pliable. Cold-rolled steel or galvanized sheet of .065 gauge may be used for the blade, which is filed to a cutting edge.—J. S. Sawyer and E. Drewitz, Woodside, L. I.

## Household Data Sheets Hidden Behind Sliding Picture

Daily radio programs and other household data can be kept handy for easy reference, yet hidden from view, by concealing them behind a sliding picture. The picture is mounted on a panel of plywood or hard-pressed board, which slides be-

tween two pieces of wood grooved and screwed to a second panel. This panel is screwed to a wall and should be of fir plywood or wallboard into which thumbtacks can be pushed easily. Short dowels at the four corners of the picture panel serve as stops to prevent the panel from being pushed too far to either side.

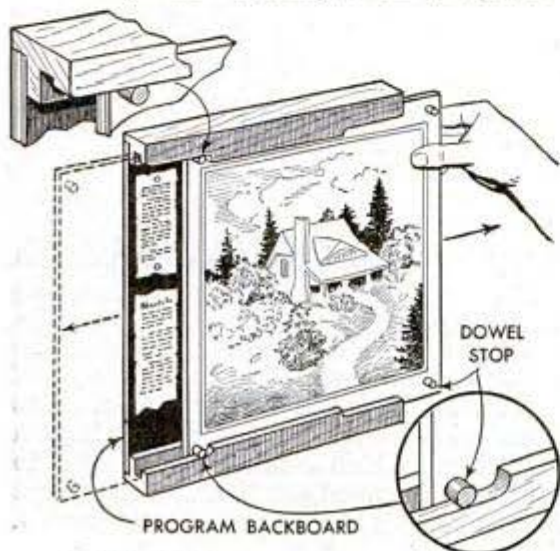

## Ink Reservoir for Writing Pen

A pen will hold an extra supply of ink if a narrow, pointed strip of celluloid is slipped under the nib and held by friction in the penholder. In this position, the strip forms a reservoir to retain the ink.



☐ A few drops of glycerin on a dried stamp pad will help to restore its freshness.

## Latch String Opens Flaps of Tent And Holds Them Out of Way



Instead of propping or tying open the flaps of your tent for convenience in passing in or out, stitch a couple of rings to the sides, drive a screw eye in the pole, near the ridge and a screw hook farther down. Thread a doubled length of stout twine through the screw eye, pass the ends through the rings and tie these onto the tent flaps by knotting them through the lace eyes provided. A little experimenting will indicate the proper length of the twine and position of eye and hook. Release of the looped twine permits the flaps to close.

## Crochet Hook Opens Wrappers Safely and Quickly

In offices where a number of wrapped newspapers or magazines must be opened in a hurry, a crochet hook will serve the purpose much better than a knife or razor blade. The hook is used as shown to cut the wrapper without damaging the contents or endangering the user.

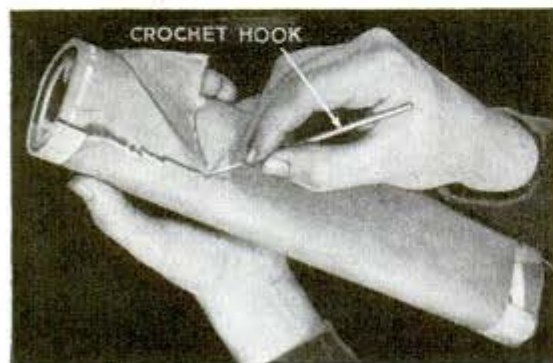

## Foot-Pedaled Catamaran Doubles as Sailboat

It's great fun to lie on the deck of this homemade catamaran, slip your feet into the toe-clips and paddle over the lake or bay, steering your course by the forward rudder with no effort at all. The pontoons, of  $\frac{3}{4}$ -in. lumber, are joined with nails—preferably galvanized—driven about an inch apart, and are caulked with strips of cotton binding-tape laid in marine or casein glue, or white lead. Plywood centerboards are screwed on the inside of each pontoon.

The deck, made from the same material as the pontoons, is supported by two arched cross-members of 2-in. lumber cut as shown and half-lapped, glued and bolted together and installed on the pontoons with screws through the two forward bulkheads. A brace running under the deck reinforces it. A stiff crosspiece supports the paddles a few inches above deck level, and on this piece the paddles are hinged. On the drive stroke the paddles swing back against the upper section to which the canvas or leather toe-clips are attached, and on the return, they swing free, dragging across the surface of the water.

To use the catamaran as a sailboat, the paddles are fastened out of the water, the handgrips are removed from the rudder and a tiller is substituted. The skipper now faces in the other direction, with the rudder at the stern. The mast, tapering from 2 in. at the bottom to  $1\frac{1}{8}$  in. at the top, is held in a step block on the narrow part of the deck and braced by wire stays made taut with turnbuckles. To furl the sail, the boom is swung up and the sail wrapped around the mast and tied. Several coats of paint carefully applied complete the job and give you a sea-worthy boat that can be used for a diving platform, surf board or craft for an outboard motor as well as a foot-powered raft.

## Easy Way to Clean Your Watch

If a watch needs cleaning because the works have become gummed slightly, often the job can be done without taking the watch apart by applying a few drops of carbon tetrachloride to the works. This chemical is one of the best solvents known for grease, which combines with dust to cause the gummed condition. The solvent is very volatile and will evaporate quickly.

# Fun at the beach with this KICK-KATAMARAN

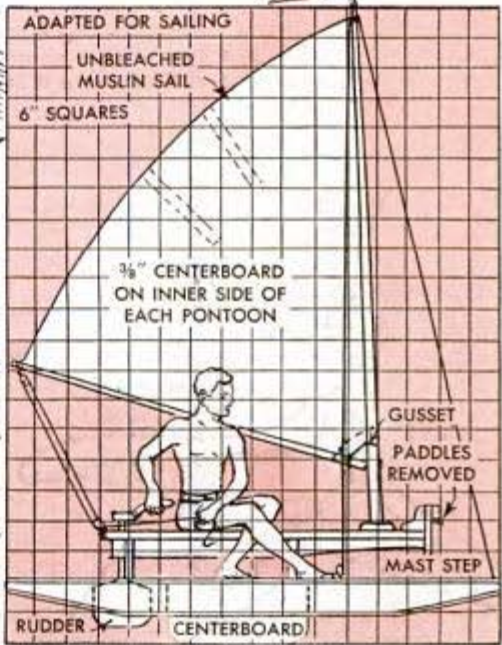
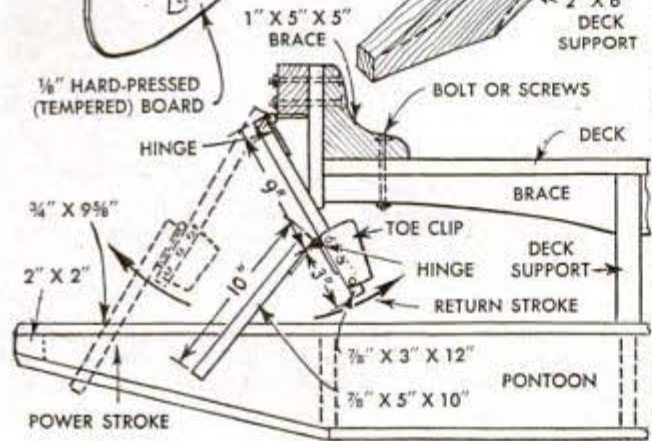
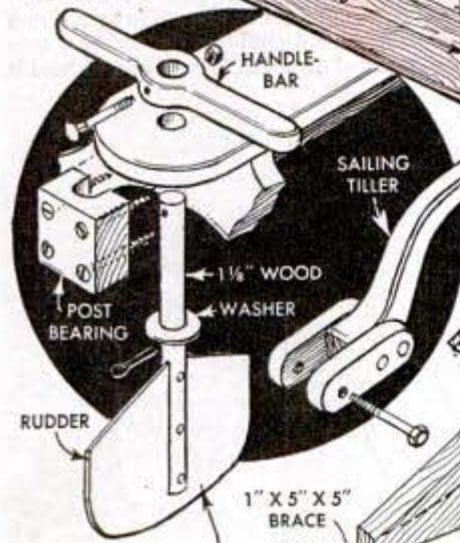
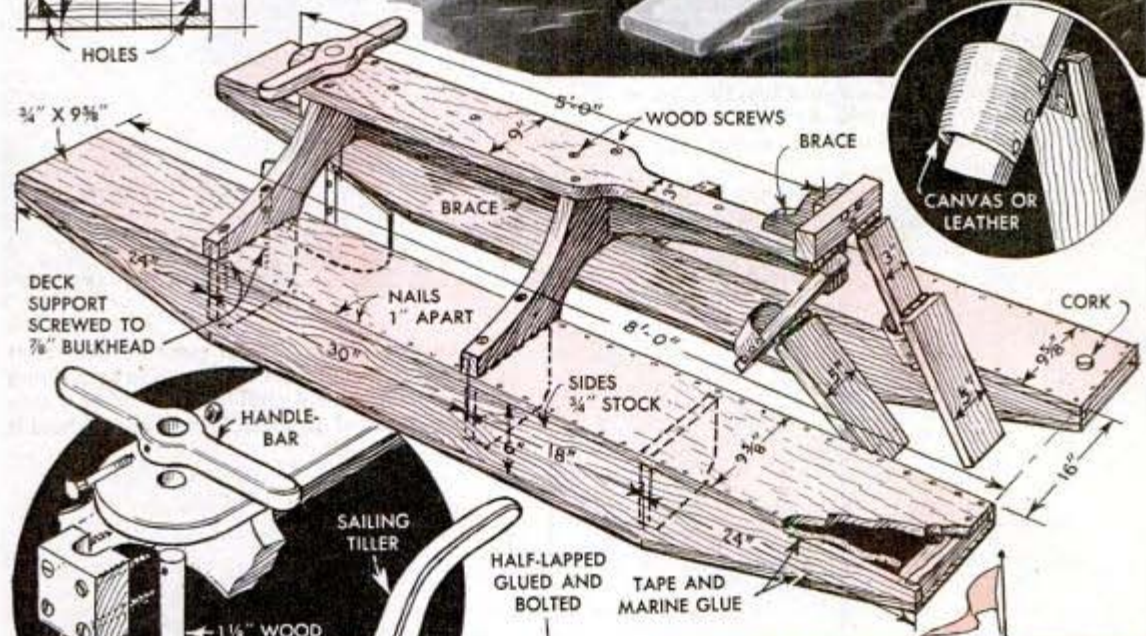
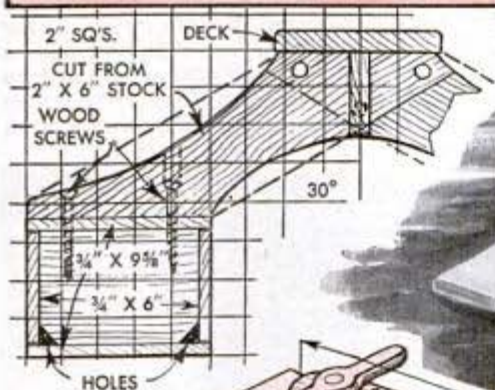

# Solving HOME



Left: Mesh dish cloths with poultry markers attached to each corner make convenient bags which will not snag hose and will hold a number of other small laundry items when hung out of the way on a hook. Below: A potato masher of the type shown will hold a recipe file card so that it can be seen easily while in use, and also keep it clean

Hemming or basting may be done more easily and quickly if the material on which you are working is pinned to a pillow held on your lap, thus leaving both hands free to work. As much as 16 in. of material can be basted without moving the pin

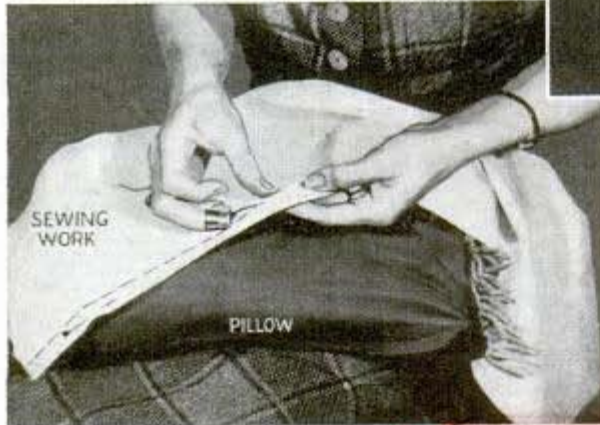
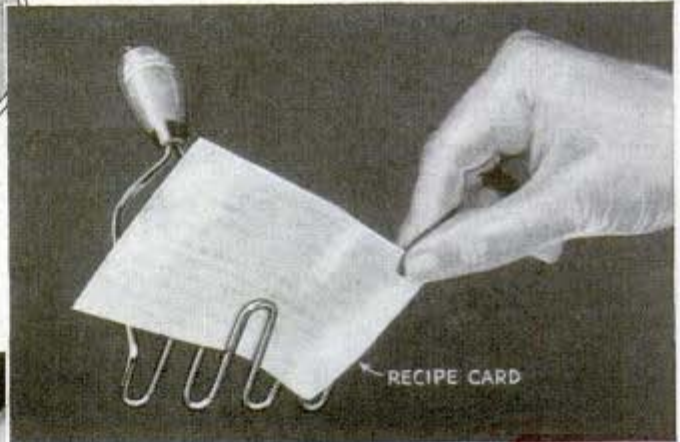

Below: A cleaning stick to scour hard-to-reach places in pots and pans can be made by pushing a small wad of steel wool into the end of a metal tube, the end of which is flattened to hold it

When waxed paper is used as a lining in cake tins, the paper may be fitted by placing it on a warmed tin and using another as a die to force it into place

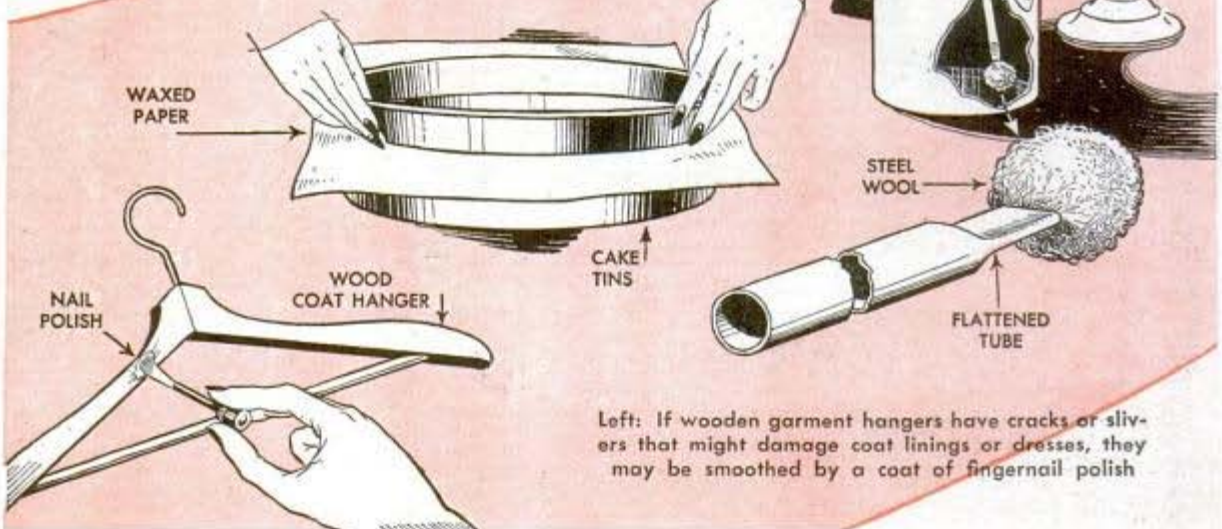

Left: If wooden garment hangers have cracks or splinters that might damage coat linings or dresses, they may be smoothed by a coat of fingernail polish



# PROBLEMS

Right: When hanging doors with butt hinges, insert only the center screw in the part of the hinge on the casing. Then, in fitting the hinges, a little tapping up or down will seat the hinge properly and will make the pin fit without binding, after which the rest of the screws can be inserted. Below: Strips of adhesive tape on the bar of a towel rack prevent the towels from slipping off



Placing a small washer under the loose end of a roll of friction tape will allow the end to be lifted easily, which is more convenient than turning under part of the end

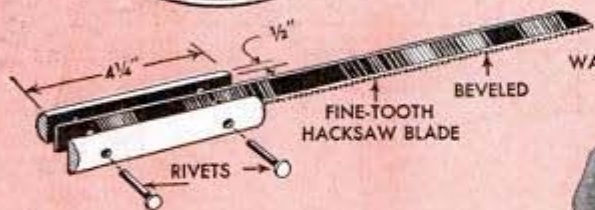

Above: A useful and inexpensive knife that will cut bread to "wafer" thickness and also is good for cutting cake can be made from a small, fine-toothed hacksaw blade which has been ground on the sides to remove the set of the teeth. For a handle, two wooden blocks of the same width as the blade are riveted to it. Below: The next time a stubborn bottle cap refuses to come off, try removing it with an ordinary nutcracker



The danger of baby's slipping on polished floors and linoleum, due to the smooth soles of its shoes, can be lessened simply by sandpapering the soles, using a very coarse grade of paper to roughen them

## Nails Pulled Out of Wood Trim Without Marring Finish

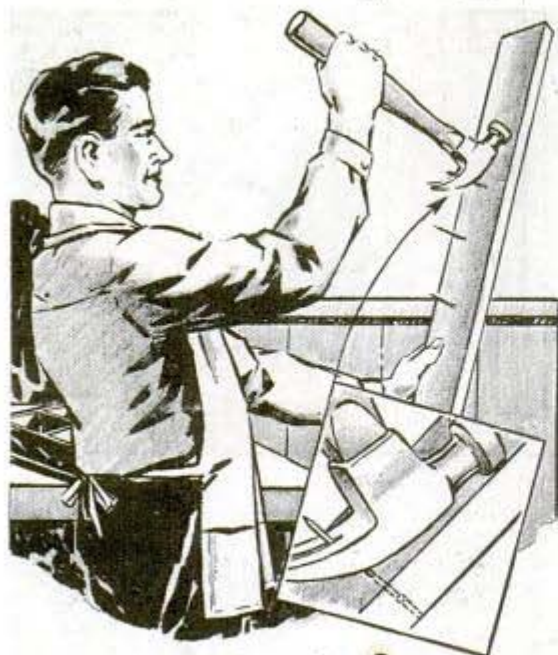

Old interior wood trim may be saved for further use if the nail heads are pulled through the board on the unfinished side. In this way, the putty or filler used to hide nail holes is not disturbed, or the finish marred in any way.

## Old Spectacle Case Used as Grip On Handles of Shopping Bag



To provide a comfortable grip for carrying a shopping bag, one housewife employs a discarded metal spectacle case. The case may be left attached to one of the ropes so it is at hand when needed.

## Inverted Pan on Clothespin Legs Makes Emergency Chick Shelter

When young chicks are left in an open pen and it is possible that they will not return to the brooder in case of a sudden shower, attach three or four clothespins to the edge of a tin pan and invert it

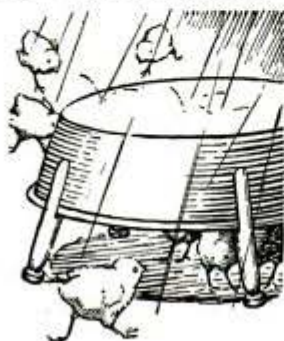

to provide an emergency shelter. Being open on all sides the shelter offers no obstruction to the entry or exit of the chicks, and they immediately learn to use it. Also, one or two chicks making use of the shelter may be seen by the others and thus be induced to take advantage of it.

## Emergency Stamp Pad

An old typewriter ribbon provides a good substitute for a rubber stamp pad in an emergency. Wrap several layers of the ribbon around a heavy piece of cardboard cut to fit inside a small tin or cardboard box. When the stamp no longer gives a clear impression, the outer layer of ribbon can be removed to expose the next layer.



## Small-Gauge Wire Straightened With Discarded Safety Razor

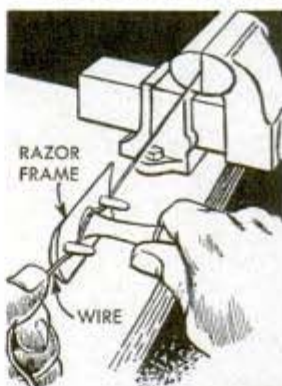

Fine wire that has become kinked can be straightened with an old safety razor of the type shown. Just grip one end of the wire in a vise, thread it through the frame of the razor as shown, and then pull the razor along the wire.

## Converting Three-Cell Flashlight For Use With Two Cells

Anyone having a flashlight that requires three or more cells can effect a saving by converting the flashlight to operate on only two cells. I did this by substituting wood plugs for all cells over two and using a bulb suitable for two cells in place of the larger one. The plugs are turned to the shape and size of a cell, and have long flat-head screws running through their centers as indicated to complete the electrical circuit.

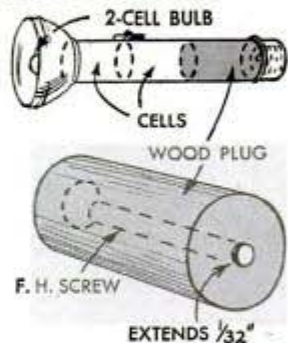

—O. A. Neumer, Jr., Lawrenceville, N. J.

# "Vest-Pocket" Summer House for Your Siesta

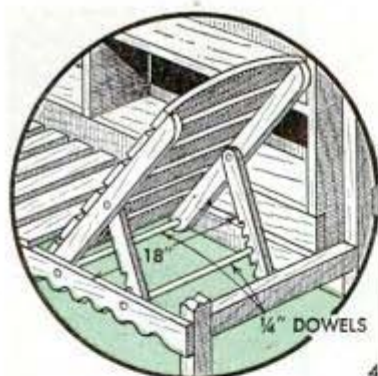

Containing many comforts of home, this cosy little shaded arbor has a couch with adjustable back and shelves for books, magazines, radio, smoking equipment, etc. Since it is exposed to the weather the year 'round, the arbor can be constructed of used lumber, which will take on a mellow tone in pleasing contrast to the foliage of climbing vines. Four posts with the lower ends tarred or creosoted, are set into the ground and the structure built on them. The diamond-pattern lattice on three sides serves as bracing, and light battens are installed on the top. Box shelves are built in the conventional manner, and the adjustable back of the couch is held in the desired position by racks engaging with a stout dowel.

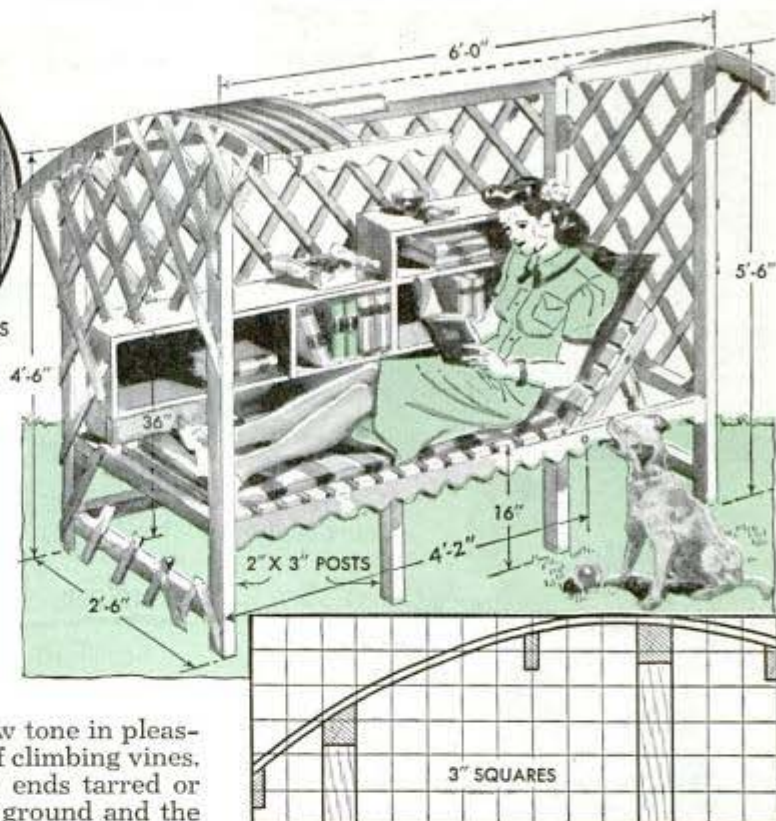

Scrollsawed wood valances are nailed over the lattice at the eaves and along the seat. A pad for the couch can be made from heavy cloth and then padded with cotton or other suitable material. Quilting the pad will keep the cotton from bunching.

## Hammer Used as Aid in Wrapping Small Lacing Cord

When lashing down a finished splice or line with waxed cord, use of a hammer handle as shown improves the job and makes the work easier. A V-notch is cut across the end of the handle to receive the work, after which the lashing cord is fed through a small hole drilled at a steep angle near the notch. By bringing the cord up and taking a turn or two around the head of the hammer any desired degree of tension can be applied.

## Seeds Keep Well in Glass Jars

Store flower and garden seeds in glass jars to protect them from mice, and treat them with a few drops of carbon disulphide to prevent spoilage. The jars also make it easy to label the seed, giving the age and type. Glass jars for seed storage will enable you to keep tomato and other seeds for more than one season and help you to accumulate a wide variety.

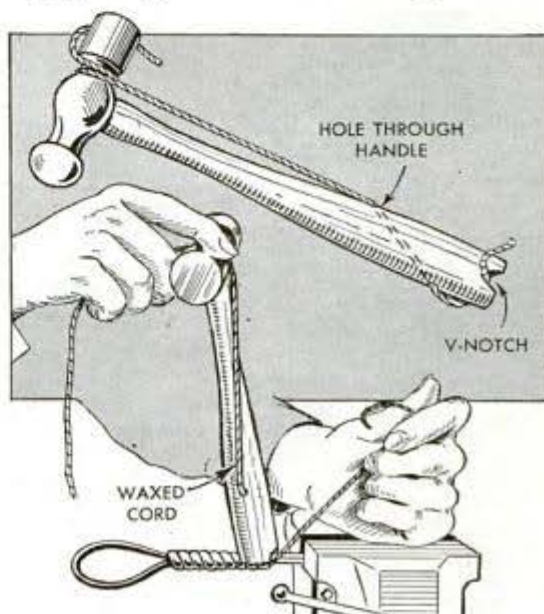



How to use and care for an outboard motor to give it long life

By C. E. Packer

WITH many outboard motor parts no longer available, unnecessary wear or damage to these little power plants becomes more than a personal inconvenience. Many of the actions most harmful to a motor often seem innocent enough. For example, a person who is most careful with his motor when carrying it in a car, may stand it on the tank and flywheel to be sure that it is held firmly as in Fig. 3. In this position, any water in the lower housing is likely to drain into the cylinder where it may cause serious damage. Sometimes you see a motor stored in a boat as in Fig. 2. The power unit being lower than the propeller in this position, is in danger of cylinder rust, piston corrosion, and wrist-pin injury. Of course, padding the engine or tying it securely to prevent bouncing around is essential, but keep the power unit higher than the propeller end.

One of the greatest single causes of trouble with an outboard motor is carelessness in mixing the fuel and oil. Even those who know better frequently trust to luck that vibration will

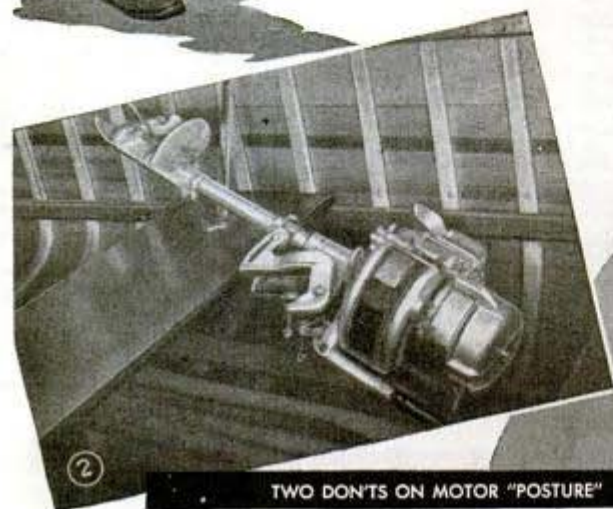

TWO DON'TS ON MOTOR "POSTURE"

# Outboard



blend the oil and the gasoline. If the gasoline and oil are not mixed thoroughly, gasoline alone may enter the motor and cause extremely rapid wear. Oil alone will make starting impossible. Therefore, it is best to mix the fuel in a clean container, such as the special outboard fuel can seen in Fig. 1. The small passages through which the fuel must travel are seen in Fig. 4. As the tiny strainer



4 KEEP GAS LINE CLEAN

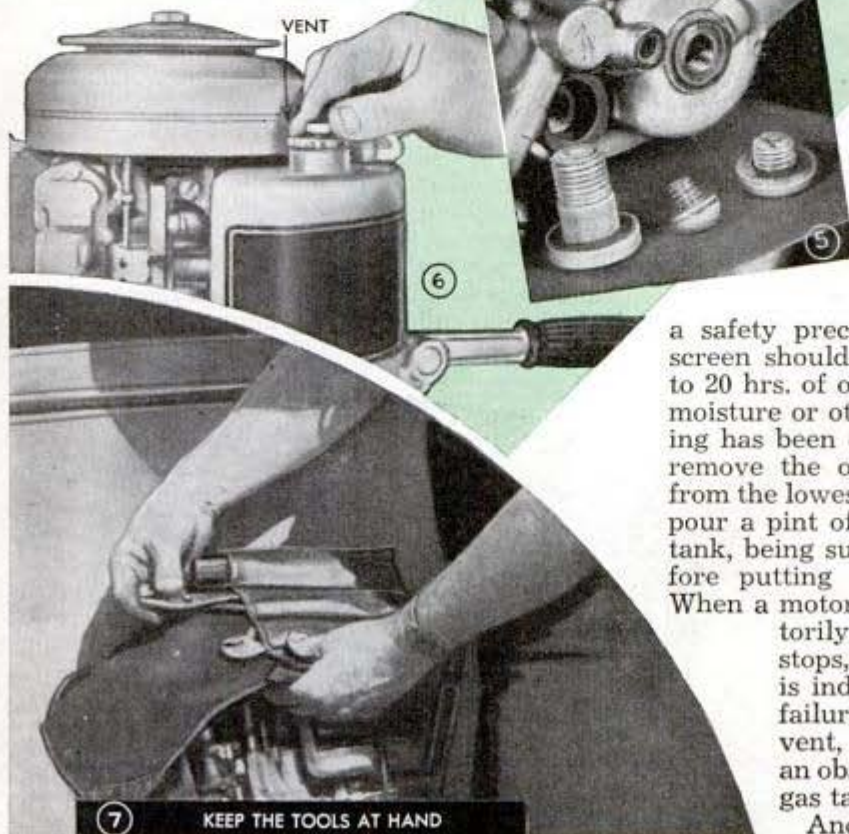

7 KEEP THE TOOLS AT HAND

screen shown on the pencil in this photograph handles the fuel and oil for a 5-hp. motor, it is apparent that a few tablespoonfuls of either oil or gasoline entering through the gas lines or carburetor bowl without being properly mixed may cause serious results. As

a safety precaution, the drain plug and screen should be removed after every 10 to 20 hrs. of operation and cleaned of any moisture or other foreign matter. If starting has been difficult, it is a good idea to remove the other screws seen in Fig. 5 from the lowest parts of the carburetor and pour a pint of clean gasoline through the tank, being sure to shake all of it out before putting the screws back in place. When a motor starts easily, runs satisfactorily for a few moments, and then stops, faulty gasoline flow usually is indicated. This may be due to failure to open the gas tank air vent, Fig. 6, or it may be due to an obstruction in the bottom of the gas tank, or in the gas line.

Another thing to remember is

## Hints on how to use outboard motors



8 FORCING PLUGS STRIPS THREADS



9 GRAPHITE ON PLUG THREADS



10 CORRECT POINT SPACING



11 CHECKING COMPRESSION

always to have the outboard tool kit aboard when under way, Fig. 7. Extensive damage to the motor often results when odds and ends of tools are resorted to in making repairs. Using pliers on the soft aluminum fittings of the motor may damage these parts so that they are useless. And, resorting to too large a wrench, Fig. 8, when installing spark plugs may strip the threads in the cylinder head. Perhaps the best protection against injury to the threads is to apply powdered graphite to the plugs before putting them in place, Fig. 9. This keeps the threads from seizing and makes the plugs screw in easily. Whenever replacing plugs, new gaskets should be used if available, and the plugs should be pulled down just tight enough so that the gaskets are noticeably compressed though not crushed. Failure to pull the plugs tight may cause them to burn. This results from gas escaping around them and raising the temperature above that for which the plugs were originally designed. In addition to this, there is a reduced transfer of heat from the plugs to the water jacket of the cylinder head. This combination teamed up in a high-speed motor can cause total plug failure in a short time. Of course, many motors are used at a lower rate of speed than formerly, trolling by the hour where permitted. Consequently, the selection of proper plugs introduces a new problem. One motor manufacturer advocates reducing the amount of oil in the fuel when the motor is used for trolling, which brings up the problem that one may troll for a period and then, finding results unsatisfactory, "give 'er the gun" and run over to another portion of the lake. Naturally if the fuel is low in oil content, heating and wear may result. For this reason, operators



12 MOTOR ANGLE ADJUSTED

## and the things that you should avoid

who know exactly how and where they intend to fish invariably reduce the oil content for long periods of trolling and keep their high-speed fuel and their trolling fuel in separate well-labeled cans. Then, on a run of 15 to 20 min. out to the fishing grounds, they will dump in just enough gasoline of high oil content to make the fast run, after which the tank is filled with gas of low oil content for trolling. However, it is a good idea to carry a few extra plugs. If a plug has an insulator that is

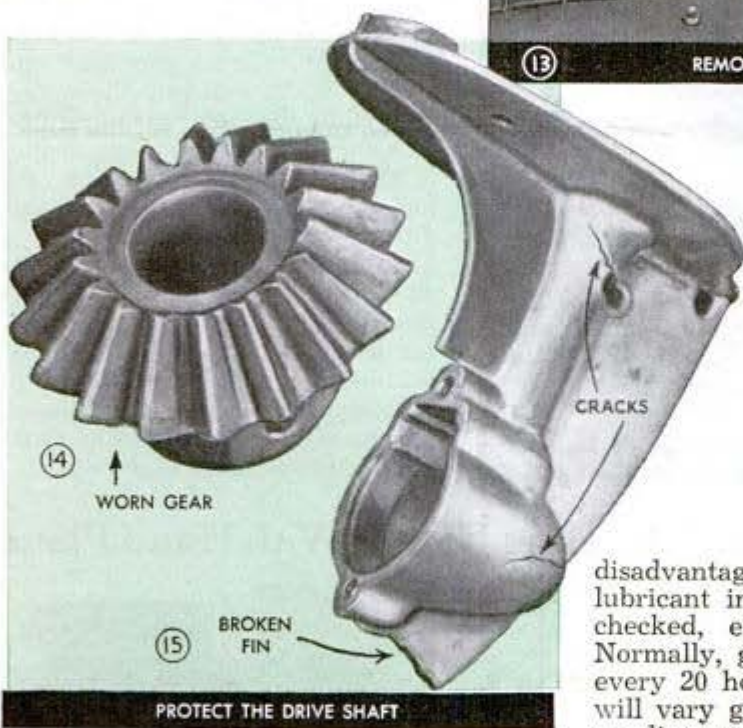
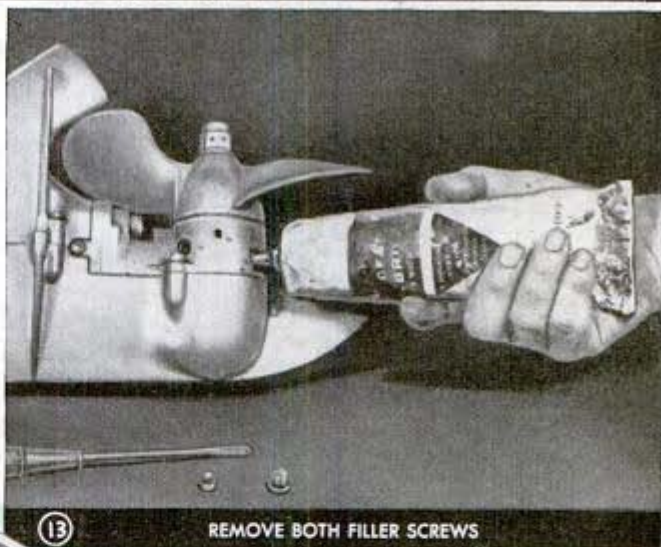

burned pure white, the plug is too "hot" for that particular motor or condition of operation.

Motors that operate satisfactorily at high speed may not run continuously and smoothly at low speed, due to slightly uneven compression. But for best results in any motor, absolutely uniform plug gaps set with a wire-type feeler gauge as in Fig. 10 will help. While the experienced operator learns to "feel" the compression of his motor by grasping the flywheel and turning it, still some operators measure the resistance by using their fish-weighing scale as in Fig. 11. In order to make comparable tests the motor should be warm and the oil mixture in the fuel should be

the same at each test period. On an alternate firing motor it is not necessary to remove a spark plug when making this test, though on a simultaneous firing (opposed) motor plugs of cylinders not being tested should be removed.

When operating a motor on different boats be sure that the drive shaft is vertical, or stands at right angles to the water when the boat is loaded. Failure to adjust the brackets seen in Fig. 12 may place the motor at a decided disadvantage in performance. Also, the lubricant in the gear housing should be checked, especially in smaller motors. Normally, grease should be added about every 20 hours of operation, though this will vary greatly in different motors depending on the tightness of the housing. When checking the unit, both upper and lower filler screws in Fig. 13 should be removed so that the housing will not be airbound. If there is any sign of water it should be removed and replaced by clean grease.

Perhaps the most common form of serious mechanical damage is caused by boulders or logs striking the underwater parts of the motor. Fig. 15 shows a gear housing from which the fin has been broken and in which two serious cracks have been caused by striking a submerged object at high speed. Even though the housing does not break as this one did, the drive shaft may be sprung enough to cause serious gear wear, as indicated by the gear in Fig.

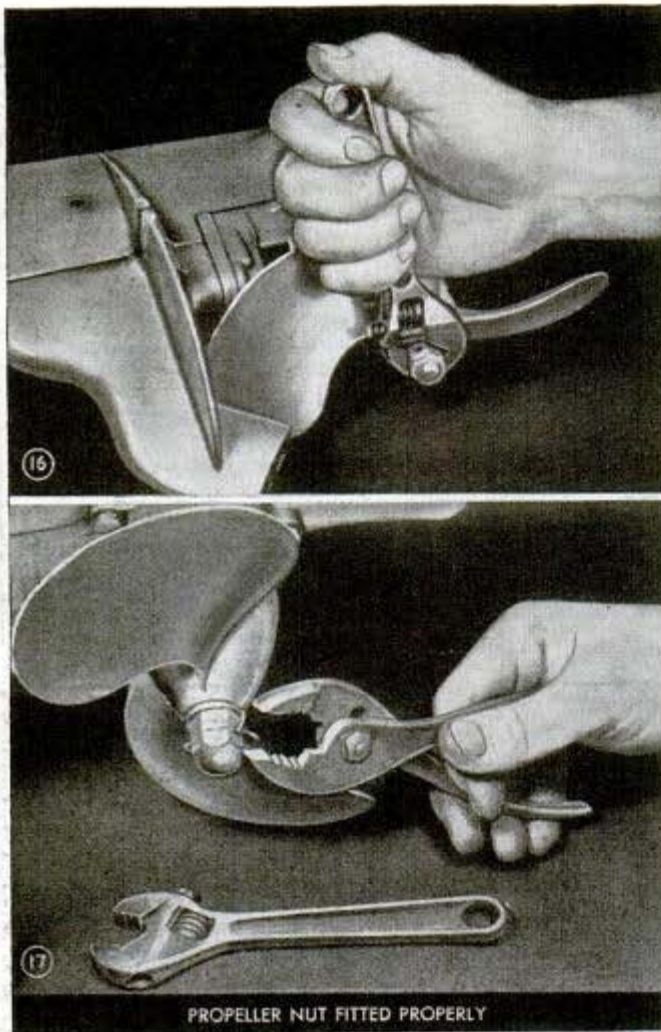

PROPELLER NUT FITTED PROPERLY

14. If shear pins in the propeller persistently "let go" without the propeller apparently striking any object it is an indication that the flywheel is loose on the crankshaft and is imparting a violent rapping action to the propeller. When replacing shear pins it is important to pull the propeller nut up firmly, Fig. 16, yet not tight enough to strip the threads. The cotter pin used to lock the nut should be clipped off short and bent down as in Fig. 17. Any accumulation of seaweed on the lower housing or other obstruction to the flow of cooling water may burn up the motor. Due to failure of the water pump and lack of observation by the user, the motor may become overheated to the point where it loses power and stops. If this happens never turn the motor on end and let water run into the cylinders while they are extremely hot, and don't start the motor so that it will pump cold water into the hot cylinders. Instead let the engine cool off for about 30 min.

Engines operated in salt water should always be rinsed by running them in a barrel of fresh water before putting them away. Failure to do this may result in the complete eating out of all aluminum parts. Next month: **Out-board Maintenance and Repair.**

## Simple Jig Aids in Edge-Beveling Boards With Hand Plane

Having a number of boards on which the edges had to be beveled at exactly 45 degrees with a hand plane, I did the job easily with the aid of this jig. Being nothing more than a triangular wood block, the jig is screwed to the plane to cover half the blade as indicated, and thus hold the plane against the work at an angle of exactly 45 degrees. In this way, accuracy is assured and the beveling job is no more difficult than regular edge-planing.

—Warren L. Jannick, Chicago.

## Preserving Leather Book Covers

Waxing the covers of leather bound books about once a year preserves them in much better condition. The treatment also benefits chairs, luggage and numerous other leather articles. Cover all but the parts to be waxed and apply a thin coating of liquid or paste wax. Let this dry slightly before polishing.

—Mrs. Hal Geihm, Aurora, Ill.

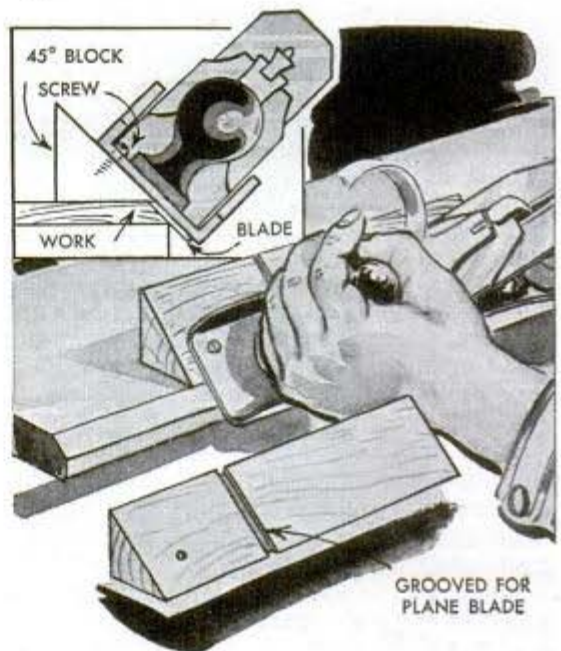



# Baby's Boat Crib Has Storage Space Under Deck

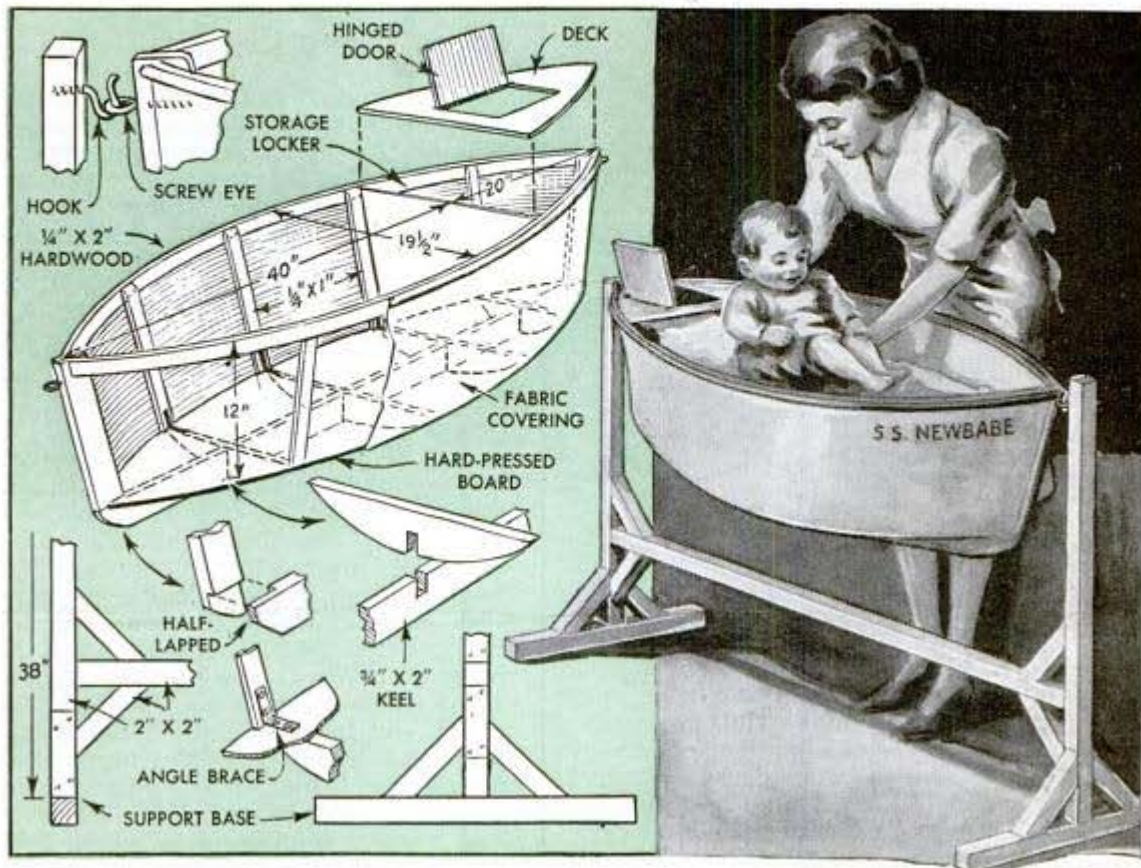

The infant member of your family will sleep comfortably in this boat crib which you can assemble at a small cost, especially if scrap lumber is available. Supported at a comfortable working height for mother, the crib has a storage locker at one end to keep baby's most needed clothing conveniently at hand. After shaping the keel, stem and stern pieces, assemble them with half-lapped joints glued and screwed together. Next shape and notch the bottom crosspieces and fasten them to the keel with nails or small screws. Hard-pressed

board makes a strong floor, and a table pad will serve for a mattress. Stretch canvas, monk's cloth or some other sturdy fabric over the frame, tack in place and trim with half-round molding. The interior side surfaces can be padded with an old blanket faced with colored satin. If a pair of compression coil springs are available, these can be fastened at stem and stern and attached to the support-hooks. Two coats of colored enamel will make the cradle an attractive and unusual piece of furniture.

—Charles J. Lowe, Tracy, Calif.

## Student Carries Ruler Easily in a Loose-Leaf Note Book

Student draftsmen and others who often have to carry a ruler as well as books and other items, will find that the ruler, or even a triangle can be carried easily in a loose-leaf note book. Just drill holes in the ruler so that it can be slipped over the rings in the note book as indicated.

—Richard F. Crocker, Worcester, Mass.

¶If you carry several keys, painting the key and lock the same color, but using different colors for each different lock set, will enable you quickly to select the desired key merely by matching the colors.



## "Raincoat" Keeps Bandage Dry During Shower Bath



An efficient "raincoat" to keep bandages dry while taking a shower can be made from oiled silk or other water-repellent material. Sew together the ends of a strip of the material of suitable size. Make a wide hem at the top and insert a strong drawstring. This shield may be used to cover a bandage on the hand, arm or leg.

## Leather Paddle Protects Wood From Hammer Marks



Since one misdirected hammer stroke can mar the finish of fine wood in furniture repairing or similar jobs, some kind of a protector is needed. One of the best of these is a piece of leather cut in the shape of

a paddle in which a hole is cut sufficiently large to take nail heads. After the nail has been started the paddle is placed over it.

## Cleaning Powder Removes Spots Of New Type Paints

Splattering of some of the new type fast-covering wall paints on woodwork or other surfaces can be removed easily by rubbing with ordinary abrasive kitchen cleansing powder. The paint will come off even after it has been allowed to set for a long period. Such a method is more effective than razor blades or fine sandpaper.

## Rugged All-Purpose Wagon Eases Home Chores

Built entirely of wood except for wheel spindles and bushings, this wagon will ease many of your home chores. Besides being ideal as a coaster for the children it can be used for bringing home groceries and merchandise or for collecting junk. With the "hayrack" in place, it will hold large quantities of grass cuttings, weeds, brush, kindling or magazines and newspapers. And, for the infant member of the family, there is a seat on a hickory spring that fits into a slot at the forward end of the wagon body. The corners of the wagon box are reinforced with sheet metal, and the rear axle and front bolster are braced with knees screwed on from the top. Slots are cut in the bottom of the box to receive the eight legs of the hayrack; another one at the front end accommodates the hickory spring for the baby seat. Wheels are 1½ in. thick and 9 in. in diameter, each consisting of two ¾-in. hardwood disks glued and screwed together with the grain running at right angles. The edges of the wheels should be beveled slightly to help prevent splintering. Machine bolts serve as wheel spindles on which the pipe wheel bushings rotate. An oilhole is drilled in each bushing to line up with one drilled at an angle into the side of the wheel. The latter hole is packed with cotton to retain oil and is plugged at the top to keep out dirt. For the baby-seat spring a hickory slat is steamed and bent to the shape indicated. The seat is pine and the curved back ¾-in. hard-pressed board.

## Finishing Nail Interlocks Joints In Door Jamb

Here's a trick one carpenter uses to interlock the joints when assembling door jambs. After nailing them together in the usual way, he drives a finishing nail in from the edge, letting it



straddle the joint as shown so that it partly embeds in the header and in the jamb, thereby locking the two together securely.

—Wayne C. Leckey, Chicago.



# Make This All-Purpose WOOD WAGON

With this wagon the children can take over many of the chores around your home. Built rugged for hard wear and heavy loads, it has a removable spring seat for the baby and a "hayrack" for bulky materials. Metal wheel spindles and bushings make the wagon a free-running coaster.

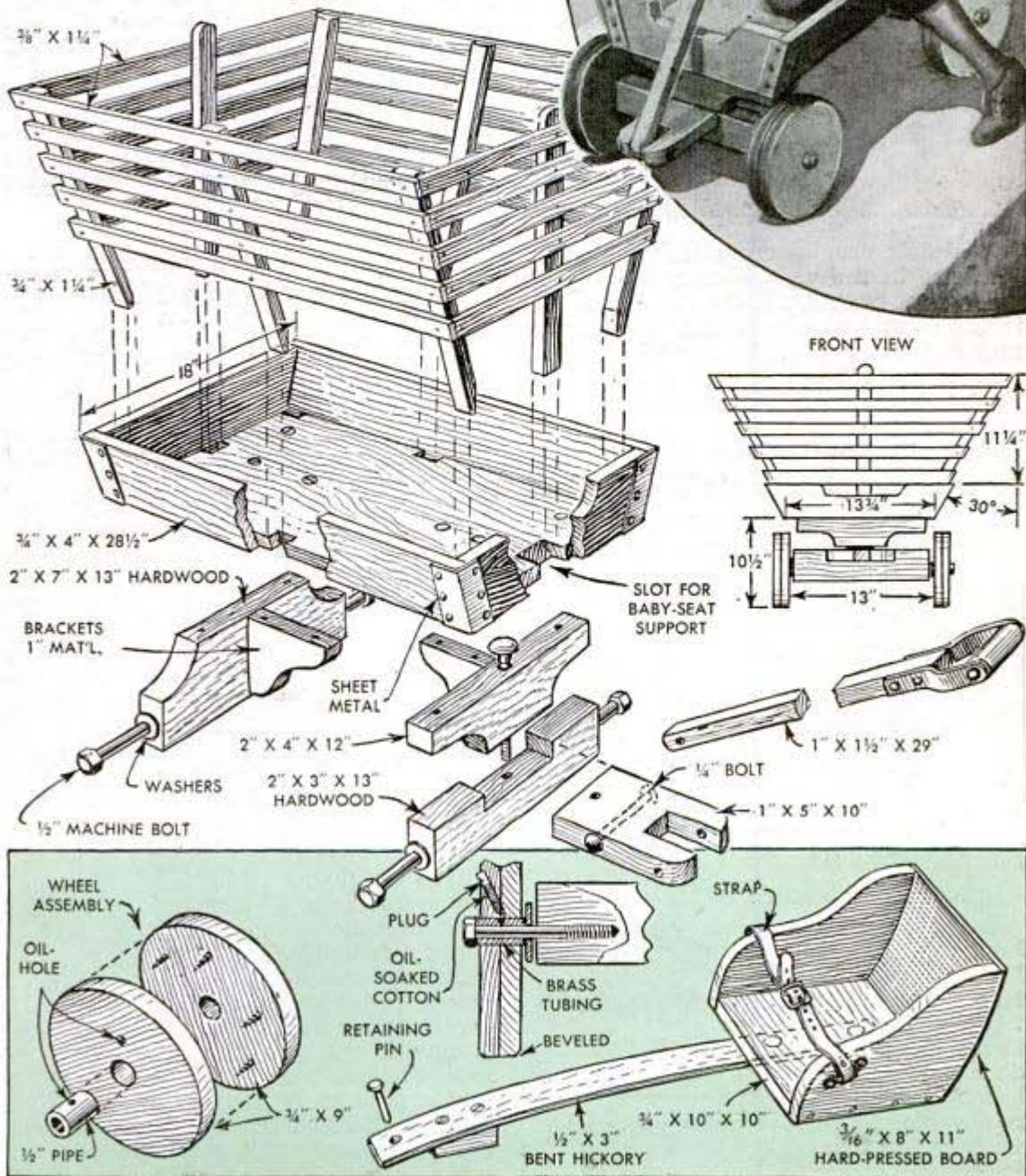

## Pivoted Footrest in Boat Swings Out of the Way for Bailing

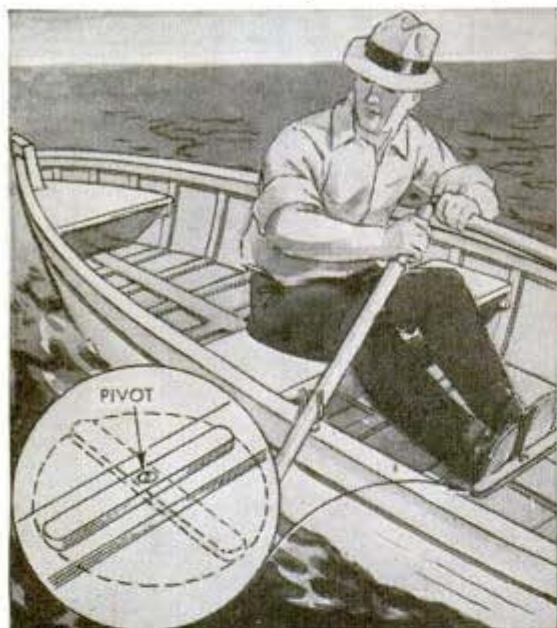

Footrests usually are attached so that they are in the way when scrubbing or bailing out the boat. If the rest is pivoted, it will serve its purpose equally well and may be turned out of the way when not in use. The pivot bolt or screw should be tight enough to hold the rest in its closed position.

## Round-Handle Tools Won't Roll If Sides Are Flattened

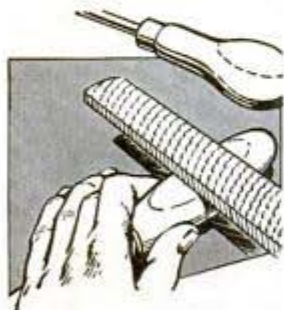

Rolling of round-handled tools on sloping surfaces can be avoided by flattening one side of the handle. This is especially helpful with tools that would be damaged by a fall.

## Removable Band Slipped on Hat Keeps Fishing Flies Handy

Instead of sticking fishing flies in his hat band and then removing them when through fishing, one sportsman keeps them in a removable band, which he carries in his tackle box



and slips over his hat. Any band of cloth can be used, but a band cut from the crown of an old hat is ideal. If the band is a little too small, it can be stretched by notching the upper and lower edges as indicated.

## "Depth Gauge" for Rotary Plow

When your rotary garden plow cuts too deeply in loose porous soils, making it difficult to push and causing it to uproot small plants, twist two or more pieces of medium heavy wire around the blades in the position shown.

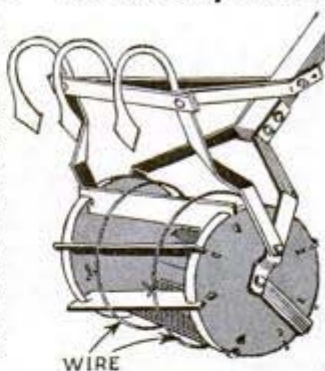

These hold the rotor to a more shallow depth. It may be necessary to readjust the scuffle blade to compensate for the shallow cut of the rotor.

## Dampened Sand Protects Ax When Burning Out Handle



You can burn a broken handle out of an ax with a blowtorch without taking the temper from the blade if it is buried in a pail of dampened sand. By using an old paint pail of a height to hold the ax eye in line with the flame of the blowtorch, you

will not be obliged to waste time in holding the torch in place during the burning.

## Preventing Loss of Hinge Pin When Tent Pole Is Folded

If the ridge-pole of your tent is hinged to fold for convenient packing, and you occasionally lose the loose pin, substitute a cotter key for it. The key should be cut off so that it does not project to damage the tent cloth. Inserted in the hinge, after the pole has been folded, the key will spread sufficiently to hold itself.

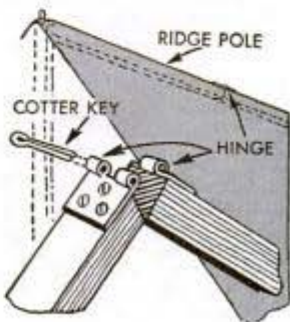

# Lazy Susan Lawn Table Serves Many Guests

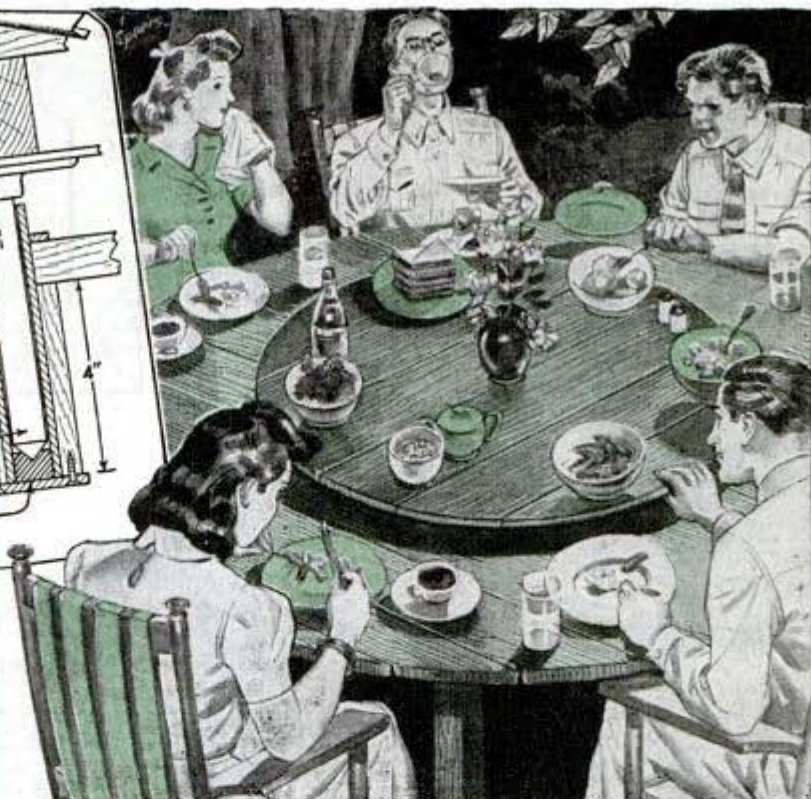
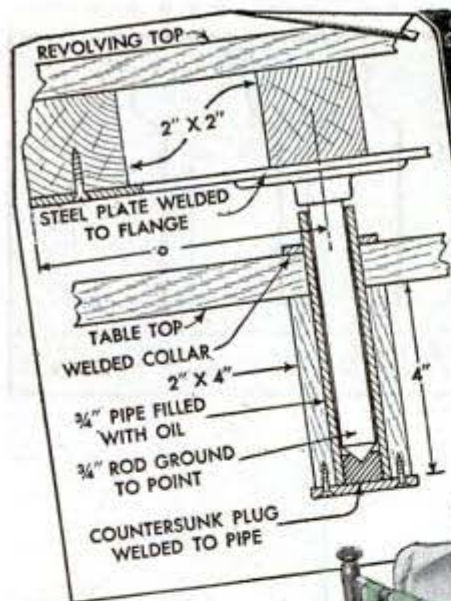

Ten or more guests can serve themselves at this "Lazy Susan" barbecue table by rotating the turntable. If a natural finish is desired, cypress is best, but common lumber, varnished or oiled (linseed oil), will do. Or, you can paint to match other lawn furniture. The axle is an iron bar threaded at one end and screwed into a pipe flange which is welded to the cleats on the underside of the turntable. A second pipe flange screwed to the upper side of the cross bar can be used as a pivot instead of the arrangement shown, but this method will not give such strong support for the turntable, especially if it is unevenly loaded with dishes.

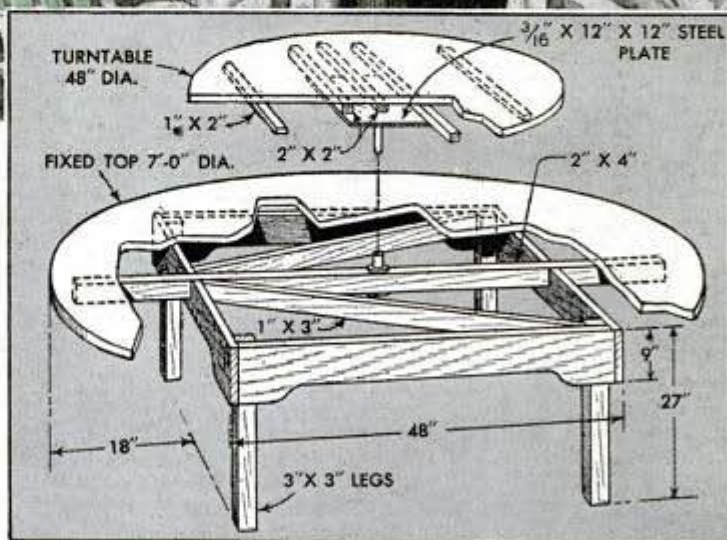

## Inexpensive Wallpaper Cleaner You Can Make at Home

For an effective wallpaper cleaner, heat salt, 3 oz. by weight, to a boil in the top half of a double boiler, but do not try to dissolve the salt completely. Transfer this mixture at once to the lower half of the boiler where plain water is boiling and add flour, 1/2 lb., kerosene, 1 tablespoonful, and stir briskly. Cover and cook for another 15 min., and knead smooth when cool. Dust and dirt can be cleaned off plastered or

wallpapered walls by forming a ball of part of the cleaner. The ball is drawn lightly over the surface, and the dirt should be kneaded into the ball as it collects.

Wiping washing machines and galvanized or porcelain wash tubs with a rag dampened in kerosene eliminates soap scum and gives the tubs a high polish. The kerosene odor soon disappears.

# How to Make



*Silt test*



By Walter E. Burton

**D**URABLE concrete is a result of careful selection of materials, correct proportioning of ingredients, especially the cement and water, and proper treatment after pouring the concrete. For best results, there are a few tests that anyone can employ to judge materials, and equally simple rules to follow in mixing the ingredients. First is the correct selection of aggregate, which is sand and gravel. Fine sand is composed of particles ranging in size from just a bit larger than dust, to pebbles that will pass through a screen having four meshes to a linear inch. Coarse aggregate or gravel consists of particles ranging in size from  $\frac{1}{4}$  in. to  $1\frac{1}{2}$  in. or more. The largest size of gravel to use is dependent, in many cases, on thickness of the concrete work. Generally, no particle larger than

one third the thickness of the thinnest section of the work should be used.

For concrete that will stand long wear, use aggregates made of hard, sound material. Soft or flaky aggregates will not stand much weathering, and sometimes are responsible for unsightly holes often seen in improperly puddled sidewalks. The aggregate should be well graded. That is, it should consist of particles of various sizes so proportioned that they will fit nicely together to form a uniform mass, with the smaller particles filling the spaces between the larger ones as in Fig. 9. In most cases, material direct from a sand or gravel bank is not proportioned correctly as to particle size, and usually contains too much sand. It must be washed, screened and recombined for best results. For this reason it is best to purchase your aggregate from a dealer who sells aggregate washed and correctly graded. Good concrete cannot be made with sand that contains an appreciable amount of extremely fine material (silt). Sand can be tested very easily for

# CONCRETE *That Will Last*

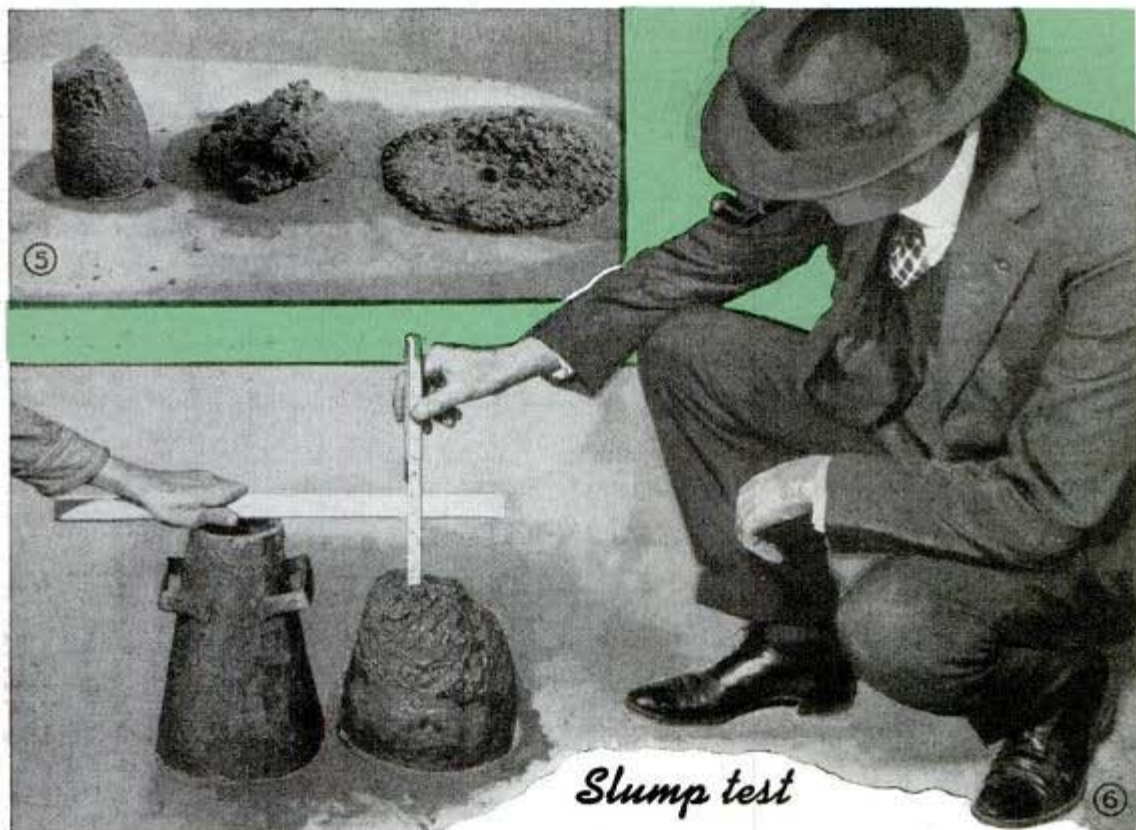

*Slump test*

silt content with nothing more than a quart fruit jar and a ruler, Fig. 1. Fill the jar to a depth of 2 in. and pour in enough water to fill the jar about three-quarters full. Screw on the lid and shake the jar vigorously for a minute. Then set it aside for an hour, or until the water clears. The silt, settling out of the water, will form a layer on top of the sand. If this layer is more than  $\frac{1}{8}$  in. thick, Fig. 2, the aggregate is unfit for use, and should be washed to remove the fine material.

Another thing that causes poor concrete is too much organic matter in the sand; bits of roots, pulverized leaf mold and so on. A simple test for this is shown in Fig. 3. Get a 12-oz. prescription bottle from the drug store, and fill it with sand to the  $4\frac{1}{2}$ -oz. mark. Dissolve sodium hydroxide (caustic soda),  $\frac{1}{4}$  oz., in water, 8 oz. and pour this into the bottle to the level of the 7-oz. mark. Cork the bottle and shake it for several seconds. Then let it stand for 24 hours. By examining the color of the liquid, you can judge the amount of organic matter present as indicated by bottles A, B and C in Fig. 3. If it is clear, the aggregate contains no organic material. A straw color is caused by the presence of some organic matter, but not enough to

cause trouble. If the solution is dark, there is too much vegetable material and the sand should not be used for concrete. This test is useful for appraising new sand deposits as well as for checking new sand you buy from a dealer or that which has been stored in the open for a long time. The test is easy to make, but caution should be exercised in handling the hydroxide solution, which is injurious to the skin, leather and clothing.

Any water that is suitable for drinking can be used for making concrete. Do not use water containing salt, as it will make reinforcing bars rust. The amount of water used in proportion to the cement is highly important. Hardening of cement is a chemical action in which the cement combines with a certain amount of water to form a permanent compound. If too much water is used, there will be small spaces or voids in the concrete after the excess water evaporates, and the concrete will not be watertight and durable. Extensive research on the amount of water to use for best results has been carried out until today the rules are fairly well fixed and easy to follow as indicated by the table in Fig. 11. When mixing concrete with special attention to the quantity of water, the amount of moisture already in the sand must be



taken into account. Water in the coarse aggregate does not matter because the maximum volume such aggregate can retain is low. Sand can be divided into four classes: very wet, wet, damp and dry. You can test these conditions accurately enough with your hand. Very wet sand is dripping wet, and leaves much moisture on the skin when handled. Wet sand, which is the condition usually encountered, feels wet to the touch, and leaves a small amount of moisture on the skin. Damp sand feels a little damp but leaves almost no moisture. Dry sand runs freely through the fingers. In general, the amount of water in a cubic foot of sand can be expressed as follows: Very wet sand,  $\frac{3}{4}$  gal. or 6 percent, wet sand,  $\frac{1}{2}$  gal. or 4 percent, damp sand,  $\frac{1}{4}$  gal. or 2 percent, and dry sand, none. If you want to be exact on the amount of

water in the sand, spread some of it, say 2 lbs., in a shallow pan. Then mix denatured or wood alcohol thoroughly with the sand and ignite it. Continue stirring as the alcohol burns. If the sand still seems damp after the alcohol has burned, repeat the treatment. Let cool for about 10 min. Then weigh the sand again. The percentage of moisture can now be calculated by subtracting the dry weight from the wet weight and multiplying by 100.

If you have a quantity of concrete to mix, first make a trial batch. Try the proportions suggested in the table. If the batch is too stiff, reduce the amount of aggregate or add more water and cement. Do not add water alone, for that upsets the cement-water ratio. If the batch is too thin,



simply add more aggregate, but not more cement. In general, a stiff concrete is best for footings, foundations, pavements and walls, while a more plastic mixture is best for work that is of thin section. You can use the slump test, Figs. 4 and 6, to determine the consistency of concrete. First make a sheet-metal cone of 16-ga. galvanized iron. Set the cone, large end down, on a flat surface, and fill the cone about one-fourth full. Compact this by puddling with a  $\frac{5}{8}$ -in. iron rod, using 25 strokes. Add concrete to fill the cone to about half its depth, again puddle with 25 strokes and finally fill the cone completely, and puddle as before. Now lift the cone straight up, leaving the concrete on the board or slab or whatever surface you used. The "slump" of the pile is the difference in inches between its height, measured as soon as the cone is removed, and the height of the cone. If the slump is from 1 to 4 in., the concrete is of the right consistency for massive construction such as pavements and floors laid on the ground. A slump of 3 to 6 in., indicates concrete suitable for posts, walls, beams, heavy slabs and tank walls. Concrete that slumps from 4 to 8 in. is best for garden furniture and vases, ordinary beams or slabs, columns and thin



walls. The three slump batches pictured in Fig. 5 show stiff, medium and wet concrete mixtures.

For sidewalks, driveways and terraces, Figs. 7 and 12, the concrete can be placed directly on the ground if there is good drainage, first tamping the earth to compact it. If drainage is poor, use a 6-in. layer of clean, coarse gravel or clean cinders beneath the concrete. Compact this sub-base thoroughly. Concrete should be placed in the forms within 30 min. after mixing, Fig. 10. Puddle it thoroughly with a stick, spade or trowel, to work the coarser particles of aggregate away from the forms and the top surface and thus produce a uniform outer surface on the work.

And finally, after you have gone to the trouble of making and placing your con-



(11) WATER AND CEMENT PROPORTIONS <small>Courtesy Portland Cement Association</small>						
Kind of Work	Water, gals. per sack of cement			Suggested trial-batch mixtures		
	Very wet sand	Wet sand	Damp sand	Cement, sacks	Aggregates Fine cu. ft.	Coarse cu. ft.
5-gal. paste, for greatest durability						
Topping for heavy wearing surfaces and other 2-course work such as pavements, tennis courts, walks, floors	4¾	4½	4¾	1	1	1½
One-course industrial, dairy and other floors, and concrete subjected to weak acids and alkalis	3¾	4	4½	1	1¾	2
6-gal. paste, for watertight concrete exposed to moderate weather						
Watertight floors, foundations, walks, drives, tennis courts, storage tanks, septic tanks, swimming pools, reinforced structural beams, slabs, etc.	4¾	5	5½	1	2¼	3
7-gal. paste for concrete not subjected to water, weather or wear						
Foundation walls, footings, mass concrete	4¾	5½	6¼	1	2¾	4
<small>Note: In calculating mixes, remember that 1 cu. yd. contains 27 cu. ft. Sand classed as "wet" in table is average sand.</small>						

crete correctly, don't lose half of its strength by improper curing. Concrete that is kept moist seven days is 50 percent stronger than concrete that is permitted to dry out immediately. Keeping it damp one month boosts the strength 100 percent. To keep sidewalks, driveways, floors and the like moist, cover them with straw, leaves or earth as soon as the surface has hardened enough to prevent marring, and sprinkle occasionally with water. Cover vertical walls with burlap, canvas or old carpet, and keep moist for ten

days. In cold weather protect the work but do not moisten it. Extra attention to quality of materials, methods of mixing, etc., will assure long life for projects such as the concrete outdoor living room in Fig. 8.

Remember to tamp the earth or base under a sidewalk or driveway thoroughly; use aggregate that has been graded properly, proportion the cement, water and aggregate correctly and mix the ingredients thoroughly. Puddle the cement to bring the fine particles to the top and make a smooth, finished surface.

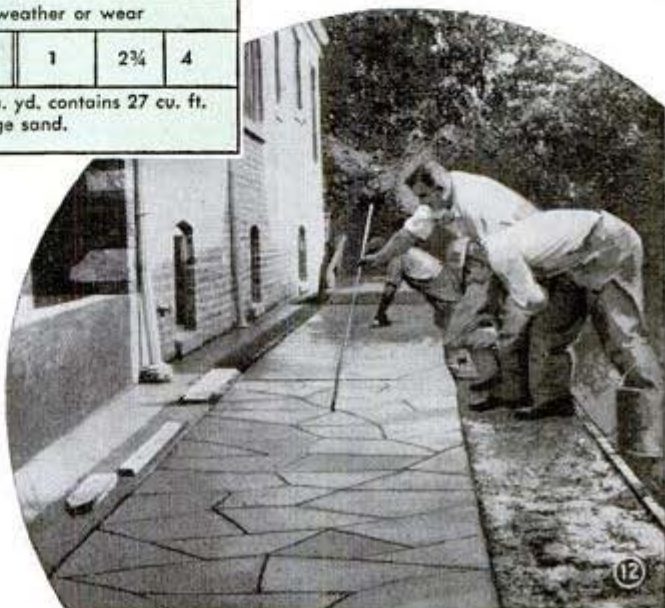

## Pusher Handle on Coaster Wagon Keeps It Under Control



To allow his child the thrill of steering his own coaster and still keep it under control to avoid possible accidents, one father made a control handle like the one shown. This consists of a handle from a discarded carpet sweeper, the braces of which may be sprung to engage holes punched in the sides of the coaster body near the back. The handle is easy to attach or remove.

## Bent Rod Makes Stake and Reel For Pony or Goat Tether

When it is desired to tether an animal where the rope must be shortened occasionally to restrict the feeding range, make the tether stake from a rod as shown. The

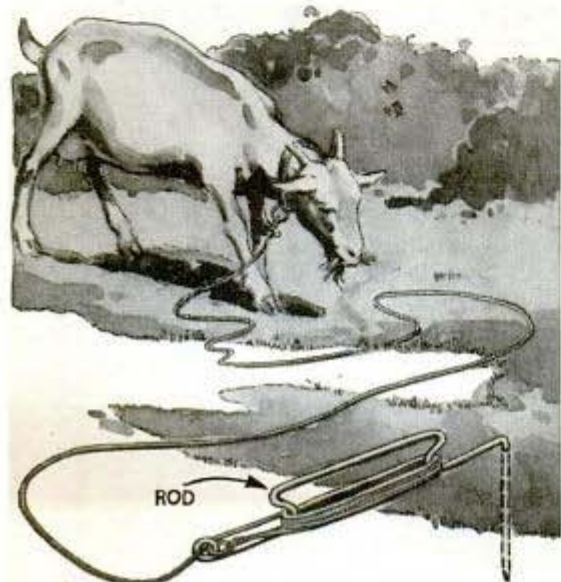

free end of the rope should be tied to the loop at the end of the rod and the remaining rope may be wrapped around the reel section to shorten it as desired.

## Capsules Removed From Box Easily With a Rubber Bulb

If you have experienced difficulty in removing vitamin capsules from their containers, try using an old medicine-dropper bulb to lift them. The bulb will slip snugly over most capsules of this type.

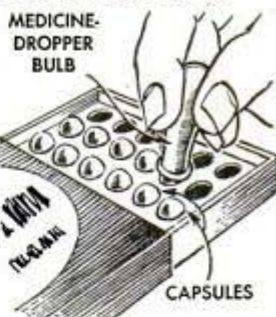

It may help to squeeze the bulb while placing it over a capsule and thus create a partial vacuum inside the bulb, when it is released, to aid in gripping the capsule.

## Tent Walls Pegged to Small Logs Exclude Insects and Water

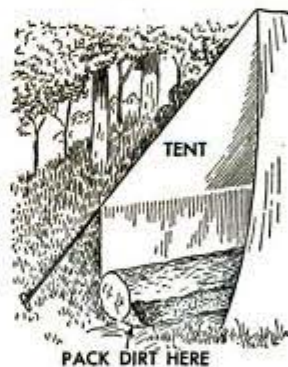

Campers who pitch a tent for several days at a time will find this method of fastening down the side walls of the tent ideal for keeping out insects and water. Just place small logs inside the tent next to the walls and fasten them to the

logs. Pack dirt along the inner sides of the logs as indicated.

—Corp. Darrell Roberts, Arcadia, Calif.

## Colored Pennants Help Locate Lost Archery Arrows

As an aid in noting the path of archery arrows that miss the target, one instructor attaches pennants of different colored cloth to a string, which is then stretched between stakes placed to one side and slightly behind the target. By noting the color of the pennant in the path of the arrow, a player can follow the line of flight easily.

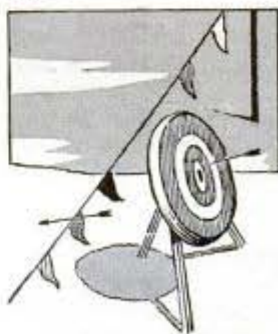

# Knockdown WORK TABLE



This handy table costs little, yet is rigid enough to be used as a model-maker's bench or a support for long work. It is useful in small apartments, for it can be taken apart by removing eight wing nuts, and stored flat behind a door or in a closet

ALL PARTS  
3/4" HARD-  
WOOD

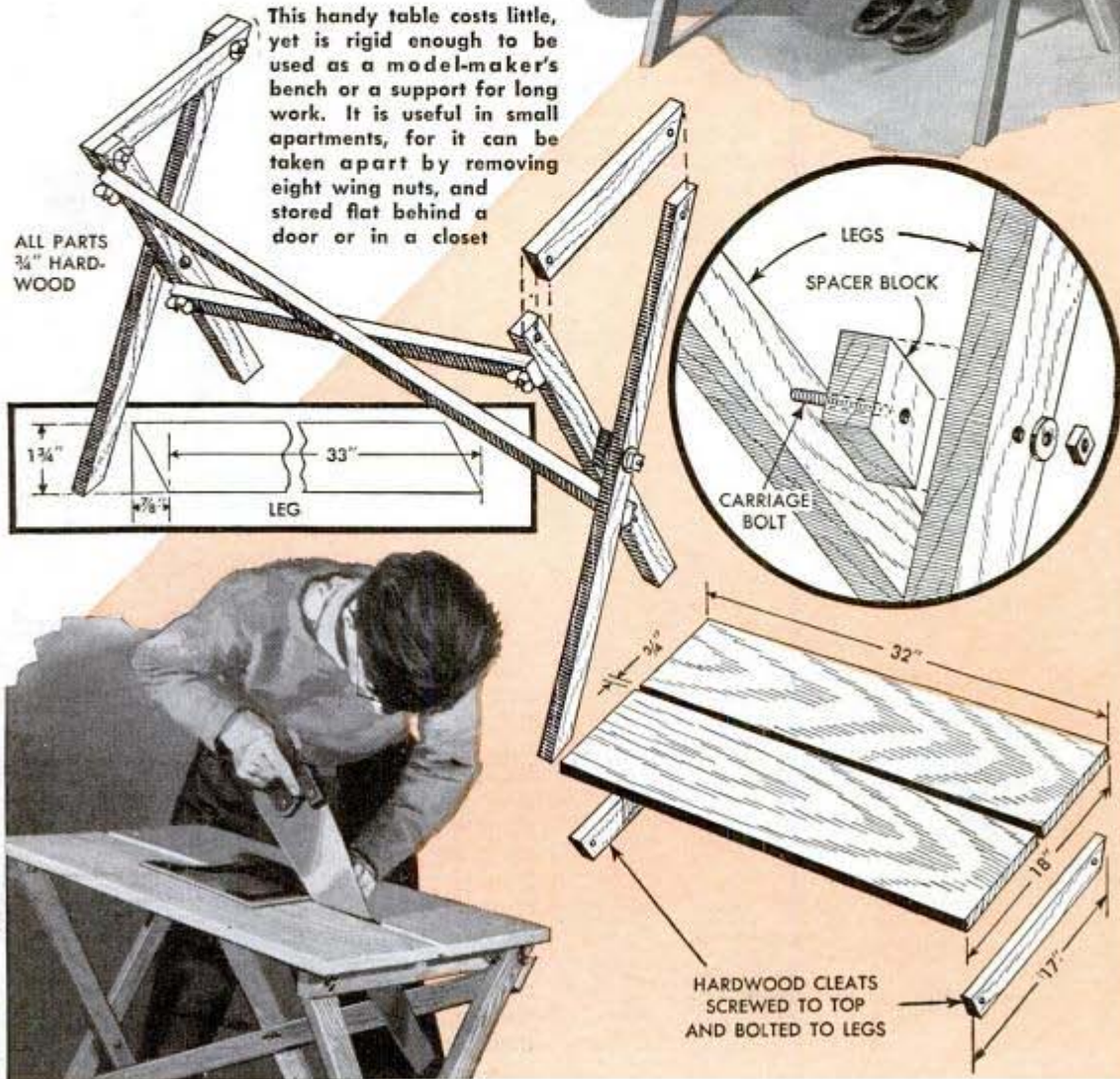

## Folding Porch Chair Converted Into Walker for a Baby

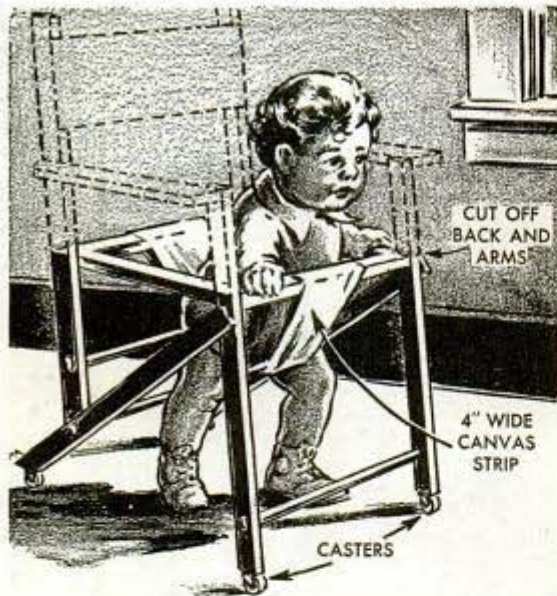

Being unable to locate a walker for our baby, I built one from the frame of a folding porch chair. The back and seat were removed from the chair and casters were put on the legs, after which a canvas strip 4 in. wide was tacked between the front and rear cross members to form a saddle. The walker still folds just like the chair, permitting it to be stored in a small space.  
—Fred A. Beard, Detroit, Mich.

## Wattage of Overhead Lamp Read Through Pinhole in Cardboard

Instead of climbing a ladder to read the wattage marked on the end of a lighted lamp bulb that is mounted in a vertical

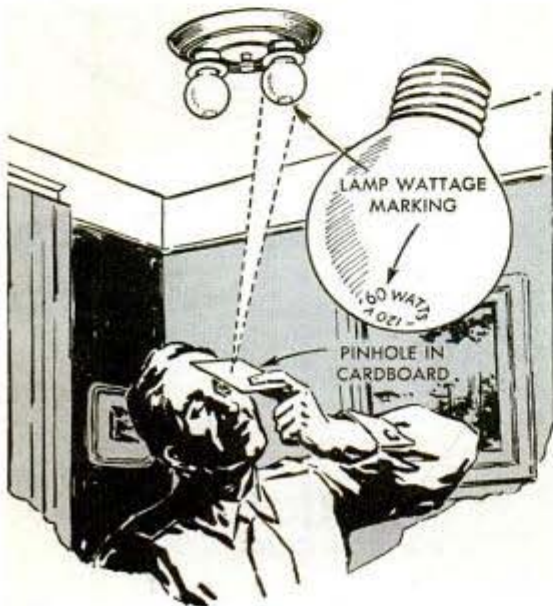

position overhead, look through a pinhole in a piece of cardboard and you can read the lettering provided the lamp is not too high from the floor. Hold the cardboard in front of your face, close one eye and look through the pinhole with the other eye.

—Thomas Trail, Baltimore, Md.

## Simple Marking Jig Aligns Mating Dowel Holes

With two pins in a block, the job of locating mating dowel holes accurately is simply a matter of placing the block on one member and pressing the joining member squarely against the pin heads to make impressions (drilling points) in both pieces. The pins, of course, must be spaced and extend the proper distance to suit the work.—Wayne C. Leckey, Chicago.

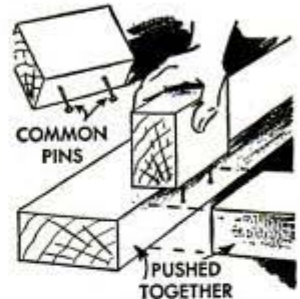

## Clip Holds Paper Basket Upright



To avoid tipping waste baskets in one office, the side of each desk is equipped with a spring-type clothespin. This is screwed to the desk at the same height as the paper basket. The edge of the latter

is slipped between the jaws of the pin and is held securely, although it is easily released for emptying.

—Ken Murray, Baltimore, Md.

## Glue Brushes From Sash Cord

Instead of discarding an old piece of sash cord, cut it into 6 or 8-in. lengths, and fray the ends so they can be used as glue brushes. These are especially useful because they can be disposed of when a job is finished, thus eliminating time required to clean an ordinary brush.



—Pvt. Don Brooks, Fort Ord, Calif.

# Refinish That Old Floor

By  
J. C. Montgomery

WITH a modern floor-sanding machine, anyone can refinish an old floor, even one in which the surface is badly scarred and the boards are buckled slightly at the joints. In most towns and cities these sanding machines are available for rent in hardware stores, lumber yards and paint stores. The floor should be sanded deeply enough to cut down the buckled joints, and to remove all the old stain and finish. Usually this is done by going over the floor first with a sanding belt of very coarse grit, then one of medium grit, and finally with one of fine grit.

After sanding, careful treatment is necessary to bring out the full beauty of the wood. Protect a newly sanded floor with paper as in Fig. 1 until it is refinished. Floors of oak or other open-grained woods should be filled. Otherwise, dirt accumulating in the pores will cause permanent



1 PROTECT FLOORS FROM FOOTPRINTS

2 Filler for 12 by 14-ft. floor

Silica (silverwhite) - . . .	2 lbs.
Boiled linseed oil . . . . .	20 oz.
Benzine - . . . . .	40 oz.
Raw sienna . . . . .	½ oz.



3 KEEP THE FILLER STIRRED

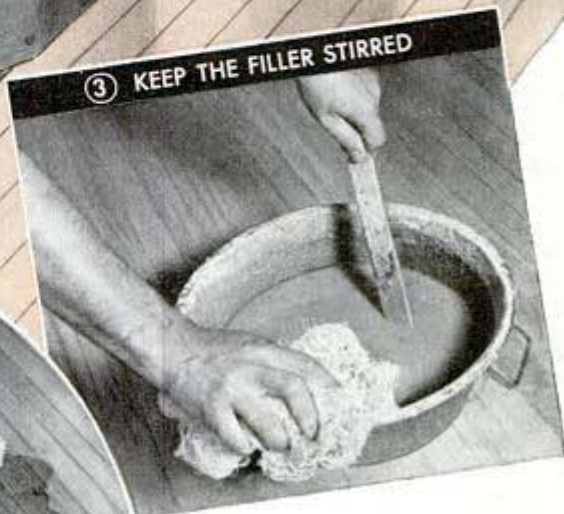

Mix just enough filler for one room at a time and work on small areas until you have gained experience in wiping the filler. As silica in the filler is heavy and sinks, stir filler thoroughly before each application



4 APPLY FILLER FIRST WITH, THEN ACROSS GRAIN



⑤ WIPING OFF EXCESS FILLER



⑥ USE OF FRESH BURLAP FOR WIPING PRODUCES A SHINY FINISH

blemishes. Sufficient filler for a room 12 by 14 ft. can be prepared inexpensively as indicated in Fig. 2. Mix the filler in a large receptacle that can be discarded afterwards, and mix only enough for one room at a time. The filler will stain the floor slightly. You can vary the amount of sienna to get darker or lighter effects. If still darker tones are desired, substitute burnt sienna or burnt umber for the raw sienna. Use pure benzene, not the kerosene-and-gasoline mixture sometimes sold.

Apply the filler liberally with a brush or a wad of cotton waste, first with and then across the grain as in Fig. 4. Since the heavy silica sinks rapidly, the filler must be stirred each time the applicator is dipped into it, Fig. 3. Work on small areas of the floor until experience in wiping has been gained. Wiping is done across the grain, Fig. 5, and is best done when the filler is partially set, which usually takes from 15 min. to  $\frac{1}{2}$  hr. If wiped too soon, the filler is removed from the pores, and if done too late, the hardening filler is difficult to remove. When the surface carries a deposit that looks and feels like moist clay, the filler is ready for wiping. Excelsior or wood wool is excellent for this purpose. Also, pieces of burlap sacking about 8 by 20 in. can be folded into useful four-ply pads, and refolded frequently to expose clean cloth. After the excess filler appears to have been removed, place your face close to the floor and look toward a light. A portable lamp is handy for this purpose.

A dark, cloudy smudge indicates that all the filler has not been removed. Further rubbing with a fresh piece of burlap will produce a shiny, finished surface, Fig. 6.

Protect your knees with burlap or other cloth padding while wiping the floor, or wear old clothes which can be discarded. All cloths and burlap containing filler should be disposed of immediately as they contain enough oil to cause spontaneous combustion. Let the filler dry at least 24 hrs. Smooth with No. 0 sandpaper, and dust. Finish with one or two coats of good, hard floor varnish. More than two coats of varnish is not recommended. Maple floors may be filled with one coat of shellac, then finished with two coats of varnish. When dry, each application of varnish should be rubbed lightly with No. 00 sandpaper and dusted before applying the next coat. Lastly, apply floor wax and rub to a high polish.

### Liquid Shoe-Polish Bottle Handy To Carry Shellac in Pocket

An easy way to carry a small amount of shellac for covering taped wire splices and similar jobs is to place it in an empty liquid shoe-polish bottle. The polish applicator, when cleaned, is handy for brushing on the shellac, and the bottle can be carried in your pocket or toolbox.



—James L. Justmann, Portland, Ore.

# Photo Kinks

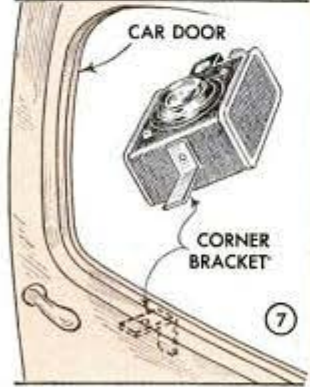
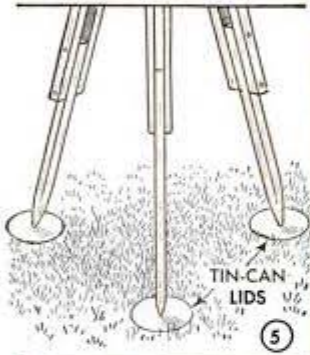
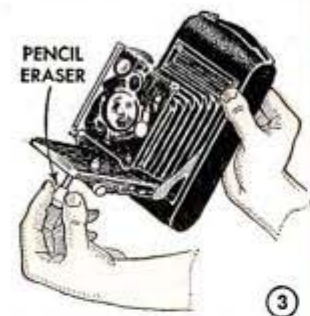

1: A coil spring under the button of the cable-release plunger prevents damaging the shutter by too sudden snapping

2: Develop 35-mm. film in a tray on paraffin-treated cardboard with notches to hold the film

3: Your camera will not slip on smooth surfaces if a pencil eraser is put on the front support

4: Cellulose cement will protect a tray thermometer against breakage

5: Lids of tin cans used to support tripod legs on loose dirt or sand

6: Place prints between blotters and run slowly through family mangle to dry them quickly

7: To use a car door as a tripod, bolt a corner bracket to your camera and slip in window slot

8: Polishing the shearing plate of your trimming board with a metal polish will permit more accurate cutting in dark-room by reflected light

9: Very fine pumice to which one drop of light oil is added makes an effective, cheap abrasive paste for local reduction of negatives

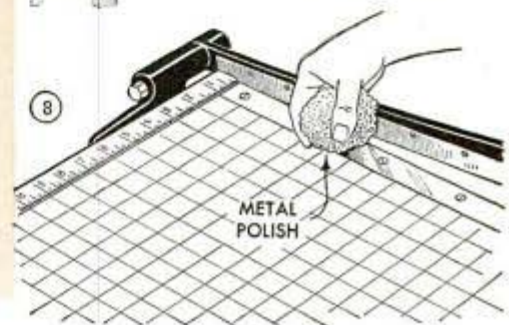
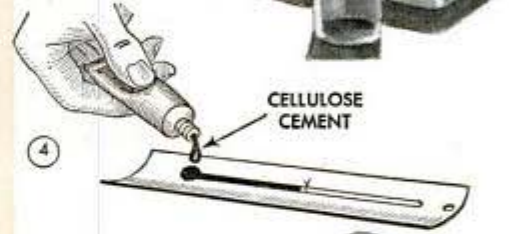

## Deckle Edges on Photo Prints Made With Pinking Scissors



Edges which will make your prints stand out when mounted in the album are cut with pinking scissors, normally used in sewing. For large prints a faint penciled guide line will help to keep the scissors going straight.—John Karlovic, Chicago.

## Supporting Camera for Low Shots

Taking advantage of the fact that a wire eggbeater of the type shown is so easily fastened between a camera tilt-head and the tripod, one photographer used such a beater to steady his camera when taking low-angle shots of plants and flowers. The extra leg thus provided can be adjusted from 4 to 8 in. in height. Of course, the same effect can be obtained by attaching a



length of doubled wire of sufficient thickness to give rigidity.

—John A. Moore, Havre, Mont.

## Flow of Water for Washing Prints Regulated by Altered Plug

When home photographers use a bathroom wash bowl to wash prints under running water, usually the excess water is drained away through the overflow. However, as hypo is heavier than water and settles on the bottom, it is much better to drain it at the bottom simply by adjusting the stopper as shown. To convert a stopper for this purpose, you remove the metal ring from it and insert a large screw eye at the angle shown and file the projecting point smooth. The stopper can be placed so that it either will let a small amount of water through or close the drain entirely in the ordinary manner.

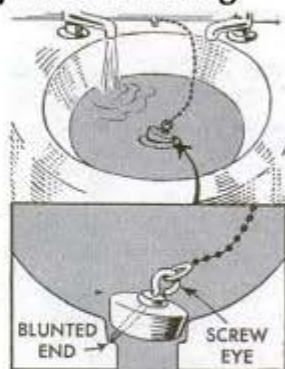

## Coffee Gives Prints Sepia Tone



If you like sepia-toned prints, you can make them inexpensively by dipping them in a solution of coffee. The strength of the coffee will determine the tint, and the proper shade can be found by experiment. After the prints are tinted, wash them in running water for a few minutes and dry in the usual manner.

—William Swallow, Brooklyn, N. Y.

☐ A quick-drying, dull-finish photographic paint is made easily by dissolving a broken phonograph record in alcohol. This also makes an excellent blackboard paint.





# SHOP NOTES

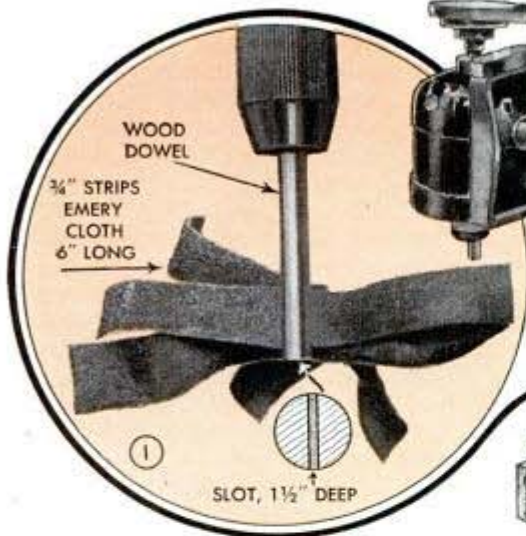

## SMOOTH SANDING

By R. F. Yates

A MATEUR mechanics often fail to obtain the full value from their coated abrasives because they do their sandpapering by rule-of-thumb methods. It is possible, however, to get more value from each piece of abrasive and turn out smoother work. Abrasive papers are coated with particles of garnet, quartz, flint or aluminum oxide. These abrasives come in standard 9 by 11-in. sheets and in belts, disks, cones, drums and strips for special purposes. Grits are numbered from 8/0 to 4, the finer grains—those from 8/0 to 2/0—having softer, more flexible paper backing. Medium grit papers used in preliminary treatment of cabinet woods range from 1/0 to 2, and very coarse papers for removing paint or for fast cutting range from 2½ to 4. There is a choice of grit for every purpose and for every type of wood; the closer the grain and the harder the wood, the finer the abrasive must be for the finishing operation.

Grit papers lose their cutting power when the abrasive particles become dull and when wood dust packs between them. By turning the sanding block at a 90-degree angle or by reversing it as soon as the paper becomes dull, a new cutting edge will be brought into use, thus adding

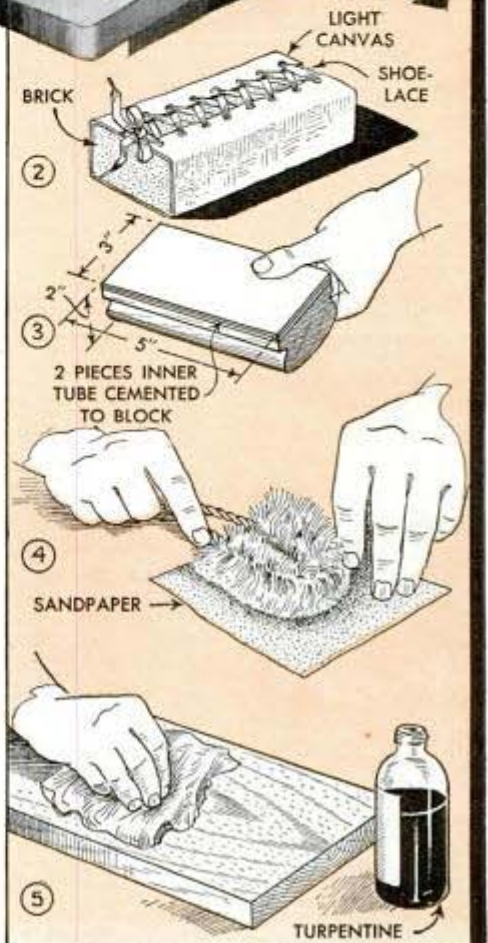

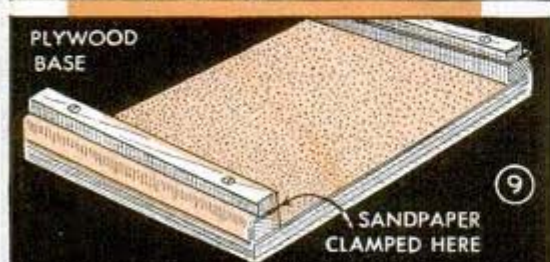
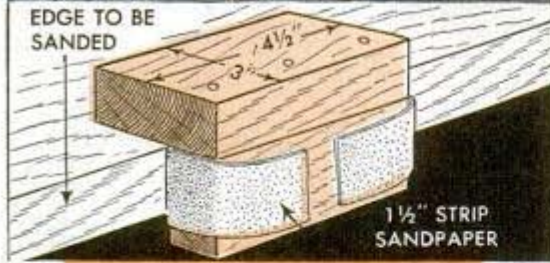
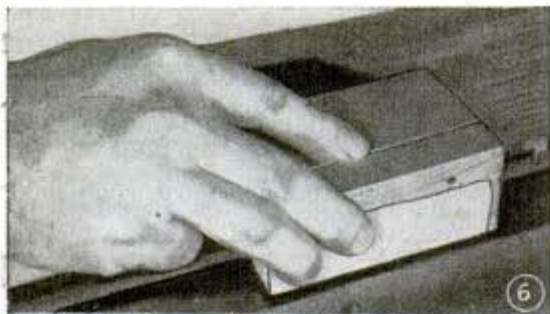

as much as 50 percent to the life of the paper. Packing of wood dust between the abrasive particles cannot be prevented but can be minimized by occasionally brushing the abrasive with a stiff brush, as in Fig. 4. Wood dust also plugs the pores of the wood and, unless it is removed, it might spoil the finish coat. To prevent this, the wood should be brushed thoroughly, then wiped off with a clean cloth moistened with turpentine, as in Fig. 5.

Where irregular surfaces are to be sanded, the little gadget illustrated in Fig. 1 will be useful. The tool is placed in the chuck of a drill press with the cutting side of the abrasive facing the direction of rotation. Fine emery cloth will last longer in this operation than paper-backed abrasives. In straight sanding, the line of movement should be with the grain. Equal pressure should be applied on all points, and the abrasive must not be twisted or it will cause cross-grain scratches that cannot be removed easily. By using blocks around which the paper is wrapped, greater pressure can be applied than with the fingers alone, and there will be less chance of grooving the wood, especially with coarse, fast-cutting papers. Such a block can be made from an ordinary brick or piece of wood covered with light canvas, as in Fig. 2. A softer block and finer paper should be used for re-working the first heavy sanding. A blackboard eraser or slab of cork makes an ideal block, or one can be made from a piece of wood to which pieces of inner tube or sponge rubber are glued, as in Fig. 3.

The sanding block shown in Fig. 6 will help to keep the edges of cabinets and tabletops square without the rounding often noticed in the work of inexperienced workmen. After a perfectly square surface is produced, a few light strokes with fine paper will take off the sharp knife edge. Wrapping the paper around a wood dowel, as in Figs. 7 and 8, will enable the craftsman to reach all curved surfaces, especially if the paper is first soaked in turpentine to make it more flexible. Where small pieces are to be sanded by hand and kept square, the sanding board shown in Fig. 9 will help a great deal. Often two edges may be sanded simultaneously with this arrangement.

Improperly treated end grain may ruin an otherwise beautifully finished piece of furniture. Therefore these ends must be sanded to an almost glazed surface, otherwise they will absorb more than their share of the stain or varnish. Some woods require sponging and re-sanding with fine paper to bring out the proper accentuation of grain effects. In such cases, water is applied to the wood with a soft cloth after the first sanding with fine-grit paper. The



wood should be thoroughly dried before re-sanding, and only very light pressure used with papers of 2/0, 3/0 or 4/0 grits.

The amateur finisher should not overlook the usefulness of steel wool. This comes in grits of 2, 1, 0, and 000. The 000 wool leaves a hardwood surface with a satin sheen that cannot be achieved with grit papers. Of course the same rules apply in using wool as in sanding to avoid cross-grain scratching.

Varnish sanding between coats was formerly pretty much a fine art. However, with wet sandpapers it is possible to achieve pleasing effects without a great deal of experience. Wet-sanding papers come in extremely fine grits from 8/0 to 6/00, are extremely tough, and are impervious to water. To make them more flexible, such papers are soaked in water before they are applied, as in Fig. 10. The varnished surfaces to be sanded are also kept moistened by water applied with a sprinkler bottle, as in Fig. 11. The water modifies the cutting action of the paper



and prevents the scratches that would result if the paper were used dry.

After using this paper, the varnished surface should be carefully sponged off and wiped as dry as possible with a chamois to avoid leaving lint on the surface. These papers work so well that they often may be used instead of the felt pad and pumice usually employed for the finish coat. However, since they cut much faster than pumice, the workman must be careful not to carry the operation beyond the point needed for the type of finish he seeks, otherwise he might find that he has cut through the varnish.

## Emergency Three-Rail Ladder Handles Two-Way Traffic



Constructed of 2 by 4-in. stock right on the job, this ladder was found to be stronger than the regular two-rail type, and had the advantage in restricted places of permitting two workmen going in opposite directions to use it at the same time. Both the steps and rails are spaced closer together than on the conventional ladder, making it easier to carry heavy loads.

## Corrugated Fastener Scrapes Wire

A corrugated fastener provides a sharp and convenient scraper and cleaner when preparing insulated wires for soldering. The irregular-shaped cutting edge is easy to hold on the wire.

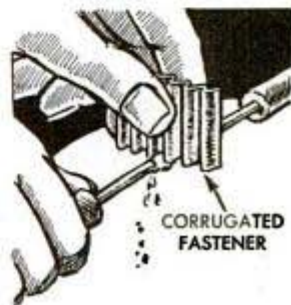

## Disks Trued-Up Quickly in Lathe With Rotary "Turning Tool"



Having a number of metal disks to be trued-up, and after finding that it required too much time to do the job in a lathe in the usual way, I used a rotary tool as shown. This was held in the tool post and when brought up against the rotating work in the chuck, pressed the disk up true. The tool consisted of a 2-in. roller mounted on a piece of 1 by  $\frac{3}{4}$ -in. steel as shown in the detail.—H. D. Chapman, Mt. Rainier, Md.

## Heavy Oil Drums Moved Easily On Detachable Casters

One filling-station operator solved the problem of moving heavy oil drums about his station by using four detachable caster units. Each unit consisted of a caster riveted to a piece of flat iron, which was bent



to the shape shown in the detail. These units slip under the drum where they are held in place by the rim around the bottom of the drum. Heavy trunk-type casters should be used for this purpose.

## Wrench Makes Reel and Holder For Plumb-Bob Line

A discarded alligator wrench provides a convenient reel and holder for a plumb-bob line. The end of the line is looped and knotted to fasten snugly over one of the wrench jaws, and then is wrapped lengthwise around it to adjust the suspension of the bob. The weight of the wrench permits the bob to be suspended from any flat surface without nailing.

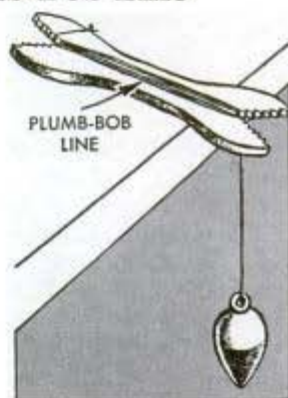

## Tin-Can Weights Avoid Errors In Weighing Coal Trucks



In weighing trucks or other vehicles on a single-beam scale where an error may be made in figuring the tare to be deducted, one coal yard operator uses extra weights made to balance each truck. These weights consist of screw-top cans

filled with sand and each carries the number of the truck it represents. The balance weight of the scale beam and the cans are provided with hooks.

## Bolt and Nut Pull Gib Keys

Instead of trying to knock out a gib key with a hammer and punch when suitable pullers aren't at hand, try using a bolt and nut. Just place the nut behind the key, as shown, then turn the bolt with a

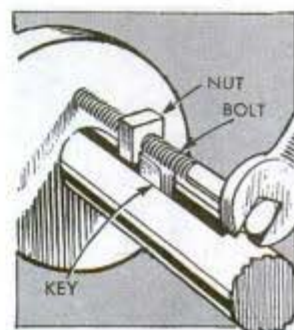

wrench. The end of the bolt resting against the pulley, wheel or other part held in place by the key will cause the nut to move along the bolt and pull the key. If space between the key and the wheel or pulley is too small to permit insertion of the nut, usually the key can be started by driving a chisel horizontally between them.

### Copper Tube Flanged With Screw

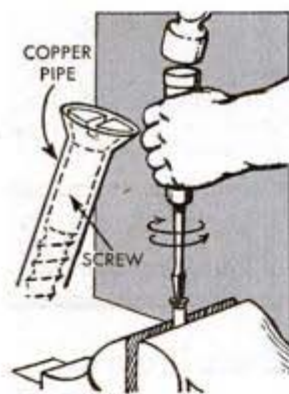

The next time you have to form a flange on the end of a piece of copper pipe or tubing and there are no suitable tools at hand, use a wood screw. Simply grip the tube carefully in a vise, insert the screw and turn it back and forth with a screwdriver, tapping the upper end of the driver lightly with a hammer as you turn the screw.

tapping the upper end of the driver lightly with a hammer as you turn the screw.

### Reflector Soldered on a Fire Pail Prevents Use for Other Purpose

Annoyed at the careless practice of some workmen using fire pails in the shop for other purposes, one garage owner soldered discarded headlight reflectors to the bottoms of the pails. These false, rounded bottoms made the buckets so they would not stand up but had to be left on the hooks that were provided for them.

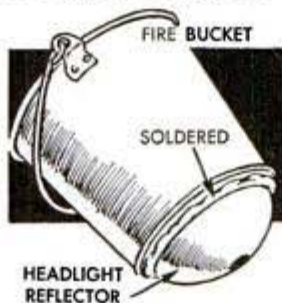

### Repairing Cracked Grain Scoop

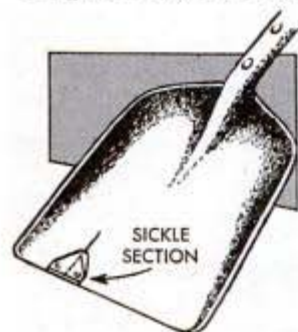

A quick and practical repair for a cracked scoop that might otherwise have to be discarded may be made by punching holes through the metal at each side of the crack so that a discarded mower section can be riveted over it. Place the sickle section on the upper side of the scoop so it will not damage a floor when the scoop is in use.

Place the sickle section on the upper side of the scoop so it will not damage a floor when the scoop is in use.

### Progress of Sales Contest Shown On This Simple 'Thermometer'

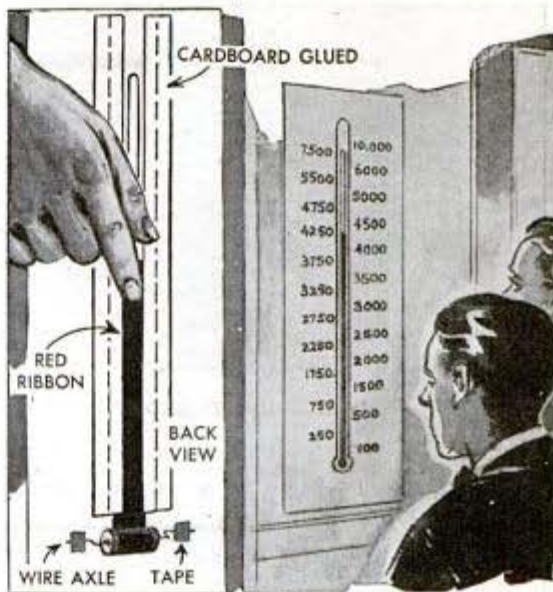

Results of a sales drive or other contest are shown at a glance on this thermometer. It consists of a large piece of heavy cardboard fitted with a red paper ribbon, which slides in a track behind a slot in the center. The track is formed by gluing strips of cardboard on each side of the slot, and the paper ribbon is wound on a spool, which rotates on an axle shaped from wire and held in place with cellulose tape. Height of the ribbon in the track is adjusted by moving it up or down with the finger as indicated in the left-hand detail.

### Fixture to Make Small Bushings Quickly in a Lathe

Having an order for several hundred small bushings to be made in our shop, we cut the cost in time and labor to a minimum by using a fixture like the one shown. Once the fixture

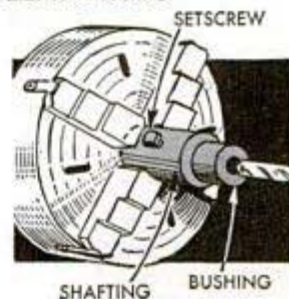

was chucked accurately in the lathe, it served as an auxiliary chuck for holding the bushing stock in true position for drilling, and from which the finished bushings could be inserted and removed by merely tightening and loosening a small setscrew. The fixture was made from a piece of shafting  $\frac{1}{2}$  in. shorter than the length of the bushings, and was bored out to the same diameter as the finished outside diameter of the bushings.

—J. E. King, Waxhaw, N. C.

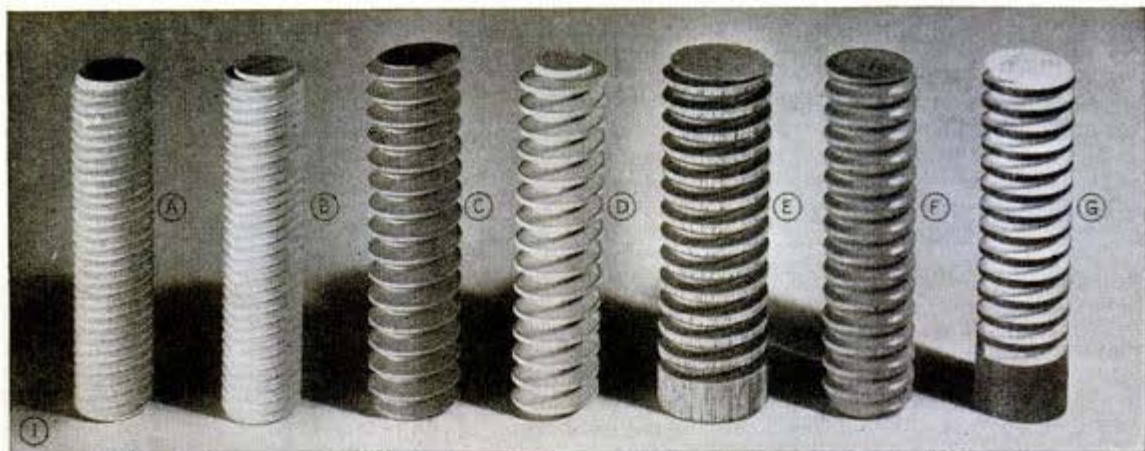

# Cutting THREADS

By Sam Brown

**T**HREADS in wood have a wide application, and the job of cutting them is quite simple. A lathe with a lead screw is almost a necessity, but work can be done with hand-screw boxes and by hand chasing.

**Woods to use:** Proper selection of wood is important. Excellent woods for this purpose are white birch, hard maple, beech, persimmon, apple, cherry, ironwood, hickory and dogwood. Walnut and mahogany rate second choice because their coarse-grain structure tears slightly. However both are workable. Among imported hardwoods there are many, such as lemonwood, ebony, cocobola, lignum vitae, etc., all so tough they can be turned with an ordinary threading tool. For most work the logical choice is white (paper) birch or hard maple, both common domestic hardwoods. A distinction should be made be-



② TANGENT CUTTER CUTS COMPLETE THREAD IN ONE PASS

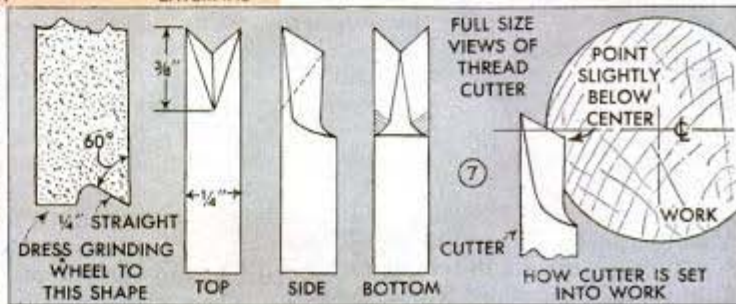
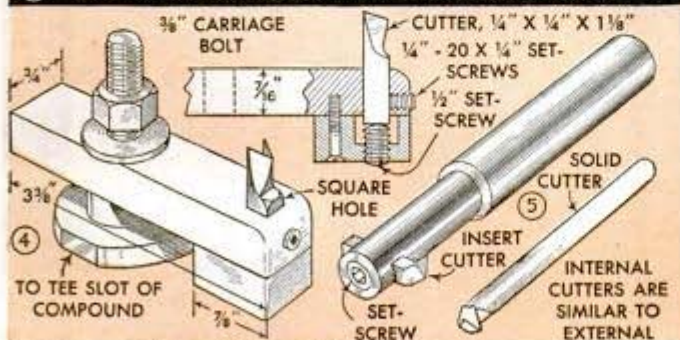

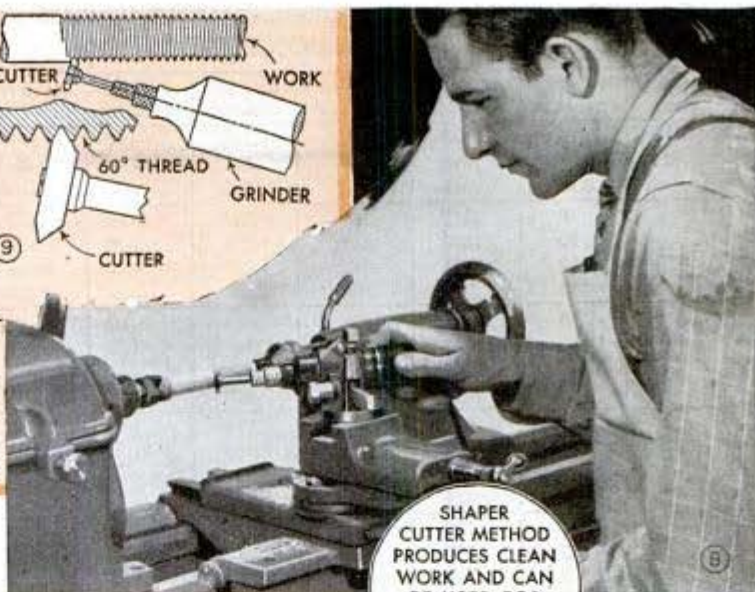
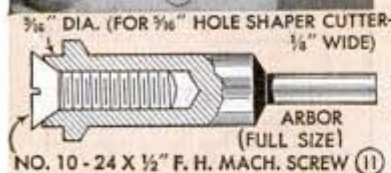
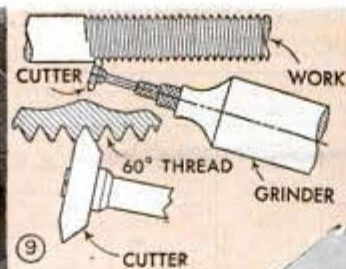

SHAPER CUTTER METHOD PRODUCES CLEAN WORK AND CAN BE USED FOR EXTERNAL OR INTERNAL THREADS

## in WOOD

tween hard and soft maple—it's all "maple" to many lumber yards, but all the difference between success and failure when it comes to holding a thread.

**Thread styles:** The conventional 60-degree thread as practiced in metal work is equally good on wood, the one difference being that in any given size the thread pitch for wood is much coarser than for metal. Fig. 1 shows typical examples, the diameters averaging about 1 in. A is birch, 8-pitch. B is maple, 8-pitch, but a double thread as differing from A. C is cherry, 4-pitch, and D is lemonwood, 4-pitch. E is walnut, 4-pitch, with flats somewhat wider than normal in order to eliminate grain chipping as much as possible. F is a 4-pitch spiral thread, excellent for decorative use and subject to very little chipping. G is birch, 4-pitch, cut with a screw box.

**Tangent cutter:** The tangent cutter shown in Figs. 2 and 3 is the best for cutting V-threads. It cuts a clean thread as coarse as 4-pitch in one pass. The cutter is V-shaped and can be compared to twin thin, sharp chisels standing on end. It is held in a special holder, Fig. 4, and is presented to the work in a tangent position, Fig. 7. The same style cutter for internal threads is of similar shape as can be seen by comparing Figs. 4 and 5. If you grind the external cutter first you will have no trouble with the internal. The cutter is made from 1/4-in. high-speed steel. It is necessary to use a 60-degree edged wheel or shape this same angle on a square-edge wheel as shown in Fig. 7. Fig. 6 shows how the blank is held against the wheel to cut the vee, which is the most important part of the grind. In use, set the cutter for a full depth-of-thread bite, and run the lathe between 50 and 100 r.p.m. If desired, the cut can be made in two passes. "Hairline" feeding should not be practiced, since this cutter needs a definite "bite" to do good work.

**Shaper method:** The shaper or milling method of thread cutting is pictured in Figs. 8 to 11 inclusive. The hand grinder or tool-post grinder used should be angled slightly to the axis of the work so that the tool will be in the clear, Fig. 9, the cutter being ground so that it will cut a 60-degree thread with grinder in



HANDLES FOR BOXES, TOOLS, ETC.



LATHE CHUCKS FOR THREADING DIRECT ON SPINDLE NOSE

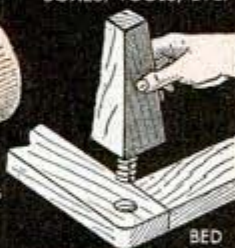

BED LEGS

SCREW-TOP BOXES



A FEW OF THE MANY APPLICATIONS OF WOOD THREADS IN CRAFT AND CABINET WORK



SPIRAL THREADS FOR LAMP STEMS



ADJUSTABLE CANDLE STAND AND ASH TRAY



MOLDINGS AND HANDLES



## 60° V-THREAD DIMENSIONS FOR WOOD

Nominal size	Threads per inch	Minor Diameter	Single depth of thread	Bore for internal	Pilot for wood tap	Wood tap thread dia.
3/8	10	.225	.075	.246	1/4	.397
	12	.249	.263	.267	---	---
	*16	.281	.047	.293	---	---
1/2	8	.312	.094	.339	5/16	.527
	10	.350	.075	.371	3/8	.522
	*12	.374	.063	.392	---	---
5/8	*13	.384	.058	.400	---	---
	8	.437	.094	.464	7/16	.652
	10	.475	.075	.496	1/2	.647
3/4	*11	.487	.069	.507	---	---
	*12	.499	.063	.517	---	---
	6	.498	.126	.534	1/2	.786
7/8	8	.562	.094	.589	9/16	.777
	*10	.600	.075	.620	---	---
	*12	.624	.063	.642	---	---
1	6	.623	.126	.659	5/8	.911
	8	.687	.094	.714	11/16	.902
	*9	.707	.084	.731	---	---
1-1/8	*12	.749	.063	.767	---	---
	4	.622	.189	.676	5/8	1.054
	6	.748	.126	.784	3/4	1.036
1-1/4	*8	.812	.094	.837	13/16	1.027
	*12	.814	.063	.892	---	---
	4	.747	.189	.801	13/16	1.179
1-1/2	*7	.909	.108	.940	15/16	1.156
	8	.937	.094	.964	15/16	1.152
	4	.872	.189	.926	15/16	1.304
1-3/4	*7	1.034	.108	1.064	1-1/16	1.281
	8	1.062	.094	1.089	1-1/16	1.277
	4	1.122	.189	1.176	1-3/16	1.554
2	*6	1.248	.126	1.284	1-5/16	1.536
	8	1.312	.094	1.339	1-5/16	1.527
	4	1.372	.189	1.426	1-7/16	1.804
2	*5	1.448	.151	1.490	1-1/2	1.793
	8	1.562	.094	1.589	1-9/16	1.777
	4	1.622	.189	1.677	1-11/16	2.054
2	*4 1/2	1.664	.168	1.711	1-3/4	2.048
	8	1.812	.094	1.839	1-13/16	2.027

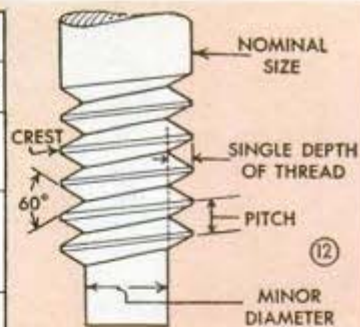

### How to Use Thread Chart

**Nominal Size**—Spindle dia. can be slightly less but never more than nominal size.

**Threads Per Inch**—Starred items are regular metal tap sizes. 8-pitch is recommended for spindles under 1 in. diameter; 4-pitch for work over 1 in. diameter.

**Minor Diameter**—Use this column when necking down for shoulder threads.

**Single Depth of Thread**—Shows total amount of infeed required, the feed being straight in plunge cuts instead of conventional compound angle feed.

**Bore for Internal Thread**—This column gives bore of internal hole previous to threading operation with any style of sharp point 60° vee cutter.

**Pilot for Wood Tap**—Homemade wood taps should have pilots of this size.

**Wood Tap Thread Diameter**—Major diameter of tap previous to turning full sharp point thread.

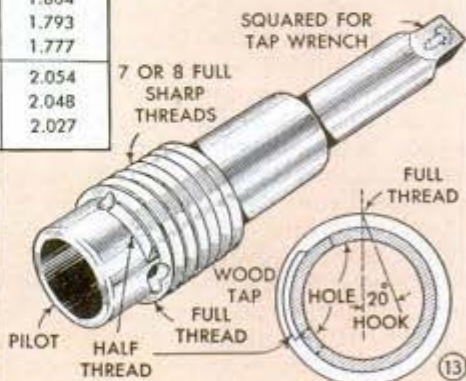

this off-angle position. The cutter is ground to proper profile shape while rotating in the lathe, Fig. 10, and then is backed off for clearance on the bench grinder. The tool isn't quite rugged enough to wade right into a 4-pitch thread or even an 8-pitch one. Two methods can be followed. Either set the cutter for a full thread and then turn the lathe slowly by hand with the thread feed engaged, or set the cutter for a light bite and run the lathe at 50 to 100 r.p.m. The direction of the lathe rotation is immaterial. With a heavy-duty tool-post grinder, the full thread can be cut in one pass with the lathe running.

**V-thread dimensions:** Follow the chart at left of Fig. 12 as a guide to thread sizes, especially when working mating parts. As a general rule, wood threads fit looser than metal threads to compensate for wood shrinkage or swelling.



**Internal threads:** Internal threads can be cut by tapping or by modifications of the methods already described. A tap for wood is shown in Figs. 13 and 14. It should be turned on the lathe, using any grade of mild tool steel; no hardening is needed. The blank should be shouldered at 60 degrees, Fig. 15, which will automatically establish the half thread needed for the first cutting point. The lathe can be turned by hand to further dress the half thread and remove surplus metal. The actual cutting points are made by spotting flats on the thread by grinding, and then drilling holes through the hollow pilot at a 20-degree hook angle as shown in Figs. 13 and 16. In addition to making the cutting points, the holes provide for chip disposal, hence should be made as large as possible without cutting into the crest of the next thread. The tap is used much the same as a metal tap, boring a hole for the pilot and then turning the tap in with a tap wrench, Fig. 18. As slight tearing of the wood may occur at entry and exit, it is advisable to clamp a block of wood on the work, Fig. 19, if the thread opening is a "show" surface. Wood taps of this kind do excellent work across the grain, but usually fail on end-grain threading. Fortunately, this condition seldom hampers actual work since end-grain threading usually indicates work of a size and shape that can be threaded in the lathe. However, where tapping of the end grain is necessary, a fair thread sometimes can be obtained by using a threaded block, Fig. 20, as a strain-lessening guide for the tap. The operation of cutting an internal thread with a tangent cutter is shown in Fig. 17, the cutter shape being very similar to the external cutter except that the top need not be raked back quite

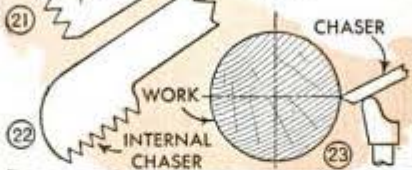
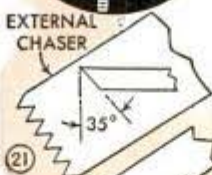
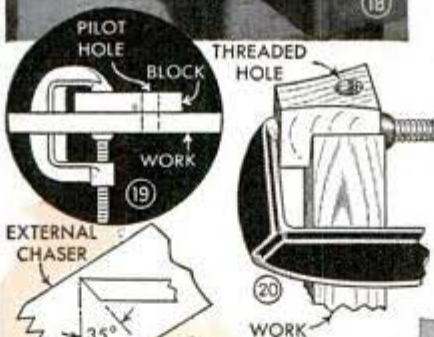
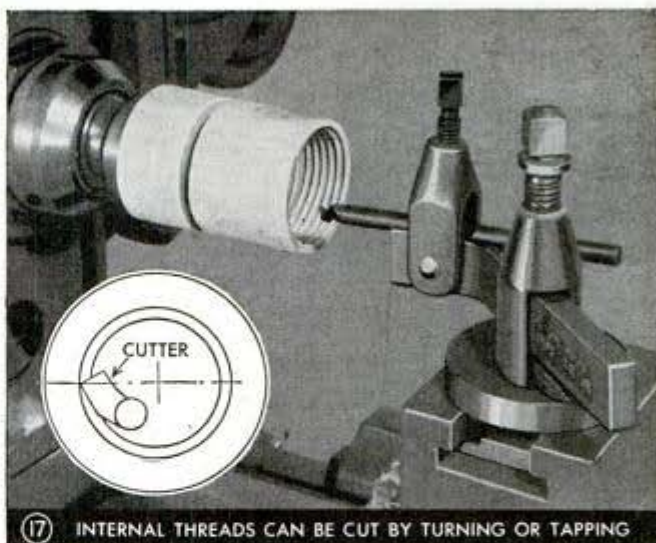

so much. Internally, the tangent cutter works best if the cut is taken in three or four equal bites.

**Hand chasing:** Lacking a lathe with lead screw, threads can be cut with hand-chasing tools. The metal for chasing tools should be good chisel stock, from  $\frac{1}{8}$  to  $\frac{1}{4}$  in. thick, depending on the coarseness of the thread. The cutting point is a series of from four to eight teeth ground to the proper shape and back-beveled about 35 degrees, Fig. 21. The simplest grinding method is



SCREW BOXES CUT CLEAN THREADS AND CAN BE USED TO ADVANTAGE WHEN A LATHE IS NOT AVAILABLE

to use an edged wheel, working the profile shape to that of a paper pattern stuck to the chisel and then backing off the heel for clearance. The operation of hand-chasing is shown in Fig. 24. The lathe must run at slow speed, not over 300 r.p.m. At speeds higher than this, it is very difficult to time the travel of the chisel, which obviously must be the same as the thread pitch. The tool should be angled down to bring the cutting points to the work centerline as shown in Figs. 23 and 24, while providing 10 to 15 degrees negative rake. The first bite is made by gently touching the chaser to the work and then moving it along toward the headstock at a speed proportionate to the pitch. This travel is aided by the fact that several teeth are in contact with the work. Repeated passes then are made over the work, concentrating on the deepening of the first five or six threads. It is good practice to have the work ten or twelve threads overlength, so that the starting threads, which may be imperfect, can be cut off. Internal threads are chased with a tool like the one in Fig. 22 in much the same manner, the tool rest being at right angles across the work opening and the chaser projected into the hole.

**Screw boxes:** Screw boxes in sizes from 1/4 to 2 in. diameter spindle thread can be purchased at a nominal cost. The cutting principle of the screw box, Fig. 25, is similar to the tangent cutter as used on the lathe, the only difference being that the cutter turns around the work while being held in the screw-box frame. No particular skill is needed in using a screw box. Use firm pressure in starting the thread, after which the rear portion of the box, which is threaded, provides a positive guide for the following threads.

**Cutting threads to a shoulder:** One of the most important applications of wood threads is the shouldered thread found in tool handles, screw-top boxes and screw-on furniture legs. A simple practice suitable for some classes of work is to use an insert thread, Fig. 26, instead of cutting the thread in solid wood. The insert thread

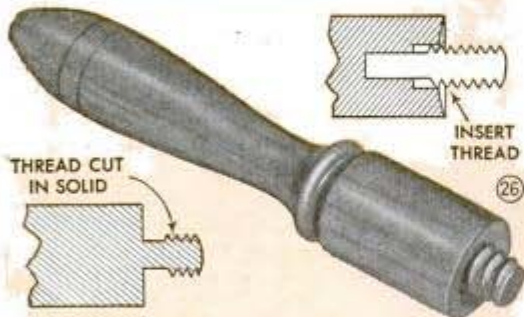

THREAD CUT IN SOLID

INSERT THREAD

26



NECK FOR CLEARANCE

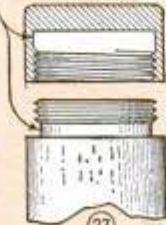

27



CUTTING THREADS TO A SHOULDER



30

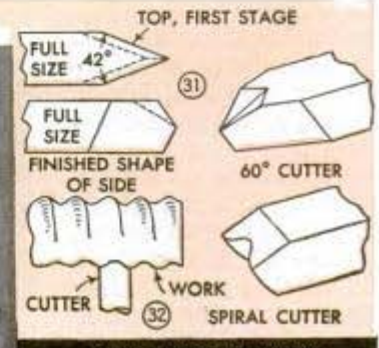

TOP, FIRST STAGE

FULL SIZE 42°

31

FULL SIZE

FINISHED SHAPE OF SIDE

60° CUTTER

CUTTER

WORK

32

SPIRAL CUTTER

OTHER TYPES OF CUTTERS

can be tenoned, but also is quite practical if the whole thread is used as a dowel joint. Working in this manner, a length of thread stock can be made up and cut off as needed for various jobs. Cutting the thread in the solid is required for screw-top boxes, and the operation is quite simple if the thread shoulder is necked down to provide a space for disengagement of the lathe thread feed, as shown in Fig. 27. In making boxes, the lid is turned first, followed by the body, Figs. 28 and 29, after which the lid is screwed to the body for finishing cuts as shown in Fig. 30.

**Other types of cutters:** Two additional cutter shapes for use on the lathe are shown in Figs. 31 and 32. Fig. 31 is a good shape for a V-thread scraping tool. This cutter is presented radially to the work like a hand chisel, and should be fed in at the rate of about .010 in. per cut. The V-cut at the top of the cutter is run in last when grinding and can be cut on the corner of a square-edge wheel. The compound angle thus obtained will result in an actual cutting edge of 60 degrees despite the initial grind of 42 degrees. The box thread, Fig. 29, was cut with this cutter, and it is particularly useful for close-in, delicate work. Fig. 32 shows a spiral cutter worked on a 1/4-in., high-speed steel blank for a 4-pitch spiral thread. This cutter is used in conventional scraping position, the grind at top providing about 15 degrees negative rake. Because of the rounded surfaces there is no tearing. Properly shaped, the cutter will cut both external and internal threads. These cutters are scrapers and for best results, spindle speed should be as high as the nature of the work and mechanism of engaging thread feed allows.

### Spring Fixture Steadies T-Square On Drawing Board

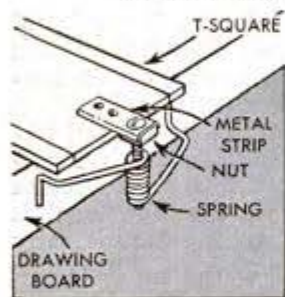

This spring attachment steadies a T-square and is especially helpful when lettering instruments are being used with the square. A piece of metal with edges bent down to accommodate the nut is screwed to the edge of the square and drilled to take a bolt, which is turned in tightly. Spring wire, such as can be obtained from an old spring-type clothespin, shaped as shown and turned onto the bolt, completes the unit. By simply removing the screws, the unit can be taken off the square when desired.

—Corp. R. B. Nowak, Camp Davis, N. C.

### You Can Get at Almost Any Screw With This Multi-Blade Driver

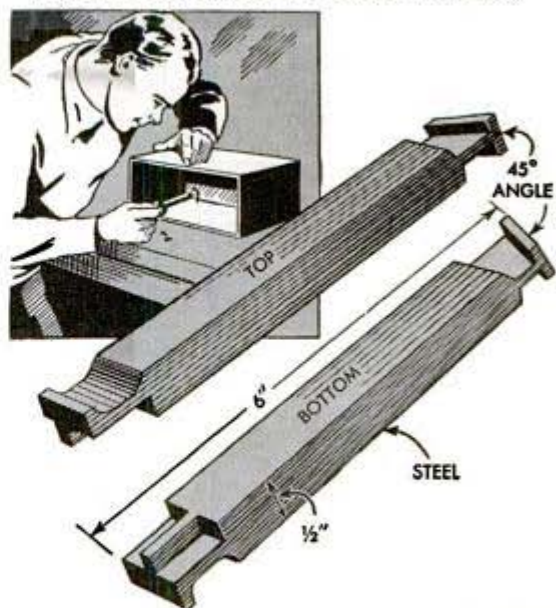

A mechanic who did a lot of assembly work designed this screwdriver, which has a number of blades each ground at a different angle, so that he could get at screws located in places difficult to reach with an ordinary screwdriver. The driver is made from a piece of 1/2-in. steel 6 in. long. If the angles of some of the blades shown are not suitable to your particular kind of work, they can be ground to suit.

—Opie Read, Jr., Chicago.

### Radiator Hose Held by Guide Slips Into Place Easily

The job of replacing the water hose between the cylinder block and the radiator is made easier with a stiff wire bent to shape as shown. After the hose is cut to proper length, it is bent downward in a vise and the wire hooked on over the ends. When the hose is placed as nearly as possible in position, pull up on the wire, and the hose will be started on the connections so that it can be pushed into place by hand. The wire is easily removed.



☐ When drilling tubular rivets from metal the rivet will be less apt to spin with the drill if you hold the metal at a 45° angle and drill straight down. The rivet will fall out easily.

## Trimming of Window Simplified With Portable Display Rack

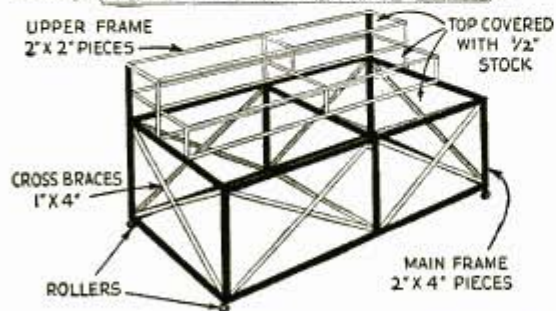

Assembled from wood, this window display rack is fitted with casters and is constructed to provide a series of shelflike sections for supplies and appliances. It permits trimming a window merely by pulling it around to a convenient position and decorating the shelves, after which the rack is quickly and easily rolled back into place. The rack is of particular advantage in garages and stores where no space has been provided in the windows for holding merchandise.

## Easy Way to Hold Metal Washers While Grinding Them



Having a number of washers that had to be ground down slightly to reduce their thickness, I did the job in the minimum of time by using this simple handle to hold them against the grinding wheel.

The handle was nothing more than a piece of wood, which had a short projection turned at one end to fit snugly in the washer holes. The handle permits holding the washers squarely against the grinding wheel with sufficient pressure to reduce their thickness quickly, and with little possibility of the wheel jerking them out of the hands.

—Claude J. Karcher, Easton, Pa.

## Mottle Finish Easily Produced By Dipping Process

This mottle finish is ideally suited for tool and kitchen utensil handles, toys and similar small turned objects. The process calls for dipping the work in clear lacquer, and immediately redipping in a colored lacquer. By withdrawing the work from the colored lacquer in a series of jerks, definite color bands are circled around the work. The colored lacquer runs immediately after dipping, intermingling with the clear base coat to form a mottle finish while retaining a definite pattern of color rings.

Starting out, the work should be sanded smoothly and given a base coat of color lacquer applied by brush or spray, Fig. 1. This coat should dry overnight to assure a "bone-dry" base. The dipping requires two tanks, one for clear lacquer and the other for a lacquer enamel. Both clear and colored lacquers should be fairly thin, about the same consistency as for spraying, say, diluted half-and-half with thinner.

The work is held on a pin board or stick, is dipped into the clear lacquer and immediately withdrawn. It should drain for three or four seconds and then is lowered smoothly into the colored lacquer. Now, if the work is lifted quickly, a solid coating of color will be deposited. If the work is held stationary for a second and then lifted slowly, the color coat will break, exposing a clean band of the base coat. Again, if the work is jerked up quickly, it will take a solid coat of color. In this manner, various widths of color bands, delicately intermingled, are obtained. Typical color schemes are red over white, blue over silver, silver over blue, green over cream, etc. Less contrasty, black over dark red or dark brown over light brown produces an imitation of highly figured hardwood.

As this is a smooth finish, it must not show drips or runs even though the finish itself is based on the running of the lacquer. Therefore, the lacquers must be thin so that they will drain clean and quickly to a single bead at the bottom which is easily removed with a soft cloth or a piece of cleansing tissue. Control over the "run" is largely obtained by changing the viscosity of the initial clear lacquer coat. If the color coat runs too much, it is a sign that the clear lacquer is too thin; if the color coat does not break when the work is lifted slowly, the clear lacquer is too thick. Excellent practice in dipping and color control can be obtained by dipping a plastic rod or square. Since this has a fixed ground color it can be dipped and then wiped clean as often as desired until the technique has been mastered.

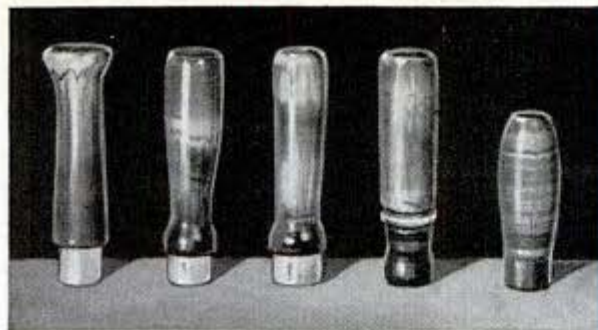

# Attractive MOTTLE FINISH by dipping

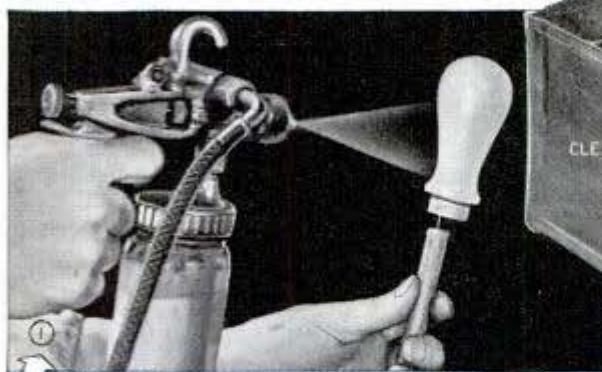

After sanding work thoroughly, spray or brush the surface color coat (cream lacquer was used on the sample shown). Allow to dry overnight



Dip work in clear lacquer, thinned about half-and-half as it comes from the can, or, at about spraying consistency. Lift quickly. Let drip about four seconds

Let work drain a few seconds and remove bead at bottom with soft cloth or tissue. Hang up to dry in same position as dipped



Immediately plunge the work into colored lacquer (the sample is blue). By lifting quickly, the work will take a smooth color coat (blue). If the work is held stationary for about one second and then lifted slowly, the color coat will break, showing a clear band of the base coat (cream). Again lifting quickly, the work will take a solid coat of blue. Repeat the banding process as often as desired



## Coupling of Long Pieces of Pipe Done Easily With This Guide

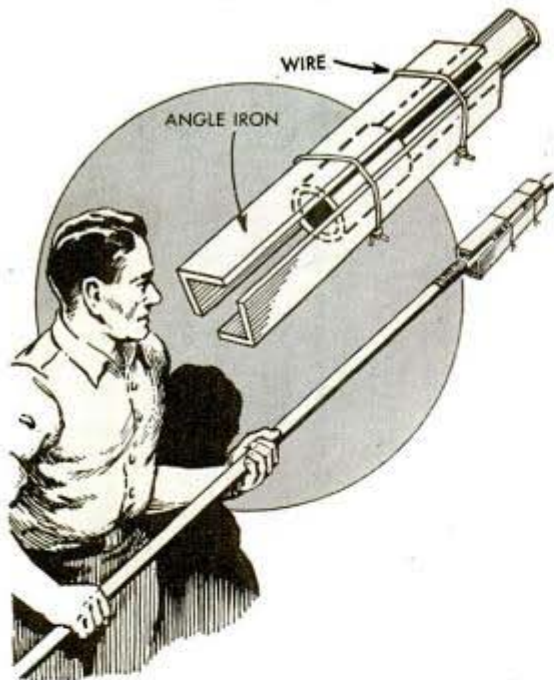

If you have to couple some long pieces of pipe single-handed and have a difficult time in getting the threaded ends of the pipes started into the couplings, rig up a simple guide like the one shown. It is nothing more than two lengths of angle iron bound around the coupling end of the pipe with wire. When the loose piece of pipe is inserted into the opening formed by the angle iron, it is guided into the coupling, thus making it easy to engage the threads and start them straight.

## Printing Raised Lettering On Small Jobs

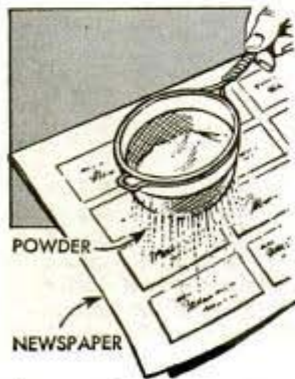

Printers who receive occasional jobs that require the use of the popular raised printing effect, but who do not have the special equipment to handle such work, will find the following method a time-saver. Spread the printed work out face up on a newspaper, and use a fine-screen coffee strainer to dust the resin powder over the printing. Then pick up the cards or envelopes, jar the excess powder off onto the newspaper, and lay them out on a large window screen. Pass the screen slowly over an electric hotplate to

raise the printing. The powder left on the newspaper is put back into the strainer to be used again.

—Francis L. Tyler, Penn Yan, N. Y.

## Locating Dowel Holes in Split Foundry Patterns

When you have to make a split wood pattern for use in foundry casting, here is an easy way to locate the holes for dowels that hold the pattern together. Place two small steel balls on one half of the pattern at the desired locations for the dowels. Then carefully place the other half of the pattern in position and tap it lightly with a hammer. This will cause the balls to make small indentations in the wood which will then serve as guides in drilling the dowel holes.

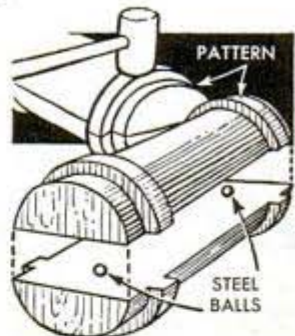

## Easy Way to Replace Valve Guides

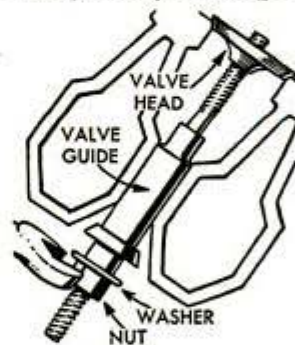

On many gasoline engines the job of installing new valve guides can be simplified with the improvised tool shown. To make the tool, cut off the head of an old valve and drill and tap it to take a length of rod that is threaded at both ends. In use, insert the tool just like a valve, start the guide in place and then drive a nut and washer on the lower end. This will force the guide into place.

—Ivan J. Stretten, Detroit, Mich.

## Lacing Holes Punched in Leather By Using Hinge as a Die

The next time you want a number of uniformly spaced holes in leather to lace it together, try using a butt hinge as a die and a nail as a punch. Drill a row of small holes through both halves of the hinge near their edges,



drilling through both halves at the same time so that the holes will correspond in both parts. Then grind off the end of a nail square, using one that is a fairly snug, sliding fit in the holes. In use, place the leather between the two halves of the hinge as indicated, clamp it in place, and then drive the nail through each hole in turn.

### Holder to Steady Small Rods While Sawing Them

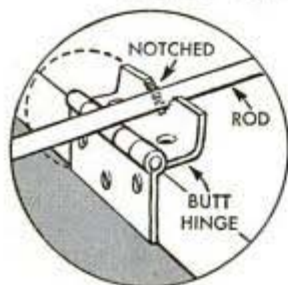

To facilitate holding small rods and dowels while sawing or filing them, one mechanic uses a hinge screwed to one edge of his workbench. When not in use, the hinge is flipped

down out of the way. The free half is bent at right angles in the center and the upper edge is notched, the edges of the notch being serrated with a file to form small teeth that aid in preventing the work from turning as it is being sawed.

### Special Chisel to Cut Sheet Metal

Most of the usual troubles encountered in cutting sheet metal with a cold chisel are avoided when a chisel shaped like the one shown is used. A straight line can be followed easily with the chisel and there is no danger of it slipping off the work. It can be shaped from a regular chisel, or it can be made up from a piece of suitable metal.

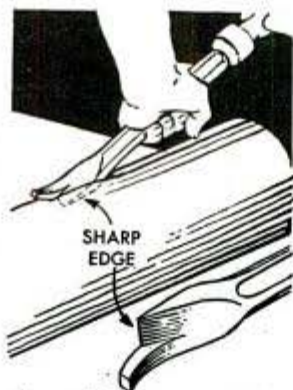

### "Brush" for Cementing Shingles Made From Lath and Screen Wire

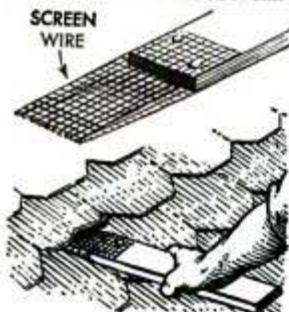

Folded and tacked to a lath, a strip of screen wire can be inserted between composition shingles for recementing them, if the proper taper brush is not at hand.

### Worn Nut on Cross-Feed Screw Of Lathe Repaired Easily

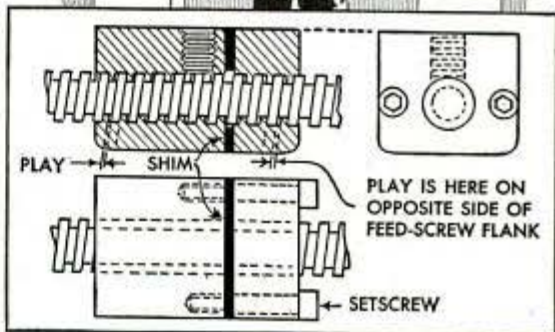

When the threads of a cross-feed-screw nut on a lathe became badly worn and allowed too much play, an emergency repair was made as shown. First, the nut was drilled and tapped lengthwise for two setscrews, after which the nut was cut in two. Then, the two parts were turned back on the cross-feed screw and shimmed apart so that the threads in both parts of the nut pressed snugly against the threads of the screw. After inserting and tightening the setscrews, all play in the threads was taken up and the nut was as serviceable as a new one. —Emil Wittman, Philadelphia, Pa.

### Snap Switch in Soldering Iron Gives Close Heat Control

Having considerable work that required intermittent use of a small soldering iron that had to be kept hot ready for instant use, one mechanic put a switch in the iron handle so that it could be turned off easily for short intervals. The switch was of the 110-volt snap-action type used frequently on radio panels.

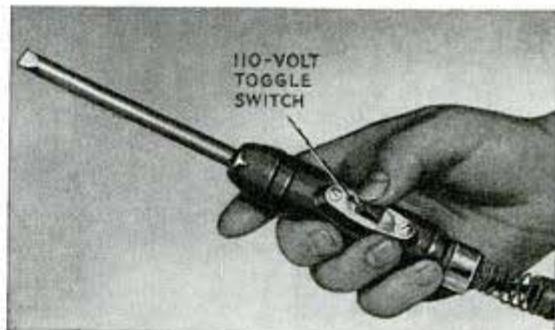

# HEAT TREATMENT

By  
H. J. Chamberland

metals to which heat treating is applied are known as carbon and alloy steels, or the steel from which they are to be made. However, many other materials also are subjected to heat treating in some form or other.

**Heat-treating furnaces:** These are of two distinct constructions—the muffle or box-type shown in Figs. 1, 3, 4 and 5 and the pot or crucible type shown in Fig. 2. Both of these types of furnaces can be used for all the variations of heat treat-

ment referred to in the preceding paragraph, although many industrial plants use separate furnaces for separate steps of the process. Source of heat can be natural gas, manufactured gas, oil or electricity. With a muffle or box-type furnace, the heat treating is done directly by the heat that is produced within the chamber, but with the pot or crucible type of furnace, the part or parts to be treated are immersed

**R**EGARDLESS of how accurately and nicely finished a die, twist drill and even your screwdriver or hack-saw blade may be, these tools would be of little value if they had not been heat-treated properly. When speaking of heat treating in general, such procedures as hardening, tempering, annealing, forging, normalizing and carburizing are included. Also, the

MEDIUM-SIZE GAS-HEATED MUFFLE FURNACE HAVING THERMOSTATIC TEMPERATURE CONTROL



2—POT-TYPE, ELECTRICALLY HEATED FURNACE WITH BUILT-IN THERMOCOUPLE  
3—GAS-HEATED MUFFLE FURNACE USED CHIEFLY FOR TEMPERING





# of STEEL

*Tempering  
Hardening  
Annealing  
Forging  
Normalizing  
Carburizing*

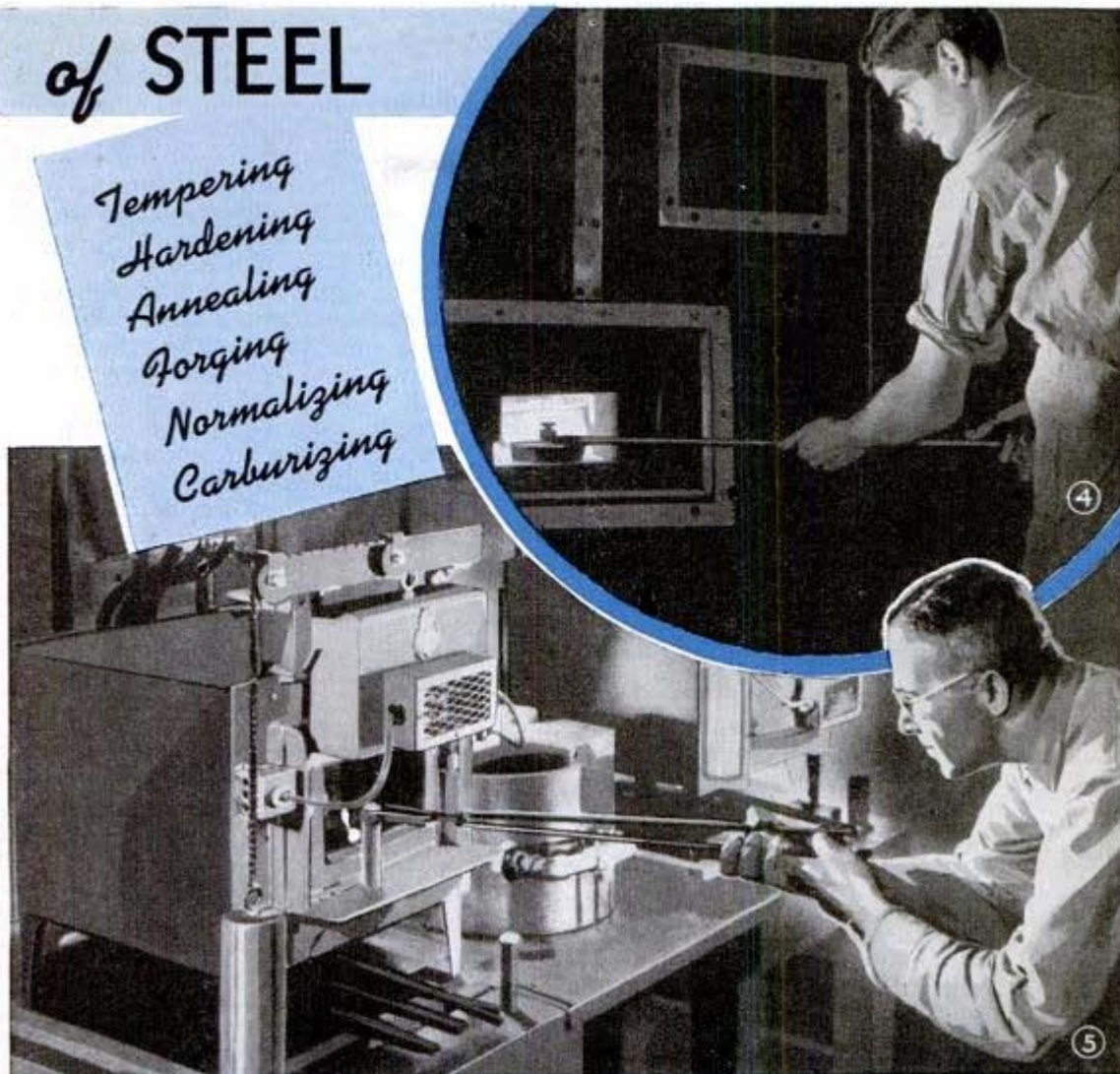

THE MUFFLE-TYPE FURNACES SHOWN ABOVE ARE HEATED AND CONTROLLED BY ELECTRICITY

in a red-hot lead or salt bath. Depending on the insulation qualities, high temperatures may be reached with both types of furnaces, although pot furnaces are used often to melt metals only, and are therefore called crucibles. Heat-treating furnaces are made in many sizes ranging from monstrous installations for battleship guns to small laboratory models used for delicate parts of scientific instruments and experimental work.

**Hardening:** Purpose of hardening is to impart certain physical properties to steel so it will resist abrasion (wear), will have tensile strength (resist straining or stretching) and impact strength (to stand blows). The degree of heat and the period of heating applied in each case depend on the type of material, the shape and size of a part, and the purpose for which it is to be used. The hardening procedure consists of heating the part or parts to a predeter-

mined temperature for a predetermined length of time. The temperature at which steel will harden most efficiently is called the critical temperature or point of recalcence. Often it is heated somewhat over this stage, removed from the furnace and quickly immersed in a tank of liquid such as water or brine maintained at a temperature of 60 to 80 degrees F. This is known as the quench. Some types of steel are quenched in oil, while others are cooled in still air.

**Tempering:** All tools or pieces of steel that have been heated to high temperatures and immediately quenched have developed internal strains. When exposed to sudden changes in temperature, the steel is likely to crack unless these strains are relieved by the heat-treating procedure known as tempering, also called drawing. It consists of reheating the steel to a comparatively lower temperature than that



6—WIRE BASKET USED TO LOWER PARTS IN QUENCHING BATH. 7—QUENCHING BATH AND CARBURIZED PARTS DUMPED INTO CHUTE



applied for hardening. This temperature may range from 300 to 600 degrees F., depending on the degree of hardness desired, or it might even go beyond this point. The furnace shown in Fig. 3 is designed particularly for the purpose of tempering, and the heat cannot be increased for hardening. Work taken from a tempering furnace should not be cooled in a quenching liquid but should be cooled in still air.

**Annealing:** After steel has been made at the mill it is not in a machinable state due to its extreme hardness, and therefore it must be softened or annealed, which is generally done at the mill. However, steel often must be annealed by the user after it has been hardened. Annealing is done in a hardening furnace, the work being subjected to a temperature of from 15 to 100 degrees below the critical point. Annealing demands a slow and increasing heat, and the work may be cooled in the furnace after shutting off the heat, or in still air, but never quenched.

**Forging:** Steel cannot be shaped by hammering unless it is thoroughly heated to a forging temperature. Parts to be forged also must be heated slowly to the required temperature which is usually from 200 to 350 degrees above the critical point. After removing the steel from the furnace, it is cooled in still air, all air currents and dampness being avoided.

**Normalizing:** Normalizing is a process quite similar to tempering but applies particularly to work that has been forged. As a general rule, steel sufficiently annealed at the mill requires no normalizing, but if it has to be done to relieve excessive forging strains, the required temperature is from 50 to 75 degrees F., above the critical point.

**Carburizing:** Carburizing is a heat-treating process whereby the use of certain special gases introduces an extra amount of carbon in low-grade steels so they can be used as substitutes for more expensive steels. This is a surface-hardening procedure. The resulting carbon content and depth of hardening or "case," as it is called, will depend on the gas mixture, type of equipment and heating time. Work to be carburized must be machined to dimensions, yet allowances for ground finishes can be made by estimating and controlling the depth of case, which may be  $\frac{3}{16}$  in. and over. If the work is executed properly, the result is a uniform glass-hard exterior section with no effects on the core or internal structure of the steel. When this is done in large quantities, carburized parts and also the quench bath are dumped as shown in Fig. 7. A fresh quenching solution is used for each batch of heated parts, the used quench having

been heated to the point where it cannot be re-used. Fig. 6 shows parts held in a wire basket to be submerged in a quenching tank. Carburizing is not the only form of surface hardening. Nitriding is a similar process using ammonia gas as a treating agent. Also, there are other patented processes. The use of a cyanide bath is well known when a shallow case is desired.

Flame-hardening is not new but still receives a great deal of attention where resistance to wear is the main objective. Induction hardening is the most recent form of surface hardening. This is accomplished by placing the work inside a magnetic field set up by an inductor coil which carries high-frequency currents. The heating and quenching cycle is but a matter of seconds.

A cold-treating furnace, shown in Fig. 8, is a carbon-dioxide refrigerator in which the temperature can be reduced to 120 degrees below zero, F. Such a cold-treating furnace is used in connection with a tempering furnace to stabilize the steel used for precision tools and instruments, and



8—COLD-TREATING EQUIPMENT OPERATES AT 120 DEGREES BELOW ZERO, FAHR. 9—DETAILS OF THERMOCOUPLE PYROMETER CONSTRUCTION. 10—VARIOUS COMBINATIONS OF THERMOCOUPLE WIRES SUITABLE FOR DIFFERENT TEMPERATURE RANGES. 11—TESTING HARDNESS OF STEEL

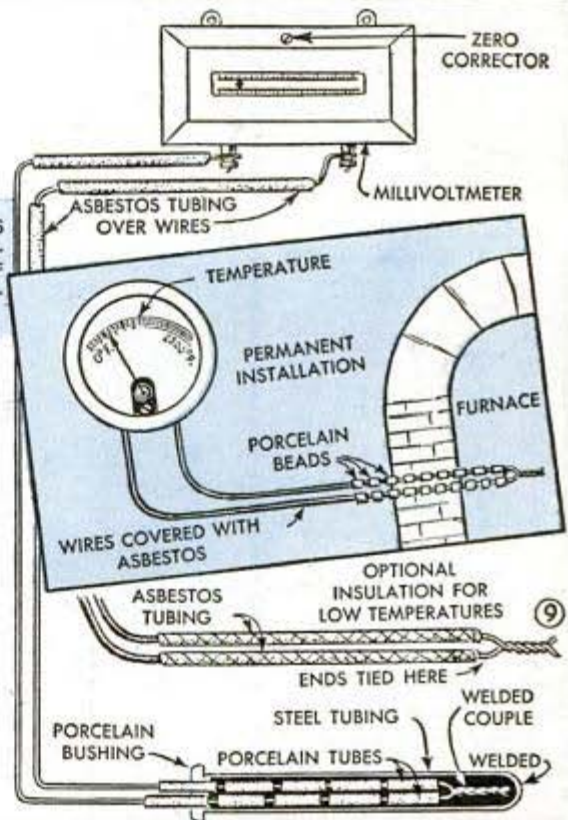

TEMPERATURE (°F)	CHROMEL-ALUMEL		NICHROME IV-NICKEL		NICHROME-NICKEL		NICHROME ADVANCE		NICHROME IV ADVANCE		IRON ADVANCE		COPPER ADVANCE	
	TO METER	TO METER	TO METER	TO METER	TO METER	TO METER	TO METER	TO METER	TO METER	TO METER	TO METER	TO METER	TO METER	TO METER
2500°	-0.60	54.85	0-50	48.72	0-30	29.52	0-60	54.40	0-70	65.44	0-50	47.52	0-15	
2400°		52.95		46.40		26.24		51.00		61.35		44.55		
2300°		51.00		44.08		24.60		47.60		57.26		41.58		
2200°		49.01		41.76		22.96		44.20		53.17		38.61		
2100°		46.97		39.44		21.32		40.80		49.00		35.64		
2000°		44.89		37.12		19.68		37.40		44.99		32.67		
1900°		42.77		34.80		18.04		34.00		40.90		29.70		
1800°		40.62		32.48		16.40		30.60		36.81		26.73		
1700°		38.43		30.16		14.76		27.20		32.72		23.76		
1600°		36.20		27.84		13.12		23.80		28.63		20.79		
1500°		33.94		25.52		11.48		20.40		24.54		17.82		
1400°		31.65		23.20		9.84		17.00		20.45		14.85		
1300°		29.33		20.88		8.20		13.60		16.36		11.88		
1200°		26.98		18.56		6.56		10.20		12.27		8.91		
1100°		24.62		16.24		4.92		6.80		8.18		5.94		
1000°		22.25		13.92		3.28		3.40		4.09		2.97		
900°		19.88		11.60		1.64								
800°		17.52		9.28										
700°		15.18		6.96										
600°		12.85		4.64										
500°		10.56		2.32										
400°		8.31												
300°		6.09												
200°		3.82												
100°		1.52												



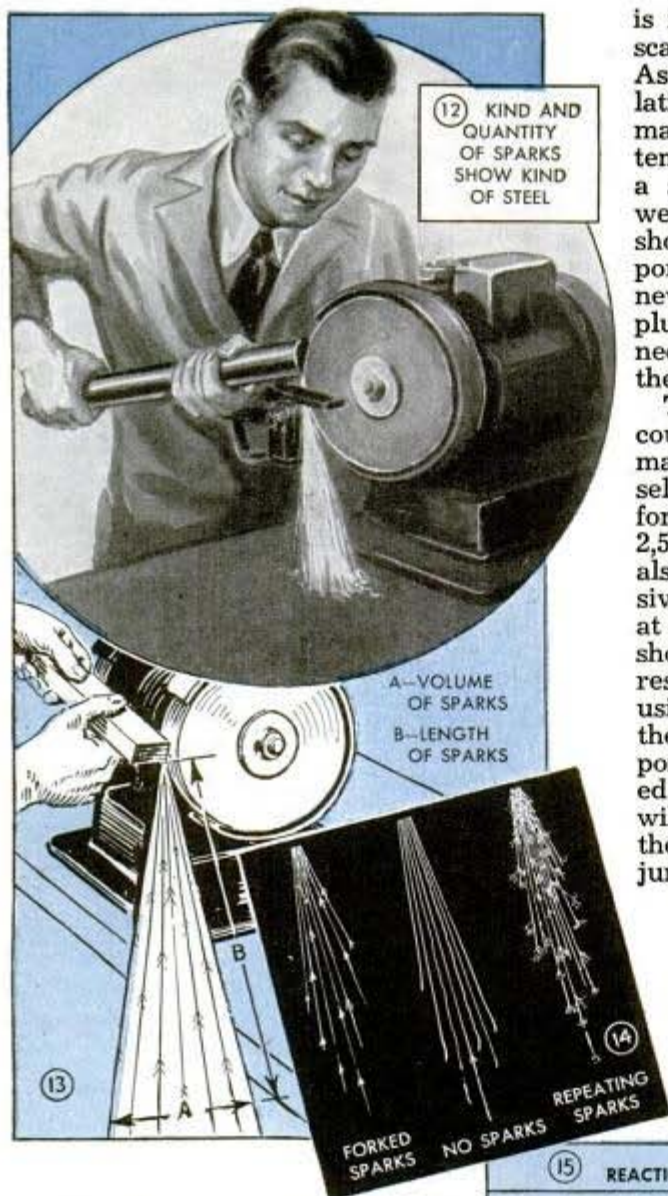

is indicated on the millivoltmeter, the scale of which is calibrated in degrees. As will be noted from Fig. 9, the insulation on the wires near the welded end may be asbestos tubing if used for low temperatures, but porcelain tubes and a steel jacket protect the wires and welded end from high temperatures as shown in the lower detail of Fig. 9. The portion subjected to heat must be renewed occasionally, and therefore a plug enabling this portion to be disconnected conveniently from the leads to the millivoltmeter is generally provided.

Those who wish to renew the thermocouple themselves will find the information in Fig. 10 convenient in order to select pairs of wires of different metals for various temperature ranges up to 2,500 degrees F. All thermocouple metals except platinum and some expensive alloys melt or cease to be sensitive at about this temperature. Fig. 10 also shows millivoltmeter readings which result at various temperatures when using the wires listed. When renewing thermocouple wires it is of utmost importance that the twisted ends are welded so that the metal from both wires will flow together. However, burning the wires must be avoided as a burned junction will be weak and will not give accurate temperature readings when connected to the millivoltmeter. If, when connected, the meter hand tends to go in the wrong direction, reverse the connections.

**Hardness testers:** Degree of hardness of a heat-treated part is measured with instruments such as

to offset the effects of subsequent temperature changes.

**Thermocouple pyrometers:** Nearly all heat-treating furnaces are equipped with thermocouple pyrometers, and many have automatic heat controls, which makes them highly efficient. Thermocouple pyrometers consist of two lengths of wire of different metals or alloys, separated from each other except at one end, which is securely twisted then welded or brazed so both metals will unite. The free ends of the wires are connected to a direct-current millivoltmeter as detailed in Fig. 9. The welded end is inserted where temperature is to be measured and the heat at this end causes a difference in electric potential, which

15 REACTION OF VARIOUS METALS TO SPARK TEST

MATERIAL	STREAM		SPARKS	
	Volume	Color	Quantity	Nature
Machine steel	Large	White	Few	Forked
Wrought iron	Large	Straw	Very few	Forked
High-speed steel	Small	Red	Extremely few	Forked
Carbon tool steel	Moderate	White	Very few	Fine-repeating
Gray cast iron	Small	Red	Many	Fine-repeating
White cast iron	Very small	Red	Few	Fine-repeating
Manganese steel	Moderately large	White	Many	Fine-repeating
Stainless steel	Moderate	Straw	Moderate	Forked
Tungsten-chromium die steel	Small	Red	Many	Fine-repeating
Tungsten carbide	Extremely small	Light orange	None	—
Nickel	Very small	Orange	None	—
Copper				
Brass				
Aluminum	None	—	None	—

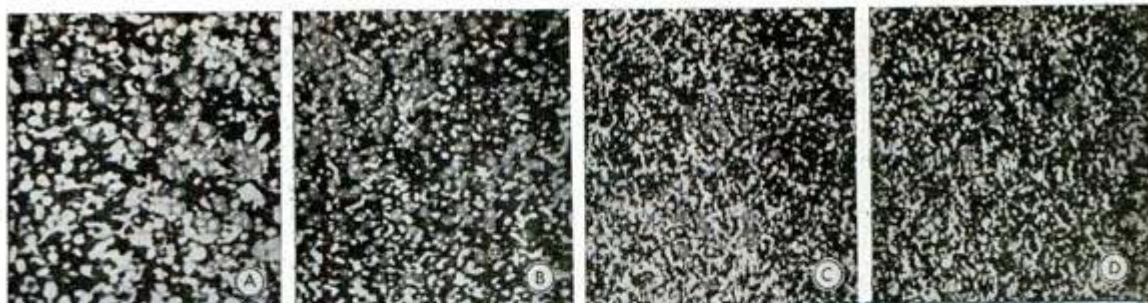

16 PHOTOMICROGRAPHS OF STEEL STRUCTURE IN PROCESS OF HARDENING FROM RAW MATERIAL TO THE DIAMOND-HARD STAGE

Rockwell or Brinell hardness testers, one of which is shown in Fig. 11. While both readings give similar results, the instruments are calibrated differently, as for example 65 on a Rockwell C scale equals 652 Brinell reading or 90 Rockwell B scale is 202 Brinell.

**Classifying steel by spark tests:** Steel is a critical material and a certain type mistaken for another can prove very costly, especially when heat treated. Spark tests, illustrated in Figs. 12 to 14 inclusive, provide an easy, reliable means of identifying steel. Any size grinding wheel of 46-P aluminum oxide, operating at the correct surface speed, will do. A portable grinder is ideal as it can be carried to the material. The testing is done preferably in total darkness, but a dim light is suitable if a black cardboard is placed behind the wheel to serve as a background. Dress the wheel face clean with an abrasive stick, using light pressure. The color and pattern of sparks based on the width and length of the stream, Fig. 13, determine the kind of steel or other metal. Not only do sparks vary in quantity but also in pattern, as shown in Fig. 14. Fig. 15 gives reaction of various metals to the spark test. Note that wrought iron and high-speed steels give very few sparks, and some produce none.

**Hardened steel structures:** The four photomicrographs of Fig. 16 show the transition which occurs in steel structures hardened throughout, from the raw material to a diamond-hard stage. In A, the white dots (known as cementite) are uniformly distributed because this is raw steel. In B, sufficient heat has been applied to partially break up the dots, while in C, additional heat has caused a wider distribution of the dots, and at this stage the steel has become quite hard. In D, the dots are so finely distributed that they appear like fine diamonds set into a matrix of steel. At this final stage, preceding quenching, the hardness is at its maximum, and tempering for a set period brings it down to the required Rockwell or Brinell figure.

Fig. 17 shows a structure resulting from induction surface hardening; the cross-sectional pattern varies with the procedure, but the hardened area itself differs slightly. Detail A shows the depth of hardening or case as it appears to the naked eye, while

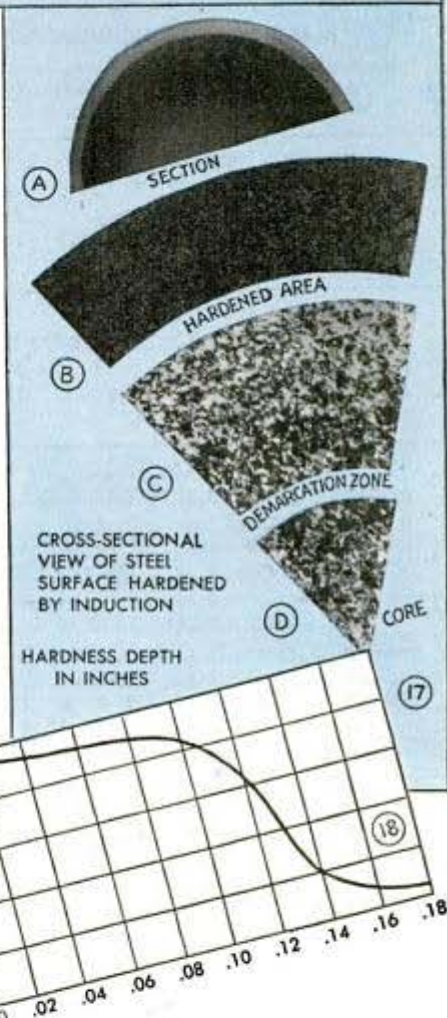

B, C and D are highly magnified views from the outer surface to the core. The graph given in Fig. 18 shows the hardness depth in inches.

The three steel blocks in Fig. 19 show the differences in surface finish as produced under varying atmospheric conditions. A was hardened in a furnace having no control of any kind, B in a furnace having only heat control and C in a furnace having both atmosphere and heat control. C apparently has the finest grain as decarbonizing was entirely eliminated.

**Tool steels:** These are intended for use as tools to cut or otherwise alter the shape

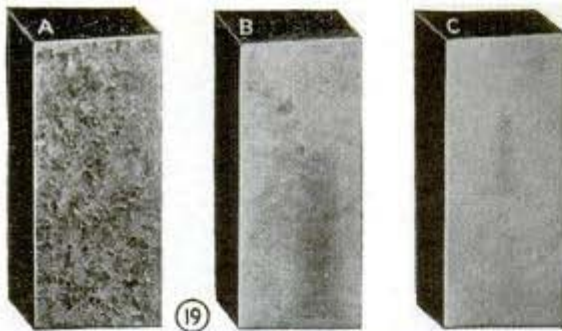

## (20) HEAT-TREATING RECOMMENDATIONS

Key to abbreviations: C—carbon, Mn—manganese, Si—silicon, Cr—chromium, V—vanadium, W—tungsten, Co—cobalt, Mo—molybdenum

### CARBON STEEL

Analysis: C .70-1.30 Mn .25 Si .22

Hardening	Tempering	Forging	Annealing
1425-1550	300-600	1600-1900	1375-1450

Quench—water or brine

### HIGH-SPEED STEEL

Analysis: C .75 W 12.00-19.00 Cr 3.80-4.20 V .95-1.15

Hardening	Tempering	Forging	Annealing
1850-2300	400-1100	1950-2200	1500-1650

Quench—oil

### HOT-WORK STEELS

Analysis: C .45 Mn .25 Si .30 W 12.00 Cr 3.50 V .75

Hardening	Tempering	Forging	Annealing
1750-1900	900-1100	1500-2000	1450-1650

Quench—oil or still air

### SHOCK-RESISTING STEELS

Analysis: C .45 Mn .25 Si .30 W 1.75 Cr 1.40 V .25

Hardening	Tempering	Forging	Annealing
1550-1800	350-700	1700-2000	1400-1500

Quench—oil

### DIE STEELS

Analysis: C .45 Mn .25 Si .30 W 1.75 Cr 1.40 V .25

Hardening	Tempering	Forging	Annealing
1500-1650	375-500	1650-1800	1500-1550

Quench—oil

of other materials. Carbon steels have long ago been replaced with alloy steels but all contain a certain percentage of carbon. The most commonly used alloy tool steels are high-speed, hot-work, shock-resisting and die steels. Alloys generally used to make them are manganese, silicon, chromium, vanadium, tungsten, cobalt and molybdenum as given in Fig. 20. Molybdenum is substituted for tungsten when the latter cannot be obtained. In the case of high-speed steel the tungsten content is reduced from 14 to about 2 percent, but a proportional increase in molybdenum preserves its cutting properties. Die steel, used for all kinds of die and punch work, has a large percentage of carbon and chromium but no tungsten.

## Adjustable Utility Pliers Cut Off For Use on Special Jobs

A pair of inexpensive adjustable pliers of the utility type can be converted easily for use as a pair of battery pliers by grinding off one jaw as shown in the upper detail.

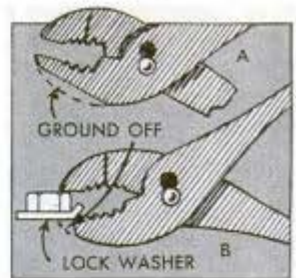

This allows the nut on a battery-terminal bolt to be turned without the lower jaw of the pliers digging into the battery top. By grinding off the end of one jaw as shown in the lower detail, the same kind of pliers can be used for bending the lock washer to lock the nut on a Bendix bolt used on some generators and starting motors.

## Detachable Shelf Made Easily

Requiring a shelf in my shop that could be removed when not in use, I made one as indicated. Ordinary metal shelf brackets were screwed permanently to the shelf and were slipped into short pieces of flat curtain rod screwed to a wall. The nails that hold the pieces of curtain rod must be driven in flush with the surfaces of the rods.

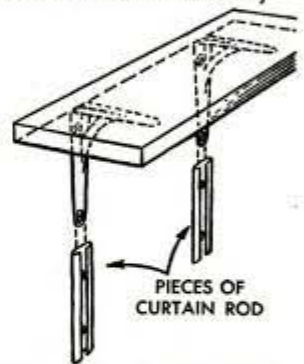

—G. E. Henderson, Argyle, Wis.

## Strong Looped-Wire Chain Links Will Not Come Unfastened

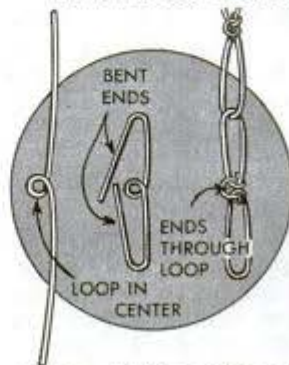

You can make small wire halter chains, dog chains, etc., with links as strong as the wire itself by cutting the wire in equal lengths that are twice as long as the finished link desired. To form the links, turn a small loop in the center of the wire and double back the ends so that they overlap slightly. Bring each free end up through the loop and wrap it around the side wire to complete the link, which is then drawn tight to close the loop.—Emil Eichler, Edmonton, Can.



# Radio

## “DON'TS”

FOR your own safety, and in the interest of your radio serviceman who is literally swamped with repair work, the following timely “DON'TS” illustrate things you must NOT DO if you expect uninterrupted enjoyment from your radio:

(1) Perhaps the most dangerous place in the home to operate a radio receiver is in the bathroom. Like any electrically operated device it should not be handled with wet hands, and the operator must not be in contact with water or grounded bathroom fixtures. Confined air, saturated with steam and talcum powder, is definitely bad for the set.

(2) Never attach a ground wire to your receiver unless directions specifically call for one. Do not connect the antenna wire to a radiator; such connections can result in a burned-out coil in the set.

(3) Do not use a screwdriver on the metal radio chassis, you may damage your set so that it cannot be repaired and you might get a serious shock.

(4) Never turn the turntable of a radio-phonograph combination by hand; forcing may bend or break the mechanism. Do not touch the pickup arm while the instrument is in process of changing records.

(5) Keep small radio sets out of windows, especially in the kitchen where you may be tempted to tune the set with one hand in water, a highly dangerous thing to do. Receivers kept in windows where they are subject to quick changes in temperature, and exposed to dampness, are regular patients in radio hospitals.

(6) This illustration should not be necessary, but any serviceman will tell you that it does happen, and he probably can show you table model sets that have been “fried” on radiators. All of these things cause unnecessary service calls, and can be avoided.

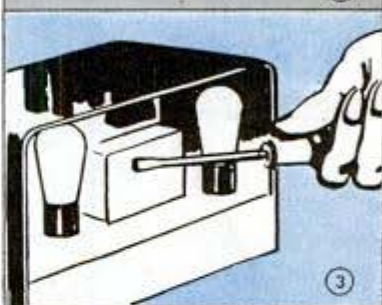

# "Pockette" PORTABLE



"POCKET" radios for experimenters have usually been one of two types: those too large to actually carry in the pocket, and the ones small enough to slip into a pocket but requiring an external antenna for reception. This one-tube "pockette" set not only fits the pocket but includes a built-in loop antenna that will bring in strong local stations without an additional external wire. The original model picked up four local stations in Denver, Colorado, and played merrily on as the operator, with headphones on his head, strolled down the street with the set in his pocket. However, those who wish to add an external antenna for distant reception may do so, as indicated in diagram Fig. 1. Mount  $C_4$  inside box and connect to lug S.

The complete unit is assembled in a case made by cutting down a cigar box of the shallow 25-cigar variety, and only a few odds and ends of parts salvaged from a discarded midget-type broadcast receiver were required. A type 1S4 miniature tube, commonly found in radio experimenter's junk boxes, is employed in a standard regenerative circuit. The only unusual feature is the tuning coil which is wound in two sections on the case of the set; these windings form a directional loop antenna. The grid winding consists of 28 turns of No. 26, 28 or 30 enameled or cotton-covered magnet wire, close-wound in a clockwise direction. The 19-turn tickler coil is wound in the same manner with the same kind of wire, and the coils are spaced  $\frac{1}{8}$  of an inch apart. Suitable wire can be salvaged from a burned-out filter choke coil

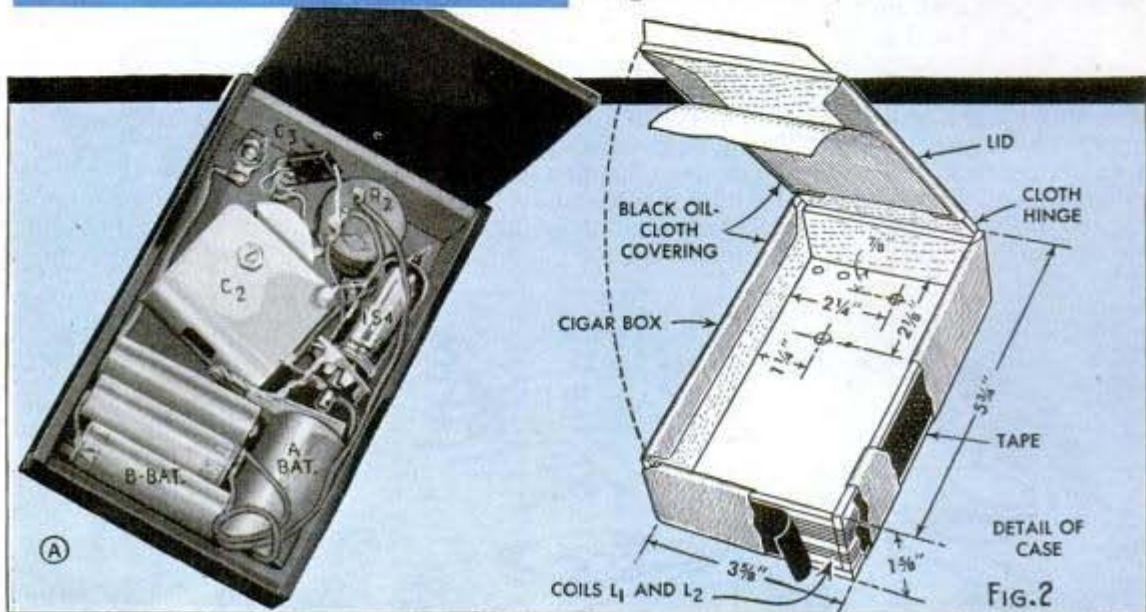
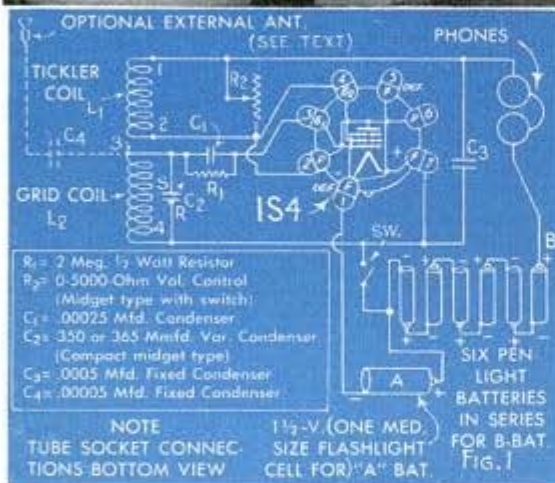



# HAS BUILT-IN ANTENNA ...

or an old audio transformer. The case dimensions are given in Fig. 2, and all coil and circuit connections are clearly shown in the pictorial wiring diagram, Fig. 3.

The coil terminals are brought into the case through small holes, and these leads should be left long enough for the circuit connections. These coils will tune from approximately 575 to 1350 kc. If your local station, or stations, tune near 550 kc., add 3 turns to the grid coil winding. Wrap a layer of adhesive tape over each coil, sealing it down to the box, overlapping the coils to protect them from moisture. The case, including the cloth-hinged lid, is then covered with black oilcloth glued to the box with a layer of household cement. Detailed student material list R-326 is available from Popular Mechanics radio department, upon receipt of postage.

Arrange the parts carefully and wire them with short flexible leads before mounting them as shown in photo A. Cement the variable condenser dial plate on the case as indicated in photo B. Connect the six "penlight" B-batteries in series with flexible leads, and insulate the end of the 1½ volt flashlight-cell A-battery from the terminals of the tube socket with a small piece of cardboard.

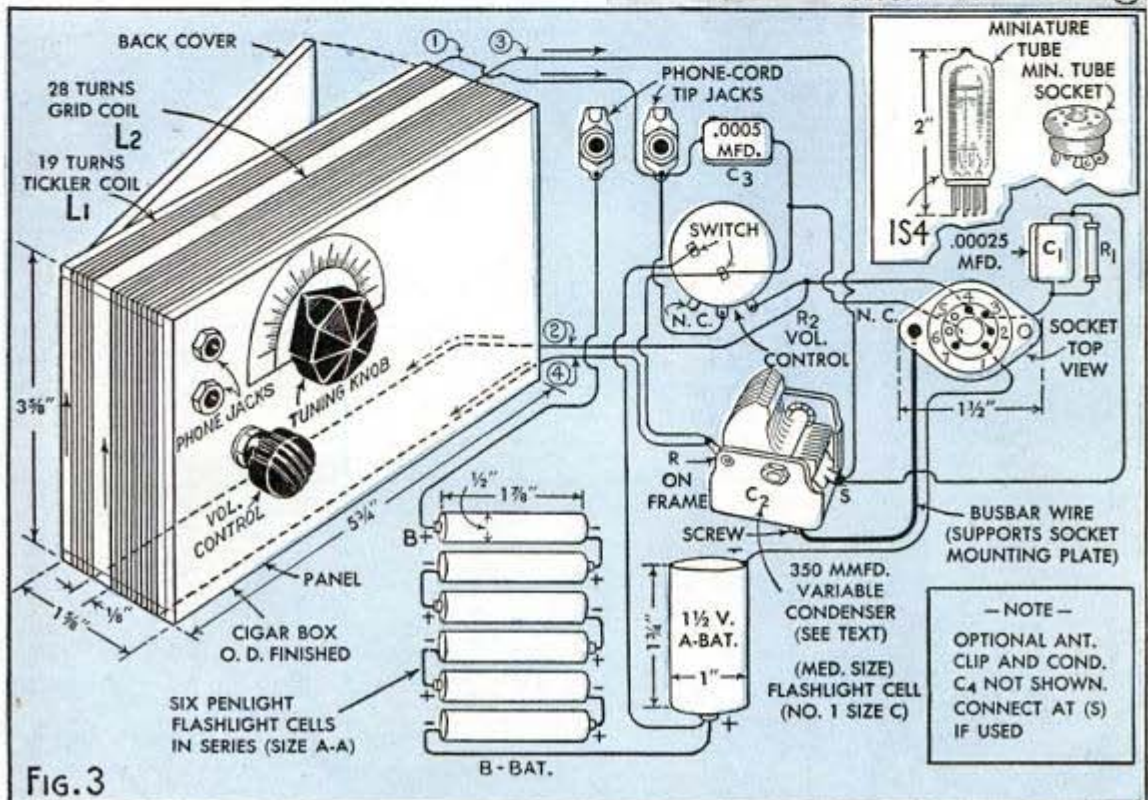
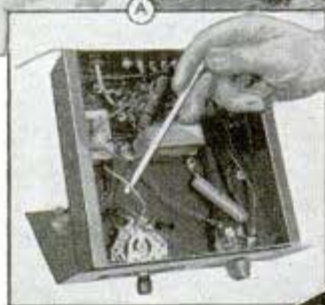

Fig. 3



# Practical RADIO HINTS

(A) Plastic crochet needle of the "dime" store variety makes a useful probe and wire-lifting tool for radio instructors or servicemen when demonstrating or locating poorly soldered or broken leads in "live" circuits under test. It provides a completely insulated tool better adapted for the purpose than a screwdriver or similar instrument that may cause a short circuit or an accidental shock to the operator



(B) A "china" marking pencil is used to write service data on glass or metal tubes in a large radio station where 50 receivers are operated on a 24-hour schedule. Home set owners will find this method better than the usual unsatisfactory gummed paper tube stickers for service memoranda and dating purposes

(C) Plates removed from a discarded variable condenser make good drawer handles for your radio workbench



(G) Antenna lead-in strip made from paper-covered copper foil obtained from scrap building material. Fahnestock clips are bolted to each end; the strip is then carefully wrapped with weather-proof tape

(H) Tuning knobs with broken edges repaired with poker chips drilled and cemented as shown

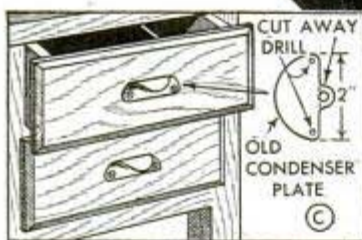
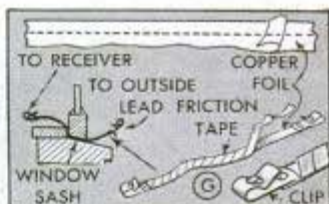

(D) Microphone for inter-office systems has control box with "busy signal" light; (E) Handy pilot light remover made from spring clothespin; (F) Improved long-life phono needle has plastic noise-reducing insulator; (J) Scratch preventer shields tacked or cemented behind control knobs

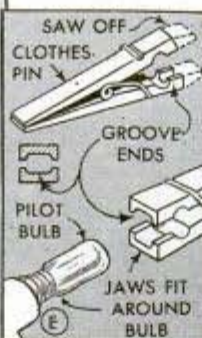



# TOOL NOTES

Maintenance  
and Repair  
Suggestions to  
Prolong Tool Life

## No. 17 . . . . . PICKING THE PROPER TOOL FOR THE JOB

There is a difference in snips. They vary in style and size in order that they may better handle a wide range of cutting work. Below are some common examples.

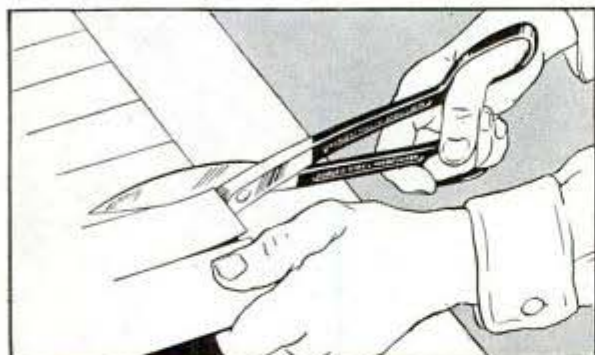

For general cutting use, **STANDARD PATTERN CRESCENT SNIPS** are recommended. Made in 8 sizes, they are designed to cut straight lines or circles of fairly large radius. Example: Cutting sheet metal to size.

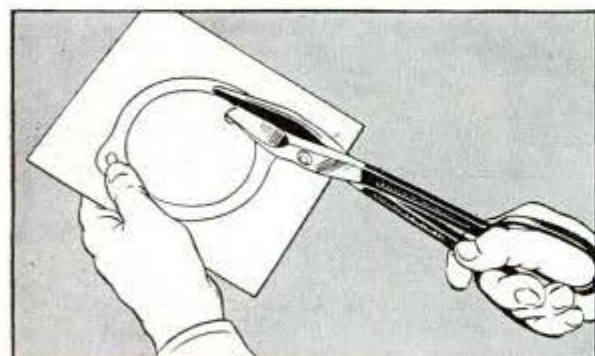

Where it is necessary to cut intricate patterns or curves of small radius, use **CRESCENT CIRCULAR CUTTING SNIPS**. The curved contour of their cutting edges makes it possible to turn the cut sharply without taking a new "bite." Example: Cutting intricate templates.



When "on-the-job" work will not permit an assortment of snips being carried, use **CRESCENT COMBINATION SNIPS**. They are designed after conventional circular cutting types and will cut curves as well as straight lines. Example: Hot air furnace work.

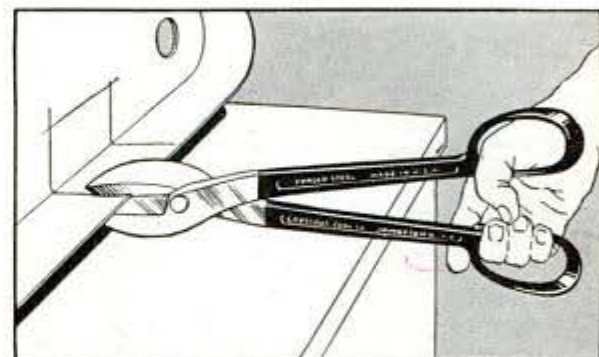

Where powerful leverage is necessary, as with heavy sheet metal, **CRESCENT HEAVY DUTY SNIPS**—with an overall length of 16¼ inches—are ideally suited. Example: Heavy bench work.

### MAIL THE COUPON FOR FREE REPRINTS



This is No. 17, in Crescent's **TOOL NOTES** Series. These informative advertisements provide practical information for users of hand tools. Mail the coupon today!

**CRESCENT TOOL COMPANY, JAMESTOWN, N. Y.**

**CRESCENT TOOLS**  
*Give Wings to Work*

.....  
Crescent Tool Co., Jamestown, N. Y. G-6

Please send your "Tool Notes" Series

for Bulletins  for 3-ring binder

Name \_\_\_\_\_

Address \_\_\_\_\_

City \_\_\_\_\_ State \_\_\_\_\_

# WORTHY WEAPON

America's fighter pilots using Allison-powered planes are downing the enemy on every battle front. ★

Allison engines by superb performance have proved their ability to take punishment, their smoothness to lessen pilot fatigue, their economy to provide long range.

★ These engines—worthy weapons today—will contribute to the comfort and safety of the planes you will ride in tomorrow.

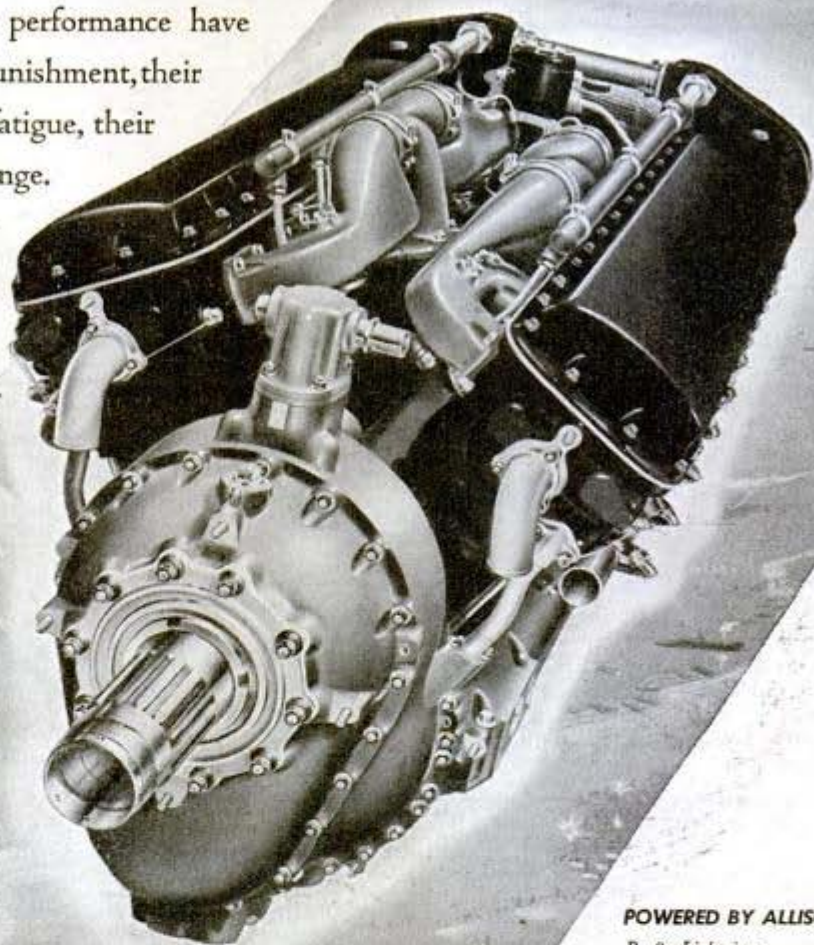

#### POWERED BY ALLISON:

P-38—Lightning  
P-39—Airacobra  
P-40—Warhawk  
A-36 and P-51A—Mustang

More than 50,000 Allison engines have been built for the above planes of the U. S. Army Air Forces.

**BUY WAR BONDS  
DO MORE THAN BEFORE**

LIQUID-COOLED AIRCRAFT ENGINES

*Allison*  
DIVISION OF

Indianapolis, Indiana



*Every Sunday Afternoon*

GENERAL MOTORS SYMPHONY OF THE AIR—NBC Network

# Here's how your car **FEELS...**



*...after*

## **MARFAK**

*chassis*

*lubrication!*

What a pleasure to drive a car that has MARFAK chassis lubrication. Your car is quieter, smoother, easier to handle. MARFAK is always applied by chart, never by chance. Eliminates the possibility of missing a king pin or a control arm lubrication fitting. And with each MARFAK job you get a stem-to-stern check-up of every point of wear, every point of adjustment. Your Texaco Dealer turns your car out feeling years younger! Ask him to give your car that "MARFAK feeling"—tomorrow!

THE TEXAS COMPANY.

Let us  
**MARFAK**  
your car



TUNE IN: FRED ALLEN every Sunday night.  
See your local newspaper for time and station.



**"One of the Freedoms I will feel I have earned will be to have a Harley-Davidson under me again"**



No letter, among the thousands we have received, is more typically American than this one from Seabee "Lefty" C—

"When I was a civilian, I had a Harley-Davidson. Its performance was superb. Have shore duty here with the Navy Seabees. Harley-Davidsons are used for specialized duties, and they never balk on the most rugged assignments. One of the freedoms I will feel I have earned will be to have a Harley-Davidson under me again and feel the good old American wind biting my face."

Many thousands of motorcycle fans feel the same way, Lefty. Like you, they are earning their freedoms — the hard way. You're all hastening the return of gypsy tours, race meets, hillclimbs and endurance runs. And we can assure you that when those "freedoms" are yours again, the newer, better Harley-Davidsons will really have what it takes to make the good old American wind bite your face! Put every spare dollar into War Bonds — thrill to your own Harley-Davidson after Victory!

**HARLEY-DAVIDSON MOTOR CO.**  
Dept. P, Milwaukee 1, Wis.

Write for free copy of  
**ENTHUSIAST  
MAGAZINE,**  
filled with motorcycle  
pictures and stories.



**HARLEY-  
DAVIDSON  
MOTORCYCLES**

## Silver Goes to Work

*Continued from page 75*

which specialize in its production. Silver also should be considered one of the most corrosion-resistant metals that we have.

"Bactericidal properties of silver have attracted considerable attention in the purification of drinking water. The germicidal value of silver leaf for preventing infections by placing it over the incision after a surgical operation long has been known."

The purity of silver is referred to as the "fineness" of the metal, and a bar that contained 99.95 percent pure silver would be designated 999.5 fine, meaning 999.5 parts per thousand were silver. In the United States the standard silver acceptable for bullion trading is 999.0 fine and is referred to as fine silver. In England and the Orient, bars 996.0 fine are acceptable.

Copper has been used as the alloying element of silver since early times when primitive peoples discovered the native silver-copper alloys. The fineness of the silver-copper alloys used in the arts and silverware industry varies generally from 750 to 925 fine. Some articles are made from alloys having the same fineness as silver coins, which in this country are 900 fine. In England and the United States the accepted standard for silverware is 925 fine and is called sterling silver. Most of the silver products we use are made from this composition.

Contrary to the usual belief, native, or pure, silver accounts for only a small part of the total production. Silver occurs in many ores, usually as a sulfide and is commonly associated with lead, copper and zinc. The silver content of the ore may vary from a few ounces per ton in lead and copper ores to hundreds or even thousands of ounces where silver is the principal value.

That silver will be used more than ever in the production of civilian merchandise after the war is an accepted fact with metallurgists and manufacturing authorities. This is made clear, they say, by the remarkable advances made in many manufacturing processes, alloys and materials and by the rigid tests of various types of construction under wartime operations.

While silver production in the Western Hemisphere has been slowed somewhat by such difficulties as labor shortages, experts point out that there is little danger of a silver shortage for years to come despite extreme war production needs. This is particularly true if the Treasury continues its policy of making government "free silver" available to industry.



## TOUGH . . . but oh so gentle

 Little engine troubles soon become big, expensive problems, if neglected. And one of the most common causes of engine trouble is worn-out piston rings.

Whenever your engine shows signs of ring failure—oil-pumping, smoke and

loss of power—go to your motor service man. He will show you how to save oil, check cylinder wear and step up engine performance—with Hastings Steel-Vent piston rings.

HASTINGS MANUFACTURING COMPANY, HASTINGS, MICH.  
Hastings Mfg. of Canada, Ltd., Toronto

★  
IT'S A PRIVILEGE  
TO BUY WAR BONDS



**HASTINGS** STEEL-VENT  
**PISTON RINGS**



TOUGH ON OIL-PUMPING GENTLE ON CYLINDER WALLS

## GIVING A MACHINE THE BREATH OF LIFE



Photo courtesy  
Fawick Airflex Co.



**I**N BUILDING precision machinery, it is usually the combination of trained mind, skilled hands and *right file* that provides the final assurance of good performance.

No single type of tool has yet been discovered which can be applied with greater versatility toward "making things work" than files. Their production is an "industrial art" which can well be a tool manufacturer's sole business.

For 80 years Nicholson has been making files and nothing else. Nicholson devotes its field studies wholly to files for industrial production, sharpening tools and implements, working different kinds of metals and other materials.

So, when you ask your hardware or mill-supply dealer for a file for a specific purpose, you can be sure that in Nicholson or Black Diamond brands you can obtain exactly *The right file for the job*—under the guarantee of *Twelve perfect files in every dozen*.

**FREE BOOK, "FILE PHILOSOPHY."** For production heads, foremen, mechanics, repair and machine shop operators. Shows scores of regular and special-purpose files.

**NICHOLSON FILE CO., 22 Acorn St., Providence 1, R. I., U. S. A.**  
(Also Canadian Plant, Port Hope, Ont.)

**NICHOLSON**  
**FILES** FOR EVERY  
PURPOSE

**NICHOLSON**  
U.S.A.  
MADE IN U.S.A.

## They Get There First

Continued from page 47

one of several TCC bases, probably Alliance, Neb., Sedalia, Mo., or Louisville, Ky. The enlisted ground crews are meanwhile trained in their specialized tasks.

The final phase of training is conducted at Laurinburg-Maxton Army Air Base near Ft. Bragg, N. C. Here the Troop Carrier Command crews meet for the first time their future passengers in battle—paratroops, glider infantrymen, and artillerymen. These are specially trained ground troops of the Airborne Command. After two to three months of practice in hauling and dropping troops, supplying them by parachute during maneuvers and evacuating "wounded," a Troop Carrier squadron is ready for assignment overseas.

The TCC's glider pilots, noted throughout the AAF as the toughest flyers in the business, are trained in the same commando course given to the Airborne troops they will carry. Reason for this is the unpleasant truth that once a glider pilot lands his craft the only way to get home is by foot or in another vehicle. When the landing is behind the enemy's lines the glider pilot must fight his way back. The TCC gives him combat training at its Glider Pilot Training Center, Bowman Field, Louisville, Ky.

Standard glider of the AAF at present is the CG-4A, a 15 place machine of fabric and tubular steel whose capacity for absorbing punishment without injuring its passengers is legendary. CG-4As have been rammed into houses, set down in lakes, crash landed in forests—but their passengers are seldom hurt. With a gliding range of about ten to one, it will travel forward ten feet for every foot of altitude. Its wing span of 83 feet 5 inches, compares favorably with that of a Flying Fortress. It is 98 feet long and weighs 3,600 pounds empty. Carrying a flight crew of pilot and co-pilot the glider is towed by the C-47s at the end of a 350-foot nylon tow rope, either singly or two to a transport. The elastic quality of the nylon, which takes up most of the shock as the glider is towed into the air, is largely responsible for the success of glider operations. The gliders have upturnable noses which allow a jeep or small field piece to be run aboard. Although the primary purpose for which Troop Carrier crews are trained is aerial invasion, its pilots run passenger and freight routes under the noses of the enemy; evacuate wounded men, and haul combat engineer battalions which special-

Continued to page 152



# AUTO-LITE SPARK PLUGS

IN SERVICE ON EVERY FRONT



*"Dang it, Uncle Rafe, quit playing paratrooper . . . comp'ny's a'comin' and maw can't find the bedsheet!"*

## NO CATCH...TO "PLUG-CHEK'S" GAS SAVING!

Auto-Lite's "Plug-Chek" Inspection Service can help save gas wasted by faulty, dirty or improper plugs. In actual tests by the American Automobile Association this spark plug service resulted in increased gas mileage up to 12%! Today some car owners get better results from "hotter" spark plugs than those which originally came with their car. This is particularly true because gas rationing so radically cuts the speeds and miles you drive. "Plug-Chek" will quickly show you whether your present plugs are operating "too hot" or "too cold" or just right. Get a "Plug-Chek" today!

THE ELECTRIC AUTO-LITE COMPANY  
TOLEDO, 1 • Merchandising Division • OHIO  
BACK THE ATTACK—BUY WAR BONDS

Tune In  
**AUTO-LITE'S**  
GREAT RADIO SHOW  
**"EVERYTHING  
FOR THE BOYS"**

Featuring men and women at  
the fighting fronts  
Tuesday Night — NBC Network





# Carhartt

**BROWN DUCK  
OVERALLS**  
For Those Extra  
Tough Jobs

**WORK CAPS**  
Washable, comfortable and  
cool, with breather eyelets.

● Here's another exclusive  
work garment you'll be glad to  
know about—Carhartt Brown Duck  
Overalls.

Built for those extra tough jobs,  
these 11 oz. bib overalls and coats  
to match are just the ticket for  
structural iron and steel workers,  
bridgemen, electricians, and line-  
men, road builders, foundry men,  
ship workers, truck drivers, freight  
handlers and a hundred and one  
other rough and ready occupa-  
tions.

Made by the makers of the fam-  
ous union label brand of Carhartt  
work clothes, they're dependable,  
wear-resisting and rugged. Back  
three generations of overall mak-  
ers who have backed the unions  
for over 50 years—**BUY CAR-  
HARTT OVERALLS!**



**HAMILTON CARHARTT OVERALL CO.**

*Established 1889*

Detroit, Mich.  
Atlanta, Ga.

Carhartt Park, Ky.  
Dallas, Texas

*On sale at your local dealer's*

# Carhartt

**UNION MADE WORK CLOTHES**

*50 Years a Friend to Organized Labor*

## KEEP MATERIALS MOVING

**with Steel-Grip Gloves**

With not a moment to be lost,  
keep men at work and materials  
moving with Steel-Grip chrome  
tanned cowhide gloves. Steel rib-  
bons over tough leather strips;  
palm and fingers reinforced, for  
utmost wear. Handle rough  
heavy, sharp materials with speed  
and safety and sureness. Or what's  
your problem? Over 4300 proven  
Steel-Grip safeguards may give  
you an immediate answer. Used by  
big industrials since 1910. Write for  
catalog or state your need today.



**INDUSTRIAL GLOVES CO.**  
651 Garfield Blvd., Danville, Ill.  
*Canada: Safety Supply Co., Toronto*

ize in reconstructing ruined landing fields.

The Troop Carriers reached Egypt in time to help General Montgomery's Eighth Army chase Rommel across Libya, hauling gasoline, food, water, ammunition and bombs. They flew in sandstorms reaching up to 8,000 feet that half blinded the pilots, pitted propellers and ruined carburetors, but they kept coming so fast that fighter planes returning from a mission often re-fueled from a C-47 awaiting them with a load of 100 octane. On return trips they piled wounded British Tommies onto stretchers and flew to hospitals on the Nile.

It was the Guadalcanal campaign which helped to develop one of the most hard-bitten and overworked airlines, the Troop Carrier aggregation known as "SCAT" (Central Pacific Air Transport) which in one month hung up a record of 1,853,000 ton miles of cargo and passenger flying. Operating from New Caledonia and Espiritu Santo, SCAT boasted that 90 percent of its planes were always in flying condition despite tropical storms and primitive maintenance conditions. It flew 2,810 missions, a total of 1,303,000 miles or fifty times the distance around the world at the equator.

At its School of Air Evacuation at Louisville, Ky., the TCC trains flight nurses. They are selected from the regular Army Nurse Corps and former airline stewardesses and given six weeks training in aviation medicine, particularly the treatment of patients in flight. Assigned to air evacuation squadrons overseas, they fly to the front with personnel and equipment, supervise the speedy conversion of the big ships into hospital planes and care for the wounded on the way back. With canvas stretcher racks installed, a C-47 carries 20 to 24 litter patients per trip. Once offloaded from hospital boats on this side of the Atlantic, our wounded men often get a second ride with the Troop Carrier Command to army hospitals located as near as possible to their homes. During one operation from an east coast port recently, the TCC moved over 600 patients in ten days to hospitals throughout the east and middle west.

"You made the lap of the trip that always seems the longest, the shortest," said one wounded soldier to his flight nurse. "We sure are grateful."

„In stories like this, and in the awards for bravery and unit citations worn by its thousands of officers and men, the I Troop Carrier Command sees the proud justification of its insignie and its motto—A giant falcon carrying an armed soldier in its talons, beneath it the Latin words: "Vincit qui primum gerit—He conquers who gets there first!"

## PRESIDENT TAFT GAVE THE STARTING SIGNAL

IT is June 1, 1909. For weeks the papers have carried the exciting news. Now, before New York's City Hall five "horseless carriages"—an Acme, a Shawmut, an Itala and two Model-T Fords—stand hub to hub.

Anxiously mechanics make final adjustments. Then, from the White House, President Taft flashes the starting signal. And America's first transcontinental auto race is under way.

West of St. Louis, seven-day rains had turned the roads into quagmires. Across the prairies and in Colorado average speeds were cut to ten miles an hour.

At Cheyenne, Wyoming, the big Itala quit the race. The others

plowed on. Near the summit of the Cascades they fought their way against towering snow drifts.

Days later, Ford Car Number 2—the winner—entered the gates of Seattle's Alaska-Yukon-Pacific Exposition. It had crossed the continent in 22 days and 55 minutes, with New York air still in the two front tires!

As he awarded the trophy cup, Col. M. Robert Guggenheim said: "Mr. Ford's theory that a light-weight car, highly powered . . . can go places where heavier cars cannot go, and can beat heavier cars costing five and six times as much, on the steep hill or on bad roads, has been proved. I believe Mr. Ford has the solution of the problem of

the popular automobile."

The proof of that statement no longer rests in a single car, which won a race, but in the 30 million cars and trucks Ford has built since then. And today millions of them are providing reliable, economical transportation for wartime America.

Meanwhile the inventive genius and the precision skills associated with the name *Ford* continue to serve the nation in the mass production of giant aircraft and other means to victory.

In the days of peace ahead, Ford's resourcefulness in developing new ideas and methods will again produce soundly-engineered motor cars, priced within reach of the largest number of people.

**FORD MOTOR COMPANY**

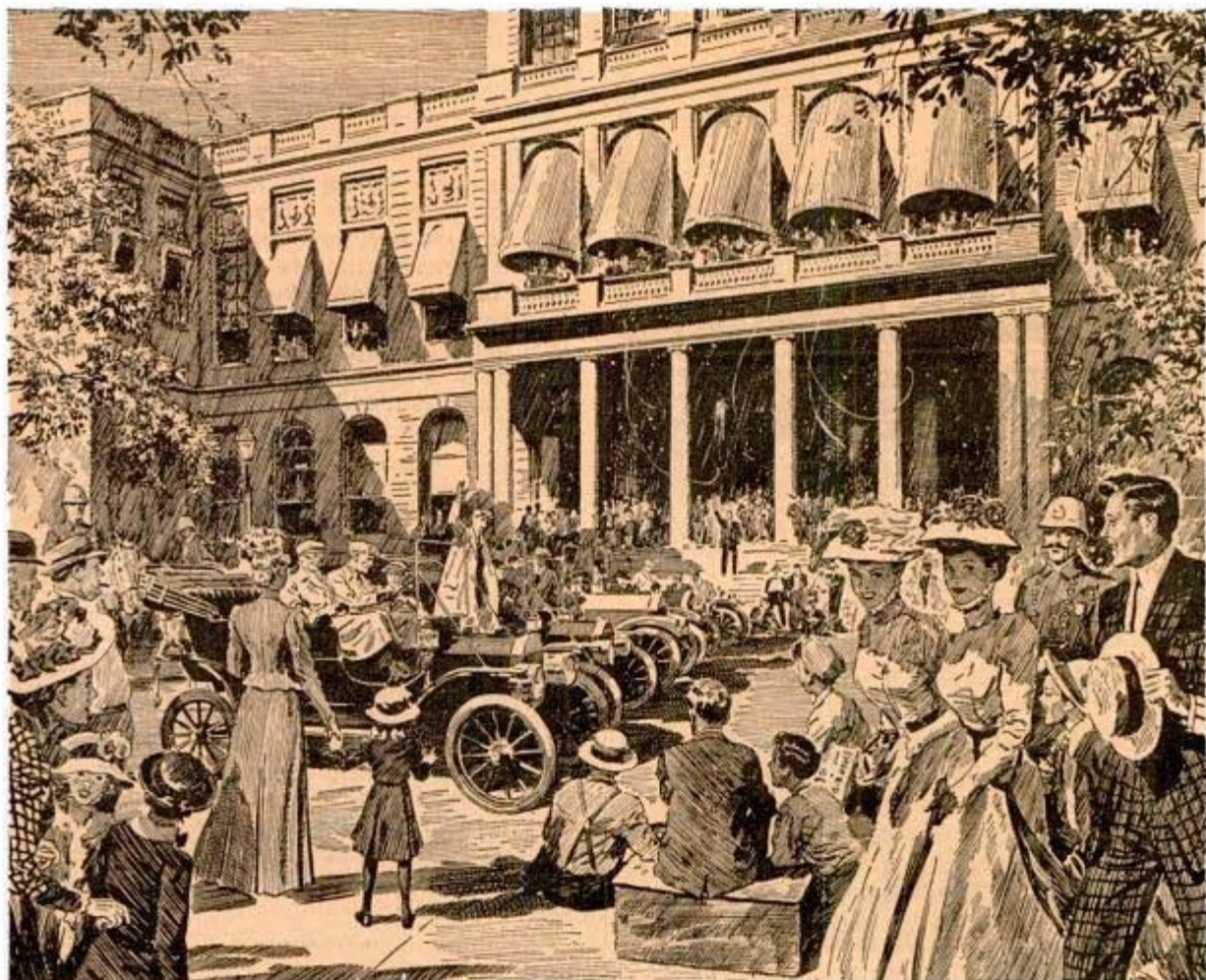

# VICTORY GARDENERS

Dirt won't stick to hands covered with DU PONT "PRO-TEK"

Before starting work, rub on "PRO-TEK" like a cold cream



After work, grime and dirt wash right off

*This cream acts like an invisible glove*

**DU PONT**



TODAY IT BELONGS TO THEM



★ Helping to guide army vehicles on strange roads. Tomorrow the new improved HULL COMPASS will be available to you at your dealer's.



HULL MFG. CO., P. O. Box 246-D7, Warren, O.

**TAPE WORMS  
ROUND WORMS  
(Ascarids)  
HOOK WORMS  
WHIP WORMS**



...you can free your dog of all these worms

with **PULVEX**  
COMBINATION TREATMENT **WORM CAPSULES**

Used by leading breeders. At leading pet, drug, department stores, 50¢ a package (double size, 75¢). Packed two ways: for puppies, for dogs.

## Featherweights on Wheels

Continued from page 79

attached to the chassis and the other end clamped to the body, replaces each conventional set of spring leaves. The springing action of the usual spring is duplicated by the twisting action of the bar, at a considerable saving in weight.

The trend of the railroads toward light-weight equipment began with the advent of the streamlined passenger trains pulled by Diesels. The indications are that even these trains can be replaced by still lighter engines and cars with no sacrifice of safety or comfort. Figures have been prepared for a new Diesel road locomotive that would be 137 tons lighter and 750 horsepower less powerful than present Diesels and that yet would have a top speed and tractive effort comparable with present engines. Weight reduction would be made possible by using Diesel engine units of smaller cylinder bore. This would reduce the length and hence the weight of the engine. Other refinements would include aluminum fuel tanks and lightweight flooring. Doing the same work as one of the present Diesels, such a lightweight engine would consume 145,000 fewer gallons of fuel oil and 900 fewer gallons of lubricating oil per year, allowing for 6,000 hours of operation with a 60 percent load factor.

Already in use on the Santa Fe and Burlington systems are a few lightweight passenger cars designed on the semi-monocoque principle, using a skin-stressed body on a fabricated and welded frame. These Hill cars employ a coil-spring suspension that gives a unique floating ride. Of about the same weight as standard lightweight railroad cars, the Hill cars are said to have a high factor of safety.

Before the war, Bethlehem Steel had completed a few dozen box cars and hopper cars of a high tensile, rust-resistant steel that provided a weight reduction of 15 percent. Additional weight economies are anticipated.

Weight engineers tell about the time, not so long ago, when an airplane builder pushed his new model out of the hangar, invited four friends on board, and revved up his 65-horsepower engine for the first test flight. To his surprise the airplane didn't even budge on its wheels, so heavily was it loaded. Weight engineering has come a long way since then, but the engineers feel that even now their work has hardly begun.

☞ To learn where to buy commercial products described in these pages, see the index.

*"I think I'd better stop now"*

**When Long Distance Says—  
"Please limit your call  
to 5 minutes"**

That's a good suggestion to follow. It means the lines to war-busy centers are crowded. It's a friendly, thoughtful act that helps the other fellow—and then some day turns right around and helps you.



**BELL TELEPHONE SYSTEM**



Millions of tons of America's food get to the stores and markets regularly because AC Spark Plug reliability keeps the trucks in service. Owners of those vital trucks save gasoline and lengthen the life of their spark plugs by having plugs cleaned and adjusted every 3,000 miles.

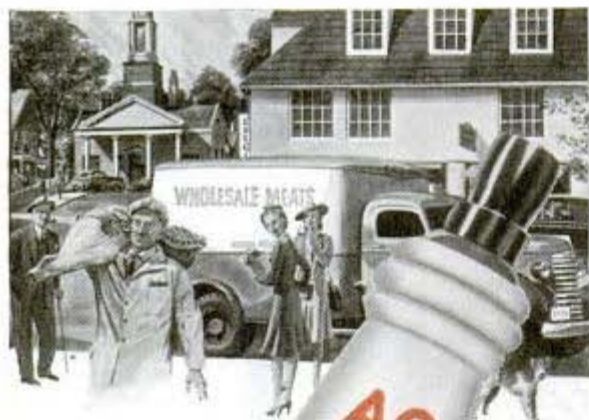

CLEAN PLUGS SAVE  
UP TO ONE GALLON  
OF GASOLINE IN TEN

**AC**  
**SPARK PLUGS**

DO MORE THAN BEFORE—BUY WAR BONDS NOW

## Heroes of the "Hump"

Continued from page 87

had become one of the biggest and busiest air centers. American engineers, pilots, and mechanics had accomplished the impossible. By expending a little effort, the Japs could once have taken Assam with its sleepy tea plantations and rice paddies. Now they know it is too late and the best they can do is drop an occasional bomb from great heights and announce to the world "China Wing wiped out."

There is keen competition between the various fields. The men keep a "score board" of the tonnage they carry, and watch it as avidly as they ever watched baseball returns. There is also competition over which unit has the best mess. The pride of one group is an ingenious stove made of two gasoline drums with the ends knocked out. The drums were welded together and set up on supports, leaving room for a grate beneath. Insulation was provided by a mixture of soil and cement. Out of this stove come roasts of buffalo, camel and goat meat to be served alongside wild pineapples, mangoes, carrots, and the dehydrated and canned rations.

President Roosevelt paid tribute to the valiant flyers of the Hump early this year with a radioed citation to the entire India-China Wing. The citation, first of its kind to a non-combat outfit, was for "exceptionally outstanding performance in the face of almost insurmountable odds."

Soon the Hump route will be augmented by the new Ledo Road across North Burma which is being built through the jungles by U. S. Army engineers. But until land or sea supply routes are opened up, the men of the India-China Wing will be flying round the clock to keep a brave ally in the fight.

## Revolution on Rails

Continued from page 25

covered that control cooling of new rails prevents the shatter cracks which form the nuclei of the fissures.

The Southern Pacific has pioneered a number of railroad safety devices. One is a boiler drop plug, a device to release steam into a locomotive firebox when water sinks below the top of the crown sheet in the boiler, threatening explosion. If the boiler water level drops low enough to uncover the crown sheet, a fusible metal which holds the button-like center in the body of the brass plug gives way and the whole button blows into the firebox, releasing

Continued to page 158

**"BIG JOE" CAN BLAST A HOLE THROUGH A FOG! . . .** It's the air raid siren that's guarding Pearl Harbor and hundreds of American towns and cities . . . and it's got the loudest mechanical voice in the world today. It can actually start fires with its tremendous vibrations! . . .

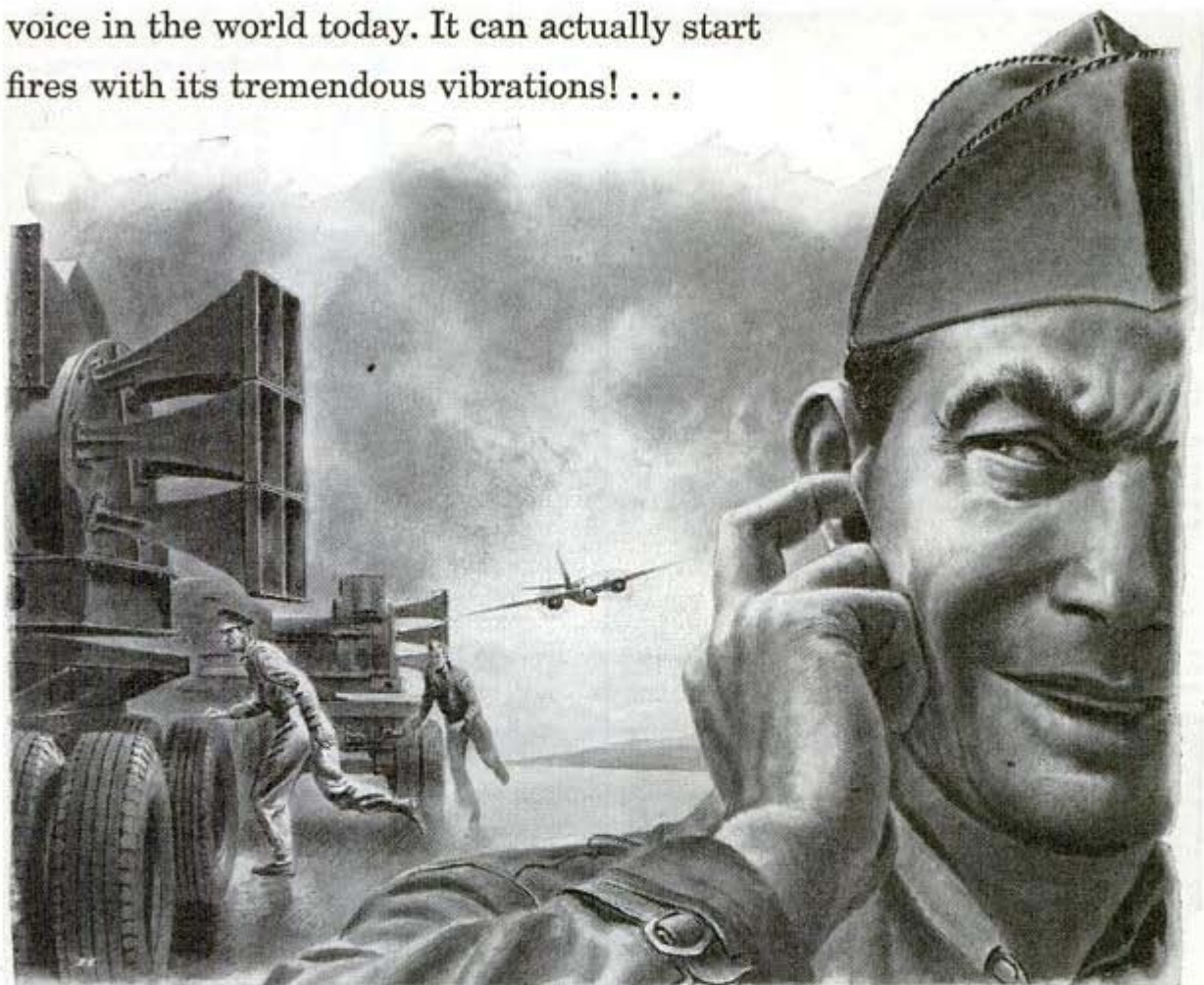

**BACK THE ATTACK WITH WAR BONDS!**

"Where does Big Joe's power come from? . . . I'll tell you! . . . From the same engine that used to hide under the hood of a Chrysler . . . the very same engine that's helping to push thousands of General Sherman tanks toward Berlin and Tokio!"

**WAR PRODUCTS OF CHRYSLER DIVISION**

Industrial Engines • Marine Engines • Marine Tractors • Navy Pontoons • Harbor Tugs • Anti-Aircraft Cannon Parts • Tank Engine Assemblies • Tank Parts • Airplane Wing Panels • Fire-Fighting Equipment • Air Raid Sirens • Gun Boxes • Searchlight Reflectors.

**CHRYSLER**



DIVISION OF CHRYSLER CORPORATION

THE NATION-WIDE CHRYSLER DEALER ORGANIZATION OFFERS OWNERS SERVICE FACILITIES TO MEET THEIR TRANSPORTATION NEEDS

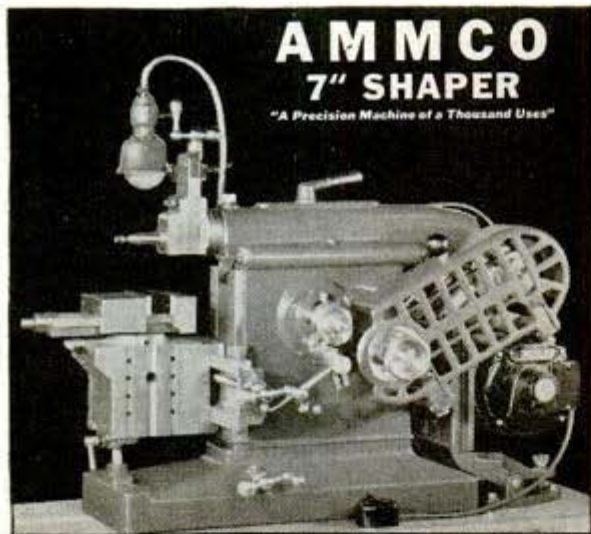

A wide variety of jobs can be done accurately, quickly, easily, and economically on the AMMCO Shaper (7" stroke).

Construction incorporates many features you would expect to find only in larger, more expensive machines... For example: WAYS of ram, tool head, and front face of the main frame are of the "VEE" type, hand scraped to insure accuracy and long life. Available for stationary installation or as portable unit.

Write today for specifications and prices

The AMMCO SHAPER can be purchased on M. R. O. PRIORITY.

# AMMCO

2140 Commonwealth Ave. North Chicago, Ill.

## FREE! LATEST, MOST COMPLETE RADIO PARTS CATALOG



EVERYTHING in RADIO and ELECTRONICS for War Training, Maintenance or Repair

### New R-F Resonance and Coil Winding CALCULATOR

Easy to use! For fast accurate determination of resonance factors and coil winding data. No. 37-955. Postpaid, only 25c.

### RADIO'S FINEST BOOK VALUES

Specially prepared to aid radio training in schools and industry. Full of valuable data. Send for all six!

- Radio Formulas and Data Book No. 37-752... 10c
- Dictionary of Radio Terms No. 37-751... 10c
- Radio Circuit Handbook No. 37-753... 10c
- Radio Builders' Handbook No. 37-750... 10c
- Simplified Radio Servicing No. 37-755... 10c
- Radio Data Handbook No. 37-754... 25c
- All Six Books No. 37-799... 75c

**ALLIED RADIO CORP.**

833 W. Jackson, Dept. 5-G-4, Chicago 7

# ALLIED RADIO

steam to smother the fire. Railroads generally are adopting alarm devices to indicate low water in the boiler.

Using a system like that employed in spraying paint, the Baltimore & Ohio Railroad developed machines which spray metal so that worn metal parts may be reclaimed at about two-thirds of the cost of the arc-weld process. Under the new system, a layer of metal is built up on the worn surface, just as a paint spray builds up a layer of pigment on a surface.

Most of this research is behind the scenes. What you see is the steam-snorting iron horse on the straightaway. Sleek steel horses like the new "Mohawks" of New York Central that whirl the Twentieth Century Limited through on schedule time and then pick up a heavy freight. Water is scooped up from 1,800-foot track pans, automatic stokers feed the fireboxes, automatic controls stop the trains if a signal is passed up and so efficient are the locomotives that one tender-full of coal lasts 600 miles.

Thus, through wartime research and improvements, the railroads are getting ready for the revolutionary changes to come.

## Roughriders of the Deep

Continued from page 53

fought from below deck had no knowledge except word passed from mouth to mouth on how a sea fight was progressing. Now an officer on the bridge plays the part of commentator and describes the action, blow by blow, over the public address system to crew members who are stationed in the turrets and the engine spaces.

The clanging of an alarm gong and the shout of "All Hands, General Quarters," is the signal that sends a destroyer's crew to their battle stations within about a half minute. Each man on board has a job. Cooks and stewards take their stations in first aid and in the damage control squads. Some serve as ammunition passers.

Battle ports are closed, the steel doors and hatches that give entry between the hull's watertight compartments are shut and dogged down, and the men in the engine and fireroom spaces settle down to the task of maintaining their power plant at utmost efficiency. Engineroom noises can be heard up on deck as the speed increases and the steady roar of the deck blowers that are sending gales of wind down into the firerooms become louder.

At nightfall comes the command: "darken ship." Canvas curtains are draped over the companionways and every light that

Continued to page 160



# SCREWBALL IDEAS ON BATTERY CARE

## # 4

WATER  
WATER



Bath tub brewers have the bright idea that since water weakens strong liquor and robs it of its kick, it will do the same thing to electrolyte, thereby weakening the power of the battery. They say not to add water, but don't believe it. A battery needs special care.

## ...THE WISE WAY IS PERIODIC RECHARGES!

**K**EEP your battery in tip-top shape by letting an experienced Exide Dealer check your battery regularly.

Restricted driving is hard on batteries. Rationed mileage keeps them from getting a normal charge from the generator, and can cause starting trouble unless certain precautions are taken.

In many cases, periodic recharges are essential, and with them, your Exide Dealer puts off the day when you'll need a new battery. When you *must* buy, get a dependable, long-lasting Exide. Buy to Last—Save to Win.

THE ELECTRIC STORAGE BATTERY CO.  
Philadelphia 32

Exide Batteries of Canada, Limited, Toronto

EXIDES ARE USED IN MORE THAN 100  
APPLICATIONS BY OUR ARMED FORCES



- 1 Don't buy *anything* you can do without.
- 2 If you **MUST** buy, insist on dependable, long-lasting merchandise.
- 3 Take care of the things you have. Make them *last*.

"BUY MORE THAN BEFORE  
IN THE 5TH WAR LOAN."



# YOU CAN'T BEAT this to relieve TORTURE of ATHLETE'S FOOT

So  
Many  
Druggists  
Say!



If you suffer from itching, burning soreness from cracked, scaly skin between toes — just feel how the first applications of medicated *liquid* Zemo relieve distress. Then Zemo, on contact, actually kills the germs that most commonly cause and spread Athlete's Foot.

Use Zemo freely — soon your discomfort should disappear. Zemo is a Doctor's formula backed by 35 years' success. The first trial convinces. All drugstores.

NOTE: For real stubborn cases buy *Extra Strength*

## ZEMO



### TOOLMAKERS

Only Gerstner Chests are good enough for your good tools. Free Catalog.

GERSTNER TOOL CHESTS

444 Columbia St. Dayton 7, Ohio

## YOUR *After-WAR* TA-PAT-CO SLEEPING BAG



## WORTH WAITING FOR!

Each day brings us nearer to the time we can offer you a Ta-Pat-Co that will have all the new features developed from years of experience in making hundreds of thousands of sleeping bags for the armed forces. This new lighter, warmer, more compact Ta-Pat-Co is worth waiting for.

THE AMERICAN PAD & TEXTILE COMPANY  
GREENFIELD, OHIO

*In peace and in war, the leading manufacturer  
of Life-Save Equipment and Sleeping Bags*

might be reflected outside is turned off. On the bridge, only a few tiny signal lamps glow in the darkness. The hooded lights that comprise the ship's interior battle lighting circuit, formerly pale blue, have been changed to ruby red. The deep red has the advantage of not affecting the pupils of the eyes. The ship's navigator can study a chart under the red chartroom lamp, then step out on the bridge with his eyes in immediate adjustment for night vision. Men and officers wear red "adaptation" glasses for a quarter of an hour before going on watch after dark. By the time they are called to duty their eyes have adjusted themselves for night seeing. Another new aid for vision is the polaroid glasses the signalmen and lookouts often wear to reduce glare when looking toward the sun.

Few of the men on our destroyers had ever been to sea before the war. They were clerks or factory workers or students or farmers, yet intensive training has turned them into capable seamen. They are fighting like veterans.

## Parlor Cars With Wings

*Continued from page 12*

designed by Henry Dreyfuss. Plenty of leg room is provided for passengers and intimate grouping of seats back-to-back. The ship for day travel accommodates 48 passengers, and the night plane has berths for 24. It has a cruising speed of 240 miles an hour and range of 2,500 miles fully loaded. Interior features include polaroid windows, which permit adjustment to any degree of light, full-length plastic mirrors, room for small suitcases beneath the seats, and "pillow" radios.

In some designs, daytime seats can be converted quickly into roomy lower berths, with uppers swinging down from overhead. As an example of the detail in which Model 39 has been worked out, passengers will use special weight-saving soap bars made of paper wafers treated with soap.

Another newcomer designed for postwar airlines is the pioneer Douglas Aircraft Company's DC-7. It is reported to have reached the mockup stage and is said to be considerably larger than the company's 42-passenger DC-4. Built for transoceanic travel, the ship will carry 86 day passengers and provide sleeping accommodations for 76. The transport will be larger than any bomber now in service, according to reports, and will have a wingspread of 173 feet and three inches and a 123-foot fuselage. Speed is estimated at 400 miles an

*Continued to page 162*

POPULAR MECHANICS



**Happiness Ahead**

**DELTA MILWAUKEE**  
*Power Tools*

...with these plans and ideas for your  
**Delta Homecraft Shop**

**Popular Books that Point the Way to Fun ... Healthful Recreation ... Home Beautification**

Check the ones you want — Order now!

**Classified Designs—A Whole Book on Each Subject!**

- 21 *Lovely Lamps*. Pleasing designs.....10¢
- 19 *Charming Chairs*. Simple, complete plans; handsome, durable chairs.....15¢
- One Evening Projects*. Quickly-built.....10¢
- Garden Furniture and Novelties*.....10¢
- 40 *Fine Tables*. Great shop projects. Real favorites — outstanding in design, construction.....25¢
- Furniture Designs*. Desks, beds, wardrobes — fine pieces of larger furniture.....25¢
- Novelties*. Useful small items.....25¢
- Toys, Games, Playground Equipment*.....10¢
- Small Furniture*. Attractive footstools, magazine racks, sewing cabinets, mirror frames, etc.....20¢

- Getting the most out of your:**
- Lathe . . . .
  - Circular Saw & Jointer . . . .
  - Drill Press . . . .
  - Abrasive Tools . . . .
  - Lathe . . . .
  - Shaper . . . .
  - Band Saw & Scroll Saw . . . .
  - . . . . 25¢ each.

- Making Money with Delta Tools*.....10¢
- How to Plan a Home Workshop*.....25¢
- Practical Finishing Methods*.....50¢

**Practical Projects—What to Make and How to Make It!**

- Nine books:
- No. 2  No. 3
  - No. 4  No. 5
  - No. 6  No. 7
  - No. 8  No. 9
  - No. 10 .....10¢ ea.

**Use this ad as your order blank — Mail it along with coupon!**

Many folks today are planning their Delta homecraft shops for after the war, using as a guide the Delta booklet shown here. Homecraft — a hobby for everyone — helps you forget your worries and brings new fun to all the family. And when you work with Delta power tools — famous for accuracy, safety, dependability — you get results you're really proud of. After the war, better-looking, finer-than-ever Delta tools will be ready, modestly priced. So start *planning* now!

Send for this free booklet. HM-12

**Free Help in Planning Your Shop!**

"Happiness is in your hands" is a fascinating booklet. Facts on manual hobbies for mental health . . . ideas for fun and profit. Check coupon below.



**Tear out and mail today!**

Editor, Delta Craft Publications  
THE DELTA MANUFACTURING CO.  
681G E. Vienna Ave., Milwaukee 1, Wis.

- Please send me your FREE booklet, "Happiness is in your hands."
- I am enclosing.....in full payment for books I have checked on list attached.

Name.....

Address.....

City.....(.....) State.....

*Some things haven't  
changed!*



... Long a symbol of constancy—THE NORTH STAR  
Long the perfect pipe material—MEDITERRANEAN BRIAR



**\$5**

Antique and Smooth Finish, Sterling Silver Band, Solid Rubber Bit, Every pipe numbered, registered and guaranteed by LHS  
AT ALL GOOD DEALERS

**NEW** LHS STERNCREST 14K

Of briar specially selected for beauty of grain, 14K solid gold band. Truly, "Perfection in a Pipe". \$7.50

L & H STERN, Inc., Stern Bldg., Brooklyn 1, N.Y.

Makers of LHS Ultra-fine \$10 Certified Purex \$3.50

**SORRY**—So many LHS pipes are going to the armed services, that your dealer may not always be able to supply you with just the model you want.

## PRELUDE to a PERFECT FINISH



Finish must now be measured in micro inches. That's where the new Chicago **FV BOND** Wheels excel. They give a precision smoothness so intensified that it passes any surface analyzer test.



**FV BOND** is available in all types of Chicago Mounted and Small Grinding Wheels—in all abrasives, grain and grade combinations. It is the result of research and experiment on hundreds of aircraft jobs.

**Chicago Mounted Wheels** are tough, long lived, dependable. Over 300 sizes, styles and grains.

**Chicago Grinding Wheels**—Only sizes up to 3" diameter for the duration, with W P B approval.

**Handee Tool of 1001 Uses and Hi-Power Grinders** are still available to all who have priorities.

Send for Free Catalog

**CHICAGO WHEEL & MFG. CO.**

1101 W. Monroe St., Dept. PM, Chicago 7, Ill.



hour, range at more than 4,000 miles, ceiling at 40,000 feet, payload 58,000 pounds.

Giant flying boats built by the Glenn L. Martin Company, including the huge Mars now operated by the Naval Air Transport Service, are an indication of what the air traveler can expect in the immediate post-war years. The production version of the Mars, the JRM-1, has two spacious decks. When used as a hospital ship it can carry 84 litter cases and 25 attendants.

When these giants go to work for the air lines, the peacetime traveler is due for a thrill. What he wants to know in practical American fashion is "how much?"

Pan American Airways has tried to answer this question with a probable flight schedule for 1948. It gives possible representative fares for 22 cities around the world, and is based on the company's plans to operate a fleet of 150 super airliners, some of which have already been ordered.

The schedule lists 10 daily flights from New York to Bermuda. Time of the trip is set at two hours and 40 minutes and the one way fare is \$20.70, round trip \$37.26. Other destinations, hours of flight from New York and one way fare, include Fairbanks, Alaska, 13 hours, \$97.50; London, 13 hours, 48 minutes, \$103.50; Buenos Aires, 21 hours, 36 minutes, \$162; and Sydney, Australia, 42 hours, \$315. The schedule boasts a week-end cruise to Paris leaving New York at 3 p.m. Oct. 1 (Friday) 1948, arriving in Paris at 8 a.m. the next day, and leaving Paris Sunday night with arrival in New York scheduled for 7 a.m. Monday.

The schedule reveals you will be able to fly from New York to Tokyo in 27 hours and 36 minutes—that is, of course, if Tokyo is still on the map in 1948.

## Torpedo Cowboys

Continued from page 3

ing a submarine net, which is usually mined and explodes if the top is touched, they submerge and the rear man dismounts and lifts the net to let the torpedo pass beneath.

Underneath the hull of the target ship they set the time fuse on the warhead, fix it to the ship's bottom, then detach the section enclosing the propulsive equipment and make their escape before the blast. Under ideal conditions the crew should be able to rejoin their comrades on the submarine from which the torpedo was launched, but in the attack at Palermo complete escape was impossible and the three pairs of torpedo cowboys headed for the Italian shore.

# Coming Up!



## ... Two TIN FISH FOR TOJO!

UNTIL it is slammed straight for the belly of a frantically twisting, dodging Jap ship, a Navy aerial torpedo should be handled with care! And that is the way this deadly pair, cradled one over the other in a rubber barge, are being transported. In rearmament service these big rubber boats provide their lethal loads with a "safety zone" . . . a plump cushion of air that completely surrounds the cargo, safeguarding it against the danger of shock or collision. Many Evinrudes are used in such service, providing capable driving power and a high degree of maneuverability.



**1** Servicing seaplanes is another job for which rubber boats are ideally adapted. For powering big rubber boats, Evinrude now produces a special model of its famed Lightfour, built with deep shaft, high-ratio reduction gear, and 360 degree steering that permits the boat to be maneuvered in any direction.



**2** Up she comes, the day's work done! This photo shows the type of bracket widely used for mounting an Evinrude on a large rubber boat. Evinrude has developed many special mounting brackets to meet the varied needs of the scores of different types of small craft used by the Army, Navy and Marine Corps.

**3** The Japs use outboards too, as is shown by this photo of a Jap outboard captured somewhere in New Guinea, and patched up by our boys to serve in ferrying supplies to the beach. Perhaps, by this time, it has been replaced by a sparkling Evinrude Speeditwin, a "popular number" in the far Pacific!



**FREE!** Send for copy of 1944 "Owners' Edition" of the Evinrude News. A pictorial magazine that covers outboards in war and peace — profusely illustrated with photos showing Evinrudes serving the Army and Navy, and pictures of happy peacetime uses to follow! Write for your copy! EVINRUDE MOTORS, 5054 N. 27th St., Milwaukee 9, Wisconsin.



# EVINRUDE

OUTBOARD MOTORS

EVERY DOLLAR YOU INVEST HELPS SPEED VICTORY—BUY MORE BONDS



## KRW ARBOR PRESSES BENCH TYPE AND HYDRAULIC

NEEDED IN EVERY SHOP—SAVE TIME AND MONEY—DO BETTER WORK, QUICKER.

No shop is complete without a small arbor press. Pressing and squeezing operations can be done better and faster on a KRW Arbor Press. Stop using vise and sledge hammer methods—they generally deliver spoiled work in the end. KRW Factory-To-You Prices give you greater value for your money. Order today.

### KRW Bench Type Arbor Presses, 3 sizes

No. 37-P 1/2 Ton, \$13.25\*  
 No. 37-O 1 Ton, \$23.00\*  
 No. 37-N 3 Ton, \$33.00\*  
 \*Prices F.O.B. Arendt, N. Y.  
 Slightly higher west of Rockies.  
 Stand illustrated extra.



KRW Hydraulic Presses are built in 25, 50, 60 and 75 ton sizes. Prices start at \$198.00\*.



**K. R. WILSON, 17 Lock St., BUFFALO 2, N. Y.**  
 Builders of Shop Equipment for Ford Dealers Since 1916

# Mortite

## YEAR AROUND PLUGGER-UPPER

A pliable Plastic that plugs holes in and around screens, casements, drain-boards, sinks, bathtubs, etc. Stops rattles.

In winter weatherstrips windows.

### MANY USES IN THE HOME

Keeps out dust and dirt, mosquitoes, flies, ants and other insects.

Easy to apply. Unrolls like ribbon. Adheres to any clean, dry surface. Just press into place and it stays put. Does not shrink, crack or chip.

About 80 feet to a roll. At your Dealer's or \$1.25 postpaid.

Send for Circular

**J. W. MORTELL CO.**

522 Burch St.

Kankakee, Ill.



## MASCOT SLIDE RULE

Fits the pocket. Quickly solves any problem in multiplication, division, proportion. Gives the square, the square root, logarithm and reciprocals of all numbers. Trig scales give sines and tangents of numbers. Fine black graduations on white celluloid. Complete with instructions. Price in fabricoid case \$1.00, in leather case \$1.25. Money back if not satisfied. Special offer to agents and dealers.



### MONITOR SLIDE RULE—6" Dia.

Made in white Vinylite. Same scales as Mascot Slide Rule. Complete with instructions. Without case, \$2.95. Leatherette case, 75c add'l.

TAVELLA SALES CO., 19-H West Broadway, New York 7, N. Y.

## NEW OTTAWA SAW

BIG FREE BOOK

World's Fastest  
 6 H.P.  
 EASY TO MOVE



Fells trees.  
 Saws big logs, small logs, limbs. Pulley for belt work. Easy to handle, weighs less than lower powered units. FULLY GUARANTEED. Cash in on four features. Turn wood lots into cash. OTTAWA MFG. CO. 727 PINE ST. OTTAWA, KANS.

## CRAFTSMEN—STOP RUST WITH

### FIENDOIL

Protect tools, clean and coat them with this anti-corrosive favored for years by gun and tackle users. Get it now at your Sports or Hardware Store.

2 oz. Bottle—35¢

MCCAMBRIDGE & MCCAMBRIDGE CO.  
 Baltimore

BUILD YOUR OWN

## ARC-WELDER

For Light or Heavy Work

No rewinding necessary—use coils taken from old auto generators. Works on 110 or 220 A.C. H's 20 different lenses. Complete plans and BIG Catalog 35c. LEJAY MFG. CO. 3347 LeJay Bldg. Minneapolis, Minn.



# WYTEFACE

TRADE MARK

STEEL MEASURING TAPES



Easy to Read

**KEUFFEL & ESSER CO.**

HOBOKEN, N. J.

# No One Need Pay More than \$40 for a Quality Hearing Aid!

*America's Overwhelming Swing to the New Zenith Radionic Hearing Aid Proves It!*



**S**UCCESS speaks for itself! America's hard of hearing—eager to enjoy a fuller life, to take a more active part in working for victory—are buying the Zenith at a rate undreamed of before in the hearing aid industry! Here, indeed, is conclusive evidence that no one need pay more than \$40 for a quality hearing aid!

How can Zenith bring its finest quality thus within reach of all? One reason, of course, is Zenith world leadership in the exclusive manufacture of radionic products. Another is this: The Zenith is built not to a price, but to an improved, modern principle of hearing aid design: **INSTANT PERSONAL ADJUSTMENT.** You, yourself, "focus" this instrument for your particular hearing needs—for different voices and surroundings—as conveniently as you focus a pair of binoculars!

That's why the Zenith requires no elaborate testing and frequent adjustments by high-paid, high-pressure salesmen . . . no special offices, home calls or other expensive "trimmings." *Zenith Quality Is in the Instrument Itself!*

No longer is there any reason to delay hearing a demonstration. You owe it to yourself—to your country—to all who have your interest at heart. Your local Zenith-franchised optical establishment invites you. No one will urge you to buy, or call at your home. For free descriptive booklet, sent in plain envelope, write Zenith Radio Corporation, Dept. PM7, P. O. Box 6940A, Chicago 1, Illinois.

**\$40** COMPLETE, READY TO WEAR  
Available at Zenith-Franchised Optical Establishments Throughout America

## Only Zenith Gives You These Great Advantages



### 1 New "Self-Focus" Hearing Control

The flick of your finger brings hearing into range for your particular needs—for different voices and surroundings—as conveniently as you focus binoculars! Outmodes old-way "fixed-adjustment" principle.



### 2 New Low-Operating-Cost Battery Circuit

An exclusive circuit—especially developed by Zenith engineers to insure outstanding performance throughout the life of the batteries. Brings average operating cost to only 3/10 of one cent per hour.



### 3 Zenith's Finest Quality —About 1/4 the Price

You get the fine precision that modern knowledge and engineering made possible, at about 1/4 the price of other quality vacuum tube instruments! One model—no "decoys." One quality, one price.



### 4 Zenith Guarantee, 5-Year Service Policy

Guaranteed by Zenith . . . world's leading manufacturer of radionic products exclusively, for a full year. You also get unique Zenith 5-year Service Policy with coverage enjoyed exclusively by Zenith wearers.

**ZENITH RADIO CORPORATION, CHICAGO 39, ILLINOIS**

Accepted by American Medical Association Council on Physical Therapy

There are cases in which deficient hearing is caused by a progressive disease and any hearing aid may do harm by giving a false sense of security. Therefore, we recommend that you consult your otologist or ear doctor to make sure that your hearing deficiency is the type that can be benefited by the use of a hearing aid.

MAKERS OF  
**ZENITH**  
RADIO  
"LONG DISTANCE"  
RADIONIC PRODUCTS EXCLUSIVELY—  
WORLD'S LEADING MANUFACTURER  
All Production Now for War or Rehabilitation

COPYRIGHT 1944,  
ZENITH RADIO CORP.

**Handy Tool  
for Handy Craftsmen!**

**It's TWO Screwdrivers  
in ONE**



**XCELITE  
"Combination Detachable"  
SCREWDRIVER**

Here's convenience plus economy!  
The dual-purpose shaft has genuine  
Phillips blade at one end, regular

Xcelite at the other. Shaft is held securely in convenient  
(hollow) handle made of the new Xcelite—shockproof,  
fire resistant! Made in Stubby size (illustrated) with  
3" overall length; also in standard sizes with three blade-  
size combinations all fitting same handle. Sales are re-  
stricted. Priority required. Please contact your hard-  
ware, radio or mill supply dealer, or write Dept. J.

**PARK METALWARE CO., INC., Orchard Park, N. Y.**

BACK THE ATTACK — KEEP THE WAR BONDS YOU BUY



QUALITY TOOLS  
PREFERRED BY THE EXPERTS

**BURN YOUR NAME ON TOOLS  
WITH THE  
ARKOGRAF**

**PROTECT YOUR TOOLS FROM THEFT**  
Write with electricity any name or design on the hard-  
est and finest tools and instruments of any metal,  
like writing on paper with pen or pencil. These  
stamps used by mechanics, garages, machine shops.  
**Complete Outfit \$3.50—Prepaid Anywhere**  
Interesting illustrated circular free. Write today.  
ARKOGRAF PEN CO., 3927 S. E. Stark, Portland 15, Ore.



**SOUTH BEND BAIT COMPANY**

**Fishing-Photo  
CONTEST**

**36 War Bond awards**  
from \$25 to \$750  
for the winning fishing  
photos. Those taken on  
past fishing trips—those  
you'll take this summer.  
Lake, stream or camp  
shots—pictures of fish-  
ing action and interest.  
Rules are simple—just  
enter your favorite fishing photos—no letters to write,  
nothing to buy, no box tops, or slogans. Special award  
to everyone entering one or more pictures. Write now  
for full information on this contest—a postal will do.

**\$3000.00**  
(AWARD VALUE)  
**IN WAR BONDS**

*For Photographs or Snapshots  
on FISHING—Judged for  
Realistic and Photographic  
Qualities*

Address all replies: Contest Editor, South Bend Bait  
Company, High St., South Bend 23, Ind., Dept. 450

**SOUTH BEND**

*A Name Famous In Fishing*

★ SPEED THE DAY OF VICTORY—BUY WAR BONDS ★

**PAINT STRIPING TOOL**

*Try it! See the Added Beauty*

**ONLY  
\$1.00  
POST  
PAID**

With this NEW TOOL (not a brush) everyone can now draw  
lines with paint, enamel, lacquer, etc. Used on autos, models,  
toys, games, imitation tile walls, cabinets, furniture, linoleum floors,  
signs, bulletin boards, sporting goods, home workshop projects, etc.  
Send only \$1.00 for complete tool for painting a 1/16" wide stripe,  
including adjustable guide, operating instructions,  
etc. C.O.D. price \$1.25.

As easy to use  
as a pencil.



Patented

Extra interchangeable tips for making 1/64", 1/32",  
3/64", 1/16", 3/32" and 1/8" wide stripe lines—  
.50¢ each.

**Every Painter and Craftsman Should Own One.**

Send for your tool and as many additional width tips  
you need today. Use it. If you are not satisfied that  
you can do better work, add character as well as  
beauty to your product or project, return the tool  
and we'll refund your money promptly.

Paint Dealers; Write for literature, etc.

**WENDELL MFG. CO. CHICAGO 18, ILL.**

**New Designs in**

**FRANZITE GRIPS**



**Modernize Your Gun! Improve Your Score!**

Most durable grips made. Positively un-  
breakable! For Colt, Smith & Wesson, Hi-Standard,  
Ortgies, Luger & Mausers in a wide choice of beautiful  
designs in ivory, pearl, walnut, onyx, etc. Low prices. FREE  
CATALOG. Dealers Wanted.

**SPORTS, INC., (Mfrs.) 2850 N. Clark St., Dept. P-7, Chicago, Ill.**



**CRAFTSMEN Get this  
BOOK OF MATERIAL, SUPPLIES  
& TOOLS... STILL AVAILABLE**

Full of valuable hints and short cuts plus catalog of a sur-  
prisingly complete list of materials, tools and supplies.  
Features Identification Panel and Chart of over 60 Haro  
Woods in Natural Color plus full color showing of over  
80 inlay leathers in natural color. Send only 25¢ stamp at  
coin, which is refunded on first order of \$1.50 or more,  
making this valuable manual cost you nothing.

**ALBERT CONSTANTINE & SON, Inc.**  
791U, East 135th St. New York, New York

**GOOD PICTURES BRING YOU TOGETHER—**

**USE Argus Cameras**

ARGUS—ANN ARBOR, MICHIGAN

**TRAILER AXLES, HITCHES, AND PARTS**

• If you are interested in purchasing trailer  
axles, hitches, and other trailer parts, contact  
us promptly. Complete house trailer blue  
prints, \$1.00. Write for free literature.



**HAMMER BLOW TOOL COMPANY, Dept. 107, WAUSAU, WIS.**

**WHEN YOU BUY FLASHLIGHT BATTERIES ASK FOR  
"EVEREADY" FRESH DATED BATTERIES**

The word "Eveready" is the registered trade-mark of National Carbon Co., Inc.

**BRUSH PLATING OUTFITS**

- for autoparts, reflectors, faucets, bicycles.
- No tanks necessary. Free particulars.

**GUNMETAL CO., AVE. M, DECATUR, ILLINOIS**

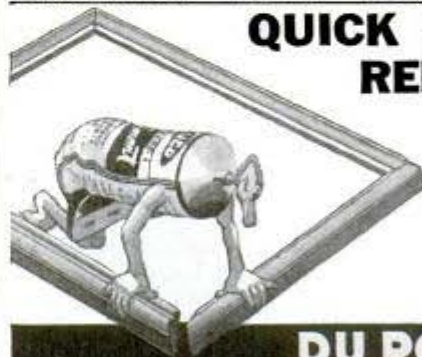

**QUICK HOME  
REPAIRS**

Mends dishes,  
glassware,  
furniture,  
luggage,  
and toys.



**DU PONT  
DU CO CEMENT**

REG. U. S. PAT. OFF.





**CHINA TODAY**



**HOME TOMORROW**

... AND *movies* OF THE MOST PRECIOUS SUBJECTS

OF ALL ... WITH BETTER-THAN-EVER EQUIPMENT!

Many a soldier is proudly sending home off-duty movies of unusual subjects taken with his Universal Ciné Camera. But he knows that his most priceless movies will be those of his own children . . . taken by him after peace comes. Universal's at war, too, making fine military optical instruments . . . learning new skills, pioneering new methods of production. Count on these to be translated into a series of truly great cameras and photographic equipment! Expect your next camera to be a Universal!

**UNIVERSAL CAMERA CORPORATION**  
NEW YORK CHICAGO HOLLYWOOD

*There's only one flag  
we're prouder of!*

Peacetime Manufacturers of Mercury, Cinémaster, Corsair Cameras and Photographic Equipment

JOIN THE FIGHT  
BUY MORE  
WAR BONDS



# AC FUEL PUMPS

You have enjoyed such good service and long life from your AC Fuel Pump because of the quality that is built in, from design to finished pump.

You will continue that performance and quality if you insist on an AC when you need a new, or a rebuilt, fuel pump.

**BUY WAR BONDS • BRING VICTORY QUICKER**

## This is the way to Make Money!

**MACHINE SAW FILING** with the Foley Automatic Saw Filer is the modern way to recondition saws. Anyone can do the work—no experience needed—no eye-strain. Start in spare time—Foley-filed saws cut so smooth and fast, they will advertise for you, bring you new customers and a steady repeat cash business.

The Foley is the **ONLY** machine that files all hand saws, also band and cross-cut circular saws—enables you to handle work from schools, shops and factories as well as farmers, carpenters, etc.

### Send for FREE PLAN

Shows how to start—no canvassing. You can get a Foley Saw Filer now—no special priority required. Send coupon today.



"I bought a Foley Saw Filer, one year later had all debts paid and also \$400 on a new home. Many days I earn as much as \$16," says J. H. Kellogg

W. L. Tarrant writes: "I left my old job last September and in 10 months have filed 2,159 saws. We have a lovely business worked up the work."

Thor Nedricke, Iowa, says: "I have filed 550 saws, made \$250. As I'm a carpenter, I just file saws in spare time—have more than I can take care of."

## FOLEY Automatic SAW FILER

**FOLEY MANUFACTURING CO.**  
716-4 Foley Bldg., Minneapolis 13, Minnesota  
Send Free Plan on Saw Filing business, no obligation

Name \_\_\_\_\_  
Address \_\_\_\_\_

★ **SAVE WASTE PAPER** ★

## DRILL PRESS OWNERS!

**HERE'S 1 TOOL WITH 5 DISTINCT USES**  
**THE BARRON MULTI-PURPOSE ROTARY WOOD PLANER**



PLANES & SURFACES • PANELS & BEADS **\$750**  
ROUFS & GROOVES • RABBETS • TENONS

Converts ANY drill press into a time saving, low cost planer, paneler, tenoner, etc. Surface finishes all types of tough grained and knotty surfaces to agree smoothness. Safe! Guaranteed harmless to drill press. Thousands now in use. **SOLD ON MONEY BACK GUARANTEE.** Full refund on 5 day trial. Shipped prepaid on receipt of \$7.50—or C.O.D. **YOU RISK NOTHING.** Free literature.

### STEEL TOP AUXILIARY DRILL PRESS TABLE

Has 200 sq. in. smooth working surface. Equipped for shaper and many other important workshop uses—a real workshop user—**\$595**



Barron Tool Co., 369 Architects Bldg., Detroit 1, Mich.



## Kandler's Special 10 TON ARBOR PRESS

For washing machine repair, electrical and general repair shops—a big-capacity press (takes work 18"x21 1/2") at only **\$3300** F.O.B.

**Write KANDLER MACHINERY**  
1407 WAVERLY DR., KALAMAZOO 17, MICH.

### READ ABOUT MOTORCYCLING



WRITE: INDIAN MOTORCYCLE COMPANY, SPRINGFIELD, MASS.

## WOOD WORKERS

### AMAZING BOOK FOR YOU

Harold Hunt wants to send revised No. 14 catalog, 124 pages of woodworking ideas. **UNEQUALED BARGAINS** in imported and American woods, supplies. Those already holding this catalog—send for revised sheets.

**CRAFTSMAN WOOD SERVICE CO.**  
2729 S. Mary St., Dept. A-47, Chicago 8, Ill.



### THINGS TO MAKE IN YOUR HOME WORKSHOP

**16 Complete Plans — only 10c**  
Useful, practical, easy-to-build projects — bird houses, lazy chair, etc. Includes photos, drawings.

**STANLEY TOOLS**  
174 Elm Street, New Britain, Conn.



## OTTAWA TRACTOR SAW

### Falls Tree—Cuts Log

Uses Power Take-off any tractor. Direct drive. Long stroke. Saws fast. Easy on fuel. Thousands of satisfied users. Big labor saver. Low in Price.

**OTTAWA MFG. CO., D727 Forest Ave., OTTAWA, KANSAS**

### Wonder-Tone NOISE ELIMINATOR

Just attach to your radio (long, short wave) and enjoy reception free from distracting noises. Send-No-Money Pay Postman 60c plus postage or send 60c and we'll send postpaid. Return in 5 days for refund if not delighted.

**WONDER-TONE COMPANY, Dept. 42, 1078 N. Clark St., Chicago 26, Ill.**



## AUTO ENGINE SPEED CONTROL GOVERNORS

Give constant speed to any auto or truck engine, when used for power. Fully guaranteed. Simple instructions. Oil ring bearing \$13.00. Ball bearing \$19.50. Prepaid. Also additional carburetor butterflies. In Montreal, 7546 Wiseman St. Latin Amer. East Asiatic Co. Free circulars.

**CANDEE, 2641-T S. Hill, Los Angeles-7**

POPULAR MECHANICS

# Ingenious New Technical Methods

Presented in the hope that they will  
prove interesting and useful to you.



## New Air Tool Drives "blind" Rivnuts Accurately... Automatically

Installing "blind" RIVNUTS quickly with precise, positive upset while working entirely from one side is now possible with the recently developed Auto RIV-Driver. Completely automatic, the tool runs a threaded mandrel into a Rivnut, upsets it, backs the mandrel out and stops the tool. Operators simply press a throttle; make no manual adjustments for any operation. Rivnuts are installed 6 to 8 times faster than formerly; rejects are almost completely eliminated.

The tool can be adjusted to upset at any depth required. Once set, adjustment is tamper-proof—every Rivnut is driven accurately and uniformly. An indicator on the tool handle lights when the upset is correct; does not light if Rivnut is improperly headed.

Powered by compressed air, the Auto RIV-Driver weighs just 4¼ pounds; is 9½ inches long; balanced for efficient handling by women operators.

You all know that our fighting men need the finest quality materials that we here at home can produce. That goes for Wrigley's Spearmint, Doublemint and "Juicy Fruit" chewing gum, too. Our stock pile of raw materials that goes into the making of Quality chewing gum is getting lower and lower. Until we can again build up our raw material inventory, we are sending all of our limited output of Quality chewing gum to our fighting men and women overseas, only.

*You can get complete information from the Independent  
Pneumatic Tool Co., 600 W. Jackson Blvd., Chicago 6, Ill.*

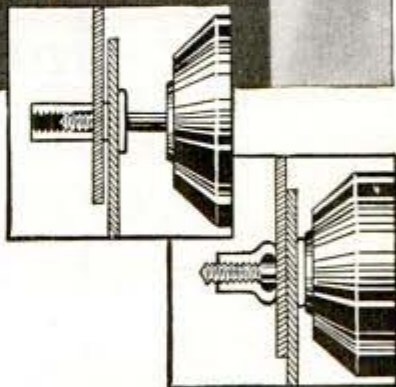

Rivnuts (mfd. by B. F. Goodrich Co.) are internally-threaded tubular rivets which can be installed "blind" while working entirely from one side of the job.



Automatic action, positive depth control and visual indicator assure correct and uniform installation of rivnuts with new Auto RIV-Driver.

Y-120

SAVE MONEY ON

# CIGARETTES

LOWER PRICES on ALL STANDARD BRANDS

Luckies - Chesterfields  
Camels - Philip Morris  
Old Golds - Dunhills  
Pall Mall - Tareyton  
Kool - Raleigh - Fatima  
Viceroy - Sheffields  
Regent - Fleetwood

• We carry an extensive line of other Cigarettes and Tobaccos.

**\$1.29**  
Carton of 10 Packs

**PERFECT ARRIVAL GUARANTEED!**

Minimum 3 Cartons  
Include Postage and Insurance as follows:  
Within 150 Miles • For 3 Cartons 12c •  
• Add 1c for each additional carton •  
Distant orders require extra postage.

SHIPPED SAME DAY TO ANY OF 48 STATES  
ON RECEIPT OF CHECK OR MONEY ORDER

Thousands of Satisfied Customers.  
This is our 25th Year in Business.

WRITE FOR COMPLETE PRICE LIST

## SILVER ROD

Dept. K, Five Corners Post Office, Jersey City, N. J.

**WAR NOTE**

Not all brands listed are available at all times. Prices subject to change without notice.



## COOLING BUILD YOUR OWN

Plans for Coolers & Blowers, Exhaust Fans, Motors, Cooler Pads, Tubing, Cooler Pumps & Floats, Electric Cellar Drainer Pumps, Pressure Switches, Plumbing and Heating supplies, Fan & Damper controls, Thermostats, Gas Stoves, Water Heaters, Electric Fans, Furnaces, Stokers for apartments, Free literature. **PEERLESS SALES, Box 122 C. V. Str., Lincoln, Nebr.**

Make **BIG MONEY AT HOME!**

**NEW Invention Electroplates by BRUSH**



Now Plates **CHROMIUM!**

ALSO GOLD, SILVER, NICKEL, COPPER, ETC.

War Increases Demand—You Profit!

New, patented invention makes possible big earnings AT HOME. Replate auto-parts—worn articles in homes, stores, hotels, restaurants, etc., with durable, sparkling, new coat of metal—with stroke of brush. Easy, simple, quick. Genuine Gold, Silver, Nickel, Cadmium, etc. Everything furnished. Outfit complete, ready for use. No shop required. Clear from \$2 to \$5 an hour in lifetime business. Small investment starts you in business. Steady repeat. Machine can pay for itself in week. Send TODAY for FREE SAMPLE and illustrated BOOKLET how you can have a life income from a business of YOUR OWN built upon satisfied customers. Act at once!

**WARNER ELECTRIC COMPANY**

360 N. Michigan Ave., Chicago, Dept. 315

**FREE BOOK & SAMPLE**

WARNER ELECTRIC CO., 360 N. Michigan Ave., Chicago, Dept. 315  
Gentlemen: Send me Free Sample and Illustrated Booklet.

Name \_\_\_\_\_  
Address \_\_\_\_\_  
City \_\_\_\_\_ State \_\_\_\_\_

## Fuse Puller - Circuit Tester

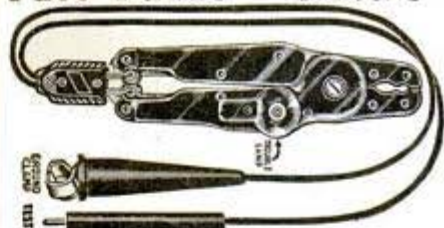

For Home or Factory

TESTS 110-250 VOLTS

When motors stop and lights go out, this tool quickly **LOCATES DEAD CIRCUITS** and safely removes blown Fuse. The Star Test Pocket Plier is made of a Transparent Plastic having in one of the legs a small lamp in series with a resistance and can be used to test 110 to 250 volts circuit. The Plier will pull fuses from 10 to 100 Amperes. Thousands of Electricians find this tool handier than Test Lamps. Price \$2.75 each without Leads, \$1.50 additional for Leads, plus 10c postage. Can be obtained from General Electric or Westinghouse Stores or directly from us. Order NOW. **STAR PLIER CO., 233 Canal St., New York 13, N. Y.**

Action! Thrills! Surprises!

**80 ACTUAL PHOTOGRAPHS \$1.00**  
OF U. S. PLANES, TANKS, WARSHIPS, CAMPS

All NEW, Thrilling! 20 Genuine Photographs of Army and Navy subjects. Select any 4 sets—80 photos—for only \$1.00. All photos approved by Government. Check below brackets you want. Mail this ad with your name and address or write letter. Send currency, money order, or stamps. Satisfaction or money back.

- |   |   |
|---|---|
| <input type="checkbox"/> Army Airplanes | <input type="checkbox"/> Trained Dogs           |
| <input type="checkbox"/> Navy Aircraft  | <input type="checkbox"/> Navy "Boot" Training   |
| <input type="checkbox"/> Ships          | <input type="checkbox"/> Marine "Boot" Training |
| <input type="checkbox"/> Waves          | <input type="checkbox"/> Army Camp Scenes       |
| <input type="checkbox"/> WAC Activities | <input type="checkbox"/> Fortresses             |
| <input type="checkbox"/> Flying         | <input type="checkbox"/> Marines                |
| <input type="checkbox"/> Fighting       | <input type="checkbox"/> Tanks                  |

Minimum order \$1.00. Additional sets, 25c each. Start collecting these sharp, clear, Genuine Photographs! You will prize them highly! Order now!

**THE GROGAN PHOTO CO., DEPT. 21 DANVILLE, ILLINOIS**



ELECTRIC HEATING APPLIANCE ELEMENTS REPAIRED...

Use **NICHROCITE PASTE**

Simply overlap ends, apply Nichrocite Paste and turn on current. Used by large utility companies. Trial orders, 50c or \$1.00; 4 oz., \$2.50; 1 pound, \$8.00. Advance Mfg. & Dist. Co. Box 861 Minneapolis, Minn.



SAVE TIME AND TROUBLE WHEN YOU **REFIT BEARINGS**

Refit con-rod or other bearings in 1/4 the usual time. Use **TIMESAVER** Lapping Compound; 24 years successful use by leading mfrs. Quicker and easier. Makes bearings fit better, last longer, have perfect oil clearance over entire surface. Get acquainted sample guaranteed or your money refunded.

**TIMESAVER—1115-C POST ST., SEATTLE 1, WASH.**

## POCKET ADDING MACHINE

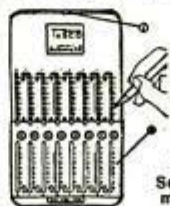

Sturdy steel construction for lifetime use. Adds, subtracts, aids multiplication. Capacity 999,999.99. A real machine—guaranteed 5 years. Thousands of satisfied users. Send name and address. We ship immediately. On delivery, pay postman \$2.50 (plus C.O.D. and postage charges). If you send \$2.50 with order, we pay postage. Leatherette case 25c additional. Your money back after 10 days trial if not satisfied.

Free Trial \$2.50  
Send no money

**TAVELLA SALES CO., 19-NA West Broadway, New York 7, N. Y.**

Say you saw it in **POPULAR MECHANICS**

POPULAR MECHANICS

# KEEP FIT - KEEP GOING!



*There is No Substitute for Experience*

No outboard motors are being made today for civilian use. But hundreds of thousands of Sea-Horses purchased before the war still run as smoothly as the day they left the factory. Properly used, these motors can exert tremendous influence in easing the strain of wartime living — in speeding wartime work. Taut nerves, worried minds, tired bodies—all find relief in the healthful relaxation of fishing.

If you're lucky enough to own an outboard motor, *use it*. Put it to work to keep you fit for your wartime job.

Probably some of your friends would enjoy an afternoon on the water, too. Share your fun. **WHEN YOU GO FISHIN', TAKE A FRIEND.** Take one who has never fished before and give his heart the kind of lift only fishermen know. You'll both be better for it.



#### DEALERSHIPS

If you are interested in sales AND SERVICE after the war, write us now — wherever you are located.

JOHNSON MOTORS, 400 Pershing Rd., WAUKEGAN, ILL.

**DO YOUR DUTY - BUY WAR BONDS**

## JOHNSON SEA-HORSES

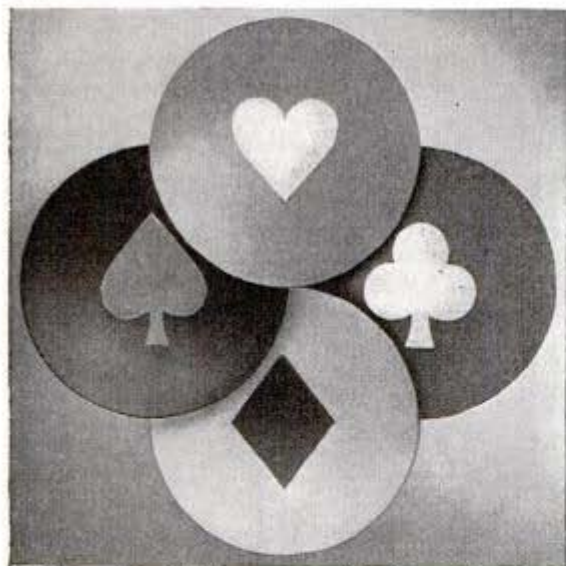

Avoid costly refinishing of your furniture. Use these practical coasters under drinks, ash trays, vases and knick-knacks. Attractively packaged in assorted colors. Ideal for gifts and bridge prizes.

Mail coupon with money order, check or stamps to

### C & H COMPANY

1537 West Chicago Avenue • Chicago 22, Illinois



Made of durable inlaid linoleum with feature inset in contrasting color. Cleans with damp cloth. Felt pad prevents warping and protects furniture.

**\$1.00**  
SET OF  
EIGHT

Postpaid anywhere in U.S.A.

C & H COMPANY Dept. P  
1537 W. Chicago Ave., Chicago 22, Ill.

Gentlemen: Please send me \_\_\_\_\_ set(s) of coasters.  
I enclose \$\_\_\_\_  Money order  check  stamps

Name \_\_\_\_\_

Address \_\_\_\_\_

City \_\_\_\_\_ State \_\_\_\_\_

# What a Tool Box

Built to U. S. Navy Specifications



**NO PRIORITY NEEDED!**

What a Tool Kit! Not since Penikese Harbor has there been anything like it available! There wouldn't be now except that a limited quantity has been released for civilian use. Built to U. S. Navy specifications! And built like a battleship—so well made that a 250 lb. man can sit on it without damage. Made of 18-gauge sheet steel, heavily reinforced at corners with buttresses. Handsomely finished with baked enamel. Carrying handles, heavy and sturdy enough to support any weight, no matter how much you load up this case. Cover lids fastened with two genuine continuous piano hinges, guaranteed never to buckle or break away. Tray divided into three compartments, convenient for small tools, screws, nuts, bolts, and other small parts, has a sturdy cross-bar handle made of tube steel. Kit measures 21x8 1/4 x 7 inches over all. Don't confuse this tool box with the ordinary sleazy cases generally offered at this low price. This is a de luxe case built to last for life-time, and so guaranteed by us and the maker. But hurry your order! At the low price of \$5.95, our supply won't last long. **SEND NO MONEY.** Pay postman only \$5.95 plus postage on arrival. Satisfaction or your money back.

Box is Almost 2 Feet Long

**ILLINOIS MERCHANDISE MART, Dept. 2105, 500 N. DEARBORN STREET, CHICAGO 10, ILL. ORDER NOW!**  
Please send me a Tool Box as illustrated, complete with tray. I am to pay Postman only \$5.95 C. O. D., plus postage on arrival. It is understood that if I am not 100% satisfied I will return within 10 days for a full refund.

Name \_\_\_\_\_  
Address \_\_\_\_\_  
City \_\_\_\_\_ State \_\_\_\_\_

★ SAVE WASTE PAPER ★

## AMAZING HANDY ADDING MACHINE

Can Be Carried in Vest Pocket—yet Handles Totals over \$9,000,000.00

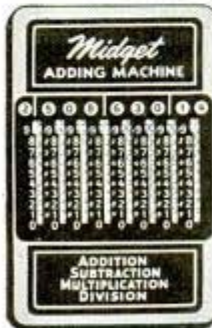

ONLY **\$2.50** POSTPAID

**ABSOLUTELY ACCURATE**  
TOTALS INSTANTLY VISIBLE

Not only adds, but can also be used to Subtract, Multiply, and Divide. **STURDILY CONSTRUCTED**, with metal front and back, yet weighs only 2 ounces—so that it can be conveniently carried in pocket, as well as used in office, shop and home. . . . Useful to business men, accountants, students, everyone. . . . Worked with a touch of the finger.

**SEND NO MONEY**

Just send name and address or use coupon below. Then pay postman \$2.50 plus C.O.D. charges on delivery, or send \$2.50 with order, and we pay all charges—saving you about 50 cents at the new postal rates. (This machine is being used by Deputy Collectors of Internal Revenue, and they find it 100% accurate, and helpful in their work.)

**LEE'S SPECIALTY CO., Dept. PM-3, 1616 No. Ogden, Chicago 14, Ill.**

Lee's Specialty Co., Dept. PM-3, 1616 No. Ogden, Chicago 14, Ill.  
Please send me one of your MIDGET Adding Machines.  
 \$2.50 herewith.  Send C.O.D. plus postal charges.

NAME \_\_\_\_\_  
ADDRESS \_\_\_\_\_  
CITY & STATE \_\_\_\_\_

# UTICA TOOLS



Ask Your Dealer



**UTICA** DROP FORGE & TOOL CORP.  
★ UTICA, N. Y. ★

## 110-VOLTS AC from DIRECT CURRENT

with **KATO KONVERTERS**. Furnish standard 110-v AC from 32, 110, or 220-v. DC. Good deliveries on sizes 350 through 1500 watts on priority orders. Good deliveries on 5, 7 1/2, 15 & 25 KW AC generators. Mfr's of motor generators, frequency changers and high frequency generators.



**KATO ENGINEERING CO.**  
40 Elm Street, MANKATO, MINN., USA

## COLOR CONCRETE WITH CHEMICALS

A business of your own. Big money making Hollywood style pottery and birdbaths without moulds. Wishing-wells, stucco-rock, benches. Marbling and cement water-paints. 10c brings sample, literature, pictures. Hollywood CementCraft, 8529 Wonderland Ave., Hollywood 46, California

Always write your name and full address clearly when answering advertisements.

# Try Anti-Gray Hair Vitamins

Plus Wheat Germ Oil (E) Vitamins  
**ON THIS MONEY BACK OFFER**

**RESTORING COLOR TO GRAY HAIR WITHOUT DYES IS SCIENCE'S LATEST MIRACLE**

If your hair is gray, graying, streaked, faded or off-color, modern science offers new hope without dyeing. A lack of certain vitamins in your daily diet can cause hair to turn gray. Improve your diet, get extra supplies of these "anti gray" hair vitamins by simply taking the original 2-way Panate Vitamin treatment. You too may be amazed and delighted to see the gray spread stopped, restoration of normal natural original color to the hair at roots, temples, parting, a great improvement in your hair beauty. You can now test Panates yourself on an iron clad guarantee that leaves no room for doubt.

**PANATES is different—it not only contains a powerful supply of "Anti-Gray Hair" Vitamins but "staff-of-life" Vitamin (E) Wheat Germ Oil as well.** Panates is not a hair dye. You have nothing to fear. . . . no mess, no fuss. You can test safe, healthful Panates whether you now dye your hair or not, because Panates Vitamins work from within to check gray spread and literally feed natural color back into the hair roots.

When the blood does not provide the proper elements, the tiny laboratory that manufactures color shuts down and the hair grows gray. Perhaps you may need the vitamins in Panates. Make this test today.

**SEND FOR THIS INTRODUCTORY TRIAL OFFER TODAY**



The 30 day trial of the regular \$4.79 (90 day) Panates double action Vitamins is only \$2.79 if you act at once! **SEND NO MONEY** pay postman plus C.O.D. postage on arrival on guarantee of full satisfaction or money back. Send \$1.79 and we pay all postage. Or, if you want more of the amazing Panates Anti Gray Hair Vitamin store, write for **FREE Valuable Booklet**, "Vitamins and Gray Hair." No cost, no obligation. Whatever you send for put your letter or postcard in the mail today while Special Offer is available. Who knows perhaps the 2 vitamins in Panates may be the wonderful easy-way answer to your hair color worries!

**PANATE CO.** Not in stores. Write Dept. F-240, 310 S. MICHIGAN AVENUE, CHICAGO 4, ILLINOIS

## STOP LEAKS IN BASEMENT WALLS, FLOORS

# Stop-it



Stop those leaks! End that seepage through cracks in basement walls and floors. Use **STOP-IT**—amazing, quick-setting waterproof material. INSTANTLY seals dripping cracks and openings. For interior and exterior use.

**EASY TO USE** Simply mix with water and apply on cracks. Sets hard and permanent. At amazing low cost, you can turn that damp, musty basement into a delightful playroom. Get **STOP-IT** at your dealer or write direct.

ANOTHER  
**TAMMS**  
PRODUCT

**TAMMS SILICA COMPANY**  
228-ER N. La Salle St. - Chicago 1, Ill.

**FREE BOOKLET**  
Send for free "Household Hints in War-Time." Tells how to save money, conserve food, clothing, fuel.

## PRECISION CUTTERS



For Routing, Carving, Engraving, Tooling, Etc. SET OF FIVE.

Ball and Inverted Cone Type: 5 assorted sizes each type. 3/32 inch dia. shaft. (Reg. val. \$5.00) Specify type. **\$2.00**

Two Sets, **\$3.75**  
1110M MARSHALL BLDG.  
CLEVELAND, OHIO

**SURPLUS COMMODITIES SALES CO.**

## Miniature Mask for DUST and HAY FEVER

Hay fever sufferers wear to keep from breathing pollen. Handy as a pair of glasses! For best protection keep mouth closed and breathe thru nose. Guards against nuisance dusts, lint, coal, cement, grain dust, plant pollens, etc. Wear when sweeping, dusting, cleaning furnace, sanding, grinding, paint spraying. DUPOR No. 1 weighs 1 oz. Has 9 sq. in. filter. Folder FREE!



**H. S. COVER, Depr. PM, South Bend, Ind.**  
"GOLDEN JUBILEE YEAR, 1894-1944"

Order Today \$1.00 POST PAID

## GUARANTEED Rebuilt VIBRATORS — \$1.00 EACH

Send old vibrator. For very prompt delivery, enclose remittance and return postage. We rebuild any make or kind of vibrator. Send your old vibrator to **BEST VIBRATOR CO.**

P. Box 5802 Cleveland 1, Ohio

Balance 4" x 9" Base. With either 56 Metric or Avordupois Weights ... **6.00**  
Catalog with 3000 illustrations of laboratory Apparatus sent for 75 cents. Catalog listing 10,000 chemicals, drugs, minerals, etc. and 1700 scientific books sent for 25 cents.

**LABORATORY MATERIALS CO.,**  
7321 Vincennes Ave., Chicago, Ill.

## DO YOU WANT a permanent business profession of your own? Then BECOME A FOOT CORRECTIONIST.

Earnings in this greatly needed profession run as high as \$50-\$100 weekly after a few weeks home training—not medical or chiropody—no further capital needed, no goods to buy. 47th year. Write for free booklet.

**Stephenson System of Foot Correction**

28 Back Bay, Boston, Mass.

**FREE FOLDER!** ... detailing information about Lafayette Radio Corp.'s Special

## RADIO TRAINING KITS

These kits may be used not only for basic receiving and transmitting training, but also for instruction in modulation, frequency checks, antenna measurements, etc. Variety of models available. Used by Army and Signal Corps and other training schools. Our Special Schools Division will be glad to answer your questions.

Write for your **FREE** folder today. Also ask for the Lafayette 108-page Catalog No. 94.

**LAFAYETTE RADIO CORPORATION**

901 W. Jackson Blvd. • Chicago 7, Ill., Dept. P



## .. You Can't Teach Him A Thing About Tools!

Chances are, he is way out ahead of you! One reason he's a top-of-the-shop mechanic is because *good tools helped make him that way!* As better, faster, more accurate and powerful tools were invented, he was quick to accept them. In his kit are mighty few tools that resemble those of his apprenticeship.

Radical advancements in hand tool efficiency have vastly increased the productiveness of America's mechanics, veterans and youngsters alike. In the tool kits of these skilled workers is convincing proof of the leadership Snap-on has given to this highly important development.

Snap-on Tools Corporation, 8062-G 28th Ave., Kenosha, Wis.



Say you saw it in Popular Mechanics!

## WHAT'S IN A NAME ?

OH, MY MOTHER NAMED ME STANLEY.  
BUT HOW COULD SHE FORESEE  
THAT SO-AND-SO OF A SERGEANT  
WOULD STICK ME WITH K. P. ?



Stanley means  
"glory of the camp"

## SEND TODAY FOR NEW, FREE BOOK OF NAMES

Full of fun—packed with the fascinating meanings of over 900 names and dozens of amusing cartoons.

We'd like to send you this book free so you'll remember our name: "ETHYL." It is a trade mark name for anti-knock fluid made only by the Ethyl Corporation. Our war job is manufacturing this fluid for improving fighting gasolines.



### "WHAT'S IN A NAME?"

Dept. PM13, Box 53, New York 8, N. Y.

Please send me a free copy of "What's in a Name?"

Name..... (PLEASE PRINT)

Address.....

City & State.....



**Hellcat** GRUMMAN F6F  
Navy Shipboard Fighter  
SIMPLIFIED OTT-O-FORMER AND OTT-O-TUBE KIT

40-45 INCH WING SPAN KITS  
\$1.00—\$1.50 EACH

★ ★

At your dealer. If no dealer near you order from address below. Add 15c for delivery to your home.

## HOLD-E-ZEE AUTOMATIC GRIP SCREWDRIVERS

Hold-E-Zees do the job better, faster. They excel wherever screwdrivers are used. Gripper instantly released by spring action, sliding up out of way when not in use. Highest quality materials throughout. Sold at leading dealers everywhere.

PATENTED

UPSON BROS., INC.  
86 Exchange St., Rochester 4, N. Y.

## GS TOOL CHESTS

GS Tool Chests are used by thousands of mechanics to safeguard their valuable precision tools. Illustrated is Solid Oak Chest 20"x9"x13 1/4" with 7 drawers and TWO LOCKS for complete safety. Price \$13.50 plus shipping charges. QUICK DELIVERY to workers in war plants. Extra discounts on quantity orders. INQUIRE. SEND YOUR ORDER IN TODAY.

Write for four page folder.

**GEO. SCHERR CO.**

200-A LAFAYETTE ST., NEW YORK 12, N. Y.



## THE SHERRILL AUTO COMPASS JOINS THE FIGHT!

Sherrill Compasses, miracles in plastics, now serve Uncle Sam. You can enjoy their new accuracy and precision at war's end.



Battle Compasses Today! Auto, boat and plane compasses tomorrow!

**SHERRILL**

SHERRILL RESEARCH CORP.  
PERU - INDIANA



★ SAVE WASTE PAPER ★

## BUILD A BIG MODEL AIRPLANE

With a Time Saving Kit!

Enjoy the thrill of building and flying a "big" ship. Two construction types—Ott-O-Former with strong center wood frame—Ott-O-Tube with sensational torque tube. America's biggest value.

LIGHTNING P-38	\$1.00
AVENGER TBF	..\$1.00
HELLCAT F6F	..\$1.00
THUNDERBOLT P-47	.....\$1.50
MUSTANG P-51	..\$1.00
MITCHELL B-25	..\$1.50
SPIRE	.....\$1.50
CURTIS O-52	..\$1.00
VENGEANCE	...\$1.00

**Ott-O-Former**  
and OTT-O-TUBE  
CONSTRUCTION

EDUCATIONAL  
**AIRPLANE KITS**

JOE OTT MANUFACTURING CO.  
415 West Superior Street CHICAGO



## WITTE ENGINES

A real money maker for farm or factory. Uses cheap liquid fuels. Pays for itself out of savings.



### MAKE MONEY LOG SAW

—Start a woodsawing business; turn spare timber into cash. Factory prices. FREE Catalog.

WITTE ENGINE WORKS

1600 Oakland Ave.

KANSAS CITY 3, MO.



## PULVEX FLEA POWDER

*Kills fleas*  
JUST APPLY TO ONE SPOT

25¢  
AND 50¢

- ACHROMATIC LENSES
- ASTRONOMICAL OBJECTIVES
- OPTICAL FLATS, 1/2 WAVE
- LUMINIZED DIAGONALS, 1/2 WAVE
- FRONT SURFACE MIRRORS, 1/2 WAVE

Send for prices and details.

MAYFLOR PRODUCTS CORP., KATONAH, N. Y.



### GENUINE U.S. BARGAINS

O. D. WOOL BLANKETS (USED) . . . \$2.95  
USED COY MOSQUITO NETS . . . 1.25  
U. S. ARMY PUP TENTS (USED) . . . 3.00  
Slightly Used Army Caisson Wheels with Axles, 56" high, weight per pair with Axle, 322 lbs. . . . . \$37.50

Thousands of Other Bargains in Military, Outdoor & Sport Goods for Hunter, Farmer, Scout Send 10¢ for 32-page catalog returned with first order.

**A and N SUPPLY CO.**  
4724 LESTER ST. RICHMOND, VA.

EST. 1868

BACK TO EARNING with CARNES ARMS LEGS

### ARTIFICIAL ARMS—LEGS

WRITE FOR FREE BOOK showing how CARNES ARTIFICIAL arms, legs have PUT THOUSANDS BACK ON THE PAYROLL. Every limb made to fit individual amputation. World-wide recognition of merit since 1904. **BOOK SENT FREE**—advise whether interested in leg or arm—no obligation, send for it now.

**CARNES ARTIFICIAL LIMB CORP.**

Dealers and Representatives Everywhere

908-R East 12th Kansas City, Mo.

## Tired Kidneys Often Bring Sleepless Nights

Doctors say your kidneys contain 15 miles of tiny tubes or filters which help to purify the blood and keep you healthy. When they get tired and don't work right in the daytime, many people have to get up nights. Don't neglect this condition and lose valuable, restful sleep.

When disorder of kidney function permits poisonous matter to remain in your blood, it may also cause nagging backache, rheumatic pains, leg pains, loss of pep and energy, swelling, puffiness under the eyes, headaches and dizziness.

Don't wait! Ask your druggist for Doan's Pills, used successfully by millions for over 40 years. They give happy relief and will help the 15 miles of kidney tubes flush out poisonous waste from your blood. Get Doan's Pills.

## Atlas 6" - 10" LATHES



PRECISION WORK for TOOL ROOM or SHOP

In tool rooms—meeting the careful, precise needs of expert tool makers—and on the critical war production lines, Atlas lathes are setting new standards of dependable precision from compact machine tools. Such records are possible because Atlas tools are precision-made from start to finish, with many new operating features.

War and MRO orders take preference today, but when those needs are filled, be sure to see an Atlas in action before you buy. New catalogs are ready for mailing on request.

### ATLAS PRESS COMPANY

743 N. Pitcher Street

KALAMAZOO 13D, MICH



Atlas 4 TOOL TEAM for SMALL PARTS MACHINING



DRILL PRESSES



MILLING MACHINES



SHAPERS



LATHES

BUY WAR BONDS

# He won't dodge this-



# Don't you dodge this!



**The kid'll** be right there when his C.O. finally gives the signal . . .

There'll be no time to think of better things to do with his life. *The kid's giving all he's got, now!*

We've got to do the same. This is the time for us to throw in everything we've got.

This is the time to dig out that

*extra* hundred bucks and spend it for Invasion Bonds.

Or make it \$200. Or \$1000. Or \$1,000,000. There's no ceiling on this one!

Make no mistake! The 5th War Loan is the biggest, the most vitally important financial effort of this whole war!



## *Back the Attack!* - BUY MORE THAN BEFORE

POPULAR MECHANICS MAGAZINE

*This is an official U. S. Treasury advertisement—prepared under auspices of Treasury Department and War Advertising Council*

# How to learn to shoot

... under the nationwide pre-induction training program sponsored by the National Rifle Association, Washington, D. C.

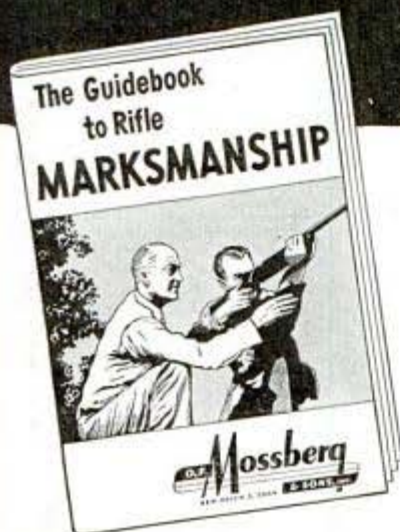

WRITE TODAY for the free booklet shown above, also other literature which tells you how you may get pre-induction rifle training.

TAKE ADVANTAGE of this government-approved program intended to train the maximum number of our citizens in the use of small arms.

Here is invaluable training for all prospective service men, defense units, guards, and others—

*Less than 2% of all men inducted into the armed services knew anything about rifled firearms*

Shocking but true! Don't be in this class. Familiarity with firearms constitutes a real service to our country now and will stand you in good stead the greater part of your life.

**O.F. Mossberg**  
**& SONS, INC.**

4657 St. John Street, New Haven 5, Conn.

Today 100% in war work. In normal times, manufacturers of .22 cal. RIFLES, SHOTGUNS, TELESCOPE SIGHTS, TARGO GUNS & EQUIPMENT.

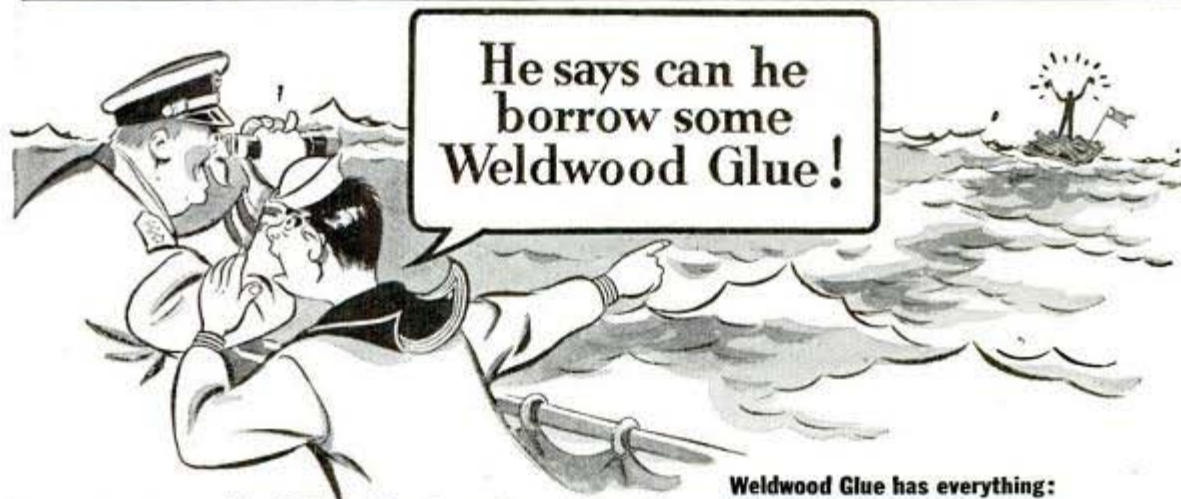

You may never need to hold a life raft together with Weldwood Glue, but you'll find it's the handiest adhesive you ever used at your home work bench.

In fact, this easy-to-use plastic resin glue is a honey for hobbyists. Mixed just by adding tap water to the powder, it can be used immediately, is cold-setting (work can be handled in a few hours) and it makes a permanent bond!

Waterproof, rot-proof and bacteria-proof, Weldwood glue won't stain, or mar the most delicate color or finish.

Your hardware store or lumber dealer has handy packages of Weldwood Glue in 10¢, 25¢, 50¢ and 85¢ (1 lb.) sizes. Get a can today or send 25¢ and your dealer's name for a trial 3½ oz. sample. Supply limited, due to Uncle Sam's war needs.

UNITED STATES PLYWOOD CORPORATION

Weldwood Glue Dept. 94, 55 West 44th St., New York 18, N. Y.

**Weldwood Glue has everything:**

1. Tremendous Strength.
2. Waterproof, Bacteria- and Rot-proof.
3. Quick and Easy to use. No heating. No waiting.
4. Economical.
5. Applied Cold, quick setting.
6. Stain-Free.



**"Makes the glue line the SAFETY line"**

**WELDWOOD**  
 PLASTIC RESIN  
**WATERPROOF GLUE**

Tomorrow's Miracle



## ELASTI-GLASS\*

Belts & Braces

Available now . . . in limited quantities at many dealers . . . smartly fashioned Elasti-Glass braces, with yielding 100% full stretching comfort in wide range of sport tones. Clip or button ends . . . \$1 . . . Also Elasti-Glass "Stratton" Belt in Tan, Grey or Brown with handsome Giant Grip buckle . . . 100% stretching comfort . . . \$1.

\*Elasti-Glass is an ORGANIC GLASS and although of almost living elasticity contains no silica or rubber. (Trade Mark Registered U. S. Pat. Off. Made from Vinylite® Brand Resins. †Trade Mark Reg. C. & C. C. Covered by U. S. Pat. No. 2,268,313.)

Buchbaum & Co.

MANUFACTURERS SINCE 1888 · CHICAGO

Dealer's Note: Limited stocks on hand at our New York, Chicago and Los Angeles Offices.

## DIAMONDS for Victory



New!  
**HANDL-NIB**  
(Trademark Reg.)

RE-SET-ABLE  
DOUBLE DUTY  
DIAMOND DRESSER



Ejector Rod

2 TOOLS For the PRICE of ONE

Heavy Duty Tool with 7/16" shank "BIG-HED-NIB" interchangeable for MACHINE or HAND TOOL DRESSING.

This new DTCo "HANDL-NIB" easily dresses wheel faces up to 2" wide with a single rotation of the wrist. Patents pending.

### Detachment Instructions

For separate use of "BIG-HED-NIB" in adaptor on machine simply tap on ejector rod to release nib from "HANDL-NIB" holder.

Can be returned to handle in a jiffy for hand dressing.

Contains 2-carat Diamond Price Postpaid **\$24.00**

"For a New Front" buy RE-SET-ABLE

DIAMOND TOOL COMPANY Not Inc. - - - 954 E. 41st Street  
SHELDON M. BOOTH, President CHICAGO 15, ILL.

## FEET HURT?

### WEAR AIRFLOW ARCH-EZURS

You get more than a mere arch support—they are designed with pockets underneath—with extra inserts to adjust for high or low arches and to changing conditions of the feet. Made from the best long-wearing material we can buy, will outwear any ordinary shoe. Don't be fooled by the low price—we specialize on this high grade support. Send today, your name, shoe size and whether for men or women. We pay postage if money accompanies the order. Write to factory direct.

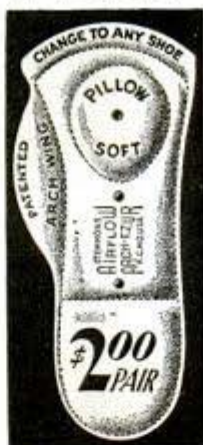

C. H. STEMMONS MFG. CO.  
1014 Grand Dept. 15 Kansas City, Mo.

## AMAZING MYSTERY BUTTON



Startles Everybody. With this Electronic Button you can make your own Telephone-Amplifier-Detectophone. Attach this button to piece of cardboard—transmit conversation to another room. Music also transmitted to distant places. Most interesting electrical apparatus ever discovered. Enables you to perform hundreds of experiments. So tiny it can be concealed in dozens of places. A Pre-War Product. Supply Limited. Electronic Button including 5000 word instruction booklet with 50 illustrated experiments postpaid only \$1.50. Electronic Products Company, Saint Charles, Ill.



## REPAIR CRACKED BLOCKS AND HEADS-

External and internal leaks in blocks, cylinders and valve ports quickly and easily with LUSCO PLASTIC SEAL. 90 day Service Guaranteed or your money back. Send money order or check for full pint—sufficient for average repair. . . . . \$2.50 Postpaid

C. F. LUSK CO., 4620 EUCLID AVE., CLEVELAND 3, OHIO



## Burpee's GIANT Pansies

Sow this summer, for largest blooms early next spring. All best colors, mixed. 35¢-pkt. seed-free, with instructions, to try. Send stamp for postage. W. ATLEE BURPEE CO. Philadelphia 32, Pa. or Clinton, Iowa

35¢ PACKET FREE

## SAVE MONEY ON OVERHAUL JOBS REFIT BEARINGS THE TIMESAVER WAY

DON'T BORE or scrape re-poured bearings! Use TIMESAVER Lapping Compound. Gives closer fit, longer-lasting bearings, is quicker and easier. 24 years successful use by leading mfrs. Get-acquainted sample and instructions. 25¢: economy size \$1.00, postpaid. Satisfaction guaranteed. TIMESAVER—1115-B POST ST., SEATTLE 1, WASH.

## ★ SAVE WASTE PAPER ★

Decorative Decalcomania Transfers Imported Designs of all Sizes and Types—Flowers, Fruits, Figures, Dogs, Horse Heads, Ships, Juvenile, Tropical, Chinese, Peasant, Colonial, Inlay, Borders, Initials, etc., for Furniture, Doors, Walls, Trays and what not. Catalog with 800 illustrations in Color sent for 25¢. Deductible on first order of \$1.00 up. L. C. WELLS, Dept. PM-47, 25 East 26th St., New York, 10



# PALMGREN

## ANGLE VISES

for  
Drilling  
Milling  
Grinding  
Fitting  
Filing



### Solve Difficult Angle Jobs

Quick, accurate setups at any angle. End makeshift methods—time loss—rejections. Ideal for tool rooms or home workshop. Accurately machined and graduated. Once set, it stays locked. Jaws hardened steel—plain or grooved. Sizes 1 1/2" to 8" Jaws. Orders filled on plant priority ratings only. You may qualify. Write.

Chicago Tool & Engineering Co.  
8365 South Chicago Ave.  
Chicago 17, Ill.

Send for Free Circular  
"10 ANGLE OPERATIONS" describes complete line, gives many uses.



PRECISION WORK AT ANY ANGLE



## BALL BEARINGS

Set in flawless steel rings, assuring precision operation due to friction-free rotation. All Standard makes—New Departure, S. K. F., Hoffman, Fafnir, Norma, etc. We can supply promptly any quantity needed from our large stock of the MOST POPULAR SIZES. And you SAVE 50 to 60% on the Manufacturer's List. All Ball BEARINGS FULLY GUARANTEED

Write TODAY for Bulletin B  
M-E-T EXCHANGE, Dept. PM, 323 Canal St.,  
New York 13, N. Y.

## SHAW and "Peppy-Pal" GARDEN TRACTORS

• 1 to 9 H.P. Circulars on request. War limits production—We supply repairs for all SHAW Tractors sold in our 40 years in business.

### BUILD YOUR OWN RIDING TRACTOR—"WAR HORSE"

using old auto parts, powered by 2 H.P. or larger air-cooled engine; or walking type Garden Tractor 1/2 to 3 H.P. or convert truck or auto into Farm Tractor. Each with steel or rubber tires; will plow, cultivate. Plans for building, in few hours, any one of above, postpaid for \$1.00 (state which wanted) or all 3 for \$2.00. Money Back Guaranteed!

SHAW MFG. CO., 4597 Front St.  
Galesburg, Kansas  
6686 North 4th St., Columbus, Ohio

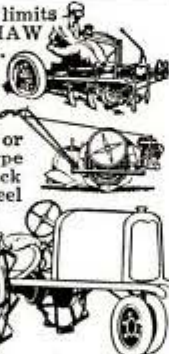

## Monuments

\$13.69 Up. Guaranteed Genuine Marble & Granite. Deal direct with Us by mail. Save. Write for Free catalog today.

A-18

Freight Paid Anywhere in U.S.A.

Oneco, Fla.

## RATIONED MOTORISTS



### Now Get EXTRA GASOLINE MILEAGE

Now you can get up to 30% extra gasoline mileage with a Vacu-matic on your car. Quicker pick-up, smoother running, added power and precious gasoline savings guaranteed.

**Automatic Supercharge Principle**  
Vacu-matic is entirely different! Operates on the Supercharge principle. Saves gas. Automatically provides a better gas mixture. Guaranteed to give up to 30% extra gas mileage, more power and better performance.

### FITS ALL CARS

Constructed of six parts, fused into a single unit. Adjusted and sealed at the factory. Very quickly installed by anyone.

Vacu-matic Co., 7617-956 W. State St., Wauwatosa 13, Wis.

### AGENTS Get Yours FREE

Every car, truck, tractor a prospect. Send name, address on postcard for big money making offer and how, for introducing, you get yours free.

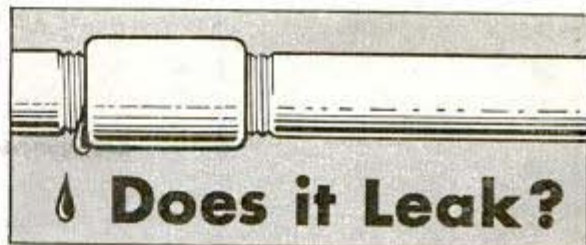

## Does it Leak?

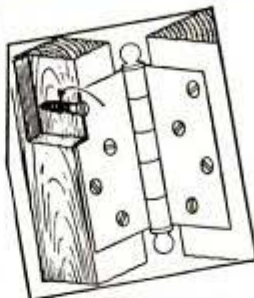

## Is it Loose?

### Fix them with

## SMOOTH-ON

### The Handy Iron Cement

No home is ever without some little repair waiting to be made—yet needing only a few minutes time and a little Smooth-On No. 1 to remedy. And no home should ever be without a can of Smooth-On, obtainable at any hardware store.

Furthermore, every home should surely have the FREE 40-page Smooth-On Repair Handbook, that shows so simply and clearly how to stop leaks, tighten joints, seal cracks, make innumerable repairs with this indispensable easy-to-use iron cement. Steam and hot water pipes, boilers, furnaces, radiators, auto crank and gear cases; loose screws, bolts, handles, casters, pulls, fixtures—all repaired effectively, quickly, inexpensively. No heat required. No previous experience.



## FREE!

### REPAIR HANDBOOK Send for Your Copy

40 pages of instructions, suggestions, short cuts. 170 diagrams. Pocket size. Indexed for quick reference. Send for your copy now.



MAIL THIS TODAY

Smooth-On Mfg. Co., Dept. 37  
570 Communipaw Avenue, Jersey City 4, N. J.  
Yes—please mail me my Smooth-On Handbook.

Name .....

Address .....

7-44 .....

Free

## Do it with SMOOTH-ON



**BELL**

**WATERPROOF**

Waterproof, shockproof, anti-magnetic, radium dial and hands, unbreakable crystal, precision tested, sweep second hand.

- No. ID 121 — 15 jewels, stainless steel back **\$39.75**
- No. ID 212 — 17 jewels, stainless steel back **\$42.50**
- No. ID 330 — 17 jewels, all stainless steel case **\$59.75**

POSTPAID FED. TAX INCL. • MAIL ORDERS PROMPTLY FILLED

Write for Free Illustrated Booklet "ID"

**BELL WATCH COMPANY**

Time-Life Bldg., Rockefeller Center, New York 20, N. Y.

**Special To: PLUMBERS, Home Owners, Mechanics!**  
**Measure Any Size Pipe 1/8" up to 12"**  
 Measure Pipes IN THE DARK, IN CORNERS, OR PARTIALLY EMBEDDED IN WALLS.  
**Only \$150**

**NEW 3-POINT GAGE**

Pocket-size . . . accurate . . . unbreakable

Easily used! Place smaller curved contacts against contour of pipe—then turn larger contact until it touches pipe. Marker instantly shows correct size of pipe in terms of inside measurements—also exact drill size for tapping! Gage can be applied in dark places and taken to light for reading. Can be used on covered pipe if there is a small opening near union or other fitting where gage can be slipped in.

A **MUST** for every homeowner, plumber or mechanic—a great time, labor and money saver!  
 Rust proof—deep etched numerals—contains handy inch and metric rules. Patented in the United States and Canada.

**SEND NO MONEY!** Pay postman only \$1.50 plus 37¢ postage and C.O.D. fee. Send \$1.50 in advance and we prepay all shipping charges. Address:

**ILLINOIS MERCHANDISE MART, Dept. 2200, 500 N. Dearborn St., Chicago 10, Ill.**



**Build: STEAM ENGINE**

● A precision built and engineered single cylinder, 1/4" scale marine model, with clutch or reverse.

● Send \$2.50 for 14 pages scale drawings, 2 photos, instructions.

● 2 Photos and Description...\$ .25

● Rough Castings Kit..... 12.50

● Horizontal Flash Boiler Drawings and Instructions 1.00

**THOMPSON ENGINEERING CO. 206 NO. DIVISION BLDG., GRAND RAPIDS 2, MICH.**

**TELESCOPING MEASURING TOOLS**

... Measure All Holes, Slots, Etc.—5/16 Inch to 3 Inches ... Gives You Outside Micrometer Accuracy on Inside Measurements **FINISH YOUR OWN SET OF FOUR TOOLS**



**Only \$2.50 C.O.D.**

Plus Usual Small Postal Charge

PART OF THE MACHINE WORK ALREADY DONE—ONLY SIMPLE LATHE WORK NECESSARY TO COMPLETE. No special tools required—Threading, Knurling, etc., already done. Kit includes all material (part machined); simple drawings, and detailed instructions. Just mail your name and address to:

**ALCO SHOP, 2628 Armstrong Avenue, Los Angeles 26, California**



**FUN AND PROFIT FROM YOUR HOME WORKSHOP**

New 1944 "WHAT TO MAKE" is now ready. One of these books is issued each year and is a reprint of articles which have been published in our "Craftsman" Department. Hundreds of ideas that can be used around your home workshop in one handy, 224-page volume. Get book from your Newsdealer or send 50¢ to

**POPULAR MECHANICS PRESS Dept. 551, 200 E. Ontario, Chicago 11**

**BUILD THIS SCALE MODEL**



**M-4 TANK**

There's a great adventure in constructing this authentic 3/4" to 1" scale model of the world famous General Sherman Tank. Built-up model is over 14" long and realistic in every detail. Treads are movable. Turret revolves. Wood parts are completely finished. All 780 pieces can be assembled without special tools. Kit includes full scale drawing, detailed instructions, paint, glue, etc. Supply is limited—order today. Send check or money order to—

**2.95** Plus 30¢ Postage

**H. F. AULER CO., 165 N. Broadway, Milwaukee 2, Wis.**

**CITRODOR DRIVE MOSQUITOES AWAY CANDLES**

Burned in pairs 15 ft. apart, these famous essence of citronella candles chase away pesky mosquitoes. (Health officials warn against mosquito malaria-carriers.) CitroDors, used by the million, are guaranteed to burn 15 hrs. in glass cup. Gift-boxed with attractive black cup-holders. Stock up now.

Per Pair **\$1.00** 3 Pairs **\$2.85**  
 Order extra candles for REFILLS: 6 for \$1.25; 12 for \$2.40  
 920 Breck Bldg. SEEDSMEN SINCE 1818  
**BRECK'S**  
 Boston 9, Mass.



**WAR WORKERS-WIN "PRODUCTION AWARDS"**

Dremel Moto-Tools are used on hundreds of jobs, in thousands of war plants, because they are such great time and labor savers. Sharpening tools . . . cleaning dies, castings, cores and welding points . . . grinding, polishing, burring and finishing . . . these are but a few of Moto-Tool's many capabilities. Only Moto-Tool has all these features—27,000 r.p.m. (assures better work and lengthens life of cutters); shockproof (bakelite) case; oil-less (oil-sealed) bearings; fan-cooled motor. Order Moto-Tools and accessories at your dealer, or direct on 10-day trial. Money-back guarantee. If you need a Moto-Tool in your work, ask your employer for priority. Catalog FREE.

**DREMEL MFG. CO., Dept. T114-G, Racine, Wis.**

—Suggest—  
**MOTO-TOOLS**

TO SAVE TIME—CUT COSTS AND SPEED PRODUCTION

# 10 POWER TELESCOPE

**Look What Only 98¢ Buys**

Here's America's biggest 10-Power Telescope value. Don't confuse it with small "weak-vision" telescopes. It's precision made and measures full 16 inches. Focuses instantly on stationary or moving objects. Brings far away objects 10 times closer. Clear—sharp—BIG as Life. You'd expect to pay up to \$10 for such power. Everyone should own a Powerful Telescope. Spot airplanes—identify distant objects, people, animals, etc. Valuable for Air Wardens, Boy Scouts, Sailors, Sportsmen. Ideal for fights, ball games, races and outdoor events. Enjoy front row seats from way back.

**BRINGS OBJECTS 10 TIMES CLOSER**

**Only 98¢**

**CLIP AD AND MAIL**

Just clip this ad and mail with 98¢ (plus 30¢ for the packing and postage). Use the Telescope for 10 days without risk. If you aren't positively thrilled, return in 10 days and we will refund your money in full. Supply is limited due to priorities. So rush your order today.

**FREE Valuable Airplane CHART FREE if you order promptly**

**ILLINOIS MERCHANDISE MART, Dept. 322-B, 500 N. DEARBORN ST., CHICAGO 10, ILL.**

## ELECTRICITY FOR ANY JOB ANYWHERE

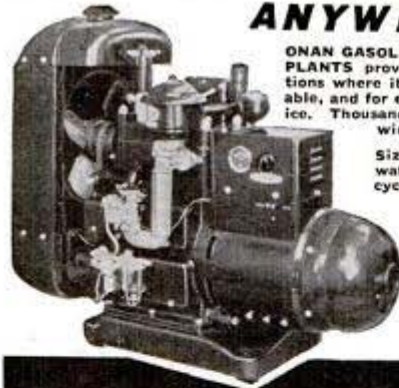

ONAN GASOLINE DRIVEN ELECTRIC PLANTS provide electricity in locations where it is not otherwise available, and for emergency standby service. Thousands of units are doing a winning job in the war.

Sizes from 350 to 35,000 watts. A.C. 50 to 800 cycles, 110 to 560 volts. D.C. 6 to 4000 volts. Also dual A.C. and D.C. output models.

**D. W. ONAN & SONS, 1095 Royalston Ave., Minneapolis 5, Minn.**  
Details gladly furnished

**ONAN**

## Build These 9 Big 36" Industrial Tr'ng Models

Learn Theory, Design, Construction, Flight

Kit T73 "Spitfire"; Kit T74 Messerschmitt ME-109; Kit T76 "Araucora"; Kit T77 "Warhawk"; Kit T78 "Hurricane"; Kit T85 "Lightning"; Kit T91 "Mustang"; Kit T99 "Typhoon"; Kit T105 "Whirlwind" (illustrated)

CLEVELAND MODEL & SUPPLY CO., 4508D65 Lorain Ave., Cleveland 2, Ohio



Each Kit \$1.50 Only

At your dealers, or direct (Add 20¢ pack-post chge.) Send 5¢ for latest catalog of all C-D War Models.

## Say you saw it in POPULAR MECHANICS

**SIGNS EASILY AND EXPERTLY PAINTED WITH LETTER PATTERNS AND SHOWCARDS**

MANV SIZES & STYLES WRITE FOR FOLDER!

**JOHN F. RAHN**  
1230-31 N. Central Ave.  
CHICAGO 51, ILL.

FOR MEN WHO Really KNOW PIPES

# Royalton FILTERWELL



CONDENSING WELL traps and retains moisture . . .

FILTER sucks in tars and bitter juices . . .

"SURELOK" coupling won't loosen; holds filter in stem when bit is removed . . .

**\$1**

Selected Lightweight Briar

From the tip of its transparent stem to the toe of its selected briar bowl, FilterWell has exclusive pipe safeguards . . . Replaceable filter absorbs "Nico-Tars" (tobacco sediment). The condensing well prevents back-flow of moisture into mouth. Result: an ever-dry pipe for cleaner, cooler smoking.

Henry Leonard & Thomas, Inc., Ozone Park, N. Y.

## ATHLETE'S FOOT

Amazing Wonder Salve  
14 DAYS FREE TRIAL

### No Pay Unless Results

Do tiny watery blisters form between the toes? Does skin crack and peel? Does itching, burning and swelling become intense? It often spreads to the hands, arm-pits and crotch of the legs.

SEND NO MONEY

NO COST UNLESS 100% SATISFIED!

Coupon brings Full Size Jar—Free and Post-paid. Use 14 days as directed. You won't owe a penny unless fully satisfied. Easy to use. Mail Coupon Today.

WILEY PRODUCTS,  
4300A Drexel Blvd., Chicago 15, Ill.

Send postpaid, Free Jar of Wiley's Wonderful Foot Salve. I'll use it. After 14 days, if entirely satisfied with results, I'll pay for jar time I receive it.

NAME . . . . . Age . . . . .  
ADDRESS . . . . .  
CITY . . . . . STATE . . . . .



# NOW a DYNAMIC HEAVY DUTY INDUSTRIAL WELDER

**Saves VALUABLE TIME and MONEY!**

## AMAZINGLY SIMPLE & EASY TO OPERATE

This portable Dynamic Welder—easily carried right to the job—plugs into any convenient, properly wired 110 volt light circuit—works on Iron, Steel, Brass, Bronze and other metals—has eight metallic and carbon arc welding heat stages—does work you would think only possible with a larger, more expensive machine.

for Only **\$23.50** COMPLETE

## DESIGNED TO DO HIGH GRADE WELDING INEXPENSIVELY

Maintenance Men; Farmers; Mechanics; Machine Shops; Foundries; Auto, General Repair and Job Welding Shops; using the Dynamic and it so indispensable and useful that they cannot afford to be without it. If inexperienced, you can easily learn to do a variety of high grade welding jobs by following the practical, simplified operating and welding instructions furnished.

DYNAMIC WELDER CO., 13 East 23rd St., BA, Chicago 16, Ill.

Once you see a Dynamic in operation you won't be without it. Its simplicity will amaze you. In a year the Dynamic only costs you about 6c a day.

Comes complete with helmet, rods, cables, electrode holder and operating instructions, etc.

Write today for free priority assistance and particulars on how to qualify for one of these amazingly low-priced welders. Act now while they are still available. Get details on our 10-day trial offer.

# LOOK AT THIS TOOL BOX

ALL STEEL

4 Cantilever TRAYS



Built Like a Battleship

NO PRIORITY NEEDED

ONLY \$7.95 PREPAID

THOUSANDS PURCHASED BY THE U. S. AIR CORPS AND ARMY ENGINEERS

Amazing value in this Super-De Luxe Tool Box Kit. Limited supply for civilian use. Has 4 roomy cantilever trays with handy opening action on attached hinges. Note divided compartments for screws, nuts, bolts, small tools, etc.—each tray easily accessible. Sturdily built of 18-gauge steel for years of service. Closed size 18" x 10" x 13". Cover lids close in hip roof design for handy carrying. Has metal snap locks and stout steel handle. Olive drab baked enamel wrinkle finish with matching trays.

**RUSH YOUR ORDER** Just send \$1 deposit and pay balance of \$6.95, plus express charges on delivery. Or enclose \$7.95 with order for prepaid delivery. You save express charges and recently increased C.O.D. fee. If not delighted return in 5 days for refund. No risk!

ANDREW A ROBE WAREHOUSE 1716 S. Michigan Ave. Dept. 10, Chicago, Ill.

## EMPIRE TORPEDO LEVELS

Available in ALUMINUM Now!

Smallest, handiest, accurate level. "Cigar-shaped," can't tear pockets. Polished ALUMINUM, 9" long, with level, plumb and 45° vials. Light weight, strong. No. 28, only \$1.75. Limited number. Order from dealer or write direct.

EMPIRE LEVEL MFG. CO. DEPT. P-119 30 SOUTH SIXTH STREET MILWAUKEE 4, WISCONSIN

# INVENTORS, SCHOOLS, CRAFTSMEN BRONZE FOUNDRY



is again available in limited quantity without priority. Orders filled in sequence as received. INVENTORS—SCHOOLS—CRAFTSMEN use FOUNDRYETTE for making castings quickly for new inventions, for instruction, and general purpose. Order now for early delivery. Three sizes are available capable of making bronze castings of 1½, 3, and 6 pounds weight, aluminum, copper, brass, etc., \$17.50, \$24.00, \$34.50. f.o.b. Kansas City. Domestic gas supply and 110 volt AC or DC energy required for operation. Write for circular.

KANSAS CITY SPECIALTIES CO. Box 6022, Dept. P-44 Kansas City, Mo.

## 15 LENSES

Plus 50 PAGE Idea Booklet to Help You...

(All Lenses New—Edges very slightly chipped) ... make your own telescopes, low power microscope, magnifiers, dummy camera, photo cells, rifle scope, detachable reflex viewfinder for 35-mm. camera, telephoto lens, photographic gadgets, for experimental optics, copying and ultra-closeup shots and hundreds of other exciting experiments.

EDMUND SALVAGE COMPANY  
27 W. Clinton Avenue, P.O. Audubon, New Jersey

Set 602-H Only \$2.60 Postpaid

## ★ SAVE WASTE PAPER ★

# END DAMP AIR with DRI-AIR



PROTECT your valuable equipment, tools, foods and furnishings from damage! End dampness in your home or workshop with amazing DRI-AIR. Makes Dry Rooms, Healthful, Pleasant Place DRI-AIR in any room, basement, storeroom or closet. DRI-AIR absorbs excess moisture from the air. Keeps rooms dry. Prevents mold and mildew. DRI-AIR kills musty odors; stops rust; keeps furniture and woodwork from warping. Complete DeLuxe DRI-AIR unit \$5.50, f.o.b. Chicago. At your dealer or order direct. Send for FREE booklet "Household Hints in War-Time." Shows how to save food, clothing, fuel.

ANOTHER TAMMS PRODUCT TAMMS SILICA CO. 228 - AS N. LaSalle St., Chicago 1, Ill.

# ENGINES IN STOCK

Complete 520



The G. H. Q. miniature gasoline engine that really operates is still available. Over 100,000 sold to date. 1/5 H. P. Complete with flywheel and propeller, fuel, 15 accessories and full instructions. Fully bench tested and ready to run. For boats, planes, midget cars, etc. \$20 complete. Send only \$1.00 — Shipped Collect C.O.D. same day. Send 25c for illustrated Catalog of hundreds of hobby items and airplane identification chart.

GHQ MOTORS, Dept. BV, P. O. Box 203, Madison Square Sta., New York 10, N. Y.



Glamorize Your Home With

# PLASTI-COTE



Amazing Liquid Plastic Paint

★ ONE COAT COVERS

PLASTI-COTE is one of chemistry's war-tested miracles—THE PAINT

OF TOMORROW—TODAY! It's self-leveling, leaves no brush marks. So, anyone can apply it. ONE COAT COVERS clapboard, stucco, brick, plaster-board, metal—any surface. Gives a hard, fadeproof finish that is amazingly durable and beautiful. Washes like finest tile.

### Money Back Guarantee

Use 25% of this liquid plastic paint. If not delighted, return the rest and receive full refund. Order for cash, post-paid; or C. O. D., plus small express charge. Colors: White, Ivory, Cream, Buff, Dusty Rose, Peach, Grey, Blue, Brown, Black, light, medium, or dark Green. Gal. covers 300 sq. ft.



ONLY \$5.95 PER GAL.

INTERIOR



CELLO-NU PRODUCTS, 333 N. Mich., Dept. 2, Chicago 1

## GET MORE POWER FROM YOUR OUTBOARD



Start easier, get more speed, power. Use TIME-SAVER Lapping Compound when you refit bearings. Gives closer fit, better compression. 24 years successful use. Used by leading outboard mfrs. Get-acquainted sample and instructions, 25c; economy size \$1.00, postpaid. Satisfaction guaranteed or money refunded.

TIMESAVER—1115-A Post St., Seattle 1, Wash.

## BUILD MODERN STREAM-LINE



Three-room house 22x24 as low as \$100, big garage, \$20, for materials. Cement compositions. Ten formulas. New easy way to apply. 100 money saving ideas. No painting. Last lifetime. Insulating. Roof, walls and gutters in one. Farm buildings for a few dollars. Make doors and windows. Homemade equipment to make building blocks, panels and floor and wall tiles in colors with molds, wooden forms, or trowel. Make durable wall-board of sawdust composition at little or no cost. Also furniture and toys. Guaranteed. Illustrated book of instructions, \$1.00 with 24 page booklet, "40 War-Time Plans." Earn \$10 a day.

HOME INDUSTRIES, 1318 So. 30th Ave., Dept. PM, Omaha 5, Nebr.

### 10c NEW BOOK OF LATHE AND DRILL PRESS SET-UPS

Practical, unusual uses, contains 49 illustrations. Post- Send 10c to cover handling and postage. Paid JACOBS MFG. CO. 154 Jacobs Rd. Hartford 1, Conn.



## WORLD'S LOWEST PRICED ADDING MACHINE

Best Pocket Size FREE TRIAL ONLY \$2.50

IDEAL FOR BUSINESS OR PERSONAL USE. GUARANTEED ACCURATE. TOTAL COST SEND NO MONEY. Not a toy. Operates with only a finger flick. Adds, subtracts, multiplies, divides. Counts up to ten million. Pays for itself over and over. Ideal Gift—for Business, Income Tax and School use. MONEY BACK GUARANTEE. Send name and address. Pay postman only \$2.50 plus postage. (Send full cash if outside U. S.) Money back in 10 days if not delighted. AGENTS WRITE.

CALCULATOR MACHINE COMPANY (Mrs.) DEPT. 155, P. O. BOX 1118 CHICAGO, ILLINOIS

# BUILD 'EM YOURSELF

THE LEJAY MANUAL of over 100 items WILL SHOW YOU HOW!

Only \$1.50

## THERE'S LOTS OF SATISFACTION

in making things for yourself—especially electrical equipment, which has so many profitable uses. Take welding, for instance; the LeJay Manual shows you how to make many types of welders and they, in turn, help you to make other things.

## PLANS EASY TO FOLLOW

Old auto generators and other pick-up material can be used in making such valuable equipment as:

- 200 Amp. Generator Welders
- Large Transformer Welders
- Gunsmith's Carbon Welder
- Workshop Spot Welder
- 6, 12, 32, 110-Volt Motors
- Electric Outboard Motor
- Wind-Driven Light Plant
- Electric Fences
- Electric Drills
- Bench Grinders
- Electric Scooter
- Armature Rewinding
- Insect Electrocutors
- Electric Bicycle Pusher, etc.

## SEND NO MONEY—BUT

Send a postcard with your name and address and a request to send the LeJay Manual C.O.D. and the postman will deliver it to your door. If you are not entirely satisfied after 3 days perusal, send it back and we will refund the \$1.50. Bear in mind, however, that C.O.D. fees have been considerably increased, so if you prefer to save this expense send \$1.50 now, under same guarantee.

WORTH \$12.35 IF PLANS BOUGHT INDIVIDUALLY

100 BUILD YOUR OWN ITEMS \$1.50

3 DAY TRIAL



WELDING GENERATORS

TRANSFORMER WELDERS



ARMATURE WINDING

ELECTRIC OUTBOARD



POWER TOOLS



WIND PLANTS



ELECT. GO-BIKE



INSECT KILLERS



MOTORS



ELECTRIC SCOOTER



ELECTRIC FENCES



LIGHT GENERATORS



TRACTOR LIGHTS



# LEJAY MFG. CO

47 LeJAY BUILDING MINNEAPOLIS - 8 - MINN.

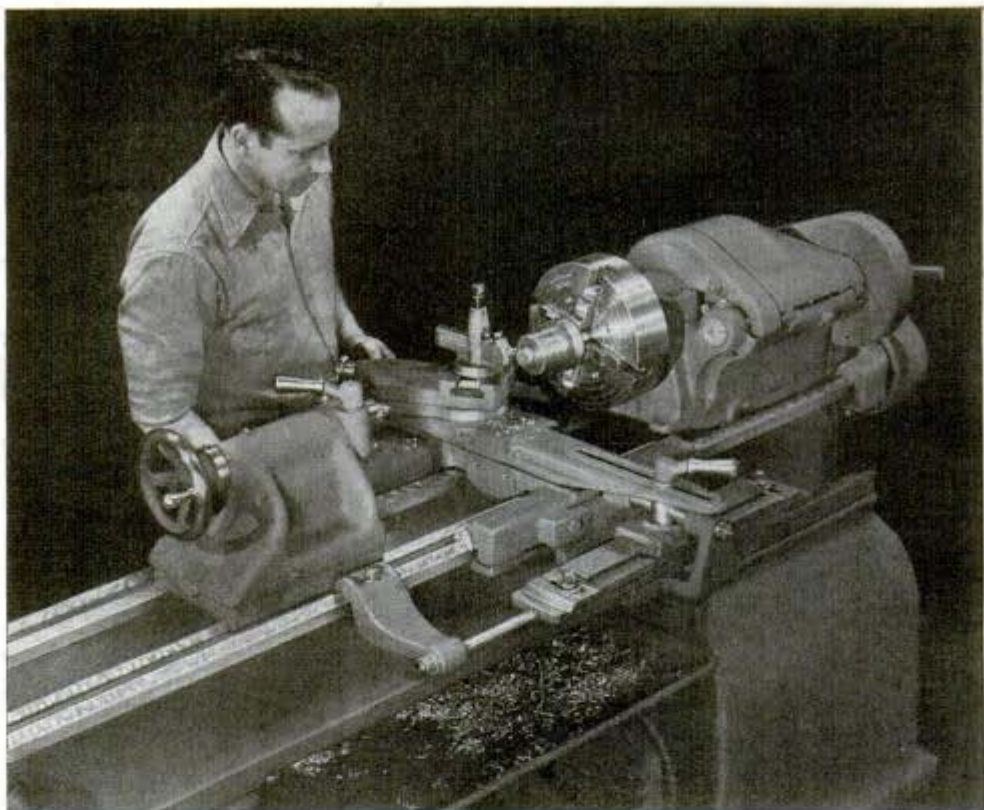

# Precision —

## THE DISTINGUISHING QUALITY OF SOUTH BEND LATHES

It is for their high precision that South Bend Lathes are best known. Their dependable accuracy has made them first choice for the most exacting operations in hundreds of essential war production plants. Finish turning and boring operations are often performed with such exactness that subsequent grinding, honing, or lapping is unnecessary.

In war production, there is no place for machine tools that can not hold required tolerances or deliver maximum output. Investigate the possibilities of South Bend Lathes

for handling your exacting jobs with greater efficiency. With them, you will find it easier to maintain precision tolerances on toolroom and production operations.

### HOW TO RUN A LATHE

A useful handbook for machinists, apprentices, and shop students. Contains complete information on the operation and care of engine lathes, grinding cutter-bits,

turning, facing, boring, tapering, drilling, reaming, tapping, thread-cutting, etc. Consists of 128 pages, 5½" x 8", and 365 illustrations. Send 25c for your postpaid copy.



BUY WAR BONDS NOW...SAVE FOR LATHES



**SOUTH BEND LATHE WORKS**  
LATHE BUILDERS FOR 37 YEARS • SOUTH BEND 22, INDIANA

PRINTED BY POPULAR MECHANICS COMPANY, CHICAGO, ILL., U. S. A.

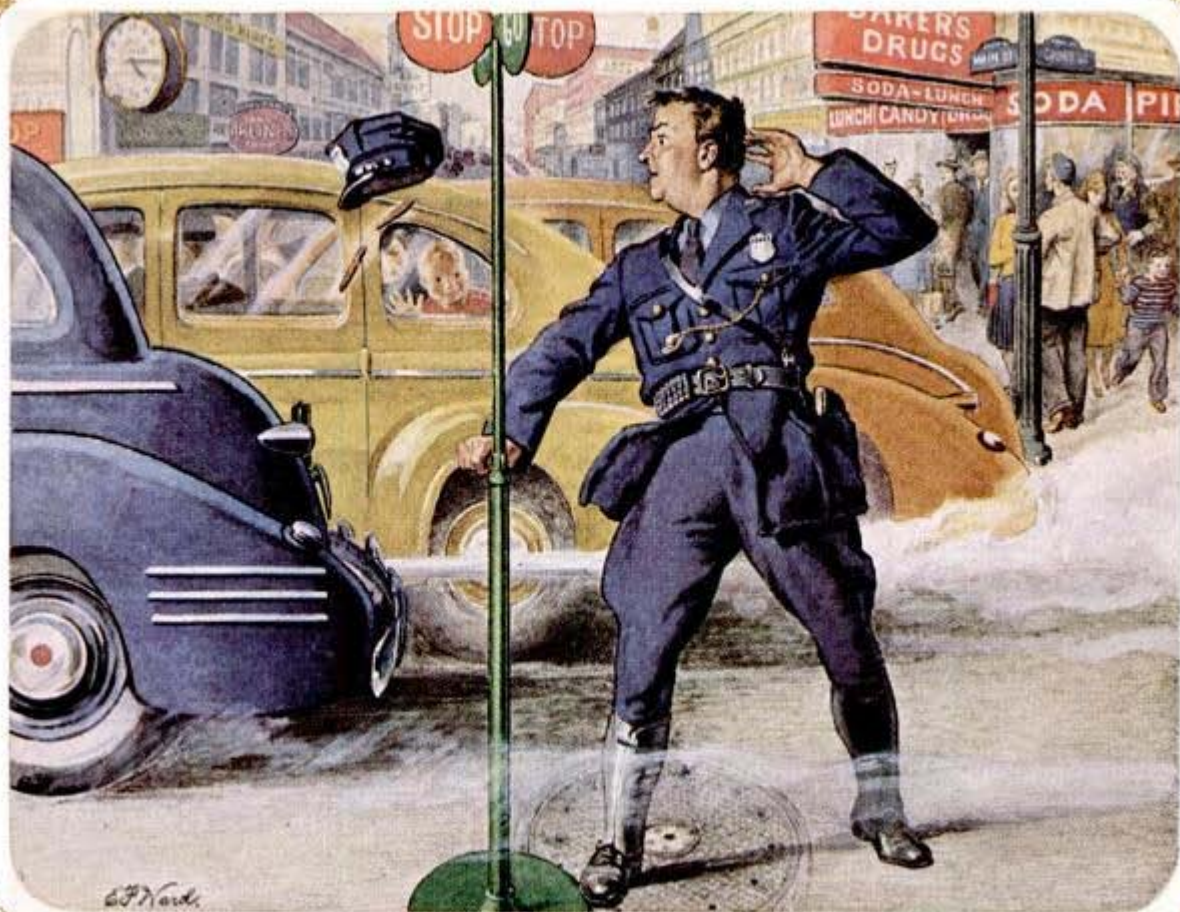

## Remember when...

### *Jack Rabbit starting was fashionable?*

**R**EMEMBER the private thrill of showing 'em the color of your exhaust smoke when the light flashed green?

The fact that such "jack rabbit" starts and sudden stops wore tires 3 times as fast as normal didn't seem important then.

*Today it is important!* The rubber crisis is *not* over. Reserves of natural rubber are dangerously low, and there are not nearly enough synthetic tires to go around. Your tires must *still* be conserved, cared for, made to last as long as possible.

Compared to the job American boys are doing across both oceans, it's no great sacrifice to give up "jack rabbit" starts and sudden stops. It's not difficult to avoid hitting curbs, bumps and ruts. Keeping tire pressure up to 32 pounds, and having small cuts and bruises repaired before they do real damage isn't

really much bother. And all it takes is a little will-power to keep your speed under 35.

Yet, there's scarcely any single war contribution you can make that is more important today than observing those simple tire-saving precautions! The Battle of Rubber and Transportation is NOT won. Do your part—let your independent tire dealer help you.

\* \* \*

*REMEMBER WHEN* you were stranded out in the country with a flat and no spare? Remember the *INDEPENDENT* tire dealer who left his dinner table to fix it for you? Owning his own business gives a man a powerful incentive to provide better service and better values. That spirit of Independence has always created good living and good jobs that have made Americans the envy of the world . . . and Seiberling believes that it can keep on doing it. That's why in the future—as always in the past—Seiberling Tires will be sold by Independent Dealers only.

# SEIBERLING *Experts in Rubber*



Wartime manufacturers of Bullet-Sealed Tubes and Military Tires for our armed forces • Bullet-Sealing Gasoline Tanks • Rubber Floats, Boats and Pontons • Rubber Parts for Gas Masks, Airplanes and Tanks. Also makers of Tires and Tubes for passenger cars and trucks • Sealed Air Tubes • Rubber Heels, Soles and Mechanical Goods.

"Just like a taste of home"

When you're thousands of miles from home ... on a tropic isle ... or high on a rocky ridge ...

How precious, then, is that "taste of home"... how comforting the rich aroma and full flavor of a slow-burning, cool-smoking Camel... the cigarette that is first choice with men in *all* the services.

That is why Camels are packed to go round the world... to *stay fresh* for months at a time and deliver to our fighting men that full, fresh Camel flavor. The Camel pack keeps *your* Camels fresh and full-flavored, too.

BUY  
WAR BONDS  
STAMPS



H. J. Reynolds Tobacco Company, Winston-Salem, N. C.

First in the Service — CAMELS

With men in the Army, the Navy, the Marine Corps, and the Coast Guard, the favorite cigarette is Camel. (Based on actual sales records.)