

HOW MUCH OIL IS LEFT?



POPULAR MECHANICS

MACHINE



REG. TRADE MARK, GREAT BRITAIN, NO. 40428

REG. U.S. PAT. OFF.

MAY
25 CENTS
30c IN CANADA



 BUY UNITED STATES
WAR SAVINGS
BONDS AND STAMPS

SEE PAGE 27

**BUY
WAR BONDS
TODAY**

*Keep America
Free*



Hands across the sky

The Army-Navy "E" flies above four Fisher Body plants for excellence in aircraft production and from two others for tank production, while the Navy "E," with four stars, is flown by still another Fisher Body plant for its naval ordnance work.

FROM the skillful hands of our craftsmen to the welcoming hands of airplane pilots, three amazing instruments are now flowing steadily and in volume.

These are the gyro-horizon, the directional gyro, and the remote indicating compass. The first two were designed by Sperry, and are built by Sperry and Fisher Body. The latter was designed by Bendix, and is built by Bendix and Fisher Body.

To meet their specifications, in the volume required, was a challenge to Fisher technicians.

But true craftsmanship knows no limits. And the extreme precision demanded in the manufacture of these instruments was but

an extension of notably accurate work done on bombers, gun-breech housings, tanks, anti-aircraft guns, and other armament.

We have learned to bank on craftsmanship — to depend on it. And any time our fighting men need a technical plus to put them in the clear, we'll burn the lights every night till they get it.

Every Sunday Afternoon
GENERAL MOTORS SYMPHONY OF THE AIR
NBC Network



armament
BODY BY

Fisher

D I V I S I O N O F G E N E R A L M O T O R S

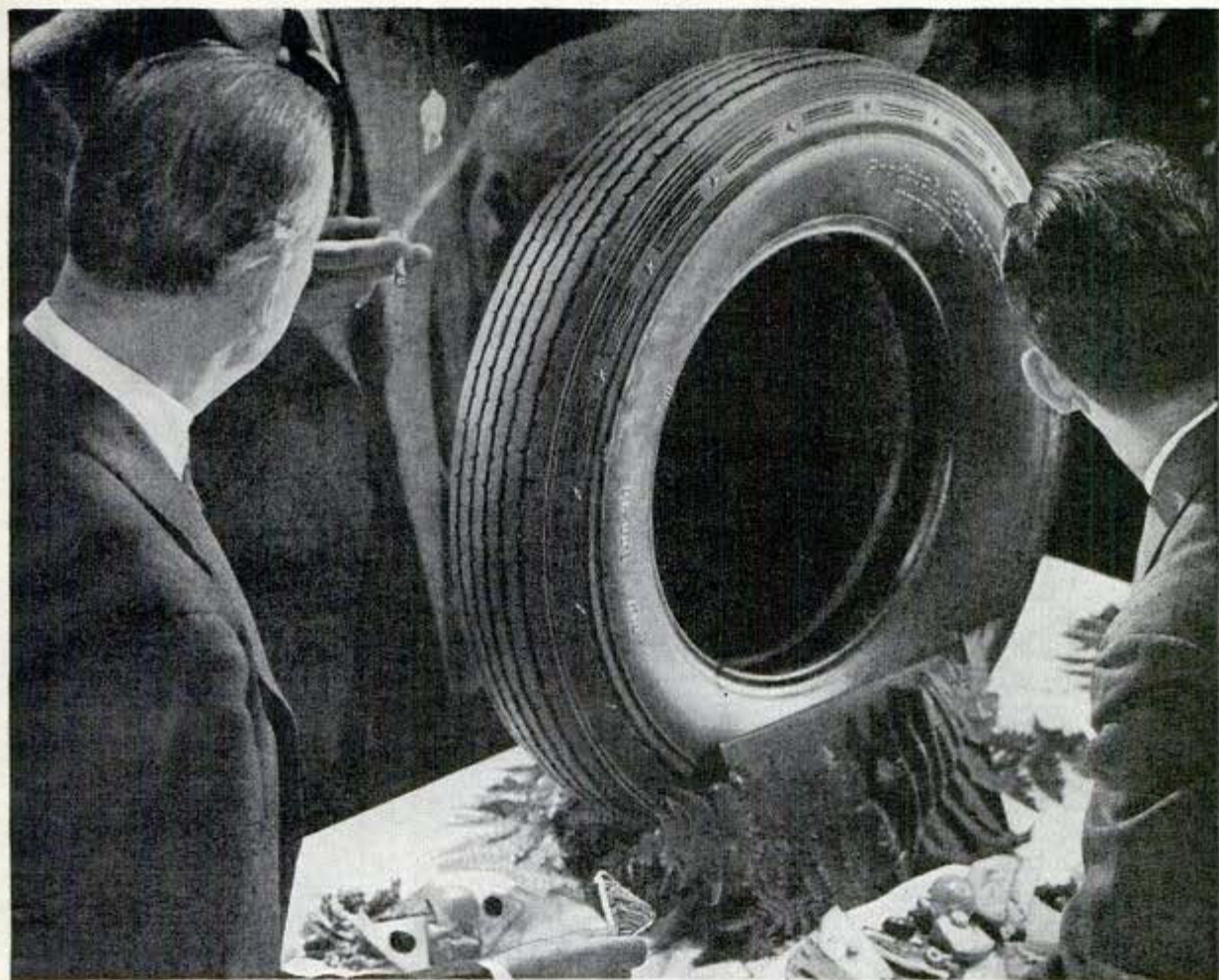

Reception for an automobile tire

The guests asked a question that was answered 80 million miles later

THEY WATCHED intently that June afternoon in 1940, eighteen months before Pearl Harbor. A tiny cardboard ship moved across a map of the Atlantic Ocean. The president of B. F. Goodrich described the little ship's voyage—bringing rubber from Malaya through the Suez to New York.

Suddenly the ship exploded, disappeared. The business men, editors and reporters in the Empire Room of New York's Waldorf-Astoria got the point even though many still said it was "a very remote possibility."

Turning, they saw a tire unveiled. It looked like any other tire . . . but more than half its natural rubber had been replaced

by the new B. F. Goodrich synthetic. It was the first tire containing synthetic rubber ever offered for sale to American car owners.

The price had to be one-third higher than current tire prices. But that didn't stop people from buying. Even owners of large fleets bought. These new tires traveled in every state, in all kinds of weather, on all types of roads.

Today they have totaled more than 80,000,000 miles. And the question everyone had asked—"How good is synthetic rubber, anyway?"—is answered by actual reports from car owners. Mileages in excess of 30,000 miles were reported. Some reported as much as 50,000 miles!

The tires that B. F. Goodrich makes for passenger cars today are all-synthetic (98%) and are almost as good as the tires that were made before the war. Truck tires aren't yet as good, especially in intercity service with overloads, but are being improved day by day. But the important thing is those extra years of experience . . . they are the reason so many motorists who qualify get their tires from B. F. Goodrich Silvertown Stores and dealers. *The B. F. Goodrich Company, Akron, Ohio.*



In war or peace
B.F. Goodrich
FIRST IN RUBBER

This One



979G-70J-D3FD



When driving nails in painted walls,
Your plaster—has it cracked?
Well, first apply some Texcel Tape,
Which keeps the wall intact.

And if the sweeper handle breaks
The work goes on as planned;
It gets a temporary mend
When Texcel Tape's at hand.



For pages torn in magazines,
In rare old books and such,
Just mend the tear with Texcel Tape—
It sticks with just a touch.

For Texcel is an improved tape
Whose "stick-um's" bonded on.
It won't come off, it won't dry out
Before the judgment dawn.



Since all the Texcel Tape that's made
Is being used for war,
Buy Bonds and Stamps 'til Victory
Returns it to your store.

Made by
Industrial Tape Corporation
A Division of
Johnson & Johnson
New Brunswick, N.J.

Texcel Tape

CELLOPHANE TAPE — STICKS WITH A TOUCH

Popular Mechanics Magazine

Registered in U. S. Patent Office and Canada

H. H. WINDSOR, Founder

H. H. WINDSOR, Jr., Editor and Publisher

May, 1944

Vol. 81, No. 5

Next Month

TWO Seabees on liberty went souvenir hunting on a Pacific isle. They wanted a Jap flag or tea set for the girls back home. They met, instead, two Japs carrying rifles. They were unarmed, but by proper use of their fists the Seabees obtained their souvenirs: two Jap rifles. These fighting engineers of the Navy are tough and proud of it. Five of them crawled into a burning boxcar loaded with ammunition and put out the fire. A Seabee patrol scouted a Jap-held island, then greeted amazed Marine Raiders when they landed. For a look at these "Horny-Handed Heroes," see the June issue.

Aviation Grows Up

IN weather that had grounded all other craft, a helicopter landed the other day on the toe of Manhattan, picked up two cases of blood plasma and flew to the aid of survivors of a sunken destroyer. The helicopter had grown up and gone to work. But is it ready for your backyard hangar? There are a lot of glib predictions. "Aviation in Long Pants," a June feature, scans the sky for postwar probabilities, tells of our air lines' plans for 350,000 miles of routes girdling the globe.

Miracle Crops

NCESSITY is the mother of chemurgy. When the Japs grabbed everything from Paramushiro to New Guinea they deprived us of rope from abaca fiber, starch from cassava, rubber and palm oil and shellac. The substitutes we have grown may be the basis of postwar prosperity. Read "Growing a New World" in June.

IN THIS ISSUE

How Much Oil Is Left?	1
Our Bull's-Eye Bombardiers	8
Flying Gas Jet	14
Trucking to Victory	18
Bouncing Baby With a Future	28
"The Caissons Go Rolling Along"	33
Building Blocks for a New World	44
Sea-Going Smoke Eaters	50
Treasure From the Dry Lakes	56
They Said It Was Too "Hot" to Fly	61
Pilots Versus the Weather	65
Putting On the War Paint	76
"Taxi Skippers" of the Coast Guard	82

Where-to-Buy-It Index—Page 8A

Lifeline of the Fleet

WHEN a Navy patrol bomber was marooned for 15 days in an Alaskan blizzard with the wind blowing at 130 knots, the crew survived without even a frostbitten toe. The Navy Bureau of Supplies had thought of everything, down to the woolen socks. Its task in provisioning the world's greatest Navy is gargantuan. To send a cruiser to sea for a month it must supply 15,000 barrels of oil, 9,900 pairs of socks, 40,000 pounds of meat, 11,000 pounds of butter, eggs and cheese, 50 tons of fruit and vegetables, tons of munitions and stores. Next month the Bureau's Chief, Admiral Young, tells how the job is done.

Magnesium, the Lightweight Giant

YOU never heard of Nevada's third largest city. The citizens of Henderson, Nev., just got around to naming it a few months ago. Two years ago it wasn't there; today it is a modern community of 10,000, site of the world's largest magnesium producing plant. That plant uses one-third of the generating capacity of Boulder Dam in turning out the light metal for our warplanes and incendiary bombs, the light metal of your postwar pots and pans. Read about this modern miracle in June.

Published monthly by POPULAR MECHANICS COMPANY, 200 East Ontario Street, Chicago (11), Ill., U. S. A. Single copy in the United States, 25 cents; subscription rates in United States and possessions, and countries of the Pan-American Postal Union, \$2.50 a year. Single copy in Canada, 30 cents; subscription rates, \$3.00 a year. To all other countries add \$1.00 a year over United States prices for overseas postage. If you plan to move, notify us at least 60 days in advance so you will not miss an issue. Give both old and new addresses. Entered as Second Class Matter, September 15, 1903, at the Post Office at Chicago, Illinois, under Act of March 3, 1879. Entered as Second Class Matter at Post Office Dept. Canada. Copyright 1944, by Popular Mechanics Company. Copyright under International Copyright Union. All rights reserved under Pan American Copyright Union. Printed in the United States of America

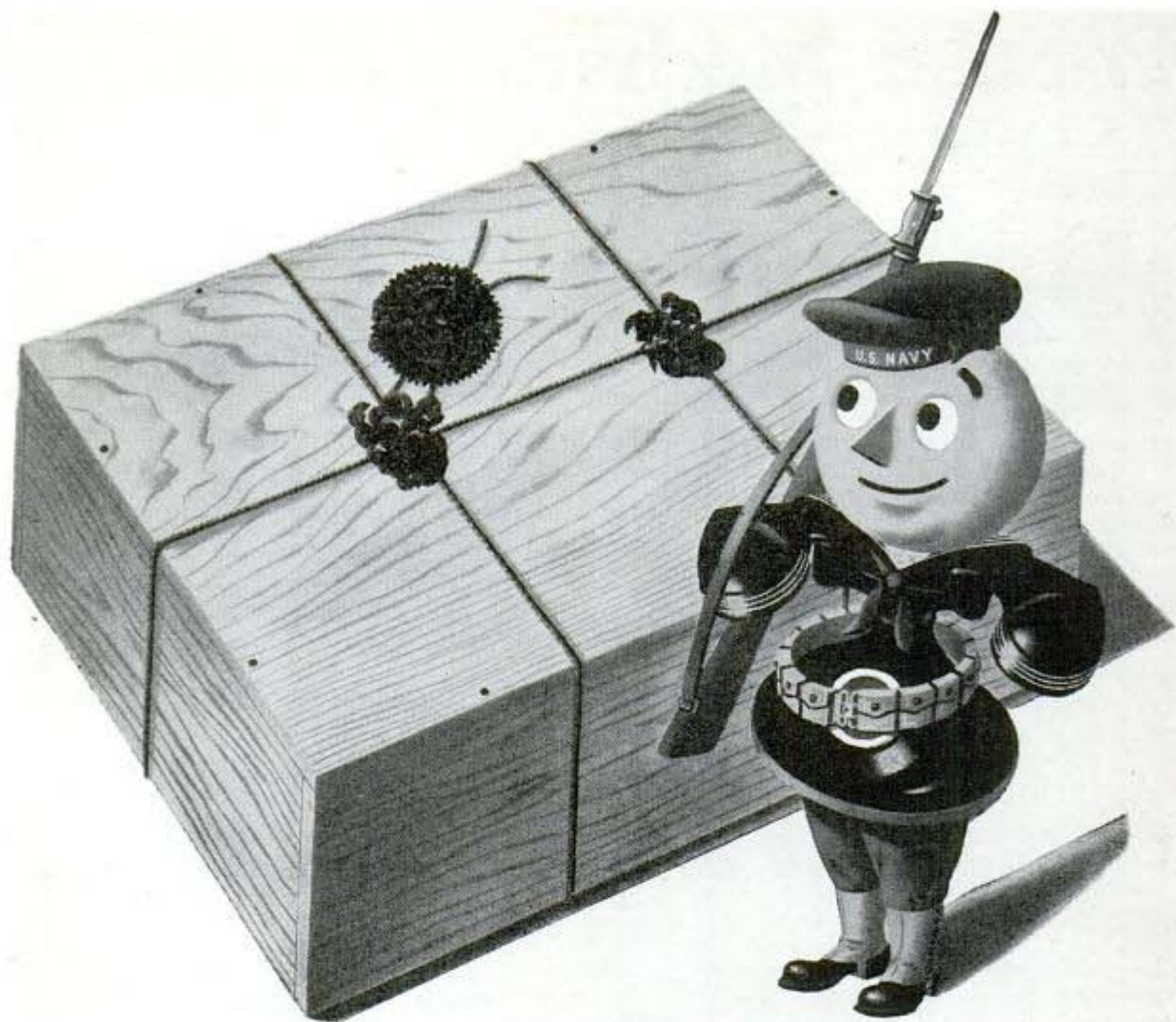

IT HELPED WIN A GREAT BATTLE

Sealed in this box and deposited in the vaults of the Bell Telephone Laboratories is a special device that helped win a great battle. It is being preserved for its historical significance.

SUCH things do not just happen. New instruments of war may appear suddenly on the battle-fronts. But behind them are long years of patient preparation.

Our scientists were organized to have this device ready for battle—just as our fighting forces were organized to be ready for that battle.

Developing secret military devices is a big job but big forces are busy on it, day and night.

Concentrating on this job are more than 7000 people in the Bell Telephone Laboratories. Its scientists and engineers and their skilled associates form a highly organized team, experienced in working things out.

Today's work for war had its beginning many years ago when these laboratories were founded as part of the Bell System's service to the public.



BELL TELEPHONE SYSTEM

POPULAR MECHANICS



MEET YOUR NEW NEIGHBOR

Everyone knows that the world is growing smaller through the development of Science and Industry—the War is a grim reminder of this fact . . . but when the job of war is done and the Peace is won the world will become a *Neighborhood of Nations*—working and living together for their mutual betterment.

Radio will serve the world in a measure far greater than ever before—for pleasure, education, safety and convenience of all mankind!

Look to Hallicrafters—they are planning ahead today for *your* radio tomorrow—plans born of wartime manufacturing experience and engineering developments.

hallicrafters RADIO

THE ALL OUT EFFORT of the people of Hallicrafters has won for them the honor of being the 1st exclusive Radio manufacturer to win the Army-Navy Production Award for the 3rd time . . . FIFTY MILLION DOLLARS worth of war research and developments will be built into your next Hallicrafters Radio!

BUY
MORE
BONDS



THE HALCRAFTERS CO., MANUFACTURERS OF RADIO
AND ELECTRONIC EQUIPMENT, CHICAGO 16, U. S. A.

PRECISION PAYS OFF IN PERFORMANCE

More than 50,000 Allison liquid-cooled aircraft engines have gone to the United Nations fighting forces.

★ Into each of these engines have gone the precision and skill amassed by Allison and General Motors during the past quarter of a century. ★ Therein lies the secret of the power of Allison engines and their reliable performance in every major engagement of our Army Air Forces.

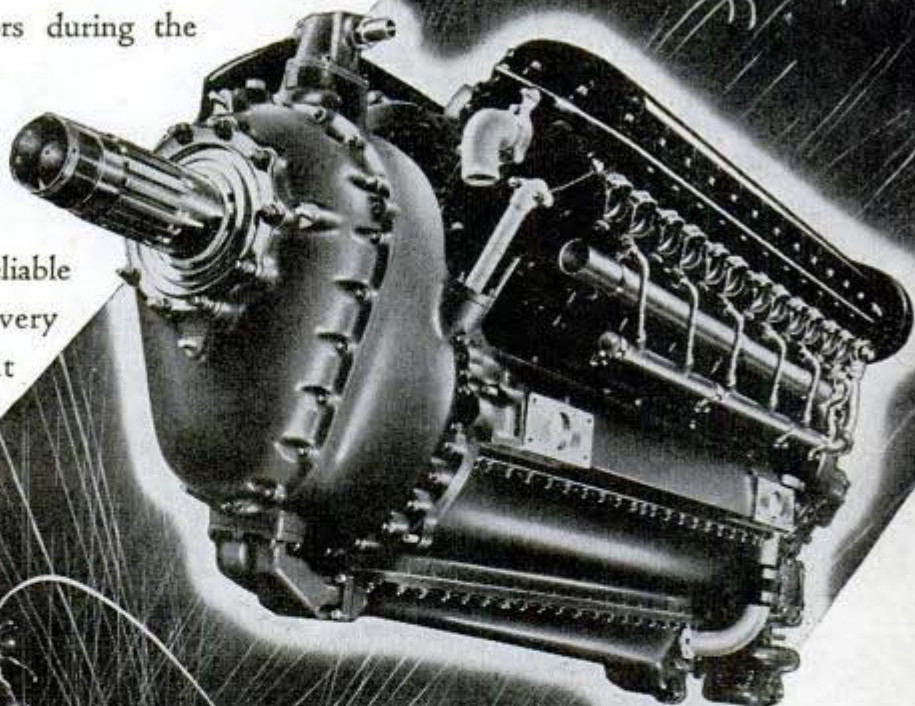

**POWERED BY
ALLISON:**

*P-38—Lightning
P-39—Airacobra
P-40—Warhawk
A-36 and P-51—Mustang*

LIQUID-COOLED AIRCRAFT ENGINES

Allison

DIVISION OF



Every Sunday Afternoon

GENERAL MOTORS SYMPHONY OF THE AIR—NBC Network

KEEP AMERICA STRONG
BUY WAR BONDS



Business Demands Accountants



... because Accountants Command Business

Accountants are usually in demand—at better than average earnings.

But today—more than ever before—the competent accountant finds his services at a premium.

Business in war has tightened up the reins and is watching costs—prices—every move—striving to operate on that basis of close control so essential to service and profits.

Then, too, business is working under tighter government regulations, with many more records and reports—war production, priorities, more and larger taxes, wage and hour laws, payroll deductions for Defense Bonds, etc., etc.

The Home Study Way to Accountancy Success

Thousands upon thousands of men have trained for Accountancy with LaSalle—at night—at home.

Their success—their progress—is a matter of record.

Whether their goal was a C. P. A. certificate or advancement in business, our files are full of letters reporting income increases far out of line with the time and cost investment.

Note for instance, these six cases out of many we might cite. (Names on request.)

A cost clerk, J. S. H. became, after completing 30 training assignments, cost accountant. Within nine months, only half through the course, he became chief cost accountant with a salary nearly four times what it was when he enrolled. C. K. was an immigrant day laborer. Within a few months he secured a bookkeeping job. Within a year, he secured three raises. In two years, he was in charge of his company's accounting department, although not yet through the training. W. J. F. moved up from store clerk to assistant bookkeeper after the first ten lessons. Now he is office man-

ager. S. W. N. knew nothing about bookkeeping. With 19 months of training he passed the C. P. A. examination on first attempt and opened his own public accounting office. Although a university graduate, P. M. was a grocery clerk at small wages. Today he is Secretary and Credit Manager with an income 300 per cent higher. Already in cost work, G. N. P. within nine months was earning 40% more; within two years, 100% more. The third year his income went up still more. Now he is manager.

These Men Won Success in Ordinary Times — You Have War Opportunities

Remarkable as is the success of these men—you will have an advantage over them—you will be entering accountancy when unusual national conditions work with you for success.

Conditions not only call for more accountants—but offer unusual opportunities for both quick and permanent success. The need for accountants will increase during war and will continue for years afterwards during the difficult post-war adjustment period.

—If You Can Qualify

Ask yourself three questions:

1. Are you ambitious?
2. Have you determination?
3. Can you see and grasp an opportunity?

If you have determination; if you are ambitious; if you can take advantage of circumstances—prove it by investigating. A three-cent stamp, sixty seconds time, and the coupon below will bring you full information regarding Accountancy training and the opportunities to which such training leads. Then you can judge intelligently.

LASALLE EXTENSION UNIVERSITY

A Correspondence Institution

Dept. 564-HR CHICAGO

Opportunities in Accountancy—Check below and we will send you a free copy of "Accountancy, the Profession That Pays," also, information about our training in Higher Accountancy, all without obligation.

Higher Accountancy

Other LaSalle Opportunities: If more interested in one of the other fields of business indicated below, check that:

- | | | |
|--|--|--|
| <input type="checkbox"/> Business Management | <input type="checkbox"/> Effective Speaking | <input type="checkbox"/> Modern Foremanship |
| <input type="checkbox"/> Expert Bookkeeping | <input type="checkbox"/> Law: LL.B. Degree | <input type="checkbox"/> Business Correspondence |
| <input type="checkbox"/> C. P. A. Coaching | <input type="checkbox"/> Commercial Law | <input type="checkbox"/> Stenotypy |
| <input type="checkbox"/> Traffic Management | <input type="checkbox"/> Industrial Management | <input type="checkbox"/> Modern Salesmanship |

Name.....Age.....

Present Position.....

Address.....City and State.....

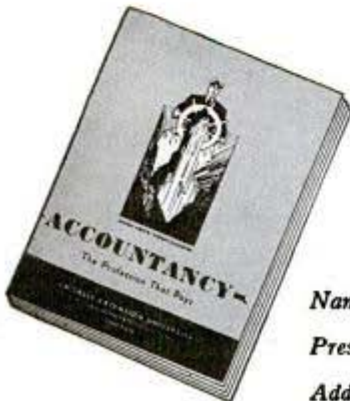

PYROIL

literally "wraps" a protective film of oil over your piston, piston rings and cylinder walls

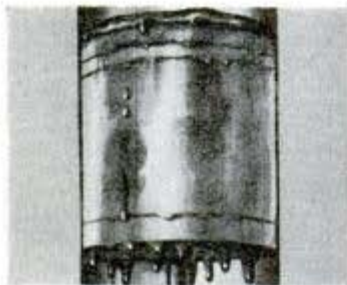

Friction—the rubbing of metal against metal is the cause of engine wear, slow starts, power loss and breakdown.

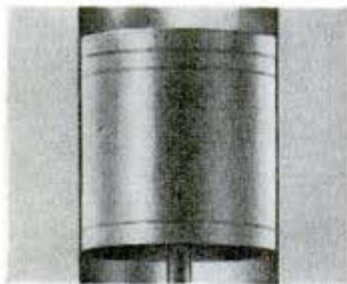

Pyroil reduces friction. It makes oil adhere to metal surfaces, assuring better performance, minimum wear, easy starting, longer engine life.

How to protect your car

The next time you need gasoline ask the service man to put one pint of Pyroil in your crankcase and add one ounce to each 5 gallons of gasoline. That's all you need to do to give your car extra protection against wear, rust, corrosion and "gumming."

Manufactured and Guaranteed by
Pyroil Company.
W. V. Kidder, Founder

YOUR GUARANTEE

12 YEARS' ACCEPTANCE BY FOREMOST AUTHORITIES—RACE DRIVERS—EXPLORERS—ENGINEERS.

THREE OUNCE SIZE

★ KEEP BUYING BONDS ★



PYROIL COMPANY
55 Pyroil Bldg., LaCrosse, Wisconsin

I want my car to last and run properly. Please tell me more about Pyroil and how it can accomplish this for me.

Name

Address

City or Town.....State.....

WHERE-TO-BUY-IT INDEX

Where no name and address appear directly under an item, the product is not believed by us to be commercially available

RCAF brings bombers back from bush.....	6
Cadets ride bikes in formation.....	7
Flow anchor for landing craft.....	7
Miniature town used in mortar training.....	12
Celestial navigation trainer.....	12
Skip bombers skim treetops.....	13
Training army motorcycle riders.....	16
Giant doors for blimp hangar.....	17
Neatness mirror for soldiers.....	17
Standpipe in Mars hull balances load.....	17
Dynamite blasts broken drill from shaft.....	26
Navigation students use 3-dimension pictures.....	26
Self-starting plane tires.....	26
Island forts protect British coast.....	27
Soldiers on treadmill test effects of cold.....	27
Paper clothesline.....	27
E. W. Twitchell Co., Philadelphia, Pa.	
Trucks anchor flying boat.....	38
Giant tong lifts 80 tons.....	38
Airplane engine adapted for tank.....	38
Sound on Cellophane tape.....	39
Fonda Corp., 309 E. 22nd St., New York	
Robot arm christens ship.....	39
Signaling mirror for lifeboat.....	39
Model tanker trains shipbuilders.....	40
Jungle phone has no batteries.....	42
Blood donor gets cells back.....	42
Portable self-powered heater.....	42
Norge Div. Borg-Warner Corp., Detroit, Mich.	
The world's mightiest battleship.....	43
Manmade storms test clothes.....	49
Ozone prevents meat spoilage.....	49
Interphone for aircraft builders.....	55
Electronics Specialty Co., Los Angeles, Calif.	
Tool locks clips on parts.....	55
Adel Precision Products Co. Burbank, Calif.	
Pilots design stratosphere suit.....	60
Fortress wing hitched to house.....	60
Heating pads for aerial guns.....	60
New lightweight gasmask.....	70
Tester for airplane fabric.....	70
Letter automat for writing servicemen.....	70
Gas chamber trains workers.....	71
Bundle carrier on hemp binder.....	71
Flak helmet for flyer.....	71
Dark goggles improve night vision.....	74
Stall detector warns pilot.....	74
Solderless splice for wire.....	74
Aircraft-Marine Products, Inc., 286 N. Broad, Elizabeth, N. J.	
Foxhole in artillery tractor.....	75
Radio gun spot welds wood.....	75
Radio Corp. of America, Camden, N. J.	
Paper dial identifies ship lights.....	75
Forest City Bookbinding Co., Caxton Bldg., Cleveland, Ohio	
Turbine controls air temperature.....	81
Hot oil dip keeps eggs fresh.....	81
Long-arm lazyman drill.....	87
Bombers resemble eagle, shark.....	88
Propellers made of rubber.....	88

Craftsman and Shop Notes Index

ART AND ARTIST

Reference data clipped to T-square.....	92
Taking care of drafting tools.....	115
Saw blade spaces shading lines.....	129
Pencil wiper and sanding pad cover.....	138

AUTOMOTIVE

Coupling trailer in limited space.....	96
Disconnecting hot-water heater.....	114
Turning down commutator.....	126
Carburetor thawed with exhaust gas.....	138
Guide to remove broken stud bolts.....	140

FARM

Portable linoleum chick pen.....	104
Ax measures and cuts sack ties.....	125
Arrangement for closing sliding door.....	126
Well platform elevated in center.....	129
Pronged scoop for baby chicks.....	136
Top "sewed" on haystack.....	138
Leather disks protect colt's mouth.....	138
Bell to signal tractor driver.....	140
Catch holds gate open.....	140
Insect powder brushed on poultry.....	140

FURNITURE

Two Victorian footstools.....	99
Making bedrail fasteners.....	161
Elevator for dressing-table cosmetic tray.....	117

HAND TOOLS

Tape prevents tearing sandpaper.....	92
Leather knife sharpener.....	92
Coin protects ruler while cutting paper.....	96
Bench stop holds chisel for grinding.....	102
Leather strip adjusts dividers.....	102
Cotter key serves as saw guide.....	113
Square used as marking gage.....	114
Slotting screws with hacksaw.....	126

Continued to page 10A

Become a Draftsman!

Tomorrow's VICTORY
is on today's
DRAWING BOARDS!

YOU can study a low-cost I. C. S. Course
in DRAFTING during your SPARE TIME!

Mechanical
Aviation
Architectural
Structural
Shipbuilding

MAIL THIS COUPON FOR COMPLETE INFORMATION — ON LOW
COST, MODERN METHODS, PERSONALIZED INSTRUCTION!

Help your country to VICTORY * Help yourself to SUCCESS!

INTERNATIONAL CORRESPONDENCE SCHOOLS

SPECIAL TUITION RATES
FOR MEMBERS OF
THE ARMED FORCES

BOX 5691-J, SCRANTON, 9, PENNA.

Without cost or obligation, please send me booklet and full particulars about the course *before* which I have marked X:

- Airplane Drafting
- Architectural Drafting
- Electrical Drafting
- Mechanical Drafting
- Sheet Metal Drafting
- Ship Drafting
- Structural Drafting
- Air Conditioning Schools**
- Air Conditioning
- Heating Plumbing
- Refrigeration
- Steam Fitting
- Chemistry Schools**
- Chemical Engineering
- Chemistry, Analytical
- Chemistry, Industrial
- Chem., Mfg. Iron & Steel
- Plastics
- Pulp and Paper Making
- Civil, Architectural and Structural Engineering Schools**
- Architecture
- Bridge and Bldg. Foreman
- Bridge Engineering

- Building Estimating
- Civil Engineering
- Contracting and Building
- Highway Engineering
- Lumber Dealer
- Sanitary Engineering
- Surveying and Mapping

- Electrical Schools**
- Electrical Engineering
- Power House Electrician
- Practical Electrician
- Practical Telephony
- Telegraph Engineering

- Internal Combustion Engines Schools**
- Auto Technician
- Aviation Diesel-Electric
- Diesel Engines
- Gas Engines

- Mechanical Schools**
- Aeronautical Engineering
- Flight Engineer
- Foundry Work
- Heat Treatment of Metals
- Industrial Design
- Mechanical Engineering
- Mold-Loft Work
- Patternmaking

- Reading Shop Blueprints
- Sheet Metal Worker
- Ship Fitting
- Shop Practice
- Steel Mill Workers
- Tool Designing
- Welding, Gas and Electric

- Radio Schools**
- Electronics
- Radio, General
- Radio Operating
- Radio Servicing

- Railroad Courses**
- Air Brake Car Inspector
- Locomotive Engineer
- Locomotive Fireman
- Railroad Section Foreman

- Steam Engineering Schools**
- Boilermaking
- Combustion Engineering
- Engine Running
- Marine Engines
- Steam Electric
- Steam Engines

- Textile Schools**
- Cotton Manufacturing
- Rayon Weaving

- Textile Designing
- Woolen Manufacturing
- Business and Academic Schools**
- Accounting Advertising
- Arithmetic Bookkeeping
- Business Correspondence
- Business Management
- Certified Public Accounting
- City Letter Carrier
- College Preparatory
- Commercial
- Cost Accounting
- Federal Tax
- First Year College
- Foremanship
- High School
- High Mathematics
- Illustrating
- Motor Traffic
- Post Office Clerk
- Railway Postal Clerk
- Salesmanship
- Secretarial Stenography
- Traffic Management
- Language Schools**
- Spanish French
- Good English

Name..... Age..... Home Address..... Working

City..... State..... Present Position..... Hours.....

Canadian residents send coupon to International Correspondence Schools Canadian, Ltd., Montreal, Canada.
British residents send coupon to I. C. S., 71 Kingsway, London, W. C. 2, England.

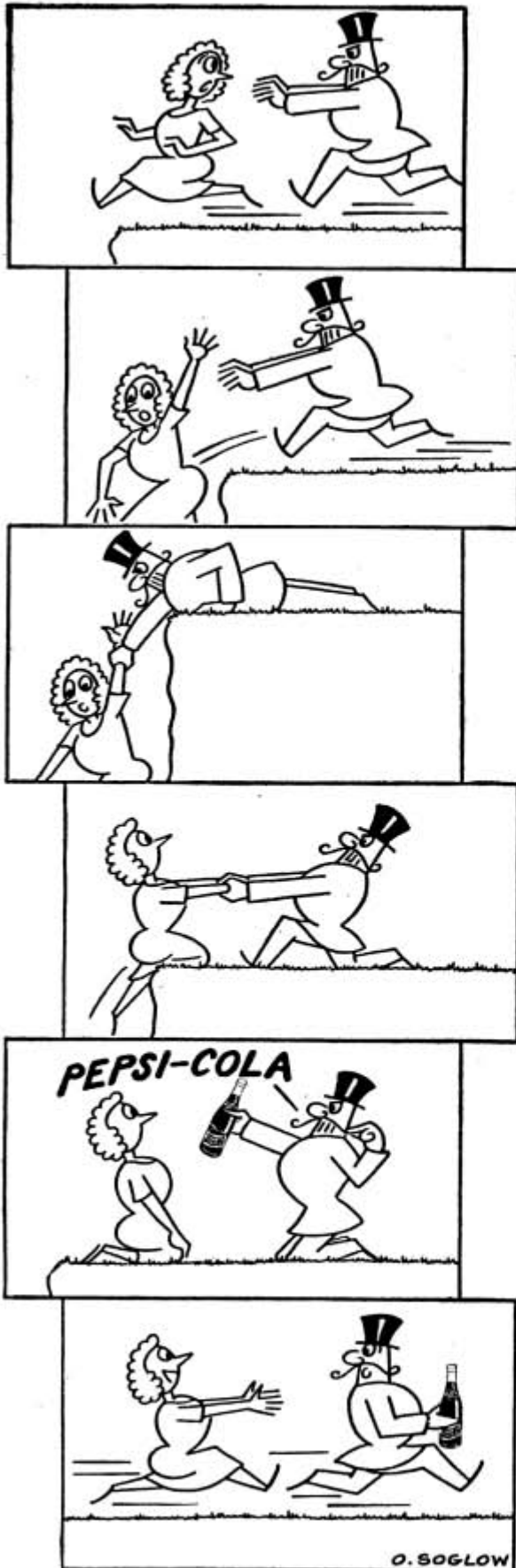

Continued from page 8A

Wire brush adapted to clean pipe.....	127
Puller for sleeve bearings.....	128
Prick-punched pattern easier to hold.....	135
Saw holder on scaffold.....	136
Fillet gages for welders.....	136
Ax wedge locked in place.....	136

HOME IMPROVEMENTS

Built-in wardrobe and vanity.....	98
Repairing leaky roof.....	126

HOUSEHOLD

Pouring guide for tiny containers.....	92
Solving home problems.....	94
Vegetable chopper from milk can.....	100
Cardboard protects thermometer.....	101
Rosin keeps shaver screw tight.....	105
Wood bottom renews coal bucket.....	112
Substitute for scouring pad.....	113
Making long ice cubes.....	114
Removable monograms for towels.....	114
Silencing Venetian blinds.....	117
Mousetrap as rain signal.....	125

LAWN AND GARDEN

Garden barrow folds for storage.....	93
Housing your garden birds.....	97
Bird perches protect new grafts.....	104
"Hedge" of morning glory vines.....	112
Lawnmower strapped to garage wall.....	114

METALWORKING

Belt dressing holds metal sheets for sawing.....	100
Chalk pattern on anvil face.....	126

MODELS AND MODELMAKING

Snap-on wings for model planes.....	96
Spring clothespin used as clamp.....	102

OFFICE

Breaking in new penpoint.....	104
Putting stencil on mimeograph.....	128

PHOTOGRAPHY

Three-dimension effects.....	118
Map-shaped photos.....	121
Curved cardboard background eliminates horizon.....	121
Eraser buffs wax on prints.....	122
Shoelace repairs cable release.....	122
Wire hook to raise light fixture.....	122
Control for photofoods.....	122

POWER TOOLS

Pointers on filing circular saw.....	104
Painting power tools.....	123
Index on chuck aids in centering.....	128
Metal polishing wheels.....	130
Jig sets bit at correct grinding angle.....	137

RADIO AND ELECTRICITY

A.C.-D.C. set testing oscillator.....	141
"Junk box" two-way phone system.....	142
Engineers plan compact low-cost television.....	144

STORE AND SHOP

Clothespin rack holds paper cups.....	116
Small parts cabinet.....	127
New paint for window lettering.....	127
Sidewalk sign anchored to flagstaff.....	128
Paper keeps canned goods from slipping.....	136
Weak blueprints read through red Cellophane.....	140

TOYS, GAMES AND NOVELTIES

Play horses.....	103
Crossbow shoots arrows or planes.....	105
Easter favors.....	113

WOODWORKING

Miter block for wide work.....	102
Know wood for better crafting.....	106
Hot wax finish.....	139

MISCELLANEOUS

Shop clock hung under shelf.....	92
Easy way to pull stakes.....	92
Copper shell removes rust from gun.....	96
Matchbook used as air rifle target.....	96
Sealing leaky gasoline faucet.....	96
Temporary microscope slides.....	102
Tape holds stencil in place.....	104
Smokers supplies stored in jar.....	105
Salvaging spilled mercury.....	112
Shelves installed between studs.....	112
Dowels hold rolled blueprints.....	114
Sheet release for small boat.....	114
Latch for sliding doors.....	125
Step ladder carried under truck.....	129
Horseshoe handles to carry shingle bundles.....	138

IMPORTANT NOTICE

It is the intention of this magazine to provide its readers with information regarding the latest developments in the mechanical arts. We take no responsibility as to whether the disclosures contained in our articles are covered by patents and advise readers to investigate this subject before making, using, or selling any of the products, machines, or processes described in order to avoid possible liability for patent infringement.

AUDELS AIRCRAFT WORKER . . . \$1

Answers Your Questions on 1—Aircraft Materials, Terms, Parts. 2—Blueprints, Working Drawings. 3—Mathematics, How to Figure. 4—Layout & Bending. 5—Tools & Machines. 6—Riveting, Spot Welding & Hints. 7—Fabrication, Angles, etc. 8—Assembly, Fuselage, Wing & Final—How to Use Tools. 9—Tables & Data, Symbols, Army & Navy Specifications, etc. 240 Pages illus.

AUDELS SHEETMETAL PATTERN LAYOUTS . . . \$4

Developed by Experts for Sheet Metal Workers, Layout Men & Mechanics. A Practical Encyclopedia in 10 Sections, size 7 x 10 x 2—1125 Pages—350 Layouts—1600 Illustrations. 1001 Key Facts. Fully indexed for ready reference in answering your layout problems. Covers all phases of sheet metal work including Pattern Cutting, Pattern Development & Shop Procedure.

AUDELS SHEETMETAL WORKERS HANDY BOOK . . . \$1

Practical inside information. Fundamentals of Sheet Metal Work. 388 pages, illustrated. 11 sections. Clearly written. Essential & important facts, figures, pointers in everyday language. Ref. Index.

AUDELS WELDERS GUIDE . . . \$1

A concise, practical text on operation & maintenance of all welding machines for all mechanics. Over 400 pages, illustrated. Covers all methods of electric and acetylene welding including airplane work.

AUDELS ANSWERS ON BLUE PRINT READING . . . \$2

For Mechanics & Builders. Covers all types of blue print reading including ship & airplane. 376 pages, fully illustrated.

AUDELS NEW MACHINIST & TOOLMAKERS HANDY BOOK . . . \$4

Covers modern machine shop practice in all its branches. 5 practical books in 1. New from cover to cover. Tells how to set up & operate lathes, screw and milling machines, shapers, drill presses and all other machine tools. 1600 pages, fully illustrated. 5 x 8 1/2 x 2. Indexed. 5 sections. 1—Modern Machine Shop Practice. 2—Blue Print Reading & How to Draw. 3—Calculations & Mathematics for Machinists. 4—Shop Physics. 5—How to Use the Slide Rule. 60 chapters. Easy to read and understand. A shop companion that answers your questions.

AUDELS MATHEMATICS & CALCULATIONS FOR MECHANICS \$2

Mathematics for home study or reference. 700 pages, 550 illus. Practical mathematics from beginning. How to figure correctly. Easy, correct methods covering a complete review. Ill. & Indexed.

AUDELS AUTOMOBILE GUIDE . . . \$4

A practical quick ready reference book for auto mechanics, service men, operators & owners. Explains theory, construction & servicing of modern motor cars, trucks, buses & auto type Diesel engines. 1310 pages, fully illustrated. 55 chapters. Indexed. A standard book for mechanics. New fluid drive covered.

AUDELS DIESEL ENGINE MANUAL \$2

A practical, concise treatise with questions and answers on the theory, operation and maintenance of modern diesel engines including General Motors 2 cycle Diesel. 384 pages, fully illus., flexible binding, pocket size. All details plainly brought out, this book is of extreme value to engineers, operators & students.

AUDELS RADIOMANS GUIDE . . . \$4

A key to the practical understanding of radio including Frequency Modulation, Television, etc., Aircraft & Marine Radio. For radio engineers, servicemen, amateurs. 772 pages. 400 Illustrations & Diagrams. Photos. Review Questions & Answers, Reference Index. Authentic, clear, concise.

AUDELS HANDY BOOK OF PRACTICAL ELECTRICITY . . . \$4

For maintenance engineers, electricians & all electrical workers. 1440 Pages, 2600 Illus. Covers important electrical information in handy form—including Marine Wiring, Radio Principles, Welding. Indexed. A Key to a practical understanding of electricity.

AUDELS CARPENTERS & BUILDERS GUIDES—4 Vols. . . . \$6

A practical illustrated trade assistant on modern construction for carpenters, joiners, builders, mechanics and all woodworkers. 4 vols., 1600 pages, 3700 illustrations, flexible covers. Each volume pocket size. Sold separately \$1.50 a vol.

AUDELS PLUMBERS & STEAMFITTERS GUIDES—4 Vols. . . . \$6

A Practical Trade Assistant & Ready Reference. Explains in plain language & by clear illustrations, diagrams, charts, graphs, pictures principles of modern plumbing practice including Marine Pipe Fitting and Air Conditioning. 4 Vols.—1670 Pages—3642 Diagrams. Each Vol. Pocket Size. Sold Separately \$1.50 a Vol.

AUDELS WIRING DIAGRAMS . . . \$1

210 Pages, Illustrated. Gives practical facts on wiring of electrical apparatus. It explains clearly in simple language how to wire apparatus for practically all fields of electricity. Each diagram is complete & self-explanatory. Highly Endorsed Pocket Companion.

AUDELS ELECTRONIC DEVICES . . . \$2

Tells What You Want to Know About Electric Eye. Easily Understood. Covers photo-electric cells & their applications. Amplifiers, illumination, frequencies, voltage, photocell, tubes, Ohm's Law, wiring diagrams, etc.

AUDELS, Publishers, 49 W. 23 St., N. Y. 10

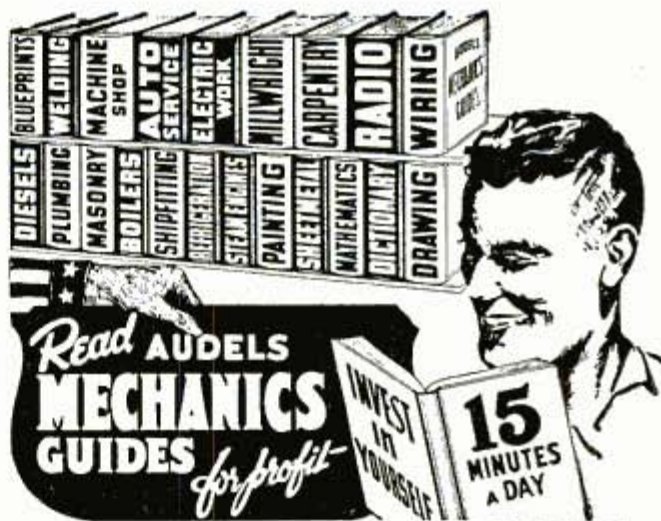

AN AUDEL GUIDE IS A GOOD FRIEND!

Use the brains and experience of others in these Guides of the Trades. Save time and money with right methods, short cuts, labor saving ideas. CHECK NOW! You can look over any Audel Guide in your home. Start the Easy Payments if satisfied.

CUT HERE MAIL ORDER

THEO. AUDEL & CO., 49 W. 23rd St., New York 10

Please mail me for 7 days' free examination the books marked (X) below. I agree to mail \$1 in 7 days on each book or set ordered, and to further mail \$1 a month on each book or set ordered until I have paid purchase price.

If I am not satisfied with Guides I will return them.

- Audels PUMPS, HYDRAULICS & AIR COMPRESSORS \$4.
- Audels WELDERS GUIDE 1.
- Audels BLUE PRINT READING 2.
- Audels SHEET METAL WORKERS Handy Book . . . 1.
- Audels SHEET METAL PATTERN LAYOUTS 4.
- Audels AIRCRAFT WORKER 1.
- Audels MATHEMATICS and CALCULATIONS . . . 2.
- Audels MACHINISTS & TOOLMAKERS Handy Book . 4.
- Audels DIESEL ENGINE MANUAL 2.
- Audels MECHANICAL Dictionary 4.
- Audels AUTO GUIDE 4.
- Audels MARINE ENGINEERS HANDY BOOK 4.
- Audels SHIPFITTERS Handy Book 1.
- Audels MARINE Engineers Guide 3.
- Gueths MECHANICAL DRAWING COURSE 1.
- Rogers Mechanical DRAWING and Design . . . 2.
- Audels MILLWRIGHTS and Mechanics Guide . . . 4.
- Audels CARPENTERS and Builders Guides (4 vols.) . 6.
- Audels PLUMBERS and Steamfitters Guides (4 vols.) . 6.
- Audels MASONS and Builders Guides (4 vols.) . 6.
- Master PAINTER and DECORATOR 2.
- Audels GARDENERS & GROWERS GUIDES (4 vols.) . 6.
- Audels ENGINEERS and Mechanics Guides . . . 12.
- Nos. 1, 2, 3, 4, 5, 6, 7 and 8 complete 1.
- Audels Answers on PRACTICAL ENGINEERING . . . 1.
- Audels Answers on REFRIGERATION 2.
- Hawkins Aids to ENGINEERS EXAMINATION . . . 2.
- Rogers MACHINIST GUIDE 2.
- Audels WIRING DIAGRAMS 1.
- Audels Handy Book of PRACTICAL ELECTRICITY . . 4.
- Audels ELECTRICAL POWER CALCULATIONS . . . 2.
- Hawkins ELECTRICAL Guides at \$1. each 10.
- Audels ELECTRONIC DEVICES 2.
- Audels ELECTRIC Dictionary 4.
- Audels RADIOMANS GUIDE 2.
- Audels NEW ELECTRIC LIBRARY at \$1.50 a Volume . 4.
- Vols. I, II, III, IV, V, VI, VII, VIII, IX, X, XI, XII.

Name _____
 Address _____
 Occupation _____
 Employed by _____ P M

UNSUSPECTED POWER



The Mysterious Influence In The Air You Breathe!

THE SOUL OF THE UNIVERSE is in the air you breathe. Deposited in your blood—with each inhalation you take—is *the intelligence* that directs the course of the planets through the misty reaches of space, and the strange phenomenon of life itself.

What is it that causes your heart to beat, your lungs to expand and contract? What mind directs *the cells* of your being, each in their purpose—some to create bone, others tissue and hair? What *consciousness* pervades these vibratory *globules of life* and gives them awareness of their Cosmic function?

Are you one of the millions who have looked *beyond yourself* for some external Divine Power or agency? Have you searched in vain for some outer sign or word of Divine assurance when in doubt or in need? Now learn of the *unsuspected power* that exists in every simple breath—and that becomes *part of you*. The ancient Egyptians believed that the essence of life was borne on the wings of the air. The Bible pro-

claims that with the first breath man becomes not just an animated being—but a "*living soul*." Try this experiment, and prove a Vital Life Force exists in the air. When you are in pain or despondent take a deep breath. Hold it as long as comfortable—then notice the momentary relief.

This Amazing Free Book

Would you seriously like to know how to draw upon this Intelligence of the Cosmic, with which the air is permeated? You can use it to awaken the creative powers of your mind, and for making life an experience of *achievement*. Use the coupon below for a free copy of the book, "The Mastery of Life." It tells how in the privacy of your home *you may learn* to use these simple, useful, *natural laws*.

USE THIS GIFT COUPON

Scribe E. A. D. The Rosicrucians (AMORC)
Rosicrucian Park, San Jose, California

I am sincerely interested in learning how to use the mysterious influences of the universe in the betterment of my life. Please send me a free copy of the book, "The Mastery of Life."

NAME _____

ADDRESS _____

Rosicrucians are NOT a religious organization

THE ROSICRUCIANS (AMORC) SAN JOSE, CALIFORNIA, U. S. A.



I WILL SEND A SAMPLE LESSON FREE to PROVE I can Train You at Home in Spare Time to BE A RADIO TECHNICIAN

**J. E. SMITH, President,
National Radio Institute
Established 29 Years**
He has directed the training of
more men for the Radio Indus-
try than anyone else.

I Trained These Men



**\$200 a Month
in Own
Business**
"For several
years I have
been in busi-
ness for myself
making around
\$200 a month. Business has
steadily increased. I have
N.R.I. to thank for my start
in this field." **ARLIE J.
FROEHNER, 300 W. Texas
Ave., Goose Creek, Texas.**

\$5 to \$10 Week in Spare Time
"I am en-
gaged in spare
time Radio
work. I average
from \$5 to \$10
a week. I often
wished that I
had enrolled
sooner. All this
EXTRA money
sure does come
in handy." **K. DUBREE,
Horsham, Pa.**



**1st Lieutenant in Signal
Corps**



"I cannot di-
vulge any in-
formation as to
my type of
work but I can
say that N.R.I.
training is com-
ing in mighty
handy these
days." **RICH-
ARD W. AN-
DERSON, (Ad-
dress omitted for military
reasons.)**

More Radio Technicians and Operators Now Make \$50 a Week Than Ever Before

I will send you a sample Lesson, "Getting ac-
quainted with Receiver Servicing," to show you
how practical it is to train for Radio at home
in spare time. It's a valuable lesson. Study it—
keep it—use it—without obligation! And with
this Lesson I'll send my 64-page illustrated book,
"Win Rich Rewards in Radio." It describes many
fascinating jobs Radio offers, explains how N.R.I.
trains you at home for good pay in Radio!

Big Demand Now for Well-Trained Radio Technicians, Operators

There's a big shortage today of capable Radio
Technicians and Operators. Fixing Radios pays bet-
ter now than for years. With new Radios out of
production, fixing old sets, which were formerly
traded in, adds greatly to the normal number of
servicing jobs.
Broadcasting Stations, Aviation and Police Radio,
and other Radio branches are scrambling for Opera-
tors and Technicians. Radio Manufacturers, now
working on Government orders for Radio equip-
ment, employ trained men. The Government too
needs hundreds of competent civilian and enlisted
Radio men and women. Then, think of the NEW
jobs that Television, Electronics and other Radio
developments will open after the war.

Many Beginners Soon Make \$5, \$10 a Week EXTRA in Spare Time

The moment you enroll for my Course I start
sending you EXTRA MONEY JOB SHEETS that
show how to earn EXTRA money fixing Radios.
Many make \$5, \$10 a week EXTRA in spare time
while still learning. I send you SIX big kits of real
Radio parts. You LEARN Radio fundamentals from
my lessons—PRACTICE what you learn by build-
ing typical circuits like those illustrated on this
page—PROVE what you learn by interesting tests
on the circuits you build.

Mail Coupon For Free Lesson and Book

The opportunity the war has given beginners to
get started in Radio may never be repeated. So
take the first step at once. Get my FIVE Lesson
and 64-page, illustrated book. No obligation—no
salesman will call. Just mail coupon in an en-
velope, or paste it on a penny postal.—**J. E. SMITH,
President, Dept. 4EP, National Radio Institute,
Washington 9, D. C.**

You Build These And Many Other Radio Circuits With Kits I Supply!

By the time you've conducted 60 sets
of Experiments with Radio Parts I
supply—have made hundreds of meas-
urements and adjustments—you'll have
had valuable PRACTICAL experience.



You build this
**SUPERHETERO-
DYNE CIRCUIT**
containing a pre-
selector oscillator-
mixer-first detector,
i.f. stage, diode-
detector-a.v.c. stage
and audio stage.
It will bring in lo-
cal and distant sta-
tions. Get the thrill
of learning at home
evenings in spare
time while you put
the set through fasci-
nating tests!

You build this
**MEASURING IN-
STRUMENT** yourself
early in the Course,
useful for practical
Radio work on
neighborhood Radios
to pick up EXTRA
spare time money.
It is a vacuum tube
multimeter, meas-
ures a.c., d.c. and
r.f. volts, d.c. cur-
rents, resistance,
receiver output.



Building this **A.
M. SIGNAL GEN-
ERATOR** will give
you valuable expe-
rience. Provides
amplitude-modu-
lated signals for test
and experimental
purposes.

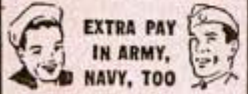

**EXTRA PAY
IN ARMY,
NAVY, TOO**
Men likely to go into
military service, soldiers,
sailors, marines, should
mail the Coupon now!
Learning Radio helps Ser-
vice men get extra rank,
extra prestige, more in-
teresting duties, MUCH
HIGHER PAY. Also, pre-
pares for good Radio jobs.

GOOD FOR BOTH 64 PAGE BOOK SAMPLE LESSON FREE

**J. E. SMITH, President, Dept. 4EP
National Radio Institute, Washington 9, D. C.**
Mail me FREE, without obligation, Sample Lesson and 64-page book,
"Win Rich Rewards in Radio." (No salesman will call. Write plainly.)

Name..... Age.....
Address.....
City..... State..... 4FR



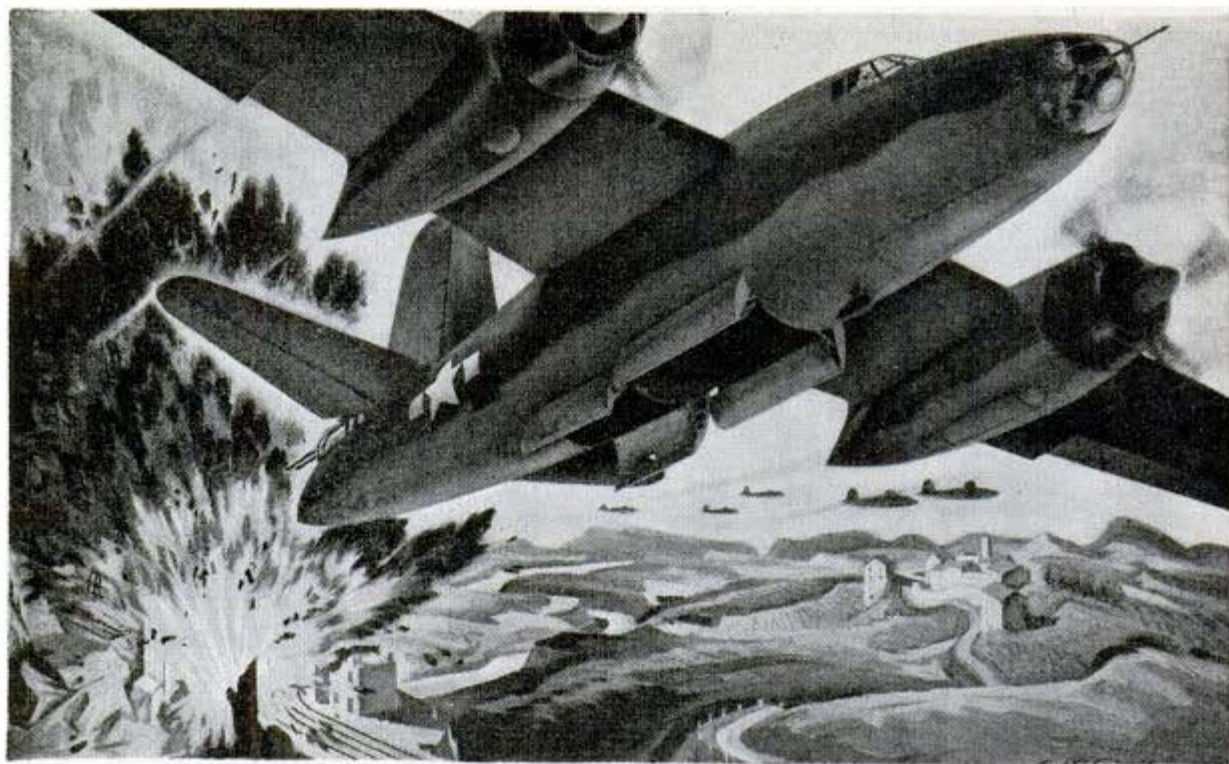

One More on the Nose!

A fighting flier wears his decorations on his chest. But a fighting plane wears *hers* on her nose.

And one look at the bombs and Swastikas painted on this B-26—"The Exterminator"—will tell you she's a two-fisted fightin' fool!

Like the notches on an old-time Injun-fighter's gun, they keep track of her score. A bomb for every one of her 40 successful missions . . . a Swastika for each of the six Nazi planes she's shot down.

"The Exterminator" fought her way through some of the war's hottest actions. She blasted Bizerte, Tunis, Sousse, Pantelleria, Sardinia, Naples and Rome. She "exterminated" the



40 MISSIONS — NOBODY SCRATCHED

Every Bombardier, every Navigator, every Pilot, every Gunner who wears A. A. F. wings, gets training unequalled by that of any air force in the world . . . training that makes him a better flier and a better fighter than the enemy he meets.

Germans' bridges, shattered their railroad yards, skip-bombed their ships. She pounded Salerno for a week to help pave the way for the 5th Army's landing.

Yet on all these flights, in all these fights, *not a man in her crew was scratched.* That's the kind of fighting record that makes bad reading in Berlin!

And that's the kind of team *you'll* be on when you fly with the A. A. F. . . . the hardest-hitting, best-trained team that ever took to the sky!

Bombardier, Navigator, Pilot, Gunner . . . whatever wings you wear . . . you'll hit the enemy often, and hit him hard. And you'll know how to get back home, so you can hit him again tomorrow.

And the Swastikas, or Rising Suns, painted on the nose of *your* plane, will be plenty of proof that you, too, are part of the "greatest team in the world!"

U. S. ARMY RECRUITING SERVICE



FLY AND FIGHT WITH THE

GREATEST TEAM IN THE WORLD

MEN  OF 17...

You can get ready now for your place on the "greatest team in the world"—the A. A. F.—as Bombardier, Navigator, Pilot or Gunner. Go to the nearest Aviation Cadet Examining Board . . . see if you can qualify for the Air Corps Enlisted Reserve. If you qualify, you will receive the Enlisted Reserve insignia shown above . . . but will not be called for training until you are 18 or over.

When called, your special aptitudes will be studied further to determine the type of training you will receive. For the A. A. F. not only builds a combat crew from the pick of the crop, but carefully selects for each position the man with the best capabilities for the job . . . and then adds the thorough training which makes this all-star team the world's finest.

Prepare yourself in advance by taking C. A. P. Cadet Training as given by your local Civil Air Patrol. Also see your High School principal or adviser about recommended courses in the Air Service Division of the High School Victory Corps. Both afford valuable pre-aviation training.

(Essential workers in War Industry or Agriculture—do not apply.)

For information on Naval Aviation Cadet Training, apply at nearest Office of Naval Officer Procurement. This advertisement has the approval of the Joint Army Navy Personnel Board.

KEEP 'EM FLYING!

INVENTORS

NOW Is the Time to PATENT and SELL Your Invention

Get
**FREE
COPY**

Now, more than ever before, is the right time to patent your invention. Why? Because manufacturers everywhere presently engaged in war production are looking ahead to the future by buying up patent rights now, so they will have new and attractive items to make and sell for civilian consumption as soon as the war is over. This is what happened during and after the last war. Hence, the smart thing for you to do is to look ahead to the future too. Protect your invention by applying for a patent now, so you will be in position to cash in on an outright sale, or on the royalties your invention will bring.

Patent Guide Shows What To Do

Our "Patent Guide for the Inventor" answers many important questions concerning Patents that inventors constantly ask. It tells what facts, details, drawings, sketches, etc. are necessary to apply for a Patent; how to protect your invention through dated and witnessed disclosure; how to do this AT ONCE to safeguard your rights; how Patent Office Records can be checked to determine whether the invention is probably patentable before filing fees need be paid; discusses costs involved and a practical way these can be paid as the application progresses. It tells how some inventors secured financial backing; how many simple inventions have proved large commercial successes; how Patents covering improvements also can be profitably utilized and marketed; tells countless other facts of interest.

Why You Need Expert Assistance

The Patent Laws were enacted for your benefit—to give you protection for the features of your invention which are Patentable. But these features must be legally and concisely set forth in the form of "claims." This phase of the procedure is so complex that the Patent Office advises the Inventor to engage a competent Registered Patent Attorney. We maintain a large staff—carefully trained registered patent attorneys—expert draftsmen—experienced searchers—to serve you. We have been serving inventors for more than 20 years.

Take First Step Now

With the Patent Guide you will receive also Free a "Record of Invention" form which will enable you at once to establish the date of your invention, before you file your Patent application. This step costs you nothing yet may be vital to your success. Remember—in Patent Matters, ACTION is IMPORTANT. Delay can be costly. Mail the coupon in an envelope, or paste it on a penny postcard NOW.

CLARENCE A. O'BRIEN & HARVEY B. JACOBSON

"Worthy of your Trust"

Registered Patent Attorneys

41-E Adams Building
Washington 4, D. C.

Get This
FREE BOOK

IMMEDIATELY MAIL COUPON TODAY!

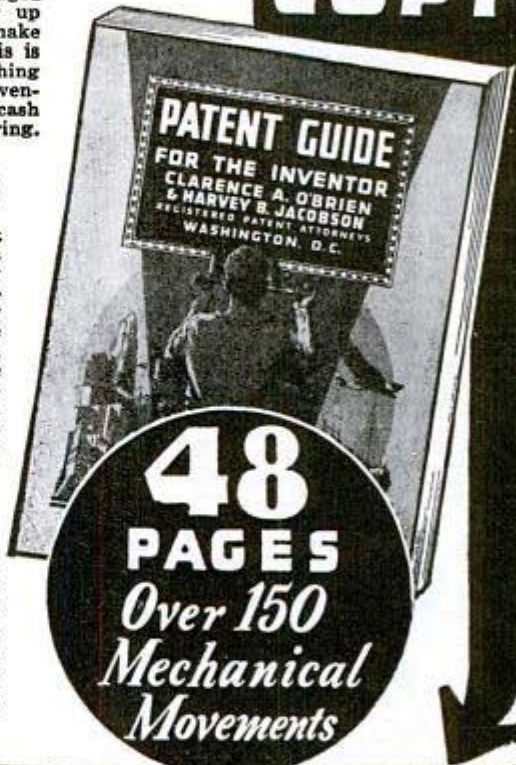

CLARENCE A. O'BRIEN & HARVEY B. JACOBSON

CLARENCE A. O'BRIEN & HARVEY B. JACOBSON
Registered Patent Attorneys before the United States Patent Office
41-E Adams Building, Washington 4, D. C.

Please send me your 48-Page "Patent Guide for the Inventor" and your specially prepared "Record of Invention" form FREE. This request does not obligate me.

Name _____

Address _____

City _____ State _____

(Please write or print plainly.)

It's YOUR future—Make the most of it!



Start now to earn the bigger pay in electrical repair

WAS there ever such an opportunity to get started in electrical maintenance and repair—and at top-notch wages? Are you ready—with experience and ability—to cash in on it? Others are getting just the sort of background needed—quick! practical!—to handle the great variety of electrical maintenance and repair work TODAY—from this well-known electrical library. You can too!

THE LIBRARY OF ELECTRICAL MAINTENANCE AND REPAIR

5 vols., 1826 pages, 1724 illustrations

Gives you the "know-how" to tackle any wiring or motor job. Five books show you HOW—to install all types of motor and generator units—to inspect and repair motor starters and generators—to diagnose motor and generator troubles—to figure new windings for old cores—DC and AC windings—to test armature windings—test induction motors, etc., etc. One book is full of trouble-shooting charts that show quickly symptoms, causes, specific remedies, etc.

Take the first step toward improving YOUR future—Mail this coupon TODAY

No money down—special price—easy payments—FREE trial

McGraw-Hill Book Co., 330 W. 42 St., New York 18, N. Y.

Send me for ten days' free examination the Electrical Maintenance and Repair Library. If satisfactory I will send you \$1.00 in 10 days and \$2.00 monthly until the price of \$15.00 is paid. If not wanted I will return books postpaid. (To insure prompt shipment write plainly and fill in all lines.)

Name

Home Address

City and State

Position

Name of Company

PM-5-44



AUTO

BOOKS SENT FREE

ON APPROVAL. Just mail the coupon and we'll send you a complete set of Six Big Auto Books, 20th Edition. Whether you are a mechanic or helper, expert or apprentice, auto owner or driver, take immediate advantage of this FREE EXAMINATION OFFER.

MAKE GOOD MONEY NOW HOLD A PERMANENT JOB

America's autos must be kept in service, now and after the war. Men with "know how" are in demand, at big pay. These books will help you get and hold an important job, or give you a chance to go into business for yourself now or later. Any man who half tries to improve himself can learn auto servicing and repairing by this quick reference method. Use the JIFFY INDEX to find easily understood answer to any auto problem. These wonder books prepared by eleven of America's great automobile engineers. Many hundreds of valuable illustrations. Send the coupon TODAY.

[A year's consulting privileges with our engineers now given with these books without extra charge.]

Vocational Publishers Since 1898

CAN YOU FIX IT?

These wonder books tell step by step HOW to make difficult repairs and adjustments—how to keep a car at maximum efficiency, including latest improvements in car design and operation. Engine troubles and how to correct them well covered.

6 BIG VOLUMES

2800 pages, 2000 illustrations, wiring diagrams, etc., including Diesel engines. Beautiful modernistic, washable cloth binding.

AMERICAN TECHNICAL SOCIETY, Dept. A519
Drexel Ave., at 88th St., Chicago 37, Ill.

I would like to examine your Six-Volume Set of Auto Books. I will pay the delivery charges only, but if I choose I may return them express collect. If after 10 days use I prefer to keep them, I will send you \$2 and pay the balance at the rate of only \$3 a month until \$24.80 has been paid. Please include consulting service as offered above.

Name

Address

City

State

Please attach letter stating age, occupation and address of employer and of at least one business man as reference. Men in service, also please give home address.



DRAW for MONEY

Be An ARTIST!

PREPARE TODAY FOR THE FUTURE THAT LIES AHEAD

Trained Artists Are Capable of Earning \$30-\$50-\$75 A WEEK

Use your spare time to prepare for a profitable Art career! Start training at home, now!

It's pleasant and interesting to study Art the W. S. A. way. **COMMERCIAL ART, DESIGNING, CARTOONING**—all in ONE complete course. No previous Art experience necessary—we teach you step-by-step by our practical home study method that has trained thousands since 1914. Write today for information in FREE BOOK: "Art for Pleasure and Profit"—tells all about our course, service—and commercial opportunities for you in Art. State age.

WASHINGTON SCHOOL OF ART
Suite 129K, 1115-15th St., N. W., Washington 5, D. C.

LEARN WATCH REPAIRING



AT HOME. By our modern and original system of instruction you can learn every part of the **WATCH REPAIRING TRADE AT HOME.** Prepare yourself for a well-paying position or start in business after completing our course of instruction. Good watch repairers are in demand and generally earn very good salaries. For particulars apply to the Wisconsin School of Watch Repairing 524 E. Mason St., MILWAUKEE 2, WIS.

TRI-STATE COLLEGE



B. S. Degree in 27 Months

Distinguished for technical 2 1/2-year courses in Civil, Electrical, Mechanical, Chemical, Radio, Aeronautical Engineering; Business Administration, Accounting, and Secretarial Science.

MEN AND WOMEN—3 yr. high school students with good record admitted. Special Preparatory Department. Short diploma courses (36 weeks) in Surveying, Drafting. Low tuition. Low living costs. Cosmopolitan student body. 61st year. Enter June, Sept., Jan., March. Catalog. 454 College Ave. **ANGOLA, INDIANA**

Learn PHOTOGRAPHY at Home

Splendid opportunities. Prepare in spare time. Easy plan. No previous experience needed, even on school education sufficient. Send for free booklet "Opportunities in Photography", particulars and requirements.

American School of Photography
1313 Michigan Ave., Dept. 1355, Chicago 5, Ill.



Write for my Free Book, "How to Become an Expert Penman," which shows what others have accomplished by taking my Course. Enclose 10c for one of my Favorite Pen Points and your name with a beautiful flourished bird written on a card. Write today.
T. M. TEVIS, Box 25K, Chillicothe, Mo.

RADIO ENGINEERING

Broadcasting, Servicing, Electronics, Aviation, Marine & Police Radio taught thoroughly. 48 weeks' Engineering course equivalent to 3 years' college radio work. All expenses low. Co-educational. Catalog free.

VALPARAISO TECHNICAL INSTITUTE, Dept. D, Valparaiso, Ind.

Short-Cut Mathematics

COMBINED WITH

Practical Mechanics Simplified

NEW 2-in-1 reading course! Now you can learn the speedy, simplified system of calculation used by draftsmen, engineers, accountants, "master minds" on the stairs. Learn easy way to multiply 4 figures by 4 figures without using old-fashioned multiplication; add long columns of figures this lightning short-cut method. Learn horsepower, slide rule, gnomon, barometers, wood measure, puzzles, etc., etc. Large illustrated volume complete with answers, only \$1 postpaid. Satisfaction or refund. Amaze friends with your magic-like mental powers.

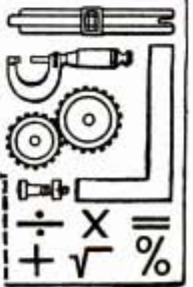

FREE Complete details... mail coupon TODAY!

Nelson Co., 321 S. Wabash, Dept. E-300, Chicago
Please send free details about "Short-Cut Mathematics and Practical Mechanics Simplified." No obligation.

Name

Address

HOW "JACK THE WEAKLING" SLAUGHTERED THE "DANCE-FLOOR HOG"!

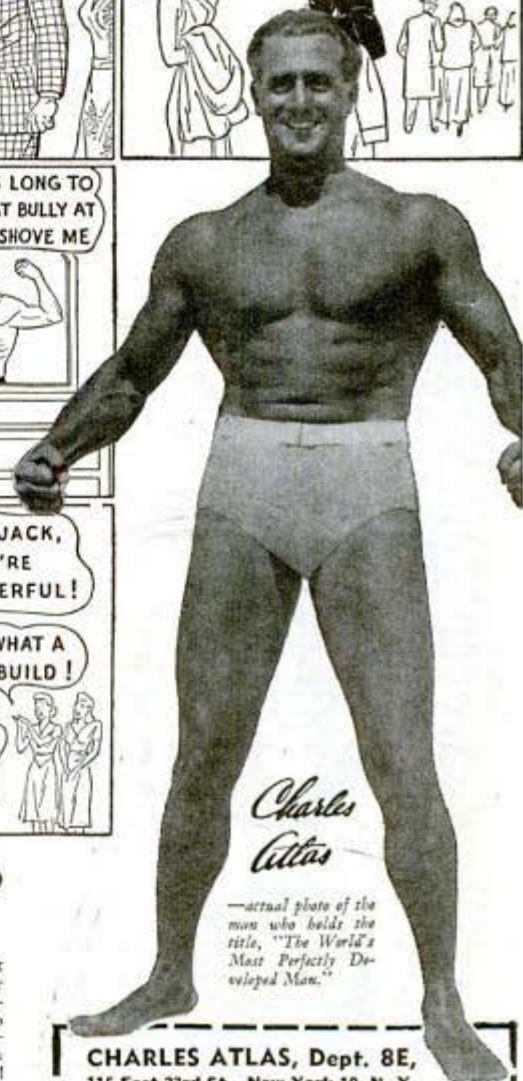

I Can Make YOU a New Man, Too —in Only 15 Minutes a Day!

HAVE YOU ever felt like Jack—absolutely fed up with having bigger, huskier fellows "push you around"? If you have, then give me just 15 minutes a day! I'll PROVE you can have a body you'll be proud of, packed with red-blooded vitality! "Dynamic Tension." That's the secret! That's how I changed myself from a scrawny, 97-pound weakling to winner of the title, "World's Most Perfectly Developed Man."

"Dynamic Tension" Does It!

Using "Dynamic Tension" only 15 minutes a day, in the privacy of your own room, you quickly begin to put on muscle, increase your chest measurements, broaden your back, fill out your arms and legs. This easy, NATURAL method will make you a finer specimen of REAL MANHOOD than you ever dreamed you could be!

You Get Results FAST

Almost before you realize it, you will notice a general "toning up" of your entire

system! You will have more pep, bright eyes, clear head, real spring and zip in your step! You get sledge-hammer fists, a battering-ram punch—chest and back muscles so big they almost split your coat seams—ridges of solid stomach muscle—mighty legs that never get tired. You're a New Man!

FREE BOOK

Thousands of fellows have used my marvelous system. Read what they say—see how they looked before and after—in my book, "Everlasting Health and Strength."

Send NOW for this book—FREE. It tells all about "Dynamic Tension," shows you actual photos of men I've turned from puny weaklings into Atlas Champions. It tells how I can do the same for YOU. Don't put it off! Address me personally: Charles Atlas, Dept. 8E, 115 East 23rd St., New York 10, N. Y.



CHARLES ATLAS, Dept. 8E, 115 East 23rd St., New York 10, N. Y.

I want the proof that your system of "Dynamic Tension" will help make a New Man of me—give me a healthy, husky body and big muscular development. Send me your free book, "Everlasting Health and Strength."

Name.....
(Please print or write plainly)

Address.....

City..... State.....

Check here if under 16 for Booklet A

INVENTORS

McMORROW & BERMAN
PATENT ATTORNEYS

135-X ALBEE BUILDING, WASHINGTON 5, D. C.

Send me your new FREE book, "How to Protect, Finance and Sell Your Invention"—and "Invention Record" form at once. I understand that this request does not obligate me.

NAME

ADDRESS

CITY

STATE

(Write or print name clearly)

Learn How To **PROTECT and SELL YOUR INVENTION**

MODERN BUSINESS WANTS INVENTIONS

Practical and novel inventions are in big demand today. The opportunity for quick money is enticing. Sales sources are many if your invention has merit. But, be sure—before you place your device in strange hands—that it is fully protected. A United States Patent gives you this protection. *The first step toward inventive success—always is—and always has been, the application for a U. S. Patent. There is no other way to protect your invention in accordance with the laws of this country.*

*Mail Coupon
Now!*

GET NEW
**FREE
BOOK**

MAKE THIS RECORD NOW

If you have an invention, and wish to secure it for the future, act at once. Have it dated now and recorded in our office. We will send you this FREE Invention Record Form for the purpose. Fill out the Invention Record Form fully describing the nature of your invention. Make a sketch of its main features. Mail it to us and we will record the date it was received in our office. The earlier the date the better your chance of combating rival inventors who may lay claim to your idea later. *Don't delay a single minute in taking this important step. Your whole future may depend upon it. Mail the coupon for our FREE Invention Record Blank and New FREE Book today!*

HOW WE SERVE YOU AS REGISTERED PATENT ATTORNEYS

The U. S. Patent Office strongly recommends—unless the inventor is familiar with such matters—that he employ the services of a Registered Patent Attorney in the preparation of his Patent Application. We are Registered Patent Attorneys fully qualified to represent you at the Patent Office. We have had long experience in studying hundreds of types of inventions. This gives us the ability to judge your invention and to describe it accurately and convincingly in technical language. It gives us the perception to center arguments upon those details of your invention which, in our judgment, will be looked upon most favorably by the Patent Office Examiner.

Mail the coupon today for our new FREE Book, "How to Protect, Finance and Sell Your Invention," and our FREE Invention Record Form—maybe this step will pave the way to future security for you and your family. Act Today!

We paint no glowing road to fortune—but if you have an invention . . . if it serves a definite new need . . . if the public accepts it—we can tell you it may provide the security and benefits you are seeking.



McMORROW & BERMAN

Patent Attorneys

135-X ALBEE BUILDING

• WASHINGTON 5, D. C.

START YOUR OWN HIGH SCHOOL!

Can you expect to advance in any trade, business, or profession without a high school education—or its equivalent?

Not to the full extent of your abilities. Progress beyond a certain point is impossible when fundamental training is inadequate. And lack of such education is becoming an even larger handicap as we move towards the post-war world.

Whatever your age, however you're situated, it isn't necessary to struggle under that handicap. By enrolling with the famous International Correspondence Schools, you can start your own high school in your own home.

I. C. S. High School Courses feature individual instruction. You're in a class by yourself—study in your spare time—acquire a high school education at astonishingly low cost. Texts are authoritative . . . progress is rapid . . . advantages are proved by thousands of successful graduates. Mail this coupon as they did!



**SPECIAL TUITION RATES
FOR MEMBERS OF
THE ARMED FORCES**

INTERNATIONAL CORRESPONDENCE SCHOOLS

BOX 5692-J, SCRANTON 9, PENNA.

Without cost or obligation, please send me booklet and full particulars about the course before which I have marked X:

HIGH SCHOOL

Air Conditioning Schools

- Air Conditioning
- Heating Plumbing
- Refrigeration
- Steam Fitting

Chemistry Schools

- Chemical Engineering
- Chemistry, Analytical
- Chemistry, Industrial
- Chemistry, Mfg. Iron & Steel
- Plastics
- Pulp and Paper Making

Civil, Architectural and Structural Engin'g Schools

- Architectural Drafting
- Architecture
- Bridge and Building Foreman
- Bridge Engineering
- Building Estimating
- Civil Engineering
- Contracting and Building
- Highway Engineering
- Lumber Dealer
- Sanitary Engineering
- Structural Drafting
- Surveying and Mapping

Electrical Schools

- Electrical Drafting
- Electrical Engineering
- Power House Electrician
- Practical Electrician
- Practical Telephony
- Telegraph Engineering

Internal Combustion Engines Schools

- Auto Technician Aviation
- Diesel-Electric
- Diesel Engines Gas Engines

Mechanical Schools

- Aeronautical Engineering
- Airplane Drafting
- Flight Engineer
- Foundry Work
- Heat Treatment of Metals
- Industrial Design
- Mechanical Drafting
- Mechanical Engineering
- Mold-Loft Work
- Patternmaking
- Reading Shop Blueprints
- Sheet Metal Drafting
- Sheet Metal Worker

Ship Drafting Ship Fitting

- Ship Practice
- Steel Mill Workers
- Tool Designing
- Welding, Gas and Electric

Radio Schools

- Electronics Radio, General
- Radio Operating
- Radio Servicing

Railroad Courses

- Air Brake Car Inspector
- Locomotive Engineer
- Locomotive Fireman
- Railroad Section Foreman

Steam Engineering Schools

- Boilermaking
- Combustion Engineering
- Engine Running
- Marine Engines
- Steam Electric
- Steam Engines

Textile Schools

- Cotton Manufacturing
- Rayon Weaving
- Textile Designing
- Woolen Manufacturing

Business and Academic Schools

- Accounting Advertising
- Arithmetic Bookkeeping
- Business Correspondence
- Business Management
- Certified Public Accounting
- City Letter Carrier
- College Preparatory
- Commercial
- Cost Accounting
- Federal Tax
- First Year College
- Foremanship
- Higher Mathematics
- Illustrating
- Motor Traffic
- Post Office Clerk
- Railway Postal Clerk
- Salesmanship
- Secretarial
- Stenography
- Traffic Management

Language Schools

- Spanish French
- Good English

Name..... Age..... Home Address..... Working Hours.....

City..... State..... Present Position.....

Canadian residents send coupon to International Correspondence Schools Canadian, Ltd., Montreal, Canada
British residents send coupon to I. C. S., 71 Kingsway, London, W. C. 2, England

America's War Made Industry—

ELECTRICAL APPLIANCE REPAIRING



OFFERS BIG MONEY — INDEPENDENCE

The restrictions on the manufacture of electrical home appliances has greatly increased the need for and earnings of skilled home appliance repairmen. Always a good business, today **ELECTRICAL APPLIANCE REPAIRING** is one of the most profitable occupations that the average mechanically inclined man can turn to. On many types of repairs it is usual for a repairman to charge on the basis of \$5.00 to \$6.00 an hour! Work as many hours as you wish—a home appliance repairman is his own boss. Operate from your garage, basement, vacant store, etc.

NO SPECIAL SKILL NEEDED!

If you are mechanically inclined—can hold and use tools—you too can be a big money-earning home appliance repairman. Age is no barrier—nor are minor physical handicaps. Learn how to repair refrigerators, vacuum cleaners, washing machines, motors, ranges, etc., etc. Our course is written in simple, easy to understand language, profusely illustrated with drawings and photography showing you step by step what troubles to look for and how to repair them. Explains and gives you a working knowledge of electricity, welding, nickel plating, etc. Shows you how to build power tools you may need and how to solicit and keep business coming to you. Not a complicated "theory course" but an honest to goodness course written and used by repairmen the country over. Price of course is so low that the savings on your own household appliance repairs will quickly pay for it. Prepare NOW for a real future.

Mail Coupon for FREE LITERATURE

CHRISTY SUPPLY CO.
2835 N. Central Ave., Dept. D-903
Chicago 34, Illinois

Please send me all the facts about America's Fastest Growing Industry—Electrical Appliance Repairing.

Name.....
Address.....
City..... State.....

★ SAVE WASTE PAPER ★

"The hours that book saves me!



... and the errors it prevents!"

BUSINESS men, secretaries, editors, and students rely upon Webster's Collegiate because it defines all the words most commonly used. Based on and abridged from WEBSTER'S NEW INTERNATIONAL DICTIONARY, Second Edition—"The Supreme Authority," and edited with the same careful scholarship. 1,300 pages; 110,000 entries; \$4.00 to \$8.75, depending on choice of bindings.

YOU MAY HAVE TO WAIT FOR YOUR COPY of WEBSTER'S COLLEGIATE. Paper rationing, plus exceptionally heavy government needs, plus an unprecedented public demand, make it impossible to supply everyone promptly. Your bookseller will do his best to provide your copy with the least delay.

G. & C. MERRIAM CO., Springfield 2, Mass.

WEBSTER'S COLLEGIATE
A Merriam-Webster

KEY TO A PRACTICAL UNDERSTANDING OF ELECTRICITY

\$1 PER MO.

• AUDELS HANDY BOOK OF ELECTRICITY

\$4 HANDY SIZE

For Engineers, Electricians, Students and all interested in Electricity. A quick, simplified, ready reference, giving complete instruction and practical information. Easy to understand. A reliable authority and a handy helper that answers your questions.

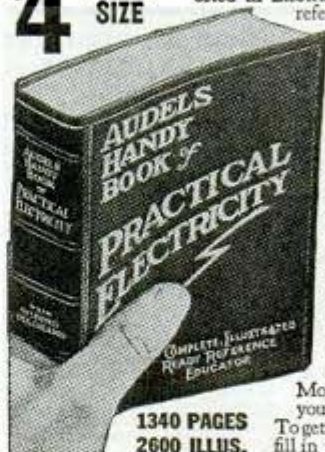

• INSIDE TRADE INFORMATION ON

The Rules and Laws of Electricity—Maintenance of Machinery—A. C. and D. C. Motors—Armature Winding and Repair—Wiring Diagrams—House Lighting—Power Wiring—Cable Splicing—Meters—Batteries—Transformers—Elevators—Electric Cranes—Railways—Bells—Sign Flashers—Telephone—Ignition—Radio Principles—Refrigeration—Air Conditioning—Oil Burners—Air Compressors—Welding, and many Modern Applications explained so you can understand.

1340 PAGES 2600 ILLUS. To get this assistance for yourself, simply fill in and mail the **FREE COUPON** below.

THEO. AUDEL & CO., 49 West 23rd Street, New York
Please send me "Auvels Handy Book of Practical Electricity" for free examination. If satisfactory, I will send you \$1 in 7 days, then \$1 monthly until \$4 is paid. Otherwise I will return it.



READ FOR PROFIT!

Name.....
Address.....
Occupation.....
Reference..... **P.M.**

WHICH OF THESE *Opportunities* INTERESTS *You* MOST?

Accounting & C. P. A.
Air Conditioning
Architecture & Building
Automotive Engineering
Aviation—Practical
Aviation Drafting & Design
Better Foremanship
Bookkeeping
Business Management
Cost Accounting for Mfg.

Diesel Engineering
Drafting & Design
Electrical Engineering
Electricity—Practical
High School Courses
Machine Shop Operations
Mechanical Engineering
Plastics Engineering
Plumbing—Practical
Private Secretary

Radio Operating & Servicing
Railway Training
Refrigeration
Sheet Metal Pattern Drafting
Shipbuilding
Shop Management
Surveying & Topographical
Drafting
Tool Making

THINK! LOOK FORWARD!

Business is making Post-war plans

Men and Women are preparing for the future

WHAT ARE YOU DOING ABOUT YOUR TOMORROWS?

● *Today*, choose the job you want—and prepare for it. Or if you are already engaged in the work you like best, start training *now* for quicker promotion. Acquire the knowledge that will help you to get ahead faster, make more money and have greater security.

Invest part of your spare time in more rapid progress. Start training now, in spare time in your own home. Be ready to grasp your opportunity and step out ahead of those who lack the ability you have attained.

American School, founded in 1897 as an educational institution *not for profit*, can help you to reach your goal just as it has helped others during the past forty-seven years. Give serious thought to the list above. Pick one or more subjects that interest you. Then check the coupon at right, add your name and address and mail it at once. The school will send you details on its training plan and outline of study prepared by specialists. There is no charge, no obligation, so send the coupon immediately.

PRACTICAL, EFFECTIVE HOME - STUDY TRAINING SINCE 1897

Take This First Easy Step

CHECK, CLIP AND MAIL COUPON NOW

AMERICAN SCHOOL, Dept. G545, Drexel at 58th, Chicago 37, Ill.
Without obligation. Please send FREE and postpaid, bulletin and details of the Subjects checked.

- | | | |
|---|---|--|
| <input type="checkbox"/> PLASTICS ENG'R | <input type="checkbox"/> Accounting and C.P.A. | <input type="checkbox"/> Drafting and Design for Men and Women |
| <input type="checkbox"/> Refrigeration and Building | <input type="checkbox"/> Cost Accounting for Manufacturing | <input type="checkbox"/> Radio |
| <input type="checkbox"/> Architecture | <input type="checkbox"/> Bookkeeping | <input type="checkbox"/> High School |
| <input type="checkbox"/> Practical Plumbing | <input type="checkbox"/> Private Secretary | <input type="checkbox"/> Air Conditioning |
| <input type="checkbox"/> Automotive Engineering | <input type="checkbox"/> Diesel Engineering | <input type="checkbox"/> Shipbuilding |
| <input type="checkbox"/> Aviation Drafting | <input type="checkbox"/> Surveying & Topographical Drafting | <input type="checkbox"/> Mechanical Eng. |
| <input type="checkbox"/> Aviation | <input type="checkbox"/> Sheet Metal Pattern Drafting | <input type="checkbox"/> Shop Management |
| <input type="checkbox"/> Business Mgmt | <input type="checkbox"/> Electrical Engineering | <input type="checkbox"/> Tool Making |
| <input type="checkbox"/> Railway Training | | <input type="checkbox"/> Better Foremanship |
| | | <input type="checkbox"/> Machine Shop Operations |

Name..... Occupation.....
Address..... Age.....
City..... State.....

AMERICAN SCHOOL

Dept. G545, Drexel at 58th Street, Chicago 37

INVENTORS

**YOU CAN HELP SHORTEN THE WAR—
HELP AMERICA WIN THE PEACE!**

TODAY'S INVENTIONS ARE KEYS TO THE FUTURE

Your IDEAS have a place in TODAY'S thinking—of war planners and peace planners. For it is to you that industry will turn for the time and labor saving devices—the new and improved products—that are NEEDED to bring about the marvels of tomorrow's world.

No matter what your idea is—don't delay in developing your invention. Once your patent is granted, it is yours, for 17 years—to sell or to license as you see fit. Many inventors are selling their patents NOW—to forward-thinking manufacturers who want to get into peacetime production as soon as the war ends.

**WE'VE HELPED MEN
LIKE YOU FOR NEARLY
HALF A CENTURY**

Nearly all inventors take advantage of specialized Patent Attorney service. A competent staff is at your disposal—your application is pushed to a speedy conclusion—saving you time, money and trouble.

**These
FREE BOOKS
tell you
WHAT TO DO**

These two books give you all the information you need. They have helped many successful inventors—they can help you. Profusely illustrated, they outline clearly every step you must take—give you valuable tips on how to make your invention practical; show details of 115 fundamental mechanical movements. Also included with these two books—you get the "Evidence of Invention" form that will help establish your claim.



★
**SEND FOR THEM
TODAY—
JUST MAIL THIS COUPON**

VICTOR J. EVANS & Co.

REGISTERED PATENT ATTORNEYS FOR NEARLY 50 YEARS

830-E Merlin Building, Washington 6, D. C.

Please send me your books, "Patent Protection" and "When and How to Sell Your Invention"—also important "Evidence of Invention" form, without cost or obligation.

Name _____

Address _____

City and State _____

★ TRAIN for SUCCESS in the Poultry Business



Study at home in spare time. Earn extra while learning.

YOU CAN MAKE MORE MONEY from POULTRY

Whether you keep 10 birds or ten hundred. Poultry properly managed will make you a good living for life. Learn latest scientific up-to-date methods of a nationally famous poultry authority. Cut losses, avoid mistakes, get biggest profits. Our Home Study course endorsed by thousands of graduates, successful poultrymen, leading colleges. This catalog free to all who want to make poultry pay—describes courses, methods, service. Write for it today to The President

NATIONAL POULTRY INSTITUTE

Dept. 50-L Adams Center, New York

PLAY GUITAR LIKE THE COWBOYS DO... 8 1/2¢ A LESSON



Just out—very latest guaranteed, simple, easy method. Play cowboy songs the Western way in a few minutes by ear. Surprise and amaze your friends. Be in big demand at parties, camps, public entertainments, on the radio, etc. 12 Complete Lessons.
SEND NO MONEY. Pay postman postage, or send \$1.00 and get EXTRA SONGS all postpaid. (Canada, \$1.25 money order only.) Nothing else to buy. Positive money back guarantee. Rush order today.
WESTERN RANGER STUDIOS, Dept. 155, Hutchinson, Kans.

REFRIGERATION SERVICE AND AIR CONDITIONING MECHANICS COURSE

Learn at home—how to start your own repair shop on little capital. No previous experience needed. Common school education sufficient. Splendid opportunity for older men. Prepare now for after the war. FREE illustrated booklet.

MECHANICS TRAINING SCHOOL

4701 W. Pico Dept. P-5 Los Angeles 6, Calif.

STAMMER?

This new 128-page book, "Stammering, Its Cause and Correction," describes the Bogue Unit Method for scientific correction of stammering and stuttering—successful for 43 years. Benj. N. Bogue, Dept. 1812, Circle Tower, Indianapolis 4, Ind.



CARTOONING PAYS WELL

Exclusive instruction by a nationally known cartoonist makes it easy to learn at home. Write for details of the course. Please state age.

NATIONAL SCHOOL OF CARTOONING
423 Penton Bldg. Cleveland 13, Ohio

LOOK! Baby Chicks

THOUSANDS WEEKLY ALL YEAR. Finest quality & Layers in 40 breeds. Hybrid Baby Pullets and Cockerels, B. W. D. Tested. Ducklings, Goslings, Baby Turkeys. Mature breeders in 65 breeds. Catalog free. ORDER NOW. Make BIG money raising NABOB QUALITY CHICKS.
NABOB HATCHERIES, BOX M, GAMBIER, OHIO

MORE SHAVES FROM BLADES AMAZING RAZOR BLADE SHARPENER



RAZOROLL sharpener for all standard makes of double-edge razor blades gives more shaves-per-blade! Helps preserve keen shaving edge longer. RAZOROLL really sharpens blades because it strips on leather—uses same principle of barber's razor strap. Gives keen, smooth shaving edges quickly. You hold blade at correct angle and with proper pressure. Then simply turn crank to sharpen both edges of blade at same time. No gears. Well made. Handsome—compact—sturdy. Weighs few ounces. Will last years. Makes ideal gift for service men.

Only \$1.00

SEND NO MONEY! Write today. Pay postman only \$1 plus few cents postage. Or send \$1.00 with order and we pay postage. Use RAZOROLL for 5 days and if you're not delighted with smooth, velvet shaves you get, return RAZOROLL and we'll return your dollar. Order today.

RAZOROLL COMPANY

620 N. Michigan Avenue Dept. 505 Chicago 11, Illinois

ELECTRON WILL POINT
WAY TO OUR FUTURE

HUGE POST-WAR MARKET
FOR FM-SETS ENVISIONED

FAMILIES PLAN LARGE
POST-WAR OUTLAYS ON
RADIOS, APPLIANCES
ARE ACCUMULATING FUNDS

Let TODAY'S
HEADLINES
Guide You to
TOMORROW'S
OPPORTUNITIES

NEW X-RAY USE FOR
RADIO, ELECTRONICS

Learn **RADIO**
ELECTRONICS DeFOREST'S
SIMPLE "A-B-C" WAY
.. at Home

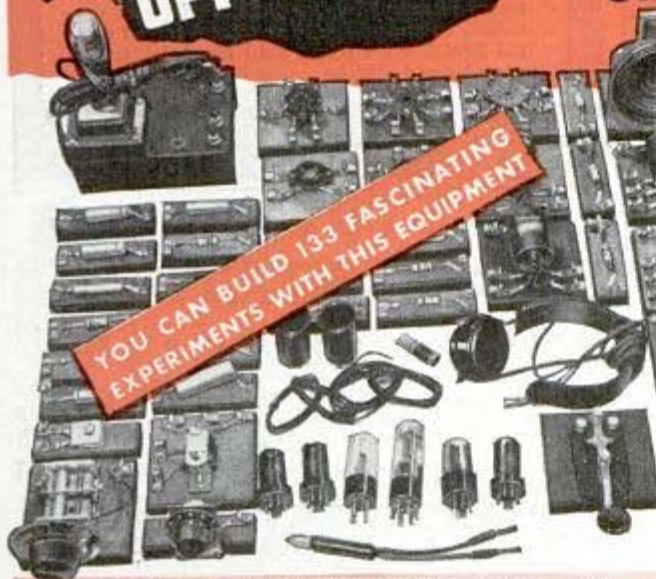

YOU CAN BUILD 133 FASCINATING
EXPERIMENTS WITH THIS EQUIPMENT

Plan your future the way business men do: Watch the headlines! Pick a field that's "in the news"—one with many opportunities for interesting, PROFITABLE EMPLOYMENT or a good chance for establishing a BUSINESS OF YOUR OWN with little capital. Pick a field that has both military as well as civilian opportunities—a field with one of America's most promising peacetime futures . . . and see how you may MAKE YOUR START TOWARD A PLACE IN THIS FIELD BEFORE JOB COMPETITION BECOMES ACUTE. WRITE FOR DeFOREST'S BIG, FREE, ILLUSTRATED BOOK—"VICTORY FOR YOU." Learn how DeForest's prepares you at home, in your leisure time—without interfering with the work you are now doing—then helps you make your start in the vast BILLION DOLLAR Radio-Electronics field.

You Get EMPLOYMENT SERVICE

DeForest's Employment Service offers you the advantage of long and favorable contacts with some of America's foremost Radio-Electronics concerns. "VICTORY FOR YOU" tells you how this Service has helped many to their start in Radio-Electronics. You'll see how DeForest students and graduates are prepared to win and to hold good paying jobs—how DeForest students start businesses of their own, with little, if any, capital.

A You "LEARN-BY-DOING"
at Home with Practical Equipment

Enjoy a "Home Laboratory." DeForest's provides 8 BIG KITS OF RADIO ASSEMBLIES AND PARTS to give you valuable practical experience at home. Build modern Radio Receivers and Circuits that operate. Build Electric Eye Devices, an Aviation Band Receiver, a Public Address System, a Wireless Microphone and numerous other fascinating experiments—in fact, 133 in all, in your spare time at home. NEW colorful Kit Supplement tells you about DeForest's "Home Laboratory," and how you use valuable Radio parts and sub-assemblies to get real practical experience as you learn.

B Home Movies Help You
Learn FASTER . . . EASIER

With DeForest's, you use a genuine DE-VEY 16mm. Motion Picture Projector and exciting training films to help you learn some of Radio's fundamentals FASTER . . . EASIER.

SEE what happens inside of many circuits you are working on. SEE how electrons function. SEE how RADIO waves are changed into sound. Get DeForest's big, free book! Use it as a key to show you the way to Radio-Electronics job opportunities of today and tomorrow—the opportunities the headlines tell about.

Send for FREE BOOK &
SUPPLEMENT TODAY!

C WELL-ILLUSTRATED
LOOSE-LEAF LESSONS



Dr. Lee DeForest

Prepared Under Supervision of Dr. Lee DeForest

DeForest's provides 90 loose-leaf lessons prepared under the supervision of the man often referred to as the "Father of Radio"—Dr. Lee DeForest, inventor of the Audion Tube, and holder of over 300 important patents . . . ACT PROMPTLY! See how you can learn

Radio the simple A-B-C DeForest's way—by Reading . . . by Doing . . . by Seeing—at Home. Mail coupon Now!

DeFOREST'S
TRAINING INC., Chicago, Ill.

DeFOREST'S TRAINING, INC.,
2533-41 North Ashland Ave., Dept. "R"
Chicago 14, Illinois, U. S. A.
Send me both your big book "VICTORY FOR YOU" and Kit Supplement, showing how I may make my start in Radio-Electronics with your simple A-B-C home training plan. No cost, no obligation.

Name.....

Address.....

City..... State.....

Help save paper! Use coupon only if you are 17 or over.

DRAFTSMEN NEEDED

Now



Industry is clamoring for more draftsmen for the job can't start until plans are drawn. Buildings, airplanes, machines, guns, tanks, bridges, all start on the drafting board, so it's no wonder that every good draftsman has a fine job. Yes, more draftsmen are needed NOW. The pay is good and the opportunities for advancement great.

Learn at Home in Spare Time

Begin now to turn spare hours into money. Be a draftsman, the connecting link between a mechanic and an engineer. Enjoy the wonderful opportunities for promotion that exist now. No experience or artistic talent is needed. You don't have to leave your present job while learning. Use spare time.

American School, Dept. DD545, Drexel Ave. at 58th St., Chicago 37, Ill.

Gentlemen: Send me FREE information covering special training in subjects checked below. No obligation on my part.

- | | |
|--|--|
| <input type="checkbox"/> Drafting and Design for Men and Women | <input type="checkbox"/> Electrical Engineering |
| <input type="checkbox"/> Cost Accounting for Mfg. | <input type="checkbox"/> Diesel Engineering |
| <input type="checkbox"/> Architecture and Building | <input type="checkbox"/> High School Course |
| <input type="checkbox"/> Automotive Engineering | <input type="checkbox"/> Plastics |
| <input type="checkbox"/> Business Management | <input type="checkbox"/> Mechanical Engineering |
| <input type="checkbox"/> Railway Training | <input type="checkbox"/> Aviation <input type="checkbox"/> Radio |
| | <input type="checkbox"/> Shipbuilding |

Name.....

Address.....

AUDELS Carpenters and Builders Guides 4 vols. \$6

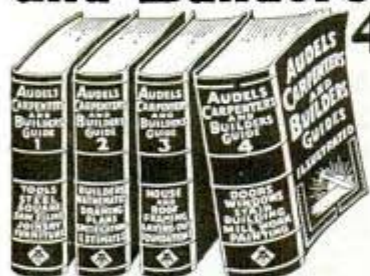

Inside Trade Information for Carpenters, Builders, Joiners, Building Mechanics and all Woodworkers. These Guides give you the short-cut instructions that you want—including new methods, ideas, solutions, plans, systems and money saving suggestions. An easy progressive course for the apprentice and student. A practical daily helper and Quick Reference for the master worker. Carpenters everywhere are using these Guides as a Helping Hand to Easier Work, Better Work and Better Pay. To get this assistance for yourself, simply fill in and mail the FREE COUPON below.

Inside Trade Information On:

How to use the steel square—How to file and set saws—How to build furniture—How to use a mitre box—How to use the chalk line—How to use rules and scales—How to make joints—Carpenters arithmetic—Solving mensuration problems—Estimating strength of timbers—How to set girders and sills—How to frame houses and roofs—How to estimate costs—How to build houses, barns, garages, bungalows, etc.—How to read and draw plans—Drawing up specifications—How to excavate—How to use settings 12, 13 and 17 on the steel square—How to build hoists and scaffolds—skylights—How to build stairs—How to put on interior trim—How to hang doors—How to lay floors—How to paint



THEO. AUDEL & CO., 49 W. 23rd St., New York City

Mail Audels Carpenters and Builders Guides, 4 vols., on 7 days' free trial. If O.K. I will remit \$1 in 7 days, and \$1 monthly until \$6 is paid. Otherwise I will return them. No obligation unless I am satisfied.

Name.....

Address.....

Occupation.....

Reference.....PM

THIS AD IS ADDRESSED TO YOU!

That idea of yours may mean your fortune; don't pass it up! That new automotive or aircraft tool or equipment may be just what the post-war era wants. Your idea may need development; perhaps it's ready for patenting or manufacture. It makes no difference to this nationally-known organization with ample engineering, production, financial, sales and distribution facilities looking for ideas for manufacture and sale in the post-war era. If patent on your idea hasn't been applied for, have it witnessed and then write us about it completely or with a minimum of detail, as you please. But whatever you do, DO SOMETHING about that idea! Write in confidence NOW to

P. O. BOX 217 STA. C TOLEDO, OHIO

STOP RADIO STATIC



The ALL WAVE radio filter is guaranteed to help you get perfect radio reception. Eliminates all hums, clicks, crackles, etc., caused by electric razors, vacuum cleaners, motors and other electrical appliances. The ALL WAVE is a scientific and compact radio filter that can be used on any make electric radio. To connect, just put your radio plug thru the ALL WAVE's slotted opening and into any wall outlet. 15 DAY FREE TRIAL. Sent C.O.D. for \$1.50 plus postage. Cash orders sent postpaid. Rush order—supply limited. Vogue Eliminator Co., 7759 S. Halsted, Dept. AW-502, Chicago 20, Ill.

Inventions Wanted Patented or Unpatented

Inventions can now be safely sold without patenting expense. If you have a practical, useful idea for sale, either unpatented or patented, write Chartered Institute of American Inventors Dept. 4, 631 Pa. Ave., N. W. Washington, D. C.

THERE'S MONEY IN CARTOONS!

RAYE BURNS will teach you HOW to CREATE ORIGINAL CARTOONS at home that you may SELL! Course contains 26 lessons and over 600 illustrations. All for Only..... **\$2.85**

Send name and address for free details.

RAYE BURNS SCHOOL, Dept. M, Box 1296, CLEVELAND 3, OHIO



Begin today. Write now for our Free Book, "How to Become a Good Penman." It contains specimens and tells how others learned to write in spare time. Enclose 10c for your name beautifully written and a pen point suitable for shaded writing. Write today.

THE TAMELYN SCHOOL OF PENMANSHIP
Y441 Ridge Building, Kansas City, Mo.

RE-SOLE YOUR SHOES

Easy—at home. Spread on So-Lo. It wears like leather. For all footwear, children's and grownups'. Also mends tires, raincoats, boots—anything of rubber, leather, cloth.



MEND THE HOLE for SPREADS on like butter. Dries tough overnight. Flexible. Non-skid. Waterproof. Won't come off—guaranteed. **So-Lo** AT ANY HARDWARE AND 10c STORE **1c**

Will PLASTICS Work Miracles?



IT SOMETIMES seems that way, but plastics are not expected to replace older materials in all industry. Instead, these synthetic products will be used where their specific properties give them an advantage in the final product.

The possibilities of increased sales from the correct use of plastics cannot be overlooked, but these possibilities will be realized only through a knowledge of the properties of each material—its limitations as well as its advantages—its physical makeup and record in service.

Plastics Institute offers a comprehensive, up-to-date source of information through its Home Study Course in plastics . . . composed of forty-four lesson assignments, complete with detailed, modern illustrations and samples of plastic materials.

For complete information, mail the coupon for your copy of the FREE booklet, the "World of Plastics." It tells you about plastics in war and peace, the Plastics Institute Home Study Course, and the Executive Educational Program.



GET THIS INTERESTING
BOOK "WORLD OF
PLASTICS" SENT FREE!
Get Full Details Now.

Plastics

INDUSTRIES TECHNICAL INSTITUTE

1221 Chanin Bldg.
New York 17

626-E LaSalle-Wacker Bldg.
Chicago 1

190 S. Alvarado St.
Los Angeles 4

MAIL COUPON FOR FREE BOOK

Plastics Industries Technical Institute
626-E LaSalle-Wacker Bldg., Chicago 1 • Dept. M-5
Gentlemen: Please send me the booklet "World of Plastics" and information on your training program. I understand there is absolutely no obligation.

NAME.....

STREET.....

CITY.....ZONE.....STATE.....

Mail in envelope or paste on penny postcard

IT'S REALLY FUN



Learned Quickly at Home
"I learned more music in a few months than I hoped to in two years. Your lessons are practical." W. S. Johnson City, Ill.



Well Worth It
"The money I spent on the course is well worth it. I do not know how the school can put out a course for so small a fee." J. S. Heron Bay, Ontario, Canada.

LEARNING MUSIC WITHOUT A TEACHER — this easy way

OVER 750,000 students have enrolled for this home study method. Many didn't know one note from another—yet they started in learning simple tunes by note. For this wonderful method makes it easy as A-B-C to learn music at home, without expensive private lessons. No tedious study and practice. Every step is right before your eyes in print and pictures. You can't go wrong. Soon you are actually playing popular pieces on your favorite instrument.

FREE Print and Picture Sample

See how easily you may learn to play your favorite instrument in spare time at home at amazingly low cost. Mail coupon today. Address: U. S. School of Music, 75 Brunswick Bldg., New York 10, N. Y.

SUCCESSFUL 46TH YR.

U. S. School of Music, 75 Brunswick Bldg., New York 10, N. Y. Please send me FREE Print and Picture Sample and Illustrated Booklet. I am interested in the instrument checked below.

(Do you have instrument?)
 Piano Accordion Tenor Banjo
 Guitar Saxophone Modern Elementary Harmony
 Violin Trumpet, Cornet Other Instrument

Name..... (Please Print)

Street.....

City..... State.....

*Actual pupils names on request. Pictures by professional models.

AVIATION Career

DON'T WAIT UNTIL THE WAR IS OVER!

Since 1929 Curtiss-Wright Technical Institute has been specializing in modern, progressive training for Aeronautical Engineers and Master Aviation Mechanics (no flying involved). Prepare now for your Aviation Career. BE READY! The opportunities are great today and will be much greater in tomorrow's Age of Flight. ACT!



CURTISS TECHNICAL



WRIGHT INSTITUTE

GRAND CENTRAL AIR TERMINAL
 GLENDALE 1, CALIFORNIA
 (LOS ANGELES COUNTY)

MAIL THIS COUPON TODAY!

Registrar, Curtiss-Wright Technical Institute, Grand Central Air Terminal, Glendale (1), California. Please send information and profusely illustrated catalogue on Aviation Training; FREE... without obligation... Dept. PM-5

Name..... Birth Date.....
 Street.....
 City..... State.....

OSWALD RABBIT Cartoon Home Movies Are ALWAYS Funny!



Feature an OSWALD film next time you entertain family and friends with a HOME MOVIE show. Screen also a Mickey Mouse—3 Monkeys—Donald Duck & Bosko cartoon. All packed with laughs.

GET THESE FEATURES
 50 Ft., 8MM\$1.25
 100 Ft., 16MM 2.50

Dr. Oswald 9-A
 Oswald The Hunter..... 17-A
 The Radio Bug..... 18-A
 The Magic Wand..... 21-A

Stage a HOME MOVIE show often! The ideal and popular type HOME ENTERTAINMENT of today.

See At Your Dealers or Order Direct For Catalog and Prices, Write to—

HOLLYWOOD FILM ENTERPRISES, Inc.
 6060 Sunset Blvd. Dept. 115 Hollywood 28, Calif.

TRAIN Your VOICE!

Results GUARANTEED

We build, strengthen the vocal organs—not with singing lessons—but by sound, scientifically correct silent and vocal exercises and absolutely guarantee complete satisfaction with results. Write for Voice Book, FREE. Sent to no one under 17 years old unless signed by parent.

PERFECT VOICE INSTITUTE, Studio 1355, 64 E. Lake St., Chicago, Ill.

Learn to MOUNT BIRDS

Tan SKINS, make up FURS

Be a Taxidermist. Double your hunting fun. We teach you at Home. Mount Birds, Animals, Fish, Heads, common specimens, Furs and profits. Decorate home and den MAKE MONEY. Mount game, tan for others. Big profits in spare time. WRITE TODAY. 100 game pictures in FREE BOOK. Hunters, get your copy. It's Now Free. Send post card. State your AGE.

FREE BOOK NORTHWESTERN SCHOOL OF TAXIDERMISTRY
 Dept. 3375 Omaha, Nebraska

Locksmithing NOW MADE EASY!

New course for practical men, mechanics, carpenters, fix-it shops, etc. Learn to fit keys, pick locks, de-code, make masterkeys. It pays. Send name for FREE details. No obligation—write today! Nelson Co., 321 S. Wabash, Dept. E-702, Chicago.

LAW

STUDY AT HOME for PERSONAL SUCCESS and LARGER EARNINGS. 32 years expert instruction—over 108,000 students enrolled. LL.B. Degree awarded. All texts furnished. Easy payments. Send for FREE BOOK—"Law and Executive Guidance."

AMERICAN EXTENSION SCHOOL OF LAW
 Dept. 41-M 8 East Huron St. Chicago 11, Ill.

TIME & MOTION STUDY

30 MILLION WORKERS and SOLDIERS will compete with you in peacetime unless you train now. Low cost professional training. Time and Motion study is insurance for present and future big pay jobs. Increase vital war work now with methods improvements. Write for details now.

INDUSTRIAL ENGINEERING COLLEGE
 4000 Washington, Chicago (24) Illinois

EARN MONEY PAINTING PORTRAITS

● No previous training or talent necessary. Unique Stuart System teaches you, by mail, in 11 simple, easy-to-follow lessons, to make excellent charcoal and oil likenesses. Detailed guidance for your every step. Send for free book today.

STUART STUDIOS, 121 Monument Circle, Rm. 654, Indianapolis 9, Ind. Please send me free book and outline of lessons.

Name.....
 Street.....
 City..... State.....

SAVE WASTE PAPER

GET INTO RADIO



You profit by a fascinating career in Radio, Radionics, Electronics, Television.

ELECTRONICS TELEVISION *Now!*

Shortages in trained, skilled men run into the hundreds of thousands. One of the biggest fields is RADIO, with its many fascinating branches. Wartime demands for Radio men are tremendous and will continue UNABATED after the war. That's important to you. You want training in a field that will continue to advance. National Schools offers you a time-tested method of Home Training which has helped thousands of men to more pay, and unlimited opportunity in the growing RADIO industry.

Shop Method Home Training by a Long Established Resident School

Get Ready For Your Opportunity . . . It's Here! Radio technical men are needed everywhere: afield in action, and at home in industry! Trained men are needed in the Army, Navy and Air and Signal Corps, Government Defense Service and Civilian fields. Now, in answer to repeated demands for Trained Radio Technicians, National Schools has extended its famous Shop Methods so you can qualify right at home. You can quickly prepare to be of greatest service to your country and yourself. Yes, right at home, in your spare time. National's time-tested plan of Home Training will definitely establish you, in a

short time, so you can hold a good job in this fascinating field. Furthermore, you become equipped for an ever bigger career in the years of reconstruction after war.



TRAIN DURING MILITARY SERVICE

Prepare for Radio Service in Army and Navy. In U. S. Gov't service you install, operate and maintain most technical equipment such as secret ultra-high frequency apparatus to locate airplanes, submarines, etc. Get promotion in rank and increased pay almost from the start.

COMMAND ANY OF THESE JOBS

Radio Expert
Electronics Engineer
Radio Broadcasting
Studio Technician
Television Technician
Aviation Radio
Ship & Harbor Radio
Business of Your Own
137 Different Types
of Jobs to Choose From

TREMENDOUS POST WAR DEMAND

NO PREVIOUS EXPERIENCE NEEDED!



Radio is only one of the courses you receive when you become a National Student. Electronics is brand new and open to every trained radio man. After this war it will produce new marvels that will be needed and used in every home. General Electric, Westinghouse and all great manufacturers have many new electronic inventions ready to market. National men, because of their knowledge and training in Electronics, will be in on the ground floor and among the first to cash in.

Television is a big new opportunity. National men will have the "know how" to merit jobs in this great industry.

RADIO EQUIPMENT INCLUDED

You work with the finest tools and materials furnished by us at no extra charge.

DUPLICATE THE SUCCESS OF THESE GRADUATES

"National Schools has done wonderful work for the man who wants to get ahead in life. Your trained man can get a job at a much higher salary."—O. K. Ivey, Washington, D. C.

"Your schooling helped me obtain a swell job. Now, in the navy, I am following the profession I learned at National. It will help my chances for rapid advancement."—H. Schroeder, U. S. Navy.

NATIONAL SCHOOLS

LOS ANGELES 37, CALIFORNIA
EST. 1905



FREE LESSON

And OPPORTUNITY
BOOK . . .

To prove that you can easily learn radio at home by National's famous "Shop Method" home training, we will send this SAMPLE LESSON without cost or obligation. With it, we will send you a big, 36 page book, "Your Future in Radio, Television and Electronics." Mail the coupon NOW.



MAIL OPPORTUNITY COUPON FOR QUICK ACTION

National Schools, Dept. 5-PMR
4000 S. Figueroa Street
Los Angeles 37, Calif.

Mail in envelope
or paste on penny postal

Please rush me, FREE and without any obligation on my part, Sample Lesson in Radio, Television and Electronics and full details of your "Shop Method" of home training. No salesman will call.

NAME _____ AGE _____

ADDRESS _____

CITY _____ STATE _____

Include your zone number

The set of
books
that makes



MASTER MACHINISTS and leads to bigger pay!

This big home-study and reference course gives you the practical facts on machines and methods you need to advance in machine shop work. Take advantage of the other man's experience as found in books, to solve your problems, increase your efficiency, with

The AMERICAN MACHINISTS' LIBRARY

6 volumes—2368 pages—2516 illustrations
(A combined home-study course and reference library)

This library of machine shop practice was written for practical men. It gives you the best methods for every kind of machine shop work. It fully explains lathes, drills, and other machine tools and their operation, automatic screw machines, speeds and feeds, gear design and production, jigs and fixtures, punch and die work, metal surfacing, etc., etc. Plainly written—completely illustrated—the best kind of help to the machine shop man who wants to advance himself.

No money down—special price—easy payments.

EXAMINATION COUPON

McGraw-Hill Book Co., 330 W. 42nd St., N. Y. 18

Send me for ten days' examination the American Machinists' Library. If satisfactory I will send you \$1.50 in 10 days and \$3.50 monthly until the price of \$19.50 is paid. If not wanted, I will return the books postpaid. (To insure prompt shipment write plainly and fill in all lines.)

Name.....
Home Address.....
City and State.....
Position.....
Name of Company..... PM-5-44

9 BIG BUILDING BOOKS



SHIPPED
FREE FOR
EXAMINATION

Learn to draw plans, estimate, be a live-wire builder, do remodeling, take contracting jobs. These 9 practical, profusely illustrated books cover subjects that will help you to get more work and make more money. Architectural design and drawing, estimating, steel square, roof framing, construction, painting and decorating, heating, air-conditioning, concrete forms and many other subjects are included.

BETTER JOBS — BETTER PAY

Keep busy now at good pay, and be prepared for after-war building boom. Big opportunities are always for MEN WHO KNOW HOW. These books supply quick, easily understood training and handy, permanent reference information that helps solve building problems.

UP-TO-DATE EDITION

These books are the most up-to-date and complete we have ever published on these many subjects.

Coupon Brings Nine Books FREE For Examination

AMERICAN TECHNICAL SOCIETY Vocational Publishers since 1898
Dept. G519 Drexel at 58th Street Chicago 37, Ill.

You may ship me the Up-to-Date edition of your nine big books, "Building, Estimating, and Contracting" without any obligation to buy. I will pay the delivery charges only, and if fully satisfied in ten days, I will send you \$1.00, and after that only \$3.00 a month, until the total price of only \$29.50 is paid. I am not obligated in any way unless I keep the books.

Name.....
Address.....
City..... State.....
Please attach a letter stating your age, occupation, employer's name and address, and that of at least one business man as a reference. Men in service, also please give home address.

SAVE WASTE PAPER

HOW TO GET AND KEEP GOOD EYESIGHT



Do you want perfect 20/20 vision? Would you like to throw away your glasses? Great numbers of men, women and children have improved and strengthened their eyes by using the famous Ross-Rehner Method, a tested and proven system of home eye exercises for correcting nearsightedness, far sightedness, color blindness and astigmatism.

Get Better Eyesight — Without Glasses

Now you can get the entire system, profusely illustrated, including a complete Eye Testing Kit, with charts to show weekly improvement. If your book store does not have it, send one dollar. Delivered postpaid, subject to return in 5 days if you are not satisfied. Order today.

HALL PUBLISHING CO.
BLOOMFIELD HILLS 2, MICHIGAN

SAVE YOUR EYES



300 WAYS TO MAKE MONEY MONEY BACK GUARANTEE

\$1.00 VALUE

25¢
68
PAGES

40,000
WORDS

In "CASH IN" you get ALL the real money-makers—dozens of profitable tested mail order plans, confidential business secrets, dozens of practical tested formulas, successful tested schemes—actual experiences of men who have started on a shoestring—with less than \$10 capital.

25¢ a copy postpaid. Send U. S. stamps or coin.

NATIONAL PLANS INSTITUTE
P.O. Box 26A, Station N, New York 23, N. Y.



Learn PLASTICS

What will happen to your war-time jobs when peace comes? Learn Plastics NOW! New, thrilling, profitable, uncrowded industry. Your opportunity. Home study and residential courses. First Plastics school in East with complete Study and Lab. courses. Write Dept. P TODAY! State one.

BOSTON TECHNICAL INSTITUTE
SCHOOL OF PLASTICS

170 COMMONWEALTH AVE., BOSTON, MASS.



STUDY ENGINEERING AT HOME With A Chartered Educational Institution

Courses in ENGINEERING: Electrical, Civil, Mechanical, Drafting, Architectural, Steam, Aeronautical, Radio, Structural, Mining, Industrial, Highway, Petroleum, Marine, Chemical.

Courses in ARTS AND SCIENCES: Philosophy; Education; Letters; Public Health; Medical Jurisprudence; Psychology; Sociology; Physics; Chemistry; Geology; Pol. Science; Theology; Law; Business and Commerce; Accounting; Mathematics; Statistics; Agriculture.

McKinley-Roosevelt Incorporated, 4610-TC, Sheridan Road, Chicago, 40



Wonderful, new device, guides your hand; corrects your writing in a few days. Big improvement in three hours. No failures. Complete outline FREE. Write C. J. Osment, Dept. 34, St. Louis, Mo.

REFRIGERATION

Repair and improve all refrigerators. New manual tells how. Charts and pictures to help you. Price only \$1.00, postpaid. Money back guarantee. Supreme Publications, 328 S. Jefferson St., Chicago 6, Illinois.



LEARN MEAT CUTTING At Home — In Spare Time

Get into the vital meat industry. Concise, practical Home Training based on 25 years proven instruction methods used at National's famous resident school. Prepares you for bigger pay as Meat Cutter, Supervisor, market manager or more money in your own store. Go as rapidly as your spare time permits. Diploma. Start NOW to turn your spare hours into money. Send for FREE bulletin today. No obligation.

National School of Meat Cutting, Inc., Dept. U-47, Toledo 4, Ohio

Tomorrow is your business



THE fast-changing post-war world isn't going to wait for any one to catch up. Tomorrow is your business and the time to equip yourself for success is now.

Thousands in the Armed Forces, thousands doing factory work in war production are preparing for business careers by studying the authoritative, practical Courses of the International Correspondence Schools. Others, already engaged in their chosen fields, are training with I. C. S. for advancement right along those lines.

From these men will come many of tomorrow's leaders. There's little room today for the executive by accident or by mere seniority — and there will be less in the even more complicated world after the war.

Outstanding business success demands: exact knowledge, power of concentration, persevering ambition, intellectual curiosity. You have the last of these qualities or you would not be reading these words. If you have the third as well — then we can give you the first, aid you in developing the second.

The long roll-call of successful graduates is the *proof* that today's I. C. S. students are tomorrow's leaders. Mail the coupon for full information on how to join them.

INTERNATIONAL CORRESPONDENCE SCHOOLS BUSINESS SCHOOLS DIVISION

BOX 5693-J, SCRANTON 9, PENNA.

Without cost or obligation, please send me booklet and full particulars about the course before which I have marked X:

- | | | | |
|--|--|--|--|
| <input type="checkbox"/> Accountancy
<input type="checkbox"/> Accountancy, with Elementary Accounting
<input type="checkbox"/> Accountancy, C.P.A. Problems and Business Law
<input type="checkbox"/> Accountancy, C.P.A. Problems and Business Law, with Elementary Accounting
<input type="checkbox"/> Bookkeeping and Cost Accounting
<input type="checkbox"/> Cost Accounting
<input type="checkbox"/> Federal Tax
<input type="checkbox"/> Junior Accountancy
<input type="checkbox"/> Advertising
<input type="checkbox"/> Advertising and Salesmanship, Combined | <input type="checkbox"/> Advertising and Show-Card Lettering, Combined
<input type="checkbox"/> Advertising, Salesmanship and Show-Card Lettering
<input type="checkbox"/> Direct-Mail Advertising
<input type="checkbox"/> Retail and Department Store Advertising
<input type="checkbox"/> Business Management
<input type="checkbox"/> Foremanship
<input type="checkbox"/> Managing Men at Work
<input type="checkbox"/> Commercial
<input type="checkbox"/> Accountant-Secretarial
<input type="checkbox"/> Bookkeeping and Business Law
<input type="checkbox"/> Business Correspondence | <input type="checkbox"/> English and Bookkeeping
<input type="checkbox"/> Stenographic-Secretarial
<input type="checkbox"/> Commercial Illustrating
<input type="checkbox"/> Caricaturing and Cartooning
<input type="checkbox"/> Commercial Art
<input type="checkbox"/> Industrial Designing
<input type="checkbox"/> Magazine and Book Illustrating
<input type="checkbox"/> Newspaper Illustrating
<input type="checkbox"/> Good English
<input type="checkbox"/> French
<input type="checkbox"/> Spanish
<input type="checkbox"/> Inventions and Their Management | <input type="checkbox"/> Salesmanship
<input type="checkbox"/> Petroleum Products Salesmanship
<input type="checkbox"/> Salesmanship and Sales Management
<input type="checkbox"/> Service Station Salesmanship
<input type="checkbox"/> Super-Service and Salesmanship
<input type="checkbox"/> Show-Card Lettering
<input type="checkbox"/> Sign Lettering
<input type="checkbox"/> Sign Lettering and Show-Card Lettering, Combined
<input type="checkbox"/> Traffic Management
<input type="checkbox"/> Motor-Traffic Management
<input type="checkbox"/> Railroad Rate Clerk's |
|--|--|--|--|

Name..... Age..... Home Address..... Working Hours.....
 City..... State..... Present Position.....

Canadian residents send coupon to International Correspondence Schools Canadian, Ltd., Montreal, Canada.
 British residents send coupon to I. C. S., 71 Kingsway, London, W. C. 2, England.

SPECIAL TUITION RATES FOR MEMBERS OF THE ARMED FORCES

Be Popular—Learn
the **Newest DANCES**
in **5 DAYS**—or **NO COST!**



**NEW REVISED EDITION
of DANCING**

includes the Rhumba, Conga,
Samba, Jitterbug . . . Fox
Trot, Waltz and Tap Dancing.

All the newest Swing steps—the Rhumba, Conga, Samba, Jitterbug, as well as the Fox Trot, Waltz and basic tap steps—explained with simple, graphic diagrams. **GET MORE FUN OUT OF LIFE!** Swing your way to popularity! Start now and fill your future with Romance! **MAKE THIS FREE TEST!** The new REVISED edition of Betty Lee's book, Dancing, helps you learn correctly and quickly. Be convinced—if not satisfied with results, you will get your money back! And remember, we include two other books—"Tip Top Tapping" and "Swing Steps"—FREE of extra charge. **SEND NO MONEY!** Pay the postman \$1.98 plus a few cents postage. Follow instructions in ALL THREE BOOKS—practice simple dance steps each day and in 5 days if you haven't learned to dance, we will refund your money!

PIONEER PUBLICATIONS, INC.
1790 Broadway, Dept. 945H
New York 19, N. Y.
Send me "Dancing," by Betty Lee, and include 2 free books.
 Ship C.O.D. I will pay on arrival, plus postage.
 I enclose \$1.98. Ship postage prepaid. If in 5 days I do not learn to dance, I may return book and you will refund purchase price.

Name.....
Address.....
City..... State.....



**AN INFANT INDUSTRY
... SUDDENLY MATURED
PLASTICS**

Get In at the Start—and Grow

Plastics is a new industry which the nation's war needs is forcing to quick maturity. Already Plastics are indispensable in practically every branch of the Service—Aircraft, Ordnance, Chemical, Marine, Signal Corps, etc. Opportunities? Nearly everything, from homes to clothing, from gadgets to tools, will be affected by Plastics.

Spare Time Training Now Ready

The time to get started is now. You can prepare at home, in your spare time, to take your place in an infant industry that even now is leaping into prominence. A new, practical training plan is now ready to help you realize your ambitions and build your future security. Act now. Don't delay. Mail this coupon today.

AMERICAN SCHOOL, Dept. P545
Drexel Ave. at 58th St., Chicago 37, Ill.
Send me FREE information covering special training in subjects checked below. No obligation on my part.
 Plastics Cost Accounting for Mfg.
 Electrical Engineering Automotive Engineering
 Drafting and Design Architecture & Building
for Men and Women Shipbuilding
 Diesel Engineering Business Management
 Mechanical Engineering High School Course
 Aviation Radio Railway Training

Name.....
Address.....

MUSIC LESSONS
COMPLETE CONSERVATORY HOME STUDY COURSES
Piano, Harmony, History of Music, Advanced Composition, Voice, Public School Music, Violin, Cornet, Trumpet, Guitar, Mandolin, Saxophone, Clarinet, Dance Band Arranging, Ear Training and Sight Singing, Choral Conducting. The only correspondence school teaching all the courses leading to the Degree of Bachelor of Music. Ask for illustrated lessons and catalog.

Give experience AGE
UNIVERSITY EXTENSION CONSERVATORY 1525 E. 53rd St.
Dept. U-44, Chicago 15, Ill.

**TRIAL LESSON IN
FREE DRAFTING**
More good jobs now in Drafting. Learn AT HOME in spare time (or at our Chicago School). Send postcard for **FREE TRIAL LESSON** and see how easy to learn and get a good job.
CHICAGO TECHNICAL COLLEGE
E-205 Tech Bldg., 2000 S. Michigan Ave., 35 Chicago, Ill.

LAW STUDY AT HOME
Legally trained men win higher positions and bigger success in business and public life. Greater opportunities now than ever before. Big corporations are headed by men with legal training.
More Ability: More Prestige: More Money
We guide you step by step. You can train at home during spare time. Degree of LL. B. Successful graduates in every section of the U. S. We furnish all text material, including 14-volume Law Library. Low cost, easy terms. Get our valuable 40-page "Law Training for Leadership" and Evidence books FREE. Send for them NOW.
LaSalle Extension University, Dept. 564-L Chicago
A Correspondence Institution

FIX TYPEWRITERS
A Simplified Practical Homestudy Course. Many of our students now have their own business—Many Repair for others. Repair Shops Swamped. Health or Age no handicap.
WEBER TYPEWRITER MECHANICS SCHOOL
5417 Santa Monica Blvd., Hollywood 27, Calif.

Learn RADIO-ELECTRONICS
12 WEEKS TRAINING IN COYNE SHOPS ON REAL RADIO - ELECTRONIC EQUIPMENT! FOR MEN 16 UP TO 50
Prepare for a great Peace time future and a good job in Radio and Electronics now. Coyne "LEARN BY DOING" training covers latest developments in this field. Prepare quickly, easily. Fascinating well paid work in maintenance, installation and servicing Radio and Electronic equipment.
I'LL FINANCE YOUR TRAINING!
Start now—pay tuition after graduation. My plan has helped thousands. I assist you in getting part-time work while at COYNE to help pay living expenses. Job Service when trained. Also have facilities for men with physical disabilities. Write!
ELECTRONICS AND TELEVISION
Tremendous expansion in Radio, Electronics, Frequency Modulation and Television predicted after the war—a world of new opportunities. Get ready for a Peace time future and a good job NOW with practical Coyne Radio Training.
FREE BOOK! Whether you're 16 or up to 50 get facts. Special Industrial Electronics training included at no extra cost now. Mail coupon today.
H. C. LEWIS, Pres., RADIO DIV., COYNE ELEC. SCHOOL
500 S. Paulina St., Dept. 54-3H, Chicago 12, Illinois
Send me FREE BOOK, "Your Future in Radio", and details of Industrial Electronics training included at no extra charge and easy "Pay-After-Graduation" plan.
NAME..... AGE.....
ADDRESS.....
CITY..... STATE.....

SAVE WASTE PAPER

Prepare for a **BRILLIANT PEACE-TIME CAREER**

Learn AIRCRAFT DESIGNING and ENGINEERING

Ryan
The Aircraft Industry Needs Trained Draftsmen & Engineers Now... and for the Big Tomorrow in Aviation
 ... Both Men and Women

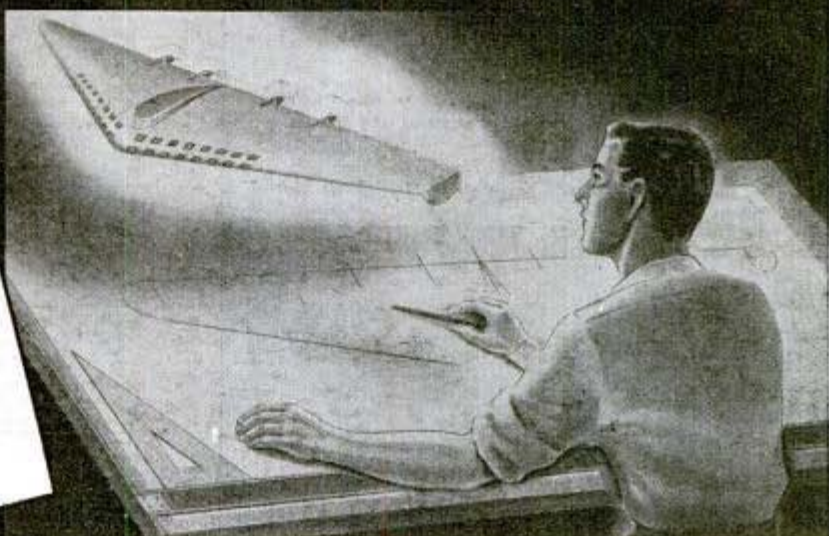

RYAN'S New Home Study Course Trains You in Spare Time

Don't let the pressure of these busy times make you lose sight of your own future. Start to train now for a career with better pay—and unlimited opportunities for advancement. With this new "boiled down" course, from a well-known, long-established organization which has been teaching aviation and flying airplanes for a generation, you can earn a coveted Ryan diploma just by using part of your spare time. The lessons are so interesting, many students finish far ahead of schedule.

Previous Training Unnecessary

You learn at home under individualized supervision. There will be no loss of any income or time from your present job. And you'll be proud to tell your friends that your school, Ryan Aeronautical Institute, is an affiliate of the famous Ryan School of Aeronautics (teaching flying), and the great Ryan Aeronautical Company (designing and building airplanes). Thus your training will be direct-from-the-industry—training approved by the other large aircraft manufacturers.

Do This—Then Judge For Yourself

Your time is the most valuable thing you have. You owe it to yourself to see that the study course on which you spend your time is the finest—the most practical. So use this coupon—now! There is no obligation—it'll take but a minute—and it may easily be your passport to a successful career in aviation. To save time, send it Air Mail.

Can you see things in space?

Do you have imagination? Can you visualize something in your mind and see it in clear detail? There are important places in aviation for this type of man. Such men will design the planes of the future.



Complete Aeronautical Drafting Outfit At NO EXTRA COST

You get this complete, professional drafting equipment set, without additional charge. There is nothing else to buy—no extra costs to bother you as you progress toward your valuable diploma—your ticket to a new, exciting, high paid career.

Free!
 This Interesting 24-page Illustrated Book, Full Information and Costs

Read What These R.A.I.-Trained Men Say:



R.A.I. Training Brings Better Job and Raise in Pay

"At the time I enrolled for your training I was doing stock work at Bell Aircraft. However in October I got transferred into the Tool Design Department. My pay has been increased and I hope to realize more profits later."
 Gerwood Gopbrook, Niagara Falls, N. Y.

Says R.A.I. Course Superior to All

"I believe your course to be far superior to anything of this nature that has come to my attention. The personal attention which a student receives amazes me. I shall always recommend R.A.I. to anyone interested in Home Study Aeronautical Training."
 A. DeLindholm, Los Angeles, California.



R.A.I. Graduate Praises Course

"I've been in the Aviation Industry long enough I believe to recognize the real material when I see it. This is it. Yes without question you have here the solution to the problem. How can I equip myself for entrance into the Engineering branch of the Aviation Industry?"
 William S. Evans, La Jolla, California.



RYAN Aeronautical Institute
 425 Lindbergh Field, San Diego 1, California

Gentlemen:

Please send me, without any obligation on my part, your FREE 24-page illustrated book, "New Horizons of Opportunity," and full information on R.A.I., including cost of training, and job opportunities.

Name _____ Age _____
 Street _____
 City _____ State _____

For ANY AUTO REPAIR JOB!

MoToR's AMAZING NEW "TROUBLE SHOOTER"

SAVES WORK, TIME, HEADACHES!

This Handy New Pocket-Size Book Spots 1,673 Causes of Car Troubles in a Jiffy!

Now YOU can locate ANY car trouble in a flash! This handy, indexed "TROUBLE-SHOOTER" book leads you at once to any one of the 1,673 possible causes of trouble. Fits your pocket for instant reference! Book stays open while you work!

You lose time, money, whenever you can't locate trouble fast. Now you can stop wasting time, temper on false alarms and useless checkups. You "get at" the toughest problems in short order with this "TROUBLE-SHOOTER"!

Easy as A-B-C to Use!

Here's how it works. Suppose, for instance, you're stumped by a battery-trouble job. NINE things can cause a battery to go wrong. If you should NOT remember JUST ONE of them—you waste time on "hunches." But NOW you can just turn, in your "TROUBLE-SHOOTER," to the check list of battery-trouble causes—and it tells you exactly where to look, what to check. It's "duck soup"!

7-DAY GUARANTEE OFFER

Simply fill in and mail special Money-Back Coupon below. enclose \$1 (cash, check or money order)—we'll make immediate shipment. Then TRY this amazing book for 7 days. Let it PROVE how much time, trouble, tinkering it saves you! If not MORE than delighted—shoot it back, your dollar refunded at once. But you won't want to part with it, we're positive! Rush coupon NOW to: MoToR Book Dept., Desk AE, 572 Madison Ave., New York 22, N.Y.

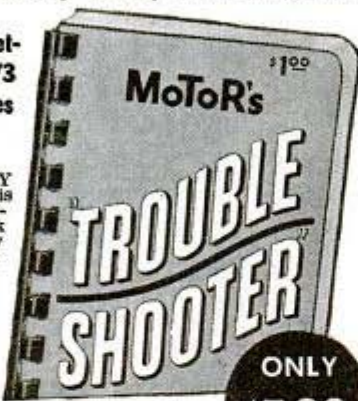

1,673 Quick-Check Guides to "What's Wrong With It?"

ONLY \$1.00

Divided into quick-indexed sections, a few of which are listed below. For example—if car has *Connecting Rod Noise*—just turn to that section, you find 8 specific things that can cause it.

- Connecting Rod Noise (8)
- Engine Misses, High Speed (80)
- Engine Misses, All Speeds (82)
- Pre-ignition or Spark Knock (17)
- Excessive Oil Consumption (45)
- Crankshaft Noise (14)
- Clutch (73)
- Piston Noise (14)
- Rear Axle (66)
- Brakes (81)
- Front Suspension, Steering (150)

—and many more!

7-DAY GUARANTEE OFFER

MoToR BOOK DEPARTMENT, Desk AE
572 Madison Ave., New York 22, N. Y.

Rush me MoToR's "TROUBLE-SHOOTER," postpaid, at once. I enclose \$1 (cash, check or money order). On this special money-back offer, if I am not delighted after 7 days' trial I'll return book, you'll refund my dollar at once.

Name

Address

City..... Zone No. (if any)..... State.....

SAVE WASTE PAPER



DRAW CARTOONS BIG MONEY!

EASY... PLEASANT WORK!
Let CHAS. H. KUHN, with 25 years actual experience in drawing a daily newspaper cartoon, teach you how to create, draw and sell your work. 52 complete lessons—one sent each week. Professional criticism on every lesson. Write today.

KUHN SCHOOL OF CARTOONING
420 MURPHY BUILDING Dept. S. INDIANAPOLIS 4, INDIANA

STAMMER

IF YOU owe it to yourself to send for our free book. 11,000 cases corrected. Est. 41 years. No hand swing or sing song. Millard Inst. of Normal Speech, 2303 W. Wis. Ave., Milwaukee, Wis.

STUDY LAW AT HOME

With A Chartered Educational Institution
Men with legal training win higher positions, larger earnings, and are bigger successes in business and public life. Opportunities NOW greater than ever before. Complete course includes 21 Hornbook series college grade textbooks. Send for 1943-44 Catalog. McKinley-Roosevelt Incorporated, 4610-LT, Sheridan Road, Chicago, 40

BOOKS FOUND FREE!

WHAT BOOKS DO YOU WANT?
We quote lowest market prices. No charge for locating Hard-to-Find Books. All books, OLD or NEW mailed POST-FREE. SEARCHLIGHT BOOK CLUB, 22 East 17th St., New York City



- Learn How To Dance 50c
 - Big Joke Book 50c
 - Learn "Swing Steps" 50c
- or ALL 3 books for \$1. Shipped prepaid in plain sealed wrapper. No C. O. D. orders. No stamps. NUDCOS, Dept. C-5, Box 126, G. P. O., New York 1.

HOME STUDY OR PRACTICAL SHOP TRAINING

Men wanted to learn following big pay trades: Auto-Diesel, Machinist, Plastics, Drafting, Refrigeration, Welding, Body and Fender, Aircraft. Established 1902. 41,000 graduates. Free booklet. Specify trade. State whether interested in Home Study or Practical Shop Training. GREER SHOP TRAINING, Dept. 154, 2017 S. Wabash Ave., Chicago, 16

Do you want

- .. to go to College?
- .. or to enter a Profession?
(Such as Accounting, Architecture, Nursing, Dentistry, Teaching, Social Work, Osteopathy, Beauty Culture, Optometry, Embalming, Chiroprody, Law, Medicine, etc.)
- .. or get an Office Position?

To get anywhere, you practically MUST finish High School FIRST. You can complete our simplified High School Course in SPARE time at home, as FAST as your time and abilities permit. Equivalent to resident school work—prepares you for college, pre-professional examinations, business, industry. Standard texts furnished. Diploma. Credit for H.S. subjects already completed. Single subjects if desired. Low tuition, easy terms. American School, Chicago, est. 1897—endorsed by educators. Finish your high school education NOW. Write TODAY!

High School Course at Home Many Finish in 2 Years

American School, Dept. H545, Drexel Ave. at 58th St., Chicago 37, Ill.
Gentlemen: Send me FREE information covering special training in subjects checked below. No obligation on my part.

- High School Course
- Cost Accounting for Mfg.
- Architecture and Building
- Automotive Engineering
- Business Management
- Electrical Engineering
- Elec. and Gas Refrigeration
- Air Conditioning
- Railway Training
- Diesel Engineering
- Drafting and Design for men & women
- Plastics
- Private Secretary
- Mechanical Engineering
- Aviation
- Radio
- Salesmanship
- Shipbuilding

Name.....

Address.....

**ELECTRICIANS!
RADIO MEN!
MECHANICS!**

7 DAYS FREE TRIAL

QUICK, EASY WAY TO GET PRACTICAL KNOWLEDGE IN

ELECTRICITY — RADIO — ELECTRONICS

SEND NO MONEY!

Examine these Sensational Books at Home and on the Job for 7 Days ... at my Expense. If not delighted, return them and you won't owe me one penny!

H. C. Lewis
Pres. COYNE
ELECTRICAL SCHOOL

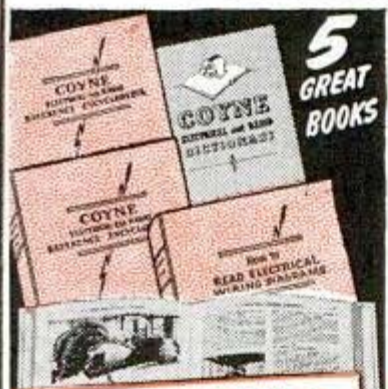

5 GREAT BOOKS

New Coyne Electrical & Radio Reference Set

Over 1450 Pages ★ 2400 Pictures, Diagrams ★ For Home Study & Job Use

5 GREAT BOOKS! EASY — PRACTICAL — THOROUGH. These 5 amazing books cover everything from simple wiring to Power-House work — Armature Winding, Appliances, Motors, Auto and Aviation Electricity, Refrigeration, Air Conditioning, Radio, Electronics, etc. All subjects plainly indexed at your finger-tips. For beginner or old timer. Praised by thousands. Includes famous 3-vol. COYNE Encyclopedia and 1 vol.

"How to Read Electrical Wiring Diagrams", each book 8 1/2 x 11 in.—plus handy Electrical-Radio Dictionary. Contains more material than many sets selling for 2 or 3 times the price. Latest 1944 edition.

Yours FREE 7 days; then either return set or send \$3, and then \$3 a month until \$13.95 is paid. Cash price \$12.55— you save 10% if sent within 7 days after books reach you.

Brand New, Giant Size..COYNE ELECTRICAL & RADIO TROUBLE SHOOTING MANUAL

Just off the press, this tremendous volume is an instant success! Actually 4 remarkable books in one. 1st, NEW Step-by-Step Trouble Shooting Course—shows how to locate causes of "grief" on any Electrical or Radio equipment. Nothing else like it! 2nd, 500 large size Electrical & Radio Shop Prints, Wiring Diagrams, Charts, with instructions on how to read and use them. 3rd, Electrical-Radio Dictionary of 1200 terms, symbols. 4th, Spare Time Job Lessons—easy ways to make manual pay for itself!

Needed by WAR WORKERS, MAINTENANCE MEN, ELECTRICAL, RADIO AND REFRIGERATION SERVICEMEN, ETC. Be a real trouble shooter—in big demand everywhere! 612 Pages, 8 1/2 x 11 inches. YOU NEED THIS MANUAL.

Examine at my risk for 7 FULL DAYS; then either return it or send \$3.00 and \$3.00 a month until \$8.95 is paid. Cash price \$8.00—save 10%.



100% Satisfaction Guaranteed by Coyne

Combination Offer!

YOU SAVE 25% — \$7.50

Own the complete COYNE PAY-RAISER LIBRARY—all 7 practical, money-making books shown on this page. Have the entire world of Electricity, Radio, Electronics, etc., at your fingertips. If bought separately, these books would cost you \$30.30. Ordering entire set gives big saving. Library includes:

- 3 vol. Elec. & Radio Encyclopedia
- Elec. & Radio Trouble Shooting Manual
- Electronics
- How to Read Wiring Diagrams
- Electrical & Radio Dictionary

Yours FREE for 7 DAYS TRIAL. Then either return all books or send \$3.00, and \$3.00 mo. until \$22.85 is paid. Cash price \$20.55—save an extra 10%. Money Back Guarantee.

Amazing New Manual on ELECTRONICS

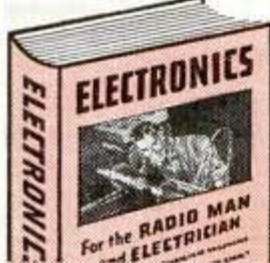

for RADIO MAN, ELECTRICIAN or MECHANIC

Learn ELECTRONICS. Big new 400 page manual prepares you for startling opportunities. Newest facts, pictures, easy-to-follow diagrams. Describes each type of tube and its uses—installation, maintenance, trouble shooting on electronic devices. ONLY BOOK OF ITS KIND ON THE MARKET! Special introductory price, \$4.95 (Cash or C.O.D.)

NO MONEY DOWN!

I will ship any or all of these new Coyne books on 7 DAYS FREE TRIAL. Look them over—use them on the job—then if not 100% satisfied shoot them back and you won't owe me a penny! If you decide to keep them, pay \$3 and then \$3 a month—or save 10% by remitting full cash price. Don't miss this big chance. Rush coupon today!

H. C. LEWIS President
COYNE ELECTRICAL SCHOOL
500 So. Paulina Street, Chicago 12, Illinois

EXAMINE 7 DAYS AT MY RISK

H. C. Lewis, President, Coyne Electrical School
500 S. Paulina St., Dept. 54-3R6, Chicago 12, Illinois

Send me the books checked below on 7 DAYS FREE TRIAL. I'll either return them in 7 days and owe you nothing, or pay as indicated below. Coyne pays all shipping charges.

- COYNE PAYRAISER LIBRARY—7 books in all. 3-vol. Elec. & Radio Encyclopedia; Trouble Shooting Manual; Electronics; How to Read Electrical Wiring Diagrams; Dictionary. Price complete, \$22.85 (payments) or \$20.55 cash.
- COYNE REFERENCE SET—5 vols. including 3 vol. Encyclopedia, 1 vol. Electrical Wiring Diagrams, and Dictionary. Price complete, \$13.95 (payments) or \$12.55 cash.
- COYNE TROUBLE SHOOTING MANUAL—(1 vol.) Price, \$8.95 (payments) or \$8.00 cash.
- COYNE MANUAL OF ELECTRONICS (1 vol.) Price, \$4.95.
- HOW TO READ WIRING DIAGRAMS. Price, \$1.95.
- COYNE ELECTRICAL & RADIO DICTIONARY. Price, 50c.

If books are satisfactory I will pay for them as follows:

- \$3 in 7 days and then \$3 a month until balance of account is paid.
- Full cash price as shown above in 7 days.

FREE

1 Yr. Technical Counsel by Mail from the Coyne staff on your problems—with any of the books!

Name.....
Address.....
City..... State.....
Name of Firm Employing You.....
Age.....

Check here if you wish to pay the postman cash price when books are delivered. Same 7-day money back guarantee of satisfaction.

AUDELS NEW MACHINISTS HANDYBOOK NOW READY!

Prepare!

A KEY TO SHOP PRACTICE
For Every Machinist, Tool-maker, Machine Operator, Draughtsman, Metal Worker, Mechanic or Student, Covers Shop Practice in All Branches.

A READY REFERENCE
Tells How to Operate and Set Up Lathes, Screw and Milling Machines, Shapers, Drill Presses and All Machine Tools.

5 PRACTICAL BOOKS IN ONE!
60 FULLY ILLUSTRATED CHAPTERS
Covering: 1—Modern Machine Shop Practice. 2—Blue Print Reading and How to Draw. 3—Calculations & Mathematics for Machinists. 4—Shop Physics. 5—How to Use Slide Rule.

Get This Information for Yourself. Mail Coupon Today. No Obligation Unless Satisfied. ASK TO SEE IT.

1600 PAGES FULLY ILLUSTRATED \$4 COMPLETE - PAY ONLY \$1 MO.

THEO. AUDEL & CO., 49 WEST 23rd STREET, NEW YORK
Mail AUDELS MACHINISTS & TOOLMAKERS HANDY BOOK. Price \$4 on 7 Days Free Trial. If O. K., I will remit \$1 in 7 days and \$1 monthly until \$4 is paid. Otherwise I will return it.

Name.....
Address.....
Occupation.....
Reference..... P. M.

The Miracle of PLASTICS

A BREATH-TAKING OPPORTUNITY

More startling than thousands of inventions—Industry is to be revolutionized before your very eyes. The time for you to prepare for this brilliant future is now—TODAY. Don't sit idly by and let this opportunity slip past you. O.I.T. training is the last word in complete, practical, up-to-the-minute job getting preparation, so thorough others are amazed at our low tuition.

CHECK BELOW - MAIL TODAY

Ohio Institute of Technology, Box P-157, Greenville, Ohio

Send me complete free information on the drafting or design engineering subjects checked below.

<input type="checkbox"/> Plastics with Design Engineering	<input type="checkbox"/> Sheet Metal Electrical Estimating
<input type="checkbox"/> Aircraft Drafting	<input type="checkbox"/> General Marine
<input type="checkbox"/> Aircraft and Layout and Detail Design	<input type="checkbox"/> Mechanical Highway Machine Design
<input type="checkbox"/> Automotive Architectural	<input type="checkbox"/> Railroad Structural
<input type="checkbox"/> Air Conditioning	<input type="checkbox"/> Tool Design
<input type="checkbox"/> Bridge	<input type="checkbox"/> Production Engineering with Tool Design
<input type="checkbox"/> Concrete	
<input type="checkbox"/> Communications	
<input type="checkbox"/> Diesel	

Name.....
Address.....
City..... State.....

Complete Course!
Let **CARL BRUNO** Teach You

How to write better at home in your spare time. Write right now! Enclose \$1 (bill) for my complete proven course and I will also send FREE two of my favorite pens and your name artistically written—Write today!

CARL BRUNO SCHOOL
5035 Gloria Avenue
Dept. 7A, Encino, Calif.

ALL FOR ONLY **\$1** POST PAID

Learn HOW TO Write BETTER

STUDY AT HOME

With A Chartered Educational Institution

Courses in **ENGINEERING**: Electrical, Civil, Mechanical, Drafting, Architectural, Steam, Aeronautical, Radio, Structural, Mining, Industrial, Highway, Petroleum, Marine, Chemical.

Courses in **ARTS AND SCIENCES**: Philosophy; Education; Letters; Public Health; Medical Jurisprudence; Psychology; Sociology; Physics; Chemistry; Geology; Pol. Science; Theology; Law; Business and Commerce; Accounting; Mathematics; Statistics; Agriculture.

McKinley-Roosevelt Incorporated, 4610-UC, Sheridan Road, Chicago, 40

How to get the **VOCABULARY** you want WITHOUT using a **DICTIONARY**

GET THIS AMAZING BOOK \$1
Famous in Our Resident School for 15 Years

Complete, practical and amazingly simplified, this unusual home study book has previously been used only by resident school students. Guaranteed to increase and broaden your vocabulary or your money back. You see results immediately. Send \$1.00 or write for details. Money back if not satisfied.

NIAGARA SCHOOL, 177 B.L.E. BLDG., CLEVELAND, OHIO

What Every Mason Wants

We have important Masonic books for Blue Lodge, Chapter, Commandery, Scottish Rite, and Shrine. **OUR RITUALS ARE USED THE WORLD OVER** Send for free catalog of books and rituals for Masons, Odd Fellows, Knights of Pythias, Knights of Columbus, Elks, etc.

EZRA A. COOK, Publisher, P.O. Box 796, PMA, Chicago 90, Ill.

ARTISTS MAKE MONEY

Find out your ability. Send name, age, occupation and address for Free Vocational Art Test.

ART INSTRUCTION, INC. (Formerly Federal Schools)
5134 Art Instruction Building, Minneapolis, Minnesota

LAW

STUDY AT HOME FOR PERSONAL SUCCESS and LARGER EARNINGS. 32 years expert instruction—over 108,000 students enrolled. LL.B. Degree awarded. All texts furnished. Easy payments. Send for FREE BOOK—"Law and Executive Guidance."

AMERICAN EXTENSION SCHOOL OF LAW
Dept. 41-M 8 East Huron St. Chicago 11, Ill.

RADIO OPERATORS WANTED

Learn to send and receive Radio Code at home or camp, or prepare for higher proficiency and rating through easy, practical system used in training radiotelegraph specialists. Good pay, adventure, interesting work. Send for revealing 52-page FREE Book.

CANDLER SYSTEM CO. Dept. 5E, Box 928 Denver, Colo., U.S.A.

LEARN CARTOONING

From my Original Cartooning Lessons. Send 3 samples your cartoons for FREE CRITICISM-CORRECTIONS, copy "Where to Sell Cartoons" and details of our Cartooning Course FREE.

TEMPLETON STUDIOS, Dept. 19, Elgin, Ill.

ANY BOOK IN PRINT!

Delivered at your door. We pay postage. Standard authors, new books, popular editions, fiction, reference, medical, mechanical, children's books, etc.—all at guaranteed savings. Send card now for Clarkson's 1944 Catalog.

FREE Write for our great illustrated book catalog. A short course in literature. The buying guide of 300,000 book lovers. FREE if you write NOW—TODAY!

CLARKSON PUBLISHING COMPANY
Dept. PM-44-A, 1253 S. Wabash Ave., Chicago, Ill.

Always write your name and full address clearly when answering advertisements.

"Give me just 10 minutes a day—
I'll PROVE I can make
YOU
COMMANDO—
in HALF
the ordinary time
or I Don't Want Your Money!"

TOUGH!

with Lion STRENGTH—Panther
SPEED—Tiger ENDURANCE,
A Priceless Armor of
LIVING MUSCLE all
over that pre-
cious body
of yours



GEORGE F. JOWETT
MOLDER OF MIGHTY MEN

Experts call him "The World's
Greatest Body Builder" Holder
of more Strength records than
any living athlete or teacher.

Here's a man among men—the
man who holds more records for
Strength than any other living man
—the man who has taught men
who are now teaching others. Let
this Master Molder of Men, give
you, too, a Jowett trained body.

READ what these famous athletes say
about Jowett. Then follow their advice.
Mail the coupon!

Charles Schaffer says: "I am proud to
have had so great a teacher as you
are. You are head and shoulders
above the rest in your profession."

Frank Dennis, Champion, says:
"From a bed of pain I became a
record holder and a national cham-
pion, for all of which I have to
thank Jowett and his wonderful
Course of Physical Instruction. My
advice to you is to get started right
now. What Jowett has made me he
certainly can make you."

FREE . . .

for quick ac-
tion! Jowett's
Photo Book of
Strong Men...
Read this thrill-
ing Story of
Jowett in words
and pictures.



Men! How I know what you want! From head to heels a
body to be proud of! Big, steel-spring muscles on your arms
and legs! A back of power! Broad military shoulders! A high,
deep barrel chest! Health! Stamina! Speed! Endurance! Vitality
Supreme! You want to be **COMMANDO TOUGH!**—to be
able to take it on dish it out with the best of them! You want
the steady nerves of an air-pilot! Of course you want these
he-man qualities. Let me PROVE I can give them to you in
double-quick time, as I have to thousands. I want every man in
America to be fit to lick a truckload of Japs or Nazis!

PROGRESSIVE POWER!

The World-Famous JOWETT SYSTEM that has PROVED ITSELF WITH
RESULTS for thousands — now yours for a song! "The Greatest System in the
World!" says R. F. Kelley, Physical Director, Y.M.C.A., Atlantic City, N. J.

In 10 minutes a day let me teach you my secrets of strength and health that re-built me from a skinny
wreck at 15, to the holder of more strength records than any other living man, athlete or trainer!
Let me do for you what I have done for thousands of men and boys, young and old—men who write
me letters of gratitude saying I saved them from weaknesses they were ashamed of—scrawny, puny
bodies people laughed at, I'll tell you it's a serious matter! I know! I've been through it! But
don't worry! Take my word for it, you too, can rebuild your own body! You, too, can put
mighty muscles on your arms and chest, your back and shoulders. You too, can gain endurance,
strength, agility, speed. Put yourself in my hands at once. Let me PROVE it!

Look at these Mighty Jowett Built Men!
Pictured on the Covers of these Book Courses

Get one of these famous illustrated Courses FREE!

HOW TO MOLD A MIGHTY BACK
By GEORGE F. JOWETT

HOW TO MOLD A MIGHTY CHEST
By GEORGE F. JOWETT

HOW TO MOLD A MIGHTY LEGS
By GEORGE F. JOWETT

HOW TO MOLD A MIGHTY GRIP
By GEORGE F. JOWETT

HOW TO MOLD A MIGHTY ARM
By GEORGE F. JOWETT

Rex Ferris Chal-
lenger all Comers
says: "I owe
everything to Jo-
wett Methods."

BUILD A MIGHTY BODY AS THEY DID

W. Burns Now A. A. V. National Strength Champion praises the Jowett System.

Albert Manger From Weakling to Champion, says: "All I have I owe to Jowett teaching."

Send Now! Only 25c each or send \$1.00 for any 4 and get the fifth Course FREE! Build a Mighty Body the Jowett Way!

You owe it to your country, your loved ones and to yourself to become more physically fit now! Start at once building yourself into a proud specimen of American manhood by practicing Jowett's easy, simple method of muscle-building! These courses were designed to sell for \$5.00 each but I have streamlined them for you at 25c each because I want every man and boy in America to have them. Everything is here. All the pictures, strength and muscle-building movements, diagrams, advice. Not a thing left out! Send 25c today for any one or better yet, send \$1.00 and I'll send you all five postage paid.

JOWETT INSTITUTE OF PHYSICAL CULTURE
230 FIFTH AVENUE, DEPT. 475 NEW YORK 1, N. Y.

Here's My Amazing 7-Day Trial Offer and Money Back Guarantee

Think of it! All five of these famous muscle-building, picture Book Courses for only ONE DOLLAR or any one of them for 25c. If you're not delighted with them—if you don't actually FEEL results within ONE WEEK, send them back and I'll refund your money without question. Don't let this opportunity slip away from you! And don't forget—by mailing the FREE GIFT COUPON at once, you receive a FREE copy of the famous Jowett Photo Book, "Nerves of Steel, Muscles like Iron."

ACTION COUNTS!

The first step toward Strength is action! If you want to be proud of yourself quickly take the first step NOW! Act like a he-man! Clip and mail the FREE GIFT COUPON.

FREE GIFT COUPON!

Jowett Institute of Physical Culture
230 Fifth Avenue, Dept. 475 New York 1, N. Y.

Yes! Send me FREE your Book of Photos, "Nerves of Steel"; also send me the JOWETT Book-Courses checked below. If not delighted I may return books (or book) in 7 days and my money will be refunded.

I enclose \$_____ Send books, checked, postage prepaid.

ALL FIVE BOOKS FOR \$1

How to Mold a Mighty Arm (25c)

How to Mold a Mighty Back (25c)

How to Mold a Mighty Chest (25c)

How to Mold a Mighty Grip (25c)

How to Mold Mighty Legs (25c)

Ship C.O.D. I will pay postman \$1.00 plus a few cents postage. (No order less than \$1 shipped C.O.D.)

NAME _____ AGE _____

ADDRESS _____

CITY _____ STATE _____

**DESIGNERS, ENGINEERS
DRAFTSMEN, METALSMITHS—**

NEW—100 clear and concise welding design ideas gleaned from practical experience of others. Every idea clearly shown by drawings—easy to understand and apply. If you are interested in welded design, you can't be without this book, nothing else like it, \$3.50 Postpaid, 5 days approval.

Design FOR ARC WELDING

will save you many times its cost on your next redesign projects. Order now, \$3.50 (Postpaid)

512 Pages, 516 illustrations. Complete manual and text book on Welding Postpaid—\$2.00



**HOBART
BROTHERS COMPANY**

Hobart Bros. Co., Box M-54, Troy, Ohio

"One of the World's Largest Builders of ARC WELDING Equipment."

LEARN ELECTRICITY MEN *whether you are* 16 or 50 HERE'S THE QUICK WAY TO AN ESSENTIAL JOB-A GOOD FUTURE



I'll Finance Your Training

Trained Electrical men needed now. It's not how young you are, or how old you are. The question is—have you the training for a real peace-time future in a field that is vital now. Not all "essential" jobs offer such opportunities. ELECTRICITY does—when you're prepared!

Here at Coyne you can train in 12 weeks—not by books or lessons, but on real actual electrical machinery and apparatus. You "Learn by Doing". And you don't need much money. I'll finance your tuition and you can pay it in easy monthly payments after your training period is over. Then if you are short of living expenses we'll get you a part time job to "earn while you learn". After graduation we give you lifetime employment service.

Right now I'm including extra training in INDUSTRIAL ELECTRONICS at no extra cost.

Mail coupon for my big free book. Get the training you need for a good electrical job. MAIL NOW.

Also have facilities for men with physical disabilities. Write.

H. C. Lewis, President
Coyne Electrical School, Dept. 54-72,
500 S. Paulina St., Chicago 12, Ill.

Send Free Book with Facts on Coyne. "Pay After Graduation" Plan and extra Industrial Electronics training now included.

NAME.....
ADDRESS.....
CITY..... STATE.....

INDIANA TECHNICAL COLLEGE

Engineering degree in 27 months. Aeronautical, Chemical, Civil Electrical, Mechanical and Radio Engineering. Govt. approved ground school courses. Prep courses, no added cost. Large industrial center. Earn living expenses. Enter June, Sept., Dec., March. Catalog, 554 E. Washington Blvd., Fort Wayne 2, Indiana.

KNOW THIS IMPORTANT SUBJECT

We Will Send Enlarged and Revised Second Edition on Money-Back Guarantee



435 Pages 203 Illustrations 50 Tables **ONLY \$3.75**

The hundreds of war-time uses of Plastics are a forecast of even greater developments offering big opportunities to those who prepare for them by study. In this book a noted Plastics authority gives you the basic information you should have. Send name and complete address for your copy. Pay postman only \$3.75 plus postage on arrival, or enclose \$3.75 and we will pay postage. If you are not satisfied, return book in 5 days and we will refund your money at once.

AMERICAN TECHNICAL SOCIETY, Department P-519
Drexel at 58th Street Chicago 37, Illinois



A SIMPLIFIED ART ANATOMY OF THE HUMAN FIGURE

ONLY \$1 POSTPAID

by Charles Carlson. The book they're talking about! One of the most informative books of its kind for both student and professional artists. Charts, notes, and over 350 drawings show detailed studies of every part of the body, posed and in action. HOUSE OF LITTLE BOOKS, 156-160 Fifth Ave., New York

JIU-JITSU HOW TO LICK THE BIG GUY

Guaranteed Learn Easily Quickly step by step. Send 10c to-day for trial lesson, full details.

MODERN SCHOOL OF JIU-JITSU, Dpt. A, 5 W. 52 St., N. Y. 19

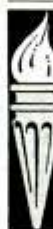

PATENTS AND TRADE MARKS C. A. SNOW & CO.

Registered Patent Attorneys Since 1875
Write for Free Book and "Certification of Invention" form
427 SNOW BUILDING, WASHINGTON 1, D. C.



PATENT YOUR IDEAS SEND FOR FREE BOOK

Written by Former Member Examining Corps (1922-24) U. S. Pat. Office.

CARL MILLER, Registered Patent Attorney
Former Member Examining Corps U. S. Patent Office
Woolworth Bldg., Dept. 54-A, New York — Bond Bldg., Dept. 54-A, Washington, D. C.

PATENTS Protect Your Idea: By securing FREE my "PROOF OF INVENTION" folder. Exceptional Personal Service. Excellent References. Established 1906.
E. E. VROOMAN, 871 Woodward Bldg., WASH., D. C.

To PROTECT YOUR INVENTION—Use this coupon, NOW

Delays are dangerous and may be very costly. My personal service assures prompt action, strict confidence, and a minimum of expense. I suggest that you send me a model or drawing, or sketch and description of your invention, and \$5.00. I will make a search and report

promptly as to its patentability and send you a copy of my 72-page booklet. Or, if you prefer to read my booklet first, mail the attached coupon at once. I will also send my "Record of Invention" form. (Over 40 years experience as a Registered Patent Attorney.)

L. F. Randolph, 302-D Columbian Bldg., Washington, D. C.

Please send me at once, free of charge, your 72 page booklet and "Record of Invention" form

Name.....

Address.....

A PERSONAL CONFIDENTIAL PATENT SERVICE

**DO ANY JOB..
EASIER.. QUICKER**



**MAKE MORE MONEY in the FIELDS of
BIG OPPORTUNITIES**

Here is the HELP YOU NEED . . . Now and After the War!

FREE TRIAL IN YOUR OWN HOME

Used by Army, Navy, Other Government
Depts., 200 Schools and Industrial Firms.

Get ready to meet keener job competition, now and when wartime jobs are over. Get into one of these big opportunity fields. Big money and many other advantages await you if you prepare now. Here is the help you need—EASY—QUICK—AT LOW COST. Thousands of men have already used these famous books. Beginners and experienced men alike have doubled and tripled their earnings with this help. You too, can now get the special knowledge you need for top pay, better jobs, or a business of your own. This is your GOLDEN OPPORTUNITY.

REFRIGERATION

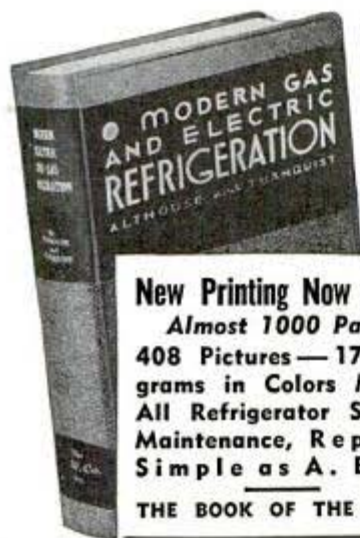

15 Million Refrigerators Need Service, Repairs

**New Printing Now Ready
Almost 1000 Pages
408 Pictures—17 Diagrams in Colors Makes All Refrigerator Service Maintenance, Repairs Simple as A. B. C.**
THE BOOK OF THE HOUR

No new refrigerators being made. None for years. Millions must be kept going. Owners will pay big for competent service which will be needed more and more. Get MODERN GAS AND ELECTRIC REFRIGERATION, the non-technical guide to all types of refrigerators and get your share of this new profit. Get a job or start your own service business. This book will help you make money anywhere. Sold on money-back guarantee. Price \$5.00.

HELPFUL BOOKS

MODERN WELDING PRACTICE

Just published. Newest book on all types of welding and heat treatment of metals. Written by recognized specialists in training men for production jobs. 430 Pages, 277 Illus. Practical and Non-Technical. Covers everything you need to know. Prepare for best pay jobs now. Price \$4.00.

SHEET METAL LAYOUT

Makes sheet metal layout work so simple that anyone can learn. Thousands of men badly needed for this big-pay work now. Even more after the war. Get this new instructor and get into the easiest, cleanest and best paying part of all sheet metal work. 143 jobs worked out in drawings and carefully explained. Size of book 8 1/2 x 11 inches. Price \$3.00.

ELECTRICAL WIRING

Complete practical instruction on every phase of house wiring in one handy volume. Goes further than most books on subject. Hand-book style. Gives National Electric Code. 400 pages, 669 illustrations. Electrical work will reach new heights after war. Get started now. \$2.50.

SEND NO MONEY

Select the Books YOU Need Now! We Ship C.O.D. Anywhere in U. S. and Will Refund Amount Paid if Not Satisfactory.

HELPS FOR BIGGER PAY

AUTO BODY AND FENDER REPAIR

Owners will spend big money to keep cars looking new because few new cars available. This book is a practical money-making guide, ideal for shop owners and every man who wants a share of the millions to be spent in keeping old cars looking new. Auto Body and Fender Repairs contains 325 pages, 232 illustrations. Covers methods, tools, etc., in plain, simple language. Price \$3.00.

The Famous DYKE'S CARBURETOR BOOK

Best pay of all times for those who specialize in this work. The standard guide for a generation. New edition covers engine tune-up, ignition, carburetion, fuel pump, valves, etc. 244 pages, 549 illustrations. \$3.00.

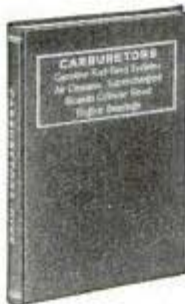

AUTOMOBILE WORK

Leading Auto Book for 32 Years



Over a half million copies of 20 editions of Dyke's have been sold. Gives specifications of old and newer cars.

This big book, a complete auto library in one volume, has 1483 pages—4600 illustrations and diagrams—weighs 6 lbs.—equal to 4 ordinary books.

Mail Coupon to: Goodheart-Willcox Co., Inc., 2009 S. Michigan Ave., Dept. 15, Chicago 16, Ill.

**World's Greatest AUTO BOOK
NEW 20TH EDITION**

New Material on Transmissions, Trucks, Tractors, Diesels, Aircraft and Auto Engines

Now with millions of cars needing repairs and thousands of men needed to do the work, you need the famous DYKE Auto Book more than ever before. Brand new 20th edition covers all principles, construction, repair, adjustment, testing, troubles and remedies of all cars. World's biggest book value \$6.00.

SEND NO MONEY! Mail Coupon

GOODHEART-WILCOX CO.,
2009 S. Michigan Ave., Dept. 15, Chicago 16, Ill.

Send books checked, C.O.D. I will pay postman, plus few cents charges. If any book is not satisfactory I will return in 5 days and you will refund money paid you.

- | | |
|--|--|
| <input type="checkbox"/> Gas & Electric Refrigeration . . . \$5.00 | <input type="checkbox"/> Electrical Wiring . . . \$2.50 |
| <input type="checkbox"/> Dyke's Auto Book . . . \$6.00 | <input type="checkbox"/> Body and Fender Repair \$3.00 |
| <input type="checkbox"/> Dyke's Carburetor Book . . . \$3.00 | <input type="checkbox"/> NOT LISTED |
| <input type="checkbox"/> Modern Welding . . . \$4.00 | <input type="checkbox"/> Aircraft Sheet Metal . . . \$2.50 |
| <input type="checkbox"/> Sheet Metal Layout . . . \$3.00 | <input type="checkbox"/> Airplane Welding . . . \$3.50 |
| | <input type="checkbox"/> Shop Math. (2 vols.) . . . \$3.00 |

If remittance accompanies order we will pay all postage charges under same return privilege.

Name

Address

City..... State.....



This MODERN Way— TO CASH IN ON YOUR USEFUL IDEAS OR INVENTIONS COSTS YOU NOTHING!

Here's really good news for you people who develop new, useful gadgets, devices, processes or methods. *At absolutely no cost to you*, either now or later, the Nation-Wide Bureau of Ideas will try to help you find buyers for your ideas! There are no strings to this offer—read the details carefully, then act promptly.

This Plan Is Amazingly Simple

Anyone with a new, useful idea may take advantage of this offer. There is no restriction on the kind of ideas you may submit to the Nation-Wide Bureau of Ideas. They may concern new mechanical devices or gadgets, new uses for existing products or materials, better processes or methods.

The Nation-Wide Bureau of Ideas prepares brief descriptions (not actual details) of the ideas received and these are sent to the Bureau's subscribers. These include well-rated companies in

all types of business who are constantly seeking worthwhile ideas. When one of these companies becomes interested in your idea, the Bureau of Ideas arranges contact with you. From that point on, you personally handle further negotiations and details with the prospective buyer. The Bureau itself does not buy or sell ideas.

No Fees to Pay—Nothing to Buy

The Nation-Wide Bureau of Ideas charges you nothing for its services. The only requirement is that you comply with *all* instructions printed below, otherwise your ideas cannot be considered. Do this for your own protection.

There is no time limit on this offer, but the sooner you get your ideas in to the Nation-Wide Bureau of Ideas, the sooner you'll benefit. Save this ad for future reference if you have no ideas right now.

Just Follow These Simple Instructions

1 Make reasonably sure that your idea is really new and useful. It may concern any product, device, material or method, new or old.

2 Submit ideas by describing them briefly. You need not reveal details. Ideas must be accompanied by the form printed in this advertisement. You need not use this actual paper, but wording of the form must be copied exactly as it is printed here. Material not accompanied by such a signed form will not be considered.

3 If you believe your idea is patentable, it may be wise to disclose its details in a sketch or written description to some other person (not to the Nation-Wide Bureau of Ideas). Date this record so you will have proof that you had the idea on a certain date. If necessary, patent application may be filed later, perhaps with the assistance of the user of your idea.

4 Many ideas are not patentable, and prospective users cannot afford to pay

as much for such ideas as for patented inventions. Therefore you must indicate your willingness to accept whatever sum the user of your idea is willing to pay, by signing the blank below. Of course, there may be several users for such ideas—you may collect from all of them.

5 Address all material to Nation-Wide Bureau of Ideas, Division Morton Manufacturing Company, 353 North Leamington Avenue, Chicago 44, Illinois.

NATION-WIDE BUREAU OF IDEAS

Morton Manufacturing Company, 353 N. Leamington Avenue, Chicago 44, Illinois

MORTON MANUFACTURING COMPANY

Nation-Wide Bureau of Ideas
353 N. Leamington Avenue
Chicago 44, Illinois

Please submit attached idea (or ideas) to your subscribers without cost to me. If such submission brings about the use of my idea, and unless or until I have patent protection, I agree to accept whatever amount the user, or users, offer, provided that the sum is not less than \$25.00. I reserve to myself the right to negotiate with anyone for sale of, or license under, any patent which has been or may be issued to me.

I fully understand that you make no representations whatsoever that a patent can or will be issued to me or that a user for my idea(s) will be found. In consideration of your services, I release you from liability of any kind or nature.

This certificate will signify my willingness to use your free service on the above basis in connection with any ideas which I may elect to submit to you at any future date.

SIGN NAME AND FULL ADDRESS IN MARGIN BELOW

USE THIS BLANK
You Pay No Fees
Buy Nothing
Either Now Or Later

Copyright, 1944
Morton Mfg. Co., Chicago

**WORLD'S
BEST
WANT AD
MEDIUM**

CLASSIFIED Advertisements



Advertisements in this section, 35 cents per word, each insertion, minimum 10 words, payable in advance
To be inserted under proper classification in June issue, copy should be in our office April 8th
June issue on sale May 1st
Popular Mechanics Magazine, 200 East Ontario Street, Chicago, Illinois

AUTOMOBILES—MIDGET CARS

AUTOMOBILE Books, "Racing photo album" 110 photos, exciting crashes, world's greatest race cars, drivers described. \$1.50. "Saga Roaring Road" 181 pages, 16 pictures. Starter Fred Wagner's early racing experiences with world famous drivers, cars described, read about Rickenbacker, Murphy, Burman, DePalma, Ford "999", Oldfield's Benz \$2.50. Automobile racing book \$1.10. Prices include reprint, illustrations, drawings army Jeep and German BMW war motorcycles. All postpaid. Clymers, 2125 W. Pico, Los Angeles 6, Calif.

GARAGE Doors opened and closed from dashboard without costly electronic apparatus. Locks when closed, but opens at touch of button. New, thoroughly tested electrical dashboard control. Simple and dependable. Parts for both control and door mechanism are inexpensive, non-critical, and obtainable locally. No castings, welding, or machine work. Applicable to overhead, swinging, and sliding doors. Complete, illustrated, built-it-yourself plans \$1.00. Kaytor Laboratories, Lynwood, Calif.

FLOYD Clymer's Historical Motor Scrapbook! 148 pages photographs, specifications, descriptions 250 early automobiles, motorcycles — including Chevrolet V-8, friction driven Plymouth, Ford "2" and "6", 3 cylinder Elmore, revolving engine automobile, Studebaker electric, Pope, Knox, Oldsmobile, Thomas, Sears, Maytag, Maxwell, Hupmobile, Mitchell, Rambler, Orient, Wayne, Brush, Peerless, Lambert, E-M-F, Flanders, Rco, Lozier, Selden-Ford patent litigation details, Lincoln truck, Overland, Marmon, electrics, foreign cars, others. Interesting, educational, historical, humorous ancient motor history includes motorcycle section, \$1.50 postpaid. Clymers, 2125 W. Pico, Los Angeles 6, Calif.

R & R Mfg. Co. New catalogue on speed equipment for cars and boats. \$1.00. Box 546, Anderson, Indiana.

OLD Time automobiles, motorcycles, illustrated, interesting folder 50c postpaid. Clymers, 2125 W. Pico, Los Angeles 6, Calif.

CATALOG Of helpful books free. Send name and address. Popular Mechanics Press, (C-43), 200 E. Ontario, Chicago.

ENGLISH Automobile publication "Motor." Interesting illustrations, descriptions, comments British automobiles. Published weekly. \$10 yearly. \$5.50 six months. Sample copy 50c postpaid. Clymers, 2125 W. Pico, Los Angeles 6, Calif.

"EXCUSE My Dust," sensational, thrilling, humorous automobile book of early small town automobile owner experiences. 359 pages by Bellamy Partridge, author Country Lawyer. With folder old motorcycles, automobiles. \$3.00 postpaid. Clymers, 2125 W. Pico, Los Angeles 6, Calif.

1944 IGNITION Supercharger \$3.50. Quick starting, mileage, pep. EG Sales Mfg. Co., 60 St. John St., New York.

AUTOMOBILE Racing book, fifth edition, well illustrated. Instructions on building bodies, frames, engines. Ford A and B conversions. Plans. AAA rules, specifications. Roadster racing. Indianapolis cars. \$1.00 postpaid, \$1.15 C.O.D. Ray Kuns, Dept. 47, Madisonville, Cincinnati, Ohio.

RENEW Car batteries inexpensively. Instructions \$1.00. Popular Service, Racine, Wisconsin.

GASOLINE Saving device, Chevrolet, Ford, 1932-1942. Walert Company, 3429 North 10th Street, Milwaukee 6, Wisconsin.

BURN 120 Octane non-rated fuels in your car. Save gasoline for the military needs. Gasoline shortage to get worse, be prepared. Easy to build your own unit for your car. Very cheap to operate. Details 25c coin. Behco, Box 55, Hyde Park Station, Los Angeles, Calif.

AUTO Books. Up-to-date list free. Popular Mechanics Press, (C-43), 200 E. Ontario, Chicago.

AUTO SUPPLIES AND EQUIPMENT

CLYMER DeLuxe chromed spotlight for automobiles, motorcycles, boats, hunters. Trigger switch, pistol grip handle, powerful beam, 32 cp., operates off any 6-8 automobile battery. Only few left, hurry. \$8.50 postpaid. Clymers, 2125 W. Pico, Los Angeles 6, Calif.

BUG Screens. Protect, beautify radiator. Prewar tailored. Mention make, year. 50c postpaid. Allen, PM427, Clinton, Mo.

OPERATE Cars, trucks, tractors, motors, with wood or coal gas. 1/5 cost of gasoline. Extensively used in Europe. Complete detailed instructions \$1.00. W. M. Cross, Lone Rock, Wis.

1,000 MOTORISTS Needed to make gas saving test. Up to 30% savings. For free test offer write Vacu-Matic Carburetor Co., 7617-935 W. State St., Wauwatosa, Wis.

SAVE Your permanent antifreeze. Reclaim by simple, practical, inexpensive method. Instructions \$1.00. Bonas Laboratory, Box 134, Dearborn, Michigan.

FOR Sale—New Kennedy deluxe tool kits. Size 22" by 10" by 11" have top tray, locking hasp, identification. Finished in green crackle. Price \$7.50 each. Lew Leibee, Hawthorne, California.

WHIRLGAS Turbinator, \$3, spins and vaporizes carburetor mixture. Adds pep and mileage. University test. Refund guarantee. Wrench installs 15 minutes. Give auto make, year. John Hanley, 5719 Loraine, Detroit 8, Mich.

DUAL Mufflers. California style fit Ford V-8, Mercury. Saves gasoline, increases power, beautiful deep tone. All attachments, pipes, etc. Easy installation. \$20.00 complete. Clymer's, 2125 W. Pico, Los Angeles 6, Calif.

VACUDEX Gives more miles from gas. Proved by prominent engineers road and laboratory tests. \$3.75 postpaid. Decker Products Co., Pelham, New York.

ATTENTION: Run your car on (natural or artificial gas) without alteration to your carburetor or gasoline system. Photo blueprints and literature, giving approximate cost, size of tank, pressure, mileage, instructions, etc. \$1.25. Harper's Machine Shop, 218 - 22nd Street, Dunbar, W. Va.

PLATING Outfits for auto parts. Connect to a battery. No tanks used. Free particulars and proofs. Gunmetal Co., Ave. J, Decatur, Ill.

THE Lord is coming! Get guaranteed proofs free. Scheall, 263XA, Duluth, Minnesota.

"EXTRA Miles." How I drive Packard 8, 50 miles for each gallon gas used. You can too. Information and instructions \$1.00. Mechanic's Special, Box 714-1A, San Bruno, Calif.

USED Parts (guaranteed) all cars. Describe needs fully; immediate reply. Victory, 2439 1/2 Gunnison, Chicago.

AUTO TRAILERS

BUILD Your own trailer! Plans \$1.00 each. House, sport, camp, utility trailers. Catalog 10c. Jim Dandy, Box 125-A, Wausau, Wisconsin.

TRACTOR With front cultivator made from auto and truck with less work, good traction, pulls 16 in. plow. Design \$1.00, week for refund. O. C. Lytle, R. 1, Kit-tanning, Penna.

MOTORCYCLES, BICYCLES, MOTOR SCOOTERS AND SUPPLIES

ENGLISH Magazine "Motorcycling" published weekly. Interesting specifications, illustrations, description British motorcycles. Racing, past and future models discussed. \$10 yearly, six months \$5.50. Sample copy postpaid 50 cents. Clymers, 2125 W. Pico, Los Angeles 6, Calif.

PARTS. Complete motor parts list. Pistons, all sizes, chains, sprockets, for Indian, Harley, 10c. Bootz, 622 East Grand, Des Moines 9, Iowa.

BOOKS! "Modern Motorcycle Mechanics and Speed Tuning," 435 pages maintenance Harley, Indian, Villiers, all British motorcycles \$2.50; with drawings, specifications, illustrations U. S. Army Jeep, German BMW war motorcycles \$3.00; "Motorcyclist's Workshop" \$1.50; "Two Stroke Motorcycles" \$1.50; "Motorcycles—How Manage Them" \$1.50; "Speed—How to Obtain It" \$1.50; "Historical Motorcycling Facts" \$1.00; "Automobile Racing" \$1.10; Motorcycle instruction manual "question-answers" \$1.10. All postpaid. Clymers, 2125 W. Pico, Los Angeles 6, Calif.

MIDGET Racer \$65, complete, crated; scooters; unrationed tires cheap, parts. Motors \$5 up. Send 25c for bargain catalogue. Midget Motors Directory, Athens, Ohio.

20, 24, 26 X 2.125 TIRES \$2.50. Tubes \$1.50 postpaid. Pulver's Sporting Goods, Hudson, N. Y.

FLOYD Clymer's Historical Motor Scrapbook! Just out. 148 pages, photographs, specifications, descriptions, 250 early motorcycles, automobiles, including Pierce "4", Merkel, Pope, Yale, Thomas, Harley, Indian, Marsh, Reading, Thor, steam motorcycle, Ace, Cleveland, Dayton, Minneapolis, front wheel driven motorcycles and scooters, British, German, French, Swedish makes. Auto section includes Chevrolet V-8, friction driven Plymouth, Ford "2" and "6", revolving engine car, steamers, electrics, Brush, Pope, Maxwell, Studebaker electric, Sears, Knox, Maytag, Hupmobile, Orient, Rambler, others. Interesting, educational, humorous ancient motoring history. \$1.50 postpaid. Clymers, 2125 W. Pico, Los Angeles 6, Calif.

PARTS And service for most motorcycles using Lauson or Briggs and Stratton motors. 3.50 x 6 tires and tubes available with ration certificate. Send for our pamphlet describing our new centrifugal clutch which will operate on most moto scoots. American Moto Scoot Company, 1305-23 W. Carroll Avenue, Chicago 7, Ill.

NEW Book just out! British Motorcycle Manual. 72 large pages complete authentic factory servicing information British war and civilian motorcycles. 140 illustrations, diagrams, drawings, engines, transmissions, Enfield, Norton, Triumph, B.S.A., Matchless, Ariel, Velocette, Burman, Lucas ignition, B.T.H. Magneto, Miller lighting sets, hydraulic forks. Wonderful book British owners, interesting, educational any motorcyclist. \$1.50 postpaid. Clymers, 2125 W. Pico, Los Angeles 6, Calif.

MOTORIZED Vehicle. Manual \$1.00. Illustrated circular 10c. Craftsman Books, Box 1153PM, Milwaukee, Wis.

"MOTORCYCLES — How to Manage Them." 260 pages, 175 illustrations, drawings. Read it, become a better motorcyclist. Expertly written. \$1.50 postpaid. Clymers, 2125 W. Pico, Los Angeles 6, Calif.

MOTORCYCLES. Scooters and parts. No priority needed. Gaynor Motors, 5950 Sunset, Hollywood, 28, California.

PLANS. Scale drawings, specifications, illustrations for building attractive motor scooter complete \$2.00; plans electrically driven bicycle \$1.50. Postpaid. Clymers, 2125 W. Pico, Los Angeles 6, Calif.

MOTORCYCLISTS — New and used parts, accessories, all models. Catalog 10c. Henderson catalog 10c additional. Triangle, 2157 Harrison, Chicago.

100 MILES Gallon! Motor-scooters, motorcycles. Whizzer bicycle engines, midget automobiles, gasoline engines. No priority necessary. Catalog 10c. Clymers, 2125 W. Pico, Los Angeles 6, Calif.

"MODERN Motorcycle Mechanics," 436 pages, 200 illustrations. Extensively covers—operating, maintenance, complete reconditioning, American and British motorcycles. Invaluable to motorcycle riders or mechanics. \$2.50 postpaid. Nicholson Brothers, Saskatoon, Canada.

THIRTY-FIVE (35) Model Harley Davidson 74. New carburetor, battery, rings and plugs. For sale, two hundred fifty dollars (\$250.00). John H. Carr, Jr., Box 78, Northport, Ala.

BOOK "Speed—How to Obtain It." 160 pages, illustrated, instructions, cams, balance, timing, valves, pistons, racing technique. World's greatest speed tuning book. \$1.50 postpaid. Clymers, 2125 W. Pico, Los Angeles 6, Calif.

ATTENTION Motorcycle owners. 1944 publication covering trouble saving tips on Indian and Harley Davidson motorcycles. Full line of new and used Indian parts. Large supply Harley Davidson parts new and used. Price 25c a copy. Copy price refunded on first order of \$2.00 or more. Preston Motors, Inc., Kendallville, Ind.

HARLEY-DAVIDSON 24 h.p. twin 45 motors. Perfect condition. \$85.00 and up. Latest design. Used to power farm equipment, ice sleds, midget cars, etc. Used Harley-Davidson parts. Send 25c for bulletin and 45 service manual. Knuth's, 2491 Fondulac, 6, Milwaukee, Wis.

WHEELS And tires—General utility 16x275 wheel and tire, ballbearing, semi-solid, pre-war rubber, \$8.95. Send dime for list. Cycle Transport Co., 1241 S. Michigan Ave., Chicago 5, Ill.

SAVE Gasoline, build a motorbike now, send 25c for complete plans. Motorbike Service, 2108 McLean, New Albany, Ind.

BOYS: "All bicycle repair secrets revealed." Bicycle repair manual, 65c. R. G. Klausner, Shelbyville, Ill.

PISTONS, Parts, accessories, chain all motorcycles. McCann's, 2104 Texas Street, El Paso, Texas.

COMPLETE Plans, drawings, specifications to build electric motorbike for \$1.00. Mowery, Box 994, Lancaster, Penna.

AVIATION

NEW Lightplane manual. Sportplane manual, lightplane blueprints, etc. Circulators 20c. Craftsman Books, Box 1153PM, Milwaukee 1, Wis.

TWO Stinsons \$69, Monocoupe \$100, Taylorcraft \$100, all cracked-up less motors. New propellers \$8.95. Send 25c for Spring War-Bargain Directory listing 182 airplanes, crackups, motors. Used Aircraft Directory, Athens, Ohio.

ELECTRIC FENCING

1-WIRE 6 Volt electric fencer, \$3.75. Write, Wholesale Fence, Hales Corners, Wisconsin.

BATTERIES, GENERATORS, ETC.

EDISON Batteries, Light Power, Fifteen year life. Five year guarantee. Complete lighting plants. Free literature. See Jay Company, 321 Yonkers Avenue, Yonkers, New York.

ELECTRICAL SUPPLIES, EQUIPMENT

FIBRE-BAKELITE Washers, strips, small pieces large assortment for insulation. Ideal for electricians, radio mechanics, hobby workshops. Over 1000 pieces. Satisfaction guaranteed. Special \$1.98. Limited supply. Order now. Widran Distributors, MA-224 West Hubbard, Chicago 10.

ELECTRIC Cellar drainers, blowers, exhaust fans. Namgre, Moore Sales, Lincoln, Nebr.

FOR Motors, welders, generators, other electrical items. Write LeJay Mfg., 847 LeJay Building, Minneapolis, Minn.

NOW—Repair your own electrical appliances with Chantite Self-welding Electrical Heating Element Flux. Instructions delivered, price \$1.00. Chantite Sales Company, 914 South Main, Fort Worth, Texas.

NEW 5 And 10 K. V. A. 4 cyl. Kohler automatic electric plants, other used plants in a.c. and d.c. to 40 K. W. Will buy used Kohler electric plants. E. F. Schmalz, 215 Wyoming Ave., Kingston, Penna.

ELECTRIC Fans — Correctly balanced 16" aluminum blades, 1/2" bore, \$3.00; heavy guard, \$2.00. Use 1/4-1/2 h.p. electric motor and make your own fans. Ted Rise-man, 427 E. Jefferson, Springfield, Ill.

EXPERIMENTERS! Large assortment, fiber washers, strips, tubing, screws, nuts, rivets, ceramics, etc. Big value, guaranteed satisfaction, only \$1.98. Marko Supply, 2924 Logan Blvd., Chicago 47, Ill.

ELECTRIC Pencl: Writes-engraves all metals. \$1.00 postpaid. Beyer Mfg., 4515-H Cottage Grove, Chicago 15.

WELDING, SOLDERING, FLATING

AT Last. Repair and maintenance welding of dirty, rusty cast iron solved by our flux. Send \$1.00 for pound package and instructions. Syracuse Flux Company, 119 So. McBride Street, Syracuse, N. Y.

MAGIC Arc electric welder has 999 uses. New model welds all metals, used by electricians, plumbers, garages, navy, many large industrial plants. Complete with all supplies, mask, rods, fluxes, instructions, \$19.95 postpaid. Immediate shipment. Literature. Sine Equipment, P376W, Quakertown, Penna.

ARC Welders wanted by the thousands. Learn with 516 page lessons manual. Over 500 how-to-do-it photos. \$2.00 copy. Money-back guarantee. Hobartweld, Box M-544, Troy, Ohio.

110 VOLT, 60 Cycle arc welders, 125 amps, 6 heats, \$35. Others, Frazee Electric Co., Box 5086, San Francisco, Calif.

WELDING And cutting outfits. Immediate delivery. Catalog 15c. Aestik Bros., 1299 Michigan, Grand Rapids 6, Michigan.

SUPER Welder—For home, farm, factory. Makes even beginner an expert. Improved on type used by Navy. Fully equipped with Metallic Arc and Flame Torch handles, carbons, rods, fluxes, mask, etc. Complete directions. Operates ac-dc, 110 volts. No extra wiring needed. Guaranteed. \$19.95. Save 2%, send check with order. Super Welder Manufacturing Co., Dept. A, 23 East 20 Street, New York.

BUILD Small, medium or large a.c. arc welder. Operate from power line. Plans \$1.00 each. Welder's Club, AB-3432, Chicago 54.

NEW Welding rod for aluminum, die cast. Generous sample, instruction 25c. Homawks, 2417-A North Ashland, Chicago.

BUILD D.C. Arc welder without rewinding armature. Plans \$1.00 each. 25 to 600 amperes from vehicle d.c. motors, light plant generators, automobile starter-generators. Welders Club, AB-3432, Chicago 54.

WELDING, Cutting, aircraft welding and soldering equipment. Electric arc welders. Superior Oxy-Acetylene Co., Hamilton, Ohio.

SLIGHTLY Used arc welders. Recommended by R.E.A. Guaranteed. Forney Mfg. Co., Fort Collins, Colo.

NEW Model electric welder 110 volt a.c.-d.c.; will weld all metals; easy to use; full directions. Complete with power unit, flame and metallic arc attachments, carbons, fluxes, rods, mask; all for \$19.95. Used by the navy. Magic Welder Mfg. Co., 193-MP Center St., New York City.

USED Arc welders \$7.50 up. Frazee, Box 5086, San Francisco, Calif.

MACHINERY, TOOLS, SUPPLIES

SCREWS, Nuts, bolts, washers, rivets, brackets, etc. Handy assortment for mechanics, garages, household use, workshops. Over 1000 pieces, 5 full pounds. Satisfaction guaranteed. Special \$1.98. Limited supply. Order now. Widran Distributors, MA-212 West Hubbard, Chicago 10.

TWIN-CYLINDER Air compressors \$13.75. Motors—various sizes, Hoffman, 2740 Coy, Cincinnati 19, Ohio.

DRILL Grinding attachment \$5.95. E. Z. Mfg., 327 California, Burbank, Calif.

ASSORTMENT New, used high-speed tools. Box 493, Flint, Mich.

LAWN Mower sharpener, simple in design. Build it yourself. Plans \$1.00. W. Hess, Dover 1, Penna.

LAY In a supply of nuts, bolts, screws, washers, rivets, etc. Over 5 lb. All sizes and shapes. Handiest assortment, over 1000 items, only \$1.98. Gateway, 4844 Milwaukee, Chicago, Ill.

READY Rest, the new soldering iron holder. Readily accessible with safety. Steals no heat. Scientifically designed to step up production of dependable soldering. Satisfaction guaranteed. \$2.25 postpaid. E. S. Mathews, Box 1064, Magnolia Park Sta., Burbank, Calif.

CLOSING. Tools, machines, welding, woodworking. See March issue. Zeidler's, Rockwell, Iowa.

CONCRETE—Building block machines and molds. Easy payments. Catalog free. Concrete Machine Co., 5129 South Compton Ave., St. Louis, Mo.

GRIND Drills like factory; attachment for bench grinder. Cheap. Factory, 811-B East 31, Kansas City, Mo.

BUILD Your tractor from second-hand automobiles. Convert your horse drawn farm equipment into tractor drawn equipment. Nolan's Garage, East Wareham, Mass.

STEEL Beam trammels for draftsmen, engineers, mechanics. Circular free. Clair Company, Box 92M, Blythebourne Station, Brooklyn, N. Y.

NEW Caliper, direct reading, speeds up defense work, cheap. Free illustrated circular. Factory, 811-G East 31st, Kansas City, Mo.

OPEN Your garage door from dash board. Look under "Automobiles."

YOU Can build shapers, mills, vises, drill presses and many other useful shop tools from Lewis castings, materials and blueprints—at savings up to 80% of new tool cost. Catalog sent on receipt of 10c covering mailing cost gives details on 23 Lewis tools. Write Lewis Machine Tool Company, Box 116, Station A, Dept. M-39, Los Angeles 31, California.

NEW Tool grinder sharpens lathe tools, slitting saws, milling and keyway cutters, wood tools and other small tools to any degree or angle. Circular and price on request. Factory, 811-G East 31st, Kansas City, Mo.

ATTACHMENT. Grind drills any twist, in long, short and 59° angles, like factory, guaranteed. \$2.95 prepaid. Factory, 1512 West Slauson, Los Angeles 44, Calif.

INDEX Heads for sale. Very inexpensive. Sixty-two different divisions. Used on small lathes, drill press, milling machines, etc. Make gears, hobbs, cutters, etc. Very accurate, and durable. Not a toy. Used by defense schools and hobbyists. Write for free folder. Long's Index Heads, 2117 East B St., Torrington, Wyo.

STEEL Wire wheel brushes \$2.50. McCann's, 2104 Texas Street, El Paso, Texas.

MICROMETERS New 0-1" \$5.95; 1-2" \$7.95; 2-3" \$9.95; 3-4" \$10.95. Reading in 1/1000". Precision. Guaranteed. C.O.D. plus postage. Cash orders prepaid. Examine five days. If unsatisfactory return for full refund. Wendler Co., Dept. 12, Fremont, Ohio.

BOATS, OUTBOARD MOTORS, ETC.

ELECTRIC Outboard motors can be built from available parts with our 7 page working drawings and step-by-step instructions. Price \$1.00. Silver Creek Precision Corp., 2 Mechanic St., Silver Creek, N. Y.

INDIAN Silver Arrow outboard motor parts. Indian Motorcycle Sales, Inc., 354 Columbus Avenue, Springfield 5, Mass.

MARINE Power—Easily convert any Ford motor (domestic and foreign) with Osco parts and kits. Complete catalogue 25c (coin). Osco Motors Corp., 2020 East Orleans Street, Dept. M, Philadelphia 34, Penna.

USED Outboard motor parts. Outboard Exchange, 1194 Remsen Ave., Brooklyn, 12, N. Y.

FULL Size, cut to shape boat patterns, blueprints, 7 1/2 - 38 feet. Illustrated "Build a Boat" catalog, 10c (coin). "How to Build Boats" book, \$1.00. Cleveland Boat Blueprints Co., Station A-66, Cleveland, Ohio.

OUTBOARDS — Save 1/2. Good used parts, all makes and models. Bargains re-built motors. Crandall Hicks Co., 959 Commonwealth, Boston, Mass.

TEN Plywood boat plans 50c. Catalog boat building plans 10c. The Rudder, 15 Murray Street, New York.

ENGINES, MOTORS, DYNAMOS

AUTHORIZED by W.P.B. to sell inventory of new a.c. and d.c. midget motors—Both geared to 4 r.p.m. Shaft speed 1250 r.p.m. 110 volts. Ideal for timing devices, displays, models. Bargain price a.c. motor \$2.00. Length 3", height 2 1/2", width 2 1/2" d.c. \$3.00. Length 5 1/2", height 2 1/2", width 3". McLaren Products Company, 114 N. W. First Street, Evansville 8, Indiana.

BIG Pay jobs in welding. Complete welding lessons and reference books, 516 pages, 41 lessons, \$2.00 copy. Money-back guarantee. Hobartweld, Box 545-M, Troy, Ohio.

MOTORS—1/2 h.p. 3450 speed, repulsion induction, a.c. \$20.00; 3/4 h.p. \$24.00; 1 h.p. \$30; 1 1/2 h.p. \$38.50, other bargains. Willmot Auto Supply, 2558 Armitage, Chicago 47, Ill.

WINDING Data, 225 motors, single and three phase, \$1.00. Motor Data Co., Box 7631 Kansas City 3, Mo.

ATHLETIC EQUIPMENT—BODY BUILDING COURSES

BAR-BELLS, Exercise equipment. Courses. Special offers! Free booklet. Good Barbell Co., 3261-PM Watson Rd., St. Louis (9), Mo.

SUPER System of natural physical training. Free booklet. Harry Good, 3261-PM Watson Road, St. Louis (9), Mo.

LEARN Guerilla self-defense. Beats Jujitsu. Circular free. Crown Books, Charlotte 3, Mich.

STREAMLINED System — rugged strength—quick easy results. \$3 course. Jim Burke, 244 Riverdale, Toronto, Ontario.

PHYSICAL Perfection course \$1.00. 1000 strong men. Sid's System, DPMM Southgate, California.

SUPER Ju-Jitsu—lightning defense and attack system. Sensational new home study course now ready! Learn to lick brutes twice your size with only your bare hands. Free details. Nelson Co., Dept. 508, Chicago.

SPORTING GOODS, GUNS, FISHING TACKLE, ETC.

SPORTSMEN: Do you specialize in outdoor sports such as fishing, hunting, trapping, big game hunting, camping, etc.? \$2.25 brings postpaid a 514 page attractively cloth bound sportsmen's encyclopedia of valuable information and hints on above titles. Increase your knowledge and chances in your favorite sport. What more need be said? Order yours now. Compare prices with similar books. Alvin Decker, 390 N. Hull Ave., Benton Harbor, Mich.

CAPTAIN Harrison's Fishing Guide. Just out. 25c (coin). Sport Fisherman, 670 East 42, Brooklyn, New York.

45 CALIBER Automatic, reloads, \$2.70 per 50. Anchor, 21, Ithaca, N. Y.

SEND 10c For list 100 used guns. Frayseth's, Willmar, Minnesota.

AUTOMATICS, rifles, shotguns—with ammunition, guaranteed N.R.A. Descriptions. List 10c. Hunting knives—Hand forged 7" blades with sheaths (service men's favorite) \$9.75 money order. Rudolph's, Atchison, Kansas.

WEAVER 3308 Scopes \$29.70, mounts additional. Binoculars, etc., stamp for list. Stanley Wentling, Palmyra 1, Penna.

BOY-SCOUTS, Campers, U.S. Army surplus used equipment, pup tents \$1.95. Mess-kits 75c. Canteens with cover cup \$1. Packs \$1. Cartridge belts 50c. Complete set \$5. Samet Sales Co., High Point, N. C.

ARCHERY Equipment: Catalogue free. Mid-West Archery, 2209-A East 75th, Chicago 49.

BOWS—Arrows for recreation, hunting, fishing. Beautiful archery instruction book, 90 pages, 50 illustrations, only 50c. Illustrated catalogue free. Archery Sales Service, 617 South State, Chicago.

SNOWSHOES: Immediate delivery, re-lacing also. Send card for sizes available. Howe Fur Company, Coopers Mills, Maine.

FISHING By moon aspects. 1944 moon chart with formula 35c. WEZ Planetarium, Box 558-P, La Jolla, Calif.

ELEVEN Good box traps. Complete blueprints. 30c. Wesho-Uco, Box 51, Detroit, Mich.

GUNS Reblued, plated, repaired. Nickel guns blued. Bluing material. Gunblu, 322M Plant, Tampa, Fla.

THE Lord is coming! Get guaranteed proofs free. Scheall, 263XS, Duluth, Minnesota.

MAKE Landing nets, turtle traps, live bags, hammocks. Patented shuttle and book 50c. Netcraft, Dept. A, Toledo, Ohio.

FIELD GLASSES, MICROSCOPES, TELESCOPES

MICROSCOPES—15 Years buying, selling, exchanging, repairing, accessories, research, industrial, amateur. National Scientific Instrument Co., 119 Chambers St., New York City 7.

MAKE Powerful, perfect telescopes, microscopes, telephoto cameras. Trifling cost. Instructions 10c each instrument. A. Jamer, Manorville, N. Y.

BINOCULARS, Field glasses, watches. Buy, sell. Paul Schweer, Donnellson, Ia.

ASTRONOMICAL Telescopes, binoculars, cameras, microscopes; bought, sold, repaired. Send 10c for list of instruments desired. Rasmussen, Box 294, Amsterdam, N. Y.

MICROSCOPES, Telescopes, binoculars; all scientific, chemical, laboratory apparatus—bought, exchanged. Exclusively our business for fifteen years. Not get-rich-quick speculators. Trial will show that we know apparatus; highest prices paid. Harry Ross, 64 West Broadway, New York.

ANTIQUES, RELICS, INDIAN GOODS, CURIOS

RELICS, Minerals, coins, miniatures. Catalog 5c. June's Antiques, Northbranch, Kansas.

25 GENUINE Indian arrowheads, \$1.00. Catalog. Geo. Holder, Glenwood, Ark.

INDIAN Relics, coins, bills, gems, crystals, curios, etc. Illustrated catalog 5c. 100 ancient arrowheads \$3.00. H. Daniel, Hot Springs, Ark.

THOUSANDS Indian arrows, tools; "rainbow variations." Don McKillop, Regina, Sask.

10 TINY Prehistoric bird arrowheads \$1.00. 4 agate bird arrowheads \$1.00. Tomahawk 50c. List. Lear's, Glenwood, Arkansas.

MINERALS, Coins, stamps, Indian relics, pistols, old glass. Catalogue 5c. Vernon P. Lemley, Las Cruces, New Mexico.

INDIAN Relics, beadwork, coins, curios, minerals, old glass. Catalog 6c. Indian Museum, Osborne, Kansas.

1944 ANTIQUE Firearms catalog. 25c. House of Guns, Belleville 9, N. J.

SWORDS, Rapiers, daggers, pistols, armor, illustrated catalog 25c. Robert Abels, 860-A Lexington Ave., New York.

DOGS, PETS, BIRDS, RABBITS

BUILD Your own rabbit hutch. Simple, inexpensive, eliminates odors, dirt, diseases. Instructions, photos, drawings 50 cents. River Hill Rabbitry, Box 644, Eagle River, Wis.

STANDARD Rabbit Journal, Milton, Pa. 3 years \$1.00, sample dime.

ST. BERNARD Puppies, registered. Trant, 2472 Mass Ave., Cambridge, Mass.

MAKE Money at home raising guinea pigs. Booklet free. Taylors Guinea Pig Farm, Hapeville, Georgia.

MICE, Rabbits, pigs, pigeons. Information 10c. Jim Houck, Tiffin, Ohio.

ST. BERNARD Puppies. Champion sired beauties. Franklin Young, R4, Riverhead, Long Island, New York.

PUPPIES, Also supplies, what do you need? Books colored pictures, descriptions 108 recognized breeds, 35c. Royal Kennels, Chazy, N. Y.

RABBITS: Flemish Giants, New Zealand. Reasonably priced. Franklin Young, Riverhead, Long Island, New York.

HELP National defense by producing meat in your back yard raising domestic rabbits. Old and young can do it. Send 25c for booklet and literature to Dept. G, American Rabbit and Cavy Breeders Ass'n, Colorado Springs, Colo.

MOST Beautiful fur. Small investment. Large profit. Free illustrated booklet. Willow Brook Farm, R. D. 13, Sellersville, Penna.

BIRD Fanciers. American Canary Magazine Monthly. Year's subscription \$2.00. 2839-P N. Halsted St., Chicago 14, Ill.

RAISE Rabbits for profit. Magazine puts you in touch with markets. Copy 10c. Booklet describing twenty breeds, and magazine for three months 25c. Address Small Stock Farmer, Dept. 3, Pearl River, N. Y.

MONEY Raising rabbits. Investigate. Folder 10c. Close Rabbitry, Tiffin, Ohio.

RAISE Highly profitable Angora rabbits. Multiply fast. Wool \$8.50 pound. Plenty markets. Particulars free. White's Rabbitry, Marion, Ohio.

FARMS, FARM LANDS, REAL ESTATE

200-ACRE Highway farm, only \$3,750! Handy location, famous Missouri Ozarks, electric line, school bus, state highway, 2½ miles store, only 110 all advantages big city; 160 tillable, 60 cultivated, 30 valley land, mostly all pasture now, 20 woven wire fenced for hogs, 3 ponds, 4 wooded; 3-room house, just fair, electricity available, 60-ft. fair barn, hay fork, garage; real buy for livestock, diversified farming; not far good fishing, hunting; now only \$3,750, \$1,450 down. Free Spring catalog 7 states, United Farm Agency, 7-MP South Dearborn, Chicago 3, Ill.

40 ILLINOIS Corn belt farms. Goodell Farm Service, Loda, Illinois.

FARM Catalog mailed free. Hundreds of bargains New York, Connecticut, New Jersey and 21 other states Maine to Florida, west to Texas, California and Oregon. Strout Realty, 256-P 4th Ave., New York 10, N. Y.

\$4.00 MONTHLY Buys 40 acres, near town; price \$150.00. Free list. Box 425-P, Carthage, Mo.

ORLANDO, Fla. Small farm. Cheap. Write owner direct. Richardson, Wyoming, Penna.

OBTAIN Free fertile South-American farm lands. Interesting descriptive folder, 10c. Three illustrated booklets, 25c. Valles, 311 Church Street, New York 13.

40 ACRES, Near White River, unimproved; poultry land. \$190. \$9 down. \$5 monthly. Free list and literature. Hubbard, 216 Grossman Bldg., Kansas City, Kans.

ORLANDO, Florida. 5 acres on paved highway. Good fruit and vegetable land; easy terms; free booklet. Dept. 10, Interstate Development Co., Orlando, Florida.

SEE The Highlands of Louisiana where winter brings no idle acres. Choice cut-over land at low prices with terms. Send for descriptive book without obligation. Long-Bell Farm Land Corporation, 896 R. A. Long Bldg., Kansas City, Mo.

GOOD Farm bargains. Washington, Minnesota, Montana, Idaho, Oregon, North Dakota. Dependable crops, favorable climate. Write for literature, lists describing typical farms. Specify which state. J. W. Haw, 119 Northern Pacific Ry., St. Paul, Minn.

WISCONSIN, Minnesota lake frontage \$7 acre! 2662A Rutherford, Hollywood 28, Calif.

FARM MACHINERY AND SUPPLIES

INTERNATIONAL Electric fence far superior, more effective and reliable. Quickly pays for itself. Repairs for all makes of electric fences. Dealers wanted. International Electric Fence Co., 910 Van Buren St., Chicago, Illinois.

POULTRY, FARM SUPPLIES

NO Down draft—Accurate revolving ventilators are best for poultry houses and brooder stoves, etc. Literature, prices. Accurate Mfg. Works, 2336-38 Milwaukee, Chicago.

RAISE Turkeys the new way. Write for free information explaining how to make up to \$3000.00 in your own back yard. Address National Turkey Institute, Dept. 3, Columbus, Kansas.

BABy Chicks, champion mated. 52 varieties, 7 hybrids, licensed inspected, blood-tested. Rush postal, large colored book, low prices. Berry's Farm, Route 12, Clarinda, Iowa.

PROFITABLE OCCUPATIONS

MEN—Open your own electrical appliance shop. Learn house wiring, motor repair, household appliance repairs. Be independent. Complete, illustrated course shows how. Free literature. Mechanics Training, 4703 West Pico, Los Angeles 6.

DON'T Be caught napping. Plan now for peace time business of your own. Particulars. Winfield Hess, Dover 1, Penna.

MUSHROOMS Grown in boxes, instructions 25c. Spawm \$1.00. Gordons, 553 William, Winnipeg, Canada.

WELDING Pays. Learn with 1942 trade school text manual. 516 pages. Over 500 photos. \$2.00 copy. Money-back guarantee. Hobartweid, Box M-543, Troy, Ohio.

MECHANICALLY Inclined men — Own and operate general appliance repair shop. Complete, illustrated course shows you how. Welding, refrigeration, motor repair, how to get business, etc., all phases covered. Free literature. Christy Supply Dept. 440, 2835 N. Central Ave., Chicago.

SIGNS Made easily. Instructions and ten sets modern alphabets; numerals, patterns. Sizes up to eight inches. All for \$1.00. Co-Operative Service, Box 638, Chicago.

LEARN Refrigeration service. Open your own shop. Complete illustrated course reasonable. Small capital required. Free booklet. Dept. PM4, Mechanics School, 4703 West Pico, Los Angeles 6.

NEED Cash? Profitable, spare-time homework. Guaranteed! 50c. Homework Service, 814 - 44th, San Francisco.

PEN Raised fur animal. Reproduces 7 every 19 weeks. Fur worth \$7.00. Disease free. Eats hay, grain, vegetables. Flesh edible. Young sell \$75.00 pair. Further details free. Will Tysen, Glenns Ferry, Idaho.

RAISE Angora rabbits—Wool brings \$8.00 pound. Particulars free. Grinstead's, Edwardsville, Illinois.

ANNOUNCING New home study course in commercial baking. Good field. Nearly depression proof. Common school education sufficient. Send for free booklet "Opportunities in the Baking Industry" and requirements. National Baking School, 1315 Michigan, Dept. 3432, Chicago.

LOCKSMITHING Course—Practical inexpensive lessons for handy men. Just out! Fit keys, pick locks, de-code make masterkeys. Satisfaction guaranteed. Send for free details. Nelson Co., Dept. 708, Chicago.

\$40.00 WEEKLY. Made growing mushrooms, fresh, dried. Dominion patent 331583. Free spawn. North American, 169P Yonge, Toronto, Canada.

BOOKS, PERIODICALS, PICTURES, POSTCARDS

MAGAZINES—Business, vocational, diversion. Current single copies only. Choose from 573 different publications, covering advertising, aviation, automotive, building, electrical, health, insurance, live stock, medical, music, photography, plumbing, radio, refrigeration, sports, watchmaking and more than 150 other fields. List with prices free. Commercial Engraving Publishing Co., 34C North Ritter, Indianapolis 1, Indiana.

THE Latest manual on multispeed three phase motors includes Nema standards connection diagrams, 2 to 36 poles wattmeter coil pitch, etc., price \$2.00 or write for more literature. Electric Generator Mfg. Co., 1333 N. Dale St., St. Paul 3, Minnesota.

RENT Books now from Victory Service, Dept. PM-1, Emmaus, Penna.

MAGAZINES (Back-dated)—Foreign, domestic, arts. All publishers. Bargain prices. Also books, booklets, pin-ups, subscriptions. Catalogs 10c (stamps accepted). Ciccone's, 863 First Avenue, New York 17.

ARTISTIC Girl pictures. Real models. 40 photos for \$1.00 postpaid. All different, postcard size. C. A. Scott, P.O. Box 342, Covington, Ky.

ART Magazines 25c; (old copies) 6—\$1.00, postpaid, catalogue 10c. Sign, Dept. Pm., Farmington, Missouri.

GORGEOUS Glamour girl pin-ups. 75x9 1/2. 12 different 75c. Free illustrated catalog. Cavalier, 5448 Stanton, Pittsburgh 6, Penna.

"LEARN To Draw From Art Models." Book contains gorgeous photographic action poses and anatomy-figure-guides, \$1.00 prepaid. Ray Rogers, 215 Montague Street, Studio 25, Brooklyn, N. Y.

FINGERPRINT Reader. learn to read and classify your fingerprints according to leading identification system. \$1.00 cash or c.o.d. Webb, Box 2816, Los Angeles 53, California.

"MAIL Merchandise Mart" features unusual merchandise, novelties, literature, swaps, opportunities. Dime brings it. A. Chervence, 1540 North State, Chicago 10.

A RATIONAL View of Life—\$1.00. Benjamin Seibert, Urbana, Ohio.

PSYCHIC Paper 10c. Bobbitt, 1609 Tenth Avenue North, Nashville 8, Tenn.

PIN-UP Pictures. 5x7. Dozen 35c. Curtis' Specialties, Box 1916, Denver, Colo.

DARING Exposure. "Rackets That Get Your Money." Twenty chapters, \$1.00. Alrao, 2321 Allen, Allentown, Penna.

NO Need to buy mail order educational books! New, read and study plan, saves you money! Details free. Phil Bruce, Box 341-AB, Palo Alto, Calif.

64 ART Cards of gorgeous beauties \$1.00. Reed Novelty, Dept. PM-1, Box 34, Queens Village 9, N. Y.

BOOK Bargains. Catalogs free. Sterling, D-71 West 85th, New York.

25 ARTISTIC Pictures; lists, books, novelties, 50c. Western Sales, Hillstreet Building, Los Angeles 14.

ANY Book (new, used out-of-print, rare) promptly supplied! Lowest prices! Send for free bargain catalogues! Old Prof's Book Shop, M16 Arcadia Court, Pontiac 16, Mich.

PICTURE Post cards produced from your photograph. For hotels, camps, resorts. 4154a Fifth Street, Philadelphia 40.

BOOKS—Tell us your wants. Chapbooks, 6 Girard, Rochester 10, N. Y.

NEW—"Fighting Sea-Bee" cards! Set of 10—cleverly worded, illustrated, for \$1.00. "Love," "My Mate," "Girl Back Home," etc. Buy for yourself; send to friends, in service and out. Photo Service, Box 5490, Metropolitan Station, Los Angeles 55, California.

HELPFUL Books for your trade, hobby or business. Lists on any subject free. Helpful Book League, 1239 Broadway, New York 1, N. Y.

SELF-EXPLAINING Bible: Illustrated circular free. Box 446-P, Minneapolis, Minn.

"PIN-UPS," 180 Gorgeous girl subjects! Huge bargain pack \$1.00. Clover Novelty Company, Dept. 32-DD, Hollis 7, N. Y.

BOOKS. (Out-of-print, new, used) quickly supplied. Many 35c bargains. Catalogue. T. Jamkowski, 18870 Marx Ave., Detroit 3, Mich.

DRUNKENNESS is a disease which responds to treatment. Medical skill plus human sympathy prove successful with liquor and drug cases. 60 years experience. Write for free booklet. P. M. Nelson, The Keeley Institute, Dwight, Ill.

GET Your copy now of the never forgettable book "I am an American." Sent postpaid 25c. Manville, Box 1873 PM, Atlanta 1, Ga.

WE Locate rare and out-of-print books. Southern Bookfinders, 1210 N 11th Ter., Birmingham, Ala.

MAGIC TRICKS, PUZZLES, JOKER NOVELTIES

"102 MAGIC Tricks" only 15c at newsstands, book, stationery stores. By mail 25c. Robbins Co., Publishers, 152 West 42nd, New York City.

NEW! Simplified card tricks! Amazing self-working bafflers 50c postpaid. James W. Roundtree, 529 Elliott St., River Rouge, Michigan.

LINDO Mindreading act—50c. Professional system simplified. Write, Lindo, Spivak, Colorado.

AMAZE Friends—Greatest mysteries explained—406 pages, \$1.00. Wilkes, Oberlin, O.

BE A magician. Large professional magic catalogue of latest tricks 25c. Ireland, C-109 North Dearborn, Chicago 2.

PUZZLES, Magic, jokers, catalogues 10c. Sign, Dept. P.M., Farmington, Missouri.

"PAPPY'S Bathroom" makes soldiers roar with laughter. You will too. Only 10c. Lewis, 340 Chestnut, Oneonta, N. Y.

LOTS Of fun. You can make an ordinary sewing needle float like a toothpick after two minutes practice. Full instructions 25 cents coin. H. Holcomb, P.O. Box F, South Charleston, W. Va.

DOUBLETALK. Great fun wherever you go. It's easy. Complete, guaranteed, 25c. Elbac, 22651 Chardon, Cleveland 17, Ohio.

AMAZE, Mystify friends—\$1000.00 worth magic secrets made the world famous. Big volume only \$1.25. Lindhorst, The Magician, 510 Pine St. Louis 1, Mo.

500 TRICKS You can do! Douglas' famous catalog of 500 tricks, 128 pages, now only 10c. America's fastest service on magic for pocket, parlor, stage, professional, amateur. Douglas Magic Shop, Box 274, Dallas, Texas.

QUALITY Magic since 1907. Send 25c for catalog. Thayers, Box 1785 Wilshire LaBrea Station, Los Angeles, Calif.

MAGIC Tricks, puzzles, books, cards, punch boards. Catalog 10c. Specialty, Box 671, St. Louis 1, Mo.

WORLD'S Largest professional magic shop keeps you in touch with latest tricks. To receive mailings send 25c for 1943 catalog. Holden, 220 W. 42nd St., New York.

NEW Vanishing key and catalog 25c. Sterling Magic, 345 John R. Detroit, Mich.

ANSWER Unknown questions. Professional "Medium's" mindreading course, \$1.00. Magical Enterprises, Box 111P, Roseville, Mich.

MAGICIANS' Headquarters. 216-page catalog, pocket, parlor, professional tricks. 25c. Kanter's, M-1311 Walnut, Philadelphia.

HOLLYWOOD Special! Magicians button, catalogue, ghost illusion and free trick for 25c. Magic House of Charles, Box 888, Hollywood, California.

EARN Money in any crowd. Call names of strangers, tell unspoken questions. Professional course mind reading, spirit writing, etc., \$1. Henderson, Box 341, San Bernardino, Calif.

HOBBIES AND COLLECTIONS

25 BEAUTIFUL 2 1/2" Ozark rocks \$2.50 postpaid. John Jennings, Eureka Springs, Ark.

DICTIONARY: The Chippewa Indian language, 50c. Patriotic covers, 6 different 25c. H. C. Hill, 703 Beach, Flint 3, Mich.

25 AMERICAN and foreign colored war plane pictures. 25 cents. James Dunn, 7252 So. Lowe Ave., Chicago 21, Illinois.

DIME Brings ten swell world's fair colorcards. Star, Whitinsville, Massachusetts.

STAMP And hobby magazine free. Barrington Smithco, Halfwaytree-10, Jamaica, B. W. I.

MAKE Money with hobbies. Postal brings details. Co-Operative, Seven Randolph Place North West, Washington, D. C.

GENUINE Arizona rubies (garnets) and desert sapphires. Send quarter for packet. Mineral Specimens Company, Box 2651, Phoenix, Arizona.

WANTED: Old cigarette cards. Write Charles Bray, East Bangor, Penna.

MATCH Hobby "bulletin" membership blank free. Box 202 Rochester 1, N. Y.

NEW MEXICO-Arizona southwest colored folders 15c. Empire, Corona, New Mexico.

LIST Of collectors desiring to exchange stamps, matchcovers, postcards, etc., 10c. Kurtz, 446 Liberty, Allentown, Penna.

"MAKE Money With Hobbies." \$1.00 postpaid. Literature free! Peck, 301B Eldred, Battle Creek 21, Michigan.

SEMPRECIOSUS Stones, how to cut and polish, equipment, etc. Book \$1.00. Home Lapidary Shop, Madera, Calif.

CHARACTER Dolls for collectors. Including story book. Stamps please. Flower Farm, Copley, Ohio.

JEWELRY Stones removed from rings, etc. 100 assorted \$2.00. Lowe's, Box 311, St. Louis 1, Mo.

UNUSED Match book covers. 100 all different \$1.00. 35 Royal Flash covers \$1.00. Free list. Charles Edelman, 1311C East 84, Cleveland 3, Ohio.

NEW—15 Different match covers 10c. Box 202, Rochester 1, N. Y.

COINS, TOKENS, CURRENCY

WE Buy Indian pennies, Lincoln pennies and old rare coins. Highest prices paid. Indian pennies worth up to \$15.00 each, Lincoln pennies up to \$2.00 each. Other rare coins \$5.00 to \$2000.000 each. Send 10c today for new 1944 price catalogue of all wanted U. S. coins. American Rare Coin Co., Dept. 1, Transportation Bldg., Chicago.

OLD Money wanted. Do you know that coin collectors pay up to \$100.00 for certain U. S. cents? And high premiums for all rare coins? We buy all kinds. Send 4c for large coin folder. May mean much profit to you. Numismatic Co., Dept. 20, Fort Worth, Texas.

WOODEN Money: Souvenirs Apollo's Quasqu-Centennial. Denominations, 10c and 25c. Four issues. Sold par. Postpaid \$1.00 or more. Money order or cash. T. E. McCullough, Vice Pres. Quasqu-Centennial Corp., Apollo, Penna.

SAN FRANCISCO Mint new silver dollars 1921, 1922, 1923, 1926, 1927, \$1.50 each. 5 different Jefferson nickels 50c, new coin book 50c. Coin Shop, Box 77, Alameda, Calif.

THREE Coins and lists 10c. Oddehon, Box 482, St. Louis, Mo.

UNCIRCULATED Jeffersons, Indians, Lincolns. Earl Timmer, Route 3, Hamilton, Ohio.

INDIAN Head penny with list 10c. Charles Banker, Salina, Kansas.

10 INDIAN Head cents, different dates, also price lists, 40c. Schultz, 1053 Richmond, Cincinnati, Ohio.

WILL Pay \$10.00 each for certain Lincoln pennies! Indianheads \$50.00; dimes \$1,000.00. Catalogue 10c. Federal Coin Exchange, 4-PM, Columbus, Ohio.

30 DIFFERENT Foreign coins \$1. 100 different \$4. Free list, approvals. Delmonte, 725 West 172, New York 32.

SCARCE Collection contains large cent over 85 years old, flying eagle cent, white Indian cent, 2c piece, 3c piece, foreign coin, foreign bill and our latest buying and selling list. All for \$1.00. 28 different dates Indian cents \$1.00. 25 different foreign coins \$1.00. Worthy Coin Corp., 23-E Cornhill, Boston, Mass.

DOLLAR Specials—(All different dates), 25 Indian cents; 4 old dimes; 35 mixed uncirculated 1944-PDS cents; 12 wooden nickels; 20 Austria-Germany Notgeld and inflation notes. Add 10c postage all orders. Highest prices paid gold, other coins, currency. Buying list 3c. Large retail catalogues 10c. Bebee Coin Company, 1180 East 63rd, Chicago 37, Illinois.

COMPLETE Catalogue of all U. S. coins 1/2c to \$1.00. 75 illustrations. 3500 quotations. Price 10c. James Randall, 341 South Dearborn, Chicago.

GET Profit and pleasure in collecting old coins. Send 10c for 56-page illustrated coin catalog. You'll be delighted with it. Send for it now. B. Max Mehl, 376 Mohl Bldg., Fort Worth, Texas. Largest rare coin establishment in U. S. Established 44 years.

COMMEMORATIVE 3/4¢ — Texas, Kentucky, York, Elgin, Cleveland, \$1.50 ea. Illustrated catalogue 10c. Norman Shultz, Salt Lake City, Utah.

FREE! Foreign coin, banknote and coin collectors illustrated catalog to approval service applicants. Send 3c postage. Tatham Coinco, Springfield-125, Mass.

I MAY Have just the scarce U. S. coins you want. Send me list. "Meet me by mail." William H. Kenworthy, Waterville, Maine.

DOLLAR Assortments, every item different. 22 paper moneys, 10 encased postage stamp money, 30 foreign coins, 25 Indian head cents; each lot \$1.00. All-Nation, 157 West Lake, Chicago 1, Ill.

VALUABLE Coin information and lists. Alwick, 5437 Nagel, St. Louis, Mo.

STAMP COLLECTING

"THE World's best \$1.00 packet." Contains 19th century airmails, commemoratives, semi-postals, regular issues, etc. Both United States and foreign. 100% satisfaction or your \$1.00 plus a 10c war stamp returned. Fort Orange Stamp Company, Albany, New York.

POSITIVELY Greatest free offer—Latest Scott's International \$5.00 Stamp Album—covering entire world, contains 36,000 illustrated, descriptive spaces, Scott's 1944 Standard \$5.00 Catalogues "Philately's Encyclopedia" — absolutely free to applicants for foreign approvals becoming customers. Plymouth, A-9, Bell, California.

60 DIFFERENT United States old issues, higher values, commemoratives—10c. Charles Stone, 3547 28th St., Astoria, N. Y.

125 ALL Different U. S. \$1.00. Old, new issues—Comms., postage, dues, famous Americans, airmails, etc. Good condition. Lightly cancelled. Guaranteed to please. Try our foreign packets 10c each, 3 for 25c. 14 packets \$1.00. All different. Bargain. Approvals sent on request. Armour Stamp Co., St. Albans, N. Y.

500 GUMMED Labels—Name, business and address. 50c. Lyle Moore, 2854 Harris Place, Norwood 12, Ohio.

FREE! \$1.00 and \$5.00 dues. Complete set free to serious collectors with unusual approvals. Send 3c postage. Forest D. Wilson, 711 North A Street, Tampa 6, Florida.

FINE Packet 10c with approvals. Rhode, 139 Windsor, Reading, Penna.

U. S. Stamp mixture. 100 lbs.—\$12.00; 50 lbs.—\$7.00; 25 lbs.—\$4.00. S. Parkey, 2328 Harrison, Detroit 16, Mich.

FREE Your choice of any 10 stamps from our first U. S. approval selection. Illustrated list included. Cosmopolitan Stamp Company, Dept. M-5, 1457 Broadway, New York City.

FREE St. Helena pictorial and big surprise packet to approval applicants. Pioneer, Box 414, Pasadena 18, California.

FINE Approvals, freshly mounted. Fast, personal service. Tell me what countries you prefer and I'll send their stamps. Skinner, 345 East Ocean, Long Beach 2, Calif.

127 DIFFERENT Stamps including Free Fighting French, Haiti, Johore, Cochon, only 10c to approval applicants. Reich Stamp Co., 4647 Kenmore, Chicago, Dept. M8.

80c VALUE—U. S. exhibition sheet, telegraph stamp—almost 60 years old, 25 more different U. S. Only 10c to new applicants for my U. S. approvals. Steger, 1165 Downing, Denver, Colorado.

1000 GRABBAGS 15c Each. 8 different \$1. Special bags. Free French included 25c. Zandy, 630 Bingham, Reading, Pa.

ARRANGED By country approvals. South and Central American, British Colonials, European, etc. H. Zimmer, 722 Culver Road, Rochester, N. Y.

ONE And two cent approvals. South America, British and French Colonials, Europe. Scotty Stamp Co., 627 W. 239th St., New York 63, N. Y.

STAMPS From 20 different countries free. Quality penny approvals included. Harding Stamp Shop, 5031 No. Harding, Chicago 26, Illinois.

PATRIOTIC Covers. 15 beautiful covers. Different. 50c. H. E. Curtis, 5748 Geary Blvd., San Francisco 21, Calif.

"THE Best"—United States and Philippine Islands approvals. Largest varieties. Lowest selling prices in America. Stamp Company, Albany 3, New York.

FREE United States price list. Postage 3c. Mark Hanna, 335 - 5th Avenue, Pittsburgh, Penna.

INTRODUCTORY — Request approvals, enclose 10c, keep 30c worth as premium. Lon's, 1360-M Pacific, St. Paul 6, Minn.

FREE! Complete "United States" stamp catalog with 1,000 illustrations! Send 10c to cover mailing. Harris & Co., 137 Transit Building, Boston, Mass.

BRITISH Colonies packet, only 3c to approval applicants. Smith, 237-A 8th Avenue, Roselle, N. J.

STOCK Book holds over 400 stamps 20c, 6 for \$1.00. Nu-Way, 205 East Broadway, New York City.

TREASURE: 500 Assorted stamps \$1.00. You'll want more. Kobernik, 3610 North Claremont Ave., Chicago.

FREE—10 Stamps from first approval selection. Quality Stamp Service, Waverly, N. Y.

EUROPE—40 Years old. 20 different 10c. Elsea, Bowling Green, Ohio.

SPOT Cash paid for stamp collections. Pkeigwin Company, Vineland, N. J.

A "RAM" Tank and Corvet stamp, 3c with approvals. Knopp, Box 1381, Bristol, Conn.

1,000 MIXED United States stamps—\$1.00 issue and comms. included—25c. Lincoln Exchange, 173 Columbia, Irvington, N. J.

DELUXE Packet, 77 different only 5c with choice approvals. Broadus, 545 Jefferson, Lexington 12, Kentucky.

10 BRITISH Colonial war tax 5c with approvals. Empire Stamps, Box 824, Buffalo, N. Y.

MIXTURES—500 England, 500 Canada, 500 U. S., all \$1.00. French, New Gretna, N. J.

CANADA Wholesale. List free to dealers. Fred C. Peters, 155 Alexander Ave., Winnipeg, Man., Can.

SPAIN 50 Different 10c to approval applicants. Paul Rawden, Box 2920 Westville, New Haven, Conn.

15 PARAGUAY, 3c With approvals. Super Stamp Shop, 6 S. Madison, Greencastle, Indiana.

50 DIFFERENT U. S., many commemoratives, 5c. Gerhardt, 2804 Rio Grande, Austin, Texas.

1000 MIXED U. S. old and new 25c, 2 lbs. \$1.00. Weatherby, So Euclid 21, Ohio.

CYPRUS, Luxembourg, Natal, Thrace, Syria! Plus 25 others! Only 10c. Approvals. Benton Ryan, Middletown, Conn.

FOUR Mozambique triangles 10c with approvals. Vargo Stamps, Racine, Wis.

AMAZING Pictorial packet 3c with approvals. Sullivan's, Fairport, New York.

10 TRIANGLES—Mozambique airmail commemoratives, 10c. Approvals. Reuter, 611-B West 40th, Los Angeles 37.

125 DIFFERENT—25c. 300—50c. Approvals. Zampino, 2022 West Ninth, Brooklyn.

FREE! 33 United Nations. 3c postage. No approvals. Hulette, 29 E. 39, New York.

\$10 WORTH New issues sets sent regularly on approval against excellent references. Stamporium, 2660 Rochester, Detroit 6, Mich.

50 FREE, Pictorial, etc., stamp dictionary, list. Bullard, Newcastle, Maine.

"UNITED States only." Better approvals. Reasonable prices. Box 488, Minneapolis.

100 ALL Different U. S. 15c. Monjar, 1750 Fairmont, Cincinnati, Ohio.

SCARCE U. S. seconds. Approvals. Herrnfelds, 551 Clinton Ave., Newark, N. J.

500 U. S. commemoratives, airmails, others, 70 varieties guaranteed, 25c. Hogan's Stamps, Ashland, Wis.

MISSION Mixture 1 lb. \$1.00. Zipper, 3226 Parade, Erie, Penna.

NICE Approvals for general collectors. Kress, Box 144, Hanover, Penna.

50 DIFFERENT U. S. revenues 98c. Approvals. Aldershot Exchange, 328 Westowne, Baltimore, Maryland.

73 DIFFERENT Tannu Tuva for \$2.00. Gabler, 1210 Brooklyn, Ann Arbor, Mich.

300 WORLD Mixture, excellent value. 30c. Burns, 153 N. Menard, Chicago 44.

25 DIFFERENT Russia 10c with free lists. Mayfield, Route Three, Chattanooga 9, Tenn.

LIBERIA—"Alligator" ship, complete. Send 10c. Approvals. Buchanan, 307 East 23rd, New York 10.

OVERSTOCKED, U. S. bargains. No's. 186, 211, 381, etc. 10c. Better grade U. S. up to 75% discount. On approval. Quinn, D-570P, Madison 1, Wis.

PRESIDENTIALS, 30 Varieties, 65c. Famous Americans, 35 varieties, 80c. Hector Little, Millbury, Mass.

PHILATELIC Specials—1,000 different British Colonials, only \$14.00; 1,000 different Europe, \$6.00; 1,000 different South and Central America, \$10.00. W. L. Bedard, Dept. C, 3420 Montclair, Detroit, Michigan.

U. S. Mint commemoratives, 25 different \$1.00. Zyla, 709 Spring, Utica, N. Y.

UNPACKED Mixtures; large variety, \$1.00 each, everything \$4.50. 6500 U. S., 1000 U. S. 1857-1926, 500 U. S. 1854-1918, 175 different U. S., 3000 British Empire. Satisfaction guaranteed. John Kuhn, 3712 85th, Jackson Heights, N. Y.

GOYA Nudes (2 vrs.) 10c. Approvals. Millhiser, 7724 Abbott, Pittsburgh, Penna.

200 DIFFERENT Foreign, 30c. Many countries. Jem Stamps, Port Jefferson, N. Y.

OLD Phonograph records are valuable. Some Bing Crosby, Louis Armstrong and others are worth several dollars each. Write for collectors catalogue—\$1.50. Hollywood Premium Record Guide, P.O. Box 2829, Hollywood 28, Calif.

SMOKY Mountain commemorative sheet, largest U. S. stamp issued, and 33 U. S. including commemoratives, airmail, revenues, etc. Catalogs 75c—To approval applicants for 5c. Curhan Stamp Company, Gloucester, Mass.

19th CENTURY U. S. comms. Civil War revenues, battleship \$5 and \$10 stamps free to U. S. approval applicants. Metropolitan Stamps, 198-C Broadway, New York.

VATICAN City, Eritrea, Falkland Islands, Mauritius, Nyassaland, Selangor, African airmail, Kenya, Tanganyika, South America, Asia, British Colonies. Many others. Small packet, 3c to approval applicants only. Kenwood Stamp Co., 321-M Burchett, Glendale 3, California.

FREE! Canadian sets, royal visit, George VI, George V, coronation, jubilee, others, to approval applicants. Ensign, Box 118-M, South Orange, N. J.

COMPLETE Mint commemorative set from Manchukuo, plus attractive Brunei pictorial—everything just 3c to approval applicants. Viking, 130 (Z) Clinton St., Brooklyn, N. Y.

WASHINGTON Bicentennial, 12 var., complete 10c. Herman Kleinman, Jenkintown 4, Penna.

WEEKLY Stamp Magazine, 26 weeks, 25c. Stamp Journal, Kalamazoo, Mich.

60 DIFFERENT United States 10c. Pricelist free. Seidenberg, Baroda, Mich.

FIND Stamps worth fortunes! Six big items! "Queer Countries" packet; Djibouti, Qwalior, etc. Packet scarce Russia, catalog price 50c! Fine packet of 25 different British Colonies—Turks and Caicos Islands, Hyderabad, Jamaica, etc. United States \$4.00 and \$5.00 high values. Big "Far East" packet of 20 different stamps from Dutch Indies, Siam, Philippines, etc. Illustrated 32 page booklet—tells where to look for and sell, stamps worth up to \$10,000 apiece! Everything for only 5c to approval service applicants! Mystic Stamp Company, Department 80-R, Camden, New York.

DANDY United States approvals. Write immediately. Sullivan, Endicott Arcade, St. Paul, Minnesota.

EXCELLENT Pictorial approvals. Reasonably priced. Crown Stamp Company, Box 331, Toronto, Canada.

U. S. Mixture, 5 lbs. \$1.75. Postage extra. U. S. price list. Stanley Gibbons, 38-P Park Row, New York.

FREE! Western Hemisphere packet. Postage 3c. Owens, 806 Welch, Bay City, Michigan.

FREE! British Empire packet. Postage 3c. Williams, 606 Archer, Bay City, Mich.

FREE! Pony Express set (facsimiles). Postage 3c. Roberts, 406 Building, Bay City, Michigan.

CANADA 100 Different 25c—approvals all countries. Lists. Victoria Stamp Co., London, 4, Canada.

FREE! The Stamp Finder! Send today for the big new edition, fully illustrated, enabling you instantly to identify all difficult stamps! Also fine packet strange, fascinating stamps from Bosnia-Herzegovina, Monaco, Pattala, Cyprus, etc., including maps, ships, animals and strange scenes. All free to approval applicants enclosing 3c postage. Garcelon Stamp Company, Box 900, Calais, Maine.

FREE! Leeward Is., Cayman Is., Turks and Caicos plus 60 different mint Geo. VI coronation poster stamps, to approval service applicants sending 3c postage. Tatham Stampco, Springfield-30, Mass.

WOW! \$10.00 Worth of fun for only 10¢! 500 foreign stamps, unsorted and unpicked (mostly on bits of paper) just as received from the church missions and other sources. Africa, So. America, Australia, China, Philippines, Dutch Indies, and other countries are represented. Includes a few commemoratives, airmails, and stamps cataloging up to 25¢ or more each! The biggest package of fun in stampdom—and you might find something really valuable! Price only 10¢ to serious approval applicants! Money back if not delighted. Jamestown Stamp Co., Dept. No. 22, Jamestown, New York.

VICTORY Packet free—Includes stamps from Tanganyika, British Cayman Islands, animal, scarce babyhead, coronation, early Victorian, airmail, map stamps, with big catalogue—all free. Send 5¢ for postage. Gray Stamp Company, Dept. PM, Toronto, Canada.

55 DIFFERENT United States 5¢ with approvals. Bookman, Box 145-M, Maplewood, N. J.

UNITED STATES approvals complete coverage, fine quality, attractive prices. Seminole Stamps, Box 436, Coconut Grove, Florida.

STAMPS Sent on approval, outstanding quality, low prices. Fred Herzberg, 168 Oak, Elmhurst, Ill.

MEXICO Census commemorative set free with approvals. Pladon Stamps, 1717-M Idaho, Toledo, Ohio.

WHOLESALE Supplements to dealers for 10¢ postage. Hundreds of bargains. Grossman Stamps, 102 West 42nd, New York.

LIBERIA Airs C4-6 (3) 10¢ with 1/4, 1/2, 1¢ approvals. Carroll's, 7454 W. 45th, Los Angeles 37, Calif.

25 DIFFERENT Canada free. Streiner, 1020 East 61, Cleveland, Ohio.

BELGIUM, 25 Different only 5¢ to new approval applicants. Charles Mangels, 194-13a 111th Road, St. Albans, N. Y.

DEALERS—Wholesale list. Postage 3¢. Frank's, 5031 Queensberry, Baltimore, Md.

BATTLESHIP Stamp and 50 interesting foreign—10¢. Approvals. Liberty Stamp Co., Dept. P2, Kirkwood 22, Missouri.

3,000 U. S. Foreign \$2: Approvals: Grist: 409 Oak, Davenport, Iowa.

FREE Stamps for details. Walter Hoenes, Dept. P.M.M., Cologne, New Jersey.

SOLOMON ISLANDS, Perak, etc.—3¢ with approvals! Saxon, Valley Stream, N. Y.

FREE, Complete Cuba tobacco set with approvals. Seminole, Glenburnie-1, Md.

WORLD'S Largest diamond and triangle stamps, free stamp magazine, stamps from fighting Free French, 25 stamps from 25 different United Nations countries, pictorials, airmails, big bargain 5¢ with approvals. Capital Stamps, Dept. 2, Little Rock, Ark.

ACCUMULATORS Of United States stamps, earn extra money by sending 10¢ for our illustrated buying lists. Wanted also foreign stamps in quantity. Longacre Hobby Co., 100 West 42nd, New York City.

175 U. S. Commemoratives, airm. etc. 10¢, 50¢—25¢. Box 457, Newark 1, N. J.

CAMERAS AND PHOTO SUPPLIES

MAKE Money in photography. Learn quickly at home. Easy plan. Previous experience unnecessary. Common school education sufficient. Booklet and requirements free. American School of Photography, 1315 Michigan, Dept. 3432, Chicago 5.

OIL Coloring photographs a fascinating hobby or profitable business. Learn at home. Easy simplified method. Previous experience unnecessary. Send for free information and requirements. National Art School, 1315 Michigan, Dept. 3444, Chicago 5.

ENLARGERS—Build your own. Kit of parts. \$6.00. Free particulars. Crescent Engineering, Box 251-P, South Pasadena, California.

BASS Says: War time proves Bass leadership. Amazing selection of finest still cameras—Leica, Contax, Korelle reflex, Argus, new and used still available. Write for quotations. Satisfaction guaranteed or your money refunded. Bass buys 'em, sells 'em, trades 'em. Bass Camera Company, Dept. AG, 179 W. Madison St., Chicago, Illinois.

HAVE You a camera? Send ten cents for recent number of our big magazine, showing how to make better pictures and earn money. American Photography, 116 Camera House, Boston, Mass.

WE Pay top prices for used cameras and photographic equipment. Turn your idle camera, enlarger, printer, lenses, developing equipment, etc., into cash. Just send us a list of what you have. State make, model, age, condition. We will write you at once, telling you what we'll pay. Prepare your list today. Send to Central Camera Co., (Photographic Headquarters since 1899), 230 S. Wabash Ave., Dept. E-16Z, Chicago, Illinois.

CASH! Spot cash for cameras, lenses, binoculars, movie or still, sound projectors. Send full description by mail, or wire for prompt cash offer. Over 30 years of dependability insures honorable dealings. Bass Camera Company, 179 West Madison Street, Chicago, Illinois.

PHOTO FINISHING

ROLL Developed and printed 25¢. 25 reprints 50¢. Skrudland, 6444-D Diversey, Chicago.

ROLL Developed "Super-Tan" treated for better and more brilliant pictures and longer lasting negatives and 2 sets fadeless Velox prints 25¢. 35mm. roll developed and enlarged \$1.00. 10 reprints 25¢. 25 reprints 50¢. 100 reprints \$1.50. Art-shop, PM 100, Sweetwater, Texas.

IMMEDIATE Prices. Pictures returned same day order received. Smashing low pre-war prices! Sixteen guaranteed deckled-edge Velox prints from roll, 25¢. Or one colored or two plain enlargements free with 8 deckled-edge prints, 25¢. 16 reprints from negatives 25¢. Candid roll developed, magic-eye timed, vaporated and enlarged to 3x4 on deckled-edge Velox paper—36 exp. 35mm. \$1.00; 18 exp. 60¢; 16 exp. No. 127 50¢; 8 exp. Bantam 25¢. Reprints 3x4, 3¢ each. We have new, perfect 35mm. film. Low prices. Free mailers, details on request. American Studios, Dept. PM-1, LaCrosse, Wis.

10 DAZZLING Hollywood "pin-up" beauties; "special award" exclusive pictures 8x10 (color cover, two-tone). Grabiel Turner! Sheridan! etc. Free with each order, 10 pocket size picture cards of additional Hollywood beauties. All 20 for \$1.00. (No C.O.D.'s). Hollywood Parade, Box 5P 7833, Del Valle Sta., Los Angeles.

BETTER, Cheaper photostamps made from your snapshots, \$1.50 per 100. Graham, Olive View 1, California.

PHOTOGRAPHY For pleasure and profit. Prepare at home. Common school education sufficient. Write for information and requirements. American School of Photography, 1315 Michigan, Dept. 3451, Chicago 5.

TEN 5x7" Enlargements \$1.00, four 50¢, 15¢ each. Six 8x10" enlargements \$1.00, three 55¢, 20¢ each. Either size oil colored 25¢ each extra. Ten reprints 25¢. Send negatives. Many other bargains. Empire Photos, Adams Center, New York.

NO Delay! Pictures returned immediately. Eight exposure rolls developed with two prints each or one enlargement each negative—only 25¢ coin. Special! Coupon on beautiful 8x10 enlargement given each 25¢ order. Details and film mailers free on request. Moen Photo Service, 452 Moen Bldg., LaCrosse, Wis.

FREE! Send negative, this ad for beautiful 4x6 enlargement. (Stamp appreciated). 16 sparkling prints, 2 Hollywood enlargements from roll or negatives 25¢. Lifetone Studios, Dept. A-539, Des Moines, Iowa.

ENLARGEMENTS: Eight 5x7 from negative \$1.00. Six 5x7 from photo \$1.00. Robert Renshaw, 222 Jeffrey St., Chester, Penna.

6-8 EXPOSURE Films developed and finished 25¢. 12-16 exposure 35¢. 18-20 exposure 35mm. 50¢. 36 exposure \$1.00. Reprints 2½¢ each; 100 reprints \$2.00. Photo Service, Box 5450, Metropolitan Station, Los Angeles 55, California.

BEAUTIFUL 8x10 Enlargement from your photo or negative 45 cents. Originals returned unharmed. Quick service. Photo Lab., 3122 N. Clark St., Chicago 14, Ill.

TROUP'S Photo Service, Troup Building, Toccoa, Georgia. 6 or 8 exposure roll film developed and printed 25¢.

16 BEAUTIFUL Oversize deckledged prints and two enlargements with first order 25¢. Owlphoto M1, Weatherford, Oklahoma.

8 PRINTS, All enlarged to nearly postcard size, from your roll or negatives, 25¢. Willard Studios, Box 3535A, Cleveland 18, Ohio.

SNAPSHOT Reprints 50 for \$1.00; 100—\$1.85; 200—\$3.50. Less than fifty, 2½¢ each. Fast service—finest workmanship. Mercury Studios, A-100 North Dearborn, Chicago 2.

BIGGEST \$1.00 Value in 35 mm. finishing today. 36 exposure fine grain 3½x4½ enlargements; deckled, embossed margin and date. Eighteen exposures 75¢; sixteen exposure splits 55¢. Free mailers. 8 exposure rolls in beautiful deckled contact finish with embossed wide margin. 25¢. Mailbag Film Service, Box 5440A, Chicago 80.

YOUR Favorite kodak pictures enlarged, size 5x7, 10¢; three for quarter, coin. Send best negatives (film) today. Address Gepert Studios, Dept. 28, Des Moines, Iowa.

8 BEAUTIFUL Enlarged prints (nearly postcard size) or 16 regular prints 25¢. 35mm. rolls enlarged 3½x4½, \$1.00. Burton Studios, 55-M, Roscoe, New York.

CHOICE Film offers—Roll developed, 8 beautiful enlarged prints (deckled if desired); or 16 brilliant "Lifetime" prints; or 8 sparkling prints plus 2 fade-proof enlargements. Pre-war quality and price—25¢. Fast service. Quality guaranteed. Free mailers. Credit for unprintable negatives. Dept. 53, May Studios, LaCrosse, Wis.

INTRODUCTORY Offer—Six enlargements from your favorite negative, 25¢. Skyland Studios, Box 411, Dept. "EM", Asheville, N. C.

35MM. Argus, Leica, etc. (except "Mercury") 36 exposure rolls, fine grain developed (Eastman DK-20) and beautifully enlarged to 3"x4" glossy prints, 90¢. Cartridge reloaded, 35c. 18 exposure rolls, 55c. reload 20c. 24-hour service. Satisfaction guaranteed. Free mailing bags, sample print. Technifinish Laboratory, 38-42 Scio St., Rochester 4, N. Y.

BEAUTIFUL 4x6 Pictures 3½¢ each, from 116 and 120 negatives. 3¼x4½ from all other sizes. All work guaranteed. Overnight service. Roll developed and 8 pictures 30¢. Roll 12 pictures 45¢. Roll 16 pictures 60¢. Enlargements on double weight portrait paper 5x7—30¢. 8x10—50¢. Copies made from any picture 75¢. Pacific Photo Service, Box 666, San Francisco, Calif.

VELOX Deckle reprints 2c. Rolls developed, two deckle edged prints each negative, 25¢. Two 5x7 enlargements 25¢. Summers Studio, Unionville, Mo.

EVERY Picture an enlargement! 8 sparkling deckle-edge enlargements and roll developed 25¢ coin; 116 size or smaller; enlarge reprints 3c. Enlarge Photo, Box 791D, Boston, Mass.

THREE Prints each good negative, 6 to 8 exposure rolls, 30¢. 12, 16, 18 exposure rolls, 50¢. Reprints, 3c. Fred D. Eastman, Bode, Iowa.

8x10 SILK Finish enlargement—25¢ plus stamp. Irving Studio, 4066A Irving Park, Chicago 41, Ill.

ROLL Developed and 8 beautiful enlargements 2 to 6 times larger. Deckled edge—high gloss. Any 8 exposure roll 25¢ coin. 12 exp. 35c—16 exp. 50c—36 exp. \$1.00. Reprint enlargements 3c each. Alden Photos, 94-3 Astor Sta., Boston, Mass.

EXCLUSIVE Introductory offer! 4 beautiful enlargements for 10¢. Send any 4 negatives of the same size (up to 2½" x 4½") and we will return to you immediately 4 valuable enlargements—deckled and dated on Velox. Negatives returned with order. Send negatives, this ad and 10¢ coin today. This ad must accompany order. Mail-N-Save, Box 310-24, Quincy 69, Massachusetts.

MILLIONS Now know "Hollytints means better prints." Sixteen Hygloss prints with 8 exposure rolls developed—25¢. Other astounding offers. Hollytints, P-1350, Hollywood, California.

ROLL Developed and 4x6 oversize glossy Velox prints. 8 exposure 30¢; 12 exposure 45¢; 16 exposure 60¢. Overnight service. Clemet Photo Service, 1318 W. Columbia Ave., Philadelphia 22, Penna.

MOTION PICTURES AND SOUND EQUIPMENT

ANOTHER First! Latest hit! "Screen-Up Girls" 8mm.—25 ft. \$1.00. 16mm. 50 ft. \$2.00 postpaid. Complete catalog with generous film sample, dime. Trans-American Sales, 532PM, Morristown, New Jersey.

CAMERA Films—100 ft. 16mm. \$2.50; panchromatic Weston 64, \$4.85; 33 ft. double 88 Weston 24, \$1.89; prices include processing. Movie accessories, chemicals, bulk films. Free circulars. Fromader Genera, Davenport, Iowa.

16MM. Sound projectors bought and sold, send dime for list. Anchor 21, Ithaca, N. Y.

FREE Projector and camera film catalog. Samples 10¢. Goodwill Company, Jackson, Tennessee.

SILENT 35mm. Films. Lists 3c. Demsey, 1613 Stewart, Youngstown, Ohio.

MOVIE Camera film 100' 16mm. \$1.00. 25' double 8mm. \$1.25. Machine developing included. Ambassador, 479-A Quincy Street, Brooklyn, N. Y.

"MARINES Capture Tarawa," "Russian Battles," 8 and 16mm., comics, westerns, dramas, 3c stamp. Excel Home Movies, 634 Acklin, Toledo 10, Ohio.

8MM-16MM. Films. Free catalogue (sample film 10c). Parkway Exchange, 1593 Union Street, Brooklyn, New York.

100' 16MM. Used sound film, \$1.00 postpaid. List of complete subjects upon request. Blackhawk Films, Dept. PM11, Davenport, Iowa.

35MM. Sound films. Bought, sold, exchanged. Lists, Star, Whitinsville, Massachusetts.

8MM-16MM. Silent-sound films. Complete rental library. All latest subjects. Free catalogue, (sample film 10c). Garden Film, 317 West 50th, New York 19.

BEAUTY Brevities, newest 1944 pretty girl movie. 8mm., 50 ft., \$2.00. 16mm., 100 ft., \$4.00. Prepaid, USA. Complete lists plus glamour sample, dime. Jenkins, 392-F, Elmira, N. Y.

SWAP 8mm., 16mm. films. Rentals. Box 201, Charleston 21, West Va.

8MM-16MM. Sound, silent films for sale. Rental Service, Oakville, Connecticut.

SEND Stamp for 16mm., 8mm. catalogue. Sterling's, 679 Northampton, Easton, Pennsylvania.

35MM. Silents bought and sold. Hoosierland, 1734 Noble, Anderson, Ind.

MOVIE Projectors—Bought and sold. United, 2309 Lawrence, Toledo, Ohio.

BEAUTY Brevities: 8mm., 50 ft., \$2.00; 16mm., 100 ft., \$4.00. Also comedy, war, glamour subjects. Lists free. Glamour sample dime. Keeley's, 42-PM, Corning, N. Y.

SPECIAL Movie film, 8mm. 25 feet double-Weston 6, \$1.25; Super Double X, Pan indoor 60, outdoor 100, \$5; Super X Pan indoor 24, outdoor 50, \$4; Pan Weston 12, \$3.50; 16mm. 100 feet Weston 6, \$2.50. Free developing. Exhibitors Film Exchange, 630 9th Ave., New York 19.

KODACHROME, Fresh stock! Daylight or Type A! Eastman packaged, 25-ft. rolls double 8mm., \$3.80 each; 100-ft. rolls 16mm., \$8.90; postpaid, cash with order! Will ship c.o.d. (Limit six rolls per customer). Standard Sales, Box 154, Kansas City 10, Missouri.

NU-ART Films are better movies. Convince yourself, buy! Stars on Ice feature 8mm. \$5.50, 16mm. silent \$8.75, sound \$17.50. Sonia Henie skating, 8mm., 50 ft., \$1.75, 16mm. silent 100 ft. \$3.50. 145 W. 45, New York 19, N. Y.

ALL Makes camera films. 100 ft. 16mm. \$2.50, 8mm. 25 ft. double \$1.25. Developing free. Also complete movie subjects available. Free catalog. Star Safety Film, 630 9th Ave., New York 19.

EASTMAN 16mm. Safety positive film, \$4.00 per 400-foot roll! Three rolls limit per order! Guaranteed fresh stock! Will ship c.o.d. Filmmcraft, 2814 Tracy, Kansas City, Missouri.

FILM—16MM. silent and sound. Also 8mm. bought, sold, rented, exchanged. The Film Exchange, 147 West 42nd Street, New York 18, N. Y.

MAMMOTH 8-16mm. Catalogs, bargains, samples, discount coupon—10c. Bargain Films, 719 East 61st Street, Los Angeles 1, California.

LEARN Movie projection, management. Free catalog. Give age. Theatre Institute, Elmira, N. Y.

RENT By week, 8mm., 16mm. films. 35c up. Dayton Film, 2227 Heppburn, Dayton, Ohio.

8MM., 16MM. Rentals, silent 40c per reel; sound features \$4.95. Free lists. National Cinema, 71 Dey St., New York.

ALL Makes camera films. 100 ft. 16mm. \$2.00, 8mm. 25 ft. double \$1.25. Developing free. Also complete movie subjects available. Free catalog. Star Safety Film, 630 - 9th Ave., New York.

BETTERPIX Outdoor safety film, 100 feet 16mm., \$2.50. 25 feet double 8mm., \$1.25. Free developing. Finished subjects sold, exchanged. Sound library. Better Films, 742 NewLots, Brooklyn 7, N. Y.

NEW 8mm. 16mm. projectors. Order now. Hurry. Dayton Film Rental, 2227 Heppburn, Dayton, Ohio.

I BUY, Sell, swap, rent s.o.f. 8 and 16mm. films. List free. Harvey Iris, Box 539, Brockton, Mass.

GUARANTEED Fresh movie film! Three spools double 8mm. \$3.45! Six spools Univex \$2.90! Dalite loading! (Limit six each type.) Will ship c.o.d. Catalog. ESO-8, 3945 Central, Kansas City 2, Missouri.

BASS Says: Leadership in the cine field is apparent in war times. Here ready—your choice of 8 mm. and 16 mm. apparatus. Write for quotations. Your old equipment is worth real money in trade—describe please. Or we buy for cash and pay immediately on receipt. Write to headquarters. Bass buys 'em, sells 'em, trades 'em. Satisfaction guaranteed or your money refunded. Bass Camera Company, Dept. A, 179 W. Madison St., Chicago, Illinois.

8MM-16MM. Home movies exchanged, bought, sold. Free particulars. Multiprices, 171 Euclid, Bridgeport 4, Conn.

\$1 BRINGS "Surprise" assortment 8mm. colorful titles! Guaranteed. LeMoine Films, Nevada, Missouri.

FILMS Bought, exchanged. Girl films. Sample, dime. Lists free. Paramount, 204 East Broadway, Monmouth, Illinois.

"THE World's Greatest Passion Play," 8mm. 16mm. and 35mm. Specify silent or sound. Rent or purchase, include stamp. Hemenway Film Co., 33-F Melrose St., Boston 16, Mass.

MUSIC AND MUSICAL INSTRUMENTS

SING Beautifully. Fame and fortune beckons. Self-coaching course by top-flight teacher. Marvelously simplified. Inexpensive. Literature free. Barcus Publications, 1003 North 13th Street, Terre Haute, Indiana.

LEARN Piano in 5 easy lessons by ear. Play any song—Easiest method known. Amazing results—Complete course \$2. Free booklet. ABC Piano Method, Dept. M5, Mt. Vernon, N. Y., Box 145.

TWO Waltzes entitled, My Prairie Rose, Assiniboine Lullaby; also Tapatoo and Red River Jig. 35c each, 4 for \$1.00. A. Mulligan, 81 Isabel St., Winnipeg.

PLANNING Study singing? Valuable information. Send name. Modern Vocalist, 3513 Woodward, Detroit 1, Mich.

PIANISTS—(Also organists). Quickly improve technic, sightreading, accuracy, memorizing, playing through mental-muscular co-ordination. Free booklet. Broadwell Studios, Dept. 44-E, Covina, Calif.

ACCORDIONS. New and used at wholesale prices. Save up to \$100.00. Buy direct from factory. Del Principe, 307 So. Wabash, Chicago.

COMPLETE Service for songwriters. Crowley, East Garfield 703, Glendale, Calif.

SONGWRITERS Wanted; prices, details, free book. Variety, 2 Salem, Ind.

POEMS Wanted for musical setting. Send poem for immediate consideration. Five Star Music Masters, 630 Beacon Building, Boston.

GOT Words for a song? I'll write music! Ahlstrand, P.O. 52, Kettle River, Minn.

SONGWRITERS! B.M.I. Publisher with established radio program seeks new songs, poems! What have you? Professional's sincere examination free! High fidelity recordings made. Transradio Music, Inc., 1650-B Broadway, New York.

SONG Poems wanted. Free booklet, full particulars. Write. Song Service, 331-C West 46th, New York.

WORDS Set to music. Famous writer, composer. Reasonable. Henry Hoare, 1640 Melrose St., Chicago 13, Ill.

SONGWRITERS—Professional offer. Edward Madden, 1300 Lodi, Syracuse, N. Y.

HAWAIIAN, Spanish guitar music. Wide choice. Expert advice. 23 years experience. Eddie Alkire, Easton, Penna.

PICTURED Music that reads itself. Blessing, 447, Lansing 2, Michigan.

NEW And reconditioned clarinets, cornets, trumpets, trombones, saxophones, flutes, piccolos, guitars, mandolins, accordions, etc. Bargain list 10c. Rudolph's, Atchison, Kansas.

HOT! Jazz playing offers pleasure, profits. Amazing new course guarantees results. Alkire Publications, Easton, Penna.

MUSIC Arranged. Songs published. Frank Wildt, Music Publisher, Lancaster, Pennsylvania.

HAWAIIAN Guitar music. List on request. Golden Gate Publications, 1724 Telegraph, Oakland 12, California.

GUITARISTS. Teaching pays well. We train you. Earn while learning. Guaranteed. Alkire Publications, Easton, Penna.

5 UPRIGHT Eb, BBB basses. Sistek, 12912 Broadway, Cleveland, Ohio.

POPULAR Piano in 12 lessons. Kelly School, 1781 Oak St., San Francisco, Calif.

SONGWRITERS! Amazing, outstanding position. Hibbeler, C5, 2157 N. Avers, Chicago.

LEARN Popular piano! Write Magic Key, 111-A Broadway, Glendale 4, Calif.

LEARN Popular piano! Play hit songs in boogie-woogie style. Pianists, send dime for sample arrangement. Home-study folder free. Christensen Studios, 751 Kimball Hall, Chicago 4, Ill.

SONG Poems wanted. Free examination. McNeil, Master of Music, 510-PM South Alexandria, Los Angeles, Calif.

OUTSTANDING Songwriting service. Roscoe Barnhart, 1320 48th, Des Moines, Iowa.

WRITE Songs. Big money and reputation. Write for information. J. Gordon Pub Co., 201 N. Hoyne Ave., Chicago.

BEFORE Sending your poem to be set to music "know your composer." Free booklet. Al Moquin, 2110 Beachwood Dr., Hollywood 28, Calif.

SONGWRITERS—Send poem for immediate examination and free rhyming dictionary. Richard Brothers, 24 Woods Building, Chicago.

SONG Poems wanted: Write for free instructive booklet, outlining opportunities. United Music Corporation, Dept. 14, Salem, Indiana.

ACCORDIONS. All makes and styles. Buy and sell. 60% discount. Metro, 44 N. Albany, Chicago.

WANTED! Lyrics, melodies for songs. We arrange, publish, sell. Superior Song Studios, Passaic, N. J.

GOOD Music composed to good words. Music printing. Reginald Belcher, Chatham, New Jersey. Established 1910.

RADIOS, SUPPLIES, INSTRUCTION

5000 PLAY "Juke box" phonograph needle. Brilliant tone. Easy on records. \$1.00 postpaid. Ball Radio, 9928 Loraine Avenue, Cleveland, Ohio.

AERIAL Wire, best grade, 4c foot in 100 foot lots, 3c in 1000 foot lots. No priority. Lew Leibe, Hawthorne, California.

BUILD Crystal microphones, phonographs. 2 crystals \$2.00. Kit of essential parts, phono or mike \$5.00. R. H. Lab, 3928 Dumaine, New Orleans, La.

MAKE Miniature crystal radios. Midget crystal and instructions 35c. Allen, PM427, Clinton, Mo.

REVISED Plans 18 long distance crystal sets, with "Radiobuilder"—25c. Laboratories, 363-C Hampton, Hayward, Calif.

BUILD Improved extra loud crystal radio. Complete details, 10c. Joseph Amorse, R-4, Hungary Road, Richmond, Va.

CRYSTAL Radio experimenters, short-wave instructions, 10c. Hulet, 29 East 39th, New York.

DX Almanac—Most complete radio log—50c. 15 Ellsmere, Worcester, Mass.

WANTED Dead or alive. Small table model flat top radios for cash. Send card giving make, model and condition for our cash estimate. Highest prices paid. Act at once. Radio & Appliance Service Co., 42 Crosby Rd., Chestnut Hill 67, Mass.

PREPARE Now for tremendous opportunities in new fields of radio after the war. Training for federal licenses. Write for particulars. American Radio Institute, 52 East 23 Street, New York 10.

RADIO Service men and experimenters send for our giant radio catalogue. Save dollars. United Radio Co. (1000M), Newark, N. J.

RECORDING Discs, 1/2c each. Make them yourself. Simple. No chemicals. No equipment. Complete illustrated plans 35c. Kaytors Lab's, Lynwood, Calif.

BUSINESS OPPORTUNITIES

START Your own business on our capital. Always your own boss. Hundreds average \$3,000 to \$5,000 annual sales year after year. We supply stocks, equipment on credit. 200 home necessities. Selling experience unnecessary to start. Wonderful opportunity to own pleasant, profitable business backed by world wide industry. Write Rawleigh Co., Dept. E-U-PPMB, Freeport, Ill.

ATTENTION, Manufacturers: — If you have a product that's salable we can market it for you. Baker Agency, 3302 Dodge, Omaha, Nebraska.

PICTURE Yourself successful—Free information. New original idea—brings more dollars to you. Write Fred L. Ulen, Lewiston, Idaho.

LEARN Refrigeration service. Open your own shop. Complete illustrated course reasonable. Small capital required. Free booklet. Dept. PM6, Mechanics School, 4703 West Pico, Los Angeles 6.

START Home business making statuary, plaques, art goods, novelties, souvenirs, concrete pottery, garden furniture, artificial marble flooring, liquid marble. Make your own flexible molds. Amazing profits. Valuable folder free. Creative Publishers, (PMS), Glencoe, Illinois.

PREPARE Start own business. Make venetian blinds. Book "How to Make for Hobby or Profit," 66 pages, 25 illustrations. \$1.00. Eiwert, 6900 North Ashland, Chicago.

START "Soap Factory" at home. No machinery. Amazing opportunity. Literature free. Kemico, SM-5, Park Ridge, Ill.

"SCHEMER" Magazine, Alliance, Ohio, publishes winning schemes, tips, formulas; 46th year, \$1.00; 3 months, 25c.

SELL Guarantee fire extinguishers. Unconditionally guaranteed. Costs 60c, retails \$1.50. Free merchandise. National, Box No. 12, Duluth, Minnesota.

SELL Envelopes by mail sparetime. Big profits. Omaha Envelope Service, Dept. 12, 4721 California, Omaha 3, Neb.—Established 1930.

COLOR Concrete with chemicals. Big money making Hollywood style pottery, birdbaths, without moulds. Wishing-wells, stucco-rock, benches, Marbling, cement water-paints. 10c brings sample, literature, pictures. Hollywood Cement-Craft, 8527 Wonderland, Hollywood 46, California.

MECHANICALLY Inclined men — Own and operate general appliance repair shop. Complete, illustrated course shows you how. Welding, refrigeration, motor repair, how to get business, etc., all phases covered. Free literature. Christy Supply, Dept. 140, 2835 N. Central Ave., Chicago.

PUBLISH Magazines under your name. Unlimited opportunity. Samples 10c. Lindblom, 210-A Fifth Avenue, New York.

PLASTIC Engineering pays big. Home study course. Low cost. Easy terms. Free booklet. Ohio Institute of Technology, Box F-154, Greenville, Ohio.

AGENTS—To mail our literature. Good profits. Home business. Maywood, 1133 Broadway, New York.

MAKE Money in a mail order business of your own. We start you. Send for facts now. Frank Rohrbacher, Box 191, Medford, Mass.

START Profitable mail order business on limited capital. Modern, inexpensive course shows how. Includes free consultation with noted author. A top-flight mail sales specialist. Eye-opening details free. Schroeder, Box 504-p, Anaheim, California.

OPERATE Your own profit business at home, spare time, full time. No peddling! Little or no investment. Booklet describing "Collection of over 100 tested money-making plans" free. Fifth Avenue Mail Order House, Dept. A, Venice, California.

MOLDBAKING—Plaster Casting. Complete formulas—fully illustrated. 25c. Ideal Service, RM-5, Park Ridge, Ill.

MANY Make money by mail, you can too. Information free. Riley, 14668 Superior Rd., Cleveland 18, Ohio.

GUARANTEED Income! Grind lawn mowers. \$2.00 capital! Mowers, Janesville, Wis.

MEN—Women—Plan now for post war conditions: booklet describing "Collection of 127 Money-Making Plans" free. Morrill, Box 847, Portsmouth, N. H.

ADVERTISE in Progressive Mail Trade, famous for famous results. There's a reason why advertisers stay in year after year. Best puller. Lowest rates. Pewitt Publications, 605 Clayton, San Francisco 17, Calif.

PLANS, Books, co-publishing mail order books. Rubber stamps all kinds. Household items. Big mail, details 10c. Rennolet, 830 - 9th St., Rock Island, Ill.

START Business. Make money without canvassing. Literature free. George Okegawa, 28-10-D South St., Hunt 2, Idaho.

MAKE Money by mail. Big profits. Information free. Muhlheim's, 1417 Harrison S., Canton, Ohio.

MAIL Order business. Be independent. Start making money at home now. Be established after the war. Write Dr. W. Abell, Parkway Bldg., Pasadena, Calif.

DEPENDABLE, Practical mail order opportunity. H. J. Darnell, 730 Hayes, Jackson, Tenn.

PROFITABLE Business plans and ideas. 25c. Spada Enterprises, 10 Lexington St., Wethersfield 9, Conn.

UNUSUAL Opportunity—Own business—New invention—Nothing like it. Make revolutionary clothes line hangers at home. Ordinary tools. Eliminates pulleys—clothes props. Costs 10c, retails \$1.00. Sell homes—apartment buildings. Direct or wholesale-retail trade. Complete drawings, instructions, sales information sent postpaid \$1.00. Rice Company, 125 N. Erie St., Dept. P, Toledo 2, Ohio.

MAIL Order business training insures your post-war future. Write for free details. Schroy System, Box 8084, Market Station, Los Angeles 21, California.

BIG Opportunity catalog, 10c! A fine money making plan included free! National Opportunity, 4101 South 38th Avenue, Minneapolis, Minnesota.

MAKE Big profits, quick! Plan, samples, magazine, 10c. Mailway Service, 1420 Mestena, Corpus Christi, Texas.

FREE—100 Stamp photos plus—free enlargement and frame coupon. Details, big mail opportunities galore—3c stamp. P. Shur Service, Box 543, Savannah, Georgia.

INCREASE Your income by mail. Opportunity of unusual merit. Free details. Edwin D. King, 4216-A You Street, Sacramento, California.

LOOKING For money making by mail opportunities of merit? You will find them by writing Houston Maupin, 5, Tipp City, Ohio.

300 MONEY Making plans 25c. Sinder, Box 888, Haverhill, Mass.

FIVE Big mailorder magazines 20c. Lewis Company, 828-M Carpenter, Oak Park, Ill.

BETTER Times will come your way, opportunities galore in Progressive Mail Trade. Send 10c for your copy today. Lyle P. Moore, 2854 Harris Place, Norwood 12, Ohio.

THE New era of postwar science and prosperity approaches. Get in line for wealth, security, and happiness! Details free. Lorentzian Institute, 453 N. Third St., San Jose, Calif.

FLEXIBLE Moulds, imitation marble, granite. Details free. Deb Dykes, 5110 Kinghill, St. Joseph, Mo.

GET Dollars by mail. Guaranteed. Instructions 10c. Terrill, Bogard 2, Mo.

PLASTICS—Made at home without equipment, 10c pound. Perfect castings and moulds—formula and instructions—50c. Fred Baker, 1849 Dufferin St., Toronto, Canada.

CAPITAL Seekers interested in raising \$25,000 or more should write to Amster Leonard, Fox Bldg., Detroit 1, Mich.

MAKE Flexible molds! Cast plaques, novelties! Sample and information free! H. Tooker, 630-K Chestnut, Hamilton, O.

HOMEWORKERS—This is really it! Castone colored bisque gifts, plaques, novelties. Material, molds, instructions furnished. Sample Castone scottie, mold model with illustrated molding circular, catalogue hundred new flexible molds 25c postpaid. Plastic Products, 1410-M Belmont, Chicago.

DOLLAR Tips new book of moneymaking ideas, formulas, plans, business secrets and home work offers. Only 25c postpaid. Order immediately. Lucas, 70 Josephine, Detroit 2, Michigan.

10 MAILORDER Magazines, including 52-page publication 20c. Weyl, Box 202-Y, Columbus 16, Ohio.

START Vitamin business! Wholesale prices. Metabasic, Station S, Box 9128, Los Angeles.

COSMETIC Manufacturing with our concentrates. Adding water makes quality cold cream, hand lotion, waveset, liquid stockings, deodorant. Gelitabs Co., Box 833B, Stamford, Conn.

MAKE Money by mail—spare time. Free details. Overton, 140 W. 42nd, New York.

TODAY'S Prize winning mail order opportunity fulfills beginners hopes. Quick, economical start. Dollar getting sales literature. Popular merchandise. Write Klemco, St. Clair Shores, Michigan.

PROFITABLE Dignified manufacturing opportunity, unlimited possibilities; product made of scrap waste lumber. Small capital required, operate from home or shop. Complete plan 25c. Engineer, Box 1857, Denver, Colo.

DISTRIBUTE Vitamin and mineral tablets and capsules. 100 different products. Low wholesale prices. Catalog. National Vitamin Company, Portland 4, Ore.

START Now in spare hours. Build into full time business. This great book only \$2.98 postpaid. S. George, 5008 Stenton Ave., Philadelphia 44; Penna.

6 MOST Read mail order magazines, 25c. Heier, 140 W. 42nd, New York.

PLASTICS Is the answer. Get started today. No equipment needed. Formula and instructions—50c. Bert Anderson, 326 George St., Toronto 2, Ontario.

RECAST Old batteries into new. Latest achievements. Battery Laboratories, Minneapolis.

IF You really want to sell something different ask about Bish-O-Craft, the "aristocrat" of tropic sea-shell costume jewelry. Bish-O-Craft, Box 117-C, Miami 38, Florida.

"**HOW** To Make Money With Hobbies"—Mail order work, handicraft, stamps, or dozens of other hobbies. 60 pages of exciting experiences, ideas, plans \$1. Free circulars of many unusual books and plans. The Hatch Press, 536 Hanover St., Dept. PM, Meriden, Connecticut.

MAGAZINES—All different—Latest. 3c. Excel, 2149 Jackson, Chicago, Illinois.

FREE Subscription to "The Mail Order News" (Somerville, N. J.) Oldest mail trade journal in America. Offer limited. Drop postal today.

"**10** GREAT Secrets of a successful letter" by Ad-Man Davison. Famous letter-writer reveals system! Small 46-page clothbound book \$1. Opportunity Press, Westport Connecticut.

WANTED Partners to day patent costs on several good inventions. Inventor, Box 1672, Oakland, Calif.

PAYING Mail business—Stamp brings proof. General Publications, Ossining, N. Y.

WEBER Typewriter Mechanics School. Simplified homestudy-repairing increasing. Hollywood 27, California.

THE Mail order business might be your big chance for a prosperous future. Instructive literature free. Elmer Swanson, Niagara, No. Dak.

OWN Your own business. Be independent. Free literature listing part of over 100 opportunities. Barnorall Industry, 19338 Griggs, Detroit, Michigan.

FREE! How to sell our latest popular books by mail. Pleasant home work. Big profits! No bookstore competition. Snappy circulars supplied. Rush name! Financial Education, 431F Commonwealth Bldg., Denver 2, Colo.

"**HOW** To Make Simple Molds and Plaster Plaques." Profit in popular novelties! Booklet 25c. Plastercraft, 1406 E. 43rd St., Cleveland 3, Ohio.

INCORPORATE Your business. Delaware laws. Many advantages, free details. Tax Research Bureau, Inc., Delaware Trust Building, Wilmington, Delaware.

TURN Accounts into cash. Good income; quick results. National Collectors, Newark, Ohio.

GET Into mail selling. Prepare for future. Start sideline business now. Splendid opportunities. Interesting, profitable propositions immediately available. Progressive Magazine tells how! Free details and premium offer. Sheboygan Publishing Co., Sheboygan, Wisconsin.

CHARTERS; Delaware; best, cheapest; free forms. Colonial Charter Co., Wilmington, Del.

DRUNKENNESS Is a disease which responds to treatment. Medical skill plus human sympathy prove successful with liquor and drug cases. 60 years experience. Write for free booklet. F. M. Nelson, The Keeley Institute, Dwight, Ill.

HOW And where to obtain capital. Fully explained, particulars free. Star Service, Wapakoneta, Ohio.

127 Ways To make money, in home or office, business of your own. Full particulars free. Elite Co., 214 Grand St., New York.

BRUSH Plating outfits connect to a battery. No tanks necessary. Good paying business at home plating autoparts, bathroom fixtures, bicycles, reflectors, silvering mirrors. No shop or experience required. Outfits furnished. Free booklet. Gunmetal Co., Ave. H, Decatur, Ill.

LIQUID Marble; snow-white, multi-colored. Glazed. Unglazed. Composition flooring. Lifetime wear. Any color. No priorities. Flexible molds. Plaster casting. Get into the big money now. Full information given free. Write Compo-Tex, Box 786, St. Louis, Mo.

BIG Profits, make and fit arch supports. Particulars. Jul Corssen, 3609 Texas, St. Louis 18, Missouri.

500% PROFIT, Puncture proofing tires. Details for stamp. Betke, Box 699, Borger, Texas.

SELL Popular specialties. Free particulars. Mogul-1H, 1321 East 105, Cleveland 6, Ohio.

GROW Drug plants and grow rich. Box 423, Kellogg, Idaho.

KUTE Klever komical calling cards. Every card a laugh. Complete assortment 10c (coin). Magic Products, 4133 Botanical St. Louis 10, Mo.

EXTRA Income—Plenty mail selling opportunities. Write Katz, 4264 N. Kimball, Chicago.

5 MOST Read mail order magazines 20c. Armand Cartier, 695A North, Pittsfield, Mass.

LIQUID Marble—Colorful, glazed! Mold, brush, spray! Composition floors, rubber-lastic molds. Particulars free. Marbleizing Service, Edwardsville, Illinois.

MAKE Money at home in spare time by mail. Write Gordon Publishers, Box 23, Pawtucket, R. I.

MONEYMAKING OPPORTUNITIES

LEARN Refrigeration service. Open your own shop. Complete illustrated course reasonable. Small capital required. Free booklet. Dept. PM5, Mechanics School, 4703 West Pico, Los Angeles 6.

MONEYMAKING Ideas galore. Mailorder, homework, business opportunities, agents propositions, swaps, bargains, etc. Big mail 10c. Val-U, Box 230-A, Burbank, Calif.

WISE Used as punch press. Perforate, form, shear, articles of steel, brass, copper, aluminum. Illustrated instructions on making vise dies \$1.00. Ray Kleffman, Box 6, Hibbing, Minn.

"DOLLAR Tips" moneymaking book 25c. "Home Factory" book 50c. Make, sell 101 things. Free details. Variety, 1116N. Capitol, Indianapolis 4, Ind.

1001 THINGS Wanted. Rabbit skins, funny papers, feathers, jokes, buttons, magazines, etc. List of articles, buyers, 25c. Richmond Pub. Co., Box 21-P, Station A, Los Angeles 31.

MECHANICALLY Inclined men—Own and operate general appliance repair shop. Complete, illustrated course shows you how. Welding, refrigeration, motor repair, how to get business, etc., all phases covered. Free literature. Christy Supply Dept. 1140, 2835 N. Central Ave., Chicago.

MAKE Your own Flexible Molds. Stairway, Art Goods, Novelties, Artificial Marble Flooring, Liquid Marble. Literature free. Kemico, 5-M, Park Ridge, Ill.

MAIL Order business is your opportunity. Many began small; now earn thousands yearly. No personal contact. Boundless opportunities. Valuable booklet, 25c. The Bookmaster, Box 588T, Stillwater, Okla.

HELP Win the war first! Then man, you'll like silvering mirrors, reflectors! Making sparkling chipped glass nameplates. Outfit prices. Sprinkle, Plater, 680, Marion, Indiana.

CATALOG, 300 Money making plans and books. One dime. Co-Operative Service, Box 638, Chicago.

100 SELLING Ideas book of moneymaking plans, formulas and business secrets. 25c postpaid. Joseph Royer, 15-M How St., Haverhill, Mass.

GIANT Mail, catalog, magazine 10c. Opportunity mail free. Harvey Teeple (PM), Decatur, Indiana.

CONTEST Books, list free. Pederson, 1609 1/2 East 5th, Duluth-5, Minn.

AMATEUR And semi-professional artists and cartoonists, cash in on your ability. Hamilton, Box 4M, Woolsey Sta., Astoria, N. Y.

SELL By mail professionally, what, where, how. Giuntas, 78-45 81st St., Glendale, N. Y.

DOLLARS By mail; spare time plans free. Varvel, 24 1/2 West 3rd South, Salt Lake City 1, Utah.

NEW Opportunities. Mail order, etc. Write. Barcus, 1001 North 13th, Terre Haute, Indiana.

FREE Moneymaking plans. Write Harris, 441 South Ashland, Lexington 19, Ky.

PROFITABLE Homework. Sample and details 10c. Woodcraft, 1320 Lindsay, Gainesville, Texas.

SELECTED Opportunities, 25c money making book only 10c. Swanson, 415 West Lead, Albuquerque, N. M.

"CASH-IN" 300 Moneymakers 25c. Earl Company, 504 Court, Albert Lea, Minn.

THOUSANDS Of articles wholesale. "Supply Source Directory" 10c. Ideal Service, D-5, Park Ridge, Ill.

HUNDREDS Of moneymaking opportunities, dime. Neil Bique, Libertyville, Ill.

THERE'S Money selling by mail! New, different plan. Easy to start—keep going. Information, 3 leading magazines, opportunity mailing, 10c. Coates, 90A Norwell, Dorchester, Mass.

95c PROFIT From every \$1. Less than \$1 starts business. Adamec, 930-B Ogden Ave., Bronx, N. Y.

USED Bicycles, how to buy, sell, good sideline money maker, complete information \$1.00. Kwist, 659 Seward, Rochester 11, N. Y.

EARN Money in fascinating business at home, with very small capital. Money back if not satisfied with complete money making starter and full particulars which I send you for 25c. Frank Sargent, Jr., P.O. Box 868, Denver, Colo.

THOUSANDS Of alarm clocks need repairing. Jewelry stores swamped. Our simplified course teaches you how to repair these clocks. Necessary tools and supplies furnished with course. Alarm Clock Repair Service, Dept. B, P.O. Box 1983, Houston, Texas.

1001 ARTICLES—Wholesale supply directory 10c. Heier, 140 W. 42nd, New York.

START A home business in spare time. Make extra money. Experience not essential. Literature free. Lambert Press, Box 453, Hot Springs, Arkansas.

BUY Better vitamins wholesale. Sample 30 days supply better vitamins and food minerals \$1.75. Study modern nutrition. Vams, 3704 W. 3rd, Los Angeles 5, Calif.

A DRIVING Force to your personal success. Unusual idea! Details. Taylor Company, 590 Grove Pl., Pontiac 8, Michigan.

PERFUME Instructions furnished. Start mail order or local business. Particulars free. Dr. Abell, Parkway Bldg., Pasadena, Calif.

IF It's wealth you desire, start a home business in spare time. Make extra money. Experience not essential. Literature free. Lucas, 70 Josephine, Detroit 2, Mich.

BOOKKEEPERS. Earn money at home posting journal entries. Ellis Business Service, Cedar Grove, North Carolina.

IF You want to trade or sell anything (regardless of what it is) send 20c coin for "Swappers Guide." It lists hundreds of swap-buy-sell opportunities all over America. Swappers Guide, 610 N. St. Joseph, Evansville, Indiana.

LICK After-war layoffs! Start own business: home, office. Booklet describing "Collection of 127 Tested Plans" free. Elite Co., 214 Grand St., New York.

PUBLISH Your own magazine. Handsome 52 page format, well edited illustrated. Cost low as \$1.00 month. Brings you prestige, profits. 10c brings sample, details. National, Ord. Nebr.

LEARN Metascience. Remarkable drugless healing. No manipulation. No apparatus. Unbelievable simplicity and results. Inexpensive correspondence course. Write Metascience, De Land, Florida.

GET Your mail order started by joining the National Mail Order Guild. They tell you all the facts—what sells by mail—who buys by mail and how to reach them. They help you every step of the way. Send for full information. No obligation. A. J. Shutt, P.O. Box 269, New Castle, Indiana.

EARN Money at home! Thousands do! "Home Worker Magazine" tells how. Sample, 25c. Sizemore, Box 7, 4917 North Kostner, Chicago.

FARMERS, Gardeners: Plant, harvest by moon signs. Big returns. Planting guide with perpetual date indicator. Prepaid \$1.00. Rural Service, 1663 Gummer Ave., Dayton 3, Ohio.

FORMULAS, PLANS, ETC.

MAKE Fast selling products. No machinery. "Chemist Approval Formulas." Literature free. Kemico, 15, Park Ridge, Illinois.

FORTY Fast seller formulas and catalog \$1.00. Co-Operative Service, Box 638, Chicago.

CHEMICAL Formulas supplied for 50c each. James Vick, Church Road, Virginia.

DELICIOUS Honey without bees. Easily made. 8c lb. Guaranteed formula \$1. Ralph Brooks, Arkansas, Wis.

"LUMINOUS Paint" shines in dark. Easily made. 100 other formulas, plans—all 25c. Soap-making course (20 formulas) \$1.00. Resilvering mirrors, formula 20c. Ideal Service, 305, Park Ridge, Ill.

MOTOR Oil 1c gallon. Reclaim used oil for profit. Formula 25c. George, 5008 Stenton Ave., Philadelphia 44, Penna.

DURABLE Paints, stains. Little or no cost. Stains, no wiping. Ten formulas, \$1.00. Fuson, Box 67, Ellensburg, Washington.

FREE Formulas. All high class commercial products. Drop postal. Parker Service, Box 870, New Haven 4, Conn.

ICELESS Ice! Colder; cleaner; cheaper. Instructions, 25c. Duffy, J-53, Covington, Ky.

FORMULAS—Latest, best. Analysis. Literature free. Belfort, Engineering Building, Chicago.

AUTHENTIC Formulary 924 pages (illustrated). 10,000 money making formulas, recipes, instructions, substitutes. \$2.00 postpaid or C.O.D. (foreign \$2.35). Catalog, Adams Brown Company, Chestnut Hill 67, Massachusetts.

REAL Manufacturing formulas. Lists free. Cummings, Chemist, Gordon Ave., Syracuse, N. Y.

FORMULAS For profitable products. Lists free. Viggiano, Chemist, 6556 Ladson, Pittsburgh, Penna.

CHEMISTRY

WINN'S New Idea Home Laboratory Chemical Kits and apparatus outfits for home experimenting. Send 5c for literature and retail supply catalogue. J. H. Winn Co., Dept. 505, 124 W. 23rd St., New York.

100 DIFFERENT Chemicals. One ounce or more each. Excellent opportunity for diversified laboratory stock. \$6.90. Midwest Chemical Co., 3724 Second Ave., South, Minneapolis, Minnesota.

COLCHICINE—Creates new mutant plants—Experiments magazine and booklet 25c. Questok, 277 Washington, Newton 58, Mass.

288 PAGE Apparatus catalog sent for 75c. Chemical catalog, 10M items, 25c. Laboratory Materials, 7321 Vincennes, Chicago.

SPECTROSCOPE For quick chemical analysis \$2.50. Kutting Sons, Campbell, California.

CHEMISTRY Laboratory apparatus and chemicals for industrial, analytical, and private experimental laboratories. Complete chemical laboratory supply service for correspondence school students. Send 3c for free 48-page catalog of chemicals and apparatus. Dept. M-43, Biological Supply Co., 1176 Mt. Hope Ave., Rochester, New York.

FREE Catalog: Chemistry, mineralogy, biology optics. Tracey Laboratories, Evanston, Illinois.

"CHEMISTRY For Beginners." "Chemistry of Familiar Things"—50c for both books. Waltman, 396 Broadway, New York.

FREE Chemical catalogue. Enclose 3c postage. Greenwood, 398 Broadway, New York.

LABORATORY Supplies at wholesale price: Chemistry, biology, physics. Catalogue, 10c. National Scientific Co., 2204 W. North Ave., Chicago, Established 1908.

HELP WANTED

MEN, 20-45 yrs., to work on railroad rail testing service cars. Those under 38 must be draft deferred. Job entails constant traveling. Electrical-mechanical experience preferred. Also stewards; salary plus all living expenses. Those now in 100% war work not considered unless released. Write full details to Personnel Department, Sperry Products, Inc., 1505 Willow Ave., Hoboken, N. J.

AGENTS WANTED

LUMINOUS Flowers, ear rings, crucifix, pictures, etc.; glo-brite in the dark; new process; sensational sellers. Write today. Glo-Brite, 1904-PM Patterson, Chicago 13.

SALESMEN—Agents wanted at army and navy bases to sell chrome finished monogrammed initials to their buddies. Wonderful to place on gifts sent home. Cost only \$7.50 gross. Sell for 10c to 25c each. Wallace Carpenter, 1522 Cambridge, Fresno, Calif.

START Your own business on our capital. Always your own boss. Hundreds average \$3,000 to \$5,000 annual sales year after year. We supply stocks, equipment on credit. 200 home necessities. Selling experience unnecessary to start. Wonderful opportunity to own pleasant, profitable business backed by world wide industry. Write Rawleigh Co., Dept. E-U-PPMA, Freeport, Ill.

PENCILS, Carbon paper and typewriter ribbons repeat. Complete line for office and advertising. 25% commission. Universal Graphite Pencil Co., Clinton, N. J.

WE Manufacture 40 fast repeating chemical products. Exclusive agencies open. Hillbor Products, 5159 Wentworth, Chicago, Ill.

AMBITIOUS School seniors—Sell classmates the "tops" in graduation name cards. Best commissions. Free cards. Agencies going like wildfire. Hurry! Craftcards, Box 235-L, Pittsburgh 30, Penna.

HOSIERY Guaranteed against everything at no extra cost! Victory sheer ladies' rayon full fashioned sells for only 94c including your profit! Also guaranteed men's hosiery. Amazing opportunity to build permanent business. No experience or money required. Simply write orders. We deliver and collect. Write today for complete free outfit. Kentcraft, Dept. AM, 44 Court Street, Brooklyn, N. Y.

AGENTS—Coin money—it's new—it's hot. Everyone wants radiant Masterette Oil paintings of loved ones. Commissions advanced. We collect, deliver. 7x9 sample \$1.00 prepaid. E. Condon, Box 157, Upper Darby, Penna.

SALESMEN—Saleswomen—6c (cost to you) Wage Earner's Record Book sells on sight to workers everywhere for 25c. \$6-\$10 daily commissions easy. Send 25c coin for sample, full details. Better still, send \$1.00 for introductory order, and make money at once. Satisfaction or money back. Offices, Boston Bldg. Brumley Products, Box 1198, Denver, Colo.

FORTUNE Telling charts, 600% profit. Samples, details 25c coin. Taylor, Box 181, Marion, Ind.

BIG Money taking orders; shirts, ties, Sox, pants, jackets, sweaters, shoes, uniforms, etc. Sales equipment free. Experience unnecessary. Nimrod, 4922-AN Lincoln, Chicago.

FOOT Tablets sell fast, big profit. Argus Co., 234-P So. Franklin, Allentown, Penna.

WHOLESALE Sources, 500,000 articles. Free directory, Maywoode, 1133 Broadway, New York.

BLADES—Best quality, factory prices. Details free. Ace Blades, Buffalo, N. Y.

PERSONALIZED Patriotic items! Today's great sellers! Sample free! Harry T. Latz Service, Inc., 242 West 55th Street, New York 19, N. Y.

500% PROFIT Selling paper advocating debt free U.S.A. Sample 3 1/2c stamps. Anderson, 119 West Fifth, Topeka, Kansas.

BIG Bargains for big profits. Men's used pants 25c, suits \$1.00, topcoats 75c, shoes 12 1/2c. Over 100 sensational values. Experience unnecessary. Free wholesale catalog. Superior, 1250-M Jefferson, Chicago.

3 FIRE Extinguisher; quick sales, wholesale or direct; liberal profits. "Fire-Killer," 109 N. Franklin, Syracuse, N. Y.

PLAYING Card game, 250% profit. Sample game 25c. Box 842, Denver 1, Colo.

SELL Stores Buck Buffer for white shoes. Big demand, season now. Profits good. Send 25c for sample, details. E. Davis, 61A Johnson Parkway, Buffalo, N. Y.

AGENTS, Big line including food products. Fast selling premium and bargain deals. Low prices. Send card for big outfit offer with gift. Ho-Ro-Co, 2775 Dodier, St. Louis 7, Mo.

PLATING Outfits for autoparts, reflectors. Connect to a battery. No tanks necessary. Free booklet and particulars. Gunmetal Co., Ave. N, Decatur, Ill.

AGENTS: Stamping names on pocket-key protectors. Sample check with your name, address, 25c. Stamping outfits. Emblem checks, check-fobs, name plates. Hart Mfg. Co., 303 Degraw St., Brooklyn, N. Y.

MAGIC Cleaner and laundry soap deal. Hotter than a firecracker. Big profits! Sample free. Bestco, 5007 Irving Park, Chicago.

EXCELLENT Sideline for printing salesmen. Decalcomania name plates in small quantities. Also, make money applying initials on automobiles. Free samples. "Ralco," 1483 Washington, Boston (18), Mass.

AGENTS—300% Profit selling gold leaf window letters; stores and offices. Free samples. Metallic Letter Co., 438-B North Clark, Chicago.

FREE Water and our concentrates, makes flavors, lotions, shampoos, 72 products, labels, bottles furnished. Qualco, E-20030 Russell, Detroit.

ELITE Collection contains 127 plans for starting own business; home, office. Descriptive booklet free. Elite Co., 214 Grand St., New York.

BIG Profits nationally advertised product, information free. Lumco, Kimball, Nebr.

SELL New-used clothing from home, auto store. Men's suits 99c, pants 27c, topcoats 44c, dresses 13c, ladies' coats 38c. Other bargains. Catalog free. S&N, 565A Roosevelt, Chicago.

POWERFUL Mile stretcher! Increase mileage-power, 400% profits! Guaranteed. Thermox, Peoria 4, Ill.

GOLD Lacquered window sign, letters. New styles. Absolutely beautiful. Free samples—catalogue. Atlas, 7941 Halsted, Chicago.

HIGH-GRADE SALESMEN

ADVERTISING Book matches—World's largest "direct selling" book match factory offers advance cash earnings calling on every type of business. Men or women. Experience unnecessary. Full part time. Low prices. High quality. Quick deliveries. Powerful patriotic display. Special designs for army camps and naval stations. Repeats. Free kit, instructions. Match Corp. of America, 3433 West 48th Pl., Dept. E-5, Chicago 32.

ADVERTISING Book matches—Cash in on political campaigns—sell Union Label matches. Cuts for all businesses and political parties—free powerhouse selling kit—low prices—protection guaranteed on repeat orders—cash commissions. Superior Match Co., Dept. M-5, 7530 Greenwood, Chicago.

SELL Janitor supplies to institutions, stores, public buildings. Johnson, 209 South Church, Rockford, Illinois.

SELL Toy guns to everybody. Parfex Co., 4183 W. 2nd St., Los Angeles 4, Calif.

DUE To manpower situation, manufacturer of industrial diamond tools has open territory for a few aggressive diamond salesmen. Duro Diamond Products, Inc., 1251 State Street, Racine, Wisconsin.

SALESMEN: Have real money making opening. Fits into war program. Old progressive firm. Dept. "F," Box 392, Dallas, Texas.

SALESMANAGER, Educational memberships. Mechanical society. Big percentage. Permanent. Quick sales. Send complete application. Nobel B. Martin, 610 Mead Bldg., Portland 4, Oregon.

EDUCATIONAL AND INSTRUCTION

BUSINESS Men, teachers, students, clerks, accountants. Learn super-speed calculation at home; 10-lesson course by mail guarantees increased speed. New, unique method. Amazing results. Free particulars. Math Institute, 204 Adams St., Mobile, Ala.

REFRIGERATION Service course, 24 illustrated manuals. Booklet free. Mechanics School, 4703 West Pico, Los Angeles 6.

LEARN Character reading. Send \$1.00 for complete course. Gilbert, 659 Ocean Ave., Brooklyn, N. Y.

BLUEPRINT Reading. Low cost instruction. Lyle, Box 1240, Sarasota, Florida.

WRITERS: Manuscripts wanted. Details free. Kline Literagency, 507 Fifth Avenue, New York 17.

BE A doctor. Learn chiropractic. Fast growing profession. (Residence course only.) Write for catalog—Dept. A, Texas Chiropractic College, San Pedro Park, San Antonio 1, Texas.

GET "Set" now! The wartime job "boom" won't last forever! Then trained men will get the permanent jobs that pay best. Learn refrigeration, airconditioning, electrotechnics, electrical engineering, radio, electronics, welding, inspection. Mention course wanted. Low tuition, earn part expenses. Big book free. Milwaukee School of Engineering, Box 644, Milwaukee, Wisconsin.

EARN More money. Be more successful. Learn how, by better use of your present abilities. Details free. Mayco, 3023 S. Orange Blossom Trail, Orlando, Florida.

NON-RESIDENT, High school, college, professional degrees. Bulletin free. Capital City College, Washington-5, D. C.

LEARN Credit and collection agency business; earn \$50-\$150 weekly upwards; interesting literature free. Write Educational Extension Service, Department 101, Wishire-Labrae Station, Los Angeles.

DRAFTING Pays big—learn now. Monroe Institute, PM-5, Alton, Illinois.

USED Technical and educational books bought, sold, rented. Catalog free. Educational Exchange, Henagar, Alabama.

"HOW To Break and Train Horses"—A book every farmer and horseman should have. It is free; no obligation. Simply address Beery School of Horsemanship, Dept. 1105, Pleasant Hill, Ohio.

GOOD Jobs and a sound future for you in hotel and institutional field, government housing, food and recreation projects. Men and women—all ages—needed for well-paid positions that offer color, excitement, ever-new and fascinating duties. Record-breaking business in hotels, clubs, institutions means even greater opportunities. Lewis School receiving calls for managers, hostesses, executive housekeepers, purchasing agents, stewards, etc. These are not temporary jobs, but important positions in an essential business that offers splendid opportunities in war or peace, good times or bad. Previous experience proved unnecessary! No need to leave your job to qualify. A good grade school education, plus Lewis Training qualifies you, at home, in spare time. Our National Placement Bureau helps to place you and—under our amazing Certified Job Plan—actually guarantees you will "make good" when placed. Write today for free book! Lewis Hotel Training School, Room CM-368, Washington 7, D. C. (First and only school of its kind—Now in its 28th year.)

EXCEPTIONAL Peacetime opportunity. Operate a collection agency-credit bureau. Quickly learned. Many make \$5000 yearly up. Write Cole Associates, Syracuse, N. Y.

STOP Radio noises! Amazing new booklet tells how, \$1.00. Moneyback guarantee. Inquiries answered. Rowe Company, 660 Mission, San Francisco 5, California.

SCIENCE Of characteristics is now being taught by correspondence: Every professional, and business man; personnel managers; sales people and teachers should know this science: It works: Try it. Prof. Henry H. Craig, Rt. 3, Box 471, Sebastopol, Calif.

PLASTIC Engineering pays big. Home study course. Low cost. Easy terms. Free booklet. Ohio Institute of Technology, Box P-153, Greenville, Ohio.

WRITE Short stories at home for pleasure and profit. Fame, riches and happiness of achievement are rewards to be realized by students who acquire tested technique. Get free booklet from home study school with 50 years experience. Write today! Blackstone-Sprague, Dept. 103, 307 North Michigan, Chicago 1.

CARPENTERS, We teach the steel square in five easy lessons by mail. It's really fun this modern way, our students learn fast by using our 1/4" size practice square which does the trick. Write for free information, or better still send 25 cents for small square and partial lesson. We have a big surprise for you. Builders' Topics, Dept. 111, Medical Arts Bldg., Seattle 1, Wash.

INVESTIGATOR Training. Phillips Secret Service, 1917-B North Kenneth, Chicago, Illinois.

LEARN Card writing at home. Write for details. Everett School of Lettering, 308 Maplewood Ave., Bridgeport, Conn.

"BE Funny for Money." Write cartoon ideas. New booklet shows how. Send 25c war stamp. Ullsh Studios, 518P Wrightwood, Chicago 14.

MUSCULAR Development. Become professional acrobat. Free health book. Write! Knoff, 2154GM North 52nd Street, Milwaukee, Wisconsin.

MAKE Up to \$25-\$35 week as a trained practical nurse! Learn quickly at home. Booklet free. Chicago School of Nursing, Dept. K-5, Chicago.

WELDING—Electric arc. Learn profitable trade quickly through actual practice. Individual welder instructions at bare cost of materials. Full particulars free. Valuable welding lessons book 50c. Hobart Welding School, Box M-542, Troy, Ohio.

NEW Writers needed to re-write ideas in newspapers, magazines, and books. Splendid opportunity to "break into" fascinating writing field. May bring you up to \$5.00 per hour spare time. Experience unnecessary. Write today for free details. No obligation. Postcard will do. Comfort Writer's Service, 210-P South Seventh St., 2, St. Louis, Mo.

RADIO Engineering, broadcasting, servicing electronics, aviation, marine and police radio taught thoroughly. All expenses low. Co-educational. Catalog free. Valparaiso Technical Institute, Dept. R, Valparaiso, Ind.

GOOD "Used" educational books on all subjects bought, sold, rented, exchanged. Satisfaction guaranteed. Complete details and 84-page illustrated bargain catalog free. Write Nelson Company, Dept. 208, Chicago.

HOME Study course, drugless therapy. Free literature. Inst. of Drugless Therapy, Tama, Iowa.

SHORTHAND In ten lessons. Sample. Kee-Way System, Dept. 444P, Syracuse 1, N. Y.

USED Educational books on all subjects sold, rented, also bought and exchanged. Moneyback guarantee. Write today for free catalog and details. Lee Mountain, Pisgah, Alabama.

EARN Certified Grapho-Analyst degree analyzing handwriting. Students report earnings up to \$1.00 an hour sparetime. \$75.00 weekly full time. Graduates in employment, credit agencies, police departments, courts, business and in private practice as personal problem and vocational advisors. Fully illustrated Grapho-Analyst and 3000 word illustrated lesson free. Institute, Box 1150, Joplin, Mo.

MEDICAL Laboratory technicians in great demand. We train you in your spare time, in your own home. You can practice while studying. Write for free catalogue. Imperial Technical Institute, Box 973-E, Austin, Texas.

DRUNKENNESS Is a disease which responds to treatment. Medical skill plus human sympathy prove successful with liquor and drug cases. 60 years experience. Write for free booklet. P. M. Nelson, The Keeley Institute, Dwight, Ill.

LOCKSMITH Course. Lock picking, key fitting, etc. \$1.00 prepaid. Locksmith, Canadian, Texas.

ARMATURE Winding course \$7.50. Automatic winding course \$3.50. Welder plans \$1.00. Frazee, Box 5086, San Francisco, Calif.

SECRET Investigation. Experience unnecessary. Investigators particulars free. George Wagner, M 125 West 86th, New York.

BECOME A Doctor of Psychology (Ps. D.) Teach secret of contentment, happiness. Solve mental worries. Free book. College of Universal Truth, 5651-B North Ashland, Chicago.

BUSINESS SERVICE

CLEVELAND, O., 10. Mail received and re-forwarded. 10c per. Confidential. V-T-P, 16416 Arcade.

WASHINGTON, D. C. We represent you here, also receive and forward your mail. Service Bureau, 1401 25th Street, S. E.

\$2.00 MONTHLY Maintains Washington, D. C. office. Your mail re-forwarded daily. Hawkins, 7-pm Randolph Place.

WORCESTER, Mass., mail address, personal, business, fun. \$2.00 monthly. Postcards 3 for 25c. Reliable. Lewis, 159 Dewey St.

CARTOONING, COMMERCIAL ART, SHOWCARD WRITING, SIGN PAINTING

POCKET Size cartoon course—22 easy lessons, over 200 sketches including figures and lettering. Prepared by nationally known artist. Mailed postpaid on receipt of 25c in coin. Snack-Pack Co., 34 E. Georgia St., Indianapolis 4, Ind.

CARTOONING Pays! Illustrated course of instructions—money making plans—cartoon markets. Free details. Cartoon Studios, 1402 Charles, LaCrosse, Wis.

CARTOONING Course. Bigger than ever. 36 easy lessons, 500 illustrations \$2.00. Sample lesson. Details free. Home's Cartooning, 3456 W. 116th, Chicago 43, Ill.

BE A gag cartoonist. Postcard brings free trial lesson. Moon Cartoon School, Dept. C, Argyle, Wisconsin.

CREATE Cartoons quickly. 350 illustration course \$1.00. Hetzler, 57 Stanton, Rochester 11, N. Y.

CHALK Talks. Laugh producing program, \$1.00. Catalog 10c. Balda The Cartoonist, Oshkosh, Wisconsin.

PHOTOSTAMPS From cartoons \$2.00 hundred. 82-29 60th Road, Elmhurst 4, New York.

"HOW To Make Money With Simple Cartoons"—A book everyone who likes to draw, should have. It is free, no obligation. Simply address Cartoonists' Exchange, Dept. 95, Pleasant Hill, Ohio.

CARTOON Course, plans, markets. Prepare for post-war cartoon job. Hartman, 2438 W. Lincoln, Nebraska.

CARTOONISTS Need gags; pay \$5 to \$15. Markets, instructions 25c. Gerardt, 716 Gaston, Fairmont, W. Va.

CARTOONING Course—30 illustrated lessons, over 500 sketches, complete \$1.00. Montes Studio, Box 892, Pasadena, Calif.

CARTOONING. Learn quickly at home. New, easy method. Originate comic characters instantly. Prepared by successful cartoonist. Complete course \$2.85. Details free. National Artists, P.O. Box 4248-A, Dallas 8, Texas.

ADVERTISING AGENCIES, LETTER WRITERS, FOR ADVERTISERS

ADVERTISE Profitably: \$20.00 reaches 5,000,000 Sunday newspaper readers with 24-word ad. Newspaper, magazine, mailing-list ratebook free. Chicago Advertising Agency, 20-PA West Jackson, Chicago 4.

35 WORDS Classified in Mailorder World Syndicate list magazines once \$1.00; thrice \$2.00. J. Ramsey, 2823-A N.E. Rodney Ave., Portland 12, Oregon.

ILLUSTRATIONS Pay! Products photographed. Low prices. Richmond Williamson, Danville, Va.

18 WORDS In 100 weeklies \$4.32. H. J. Darnell, Jackson, Tenn.

ADVERTISE: 24 Words, 149 newspapers \$6.50. Lists free. Advertising Bureau, 4515-C Cottage Grove, Chicago 15.

FREE—New Advertisers Rate Guide. 44 pages. Includes everything. Lowest rates. E. H. Brown Advertising Agency, Merchandise Mart, Chicago.

ADVERTISING Placed all magazines, newspapers U.S.A., Canada. Lowest rates. Free Service. 54-page catalog free. Baker Advertising Agency, A-189 W. Madison, Chicago.

ADVERTISING Placed, any publication. Lowest rates, complete agency service. Skilled advertising—merchandising counsel. Ratelist and booklet, entitled "Advertising Results For Sale" free. Baker Agency, 3302 Dodge, Omaha, Nebraska.

FREE—"Amazing New Book"—"Profits From Classified Advertising." Tells how and what to advertise. Be sure to read this book before you invest one cent in advertising. Remember—it's free! Write for your copy now. P. W. Johnson, Classified Advertising Manager, 200 East Ontario Street, Chicago, Illinois.

24 WORDS, 30 Newspapers \$2.00. Goodall, 37 Gardner, Vallejo, California.

MAIL Order operators—Get skillfully prepared copy when placing advertising. Our "lowest" line rate plus experience gives you more profits per dollar spent. Van De Mark, Times Star Tower, Cincinnati 2.

INCH Display advertisement, 50 magazines, year \$16. Wood's Popular Services, Atlantic City, (N. J.)

TYPEWRITERS, DUPLICATORS, OFFICE DEVICES

DUPLICATORS, Dictaphones, addressographs and other office machines rebuilt, guaranteed machines for sale. No priority. We offer highest cash prices for used office machines. Pratt Office Machines, Inc., 425-PM No. LaSalle St., Chicago, Ill.

MAKE inexpensive duplicator. Instructions 25 cents. Francis Quinn, 207 East 25, New York 10, N. Y.

DUPLIGRAPH Reproduces writing, typewriting, drawings. 8½x11 size \$2.50. P.O. Box 1637, San Antonio, Texas.

"PRINTOMATIC" Self-feeding rotary stencil post card printer, complete, \$9.50. All makes duplicator supplies. Literature free. Pittsburgh Typewriter Supply, 336-R Fourth Avenue, Pittsburgh 22, Penna.

PRINT-O-MATIC For \$9.50, kit of supplies included. Used mimeograph \$25.00. Office machines bought, sold. Handy catalog 10c. Write Schubert, 3230 Lowry, Los Angeles 27.

RUBBER STAMPS, OFFICE SUPPLIES

YOUR Name, address on deluxe cushion mount rubber stamp \$1.00. Pad 25c, postpaid. Cash with order. Edgewood Press, Edgewood, Maryland.

ONE Line 15c, 2—25c, 3—35c. Stamp Works, Auburn, Nebr.

3 LINES 30c; Cushioned, indexed, 35c. Signatures \$1.50. Stamprite, Wauwatosa, Wis.

KNOB Handle, cushioned, 2 lines 30c, 3—40c. Stamp Works, Centerport, N. Y.

PRINTING, MULTIGRAPHING, MIMEOGRAPHING, GUMMED LABELS

100 LETTERHEADS And envelopes \$1.00. Comic cards packet 25c. Dikover Press, 5233 Cleveland, Kansas City 4, Missouri.

PRINTING. Most for your money, \$1 and \$2 specials postpaid. Write Standard Printing Company, Worcester 8, Mass.

250 8½x11 LETTERHEADS, 6¼ Envelopes or business cards \$1.70 each. Three for \$4.95. Quick service. Nationwide, 1747 Page, Cleveland 12, Ohio.

200 LETTERHEADS Or billheads; 300 cards. Each \$1.00 postpaid. Benneville, 907 West Roosevelt, Philadelphia 40, Pa.

GUMMED Perforated address labels, 3300 for \$1.00. Keller, Michigantown, Ind.

ANYTHING Printed, reasonable. State requirements. Excelsior Printers, 122, Weatherford, Texas.

100 LETTERHEADS And envelopes \$1.00. Regal, 1366 Bellefair, Springfield, Ohio.

PERSONALIZED Stationery, 50 printed sheets, 50 envelopes, \$1.25; raised letters, \$1.50. Samples. Merz Printery, 135 Lenox, Rochester 11, New York.

5000 ELEGANT Envelope slips, \$4.50. All printing low prices. Samples. Goodprint, Harrisonburg, Va.

FREE Printing and multigraphing price list. Mangof, 555 South 20th, Newark 3, N. J.

FINE Stationery our specialty. Globe Print Shop, Spivak, Colo.

100 HAMMERMILL Bond 8½x11 letterheads and 100 envelopes \$1.00 prepaid. Apostle's, 112P Buck, Paulsboro, N. J.

MIMEOGRAPHING—Letters, illustrated bulletins, any copy. Quick reasonable. Prices, samples free. Mailers Service, Box 606-A, Chicago 90, Ill.

LETTERHEADS \$3.00 Thousand—notebooks \$2.50 thousand — billheads \$2.50 thousand—envelopes \$3.10 thousand—business cards \$1.80 thousand—other prices equally low. Samples free. Independent Print, 1511 Chicago St., Omaha, Nebraska.

LET Us help you in all your printing needs. Lowest prices. State requirements. Printing Service, 7922 South Vermont Avenue, Los Angeles 44, California.

200 BOND Letterheads, envelopes, 89c. 2000—\$5.98. Samples. Joseph Johnson, 1382-A Fifth Ave., New York 29.

2500 BOOK Matches with your business, name, address, phone number on front cover, patriotic slogan "Keep 'Em Flying" on reverse side. All for \$9.95 f.o.b. Chicago. Cash with order. 1000 business cards, raised lettering or flat printing \$2.95 postpaid. Mail Order Press, 417 So. Dearborn St., Chicago 5, Ill.

LABELS—500 Red, white and blue, gummed labels printed with name, address, town and state. Only \$1.00 postpaid. Independent Print, 1511 Chicago St., Omaha, Nebr.

BETTER Quality printing postpaid: 250 8½x11 good bond letterheads and 250 6¼ envelopes \$3.25. 500 of each \$5.75. Mero Products, Box 344, Punxsutawney, Penna.

50 PERSONAL Cards printed with name. Send 25c. Personal Card Co., Box 370, New Haven, Conn.

1000 8½x11 LETTERHEADS \$4.00, 2000 \$6.75, 5000 \$15.00 f.o.b. Samples. William Jones, Mineola, N. Y.

500 3½x1½ FOUR Line gummed stickers. 25c. Moritz Printery, Saginaw, Mich.

BETTER Grade printing reasonable. Estimates on anything. Economic Press, Leona, N. J.

DOLLAR Printing—mimeographing, 25 specials. Mogul-IG, 1321 East 105, Cleveland 6, Ohio.

PRINTING OUTFITS AND SUPPLIES

PRINTING Equipment, type and supplies. Send stamp for details or dime for complete illustrated supply book. Kelsey Inc., X-11, Meriden, Conn.

PRINTING Presses \$25.00. Large \$35.00. Good on army canvas. Prepay. Valco, 1618 Chestnut, St. Louis, Missouri.

PRINT At home. 10c will bring a complete catalog of presses, type and supplies. P. Peiffer & Company, 6 Columbia St., Newark, N. J.

PRINTER'S Supply bargain catalog. Send stamp. Bradshaw's, 3214-P Huron, Chicago 24.

USED Presses, type, supplies. Lists 3c. Turnbaugh Service, Loysville, Penna.

INEXPENSIVE Home-made printing press. Details free. Novelty Shop, Downs-ville, Louisiana.

BARGAINS—Presses, type, supplies. Send stamp. 8 Waiden, Cambridge, Mass.

PATENT ATTORNEYS

PATENTS. Promptness assured. Wilfred E. Lawson, 1524 K St., N.W., Washington, D. C.

C. A. SNOW & Co., M-427 Snow Bldg., Washington 1, D. C. Registered patent attorneys. Established 1875. Literature mailed on request.

PATENTS Obtained; selling service, information, recording forms free. Labiner, World Building, New York.

L. F. RANDOLPH, 302-B Columbian Bldg., Washington, D. C. Low cost. Book and information free.

INVENTORS: Learn now—without obligation—how to protect and sell your invention. Secure free "Record of Invention" form with instructions for making disclosure and establishing date of your invention—and new free book "Patent Guide for the Inventor," containing complete information about patent procedure and how to sell inventions; giving illustrations of many successful inventions; over 150 basic mechanical movements. Delay may be costly. For prompt confidential service—write today to Clarence A. O'Brien & Harvey Jacobson, Registered Patent Attorneys, 41B-E Adams Building, Washington, D. C.

WHO Buys Inventions? Manufacturers everywhere have written us seeking new patented inventions. Present defense program offers splendid opportunity to inventors with meritorious ideas. As registered patent attorneys in Washington we have served hundreds of inventors—for full information on how to protect your invention write for free book, "How to Protect, Finance and Sell Your Invention." Also free special form "Invention Record" upon which to sketch and describe your invention. No obligation. McMorro & Berman, Registered Patent Attorneys, 1346 Albee Building, Washington, D. C.

INVENTORS—First things come first. Your first move toward securing a patent on your invention is acquiring full information on what to do. Our two books "Patent Protection" and "When and How to Sell Your Invention" contain this information and other helpful data. Get them immediately, together with our "Evidence of Invention" form. They cost you nothing, you assume no obligation. Write now to Victor J. Evans & Co., Registered Patent Attorneys, 831-E Merlin Building, Washington 6, D. C.

"PATENT-Particulars" and blanks, free, airmailed. Sterling Buck, Park-North Avenues, Baltimore 17, Md. Government-registered 37 years.

"INVENTOR'S Guide," 100 mechanical movements, free; advises on patenting, selling inventions. Frank W. Ledermann, 154 Nassau Street, New York.

PATENTS. Protect your idea by securing free "Proof of Invention" folder. Exceptional personal service. Established 1906. E. E. Vrooman, 871 Woodard Bldg., Washington, D. C.

INVENTORS—Before disclosing your invention to anyone send for form "Evidence of Conception"; "Schedule of Government and Attorneys' Fees" and instructions. Sent free. Lancaster, Allwine & Rommel, 411 Bowen Building, Washington, D. C.

PATENTS—Trade marks. Preliminary advice, book and disclosure form free. Personal service. Irving L. McCathran, 315 McLachlen Bldg., Washington 1, D. C. Registered Patent Attorney.

FOR INVENTORS

INVENTORS: Learn now—without obligation—how to protect and sell your invention. Write for free "Record of Invention" form and complete instructions for making disclosure and establishing date of your invention. We also send our new free "Patent Guide for the Inventor," containing complete information about patent procedure and how to sell inventions; giving illustrations of many successful inventions; over 150 basic mechanical movements. We assure you prompt, confidential service. Delays may be dangerous. Write today for your free "Patent Guide" and "Record of Invention" form. Clarence A. O'Brien & Harvey Jacobson, Registered Patent Attorneys, 41A-E Adams Building, Washington, D. C.

INVENTORS—Information on what to do first toward securing a patent on your invention is of vital importance. "Patent Protection" and "When and How to Sell Your Invention"—two valuable, richly illustrated books—explain fully what to do first, and a lot more. Get this information quickly together with "Evidence of Invention" form. All three will be sent to you free. Write immediately to Victor J. Evans & Co., Registered Patent Attorneys, 832-E Merlin Building, Washington, D. C.

SMALL Rubber factory is looking for new items to manufacture postwar. Do you have a patent or a good idea? Perhaps we can help you with design or financing. Reliance Rubber Company, 1515 Powell Street, Oakland 8, California.

MANUFACTURERS Names — all lines. Price-list free. Tupper, 18-A Lyman, Beverly, Mass.

CASH For practical ideas and inventions. Mr. Ball, AB-9441 Pleasant, Chicago.

INVENTORS! Free booklet, "Selling Your Invention," explains correct way to market your invention. Inventors Patent Exchange, 635 Main, Hartford, Conn.

INVENTORS: New military and commercial inventions urgently needed by manufacturers. Write for particulars. Chartered Institute, Dept. 4-A, Washington, D. C.

INVENTORS! Have you good patentable ideas? Write Mr. Metzler, 11 West 42nd, New York.

I SELL Patents. Established in 1900. Charles A. Scott, 773PM Garson Ave., Rochester, N. Y.

INVENTIONS WANTED

OPPORTUNITY For practical inventions! We want new electrical, mechanical, electronic, or chemical products of industrial or semi-consumer type. Interested in suitable products whether experimental stage, patented, or being manufactured. Send description now for consideration. All information held strictly confidential. Your rights protected. Ideal Commutator Dresser Company, Sycamore, Illinois.

ALL Kinds. We have facilities and finances to make and sell your ideas, both mechanical and chemical. Send model, sample, details and wishes. General Sales & Supply Company, 110 East Main St., Madison 3, Wisconsin.

WANTED—New inventions. Will engineer manufacture and sell on royalty basis or buy outright. Alfco Products Co., Continental Bldg., St. Louis, Mo.

LOOKING For good idea, or patent, not too complicated for manufacturing. Moore, 333 Lorraine, Glendale, Calif.

INVENTORS! Have you good, patentable ideas? Write—Mr. Metzler, 11 West 42nd, New York.

WANTED—Good post-war inventions, all kinds, patented, unpatented. Booklet, references, free. Invention Reporter, 5B-11236 So. Fairfield, Chicago.

WANTED—New tools for automotive and aircraft work. Will buy patents or designs outright or as finished tools. Give details. Betterfit Tools, Box 56, New Britain, Conn.

CASH For inventions, patented, unpatented. Mr. Ball, A-9441 Pleasant, Chicago.

INVENTORS: Have you a sound, practical invention for sale, patented or unpatented? If so, write Chartered Institute of American Inventors, Dept. 4-D, Washington, D. C.

MANUFACTURER Wants sensible mechanical device or idea with quick sales possibilities in low-priced field. Write Matt, 1412-D Great Northern Building, Chicago 4.

PATENTS FOR SALE

NOVEL, Compact, first-aid unit designed resembling fountain pen. Patent applied for. Royalty. Present, post-war possibilities. Cpl. Raymond L. Watkins, 58th Station Hospital, APO 782, New York, N. Y.

DOLLARS For someone. Patent 2341107 for sale outright. Precision locating tool for templates, jigs, dies. Does the work of a high priced jig borer. Fits in toolchest. Indispensable for layout work. Every machinist, tool, die and gage maker should have one. H. L. MacDonald, 418 Parkway, Revere, Mass.

PLASTIC "Strip" refillable binding device—for loose leaves, booklets, catalogs, pads, etc. The "strip" binder refillable! Patent 2,314,204. Fontecilla, 452 Forest, Dayton, Ohio.

UNPATENTED Kitchen gadget, might be good, my mother-in-law likes it. Reasonable. Box 1399, El Paso, Texas.

PATENT, Punch knife, excellent defense weapon. Foster, 2574 Ida, Omaha 11, Nebr.

MANUFACTURING

PRECISION Machining, models, production. Small lot industrial diamonds re-setting. Specialty Machine Shop, 2821 Mitchell St., Racine, Wis.

MODEL Making for inventors, etc. Gear cutting. Baum's Metal Specialties, Kansas City, Mo.

MODELS—Small lot manufacturing. Metals, plastics, etc. Milburn, Burlington, Kentucky.

25 SHELVES You Can Make. Booklet describing everything from wall shelf for dishes to knickknack shelf of white enameled wire and blue glass. 25c. Popular Mechanics Press, (C-43), 200 E. Ontario, Chicago.

MODELS AND MODEL SUPPLIES

TWIN Screw S-62 Boucher engines with gears, shafts, couplings, tubes, struts, propellers, etc. \$50.00. E. Ellenberger, Brecksville, Ohio.

CATALOG 50 Engines, model railroad supplies, 25c refunded. Howardco, A2417 North Ashland, Chicago.

PLANES, Boats, hundreds of hobby items. Catalog 6c. America's Hobby Center, Dept. B 54, 40 E. 21 St., New York 10, N. Y.

RAILWAY Models, complete line, informative catalogs O gauge, 104 pages, 25c; HO, 48 pages 15c. Walthers, 247 Erie, Milwaukee, Wisconsin.

SHIP Models and yacht supplies complete. Large 64 page catalogue 20c. Bill Wild's, 510 East 11 St., New York City.

MODEL Kits and supplies, catalog 10c. Steve Patti Co., 1443 W. Forest Home Ave., Milwaukee 4, Wisconsin.

SHIP Model kits and fittings. Complete line Fisher model yacht equipment. All Boucher, Fisher, Marine Model and Ideal kits, fittings and blueprints at standard prices. Most complete stock in New England. James Bliss & Co., Inc., 220 State Street, Boston, Massachusetts.

CASH Paid for old locomotives, passenger cars, freight cars, also want Hudson type locomotives, "O" gauge. Robert I. Mobley, 6110 Santa Monica Blvd., Hollywood, California.

HOME CRAFTSMEN

28 LAWN Ornament patterns 25c. Other patterns; 15"-20" high; Dutch girl; Dutch boy, pirate, bull terrier, Mexican girl, Mexican boy, dwarf, penguin, flower girl, 10c each; 3 for 25c. 25 novelty patterns 30c. All 62 full size patterns \$1.00 postpaid. Strother, Box 383-FN, Belington, W. Va.

CRAFTSMEN Build and sell new venetian type awning made of redwood or pine. Easy to build. Detailed blueprint of design will start you off on a good summer business. Plans \$1.00. Lohrand, 174 Oakwood, Barberton, Ohio.

LUMBER, Walnut, cherry, oak, cut to order. Sample lot \$1.00. Jason E. Lyon, Harrisonburg, Va.

LUCITE, Plexiglas sheets, rods again available. Cut to order. Sheet assortment with plans, instructions \$1.00. Instructions 10c. Transposter, 76 Kilmarnock, Boston 15, Mass.

BEAUTIFUL Wrought iron ashtray, material, instructions 50c. B. R. Aircraft, 6505 Maplewood, Baltimore 12, Maryland.

LEARN Clinker-craft. Fifty cents brings full directions. Art-Garden Co., Napoleon, Mich.

NOVELTIES From scrap wood; 25 patterns 25c. 15 full size lawn ornament patterns only 35c. Lynds, Medway, Mass.

PLANS, Details and photo of modern desk, material lists, \$1.00. Photo, dime. Nesbit A. Boyles, FM5, Hartford City, Ind.

FLEXIBLE Moulds easy to make with Roni Rub'r Compound. \$1.50 pound postpaid, guaranteed. Color patterns—soldier, sailor, marine, 3 for 25c postpaid. Princiotta, Box 5, Whitestone, N. Y.

LUCITE—Transmits light around curves—beautiful clear plastics. Bargain 1 lb. assortment of odd pieces (approximately 6 rods and 6 flat sheets), \$1.00 postpaid. Craft Service, 337 University Avenue, Rochester, New York.

CATALOG: Tools, decal transfers. Patterns novelty furniture, lawn ornaments, silhouettes, letters and numerals. Other lines. 500 articles finely illustrated. Write Wo-Met Shop, Ashburn, Georgia.

WATCHES, OLD GOLD, JEWELRY, ETC.

OPALS, Sample packet \$5.00. Catalogue free. Norman Seward, Melbourne, Australia.

WE Pay top prices for old gold, silver, platinum, watches, jewelry. Any amount or condition. Free particulars. Hamilton and Company, 407A North Broadway, St. Louis, Mo.

ELITE Diamond rings—Perfect imitations. Men's belcher—Women's tiffany gold p. \$1.00. Women's modern—cluster or wedding sterling \$2.00. Sample bargains limited. Rush order. State size. Ollendorf, 1220 Builders Building, Chicago.

GOLD \$35.00 Ounce — Mail old gold teeth, jewelry, rings, watches—receive cash by return mail. Satisfaction guaranteed. Free information. Writeseil Enterprises, PM-2555 Cleveland, Columbus 3, Ohio.

WATCHES, Materials, tools, jewelry, diamonds — bought or sold. Catalogue. Gales, Box 1000, Chicago.

LADIES' And men's Swiss reconditioned wrist watches, yellow and rose gold color, \$19.75 money order. Alarm clocks urgently needed by war workers. 50c each paid for repairable clocks. Rudolph's, Atchison, Kansas.

TOBACCO, SMOKERS' SUPPLIES

CIGARS. Mild. Trial box 50, \$3.00 plus 20c mailing. Many other brands. Literature free. Zibar, Roselle, New Jersey.

FREE To pipe smokers—For a new pipe smoking thrill, write us your brand of tobacco and get free package mild, tasty, natural-flavored "Green River." Pete Moberly, Box 967, Owensboro, Kentucky.

ELECTRIC SHAVERS, RAZORS, BLADES, SHARPENING

GUARANTEED Hair trimmer 60c, extra blades 5c. Watson Hauger, 224AZ Ridge, New Kensington, Pennsylvania.

100 DOUBLE-EDGE Blue steel razor blades \$1.20 prepaid. Fully guaranteed. S. W. Smith Distributors, 321 Broadway, New York 7, N. Y.

DOUBLE Edged blades \$1.50 per hundred. Bonfoey, 429 West Boulevard, Charlotte, N. C.

FOR SALE—MISCELLANEOUS

SELL Cheap—Marine engine business, finished parts, wood patterns. P.O. Box 17, Sta. A, New Haven, Conn.

WANTED—MISCELLANEOUS

MANUFACTURERS — Your waste may be made more profitable. What are you scrapping? Write Matt, 1412-B Great Northern Bldg., Chicago 4.

SMALL Precision lathe, drill press, circular saw, radio testing equipment. P.O. Box 441, Lakeland, Florida.

WE Pay you well for "anything" you wish to sell: Tools, instruments, equipment, merchandise, jewelry. Justice Jobbers, Box 150, Chicago.

MUST Have machine shop equipment. Lathes, shapers, milling machines, drills, etc. Will pay cash, price no object. May & Lake Manufacturing Co., 1034 W. Lake St., Chicago, Illinois.

MERCURY (Quicksilver) — Cadmium, bismuth, tungsten, molybdenum, cobalt, vanadium. Write for quotations stating quantity. You'll receive guaranteed prices. Metallurgical Products Co., 35th and Moore Sts., Philadelphia, Penna. Established 1909.

WANTED: Mercury (quicksilver). We pay \$1.00 per pound. Western Metal Co., Bloomington, Illinois.

PERSONAL

PENMANSHIP Corrector—Corrects your penmanship—few hours. Write, Ozment, 9, St. Louis, Mo.

YOUR Church can raise more money. 25 practical plans 25c postpaid. William Droste, 2750 Chicago Blvd., Suite 111P, Detroit 6, Michigan.

DISCOVER Your best abilities through scientific aptitude tests. Information 10c. Testing Service, 206 Commercial Building, Rockford, Illinois.

LEGAL Matters in Mexico, confidential. F. Morales, Ave. Mexico 161, Tijuana, Mexico.

HAIR Falling or thinning? Miraculous secret preparation. Curbs dandruff. Encourages healthy growth of hair. Free booklet offered. Write Dept. K, Meta Esoteric Co., 140 West 42nd St., New York City.

PSORIASIS Sufferers: Pixacol has brought relief when everything else failed. Use only as directed. Apply externally, dries quickly, convenient. Try regular \$1 bottle without investing a cent! Write: Pixacol, Box 1298, Cleveland 3, Ohio.

HAIR Falling? Dandruff? Write Trichologist, 137 Lewis St., Phillipsburg, N. J.

"PIN-UPS." Today's biggest bargain assortment \$1.00. James Reed, SP-1, Hollis 7, N. Y.

LIVE Longer, feel better, enjoy life. Free information. Fairchild Company, Mt. Vernon, Ohio.

FALLING Hair, its cause and prevention, is fully explained in an informative and educational pamphlet entitled "How to Keep Your Hair Till Ninety." For free copy write, James Hilton, 4819 Fourth Ave., Brooklyn, N. Y. 20.

WEDDING Invitations, low prices, quick service; samples loaned. 4154W Fifth Street, Philadelphia 40.

MARRIAGE Certificates, two colors, dollar. Caswell Associates, R. 2, Altoona, Penna.

PERSONS Located. Records — Birth, baptismal, adoption, marriage, wills, estates. U. S., Canada. Chaffee, 308 Washington, Chicago 6.

GLASSES. Complete in your choice of frame or mounting at amazing low prices. Broken lenses duplicated. Send for free price list today. Wright Optical Company, P.O. Box 2043, St. Louis, Mo.

FEET Hurt? Free literature. Write Elsholz, Box 9014, Pittsburgh 24, Penna.

TRIM-RITE Hair trimmer, saves barber costs. Illustrated circular postal. Bay State Service, 16 Bulfinch, Boston 14, Mass.

DRUNKENNESS is a disease which responds to treatment. Medical skill plus human sympathy prove successful with liquor and drug cases. 60 years experience. Write for free booklet. P. M. Nelson. The Keeley Institute, Dwight, Ill.

MEXICAN Legal matters reliably handled. A. Munoz, 240, Juarez, Mexico.

BUY Vitamins direct. Save. Postcard. Matoska Products, White Bear Lake, Minn.

MISCELLANEOUS

"UTILITE Brand flashlight and lantern." Excellent for use about home and garage. Sent postpaid for \$1.00 or C.O.D. plus costs, complete. Money back in five days if not delighted. Crystal, 735 High St., Newark, N. J.

20 HOME Menders for only \$1.00. Handy "Fix-Me" packets—Just add water and apply! New idea—practical! Economical! Everything needed to repair, mend, renew. "Dehydrated"—in powder form. No waste. Use as needed. 20 all-different products include: cements for china, tile, glass, rubber, metal, linoleum; furniture glue; refrigerator "touch-up"; rust removers for metals and fabrics; rust preventor; paint brush cleaner; silver polish; paint remover and six others. A nickel a packet at 5c to \$1.00 stores. Or send your name and address to So-Lo Works, Incorporated, Dept. H-5, Loveland, Ohio. We'll send all 20 "Fix-Me's" C.O.D. for \$1.00 plus postage and C.O.D. fees. Money instantly refunded if not delighted.

A THOUSAND Laughs—Unique Jackass cigarette dispenser. Holds 10 cigarettes. Simply press donkey's head down, tail rises—presto—out slips cigarette. Satisfaction guaranteed. Shipped C.O.D. for 98c plus small money order fee or \$1.00 with order. Sanimo Industries, Dept. C-7, Spencer, Ind.

TRICK Chalk stunts. Catalog 10c. Balda The Cartoonist, Oshkosh, Wis.

GREAT Fun. Letters mailed from N. Y. 15 cts. Forwarding service. Details free. Fascinating samples. Pin-ups, photos, views. Sparetime offers. 25c. Haller, 436 New York Ave., Brooklyn 25, N. Y. Write. Any day. Any year.

GET More business. Candied apples, caramel corn, barbecue sauce recipes, all for \$1.00. Zehnder Sales, Phillipsburg, N. J.

GIGANTIC Mails, magazines, circulars, samples, listing 10c. Waddell's, 309 East 75th, New York 21.

"PIN-UPS." Glorious girls—postcard size. Samples 25c. Big bargain assortment \$1.00. Clover Novelty, Hollis 7, N. Y.

INCOME Tax deduction slide rule. 20c postpaid. Reed Rules, 3760 Keltown Ave., Los Angeles 34, Calif.

BIG Mail for you. Latest moneymaking offers, opportunities, catalogs, magazines. Name listed in directory 10c. Ideal Service, 105-M, Park Ridge, Ill.

UNPAINTED Wall plaques 2½c up. Write, Oman, 642 Broadway, St. Paul 1, Minnesota.

"CLASSIFIED Swap Directory" \$1.00. Get started swapping. Golden Rule, 654 N. Florence, Burbank, Calif.

MAGAZINES, Circulars, opportunities. Dime. Edward Lau, Box 1258, Honolulu 7, Hawaii.

BUY, Sell, swap, anything. Hughes Bulletin 10c copy. Hughes Service, Shillington, Penna.

CARTOONS Drawn from snapshots! Send photo and \$1.00. Superior Designers, State College, Box 192, Orangeburg, S. C.

"YOU Can Fix It" book. A handy guide to home repairs. \$1.00. Bob Brunzell, 4912 Park Avenue, Minneapolis 7, Minn.

BRINKO Cleaner and polish, one operation. No mixing. Unconditionally guaranteed. 50c package equals quart-liquid. G. H. Brinkley, 1520 N. Regester, Baltimore 13, Maryland.

QUILTING? Silks, cottons, velvets, woolens. Samples free. Rainbow, Decherd, Tenn.

A SOLDIER'S Life in the Philippines. (Poems). Unusual, interesting booklet. 25c. Campbell Dogkins 145 East Second Street, Lexington, Kentucky.

BOYS! Tan alligator and snake skins for extra money. Complete instructions 25c coin. Write Warren Vincent, Route 19, Box 1125, Houston, Texas.

BARBER Shears; superfine, 7½" forged steel. Ideal for home or professional use. Sacrificing, closeout price only \$2 per pair, C.O.D. plus postage. Cash orders prepaid. Money back guarantee. Quantities limited! Wendler Co., Dept. 20, Fremont, Ohio.

UNUSUAL Novelties. Samples 10c. Modern, Box 2, Sta. B, New York 2.

SELL by mail. "Progressive Mail Trade" tells how. Sample copy 10c. Roy Hanke, 21-A Mariner Street, Buffalo 1, N. Y.

LOCATING Underground oil deposits for oil wells and structures. Price \$3. Chas. Bohn, Du Bois, Nebr.

FIREPROOF Children's clothes, curtains, canvas, textiles, etc. Avoid tragedy and destruction. Use Anti-Pyro preparation neatly and economically at home. Guaranteed. Generous sample and price list 25c. Roman Consumer Services, 418 Overbrook Blvd., Pittsburgh 10, Penna.

POOL Your friends. Pretend you're visiting Brooklyn, or New York, 3 post-card views send 25c (20—\$1.00) you write message, address, I remain in Brooklyn or New York. Letters 15c. Hayes, 289 Convent Ave., New York, N. Y.

ENTERTAINING Poem describing a trip to Portland, Willamette Valley—480 lines, 25c. Lewis Vikia, Rt. 1, Lonsdale, Minn.

TRY Unique Buy-Sell-Swap service. Latest bulletins 10c. Details free. A. Brand, Sycamore, Illinois.

INFORMATION. Any subject. Moderate rates. The Roxbys, 747 So. New Hampshire Ave., Los Angeles 5.

OZARK Guide. Lonsdale, Arkansas. For homeseekers, sportsmen, folklorists. Year, \$1.00.

MAIL Order magazines! Giant mail 10c. Peck, 301D Eldred, Battle Creek 21, Mich.

SOUTHERN California questions answered 50c, records searched \$2.50, business transacted \$5.00. Atkins, 1075 Armada, Pasadena.

ELECTRIC Paint or garden sprayer. Easily converted from cheap auto air horn. Complete illustrated plans 35c. Kaytor Lab's, Lynwood, Calif.

OPEN Your garage door from dash board. Look under "Automobiles."

THE Lord is coming! Get guaranteed proofs free. Scheall, 263-X, Duluth, Minnesota.

MEDICAL Laboratory technicians in great demand. We train you in your spare time, in your own home. You can practice while studying. Write for free catalogue. Imperial Technical Institute, Box 973-J, Austin, Texas.

FREE—Stories. Book, Boys, girls, Berg, 659 Churchill Road, Bridgeport, Conn.

PLANT Bansel edible soy beans—250. 25c. Green Valley Gardens, 126 North Main, Tulsa 3, Oklahoma.

RECEIVE Mails, magazines, samples. Your name in numerous mailing lists 10c. Howard, 396 Broadway, New York.

FARM And garden tractors. Complete information on two tractors you can build from auto parts, etc., at small cost, 25c. Popular Mechanics Press, (C-43), 200 E. Ontario, Chicago.

COMEDIAN'S, Vaudevillians, original scripts! Kleinman, 25-31-B 30th Road, Long Island City 2, New York.

BURIED Treasure and lost mines—200 locations in United States. Information free. Treasure Trove, Box 346-F, Springdale, Ark.

BIGGEST Money in tattooing now! No experience required. Complete instructions with outfits. Send for free literature. Tatuco, 651 South State, Chicago.

CARTRIDGES For collectors. Send \$3.50 for assortment fifty rifle and pistol cartridges—all different. Shipped express. American Sporting Goods Co., 2621 Olive, St. Louis 3, Mo.

WHAT Every Mason wants. We have Masonic books for Blue Lodge, Chapter, Commandery, Scottish Rite and Shrine. Our rituals are used the world over. Send for free catalog of books and rituals for Masons, Odd Fellows, Knights of Pythias, Knights of Columbus, Elks, etc. Ezra A. Cook, Publisher, Inc., P.O. Box 796-PMA, Chicago 90, Ill.



You may be sitting pretty now... but...

AFTER WAR, WHAT?

You are probably sitting pretty now. Almost anyone can get a fair job with good money.

But when peace comes, when millions of men come out of the army and navy, when industry converts back—where will you be? There will be keen competition between companies and readjustments of many jobs. Will you be one whom industry labels "Must Keep"—even lists for promotion?

You can by thorough preparation now. And you can prepare in spare time, without a moment's interruption of your present job, and at low cost. Thousands are doing it—are raising themselves above the crowd.

Ask for our free 48-page booklet on the field of your liking. Get the facts about the requirements and opportunities and about our practical home study training.

LASALLE EXTENSION UNIVERSITY

A Correspondence Institution

Dept. 564-R CHICAGO, ILL.
I want to know how I can prepare for post-war competition. Send me your free booklet on the field I have listed below.

- | | |
|---|--|
| <input type="checkbox"/> Foremanship | <input type="checkbox"/> Industrial Management |
| <input type="checkbox"/> Bookkeeping | <input type="checkbox"/> Accounting |
| <input type="checkbox"/> Traffic Management | <input type="checkbox"/> Executive Management |
| <input type="checkbox"/> Law: LL.B. Degree | <input type="checkbox"/> Salesmanship |

Name.....Age.....

Position.....

Address.....

IMPROVE YOUR PLAYING



Quickly improve playing, technique, sightreading, accuracy, memorizing thru Mental-Muscular Co-ordination. Quick results. Send now for Free Booklet. Broadwell Studios, Dept. 154E Covina, Calif.

LEARN SPANISH

Prepare For A Big Future

Prepare NOW for vast unexploited fields in South America. Learn Basic Spanish at home in your spare time . . . for only \$1.50. Book includes huge Spanish-English vocabulary, pronunciation, idioms, numerals, time, months, days, newspaper and magazine Spanish. Also includes translations. A valuable aid. A responsible job can be waiting for you after the war because you know Spanish. **STUDY NOW . . . 270 pages . . . \$1.50.** This book is sold on 5 day money-back guarantee. Pay postman \$1.50 plus COD charges. If cash in advance, we pay postage.

FRED'K J. DRAKE & COMPANY
600 W. Van Buren St., PM-5, Chicago, Ill.
Drake books are sold at leading book stores



THIS GREAT BOOK

HOW to BREAK and TRAIN HORSES

FREE!

Every farmer, every lover of horseflesh should have a copy of it. This amazing book tells how to know horses—how to break them—how to train them—how to make money as a master horseman. Write for it today—**FREE**, together with my special offer of a course in Animal Breeding without cost to you. If you are interested in Gaiting and Riding the saddle horse, check here Do it today—now. You'll never regret it.

BEERY SCHOOL OF HORSEMANSHIP
Dept. 1105-D - - Pleasant Hill, Ohio



JOKE BOOKS For Adults

The kind they like. You will be both a Riot and the Life of the Party with a set of these pocket size joke books. They are full of Entertainment, Fun and Humor. A set of six books only 50c or a special assortment of 12 books all different for \$1.00. Print name and address, send cash or stamps to:

TREASURE NOVELTY CO.,
72—5th Ave., Dept. 1205, N. Y. 11, N. Y.

Get into the BAKING BUSINESS

Bakers make good money! Now 7th Industry in wages! Nearly depression-proof. New home study Baking Course qualifies you. Common school education sufficient. If you're ambitious, write for **FREE BOOK**, "Opportunities in Baking." National Baking School, 1315 Michigan, Dept. 1355, Chicago



ALARM CLOCKS

How to clean and adjust them at home. Easy if you know how. Make—save money. Copyrighted booklet—25c (coin).

THIES JEWELRY STORE, GENOA 8, ILLINOIS

Learn this Profitable Profession



IN 90 DAYS AT HOME

Money-Making Career Open to Men and Women, 18 to 50

Hundreds of men and women between 18 and 50 make \$10 to \$20 in a single day giving scientific Swedish Massage and Hydro-Therapy treatments. There is big demand from doctors, hospitals, sanatoriums and clubs. Graduates earn large full time incomes from these or in private practice in their own offices. Others make good money from home treatments given in spare time. Learn this income-making profession in your own home, through our home study course. Same instructors as in our nationally known resident school. You can win independence and prepare for future security by qualifying for your Diploma. Course can be completed in 3 to 4 months. Many earn while they learn. Begin your training at once.

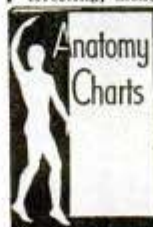

Anatomy Charts & Booklet FREE

Enroll now and we will include, at no extra cost, many needed supplies. Fit yourself to help meet growing demand for massage now and after the war. Send the coupon at once for complete details, **Anatomy Charts and 32-Page Illustrated Booklet, FREE, postpaid.**

THE COLLEGE OF SWEDISH MASSAGE
Dept. 564, 100 East Ohio St., Chicago 11, Illinois

Please send me **FREE** and postpaid, **Anatomy Charts, 32-page Booklet** and complete details on Home Training.

Name.....

Address.....

City.....State.....

What Can You Read In This



FINGER PRINT?

Study it carefully. There is a secret hidden in it, just as there is in every finger print. For 27 years we have been training men to become Finger Print experts. Over 53% of all American Identification Bureaus employ I.A.S. trained men. Get into this steady-employment, good pay profession. Learn at home. Small cost. Fine opportunities.

"THE BLUE BOOK OF CRIME"

FREE This thrilling book tells all about many famous crime cases and how you can qualify for one of the fine positions in the Identification field. Write for it, stating your age.

INSTITUTE OF APPLIED SCIENCE
Dept. 1355, 1920 Sunnyside Ave., Chicago 40, Ill.

HERE IS YOUR SUCCESS CHANCE
BE A

RADIO-ELECTRONIC TECHNICIAN



**SPRAYBERRY TRAINS YOU QUICKLY
FOR WAR AND PEACETIME WORK**

YOU GET A DUAL-PURPOSE RADIO SET

The offer I make you here is the opportunity of a lifetime. It's your big chance to get ready for a wonderful future in the swiftly expanding field of Radio-Electronics INCLUDING Radio, Television, Frequency Modulation, and Industrial Electronics. Be wise! NOW is the time to start. No previous experience is needed. I supply you with Radio Parts which you use to gain pre-experience in Repair work. These same Parts are used for testing and for Signal Tracing, etc.

FULL RADIO SET

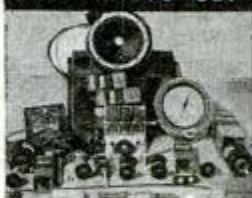

PREPARES YOU for a BUSINESS of YOUR OWN

... or Good Radio Jobs, Civilian or Military

The Sprayberry course starts right at the beginning of Radio. It gets the various subjects across in a clear, simple way. I make it easy for you to learn Radio Set Repair and Installation Work . . . by practical, proved, time-tested methods. I teach you how to install and repair Electronic Equipment. Soon you'll be qualified for a good paying job in one of the nation's Radio plants doing war work OR, if you enter the Army, Navy, or Marines, my training will help you win higher rating and better pay.

READ WHAT GRADUATE SAYS

"Wins Out in Army Test"

"Since I completed your elegant Course in Radio I have been drafted into the Army and put into the Signal Corps. I had to compete to get the job I now hold and as a result of my training with you, I made the best grade and got the job. The point I am driving at is if it hadn't been for your thorough course in Radio I would probably be peeling potatoes now. I recommend your training to all because it is written in language that the average layman can understand." — A R C H PLUMMER, JR., Fort Meade, Md.

Grasp This Opportunity!

**GET BIG
FREE
BOOK**



MAIL COUPON

SPRAYBERRY ACADEMY OF RADIO
F. L. Sprayberry, President
Box 500RE, Pueblo, Colorado.

Please rush my FREE copy of "HOW TO MAKE MONEY IN RADIO, ELECTRONICS and TELEVISION."

Name Age

Address

City State

(Mail in plain envelope or paste on penny postcard)

LEARN MOVIE PROJECTION THEATRE MANAGEMENT

The Motion Picture Theatre Business offers big opportunities for trained men. Free catalog. Give age. Established 17 years.

THEATRE SCHOOL, 370 Washington Street, Elmira, New York

LEARN MONEY- MAKING CARTOONING

IN SPARE TIME — by Easy Picture Chart Method

Same Simplified Method that has helped train creators of "Terry & Pirates," "Freckles," "Out Our Way," "Winnie Winkle," "Reg'lar Fellers," "Strange As It Seems," "The Neighbors," and many others. Earn while learning. Send 10c for Picture Chart (to test your ability), and full details. (State age.)

THE LONDON SCHOOL, 4405 National Bldg., Cleveland 14, Ohio



BETTER SIGHT

SIGHT-TRAINING technique improved. Everybody gets results now. WRITE: Dept. D-5 "USTI" 4057 Budlong Ave., Los Angeles 37, Calif.



Please send me your FREE Sight Chart with instructions.

Name

Address

Quick! Right Now Get into DRAFTING



I'll train you until you have a GOOD PAY JOB

With industry working feverishly—the field for Draftsmen is bigger than ever. More important—draftsmen and designers must come first in changing back to peace-time production. Get into a better job with more pay and fascinating, pleasant work. Engineer Dobe will train you at home—in your spare time, to get experience on actual work, the same kind of jobs you will do in the best paid position, and train you until you are competent, experienced, holding such a position that will mean advancement and pay raises as deserved. When competent will recommend your practical work experience as references. No need for previous training to start with me—and lack of higher education should not hold you back. You can pay monthly for your practical training from an engineer; the cost is reasonable. Write today for full illustrated details and booklet. Give your age to get reply.

All working tools FURNISHED

Professional drawing instruments, all working tools, also drawing table furnished with training. Start in right Now.



GET THE FACTS TODAY!

ENGINEER DOBE, Div. 3375, Libertyville, Ill.
Please send me training facts on "Drafting and Industrial Designing". Also advertised list of positions for Draftsmen and Designers Wanted.

Name.....Age.....
Address.....
Town.....State.....

HOME TRAINING FOR Machinists

Beginners and old-timers rave over
this easy "war-time speed-up"

MACHINE SHOP TRAINING COURSE

Total Price \$12.50—Easy Terms

Now for the first time in concentrated into a complete 3-volume course. Vitally necessary for all Machinists. Quick Training Course for beginners who seek good pay jobs in Machine Shop Work.

HUNDREDS OF DRAWINGS AND TIME SAVING CHARTS

This training at home is comparable to the practical fundamentals learned by resident students at famous National Schools. Easy to follow and understand. Machine tools completely described and demonstrated. Measurements and gauges. Drill Press operations. Milling Machines, Shapers, Planers, Grinders, Blueprint Reading and Drafting. Hundreds of other subjects essential in your daily work leading to better pay.

SEND NO MONEY!



FREE 7-DAY
TRIAL EXAMINATION

NATIONAL SCHOOLS, DEPT. D-5
4000 S. Figueroa Street
Los Angeles 37, California

Ship me for examination Modern Machine Shop Training Course, 3 vols., plus gifts. Within 7 days I will either return shipment or mail you \$3.00 and \$3.00 a month until \$12.50 is paid (final payment \$1.50) Saves 10%. Deduct \$1.25 if you enclose cash (\$11.25) with this coupon. Same return privilege.

Name.....
Address.....
City and State.....
Include your zone number

BONUS
For Promptness
7 Drafting Lessons, Machinist's Dictionary, Shop Mathematics Texts. Mail the coupon now!

LEARN AT HOME TO MOUNT BIRDS



Animals, Heads, Fishes, Pets; to TAN. Be a Taxidermist. Profit and FUN.

Hunters, save your valuable TROPHIES. Mount ducks, squirrels, everything. Learn to TAN for leather and furs. Wonderful HOBBY Have a HOME MUSEUM—BIG PROFITS mounting for others. INVESTIGATE NOW.

FREE BOOK With 100 fine game pictures. NOW absolutely FREE. Write TODAY.

Send Postal TODAY for FREE BOOK. State AGE. N.W. SCHOOL OF TAXIDERM, Dept. 3375, Omaha, Neb.



LIQUID MARBLE

Make beautiful artificial Marble slabs. Pour from liquid state. Glazed or un-glazed. Mottled, veined, snow-white, or multi-colored. Unsurpassed on kitchen or bathroom walls. Easy to make and install. PLASTIC FLOORING. Any color. Lifetime wear. Dustproof, Soundproof, Vermin-proof. Resilient to the tread. Lay out solid or in pattern design. FLEXIBLE MOLDS for plaster casting. Make your own molds for few cents each. \$1.00 in raw materials will make up to \$25.00 of finished goods. We furnish names of buyers. Write now for free information. COMPO-TEX, BOX 786-S, ST. LOUIS (1), MO.

Correspondence Courses in RADIO and ELECTRICAL ENGINEERING

LOW AS \$25
ELECTRICAL ENGINEERING. Get good grasp of wide electrical field. Modern. Very understandable. Theory made easy. RADIO ENGINEERING. Extra fine course in radio, public address, photo-electric work. Train you to be super-service man, real vacuum tube technician. Tuition ONLY \$25, plus course. Deferred payment plan. Servicemen needed badly.

Write for free copies of school catalogs, student magazines, etc. FREE LINCOLN ENGINEERING SCHOOL, Franklin Stn., Box 61—P-65 (Formerly at Lincoln, Neb.) WASHINGTON, D. C.

PLASTICS

Learn the modern way. School founded in 1910. Write for booklet PM. Affiliated schools in principal Eastern cities. W. R. B. Williams, Pres.

NEW YORK TECHNICAL INSTITUTE, 100-5TH AVE., NEW YORK 11, N. Y.

ELECTRICAL BOOKS

shipped FREE

FOR EXAMINATION MODERN ELECTRICITY INCLUDING RADIO AND REFRIGERATION

10 BIG BOOKS

Here's great news for anybody interested in Electricity. NEW 18th edition of Applied Electricity brought right down to date with NEW Electrical subjects fully covered, including Electrical Blue Print Reading. 10 big Volumes and all shipped FREE for examination.

BIG FIELD! Big Demand!

New Edition For Beginners and Experts
Over 3000 pages—hundreds of illustrations—the most complete work of its kind we have ever published. Dynamos, motors, power stations, wiring radios, everything electrical explained so anyone can understand it.

Big Pay! Men who understand electricity are urgently needed in thousands of War Production industries. Airplanes, ship building, arms plants, machine shops—practically every industry depends on electricity and men who know this subject make big money. Pleasant, fascinating work, easy to learn and do; learn with these books. Send coupon for a set for FREE examination and see for yourself.

SEND NOW [A year's consulting privileges with our engineers now given to all buyers of this famous Cyclopedia of Electricity.]
AMERICAN TECHNICAL SOCIETY
Vocational Publishers since 1898

American Technical Society, Dept. E519, Drexel at 58th St., Chicago 37
Send for 10 days' free use, 10 volume set of New 18th Edition, Applied Electricity, including a certificate entitling me to consulting privileges for one year. I will pay the delivery charges only on the books. If I wish I may return them in 10 days and owe you nothing, but if I keep them, I will send \$2.00 after 10 days, then \$3.00 a month until the total price of only \$29.80 is paid.

NAME.....
ADDRESS.....
CITY.....STATE.....

Please attach letter stating age, occupation and name and address of employer and give at least one business name as reference. Men in service, also please give home address.

924 PAGE AUTHENTIC FORMULARY

10,000 Formulas, Recipes, Trade Secrets for making most any conceivable product. Prepared by experts in simple, non-technical language. Countless profitable business opportunities. Valuable reference for manufacturers or students. \$2.00 postpaid. Canada or Foreign \$2.35. U.S. Funds. (C.O.D. orders accepted for U.S. delivery only.)

Prepare for "After-War-Business"

Especially recommended for servicemen returning to civilian life

ADAMS BROWN COMPANY • • • Dept. 10 • • • Chestnut Hill 67, Massachusetts



Watch Repairing

LEARN AT HOME — SPARE TIME

New 1944 course! Teaches watch and clock trade. Big opportunities now. No previous experience needed. Easy self-study training at amazing low price. Money-back guarantee. FREE . . . write today for big Success-Catalog. No obligation. Nelson Co., 321 S. Wabash, Dept. E-802, Chicago 4.

15 LENSES

Plus 50 PAGE Idea Booklet to Help You . . .

(All Lenses New—Edges very slightly chipped) . . . make your own telescopes, low power microscope, magnifiers, dummy camera, photo cells, rifle scope, detachable reflex viewfinder for 35-mm. camera, telephoto lens, photographic gadgets, for experimental optics, copying and ultra-closeup shots and hundreds of other exciting experiments. **EDMUND SALVAGE COMPANY** 27 W. Clinton Avenue, P. O. Audubon, New Jersey

Set 602-H Only **\$2.60** Postpaid



WARTIME PHOTOGRAPHY

—while preparing for a sound future career! Trained men and women photographers are needed now more than ever before. Quality at largest, oldest school that

has trained many of today's most successful photographers. Over 600 N. Y. I.-trained men winning promotion, higher pay in photo divisions of Armed Services. Resident or home study courses. Big FREE book gives details.

N. Y. INSTITUTE OF PHOTOGRAPHY, Dept. 49, 10 W. 33 St., New York 1, N. Y.

Keep that "TICKING" Car

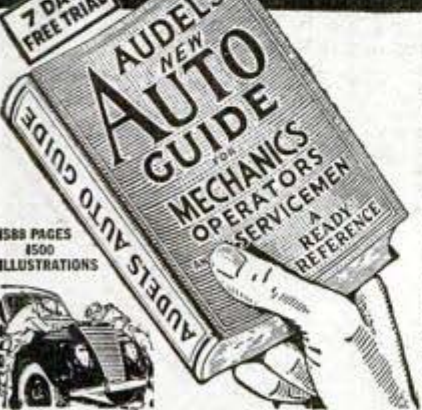

Every operator and mechanic needs AUDELS AUTO GUIDE.

This book saves time, money and worry. Highly endorsed. It presents the whole subject of auto mechanics:

- 1—Basic principles
 - 2—Construction
 - 3—Operation
 - 4—Service
 - 5—Repair
- Handy Size. Easily understood.

NEW FLUID DRIVE, HYDRAULIC SHIFT AND DIESEL ENGINES FULLY COVERED

Over 1500 pages—1540 illustrations showing inside views of modern cars, trucks and buses with instructions for all service jobs. **ASK TO SEE IT!—To Get This Assistance for Yourself Simply Fill in and Mail Coupon Today.**

4 COMPLETE • PAY ONLY \$1. A MONTH

AUDEL Publishers, 49 West 23rd St., New York MAIL AUDELS NEW AUTO GUIDE for free examination. If O. K. I will send you \$1 in 7 days; then remit \$1 monthly until price of \$4 is paid. Otherwise I will return it.

Name _____
 Address _____
 Occupation _____
 Employed by _____ P.M.

Bus Driver Sells 8 Stories

"Since reporting the sale of my first attempt at a magazine article, I have sold three others. Also four feature stories were accepted by the local newspaper. The credit is all yours. When you consider that I'm a driver for the local bus company, you can readily see my time is well taken up."—Herman R. Bach, Box 113, Pacific Grove, Calif.



Why Can't You Write?

It's much simpler than you think!

SO many people with the "germ" of writing in them simply can't get started. They suffer from inertia. Or they set up imaginary barriers to taking the first step.

Many are convinced the field is confined to persons gifted with a genius for writing.

Few realize that the great bulk of commercial writing is done by so-called "unknowns." Not only do these thousands of men and women produce most of the fiction published, but countless articles on business affairs, home and shop crafts, war activities, gardening, local events, homemaking, etc., as well.

Such material is in constant demand. Every week thousands of checks for \$25, \$50 and \$100 go out to writers whose latent ability was perhaps no greater than yours.

The Practical Method

Newspaper work demonstrates that the way to learn to write is by writing! Newspaper copy desk editors waste no time on theories or ancient classics. The story is the thing. Every copy "cub" goes through the course of practical criticism—a training that turns out more successful authors than any other experience.

That is why Newspaper Institute of America bases its writing instruction on the Copy Desk Method. It starts and keeps you writing in your own home, on your own time. And upon the very same kind of actual assignments given daily to metropolitan reporters. Thus you learn by doing, not by studying the individual styles of model authors.

Each week your work is analyzed constructively by practical writers. Gradually they help to clarify your own distinctive style. Writing soon becomes easy, absorbing. Profitable, too, as you gain the "professional" touch that gets your material accepted by editors. Above all, you can see constant progress week by week as your faults are corrected and your writing ability grows.

Have You Natural Ability?

Our Writing Aptitude Test will reveal whether or not you have natural talent for writing. It will analyze your powers of observation, your imagination and dramatic instinct. You'll enjoy taking this test. There is no cost or obligation. Simply mail the coupon below, today. Newspaper Institute of America, One Park Avenue, New York 16, N. Y. (Founded 1925)

NOTICE TO CANADIANS

Newspaper Institute's operations in Canada have been approved by the Foreign Exchange Control Board, and to facilitate all financial transactions, a special permit has been assigned to their account with The Canadian Bank of Commerce, Montreal.

Free

Newspaper Institute of America, One Park Avenue, New York 16, N. Y.

Send me, without cost or obligation, your *Writing Aptitude Test* and further information about writing for profit as promised in *Popular Mechanics*, May.

Mr. _____
 Mrs. _____
 Miss _____
 Address _____
 (All correspondence confidential. No salesman will call on you.) 72-E-594

Copyright 1943 Newspaper Institute of America

Always write your name and full address clearly when answering advertisements.

A BOY... A WATER WHEEL... AND A DREAM !

IT WORKED! No boy had ever seen a more beautiful sight.

Over a little dam spilled the water of the country ditch. The homemade water wheel began to turn on its rake-handle shaft. Faster and faster it went. Next step was to connect it to an old coffee mill inside the woodshed.

Pebbles were poured into the churning mill. They sparked and crackled like a Fourth of July display, grinding noisily into sand to be used later for a casting mold.

Here was the first moving device created by Henry Ford!

Meantime, somewhere inside

his inquiring mind, a dream was struggling to shape itself. A dream of other wheels that would one day turn to lighten the burdens of farm and industry . . . to change the habits of the nation.

From water wheels to watches, to steam engines, to gasoline engines, Henry Ford's interest in wheels progressed. And the rest is history—the history of the automobile industry.

From May, 1895, when the first Ford car was wheeled into Bagley Avenue, Detroit, more than 30,000,000 Ford-built cars

FORD MOTOR COMPANY

and trucks have been produced.

Yet the thought and spirit that prompted that experiment with the water wheel have never changed at Ford Motor Company. There is still the same ingenuity that is not afraid to be original . . . the wanting-to-find-out-for-oneself that makes for progress.

Today, this philosophy and the skills developed through more than 40 years are being applied to America's vital needs. From this will arise new techniques to serve the nation when Ford resumes production of sturdy, comfortable transportation, priced within reach of the greatest number. As Henry Ford has said: "Our times are primitive. True progress is yet to come."



Popular Mechanics Magazine

REGISTERED IN U. S. PATENT OFFICE AND CANADA

WRITTEN SO YOU CAN UNDERSTAND IT

Vol. 81

MAY, 1944

No. 5

HOW MUCH OIL IS LEFT?



Seismograph apparatus on boat may reveal oil-bearing formations far below this southern swampland

By Wayne Whittaker

IN THE FACE of ominous warnings issued to oil users, the average American wants to know: Are we really running out of oil?

His worries are increased by reports that last year our wells produced in excess of 4,000,000 barrels a day to meet the increased demands of war. He has been told the annual production of crude oil was about five times greater than the oil discovered in new fields and extensions of old ones during 1943—an alarming threat to our known oil reserves which are estimated at 20 billion barrels.

While the American oil industry is busy helping keep the Allied war machines powered and lubricated, Mr. and Mrs. America are

Oil is pumped where you find it—even if that happens to be under a shallow lake





Courtesy of The Pure Oil Company

Kneedeep in swamp, surveyor records findings in hunt for oil along the Gulf Coast. Headnet helps fight mosquitoes. Below, drawing shows how seismograph helps find oil "traps"

wondering if we will be running short of petroleum in 10, 15 or 50 years.

What will we use for power in our automobiles, trucks and airplanes should such a catastrophe occur? The honest answer to the query about how much oil we have left is that no one knows beyond the 20 billion barrel estimate.

History, however, has a habit of repeating itself. Theron Wasson, chief geologist for the Pure Oil Company and a recognized authority on oil reserves, finds reassurance for apprehensive Americans by turning the pages back to 1921. He points out that published reports of the American Petroleum Institute show that in that year geologists and engineers made a report to the government estimating our known reserves at 9 billion barrels. From 1921 to the close of 1943 more than 22 billion barrels of crude oil have been produced within the United States. And today we have assurance that a minimum of 20 billion barrels more exist which can be recovered by known methods.

Correcting these recoverable re-

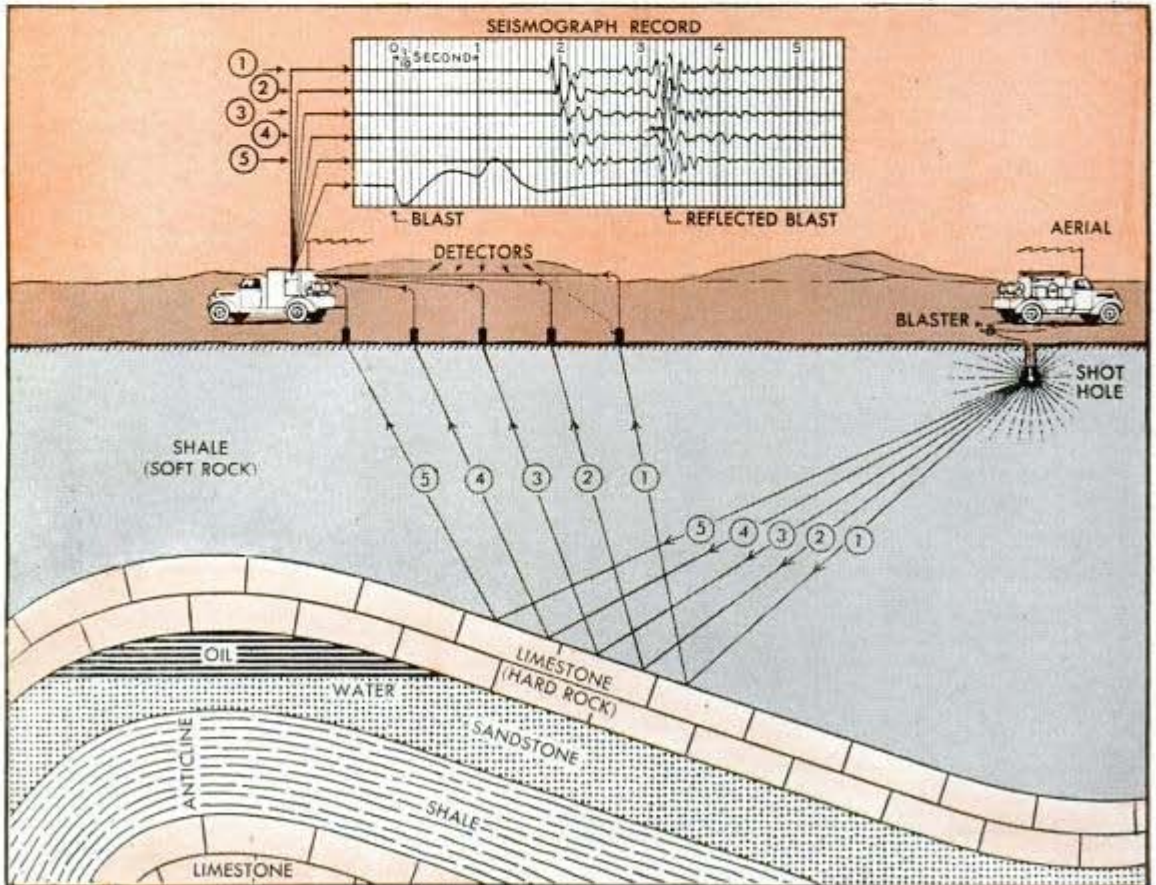

serves backward, we find the reserves in 1921 could have been correctly reported as 42 billion barrels instead of 9 billion. In other words, the 1921 reserves were about four and one-half times greater than the estimate. In 1921 the unknown and undiscovered reserve was 33 billion barrels.

How far wrong is the 20 billion barrel estimate of today? Probably it is less in error than the estimate of 1921, for since then many prospective oil producing areas have been completely drilled up. There is, however, a safety factor in that we still have new territory to explore where deeper oil producing sands will certainly be found. But the fact remains that beyond the 20 billion barrel recoverable reserve which has been proved by drilling we do not know how much more oil there

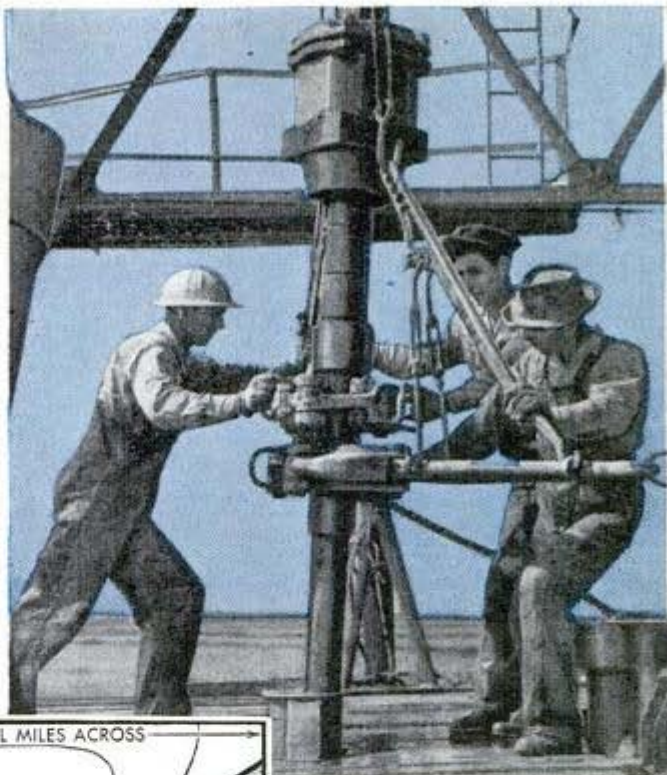

Drill crew making a connection during operations on new field

Cross-section shows why some wells produce only water or gas

Below, precision distillation column in a petroleum laboratory

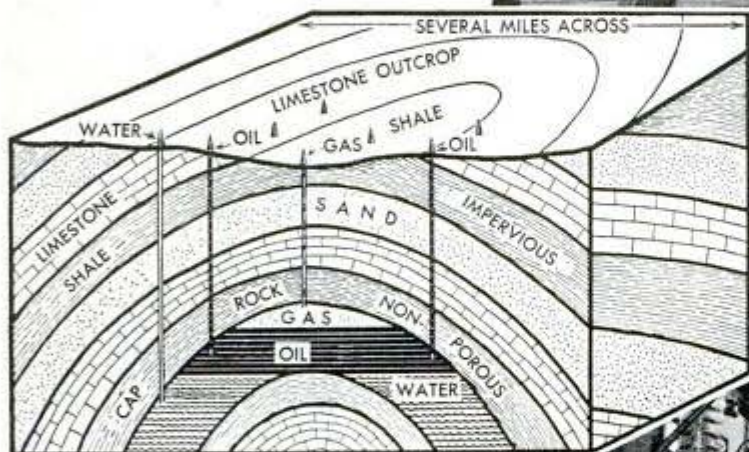

may be left for future discovery.

Today, before prospective oil areas are drilled, a great deal of preliminary geological work is desirable. Surface and sub-surface geology, core drilling, microscopic study of rock samples, electric logging of wells drilled, geophysical instruments—these are the tools of the modern oil prospector.

"The geologist does not locate oil," Mr. Wasson pointed out, "but from his studies of the rocks he determines the most likely places to drill. The drill alone determines the existence or nonexistence of oil. Today geologists are searching for new fields in previously undrilled areas, and it is certain that new fields will be found.

"Something like a billion and a half barrels of crude oil came out

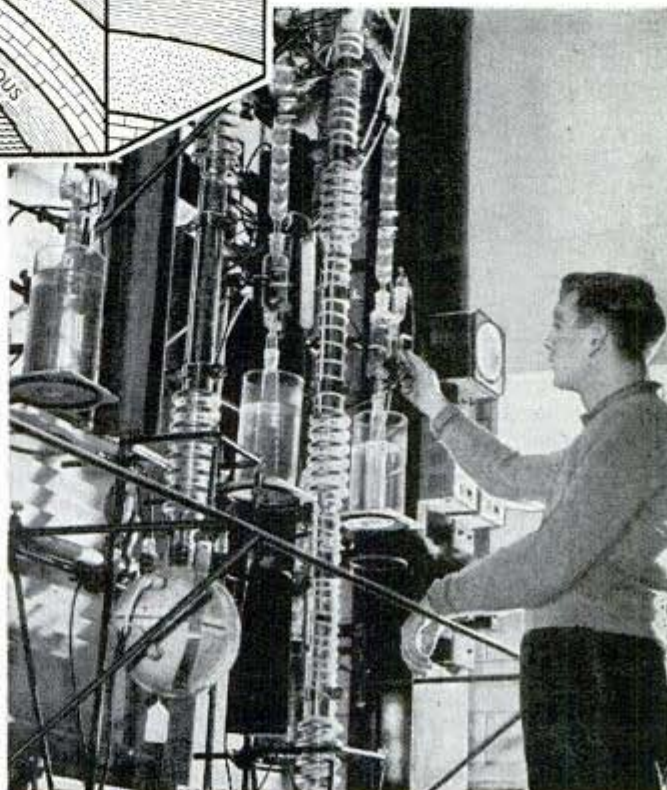

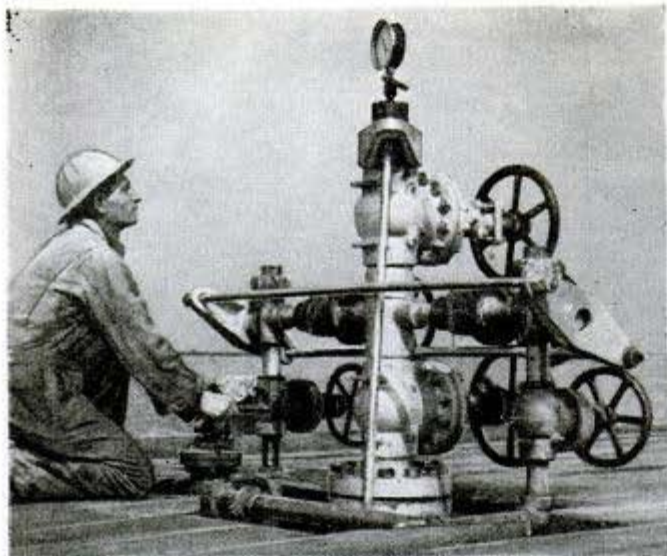

Pumper keeps sharp eye on pressure gauge of oilman's "Christmas tree." Below, upthrust of salt dome forms trap in rock

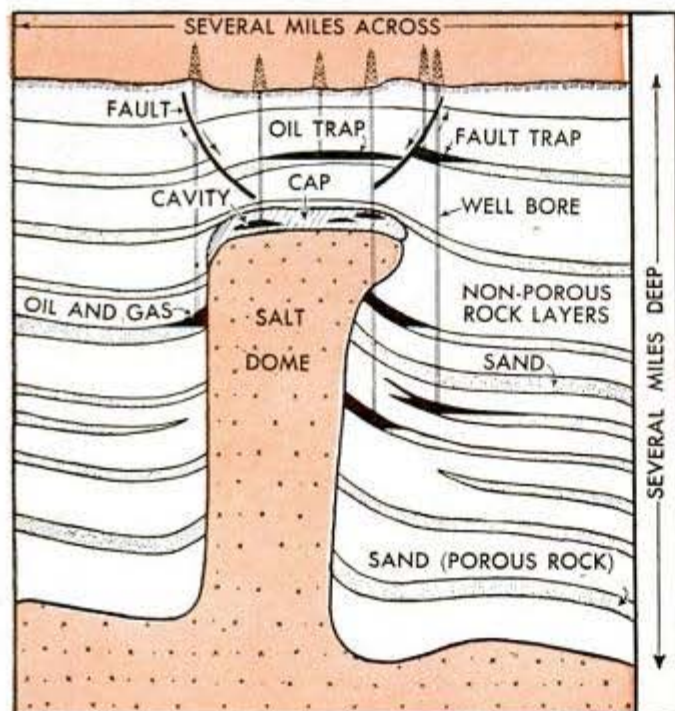

of the ground in the United States during 1943; more strictly speaking, it came out of the rocks. Crude oil is found in porous rock layers that were laid down long ago in salt water seas. Many people think of oil as existing in lakes, rivers, or caves under ground. This is not true. It is held in the pores or openings between the grains of rocks. The tendency of oil to float on water causes it to rise to the highest available point in water-soaked rocks. If natural formations prevent it from es-

Drilling a new well in the race to keep U. S. wartime oil production in excess of 4,000,000 barrels daily

caping, it is caught in what geologists call an 'oil trap'."

One type of trap is an arch of rock layers known as an "anticline" with the porous layer overlain by a nonporous layer of shale or limestone. The oil is trapped underneath the crest of the anticline. Oil is also found in connection with salt domes, particularly in Louisiana and Texas, which have pushed upward causing sealing formations that trap oil.

One ingenious way of finding these traps is by means of man-made "miniature earthquakes" in conjunction with the seismograph, an instrument for recording tremors of the earth. These "earthquakes" are created by exploding a small charge of dynamite in the ground. Earth tremors, or elastic waves, caused by the explosion travel in all directions, including downward. When they hit a strata of hard rock a small part of the wave is reflected to the surface. The time it takes a wave to travel to hard rock and back to the surface enables trained men to determine the depth of this layer of rock. Thus, the presence of anticlines and other structures favorable to oil deposits is discovered.

Secondary recovery of oil from "exhausted" pools, which are yielding millions of barrels of

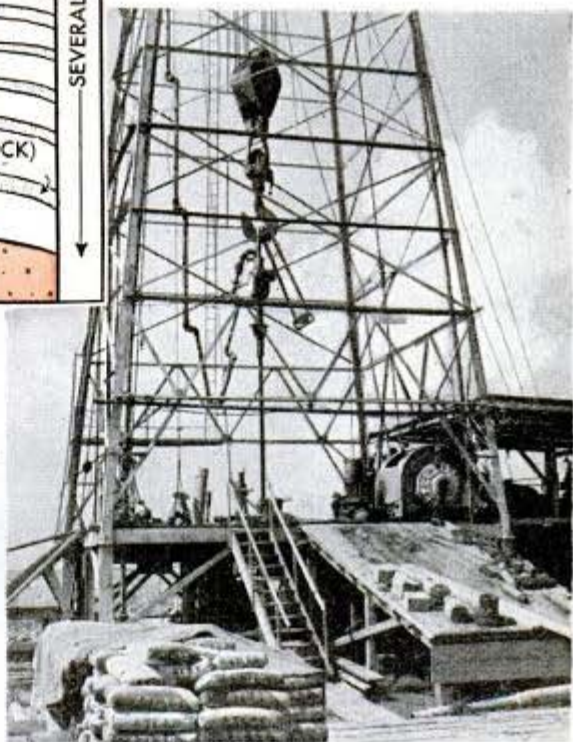

crude, must not be omitted from a study of oil reserves. One process consists of drilling "five-spot" wells in old fields. Squares are laid out and holes are drilled in the four corners. Water is pumped into the corner holes which forces the oil to the center of the square where oil is pumped from a fifth hole. This method has proved highly successful in a Pennsylvania field.

"Geologists are sometimes asked why they don't drill deeper if they want to increase our oil supply," Mr. Wasson said. "Although modern equipment makes it possible to drill at depths as great as 15,000 feet, that is no assurance oil will be found."

Beneath the upper layers of limestone, shale, earth and other materials one finds granite. It is futile to drill for oil below granite, for oil-containing formations have never been discovered beneath it.

Back in 1915, wells of 2,000- and 3,000-foot depths were considered deep holes. Today in Texas and Louisiana production is often obtained below 13,000 feet. The deepest hole was drilled 15,004 feet in central California, but no oil was found at that depth, and it was cemented off at about 13,000 feet where oil had been struck.

Another important factor to be considered is the oil reserve owned by American companies outside of the United States. This tremendous source of oil is not included in the 20-billion-barrel estimate.

The nearest large foreign reserve—which was discovered by United States geologists and developed by American companies—is in Venezuela. Ocean tanker distances from New York to the oil fields of northern Venezuela and to the great tanker ports of Port Arthur and Galveston, Texas, are about the same. Venezuela reserves are estimated in billions of barrels.

Another South American neighbor, Colombia, also has rich fields that are being developed by American oil companies. Great reserves are to be found in the Near East—Iraq, Arabia—and in Russia. The Iraq fields are mostly under British control, but United States companies have large interests in Iraq. Russia's oil reserves are unknown, but probably vast.

The Dutch East Indies, now held by the Japs, have large reserves. The Canadian reserves are small, and leading geologists doubt whether the tar sands there will be fully exploited for many years. The widely publicized Canol project near the Arctic Circle is now getting into production with 26 shallow wells and a 600-mile pipeline.

No one can say just how much these foreign oil reserves would mean to America in a pinch. It is one of the problems that will probably confront the peace table.

Continued to page 160

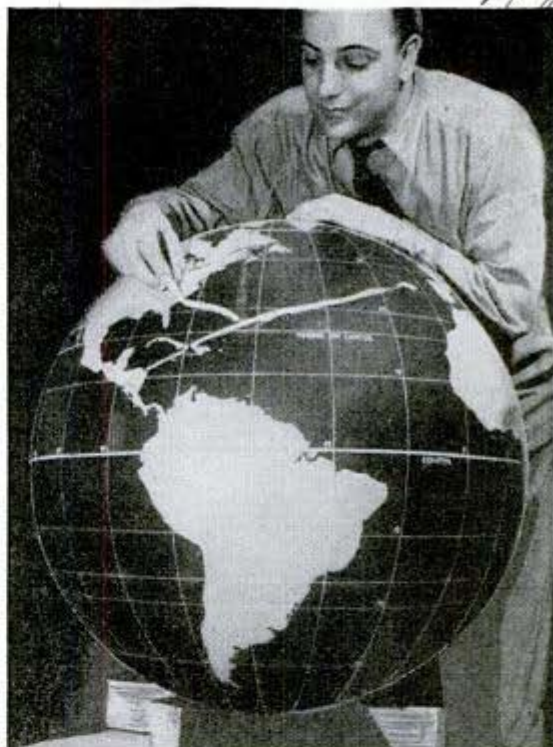

Home
To help train Navy navigators for global warfare, large-sized plaster globes have been developed. Chalk can be used on the blackboard-like surface to trace navigation routes. The globes have a tolerance of 1/3000 inch in manufacture, to allow almost perfect alignment of country boundaries.

Don't Waste "Wastepaper"

THERE'S no such thing as wastepaper. Paper is precious. When you waste, burn or otherwise destroy even a scrap of it, you are destroying part of the pattern of victory. This magazine, like all others, like your daily newspaper, has reduced its production to save paper for vital war purposes.

Bundle up the paper from your wastebasket; tie up old magazines and cartons and newspapers. Sell it to a wastepaper dealer, give it to your favorite charity or call the local salvage committee. The shortage of paper is grave. Don't waste wastepaper!

RCAF Brings Bombers Back From the "Bush"

017

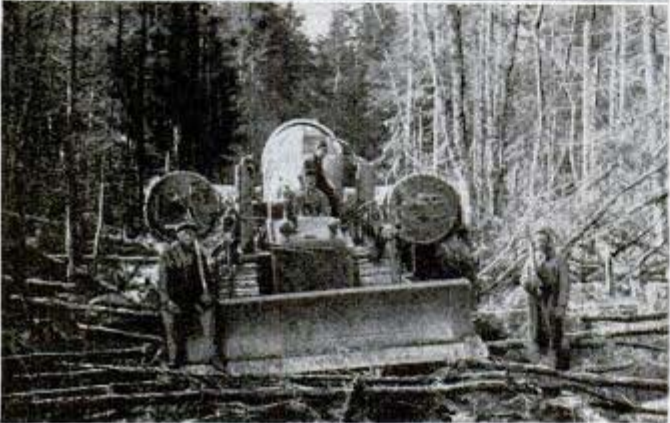

More than one bomber of the Royal Canadian Air Force now flying out over the Atlantic on coastal patrol has been salvaged from the wild "bush" country after a forced landing. Bringing 'em back to fly again is the difficult job of the RCAF's "salvage department." A typical case was that of a \$250,000 Ventura bomber forced down on the ice of a wilderness lake by engine trouble and bad weather. The five-man crew was rescued by a plane equipped with skis. Then an air force rescue crew with the aid of army engineers hewed a trail from the lake through virgin bush to the nearest road 14 miles away. To save the valuable bomber from sinking through the ice into 23 feet of water, poles made from 56-foot trees were sunk in the lake bottom. The bomber was roped to the poles and floating wooden platforms were built. The machine gun, gun turret, wings and engines were removed and hauled across the lake on sleds. Trucks carried the parts out over the new road, which took five weeks to build, and the fuselage was attached to a bulldozer and moved inch by inch out of the wilderness. On the way it nearly slipped over a cliff and was saved by the quick thinking of soldiers and airmen. Once out of the bush, the aircraft was trucked to the nearest airfield where it was re-assembled and was soon back on patrol. Recently a Canso amphibian loaded with depth charges was salvaged in rough seas off the coast of Newfoundland where it sank. It was grappled for and brought to the surface without exploding the charges. A Hudson bomber forced down on a mountainside was salvaged by removing the engines and lowering the plane down the mountain to an ice-covered lake where the engines were refitted so the plane could take off on its own power.

RCAF bomber forced down on melting ice of wilderness lake was brought back in pieces and flies again on Atlantic patrol. Third photo shows bomber roped to poles to keep it from sinking. Bulldozer hauled the fuselage through the bush

Cont: Mr. James Montague
 1417 Carbon Commissioner Bldg.
 Toronto, Ontario, Canada

Winged Bikes Teach Cadets Flight Formation

Canadian air cadets at one training center learn to fly in formation on bicycles fitted with wings and tail assemblies to resemble British Spitfires. The students are divided into two flights of six each, and they are taught hand and voice signals. Bicycle formations include V-formation of two flights, one be-

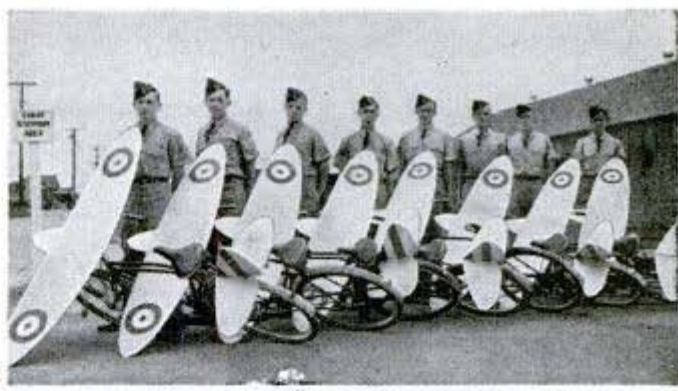

Right, Canadian cadets on the "flight line." Below, practicing V formation

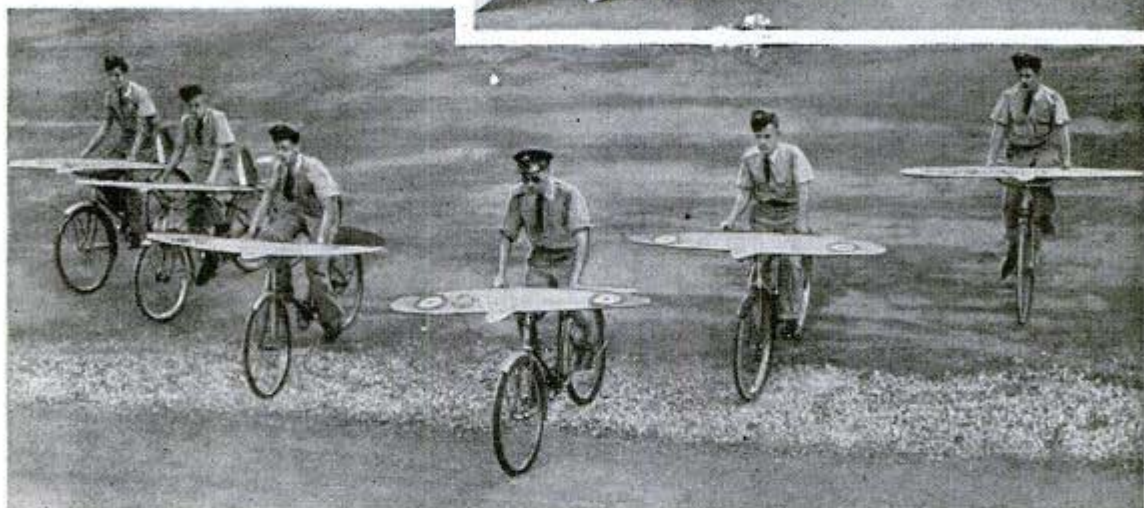

hind the other; echelon left and echelon right, line astern and line abreast. In experiments conducted at the Fingal, Ont., bombing and gunnery school, each flight

was led at the beginning by an experienced pilot. After the cadets learned the various formations, the best man in each flight was chosen as permanent leader.

7819

"Plow" Anchor for Landing Craft Helps Barge Off Beach

Oceangoing LST's (Landing Ship, Tanks) are equipped with anchors which prevent the boats from swinging in toward shore and also help the vessels get off the beach. The anchor, which is dropped astern, has flat pointed "flukes" that dig into the ground. By reeling in on the anchor after the barge is unloaded, the boat is eased away from the beach. The 328-foot LST requires a 3,000-pound anchor of this type, but one of conventional design would have to weigh 5,000 pounds. Similar anchors are used on Navy and Coast Guard craft.

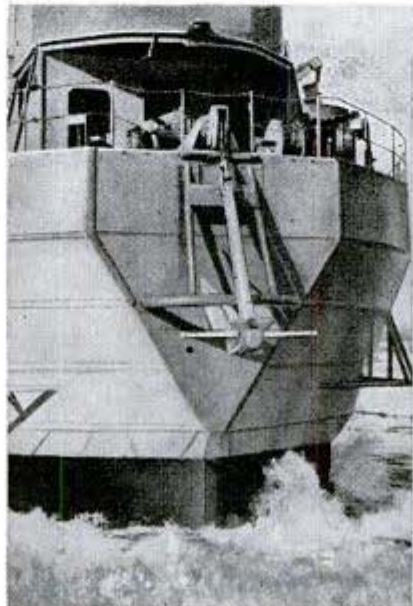

Anchor and reel ride stern of barge; closeup shows "flukes" that dig in

MAY, 1944

*A. S. Danforth
2121 Adlston Way
Berkeley 4, Calif.*

Mr. Thomas P. Sammons Jr.
3872 Franklin Avenue
Los Angeles 27, Calif.

71958

OUR BULL'S-EYE BOMBARDIERS



The bombardier's work starts an hour or two before the plane takes off. He checks the bombs and their fuses in the bomb bay and inspects the big blockbusters that are carried outside, attached to the wing. He makes pre-flight checks of his instruments. He attends the briefing at which he is told the name and location of the bombing target and the direction from which to approach so as to encounter minimum anti-aircraft fire. Air intelligence gives him maps and photographs of the target area so that he will be able to distinguish the target in spite of its camouflage and won't be fooled by a dummy target a few miles away.

En route to the target, he has multiple duties. He is the gunner who must ward off enemy aircraft that attack from head on. He is concerned with pi-

Left, student bombardier watches for target on night practice mission. Below, his front seat in the nose of a Flying Fortress

FROM the time the bombardier lines up the cross hairs of his bombsight with the target and then sets the trigger, the results are practically inevitable. At that moment the huge bomber becomes a mechanical robot that could complete its purpose without human supervision.

The crew could vanish and still the plane would maintain its course, the bomb release would operate at the correct instant, and the bombs would hurtle down on a collision course with the target.

America's famous bombsight is a mechanical and electrical automaton. The bombardier gives it the information it needs and the sight does the rest. Coupled to an automatic flight control device, it takes charge of the plane, flies it to the mathematical point in space at which the bombs must be dropped if the target is to be hit, and drops them.

This is the sight that has the reputation of being able to drop a bomb into a pickle barrel from 20,000 feet. That is an exaggeration, of course, yet it is the reason why American pinpoint bombing of enemy targets has been so successful.



lotage, checking ground points to make certain the bomber is on course. Often he is the plane's doctor, in charge of first aid for the wounded. He keeps track of the weather so that he can give the information to the base forecasters. He may be in charge of the blinker gun for signaling other planes in the formation and for exchanging recognition signals.

Meanwhile he is preparing his own instruments. He makes observations through the drift meter so that he can compensate for side winds. After the final altitude is reached and no more changes in temperature are expected he begins to set into his bombsight some of the data it needs.

He turns one wheel to the bombing altitude, which is the altitude above sea level from which the bombs are to be dropped minus the altitude of the target. He turns a dial to the desired dropping angle, which depends on the weights of the bombs and hence their trajectories. He feeds into the bombsight the plane's true air speed and its drift. On an intervalometer panel he marks



Here's the bombardier's-eye view as he makes the target run. Notice target "X"

Bomb away! Through bomb bay doors the practice egg falls toward target

Here a flash from a companion plane catches bomb at moment of release

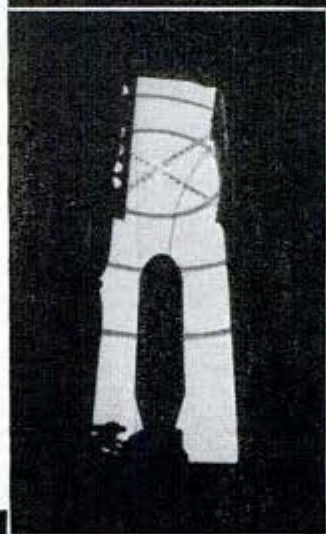



Smoke rises from phosphate works and air field on Jap-held Nauru island as a B-24 Liberator turns homeward. Below, bombardier on his "office chair" crouches over bombsight of a Flying Fortress

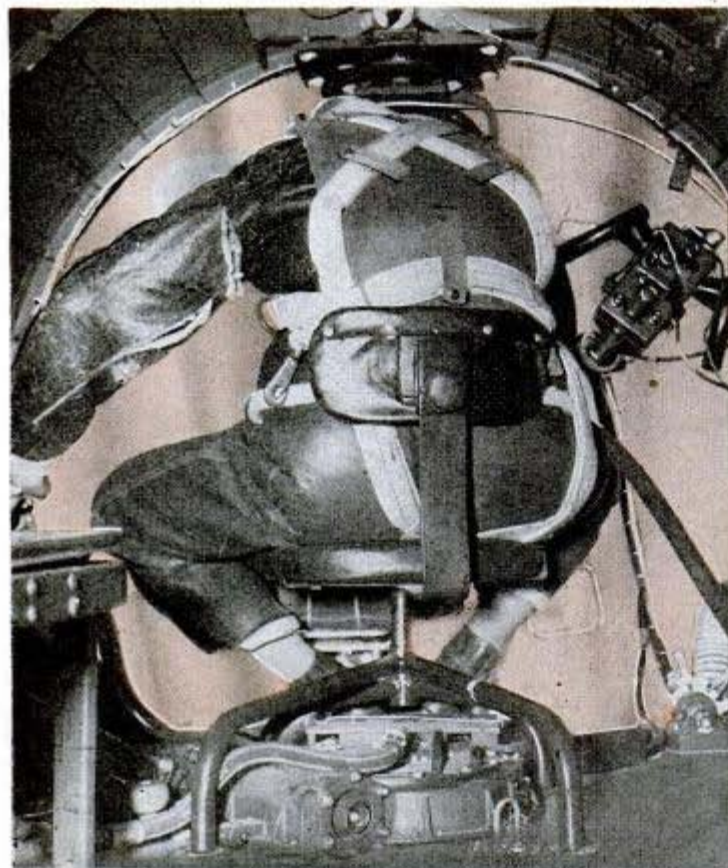

out the particular bombs that are to be dropped and their rate. This is based on the distances apart at which they are to land.

The bombardier takes complete charge as the target is approached. He locks in his automatic flight control that flies the plane far steadier than could a human pilot. Every inequality of the air, even the gusts from nearby anti-aircraft shell explosions, are countered by the servomotors so smoothly that the plane moves steadily and inexorably on its course.

The bombardier pulls the lever that opens the bomb bay doors, then another lever that arms the bombs, freeing the spinners on the fuses. The plane is moving straight toward the target and the bombardier turns the telescopic eyepiece of his sight until its cross hairs are on the target. He pulls another control that clutches in the mechanism of the sight, setting it in operation, and locks on the bombing trigger.

This is the point at which



Setting instrument dials on target run

the bombardier could turn the whole operation over to his instruments. The bombsight will keep a steady watch on the target without his presence. The rate of approach has already been determined and the bombs will be released when the dropping point is reached.

Actually, the bombardier stays at his post. He is concerned now with final minute corrections that, from possibly 30,000 feet, will guarantee bull's-eye bombing. He watches a couple of bubbles on the bombsight so that he can compensate for tiny deviations in flight, keeping the plane exactly parallel with sea level. He is still absorbed in this task when the indicator lights flash on; the bombs are on their way.

This description doesn't begin to tell of the difficulties of a bombardment flight. Enemy fighter planes may have been charging in; anti-aircraft fire may have been so bad that violent changes in course were necessary up to the time the bombing run was started. The bombardier may find the target so well camouflaged that he must make another run. After dark it is worse. The target is hard to find even with the aid of flares, and it may be obscured by clouds of smoke from smoke pots. Enemy search-

Continued to page 160

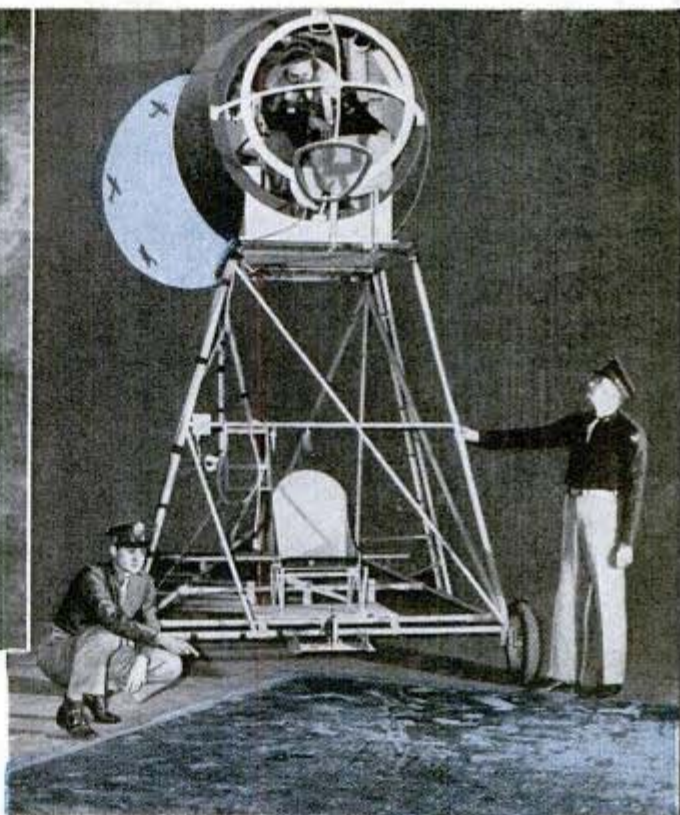

In a mockup of his flight quarters, a student bombardier makes a "bombing run" over a mosaic map of enemy area. Below, the spinner and fuse in nose of a bomb are inspected before flight



77834

Mortar Crew Shells Tiny Town With Marbles

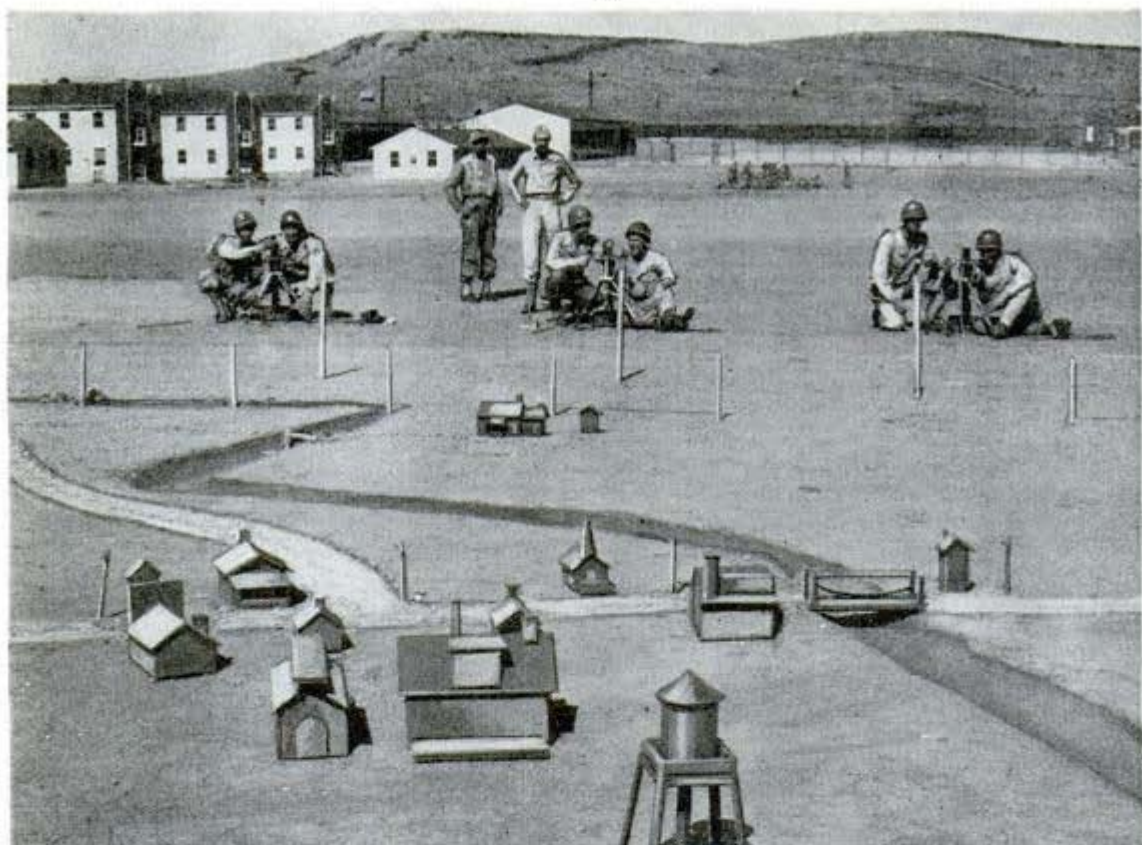

Members of Company E of the 66th Infantry at Camp Carson, Colo., learn the correct use of the 60-mm. mortar with a miniature village for the target. The shells are marbles "fired" with a spring inside imitation mortar shells made of wood. After the spring is set, a marble is placed on top of the shell which is then dropped

down the gun. The spring is released by means of a ring that is part of the shell, and the marble shoots out in an arc similar to that of a real shell. The gun is set just as if live ammunition were being used with the exception of range which is judged on a proportionate basis. After practice, repairs are made with wood and paste.

0.15

"Stars" in Dome Over Trainer Are "Shot" by Navigator



Student crew on "bombing mission"; trainer can spin or hold the course

Conditions encountered on actual bombing missions are simulated with a celestial navigation trainer which accommodates pilot, bombardier and radio operator as well as the navigator. The trainer, which never leaves the ground, is suspended in a framework which enables it to turn, spin, or hold the course. Pinpoints of light in a revolving overhead dome represent stars which are accurately placed so the navigator can take a reading with his sextant. Beneath the trainer is a screen on which is projected a movie of passing terrain, and another projector shows cloud formations. An instructor under the trainer assigns problems and synchronizes the stars. The trainer is air-conditioned to protect the instruments.



*Carrier Corp.
Syracuse, N. Y.*

AAF "Skip" Bombers Sweep Over Treetops To Score Bull's-Eye

Skip-bombing, low-level bombing, or "masthead-height" bombing are all different descriptions of the same technique, an American-invented method of hitting the bomber's target with a minimum of risk to the plane and the maximum chance of a score. Planes with terrific forward firepower are used, to blast at the enemy's anti-aircraft gun crews while the bomber is lining up for its run on the target. Most sensational achievement of skip-bombing was the decimating of the Japanese invasion fleet in the Battle of the Bismarck Sea. In that and similar bombing forays, use was made of the fact that a bomb, dropped from a low level on the water, hurtles forward, much as a stone thrown across the surface of a pond. But the same technique works on land. In the assault on Pantelleria, one American pilot "skipped" a bomb inside an underground hangar, creating havoc within. Skip-bombing crews, trained in an area of Florida roughly the size of Sicily, fly in for their bombing runs at altitudes as low as 50 feet, and it is their standing joke that "when we fly above 150 feet we are so unaccustomed to the height that we have to use oxygen." The planes hug the terrain, rising over the ridges, and swooping down into the depressions. By approaching at minimum altitudes, they frustrate "enemy" plane-spotting devices, and also are upon their targets before anti-aircraft gun crews can bring their guns to bear. By releasing their bombs about 300 feet from the target, they take advantage of the bomb's "skip," and by using delayed-action bombs the planes can be out of the danger area from the ensuing explosion before the bomb goes off. The "skip" bombing pilots race in over their targets at a speed in excess of 200 miles per hour. At the Army Air Forces Tactical Center, with headquarters at Orlando, Fla., squadrons of A-20's almost clip the tips of the pine trees on simulated bombing attacks.



Army Air Corps photos

MAY, 1944

*Wm. H. Newton, 1st Lt. Air Corps
Public Relations Officer
Army Air Forces Tactical Center
Orlando, Fla.*

FLYING GAS JET

Air compressibility, which becomes manifest at about the speed of sound, affects the propeller "long before the wings of a plane are affected," says Captain Kotcher, in Air

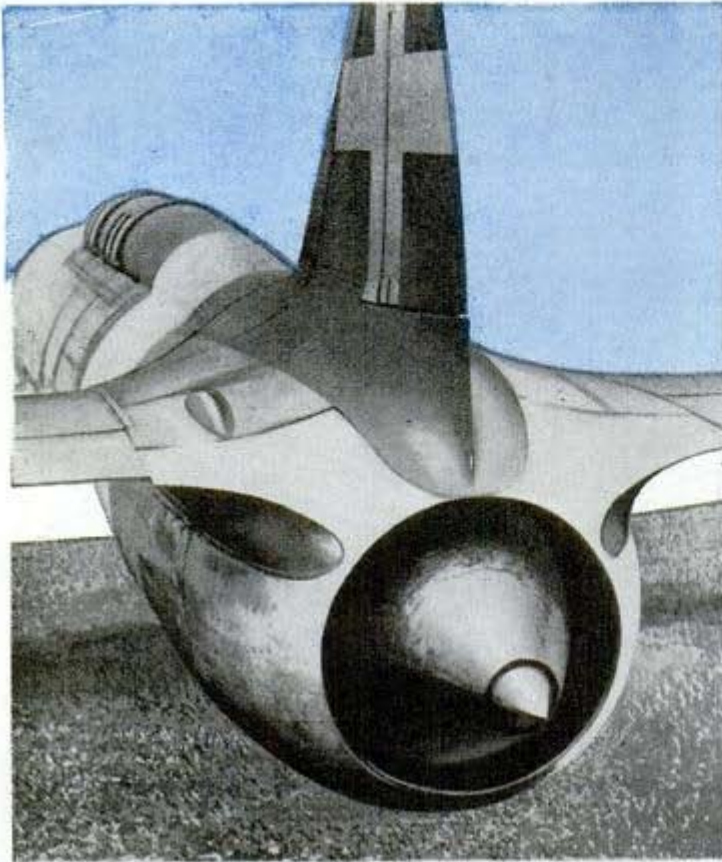

Force. "The jet engine eliminates propellers. It will not eliminate the inevitable effect of compressibility on wings, but since the breakdown of flows occurs on a propeller long before it does on wings, it enables the plane designer to realize the difference in speeds between the points where the propeller is affected and where the wing is affected. This difference may be about 100 miles an hour for the immediate future."

In this country the first flights were made in a twin-

THE FIRST fundamental improvement in flight since the Wright brothers attached an engine and propellers to a glider and rose off the ground 41 years ago is embodied in the jet propulsion airplanes with which the United States has been experimenting for the last year.

Odd as it seems, today's fastest conventional aircraft are nothing more than improved models of the original Wright plane. Modern aircraft are larger, vastly more efficient; yet they operate by the same means, air screws driven by internal combustion engines.

A jet-driven plane was decided upon by General H. H. Arnold and other Air Force officers "when present planes gave indications they had about reached the limit of performance obtainable by means of propellers," writes Capt. Ezra Kotcher of the A.A.F. Materiel Command in Air Force magazine. "The limit was imposed by the rapid falling off in the efficiency of the propeller when the effects of compressibility set in at extremely high speeds."

The drop in propeller efficiency at high speeds and in thin air have limited propeller-driven aircraft roughly to 500 miles per hour and 50,000 feet altitude.

Above, tail view of Italy's jet plane of 1940. Below, one of four engines of the Constellation. By eliminating propellers, jet plane may add 100 miles an hour

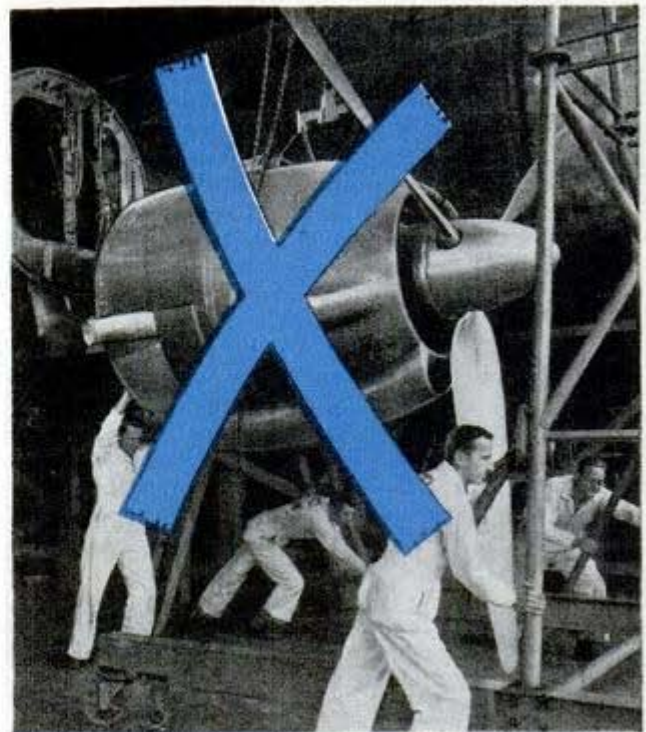

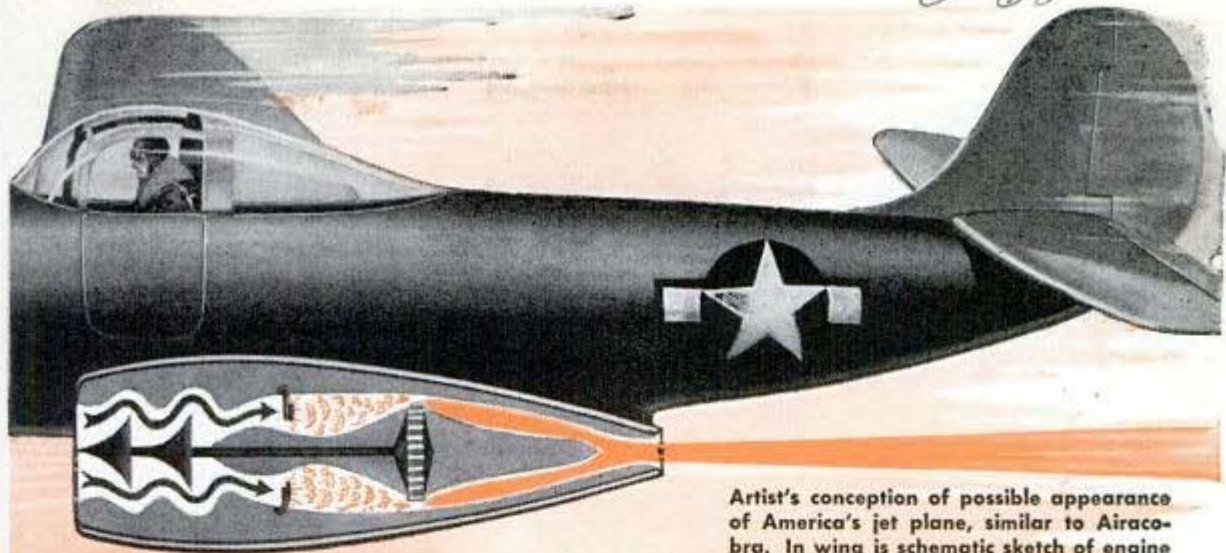

Artist's conception of possible appearance of America's jet plane, similar to Airacobra. In wing is schematic sketch of engine

engined jet plane built by Bell Aircraft, based in part on British developments. The experimental models have top speeds between 500 and 600 miles per hour. Pilots who have flown them can scarcely hear the weird noise of the exhaust and are impressed by the absence of vibration, the smoothness and ease of control. A jet propulsion airplane is simpler to fly than a primary trainer.

"The number of gadgets and dials are cut down considerably from the number in the conventional fighter plane," writes Captain Kotcher. "One throttle does all the work, forward to go, further forward for greater speed, back to slow down or stop. The aircraft is built low to the ground because there is no ground clearance to provide for the propeller."

But with little vibration to help tell him how his airplane is handling, a pilot has to dispense with "seat of the pants" flying and depend more on instruments. In fact, it was necessary to install a vibrator on the instrument panel of the Bell jet plane so that its pilots would be assured the instruments were not stuck.

For the time being, it appears that jet propulsion will be most valuable where high speed and fast

acceleration are more important than economy and long range. Possibly the jet drive eventually will be so efficient it will replace propellers for all types of air travel.

The jet propulsion craft are based on an

Continued to page 162

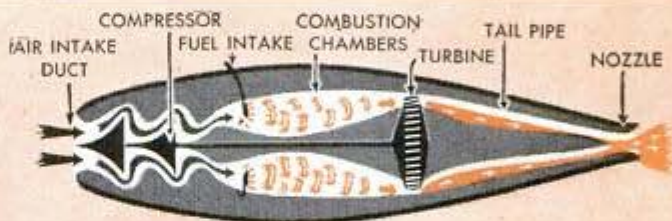

THERMAL JET: This formalized conception by a staff artist of Air Force magazine of a jet propulsion motor is not intended to illustrate mechanical workings or portray any specific engine design. In the thermal-jet system, oxygen is obtained from air which enters intake ducts and is sent by compressors into combustion chambers. Fuel is added to the compressed air and ignited. The resulting gases flow through a turbine, which drives the compressors, and from there to a tailpipe where they are nozzled down, attaining great speed and forming the propulsive jet

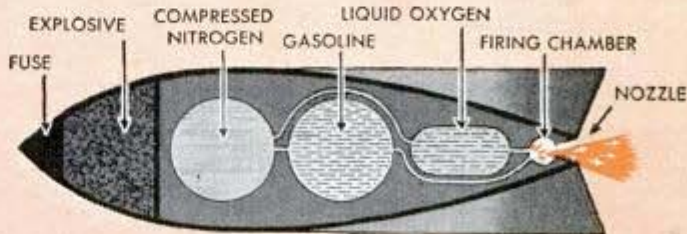

ROCKET: Both the thermal jet and rocket systems get their thrust from a rearward jet which forces the mechanism forward. The rocket contains all the elements needed for combustion. In the example above, compressed nitrogen provides pressure to force gasoline and liquid oxygen into a firing chamber where they ignite, and the resulting high-pressure, high-temperature gas escapes and sends the rocket forward. Many rockets use a relatively slow burning powder instead of liquid fuels. The powder contains the oxygen necessary for burning

Drawings by courtesy Air Force Magazine

Army Rough Riders on Wheels Set Dizzy Pace

*Major S. P. Leggett - Bureau Public Relations
Warrior Blvd. - Am. 24-886, Pentagon Bldg.
Washington, D.C.*

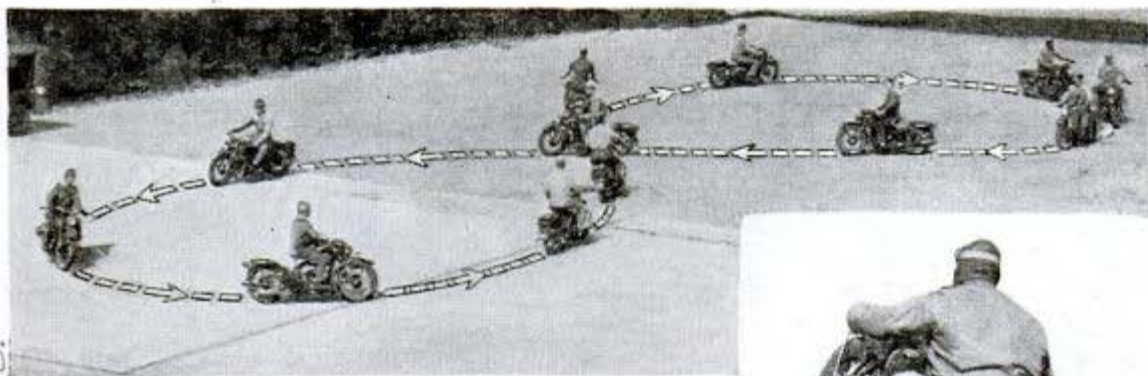

Dodging shell holes, climbing steep embankments, or turning on the proverbial dime to avoid a booby trap are all in the day's work for Uncle Sam's motorcycle soldiers. Above, rookie riders doing figure eight on test course. Right, expert rough rider goes "over the top"



Starting out for road practice at the Holabird Ordnance Automotive School, the men learn hand signals and become experts in precision riding. Below, skill acquired by riding through obstacles on banked hill will come in handy on reconnaissance or convoy duty

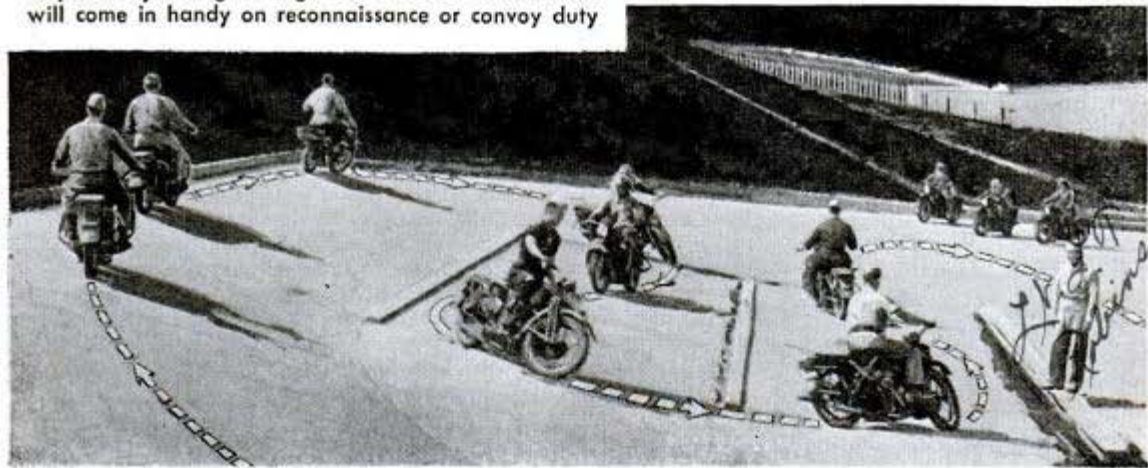

Giant Doors for Blimp Hangar Weigh 240 Tons

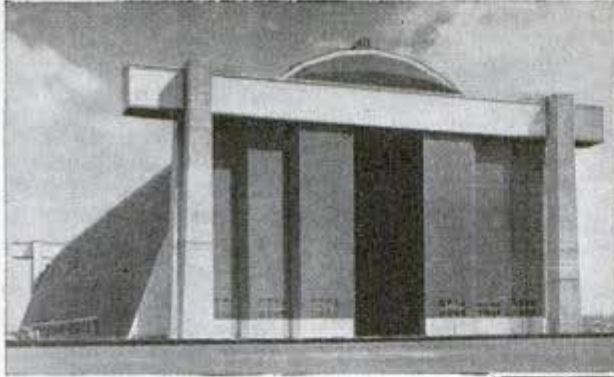

Built in six sections, each of which weighs 40 tons, doors for the Navy's lighter-than-air hangars are believed to be among the largest in the world. The doors are 120 feet high and 220 feet wide, constructed of steel frame faced with wood. When an electric button is pushed, the doors part in the center and the sections move at different speeds to reach the outer edges of the hangar together. Each 37-foot-wide section is erected in one piece. The doors were built by The Ingalls Iron Works Co. of Birmingham, Ala.

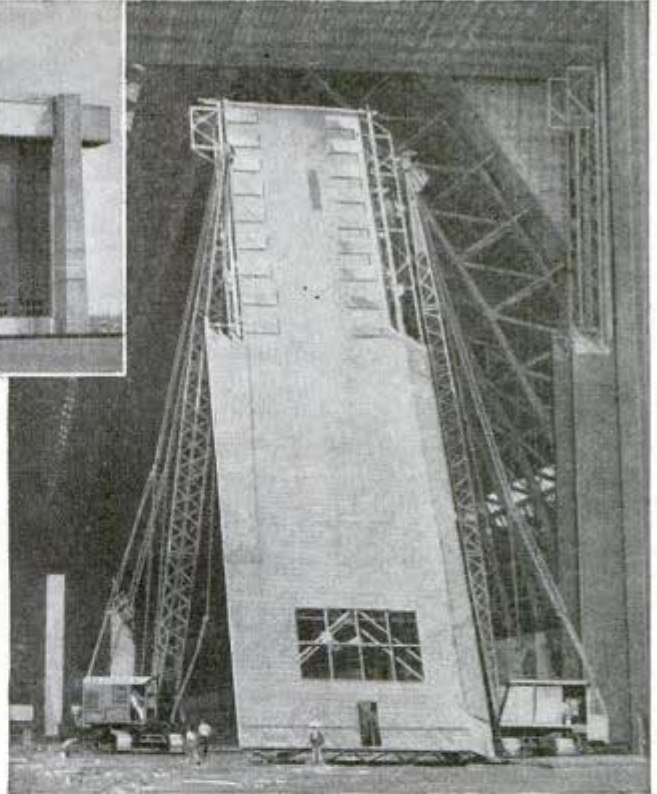

Installing one of skyscraper doors in hangar shown at top

"Neatness Mirror" Is Reminder to Yank Leaving Camp

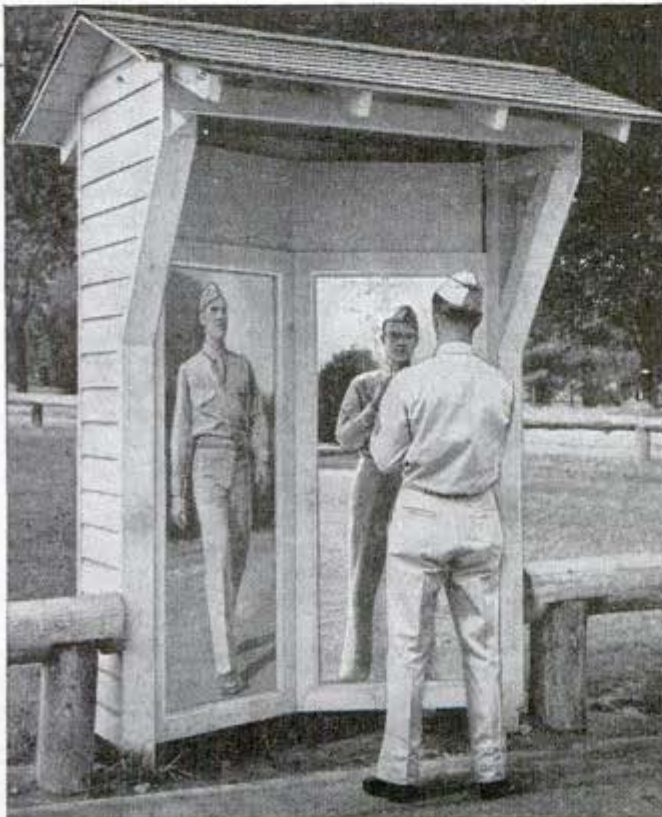

To compare his own appearance with that of the commander's views on how a model soldier should appear, any man at the Quartermaster Corps Replacement Center at Camp Lee, Va., need only step before one of several "neatness mirrors." Thus, soldiers departing on leave may give themselves a last-minute critical look, to discover whether their appearance will reflect credit on their establishment. A full length picture of a soldier properly attired aids in the comparison.

'Standpipe' in Hull of Mars Helps Balance Its Load

Loading of flying boats is simplified by a weight and balance indicator, installed by Glenn L. Martin Co. engineers on the Mars. A three-inch standpipe in the hull near the bow, and another near the second step, provide readings of draft and trim angle. These are plotted on a chart to obtain loaded weight and center of gravity.

7876

TRUCKING to VICTORY

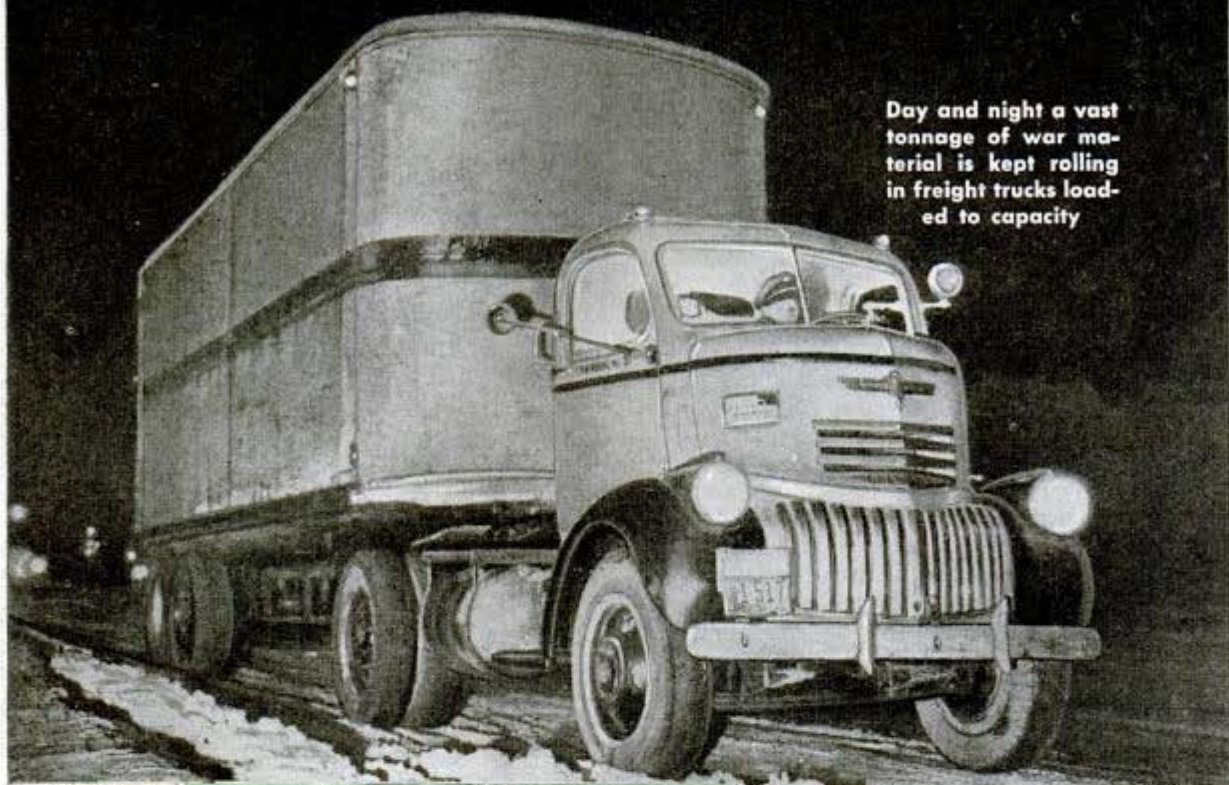

Day and night a vast tonnage of war material is kept rolling in freight trucks loaded to capacity

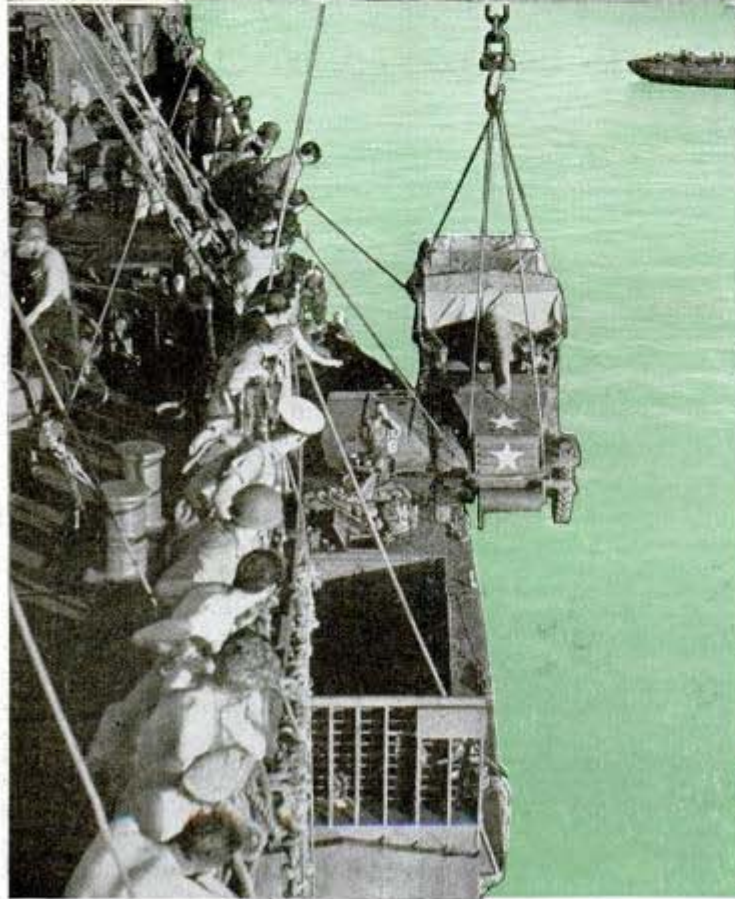

1424-16th St., N.W.

By John V. Lawrence

Managing Director,
American Trucking Associations, Inc.
Washington, D. C.

THE trucking industry is doing a great job in this war. On the home front it comprises a vast network of thousand-mile assembly lines, rushing parts from small contractors to the final assembly plants. It is trucking's proud boast that with one-twentieth the carrying capacity of the rails, trucks are hauling one-quarter the rail load.

On the battle fronts—the South Pacific, India, Russia, the Mediterranean — trucks are helping the United Na-

Half-track is lowered from warship as marine driver stays behind wheel, ready to roar away from the beach





tions to win by using that war-tried axiom of military success, "getting there fustest with the mostest."

The first motor truck made its appearance in 1902 in Detroit. By 1917, there were about 200,000 of them. World War I was the springboard which started trucking on its way toward becoming a major transportation industry.

Let's look at some of the jobs that America's 4,600,000 trucks are doing to help smash Hitler:

By means of trucks, an automotive prime contractor in Michigan extended his assembly line 125 miles to include facilities of four subcontractors in three other cities.

Close teamwork between steel makers and truck and air transportation recently enabled a factory in England that is making vital tank bearings to receive a shipment of specially treated steel within four days. Trucks rushed the steel from the Middle West to an Eastern wire-drawing plant and then to another plant for heat treatment.

Not long ago an outfit of soldiers had been given



Small screen mounted in truck shows troops views of battles in which they have fought. Below, a huge boiler is loaded on a truck to be hauled overland

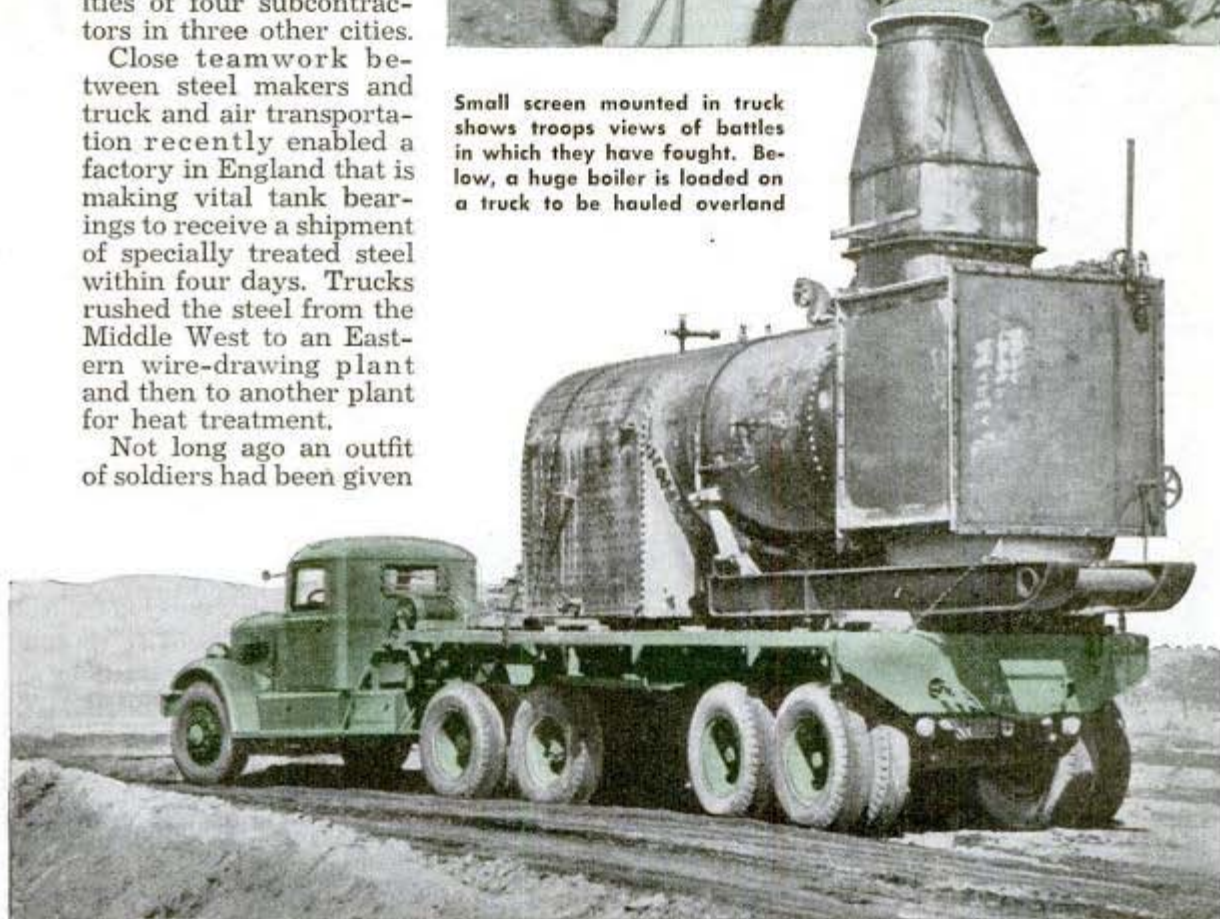



One of the military truck's vital jobs—setting up lines for the Signal Corps

hurry-up orders to go from Oklahoma City to Blythe, Calif. But they couldn't operate without rifles, tents, blankets or mess gear. Normal rail time for moving such equipment was seven or eight days. Cain's truck lines took the job and delivered all the stuff in the little desert town in just 41 hours—the trucks arriving an hour before the troop train.

Trucking operators have had to re-design many of their trucks and some of their equipment to keep up with war demands. One rolling giant is a truck-trailer being used to carry sub-assemblies of Consolidated

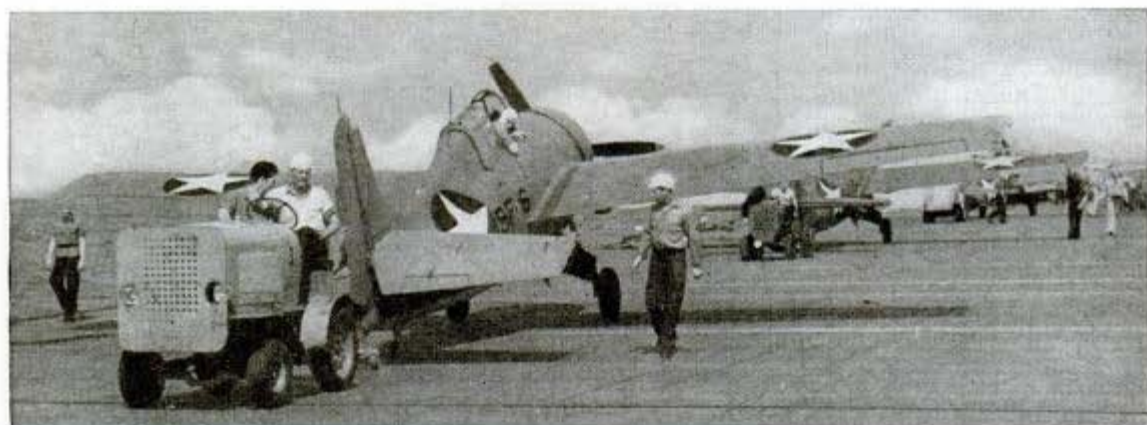

Flight deck jeeps moving planes for takeoff aboard a U. S. aircraft carrier. Below, military cargo carrier being tested on Studebaker proving ground

B-24 bombers from the Ford Willow Run plant in Michigan to final assembly plants more than a thousand miles away.

These huge trailers, probably the longest in service, are more than 64 feet long, nearly 8 feet deep inside and 10 feet wide. Two of them can carry an entire four-engine bomber, including everything except the propellers.

Trucking has played a vital part in removing many of the non-war federal agencies from overcrowded Washington, including the historic Patent Office. For two weeks, Allied Van Lines and two



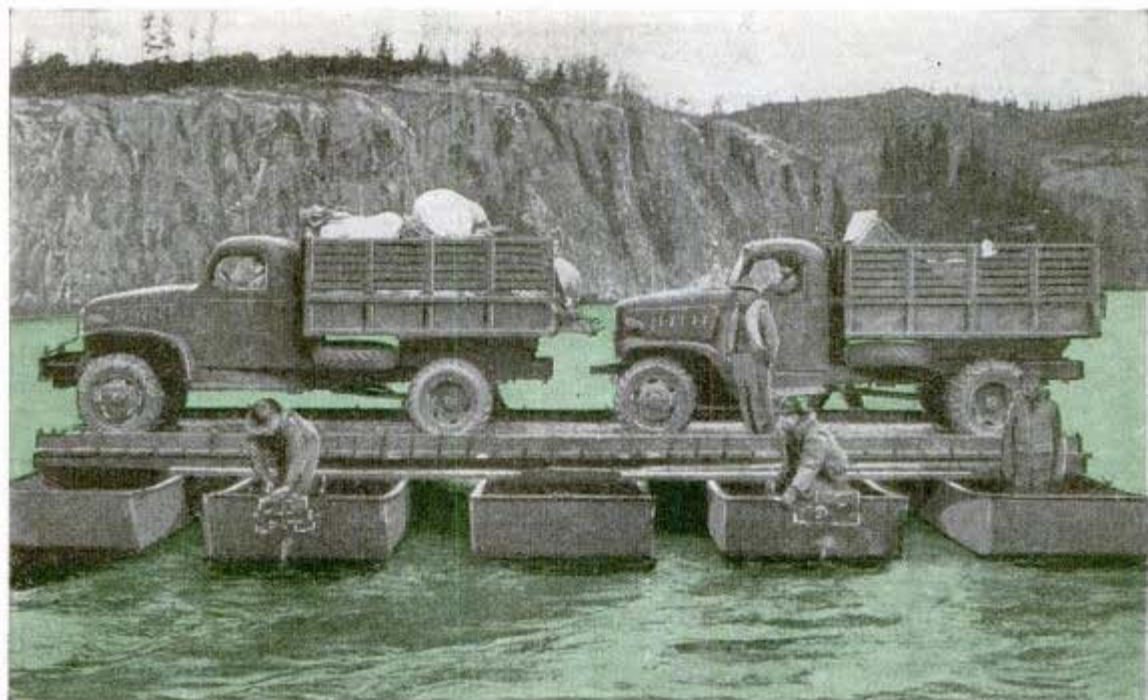

Cargo-carrying trucks following the famous Alaska Highway are ferried across an Alaskan river

of its member carriers were hauling a total of almost 2,000,000 pounds of papers and equipment to Richmond, Va. It was regarded as the largest office moving job in history.

The Navy, too, is served by America's millions of trucks. In these days when life rafts are among the most important items aboard ship, trucks have been able to perform valuable service in delivering them to port cities. The Transco System of Denver, Inc., was called upon to deliver a cargo of life rafts from a plant in New England to the Pacific coast some 36 hours ahead of schedule.

The drivers of the trucks, fully conscious of the importance of their mission, passed up many a meal, cup of coffee and inspection as they roared across the country. In a climax as spectacular as any that could be devised in Hollywood, with a raging storm that extended from Chicago to the Rocky Mountains and a bridge washout that required a 200-mile detour, the rafts were hoisted aboard the transports a day and a half ahead of schedule.

Army statistics show that out of every 1,000 men inducted, 106 are

skilled in truck or tractor operation and 38 others were chauffeurs, mechanics, or servicemen in civilian life. This "savvy" of things mechanical—plus the herculean production capacity of Detroit—gives Uncle Sam a potent military factor.

In two years of war, 25 of America's peacetime automotive factories have become the greatest producers of destruction the world has ever known. Trucks and automotive tanks are serving in 70 theaters of war—blasting the Jap and Nazi, carrying men to the front lines, and getting supplies where they are most needed.

The extent to which the Army is relying on motorization is illustrated by the fact that the 400,000 horsepower of today's in-

Phone booths mounted in trailer are boon to war plant workers

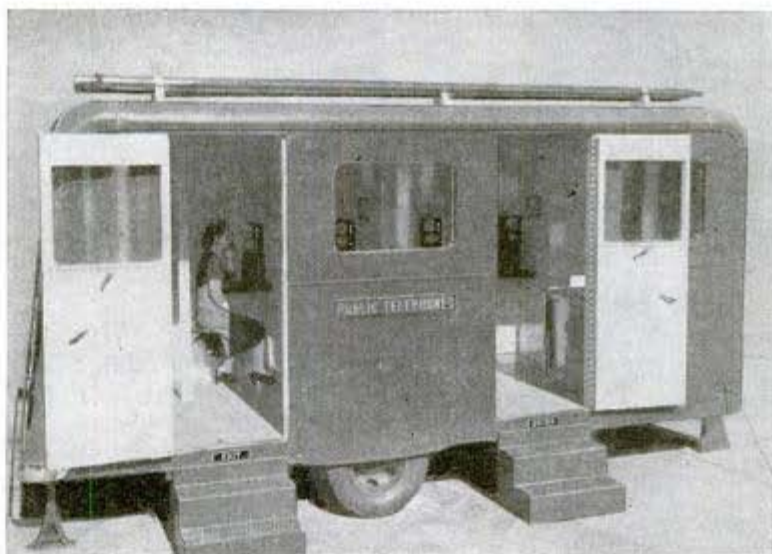

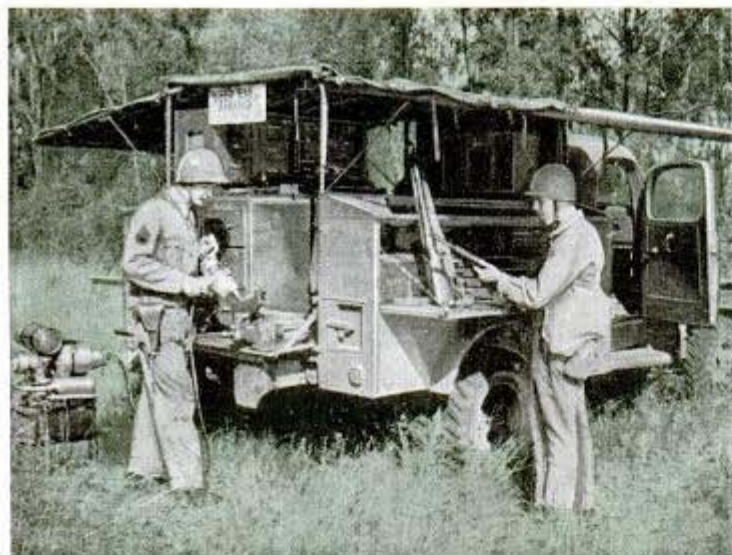

Mobile ordnance repair unit is equipped to service any gun from pistol to howitzer. It is one of many trucks specially designed for war use

fantry division is 125 times larger than the 3,200 horsepower of the infantry division of World War I.

The fact that today's battles can be fought anywhere at anytime has given the motor truck a new importance. But they've got to be built rough and tough. Army trucks in Russia must operate in sub-zero cold; in India, Africa and Australia, the dust sometimes gets so thick that drivers must wear respirators to keep the stuff out of their lungs; in New Guinea there are torrential rains and axle-hugging mud to cause trouble.

Out of the demand for an all-purpose truck, the Army developed the basic two and a half ton, "six by six"—six wheels and

all of them driving. It is used as a troop carrier, cargo carrier, a prime mover for the 75 mm. gun and the 105 mm. howitzer. Fourteen men can ride in the body of a "six by six." Other trucks range in size from the half-ton jeep to 12-ton monsters.

The record of American-built motorized equipment on the battlefield is bearing out the automotive industry's peacetime reputation for quality. In the North African campaign, for example, one motorized unit consisting of 166 vehicles, went through 32 days of continuous combat with only 12 minor mechanical failures, even though the vehicles had been driven

nearly 500 miles across Egypt before the battle lines were reached.

Trucks are usually shipped overseas in a "knocked down" state to conserve shipping space. From the docks they are rushed to motor assembly dumps. Competition between the crews who assemble the parts is keen—with every crew trying to set new records. The average time required by a five-man crew to uncrate the parts of a two and a half ton cargo truck and roll it off the assembly line is five hours.

Trucks are performing hundreds of important tasks with the Infantry, Quartermaster Corps, Air Service, Signal Corps, Corps of Engineers, Coast Guard and the

Trailer meets train and airplane wings start the last lap to an assembly plant

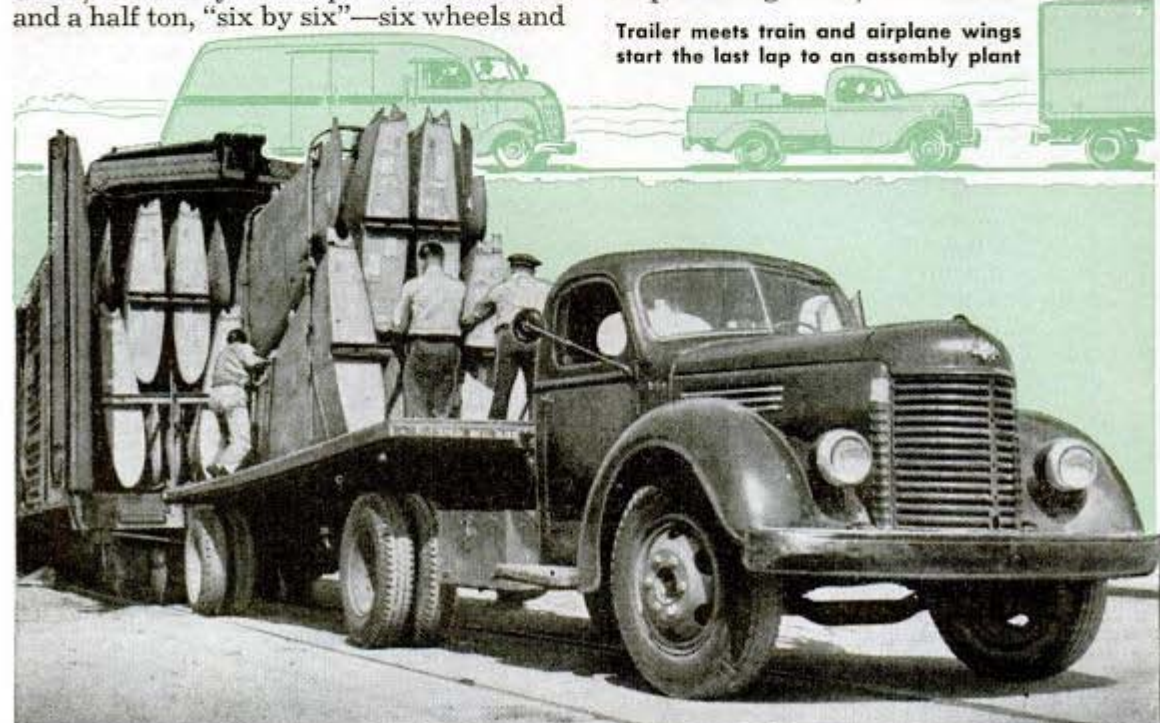

Marines. Many of these arms of the service are equipped with special trucks designed for unusual tasks. In the Southwest Pacific the Army has a truck-mounted water purification unit. It goes anywhere that wheels can roll and transforms the most polluted stream into a source of safe drinking water.

One of the most important pieces of equipment mounted on a truck chassis is the two stage air compressor, widely used by the Corps of Engineers. This truck provides flexible power for drilling, sawing, chipping and similar operations. It also plays an important part in demolition work, and is used for inflating the floats for pneumatic pontoon bridges.

Then, there is the lowly dump truck for all types of work. This is used in many units of the Corps of Engineers—a vehicle that is seen in the Army of no other country. This truck can easily carry the 13 men of a squad and their equipment.

Another less familiar but highly utilitarian truck built for the Ordnance Department is equipped with a small-arms repair body. With

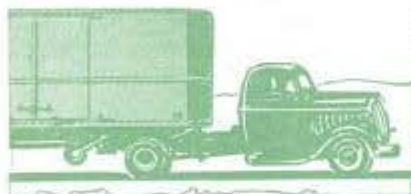

this unit, gun repair crews can proceed at a high speed right onto the field of battle. Other completely equipped machine shops on wheels repair tanks and half-tracks wherever they happen to be knocked out.

Among the latest developments in mobile units are a complete lubricating truck, a tire repair shop and a water trailer. The lubricating truck, or "service station on wheels," can service two vehicles at once. It has a gasoline-engine-powered air compressor to operate greas-

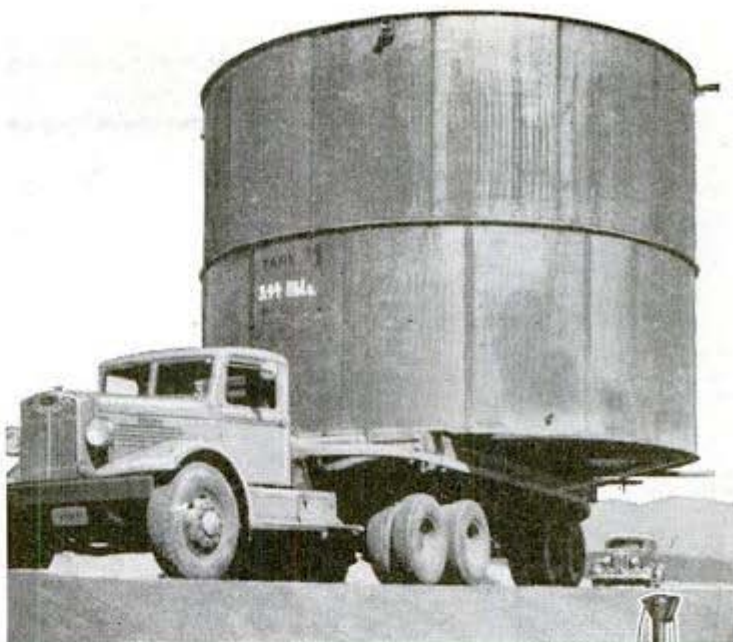

Even oil storage tanks sometimes are carried by trucks for hundreds of miles. Below, special equipment for digging telephone postholes fast



A jeep "goes ashore" from a 2½-ton truck "somewhere in New Guinea"





Bread fresh from the oven is ready for front-line soldiers at army's mobile field bakery

ing equipment, put air in tires and do similar tasks. It carries 100-pound drums that contain oil and grease.

The tire repair shop is designed to handle blowouts and tire repairs on the move. Punctures are patched and impact breaks repaired while the convoy continues on its way. The water trailer is fitted with two large spigots for quick radiator filling. Four small spigots are used for filling the canteens of thirsty drivers.

To replace shovels and sweat, there is a "six by six" fitted with an unusual looking machine for the rapid drilling of ground holes and for land-mine laying, tank-trap construction, or any operation where holes must be bored in the earth.

Another truck equipped with a special body is used by the Signal Corps, and contains both sending and receiving radio apparatus.

The Army must be fed, and today's soldier uses trucks not only to transport food but as mobile bakeries and kitchens. Mobile laundry units have been procured by the Quartermaster Corps, as well as sterilization bath units for overseas use. Army clothes are now washed and deloused by special paraphernalia in these special mobile laundries. They are mounted on semi-trailers, and 16 of them can serve approximately 48,000 men per week.

When, in earlier wars, a soldier broke or misplaced his glasses, there was nothing

This giant wrecker can hoist 10 tons or eight vehicles like the tiny jeep it dwarfs in passing



for him to do but to continue on with impaired vision. Thanks to motorization, circumstances are different in today's war. Mobile optical shops have been designed, equipped and mounted on a truck chassis. A typical optical shop contains special optical machinery, 36,000 lenses, 8,400 frames, 600 pairs of extra temples, and 1,200 spectacle cases.

Trucks fill a vital need of anti-aircraft units of the Coast Artillery with a two and a half ton, six-wheel vehicle for transporting giant searchlights. This unit has a five-man cab, in order to carry the entire searchlight crew. In addition, such trucks travel in pairs, one carrying the searchlight, and the other the electrical generating equipment and listening devices.

Army trucks haul oil for smoke screen "smudge pots"—particularly in the Panama Canal Zone and where other vital fortifications are located. Some are equipped with cranes for delivering bombs to airplanes. Others are used for fire protection at air fields and Army posts.

Some trucks house map reproduction laboratories and photographic development dark rooms, while others serve as mobile tailor and cobble shops. Right here at home you will even find mobile recruiting stations mounted on truck chassis.



A sling full of supplies for our fighting men is hoisted into a waiting truck

A completely mechanized battalion laying mines on roads to stop enemy tanks and scout cars



U. S. Army Signal Corps photo

0-10

Dynamite Blasts Broken Drill From Crankshaft

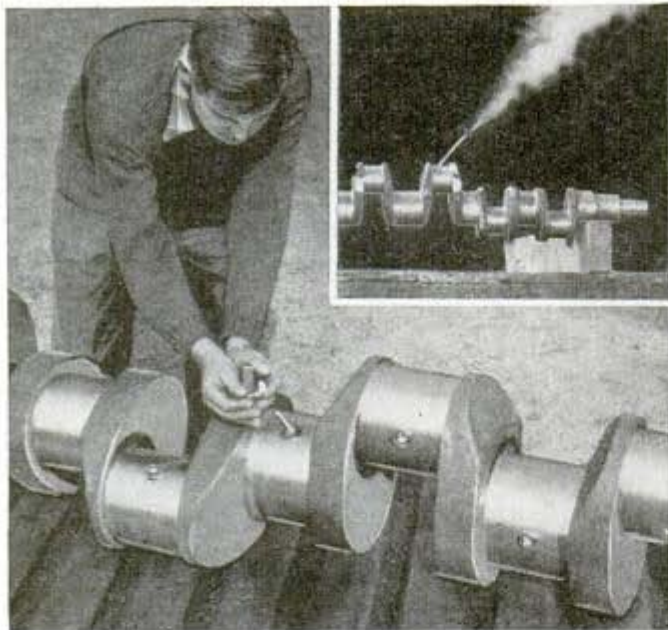

Broken drills or other obstructions are removed from oil holes in steel crankshafts with a small charge of dynamite, usually less than a thimbleful. The dynamite, which must be handled carefully, is set off with a fuse, and has no more effect upon the metal than a fired cartridge upon a rifle barrel. After the fuse is ignited, a heavy plank or metal shield is placed over the charge. Broken drill bits of large size often require several charges. In one month, the Ohio Crankshaft Company in Cleveland salvaged 93 crankshafts with this dynamite technique developed by an employee.

Ohio

Lighting fuse attached to small charge of dynamite in oil hole to blast drill from the shaft

77963

Cadet's Polarizing Goggles Give "Depth" to Picture

Military navigation students are trained to "see and think three-dimensionally" with a viewing device similar to the stereoscope. Two pictures of the heavens and earth are superimposed on a plastic sheet, and when viewed through polarizing goggles present a single picture in three dimensions. The picture is called a vectograph. It can be thrown on a screen by a projector and studied by a group of students. The vectograph was developed by Prof. John T. Rule of Massachusetts Institute of Technology.

Student navigators get a three-dimensional view by viewing the "blurred" picture with goggles

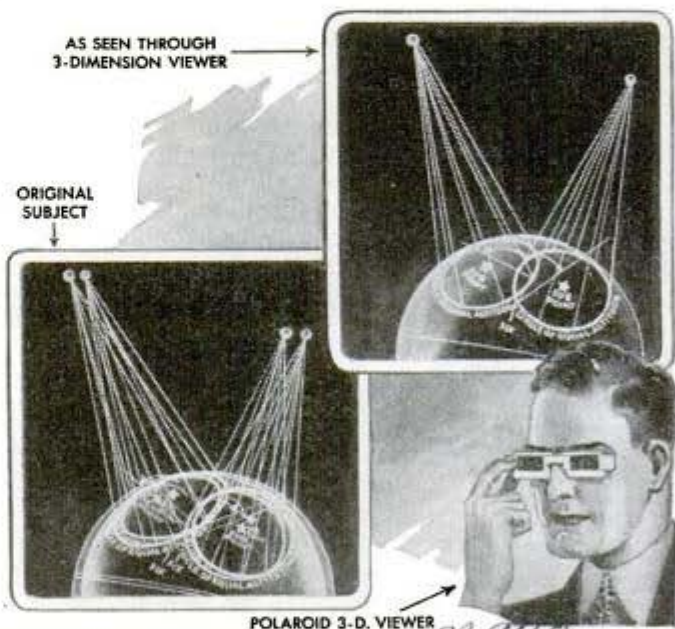

77970

"Self-Starting" Airplane Tires Have Fins in Sidewalls to Catch Air

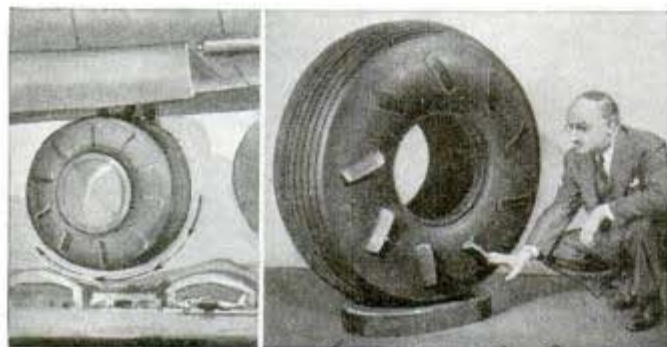

Smoother landings and a reduction in landing-shock wear are predicted with a "self-starting" airplane tire that attains a high rolling speed before it touches the ground. Fins built into the sidewalls of the tire catch the air and set the wheel spinning. The fins, made of rubber and fabric, flatten out for the "upper half" of each rotation of the wheel. This eliminates the air-drag effect of rigid fins or vanes.

*B. F. Goodrich Co.
So. Main St.
Akron, Ohio*

British "Island Forts" Blast Low-Flying Aircraft

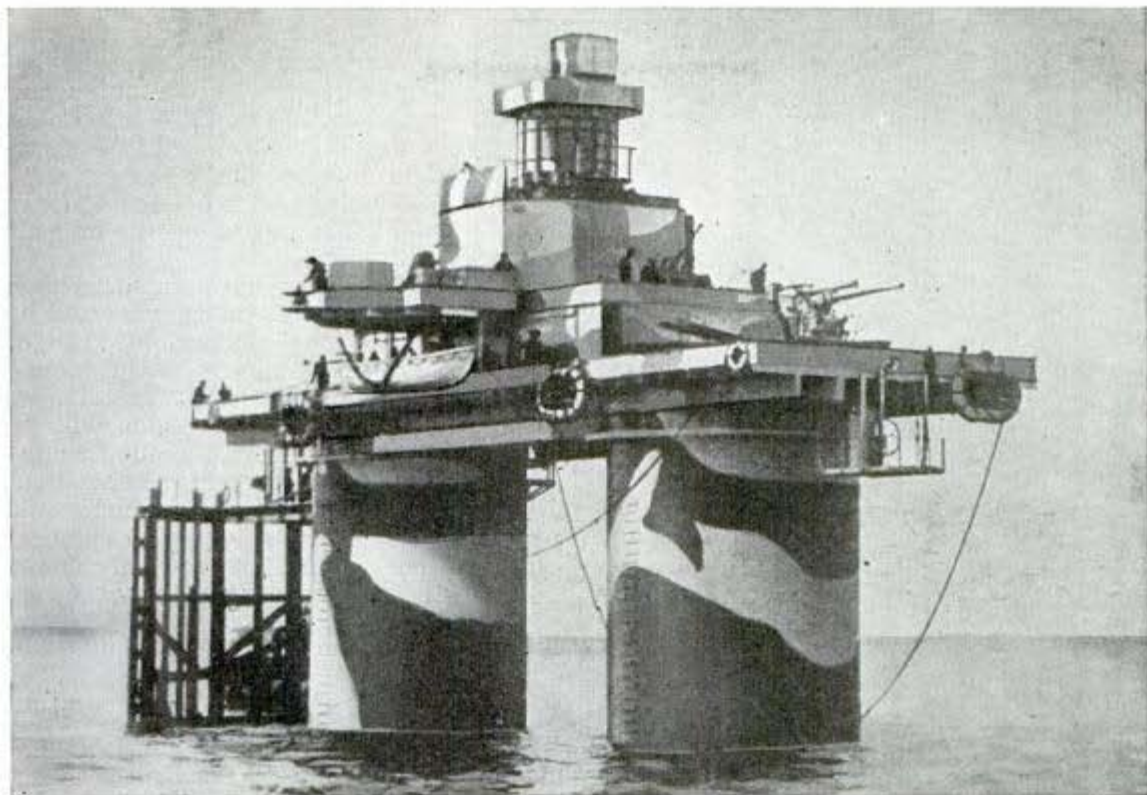

Britain built these formidable outposts along England's east coast to guard ships against Nazi planes

"Island Forts" are protecting Britain's east coast shipping from low-flying aircraft. Rearing out of the water like stationary sea monsters, they bristle with guns and armor and have shot down a

number of German planes. The fortresses are commissioned as ships, being named after the sands on which they stand. All armament is manned by Royal Marines, and officers have naval ratings.

71878

Soldiers on "Icebox" Treadmill Test Effects of Battle Cold



Soldiers exercising in subzero chamber. They breathe into recording device which shows effect of Arctic cold on troops

To determine just how efficient a soldier is in combat under sub-zero conditions, the Armored Medical Research Laboratory at Fort Knox puts soldiers on a treadmill, marching endlessly in temperatures down to 40 below, with an occasional 60-mile gale for variety. The tests proceed in a special cold room, whose temperature and other climatic conditions are carefully controlled. Clad in parkas and pile-lined garments, the men breathe into a recording device, their respirations revealing the state of their metabolism, and revealing to physiologists their every reaction.

☐ Paper clothesline, which is water repellent and supports a load of 250 pounds, can be left up permanently outdoors.

Mr. Allen Marie Miller
7 Park Ave.
N. Y. 17, N. Y.

71928

BOUNCING BABY with a

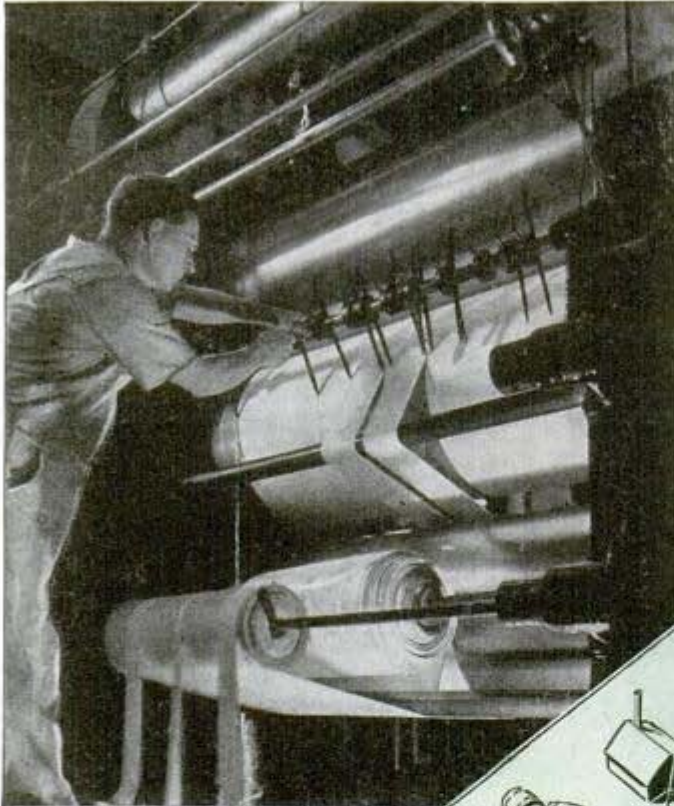

Cutting rubber strips for tires in a Firestone synthetic plant. Below, an armful of synthetic rubber made from petroleum gas Standard Oil Co. of N. J.



TWO years ago synthetic rubber was a frail industrial baby, kept alive in laboratories and nourished from tiny test tubes. Today it has bounced full-grown into the nation's economy with the stature of a billion-dollar giant who has saved the day for Uncle Sam.

When the war ends, these new, elastic industrial muscles will be flexed to perform thousands of tasks. The strange-looking chemical plants, mostly tanks and pipes without roofs or walls, will be producing enough synthetic rubber per year to make a band about as big as a stovepipe which could be snapped around the earth at the equator without stretching. This rubber band would weigh about 900,000 tons.

One plant alone, at Institute, W. Va., will be turning out

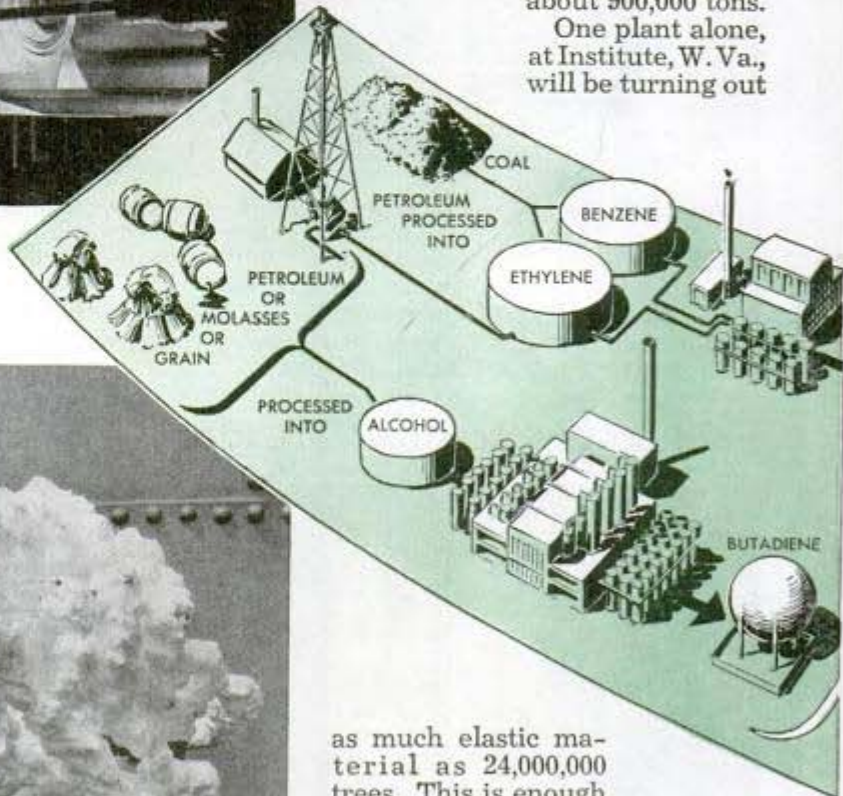

as much elastic material as 24,000,000 trees. This is enough rubber to manufacture 63,000 passenger car tires per day.

While this huge output consists almost entirely of four types of synthetic rubber, the bulk made from alcohol or petroleum, it is estimated that more than 4,000 other rubber substitutes have been developed. Homes, farms, factories—even your postwar

FUTURE

clothing, furniture and autos will be changed by these elastic plastics.

Take your postwar automobile. Even if low-cost natural rubber returns, synthetics will add to tire mileage. Dipping the finished tire in synthetic rubber provides a coating which protects the tire from the rotting effects of sun, grease and oil.

There will be no necessity of checking the air in your tires every time you buy gas. A synthetic rubber made of coal, limestone, salt and water is now being formed into a leakproof inner tube, a function natural rubber has never been able to fill.

Travel fatigue from continued vibration and rumble, can be eliminated by synthetic cellular rubber. This material, used as a lining for car bodies, will silence the car and add such excellent insulating qualities that it will probably improve your postwar refrigerator as well

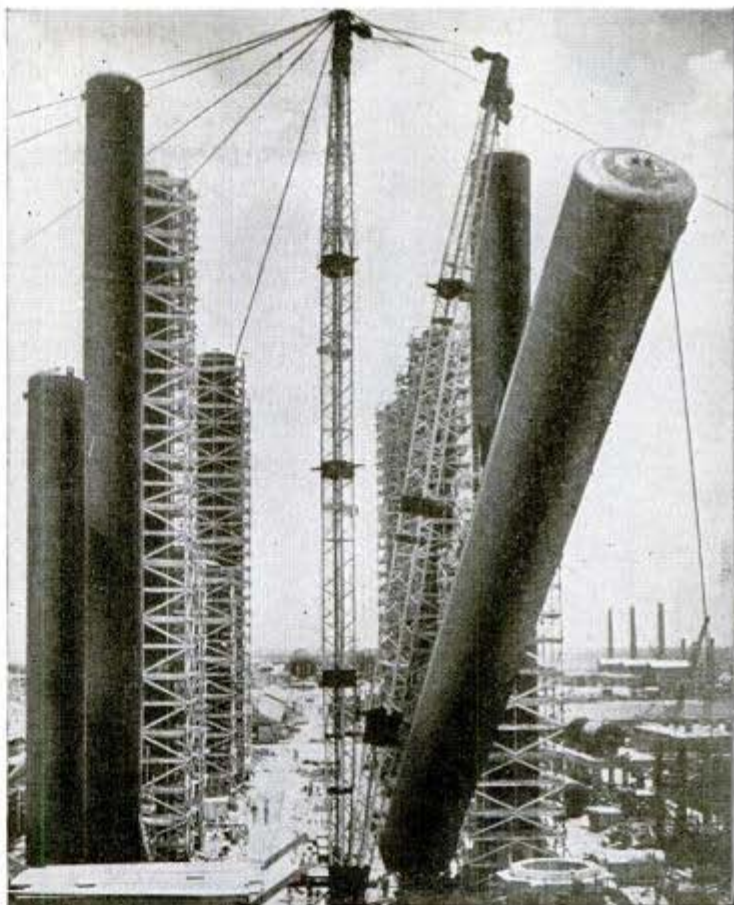

200-ton butadiene towers nearly as tall as a 17-story building rise at a new plant at Port Neches, Texas

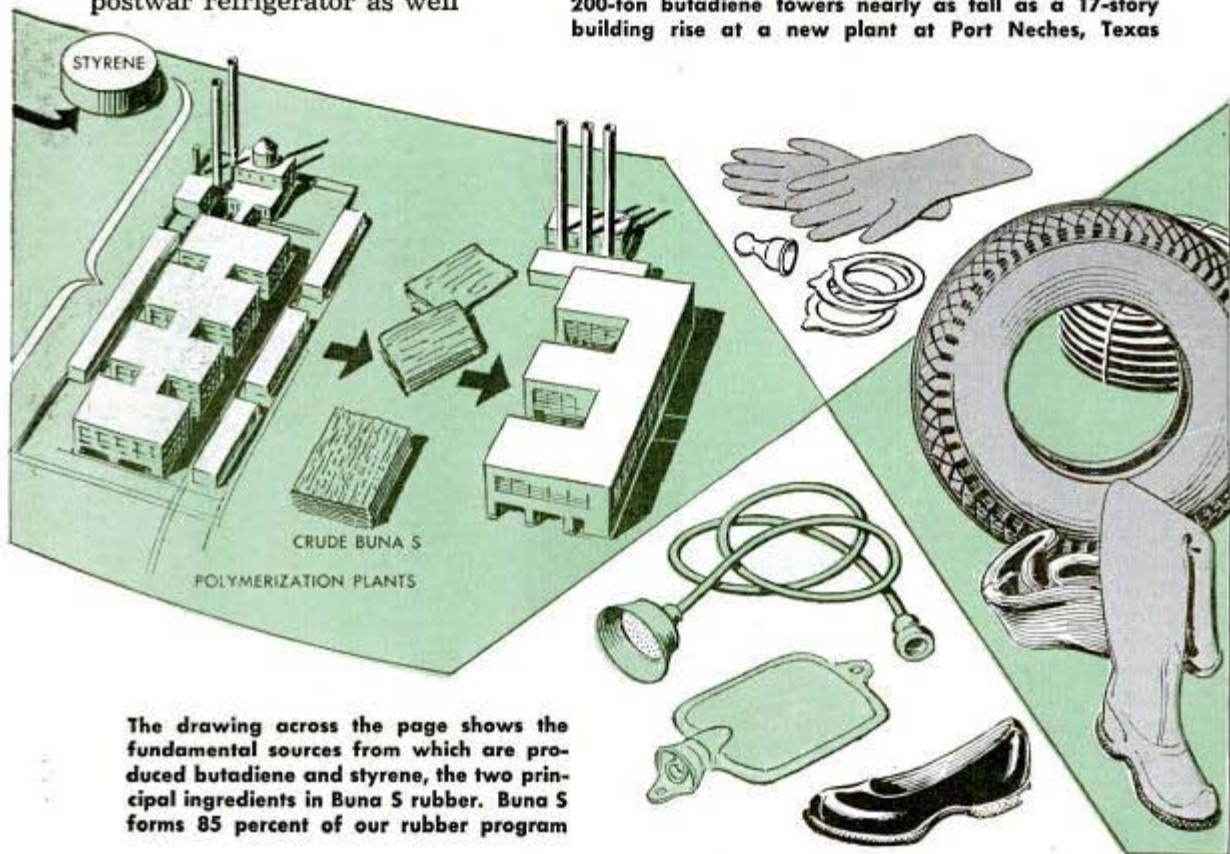

The drawing across the page shows the fundamental sources from which are produced butadiene and styrene, the two principal ingredients in Buna S rubber. Buna S forms 85 percent of our rubber program

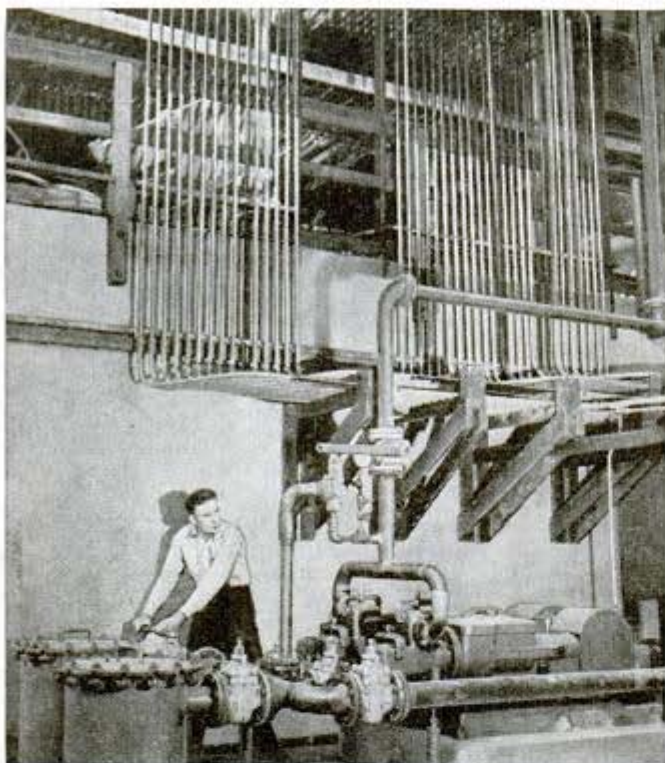

Synthetic rubber latex blending tanks at Institute, W. Va.

as modify the temperature of your auto. Tested as lining in army tanks it was found also to be nearly flameproof.

Rubber cushions may eliminate seat springs and manmade rubbers have been found to excel natural rubber for windshield wipers, fan belts, ignition cables, wire insulation, gaskets.

Flaming death for motorists when a crack-up explodes gasoline should be less of a menace in the postwar car because of the development of self-sealing aircraft gasoline tanks. These tanks use two types of synthetic—an inner layer which does not deteriorate in the presence of gasoline and another layer which swells in the presence of gasoline. This sealing takes place so rapidly that a bullet hole is sealed much as clotting stops the loss of blood before more than a teaspoonful of gasoline has been lost.

The roof of your postwar home may be made of a new compound resisting ice, rain, sun, heat

The Institute plant is operated for the government by U. S. Rubber Co. This tower cools 20,000 gallons of water per minute

30 Institute, W. Va.

and cold. You may have floors composed of an attractive and durable synthetic rubber now applied to decks of warships which enables a sailor to retain his footing even when the rubberlike material is wet and tilted to a 45-degree angle.

Impregnation of fabrics with synthetic rubber compounds is likely to mean easier cleaned and more lasting draperies and upholstery. Kitchen drainboards, hot water bottles, and hundreds of other household articles have proved superior when made with synthetic rubber. It may be molded into chairs and smaller articles of furniture.

Synthetic rubber shoe soles are superior to leather for such workers as railroad track walkers. Fishing togs, which are both light and weatherproof are only waiting peace for production. Elastic thread which resists laundering and perspiration is ready for production and what may be expected in the line of rubbers and boots is

indicated by the fact that synthetic rubber jungle boots have replaced leather in the steaming swamps not only because they resist water and heat, but because they will not mold, mildew or rot.

Special synthetic rubbers are being put to such varied uses as printing plates, sponges, fire hoses, TNT buckets, conveyor belts, insulation tape, caulking compounds and adhesives. A moistureproof film is playing a vital role in the treatment of infantile paralysis. One of the steps in the

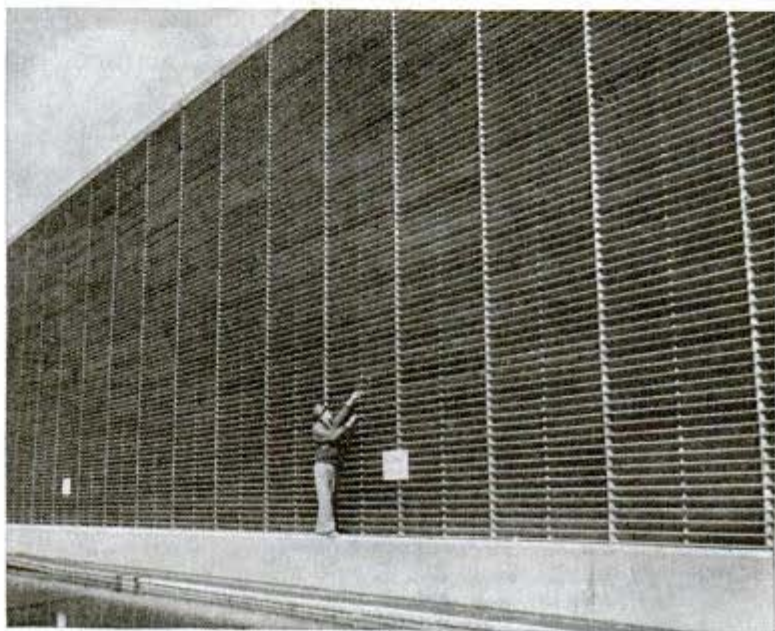

famous Sister Kenny treatment, is the wrapping of a patient at frequent intervals in blankets soaked with extremely hot water. This helps to keep the muscles limber and prevents further atrophy. After the blankets are applied to a patient, in many hospitals, a wrapping of plio-film is added. Its low conductivity helps to retain heat and moisture.

On the war front, synthetic rubbers are serving in life rafts, life preservers, salvage balloons used to raise sunken

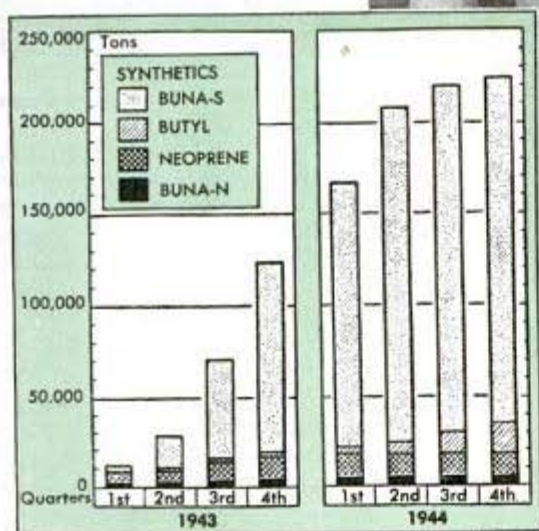
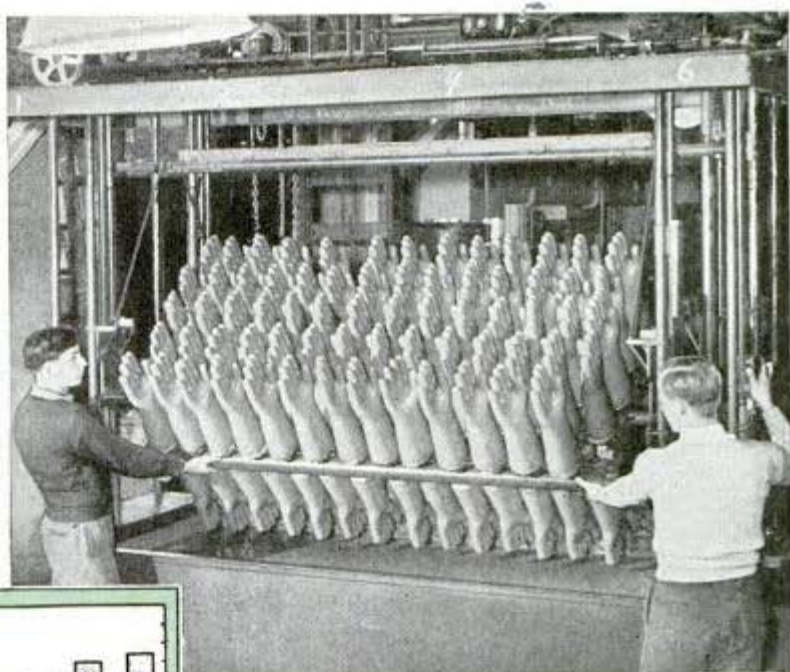

Dipped in Neoprene, these synthetic rubber gloves for the army are impervious to deadly mustard gas

Chart at left shows estimate of our synthetic output

In these towers and reactors at Standard Oil's Baton Rouge refinery, petroleum gas for rubber is processed

airplanes, propellers, flameproof hoses, fuel tanks, firefighting suits and buoyant wading garments. A Flying Fortress uses 1,250 pounds of rubber, a medium tank 1,750 pounds and a battleship 150,000 pounds.

Fortunately there has been no shortage in synthetic rubbers for our armed forces, although the scarcity of civilian tires often leads to this belief. In fact, we have produced so much rubber in so short a time that there have been periods with a surplus. The reason this surplus has not gone into civilian tires is that tire plants have been dismantled or scrapped,

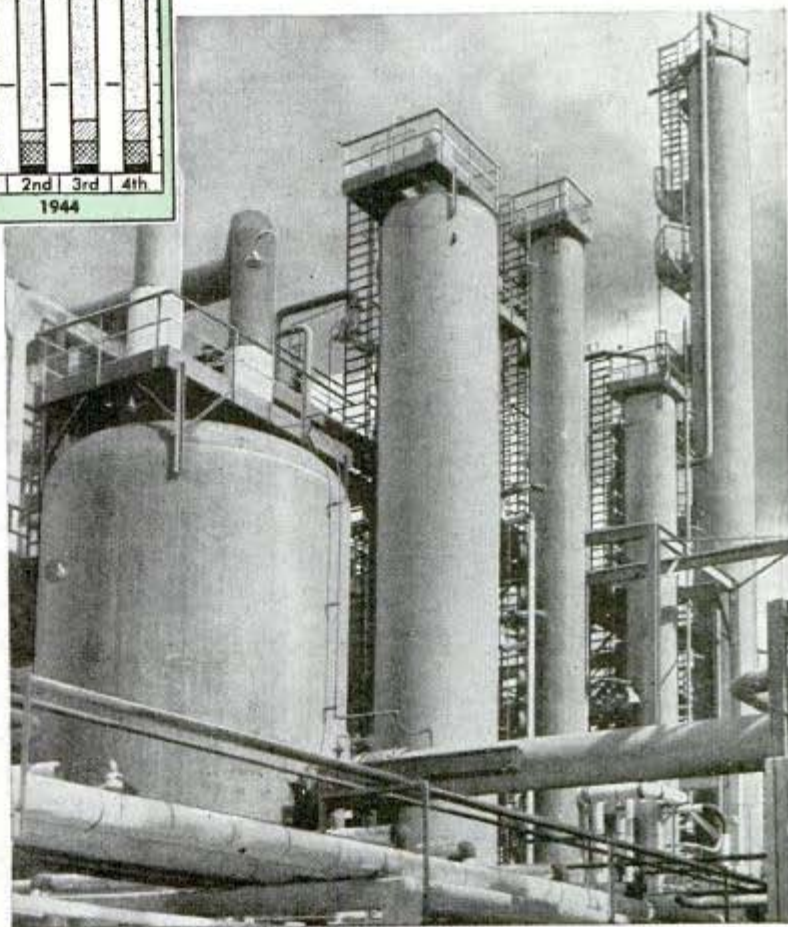



U. S. Department of Agriculture photos

Heat is No. 1 enemy of household rubber. Don't use the stove for a drier! Stuffing galoshes preserves shape

experienced rubber workers have gone into other industries and too few men are available who know how to make tires of synthetic rubber, a more complicated task than standard tire making.

The principal synthetic rubbers in the government program are Buna S, Butyl, Neoprene and Buna N. The first two can be made from petroleum. Buna S is the only rubber to be used in quantity for tires. Buna S plants supply about 85 percent of

the total synthetic rubber manufactured. It is made by combining styrene and butadiene in a latex-like emulsion which is then processed much like natural latex. The process is called polymerization, which means stringing together of similar molecules to form long molecular chains. Raw materials for styrene may be obtained from coal. Butadiene may be made from petroleum, from alcohol, or by special fermentation processes.

Butadiene is a gas at ordinary temperatures and pressures. It is liquefied by pressure or refrigeration for easier handling. It is manufactured both by extracting it directly from cracked gases, and by removing hydrogen atoms from butylene, a refinery gas.

In making Buna S, butadiene and styrene are polymerized in large reactors, resembling giant kettles. A soapy emulsion and a catalyst are placed with them in these reactors. These various products are heated to exact temperatures and under carefully controlled conditions the molecules "hook up" and form a milky latex similar in appearance to that obtained from the rubber tree.

Buna S is highly resistant to heat, abrasion and the aging action of sunlight and air. It can be vulcanized and worked by the same machines used for natural rubber.

Butadiene storage tanks at Institute, W. Va. Pressure is so high only spherical tanks can hold gaseous butadiene
OWI photo



Mr. ... 3872 ... 7843
Los Angeles
GO ROLLING ALONG

"The CAISSONS



THE battle had reached its critical stage and now the Germans were massing more infantry for a final powerful effort. There would be a smile on Der Fuehrer's face tonight if the Americans could be pushed back.

But the German drive never got started.

Without warning, their assembly area suddenly became an inferno of noise, concussion, and flying steel. When the terrific explosions ended there weren't enough men left to halt the advance of a baby buggy.

It was no new American super rocket nor yet "pin point" bombing by aircraft that had cut them down. The devastation was caused by Yankee field artillery.

Twelve big 155 millimeter field guns in less than one and a half minutes had poured tons of high explosive shells

A far cry from horse-drawn guns of World War I is this self-propelled 155 mm. giant, the M-12, mounted on chassis of medium tank. Hinged supports at rear dig into ground. Below, loading the M-12





Swabbing out the barrel of an M-12 getting ready for next round of firing. Gunners seldom see shells land

Captured Italian antiaircraft and antitank gun is shown in firing position; truck has a Diesel engine
Signal Corps photo



into the area. Some of the shells were fused to burst on impact, others were timed to explode over the heads of the enemy, hurling metal in all directions.

Tanks, rockets, airplanes, and all the new weapons of war might make you suppose that artillery is out of date. The truth is that nothing has been found that can deliver so consistently the telling punch of a big shell. Field guns continue to be one of the most important weapons of the world's armies.

With massed artillery fire the Russians have turned German advances into routs. With shellfire, British and American forces have smashed German strongholds that resisted tanks and aircraft.

Artillery has come a long way since the days of the first world war. Then the howitzers and guns were horse-drawn; now they are

either self-propelled or are towed by wheel- or tractor-type prime movers. Obtaining the initial firing data used to be a slow and complicated process; now such adjustments are made by slide rule. Artillery fire was not always accurate in the past; today a gun crew can lay most of its shells inside a 35-yard radius four miles away.

The Germans are proud of their "88" which has been a potent weapon against Allied tanks and troops. The American answer to the "88" is the new 105 millimeter howitzer that packs the wallop of a medium field piece and yet is light enough to be served by only a few men, towed rapidly behind a truck, and moved quickly into advanced positions. The 105 has a split trail, a wide angle of fire, and uses a round that contains both shell and powder charge. It is possibly the most accurate gun of its type in the world.

Back of the 105 howitzers in a typical battle area lie the long range guns that can reach out over the scene of combat and pick off distant enemy targets. Among such cannon is the 155 millimeter howitzer whose short barrel can throw shells at high angles and drop them on hidden targets.

As mobile and of longer range than the howitzer is the new self-propelled M-12 155 millimeter gun. This weapon is mounted on the chassis of a medium tank and can make its way unassisted across rough ground to reach a good position. The armored rear wall of the gun compartment is hinged so that it swings down to form a spade that digs into the earth as a support. This gives the mobile cannon the firing stability of a fixed gun.

Aiming M-12 at distant target first plotted on the firing chart

MAY, 1944



Hidden under trees, this switchboard is nerve center of artillery unit

In the same category is the big 15-ton M-1 "Long Tom" gun of 155 millimeter size, with the longest barrel of all. It can reach out to targets 15 miles away. The Long Toms made a name for themselves, together with aircraft, in the re-taking of Kasserine Pass in North Africa, and they played an important part in Sicily and in





Preparing to fire 105 mm. howitzer—America's answer to Nazi's "88"

the northward advance through Italy. The M-1s are mounted on huge rubber tires for transport and are towed by tractor-type prime movers that also serve to carry the gun crews and ammunition.

There are four big guns in a battery. Three such batteries make up a field artillery battalion that has its own aerial and ground observers, radios, fire direction center, and telephone network. The entire organization is mobile, ready to pick up and leave or to dig in at a new location in a matter of minutes. The guns are moved into position under trees or are blended into their surroundings with camouflage. Each gunner digs himself a fox hole, and linemen hurriedly lay telephone wires for fire control and other communication.

There's no time for idle talk behind the

flies from the ground. Members of the gun crew are in a crouched position. Their mouths are open to equalize the pressure on their ear drums.

The other three guns of the battery fire in sequence and then, possibly 15 or 20 seconds later, you begin to hear the distant explosions of shells bursting on their targets. Meanwhile, the gun crews are swabbing out the powder chambers and preparing more rounds for firing. The gunners seldom see their shells land. The targets are usually out of sight and there's little time to watch, anyway.

No two shells from the same gun are likely to land in exactly the same spot. Variations in temperature, atmospheric pressure, and the winds aloft all require minute adjustments in the aim. In addition there is "probable error," a factor that disperses the shells over all parts of the target area. Even the force with which a shell is rammed into the breech may influence the range.

Aiming big artillery field pieces is usually done by map. Once a gun is oriented it can be brought to bear on any target within its range by a few turns of its traversing and elevating wheels.

"Enemy tanks and artil-

M-12 takes short cut over open country on way to front lines



lery are moving along a road 400 yards beyond Check Point 28," may be the report phoned in to the fire direction center by a distant observer. Immediately, plotters figure this location on their firing charts and then take off the ranges and deflections that are to be telephoned to the executive officers at the guns. Sometimes one preliminary round is fired by one gun so the aim of the others may be corrected, if necessary, after the observers spot the shell burst.

Right, commander using aiming circle instrument signals to gun crew. Below "AA" gun mounted on truck



If it is planned to catch the target by surprise, such a sighting round may be aimed at a point that is a known distance from the target. The relation of this shell burst to its target allows the plotters to estimate the aim to be used by all the guns for hitting their real target.

Quite possibly, too, this preliminary round will be fired by a gun that has been moved

Continued to page 152

Three Yanks inspecting a captured German "super" 75 mm. antitank gun
Signal Corps photo

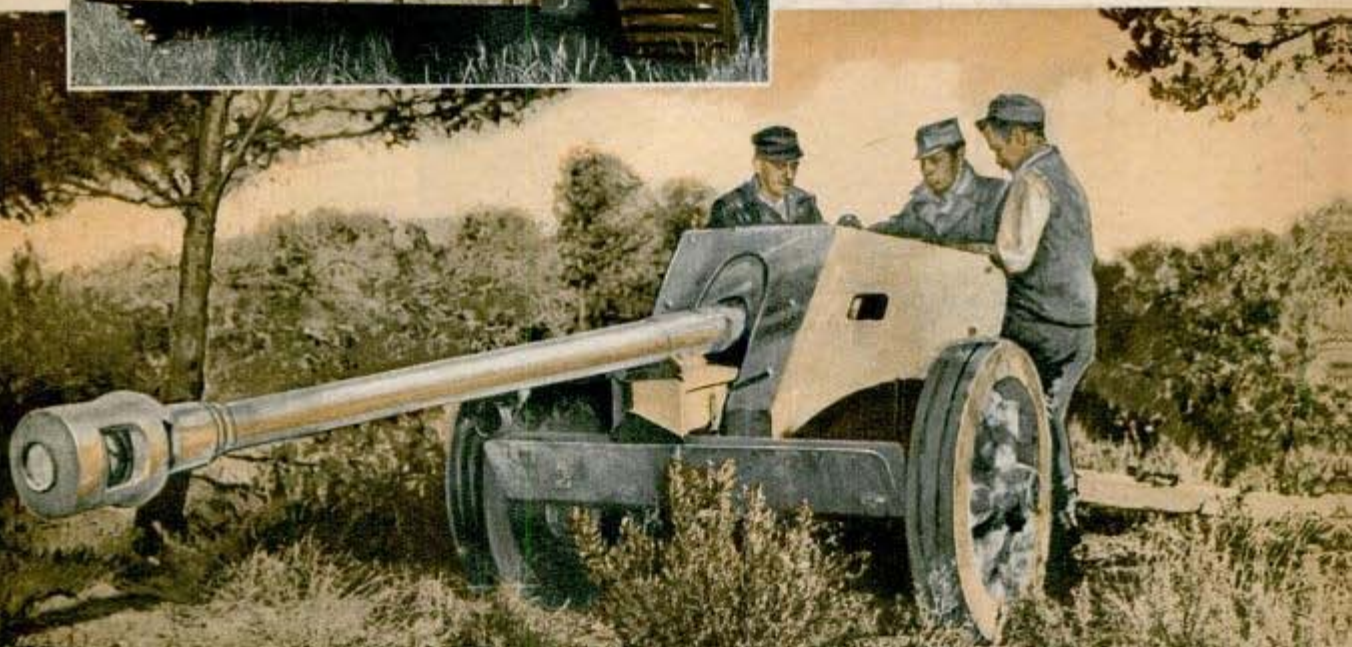

Public Relations Office
U. S. Coast Guard
Washington, D. C.

0003

Trucks Guard Flying Boat From Arctic Squall



An Arctic squall in Alaska gave Navy trucks a new job—acting as anchors and windbreakers for a Catalina

Navy trucks—a whole fleet of them—prevented the wrecking of a U. S. Coast Guard PBY flying boat at an Alaskan base. A sudden Arctic squall, known as a willi-

waw, threatened the PBY with destruction. The trucks were driven onto the landing strip around the plane and served as both windbreak and anchor.

7975

Giant Tong Lifts 80 Tons in Claws With 69-Inch Spread



The tong is so massive it can easily pick up ingots weighing 80 tons

Ingots weighing tons are lifted like feathers with a massive tong that has a lifting capacity of 80 tons. The big tong, used in a major steel plant, has an opening of 69 inches and weighs 12,489 pounds. It is suspended from an overhead crane, and operates automatically

034

Air Engine Adapted For Tank Drive by Minor Changes

Wright Whirlwind airplane engines are almost identical with the Wright engines used to power the General Grant and General Sherman tanks and the M-7 self-propelled 105-mm. howitzer. The engine was adapted for use in tanks by the addition of a combination cooling fan and flywheel mounted on the propeller shaft in place of the propeller and by changes in the induction system.

sent by: Appenstall Co.
4622 Hatfield St.
Pittsburgh, Pa

Fonda Corp. 014
309 E. 22nd St.
N.Y., N.Y.

Sound on Cellophane Tape Played Like Record

About the size of a portable radio, a sound-recording machine makes records on Cellophane tape. It can be plugged into a radio or microphone for recording, and the flip of a switch plays the record back. The Cellophane used is twice the thickness of cigarette wrappings and about an inch wide. Three hundred and fifty feet of tape provides eight hours of recording. The inventor got his idea from movie sound track.

Don Jay Fonda

Sound-recording Cellophane tape is being developed for home use. The sound is recorded and re-played in a machine plugged into the radio



Robot Arm Swings Bottle To Christen Ship 7943

"Christine" has christened more than a dozen new army tugs in the last six months. "She" swings a mechanical arm to whack the new vessel with a bottle of champagne as it goes down the ways, putting even the christening on a production line basis. The device is attached to the bow of the ship by tack welding, and consists of a pivoted arm held out horizontally from the bow by a spring catch. This catch is released by a trigger attached by a line to a stationary object. As the vessel slides into the water, the slack in the string is taken up and the bottle fixed to the end of the arm swings against the bow.

*Consolidated Shipbuilding Corp.
Morris Heights, N.Y., N.Y.*

Small Signaling Mirror for Lifeboats "Hits" a Target 10 Miles Away

Resembling a small mirror with a cross-shaped aperture in the center, a signaling device takes the guesswork out of "hitting" a target 10 miles away. It consists of a plate of heat-treated glass coated on the back with a transparent protective lacquer. On the center of the back side is a mirror about the size of a silver dollar, and in the center of this "aiming" mirror is the aperture. A cross-shaped spot of light from the aperture is caught on the upraised hand of the user as he "aims" at the

target, tilting the mirror to superimpose the cross-shaped image in the rear mirror upon the aperture while he sights through this opening at the target. The device is used on rafts and lifeboats, and by airplane pilots stranded in isolated country.



MODEL TANKER *trains* SHIPBUILDERS

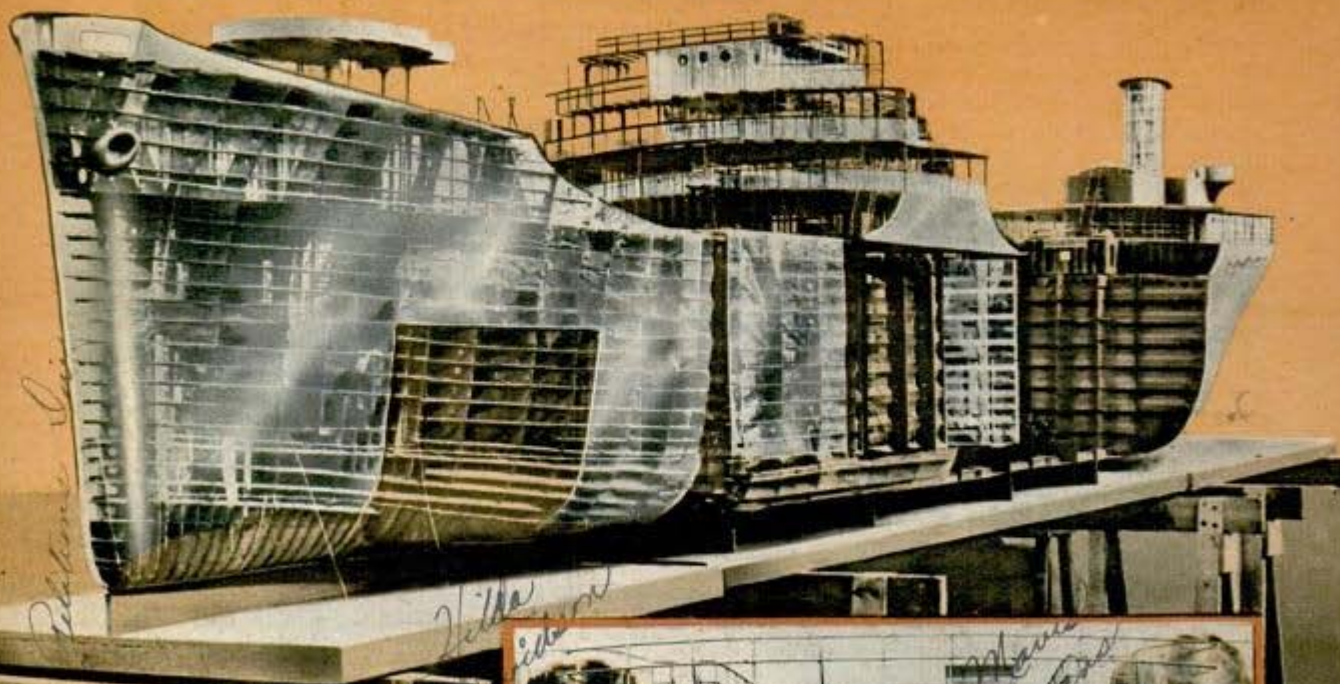

The Marinship Corp., Sausalito, Calif., has a "shipyard" within a shipyard—the Marinship Model Shop, where miniatures of the company's products are made to simplify the training of new workers. Above, a 20-foot model of a 16,500-ton tanker, made in sections can be used separately or combined. Right, women at work on an intricate midship deck house assembly. Employees of the ship builders learn how to do their jobs by studying each part in miniature

Marinship Corp., Sausalito, California, Mr. Ed Jones, Employer

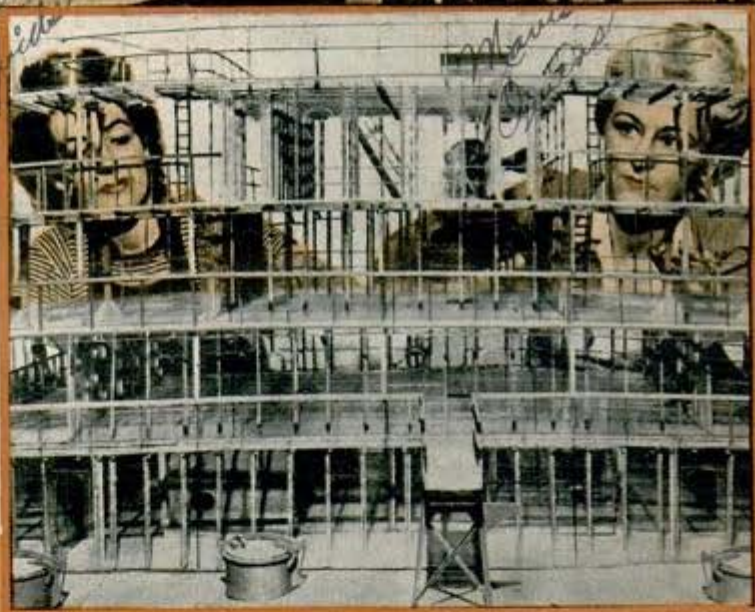

Left, the 8½-ton steering gear flat is lifted from pre-hull assembly skids by a single crane before installation on ship rising on ways in the background. Below, a copy of the same flat has been fabricated in inverted position and "flopped" into the proper position to be put on a hull, just as is done in yard

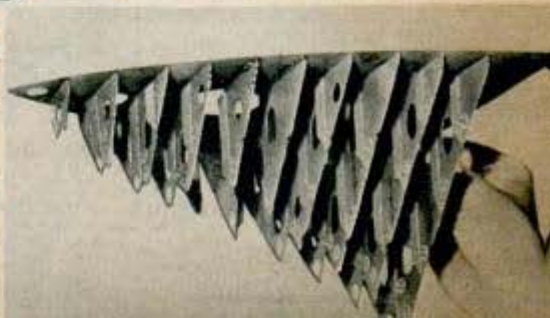
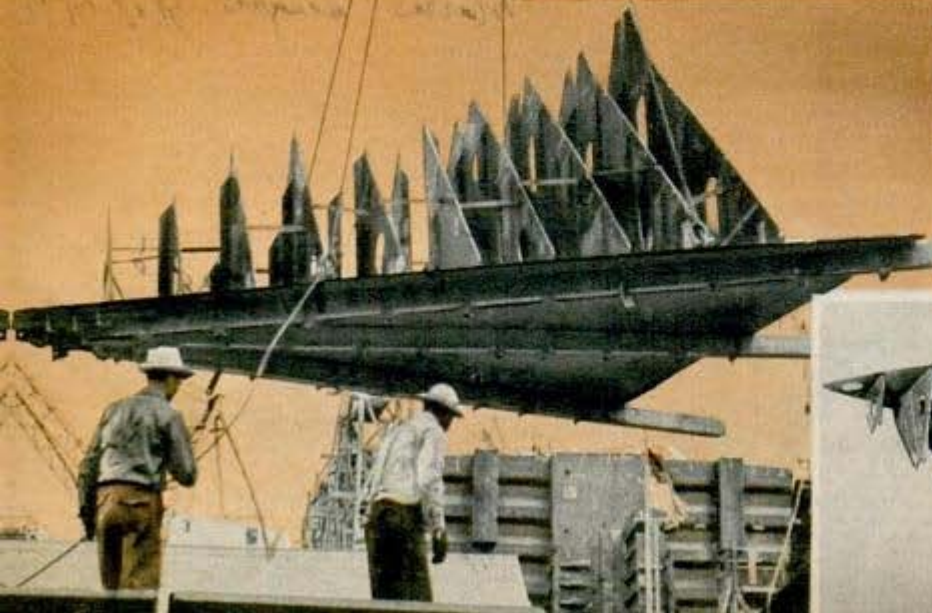

Craftsmen supply the ticklish detail work necessary for the midship deck house assembly. This intricate job is so tremendous that only one complete model of the entire ship has been made. The models often are used for experiments in planning how to put large sections of the ship together. Edward A. Owens, formerly of the U. S. Engineers Corps, is head of the shop. Most of his assistants have had either art or drafting school experience

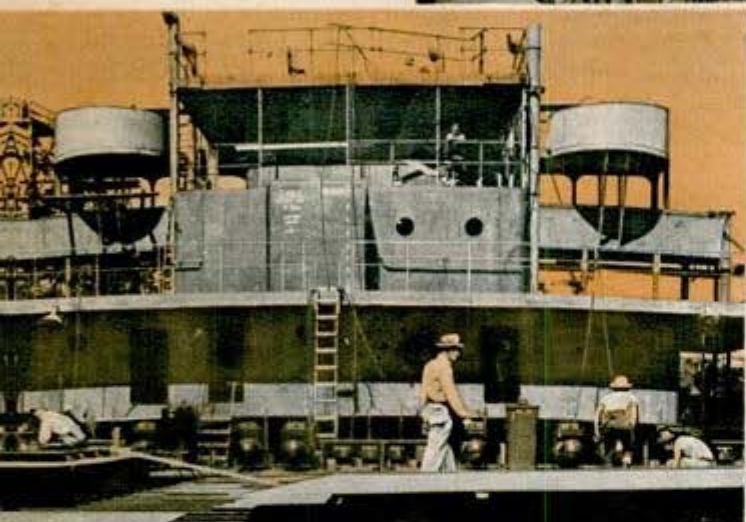
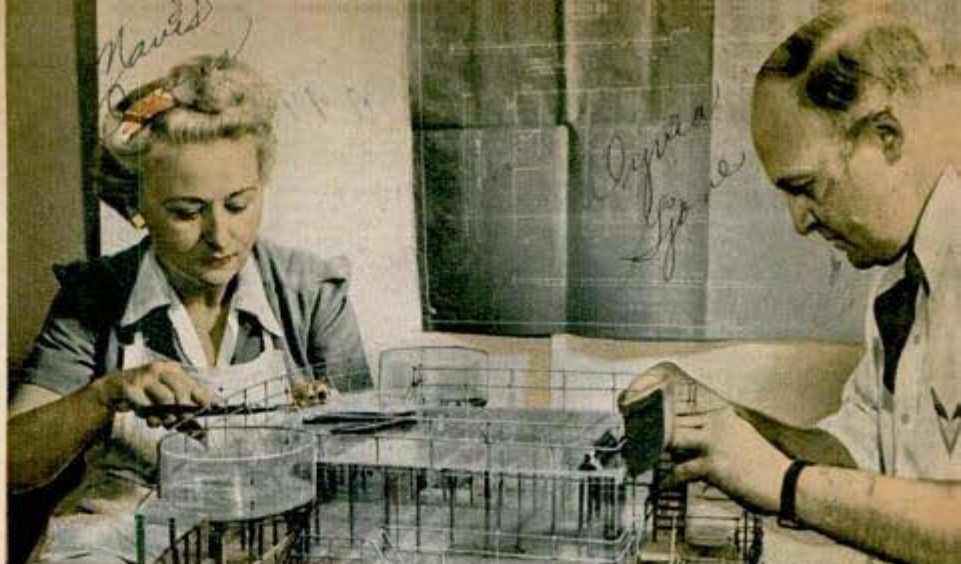

Left, a view of the midship deck house as it is in the shipyard. The scale for the models is a half inch to one foot. In the shop draftsmen lay out and cut templates, or patterns, from the ship's blueprints and construct the miniatures out of acetate and fiberboard. Then they make scale duplicates of the prefabricated sections produced in the shipyard



Two gantry cranes are needed to lift the 65-ton lower stern section, carry it the length of the shipways, and lower it into position aft. Below, model of lower stern has a hole for shaft tunnel which eventually will carry tail shaft. Note stern frame ready for rudder

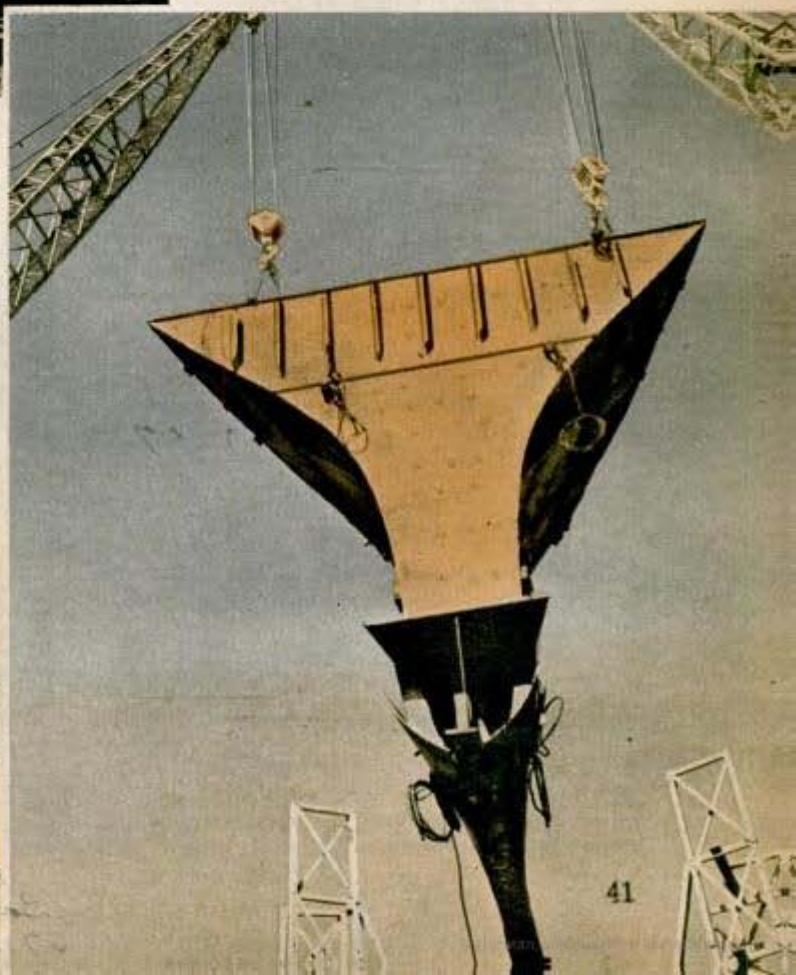

7974

Jungle 'Phone Without Batteries Has Five to 10 Mile Range



Operated without cumbersome batteries, a sound-powered telephone adopted by the U. S. Army Signal Corps is used in jungle combat areas. It has a normal range of five miles, and under favorable conditions can carry messages up to 10 miles. There is no current flowing through the circuit as in an ordinary telephone. Instead of the usual microphone, the instrument has a diaphragm which is attached to a coil. The coil is set up within an electro-magnetic field and as it vibrates the field is cut, inducing a current.

357

Blood Donor Gets Cells Back After Separation of Plasma

Restoring the red cells to the blood donor, rather than discarding them, as is done now, would make 800 percent more plasma available to the armed forces, according to a recent article in the Journal of the American Medical Association. The interval between blood donations now considered safe for the donor is based on the rate of regeneration of hemoglobin, red coloring matter and oxygen carrier of the blood. The total protein lost by each donor with

each pint of blood donated is slightly over three ounces. If the red cells are reinfused into his veins, he is spared 80 percent of this drain and theoretically should be able to donate plasma five times more frequently than the present practice of every eight weeks. Shortening of the interval between donations to one week, which might cause an unfavorable change in disease-resisting factors in the donor's blood, is not advised, however, until further studies are made.

040

Portable Self-Powered Heater Operates by Forced Air

Postwar domestic heating may be revolutionized by a portable, automatic forced warm air furnace developed by the Army Air Forces. The furnace, which weighs only 45 pounds and is about as large as an average traveling bag, is equipped with its own fuel supply and a tiny, precision-built prime mover. It is expected the heater's flow of pure heated air would keep an average single family home warm in the coldest weather, since tests show the unit will operate successfully in temperatures 70 degrees below zero. The Norge Division of the Borg-Warner corporation, Detroit, Mich., cooperated with the Air Forces in the development of the furnace.



Norge Div.
POPULAR MECHANICS
Borg-Warner Corp.
670 E. Woodbridge St., Detroit 26, Mich.

Cont: Mr. Pennington
344 N. Grand Ave.
Albany, N.Y.

The WORLD'S MIGHTIEST BATTLESHIP

Hailed as the mightiest warship in the world, the new 45,000-ton U.S.S. Missouri, being launched here, is 880 feet long (149 feet shorter than the Normandie) and is expected to be faster than any craft her size. She has an electrical plant which could supply Santa Fe, N. M. Cost was over \$100,000,000

The Missouri required 1,135,000 rivets, 4,400,000 feet of welding and 175 tons of blueprints in its construction. Deck areas total 418,000 square feet, the same as a 15 story building 150 feet square. The water she displaces could flood 46 acres of land and her wiring system is 1,700 miles long. Prototype is U.S.S. Iowa, launched in 1942

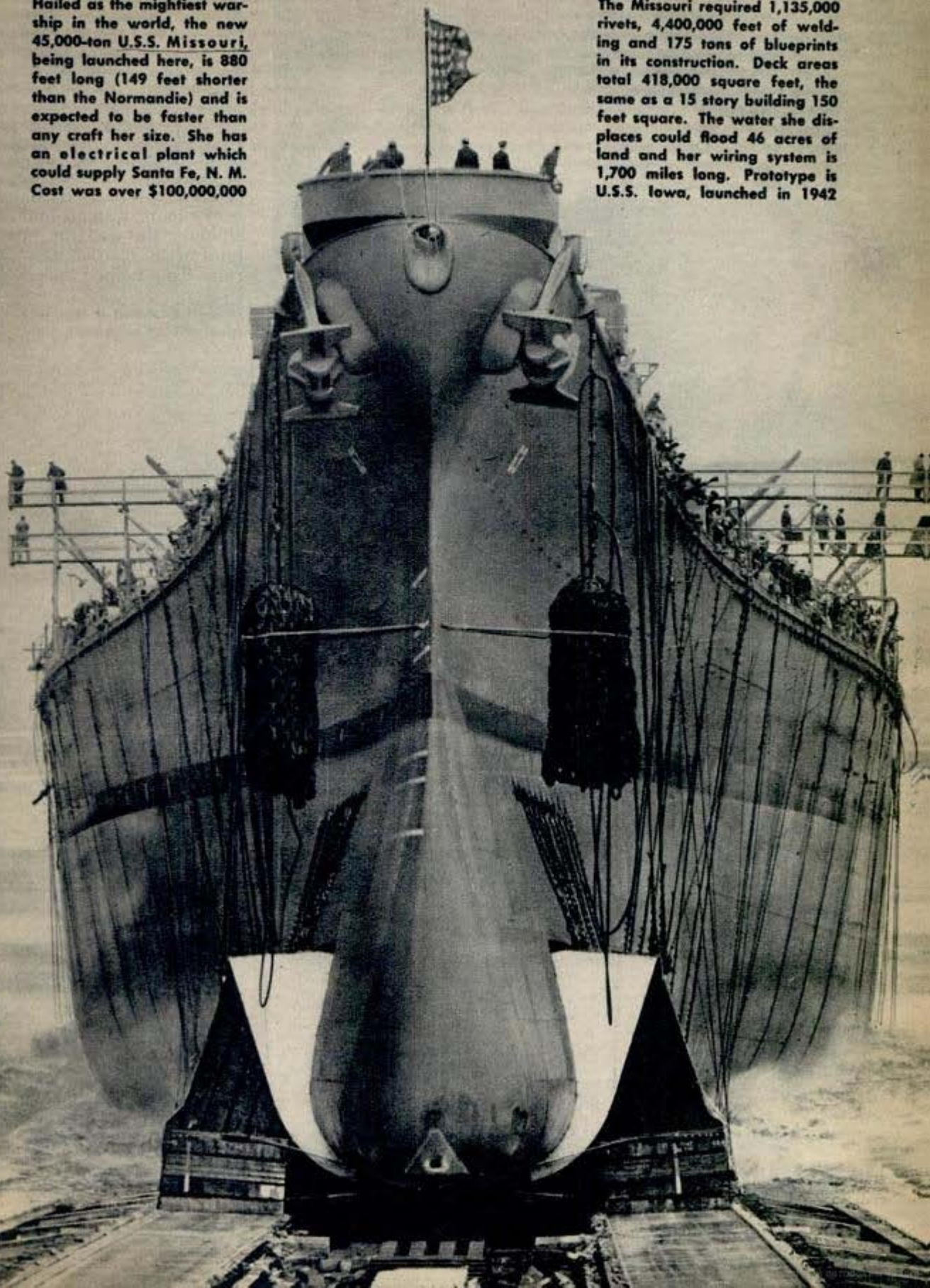

BUILDING BLOCKS for a NEW WORLD



cover at the corner, all owe their existence to the plentiful structural plastic—concrete.

To meet the demands of war, mountains of limestone, chalk and shells are being crushed for mixture with shale, clay or blast furnace slag, and gypsum to produce portland cement. In the first year of the war, 1.4 barrels of cement were used for every man, woman and child in the nation—a total of 182,000,000 barrels. This helped speed

Masked workman is repairing tube mill at a cement plant

THE stuff that helped pull your flivver out of the mud a few years ago is helping win a war today, and at the same time playing a major role in the development of innovations that will make a more livable postwar world. It's the "work horse" of all branches of the construction industry—concrete.

Great war plants that seem to mushroom up over night, airports crisscrossed with sturdy runways, ships that are built with a minimum of precious steel, massive dams bottling up the power to produce goods of war, vast housing projects for workers, fuel tanks, and even the new type of manhole

*Portland Cement Association
33 W. Bond
Chicago, Ill.*

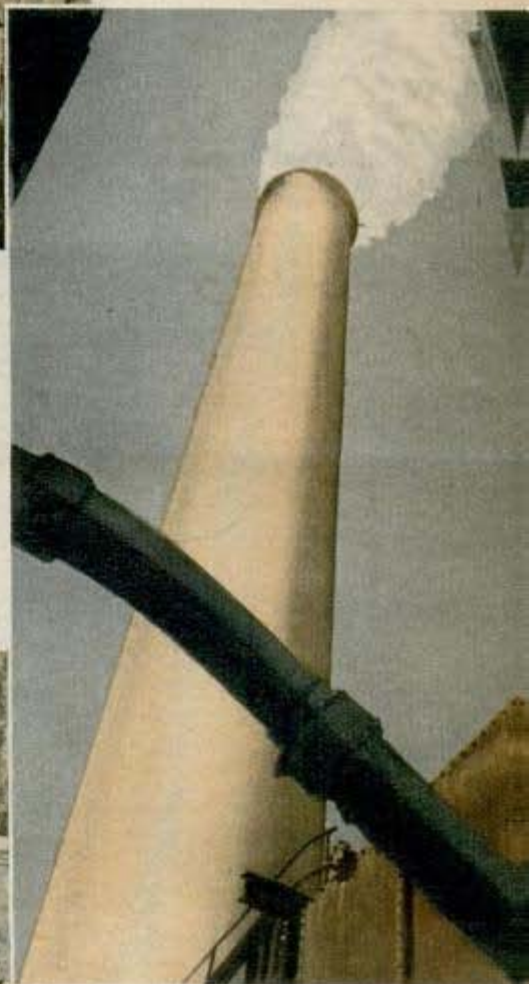

Concrete smokestack (above) is symbolic of the important part cement plays in vital war industries in the United States. Left, finishing machine moving over a strip of pavement



*Home News Service, Inc.
Subject: Wallace Neff
Los Angeles, Calif.*

7) 884



Slab of pre-cast bridge poised above abutments is being eased into place—a delicate operation. Below, “backstage” view of some concrete work on the Hiwassee dam in Tennessee Valley

the construction of scores of war factories, and built 27,000 acres of concrete runways that would make a flight strip 150 feet wide from Washington, D. C., to Denver. An all-time record for cement construction was set during 1942.

When building contractors were ordered to rush construction in the face of war shortages of materials and labor, they turned to concrete and new methods. In working out designs to save steel, they learned that many old building codes require wasteful overdesign. They substituted reinforced concrete for traditional steel frame construction in many industrial buildings.

In one military project involving five warehouses, a change in design to reinforced concrete saved 47,053 tons of steel. To a nation at war, this means a saving of vital metals for guns and tanks. To a nation at peace, it means factories and warehouses at lower cost.

One revolutionary type of home construction available for the postwar era starts with a concrete floor on which the four side walls of the house are cast

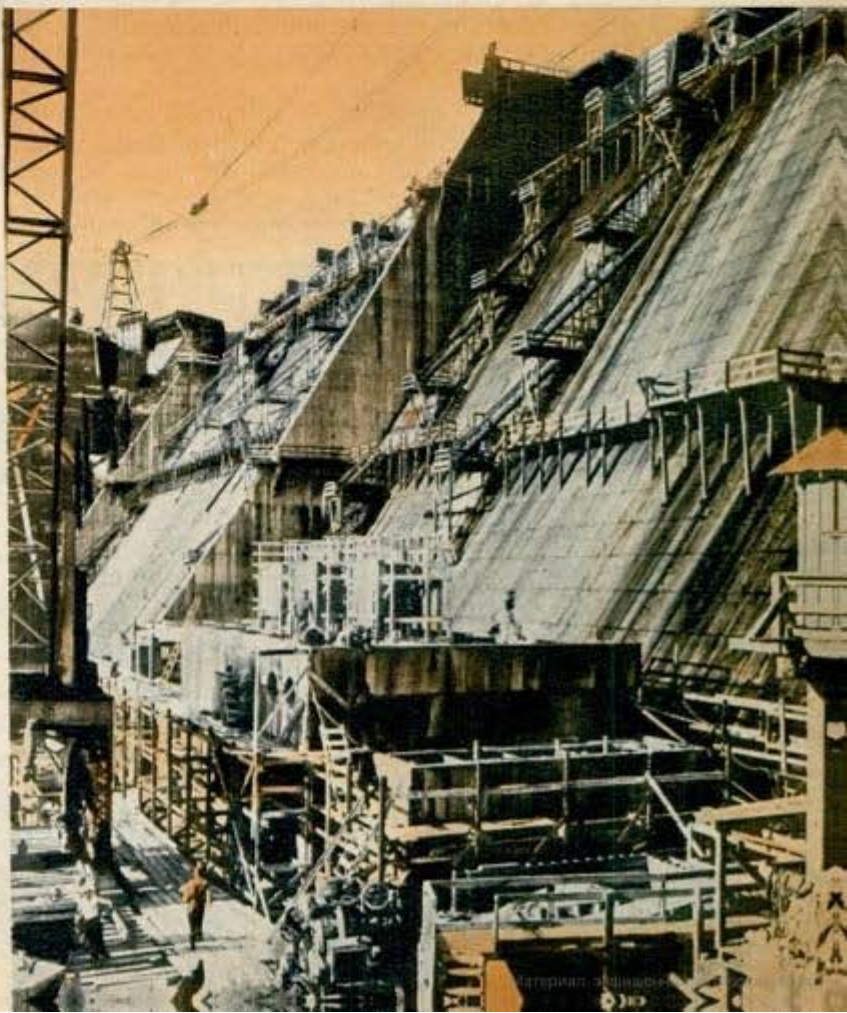



Gas-driven machine oils inside of cement form, tamps dirt on sides

flat, one at a time. As each wall hardens, it is tilted into vertical position with simple hand-operated hoisting equipment. Door and window frames, pipe ducts, and recesses for electrical switches are inserted in the wall forms before the concrete is placed. Methods have also been worked out for concrete houses and other small buildings which will be built of large pre-cast sections.

These designs, products of intensive research, make use of concrete mixtures that will keep out heat or cold, resist the pene-

tration of tropical rain-storms, and absorb sound. Soundproof sleeping rooms will be commonplace in the home of the future, regardless of the type of construction. Use of concrete floors with radiant heat ducts built in is also predicted.

But before we can build that cozy postwar home, there's a war to be won, steel and skilled labor to be conserved for war use, and valuable time to be saved. Efforts to conserve all three have resulted in wide use of concrete "barrel shell" and ribbed-arch roof designs. Used in war plants, warehouses and hangars, roofs of these types give long clearance between columns and can be built with a shell as thin as three inches. Time-saving traveling forms have been adapted to the construction. Also, a vacuum device to draw water from the fresh concrete hastens the hardening process.

The traveling forms, mounted on wheels, are used for either walls or roof. As one section of a building hardens, they are moved forward and used again and again. With this method, one war plant covering 1,500,000 square feet was erected in 60 days.

Another revolutionary type of construction, reserved for smaller buildings and war housing, makes use of a "balloon"

This barrel-type concrete house was "poured" in three units; interior finish is plaster on metal lath



form. Concrete is placed through a cement gun over an inflated bag made of rubberized canvas or other suitable material. This forms an igloo type of structure. Wire mesh reinforcement is placed over the balloon form before applying concrete.

Knowledge gained in paving airport runways to support giant bombers will be applied to postwar highways and airport runways alike. Runways can be designed to support wheel loads of 180,000 pounds. In fact, formulas have been worked out under sponsorship of the Portland Cement Association so that road slabs or runways can be built economically to support any anticipated load. Runways should be skid-resistant and present good visibility from the air by day and good reflection for night lighting.

Highway paving, which has been almost at a standstill since Pearl Harbor except for strategic military roads, is expected to boom when the war ends. Although the United States has more concrete roads than

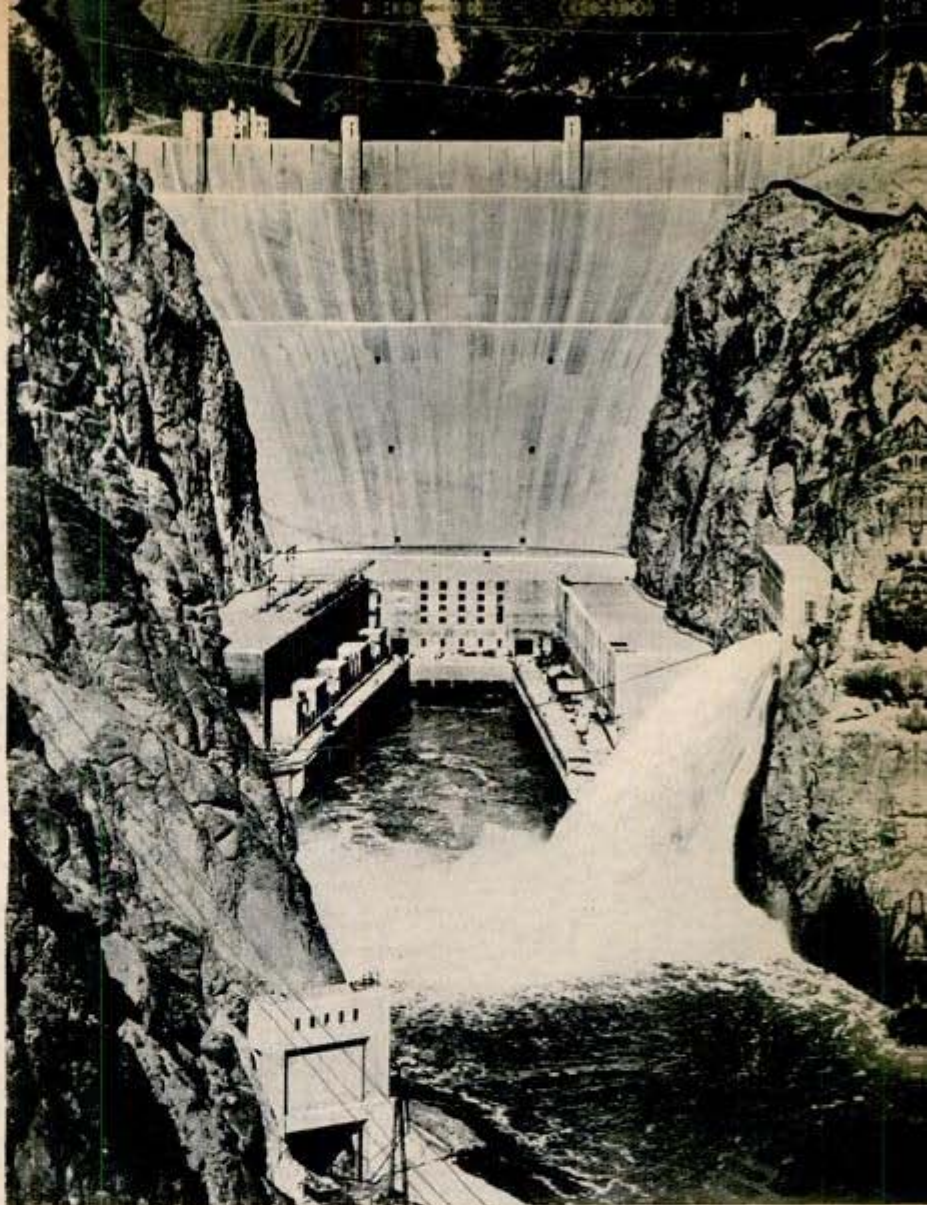

Seven million tons of concrete were used to build Boulder Dam which towers 730 feet above foundation rock. Left, prow of concrete ship under construction. Below, lofty railroad viaduct of unusual design

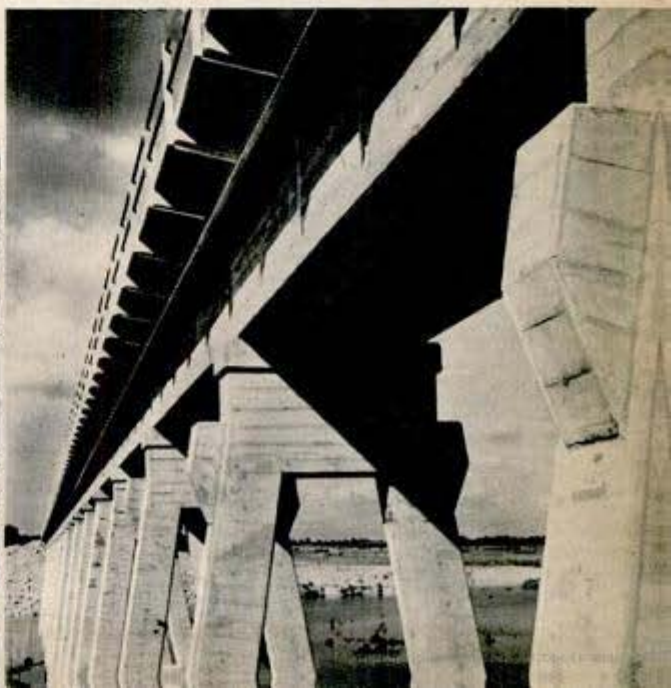
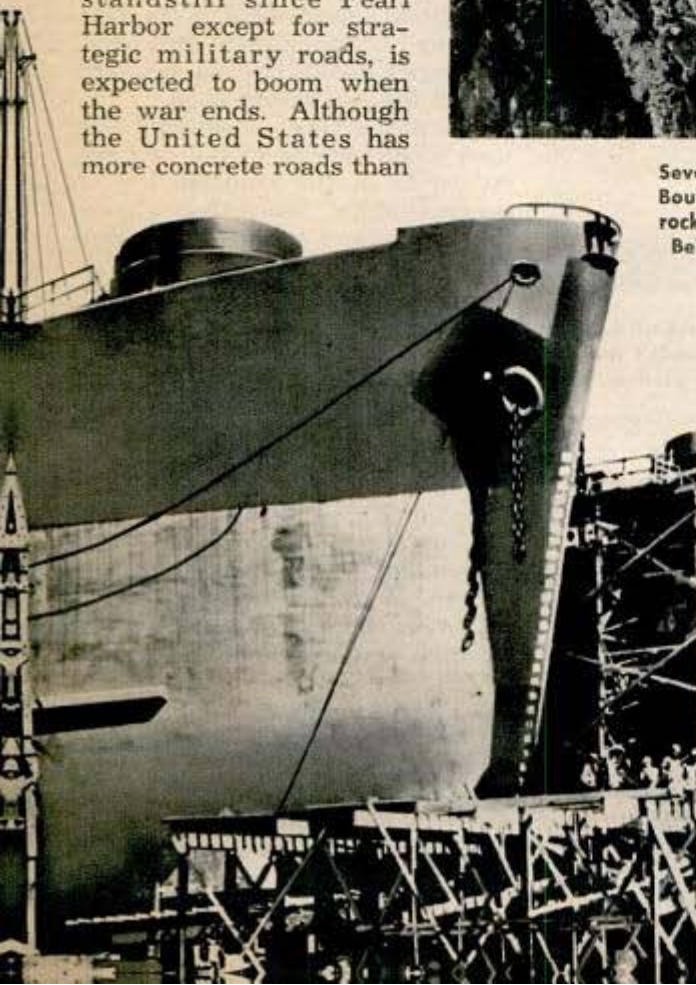



Strip of soil-cement highway gets a final sheepfoot rolling and smoothing with scraper. It forms smooth hard-packed road



Concrete test tracks are used to check Army trucks at General Motors proving ground. Below, unique building in Los Angeles was built by pouring concrete over canvas bag filled with air

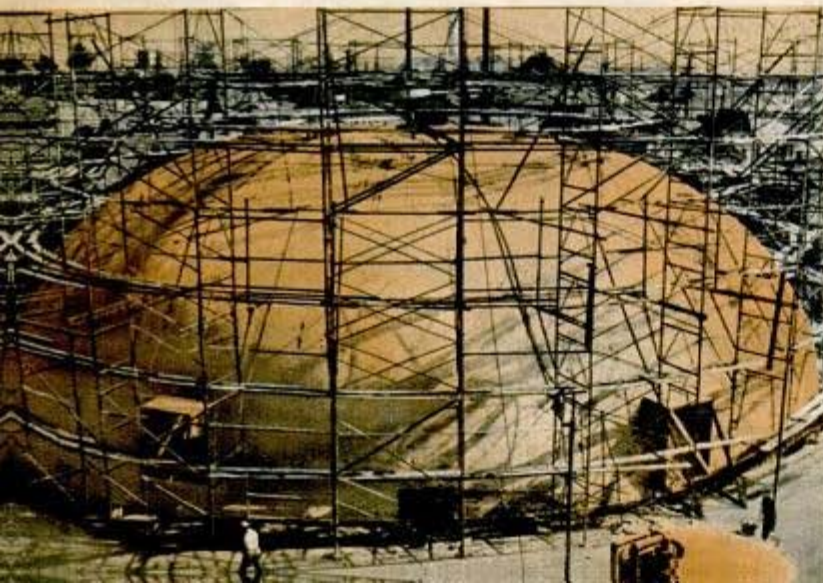

any other nation—112,168 miles as of December 31, 1940—there are still many miles of highways needing all-weather surfacing.

Soil-cement is being widely used for light-traffic roads and streets, and secondary airport runways. This pavement is made by mixing about 10 percent portland cement with approximately 90 percent native roadbed soil. Eleven million square yards of soil-cement airport runways were built in the U. S. last year. In addition, 4,500,000 square yards of soil-cement light-traffic roads, streets, and military drill grounds were constructed.

While successful soil-cement construction is dependent on laboratory and field tests developed by the Portland Cement Association, the technique is quickly mastered by contractors and engineers. The army is now training soil-cement technicians, many of whom are expected to carry their wartime jobs over into civilian life. Because soil-cement construction is a simple, speedy, low-cost process, it is expected to be extensively used in postwar improvement of many secondary highways.

Soil-cement blocks are seen as a possibility in the field of low-cost housing and small farm buildings, but experiments in this line are still in the laboratory stage.

One of the most sensational war uses of concrete to the average citizen is in the construction of concrete ships. More than a hundred ships and barges have been built or are under construction at yards in California, Florida, Georgia and Texas. Most of them are designed to carry oil. But there is nothing new about a concrete ship. Several were built in World War I, and the first one, built by a Frenchman named Cambot, was exhibited at the Paris exposition in 1855.

Concrete ships, requiring about 40 percent less metal than steel-hull cargo vessels, are looked upon as emergency vessels. They are durable enough, but their weight is greater than steel ships and they are not as maneuverable. Shipbuilders do not believe many will be built after the war.

One use of concrete that will never capture a headline, but is far more important than concrete

7864

ships to a nation at war, is its increased use for floors in farm buildings. In this way, concrete is helping feed the world by combating grain-hungry rats, and also saving the lives of thousands of young porkers. An estimated 30,000 concrete feeding floors for hogs built since Pearl Harbor are greatly reducing the former annual pig disease death rate which has reached 40,000,000.

The part concrete plays in the erection of great dams to store up water to produce electric power, or for use in irrigation projects, is highlighted by the war. In the field of conservation, one wartime development is an unusual type of concrete flume for soil erosion control. A stiff mixture of concrete is placed over earth shaped to the desired contour, eliminating the use of forms.

Due to the shortage of metals, new uses for concrete have developed into a mass production business. Typical examples are precast manhole covers and bases (each unit saves about 380 pounds of cast iron), concrete masonry walls to guard factories and public utilities, fuel tanks, ammunition dumps, window sash weights by the thousand, even concrete masonry storage cellars for Victory garden vegetables.

At two recently constructed military airports, 36,000 precast concrete units were used for catch basin gratings in the drainage systems, saving 700 tons of cast iron.

Concrete is helping railroads maintain roadbeds for the greatest volume of traffic in history. Cement grout, a mixture of portland cement, fine sand, and water, is forced into soft spots under the tracks to restore load-carrying capacity. This process eliminates any delay that might be incurred by rebuilding weak sub-grades.

Pinch-hitting concrete also helps lift the burden from overworked transportation facilities. The bulk of concrete materials—sand, gravel and water—is generally available locally, thus avoiding long hauls. In addition, the principles of making quality concrete are widely known. Construction crews relatively unfamiliar with concrete technique can be easily trained to turn out good work whether the project be a seven-million ton dam, such as Boulder, or a small installation to support an anti-aircraft gun.

Fortunately for both war and peacetime construction, the materials for cement making are virtually inexhaustible. With the present equipment, the industry has a capacity that exceeds the demand by nearly 100 million barrels.

Symbolic of the important part concrete is quietly playing in the war, is a picture of the wheels of a Flying Fortress skimming over a concrete runway. When the last land-based plane takes off for Berlin or Tokyo, concrete will still be doing its bit to lift the bomb load into the sky.

Man-Made Storms Test Clothes For High-Altitude Flyers



In their endless research into the mysteries of high-altitude flying, experts of the aero-medical laboratory at Wright Field have brought the world's weather into a single room. Much of their study has to do with the proper types of clothing for the extreme cold and rarefied atmosphere of the upper air. To test the wearing qualities of a specially made raincoat, the experts had a soldier don it and submit to a barrage of weather, including man-made rainstorms, sandstorms, snow and hail.

Dayton, Ohio.

Ozone Fed Into Storage Vault Prevents Meat Spoilage

Meat can be protected from spoiling through an ozone treatment, according to the research department of the Westinghouse Electric and Manufacturing Company. A small but constant supply of ozone is fed into the conditioned air that is circulated in the space where the meat is stored or is undergoing tenderizing treatment. The ozone is generated preferably by an ultraviolet lamp placed in an air duct. Ultraviolet radiation converts ordinary oxygen into the short-lived triatomic molecules of ozone. To prevent the ozone concentration from rising too high, a chemically treated glass-wool filter is introduced into the air circuit, with automatic means of throwing it into or out of action if necessary.

Pittsburgh, Pa.

Mr. Warren Allen & Abbott
7 Park Ave., N. Y. 16, N. Y.

SEA-GOING SMOKE EATERS

ONE of the grim lessons of this war is that fire, following the crash of shells and the blast of bombs during a battle at sea, often does more to sink a gallant ship than roaring explosives and hurtling steel.

Fortunately for our fighting craft and the fighting men who operate them, the Navy has long been aware that the changing character of warships and explosives has rendered more dangerous than ever the factor of fire. Firefighting equipment and methods were tested, manuals of instruction were outlined and training schools laid out, with the result that today the Navy has more than 15,000 flame-tested firefighters—sea-going smoke eaters—among its crews.

So many ships and lives have been saved that the Navy is considering whether giant fireboats should become parts of battle units, accompanying formations into fights and moving from ship to ship, quickly quenching blazes with multiple streams of



Above, Navy firefighters in action. At left, a Marine Corps photograph shows member of Marine-manned Pearl Harbor Fire Department descending a lifeline

water, clouds of liquid fog, or mists and streams of chemicals. Then for the first time men may see a strange sight, a firefighting ship with huge nozzles instead of main batteries; rows of gleaming water and chemical outlets along its decks, like smaller guns.

Rushing alongside a flaming battleship, the fire ship could fling scores of hoses across the burning craft, swing huge automatic booms over the smoking hatches and shell holes to dump tons of fire-throttling liquids. Vents may pour dousing mists until the burning ship and her crew are cloaked in a screen of cooling clouds. Hundreds of asbestos-clad, helmeted and gas-masked firefighters may swarm to the hot decks. In a jiffy the fire may puff away from the sooty and charred battleship in a rising cloud of vapor without even interrupting the steady crash of her great guns.

One thing is certain: if these gargantuan fireboats do become a part of battle fleets, plenty of men will be



U. S. Navy photos
A trainee at a naval school near Baltimore practices a high-level jump during fireman's school that prepares men for any emergency. Below, two officers are shown how to fight an open tank oil fire





Keeping a protective fog in front, students attack a simulated ship fire

ready to operate them, thanks to the Navy's firefighting schools at Norfolk, Boston, Mare Island, Bremerton and Pearl Harbor, conveniently located so that whenever a warship docks in the vicinity members of the crew can be sent to the school for a course of training which lasts one, three or ten days according to the time available.

Here they find most unusual classrooms which spout flames, smoke and heat; classrooms which, on the other hand, strike officer and sailor students as strangely familiar for they consist chiefly of a "mock up" of three compartments of a naval vessel. Constructed of concrete, fire brick

and steel, these compartments are models of the forecandle, boiler room and engine room of a typical destroyer. Everything except the machinery is reproduced, and in actual size. In addition to the simulated destroyer compartments, the schools have other enclosures for practice in extinguishing oil and gasoline fires. A shallow water tank is used for practice with shallow diving equipment. The tank also serves as a source of water supply when a portable pump, the handybilly pump, is demonstrated.

These ship sections have hatches, air ventilators, smokestacks, and even steel decks which become hot under the feet of the trainees or are covered with ankle-deep layers of carbon dioxide snow as the men battle real flames with real equipment, often clad in asbestos suits.

The training devices vary at different schools. One will have a "Christmas Tree," the oil-field arrangement of pipes which spout flaming gasoline. Another will have towers from which men leap into fire nets. A third will have a unit which reproduces the sleeping quarters of a large warship. A fourth will make use of a hangarlike

Navy and Coast Guard craft pour water on blazing Navy loading depot. Not a piece of Navy freight was lost

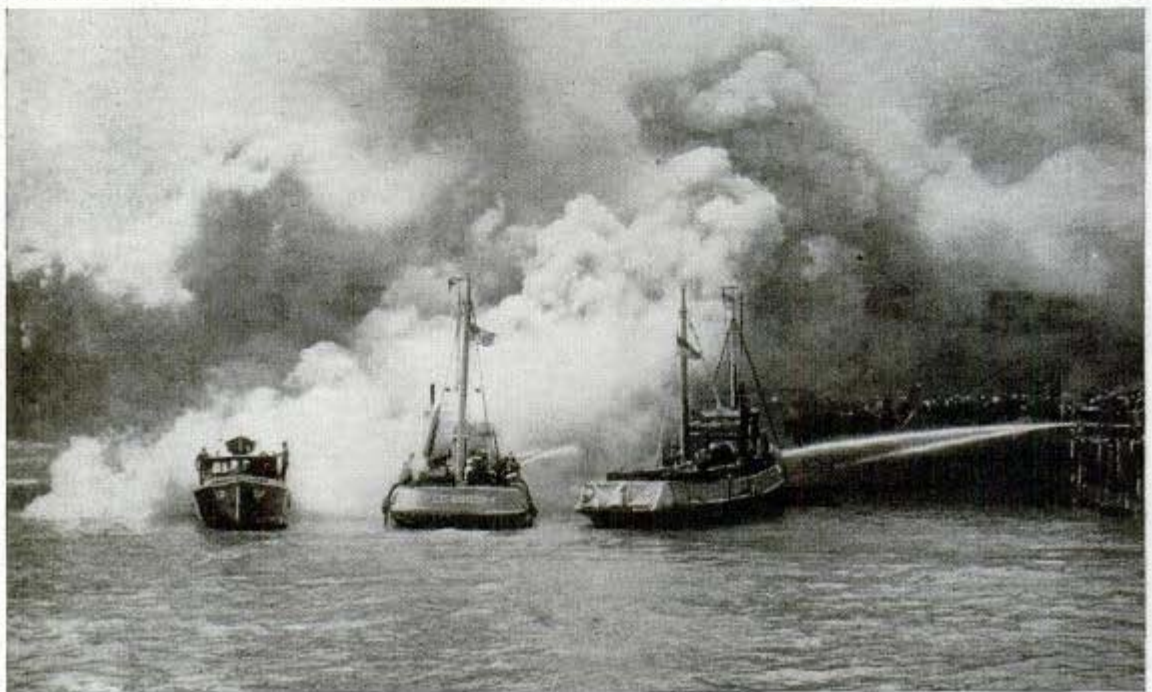



structure in which damaged and obsolete planes are sprayed with gasoline which is set afire and quickly extinguished.

The students who can remain for the ten-day course receive thorough training. They learn about fire-extinguishing agents—carbon dioxide, chemical and mechanical foam, water, steam, fog and fog-foam. They learn about the fire mains aboard Navy vessels, about hose and nozzles, hose evolutions, water pressure, and the capacity of hose and pumps. Further, they learn about the various measures made necessary in Navy vessels by the hazards of battle.

In the conduct of the Navy's firefighting schools, theory is subordinated to actual practice. Although the students see motion pictures of fires and firefighting in progress and attend lectures, they are given many opportunities to see real fires and to participate in the work of extinguishing them. They man the hose, and handle the Navy's all-purpose fog nozzles. They put out burning oil with low-velocity fog streams. They spread foam on oil fires. They release carbon dioxide on electrical switchboard fires, and turn steam into compartments, or don asbestos suits and breathing apparatus and climb down hatches to apply water on fires in waste materials.

Classification of fires as A-fires, B-fires and C-fires does not long remain a matter of theory to the students in the Navy's firefighting schools. They see fires of each class kindled and they participate in or direct the work of extinguishment. These fires are set in the simulated destroyer compartments in order to give the closest resemblance to actual fires

Annapolis midshipmen take a firefighting course as part of their curriculum. Below, what the well dressed man wears in a blazing ship's hold





Students learn to hold hose above the hot deck, to keep hose from burning

aboard Navy vessels. In these compartments all machinery spaces are indicated and passageways, vents and all other openings are reproduced; the students find conditions exactly as they would be in an actual destroyer with a fire in one or more of its vital compartments.

For the demonstration of Class A fires, waste material of various sorts, such as old mattresses, is piled in one end of the "fore-castle" compartment. The pile is saturated with oil and ignited. The students detailed to extinguish this fire know from their instruction that water is the indicated agent, since the burning waste will respond best to a wetting, which brings the temperature below the ignition point. The students realize they must carry a hose line into the

compartment in order to direct it upon the fire for the proper wetting effect; they realize too that they must protect themselves against smoke and poisonous gases, and against the possibility of coming momentarily into contact with the flames. They put on asbestos suits and breathing apparatus, and climb down through the hatch, confident that they can remain below for nearly an hour, if necessary, and that their asbestos suits will afford protection against flames, and for a few minutes at a time against the heat that would otherwise be intolerable.

In the next demonstration the bottom of the "boiler room" compartment is flooded with fuel oil, and the oil is ignited. The resulting fire is a Class B fire, one that is not ordinarily to be attacked with water, since water is likely to cause such fires to spread, although in certain circumstances water may be successfully used. The students need only to look down through the hatch to realize that they are not to go down into the compartment; the entire floor space is ablaze. The students remain at the hatch. One applies fog through the hatch with an applicator to put a cover over the fire and keep down the heat so that another student can stand at the hatch and apply a smothering blanket of foam. The foam quickly builds up a sufficient

depth to extinguish the burning oil. And the fire fighters have learned how to put out one of the most difficult fires, one they are most likely to encounter at sea.

Next problem is how to extinguish a fire in electrical equipment, a Class C fire. In the "engine room" compartment gasoline in a trough just below an electrical switchboard is ignited. For this fire the students know that they must use an extinguishing agent that is

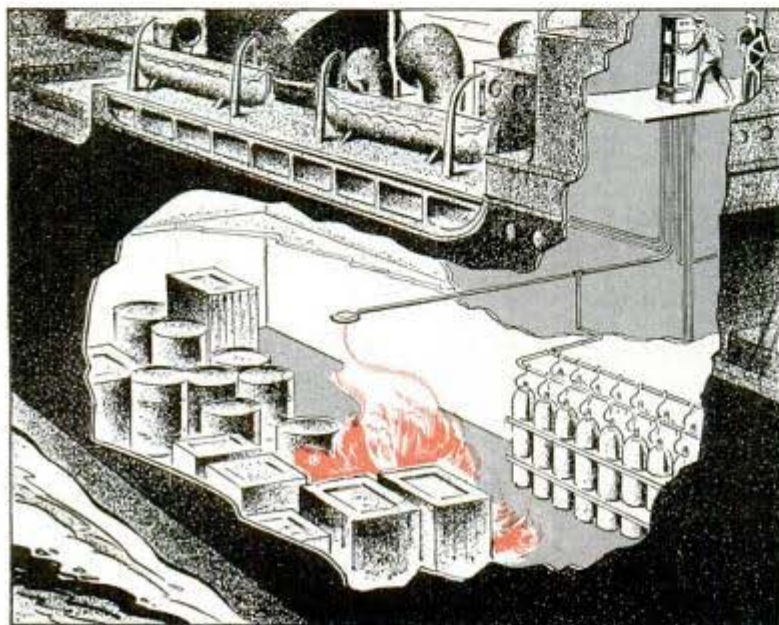

Smoke from fire in cargo hold reaches wheelhouse via pipes, sounds alarm, and carbon dioxide is piped to fire by same duct
Courtesy Walter Kidde & Co.

*Electronics Specialty Co.
Los Angeles, Calif.*

Interphone for Aircraft Builders "Talks" Parts Into Place

71865-

a non-conductor of electricity. They extinguish the fire with carbon dioxide from portable, fifteen-pound containers. Low-velocity fog would be their second choice for this fire; but they know that while the finely diffused fog is a poor conductor of electricity, it has a wetting effect, and therefore it would put the electrical equipment out of service, and would cause damage by corrosion. Water must not be used on electrical equipment fires unless it can be applied in some way that will remove danger of electric shock.

An important part of the training of the Navy's firefighting school students deals with what to do when the fire main in any section of a Navy vessel fails to work. The students learn how to resort to jumper lines that reach around ruptured sections of the main, and to set up and operate the portable handybilly pump.

They learn to use the Navy's remarkable discovery, a cream giving protection against flash burns which rank second to shell and fragmentation wounds as a cause of naval casualties. Applied to exposed portions of the body in two minutes, it dries in five and then will protect the skin for eight hours against burns of more than 1,000 degrees Centigrade.

All in all, the neighborhood firehouse is going to be a popular place for many Navy men after the war and most of them will be able to swap yarns with fire department veterans on equal terms.



Developed for use in pilot training schools, a portable interphone has been adopted by industry to speed war production. With this unit, a mechanic working in the pilot's compartment can communicate with his assistants in the tail gunner's quarters or engine nacelle. The interphone set, complete with batteries, tubes, microphones, and headphones, weighs less than three pounds. The amplifier unit is worn around the operator's waist. Shipbuilders and companies engaged in bridge or building construction are finding the interphone helpful to foremen who can literally "talk" a section into proper position as a distant crane swings it around.

71968

"Jack-Knife" Tool Locks Clip With Wire Over Open End

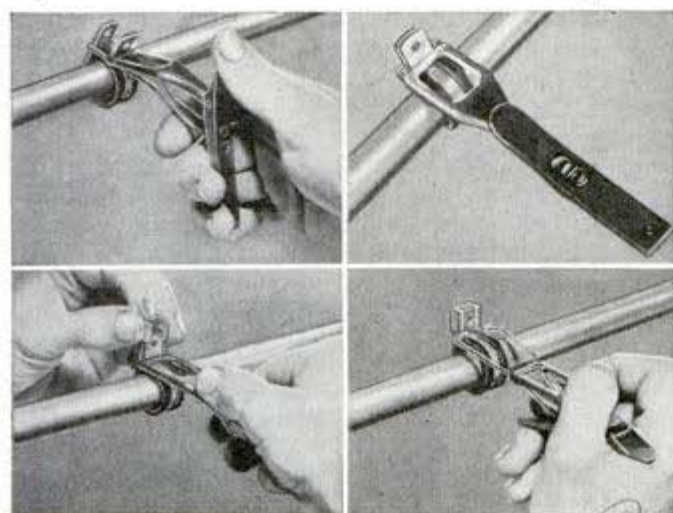

Securing clips to various parts on an assembly line is made easy with a handy pincer device that effects a temporary closure. The tool consists of a metal handle in two parts joined at a fulcrum for leverage, and a stout wire attached to the handle which acts as a pincer. The pincer is placed over the open ends of the clip and closed with an easy pressure of the thumb on the handle. A latch placed over the end of the clip holds it in place until it can be fastened permanently. This method speeds production by permitting the pre-assembly of a number of clips at one time.

*Adel Precision Products Co.
Burbank, Calif.*

77 749

Off: Public Relations Dept. American Potash & Chemical Corp. 609 S. Grand, Los Angeles, Calif.

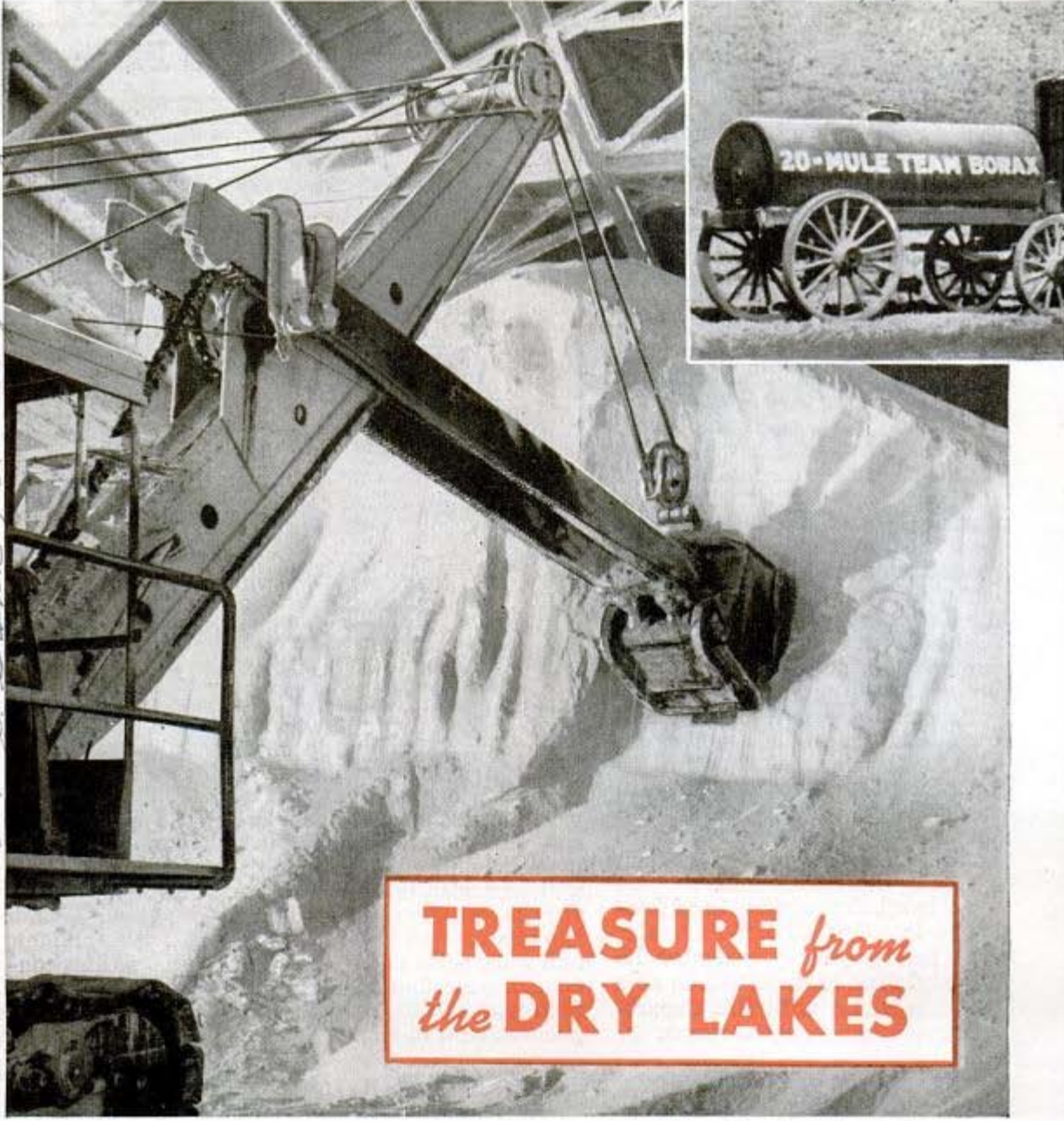

TREASURE *from*
the DRY LAKES

Muriate of potash, one of the many chemicals found in the dried up lakes, being loaded for shipment. The demand for chemicals is so great that a pile as large as this seldom accumulates

By Thomas E. Stimson, Jr.

EVER drive a car at 70 miles per hour across a lake?

That's not a silly question.

Out in the west there are lakes where you can't swim a stroke and where boating and fishing are impossible. In pre-ration days it was good sport to test the top speed of your car on them. These lakes are as dry as a bone.

The dry lakes of the western deserts are flat, bare expanses of clay and chemicals, the dried remains of great bodies of water that existed in prehistoric times. One of

them from a distance may have the blue-gray appearance of water, and birds are fooled into coming down for a drink. Ducks sometimes make crash landings on the hard surface. Other lakes are sparkling white and look like vast sheets of common table salt. That's exactly what they are, with a few impurities mixed in.

The dry lakes are not only natural wonders but some of them, and one in particular, are fabulous chemical warehouses from which valuable minerals may be extracted. Various grades of salt are refined



"20 mule team" is hitched to wagons which hauled borax out of Death Valley in the last century. Right, mask for protection against the glare of the lake's surface

from one, soda ash is obtained from another. Borax is taken from a third.

No other of the lakes, however, seems to contain the concentrations of chemicals that are found in Searles dry lake near Death Valley in California. This one has been called the arsenal of Mars. It is yielding millions of tons of essential materials for smokeless powder, gas mask cartridges, bombsights, and radio tubes, among other things. Twenty percent of the lithium produced in the United States, 20 percent of domestic potash, 45 percent of the nation's borax, and 90 percent of its sodium sulphate, are extracted from its saline residue.

The reason some of the dry lakes are stocked with minerals is that in past eons they acted as concentration basins for salts that were leached out of the rocks by rain and were carried down to the lakes by streams. When the climate changed to its present arid state, the lakes dried up, leaving the chemicals stored in their beds. The present sun-baked surfaces of some of the lakes are 600 feet or more below their original water levels.

Many of the lake sur-

Survey party establishing section lines on the surface of Searles lake. The government holds lake as a potash reserve





Sulphate is tested in a tower laboratory set up by a chemical corporation

faces are flat enough for automobile races, others are so rough that it takes an hour to walk a mile. The "Devil's Golf Course" in Death Valley is a dry lake of this type. A test well drilled 1,000 feet deep into this dry lake pierced alternate layers of clay and salt all the way down.

On some of the lakes you can see the phenomenon of "self-rising ground." Chemical action below the surface may push the material up into reefs and hummocks four or five feet tall. Six weeks or six months later the hummocks have subsided or changed to entirely new shapes.

deep and about 11 square miles in area. Under its dry crust this mass of salt is saturated with brine. The liquid is rich in potash and lithium salts and also contains salts of sodium, boron, bromine, arsenic, phosphorus, and divers other minerals including soda ash.

This dry lake sounds better than a gold mine and it is, but like many gold mines it took a fortune and a prodigious amount of work to unlock its wealth. It is estimated that the American Potash and Chemical Corporation and its predecessors spent \$9,000,000 in learning how to separate the

Brine from Searles lake travels to American Potash & Chemical Corporation plant through a huge pipe line

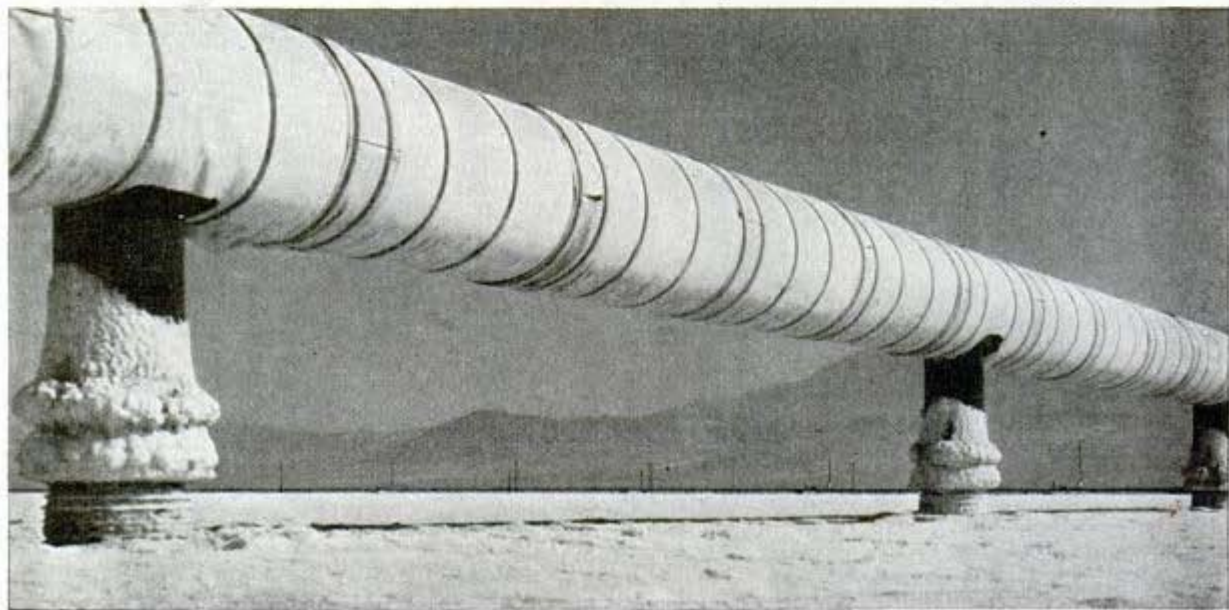

Winter rains sometimes flood the lakes. The dry desert atmosphere can evaporate as much as 10 feet of water a year. Some lakes, too, are moist a few inches or a few feet below the surface, with a dry top crust over which you can drive a truck safely.

Searles lake is like that. Many thousands of years ago it was a member of a chain of lakes, joined by streams, that stretched from the present Sierra Nevada mountains to Death Valley. The odd thing is that, although apparently fed from the same source, the remains of each of these lakes contains different concentrations of minerals.

Searles has a "crystal body" from 55 to 80 feet

tangled-up chemicals in the lake.

John Searles, a prospector who realized some of the possibilities of the dry lake in 1862, scraped borax from its surface. Searles is said to have originated the famous 20-mule borax teams for hauling the product to market.

Later on, reefs of trona or soda ash at one side of the lake were worked because of the demand for this alkali. During the first World War, when potash was desperately needed for war uses and agriculture, the lake was developed as a source of that chemical. Gradually the steps were perfected by which practically all valuable ingredients of the crystal body are recovered.

The process consists of pumping saturated brine from wells dug into the salt mass and then subjecting the brine to a number of evaporation and fractional crystallization steps. The salts are about as badly mixed up as are the hydrocarbons in petroleum, and the extraction processes are comparable in their complexity to the methods by which crude oil is broken down into its different products. Some 15 chemicals are removed from the brine before the end liquor is pumped back into the lake.

Continued to page 154

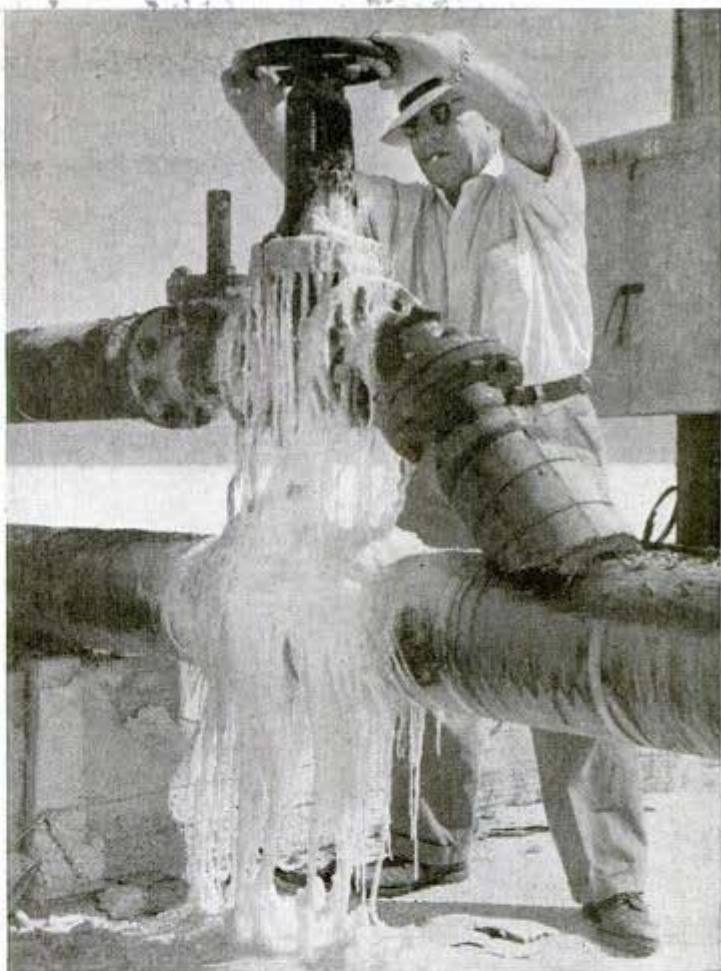

Brine leaking from valve in the pipe line crystallizes into "icicles." Below, salt crystals have caked up on and almost buried this old automobile wheel which had been abandoned in the lake

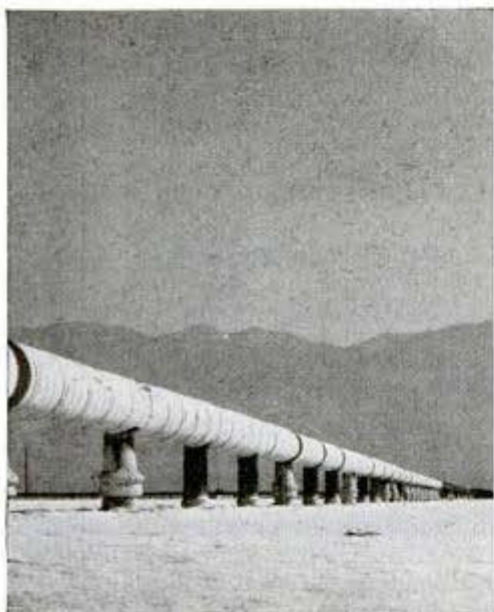

Pilots Design "Sit-Down" Suit for Stratosphere



When a Royal Canadian Air Force pilot takes to the substratosphere, he has no kick about his high altitude flying suit because he helped design it himself. Four thousand questionnaires sent to the airmen resulted in a two-piece suit designed for sitting instead of standing. It bags at the knees, elbows and seat, and has zippers arranged so a man can get out of it in two seconds flat. A pencil pocket with a point protector is sewn in the left sleeve, and there is an outside watch pocket on the chest. The suit is made of fine blue twill with a loosely woven woolen lining. The gloves have bulging knuckles designed for bent fingers. An "electric" undersuit is made of cotton, and sewn into it is an 88-foot strip of inch-wide metal gauze to give warmth at 70 below zero. There are also electric undergloves and undersocks.

Flying Fortress Wing Is Hitched to House for Training

Casual visitors to the Boeing Flying Fortress school at Seattle might wonder if they were looking at the airplane of tomorrow, but the one-wing Fortress hitched to a house is in reality a trainer for student pilots—lieutenants, captains and majors of the Army Air Forces. The twin engines of its port wing roaring in suppressed desire to fly, the earthbound Fortress is used to teach flyers to get maximum power from the motors, and to teach Air Force mechanics how to start and warm up the engines. In the soundproof cabin of the engine run house are all instruments and controls of a B-17 cockpit.

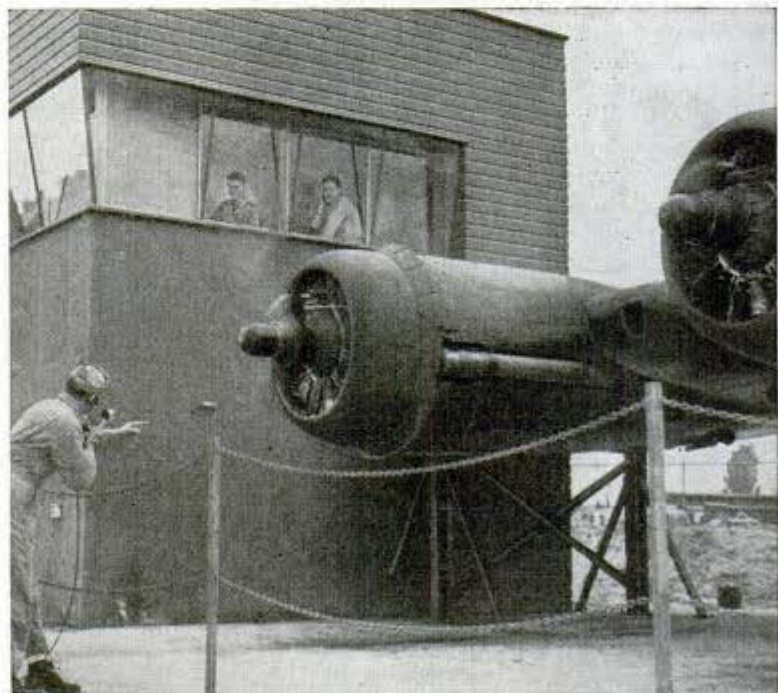

Rubber Heating Pads for Aerial Guns Avert Jamming in Sub-Zero

Jamming of automatic guns in sub-zero temperatures is prevented by installing conductive rubber gun heating pads on the machine guns and cannon of allied planes. The unit, which consists of a cotton fabric impregnated with a special synthetic rub-

ber compound that acts as the conductor, makes possible pre-heating of gun breeches while the plane is grounded and maintains required temperatures for instantaneous use at high altitudes. Current is supplied by the plane's generators.

Glenn L. Martin Co.
Baltimore, 3, Md. 049

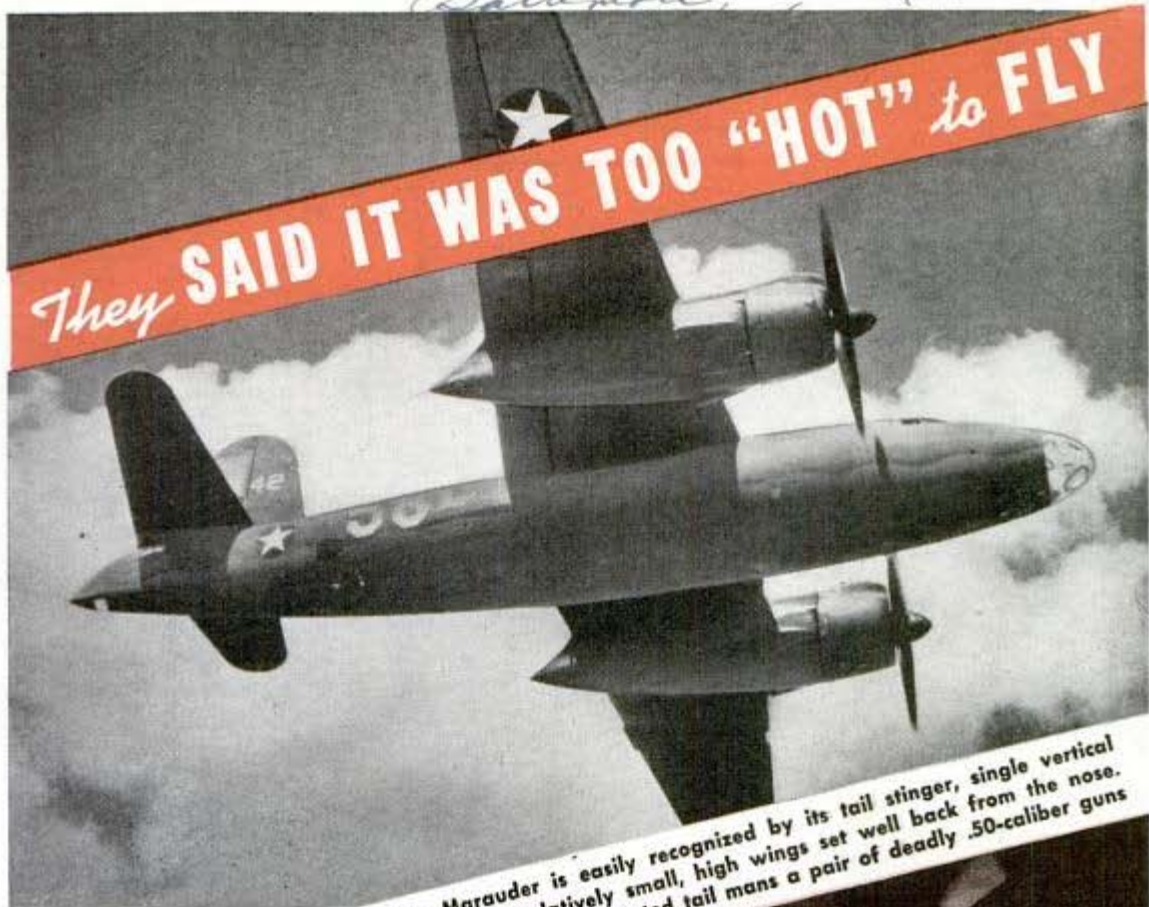

The Marauder is easily recognized by its tail stinger, single vertical tail fin, its relatively small, high wings set well back from the nose. The gunner in the pointed tail mans a pair of deadly .50-caliber guns

By Roderick M. Grant

THEY called it "the plane that's too hot to fly," too heavy for human pilot to handle.

In a way, they were right. It was too hot and heavy. Not for our pilots. Too hot for the Japs at Midway and Kiska, for the Luftwaffe over the Invasion Coast.

The B-26 Marauder, born a medium bomber, had scarcely emerged from its experimental infancy when in June, 1942, it made its debut as the Army's first torpedo plane and in five critical days sank a Jap cruiser and two destroyers and torpedoed an aircraft carrier in the Aleutians, and left two more carriers burning and sinking at Midway with "tin fish" in their sides.

They were still saying the B-26 couldn't fly on its puny wings with one engine shot out when the Marauders of the Eighth Air Force in Britain began a personal grudge fight over the fighter fields of France and Holland, a fight that pretty much silenced their slanderers.



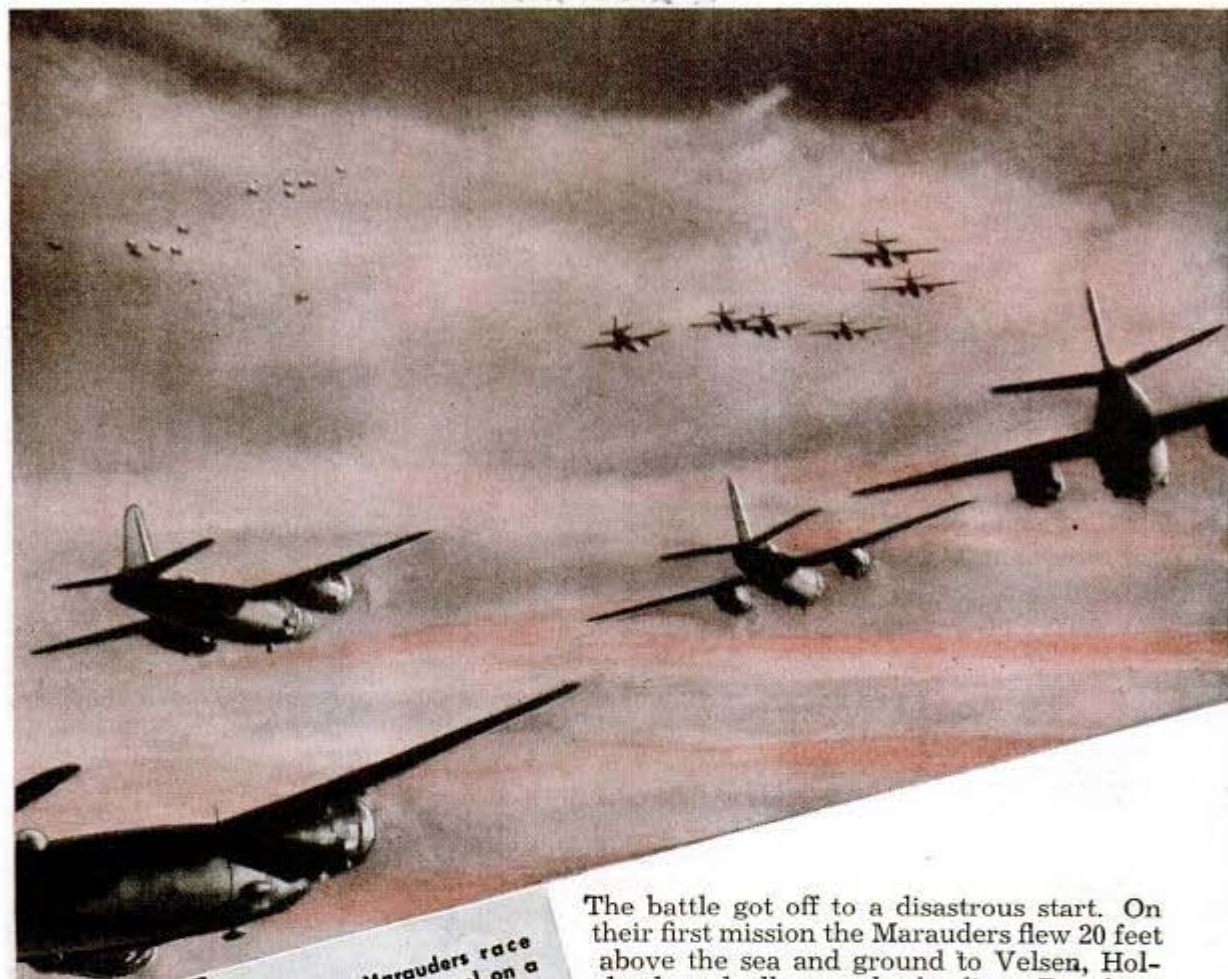

Above, Marauders race across the Channel on a bombing mission. In 4,600 sorties only 13 of the B-26's were lost. Below, the tail turret of a B-26 used to train gunners at Tyndall Field, Fla.

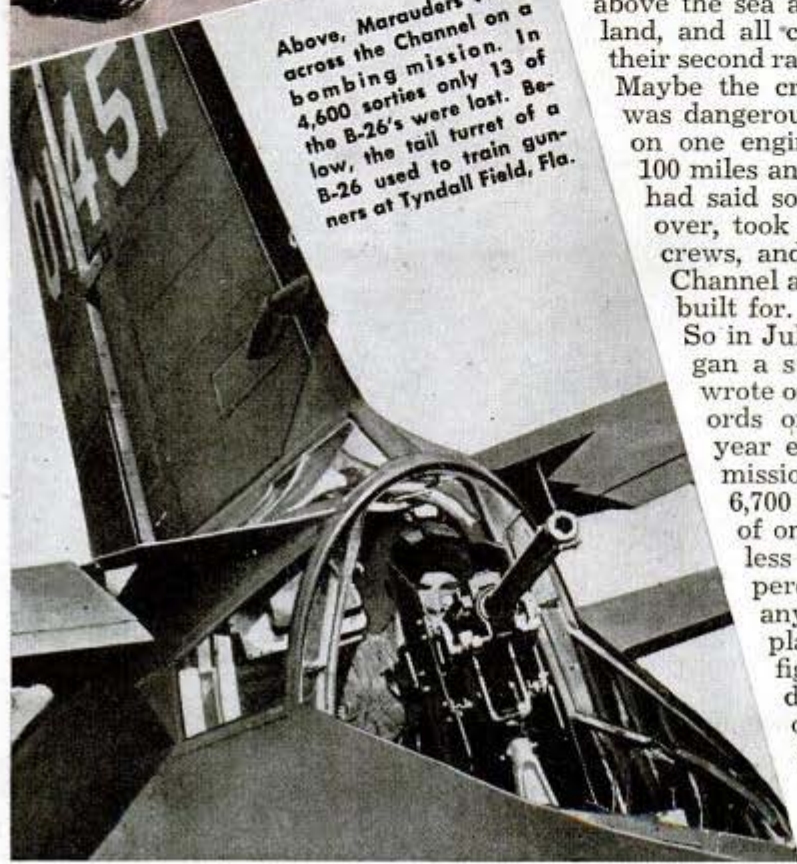

The battle got off to a disastrous start. On their first mission the Marauders flew 20 feet above the sea and ground to Velsen, Holland, and all came back alive. But from their second raid 10 planes never returned. Maybe the critics were right; maybe it was dangerous to fly, couldn't stay aloft on one engine, couldn't land safely at 100 miles an hour. A Senate committee had said so. The tacticians thought it over, took two months to retrain the crews, and sent them back over the Channel at the altitude the plane was built for.

So in July, 1943, the Marauders began a succession of sweeps that wrote one of the most amazing records of air warfare. Before the year ended they completed 100 missions comprising more than 6,700 individual sorties at a cost of only 21 Marauders—a loss of less than three-tenths of one percent, the lowest achieved by any combat group. Only three planes were downed by Nazi fighters, the Marauders shot down 31 enemy fighters, 19 other probables and 21 more damaged. They plastered Luftwaffe fighter fields, railway yards, canals, coastal batteries and arms

plants with 7,000 tons of bombs. Reconnaissance showed some of the Nazi fields had to be abandoned under the daily blasting of these planes that flew 100 miles an hour faster than the Flying Fortress.

Carrying large bomb loads over a 300-mile range, the Marauders had a field day over Tunisia, Pantelleria, Sicily and southern Italy. General Jimmy Doolittle, back from Tokyo, led a flight of B-26's in the first bombing of Rome.

One of the retired veterans of the Mediterranean air war is a Martin Marauder bearing the cheerful name "Coughin' Coffin." The name was earned. When the crew first met their ship, they were warned it had an unaccountable habit of doing flip-flops in the air, and its engines



The bombardier (above) also mans the nose guns. At left, the pilot of "Old No. Nine" points to his Marauder's record of five ships sunk. Below, coming home safely with left wing riddled by antiaircraft

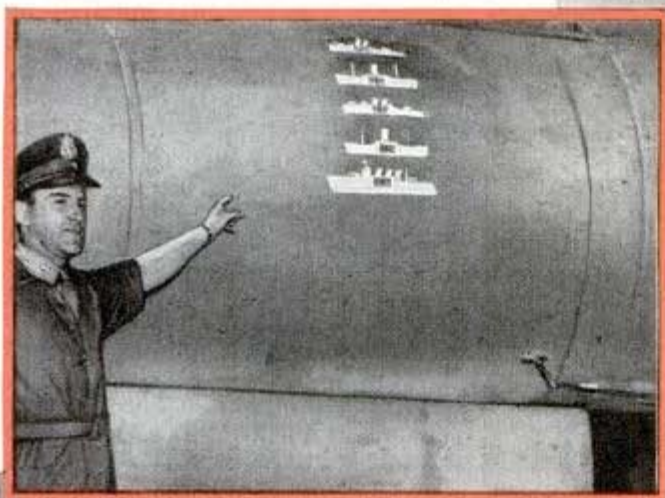



Bombs fall away over Nazi air fields of the invasion coast. The B-26 carries a heavy load at nearly pursuit-plane speed



Above, General Electric men test controls of Martin bomber turret with tracer fire. Below, preparing to install a new engine



were afflicted with asthma. Maj. William R. Pritchard of Mobile, Ala., who flew it to Africa and home again, found he wasn't being kidded. The "Coughin' Coffin" coughed like an invalid and would turn belly-up in the air like a tickled puppy.

But the "Coughin' Coffin" came home with an honorable discharge after 50 combat missions in which it shot down eight German fighters and sank three ships, one an Italian cruiser. It was cited by Prime Minister Churchill for bombing a bridge in Tunisia. Three times it had come back on one engine (they said a Marauder couldn't), and from the final trip over Sicily the "Coughin' Coffin" came home with the hydraulic system shot out, one landing wheel missing, the fuselage in tatters with 270 flak holes, and in its crash landing was wrecked beyond further combat usefulness. But in all those battles not one member of the crew received a scratch, and the "Coughin' Coffin" was able, after first aid, to fly the Atlantic and retire to an honorable career as a trainer.

At a Marauder field in England the ground crews were sweating out one of the first cross-Channel blitzes. At last they heard the roar of twin Wasps, and one by one they counted the returns.

Finally the last ship, piloted by Major Celio, came over the field. A shell had blasted the left nacelle door, jets of hydraulic fluid sprayed intermittently through the open bomb bay doors, and the left wheel was stuck. The tower told him to go back upstairs and abandon ship. He kept circling. Operations repeated the order to jump, but Major Celio radioed that Sergeant Cook was on the catwalk

Continued to page 156

PILOTS

VERSUS *the* WEATHER

7173
*Public Relations Office
Naval Command,
Wright Field, Dayton, Ohio*



Official U. S. Air Force photo
Navy maintenance men dislodging a PBY stuck in an Aleutian snowbank. Below, weather officers brief pilots before a flight

WEATHER can make generals change battle plans, disrupt transportation schedules, force pilots to fly blind, often to their deaths. It causes all icing accidents, most mid-air collisions, many landing and takeoff crashes.

The turning of the tide of battle in Tunisia was delayed two days by a ground fog, which made it too dangerous to send bombers to hammer the Germans surging through Kasserine Pass.

No longer, however, can it be said that "Everybody talks about the weather, but nobody does anything about it." Much is being done to minimize its ill effects, especially on military aviation.

At hundreds of stations all over the world, Army weather observers probe the upper air with meteorological balloons; take note of wind velocity, humidity, and precipitation and other clues to weather's imminent behavior. Then they make weather maps



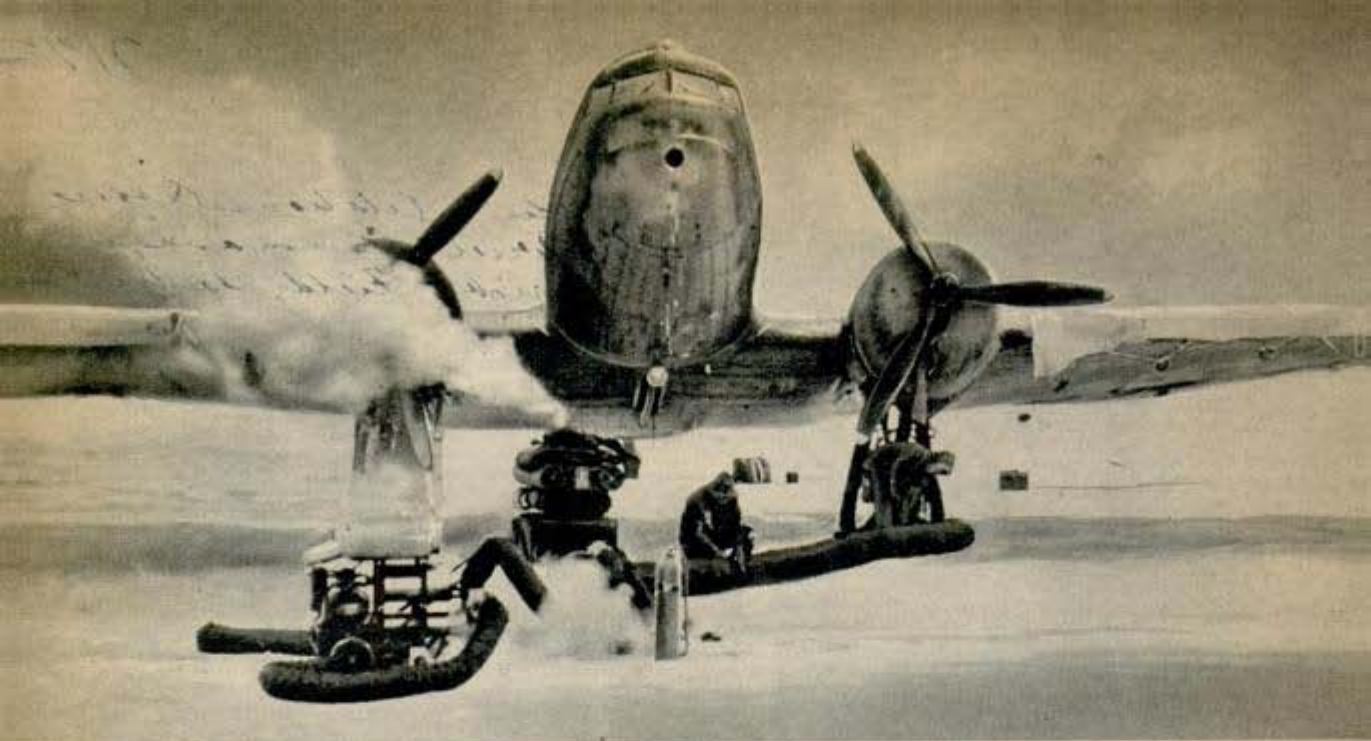

Hot air defrosts motors of an ATC cargo plane in preparation for its flight from an Alaskan base

and forecasts, which the Army Air Forces' Communications Wing, by means of the world's largest aviation radio network, supplies to stations on six continents. Here is a forecast given in a briefing session to flyers about to take off for overseas:

"Gentlemen, the course tonight will be a rhumb line. In order to top the lower layer of cumulus clouds, climb to 6,000 feet after takeoff and maintain this altitude for two hours and 20 minutes. By this time the cloud system accompanying a cold front should come into view. Fly at 2,000 feet through this front to avoid serious icing conditions, which will exist from 4,000 to 12,000 feet. You will encounter light turbulence passing through the front. Two hours and 45 minutes after departure you will have cleared this front. Then climb to 13,000 feet to take advantage of a 50-knot tail wind. Maintain this altitude for the duration of your flight. You will be on top of all cloud formations and will be able to use celestial navigation. Landing conditions at the terminal will be: ceiling, 2,000

feet, broken clouds, unlimited visibility. Alternate airports are shown on your forecast folder. Are there any questions?"

Probably not; little room was left for misunderstanding.

Warnings of sudden changes in the weather are sent to pilots in cross-country flight by means of an advisory service established by the Flight Control Domestic Wing of the Army Air Forces. Pilots plan their flights carefully, indicating the communications contacts they will make en route; reporting their exact positions at each radio fix, and maintaining an alert listening watch throughout each flight.

Meanwhile, advisory officers, equipped with flight plans of all cross-country missions within their areas, plot each flight on a magnetic map, moving the flight along according to the speed and course indicated, and checking it repeatedly against position reports from stations in radio contact with the pilot. While primarily for the purpose of relaying information about the weather, the Pilots' Advisory Service also

warns of large formation flights, revised orders, or other emergency.

What a pilot can do about the weather is a matter of common sense and know-how. Much of this comes through training, but one of the handiest places to find the best advice on the subject is

Through this outrigger water is sprayed into propeller to permit ice formation study while in air

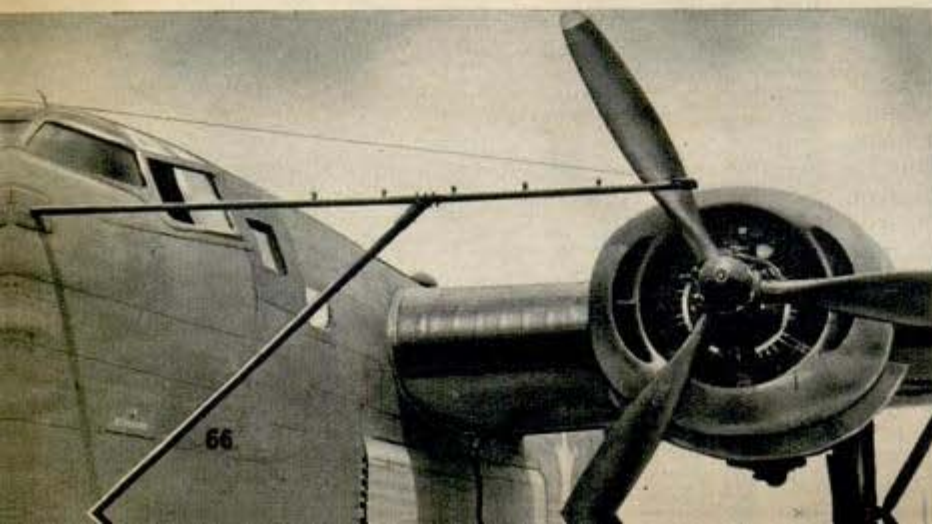

in the new Pilots' Information File. This readable, pictorial loose-leaf booklet was revised from dull technical orders by writers of AAF's Safety Education Division.

In a section entitled "You and the Weather," the Pilots' Information File tells the flyer practically everything he needs to know about winds, rain, snow, hail, thunderstorms, downdrafts, fogs, dust and sand storms, tornadoes, and warm and cold fronts. It describes the types of clouds and the significance of each in its effect on flying conditions. For

example, the File says of thunderstorms:

"Don't fly through them if they can be avoided. Turbulences within a thunderstorm can tear apart the strongest airplane. Air currents travel upward in the center of a thunderstorm and downward around the edges.

"Don't go below a thunderstorm unless the base is at least 2,000 feet above the ground.

"Do not try to fly around thunderstorms lying in lines as along a line squall. They usually extend for too great distances. If it is absolutely necessary to fly through a line squall, it is better to fly in the gray part where light rain is falling rather than in the small



Sighting on balloon with theodolite to obtain wind direction and speed

clear spaces that may exist between thunderstorms, because there is usually severe turbulence along the edges of a clear space. However, if the clear spaces are wide it is possible to go through them.

"If necessary to fly through a thunderstorm, the best altitude is about 2,000 feet above the ground where the turbulence is usually the least.

"An isolated thunderstorm, not associated with a front or the windward side of a mountain, usually can be flown around. Go around it in the direction from which



Electrically heated shoes being plugged into trouser cuffs. Below, Liberators landing in snow





Putting a B-25 under wraps on a cold night in the Andreanoff Islands

it is coming, not in the direction toward which it is moving."

One Air Forces pilot writes of what can happen when such advice is not heeded:

"After about two and one-half hours, we became tired of dodging thunderheads, so we decided to go on through the lightest looking section of the storm. We entered at 10,000 feet with wheels down and air speed reduced to 120 miles per hour. We hadn't been in 30 seconds when the artificial horizon and the gyro compass both went out and the needle was fluctuating wildly. Our only remaining instrument that showed any semblance of being cor-

rect was the airspeed. It gave a continual reading of between 50 and 60 m.p.h. with the wheel pressed against the instrument panel. We must have held the elevators full forward at least 15 seconds before our airspeed picked up to normal. At this point we were thrown out of the thunderhead through no effort of our own, and found we had come out 180 degrees from the direction of entry, with numerous dents and a few holes in the fuselage. The ultimate solution came by way of a detour of better than 100 miles."

One of the principal hazards weather produces is icing, not only of wings, tail surfaces, and propellers, but of carburetors. Temperature generally warns when ice is likely to form on the former, but, because of the cooling effect of the evaporation of fuel after it has been introduced into the carburetor air stream, a plane's carburetor can ice when the free-air temperature is as high as 95 degrees Fahrenheit.

Formation of this type of ice is normally indicated

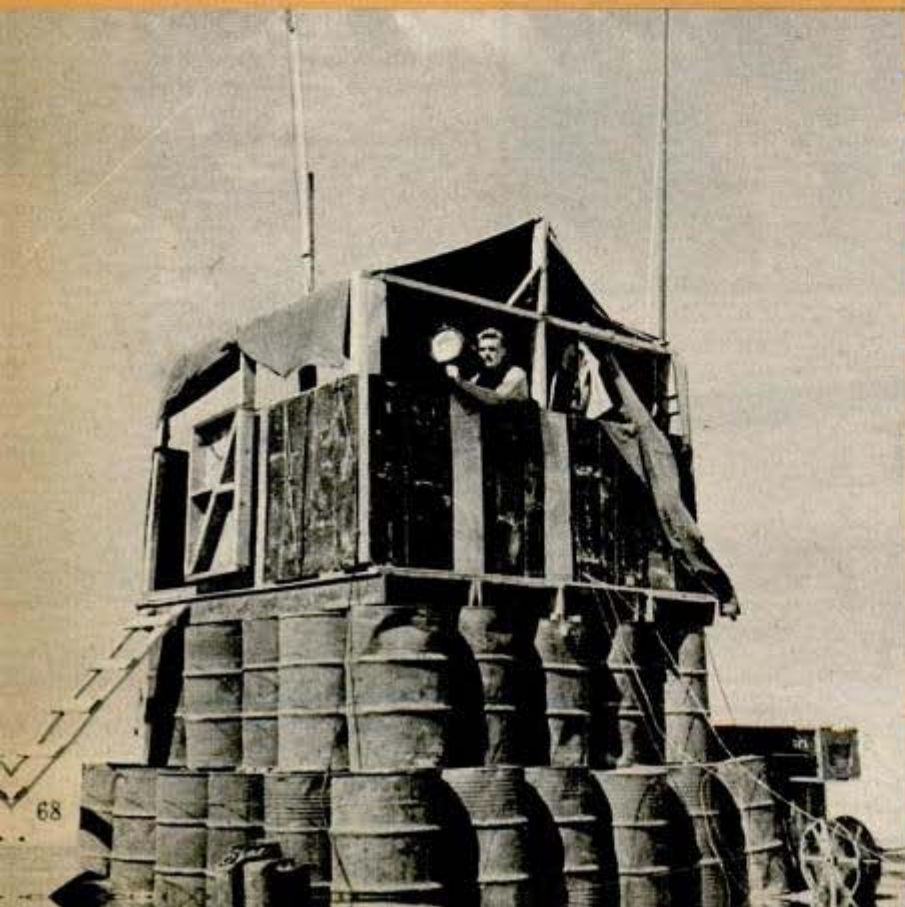

FRACTO-CUMULUS OR "SCUD"
(RAGGED STORM-REMNANTS)

Directing air traffic in Africa from a control tower built on oilcans. Drawing of cold front storm area (right) is from the A.A.F. Pilot's Information File



Navy ground crew wades into icy water to bring in bomber

by a gradual loss of revolutions per minute, if a fixed pitch propeller is used, or a gradual loss of manifold pressure, without any change in the throttle position or the attitude of flight. Under most conditions, carburetor ice forms so slowly that pilots are frequently caught off guard, but it may form so rapidly that loss of power is abrupt.

The Pilots' Information File advises that the carburetor air heater is the best means of pre-

Continued to page 150

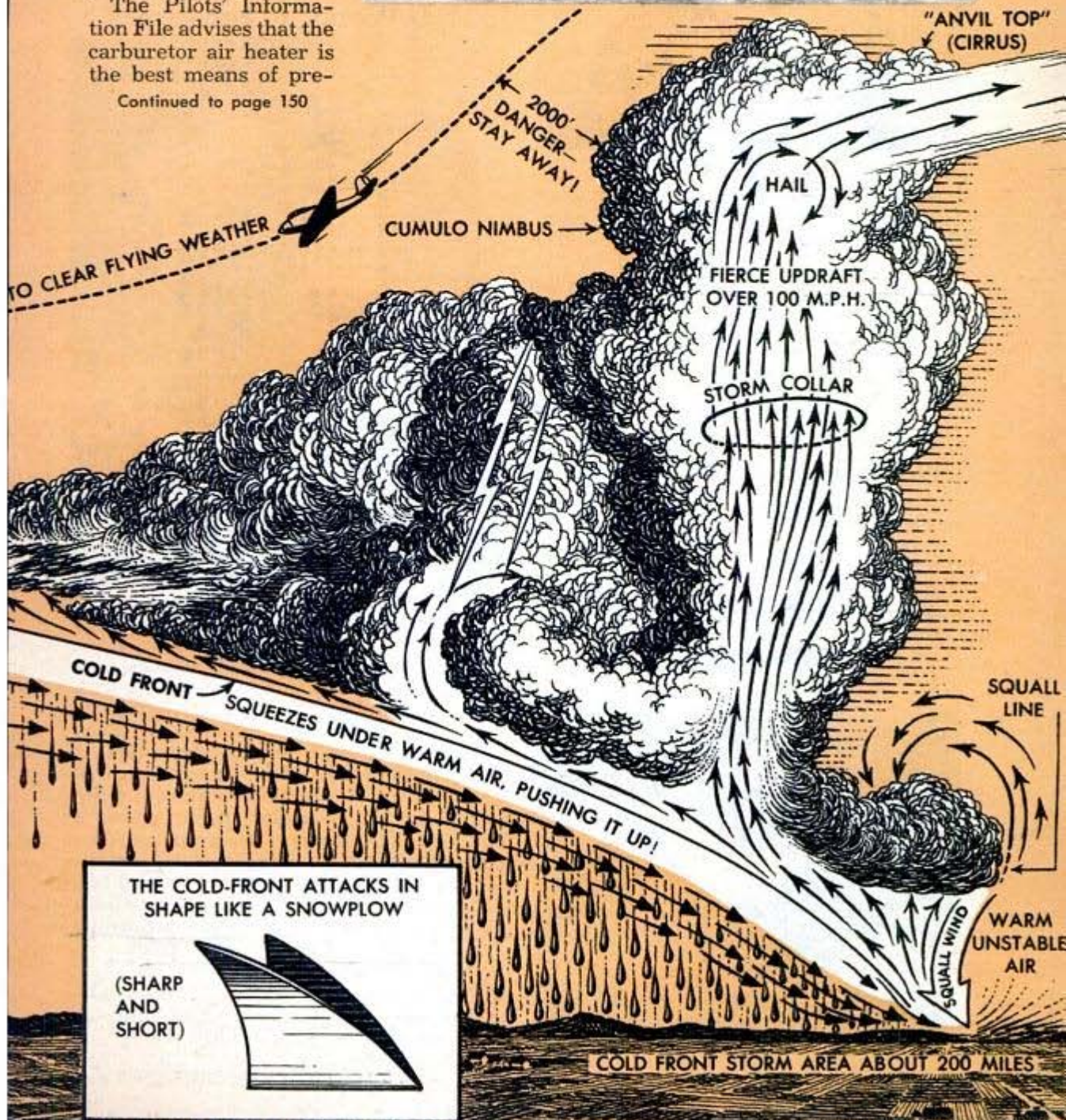

THE COLD-FRONT ATTACKS IN SHAPE LIKE A SNOWPLOW

(SHARP AND SHORT)

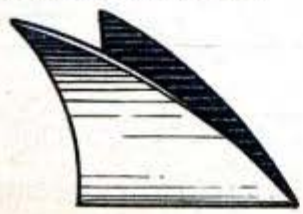

COLD FRONT STORM AREA ABOUT 200 MILES

Dept. of Commerce
Washington, D. C.

04 Canister on Cheek of Mask Eliminates the Hosetube



Paratroopers, infantrymen and other assault troops receive maximum protection against poison gas and a minimum of interference with a new lightweight mask. The assault service mask, developed by the Army's Chemical Warfare Service, has the canister attached directly to the face-piece, eliminating the cumbersome hosetube. When not in use, the mask is carried in a waterproof container which can be worn on the back, chest or leg.

Tester for Fabric on Airplanes Eliminates Cutting Out Pieces

7960
Airplane fabric is tested quickly with a mechanical tester that operates like a



spring center punch. The tester, developed by the Civil Aeronautics Administration, has a disk-like pad on one end which is placed against the fabric to be tested. When the handle of the tester is pressed down, a center plunger is driven through the pad and against the fabric with a known force. The blow shows whether the fabric is dangerously rotten, and whether the "dope" covering it is brittle. The tester eliminates the former practice of cutting out pieces for laboratory tests. It has been used in tests at 40 degrees below zero and up to 160 degrees. The internal spring is adjusted for various grades of fabric.

09 "Letter Automat" for Yank Notes Aids Writing to Servicemen



One company makes it easy for its employees to write to former colleagues in the armed services with a "letter automat." It consists of a homemade wooden desk with an opening in the top across which paper is fed from a roll of Teletype paper. Each roll provides space for anywhere from a dozen to 40 individual messages. A turn of the crank at the side of the desk rolls written matter onto a roller and brings up a clean section of paper. Biographical data concerning the serviceman to whom the letter is addressed is posted on a mail box above the desk. The "automat" was built by two employees of the Owens-Corning Fiberglas Corporation, Toledo, Ohio.

☐ The gasoline consumed in a 1,000-bomber raid over Berlin would drive your car at 12,000 miles a year for 1,000 years.

Gas Chamber Trains Workers for an Emergency

71 952

Workers in the Bethlehem Steel company plants are learning to use gas masks similar to those used by the army. This is to protect them in emergency cases from the dangers of industrial gases used in steel plants. The training program is conducted in large chambers filled with non-poisonous, stinging gas. The trainees crawl through mock tunnels, load wheelbarrows, and repair pipes, while an instructor stationed outside the chamber directs them over a public address system.

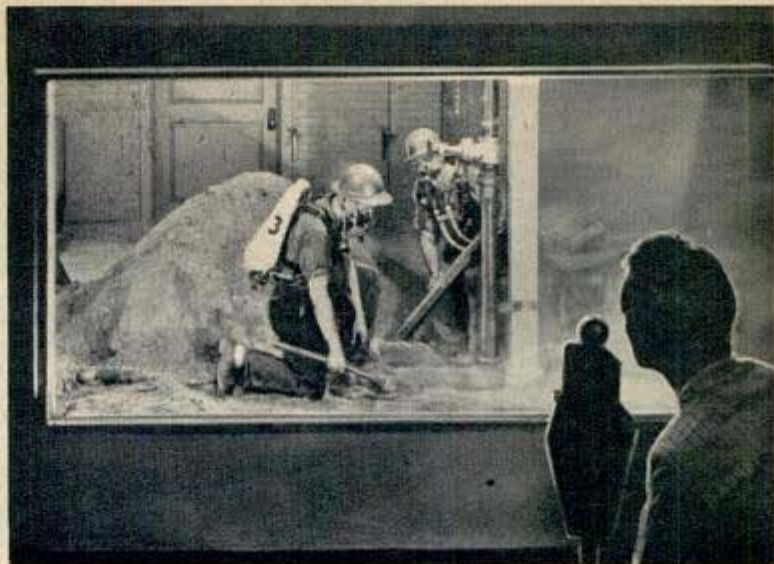

Bundle Carrier on Binder Speeds Hemp Harvest

Harvesting hemp, one of America's new wartime crops, is speeded up with an improved gatherer-binder. Attached to the binder, developed by the International Harvester Company, is a carrier which swings the tall bundles out of the path of a tractor, saving the labor of one man. Formerly, the stalks were picked up, carried to the top deck of the machine and kicked out behind. Hemp is a substitute for abaca, prewar import from the Philippines and the Dutch East Indies used for making high grade rope. Hemp makes satisfactory rope and also various types of smaller cordage.

71 965

180 H. Montgomery
Chicago, Ill.

"Flak" Helmets for Flyers Cover Earphones

American pilots and crews are protected against shell fragments from "flak" with an improved steel helmet that affords added protection to the neck and face. The M-4 flak helmet of square design covers a pilot's earphones, microphone, oxygen mask, goggles and head covering. A similar helmet of rounded design, the M-5, was developed for use in restricted turrets. Both helmets are products of the flying clothes branch of the A.A.F. Materiel Command at Wright Field.

71 973



GRANDPAPPY of BOWLING



One of the oldest known sports, lawn bowling is increasingly popular as easy, healthful exercise

LAWN bowling, called the "grandfather" of all bowling, is enjoying a revival of interest in this country which promises to make it a major summer outdoor sport. Simple to learn and requiring little physical effort, the game is played by persons of both sexes from 9 to 93 years old. It has a natural appeal for America's millions of indoor bowlers and lately is being taken up increasingly by war plant



Correct way to grasp bowl for good bowling

workers who are looking for easy, healthful relaxation out of doors. After the war United States servicemen returning from Canada and England, where lawn bowling is a Class 1 sport, are expected to give it another spurt of popularity.

The game has undergone a few changes since it was invented in ancient times, according to some sports historians, by shepherds who used rounded stones for "bowls." The modern tools are black "bowls," smaller than indoor bowling balls and biased on one side to allow the player to deliver a curve; and a porcelain object ball, the "jack," about the size of a billiard ball. In outdoor bowling, "alleys" are "rinks," 120 feet long and 14 feet wide. The game is started when the first player rolls the jack down the rink past the 75-foot mark, whereupon it becomes the object ball. Then the players bowl alternately and points are made by the players or teams which come closest to the jack. The game is played in innings, or "ends." In

Arthur H. Hartley, national champion, measures to determine which bowls are closest to the jack

Photos courtesy Brunswick-Balke-Collender Co. and Arthur H. Hartley



629 S. Wabash Ave.
Chicago, Ill.
POPULAR MECHANICS



As beginners watch, the "skip," or captain, tells teammates where to roll bowl. At right, the proper stance and delivery

championship play a game is 15 ends but in impromptu matches 21 ends are played. Lawn bowling puts a premium on practice and a skillful woman player can play on even terms with male experts.

Needing only a small grassy plot for a rink, the game is played on college campuses, on golf courses, or in backyards.

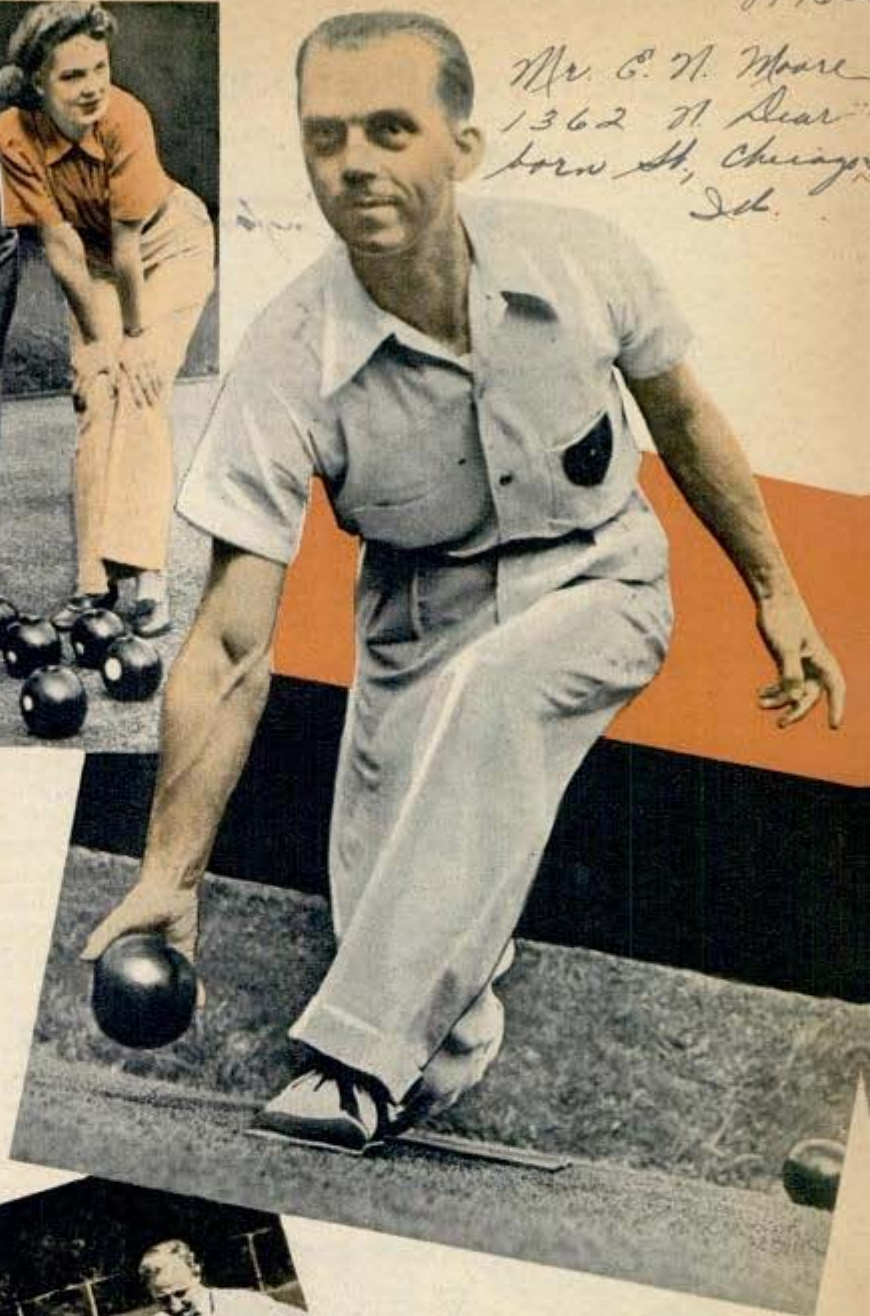

7776
Mr. G. N. Moore
1362 N. Dearborn St., Chicago, Ill.



State, regional and sectional lawn bowling associations have been organized and local leagues are continually being formed. The national champion is chosen at an annual tournament which is sponsored by the American Lawn Bowling association.

"Skip" giving directions to teammate about to bowl from the opposite end of the rink

71917

Night Flyers Don Goggles to Acquire 'Cat's Eyes'



Night vision is improved by wearing dark goggles during the day, according to tests conducted by the Royal Air Force. Student flyers wear their goggles whenever possible, including recreation periods devoted to soccer and other games. In some cases, wearing the goggles has improved a student's night vision from 25 to 40 percent.

0 32

Stall Detectors to Warn Pilot With Signals in Cockpit

Two devices to eliminate the hazard of stalling, which causes over half of all fatal private flying accidents, have been developed by the Civil Aeronautics Administration. In both the pilot is warned of an approaching stall by the sounding of a horn and the flashing of a light. In one method these signals are actuated when the airplane reaches a certain angle and the air flow is reversed. This forces a vane which projects from the leading edge of the wing to move upward from its position in normal flight, thereby closing a switch. In the other instrument, pressure reversal sucks a diaphragm upward and forces an attached metal plate against electrical contacts. A cutout button will eliminate horn noises when radio reception is desired.

71931

Solderless Splice for Wires Can Be Quickly Uncoupled

Joining of wires is made easy with a splicing terminal that consists of two identical parts. The parts lock together by means of a knife-switch principle, eliminating the need for soldering. Tubing holds

the splicing together and prevents uncoupling. The connection has great tensile strength for pulling on the wires tends to make the coupling tighter. The splicing can be uncoupled in a jiffy.

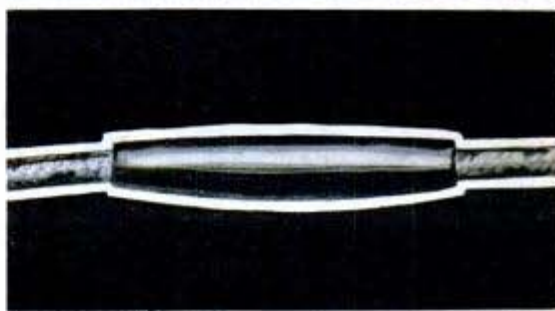
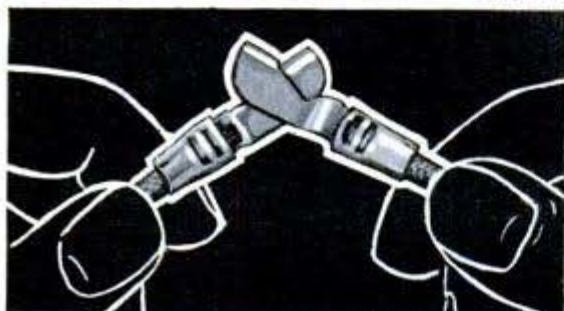
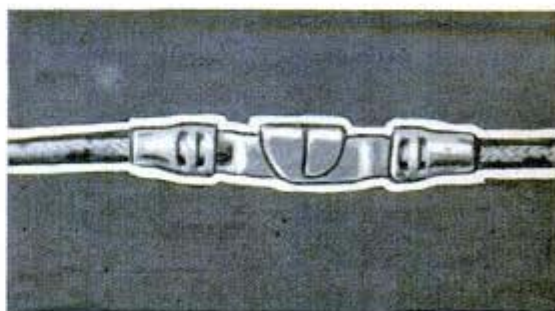
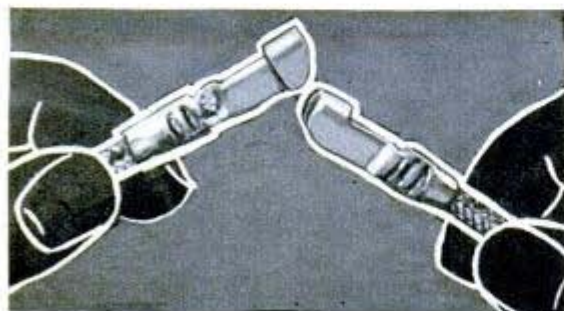

Aerotech Marine Products, Inc.
 286 N. Broad St.
 Elizabeth, N. J.

'Fox Hole' in Artillery Tractor Holds Gun Crew and Shells



Heavy artillery is moved into front line positions with an 18-ton tank-type military tractor that provides an armored "fox hole" for the gun crew. It also carries in-

itial rounds of ammunition and is armed with a .50-caliber machine gun. The tractor pulls heavy artillery through hub-deep mud and over rough terrain at high speed.

Wood Is "Spot Welded" By Radio Gun

With a little glue and a radio-frequency gun, thin sheets of wood are "spot welded" together to facilitate handling while being shaped into aircraft parts. Formerly, the wooden sheets were held together with staples which had to be removed afterward. The current in the gun travels about one-sixteenth of an inch and its length of application, controlled automatically, determines whether the wood is to be merely tacked together or permanently set. Radio-frequency gluing, now limited to handling small parts, may be used in the manufacture of automobile bodies in the future.



*71953
F. C. Victor Div.
Radio Corporation of America
Cleveland, N. C.*



Paper Dial Identifies Ship Lights As Aid to Navy Trainees

To train seamen in quick identification of the running lights of ships, a handy paper dial has been introduced. On the upper circular card are the outlines of a ship, perforated with small holes indicating the position of lights on masts, cabin and deck. As the card is rotated, yellow, red and green spots show through the perforations, and an arrow points to a number on the rim by which the lights can be interpreted from a printed guide on the back of the dial. An advantage of the device is that it indicates not only the combinations of lights, but also their relative positions on a ship.

*The Forest City Bookbinding Co.
Canton Bldg.
Cleveland, Ohio*

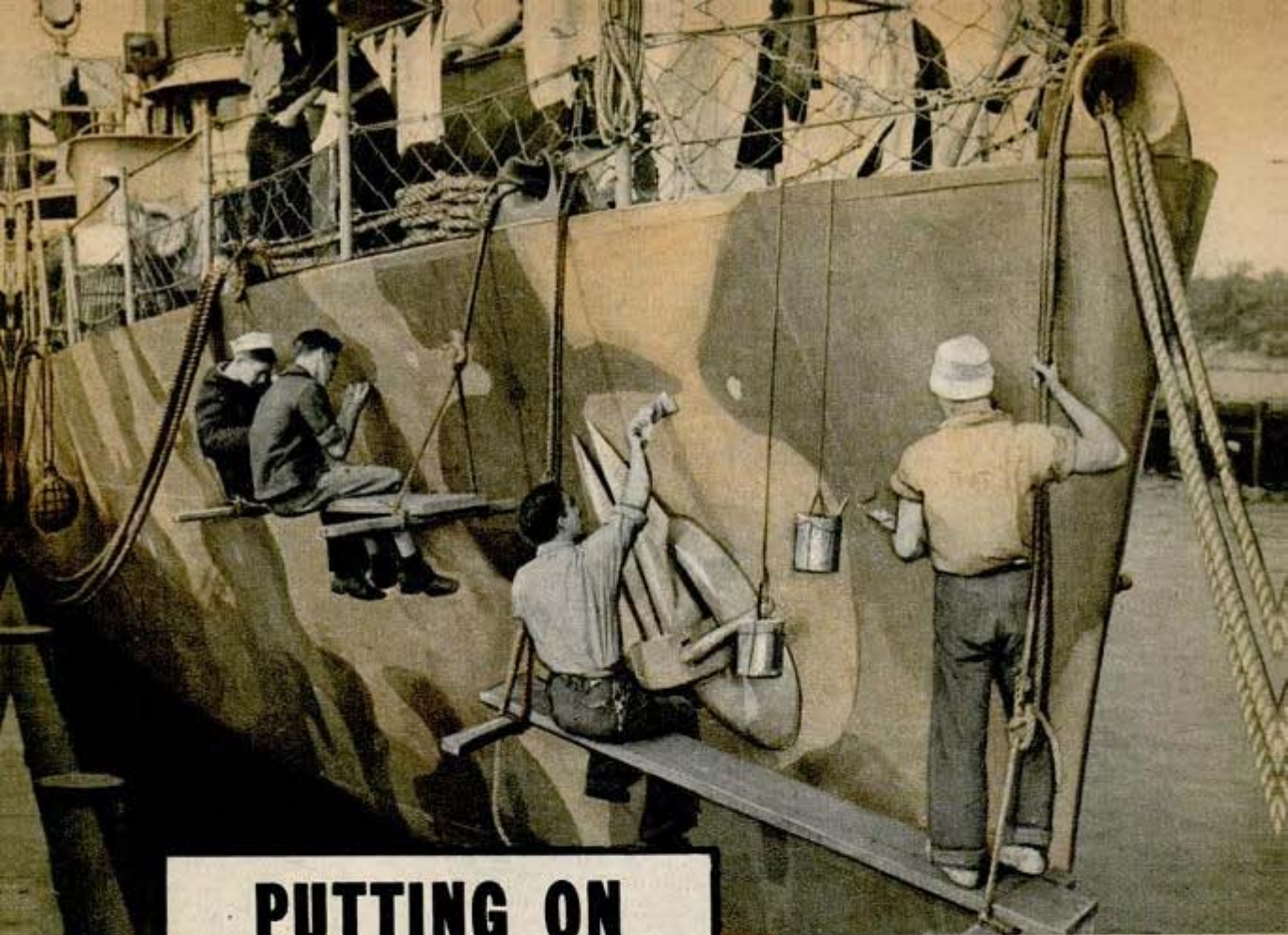

PUTTING ON *the* WAR PAINT

U. S. Navy photos
Above, four sailors camouflage a PC boat before it goes sub-hunting. Left, putting war paint on a big gun of U.S.S. Arkansas



ONE of the most obvious things in this world is paint. It hits our vision so constantly that we seldom notice it.

Yet, without paint, we might as well halt our war effort and sue for peace. Without paint, our tanks would soon rust into uselessness. Our warships would be slowed down by barnacles until they would be soft touches for faster enemy vessels. Our uncamouflaged planes would be sharp targets for anti-aircraft guns.

One classic example is the naval engagement in which a British battleship encountered a German craft of the same general class. After a slugging match, the British ship had the German vessel ready for the kill. The German ran for it and escaped—only because its hull had been recently painted and the British craft had been at sea so long it was encrusted with barnacles. The difference in speed was just enough to save the German battleship. A few

Mr. Elliott

77 797

thousand dollars worth of paint was worth \$30,000,000 and the lives of a lot of crewmen.

This couldn't happen today, thanks to one of the hundreds of new discoveries in paint and its application since Uncle Sam rolled up his sleeves and began fighting. What scientists have learned about putting on the war paint will affect our post-war lives more than we can anticipate.

During the last war, we were all in the same boat—so to speak—with regard to the problem of barnacles on ship hulls. But the Navy and the Fish and Wild Life Service of the Department of Interior developed plastic paints distasteful to barnacles and other marine growths which were attaching themselves to sea planes so plentifully that they often cut the takeoff speed in half and made it difficult to lift a plane from the water. Naval vessels often accumulated 300 tons of fouling material between paintings.

Dr. H. F. Prytherch, a government marine biologist, found two



*Spec. Vinton 4 11/2 yrs
12 S. 14th St., Pittsburgh, Pa.*

U. S. Marine Corps photo
Even hand grenades wear camouflage suits. Yellow paint was too easily spotted in the jungle, and here grenades are being repainted green. Below, camouflaging a Pan American Clipper

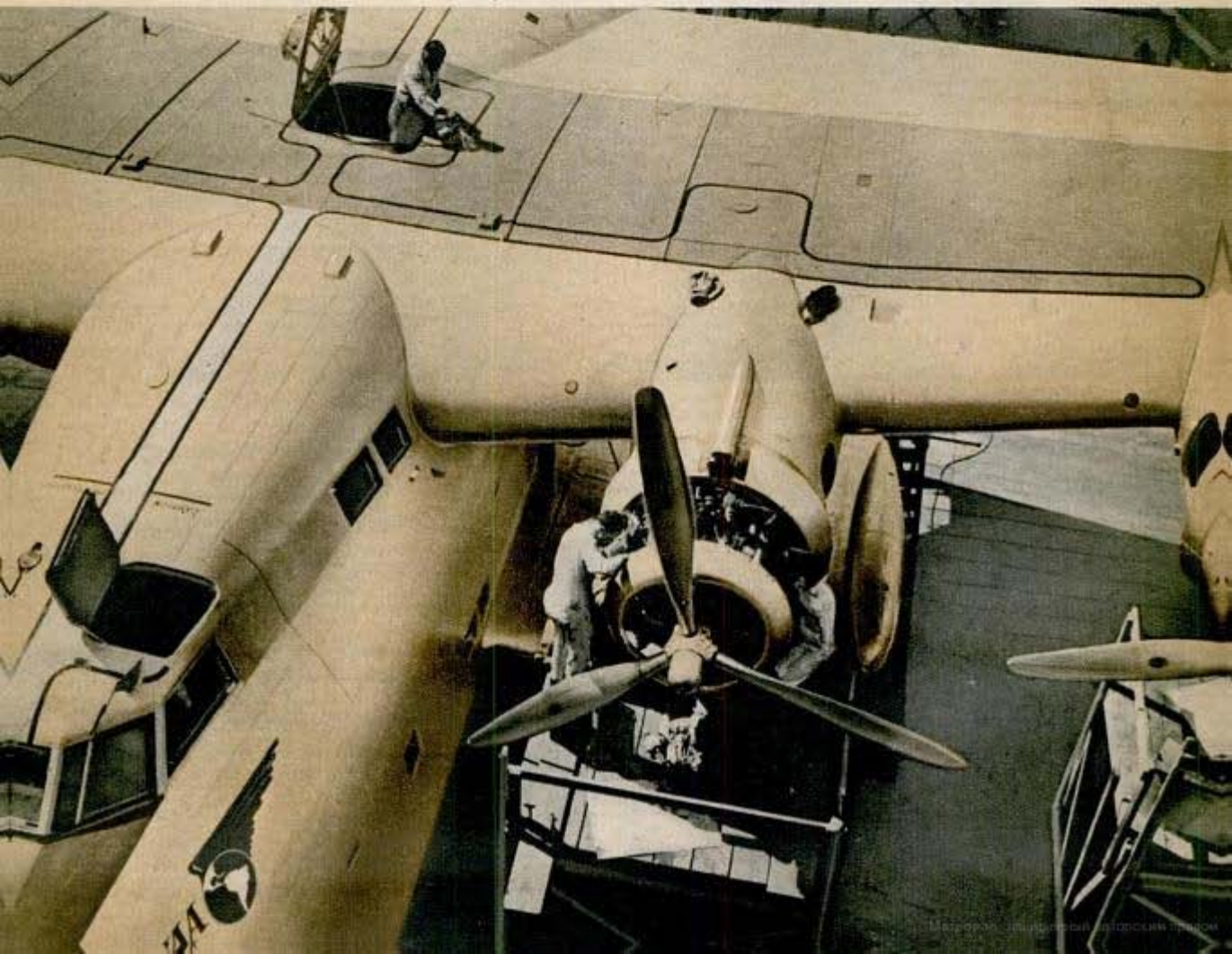



Spraying paint on anchor chain of a U. S. Maritime Commission ship

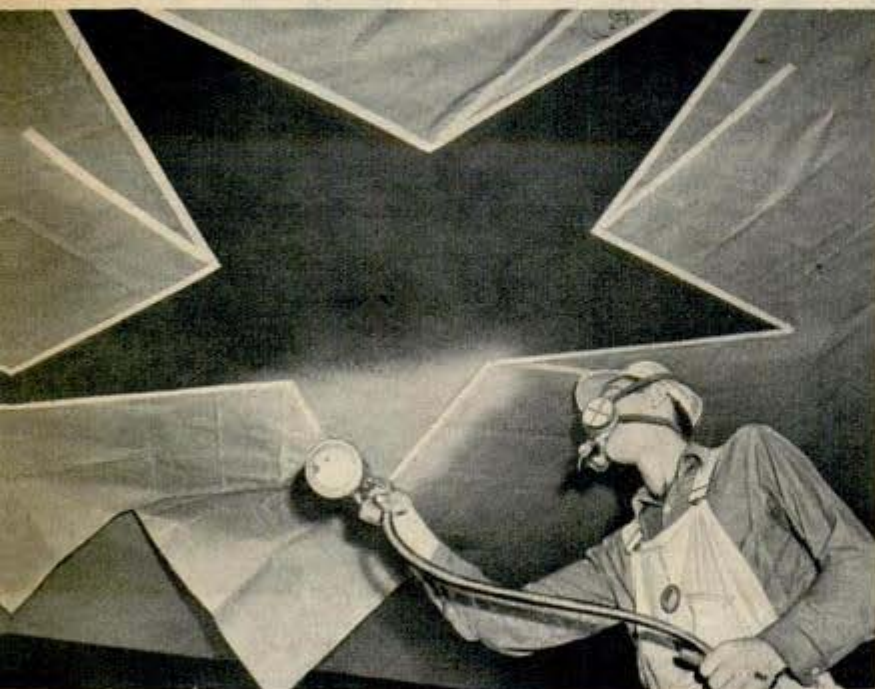

Painting the white star of the U. S. Army Air Force on a Flying Fortress. Below, spraying airplane cylinder heads in Studebaker plant



paints which reacted on the marine creatures like purple paint on a parlor wall. The Navy found another. The barnacles have stayed away from our ships ever since.

Postwar use of "ghost" paint to illuminate and decorate the walls of your house will bring startling effects, thanks to new things learned about phosphors and ultraviolet light which were stimulated by wartime research on airplane dials, blackout signs and lights of low reflecting character.

Ultraviolet beams from hidden fixtures playing on phosphorescent paints will not only enable you to change the hue of a room's walls by the flick of a switch, but varicolored designs can be applied to the walls, in wallpaper patterns if desired, by changing the color-reaction, the tone and the thickness of phosphorescent paints. And the room of the future need never be entirely dark, new paint being able to store up enough energy from daylight to last through the night.

In fact, an instantaneous flash of bright light like that from a photoflash lamp is sufficient to charge a phosphor-coated wall for as long as nine hours with cold "firefly" light. These phosphors act like storage batteries, soaking up a great quantity of light and then releasing it in small amounts over a long period. A room coated with phosphor chemicals will, when highly charged, emit illumination about equal to moonlight, according to Westinghouse lighting engineers.

Postwar fluorescent fixtures may be made of pressed wood coated with a new enamel which reflects more light and eliminates the chipping suffered by porcelain-coated steel. A very white flat paint has been found to cause a hot water radiator to emit 95 percent of the heat instead of sending 25 percent back to the boiler, as happens in the case of conventional metallic paint.

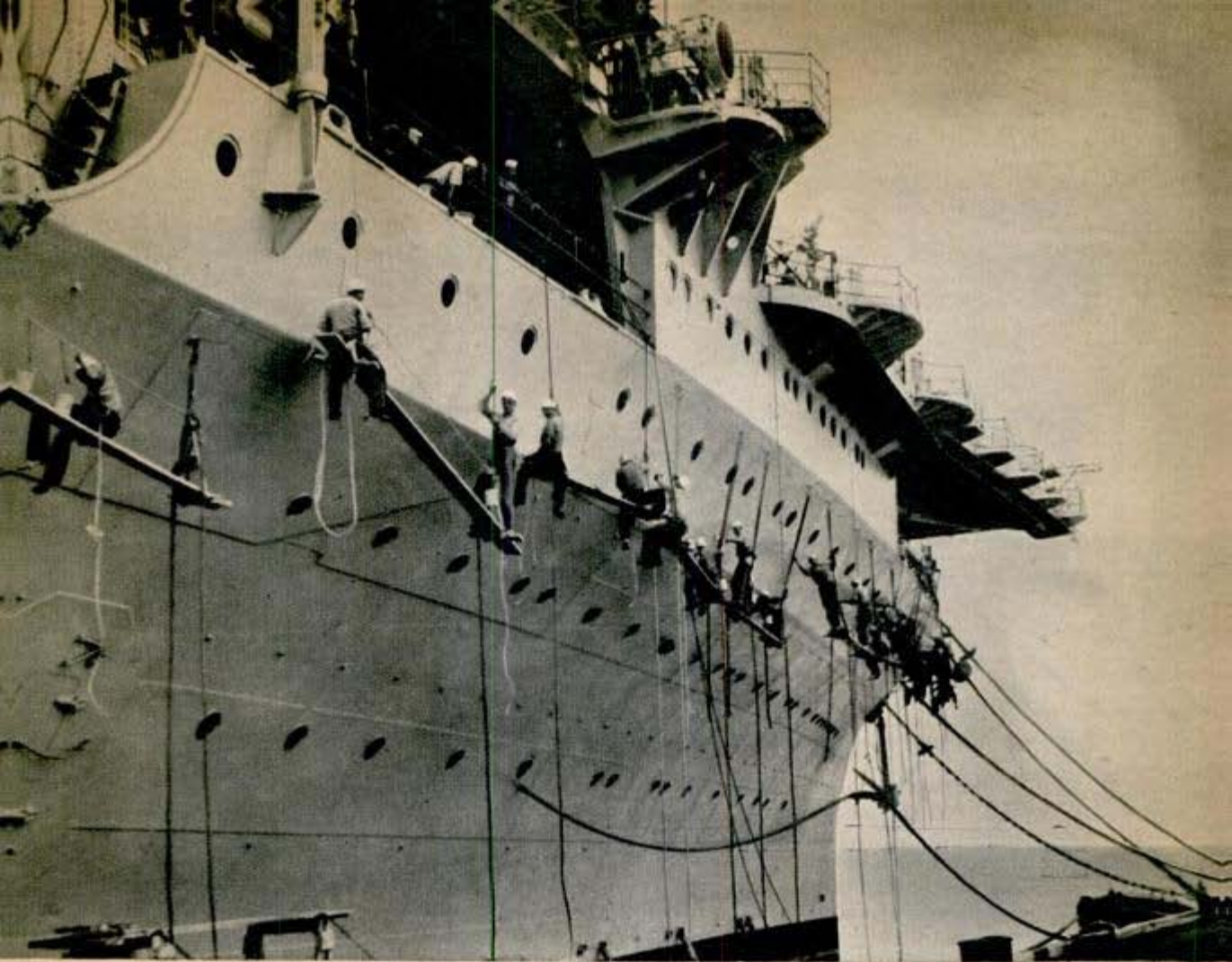

It's spring cleaning and painting time on the U.S.S. Ranger, veteran of our aircraft carrier fleet

War research has stepped up efficiency of infrared methods of drying paint until a vehicle which once took a whole day to dry can now be dried in four minutes.

A new fireproof, abrasive war paint, employing finely crushed semi-precious stones such as garnets, will provide a non-skid finish for home and factories. It was developed by Goodyear Tire and Rubber Company for the Navy to prevent sailors from slipping during battle. At present, the ground garnets in their synthetic resin binder paint are being applied with spray guns on the flight decks of plane carriers as well as on gun emplacements, decks, passageways, landings, stairways and in officers' and crews' quarters for Navy warcraft of all kinds from battle-ships to submarines and PT boats. Tests have shown it can withstand forces up to 7,000 pounds per square inch. Its thickness is

approximately ten times that of ordinary paint film, and yet it dries completely in eight hours. It resists cold, heat and the corrosive actions of oil, grease, salt, soap and similar materials.

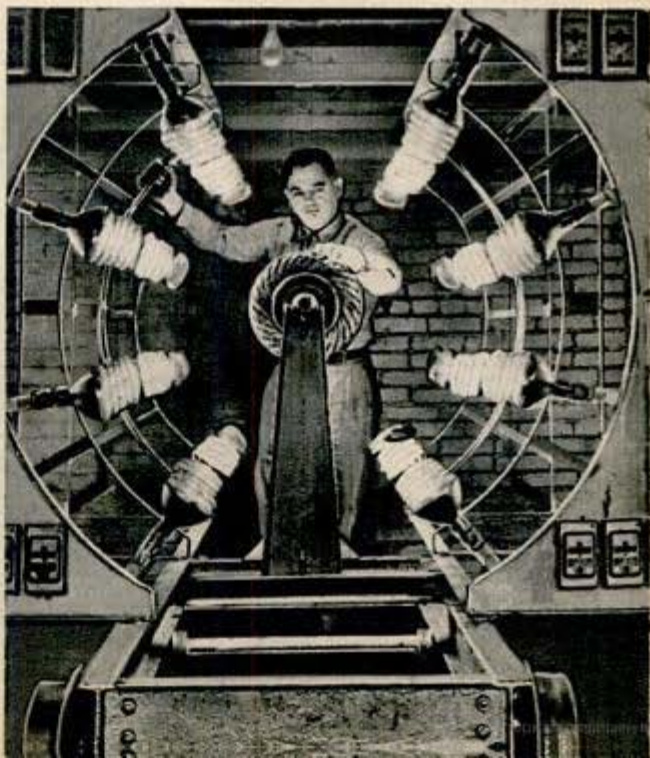

Infrared lamps speed the drying of varnish used in reconditioning electric motors in a mine locomotive repair shop
Westinghouse photo

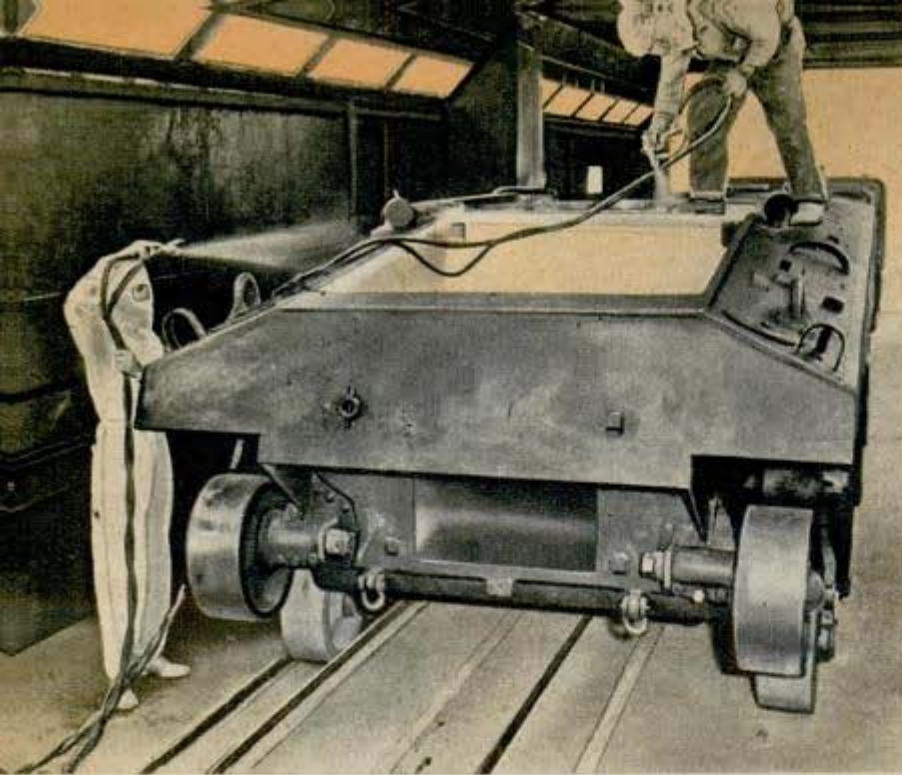

An M-4 tank gets a white interior, an overcoat of olive drab paint

The laboratories of companies like Du Pont, Westinghouse, Sherwin-Williams, General Electric, RCA and Devoe and Reynolds have been working in close unison to supply the Navy, which uses more than 50,000 carloads of paint a year for ships alone. A battleship like the new U.S.S. Iowa requires 400,000 pounds of paint, of hundreds of varieties. A white, fire-retardant paint used for the interiors of cruisers and battleships won't burn at temperatures which melt many metals.

With our vessels scattered around the globe, the job of shipping paint became important. So paint scientists produced concentrated paint which can be thinned with gasoline, naphtha, or even water, despite the saying that oil and water never mix. After the war you will be thinning out oil paints with water for such jobs as painting over wallpaper.

An interesting activity in the merchant marine is the painting of eyes in the bows of ships, a custom started by the superstitious Chinese in ancient days, to protect the craft from the perils of the deep which it needed eyes to see. Also novel is the fact that the name of each new Liberty Ship is painted on its bow before launching, and then is promptly painted

Some of our new cargo ships follow the ancient Chinese custom of painting eyes on the prow to ward off perils of the ocean

U. S. Maritime Commission photo

out, since these vessels plow the seas in complete anonymity.

The seagull is the pattern for the painting of most of our seaplanes, blue on the underside to blend with the sky and blue-gray to match the top feathers of the bird which nature protectively colored to merge with the seas below. Where the plane flies over jungle, the upper side is likely to harmonize with the foliage. If a plane is to be shipped on the deck of a vessel, it is likely to be painted blue-gray for the voyage and repainted at its destination according to the locality to which it is assigned. Training planes are usually finished in bright colors to prevent collisions and to make the craft easy to distinguish against the ground if forced down.

The coloring of airplanes is relatively simple compared with the problems of getting the right paint on the right surface, since metals, plywood and fabric are often used in combination on the same craft, and what works on one surface is useless on another. On aluminum alloy plane parts, it is necessary to protect the surface with a thin film of the pure metal to produce the

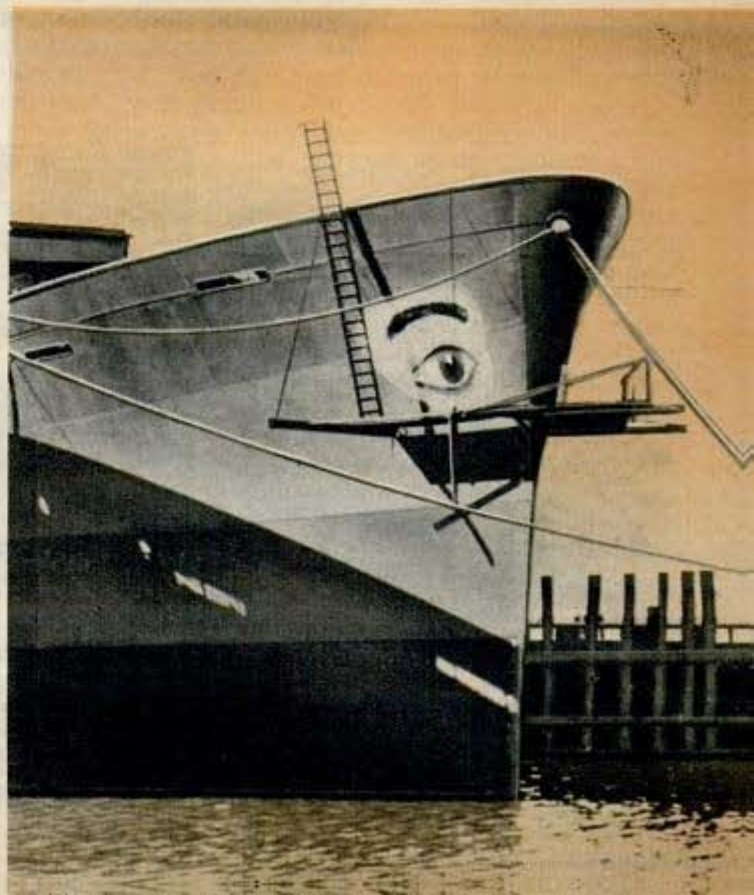

aluminum oxide that serves as an invisible coating on each kitchen pot and pan. But this thin skin of aluminum in turn must be covered with a "shop coat" during manufacture or it will be scraped off, permitting the alloys to develop faults and holes.

The paint which goes on fabric parts not only shields them from sun, rain and air, but acts as a shrinker, drawing the fabric as tight as a drumhead.

Paint for plywood planes and parts must permeate the wood so that it will not be warped by moisture.

In addition, all these paints must resist gasoline, hydraulic brake fluids and de-icing compounds.

Paint also crawls across the extended battlefronts of the world on tanks, tank destroyers, jeeps and hundreds of vehicles. Here protection against the elements is necessary and defensive camouflage is applied according to the scene of operations. Since these vehicles must not only merge with jungle and desert, but snow, ice and mud, the job is a complex one. In one case a tank surface must be glossy to reflect sunlight. In another, dull to prevent reflection. Finishes must resist bitter cold and torrid heat and the cutting action of desert sand which will often polish the paint off in a few days.

Even the simple quality of dullness was a problem. Though paint men could produce a finish with very poor ability to reflect light, it was discovered that it made a great difference what angle the light came from. A dull coat would not reflect a dangerous amount of tell-tale light from the sun, a searchlight or a flare coming from almost directly overhead, but it might mirror brilliantly a beam striking at tree-top elevation. Du Pont chemists were given the task of developing a method of measuring the reflectance factor of dull paints at all angles of incidence. Today a secret device does this quickly.

Thousands of puzzles were encountered and solved with paint. Steel landing mats in the mud of Aleutian airfields quickly turned red with rust. They served as flaming beacons in the slanting rays of the sun, guiding Jap bombers. Du Pont solved this one with a finish that could be swiped on mats already laid.

Army engineers desired camouflage paints for bridges and field installations. Other varieties of coating were needed for steel wool, glass wool and unusual concealment materials. Trees cut for camouflage purposes soon wilted and turned brown, exposing the very spot they were intended to hide. A preparation was concocted which, when sprayed on, kept them green.

On the factory front, Du Pont developed

Continued to page 154

MAY, 1944

General Electric Co.
Schenectady, N.Y.
Turbine With a Sense of Touch
Controls Air's Temperature 901

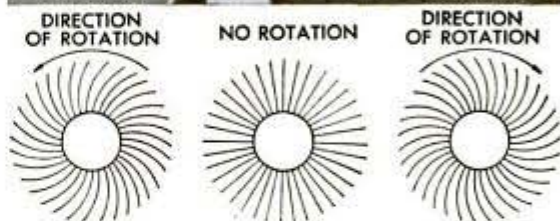

Control of the temperature of ducted air in any installation is claimed for the "Temp-Turb" temperature control, an air-operated device which is sensitive to heat and cold. Its direction of operation is dependent on the temperature of the air that operates it. Flowing air—for instance from the air scoop in a moving plane—energizes the turbine blades. These are bimetallic similar to a thermostat—and so reverse their direction of curvature as their temperature goes above or below a fixed control point. When the air is at the temperature of the control point the blades are straight, so no rotation is produced. Increasing the temperature curves the blades in one direction, and decreasing it makes them curve the other way. The direction of rotation is dependent upon the curve of the blades. The action of the "Temp-Turb" opens or closes the shutters of the heating unit and thus keeps the temperature of the flowing air within specified limits.

Hot Oil Dip Keeps Eggs Fresh

Fresher eggs for Mrs. America's table may result from a discovery at the University of Missouri. Eggs were dipped in hot mineral oil, which seals shell pores and kills bacteria, and remained fresh after 45 days of room temperature storage. The Army has tested the process under hot desert conditions.

C. D. du Pont
Public Relations Dept.
Wilmington 98, Del.

★ ★ ★ "TAXI SKIPPERS" of the

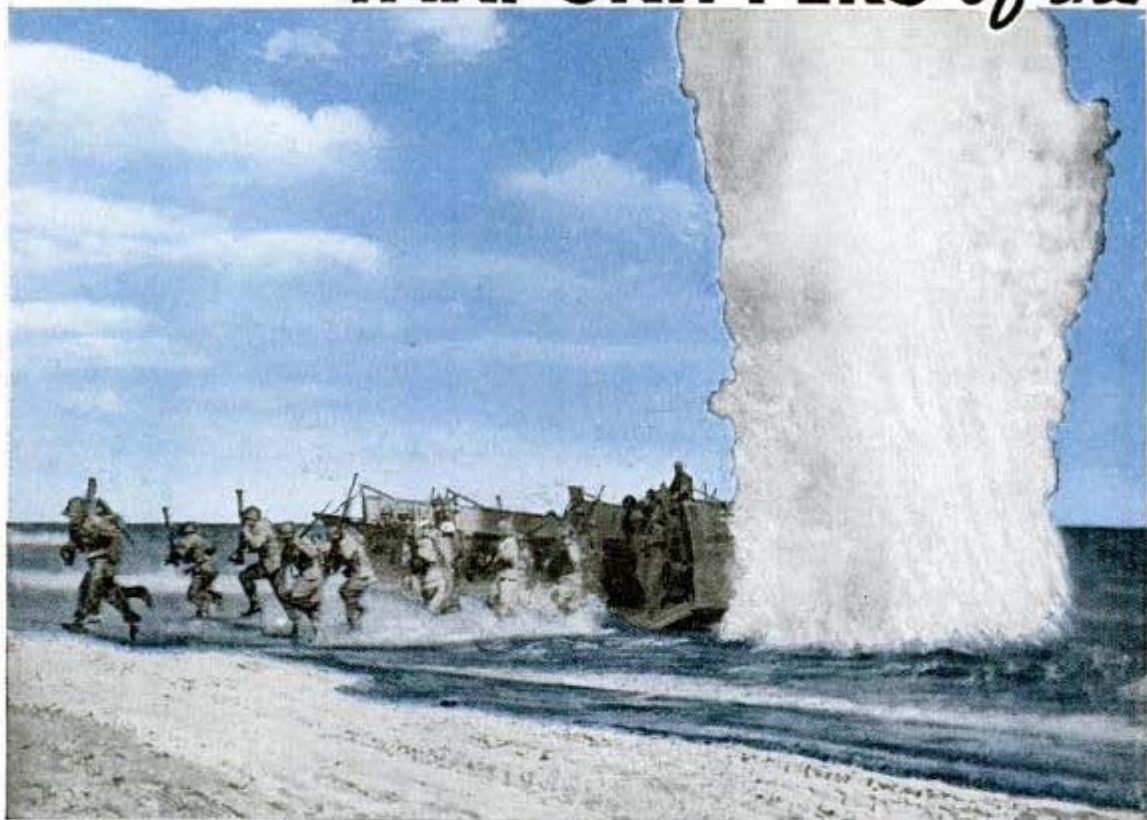

Exploding mines and a hail of machine gun bullets fail to stop Coast Guardsmen landing the "amphibs"

AN ARMY officer stepped from his amphibian craft onto the white beach of a South Pacific island. He surveyed the camouflaged military beehive on the fringe of jungle torn by machine gun fire. The officer, who was looking for marine headquarters, approached a group of men in khaki pants and shirts who were struggling with an oil drum.

"Say, marines," he called, "could you—" "We're not marines, sir," one of the khaki-clad and perspiring members of the group replied, "We're members of the Coast Guard."

A little farther on, the officer encountered two young men stripped to the waist and wearing sailor's pants.

"Say, Navy," he said, "could you direct me—"

"We're members of the Coast Guard," one of the young men said, "but if you're looking for marine headquarters, sir, just take that trail to the right."

The Army officer wasn't nearly as surprised to find the Coast Guard entrenched on a South Pacific island as Americans at home would have been on hearing the news. Many persons still think of the Coast Guard as dashing up and down the Atlan-



An invasion rehearsal held off shore of Pacific island

COAST GUARD ★ ★

tic or Pacific coasts in cutters, or conveying merchant vessels. That is just part of the Coast Guard's farflung war activities. Since America went on the offensive, one of the Coast Guard's biggest, most important and by far its most dangerous task, has been landing assault troops of the American Expeditionary Forces on hostile enemy beaches. Once the actual landing operation is accomplished, the landing crews don't scurry off to transports out of range of enemy guns. They stay within walkie-talkie call.

Working as an interlocking arm of the Navy, often in mixed crews and in close co-operation with the Army's Engineer Amphibian Com-

Tank is lowered over the side of Coast Guard-manned transport. Below, testing gun in the snug cockpit of invasion barge

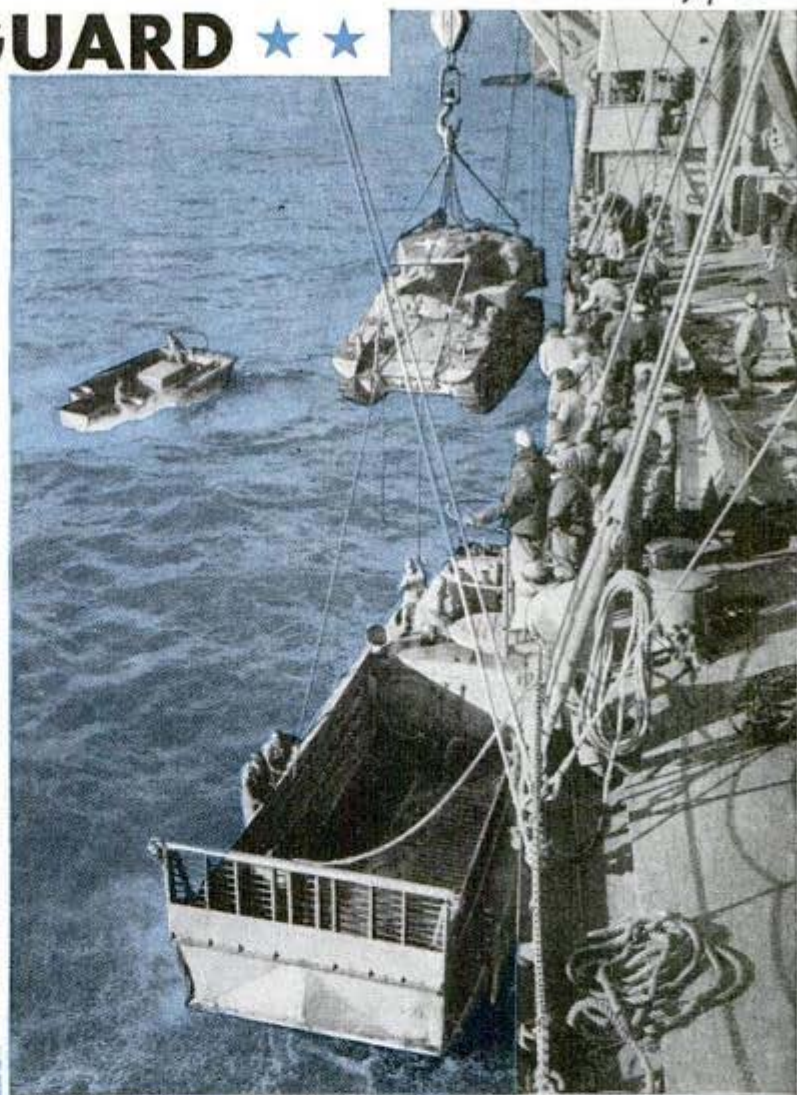



Amphibious "duck truck" piloted by Coast Guardsmen races through surf

to clear the mine fields and barricades, and wipe out machine gun nests, the "taxi skippers" shuttle back and forth bringing infantry reinforcements, ammunition, big guns, tanks and mountains of supplies.

The ramp-loading landing craft operated by the Coast Guard and Navy crews at Gela ranged from 36-foot troop carriers to the huge LCT boats (Landing Craft for Tanks) and the medium LCM (Landing Craft for Mechanized Equipment). A number of small craft were crippled by enemy shells before the amazingly accurate fire from warships silenced shore

mand, officers and enlisted men of the Coast Guard have collected a sky full of bronze stars to wear on their medal ribbons, testimonials to their performance of duty under enemy fire.

In the glare of searchlights on Gela Beach in Sicily, and at many an island landing in the Pacific, members of the Coast Guard and their fellow amphibians of the Navy held their exposed stations in landing craft while bullets spattered the sea. More than one trooper has yelled to the coxswain piloting his boat to get down or he would be shot. The reply is always the same:

"We got to land you guys in the right place and we can't do it in the bottom of the boat."

After the assault troops are set ashore

batteries and knocked out enemy tanks (one cruiser bagged 14 big German tanks). The boats that could limped back to their mother transports, which at the initial stage of operations were stationed about five miles off shore. One Coast Guard captain on board a transport answered all questions about what to do with the crippled craft with the terse retort:

"Pull 'em up. Pump 'em out. Patch 'em up. Put 'em back."

In the Sicilian action, Coast Guardsmen were in charge of every type of vessel with the exception of the regular Navy fighting boats—battleships, cruisers and destroyers. One Coast Guard officer who was at Gela Beach, Lt. Blair Walliser, said the crews on landing craft worked from 24 to 48 hours

A "wave" of invasion barges circling their transport waiting for precise moment to start toward beach





without stopping. Their food consisted of Army emergency rations.

"Despite the continuous bombing and strafing attacks by Nazi planes," said Lt. Walliser, "and the heavy fire from Italians on shore, our men kept those landing craft rolling onto the beaches in a continuous tidal wave. Before the shooting started, the Italian searchlights kept wavering over the invasion fleet and then flickering away in a mysterious fashion. We found out later from Italian prisoners that at first they thought we were part of their own fleet setting out on a secret mission."

The Coast Guard and Navy crews who distinguished themselves in the Sicily invasion, as well as in Africa, the Aleutians, Tarawa, and other South Pacific islands, received expert training at amphibian stations along the Atlantic and Gulf coasts. The men studied every

Troops huddle in bottom of landing barge as it speeds toward the shore. Below, mine explodes on the beach to lend reality to practice landing



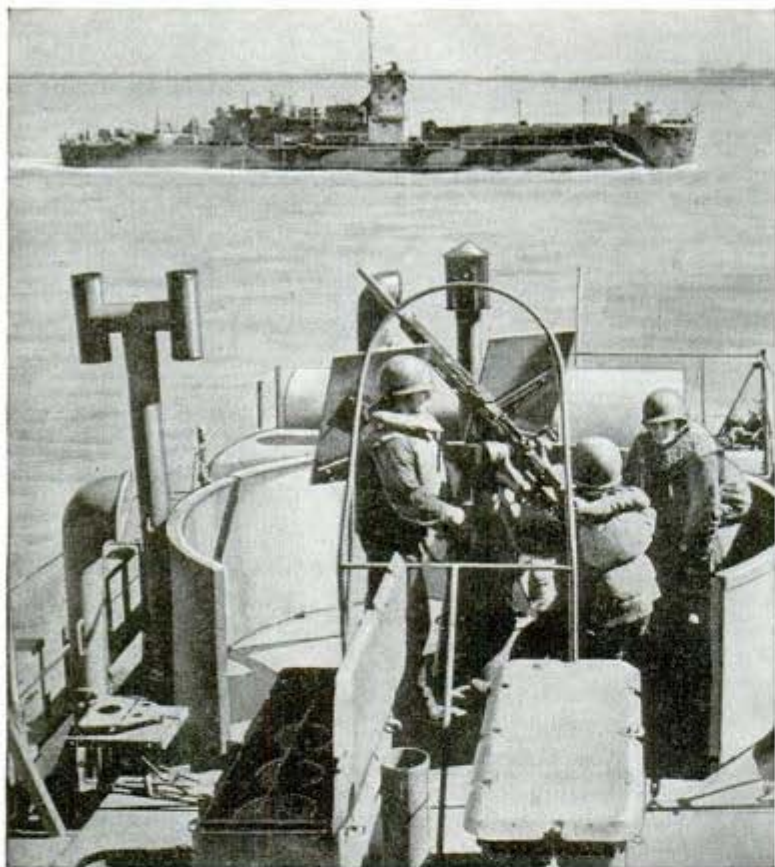

Coast Guardsmen man "battle station" on barge leaving camouflaged ship

type of landing craft, often under instructors sent from the shipyards that built them. They learned how to operate the gasoline and Diesel motors and how to repair them in an emergency. They were also taught to man the guns on the taxi fleet. The number and caliber of guns on any type of landing craft are Navy secrets. One type of landing craft they use is carried in several pieces and assembled on the transports. This saves 80 percent in shipping space.

During practice landings with the ramp-loading boats, the men learn the dangers of a sidewise landing in a heavy surf. The boats, which can poke their noses almost up on a sandy beach and back away with ease, must make a straight approach. If they are caught in the surf and swept sidewise they are almost helpless.

"The morning we landed troops on Guadalcanal

Rubber rafts like this helped marines make shore at Tarawa

plies that may be sent along later on merchant vessels, and they are ready on a moment's notice to support the troops in any action.

John H. Coppens, boatswain's mate first class, a veteran of the Battle of Guadalcanal where he helped land the first marines to go ashore, tells the dramatic story of rescuing 800 men trapped on a beach-

we knew just what to do and where to be thanks to those maneuvers," said one coxswain. "The men on the transports first put our barges, together with us skippers and our crews, over the side. This took about 15 minutes. We quickly warmed up our boats—just as we had done many times along the Atlantic Coast—and cruised around the ship to the cargo net where we loaded the marines. Then we kept close to the transport until there were enough barges to make a 'wave'."

When a detachment of assault troops, supporting units and supplies are landed, the work of the taxi skippers has only begun. While the mother transport goes about her business elsewhere, the skippers and their small craft are often left on the beachhead with the attacking force. Their business is to bring in sup-



head 10 miles from Henderson Field. This was six weeks after the initial landing.

"We landed the men on that beach early one morning and they expected to wipe out a detachment of bothersome Japs," he said. "All of us approved of that operation because we were getting tired of snipers' bullets whizzing over our heads as we sat around during the evenings.

"Things didn't work out as planned that day. The Japs had machine gun positions on a high ridge back from the beach. They had their mortars set up behind the ridge and their best snipers in the trees. Just before supper, the marines sent out an S.O.S. with their walkie-talkie radio. We lost no time in getting under way in our 36-footers because when the marines send out an S.O.S. things are really tough."

As coxswain on a 36-foot personnel barge, Coppens had a two-man crew composed of engineer and deck hand. The latter is called a "bow hook." He rides in the bow and acts as gunner.

"The first landing craft that arrived at the beachhead strafed the ridge with machine gun fire," Coppens said. "One man who survived got the Navy Cross and the others the Congressional Medal of Honor. The rest of us closed in and worked fast because the Japs were peppering that beach with deadly mortar fire. Our boat had to pass through crossfire from two points before we could get near enough to the beach to get the marines."

Operating under continuous fire, the skippers of the taxi fleet made trip after trip to the beach until the last marine was removed. Some of the barges were unarmed. For this action, which is far from unique in the annals of landing barge crews, Coppens and the other skippers were cited for heroic action by Rear Admiral T. S. Wilkinson, deputy commander of the South Pacific Area. They were commended for "conduct in keeping with the highest traditions of the naval service of the United States."

Another example of this type of conduct occurred on a big transport commanded by a Coast Guard captain during the invasion of Sicily. A young deck officer spotted four attacking Messerschmitts during unloading operations and rushed up to the captain.

"Messerschmitts attacking, sir," he said. "Should we give the general alarm?"

General alarm means all battle stations must be manned.

"How many Messerschmitts are attacking?" asked the captain.

"Four," answered the young officer.

"Four!" snorted the captain. "Continue unloading operations as usual."

That's the spirit of the men in Uncle Sam's "taxi fleet."

Long-Arm "Lazyman" Drill Bores Hole in Lofty Plate

1840



*Inv. Capt. Brewster N. J.
Bardonia*

Shipyard worker steps on foot pedal which operates drill mounted on adjustable rod for overhead work

Ladders and complicated scaffolding are eliminated with an electric drill mounted on a long rod which is adjustable to various heights. The drill, called the "Lazyman" by workmen in the Todd Shipyards where it was invented, is operated by a foot pedal. It is used to drill holes in overhead plates, and its long reach saves many hours of production time. *1. Bardonia, N. J., N. J.*

Names and addresses of makers or sellers of commercial products described in this magazine are listed in the Where-to-Buy-It index. Write to them for additional information and be sure to Say You Saw It in Popular Mechanics.

Bombers Have Eagle Beak and Sharklike Tail

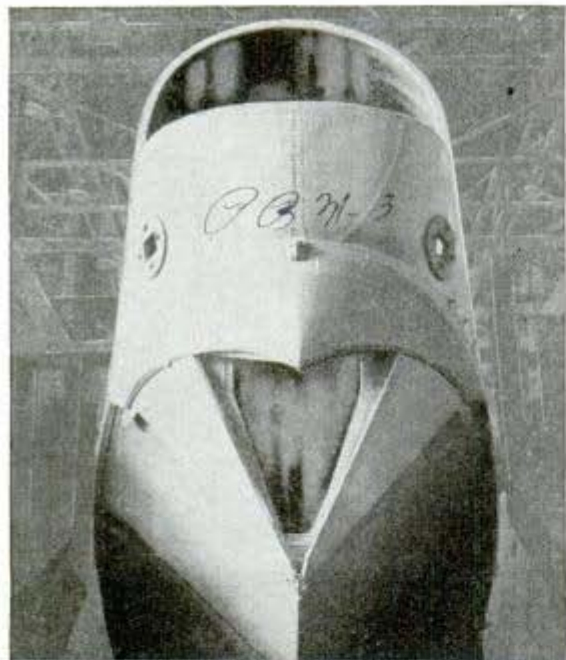

From ancient days warriors decorated their weapons to resemble rapacious animals and birds, but modern engineering often builds in an incidental likeness to a beast of prey. A head-on view of a Martin Mariner patrol bomber is a case in point. It requires no imagination to see in the warplane's prow the likeless of an eagle, beak open in a scream. The tapering tail of this big flying boat resembles a shark's nose, with a blackened port for an eye and a toothless mouth imaginable where the tail curves down to form the keel. The planes are in quantity production at the Glenn L. Martin plant in Baltimore.

Mechanical eagle with open beak is a Martin patrol bomber. Below, tail of flying boat resembles nose of shark—note eye



Hard Rubber Propellers With Metal Core Can Stand 60-Ton Stress

Propellers made of hard rubber into which bubbles of gas have been blown are lighter than those made of aluminum or magnesium alloy, but are able to stand a flight stress of 60 tons. The new propeller has a metal core, and over the hard sponge rubber is a shell of Du Pont's neoprene chemical rubber. The polished surface cuts

down wind resistance, serves as weather-proofing, and offers protection against cinders and gravel. Temperatures ranging from 70 degrees below zero Fahrenheit to 140 above have little effect on the propeller. Another advantage is in the new design of the propeller which is said to keep the motor cooler during takeoffs and in climbing.



The CRAFTSMAN

2 Victorian FOOTSTOOLS

By Charles and Bertram Brownold

STURDY and easy to make, these two footstools are neat in appearance and have the advantage of being easy to recover when the cloth becomes soiled. The settee-type stool shown in Fig. 1 is unusually comfortable and restful to your feet, which are supported by the sides of the stool and thus prevented from turning outward with a resultant tiring twist of the leg muscles. Fig. 8 shows how the parts are assembled, and Fig. 4 shows a half pattern of one of the sides. Each of these consists of two curved

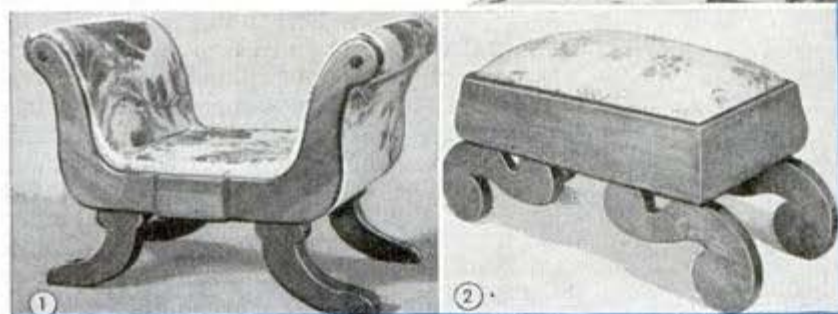

You can use light, gaily colored cloth covers on these footstools because it is a simple matter to replace the covers when they become soiled

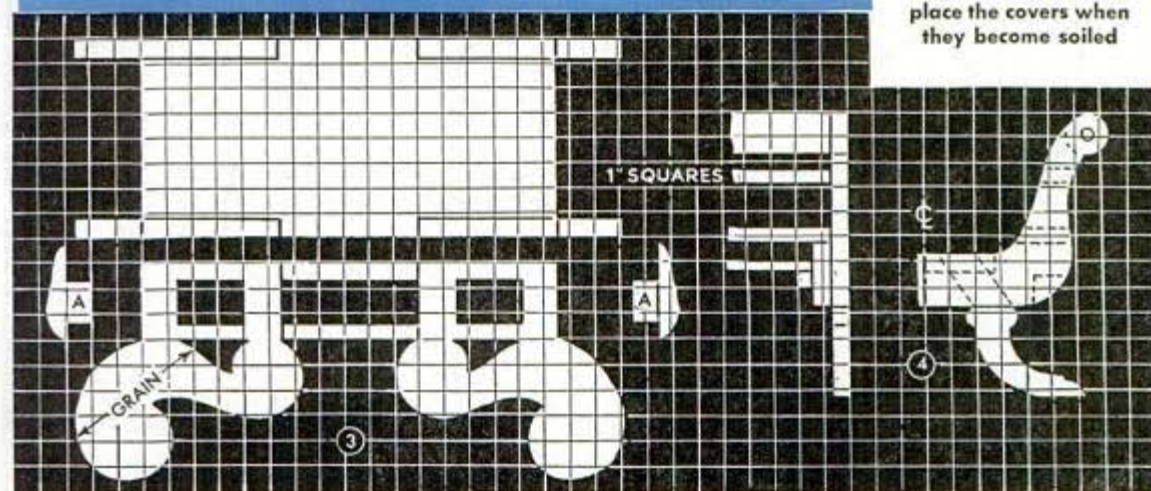

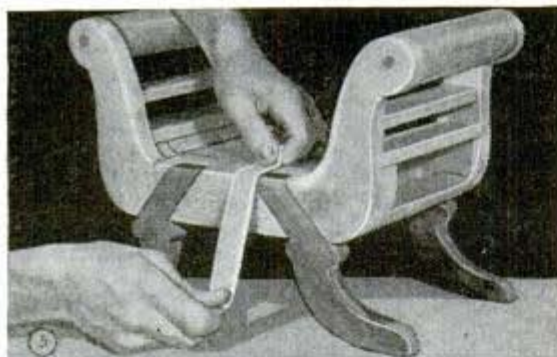

vertical pieces cut to the size and shape shown in Fig. 9, and jointed to a third piece of 2-in. stock, which is notched to take them as well as the legs. Size and shape of the legs can be determined from the half pattern in Fig. 4. After gluing up the two sides, they are assembled together by a 7-in. length of 2-in. round stock and three wood strips across each end. These are shaped as indicated in Fig. 9, and are positioned as shown in the end view of Fig. 4. A cushion or bottom can be made by upholstering a piece of $\frac{1}{4}$ -in. plywood or hard-pressed board to rest on cleats, which are screwed to the inner surfaces of the stool sides.

After the framework of the stool has been assembled, the edges are sanded as in Fig. 5 to provide neat rounded corners over which to stretch the cloth covering. Special care should be taken when sanding the edges of the strips across the ends to see that the graceful curve of the sides is maintained. The stool is covered first with cotton flannel, putting the nap side out, Fig. 6. The fleeciness of the flannel tends to soften the outlines of the frame. To get a smooth fit, remove the bottom and tack the flannel under the inner edges of the end strips. The bottom is covered separately and is screwed in place later. After the flannel has been tacked in place, tack on the outer covering. This cloth must be drawn over the edges of the framework and tacked to the sides. Facing strips of $\frac{1}{4}$ -in. wood to match the legs are used to conceal the tacks as in Fig. 7. Each strip is made of three pieces glued together, two of which are the size and shape of the side half patterns in Fig. 4. These are butted together and held by a third piece glued to them as an overlay. To recover the stool, the facing strips and the bottom can be removed in a jiffy.

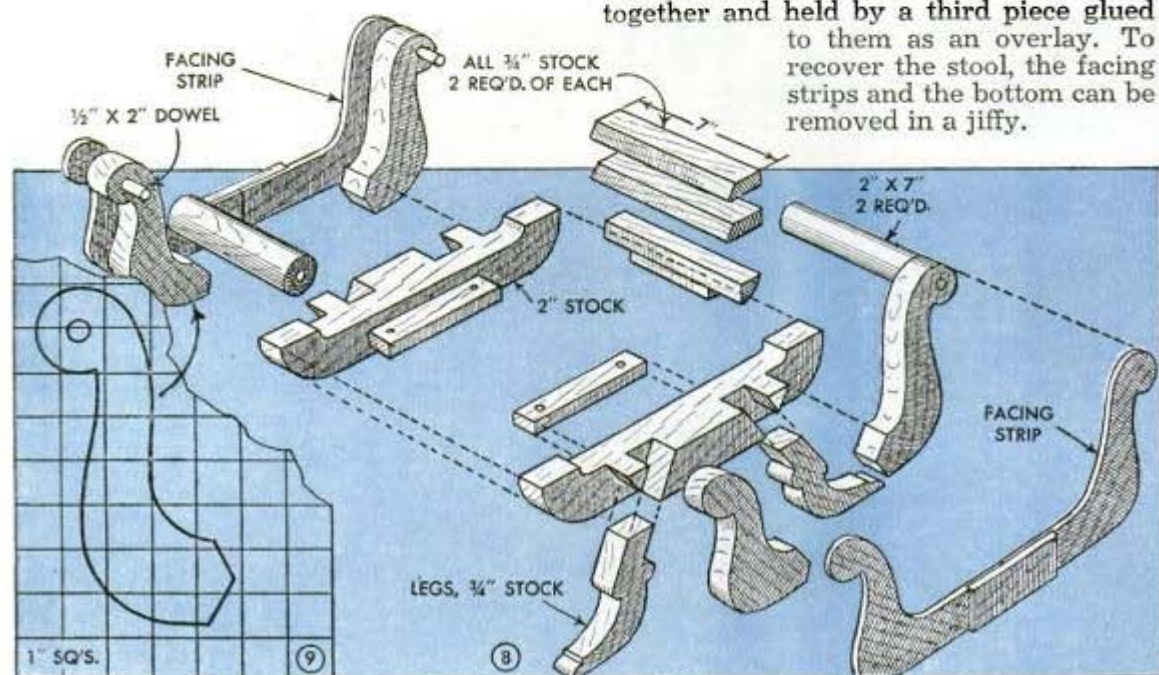

The stool shown in Fig. 2 has legs jigsawed from $\frac{3}{4}$ -in. stock to the shape shown in Fig. 3. After the legs have been cut and sanded, they are screwed to a top consisting of two boards cut out at the corners to take them flush as in Figs. 10 and 15. Molding 4 in. wide on its flat surface is fastened to the sides and ends of the stool, the molding first having been mitered at the ends. The molding can be purchased or it can be made from standard crown molding as shown in Fig. 14. It is attached by means of small blocks glued and screwed to it as indicated in Fig. 15, and as shown at A in Fig. 3. The blocks are slipped between the top boards and also between openings in the upper parts of the legs as in Fig. 11. Screws driven down through the upper board of the top and into the blocks as in Fig. 12, hold the molding in place.

The cushion rests in a recess formed by the upper edges of the molding projecting above the stool top, and is made by tacking cloth to a piece of plywood or hard-pressed board and stuffing cotton batting between them, Fig. 13. A better way to make the cushion so it will have a smooth and symmetrical contour is to first place the batting on the board and then lay the cloth over it and tack it to the underside of the board, pulling the cloth taut as you proceed. Then the cloth is covered with figured material of the desired color and pattern. The cushion is easy to remove for recovering.

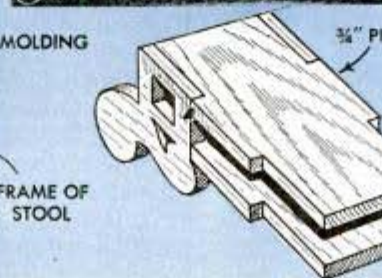
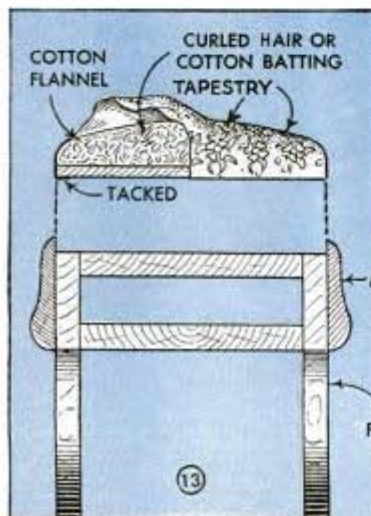
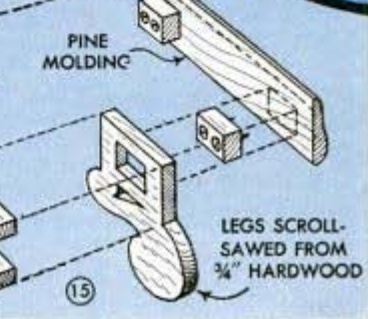
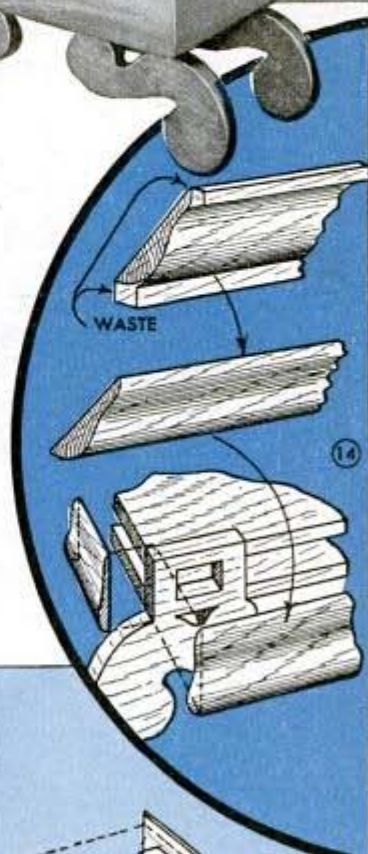

Shop Clock Hung Under Shelf Out of the Way

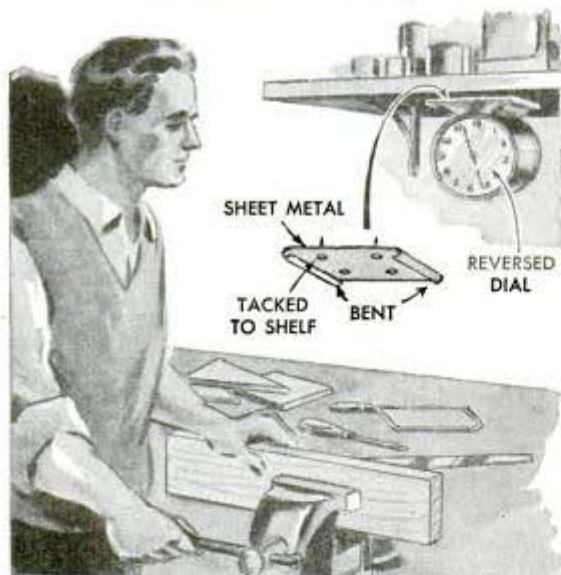

If your alarm clock in the workshop is in the way on a shelf, where it also may be pushed off and damaged, bend a strip of tin to engage the clock base and tack this under the shelf. As the clock will be supported in an inverted position you will have to loosen the face and give it a half turn for easy reading.

Tape Prevents Tearing Sandpaper

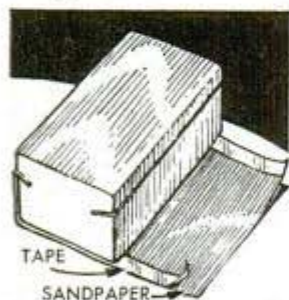

To avoid torn edges of sandpaper strips when they are used on a sanding block or in a special holder, one craftsman sticks a length of cellulose tape along each edge as shown. If cellulose tape is not available, decorators' tape will serve for the purpose.

Pick and Discarded Machine Gear Pull Steel Anchor Stakes

The difficulty of pulling a number of steel or wood stakes can be simplified by the use of a gear and pick as shown. The gear should be about 6 in. in diameter and should have a center hole somewhat larger than the diameter

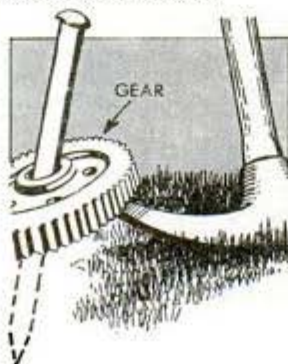

of the stakes to be pulled. By dropping the gear down over the stake and prying it up at the outer edge with the point of the pick, considerable leverage can be exerted, and the tilted gear will grip the stake tightly enough to lift it.

Leather Tacked to Wood Strip Makes Good Knife Sharpener

An inexpensive and handy knife sharpener can be made by tacking smooth strips of leather to opposite sides of a $\frac{3}{4}$ -in. wood strip $1\frac{1}{2}$ in. wide and about 10 in. long. Impregnate the leather on one side of the sharpener with coarse valve-grinding compound, and the other side with fine grinding compound. In use, give the knife a few strokes over the coarse side and finish on the fine side.

—Herbert Carr, Jr., Bangor, Me.



Artist's Data Card on T-Square Convenient for Reference

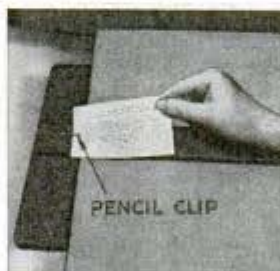

Artists and draftsmen whose work requires frequent reference to a data card will find that such a card or slip of paper may be held conveniently on the T-square by means of a pencil clip. The band portion of the clip is opened and the resulting prongs are tacked to the square in the position indicated.

Wire Serves as Pouring Guide

When you have to pour liquid from a small bottle into a container having a very small opening, such as a cigar lighter, try the following trick: Bend a wire as indicated, insert it into the bottle and use this as a guide for the liquid to enter the container. Pouring cannot be rapid, but if the thumb is held over the bottle mouth and the liquid released very slowly, it will follow the wire.

—John R. Clawson, Fort Hamilton, N. Y.



Garden Barrow

FOLDS FOR STORAGE

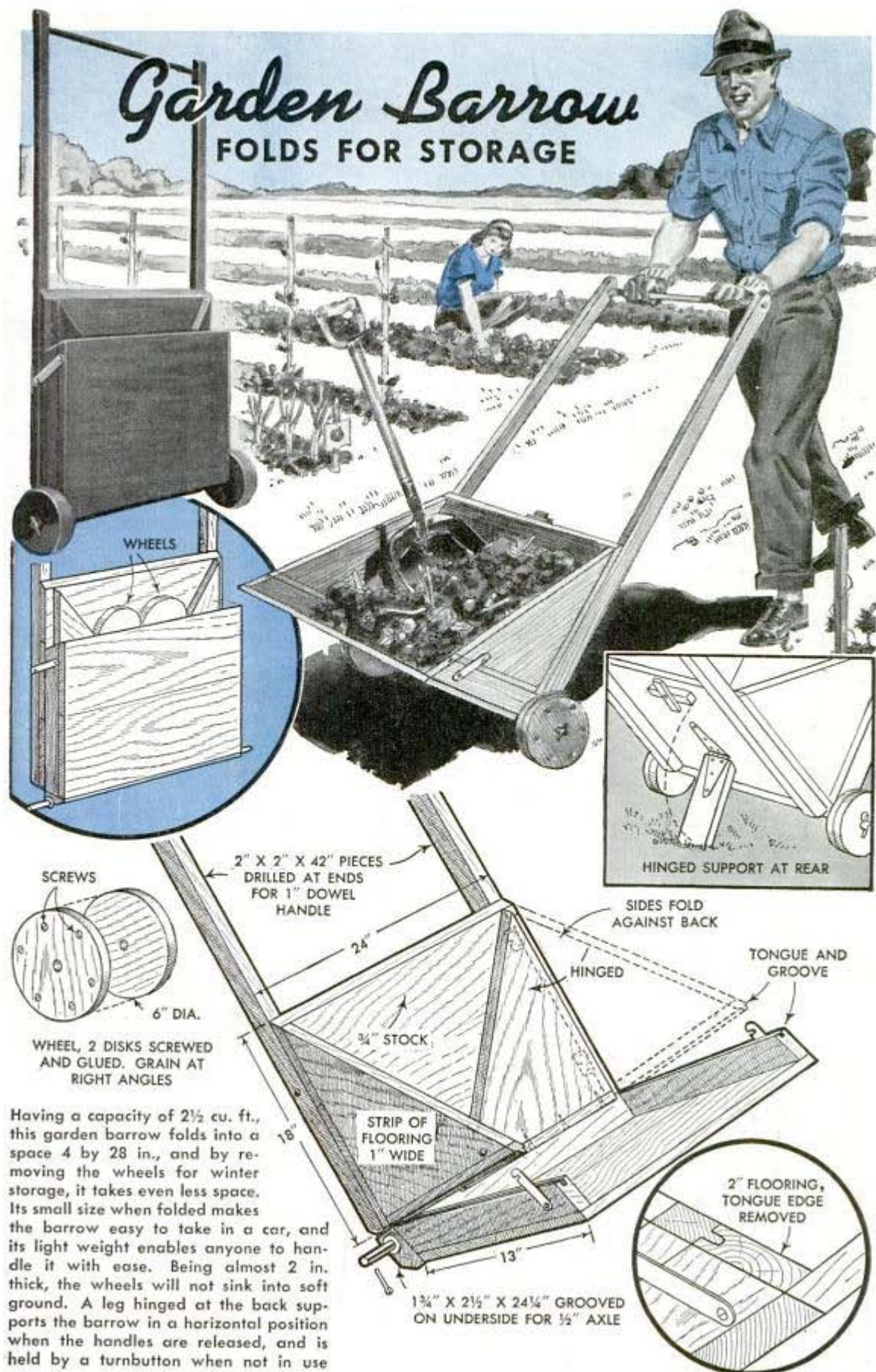

WHEELS

SCREWS

2" X 2" X 42" PIECES
DRILLED AT ENDS
FOR 1" DOWEL
HANDLE

6" DIA.

WHEEL, 2 DISKS SCREWED
AND GLUED. GRAIN AT
RIGHT ANGLES

SIDES FOLD
AGAINST BACK

HINGED

TONGUE AND
GROOVE

STRIP OF
FLOORING
1" WIDE

1 3/4" X 2 1/2" X 24 1/4" GROOVED
ON UNDERSIDE FOR 1/2" AXLE

2" FLOORING,
TONGUE EDGE
REMOVED

Having a capacity of 2½ cu. ft., this garden barrow folds into a space 4 by 28 in., and by removing the wheels for winter storage, it takes even less space. Its small size when folded makes the barrow easy to take in a car, and its light weight enables anyone to handle it with ease. Being almost 2 in. thick, the wheels will not sink into soft ground. A leg hinged at the back supports the barrow in a horizontal position when the handles are released, and is held by a turnbutton when not in use

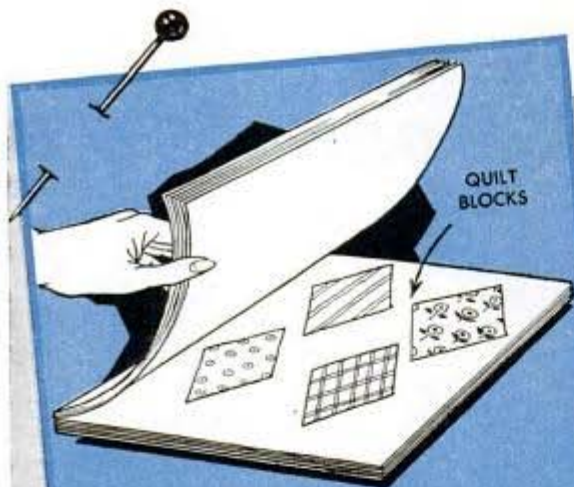

To keep quarter sections of quilt blocks flat and sorted in harmonious color combinations, place them between the pages of a magazine

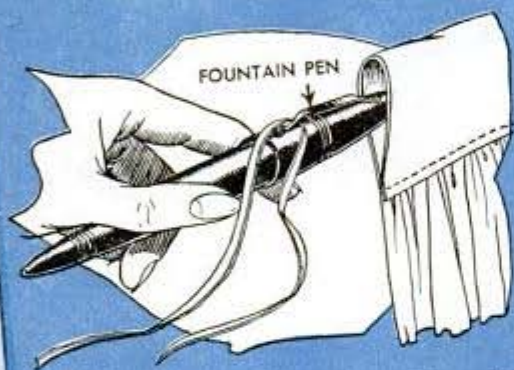

A ribbon or draw string can be run through a large hem quickly by using a fountain pen as a "needle," the string being held by the clip



Small throw rugs will "stay put" on highly waxed floors if they are sewed to the back of oilcloth, glossy side next to the floor

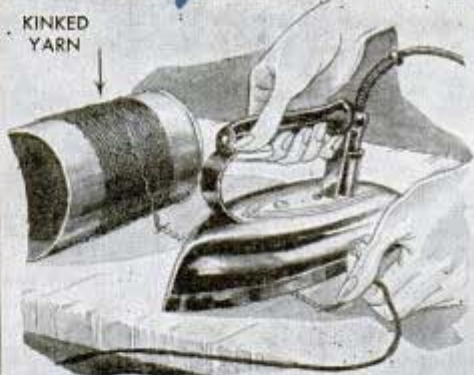

An easy way to steam the kinks from yarn that is to be re-used, is to wind it on a can, dampen and then iron as it is drawn through holes in a pressing cloth



You can thread a needle in less time if each spool has a bit of beeswax on it through which you can draw the thread to stiffen the end for insertion in the eye



Tabs of tape holding safety pins at each end of a wire clothes hanger will keep a skirt stretched without wrinkling it in a wardrobe case

PROBLEMS

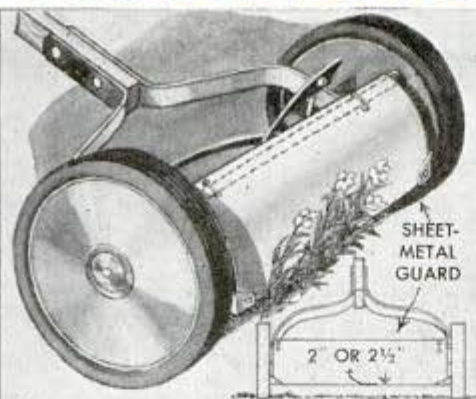

This sheet-metal guard permits trimming the grass close to flowers and shrubs, which are pushed back to protect them



A sturdy cardboard box with top removed and edges strengthened by a frame provides a lightweight box for toys. A small box on the side holds books.

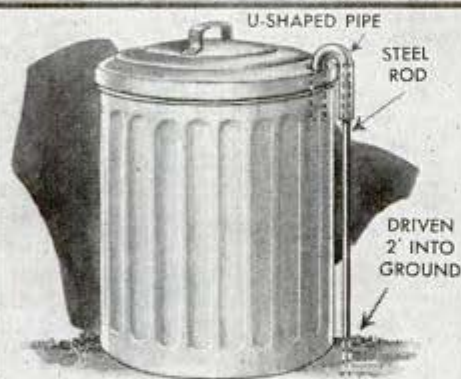

A U-shaped pipe placed over a steel rod and through a hole in the garbage-can lid will hold the can so dogs won't tip it

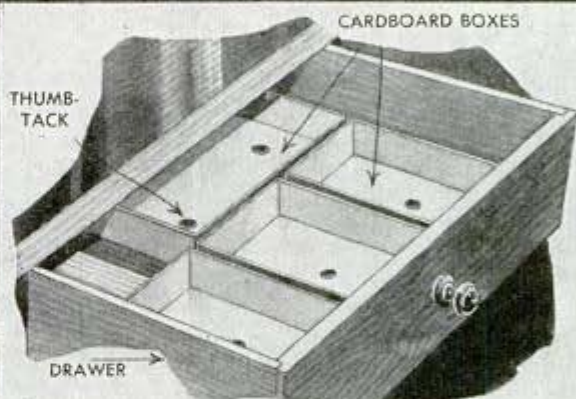

Drawers in which small items of different sizes are kept will stay more orderly if suitable cardboard boxes are fastened to the bottom with thumbtacks

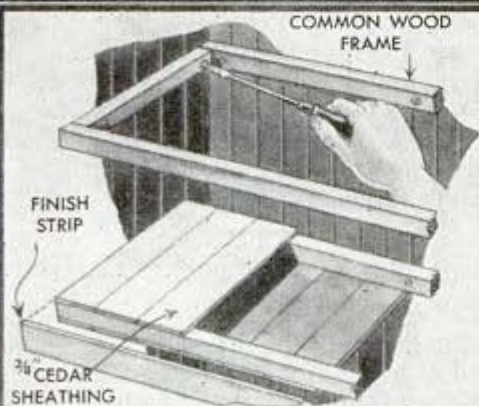

If 1-in. cedar boards are not available for closet shelves, make a frame of pine and cover this with $\frac{3}{8}$ -in. cedar sheathing



Spraying dry clothes on the line with a fine mist from a garden hose is a quick way to dampen them

Snap-On Wings for Model Planes Are Less Likely to Be Broken

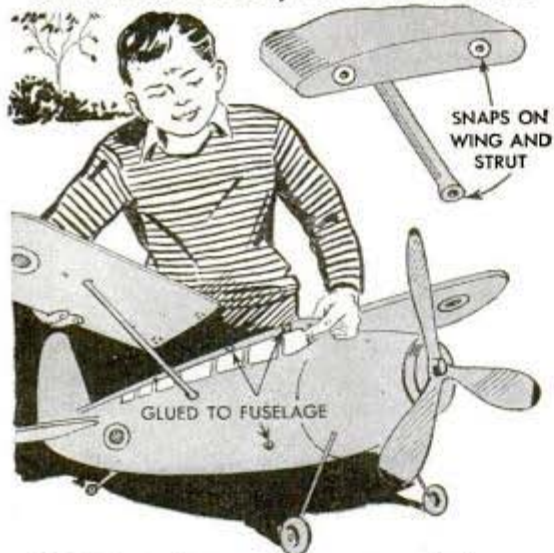

Model airplane wings are much less apt to be smashed when the plane strikes an object or makes a poor landing if they are attached to the fuselage with ordinary dress snaps, which will allow the wings to pull away from the fuselage without damage. One half of each snap should be glued to the wing and strut ends, and the matching halves glued to the correct locations on the fuselage. Allow the first coating of glue to set until thoroughly dry; then reinforce with more glue. The fuselage should be made somewhat stronger to take the added strain, but the extra weight will not be enough to interfere with flight. For carrying or for storage the easily removable wings also prove handy.

—Lynn Christensen, Long Beach, Calif.

Small Coin Protects Edge of Ruler When Cutting Paper With Razor

To protect the edge of a wooden ruler from being slivered with a razor blade when cutting paper or cardboard, hold a small coin or similar metal disk between

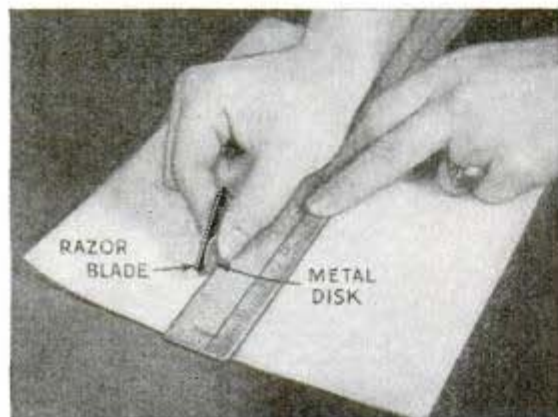

the blade and the ruler edge. This can be done by holding the coin and blade with the fingertips as shown.

Empty Copper Shell Removes Rust Without Scratching Gun

When a gun becomes rust spotted, don't use a knife to scrape away the spots. Flatten an empty copper cartridge and use it as a scraper. The soft copper will not scratch the steel, but will remove the rust.



Empty Match Book on a String Provides Air-Rifle Target



A target for air-rifle practice can be made by clipping an empty match book to a wire stretched between two supports. As these books are usually waxed, they will deflect the shot and spin if hit.

Soap Seals Leaky Gasoline Faucet

If a leaky faucet on a gasoline barrel is of the type shown, you can seal it and also lubricate the valve for easy turning by applying a coating of soap to the valve. Yellow laundry soap is best if available.



Coupling Trailer More Easily In Close Quarters

In situations where a trailer cannot be reached conveniently for coupling, attach a towing chain or rope to the trailer coupling. After carefully pulling the trailer a few yards, it should be aligned with the tow car, which can be backed up and coupled in the regular manner. On a slope, of course, chock blocks and the trailer's brakes should be used to prevent accidents.

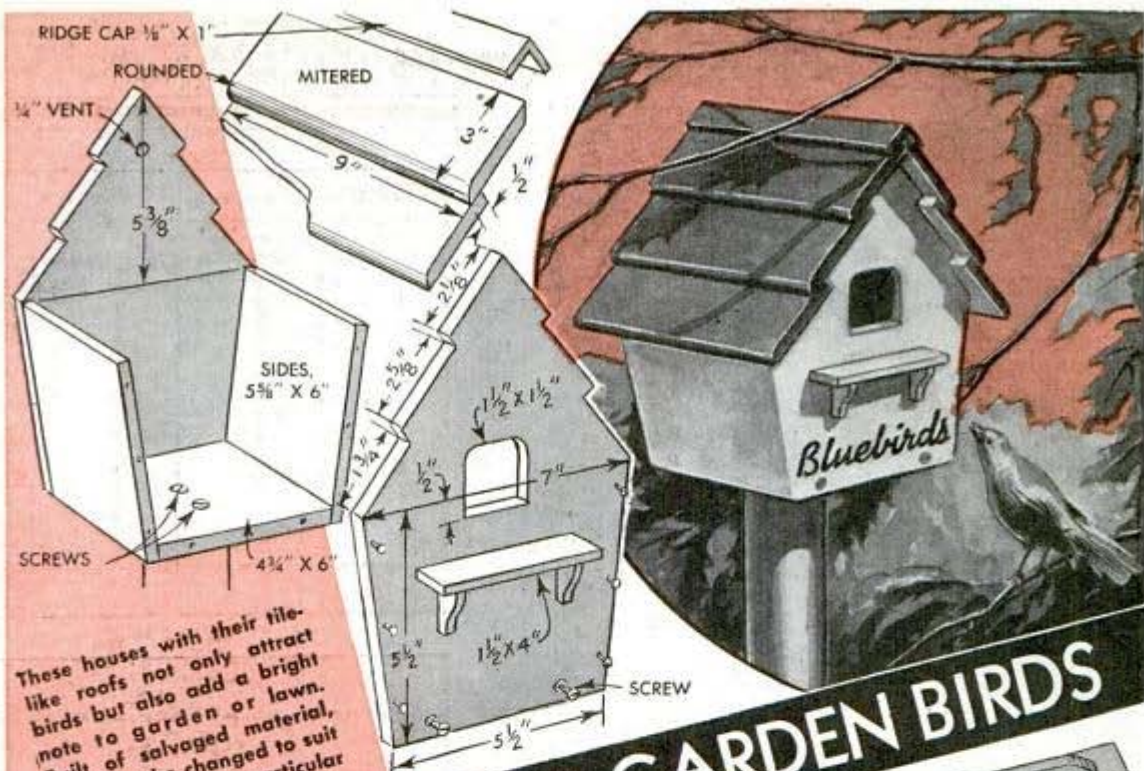

These houses with their tile-like roofs not only attract birds but also add a bright note to garden or lawn. Built of salvaged material, they may be changed to suit the needs of any particular bird desired

HOUSING YOUR GARDEN BIRDS

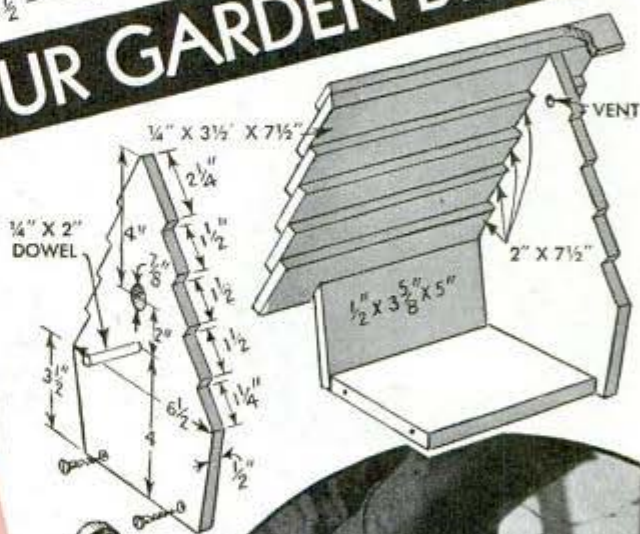
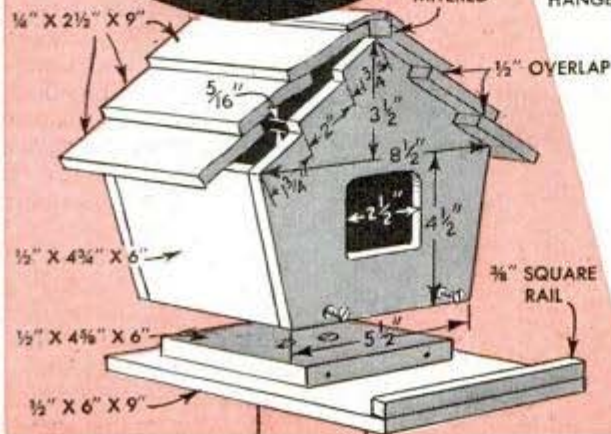
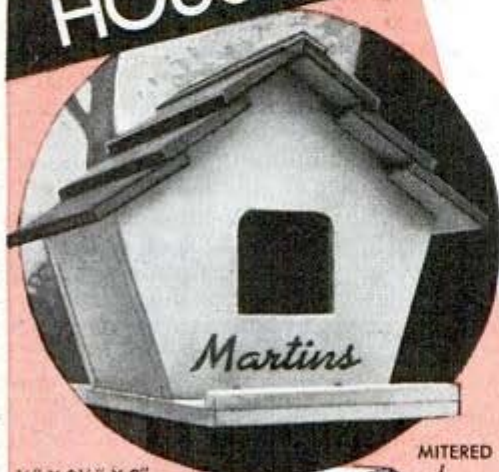

Built-in BEDROOM

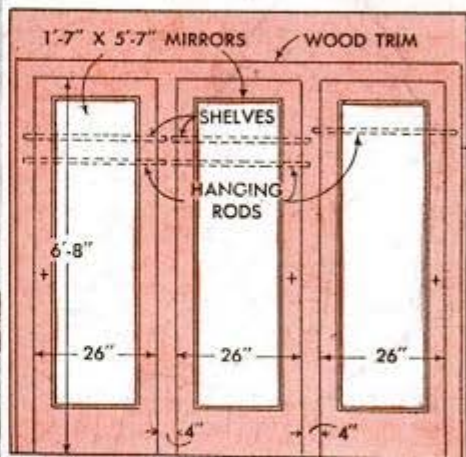

ELEVATION

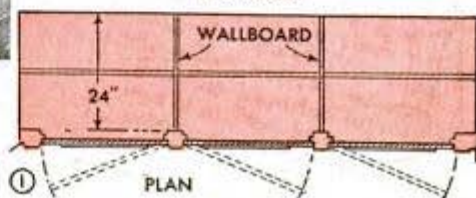

PLAN

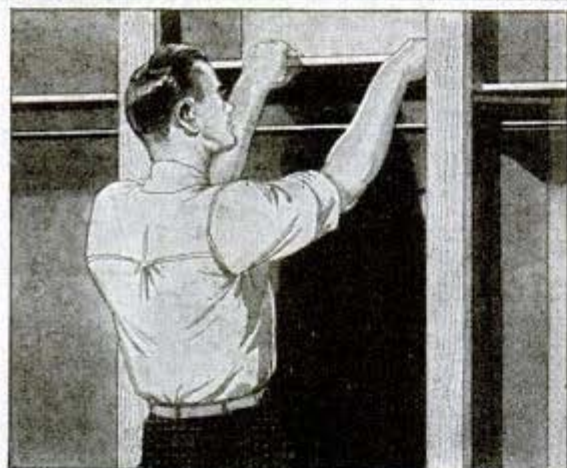

MANY of the problems of furnishing an attic bedroom and providing adequate closet space are solved by building in a wardrobe like the one shown above, or a vanity with wardrobe sections at the sides like the one shown on the opposite page. Used in the U. S. Gypsum Company's Remodel Research house, the wardrobe and vanity are easy to build, and they dress up a room, especially if it is long and narrow.

Faced with plaster board or other hard wallboard, the wardrobe detailed in Figs. 1 and 2 is just a simple framing job to provide three compartments or closets of

equal size, each being fitted with a mirrored door. Although plain flush or paneled doors can be used, the added attractiveness of the mirrored doors makes their extra cost well worthwhile. Since the width and height of your room will govern the size of the wardrobe, the dimensions given in Fig. 1 are only approximations and are intended as a guide in proportioning the one you build. As large panels of wallboard are used for the facing, back and partitions, the framework

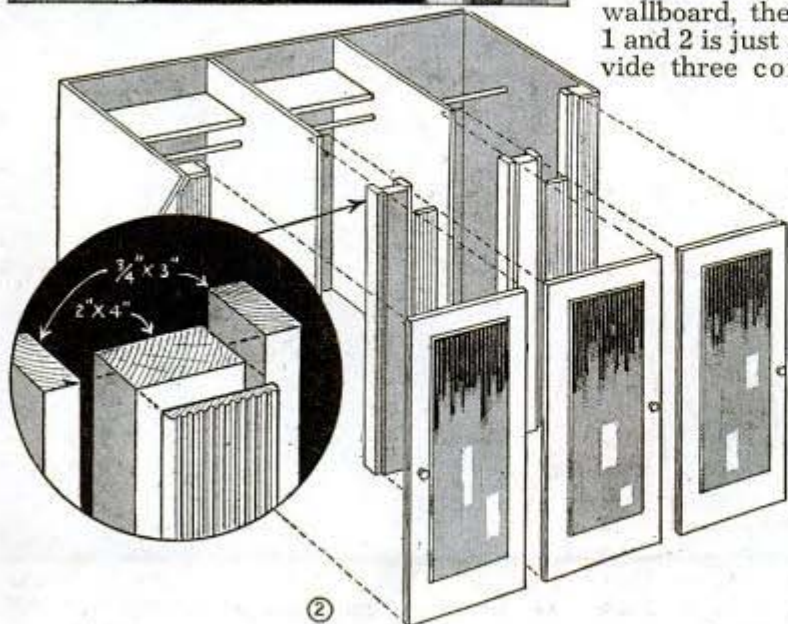

2

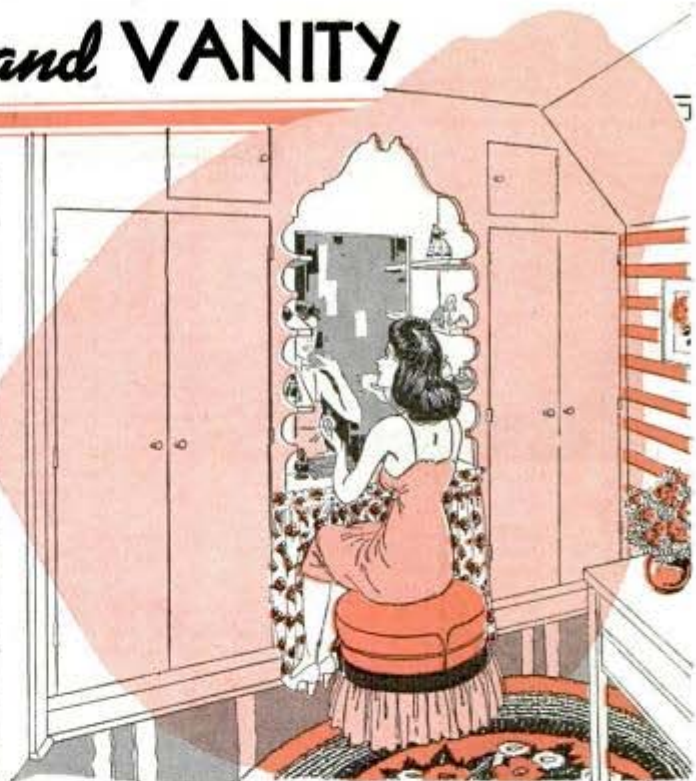
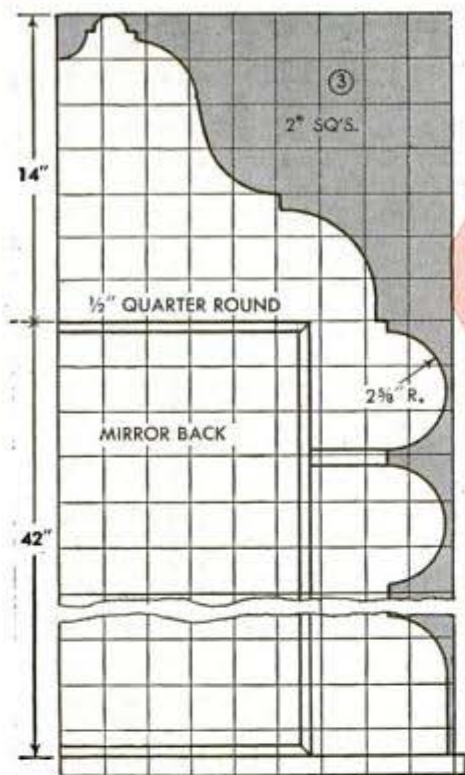
WARDROBE *and* VANITY

Wardrobe and Vanity

can be scantier than when regular wood boards are used. The circular detail of Fig. 2 shows how the doors are framed. The beaded trim is standard stock that can be obtained at most lumber yards. The shelves shown near the tops of the compartments are supported on cleats, and the hanging rods for garments can be supported by suitable brackets.

The vanity and wardrobe shown in Fig. 4 is ideal for a lady's room. It has a wardrobe at each side and storage compartments at the top. Overall general dimensions are given in Fig. 5. The size and shape of the scrollwork around the vanity portion is shown by the half pattern in Fig. 3. The skirted front of the lower section of the vanity hides handy shoe racks, and narrow shelves along the sides of the upper part hold various toilet articles. Two lights behind the scrolled front near the top provide illumination. As indicated in the top view of Fig. 5, the back of the vanity is set out 6 in. from the wall and is cut out to receive a large mirror, which is slightly larger than the opening so that it rests against the back where it can be held by a rabbeted frame

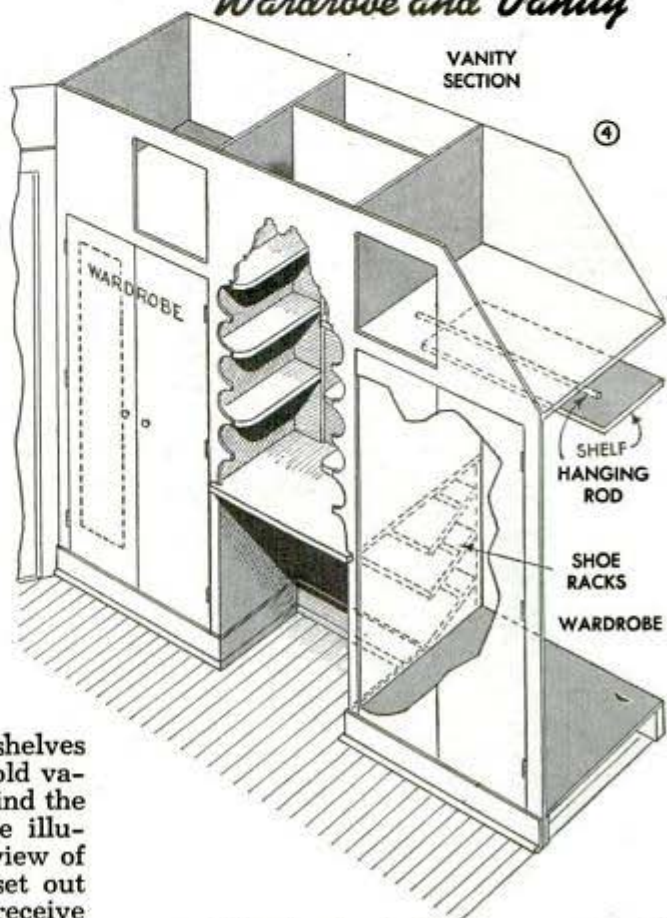

screwed to the back. The screws should be driven in from the front through the back and into the frame, countersinking



and putting the heads. Do this carefully so that the heads will not be visible after the back has been painted.

Construction and framing of the vanity are somewhat similar to that of the wardrobe except that the vanity has flush, double-hung doors for each wardrobe section and raised floors. Making the raised floors is just a matter of laying them over box frames that will fit snugly inside the wardrobe sections and then letting the ends and facing of the vanity extend down over them. Mitered baseboards and quarter rounds provide a finished appearance where the vanity contacts the room floor.

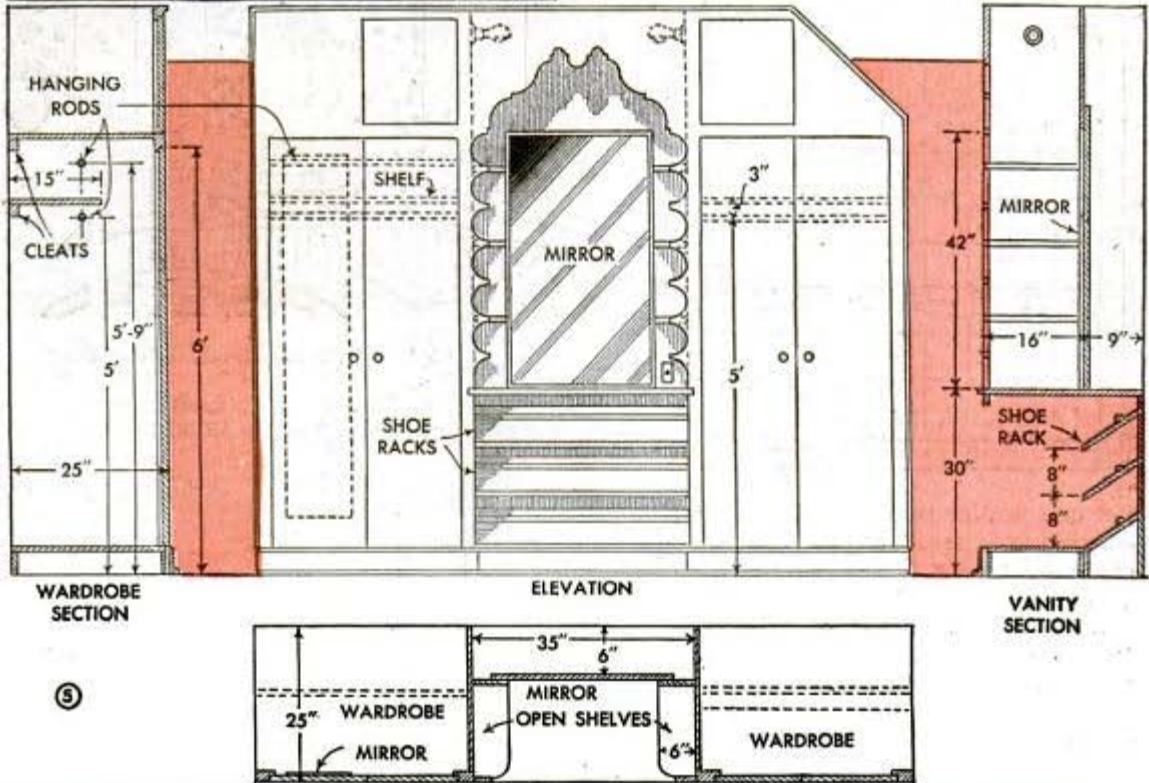

Belt Dressing Holds Metal Sheets Together for Duplicate Sawing

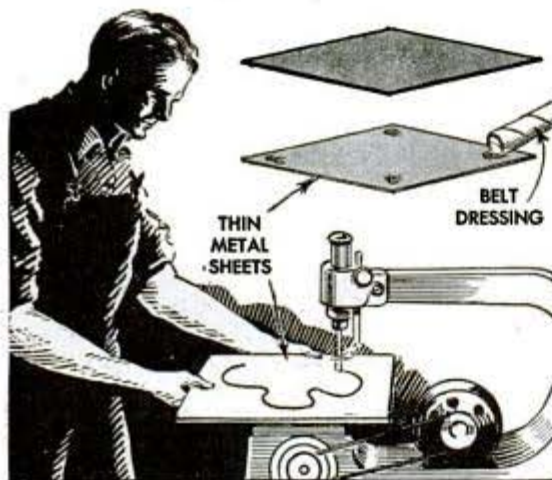

If you have several sheets of thin metal to cut in duplicate pattern, you can hold them securely together by placing dots of stick belt dressing at the corners and then pressing the sheets firmly together. Very little dressing is required and can be placed where the saw blade will not cut through it.

Milk Can Used as Food Chopper

An evaporated milk can with one end entirely removed makes a good vegetable chopper. If the edge is ragged, hold the can over a flame until heat melts the solder and the rim falls away. This simple chopper does an excellent job, especially when used in wooden bowls.

—Mrs. S. Everingham, Latham, N. Y.

You Can Make Your Own Bedrail Fasteners

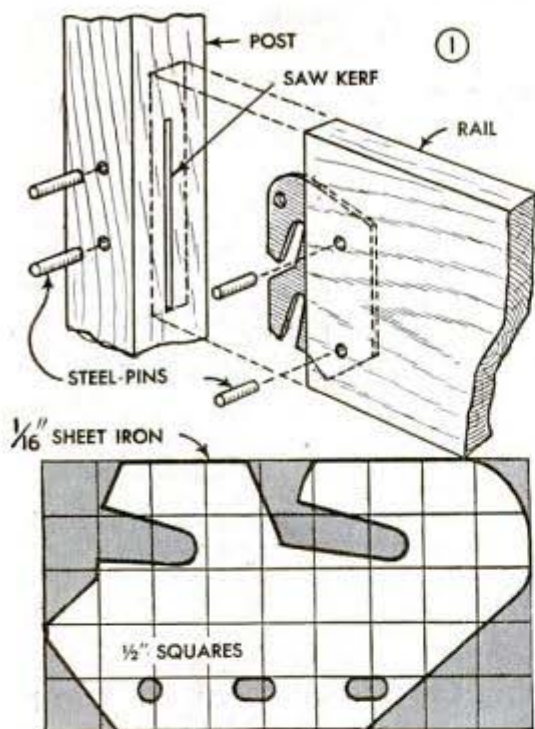

If you are unable to purchase bedrail fasteners when making a bed, they can be shaped easily from scrap metal as in Fig. 1. Cut or file four pieces as shown in the squared detail. Much of the work can be done by drilling a series of holes and then filing the pieces to the finished size. Cut grooves in the ends of the bedrails deep enough to allow the fasteners to be supported at least one half of their length. It is best not to run the saw kerfs through to the top of the rail. Limit the cut to the end and bottom edges only. Drill holes for pins in both the rail and post, and drive in the pins. You can hide them by drilling the holes from the inside surface of the rail and post, stopping them before the drill breaks through the outside surface. Another way of fastening the rails to the posts is shown in Fig. 2. Prepare the rails as though you planned to fasten them permanently to the posts with 1/2-in. dowels. Glue the dowels in the rail ends, letting them project 3/4 in. Then drill a pilot hole for a handrail bolt in the post and another hole in the end of the rail to a depth of 2 1/2 or 3 in. to take the bolt, which is fitted with a nut that is notched around the edges. Now, bore a hole running through the thickness of the rail to accommodate the nut. Place the rail in position and drive the nut on the threaded end of the bolt. You can do this with a punch and hammer as shown in the upper right-hand detail. If you cannot obtain a handrail bolt, a car-

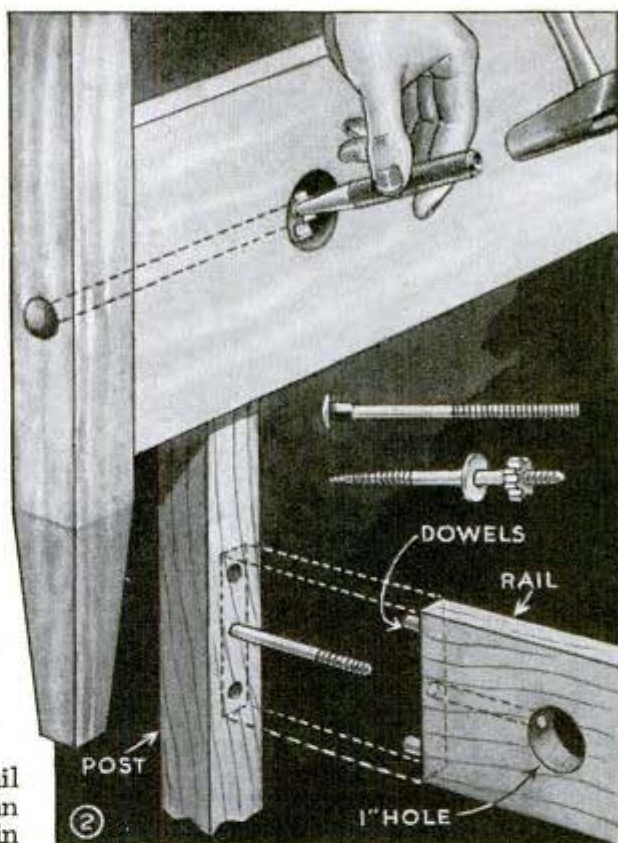

riage bolt can be substituted. Only the rounded head will show, and if this is objectionable you can counterbore the hole to sink the head and conceal it with a plug.

Cardboard Protects Thermometer Inside Its Container

The safest place to keep a glass thermometer is in its original container. But to unwrap the thermometer from the tissue paper every time it is needed is annoying and a waste of time. A simple way to avoid this is to insert a strip of corrugated cardboard into the container beside the thermometer. This serves the same purpose as the tissue paper and permits the thermometer to be withdrawn and inserted easily.

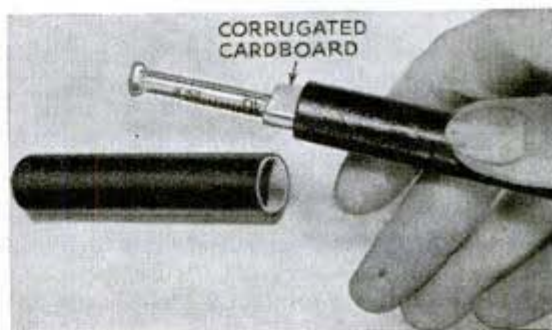

It Is Easy to Miter Wide Work With This Simple Block

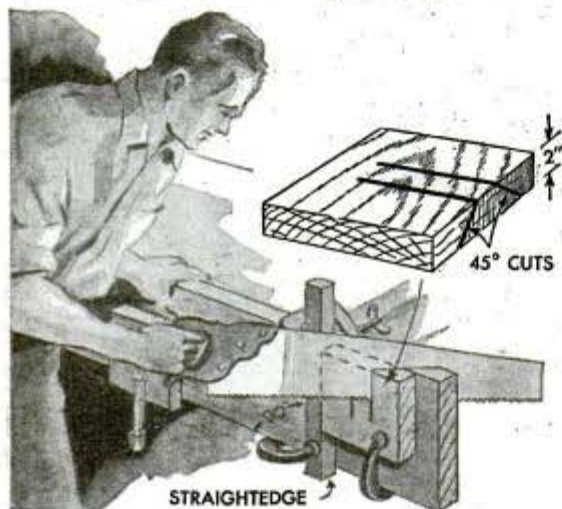

Work too wide to cut in a miter box can be mitered to the usual angles by using this block. To make it, select a straight-grained section from a 2 by 10-in. board. Lay out the cuts desired and carefully saw the slots, making them 8 in. deep. Slots of 30, 45 and 90 degrees are the most common. To use the block, clamp a wood straightedge across the stock to be mitered with C-clamps. Apply them loosely at first and hold the block against the straightedge, moving the whole assembly laterally until the miter slot is in the right position. Be sure the straightedge is square with the work. Then tighten the clamps and saw the miter, making the first cut to the bottom of the slot. Then, hold the saw firmly in the slot and move the block downward for the next part of the cut, repeating this procedure until the stock has been severed.

Temporary Microscope Slides

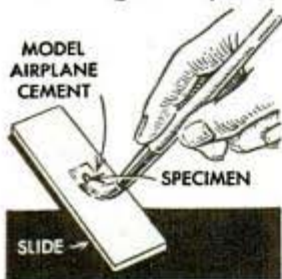

If you want to make up a few microscope slides for temporary use, you can do the job very easily by attaching the specimens to the glass with model-airplane cement, which is available at any hobby shop. First, clean a blank slide in warm water, and then wash the specimen in alcohol and rinse it in cool water. Place the specimen on the slide and absorb all excess liquid with a dry cloth. Now, with a small camel's-hair brush, apply a thin coat of cement to the specimen, letting the cement extend down onto the slide. After the cement has dried, the spec-

imen will adhere to the slide and will be protected from dust and moisture. The specimen can be removed by washing the slide in warm water.

Chisels Held at Grinding Angle In Slotted Bench Stop

Amateur woodworkers who have difficulty sharpening their chisels correctly can avoid this trouble by using a bench stop to support the chisel at the correct angle against the grinding wheel. The chisel

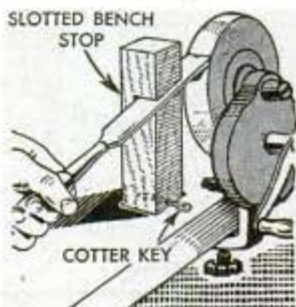

is held in a slot in the stop, which is kept at the desired height above the bench by means of a nail or cotter key as indicated. When not in use, the stop is removed or pushed down flush with the bench top.

Spring Clothespin Used as Clamp When Assembling Model Work

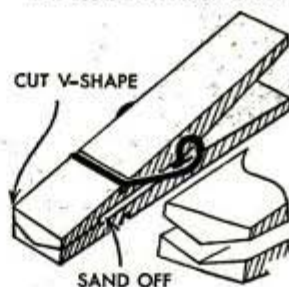

I have found that by slightly altering the jaws of a spring-type clothespin it is very handy for holding up dihedral joints on a model glider or airplane. The inner surfaces of the

jaws of the pin are sanded to a V-shape, after which the remaining inner surfaces of the jaws are sanded down back to the spring to provide a throat.

—Alfred Languirand, New Bedford, Mass.

Leather Strip Opens Dividers

To save time when laying out work on a bench, one artist glued a strip of soft leather to the edge of the bench where it would be convenient to his right hand. Now, whenever it is necessary to adjust a pair of dividers, he merely holds them in his hand and runs the knurled nut across the leather strip to rotate it. Of course, the dividers should be held in the closed position while rotating the nut.

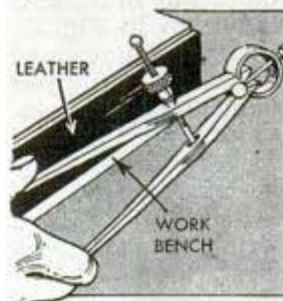

RIDE 'EM Cowboy!

Children Like these
Play Horses

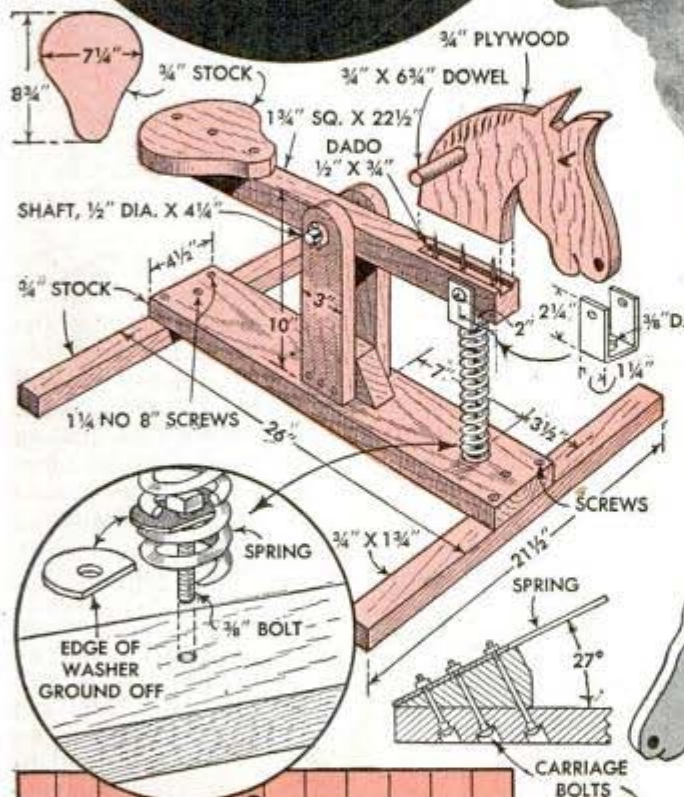

Coil-Spring Model

The model detailed at the left has the riding arm pivoted on a shaft at the center, the action being provided by a coil spring. A spring about 1 in. in diameter and having twenty coils of 1/16-in. wire will support the average child. The spring should allow movement of at least 4 in. Any wrecking yard will yield a variety of suitable springs. If one strong enough cannot be found, try using two weaker ones side by side.

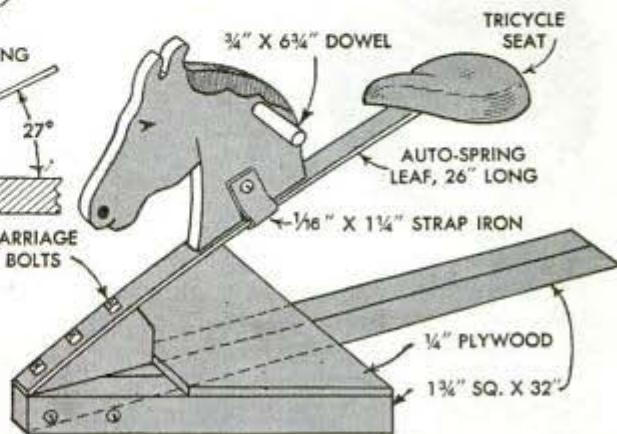

Spring-Leaf Model

For the spring-leaf model, an automobile bumper spring that is not too stiff is better than an auto-spring leaf. Spring steel is difficult to drill so it is advisable to have this work done with a cutting torch. The horse's head is held in place by a metal clip and is adjustable along the spring. A wooden seat can be used instead of a tricycle seat.

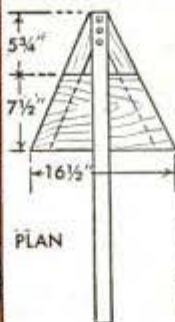
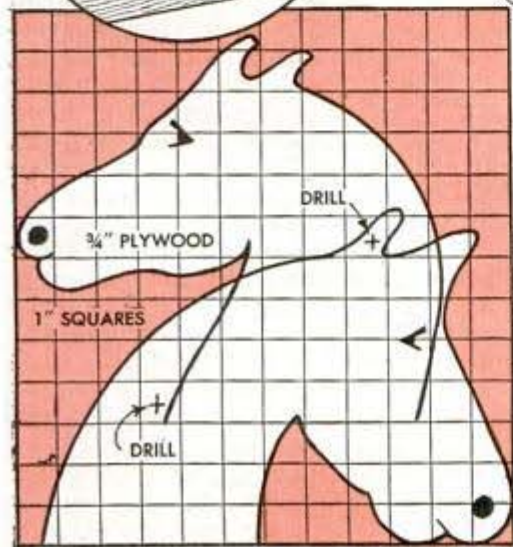

Strips of Linoleum Replace Wire For Portable Chick Pens

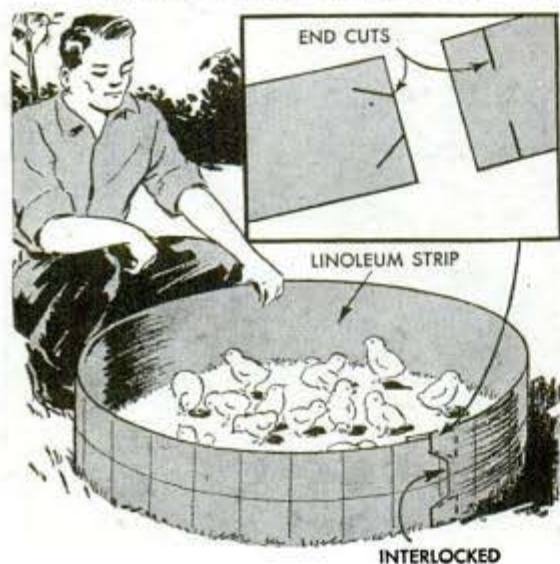

If you are unable to obtain wire to use as portable pens for your baby chicks, fair substitutes can be made from strips of linoleum. The ends of each strip are notched as shown, so that they can be locked together, making a circular pen that can be moved easily. When not in use, the linoleum can be opened flat for storage.

"Breaking In" New Pen Point



Oil or other rust inhibitor used on new pen points can be removed so that ink will flow readily by holding the pen in the flame of a match, taking care not to heat the metal enough to remove

the temper. In most cases, it is impossible to remove the inhibitor by wiping with a cloth, as some of the liquid will remain between the pen nibs.

Disturbing of New Grafts by Birds Prevented With Long Perches

After grafting, I have often lost valuable cions because birds would alight on them and displace them. Noticing that the birds always alighted on the highest cion, I prevented the



trouble by providing perches which extended a few inches above the cions. The perches are merely small sticks taped or tied to the parent branch. One perch will protect two or more cions if the latter are on the same branch. When the grafts become strong enough to support a bird, the perches should be removed.

—Chas. S. Marshall, Baptistown, N. J.

Pointers on Filing Circular Saw

When sharpening saw blades of a bench-type circular saw used in home workshops, the height of the raker teeth in relation to the pointed teeth often is overlooked. The ends of the raker teeth should be about $\frac{1}{64}$ in. lower than the other teeth. In jointing and filing a saw blade the diameter is always being diminished so that a set gauge would not always be a correct guide. A simple method of checking the teeth is to draw on

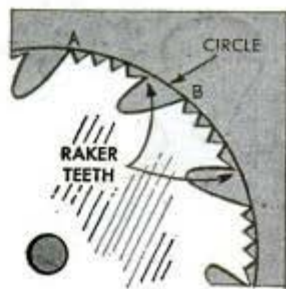

on a board a circle of the same diameter as the saw blade. Then, after filing, lay the blade on this circle having two teeth as at A and B just touching the circle. The raker teeth should miss the circle about $\frac{1}{64}$ in. If they do not, pick up the blade and give the raker teeth a stroke with the file and repeat until correct.—A. J. Harsted, Helena, Mont.

Stencil "Taped" in Place

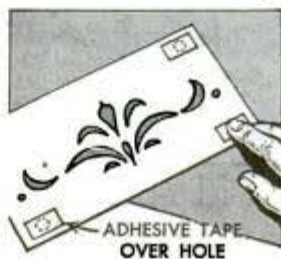

Inexperienced users of decorative stencils will find that this idea enables them to work faster and do a better job, because tape helps hold the stencil in place. Just cut a

$\frac{3}{4}$ -in. hole at each corner of the stencil and over these place pieces of adhesive or masking tape, preferably the latter. In use, place the stencil in the desired position and with the finger tip, press the tape through the opening in contact with the surface to be stenciled. In this way, the tape helps prevent the stencil from slipping while applying the color.

☐ A small, inexpensive mirror hung on the wall opposite the medicine cabinet will enable you to see the back of your head. Moving the door of the cabinet in or out will bring the image into the right place.

Crossbow Shoots Arrows or Launches Planes

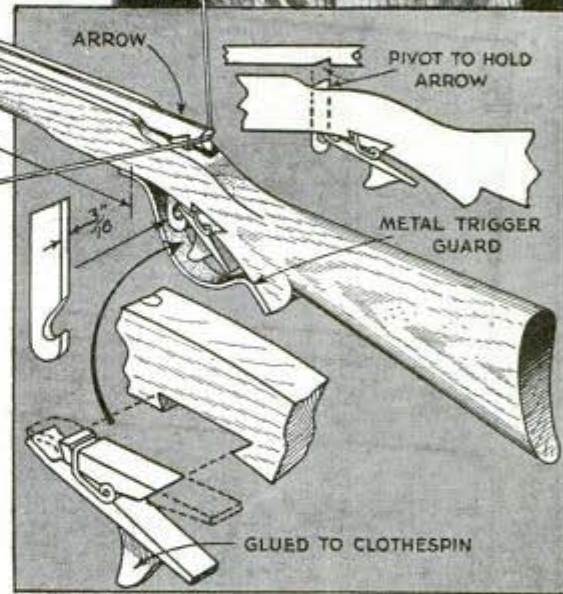
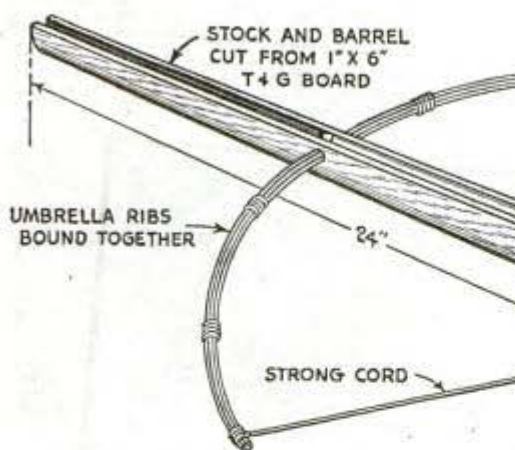
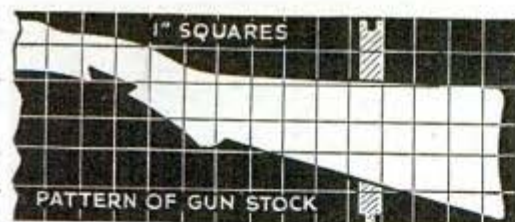

Ideal for shooting arrows or launching model airplanes, this crossbow has an easy-to-make trigger assembly and utilizes three or four umbrella ribs lashed together as a bow. The barrel and stock are shaped from a piece of tongue-and-grooved board, and the trigger is assembled from a thin wooden piece and a spring-type clothespin. Sand the groove in the barrel smooth and wax it and the hardwood arrows so they will slide easily. When using the crossbow to launch planes, the fuselages should be of a shape to slide freely in the groove, and the tail ends notched the same as the arrows

Smoker's Accessories Kept Dry in Jar Under Deck of Boat

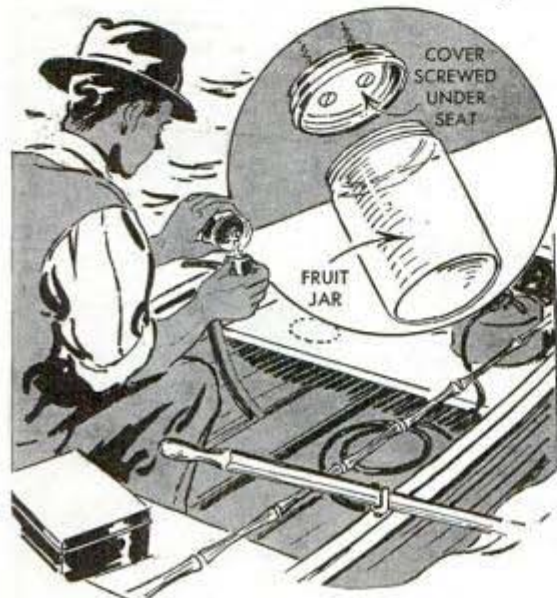

On fishing trips, a good way to carry your pipe, tobacco, cigarettes and matches is to put them in an ordinary fruit jar which is suspended under the deck or seat of the boat. To do this the lid of the jar is nailed or screwed to the underside of a seat so that the jar can be removed by unscrewing it from the lid. Using a rubber jar ring prevents the tobacco from drying out.

Rosin Keeps Shaver Screw Tight

I had a great deal of difficulty with the thumb screw that holds the head of my electric shaver in position, as it always became loose due to the vibration of the motor, no matter how tightly it was screwed. So, I took the screw out, sprinkled it with powdered rosin and put it back, which cured the trouble completely.

—Fred Cornelius, El Paso, Tex.

KNOW WOOD for BETTER



1—This arch will last. It is:
 (a) Hard Maple (c) Redwood
 (b) White Pine (d) Red Gum



2—The end grain shows this wood has been:
 (a) Slash-sawed (c) Flat-cut
 (b) Quarter-sawed (d) Plain-sawed



3—Steam bending is easy with:
 (a) Mahogany (c) Birch
 (b) White Pine (d) White Oak



4—Careful! This wood splits:
 (a) Beech (c) Sycamore
 (b) Ash (d) Poplar



5—Excellent for white inlays:
 (a) White Pine (c) Holly
 (b) Poplar (d) Prima Vera



6—This mallet head is one of the hardest woods. It is:
 (a) Harewood (c) Cocobala
 (b) Chestnut (d) Amaranth



7—This shutter will be very durable against all kinds of weather:
 (a) Hickory (c) Cypress
 (b) Spruce (d) Basswood

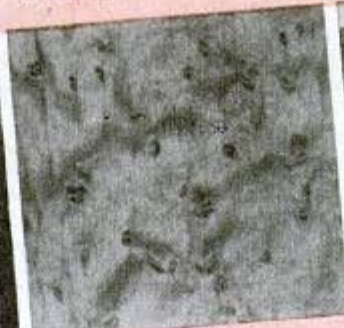

8—It's easy to see this is:
 (a) Bird's-eye Maple (c) Flake Figure
 (b) Sycamore Burl (d) Feather Crotch



9—Excellent for boat planking:
 (a) Mahogany (c) Fir
 (b) Ash (d) Red Oak

ANSWERS:
 1—(c)
 2—(d)
 3—(a)
 4—(b)
 5—(c)
 6—(a)
 7—(c)
 8—(a)
 9—(a)
 10—(a)
 11—(c)

Do You Know Your WOODS?
 TRY THIS SIMPLE CRAFT QUIZ



10—Best wood for paint:
 (a) Orientalwood (c) Maple
 (b) White Pine (d) Lacewood



11—This is most likely to happen when wood is:
 (a) Green (c) Heartwood
 (b) Flat-cut (d) Edge-grain

CRAFTING

KNOWING wood not only adds to the enjoyment of crafting but also helps in making any project a success. Naturally, the crafter is chiefly interested in how the wood will look when finished, but other important features should not be neglected.

Stability: "Will it stay put?" is an important consideration in all forms of woodcrafting. All woods shrink in seasoning, which causes distortion or warp, the four principal types being shown in Fig. 4. Some woods warp more than others, as indicated in Table No. 1, and can be made more stable by proper use. The common method of testing a board for warp is shown in Fig. 1. Sticks placed at either end of the board reveal cup and also show any twist or wind. The top edge of one stick should be light and the other dark to provide maximum vision. Just what makes a board warp is often illustrated by means of a fan made from a strip of thin paper about 6 in. wide by 2 ft. long. Brush marks are drawn across the fan to represent boards sawed from a tree, Fig. 3. Shrinkage in wood always occurs along the annual rings, so that if the fan is cut on either side, it will immediately shrink just like a split log would do. What happens to the original straight boards is shown by the

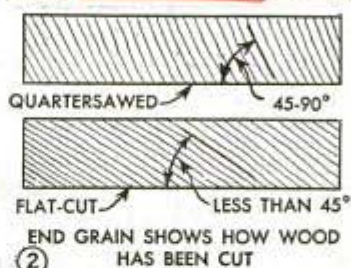

②

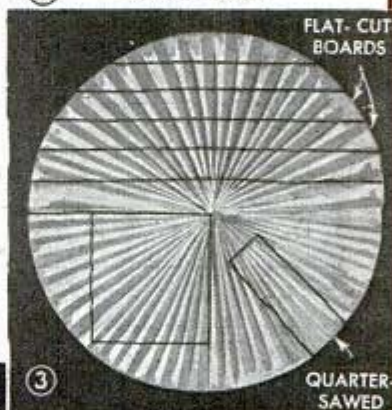

③

SIGHTING IS A COMMON METHOD OF CHECKING TO DETERMINE AMOUNT OF TWIST OR WIND IN A BOARD. DIAGRAMS BELOW SHOW THE FOUR TYPES OF WARP

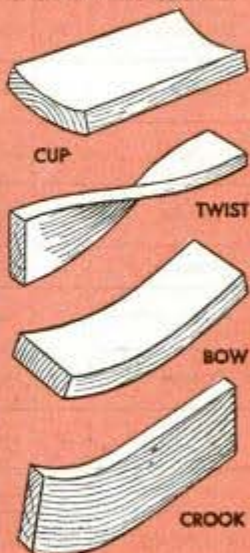

TYPES OF WARP ④

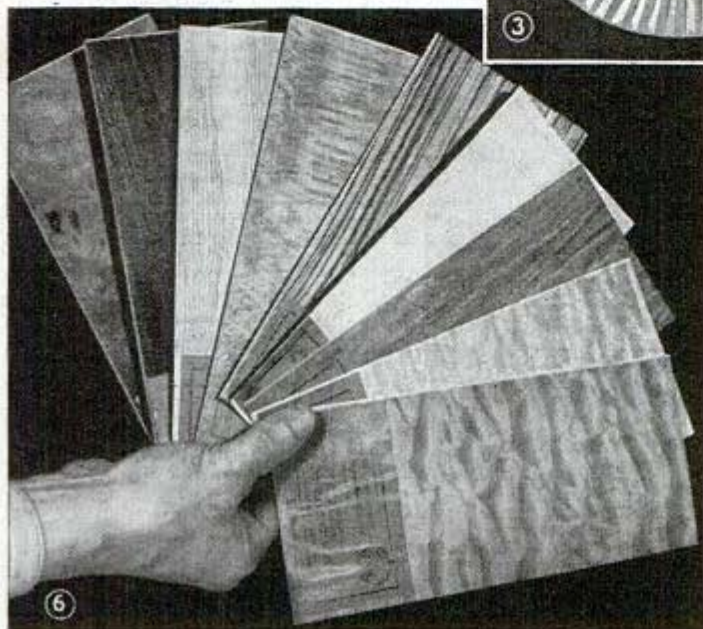

⑥

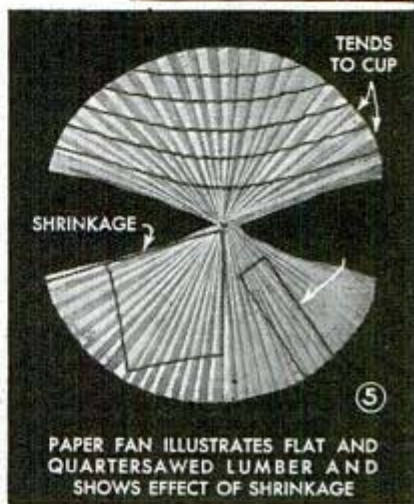

⑤

PAPER FAN ILLUSTRATES FLAT AND QUARTERSAWED LUMBER AND SHOWS EFFECT OF SHRINKAGE

Table No. 1

WORKING PROPERTIES OF COMMON WOODS

Name of Wood	General Characteristics							Machining					Remarks
	Weight Per Cubic Foot (1)	Hardness	Strength (2)	Stability (3)	Gluing	Nailing (4)	Steam Bending	Planing and Jointing (5)	Turning (6)	Sanding (7)	Shaping	Marbling (8)	
Ash	35	Med.	Med.	Best	Fair	Good	Good	Good 10-25	Fair	Best 2/0	Best	Fair	Tough—Hard to work with hand tools
Basswood	24	Soft	Weak	Good	Best	Best	Poor	Good 20-30	Poor	Poor 4/0	Poor	Fair	Excellent for toys, drafting boards, corestock
Beech	39	Hard	Med.	Poor	Poor	Poor	Good	Fair 10-20	Fair	Good 4/0	Fair	Best	Not durable outside. Hard on tools because of mineral deposits in cells
Birch	40	Hard	Strong	Good	Fair	Poor	Good	Good 15-20	Good	Fair 4/0	Best	Best	Excellent for furniture, turning, dowels, handles
Butternut	25	Soft	Weak	Best	Good	Fair	Poor	Good 10-25	Good	Fair 4/0	Fair	Fair	Furniture—Perfect for walnut imitation
Cherry	36	Med.	Med.	Good	Best	Fair	Poor	Best 10-25	Best	Best 4/0	Best	Best	Furniture, boat trim, novelties
Chestnut	27	Soft	Weak	Best	Best	Good	Fair	Good 15-20	Best	Best 3/0	Good	Good	Stains badly in contact with wet iron. Very dusty in all machining operations
Cottonwood	27	Soft	Weak	Fair	Best	Best	Poor	Poor 5-20	Poor	Poor 4/0	Poor	Fair	Excellent for boxes and other nailing jobs. Wears very well for a soft wood
Cypress	29	Soft	Med.	Good	Fair	Fair	Poor	Good 15-25	Poor	Fair 2/0	Poor	Poor	Tends to splinter. Most durable of American woods for outdoor and soil exposure
Elm (Southern)	34	Med.	Med.	Poor	Fair	Best	Good	Poor 15-20	Poor	Good 2/0	Poor	Good	Very durable under paint. A good furniture wood despite difficulties in machining
Gum (Red)	33	Med.	Med.	Poor	Best	Good	Fair	Fair 10-20	Best	Fair 4/0	Fair	Fair	One of the most used furniture woods for imitations of walnut and mahogany
Hickory	42	Hard	Strong	Good	Good	Poor	Good	Good 10-25	Good	Best 2/0	Fair	Best	Excellent for furniture and long a favorite for steam bending, tool handles, wheels
Magnolia	30	Soft	Weak	Fair	Best	Best	Best	Good 5-15	Fair	Good 4/0	Good	Poor	Excellent for steam bending, although little used as such. Often marketed as poplar
Mahogany	35	Med.	Med.	Best	Best	Good	Poor	Good 5-25	Best	Good 4/0	Best	Best	One of the best furniture woods
Mahogany (Phil.)	33	Med.	Med.	Best	Best	Good	Poor	Good 5-25	Good	Poor 3/0	Fair	Fair	Generally coarser and softer than true mahogany. Furniture, boat planking, trim
(9) Maple (Hard)	41	Hard	Strong	Good	Fair	Poor	Fair	Fair 15-20	Good	Good 4/0	Best	Best	Fine furniture, flooring, turnings, bowling pins. One of the best hardwoods
Maple (Soft)	31	Med.	Med.	Fair	Good	Fair	Fair	Poor 10-15	Fair	Good 4/0	Fair	Poor	Same uses as hard maple but an inferior wood. Difficult to machine smooth
Oak (Red)	39	Hard	Strong	Best	Good	Good	Best	Best 10-25	Good	Best 2/0	Fair	Best	Substitute for white oak in cheaper work
Oak (White)	40	Hard	Strong	Best	Good	Good	Best	Best 10-20	Good	Best 2/0	Good	Best	Interior trim, floors, furniture. One of the most used American woods
Pine (White)	25	Soft	Weak	Good	Best	Best	Poor	Good 10-25	Good	Fair 2/0	Good	Fair	Best all around soft wood. Excellent for paint
Pine (Yellow)	38	Hard	Strong	Fair	Fair	Poor	Poor	Good 10-25	Poor	Fair 2/0	Good	Good	Main uses—House construction, trim, floors
Poplar	29	Soft	Weak	Good	Best	Best	Fair	Good 5-20	Good	Poor 4/0	Poor	Fair	Excellent for carvings, toys, corestock
Redwood	29	Soft	Med.	Best	Best	Good	Poor	Good 10-25	Fair	Poor 2/0	Good	Poor	Excellent for outdoor furniture, window sills, etc.
Sycamore	35	Med.	Med.	Poor	Good	Best	Poor	Poor 5-15	Good	Poor 3/0	Poor	Best	Interior trim, furniture. Difficult to machine, but excellent appearance
Walnut	36	Med.	Strong	Best	Best	Fair	Good	Good 15-20	Best	Best 4/0	Good	Best	Has every good feature for furniture and cabinet work

NOTES

Data in this chart is largely from extensive tests made by U. S. Forest Products Laboratory, with some additions.

1. Pounds per cubic foot, dry. All woods vary in weight, even in the same tree from trunk to top. A variation of 10% over or under average should be allowed.
2. Composite strength value. Woods rated weak are strong enough for all average work.
3. Rated on unrestrained warp. Most woods are quite stable if properly seasoned and cared for.
4. Rated on ability to take nails near end without splitting.
5. All flat grain stock, shallow cut. Rating is average

from runs at 15, 20 and 25-degree cutting angles. Bottom figure is best knife angle for smooth cutting.

6. Rated on smooth cutting and ability to hold detail. Not much difference between best and good.
7. Rated on freedom from fuzz. Bottom figure is coarsest abrasive grit which can be used without scratching.
8. Rated on smoothness of cut. Work speed decreases with hardness of wood and this factor might be of more importance than smoothness in production work.
9. Sugar, white or hard maple. Should be distinguished from silver, red, big-leaf or soft maple, which is an inferior machining wood although often marketed simply as "maple."

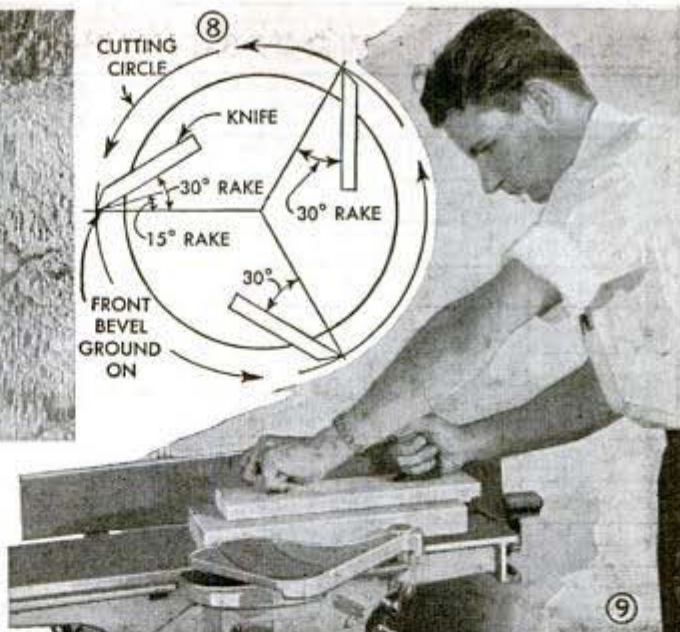
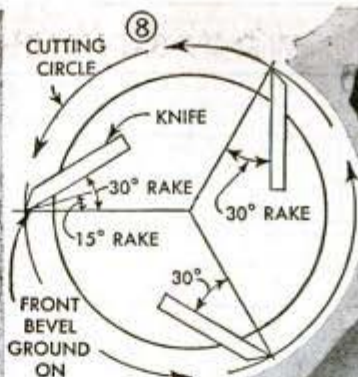
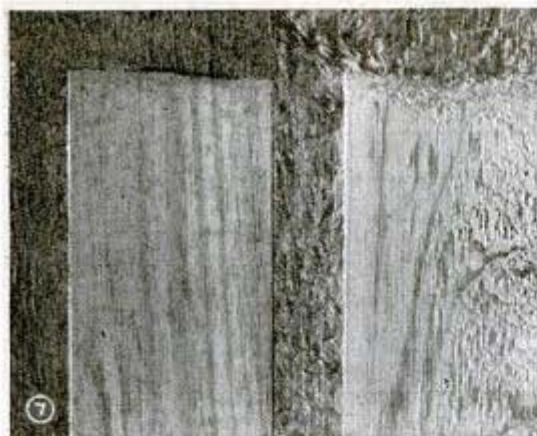

JOINTING IS THE SEVEREST TEST OF THE WOOD'S ABILITY TO MACHINE. BETTER CUTTING CAN OFTEN BE OBTAINED BY CHANGING RAKE ANGLE OF KNIVES

fan, Fig. 5. The flat-cut boards always curl away from the heart and the square timber shrinks badly on one side, but the quartersawed board is quite stable. From these observations, it is apparent that quartersawed lumber is preferable for maximum stability. Also, if the board is cupped, it is certain that the rounded side is the heart side. Fig. 2 shows how the end grain indicates the type of sawing. Quartersawed lumber also is known as radial-cut, edge-grain, rift-grain and comb-grain. Flat-cut lumber is variously named slash-grain, bastard-grain, plain-sawed and tangential cut.

The right side: When using flat-cut lumber, keep the heart side toward the outside surface of the work. Then, if the board does cup, it will show rounded on the face, which is much better than a hollow and much stronger structurally. An exception is painted wood used outdoors. Paint holds better on the bark side and there is less danger of the grain shelling out.

Moisture content: Wood for furniture will be stable if the moisture content is from 6 to 8 percent. This is obtained automatically if the wood is stored for three or four weeks in the same atmosphere at which it will be used. Lumber from commercial dry kilns has a moisture content of about 8 percent. Lumber air-dried outdoors will have a moisture content of about 20 percent, and should not be used for furniture until it has seasoned three or four weeks indoors. Sometimes it is a good idea to check the moisture content of wood before using it. Weigh a small sample exactly and then put it in the kitchen oven. Check the weight at intervals until the wood ceases to lose weight. Ascertain the weight difference and divide by the original weight to get the moisture content. For example, if the test piece weighs 10 oz. at the start and 8 oz. oven dry, the difference is 2 oz., representing moisture, or 20 per-

cent moisture content. The test can be done in a half hour by splitting the sample into thin strips to hasten drying.

Machining: Some woods machine much better than others. Note in Fig. 7 how walnut takes a smooth jointer cut, while soft maple is very rough. Suitability of various woods for machining is indicated in Table No. 1. Jointing, Fig. 9, is the most important test. Other than the wood itself, the method of machining affects the finished work. This can be observed in jointing, where much better work often can be done by changing the rake angle of the knives. Most small jointers have the knives fixed at about 30 degrees rake. This is excellent for knife efficiency, but the sharp angle tends to tear the grain of many woods. For production work in these woods it is advisable to reduce the rake angle by using shims or grinding a front bevel as shown in Fig. 8. Other useful characteristics of woods are given in the table. The "hardness" column lists woods according to whether they are physically hard or soft. Generally, the botanist's classification of hardwoods (broad-leaved trees) indicates a physically hard wood, but there are several exceptions, including such hardwoods as basswood, poplar, cottonwood and aspen, all of which are quite soft. Exceptions in reverse also will be found. Yellow pine, for example, although botanically a softwood (coniferous or needle-leaved trees), is actually harder than many hardwoods. If the wood is hard, it is always heavy without exception; if the wood is hard, it generally is strong.

Table No. 2

WOODS-FINISHING DATA

Note: NGR = Non-Grain-Raising
(Applies to stain)

	Natural Color	Usual Grain Figure	Stain		Filler		Bleach	Paint	Natural Finish	Remarks
			Type (1)	Color	Wt. (2)	Color				
Alder (Red)	Pink to Brown	Plain or Figured	Wiping or Water	Red or Brown	None		Yes	Yes	Yes	Principal hardwood of Pacific coast. Like red gum
Amaranth (Purpleheart)	Purple	Mild Stripe or Mottle	None		None or 6	Match Wood	No	No	Yes, Pref.	Usually finished natural to retain purple color
Ash (U.S.A.)	White to Brown	Plain or Fiddleback	Any	Any	15	White or Brown	Yes	Yes, Fill First	Yes	White filler used for frosted finish (3)
Basswood	Cream	Very Mild	NGR	Red or Brown	None		Not Nec.	Yes	No	Fuzzy grain. Usually muddy under oil stain
Birch	Cream	Mild	Any	Walnut or Mahogany	8	Natural or Brown	Yes	Yes, Interior	Yes	Used extensively for walnut and mahogany
Butternut	Heart: Amber Sap: Cream	Like Walnut	Water	Walnut or Oak	14	Medium Brown	Yes	No	Yes	Good for amber walnut without bleaching
Cedar (Aromatic Red)	Heart: Red Sap: Cream	Knotty	None		None		No	No	Yes, Pref.	Red wiping stain can be used to blend sap wood
Cherry	Red to Brown	Good	Water	Red or Brown	6-8	Red to Black	No	No	Yes	Takes excellent finish. Good for brown mahogany
Chestnut	Gray-Brown	Heavy Grain	Oil or Wiping	Red or Brown	15	Red or Brown	No	Yes	Yes	Large pores. Good for novelty finishes (3)
Cypress	Heart: Brown Sap: Cream	Plain or Figured	Water, Oil or Wiping	Red or Brown	None		No	Yes (6)	Yes	Good for sand blast (4) if water stained, see (5)
Ebony	Dark Brown to Black	Plain or Stripe	NGR	Dark Red or Brown	None or 3	Brown or Black	No	No	Yes	Oily. Gaboon ebony is blackest
Elm (Southern)	Brown to Cream	Heavy Grain	Water	Red or Brown	12	Dark Brown	No	Yes	Yes	Cross-grained. Sometimes hard to get even color
Fir (Douglas)	Cream to Red	Plain or Wild	Wiping or Oil	Brown	None		No	Yes (7)	No	Good for sand blast (4) Not pleasing stained
Gum (Red)	Heart: Br. Red Sap: Cream	Plain or Figured	Any	Red or Brown	None or 3	Match Wood	Yes	Yes	Yes	Most used wood for walnut and mahogany imitations
Hickory	White to Cream	Usually Straight	Water	Red or Brown	15	Brown	Yes	No	Yes	Good walnut or mahogany—blond finishes
Holly	Silver White	Mild	Water	Amber	None		Not Nec.	Yes	Yes	One of the whitest woods. Usually finished natural
Magnolia or Poplar	White to Yellow	Mild	Oil or Water	Red or Brown	None		No	Yes	No	Usually pointed. Makes fair satinwood imitation
Lacewood (Silky Oak)	Medium Brown	Flake	Water	Oak or Lt. Walnut	12	Dark Brown	Fairly Well	No	Yes	Excellent cabinet wood. Very decorative
Mahogany	Brown to Red-Brown	Stripe	Water	Red or Brown	12	Red to Black	Yes	No	Yes	Best known cabinet wood. Excellent for finish
Mahogany (Philippine)	Brown to Red-Brown	Stripe	Water or Wiping	Red or Brown	18	Red to Black	Yes	No	Yes	NGR stain preferable to minimize grain-raising
Maple	Cream	Varied	Water and Wiping	Maple	None		Yes	No	Yes	Use NGR stain and tone with wiping stain after sealer
Oak (English Brown)	Deep Brown	Plain, Flake or Swirl	NGR	Brown	15	Brown to Black	Yes	No	Yes	One of the best cabinet woods. Also "Pollard Oak"
Oak (Red)	Red-Brown	Plain or Flake	NGR	Green Toner (8)	15	Brown	Yes	Yes	No	Bad grain-raising with water stain, hence NGR stain preferable. Good for novelty finishes (3)
Oak (White)	White to Light Brown	Plain or Flake	NGR	Brown	15	Brown	Yes	Yes	Yes	
Orientalwood	Light Brown	Stripe Crossfire	Water	Amber or Brown	12	Brown	No	No	Yes	Good walnut effects
Pine (White)	White to Cream	Mild	Water (5) or Oil	Brown Only	None		No	Yes	No	Best for painting
Prima Vera	Yellow-White	Stripe Crossfire	Water	Amber	12	Natural or Dark	Yes	No	Yes	Also "White Mahogany". Excellent "blond" color
Redwood	Red	Mild St. Grain	Red only for toning		None		No	Yes	Yes	Excellent exterior wood. Best painted
Rosewood (Brazil)	Red-Brown	Varied	NGR	Red	15	Dark Red or Black	No	No	Yes	Oily. Wash off with lacquer thinner before staining or finishing
Rosewood (East Indies)	Red-Purple	Stripe	NGR	Dark Red	12	Dark Red	No	No	Yes	
Sapeli	Medium Brown	Stripe	Water	Red or Brown	10	Dark Brown	No	No	Yes	Very similar to striped mahogany
Sycamore	White to Pink	Flake	Water	Amber or Brown	None		Seldom	Yes	Yes	Good for natural finish
Walnut	Heart: Brown Sap: Cream	Varied	Water	Walnut	14	Brown to Black	Yes	No	Yes	Obtainable in all figures
Zebrawood	Tan with Brown Stripe	Heavy Stripe	Water	Light Oak	12	Natural	No	No	Yes	Very pronounced grain. Good for modern effects

NOTES

- Where water stain is indicated, NGR (non-grain-raising) stain can also be used. "Oil" means penetrating oil stain; "wiping" means wiping oil stain.
- Pounds of filler paste per gallon of thinner.
- All coarse-grain woods are good for novelty finishes, using contrasting filler, usually white.
- Woods with alternate hard and soft streaks can be sand-blasted or burned with torch to cut out soft wood.
- Water stains take better on resinous woods if wood is first sponged with 4 oz. sol soda and 1 oz. washing soda to gallon of water.
- Add 1 pt. benzol per gal. of paint for better penetration (primer only).
- Special sealers available to kill grain.
- For brown tones, first spray weak green stain to kill red color of wood.

Finishing: Finishing often is the prime characteristic in selecting a cabinet wood. When you have a wood that machines and finishes nicely, then you have a top-notch cabinet wood. Information given in Table No. 2 will help in selecting a wood for finish, and is a fair guide as to how the wood should be finished. Finishing is closely related to the natural beauty of the wood, necessitating some knowledge of grain and "figures" for suitable selections. Figures in wood constitute a whole subject in themselves, and the few samples shown in Figs. 10 to 16 can be taken only as typical examples. Perhaps the best way to become acquainted with figures and also the many different kinds of woods is to purchase a set of wood samples, Fig. 6. A set of fifty samples is an inexpensive and worthwhile investment, and it is surprising how quickly identification and general knowledge of various woods can be learned by "leafing" through such a set. The samples are small wood blocks packaged in a neat box and should be kept in a clean, dry place.

Grading of wood: A knowledge of wood grading is useful. For example, if you want a poplar board for painting, you would order "stained saps," (fifth-grade lumber), and the finished job would be practically as good as if made from "firsts and seconds." Essential grading data is given in Table No. 3. This table is not complete nor absolutely accurate, but it can be taken as a general guide. There are actually ten grades of lumber. Of these, eighth and ninth grade mahogany is the only one of interest to the crafter. This grade comprises wood of firsts and seconds quality but in short lengths. It should be noted in the table that numbered gradings are not comparable between different woods. For example, fifth grade poplar is a much better wood for a paint job than fifth grade chestnut. Grading rules for softwoods are much different than for hardwoods, and the differences should be carefully noted from the table.

Table No. 3 GRADING OF WOODS (Condensed)

Hardwoods	General Grading—Indicates let-down in quality					
	1st Grade	2nd Grade	3rd Grade	4th Grade	5th Grade	6th Grade
Ash, Beech, Birch, Hard Maple, Red Alder	Firsts and Seconds	Selects	No. 1 Common	No. 2 Common	Sound Wormy	
Cherry	Firsts and Seconds	Selects	No. 1 Common	No. 2 Common	No. 3A Common	
Chestnut	Firsts and Seconds	Selects	No. 1 Common	Sound Wormy	No. 2 Common	
Cottonwood, Red Gum	Firsts and Seconds	Selects	No. 1 Common	No. 2 Common	No. 3A Common	
Elm, Hickory	Firsts and Seconds	No. 1 Common	No. 2 Common	No. 3A Common	No. 3B Common	
Mahogany	Firsts and Seconds	Selects	No. 1 Common	No. 2 Common	No. 3 Common	
Red Oak, White Oak, Locust, Sycamore	Firsts and Seconds	Selects	No. 1 Common	No. 2 Common	Sound Wormy	
Poplar	Firsts and Seconds	Saps	Selects	Stained Saps	No. 1 Common	
Walnut, Butternut	Firsts and Seconds	Selects	No. 1 Common	No. 2 Common	No. 3 Common	
Firsts—About 91% clear both sides.		Selects—90% clear one side.				
Seconds—About 83% clear both sides.		No. 1 Common—About 75% clear face.				
Firsts and Seconds—Best commercial grade. Not less than 20% firsts.		No. 2 Common—About 66% clear face.				
		Sound Wormy—No. 1 common but with wormholes.				
Softwoods	1st Grade	2nd Grade	3rd Grade	4th Grade	5th Grade	6th Grade
Boards	A Select	B Select	C Select	D Select	No. 1 Common	No. 2 Common
Dimension Stock	No. 1 Common	No. 2 Common	No. 3 Common			
<p>A Select—Clear and suitable for natural finish. B Select—Allows a few small defects but suitable for natural finish. C Select—Allows a few defects which can be covered by paint. D Select—Allows any number of defects, which can be concealed by paint.</p> <p>No. 1 Common—Sound and tight-knotted wood</p>						



FIGURES IN WOOD ARE VARIED WITH ABOUT 25 RECOGNIZED STYLES, A FEW OF WHICH ARE SHOWN ABOVE

"Hedge" of Morning-Glory Vines Is Neat and Attractive



An inexpensive but very attractive "hedge" can be grown by training morning-glory vines on stakes and cord. In the spring, just drive forked stakes into the ground at 3-ft. intervals along the desired hedge line. Then stretch strong cord from one stake to another and sow morning-glory seeds directly below the cord. As these vines climb the stakes and twine around the cord, they form a graceful garland between each stake.

—Mrs. George Rundle, Batavia, Ill.

Spilled Mercury Easily Salvaged With Flask and Tube Siphon

Spilled mercury is gathered up efficiently with this siphon, even when small drops are scattered over a large area. A tight-fitting stopper, with glass tubes inserted as

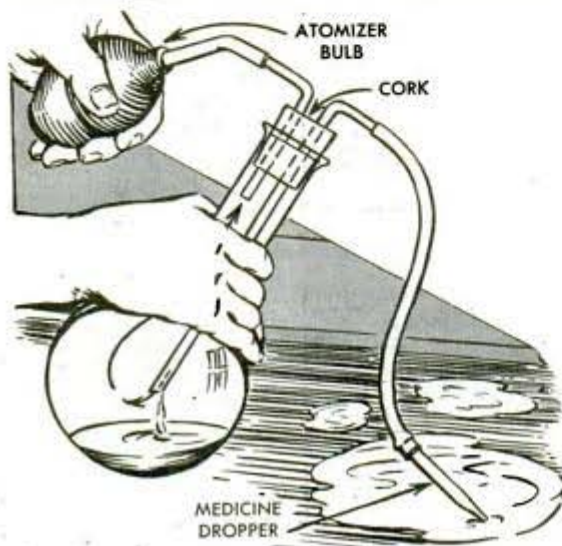

shown, is placed in a flask. A rubber tube to which a medicine dropper has been attached is slipped over the end of the longer glass tube, and another rubber tube carrying an atomizer bulb is attached to the second glass tube. In use, the bulb is squeezed and the medicine dropper placed in the spilled mercury. When the bulb is released, the mercury will be drawn into the flask. Dirt which may also be drawn in can be skimmed off with filter paper.

Cotter Key in Vise Guides Saw When Cutting Sheet Metal

To help stiffen thin sheet metal held in a vise and guide the saw for a straight cut, one mechanic employs a cotter key as shown. The key is clamped behind the metal where the legs serve as a saw guide.

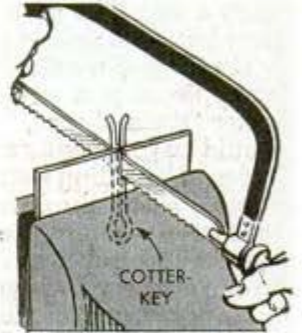

Installing Shelves Between Studs

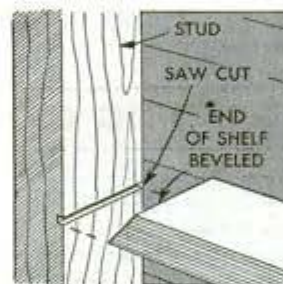

When it is desired to fit narrow shelves between building studs you can eliminate the usual cleating-and-nailing procedure by making a $\frac{1}{16}$ -in. saw cut in each stud at the point where you

want the shelf. Bevel each end of the shelf, making it about $\frac{1}{8}$ in. longer overall than the distance between the studs. Then, simply drive the shelf in place.

Emergency Bottom for Bucket

There's no use in discarding a coal bucket or other container used for carrying nonliquid material just because the bottom has rusted out. All you have to do is cut a wood disk to reinforce the present bottom. Driving three or four short nails through the bottom into the wood will hold the latter in place. If the container is a coal bucket, a disk of tempered hard-pressed board, which does not ignite easily, used instead of the wood will enable you to carry hot ashes.



Favors and Centerpieces for Your Easter Party

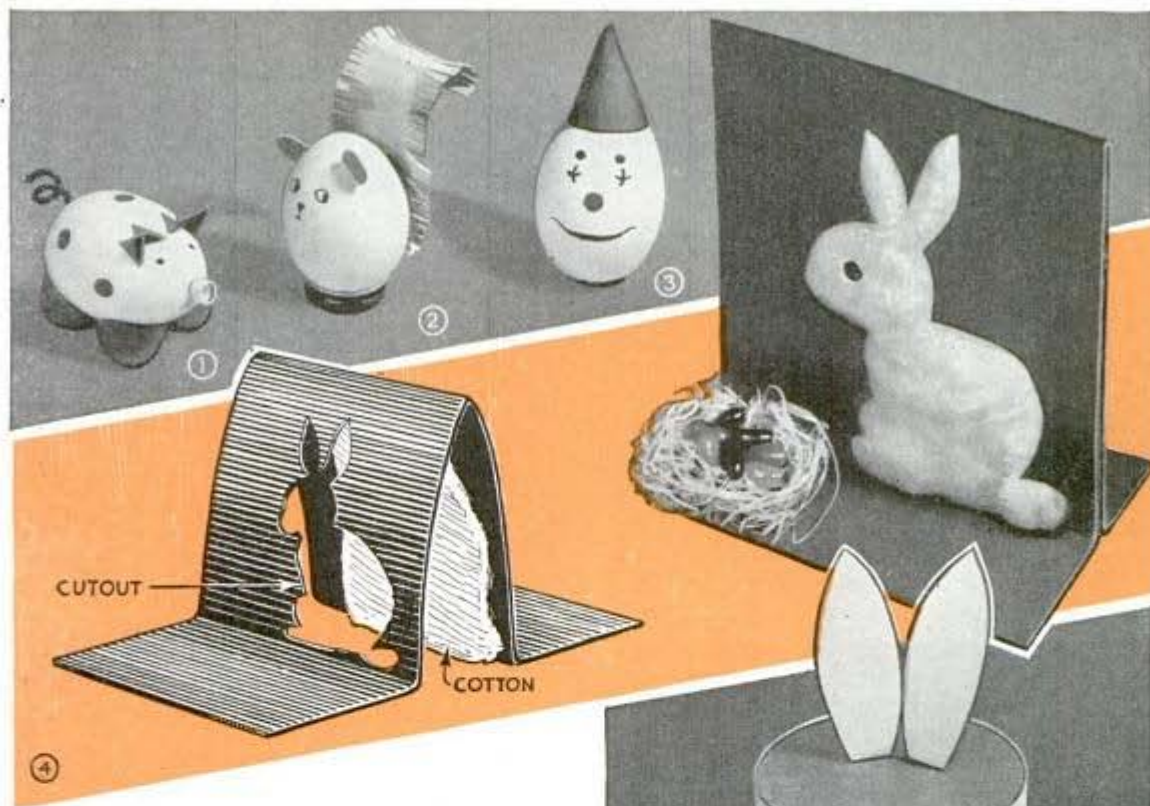

It's easy to make these appropriate favors and table decorations for Easter. The humorous trio pictured in Figs. 1, 2 and 3 are made from empty eggshells, or hard-boiled eggs may be used. Porky the pig in Fig. 1 has paper ears, a macaroni-ring snout, date legs, ink dots for his spots and eyes, and a yarn tail. Perched atop an inverted bottle cap, the alert little squirrel in Fig. 2 has a brown-shelled egg or one dyed brown. His tail consists of a 4-in. strip of brown paper, fringed and curled. Ears are cut from the same material, and the features are inked on. The grinning clown utilizes an empty egg shell and owes his upright position to a small stone which was dropped gently through the hole made for removing the egg contents. The peaked paper cap gives him a saucy air and effectively hides the hole. He has a dot nose and India-ink eyes and mouth. Appearing real enough to cuddle, the bunny in Fig. 4 is made from paper and cotton. Use soft pastel mat stock for the folder, cutting a strip 5 by 10 in. Fold the strip at the center and then fold back the ends to form a support. Make a bunny cutout in the front of the folder and glue a pad of cotton to the inside back of it. Then glue the edges together. The cotton will fluff out through the cutout to make a realistic looking bunny. Use pink felt, flannel or paper for the eye and shape a nest from a few wisps of colored excelsior.

The dignified little bunny centerpiece in Fig. 5 is made from a salt carton covered with white felt, flannel or paper. The ears and feet are cut from the same material. Eyes and nose should be bits of pink material. Give him a dainty pink or blue necktie of ribbon or yarn. If desired, the bottom may be removed from the carton and tiny favors or gifts placed inside.

☛ A substitute scouring pad can be made from a 3 or 4-ft. length of furnace chain. Thread a fine wire or strong cord through the chain links at 5-in. intervals, bunch the resulting chain loops to form a pad and tie the ends of the wire or cord tightly.

Vertical Dowel Rods in Table Top Hold Rolled Blueprints



Lacking rubber bands to hold rolled blueprints conveniently at hand on his work table, one draftsman slips them over dowels projecting from the table near the rear edge. The dowels are spaced only $\frac{1}{2}$ in. from the wall so that prints slipped over them cannot unroll.

Try Square Converted for Use As a Marking Gage

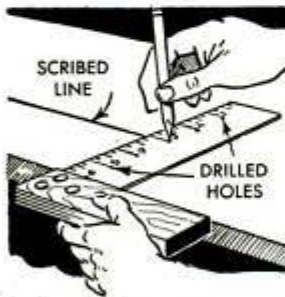

Holes drilled at each of the inch marks in the metal rule of a square make it possible to use the square to mark off long lengths of lumber more accurately. Inserting the pencil through the

hole at the proper mark as shown enables you to use the square as a marking gage.
—Pvt. Cliff Tambyll, Champaign, Ill.

Speedy Car-Heater Hook-Up

A fast way of disconnecting a car hot-water heater without the aid of shut-off valves or plugs is merely to double the hose connections back on themselves.

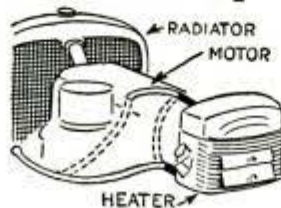

That is, one engine-to-heater hose is disconnected at the engine and doubled right back onto the heater as indicated by the dotted lines. Then the other hose is disconnected from the heater and placed on the engine con-

nection from which the first hose was removed. The hose is kept from drying out or becoming lost, and is instantly available when reconnecting the heater.

Lawnmower Held Against Wall By Strapping It to Stud

To keep small children from playing with his lawnmower, one home owner strapped it to his garage wall with a discarded trouser belt as shown. The buckle portion of the belt was tacked to the handle of the mower and the strap end

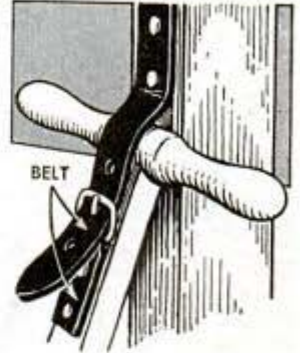

to the stud of the wall. By holding the handle of the mower against the stud and inserting the strap through the buckle, the mower may be fastened securely.

Long Ice Cubes Are Convenient



Long, triangular pieces of ice that will slip easily into the mouth of a vacuum bottle can be made by providing new dividers for your refrigerator ice trays. Merely fold a long strip of heavy waxed paper into pleats as shown and slip

them into the tray after it has been filled with water. When frozen, the sections can be parted with the fingers.

Removable Monogram for Towel

In a large family where it is impossible to give each member towels of different colors for identification, a handy way of identifying each towel is to sew one half of a snap fastener on



one corner of the towel, the other half being sewed to a bit of cloth having the initials of the owner embroidered on it. In this way, the initials can be removed for laundering and then placed on any towel.

—M. W. Kendziorek, Colon, Panama.

Take Care of Your DRAFTING TOOLS



By Harry Radzinsky

IF A well-made set of drafting instruments is used and cared for correctly, they will last practically a lifetime. Rust is the enemy of all fine tools. Therefore, drafting instruments should be stored in their case and kept in a dry place when not in use. Throwing them together as in Fig. 1, in a drawer or on a table is bad practice, as they may become bent and the points of certain ones damaged. When placing tools in the case, see that they are free from ink, open the nibs of ruling pens, Fig. 2, and spread the legs of the bow compasses to fit snugly in the recesses provided for them. Opening the pens and compasses in this way lessens their spring tension. If you spread the tools on top of your desk or work table, it is good practice to provide a thick felt pad on which to place them.

When opening or closing the legs of a bow compass for rough adjustment, press the legs toward one another as in Fig. 3 so that the adjusting nut can be spun freely with a finger. This permits quick, rough adjustment and saves wear on the screw threads. Always keep compass needle points correctly adjusted. If the point is too short it may slip on the paper and let the compass skid. On the other hand, a long projecting point will have to be driven deeply into





6 KEEP RULING PEN SHARP

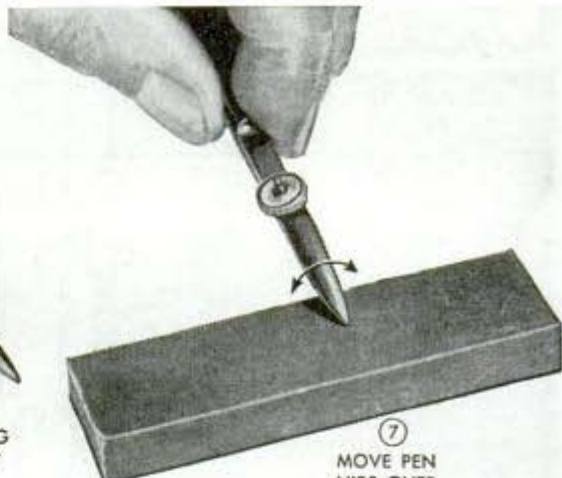

7 MOVE PEN NIBS OVER STONE WITH ROLLING MOTION

the paper to permit the pen or pencil point to reach the paper. A needle point that projects about $\frac{1}{64}$ in. more than the pen or pencil point will be found most satisfactory. Should you damage a needle point that is not of the separable or replaceable type, you can repoint it with a small honing stone. Both legs of dividers should be re-pointed in this manner, Fig. 4, so that they will be exactly the same length.

It is best not to fill a ruling pen to a depth of more than $\frac{1}{4}$ in. An overfilled pen is likely not only to cause blots, but the ink will thicken or dry in the pen before it is used up. Ink should not be permitted to harden in a pen, as it will reduce the width of the lines made with the pen. A soft lintless cloth makes the best pen wiper. However, if ink has dried and hardened between the nibs of a ruling pen or compass, it should be scraped out with a wafer-type, safety-razor blade, Fig. 5, first opening the nibs as widely as possible. Light pressure

is used on the blade in order not to dull the edges of the nibs.

When used with ink of the proper consistency, a ruling pen should be capable of producing a fine hairline. After the pen has had some use, it may require sharpening. This is easy to do on a fine-grained oilstone as in Figs. 6 and 7. In doing this, the first step is to close the nibs until they touch each other; then run their ends over the stone carefully to bring them to the same length and give them their proper oval shape. When this has been done, the nibs are spread, after which one of them is held with the convex side against the stone and is moved over the stone with a rocking motion to follow the curvature of the nib and bring it to a sharp edge. Then the pen is turned over and the second nib treated in the same way. Do this carefully and check the work frequently as grinding progresses.

Clothespin Rack Holds Drinking Cups Near Water Cooler

In one small factory where the workmen disliked the small envelope type of drinking cup, which was used once and then discarded, it was decided to put in a dispenser of better grade cups that could be used several times before discarding them. To assure that each workman would use only his own cup, spring-type clothespins were screwed to a board, which was then nailed to the wall near the water cooler to hold the cups, the workmen's names being printed under the clothespins as indicated. The clothespins hold the cups in an inverted position which helps keep out dust.



When painting or varnishing the inside of a boat, rub down the finish with sandpaper instead of steel wool, as small pieces of the latter may remain in the boat and later rust and cause unsightly spots.

Cosmetic Tray in Vanity Raised When Needed

This dressing table features a central section that can be elevated at the touch of the foot, raising a shelf from below the table level which holds cosmetics, bobby pins and other items. The body of the table itself can be made by covering a packing box of suitable size or by building a frame of light material covered with plywood or hard-pressed board. Corner posts of the elevator are made of $\frac{3}{4}$ -in. quarter round. The whole elevator assembly slides up and down a "track" formed by $\frac{1}{4}$ -in. stock. Pressing the foot on the lever brings the second shelf into position and a barrel bolt underneath keeps it in place.

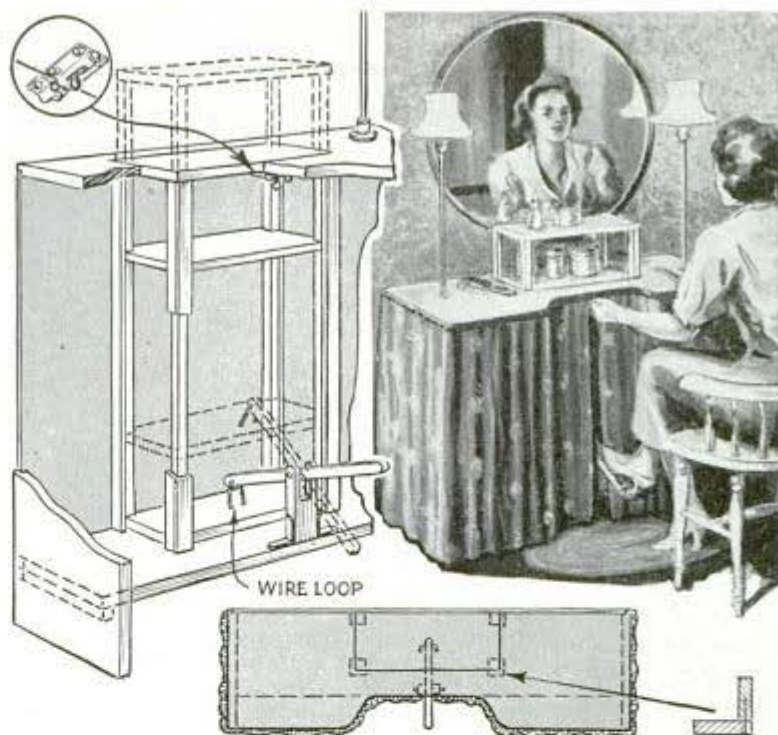

Instantaneous Sheet-Rope Release for Small Sailboats

Being able to release the main sheet instantly, when handling a small sailboat in a stiff breeze, may mean the difference between a capsize and a safe maneuver. This simple holder will grip the sheet rope tightly under strain, but will let go immediately when the strain is removed. The holder consists of two hardwood blocks shaped as shown and fastened in a convenient place

inside the gunwale. As indicated, one block is screwed in a fixed position and the other is pivoted directly above it in such a position that when the sheet rope is placed between the blocks and pulled sternward the top block will be pulled in toward the bow and pinch the rope. Instant release is obtained by jerking the slack sheet forward so that the pinch is broken. Then the rope will be shaken out from between the blocks and run free.

—L. B. Robbins Harwich, Mass.

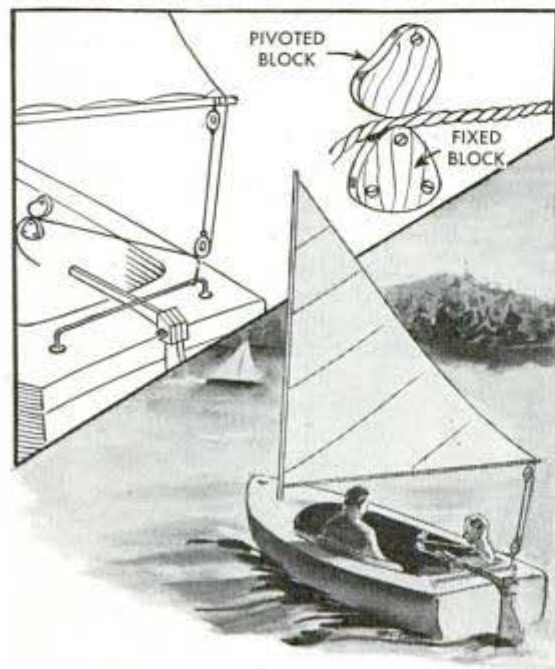

Silencing Venetian Blinds on Door

Do venetian blinds on one of your doors make an annoying noise or strike the door and mar its finish every time it is closed? You can prevent this easily by putting strips of cloth or thin felt on the door where the blinds strike it. A couple of thumbtacks for each strip will hold it in place. Being behind the blinds, the cloth will be unnoticeable, especially if its color matches that of the door.

—George Mullin, Tulsa, Okla.



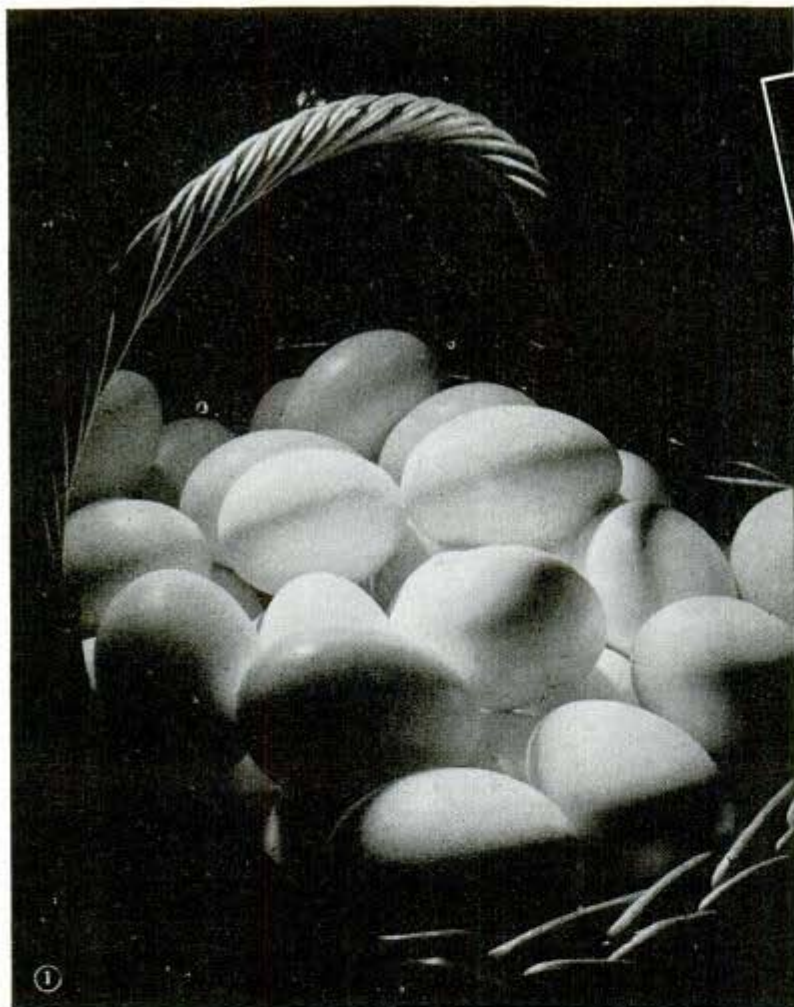

Right

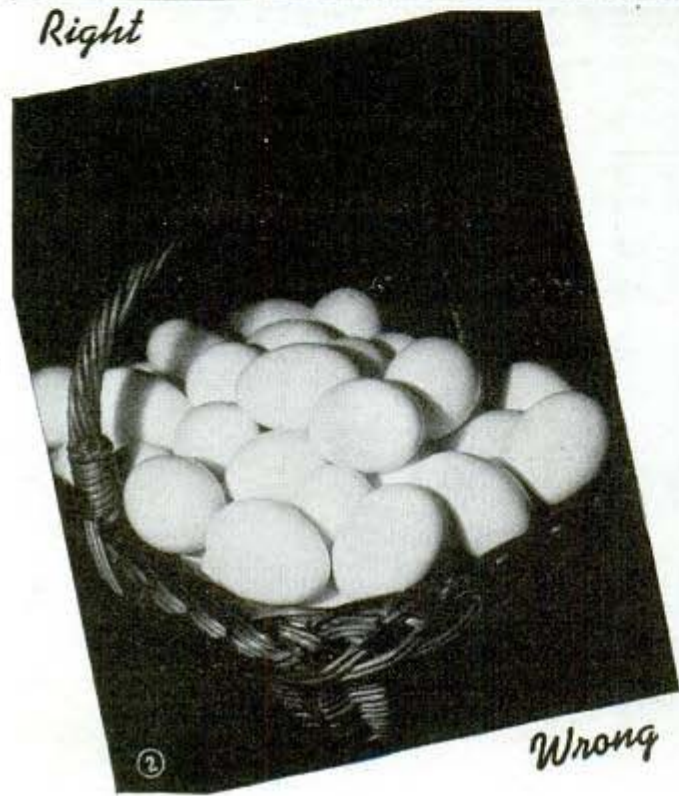

Wrong



Right

THREE - *Effects in*

DIFFERING from the true three-dimension effects obtained with stereoscopic cameras and viewers, you can produce illusions of three dimensions with a single-lens camera by means of simple tricks such as the use of lights and shadows to get depth impressions, and by "framing" photos. The basic difference between stereoscopic pictures and simulated three-dimension effects lies in the fact that stereoscopic cameras have two lenses about $2\frac{1}{4}$ in. apart (same as average distance between a pair of human eyes), which makes it possible to take two pictures of the subject from slightly different angles. When the resulting pictures are mounted side by side and viewed through two similarly spaced lenses, stereoscopic effects often are phenomenal. However, these effects cannot be observed simultaneously by groups and have not been found practical for regular magazine reproduction, with the result that stereoscopes have been abandoned more or less in favor of just ordinary photos taken with single-lens cameras. As these



DIMENSION

Your Photos

by Fred G. Korth

cannot look slightly around an object like a pair of human eyes or like stereoscopic cameras, photos taken will appear as if the subject were viewed with one eye shut. Therefore, to obtain three-dimension effects you must resort to good observation and tricks to bring out depth in your photos, thus creating the illusion of a third dimension.

Most important is correct lighting. Assuming that you know what subject you are to photograph, how long to expose a certain kind of film and how to process the film and paper in the darkroom, it is lighting that makes the pictures good or bad, and gives them either the depth you want or results in the flatness you try to avoid. Photos having depth must "lure" the observer to look into instead of at them. The easiest way to produce such photos is to place the light at the far end. Then the eyes of an observer wander through the dark space in the foreground into the distance where the center of interest has been highlighted. If some dark object is more

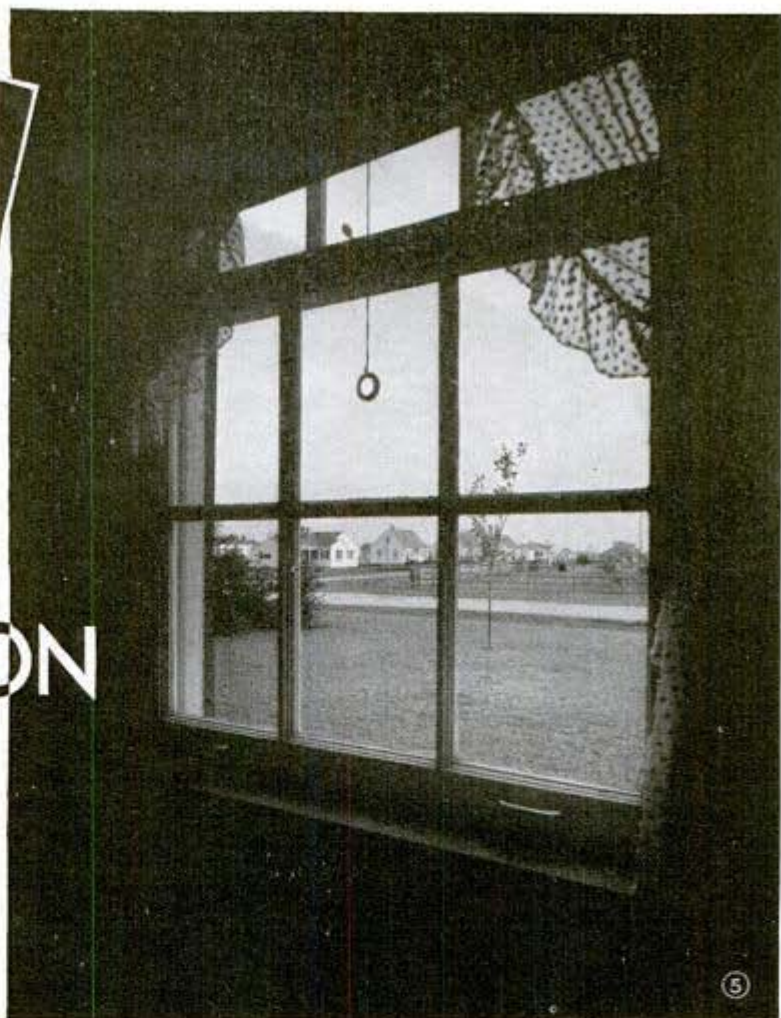

"Framing"





or less silhouetted in front, the observer tends to reach around and beyond it into the brighter distance. The result is definitely an illusion of depth, which should be credited to good judgment in lighting.

As examples of what can be done with good and bad lighting compare Figs. 1 and 2. Both of these are photos of eggs in a basket. The charm of Fig. 1 lies in the fact that this very ordinary subject matter has been lighted in an unusual manner. The eggs in the foreground and also the front of the basket itself are silhouetted. Lighting accentuates the middle distance. Eyes of the observer are led to this bright spot. This picture has many tone values from black to white and the large black area helps to emphasize the limited light area, which is the center of interest. In Fig. 2 all of this charm is lost. The light has been directed at the front of the basket from a position next to the camera. The eggs have lost most of their roundness and many of their outlines are not distinguishable. The lack of middle tones gives this photo all the characteristics of so-called "soot-and-whitewash" photos.

Figs. 3 and 4 represent two shots of the same little kitchen. Even though the photographer has avoided the absolutely bad placement of the light alongside the camera, there is a distinct difference between the two positions of the light. In Fig. 3 it is located at the far end of the picture, where it belongs for depth effect, while in Fig. 4

it is located in the foreground of the kitchen. Notice that the distance appears shorter in Fig. 4 than it does in Fig. 3.

Framing a picture within a picture is illustrated in Figs. 5 and 6. Imagine a number of little houses strung out into the distance and nothing but grass for the background with a large expanse of sky and not much sun above. Then view the same scene through a window as in Fig. 5, which not only adds a part of one of the houses, but also the illusion of three dimensions. It produces a dark background around which the observer mentally reaches toward the light houses in the distance. This principle of framing a picture may be used endlessly. Often nature helps out with dark frames for the foreground. All you have to do is to look for them. Fig. 6 is an example. The trees in front help to create the feeling of space between them and the water, the far shore and the sky. The same method has been applied in Fig. 7. Here the tone values of the dark fountain and tree against the mission church produce the framing effect and create the feeling of distance. Fig. 8 was taken at sunset. A sunset scene alone is often sufficient for a good picture showing depth, as the light is in the distance and the clouds and foreground are much darker. But in this case, an extra dark foreground was built up by placing the camera very low and by silhouetting the grass and the child against the sunset. Exposure was made for the sky and not for the dark foreground, because an over-exposure might block the fine tones in the sky and render the foreground too light.



Map-Shaped Photos for Unusual Travel Album



ILLINOIS



PAPER MASK

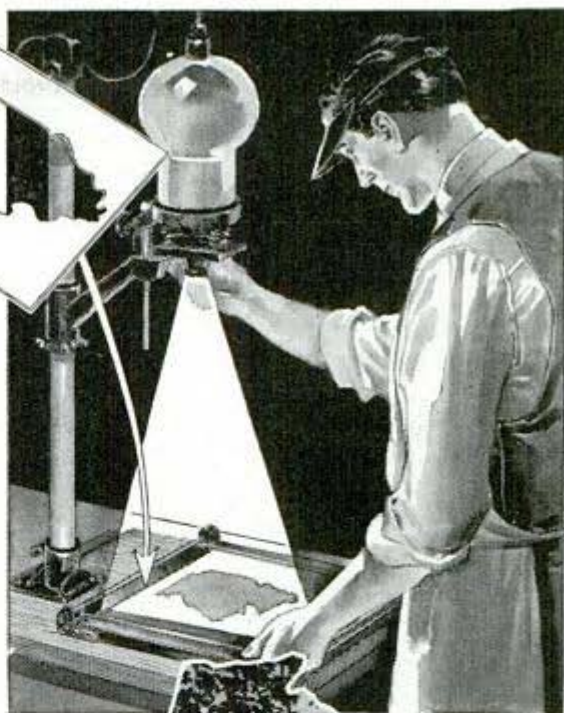

WISCONSIN

An album of photos taken in various states or countries takes on a realistic touch when a representative scenic photo in each state is printed through a black paper mask that has been cut to the outline of the state's borders. Choosing a view that not only suits the region it represents but also a composition to fit the particular outline adds interest to both travel and photography. The lower photo, for example, follows the outline of Wisconsin and shows a scene at one of the many lakes for which the state is famous. The stream, woodland and pasture of the upper photo are typical of Illinois, and their composition is excellent when fitted into the boundary of the state. A number of these photo maps could be assembled to form a photo-atlas, and they can be used in other ways also.—Emil Pearson, Redgranite, Wis.

Curved Background Eliminates Horizon Line in Photos

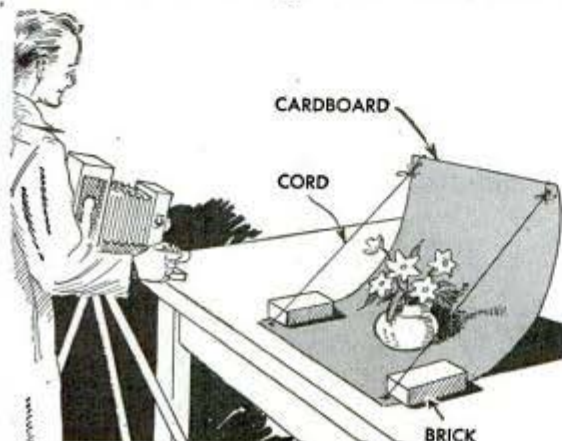

You can provide unbroken backgrounds for your still life and other table-top photographs by bending a single sheet of cardboard to serve as both table surface and backdrop. Two lengths of cord will hold the board to the curve desired and a couple of bricks may be used to weight it down. This setup eliminates the horizon line resulting when two boards are placed at right angles to each other, which is often disturbing to the eye. Common poster board is ideal for the purpose. It is available in a selection of colors which will appear as different shades of gray in black-and-white photography.

Eraser Buffs Wax Coat on Prints To Improve Their Appearance



Wrapped with a clean cloth, a blackboard eraser makes a good buffer for polishing waxed prints, since it does not scratch the surface. Waxing matte or semimatte prints with a thin film of automobile or furniture wax paste removes the dust and cleans the surface, and buffing gives the print a rich appearance with added contrast.

Shoe Lace Repairs Cable Release

When the cloth cover on a cable release becomes worn, it can be replaced with a small tubular shoe lace. Remove the old covering carefully, after unscrewing the knurled collars at each end. Then slip the



lace on and anchor it at each end with a little shellac, after it has been stretched tight and cut off to the proper length. Screwing the collars back in place completes the job. Care must be taken that no shellac gets inside where the cable slides.
—A. L. Mills, Chicago.

Hook Raises Low Light Fixture Out of Photographer's Way

Low-hanging chandeliers are often a problem to photographers in taking indoor shots. A short length of stiff wire bent to an S-shape as shown, and carried among the other accessories will be handy to loop over as many rings of the chandelier as necessary to raise it to the proper height where it will be out of the way.



Control for Photoflood Lamps

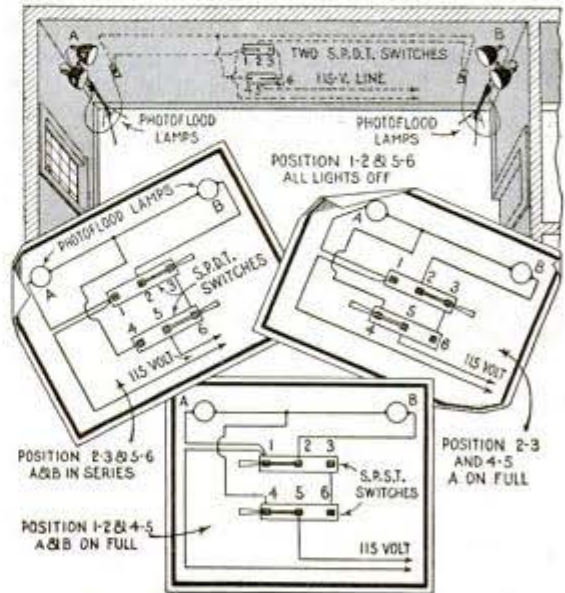

While experimenting recently with a series-parallel control for photoflood lamps, I discovered that greater control of the lights could be had by using two single-pole double-throw switches than is possible with the usual double-pole double-throw switch. With the hookup shown, lamps may be burned individually or together at full brilliance, or they can be connected in parallel. Any number of lamps in multiples of two may be used, up to the capacity of the equipment and the source of the current supply.—Bertram P. Hathaway, Somerset Centre, Mass.



SHOP NOTES



FRESH paint not only protects your power tools against rust, but also improves their appearance, Figs. 1 and 2, as well as the general appearance of your shop. All tools should be the same color. Machine-tool gray is the most popular color, but if you like blue, buff or green, go right ahead. Avoid strong colors—a whole shop full of bright red tools gets to be very tiresome.

First consideration should be given to the matter of paint. If you have a spray gun, lacquer is the logical choice, but if you use a paintbrush, you will get good results and fast drying with any of the popular 4-hour synthetics. Paint will not adhere to a dirty surface, so step number one on the schedule, Fig. 7, calls for a thorough cleaning with soap and water. Follow this with a warm-water rinse and allow to dry. Sanding comes next, Fig. 4, and can be a little or a lot depending on the existing finish. Use aluminum-oxide paper, dry. No. 1/0 is a good starting grit and should be



Above, using a backing block of felt or cork to build a level surface when sanding. Below, masking tape or compound will protect polished parts

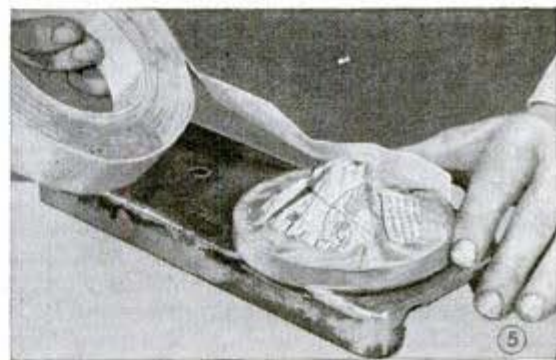



LACQUER PUTTY IS USED TO FILL DEPRESSIONS

followed by 3/0 for finish. Blow or dust the surface clean and wipe with a soft cloth moistened with alcohol. Right here you may find that the existing finish is in fairly good shape, permitting the direct application of top coats to finish the job. However, if you want a smooth, slick job, the next step is to apply a full wet coat of primer-surfacer. The material can be obtained with either a lacquer or synthetic base, and in a variety of colors. Primer-surfacer is almost pastelike in the can and is still quite heavy after reducing (follow the directions on can). However, it sprays smoothly with even light-duty guns. Even with the remarkable "build" of the primer-surfacer, you probably will find a few low spots or holes in the surface being finished. Fill them with lacquer putty. Use this product as it comes in the container, applying and smoothing with a putty knife, Fig. 6.

The combined primer-surfacer and putty coat is now ready for sanding. Use wet-or-dry paper with water as a lubricant. Start with 3/0 grit and finish off with 5/0 or 6/0 (180 or 220-grit). Clean off the slush with a soft rag, and then decide whether it is smooth enough for top coats or whether it needs another coat of primer-surfacer. If the machine is a lathe or other tool apt to come in contact with oil, be satisfied with nothing less than a perfectly smooth surface. As many as five coats of surfacer may be needed to smooth up a pebbly or pitted cast-iron surface, sanding each coat until the bare metal shows in the high spots. This is not hard work since the surfacer sands easily and does not clog the paper. If several coats of surfacer are required, it is a good idea to use two different colors.



SMOOTH THE PUTTY WITH A PUTTY KNIFE. A PIECE OF STIFF LEATHER IS USEFUL ON ROUNDED SURFACES

⑦ FOLLOW THIS SCHEDULE

- 1—Wash with soap and water or household cleanser. Rinse clean and dry.
- 2—Sand. Use 1/0 for roughing; 3/0 for finish. Wipe clean with alcohol rag.
- 3—Apply full wet coat of primer-surfacer. Allow 30 minutes dry for lacquer-type material; 1 to 2 hours for synthetic.
- 4—Sand lightly with 3/0 wet-or-dry paper with water as lubricant.
- 5—Fill holes or low spots with lacquer putty. Allow 1 hour or more drying time, depending on depth of coating.
- 6—Wet sand with 3/0 wet-or-dry paper backed with felt block. Wipe clean with soft lintless rag. Inspect. If surface is not smooth, repeat operations 3, 4 and 5.
- 7—Apply one or more coats of lacquer, enamel or synthetic. Use same type of finishing material throughout—never apply lacquer top coat over synthetic base.
- 8—If more than one finish coat is applied, scuff-sand between coats with 6/0 paper, dry.
- 9—If desired, finished surface can be rubbed down with any type of rubbing compound. Many workers use a sprayed-on coat of clear lacquer thinner as a means of obtaining a smooth surface with uniform gloss.

By this method, low spots in the surface are detected instantly. Partial coats directed at a particularly bad spot can be applied and are easily feathered out by sanding. Always use a backing block when sanding; hand backing is useless for building a level surface.

Before applying the finish paint, make certain that there are no breaks to bare metal in the primer-surfacer coat. With a good foundation, one coat of lacquer will do for the finish. If a second coat of lacquer is to be applied, scuff-sand the first coat with 5/0 paper, wet or dry. If you are using synthetic, the first coat should be sanded thoroughly since this product does not "melt" and combine with succeeding coats.

Most tools will require a certain amount of masking if painted with a spray gun, Figs. 3 and 5. The product commonly used for this is masking tape, although old newspapers will do in some places. Large areas of polished metal, such as tables, can be protected by masking compound if desired. However, it is usually quite easy to protect these surfaces by proper manipulation of the gun. Best results are obtained by partially dismantling the tool, removing bright metal where possible, and breaking the paint job into several separate pieces.

Unusual Cam Latch Holds Sliding Door Securely

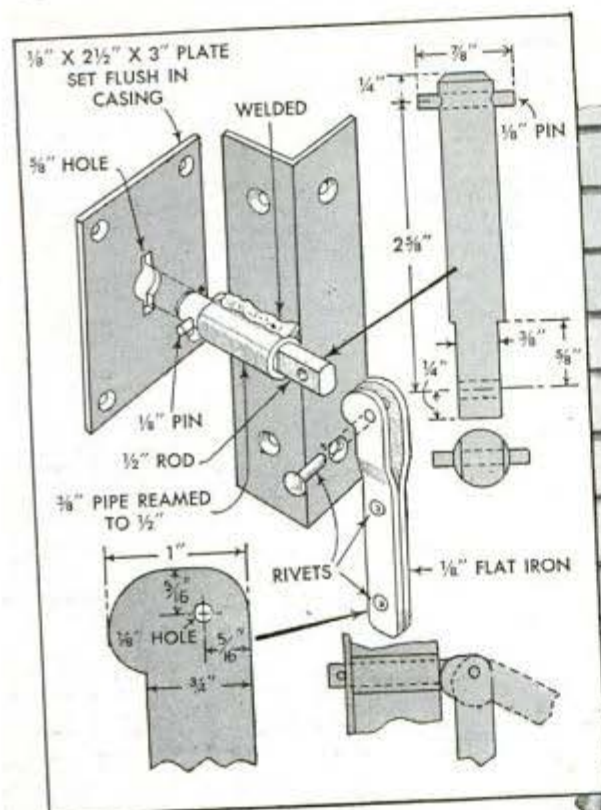

The problem of locking a sliding door and at the same time holding it snugly against the casing to exclude cold air is solved with this cam latch. As shown in the detail, it is mounted on the edge of the door and engages a latch plate on the casing. Pushing the pinned end of the latch bolt into a double-winged keyhole in the plate and then turning the bolt secures the

latch. Lowering the latch handle causes the cammed end of the latter to press against the bolt housing, which is a short piece of pipe, and thus force the door tightly against the frame. The latch can be made from a few scrap parts.

—A. J. Van Dusen, Eldridge, N. Y.

Twine to Make Sack Ties Measured and Cut With an Ax

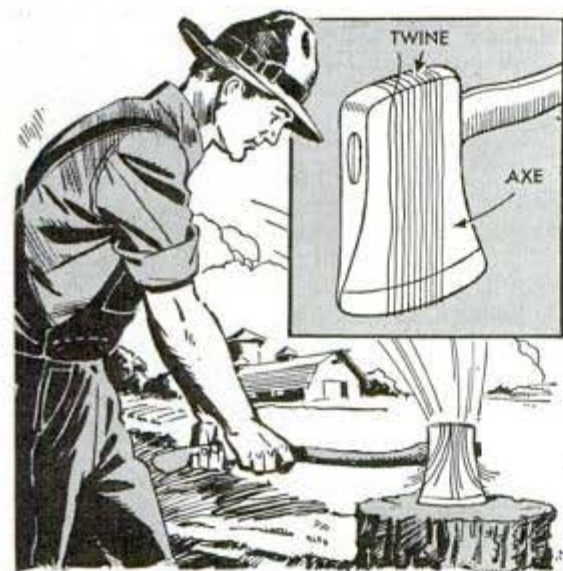

The next time you need a number of sack ties, try cutting them with an ax as shown. This method will assure uniform length and save time. Just wrap twine or string used around an ax and then drive the blade into a block of wood to cut the string.

Mousetrap Serves as Rain Signal

When it rains during the night, you will be warned to close the window if you have prepared an ordinary mousetrap by holding the spring open with a strip of newspaper, the loose ends of which are fastened to the trap by cellulose tape, gummed paper or staples. If any rain hits it, the newspaper will soften, allowing the trap to close with a bang. To produce a louder sound, turn a small pan upside down and place the trap on it.

—J. A. Swank, Dayton, Ohio.

Chalk-Mark Pattern on Anvil Aids in Shaping Work



In order to bend a number of iron rods to an accurate shape without stopping to compare them with a pattern, one blacksmith chalked a pattern on the face of the anvil. Checking the work then was just a matter of comparing it with the mark.

Sliding Doors Are Closed Easily By Rope and Pulleys

To close a heavy sliding door on his barn with little labor and inconvenience, a farmer uses the rope-and-pulley arrangement shown. The rope, passing through the pulleys, is attached to the door and corner of the barn, and one of the pulleys also is attached to the barn corner, the other being fastened to a length of pipe to serve as a handle. Thus, by pulling down



on the handle the door is closed. The pulley arrangement reduces the pull by at least one-half. Also the attachment of the rope at the top of the door brings the pull in line with the door rollers so that there is no friction from binding, which often happens when the door is closed by pulling on the regular handle.

Repairing Leaky Metal Roof

If a corrugated metal roof leaks at the joints, sometimes it can be repaired by applying strips of asphalt roofing paper to the joints between the metal sheets as indicated. Make the strips about 2 in. wide. This repair is especially helpful if high winds have a tendency to drive rain between the sheets at the joint.



Depth Gage on Hack Saw Blade For Slotting Screws

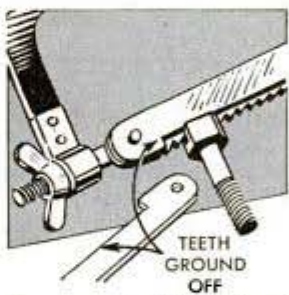

Having a number of screw heads to slot with a hack saw, one workman used an old worn-out blade as a depth gage to speed up the work. The teeth of the old blade were ground back a distance equal to the desired depth of the slots, after which it was put in the saw frame beside the regular blade as indicated. In this position, the good blade could cut into the screw heads only to a depth permitted by the altered blade.

Commutator Trued Accurately With the Aid of Prussian Blue

When the commutator of an auto generator or starting motor is worn out of round, or has grooves cut into its surface by brush friction, it is good practice to turn it down to a slightly smaller diameter, but with its original cylindrical shape. In doing this work, make it a point to remove no more copper than is absolutely necessary. To determine when to stop cutting, give the commutator a coating of Prussian blue. Watch during the turning operation and when the blue has disappeared, permit the tool to finish its lateral travel and then stop the cutting.

—W. C. Wilhite, Carlinville, Ill.

Small-Parts Cabinet Folds Flat Against the Wall

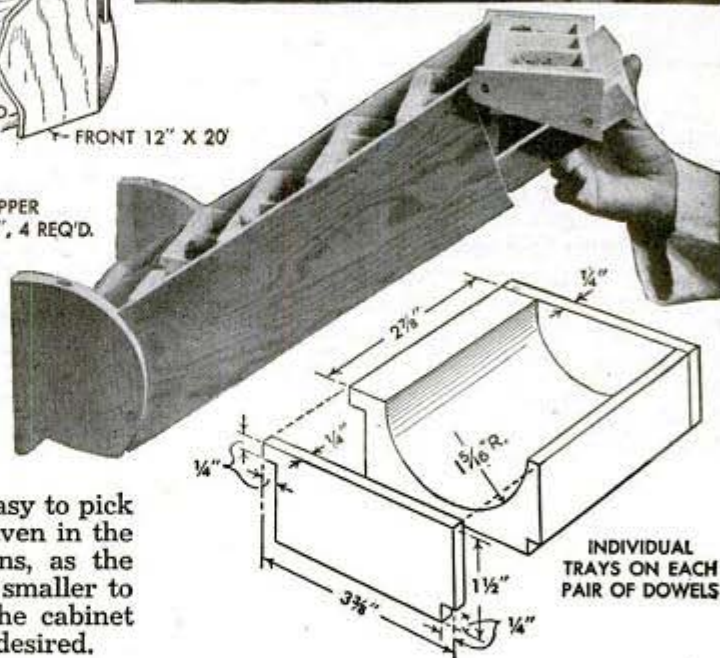
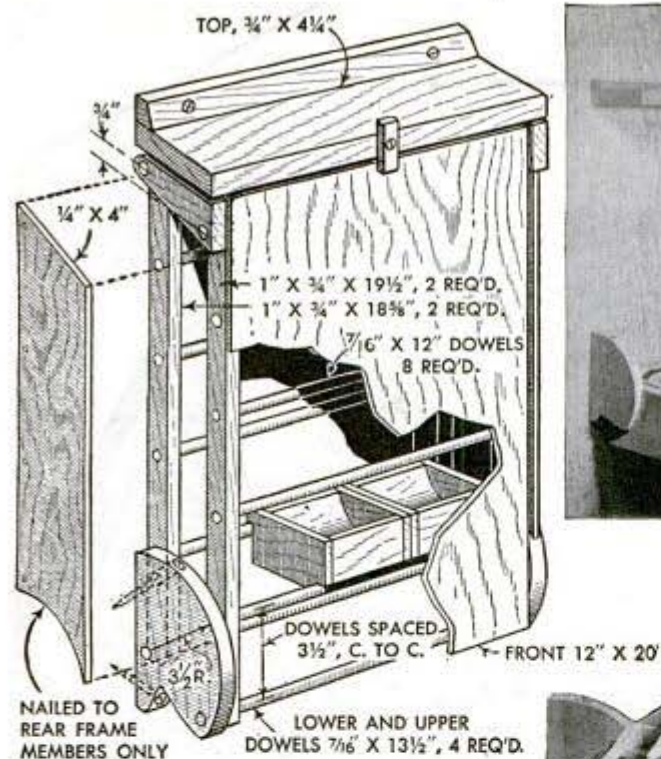

Folding against a wall out of the way when not in use, this cabinet takes little space and has small removable trays that can be taken right to the job at hand. The cabinet is made easily from small scraps of pine, plywood and dowels, and the rounded tray bottoms make it easy to pick out the contents. Dimensions given in the drawings are merely suggestions, as the cabinet may be made larger or smaller to fit available space or needs. The cabinet can be varnished or painted if desired.

Guides and Handle Simplify Use of Pipe-Cleaning Brush

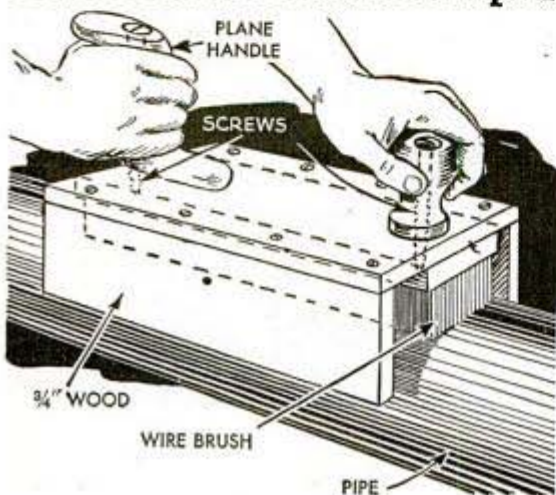

Given a job of cleaning paint and rust from used pipe, one workman screwed sides to a large wire brush so that he could use it without it slipping off the work. A handle and knob from an old plane made operation of the brush easy.

—James Vick, Church Road, Va.

New Paints for Window Lettering

For temporary window lettering which will not wash off in even a heavy rain, try the new plastic-resin type paints. They are inexpensive, easy to use and come in a variety of colors. To remove, use a fairly strong cleaner and a scrub brush.—R. Verbrugghe, Grosse Pointe Park, Mich.

Scale Around Chuck Screw Hole Aids in Centering Work

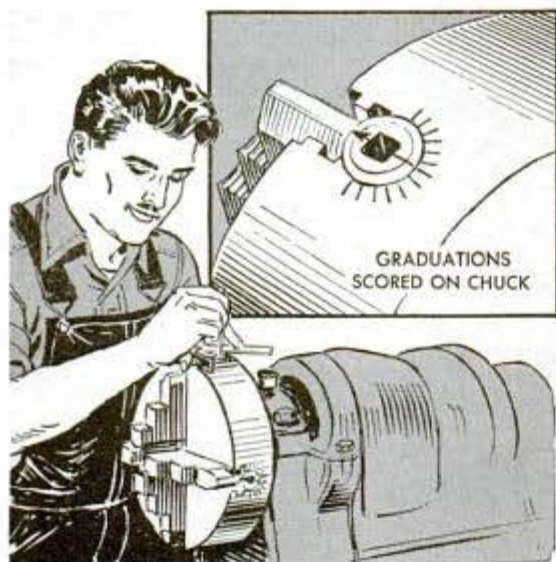

To aid in quickly centering work in a chuck, one machinist scored graduations on the chuck surface around the jaw screw openings, and then made an index mark or line across the exact center of each screw. With this arrangement, the work is first chucked as accurately as possible by reference to the concentric circles on the face of the chuck, after which it is brought to a true center by adjusting each screw so that all index marks point to identical lines on the scales. To graduate the chuck, first chuck a piece of true work accurately. It is important that this be done with absolute accuracy. Then score a preliminary line across the edge of each screw, extending it about $\frac{1}{4}$ in. onto the chuck surface. This line should pass exactly through the centerline of the screw, and should be parallel with the lathe centerline. Now, the screws can be removed to deepen the scores. After replacing the screws, as many lines as desired can be scored on the chuck surface at the sides of the first line. Care must be taken to see that the lines are of equal spacing at all of the screws.

Sleeve-Bearing Puller Made Easily

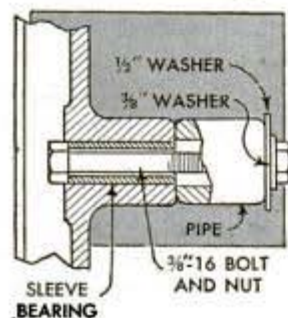

If you have some sleeve bearings to remove and there is no suitable puller at hand, the job can be done with a bolt. Grind down the bolt head to the same diameter as the outside di-

ameter of the bearing. Then insert the bolt into the bearing, and over the projecting threaded end slip a piece of pipe having a length at least equal to that of the bearing. Now, place a large and small washer over the bolt as shown and turn on the nut. Driving on the nut with a wrench will pull the bearing.

—Ralph H. Preston, Roseland, N. J.

Stencil Attached to Mimeograph Without Wrinkling It

The difficult job of putting a stencil on a mimeograph machine without wrinkling it can be made much easier by using a trouser hanger as shown. First, attach the reinforced end of the stencil on the machine and then grip the other end with the hanger. This will keep the stencil smooth and straight as it is placed on the cylinder.—A. H. Waychoff, Phoenix, Ariz.



Curbstone Flagstaff Anchors Sign In Place on Sidewalk

One merchant, who always displayed the flag on the sidewalk in front of his store, utilized the staff to keep a sign from being tipped over. To do this, U-shaped metal straps were riveted to the sign to provide loops through which the flagstaff was inserted as indicated.



Piece of Hacksaw Blade Spaces Shading Lines

Shading lines can be drawn rapidly with this simple device, which assures that they will be uniformly spaced. The device is made from two triangles, one being larger than the other. A piece of hacksaw blade is riveted near the longer side of the large triangle, and a pointed block of celluloid is cemented to the smaller triangle to engage the saw teeth when the two triangles are used as shown. Now, by moving the small triangle along progressively to engage the saw teeth as the shading lines are drawn, all lines will be spaced uniformly.

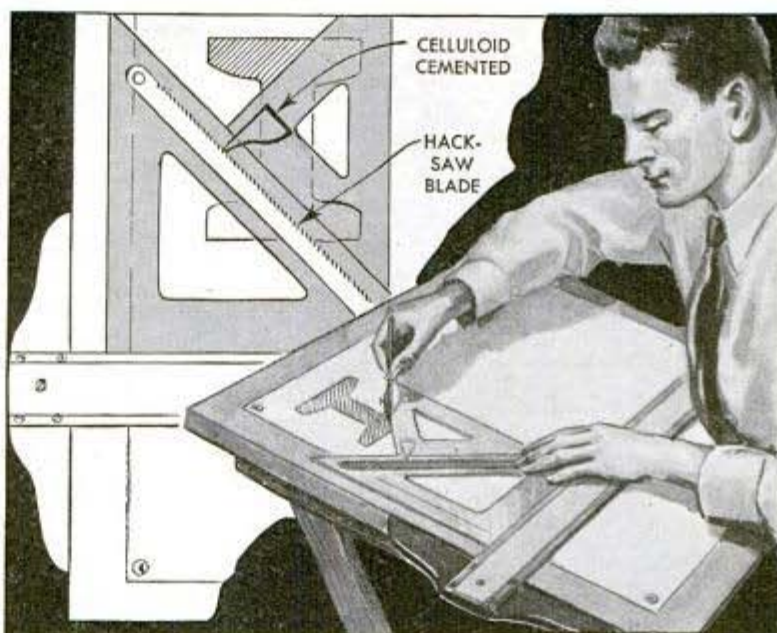

Well Platform With High Center Excludes Waste Water

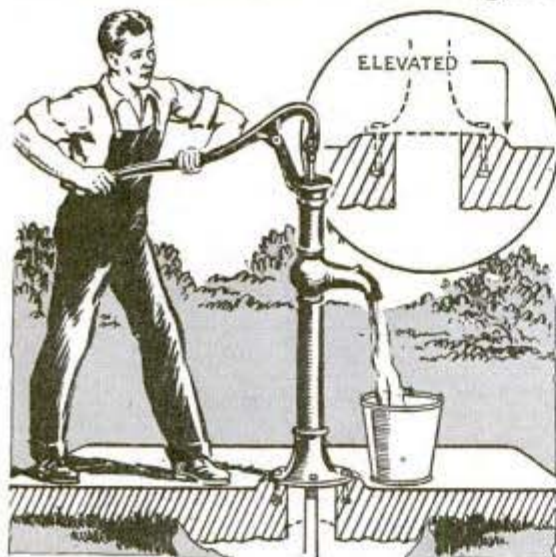

To keep all surface water from running into his well, including waste water from the pump spout or that spilled from buckets and other containers while filling them at the pump, one farmer made a concrete platform and elevated the center around the pipe opening as indicated. When the top of the well is wide, it is a good idea to reinforce the concrete with rods or other suitable pieces of metal. Lengths of woven wire fencing are good for this purpose when not too rusty. If the platform is to be practically airtight, a vent should be provided. This can be a short piece of large diameter pipe reaching through the platform and projecting a few inches above it. Screen wire over the upper end of the vent will keep out insects and particles of foreign matter. The wire is best attached by soldering it to the pipe.

Repairman Carries His Planks and Stepladder Under Truck Body

As our business consists of general building repairing, it usually is necessary to take a plank and stepladder to most of our jobs. To be sure that these would always be at hand, and also to leave more room on the truck for other tools and materials, the ladder and planks were carried under the truck body as indicated.

—Philip Maskeill, Astoria, N. Y.

ⓘ Avoid damage from the end of a disconnected auto starting motor wire by slipping a short length of garden hose over it.

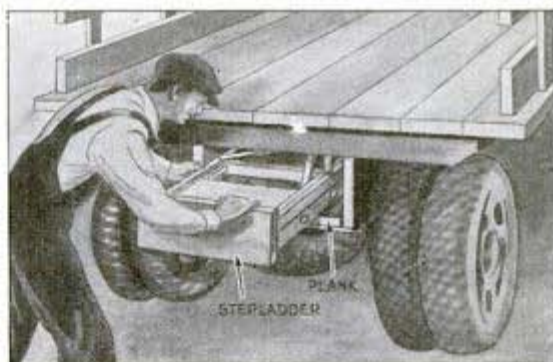

Metal POLISHING

By H. J. Chamberland

METAL polishing is an abrasive operation which imparts a predetermined grade of surface finish for appearance rather than size tolerance. The purpose may be a complete operation to obtain a final finish or it may be a preparatory step for nickel or chromium plating. Metal polishing is closely related to grinding in that both operations require manufactured abrasives as a cutting agent.

Polishing wheels, such as the one in Fig. 5 where an airplane connecting rod is being finished, consist of wheels built up from layers of felt, canvas, sheepskin, walrus or other kind of leather either glued or sewed together. Unlike grinding wheels, polishing wheels are flexible and are classified as hard, medium and soft, depending on the degree of flexibility which is determined by the material of which they consist and by the method used in binding the layers together. Polishing wheels are available in a semi-finished stage only and must be given their abrasive properties in the shop where used. The application of the abrasive to the periphery of the wheel is

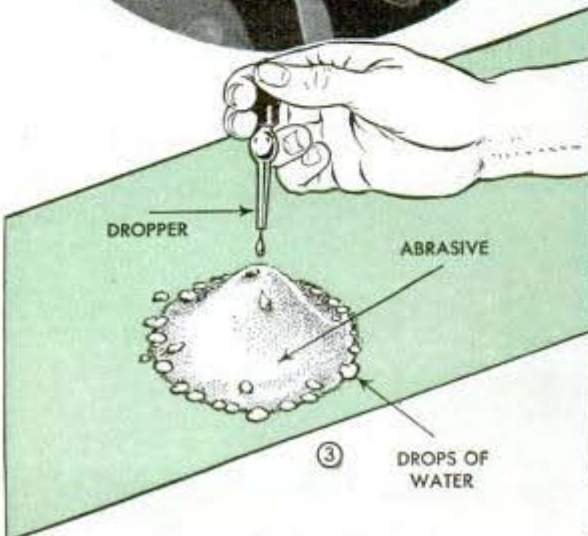

④ POLISHING OPERATIONS				
Part or Material	First	Second	Third	Fourth
Aluminum Castings	60-80	120-180	Buff	
Aluminum Sheets	120	180	Buff	
Band-Saw Steel and Similar Stock	60-80	120-150		
Brass Castings	60-80 With Oil	150-180 With Oil		
Brass Sheets	180-220	Buff		
Hammer Heads	46-60	100-120		
Knives—Table and Steel Blades	80-90	120-150		
Monel-Metal Castings	80	120	150	
Monel-Metal Sheets	180	180 With Oil	220 With Oil	Buff
Plow Discs	30-46	70-90		
Shovels	36-46	120		
Shears Tinsmith	46	60	120-150	180
Stainless Steel Mirror Finish	60-80	100-120	150 With Oil	220 With Oil
Stainless Steel Commercial Finish	80	100	120 With Oil	150
Wrenches	30-46	80	120 With Oil	
Lenses—Eye Glass and Telescopic	60-80	180-220	Optical Flour	Rouge

WHEELS . . .

called "setting-up" and the thickness of this application is referred to as "wheel head." The abrasive grain generally is aluminum oxide and varies in size to meet finish requirements. A specially selected and prepared glue is used to hold the grain in the wheels.

Most polishing wheels are mounted on pedestals, but there are portable ones also which are carried to the job as shown in Fig. 1. Small, irregularly shaped parts are polished most conveniently on an endless leather or canvas belt as in Fig. 2, which is coated with abrasive grains in the same manner as polishing wheels.

Selection of abrasive grain: The aluminum-oxide grain must be of the highest quality, must be extremely hard, tough and uniform in structure, size and shape. All these properties are important because there are various grades of finishes, obtained by as many as five consecutive operations. Often a different shape of grain, exclusive of size, is required for each



Photos by courtesy of Norton Co.

⑦ PROPORTIONS OF GLUE AND WATER FOR VARIOUS GRADES OF ABRASIVES

Size of grain Aluminum oxide	Glue % by weight	Water % by weight
24—36	50	50
46—54	45	55
60—70	40	60
80—90	35	65
100—120	33	67
150—180	30	70
220—240	25	75

polishing stage from rough to final finish. When selecting the type of grain, its rate of capillarity or how fast it will absorb water is an important consideration. In making the capillarity test, water is applied drop by drop to a pile of abrasive grains as shown in Fig. 3. If it rolls off, the grains are low in capillarity and a wheel set up with such grains will wear down quickly due to uneven spread of the glue. If the grain absorbs water readily, it will permit the glue to spread uniformly, resulting in durable fast-cutting wheels. Standard sizes of grain vary from coarse to fine and are known by numbers such as 24, 46, 70,

100 and up to 240. From 240 to 600 the grain is fine, extra-fine and super-fine flour. Fig. 4 gives a table of general recommendations regarding grain size for polishing operations on various materials and jobs.

Selecting and preparing glue: For maximum results it is advisable to use a good grade of animal hide glue as an adhesive. Bone, fish or cold glues are not suitable for this purpose. The glue and water should be mixed by weight accurately to eliminate any guesswork. It should be freshly made and used within 3 hrs. Fig. 7 gives size of grain and corresponding percentage of glue and water to use. The glue is soaked in cold water for some time to make it dissolve more readily when heated. Ground glue should soak from 1 to 2 hrs., flake glue from 6 to 8 hrs. and cake glue from 12 to 14 hrs. To melt the glue, a water-jacketed glue pot is recommended. The correct tem-



depending on how close to the edge of the wheel the layers are glued together. This wheel is used extensively to polish cutlery, and small tools such as auger bits, Fig. 8, button dies or similar parts with parallel sides. The advantage of this type wheel is that its periphery can be shaped to that of the surface to be polished. Any size grain can be used with the compressed wheel.

The felt wheel usually is set up with grain size 150 and finer. It is extensively used for producing a high finish on steel and iron or a somewhat medium finish on brass and aluminum castings. The sewed buff wheel is an all-purpose type and, as it is soft and flexible, it gives an excellent finish on brass, aluminum and sheet steel.

The sheepskin leather wheel is very flexible on brass and aluminum alloys and small stainless steel parts made of sheet stock. The walrus leather wheel is for finishing and is used to polish jewelry, instruments and small gun parts. Wooden polishing wheels are still used in many small plants and are most economical for experimental and home-workshop use.

Setting-up polishing wheels: Before attempting to set up a polishing wheel, make sure that the room is free from drafts and that the temperature is between 70 and 80 degrees F. to prevent jelling of the glue. If the abrasive and wheel are of



perature of the mixture, abrasive and room, as will be explained later, is highly important. Therefore, be sure to use a thermometer in the glue pot whether or not the heater has a thermostatic control.

Using correct type of wheel: For best results, the use of the correct type of wheel is just as important as the proper abrasive grain. The sewed canvas wheel is used generally for severe and not too important polishing operations when the grain size ranges from 24 to 46.

The disk canvas wheel is also a heavy-duty type. Each disk comprising the wheel is glued on both sides to stiffen the canvas, the glue extending close to the edge of the wheel when a hard face or head is desired. Such a wheel can be used to polish plow disks as in Fig. 6.

The compressed wheel is made of canvas or leather similarly glued on the sides. There are three grades known as hard, medium and soft,

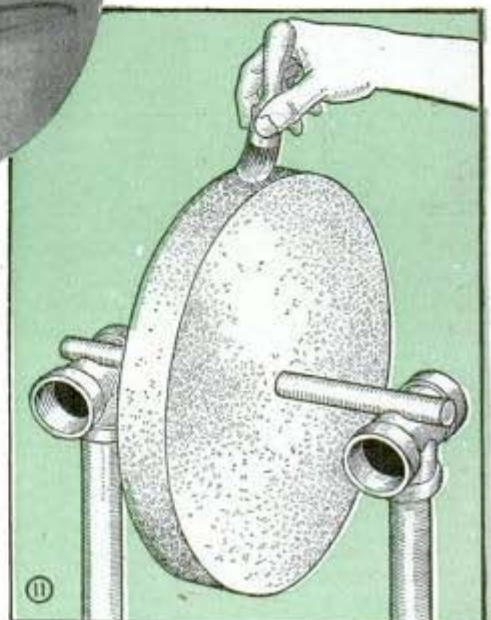
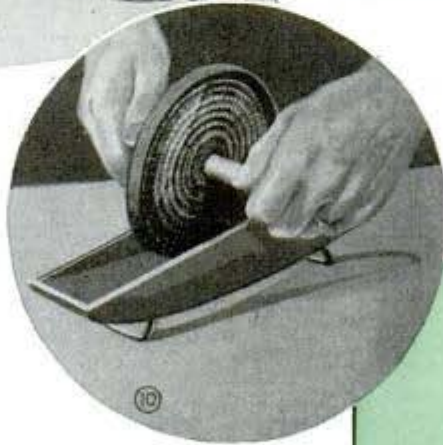

the same temperature, the glue should be heated to 160 degrees F. While small wheels may be held by hand while applying the glue as in Fig. 9, larger wheels should be mounted as shown in Fig. 11. After applying the glue, the wheel is rolled in a trough containing a sufficient quantity of abrasive grain as in Figs. 10 and 13, which illustrate troughs for small and large wheels respectively. Rolling should proceed evenly so the wheel will pick up all grains it can hold, and as quickly as possible for maximum adhesive results. In setting up wheels, some experts prefer preheating the grain and the cloth wheels to 100 or 120 degrees F., and then applying the glue at 140 degrees, the idea being that the grain will penetrate the glue more readily, and as a

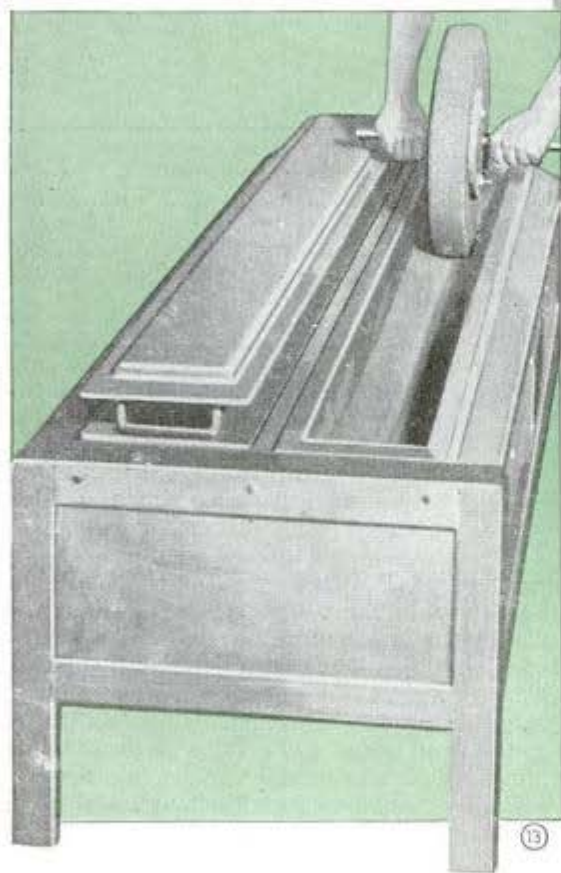

abrasive grains are sprinkled on the belt after painting it with glue. Fig. 12 shows what is known as the centerless method of cylindrical polishing, a compressed wheel and a wide leather belt being used for the purpose. The wheel rotates the shaft by friction at the required speed and the belt, operating at a much higher surface speed, does the polishing.

Drying glue-coated wheels: Animal-hide glue is known to take on or give off moisture, depending on the humidity. This glue is strongest when it contains 10 to 12 percent moisture and therefore the wheels should be dried. Large industrial plants have air-conditioned drying rooms for this purpose. The correct drying temperature should be 85 degrees F., and the relative humidity should be 50 percent. Under such conditions one-coat wheels will dry in 24 hrs. and two-coat wheels in 48 hrs. Factors that govern drying time are thickness of wheel head, strength of the glue and size of the grain. Generally, the thicker the wheel head, which indicates the number of coats, the longer will be the drying time required. One method of determining whether a wheel head is sufficiently dry, is to hit it with a round steel bar held at about 45 degrees as shown in Fig. 18, and observe how readily cracks appear. This should be done around the wheel entirely and then repeated at the opposite angle to form a series of X-cracks. Cracking the wheel gives a springy cutting edge, resulting in a combined wiping and polishing

result produce a superior polishing wheel.

Polishing belts are set up by spreading, with a trowel, knife or brush, a suitable paste made by adding preheated abrasive grains to a heated glue solution. The mixture should contain the maximum amount of grains for a workable consistency. When coarse grains are used for severe polishing jobs, they should be pressed in with a roller. In this case it is advisable to give the belt a sizing coat consisting of water, 8 parts and glue, 1 part. Frequently, finer



action. Final step is to dress the edge with a piece of broken grinding wheel.

Balanced wheels important: Material for polishing wheels is machine-cut and the hole is made sufficiently large for the use of a bushing, otherwise the wheels would lack the necessary support when placed on a spindle. The hole in the bushing should provide for a good fit on the spindle to keep the wheel in proper balance. Polishing wheels, like grinding wheels, require a collar on each side, the diameter of the collar depending on the diameter and type of wheel.

Once a polishing wheel is worn, the old grain and glue must be removed with an abrasive stick and the wheel should be trued, which can be done with the end of an old file, before taking the

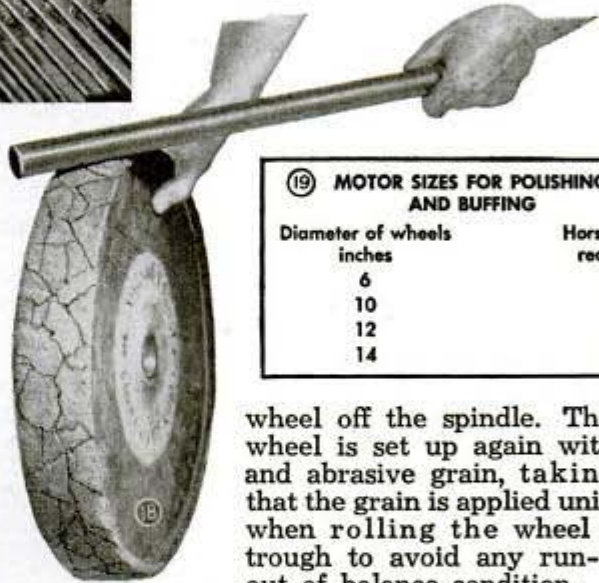
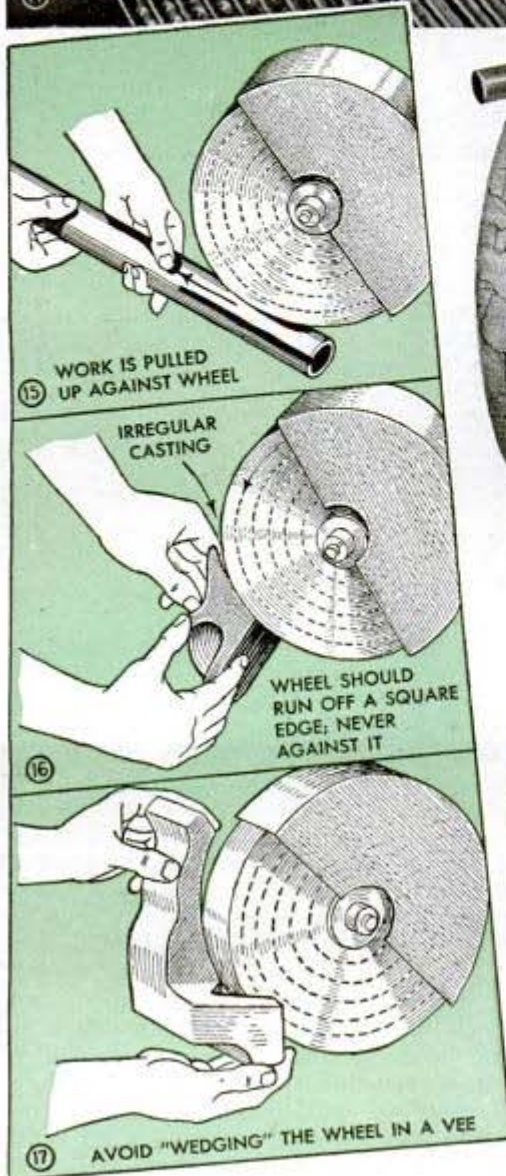

19 MOTOR SIZES FOR POLISHING AND BUFFING

Diameter of wheels inches	Horsepower required
6	1/4
10	1
12	2
14	3

wheel off the spindle. Then the wheel is set up again with glue and abrasive grain, taking care that the grain is applied uniformly when rolling the wheel in the trough to avoid any run-out or out-of-balance condition.

Wheel speed: Before operating a wheel, the operator should check up pulley relation and adjust the guard. Assuming that the spindle bearings are in first-class condition and that the wheel is in perfect balance, the next step is to determine its vibration points. If a good job of setting-up has been done, the grains being strongly bonded, the wheel can be operated at a higher speed than is possible with a weaker wheel head. With very good equipment, wheels should be operated at about 7500 surface feet per minute (s.f.p.m.) for best polishing results. However, for general economy, some polishers claim that best all-around polishing speed is around 5000 s.f.p.m. as the wheels wear more rapidly as the speed increases, necessitating more frequent resetting, and the increase in cutting action at higher speeds does not seem to compensate for excessive wheel wear. Fig. 21 shows a graph giving s.f.p.m. of various size wheels at different speeds, while Fig. 19 gives horsepower requirements to operate wheels of various sizes satisfactorily.

Safety precautions and helpful hints: When polishing is done with a small bench type of grinder, certain safety precautions should be observed. After checking to see that the guard is set to clear the work, make sure that the wheel is tight on the shaft and runs true. A polishing wheel should always rotate in the same direction. An arrow painted on one side will serve as a reminder when the wheel is put on a spindle. Work is pulled upward against a wheel as

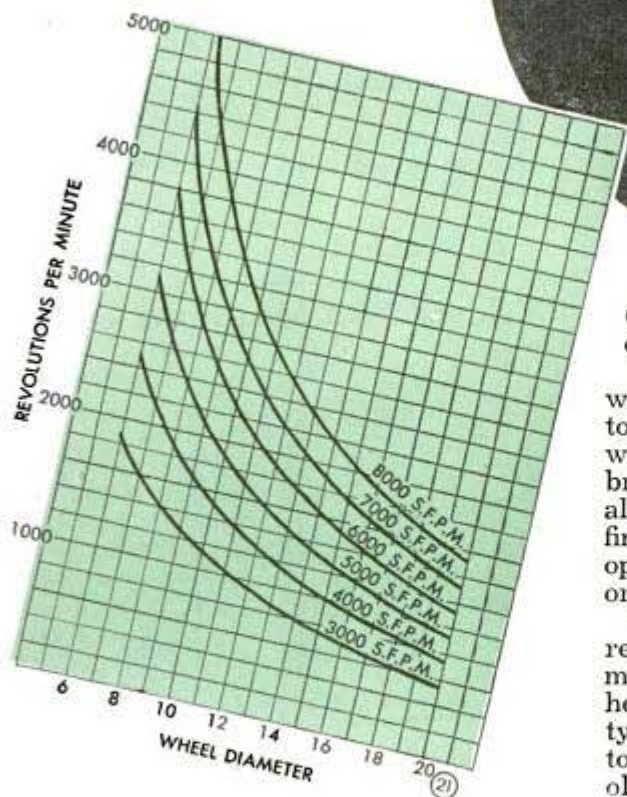
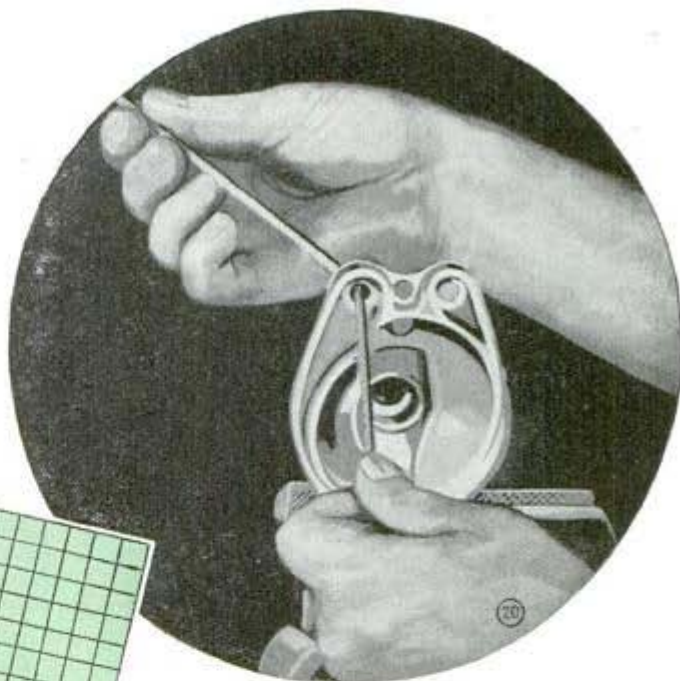

shown in Fig. 15. With irregular castings, the wheel should run off a square edge as in Fig. 16, but never against a square edge or the work may be pulled from the hands and thrown with dangerous force. The same risk is incurred when the wheel is "wedged" in a narrow portion of the work as shown in Fig. 17.

Where several polishing operations are to be done in sequence, wheels of the same diameter but having different abrasive coatings may be ganged on a single spindle as shown in Fig. 14. This arrangement is followed in large shops where convenience and the saving of time help to speed up production. When hard-to-get-in places have to be polished, narrow strips of twisted, tube-like abrasive cloth can be used by hand as in Fig. 20, or on a small mandrel chucked in an electric drill or grinder.

Conelike polishing points of similar spiral design also are available.

Greasing the wheels with oil or tallow will prevent loading. This is recommended to buff or finish aluminum sheets and all wheels required to polish aluminum and brass castings. Buffing operations are usually performed by skilled operators. Satin finishes are obtained on brass by a first operation called "cutting down" and a coloring agent is used for second buffing.

When a large quantity of identical irregularly shaped parts require polishing, much time is saved by forming the wheel head or face accordingly. The compressed type of wheel may be shaped quite readily to the required outline with the end of an old file ground with a clearance and corners slightly rounded. The wheel will require a certain amount of dressing after setting up to fit the surface to be polished.

Metal Pattern Is Prick-Punched To Hold It Easily in Place

To facilitate holding a small metal pattern on work to be marked, one worker indents a section of the pattern with a prick-punch to make several slight, sharp elevations. The pattern may thus be held with the fingertips.



Wooden Scoop Handles Chicks Safely and Rapidly



The slow job of transferring baby chicks from the brooder trays to the shipping cases led one hatchery operator to use a prong-scoop like the one shown. The prongs are small dowels, rounded at the ends and inserted into holes in a wooden handle, the dowels being spaced about 1 in. apart. When lifted with the scoop, the legs of the chicks extend down between the prongs so that they cannot easily jump off the scoop.

Slot in End of Scaffold Bracket Holds Saw Out of the Way

Instead of laying a handsaw down on a scaffold where it may be stepped on or kicked off to endanger persons below, one carpenter slotted the projecting end of one

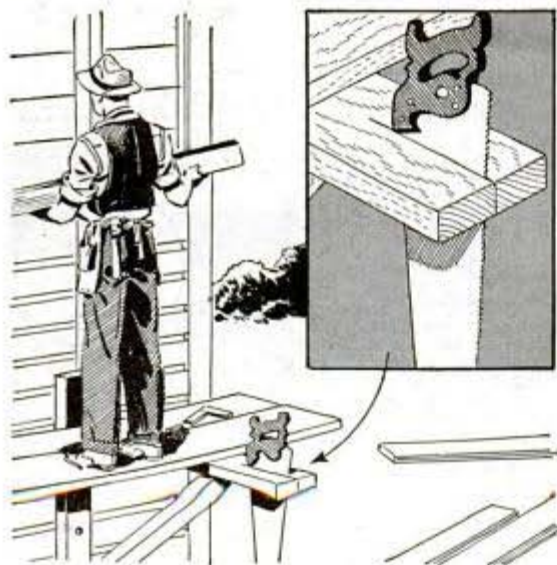

of the scaffold brackets to take the saw when it was not in use. Width of the slot should be a trifle more than the thickness of the saw blade to permit easy insertion.

Paper Layers Keep Stacked Cans From Tipping Over on Shelves

In stores and other places where canned goods are stacked in tiers, they can be kept from tipping over by placing newspapers between each row of cans as indicated. This idea will be found especially handy in self-service stores where patrons may bump against the cans, or where they may be dislodged accidentally when removing one.



Welders' File Measuring Gages

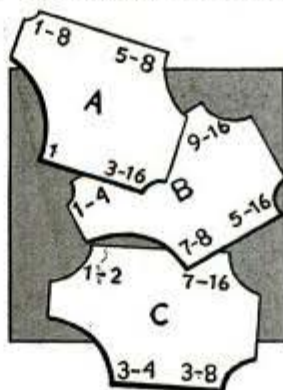

A set of three gages like the ones shown will enable welders to gage fillet welds accurately, which, for best results, should be as wide as they are high, and slightly rounding or convex. The gages shown have a full radius cut in them for clearance only,

and the weld should not necessarily fill the full gap except for height and width. To make the gages, use a corrosion resistant metal such as monel or brass about $\frac{1}{16}$ in. thick.—P. M. Wilson, Napa, Calif.

Wedge Locked in Ax Handle

Prepared as shown, a wedge to keep an ax on its handle cannot work out because it is locked in place by a headless nail. The nail is placed in a shallow groove cut across the wedge, which then is driven into the split end of the handle. Any tendency of the wedge to move outward causes the nail to bind tightly between the wedge and handle.—Benj. Nielsen, Aurora, Nebr.

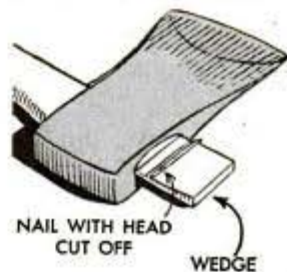

Grinding Angles of Tool Bits Set by Lathe Jig

Mounted on the compound rest of a lathe, this attachment or jig provides a means of setting a tool bit at an accurate angle for grinding. Construction is shown in Fig. 3. The rotating spindle is small enough so that it can be chucked directly in the tool post for cutting the tool-bit slot, Fig. 4. Clamping of the rotating spindle is done by a split bushing to prevent marring from direct contact of the set-screw. The scale, Fig. 2, can be a ten-cent protractor mounted on a plate, which is held in place by a tight fit against the base block. In use, the bit is clamped in the holder and then it is set by means of the protractor scale and the compound scale so that the edge to be ground will be in proper contact with the grinding wheel as in Fig. 1. The preferable grinding wheel is the recessed type, but a plain wheel will do. Wheel speed need not be over 1000 r.p.m. with a

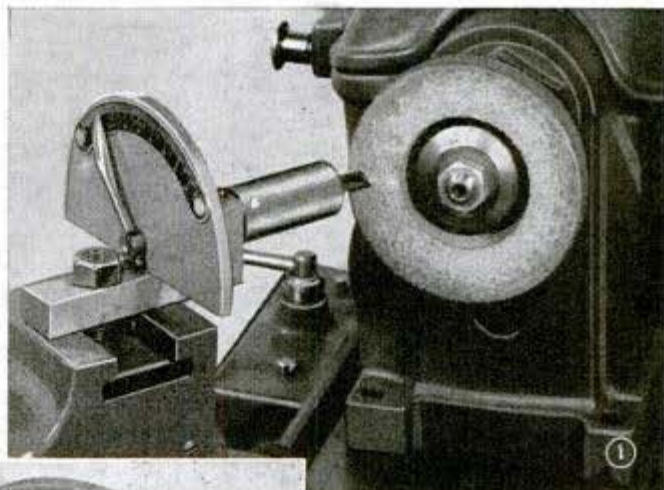

4-in. wheel. Fast cutting is obtained by feeding the bit in with the lathe cross slide, taking off a small bite at a time until the full shape is obtained. Do this carefully so that you do not remove too much metal before you realize it. Angle settings can be obtained from any lathe-bit chart, four of the more common bit shapes being shown in Fig. 5.

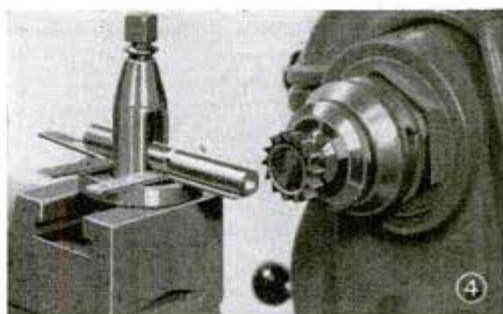
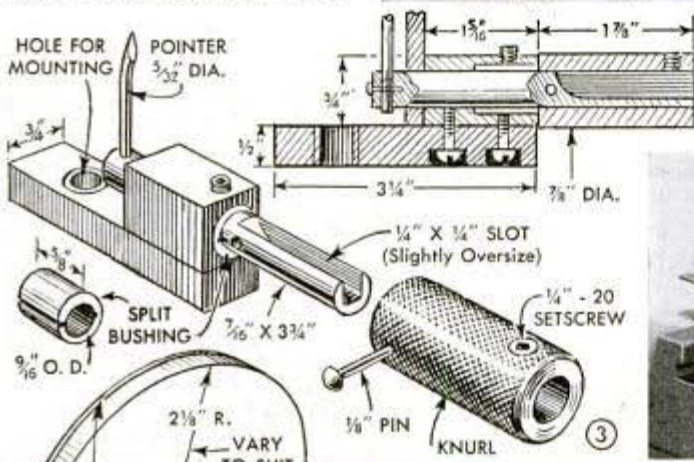

SCALE ON BACK: 2 1/8" R. VARY TO SUIT. END VIEW AS SEEN BY OPERATOR: 3/16"

ANGLE SETTINGS FOR TOOL BITS

	RIGHT HAND TURNING			RIGHT HAND SIDE			RIGHT HAND CORNER		BRASS TURNING			
	A	B	C	A	B	C	A	B	A	B	C	D
SIDE OF BIT DOWN	1	4	Grind Freehand	1	3	2	1	3	1	3	2	Grind Freehand
COMPOUND SETTING	45° R	62° R		28° R	26° R	0°	26° R	53° R	14° R	14° R	15° R	
SCALE SETTING	22° R	0°		13° R	10° L	12° L	17° R	30° L	13° R	13° L	0°	

BOTH SCALE SETTINGS ARE DIRECT READING, STARTING AT ZERO. COMPOUND SWING IS SWING OF HANDLE

Old Horseshoes Provide Handles For Carrying Shingles



For convenience in carrying bundles of wooden shingles, one carpenter uses discarded horseshoes as handles. These are hooked under the cross straps of the bundles so that one can be carried in each hand. It may be necessary to grind off the corks of the shoes so they can be inserted under the straps easily.

Top "Sewed" on Large Haystack To Avoid Damage by Wind

To save ropes or wires that would be needed to anchor the top of a large haystack against wind damage, one farmer sewed the top in place with binding twine. An eye was drilled through the small end of a long bamboo fishpole which served as a needle for use in stitching the twine



through and over the stack to bind it securely. Each stitch should be tied so that removal of the hay in small quantities will not loosen the remaining ties.

Leather Disks on Bridle Bit Protect Colt's Mouth

When breaking a colt, the bridle bit sometimes makes its mouth sore, and because of the animal's refusal to respond to the reins, the bit often is pulled to one side through its mouth. I find that much of this trouble can be prevented and the colt taught to respond to the reins quicker if a 3-in. leather disk is placed over the bit at each side of the mouth.

—Mike R. Hofer, Rockyford, Alberta, Can.



LEATHER DISK

Wiper and Sanding-Pad Cover Prevent Smudged Drawings



The possibility of accidentally smudging a drawing with graphite dust from a newly sharpened pencil is minimized by one artist who keeps a pencil wiper close at hand, and also covers his pencil sanding pad. These are suspended from his

drawing table as indicated. The pencil wiper consists of strips of paper toweling and the cover for the sanding pad is a small paper sack.—Ray Ligoeki, Hammond, Ind.

Frozen Truck Fleet Carburetors Thawed With Exhaust Gas

Truck and army motor-fleet operators in cold climates can save many hours of time lost in disassembling and thawing frozen carburetors by the following method: Secure a 10-ft. length of hose, to fit on or into one end of the tailpipe of a car or truck that is running and direct the warm exhaust gas over the frozen carburetor. This will melt the ice and the water can be drawn through by generous use of the choke.

—R. S. Demitz, Fort Benning, Ga.

HOT WAX FINISH

THIS finish differs from conventional wax treatment in that it is applied directly to the bare wood. Best woods to use for this treatment are beech, birch, cherry or maple. Both the work and wax must be kept hot throughout the entire application. Buffing the work after the wax coating has cooled should be done across the grain of the wood to give a filling action, following this treatment by a light buffing with the grain. Colored finishes can be obtained by first staining the work before the wax is applied. Also, excellent effects can be had by using tinted wax, which is obtained by coloring the wax with a small amount of oil color while mixing it.

Ideal for Small Projects



① Shred the lump of wax. Car-nauba wax is by far the best natural wax to use by virtue of its extreme hardness, but bees-wax, ceresin, candelilla or even paraffin can be used



② Add to 2 oz. of shredded wax, 1 pt. of naphtha or turpentine, naphtha preferred. Colored wax can be made by adding a small amount of oil color

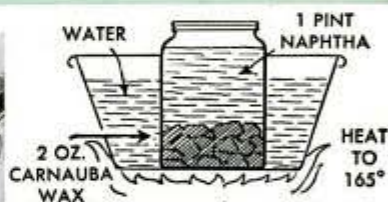

③ (Above) Place the mixture in a pan of water and heat. The wax will dissolve at about 165° F. Use electric fan to blow naphtha fumes out of open window



④ Work must be sanded very fine and must be heated to at least 110° before wax is applied. An electric light bulb in cardboard box can be used for heating



⑤ (Left) Wax must be applied hot, either a freshly made solution or old solution reheated. Temperature should be 150° F. or higher. Wax should be applied quickly and evenly while work is still warm

Bell for Rider on Towed Machine To Signal Tractor Driver

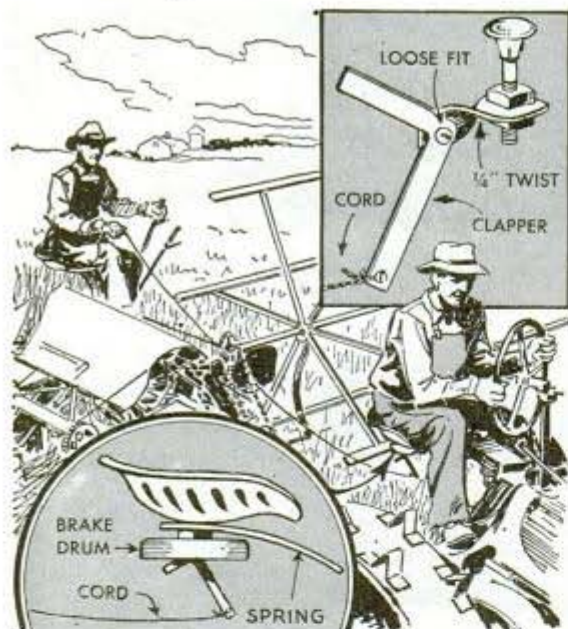

When a machine that makes considerable noise, such as a grain binder, is pulled by a tractor it often is difficult for the operator riding on the towed machine to signal the tractor driver. To overcome this trouble, one farmer installed a signal bell under the tractor seat. The bell consisted of an old auto brake drum fitted with a clapper as shown, the long arm being provided with a cord extending to the towed machine so that a pull on the line would ring the bell. If the machines are operated on rough ground where the clapper would swing sufficiently to give false signals, the long arm could be provided with a spring to avoid this trouble.

Simple Catch Engages Ground To Hold Gate Open

Disliking to use a latch post that would always be in the way to hold open a large

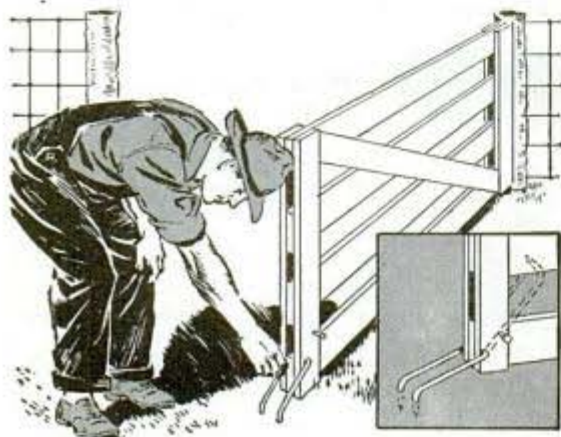

gate, one farmer bored a hole through the end of the gate to take a length of iron rod, which was then bent to the shape shown. This provided a holder that could be dropped down to keep the gate open or raised to rest against a projecting nail.

Broken Studs Drilled From Motor With Aid of Simple Guide

If you are unfortunate enough to twist off a cylinder-head stud bolt and have to drill it out, this guide for the drill bit will help avoid damage to the threads in the motor block. Also, it will enable you to use a larger drill

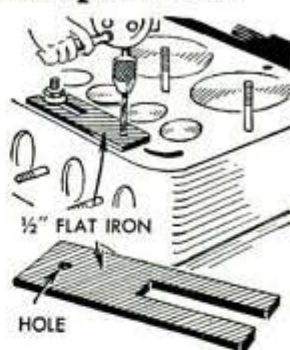

than when the work is done freehand, thus making it easier to remove the metal after the bolt has been drilled. As indicated, the guide is locked under an adjacent stud and adjusted so the guide hole is centered over the broken part of stud to be removed.

Brush Better Than Sifter Can To Apply Insect Powder



Although insect powders for poultry usually are supplied in sifter-top cans, it is difficult to apply the powder properly under the wings of the fowl because the feathers lie so close to the skin. To overcome this, one poultryman employs a discarded soft vegetable brush for the work. The powder

is emptied into an open pan, and the brush, dipped into this, is used to ruffle the feathers and apply the dust.

Weak Blueprints Easier to Read Under Red Cellophane

Placing a sheet of red Cellophane or similar transparent material over improperly printed or faded blueprints will enable you to read them much more easily. The method is particularly useful for reading fine detail. For permanent use, a piece of red Cellophane can be mounted in a wood or cardboard frame.



Radio

A.C.-D.C. Test Oscillator

By R. C. HITCHCOCK

ADJUSTABLE to any frequency in the broadcast band, this simple signal generator can be used to "line up" unbalanced tuned radio frequency (TRF) sets in easy stage-by-stage steps merely by adjusting the trimmer condensers for maximum output. It is also handy for aligning the pre-amplifier (RF) stage of a superheterodyne receiver, but it does not cover the intermediate (IF) stages.

It consists of a few old standard radio parts, a hand wound coil and a 25-watt Mazda lamp.

The simplified wiring diagram appears in Fig. 2, and the schematic circuit in Fig. 3. Insulated wire is used and the grid and plate leads should be well separated. Assembled in a 5 by 5 by 7-in. plywood case, as shown in photos B and C, the lamp socket and line-cord receptacle are flush mounted to enclose live circuit parts.

To calibrate the unit, use a broadcast receiver with accurate dial; place the oscillator on top as in photo A, and calibrate the 0 to 100 oscillator dial similar to the sample chart Fig. 1. Set receiver dial at 550 kc. and tune oscillator until set speaker gives loudest response. Note this reading on your chart, then set receiver for next reading.

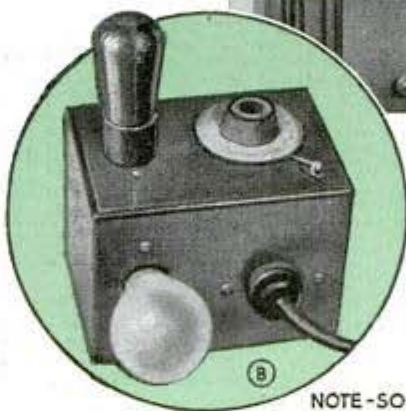

Radio Frequency kc/sec	Oscillator Dial Reading
550	95
700	78
900	55
1100	35
1300	22
1500	13

FIG. 1

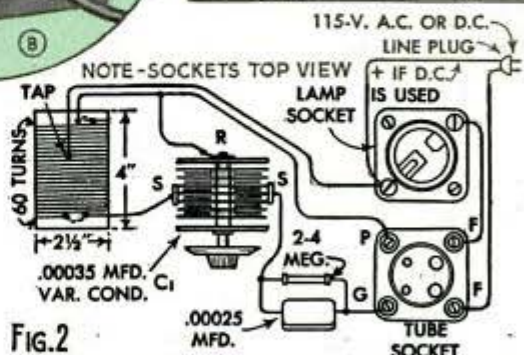

FIG. 2

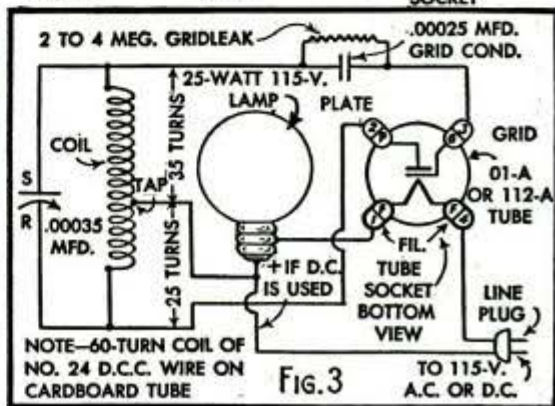
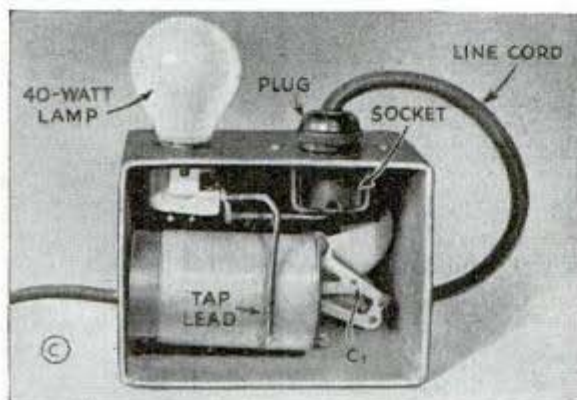

FIG. 3

"JUNK BOX" TWO-WAY

By S. A. Johnson



VALUABLE time and many steps can be saved with this electronic phone system. Providing two-way communication between points up to 500 feet apart, it has a wide variety of uses. It can be operated between the house and barn, or garage; between the basement workshop and an upstairs room, and similar applications. No light shows at the remote station, therefore it may be used in a photographic darkroom; many other practical uses will suggest themselves to the builder.

Although made from common salvaged parts and a few odds and ends from the "dime" store, it is a good performer and a real time saver. The breadboard units may not look as keen as the metal cabinets of peacetime, but they serve the purpose. The connecting circuit includes an independent pushbutton buzzer calling system operated from a 6-volt storage battery at the remote station. The master station employs a 2-tube audio amplifier that operates from any 110-volt line; correct filament supply for the tubes is

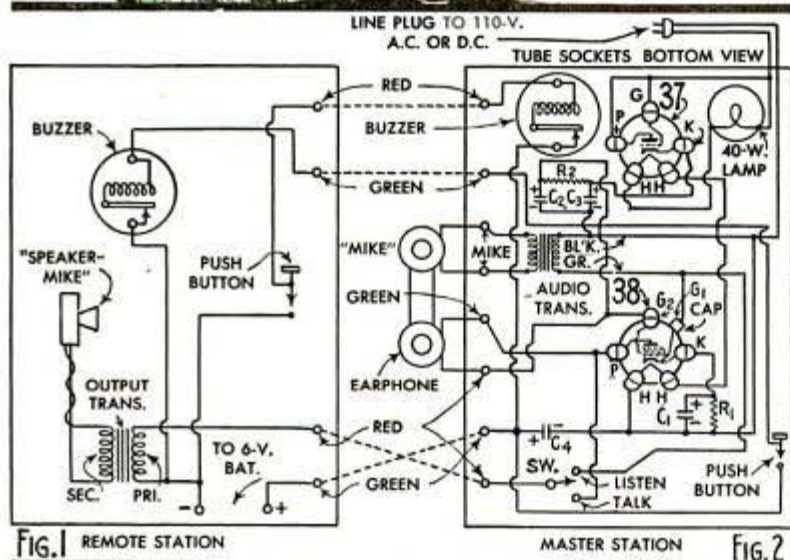
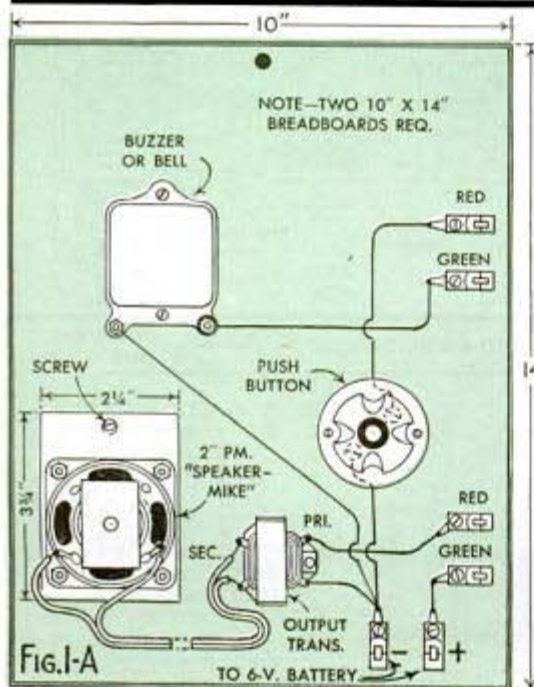

FIG. 1 REMOTE STATION

MASTER STATION

FIG. 2



REMOTE STATION TOP VIEW

obtained by dropping the line voltage through a 40-watt lamp; the audio transformer ratio is $3\frac{1}{2}$ to 1.

To make it possible to use only one amplifier, a talk-listen switch is used at the master station. This consists of an old toothbrush handle, two stop screws, thumb tacks and a rubber band. An extension handle is fastened with a round head machine screw that pro-

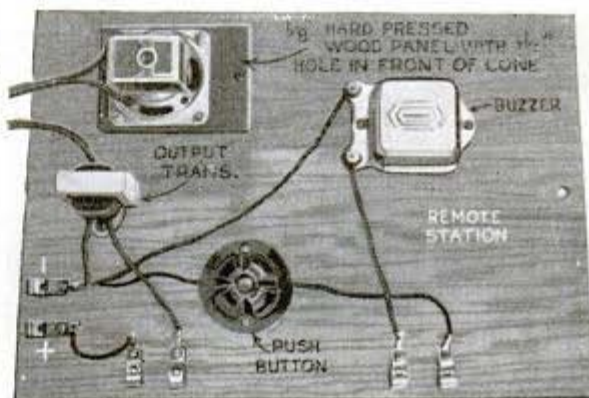

PHONE SYSTEM SAVES TIME

vides the switch contact. The user merely pushes this switch down to talk and releases it to listen; no switching is necessary at the remote station. The amplifier at the master station need be plugged into the power line only when conversation is required, as calling system is separate. A switch may be included in the lamp socket if desired.

Schematic circuit diagrams of both units, with color-coded connecting wires, appear in Figs. 1 and 2. Tag or identify your connecting wires in the same manner in order to avoid wrong connections. The simplified wiring diagrams are shown in Figs. 1-A and 2-A. All connections are clearly shown in these diagrams, and the photos. Detailed student material list R-324 is available from Popular Mechanics radio department, upon receipt of postage. The little P.M. speaker used at the remote station is held to the ear when listening, and used as a hand "mike" for talking. As both units are hung on the wall, this "speaker-mike" is hung on a convenient nail or screw, when not in use. The "French type phone" used at the master station is made from two old earphones fitted with separate pairs of leads, and mounted on a curved scrap metal bracket 7 in. long and 1 1/8 in. wide, bent to the proper shape for convenient use as shown in the photos. Try reversing the earphone unit leads for strongest signals.

Any type of salvaged two-wire insulated cord can be used to connect the two stations or, indoors, four single lengths of ordinary doorbell wire may be employed.

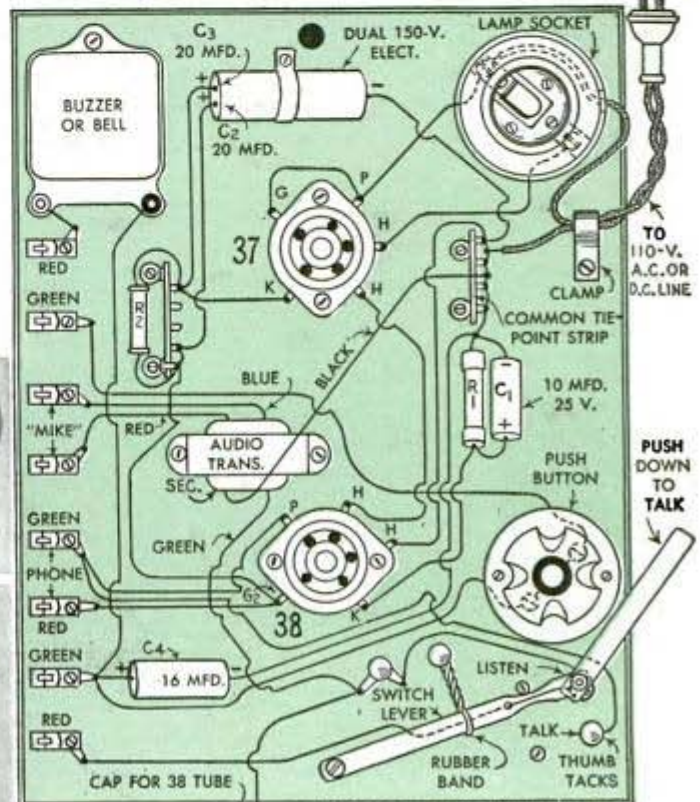
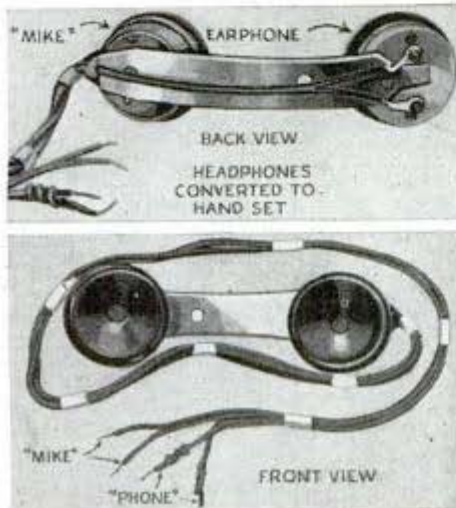
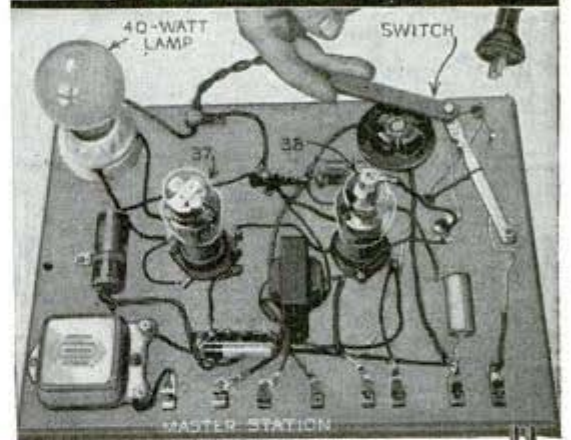
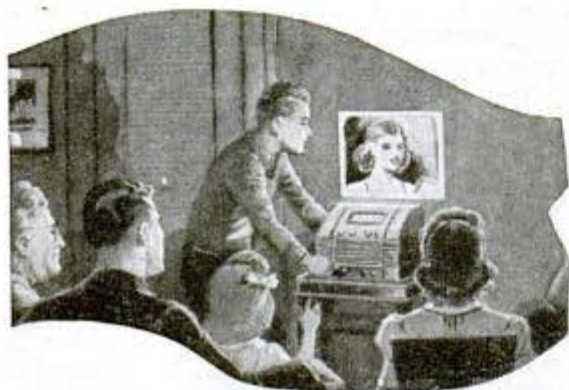

FIG. 2-A

RESISTORS $R_1 = 2,000$ OHMS 1 WATT,
 $R_2 = 4,000$ OHMS 2 WATTS

Engineers Plan Compact Low-Cost Television



PROJECTING large images on a wall screen through a lens system made of plastics, a compact instrument, approximately 18 in. wide and 14 in. high, is being planned by Emerson engineers to include a complete radio and television receiver, using a 3-in. cathode-ray tube. The engineers claim that the television image will be enlarged and projected to 15 by 20-in. proportions on a screen, with brilliance equal to that of home movies. They plan to limit the cost to \$150. An "X-ray" view of the 3-in. tube, and its approximate position in the proposed table model instrument appears in sketch A.

In the latest prewar developments of television there were three basic types of sight and sound receivers: Table models employing a 5-in., or larger, cathode-ray tube mounted for direct viewing; large consoles, in which the image is projected on a mirror mounted on the tilted lid, as illustrated in sketch B; and the conventional floor model (C) for direct viewing. The last two types employ large cathode-ray tubes, 12 in. or more, in diameter. The pooling of constructive thinking and research by radio and electronic engineers and manufacturers will effect a rapid spread of interest in practical postwar television for the home when civilian production becomes possible. It is the opinion of Emerson and other engineers that once a practical, comparatively low-priced television receiver similar to the one shown in sketch A, is available for developing mass consumer demand, there soon will be enough sets in use to support efficient commercial television broadcasting stations transmitting regular programs. Thus a great new peacetime industry will be on its way toward solving some of the problems of re-employment.

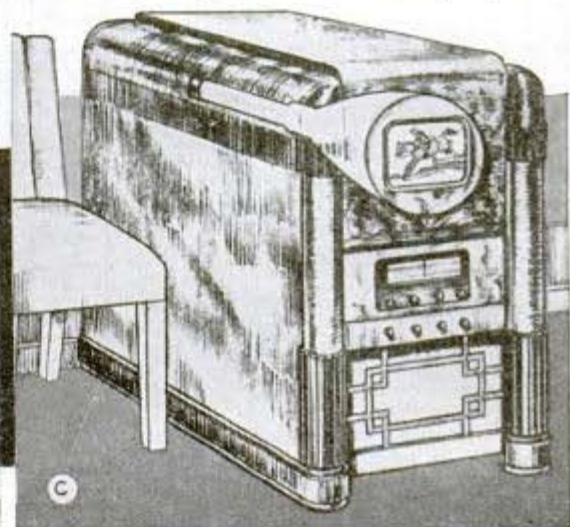
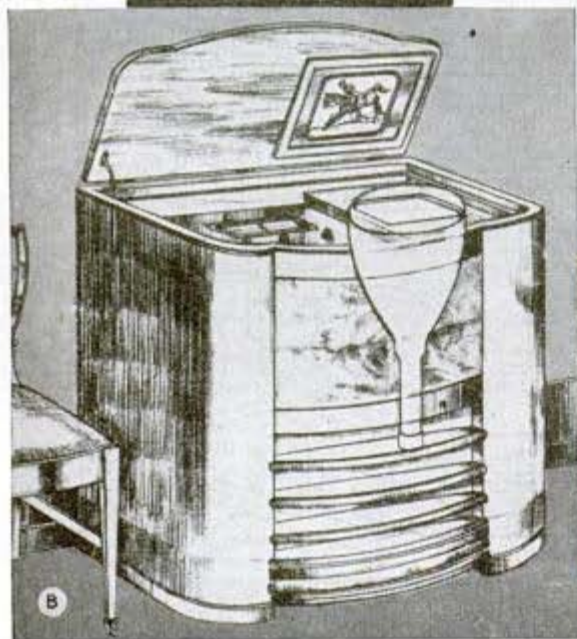
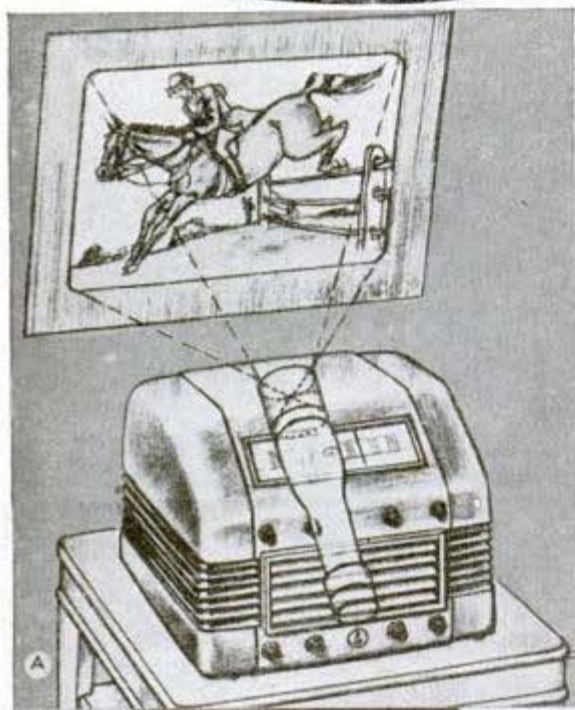

TODAY... over there

Dear Folks,
Hope you get the same
kick out of showing
these films as I had
making them. Of course



TOMORROW... back home

MOVIES BETTER THAN EVER— WITH FINER CAMERAS, FINER PROJECTORS

Lucky is the soldier camera fan who can snatch a spare moment of refuge from war with his beloved hobby—out where scenes are exciting and subjects exotic. But when he comes home Universal can promise him still other photographic thrills. For today Universal is employing new skills, pioneering new methods in the unceasing production of fine precision instruments for our armed forces. And tomorrow, after Victory, Universal will translate these same high achievements in optical instruments into a whole series of truly great cameras and other photographic equipment. Expect your next new camera to be a Universal!



There's only one
flag we're
prouder of!

UNIVERSAL CAMERA CORPORATION NEW YORK • CHICAGO • HOLLYWOOD

Peacetime Manufacturers of Mercury, Cinemaster, Corsair Cameras and Photographic Equipment

THE HOW AND WHY OF

USE OF WILLIAMS' KNURLING TOOL HOLDERS

WILLIAMS

DROP-FORGED TOOLS

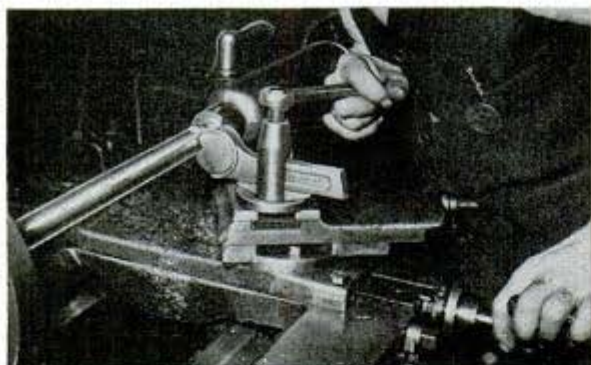

The self-centering Head of this Williams' No. 1-K Holder assures equal pressure of both Knurling Rolls against the work.

knurling is to start at the extreme end of the work, start the Tool so that only half the width of the roll face contacts the work when forced in with the hand cross feed. Engage the longitudinal power feed and let the Tool travel across the face of the work for desired distance. Now reverse direction of carriage travel, without removing Tool from the impression, and feed back across the face of the work. Slight additional cross feed may be applied, as the carriage reverses, to further sharpen knurling.

Some machinists use oil when knurling—others prefer air pressure so as to blow all chips clear. Illustration below shows sample of knurling by both methods. Actually both samples are of about equal quality.

Unretouched photo of work sample. Air pressure used on knurling at the left end—oil on knurling at right. Piece is 3/4" mild steel bar; coarse knurled with Williams' No. 11-K Holder; spindle speed 250 R.P.M.; both ends knurled with one pass up and reverse.



WILLIAMS' KNURLING TOOL HOLDERS

No. 00-K to 2-K, 4 sizes, 5/16" x 3/4" x 5" to 5/8" x 1-3/8" x 7-1/2" with self-centering Head and fitted with ONE pair of knurls.



Nos. 11-K and 12-K, 2 sizes, 1/2" x 1-1/8" x 6-5/8" and 5/8" x 1-3/8" x 6-5/8" with Revolving Head and THREE pairs of knurls, for fine, medium and coarse work.

KNURLS FOR WILLIAMS' HOLDERS



DIAMOND PATTERN



STRAIGHT-LINE PATTERN

Both patterns furnished in pairs, to fit standard makes of Knurling Tools, in 3 different pitches: Coarse, 14 pitch; Medium, 21 pitch; Fine, 33 pitch.

● Knurling differs from most lathe operations in that it is not a *cutting*, but rather an *embossing* or extruding operation. Knurling actually increases the diameter of the work. Whenever possible, work to be knurled should be held between centers. Long and extremely light pieces should be supported with a Steady Rest. In other words, the work must be prevented from springing away from the cross pressure of the knurling rolls.

Set the Knurling Tool Holder well back in the Tool Post and so positioned that top and bottom rolls are equidistant above and below center of the work, as sketched above. Tool Post screw should be securely tightened.

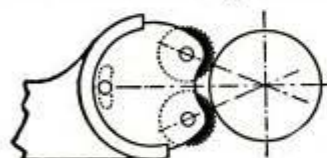

With lathe in slow speed, begin at Tailstock end so as to feed towards Headstock. Force the Knurling Tool into the work—*abruptly*—to approximately full depth of the knurl. This should be accomplished *before* rolls can make one complete revolution. If the

work, as sketched above. Tool Post screw should be securely tightened. With lathe in slow speed, begin at Tailstock end so as to feed towards Headstock. Force the Knurling Tool into the work—*abruptly*—to approximately full depth of the knurl. This should be accomplished *before* rolls can make one complete revolution. If the

FREE DATA SHEETS

J. H. WILLIAMS & CO., BUFFALO 7, N. Y.

ON USE OF SHOP AND HAND TOOLS

Your name and address in the margin below will bring 12 Tool Holder Data Sheets (punched for 3-ring binder) and a list of our complete Data Sheet series. Mail to above address, Dept. PM-5.



WHERE PERFORMANCE REALLY COUNTS...



Dependable

..CHAMPION SPARK PLUGS

ARE ON ACTIVE DUTY!

"Rugged" is one of the servicemen's most apt and widely used words, and rugged precisely describes them and the kind of service encountered by their mechanized vehicles—jeeps, trucks, half tracks and tanks. In this service Champion Spark Plugs meet every requirement for dependable ignition.



Champions are in the service on every front on land, sea and in the air. This is the greatest testimonial ever accorded Champion Spark Plugs—proof positive that their many exclusive and patented features really mean better performance and greatest dependability.



TO SAVE GASOLINE—KEEP SPARK PLUGS CLEAN

LET'S ALL BACK THE ATTACK—WITH WAR BONDS



The Toughest Man in the World to Please

THE "hard-to-please" attitude of the Defoe shipbuilder is not a war measure. It's a life-long Defoe tradition. Harry J. Defoe—who founded the yard nearly forty years ago—and his crew are old hands at building sea-going vessels. They know that even peacetime ships that go down to sea must be built to withstand battering that no land-bound structure receives.

Today this experience is paying extra dividends to the Navy in the form of sound construction, added protection for crews, and lower manufacturing costs. The fleet built for

the Navy in the Defoe yards since Pearl Harbor numbers more than 65 fighting ships. And now a squadron of LCI (L) Landing Barges is taking form on the production line. These ocean-going invasion vessels are the spearhead of America's growing offensive. In making them, we pledge your sons all our skill and experience, all the Defoe tradition of safe, sound, deep-sea shipbuilding.

When Peace returns, Defoe's advanced manufacturing technique and skilled craftsmanship will provide quality products of greater value and lower cost for all Americans to enjoy.

DEFOE SHIPBUILDING COMPANY, BAY CITY, MICHIGAN

Three White Star Renewal Citations now decorate the Navy "N" Award won by Defoe workers.

SHIPS FOR VICTORY



Defoe

SERVANTS FOR PEACE



Motorola Radio "HANDIE-TALKIE" fights with

CARLSON'S RAIDERS

in
GUNG HO!

The great story of Lt. Col. Evans Carlson and his Marine Corps raid on Jap-held Makin Island can now be seen in Walter Wanger's exciting Universal war movie. It's a four-star picture!

You'll see Motorola Radio's famous Handie-Talkie at work in battles against the Jap that add greater glory to our fighting leathernecks. The picture takes its title from the Marine battle cry, "GUNG HO," which in Chinese means "work together". That's a good slogan for everyone on the home front too!

"HANDIE-TALKIE"
IS ANOTHER

Motorola
Radio
"FIRST"

Motorola **RADIO**
FOR HOME & CAR
GALVIN MFG. CORPORATION · CHICAGO





BROKEN PLASTER

It's easy to repair cracked walls with Rutland Patching Plaster. Just mix Rutland with water . . . wet the old plaster . . . and apply with knife or trowel. Rutland is the *original* ready-to-use patching plaster. Extra fine and white. Does not shrink or crack when it sets. Makes a patch as smooth and lasting as the wall itself.



HOLES IN CONCRETE

Never neglect small breaks in cement floors, walks, walls, etc. Mend them promptly with Rutland Concrete Patcher. Just mix with water and apply with trowel.

RUTLAND

REPAIR PRODUCTS

Rutland Fire Clay Company, Rutland, Vt.

Pilots Versus the Weather

Continued from page 69

venting or eliminating this ice. In some planes, alcohol carburetor de-icing equipment is also present, but it should not be used except in emergencies.

The P.I.F., as flyers call it, tells what ice does to a plane:

"It reduces the aerodynamic efficiency of the wings, thereby reduces the lift and increases the stalling speed. Reduces the aerodynamic efficiency of control surfaces and thereby reduces controllability. Increases the drag of struts, etc. Increases the load. Causes improper functioning of air-speed indicators, and other instruments that are venturi operated, by icing the venturi throats and pitot tubes. Causes engine malfunctioning due to carburetor ice. Reduces propeller efficiency."

Icing is usually heaviest between 15 and 32 degrees Fahrenheit, but has been known to form at temperatures as high as 40 degrees. On the other hand, in extreme northern latitudes, moisture, upon which formation of ice is dependent, has been found in the atmosphere at -40 degrees Centigrade. The most likely icing location, and the most dangerous, is over mountains.

To combat ice, many effective devices have been invented. Most wing and tail de-icing systems consist of a pump supplying air to inflatable rubber shoes on the leading edges of wing and tail surfaces. As the de-icer shoes inflate and deflate alternately the ice is broken from them.

Ice on the propellers is combated by anti-icing spinners, which must be coated with de-icing oil prior to the first flight each day. A slinger ring distributes de-icing fluid to the propeller blades. Icing of the air-speed pitot tube, with consequent false readings of the altimeter and rate-of-climb indicator as well as the air-speed indicator, can be prevented by a pitot tube heater. Certain planes have windshield de-icers, which coat the glass by pumping de-icer fluid through perforated tubes.

Since flyers experience temperature ranges from 130 degrees to -50 degrees Fahrenheit it has been necessary to develop special clothing and rules for behavior which enable them to stand temperature extremes with the least discomfort.

In desert operations, for instance, the old-fashioned practice of wearing a woolen band around the middle and over the stomach to absorb perspiration and prevent stomach chills is recommended. Flyers are warned to sip water, not gulp it; to refrain from smoking, for it increases thirst; to

Continued to page 152

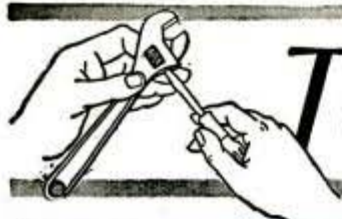

TOOL NOTES

Maintenance
and Repair
Suggestions to
Prolong Tool Life

No. 16 PICKING THE PROPER TOOL FOR THE JOB

To the uninitiated, a screwdriver is just a screwdriver, but to the trained mechanic, the proper screwdriver for the job is *the* only screwdriver to use. Below are some examples:

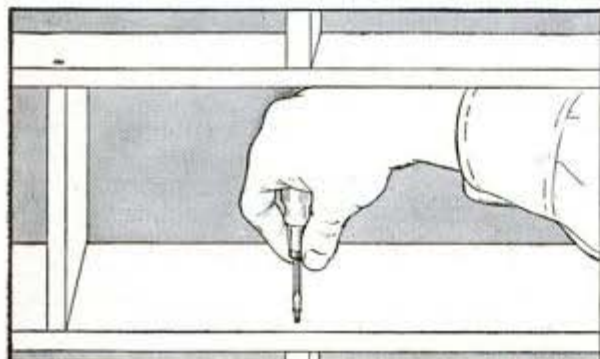

When working between obstructions, don't try to use a long screwdriver at an angle. Use a CRESCENT SHORT SCREWDRIVER. It will do the job better without marring the screw head and with less effort. Example: working between shelving.

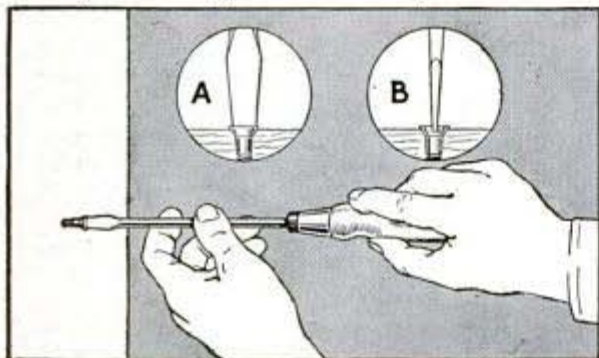

Select the screwdriver with the proper width of blade to handle the particular size of screw being used. Inset A shows the correct blade width which is approximately the same as the screw head diameter. Inset B shows how the thickness of the blade should conform to the width of the screw head slot.

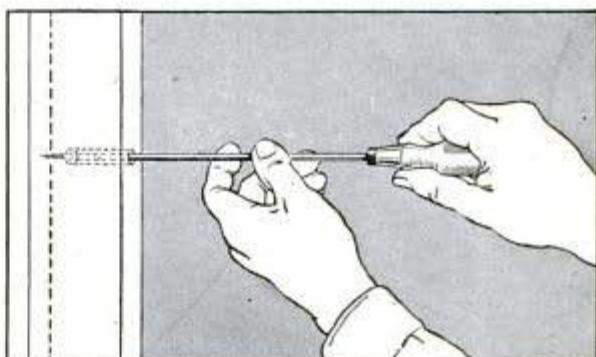

When inserting a screw in a deeply countersunk hole or electrical work where limited clearances will not admit a wide blade, use a CRESCENT ELECTRICIAN'S AND CABINET SCREWDRIVER, available in lengths varying from 6½" to 16½". Example: working in countersunk holes with short screws.

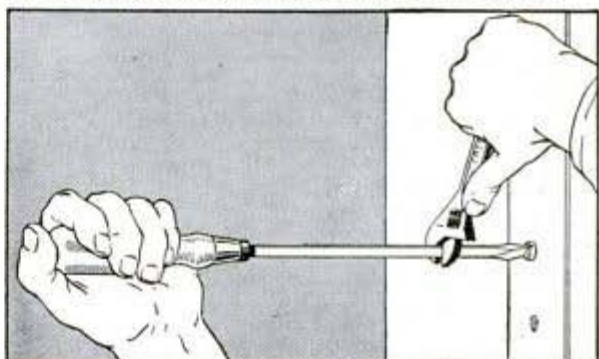

Where extra tightening pressure must be exerted, use a CRESCENT SQUARE ROD SCREWDRIVER in conjunction with a CRESCENT WRENCH as shown above. Example: tightening machine screws or over-size wood screws.

MAIL THE COUPON FOR FREE REPRINTS



This is No. 16, in Crescent's TOOL NOTES Series. These informative advertisements provide practical information for users of hand tools. Mail the coupon today!

CRESCENT TOOL COMPANY, JAMESTOWN, N. Y.

CRESCENT TOOLS
Give Wings to Work

.....
Crescent Tool Co., Jamestown, N. Y. F-6

Please send your "Tool Notes" Series
 for Bulletins for 3-ring binder

Name _____

Address _____

City _____ State _____

WORKSHOP WISDOM

How to make a good crack-filler

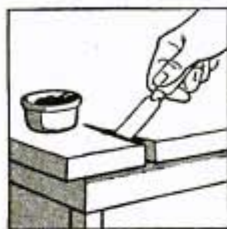

HERE'S a low-cost filler for building up loose joints, filling gouges or cracks in furniture—and hundreds of other uses.

Mix 1 measure of Casco Glue Powder with 1 measure of water and let stand for 15 minutes.

Then add it to a dry mixture of $1\frac{1}{2}$ measures of sifted sawdust, $\frac{1}{2}$ measure of flour, $\frac{1}{2}$ measure of whiting. Mix to a heavy paste, using $\frac{1}{4}$ measure of denatured alcohol to smooth the filler.

Round the filler off slightly above the work to allow for slight shrinkage. Finish off with sandpaper when dry.

Casco Glue has a 4-point advantage

Unusual strength. Casco Glue hardens and sets chemically to form a bond of remarkable strength and toughness.

Greater durability. This glue is highly resistant to dampness, heat, and age.

Easy to mix. Casco Glue mixes readily with cold water . . . no heating problems.

Economical. A little Casco goes a long way. Mix it as you need it. The powder, if tightly covered, lasts indefinitely.

For special outdoor jobs and water projects, specify Cascamite—the completely waterproof plastic adhesive.

You can get both Casco Glue and Cascamite in 10c, 25c, and larger sizes at all hardware stores.

Write a post card today for free Casco Project Booklets and free Gluing Guide containing 80 household gluing hints. Address: Casein Company of America, Dept. P-5, 350 Madison Ave., New York 17, N.Y.



CASCO Powdered Casein GLUE

"Sets chemically—hardens permanently"

take salt tablets daily. When the weather is extremely cold, it is useful to exercise enough to keep warm, but strenuous exercise produces perspiration which may turn to frost inside one's clothing. Flyers are urged to take hot drinks and hot food, and to eat as much fat and sugar as possible.

Electric flying suits, gloves and shoes have the advantage of eliminating bulkiness and resulting awkwardness in manipulating controls. They are worn like underwear, with a light summer flying suit over them, and protect the wearer in temperatures as low as -35 degrees Fahrenheit. One disadvantage is that the plane's electrical supply might fail or the flyer have to bail out. It is wise to carry a heavy-clothing kit, too. And don't try to take a reading on a magnetic compass within 30 inches of an electrically heated suit. You're likely to get lost.

Long-range weather forecasts are now a working actuality. What the weather will be like at the end of two days, or 30 days can be told "with sufficient accuracy to permit of making preparatory plans for future operations," Gen. H. H. Arnold, in command of the Army Air Forces states.

"The Caissons Go Rolling Along"

Continued from page 37

some distance away from the rest of the battery or the battalion to avoid giving the enemy advance knowledge of where our guns are located. Corrections continue to be made after the mass firing begins.

Shrapnel is out of date and the last round of it, left over from the last war, was fired some time ago. All shells now are of the high explosive type, fused to burst over the heads of the enemy or upon actual contact with a target or, in case the target is to be penetrated before the explosion occurs, after a long delay following impact.

A modern artilleryman is vastly different from the swaggering, hairy-eared cannoneer of olden times. A crack battery commander is essentially a mathematician although he solves most aiming problems with slide rules and computers.

He and his fellows will point out to you that the big howitzers and guns are the "cheapest" weapons there are for destroying targets within their reach. Their accuracy is practically perfect, the targets may be fired upon at will and for as long as is necessary. Artillery isn't "grounded" when the weather turns bad and the guns can be turned at new targets whenever they are spotted. Not even the giant rockets used by the Russians and Germans possess the fire power and accuracy of the big guns.

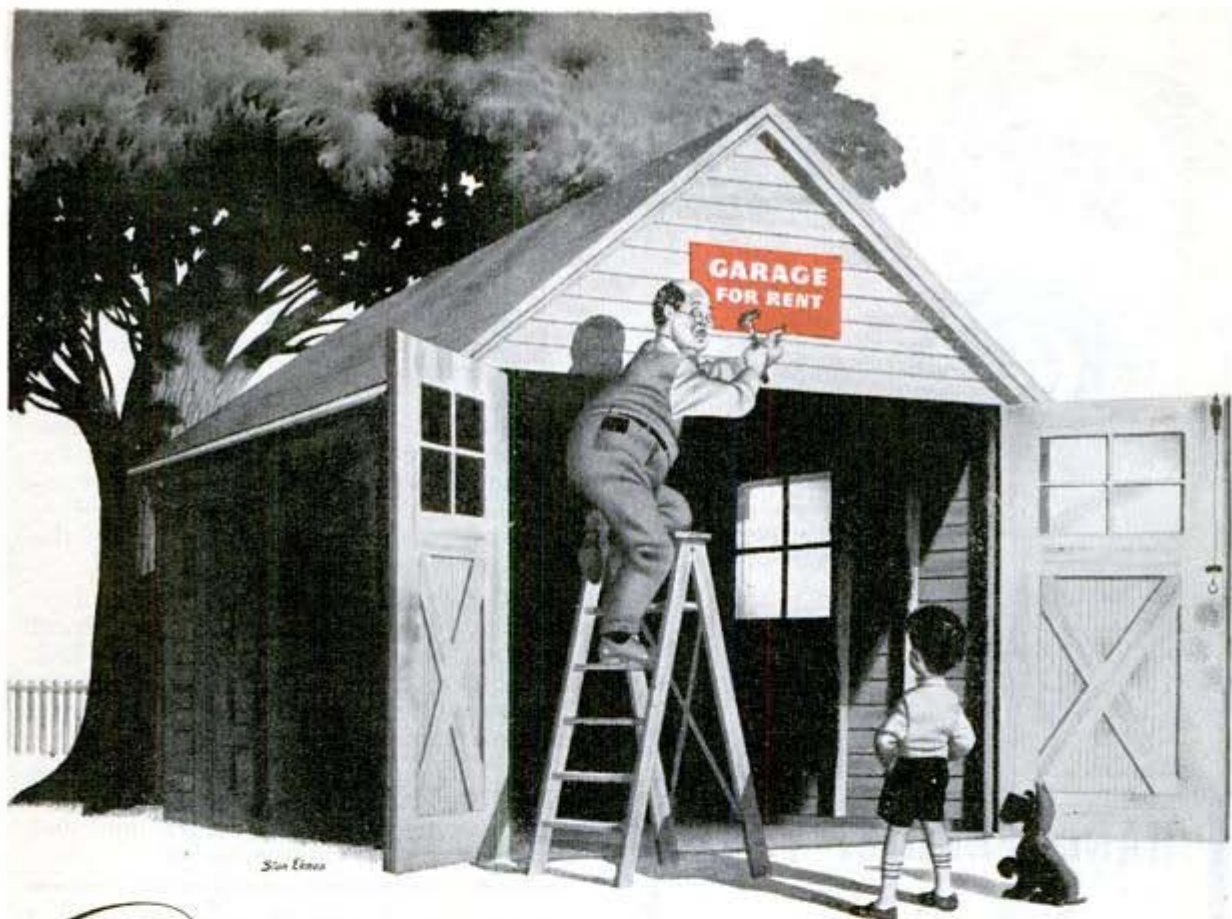

Sam Lewis

Don't let this happen to you...

► This family has just lost one of its most essential possessions—the family automobile. It wore out and it can't be replaced. This can happen to millions of families if they continue to neglect their engines, despite repeated warnings. An automobile engine can be worn out in a few years, or made to last almost indefinitely, depending on the care it gets.

There are men in every community who know how to protect your engine and insure its long life. They are the motor service men.

Go to one of these men, and put your car in his hands, to watch and protect. It's everyone's duty to do this, as well as good judgment.

HASTINGS MANUFACTURING CO. • HASTINGS, MICH.
Hastings Mfg. of Canada, Ltd., Toronto

★ *It's a privilege to buy War Bonds*

TOUGH... BUT OH SO GENTLE



HASTINGS STEEL-VENT

Piston Rings

TOUGH on oil-pumping • GENTLE on cylinder walls



HANDKERCHIEF TEST



**PROVES VITAL ZONE SPOTLESS
AND FREE FROM "GOO"—no matter
how often you smoke it!**



HESSON GUARD MILANO



**HELP MAKE
THE OLD
THINGS DO!**

Mends
dishes,
glassware,
furniture,
toys and
luggage.

DU PONT DURO CEMENT

REG. U. S. PAT. OFF.

Putting on the War Paint

Continued from page 81

a system of "three-dimension" painting which reduces accidents and fatigue by scientific application of color to manufacturing machines.

But some of the best ideas for painting to fool the eye came from the men at the front. One air squadron in Asia was whitened down to its last serviceable plane. To keep the superior forces of Japs away and to impress them with the strength of the flying group, the single plane would be flown on a mission, landed and its nose quickly repainted green, or red, as the situation demanded. Thus disguised as another plane, it would take off again before the paint was dry. This trick bluffed the Japs into staying away from the field.

In the depths of the jungle, the Japs would taunt a Yank into picking up a hand grenade. They could recognize the look and glint of a yellow grenade in a flash. They knew just where to fire to knock over the American before he could heave it.

The Yanks applied paint of a protective color to the grenades, painted their throwing hands or daubed them with mud and went right on heaving grenades.

Treasure From the Dry Lakes

Continued from page 59

Today, from a big plant on the "shore" of the dry lake, a vast tonnage of war materials is being shipped over the company's "Three Elephant" railroad. Muriate of potash for agricultural fertilizers, sulphate of potash for smokeless powder and synthetic rubber, lithium for gas masks and welding fluxes, bromine for synthetic rubber and fumigants, salt cake that winds up in aircraft wings and in shell wadding, and borax products that play their part in producing optical glass for range finders, bombsights, and fire-control instruments, are all produced in the plant. It is estimated that at present rates of production the dry lake can continue to supply these needs for another century or more.

Conquering the chemistry of the lake is only part of the story. The desert itself had to be conquered so that people could live there the year around. The town of Trona with a population of about 2,000, nearly half of whom are employed in the plant, is in the Mojave desert, a region so arid and desolate that it might be on the surface of the moon. Its scenery is weird. Rainfall amounts to only four inches a year and temperatures of 118 degrees in the shade have been recorded.

Continued to page 156

THE WINNER HAS CHANGED HIS APPEARANCE, TOO



Hundreds followed him across the fairway—watched him use his skill to sink that final putt and set an unsurpassed score. Now, as he saps mines and booby-traps, his gay informal clothes are left behind. He looks different. But his character is the same.

Plumb, too, has a different appearance. Some of the finish is gone—eliminated by Government Order. Yet, the character of Plumb is the same. The one-piece steel head, tempered to faultless perfection. The sturdy handle of firm, tested hickory. The hang. The perfect balance. These are the features by which you will always recognize a Plumb tool. Yes, Plumb is proud of its service uniform. Fayette R. Plumb, Inc., 4837 James Street, Philadelphia 37, Penna.



PLUMB TOOLS ILLUSTRATED. Top to Bottom, Nail Hammer, Half Hatchet, Ball Pein Hammer, Single Bit Michigan Axe.

Quality Comes **FIRST**
PLUMB
is **FIRST** in Quality

PLUMB

HAMMERS • HATCHETS • AXES • SLEDGES

Carhartt

BROWN DUCKS

Give Extra Protection!



● You'll find these new-style 11 oz. heavy Brown Duck Carhartts, with coats to match, the ideal work garment for those extra tough jobs. Structural iron and steel workers, foundry men, linemen, electricians, road builders, freight handlers, truck drivers and a host of others swear by their exclusive, extra protection, water repellent features.

They give greater satisfaction, longer wear, real work comfort—are tops in appearance, protection and full cut fit.

IF YOUR DEALER CAN'T SUPPLY you from stock send in your measurements and \$3.50. We'll send them charges prepaid.

WORK CAPS in materials to match. Washable, comfortable, with breather eyelets.



HAMILTON CARHARTT OVERALL CO.

Detroit, Mich.
Atlanta, Ga.

Carhartt Park, Ky.
Dallas, Texas

On sale at your local dealers

Carhartt

UNION MADE WORK CLOTHES

50 Years a Friend to Organized Labor

SAVE THAT MOTOR!

Give electric tools longer life with Heavy Body 3-IN-ONE Oil! Right for electric refrigerators and washing machines, too. Lubricates, cleans, polishes, prevents rust. At Hardware, Drug, Grocery, 10¢ Stores.



HEAVY BODY

"3-IN-ONE" OIL

Early prospectors suffered from heat and thirst and some of them never returned from prospecting trips into the area. Yet today people are living comfortably here.

This seeming miracle was accomplished by common sense. Good water and proper food are necessities that the pioneers didn't possess. Potable water for Trona is obtained by pipe lines that extend to 38 different fresh water springs, plus distillation apparatus that takes over when the springs run low. Food supplies for well balanced diets are shipped in from the coastal agricultural regions in place of the coarse fare that early miners packed in with them.

Peak summer heat is intense but it is a dry heat with a humidity of only 10 percent. Homes are well insulated against outside temperatures and are provided with evaporative "desert" coolers that pull the temperature way down. The weather may drop as low as 12 degrees above zero in the winter and in some homes a steam radiator stands adjacent to the summer cooling apparatus.

Old John Searles, if he could return to the desert, would think he was seeing a mirage when he viewed Trona working on three shifts and shipping 40 railroad cars of vital chemicals out of his lake every day.

They Said It Was Too 'Hot' to Fly

Continued from page 64

above the open bomb bay, without parachute, working with pliers to crimp shut the broken hydraulic lines in the hope the landing gear could be put in operation. After an hour the left wheel was seen moving slowly down into position—but its tire had been shot to shreds.

A third time Major Celio was ordered to abandon ship. But he liked that ship.

"This is going to be a major repair job," the major told Operations, "so I'm going to land at the _____ repair depot. Send a car for me and the crew."

Somehow he did it, with one rudder cable, easing the heavy ship down with the weight on the good tire. As the left wheel touched, the torn tire flew off, the wheel dug in and the plane did a dizzy about-face and stopped. Five days later it was back in action.

Two or three miles above ground is one of the most dangerous areas, well within reach of anti-aircraft shells and a playground for enemy fighters; but that is the zone preferred by the Marauders, which flew most of the time with a Spitfire cover. One of their neatest precision jobs was the bombing of the Le Trait shipyard, a target

Continued to page 158

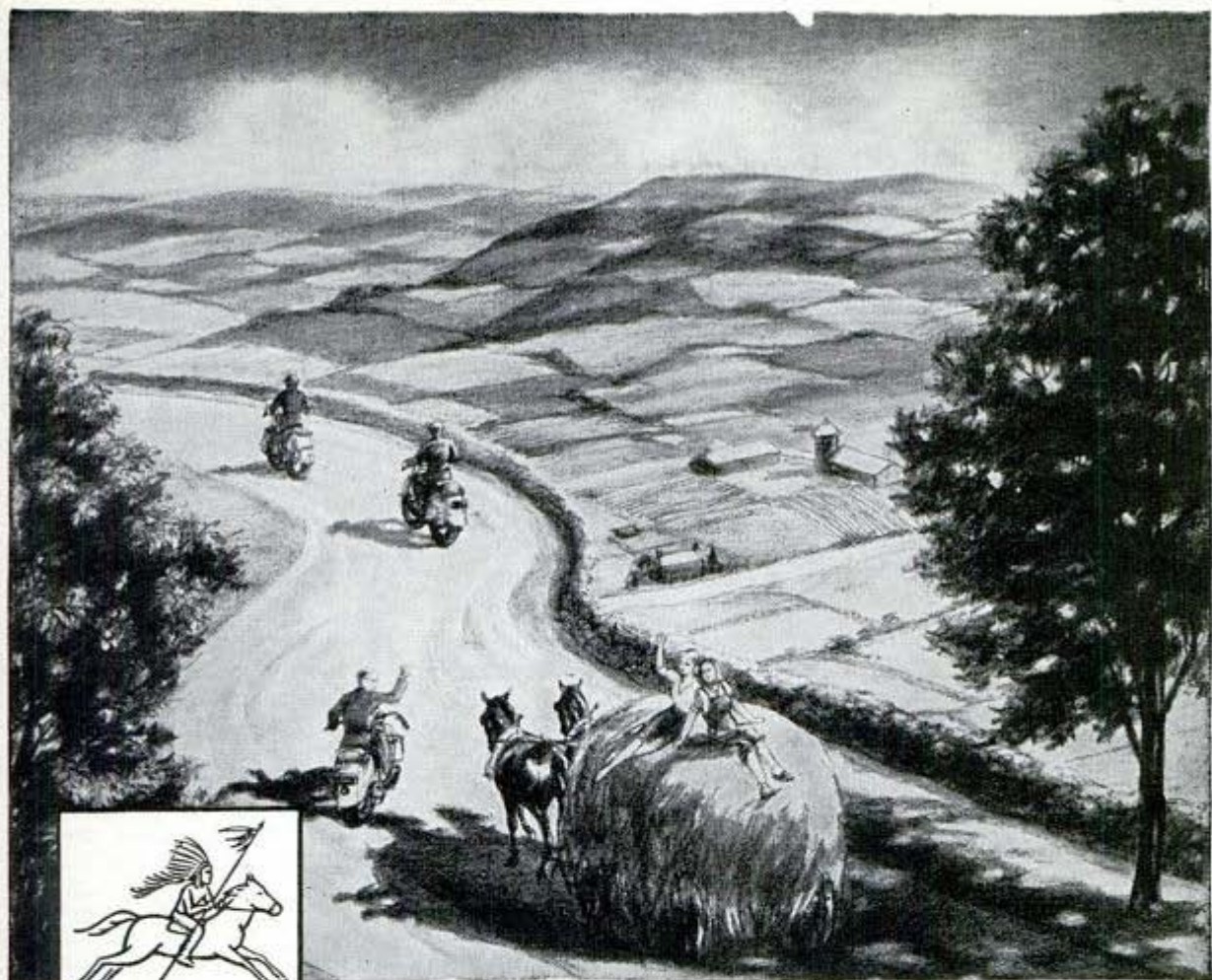

Modern Indian Trails

Just off the highways of our nation, there are a million little tempting side roads that wind their way right into the heart of this great country of ours... modern "Indian Trails," teasing you to see what's at the other end. On an Indian you can "blaze" these trails easily, safely and comfortably.

One of the biggest thrills of "trail blazing" on an Indian is the feeling that you and your motorcycle are "one." Indians are alive with power. They give you a feeling of confidence and safety... respond easily to your slightest touch... and ride so smoothly you'll find it a pleasure to reel off the

miles. Make your plans now so that when this war is over, you can enjoy motorcycling at its finest, in the saddle of an Indian.

INDIANS ON THE WARPATH

Right now, all new Indian Motorcycles go straight to war, and what a fighting record they're turning in! But new, improved, postwar Indians are already being blueprinted. *They're the motorcycles to wait for!*



**BUY WAR BONDS NOW
TO BUY AN INDIAN LATER**

Indian Motorcycle Company
Springfield, Massachusetts

Please send at once, a thrilling, action-packed FREE copy of *Indian News*.

*Read
about
Motorcycling*

Name.....
Address.....
City.....State.....

PM-5

Indian

MOTORCYCLES

Some things haven't changed!

LHS

STERNCREST

STERLING

Every pipe produced from genuine imported Mediterranean briar of pre-war quality, and shaped by the skilled hands of master craftsmen to be "A thing of beauty and a (smoking) joy forever". Sterling Silver band; solid rubber bit. Every pipe numbered, and registered by LHS, as your guarantee of pipe perfection.

\$5

Smooth and
Antique
Finish.

Many hand-
some models.



"Perfection ... in a Pipe"

LHS **STERNCREST** 14K

The custom craftsmen of LHS select the very choicest grains for these patrician pipes. They finish them by an exclusive process that brings out the full beauty of the briar, —circle them with a band of solid gold. Truly, "Perfection—in a Pipe" **\$7.50**

L & H STERN, Inc., Stern Bldg., Brooklyn, N.Y.

Makers of the famous

LHS Ultra-fine \$10 Certified Purux \$3.50 Superfine Purux \$1.50

Put this in your
pipe and smoke it.

BUY WAR BONDS

330 by 650 yards, virtually destroyed along with hits on a sub and a tanker.

One day a Marauder named "Loretta Young" took a beating on a visit to Lille-Nord. It's hard to explain why she ever got home. It's one of those miracles that American manufacturers and Yankee pilots perform together so spectacularly.

"We made our bombing run OK," related 1st Lt. Milfred O. Elling, "Loretta's" pilot, "but the flight ahead turned off before we hit the target and our fighter escort went with them. We were flying the last ship in the formation. I thought 'Now is the time for enemy fighters to jump us.'"

Seconds later an FW-190 came diving out of the clouds, followed by three others. Staff Sergeant Gordon A. Sampson, tail gunner, opened up on them.

"We opened up about the same time," he said, "with the FW about 350 yards away. I heard his 20mm. shells tearing into our ship, and I kept on firing a steady burst until he went down smoking."

One shell had bored through the Plexiglas tail and pierced his sleeves, grazing his left arm, tore through two bulkheads and exploded against the dynamo, shattering the turret. Another shell shot off the left elevator, a third exploded inside the right wing and sliced an aileron control cable, two more exploded inside the outboard right wing, and the right propeller took four more. The interphone went dead and the controls started jumping. Copilot, 2nd Lt. Clifford Brokaw went back to investigate, found the waist gunner binding the wounds of Sgt. Clarence S. Cyford, turret gunner. They moved him forward to be ready for "ditching" in the Channel. But "Loretta" was still under control at 6,000 feet. Lieutenant Elling told the crew to don 'chutes before he tried the landing gear and flaps over the home field.

"I didn't have enough control to prevent a dive if they didn't work," the pilot said. "I guess the others thought I wasn't going to try to take her in, but we have always been told a lot of stuff about bringing our ships back, and I thought I could. We didn't glide in. We fell like a rock. But 'Loretta' made it, and she'll fly again."

To the ground crew and the crash squads that watched her come down, Loretta's landing looked mighty sweet.

By the time you read this, grandchildren of the first Marauder may be coming off the line and the B-29 Super-Fortress may have relegated the B-26 to the category of "light bomber." Light bomber, indeed! It's 15 tons of dynamite flying at nearly pursuit-plane speed, sometimes with twelve

Continued to page 160

SCREWBALL IDEAS ON BATTERY CARE #2

Leave your motor running when parked for a recharge

The only trouble with this idea is that it won't work! It burns up "A" coupons fast; and further discharges the battery because an idling motor usually draws a net discharge of from 2 to 5 amps.

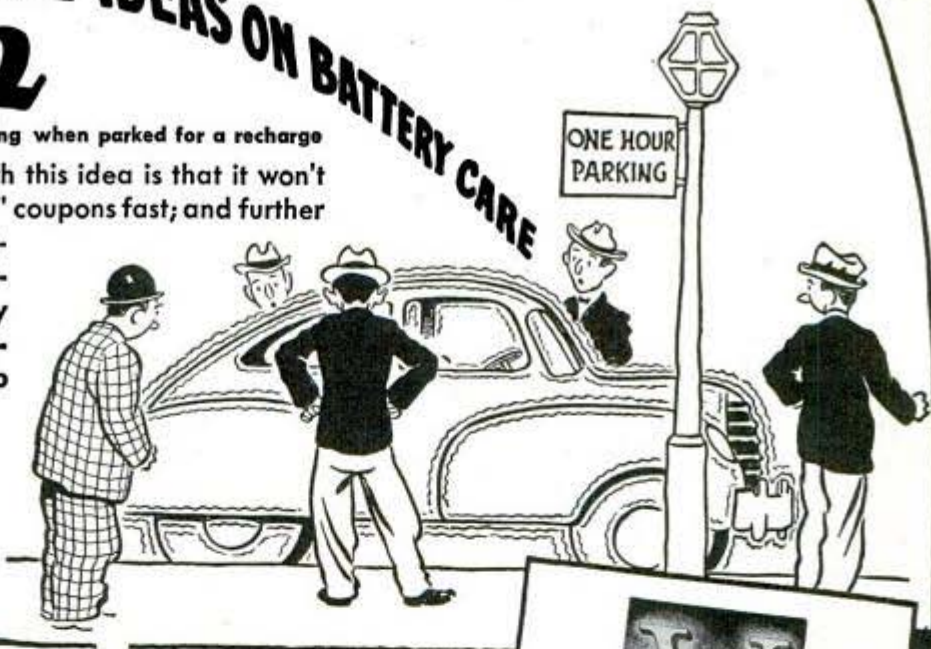

...THE WISE WAY IS PERIODIC RECHARGES!

Restricted driving is hard on batteries. Rationed mileage keeps them from getting the normal recharge from the generator, making certain precautions necessary if starting trouble is to be avoided.

An experienced Exide Dealer knows how to keep batteries in top shape. See him for a check-up every two weeks. In many cases, periodic recharges may be just the right medicine for your battery, and with them, an Exide Dealer can put off the day when you'll need a new battery. When you *must* buy, get a dependable, long-lasting Exide. Buy to Last—Save to Win.

THE ELECTRIC STORAGE BATTERY CO
Philadelphia 32
Exide Batteries of Canada, Limited, Toronto

EXIDES ARE USED IN MORE THAN 100
APPLICATIONS BY OUR ARMED FORCES

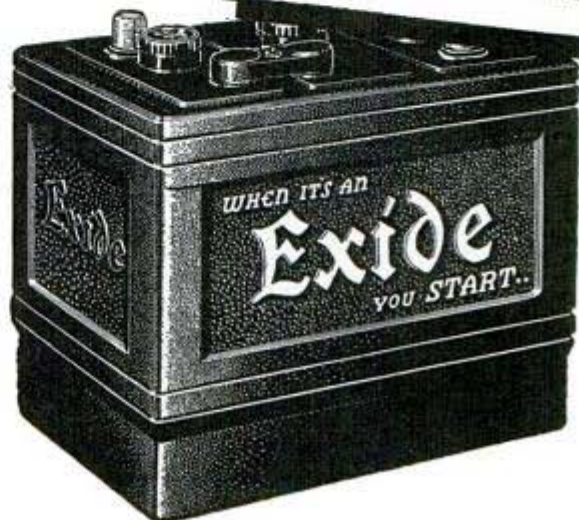

- 1 Don't buy *anything* you can do without.
 - 2 When you **MUST** buy, insist on dependable, long-lasting merchandise.
 - 3 Take care of the things you have. Make them last.
- These conservation rules save materials for war production, help curb inflation, give you more money to invest in War Bonds.

Coach and bus operators know that new AC Spark Plugs mean better engine performance and gasoline economy. They also know that regular cleaning and adjusting make those spark plugs perform better, longer. When plugs must be replaced, you, too, can be assured of utmost reliability by specifying AC Spark Plugs.



CLEAN SPARK
PLUGS SAVE UP
TO ONE GALLON
OF GAS IN TEN

AC
SPARK PLUGS

BUY WAR BONDS - BRING VICTORY QUICKER

.50-caliber machine guns—only one less than the four-engine heavy bombers.

When the first Marauder took the air from the Martin plant Nov. 25, 1940, it was dressed fit to kill. It wore America's first self-sealing gas tanks, the Army's first power-operated gun turrets, the first all-plastic bombardier's nose, and one of the first tail turrets. That out-thrust, pointed "stinger," the rather small, high wings set well back from the nose, the vast roar of the double Wasp engines are familiar sky-marks over the invasion coast.

The cross-Channel suburban delivery service of the Marauders was organized with two objectives: to blast the Nazi fighters out of western Europe, and to build an experienced force to support the landing boats and ground forces on Invasion Day. The objectives are being reached.

How Much Oil Is Left?

Continued from page 5

Americans had been coasting along with a comfortable oil reserve until the necessities of a gasoline and fuel oil war descended. Sharply increased demand of special products has placed a strain on our oil economy, but when the war is over it is probable that a reduced demand and the availability of drilling equipment and materials will result in an adequate supply.

The estimate of our reserves at 20 billion barrels is conservative. Certainly new fields will be discovered—they always have been, and the geologist of today is much more competent than 15 years ago. And there are new tools developing for his use.

So far we have brought 28 billion barrels of oil to the surface in the United States. We know where there are 20 billions more. No oil geologist would say we are even close to the end of our oil discoveries.

We shall find more oil—lots of it. History makes us certain.

Our Bull's-Eye Bombardiers

Continued from page 11

lights reduce the bombardier's vision. On mass bombing raids care must be taken to avoid collisions. Thickness of traffic on a big raid has led to a new kind of mass bombing. The planes make their approach in close formation. The bombardier of the leading plane uses his bombsight to hit the target's center, while bombardiers of the other planes release their bombs manually upon seeing the leader's bombs drop away. From 20,000 feet or more, one-quarter to one-third of all bombs dropped this way

Continued to page 162

"Always Ready FOR ANY TEST"

HERE'S another typical letter from our far-flung battle fronts:

"In the past six months I've been riding Harley-Davidsons somewhere in North Africa. Have ridden other makes but none take the punishment that the Harley-Davidson has taken. I usually put about 200 miles a day on my motorcycle—so you can see I know what I'm talking about. She is ever faithful, always ready for any test."

That's the story of Harley-Davidson stamina and dependability in a nutshell. BUY WAR BONDS NOW—get set for your new Harley-Davidson as soon as the "fracas" is over—and the days come again for the fun and thrills of hillclimbs, endurance runs, race meets, gypsy tours and other exciting motorcycling events!



**HARLEY-
DAVIDSON**
MOTORCYCLES

HARLEY-DAVIDSON MOTOR CO.
Dept. P, Milwaukee 1, Wisconsin

Write for free copy of ENTHUSIAST MAGAZINE
filled with motorcycle pictures and stories.

Name _____

Address _____

City _____ State _____



**SEND COUPON
NOW**

FREE!



Planes—trains—trucks—contractor's machinery—farm implements . . . with little new equipment available for the home fronts, old equipment simply must continue to carry on. Under the strain of long, hard use, more and more repairs are needed. And files are some of the most useful repair tools.

For files to do their best work and last as long as possible, (1) use files of highest quality and (2) use *The right file for the job*. Nicholson Files will assure you the first—and here's a book that will help you with the second:

FREE—Nicholson File Catalog

It will help any repairman or mechanic select the assortment of file kinds, cuts and sizes best suited to his particular needs. **SEND FOR IT;** keep it handy; take it with you when you go to tell your hardware or mill-supply dealer what files you want.

NICHOLSON FILE CO.

22 Acorn St.,
Providence 1, R. I.,
U. S. A.

(Also Canadian Plant,
Port Hope, Ont.)

NICHOLSON
FILES FOR EVERY PURPOSE

land within 1,000 feet of the target's center.

For training, a wooden mock-up of the bombardier's compartment is mounted on high legs, with motored wheels so that it can creep over enlarged aerial photographs of typical target areas at a speed scaled to the photographs. From his seat in the overhead mock-up the trainee with his bombsight picks out the target on the map and goes through the bombing procedure.

Usual high-altitude bombing techniques must be modified against enemy war vessels that maneuver violently as the bombers approach. One dodge used by Jap and German ship captains is to keep going straight ahead at full speed, meanwhile watching the bomber through binoculars. The instant the bombs are seen to fall from the plane, the ship makes an abrupt turn. One solution to this has been to bomb short so that the bombs will come closer to hitting the target no matter which way she turns. Sometimes a Jap ship steams in a wide circle to escape falling bombs, a maneuver that doesn't always work if there are several planes that can drop a pattern of bombs across her route. Skip bombing from mast height is another method.

Flying Gas Jet

Continued from page 15

adaptation of the gas turbine, a new kind of engine, simple, light, and efficient, burning a mixture of air and some such fuel as kerosene or fuel oil. The hot expanding gases of combustion whirl the blades of a turbine wheel as they move toward an exhaust port. The turbine, in turn, is geared or shafted to a supercharger that continues to pack air into the combustion chamber. Excess power not used by the supercharger can be put to other work.

The principle of the gas turbine has been known for a long time but there were no metals that could withstand the heat of the combustion chamber and be used for turbine blades. Satisfactory semi-refractory metals have now been produced. In its aircraft adaptation, the turbine wheel of the gas turbine uses only enough power to operate the supercharger. The exhaust gas, still under pressure, jets out at high velocity through a rear nozzle. The sustained, high speed flow of exhaust gas provides the thrust that moves the airplane ahead.

A true rocket is not the same thing. A sky rocket or bazooka shell, two examples of rockets, each gets its drive from the jetting of gases manufactured by its own fuel, independent of the atmosphere. That is, a rocket carries its own oxygen supply, often

Continued to page 164

Zenith's Crusade to Lower the Cost of Hearing
Brings High Quality within Reach of All!

The New Zenith Radionic Hearing Aid

Another Zenith "First!"

DAILY, all over America, hard of hearing persons who had given up hope of being helped, or who could not afford an adequate hearing aid, are finding a new world of happiness. They are discovering the thrill of "Radionic Hearing" with this high quality precision instrument at about one-quarter the price of other vacuum-tube instruments on the market today!

Zenith, pioneer in radionics and world's leading manufacturer of radionic products exclusively, has brought the hard of hearing "Another Zenith First." It places the fine precision quality that modern science and engineering can produce within reach of *all* who need it.

If we at Zenith never made a dollar on the New Zenith Radionic Hearing Aid, we would feel repaid a thousandfold by the expressions of delight, the smiles and in many cases the tears, of sheer gladness on the faces of these grateful people.

For the first time, many of them are able to hold vital wartime jobs and do their rightful share in Uncle Sam's wartime emergency. Many are hearing, *for the first time in years*, the voices of their children, their families, their friends. Handicapped youngsters, too, can now be saved from lives of failure and misunderstanding due to hearing deficiencies. 78% of all who are buying this revolutionary new instrument have never owned an adequate hearing aid before!

If you are hard of hearing, you owe it to yourself—your friends—and your country—to see a demonstration of the great advantages which **ONLY ZENITH** offers in a hearing aid. If you have a relative or friend who is hard of hearing, *you owe it to them* to urge attending a demonstration now going on at your local optical establishment franchised by Zenith. Let *their* ears be the judge. No one is pressed to buy. No salesman calls at the home. Meanwhile, send for our free descriptive booklet.

To Physicians: A detailed scientific description will be sent upon request. Further technical details will appear in medical journals.

*

There are cases in which deficient hearing is caused by a progressive disease and any hearing aid may do harm by giving a false sense of security. Therefore, we recommend that you consult your otologist or ear doctor to make sure that your hearing deficiency is the type that can be benefited by the use of a hearing aid.

Write for Free Descriptive Booklet, Address Dept. PM-5

ZENITH RADIO CORPORATION

P. O. BOX 6940A, CHICAGO 1, ILLINOIS

COPYRIGHT 1944, ZENITH RADIO CORP.



\$40

READY TO WEAR

Complete with Radionic Tubes, Crystal Microphone, Magnetic Earphone and Batteries. One model—no "decoys" . . . One price—\$40 . . . One quality—our best. Covered by a liberal guarantee.

Accepted by American Medical Association
Council on Physical Therapy

ONLY ZENITH GIVES YOU:

- 1 The fine precision quality that modern knowledge and engineering make possible in a hearing aid, yet priced at only \$40, complete, ready to wear. One model—no "decoys" . . . One price—\$40 . . . One Quality—our best. You need not pay more or accept less.**
- 2 Four-Position Tone Control.** The flick of your finger instantly adjusts it to the most effective combination of low, medium and high tones for individual needs in varying surroundings, hearing deficiencies in various ranges. No further adjustments necessary.
- 3 Special Battery-Saver Circuit.** Insures economy in battery consumption . . . results in substantial saving of battery life and battery replacement expense.
- 4 Zenith Quality—Zenith Guarantee.** Zenith, world's leading manufacturer of radionic products exclusively, is fortunate in having the knowledge of precision production that makes possible this quality hearing aid at a remarkably low price. Guaranteed for a full year, with unique service insurance plan.

The Zenith Radionic Hearing Aid is available through reputable optical establishments franchised by Zenith.

BY THE MAKERS OF

ZENITH
RADIO
LONG DISTANCE

RADIONIC PRODUCTS EXCLUSIVELY—
WORLD'S LEADING MANUFACTURER

Atlas

MODERN SHOP EQUIPMENT

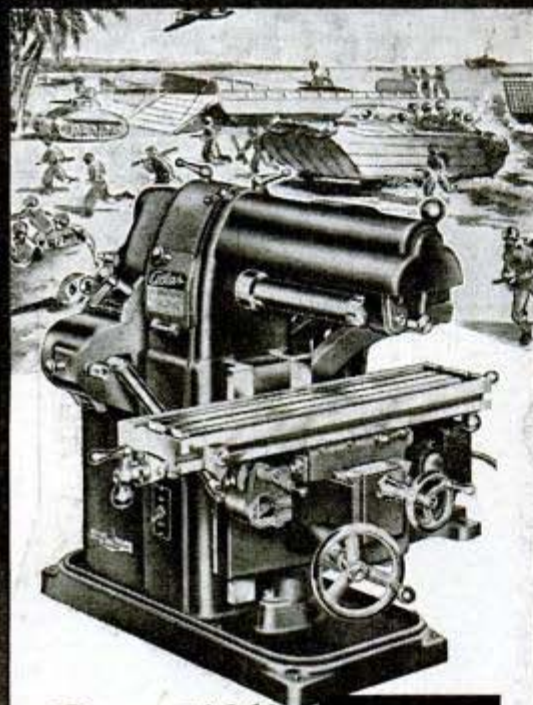

PRECISION PAVES THE WAY TO TOKYO!

Sharper shooting...
closer bombing...
quicker thinking—
that's our edge on
the Nips!

MILLING MACHINE

Table.....
4 1/2" x 18 1/2"
Table Travel
Longitud. 10"
Vertical.....6"
No. of Spindle
Speeds.....12
Speed Range...
61 to 2860 RPM
Overall 25 1/2" x
32 1/2" x 22"
Motor...1/3 HP
.....1740 RPM

In hundreds of war plants, Atlas Bench Milling Machines and other Atlas machine tools help deliver the precision that puts the punch in our fighting machines.

When the war's over you'll want some of these low-cost, compact tools for *your* shop! Remember Atlas for lathes, milling machines, shapers and drill presses.

ATLAS PRESS CO., 543
N. Pitcher St., Kalamazoo,
13D, Michigan.



**BUY
BONDS
NOW**

- FOR A NEW *Atlas* SHOP
AFTER THE WAR

liquefied oxygen. It can move in a vacuum. A jet propulsion airplane takes on air and mixes it with fuel for combustion. Each type moves ahead by pushing against the expanding column of its own exhaust gas.

A modern gasoline engine, with its accessories, makes up some 30 percent of the gross weight of a plane. Gas turbines are simpler and lighter, use lower grade fuel.

True rocket motors are handicapped by the weight of their fuel loads, which must be burned at great speed to provide thrust. This limits a rocket to a short period of operation. However, auxiliary rocket motors that exert their thrust during the taxi, take-off, and climb can boost a heavy airplane up to a safe operating altitude where the plane's regular engines can maintain its flight. Ordinarily an airplane can cruise with about 50 percent more cargo than it can lift from the ground. Another use for true rockets may be in aircraft that are lifted by propellers or jet to the thin air of high altitude, where rocket motors could be turned on to provide a fast speed.

Our first jet plane is powered by General Electric motors. Air Force described its weird sound effects thus: "When at some distance away, it sounds not unlike a train rumbling along, far away at night. Some people say it wails like a tired banshee. You seldom hear a jet propelled plane until it is almost past you. As it goes away you hear the roar of the jet. . . ."

"It has been reported from England that hats and coats have gone through the engine when mechanics move right up against the intake while the engine was screaming its warning during ground runs at high rpm. Another little legend about the 'Squirt' started in England. It was that birds flying into the intakes emerged dressed and skewered, suitable for serving. The plane, which doesn't announce itself, could sneak up on a goose, but that is not considered a problem since the intake ducts are designed so that miscellaneous objects are not attracted into them."

An intriguing propaganda story out of Germany tells of a new rocket explosive or fuel which, if it has been developed, would be a revolutionary source of power. The story indicates that unstable elements made radioactive in some such device as a cyclotron, have been combined with other elements to produce terrific explosions. The announcement is the same as saying that the Germans have gone part of the way in extracting power from the atom. When such a discovery is actually made, civilization will have a new source of power so efficient that petroleum and coal would become second class fuels.



"What would the Army do without the Engineers?" pops the \$64 question in "Song of the Engineers". A hard one to answer! Wherever the Army advances, in tropic jungle or Arctic outpost, the Engineers are out in front preparing the way . . . building air fields . . . throwing bridges across broad rivers . . . constructing highways over formidable mountains . . . resourcefully transforming "impossible" assignments into routine tasks.

Speed is a vital factor with the Engineers, and outboard motors have proved highly useful in ferrying and bridging operations. The Evinrude above, fresh from its packing case, will soon know what it is to "get the works" from the hard-working Engineers.



1 Mounted on the stern of a standard Engineers' ponton, (the Army term is *ponton*, not "pontoon"), this Evinrude makes fast work of transporting bridge material. It takes *stamina* as well as power to deliver the goods in this kind of service!



2 Ferries built quickly — here's how the Engineers do it! Several pontons are decked together with standard bridge material and, with motors mounted, the ferry is ready! Here 3 Evinrudes do a "triple screw" job pushing a truck up stream.



3 Ready to go with another load. Such service is not as spectacular as that performed by the great Evinrudes that drive the Engineers' speedy Storm Boats, but it's as important — and it may have to be performed under battle conditions!



4 After Victory there will be thrilling new Evinrudes for all to enjoy! Today it is *our* job to deliver to our fighting forces the finest motors that all our skill and long experience can build! EVINRUDE MOTORS, Milwaukee, Wisconsin

EVERY DOLLAR YOU INVEST HELPS SPEED VICTORY . . . BUY MORE WAR BONDS

BEFORE STARTING DIRTY WORK

Rub on "PRO-TEK" like a cold cream



When through work, grime and paint wash right off

It acts like an invisible glove



DU PONT
PRO-TEK
REG. U. S. PAT. OFF.
HAND PROTECTIVE CREAM

SOLDIERS, SAILORS & WAR WORKERS



Your Watch with a Broken Crystal Is Useless
— Exposed to Damage from Glass and Dust.

PROTECT YOUR WATCH—Avoid costly repairs—Go to any jeweler—ask for a G-S FLEXO CRYSTAL 100% BREAK-PROOF—Any size—Any shape. Can be fitted while you wait. Mfgs. of military water-proof watches, gauges, instruments now use G-S FLEXO CRYSTALS—100% BREAK-PROOF.

Inquiries invited from manufacturers.

GERMANOW-SIMON MACHINE COMPANY, Rochester, N. Y.

PALMGREN "300"

ELECTRODE HOLDER



WITH AUTOMATIC LOCKING BARREL

FIRST TO GUARANTEE

100% Insulated—Electrodes Used To Butts

NO CLAMP HANDLE—NO SPRINGS—Nothing to interfere—cause delays or get out of order. SOLDERLESS CABLE CONNECTOR—For quick detach from cable—no time wasted. ONE MODEL—300 AMPERES—For universal work—takes smallest Electrodes up to 5/16" inclusive. BALANCED—LIGHT—STREAMLINED—For greater efficiency—more work—less fatigue. AUTOMATIC LOCKING BARREL—Screw removed with one hand. Electrodes replaced in a jiffy. At Your Dealer or Direct. Priority Needed. Distributors Wanted.

CHICAGO TOOL AND ENGINEERING CO.
8365 South Chicago Ave. Chicago 17, Ill.



Free Catalog

Just Off the Press

Fully illustrated, showing special footwear and clothing for fishermen and campers, also special fishing tackle.

L. L. Bean, Inc.

Freeport 69, Maine
Mfrs. Fishing and Camping Specialties



MAKE THINGS of Plastic

Use your wood and metal working equipment to make picture frames, hand bag ornaments, trays, monograms and many other articles of clear

LUCITE or PLEXIGLAS

A source of both pleasure and profit. Easy, Fascinating. Inexpensive. We furnish material, working drawings and full instructions.

SPECIAL \$1.00 Starting Offer

Shop drawings for 30 projects, full instructions only \$1.00* postpaid, 50¢* inches of material included without extra cost. This offer good in Continental U. S.

SURETY PLASTIC CO., Dept. 40, 1621 Canton St., Toledo, 2, Ohio

110-VOLTS AC from DIRECT CURRENT

with KATO KONVERTERS. Furnish standard 110-v AC from 82, 110, or 220-v. DC. Good deliveries on sizes 350 through 1500 watts on priority orders.

Good deliveries on 5, 7½, 15 & 25 KW AC generators. Mfg's of motor generators, frequency changers and high frequency generators.

KATO ENGINEERING CO.
38 Elm Street, MANKATO, MINN., USA



BUILD ARC WELDER FROM OLD GENERATOR

For Light or Heavy Work. 30-200 amperes. Complete PLANS 35c. Send today and we'll include FREE our Big NEW Catalog.

LEJAY MANUFACTURING CO.
1347 LeJay Bldg., Minneapolis, Minn.



NEW OTTAWA SAW

BIG FREE BOOK World's Fastest 6 H.P. EASY to MOVE

Fells trees. Saws big logs, small logs, limbs. Pulley for belt work. Easy to handle, weighs less than lower powered units. FULLY GUARANTEED. Cash in on fuel shortage. Turn wood lots into cash. OTTAWA MFG. CO. 527 PINE ST. OTTAWA, KANS.

SAVE WASTE PAPER



All These DELTA Home Shop Plans·Tips·Ideas yours for **8 1/3¢** in "The Deltagram" a Magazine for Craftsmen



- All this and more in ONE Recent Issue... a bargain in shop help**
- Dimensioned pattern for "Duck" Rocker, a toy to delight the little fellow.
 - Plan for an attractive "Feeding Station" for birds.
 - Directions for making a Ring Toss Game—fun for the whole family.
 - Plan for a Wall Pipe Rack.
 - Plan for Artist's Easel.
 - How to make New Furniture from Old.
 - Two designs with complete plans for modern Aquarium Tables.
 - Plus pages of Shop Tips, News, etc., etc.

What to make and how to make it ... 6 Big Issues a Year for only Fifty Cents!

"I sure enjoy the Deltagram and would not give it up for twice the price." . . . "Keep up the good work." . . . "The Deltagram is our shop bible." . . . Those are typical of comments we get from Deltagram readers all over the country. Young and old, novice and expert, they tell us how much help, how much fun, how many money-saving and money-making ideas they get from this bargain in homecraft material.

65 each year!) is tested right in Delta's own home-craft shop.

Every plan, every shop tip, every design is so crystal-clear and complete that even the beginner can follow it safely and easily, without costly waste of time and materials. In every issue you find items for the junior craftsman, as well as projects to challenge the expert.

"Knowledge Is Power"

And knowledge is also fun, when it helps you get more enjoyment from your shop, helps you turn out better-looking, more praiseworthy work. Every page of every issue of The Deltagram adds to your knowledge — and for just 50 cents a year, 8 1/3¢ an issue!

Practical

Published six times a year by the world's largest manufacturer of home power tools, The Deltagram is practical in every detail. Every project plan (and there are about



PLAN NOW to complete your shop with these and other outstanding Delta Power Tools after the war. Put every nickel you can spare into war bonds now so that you will have the money when these famous tools are again available for home shops.



Send your order now. Fill out the coupon below, tear it out and mail it today with 50 cents in check, money order, or stamps. Start enjoying your Deltagram right away.



Editor, The Deltagram
THE DELTA MFG. CO.
681E E. Vienna Ave., Milwaukee 1, Wis.

Please enter my subscription for one full year (6 issues) of The Deltagram, for which I enclose 50 cents.

Name.....
Address.....
City..... (.....) State.....

ELECTRIC OUTBOARD MOTORS

While they last, these well-engineered factory-built, motors offer you an opportunity for fishing and healthful relaxation without using needed gasoline. Complete with adjustable transom bracket, tiller grip switch and efficient metal propeller. Power enough for boats up to 16 foot... ideal for trolling... silent, sturdy, simple. Operates on one or two 6 volt storage batteries. Price \$49.95, less battery.



UNIVERSAL BOAT AND LUGGAGE TRAILERS

Will handle any flat, vee or round bottom boat up to 18 foot. S-C Trailers are well-engineered... sturdily-built with an all-metal chassis. Complete with ball-hitch and ball, and tail light. Drop-center wheels take standard size tires. Shipped in sturdy case, 78" x 42 1/2" x 12", which when fastened to chassis forms utility body or luggage carrier for 1000-lb. load. Assembled easily and quickly by anyone. Price \$89.50 less tires.

Above prices are F.O.B. Silver Creek, N.Y., or thru your local marine or sporting goods dealer. Ask him, or write for descriptive folder. Retail orders sent to the factory will be shipped C. O. D. Supply is limited.



SILVER CREEK PRECISION CORP.
2 Mechanic St., Silver Creek, N. Y.



Have
YOUR OWN
Business

SAW FILING

You can have a good, steady, cash business of your own reconditioning saws with the Foley Automatic Saw Filer, which makes old saws cut like new again. The Foley is the ONLY machine that files all hand saws, also band and circular saws. Easy to operate—no eyestrain.

SEND FOR FREE PLAN—shows how to start in spare time—no canvassing. You can get a Foley Filer now—no special priority application required. Send coupon today—no salesman will call.

FOLEY Automatic SAW FILER

FOLEY MANUFACTURING CO.
516-4 Foley Bldg., Minneapolis 13, Minnesota
Send Free Plan on Saw Filing business, no obligation

Name _____

Address _____



12 in Cold Rolled Steel PERFECT GRIP WRENCHES *Only 98¢*

NEEDS NO PRIORITY

Six cold-rolled steel wrenches with 12 grips, accurately graduated from 5/16" to 7/8". Made of 1 1/2-gauge steel. 105 Rockwell Test for hardness. Cadmium plated. Will stand up with most expensive wrench sets on the market. Guaranteed not to break. We send you a new one FREE if one of these wrenches ever breaks. Just clip this ad and mail with 98¢ plus 10¢ for postage and your name and address. We will rush your set of wrenches to you by return mail, all postage charges prepaid. If you are not more than satisfied return within ten-days for full refund. Address:

ILLINOIS MERCHANDISE MART, Dept. 801 500 N. Dearborn St. Chicago 10, Ill.

AMAZING HANDY ADDING MACHINE

Can Be Carried in Vest Pocket—yet Handles Totals up to \$99,999.99

ONLY \$2.50 POSTPAID With Leatherette Case

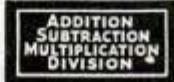

ABSOLUTELY ACCURATE

Not only adds, but can be also used to Subtract, Multiply, and Divide. STURDILY CONSTRUCTED, with metal front and back, yet weighs only 5 ounces—so that it can be conveniently carried in pocket, as well as used in office, shop and home. Useful to business men, accountants, students, everyone... Worked with a touch of the finger.

SEND NO MONEY

Just send name and address. Then pay postman \$2.50 plus C.O.D. charges on delivery. Or send \$2.50 with order, and we pay all charges—saving you 40¢ at new postal rates.

LEE'S SPECIALTY CO., Dept. PM-1, 1616 No. Ogden Chicago 14, Ill.

NEW PRODUCTS WANTED PATENTED OR PATENTABLE

For immediate manufacturing or Post War. Prefer Items that will retail for \$1.00 or less.

Manufacturer with own sales organization has well-equipped plant with Tool Room, Hand Screw Machines, Engine Lathes, Milling Machines, Punch Presses, Drill Presses, etc., wants products which will fit our equipment. If your item is sound and accepted, satisfactory royalties will be paid.

WILSON INDUSTRIES, INC.
551 WEST LAKE ST. CHICAGO, ILL.

Monuments Freight Paid Anywhere in U.S.A.

\$13.69 Up. Guaranteed Genuine Marble & Granite. Deal direct with Us by mail. Save. Write for Free catalog today.

U. S. MARBLE & GRANITE CO. Oneco, Fla.

Wonder-Tone NOISE ELIMINATOR

Just attach to your radio (long, short wave) and enjoy reception free from distracting noises. Send-No-Money Pay Postman 60¢ plus postage or send 60¢ and we'll send postpaid. Return in 5 days for refund if not delighted.

WONDER-TONE COMPANY, Dept. 40, 7078 N. Clark St., Chicago 28, Ill.

SIGNS AND SHOWCARDS EASILY AND EXPERTLY PAINTED WITH LETTER PATTERNS

MANY SIZES & STYLES! WRITE FOR FOLDER!

JOHN F. RAHN
1330-31 N. Central Ave. CHICAGO 51, ILL.

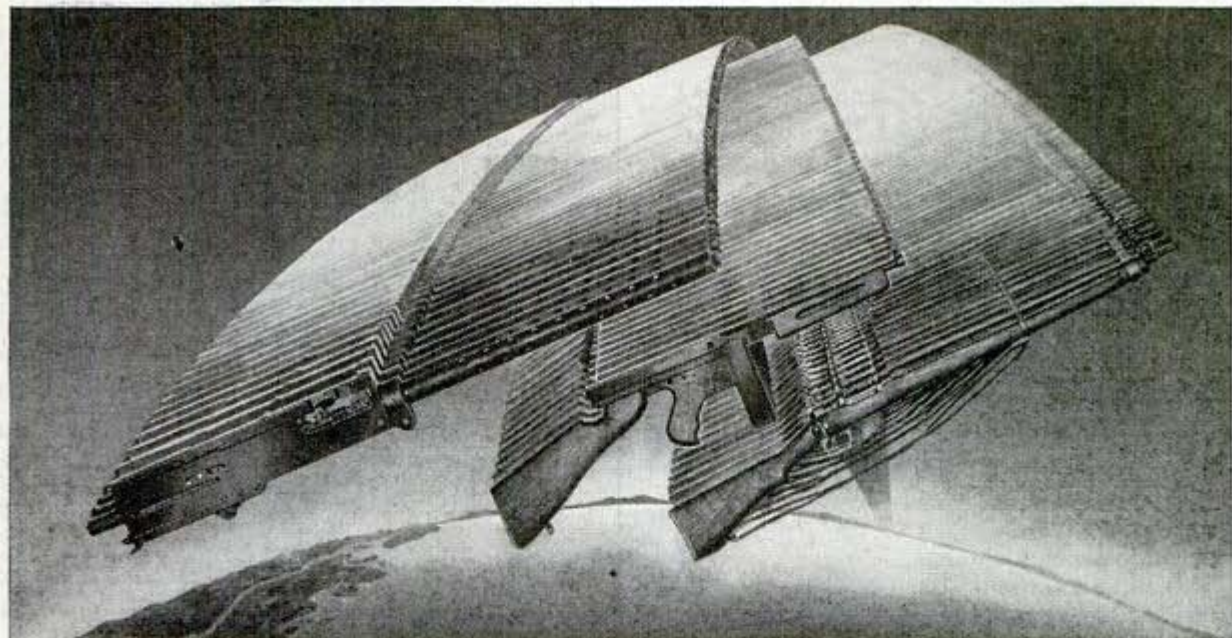

MORE THAN 2 MILLION OF THEM TO BACK THE BOYS OVERSEAS

Deeds of courage and self-sacrifice, never surpassed in all history, are being achieved by our fighting men on the battle fronts of the world.

These men who are doing the fighting know how vital it is to have the essential weapons of war and *plenty of them*. Savage is backing their drive to victory by furnishing these weapons, produced with all the skill and "know-how" gained from long experience in precision manufacturing.

The following excerpt from an official letter to Savage from the Army Service Forces, Office of the Chief of Ordnance, speaks for itself.

"I congratulate all members of your organization on the fact Savage Arms Corporation plants in Utica, New York, and Chicopee Falls, Mass., have produced more than 2,000,000 military small arms weapons. This is truly a great record.

"The Rochester Ordnance District relied heavily upon your Utica organization to give us submachine guns and aircraft type machine guns when they were most urgently needed.

"You did not fail us, and you produced not only the required numbers of these arms, but they have been proven most dependable in battle."

The same Savage skill which has produced more than two million weapons of war for our fighting men will make certain a great peacetime line of Savage sporting arms for every shooter and every shooting requirement.

Savage Arms Corporation, Utica, N. Y.

SAVAGE



**Savage Model 6
Automatic .22 Rifle**

Before the war... an extremely popular type of rifle for small game and vermin shooting.



YOUR *After-WAR*
TA-PAT-CO
LIFE-SAVE VEST



BUILT FOR ACTION!

Snags, tears, even bullets and shrapnel can't sink a Ta-Pat-Co kapok life-save vest. Flexible construction at waist line permits you to bend, sit or squat in comfort. No padding at shoulders. Your arms are free for action. After the war your sporting goods dealer will have these Ta-Pat-Co vests for your safety and comfort.



THE AMERICAN PAD AND TEXTILE COMPANY
GREENFIELD, OHIO

*In peace and in war the leading manufacturer of
Sleeping Bags and Life-Save Equipment*

ORBITAL MOTION

MAKES STERLING SANDING BETTER THAN
HAND OR ORDINARY MACHINE SANDING!



Pencils moving in circles illustrate principle of orbital motion!

EASY TO OPERATE!
FAST!

STERLING 1000 ELECTRIC PORTABLE SANDER

Superior to hand or ordinary machine sanding in both quality and speed. Orbital motion of Sterling sanding pad produces a uniform extra-smooth surface on wood, metals and plastics.

The Sterling 1000 covers the entire range of abrading from coarse sanding to lapping and finishing. Operates with exceptional precision. Sturdy construction—long life assured! Priority of AA-4 or better required. Write for details!

STERLING TOOL PRODUCTS COMPANY
356 East Ohio Street, Chicago 11, Illinois
615 W. Washington Blvd. Los Angeles, California
74 Wellington St., W. Toronto 1, Ontario, Canada

Save Fingers with

Steel-Grip Finger Guards

Hundreds of factories are saving time and injuries in war production by protecting workers with Steel-Grip Finger Guards. Used for handling rough or sharp articles, for buffing, grinding, sanding, polishing, punch press work and hundreds of other jobs. Protect fingers or thumb, front or back, from cuts, abrasions or blisters. Made of durable leather with elastic web back for snug, cool, comfortable fit. Easy on and off. One size fits all, men or women. Send 10c each for samples or trial order box of 60 at 8 1/2c each, less 10%.



OLD HICKORY
STEEL GRIP
MADE IN U.S.A.

Famous Industrial
Safeguards Since 1910

Catalog of Steel-Grip Safety
Apparel free on request
INDUSTRIAL GLOVES CO.
651 Garfield Blvd., Danville, Ill.
Canada: Safety Supply Co., Toronto

CRAFTSMEN—STOP RUST WITH

FIENDOIL

Protect tools, clean and coat them with this anti-corrosive favored for years by gun and tackle users. Get it now at your Sports or Hardware Store.

2 oz. Bottle—35¢

MCCAMBRIDGE & MCCAMBRIDGE CO.
Baltimore

GOING PLACES TOGETHER!

* Companions wherever the army goes. The improved HULL COMPASS will be available to motorists after victory—battle-tested for your car.



HULL MFG. CO.
P. O. Box 246-D5
WARREN, OHIO

Class Pins and Rings ★
Artistic pins, rings and emblems. Finest quality. Reasonable prices from 55c up. Write today. Dept. N. **FREE Catalog**
Metal Arts Co., Rochester 5, N. Y.

GERSTNER Chests
Most popular with any good mechanic. Free catalog for toolmakers and machinists.
GERSTNER TOOL CHESTS
444 Columbia St. Dayton 7, Ohio

ARTIFICIAL ARMS—LEGS
WRITE FOR FREE BOOK showing how CARNES ARTIFICIAL arms, legs have PUT THOUSANDS BACK ON THE PAYROLL. **FREE BOOK**
Every limb made to fit individual amputation. World-wide recognition of merit since 1904. **BOOK SENT FREE**—advise whether interested in leg or arm—no obligation, send for it now.
CARNES ARTIFICIAL LIMB CORP.
Dealers and Representatives Everywhere
908-N East 12th Kansas City, Mo.



SHAW and 'Peppy-Pal'
'DU-ALL' GARDEN TRACTORS

• 1 to 9 H.P. Circulars on request. War limits production —We supply repairs for all SHAW Tractors sold in our 40 years in business.

BUILD YOUR OWN RIDING TRACTOR—"WAR HORSE"

using old auto parts, powered by 2 H.P. or larger air-cooled engine; or walking type Garden Tractor 1/2 to 3 H.P. as shown; or convert truck or auto into Farm Tractor. Each will plow, cultivate. Plans for building. In one day, any one of above, postpaid for \$1.00 (state which wanted) or all 3 for \$2.00. Money Back Guarantee!



SHAW MFG. CO., 4505 Front St., Galesburg, Kansas
6680 North 4th St., Columbus, Ohio



There's Been a Big Change



WARFARE TODAY is more scientific—transportation more efficient, communication faster, materials more powerful.

There's been a definite improvement in tapered roller bearings, too. Transportation, agricultural, and industrial equipment all demanded a better bearing—a bearing with

more rollers. Tyson developed that bearing—added *thirty percent more rollers* around the raceway.

Today, Tyson users get far greater load-capacity . . . more strength and rigidity . . . in many cases, *doubled* bearing life. The big name in bearings today is . . . **TYSON!**

 TYSON BEARING CORPORATION, MASSILLON, OHIO

COUNT THE ROLLS · THE ROLLS COUNT

Tyson
TODAY'S HEAVY-DUTY BEARING



★ BUY MORE WAR BONDS ★

To dad or brother, hubby or lover
 ...your gift of a fine pipe will mark
 you as a "solid sender." The Biltmore
 Blue Ribbon is a sweet-smoker, light
 in the teeth, cool on the draw... a life-
 time of pleasure. Many models...
 choice century-old American briar...
 rich-grained, with a craftsman finish.
 Biltmore Pipe Co., 220 Fifth Ave., N.Y.

The "BULLDOG"
 \$3.50



For a super special gift
 choose a Biltmore of im-
 ported Algerian Briar, at
 \$5 \$7.50 \$10

Biltmore
 "BLUE
 RIBBON"
 PIPES

RESET LOOSE TILES!

Loose bathroom tiles
 and fixtures can be
 quickly reset with
PLASTIC WOOD!
 Handles like putty;
 hardens into wood. At
 Paint, Hardware, and
 10¢ Stores.



**PLASTIC
 WOOD**

ARBOR PRESSES — FOOT PRESSES

SPEED-UP WAR WORK



Powerful, low cost FAMCO ARBOR PRESSES are used for assembling and dismantling jobs. Faster, more efficient than hand methods. Available in 33 models for floor or bench installations. Delivers smooth pressure. Only Famco offers adjustable gib feature to maintain accurate ram alignment.

FAMCO FOOT PRESSES are used to punch out parts, speed up assembly operations. Available in 19 types for bench and floor stand mounting. Requires little space.

Prompt shipment upon receipt of proper priority. Write today for catalog and prices.

Model O ARBOR PRESS (Bench Type) — Delivers 1/2 ton pressure. Capacity over table 4 1/2" dia. work 6 1/2", square ram, 3/4 by 7 1/2"; height, 10"; weight, 35 lbs. Price (F.O.B. Racine) only \$11.00.

Model 6 FOOT PRESS (Bench Type) — 48 1/2" high; depth of throat, 4"; ram to base, 4"; maximum stroke, 1 1/2"; capacity, 3/4" in 1/16" soft steel; weight, 70 lbs. Price (F. O. B. Racine) only \$32.00.



FAMCO MACHINE CO., Dept. VH, RACINE, WIS.

PAINT STRIPING TOOL

Try it! See the Added Beauty

ONLY
\$1.00
 POST PAID

With this NEW TOOL (not a brush) everyone can now draw lines with paint, enamel, lacquer, etc. Used on autos, models, toys, games, imitation tile walls, cabinets, furniture, linoleum floors, signs, bulletin boards, sporting goods, home workshop projects, etc.

Send only \$1.00 for complete tool for painting a 1/16" wide stripe, including adjustable guide, operating instructions, etc. C.O.D. price \$1.25.

As easy to use
 as a pencil.



Extra interchangeable tips for making 1/64", 1/32", 3/64", 1/16", 3/32" and 1/8" wide stripe lines—.50c each.

Every Painter and Craftsman Should Own One.

Send for your tool and as many additional width tips you need today. Use it. If you are not satisfied that you can do better work, add character as well as beauty to your product or project, return the tool and we'll refund your money promptly.

Paint Dealers: Write for literature, etc. 4234-B Lincoln Ave. WENDELL MFG. CO. CHICAGO 18, ILL.

Mortite

THE UTILITY TAPE OF MANY USES

A pliable plastic that comes all ready for use inside or outside. Unrolls like ribbon. Adheres to any clean, dry surface. Just press into holes and cracks with the fingers and it stays put. Will not crack, shrink or chip off. Can be painted.

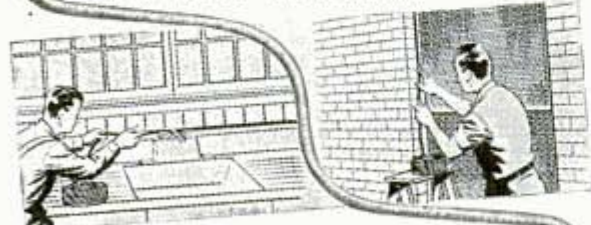

- A good plugger-upper.
- Seals cracks in plaster and woodwork, around screens, windows, casements, transoms, baseboards.
- Keeps out dirt, dust and vermin. Stops rattles.
- Permanent glazing for wood or metal sash.
- Plugs leaks around bathtubs, toilets, sinks, laundry tubs, etc.
- Makes good packing and gaskets.

About 80 feet of 1/4" Mortite to a roll. At your dealer's, or \$1.25 postpaid.

Send for Circular

J. W. MORTELL CO.
 Also Makers of NoDrip, and other
 Technical Coatings since 1895
 522 BURCH ST., KANKAKEE, ILL.



New Designs in FRANZITE GRIPS

Modernize Your Gun! Improve Your Score!
 Most durable grips made. Positively unbreakable! For Colt, Smith & Wesson, Hi-Standard, Ortgies, Luger & Mausers in a wide choice of beautiful designs in ivory, pearl, walnut, onyx, etc. Low prices. FREE CATALOG. Dealers Wanted.

SPORTS, INC., (Mrs.) 2850 N. Clark St., Dept. P-5, Chicago, Ill.

TRAILER AXLES, HITCHES, AND PARTS

If you are interested in purchasing trailer axles, hitches, and other trailer parts, contact us promptly. Complete house trailer blue prints, \$1.00. Write for free literature.

HAMMER BLOW TOOL COMPANY, Dept. 105, WAUSAU, WIS.

WOOD WORKERS

AMAZING BOOK FOR YOU
 Harold Hunt wants to send revised No. 14 catalog, 124 pages of woodworking plans, UNEQUALED BARGAINS in imported and American woods, supplies. Those already holding this catalog—send for revised sheets.
CRAFTSMAN WOOD SERVICE CO.
 2729 S. Mary St., Dept. A-45, Chicago 8, Ill.



Pair of Dividers on End of Pole To Check Roof Pitch



To gain a fairly accurate estimate of the roof pitch of any building of ordinary height, a carpenter pushes one point of a pair of dividers into the end of a pole, opens the other leg of the tool to a wider angle than the apparent pitch of the roof, then pushes the pole upward so that the tool closes against the cornice as indicated. If the pole is held in a truly vertical line, the angle reproduced by the dividers will indicate the approximate roof pitch.

Pivoted Holder Keeps Ink Safe On Drawing Board

Spilling of ink when the drawing board is adjusted is prevented and the ink bottle is conveniently at hand if this wire holder is used. A piece of fairly heavy spring wire is bent to the shape shown so that the neck of the bottle will slip into the loop and yet be held firmly. The straight end of the wire is inserted in a slightly oversize hole drilled in the edge of the board. The bottle will hang safely and swing freely in any position in which the board is used. If several holes are drilled, the bottle may be hung wherever it is most convenient for the particular work being done.

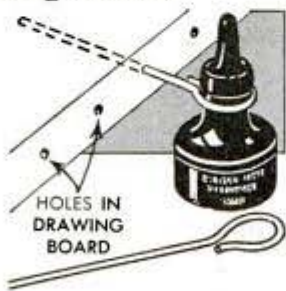

Painting window screens is easier if they are suspended from a clothesline. They dry rapidly, and both sides can be reached.

We will train you at home in



Diesels are weapons against the Axis... they are saving precious gasoline by using more easily obtained fuel oils... running upwards of twice as far on the same quantity of fuel... packing more power into smaller spaces. It's been said that DIESELS may revolutionize the powering of ships, tractors, power-stations, autos, trucks and possibly airplanes, when the war is won.

The DIESEL AGE

Wars have always brought important new developments... and this war has opened uses for DIESELS that might otherwise have taken decades. You should prepare yourself now for this Diesel Age... by learning how to maintain, service and operate this modern, efficient, dependable type of power plant.

YOU CAN LEARN AT HOME EASILY

Learning Diesel at home is interesting, can make your spare hours pay dividends. The profusely illustrated Hemphill lessons clearly show you how to operate and to service practically every type of Diesel now in use... how to adjust fuel injection systems... how to make performance tests... how to install auxiliary equipment.

SAME BASIC TRAINING AS ARMY, NAVY and COAST GUARD TRAINEES HAVE RECEIVED AS HEMPHILL DIESEL STUDENTS...

When the war first started, Diesel-trained men were immediately needed by the Services... and the Hemphill Diesel Schools course was selected for the training of these men. Exactly the same fundamental training received by these men is available to you... except you receive the lessons at your home and send in your examination papers for grading to the Extension Division of the Hemphill Schools. This is your opportunity to receive the finest training ever offered.

ACT NOW... BE READY FOR POSTWAR OPPORTUNITIES

FREE BOOKLET... Find out about Hemphill Diesel home study training... new booklet gives full information... use coupon for your copy today.



HEMPHILL DIESEL SCHOOLS
New York: 3126 Queens Blvd., Long Island
Chicago: 517 S. Western Ave.
Los Angeles: 3457 Eagle Rock Blvd.

HEMPHILL DIESEL SCHOOLS (Use Nearest Address)

Please send booklet and information on your home study Diesel Course, without obligation.

Name _____

Street _____

City _____ Zone _____ State _____

P-5

SEND THIS COUPON TODAY

A FAST WORKER on Hard-to-Get-At Spots

for Radio Panels
Switchboards, General Use

XCELITE Hollow Shaft Nut Drivers



Awkwardly located nuts on radio panels, telephone and power switchboards—especially nuts with protruding bolts or studs—are readily handled with this unique, time-saving tool. Handle of genuine, transparent Xcelite plastic, shock-proof and fire-resistant. Hollow shafts are made of high quality steel, with deep precision-formed sockets. Available in seven nut sizes, from 5/16" to 5/8". Also supplied with insulated shafts if desired. Most Xcelite Tools are available on satisfactory priorities—delivery is necessarily delayed by war conditions. Ask your hardware, radio or electric dealer—or write Dept J.

PARK METALWARE CO., INC., Orchard Park, N. Y.

Back the Attack—Buy More War Bonds

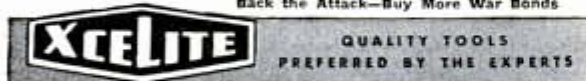

YOU NEED HEATABS in Many Ways

for HUNTING
FISHING



HEATING MILK
FOR BABY



IN THE
SICKROOM

"SUNDAY, Monday, and Always!" Speaker HEATABS, and the "pocket stove" of your choice, furnish you heat . . . anytime, anywhere! Heat all foods . . . fry or boil . . . start camp and picnic fires. Used extensively by all branches of the armed forces . . . and by doctors, nurses for emergencies and first aid. Hundreds of uses at home, at work and at play.

Send the "FIELD STOVE" or Deluxe "COMPACT COOKIT" and HEATABS to your friends or relatives in Service . . . Help them have their meals hot, just like mother used to!

FIELD STOVE and HEATABS, \$1.00
Deluxe COMPACT COOKIT and HEATABS . . . \$2.00, Postpaid.

J. W. SPEAKER CORPORATION
3059 N. Weil St. Milwaukee 12, Wis.
Dept. PM

NO SMOKE
NO SOOT
NO ASH
NO Poison FUMES

all
HEAT!

FRY FIELD "STOVE"

HEAT

COMPACT "STONE"

BOIL

ORDER BY MAIL
IF YOUR DEALER
CAN'T SUPPLY YOU

**Speaker
HEATABS**

TABLETS OF
concentrated
HEAT

Fuse Puller — Circuit Tester

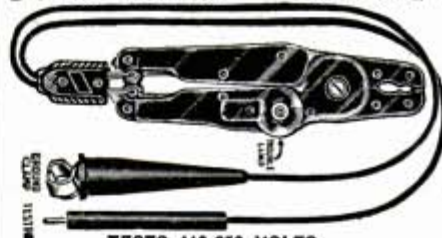

For
Home
or
Factory

TESTS 110-250 VOLTS

When motors stop and lights go out, this tool quickly **LOCATES DEAD CIRCUITS** and safely removes blown Fuse. The Star Test Pocket Plier is made of a Transparent Plastic Having in one of the legs a small lamp in series with a resistance and can be used to test 110 to 250 volts circuit. The Plier will pull fuses from 10 to 100 Amperes. Thousands of Electricians find this tool handier than Test Lamps. Price \$2.75 each without Leads, \$1.50 additional for Leads, plus 10c postage. Can be obtained from General Electric or Westinghouse Stores or directly from us. Order NOW. **STAR PLIER CO., 233 Canal St., New York 13, N. Y.**

\$20.00
COMPLETE

ENGINES IN STOCK



The G. H. Q. miniature gasoline engine that really operates is still available. Over 100,000 sold to date. 1/5 H.P. Complete with flywheel and propeller, fuel, 15 accessories and full instructions. Fully bench tested and ready to run. For boats, planes, midget cars, etc. Send only \$1.00 — Shipped Collect C.O.D. same day. Send 25c for illustrated Catalog of hundreds of hobby items.

GHQ MOTORS, Dept. BV, 40 East 21 St., New York 10, N. Y.

SEE BEFORE YOU BUY



Diamond-dazzling Zircons from the Mines of far-away Mystic Slam. *Effective and inexpensive.* Stand acid; cut glass; full of FIRE! Thrilling beauty in exquisite mountings for Lady or Gent. Sent on trial. Write for catalogue now.

NATIONAL ZIRCON CO., Dept. 528, Wheeling, W. Va.

Catalog FREE!

DO YOU

WANT a permanent business profession of your own? Then **BECOME A FOOT CORRECTIONIST.** Earnings in this greatly needed profession run as high as \$50-\$100 weekly after a few weeks home training—not medical or chiropody—no further capital needed, no goods to buy. 47th year. Write for free booklet.

Stephenson System of Foot Correction

28 Back Bay,

Boston, Mass.

BACKACHE, LEG PAINS MAY BE DANGER SIGN

Of Tired Kidneys

If backache and leg pains are making you miserable, don't just complain and do nothing about them. Nature may be warning you that your kidneys need attention.

The kidneys are Nature's chief way of taking excess acids and poisonous waste out of the blood. They help most people pass about 3 pints a day.

If the 15 miles of kidney tubes and filters don't work well, poisonous waste matter stays in the blood. These poisons may start nagging backaches, rheumatic pains, leg pains, loss of pep and energy, getting up nights, swelling, puffiness under the eyes, headaches and dizziness.

Don't wait! Ask your druggist for Doan's Pills, used successfully by millions for over 40 years. They give happy relief and will help the 15 miles of kidney tubes flush out poisonous waste from the blood. Get Doan's Pills.



JOHNSON'S entire outboard production, of course, is for the armed services and essential needs. It's a two-way proposition. The armed services benefit from Johnson's twenty-two year experience in outboard manufacture. And Johnson benefits by "keeping its hand in" on the product for which it is famous.



When the war is won, we shall not merely pick up where we left off. We shall go on from where this new experience has taken us . . . **Johnson Motors, Waukegan, Illinois.**

DEALERSHIPS: Wherever you are located, if you are interested in sales AND SERVICE after the war, write us now.

*There is No Substitute
for Experience*



DO YOUR DUTY—BUY WAR BONDS

JOHNSON SEA-HORSES FOR DEPENDABILITY



STOP LEAKS IN BASEMENT WALLS, FLOORS

Stop-it



Stop those leaks! End that seepage through cracks in basement walls and floors. Use **STOP-IT**—amazing quick-setting waterproof material. **INSTANTLY** seals dripping cracks and openings. For interior and exterior use.

EASY TO USE Simply mix with water and apply on cracks. Sets hard and permanent. At amazing low cost, you can turn that damp, musty basement into a delightful playroom. Get **STOP-IT** at your dealer or write direct.



TAMMS SILICA COMPANY
228-EG N. La Salle St. - Chicago 1, Ill.

FREE BOOKLET
Send for free "Household Hints in War-Time." Tells how to save money, conserve food, clothing, fuel.



OTTAWA TRACTOR SAW

Falls Tree—Cuts Log

Uses Power Take-off any tractor. Direct drive. Long stroke. Saws fast. Easy on fuel. Thousands of satisfied users. Big labor saver. Low in Price.

Write for **FREE Book and Prices**

OTTAWA MFG. CO., D527 Forest Ave., OTTAWA, KANSAS

FREE TO HOME CRAFTSMEN



A FULL YEAR'S SUBSCRIPTION TO CONSTANTINE'S Chips & Chats

An interesting bi-monthly publication for Craftsmen. Exchange ideas from all over America. Publishes photos of your projects. Lists current supply of materials and tools still available. Contains helpful ideas in every issue. Free with Constantine's Master Manual which costs only 25c, coin or stamps, and which is refunded on first order of \$1.50 or more. Send today.

ALBERT CONSTANTINE & SON, INC.
7917. East 135th St. New York, New York



Waterproof, shockproof, anti-magnetic, radium dial and hands, unbreakable crystal, precision tested, sweep second hand.

No. HN 121—15 jewels, stainless steel back **\$39.75**

No. HN 331—15 jewels, stainless steel case **\$49.50**

No. HN 328—17 jewels, SELF-WINDING, stainless steel case **\$59.75**

POSTPAID FED. TAX INCL. * MAIL ORDERS PROMPTLY FILLED

Write for Free Illustrated Booklet "HN"

BELL WATCH COMPANY

Time-Life Bldg., Rockefeller Center, New York 20, N. Y.

IMMEDIATE DELIVERY



This Reed Micrometer reading to 1/10000" costs you only

\$7.65

plus 10c postage.

IMAGINE A TOOL WITH 1/10000" vernier at that low price. SEND YOUR ORDER FOR QUICK DELIVERY.—Unconditional money back guarantee— if not fully satisfied.

REED MICROMETERS made in the U.S.A. for 30 years, now available at once to war workers. Fully guaranteed. Must pass most rigid tests for accuracy. Used by thousands of America's best mechanics. Tolerances are closer. Blue-prints often call for "tenths." That is why REED MICROMETERS are now made to read to 1/10000" AND AT NO EXTRA COST TO YOU. "MIKES" reading to 1/1000" may well become obsolete. Don't depend on a tool that reads only in "thousandths." If you do precision work, you'll want the REED MICROMETER with 1/10000" graduations. ORDER TODAY!

Write for our new FREE 8 page folder, "MEASURE TO 1/10000" AT NO EXTRA COST." You'll find it interesting.

★ ★ SHOP AGENTS WANTED TO SELL REED MICROMETERS. INQUIRE TODAY FOR PARTICULARS. ★ ★
GEORGE SCHERR CO., INC., 128A Lafayette St., Tel. Canal 6-3512, New York 13, N. Y.



How to SAVE PAINT BRUSHES

BEFORE—Bristles caked, stiff, useless. AFTER—Bristles silky-soft and flexible—ready for easier—faster—better painting. DIC-A-DOO

Paint Brush Bath makes the difference. Restores old brushes. Saves new brushes. Buy 5¢ package, 10¢ box at PAINT, HARDWARE, FIVE & TEN CENT STORES.—The Patent Cereals Co., Geneva, N. Y.—makers of DIC-A-DOO Paint Cleaners.

DIC-A-DOO
 PAINT BRUSH BATH



**TAPE WORMS
 ROUND WORMS
 (Ascarids)
 HOOK WORMS
 WHIP WORMS**



...you can free your dog of all these worms

with **PULVEX**
 COMBINATION WORM CAPSULES

Used by leading breeders. At leading pet, drug, department stores, 50¢ a package (double size, 75¢). Packed two ways: for puppies, for dogs.

"HOW TO WORK WITH TOOLS AND WOOD" A popular book on woodworking, packed with illustrated instructions for beginners, and with useful data for experienced woodworkers. Every home workshop should have a copy. A Big Value at \$1.00

STANLEY TOOLS Division of The Stanley Works, 154 Elm St., New Britain, Conn.

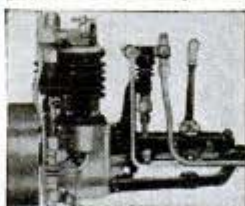

Build: STEAM ENGINE

- A precision built and engineered single cylinder, 1/4" scale marine model, with clutch or reverse.
- Send \$2.50 for 14 pages scale drawings, 2 photos, instructions.
- 2 Photos and Description...\$.25
- Rough Castings Kit.....\$ 12.50
- Horizontal Flash Boiler Drawings and Instructions 1.00

THOMPSON ENGINEERING CO. 206 NO. DIVISION BLDG., GRAND RAPIDS 2, MICH.

Get Pre-Flight Training—Easy—Quick! Build Cleveland Models "The Models the Men in the Air Forces Build"



Grumman "AVENGER" TBD
 Heavily armored, carrier-based torpedo bomber of Midway Island fame. Span 39 3/4". C-D Master Kit SF-93.....\$4.00



German Focke-Wulf 190
 Germany's chief fighter against Allied bombing raids. Highly efficient. Span 27 3/4". C-D Master Kit SF-82.....\$3.00

Send 5c for new Cleveland catalog (none free).

36" Industrial Training Models

Ideally suits both classroom work and flying

Build these big 3-ft. span models. Realistic beauties.

Kit T74: Messerschmitt ME-109
 Kit T-76: Bell "Aircobra"
 Kit T77: Curtiss P-40 "Warhawk" (shown)

Kit T78: Hawker "Hurricane"
 Kit T85: Lockheed P-38 "Lightning"
 Kit T91: P-51 "Mustang"

Each Complete Kit, only \$1.50

"Soars for Hours"
Build America's Biggest \$1 Model
SUPER CONDOR Soarer—Stronger, longer flights, more graceful lines, construction simplified. Easier than ever to build. Kit E-5010, only \$1.00

CLEVELAND MODEL & SUPPLY CO. "World's Largest Mfrs. of Quality Model Aircraft Since 1919" 4508D45 Lorain Ave., Cleveland 2, Ohio

Weldwood Glue Has Everything:

1. Tremendous strength.
2. Waterproof, bacteria- and rot-proof.
3. Quick and easy to use. No heating. No waiting. Mixed just by adding water to powder.
4. Economical.
5. Applied cold, quick-setting.
6. Stain-free. *Supply limited due to Uncle Sam's war needs.*

UNITED STATES PLYWOOD CORPORATION
Weldwood Glue Dept. 70, 55 W. 44th St., N.Y. 18, N.Y.
"Makes the glue line the SAFETY line"

WELDWOOD
PLASTIC RESIN
WATERPROOF GLUE

Snap-On
WITH THE NEW PATENTED HOOKS

SCREEN PATCHES

6 for 25¢ ON CARD

Tiny, patented hooks snap on easily without removing screen. One or more patches repair average size hole.

"HAVE A PATCH READY"

LOCAL STORES

SCREEN PATCH CO., Commercial Trust Bldg., Phila. 2, Pa.

SAVE WASTE PAPER

Save Glueing Time with **EMPIRE SPEED CLAMP**

- Quickest and easiest woodworkers clamp. One clamp handles all sizes from 1/2" to 11". Clamps instantly. Doesn't mark work. Sturdy, light weight (3/4 lb.) made of selected maple. Low price . . . \$1.50 postpaid.

ALUMINUM TORPEDO LEVEL Available Now

Handy accurate level. "Cigar-shaped," can't tear pockets. Polished aluminum, 9" long, with Level, Plumb and 45° vials. Light weight, strong. No. 26, only \$1.75.

SAVE MONEY! Order BOTH Speed Clamp and Aluminum Torpedo Level, \$3.25 value, only \$3.00 postpaid. Limited number available!

EMPIRE LEVEL MFG. CO. DEPT. P-210 717 SOUTH SIXTH STREET MILWAUKEE 4, WISCONSIN

WYTEFACE
TRADE MARK

STEEL MEASURING TAPES

Easy to Read

KEUFFEL & ESSER CO.
HOBOKEN, N. J.

CONVERT A SEDAN INTO AN AMBULANCE IN 60 SECONDS!

First-Aider in trunk compartment

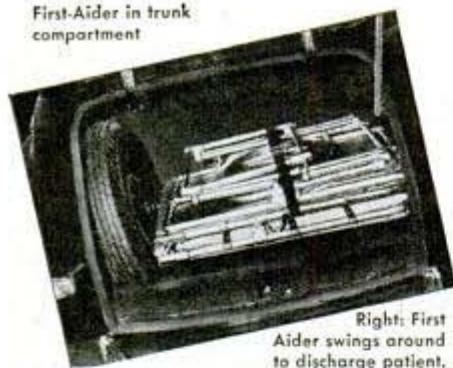

Right: First Aider swings around to discharge patient.



Patient rides comfortably.



The new Swift First-Aider is the answer to the ambulance problem! Once the bracket is attached to the floor of any two-door sedan (easily done in 30 minutes) you can convert the car to an ambulance in 60 seconds. Does not mutilate car. Complete outfit folds into small space in trunk compartment. Gives better ride because patient rides between axles. Hundreds in use by police, sheriff depts., State police, war plants, doctors, airports and hospitals. Weighs less than 72 lbs. Price only \$125.00 FOB Saginaw, Michigan. If your dealer cannot supply you, write for literature and order direct from:

SWIFT BODY AND EQUIPMENT CO., INC.
106 HOYT ST., SAGINAW, MICHIGAN
Ambulance Manufacturers since 1915
Distributors inquiries invited

HOLD-E-ZEE AUTOMATIC GRIP SCREWDRIVERS

Hold-E-Zees do the job better, faster. They excel wherever screwdrivers are used. Gripper instantly released by spring action, sliding up out of way when not in use. *High-quality materials throughout.*

Upson Bros., Inc.
86 Exchange St.
Rochester 4,
N. Y.



At
Leading
Dealers Everywhere

Thompson BEATS the World on BOATS



**Better Built
Lower Prices**



Canoes \$75 and up

Rowboats \$48 and up

Outboards \$48 and up

**Safe Boats With
Full Length Spray Rails**

Keep passengers perfectly dry—even at high speeds. Catalog also shows today's seven most popular models of sailboats. Two big factories. Prompt shipment.

CATALOG FREE
Write for your copy. State kind of boat in which you are interested.
THOMPSON BROS. BOAT MFG. CO. (114)
213 Ann St. PESHIGO, WIS. (Write to either place)
113 Elm St. CORTLAND, N.Y.

Light "Car-Top" Boat
THOMPSON BROS. BOAT MFG. CO. (114)
113 Elm St. CORTLAND, N.Y.

3¢ a day Hospitalization Plan

Hospital Paid
Sickness or Accident
90 Days!
Surgeon's Fee
Sickness or Accident
up to **\$150.00**
Loss of Income
\$25.00 Wkly.
Loss of Limbs or Eyes
up to **\$750.00**
Accidental Death
\$1000.00
Also many extras

Hospital bills, surgeon's bills!... what a hole they put in savings! But today 10,000,000 people use their policies to pay these bills.

SICKNESS OR ACCIDENT
From the very first day you are hospitalized our 3¢ a-day plan pays hospital room, surgeon's fee, ambulance, many extras. Choose your own doctor and hospital. Individuals or families insured, age 1 to 60. No salesmen. Mail coupon now! You never can tell what tomorrow may bring!

Commonwealth Mutual Ins Co of America
208 E. Lexington St. Baltimore-2 Md. Dept PM 5
Send details & free book—no obligation.

Name.....
Address.....
City..... State.....

SEND FOR BIG FREE BOOK NOW!

FREE! LATEST, MOST COMPLETE RADIO PARTS CATALOG



EVERYTHING in RADIO and ELECTRONICS for War Training, Maintenance or Repair

**New R-F Resonance and
Coil Winding CALCULATOR**

Easy to use! For fast accurate determination of resonance factors and coil winding data. No. 37-955. Postpaid, only 25¢.

RADIO'S FINEST BOOK VALUES

Specially prepared to aid radio training in schools and industry. Full of valuable data. Send for all six!

- Radio Formulas and Data Book No. 37-752... 10¢
- Dictionary of Radio Terms No. 37-751... 10¢
- Radio Circuit Handbook No. 37-753... 10¢
- Radio Builders' Handbook No. 37-750... 10¢
- Simplified Radio Servicing No. 37-755... 10¢
- Radio Data Handbook No. 37-754... 25¢
- All Six Books No. 37-799... 75¢

ALLIED RADIO CORP.

833 W. Jackson, Dept. 5-E-4, Chicago 7

ALLIED RADIO

POPULAR MECHANICS

Hank Likes Hawaiian Wiggler!



No. 3
Hawaiian Wiggler \$1.10

Below is a photo of Henry White, veteran guide of Chaffey's Locks Ontario, with a string of large mouth bass taken out of the lily pads on the No. 3 Hawaiian Wiggler.

Gets Bass In Tough Places

Many fishermen think this bait can't be beat for casting in pads, snags, or gooey moss. She gets bass in tough places where other baits just can't be used. The No. 3 Hawaiian Wiggler casts like a bullet even in windy weather.

Write for Catalog

It is loaded with interesting photographs and letters from fishermen telling of record catches made with Hawaiian Wiggles and Jitterbug, famous surface bait. Catalog is yours for the asking.

FRED ARBOGAST

1605 North St., Akron 3, Ohio



KRW ARBOR PRESSES BENCH TYPE AND HYDRAULIC

NEEDED IN EVERY SHOP—SAVE TIME AND MONEY—DO BETTER WORK, QUICKER.

No shop is complete without a small arbor press. Pressing and squeezing operations can be done better and faster on a KRW Arbor Press. Stop using vise and sledge hammer methods—they generally deliver spoiled work in the end. KRW Factory-To-You Prices give you greater value for your money. Order today.

KRW Bench Type Arbor Presses, 3 sizes

No. 37-P 1/2 Ton, \$13.25*
No. 37-O 1 Ton, \$23.00*
No. 37-N 3 Ton, \$33.00*
*Prices F.O.B. Arcado, N. Y.
Slightly higher west of Rockies.
Stand illustrated extra.



KRW Hydraulic Presses are built in 25, 50, 60 and 75 ton sizes. Prices start at \$198.00*.



K. R. WILSON, 17 Lock St., BUFFALO 2, N. Y.
Builders of Shop Equipment for Ford Dealers Since 1916



35 THRILLING KITS
15 CENTS TO \$3.00

★ ★
Go to your Dealer Today

BUILD MODEL AIRPLANES WITH OTT-O-FORMER KITS AND GET 'EM FLYING QUICKER!

Save one-half building time. Two construction types—Ott-O-Former with strong center wood frame—Ott-O-Tube with sensational torque tube. America's biggest value.

LIGHTNING P-38
AVENGER TBF
HELLCAT F6F
FLYING FORTRESS B-17
THUNDERBOLT P-47
WARHAWK P-40
MOSQUITO DH-98
MUSTANG P-51
MITCHELL B-25
CORSAIR F4U
SPITFIRE
ZERO
FOCKE-WULF
—AND OTHERS

Ott-O-Former
and OTT-O-TUBE
CONSTRUCTION
EDUCATIONAL
AIRPLANE KITS

JOE OTT MANUFACTURING CO.
815 West Superior Street CHICAGO

PRELUDE to a PERFECT FINISH



Finish must now be measured in micro inches. That's where the new Chicago **FV BOND** Wheels excel. They give a precision smoothness so intensified that it passes any surface analyzer test.



FV BOND is available in all types of Chicago Mounted and Small Grinding Wheels—in all abrasives, grain and grade combinations. It is the result of research and experiment on hundreds of aircraft jobs.

Chicago Mounted Wheels are tough, long lived, dependable. Over 300 sizes, styles and grains.

Chicago Grinding Wheels—Only sizes up to 3" diameter for the duration, with W P B approval.

Handee Tool of 1001 Uses and Hi-Power Grinders are still available to all who have priorities.

Send for Free Catalog

CHICAGO WHEEL & MFG. CO.

1101 W. Monroe St., Dept. PM, Chicago 7, Ill.



Make BIG MONEY AT HOME!

NEW Invention Electroplates by BRUSH



Now Plates **CHROMIUM!**

ALSO GOLD, SILVER, NICKEL, COPPER, ETC.

War Increases Demand—You Profit!

New, patented invention makes possible big earnings AT HOME. Replate auto-parts—worn articles in homes, stores, hotels, restaurants, etc., with durable, sparkling, new coat of metal—with stroke of brush. Easy, simple, quick. Genuine Gold, Silver, Nickel, Cadmium, etc. Everything furnished. Outfit complete, ready for use. No shop required. Clear from \$2 to \$5 an hour in lifetime business. Small investment starts you in business. Steady repeat. Machine can pay for itself in week. Send TODAY for FREE SAMPLE and illustrated BOOKLET how you can have a life income from a business of YOUR OWN built upon satisfied customers. Act at once!

WARNER ELECTRIC COMPANY

360 N. Michigan Ave., Chicago, Dept. 313

FREE BOOK & SAMPLE

WARNER ELECTRIC CO., 360 N. Michigan Ave., Chicago, Dept. 313
Gentlemen: Send me Free Sample and Illustrated Booklet.

Name _____
Address _____
City _____ State _____

PAY-RAISING — EXTRA MONEY BOOKS

Use these books to prepare for a better job—bigger pay—to start a profitable spare time or full time business of your own, improve your home, start a hobby. Popular Mechanics specializes in supplying out-many subjects.

- Painting, Furniture Finishing & Repairing
New self-help book for craftsmen, home owners \$1.50
- Shop Notes for 1944
Now ready. For every man who uses tools. 50c
- Shop Notes Library
5 vols.—1944, 43, 42, 41, 40 (no dup. mat.) \$2.50
- Refrigerated Locker Manual
Plant operation, quick freeze, etc. \$3.00
- How to Read Blueprints
Self-help book starts with language of blueprints and leads up to reading actual machine shop plans \$1.50
- Welding, Brazing & Soldering
How to build own equipment and use it effectively \$1.25
- Garden Book
Build own trellises, lawn furniture, fireplaces, ornaments, etc. \$1.00
- Forty Power Tools
Build own saw, drill, lathe, sander, etc. from scraps—save money \$1.25
- Rewinding & Servicing Electric Motors (No. 75) 25c
- Running a Milling Machine (new) \$1.50
- Turn Scrap Into Money
Convert old auto generators into motors, welders, etc. \$1.00
- House Wiring (No. 89)
All information needed to do complete job. 25c
- Modern Refrigeration
Electric, gas. Be service expert \$5.00
- Dyk's Auto Ency. (includes Diesels, airplane engines) New 20th Ed. World's greatest book for mechanics \$6.00
- Sheet Metal Work
Self instruction in all phases \$2.50
- Tool & Saw Sharpening (No. 92) 25c
- Armature Winding
Construction, winding, repairing AC & DC Motors, generators . . . \$2.00
- Build Your Own Boat
Describes 17 popular boats—rowboats, sailboats, plywood outboard, etc. 192 pages \$1.50
- Forging Practice \$1.50
- High School Self Taught 4 yr. course in one vol. \$1.98
- Carpentry
Learns modern methods \$2.00
- Foundry Work \$2.00
- What to Make for 1944
New 224 page book of handicraft projects. 50c
- What to Make Library
5 vols.—1944, 43, 42, 41, 40 (no dup. mat.) \$2.50
- Blueprint Reading
For building trades. . . \$1.25
- Patent Making
Wood, metal \$2.00
- Action Toys (No. 66)
Plans for 21 easy-to-make toys 25c
- The Young Craftsman
New book describes over 450 things boys can make \$1.00
- Five Acres and Independence
How to make money on small farm. \$2.50
- Deluxe Small Homes
Selection of 210 popular designs \$1.00
- Knots, Ties, Splices
For everyone who uses rope \$1.00
- Engine Lathe Operations
For those without previous training \$1.98
- Plastics
Latest information on manufacture and use \$3.75
- Workbenches & Tool Cabinets You Can Build (No. 47) 25c
- Your Car
Hundreds of simple car repairs, short cuts that will help make it last for the duration. . . \$1.25
- The Boy Mechanic
The book for your boy—any boy \$2.00
- Modern Radio Servicing \$5.00
- Concrete Handbook
New book on using concrete around home, garden, farm \$1.50
- Oil Burner Handbook
New book takes guess work out of servicing \$2.50
- Steel Square Pocket Book
Best methods of using \$1.00
- Motor's Truck Repair Manual
Covers repair work, servicing every truck 1936 to 1942 \$8.00
- Photo Guide
Construct own equipment, gadgets. Make better photos. \$1.25
- Elementary Forge Practice \$2.00
- Welding, Electric \$1.25
- Welding, Oxy-Acetylene
Welding, cutting. . . \$1.25
- Metallurgy \$2.50
- Fluorescent Lighting
New manual on construction, installation, repair \$3.00
- Shipbuilding Blueprint Reading \$3.00
- American Machinists' Handbook
World's most used technical book \$4.00
- Machinery's Handbook
Established standards and practices \$6.00
- Ropp's Calculator
Figuring made easy. . . 50c
- Plumbing Installation & Repair
For those without previous training \$1.50
- Aircraft Sheet Metal Workers Manual \$2.00
- Complete Book of Garden Magic
Covers all phases of gardening \$3.00
- Wine Makers' Manual . . \$1.50
- Judo. 30 Lessons in Modern Jiu-Jitsu \$1.89
- Modern Core Practices & Theories
Only book published treating completely with production and use of cores in metal casting \$8.00
- Watch Repairing Simplified \$3.00
- Propagation of Plants
Covers every conceivable method \$3.50
- Lessons in Ornamental Penmanship \$1.00

MAIL THIS COUPON TODAY

Check the books you want, write your name and address below, and mail this advertisement with money order or check. Outside U. S. A. include 15% additional for shipping charges. Books selected will be mailed promptly on our "money back if you're not entirely satisfied" guarantee.

Name _____
City _____ State _____
Address _____

Mail to **POPULAR MECHANICS PRESS**
Dept. 539—200 East Ontario St., Chicago 11, Ill.



You have enjoyed such good service and long life from your AC Fuel Pump because of the quality that is built in, from design to finished pump.

You will continue that performance and quality if you insist on an AC when you need a new, or a rebuilt, fuel pump.



FUEL PUMPS

BUY WAR BONDS • BRING VICTORY QUICKER

BURN YOUR NAME ON TOOLS

WITH THE **ARKOGRAF**

PROTECT YOUR TOOLS FROM THEFT

Write with electricity any name or design on the handles and finest tools and instruments or any metal, like writing on paper with pen or pencil. Thousands used by mechanics, garages, machine shops. Complete Outfit \$3.50—Prepaid Anywhere. Interesting illustrated circular free. Write today. ARKOGRAF PEN CO., 3927 S.E. Stark, Portland 15, Ore.



AUTO ENGINE SPEED CONTROL GOVERNORS

Give constant speed to any auto or truck engine, when used for power. Fully guaranteed. Simple instructions. Oil ring bearing \$13.00. Ball bearing \$19.50. Prepaid. Also additional carburetor butterflies. In Montreal, 7546 Wiseman St. Latin. Amer. East Asiatic Co. Free circulars. **CANDEE, 2641-Q S. Hill, Los Angeles-7**

ELECTRICITY FOR ANY JOB ANYWHERE



ONAN GASOLINE DRIVEN ELECTRIC PLANTS provide electricity in locations where it is not otherwise available, and for emergency standby service. Thousands of units are doing a winning job in the war.

Sizes from 350 to 35,000 watts, A.C. 50 to 800 cycles, 110 to 660 volts, D.C. 6 to 4000 volts. Also dual A.C. and D.C. output models. D. W. ONAN & SONS, 1093 Royalston Ave., Minneapolis, MINN. Details gladly furnished



MAY, 1944

NEW Adjustable Mirror INSPECTION TOOLS let you see difficult places!

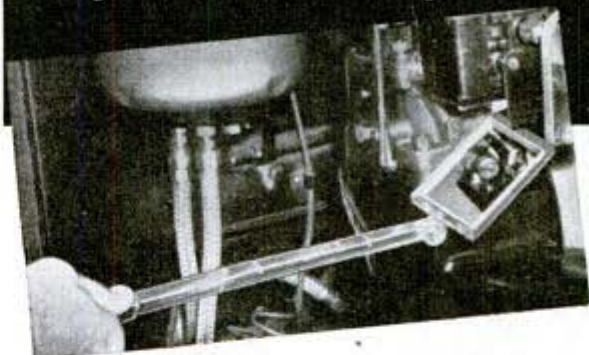

INSPECT PLACES OUT OF SIGHT OF STRAIGHT VISION

You'll want a set of these plastic Adjustable Mirror Inspection Tools which will enable you to clearly see behind gears, into a tank, inside the angle of a pipe, inside a casting, underneath a fitting, around a corner; in fact, the different sizes with their hinged mirrors adjustable to almost any angle, will permit you to clearly see the back, bottom, side, top or between just about any part that is hidden from straight vision. War plants throughout the United States, Canada and abroad now using thousands of these ingenious Mirror Inspection Tools find them indispensable. Every mechanic, inspector, operator, or handy man around the home absolutely needs and should have a set for any precision machinery, repair, inspection or manufacturing job that requires close inspection of difficult places with a minimum amount of time and effort. Lightweight, flexible shaft, easily carried. Important people in responsible jobs everywhere say they don't see how they ever got along before, without these necessary inspection tools. Take advantage of this special introductory offer—send only \$4.20 for a full set of these priceless "extra eyes." Price includes cost of handling and postage. Add 15c on all C.O.D. orders.

Instant Thumb Adjustment

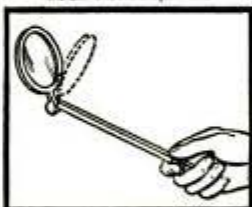

5 sizes—one to fit every need

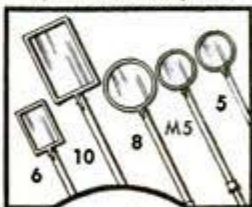

JAMES L. DECKER PRODUCTS CO.
P. O. Box 1092
Beverly Hills, California

Only
\$4.20
Set of 5
(1 Magnifying)

Send for a set NOW!

JAMES L. DECKER PRODUCTS CO.
P. O. Box 1092
BEVERLY HILLS, CALIFORNIA

FULL SET—\$4.20; Add 15c C.O.D. When ordering less than 5 add 15c extra for handling and postage.

Please send me Inspection Mirrors as ordered below, for which I enclose

remittance of \$ _____ Or send C.O.D.

WRITE IN HOW MANY OF EACH DESIRED:

() 1 Full Set of 5—\$4.20 ea. () 1 10-oblong mirrorhead—2 1/4 x 3 1/2 in.—18 1/2 in. overall length \$1.50 ea. () 1 M5-Magnifying-mirrorhead—1 1/2 in. diameter, 9 1/2 in. overall length 90c ea. () 1 8-round mirrorhead—2 1/4 in. diameter—10 1/4 in. overall length 70c ea. () 1 6-oblong mirrorhead—2 1/4 in. x 1 1/4 in. 10 in. overall length 60c ea. () 1 5-round mirrorhead—1 1/2 in. diameter, 9 1/2 in. overall length 50c ea.

NAME _____
ADDRESS _____
CITY _____ STATE _____

SAVE WASTE PAPER

181

IT'S NEW!



48 PAGES HAVE BEEN ADDED!

If you liked our 1943 "Secrets", you will like our 1944 edition even better. It's chock full of little known facts and hitherto unpublished secrets for getting those wary fish and crafty game. Contains page upon page of "how-to" and "what-to-do". Written by a well-known sportsman and author, it's a pocket guide every fisherman and hunter should have. Only 10c postpaid — and worth a hundred times that much. Send for your copy today.

HODGMAN RUBBER COMPANY
DEPT. P
FRAMINGHAM, MASSACHUSETTS

FALSE TEETH FIT TIGHT with Dentyte

Soften DENTYTE by warming — spread it on your plate — put in mouth and bite to make a perfect impression. Remove plate — and allow few minutes to "set". You get an absolutely perfect fit. Sore gums vanish — no more slipping or loose teeth. DENTYTE is firm but resilient. Each lining lasts for months. Immediately removable with fingers. Full size jar — (a year's undreamed of comfort per plate), postpaid only **Positively Guaranteed**



\$1 Send dollar bill at our risk. Easy to order. Easy to use.

Agents wanted everywhere

Dental Products Corp., Dept. PM-142, Manheim, Pa.

Handy Mail Order List

Little Library of Useful INFORMATION

5 for \$1.00
12 for \$2.00
25¢ Each

Here at amazingly low cost is the practical help and information you have always wanted. Articles in previous issues of Popular Mechanics have been classified according to subject and are now available in these handy reprint booklets.

- How to Use Measuring Tools—Micrometers, Calipers, etc.—106.
- Power Driven Saws—74.
- Drill Presses, Grinders, Etc.—79.
- Wood, Metal Turning—Lathes—81.
- Filing Machine, Hack Saw, Cutoff Wheel, Shaper—82.
- Lathe Tools You Can Make—101.
- Workbenches—Tool Cabinets—47.
- Spray Painting—94.
- From Pattern to Casting—91.
- Tool and Saw Sharpening—92.
- Sharpening Drills, Wood Bits—90.
- Successful Wood Turning—32.
- How to Read Blueprint—71.
- Metal Turning Lathe Kinks—99.
- Operating a Metal Lathe—100.
- Heat Treating, Hardening—102.
- Working With Glass—103.
- Servicing Elec. Motors—75.
- Electromagnets & Solenoids—44.
- Transformer Construction—41.
- The Boy Electrician—43.
- Soldering and Brazing—17.
- Arc and Spot Welders—5.
- Electroplating With Nickel, Chromium, Cadmium, Etc.—86.
- Plating Leather, Wood, etc.—87.
- Lower Your Fuel Costs—31.
- Curing Leaky Basements—45.
- Fitting Home Game Room—55.
- Indoor & Outdoor Fireplaces—88.
- Backyard Gardening—39.
- Lawn and Garden Novelties—72.
- Trellises, Pergolas, Fences—75.
- Lawn and Garden Furniture—77.
- Playground Equipment—73.
- Concrete Garden Furniture—6.
- Making Serving Trays—53.
- Sanders—80.
- House Wiring—89.
- Treasure Finders—13.
- Hanging Wallpaper—38.
- Built-in Fixtures—78.
- Bird Houses—7.
- Magazine Racks—49.
- Clock Cases—50.
- Book Ends—52.
- Small Tables—84.
- Smoking Stands—56.
- Decks—58.
- Book Cases—59.
- Action Toys—66.
- High Flying Kites—67.
- Telescopes—20.
- Metal Craft—28.

- Working With Plastics—61.
- Simple Home Improvements—104.
- Ridding Home of Insect Pests—107.
- Children's Room Furniture—51.
- Jigsawed Novelties—57.
- Doll House & Doll Furniture—60.
- 25 Shelves You Can Make—64.
- Novelties Turned on Lathe—62.
- Inlay Pictures—Veneering—63.
- Wood, Soap Carving—65.
- Windmills & Weathervanes—68.
- Lamps from Wood, Metal—69.
- Home Work Opportunities—19.
- Wood Finishing—40.
- Boats—14 ft. Outboard—2.
- Boats—14 ft. Sail Dinghy—26.
- Boats—21 ft. Sloop—46.
- Rowboats, Small Dinghy—83.
- Small Sail Boats—84.
- Two Outboard Runabouts—85.
- Build Own Canoe, Kayak—30.
- Build Glass-Ice Yacht—22.
- Auto Kinks, Shortcuts—10.
- Building Trailers—27.
- Motor-Driven Midget Cars—34.
- Stop Auto Electrical Troubles—95.
- Photo Printers and Dryers—25.
- Photo Darkroom Equipment—96.
- Trick and Table Top Photos—97.
- Cosmetic Formulas—12.
- Food Products Formulas—15.
- Metal Plating and Coloring—21.
- Re-Silvering Mirrors—70.
- Chemical Experiments—93.
- Log Cabin, Tourist Houses—14.
- Trapping Small Animals—33.
- Farm and Garden Tractors—8.
- Building Extra Attic Rooms—23.
- Attractive Basement Rooms—24.
- Small Looms—37.
- Cum Cutting—42.
- Photo Enlargers—1.
- Photo Kinks—98.
- Cleaning Formulas—11.
- Taxidermy—9.
- Magic—29.
- Training Dogs—35.
- Small Furnaces—36.

Check Titles Wanted, Write Name and Address in Margin and Mail to
POPULAR MECHANICS PRESS, Dept. 538, 200 E. Ontario, Chicago, 11

BOYS

Ask Dad to Get
this Great Book
for You!



This new book tells and shows how to make over 450 things—useful articles for the home, toys, furniture, boats, novelties, photo equipment, electrical gadgets, etc. of the more simple, easy-to-make type. Only ordinary tools are needed. No special skill required. Tell Dad to send \$1.00 to address below NOW. We'll send Dad's money back if you and he don't think it's worth double the cost.

POPULAR MECHANICS PRESS
200 EAST ONTARIO STREET
DEPT. 537, CHICAGO 11, ILL.

MAKES AND SAVES MONEY FOR YOU Only 50c

NEW 1944 BOOK FOR EVERY MAN WHO USES TOOLS

One of these books is issued each year and is a reprint of articles published in our Shop Notes Department. It contains cream of experience of years, of hundreds of our country's most successful mechanics. Get this great book from your News Dealer, or send 50c to

POPULAR MECHANICS PRESS
Dept. 535 • 200 E. Ontario • Chicago 11

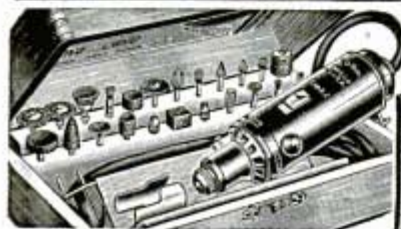

WAR WORKERS—WIN "PRODUCTION AWARDS"

Dremel Moto-Tools are used on hundreds of jobs, in thousands of war plants, because they are such great time and labor savers.

- Kit No. 1 with 23 high grade accessories and Model 1 Moto-Tool in hard wood case \$17.50
- Kit No. 2, same as above with Master Model Moto-Tool \$23.50

Sharpening tools . . . cleaning dies, castings, cores and welding points . . . grinding, polishing, burring and finishing . . . these are but a few of Moto-Tool's many capabilities. Only Moto-Tool has all these features!—27,000 r.p.m. (assures better work and lengthens life of cutters); shockproof (bakelite) case; oil-less (oil-sealed) bearings; fan-cooled motor (can't overheat). Order Moto-Tools and accessories at your dealer or direct on 10-day trial. Money-back guarantee. If you need a Moto-Tool in your work, ask your employer for a priority number. Catalog FREE.

DREMEL MFG. CO., Dept. T114-E, Racine, Wis.

—Suggest—
MOTO-TOOLS

TO SAVE TIME—
CUT COSTS AND
SPEED PRODUCTION

LOOK for New Post-War WITTE DIESELECTRIC PLANTS

The finest Dieselectric Plants ever to carry the WITTE name will be ready for you after victory . . . to supply power and light at amazingly low cost. Over 74 years manufacturing experience contributes to their reliability. Today, WITTE Units are serving the victory cause all over the world.



WITTE ENGINE WORKS
LARGEST BUILDER OF SMALL DIESELS
KANSAS CITY, MO., U. S. A.

MASCOT SLIDE RULE

● Fits the pocket. Quickly solves any problem in multiplication, division, proportion. Gives the square, the square root, logarithm and reciprocals of all numbers. Trig scales give sines and tangents of numbers. Fine black graduations on white celluloid. Price in fabricoid case \$1.00, in leather case \$1.25. Money back if not satisfied. Special offer to agents and dealers.



MONITOR SLIDE RULE—6" Dia.

[Made in white Vinylite. Same scales as Mascot Slide Rule. Without case, \$2.95. Leatherette case 75c additional.]

TAVELLA SALES CO., 19-F West Broadway, New York 7, N. Y.

FREE VITAMINS for GRAY HAIR

If your gray, graying, streaked, faded off-color hair is

due to vitamin deficiency, here's wonderful news! The amazing story of Anti-Gray Hair Vitamin research and discoveries, compiled in a very interesting and valuable booklet, is yours free for the asking. Write today and you will learn how you can get the full size \$4.79 treatment of PANATES two-way Vitamins free on a special money-saving introductory 3 for 2 money-back offer. Send no money. Nothing C.O.D. Write

PANATE COMPANY, Dept. 49-E, 310 So. Michigan, Chicago 4, Ill.

DEAF HEARING AID WITHOUT BATTERY 10 DAY TRIAL OFFER

Automatic hearing device **Without BATTERY**. No headband. Worn on ear unnoticed. Featherlight. Used by thousands. Send today for free information and names of happy users in your vicinity. **Optical Dealers write for proposition.**

AMERICAN EARPHONE CO., 10 East 43rd St., (Dept. 172) N. Y. 17, N. Y.

FIBRE ARMS AND LEGS!



Light, correctly fitted, strong and comfortable. Natural appearance. Braces for all deformities. Scientific design. Fair Terms.

BUCHSTEIN-MEDCALF

610-3rd Av. S., Minneapolis, Minn.

BABY CALCULATOR
CHICAGO 318
NEWLY APPLIED FOR



ADDITION
SUBTRACTION
MULTIPLICATION
DIVISION

WORLD'S LOWEST PRICED ADDING MACHINE

IDEAL FOR BUSINESS OR PERSONAL USE. GUARANTEED ACCURATE. TOTAL COST ONLY \$250

Not a toy. Operates with only a finger flick. Adds, subtracts, multiplies, divides. Counts up to ten million. Pays for itself over and over. **Ideal Gift—for Business, Income Tax and School use. MONEY BACK GUARANTEE.** Send name and address. Pay postman only \$2.50 plus postage. (Send full cash if outside U. S.) Money back in 10 days if not delighted. **AGENTS WRITE.**

CALCULATOR MACHINE COMPANY (Mrs.)
DEPT. 153, P. O. BOX 1118 CHICAGO, ILLINOIS



DRY UP THAT WET CELLAR FROM THE INSIDE with SMOOTH-ON

YOU can do it yourself—a job that will *last*—sealing up wall and floor cracks, crevices, porous spots with special Smooth-On No. 7 Iron Cement.

You *paint* it on, with a brush. Adheres to wet or dry surfaces, to concrete, cement, brick, stone. Not only cellars, but also garages, stables, out-buildings, cisterns, water troughs, septic tanks, fountains, swimming pools, etc., waterproofed with Smooth-On No. 7. Concrete floors made even and mended.

This year decide to get rid once and for all of leakage, dampness, mustiness in that cellar of yours. Your neighborhood hardware dealer has Smooth-On No. 7 or will get it for you. In 5-lb., 25-lb., 50-lb. and 100-lb. sizes. See your dealer today ... And send for this—

FREE Book of Directions

The Smooth-On Home Repair Hand-book describes and shows exactly how to waterproof leaky walls and floors; Also gives instructions for over a hundred other useful repairs anyone can make with Smooth-On Cements. Pocket size, 40 pages, 170 diagrams. Convenient index. Use the coupon.



Smooth-On Mfg. Co., Dept. 37,
570 Communipaw Ave., Jersey City 4, N. J.

Please send me my Smooth-On Hand-Book.

Name

Address

5-44

Free
Do it with SMOOTH-ON

SYN-FLO ...

**A NEW MAGIC
LIQUID-PLASTIC
ENAMEL**

- ★ Finishes walls like **TILE**
- ★ Finishes woodwork like **PORCELAIN**

This is really it! Modern science has produced this new white **PLASTIC** coating you apply with a brush. It actually has the same chemical properties of genuine molded plastic products.

A BRUSH-ON PLASTIC

With an ordinary brush you flow this coating on your woodwork and it dries to a smooth porcelain finish—hard, water-proof, abrasion-resistant—stays brilliant white.

You won't have to wait until after the war for this new, scientific, plastic discovery. Limited quantities now available.

MONEY-BACK GUARANTEE

One gallon **SYN-FLO Liquid Plastic** will cover walls of average room. Send only \$5.95 for full Gallon **SYN-FLO** with Special Thinner, express prepaid. Will ship C.O.D. if desired.

LIMITED SUPPLY AVAILABLE TO PUBLIC NOW. ORDER AT ONCE! FREE ILLUSTRATED CIRCULAR ON REQUEST.

SUPERIOR PAINT and VARNISH WORKS
2256-2274 N. Elston Ave., Chicago 14



**INTRODUCING-New Victory Model
HANDIWELD ELECTRIC**

ARC WELDER

RETAILS ONLY
\$1.95

FULLY GUARANTEED



PLUGS INTO LIGHT SOCKET

Victory Model Handiweld Arc Welder operates from 110 volts, A.C. or D.C. current same as other arc welders—higher priced; generates tremendous heat to weld all metals. Not a toy welder that uses carbon, but actually uses standard coated rods—sizes 1/16" and 3/32". However, due to Priorities a generous supply of 1/16" rods only are supplied with the welder. Guaranteed not to burn out. Repairs fenders, auto bodies, radiators, machinery parts, etc. Take Victory Model Handiweld anywhere to job, operate right from light socket. You'll find a thousand uses for this welder around

your home, garage, workshop. Also in garages, factories, repair shops, tin shops; mechanics, inventors, plumbers, farmers, etc. Order a "Victory Model" Handiweld now.

SEND NO MONEY We'll rush one to you with rods, helmet, operating instructions, and all necessary parts with the exception of a large jar and a small piece of extension cord; these most everyone has. Pay postman only \$1.95 plus a few cents postage. If not delighted return Victory Model Handiweld in 5 days from receipt and money paid for it will be refunded promptly. Rush your order now.

KUMFY PRODUCTS, Dept. D-202, CINCINNATI, OHIO

LOOK! Big Outfit with Apparatus
25 TRICKS PUZZLES & JOKES
Send for easily learned tricks that mystify, startle, amaze! Card tricks; magic tricks; practical jokes. 25 different articles and gadgets for a \$1.00 bill. C.O.D., 39c extra. Joke Book included FREE and extra if you order now. Money back guarantee.
TRIX CO., 82 W. Washington St., Dept. F-66, Chicago 2, Ill.



**CASH BENEFITS FOR
SICKNESS
ACCIDENT
LOSS of TIME
HOSPITALIZATION**

GET THIS PROTECTION!

Here is the kind of all-around protection you need and can easily afford. Why risk your savings, your earnings, possibly your future? This generous low cost policy protects you against emergencies that happen every day! Even common sickness and ordinary accidents are covered. It is not necessary that you be confined to a Hospital to collect generous benefits according to the terms of the policy. Another important provision is CASH for LOSS of TIME from work, plus extra Hospitalization benefits. Investigate this liberal policy at once. No medical examination. No red tape. No agents. See and decide for yourself! Don't wait until too late—write for Free Information TODAY!

Costs only \$1 a month

POLICY PAYS ACCUMULATED CASH BENEFITS:

Up to **\$7.50** Each Day while in **HOSPITAL**

Up to **\$3,600.00** for **LOSS of TIME** due to **ACCIDENT DISABILITY**.

Up to **\$100.00** a month for **LOSS of TIME** due to **SICKNESS DISABILITY**

Up to **\$5,000.00** for Accidental Loss of Life, Limb or Sight

MANY OTHER GENEROUS BENEFITS All as plainly stated in the Policy.

GEORGE ROGERS CLARK CASUALTY CO.
Dept. 29-E • Rockford, Ill.

★ ★ ★
FORTY POWER TOOLS
You Can Build at Low Cost

Now a **NEW EDITION**
FEATURING TOOLS MADE OF WOOD

Power tools for your home workshop—at a cost anyone can afford. Make them yourself—lathes, drill presses, sanding machines, shaper, circular, band, and scroll saws and other power tools—from old auto, sewing machine, and other discarded parts that cost very little. Get the new edition, "Forty Power Tools You Can Make", and follow simple instructions, diagrams and photographs. Make yourself up to date, efficient machines that will do a good job for you and save you time, hard work, and many dollars. Send \$1.25 for "Forty Power Tools You Can Make" today or order on postal card and pay postman on delivery anywhere in U. S. A. Your money back if not satisfied.

POPULAR MECHANICS PRESS, Dept. 536, 200 E. Ontario, Chicago, 11

Decorative Decalcomania
Transfers. Imported Designs of all Sizes and Types—
Flowers, Fruits, Figures, Dogs, Horse Heads, Ships, Juvenile, Tropical, Chinese, Peasant, Colonial, Inlay, Borders, Initials, etc., for Furniture, Doors, Walls, Trays and what not. **Catalog with 800 illustrations in Color sent for 25c.** Deductible on first order of \$1 up. **L. C. WELLS, Dept. PM-45, 25 East 26th Street, New York, 10.**

SAVE WASTE PAPER

POPULAR MECHANICS



A New Type of Home for Better Postwar Living!

For the first time in history, a home completely factory-built. Also completely equipped—even to plumbing and lighting fixtures. Designed on a new principle that greatly reduces building costs. A variety of distinctive models. Many novel interior effects. Moderate in price—as low as \$3,000. Available after the war at factory branches and dealers throughout the country. Send for Free Catalog.

PALACE CORPORATION
Flint, Michigan



COUNT TELEGRAPH WIRES IN THE DISTANCE



9 POWER TELESCOPE \$2.99

Objects 900 yards away appear as 100 yards distant. Brings objects 9 times closer. Telescope closed is less than 1 ft. Spot planes, ships, people, sporting events, etc. Has large 50 mm lens (2 inches in diameter) something usually found only in higher priced telescopes. **20 DAY FREE TRIAL.** Try for 20 days at our risk! Return if not completely satisfied. **SEND NO MONEY.** Just pay postman \$2.99 plus few cents postage. Cash orders sent postpaid. Don't wait—production of telescopes may be curtailed as it has been on binoculars. **Vogue Telescope Co., 7759 S. Halsted, Dept. TE-313, Chicago**



PULVEX
FLEA POWDER

ALSO KILLS LICE & TICKS

25¢
AND 50¢

GENUINE U.S. BARGAINS

O. D. WOOL BLANKETS (USED) . . . \$2.95
ALUMINUM MESS PANS (USED)35
U. S. ARMY PUP TENTS (USED) . . . 3.50
Slightly Used Army Caisson Wheels with Axles, 56" high, weight per pair with Axle, 322 lbs. \$37.50

Thousands of Other Bargains in Military, Outdoor & Sport Goods for Hunter, Farmer, Scout Send 10¢ for 32-page catalog returned with first order.

A and N SUPPLY CO.

EST. 1868

4724 LESTER ST.

RICHMOND, VA.



MEDICO

FILTERED

SMOKING

REMOVABLE FILTER
(famous in pipes)
A SENSATION IN CIGARETTE
AND CIGAR HOLDERS

\$1
WITH BOX
OF FILTERS
FREE!

The patented filter is the heart of Medico Filtered Smoking. Its 66 mesh-screen baffles whirlcool smoke—retain flakes—and absorb moisture. When filter is discolored, it has done its job. Discard it and put in a fresh one—costs only ONE CENT. Enjoy the benefits of Frank Medico Pipes, Cigarette and Cigar Holders.



GENUINE FILTERS
FOR MEDICO
PACKED ONLY IN THIS
RED & BLACK BOX

SAVE WASTE PAPER

New Accurate 10" Slide Rule

Instruction Book FREE

MADE IN U.S.A.

LOWMICE ENGINEERING SERVICE PER.

50¢

SPECIAL COMBINATION OFFER

Standard 10" Slide Rule and Instruction Book; Pocket Calculator for adding and subtracting up to 999,999; 6" Transparent Protractor and Graph Rule graduated in centimeters and inches.

—ALL 3 for \$1.00 cash (\$1.10 Foreign) POSTPAID.

New "TRIG" 10" Slide Rule, with Pocket Calculator and Transparent Protractor. **\$1.50 (\$1.60 Foreign) POSTPAID.**

Enables you to do difficult calculations instantly without paper or pencil—multiplying, proportions, division, extracting roots, etc. Accurate, white composition face. Has standard A, B, C, D, CI and K scales.

For complete outfit, including slide rule, 28-page illustrated instruction book, carrying case, send 50¢ (60¢ Foreign). New "TRIG" 10" Slide Rule, with same six scales as above plus S, L, and T scales on Reverse of Slide for problems in Trigonometry; Gunmetal Finish Indicator; complete instructions—\$1.00. Mailed postpaid. Satisfaction Guaranteed or money refunded. (See Special Combination Offer.) Order NOW.

HEWIG CO., Box B-143, Grand Central Annex, New York City

TWO MORE CHAMPS



in the LOUISVILLE SLUGGER HALL of FAME

• The personal autographs of batters like Stan Musial and Rudy York are found only on Genuine Louisville Sluggers because — like the Champs before them — they won their crowns and play with no other. Musial was the outstanding hitter for 1943 and York the champion home run clouter. Ask your Dealer or send 5c to Dept. P-31 for this new book. Hillerich & Bradsby Co., Louisville 2, Kentucky.

Louisville SLUGGER BATS
FOR BASEBALL & SOFTBALL

COLOR CONCRETE-WITH CHEMICALS

A business of your own. Big money making Hollywood style pottery and birdbaths without moulds. Washing-wells, stucco-rock, benches. Marbling and cement water-paints. 10c brings sample, literature, pictures. Hollywood CementCraft, 8529 Wonderland Ave., Hollywood 46, California

The Book-of-the-Year

FREE! NEWEST CATALOG!

RADIO AND ELECTRONIC PARTS AND EQUIPMENT

A big, fat volume... crammed from cover to cover with listings and descriptions of items for wartime industrial and civilian life. HURRY... write for your FREE copy.

STOP! READ! For non-critical consumer applications, we carry a supply of all standard radio replacement parts in addition to a wide selection of useful parts and equipment. Write for details!



LAFAYETTE RADIO CORP.
901 W. JACKSON BLVD., CHICAGO 7, ILL., DEPT. P-5

Please send me a FREE copy of the new Lafayette Radio Corporation Catalog No. 94.

NAME

ADDRESS

CITY STATE

● SAVE WASTE PAPER ●

UTICA TOOLS



ALL TYPES
FOR MORE TOOL
MILEAGE

Ask Your Dealer



UTICA DROP FORGE & TOOL CORP.
★ UTICA, N. Y. ★

MY \$2.50 PRACTICAL JOKER'S KIT and CARD TRICK SPECIAL... NOW, \$1

Special Mail Offer—Regular \$2.50 KIT of my most popular JOKE APPARATUS and genuine magician's secret CARD DECEPTIONS. Contains Exploding Cigarette plugs, Magic Midget Bottle, Dirty Soap, Buggy-Boo—and many more famous side-splitters—PLUS easy-to-do, close-up Card Bafflers which I guarantee are real magician's tricks (I know—I worked with both Houdini and Thurston), Grand for parties. Wonderful for service men. Send your \$1 now for complete KIT. I pay postage, mail at once. My usual 5-day money-back guarantee. FREE! Early orders get my amazing VANISHING ACES trick. Visiting St. Louis? Stop in and say "hello."

WILL LINDHORST, Magician 508 Pine ST. LOUIS, MO.

HOSPITALIZATION PLAN...FOR YOUR WHOLE FAMILY



COSTS ONLY
3¢ A DAY For ADULTS
1½¢ A DAY FOR CHILDREN

Bills Paid
UP TO
\$510.00
for EACH
One in Your
Family

Total paid for
2 persons, up
to \$1,020.00;
for 3 persons,
up to \$1,530.00,
etc. Many extra,
unusual
benefits included.

WHY RISK YOUR EARNINGS AND SAVINGS? Protect them now with remarkable low cost Hospital and Surgical Policy that **COVERS EVERY MEMBER** of your family, ages 3 months to 65 years.

Hospital and Surgical Bills PAID for Sickness, Accidents and Operations

When sudden sickness or accident strikes, you or anyone in your family can use any hospital you select and any doctor. This Policy pays the many expenses as clearly explained by the Policy in simple, straightforward language. Pays hospital and surgical bills for sicknesses, accidents, and operations, and even makes special provisions for **Childbirth**. No medical examination necessary. Issued at special family rates. Also available to individuals for a bit more. Mail coupon TODAY. No agent will call.

Mail Coupon Now

STERLING INSURANCE CO.
4773 Jackson-Franklin Bldg., Chicago 6, Ill.
Send me FREE INSPECTION Offer of LOW-COST Family Hospitalization Plan.

Name

Address

City State

MONEY for YOU!

INTRODUCING AMAZING AUTOFYRSTOP

Quick CASH PROFITS demonstrating AUTOFYRSTOP, remarkable new combination automatic and manual fire extinguisher and alarm. Holds unequalled records. Sells fast to defense plants, homes, schools, stores, etc. Low priced. **BIG PROFITS.** Experience unnecessary. Details FREE. Write: **AUTOFYRSTOP CO., Dept. M-54** 2035 Washington Ave., Philadelphia, Pa.



KILLS FIRE BY ITSELF

Sales Organization of 300 Men Needs Items

We have been in business 61 years, have an AA-1 rating and do a multi-million dollar business in advertising specialties and also specialties for resale by stores.

We want new sources of supply. If you can manufacture any item, write us details. We can design a new product for you if necessary, and give you continuous business now and post war. Some plants which started from zero with us a few years ago are selling us hundreds of thousands of dollars of merchandise annually.

We have distribution facilities, reputation and money. Do you have a product or an idea? Write C. W. Belden, Product Engineer, c/o The Kemper-Thomas Company, Cincinnati, O.

MAGIC LIQUID MAKES PHOTOS APPEAR

On Scarfs, Ties, Stationery, Etc.

Reproduce any snapshot on cloth, leather, wood, paper. Simply apply liquid. Like magic photo appears within 2 minutes in broad daylight. Harmless to negative. Won't wash off. Full colors included. Complete kit for 100 photos only \$1.29. Send no money, just name. Pay postman \$1.29 plus few cents postage on delivery. Or send cash with order and get postpaid. (Canada \$1.50 money order only.) Order today. L. & M Mfg. Co., Dept. 321, 229 W. Breckenridge, Louisville 3, Ky.



ARE YOU AN OLD MAN AT QUITTING TIME?



Do you think it's *all right* for you to feel so *fagged out* at quitting time? Do you *know why* you're so tired? With many men it's the *unsuspected strain* and "drag" on delicate, hidden cords that *saps energy*... and in many cases these strains can be relieved comfortably with the help of a Bauer & Black Suspensory.

READ THIS FREE ILLUSTRATED BOOK!

It shows and tells how men in all sorts of occupations claim they've found the answer to "QUITTING TIME FATIGUE"... *why they say they feel years younger*... more active... more alive... all through the day!

DON'T FEEL "BUSHED" ANOTHER DAY SEND THE COUPON NOW!



BAUER & BLACK

Suspensories

Division of The Kendall Company

Dept. S-306

2500 South Dearborn St., Chicago, Ill.

Maybe I'm missing something. Send me your booklet on suspensories... quick.

Name.....

Address.....

City.....

State.....

ELECTRIC RANGE HEATING ELEMENTS REPAIRED... Use Nichrocite Paste

Simply overlap ends, apply Nichrocite, paste and turn on current. Used by large utility companies. Trial Order, 50c; 4 oz., \$2.50; 1 Pound, \$8.00. ADVANCE MFG. & DIST. CO. Box 861 Minneapolis, Minn.

Say you saw it in Popular Mechanics!

IF YOU WANT AN ARC WELDER ...BETTER SEE HOBART USE THE COUPON!



Don't Wait! Get Complete DELIVERY Information from us NOW.

If you are on important work, you should have the advantages of "Simplified" Arc Welding to help you speed your work, cut costs, get stronger, better jobs. Hobart Welders have many advantages not found in other welders, are more suitable for your work. Let us send you catalog and details on how you can get a welder NOW. Use the coupon.

HOBART BROS. CO., Box M-541, Troy, Ohio

HOBART "Simplified" ARC WELDERS

"One of the World's Largest Builders of Arc Welders"

Catalog FREE!



Am interested in a _____ amp Welder for immediate delivery.

Send items checked—no obligation.

Complete Welder Catalog

Vest Pocket Welders' Guide

Name.....

Address.....

Hobart Bros. Co., Box M-541, Troy, Ohio

FREE Gum-Tite CLEANER
with every tube of . .
MIRACLE ACTION



SEND NO MONEY

GUM-TITE has a money-back guarantee, and if you are not satisfied in five months, return empty tube and dollar will be refunded. For snappy, happy mouth comfort order GUM-TITE at once.

**TIGHTENS YOUR FALSE TEETH
LASTS 4 to 6 MONTHS**

Keeps Food Out • **Smooths Gums**
Easy to Use • **Rids Denture Breath**

Why be embarrassed by loose, slipping teeth that hiss and click? Eat what you want and have that feeling of having your own teeth. You just tighten them with smooth-flowing, long lasting GUM-TITE without risking even a penny. If you are not satisfied, just return within five months for refund. Its miracle action forms a comfort cushion which soothes your gums, keeps out food, bans denture breath. **EASY TO USE—APPLY IT YOURSELF.** Just wash the plate—dry well. Squeeze GUM-TITE on plate—put plate in mouth. In a jiffy your plate feels like new and stays that way. GUM-TITE is the one and original plastic reliner. Not a powder or paste! It doesn't burn or irritate. Save yourself from discomfort and embarrassment by writing for GUM-TITE today.

RUSH! your order for a tube at only \$1.00 (3 for \$2.50). You must be 100% satisfied, or your money will be refunded on immediate request up to five months.

AGOR PRODUCTS COMPANY
Dept. No. PA-6
4554 Broadway
Chicago 40, Ill.
Please send me free your GUM-TITE cleaner. I will pay postman \$1.00 (or \$2.50) plus postage on arrival.
Name.....
Address.....

BENJAMIN

H-C PELLETS ARE AVAILABLE

at dealers or direct. Cal. .22 and Cal. .177. Production of all models Benjamin Air Rifles and Benjamin Air Pistols has been suspended for the duration as our facilities are engaged in War Work. **WRITE FOR OUR ILLUSTRATED PRICE LIST and BUY MORE WAR BONDS.**

BENJAMIN AIR RIFLE CO., 812 Marion St., St. Louis, (4) Mo.

BRUSH PLATING OUTFITS

for autoparts, reflectors, faucets, bicycles.
No tanks necessary. Free particulars.

GUNMETAL CO., AVE. M, DECATUR, ILLINOIS

**MARK NUMBER 10
PRECISION ADJUSTMENT
BEAM COMPASS**
Heavy Chrome Plate
\$10.00

Finest beam compass
A thousand uses!

Finely lathed pencil chuck

More adjustment in 2.00"

SEND NO MONEY! Just pay postman on delivery. Money refunded within 30 days if not completely satisfied

Order Now. We ship immediately, No Priority required!
Compass has replaceable steel pivot point. Pencil chuck removable for all size leads. Attachment for two steel points for die and pattern makers. Micro-adjustment screw for fine work. Additional clip supplied for added pencil or scriber. \$10.00 post paid.
(Ask about the Mark vest pocket depth gauge and other products. We can use a few additional distributors.)

MARK SPECIALTY COMPANY, 408 Temple Bldg., Rochester 4, N. Y.

PALMGREN
ANGLE VISES

for
Drilling
Milling
Grinding
Fitting
Filing



Solve Difficult Angle Jobs

Quick, accurate setups at any angle. End makeshift methods—time loss—rejections. Ideal for tool rooms or home workshop. Accurately machined and graduated. Once set, it stays locked. Jaws hardened steel—plain or grooved. Sizes 1 1/2" to 8" Jaws. Orders filled on plant priority ratings only. You may qualify. Write.

Chicago Tool & Engineering Co.
8365 South Chicago Ave.
Chicago 17, Ill.

Send for Free Circular
"101 ANGLE OPERATIONS"
describes complete line, gives many uses.

PRECISION WORK AT ANY ANGLE

Got a HOT idea?

OR A SWELL GADGET?

**P.W.P.
POST WAR
PLANNING**

Let's get together—our Engineering and Production Staff and our Unlimited Financing will develop and promote your brain-child for P. W. P., and arrange for patent. You are fully protected—Specializing in Plastics, Electronics, Metal or Wood. Write Today.

ADDRESS DEPT. (H) BOX 2745, KANSAS CITY, MO.

SAVE WASTE PAPER

Do you WORRY

Why worry and suffer any longer if we can help you? Try a Brooks Patented Air Cushion. This marvelous appliance for most forms of reducible rupture permits Nature to do her part—holds most ruptures securely and gently—day and night. Thousands made happy. Light, neat-fitting. No hard pads or stiff springs to chafe or gouge. Made for men, women and children. Durable, cheap. **Sent on trial** to prove it. Never sold in stores. Beware of imitations. Write for Free Book on Rupture, no-risk trial order plan, and proof of results. All Correspondence Confidential.



Brooks Company, 158-C State St., Marshall, Mich.

**FOR THE
DURATION**

Worth looking for — dealers' stocks are limited. Worth waiting for — if you can't find them. Worth caring for — if you own them.



BASS WEEJUNS
America's original Indian-construction informal shoe!



BASS SKI BOOTS
There's extra skiing pleasure in this famous ski boot!



BASS SPORTOCASINS
The "in-flow-through" to golfing foot comfort!



BASS QUAIL HUNTER
True moccasin comfort for many hunting and fishing trips!

FREE

Write for booklet. You'll want to know all about famous Bass Footwear, even though some models are temporarily unavailable. G. H. Bass & Co., 65 Main St., Wilton, Maine.

WEAR BASS MOCCASINS

HOW TO BUILD



WELDING GENERATORS
TRANSFORMER WELDERS



ARMATURE WINDING



ELECTRIC OUTBOARD

POWER TOOLS



WIND PLANTS

ELECT. GOBIKE



MOTORS

INSECT KILLERS



ELECTRIC SCOOTER

ELECTRIC FENCERS



LIGHT GENERATORS



TRACTOR LIGHTS



Get Fun and Profit with THIS BOOK OF OVER 100 ITEMS

Built from old Auto
Generators and Parts

WORTH \$12.35 IF PLANS
BOUGHT INDIVIDUALLY!

Only
\$1.50

Welding—one of the most important of mechanical processes—is covered very thoroughly in the LeJay Manual, which gives you all the necessary information for making welding equipment of different types. It also shows you how to make your own power tools, generators and motors, as well as wind plants for cheap power.

**NO SPECIAL TOOLS or
EXPERIENCE NEEDED**

**IT IS NOT NECESSARY
TO SEND MONEY**

Most of the necessary material can be found around garages, workshops and old autos, and you gain experience as you work out these plans. From making the electric scooter or the bike pusher to equipping the camp or cottage with power, there is lots of fun for your leisure hours in this interesting work.

Fill in and mail the coupon below and we will send you the LeJay Manual C.O.D. Dip into it and if you are not entirely satisfied after 3 days, send it back and your money will be returned. If you prefer to save C.O.D. fees, send \$1.50 now; same guarantee.



GET this Book—

It shows
you how to make:

200 Amp. Generator Welders . . .
Workshop Spot Welder . . . Large
Transformer Welders . . . Gunsmith's
Carbon Welder . . . Electric Fencers
. . . Bench Grinders . . . Electric Drills
. . . Armature Rewinding . . . 6, 12,
32, 110-Volt Motors . . . Wind-Drive
Light Plant . . . Insect Electro-
cutors . . . Electric Bicycle
Pusher . . . and Many Other
Things.

3 DAYS TRIAL—

LEJAY MFG. CO.

47 LEJAY BUILDING

MINNEAPOLIS 8, MINNESOTA.

Mail Coupon Today WITH ONLY \$1.50

LEJAY MFG. CO.,

47 LeJay Building, Minneapolis 8, Minn.

Gentlemen: Please send me C.O.D. your big 1944 LeJay Manual, on the understanding that if, after 3 days trial, I should return the Manual, you guarantee to return the \$1.50 purchase price.

I enclose \$1.50 for the above Manual, same guarantee .

NAME

ADDRESS

CITY..... STATE.....



CASH

WHEN YOU NEED IT MOST

AMAZING **NEW GOLD SEAL POLICY**

COSTS LESS THAN \$1 a month

PAYS accumulated **ACCIDENT BENEFITS** for Accidental Loss of Life, Limb, or Sight up to **\$6000.00**

For **LOSS OF TIME!** Accident Disability Benefits up to \$100 a month for as long as 24 months, or **\$2400.00**

SICKNESS BENEFITS For Loss of Time due to Sickness, a maximum Monthly Income of **\$100.00 PER MO.**

HOSPITAL EXPENSES for Sickness or Accident, including \$5.00 a day for hospital room, up to **\$650.00**

All Around PROTECTION! . . . Accidents happen to 20 persons every minute of every day; and sickness strikes when least expected. So why take chances? NOW you can have all-around insurance protection, backed by an old-line LEGAL RESERVE Company for less than \$1 a month. Policy pays for ALL accidents, ALL the common sicknesses, even for minor injuries; and disability benefits start from very first day.

NO MEDICAL EXAMINATION required! No red tape! Policy issued BY MAIL at BIG SAVINGS. Ages 15 to 69. Actual Policy sent for 10 Days' FREE Examination. **ACT NOW!** Write for it today. No cost. No obligation. No salesman will call.

FREE 10-Day Inspection Coupon

THE SERVICE LIFE INSURANCE COMPANY
428 Service Life Bldg. Omaha, Nebr.

Without cost or obligation, send your **GOLD SEAL \$1-A-MONTH** Policy for 10 DAYS' FREE INSPECTION.

Name _____ Age _____
Address _____
City _____ State _____
Beneficiary _____

DID GRAY HAIR

Rob them of \$95 a Week?



Now Comb Away Gray This Easy Way

GRAY hair is risky. It screams: "You are getting old!" To end gray hair handicaps all you now have to do is comb it once a day for several days with a few drops of Kolor-Bak sprinkled on your comb, and afterwards regularly once or twice a week to keep your hair looking nice. Kolor-Bak is a solution for artificially coloring gray hair that imparts color and charm and abolishes gray hair worries. Grayness disappears within a week or two and users report the change is so gradual and so perfect that their friends forget they ever had a gray hair and no one knew they did a thing to it.

MAKE THIS TRIAL TEST

Will you test Kolor-Bak without risking a single cent? Then, go to your drug or department store today and get a bottle of Kolor-Bak. Test it under our guarantee that it must make you look 10 years younger and far more attractive or we will pay back your money.

FREE Buy KOLOR-BAK today, send top flap of carton to KOLOR-BAK, Dept. 49-E, Box 1723, Chicago, Ill. and receive FREE and POSTPAID 412 page Webster's Dictionary, War Atlas and Service Insignia Guide.

EXTRA GASOLINE MILEAGE

FOR RATIONED MOTORISTS



Now you can get up to 30% extra gasoline mileage with a Vacu-matic test on your car. Quicker pick-up, smoother running, added power and precious gasoline savings guaranteed.

AUTOMATIC SUPERCHARGE PRINCIPLE
Vacu-matic is *entirely different!* Operates on the Supercharge principle. Saves gas. Automatically provides a better gas mixture. Guaranteed to give up to 30% extra gas mileage, more power and better performance.

FITS ALL CARS Constructed of six parts, fused into a single unit. Adjusted and sealed at the factory. Very quickly installed by anyone.

AGENTS *Get Yours FREE*

Every car, truck, tractor a prospect. Send name, address on postcard for big money making offer and how, for introducing, you get yours free.

Vacu-matic Co., 7617-930 State Street, Wauwatosa 13, Wis.

60 Assorted CIRCULAR SAW BLADES

and TWO MANDRELS all for . . .



This sensational value is limited to supply on hand. Act fast if you want to get in on this bargain. Blades are of laboratory tested fine tool steel (total carbon, 1.19; Manganese, .53; Nickel, Nil; Chromium, .03; Vanadium, .005; Molybdenum, .04). Sixty assorted blades sizes from .43 x .005 to 1.20 x .020. Blades to cut all types of materials, steel, wood, fibre, plastics, etc. The mandrels are 3/32". Use them on Electric Hand Tools, Small Lathes and Millers. Send \$1.00 with order, balance on Delivery plus the usual Parcel Post collection charges.

\$4.85 NO PRIORITIES NEEDED

SURPLUS TRADING CO.
6 MURRAY STREET DEPT. A NEW YORK 7, N. Y.

SAVES VALUABLE TIME AND MONEY

NOW a **DYNAMIC** **HEAVY DUTY** **INDUSTRIAL WELDER**

**WORKS OFF
110 VOLT
ELECTRIC
LIGHT
CIRCUIT**



**AMAZINGLY SIMPLE
AND EASY TO OPERATE**

This portable **DYNAMIC WELDER** easily carried right to the job—plugs into any convenient, properly wired 110 volt light circuit.

**WORKS ON IRON, STEEL,
BRASS, BRONZE AND
OTHER METALS**

Has eight metallic and carbon arc welding heat stages. Does work you would think only possible with a larger, more expensive machine.

DESIGNED TO DO HIGH-GRADE WELDING INEXPENSIVELY

Maintenance men, farmers, mechanics, machine shops, foundries, auto, general repair and job welding shops using the **DYNAMIC WELDER** find it so indispensable and useful that they cannot afford to be without it. If inexperienced you can easily learn to do a variety of high-grade welding jobs by following the practical simplified operating and welding instructions furnished.

GET DETAILS on our 10-DAY TRIAL OFFER

Once you see a **DYNAMIC** in operation you won't want to be without it. Its simplicity will amaze you. In a year the **DYNAMIC** only costs you about 6c a day. Comes complete, ready to operate, with helmet, rods, cables, electrode holder and operating instructions, etc. Nothing else to buy. Write today for free priority assistance and particulars on how to qualify for one of these amazingly low-priced welders. Act now while they are still available.

READ WHAT USERS SAY

Repair Shop Owner says, "It will do more than you say."

"I want to say I operate a repair garage and am more than satisfied with the welder. It will do more than you say."
C. F., Butler, Ohio

It's the Greatest Portable Outfit

"Now I am equipped for all kinds of welding and before I go further I must say it's the greatest portable outfit for welding any man could ever wish to own. I wouldn't sell mine for the cost of plenty welders I have seen which were very high in cost but not in convenience. You may put me on file as a booster of your wonderful welding product."

W. J. B., St. John, N. B., Canada

Better Than I Expected

"I have done quite a little welding with my welder and will frankly say it is better than I expected. The price, convenience, and variety of work that can be done with the Dynamic are the attractive points."

W. R. P., Portland, Ore.

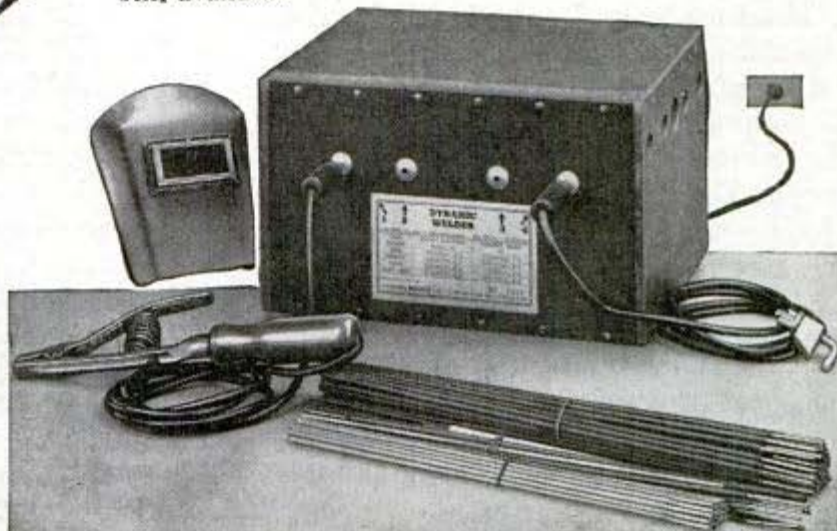

DYNAMIC WELDER CO.

13 EAST 23rd STREET AL
CHICAGO 16, ILL.

Plan Now FOR POST-WAR PRODUCTION

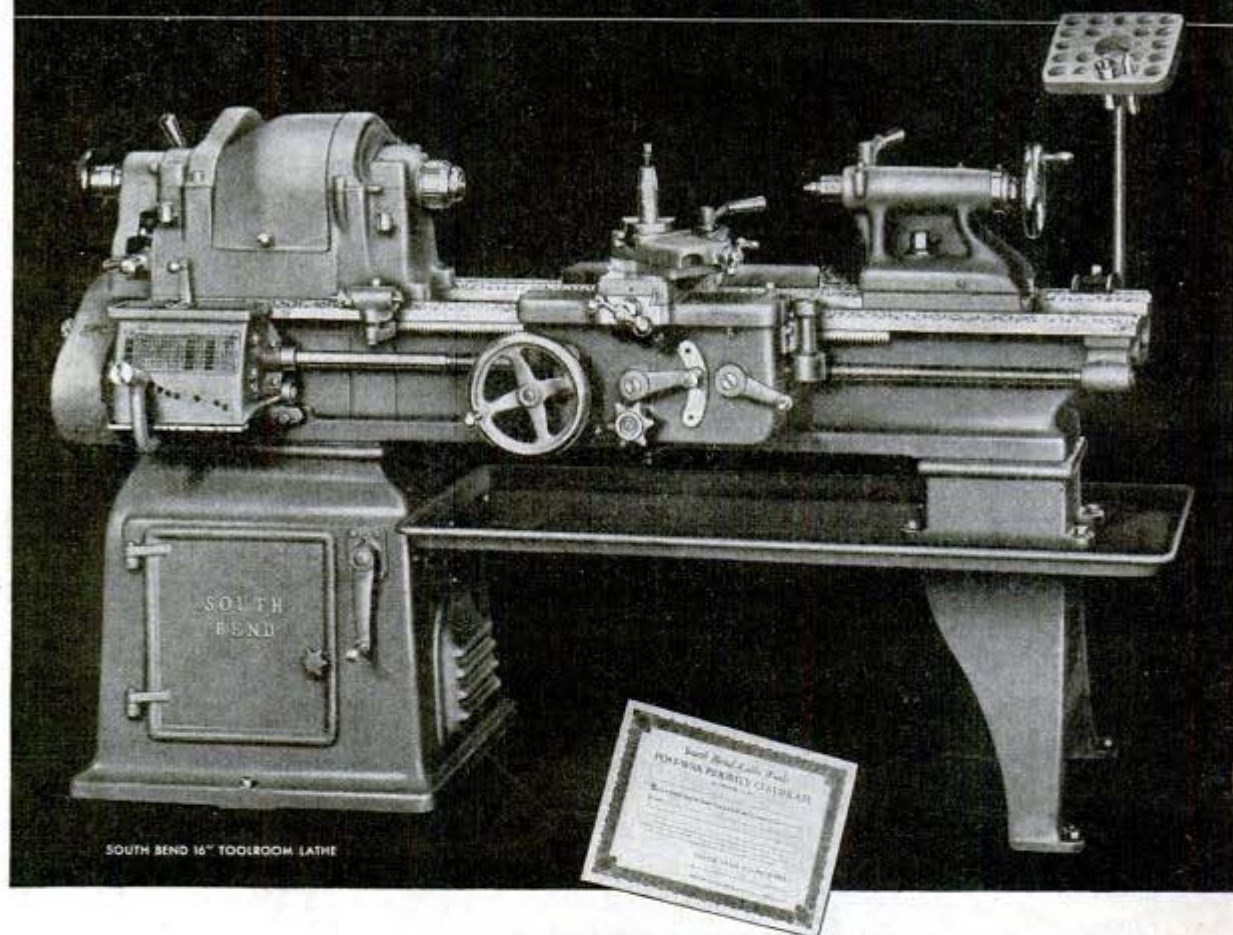

While producing for war is still America's No. 1 job—the time to look ahead to the greatest era of peace-time production is now. Ordering post-war machine tools immediately is the first step in reconverting to peace-time production. Early delivery means quicker reconversion—a very important competitive factor.

Where future-planning includes new lathe equipment, South Bend Lathe Works offers a practical post-war priority plan. You can place your order now for any South Bend Lathe. No deposit or down payment is required. We ask only that your order be placed in good faith. Each order received will be acknowledged by a numbered Post-war Priority Certificate.

When civilian production is resumed, lathe orders will be filled as nearly as possible in the order established by the certificate numbers. Today's prices will apply unless conditions beyond our control necessitate changes. The order may be cancelled at any time. All South Bend Engine Lathes, Toolroom Lathes, and Turret Lathes, embodying improvements developed to meet exacting war production requirements, will be available. No revolutionary changes in design are contemplated.

Investigate this effective plan that will help strengthen your post-war position. Write now for full details of our Post-war Priority Plan and a copy of Catalog 100-C.



SOUTH BEND LATHE WORKS

LATHE BUILDERS FOR 37 YEARS

SOUTH BEND 22, INDIANA

PRINTED BY POPULAR MECHANICS COMPANY, CHICAGO, ILL., U. S. A.

LIGHTER MOMENTS with **fresh Eveready Batteries**

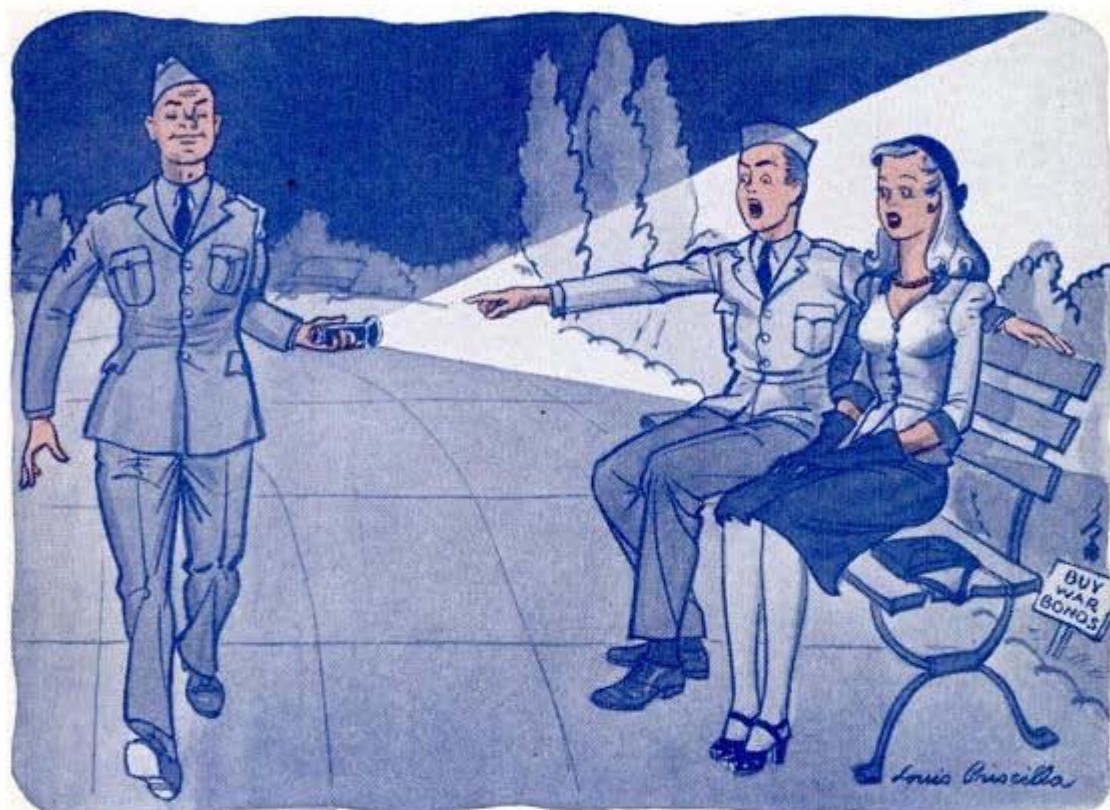

"You're violating the blackout, Sergeant."

A THOUGHT to keep in mind, next time your dealer is out of "Eveready" flashlight batteries: Nearly all we can make right now are being put to good use by either the armed forces or essential war industries.

You, personally, can save a soldier's life by giving a pint of blood to the Red Cross. They maintain Blood Donor Centers in 35 cities. Call for an appointment now!

FRESH BATTERIES LAST LONGER ... Look for the date line →



EVEREADY

TRADE-MARK

The word "Eveready" is a registered trade-mark of National Carbon Company, Inc.

**THEY'VE
GOT
WHAT IT
TAKES!**

Young Lady with a Lens

CAMERA GUNNER! Sergeant Florence aims her special aerial camera at the terrain far below. When the film is developed—few secrets are hidden from Sergeant Florence's camera!

...She's a Marine—and a camera sharpshooter of Marine Aviation, whose aerial pictures are used in vital map-making. Her rank is Sergeant... Sgt. Florence _____ (full name omitted by regulation), of the Marine Corps Women's Reserve. Her cigarette is Camel—the favorite with men in the Marines, in *all* the services. "I like everything about Camels," says Sergeant Florence, "especially their *freshness!*" That's right, Sergeant Florence! Camels stay fresh—they're *packed to go round the world!*



CAMEL'S
FLAVOR AND
MILDNESS
SUIT ME TO
A 'T'

ME, TOO!
THEY'RE SO EASY
ON MY THROAT,
AND THEY ALWAYS
TASTE SO
FRESH!



**FIRST
IN THE SERVICE**

The favorite cigarette with smokers in the Army, the Navy, the Marines, and Coast Guard is Camel. (Based on actual sales records.)

The "T-Zone"
—where
cigarettes
are judged



• Give Camels a try. Compare them for taste, for your throat... your "T-ZONE." On the basis of the experience of millions of smokers, we believe you will like the extra flavor Camel's costlier tobaccos give. We believe your throat will confirm the findings of other smokers.

Camels

R. J. Reynolds Tob. Co., Winston-Salem, N. C.