

FLAK, UNLIMITED

POPULAR MECHANICS MAGAZINE

APRIL
25 CENTS
30c IN CANADA

REG. TRADE



BUY UNITED STATES
WAR SAVINGS
BONDS AND STAMPS

SEE PAGE 17





Remember when... *Jim used to average 70 - and brag about it?*

SEEMS A LONG TIME, doesn't it, since Jim and chaps like him used to sit around and brag about how they made the other fellow eat their dust?

To hear them talk, a couple of hundred miles in less than a couple of hundred minutes was just ordinary going!

That sort of conversation is out of fashion now. So is that sort of driving - and for mighty good reasons.

Fast driving is plenty tough on tires - and tire wear is one of the deadliest enemies we have to face on the home front.

There's only one safe plan to follow if you own a car today: *Figure that your present tires are going to have to last you for the duration (and perhaps for some time beyond) and treat them accordingly.*

There *may* be enough replacement tires for non-military uses before the war is over. There *may* be synthetic tires of such quality and in such

numbers that they will offset the lack of natural rubber.

But don't count on it. If you do, you may have to lay up your car. You don't want that to happen and neither does Uncle Sam, because those of us here at home must help to fight this war with our cars as well as with our sweat and our dollars. One of the major battles we are engaged in is the Battle of Rubber. *You can help to win it!*

* * *

REMEMBER WHEN there were new tires for sale on almost every corner, and at almost any price you wanted to pay? But then, as now, it was the **INDEPENDENT** tire dealer upon whom you could most surely depend for quality and fair dealing, and for interested, personal service. We at Seiberling believe in the future of the American brand of independence and of the independent American business man. That's why Seiberling Tires always have been and will continue to be sold by **INDEPENDENT** dealers only.

SEIBERLING *Experts in Rubber*



Wartime manufacturers of Bullet-Sealed Tubes and Military Tires for our armed forces • Bullet-Sealing Gasoline Tanks • Rubber Floats, Boats and Pontons • Rubber Parts for Gas Masks, Airplanes and Tanks. Also makers of Tires and Tubes for passenger cars and trucks • Sealed Air Tubes • Rubber Heels, Soles and Mechanical Goods.



MEET YOUR NEW NEIGHBOR...

Everyone knows that the world is growing smaller through the development of Science and Industry—the War is a grim reminder of this fact . . . but when the job of war is done and the Peace is won the world will become a *Neighborhood of Nations*—working and living together for their mutual betterment.

Radio will serve the world in a measure far greater than ever before—for pleasure, education, safety and convenience of *all* mankind!

Look to *Hallicrafters*—they are planning ahead TODAY for *your* radio TOMORROW—plans born of wartime manufacturing experience and engineering developments.

hallicrafters RADIO

THE ALL OUT EFFORT of the people of Hallicrafters has won for them the honor of being the 1st exclusive Radio manufacturer to win the Army-Navy Production Award for the 3rd time . . . FIFTY MILLION DOLLARS worth of war research and developments will be built into your next Hallicrafters Radiol



BUY MORE BONDS!

THE HALLCRAFTERS CO., MANUFACTURERS OF RADIO
AND ELECTRONIC EQUIPMENT, CHICAGO 16, U.S.A.

APRIL, 1944

This One



HXB7-G8U-GTQ7

1A



THERE ARE STILL UNDISCOVERED CONTINENTS

COLUMBUS had a definite goal—a west-bound sea route to Asia. But what he found was a new continent—a new source of Nature's wealth.

Modern research also has its goals: it, too, discovers new resources. Starting from the knowns of science, it charts its voyages into the unknown. Behind each voyage is a theory that there is a passageway.

But research doesn't hold stubbornly to its theories. If it finds islands instead of a continent, it accepts them, for it expects the unexpected. It studies their relation to the known lands of science. And on the basis of its increased knowledge, it makes revised plans for progress. In science there is always a continent ahead.

Just what research will disclose can never

be forecast. But history has proved that from research flow discoveries of value to mankind. From Bell Telephone Laboratories there has poured a full stream of improvements in the telephone art.

Bell Laboratories has kept America leading the world in telephony. And its researches have contributed importantly to other arts of communication—to the phonograph and sound-motion pictures, to radio broadcasting and television.

Today, as ever since Pearl Harbor, its efforts in research and design are devoted to the war needs of the nation.

When peace comes, its organized teams of research scientists and engineers will continue to explore and invent and perfect for the improvement of telephony.



BELL TELEPHONE SYSTEM

Popular Mechanics Magazine

Registered in U. S. Patent Office and Canada

H. H. WINDSOR, Founder

H. H. WINDSOR, Jr., Editor and Publisher

April, 1944

Vol. 81, No. 4

Next Month

THE old saying that luck is the point where opportunity and preparedness meet certainly applies to Uncle Sam's pinpoint bombardiers. It may be an exaggeration to say they can drop a bomb into a pickle barrel on the Unter den Linden—but they can come close. Despite rocket-launching fighter planes, heavy flak and blinding searchlights, the bombardier can hit the target with America's famed bombsight. This mechanical and electrical wonder coupled to an automatic flight control device actually flies a plane during the bombing run. How it works is told in a May feature, "Our Bull's-Eye Bombardiers."

Bouncing Baby

WHEN America's synthetic rubber industry hits its full stride in the near future, one huge plant alone will be turning out enough rubber to make 63,000 passenger car tires a day. A boon in wartime, this product will find hundreds of peacetime uses with its superior resistance to grease and sun. How this "Bouncing Baby With a Future" will affect postwar products is told in an outstanding article next month.

Building Blocks

IT pulled your flivver out of the mud a few years ago. Today, concrete is helping win a war by enabling war plants to mushroom up over night, and bottling rivers to produce power. After the war, it will give you a better house with soundproof bedrooms included. A May article tells how wartime know-how is making "Building Blocks for a New World."

IN THIS ISSUE

Pistol-Packin' Warplanes	1
The Navy's Tools of War	7
The Tube That Is Remaking the World	18
Tenderfoot Skipper	27
The Camera Clicks for Uncle Sam	34
Dress Rehearsal for War	44
More Power for the Farmer	50
They Bring Themselves Back Alive	56
Our Next World War—Against Insects	66
New Magic in Black Gold	72
Flak, Unlimited	77
No. 1 Enemy on the Home Front	82

Where-to-Buy-It Index—Page 8A

"The Caissons Go Rolling Along"

WHILE rocket-launching weapons and super-bomb-ers capture the headlines, heavy field guns keep right on capturing enemy positions. The high respect with which the enemy regards Yankee field artillery was evidenced by a captured Nazi officer who asked to see our "automatic" field piece. He thought there was no other explanation for the barrage of shells that reduced a fortress to dust. An article next month takes you behind the scenes with a gun crew at the front where you will meet 15-ton "Long Tom," our new 105-mm. howitzer, and other mobile giants.

4,600,000 Trucks Go to War

RUMBLING over frozen roads on the Russian front, sloggling through jungle mud, or serving on the home front as vital carriers on a network of 1,000-mile assembly lines, are 4,600,000 U. S. trucks performing hundreds of daily tasks to help smash the Axis. One truck line delivered a cargo of life rafts from New England to a West Coast port 36 hours ahead of schedule after a dramatic race against time across the country. Read "Trucking to Victory" next month.

Published monthly by POPULAR MECHANICS COMPANY, 200 East Ontario Street, Chicago (11), Ill., U. S. A. Single copy in the United States, 25 cents; subscription rates in United States and possessions, and countries of the Pan-American Postal Union, \$2.50 a year. Single copy in Canada, 30 cents; subscription rates, \$3.00 a year. To all other countries add \$1.00 a year over United States prices for overseas postage. If you plan to move, notify us at least 60 days in advance so you will not miss an issue. Give both old and new addresses. Entered as Second Class Matter, September 15, 1903, at the Post Office at Chicago, Illinois, under Act of March 3, 1879. Copyright 1944, by Popular Mechanics Company. Copyright under International Copyright Union. All rights reserved under Pan American Copyright Union. Printed in the United States of America

SCREWBALL IDEAS ON BATTERY CARE

#1

Here's a lulu straight from the squirrel cage. Move up your idling speed to make the generator deliver maximum output. Yes, it might save you a recharge, but man, how it eats those "A" coupons up!

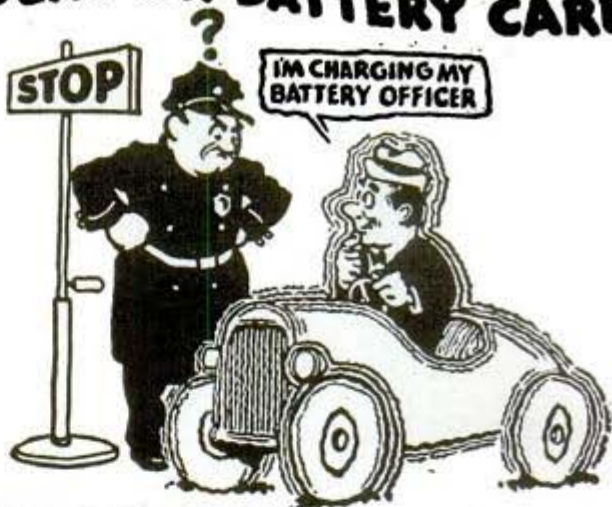

but.. THE WISE WAY

IS PERIODIC RECHARGES!

RESTRICTED driving is hard on batteries. Rationed mileage keeps them from getting a normal recharge from the generator, and can cause serious starting trouble unless certain precautions are taken.

Keep your battery in tip-top shape by letting an experienced Exide Dealer give it a check-up every two weeks. In many cases, periodic recharges are essential, and with them, your Exide Dealer puts off the day when you'll need a new battery. When you must get a battery, get a dependable, long-lasting Exide. Buy to Last—Save to Win.

THE ELECTRIC STORAGE BATTERY CO.
Philadelphia 32

Exide Batteries of Canada, Limited, Toronto

EXIDES ARE USED IN MORE THAN 100
APPLICATIONS BY OUR ARMED FORCES



- 1 Don't buy *anything* you can do without.
 - 2 If you **MUST** buy, insist on dependable, long-lasting merchandise.
 - 3 Take care of the things you have. Make them last.
- These conservation rules save materials for war production, help curb inflation, give you more money to invest in War Bonds.

VETERAN IN SEARCH OF A PEACETIME FUTURE

THIS veteran knows of no job to come back to after the war.

It was born of war necessity — built to perform a strategic purpose new in the history of aircraft.

The requirements were an engineering challenge. It had to be strong to do its heavy work. Yet it had to be light and fit in the small space available.

That is why even optimists doubted such a device could be built.

But here it is: The Lear Actuator.

Its job is operating flaps, landing gears, shutters and other equipment on the power of an ordinary storage battery.

Now, of course, our plants are working round the clock to make enough of these for Uncle Sam.

But we know that such unique devices, the midget motors that drive them and all the 250 Lear products, must have an important future in some peacetime applications.

They may park your car with the push of a

button — or do any of thousands of jobs we haven't thought of.

That is why we are telling you about them. We want to find jobs for these able veterans.

And at the same time we want you to know that there is available the kind of engineering thinking and production technique that made them possible.

PLANTS:

Piqua, Ohio and Grand Rapids, Michigan.

BRANCHES:

New York, Los Angeles, Chicago, Detroit, Cleveland, Providence.



**LEAR
AVIA
INC.**

PIQUA - OHIO

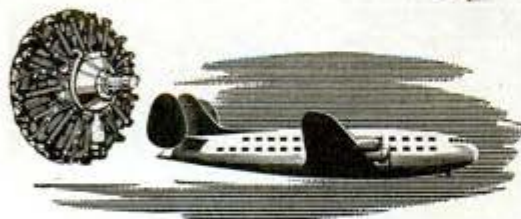

This measuring glass contains slightly over half a pint of gasoline. Mixed with about 75 cubic feet of air and metered into a Cyclone 9 engine, this cupful of fuel, in contributing its share of the total power, will produce one horsepower for one hour.

No other type of gasoline engine does as much work on this amount of fuel; your car would require about 20% more gasoline to produce 1 horsepower for 1 hour. In engineering terms, the Cyclone's cruising consumption is at the rate of 0.41 pounds of fuel per horsepower per hour. Cyclones have operated on extended flights at cruising power on 0.39 pounds per horsepower hour—even less under careful control—but 0.41 represents the average for millions of hours of routine operation.

Minimum fuel consumption is determined by the engine design, depending on such factors as the compression ratio, the induction system, and the contour, size, and cooling of the combustion chamber. The carburetor's function is to provide the most desirable mixture for its engine under various conditions, but it cannot determine fuel economy because an engine will not run leaner at a given power than its design permits.

On a ten-hour flight in a four-engined airplane the seemingly fractional difference in consumption between the Cyclone 9's average lean rate of 0.41 lbs. and the general average rate of 0.45 lbs. can amount to a saving of 160 gallons. The fuel saved with Cyclones represents almost 1,000 pounds of extra cargo or five additional passengers. In a year, this difference can mean a saving of 50,000 gallons on a four-engined plane—fuel approximately equal in cost to an engine.

★ ★ ★

Wright Cyclones pay their way.

Cyclones and Whirlwinds · Light · Compact · Powerful

WRIGHT Aircraft Engines



WHITE COLLAR or OVERALLS-



Which will YOU wear after the war?

HUNDREDS of thousands of white collar workers have put on war overalls for the duration. Millions of both white collar and overall workers have put on uniforms. Hosts of home women are patriotically taking jobs.

After the war, millions will be coming back from army, navy and air force to civilian jobs; great war materials factories will be re-converting to civilian production; old peace-time functions of business will be springing up—where will you fit in the situation?

If you are wise, you will look ahead and prepare. You will not wait on chance. You will analyze the probable conditions in peace employment, decide where your likes and aptitudes fit best, and get ready. You will decide whether your best opportunities lie in production or office or store. You will determine whether you wish to work for someone else or develop a business of your own. You will train now to be above the average and, therefore, surer to get the opportunity you want after the armistice.

Nor will you wait very long. Nobody knows when this war will end or how soon this problem will hit you in the face.

We Can Help You Decide

If you have some question either about postwar opportunities or about your own fitness for some particular one, probably we can help you. In our 34 years, over one million adults have enrolled for our training, we have built training courses for many

major fields of commerce and industry, and we have gathered a wealth of information about job opportunities and requirements. That information is at your service.

We Can Help You Prepare

And when you have decided what field of work offers most to you for a life career, we can help you prepare for it—quickly, economically, thoroughly, in your spare time and without any interference with your present work—if it is in the list below. A 48-page booklet on the field of your choice, discussing the field and our training for it, has been prepared to help answer your questions. The coupon below or your letter will bring it to you, without cost or obligation.

Do not delay. Whether the war lasts six months or three years, now is the time to make sure your preparation for postwar success shall not be “too little and too late.”

La Salle Extension University A Correspondence Institution

DEPT. 464-R

CHICAGO

I want to pick my career for after the war and get ready for it now. Send me your free booklet on the field I have checked below and full information about your training in that field.

- | | |
|---|--|
| <input type="checkbox"/> Foremanship | <input type="checkbox"/> Industrial Management |
| <input type="checkbox"/> Bookkeeping | <input type="checkbox"/> Accounting |
| <input type="checkbox"/> Business Law | <input type="checkbox"/> Law: LL.B. Degree |
| <input type="checkbox"/> Executive Management | <input type="checkbox"/> Traffic Management |
| <input type="checkbox"/> Salesmanship | <input type="checkbox"/> Business Correspondence |
| <input type="checkbox"/> Business English | <input type="checkbox"/> Stenotypy |

Name.....Age.....

Present Job.....

Address.....

for GAS RATIONED AUTO OWNERS...



← This little fellow is Corrosion—he rusts and destroys any metal surface he can reach.

Pistons and cylinder walls of infrequently driven cars are his meat. The oil drains off—and Corrosion sets in.



The drivers who use Pyroil baffle Corrosion. Pyroil makes oil adhere to metal surfaces offering protection against rust and corrosion.

HOW TO PROTECT YOUR CAR

Simply put 1 pint of Pyroil in the crank case, and add one ounce to each 5 gallons of gasoline. Pyroil maintains a constant oil film over the cylinder walls. It insures thoroughly lubricated piston rings. It prevents rust and corrosion, and prevents "gumming." Your car starts quicker—you stop excessive wear.



YOUR GUARANTEE

12 YEARS' ACCEPTANCE BY FOREMOST AUTHORITIES—RACE DRIVERS—EXPLORERS—ENGINEERS.

Keep Buying Bonds

DISTRIBUTORS: Check and Mail Coupon for Franchise Facts.

PYROIL COMPANY

54 Pyroil Bldg., LaCrosse, Wisconsin

I want my car to last and run properly until Victory. Please tell me more about Pyroil and how it can accomplish this for me.

Send Details of your Plan for Distributors

Name

Address

City or Town

State

WHERE-TO-BUY-IT INDEX

Where no name and address appear directly under an item, the product is not believed by us to be commercially available

"Helldivers" increase range and speed.....	5
Giant "chess board" guides floor planners.....	6
Toys teach navy officers ship loading.....	6
Letter patterns for sign painter.....	13
John F. Rahn, 1330 N. Central Ave., Chicago	
Toothbrush holds dental floss.....	13
J. A. Landis, Eaton, Ohio	
Giant army tank retriever.....	16
Hogs operate swinging door.....	16
Bowers Mig. Co., Third and Walnut Streets, Wahoo, Nebr.	
Water spray shields lifeboat.....	17
Nazi secret weapons.....	26
New system for television.....	32
Largest glider ready for invasion.....	33
Guns tested with compressed air.....	33
Engineers take bridge for barge ride.....	33
Postwar plane is icebox on wings.....	39
Cadet "dunker" trains Navy pilots.....	39
German Mark VI "Tiger" tank.....	40
Coal chutes made of glass.....	42
Pittsburgh Plate Glass Co., Pittsburgh, Pa.	
Railroads top records in '43.....	42
Work stand for plane mechanic.....	42
Pacific Engineering Corp., 3123 San Fernando Rd., Los Angeles	
Painting tool for telephone wires.....	43
Midget model of tractor.....	43
Amplifier projects voice 18 miles.....	43
Bendix-Westinghouse Automotive Brake Co., Elyria, Ohio	
Pylon marker for U. S. airplanes.....	48
Electronic ear tests shells.....	48
Trucks roll along Alaska highway.....	49
Moisture magnet and humidity cell.....	49
Roofing Products Co., 201 N. Wells St., Chicago 6, Ill.	
Lamps lighted by radio beams.....	55
"Stop light" inspection gage.....	61
Sheffield Corp., Dayton, Ohio	
Tire made from elastic plastic.....	61
Training flyers on the ground.....	62
Giant flywheel stores power.....	64
Machine drills 52 holes at once.....	64
Tower and crane aid mechanics.....	65
Aviation Equipment Co., Tonawanda, N. Y.	
Telephone lines 1 foot long.....	65
Method of starting cold engines quickly.....	65
Nazi "plow" wrecks railroads.....	71
Navy tug has a train ride.....	76
"Supercharged" airplane heater.....	76
Peek-a-boo jeep hauls target.....	81
Chemical turns skin white.....	81
"Rock-a-bye" file cabinet.....	87
Rockwell Barnes Co., 35 E. Wacker Dr., Chicago	
Trailers carry big bombs.....	88
Truck pushes freight cars.....	88
Fluorescent stars dot celestial sphere.....	88
Five-tube classroom demonstrator kit.....	144
Allied Radio Corp., 901 W. Jackson Blvd., Chicago	

Craftsman and Shop Notes Index

AUTOMOTIVE

Keep your car rolling.....	114
Saving anti-freeze solution.....	117

FARM

Brake drum used as pump splash pan.....	96
Reclaiming used baling wire.....	105
Locking worn coupling on pump rod.....	126
Two-row cornstalk cutter.....	129
Produce signs hang on fence.....	140
Funnel holds plumb bob for fence setting.....	140

HAND TOOLS

Glass cutter stored in oil.....	96
Square cleaned with putty.....	96
Solder and flux kept together.....	105
Holder to start small nails.....	108
Twin hacksaw blades cut thin tubing.....	112
Wrench for oil-drum plugs.....	126
Pin vise from tap wrench.....	128
Hook holds handle on file.....	128
Using precision measuring tools.....	130
Covers for screwdriver tips.....	136
Using hacksaw blade without a frame.....	138

HOME IMPROVEMENTS

Three step-saving coal bins.....	109
Window pan catches melting frost.....	122

(Continued to page 10A)



DRAFTING

SPRINGBOARD TO SUCCESS!

MANY men today are using drafting boards to help win this war! • The International Correspondence Schools Courses in Mechanical or Architectural Drafting have fitted many hundreds of ambitious men for better jobs in this well-paid field!

• All I. C. S. Courses (covering 400 business and technical subjects) are prepared by leading *practical* authorities, constantly revised to meet new developments. *Yet the cost of I. C. S. training is surprisingly low.* • It's not too late for *you* to start—help your country, help yourself! Mail this coupon *today!*

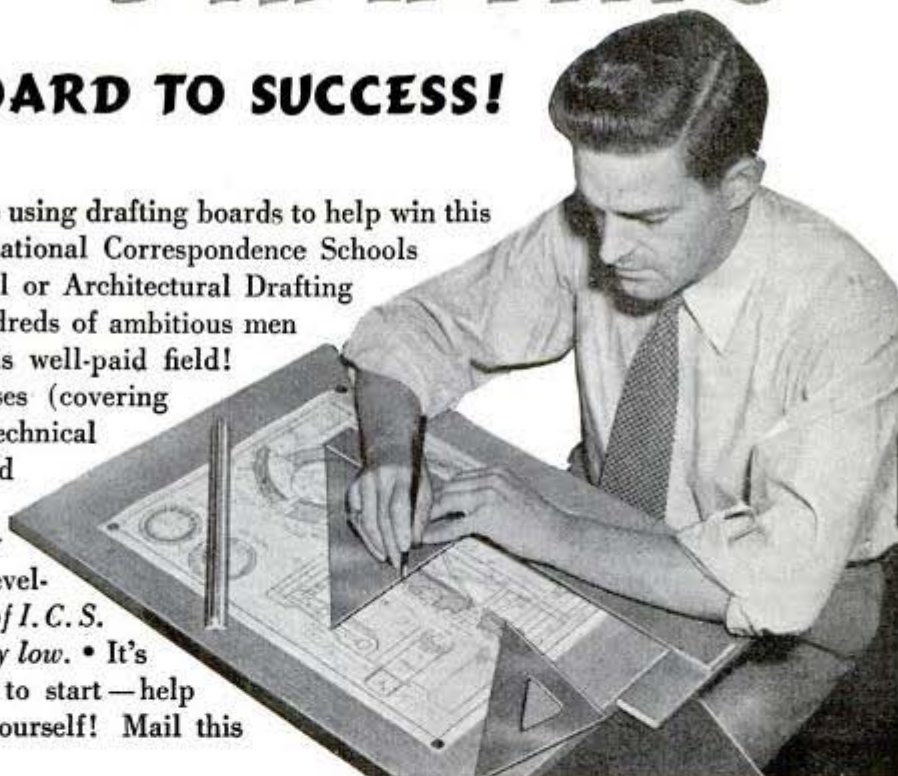

INTERNATIONAL CORRESPONDENCE SCHOOLS

**SPECIAL TUITION RATES
FOR MEMBERS OF
THE ARMED FORCES**

BOX 5688-J, SCRANTON 9, PENNA.

Without cost or obligation, please send me booklet and full particulars about the course *before* which I have marked X:

DRAFTING

Air Conditioning Schools

- Air Conditioning
- Heating Plumbing
- Refrigeration
- Steam Fitting

Chemistry Schools

- Chemical Engineering
- Chemistry, Analytical
- Chemistry, Industrial
- Chemistry, Mfg. Iron & Steel
- Plastics
- Pulp and Paper Making

Civil, Architectural and Structural Engin'g Schools

- Architectural Drafting
- Architecture
- Bridge and Building Foreman
- Bridge Engineering
- Building Estimating
- Civil Engineering
- Contracting and Building
- Highway Engineering
- Lumber Dealer
- Sanitary Engineering
- Structural Drafting
- Surveying and Mapping

Electrical Schools

- Electrical Drafting
- Electrical Engineering
- Power House Electrician
- Practical Electrician
- Practical Telephony
- Telegraph Engineer

Internal Combustion Engines Schools

- Auto Technician Aviation
- Diesel-Electric
- Diesel Engines Gas Engines

Mechanical Schools

- Aeronautical Engineering
- Airplane Drafting
- Flight Engineer
- Foundry Work
- Heat Treatment of Metals
- Industrial Design
- Mechanical Drafting
- Mechanical Engineering
- Mold Loft Work
- Pattern Making
- Reading Shop Blueprints
- Sheet Metal Drafting
- Sheet Metal Worker

Ship Drafting Ship Fitting

- Shop Practice
- Steel Mill Workers
- Tool Designing
- Welding, Gas and Electric

Radio Schools

- Electronics Radio, General
- Radio Operating
- Radio Servicing

Railroad Courses

- Air Brake Car Inspector
- Locomotive Engineer
- Locomotive Fireman
- Railroad Section Foreman

Steam Engineering Schools

- Boilermaking
- Combustion Engineering
- Engine Running
- Marine Engines
- Steam Electric
- Steam Engines

Textile Schools

- Cotton Manufacturing
- Rayon Weaving
- Textile Designing
- Woolen Manufacturing

Business and Academic Schools

- Accounting Advertising
 - Arithmetic Bookkeeping
 - Business Correspondence
 - Business Management
 - Certified Public Accounting
 - City Letter Carrier
 - College Preparatory
 - Commercial
 - Cost Accounting
 - Federal Tax
 - First Year College
 - Foremanship
 - High School
 - Higher Mathematics
 - Illustrating
 - Motor Traffic
 - Postal Office Clerk
 - Postal Clerk
 - Salesmanship Secretarial
 - Stenography
 - Traffic Management
- Language Schools**
- Spanish French
 - Good English

Name.....Age.....Home Address.....
City.....State.....Present Position.....Working Hours.....

Canadian residents send coupon to International Correspondence Schools Canadian, Ltd., Montreal, Canada.
British residents send coupon to I.C.S., 71 Kingsway, London, W. C. 2.

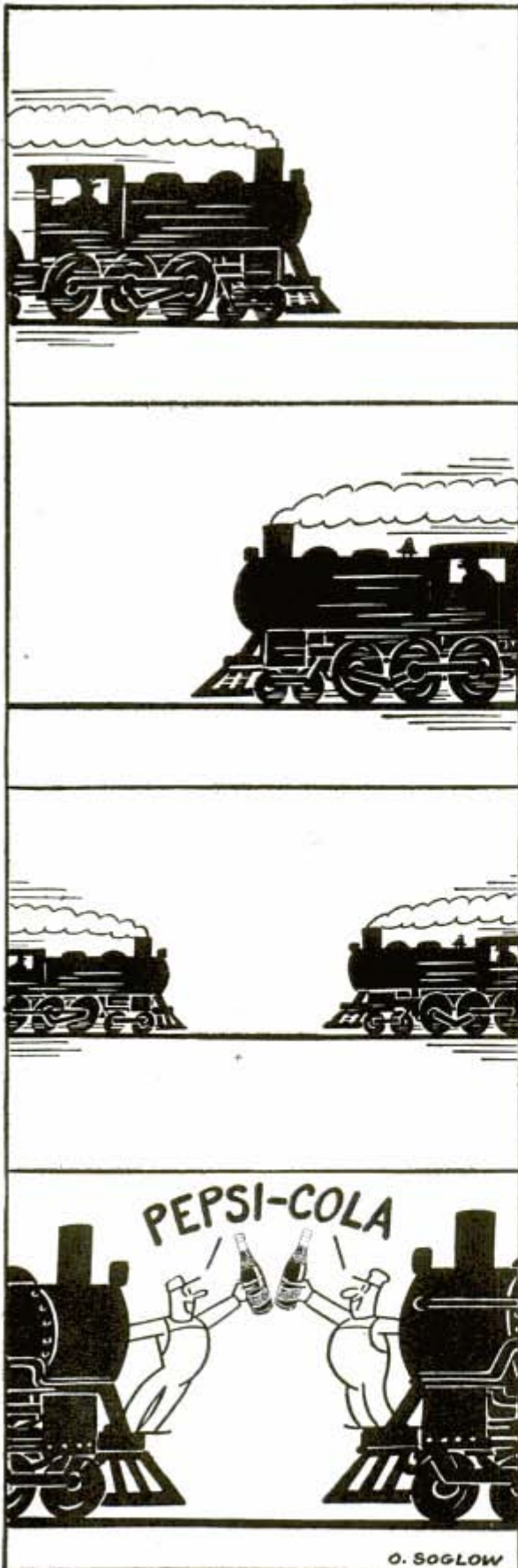

(Continued from page 8A)

HOUSEHOLD

Good grip on electric plug.....	93
Solving home problems.....	94
Holder for cutting sandwiches.....	103
Clothesline tightener.....	105
Using night latch on sliding doors.....	108
Mothballs on pins find many uses.....	118
Glass strip holds aquarium plants.....	118
Iron cleats lengthen life of shovel.....	140

LAWN AND GARDEN

Tool box on wheelbarrow.....	93
Hothouse has sides of translucent cloth.....	97

PHOTOGRAPHY

Print straightener.....	119
Eraser reduces shadows.....	120
Closeups with folding camera.....	120
Funnel aids in washing prints.....	120
Clothespin handle on reflector.....	120
Ice and salt cool solutions.....	120
All-wood tripod.....	121

POWER TOOLS

Saddle block pusher for bench saw.....	122
Drilling deep holes in metal.....	123
Lathe tool post grinder.....	127

RADIO AND ELECTRICITY

Adaptors for wartime tube substitutions.....	141
Portable phono-attachment and "mystery" player.....	142
Flexible five-tube circuit demonstrator in panel form.....	144

STORE AND SHOP

Packages opened with tracing wheel.....	96
Hinge stops keep bench from rolling.....	118
Holding blowtorch while filling tank.....	126
Sandpaper cone lifts eggs from crate.....	126
Ink can covers removed easily.....	128
Sharpener for shop crayon.....	128
Paraffin-coated gloves for washing press.....	136
Colors identify oil cans.....	137
Revolving small-parts bin.....	138
Knife to brand cured meat.....	138
Miter box for cutting pipe and rods.....	138
Production methods of making cutouts.....	139
Keeping laboratory hose on hook.....	140
Straightening linotype matrix.....	140

TOYS, GAMES, NOVELTIES

All-wood pump car.....	89
Self-setting air-rifle target.....	92
Extension sides for dart target.....	93
Caroms stored on cue.....	108

WOODWORKING

Trouser hanger as gluing clamp.....	92
Graceful candle holders turned on lathe.....	104
Mirror-backed china stand.....	106
Cleats hold miter box on bench.....	108
Emergency marking gage.....	112
Matching red cedar properly.....	112
Adjustable letter holder.....	113

MISCELLANEOUS

Ladder hoist lifts birdhouse.....	92
Poultry ring as slide-fastener pull.....	96
Repair for slide fastener.....	96
Honor rolls for men in service.....	98
Repair for coaster-wagon wheels.....	103
Packing boxes for servicemen.....	103
Extra car keys carried in wallet.....	105
Wire holder for coffee cups.....	108
Concrete sash weights.....	108
Cleaning wide-hole pipe stem.....	112
Thumb used as thickness gage.....	112
Cutouts made on sewing machine.....	118
Lock washers made from coil spring.....	118
Altering padlock shackles.....	122
Nail polish protects watch strap.....	122
Wax paper stiffens small flags.....	122
Allow shrinkage space above steel support.....	126
Wheels on stirrup improve scaffold.....	128
Adjustable table for welder.....	137
Screw vent for metal container.....	140

IMPORTANT NOTICE

It is the intention of this magazine to provide its readers with information regarding the latest developments in the mechanical arts. We take no responsibility as to whether the disclosures contained in our articles are covered by patents and advise readers to investigate this subject before making, using, or selling any of the products, machines, or processes described in order to avoid possible liability for patent infringement.

AUDELS AIRCRAFT WORKER . . . \$1

Answers Your Questions on 1—Aircraft Materials, Terms, Parts. 2—Blueprints, Working Drawings. 3—Mathematics, How to Figure. 4—Layout & Bending. 5—Tools & Machines. 6—Riveting, Spot Welding & Hints. 7—Fabrication, Angles, etc. 8—Assembly, Fuselage, Wing & Final—How to Use Tools. 9—Tables & Data, Symbols, Army & Navy Specifications, etc. 240 Pages illus.

AUDELS SHEETMETAL

PATTERN LAYOUTS . . . \$4

Developed by Experts for Sheet Metal Workers, Layout Men & Mechanics. A Practical Encyclopedia in 10 Sections, size 7 x 10 x 2—1125 Pages—350 Layouts—1600 Illustrations. 1001 Key Facts. Fully indexed for ready reference in answering your layout problems. Covers all phases of sheet metal work including Pattern Cutting, Pattern Development & Shop Procedure.

AUDELS SHEETMETAL WORKERS

HANDY BOOK . . . \$1

Practical inside information. Fundamentals of Sheet Metal Work. 388 pages. Illustrated. 11 sections. Clearly written. Essential & important facts, figures, pointers in everyday language. Ref. Index.

AUDELS WELDERS GUIDE . . . \$1

A concise, practical text on operation & maintenance of all welding machines for all mechanics. Over 400 pages, illustrated. Covers all methods of electric and acetylene welding including airplane work.

AUDELS ANSWERS ON

BLUE PRINT READING . . . \$2

For Mechanics & Builders. Covers all types of blue print reading including ship & airplane. 376 pages, fully illustrated.

AUDELS NEW MACHINIST &

TOOLMAKERS HANDY BOOK . . \$4

Covers modern machine shop practice in all its branches. 5 practical books in 1. New from cover to cover. Tells how to set up & operate lathes, screw and milling machines, shapers, drill presses and all other machine tools. 1600 pages, fully illustrated, 5 x 6 1/2 x 2. Indexed. 5 sections. 1—Modern Machine Shop Practice. 2—Blue Print Reading & How to Draw. 3—Calculations & Mathematics for Machinists. 4—Shop Physics. 5—How to Use the Slide Rule. 60 chapters. Easy to read and understand. A shop companion that answers your questions.

AUDELS MATHEMATICS &

CALCULATIONS FOR MECHANICS \$2

Mathematics for home study or reference. 700 pages, 550 illus. Practical mathematics from beginning. How to figure correctly. Easy, correct methods covering a complete review. Ill. & Indexed.

AUDELS AUTOMOBILE GUIDE . . . \$4

A practical quick ready reference book for auto mechanics, service men, operators & owners. Explains theory, construction & servicing of modern motor cars, trucks, buses & auto type Diesel engines. 1540 pages, fully illustrated. 55 chapters. Indexed. A standard book for mechanics. New fluid drive covered.

AUDELS DIESEL ENGINE MANUAL \$2

A practical, concise treatise with questions and answers on the theory, operation and maintenance of modern diesel engines including General Motors 2 cycle Diesel. 384 pages, fully illus., flexible binding, pocket size. All details plainly brought out, this book is of extreme value to engineers, operators & students.

AUDELS RADIOMANS GUIDE . . . \$4

A key to the practical understanding of radio including Frequency Modulation, Television, etc., Aircraft & Marine Radio. For radio engineers, servicemen, amateurs. 772 pages, 400 illustrations & Diagrams. Photos. Review Questions & Answers, Reference Index. Authentic, clear, concise.

AUDELS HANDY BOOK OF

PRACTICAL ELECTRICITY . . . \$4

For maintenance engineers, electricians & all electrical workers. 1440 Pages, 2600 Illus. Covers important electrical information in handy form—including Marine Wiring, Radio Principles, Welding. Indexed. A Key to a practical understanding of electricity.

AUDELS CARPENTERS & BUILDERS

GUIDES—4 Vols. . . . \$6

A practical illustrated trade assistant on modern construction for carpenters, joiners, builders, mechanics and all woodworkers. 4 vols., 1600 pages, 3700 illustrations, flexible covers. Each volume pocket size. Sold separately \$1.50 a vol.

AUDELS PLUMBERS & STEAMFITTERS

GUIDES—4 Vols. . . . \$6

A Practical Trade Assistant & Ready Reference. Explains in plain language & by clear illustrations, diagrams, charts, graphs, pictures principles of modern plumbing practice including Marine Pipe Fitting and Air Conditioning. 4 Vols.—1670 Pages—3642 Diagrams. Each Vol. Pocket Size. Sold Separately \$1.50 a Vol.

AUDELS WIRING DIAGRAMS . . . \$1

210 Pages. Illustrated. Gives practical facts on wiring of electrical apparatus. It explains clearly in simple language how to wire apparatus for practically all fields of electricity. Each diagram is complete & self-explanatory. Highly Endorsed Pocket Companion.

AUDELS ELECTRONIC DEVICES . . \$2

Tells What You Want to Know About Electric Eye. Easily Understood. Covers photo-electric cells & their applications. Amplifiers, illumination, frequencies, voltage, photocell, tubes, Ohm's Law, wiring diagrams, etc.

AUDEL, Publishers, 49 W. 23 St., N. Y. 10



AN AUDEL GUIDE IS A GOOD FRIEND!

Use the brains and experience of others in these Guides of the Trades. Save time and money with right methods, short cuts, labor saving ideas. CHECK NOW! You can look over any Audel Guide in your home. Start the Easy Payments if satisfied.

CUT HERE MAIL ORDER

THEO. AUDEL & CO., 49 W. 23rd St., New York 10

Please mail me for 7 days' free examination the books marked (X) below. I agree to mail \$1 in 7 days on each book or set ordered, and to further mail \$1 a month on each book or set ordered until I have paid purchase price.

If I am not satisfied with Guides I will return them.

- Audels PUMPS, HYDRAULICS & AIR COMPRESSORS \$4.
- Audels WELDERS GUIDE 1.
- Audels BLUE PRINT READING 2.
- Audels SHEET METAL WORKERS Handy Book 1.
- Audels SHEET METAL PATTERN LAYOUTS 4.
- Audels AIRCRAFT WORKER 1.
- Audels MATHEMATICS and CALCULATIONS 2.
- Audels MACHINISTS & TOOLMAKERS Handy Book 4.
- Audels DIESEL ENGINE MANUAL 2.
- Audels MECHANICAL Dictionary 4.
- Audels AUTO GUIDE 4.
- Audels MARINE ENGINEERS HANDY BOOK 4.
- Audels SHIPFITTERS Handy Book 1.
- Audels MARINE Engineers Guide 3.
- Gueths MECHANICAL DRAWING COURSE 1.
- Rogers Mechanical DRAWING and Design 2.
- Audels MILLWRIGHTS and Mechanics Guide 4.
- Audels CARPENTERS and Builders Guides (4 vols.) 6.
- Audels PLUMBERS and Steamfitters Guides (4 vols.) 6.
- Audels MASONS and Builders Guides (4 vols.) 6.
- Master PAINTER and DECORATOR 2.
- Audels GARDENERS & GROWERS GUIDES (4 vols.) 6.
- Audels ENGINEERS and Mechanics Guides 12.
- Nos. 1, 2, 3, 4, 5, 6, 7 and 8 complete 12.
- Audels Answers on Practical ENGINEERING 1.
- Audels Answers on REFRIGERATION 2.
- Hawkins Aids to ENGINEERS EXAMINATION 2.
- Rogers MACHINIST GUIDE 2.
- Audels WIRING DIAGRAMS 1.
- Audels Handy Book of PRACTICAL ELECTRICITY 4.
- Audels ELECTRICAL POWER CALCULATIONS 2.
- Hawkins ELECTRICAL Guides at \$1. each 10.
- Audels ELECTRONIC DEVICES 2.
- Audels ELECTRIC Dictionary 2.
- Audels RADIOMANS GUIDE 4.
- Audels NEW ELECTRIC LIBRARY at \$1.50 a Volume 4.
- Vols. I, II, III, IV, V, VI, VII, VIII, IX, X, XI, XII.

Name _____

Address _____

Occupation _____

Employed by _____ P M



Guardian Angels

The fireworks are all over. The "Sad Sack" is nearly home. A few minutes more, and she'll put her crew down safe on a friendly field.

She went out this morning full of fight, with her belly full of bombs . . . all four motors roaring defiance at every German in Italy.

She hammered the Nazi railyards at Terni, and left them a tangle of wreckage.

But she had to take a few on the chin to do it.



1st LT. DONALD J. JUSTER, of St. Albans, N. Y. . . . Air Medal with 9 Clusters, Bombardier of the Flying Fortress the "Sad Sack". . . "I'll say an escort of fighter planes is a mighty sweet sight to see! Bombers and fighters, working together, make the A.A.F. an unbeatable team. And if you don't think so, take a look at Germany's big industrial centers from the air."

1st LT. JOHN D. JOYCE, of Griffith, Indiana . . . Air Medal with 10 Clusters, Distinguished Flying Cross recommended . . . P-38 Pilot. "I've helped escort the 'Sad Sack' on many a bombing mission . . . and seen Don Juster bullseye his bombs on plenty of Jerry objectives. And I want to tell you that's when teamwork pays off . . . teamwork that makes the A.A.F. the 'greatest team in the world!'"

When the escort fighters picked her up, the "Sad Sack" was on the spot . . . straggling behind her formation, with one engine knocked out by flak . . . trying to fight off a Focke-Wulf pack that was swarming in for the kill.

The sweetest sight her crew ever saw was that escort of P-38's . . . screaming down to the rescue with their noseguns squirting fire . . . chasing the Jerries out of there or shooting them down in flames.

That's why bomber-men call them "Guardian Angels", these escort fighter planes. For they bring back bombers and bomber crews to fly and fight again!

And that's the kind of team *you'll* be on when you wear A.A.F. wings . . . Pilots, Navigators, Bombardiers, Gunners, doing their job *together* . . . flying and fighting for the *team*, "the greatest team in the world!"

U. S. ARMY RECRUITING SERVICE



FLY AND FIGHT WITH THE

GREATEST TEAM IN THE WORLD

MEN  OF 17...

You can get ready now for your place on the great A.A.F. flying team. Go to the nearest Aviation Cadet Examining Board . . . see if you can qualify for the Air Corps Enlisted Reserve. If you qualify, you will receive the Enlisted Reserve insignia . . . but will not be called for training until you are 18 or over.

When called, your special aptitudes will be studied further to determine the type of training you will receive. For the A.A.F. not only builds a combat crew from the pick of the crop, but carefully selects for each position the man with the best capabilities for the job . . . and then adds the thorough training which makes this all-star team the world's finest.

Prepare yourself in advance by taking C.A.P. Cadet Training as given by your local Civil Air Patrol. Also see your High School principal or adviser about recommended courses in the Air Service Division of the High School Victory Corps. Both afford valuable pre-aviation training.

(Essential workers in War Industry or Agriculture—do not apply.)

For information regarding Naval Aviation Cadet Training, apply at the Naval Aviation Cadet Selection Board in any Office of Naval Officer Procurement, or at any Navy Recruiting Station; or, if you are in the Navy, Marine Corps or Coast Guard, apply through your commanding officer. . . This advertisement has the approval of the Joint Army Navy Personnel Board.

KEEP 'EM FLYING!

SAMPLE
LESSON

GET BOTH FREE

64 PAGE
BOOK

GETTING ACQUAINTED WITH
RECEIVER SERVICING

I will send you this FREE Lesson, "Getting Acquainted With Receiver Servicing," to show you how practical it is to train for Radio in spare time. It's a valuable lesson. Study it—keep it—use it—without obligation! Tells how "Superhet" Circuits work, gives hints on Receiver Servicing, Locating Defects, Repair of Loudspeaker, I. F. Transformer, Gang Tuning Condenser, etc. 31 illustrations. And with it I'll send my FREE 64-page book, "Win Rich Rewards in Radio." It describes many fascinating jobs Radio offers, explains how N.R.I. trains you at home for good pay in Radio!

HOW TO TRAIN
AT HOME AND
*Win Rich
Rewards
in Radio*



See How I Train You at Home in Spare Time to BE A RADIO TECHNICIAN



J. E. SMITH
President
National Radio
Institute
(Our 30th year)

I Trained These Men

\$10 a Week in Spare Time

"I repaired some Radio sets when I was on my tenth lesson. I really don't see how you can give so much for such a small amount of money. I made \$600 in a year and a half, and I have made an average of \$10 a week—just spare time." JOHN JERRY, 1537 Kalamath St., Denver, Colo.

\$200 a Month in Own Business

"For several years I have been in business for myself making around \$200 a month. Business has steadily increased. I have N.R.I. to thank for my start in this field." ARLIE J. FROEHLER, 300 W. Texas Ave., Goose Creek, Texas.



1st Lieutenant in Signal Corps

"I cannot divulge any information as to my type of work, but I can say that N.R.I. training is certainly coming in mighty handy these days." RICHARD W. ANDERSON (Address omitted for military reasons.)



Here's your chance to get a good job in a busy wartime field with a bright peacetime future! There is a real shortage today of trained Radio Technicians and Operators. So mail the Coupon for a FREE sample lesson and a copy of my 64-page, illustrated book, "Win Rich Rewards in Radio." It describes many fascinating types of Radio jobs; tells how N.R.I. trains you at home in spare time; how you get practical experience by building real Radio Circuits with SIX BIG KITS OF RADIO PARTS I send!

More Radio Technicians, Operators Now Make \$50 a Week Than Ever Before

Fixing Radios pays better now than for years. With new Radios out of production, fixing old sets, which were formerly traded in, adds greatly to the normal number of servicing jobs.

Broadcasting stations, Aviation and Police Radio, and other Radio branches are scrambling for Operators and Technicians. Radio Manufacturers, now working on Government orders for Radio equipment, employ trained men. The Government, too, needs hundreds of competent civilian and enlisted Radio men and women. You may never see a time again when it will be so easy to get started in this fascinating field.

Many Beginners Soon Make \$5, \$10 a Week EXTRA in Spare Time

The moment you enroll for my Course I start sending you EXTRA MONEY JOB SHEETS that show how to earn EXTRA money fixing Radios. Many make \$5, \$10 a week EXTRA in spare time while learning. I send you SIX big kits of real Radio parts.

You LEARN Radio fundamentals from my lessons—PRACTICE what you learn by building typical circuits—PROVE what you learn by interesting tests on the circuits you build.

EXTRA PAY IN ARMY, NAVY, TOO

Men likely to go into military service, soldiers, sailors, marines, should mail the Coupon now! Learning Radio helps Service men get extra rank, extra prestige, more interesting duties, much higher pay. Also prepares for good Radio jobs after service ends. Over 1,700 Service men now enrolled.



Be Ready to Cash in on Good Pay Jobs Coming in Television, Electronics

Think of the NEW jobs that Television, Frequency Modulation, Electronics, and other Radio developments will open after the war! You have a real opportunity. Get into Radio NOW and be ready to cash in when Victory releases these amazing wartime Radio developments for peacetime uses!

The opportunity the war has given beginners to get started in the fascinating field of Radio may never be repeated. So take the first step at once. Get my FREE Lesson and 64-page, illustrated book. No obligation—no salesman will call. Just mail Coupon in an envelope or paste it on a penny postcard. —J. E. SMITH, President, Dept. 4DP, National Radio Institute, Washington 9, D. C.

TRAINING MEN FOR VITAL RADIO JOBS

GOOD FOR BOTH 64 PAGE BOOK SAMPLE LESSON FREE

MR. J. E. SMITH, President, Dept. 4DP
NATIONAL RADIO INSTITUTE, Washington 9, D. C.

Mail me FREE, without obligation, your Sample Lesson and 64-page book, "Win Rich Rewards in Radio." (No Salesman will call. Please write plainly.)

Name..... Age.....

Address.....

City..... State..... 4FR

YOU BUILD MANY CIRCUITS WITH PARTS I SEND

By the time you've built this Super-heterodyne and many other Radio circuits with these six big kits of Radio parts I send, you will have valuable experience.



You'll want
this swell
**AVIATION
BOOKLET!**



IF YOU are looking forward to the coming air age, you'll really enjoy this new 32-page booklet "Piper Cub . . . In War and In Peace". It is beautifully illustrated in full color and includes an interesting history of the light airplane. It pictures and describes the wartime and peacetime uses of Piper Cubs. It tells what the coming air age will mean to you. And, a large section is devoted to a clear description of the basic principles of flight, written by a government-certificated flight instructor.

Just send 10c for your copy to cover postage-handling. Piper Aircraft Corporation, Department PM44, Lock Haven, Pennsylvania.



16mm. SOUND FILM—"The Construction of a Light Airplane." For distribution points, write: Supervisor, Audio-Visual Aids, Extension Services, Pennsylvania State College, State College, Pennsylvania.

PIPER Cub
POINTS THE WAY TO WINGS FOR ALL AMERICANS

**"The Supreme
Authority"**
IS WORTH WAITING FOR

Be Sure
You Get the
**MERRIAM-
Webster**



**WEBSTER'S
NEW INTERNATIONAL
DICTIONARY**
Second Edition
UNABRIDGED

DEMAND is heavy and paper rationed but better to wait for your copy of the MERRIAM-Webster than accept a substitute. Ask for the genuine Webster—the MERRIAM-Webster—identified by the circular trade-mark. Contains 3,350 pages, illustrations for 12,000 terms, and a total of 600,000 entries—122,000 more than any other dictionary. Order now from your bookseller or stationer. He will get your copy as soon as he can.

G. & C. MERRIAM CO., SPRINGFIELD 2, MASS.

Learn to MOUNT BIRDS

Tan SKINS, make up FURS

Be a Taxidermist. Double your hunting fun. We teach you at Home. Mount Birds, Animals, Fish, Heads, common specimens. Fun and profits. Decorate home and **don't MAKE MONEY.** Mount game, tax for others. Big profits in spare time. **WRITE TODAY.** 100 game pictures in **FREE BOOK.** Hunters, get your copy. It's **FREE NOW.** Send post card. State your AGE. **NORTHWESTERN SCHOOL OF TAXIDERMISTRY** Dept. 3374 Omaha, Nebraska

CARTOONING

PAYS WELL

Exclusive instruction by a nationally known cartoonist makes it easy to learn at home. Write for details of the course. Please state age.

NATIONAL SCHOOL OF CARTOONING
423 Penton Bldg. Cleveland 13, Ohio

Short-Cut Mathematics
COMBINED WITH
Practical Mechanics Simplified

NEW 2-in-1 reading course! Now you can learn the speedy, simplified system of calculation used by draftsmen, engineers, accountants, "master minds" on the stage. Learn easy way to multiply 4 figures by 4 figures without using old-fashioned multiplication; add long columns of figures this lightning short-cut method. Learn horsepower, slide rule, micrometer, logarithms, wood measure, pulleys, etc., etc. Large illustrated volume complete with answers, only \$1 postpaid. Satisfaction or refund. Amaze friends with your magic-like mental powers.

FREE Complete details . . . mail coupon **TODAY!**

Nelson Co., 321 S. Wabash, Dept. D-300, Chicago
Please send free details about "Short-Cut Mathematics and Practical Mechanics Simplified." No obligation.

Name
Address

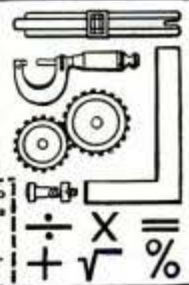

INVENTORS

NOW Is the Time to PATENT and SELL Your Invention

Now, more than ever before, is the right time to patent your invention. Why? Because manufacturers everywhere presently engaged in war production are looking ahead to the future by buying up patent rights now, so they will have new and attractive items to make and sell for civilian consumption as soon as the war is over. This is what happened during and after the last war. Hence, the smart thing for you to do is to look ahead to the future too. Protect your invention by applying for a patent now, so you will be in position to cash in on an outright sale, or on the royalties your invention will bring.

Get
**FREE
COPY**

Patent Guide Shows What To Do

Our "Patent Guide for the Inventor" answers many important questions concerning Patents that inventors constantly ask. It tells what facts, details, drawings, sketches, etc. are necessary to apply for a Patent; how to protect your invention through dated and witnessed disclosure; how to do this AT ONCE to safeguard your rights; how Patent Office Records can be checked to determine whether the invention is probably patentable before filing fees need be paid; discusses costs involved and a practical way these can be paid as the application progresses. It tells how some inventors secured financial backing; how many simple inventions have proved large commercial successes; how Patents covering improvements also can be profitably utilized and marketed; tells countless other facts of interest.

Why You Need Expert Assistance

The Patent Laws were enacted for your benefit—to give you protection for the features of your invention which are Patentable. But these features must be legally and concisely set forth in the form of "claims." This phase of the procedure is so complex that the Patent Office advises the Inventor to engage a competent Registered Patent Attorney. We maintain a large staff—carefully trained registered patent attorneys—expert draftsmen—experienced searchers—to serve you. We have been serving inventors for more than 20 years.

Take First Step Now

With the Patent Guide you will receive also Free a "Record of Invention" form which will enable you at once to establish the date of your invention, before you file your Patent application. This step costs you nothing yet may be vital to your success. Remember—in Patent Matters, ACTION is IMPORTANT. Delay can be costly. Mail the coupon in an envelope, or paste it on a penny postcard NOW.

CLARENCE A. O'BRIEN & HARVEY B. JACOBSON

"Worthy of your Trust"

Registered Patent Attorneys

41-D Adams Building
Washington 4, D. C.

Get This
FREE BOOK

IMMEDIATELY MAIL COUPON TODAY!



**CLARENCE A. O'BRIEN
& HARVEY B. JACOBSON**

CLARENCE A. O'BRIEN & HARVEY B. JACOBSON

Registered Patent Attorneys before the United States Patent Office
41-D Adams Building, Washington 4, D. C.

Please send me your 48-Page "Patent Guide for the Inventor" and your specially prepared "Record of Invention" form FREE. This request does not obligate me.

Name _____

Address _____

City _____ State _____

(Please write or print plainly.)

DRAFTING



GET THIS
Free TRIAL LESSON
Send Coupon



TO PROVE TO YOU how easy it is to learn Drafting at home by the Chicago Tech method, this 40 year old technical college will send you a *Free Trial Lesson in Drafting*. No charge for this Lesson now or later.

Mail Coupon Below

Get ready for a peacetime career. Look into the opportunities in Drafting. Read the want-ads for proof of the urgent demand for draftsmen in the aircraft, machinery, electrical and building fields. The draftsman always comes first on any new project in industry,—in peace or wartime.

The Draftsman—"The Key Man"

No new machines can be built, no airplanes constructed, no bridges or buildings erected, no ships or submarines launched until the draftsman has completed his work. Real immediate opportunities exist in Drafting—the profession upon which all construction is vitally dependent. Drafting is clean, interesting, well paid work. Investigate today what Drafting offers you.

Learn in Spare Time,—at Home!

(or at the College in Chicago)

With our easy step-by-step method (and the tools we furnish) you can learn in your spare time at home. Convenient terms. Now is the time to prepare in Drafting for peacetime opportunities. Send the coupon or a post card for the Trial Lesson and complete information,—all FREE.

CHICAGO TECHNICAL COLLEGE

D-205 Tech. Bldg., 2000 S. Michigan Ave., Chicago 16, Ill.

Yes,—please send me *FREE Trial Lesson in DRAFTING*

- | | |
|---|--|
| <input type="checkbox"/> Aircraft Drafting | <input type="checkbox"/> Machine Drafting |
| <input type="checkbox"/> Electrical Drafting | <input type="checkbox"/> Structural Drafting |
| <input type="checkbox"/> Architectural Drafting | <input type="checkbox"/> Building Construction |

Name.....

Address.....

City..... State.....

Occupation..... Age.....



Donald Duck CARTOON FILMS

UNIVERSAL COMEDY FAVORITE

Every DONALD DUCK Home Movie a laugh riot from start to finish.

Get These Features

50 Ft. 8MM...\$1.50
100 Ft. 16MM...\$3.00

The Ham Actor..... 914-A
Red Hot Bullets..... 1553-A
Donald's Ice Capers..... 1559-A

Show also a Mickey Mouse, 3 Monkeys, Bosko and Oswald Rabbit feature for a grand evening of HOME entertainment.

See at your photo dealers or order direct. Catalog and prices on request. Write to—

HOLLYWOOD FILM ENTERPRISES, INC.
6060 Sunset Blvd. Dept. 115 Hollywood 28, Calif.

REFRIGERATION SERVICE AND AIR CONDITIONING MECHANICS COURSE

Learn at home—how to start your own repair shop on little capital. No previous experience needed. Common school education sufficient. Splendid opportunity for older men. Prepare now for after the war. FREE illustrated booklet.

MECHANICS TRAINING SCHOOL
4701 W. Pico Dept. P-4 Los Angeles 6, Calif.

LEARN WATCH REPAIRING



AT HOME. By our modern and original system of instruction you can learn every part of the **WATCH REPAIRING TRADE AT HOME.** Prepare yourself for a well-paying position or start in business after completing our course of instruction. Good watch repairers are in demand and generally earn very good salaries. For particulars apply to the Wisconsin School of Watch Repairing 524 E. Mason St., MILWAUKEE 2, WIS.



Wonderful, new device, guides your hand; corrects your writing in a few days. Big improvement in three hours. No failures. **Complete outline FREE.** Write C. J. Ozment, Dept. 34, St. Louis, Mo.

WANTED: IDEAS AND INVENTIONS

If you have a new toy, electrical appliance or household item to be made of wood or metal, let's get together! We have hundreds of distributors, a complete processing, selling, engineering and financing organization! Write NOW—Dept. P-3 Tennessee Valley Associates, Gambill Building, Nashville, Tennessee

RADIO ENGINEERING, Broadcasting, Servicing, Electronics, Aviation, Marine & Police Radio taught thoroughly. 48 weeks' Engineering course equivalent to 3 years' college radio work. All expenses low. Co-educational. Catalog free.

VALPARAISO TECHNICAL INSTITUTE, Dept. D, Valparaiso, Ind.



SAVE RUBBER

Easy to fix cuts, bruises, worn spots in tires. SO-LO also mends shoes, raincoats, boots—anything of rubber, leather, cloth.



MEND the HOLE for 1¢
SPREADS ON like butter Dries tough overnight Flexible Non-skid. Waterproof. Won't come off—guaranteed
So-Lo AT HARDWARE & 10c STORES

Are You Satisfied with

YOUR BODY?

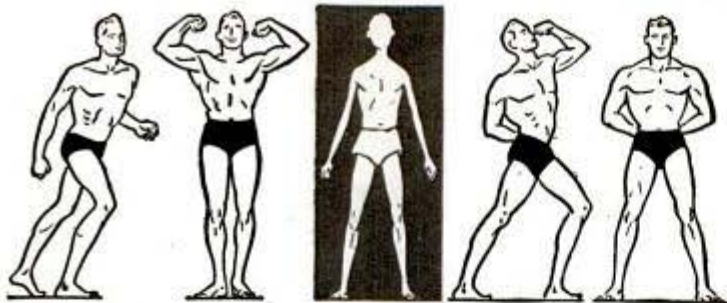

Let Me PROVE I Can Make You a NEW MAN in Only 15 Minutes a Day!

HOW do YOU look *stripped*—in locker-room or gym? Skinny, scrawny, sparrow-chested, self-conscious, HALF ALIVE?

How do you feel when people notice *your* physique? Can you stand their gaze? If you're not satisfied with your present physical development, let me prove I can make you a New Man—in only 15 minutes a day, right in the privacy of your own home! I'll give you biceps like iron and a fine, deep chest. I'll broaden your shoulders, add ridges of solid muscle to your stomach, fill out your arms and legs. If you are fat and flabby, I'll streamline you into a picture of radiant manhood.

What *Dynamic Tension* Can Do

How? *Dynamic Tension!* That's the secret that changed me from a flat-chested 97-lb. weakling into the red-blooded HE-MAN that I am today. That's how I'm turning thousands of fellows like yourself into New Men—with husky, handsome body and tireless endurance. I can do the same for you. Let me PROVE it!

Dynamic Tension is a PRACTICAL and NATURAL method. You use no tiring apparatus, no muscle-straining gadgets. My method is actually FUN! In only 15 minutes a day, you will actually see your muscles increase into powerful bulges of brawn and strength. You'll enjoy new stamina, a glad-to-be-alive feeling. Before you know it, you'll have a rugged, handsome body, a rough-and-ready ambition surging out of you that the world can't lick! I'll show you how it really feels to LIVE!

SEND FOR FREE BOOK

All I ask is that you mail the coupon NOW for my illustrated FREE book, "Everlasting Health and Strength." It shows actual photos of pupils I've changed from weaklings into remarkable specimens of manhood. If you want a body that men respect and women admire, then get this coupon into the mails as fast as you can. Address me personally. CHARLES ATLAS, Dept. 8D, 115 E. 23rd St., New York 10, N. Y.

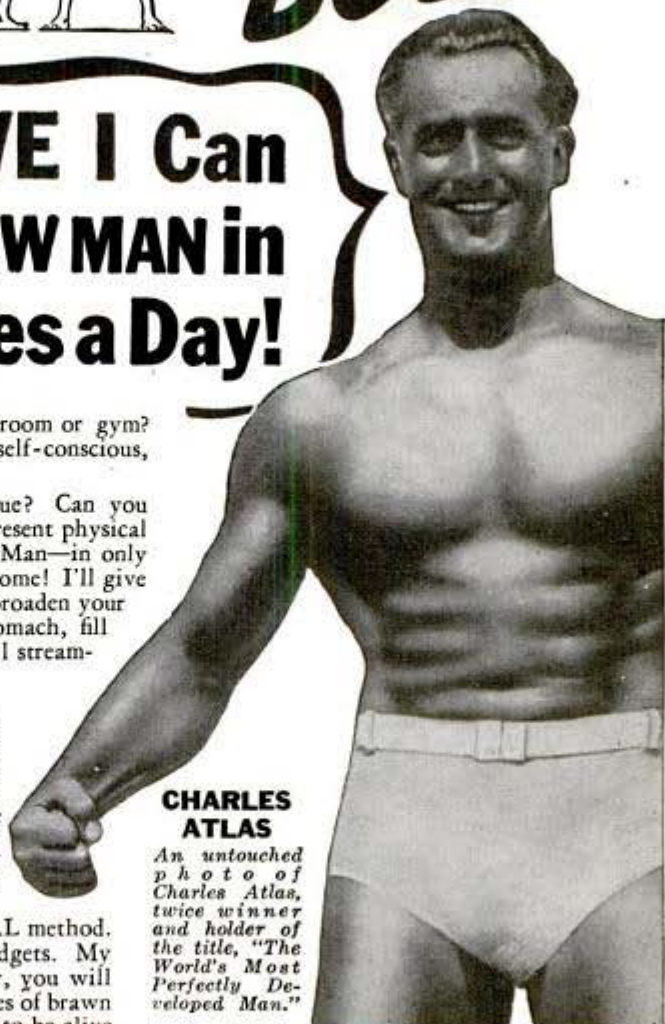

CHARLES ATLAS

An untouched photo of Charles Atlas, twice winner and holder of the title, "The World's Most Perfectly Developed Man."

CHARLES ATLAS, Dept. 8D,
115 East 23rd Street, New York 10, N. Y.

I want the proof that your system of "Dynamic Tension" will help make a New Man of me—give me a healthy, husky body and big muscle development. Send me your free book, "Everlasting Health and Strength."

Name

(Please print or write plainly)

Address

City..... State.....

Check here if under 16 for Booklet A

INVENTORS

McMORROW & BERMAN
PATENT ATTORNEYS

135-W ALBEE BUILDING, WASHINGTON 5, D. C.
Send me your new FREE book, "How to Protect, Finance and Sell Your Invention"—and "Invention Record" form at once. I understand that this request does not obligate me.

NAME
ADDRESS
CITY
STATE (Write or print name clearly)

Learn How To **PROTECT and SELL YOUR INVENTION**

*Mail Coupon
Now!*

**GET NEW
FREE
BOOK**



MODERN BUSINESS WANTS INVENTIONS Practical and novel inventions are in big demand today. The opportunity for quick money is enticing. Sales sources are many if your invention has merit. But, be sure—before you place your device in strange hands—that it is fully protected. A United States Patent gives you this protection. *The first step toward inventive success—always is—and always has been, the application for a U. S. Patent. There is no other way to protect your invention in accordance with the laws of this country.*

MAKE THIS RECORD NOW If you have an invention, and wish to secure it for the future, act at once. Have it dated now and recorded in our office. We will send you this FREE Invention Record Form for the purpose. Fill out the Invention Record Form fully describing the nature of your invention. Make a sketch of its main features. Mail it to us and we will record the date it was received in our office. The earlier the date the better your chance of combating rival inventors who may lay claim to your idea later. *Don't delay a single minute in taking this important step. Your whole future may depend upon it. Mail the coupon for our FREE Invention Record Blank and New FREE Book today!*

HOW WE SERVE YOU AS REGISTERED PATENT ATTORNEYS The U. S. Patent Office strongly recommends—unless the inventor is familiar with such matters—that he employ the services of a Registered Patent Attorney in the preparation of his Patent Application. We are Registered Patent Attorneys fully qualified to represent you at the Patent Office. We have had long experience in studying hundreds of types of inventions. This gives us the ability to judge your invention and to describe it accurately and convincingly in technical language. It gives us the perception to center arguments upon those details of your invention which, in our judgment, will be looked upon most favorably by the Patent Office Examiner. Mail the coupon today for our new FREE Book, "How to Protect, Finance and Sell Your Invention," and our FREE Invention Record Form—maybe this step will pave the way to future security for you and your family. Act Today!
We paint no glowing road to fortune—but if you have an invention . . . if it serves a definite new need . . . if the public accepts it—we can tell you it may provide the security and benefits you are seeking.

McMORROW & BERMAN

Patent Attorneys

135-W ALBEE BUILDING • WASHINGTON 5, D. C.

Join the Ranks of the Well-paid TRAINED MEN

MANY THOUSANDS MORE ARE URGENTLY NEEDED. PREPARE YOURSELF FOR A BETTER POSITION AND BETTER PAY

Ambitious men everywhere have succeeded through home-study courses of the International Correspondence Schools. So can you.



We offer you the benefit of our 52 years' successful experience as the creative pioneers of self-instruction through home study.

If you need technical training, our advice on any matter concerning your work and your career is yours for the asking—free and without obligation. Let us send you full information about I. C. S. training in the subject in which you are specially interested. **DON'T DELAY.** Make "ACTION" your watchword.

The successful man **DOES** today what the failure **INTENDS** doing tomorrow. Write to us **TODAY.**

-----USE THIS COUPON-----

INTERNATIONAL CORRESPONDENCE SCHOOLS

BOX 5690-J, SCRANTON 9, PENNA.

Please send Special Free Catalog on _____

Name _____

Working Hours _____ Age _____

Home Address _____

Special Tuition Rates for members of the Armed Forces

The I. C. S. offers courses of instruction in a wide range of subjects, including:

TECHNICAL COURSES

Air Conditioning Schools

Air Conditioning
Heating
Plumbing
Refrigeration
Steam Fitting

Chemistry Schools

Chemical Engineering
Chemistry, Analytical
Chemistry, Industrial
Chemistry,
Mfg. Iron and Steel
Pulp and Paper Making

Civil, Architectural and Structural Engineering Schools

Architecture
Architectural Drafting
Bridge and Building
Foreman
Bridge Engineering
Building Estimating
Civil Engineering
Concrete Engineering -
Contracting and Building
Highway Engineering
Retail Lumberman
Structural Drafting
Structural Engineering
Surveying and Mapping

Electrical Schools

Electrical Engineering
Electric Wiring
Gas and Electric Welding
Industrial Electrician
Lighting Technician
Power House
Practical Telephony
Radio, General
Radio Operating
Radio Servicing
Telegraph Engineering

Internal Combustion Engines Schools

Automobile Technician
Aviation Diesel—Electric
Diesel Engines
Gas Engines

Mechanical Schools

Airplane Drafting
Foundry Work
Heat Treatment of Metals
Inventing and Patenting
Machine Shop Practice
Mechanical Drafting
Mechanical Engineering
Metal Pattern Drafting
Mold Loft Work
Reading Shop Blueprints
Sheet Metal Worker
Ship Drafting Ship Fitting
Shop Practice
Steel Mill Workers
Tool Designing
Wood Pattern Making

Railroad Courses

Air Brake Car Inspector
Locomotive Engineer
Locomotive Fireman
Railroad Car Repairer
Railroad Section Foreman

Steam Engineering Schools

Boiler Making
Combustion Engineering
Engine Running
Marine Engines
Petroleum Refining Plant
Steam Electric
Steam Engines

Textile Schools

Cotton Manufacturing
Textile Designing
Woolen Manufacturing

BUSINESS and ACADEMIC COURSES

Academic Schools

Arithmetic
College Preparatory
First Year College
High School
Higher Mathematics
Illustrating

Business Schools

Accounting Advertising
Bookkeeping
Business Correspondence
Business Management
Cert. Pub. Accounting
Commercial
Cost Accounting
Foremanship
Salesmanship
Secretarial
Stenography
Traffic Management

Civil Service Schools

City Letter Carrier
Post Office Clerk
Railway Postal Clerk

Language Schools

French
Good English
Spanish



HERE IS YOUR SUCCESS CHANCE
BE A
**RADIO-ELECTRONIC
TECHNICIAN**



**SPRAYBERRY TRAINS YOU QUICKLY
FOR WAR AND PEACETIME WORK**

YOU GET A DUAL-PURPOSE RADIO SET

The offer I make you here is the opportunity of a lifetime. It's your big chance to get ready for a wonderful future in the swiftly expanding field of Radio-Electronics INCLUDING Radio, Television, Frequency Modulation, and Industrial Electronics. Be wise! NOW is the time to start. No previous experience is needed. I supply you with Radio Parts which you use to gain pre-experience in Repair work. These same Parts are used for testing and for Signal Tracing, etc.

FULL RADIO SET

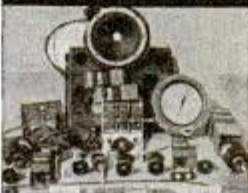

**PREPARES YOU for a
BUSINESS of YOUR OWN**

. . . or Good Radio Jobs, Civilian or Military

The Sprayberry course starts right at the beginning of Radio. It gets the various subjects across in a clear, simple way. I make it easy for you to learn Radio Set Repair and Installation Work . . . by practical, proved, time-tested methods. I teach you how to install and repair Electronic Equipment. Soon you'll be qualified for a good paying job in one of the nation's Radio plants doing war work OR, if you enter the Army, Navy, or Marines, my training will help you win higher rating and better pay.



READ WHAT GRADUATE SAYS

"Wins Out in Army Test"

"Since I completed your elegant Course in Radio I have been drafted into the Army and put into the Signal Corps. I had to compete to get the job I now hold and as a result of my training with you, I made the best grade and got the job. The point I am driving at is if it hadn't been for your thorough course in Radio I would probably be peeling potatoes now. I recommend your training to all because it is written in language that the average layman can understand." — ARCH PLUMMER, JR., Fort Meade, Md.

Grasp This Opportunity!

**GET BIG
FREE
BOOK**



MAIL COUPON

SPRAYBERRY ACADEMY OF RADIO

F. L. Sprayberry, President
Box 500RD, Pueblo, Colorado.

Please rush my FREE copy of "How to MAKE MONEY in RADIO, ELECTRONICS and TELEVISION."

Name..... Age.....

Address.....

City..... State.....

(Mail in plain envelope or paste on penny postcard)

POULTRY PAYS
IN
PATRIOTISM
PROFITS
PLEASURE

Learn at home, the EASY, SCIENTIFIC, and INEXPENSIVE way. Our course covers ALL phases of Poultry raising, including plans for buildings, breeding, hatching, culling, sexing, caponizing, marketing, judging, exhibiting, and many others, etc., as planned by Harry M. Lamont, former Senior Poultryman for the United States Department of Agriculture.

In the past twenty years, we have helped thousands of students to establish poultry farms, to increase profits on established plants, to secure positions in the many branches of the Poultry business, and many just to enjoy a small, profitable, breeding plant.

The Government needs your help for its huge requirements for Poultry and eggs. Poultrymen responded magnificently last year. But this year the emphasis is on MORE EGGS PER BIRD—more eggs from fewer birds means less feed. We can teach you the EASY, SCIENTIFIC, and PROFITABLE way to assist this program.

Write TODAY for catalog "How to Raise Poultry For Profits." It fully explains courses and easy payment plan.
NATIONAL POULTRY INSTITUTE
Dept. 50-K Adams Center, N. Y.



Send Today

LIQUID MARBLE Make beautiful artificial Marble slabs. Pour from liquid state. Glazed or un-glazed. Mottled, veined or snow-white. Unsurpassed for lining kitchen or bathroom walls. Easy to make and install. **COMPOSITION FLOORING.** Any color. Lifetime wear. Dustproof. Soundproof. Vermin-proof. Resilient to the tread. Lay out solid or in pattern design. **FLEXIBLE MOLDS** for plaster casting. Make your own molds for few cents each. \$1.00 in raw materials will make up to \$25.00 of finished goods. We furnish names of buyers. Write now for free information.
COMPO-TEX, BOX 786-S, ST. LOUIS (1), MO.

IMPROVE YOUR PLAYING **PIANISTS**—(also organists)—Greatly improve playing, technique, sight-reading, accuracy, memorizing thru Mental-Muscular Co-ordination. Quick results. Free Booklet.
Broadwell Studios, Dept. 154D Covina, Calif.

LAW **STUDY AT HOME for PERSONAL SUCCESS and LARGER EARNINGS.** 31 years expert instruction—over 100,000 students enrolled. L.L.B. Degree awarded. All texts furnished. Easy payments. Send for FREE BOOK—"Law and Executive Guidance."
AMERICAN EXTENSION SCHOOL OF LAW
Dept. 40-M 8 East Huron St. Chicago, Ill.

LOOK! Baby Chicks **THOUSANDS WEEKLY ALL YEAR.** Finest quality & Layers in 40 breeds. Hybrid Baby Pullets and Cockerels, B. W. D. Tested. Ducklings, Goslings, Baby Turkeys. Mature breeders in 65 breeds. Catalog free. **ORDER NOW.** Make BIG money raising **NABOB QUALITY CHICKS.**
NABOB HATCHERIES, BOX M, GAMBIER, OHIO

Always write your name and full address clearly when answering advertisements.

Store Route Plan PAYS BIG MONEY **SELL COUNTER CARD PRODUCTS** Build a good-paying business of your own! Call on dealers of all kinds; show nationally-advertised Aspirin, Vitamins, Cosmetics and 200 other necessities. Big 5c and 10c retail packages, high quality. Attractive counter displays sell goods fast. Free book gives amazing facts. Write!
World's Products Co., Dept. 10-S, Spencer, Ind.



PLASTICS

THE GREAT *New* FIELD OF OPPORTUNITY PLASTICS ENGINEERS AND TECHNICIANS NEEDED IN NOT ONE BUT MANY CLASSES OF INDUSTRY

● Leaders in science and industry have long been saying, "Keep your eye on Plastics." But now the time for action has arrived. The future of huge possibilities has already begun. Developments in Plastics for hundreds of wartime uses have set the pace for revolutionary changes in peacetime production of thousands of products.

THIS IS YOUR BIG CHANCE

Today there's a big need in vital war production for those who are trained in Plastics. From one to a hundred articles made of Plastics must be supplied for every man in our fighting forces. Start training now in Plastics Engineering, in spare time in your own home. Fit yourself for a responsible, well-paid position. Help to win Victory. And at the same time you will be preparing for even greater opportunities when the war is over.

There is scarcely an industry in which these so-called "miracle materials" will not play an important part. After the war many old materials, methods and skills will be replaced. Acquire the all-important "know how." Be in a position to step into one of the key jobs.

YOU CAN LEARN WHILE YOU EARN

Turn at least part of your leisure time into money. Qualify at home for a larger income in an interesting career. Build greater security for your future in a vocation that looms large on the horizon of the new industrial era. Hours you might otherwise waste can put you well on your way toward lasting success.

It's easy to find out about Plastics training. To get details and outline of study prepared by specialists, and about the school that has helped thousands to success during the past 46 years, write us or check and mail the coupon. Send today. The sooner you take this easy step, the sooner you will reach your goal and reap the rich rewards.

AMERICAN SCHOOL OFFERS COMPLETE TRAINING SERVICE IN MANY SUBJECTS

You who have not completed high school or have missed vocational training in college, and who cannot spare time to go away to school, can complete your education in your choice of many subjects. Several of these are listed in the coupon at right. Check the subject in which you are interested, fill in your name and address, clip and mail the coupon today.

HOME - STUDY TRAINING SINCE 1897

Take This First Easy Step

CHECK, CLIP AND MAIL COUPON NOW

AMERICAN SCHOOL, Dept. G445, Drexel at 58th, Chicago 37, Ill.
Without obligation, Please send FREE and postpaid, bulletin and details of the Subjects checked.

- | | | |
|--|---|--|
| <input type="checkbox"/> PLASTICS ENGR | <input type="checkbox"/> Accounting and C.P.A. | <input type="checkbox"/> Drafting and Design for Men and Women |
| <input type="checkbox"/> Refrigeration | <input type="checkbox"/> Cost Accounting for Manufacturing | <input type="checkbox"/> Radio |
| <input type="checkbox"/> Architecture and Building | <input type="checkbox"/> Bookkeeping | <input type="checkbox"/> High School |
| <input type="checkbox"/> Practical Plumbing | <input type="checkbox"/> Private Secretary | <input type="checkbox"/> Air Conditioning |
| <input type="checkbox"/> Automotive Engineering | <input type="checkbox"/> Diesel Engineering | <input type="checkbox"/> Shipbuilding |
| <input type="checkbox"/> Aviation Drafting | <input type="checkbox"/> Surveying & Topographical Drafting | <input type="checkbox"/> Mechanical Eng. |
| <input type="checkbox"/> Business Mgmt | <input type="checkbox"/> Sheet Metal | <input type="checkbox"/> Shop Management |
| <input type="checkbox"/> Railway Training | <input type="checkbox"/> Pattern Drafting | <input type="checkbox"/> Tool Making |
| | <input type="checkbox"/> Electrical Engineering | <input type="checkbox"/> Better Foremanship |
| | | <input type="checkbox"/> Machine Shop Operations |

PRACTICAL, EFFECTIVE

Name..... Occupation.....
Address..... Age.....
City..... State.....

AMERICAN SCHOOL

Dept. G445, Drexel at 58th Street, Chicago 37

PATENTS

PREPARED AND PROSECUTED

NOW



WILL HAVE THE INSIDE TRACK AFTER THE WAR!

AMERICA LOOKS TO YOU INVENTORS FOR BETTER LIVING STANDARDS. When America's manufacturers start their conversion to peace-time trade after the war, each of them will want to lead the way to supply ready markets and a waiting public. They'll want new devices, new methods and new materials QUICKLY. The man who can be the first to offer a complete patent for sale or on a royalty basis naturally will have first consideration. TODAY presents a GOLDEN OPPORTUNITY TO DO SOMETHING ABOUT THAT IDEA OF YOURS.

Use this "period of

waiting" to best advantage. Start your patent application through NOW and then when Peace comes, you'll be the man in demand!

NEARLY HALF A CENTURY AGO WE STARTED HELPING MEN LIKE YOU

A good strong patent is your best means of CASHING IN* on your idea. Years ago, inventors found out that the assistance of a trained, Registered Patent Attorney was invaluable almost indispensable. Professional inventors invariably secure their patents in this manner. Inviolable secrecy is preserved until you are ready to present your protected device to commerce. We can help you. . . . WRITE US TODAY!

THESE FREE BOOKS MAY BE YOUR KEY TO SUCCESS

Send for them!

They answer the questions you want to know about just how to go about getting a patent. Illustrate 115 mechanical movements. They're packed with information of interest to inventors. In addition, we'll send you a free "Evidence of Invention" form which may help in establishing your claims. All this will be sent to serious men entirely without obligation! USE THE COUPON NOW while you're thinking about it!

DO SOMETHING ABOUT IT NOW!



64 pages of facts for INVENTORS

... and the important Evidence of Invention Form!

COUPON BRINGS YOU THESE 2 BOOKS FREE!

VICTOR J.
EVANS & Co.

Merlin M. Evans

REGISTERED PATENT ATTORNEYS

**MAIN OFFICE: 830-D MERLIN BUILDING
WASHINGTON 6, D. C.**

**Pittsburgh Office: 521-N Empire Building
Los Angeles Office: 738-N Security Building**

Rush by return mail, Free copies of your books, "Patent Protection" and "When and How to Sell an Invention"—also important—"Evidence of Invention" form.

Name

Address

City and State

THE
SIMPLE
A-B-C
DeFOREST
WAY!

Learn RADIO

ELECTRONICS

quickly • easily AT HOME

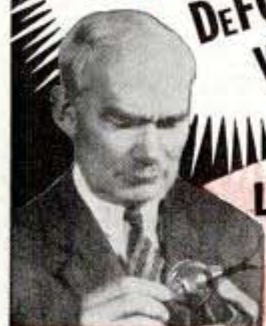

The famous Dr. Lee DeForest supervised the preparation of DeForest's Training

You GET **A** LOOSE-LEAF LESSONS

DeFOREST'S TRAINING includes 90 loose-leaf lessons, prepared under the supervision of one of the world's foremost Radio authorities, Dr. Lee DeForest—inventor of the audion tube which has helped make modern radio possible...holder of over 300 radio patents...and often called "Father of Radio."



YOU CAN BUILD 133 FASCINATING EXPERIMENTS WITH THIS EQUIPMENT

FOR A BETTER OPPORTUNITY TODAY — PLUS A BETTER POST-WAR FUTURE

Get into Radio and Electronics—a billion dollar OPPORTUNITY FIELD OF TODAY that promises such a THRILLING POST-WAR FUTURE. See how you may get ready for a GOOD JOB... or a BUSINESS OF YOUR OWN... BETTER PAY and HIGHER RATING in military service. Read how DeFOREST'S prepares you for your start in Radio-Electronics quickly, easily, in your spare-time at home—the simple "A-B-C" DeFOREST'S Way. You'll find all these answers, and more, in DeFOREST'S big, illustrated book, "VICTORY FOR YOU!" Write for it today. It's FREE.

You Get This Exclusive 3-WAY Combination of Radio Training Advantages

You READ... you SEE... you DO! (A) You get well-illustrated lessons prepared the modern loose-leaf way to help keep your training up-to-date. (B) You get real, practical RADIO EXPERIENCE from eight big kits of standard Radio parts and assemblies. (C) You get the use of a 16 mm. MOVIE PROJECTOR AND 12 TRAINING FILMS. You S-E-E "hidden actions" of Radio circuits from fascinating, easy-to-learn-from ACTION MOVIES. You get what we think are the major Radio training aids—AT HOME!

You Get EMPLOYMENT SERVICE

DeFOREST'S Training includes an effective EMPLOYMENT SERVICE that has long-established contacts with many companies employing trained Radio men. You enjoy this valuable assistance once you are trained. DeFOREST'S is affiliated with the DeVRY CORPORATION—well known manufacturer of Motion Picture Sound Equipment.

C You SHOW MOVIES AT HOME

You get the use of a genuine DeVry 16 mm. motion picture projector and films which provide the easy to understand, highly effective modern visual training—a method used today to train better and faster in war plants and military service. Radio principles come to life! ... you see electricity in action, electronics made CLEAR the EASIER DeForest way. Get DeForest's BIG FREE BOOK, "VICTORY FOR YOU!"—a key to a good pay job in the electronics industry, to a business of your own or to better military rating and pay. Act now. Mail the coupon today!

SEND FOR FREE BOOK!

B You WORK AT HOME WITH PRACTICAL EQUIPMENT

You enjoy a "Home Laboratory." You get valuable Radio experience by building modern Radio circuits that operate; also, "Electric Eye" devices, Light Beam Transmitter, Public Address System, Wireless Microphone, etc. 133 fascinating experiments in all—in spare time, at home.

DeFOREST'S
TRAINING INC., Chicago, Ill

DeFOREST'S TRAINING, INC.
2535-41 N. Ashland Ave., Dept. P,
Chicago, U. S. A.

Please send me—FREE and WITHOUT OBLIGATION—illustrated book, "VICTORY FOR YOU," showing how I can prepare for Radio with your Home Movies and Laboratory Kits.

Name.....Age.....
Address.....
City..... State.....
(Please help our country save paper. Do not reply unless you are 17 or over).



ELECTRICAL BOOKS

shipped
FREE

10
BIG BOOKS

Here's great news for anybody interested in Electricity. NEW 18th edition of Applied Electricity brought right down to date with NEW Electrical subjects fully covered, including Electrical Blue Print Reading. 10 big Volumes and all shipped FREE for examination.

New Edition For Beginners and Experts

Over 3000 pages—hundreds of illustrations—the most complete work of its kind we have ever published. Dynamos, motors, power stations, wiring radios, everything electrical explained so anyone can understand it.

BIG FIELD! Big Demand! Big Pay! Men who understand electricity are urgently needed in thousands of War Production Industries. Airplanes, ship building, arms plants, machine shops—practically every industry depends on electricity and men who know this subject make big money. Pleasant, fascinating work, easy to learn and do; learn with these books. Send coupon for a set for FREE examination and see for yourself.

SEND NOW [A year's consulting privileges with our engineers now given to all buyers of this famous Cyclopaedia of Electricity.]

AMERICAN TECHNICAL SOCIETY
Vocational Publishers since 1898

American Technical Society, Dept. E419, Drexel at 58th St., Chicago 37
Send for 10 days' free use, 10 volume set of New 18th Edition, Applied Electricity, including a certificate entitling me to consulting privileges for one year. I will pay the delivery charges only on the books. If I wish I may return them in 10 days and owe you nothing, but if I keep them, I will send \$2.00 after 10 days, then \$3.00 a month until the total price of only \$29.80 is paid.

NAME.....
ADDRESS.....
CITY..... STATE.....

Please attach letter stating age, occupation and name and address of employer and give at least one business man as reference. Men in service, also please give home address.

AUDELS Carpenters and Builders Guides

4 vols. \$6



Inside Trade Information for Carpenters, Builders, Joiners, Building Mechanics and all Woodworkers. These Guides give you the short-cut instructions that you want—including new methods, ideas, solutions, plans, systems and money saving suggestions. An easy progressive course for the apprentice and student. A practical daily helper and Quick Reference for the master worker. Carpenters everywhere are using these Guides as a Helping Hand to Easier Work, Better Work and Better Pay. To get this assistance for yourself, simply fill in and mail the FREE COUPON below.

How to use the steel square—How to file and set saws—How to build furniture—How to use a mitre box—How to use the chalk line—How to use rules and scales—How to make joints—Carpenters arithmetic—Solving mensuration problems—Estimating strength of timbers—How to set girders and sills—How to frame houses and roofs—How to estimate costs—How to build houses, barns, garages, bungalows, etc.—How to read and draw plans—Drawing up specifications—How to excavate—How to use settings 12, 13 and 17 on the steel square—How to build hoists and scaffolds—skylights—How to build stairs—How to put on interior trim—How to hang doors—How to lath—lay floors—How to paint



THEO. AUDEL & CO., 49 W. 23rd St., New York City

Mail Audels Carpenters and Builders Guides, 4 vols., on 7 days' free trial. If O.K. I will remit \$1 in 7 days, and \$1 monthly until \$6 is paid. Otherwise I will return them. No obligation unless I am satisfied.

Name.....
Address.....
Occupation.....
Reference..... PM

HOW TO GET AND KEEP GOOD EYESIGHT

Do you want perfect 20/20 vision? Would you like to throw away your glasses? Great numbers of men, women and children have improved and strengthened their eyes by using the famous Ross-Rehner Method, a tested and proven system of home eye exercises for correcting nearsightedness, far sightedness, color blindness and astigmatism.

Get Better Eyesight—Without Glasses

Now you can get the entire system, profusely illustrated, including a complete Eye Testing Kit, with charts to show weekly improvement. If your book store does not have it, send one dollar. Delivered postpaid, subject to return in 5 days if you are not satisfied. Order today.

SAVE YOUR EYES

HALL PUBLISHING CO.
BLOOMFIELD HILLS 2, MICHIGAN



PLAY GUITAR LIKE THE COWBOYS DO... 8 LESSONS

Just out—very latest guaranteed, simple, easy method. Play cowboy songs the Western way in a few minutes by ear. Surprise and amaze your friends. Be in big demand at parties, camps, public entertainments, on the radio, etc. 12 Complete Lessons.

SEND NO MONEY. Pay postman only \$1.00 plus postage, or send \$1.00 and get EXTRA BONGS all postpaid. (Canada, \$1.25 money order only.) Nothing else to buy. Positive money back guarantee. Rush order today.

WESTERN RANGER STUDIOS, Dept. 154, Hutchinson, Kans.

STUDY AT HOME

With A Chartered Educational Institution

Courses in **ENGINEERING:** Electrical, Civil, Mechanical, Drafting, Architectural, Steam, Aeronautical, Radio, Structural, Mining, Industrial, Highway. Petroleum, Marine, Chemical.

Courses in **ARTS AND SCIENCES:** Philosophy; Education; Letters; Public Health; Medical Jurisprudence; Psychology; Sociology; Physics; Chemistry; Geology; Pol. Science; Theology; Law; Business and Commerce; Accounting; Mathematics; Statistics; Agriculture.

McKinley-Roosevelt Incorporated, 4610-UC, Sheridan Road, Chicago, 40

Free Book

MOUNT BIRDS, ANIMALS, FISH

Yes FREE. Explains Taxidermy. Tells how to learn at home by mail to mount birds, animals, heads... to TAN skins and furs. Great for MEN and BOYS. Fun! Also earn money in spare time. **WRITE TODAY—NOW** for free book containing 100 game pictures. State AGE, N.W. School of Taxidermy, Dept. 3374, Omaha, Neb.



Your VOICE!

Results GUARANTEED

We build, strengthen the vocal organs—not with singing lessons—but by sound, scientifically correct silent and vocal exercises and absolutely guarantee complete satisfaction with results. Write for Voice Book, FREE. Sent to no one under 17 years old unless signed by parent.

PERFECT VOICE INSTITUTE, Studio 1354, 64 E. Lake St., Chicago, Ill.



Write for my Free Book, "How to Become an Expert Penman," which shows what others have accomplished by taking my Course. Enclose 10c for one of my Favorite Pen Points and your name with a beautiful flourished bird written on a card. Write today.

T. M. TEVIS, Box 25K, Chillicothe, Mo.

EARN MONEY PAINTING PORTRAITS

No previous training or talent necessary. Unique Stuart System teaches you, by mail, in 11 simple, easy-to-follow lessons, to make excellent charcoal and oil likenesses. Detailed guidance for your every step. Send for free book today.

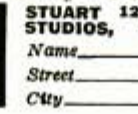

STUART 121 Monument Circle, Rm. 644, Indianapolis 9, Ind. STUDIOS, Please send me free book and outline of lessons.

Name.....
Street.....
City..... State.....

Will PLASTICS? Revolutionize Industry

WILL PLASTICS revolutionize industry... change our mode of living... or perform miracles? We do not believe they will. If, however, your business or employment has to do with products of metal, wood, leather, paper, fabric, ceramics, or coating material, you cannot afford to ignore the importance of plastics in your post-war planning.

Plastics are suitable for many new applications, but the intelligent use of plastics can only be determined by knowing their advantages and limitations.

Plastics Institute offers a comprehensive, up-to-date source of information through its Home Study Course in plastics... composed of forty-four lesson assignments, complete with detailed, modern illustrations and samples of plastics materials... prepared and conducted by recognized plastics authorities. This course takes you step by step through all phases of plastics, from sources and properties of materials to commercial applications in finished products... through mold design and molding, fabricating, laminating, testing and plant operation.

For complete information, mail the coupon for your copy of the FREE booklet, the "World of Plastics." It tells you about plastics in war and peace, the Plastics Institute Home Study Course, and the Executive Reference Set.



GET THIS INTERESTING
BOOK "WORLD OF
PLASTICS" SENT FREE!
Get Full Details Now.

Plastics

INDUSTRIES TECHNICAL INSTITUTE

1221 Chanin Bldg.
New York 17

626-E LaSalle-Wacker Bldg.
Chicago 1

190 S. Alvarado St.
Los Angeles 4

MAIL COUPON FOR FREE BOOK

Plastics Industries Technical Institute *Mail in envelope or*
626-E LaSalle-Wacker Bldg., Chicago 1 *paste on penny postcard.*
Gentlemen: Please send me the booklet "World of Plastics" and information on your training program, I understand there is absolutely no obligation.

NAME.....
STREET.....
CITY..... ZONE..... STATE.....

Dept. M-4

The set of books that makes **MASTER MACHINISTS** and leads to bigger pay!



This big home-study and reference course gives you the practical facts on machines and methods you need to advance in machine shop work. Take advantage of the other man's experience as found in books, to solve your problems, increase your efficiency, with

The AMERICAN MACHINISTS' LIBRARY

6 volumes—2368 pages—2516 illustrations
(A combined home-study course and reference library)

This library of machine shop practice was written for practical men. It gives you the best methods for every kind of machine shop work. It fully explains lathes, drills, and other machine tools and their operation, automatic screw machines, speeds and feeds, gear design and production, jigs and fixtures, punch and die work, metal surfacing, etc., etc. Plainly written—completely illustrated—the best kind of help to the machine shop man who wants to advance himself.

No money down—special price—easy payments.

EXAMINATION COUPON

McGraw-Hill Book Co., 330 W. 42nd St., N. Y. 18

Send me for ten days' examination the American Machinists' Library. If satisfactory I will send you \$1.50 in 10 days and \$3.00 monthly until the price of \$19.50 is paid. If not wanted, I will return the books postpaid. (To insure prompt shipment write plainly and fill in all lines.)

Name
Home Address
City and State
Position
Name of Company PM-4-44

Do you want

- .. to go to College?
- .. or to enter a Profession?
- (Such as Accounting, Architecture, Nursing, Dentistry, Teaching, Social Work, Osteopathy, Beauty Culture, Optometry, Embalming, Chiropraxy, Law, Medicine, etc.)
- .. or get an Office Position?

To get anywhere, you practically **MUST** finish High School **FIRST**. You can complete our simplified High School Course in SPARE time at home, as FAST as your time and abilities permit. Equivalent to resident school work—prepares you for college, pre-professional examinations, business industry. Standard texts furnished. Diploma. Credit for H.S. subjects already completed. Single subjects if desired. Low tuition, easy terms. American School, Chicago, est. 1897—endorsed by educators. Finish your high school education NOW. Write TODAY!

High School Course at Home Many Finish in 2 Years

American School, Dept. H445, Drexel Ave. at 58th St., Chicago 37, Ill.

Gentlemen: Send me FREE information covering special training in subjects checked below. No obligation on my part.

- | | |
|--|--|
| <input type="checkbox"/> High School Course | <input type="checkbox"/> Diesel Engineering |
| <input type="checkbox"/> Cost Accounting for Mfg. | <input type="checkbox"/> Drafting and Design for men & women |
| <input type="checkbox"/> Architecture and Building | <input type="checkbox"/> Plastics |
| <input type="checkbox"/> Automotive Engineering | <input type="checkbox"/> Private Secretary |
| <input type="checkbox"/> Business Management | <input type="checkbox"/> Mechanical Engineering |
| <input type="checkbox"/> Electrical Engineering | <input type="checkbox"/> Aviation <input type="checkbox"/> Radio |
| <input type="checkbox"/> Elec. and Gas Refrigeration | <input type="checkbox"/> Salesmanship |
| <input type="checkbox"/> Air Conditioning | <input type="checkbox"/> Shipbuilding |
| <input type="checkbox"/> Railway Training | |

Name
Address

Say you saw it in Popular Mechanics!

BE A FACTORY EXECUTIVE

The vast production program, now under way—and which will continue for many years after the war—calls for many more trained factory executives. Industry needs foremen, supervisors, and superintendents who know up-to-date factory administration methods—and the art of human leadership. So, this is

YOUR CHANCE OF A LIFETIME

Don't miss this chance to train yourself for a well-paid factory executive job. The speedy "Lincoln Factory Executive Service" meets your every need. Low fees—easy to pay.

Send for FREE Descriptive 48 Page Booklet

Lincoln Trained Men are continually moving up into well paid jobs. You can too. Let us show you. Free booklet, "Getting Ahead in Industry" explains fully. Write, today, for your copy.

LINCOLN EXTENSION INSTITUTE, Inc.
Dept. M444 75th at Detroit Ave. Cleveland 2, Ohio

Leading PHOTOGRAPHERS RECOMMEND

● 34 years' experience training men and women for photographic SUCCESS. Commercial, Portrait, News, Industrial, Motion Picture, Color Photography. Resident or home study training. Personal instruction from outstanding faculty of top-notch photographers. Start immediately. Write for free book.

NEW YORK INSTITUTE of PHOTOGRAPHY
Oldest, Largest, Best Equipped Photo School (Founded 1910)
DEPT. 49 10 WEST 33 ST., NEW YORK 1, N. Y.

Correspondence Courses in RADIO and ELECTRICAL ENGINEERING **LOW AS \$25**

ELECTRICAL ENGINEERING. Get good grasp of wide electrical field. Modern. Very understandable. Theory made easy.
RADIO ENGINEERING. Extra fine course in radio, public address, photo-electric work. Trains you to be super-service man, real vacuum tube technician. Tuition ONLY \$25, either course. Deferred payment plan. Servicemen needed badly.
Write for free copies of school catalogs, student magazines, etc.
LINCOLN ENGINEERING SCHOOL, Franklin Stn., Box 61—P-64
FREE (Formerly at Lincoln, Nebr.) WASHINGTON, D. C.

Inventions Wanted
Patented or Unpatented

Inventions can now be safely sold without patenting expense. If you have a practical, useful idea for sale, either unpatented or patented, write **Chartered Institute of American Inventors**
Dept. 4, 631 Pa. Ave., N. W. Washington, D. C.

STAMMER? GET THIS FREE BOOK!

This new 128-page book, "Stammering, Its Cause and Correction," describes the Bogue Unit Method for scientific correction of stammering and stuttering—successful for 43 years. Benj. N. Bogue, Dept. 1811, Circle Tower, Indianapolis 4, Ind.



DRAW for MONEY
BE AN ARTIST!

Trained Artists are Capable of Earning \$30, \$50, \$75 a week

Use Your Spare Time to Prepare for a Profitable Art Career! **COMMERCIAL ART, DESIGNING and CARTOONING**—all in ONE complete home study course. No previous Art experience necessary—we teach you step by step—hundreds have profited by our practical method. **TWO ART FITS FURNISHED.** Full information in colorful, FREE BOOK, "Art for Pleasure & Profit"—tells all about our course, service, what our graduates say—and commercial opportunities for you in Art.

FREE BOOK gives details!

WASHINGTON SCHOOL OF ART
Studio 124 K, 1115 15th St., N.W. Wash. 5, D. C.
Send me your booklet and full particulars about your course.

Name AGE
Address
City State

Now YOU Can Lick Any AUTO REPAIR JOB!

IN LESS TIME—WITH LESS WORK



**FREE
7-DAY OFFER**



MoToR's New Auto REPAIR MANUAL
shows you how to service and
repair ANY part of ANY car!

No auto repair job is too tough when you've got MoToR's AUTO REPAIR MANUAL! YOU can repair anything from carburetor to rear end—quickly, easily, right! Just look up make, model, and the job in the quick index—and go to work! Clear, illustrated instructions lead you step by step.

To make such an amazing book possible, the engineer-editors of MoToR Magazine collected and "broke down" 150 official factory shop manuals for you, spotted all the vital repair information you need, dove-tailed it all together into ONE handy, easy-to-understand book.

No Other Manual Like It!

This BIG book—640 pages, 8½ x 11 inches, bound in sturdy covers—brings you nearly 200,000 service, repair, adjustment, replacement, tune-up facts on every car built from 1935 to 1942. More than 1000 cut-away photos, dia-

grams, drawings show you exactly WHAT to do and HOW to do it! Used by the U. S. Army, trade and technical schools everywhere, thousands of auto servicemen.

Now YOU—without cost—can see for yourself what a wonderbook MoToR's Auto Repair Manual really is. TRY it—FREE for 7 days! Learn first-hand how it can pay for itself the first few times you use it.

SEND NO MONEY 7-Day Free Examination

Just mail coupon below—without money! When the postman brings your book, pay him nothing. First make it *show* you what it's got! Unless you agree this is the greatest time-saver and work-saver you've ever seen—return book in 7 days and pay nothing. Mail coupon today! Address: MoToR Book Department, Desk 1D, 572 Madison Ave., New York 22, New York.

USED BY
U.S.
ARMY

Clear, Pictured Facts on Every Job on Every Car Built Since 1935!

Nearly 200,000 service and repair facts on all these makes:

American	Ford	Oldsmobile
Bantam	Graham	Overland
Auburn	Hudson	Packard
Austin	Hupmobile	Pierce
Buick	Lafayette	Arrow
Cadillac	La Salle	Plymouth
Chevrolet	Lincoln	Pontiac
Chrysler	Lincoln	Reo
Cord	Zephyr	Studebaker
De Soto	Mercury	Terraplane
Dodge	Nash	Willys

640 large pages; including 50 pages of carburetor text, charts, illustrations, covering all models. Over 450 charts, tables; Tune-up Chart; Valve Measurements; Compression Pressure; Torque Wrench Reading; Starting Motor; Engine Clearances; Generator; Clutch & Brake Specifications; Front End Measurements, etc.; Engines; Electric, Fuel, Cooling, Lubricating Systems; Transmissions; Universals; Front Ends; Wheels; Rear Ends, etc.

Same FREE 7-Day Offer Applies on New MoToR'S TRUCK REPAIR MANUAL

For mechanics, truck specialists, service stations, fleet owners. Covers EVERY job on EVERY truck made since 1936! 1400 pictures, 900 pages, 300,000 facts. Used by Armed Forces. Warranted to contain every essential fact you need to know. Sturdy binding, size 8½ x 11.

Covers all types Gasoline Engines; Diesels and Hessel-mans, Fuel Systems, Governors, Lubrication Systems, Ignition Systems, Starters, Generators, Clutches, Transmissions, Axles, Torque Dividers, Transfer Cases, Brakes, Steering, etc. etc.

Offered on same FREE 7-Day examination as Auto Repair Manual. Check box in coupon at right.



MoToR Published by MoToR, The Leading Automotive Business Magazine. MoToR's manuals assure high standards of repair work.

MAIL COUPON NOW FOR 7-DAY FREE TRIAL

MoToR Book Dept., Desk 1D, 572 Madison Ave., New York 22, N. Y.

Rush to me at once: (check box opposite book you want).

MoToR's AUTO REPAIR MANUAL. (formerly "MoToR's Factory Shop Manual"). If O.K. I will remit \$1 in 7 days, and \$1 monthly for 4 months, plus 35c delivery charge with final payment (\$5.35 in all). Otherwise I will return book postpaid in 7 days. (Foreign price, remit \$7 cash with order).

MoToR's TRUCK REPAIR MANUAL. (Described at left in the box.) If O.K. I will remit \$2 in 7 days, and \$2 monthly for 3 months, plus 35c delivery charges with final payment (\$8.35 in all). Otherwise I will return book postpaid in 7 days. (Foreign price, remit \$11 cash with order).

Name _____ Age _____

Address _____

City _____ Zone No. _____ State _____
(if any)

Occupation _____

SAVE 35c! Check here if enclosing full payment (check; money-order) WITH coupon. We pay 35c shipping costs.

NOW-is the ideal time to get into **DRAFTING**



Learn at home from an Engineer until you have a **GOOD PAY JOB**

With industry working feverishly—the field for Draftsmen is bigger than ever. More important—draftsmen and designers must come first in changing back to peace-time production. Get into a better job with more pay and fascinating, pleasant work. Engineer Dobe will train you at home—in your spare time, to get experience on actual work, the same kind of jobs you will do in the best paid position, and train you until you are competent, experienced, holding such a position that will mean advancement and pay raises as deserved. When competent will recommend your practical work experience as references. No need for previous training to start with me—and lack of higher education should not hold you back. You can pay monthly for your practical training from an engineer; the cost is reasonable. Write today for full illustrated details and booklet. Give your age to get reply.

All working tools FURNISHED

Professional drawing instruments, all working tools, also drawing table furnished with training. Start in right Now.



GET THE FACTS TODAY!

ENGINEER DOBE, Div. 3374, Libertyville, Ill.
Please send me training facts on "Drafting and Industrial Designing". Also advertised list of positions for Draftsmen and Designers Wanted.

Name.....Age.....
Address.....
Town.....State.....

AUDELS NEW MACHINISTS HANDYBOOK NOW READY!



A KEY TO SHOP PRACTICE
For Every Machinist, Toolmaker, Machine Operator, Draughtsman, Metal Worker, Mechanic or Student. Covers Shop Practice in All Branches.

A READY REFERENCE
Tells How to Operate and Set Up Lathes, Screw and Milling Machines, Shapers, Drill Presses and All Machine Tools.

5 PRACTICAL BOOKS IN ONE!
60 FULLY ILLUSTRATED CHAPTERS
Covering: 1—Modern Machine Shop Practice. 2—Blue Print Reading and How to Draw. 3—Calculations & Mathematics for Machinists. 4—Shop Physics. 5—How to Use Slide Rule.

Get This Information for Yourself. Mail Coupon Today. No Obligation Unless Satisfied. ASK TO SEE IT.

1600 PAGES FULLY ILLUSTRATED \$4 COMPLETE • PAY ONLY \$1 MO.

THEO. AUDEL & CO., 49 WEST 23rd STREET, NEW YORK
Mail AUDELS MACHINISTS & TOOLMAKERS HANDY BOOK. Price \$4 on 7 Days Free Trial. If O. K. I will remit \$1 in 7 days and \$1 monthly until \$4 is paid. Otherwise I will return it.

Name.....
Address.....
Occupation.....
Reference..... P. M.

Say you saw it in Popular Mechanics!

PRINT ANY PHOTO on Paper, Cloth, Leather or Wood

SIMPLE, EASY TO USE

Magic liquid takes only 2 minutes to reproduce any snapshot you have on stationery, handkerchiefs, ties, scarfs, etc. Won't wash off. Won't hurt negative or fabric it's used on. Personalize your belongings! An ideal gift. Complete outfit with full colors included, enough for 100 photos—only \$1.00 postpaid. Sent C.O.D. for \$1.18.

CHRISTY PHOTO SUPPLY
DEPT. 110, 2835 N. CENTRAL CHICAGO



Complete Course
Only \$7.50

DRAW CARTOONS BIG MONEY!

EASY... PLEASANT WORK!

Let CHAS. H. KUHN, with 25 years actual experience in drawing a daily newspaper cartoon, teach you how to create, draw and sell your work. 52 complete lessons—one sent each week. Professional criticism on every lesson. Write today.

KUHN SCHOOL OF CARTOONING
420 MURPHY BUILDING Dept. S. INDIANAPOLIS 4, INDIANA

Got a HOT idea?



OR A SWELL GADGET?

Let's get together—our Engineering and Production Staff and our Unlimited Financing will develop and promote your brain-child for P. W. P., and arrange for patent. You are fully protected—Specializing in Plastics, Electronics, Metal or Wood. Write Today.

ADDRESS DEPT. (H) BOX 2745, KANSAS CITY, MO.

A SIMPLIFIED ART ANATOMY OF THE HUMAN FIGURE
ONLY \$1 POSTPAID
by Charles Carlson. The book they're talking about! One of the most informative books of its kind for both student and professional artists. Charts, notes, and over 350 drawings show detailed studies of every part of the body, posed and in action. HOUSE OF LITTLE BOOKS, 156-160 Fifth Ave., New York

Get into the BAKING BUSINESS

Bakers make good money! New 7th Industry in wages! Nearly depression-proof. New home study Baking Course qualifies you. Common school education sufficient. If you're ambitious, write for FREE BOOK "Opportunities in Baking." National Baking School, 1315 Michigan, Dept. 1354, Chicago



ZEST IS BEST

BE STRONG, muscular, full of pep.
Amazing new body-building course.
Details Free.

OLYMPIC SYSTEM, Dept. 10, Waterville, Maine

STOP RADIO STATIC



The ALL WAVE radio filter is guaranteed to help you get perfect radio reception. Eliminates all hums, clicks, crackles, etc., caused by electric razors, vacuum cleaners, motors and other electrical appliances. The ALL WAVE is a scientific and compact radio filter that can be used on any make electric radio. To connect, just put your radio plug thru the ALL WAVE's slotted opening and into any wall outlet. 15 DAY FREE TRIAL. Sent C.O.D. for \$1.50 plus postage. Cash orders sent postpaid. Rush order—supply limited. Vogue Eliminator Co., 7759 S. Halsted, Dept. AW-402, Chicago 20, Ill.

Where will YOU be when the curtain goes up on tomorrow?



• Tomorrow's stage is being set for new developments, new industries, new opportunities. What will be *your* role in this post-war production? Will you be one of the successes—or one of those left on the street corner?

In new industries—plastics, electronics, Diesel engines, air conditioning, light metals—and the expanding older ones, the leading roles will go to the men who are *training* for them *now*.

Many are studying with the famous International Correspondence Schools. Authoritative, practical I. C. S. Courses are written by successful men for the ambitious "comers" due to succeed them.

I. C. S. has trained thousands of leaders in American industry and business.

Its 52 years of experience in vocational education, its 26 Schools, its more than 400 courses are at your disposal.

Pick your place on tomorrow's stage and mark the coupon accordingly. *This* is the day to *act*.

INTERNATIONAL CORRESPONDENCE SCHOOLS
Scranton 9, Penna.

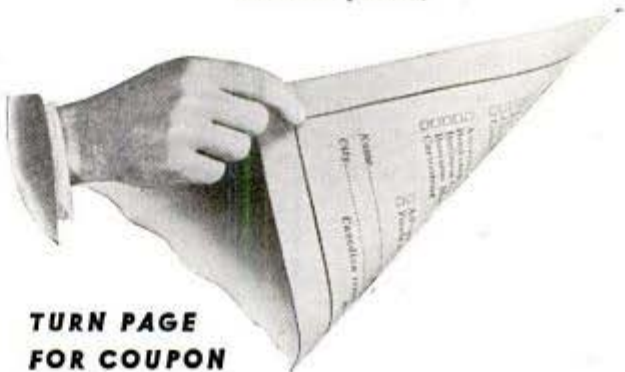

**TURN PAGE
FOR COUPON**

INTERNATIONAL CORRESPONDENCE SCHOOLS

TECHNICAL AND INDUSTRIAL COURSES

<p>Air Conditioning Schools</p> <p>Air Conditioning Heating Plumbing Refrigeration Steam Fitting</p> <p>Chemistry Schools</p> <p>Chemical Engineering Chemistry, Analytical Chemistry, Industrial Chemistry, Mfg. Iron and Steel Plastics Pulp and Paper Making</p> <p>Civil, Architectural and Structural Engineering Schools</p> <p>Architecture Architectural Drawing Bridge and Building Foreman Bridge Engineering Building Estimating Civil Engineering Contracting and Building Highway Engineering Lumber Dealer Sanitary Engineering Structural Drafting Structural Engineering Surveying and Mapping</p>	<p>Electrical Schools</p> <p>Electrical Drafting Electrical Engineering Electric Utilities Electronics Power House Electrician Practical Electrician Practical Telephony Radio, General Radio Operating Radio Servicing Telegraph Engineering</p> <p>Internal Combustion Engines Schools</p> <p>Aircraft and Engine Mechanic Automobile Technician Aviation Diesel—Electric Diesel Engines Gas Engines</p> <p>Mechanical Schools</p> <p>Aeronautical Engineer's, Junior Airplane Drafting Coal Mining Flight Engineer's Foundry Work Heat Treatment of Metals Industrial Engineering Inventing and Patenting Machine Shop Practice Mechanical Drafting Mechanical Engineering</p>	<p>Mold-Loft Work Navigation Patternmaking Reading Shop Blueprints Sheet Metal Drafting Sheet Metal Worker Ship Drafting Shipfitting Shop Practice Steel Mill Workers Tool Designing Weather Observing Welding, Gas and Electric</p> <p>Railroad Courses</p> <p>Air Brake Car Inspector Locomotive Engineer Locomotive Fireman Railroad Rate Clerk Railroad Section Foreman</p> <p>Steam Engineering Schools</p> <p>Boilermaking Combustion Engineering Engine Running Marine Engines Petroleum Refining Plant Steam Electric Steam Engines</p> <p>Textile Schools</p> <p>Cotton Mfg. Rayon Weaving Textile Designing Woolen Mfg.</p>
---	--	--

BUSINESS AND ACADEMIC COURSES

<p>Academic Schools</p> <p>Arithmetic College Preparatory Commercial High School First Year College High School Higher Mathematics Illustrating</p> <p>Business Schools</p> <p>Accounting Advertising</p>	<p>Bookkeeping Business Correspondence Business Management Certified Public Accounting Commercial Cost Accounting Federal Tax Course Foremanship Motor Traffic Management Salesmanship</p>	<p>Secretarial Stenography Traffic Management</p> <p>Civil Service Schools</p> <p>City Letter Carrier Post Office Clerk Railway Postal Clerk</p> <p>Language Schools</p> <p>French Good English Spanish</p>
---	--	---

INTERNATIONAL CORRESPONDENCE SCHOOLS BOX 5689-J, SCRANTON 9, PENNA.

Please send me complete information on the following subject:

(Write above Technical, Business or General Educational Subject in which you are interested.)

Name..... Age.....

Home Address.....

City..... State.....

Present..... Working.....

Position..... Hours.....

Special Tuition Rates for Members of the Armed Forces

QUICK CASH for YOU

INTRODUCING AMAZING AUTOFYRSTOP



—the remarkable new combination automatic and manual fire extinguisher and alarm that is setting records. TREMENDOUS MARKET. Sells on 2-minute demonstration to defense plants, homes, schools, stores, etc. LOW PRICED.

**KILLS
FIRE
BY ITSELF**

Big Profits. Write for FREE facts. EXPERIENCE NOT NECESSARY. AUTOFYRSTOP CO., Dept. M-44, 2035 Washington Ave., Philadelphia, Pa.

OPTICAL 15 LENSES

Plus 50 PAGE Idea Booklet to Help You . . .

(All Lenses New—Edges very slightly chipped) . . . make your own telescopes, magnifiers, dummy camera, photo cells, rifle scope, detachable reflex viewfinder for 35-mm camera, telephoto lens, photographic gadgets, for experimenting, optical copying and ultra-closeup shots and hundreds of other exciting experiments.

Set 602-H
Only

\$2.60

EDMUND SALVAGE COMPANY

Postpaid

27 W. Clinton Avenue, P. O. Audubon, New Jersey

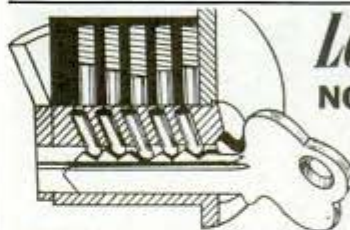

Locksmithing NOW MADE EASY!

New course for practical men, mechanics, carpenters, fix-it shops, etc. Learn to fit keys, pick locks, de-code, make masterkeys. 14 days. Send name for FREE details. No obligation — write today! Nelson Co., 321 S. Wabash, Dept. D-702, Chicago.



Begin today. Write now for our Free Book, "How to Become a Good Penman." It contains specimens and tells how others learned to write in spare time. Enclose 10¢ for your name beautifully written and a pen point suitable for shaded writing. Write today.

THE TAMBLYN SCHOOL OF PENMANSHIP
7441 Ridge Building, Kansas City, Mo.

IF YOU STAMMER

you owe it to yourself to send for our free book. 11,000 cases corrected. Est. 41 years. No hand swing or sing song. Millard Inst. of Normal Speech, 2303 W. Wis. Ave., Milwaukee, Wis.

TIME & MOTION STUDY

30 MILLION WORKERS AND SOLDIERS will compete with you in peacetime unless you train now. Low cost professional training. Time and Motion study is insurance for present and future big pay jobs. Increase vital war work now with methods improvements. Write for details now. INDUSTRIAL ENGINEERING COLLEGE, 4000 Washington, Chicago (24) Illinois

FIX ANY RADIO

Amazing New Invention



Learn quickly to repair all radio sets. New, revolutionary different picture method permits you to do radio servicing almost immediately. No previous radio knowledge required. Introductory training included. Find any fault quickly. Use a screw driver, pliers, and a piece of wire — no testers needed. Simple, point-to-point picture suggestions tell you where to look for faults and how to make the repair. Plan U. S. Copyrighted. Covers every radio set—new and old. You may try the plan for 10 days without any risk or obligation.

Easy to Apply

SATISFACTION GUARANTEED

Read the introductory job sheets, follow the step-by-step picture blueprints, and fix any radio in minutes instead of hours. The complete simplified training is yours for only \$1.50, postpaid. 10 days trial. Money back guarantee.

SUPREME PUBLICATIONS
328 S. Jefferson St., Chicago 6, ILL.

Price only \$1.50 postpaid. In large Manual form, 8 1/2 x 11 in. 112 large pages. Data on 346 radio tubes. 16 trouble shooting blueprints. Over 1,000 time-saving radio service hints. Developed by M. N. Beitman, noted engineer and author. Use 10 days without risk. Write today.

America's War Made Industry—

ELECTRICAL APPLIANCE REPAIRING

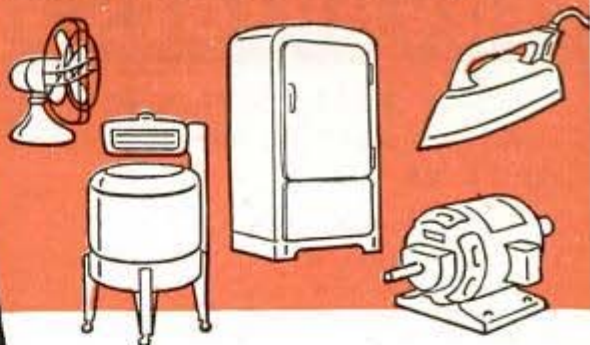

OFFERS BIG MONEY

The restrictions on the manufacture of electrical home appliances has greatly increased the need for and earnings of skilled home appliance repairmen. Always a good business, today ELECTRICAL APPLIANCE REPAIRING is one of the most profitable occupations that the average mechanically inclined man can turn to. On many types of repairs it is usual for a repairman to charge on the basis of \$5.00 to \$6.00 an hour!

NO EXPERIENCE NEEDED—New Course Tells All

If you are at all mechanically inclined—that is to say—can hold and use tools—then you have all the qualifications required for becoming a big money-earning home appliance repairman. It does not matter if you have not had a great deal of schooling or had no previous training along these lines. Age is no barrier . . . nor is any minor physical handicap.

Read What Other Students Say

I really believe your course the best investment a mechanically minded man can make.

—Claude E. Allen, Indianapolis, Ind.

Your course on Appliance Servicing is the most complete and up-to-date I have heard of.

—Frank Kremen, Tarentum, Penn.

I have received your Course in Appliance Repairing and I must say I am well pleased with same. I am only sorry I did not have said Course some years ago. I have learned so much more through this course I would not part with it.

—Charles Schwarz, Hamilton, Ohio.

The Course in Appliance Servicing arrived a few days ago. Want to take out a few minutes of my valuable time to let you know that this is just what I have been looking for ever since I opened up my Fix-It shop. I must admit that you told the truth when you said that it contains quite a bit more information than I bargained for.

—P. J. Brett, Sebring, Ohio.

I am a mechanic for the Western Union Telegraph Co. Three days after receiving the lessons in refrigeration I earned the exact cost of the course.

—Henry S. Lee, Washington, D. C.

I shall appreciate hearing from you all once more as I would not take \$200.00 for my book of lessons.

—Albert Losli, Denver, Colorado.

PERSONAL INDEPENDENCE

Work as many hours as you wish—for the home appliance repairman is his own boss. Establish yourself in a profitable lifetime business. Operate from your garage, basement, vacant store, etc. You don't need elaborate fixtures or expensive equipment to be a successful repairman. If now in war work, start your home appliance repair business in your spare time and be set with a business of your own when the war is over.

Profusely illustrated, our new course shows you in simple, easy to understand language and drawings how to make each repair on refrigerators, vacuum cleaners, washing machines, motors, etc. Explains and gives you a working knowledge of electricity, welding, nickel plating, etc. Shows you how to build the power tools you need and how to solicit and keep business coming to you. Not a theory course but an honest to goodness course written by and used by repairmen the Country over. Price of course is so low that the savings on your own household appliance repairs will quickly pay for it. Act now!

Mail Coupon for FREE LITERATURE

Christy Supply Co.
2835 N. Central Ave., Dept. D-803
Chicago, Illinois

Please send me all the facts about America's Fastest Growing Industry—Electrical Appliance Repairing.

Name

Address

City..... State.....

Attention inventors

DO YOU HAVE A PRODUCT THAT CAN BE MADE OF METAL? WRITE US ABOUT IT TODAY!

Your product idea may have a volume market in the Ten-cent stores or thru the catalog houses.

We are interested in new product ideas that we can manufacture for the following markets:

- Farm Machinery & Parts
- Auto Accessories
- Builders' Hardware
- Garden & General Tools
- Household & Kitchen Appliances
- Small Electrical Parts

It makes no difference how simple your product idea may be. If it can be made out of metal—die-cast, stamped, machined—let us know about it right away. Don't delay—a fortune may be waiting for you!

Before the war we manufactured and distributed to the chain store field under "HECO" trademark. We have a large, modern plant . . . excellent engineering, manufacturing and distributing facilities. We enjoy a sound financial standing. At present we are redesigning our own products for the postwar market. Maybe your item can be added to our line.

DO IT TODAY . . . send us your drawings, sketches or explanation. We prefer that they have "Date of Conception" or "Patent Application" protection. Mail 1st Class. You will hear from us promptly.

Write

NEW PRODUCTS DIVISION

HECKETHORN

Dept. M

Manufacturing and Supply Company

Littleton, Colorado

Say you saw it in Popular Mechanics!

Law!

LEARN AT HOME

Are you adult, alert, ambitious, willing to study? Investigate LAW! We guide you step by step—furnish all texts, including 14-volume Law Library. Training prepared by leading law professors and given by members of bar. Degree of LL. B. conferred. Low cost, easy terms. Send NOW for Free, 48-page "Law Training for Leadership."

LASALLE EXTENSION UNIVERSITY, Dpt. 464-L, Chicago
A CORRESPONDENCE INSTITUTION

MAKE THINGS of Plastic

Use your wood and metal working equipment to make picture frames, hand bag ornaments, trays, monograms and many other articles of clear

LUCITE or PLEXIGLAS

A source of both pleasure and profit. Easy. Fascinating. Inexpensive. We furnish material, working drawings and full instructions.

SPECIAL \$1.00 Starting Offer

Shop drawings for 30 projects, full instructions only \$1.00 postpaid. 50 sq. inches of material included without extra cost. This offer good in Continental U. S.

REX ASSOCIATES,
2144 Madison Ave.

Dep't. 5
Toledo 2, Ohio

LEARN MOVIE PROJECTION THEATRE MANAGEMENT

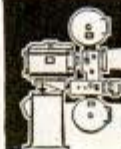

The Motion Picture Theatre Business offers big opportunities for trained men. Free catalog. Give age. Established 17 years.

THEATRE SCHOOL, 370 Washington Street,
Elmira, New York

ARTISTS MAKE MONEY

Find out your ability. Send name, age, occupation and address for Free Vocational Art Test.

ART INSTRUCTION, INC. (Formerly Federal Schools)
4134 Art Instruction Building, Minneapolis, Minnesota

FIX TYPEWRITERS

A Simplified Practical Homestudy Course. Many of our Students now have their own Business—Many Repair for others. Repair Shops Swamped. Health or Age no handicap.
WEBER TYPEWRITER MECHANICS SCHOOL
5417 S.M. Blvd., Hollywood 27, Calif.



don't WORRY

Why put up with years of needless discomfort and worry? Try a Brooks Automatic Air Cushion. This marvelous appliance permits the opening to close, yet holds reducible rupture securely, comfortably—day



and night. Thousands report amazing results. Light, neat-fitting. No hard pads or stiff springs to chafe or gouge. Made for men, women and children. Durable, cheap, **Sent on trial** to prove it. Never sold in stores. Beware of imitations. Write for Free Book on Rupture, no-risk trial order plan, and proof of results. All correspondence confidential.
BROOKS COMPANY, 158-C State St., Marshall, Mich.

GET INTO RADIO

ELECTRONICS TELEVISION *Now!*



You profit by a fascinating career in Radio, Radionics, Electronics, Television.

Shortages in trained, skilled men run into the hundreds of thousands. One of the biggest fields is RADIO, with its many fascinating branches. Wartime demands for Radio men are tremendous and will continue UNABATED after the war. That's important to you. You want training in a field that will continue to advance. National Schools offers you a time-tested method of Home Training which has helped thousands of men to more pay, and unlimited opportunity in the growing RADIO industry.

Shop Method Home Training by a Long Established Resident School

Get Ready For Your Opportunity . . . It's Here! Radio technical men are needed everywhere; afield in action, and at home in industry! Trained men are needed in the Army, Navy and Air and Signal Corps, Government Defense Service and Civilian fields. Now, in answer to repeated demands for Trained Radio Technicians, National Schools has extended its famous Shop Methods so you can qualify right at home. You can quickly prepare to be of greatest service to your country and yourself. Yes, right at home, in your spare time. National's time-tested plan of Home Training will definitely establish you, in a

short time, so you can hold a good job in this fascinating field. Furthermore, you become equipped for an ever bigger career in the years of reconstruction afterwar.



TRAIN DURING MILITARY SERVICE

Prepare for Radio Service in Army and Navy. In U. S. Gov't service you install, operate and maintain most technical equipment such as secret ultra-high frequency apparatus to locate airplanes, submarines, etc. Get promotion in rank and increased pay almost from the start.

COMMAND ANY OF THESE JOBS

Radio Expert
Electronics Engineer
Radio Broadcasting
Studio Technician
Television Technician
Aviation Radio
Ship & Harbor Radio
Business of Your Own
137 Different Types
of Jobs to Choose From

TREMENDOUS POST WAR DEMAND NO PREVIOUS EXPERIENCE NEEDED!



Radio is only one of the courses you receive when you become a National Student. Electronics is brand new and open to every trained radio man. After this war it will produce new marvels that will be needed and used in every home. General Electric, Westinghouse and all great manufacturers have many new electronic inventions ready to market. National men, because of their knowledge and training in Electronics, will be in on the ground floor and among the first to cash in.

Television is a big new opportunity. National men will have the "know how" to merit jobs in this great industry.

RADIO EQUIPMENT INCLUDED

You work with the finest tools and materials furnished by us at no extra charge.

DUPLICATE THE SUCCESS OF THESE GRADUATES

"National Schools has done wonderful work for the man who wants to get ahead in life. Your trained man can get a job at a much higher salary."—O. K. Ivey, Washington, D. C.

"Your schooling helped me obtain a swell job. Now, in the navy, I am following the profession I learned at National. It will help my chances for rapid advancement."—H. Schroeder, U. S. Navy.

NATIONAL SCHOOLS

LOS ANGELES 37, CALIFORNIA
EST. 1905



FREE LESSON

And OPPORTUNITY
BOOK . . .

To prove that you can easily learn radio at home by National's famous "Shop Method" home training, we will send this SAMPLE LESSON without cost or obligation. With it, we will send you a big, 36 page book "Your Future in Radio, Television and Electronics." Mail the coupon NOW.



MAIL OPPORTUNITY COUPON FOR QUICK ACTION

National Schools, Dept. 4-PM R, 4000 S. Figueroa Street, Los Angeles 37, Calif. Mail in envelope or paste on penny postal

Please rush me, FREE and without any obligation on my part, Sample Lesson in Radio, Television and Electronics and full details of your "Shop Method" of home training. No salesman will call.

NAME _____ AGE _____

ADDRESS _____

CITY _____ STATE _____

Today's Thinkers
will become
Tomorrow's Leaders



TODAY is yesterday's tomorrow. Has it added anything to your life? Have you moved forward in thought as well as in time? Those who wait for today's events to give them the cue as to what to do, will find themselves lagging behind. The present is only a pedestal for progressive men and women to stand upon to see beyond, to look ahead to the great tomorrow. All about you are only the evidences of what has been done. They are now history—of the past. Can you visualize the tomorrow, next week or a year from now? If you cannot, you are a slave of the present, and marked for a life of uneventful monotonous routine.

This FREE book will give you
a new view of Life

YOU CAN possess the imagination, the creative thought and far-reaching vision that has produced some of the world's most dynamic characters. Behind every new development, act of progress or success was a silent thought—a creative idea. Thousands today, in the privacy of their homes, unknown, unheralded, are using secret principles for stimulating the creative, unused faculties of mind. From their thoughts will come the new industries, finance, business, and civilization of tomorrow. These thinkers, men and women like yourself, are using a METHOD OF MIND DEVELOPMENT taught for centuries, which will fit them for a place of leadership in their chosen walks of life. SHARE THEIR SECRET of accomplishment by writing your request for this book to the Rosicrucians. Therein will be explained how you, too, may acquire these teachings which can mean so much to you in the new tomorrow.

Address: Scribe B. A. E.

The ROSICRUCIANS
[A M O R C]

SAN JOSE CALIFORNIA

Scribe B. A. E.
The Rosicrucians, San Jose, California.

I am sincerely interested in an intelligent method for attaining a mastership of life. Send me without obligation, your FREE Book which explains how I may receive and use your age-old method.

Name.....

Address.....

(The Rosicrucians are NOT a religious organization.)

Say you saw it in Popular Mechanics!

● THIS AD IS
ADDRESSED TO YOU!

That idea of yours may mean your fortune; don't pass it up! That new automotive or aircraft tool or equipment may be just what the post-war era wants. Your idea may need development; perhaps it's ready for patenting or manufacture. It makes no difference to this nationally-known organization with ample engineering, production, financial, sales and distribution facilities looking for ideas for manufacture and sale in the post-war era. If patent on your idea hasn't been applied for, have it witnessed and then write us about it completely or with a minimum of detail, as you please. But whatever you do, DO SOMETHING about that idea! Write in confidence NOW to

P. O. BOX 217 STA. C TOLEDO, OHIO

STUDY **ENGINEERING** AT HOME

With A Chartered Educational Institution

Courses in **ENGINEERING**: Electrical, Civil, Mechanical, Drafting, Architectural, Steam, Aeronautical, Radio, Structural, Mining, Industrial, Highway, Petroleum, Marine, Chemical.

Courses in **ARTS AND SCIENCES**: Philosophy; Education; Letters; Public Health; Medical Jurisprudence; Psychology; Sociology; Physics; Chemistry; Geology; Pol. Science; Theology; Law; Business and Commerce; Accounting; Mathematics; Statistics; Agriculture.

McKinley-Roosevelt Incorporated, 4610-TC, Sheridan Road, Chicago, 40

Externally
Caused

PIMPLES

ACNE, BLACKHEADS, OILY SKIN, RED PATCHES

Discouraged by soaps and salves? **SEBOLINE** applied nightly often shows improvement in a week. **Money Back** if not completely satisfied after 2 weeks. **Skin Specialist Prescription. SENT ON TRIAL.** You risk nothing.

FREE Send for Free Booklet at Once. Don't suffer embarrassment any longer. **WRITE TODAY.**
Seboline Lab., Dept. H-1, P. O. Box 350, Independence, Mo.

Learn
PHOTOGRAPHY
at Home

Splendid opportunities. Prepare in spare time. Easy plan. No previous experience needed, common school education sufficient. Send for free booklet "Opportunities in Photography", particulars and requirements.

American School of Photography
1315 Michigan Ave., Dept. 1354, Chicago, Ill.

LEARN MODERN HEAT TREAT \$100

Color-Chart; Melting-Point of Over a Dozen Different Metals; Critical Range; Liquid Carburizing; Hi-Speed Copyright Booklet, 100
Steel—Hardening; Drawing; Annealing; Normalizing; and Plenty More Information—
Money Back Guarantee. **Blacksmith Tempering and Holding Colors—Booklet 50c**

SMITH, P. O. BOX 202, EAST LANSING, MICHIGAN

JIU-JITSU HOW TO LICK
THE BIG GUY

Guaranteed. Learn Easily Quickly step by step. Send 10c to-day for trial lesson, full details.

MODERN SCHOOL OF JIU-JITSU, Dpt. A, 5 W. 52 St., N. Y. 19

MONEY FOR **MEN** ALL DATA FREE

THE PLASTIC Industry needs manufacturers on small scale and for big production of Lamp and Clock Stands, Art Goods and Novelties in Plastex and Marble imitation. Experience unnecessary. 1/2c material makes regular 10c store sellers. Rubber moulds furnished for speed production. Small investment brings good returns. WE ARE NOW PLACING BIG CHAIN STORE ORDERS WITH MANUFACTURERS. Ambitious men have chance for real prosperity. Our FREE booklet will interest and benefit you.

PLASTEX INDUSTRIES, Dept. P, 1095 Washington Av., New York 56, N.Y.

**DO ANY JOB..
EASIER.. QUICKER
MAKE MORE MONEY**



**in the FIELDS of
BIG OPPORTUNITIES**

Here is the HELP YOU NEED . . . Now and After the War!

FREE TRIAL IN YOUR OWN HOME

Used by Army, Navy, Other Government Depts., 200 Schools and Industrial Firms.

Get ready to meet keener job competition, now and when wartime jobs are over. Get into one of these big opportunity fields. Big money and many other advantages await you if you prepare now. Here is the help you need—EASY—QUICK—AT LOW COST. Thousands of men have already used these famous books. Beginners and experienced men alike have doubled and tripled their earnings with this help. You too, can now get the special knowledge you need for top pay, better jobs, or a business of your own. This is your **GOLDEN OPPORTUNITY.**

REFRIGERATION

15 Million Refrigerators Need Service, Repairs

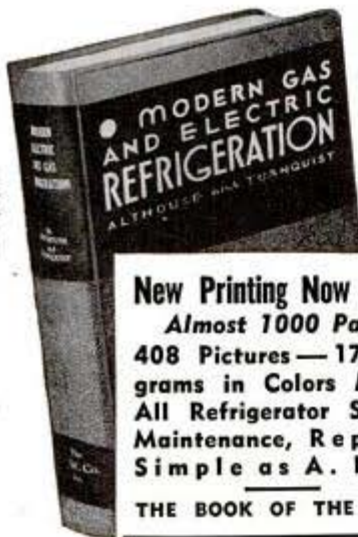

**New Printing Now Ready
Almost 1000 Pages
408 Pictures—17 Diagrams in Colors Makes All Refrigerator Service Maintenance, Repairs Simple as A. B. C.
THE BOOK OF THE HOUR**

No new refrigerators being made. None for years. Millions must be kept going. Owners will pay big for competent service which will be needed more and more. Get **MODERN GAS AND ELECTRIC REFRIGERATION**, the non-technical guide to all types of refrigerators and get your share of this new profit. Get a job or start your own service business. This book will help you make money anywhere. Sold on money-back guarantee. Price \$5.00.

SEND NO MONEY

Select the Books YOU Need Now! We Ship C.O.D. Anywhere in U. S. and Will Refund Amount Paid if Not Satisfactory.

HELPS FOR BIGGER PAY

AUTO BODY AND FENDER REPAIR

Owners will spend big money to keep cars looking new because few new cars available. This book is a practical money-making guide, ideal for shop owners and every man who wants a share of the millions to be spent in keeping old cars looking new. Auto Body and Fender Repairs contains 325 pages, 232 illustrations. Covers methods, tools, etc., in plain, simple language. Price \$3.00.

The Famous DYKE'S CARBURETOR BOOK

Best pay of all times for those who specialize in this work. The standard guide for a generation. New edition covers engine tune-up, ignition, carburetion, fuel pump, valves, etc. 244 pages, 249 illustrations, \$3.00.



HELPFUL BOOKS

MODERN WELDING PRACTICE

Just published. Newest book on all types of welding and heat treatment of metals. Written by recognized specialists in training men for production jobs. 430 Pages, 277 illus. Practical and Non-Technical. Covers everything you need to know. Prepare for best pay jobs now. Price \$4.00.

SHEET METAL LAYOUT

Makes sheet metal layout work so simple that anyone can learn. Thousands of men badly needed for this big pay work now. Even more after the war. Get this new instructor and get into the easiest, cleanest and best paying part of all sheet metal work. 143 jobs worked out in drawings and carefully explained. Size of book 8 1/2 x 11 inches. Price \$3.00.

ELECTRICAL WIRING

Complete practical instruction on every phase of house wiring in one handy volume. Goes further than most books on subject. Hand-book style. Gives National Electric Code, 400 pages, 669 illustrations. Electrical work will reach new heights after war. Get started now. \$2.50.

AUTOMOBILE WORK

Leading Auto Book for 32 Years

★ ★ ★

★ ★ ★

★ ★ ★

★ ★ ★

★ ★ ★

★ ★ ★

★ ★ ★

★ ★ ★

★ ★ ★

★ ★ ★

★ ★ ★



World's Greatest AUTO BOOK

**NEW 20TH EDITION
New Material on Transmissions, Trucks, Tractors, Diesels, Aircraft and Auto Engines**

Now with millions of cars needing repairs and thousands of men needed to do the work, you need the famous DYKE Auto Book more than ever before. Brand new 20th Edition covers all principles, construction, repair, adjustment, testing, troubles and remedies of all cars. World's biggest book value \$6.00.

This big book, a complete auto library in one volume, has 1483 pages—4600 illustrations and diagrams—weighs 6 lbs.—equal to 4 ordinary books.

Mail Coupon to: Goodheart-Willcox Co., Inc., 2009 S. Michigan Ave., Dept. 14, Chicago 16, Ill.

SEND NO MONEY! Mail Coupon

GOODHEART-WILCOX CO.,
2009 S. Michigan Ave., Dept. 14, Chicago 16, Ill.

Send books checked. C.O.D. I will pay postman, plus few cents charges. If any book is not satisfactory I will return in 5 days and you will refund money paid you.

- Gas & Electric Refrigeration . . . \$5.00
- Dyke's Auto Book . . . \$6.00
- Dyke's Carburetor Book . \$3.00
- Modern Welding . . . \$4.00
- Sheet Metal Layout . . . \$3.00
- Electrical Wiring . . . \$2.50
- Body and Fender Repair. \$3.00
- NOT LISTED**
- Aircraft Sheet Metal . . \$2.50
- Airplane Welding . . . \$3.50
- Shop Math. (2 vols.) . \$3.00

If remittance accompanies order we will pay all postage charges under same return privilege.

Name

Address

City..... State.....

War days are OPPORTUNITY DAYS for YOU . . . in Accounting . . .

If you like to work with figures and are earnestly ambitious, accounting today offers you unparalleled opportunity—to serve your country and to profit.

For there just aren't enough bookkeepers and accountants to fill the needs of government and industry. There are thousands of new and vacant jobs. These jobs pay well and they are open to both men and women. Moreover, this need will continue through the war and the post-war adjustment period.

Ask us to prove this—and to show you how you can grasp this opportunity quickly.

Ask for this free 48-page booklet

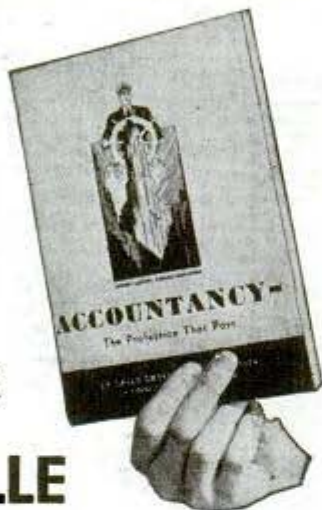

LASALLE EXTENSION UNIVERSITY A Correspondence Institution

Dept. 464-H CHICAGO

I want to know what opportunity there is for me in Accounting now and how I can prepare for it. Send me your free booklet and any other pertinent information.

Name..... Age.....

Present Position.....

Address.....

LAW STUDY AT HOME for PERSONAL SUCCESS and LARGER EARNINGS. 31 years expert instruction—over 106,000 students enrolled. LL.B. Degree awarded. All texts furnished. Easy payments. Send for FREE BOOK—"Law and Executive Guidance."
AMERICAN EXTENSION SCHOOL OF LAW
Dept. 40-M 8 East Huron St. Chicago, Ill.

MUSIC LESSONS COMPLETE CONSERVATORY HOME STUDY COURSES
Piano, Harmony, History of Music, Advanced Composition, Voice, Public School Music, Violin, Cornet, Trumpet, Guitar, Mandolin, Saxophone, Clarinet, Dance Band Arranging, Ear Training and Sight Singing, Choral Conducting. The only correspondence school teaching all the courses leading to the Degree of Bachelor of Music. Ask for illustrated lessons and catalog.

Give experience..... age.....
UNIVERSITY EXTENSION CONSERVATORY 1525 E. 53rd St., Dept. U-43, Chicago, Ill.
COUNT TELEGRAPH WIRES IN THE DISTANCE



9 POWER TELESCOPE \$2.99

Objects 900 yards away appear as 100 yards distant. Brings objects 9 times closer. Telescope closed is less than 1 ft. Spot planes, ships, people, sporting events, etc. Has large 50 mm lens (2 inches in diameter) something usually found only in higher priced telescopes. 20 DAY FREE TRIAL. Try for 20 days at our risk! Return if not completely satisfied. SEND NO MONEY. Just pay postman \$2.99 plus few cents postage. Cash orders sent postpaid. Don't wait—production of telescopes may be curtailed as it has been on binoculars. American Telescope Co., 7759 S. Halsted, Dept. TE-213, Chicago

MAGIC LIQUID MAKES PHOTOS APPEAR
On Scarfs, Ties, Stationery, Etc.
Reproduce any snapshot on cloth, leather, wood, paper. Simply apply liquid. Like magic photo appears within 2 minutes in broad daylight. Harmless to negative. Won't wash off. Full colors included. Complete kit for 100 photos only \$1.29. Send no money, just name. Pay postman \$1.29 plus few cents postage on delivery. (Canada, \$1.50 money order only.) Order today.
L & M Mfg. Co. Dept. 316, Neave Bldg., Cincinnati 2, Ohio

JOKE BOOKS For Adults
The kind they like. You will be both a Riot and the Life of the Party with a set of these pocket size joke books. They are full of Entertainment, Fun and Humor. A set of six books only 50c or a special assortment of 12 books all different for \$1.00. Print name and address, send cash or stamps to:
TREASURE NOVELTY CO.,
72—5th Ave., Dept. 1204. N. Y. 11, N. Y.

LEARN CARTOONING
From my Original Cartooning Lessons. Send 3 samples your cartoons for FREE CRITICISM-CORRECTIONS, copy "Where to Sell Cartoons" and details of our Cartooning Course FREE.
TEMPLTON STUDIOS, Dept. 18, Elgin, Ill.

INDIANA TECHNICAL COLLEGE
Engineering degree in 27 months. Aeronautical, Chemical, Civil Electrical, Mechanical and Radio Engineering. Govt. approved ground school courses. Prep courses, no added cost. Large industrial center. Earn living expenses. Enter June, Sept., Dec., March. Catalog. 544 E. Washington Blvd., Fort Wayne 2, Indiana.

WE MEND MEN BY AUTO-MATIC
FIBRE-LITE ARMS & LEGS
With Soft Adjustable COMFORT SOCKETS. Cash or Terms. TRUSSES, BRACES, SOX, SUPPORTS. Give Full Details.
WORMAN CO., 310-P, THIRD AV. SO. MINNEAPOLIS-15, MINN. U.S.A.

Always write your name and full address clearly when answering advertisements.

GRAY HAIR VITAMIN



TRIAL SIZE 25c—30 DAY SUPPLY \$1.00

Men! Women! A certain missing vitamin in your diet can cause your hair to turn gray. Modern science now offers new hope if your hair is graying, streaked or fading. Take one full power 10 mgrm. tablet daily of Cal-Pan Calcium Panthothenate—the "anti-gray hair vitamin" and you will improve your diet with an extra supply of this lacking vitamin. It will be amazing to see natural color returning to your hair, starting at the roots, temples and part. Watch for great improvement in your hair beauty. Cal-Pan contains a generous supply of "Anti-gray hair vitamin" not a dye. In a national test by Good Housekeeping magazine hair grew out in natural colors in almost 9 out of 10 cases safely. Does not interfere with permanents or dyed hair because Cal-Pan literally starts its work from within, non-fattening. Buy for less. 7 Day trial size 25c (cash with order), full 30-day supply \$1.00 or 100 Days' supply \$2.50 plus COD postage on arrival, or send money with order and we pay postage. GUARANTEED satisfaction or money back. There's hope. Order now. Plain package—prompt shipment. ACE VITAMIN CO., Dist. 29, 4112 North Menard, Chicago 34, Illinois.

Learn AIRCRAFT DESIGNING and ENGINEERING This New Way at Home

Men and Women Needed Now to Train For Well Paid, Essential War Work and High Class Peacetime Positions



Don't let the pressure of these busy times make you lose sight of your own future. Start to train now for a career with better pay—and unlimited opportunities for advancement. With this new "boiled down" course, from a well-known, long-established organization which has been teaching aviation and flying airplanes for a generation, you can earn a coveted Ryan diploma just by using part of your spare time. The lessons are so interesting, many students finish far ahead of schedule.

Needed NOW—Trained Draftsmen and Engineers To Help Build America's War Planes. Needed TOMORROW—More Trained Men and Women To Help Build The New Different Revolutionary Planes of Aviation's Great Peacetime Future

Previous training is unnecessary. You learn at home under individualized supervision. There will be no loss of any income or time from your present job. And you'll be proud to tell your friends that your school, Ryan Aeronautical Institute, is operated as an affiliate of the famous Ryan School of Aeronautics (teaching flying), and the great Ryan Aeronautical Company (designing and building airplanes). Thus your

training will be **direct-from-the-industry**—training which has been approved by the other large aircraft manufacturers.

Read What These R.A.I.-Trained Men Say:



R.A.I. TRAINING BRINGS BETTER JOB AND RAISE IN PAY
"At the time I enrolled for your training I was doing stock work at Bell Aircraft. However in October I got transferred into the Tool Design Department. My pay has been increased and I hope to realize more profits later." Garwood Baybrook, Niagara Falls, N.Y.



SAYS R.A.I. COURSE SUPERIOR TO ALL
"I believe your course to be far superior to anything of this nature that has come to my attention. The personal attention which a student receives amazes me. I shall always recommend R.A.I. to anyone interested in Home Study Aeronautical Training." A. DeLindholm, Los Angeles, California



R.A.I. GRADUATE PRAISES COURSE
"I've been in the Aviation industry long enough I believe to recognize the real material when I see it. This is it. Yes without question you have here the solution to the problem. How can I equip myself for entrance into the Engineering branch of the Aviation industry." William S. Evans, La Jolla, California.

Complete Aeronautical Drafting Outfit At NO EXTRA COST

Every R.A.I. student gets this complete, professional drafting equipment set, without additional charge. There is nothing else to buy—no extra costs to bother you as you progress toward your valuable diploma—your ticket to a new, exciting, high paid career.



RYAN Aeronautical Institute

424 Lindbergh Field, San Diego 1, California

Gentlemen:

Please send me, without any obligation on my part, your FREE 24-page book, "NEW HORIZONS OF OPPORTUNITY," with 60 illustrations, and full information on R.A.I., including cost of training, and on job opportunities both before and after graduation.

Name _____ Age _____
Street _____
City _____ State _____

Do This—Then Judge For Yourself

Your time is the most valuable thing you have. You owe it to yourself to see that the study course on which you spend your time is the finest—the most practical. So use this coupon—now! There is no obligation—it'll take but a minute—and it may easily be the first step in opening the door to higher pay than you've thought possible—to being looked up to for the important interesting work you do.



Free! This Valuable Book
24 Pages, 60 Illustrations
Full Information and Costs



FREE! ARC WELDER'S GUIDE

Check full of information you need to know—often on a moment's notice... If you are a welder, you should have one of these handy books with you at all times. Answers many a question for you. Handy chart lets you check your welds for quality and tells you what's wrong. Welding symbols in handy form; in fact it's a condensed vest pocket manual. We'll send it for the asking.

SEND TODAY
for your copy of this useful booklet!

HOBART BROS. CO., Box M-44, TROY, OHIO

HOBART "Simplified" ARC WELDERS

HOBART "One of the World's Largest Builders of Arc Welders"

NOW YOU CAN GET **PROMPT DELIVERY** on Hobart Welders if on important work



MEN whether you are 16 or 50

HERE'S THE QUICK WAY TO AN ESSENTIAL JOB-A GOOD FUTURE

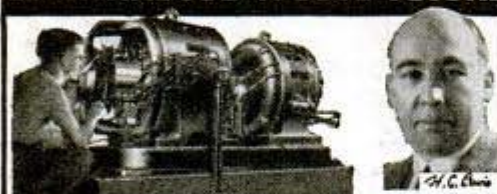

Learn **ELECTRICITY** IN 12 WEEKS

ON REAL MOTORS, GENERATORS, ETC.

All Finance Your Training

Trained Electrical men needed now. It's not how young you are, or how old you are. The question is—have you the training for a real peace-time future in a field that is vital now? Not all "essential" jobs offer such opportunities. **ELECTRICITY** does—when you're prepared!

Here at Coyne you can train in 12 weeks—not by books or lessons, but on real actual electrical machinery and apparatus. You "Learn by Doing". And you don't need much money. I'll finance your tuition and you can pay it in easy monthly payments after your training period is over. Then if you are short of living expenses we'll get you a part time job to "earn while you learn". After graduation we give you lifetime employment service.

Right now I'm including extra training in **INDUSTRIAL ELECTRONICS** at no extra cost.

Mail coupon for my big free book. Get the training you need for a good electrical job. **WRITE NOW.**

Also have facilities for men with physical disabilities. Write.

H. C. Lewis, President
Coyne Electrical School, Dept. 44-72,
500 S. Paulina St., Chicago 12, Ill.

Send Free Book with Facts on Coyne, "Pay After Graduation" Plan and extra Industrial Electronics training now included.

NAME.....
ADDRESS.....
CITY..... STATE.....

BENJAMIN H-C PELLETS ARE AVAILABLE

at dealers or direct. Cal. .22 and Cal. .177. Production of all models Benjamin Air Rifles and Benjamin Air Pistols has been suspended for the duration as our facilities are engaged in War Work. **WRITE FOR OUR ILLUSTRATED PRICE LIST AND BUY MORE WAR BONDS.**

BENJAMIN AIR RIFLE CO., 812 Marion St., St. Louis, (4) Mo.



ITALIAN ACCORDIONS

Hand Made. Very best. Lowest prices. Buy Direct from Factory and Save Money. Send name and address for FREE catalog.

ITALIA & P. SOPRANI ACC. MFG. CO.
323 W. POLK ST., DEPT. PM-4 CHICAGO, ILL.

IDEAS WANTED For chain store merchandise, new products or new presentations. Will pay cash or royalty. Submit full details in writing. **MODERN NOVELTIES, INC.,** Crown Bldg., Cleveland, O.

START YOUR OWN SHOP

Men wanted now and after the war for Plastics, Auto-Diesel, Machinist, Drafting, Refrigeration, Welding, Body & Fender, Aircraft. Earn real money or be independent in your own business. Free booklet. Specify trade. State whether interested in Home Study or Practical Shop Training. **GREER, Dept. 244, 2017 S. Wabash Ave., Chicago**

PATENTS AND TRADE MARKS

C. A. SNOW & CO.

Registered Patent Attorneys Since 1875

Write for Free Book and "Certification of Invention" form

427 SNOW BUILDING, WASHINGTON 1, D. C.

PATENT YOUR IDEAS

SEND FOR FREE BOOK HOW TO OBTAIN A PATENT

Written by Former Member Examining Corps (1922-24) U. S. Pat. Office.

CARL MILLER, Registered Patent Attorney
Former Member Examining Corps U. S. Patent Office
Woolworth Bldg., Dept. 44-A, New York — Bond Bldg., Dept. 44-A, Washington, D. C.

PATENTS Protect Your Idea:

By securing FREE my "PROOF OF INVENTION" folder. *Exceptional Personal Service. Excellent References. Established 1906.*

E. E. VROOMAN, 871 Woodward Bldg., WASH., D. C.

To PROTECT YOUR INVENTION - Use this coupon, NOW

Delays are dangerous and may be very costly. My personal service assures prompt action, strict confidence, and a minimum of expense. I suggest that you send me a model or drawing, or sketch and description of your invention, and \$5.00. I will make a search and report

promptly as to its patentability and send you a copy of my 72-page booklet. Or, if you prefer to read my booklet first, mail the attached coupon at once. I will also send my "Record of Invention" form. (Over 40 years experience as a Registered Patent Attorney.)

L. F. Randolph, 302-D Columbian Bldg., Washington, D. C.
Please send me at once, free of charge, your 72 page booklet and "Record of Invention" form.

Name.....
Address.....

A PERSONAL CONFIDENTIAL PATENT SERVICE

Read Any of these BARGAINS in TECHNICAL BOOKS ON FIVE DAY'S TRIAL

LEARN MORE EARN MORE

1. **MACHINERY'S HANDBOOK.** Contains engineering and manufacturing standards, machine shop data, rules, formulas, tables. For designers, shopmen. 1815 pages. \$5.98.
2. **MECHANICAL ENGINEERS HANDBOOK.** Fourth edition of famous handbook, revised with latest findings, added material covering theory of models, wind pressure, metallurgy. \$7.00.
3. **THE "RADIO" HANDBOOK.** Eighth Edition by editors of "Radio." Most comprehensive. Radio engineering up-to-date in 640 pages. Including very latest developments in word and picture. No radio engineer, manufacturer or amateur should be without this book. List \$4.00, our price \$2.98.
4. **HANDBOOK OF CHEMISTRY AND PHYSICS.** Over 2500 pages of indispensable data on all phases of chemistry, physics, latest research data, complete mathematical tables. \$4.00.
5. **CHEMICAL TABLES.** From Handbook of Chemistry and Physics. Valuable tables for chemists, mathematical Tables—Table of Logarithms. Data on electrochemistry. Index of refraction. Index of Organic Compounds, etc. 1400 pages. Leather bound. List \$3.50, our price \$1.98.
6. **A COURSE IN BLUEPRINT READING, CHECKING, TESTING.** In 2 Books, also insert with Answers. Complete course for standard shop practice. Be a valuable workman. \$1.98.
7. **SIMPLIFIED RADIO SERVICING.** Ideal for trouble shooting; for home radio repair or money-making radio servicing. Easy to understand, yet comprehensive for the expert. Profusely illustrated. \$1.50.
8. **UNIVERSAL MACHINIST'S HANDBOOK.** Complete handbook of mechanical, mathematical data—indexed. Over 400 charts, formulae, equations, diagrams, etc. Up-to-date, authentic for engineers, mechanics, technicians. \$1.98.
9. **SLIDE RULE AND HOW TO USE IT.** Use of slide rule now a necessity in technological, shop and school work. Makes rapid calculation easily understood. SLIDE RULE FREE with each book. \$2.98.
10. **ENGINE LATHE OPERATION.** Learn highly paid job operating lathe, milling, drilling, threading, boring machine. Beginner's authentic, easy "show how—tell how" book. \$1.98.
11. **METHODS OF MEASUREMENT.** Today's methods demand strict standards of measurement. Learn best, quickest methods. \$1.98.
12. **LIVING MATHEMATICS REVIEWED.** Review of mathematics essential in business and shop work today—Arithmetic, Algebra; Plane and Spherical Geometry; Spherical and Military Trigonometry; complete exercises & answers. \$2.50.
13. **PRACTICAL PLANE TRIGONOMETRY.** Quick reference for beginner and advanced student. Learn to apply trigonometry to everyday technical problems. Amaze others by your speed and accuracy. \$2.00.
14. **DYKE'S AUTOMOBILE AND GASOLINE ENGINE ENCYCLOPEDIA.** Revised, enlarged, up-to-date. Everything you want to know about automobiles and gas engines; covers trucks, tractors, diesels, aircraft. 3,362 illustrations. Colored inserts. New, 20th edition of world's greatest auto book. \$6.00.
15. **MODERN ELECTRICAL AND GAS REFRIGERATION.** Non-technical, practical, usable guide for service and repair of electric and gas refrigerators. 17 diagrams in color. 928 pages. \$5.00.
16. **GAGES AND THEIR USE IN INSPECTION.** Get more efficient use of gages. Read complete study of gages—why made—how used. \$1.50.
17. **2100 NEEDED INVENTIONS.** A "gold mine" reference work. A self starter for inventive minds. Now \$2.00.
18. **FORTUNES IN FORMULAS.** Henley's 20th Century Book of Recipes. Over 800 pages. Thousands of recipes. Secret processes revealed. Intrinsic value to chemists, metallurgists, manufacturers of cosmetics, medicines, foods, anything. Formerly \$4.00, our price \$1.49.
19. **AMERICAN ELECTRICIANS' HANDBOOK.** New 5th edition. Authentic data for installation and operation of electrical apparatus, materials. 1400 pages of practical information. \$4.98.

You don't have to buy books from descriptions alone. You don't have to pay retail store prices for mechanical or technical books. The Wilcox & Follett plan gives you your choice of STANDARD books that you need to meet tougher job competition, books that will help you be sure of a job when the war is over—many of them at prices below publisher's prices and any or all of them on five days' trial. Go over this list carefully. Pick out the books you want. Put a circle around the numbers in the coupon. SEND NO MONEY! Cash is not needed when you order. You have five days in which to examine any books you order and decide whether you want to keep them. This is the Wilcox & Follett plan—this is the way to buy books that will help you to better jobs, bigger pay, or a business of your own. Knowledge is power. Here is your opportunity to get it.

SEND NO MONEY

20. **THE STEEL SQUARE.** The only complete book on this basic tool. Invaluable guide in figuring carpentry. Over 300 illustrations. 500 pages. \$1.79.
21. **PLASTICS, PROBLEMS & PROCESSES.** Over 350 pages of latest information on Plastics, origin, kinds, application, designs, etc. \$3.00.
22. **MAKE IT & FIX IT YOURSELF.** 500 page guide book shows how to do all types repair jobs. Make profitable items. Save money. Make money. Edited by Popular Mechanics. \$1.98.
23. **HANDBOOK OF MECHANICAL DESIGN.** A vast fund of engineering data. Covers many practical methods of design procedure not found in ordinary handbooks. \$4.00.
24. **WOOD FINISHING. Plain & Decorative.** Know handling of all stains, colors, materials, mixing—brushing, rubbing, polishing, etc. Get proven formulas, best methods, 360 pages. \$2.00.
25. **SHEET METAL WORKER'S MANUAL.** 15 comprehensive sections cover entire sheet metal industry from drafting to shop execution; welding processes, pattern making, etc. Metals and alloys. Geometry. Useful tables. 552 pages. 375 illustrations. \$2.00.
26. **DRAKE'S CYCLOPEDIA OF RADIO AND ELECTRONICS.** Enlarged, revised, up-to-date reference book. Covers all phases of radio transmission, sound pictures, short wave, television, photo-cells, etc. Complete. Non-technical for the novice, authentic for the engineer. Covers 500 articles. Over 1300 illustrations, tables, graphs. 1000 pages. \$5.00.
27. **PRACTICAL ELECTRICITY AND HOUSE WIRING.** Every type wiring job covered. Every material, equipment, code, system fully explained. 227 illustrations show how to plan installations, alterations; also motors, etc. 200 pages. \$1.50.
28. **CARPENTRY (CRAFT PROBLEMS).** More than 700 illustrations provide working knowledge on all building details. Experts' best methods for measuring, cutting, fitting—all materials. 300 pages. \$2.00.
29. **MODERN HOMECRAFT.** Modern furniture design, construction, finishing, complete. Detailed drawings simplify and insure expert workmanship. 240 pages. \$3.00.
30. **DIESEL ENGINES AND DIESEL ELECTRIC POWER.** Complete, practical instruction on Diesel Engines and power equipment. Easy-to-understand language, illustrated by over 200 helpful illustrations of construction, operation, care, adjustment, etc. 308 pages. \$2.50.
31. **AIRCRAFT POWER PLANT MANUAL.** New comprehensive reference—latest data on all "in-use" aircraft engines and plane operating systems. All you need to know for big pay trouble-shooting, servicing, repairs, overhauling, etc. Has mathematical tables. Over 300 illustrations. Big 760 page textbook. \$4.00.
32. **GENERAL CHEMISTRY.** Third Edition. A well bound 700 page book containing indexed reference to authentic treatise on every subject. Invaluable to chemists, laboratories, manufacturers, students. List \$3.75, our price \$1.98.
33. **MODERN WELDING PRACTICE.** Prepare now for big pay jobs. Newest book on all types welding, heat treatment of metals. 430 pages. 277 illus. by recognized specialists. \$4.00.
34. **TECHNICAL DRAWING.** A comprehensive treatment of the science of technical drawing as required in modern industry today. Contains large variety of practical problems to develop skill. 560 pages. List \$3.00, our price \$1.98.
35. **PRACTICAL RADIO FOR WAR TRAINING.** Train at once for Army, Navy, War plant, serviceman. Be prepared for big pay peacetime job in Radio, Electronic World. Comprehensive book. \$2.95.
36. **AIRCRAFT INSTRUMENTS.** All instruments used by pilot and navigator explained in non-technical terms. Complete manual of operation and maintenance. 200 illustrations. \$1.50.
37. **MILL AND FACTORY.** Book of Tool Care. Invaluable manual covering right and wrong care of tools and equipment. Charts to guide proper tool selection to speed production. \$1.00.
38. **MACHINE SHOP WORK.** Essential to both skilled and apprentice mechanics. 5th new edition, up-to-date, profusely illustrated. Covers use of all hand tools, all power driven tools, slide rule measurement, etc. List \$2.75, our price \$1.98.
39. **THE SHIPBUILDERS' BLUE BOOK.** The second, revised edition—only practical handbook containing information invaluable to shipworkers. Covers 36 vital features. List \$2.50, our price \$1.49.
40. **AUTO BODY AND FENDER WORK.** Get your share of the millions spent keeping old cars in running condition. Tells best, latest repair methods. 232 illust. 325 pages. \$3.00.
41. **AIRCRAFT WELDING** written in non-technical language. Covers tools, materials—weldability of various metals—basic requirements, safety. \$1.50.
42. **AIRCRAFT ENGINES.** Easy-to-understand. All intricacies of all modern aircraft engines, lubrication, fuels, ignition, instruments, etc. clarified by over 200 interesting illust. and explanatory views. \$1.50.
43. **PLUMBING.** Installation and Repair. Expert instruction enables inexperienced to plan and install simple plumbing and hot water systems according to good practice without violation of general regulations. 153 illustrations. 200 pages. \$1.50.
44. **SPRAY PAINTING.** Industrial, Commercial. Learn expert spraying technique for employment in industrial spray booths; interior, exterior decoration, sign shop, studio work. \$1.50.

FREE Big Illustrated Catalog listing over 317 books on machinery, electricity, diesel, mathematics, welding, refrigeration, chemistry, radio, television, navigation, aviation, etc.—ALL AT GUARANTEED SAVINGS. Use Coupon below.

MAIL THIS COUPON TODAY!

Wilcox & Follett Co., Dept. 24, 1255 S. Wabash, Chicago 5, Ill.

Gentlemen: Please send me the books whose numbers I have encircled below. Upon their arrival I will deposit with the postman the price of the books, plus a few cents postage and handling charges. It is understood that I may return any and all books at the end of five days and you will return my deposit. If I keep the books beyond the free examination period, my deposit will be considered payment in full. (Encircle number of books you want.)

1 2 3 4 5 6 7 8 9 10 11 12 13 14 15 16 17 18 19 20 21 22 23 24
25 26 27 28 29 30 31 32 33 34 35 36 37 38 39 40 41 42 43 44

NAME Address
City State

Check here if you enclose remittance with order, in which case we pay postage and handling charge, 5-day return for refund privilege applies.

Please send illustrated catalog listing over 317 Mechanical-Technical books on all subjects—FREE.

WILCOX & FOLLETT CO.
Dept. 24, Chicago 5, Ill.

It's Fun to Draw

A COMPLETE SELF-INSTRUCTION COURSE AND REFERENCE BOOK
with over 1000 "How-to-do-it" SKETCHES AND DRAWINGS
9 Sections—a \$9 Value All for only \$1.00



HERE'S HOW IT'S DONE!

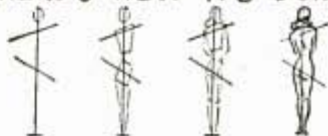

Anyone who has learned to write, can learn to draw! This helpful book removes the mysticism that has surrounded art. By reducing the elements of drawing to its simple steps, it teaches THE BEGINNER to draw, and then takes him by easy, clearly illustrated instructions, into more and more advanced subjects.

As the illustrations show—this complete course covers BRANCHES OF PRACTICAL ART. Each division is explained by a specialist. No previous knowledge on your part is expected. Within a few days, you will be drawing with an ease and enjoyment you never thought possible. For the professional artist, it is a REFERENCE BOOK and veritable mine of information.

This book guides you from the first stroke on paper to selling the finished art work. Includes: specific instruction, advice, tricks, time-savers, special effects, on—Still Life; Animal Anatomy; Human Figure; Faces and Portraits; Advertising and Commercial Art; Cartoons; Animated Cartooning; Advertising and Commercial Art; Illustrations for Newspapers, Magazines, Books; Designing Book Jackets; The Use of Color; etc. Teaches you by sketches, diagrams, and instructions, how to draw—hands, feet, heads, bodies, cats, noses, mouths, eyes—in different positions, of different sexes and ages, and with different perspectives. Shows you how to attach and indicate—Action, Proportion, Balance, Composition, Shading, Rhythm, Symmetry; and how to express: laughter, anger, terror, grief, surprise and other emotions. Also, how to draw caricatures, cartoons and comic drawings. Also how to letter, with 37 COMPLETE ALPHABETS shown. Includes a glossary of Art Terms, Supplies, Types of Work, Mediums, etc. Completely and profusely illustrated with over ONE THOUSAND instructive and Example Drawings, Sketches and Pictures.

Ordinarily a course of this scope costs much more money, but to make it available to everyone seeking a practical knowledge and enjoyment of Art, we have set the special low price of ONLY \$1.00 FOR THE COMPLETE COURSE, NOTHING ELSE TO PAY! This is, undoubtedly, the greatest bargain in the world today! As the supply is limited, we suggest that you write now for this amazing book and value.

Knickerbocker Pub. Co., 120 Greenwich St., Dept. X-82, New York 6, N. Y.

Knickerbocker Pub. Co., Dept. X-82
120 Greenwich St., New York 6, N. Y.

Rush me a copy of "IT'S FUN TO DRAW." If not delighted, I may return book and get my money back.

- I enclose \$1.00 in full payment. Send postpaid.
 Send C.O.D. I will pay postman \$1.00 plus postage.

Name.....

Address.....

City & State.....

ONLY \$1

EXAMINE FREE!

You take absolutely no risk—so mail the coupon NOW!

Merely mail the coupon below. When your copy of *It's Fun to Draw* arrives—read and test it for 5 days. If, after this examination, it hasn't opened up new paths of fun and artistic ability for you—return it, and it won't cost you a single penny. If you decide to keep it, the FULL PRICE is only \$1.00.

OVER 1,000 SKETCHES AND DRAWINGS

It's Fun to DRAW

THE COMPLETE BOOK OF ART INSTRUCTION AND REFERENCE
edited by ALAN D. BOGARD

**WORLD'S
BEST
WANT AD
MEDIUM**

CLASSIFIED Advertisements



Advertisements in this section, 35 cents per word, each insertion, minimum 10 words, payable in advance

To be inserted under proper classification in May issue, copy should be in our office March 8th

May issue on sale April 1st
Popular Mechanics Magazine, 200 East Ontario Street, Chicago, Illinois

Popular Mechanics Magazine,
Chicago, Illinois

Gentlemen: We have experimented with many other advertising mediums but our greatest results have always come from Popular Mechanics. Just as an illustration, one small ad in a recent issue so swamped us with cash orders that we not only exhausted our own supply but that of six affiliated dealers. Now we are busy refunding the cash to our customers.

(Original letter on file in our office)

Sincerely yours,
MEXICAN PRODUCTS

AUTOMOBILES—MIDGET CARS

AUTOMOBILE Books. "Racing photo album" 110 photos, exciting crashes, world's greatest race cars, drivers described, \$1.50. "Saga Roaring Road" 181 pages, 16 pictures, Starter Fred Wagner's early racing experiences with world famous drivers, cars described, read about Rickenbacker, Murphy, Burman, DePalma, Ford "999", Oldfield's Benz \$2.50. Automobile racing book \$1.10. Prices include reprint, illustrations, drawings army Jeep and German BMW war motorcycles. All postpaid. Clymers, 2125 W. Pico, Los Angeles 6, Calif.

PROFESSIONAL Midget racers, motor-scooters, midget cars. Parts, plans. Handbook catalog—50 illustrations, plans—20c. Midwest, 2557 Charlestown, Toledo, Ohio.

AUTOMOBILE Racing book, fifth edition, well illustrated. Instructions on building bodies, frames, engines. Ford A and B conversions. Plans, AAA rules, specifications. Roadster racing, Indianapolis cars. \$1.00 postpaid, \$1.15 C.O.D. Ray Kuns, Dept. 47, Madisonville, Cincinnati, Ohio.

R & R Mfg. Co. New catalogue on speed equipment for cars and boats. \$1.00. Box 546, Anderson, Indiana.

RENEW Car batteries inexpensively. Instructions \$1.00. Popular Service, Racine, Wisconsin.

GASOLINE Saving device, Chevrolet, Ford, 1932-1942. Walert Company, 3429 North 10th Street, Milwaukee 6, Wisconsin.

GARAGE Door opener with dash board control. For overhead, swinging, and sliding doors. No radio or photo-electric apparatus required. Made with simple hand tools. Complete illustrated plans \$1.00. Kaytor Lab's, Lynnwood, Calif.

BURN 120 Octane non-rationed fuels in your car. Save gasoline for the military needs. Gasoline shortage to get worse, be prepared. Easy to build your own unit for your car. Very cheap to operate. Details 25c coin. Behco, Box 55, Hyde Park Station, Los Angeles, Calif.

1944 IGNITION Supercharger \$3.50. Quick starting, mileage, pep. EG Sales Mfg. Co., 60 St. John St., New York.

FLOYD Clymer's Motor Scrapbook. Illustrations, descriptions, history, 200 early automobiles—read about V-8 Chevrolet, 3 cylinder car, Plymouth friction drive, Ford "6", rotary powered car, steamers, electric, foreign cars. Also early motorcycles section. Educational, interesting, surprising. \$1.50 postpaid. Clymers, 2125 W. Pico, Los Angeles 6, Calif.

"EXCUSE My Dust," just out, sensational new early day automobile book, 359 pages, by Bellamy Partridge, author "Country Lawyer." With folder old cars, motorcycles. \$3.00 postpaid. Clymers, 2125 W. Pico, Los Angeles 6, Calif.

AUTO SUPPLIES AND EQUIPMENT

ATTENTION: Run your car on (natural or artificial gas) without alteration to your carburetor or gasoline system. Photo blueprints and literature, giving approximate cost, size of tank, pressure, mileage, instructions, etc. \$1.25. Harner's Machine Shop, 218 - 22nd Street, Dunbar, W. Va.

WHIRLGAS Turbinator, \$3, brings profitable, efficient, economic motor performance by thorough vaporization of carburetor mixture. Refund guarantee. Wrench installs 15 minutes. Give auto make, year. John Hanley, 5719 Loraine, Detroit 8, Mich.

PLATING Outfits for auto parts. Connect to a battery. No tanks used. Free particulars and proofs. Gunmetal Co., Ave. J, Decatur, Ill.

THE Lord is coming! Get guaranteed profits free. Scheall, 263XA, Duluth, Minnesota.

OPERATE Cars, trucks, tractors, motors, with wood or coal gas, 1/2 cost of gasoline. Extensively used in Europe. Complete detailed instructions \$1.00. W. M. Cross, Lone Rock, Wis.

ROBERT Roof's Weldo stops leaks at once in radiators, blocks and cylinder heads \$1.00. Venture gasoline savers for V8 Fords \$3.50. Box 546, Anderson, Ind.

PRESERVE Your tires with plastic. Details free. Betke, Box 699, Borger, Texas.

"EXTRA Miles." How I drive Packard 8, 50 miles for each gallon gas used. You can too. Information and instructions \$1.50. Mechanic's Special, Box 714-1A, San Bruno, Calif.

DUAL Mufflers, California style fit Ford V-8, Mercury. Saves gasoline, increases power, beautiful deep tone. All attachments, pipes, etc. Easy installation. \$30.00 complete. Clymers, 2125 W. Pico, Los Angeles 6, Calif.

USED Parts (guaranteed) all cars. Describe needs fully; immediate reply. Victory, 2439 1/2, Gunnison, Chicago.

CLYMER DeLuxe chromed spotlight for automobiles, motorcycles, boats, hunters. Trigger switch, pistol grip handle, powerful beam, 32 cp., operates off any 6-8 automobile battery. Only few left, hurry. \$8.50 postpaid. Clymers, 2125 W. Pico, Los Angeles 6, Calif.

AUTO TRAILERS

BUILD YOUR OWN trailer! Plans \$1.00 each. House, sport, camp and utility models. Catalog 10c. Jim Dandy, Box 125-A, Wausau, Wisconsin.

MOTORCYCLES, BICYCLES, MOTOR-SCOOTERS AND SUPPLIES

"MODERN Motorcycle Mechanics," 436 pages, 200 illustrations. Extensively covers—operating, maintenance, complete re-conditioning, American and British motorcycles. Invaluable to motorcycle riders or mechanics. \$2.50 postpaid. Nicholson Brothers, Saskatoon, Canada.

ATTENTION Motorcycle owners, 1944 publication covering trouble saving tips on Indian and Harley Davidson motorcycles. Full line of new and used Indian parts. Large supply Harley Davidson parts new and used. Price 25c a copy. Copy price refunded on first order of \$2.00 or more. Preston Motors, Inc., Kendallville, Ind.

HARLEY-DAVIDSON 24 h.p. twin 45 motors. Perfect condition. \$85.00 and up. Latest design. Used to power farm equipment, ice sleds, midget cars, etc. Used Harley-Davidson parts. Send 25c for bulletin and 45 service manual. Knuth's, 2491 Fondulac, 6, Milwaukee, Wis.

WHEELS And tires—General utility 10x275 wheel and tire, ballbearing, semi-solid, pre-war rubber, \$8.95. Send dime for list. Cycle Transport Co., 1241 S. Michigan Ave., Chicago 5, Ill.

MAKE Your old high pressure bike a Victory model. Mail hubs. We will build up two wheels complete with tires and tubes, mounted for \$11.00. United States only. Pulver's Sporting Goods, Hudson, N. Y.

BUILD 5 Different scooters, 3 wheels side by side. Midget, trailer, unicy, air-cooled engine, etc. Large manual \$1.00. Illustrated circular 10c. Craftmann Books, Box 1153-MP, Milwaukee, Wis.

MOTORS Rebuilt. Large parts stock. Used motorcycle catalog 15c. Indian Motorcycle Sales, Kansas City 1, Mo.

BUILD A Velocar (pedal car). Dime for illustrated literature. Velocar Reg'd, 1643 Bourbonniere, Montreal, Canada.

PLANS, Scale drawings, specifications, illustrations for building attractive motor scooter complete \$2.00; plans electrically driven bicycle \$1.50. Postpaid. Clymers, 2125 W. Pico, Los Angeles 6, Calif.

24, 26 X 2.125, 26 X 1.375 TIRES \$2.50. Tubes \$1.50 postpaid. U. S. only. Pulver's Sporting Goods, Hudson, N. Y.

MOTORCYCLE Parts, new and used. List 10c. Balliak, 811 N. 9th, St. Louis 1, Mo.

BOOKS! "Modern Motorcycle Mechanics and Speed Tuning," 435 pages maintenance Harley, Indian, Villiers, all British motorcycles \$2.50; with drawings, specifications, illustrations U. S. Army Jeep, German BMW war motorcycles \$3.00; "Motorcyclist's Workshop" \$1.50; "Two Stroke Motorcycles" \$1.50; "Motorcycles—How Manage Them" \$1.50; "Speed—How to Obtain It" \$1.50; "Historical Motorcycling Facts" \$1.00; "Automobile Racing" \$1.10; Motorcycle instruction manual "question-answers" \$1.10. All postpaid. Clymers, 2125 W. Pico, Los Angeles 6, Calif.

SAVE Gasoline, build a motorbike now, send 25c for complete plans. Motorbike Service, 2108 McLean, New Albany, Ind.

BOOK "Speed—How to Obtain It," 160 pages, illustrated, instructions, cams, balance, timing, valves, pistons, racing technique. World's greatest speed tuning book. \$1.50 postpaid. Clymers, 2125 W. Pico, Los Angeles 6, Calif.

SEND 10c For Handbook of Information, Lists new parts and accessories for Indian, Harley, Boots, 622 East Grand, Des Moines, Iowa.

ENGLISH Motorcycle magazine, Illustrations, descriptions British makes, past, future, war models. Interesting, educational. Published weekly, \$10.00 year, \$5.50 six months. Sample copy 50 cents postpaid. Clymers, 2125 W. Pico, Los Angeles 6, Calif.

LARGE Stock of Indian 45 and 74 late model engines, cylinders, wheels, side-cars, transmissions, pillion seats, etc., etc. Parts are used but in excellent condition. Big discounts off American list prices. Extra discounts to dealers. Levy Auto Parts Company, 735 Queen St. W., Toronto, Ontario.

BOYS: "All bicycle repair secrets revealed." Bicycle repair manual, 65c. R. G. Klausner, Sheboyville, Ill.

FLOYD Clymer's Motor Scrapbook. Illustrations, early advertising, motorcycle scooter history. Pierce "4", Thomas, Yale, Merkel, Indian, Harley, Marsh, Columbia, Reading, Thor, steam motorcycle, many others. Illustrated descriptive section 200 early makes automobiles in same book. \$1.50 postpaid. Clymers, 2125 W. Pico, Los Angeles 6, Calif.

MOTORCYCLISTS — New and used parts, accessories, all models. Catalog 10c. Henderson catalog 10c additional. Triangle, 2157 Harrison, Chicago.

PISTONS, Parts, accessories, chain all motorcycles. McCann's, 2104 Texas Street, El Paso, Texas.

"MOTORCYCLES — How to Manage Them," 260 pages, 175 illustrations, drawings. Read it, become a better motorcyclist. Expertly written. \$1.50 postpaid. Clymers, 2125 W. Pico, Los Angeles 6, Calif.

MOTORCYCLES, Scooters and parts. No priority needed. Gaylor Motors, 5950 Sunset, Hollywood, 28, California.

MIDGET Racer \$65 crated; motors \$5 up. Wheels, tires, parts. Send 25c for Bargain Directory. Midget Motors Directory, Athens, Ohio.

100 MILES Gallon! Motor-scooters, motorcycles, Whizzer bicycle engines, midget automobiles, gasoline engines. No priority necessary. Catalog 10c. Clymers, 2125 W. Pico, Los Angeles 6, Calif.

COMPLETE Plans, drawings, specifications to build electric motorbike for \$1.00. Mowery, Box 994, Lancaster, Penna.

AVIATION

NEW Lightplane manual. Sportplane manual, lightplane blueprints, etc. Circulars 20c. Craftsman Books, Box 1153PM, Milwaukee 1, Wis.

AIRPLANES. Motors, crackups, salvage. Send 25c for new Spring War-Bargain Directory just out. Used Aircraft Directory, Athens, Ohio.

NEW Army summer flying khaki helmets, chin pads, ear pads, goggles holders postpaid \$1.00. Marvin Northrop Aeroplane Company, Minneapolis 1, Minnesota.

ELECTRICAL SUPPLIES, EQUIPMENT

FIBRE-BAKELITE Washers, strips, small pieces large assortment for insulation. Ideal for electricians, radio mechanics, hobby workshops. Over 1000 pieces. Satisfaction guaranteed. Special \$1.98. Limited supply. Order now. Widran Distributors, A224 West Hubbard, Chicago.

WORLD'S Fair lights—Mercury quartz arc lights—400 watt, 220 volt ac complete with base, socket, reflector; built approximately 2x8 inches; each \$16. Mazda spot lights, 1500 watt, 110 volt, complete \$9 each. 1/2 inch electric cellonoid valves, weight 13 pounds bronze, normally closed; 50 pound pressure, 110 volt; price \$12.00—1 1/4 inch valve as above, 40 pounds, \$25 each. Bodine 3 phase synchronized back geared motors. Brown, 144-15—20th Avenue, Whitestone, Long Island.

ELECTRIC Pencil: Writes-engraves all metals. \$1.00 postpaid. Beyer Mfg., 4515-H Cottage Grove, Chicago 15.

FOR Motors, welders, generators, other electrical items. Write LeJay Mfg., 847 LeJay Building, Minneapolis, Minn.

BLOWERS, Exhaust fans, evaporative cooler parts, plumbing, automatic heating supplies. Biggs Supply, Lincoln, Nebr.

RELIGHT And use burned-out fluorescent tubes indefinitely. Easy to do. Complete information \$1.00. Research Lab., 2414-S-8th St., Council Bluffs, Ia.

WELDING, SOLDERING, PLATING

BUILD Small, medium or large a.c. arc-welder. Operate from power line. Plans \$1.00 each. Welder's Club, AB-3432, Chicago 54.

NEW Welding rod for aluminum, die cast. Generous sample, instruction 25c. Homawks, 2417-A North Ashland, Chicago.

BUILD D.C. Arcwelder without rewinding armature. Plans \$1.00 each. 25 to 600 amperes from vehicle d.c. motors, light plant generators, automobile starter-generators. Welders Club, AB-3432, Chicago 54.

WELDING, Cutting, aircraft welding and soldering equipment. Electric arc welders. Superior Oxy-Acetylene Co., Hamilton, Ohio.

ARC Welders wanted by the thousands. Learn with 516 page lessons manual. Over 500 how-to-do-it photos. \$2.00 copy. Money-back guarantee. Hobartweld, Box M-1634, Troy, Ohio.

SLIGHTLY Used arc welders. Recommended by R.E.A. Guaranteed. Forney Mfg. Co., Fort Collins, Colo.

NEW Model electric welder 110 volt a.c.-d.c.; will weld all metals; easy to use; full directions. Complete with power unit, flame and metallic arc attachments, carbons, fluxes, rods, mask; all for \$19.95. Used by the navy. Magic Welder Mfg. Co., 193-MP Center St., New York City.

USED Arc welders \$7.50 up. Prazee, Box 5086, San Francisco, Calif.

SUPER Welder—For home, farm, factory. Makes even beginner an expert. Scientifically constructed. Fully equipped with carbons, rods, flutes, mask. Complete directions. Operates on 110 volts, ac or dc. No special wiring needed. Guaranteed. \$18.45. Save 2%, send check with order. Super Welder Manufacturing Co., Dept. A, 23 East 20 St., New York 3, N. Y.

MACHINERY, TOOLS AND SUPPLIES

SCREWS, Nuts, bolts, washers, rivets, brackets, etc. Handy assortment for mechanics, garages, household use, workshops. Over 1000 pieces, 5 full pounds. Satisfaction guaranteed. Special \$1.98. Limited supply. Order now. Widran Distributors, A212 West Hubbard, Chicago.

CONCRETE Building block machines and molds. Easy payments. Catalog free. Concrete Machine Co., 5129 South Compton Ave., St. Louis, Mo.

GRIND Drills like factory; attachment for bench grinder. Cheap. Factory, 811-B East 31, Kansas City, Mo.

"POCKET Rule"—(Stainless steel) with depth gauge, pocket clip and decimal equivalents. Divided in 32 and 64. Price \$1.00 including free scriber. Layout Tool Service, 170 Wyndale Road, Rochester, N. Y.

STEEL Beam trammels for draftsmen, engineers, mechanics. Circular free. Clair Company, Box 92M, Blythebourne Station, Brooklyn, N. Y.

BUILD Your tractor from second-hand automobiles. Convert your horse drawn farm equipment into tractor drawn equipment. Nolan's Garage, East Warcham, Mass.

NEW Caliper, direct reading, speeds up defense work, cheap. Free illustrated circular. Factory, 811-G East 31st, Kansas City, Mo.

OPEN Your garage door from dash board. Look under "Automobiles."

YOU Can build shapers, mills, vises, drill presses and many other useful shop tools from Lewis castings, materials and blueprints—at savings up to 80% of new tool cost. Catalog sent on receipt of 10c covering mailing cost gives details on 23 Lewis tools. Write Lewis Machine Tool Company Box 118, Station A, Dept. M-39, Los Angeles 31, California.

PNEUMATIC 1/4 inch drill. You make it in two hours. Costs under \$10. Further information free. Rohde, 1575 Galena St., Denver 8, Colo.

NEW Tool grinder sharpens lathe tools, slitting saws, milling and keyway cutters, wood tools and other small tools to any degree or angle. Circular and price on request. Factory, 811-G East 31st, Kansas City, Mo.

GEARS—Micarta silent bakelite. Prompt delivery. Write for quotation. Greaves Machine Tool Company, Cincinnati 2, O.

ARC Welder, make it yourself for less than \$1, in thirty minutes out of available scrap. Learn welding for profit. Amazing discovery guaranteed to weld. No toy; works on house or farm electricity. Mail us \$1 for complete directions to make and operate. "Imasco" Sales Corporation, 6347 Parnell, Chicago, Illinois.

TWIN-CYLINDER Air compressors \$13.75. Motors—various sizes. Hoffman, 2740 Coy, Cincinnati 19, Ohio.

ATTACHMENT, Grind drills any twist, in long, short and 59° angles, like factory, guaranteed, \$2.95 prepaid. Factory, 1512 West Slauson, Los Angeles 44, Calif.

INDEX Heads for sale. Very inexpensive. Sixty-two different divisions. Used on small lathes, drill press, milling machines, etc. Make gears, hobbs, cutters, etc. Very accurate, and durable. Not a toy. Used by defense schools and hobbyists. Write for free folder. Long's Index Heads, 2117 East B St., Torrington, Wyo.

STEEL Wire wheel brushes \$2.50. McCann's, 2104 Texas Street, El Paso, Texas.

MICROMETERS New 0-1" \$3.95; 1-2" \$7.95; 2-3" \$9.95; 3-4" \$10.95. Reading in 1/1000". Precision. Guaranteed. C.O.D. plus postage. Cash orders prepaid. Examine five days. If unsatisfactory return for full refund. Wendler Co., Dept. 12, Fremont, Ohio.

MACHINISTS Tool chests at bargain prices. List free. Cepuder, 3602 Wesley, Berwyn, Ill.

DRILL Grinding attachment \$5.95. E. Z. Mfg., 327 California, Burbank, Calif.

BOATS, OUTBOARD MOTORS

MARINE Power—Easily convert any Ford motor (domestic and foreign) with Osco parts and kits. Complete catalogue 25c (coin). Osco Motors Corp., 2020 East Orleans Street, Dept. M, Philadelphia 34, Penna.

USED Outboard motor parts. Outboard Exchange, 1194 Remsen Ave., Brooklyn, 12, N. Y.

FULL Size, cut to shape boat patterns, blueprints. 7 1/2 - 38 feet. Illustrated "Build a Boat" catalog, 10c (coin). "How to Build Boats" book, \$1.00. Cleveland Boat Blueprints Co., Station A-66, Cleveland, Ohio.

OUTBOARDS — Save 1/2. Good used parts, all makes and models. Bargains re-built motors. Crandall Hicks Co., 959 Commonwealth, Boston, Mass.

MAKE 16" Rowboat. Blueprint, 30c. Wesho-Uco, Box 51, Detroit, Mich.

TEN Plywood boat plans 50c. Catalog boat building plans 10c. The Rudder, 15 Murray Street, New York.

BOAT Designers are highly paid professionals. Complete course by mail. Catalog. Westlawn, Montville, N. J.

ENGINES, MOTORS, DYNAMOS

AUTHORIZED By W.P.B. to sell inventory of a.c. and d.c. midget motors—Both geared 4 r.p.m. Shaft speed 1250 r.p.m. 110 volts. Ideal for timing devices, displays, models. Bargain price a.c. motor \$2.00, prepaid. Length 3", height 2 1/2", width 2 1/2" d.c. \$3.00 prepaid. Length 5 1/2", height 2 1/2", width 3". McLaren Products Company, 114 N. W. First Street, Evansville 8, Indiana.

CONTROL Motors for intermittent duty. Brand new. Nationally known. 1/50 h.p., 24-32 volts, 60-cycle a.c., 1,200 r.p.m. \$1.78 each postpaid. Lots of 6, \$1.48 each postpaid. Ideal for experimenters and inventors. Troysales, Box 562, Minneapolis, Minn.

BIG Pay jobs in welding. Complete welding lessons and reference books, 516 pages, 41 lessons, \$2.00 copy. Money-back guarantee. Hobartweld, Box 1635-M, Troy, Ohio.

WINDING Data, 225 motors, single and three phase, \$1.00. Motor Data Co., Box 7631 Kansas City 3, Mo.

GASOLINE And Diesel engines, power units, generators, new and re-conditioned electric lighting systems. Kohler and other makes. H. Lesley Philips, Glenmoore, (Chester Co.), Penna.

ATHLETIC EQUIPMENT—BODY BUILDING COURSES

BAR-BELLS, Exercise equipment, courses, special offers! Free booklet. Good Barbell Co., 3261-PM Watson Rd., St. Louis (9), Mo.

PHYSICAL Perfection course \$1.00. 1000 strong men. Sid's System, DPMM Southgate, California.

SUPER Ju-Jitsu—lightning defense and attack system. Sensational new home study course now ready! Learn to lick brutes twice your size with only your bare hands. Free details. Nelson Co., Dept. 508, Chicago.

STREAMLINED System — rugged strength—quick easy results. \$3 course. Jim Burke, 244 Riverdale, Toronto, Ontario.

SUPER System of natural physical training. Free booklet. Harry Good, 3261-PM Watson Road, St. Louis (9), Mo.

SPORTING GOODS, GUNS, FISHING TACKLE, ARCHERY, TRAPPING

ARCHERY Equipment: Catalogue free. Mid-West Archery, 2209-A East 75th, Chicago 49.

BOWS—Arrows for recreation, hunting, fishing. Beautiful archery instruction book, 90 pages, 50 illustrations, only 50c. Illustrated catalogue free. Archery Sales Service, 617 South State, Chicago.

SNOWSHOES: Immediate delivery, re-lacing also. Send card for sizes available. Howe Fur Company, Coopers Mills, Maine.

FISHING By moon aspects, 1944 moon chart with formula 35c. WEZ Planetarium, Box 558-F, La Jolla, Calif.

ELEVEN Good box traps, Complete blueprints, 30c. Wesho-Uco, Box 51, Detroit, Mich.

GUNS Reblued, plated, repaired. Nickel guns blued. Bluing material. Gunblu, 322M Plant, Tampa, Fla.

"WILLIE-KETCHMORE"—"44" Tackle- kit "hit" \$1.00. Comiepak, Black River Falls, Wis.

THE Lord is coming! Get guaranteed proofs free. Scheall, 263XS, Duluth, Minnesota.

TRAP Pheasants alive. Trap blueprints, 30c. Wesho-Uco, Box 51, Detroit, Mich.

CANTEENS, Army regulation, stainless steel, \$1.50 prepaid. Stark, 517 Roscoe St., Chicago 13, Illinois.

"HANDARMS," "Shotguns," "rifles," with ammunition. Guaranteed N.R.A. descriptions. List 10c. Rudolph's, Atchison, Kansas.

SEND 10c For list 100 used guns. Frayseth's, Willmar, Minnesota.

SPORT Fishing Guide. Complete fishing information. Just out. 25c. Sport Fisherman, 670 E. 42, Brooklyn, N. Y.

"HOW To Mount Fish as a Hobby." \$1.00. Lewis Enholm, Wellston, Mass.

MAKE Landing nets, turtle traps, live bags, hammocks. Patented shuttle and book 50c. Netcraft, Dept. A, Toledo, Ohio.

UNITED States navy jungle machetes, 22" blade, 27" overall, ideal for woodsmen, farmers, etc. Brand new \$4.95. We also stock jungle hunting knives in 5, 6, 7, and 8" blade lengths. Beikirch's Hardware, 755 Winton Rd. N., Rochester 9, N. Y.

PEACE From mosquitoes, gnats, flies, using black Turlatane headnets, hatbrim to chest \$1.75, to collar \$1.50, of green turlatane \$1.25. White gauze cot canopy \$2.75, all postpaid. Folder wanted? Cope Mfg. Co., 3726 North Tenth Street, Philadelphia, Penna.

COMPLETE Archery catalog free. 3 booklets 35c. Bullseye, Channing, Mich.

ANTIQUES, RELICS, INDIAN GOODS, CURIOS

INDIAN Relics, coins, bills, gems, crystals, curios, etc. Illustrated catalog 5c. 100 ancient arrowheads \$3.00. H. Daniel, Hot Springs, Ark.

25 GENUINE Indian arrowheads, \$1.00. Catalog. Geo. Holder, Glenwood, Ark.

MUSEUM Material 25 pounds \$5.00 f.o.b. Catalogue 25c. Museum Supplies, 6601 Oshkosh, Chicago, Illinois.

MINERALS, Coins, stamps, Indian relics, pistols, old glass. Catalogue 5c. Vernon P. Lemley, Las Cruces, New Mexico.

INDIAN Relics, beadwork, coins, curios, minerals, old glass. Catalog 6c. Indian Museum, Osborne, Kansas.

BENJAMIN Franklin authenticated page, printed 1742, 50c. Burnett, 88 Garfield Ave., Providence 8, Rhode Island.

FIVE Stoneage Indian tools 50c. Catalog 5c. Sistershop, Northbranch, Kansas.

1944 ANTIQUE Firearms catalog, 25c. House of Guns, Belleville 9, N. J.

SPEARHEAD, Birdpoint, 5 arrowheads and 50 grave beads, \$1.00. Paul Summers, Stamford, Texas.

ANCIENT Stone tomahawk 50c. 10 tiny bird arrowheads \$1.00. List free. Lear's, Glenwood, Arkansas.

SWORDS, Rapiers, daggers, pistols, armor, illustrated catalog 25c. Robert Abels, 860-A Lexington Ave., New York.

ANTIQUES, Firearms, swords, daggers, powderhorns, china glass, prints, silver. Lists free. Antique Shop, 8 South 18th, Philadelphia, Penna.

FIELD GLASSES, TELESCOPES, MICROSCOPES

MAGNIFIER. Powerful folding pocket magnifier, in handsome case. Has scientifically ground $1\frac{1}{2}$ " reading and magnifying lens. Only \$1.00 postpaid. Utica Mail Order Co., 923 Eagle St., Utica, New York.

BINOCULARS. Field glasses, watches. Buy, sell. Paul Schaefer, Donnellson, Ia.

EYEGLASSES, Special offer. Free price list. Write, Henry Lighter, 208 West 23rd St., New York.

ASTRONOMICAL Telescopes, binoculars, cameras, microscopes; bought, sold, repaired. Send 10c for list of instruments desired. Rasmussen, Box 294, Amsterdam, N. Y.

OVER 15 Years—buying, selling, exchanging microscopes, accessories, research, industrial, amateur. National Scientific Instrument Co., 119 Chambers St., New York City 7.

LENSES For 100 power astronomical telescope \$1.00. Instructions 10c. A. Jamer, Manorville, N. Y.

MICROSCOPES, Telescopes, binoculars; all scientific, chemical, laboratory apparatus—bought, exchanged. Exclusively our business for fifteen years. Not get-rich-quick speculators. Trial will show that we know apparatus; highest prices paid. Harry Ross, 64 West Broadway, New York.

MICROSCOPES, Scientific laboratory equipment—bought, sold, repaired, exchanged. Catalog 10c. George Klein, 225 Fifth Avenue, New York.

DOGS, PETS, BIRDS, RABBITS

FANCY And utility pigeons—Catalog 3c. William Howe, Princeton, Illinois.

MICE, Rabbits, pigeons, Catalogue list 10c. Houck's Company, Tiffin, Ohio.

WILD Geese, ducks, peafowl, pheasants, pigeons, rabbits. Prices free. Will buy surplus stock. Jewel Game Farm, Danville, Ill.

COCKER Spaniels: Expect litter of fine cockers. Good parentage. Reasonable. Write for information. D. Alkon, 310 West 95th St., New York City 25.

RACING Pigeons. Finest pedigreed stock, reasonable. King Lofts, Hayward, Calif.

ST. BERNARD Puppies. Champion sired beauties. Franklin Young, R4, Riverhead, Long Island, New York.

PUPPIES, Also supplies, what do you need? Books colored pictures, descriptions 108 recognized breeds, 35c. Royal Kennels, Chazy, N. Y.

RABBITS: Flemish Giants, New Zealand. Reasonably priced. Franklin Young, Riverhead, Long Island, New York.

HELP National defense by producing meat in your back yard raising domestic rabbits. Old and young can do it. Send 25c for booklet and literature to Dept. G. American Rabbit and Cavy Breeders Ass'n, Colorado Springs, Colo.

RAISE Your own meat—also make money raising pigeons. Booklet dime. Gebhardt Farm, Muscatine, Iowa.

MOST Beautiful fur. Small investment. Large profit. Free illustrated booklet. Willow Brook Farm, R. D. 15, Sellersville, Penna.

BIRD Fanciers. American Canary Magazine Monthly. Year's subscription \$2.00. 2839-P N. Halsted St., Chicago 14, Ill.

RAISE Rabbits for profit. Magazine puts you in touch with markets. Copy 10c. Booklet describing twenty breeds, and magazine for three months 25c. Address: Small Stock Farmer, Dept. 3, Pearl River, N. Y.

MAKE Money at home raising guinea pigs. Booklet free. Taylors Guinea Pig Farm, Hapeville, Georgia.

MONEY Raising rabbits. Investigate. Folder 10c. Close Rabbitry, Tiffin, Ohio.

RAISE Highly profitable Angora rabbits. Multiply fast. Wool \$8.50 pound. Plenty markets. Particulars free. White's Rabbitry, Marion, Ohio.

RAISE Jumbo bull frogs, prices free. Fish Culturist new paper, 25 cts. Vol Brashears, Berryville, Arkansas.

PIGEON Bargains! Genuine racing homers! \$2.50 pair—6 pairs \$12.00. Morris Farm, Batavia, Ill.

PARRAKEETS — Love birds \$1.00. Finches, birds, tame rabbits \$1.00. Paul Dueterhoeft, Westfield, Wis.

SEEDS AND NURSERY STOCK

PEONY Plants, pink 69c, 3—\$1.00. Cactus catalog 10c. Robinsons, San Pablo, Calif.

FARMS, FARM LANDS, REAL ESTATE

EQUIPPED 160-Acre North Central Arkansas farm, 3 houses, only \$2,750! County road, $\frac{3}{4}$ mile school, church, $4\frac{1}{2}$ to depot town; 93 tillable, 33 cultivated, 10 lespedeza, balance woodland pasture with wells and branch, wire fencing, plenty firewood, 60 peach trees, 12 apples, plums; good 6-room house, fireplace, well, oak-shaded yard, scenic views, good 40-ft. barn, poultry buildings, two 2-room fair tenant houses; opportunity bargain, \$2,750 with 4 milk cows, heifer, 3 bulls, sow, 10 pigs, 150 chickens, team, farming equipment, all crops time of sale included! Details page 42 free winter catalog 7 states. United Farm Agency, 7-MP South Dearborn, Chicago 3, Ill.

CANADIAN Tax sale lands for a dollar an acre and up. Small monthly payments. Farms, timber, hunting and fishing camps, minerals. Limited number of properties. Write at once for free catalogue. Tax Sale Service, Room 613, 72 Queen St., W., Toronto, Canada.

\$4.00 MONTHLY Buys 40 acres, near town; price \$150.00. Free list. Box 425-P, Carthage, Mo.

40 ACRES, Near White River, unimproved; poultry land. \$190, \$5 down, \$5 monthly. Free list and literature. Hubbard, 216 Grossman Bldg., Kansas City, Kans.

ORLANDO, Florida, 5 acres on paved highway. Good fruit and vegetable land; easy terms; free booklet. Dept. 10, Interstate Development Co., Orlando, Florida.

GOVERNMENT Land \$1.00 acre up. Information all states 25c. National Tax Service, 1037A Majestic Bldg., Detroit.

SEE The Highlands of Louisiana where winter brings no idle acres. Choice cut-over land at low prices with terms. Send for descriptive book without obligation. Long-Bell Farm Land Corporation, 896 R. A. Long Bldg., Kansas City, Mo.

GOOD Farm bargains. Washington, Minnesota, Montana, Idaho, Oregon, North Dakota. Dependable crops, favorable climate. Write for literature, lists describing typical farms. Specify which state. J. W. Haw, 119 Northern Pacific Ry., St. Paul, Minn.

WISCONSIN, Minnesota lake frontage \$7 acre! 2662A Rutherford, Hollywood 28, Calif.

OBTAIN Free fertile South-American lands yielding four annual crops, tropical fruits, rubber, livestock. Send 25c for three illustrated booklets, 26,000 words valuable information. Valles, 311 Church Street, New York 13.

FARM Catalog mailed free. Hundreds of bargains New York, Connecticut, New Jersey and 21 other states Maine to Florida, west to Texas, Calif. and Oregon. Strout Realty, 256-P 4th Ave., New York 10, N. Y.

OZARK Land; \$3 acre; terms. Williams Realty, Mt. Vernon, Ill.

FARM MACHINERY AND SUPPLIES

INTERNATIONAL Electric fence far superior, more effective and reliable. Quickly pays for itself. Repairs for all makes of electric fences. Dealers wanted. International Electric Fence Co., 910 Van Buren St., Chicago, Illinois.

BUILD This new attachment for your wheel hoe from easily obtainable new or used parts found on every farm. Fast and easily operated. Sure death to weeds. Beats anything on the market. Full directions, 25 cents. C. Hartman, Joppa, Md.

POULTRY, FARM SUPPLIES

100 CHICKS \$4.75—200 \$9.00 postpaid. Empire Hatchery, Seward, N. Y.

CHICKS—Heavy Red cockerels, \$8.50 per 100, Leghorns, \$3.95. Pure breeds, cross breeds. Sexed, non-sexed. Write for folder, prices. Amstutz Hatcheries, Box 43, Orrville, Ohio.

"BETTER AAAA chicks low as \$3.95. 30 breeds, strong, growing live delivery. Prepaid. Shanks Poultry, Clyde, Texas.

RAISE Turkeys the new way. Write for free information explaining how to make up to \$3000.00 in your own back yard. Address National Turkey Institute, Dept. 3, Columbus, Kansas.

KNOW How to raise poultry for profit. Read Northeastern Poultryman. Every issue packed with helpful hints and practical suggestions. Latest articles on breeding, feeding, and management. Read nationally. Subscribe now 1 year 65c; 2 years \$1.00. Northeastern Poultryman, 4M Park St., Boston 8, Mass.

BABY Chicks, champion mated. 52 varieties, 7 hybrids, licensed inspected, blood-tested. Rush postal, large colored brood, low prices. Berry's Farm, Route 12, Clarinda, Iowa.

YOUR Greatest poultry problem will look simple when you read American Poultry Journal regularly. 500,000 poultrymen do, why not you? Only 25c year, 5 years \$1.00. American Poultry Journal, 535 S. Clark, Chicago.

1 EXTRA Egg pays for a copy! Magazine gives modern guidance. Subscribe! One year 25c; 5 years, \$1.00. Poultry Tribune, Dept. 151, Mount Morris, Ill.

PROFITABLE OCCUPATIONS

MECHANICALLY Inclined men — Own and operate general appliance repair shop. Complete, illustrated course shows you how. Welding, refrigeration, motor repair, how to get business, etc., all phases covered. Free literature. Christy Supply Dept. 439, 2835 N. Central Ave., Chicago.

"SOILLESS Gardening"—Grow abundant vegetables and flowers anywhere. Profitable fun. Complete guide \$2 postpaid. Wellersdick, Box 303, Thomaston, Conn.

SIGNS Made easily. Instructions and ten sets modern alphabets; numerals patterns up to 8 in., \$1.00. Samples 20 cents with catalog of many additional income plans. Co-Operative, Box 638, Chicago.

LEARN Refrigeration service. Open your own shop. Complete illustrated course reasonable. Small capital required. Free booklet. Mechanics School, Dept. PM3, 4701 West Pico, Los Angeles 6.

ANNOUNCING New home study course in commercial baking. Good field. Nearly depression proof. Common school education sufficient. Send for free booklet "Opportunities in the Baking Industry" and requirements. National Baking School, 1315 Michigan, Dept. 3432, Chicago.

LOCKSMITHING Course—Practical inexpensive lessons for handy men. Just out! Fit keys, pick locks, de-code, make masterkeys. Satisfaction guaranteed. Send for free details. Nelson Co., Dept. 708, Chicago.

\$40.00 WEEKLY, Made growing mushrooms, fresh, dried, Dominion patent 331583. Free spawn. North American, 169P Yonge, Toronto, Canada.

PEN Raised for animal. Reproduces 7 every 19 weeks. Fur worth \$7.00. Disease free. Eats hay, grain, vegetables. Flesh edible. Young sell \$75.00 pair. Complete details \$1.00. Will Tysen, Glenns Ferry, Idaho.

DON'T Worry about meat rationing! Raise rabbits! It's easy! Multiply rapidly. A treat to eat. Send for free illustrated booklet. Dr. Frank M. Baddour, Box B, Lebanon, Tenn.

WELDING Phys. Learn with 1942 trade school text manual. 516 pages. Over 500 photos. \$2.00 copy. Money-back guarantee. Hobartweid, Box 14-1633, Troy, Ohio.

UPHOLSTER And can chairs. Complete instructions \$1.00. Box 179, Mystic, Conn.

RAISE Angora rabbits—Wool brings \$8.00 pound. Particulars free. Grinstead's, Edwardsville, Illinois.

MUSHROOMS Grown in boxes, instructions 25c. Spawn \$1.00. Gordons, 553 William, Winnipeg, Canada.

STANDARD Rabbit Journal, Milton, Pa. 3 years \$1.00, sample dime.

BOOKS, PERIODICALS, PICTURES, POSTCARDS

WESTERN True tales and rare pictures fill the 32 pages of this magazine published here on the farm at Knott's Berry Place famed for introducing the Boysenberry and the chicken dinner enjoyed by millions. Here in Ghost Town thousands find interest in this replica of the old gold towns and are thrilled with the famous oil painting "Courage." A 4-color picture of this painting (suitable for framing) depicting the covered wagon train of '68 crossing the desert, sample copy and 36-page illustrated souvenir of Ghost Town and story of this roadside inn—all three postpaid, 25 cents, coin or stamps. Address Ghost Town News 11, Buena Park, Calif.

REBINDING We bind magazines, old books, Bibles, hymnals. Heckman Bindery, Dept. D, North Manchester, Indiana.

MAGAZINES—Business, vocational, diversion. Current single copies only. Choose from 566 different publications, covering advertising, aviation, automotive, building, electrical, health, insurance, live stock, music, photography, plumbing, printing, radio, refrigeration, sports, watchmaking and more than 150 other fields. List with prices free. Commercial Engraving Publishing Co., 34C North Ritter, Indianapolis 1, Indiana.

SELF-EXPLAINING Bible: Illustrated circular free. Box 446-P, Minneapolis, Minn.

HELPPFUL Books for your trade, hobby or business. Lists on any subject free. Helpful Book League, 1239 Broadway, New York 1, N. Y.

PICTURE Post cards produced from your photograph. For hotels, camps, resorts. 4154a Fifth Street, Philadelphia 40.

3 LARGE Mailorder magazines 10c. Lucas, 70 Josephine, Detroit 2, Michigan.

"PIN-UPS," 180 Gorgeous girl subjects! Huge bargain pack \$1.00. Clover Novelty Company, Dept. 32-DD, Hollis 7, N. Y.

GLAMOUR Girl pictures. Size 3 1/2 x 4. Dozen 25c coin. Curtis Specialties, Box 1916, Denver, Colorado.

BOOK Bargains: buy, sell, exchange. Free catalog. What have you got to sell us? Co-operative Service, P.O. Box 638, Chicago.

BOOKS, (Out-of-print, new, used) quickly supplied. Many 35c bargains. Catalogue. T. Jamkowski, 18870 Marx Ave., Detroit 3, Mich.

DRUNKENNESS Is a disease which responds to treatment. Medical skill plus human sympathy prove successful with liquor and drug cases. 60 years experience. Write for free booklet. P. M. Nelson, The Keeley Institute, Dwight, Ill.

"THE Fun Book"—\$1.00. Circular free. Mag. 2385 Castle, Cleveland 13, Ohio.

64 ART Cards of gorgeous beauties \$1.00. Reed Novelty, Dept. PM-1, Box 24, Queens Village 9, N. Y.

20 THRILLING "Pin-up" beauties from original Hollywood photos (exclusive release) \$1.00. Libman Co., Dept. P4, Box 7833, Del Valle Sta., Los Angeles.

A RATIONAL View of Life—\$1.00. Benjamin Seibert, Urbana, Ohio.

BOOKS—Write us your wants. Chapbooks, 6 Girard, Rochester 10, N. Y.

BIG Bargain book catalog free. Cavalier, 5448 Stanton, Pittsburgh 6, Penna.

GET Your copy now of the never forgettable book "I am an American." Sent postpaid 25c. Manville, Box 1873 PM, Atlanta 1, Ga.

3 LARGE Mailorder magazines 10c. Lucas, 70 Josephine, Detroit 2, Michigan.

FLOYD Clymer's "Motor Scrapbook"—Illustrations, descriptions, advertisements, 200 early automobiles, motorcycles. Read about Chevrolet V-8, friction drive Plymouth, three cylinder Elmore, radial engine automobile, 1907 Ford "6," steamers, electric, foreign cars, Indian, Harley, Excelsior, Pope, Cleveland, Reading, Thor, Merkel, Yale, Pierce "4", steam motorcycles. Educational, interesting, surprising. Clymers, Dept. PM, 2125 W. Pico, Los Angeles 6, Calif.

WHAT Every Mason wants. We have Masonic books for Blue Lodge, Chapter, Commandery, Scottish Rite and Shrine. Our rituals are used the world over. Send for free catalog of books and rituals for Masons, Odd Fellows, Knights of Pythias, Knights of Columbus, Elks, etc. Ezra A. Cook, Publisher, Inc., P.O. Box 706 P.A., Chicago 90, Ill.

"PIN-UPS," 12 Large gorgeous girls photos. 75c. Krer, 1339 Wenonah, Berwyn, Ill.

NUMEROUS Unusual merchandise, novelty literature, swap offers you'll find in "Mail Merchandise Mart." Dime brings copy. A. Chervence, 1540 North State, Chicago 10.

WE Locate rare and out-of-print books. Southern Bookfinders, 1210 N 11th Ter., Birmingham, Ala.

COLO. Cards, 15, 25c. Ormald, Watson, Green Acres, Littleton, Colorado.

GAMES, ENTERTAINMENT

PLAY "Sea Blitz" newest game sensation. Thrilling, educational. Only 69c. Write War Games, Box 1267, Marysville, Washington.

PLAY Chess by correspondence. Games matched between players of equal skill. Moves forwarded promptly. \$1.00 per game. Paul Eberts, 4220 West 16th, Little Rock, Arkansas.

MAGIC TRICKS, PUZZLES, JOKER NOVELTIES

LEARN Ventriloquism the easy way. "Treasure Chest" teaches how to make your own figure, the ventriloquist's voice, preparing your act, routine, dialog, etc. Price 25c. postpaid. Magic catalogue of 300 tricks included. The Fun Shop, 623 S. Hill St., Los Angeles, Calif.

AMAZE Mystic friends—\$1000.00 worth magic secrets made me world famous. Big volume only \$1.25. Lindhorst, The Magician, 510 Pine, St. Louis 1, Mo.

FIVE Mind reading acts, 8 magic tricks, 2 handwriting graphocharts, 3 fortune telling charts all for \$1.00 postpaid. Circulars free. Brain's Book Shop, 118P Washington Ave., Endicott, N. Y.

NEW! Simplified card tricks! Amazing self-working bafflers 90c postpaid. James W. Roundtree, 529 Elliott St., River Rouge, Michigan.

500 TRICKS You can do! Douglas' famous catalog of 500 tricks, 128 pages, now only 10c. America's fastest service on magic for pocket, parlor, stage, professional, amateur. Douglas Magic Shop, Box 274, Dallas, Texas.

LEARN Ventriloquism, 3c stamp brings particulars. Smith, 801 Bigelow, Peoria, Illinois.

QUALITY Magic since 1907. Send 25c for catalog. Thayers, Box 1785 Wilshire LaBrea Station, Los Angeles, Calif.

MAGIC Tricks, puzzles, books, cards, punch boards. Catalog 10c. Specialty, Box 671, St. Louis 1, Mo.

WORLD'S Largest professional magic shop keeps you in touch with latest tricks. To receive mailings send 25c for 1943 catalog. Holden, 220 W. 42nd St., New York.

NEW Vanishing key and catalog 25c. Sterling Magic, 345 John R, Detroit, Mich.

ANSWER Unknown questions. Professional "Medium's" mindreading course, \$1.00. Magical Enterprises, Box 111P, Roseville, Mich.

TRICKS. Make them yourself, five complete drawings and instructions \$1.00. Aldeen's, 190 Ward St., New Brunswick, N. J.

MAGICIANS' Headquarters. 216-page catalog, pocket, parlor, professional tricks, 25c. Kanter's, M-1311 Walnut, Philadelphia.

NEW! Simplified card tricks! Amazing self-working miracles! Particulars free. Buse, 878-P Fillmore, Buffalo, N. Y.

HOLLYWOOD Special! Magicians button, catalogue, ghost illusion and free trick for 25c. Magic House of Charles, Box 888, Hollywood, California.

DOUBLETALK. Great fun wherever you go. It's easy. Complete, guaranteed. 25c. Elbae, 22651 Chardon, Cleveland 17, Ohio.

EARN Money in any crowd. Call names of strangers, tell unspoken questions. Professional course mind reading, spirit writing, etc., \$1. Henderson, Box 341, San Bernardino, Calif.

NEW Amazing bombing mystery puzzle. Battle won in 28 minutes, if you're good. 10 war planes; pocket size container. Entertain guests and customers; educational too. Copyright 1943. Send \$1.00 for 5 sets postpaid. W. L. Fuchs Company, 400P Buder Bldg., St. Louis 1, Mo. Reference: Dun & Bradstreet.

"102 MAGIC Tricks." No apparatus required. Only 15c at newsstands, chain and book stores, Robbins Co., Publishers, 152 West 42nd, New York City.

DIP Hand in water apparently boiling vigorously over fire. Sensational! 15c. Magic Master, Box 252, Rochester, N. Y.

HOBBIES AND COLLECTIONS

WANTED: Celluloid (pin-back) buttons, political, union, miscellaneous. Belim, 2549 Irving, Denver, Colo.

NEW Hobby. Collect patriotic slogan stickers. 25 different for dime. Charles Fox, Argos, Indiana.

CHARACTER Dolls for collectors. Including story book. Stamps please. Flower Farm, Copley, Ohio.

SEMPRECIOSUS Stones, how to cut and polish, equipment, etc. Book \$1.00. Home Lapidary Shop, Madera, Calif.

JEWELRY Stones removed from rings, etc. 100 assorted \$2.00. Lowe's, Box 311, St. Louis 1, Mo.

20 DIFFERENT Cactus plants postpaid. \$1.00. Eulalia Turner, Azusa, Calif.

MINERALS—Ten pretty specimens 35c. Bjork, 1434 1/2 Larimer, Denver 2, Colo.

FOREIGN Military insignia: Send 15c for sample; price lists. Hobbyguild, M35 West 32nd St., New York.

UNUSED Match book covers, 100 all different \$1.00. 35 Royal Flash covers \$1.00. Free list. Charles Edelman, 1311C East 84, Cleveland 3, Ohio.

NEW—15 Different match covers 10c. Box 202, Rochester 1, N. Y.

COINS, TOKENS, CURRENCY

COMMEMORATIVE 1/2 — Texas, Kentucky, York, Elgin, Cleveland. \$1.50 ea. Illustrated catalogue 10c. Norman Schultz, Salt Lake City, Utah.

GET Profit and pleasure in collecting old coins. Send 10c for 56-page illustrated coin catalog. You'll be delighted with it. Send for it now. B. Max Mehl, 370 Mehl Bldg., Fort Worth, Texas. Largest rare coin establishment in U. S. Established 44 years.

COMPLETE Catalogue of all U. S. coins 15c to \$1.00. 75 illustrations. 3500 quotations. Price 10c. James Randall, 341 South Dearborn, Chicago.

FREE! Foreign coin, banknote and coin collectors illustrated catalog to approval service applicants. Send 3c postage. Tatham Coinco, Springfield-125, Mass.

LARGE List of large cents, Indian heads, fine foreign coins. Leo Greenstreet, Union, Mo.

OLD Money wanted. Will pay fifty dollars for nickel of 1913 with Liberty head (no buffalo). We pay cash premiums for all rare coins. Send 4c for large coin folder. May mean much profit to you. Numismatic Co., Dept. 20, Fort Worth, Texas.

10 INDIAN Head cents, different dates, also pricelists, 35c. Schultz, 1053 Richmond, Cincinnati, Ohio.

WILL Pay \$10.00 each for certain Lincoln pennies! Indianheads \$50.00; dimes \$1,000.00. Catalogue 10c. Federal Coin Exchange, 3-PM, Columbus, Ohio.

THREE Coins and lists 10c. Oddehon, Box 482, St. Louis, Mo.

SET (19) Brilliant uncirculated Jeffersons \$4.75 postpaid. Wanted rolls Jeffersons. Earl Timmer, Route 3, Hamilton, O.

I MAY Have just the scarce U. S. coins you want. Send me list. "Meet me by mail." William H. Kenworthy, Waterville, Maine.

U. S. And foreign coins. Sell, buy and appraise. F. K. Saab, Box 1564, St. Louis 1, Missouri.

30 DIFFERENT Foreign coins \$1. 100 different \$4. Free list. Delmonte, 725 West 172, New York 32.

FREE 1943-S cent with each lot cents 10 different San Francisco Lincolns 25c. 10 different Indians 25c. 1943-S nickel dime 25c, old 2c piece 25c. Coin Shop, Box 77, Alameda, California.

50,000 COINS, Medals, Confederate bills. Lists free. Nagy, 8-K South 18th, Philadelphia, Penna.

VALUABLE Coin information and lists. Alwick, 5437 Nagel, St. Louis, Mo.

DOLLAR Assortments, every item different. 22 paper moneys, 10 encased postage stamp money, 30 foreign coins, 25 Indian head cents; each lot \$1.00. All-Nation, 157 West Lake, Chicago 1, Ill.

IT'S Fun collecting coins using album providing spaces for card date. Albums for pennies, nickels, dimes, quarters, halves, only 25c each. Bens Coin Co., 72 West Washington, Chicago 2, Ill.

SHORT Snorters! Twenty-two different foreign paper currency that will add nine feet to your Short Snorter bills. Send just a dollar to All-Nation, 157p West Lake St., Chicago 1, Ill.

STAMP COLLECTING

SMOKY Mountain commemorative sheet, largest U. S. stamp issued, and 33 U. S. including commemoratives, airmail, revenues, etc. Catalogs 75c—To approval applicants for 5c. Curhan Stamp Company, Gloucester, Mass.

19th CENTURY U. S. commems. Civil War revenues, battleship \$5 and \$10 stamps free to U. S. approval applicants. Metropolitan Stamps, 198-C Broadway, New York.

VATICAN City, Eritrea, Falkland Islands, Mauritius, Nyassaland, Selangor, African airmail, Kenya, Tanganyika, South America, Asia, British Colonies. Many others. Swell packet, 5c to approval applicants only. Kenwood Stamp Co., 321-M Burchett, Glendale 3, California.

SUPER U. S. mixture containing over 125 varieties 19th century issues, famous Americans, large commemoratives, airm. revenues, dues, specials, will catalog over \$20. Everything is in this mixture! Price \$1. postpaid. International Stamp Co., Hallettsville, Texas.

SPECIAL Album free. The United States flag series for twelve overrun nations is the most unique, remarkable, impressive, and beautiful set of stamps ever issued. It fairly cries for a special album worthy of it, such as we have published. It's a very fine album of 34 pages. Cover designed by a famous artist. Arrangement artistic and practical, telling the history of each honored nation.—It is free to sincere approval applicants. Just send 10c for mailing expenses, and state whether you desire approvals of the United States or foreign stamps or both. Approval Headquarters, Globus Stamp Company, 268 Fourth Ave., New York City 10, Dept. 201.

FREE! Canadian sets, royal visit, George VI, George V, coronation, jubilee, others, to approval applicants. Ensign, Box 118-M, South Orange, N. J.

A \$2,000 Stamp plus 50 different, 3c with approvals. Knopp, Box 1381, Bristol, Conn.

80c VALUE—U. S. souvenir sheet, telegraph stamp almost 60 years old, 25 more different U. S. Only 10c to new applicants for my U. S. approvals. Steger, 1165 Downing, Denver, Colorado.

TANNOU Touva "teddybear" triangle, Uganda, Slovenia, 70 year old South Australia, 43 wear old U. S. Colony, stork, slave stamps; others. 3c with approvals. Dominion Stamps, Arlington, Virginia.

COMPLETE Mint commemorative set from Manchukuo, plus attractive Brunel pictorial—everything just 3c to approval applicants. Viking, 130 (Z) Clinton St., Brooklyn, N. Y.

BRITISH Colonies packet, only 3c to approval applicants. Smith, 237-A 8th Avenue, Roselle, N. J.

AIRMAILS, Pictorials arranged by country, on approval. Henry Zimmer, 723 Culver Road, Rochester, N. Y.

127 DIFFERENT Stamps including Free Fighting French, Haiti, Johore, Cochon, only 10c to approval applicants. Reich Stamp Co., 4647 Kenmore, Chicago, Dept. M8.

AIRMAILS, 25 Different, 10c to approval applicants. Paul Rawden, Box 2920, Westville, New Haven, Conn.

PHILATELIC Shopping News—Bargains galore! Free copy. Stamporium, 2660 Rochester, Detroit 6, Mich.

SPOT Cash for your stamp collection or odd lots. PKeigwin Company, Vineland, N. J.

WASHINGTON Bicentennial, 12 var., complete 10c. Herman Kleinman, Jenkintown 4, Penna.

100 DIFFERENT Including scarce airmail triangle, 3c to approval service applicants. Avalon Stamp Co., Dept. M, Springfield 6, Mass.

WEEKLY Stamp Magazine, 26 weeks, 25c. Stamp Journal, Kalamazoo, Mich.

60 DIFFERENT United States 10c. Pricelist free. Seidenberg, Baroda, Mich.

FIND Stamps worth fortunes! Six big items! "Queer Countries" packet; Djibouti, Qwalior, etc. Packet scarce Russia, catalog price 50c! Fine packet of 25 different British Colonies—Turks and Caicos Islands, Hyderabad, Jamaica, etc. United States \$4.00 and \$5.00 high values. Big "Far East" packet of 20 different stamps from Dutch Indies, Siam, Philippines, etc. Illustrated 32 page booklet—tells where to look for, and sell, stamps worth up to \$10,000 apiece! Everything for only 5c to approval service applicants! Mystic Stamp Company, Department 80-R, Camden, New York.

DANDY United States approvals. Write immediately Sullivan, Endicott Arcade, St. Paul, Minnesota.

EXCELLENT Pictorial approvals. Reasonably priced. Crown Stamp Company, Box 331, Toronto, Canada.

U. S. Mixture, 5 lbs. \$1.75. Postage extra. U. S. price list. Stanley Gibbons, 38-P Park Row, New York.

FREE! Western Hemisphere packet. Postage 3c. Owens, 806 Welsh, Bay City, Michigan.

FREE! British Empire packet. Postage 3c. Williams, 606 Archer, Bay City, Mich.

FREE! Pony Express set (facsimiles). Postage 3c. Roberts, 406 Building, Bay City, Michigan.

CANADA 100 Different 25c—approvals all countries. Lists, Victoria Stamp Co., London, 4, Canada.

1000 MIXED U. S. old and new 25c. 2 lb. \$1.00. Weatherby, Troy, Ohio.

WOW! \$10.00 Worth of fun for only 10c! 500 foreign stamps, unsorted and unpicked (mostly on bits of paper) just as received from the church missions and other sources. Africa, So. America, Australia, China, Philippines, Dutch Indies, and other countries are represented. Includes a few commemoratives, airmails, and stamps cataloging up to 25c or more each! The biggest package of fun in stampdom—and you might find something really valuable! Price only 10c to serious approval applicants! Money back if not delighted. Jamestown Stamp Co., Dept. No. 22, Jamestown, New York.

FREE! The Stamp Finder! Send today for the big new edition, fully illustrated, enabling you instantly to identify all difficult stamps! Also fine packet strange, fascinating stamps from Bosnia-Herzegovina, Monaco, Patiala, Cyprus, etc., including maps, ships, animals and strange scenes. All free to approval applicants including 3c postage. Garcelon Stamp Company, Box 900, Calais, Maine.

FREE! Leeward Is., Cayman Is., Turks and Caicos plus 60 different mint Geo. VI coronation poster stamps, to approval service applicants sending 3c postage. Tatham Stampco, Springfield-30, Mass.

FREE! Complete "United States" stamp catalog with 1,000 illustrations! Send 3c for postage. Harris & Co., 137 Transit Building, Boston, Mass.

VICTORY Packet free—Includes stamps from Tanganyika, British Cayman Islands, animal, scarce babyhead, coronation, early Victorian, airmail, map stamps, with big catalogue—all free. Send 5c for postage. Gray Stamp Company, Dept. PM, Toronto, Canada.

1,000 GRABBAGS 15c each, 8 different \$1. Zandy, 630 Bingham, Reading, Pa.

KNOW What stamps you have. Use my check list and inventory. Foreign, 25 cents. U. S., 50 cents. Woodrow Maloney, 228 Oley Street, Reading, Penna.

FREE—10 Stamps from first approval selection. Quality Stamp Service, Waverly, N. Y.

100 DIFFERENT—Commemoratives, airmails, triangles, diamonds, 10c. Approvals. Kostillo, Benwood, W. Va.

CANAL Zone: Franklin, Washington overprints both 5c. See Jaye, 2416 North Oakley, Chicago, Ill.

FREE Ecuador packet for return postage. Approvals sent. Ephriamm, 914 Sherman, Evanston, Illinois.

FREE Your choice of any 10 stamps from our first U. S. approval selection. Illustrated list included. Cosmopolitan Stamp Company, Dept. M-4, 1457 Broadway, New York City.

FREE United States price list. Postage 3c. Mark Hanna, 335 - 5th Avenue, Pittsburgh, Penna.

UNITED States collectors to serious approval applicants. We offer two United States regular postage stamps cataloging \$1.10 for only 10c. Supply limited. Write immediately. Orange Stamp Company, Albany 3, New York.

APPROVALS For less. Catalogued. Classified. References. John A. Kinnear Co., 561 Empire Bldg., Seattle 4, Wash.

SCOTT \$8.00 Looseleaf album given our regular approval customers. Reference, Marvelia Co., Burt Building, Dallas, Tex.

750 GUMMED Album page titles (world) 75c. Avalon, 1630 1/4 West Twelfth Place, Los Angeles, Calif.

500 U. S. Many commemoratives, airmails, others, 70 varieties guaranteed, 25c. Hogan's Stamps, Ashland, Wis.

55 DIFFERENT United States 5c with approvals. Bookman, Box 145-M, Maplewood, N. J.

UNITED States approvals complete coverage, fine quality, attractive prices. Seminole Stamps, Box 436, Coconut Grove, Florida.

STAMPS Sent on approval, outstanding quality, low prices. Fred Herzberg, 168 Oak, Elmhurst, Ill.

MEXICO Census commemorative set free with approvals. Pladon Stamps, 1717-M Idaho, Toledo, Ohio.

WHOLESALE Supplements to dealers for 10c postage. Hundreds of bargains. Grossman Stamps, 102 West 42nd, New York.

LIBERIA Airm C4-6 (3) 10c with 1/4, 1/2, 1c approvals. Carroll's, 745A W. 45th, Los Angeles 37, Calif.

UNITED States approvals, large variety at America's lowest selling prices. Stamp Company, Albany 3, New York.

SURPRISE Mint set 10c. Approvals. Norlen Stamps, 1417 East 34 St., Brooklyn, New York.

3 DIAMONDS And triangles 3c with approvals. Beaman, Glenburnie 1, Maryland.

MY Approvals speak for themselves. Donald Johnson, 126, Lacon, Illinois.

25 DIFFERENT Canada free. Streiner, 1020 East 61, Cleveland, Ohio.

BELGIUM, 25 Different only 5c to new approval applicants. Charles Mangels, 194-13a 111th Road, St. Albans, N. Y.

100 DIFFERENT U. S. commemorative stamps one dollar. Irene, 1718 College S.E., Grand Rapids, Mich.

DEALERS—Wholesale list. Postage 3c. Frank's, 5031 Queensberry, Baltimore, Md.

BATTLESHIP Stamp and 50 interesting foreign—10c. Approvals. Liberty Stamp Co., Dept. P2, Kirkwood 22, Missouri.

FINE Approvals, freshly mounted. Fast, personal service. Tell me what countries you prefer and I'll send their stamps. Skinner, 345 East Ocean, Long Beach 2, Calif.

BEAUTIFUL U. S. revenue stamped paper 3c with U. S. or foreign approvals. Hill, Dept. 7, 14894 Elm, Cleveland 12, O.

UNITED States 200 different \$1.00. French, New Gretna, New Jersey.

"UNITED States stamps only." Better approvals reasonable. Box 488, Minneapolis.

FREE 50 South American with approvals. Jean Husak, 1408 West Genesee, Syracuse 4, N. Y.

FREE—New Zealand beauties (1943 triangles picturing Princesses Margaret and Elizabeth) to serious collectors sending postage and requesting approvals. George W. Emptage, Cordell, Okla.

NEW Approval applicants enjoy our 10% bonus plan. Details. Atkins, 1075 Armada, Pasadena, Calif.

3,000 U. S. Foreign \$2; Approvals: Griest: 409 Oak, Davenport, Iowa.

60 DIFFERENT United States, airmails, higher values, commemoratives, old issues, 10c. Charles Stone, 3547 28th St., Astoria, N. Y.

50 DIFF. 10c, Approvals 1/2c. Dustin, 83 Cedar, Fitchburg, Mass.

BARGAIN Lots—\$1.00 postpaid! Composed of broken sets, approval remnants, etc. High value! Pvt. Merwin Copeland, Station Hospital, Fort Rosecrans, Calif.

55 DIFF. U. S. or foreign airmail, commemorative, etc. 3c. Approvals. Parkview Co., 4537a Parkview, St. Louis 10, Mo.

FREE—New Union South Africa war set to approval applicants. Charles Cleveland, 806 North Humphrey, Oak Park, Ill.

INVEST A 1c postal. Write for "Treasure Island" gift offer—giving, entirely free—to purchasing approval applicants of foreign stamps; latest big, 1200 page Scott's \$5.00 International Stamp Album (or \$8.00 loose-leaf; Scott's 1944 \$5.00 Standard Catalogue. "Treasure Island" Service, Vista, California.

FOUR Mozambique triangles 10c with approvals. Vargo Stamps, Racine, Wis.

166 U. S. commemoratives, etc., 10c. 1000-25c. Kolona, Troy 3, Ohio.

WE Buy United States and foreign collections, accumulations. Also will pay highest prices for used United States commemoratives. Port Orange Stamp Company, Albany 3, New York.

40 MEXICO 10c. 100-25c. Approvals. Zampino, 2022 West Ninth, Brooklyn.

105 VARIETIES Including Russian pictorials, French Colonials, dime. Approvals. Rex Stamp Company, 39 Blackstone, Bangor, Maine.

25 COUNTRIES, Solomon Islands, Seychelles, Djibouti, etc. 10c. Approval applicants. Smalley, 1406 Welch, Houston, Texas.

SCARCE Five British coronations 10c. Approvals. Thode, 14302 - 119 Ave., Jamaica, N. Y.

10 SIAM Only 5c! With approvals. Benton Ryan, Middletown, Conn.

FREE Stamps for details. Walter Hoenes, Dept. PMM, Cologne, New Jersey.

"FOUR Star" approvals? Famous for thirty years. Nothing like them. Write today! Kessels, Tucson, Arizona.

SOLOMON Islands, Perak, etc.—3c with approvals! Saxon, Valley Stream, N. Y.

CZECHOSLOVAKIA, 100 Different, only \$1.00 postpaid. W. Bedard, Dept. C, 3420 Montclair, Detroit 14, Mich.

100 DIFFERENT 10c With approvals. Jacobsen, 140 West 75th Street, New York 23, N. Y.

FREE! Approval applicants select 10c worth free—your choice. Excel, Box 1315, Chicago 90.

FREE, Complete Cuba tobacco set with approvals. Seminole, Glenburnie-1, Md.

ROCKET Mail! Can you imagine mail shot by rocket? It has been done! This is the day of rocket guns, rocket airplanes, and now it is rocket mail. We offer absolutely free a beautiful essay of the rocket airmail stamp of mail shot by rocket from Newark to New York. This essay is guaranteed genuine and is most unusual. The stamp has sold for as much as \$10.00 per copy. But our offer is free. This most unusual rocket mail item will be sent absolutely free to every approval applicant, and if your collection does not have a rocket mail stamp, by all means get your free copy of this offer today. George Wentz, San Marcos, Texas.

118 DIFFERENT Stamps including commemoratives, charities, airmail, sets, etc. 3c with approvals. We buy stamp collections. Badger Stamp Co., Milwaukee P-3, Wisconsin.

SUPERB Approvals, net prices. Stamps 1/3 to 1/8 catalogue. P. G. Beals, 170A Tremont St., Boston, Mass.

NOSSI Be, set 1940 Syria pictorials, 3c with approvals. Superior, 1019 Greyton, Cleveland Heights, Ohio.

URUGUAY—25 Different free! Approval applicants only! 3c return postage. Win-Rad, Box (P)32, Rugby Station, Brooklyn, N. Y.

"ALLIGATOR" Ships complete, Liberia. Send 10c. Approvals. Buchanan, 307 East 23rd, New York 10.

WORLD'S Largest diamond and triangle stamps, free stamp magazine, stamps from fighting Free French, 25 stamps from 25 different United Nation countries, pictorials, airmails, big bargain 5c with approvals. Capital Stamps, Dept. 2, Little Rock, Ark.

ACCUMULATORS of United States stamps, earn extra money by sending 10c for our illustrated buying lists. Wanted also foreign stamps in quantity. Longacre Hobby Co., 100 West 42nd, New York City.

42 DIFFERENT Mint, 5c. Approvals. Best, Box 139, Bangor, Maine.

RARE Free French set, cash premium, both 3c! Approvals. Miner, South River, Wilkes-Barre, Penna.

35 FAMOUS Americans complete, 75c; 12 overrun nations (flags) complete 50c. Bens Stamp Co., 72 West Washington, Chicago 2, Ill.

EXTRAORDINARY Pictorial collection: Nigeria, Dutch Indies, Bermuda, Senegal, Philippines, Southern Rhodesia, Ivory Coast, Puerto Rico, Wurttemberg, Ceylon, Wallis and Futuna, Newfoundland, Martinique, Victoria. Everything 5c. Imperial Company, New York City 34.

175 U. S. Commemoratives, ahrs, etc. 10c. 500-25c. Box 457, Newark 1, N. J.

PENNY Approvals, that satisfy. Neil Gronberg, Box 5441-P, Philadelphia 43, Penna.

CAMERAS, PHOTO SUPPLIES

BASS Says: War time proves Bass leadership. Amazing selection of finest still cameras—Leica, Contax, Korelle reflex, Argus, new and used still available. Write for quotations. Satisfaction guaranteed or your money refunded. Bass buys 'em, sells 'em, trades 'em. Bass Camera Company, Dept. AG, 179 W. Madison St., Chicago, Illinois.

ENLARGERS—Build your own. Kit of parts, \$6.00. Free particulars. Crescent Engineering, Box 251-P, South Pasadena, California.

MAKE Money in photography. Learn quickly at home. Easy plan. Previous experience unnecessary. Common school education sufficient. Booklet and requirements free. American School of Photography, 1315 Michigan, Dept. 3432, Chicago.

CASH! Spot cash for cameras, lenses, binoculars, movie or still, sound projectors. Send full description by mail, or wire for prompt cash offer. Over 30 years of dependability insures honorable dealings. Bass Camera Company, 179 West Madison Street, Chicago, Illinois.

HAVE You a camera? Send ten cents for recent number of our big magazine, showing how to make better pictures and earn money. American Photography, 116 Camera House, Boston, Mass.

FILTERS, Sunshades, filter holders—Limited supply—fit any camera. Made of pre-war aluminum, filters of solid optical glass. Filters available in every color. Impossible to obtain after present supply is exhausted for the duration. Send only \$1.00 per item and lens diameter, shipped postpaid return mail. With every order for 1 holder and 2 or more filters we will ship without charge a genuine aluminum sunshade of the same size. Act immediately—this offer holds good only while present supply lasts. Absolute satisfaction guaranteed or your money immediately refunded. Order shipped same day received. V X Company, 1828 Central Avenue, Indianapolis 2, Indiana.

WE Pay top prices for used cameras and photographic equipment. Turn your idle camera, enlarger, printer, lenses, developing equipment, etc., into cash. Just send us a list of what you have. State make, model, age, condition. We will write you at once, telling you what we'll pay. Prepare your list today. Send to Central Camera Co., (Photographic Headquarters since 1899), 230 S. Wabash Ave., Dept. D-16Z, Chicago, Illinois.

PHOTO FINISHING

8 PRINTS, All enlarged to nearly postcard size, from your roll or negatives, 25c. Willard Studios, Box 3535A, Cleveland 18, Ohio.

BIGGEST \$1.00 Value in 35 mm. finishing today. 36 exposure fine grain 3 1/4 x 4 1/2 enlargements; deckled, embossed margin and date. Eighteen exposures 75c; sixteen exposure splits 55c. Free mailers. 8 exposure rolls in beautiful deckled contact finish with embossed wide margin. 25c. Mailbag Film Service, Box 5440A, Chicago 80.

YOUR Favorite kodak pictures enlarged, size 5x7, 10c; three for quarter. coin. Send best negatives (film) today. Address Grepert Studios, Dept. 28, Des Moines, Iowa.

8 BEAUTIFUL Enlarged prints (nearly postcard size) or 16 regular prints 25c. 35mm. rolls enlarged 3 1/4 x 4 1/2, \$1.00. Burton Studios, 55-M, Roscoe, New York.

QUALITY Photostamps \$2.00 hundred. 82-29 60th Road, Elmhurst 4, New York.

CHOICE Film offers—Roll developed, 8 beautiful enlarged prints (deckled if desired); or 16 brilliant "Lifetime" prints; or 8 sparkling prints plus 2 fade-proof enlargements. Pre-war quality and price—25c. Fast service. Quality guaranteed. Free mailers. Credit for unprintable negatives. Dept. 53, May Studios, LaCrosse, Wis.

INTRODUCTORY Offer—Six enlargements from your favorite negative, 25c. Skyland Studios, Box 411, Dept. "EM," Asheville, N. C.

SNAPSHOT Reprints 50 for \$1.00; 100—\$1.85; 200—\$3.50. Less than fifty, 2 1/2c each. Fast service—finest workmanship. Mercury Studios, A-109 North Dearborn, Chicago 2.

35MM, Argus, Leica, etc. (except "Mercury") 36 exposure rolls, fine grain developed (Eastman DK-20) and beautifully enlarged to 3" x 4" glossy prints, 90c. Cartridge reloaded, 35c. 18 exposure rolls, 55c, reload 20c. 24-hour service. Satisfaction guaranteed. Free mailing bags, sample print. Technifinish Laboratory, 38-42 Scio St., Rochester 4, N. Y.

BEAUTIFUL 4x6 Pictures 3 1/2c each, from 116 and 120 negatives, 3 1/4 x 4 1/2 from all other sizes. All work guaranteed. Overnight service. Roll developed and 8 pictures 30c. Roll 12 pictures 45c. Roll 18 pictures 60c. Enlargements on double weight portrait paper 5x7—30c, 8x10—50c. Copies made from any picture 75c. Pacific Photo Service, Box 666, San Francisco, Calif.

PHOTOGRAPHY For pleasure and profit. Prepare at home. Common school education sufficient. Write for information and requirements. American School of Photography, 1315 Michigan, Dept. 3451, Chicago.

VELOX Deckle reprints 2c. Rolls developed, two deckle edged prints each negative, 25c. Two 5x7 enlargements 25c. Summers Studio, Unionville, Mo.

EVERY Picture an enlargement! 8 sparkling deckle-edge enlargements and roll developed 25c coin; 116 size or smaller; enlarge reprints 3c. Enlarge Photo, Box 791D, Boston, Mass.

THREE Prints each good negative, 6 to 8 exposure rolls, 30c. 12, 16, 18 exposure rolls, 50c. Reprints, 3c. Fred D. Eastman, Bode, Iowa.

ROLL Developed, "Super Tan" treated for finer and more brilliant pictures and everlasting negatives and 2 sets of fadeless Velox prints only 25c. 10 reprints 25c. 25 reprints 50c. 100 reprints \$1.50. Free coupons with every order entitles regular customers to free 5x7 and 8x10 enlargements. Artshop, PM100, Sweetwater, Texas.

8x10 SILK Finish enlargement—25c plus stamp. Irving Studio, 4006A Irving Park, Chicago 41, Ill.

ROLL Developed and 8 beautiful enlargements 2 to 6 times larger. Deckled edge—high gloss. Any 8 exposure roll 25c coin. 12 ex. 35c—16 ex. 50c—36 ex. \$1.00. Reprint enlargements 3c each. Alden Photos, 94-3 Astor Sta., Boston, Mass.

ENLARGEMENTS: Eight 5x7 from negative \$1.00. Six 5x7 from photo \$1.00. Robert Renshaw, 222 Jeffrey St., Chester, Penna.

SENSATIONAL Introductory offer! Send negative, this ad, and 3c for professional 7x5 1/2 enlargement! 16 regular-size or 8 double-size reprints, from negatives, 25c! Kodak roll developed with 16 guaranteed deckled-edge prints, 25c! Candid roll—36 exp. 35mm. developed, vapoed, enlarged to 3x4, \$1.00! 18 exp. 60c. Reprints, 3x4, 3c each. We have new, perfect 35mm. film. Low prices. Free—with order—photo folder which holds 8 snapshots! Free mailers, details on request. American Studios, Dept. 206, LaCrosse, Wisconsin.

EXCLUSIVE Introductory offer! 4 beautiful enlargements for 10c. Send any 4 negatives of the same size (up to 2 1/2" x 4 1/2") and we will return to you immediately 4 valuable enlargements—deckled and dated on Velox. Negatives returned with order. Send negatives, this ad and 10c coin today. This ad must accompany order. Mail-N-Save, Box 310-24, Quincy 69, Massachusetts.

MAKE Prints from negatives. No dark room necessary. Complete kit. Nothing else to buy. Postpaid \$1.00. Berent's, 4300 Hampton Blvd., Norfolk, Virginia.

6-8 EXPOSURE Films developed and finished 25c. 12-16 exposure 35c. 18-20 exposure 35mm. films 50c. 36 exposure \$1.00. Reprints 2 1/2c each. 100 reprints \$2.00. All rolls developed and enlarged to 3 1/2 x 5". Send for free mailing bag. Photo Service, Box 5450, Metropolitan Station, Los Angeles, California.

WE Oil-tint your favorite photos in natural color. Send 50c for each picture up to 9" x 12". Larger prints \$1.00 each. Give us complete color description of hair, eyes and clothing. Harding, 3802 Gwynn Oak Avenue, Baltimore 7, Maryland.

MILLIONS Now know "Hollytints means better prints." Sixteen Hygloss prints with 8 exposure rolls developed—25c. Other astounding offers. Hollytints, P-1350, Hollywood, California.

ROLL Developed and 4x6 oversize glossy Velox prints. 8 exposure 30c; 12 exposure 45c; 16 exposure 60c. Overnight service. Clemet Photo Service, 1318 W. Columbia Ave., Philadelphia 22, Penna.

PHOTO Stationery, personalized with your picture and name on 35 sheets good bond writing paper and 35 second sheets—all 70 sheets \$1.00 postpaid—send any clear snapshot, safe return guaranteed. Sanford's, 225 Baum Bldg., Omaha, Nebr.

TEN 5x7" Enlargements \$1.00, four 50c, 15c each. Six 8x10" enlargements \$1.00, three 55c, 20c each. Either size oil colored 25c each extra. Ten reprints 25c. Send negatives. Many other bargains. Empire Photos, Adams Center, New York.

16 BEAUTIFUL Oversize deckled prints and two enlargements with first order 25c. Owiphot M1, Weatherford, Oklahoma.

ENLARGEMENTS On fine grain, double weight paper, 5x7, 25c; 8x10, 50c each. Send negative. Photolure, Box 1011, Fort Wayne, Indiana.

BEAUTIFUL 8x10 Enlargement from your photo or negative 45 cents. Originals returned unharmed. Quick service. Photo Lab., 3122 N. Clark St., Chicago 14, Ill.

MOTION PICTURES AND SOUND EQUIPMENT

SALE—Rent 8-16mm. films. Catalogues 10c. Don Elder's, 739-A Boylston, Boston 16, Massachusetts.

LEARN Movie projection, management. Free catalog. Give age. Theatre Institute, Elmira, N. Y.

RENT By week. 8mm., 16mm. films. 35c up. Dayton Film, 2227 Hepburn, Dayton, Ohio.

8MM., 16MM. Rentals, silent 40c per reel; sound features \$4.95. Free lists. National Cinema, 71 Day St., New York.

ALL Makes camera films, 100 ft. 16mm. \$2.00. 8mm. 25 ft. double \$1.25. Developing free. Also complete movie subjects available. Free catalog. Star Safety Film, 630 - 9th Ave., New York.

BASS Says: Leadership in the cine field is apparent in war times. Here ready—your choice of 8 mm. and 16 mm. apparatus. Write for quotations. Your old equipment is worth real money in trade—describe please. Or we buy for cash and pay immediately on receipt. Write to headquarters. Bass buys 'em, sells 'em, trades 'em. Satisfaction guaranteed or your money refunded. Bass Camera Company, Dept. A, 179 W. Madison St., Chicago, Illinois.

BETTERPIX Outdoor safety film, 100 feet 16mm., \$2.50. 25 feet double 8mm., \$1.25. Free developing. Finished subjects sold, exchanged. Sound library. Better Films, 742 NewLots, Brooklyn 7, N. Y.

SOUND 35mm. DeVry reconditioned (suitcases) projector, amplifier, speaker, \$249 complete. Twin (aluminum) Universal 1000 watt sound projectors, amplifier, speaker, complete \$420. Rewinds, splicers, screens, films. DeVry 35, Newsreel camera, complete, special \$75. Acme Almetal 1000 watt silent projector regular \$250, special \$65. Holmes portable \$75, pedestal type \$115. DeVry semiportable 2000 feet silent (Simplex magazines) complete, \$78. Wire deposit, remittance. Mogull's Film-Camera Corp., 64 West 48th Street, New York.

CAMERA Films—100 ft. 16mm. \$2.50; panchromatic Weston 64, \$4.85; 33 ft. double 88 Weston 24, \$1.89; prices include processing. Movie accessories, chemicals, bulk films. Free circulars. Fromader Genera Co., Davenport, Iowa.

NEW 8mm. 16mm. projectors. Order now. Hurry. Dayton Film Rental, 2227 Hepburn, Dayton, Ohio.

100' 16MM. Used sound film, \$1.00 postpaid. List of complete subjects upon request. Blackhawk Films, Dept. FM10, Davenport, Iowa.

ANNOUNCING New film exchange service. 8mm. film exclusively. J. Watts, Box 941, Akron 9, Ohio.

35 MM. Silent, sound films and equipment. Lists. John Black, Shawano, Wis.

BELL, Howell 16mm. auditorium projector \$440.00. Sterling's, 679 Northampton, Easton, Pennsylvania.

SOMETHING New, movie screen coating. Free literature. Snow White Screen Company, Danville, Illinois.

I BUY, Sell, swap, rent s.o.f. 8 and 16mm. films. List free. Harvey Iris, Box 539, Brockton, Mass.

SILENT 35mm. films! Lists 3c. Demsey, 1613 Stewart, Youngstown, Ohio.

MOVIE Projectors—Bought and sold. United, 2309 Lawrence, Toledo, Ohio.

8MM.-16MM. Home movies exchanged, bought, sold. Free particulars. Multiprisers, 171 Euclid, Bridgeport 4, Conn.

35-16MM. Films, equipment, bought, sold. Cinema Supply, Lakefield, Minn.

8MM-16MM. Silent films for sale. Rental Services, Oakville, Connecticut.

\$1 BRINGS "Surprise" assortment 8mm. colorful titles! Guaranteed. LeMoine Films, Nevada, Missouri.

MOVIE Films—Largest 8mm. assortment comedies, westerns, dramas, glamour shows. 8mm. movie machines wanted. Zientek Films, 1129 Monroe Circle, Brooklyn, Baltimore 25, Maryland.

FREE, 1944 Movie film catalog. Samples, 10c. Goodwill Company, Jackson, Tenn.

CUSTOM Titles for 16mm. movies. Color, black and white, all professional effects. Bay State Films, 458 Bridge Street, Springfield, Massachusetts.

\$2.95 180 FT. Complete reel, perfect condition, used, 8mm. film. Castle, Official, others. List free. Cruber's Camera, 141 Washington St., Newark, N. J.

JOE Lewis famous fights! Latest release! 8mm.-16mm. silent-sound. Films rented everywhere. Free catalogue (sample film 10c). Garden Film, 317 West 50th, New York 19.

100' 16MM. Used sound film. \$1.00 postpaid. Write for list of complete subjects. Blackhawk Films, Dept. PM9, Davenport, Iowa.

FIRST Again! Latest hits! "Sarong girls"—different, 8mm., 50 ft., \$2.00, 16mm., 100 ft., \$4.00 postpaid. Complete catalog with generous film sample, dime. Trans American Sales, 532PM, Morristown, New Jersey.

KODACHROME. Fresh stock! Daylight or Type A! 25-ft. rolls double 8mm., \$3.80 each; 100-ft. rolls 16mm., \$8.90; postpaid, cash with order! Will ship c.o.d. (Limit six rolls per customer). Standard Sales, Box 154, Kansas City 10, Missouri.

8MM.-16MM. Films. Free catalogue (sample film 10c). Parkway Exchange, 1593 Union Street, Brooklyn, New York.

EASTMAN 16mm. Safety positive film, \$4.00 per 400-foot roll. Three rolls limit per order. Guaranteed fresh stock. Will ship c.o.d. Filmcraft, 2814 Tracy, Kansas City, Missouri.

MAMMOTH 8-16mm. Catalogs, bargains, discount coupon—3c. Bargain Films-M, 719 East 61st Street, Los Angeles 1, California.

PRETTY Girl movies, 8mm.-16mm. Complete lists, sample, dime. "Sarong Girls," 8mm., 50 ft., \$2.00; 16mm., 100 ft., \$4.00, prepaid U.S.A. Also beautiful Kodachrome subjects available. Jenkins, 392-F, Elmira, N. Y.

"NAVAL Academy," new 100 ft., 16mm., \$2.75; 400-ft., 16mm., \$8.75. Oriole Films, Box 942, Baltimore.

GUARANTEED Fresh movie film! Three spools double 8mm. \$3.45! Six spools Univex \$7.90! Dalite loading! (Limit six each type.) Will ship c.o.d. Catalog. Eso-S, 3945 Central, Kansas City 2, Missouri.

FILMS Bought, exchanged. Girl films. Sample, dime. Lists free. Paramount, 204 East Broadway, Monmouth, Illinois.

"THE World's Greatest Passion Play," 8mm. 16mm. and 35mm. Specify silent or sound. Rent or purchase, include stamp. Hemenway Film Co., 33-F Melrose St., Boston 16, Mass.

BIG Discounts on new films. Purchase by mail and save money. Sample glamour film and bargain lists 10c. Lester White, Box 66, West Newton, Mass.

TAKE Movies, 100' 16mm. \$1.90. 25' double 8mm. \$1.25. Developing included. Bulk 8mm. Ambassador, 479-A Quincy Street, Brooklyn, N. Y.

MUSIC AND MUSICAL INSTRUMENTS

NEW "Pedler" clarinet boehm system with accessories in crush plush case \$39.75. Slightly used accordions, 12 bass "Hohner" \$49.75, 96 bass "Scandalli" \$195.00, new 120 bass Hohner "Carman" \$275.00. Upon receipt of money order will send privilege of examination. Rudolph's, Atchison, Kansas.

POPULAR Piano in 12 lessons. Kelly School, 1781 Oak St., San Francisco, Calif.

LEARN Piano in 5 easy lessons by ear. Play any song—Easiest method known. Amazing results. Complete course \$2. A B C Piano Method, Dept. M4, Mt. Vernon, N. Y. Box 145.

ACCORDIONS: New and used, bought, sold and repaired at wholesale prices. Cash and terms. Del Principe, 307 So. Wabash, Chicago.

SONGWRITERS! Amazing, outstanding proposition. Hibbeler, C5, 2157 N. Avers, Chicago.

LEARN Popular piano! Write Magic Key, 111-A Broadway, Glendale 4, Calif.

LEARN Popular piano! Play hit songs in boogie-swing style. Pianists, send dime for sample arrangement. Home-study folder free. Christensen Studios, 751 Kimball Hall, Chicago 4, Ill.

SONG Poems wanted. Free examination. McNeil, Master of Music, 510-PM South Alexandria, Los Angeles, Calif.

OUTSTANDING Songwriting service. Roscoe Barnhart, 1320 48th, Des Moines, Iowa.

WRITE Songs. Big money and reputation. Write for information. J. Gordon Pub Co., 201 N. Hoyne Ave., Chicago.

BEFORE Sending your poem to be set to music "know your composer." Free booklet. Al. Moquin, 2110 Beachwood Dr., Hollywood 28, Calif.

SONGWRITERS—Send poem for immediate examination and free rhyming dictionary. Richard Brothers, 24 Woods Building, Chicago.

SONG Poems wanted: Write for free instructive booklet, outlining opportunities. United Music Corporation, Dept. 14, Salem, Indiana.

ACCORDIONS. All makes and styles. Buy and sell. 60% discount. Metro, 44 N. Albany, Chicago.

PIANISTS—(Also organists). Quickly improve technic, sightreading, accuracy, memorizing, playing through mental-muscular co-ordination. Free booklet. Broadwell Studios, Dept. 44-D, Covina, Calif.

SEND No money. Play swing piano by ear in six weeks. Complete course. Write "Send course will send \$1.00 or return within 7 days." Planow, 670 N. Kenmore, Hollywood, California.

ACCORDIONS. \$5.00 Down. New and used. All makes and styles. American Accordion Co., 31 S. Cicero Ave., Chicago.

POEMS Wanted for musical setting. Send poem for immediate consideration. Five Star Music Masters, 630 Beacon Building, Boston.

DO You want to publish your song? Information free. Mid-West Music Press, 1507 E. 55th St., Chicago 15, Ill.

MUSIC Printed, lead sheets, piano. Amazing prices. H. Brown, 313 East Sixth, Marion, Ind.

PICTURED Music books one dollar. Blessing, 447 Lansing 2, Michigan.

WANTED! Lyrics, melodies for songs. We arrange, publish, sell. Superior Song Studios, Passaic, N. J.

HARMONY Teaching in 7 lessons; \$1.00 each lesson, 7 lessons \$5.00. Gara Guly, 519 W. 31, Los Angeles 7, Calif.

SONG Poems wanted. Write for free booklet, instructions. Song Service, 331-O West 46th, New York.

SONGS Published. Examination and melodies free. National Songwriters, 6603 Sunset, Hollywood.

GOT Song-words? I'll write music! D. Ahlstrand, Kettle River, Minnesota.

SONGWRITERS! B.M.I. Publisher with established radio program seeks new songs, poems! What have you? Professional's sincere examination free! High fidelity records made. Transradio Music, Inc., 1650-B Broadway, New York.

GOOD Music composed to good words. Music printing. Reginald Belcher, Chatham, New Jersey. Established 1910.

"SONGWRITERS—Professional Plan." Edw. Madden, 1300 Lodi, Syracuse, N. Y.

RADIOS, SUPPLIES, INSTRUCTION

PREPARE Yourself now for a well paying radio position after the war. Obtain your FCC commercial radiotelephone and telegraph licenses through our home study courses, written for the man who has forgotten higher mathematics. An easy read, easily understood course. Moderate tuition fee. Write for particulars. American Radio Institute, 44 East 23rd Street, New York, N. Y.

RADIO Service men and experimenters send for our giant radio catalogue. Save dollars. United Radio Co. (1000M), Newark, N. J.

RECORDING Discs, 1/2c each. Make them yourself. Simple. No chemicals. No equipment. Complete illustrated plans 25c. Kaytors Lab's, Lynwood, Calif.

GUARANTEED Rebuilt vibrators, \$1.00 ea. Send old vibrator. Best Vibrator Co., Box 5802, Cleveland 1, Ohio.

CRYSTAL Radio experimenters. Write Hulet, 29 East 39th, New York.

MAKE Simple tubeless batteryless distance getting crystal radio. Crystal and illustrated instructions, 25c. Alva Allen, PM247, Clinton, Missouri.

REVISED Plans 18 long distance crystal sets, with "Radiobuilder"—25c. Laboratories, 363-C Hampton, Hayward, Calif.

WANTED—Oscilloscopes, tube testers, vacuum tube, voltmeters. Chanalysts, Meissenger, Analyst, small radios, any make. T. A. Freck, Freck Radio & Supply Co., Asheville, N. C.

HELPFUL Radio books. Up-to-date list free. Popular Mechanics Press, (C-43), 200 E. Ontario, Chicago.

BUSINESS OPPORTUNITIES

UPHOLSTERING. Rebuilding furniture pays. Easy to learn. Pleasant work. Do own upholstery. Start own business, or work for others. Illustrated course \$1.00. Save time. Order today, or write, Upholstering Institute, Dept. 217, Lombard, Ill.

START Your own business on our capital. Always your own boss. Hundreds average \$3,000 to \$5,000 annual sales year after year. We supply stocks, equipment on credit. 200 home necessities. Selling experience unnecessary to start. Wonderful opportunity to own pleasant, profitable business backed by world wide industry. Write Rawleigh Co., Dept. D-U-PPMB, Freeport, Ill.

START Home business making statuary, plaques, art goods, novelties, souvenirs, concrete pottery, garden furniture, artificial marble flooring, liquid marble. Make your own flexible molds. Amazing profits. Valuable folder free. Creative Publishers, (PM4), Glencoe, Illinois.

START "Soap Factory" at home. No machinery. Amazing opportunity. Literature free. Kemico, SM-4, Park Ridge, Ill.

PAYING Mail business—Stamp brings proof. General Publications, Ossining, N. Y.

BIG Money in mailorder. Literature free. Crown Books, Charlotte 6, Mich.

WEBER Typewriter Mechanics School. Simplified homestudy-repairing increasing. Hollywood 27, California.

MAIL Order business course, with lifetime guidance. Make money at home now. Be financially independent after the war. Literature free. Schroy System of Self-Help, Box 8084, Market Station, Los Angeles 21, California.

THE Mail order business might be your big chance for a prosperous future. Instructive literature free. Elmer Swanson, Niagara, No. Dak.

MOLDBAKING—Plaster Casting. Complete formulas—fully illustrated. 25c. Ideal Service, RM-4, Park Ridge, Ill.

MAKE Money at home in sparetime. Mailorder business is your opportunity. Start with as little as \$2.00. New—amazing system that works wonders, prepared by expert. Startling information free. Alfred Siddall, Atascadero, Calif.

PROFITABLE Full or part time business, home or office, tested methods, proven results, details free. Box 26, Elmwood, Conn.

CASH In on new business opportunities. Complete money making starter 25c. Information free. Frank Sargent, Jr., P.O. Box 868, Denver, Colo.

MECHANICALLY Inclined men—Own and operate general appliance repair shop. Complete, illustrated course shows you how. Welding, refrigeration, motor repair, how to get business, etc., all phases covered. Free literature. Christy Supply Dept. 139, 2835 N. Central Ave., Chicago.

OPERATE Your own business by mail. Sell books and courses. We show you how. Dean's, Box 900, Galveston, Texas.

START Own business: home, office. 127 moneymakers plans and formulas. Free details. Abbott, 5552-S Drexel, Chicago 37, Ill.

OWN Your own business. Be independent. Free literature listing part of over 100 opportunities. Barnorlani Industry, 19338 Griggs, Detroit, Michigan.

EXTRA Income—Plenty mail selling opportunities. Write Cole, 515 Jefferson, Lovejoy, Ill.

EXCELLENT And unlimited opportunities for those with average intelligence and some capital. Free literature. Bankewitz, 114 Virginia Avenue, Hempstead 8, N. Y.

START Greeting card business at home. Amazing profits. Powerful literature furnished. Free details. Matuska, Girard, Ill.

FREE! How to sell our latest popular books by mail. Pleasant home work. Big profits! No bookstore competition. Snappy circulars supplied. Rush name! Financial Education, 431F Commonwealth Bldg., Denver 2, Colo.

"HOW To Make Simple Molds and Plaster Plaques." Profit in popular novelties! Booklet 25c. Plastercraft, 1406 E. 43rd St., Cleveland 3, Ohio.

INCORPORATE Your business. Delaware laws. Many advantages, free details. Tax Research Bureau, Inc. Delaware Trust Building, Wilmington, Delaware.

TURN Accounts into cash. Good income; quick results. National Collectors, Newark, Ohio.

GET Dollars by mail! 90c profit, instructions 10c. Terrill, Bogard 2, Mo.

MAKE Money. Your own business. Choose from many tested plans. Free particulars. Co-operative Business Service, P.O. Box 638, Chicago.

GET Into mail selling. Prepare for future. Start sideline business now. Splendid opportunities. Interesting, profitable propositions immediately available. Progressive Magazine tells how! Free details and premium offer. Sheboygan Publishing Co., Sheboygan, Wisconsin.

LEARN Refrigeration. Open your own shop. Be independent after the war. Common education sufficient. Illustrated course shows how. Booklet free. Mechanics School, Dept. PM, 4701 West Pico, Los Angeles 6.

KARAKUL Sheep are profitable. Write: Addis A. Kelley, Maywood, California.

CHARTERS: Delaware: best, cheapest; free forms. Colonial Charter Co., Wilmington, Del.

COLOR Cement with chemicals. Make artistic cement garden ornaments Hollywood style. Sample 10c. Hollywood Cementcraft, 8527 Wonderland, Hollywood, 46, Calif.

DRUNKENNESS Is a disease which responds to treatment. Medical skill plus human sympathy prove successful with liquor and drug cases. 60 years experience. Write for free booklet. P. M. Nelson, The Keeley Institute, Dwight, Ill.

PLASTEX Industries offers industrious men an opportunity to start a business of their own, manufacturing art goods, novelties, souvenirs, etc., in Plastex and marble imitation. 5c material makes \$1 articles. Rubber moulds furnished for speed production. Small investment brings good returns. We are now placing big chain store orders with manufacturers. Write for interesting booklet mailed free. Plastex Industries, Dept. A, 1085 Washington Ave., New York.

HOW And where to obtain capital. Fully explained, particulars free. Star Service, Wapakoneta, Ohio.

127 WAYS To make money, in home or office, business of your own. Full particulars free. Elite Co., 214 Grand St., New York.

BRUSH Plating outfits connect to a battery. No tanks necessary. Good paying business at home plating autoparts, bathroom fixtures, bicycles, reflectors, silvering mirrors. No shop or experience required. Outfits furnished. Free booklet. Gunmetal Co., Ave. H, Decatur, Ill.

LIQUID Marble; snow-white, multi-colored. Glazed. Unglazed. Composition flooring. Lifetime wear. Any color. No priorities. Flexible molds. Plaster casting. Get into the big money now. Full information given free. Write Compo-Tex, Box 788, St. Louis, Mo.

YOU Too can learn how to make, mold or cast real plastics. Send stamped envelope Box 498, Gainesville, Texas.

MAKE This yourself. Ten cent 1c. Owner delighted at \$2.50. Clean, red hot agent or mail article. 17-year lid cleared \$1,000 3 months. Details free. Will Tysen, Glens Ferry, Idaho.

NEED Extra dollars? Literature 3c. Foster, Box 2408, Oklahoma City 8, Okla.

MANY Make money by mail, you can too. Information free. Riley, 14568 Superior Rd., Cleveland 18, Ohio.

INCREASE Your income. Sample copy of big mail order magazine 10c. Wilson, R. 4, Martinsville, Ind.

PUBLISH Magazine under your name. Samples 10c. Lindblom, 210 Fifth Ave., New York.

BUY, Sell by mail! Learn how! Opportunity mail 10c. Edward MacDonald, Box 126-A, Seattle, Wash.

PROFITABLE Business plans and ideas. Free particulars. Spada Enterprises, 10 Lexington St., Wethersfield 9, Conn.

MERCHANDISE Marketing sales agencies wanted. Rankin, Glover Bldg., Kansas City, Mo.

DEPENDABLE, Practical mail order opportunity. H. J. Darnell, Jackson, Tenn.

CIRCULAR Mailing. Learn all about this well-paying business, 25c. Russell, 912-A Anniston, Sylacauga, Alabama.

GUARANTEED Income! Grind lawn mowers. \$2.00 capital! Mowers, Janesville, Wis.

CAPITAL Seekers—Interested in raising \$25,000 or more for a legitimate project should write to Amster Leonard, Fox Theater Bldg., Detroit 1, Mich.

INCREASE Your income by mail. Opportunity of unusual merit. Edwin D. King, 4216-A You Street, Sacramento, California.

BIG Profits, make and fit arch supports. Particulars. Jul Corssen, 3609 Texas, St. Louis 18, Missouri.

PERMANENT, Flexible molds. Casting plaster other materials from your models. Stamped envelope. Box 177, Gainesville, Texas.

WE Start you in business at home, sparetime, earning \$10-\$20 weekly, selling by mail. Joseph Driscoll Sales Service, Denver, Colo., Box 2771-A.

MILLION Dollar idea ready to put into operation, for sale for \$10,000 and 5% in company. Do not write if you do not mean business. Write E. George, 208 State Street, Helena, Montana.

STOP Chasing rainbows! Establish advertising novelty, calendar business. Over \$10,000 annually possible. Inexperienced beginner earned \$9.34 in hour. \$30 kit free to producers. Howlett, Huntington Station, New York.

SELL Envelopes by mail, sparetime. Big profits. Omaha Envelope Service, Dept. 5, 4721 California, Omaha 3, Neb.—Established 1930.

A RED Hot money making offer. Dime. Ella Hubbard, 4703 Spring Ave., Dallas, Texas.

500% PROFIT. Puncture proofing tires. Details for stamp. Betke, Box 699, Borger, Texas.

GUARANTEED Mailorder letters, circulars, folders, campaigns prepared. Big positive results reported. Reasonable! Pinkel-Adverselling, 1201 1/2 South Ogden, Los Angeles 35, California.

QUICKEST, Cheapest, shortest way to learn mailorder business. 4,500 word folio 25c. Hoffmann, 2740 Coy, Cincinnati 19, Ohio.

THOUSANDS Of Map-O-Time will be sold. Prospects—thousands of teachers, thousands of professionals, millions of war news readers and listeners. Details free. Sample \$1.00. Map-O-Time Company, 1417 E. State, Schenectady (4), N. Y.

BRAND New book—68 pages, 40,000 words—300 tested moneymakers, business secrets, successful mailorder plans, formulas, wholesale supply sources—25c, moneyback guarantee. Smith Publications, 213 Comstock, Syracuse, N. Y.

127 PRACTICAL Business plans. Experience unnecessary. Details free. E. L. Malloy, P.O. Box 174-A, Taft, California.

SELL Popular specialties. Free particulars. Moxul-1H, 1321 East 105, Cleveland 6, Ohio.

KUTE Kiever komical calling cards. Ever card a laugh. Complete assortment 10c (coin). Magic Products, 4133 Botanical, St. Louis 10, Mo.

FREE Moneymaking plans. Write Harris, 441 South Ashland, Lexington 19, Ky.

"HOW To Make Money With Hobbies" \$1.00. Circulars free. Arlington Sales Co., Box 113, Arlington, N. J.

GROW Drug plants and grow rich. Box 423, Kellogg, Idaho.

EXTRA Income—Plenty mail selling opportunities. Write Katz, 4254 N. Kimball, Chicago.

FREE Particulars what, where, how to sell by mail. Giuntas, 78-45 81st Street, Glendale, N. Y.

BUILD Spare-time or fulltime business. Dollar tips (25c) explains. Bill Patrick, Marengo 8, Illinois.

SUCCESS Says hello to you! Your own boss. Your own business, right at home! Amazing new mail order course shows you. Tiny capital quickly starts you. Thrilling literature free. P. O. Box 282, Naugatuck, Conn.

5 MOST Read mail order magazines 20c. Armand Cartier, 695A North, Pittsfield, Mass.

START A home business in spare time. Now is your chance. Make extra money. Experience not essential. Literature free. Norbert Koppel Publications, 3102 Brighton 1st Pl., Brooklyn, N. Y.

MAKE Money. Write. Carl A. Jonas, 27 Church Street, Lowell, New York.

"THE Magic Story." Attain success quickly. Free literature. Taylor Company, 590 Grove Pl., Pontiac 8, Michigan.

LIQUID Marble—Colorful, glazed! Mold, brush, spray! Composition floors, rubber-lastic molds. Particulars free. Marbleizing Service, Edwardsville, Illinois.

MAKE Money at home in spare time by mail. Write Gordon Publishers, Box 23, Pawtucket, R. I.

BIG Profits! Vitamins, minerals, wholesale! Metabasic Foods, Station S9128, Los Angeles.

FIVE Big mailorder magazines 20c. Lewis Company, 828-Carpenter, Oak Park, Ill.

START Your own refrigeration and air conditioning repair shop. Small capital. Good opportunity. Free booklet. Greer, Dept. 344, 2017 South Wabash Avenue, Chicago.

MAKE Flexible molds! Cast plaques, book ends, novelties! Literature free! H. Tooker, 630-K Chestnut, Hamilton, Ohio.

"SCHEMER" Magazine, Alliance, Ohio, publishes winning schemes, tips, opportunities. 46th year, \$1.00. Two copies, 10c.

POST-WAR Prosperity for those who start our plan now. Free information. Batesco, 207 N. Hamilton, Madison, Wis.

BE Your own boss! Robert Colliers mail order business course shows you how to make good money at home—spare or fulltime. Teaches professional mail order technique. Valuable folder free! Write Box 508, Hollywood, Calif.

GROW Green vegetables in cellar, garage, six days. Sell hotels, grocers. Complete instructions \$2.00. Temple, Box 533, St. Petersburg, Fla.

MONEYMAKING OPPORTUNITIES

IF It's wealth you desire, start a home business in spare time. Make extra money. Experience not essential. Literature free. Lucas, 70 Josephine, Detroit 2, Mich.

MECHANICALLY Inclined men—Own and operate general appliance repair shop. Complete, illustrated course shows you how. Welding, refrigeration, motor repair, how to get business, etc., all phases covered. Free literature. Christy Supply Dept. 1139, 2835 N. Central Ave., Chicago.

300 TESTED Moneymakers. 64-page brochure, 25c postpaid. No ads. All meat. The Bookmaster, Box 588-M, Stillwater, Okla.

SELL Books and courses by mail in your spare time. Siddall, Atascadero, Calif.

MAKE Your spare time pay dividends representing us. Our product stays sold, good repeater. Write Howard Good, 726 Summit, Toledo, Ohio.

FOR Post war profits, get ready now, tested methods for financial independence, details free. Box 26, Elmwood, Conn.

MAKE Your own Flexible Molds. Statuary, Art Goods, Novelties, Artificial Marble Flooring, Liquid Marble. Literature free. Kemico, 4-M, Park Ridge, Ill.

HAVE Your own factory. Use common vise for punch press. Shear, perforate, form articles of steel, brass, copper, aluminum accurately. Illustrated instructions how to make vise die sets \$1.00. Ray Kleffman, Box 6, Hibbing, Minn.

BOOKKEEPERS. Earn money at home posting journal entries. Ellis Business Service, Cedar Grove, North Carolina.

GROW Dwarfed trees few inches high for yourself or sell. Instructions 15c. Charles McGuire, P.O. Box 628, Dept. G, Seattle 11, Wash.

START A home business. Spare time. Extra money. Experience unnecessary. Literature free. Des Moines Home Cleaning Service, 2102-38, Des Moines, Iowa.

IF You want to trade or sell anything (regardless of what it is) send 20c coin for "Swappers Guide." It lists hundreds of swap-buy-sell opportunities all over America. Swappers Guide, 610 N. St. Joseph, Evansville, Indiana.

LICK After-war layoffs! Start own business; home, office. Booklet describing "Collection of 127 Tested Plans" free. Elite Co., 214 Grand St., New York.

MAILORDER Income. Boundless opportunities. Particulars stamp. MacMillen, 273D, Lancaster, Ohio.

BIG Mail, samples, magazines, money making propositions, dime. Edward Lau, Box 1258, Honolulu, Hawaii.

PERFUME Instructions furnished. Start mail order or local business. Particulars free. Dr. Abell, Parkway Bldg., Pasadena, Calif.

PUBLISH Your own magazine. Hand-some 52 page format, well edited, illustrated. Cost low as \$1.00 month. Brings you prestige, profits. 10c brings sample, details. National, Ord. Nebr.

LEARN Metascience. Remarkable drug-less healing. No manipulation. No apparatus. Unbelievable simplicity and results. Inexpensive correspondence course. Write Metascience, De Land, Florida.

MONEYMAKING Ideas galore. Mail-order, homework, business opportunities, agents propositions, swaps, bargains, etc. Big mail 10c. Val-U, Box 230-A, Burbank, Calif.

BIG Mail! Special offers. Directory listing. Mail order magazine 3 mos. All, 25c. Richmond, Box 21-F, Sta. A, Los Angeles, Calif.

THOUSANDS Of articles wholesale. "Supply Source Directory" 10c. Ideal Service, D-4, Park Ridge, Ill.

HELP Win the war first! Then man, you'll like silvering mirrors, reflectors! Making sparkling chipped glass nameplates. Outfit prices. Sprinkle, Plater, V60, Marion, Indiana.

AMATEUR And semi-professional artists and cartoonists, cash in on your ability. Hamilton, Box 4H, Woolsey Sta., Astoria, N. Y.

EARN Money evenings, copying and duplicating comic cartoons for advertisers. Adservice, Argyle, Wisconsin.

GIANT Mails 6c, catalog, magazine 4c. Opportunity mail free. Harvey Teeple, Decatur, Indiana.

WAR—Peace. Spare time home money making propositions. Charles, 12 AB, Norwood, Ohio.

MONEY Making mail order plan set-up, and new book "How to Be a Successful Mail Dealer" all for one 50c coin. Schutt Company, 243 East Ohio Street, Indianapolis, Indiana.

STOP Look listen. Better your financial condition with Selected Opportunities 25 cts. Jo France, 1040 So. Western Ave., Los Angeles 6, Calif.

GET Your mail order start by joining the National Mail Order Guild. They tell you all the facts—what sells by mail—who buys by mail and how to reach them. They help you every step of the way. Send for full information. No obligation. A. J. Shutt, P.O. Box 269, New Castle, Indiana.

"DOLLAR Tips." Book of moneymaking ideas, formulas, plans, business secrets 25c postpaid. Joseph Royer, 18-M How Street, Haverhill, Mass.

PROFITABLE Home-work. Interesting details for stamp. Woodcraft, 1320 Lindsay Street, Gainesville, Texas.

MONEY By mail opportunities. Free details. Earl Company, 504 Court, Albert Lea, Minn.

EARN Money at home! Thousands do! "Home Worker Magazine" tells how. Sample, 25c. Sizemore, Box 7, 4917 North Kostner, Chicago.

MAIL Selling opportunities galore! Dollar orders filled free. Investigate! Direct-Mail Sales Co., 1947-A Louise, Detroit 3, Michigan.

FARMERS, Gardeners: Plant, harvest by moon signs. Big returns. Planting guide with perpetual date indicator. Pre-paid \$1.00. Rural Service, 1663 Gummer Ave., Dayton 3, Ohio.

UNEMPLOYMENT, Age, or handicaps can be turned to success by using our plans. Start now. Free information. Batesco, 207 N. Hamilton, Madison, Wis.

FULL Or part time. Propositions galore in "Money Making Business Starters." A dollar value for 25 cents. John Perrone, Mail Service, 2325 Southern Boulevard, New York 60, N. Y.

NOT More than \$50 can be made on this \$1.00 investment. Still sounds interesting, doesn't it? For complete details write to R. Varvel, 241½ West 3rd, (South) Salt Lake City 1, Utah.

FORMULAS, PLANS, ETC.

CONCRETE, Make your own blocks or tile, mold costs but little. Plans \$1.00 or money order. Details free. W. Denham, Box 1083, Mobile, Alabama.

FORMULAS — Latest, best. Analysis. Literature free. Belfort, Engineering Building, Chicago.

AUTHENTIC Formulary 924 pages (illustrated). 10,000 money making formulas, recipes, instructions, substitutes. \$2.00 postpaid or C.O.D. (foreign \$2.35). Catalog. Adams Brown Company, Chestnut Hill 67, Massachusetts.

REAL Manufacturing formulas. Lists free. Cummings, Chemist, Gordon Ave., Syracuse, N. Y.

"LUMINOUS Paint" shines in dark. Easily made. 100 other formulas, plans—all 25c. Soap-making course (20 formulas) \$1.00. Resilvering mirrors, formula 20c. Ideal Service, 304, Park Ridge, Ill.

PRACTICAL Formulas requiring no machinery for manufacturing. Not the lowest price, but the best. Write Schaffner Laboratories, Avalon, Penna.

MONEY Maker formulas. Proven for any commodity. Send 25c for list. Tam-bay Laboratories, Box 1462, Tampa, Fla.

PLASTICS—Made at home without equipment, 10c pound. Perfect castings and moulds—formula, and instructions—50c. Fred Baker, 1849 Dufferin St., Toronto, Canada.

ANY Formula \$2.00 or money back. Case Kowal, Chemist, 1846 Cullerton, Chicago.

LATEST Moneymaking formulas 2 cents each. Send for lists. Martin, Dept. 215, 7704 New Utrecht Ave., Brooklyn, N. Y.

FORMULAS For profitable products. Lists free. Viggiano, Chemist, 6556 Lad-son, Pittsburgh, Penna.

MAKE Fast selling products. No machinery. "Chemist Approval Formulas." Literature free. Kemico, 15, Park Ridge, Illinois.

LATEST Formula books, particulars free. Warren White, 1300 Commerce, Dallas 1, Texas.

PROFIT Producing formulas. Literature free. L. H. Cusack, Fulton, N. Y.

CHEMISTRY

HANDBOOK For chemical experimenters, hundreds of experiments, illustrated, 50c. Experiment booklet 15c. Chemical catalogue 5c. Reading Scientific Company, Reading, Penna.

WINN'S New Idea Home Laboratory Chemical Kits and apparatus outfits for home experimenting. Send 5c for literature and retail supply catalogue. J. H. Winn Co., Dept. 503, 124 W. 23rd St., New York.

FREE Catalog: Chemistry, mineralogy, biology, optics. Special book sale: "How to Make Chemical Laboratory." Send \$1.00. Tracey Laboratories, Evanston, Ill.

288 PAGE Apparatus catalog sent for 75c. Chemical catalog, 10M items, 25c. Laboratory Materials, 7321 Vincennes, Chicago.

SPECTROSCOPE For quick chemical analysis \$2.50. Kutting Sons, Campbell, California.

CHEMISTRY Laboratory apparatus and chemicals for industrial, analytical, and private experimental laboratories. Complete chemical laboratory supply service for correspondence school students. Send 3c for free 48-page catalog of chemicals and apparatus. Dept. M-43, Biological Supply Co., 1176 Mt. Hope Ave., Rochester, New York.

FREE Catalog: Chemistry, mineralogy, biology, optics. Tracey Laboratories, Evanston, Illinois.

"CHEMISTRY For Beginners," "Chemistry of Familiar Things"—50c for both books. Waitman, 396 Broadway, New York.

FREE Chemical catalogue. Enclose 3c postage. Greenwood, 398 Broadway, New York.

LABORATORY Supplies at wholesale prices: Chemistry, biology, physics. Catalogue, 10c. National Scientific Co., 2204 W. North Ave., Chicago. Established 1908.

HELP WANTED

MEN, 20-45 Yrs. to work on railroad rail testing service cars. Those under 38 must be draft deferred. Job entails constant traveling. Electrical-mechanical experience preferred. Also stewards; salary plus all living expenses. Those now in 100% war work not considered unless released. Write full details to Personnel Department, Sperry Products, Inc., 1505 Wil- low Ave., Hoboken, N. J.

AGENTS WANTED

SELL 50 For \$1.00 name imprinted stationery—free samples. Odd cards 2½c. Fast selling line everyday greeting card assortments 35c up. Cards for boys and girls in service. Special offer. New England Art Publishers, North Abington, Mass.

SELL "Personalized soap" for service men. Name and emblem on each cake. Details free. Dunbar, New Brunswick 4, N. J.

UNUSUAL Opportunity. Make big money. New non-breakable 1" magnifying glass eye loupe. Very attractive. Amazing profits. Large field of users: machine shop workers, watch makers, etc. Dollar sample only 45c. Mark Specialty Co., 14 Franklin, Rochester, N. Y.

AGENTS: Make money fast selling high-potency Vitamin tablets at about half the usual price. Formula comparisons will convince you that you have no real competition. Big profit margin for you. Write for attractive money-making proposition. Vitamin House, 277 Broadway, New York.

AMBITIOUS School seniors—Sell classmates the "tops" in graduation name cards. Best commissions. Free cards. Agencies going like wildfire. Hurry! Craftcards, Box 235-L, Pittsburgh 30, Penna.

PLAYING Card game. 250% profit. Sample game 25c. Box 842, Denver 1, Colo.

ELECTRIC Directional signs. Sample Exit complete with socket, 8"x6" glass, \$1.50 and folders. Kelly Specialty, 5958 Washington, Chicago.

CALL On friends with easy to sell personalized stationery with name in raised type. Big profits. Free samples. Also genuine four-leaf clover plastic key tag with chain. Grand good-luck gift. Sample 25c postpaid. Merz Printery, 135 Lenox Street, Rochester 11, N. Y.

SELL Stores Buck Buffer for white shoes. Big demand. Season now. Profits good. Send 25c for sample, details. E. Davis, 61A Johnson Parkway, Buffalo, N. Y.

AGENTS. Big line including food products. Fast selling premium and bargain deals. Low prices. Send card for big outfit offer with gift. Ho-Ro-Co, 2775 Dodier, St. Louis 7, Mo.

PLATING Outfits for autoparts, reflectors. Connect to a battery. No tanks necessary. Free booklet and particulars. Gunmetal Co., Ave. N, Decatur, Ill.

AGENTS: Stamping names on pocket-protectors. Sample check with your name, address, 25c. Stamping outfits, Emblem checks, check-fobs, name plates, Hart Mfg. Co., 303 Degraw St., Brooklyn, N. Y.

MAGIC Cleaner and laundry soap deal. Hotter than a firecracker. Big profits! Sample free. Bestco, 5007 Irving Park, Chicago.

EXCELLENT Sideline for printing salesmen. Decalcomania name plates in small quantities. Also, make money applying initials on automobiles. Free samples. "Ralco," 1483 Washington, Boston (18), Mass.

AGENTS—300% Profit selling gold leaf window letters; stores and offices. Free samples. Metallic Letter Co., 438-B North Clark, Chicago.

FREE Water and our concentrates, makes flavors, lotions, shampoos, 72 products, labels, bottles furnished. Qualco, E-20030 Russell, Detroit.

ELITE Collection contains 127 plans for starting own business; home, office. Descriptive booklet free. Elite Co., 214 Grand St., New York.

AGENTS—Coin money—it's new—it's hot. Everyone wants radiant Masterette Oil paintings of loved ones. Commission advanced. We collect, deliver. 7x9 sample \$1.00 prepaid. E. Condon, Box 157, Upper Darby, Penna.

SCHOOL Seniors—Sell America's most beautiful, distinctive graduation name cards. Positively highest commission. Lowest prices. Free sample kit. Printcraft, 1423 E. Elm Street, Scranton, Penna.

AGENTS—Visiting factories, shipyards, airports, hospitals—see Sleep-Rite—Personal Column.

SILVER Plating and polishing liquid. Apply with cloth. Cleans, silverplates, polishes, simply by rubbing. Renews silverware. Jewelry, musical instruments, automotive trim, kitchen and bathroom fixtures, chandeliers, etc., like new. Nu-Silver, Aurora, Ill.

ROUTE Men, Agents, nine fast selling items. 100% profit. Transportation paid. Get prices. Coldrex Company, 3, Raleigh, N. C.

BIG Profits nationally advertised product. Information free. Lumco, Kimball, Nebr.

START Your own business on our capital. Always your own boss. Hundreds average \$3,000 to \$5,000 annual sales year after year. We supply stocks, equipment on credit. 200 home necessities. Selling experience unnecessary to start. Wonderful opportunity to own pleasant, profitable business backed by world wide industry. Write Rawleigh Co., Dept. D-U-PPMA, Freeport, Ill.

BIG Money taking orders; shirts, ties, socks, pants, jackets, sweaters, shoes, uniforms, etc. Sales equipment free. Experience unnecessary. Nimrod, 4922-AN Lincoln, Chicago.

MEDICINE Men. Write today for prices on our tonics, herbs, liniments, ointments, tablets, soap, vitamins liquid or tablets, anything and everything you need at lower prices. Celtons Medicine Co., 1016 Central Ave., Cincinnati 2, Ohio, Dept. P.M.

SELL "Little Doc" Liquid Gloves. Protect defense workers hands. Big profits. Schaffner's, Avalon, Penna.

SELL The new soap "Lather Leaves". Write, A. C. Hamel, Distr., Woolrich 8, Penna.

SELL New-used clothing from home, auto, store. Men's suits 99c, pants 27c, topcoats 44c, dresses 13c, ladies' coats 38c. Other bargains. Catalog free. S&N, 565A Roosevelt, Chicago.

SELL Mirrored framed pictures, religious, patriotic, scenery. Samples \$1.00. Zumpano, Chrystie St., New York City.

SELL Bombing mystery puzzles as side line or use as morale and business builder entertaining your regular customers. Send \$1.00 for 5—or 25c each. W. L. Fuchs Co., Dept. P.-A., Buder Bldg., St. Louis 1, Mo.

POWERFUL Mile stretcher! Increase mileage-power. 400% profits! Guaranteed. Thermox, Peoria 4, Ill.

BIG Bargains for big profits. Men's used pants 25c, suits \$1.00, topcoats 75c, shoes 12 1/2c. Over 100 sensational values. Experience unnecessary. Free wholesale catalog. Superior, 1250-C Jefferson, Chicago.

GOLD Lacquered window sign, letters. New styles. Absolutely beautiful. Free samples—catalogue. Atlas, 7941 Halsted, Chicago.

AMAZING Moneymaker. "Oilette" enlargements from any photo. Just take orders. We deliver. Agents cleaning up. Write quick. MacDonald Studios, P.O. Box 28, Jackson Heights, N. Y.

COST 3c. Sells 25c. McDaniel, 939 East Euclid, Detroit 11, Mich.

HIGH-GRADE SALESMEN

WANTED Salesmen calling on garages, service stations and auto dealers to sell tested, reliable radiator and cylinder crack weld—cubes and liquid—repairs internal motor leaks—exclusive product. Liberal commission. Lusk Company, 4618 Euclid Ave., Cleveland 3, Ohio.

SELL Exclusive printing line. Repeat business yours. Commissions, samples 25c deposit. Mango, 555 So. 20th, Newark 3, N. J.

SALESMEN: Have real money making opening. Fits into war program. Old progressive firm. Dept. "F," Box 392, Dallas, Texas.

ADVERTISING Book matches—Cash in on political campaigns—sell Union Label matches. Cuts for all businesses and political parties—free powerhouse selling kit—low prices—protection guaranteed on repeat orders—cash commissions. Superior Match Co., Dept. M-4, 7530 Greenwood, Chicago.

BLADES—Best quality, factory prices. Details free. Ace Blades, Buffalo, N. Y.

SALESMANAGER. Educational memberships. Mechanical society. Big percentage. Permanent. Quick sales. Send complete application. Nobel B. Martin, 610 Mead Bldg., Portland 4, Oregon.

ARTISAN Solder flux, all metals; marvelous repeater, factories, garages; sideline; limitless field; liberal. Hoover Labs., Newark, Ohio.

WANTED Advertising representatives. Information. Dissin Co., Bond Bldg., Washington, D. C.

ADVERTISING Salesmen—New complete line calendars, novelties, quality pencils. Liberal commissions and bonus to producers. State experience, references. Klein Advertising Co., Quincy, Illinois.

WE Are manufacturing complete line of cosmetics for the barber and beauty culture trade as well as a line of auto polishes (distinctly new), furniture polish, mechanics hand soap, rug and upholstery cleaner, also general household cleaning items. For the first time we are selling these items through salesmen and saleswomen, giving them select and exclusive territory and all repeat business in their territory on this fast repeating line. With plenty of help from the home office. Write for prospectus and full details. The Chemical Products Co., 1412 Hayden Avenue, Cleveland 12, Ohio.

EDUCATIONAL AND INSTRUCTION

"HOW To Break and Train Horses"—A book every farmer and horseman should have. It is free; no obligation. Simply address Beery School of Horsemanship, Dept. 1104, Pleasant Hill, Ohio.

LEARN The credit and collection business; earn \$50-\$150 weekly upwards; interesting synopsis free. Write Educational Extension Service, Dept. 101, Box 1945, Wilshire-Labrea Station, Los Angeles.

BUSINESS Men, teachers, students, clerks, accountants. Learn super-speed calculation at home; 10-lesson course by mail guarantees increased speed. New, unique method. Amazing results. Free particulars. Math Institute, 204 Adams St., Mobile, Ala.

GOOD Jobs and a sound future for you in hotel and institutional field, government housing, food and recreation projects. Men and women—all ages—needed for well-paid positions that offer color, excitement, ever-new and fascinating duties. Record-breaking business in hotels, clubs, institutions means even greater opportunities. Lewis School receiving calls for managers, hostesses, executive housekeepers, purchasing agents, stewards, etc. These are not temporary jobs, but important positions in an essential business that offers splendid opportunities in war or peace, good times or bad. Previous experience proved unnecessary! No need to leave your job to qualify. A good grade school education, plus Lewis Training qualifies you, at home, in spare time. Our National Placement Bureau helps to place you and—under our amazing Certified Job Plan—actually guarantees you will "make good" when placed. Write today for free book! Lewis Hotel Training School, Room CH-368, Washington 7, D. C. (First and only school of its kind—Now in its 28th year.)

CARPENTERS—We teach the steel square in five easy lessons by mail. Our copyrighted 1/4 size practice square does the trick. It's the chance you have been looking for. Send for free information, or send 25 cents for square and sample questions. Builders' Topics, Top Floor, Medical Arts Bldg., 1117 2nd Avenue, Seattle 1, Wash.

MEN—Women—children, paint signs and pictures, for your neighbors, 10 minute instruction lessons 10c each by mail. "Svitak" Correlated Ideas Exchange, 1877 Riverside Drive, Los Angeles 26, California. 9 years in this locality.

NEW Writers needed to re-write ideas in newspapers, magazines, and books. Splendid opportunity to "break into" fascinating writing field. May bring you up to \$5.00 per hour spare time. Experience unnecessary. Write today for free details. No obligation. Postcard will do. Comfort Writer's Service, 210-P South Seventh St., 2, St. Louis, Mo.

REFRIGERATION Service course, 24 illustrated manuals. Booklet free. Mechanics School, 4703 West Pico, Los Angeles 6.

RADIO Engineering, broadcasting, servicing electronics, aviation, marine and police radio taught thoroughly. All expenses low. Co-educational. Catalog free. Valparaiso Technical Institute, Dept. R, Valparaiso, Ind.

GOOD "Used" educational books on all subjects bought, sold, rented, exchanged. Satisfaction guaranteed. Complete details and 84-page illustrated bargain catalog free. Write Nelson Company, Dept. 208, Chicago.

HOME Study course, drugless therapy. Free literature. Inst. of Drugless Therapy, Tama, Iowa.

SHORT HAND In ten lessons. Sample. Kee-Way System, Dept. 444P, Syracuse 1, N. Y.

USED Educational books on all subjects sold, rented, also bought and exchanged. Moneyback guarantee. Write today for free catalog and details. Lee Mountain, Pisgah, Alabama.

EARN Certified Grapho-Analyst degree analyzing handwriting. Students report earnings up to \$1.00 an hour sparetime. \$75.00 weekly full time. Graduates in employment, credit agencies, police departments, courts, business and in private practice as personal problem and vocational advisors. Fully illustrated Grapho-Analyst and 3000 word illustrated lesson free. Institute, Box 1150, Joplin, Mo.

MEDICAL Laboratory technicians in great demand. We train you in your spare time, in your own home. You can practice while studying. Write for free catalogue. Imperial Technical Institute, Box 973-E, Austin, Texas.

DRUNKENNESS Is a disease which responds to treatment. Medical skill plus human sympathy prove successful with liquor and drug cases. 60 years experience. Write for free booklet. P. M. Nelson. The Keeley Institute, Dwight, Ill.

LOCKSMITH Course. Lock picking, key fitting, etc. \$1.00 prepaid. Locksmith, Canadian, Texas.

WELDING—Electric arc. Learn profitable trade quickly through actual practice. Individual welder instructions at bare cost of materials. Full particulars free. Valuable welding lessons book 50c. Hobart Welding School, Box M-1632, Troy, Ohio.

LEARN To sing! Voice culture made easy through a new modern method. Literature free. Pittman, Box 1653, Las Vegas, Nevada.

ARMATURE Winding course \$7.50. Automotive winding course \$3.50. Welder plans \$1.00. Frazee, Box 5086, San Francisco, Calif.

BODY Rejuvenation! Become professional acrobat. Free health book. Writel Knoff, 2154PM North 52nd Street, Milwaukee, Wisconsin.

USED Technical and educational books bought, sold, rented. Catalog free. Educational Exchange, Henagar, Alabama.

INVESTIGATOR Training. Phillips Society Service, 1917-B North Kenneth, Chicago, Illinois.

EXCEPTIONAL Opportunity. Operate a collection agency-credit bureau. Quickly learned. Many make \$5,000 yearly, up. Write Cole Associates, Syracuse, N. Y.

SECRET Investigation. Experience unnecessary. Investigators particulars free. George Wagner, M 125 West 86th, New York.

BE More successful. Use more of your present ability. Send for free details. Mayo, 3025 S. Orange Blossom Trail, Orlando, Florida.

MAKE Common clock ring electric alarm at different time in each room. Instructions 25c. Tuck, 73 Shirley, Pontiac 20, Mich.

BECOME A Doctor of Psychology (Ps. D.) Teach secret of contentment, happiness. Solve mental worries. Free book. College of Universal Truth, 5651-B North Ashland, Chicago.

GET "Set" now! The wartime job "boom" won't last forever! Then trained men will get the permanent jobs that pay best. Learn refrigeration, airconditioning, electronics, electrical engineering, radio, electronics, welding, inspection. Mention course wanted, low tuition, earn part expenses. Big book free. Milwaukee School of Engineering, Box 644, Milwaukee, Wisconsin.

HEALTH, Wealth, and happiness for you. Famous Astrohealth chart (16x24) shows you how. Send \$1.00 for this fascinating guaranteed chart and start life anew. Aristo Products Company, 847 N. Edgemont, Hollywood 27, California.

DRAFTSMEN: Increase your income \$100 to \$1000 or more. Prepare now for post-war opportunities. Send \$1 for sample instruction sheet and prospectus. Satisfaction guaranteed. Draftsmen Foundation, 45 Milk St., R902, Boston, Mass.

IT'S Your duty, building morale. Write servicemen! Learn through booklet, "Personalized Letters," how to correspond interestingly. Mail 25c. Hall's Publishing, Oak Dalton, Massachusetts.

BUSINESS SERVICE

JACKSONVILLE 5, Florida, mailing address. BMA Co., 5027 Sunderland, \$3.00 per month. Additional information 10c.

CHICAGO Mail address. Your business, personal mail received, reforwarded daily. 3 months \$3. General, 30 West Washington. (Established 1919.)

TOLEDO, Ohio, mail address. Personal-business. Reliable representation. Write Mr. Good, 726 Summit Street.

IF It's hard to get back let us collect it for you. We serve account and noteholders everywhere. No collection—no fee. Cowles, 100 E. Bellevue, Chicago 11, Ill.

CHICAGO Mail address. Your business, personal mail received. Regular daily reforwarding service. 3 months \$5. General, 30 West Washington. (Established 1919.)

CARTOONING, COMMERCIAL ART, SHOWCARD WRITING, SIGN PAINTING

LEARN Cartooning, how to create gag cartoon ideas. Cartoon business plans, markets. Hartman Studios, 2438 W. Lincoln, Nebr.

BARGAINS—Books and courses on sign, poster painting, cartooning, quick landscape painting, story writing, etc. Write today for big illustrated list free. Art Book Shop, 100 Elm St., Kimmiswick, Mo.

POCKET Cartoon course. 22 easy lessons in cartooning, prepared by a nationally known cartoonist with more than 20 years experience. Mailed postpaid on receipt of 25c in coin. Snack Pack Company, 34 E. Georgia St., Indianapolis 4, Ind.

CARTOONISTS Need gags; pay \$5 to \$15. Markets, instructions 25c. Gerardt, 710 Gaston, Fairmont, W. Va.

LEARN To draw nudes. Over 350 illustrations, charts and notes, giving detailed study of every part of the human body. Send for "Art Anatomy of the Human Figure" by Charles Carlson. Only \$1.00. Ball Square Company, 210 Fifth Ave., Suite 1102, New York City.

CARTOONING Course—30 illustrated lessons, over 500 sketches, complete \$1.00. Montes Studio, Box 892, Pasadena, Calif.

CHALK Talks. Laugh producing program, \$1.00. Catalog 10c. Balda The Cartoonist, Oshkosh, Wisconsin.

CARTOONING. Learn quickly at home. New, easy method. Originate comic characters instantly. Prepared by successful cartoonist. Complete course \$2.85. Details free. National Artists, P.O. Box 4248-A, Dallas 8, Texas.

CARTOONING. Easy method, 36 lessons. Complete \$1.00. Home Instructions, 3456 West 116th, Chicago 43.

ADVERTISING AGENCIES, LETTER WRITERS, FOR ADVERTISERS

COMMERCIAL Art, advertising illustrations, any purpose. Trade-mark, letterhead or label designing. Reasonable prices. Baker Studios, 3302 Dodge, Omaha, Nebraska.

ADVERTISE: 24 Words, 149 newspapers \$6.50. Lists free. Advertising Bureau, 4515-C Cottage Grove, Chicago 15.

FREE—New Advertisers Rate Guide, 44 pages. Includes everything. Lowest rates. E. H. Brown Advertising Agency, Merchandise Mart, Chicago.

ADVERTISING Placed all magazines, newspapers U.S.A., Canada. Lowest rates. Free Service. 54-page catalog free. Baker Advertising Agency, A-189 W. Madison, Chicago.

ADVERTISING Placed, any publication, lowest rates, complete agency service. Skilled advertising—merchandising counsel. Ratelist and booklet, entitled "Advertising Results For Sale" free. Baker Agency, 3302 Dodge, Omaha, Nebraska.

FREE—"Amazing New Book"—"Profits From Classified Advertising." Tells how and what to advertise. Be sure to read this book before you invest one cent in advertising. Remember—it's free! Write for your copy now. F. W. Johnson, Classified Advertising Manager, 200 East Ontario Street, Chicago, Illinois.

24 WORDS, 30 Newspapers \$2.00. Good-all, 37 Gardner, Vallejo, California.

SPECIAL Low-costing, most effective, inexpensive advertising. Van Scoy, 1501 West 11 Place, Los Angeles.

ADVERTISING Placed everywhere lowest rates. Reliable guidance on publications, expert assistance on ads without charge. Newspaper, magazine, mailing-list, ratebook free. Chicago Advertising Agency, 20-P West Jackson, Chicago 4.

MAIL Order operators—Get skillfully prepared copy when placing advertising. Our "lowest" line rate plus experience gives you more profits per dollar spent. Van De Mark, Times Star Tower, Cincinnati 2.

INCH Display advertisement, 50 magazines, year \$16. Wood's Popular Services, Atlantic City, (N. J.)

TYPEWRITERS, DUPLICATORS, OFFICE DEVICES

"PRINTOMATIC" Self-feeding rotary stencil post card printer, complete, \$9.50. All makes duplicator supplies. Literature free. Pittsburgh Typewriter Supply, 336-R Fourth Avenue, Pittsburgh 22, Penna.

PRINT-O-MATIC For \$9.50, kit of supplies included. Used mimeograph \$25.00. Office machines bought, sold. Handy catalog 10c. Write Schubert, 3230 Lowry, Los Angeles 27.

RUBBER STAMPS AND OFFICE SUPPLIES

ONE Line 15c, two lines 25c, three lines 35c. Excello Sales, Dept. B, Box 500, Shreveport, Louisiana.

ONE Line 15c, 2-25c, 3-35c. Stamp Works, Auburn, Nebr.

3 LINES 30c; Cushioned, indexed, 35c. Signatures \$1.50. Stamprite, Wauwatosa, Wis.

3 LINES 30c; Cushioned, indexed, 35c. Signatures \$1.50. Stamprite, Wauwatosa, Wis.

KNOB Handle, cushioned, 2 lines 30c, 3-40c. Stamp Works, Centerport, N. Y.

PRINTING, MULTIGRAPHING, MIMEOGRAPHING, GUMMED LABELS

PRINTING—Neat work—Low prices. Free samples. Shiretown Press, 17 Pleasant Street, Plymouth, Mass.

200—8½x11 HAMMERMILL Letterheads \$1.00 postpaid. Race Printery, Hudson, N. Y.

5000 ELEGANT Envelope enclosures, 200 words, \$3.99. All printing low prices. Samples. Goodprint, Harrisonburg, Va.

MIMEOGRAPHING—Letters, pricelists, formulas, instructions. Lowest prices. Lem's Letter Shop, 5710 Stanton, Detroit 8.

100 LETTERHEADS And envelopes \$1.00. Regal, 1366 Bellefair, Springfield, Ohio.

ENVELOPES, Letterheads, cards, 250 \$1.00. Seejay, 2416 North Oakley, Chicago, Ill.

GOOD Printing, reasonable. Lowest prices, estimates. 1227 Jefferson, Buffalo, N. Y.

1000 8½x11 LETTERHEADS \$4.00, 2000 \$6.75, 5000 \$15.00 f.o.b. Samples. William Jones, Mineola, N. Y.

OFFSET Printing, advertising literature, office forms. 4154p Fifth Street, Philadelphia 40.

GUMMED Perforated, address labels. Write for prices. Keller, Michigantown, Ind.

100 8½x11 LETTERHEADS And 100 envelopes \$1.00 postpaid. Raised letter \$1.50. St. Anthony Printing Co., 4701 Sheridan, Chicago, Ill.

250 BOND Letterheads, 250 envelopes \$3.00. Peerless Press, Loganton, Penna.

LET Us help you in all your printing needs. Lowest prices. State requirements. Printing Service, 7922 South Vermont Avenue, Los Angeles 44, California.

\$2.00 POSTPAID: 200 8½x11 Good bond letterheads and 200 6¼ envelopes, 500 of each \$4.75 postpaid. Mero Products, Box 344, Punxsutawney, Penna.

500 ¾x2¼ FOUR Line gummed stickers. 25c. Moritz Printery, Saginaw, Mich.

1000 BUSINESS Cards \$2.00. Rubber stamp your name 25c. Willmar Press, 120 Beacon Ave., Providence, R. I.

BETTER Grade printing reasonable. Estimates on anything. Economic Press, Leonia, N. J.

STATIONERY, 200 Sheets—100 envelopes, all printed \$1.25 prepaid. Catalogue 10c. Sign, Dpt. PM, Farmington, Mo.

DOLLAR Printing—mimeographing, 25 specials. Mogul-IG, 1321 East 105, Cleveland 6, Ohio.

2500 BOOK Matches with your business name, address, phone number on front cover. Patriotic slogan "Keep 'Em Flying" on reverse side. All for \$9.95 f.o.b. Cash with order. 1000 business cards, raised lettering \$2.95. 1000 business cards, flat printing \$2.95 postpaid. Mail Order Press, 417 So. Dearborn St., Chicago 5, Ill.

DOLLAR Specials; postpaid: 200 letterheads; 6¼ envelopes; statements; invoices; cards. Franklin Press, 228 Neville Block, Omaha, Nebr.

FIRST Quality printing—reasonably priced. Samples. Treaster Printing, Milroy, Pennsylvania.

PRINTING OUTFITS AND SUPPLIES

PRINTER'S Supply bargain catalog. Send stamp. Bradshaw's, 3214-P Huron, Chicago 24.

PRINTING Outfits and supplies. Send stamp for details or dime for complete illustrated supply book. Kelsey, Inc., W-11, Meriden, Conn.

USED Presses, type, supplies. Lists 3c. Turnbaugh Service, Loysville, Penna.

DUPLIGRAPH Reproduces writing, typewriting, drawings. 8½x11 size \$2.50. P.O. Box 1637, San Antonio, Texas.

BARGAINS—Presses, type, supplies. Send stamp. 8 Walden, Cambridge, Mass.

INEXPENSIVE Home-made printing press. Details free. Novelty Shop, Downsville, Louisiana.

ENGRAVINGS, Halftones, stock cuts, Proofs 3c. Richardson, 467-A Holden, Wyoming, Penna.

PATENT ATTORNEYS

INVENTORS: Learn now—without obligation—how to protect and sell your invention. Secure free "Record of Invention" form with instructions for making disclosure and establishing date of your invention—and new free book "Patent Guide for the Inventor," containing complete information about patent procedure and how to sell inventions; giving illustrations of many successful inventions; over 150 basic mechanical movements. Delay may be costly. For prompt confidential service—write today to Clarence A. O'Brien & Harvey Jacobson, Registered Patent Attorneys, 41B-D Adams Building, Washington, D. C.

PATENTS. Promptness assured. Wilfred E. Lawson, 1524 K St., N.W., Washington, D. C.

INVENTORS—First things come first. Your first move toward securing a patent on your invention is acquiring full information on what to do. Our two books "Patent Protection" and "When and How to Sell Your Invention" contain this information and other helpful data. Get them immediately, together with our "Evidence of Invention" form. They cost you nothing, you assume no obligation. Write now to Victor J. Evans & Co., Registered Patent Attorneys, 831-D Merlino Building, Washington 6, D. C.

C. A. SNOW & Co., M-427 Snow Bldg., Washington 1, D. C. Registered patent attorneys. Established 1875. Literature mailed on request.

PATENTS Obtained; selling service, information, recording forms free. Labiner, World Building, New York.

L. F. RANDOLPH, 302-B Columbian Bldg., Washington, D. C. Low cost. Book and information free.

"PATENT-Particulars" and blanks, free, airmailed. Sterling Buck, Park-North Avenues, Baltimore 17, Md. Government-registered 37 years.

"INVENTOR'S Guide," 100 mechanical movements, free; advises on patenting, selling inventions. Frank W. Ledermann, 154 Nassau Street, New York.

PATENTS. Protect your idea by securing free "Proof of Invention" folder. Exceptional personal service. Established 1906. E. E. Vrooman, 871 Woodard Bldg., Washington, D. C.

INVENTORS—Before disclosing your invention to anyone send for form "Evidence of Conception"; "Schedule of Government and Attorneys' Fees" and instructions. Sent free. Lancaster, Allwine & Rommel, 411 Bowen Building, Washington, D. C.

PATENTS—Trade marks. Preliminary advice, book and disclosure form free. Personal service. Irving L. McCathran, 315 McLachlen Bldg., Washington 1, D. C. Registered Patent Attorney.

FOR INVENTORS

INVENTORS—Information on what to do first toward securing a patent on your invention is of vital importance. "Patent Protection" and "When and How to Sell Your Invention"—two valuable, richly illustrated books—explain fully what to do first, and a lot more. Get this information quickly together with "Evidence of Invention" form. All three will be sent to you free. Write immediately to Victor J. Evans & Co., Registered Patent Attorneys, 832-D Merlino Building, Washington, 6, D. C.

CASH For practical ideas and inventions. Mr. Ball, AB-9441 Pleasant, Chicago.

INVENTORS! Free booklet, "Selling Your Invention," explains correct way to market your invention. Inventors Patent Exchange, 635 Main, Hartford, Conn.

INVENTORS. Industry needs your ideas now! Two reasons—1. Manufacturers are getting ready now for post war sales and production. 2. Right now, manufacturers are seeking products their expanded facilities can handle; factories must have products to take up the slack after war orders stop. Your chance comes with patent protection now—delay may endanger your chance. Get our new free Inventor's Book today and valuable "Invention Record" form. This request does not obligate you. Act now. Write today. McMorrow & Berman, Patent Attorneys, 1345 Albee Bldg., Washington, D. C.

INVENTORS: New military and commercial inventions urgently needed by manufacturers. Write for particulars. Chartered Institute, Dept. 4-A, Washington, D. C.

INVENTORS: Learn now—without obligation—how to protect and sell your invention. Write for free "Record of Invention" form and complete instructions for making disclosure and establishing date of your invention. We also send our new free "Patent Guide for the Inventor," containing complete information about patent procedure and how to sell inventions; giving illustrations of many successful inventions; over 150 basic mechanical movements. We assure you prompt, confidential service. Delays may be dangerous. Write today for your free "Patent Guide" and "Record of Invention" form. Clarence A. O'Brien & Harvey Jacobson, Registered Patent Attorneys, 41A-D Adams Building, Washington, D. C.

SEE Our display ad, "Attention Inventors." New Products Division, Heckethorn Manufacturing & Supply Company, Littleton, Colorado, page 32A this issue Popular Mechanics monthly.

INVENTORS! Have you good patentable ideas? Write Mr. Metzler, 11 West 42nd, New York.

I SELL Patents. Established in 1900. Charles A. Scott, 773PM Garson Ave., Rochester, N. Y.

INVENTIONS WANTED

PLASTIC Manufacturer will buy or manufacture on royalty basis, patented or patentable articles. Twenty years plastic experience. United Plastic Works, 8947 Exposition Blvd., Los Angeles 34, Calif.

ENTERPRISING Concern wants post-war products; extremely well set up, equipped shop; can manufacture, finance, handle sales. Write Barco Machine Products Company, 1975 East 65th Street, Cleveland, Ohio.

INVENTORS! Have you good, patentable ideas? Write—Mr. Metzler, 11 West 42nd, New York.

WANTED—Good post-war inventions, all kinds, patented, unpatented. Booklet, references, free. Invention Reporter, 5B-11236 So. Fairfield, Chicago.

WANTED—New tools for automotive and aircraft work. Will buy patents or designs outright or as finished tools. Give details. Betterfit Tools, Box 56, New Britain, Conn.

CASH For inventions, patented, unpatented. Mr. Ball, A-9441 Pleasant, Chicago.

INVENTORS: Have you a sound, practical invention for sale, patented or unpatented? If so, write Chartered Institute of American Inventors, Dept. 4-D, Washington, D. C.

ALL Kinds. We have facilities and finances to make and sell your ideas, both mechanical and chemical. Send model, sample, details and wishes. General Sales & Supply Company, 110 East Main St., Madison 3, Wisconsin.

MANUFACTURER Wants sensible mechanical device or idea with quick sales possibilities in low-priced field. Write Matt, 1412-D Great Northern Building, Chicago 4.

PATENTS FOR SALE

AUTOMOTIVE, Transportation, paint, mechanical, industries, inventions ready, mass production any shop, metal items. Address Inventor Fred M. Giddings, Galesburg, Illinois.

WAR Novelty for sale. Allan Browne, 4715 Michigan Ave., Chicago.

PATENT No. 2149761, bicycle lock. Make outright offer. Ray E. Coats, Bowen, Illinois.

ONE Piece safety razor handle operated changing blade fast. Investigate this. Rojahn, 1044 - 76th St., Brooklyn, N. Y.

UNPATENTED Inventions. Automotive, air conditioning, plastics, household, garden tools, aeronautical, marine. Address Inventor Mustain, 18 North 12 St., Newark 7, N. J.

FOR Sale. Pending patent. Fluorescent light or will consider forming company to manufacture. Also album magazine photo record changer, new principle clock, self winding film and others. Invention problems solved. Inventions to order. Mr. Tyree, Box 1672, Oakland, Calif.

AUTOMOTIVE Valve keeper tool Pat. 2318866. Simple construction. June, 932 West 57 Street, Seattle, Washington.

MANUFACTURING

MODELS—Small lot manufacturing. Metals, plastics, etc. Milburn, Burlington, Kentucky.

MANUFACTURING, Precision machining, production. Specialty Machine Shop, 2821 Mitchell St., Racine, Wis.

MODELS AND MODEL SUPPLIES

TRAIN Fans! If you build your own accessories and switches, this device is indispensable. Compact, powerful, double-acting Solenoid Machine, 8-15 v, compounded leverage provides movement range 1/4" to 3/4". Adjustable friction lock. With ratchet device will operate turntable or bridge. Complete with wiring and keyboard type controls, \$10.00 pair. Postpaid cash with o-d, or send \$1.00 balance c.o.d. Cole-uilt Products, 7075 Sta. G, Los Angeles 37.

COMPLETE Kits ship models, coach models, covered wagon. All parts cut to fit—no shaping required—tack hammer only tool needed. Everything included—sails, wire and rigging. Send 3c stamp for catalog. Miniature Ship Models, Dept. R, Perkasie, Penna.

MODEL Kits and supplies, catalog 10c. Steve Patti Co., 1443 W. Forest Home Ave., Milwaukee 4, Wisconsin.

SHIP Model kits and fittings. Complete line Fisher model yacht equipment. All Boucher, Fisher, Marine Model and Ideal kits, fittings and blueprints at standard prices. Most complete stock in New England. James Bliss & Co., Inc., 220 State Street, Boston, Massachusetts.

PLANES, Boats, hundreds of hobby items. Catalog 6c. America's Hobby Center, Dept. B44, 40 E. 21 St., New York 10, N. Y.

CASH Paid for old locomotives, passenger cars, freight cars, also want Hudson type locomotives, "O" gauge. Robert I. Mobley, 6110 Santa Monica Blvd., Hollywood, California.

SHIP Models and yacht supplies complete. Large 64 page catalogue 20c. Bill Wild's, 510 East 11 St., New York City.

HOME CRAFTSMEN

CELLULOID—Beautiful assortment. Mottles, opaques, onyx, pearls. Used by ring makers everywhere. One pound assortment—pieces approximately 39 sq. in. each. Price \$1.00. Craft Service, 337 University Ave., Rochester, N. Y.

DESIGN At home, leather novelties, costume ornaments. Complete kit, 25c. Cowhide name pin free. Vogue Leathers, Box 6, Fairfield, Iowa.

JIGSAW Blades—12 assorted hookless type 10c plus 2c postage. B. Gloris, 4927 St. Paul Ave., Chicago 39, Ill.

28 LAWN Ornament patterns 25c. Other patterns; 15"-20" high; Dutch girl; Dutch boy, pirate, bull terrier, Mexican girl, Mexican boy, dwarf, penguin, flower girl, 10c each; 3 for 25c. 25 novelty patterns 30c. All 62 full size patterns \$1.00 postpaid. Strother, Box 383-FL, Belington, W. Va.

PRINTS And instructions for building garden tractor, \$1. William Tanger, Bellefontaine, Ohio.

CATALOG: Tools, decal transfers. Patterns novelty furniture, lawn ornaments, silhouettes, letters and numerals. Other lines, 500 articles finely illustrated. Write Wo-Met Shop, Ashburn, Georgia.

NOVELTIES From scrap wood, 25 patterns, 25c. Patterns, kits, lists 5c. Lynds, Medway, Mass.

LUCITE—Transmits light around curves—beautiful clear plastics. Bargain 1 lb. assortment of odd pieces (approximately 6 rods and 6 flat sheets), \$1.00 postpaid. Craft Service, 337 University Avenue, Rochester, New York.

FUTURISTIC Ash stand. Easily made plans 25c. Robert Cunningham, 18 Warner St., Hartford, Conn.

KIDDIES Wooden indoor two seat swing, plans \$1.00. Cook, Box 368, Nederland, Texas.

LUCITE And Plexiglas pieces—Large package \$1.00 postpaid. Barnett Specialty, Box 212, North Hollywood, California.

25 SHELVES You Can Make. Booklet describing everything from wall shelf for dishes to knickknack shelf of white enameled wire and blue glass. 25c. Popular Mechanics Press, (C-43), 200 E. Ontario Chicago.

WATCHES, OLD GOLD, JEWELRY

ELITE Diamond rings—Perment imitations. Men's belcher—Women's tiffany gold p. \$1.00. Women's modern—cluster or wedding sterling \$2.00. Sample bargains limited. Rush order. State size. Ollendorf, 1220 Builders Building, Chicago.

GOLD \$35.00 Ounce. Mail old gold teeth, diamonds, jewelry, watches. Receive cash by return mail. Satisfaction guaranteed. Free information. Dr. Weisberg's Gold Refining Company, 1500-Q Hennepin, Minneapolis, Minn.

LADIES And men's Swiss reconditioned wrist watches, yellow and rose gold color, \$19.75 money order. Rudolph's, Atchison, Kansas.

WATCHES, Materials, tools, jewelry, diamonds—bought—sold. Catalogue, Gales, Box 1000, Chicago.

WANTED—Old gold. Mail gold teeth, rings, watches, etc. Highest prices. W. C. Williams, 800 Redington, Hanford, Calif.

RAZORS, BLADES, SHARPENING

COMPLETE Hair trimmer 60c, extra blades 5c. Watson Hauger, 224AU Ridge, New Kensington, Pennsylvania.

MEN: Double edge razor blades \$1.50 per hundred postpaid. Write Blu-Mar Sales Co., 35 Cascade Ave., Lowell, Mass.

TOBACCO, SMOKERS' SUPPLIES

CIGARS—Hand made, mild. Trial box 50, \$3.00, plus 20c shipping cost. Many other brands. Literature free. Zibar, Roselle, N. J.

FREE To pipe smokers—For a new pipe smoking thrill, write us your brand of tobacco and get free package mild, tasty, natural-flavored "Green River." Pete Moberly, Box 967, Owensboro, Kentucky.

SURVEYING INSTRUMENTS

GUARANTEED Factory rebuilt transits and levels for sale (cash or terms) or rent (with purchase option). We will repair, trade, or buy old instruments. Ship prepaid for estimate and valuation. For complete information, write for list M94. Warren-Knight Co., (Manufacturers of Transits and Levels), 136 N. 12th St., Philadelphia 7, Penna.

WANTED—MISCELLANEOUS

MUST Have machine shop equipment. Lathes, shapers, milling machines, drills, etc. Will pay cash, price no object. May & Lake Manufacturing Co., 1034 W. Lake St., Chicago, Illinois.

MERCURY (Quicksilver) — Cadmium, bismuth, tungsten, molybdenum, cobalt, vanadium. Write for quotations stating quantity. You'll receive guaranteed prices. Metallurgical Products Co., 35th and Moore Sts., Philadelphia, Penna. Established 1909.

WE Pay you well for "anything" you wish to sell: merchandise; jewelry; tools; instruments; equipment. Justice Jobbers, Box 150, Chicago.

COIN Operated machines, all kinds. Austin, 3234 Sterling, Alameda, Calif.

HAVE You any liquid mold making rubber to sell? Any amount. (Selling out: dollar novelties 25c). Bishop's, 5708 W. North Ave., Milwaukee 8, Wis.

MERCURY—Highest prices. Free containers. Write. Wholesale Terminal, Norwood, Massachusetts.

WANT 22 Shorts ammunition. Any amount. Will pay highest price per case (10,000). Immediate cash. Distance no barrier. Peerless Vending Machine Co., Department PM, 220 West 42nd Street, New York City.

WANTED: Mercury (quicksilver). We pay \$1.00 per pound. Western Metal Co., Bloomington, Illinois.

PORTABLE Typewriter, excellent condition. J. Reiney, 5110 Sixth Avenue, Brooklyn, N. Y.

PERSONAL

WRITE Beautiful penmanship — few hours—with "Graved Letters." Write. Ozment, 9, St. Louis, Mo.

MEN, Feel vitally fit! Amazing time-tested course helps stimulate entire system, restoring youthful pep and vigor in many cases. No medicine. No surgery. Benefits assured on money-back guarantee. Free information sent in plain, sealed envelope. Send name, address today to Basic Methods, 675 Eliot, Denver 4, Colo.

SLEEP-RITE Ear stoppers, stop noise, insuring soldiers, sailors, watchmen, firemen, sound sleep. \$1.00. Trial 10c. Booklet free. Raymond Dow, 15 Park Row (1215), New York 7.

DRUNKENNESS is a disease which responds to treatment. Medical skill plus human sympathy prove successful with liquor and drug cases. 60 years experience. Write for free booklet. P. M. Nelson. The Keeley Institute, Dwight, Ill.

PSYCHIC Paper 10c. Bobbitt, 1609 Tenth Avenue North, Nashville 8, Tenn.

HAIR Falling? Dandruff? Write Trichologist, 137 Lewis St., Phillipsburg, N. J.

PERSONALITY Expert will analyze your handwriting. Send four lines, trial offers 10c, 25c, 50c, 9063 179 St., Jamaica 3, New York.

MEXICAN Legal matters reliably handled. A. Munoz, 240, Juarez, Mexico.

NEW Plan pays family hospital and surgical bills. Costs only 3c a day for grown-ups; 1½c a day for children. Pays up to \$510.00 each year for each person. Special family group rates. Big, reliable company. Write for free inspection offer. Sterling Insurance Co., 4772 Jackson-Franklin Bldg., Chicago, Ill.

FALLING Hair, its cause and prevention, is fully explained in an informative and educational pamphlet entitled "How to Keep Your Hair Till Ninety." For free copy write, James Hilton, 4819 Fourth Ave., Brooklyn, N. Y. 20.

NEXT Time you "feel rotten" try breathing right! Capt. Godfrey Rodriguer was discharged from the Dutch army as incurably tubercular. Today he has a chest measurement of 46", a waist of 34" and a chest expansion of 9" . . . and all he did was learn how to breathe. "Right breathing will rid you of 'a bay window,'" says Rodriguer. "Right breathing has made me immune to colds and coughs, sinus and flu. I defy anyone to give me a cold." Send for particulars regarding Rodriguer's simple method of breathing. No obligation. A. J. Schutt, 506½ S. 15 St., New Castle, Ind.

STOP Itch, clear skin. New hope for all skin sufferers. Free if not relieved in 10 days. Send \$2, c.o.d. postage extra. Paul Bros. Pharmacists, 1221 White Plains Road, (Dept. P.M.3), New York 60, N. Y.

CASH In on your natural abilities. Know them from Courtney's Scientific Adaptitude Test. Complete trial test 10c. Courtney, Counselor, 918 South Summerlin, Orlando, Florida.

BUY Vitamins direct. Save. Postcard. Matoska Products, White Bear Lake, Minn.

BIRTH Certificate, estate, other facts available and developed U. S., Canada. Heirs, others located. Chaffee, 308 W. Washington, Chicago 6.

MISCELLANEOUS

OLD Sway-backed bed springs made like new. Why spend 1/3 of your life on a spring that sags? Send \$1.00 for information that overcomes sagging springs. Credited on purchase of new spring after Victory. Williams Furniture, Elgin, Ill.

98c WATCH Runs 12 years—still going. Stubborn clocks quickly respond, run again. New, household formula. Complete information 50c. Hale Clocks, Venice, Calif.

POTPOURRI Fragrance jar—Ornamental chemical garden—Oriental barometer. Directions 25c (coin). Profitable. No equipment necessary. Frank, Box 633, Stamford, Conn.

MILITARY Medallion—Send \$2.00 and photo. No foreign business. J. Black, 1249 South Grand, Los Angeles.

TEXAS Pecan pralines. Famous southern candy lifted to new heights of toothsome goodness. Pound and half postpaid \$2.00. Nutty Brown Products, Box 7415, Houston, Texas.

ATTENTION Nurserymen: 320 names and addresses of landscape architects. \$6.00, cash. BMA Co., 5027 Sunderland, Jacksonville 5, Florida.

ELECTRIC Paint or garden sprayer. Easily converted from cheap auto air horn. Complete illustrated plans 35c. Kaytor Lab's, Lynwood, Calif.

PENCILS, Better sort. Individual, firm name. Imprinted gold. Dozen 50c. Gross \$3.60. Economical, better for school. Pencil Market, 611 - 15th St., Knoxville 16, Tenn.

NOW, You can make your own printing cuts by simple, easy "Plastoplate" process. No messy chemicals. Adaservice, Argyle, Wisconsin.

ANY Book (new, used, out-of-print, rare) promptly supplied! Lowest prices! Send for free bargain catalogues! Old Prof's Book Shop, 116 Arcadia Court, Pontiac 16, Mich.

BIG Mail for you. Latest moneymaking offers, opportunities, catalogs, magazines. Name listed in directory 10c. Ideal Service, 104-M, Park Ridge, Ill.

MEND Socks, shirts without sewing. Use hot fatiron and our treated colored cloth patches. Complete 25c. Korn, 350 Irving, Brooklyn, N. Y.

OPEN Your garage door from dash board. Look under "Automobiles."

THE Solution of the trisection problem, \$1.25. Trisect angle with ruler and compass only. Edward Vennigerholz, 208 S. Asbury, Moscow, Idaho.

RAYBURN'S Ozark Guide, Lonsdale, Arkansas. For homeseekers, sportsmen. Year, \$1.00.

'44 ESQUIRE Desk calendars—Twelve Varga girls 50c. Esquire Agent, 1919 Girard, Philadelphia, Penna.

FINGERPRINT Powder; new and superior powder. William Croll, Box 502, Norristown, Penna.

THE Lord is coming! Get guaranteed proofs free. Scheall, 263-X, Duluth, Minnesota.

MEDICAL Laboratory technicians in great demand. We train you in your spare time, in your own home. You can practice while studying. Write for free catalogue. Imperial Technical Institute, Box 973-J, Austin, Texas.

CODEMASTER Complete with key, buzzer, code instructions—only \$1.00. Battery 30c. Include 20c postage or c.o.d. Guaranteed. Rathert Elect. Co., Cresco, Iowa.

BRINKO Cleaner and polish, one operation. No mixing. Unconditionally guaranteed. 50c package equals quart liquid. G. H. Brinkley, 1520 N. Regester, Baltimore 13, Maryland.

TOOLMAKERS Make your postwar job secure by learning trigonometry the easy way. Get Shopman's Trigonometry now, \$1.00 while they last. C. J. Turcotte, 202 Hastings, Flint, Mich.

FREE—Stories, Book. Boys, girls. Berg, 659 Churchill Road, Bridgeport, Conn.

GET Humorous Alaska license to hunt Japs. Send 25c. A remarkable novelty. Alaska Sportsman, Ketchikan, Alaska.

THE Exact day of the week sent for any date (month and year) 25c. Knight, 286 Commonwealth, Boston.

HEATING Six rooms \$20 yearly. Circulars 10c. Rosenzweig, RR10-A4, Cincinnati.

FOOL Your friends. Pretend you are in San Francisco, Reno, Nevada, 3 post-card views sent 25c (20—\$1.00). You write message, address, return, I remain in San Francisco or Reno. Letters 15c. Smith, 153 Liberty, San Francisco.

WALLETS With a separate celluloid case for only \$1.00. Silbert, 61 Willett St., New York City.

INDIVIDUAL Income tax returns prepared. 1040A \$2.00, 1040 \$5.00. Atkins, 1075 Armada, Pasadena.

HOLLYWOOD Kombi (combination) high chair, go-cart, rocker, unpainted standard size, practical, efficient. In one folded into one tog packer, c.o.d. only, \$15.00. Plans to use making one 25c. Ruppinger Con. Co., 1058 So. Windsor, Los Angeles 6, Calif.

ASTOUND Friends. Write them from Australia, England, Africa, Hawaii. Three postal, instructions, 50c. Mallaway, Box 262, Rochester, New York.

HEALTH Swings: Fun and exercise for normal or handicapped children \$3.50 delivered without ropes. Rollo Every, 22 South Hollywood, Daytona Beach, Florida.

PLANT Bansel edible soy beans—250, 25c. Green Valley Gardens, 126 North Main, Tulsa 3, Oklahoma.

RECEIVE Mails, magazines, samples. Your name in numerous mailing lists 10c. Howard, 396 Broadway, New York.

COMEDIAN'S, Vaudevillians, original scripts! Kleinman, 25-31-B 30th Road, Long Island City 2, New York.

PERSONALITY Expert will analyze your handwriting. Write about hobby or pastime. Trial offer 25c. 9063 179th Street, Jamaica 3, New York.

BUY — Sell — Swap anything. Hughes Bulletin 10c copy. Hughes Service, Shillington, Penna.

60 PIECE Mammoth mail. Thousand opportunities, magazines, 10c. Variety Mailers, 1116-N, Capitol, Indianapolis 4, Ind.

UNPAINTED Wall plaques 2½c up. Write. Oman, 642 Broadway, St. Paul 1, Minn.

BURIED Treasure and lost mines—200 locations in United States. Information free. Treasure Trove, Box 346-F, Springdale, Ark.

MANUFACTURERS — Your waste may be made more profitable. What are you scrapping? Write Matt, 1412-B Great Northern Bldg., Chicago 4.

JUST The thing for your basement barroom or den! Old German and Bavarian beer steins; a few with Swiss musical works. From \$9 up. Al Hiller, Box 396, Bridgeton, New Jersey.

CONVERT Range boiler to automatic oil burning water heater for \$5.00. Plans one dollar. Burner Service, R. No. 1, Box 468, Aptos, Calif.

BIGGEST Money in tattooing now! No experience required. Complete instructions with outfit. Send for free literature. Tatuco, 651 South State, Chicago.

DELIGHT Your friends. Pretend you are in Cambridge, Mass. 4 post card views 25c (25—\$1.00). You write message, address, stamp and return. I will remain them in Boston or Cambridge, Mass. Letters 25c. E. D. Healy, 9 Gorham St., West Somerville, Mass.

POCKET Shoe cloth 5c postpaid. Essential Products Co., Williamsburg 1, Mo.

*Exotic - Glowing
Orchids and Gardenias*



only
\$1
each

GLOWS in the **DARK!**

Fulfill your heart's desire without paying fabulous prices! Know the thrill of wearing glamorous Orchids or gorgeous Gardenias whenever you wish! Life-like full size costume accessories by day, these amazing creations **GLOW IN THE DARKNESS** at night! Positively enchanting with any costume—breath-taking ornaments for the hair! Perfectly adorable for any occasion. Not metal, but soft, leafy colorful floral reproductions of lasting beauty! Will not wilt or die. Order several Glowing Flowers—the cost is low!

For GIFTS... Perfectly exquisite—ultra-smart!

**1 Glowing Flower Only \$1 | 3 at one time . . . \$2.50
2 at one time . . . \$1.70 | 7 at one time . . . \$5.00**

You may select either Flower or any assortment. State quantity desired and enclose cash or money order. We prepay postage. Glowing Flowers sold on a **MONEY BACK GUARANTEE!**
**CHARMS & CAIN • 407 So. Dearborn St.
Dept. 440 Chicago, 5, Illinois**

Always write your name and full address clearly when answering advertisements.



LEARN MEAT CUTTING FIRST LESSON
At Home — In Spare Time **FREE**
7 DAYS TRIAL

Let the vital Meat Industry be YOUR guide to Better Pay, Bigger Opportunities NOW, and, at the same time, afford you the security of a bright peacetime future! Thousands of Meat Cutters, Managers, Supervisors, Graders, Counter-men, Inspectors, Ships Cooks, Hotel and Restaurant Meat Men are needed.

To meet the growing demand for trained Meat Men, National School of Meat Cutting—established 25 years—has arranged its famous "Learn By Doing" Resident Training Methods into convenient, practical Home Study form. Now by the miracle of this EXTENSION TRAINING you can prepare in your spare time, at home, for a better job, bigger responsibilities, or more money in a store of your own!

NO ADVANCED KNOWLEDGE OR PREVIOUS EXPERIENCE NEEDED

Beginners, Old-Timers, Market Owners—all can use this concise, practical Home Study Course as a stepping-stone to More Efficient Work, an Expert's Pay, Bigger Profits! In plain, simple language you are told what to do. Then, easy to follow charts, drawings and illustrations show how it's done. Before long, you'll Cut Better Percentage, Buy Better, Merchandise, Grade, Advertise and Display meats like the experts do. Almost from the start, you'll command increased pay or larger profits in your own store!

GET FACTS FREE

This time-proven Home Study Course has helped so many others in so many ways that you should investigate it! Send for FREE Bulletin giving you all the facts and learn how you can get the first lesson of this remarkable training for 7 days' FREE Examination. No obligation. Mail the Coupon NOW!

National School of Meat Cutting, Inc.,
Dep't. U46, Toledo 4, Ohio.

Send me your FREE Bulletin and particulars of your 7 day FREE EXAMINATION OFFER. No obligation. No salesman will call.

I work in a market I own my own store I know nothing about meats

Name
Street
City State



PIN-UP EYEFULS

30 Gorgeous Gals In Full Color

Now . . . thrilling, glamorous, gorgeous, breath-taking girl beauties in life-like, cozy, full color pictures—PIN-UP EYEFULS for your den or barracks. Size 4x3 to 5x8.



FREE PICTURE CATALOG

Just send \$1 for 30 PIN-UP EYEFULS, postpaid with PICTURE CATALOG Listing (300 full-color reproductions of original paintings by well-known artists for framing) included free of extra cost. A gorgeous offering of girls, babies, floral and religious pictures for envelope Tuck-Ins and Pin-Ups.

FRANK MATTHEWS

111 W. Washington, Dept. 32-A, Chicago 2, Ill.

MODEL RAILROADING
THE WORLD'S MOST FASCINATING HOBBY



FREE 32-page booklet tells all about this absorbing hobby for skilled tradesmen, business and professional men. Give yourself hours of satisfaction and relaxation building your own scale model railroad which performs and looks like the real thing. It's easy and relatively inexpensive. Get started now. Send at once for our free booklet "Your Model Railroad."

MODEL RAILROADER MAGAZINE
DEPT. M. MILWAUKEE 3, WISCONSIN

MAKE MONEY AT HOME!
Learn to color photos and miniatures in oil. No previous experience needed. Good demand. Send for free booklet, "Make Money at Home" and requirements.
NATIONAL ART SCHOOL
1315 Michigan Ave. Dept. 1354 Chicago

KEY TO A PRACTICAL UNDERSTANDING OF ELECTRICITY

\$1 PER MO.

• AUDELS HANDY BOOK OF ELECTRICITY
\$4 HANDY SIZE For Engineers, Electricians, Students and all interested in Electricity. A quick, simplified, ready reference, giving complete instruction and practical information. Easy to understand. A reliable authority and a handy helper that answers your questions.

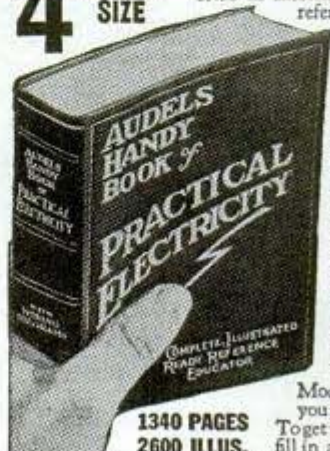

• **INSIDE TRADE INFORMATION ON**

The Rules and Laws of Electricity—Maintenance of Machinery—A. C. and D. C. Motors—Armature Winding and Repair—Wiring Diagrams—House Lighting—Power Wiring—Cable Splicing—Meters—Batteries—Transformers—Elevators—Electric Cranes—Railways—Bells—Sign Flashers—Telephone—Ignition—Radio Principles—Refrigeration—Air Conditioning—Oil Burners—Air Compressors—Welding, and many Modern Applications explained so you can understand.

1340 PAGES To get this assistance for yourself, simply 2600 ILLUS. fill in and mail the FREE COUPON below.

THEO. AUDEL & CO., 49 West 23rd Street, New York
Please send me "Audels Handy Book of Practical Electricity" for free examination. If satisfactory, I will send you \$1 in 7 days, then \$1 monthly until \$4 is paid. Otherwise I will return it.



READ FOR PROFIT!

Name
Address
Occupation
Reference P.M.



Wow Them with TRICKS

Puzzles - Jokes
Learn in 5 Minutes!

Baffling Card Tricks, Screamingly Funny Practical Jokes—Complete with Apparatus and Instructions!

GIANT OUTFIT Only \$1

Mystify your friends and fellow workers—read their minds—make cards disappear BY MAGIC! Be the life of every party with easily-learned tricks that startle, puzzle, amaze, and leave your friends breathless with surprise! Get this thrilling BAG-O-TRIX & PUZZLES that will skyrocket you to popularity. Do the "impossible" right before their eyes! BAG-O-TRIX & PUZZLES contains full apparatus, 25 Different Articles and Gadgets for Baffling Card Tricks, daring practical jokes—things you can easily learn to do like a professional performer in 5 minutes. Take this short cut to instant popularity.



FREE JOKE BOOK

Pages and pages of laughs—funny stories, spicy jokes you'll enjoy reading and telling. Included absolutely FREE if you order BAG-O-TRIX & PUZZLES promptly! Hurry!

Fun to learn—more fun to do. Guarantees hours of laughs for everyone—young and old, men and women. Service men will like it, too. Simple complete instructions included.

Send NO MONEY!

Just send your name and address on postcard. Pay postman only \$1.00 plus few cents postage when BAG-O-TRIX AND PUZZLES reaches you. Or send \$1.00 with order and we pay postage. EXTRA—big Joke Book included free if you order NOW. If not delighted, return BAG-O-TRIX and PUZZLES within 5 days for full refund. Be the magician in your crowd. Order today!

TRIX CO., 82 W. Washington St., Dept. E-66, Chicago 2, Ill.



AUTO

BOOKS SENT FREE

ON APPROVAL. Just mail the coupon and we'll send you a complete set of Six Big Auto Books, 20th Edition. Whether you are a mechanic or helper, expert or apprentice, auto owner or driver, take immediate advantage of this FREE EXAMINATION OFFER.

MAKE GOOD MONEY NOW HOLD A PERMANENT JOB

America's autos must be kept in service, now and after the war. Men with "know how" are in demand, at big pay. These books will help you get and hold an important job, or give you a chance to go into business for yourself now or later. Any man who half tries to improve himself can learn auto servicing and repairing by this quick reference method. Use the JIFFY INDEX to find easily understood answer to any auto problem. These wonder books prepared by eleven of America's great automobile engineers. Many hundreds of valuable illustrations. Send the coupon TODAY.

A year's consulting privileges with our engineers now given with these books without extra charge.

Vocational Publishers Since 1898

CAN YOU FIX IT?

These wonder books tell step by step HOW to make difficult repairs and adjustments, how to keep a car at maximum efficiency, including latest improvements in car design and operation. Engine troubles and how to correct them well covered.

6 BIG VOLUMES

2800 pages, 2000 illustrations, wiring diagrams, etc., including Diesel engines. Beautiful modernistic, washable cloth binding.

AMERICAN TECHNICAL SOCIETY, Dept. A-419
Drexel Ave. at 58th St., Chicago 37, Ill.

I would like to examine your Six-Volume Set of Auto Books. I will pay the delivery charges only, but if I choose I may return them express collect. If after 10 days use I prefer to keep them, I will send you \$2 and pay the balance at the rate of only \$3 a month until \$24.80 has been paid. Please include consulting service as offered above.

Name
Address

City State

Please attach letter stating age, occupation and address of employer and of at least one business man as reference. Men in service, also please give home address.

Say you saw it in Popular Mechanics!

Sells Story 4 Months After Enrolling

"About 4 months ago I came across the Newspaper Institute advertisement in a magazine. I wrote for and later passed their Writing Aptitude Test. Since I have been studying the N. I. A. Course, I have already added to my earnings. It has been one of the happiest experiences of my life. Anyone actually interested in learning to write, will find N. I. A. training a thoroughly practical way."
—Alexander Pathe, Cleveland, Ohio.



Why Don't You Write?

It's much simpler than you think!

SO many people with the "germ" of writing in them simply can't get started. They suffer from inertia. Or they set up imaginary barriers to taking the first step.

Many are convinced the field is confined to persons gifted with a genius for writing.

Few realize that the great bulk of commercial writing is done by so-called "unknowns." Not only do these thousands of men and women produce most of the fiction published, but countless articles on business affairs, home and shop crafts, war activities, gardening, local events, homemaking, etc., as well.

Such material is in constant demand. Every week thousands of checks for \$25, \$50 and \$100 go out to writers whose latent ability was perhaps no greater than yours.

The Practical Method

Newspaper work demonstrates that the way to learn to write is by writing! Newspaper copy desk editors waste no time on theories or ancient classics. The story is the thing. Every copy "cub" goes through the course of practical criticism—a training that turns out more successful authors than any other experience.

That is why Newspaper Institute of America bases its writing instruction on the Copy Desk Method. It starts and keeps you writing in your own home, on your own time. And upon the very same kind of actual assignments given daily to metropolitan reporters. Thus you learn by doing, not by studying the individual styles of model authors.

Each week your work is analyzed constructively by practical writers. Gradually they help to clarify your own distinctive style. Writing soon becomes easy, absorbing. Profitable, too, as you gain the "professional" touch that gets your material accepted by editors. Above all, you can see constant progress week by week as your faults are corrected and your writing ability grows.

Have You Natural Ability?

Our Writing Aptitude Test will reveal whether or not you have natural talent for writing. It will analyze your powers of observation, your imagination and dramatic instinct. You'll enjoy taking this test. There is no cost or obligation. Simply mail the coupon below, today. Newspaper Institute of America, One Park Avenue, New York 16, N. Y. (Founded 1925)

NOTICE TO CANADIANS

Newspaper Institute's operations in Canada have been approved by the Foreign Exchange Control Board and to facilitate all financial transactions, a special permit has been assigned to their account with The Canadian Bank of Commerce, Montreal.

Free

Newspaper Institute of America,
One Park Avenue, New York 16,
N. Y.

Send me, without cost or obligation, your Writing Aptitude Test and further information about writing for profit as promised in Popular Mechanics, April.

Mr. {
Mrs. {
Miss {
Address.....

(All correspondence confidential. No salesman will call on you.) 72-D-814
Copyright 1943 Newspaper Institute of America



Know Electricity as Experts Know It—and Get an Expert's Pay!

What about your future? Who is safe today? Surely not the man who is contented to stand still! Know your job thoroughly—prepare yourself for jobs ahead. To do just this thousands of men have used

The Croft Library of Practical Electricity

The Croft Library is a complete electrical educator. It is founded on practice—on 20 years of shirt-sleeve experience—on work as it is actually done. It is jammed from cover to cover with the kind of hard-headed facts you want. Written so that the beginner can easily understand it, yet so sound, so thorough, that it is the daily guide of 60,000 highly paid electrical workers and engineers. Croft tells you the things you need to know about motors, generators, armatures, commutators, transformers, circuits, switchboards, distribution systems—electrical machinery of every type—wiring for light and power—wiring of finished buildings—underwriters and municipal requirements—illumination in its every phase—the most improved methods of lighting—lamps and lamp effects, etc.—how to do a complete job, from planning it, to completion.

No money down—easy payments

Fill in and mail the coupon attached and we will send you the entire set of seven volumes for ten days' examination on approval. We take all the risk—you assume no obligation. If you decide to keep the books, send \$3.50 in ten days and the balance at the rate of \$3.00 a month. Send the coupon NOW and see the books for yourself.

EXAMINATION COUPON

McGraw-Hill Book Co., 330 W. 42nd St., N. Y. 18

Send me for ten days' examination on approval the Croft Library of Practical Electricity, 7 vols. If satisfactory I will send you \$3.00 in 10 days and \$3.00 monthly until the price of \$18.00 is paid. If not wanted, I will return the books postpaid. (To insure prompt shipment write plainly and fill in all lines.)

Name.....
 Home Address.....
 City and State.....
 Position.....
 Name of Company..... PM-4-44

Learn this Profitable Profession



IN 90 DAYS AT HOME

Money-Making Career Open to Men and Women, 18 to 50

Hundreds of men and women between 18 and 50 make \$10 to \$20 in a single day giving scientific Swedish Massage and Hydro-Therapy treatments. There is big demand from doctors, hospitals, sanatoriums and clubs. Graduates earn large full time incomes from these or in private practice in their own offices. Others make good money from home treatments given in spare time. Learn this interesting, money-making profession in your own home, through our home study course. Same instructors as in our nationally known resident school. You can win independence and prepare for future security by qualifying for your Diploma. Course can be completed in 3 to 4 months. Many earn while they learn. Begin your training at once.



Anatomy Charts & Booklet FREE

Enroll now and we will include, at no extra cost, many needed supplies. Fit yourself to help meet growing demand for massage now and after the war. Send the coupon at once for complete details, Anatomy Charts and 32-Page Illustrated Booklet, FREE, postpaid.

THE COLLEGE OF SWEDISH MASSAGE
 Dept. 464, 100 East Ohio St., Chicago 11, Illinois

Please send me FREE and postpaid, Anatomy Charts, 32-page Booklet and complete details on Home Training.

Name.....
 Address.....
 City.....State.....

Do You Want to SAVE GASOLINE?



WANTED! MOTORISTS TO MAKE 30 DAY GAS-**SAVING TEST**

This U. S. patented device must save gasoline on your car or we pay you, on request, \$1.00 for your trouble. Investigate this mysterious gasoline vaporizer that saves car owners everywhere. Many have reported substantial benefits up to 30% in gasoline saving and others report they have used the Stransky Vaporizer on two to five different cars and has given up to 250,000 miles of satisfactory service. Write for details.

FOR ALL CARS

—trucks, tractors and many airplanes. Easily installed in 5 minutes. No adjustments.

BUILT ON SUPERCHARGE PRINCIPLE

Automatic, self-regulating. Has no springs, diaphragm or delicate parts to get out of order—guaranteed to last the life of your car.

DISTRIBUTORS EARN YOURS FREE

For introducing this whirl-wind money maker. Write today for unusual money making offer to handle this remarkable device. Spare or full time. Pleasant work—be your own boss.

SEND-NO-MONEY We will let you try it on your own car for 30 days. So write today, for complete details. Address J. A. STRANSKY MFG. CO., Dept. 751-D, Pukwana, South Dakota

"HYPNOTIZE" INSTANTLY

New book, HYPNOTRICKS, reveals new methods for instantaneous hypnotic effects. Many professionals using these methods. Explains over twenty hypnotic effects, also tells how to "hypnotize" an entire audience or group. None dangerous. Many secrets revealed for the first time. Send \$1.00 TODAY.

Karson Xclusives, Dept. M, 1653 Main St., Springfield, 3, Mass.

Be Popular—Learn the Newest DANCES in 5 DAYS—or NO COST!



NEW REVISED EDITION OF DANCING

includes the Rhumba, Conga, Samba, Jitterbug . . . Fox Trot, Waltz and Tap Dancing.

All the newest Swing steps—the Rhumba, Conga, Samba, Jitterbug, as well as the Fox Trot, Waltz and basic tap steps—explained with simple, graphic diagrams. GET MORE FUN OUT OF LIFE! Swing your way to popularity! Start now and fill your future with Romance! MAKE THIS FREE TEST! The new REVISED edition of Betty Lee's book, Dancing, helps you learn correctly and quickly. Be convinced—if not satisfied with results, you will get your money back! And remember, we include two other books—"Tip Top Tapping" and "Swing Steps"—FREE of extra charge. SEND NO MONEY! Pay the postman \$1.08 plus a few cents postage. Follow instructions in ALL THREE BOOKS—practice simple dance steps each day and in 5 days if you haven't learned to dance, we will refund your money!



PIONEER PUBLICATIONS, INC.
 1790 Broadway, Dept. 944H
 New York 19, N. Y.

Send me "Dancing," by Betty Lee, and include 3 free books.
 Ship C.O.D. I will pay on arrival, plus postage.
 I enclose \$1.98. Ship postage prepaid. If in 5 days I do not learn to dance, I may return book and you will refund purchase price.

Name.....
 Address.....
 City.....State.....

Say you saw it in Popular Mechanics!



PLAYS AT DANCES

"Your lessons have been most satisfactory. I can play all of the popular songs. I have earned money playing at dances."
*E. N. J., New York.



PLAYS ON RADIO

"I can't keep from telling you that I have a good position playing from KTHS, Hot Springs, Ark., every morning."
*J. S., Okla.



WOULDN'T TAKE \$1000 FOR COURSE

"The lessons are so simple that anyone can understand them. I have learned to play by note in a little more than a month. I wouldn't take a thousand dollars for my course."
*S. E. A., Kansas City, Mo.

THOUSANDS NOW PLAY who never thought they could!

**You, too, can play any instrument
by this EASY A-B-C METHOD**

You think it's difficult to learn music? That's what thousands of others have thought! Just like you, they longed to play some instrument. But they denied themselves the pleasure—because they thought it took months and years of tedious study to learn.

And then they made an amazing discovery! They learned about a wonderful way to learn music at home—without a private teacher—without tedious study—and in a surprisingly short time. They wrote to the U. S. School of Music about this remarkable short-cut method. A free print and picture sample actually showed them how easy it was to learn.

The result? Over 750,000 people have studied music at home this simple, A-B-C way. They have found the key to good times, popularity and profit.

And that's what you can do, right now. Simply mail the coupon below. Get the proof that you, too, can learn to play your favorite instrument—quickly, easily, in spare time at home. Just read the fascinating illustrated booklet—examine the print

and picture sample. If interested, tear out the coupon now, before you turn the page. U. S. School of Music, 74 Brunswick Bldg., New York 10, N. Y. Forty-sixth year. (Established 1898)

*Actual names on request. Pictures by professional models.

SEND FOR FREE PRINT AND PICTURE SAMPLE

U. S. School of Music, 74 Brunswick Bldg., New York 10, N. Y.

I am interested in music study, particularly in the instrument indicated below. Please send me your free booklet, "How to Learn Music at Home" and your Print and Picture Sample. (Do you have instrument.....)

Piano	Piano Accordion	Reed Organ	Clarinet
Guitar	Saxophone	Tenor Banjo	Trombone
Violin	Trumpet, Cornet	Ukulele	Other Instruments

Name (PLEASE PRINT)

Street

City..... State.....

Check here if under 16 years of age.

SAVE 2c—Stick coupon on penny postcard

Keep that "TICKING"
Car

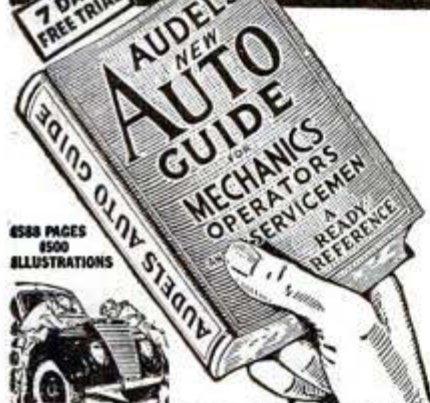

Every operator and mechanic needs AUDELS AUTO GUIDE.

This book saves time, money and worry. Highly endorsed. It presents the whole subject of auto mechanics:

- 1—Basic principles
 - 2—Construction
 - 3—Operation
 - 4—Service
 - 5—Repair
- Handy Size, Easily understood.

6588 PAGES
8500 ILLUSTRATIONS

NEW FLUID DRIVE, HYDRAULIC SHIFT AND DIESEL ENGINES FULLY COVERED

Over 1500 pages—1540 illustrations showing inside views of modern cars, trucks and buses with instructions for all service jobs.

4 COMPLETE • PAY ONLY \$1. A MONTH

ASK TO SEE IT!—To Get This Assistance for Yourself Simply Fill in and Mail Coupon Today.
AUDEL Publishers, 49 West 23rd St., New York
MAIL AUDELS NEW AUTO GUIDE for free examination. If O. K. I will send you \$1 in 7 days; then remit \$1 monthly until price of \$4 is paid. Otherwise I will return it.

Name.....

Address.....

Occupation.....

Employed by..... P M

AVIATION Career

DON'T WAIT UNTIL THE WAR IS OVER!

Since 1929 Curtiss-Wright Technical Institute has been specializing in modern, progressive training for Aeronautical Engineers and Master Aviation Mechanics (no flying involved). Prepare now for your Aviation Career. **BE READY!** The opportunities are great today and will be much greater in tomorrow's Age of Flight. **ACT!**



**CURTISS
TECHNICAL**



**WRIGHT
INSTITUTE**

GRAND CENTRAL AIR TERMINAL
GLENDALE 1, CALIFORNIA
(LOS ANGELES COUNTY)

MAIL THIS COUPON TODAY!

Registrar, Curtiss-Wright Technical Institute, Grand Central Air Terminal, Glendale (1), California. Please send information and profusely illustrated catalogue on Aviation Training. **FREE** ... without obligation ... Dept. PM-4

Name..... Birth Date.....

Street.....

City..... State.....

HOSPITAL and DOCTOR BILLS PAID!



HOSPITALIZATION PLAN

POLICY PAYS
Hospital and Doctor Bills up to:

\$6.00 Each Day HOSPITAL \$540
Room and Board for Adults up to 90 days

\$25 Each Week LOSS of TIME \$300
from work up to 12 weeks

DOCTOR \$135
Expenses

LOSS of LIFE \$1000
Many other liberal benefits. All plainly stated in Policy.

3¢ costs about A DAY

Don't go into debt when Sickness or Accident strikes. Be prepared—protect yourself NOW! This dependable Hospital and Doctor Expense Policy PAYS YOUR BILLS FROM THE VERY FIRST DAY exactly as provided. Any recognized Hospital and any Doctor may be selected. Policy issued to Individual or Family. No red tape—no medical examination—no agents. Write today!

George Rogers Clark Casualty Co., Rockford, Ill. Dept. 3510

MAIL COUPON NOW!

George Rogers Clark Casualty Co. Dept. 3510 Rockford, Illinois

Please rush FREE information about Hospital and Doctor Expense Policy.

Name

Address

City & State

PLASTICS ★ ★ DESIGN ENGINEERING

Wartime applications have proved the peacetime possibilities of PLASTICS. Get ready now for this big postwar opportunity. Prepare yourself for a highly paid position in Plastics Industrial Engineering. Complete home training course now available. Send name and state age.

OHIO INSTITUTE OF TECHNOLOGY, Box P-151, Greenville, Ohio

TWO FINE PIECES OF U. S. NAVY JEWELRY

Grand "Sweetheart" Combination Gift!

... the pin for HER ... the ring for HIM



No. 3121—Men's heavy ring in 10K Solid Gold, only \$16.50, in Sterling Silver, \$7.50. Lady's pin (No. 571) in solid sterling, 14K gold plate anchor, \$3.00. Pictures actual size. Prices include postage and 20% Federal Tax. Satisfaction guaranteed. Send for free circular of Navy jewelry.



HERFF-JONES-CHICAGO, Inc., Dept. P, 32 W. Randolph, Chicago 1, Ill.



RADIO OPERATORS WANTED

Learn to send and receive Radio Code at home or camp, or prepare for higher proficiency and rating through easy, practical system used in training radiotelegraph specialists. Good pay, adventure, interesting work. Send for revealing 52-page FREE Book. Dept. 5D, Box 928 Denver, Colo.

CANDLER SYSTEM CO.

What Every Mason Wants



We have Masonic books for Blue Lodge, Chapter, Commandery, Scottish Rite, and Shrine.

OUR RITUALS ARE USED THE WORLD OVER for free catalog of books and rituals for Masons, Odd Fellows, Knights of Pythias, Knights of Columbus, Elks, etc.

EZRA A. COOK, Publisher, P.O. Box 796, P.A., Chicago 90, Ill.

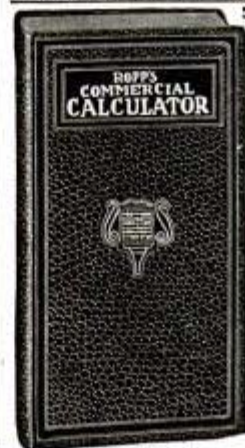

Mathematics Made Easy by ROPP'S CALCULATOR AND SHORT-CUT ARITHMETIC

Shows the Answer as Quickly as a Watch shows the Time to all Problems likely to occur in the Office, Store, Shop, Bank, Farm, or Factory.

Over 2,000,000 Sold Explains and simplifies every principle in Arithmetic, Mechanics, and Mensuration.

PRICES POSTPAID
Desk Size, Flexible Keratol Binding, \$2.00
Pocket Size, Art Leather Binding, \$1.00
Pocket Size, Cloth Binding, \$0.50

POPULAR MECHANICS PRESS
Dept. 531 200 E. Ontario St. Chicago, 11

THERE'S PROFIT in ELECTRICITY—LEARN from PRACTICAL ELECTRICS, \$1.00



Whether you want to enter the electrical field as a profession—or whether you want to know more about fixing electrical gadgets around the house, you will find Practical Electrics a profitable investment. You can find the right answers quickly. It gives you the

fundamentals of electricity, electrical circuits, motors, transformers, electrical symbols, trouble shooting, etc.—all in plain, simple, understandable language. Send \$1.00 today for a copy of Practical Electrics, the ready reference book of electricity.

AUTOPOWER, INC., 2125 PINE STREET, ST. LOUIS, MISSOURI

Prepare for a PROFITABLE FUTURE in...

ARC WELDING

516 Pages, 512 Illustrations, Charts, Diagrams and Tables.

ONLY \$2.00 Postpaid

Sent Subject to 5 Day Approval

Here's a really practical Welding Manual. Worth ten times its low cost—516 pages, 512 illustrations—indexed for ready reference. Used as a text book in the Hobart Welding School and hundreds

of other schools. Better send for it today.

HOBART WELDING SCHOOL gives you latest type training on actual work at bare cost of materials used. Write for complete details.

HOBART BROS. CO., Box M-441, TROY, OHIO



HOBART

"One of the World's Largest Builders of Arc Welders."

"Practical Design for Arc Welding." An idea service—useful in designing or redesigning. Initial pages FREE. Ask for it.

MORE SHAVES FROM BLADES

AMAZING RAZOR BLADE SHARPENER



RAZOROLL sharpener for all standard makes of double-edge razor blades gives more shaves-per-blade! Helps preserve keen shaving edge longer. RAZOROLL really sharpens blades because it stroges on leather—uses same principle of barber's razor strop. Gives keen, smooth shaving edges quickly. You hold blade at correct angle and with proper pressure. Then simply turn crank to sharpen both edges of blade at same time. No gears. Well made. Handsome—compact—sturdy. Weighs few ounces. Will last years. Makes ideal gift for service men.

Only \$1.00

SEND NO MONEY! Write today. Pay postman only \$1 plus few cents postage. Or send \$1.08 with order and we pay postage. Use RAZOROLL for 5 days and if you're not delighted with smooth, velvet shaves you get, return RAZOROLL and we'll return your dollar. Order today.

RAZOROLL COMPANY

620 N. Michigan Avenue Dept. 504 Chicago 11, Illinois

LEARN MONEY-MAKING CARTOONING

IN SPARE TIME — by Easy Picture Chart Method

Same Simplified Method that has helped train creators of "Terry & Pirates," "Freckles," "Out Our Way," "Winnie Winkle," "Regular Feilers," "Strange As It Seems," "The Neighbors," and many others. Earn while learning. Send 10c for Picture Chart (to test your ability), and full details. (State age.)



THE LONDON SCHOOL, 4404 National Bldg., Cleveland 14, Ohio

HOME STUDY OR PRACTICAL SHOP TRAINING

Men wanted to learn following big pay trades: Auto-Diesel, Machinist, Plastics, Drafting, Refrigeration, Welding, Body and Fender, Aircraft. Established 1902. 41,000 graduates. Free booklet. Specify trade. State whether interested in Home Study or Practical Shop Training.

GREER SHOP TRAINING, Dept. 144, 2017 S. Wabash Ave., Chicago

FIBRE ARMS AND LEGS!



Light, correctly fitted, strong and comfortable. Natural appearance. Braces for all deformities. Scientific design. Fair Terms.

BUCHSTEIN-MEDCALF

610-3rd Av. S., Minneapolis, Minn.

Get Your U. S. WAR BONDS ★ STAMPS

9 BIG BUILDING BOOKS



SHIPPED
FREE FOR
EXAMINATION

Learn to draw plans, estimate, be a live-wire builder, do remodeling, take contracting jobs. These 9 practical, profusely illustrated books cover subjects that will help you to get more work and make more money. Architectural design and drawing, estimating, steel square, roof framing, construction, painting and decorating, heating, air-conditioning, concrete forms and many other subjects are included.

BETTER JOBS — BETTER PAY

Keep busy now at good pay, and be prepared for after-war building boom. Big opportunities are always for MEN WHO KNOW HOW. These books supply quick, easily understood training and handy, permanent reference information that helps solve building problems.

UP-TO-DATE EDITION

These books are the most up-to-date and complete we have ever published on these many subjects.

Coupon Brings Nine Books FREE For Examination

AMERICAN TECHNICAL SOCIETY Vocational Publishers since 1898
Dept. G419 Drexel at 58th Street Chicago 37, Ill.

You may ship me the Up-to-Date edition of your nine big books, "Building, Estimating, and Contracting" without any obligation to buy. I will pay the delivery charges only, and if fully satisfied in ten days, I will send you \$2.00, and after that only \$3.00 a month, until the total price of only \$29.90 is paid. I am not obligated in any way unless I keep the books.

Name.....

Address.....

City..... State.....

Please attach a letter stating your age, occupation, employer's name and address, and that of at least one business man as a reference. Men in service, also please give home address.

THIS MAN'S JOB



Pays well in good or bad times... He's a FINGER PRINT EXPERT

Learn this fascinating profession right at home!

I.A.S. has taught thousands of men and women this exciting, profitable, pleasant work. Let us teach you, too, in your own home, during spare time. You should have no doubt of the possibilities in this fine field. Think of it...

53% of all identification bureaus in America employ I. A. S.

graduates or students. This fact alone is ample evidence of the thorough, practical training given. What others have done, you too, should be able to do.

Here Is Proof That It Is NOT Difficult



Of the six finger prints at the left, two of them are alike. See if you can find the matching prints. Of course, there is much more to learn than the mere matching of finger prints, but you get the idea.

Fit Yourself Now for a Post-War Job

Instead of being just one of millions of men looking for peacetime jobs, prepare now to obtain a position that pays well from the start and offers a fine future throughout a lifetime. Send today (stating age) for our great Free Book. Use the coupon!

INSTITUTE OF APPLIED SCIENCE
Dept. 1354, 1920 Sunnyside Ave., Chicago 40, Ill.

Send for FREE copy of
"THE BLUE BOOK OF CRIME"

INSTITUTE OF APPLIED SCIENCE
Dept. 1354, 1920 Sunnyside Ave., Chicago 40, Ill.

Gentlemen: Without obligation, send me the "Blue Book of Crime" and complete list of Identification Bureaus employing I.A.S. students or graduates, also information regarding cost and terms. (Literature sent only to persons stating age.)

Name..... Age.....

Address.....

City..... State.....

4 PAINTING SIZE PETTY GIRLS DIRECT FROM THE ARTIST

**4 BEAUTIFUL GIRLS
REPRODUCED IN
TRU-LIFE COLORS**

- Bathing Girl • Boudoir Girl
- Mirror Girl • Sunshine Girl

Masterpieces from the palette of George Petty
four different girls with the alluring,
shapely figures that Petty has made famous...
faithfully portrayed in rich colors by photo-
lithography on heavy paper... large size
(1 x 1½ ft.)... ready to frame or pin up...
shipped to reach you fresh and unfolded
(special packing used for overseas orders)...
NOW obtainable nowhere else... your money
back if you are not delighted... all four pic-
tures for only \$2.00 for the set, postpaid...
supply limited, order
today from—

GEORGE PETTY
1222-B Mound Avenue
Racine, Wisconsin

**MAIL THIS
PETTY GIRL
COUPON**

GEORGE PETTY
1222-B Mound Avenue, Racine, Wis.

I enclose \$2 Money Order Check Cash for which
please send to the address below 1 set of 4 Petty Girls

Name _____

Address _____

City _____ State _____

How to Get a BIG PAY Real Estate JOB

- PROPERTY MANAGER
- BROKER
- LOANS
- YOUR OWN BUSINESS

- APPRAISER
- INSURANCE

Real estate firms, insurance companies, banks,
Federal agencies each year require thousands of
trained men and women for property manage-
ment, brokerage, appraisal, real estate loans and
insurance work. Dignified, pleasant work with
plenty of opportunities to advance. Salaries up
to \$2500.00 to \$10,000.00 a year. Many make
fortunes selling real estate on commission. Not
one but 6 big sources for profit in your own busi-
ness. Coming real estate boom means even bigger demand for workers,
greater earnings, larger profits. Take advantage of tested methods and
experiences of successful real estate men. Same valuable instruction
material as given by author as Director of special real estate courses
at Columbia, Yale, Chicago, Tulane, Southern California, other uni-
versities and real estate boards—now in convenient book form. Send
coupon for 7 days' FREE examination.

Modern Real Estate Practice

5 Volume Library for Home Study and Reference Ready

First and only complete library and home training course in this big
field. For real estate people, beginners, property owners, builders.
Shows how to manage income property, how to sell real estate.
26 ways to get prospects, short cuts to appraising property values,
handling loans and insurance, methods for running largest to smallest
real estate office. Residential, commercial, industrial, farm property.
Complete information on securing tenants, holding tenants, listing
systems, real estate maintenance, purchasing, collections, management
budget, inspection reports, showing property, sales aids, closing the
deal, creative selling, market analysis, real estate law, leases, tax-
ation, financing, community planning, growth and decline
of neighborhoods, how cities grow, speculative building,
farm management, etc. Mail coupon now—SEE this remark-
able library—the only one of its kind.

FREE 7 DAYS' EXAMINATION

LANE PUBLISHING COMPANY,
100 E. Ohio St., Dept. 84, Chicago 11, Illinois

Send me for 7 days' examination, the Modern Real Estate Practice Library, also
Free Home Study Guide. If satisfactory, I will send you \$3.00 in 7 days, then
\$3.00 a month until the price of \$24.00 is paid. If not wanted, I will return the
books postpaid. (Save 10%... send cash price of \$21.00 with order if preferred
... you save \$2.60. Same return privilege.)

NAME _____

HOME ADDRESS _____

Please attach letter stating age, occupation, employer's name and address and
that of at least one business man as reference.

BETTER SIGHT

SIGHT-TRAINING technique improved. Every-
body gets results now. WRITE: Dept. D-4
"USTI" 4057 Budlong Ave., Los Angeles 37, Calif.

Free
SIGHT
CHART

Please send me your FREE Sight Chart with
instructions.

Name

Address

Learn PLASTICS

What will happen to your war-time jobs when
peace comes? Learn Plastics NOW! New, thrill-
ing, profitable, uncrowded industry. Your op-
portunity. Home study and resident courses.
First Plastics school in East with complete
Study and Lab. courses. Write Dept. P
TODAY! State age.

BOSTON TECHNICAL INSTITUTE
SCHOOL OF PLASTICS

422 COMMONWEALTH AVE., BOSTON, MASS.



STUDY LAW AT HOME

With A Chartered Educational Institution

Men with legal training win higher positions, larger earnings, and are bigger success-
es in business and public life. Opportunities NOW greater than ever before. Complete
course includes 21 Hornbook series college grade textbooks. Send for 1943-44 Catalog.
McKinley-Roosevelt Incorporated, 4610-LT, Sheridan Road, Chicago, 40

ALARM CLOCKS

How to clean and repair them at home. It's easy if you know
how. Make-Save money. Complete instructions. 25c

THIES JEWELRY STORE

482 MAIN GENOA, ILLINOIS

BOOKS FOUND FREE!

WHAT BOOKS DO YOU WANT?

We quote lowest market prices. No charge for locating Hard-
to-Find Books. All books. OLD or NEW mailed POST-FREE.
SEARCHLIGHT BOOK CLUB, 22 East 17th St., New York City

RAISE GUINEA PIGS

MAKE MONEY. Thousands needed—War demand
great. We supply breeders and buy the young. Write to-
day for FREE illustrated bulletin. RESEARCH SUP-
PLY CO., Dept. F-8, 2436 W. York St., Phila. 32, Pa.





MONUMENT

Genuine Granite or Marble. \$13.00
D.P. Order Direct By Mail and save.
Deal with U. S. MARBLE &
GRANITE CO., A-18, Oneco, Fla.

BIG
FREE
CATALOG

Freight Paid
anywhere in
U.S.A. Let-
tered. Guar-
anteed. Free
Catalog &
samples of
stone.

Pays HOSPITAL BILLS for Whole Family

**Costs 3c a Day for Adults
Only 1½c a Day for Children**

It's here! The new Family Hospital and Surgical Expense Policy
you need and want! One policy insures whole family—mother,
father, children, anyone from 3 months to 65 years. No med-
ical examination. Pays hospital and surgical bills up to \$510.00
for EACH and EVERY person insured. Pays up to \$100.00
doctor's fees for operations. Pays for operating room, medi-
cines, ambulance, etc. Covers sicknesses, accidents, opera-
tions, childbirth, female disorders, and many other disabilities
not covered by other policies. You select your own doctor
and hospital. This full-coverage Family Hospital and Surgical
Policy issued DIRECT to you at special family rates by big,
strong company with over \$2,500,000.00 in assets. Investigate!
SEND NO MONEY, but mail the coupon below quick for full
details—sent FREE. No agent will call on you. Act today!

STERLING INSURANCE CO.

4771 Jackson-Franklin Bldg., CHICAGO 6, ILL.

Send me your FREE INSPECTION Offer of LOW-COST
Family Hospitalization Plan.

NAME _____

ADDRESS _____

CITY _____ STATE _____

INTRODUCING-New Victory Model HANDIWELD ELECTRIC ARC WELDER

FULLY
GUARANTEED

RETAILS
ONLY
\$1.95



PLUGS INTO LIGHT SOCKET

Victory Model Handiweld Arc Welder operates from 110 volts, A.C. or D.C. current same as other arc welders, higher priced; generates tremendous heat to weld all metals. Not a toy welder that uses carbons, but actually uses standard coated rods—sizes 1/16" and 3/32". However, due to Priorities a generous supply of 1/16" rods only are supplied with the welder. Guaranteed not to burn out. Repairs fenders, auto bodies, radiators, machinery parts, etc. Take Victory Model Handiweld anywhere to job, operate right from light socket. You'll find a thousand uses for this welder around

your home, garage, workshop. Also in garages, factories, repair shops, tin shops; mechanics, inventors, plumbers, farmers, etc. Order a "Victory Model" Handiweld now.

SEND NO MONEY We'll rush one to you with rods, helmet, operating instructions, and all necessary parts with the exception of a large jar and a small piece of extension cord; these most everyone has. Pay postman only \$1.95 plus a few cents postage. If not delighted return Victory Model Handiweld in 5 days from receipt and money paid for it will be refunded promptly. Rush your order now.

KUMFY PRODUCTS, Dept. C-202, CINCINNATI, OHIO

REFRIGERATION

Repair and improve all refrigerators. New large manual tells how. Charts and pictures to help you. Only \$1.00, postpaid. Money back guarantee. Supreme Publications, 328 S. Jefferson St., Chicago 6, Illinois

HOME TRAINING FOR Machinists

Beginners and old-timers rave over
this easy war-time speed-up

MACHINE SHOP TRAINING COURSE

Total Price \$12.50—Easy Terms

Now for the first time the world of machinery is concentrated into a complete 3-volume course. Vitally necessary for all Machinists. Quick Training Course for beginners who seek good pay jobs in Machine Shop Work.

HUNDREDS OF DRAWINGS AND TIME SAVING CHARTS

This training at home is comparable to the practical fundamentals learned by resident students at famous National Schools. Easy to follow and understand. Machine tools completely described and demonstrated. Measurements and gauges. Drill Press operations. Milling Machines, Shapers, Planers, Grinders, Blueprint Reading and Drafting. Hundreds of other subjects essential in your daily work leading to better pay.

**NATIONAL SCHOOLS, DEPT. D-4
4000 S. Figueroa Street
Los Angeles 37, California**

Ship me for examination Modern Machine Shop Training Course. 3 vols., plus gifts. Within 7 days I will either return shipment or mail you \$3.00 and \$3.00 a month until \$12.50 is paid (final payment \$2.50) Save 10%. Deduct \$1.25 if you enclose cash (\$11.25) with this coupon. Same return privilege.

Name

Address

City and State

Include your zone number

SEND NO MONEY!

**FREE 7-DAY
TRIAL EXAMINATION**

**BONUS
For Promptness**
7 Drafting Lessons, Machinist's Dictionary, Shop Mathematics Texts.
Mail the coupon now!

HELP YOURSELF TO REAL SUCCESS

This easy, low-cost way!

Prepare yourself now for lasting success and independence. Be ready for the rich postwar jobs. These books, written by nationally known authorities, provide the added knowledge that takes you out of the "run of the mill" class . . . and puts you up with the leaders. Here is your opportunity . . .

WOOD FINISHING

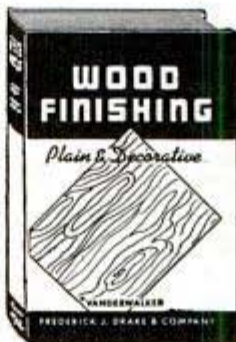

No new homes being built . . . old floors looking worse. Here is a chance to step in and make them beautiful again . . . (and earn extra money). **WOOD FINISHING** is a book of formulas and detailed instruction in methods, tools and materials. Period finishes, staining, filling, varnish, painting, enameling, glazing, and lacquers. 360 informative pages only . . . \$2.00.

PRACTICAL ELECTRICITY and HOUSE WIRING

This handy Electrician's guide-book contains material on wiring methods for homes, farms, and motors; insulations, installing fixtures and switches; principles of efficient lighting, and AC and DC electricity. 200 informative pages and 227 illustrations for only . . . \$1.50.

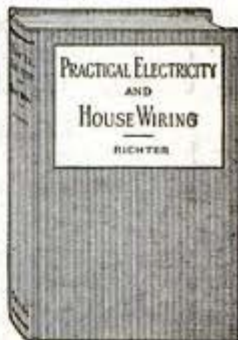

BUILDING

A new building book for carpenters that covers in an easy to understand manner, instructions and diagrams on . . . form building, scaffolding, finishing, plans for small houses, stair building, and . . . roof framing! 495 illustrations and 210 pages . . . all . . . for only \$2.00.

PLUMBING

A wonderful book for the amateur or apprentice plumber. Also good reference for master plumbers. Covers entire plumbing system, fixtures, traps, drains, waste pipes, valves, pipe joints, plans and layouts and many other subjects. 200 pages and 153 illustrations. Only . . . \$1.50.

Drake books sold by all leading booksellers

SEND NO MONEY

MAIL THIS COUPON

FRED'K J. DRAKE & CO.
Dept. PM-4-600 West Van Buren Street
Chicago, Illinois.

Send me the books checked . . . C.O.D. If, within 5 days, I am not completely satisfied, I will return the books and you will refund my money.

- Wood Finishing . . . \$2.00
- Practical Electricity and House Wiring . . . \$1.50
- Building . . . \$2.00
- Plumbing . . . \$1.50

NOTE: If you send cash with the order, we will pay the postage. Money back guarantee stands!

Name

Address

City State

Always write your name and full address clearly when answering advertisements.

The fight on the doorstep

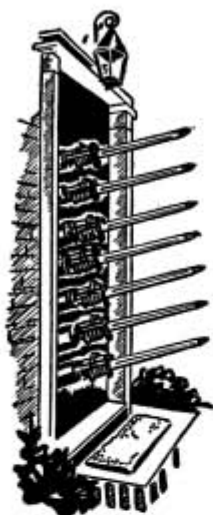

THIS WAR can't be won on battlefields alone. One of the most critical campaigns of all must be waged right on the doorstep of every family in America.

This is the fight against higher prices and higher wages. It's a fight that *must* be won... or victories in battle will be meaningless.

It's like this. In America this year, our total income after taxes will be about 133 billion dollars. But there'll be only about 93 billion dollars' worth of goods to spend it on. If we all start trying to buy as much as we can, prices will shoot up.

As prices rise, people will ask for—and, in many cases, get—higher wages. That will put up the cost of manufacturing, so up will go prices again. Then we'll need another pay raise. If we get it, prices rise again. It's a vicious circle.

The Government has done a lot to help keep prices down. But the Government can't do it all alone. It needs *your help!*

Your part in this fight won't be easy. It may even mean doing without a few necessities. Tough? Maybe... but don't say that where the veterans of Italy and New Britain can hear you!

You *want* to do your part, of course. So do we all... farmers, laborers, white-collar workers, business executives. And the way to do your part *right* now is to observe the following seven rules...

1. Buy only what you NEED. And before you buy anything, remember that patriotic little jingle: "Use it up. Wear it out. Make it do or do without."

2. Keep your OWN prices DOWN! If you sell goods, or your own time and labor, *don't ask for more money* than you absolutely must! No matter who tries to talk you into asking more... *don't listen!*

3. No matter how badly you need something... never pay more than the posted ceiling price! Don't buy rationed goods without giving up the required coupons. If you do, you're helping the Black Market gang.

4. Pay your taxes cheerfully! Taxes are the cheapest way to pay for a war! The **MORE** taxes you pay now—when you have some extra money—the **LESS** taxes you'll pay later on!

5. Pay off old debts. Don't make any new ones! Get, *and stay*, square with the world!

6. Start a savings account. Make regular deposits, often! Buy life insurance. Keep your premiums paid up.

7. Buy War Bonds... regularly and often! *And hold on to them!* Don't just buy them with spare cash you can easily do without. Invest every dime and dollar you don't actually **NEED**... even if it *hurts* to give those dimes and dollars up!

**Use it up...Wear it out.
Make it do...Or do without.**



A United States War message prepared by the War Advertising Council; approved by the Office of War Information; and contributed by the Magazine Publishers of America.

10 POWER TELESCOPE

Look What Only 98¢ Buys

Here's America's biggest 10-Power Telescope value. Don't confuse it with small "weak-vision" telescopes. It's precision made and measures full 16 inches. Focuses instantly on stationary or moving objects. Brings far away objects 10 times closer. Clear—sharp—BIG as Life. You'd expect to pay up to \$10 for such power. Everyone should own a Powerful Telescope. Spot airplanes—identify distant objects, people, animals, etc. Valuable for Air Wardens, Boy Scouts, Sailors, Sportsmen. Ideal for fights, ball games, races and outdoor events. Enjoy front row seats from way back.

BRINGS OBJECTS 10 TIMES CLOSER

Only 98¢

CLIP AD AND MAIL
Just clip this ad and mail with 98c (plus 10c for the packing and postage). Use the telescope for 10 days without risk. If you aren't positively thrilled, return in 10 days and we will refund your money in full. Supply is limited due to priorities. So rush your order today.

FREE Valuable Airplane CHART FREE if you order promptly

ILLINOIS MERCHANDISE MART, Dept. 322, 500 N. DEARBORN ST., CHICAGO 10, ILL.

We will train you at home in DIESEL

Diesels are weapons against the Axis... they are saving precious gasoline by using more easily obtained fuel oils... running upwards of twice as far on the same quantity of fuel... packing more power into smaller spaces. It's been said that DIESELS may revolutionize the powering of ships, tractors, power-stations, autos, trucks and possibly airplanes, when the war is won.

The DIESEL AGE

Wars have always brought important new developments... and this war has opened uses for DIESELS that might otherwise have taken decades. You should prepare yourself now for this Diesel Age... by learning how to maintain, service and operate this modern, efficient, dependable type of power plant.

YOU CAN LEARN AT HOME EASILY

Learning Diesel at home is interesting, can make your spare hours pay dividends. The profusely illustrated Hemphill lessons clearly show you how to operate and to service practically every type of Diesel now in use... how to adjust fuel injection systems... how to make performance tests... how to install auxiliary equipment.

SAME BASIC TRAINING AS ARMY, NAVY and COAST GUARD TRAINEES HAVE RECEIVED AS HEMPHILL DIESEL STUDENTS...

When the war first started, Diesel-trained men were immediately needed by the Services... and the Hemphill Diesel Schools course was selected for the training of these men. Exactly the same fundamental training received by these men is available to you... except you receive the lessons at your home and send in your examination papers for grading to the Extension Division of the Hemphill Schools. This is your opportunity to receive the finest training ever offered.

ACT NOW... BE READY FOR POSTWAR OPPORTUNITIES

FREE BOOKLET... Find out about Hemphill Diesel home study training... new booklet gives full information... use coupon for your copy today.



HEMPHILL DIESEL SCHOOLS
New York: 3126 Queens Blvd., Long Island
Chicago: 517 S. Western Ave.
Los Angeles: 3457 Eagle Rock Blvd.

HEMPHILL DIESEL SCHOOLS (Use Nearest Address)

Please send booklet and information on your home study Diesel Course, without obligation.

Name _____
Street _____
City _____ Zone _____ State _____

P-4

SEND THIS COUPON TODAY

Learn RADIO-ELECTRONICS

12 WEEKS TRAINING IN COYNE SHOPS ON REAL RADIO - ELECTRONIC EQUIPMENT!

FOR MEN 16 UP TO 50

Prepare for a great Peace time future and a good job in Radio and Electronics now. Coyne "LEARN BY DOING" training covers latest developments in this field. Prepare quickly, easily. Fascinating well paid work in maintenance, installation and servicing Radio and Electronic equipment.

I'LL FINANCE YOUR TRAINING!
Start now—pay tuition after graduation. My plan has helped thousands. I assist you in getting part-time work while at COYNE to help pay living expenses. Job Service when trained. Also have facilities for men with physical disabilities. Write!

ELECTRONICS AND TELEVISION
Tremendous expansion in Radio, Electronics, Frequency Modulation and Television predicted after the war—a world of new opportunities. Get ready for a Peace time future and a good job NOW with practical Coyne Radio Training.

FREE BOOK! Whether you're 16 or up to 50 get facts. Special Industrial Electronics training included at no extra cost now. Mail coupon today.

H. C. LEWIS, Pres., RADIO DIV., COYNE ELEC. SCHOOL
500 S. Paulina St., Dept. 44-3H, Chicago 12, Illinois

Send me FREE BOOK, "Your Future in Radio", and details of Industrial Electronics training included at no extra charge and easy "Pay-After-Graduation" plan.

NAME.....AGE.....
ADDRESS.....
CITY.....STATE.....

Say you saw it in Popular Mechanics!



**"Good Pictures"
BRING YOU TOGETHER**

EACH picture you take of WAACS, WAVES or SPARS, Soldiers, Sailors or Airmen, is a good picture of Americans at war. Your Argus will give you a personal record of the determination of Americans to win the war.

Use your Argus with care. Save vital film and make each picture a "Good Picture."



AWARDED TO PLANT 2
OPTICAL DIVISION

"Good Pictures"

This 56-page booklet is published by Argus to help solve the problems of exposures, lens, films, etc. Get your copy by sending 25c to Argus, Ann Arbor, Michigan. Dept. S.

Fine American Cameras

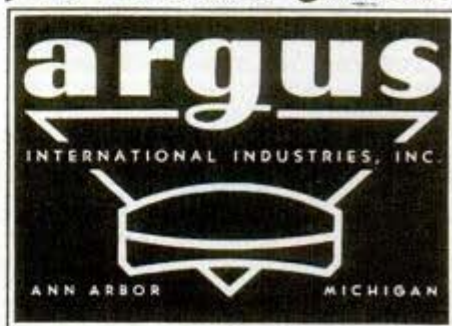

Major Julian C. Loggell

Popular Mechanics Magazine

REGISTERED IN U. S. PATENT OFFICE AND CANADA

WRITTEN SO YOU CAN UNDERSTAND IT

71925

Vol. 81

APRIL, 1944

No. 4

PISTOL-PACKIN' WARPLANES



Tracer bullets fired by student gunner cut fiery path in night sky. Below, fighter's wing bristles with .50-caliber guns

NEW developments in firepower are making American fighting planes the most formidably armed in the world.

Among the accomplishments that are, or soon will be, paying dividends in enemy planes shot down and Allied aircraft returning safe are the following:

Increased firepower for nose and tail positions of all types of bombing planes; power-driven nose turrets in heavy bombers; interchangeable nose turrets in one light bomber; heavier guns; remote-control fire control systems; hydraulic and electric turrets with multiple guns; remotely controlled and power-boosted hand-held machine gun mounts; multiple gun turrets for night fighters; forward-firing fixed 20-millimeter cannon in a light bomber; fighter gunsights which extend

sighting ranges; fixed gun installations for fighter aircraft to provide automatic corrections for lead, range, altitudes and speed; improved computing sights; combination gunsights and dive-bombing sights; personnel flak suits and armored helmets;

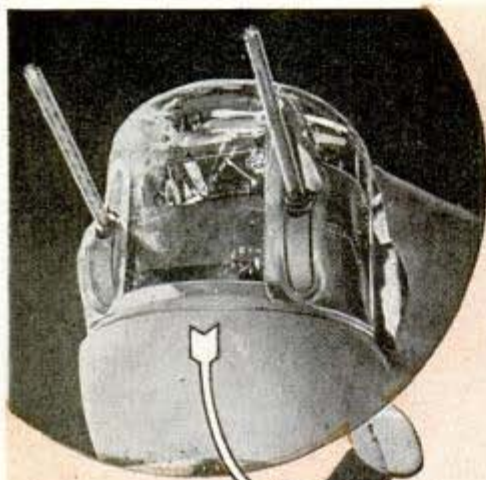

The Consolidated B-24 Liberator (center) is one of our most heavily armed aircraft, with 13 .50-caliber guns. Above is the top turret, which makes 360 degree rotation. Below, new hydraulic-type nose turret

The power-driven tail turret of the Liberator, above, packs two .50-caliber guns. Below is the Sperry ball-turret, also with two 50's

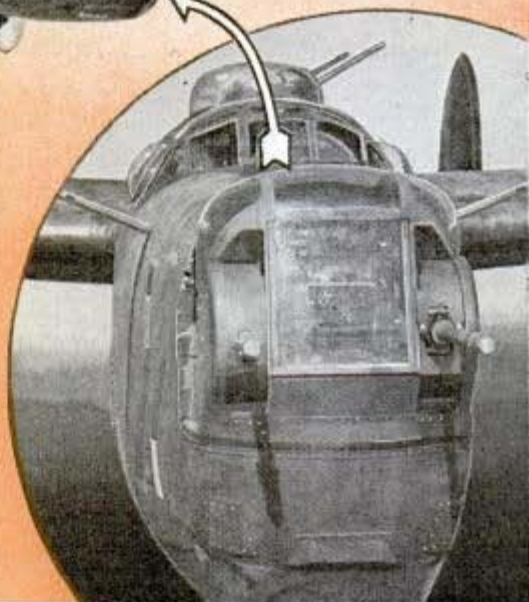
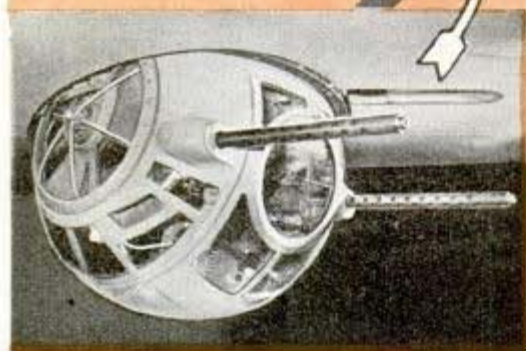

16-millimeter camera in nose of a fighter plane takes movie of air action



improvements in armor and bullet-resistant glass; improvements in the gunsight aiming point camera; placement of guns for maximum protection.

Creating firepower—the sting in aircraft—is the job of the Armament Laboratory, Materiel Command, Army Air Forces, at Wright Field, Ohio. This task has been made somewhat easier by development of America's .50-caliber machine gun, a weapon that fits easily into all types of U. S. aircraft. Weighing about 65 pounds and capable of firing 800 rounds per minute, this gun uses a shell so small that up to 1,000 rounds per gun can be carried. The projectile leaves the muzzle at approximately 3,000 feet per second and packs sufficient wallop to kill a man at four miles. At the usual air fighting ranges, the shell can penetrate all parts of an enemy aircraft.

According to Colonel Frank C. Wolfe, Chief of the Armament Laboratory, the number of guns carried depends largely on the airplane's configuration. In bomber types, the guns are mounted usually in



Above, "heavy artillery" on wings—a 75-millimeter gun in nose of a B-25 Mitchell. At right, machine guns and other weapons are test-fired to destruction in laboratory



pairs distributed from nose to tail to afford protection from every direction. In fighters the number varies from four to eight. It is estimated that when all eight .50 caliber guns on Republic's P-47 Thunderbolt are firing, the bullets deliver to an enemy target more horsepower punch than the 2,000-horsepower engine which powers the plane. Similarly a flight of thirteen Thunderbolts has three times the striking power of a machine gun unit of a German infantry regiment; a formation of 13 bombers, car-

rying a new heavy cannon now going on some medium types, has twice the firepower of the 75 howitzer used by the German regiment.

Computing sights have been used on American bombers for some time, forcing the enemy to stay out of range. These sights are being improved continually. The problems involved in correcting completely for aircraft gun-laying are numerous and, to obtain hits, they must be solved to a fine degree of accuracy. These solutions include

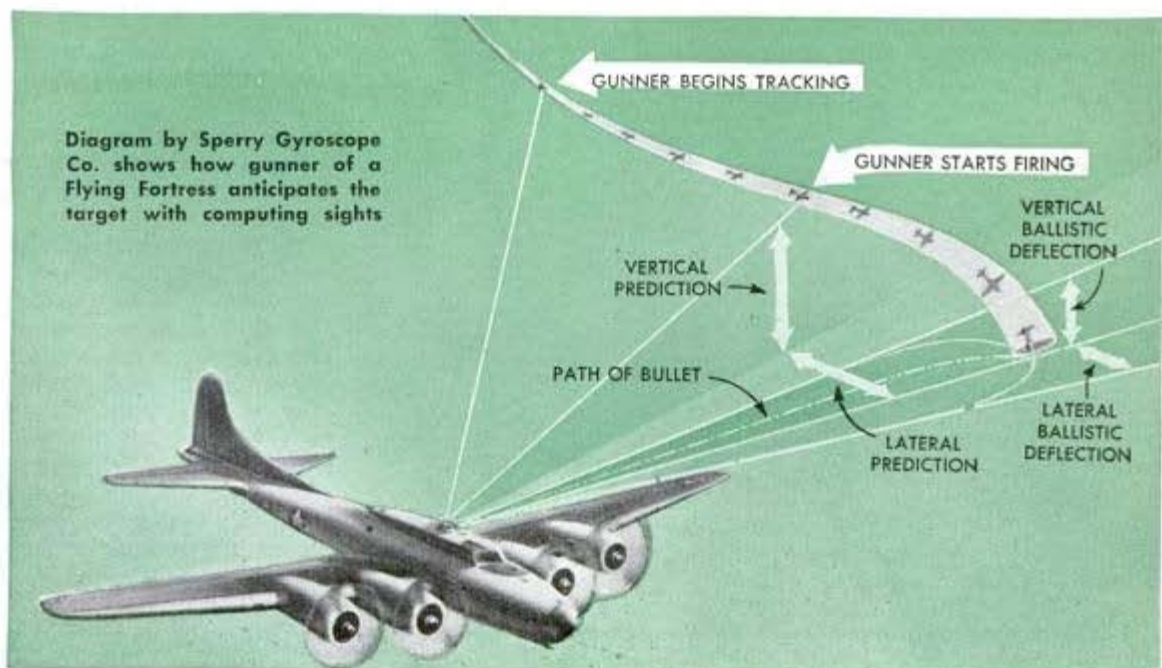



Above, the "little black box" that aims turret guns of big bombers. Right, a frame from gun camera film

accurate and instantaneous computation of and correction for lead and ballistic variations caused by altitude, range and speed of the firing airplanes. In fact, Colonel Wolfe says, the corrections obtained through use of computers parallel those of the bombsight, but actually involve a greater number of factors which must be solved with even less assistance from the gunner.

Although computing sights have been limited to turrets in bombers and attack planes, computing sights have been developed for all other gun positions.

Fire control for aircraft has been developed to an art. One version is a remote control system by which the gunner and his weapons can be separated; resulting in

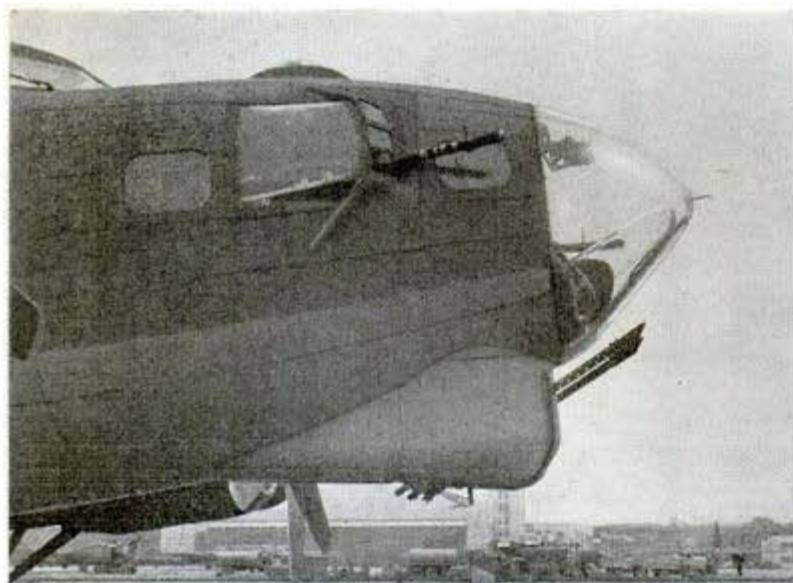

less vibration for the sighting mechanism, less fatigue for the gunner, and increased accuracy. One development of this type is the "chin" turret on the latest B-17, replacing the hand-operated machine guns. An electrically operated turret, with .50 caliber guns, guards the Consolidated Liberator's nose.

What is adequate firepower for any given type? No one can answer the question put like that. Each airplane must



be given different treatment. The new B-29 super-bombers must be presumed to have vastly greater firepower than any fighting craft in the world. The B-29 is larger than the B-17 or B-24, therefore has a larger area to protect; also having a greater range, must depend upon its own guns over areas where fighter "umbrellas" cannot operate.

Among the devices used to improve the accuracy of gunners is the gunsight aiming-point camera, mounted behind the gunsight so that pictures of the sight reticle may be taken on 16-millimeter film. In this way, it is possible to capture on film exactly what the practicing gunner has

The Boeing B-17 sticks out a new chin turret—its whiskers two .50-caliber guns
U. S. Army Air Forces photo

seen through the sight and corrections may be made in his aim. The camera also has been used in actual combat.

In determining the accuracy of gunfire following automatic computation, there are two main factors, tracking and ranging. Tracking means keeping the gunsight precisely on the target; ranging is manipulation of the sight's range-measuring mechanism to keep the correct range constantly in the computer. Thus, if the gunner fails to track smoothly and range precisely, inaccurate data will be given the computing gunsight. The aiming point camera reveals any such deviations in aim.

Some of the armament testing facilities are "cold rooms" for test firing at very low temperatures, outdoor and indoor firing ranges, high altitude pressure chambers, computer and sight testing apparatus, and electronic tests. At Wright Field, guns and related equipment are tested in temperatures down to 60 or 65 degrees below zero, and in extreme heat. The Armament Laboratory also houses a "torture chamber" in which various guns and cannon used in aircraft are subjected to life tests, being fired continuously until some part breaks down. In this manner, any inherent weakness may be detected long before the guns are sent into combat.

Varying conditions of aerial warfare bring the necessity for modification of aircraft, changes that will enable Allied pilots and crews to inflict more damage on the enemy or provide a better defense. For instance, there arose the need for a night fighter, with special equipment, to be used in sweeps over Europe after nightfall. The British had been using the Douglas A-20, with modifications, for these "intruder" actions, sweeping low over enemy airfields and other installations to bomb and machine gun buildings, aircraft, gun emplacements and personnel. To make this type of action more effective, the Armament Laboratory initiated developments which resulted in recommendations for a definite night fighter type. Now America has the ship, a conversion of the A-20. Designated as the P-70, this craft carries special guns and other equipment, and is so designed as to give greater visibility, so necessary in night flying operations.

Super Dive Bomber of U. S. Navy Increases Range and Speed



Some News pictures, Inc.

Navy "Helldivers," the new Curtiss-Wright dive bombers which recently made a sensational debut in the South Pacific, carry a greater bomb load faster and farther than any similar craft in the world. The bomber, designed for either carrier-based or land-based operations, is a two-place, all-metal, low mid-wing monoplane possessing maximum striking power. It is speedy enough to keep up with the Navy's new fighter escorts. Between June, 1942, when the first production model was tested, and November, 1943, 889 major design changes were made, many of them dictated by combat experience. One hundred and fifty pounds of armor plate were added behind the pilot and gunner, self-sealing fuel tanks and protected oil lines installed, and the flap mechanism was re-designed to enable the pilot to open or close the flaps three times faster. Among dive-bomber innovations are the housing of the entire bomb load within the belly of the fuselage, and a folding "turtleback" which collapses in combat to assure excellent visibility for the gunner. In the development of the Helldiver, the biggest problem confronting Curtiss engineers was to design a high speed bomber with slow stalling speed that would permit landing on carriers.

Scientists at Purdue University have developed a method of producing menthol synthetically from thymol, found in oil of thyme, of which there is no current shortage. The synthetic menthol has the same taste and odor as natural menthol, and pharmaceutical differences are slight.

77. 847

Giant "Chess Board" Guides Floor Planners

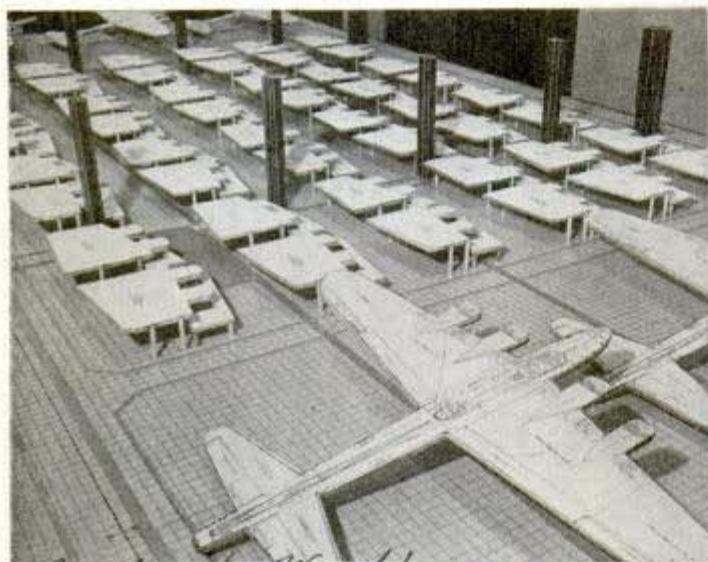

Three-dimensional models used in experimental layout account for every inch of floor space and show clearance for cranes

Below, stakes in this game are more Flying Fortresses. Boeing planners shift models of machine tools on floor plan of shop



Seattle 147 Wash.

When a foreman in the Boeing Aircraft plant wants to rearrange his work area, the suggested changes are first "played" on a huge "chess board" guide. Instead of the conventional knights, rooks and pawns, the Boeing planners use models of machines and work benches. The board consists of metal sheets marked off in squares, each representing four square feet of floor space. The models are marked to show where power lines plug in, and while some show only the floor space required for a particular piece, others are

built up to scale height so clearance may be judged for cranes. When the final setup is approved, the models are photographed as a "blueprint" for shop movers.

Navy Officers "Play" With Toys to Learn Ship Loading

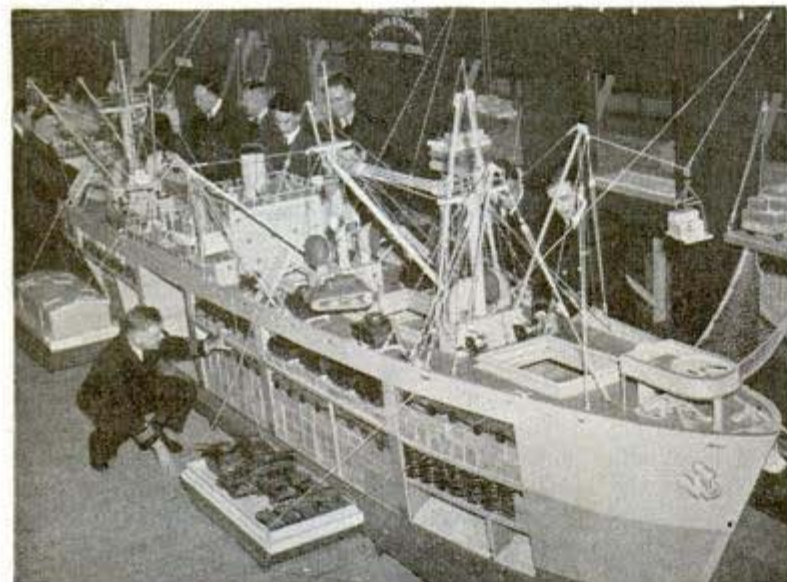

Students at the Stevardoring School on the East Coast are being taught modern methods of handling cargo with the aid of a 27-foot scale model of a Liberty ship, complete with deck fixtures. The model's starboard side is cut away to permit observers to look into holds of the ship, to mark the proper storage of cargo. The model is built on a scale of three-quarters of an inch to a foot.

¶ Sixty million rats caused damage estimated at more than \$200,000,000 in the United States during 1943.

This 27-foot scale model of a Liberty ship has complete deck fixtures

St. Andrew Hamilton, #283 *San Diego, Calif* *71845*

The NAVY'S TOOLS of WAR

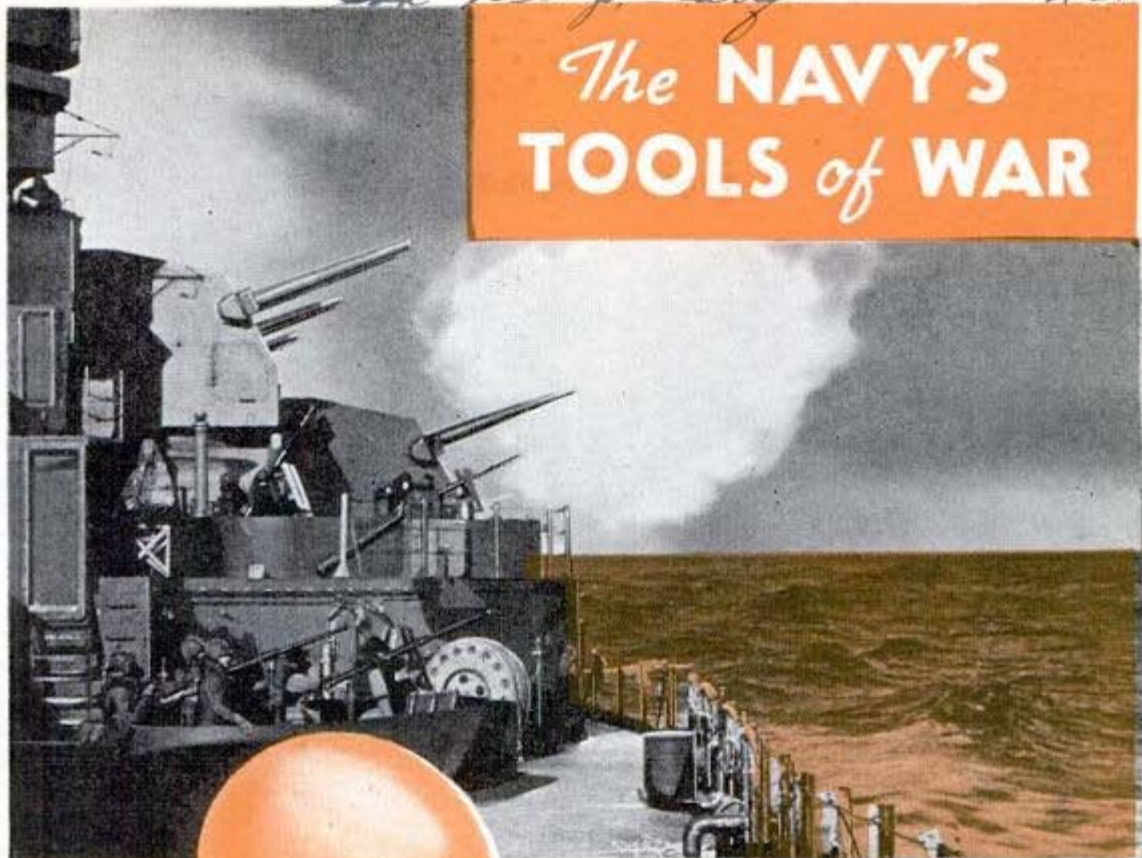

U. S. Navy photos

A battleship's battery of fast-firing dual-purpose guns sends shells high in air to scatter fragments over wide area. Below, releasing balloons as antiaircraft targets

By

Rear Adm. W. H. P. Blandy

NAVAL ORDNANCE today is a far cry from what was meant by the term in sailing days, when you loaded your smoothbore guns with black powder and round shot, and boarded your enemy with cutlass and pike, pistol and dirk.

You aimed your guns in those days by "sighting down the line of metal." You fired on the uproll to cut up your enemy's spars and rigging if you wanted to take his ship as a prize; on the downroll into his hull if you wished to sink him.

Today, Naval ordnance comprises guns of all calibers, from half an inch to 16 inches, weighing from 100 pounds to 100 tons; their mounts ranging from a slender pedestal of 300 pounds to an armored three-gun 16-inch turret



Until recently Chief of the Navy Bureau of Ordnance, Admiral Blandy has been given a command at sea. This article is a condensation of a speech he delivered before the Detroit Economic Club

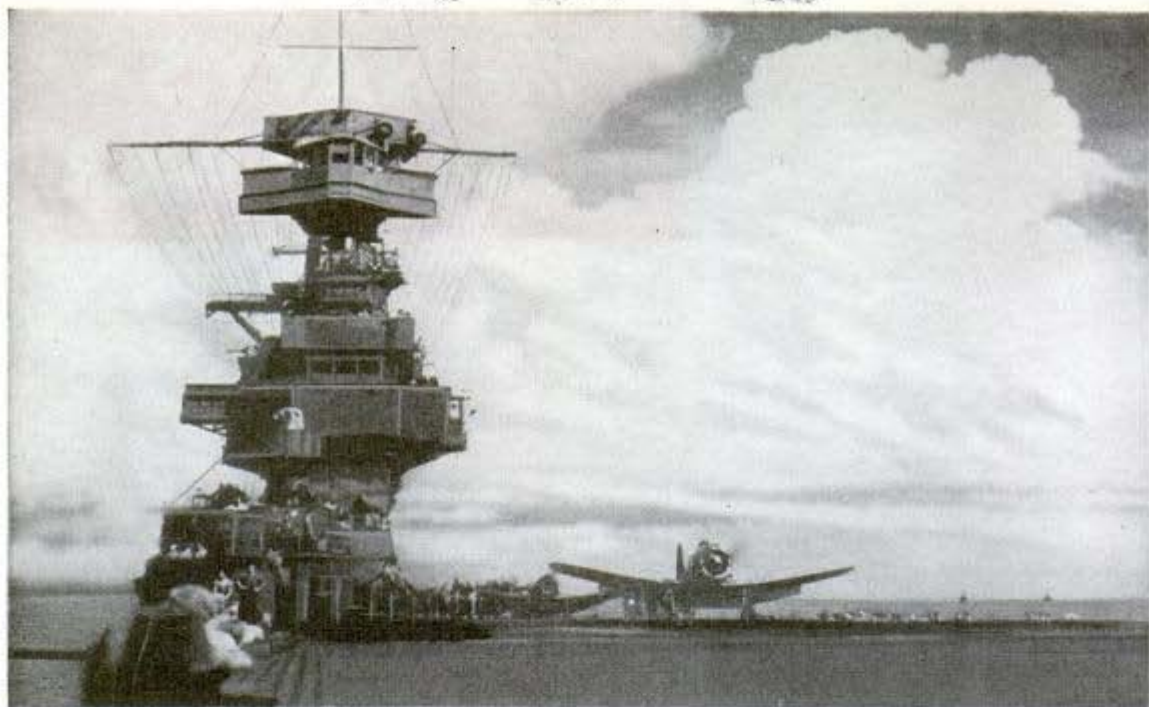

Hard-hitting scout bombers roll across the deck of an aircraft carrier, above. In the blister turret of a Navy PBY patrol bomber, below, a gunner is adjusting the sight of his .50-caliber machine gun



It includes also heavy armor, some of it thicker than the 16-inch shell it must keep out; torpedoes, for destroyers, cruisers, PT boats, submarines, airplanes; bombs and bombsights; mines; depth charges and their projectors; nets and booms for protecting a Naval anchorage; flares, rockets and other pyrotechnics.

In other words, Naval ordnance includes everything which is thrown at the enemy by ships and Naval planes, the weapons which do the throwing, instruments for improving their accuracy, and protective devices to parry the other fellow's blows. And it has extended its field from the surface of the sea to hundreds

weighing as much as a whole destroyer; armor-piercing, antiaircraft, incendiary, illuminating, shore-bombardment projectiles; fuses and high explosives for bursting these shells; and smokeless powder in metal cases or silk bags to discharge them at great velocity. It also includes hoists and rammers to bring the ammunition from the shell rooms and magazines and load the guns; range-finders, computing instruments, transmitting and receiving instruments, and gun directors.

of feet below and thousands of feet above it.

If you are going after a battleship, you've got to use an armor-piercing bomb to sink her, for the modern battleship has a protective deck about half a foot thick over her vitals, and the tops of her gun turrets are just as heavy. The "general purpose" or demolition bomb, with a thin case and a lot of explosive, just won't do the trick.

I've seen a turret top which had been hit with such a bomb. The only repair equipment needed was a paintbrush. Nobody

inside the turret was injured except the turret officer, whose ear was scratched by the periscope, the upper part of which was thrown back violently by the blast.

To get through heavy armor, a bomb, like a shell, must be specially designed. The principal features are a delayed-action fuse, a very thick wall and heavy nose, and a small bursting charge. It must of course have plenty of striking velocity. The latter can be achieved only by dropping from high altitude, or by diving at extreme speed. In either case, accuracy is difficult.

Even at medium altitudes, to bomb a point target like a ship accurately in horizontal flight requires a precision bombsight. The Norden bombsight is still the finest known. It was designed by Mr. Carl Norden and developed jointly by Mr. Norden and the Navy's Bureau of Ordnance, which furnishes this sight to both Army and Navy.

While light-case bombs cannot sink a battleship, they can seriously damage her communication equipment, exposed fire-control stations, the lighter anti-aircraft batteries, pierce the light upper decks and start fires. The same bombs can sink lighter Naval vessels, and of course transports and cargo ships. Against the latter, if unarmed or poorly armed, the bombs can be delivered by "masthead" bombing which is just like dropping a message on the deck, though less polite.

The best plan of attacking well-armed ships with bombs at short range is dive-bombing. You must have planes specially built to stand the terrific stresses of the pull-out. The planes push over at altitudes high enough to afford fair protection from the ships' guns, take advantage of cloud cover or a brilliant sun if available, and come down "like a bat out of hell," at

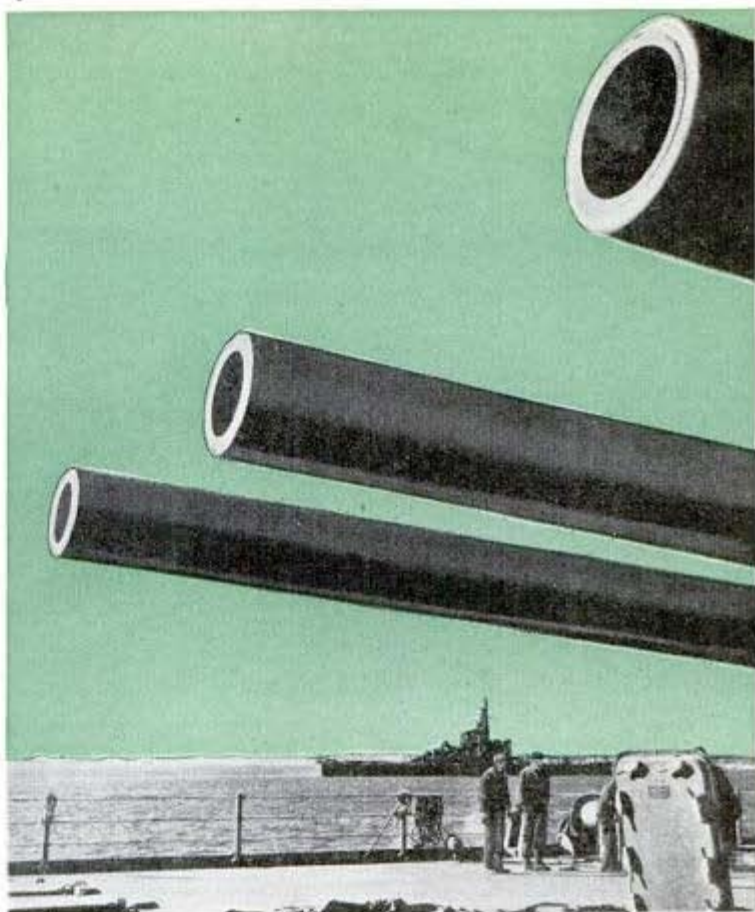

Two of Uncle Sam's new battleships ride at anchor off the coast. In the foreground are three of the nine 16-inch guns of the main battery. Below, signaling with blinker. Note new helmet on man with headphones

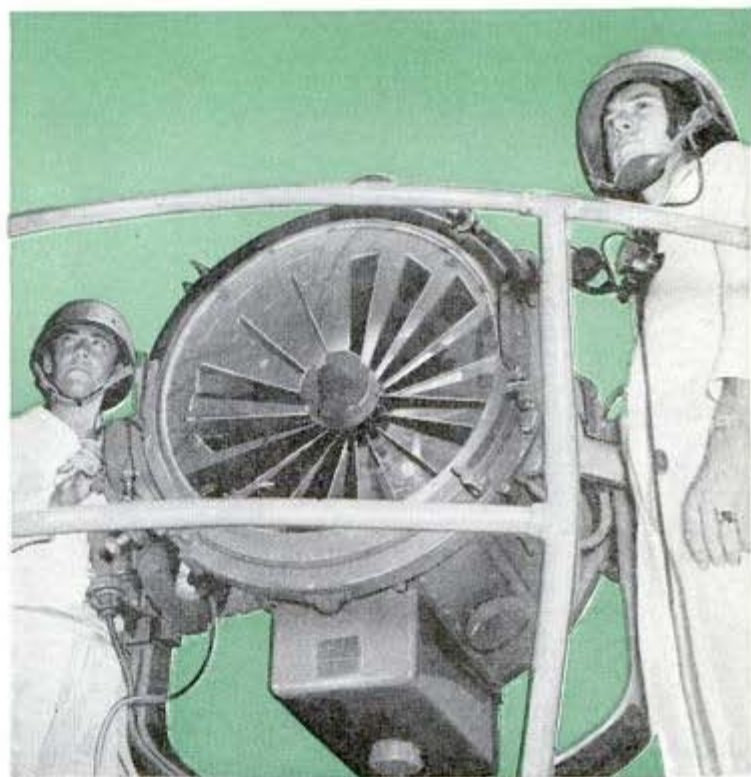



"Wolf packs" of fast, long-range patrol torpedo boats are one answer to the wolf packs of submarines

an angle as steep as 70 degrees in the final dive. The maneuvering of the target ship interferes considerably at times, but a good pilot can take care of it.

The percentage of hits is usually much higher than in level bombing at high altitudes. So also is the percentage of plane losses, though much less than the low altitudes reached would indicate: The ship's gunners are firing with the guns elevated to difficult and awkward angles, the sun may be in their eyes, the ship is probably swinging violently, heeled over and maybe rolling. Theirs is not an easy job.

But to sink ships, it's always better to let water into them instead of air. That's where the torpedo comes in. Deadliest weapon of the sea, it is also the most difficult to make, maintain, and adjust.

You have heard of "one-man submarines." A torpedo is literally a "no-man" submarine; and it is dropped from the air at such heights and such speed as would break every bone in a man's body, and make a mass of junk out of a car or plane. Yet the 5,000 parts and intricate assemblies of the torpedo must take this beating and then propel and control and explode this underwater hell-cat as if launched from a barge or pier.

Hundreds of pounds of TNT geyser up as a "YP" off Florida coast drops depth charge

After its initial dive, the torpedo must take and hold the exact depth set on the index. This might be 10 or 12 feet for a destroyer or light cruiser but much deeper for a battleship (this Goliath must be hit below the belt—the armor belt—or you won't hurt him much.)

The slippery messenger of death must



steer a straight course with only a gyro for a helmsman. And of course it isn't just aimed straight at its moving target, or it would pass astern. Just where it should be aimed is a neat little problem in geometry, based upon the enemy ship's course and speed, direction of the ship from the plane, and the average speed of the torpedo, throughout both air and water travel. The final duty of a torpedo is to explode when it hits the target, and not when it first hits the water.

Submarine torpedoes are much like those used by aircraft, but are larger, and don't have to be beefed up to stand the blow due to dropping from a height. They are discharged from the submarine's tubes, in bow and stern, by com-

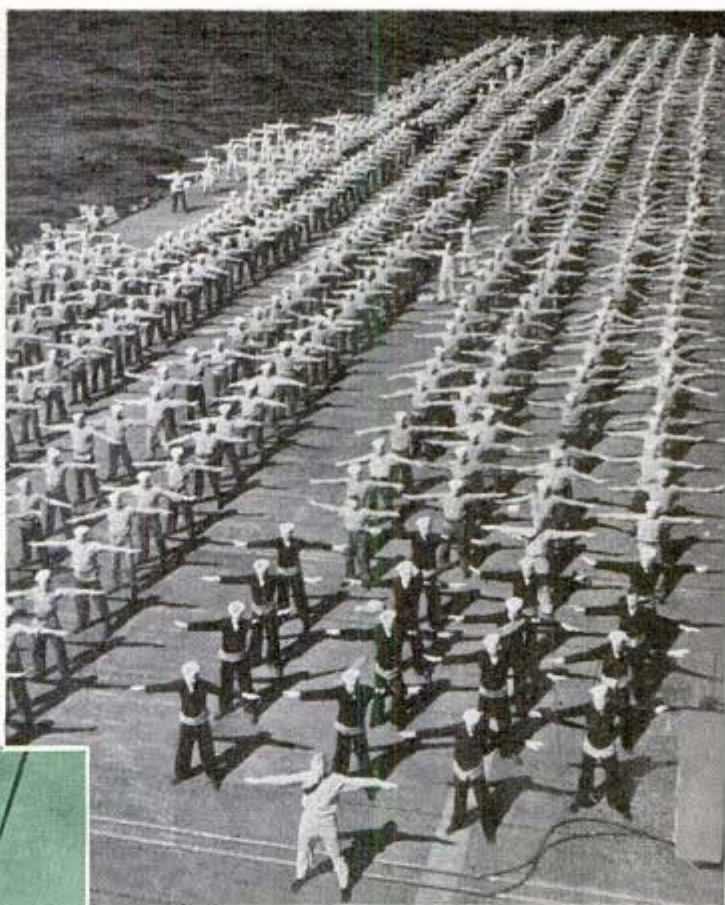

Even in war zone, officers and men aboard a U. S. aircraft carrier exercise daily to keep in tip-top condition



pressed air. The sub can throw them straight, or pitch some fancy curves. Curved or angle shots are accomplished by setting the gyro for the final course, and then firing the torpedo with the rudder locked right or left until that course is reached, when the rudder automatically unlocks and the gyro takes control.

Another Naval air weapon is the anti-submarine depth bomb, which can be set to explode by hydrostatic pressure at any depth

A casualty of the hard fight that won Attu away from the Japs is swung from a ramp boat to ship in Massacre Bay

Dual-purpose guns of an American warship guard a convoy of troop and cargo ships on way to Mediterranean



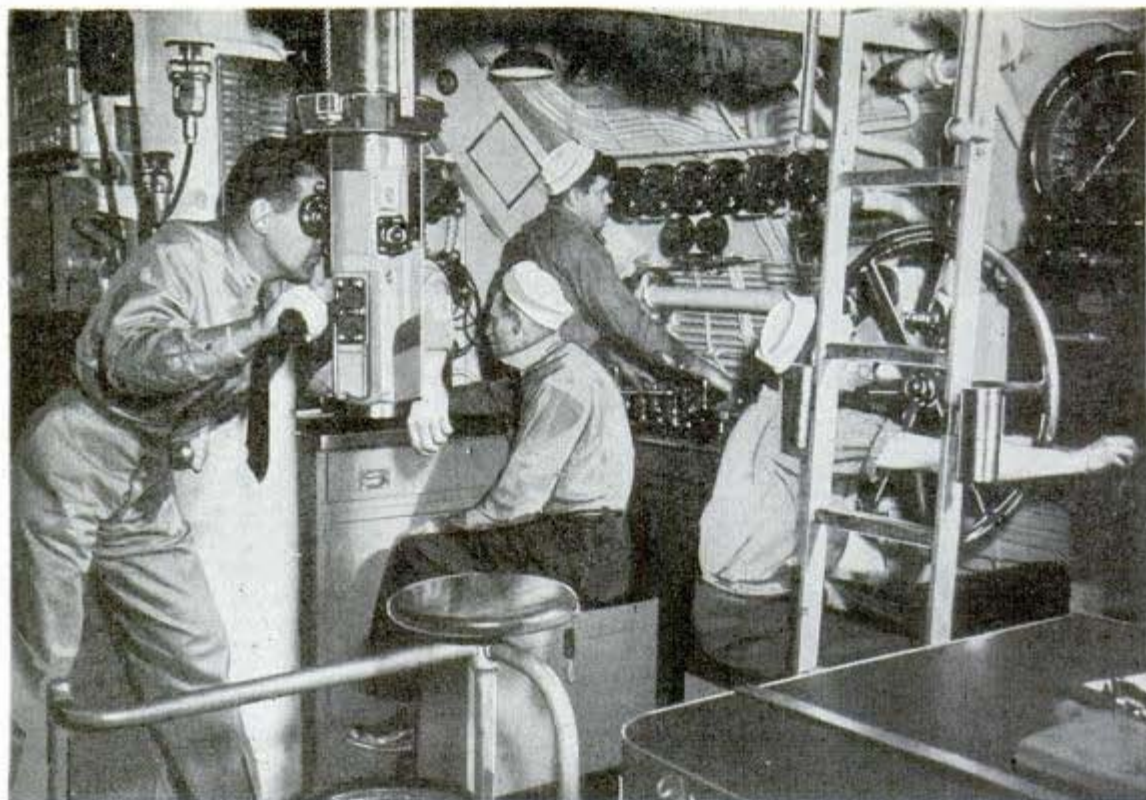

Aboard a Yankee submarine an officer sights an enemy ship through the periscope as crew mans battle stations

desired. I think submarine men agree that this bomb used by the airplane, with the pilot's wide horizon, his "plan view" of the sea, and his ability to strike swiftly, is one of their greatest hazards.

Depth bombs and depth charges must explode only a few yards from the tough hide of the modern sub, to deliver a death blow. But at greater distances, serious and even disabling damage can be done to

lighting, hydroplanes and rudders, batteries, fuel tanks, and instruments, and of course it doesn't help morale.

There are exceptions to this statement. One was a Negro mess attendant on his first patrol in one of our subs. The skipper had just neatly torpedoed a large ship escorted by destroyers, and was "grabbing for the bottom." Every destroyer in the screen was on top of him in no time. Down came the depth charges, exploding with terrific force. Men were knocked down, all power was temporarily lost, and everybody in the crew was feeling pretty glum.

That is, everybody but Jones. He sat on a stool in a corner of the control room, chuckling louder in blissful ignorance with each explosion.

Finally, he burst out, "Captain, we sho' is givin' 'em hell, ain't we?"

Closely akin to the torpedo is the naval mine, one of the most ingenious destructive devices

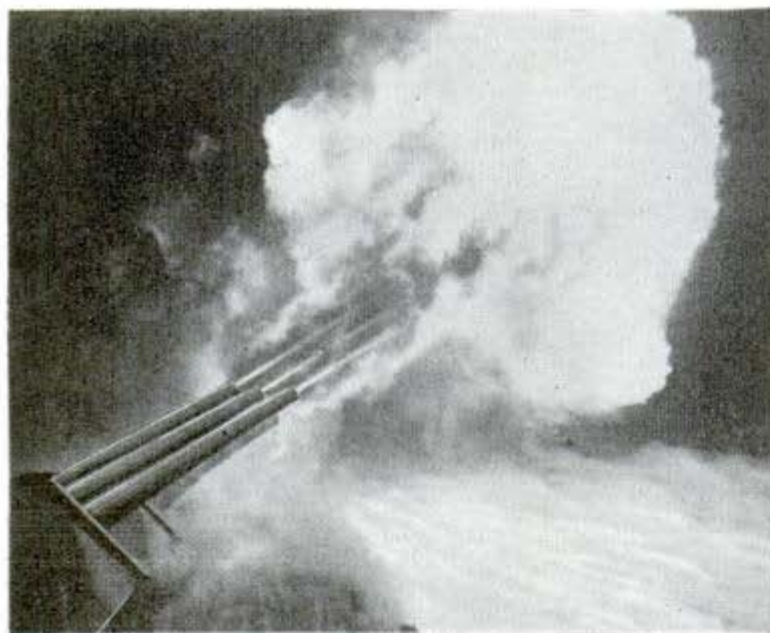

The 14-inch guns of a battleship arch shells across the horizon in a "softening up" bombardment

known. Weighing up to a ton, and exploded in numerous ways by the influence of a passing ship, they may be laid by surface ships, dropped by planes, or pushed out of the torpedo tubes of submarines.

Some mines are of contact type, some magnetic, some acoustic, and some are detonated from the shore by electric cables. The magnetic mine, contrary to popular belief when the Germans introduced it early in the war, is not drawn like a magnet to the ship's side; the mine stays on the bottom. The magnetic field which surrounds the ship generates a current in the mine's firing device, and explodes the charge. The counter measure is degaussing, passing current through coils around the ship to neutralize its magnetic field.

The 6-inch rifles of our modern light cruisers have no equal for fast, accurate shooting. These weapons are mounted in five 3-gun turrets, and fire shells weighing something over 100 pounds. When cruiser meets cruiser, it's just as well to have a few of the heavy 8-inch type. A 10-gun salvo of 250-pound armor-piercing shells from one of these ships polished off the Jap cruiser which was firing on the Boise off Guadalcanal.

These heavy cruiser 8-inch guns, like the light cruiser 6-inch, are also useful for shore bombardment. All shells used for this purpose have thin walls, correspondingly large explosive charges, and instantaneous impact fuses. Heavy and light cruisers and destroyers use their batteries against shore objectives just like land artillery, in preparation for the infantry assault. Planes also bomb shore installations effectively; but when you can get ships into position for bombardment, they have the advantage of continuous fire, while a plane, after dropping its bombs, must go back and reload.

The most powerful engine of destruction used at sea is still the big gun of the battleship. Of 16-inch caliber, weighing about a hundred tons, firing one-ton projectiles which travel half a mile a second, the latest United States battleship main battery gun has shown itself well worthy to retain its place on the Naval team.

The process of laying guns for long-range fire involves all sorts of abstruse data, such as courses and speeds of firing ship and target, wind velocities and barometric pressures, powder temperature, and even an allowance for the rotation of the earth during the flight of the projectile. But all this data is incorporated into the problem almost automatically and in amazingly brief time.

A fire controlman in the foretop operates a sort of super-gunsight called a director,

(Continued to page 162)

APRIL, 1944

*Mr. John F. Lendie
1330 N. Central Ave.
Chicago, Ill. 7899*

Letter Patterns for Painter Lend Professional Touch



Sign painting is made easy with letter and numeral patterns that save time for the experienced painter and give a professional appearance to the work of an amateur. The patterns, available in many sizes, are made of durable stencil paper. All the painter has to do is trace around the letters with a pencil and fill in with color.

78966

Toothbrush Holds Dental Floss

Dental floss can be manipulated easily when mounted on a holder which is part of a toothbrush handle. The floss is secured to the turned-down end of the handle and carried back to notches part way up the handle. By placing the forefinger against the floss, the effect is that of a saw which is fitted easily between the teeth.



*J. A. Lendie
201 E. Main
Canton, Ohio*

Mr. G. W. Moore
1362 N. Dearborn, Chicago

GUNS on WHEELS



Signal Corps photos

Getting guns into strategic positions "fustest with the mostest" firepower is accomplished with artillery on wheels. To meet the swiftness of attack by mechanized units, or to prepare new positions against assault from the air, calls for fast-moving artillery. Above, coast artillery antiaircraft regiment on maneuvers moves a 90-millimeter gun into position to repel an expected attack over ridge

An M-2 tractor digs into sand as it pulls big 155-mm. howitzer in desert



Officer candidates demonstrate manual operation of 40-mm. anti-aircraft gun. Crew, from left to right, elevator setter peering through sight, the gunner, two ammunition carriers, and the azimuth setter who is busy measuring arc of the horizon

7673



Ski patrol (above) swaps wheels for toboggan for winter transportation of heavy machine gun on difficult approach. Panel at right shows versatility of U. S. equipment. Top, at a Caribbean outpost, crew of 37-mm. anti-aircraft gun practices tracking planes. Center, 8-inch railway gun in position to blaze away at foe. Bottom, members of an infantry unit try out their 37-mm. gun in a mountain pass in Alaska. Below, huge 14-inch railway gun gives good account of herself during Army and Navy joint maneuvers in Panama and adjacent waters. It takes thousands of pounds of finest steel and rubber to give these guns mobility needed in modern war

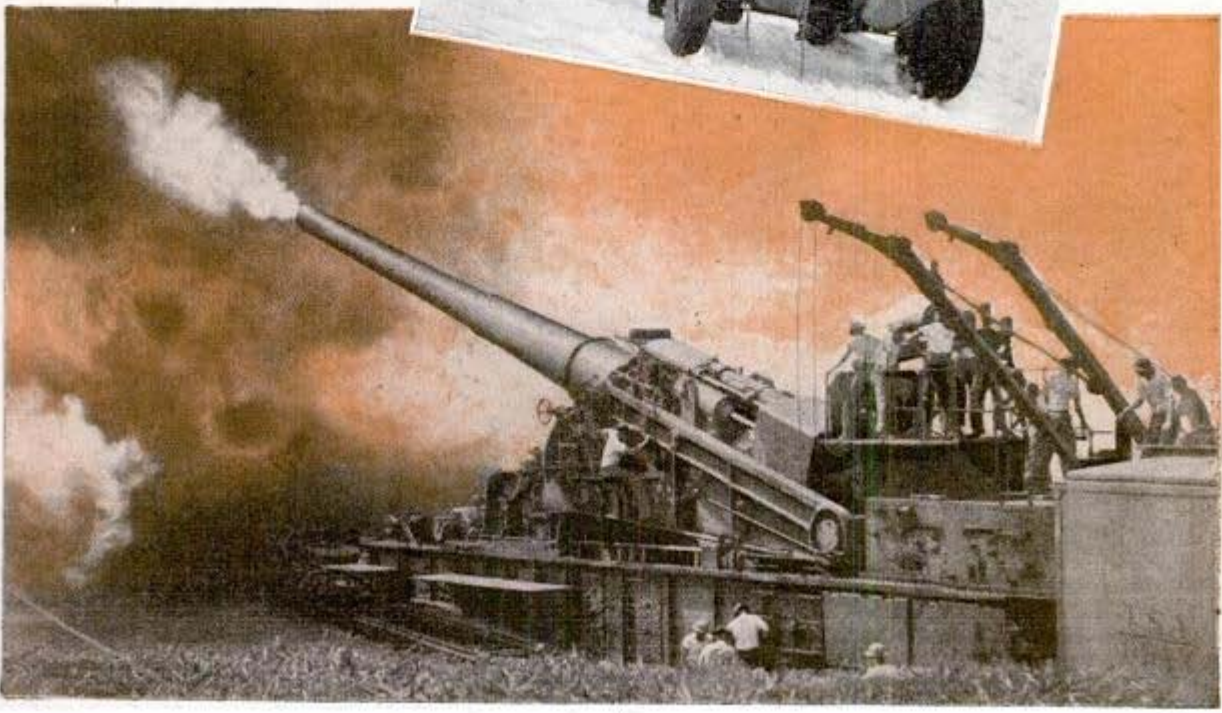

*Pacific Car & Foundry Co.
Renton, Wash.*

71838

Army Tank Retriever Is Long as a Railway Car

Newest and biggest Army combat vehicle is the 25-ton tank retriever, a 10-wheeled behemoth built to go any place a tank can go, and to retrieve disabled tanks and take them back to repair stations. About as long as a standard railway mail car the trailer can hold one medium tank or two small



tanks. When loaded it weighs 80 tons, twice the weight of two loaded box cars. Each rim and tire of the huge vehicle weighs 900 pounds. To enable it to operate far from its base, the cab of the retriever is equipped with a small stove for cooking canned rations, and it carries large quantities of water, gasoline and oil, and complete repair equipment.

71740

Hogs Operate "Swinging Door" That Keeps Out Drafts

By means of a wing attachment, the hog-house door may be made self-closing; yet pigs as young as one week old are said to

be able to operate the door with ease. Little pigs open the door by squeezing in behind the wing, and older hogs flip it open with their snouts. The wing is attached to any ordinary hinged door with two half-oval bars. A bracket bolts onto the building, and a weight on a chain passes through a pulley to attach to the bracket in any of several positions that will make the tension greater or less, as required. Chief advantage of such a door is that it permits the hogs free run of pen and runway, while also assuring ventilation without drafts.

Automatic File Finds Lost Bags By Sorting Card Index

Bus lines in the west have adopted an automatic card index system for locating lost baggage with a minimum of delay and confusion. For every lost piece of baggage the station master punches a hole in a card which contains pertinent items of description—type and color of bag, number of straps, and its contents. The card is filed in a modern index system. When an operator receives a report of a lost bag, cards relating to bags of that description can be found quickly by pressing appropriate buttons which automatically locate them.

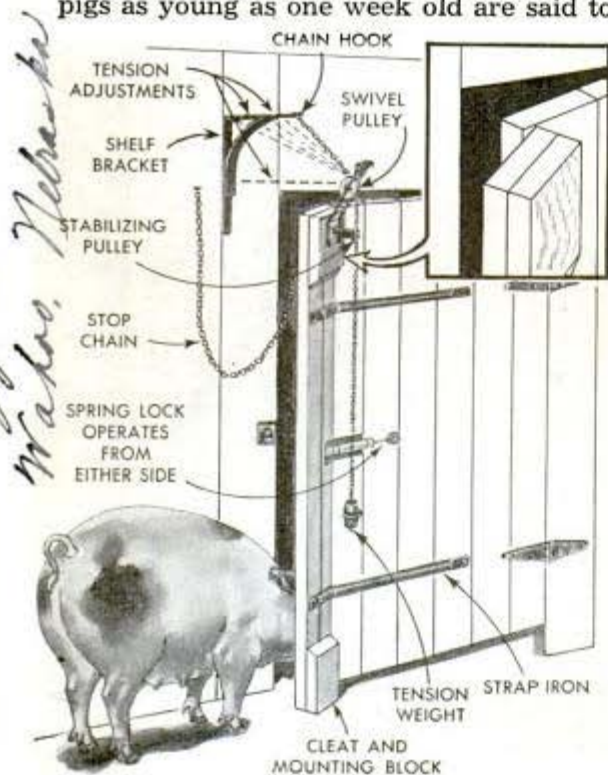

*Bauer Mfg. Co.
Wahoo, Nebraska*

Water Spray Shields Lifeboat in Sea of Flames

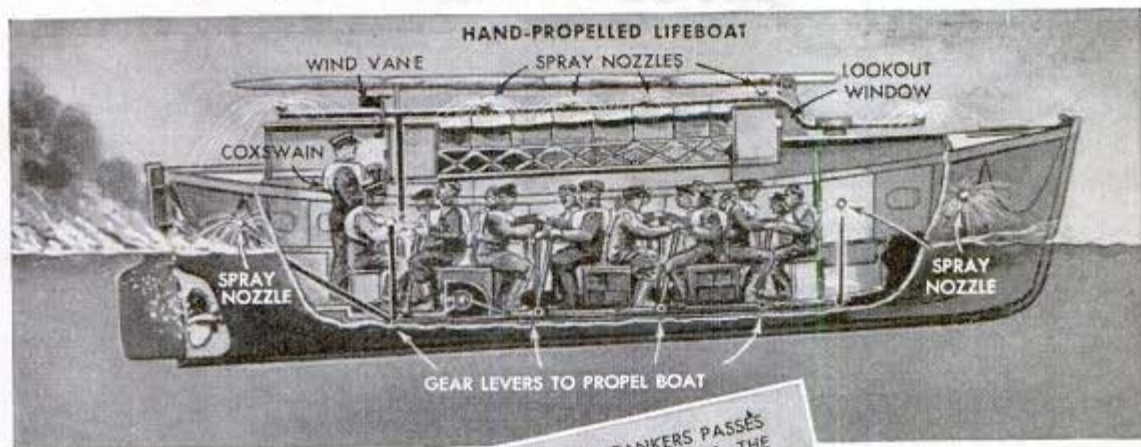

FIREPROOF LIFEBOAT FOR OIL TANKERS PASSES THROUGH OIL BLAZING ON THE SURFACE. THE CREW ARE INSIDE, PROTECTED BY THE ASBESTOS HOOD AND NUMEROUS WATER SPRAYS

Hand-operated model of fireproof lifeboat (above) is propelled by movement of gear levers backward and forward. The cutaway shows position of coxswain, who keeps craft running to windward with aid of indicator. British ordered 500 of these lifeboats built after successful tests

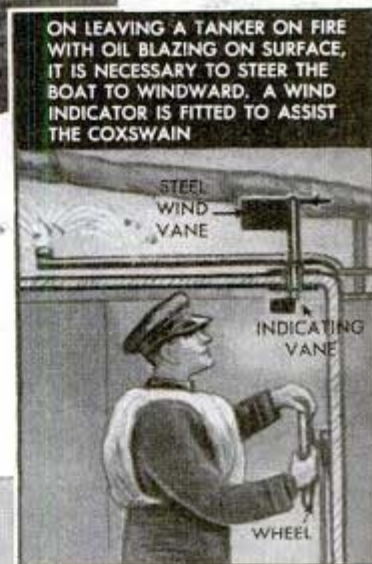

To save the lives of seamen on torpedoed tankers, British engineers designed this all-steel fireproof lifeboat which accommodates 33 men. A sliding asbestos hood and a shield of cold water ejected from numerous sprays mounted at various points, enable the boat to move through a sea of blazing oil. The lifeboat is built in two models, one manually operated, and the other (shown in cutaway below) has a small Diesel engine. It moves at five knots an hour

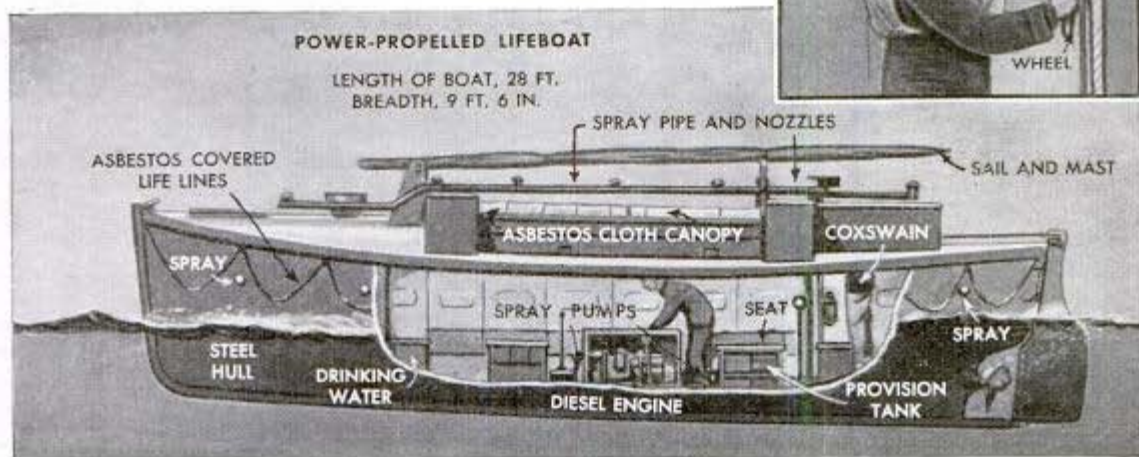

71380

The TUBE that is REMAKING the WORLD



Left, tube used for electrolytic tinplating. Above, RCA radio "sewing machine" stitches thermoplastic

Westinghouse photo

John D. Rockefeller, Pa.
By Roderick M. Grant

IT IS only an hour's travel from New York to San Francisco by the electronically controlled vacuum tube, a prophetic vision of Dr. Irving Langmuir, Nobel prize winner in chemistry.

Not tomorrow, of course. But this General Electric research scientist, looking far beyond the practical problems of wartime electronics, sees no fundamental reason why we could not travel at 2,000 to 5,000 miles an hour in magnetically suspended vehicles floating in a vacuum tube. He visions, too, an orchard without workers, cared for and cultivated and its fruit picked by machines governed by electronic controls.

Day after tomorrow, perhaps.

But the "house of magic" is already open for business. In a busy factory a little copper ring that might be a miniature lawn sprinkler encircles a tiny gear. As the operator presses a button, there begins an automatic sequence of seeming miracles.

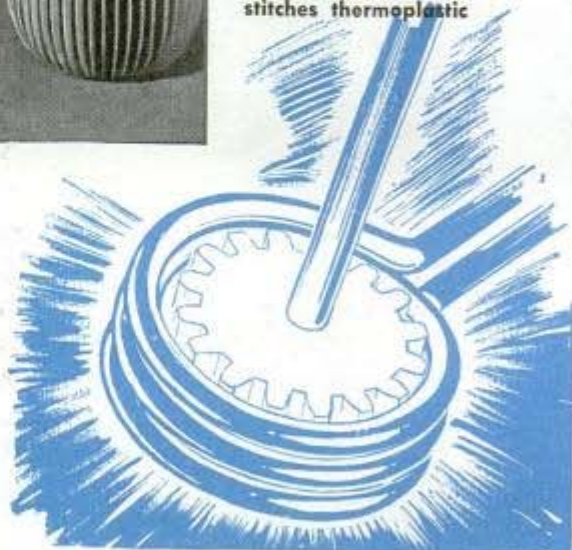

High-frequency radio waves heat-treat gear in coil

In three seconds the gear is blushing cherry red. Seconds later, myriad jets of water spring from the ring to quench the red-hot metal. As the little cloud of steam clears, the gear is lifted away, its hide toughened for a long and hard life by the heat induced by those same high-frequency radio waves that carry voices around the world. Once the heat treatment by other means took minutes, even hours; now

*Radio Corp. of America, A. C. A. Bldg.
36 Rockefeller Plaza, N. Y., N. Y.*

seconds. It is electronic magic at work.

Suddenly there is glamor in Electronics. What if the electron tube already has spent a generation at hard labor? What if more than 25 billion kilowatt hours—one tenth of all the vast pool of electric energy generated in the United States—flowed through electronic devices last year? What if electronics has long since reached voting age? Suddenly it has acquired glamor. There is always glamor in an unknown filled with magic promises.

For in it lies the wonder of airplanes landing safely on a fogbound airport, of dust-free homes, doors that open and lights that flash on as if in answer to your wish, of elec-

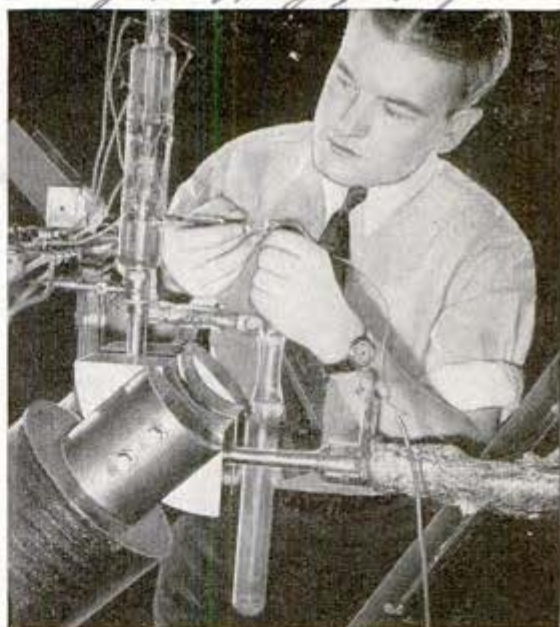

Above, electronic mass spectrometer analyzes gases in synthetic rubber production. Left, Westinghouse circuit breaker that blows out high-voltage arc with compressed air. Below, the RCA electron microscope

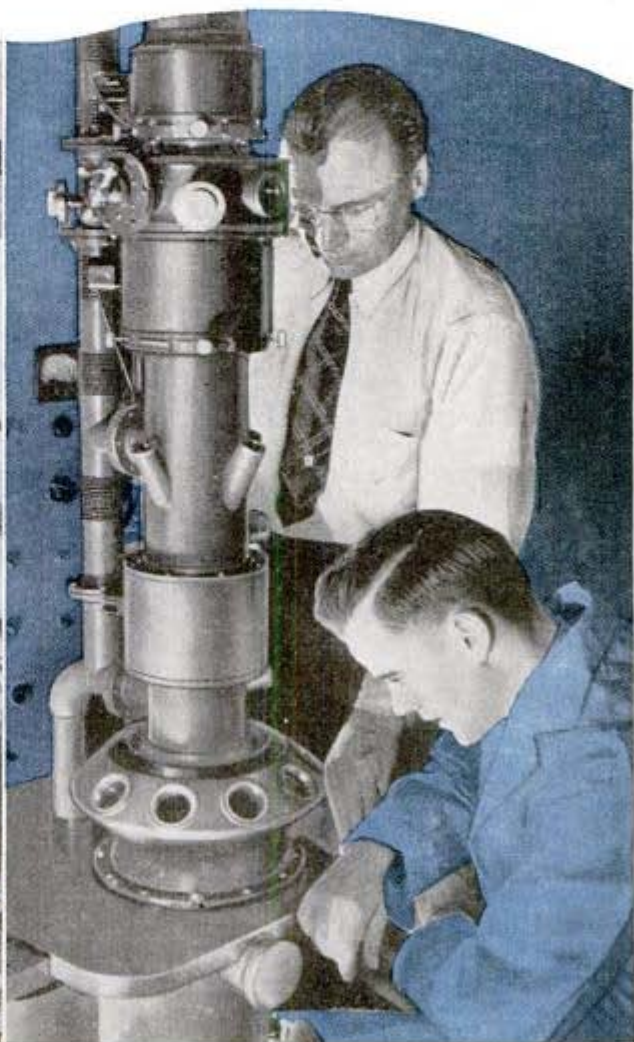
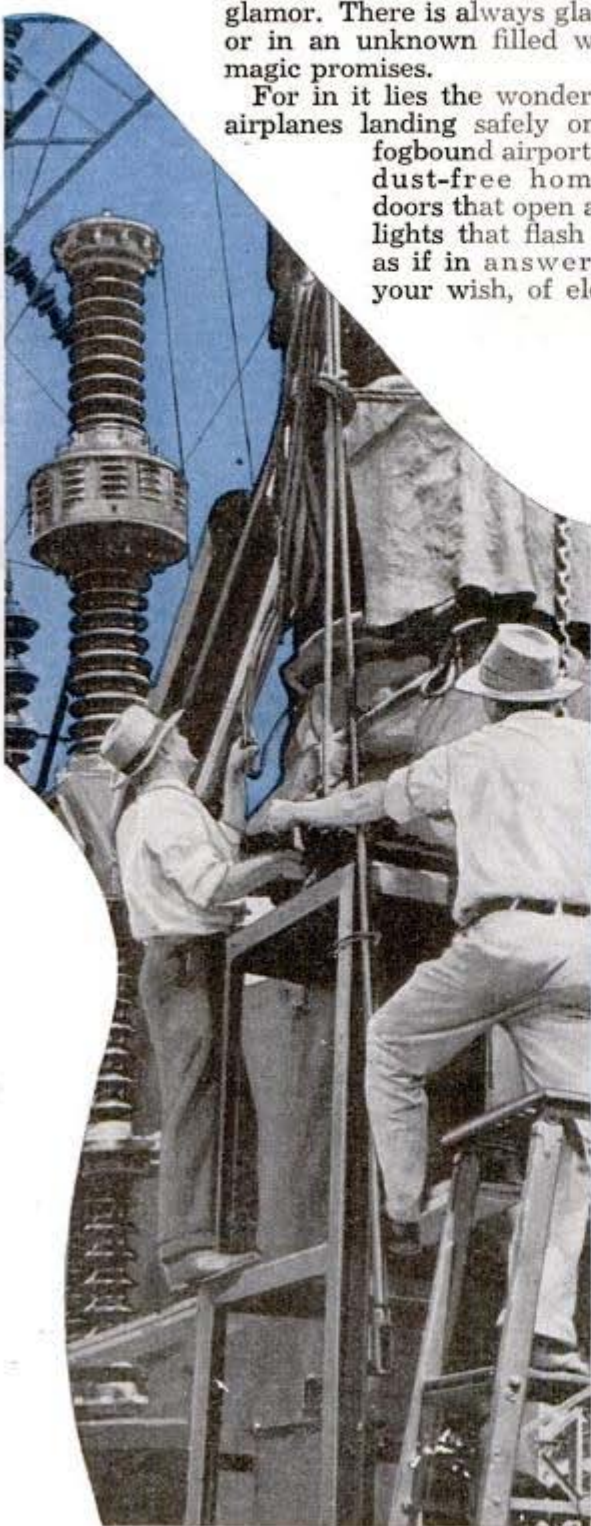



A Westinghouse research scientist demonstrates his electronic dealer—four electric eye circuits can sort cards into suits or deal poker hands

tron microscopes unveiling the mystery of the disease virus, of cathode rays revealing the speaker pink and natural as life when you lift your telephone receiver.

That is electronics in the world of tomorrow that will surely come when the economic world is ready for it. But there are oldsters who say to youngsters: "You can have your electronics and your dream world. To me it is just a five dollar word that wasn't in the textbooks when your old man went to school. Electrons are over my head; in my time I'll never need to understand them."

Yes, old man, electrons are over your head, and in your hair, and in your very substance. You may ignore them, but you cannot avoid them. They are on every fac-

tory payroll today. They answer your fingertip when you tune in the news broadcast from Chungking, when you pick up the telephone to talk with the boy at Lowry Field; they guard you as you ride the fast train and air liner, they heal your pain under the bombardment of high-frequency therapy.

To put it simply, electronics is the science of putting electrons to work, and the vacuum or gas-filled tube is the means to the end. Fluorescent lamps and radio tubes, X-ray tubes and television screens are all members of the family. So are the tubes that heat-treat steel and convert alternating into direct current,

and measure the scarcely perceptible electricity in your brain and heart. Tubes are available that will detect and measure currents far less than a billionth of an ampere, or generate frequencies of a billion cycles. There are tubes that will fit in a thimble, others that are bigger than a man.

Essentially a tube is a valve governing the flow of electrons. Boiled off from the cathode by a heater coil, or lured from it by light as in the phototube, the electrons stream toward the positive anode and close the circuit broken inside the tube by the gap of vacuum or low-pressure inert gas.

The volume of their flow can be controlled precisely by a grid, in simplest terms a wire mesh which functions like a venetian blind between cathode and anode.

An ordinary light microscope in General Electric laboratory made the photograph of a mosquito's wing at left. Feathers on edge of wing are shown magnified (right) by electron microscope

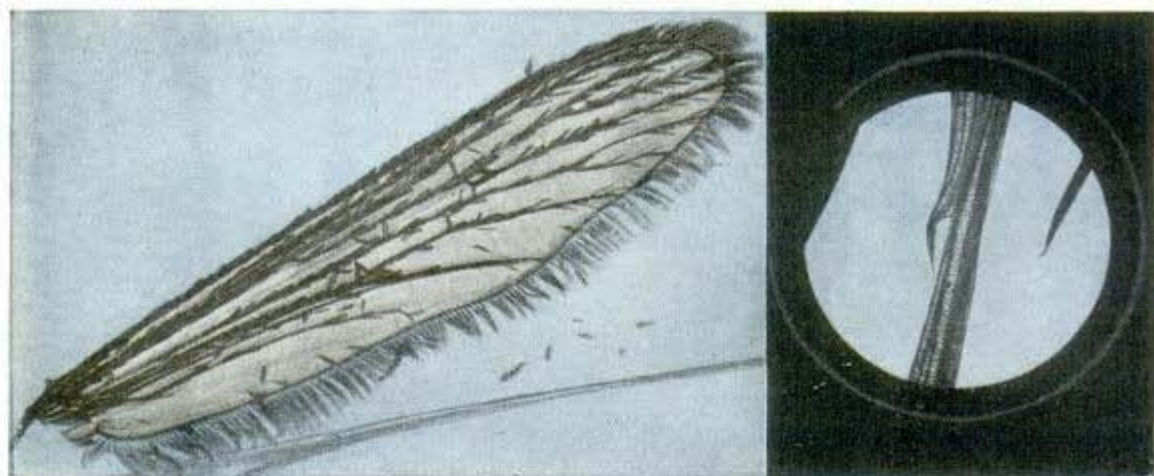

Positive voltage fed into the grid increases — amplifies — the outflow of negative electrons; negative voltage closes the blind, diminishes the stream. If the tube is used for radio reception, the grid is fed signal current from your antenna. If it is to amplify sound, the grid gets its orders from a microphone. If it is to respond to light signals, an electric eye governs the voltage on the grid. If it is to rectify alternating into direct current, the tube is connected in series with an a-c circuit; during the half-wave of a-c voltage when the anode is negative, electrons from the cathode are repelled and the current is interrupted, resulting in translation of the a-c flow into a pulsating direct current. The tube is a one-way street.

You can stump the wisest scientist by asking why an electron behaves as it does. He only knows that it does. That, theoretically, it is the smallest known subdivision of matter, a negatively charged infinitesimal something that whirls around the atom's nucleus of protons and neutrons as the planets whirl about the sun. That 30 octillion electrons weigh somewhat less

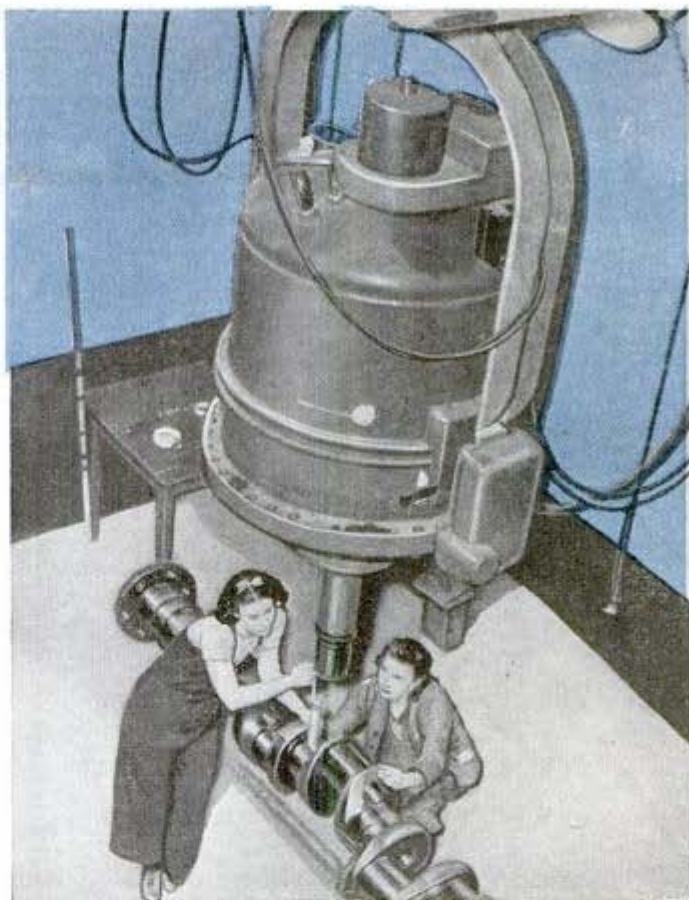

General Electric's million-volt X-ray, as easy to operate as a dentist's, penetrates eight inches of steel. Below, high-voltage rectifier tubes change alternating into direct current

Westinghouse photo

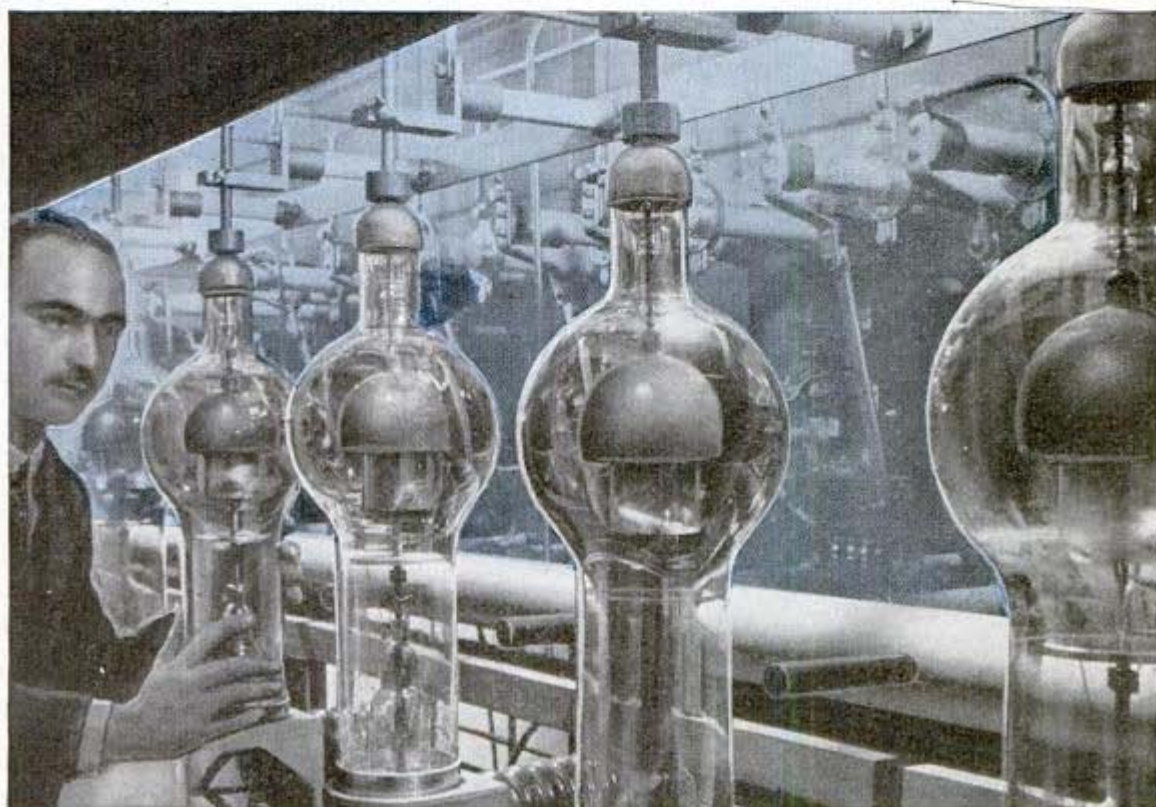

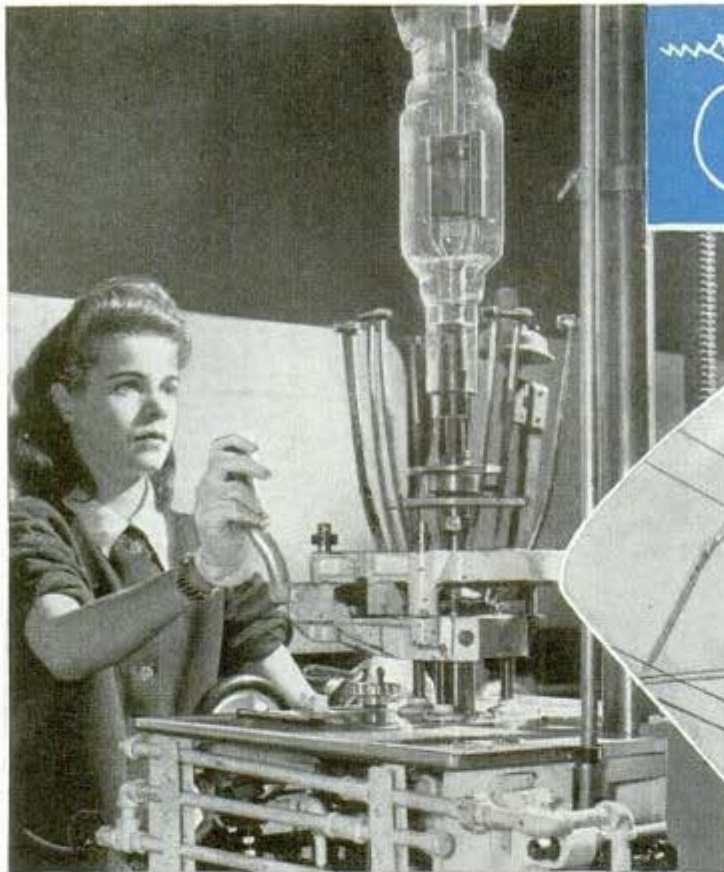

Revolving cluster of "flame throwers" seals end of transmitting tube. Below, light falling on metal releases electrons in phototube

than an ounce. That six quintillion electrons flow through the filament of a 100-watt lamp each second it is burning. Little things, aren't they?

But because smart gentlemen in research laboratories have learned how to make the electron sit up and beg, they have revolutionized industry and modern living. With tubes they amplify and rectify current, control power flow with ultra-precision, generate high-frequency alternating current, transform light into current and current into light.

The "mining" of magnesium from the ocean, the extraction of bauxite for aluminum from mud require direct current. Most of the electricity generated is alternating current. The Ignitron, Westinghouse electronic rectifying tube, came along in time to convert a gigantic stream of electrons into direct current for our wartime aluminum and steel mills, our magnesium plants, our electric railways and traction lines, and for electroplating operations possible only with direct current. Electronic rectifiers also feed the Westinghouse Precipitron, electrostatic air clearer which presages the smokeless city and

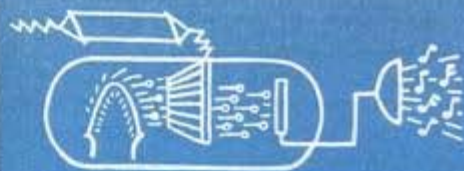

Sketch shows how energy caught by your aerial is fed into grid of electron tube and is thus amplified

Below, changing antennas in "switch-yard" of GE short-wave radio station

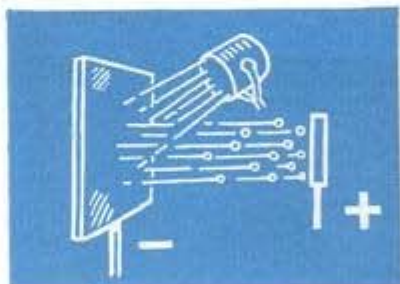

dustless home of tomorrow and is serving today in factories and laboratories where clean air is essential for making delicate precision instruments, processing military film and polishing lenses.

A few years ago world's fairgoers were agog at the spectacle of corn popping in the mysterious emanations of high-frequency heat. Electronic heat treatment has now progressed from the amusement stage to the industrial theater, annihilating time in bonding plywood and hardening metal surfaces, detonating explosive rivets, molding thermosetting plastics and "stitching" thermoplastics. To make it personal, a first cousin of the short-

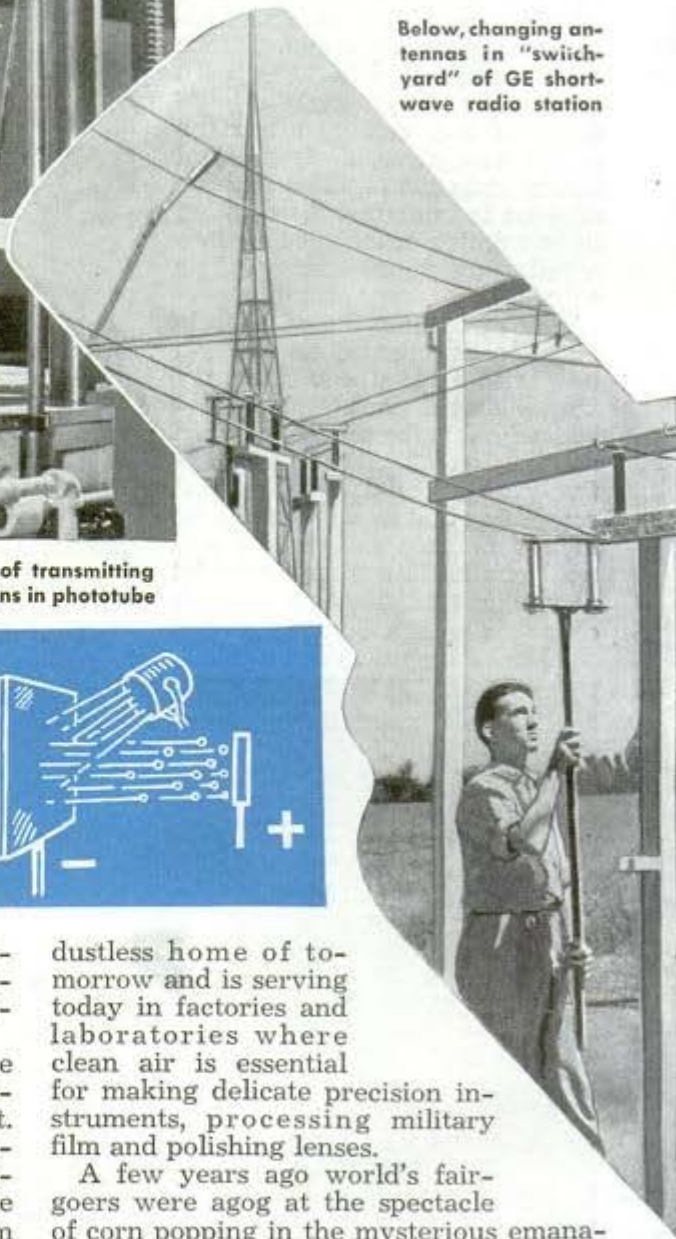

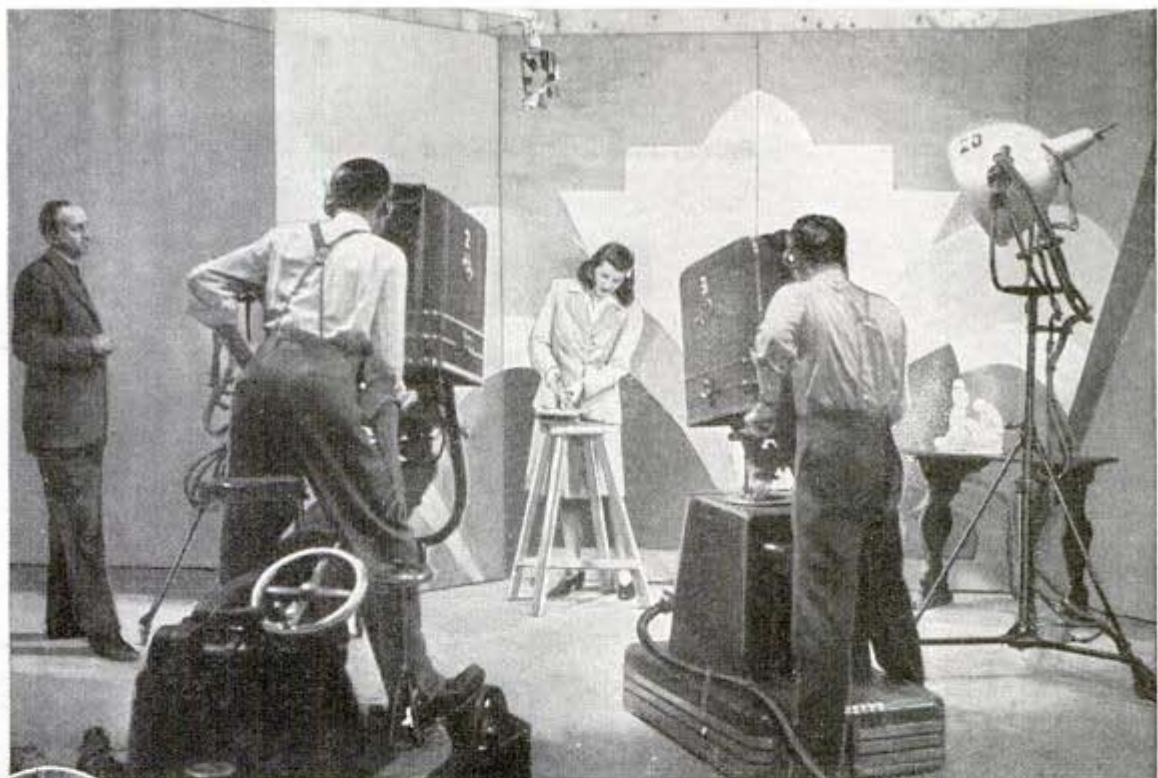

Top, sculpture demonstration goes on air from GE television station at Schenectady



At left, another schematic drawing by General Electric indicates how high-speed electrons, striking metal atoms, make these atoms give off the penetrating X-rays

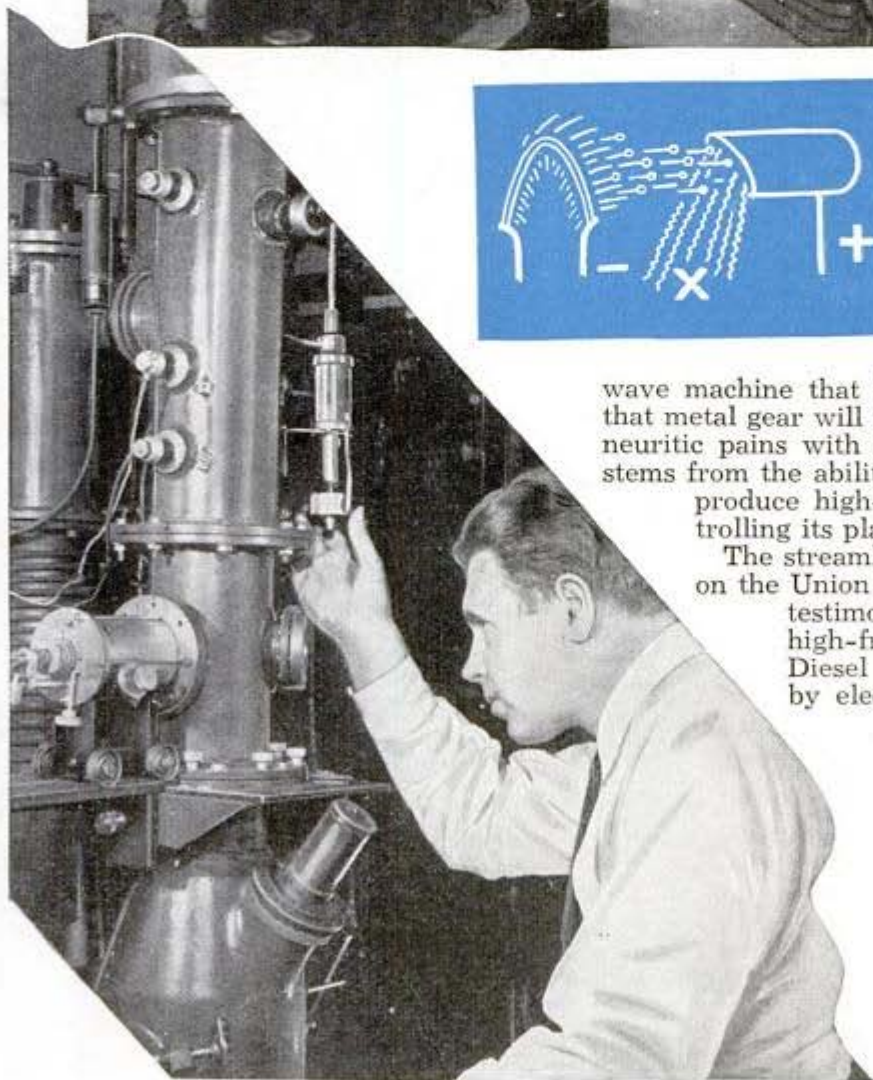

Schenectady, N.Y.
 wave machine that heat-hardened the skin of that metal gear will treat your ailing bones and neuritic pains with deep heat. All this magic stems from the ability of the electronic tube to produce high-frequency waves by controlling its plate current with grids.

The streamliner "City of Los Angeles" on the Union Pacific railroad will give a testimonial to the beneficence of high-frequency heat therapy. Its Diesel crankshaft was hardened by electrical induction. After a million miles of travel, inspection revealed only .001 inch of wear on the crank pins—despite the equivalent of 40 trips around the world.

A "radio sewing ma-

Studying rustproof coatings, a research man fires electronic bullets which rebound from coating, strike photographic film; film shows molecular structure of coating



Instead of hand-driven hammers, light beams striking "electric eyes" evoke music from this marimba in Westinghouse Research Laboratories

electronic tube in a control circuit that can be governed as desired by temperature, time, speed or other factors. As timer, phototube, speed gauge or pyrometer transmits its signal to the grid, the work circuit is automatically opened, closed or modified. Acting with the speed of light, responding to stimuli no human could detect, and working without any moving parts to suffer wear, the tube makes and breaks contacts, measures out exact dosages of current required by a resistance welder for high-quality, uniform welds. An electronic control may send as many as 1,800 "needles" of current per minute stabbing through aluminum aircraft parts, producing faster and stronger welds than ever.

chine" developed by RCA stitches thermo-plastics together with a bond stronger than the molded synthetic material itself. A "radio pistol" firing high-frequency "nails" in a narrow beam tacks together stacked sheets of plywood with spots of penetrating heat that seals the plastic glue between the sheets. The molding cycle for shaping wooden propellers was cut from seven hours to three by induction heating. A high-frequency method of making tin plate, developed a year ago at Westinghouse, uses only a third as much war-scarce tin as conventional methods, is much faster, and saved 16,000 tons in 1943. As an indication of its versatility, electronic heating is even used to kill weevils and beetles in stored grain without harming the grain germ and the vitamin content.

Electronic magic keeps motors driving at constant speed through a varying load, oversees the melting of metals under the watchful eye of a photoelectric pyrometer focused on the furnace flames, responds instantly with corrective measures when a multicolor rotogravure press moving at 1,000 feet per minute varies by 1/1,000th of one percent from perfect color register on the printed page, detects pinhole flaws in metals and fabrics rolling from high-speed mills.

In New York City's famous Radio City Music Hall an operator sits at a control board whose 1,500 electronic tubes can

Electronic amplification carries your voice in steps across the continent over telephone lines, boosts the tiny signal transmitted from reconnaissance plane to field headquarters, magnifies tiny impulses so that engineers can study them, permits precise balancing of airplane crankshafts and propellers, giant gears and peanut-size motors.

Exact control of power in industrial processes is achieved by using the

The RCA electron microscope produced this remarkable view of the windpipe of a mosquito

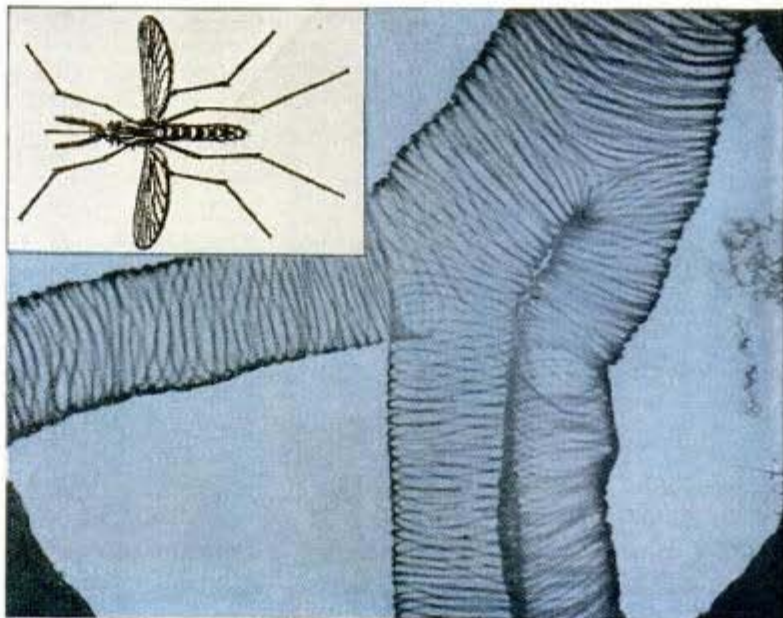

swell all the lights in the great auditorium in a vast, stepless crescendo. By the same principle of grid control, manufacturers govern the flow of power for delicate processes with stepless increase or decrease of direct current.

The human senses seem crude and unresponsive by contrast with the superlative responsiveness of the electronic family. A new General Electric lamp using a mercury bulb no bigger than a cigarette meters out a high-intensity flash for millionth-of-a-second photographs, delivering a less-than-momentary 4,000,000 watts of direct

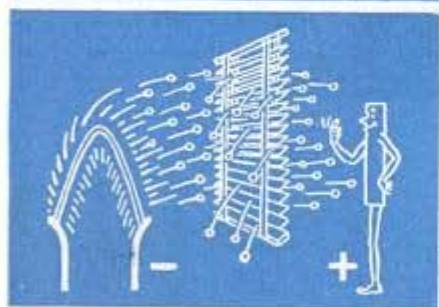
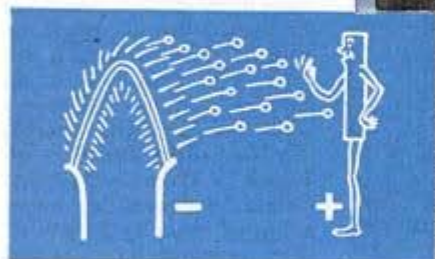

The bomblike Ignitron tube produces direct current for aluminum, magnesium and other industries. Left, positive voltage attracts electrons from filament to metal plate; by changing the voltage of a grid interposed like a Venetian blind between filament and plate, flow of electrons can be increased or diminished. Below, Westinghouse high-speed X-ray tube stopped all motion, seeing through foot and ball in millionth of a second

current rectified from an ordinary 115-volt house circuit. Another portable General Electric instrument will record one-millionth of a millionth of a watt; it is used to record the human pulse beat, write high-speed records of minute changes of temperature in industrial furnaces, measure carbon monoxide in tunnels, record vibrations in buildings. An electronic "chemist" devised by a Westinghouse

(Continued to page 154)

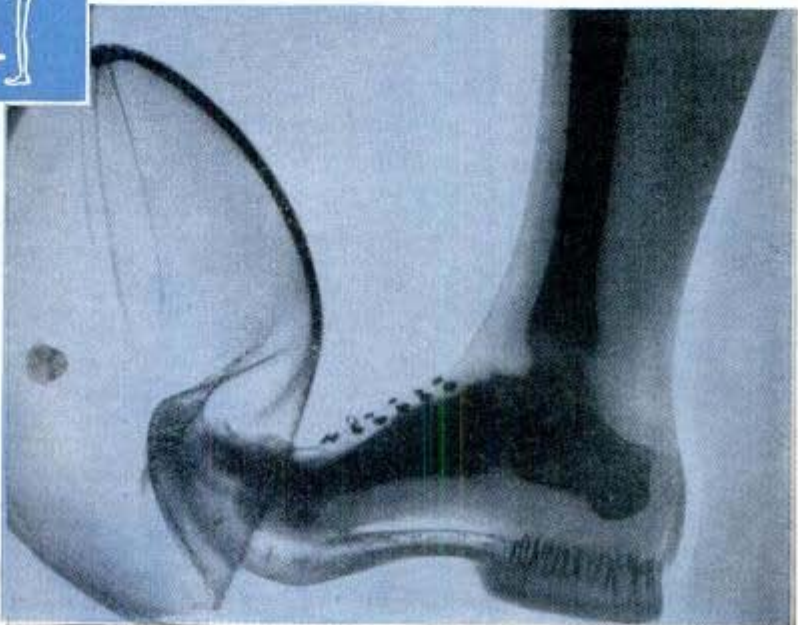

Germans Hurl Rockets From Secret Weapons



In a desperate attempt to halt the Russian armies on the eastern front and to check the destructive daylight air raids by U. S. bombers, the Nazis are resorting to rocket weapons which are said to include radio-controlled rocket glider bombs, big rocket guns set up on the coast of France to shell London, new rocket-launching devices which are attached under the wings of fighter planes, rocket throwers used by ground troops to hurl a steady stream of self-propelled shells and others. Such weapons are considered by many military experts as "propaganda weapons" rather than tools of war to subdue a hard-hitting enemy. Rockets are far less accurate than rifled guns or even a smooth-bore weapon. Also, rockets of long range must allow greater proportion of weight for the propelling charge, thus reducing the amount of explosive for demolition purposes. Ordnance men and physicists question the Nazi claim that they can launch a 12-ton rocket from France to destroy 20 square miles of area in England. More practical is the launching of rockets from planes

Above, closeup of Germany's "secret" rocket gun which the Nazis claim has been used with success on the eastern front. From this rear view the gun appears similar to weapons with many launching tubes developed by Russians

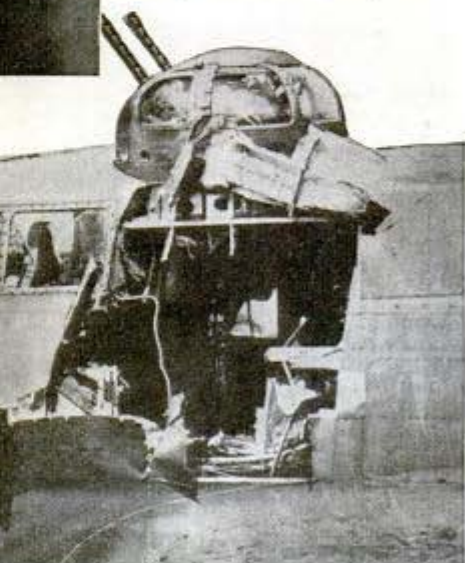

The hole in the fuselage of this bomber was torn by a rocket-propelled shell over Germany. These rockets are hurled, somewhat inaccurately, at the close formations of our heavy bombers. Left, six-barreled rocket weapon captured from the Nazis. It is called a "nebelwerfer," or fog thrower

TENDERFOOT SKIPPER



*PC Unit A-51
Naval Operating
Base
Norfolk 11, Va.*

By **Lt. John B. McLaughlin, USNR**

FOR weeks the crew of our trim little 110-foot subchaser had been training night and day in preparation for the day we'd get our "orders." First at a Texas building yard waiting for the finishing touches, then at the Navy Yard in New Orleans getting all sorts of intricate equipment installed during what is called a "fitting out" period, and finally at a Sub Chaser Training Center for a two-week "shakedown" period during which ship, crew, and officers were put through their paces. At last all of the preparation was over and I gave the order

† In wheelhouse of PC boat, officer of the deck directs movements of little sub chaser

Deadly match for warships, subs or planes, a PT boat bristles with guns and torpedoes





Official Navy photos

Sighting 20 mm. anti-aircraft gun mounted on PT boat



Above, destroyer crew manning secondary (emergency) controls which duplicate those in pilot house. Men keep sharp lookout



to my chief boatswain's mate to "post the special sea detail."

In rapid succession I gave the orders, "Let go lines 1, 3 and 4 . . . hold 2 . . . starboard engine ahead . . . port engine back . . . cast off 2 . . . st'b'd engine stop . . . right 10 degrees rudder . . . all engines back . . . one long blast . . . rudder amidships."

Quietly and smoothly our "little battleship" glided out into the channel and another ship had joined the rapidly growing fleet of "sub-busters." There are four basic types of subchasers in the Navy; VP's which are the large private yachts that have been converted into fighting ships; SC's which are the 110-foot ships; PC's which are 176 feet in length; and, of course, destroyers and the new destroyer escorts.

At the sea buoy we rendezvoused with two other subchasers that were to accompany us to the port named in our orders. After much signaling between the ships by "blinker" (a searchlight used for signaling) the speed, initial course, and formation were set and we were on our way. This was my first long trip as "skipper."

Since entering the service, I had been taught navigation, gunnery, seamanship, tactics, communication, and Navy Regulations for eight long weeks at the Navy Training School at Boston, been through five weeks of training in antisubmarine warfare at SCTC (Sub Chaser Training Center), and two weeks at the Fleet Sound School learning the rudiments of submarine sound detecting equipment.

Prior to that I was a happy suburbanite rushing to catch the 8:10 train every morning to my job in the advertising department of a large oil company in Chicago. Now in a little less than six months I found myself on the high seas as captain of a fighting ship. My executive officer was a young architect from Houston, Texas, and my junior officer came from the campus of Boston College. Our training was typical of that given to hundreds of other men from civilian life who were already, or were soon to become, officers in our sub-chaser fleet.

Although we were just sailing out on our first assignment and hadn't as yet even seen the enemy, we already had a deep hatred for him. From some of the members of our crew who had been torpedoed, and from conversations with fellow-students at SCTC who were back for a "refresher course" after months at sea, we had heard tales of Axis subs that made us itch to get at 'em. We remembered a battered lifeboat at SCTC filled with sixty bullet holes. It was brought in by a rescue ship with the bodies of sixteen machine-gunned American sailors.

As we took our departure from the sea buoy I "secured" the special sea detail and ordered the "chief" (chief boatswain's mate) to post the watch. On an SC the

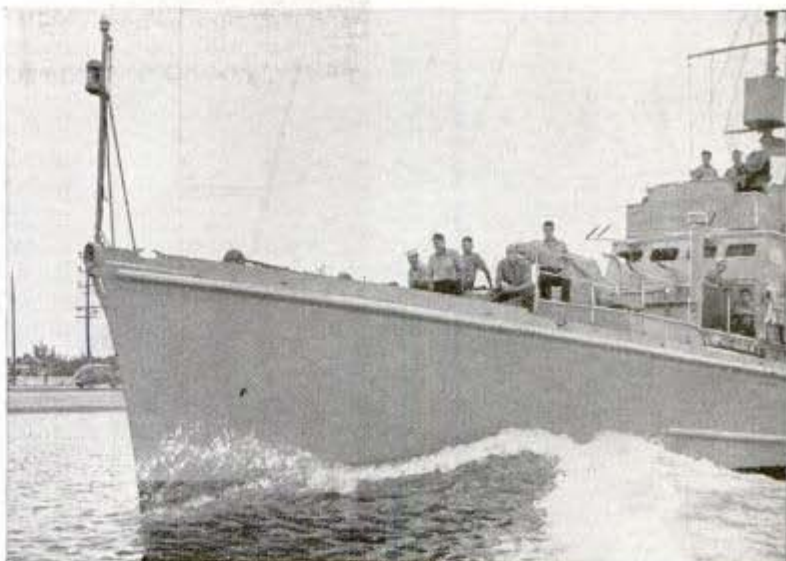

Cruising near Navy's Submarine Chaser Training Center, this speedy 110-foot SC boat carries depth charges and powerful guns



Ready to let go with a depth charge, Coast Guardsman awaits order to fire. Below, camouflaged destroyer, the USS Nicholas, ready to combat enemy craft. Note the torpedo tubes amidships

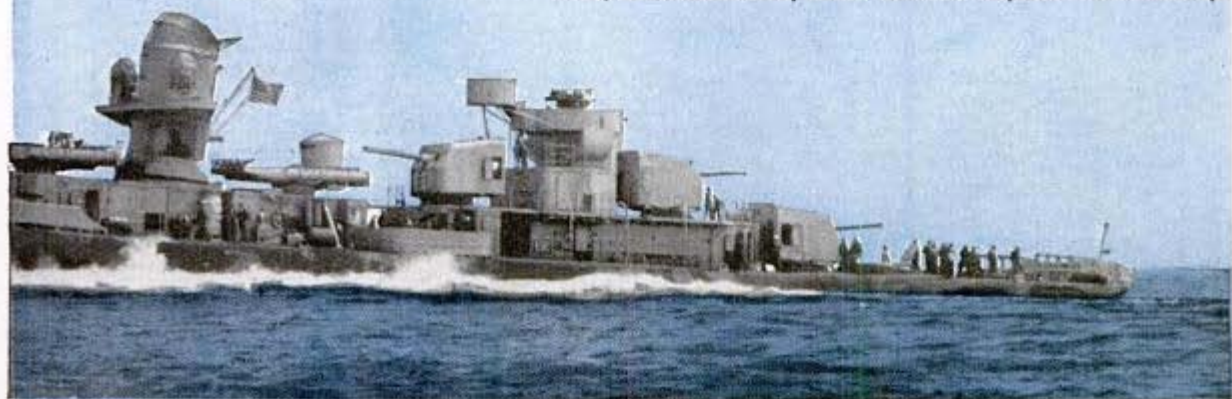



Winding up magazine of 20 mm. gun to force shells into breech

crew is divided into two watches, port watch and starboard watch. Half the men are on duty for four hours while the other half rests. This is called standing a "Watch and Watch." It's a tough grind on a crew but sufficient battle stations are manned to be able to make an immediate attack on a submarine. Unless we had to make what is called an "urgent" attack, however, we

usually sounded the general alarm and called the entire crew to man battle stations. When all battle stations are manned it is called "General Quarters." On our little ship we finally got to the point where every man would be at his station within 26 seconds after the General Quarters siren had been sounded. Why the speed? Because a sub can crash dive in from 30 to 40 seconds.

During the first few days of our trip the sea was like glass, the weather was perfect, and the men slipped into the routine like old hands. On our second night out we had our first bit of excitement. At about 0100 (which is the Navy way of saying 1 a.m.) the O.D. (officer of the deck) called me in the wardroom on the phone and reported that the crow's-nest lookout had just sighted a steady white light on our starboard bow. As you know, during wartimes, ships cruise at night without a trace of light showing, and so the only conclusion the O.D. could make was that this must be a navigational light or lighthouse, even though he knew we were supposed to be many miles away from land.

Up the ladder to the bridge I went on the "double" and as I studied the light through glasses (binoculars) the first thought that struck my mind was: "Lord—is my navigation that lousy?" But after studying the light, checking our course, and scanning the charts, I knew it couldn't be a lighthouse. And it wasn't. In a short time the

lookout reported "Now there are two steady, white lights." Then over the phones came, "Sir, it looks like a Christmas tree, now." Sure enough, as we drew closer, there was a strange sight for sailors to see nowadays—a fully lighted liner. It looked like a peacetime cruise ship to our startled eyes. The O.T.C. (Officer in Technical Command of two or more ships) who was on one of the PC's with us, decided not to investigate, and so our "cruise ship" passed us by in the night. Later we learned it was an Argen-



Submarine fighters manning fast Diesel-powered PC boat

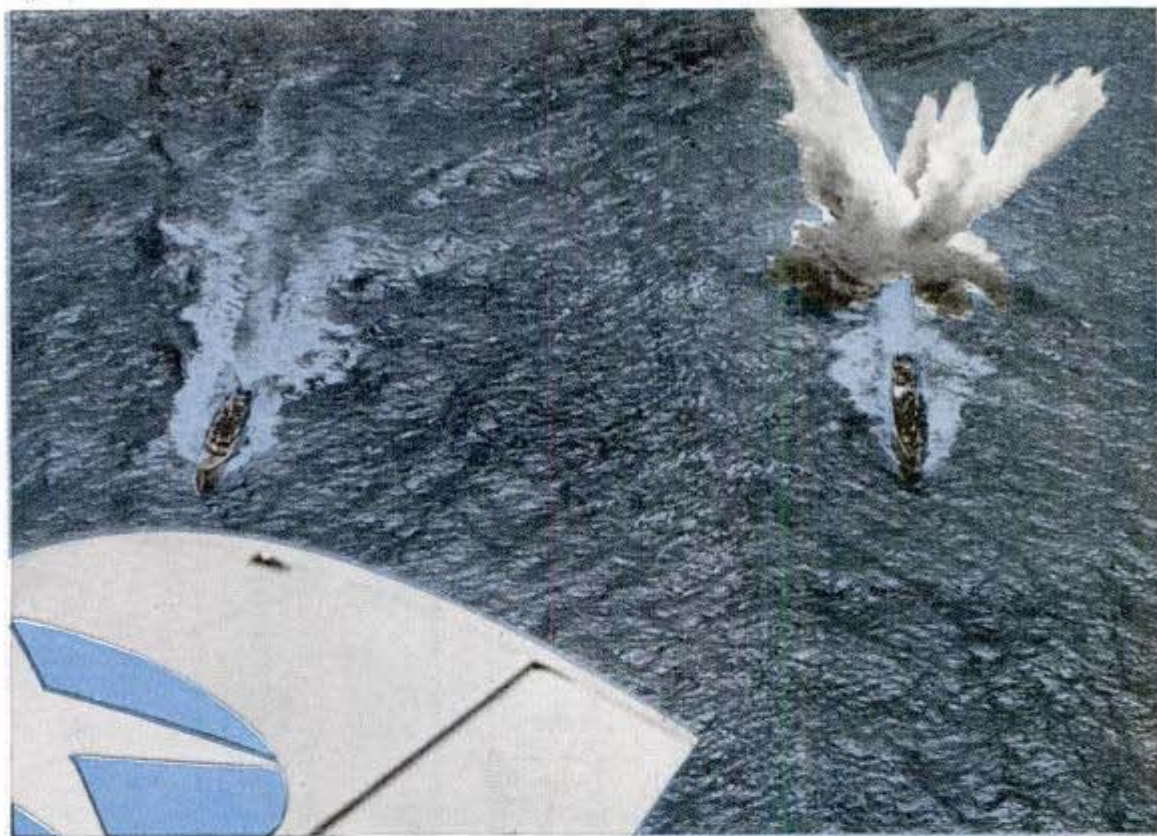

Aerial cameraman catches PC boats in practice run dropping depth charges which toss spray high into air

tine ship and that was the way they cruised at night to let any curious subs know they were "neutral." Once in a while they'd sail close to darkened convoys which made skippers angry enough to shoot.

The next day we had our first sample of rough seas. Our 110-foot ship pitched and tossed, and great waves broke clear over the masthead enveloping the SC in one sheet of green after another. She keeled over from side to side oftentimes as much as 45 degrees. Keeping our footing was a tough job, sleep became impossible, and eating became an art. By nightfall nearly half the crew was manning the rails sicker than most of them had ever been in their lives. I've read several magazine stories about how Corvettes and PC's were the "roughest things afloat" but I'll guarantee the guys who wrote those stories have never been on an SC in a heavy sea.

The following noon, we heard the crow's nest lookout sing out "Land Ho—dead ahead." Shortly we reached a sea buoy and saw a long line of mine sweepers coming toward us as they swept the approaches to the port. We docked at the sub-base, made our arrival reports, and cared for the

(Continued to page 156)



PT boat gunner operating twin .50-caliber anti-aircraft guns

Limitless Horizon Is Foreseen for Television

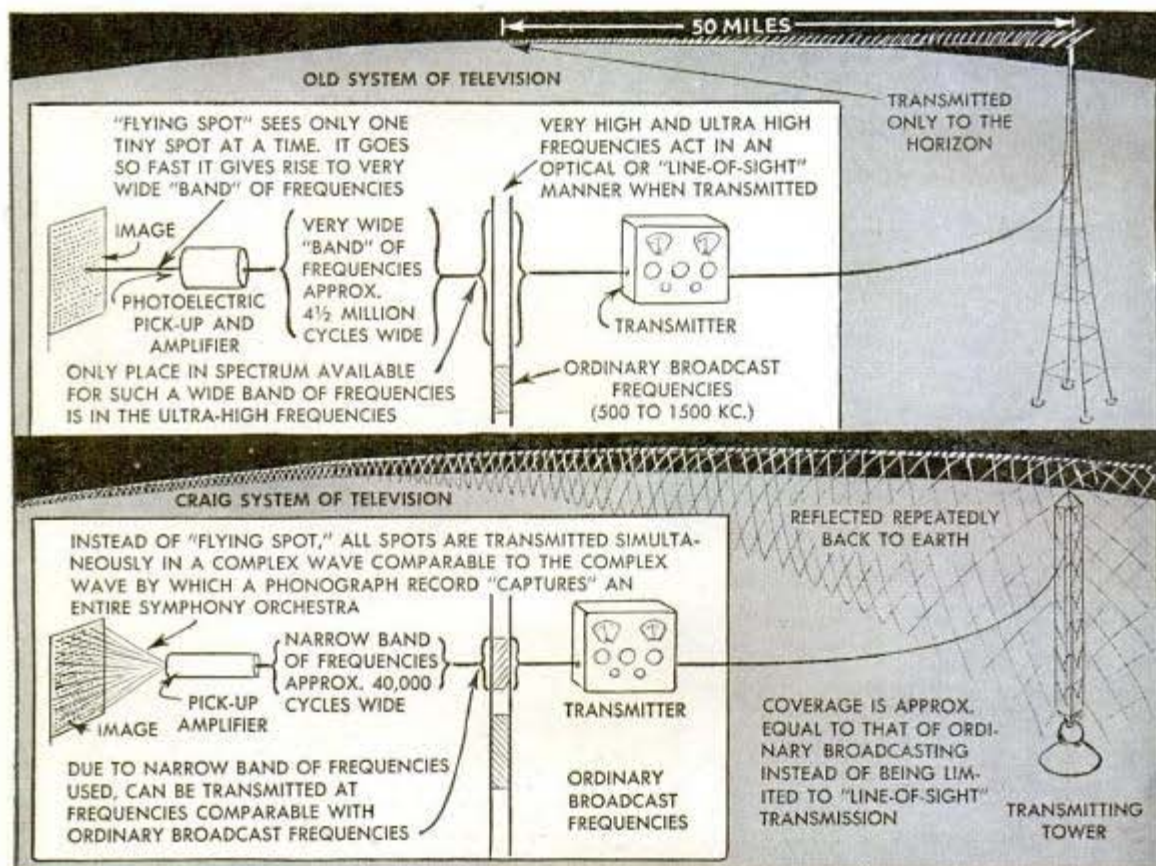

Fetters that have limited the development of television may be shaken off by a new broadcasting technique that promises to revolutionize the industry while still in its infancy. Not yet given a full-scale trial but proved in laboratory experiments to the satisfaction of its inventor, the system would make possible limitless broadcasting at far less cost than the present transmitting method, which reaches receivers only within about 50 miles, and it would also obviate the present necessity for intense lighting of the scene at the television pick-up. The inventor is Dr. Palmer H. Craig, head of the Department of Electrical Engineering at the University of Florida, electronics inventor who has worked with television for 15 years. Existing television cameras scan the entire image — taking some 240,000 separate impressions in $\frac{1}{30}$ second, in sequence, thus requiring an intense light. The transmitter broadcasts only to the visible horizon, using a wide band of frequencies and so being restricted to high-frequency wavelengths. Dr. Craig would substitute for the high-speed sequence scanner a complex arrangement of 240,000 electronic "pick-up" loops which would record simultaneously 240,000 divisions of the image.

"Each elementary area of the photosensitive screen," says Dr. Craig, "will have its corresponding voltage of definite frequency induced in the loop system. If these loops are all connected in series there will result a complex voltage wave containing all the frequencies and amplitudes corresponding to all the elementary areas of the photosensitive screen, therefore characteristic of the incident light."

Little power would be needed to broadcast the multiple image on a narrow wave band, and the signals would be unscrambled by the receiver to reconstruct the image—the amplitude of the wave determining the intensity of the light, the frequency determining the position of each area in the reconstructed image.

Plastic "Shaving Cream" for Pig

More high grade pork products are assured with a plastic covering that removes all the hairs from a pig when it is peeled off. The chemical shave, accomplished with a resin produced by the Hercules Powder Company, not only removes the toughest whiskers but saves valuable time. The pork carcass can be painted or dipped, and the resin chemical is remelted and used over.



7936

Largest Glider of U. S. Air Force Is Ready for Invasion

When American glider-borne troops make their silent approach to enemy territory, they may be riding in the Army Air Force's largest glider. This craft, built by the Northwestern Aeronautical Corpor-

ation, was recently given official tests. The company was given the "go ahead" signal to build many gliders of this type. Details of construction and the number of fully-equipped troops it will carry are secret.

Test for Big Guns Uses Air Device In Lieu of Firing

7961

Five-inch naval guns are tested without firing a shot by means of an air compressor that duplicates conditions resulting from actually discharging the guns. The kick, rammer, and firing are tested with the device which was developed by engineers at the Fisher Body Pontiac Division of General Motors where the big guns are assembled. Use of the compressor not only saves time, but conserves much valuable ammunition.



Detroit, Mich.

210-Foot Bridge Is Taken for a Barge Ride to Train Army Engineers

7954

When army engineers at Camp Ellis, Ill., needed a steel bridge for training purposes, they floated an old 210-foot span 60 miles down the Illinois River to their camp site. The bridge was mounted on two barges, and the engineer "tars" pitched their tents

aboard for the trip to camp. Trainees will learn the technique of bridge-building by taking the bridge apart and reconstructing it over and over. When they are through with it, about 80 tons of steel will be turned over to the scrap metal drive.

Acme Newspictures, Inc.



The CAMERA CLICKS for UNCLE SAM

*Mr. Warren Allen Elliott
7 Park Avenue
N. Y. 16, N. Y.*



Pratt Institute photo
This camouflage model will reveal defects to camera hidden from the human eye. Below, Westinghouse employee using new type camera to take badge photo



ONE of the strangest photographic exhibitions in history was opened not long ago by the U. S. Navy.

The scene was the Norfolk Navy Yard. A sleek destroyer escort had just been finished and okayed. It was the first of a new type. It was a beauty.

At a given command, a group of photographers swarmed over and throughout the ship shooting hundreds of pictures. Thousands of prints were rushed out of dark-rooms on large rectangles of heavy paper.

The photographs didn't show the graceful symmetry of the little warship, nor were they hung on walls to be judged for composition values.

They showed the innermost, secret and complex details of the construction of the vessel and they were distributed in sets of a couple of hundred each to a long line of ways where the frames of a large number of destroyer escorts, duplicates of the first, were being put together. Each durable, weatherproof photo was placed as near as possible to the section of the craft which was shown in the picture.

Thousands of workmen, many of them inexperienced, gathered in knots along the assembly line studying the prints. Most of them couldn't read a blueprint, but all could glean information from a photo.

To a man, they began to see how each

trim craft would be put together. Each worker visualized his part in the operation. Cheers went up. Backs were slapped. Hammers began to pound. Welding arcs sputtered. Enthusiasm grew.

The camera had clicked once more for Uncle Sam in this increasingly scientific and complicated war. The new system of "true-life" blueprints is spreading to all shipyards where mass production with unskilled labor is possible.

Millionth-of-second speed light cameras reveal how water flows from a faucet
Courtesy
General Electric Co.



The scene changes to a gigantic Ford Company war plant. The camera is wearing overalls, instead of navy dungarees. A squat, grim tank—a new model dedicated to deadliness—rolls into a room where lights pour on it from all angles. The usual drab coat of camouflage is replaced with bright photogenic colors. Movie cameras whir, still cameras click as mechanics go to work on the tank, take it apart section by section and put it together again.

Once more film is developed and prints are made. Sets of the prints are not only used in the tank assembly line, but flown all over the world to spots where American tank crews and mechanics will have a chance to study the secrets of the new vehicle before it arrives for action.

APRIL, 1944



Taking a picture with the first million-volt X-ray camera developed by General Electric. Below, photographing assembly of a new tank

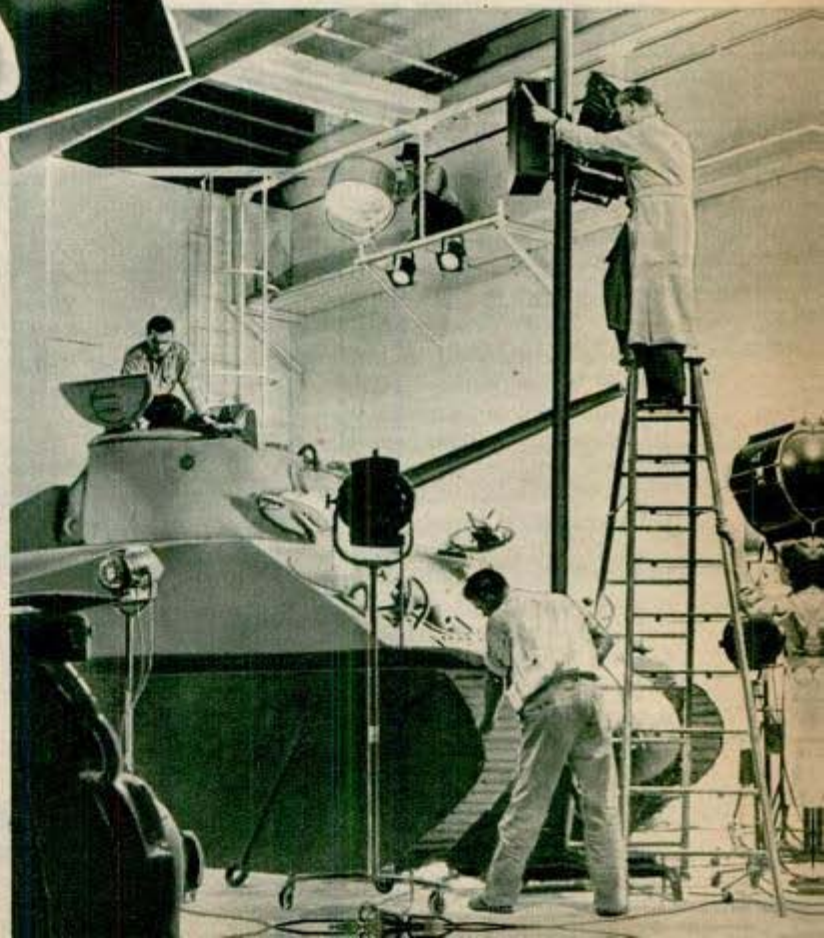

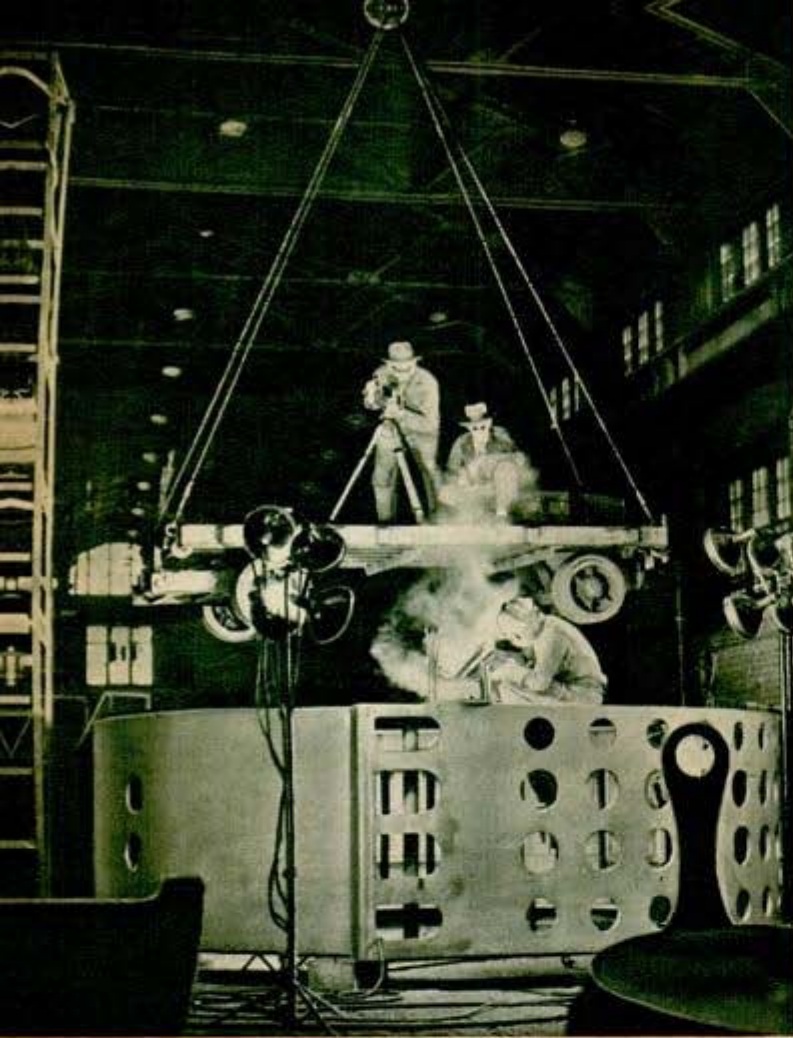

On platform suspended from crane, Hollywood cameramen record "The Inside of Arc Welding." Below, slit in edge of wheel allows 1/10,000 second for filming an electric arc
Westinghouse photo

In a General Motors plant, the camera comes through with another startling war-born innovation for Uncle Sam. This time it is an X-ray camera producing "cold glow" photographs with light similar to that of the firefly and using blueprints made of steel. These eliminate errors caused by shrinkage of blueprint paper, and avoid misfits in plane parts manufactured at far-separated points.

A white surface is painted on a sheet of steel one-sixteenth of an inch thick. On this, the design for an airplane part is drawn to exact size with a chemical that can be activated by X-rays. A shot of X-rays causes the



pattern to glow. The sheet of steel is placed on another which will form the pattern. A coating of photographic emulsion on the second sheet of steel is affected by the glow, just like an ordinary photographic print. Thus the design is transferred. The completed patterns are shipped to plants where plane parts are cut.

The huge General Electric plants have moving picture studios rivaling some in Hollywood, and one of their specialties is the production of training films which enable armies of new war workers to march on the job with quickly acquired mass-education provided by the camera.

More than 700,000 separate photographic prints are made each year in the many buildings of this company, and its file of negatives is well along toward the million mark.

Photographs with an exposure of one millionth of a second, brief enough to stop a rifle bullet or any fast moving object, can now be made by an electronic light equipment developed by engineers in General Electric's laboratory. This device, using a small mercury lamp no bigger than a cigarette, consists of a small portable box, 10 inches square and weighing less than 20 pounds. The mercury lamp would last the ordinary newspaper photographer 500 years if he could live that long, for it is good for 1,000,000

exposures. Just now it is working entirely for the war effort.

Westinghouse is a pioneer in the use of the camera for industrial research by big corporations. Some of the results have not only speeded up the victory tempo for Uncle Sam, but will help make possible less expensive and more efficient homes, automobiles, airplanes, furniture and other items in the postwar period.

One Westinghouse camera development makes slow-motion pictures showing the actions of atoms of steel as a piece of metal is placed under strain by being pulled with hydraulic pressure. Metallurgists get a new idea of what happens when metals are undergoing great stress as in forging processes.

Another Westinghouse camera, minus shutter, but using a flash of ten millionths of a second, has been rigged up to study the true character and actions of droplets of liq-



Above, crew of cameramen making a General Electric motion picture on use of electron microscope



Left, steel disk is clamped between two sheets of film, then shut up in "tin can camera" for exposure
Westinghouse photo

Below, part of giant camera which occupies two rooms, has four-man crew, and turns out 6-foot films
Courtesy Bell Telephone Laboratories

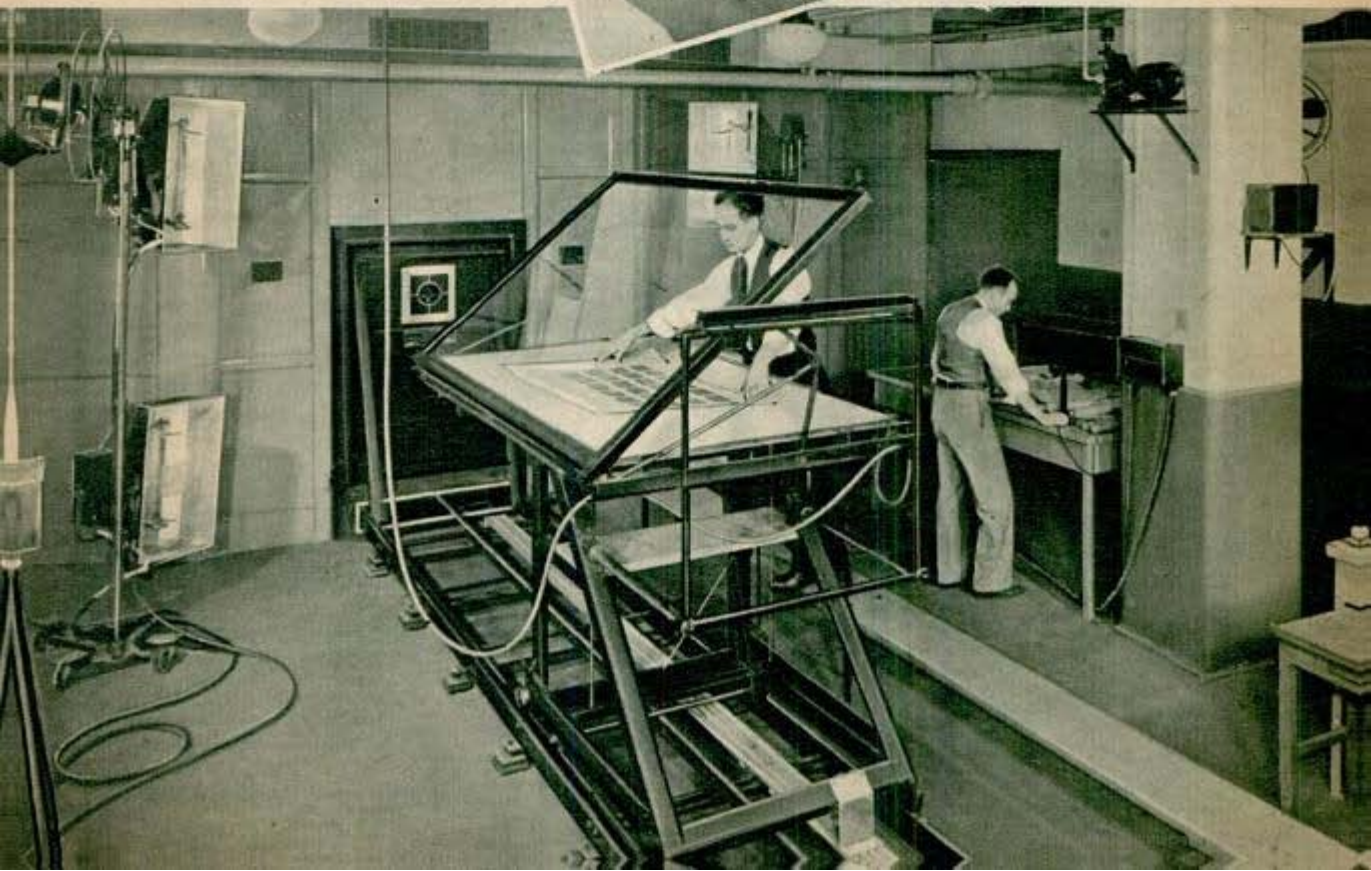



Westinghouse photo
Spectrograph identifies elements of unknown materials on film which records light rays sorted by a prism

uid in sprays. The applications may serve to make your postwar automobile or plane motor operate more efficiently.

A makeshift camera constructed of a tin can, without lens, shutter or any of the usual gadgets, enables the company's scientists to study the actions of phosphorus in steel. Steel disks to be investigated are clamped between sheets of photographic film and brass plates, dropped into the can

where by the emanations of the phosphorus itself, photos are produced solving puzzles of years' standing.

A special wheel equipped with a slit which speeds past a Westinghouse camera lens in one ten-thousandth of a second takes pictures of electric arcs. Another automatic Westinghouse camera, operated with a battery, makes photos of lightning flashes as they hit power lines, using the juice of lightning itself to start the camera working. The "criminal" bolt of lightning is made to take its own rogue's gallery portrait to be studied later by scientific detectives in the corporation's laboratories.

A complicated camera of the underwater type, put together by Westinghouse engineers, enabled the lens to see inside of an oil circuit breaker, making films which showed that electric arcs performed "bubble dances" inside gas particles formed in the oil switches by the action of the current. More efficient circuit breakers have been made because of these movies, snapped at the rate of 2,000 exposures a second.

Making X-rays was speeded up to one millionth of a second by Westinghouse research, enabling this type of camera to probe the secrets of machines whirling at tremendous speeds. One "skeleton" photo of a man shaving himself easily stopped the vibrations of an electric shaver for scientific study.

By using a polarized-light camera to take pictures of the inside of plastic models of turbine nuts and bolts, a Westinghouse engineer has discovered how to make this ancient fastening device 40 percent stronger. He found that nuts with broad shoulders and tapered bodies distribute stress on threads more evenly than does the ordinary nut.

In his experiments, the engineer made various types of nuts and bolts, attached weights to the bottom of each model and then heated them to "freeze" the stress lines. Cutting slices from the center of each model, he photographed the thin plastic sections. The pictures revealed which nut divided the "pull" among threads.

Cameras of one type or another are testing steel used in tanks, ships and guns, seeking flaws in completed metal parts,

(Continued to page 148)

Westinghouse photo
Making movie of lines formed by the movement of atoms

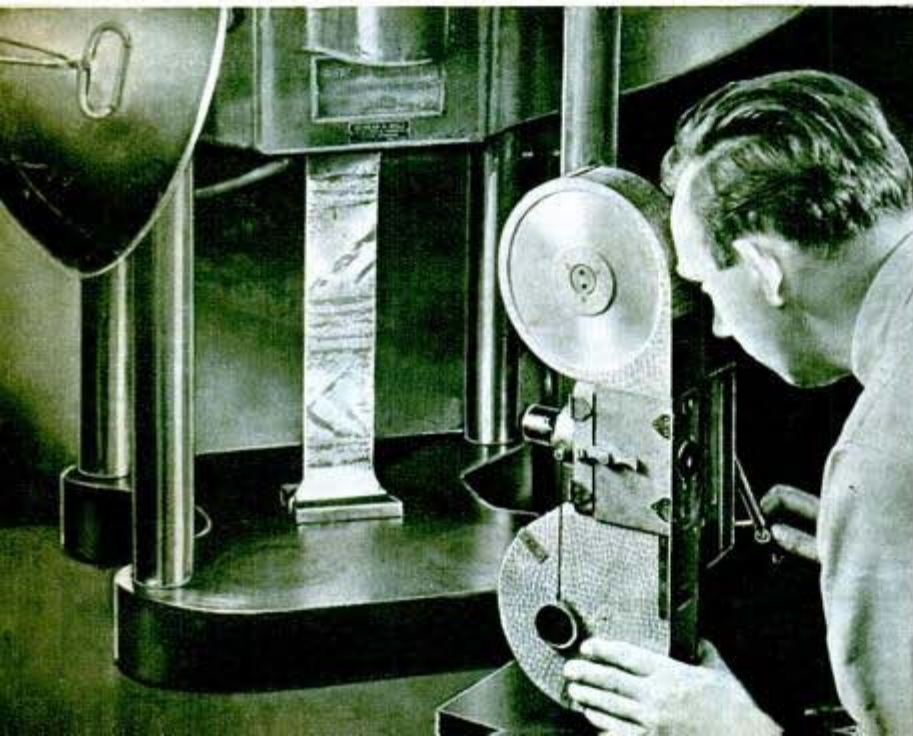

71 942

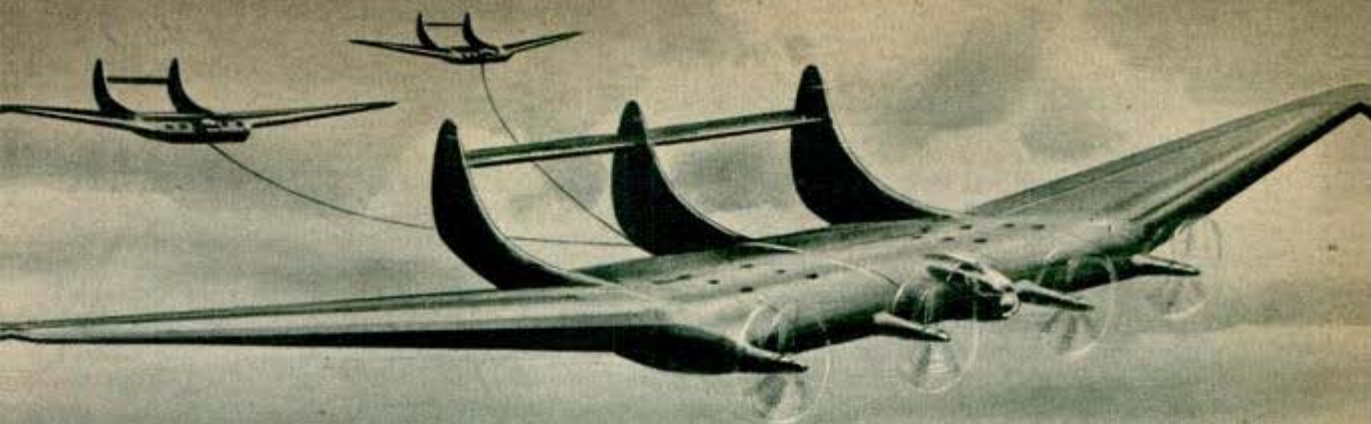

Canadian Car and Foundry Co., Ltd
Montreal, Quebec, Canada

"Ice Box" on Wings Loads Containers In "Bomb Bay"

Powered by four 5,200-horsepower engines, flying wings in the postwar era may haul fresh fruit from Florida to Canada. A 120-ton flying wing cargo plane, designed by Vincent Bernelli for Colonial Airlines, would deliver the fruit in Montreal just 14 hours after it was picked. With a 210-foot wing span and a 71-foot body, the refrigerated express plane will carry enough gas to make a nonstop flight of 1,600 miles with a 40-ton payload. The plane is expected to revolutionize the handling of air cargo by rapid loading of pre-packed 5,000-pound containers. The containers will be lifted

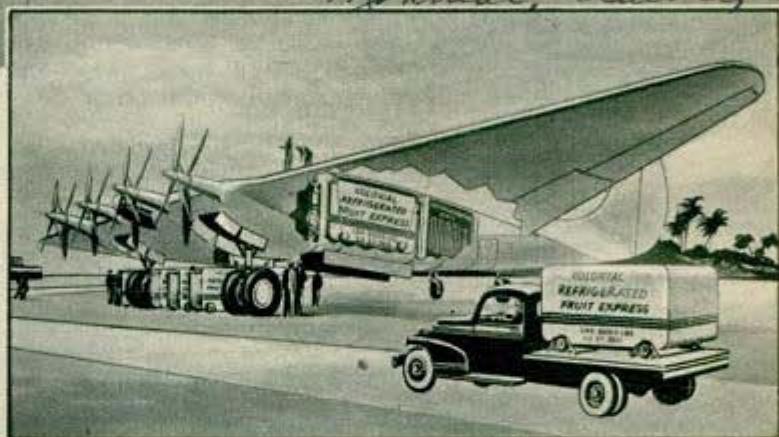

into the flying wing by apparatus similar to that now used to load "block busters" through the bomb bays. It will be possible for the plane to tow one or more flying wing gliders for dropping additional cargo at intermediate points along the route without interrupting its flight. Glider plans, however, await future technical developments, according to the inventor.

Cadet "Dunker" Teaches Pilots To Quit Ship

Made from a sawed-off two-seater training plane, the "Dilbert Dunker" helps train cadets to escape from a plane forced down at sea. Future pilots are hoisted aloft in the dunker, and then lowered into the water. The dunker quickly sinks as fully clothed cadets scramble out, inflate their life raft, and climb aboard the rubber boat. "Dilbert" comes from the name given cadets who are always doing something wrong.



Tested at Naval Air Training Center Corpus Christi, Texas

Monster Tank Can Cross a River 15 Feet Deep

Allied guns in Africa and on the Russian front shattered the myth of invincibility of the German Mark VI "Tiger" tank long before the secrets of this 56-ton monster were revealed. The main armament of this cumbersome "fortress on tracks" is an 88-mm. gun which fires shells three feet long. The gun has a special mounting and is fitted with a special muzzle brake to reduce recoil. Rate of fire is slow due to the difficulties in handling the big shells which are

stored in horizontal bins. Additional fire-power is afforded by two 7.92-mm. machine guns. A watertight compartment for the engine at the rear, rubber seals fitted to all the main openings, and air intakes that have telescopic extensions enable the tank to cross rivers 15 feet deep. The "Tiger" is operated by a five-man crew, has a top speed of 17 miles per hour, and a cruising radius of about 75 miles. Lack of maneuverability makes the tank an easy target.

*International News Photo.
235 C. 4524 A.
7/24/44*

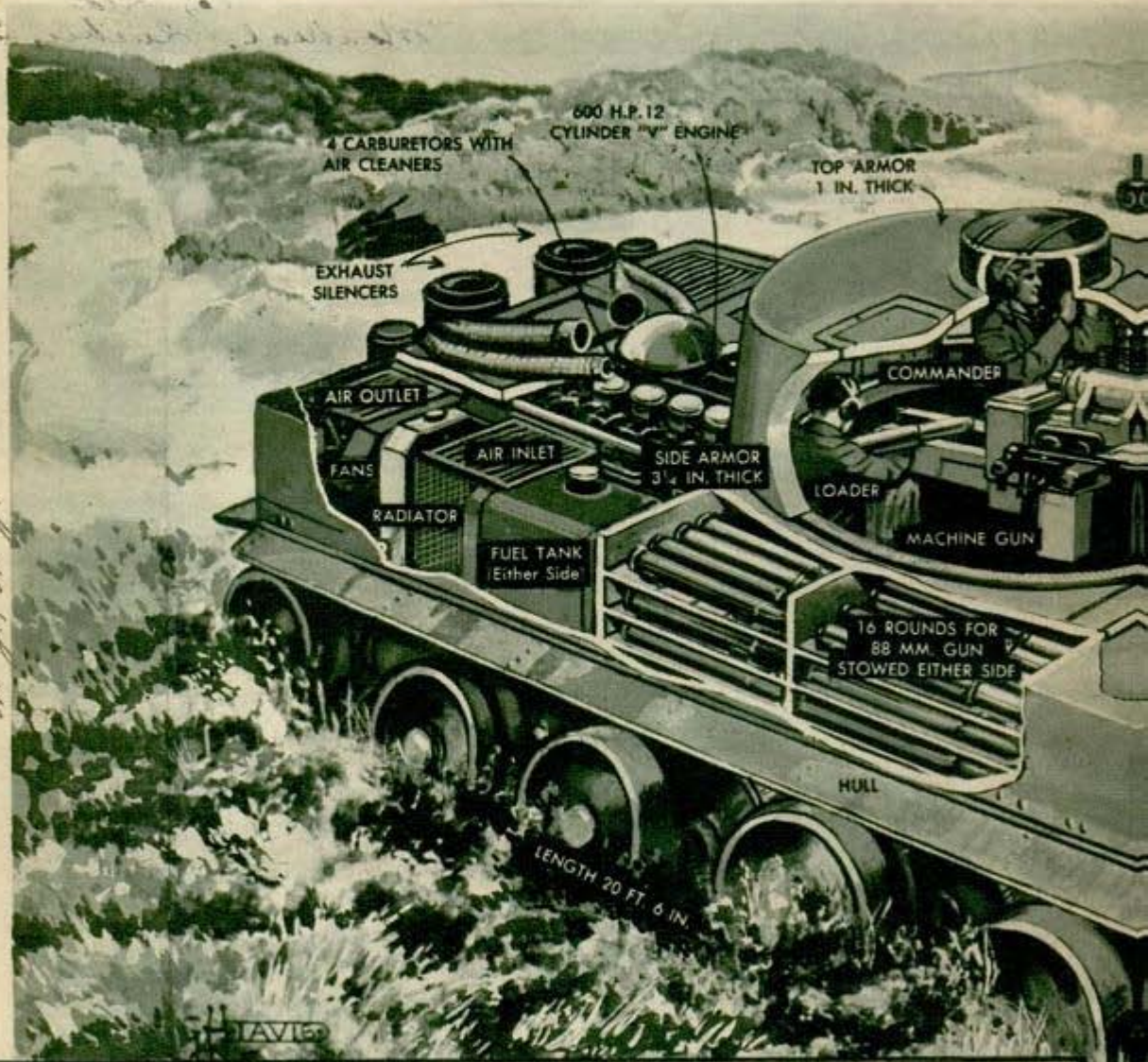

THE GERMAN "TIGER" TANK IS CAPABLE OF BEING MADE WATERTIGHT AND CROSSING RIVERS, ON THE RIVER BED, TO A DEPTH UP TO 15 FEET



German "Tiger" Fires Shell Three Feet Long

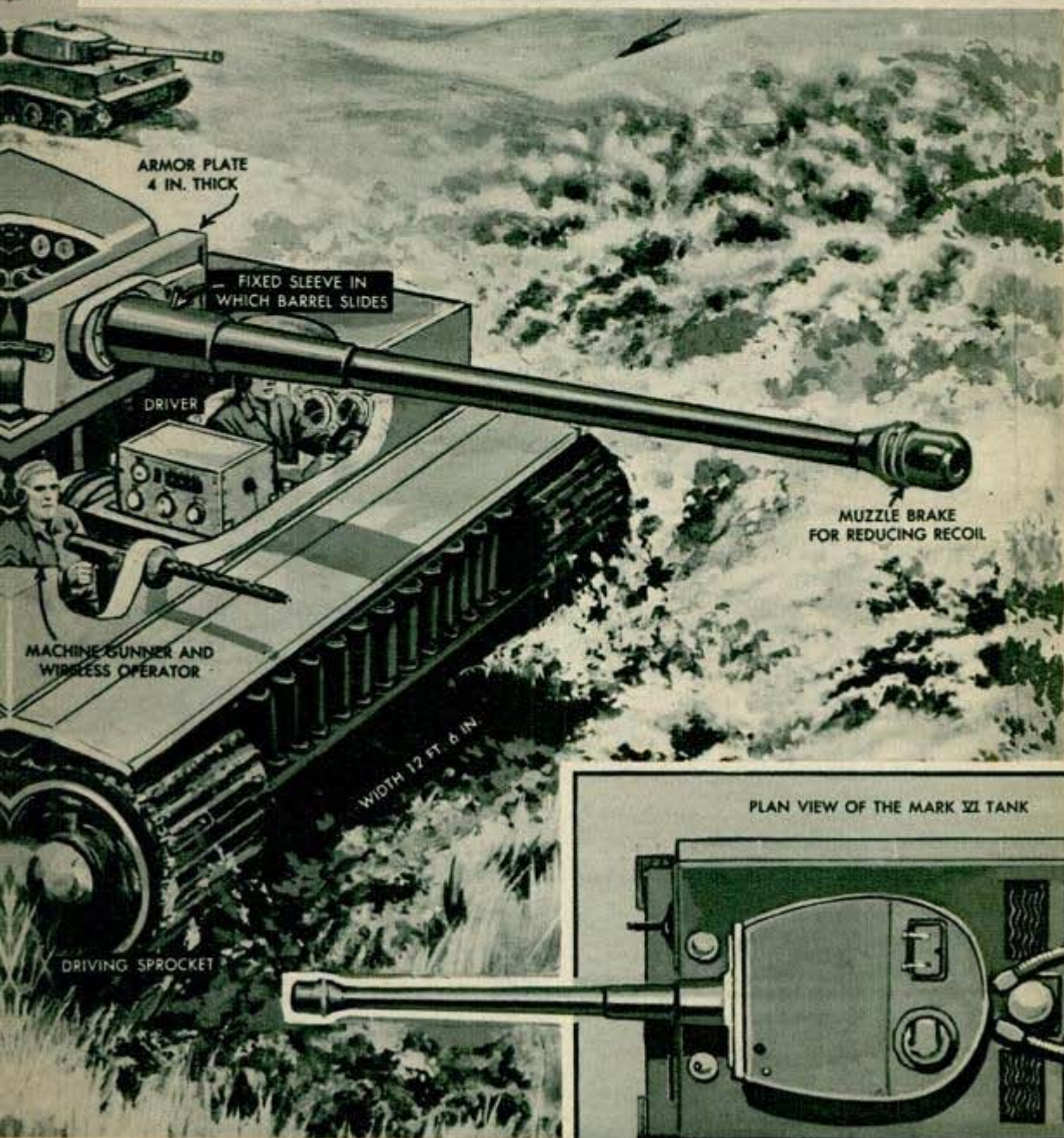
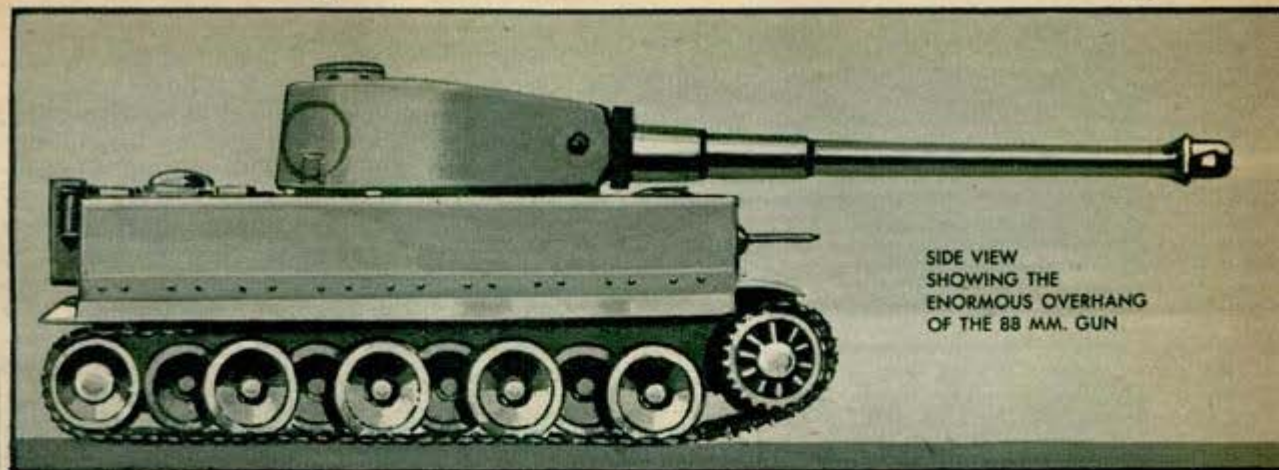

Pittsburgh Plate Glass Co.
Great Bldg., Pittsburgh 911

Coal Chutes Made of Glass Last Longer Than Metal



Comparing glass and steel chutes after friction test

To save strategic metal, glass is being used to make coal chutes which have been found to wear longer than steel plates. Coal wears out steel plates in three months due to the action of sulphur water and constant friction. Under actual working conditions in a coal breaker handling a daily load of 100 tons, glass chutes showed little wear after 18 months. Because it is easy to clean, it is expected that glass will also be used in chutes and conveyors designed to handle foods and other products.

U. S. Railroads Top All Records For Transportation in '43

With fewer locomotives and freight cars than in 1918 and many thousands of miles less track, the American railroads in 1943 handled the greatest volume of freight and passenger traffic in history and broke every transportation record existing. Measured in tons carried per mile, freight traffic gained 14 percent over 1942 to total 725,-

42 "Railway Age"

Dec issue '43

000,000,000 ton-miles, one and three-quarters times the volume in 1918. Passenger-miles totaled 85 billion, 58 percent above 1942 and twice the 1918 figure. Ten million servicemen traveled in special trains or special cars, besides the millions on regular trains. The average load of freight per train was 1,116 tons. The average capacity of freight cars reached 50.8 tons, and the average load per car of carload freight was 41 tons. The average daily movement of freight cars was 51.2 miles, compared with 48.8 in 1942. Locomotives, too, set new high records for performance; freight engines averaged 125 miles a day, compared with 122.4 miles a year ago; passenger locomotives traveled 220.3 miles on the average, compared with 206.8 miles daily in 1942. Their tractive power averaged 52,548 pounds, the highest ever achieved and 34 percent more powerful than 20 years ago.

Work Stand for Plane Mechanic Adjusts to Desired Level

Servicemen can work at a convenient level on wings or fuselage with an adjustable extension work stand. Adjustment is made with a hydraulic strut actuated by a hand operated hydraulic pump. The mobile stand is made of tubular steel, and can support 1,500 pounds.

Pacific Engineering Corp.
3123 San Fernando Rd.
Los Angeles 41, Calif.



Tubular steel stand aids mechanics working on plane

POPULAR MECHANICS

Иллюстрация, защищенная авторскими правами

71924

Painting Tool for Wire Coats 10 Feet a Minute

Telephone wires that extend from poles to buildings are quickly recoated with a painting tool which is pulled along the wires. The tool, developed in the laboratories of the Bell Telephone Company, is a trough-shaped container with a guide pin and stiff brushes at one end. The pin keeps the wire immersed in the paint and the brushes remove the excess. The painter is drawn along the wire about 10 feet per minute to insure adequate penetration of the braid.

Newark, N. J.

Tool with trough-shaped container is pulled along wire. Insets show how brushes remove excess paint

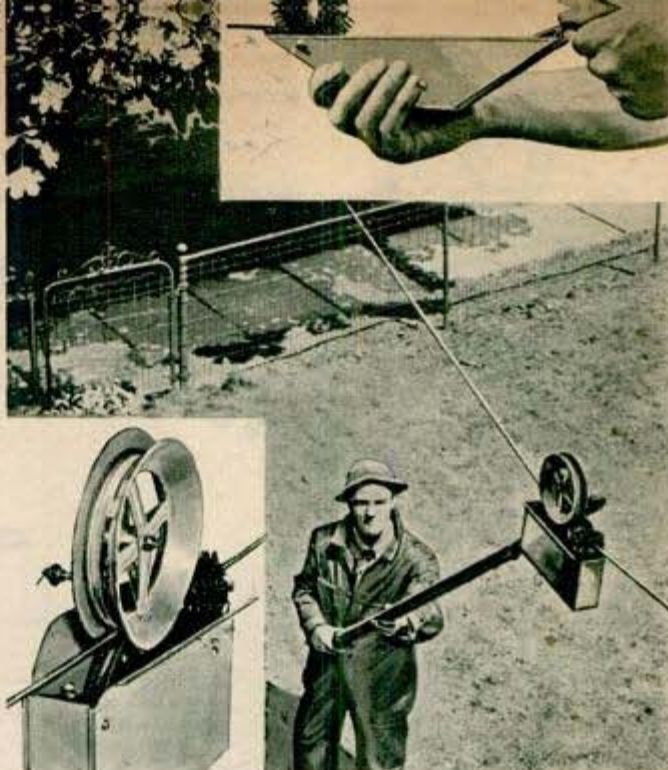

71962

Midget Model of Tractor Has Caterpillar Tread

Built in a home work shop, a small Caterpillar-type tractor operates like the real thing and can pull loads up to 200 pounds. It is powered by a three-fourths horsepower engine. The tractor is 27 inches high, 26 inches wide, 48 inches long, and weighs 240 pounds. Steering is accomplished by two six-inch cone clutches and brakes on the rear axle that are controlled by levers just as in a real tractor. The controls also include a choke, throttle and "cut-out" switch. Robert C. Cross, of Woodland, Calif., built the tractor for his small son. The cost was approximately \$125.

507 Main St.



71130

Voice Heard for 18 Miles Projected by Mobile Unit

Alarm signals, voice or music can be heard for a distance of 18 miles with a sound amplifying system mounted on a trailer. Despite the range of this system, there is said to be no distortion of sound for persons standing within a few feet of the unit. Some of its military and civilian uses include signaling planes at airports, directing soldiers and sailors in battle, and as an air raid signal. The outfit has its own built-in power plant and can be set up ready for operation in a few minutes.



Bendix - Westinghouse Auto - motive Air Brake Co. - Cuyahoga, Ohio

Thomas C. Shinson, Jr. 11 897
3872 Franklin Ave.
Los Angeles 27, Calif

DRESS REHEARSAL for WAR

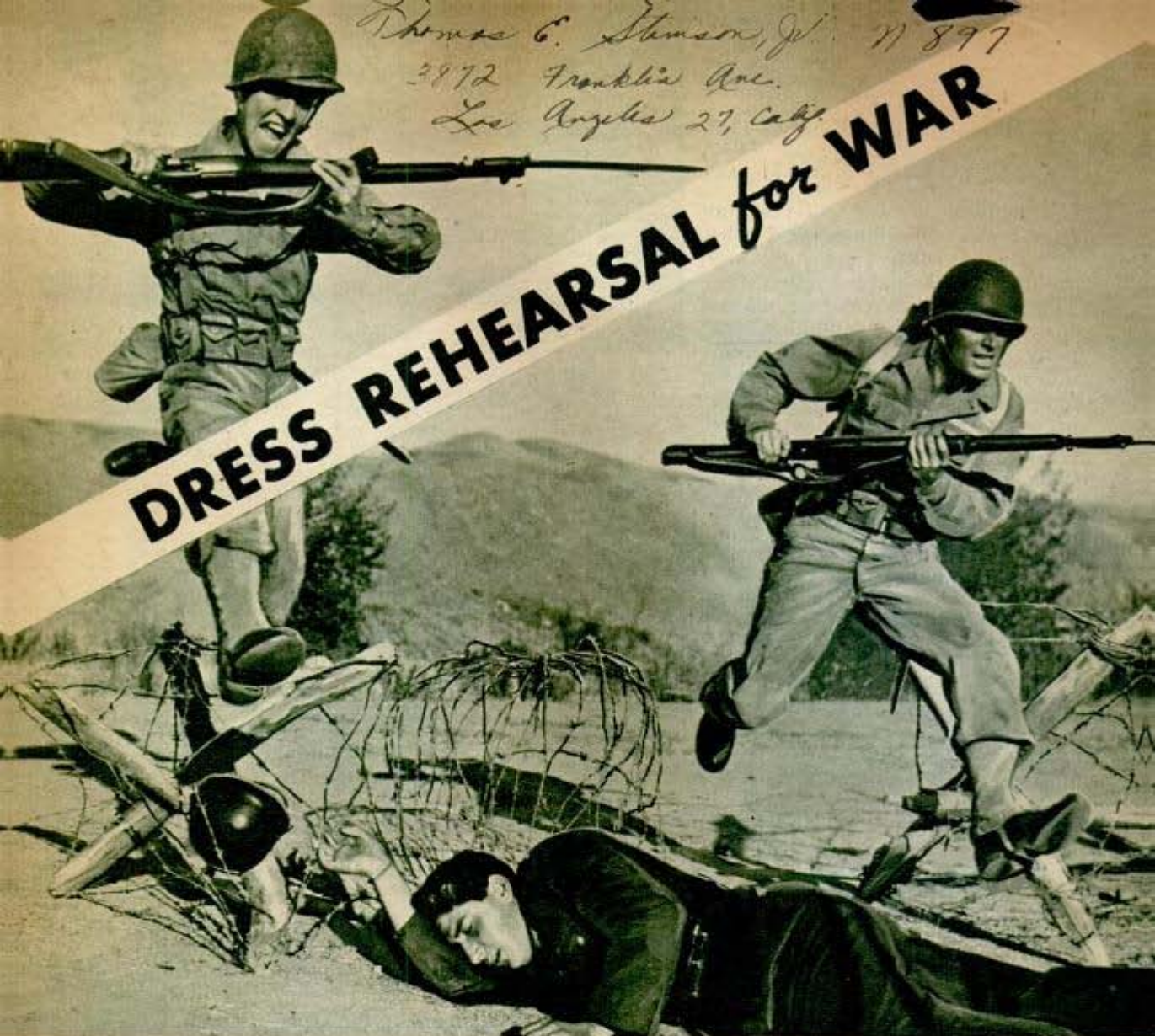

While "sniper" bullets whistle overhead, soldiers dash over barricade past "dead" man in German uniform

JOHNNY G. I. was no raw recruit the first time he faced enemy guns.

He had become a battle veteran long before.

He had been shot at by snipers and had been dive-bombed by aircraft in a combat tryout that was part of his training. He already knew what it was like to crawl along the ground under the whistling death of machine gun bullets. Crouched in a fox hole, he had been run over by ponderous tanks. All this was part of a mental conditioning program designed to give him the confidence of a seasoned soldier.

The rehearsal that he went through wasn't a game. The machine gun bullets passed uncomfortably close to his head. The land mines that exploded in his path showered him with dirt and debris. The sniper's carefully aimed bullets came within a few inches of killing him and the sniper kept up his fire until Johnny G. I. took cover.

The American doughboy's profession is that of a killer. He is taught, with all the science and skill that his officers have, to find the enemy and kill him, and to avoid being killed while doing it. Part of that training is to condition him against the shocks and realities of modern combat. All infantry replacements and all new units are getting this battle practice; men already abroad are given it whenever possible. Even Army nurses are learning what it's like to be under fire.

At Camp Roberts in California there's a "French Village" of some 20 houses, complete to rough furnishings, that is a nightmare of land mines, barking machine guns, booby traps, and pop-up targets that you must put bullets through as you run past. The village has been captured 500 times or more in training, and it's beginning to look it. Its walls are torn by bullets, its windows are shattered, and its streets have been ripped up by explosions. It is an out-

door classroom in which the technique of village fighting is taught.

You are issued live ammunition and are told frankly what to expect. "Keep under cover and fight from house to house!" the instructor yells. "The streets are being raked by machine gun fire and those guns don't have safety stops on them. Some of you men may get killed. Simulate throwing a hand grenade inside before entering a house, and fire at every target you see! Let's go!"

The group, in extended order, starts out on the run, guns at high port for instant use. Suddenly the mighty concussion of a land mine lets go at one side and the earth shakes. The men keep going. They have entered the houses on each side of the street now and some of them are working along the roofs, keeping low to avoid possible sniper's bullets.

At the corner of a house the cardboard outline of a helmeted head suddenly pops up, pulled by a wire in an instructor's hand. "Wham!" One of the men puts a bullet through the target. By now the firing is general. The men inside the houses, racing upstairs and from room to room, encounter other targets that pop up from behind barricaded beds or tables. They fire a round at each. Occasionally a sharper explosion tells that an unwary man has stepped on a loose stair or has set off some other type of booby trap, exploding a dynamite cap.

Machine guns are keeping up a slow hammering in the streets, kicking up dirt, and there's an occasional whine as a ricochet flies over. Hugging one side of an alley, the men are subjected to ma-



Trainees fire at street targets from the window of a realistic "bar" in training village at Camp Roberts, Calif. Village has about 20 buildings



Attached to loose stair in an "abandoned" house is a booby trap which consists of a dynamite cap. It is activated by unwary soldier stepping on stairs. Below, marching in three "Nazis" wearing captured uniforms





Inching or leaping from building to building in training village, soldiers learn how to take cover from enemy bullets and still advance. Targets consisting of cardboard helmets pop up in unexpected places. Below, man leaps across open space between buildings



chine gun fire that sweeps down the middle of the road, and another gun at the corner has them bracketed.

From this description of village fighting you might think that it's impossible to avoid a few deaths or injuries. That's exactly the way it seems to the men, too, but the fact is that the whole affair is carefully staged. Instructors are with each group, telling them what to do and when to do it, and the schedules are all timed together.

There are half a dozen different combat courses at Camp Roberts that simulate battle under as many different conditions. Men advance across fields under artillery fire that whiffs past overhead, to learn what it's like to go forward under the protection of their own artillery. Marching down a road, the men may suddenly scatter and then aim their empty guns at a low flying attack plane whose guns have plenty of ammunition. In fact, the pilot is doing his best to scare them. He pours in bursts from his .50 calibers at targets just past the men. The soldiers are getting a taste of ground strafing.

One combat course is along a ravine and is designed to teach a man the technique of fighting back, far better than lectures and demonstrations can do it. One at a time, men are sent along a path on the bottom of the ravine, on reconnaissance.

If they are fired upon they must protect themselves by taking cover, they are told, then hunt for the sniper target and knock it out. A man keeps a pretty careful watch as he advances along the path. He may spot a target in the brush, on the crest of a hill, or in a tree, at any time. But the chances are that he sees nothing before the time a bullet smacks the dirt at his feet and he hears the report of the gun. A sniper has taken a shot at him and he jumps for cover. Another bullet lands close by if he doesn't conceal himself fast enough. The trained marksman who is actually shooting at him is carefully hidden, but there is a target that is visible in the general direction from which the shot came. The soldier must find and hit that target before he can continue to the next without drawing more fire.

Infiltration courses, in which the



Photo by McCormach, Field Artillery, Camp Roberts

Soldiers on infiltration course creep forward as a land mine explodes and real bullets kick up the dust

men crawl along the ground and under barbed wire barricades while machine gun bullets whiz past a foot or so above them, teach them the art of hugging the ground closely. Crawling over such a course, in the dark, is vastly different from a daytime crawl in which you can see your companions close by. After dark each man is on his own. Except for a stealthy rustle here and there in the silences the only sounds are those of the guns. It's pitch black except for the red streaks of tracer bullets that barely seem to miss you, and you pray that there's no rising ground ahead over which you must crawl.

A different kind of course is a "no man's land" of shell holes, fences, and ridges over which the men advance in a run, stopping only to fire at targets that suddenly present themselves ahead. This course is designed to show the soldier how he

must constantly hold himself ready to fire at once on the enemy, in actual battle. The targets are hinged and are raised from the ground by wires pulled by an operator in the background.

It has been said that American soldiers who had never fired a gun were sent into action during the last war. That isn't true now. As part of their basic training all sol-



Trainee battles a cornered "German" in realistic fight

APRIL, 1944



diers learn the uses of their weapons. They fire against still and moving targets and at silhouettes of tanks, throw grenades and operate machine guns.

They even have brushes with Germans and Japs in uniform. Both Nip and Nazi uniforms have been "imported" to this country from captured enemy military warehouses, and these uniforms lend a realistic touch. Soldiers dressed in enemy clothes are captured by their mates who are being taught how to handle prisoners. The questioning of prisoners and the interpretation of letters that are planted in their pockets are other subjects in which the enemy uniforms play a part. All these training aids help give our soldiers the bravery and ability that they are displaying in battle.

Bullet-scarred target of Jap actuated by wire pops up by house as men advance

Pylon Marker for U. S. Airlines Gives "Air Address"

Pilots of "family planes" of the future, unskilled in navigation, may plot their courses with the aid of pylon markers placed about 10 miles apart. Numerals on the markers would indicate latitude and longitude. To make it easy for the pilot, all aeronautical charts would have reference numbers along the margins. The "skyway marker system" was worked out by Prentiss Cleaves, test pilot for Cessna Aircraft Company, who says that anyone could master the system in 15 minutes.

Wichita, Kansas

"Electronic Ear" Tests Shells As They Drop on Anvil

Ordnance plants have adapted the old shopkeeper's trick of tossing coins on a counter to hear whether they "ring true" to test 20 mm. shells. An "electronic ear," called "Sonotest," has been devised to show whether shells are safe to use and load by the way they ring when dropped on an anvil. Properly made shells, without cracks and with their copper rotating bands well seated, will have a certain vibration frequency, or range of tone. Perfect shells will also ring longer than cracked or mis-banded ones. The sound is picked up by a microphone, and the resulting electrical oscillations are fed through electric tubes. If the shell is good, a green light flashes; if imperfect, another light warns the operator to discard it. Each shell is tested twice: once by dropping it on its bottom, once by dropping it on its side.

*article in issue of Army
Ordnance, Jan. '44*

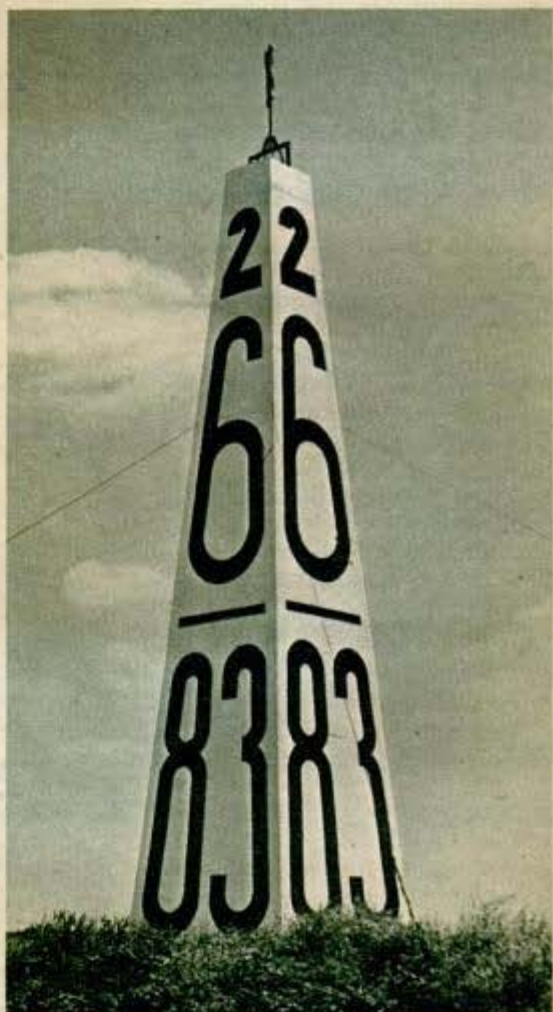

Endless Convoys Roll Along Alaska Highway 11772

Over one of the newest and most important highways in the world, a continuous stream of trucks in convoy moves north through dust, snow and rain. The trucks rumbling over the Alaska highway are loaded to capacity with vital supplies for northern outposts. The road is still unpaved and rough in places, but there are stretches where drivers can "hit it up" to 40 miles an hour. The hardy army drivers, who wear weird-looking dust masks in summer and sheepskin-lined clothes in winter, operate in relays. They catch cat-naps of about six hours at stations spaced



Aerme Newpostures; Sur...



In dry weather, the dust never has chance to settle on the highway so drivers wear dust masks (top). The dispatch board (left) shows position of every truck

100 miles apart. Dispatching of supplies over the highway is well organized, and at the Dawson Creek, B.C., headquarters of the U. S. Army Northwest Service Command, officers know the location of every truck on the 1,600-mile road. After the war, this road will form a vital part of the Pan American Highway System stretching from Fairbanks, Alaska, to Buenos Aires. The highway is now completed from Fairbanks to a point in southern Mexico.

Moisture Magnet and Powder Combat Mildew, Dryness 11855

Two developments to keep the moisture content of air at the desired proportion are a claylike "moisture magnet," which absorbs excessive dampness, and a "humidity storage cell," a powder that absorbs extra moisture in damp periods, and releases this moisture into the air when the air is dry. The moisture magnet prevents mildew in closets and trunks, prevents rust from dampness to tools or sporting goods, and is also adapted to absorb excess dampness in the refrigerator, and, by preventing the accumulation of frost on the coils, delay

defrosting. The absorption turns the material into a semisolid, and it can be baked dry again in the oven, and reused. The "humidity storage cell" is said to give off moisture to dry air, when it has been dampened, and to absorb moisture when the air is wet, thus acting as a constant air conditioning agent.

Write to the firms listed in the Where-to-Buy-It index to learn more about products described in this magazine. Say You Saw It in Popular Mechanics.

*Sanying Products Co.
201 N. Wells St.
Chicago, Ill.*

MORE POWER

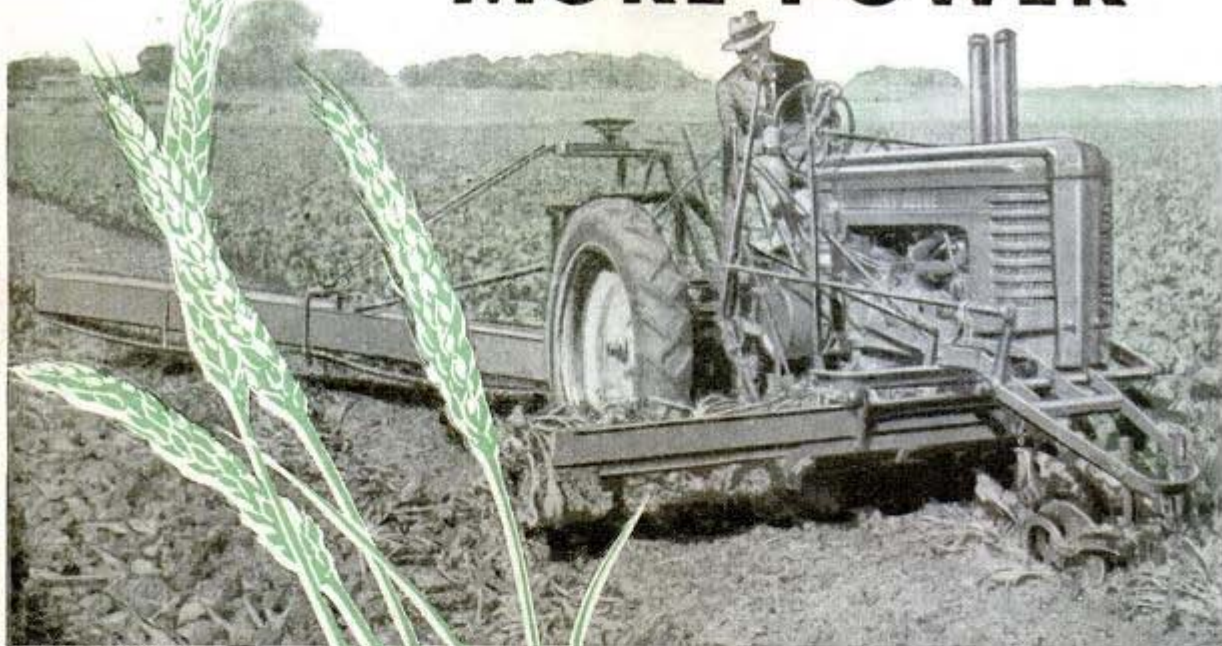

Courtesy Deere & Co.
 Sugar beet topper and lifter places the beets in one windrow and tops in another where they can be saved for stock feed. Below, Ford-Ferguson tractor has unit which enables farmer to turn furrow close to the fence



almost endless variety of mechanical hands that makers of farm equipment are developing that will cut costs for the small farmer.

"We are working and planning to do our important share in keeping the small farm operator abreast of advancing farm technology, to help him achieve economic independence—for only by doing that can we keep American agriculture sound at the core."

These words of J. L. McCaffrey of International Harvester Co. summarize the goals of all the farm-machinery makers: Help the small farmer to help himself.

For this program to succeed, there must be

less work done by the horse and by the human hand.

"Any young man who has been made mechanically minded by operating the machines of war will not be attracted back to the farm by the thought of plodding along behind eight slow hoofs," says Harry Ferguson, whose firm manufactures the implements used with the Ford tractor, and is responsible for a system of linkage and hydraulic control that makes the lightweight tractor amazingly versatile.

BACK in World War I they used to sing: "How you gonna keep 'em down on the farm after they've seen Patee?"

That song was as prophetic as it was humorous, for the years between the wars were marked by an almost continuous trek of men and women from the rural areas to the cities.

But after this war the experts think they know how to get 'em back on the land—with machinery that will enable the one-family farm to operate at a profit. It's the

Mr. Caber, D. S. ...

for the FARMER

71 739.

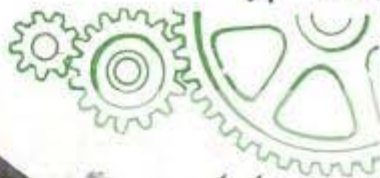

Courtesy Caterpillar Tractor Co.
This beet loader can handle one ton of beets per minute

A modern tractor replaces 28 horses, saving 277 hours a year that would otherwise be spent on caring for work stock and raising its feed. This is equal to a whole month's work. The tractor gets work done in less time, saves the time spent on caring for animals, and releases for other crops the fields used to grow feed for the animals.

If a half-million modern tractors could be put down on farms that today use animal power, imme-



Photo from Diesel Progress
Four-row potato digger (above) powered with a Diesel engine. Left, tractor pulling a terracer



diately 15,388,888 man-days a year could be saved—equal to the addition of over 60,000 men to the farm labor supply, just at the time when they are most needed.

The matter of priorities makes it highly unlikely that anything like that number of farm machines will be manufactured for

2 71 4. 500 St. 71 4. 71 4.



Ditch-digging scoop has hydraulic finger-tip control

the duration; but war's end will certainly bring some eye-openers in the way of mechanical aids.

All the big farm-equipment makers freely admit that they are now experimenting with machines that may revolutionize farming.

"It is true that there will be quite a number of new machines put on the market as soon as the war is over," says a spokesman for Deere & Co. "Naturally, the various manufacturers are not uncovering what they are going to have to offer."

They won't mention everything, but one new machine, the John Deere sugar-beet topper and lifter, is symptomatic of things to come.

Traditionally, growing and harvesting sugar beets has required vast amounts of hand labor. On one 158-acre tract of the Great Western Sugar Company an experiment is under way in growing beets almost completely without the use of hand labor. The whole acreage was mechanically planted, and it was expected it would be mechanically harvested.

The John Deere sugar beet topper and lifter has been manufactured in limited quantities. Its task is to top the beets, locate the beet in the ground, lift it, shake loose the dirt, then deposit the beets in windrows. Tops are picked up at the front end by fingers mounted on a drum immediately behind the topping knife. They are disposed of in windrows of three or four rows each, where

they can easily be saved for stock feed. The topped beets are lifted at the rear of the tractor and tossed onto an agitating elevator by a pair of kicker wheels. A swinging conveyor places the beets in windrows of six or eight rows each, ready for loading, either by hand or with a mechanical loader.

Caterpillar Tractor Co.'s Diesel tractor and beet loader can load a ton of sugar beets a minute.

Mechanization is making tomatoes as easy to raise as corn, cotton, potatoes, beans, or any other

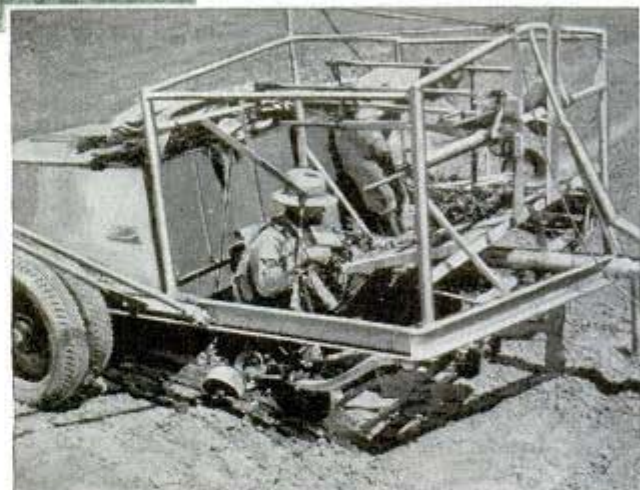

Courtesy Diesel Progress

Two men can transplant 20,000 tomato plants a day with this machine; it has a 650-gallon water tank which furnishes a pint for every plant as it is set



row crop. One tomato transplanter built and used in the Santa Clara Valley of California is capable of setting out about 20,000 plants a day! Victory gardeners who have spent an entire afternoon setting out several dozen plants can appreciate that figure.

California potato farmers are using a four-row potato digger, made by shifting International Diesel engines from the chassis of their tracktype tractors to the digging device. Yields in this California area range from 300 or 400 up to even 600 bushels an acre.

Several manufacturers are developing new machinery for handling hay. Grass has always been one of the world's basic crops. In the United States, roughly one in every five cultivated acres grows hay—only corn is greater in total acreage and dollar value. Grasses and legumes are vital to soil conservation, erosion control, crop control and crop rotation—but tools for handling hay have changed little in recent years.

Allis-Chalmers has developed a forage harvester, still in the experimental



Portable saw mounted on back of Ford-Ferguson tractor enables farmers to take power to the wood instead of old way of taking wood to the saw



Courtesy International Harvester Co.

Harvesting flax with a one-man, self-propelled combine which will always pick up the heads first regardless of whether crop was cut by right or left-hand travel. Below, Allis-Chalmers forage harvester in operation

Milwaukee, Wis.





Width of soybean rows is no problem with Ferguson cultivator which has wheels that are easily extended

state but capable of handling, under good conditions, from four to six tons an hour. In one field operation it cuts the standing green crop, chops it to the desired length and loads it into a trailed wagon, to be unloaded and delivered into the silo by blower, silo filler or elevator. Or, equipped with a pick-up attachment, it will take hay from windrow or swath, chop and deliver it to wagon or rack, ready for the mow or other storage. Straw can be recovered behind the combine, for feed or bedding.

Other developments include:

A successful mechanical cotton picker, probably not to be placed in quantity production until after the war.

Progress in the development of an economical beet-harvester.

Constant work on tractors, with the goal of making more power available to the farmers.

A self-propelled combine, operating under its own motive power instead of being pulled by tractors, and representing a distinct technological improvement on some types of farms.

Every one of the manufacturers, though, warns that the beating of swords into plowshares isn't go-

ing to happen overnight; there will be a year or two of transition after the war ends, and perhaps even more time to complete field tests on some machines, to make sure they are foolproof. But in the war production program the big manufacturers have learned many things about motors, traction, metals, mechanical aids, that will be directly applicable to peacetime farming.

Typical of the versatility that can be achieved with farm machinery is the "Ferguson System," combined with the Ford tractor, to give the family-farmer an almost endless variety of mechanical hands. Fundamentally, the Ford-Ferguson system is the uniting of tractor and implement

(Continued to page 150)



With this pick-up baler, one man can do the work of many

Lamps Lighted by Radio Beams Need No Wires



Photos from Westinghouse Electric & Mfg. Co. Lamps which are lighted by wireless electronic power, heating with infrared rays, and the use of light for cooking are some of the current developments that may find wide usage in the homes of tomorrow. Also new is the shatterproof bulb (above) designed for use in shipyards where welding sparks are hazards. It has a special lacquer coating and sturdy filament. Above, right, twin infrared lamps rigged up beneath desk serve as foot warmers. These lamps dry paint on tanks in few minutes

*40 Wall St.
N.Y., N.Y.*



Cooking bacon and eggs on the upturned lens of headlamp from army bomber shows how wartime lamps may be converted to peacetime use. This sealed-beam type of lamp cooked the bacon and eggs in four minutes. Lighting engineers predict that similar lamps for heating will be mounted in ceilings or recessed in the walls alongside ultraviolet lamps. Left, the glowing fluorescent tubes have no wires and get their radiated power from electron generating tubes. Used for lighting airplane instrument dials, or clocks, they require less current than an electric clock. Despite spectacular strides in transmission of electric power without wires, engineers believe that in most instances the practical use is many years away

Mr. Allen Warren & Matt, 7 Park Ave.
N. Y. 16 N. Y.

THEY BRING THEMSELVES

From Main Street to a snug raft in midocean or a tropic jungle is quite a social revolution but the Yankees are mastering it with ingenuity. The fishing kit at left is standard on Navy lifeboats; sign talk with arm motions has also become standard



A NOVEL development of this war is the way ingenious lads from Main Street, U. S. A. are managing to bring themselves back alive when marooned in the steaming jungles, on the oceans and in densely thicketed islands of the South Seas.

Cheating death in the tropics is being reduced to a science. Every branch of the armed forces is building up courses of instruction teaching how to forage for food and drink, how to sleep, travel, signal for help and hide from enemies, both human and animal. But much information on which the instructors are basing training courses, devising special equipment and improving materials to withstand the ravages of tropical climate came from the experiences of quick-witted young pioneers who fought to safety on their own.

Most of the men who found themselves stranded in the green hells of the tropics have been fliers and airplane passengers, and in the early days of the war, the spec-

tacular instances involved crash landings at sea followed by days of drifting and torture by hunger and thirst. Out of these harrowing episodes came improved life-rafts, emergency fishing equipment, methods of purifying salt water, trick sails, aluminum paddles, waterproof signal lights, better emergency rations, two-way radios and now even red sunshades to attract rescuers and protect drifters.

Many shipwrecked men succeeded in landing on a desert island only to starve, or be poisoned by eating deadly tropical fish or fall victims to hostile natives or Japanese. Others came through alive, and from what these survivors learned about

77 728

BACK ALIVE

Five-foot parachutes of paper (right) used to drop food, weapons, ammunition and medical supplies to troops cost only \$2.50 compared to the \$75 or \$100 nylon or silk chute. Below, a British patrol keeps rifles dry while wading a jungle river in Burma



life in the jungle a basis was formed for army, navy and marine textbooks.

During the campaigns in Burma, thousands of troops isolated hundreds of miles from help—lacking food, water fit to drink, ammunition and medical supplies—were nursed to safety by fleets of airplanes which dropped necessities by parachute. So parachuting supplies into the jungle has become a science too, the latest innovation of which is the Dennison five-foot paper parachute which will carry a 50-pound load to earth although



Pan American Clippers carry gasoline-operated stills for producing fresh water from the ocean



Pan American crew members spot safety equipment on diagram of Clipper. Papuan natives build litter to carry blood plasma to Yanks in jungle
American Red Cross photo



it weighs only 21 ounces and costs only \$2.50 as compared to a \$75 to \$100 silk or nylon chute.

Few have extricated themselves from the jungle with better effect than Lieut Wallace L. Dinn after he had bombed a Jap base, lost his plane, and floated down on the same island ten miles away. He landed in the midst of a savage tribe which had just finished eating two Jap aviators and they seemed to be interested in his muscular physique and a change of diet.

Like a Yankee Clipper ship trader, he quickly managed to master pidgin English—hiring big fella canoe by promises of many big fella knives; induced natives to take him to an island where a Jap flier was marooned, captured him for questioning and sailed into an American naval base in a war canoe, like an island potentate.

Ingenuity saved four aviators whose plane conked out over a South American jungle. The pilot picked out a flat spot and made a belly land-

ing, only to slither to a stop in quaking mud five feet deep, with a consistency approaching that of quicksand. While waiting for an injured comrade to improve, they lived on top of the plane, collected rain water in parachutes, fashioned "snowshoes" which would support them on the mud, then slogged along 20 days until they reached a stream, built a raft and floated to civilization.

Lieut. Tommy Harmon, former University of Michigan football star, survived seven days in the jungle after finding himself hanging by his parachute lines from a tree, his companions dead. Tortured by insects and slashed by sharp tropical leaves, he lived through three attacks by crocodiles, kicking them out of his path, set a course by his pocket compass, followed it across swamps 15 feet deep, learned to avoid impure, slimy waters by following streams to their point of origin where water was fresh, mastered the art of constructing a nightly lean-to of branches, leaves and mosquito netting and had the presence of mind to recognize a slash on a tree as a mark of a trail leading toward

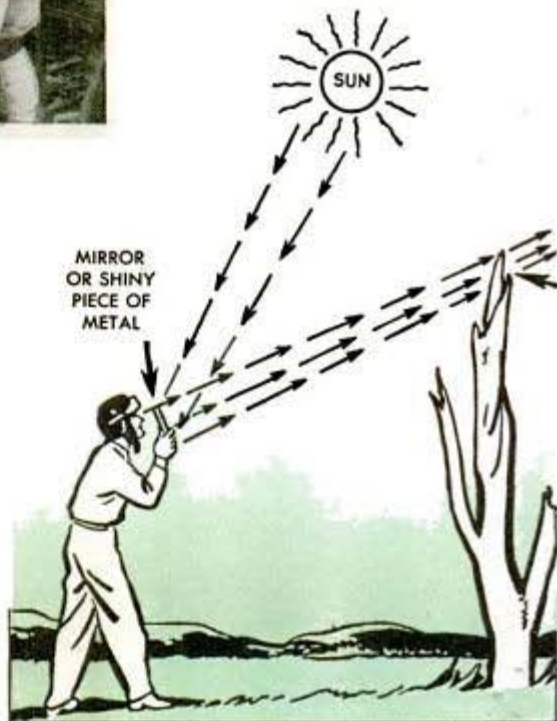



American Red Cross photo
Friendly New Guinea natives carry an American out of the jungle to safety

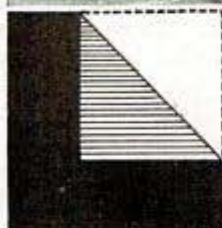

**Need Gasoline and Oil
 Plane is Flyable**

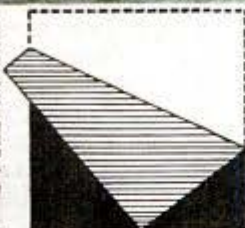

**Need Tools
 Plane is Flyable**



**Need Medical
 Attention**

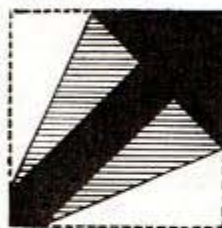

**O K to Land—Arrow
 Shows Landing Direction**

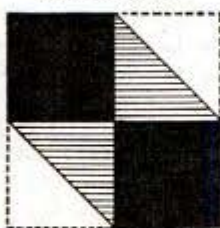

**Do Not Attempt
 Landing**



**Indicate Direction of
 Nearest Civilization**

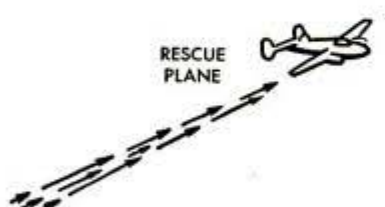

RESCUE PLANE

TOP OF MIRROR
 MUST BE LINED
 UP WITH TOP OF
 AIMING STICK AND
 RESCUE PLANE

"Code" messages above, for signaling with blue and yellow panels to plane, are from U. S. Army Air Force handbook, "Jungle and Desert Emergencies." How to attract plane with mirror is shown below, at the left

on his shoeless foot and started for "home." The socks soon wore out, so he cut a sole from the top of his remaining boot with a razor blade. When this was gone he made another shoe from his life preserver. This was cut to pieces also and he improvised another shoe from the sleeve of his flying jacket. Wearing this, he plodded through the jungle, eating bananas and other wild fruit until natives picked him up.

The crew of a battered B-17 bomber operating out of Guadalcanal pancaked to the sea 500 miles from land and dragged themselves on rafts. Dressing each other's wounds, they made a rain catcher out of a canvas flare container cover, fashioned a sail out of parachutes, used a nail file to form a fish hook from an emergency ration can opener, kept themselves alive until they landed on a native island. Here they taught natives to sing in return for food and obtained the use of a canoe by promising knives and axes. They sailed back to safety.

Thousands of experiences have been translated into

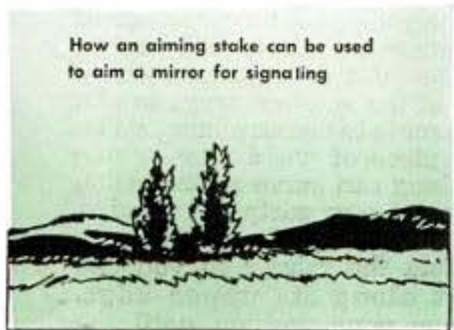

How an aiming stake can be used to aim a mirror for signaling



Concealed by camouflage resembling a tree stump, one Marine keeps watch while partner reports to command post by field telephone. Below, seven-man raft for Flying Fortresses, made by U. S. Rubber Co., has a sail and tarpaulin for sun protection



jungle, desert and sea tactics which have been written into textbooks. One of these, "Jungle and Desert Emergencies," issued by the U. S. Air Forces, a pocket-size volume printed on water-resistant paper and impregnated with an insect-repellent chemical, sums up the latest in modern pioneer lore.

"Don't fear the jungle," it advises, pointing out that a man can live weeks in the wilds if he avoids panic and uses his head. Good food and water are fairly plentiful in the jungle if you know where to look, it says. Most wild animals won't bother you unless you bother them. There is little more chance of being bitten by a poisonous snake than there is of being struck by lightning back home. With the exception of those of New Guinea and Assam, jungle natives will be friendly if you make friendly approaches to them. Don't try to bully them. Malaria is your worst enemy. If you have your first-aid kit, start immediately to take preventive doses of quinine or atabrine.

Aviators have learned to signal for help by placing bright-colored or reflecting objects where they will mirror the sun back into the sky. Gasoline fires are being used. Engine oil thrown on a fire will produce black smoke. Water will send up clouds of steam. Yellow and blue panels can be folded to give messages to planes overhead. A code of arm and body signals conveys messages to rescuers. Marooned men are trained in the use of mirror signals as follows:

"When the sun is shining, a mirror or any piece of shiny metal—your rear-vision mirror, a food tin, or a piece of metal from the plane—can be used as one of the best of all signaling devices. However, the mirror must be accurately aimed if the reflection of the sun in the mirror is to be seen by the pilot of a passing plane. One of the simplest ways to aim a mirror is to use an aiming stake. Any piece of wood four or five feet long can serve as the stake, or one of your party can stand in position.

"Hold the mirror so you can sight along its upper edge. Change your position until the

*The Sheffield Corp.
Dayton, Ohio. 7/664*

top end of the stick and the plane line up, then adjust the angle of the mirror until the beam of light reflected by the mirror hits the top of the stick. If stick and plane are then kept in the sighting line, the reflection will be visible from the plane.

"Some emergency kits are now fitted with a special signaling mirror, which is a double-faced mirror and provided with a sighting or aiming hole.

"Hold the mirror about three inches away from your face and sight at the plane through the sighting hole. The light from the sun shining through the hole will form a light spot on your face and this spot will be reflected in the rear surface of the mirror. Then, still sighting on the plane through the hole, adjust the angle of the mirror until the reflection of the light spot on your face in the rear mirror just coincides with the hole. In other words, when the reflected spot disappears and the plane is still visible through the hole you can be sure that the reflected light from the sun is accurately aimed at the plane."

Water is important. Following a brook downstream will often lead to civilization. Digging a four foot hole will usually produce drinking water. Animal trails lead to water. The stems of many vines ooze water when cut. Rain water can be collected from depressions in large leaves.

A parachute makes a good tent, knapsack, rain collector, or a trap which may be placed across a stream holding fish where they can be speared with a lance whittled from bamboo.

Men are taught not to fight the jungle by pushing through it. The correct thing is to part the underbrush, crawl under it or go around.

Most tropical aviators know how to operate a simple firemaker by twirling a stick into a collection of dry tinder placed around a hole in a piece of wood. They can improvise bird and animal traps.

Some general diet rules are these: eat nothing that has a bitter taste unless you are sure what it is. Avoid all plants that have a milky sap. Anything that you see monkeys eat, you can eat. All shellfish are non-poisonous. Balloon fish are deadly. If in doubt about the wholesomeness of food, try a very small particle. Most snakes are edible except sea snakes. All birds and animals are good fare, along with grubs and grasshoppers, but caterpillars are to be avoided. Don't eat the legs and wings of insects.

A score of men from the Army, Navy and Pacific Rangers spent three weeks marooned on a tropic isle off Hawaii to prove that a smart man with a machete, bolo, trench, or cane knife could find a good liv-

(Continued to page 152)

'Stop Light' Inspection Gage Shows Tolerance Limits



In checking close tolerances, the element of human error is said to be eliminated with an electric limit type comparator, which shows by colored lights whether the work is within the tolerance limits. Readings to an accuracy of one ten-millionth of an inch may be made quickly by an untrained worker. A red light shows under-size, a green light oversize, and an amber light shows measurements within tolerance. The traffic-light type of reading may be supplemented, for a color-blind inspector, by bells or buzzers as signals.

0 006 Tire Made From Elastic Plastic Is Resistant to Sun's Rays

In the race to produce the best postwar tire, natural and synthetic rubber may be given some stiff competition by the new elastic plastic, called Plioflex. One tire made of the plastic has run 8,000 miles. Plioflex, developed by the Goodyear Research Laboratory, in Akron, Ohio, is said to be the first elastic plastic capable of being vulcanized during molding operations, and can be handled in hot molds just like natural rubber. The finished product is not affected by the sun's rays. Postwar uses predicted for it in addition to tires, include a lightweight garden hose, heels and soles for shoes, various automobile parts molded from rubber, and coating for fabrics and papers. One possibility is a Plioflex shoe with a finish resembling leather. The plastic can be colored any shade of the rainbow.

Public Relations Dept. 61

TRAINING

FLYERS

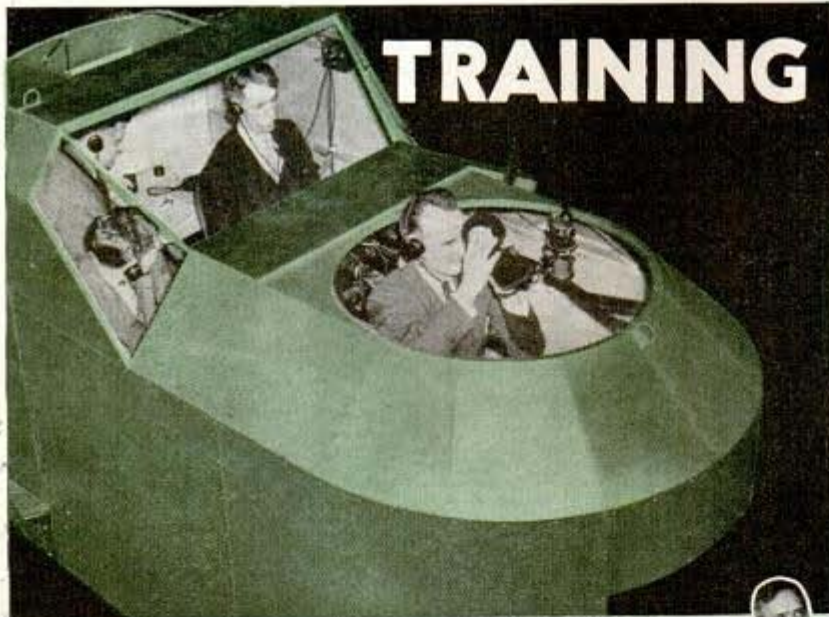

U. S. pilots and bomber crews master their first problems of flight and combat with the aid of intricate training devices — on the ground. Left, student navigator "shoots the stars" from dummy fuselage. Stars are projected on celestial dome overhead. Behind him are the instructor, the pilot and radio operator

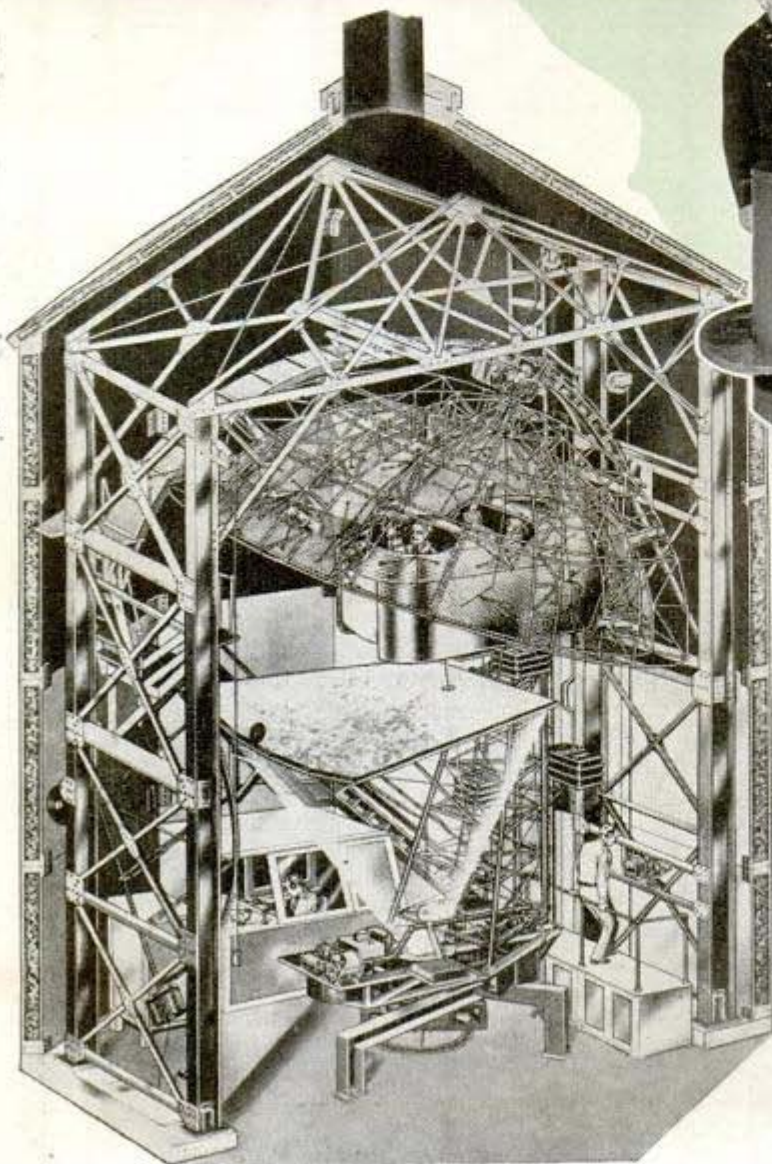

Student gunner (above) looks into viewing box of "panoramic" trainer learning how to "lead" target. Left, cutaway of celestial navigation trainer showing instructor sitting in booth at base of unit. Passing terrain is projected on screen beneath student "crew," stars on dome above. Below, teaching range estimation with mirrors simulating a range of 2,800 feet

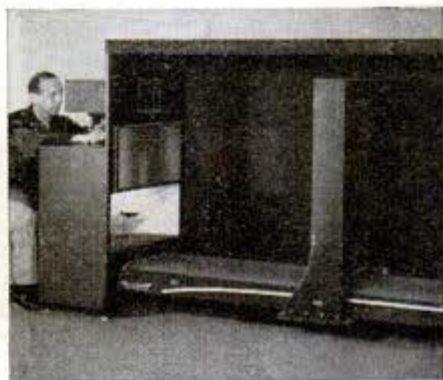

*Col. Dwight H. Fidelity, Air Corps, 2037
 Training Aids Div., 1 Park Ave., N. Y. 17, N. Y.*

on the GROUND

Instructor (right) is giving a student navigator "preflight" information for a dead reckoning mission in the Navitrainer. Navigation instruments are like those student will use later on to guide bomber to enemy target

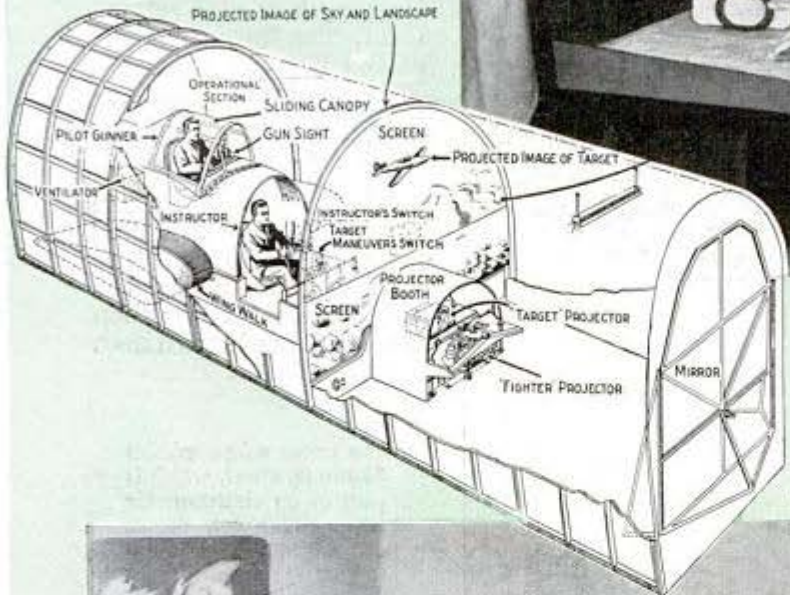

Cutaway view (left) of the "gunair-structor" which gives illusion of flight with horizon projected on a screen and moved through controls. It teaches correct aim for every position of target. Below, fixed gunnery deflection trainer has target which is set for any air speed



"Ditching dummy" (below) teaches land plane crew how to cheat death at sea after crash

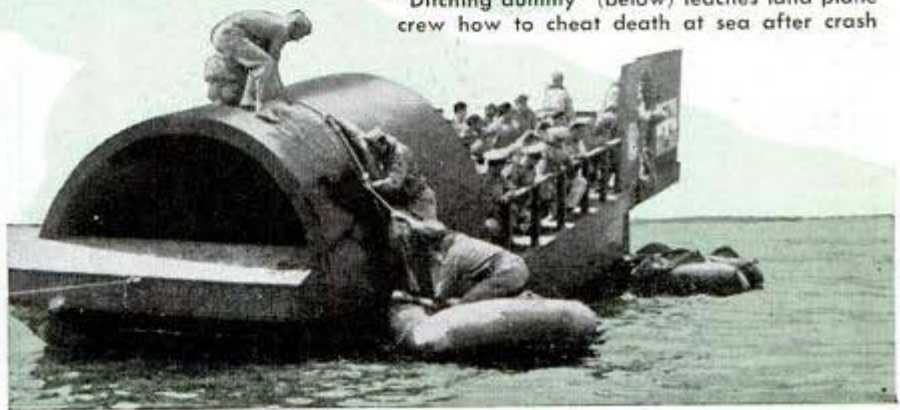

"Spinning Top" Stores Power for Rolling Steel

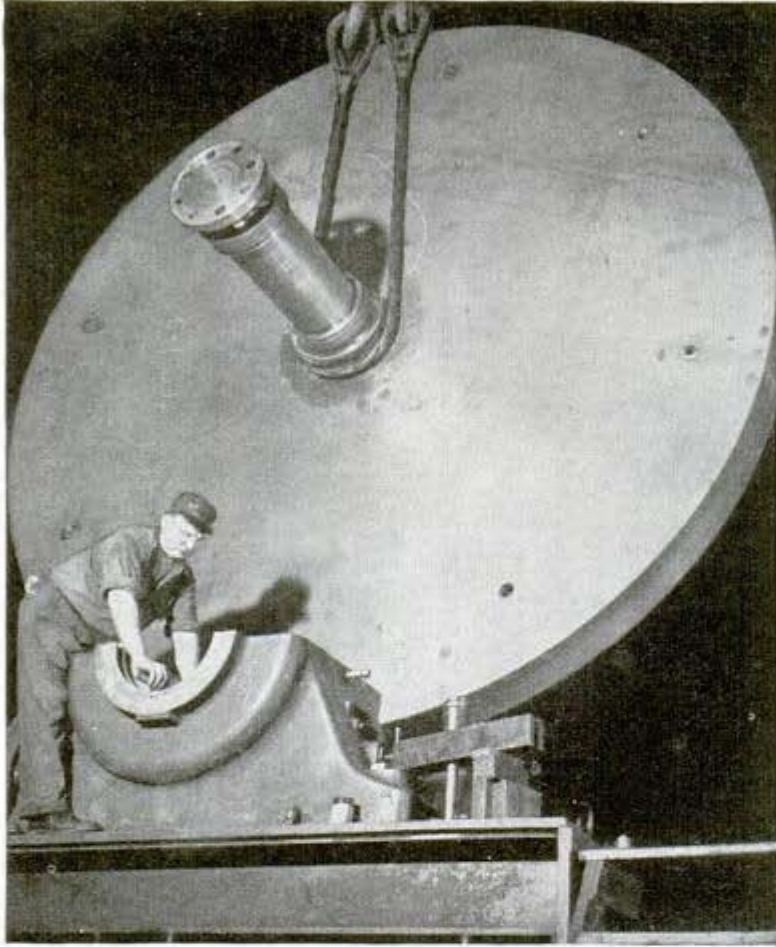

Enough energy will be stored by one giant flywheel that is part of an electric motor-generator set to raise a battleship a foot in the air. This storehouse of power will take care of peak loads in rolling slabs of steel at the Kaiser plant at Fontana, Calif. The flywheel, built at the East Pittsburgh Works of the Westinghouse Electric & Manufacturing Company, is 14 feet high and weighs 38 tons. At top speed, the outer edge is traveling 250 miles an hour. The huge wheel is balanced so that it vibrates less than the width of a human hair.

The outer edge of this 38-ton flywheel, which is part of an electric-motor generator set, moves 250 miles an hour at top speed. It serves as power storehouse for peak loads in rolling steel

52 Holes at Once Are Drilled in Aircraft Part

To speed the manufacture of airplane parts, one machine at the General Electric Company's Fort Wayne, Ind., plant drills 52 holes in a single operation. It is used to make casings for superchargers. The machine is adjusted for precision work measured by thousandths of an inch.

Resembling stalactites, drills in this time-saving machine are poised over supercharger casing. A single operation makes a maximum of 52 holes

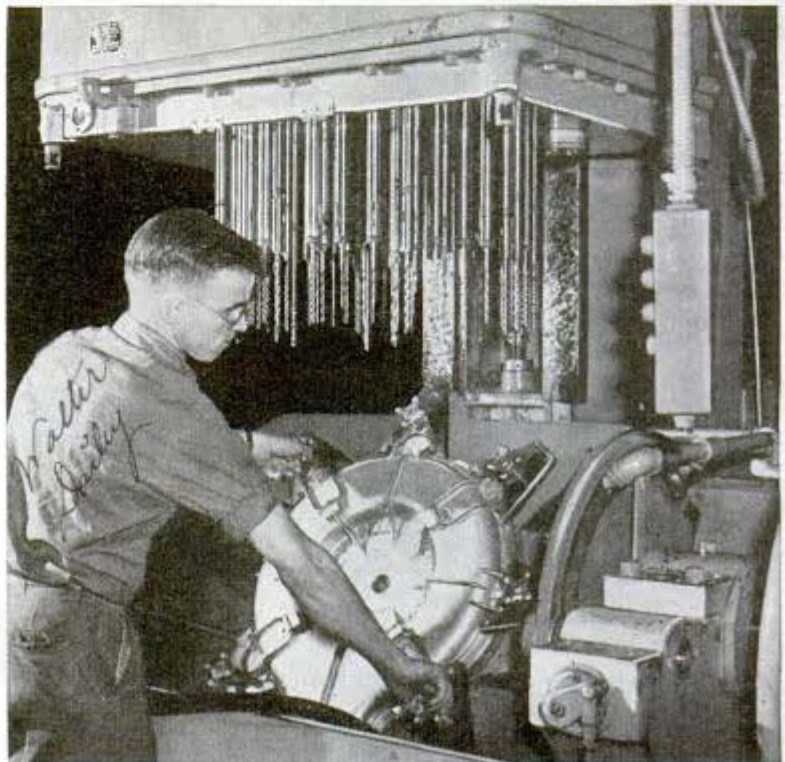

71 908

Office of Public Relations
Langley AFB, Washington, 205 401

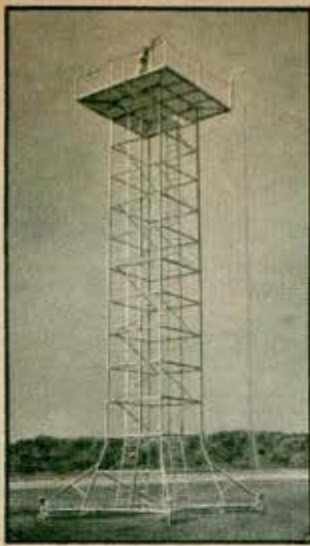

Jiffy-Built Tower, Motor Crane, Aid Aviation Mechanics

To aid mechanics in the repair of airplanes and their hangars a "high stand" and a crane for removing aircraft motors were demonstrated at the Marine Corps Air Station at Quantico, Va. The stand may

be erected to varying heights. At its highest point it is suitable for maintenance of hangars, and for use as a platform for machine guns. The crane is 25 feet high, and its capacity is 6,000 pounds.

12-Inch Telephone Lines Connect Riveting Teams

Riveters and rivet-buckers, as well as other teams of workers in the Boeing Aircraft plants, communicate by telephone. In some cases telephones are required when the workmen are only a foot apart. When working on opposite sides of a large plane part the workers cannot see each other and the noise of the factory makes ordinary voice communication virtually impossible. Some of the telephone lines extend as far as 50 feet so that workmen can talk to each other while working on remote parts of a ship. In the Wichita plant, the Boeing company has more than 200 such telephone sets.



Wichita Div., Wichita, Kansas 7951

Cold Engines Started Quickly by Diluting Oil After It Leaves Motor

Developed for aircraft engines that must be started at a moment's notice despite zero cold, a new cold-weather lubrication

system is also adaptable to automobiles, trucks and tractors. It consists of diluting lubricating oil with gasoline after it leaves

the motor on a return trip to the warm-up compartment. Previously, the gasoline was added before the oil entered the motor where it was partially evaporated by the hot motor. Pilots had enough thin oil to start with, but the rest of the system was clogged with thick oil and there was danger of bursting the air cooler. The improved method was developed by a Glenn L. Martin Company engineer.

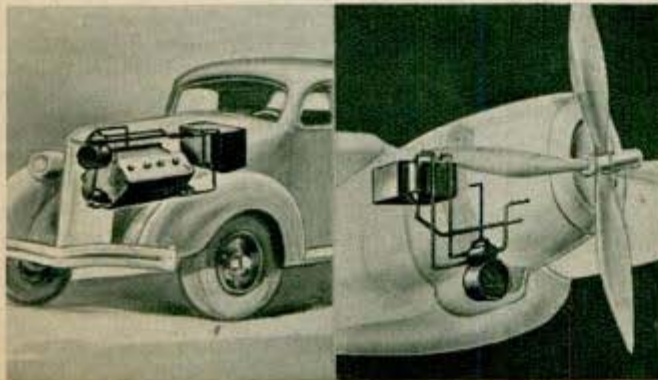

Baltimore, 3, Maryland

OUR NEXT WORLD WAR -

Mr. J. W. Elliott
7 Park Avenue
N.Y. 24, 16, N.Y.

NEXT to the impact of Jap steel, our fighters in the Far East fear most the sting of a mosquito. Next to the roar of a Jap bomber, they dread the hum of the tropical pest which carries a deadly cargo of malaria and yellow fever germs.

In the European war theater the familiar "cooties" of the last World War are keeping troops busy scratching when not fighting Axis foes. Typhus is the main weapon of these lice.

In the United States, the shortage of farm manpower has left millions of acres untilled and subject to the fresh encroachments of hungry insect hordes. The shortage of insecticides has added to this problem.



Spider photo from "The World Is My Garden," by David Fairchild, published by Charles Scribner's Sons. **Top**, spraying trees with insecticide to control destructive infestation (photo from DuPont). **The tough-looking hombre above is a turret-making spider. Below**, mosquito bar covers a soldier's hammock hung between trees in a tropical jungle



Stimulation of travel has multiplied all of these menaces because both insects and the germs they carry are restless hitchhikers, seeking new fields for their ceaseless campaign against mankind by plane, train, bus, truck, automobile, ship and even by the person of man himself. The comparative shrinkage in the size of the world has made the insect menace a really alarming one for the first time in history.

77806

AGAINST INSECTS

Uncle Sam, fighting one World War, is preparing for the next—and this one will be a long and bitter battle to crush the creeping, wriggling, flying, burrowing billions whose numbers and depredations baffle human comprehension.

Not that we are doing nothing about the present menace to our troops and civilians. The sharpest scientific brains of the nation are already enlisted in the war on insects. But at best, present efforts can be only a holding action as compared with the coming fight on man's insect enemies. Under the leadership of Surgeon General Thomas Parran of the United States Public Health Service a movement has started for a joining of world-wide forces of friend and foe alike, when peace comes, to eliminate the insect threat to man's welfare.

The size of the army we face may be judged by the following recently revealed facts and estimates:

Calculating the world's population at above 2,000,000,000 human beings, there are probably that many insects on or in the soil of an average square mile of land. In addition, there are as many as 5,000,000 insects in the air above each square mile. The total weight of the world's insects is probably greater than the weight of all other land animals combined, big as they are by comparison.

How prolific insects are is shown

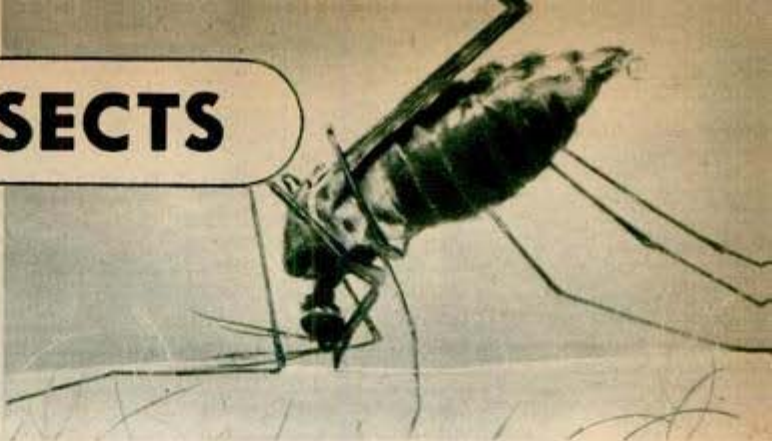

U. S. Public Health Service photo

Anopheles quadrimaculatus making a bayonet charge. This is the malaria-bearing mosquito, its beak boring into skin



U. S. Department of Agriculture photo

Mosquitoes shun arms treated with a repellent (above, at left) to alight on untreated arm of entomologist. Below, airplane sprays poison on breeding place of mosquitoes



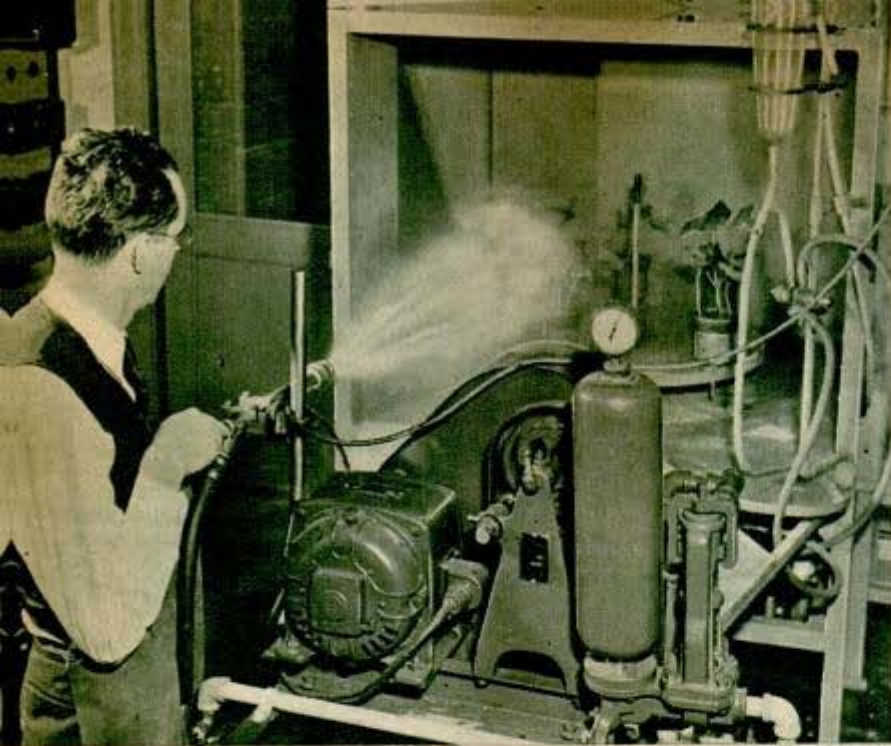

Spraying plants in the DuPont pest control laboratory. The apparatus duplicates effect of pressure sprays used on mobile rigs in the field

While it takes exactly seventeen years for one variety of locust, or cicada, to reach the adult stage and some worms six to eight years to grow up and turn into beetles, the mosquito can become a full-grown nuisance in about ten days, ready to spread disease. This is one reason the mosquito is man's greatest insect enemy.

The queen of a colony of termites, which resemble winged ants and which attack any form of wood including the front porch, spends all of her time laying eggs and to do so sometimes swells to the incredible length of eight inches.

Caterpillars eat an estimated \$25,000,000 worth of our food a year. Our farm-

ers raise 2,000,000 acres of corn each year merely to feed the corn ear worm. Each female lays about 1,000 eggs and they go through two or three generations a season. From five to 10 percent of our apples are ruined by the codling moth. The annual insect damage to our trees is estimated above \$150,000,000 a year. Clothing moths alone cost us around \$20,000,000. Insects which feed on our stored grains and flour run up a food bill of \$300,000,000.

Most of these figures were compiled by Anthony Standen, leading entomologist and author of the book "Insect Invaders," who, summing up a world-wide experience in killing the creatures, remarks: "I hate insects. I admit that they are completely and utterly fascinating, but for me it is the

by the fact that a pair of flies starting in April might have by August 191,010,000,000,000,000,000,000 descendants, if they all lived, or nearly five trillion tons, at a rate of 20,000 flies to the pound. Each fly is capable of giving a human being typhoid, diarrhea, amoebic dysentery, tuberculosis, anthrax, leprosy, tapeworm, hookworm, whipworm, bubonic plague, yaws, ophthalmia, trachoma, erysipelas, septicemia and gangrene.

The animal group made up of insects includes around 640,000 species. There are more than a quarter of a million types of beetles, 120,000 kinds of butterflies and moths as against less than 1,000 varieties of fleas. We notice fleas more because they attack man and his domestic animals.

A Marine Corps sergeant murders mosquito larvae by laying a coat of oil on the surface of a swamp near an American camp on Guadalcanal, helping to control malaria in that region

U. S. Marine Corps photo



fascination of horror." He fixes the total cost of insects to this nation at \$1,000,000,000 a year aside from the toll of disease they spread.

The farmer has long been aware of the voracious Japanese beetle and his thousands of annoying cousins, the orchardist dreams of fruit moths on his bad nights, the housewife shudders at the discovery of a domesticated insect and many victory gardeners grew downright discouraged when they saw what insects could do to their little plots. But it was the American defeat at Bataan which aroused the nation's military leaders to the danger which insects held for our war effort. We were not beaten by the Japs. We were licked by malarial mosquitoes and the lack of quinine.

Nor was it the Japs who delayed



Fumigating a Pan American Clipper to kill insects on arrival from tropic port

Grasshoppers (left) have proved one of the greatest pests in our grain regions

American Home Products Corp. insecticide laboratory raises millions of flies

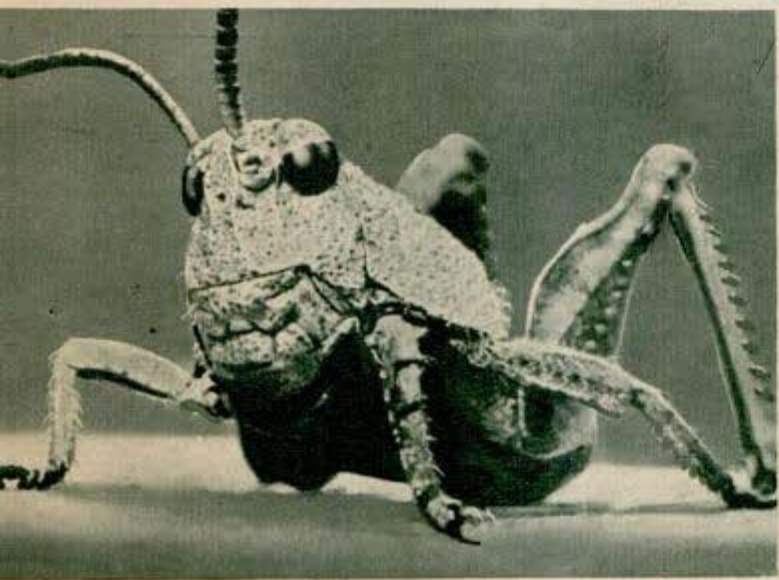
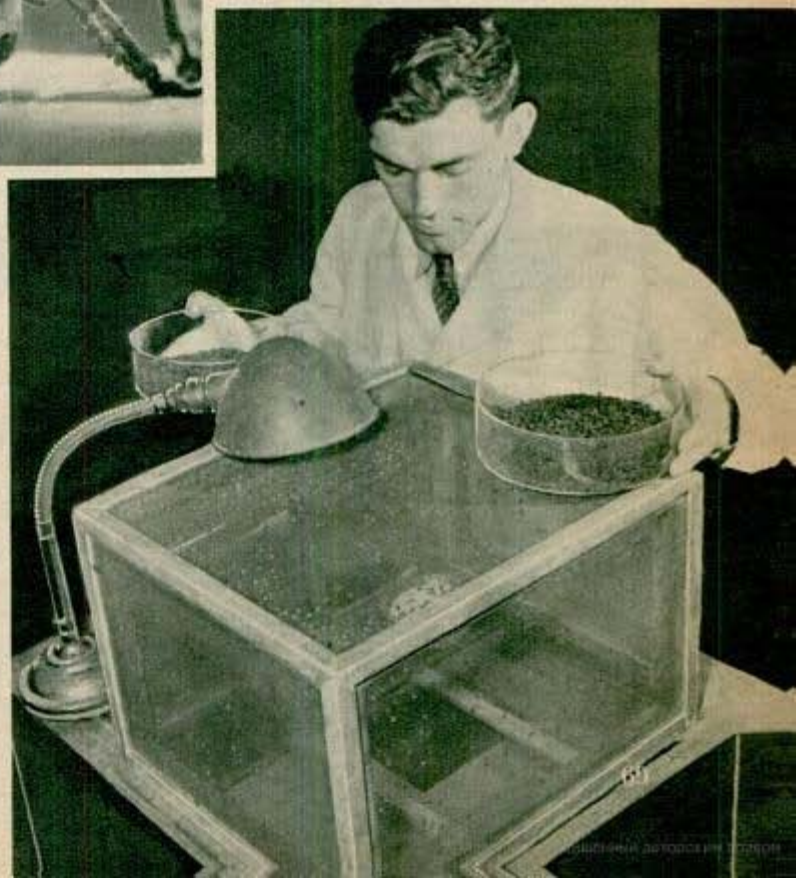

Photo from "The World Is My Garden," by David Fairchild, published by Charles Scribner's Sons

the capture of Guadalcanal. Again it was the mosquitoes in the festering jungles which sent marines to their hospital cots weak and shivering from malaria. As jungle fighting increased, the malaria rate jumped from 30 per thousand men in 1942 to 80 per thousand in 1943.

Strangely, the first two years of war have revealed that the best weapon against the most numerous insects encountered by servicemen is the old familiar standby—mosquito netting. You may get proof of this the next time you attempt to buy curtains, since the greater part of the curtain industry is turning out netting for the millions of





It's breakfast time for lice in the Department of Agriculture. An entomologist lifts patches bearing lice gorged on human blood

troops who will be overseas. A single army order called for 27,769,000 square yards of olive drab netting.

Probably the second most effective weapon resulted from the Department of Agriculture research which converts pyrethrum—a high ranking insecticidal material—into a more potent form than ever before, an aerosol or fine mist that is a cross between a fumigating gas and an ordinary fly spray.

At a twist of the thumb, the insecticidal aerosol comes out from a special container—a so-called “bomb”—as a fog that remains suspended in the air longer than any spray and penetrates into hidden places where insects may find protection against the droplets of a liquid spray. The knock-out fog from one such release will kill the insects in a room 10 feet square and 10 feet high. One bomb holds the makings of enough aerosol to keep 10 such rooms free from mosquitoes for 50 days.

This “bomb” method, not now available for civilian use, will be one of the principal weapons for the post-war drive on insects. Another development promised to civilians by Du Pont will be nylon window screens, not only rustproof but almost transparent.

Promising, too, are experiments conducted in fumigating airplanes with an insecticide carried into small cracks on particles of smoke.

In an effort to test new insect poisons to relieve the wartime shortage, the Department of Agriculture raises large colonies of cooties, feeding them their favorite food, human blood, from the

persons of volunteers. Along a similar line, chemists of the American Home Products Corporation in New Jersey feed flies a special, balanced diet of enriched bread, irradiated yeast, malt, bran and milk. It's like giving a doomed criminal a sumptuous meal before execution, for, as soon as the flies get fat and healthy they are put in a death chamber and sprayed with a given amount of insecticide. The number of dead flies determines the rating of the preparation being tested.

Literally thousands of poisonous substances are being investigated as well as hundreds of traps, lures and methods. Meanwhile, drainage of marshes, oiling of ponds and ditches, dusting and spraying of crops continue pending the day that the real war on insects can be declared.

In the interim, the march of the invading insects goes on, covering the earth from pole to pole with the exception of the oceans which they have never been able to penetrate.

Even in steel, concrete and brick cities like New York they manage to flourish and scientists examining the roofs of skyscrapers as tall as those in Rockefeller Center have been puzzled to find the same caterpillars, beetles, flies and moths you would expect to see in a cornfield. In fact, a shop-keeper in this section opened his doors one morning to find scores of specimens of the praying mantis crawling over counters and shelves.

Spray “bomb” shoots mosquito-killing mist into a soldier's pup tent in a swampy region infested with malaria



71 957

Nazi "Plow" Plants TNT in Torn Railway Bed

Retreating German troops in Italy wreck railroad tracks with a 10-ton machine that literally plows up the ties. The machine (right) is dragged along the tracks, chutes on the sides dropping explosives on the rails. British commandos captured this "plow" in Teroli railroad yards

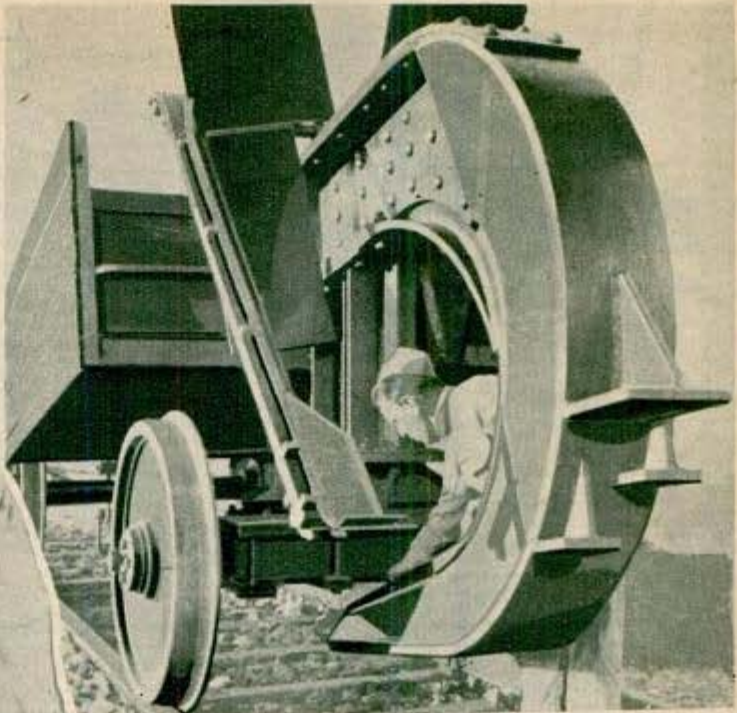

Left, inspecting two-pound charge dropped by track wrecker during demonstration in Italy. The explosives are dropped down chutes and held to the rails by clips. They are set to explode in a few seconds

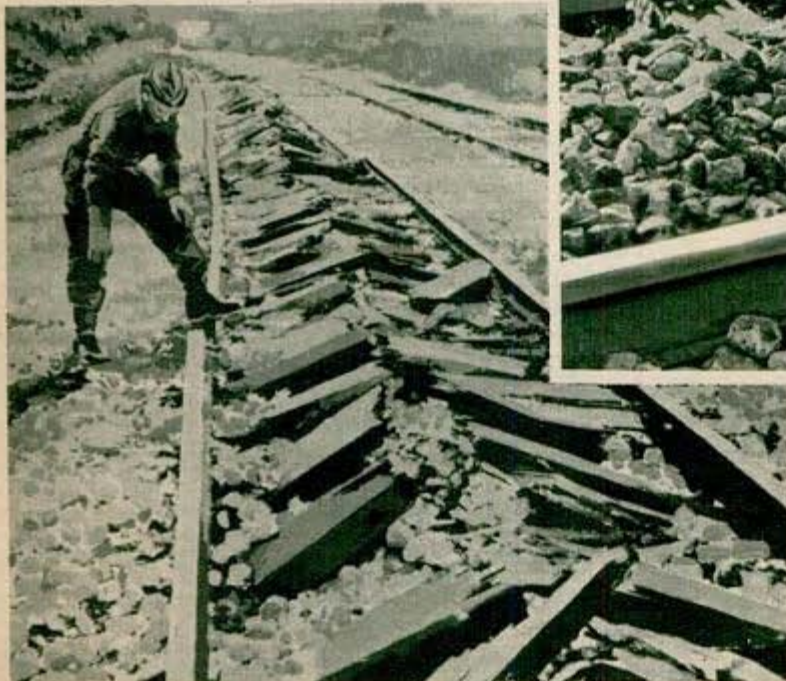

Along "road to Rome," Fifth Army found Nazi demolition crews had blown small gap in rails about every 20 paces. Left, British soldier looks over section of a main railroad line after Germans had torn it up with the wrecker that snaps ties like matches

used by Germans in Italy

N 735

Stanison, Jr. 3872 Franklin Ave., Los Angeles 21, Calif.

NEW MAGIC in BLACK GOLD

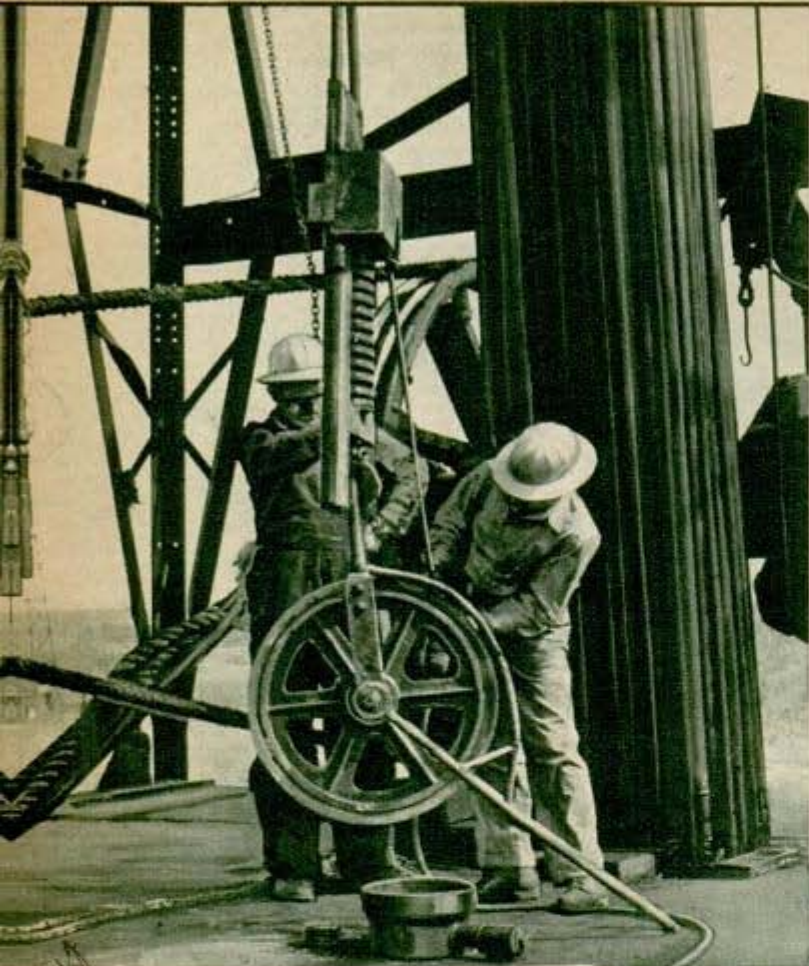

compile at the end of the test which you could translate into aircraft speed, range, and load.

Better fuels and lubricants for efficient aircraft engines are only two of the thousand and one subjects being studied at the "University of Petroleum," Shell Development Company's research laboratories at Emeryville, Calif. On its seven-acre "campus" a staff of 800 scientists and research people are busy taking apart the hydrocarbons that make up crude oil, then putting them back together in new combinations.

They can turn crude oil into a gas, a liquid, or a solid. They can take highway paving material and gas for barrage balloons out of the same barrel of crude. Better yet, from that barrel they can extract material for making false teeth, explosives, synthetic vitamins, rubber,

Left, measuring depth of oil well with Lane-Wells measuring sheave, accurate within fraction inch. Below, checking amount of lead in high-octane gasoline

Dr. J. D. Landis, Asst. Mgr. Shell Oil Co., Shell Oil Co., San Francisco, Calif.

THE young technician grinned as he chalked up a new flight on the bulletin board:

"Round trip, Honolulu to Tokyo. Bomb load, 10 tons.

That flight existed only in his imagination, of course, yet it added a touch of adventure to the prosaic engine test he was making. He knew that if such a flight becomes practical it might owe a lot to just the kind of routine test he was running today.

He returned to his control panels, flipped a couple of switches, and settled down to watching a dozen dials and gages as the test equipment behind the glass window took up its steady roar. Today's experiment concerned a new design of aircraft cylinder, fed with a super-high-octane fuel and lubricated with a special oil. He'd have some interesting figures to

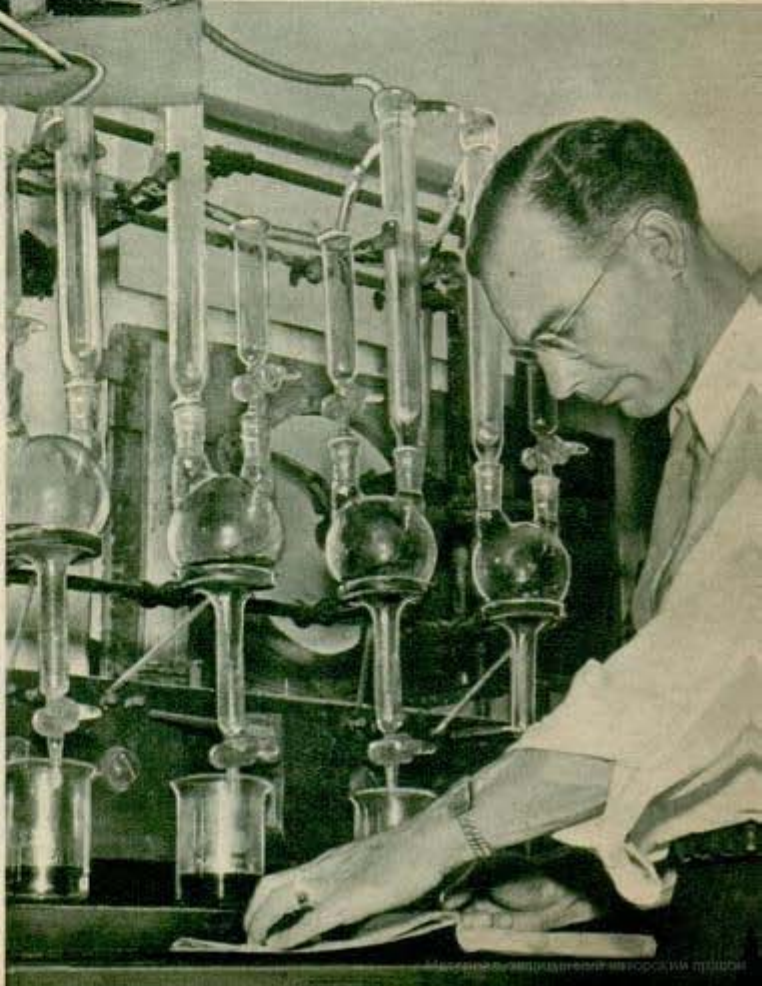

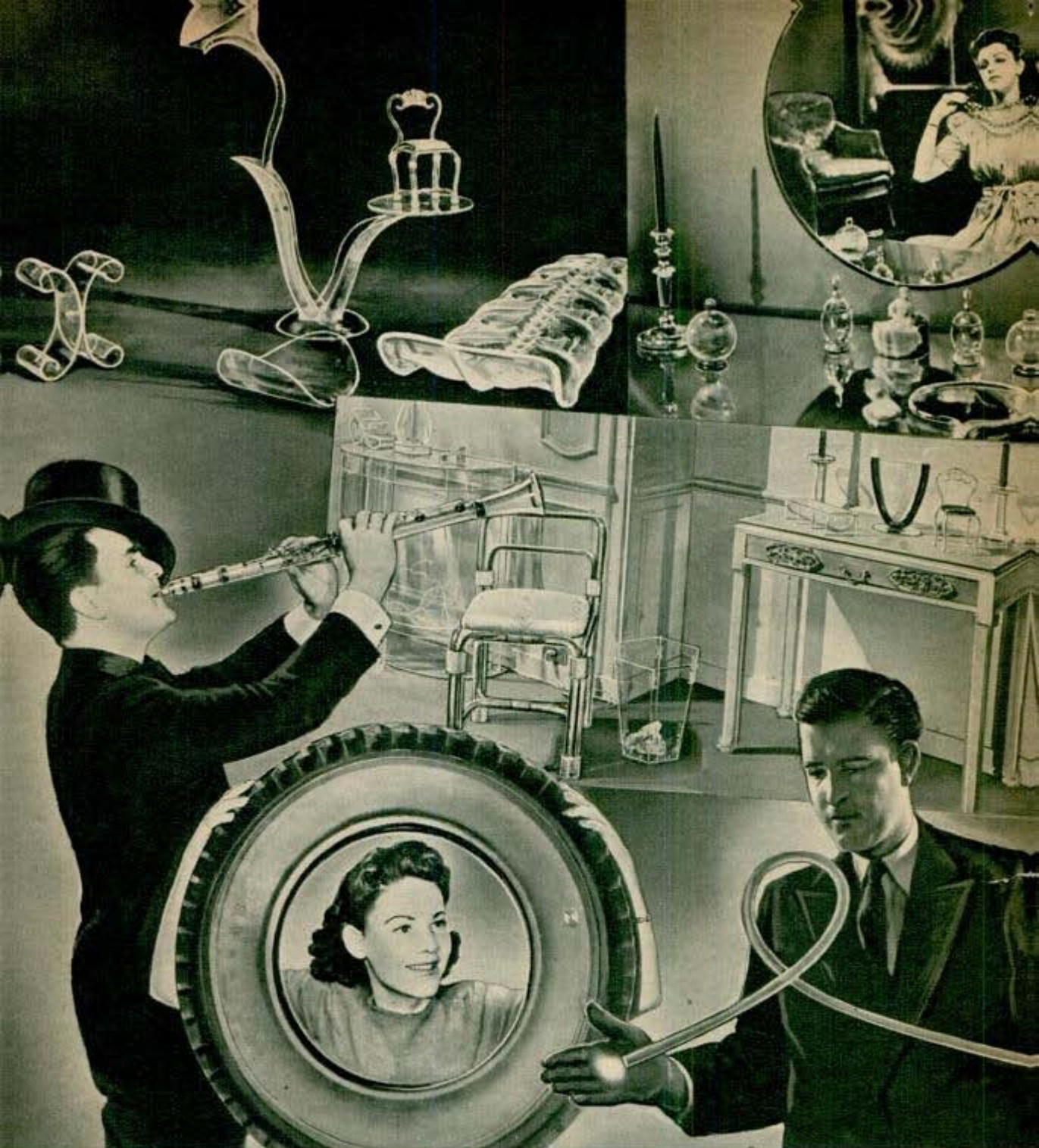

Petroleum gets around in myriad disguises: table ornaments, necklace, clarinet and furniture of petroleum plastics, light-conducting styrene rod and synthetic rubber tires are only a few of its ultimate forms

gasoline, flavoring extracts, and garden fertilizers.

Military secrecy surrounds much of today's research. Not until "V Plus Two" can some of the new discoveries be put to ordinary uses. "V Plus Two" is the handy formula that represents, roughly, the years after victory when much that is new in science will be available to you and the chap next door.

But it is no secret that the petroleum industry is talking about 50-mile-per-gallon

gasoline and 100,000-mile tires. Such gasoline, in fact, is the high-octane stuff that is going into the fuel tanks of military aircraft. It wouldn't do much in your present engine, built for medium-compression pressures. More efficient engines must be built to take advantage of high octane fuel—smaller, lighter, and of higher compression than the engines we use today.

Still, the industry doesn't guarantee to put 50-mile gasoline in every pump. With conservation of our petroleum resources of



North American Aviation employees exhibit helmets and visors of petroleum plastics. Below, electron diffraction camera analyzes samples of crude oil

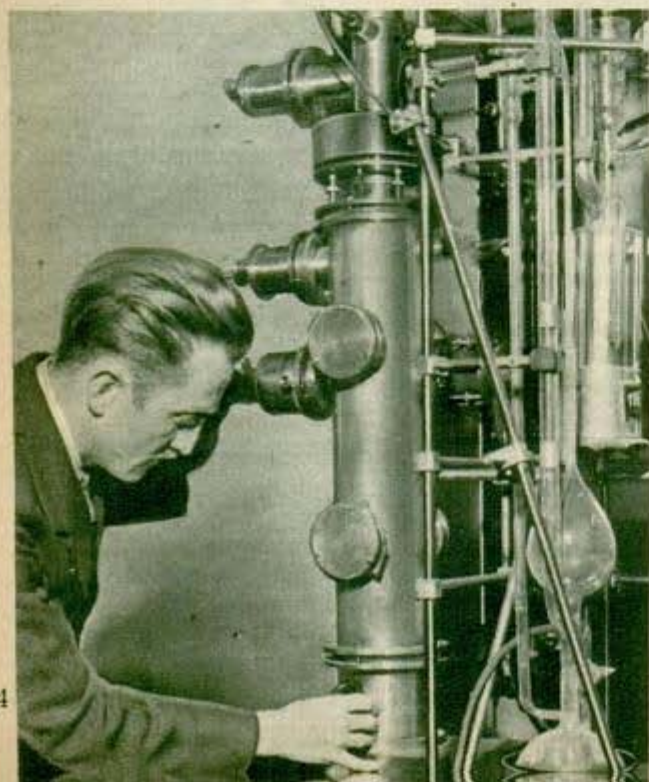

more importance than ever, the fuel of the future may well be that particular grade that delivers the greatest number of miles from every gallon of crude oil. There are lots of complications and it's too soon to say, now, what the octane number of that optimum fuel will be.

Shell's scientists study petroleum under infrared radiations and probe it with ultra-violet light. They whirl it in a super-centrifuge powerful enough to centrifuge the copper out of brass. They subject it to X-rays and weigh it on balances that show a difference of $\frac{1}{450}$ -millionth of a pound. They distill it in vessels that contain only one-millionth the pressure of the atmosphere, and they photograph its makeup in electron diffraction cameras that reveal molecular chains.

This latest research tells them some of the things they can do with the hydrogen and carbon molecules in crude oil, then they set out to manufacture a tiny bit of the substance their research discovered. First they do it on the laboratory table,

then they move to a pilot plant that resembles part of a miniature refinery. In this plant they apply the heats, pressures, and catalysts needed to produce the new chemical compound, and work out any production bugs that develop.

Research like this produced cresylic acid from petroleum at a price that permits it to be used in refining low-grade copper ore. Such investigations produced a chemical method of superfinish for smoothing the wearing surfaces of engines. The scientists found chemicals which under certain conditions reduce the melting point of metals right at the surface. Added to lubricating oil, it permits the heat of friction to



Test machines rub steel balls together to measure metallic wear under various pressures and lubricants

finally, with butadiene, another petroleum derivative, into rubber. It is being produced in vast quantities for this last use today.

Shell is concerned not only with new and better products but with better ways to explore for oil, more efficient methods of recovering it from the earth, and improved ways of breaking it up into the products.

(Continued to page 160)

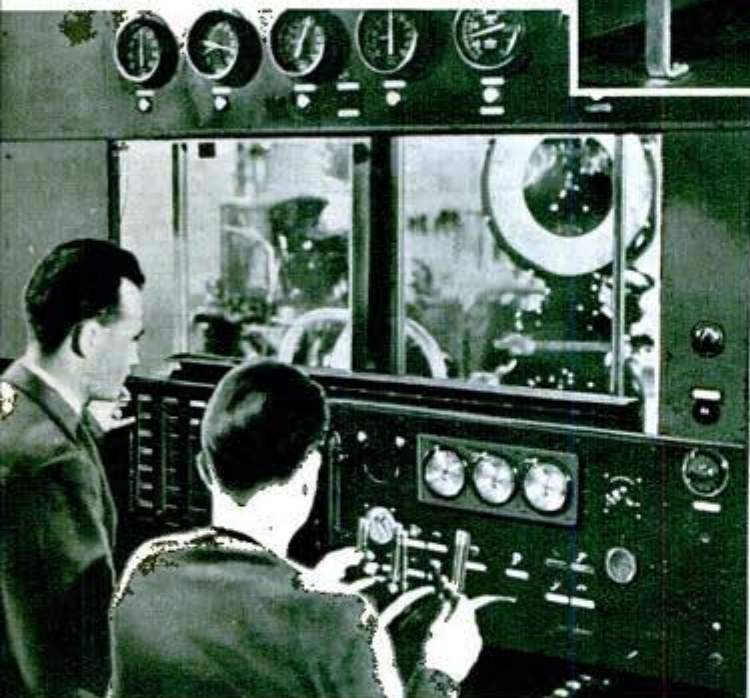

Technicians above watch behavior of engine burning special fuel in test cell. Below, "plugging back" a well with bridging plug to explore intermediate strata for oil

smooth out all the microscopic high points on cylinder walls and bearings.

Such research produced styrene from petroleum, a chemical jack-of-all-trades that starts out as a pungent water-clear liquid and can be turned into a transparent solid for use as window panes; into insulators for high voltage electricity; into a cellular honeycomb that weighs one-twentieth as much as cork; into a cottony fiber that insulates against heat, and

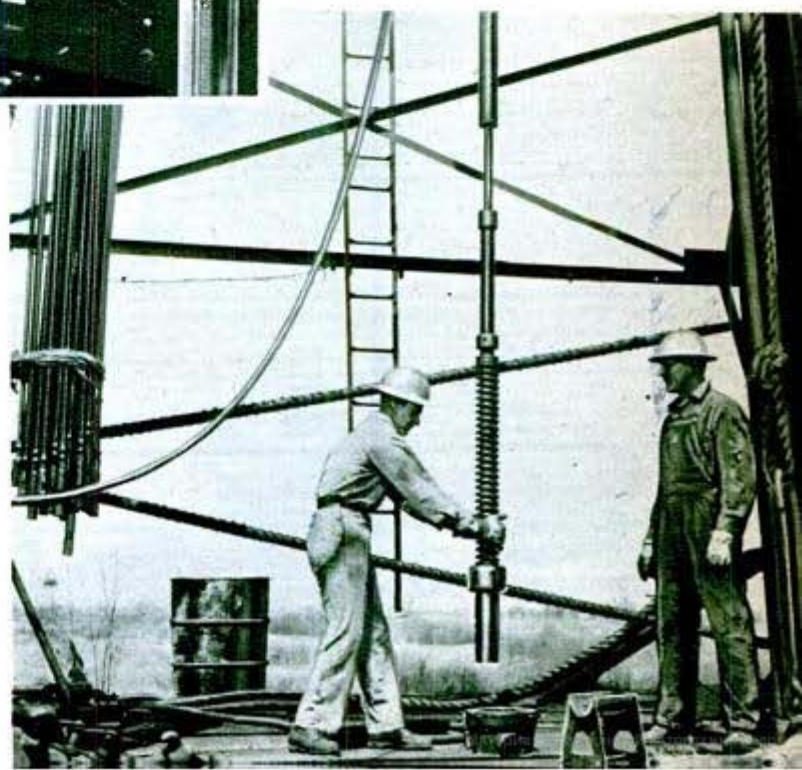

Navy Tug Has a Train Ride to Launching Site



Tough little tugs built for the Allied war fleets at Trenton, Ont., see a good deal of Canada before they go off to war. Their 13½-ton Diesel engines are built in Vancouver, their plates come from Montreal, and other prefabricated parts from around the Dominion. The welding and assembly

are completed in a plant two miles from water, so the tugs are loaded on flatcars for a two-mile train ride to the launching site. After trial runs on Lake Ontario, including tests of fire fighting apparatus, they are shipped aboard big ocean transports from American ports to their theaters of duty.

71919

'Supercharged' Airplane Heater Weighs Only Six Pounds

Stratosphere comfort is assured with a midget heater designed for use in bombers, fighters, or any high altitude craft. The

gasoline-burning heater, which weighs only six pounds, lights and burns almost instantly at temperatures down to 70 de-

grees below zero and altitudes ranging from 57,000 feet (simulated altitude in pressure chamber test) to sea level. To support combustion in the upper altitudes, a surplus of air is mixed with the fuel as in the cylinder of a supercharged engine. Vaporized fuel is burned in the center of a column of spinning air produced in the combustion tube by an electric-motor-driven fan. Large planes use as many as 15 of the midget heaters, not only to warm compartments but to prevent ice from forming on wings, to keep bomb sights clear, to keep instruments, gun breeches and other equipment operative, and for warming the engines. The unit was developed by Surface Combustion Laboratories, Columbus, Ohio, and Wright Field engineers.



*Mr. C. C. Powers
2108 Terminal Tower
Cleveland, Ohio.*

*Surface Combustion
Toledo, Ohio.*

FLAK, UNLIMITED

*Mr. Simon
3872 Franklin
San Diego 270*

ONE of the mechanical marvels of the war is the Bofors 40 millimeter antiaircraft gun. An electric brain tells it where to aim. Electric muscles point its barrel at the target. Its shells are fired automatically. The human gun crew simply keeps it supplied with ammunition.

This automatic cannon uses high explosive tracer shells that can be fired at up to 120 rounds per minute, and fused to burst upon contact with any part of an airplane's structure. One shell can blast apart an aircraft engine or rip off a wing section.

What good is it against enemy aircraft that stay out of range? It keeps them high and makes bombing inaccurate. The automatic's big brother, the 90 millimeter high altitude gun, works on aircraft that stay in the upper levels.

But the Nips and Nazis are doing relatively little bombing from high altitudes. Much of their operations against Allied installations are at low altitudes, within the range of .50 caliber machine guns and the 40s.

A 40 millimeter cannon has its own power supply and its own mechanical director. The director is a mathematical computing machine that is mounted on a turntable so that its operators can watch and track the target aircraft through telescopes that are attached to it. The machine translates the movements of the telescopes into firing data and at the same time computes the lead that will be necessary to hit the flying target.

The director is connected to the gun itself by an electrical cable through which power is supplied to operate motors that control the gun's traversing and elevating gears. Thus the gun is aimed by remote control. Only the ammunition passers are normally stationed at the gun itself during action. In case of battle damage to the power supply or to the director, the men who operate the director take their posts at

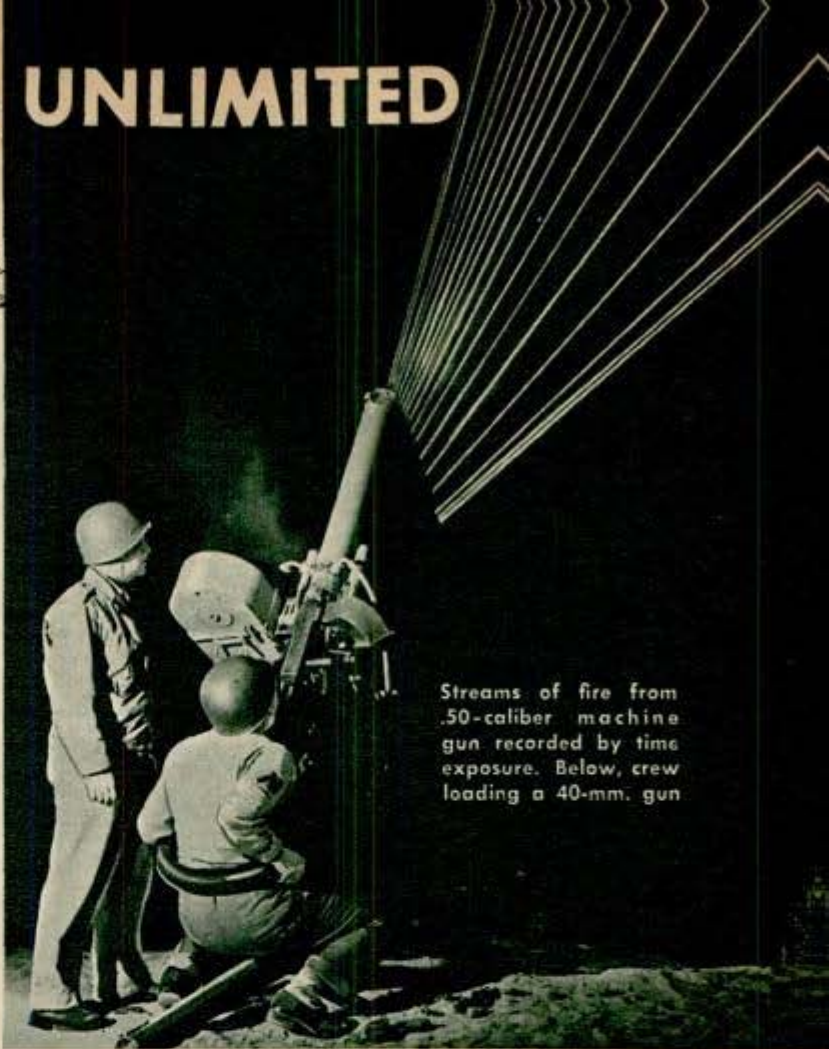

Streams of fire from .50-caliber machine gun recorded by time exposure. Below, crew loading a 40-mm. gun





the gun and aim it by hand. They also serve at the gun itself when the barrel is depressed for firing at ground targets. The 40 is an effective weapon against vehicles, tanks, and torpedo boats.

Even the member of the crew who loads clips of shells into the gun becomes an automaton during battle. He stands with one foot pressed against the firing pedal, a rope tied around his ankle. To stop the gun, another member of the loading crew grabs the

Passing ammunition for 40 mm. gun which fires up to 120 rounds a minute. Note size of shell

Right, men at table in plotting room practice charting incoming enemy aircraft on the squares



Crew of 40 mm. gun takes bead on aerial target. Gun is fired by remote control or by hand in emergency



rope and yanks the loader's foot off the pedal. The loader himself can't hear the "cease fire" command above the explosions of his gun and he's too busy to watch for such an order.

The nerves of a 40 millimeter gun crew are keyed to hair-trigger action in combat areas. An aerial attack may be over almost as soon as it begins. There may be only a momentary roar and then the enemy plane hurtles past overhead, out of range and out of sight almost before the gunners can swing their weapon toward it. The automatic 40s as well as .50 caliber machine guns are scattered through areas that are within range of enemy air attack. The big machine guns, too, can tear an airplane apart with their streams of bul-

lets. Their effectiveness has recently been increased by means of a new type of incendiary bullet that sets fire to the plane upon contact and that is capable of blowing up self-sealing fuel tanks in aircraft.

Because of the suddenness with which an air attack may come, members of gun crews are always at their guns while on duty. The anti-aircraft artillery guards against surprise by maintaining an aircraft warning network that reports the presence, direction, and altitude of all enemy aircraft that are sighted from any of the observation posts. Half a minute's warning is more than enough for a gun crew to swing the gun in the expected direction, ready to open fire.

Often the guns are mounted on the roofs of buildings or on the tops of special anti-aircraft towers that provide better visibility horizons and fields of fire. In spite of the fact that they disclose their positions when they go into action, the guns are usually camouflaged. This prevents enemy air observers from detecting their locations ahead of time. A haystack in a field, an agricultural tractor, even what appears to be an ordinary house may be nothing more than a shell that is collapsed for action. Dummy gun emplacements, too, are used to fool the enemy, and the anti-aircraft crews sometimes replace the dummies with real guns, or place dummies in the concealed positions that they once used, to help keep enemy air-men confused.

A complete defense against air attack in-

Spotter at field telephone calls in alarm



Member of director crew gives alert to gunners; note optical gas mask. Below, powerful searchlight hunts air target



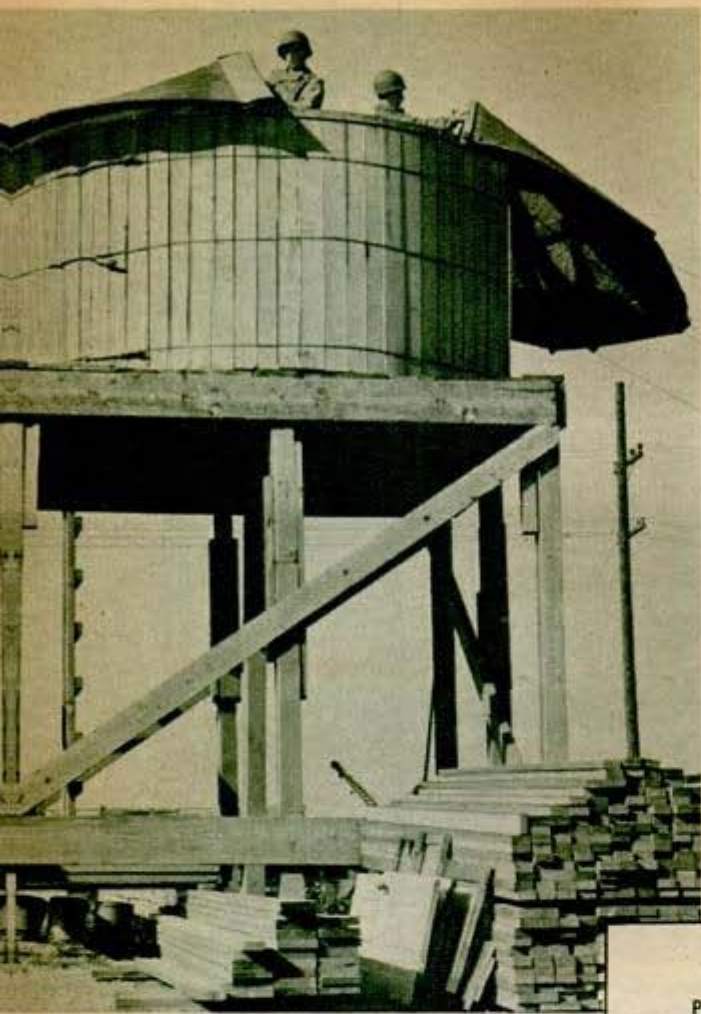

Roof of this dummy water tower pushes back to reveal .50-caliber machine gun

cludes an aircraft warning network, fighter planes, light and heavy anti-aircraft guns, radio detectors, searchlights, barrage balloons, and smoke pots.

Barrage balloons are a pretty effective defense against dive bombing and low level attacks. The big balloons contain hydrogen, a source of possible danger when they are hauled down to the ground for maintenance or during stormy weather. Members of the balloon crews never wear woolen shirts and they must wear hats at all times, two precautions to avoid stray static sparks that might ignite leaking hydrogen. Keeping the head covered prevents possible static accumulations in the hair. Cats and dogs are also barred from balloon

Five-man director crew wearing optical gas masks supply it with necessary data by which the machine translates movement of target to anticipate position

sites to prevent accidents from static sparks.

Rows of smoke pots can be used to blanket a whole area under a thick, low-lying fog bank that conceals specific targets from the air.

No perfect anti-aircraft defense seems to have been developed by any of the belligerents. The best techniques are to use combinations of defense weapons both to distract the attackers from their targets and to knock down so many planes that the raids become too costly to be continued.

In this respect the United States has been eating its cake and having it too. Our air raids against our enemies in many cases have been conducted with minimum losses and at the same time our ground defense units have beaten off, time after time, determined enemy attacks.

Our big armored battle planes have been riddled by anti-aircraft shell fragments without disabling them. In one phase of the African campaign 20 American bombers raided an enemy target and every airplane returned safely to its base in spite of the fact that each of them had received hits from German anti-aircraft guns.

American anti-aircraft crews always expect to make their hits count more effec-

(Continued to page 148)

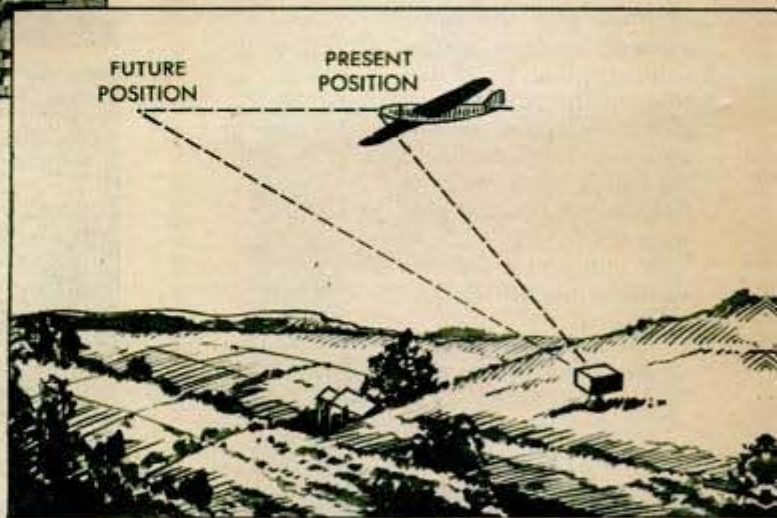

*Capt. Eugene C. Merrill, Air Force Group
Bureau of Public Relations, War Dept 722
Washington, D.C.*

Peek-a-Boo Jeep Hauls Target for Air Gunners

All the tactical problems of combat gunnery in the clouds are simulated by the "target jeep" constructed by the Air Service Command engineers at Spokane Air Depot. By an ingenious series of gear wheels, cams and rocker extension arms, the jeep provides machine gunners and cannoneers of the Second Air Force with a small-sized target whose bobbing and weaving calls for even greater accuracy than is demanded in actual combat. The jeep's target arms rise and fall at irregular intervals, and with such rapidity that gunners must be ever on the alert to hit it. The jeep operates



Spokane Wash.

Driverless jeep, guided by monorail, moves aerial target behind eight-foot embankment. Gear wheels (left) cause target to perform "combat maneuvers"

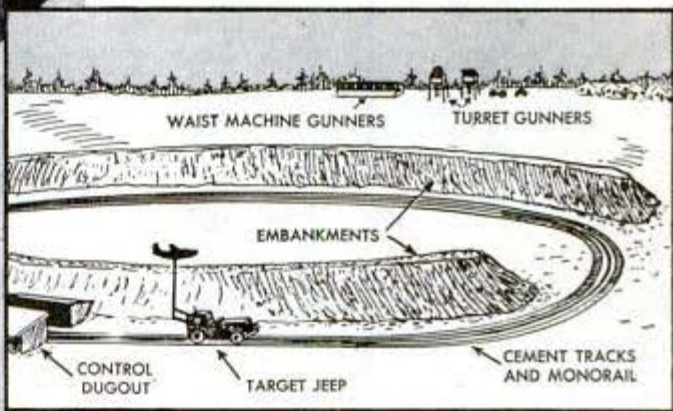
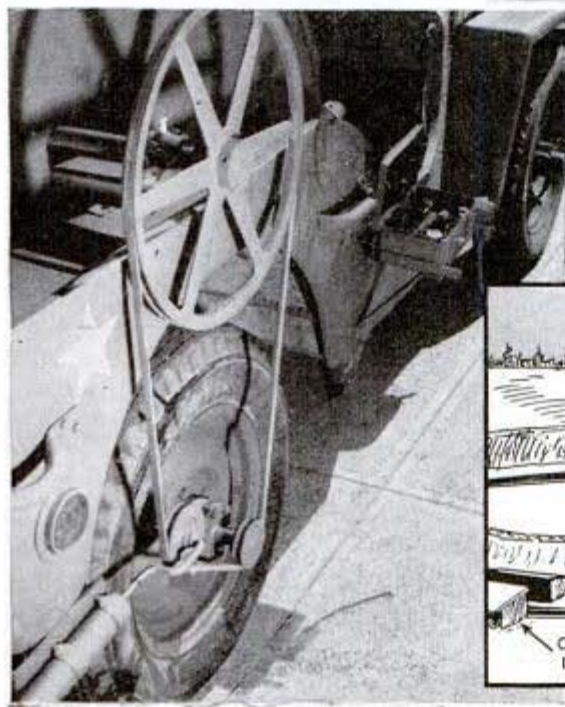

without benefit of a driver, who might be hit by splinters. It is guided by a monorail, which governs the direction of the front wheels, while two concrete rails guide the tires. The jeep runs throughout its course behind an eight-foot embankment, over which the plane target periodically bobs into view, as an eccentric cam throws the

extension arm upward. When operators in the control house on the target range wish to stop the jeep, they stick a broomhandle out to trip a lever hanging from the switch-box on its side. The target mechanism is operated from a pulley on the rear axle, and a change in these gear wheels regulates the speed of the target operation.

Chemical Turns Any Skin White; Effects Will Last Up to Six Years

Discovery of a chemical that turns skin of any color white has been announced by Dr. Louis C. Schwartz, medical director of the United States public health service. During a study of a skin disorder among Negroes employed in a leather plant, the

hands of workers wearing chemically treated gloves became white. The chemical was intended to prevent deterioration of the gloves. Later experiments on the skin of animals disclosed that the change lasted from six months to six years.

during session of Medical Society of Pennsylvania.

NO. 1 ENEMY *on the* HOME FRONT



"Turret guns" atop crash truck fight test fire in gasoline-soaked fuselage at the new Douglas-Chicago aircraft factory

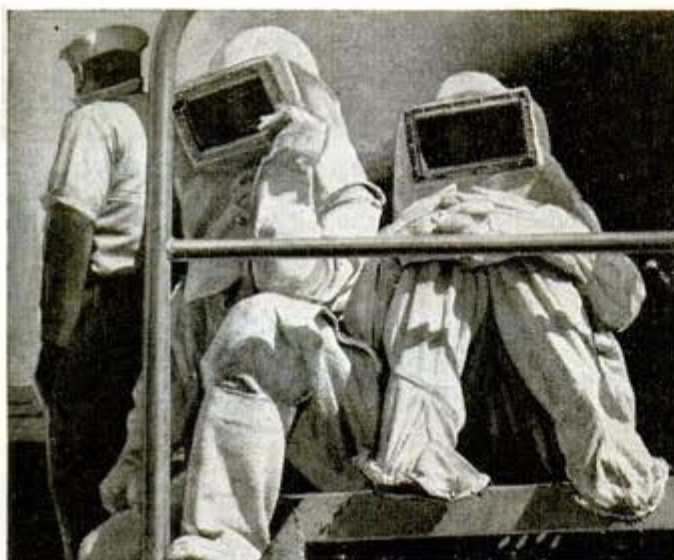

Asbestos-clad fire fighters on aircraft carrier can get close to blaze. Below, all-steel trailer-type fire engine is hauled behind passenger car or can be mounted on deck of a ship

Chrysler Corp. photo

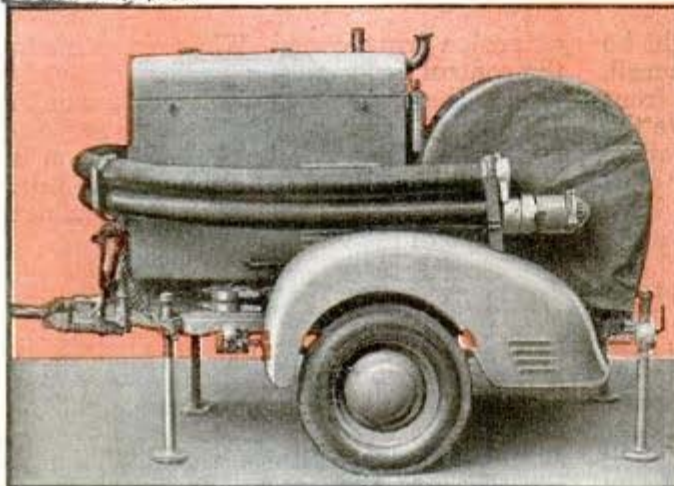

HOMES that fire destroyed in one year would have housed the entire city of Los Angeles. In one month, dwellings of 395,000 persons were ruined by fire, while only 350,000 new units were built. Forest fires destroyed enough timber to build 20,000 Liberty ships. Farm buildings burned to the ground every 15 minutes. One fire alone destroyed enough flour to feed an army of 500,000 men for an entire year. Fire last year killed more Americans than died in the hills of Sicily and on the beach at Salerno.

Yet four out of every five of these fires were the fault of some single human being. That many—80 percent—result from nothing but carelessness. That many, with all the lives they cost and the property they destroyed, were preventable.

"Fire is a double waste," says Lt. Gen. William S. Knudsen, production director for the War Department. "It attacks buildings, equipment and materials. It stops production and causes waste of precious man hours. Fire can be prevented by care."

The great war plant building program admittedly increased, in some cases, the likelihood of fire. As Percy Bugbee, general manager of the National Fire Protection Association, pointed out:

"The urge for speed and production brought about the erection of buildings of huge area and of inferior construction and, in many cases, without adequate fire-protection facilities."

Mr. James Cahin

71846



This does not mean that an industrial plant, just because it is new, necessarily does not have adequate fire protection. But it does show the need for additional caution.

Moreover, even in plants with all the safety devices that exist—with all the fire walls, automatic sprinklers, automatic fire alarms, watchmen constantly on the prowl and a plant fire department equipped for anything—even in such a plant fire can be the home front's worst menace. Because no fire-fighting tool ever invented was proof against that greatest of incendiaries, carelessness.

Simple things cause fires: a choked chimney, a faulty furnace, an inflammable roof; broken electrical equipment, careless handling of gasoline, a dropped cigaret, neglected rubbish piles. But a simple hazard and a simple careless act

Sea-going firemen are protected by "spray umbrella" at Navy fire-fighting school. Below, special nozzle to produce "waterfog" Courtesy Rockwood Sprinkler Co.

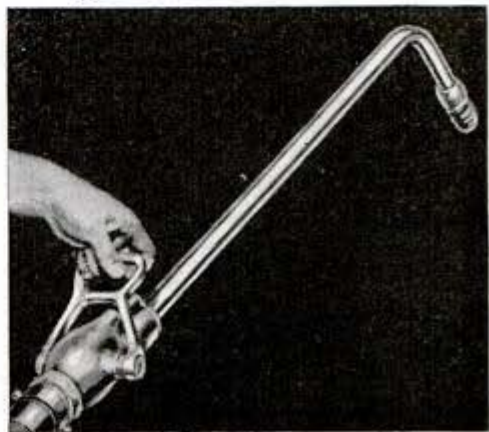

APRIL, 1944

38 Harlow St. 83

Worcester, Mass.

История, общественный авторский право

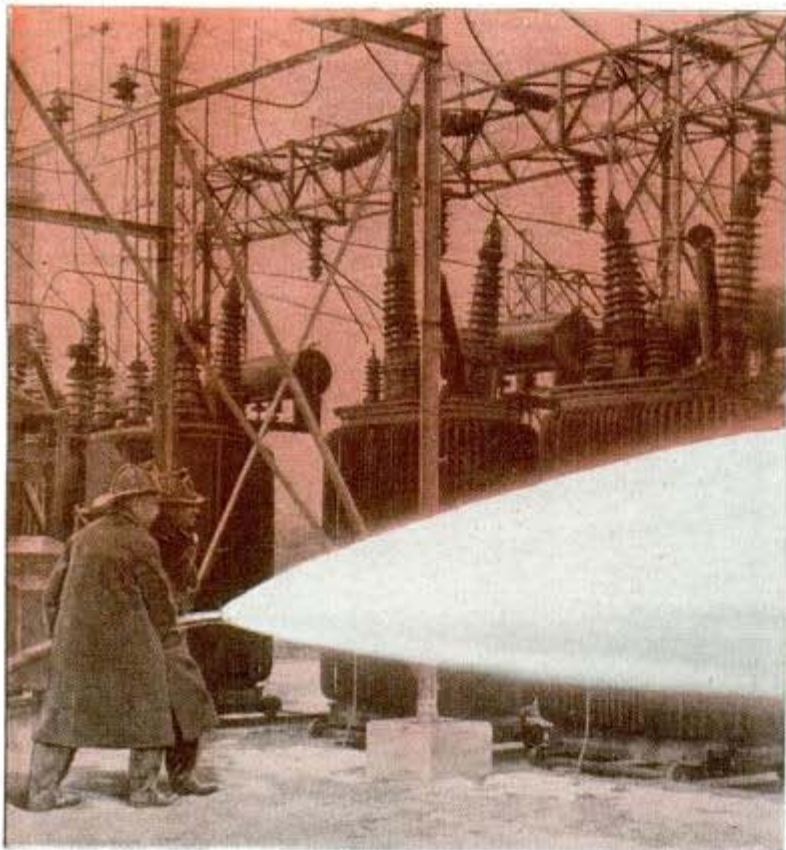

Courtesy American LaFrance-Foamite Corp.

Safety nozzle sprays stream of water on live circuit of 250,000 volts

may have complicated and costly results.

"Fire caused by carelessness and ignorance is just as effective an aid to the enemy as though it were caused by sabotage or incendiary bombs," Mr. Bugbee reasons. Which leaves it up to every individual to be his own "fire watcher," and to be just as devoted to that job as if he were actually on a rooftop, spotting the outbursts of flame from enemy bombs.

Science and industry have combined to give America unsurpassed tools for fighting this, man's most ancient enemy. But the tools are of most value when, like a football team's numerous reserves, they merely back up the people who are the real first line of fire defense.

Recent advances in fire fighting technique have seen principally an increased use of smothering agents, of sprays, and of chemicals that either combat flames directly or act as fireproofing agents.

Treated wood is lifted from test chamber by crane after exposure to flames

Photo from DuPont Co.

Use of carbon dioxide gas, which smothers flames by depriving them of the oxygen needed for combustion, has increased. Portable equipment is used, or fixed installations down which the gas, stored in highly compressed liquid form, can be channeled. One such installation developed by Walter Kidde & Co., and widely used on American and British merchant ships, features a "juke box that can smell smoke."

This is a cabinet set in the ship's wheelhouse. It contains a photoelectric cell actuated by a constant light beam. Smoke interfering with this beam sets off the fire alarm.

Pipes on the underside of each deck constantly collect air samples from every hold, and this air is drawn through the "juke box" by a fan. When smoke is detected an alarm bell rings; the location of the burning hold is indicated, and billowing clouds of carbon dioxide can be directed back into the hold down the very pipe that also acts as the smoke detector.

War plants use similar cabinets with the

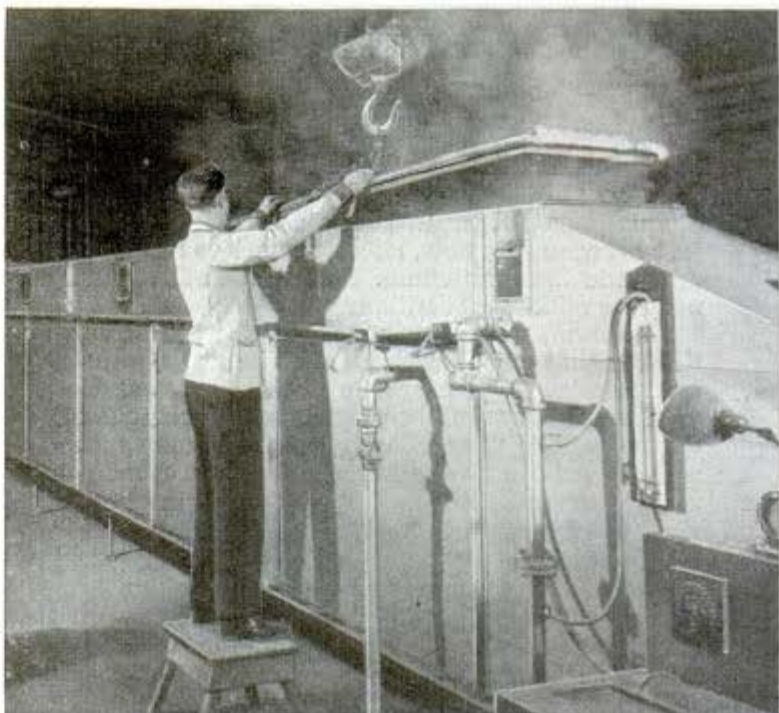

"photoelectric nose" to detect smoke. Discharging a few cylinders of carbon dioxide over the fire reduces the air's normal 21 percent oxygen content to 14 or 15 percent, and in that tenuous atmosphere few inflammable liquid fires can continue to burn. Even carbonaceous fires, involving wood, paper, cotton and the like, are so checked that spraying water on the glowing embers kills them.

The C-O-Two Company has devised a hand-grip valve that will fit any hand-type carbon dioxide extinguisher, to replace the wheel valve. With it, the gas can be turned on and off with one hand while the operator plays gas on the blaze with the other hand. The tremendous pressure within the cylinder keeps the valve tightly closed when the grip is released.

Another method of smothering stubborn fires, developed by the Pyrene Manufacturing Co., is said to enable the fireman to manufacture on the spot 350 gallons of fire-smothering foam from only 19 gallons of water and one gallon of "Phomaide" solution. Water is brought from hydrant, suction or booster tank, through the hose line, and the foaming solution, carried in

Smothering "spill" fire spreading in stream of oil with carbon dioxide gas from portable extinguisher
40 C. 34th St.
 Courtesy Walter Kidde & Co.

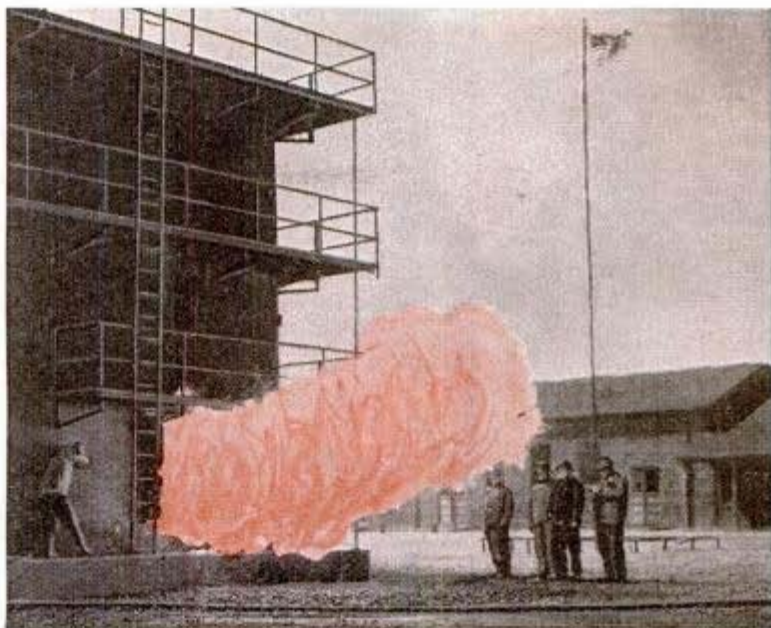

Fighting flames from explosion during test. Below, torch fails to ignite a fireproof blackout curtain
 Courtesy DuPont Company





Courtesy John Bean Mfg. Co.

Fine spray from fire fighter gun protects fireman

a tank on the fireman's hip, is mixed with water and air in a special play pipe to form the foaming clouds.

Both foam and high-pressure spray are utilized in airport crash trucks to fight stubborn gasoline and lubricating-oil flames that may spread from a cracked-up plane. The John Bean Manufacturing Company, a division of the Food Machinery Corporation, uses extremely high pumping pressures to create a fog that is said to quench flames with utmost speed, at the same time minimizing water damage.



Courtesy C-O-Two Fire Equipment Co.

Slight squeeze opens valve of extinguisher. Left, "waterfog" during test
 Courtesy Rockwood Sprinkler Co.



and smothering effect of the misty clouds.

A development of the American-LaFrance-Foamite Corporation is a spray gun for the standard hoseline, producing any stream required from a straight, full-pressure one to a full curtain of mist. Another is a nozzle that permits firemen to play water safely on electrical equipment with a charge of as high as 250,000 volts.

Normally, of course, water could hardly be applied with safety by

Rockwell-Barney Co.
35 E. Wacker Dr.
Chicago, Ill.

"Rock-a-Bye" File Saves Space And Speeds Work of Operator

71832

hand hose on live electrical equipment because the water itself conducts electricity. The company's "Poweron" nozzle is said to be safe at distances of only a few feet, and at low pressures.

Similarly, the same company's 100-pound "Alfite" engine is a piece of portable equipment approved for use on electrical fires.

Rockwood Sprinkler Company manufactures equipment that makes it possible to use ordinary water on flammable liquid fires. It comes as fixed piping for such hazards as quench tanks, dip tanks, transformers, dryers, and the like, and as a portable nozzle or applicator that can be used directly on a fire hose line.

The future for such fine sprays in firefighting is thus summarized by Rockwood spokesmen:

"In addition to playing a major role in our war activities, we believe that Waterfog will revolutionize fire fighting after the war, when the men who are being trained by the Navy and who are using Waterfog to control and extinguish dangerous flammable liquid fires at sea are returned to civil life."

Chrysler is turning out in mass production an all purpose fire engine that can be hauled as a trailer behind an ordinary passenger car or placed intact on any other sort of mounting, such as the deck of a barge or ship. These miniature fire-fighters are of especial value in areas subject to air raids, for many of them can be spotted advantageously at minimum cost.

They comprise an engine with an automobile rating of 115 horsepower operating a pump of 500-gallons-per-minute capacity at 120 pounds pressure, or as an alternative, 250 gallons a minute at 200 pounds pressure for fires demanding a very powerful stream. Generally carried are two sections of suction hose and 500 feet of 2½-inch standard fire hose, and a variety of nozzles.

The engine and pump unit is mounted on skids so that it may be placed in a two-wheeled, steel-framed trailer. London uses several thousand similar small-sized pumpers for air raid service.

Control of fire should also emphasize prevention, according to

(Continued to page 152)

Reaching for folders in rear is eliminated with rocker compartment that permits the folders to be removed sideways from case



Considerable savings in floor space and in the time of filing personnel are claimed for the "Rock-a-File" cabinet, with compartments that open sideways. The whole inner compartment rocks through a quarter turn. Time is saved, the maker says, through quicker action, by the elimination of vertical lifting of filing folders at arm's length, and the end to stretching to reach rear folders. Folders are slid out sideways. With more than one operator working on the files, there is less interference, and the operators are able to work closer to the folders. Compartments may be left open—all day if desired—to reduce the total muscular effort. The saving in floor space is credited to the relatively small projection of the compartments when swung out, as compared with drawer-type files. The fact that the weight of the filed material is always well within the file shell is said to prevent overbalancing.

Some woods, such as red oak, are so porous that it is possible to blow out a candle through the wood.

Trailers Carry Big Bombs

Blockbusters, two- and four-ton bombs whose blasting effect is proved by reconnaissance photos to reduce huge urban areas to rubble, are trundled aboard R.A.F. night bombers in cradles of heavy steel. The huge bombs look like nothing so much as inoffensive railway tank cars, but their cylindrical sides contain from 4,000 to 8,000 pounds of steel and powerful high explosive. Lancasters of the Royal Air Force have been used with particular success to transport these bombs over the walls of Hitler's "European Fortress."



'Locomotive' Truck Pushes Eight Cars Along Rails

With a converted undercarriage, a U. S. Army truck is pushing freight on a railroad in England. Before it started doubling for a locomotive, the truck was an ordinary two and a half ton vehicle. It pushes seven or eight freight cars along a road operated by the U. S. Army railroad unit. This group is composed of well-trained men who formerly worked for railroads in the states.



Shining Fluorescent Stars Dot Celestial Sphere

By cementing together two astro-domes, the translucent "bubbles" through which navigators on bombers take their bearings, Lt. Col. J. E. Davis of Wright Field made a unique celestial sphere. The stars appear as they do when one looks up at them from the ground if you peer through the plastic sphere. Ordinary celestial spheres show the stars from a position looking down at them from outside the universe. Col. Davis drilled holes for the star positions and filled them with fluorescent material.



Public Relations Service
410 Michigan Ave
Detroit, Mich.

77713

in England

77863



The CRAFTSMAN

"Duration" PUMP CAR is all wood

There's no reason why junior can't have a pump car due to metal priorities because you can make an all-wood model. However, for axles and bearings, it's best to find some scrap pieces of flat iron and some 1/2-in. rod or carriage bolts



By Charles and Bertram Brownold

IN BUILDING this pump car you start construction with either the wheels or the framework, but the latter and the rear wheels must be assembled together. The two rear wheels, which function as a single unit, each consist of four 1/4-in. disks of hardwood—or waterproof plywood, if you are able to get it. The disks are cut slightly oversize on a scroll or band saw, then glued together under pressure as shown in Fig. 3, using waterproof glue and arranging the disks so that the grain of each one will run at right angles to that of adjacent ones.

Small scraps of wood under the jaws of the clamps will prevent marring the work. After the glue has dried thoroughly, the disks are turned to exact size on a lathe, and two 1-in. holes are bored through each wheel according to the dimensions given in Fig. 6; the center holes to take the axles and the others to take the crank pin.

Then you assemble each wheel to a side frame member with a turned hardwood axle and a wooden washer, shown in Fig. 4, fastening the axle in the center hole of the wheel with glue, and using a hardwood wedge to spread the slitted end of the axle as shown in Fig. 1. In this all-wood design,

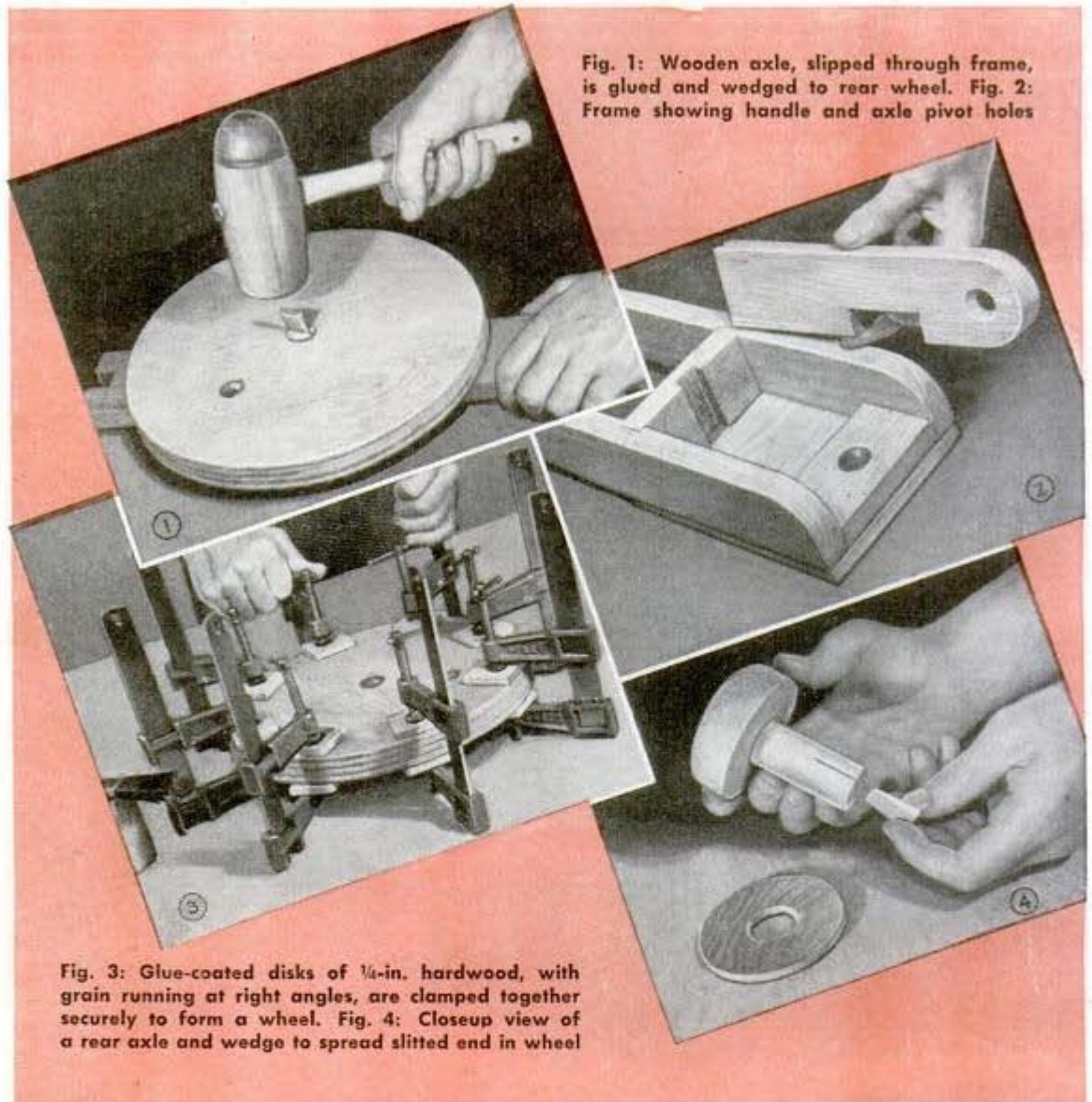

Fig. 1: Wooden axle, slipped through frame, is glued and wedged to rear wheel. Fig. 2: Frame showing handle and axle pivot holes

Fig. 3: Glue-coated disks of 1/4-in. hardwood, with grain running at right angles, are clamped together securely to form a wheel. Fig. 4: Closeup view of a rear axle and wedge to spread slitted end in wheel

the axles are intended to turn in the frame members. Naturally both must be hardwood so they will last as long as possible. To assemble the rear wheels and the connecting rod between them, the latter is slipped over the crank pin, a wooden washer being placed on either side of the connecting rod, after which the crank pin is secured to each wheel with glue and wedges as was done with the axles.

Assembling the front and rear pieces of the frame to the side members comes next, which is followed by the installation of the handle, front axle and wheels, and the seat, all of which are detailed in Fig. 6. The assembly of the front portion of the frame is shown in Fig. 2. Notice the hole for the pivot pin that holds the front axle. The pin is glued and wedged in this hole, and a cotter pin is inserted through the lower end of the pin to keep the axle from slipping off when the car is lifted.

When wooden axles and pins are used in wooden bearings, the bearing holes should be slightly oversize to avoid "freezing" of the axles or pins due to their swelling caused by absorption of moisture. Soaking the axles and pins in hot, melted paraffin will reduce the absorption of moisture. If holes in the frame members and wheels are bored with a hand brace and bit, clamping the parts down horizontally on a bench and using a small try square as shown in Fig. 5, will help in boring the holes true.

Fig. 7 shows how 1/2-in. carriage bolts can be used for axles and how small iron plates attached to the wheels can be arranged as bearings. Note from the center detail that the heads of the bolts used for the rear axles are cut off and that the threaded portion of each bolt is fastened firmly to the frame with two nuts, washers and lock washers. A pin through the frame locks the axle in position. In this assembly

the wheels turn on the axles. The rear wheels will not slip off their axles, nor will the axles project far enough inside the wheels to interfere with the connecting rod, if spacing of the parts is carried out with care, measuring all distances accurately between the frame members and the rear wheels, and also between the rear wheels themselves. Washers on each side of the connecting rod should center it and give it slight clearance. As individual thicknesses of each assembly may vary slightly, exact dimensions as given may have to be varied somewhat to suit. Two iron plates are recessed in each wheel directly over its center. These are held together by two flat-head bolts, the heads of which fit flush on one plate. The other plate is drilled and tapped to receive their threaded ends.

The wooden front-wheel axle is slotted or drilled to receive lengths of $\frac{1}{2}$ -in. rod or sawed-off portions of carriage bolts as shown in the right-hand detail of Fig. 7, which are held in place by means of stove bolts. Front-wheel bearings are iron plates like those on rear wheel.

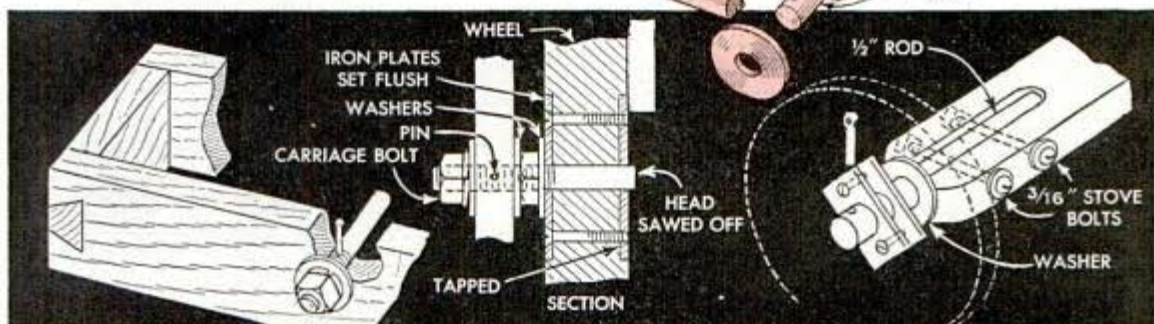
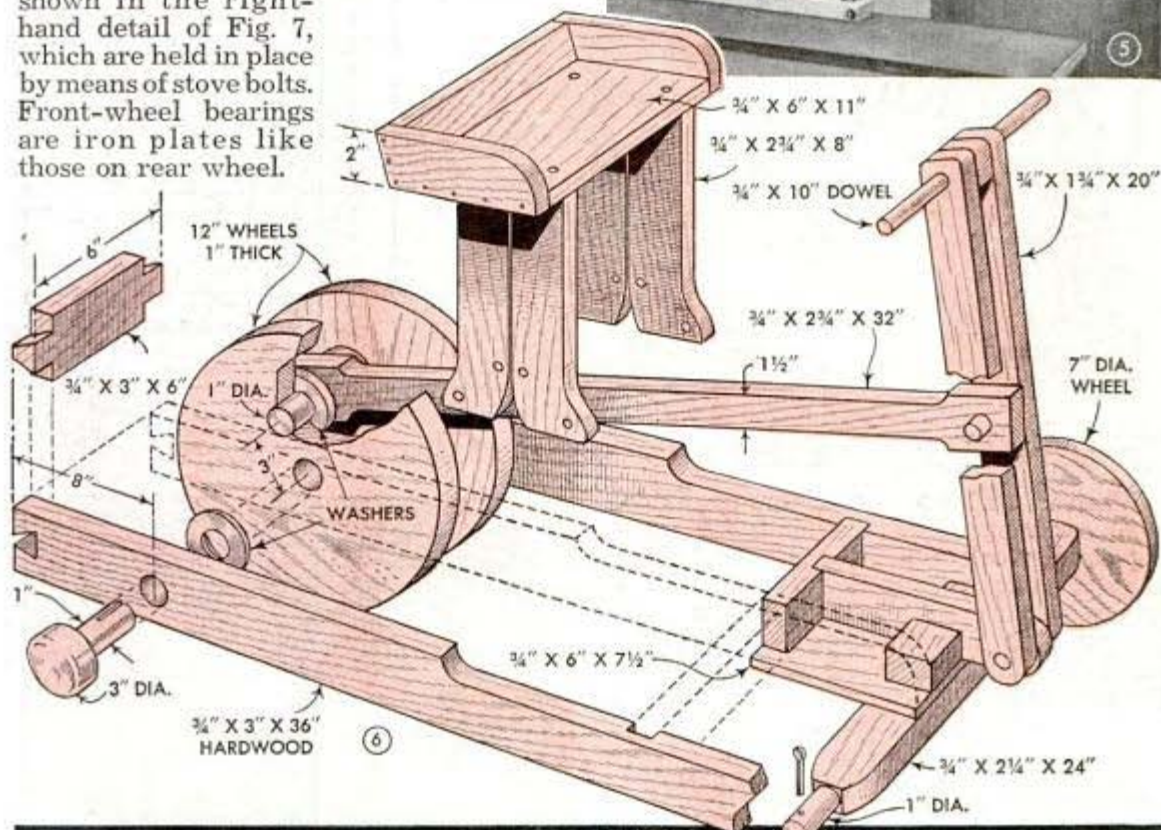

7 METAL WHEEL BEARINGS AND AXLES CAN BE USED INSTEAD OF WOOD TO REDUCE WEAR

Ladder Hoist Swings Heavy Birdhouse on Pole

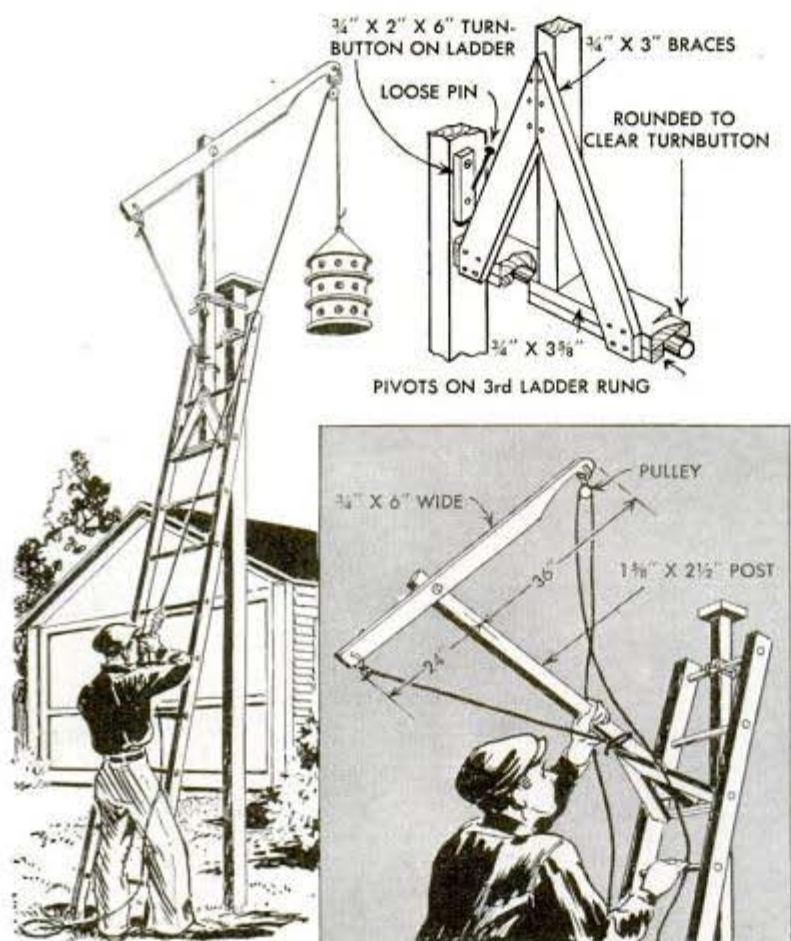

If you have occasion to put up or take down a large birdhouse, or do other light hoisting jobs, this simple hoist and a ladder will enable you to do the work easily. As shown, the hoist is supported on a rung of the ladder where it is held by turnbuttons and two cleats nailed to the underside of the horizontal support piece. A cross-arm or crane is bolted to swing on an upright, which can be any desired height. In use, the cross-arm is held at the desired angle by a rope tied to the upright, while the latter is tied to the birdhouse pole, the ladder also being tied to the pole. After the house has been raised to the necessary height, the hoisting rope is tied to the ladder and the rope which secures the hoist is let out until the hoist swings back far enough to ease the house into position.

—A. L. Mills, Chicago.

Trouser Hanger Serves as Gluing Clamp for Light Work

When there is no other clamp available, a trouser hanger comes in handy for holding small work while the glue dries, or when it is necessary to clamp work together for trial assembly. After slipping the hanger over the work, move down the small ring on the hanger hook to press the jaws of the hanger firmly against the work.

—Wm. Swallow, Brooklyn, N. Y.

Air-Rifle Target Is Self-Setting

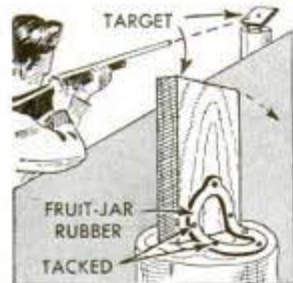

A small block of wood and a discarded fruit-jar rubber are all you need to make this simple self-setting target. Use the rubber as a hinge and mount the target on any suitable support. The

target must be light enough for the rubber to return it to vertical position when hit.

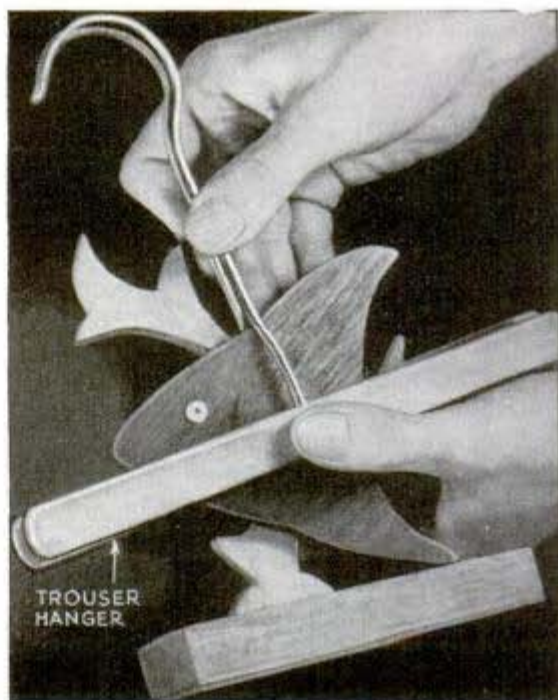

Dart Target Has Folding Back for Easy Storage

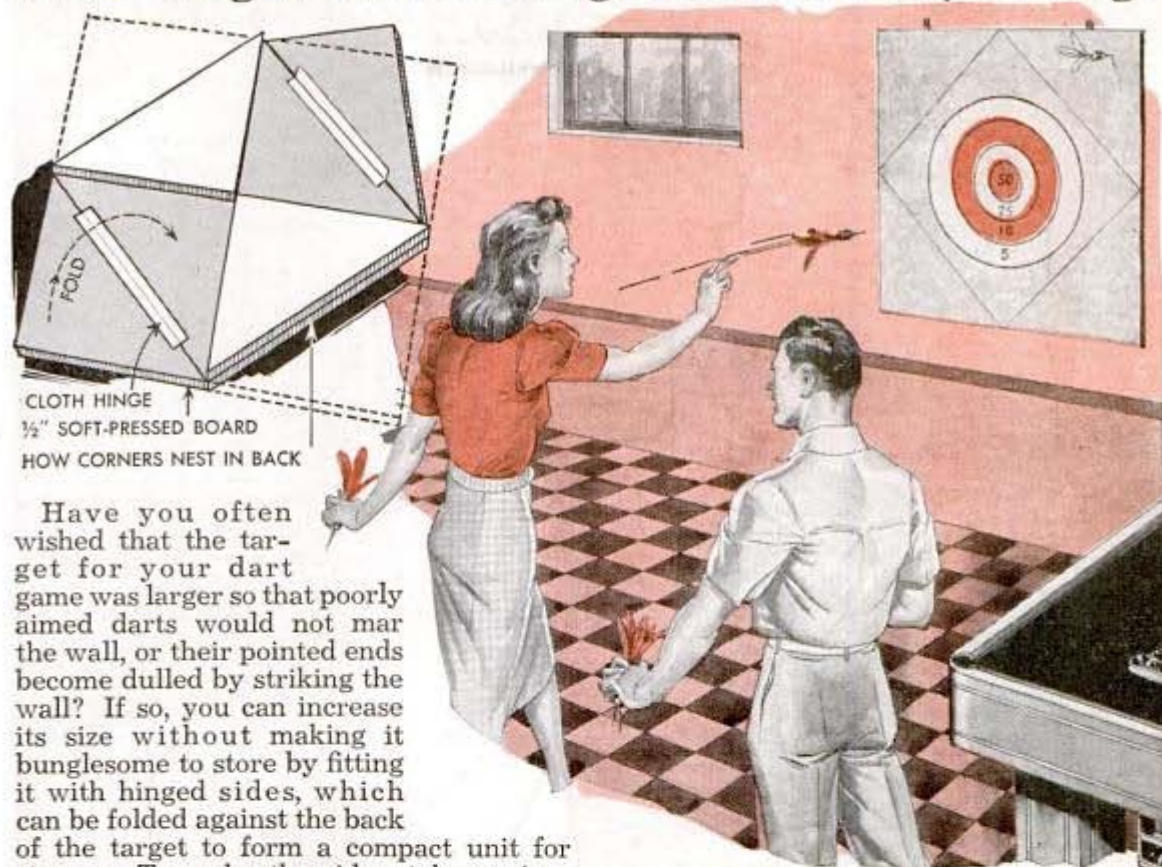

Have you often wished that the target for your dart game was larger so that poorly aimed darts would not mar the wall, or their pointed ends become dulled by striking the wall? If so, you can increase its size without making it bunglesome to store by fitting it with hinged sides, which can be folded against the back of the target to form a compact unit for storage. To make the sides, take a piece of soft-pressed board, the kind used in insulating work, of the same size as the target and cut it diagonally from opposite corners. This will give you four triangular

pieces which are hinged to the target edges with cloth tape. Hang the target as indicated in the upper right-hand detail.

—R. Boettinger, Englewood, N. J.

Self-Closing Tool Box is Handy on Garden Wheelbarrow

To keep small gardening tools at hand when needed, pivot a box made of light



wood between the legs of your wheelbarrow. Make the box to the shape indicated and pivot it off center, placing the pivot screws near the front edge. The weight of the tools then will serve to hold the box closed. Stops at the upper edge keep the box from tipping too far forward.

Grooves Filed in Electric Plug Provide Firm Finger Grip

Flat plugs on the ends of some electric appliance cords often are difficult to grip firmly enough to pull them from wall receptacles. However, if several grooves are filed in the sides of the plug as indicated, a surface that can be gripped firmly is provided.

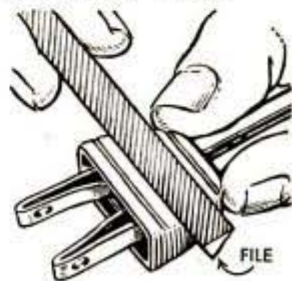

Solving HOME



A wire-type fireplace screen placed over a wall register or near a radiator provides a convenient rack on which to place small laundered articles to dry



A small child can be prevented from completely removing its shoe laces by tying knots in them between the second and third holes as shown

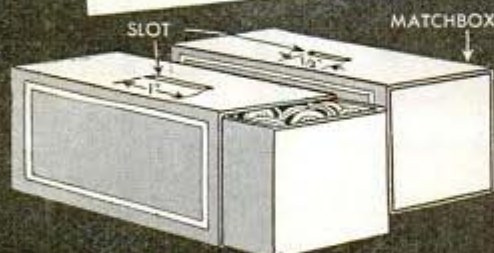

Match boxes with slots cut in the tops and labeled for size and color make neat button "banks" to keep in your sewing cabinet



Lemons will keep much longer if they are given a light coating of melted paraffin which may be applied with a small brush



To keep a ball of yarn from rolling on the floor when quilting, slip it over a curling iron and clip the tongs to the quilt cloth

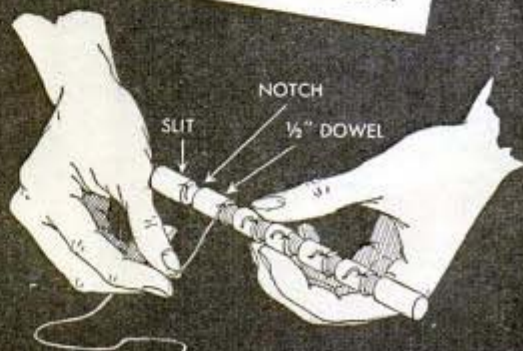

Save tag ends of embroidery threads for future mending by wrapping them on a notched dowel. A slit at each notch prevents unwinding

PROBLEMS

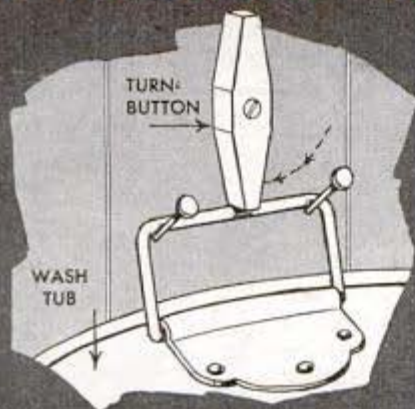

A washtub hung on the outer wall of a building won't rattle if a wooden turn button is provided to wedge tightly against the handle of the tub



Repapering data, such as rolls needed and room measurements, are always at hand if they are written on the back of a wall picture hung in the room



Hinges will need oiling less frequently if the pin has a flat spot filed on one side as indicated to serve as an oil reservoir

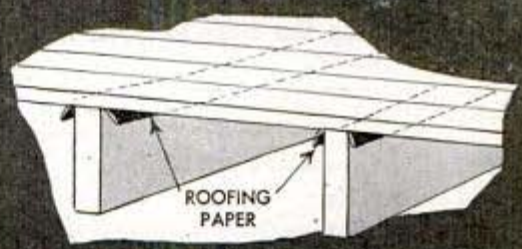

Porch joists will be protected from moisture when the floor is scrubbed, if they are covered with strips of roofing before flooring

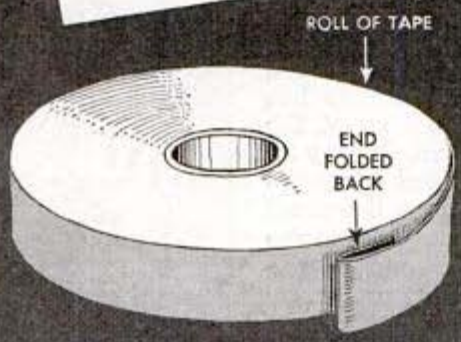

By folding under the end of cellulose or other tape before pressing it against the roll, it will come free easier when next used

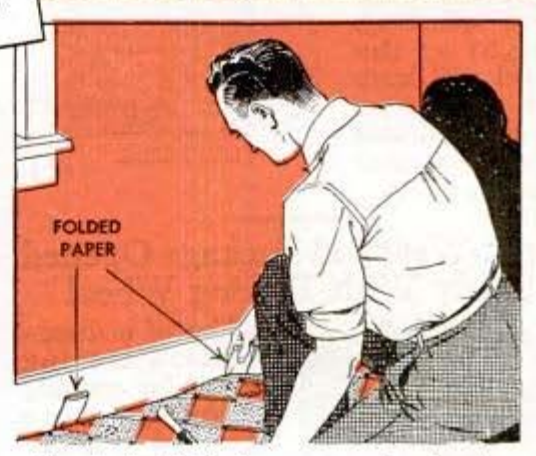

"Handles" of folded newspaper placed under the edge of linoleum, facilitate lifting it when fitting against a wall for trial

Glass Cutter Is Kept in Condition By Storing It in Oil



The wheel of your glass cutter will stay free of rust and roll more easily if it is kept in a test tube containing a mixture of light oil and kerosene. A cork to fit the test tube is placed on the cutter handle as shown and secured with sealing wax. The cork remains on the handle when the cutter is in use and seals the tube as soon as the cutter is put away.

Splash Pan Under Well Pump Is Self Draining

Filled with coarse gravel, an old brake drum makes a good pan under a well-pump spout to prevent water from splashing. Weight of the gravel will keep the drum in place, and the hole allows water to drain away.

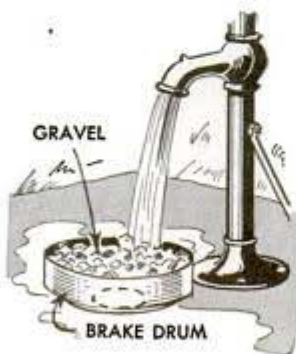

Paper-Wrapped Package Opened Safely With Tracing Wheel



Use of a dress-maker's tracing wheel for opening merchandise wrapped in heavy paper bags or bundles is less apt to damage the contents of the package than use

of a knife. The wheel cuts a perforated line through the paper which permits it to be torn open without difficulty and in the shortest possible time. Use of a knife for this work often results in cutting or destroying the contents of the package.

Cleaning Steel Square With Putty Removes Dirt From Markings

If your steel square or rule has become soiled with dirt or grease so that the indented markings are hardly visible, you can do a thorough job of cleaning them by dabbing and rubbing the surface with a small ball of putty. This is used somewhat like wallpaper cleaner.



Poultry Rings Decorate Purse



You can obtain durable, novel and decorative pulls for slide fasteners on pocketbooks by using a plastic poultry leg marker. The rings are available in many bright colors and

can be combined into necklaces, bracelets, small individual key rings and are useful for many other purposes which you can devise.—Benjamin Nielsen, Aurora, Nebr.

Simple Repair for Slide Fastener Saves Valuable Garments

It isn't necessary to throw away an expensive jacket just because the slide fastener has torn loose at the bottom. It may be repaired by prying open the small starting tabs at the lower end of the fastener and inserting metal strips, which have been punched so that they may be sewed to the garment, into the tabs, as shown. Then the tabs are closed on the strips with a pair of pliers and soldered. With this repair, the ends are held firmly in place and will not pull loose from the garment.—R. Kottmeier, Hamilton, Ont.

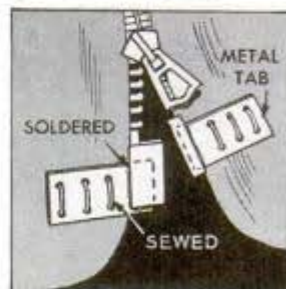

Roomy Hothouse Has Sides of Translucent Cloth

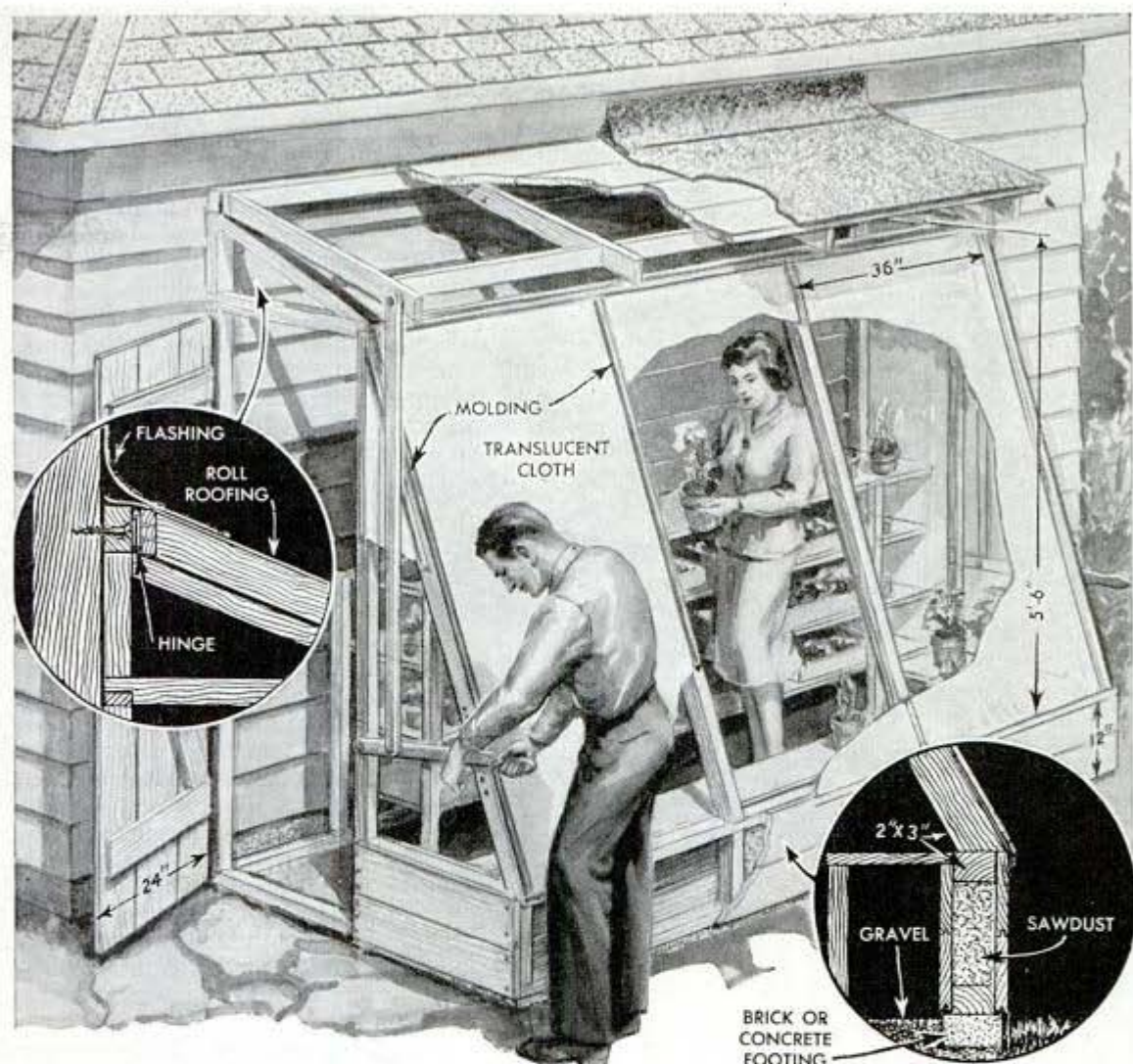

Inability to purchase good building materials should not prevent construction of this inexpensive hothouse because all the materials are readily available. For framing, short lengths of stock can be obtained at your local wrecking yard. All the open panels of the frame are covered with translucent cloth, which is inexpensive and available from mail-order houses at a few cents per square foot. The cloth is attached with tacks, which are then covered with light wood molding. The roof, covered with tar paper, is small and light and is hinged to raise for ventilation by means of a lever at each end. These are adjustable and are held in the desired positions by pegs stuck in holes drilled in the corner studs. Side-walls are only a foot high and are insulated with sawdust as shown in one of the details. The sills should be creosoted and set on a brick or concrete footing. Shelves are provided inside as shown. In severely cold sections the translucent cloth could be

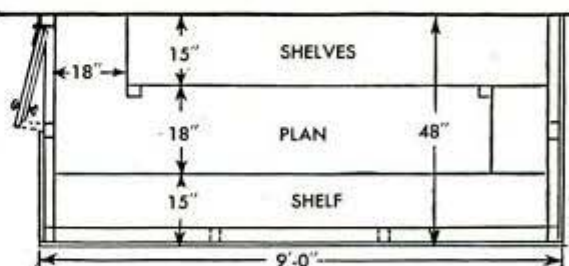

installed on the inside of the framing as well as on the outside, forming an air space between. This type of cloth retains heat better than glass and is durable and waterproof. Heating depends on the weather of your locality. In extremely cold districts a small stove may be necessary. In milder localities, a small electric heater, of the type having a fan and controlled by a thermostat, will maintain the required temperature through winter nights when only a little heat is necessary.

HONOR

for our

DISTINCTIVE and imposing honor rolls placed outdoors amid artistic and well-cared-for landscaping in city wards, parks, small neighborhood communities and on club grounds, can be built by handy craftsmen in any vicinity. Although most of the designs suggested in this article are intended for outdoor use, some of them will serve just as well indoors. For outdoor installations a flagpole is required and therefore various methods of making them are shown and outlined.

14-FT. FLAGPOLE



A substantial honor roll of generous proportions is the classic design shown in Figs. 1 and 2. The glass-paneled cabinet, (cross section shown in Fig. 5), is held on four ornamental cement supports which are placed on radial lines of a circular cement footing. A 14-ft. flagpole rises from the center of the footing, through the cabinet, while a low-privet hedge, enclosing a ring of suitable flowers or plants, surrounds the structure. If desired, the hedge may be cut and a walk laid to join the footing.

To cast the cement supports, you use wooden molds

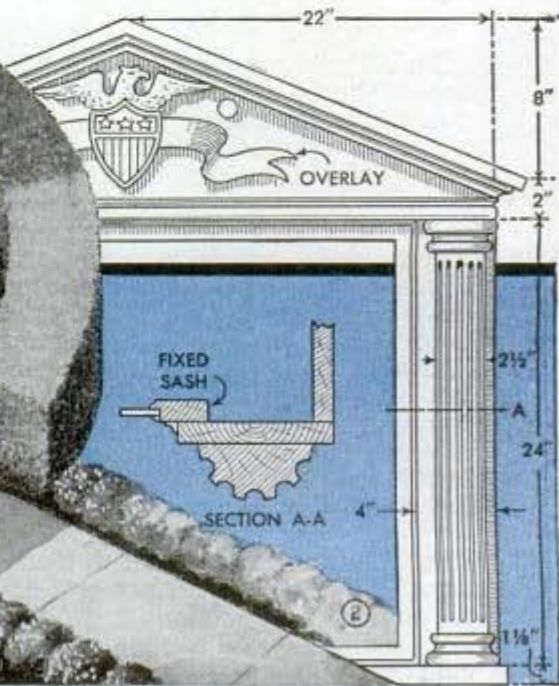
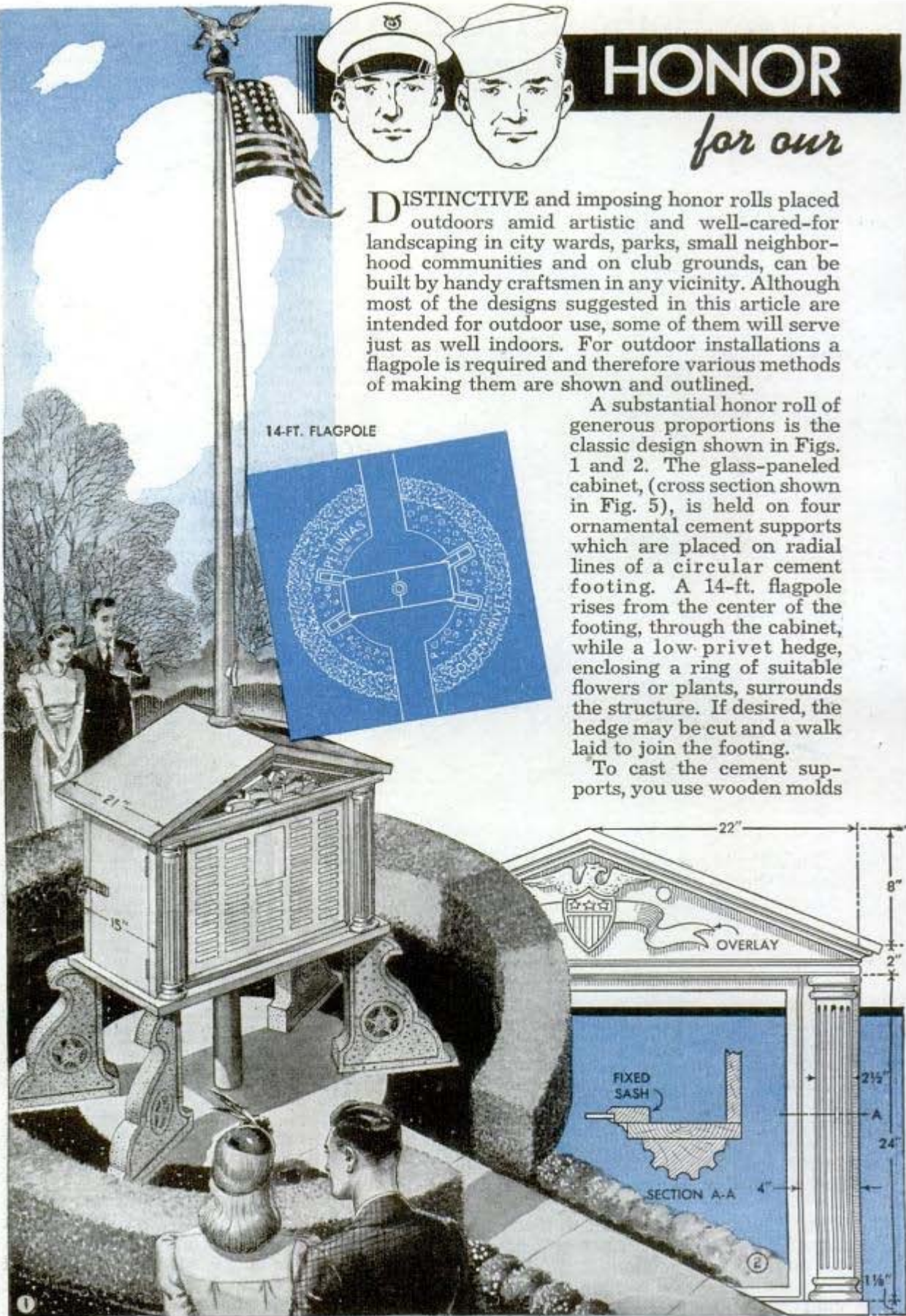

ROLL

boys...

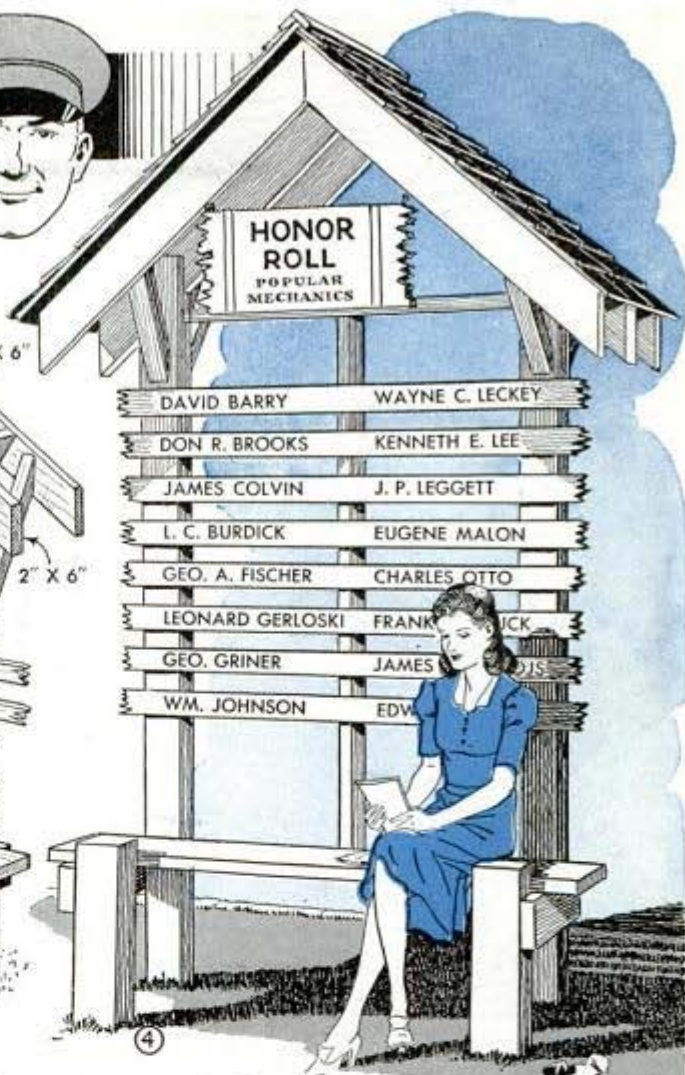
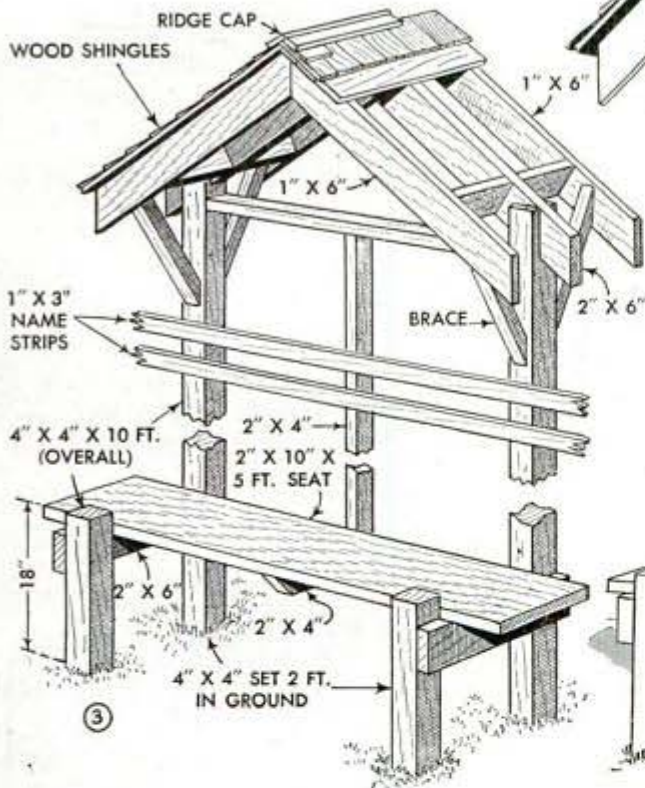
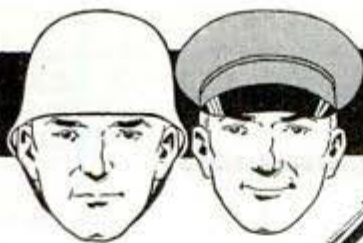

detailed in Figs. 6, 7 and 8. The supports are cast in halves; hence left and right molds are required. Edges of the molds are scrollsawed from 2-in. stock, and a panel of $\frac{1}{4}$ -in. stock is cut out to conform to the mold outline and to include a star in a circle. Be sure to bevel the edges of the $\frac{1}{4}$ -in. stock to provide sufficient "draft" to permit easy removal of the form. Notice how the sides of the mold are screwed together so that they can be removed easily in 48 hrs., when the concrete has set hard. All wood to contact the cement should be sanded smooth, and it should be well oiled each

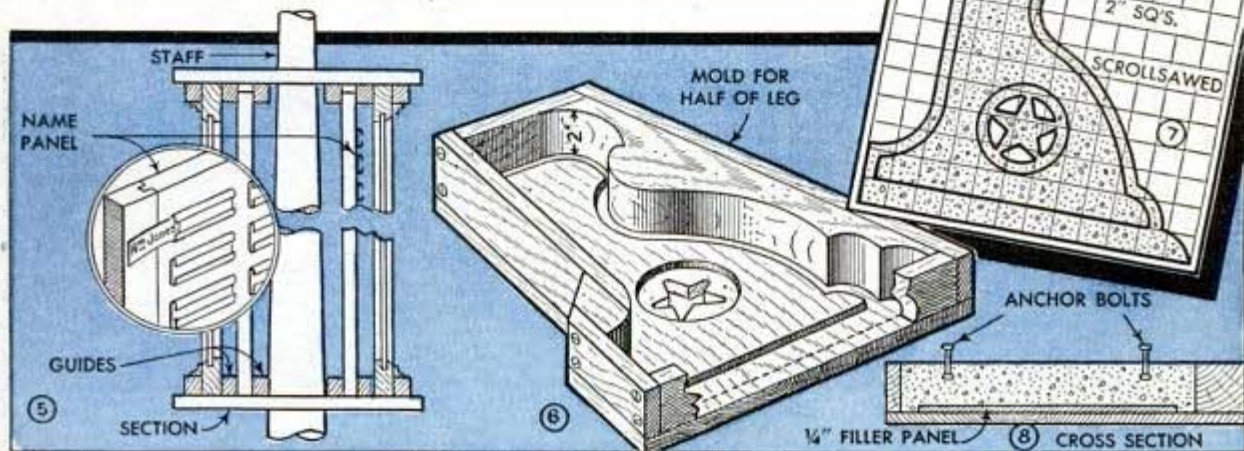

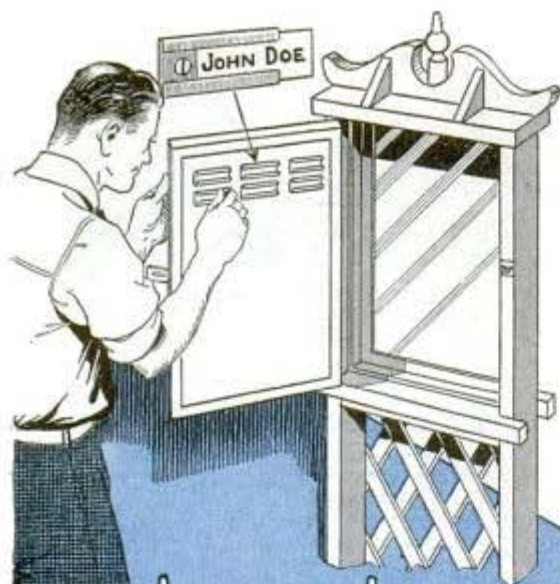

latter are permanent sash, while the ends are hinged so that they can be opened to permit removing the name panels which slide between guides. The roof may be covered with canvas or other waterproof fabric and painted, or it may be covered with roofing paper.

Figs. 3 and 4 show a simple rustic type of honor roll combined with a seat and provided with a narrow roof. In this case the names are painted on 1 by 3-in. strips, previously stained and coated with spar varnish. When wood is set in the ground it should extend below frost level to prevent heaving caused by alternate freezing and thawing, and the portion in the ground should be well soaked with creosote to prevent the wood from rotting.

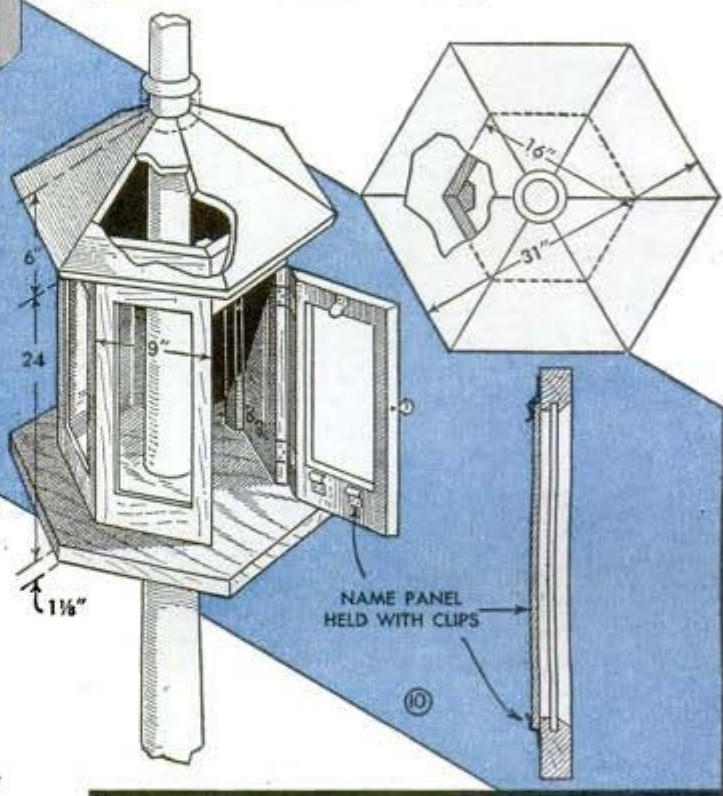
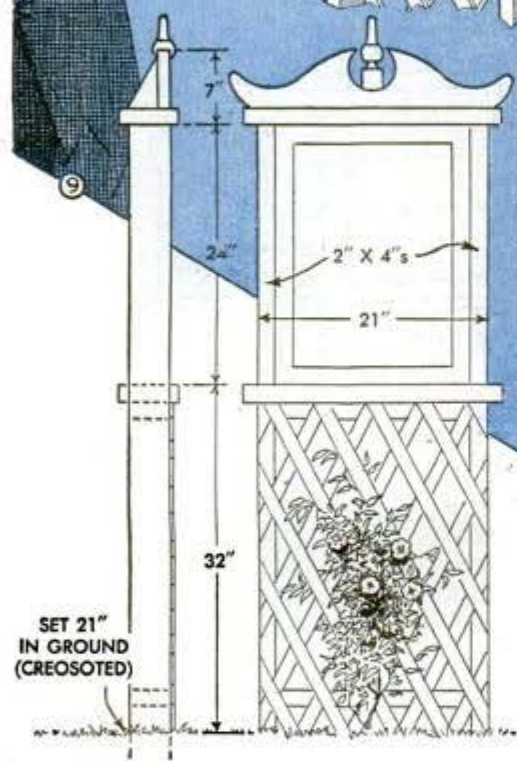

time the mold is used. Proportions for the mix are cement, 1 part, torpedo sand, 3 parts, measured by volume. Add water to produce a heavy mush—not too “runny.” Shovel the mix into one of the molds, tamping well, and when the mold is filled flush force in two bolts as shown in Fig. 8. These bolts are used to hold the two halves of the casting together. As soon as the cement has set sufficiently to permit bringing the flat inside surfaces of the castings together, one mold is placed directly on the other so that all outside edges are in perfect alignment. When the cement has set hard, the two slabs will be one unit. Bolts must be installed also in the top to permit attachment of the cabinet. Front and back of the

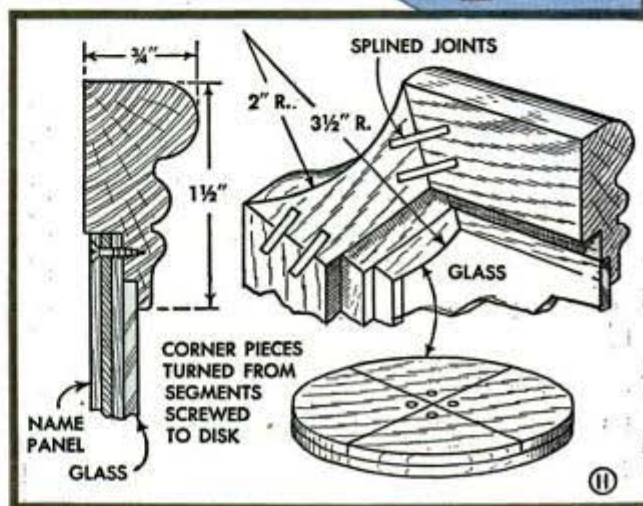

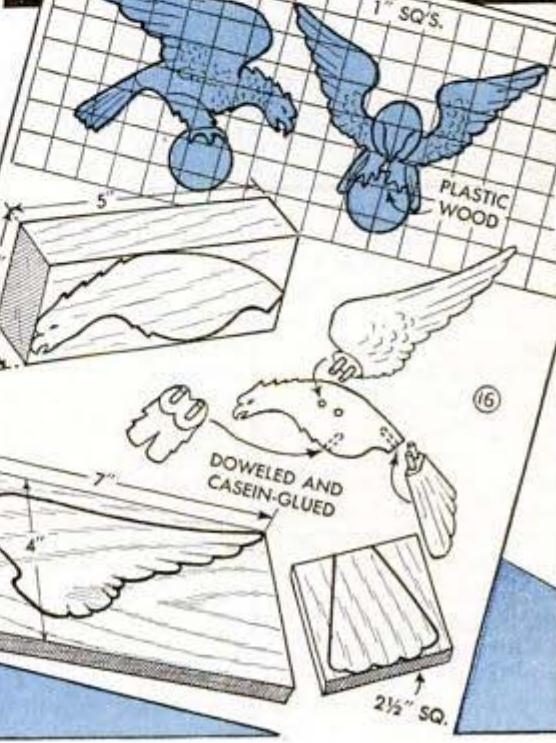
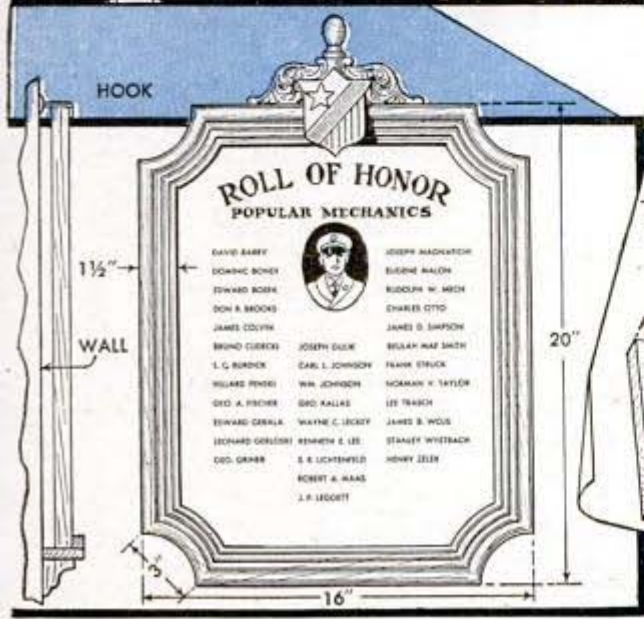
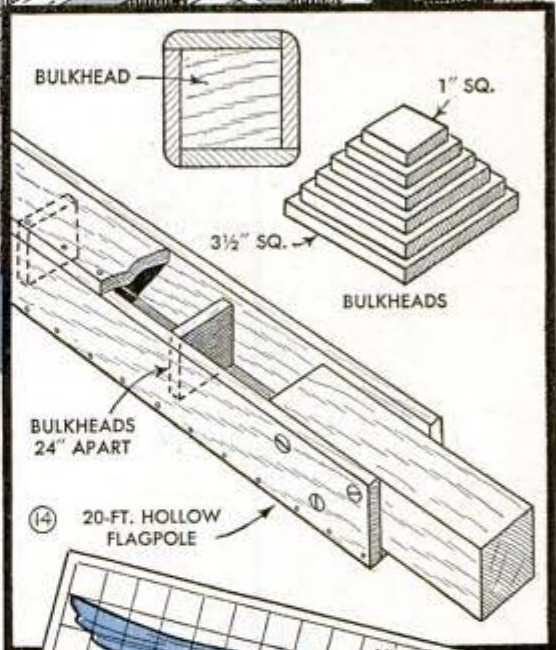
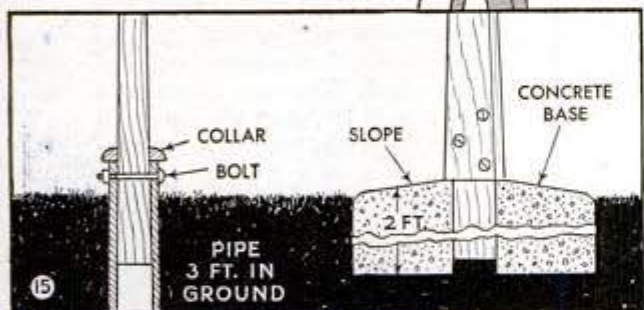
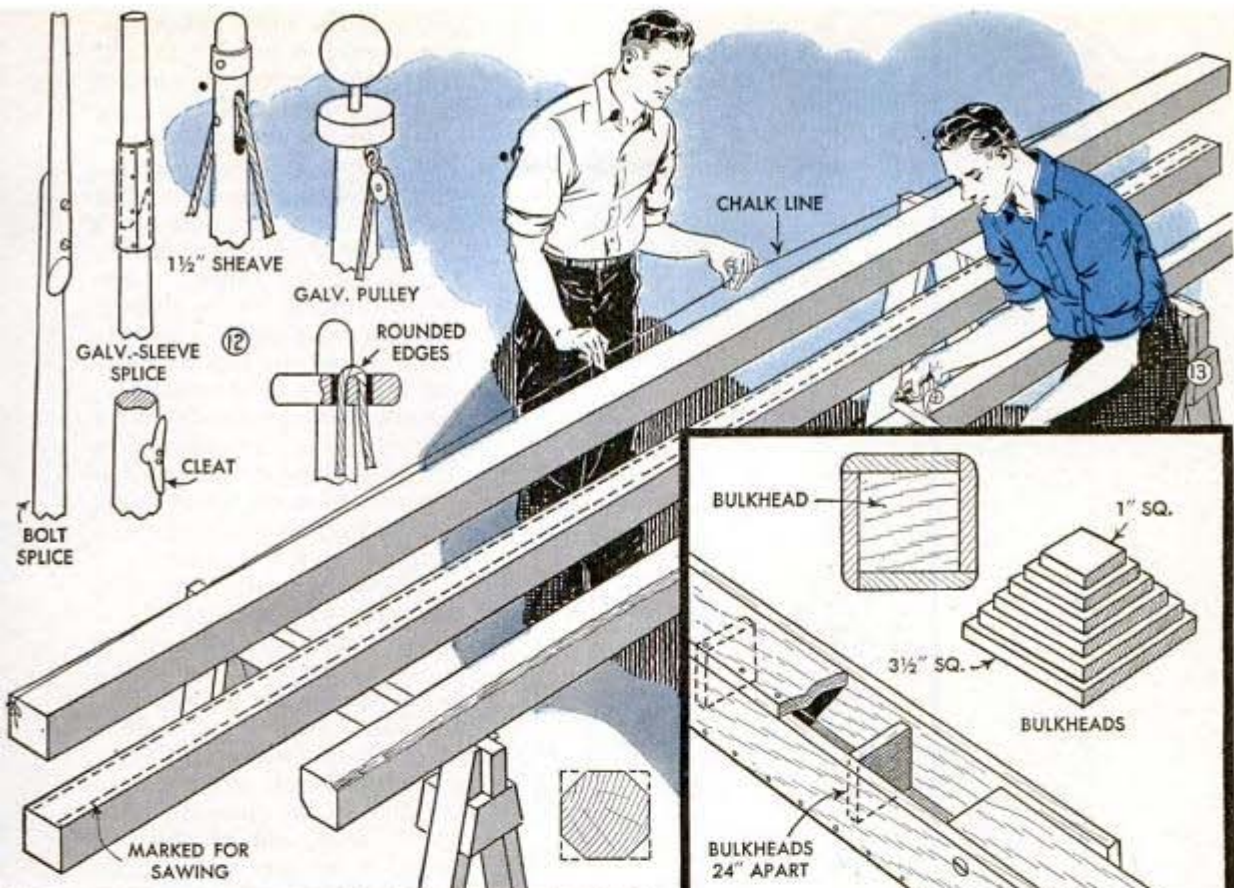

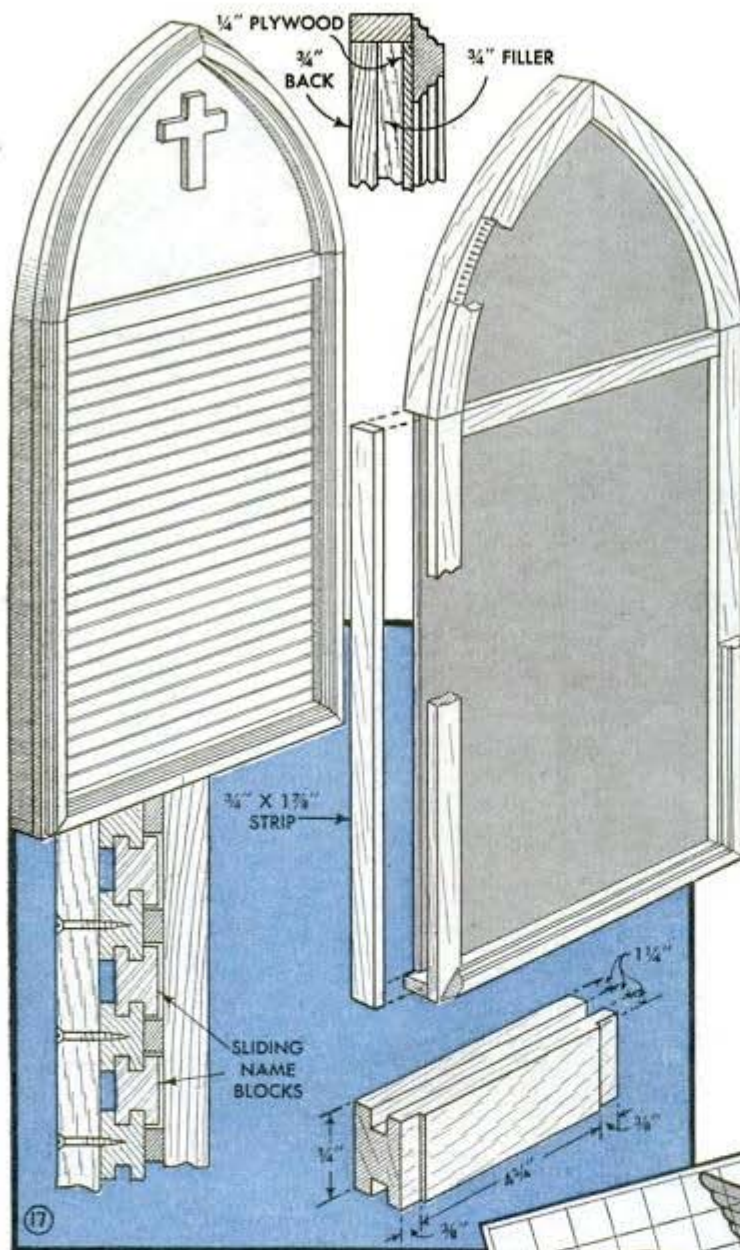

Smaller honor rolls are shown in Figs. 9 and 10. Fig. 9 shows a simple cabinet consisting of a frame of 2 by 4-in. stock. It has a stationary sash on one side and a hinged name panel on the other. Space below the cabinet is latticed to support a suitable flowering vine. The kiosk type of cabinet, Fig. 10, requires slightly more space than the flagpole on which it is mounted. It consists of six sashes having beveled edges to fit snugly together. One sash is hinged for access to the inside where a panel of hard-pressed board carrying the name cards is fastened to the inside of each sash with suitable wood or metal clips. Especially adapted for inside use are the two honor rolls shown in Figs. 11 and 17. The former has a molded frame, cut on a shaper, and is provided with an emblem at the top. The Gothic type in Fig. 17 is

particularly well suited for use in churches.

In case you are able to get a spruce timber 12 ft. long and 4 in. square, an excellent flagstaff is made as in Fig. 13. With a chalkline the taper is first marked on a side, from 4 in. at one end to 1 1/2 in. at the other. After sawing along these marks, the same procedure is followed to cut the two remaining tapers, which results in a square, tapered pole. With a drawshave it is trimmed to octagonal shape after which a plane is used to dress it round. Sandpapering is necessary before finishing.

Where only short lengths of board are available, a square, hollow staff can be made by installing bulkheads under the joints, Fig. 14. However, there should be only one joint on a side at each bulkhead, and the latter should be spaced 24 in. apart. Methods of splicing round stock are shown in Fig. 12. Hardwood cleats are standard equipment on all flagpoles for securing the halyard. Sheaves or pulleys are best to carry the halyard at the peak, but if not avail-

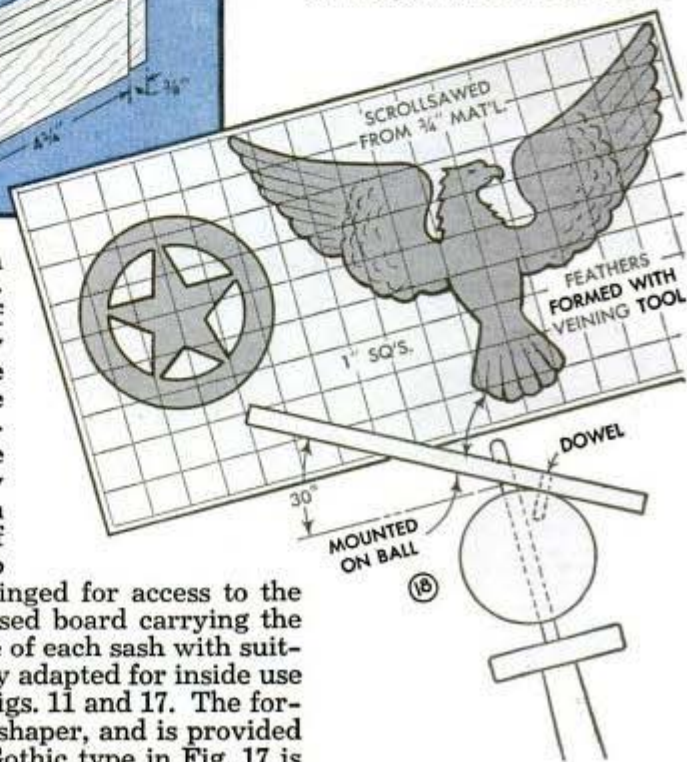

able, two eyes in a wooden collar will do, in which case the edges of the holes must be rounded and sanded smooth to avoid chafing the rope.

Two installations that permit the staff to be taken down are shown in Fig. 15. For a round pole, sink a 3-ft. length of 4-in. pipe in the ground and set the end of the pole in it, anchored with a bolt and provided with a wooden collar to keep out rain. A concrete footing may be added for additional reinforcement. A hollow square staff of the kind shown in Fig. 14, can be lifted off the core if the latter is set in concrete, by simply removing the screws, if the core itself does not come out easily due to swelling of the wood. In cold climates it is not generally recommended to set wooden posts in concrete bases because freezing causes moist wood to swell which sometimes results in breaking the concrete base if this is relatively small in size.

As brass or bronze castings for eagles are not available, an effective wooden job can be substituted by cutting the silhouette shown in Fig. 18 with a scroll saw, and adding the feather outlines with a veining tool. When mounted at a 30-degree angle on a ball at the top of a staff, the bird is not easy to distinguish from one of three dimensions. If you are experienced in wood carving you may prefer the built-up eagle shown in Fig. 16. The wings, tail and legs are carved separately and fastened to the body with dowels and waterproof glue. Claws are formed directly on the ball. A much simpler ornament for the top of a staff is the star and ring shown in the left-hand detail of Fig. 18. The ornament is scroll-sawed from hardwood.

Holder for Cutting Sandwiches Made From Pancake Turner



The split base of an ordinary pancake turner soldered to a wire handle formed as shown provides a unit which will permit cutting and serving a sandwich without touching the food with the hands. The sandwich is pressed down with the flat section of the unit, and the knife is then run through the split. When cut, the sandwich is scooped up and placed on the plate.

Edible Packing for Packages Sent to Servicemen

Peanuts, popcorn and similar edible items will provide suitable packing for boxes sent to servicemen stationed in the country, and at the same time they make good use of space otherwise wasted. Such filler packing keeps articles in boxes from rattling or breaking.



Hub on Disk-Type Coaster Wheel Repaired With Pipe Nipple

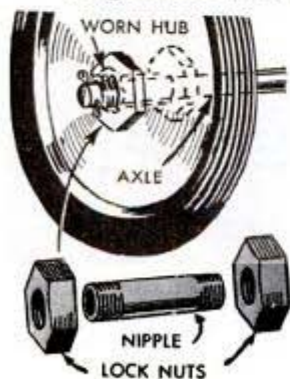

Disk-type wheels on coaster wagons that wear so badly in the hubs that they are useless, often can be repaired with a pipe nipple and a couple of lock nuts. Select a nipple of a size to make a good rotating fit on the axle and insert it

through the worn hole in the hub. Center it accurately and then hold it in place with a lock nut on each side. If the hole in the hub is large enough to let the nuts slip through, use large sheet-metal washers behind them.



Turn these Graceful CANDLE HOLDERS

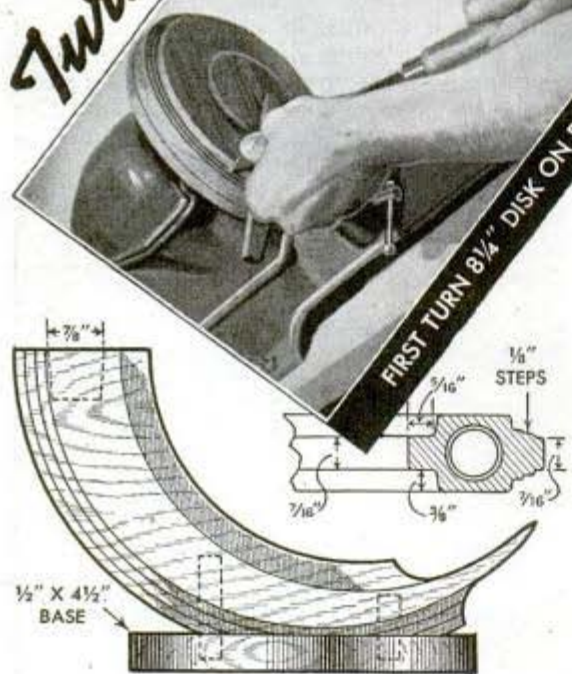

FIRST TURN 8 1/4" DISK ON FACEPLATE - THEN CUT IN HALF AND DOWEL OFFSET - REMOUNT AND TURN

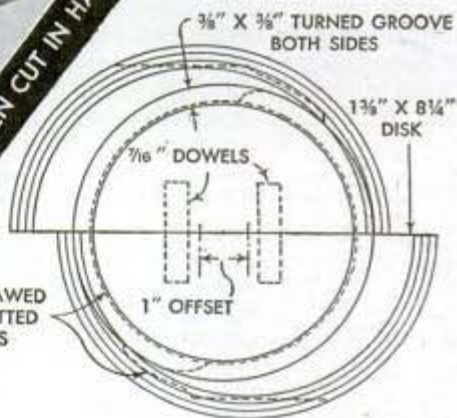

After turning a 1 3/8 by 8 1/4-in. disk, turn a duplicate pattern on both sides as shown in the photos and the cross-sectional view in the lower detail. Then, saw the disk in half and reassemble it with dowels, offsetting the halves 1 in. Remount the disk and turn a groove in both sides as in the upper photo, and band-saw it as indicated by the dotted lines in the right, center detail. Complete the holders by drilling candle sockets in the upper ends and then doweled them to circular bases as indicated in the lower detail.

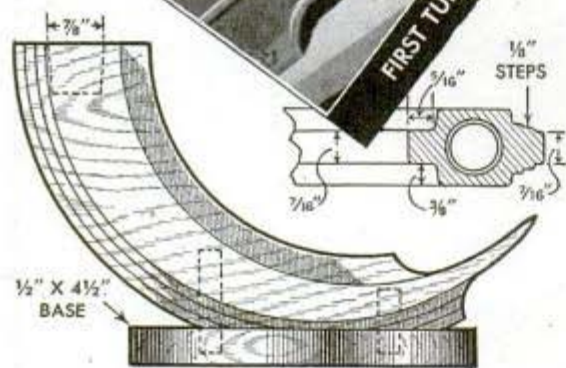

Handy Tightener to Take Up Slack in Clothesline

This simple tightener can be made quickly by bolting three halves of empty thread spools in a staggered position on a piece of plywood or other thin block of wood. One way of using the tightener is to place the line between the two spools that are spaced closest together, after which the upper end of the block is pulled down so that the third spool can be hooked under the line, thus taking up the slack as shown in the upper detail. The lower two details show other methods of using the tightener, the one in the center taking up the least amount of slack in the line, while the one at the bottom gives the greatest tightening effect. Of course, the spacing of the spools is another factor

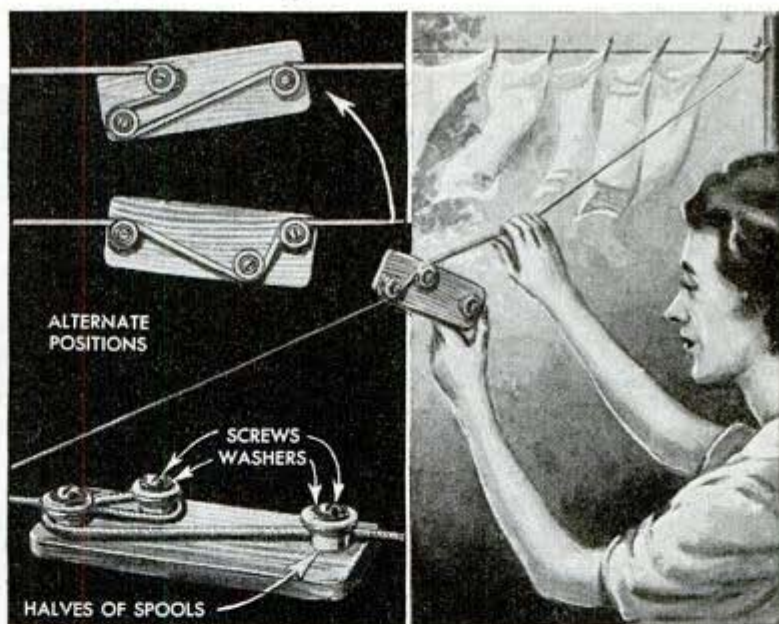

that controls the extent of tightening the line, and they can be spaced to suit.

—Royce M. Roath, Earlville, Ill.

Solder and Flux Are Always Kept Together in This "Kit"

In order to keep his soldering accessories together in a handy kit, one man soldered together a reel of acid-core solder, one of rosin-core solder and a can of flux. In this way he did not have to waste time looking for various accessories in the shop, and there is no likelihood of forgetting to take a particular kind of solder or flux along on a job where it might be the one needed most. Of course, the number of reels of solder and cans of flux need not be limited to three as shown in the photo, but if desired, still more units can be added in the same manner.



Emergency Set of Car Keys Is Carried Conveniently in Your Wallet

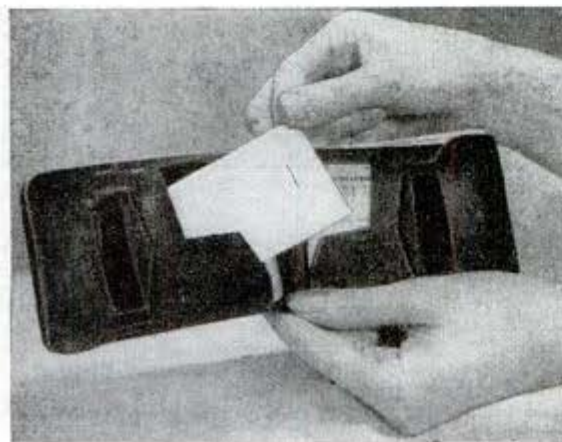

Instead of keeping an extra set of keys hidden somewhere on the car for emergency use in case the regular set is lost or locked inside the car, I find it more convenient to carry them in my wallet. I staple them between two business cards, although any fairly stiff cards will do. A folded postcard is ideal for the purpose.

—Roland Swedlund, Buffalo, N. Y.

☞ To straighten used baling wire, a headless nail is driven into a sturdy post. When the eye of the baling wire has been looped over the nail, the other end is jerked quickly with a pair of heavy pliers, and the wire is ready to be used again.

for Your RARE CHINA

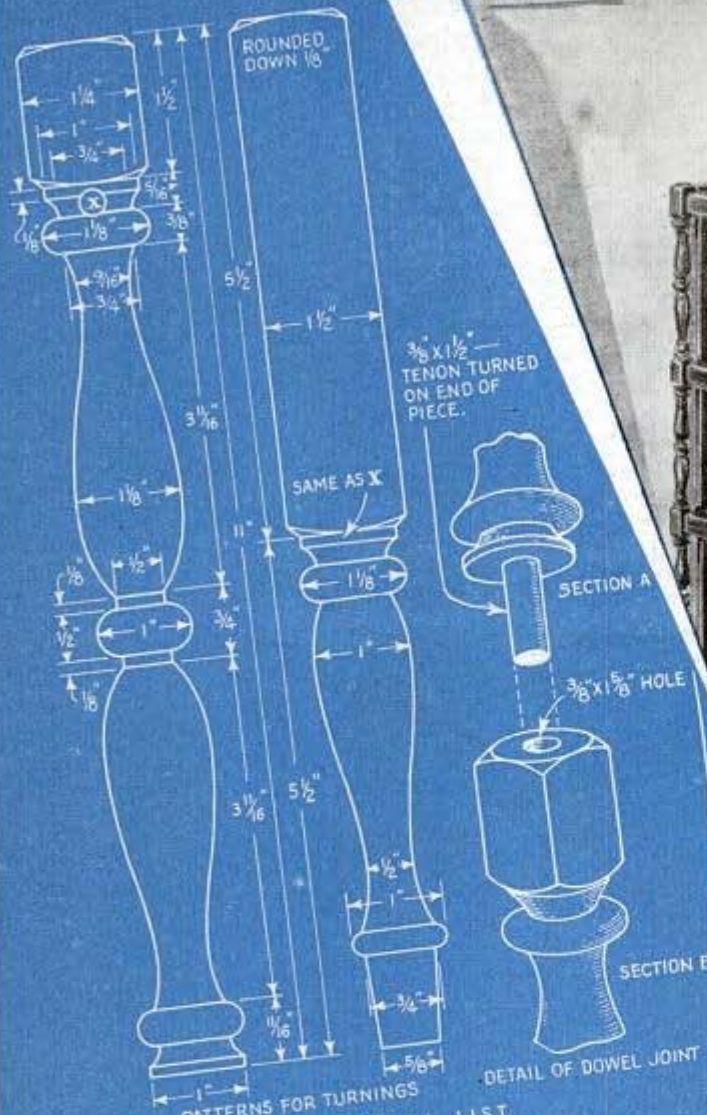

MATERIAL LIST

- 8 pcs. $1\frac{3}{4} \times 1\frac{3}{4} \times 25$ in. maple—Corner posts*
 - 5 pcs. $\frac{3}{4} \times 8\frac{1}{2} \times 18\frac{1}{2}$ in. mahogany—Shelves
 - 9 pcs. $\frac{1}{4} \times 1 \times 18$ in. maple—Gallery sides
 - 2 pcs. $\frac{1}{4} \times 5 \times 8$ in. maple—Enclosure ends
 - 1 pc. $\frac{1}{4} \times 5 \times 8$ in. maple—Enclosure back
 - 4 pcs. $\frac{1}{4} \times \frac{1}{2} \times 14\frac{1}{2}$ in. pine—Mirror cleats
 - 6 pcs. $\frac{1}{4} \times 1 \times 10$ in. maple—Mirror frame
 - 2 pcs. $\frac{1}{4} \times \frac{3}{4} \times 33\frac{1}{2}$ in. pine—Mirror cleats
 - 1 pc. $\frac{1}{2} \times 3 \times 16\frac{3}{4}$ in. maple—Drawer front
 - 2 pcs. $\frac{1}{2} \times 3 \times 8\frac{1}{4}$ in. pine—Drawer sides
 - 1 pc. $\frac{1}{4} \times 3 \times 16\frac{1}{2}$ in. pine—Drawer back
 - 1 pc. $\frac{1}{4} \times 3 \times 16\frac{1}{2}$ in. plywood—Drawer bottom
 - 1 pc. $\frac{1}{4} \times 8\frac{1}{2} \times 16\frac{1}{2}$ in. pine—Drawer guides
 - 2 pcs. $\frac{1}{2} \times \frac{3}{8} \times 8\frac{1}{2}$ in. pine—Vertical strips
 - 4 lin. ft. $\frac{1}{4} \times \frac{1}{4}$ in.—Mold for drawer front*
- * Allowance made for turning or mitering

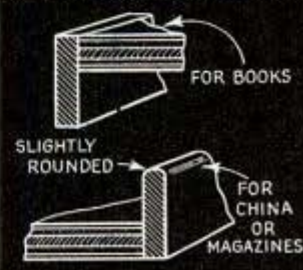
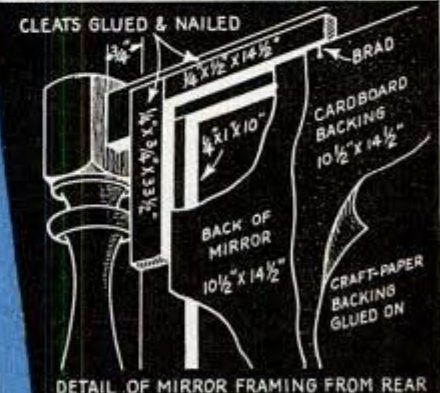

NOTE: DESIGN MAY BE CONVERTED FOR USE AS BOOKCASE BY SETTING SHELVES FLUSH WITH TOP OF GALLERY RAILS

Miter Box Held Securely in Place By Cleats to Fit Holes in Bench

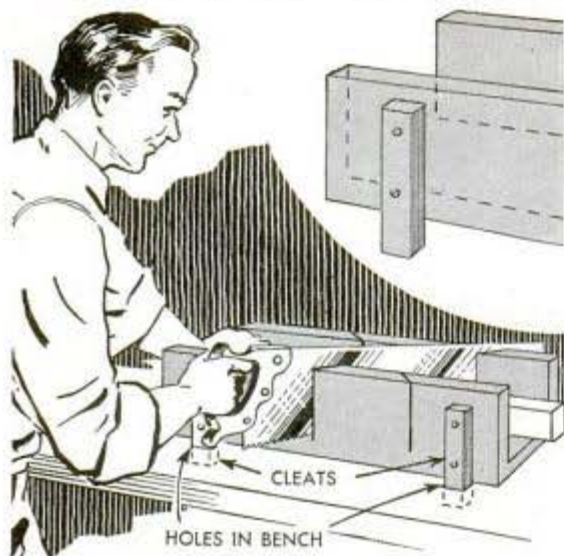

After experiencing difficulty in holding his homemade miter box securely while using it, one craftsman nailed cleats to the side of the box so that they projected to fit into holes drilled into his bench top. If desired, the projecting ends of the cleats can be rounded to a small diameter to reduce the size of the holes in the bench.

Caroms Are Stored on Cue Stick

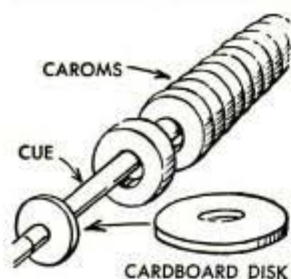

The annoyance of finding a number of caroms missing when the board is brought from the store-room for a game, may be avoided by keeping the caroms on one of the cue sticks. A

cardboard disk slipped over the small end of the cue keeps the caroms from sliding off.

This Holder Starts Small Nails In Hard-to-Reach Places

Starting a nail in a place that is hard to reach is no problem with this holder, which grips the nail firmly until released. The holder consists of a bicycle spoke inserted into a piece of small tubing, the tubing being of a length that will al-

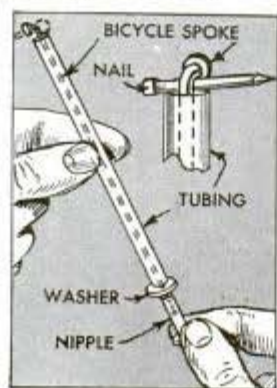

low the nail to be pulled up tightly under the bent end of the spoke when the nipple is turned up against the tube at the other end.—C. G. Cutting, Brightwaters, N. Y.

No 'Hot Finger' From Paper Cups Carried in Wire Holder

The problem of carrying paper cups of hot coffee without burning their hands was solved by employees of an eastern war plant who formed holders of wire for the purpose. A large loop was made to fit underneath the rim of the cup and another loop attached to serve as a handle, as illustrated.—Kenneth Murray, Baltimore, Md.

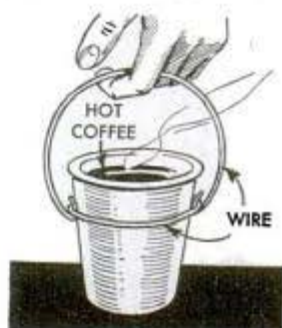

Concrete Sash Weights Substitute For Hard-to-Get Metal Ones

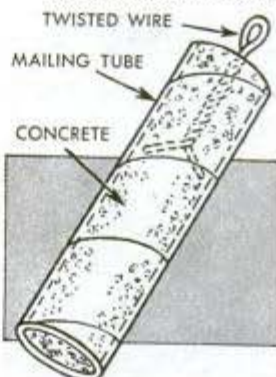

A carpenter who was unable to buy sash weights due to the shortage of metal, made some by filling lengths of mailing tube with concrete. Twisted wire to serve as eyes for attaching the cords, were embedded in the wet concrete. Weights

for closing gates can be made in a similar manner by filling cans with concrete.

Night Latch Used on Sliding Door

Desiring to use a night lock on the sliding doors of his garage, one man fixed up the lock by making a striker plate of the shape shown. Then, by mounting the latch in a vertical position on the edge of one door, and screwing the plate to the edge of the other door, the latch bolt would easily slide into the slotted striker plate. It will be necessary, of course, to bevel the latch bolt as indicated, so that it will slide under the latch plate.

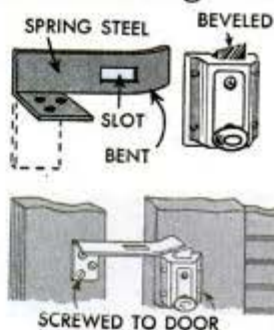

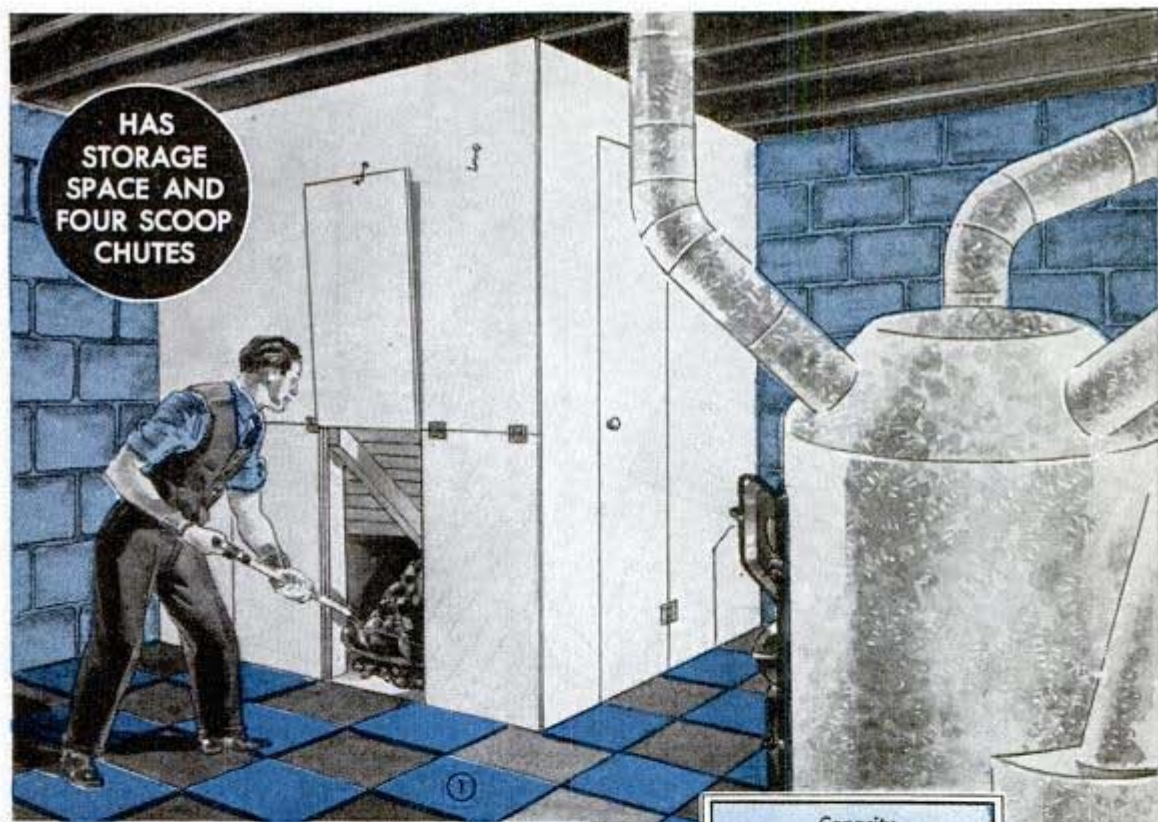

HAS
STORAGE
SPACE AND
FOUR SCOOP
CHUTES

Capacity		
Size	Tons	
6 X 7 X 7 Ft.	6½	
6 X 8 X 8 Ft.	8	
6 X 9 X 9 Ft.	9¾	

3 Step-saving COAL BINS

IT TAKES no more skill to build a neat, long-lasting coal bin that is planned for convenience than it does to nail up two or three walls merely to retain fuel in one corner of your basement. A well planned bin should be as close as possible to the heating plant and yet be easily accessible for fuel delivery. It should be as nearly dust-tight as possible to help keep the basement clean. Also, if possible, it should be large enough to hold a season's fuel supply, thus making frequent deliveries unnecessary. Size of the bin will depend on the amount of fuel required. The bins shown here were designed by Anthracite Industries Incorporated, and the capacity tables are for anthracite coal. Similar types of bins,

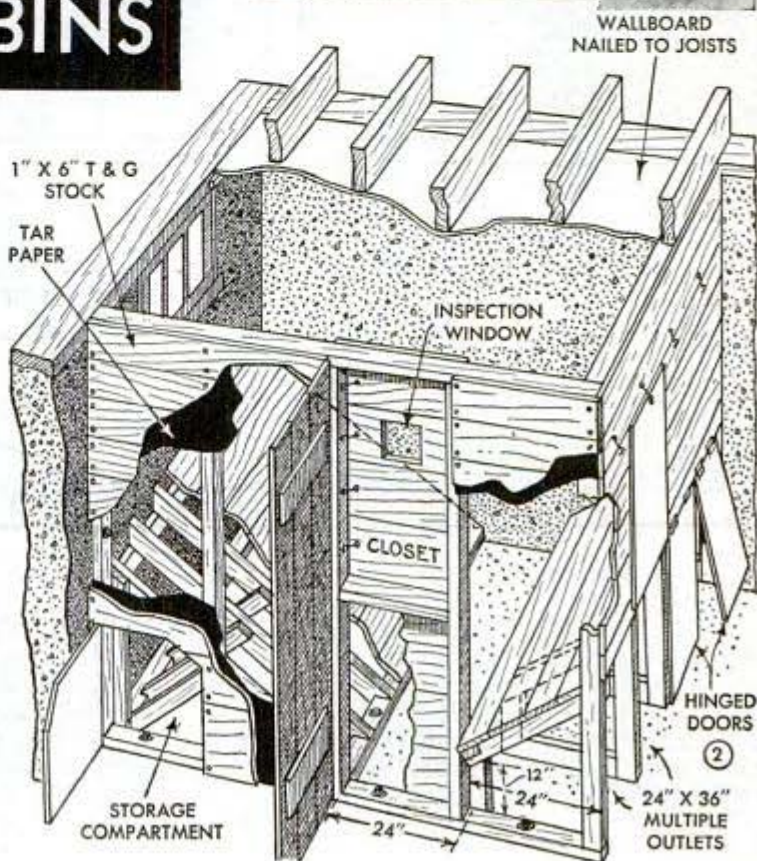

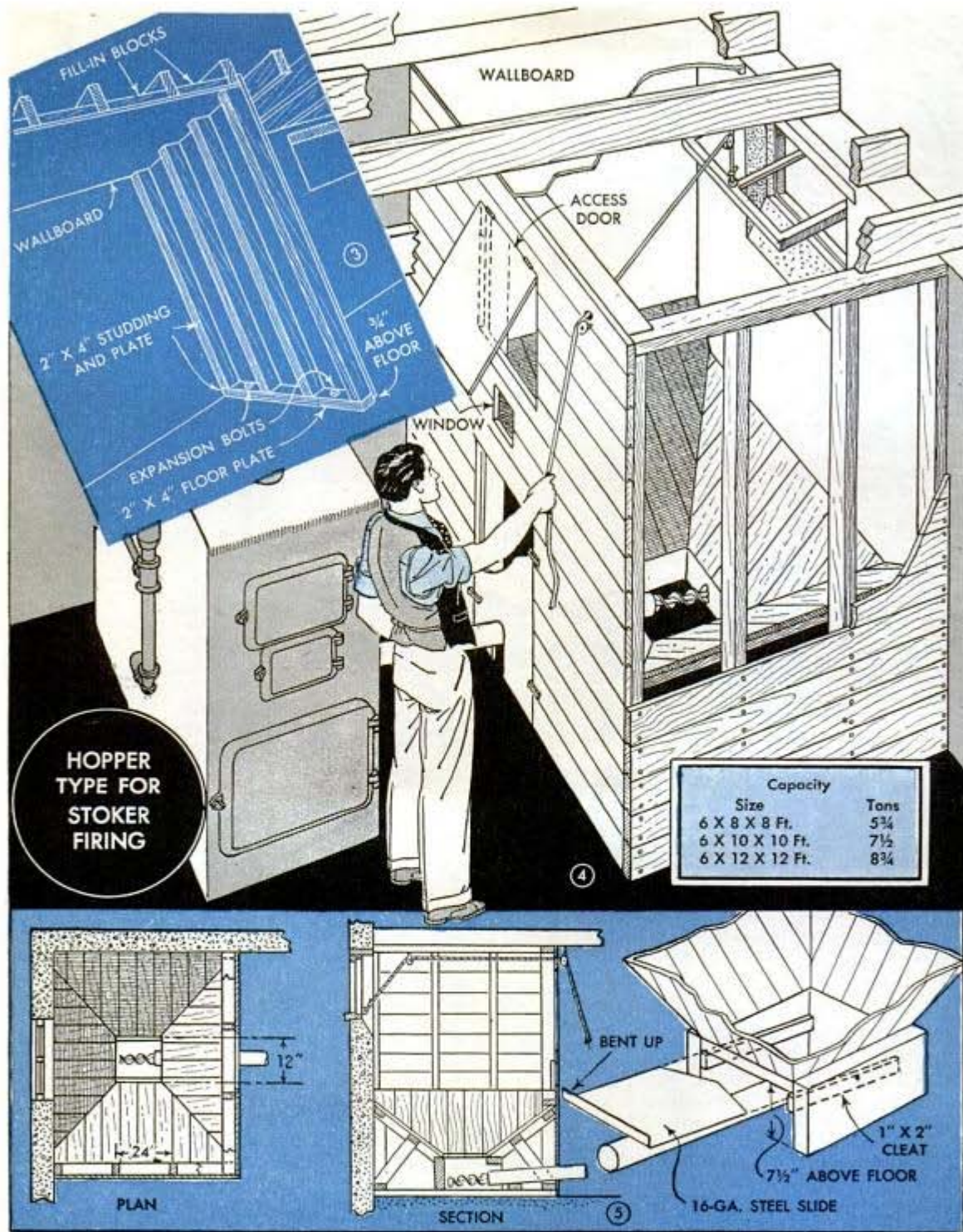

larger in size, can be used for soft coal. For estimating the size required, it is best to ask your dealer how many cubic feet there are in a ton of the coal you are using, and then build your bin accordingly. When planning it, allow for a clearance of 1 1/2 to 2 ft. between the fuel and the ceiling. It is hard work to shovel the coal up against the ceiling, and some dealers won't do it.

Well seasoned tongue-and-groove lumber, waterproof plywood (the plies of reg-

ular plywood may separate in a damp basement), and masonry (concrete or cinder blocks) are the materials most used for coal bins. The type of bin bottom, flat or sloped, is a matter of choice. A sloped bottom is practically a necessity for a bin-type stoker, and has the advantage of feeding the coal to the scoop chute when hand firing.

The bin pictured in Fig. 1 and detailed in Fig. 2 has the bottom sloped on two sides, and has four scoop chutes along the front,

each being covered with a hinged door. Also, space under the other slope is utilized for storage, and a door to enter the bin is provided. Boards hinged to the inner edge of the door frame retain the fuel and the space between the boards and door provides a closet to hold firing tools. The ceiling is made dust-tight with wallboard nailed to the joists as in Fig. 3, and all framing is of 2 by 4-in. stock. Floor plates are fastened with expansion bolts as are the studs that join the basement walls.

The hopper-type bin for stoker firing in Fig. 4 is of similar construction except that scoop chutes are eliminated. The bottom is sloped from all four sides to a small box containing the stoker conveyor. The box is detailed in Fig. 5 and is about 7½ by 16 in. in size. A steel slide is used to close the hopper when the stoker conveyor needs attention. A small access door is provided and the fuel delivery window can be operated from outside the bin.

Although more expensive, the neat masonry bin shown in Fig. 7 has the advantage of being the most nearly dust-tight, and it will not deteriorate in a damp basement. The bottom slopes four ways toward the scoop chute, which is at the forward corner. The sloped portions are covered with



a 2-in. layer of concrete poured over a fill of earth or ashes well compacted.

Notice in Fig. 7 that the sides of the scoop chute are of the same material as the walls and are sloped at the same angle as the bottom. A wooden panel made up from short boards covers the sloped top of the chute as indicated.

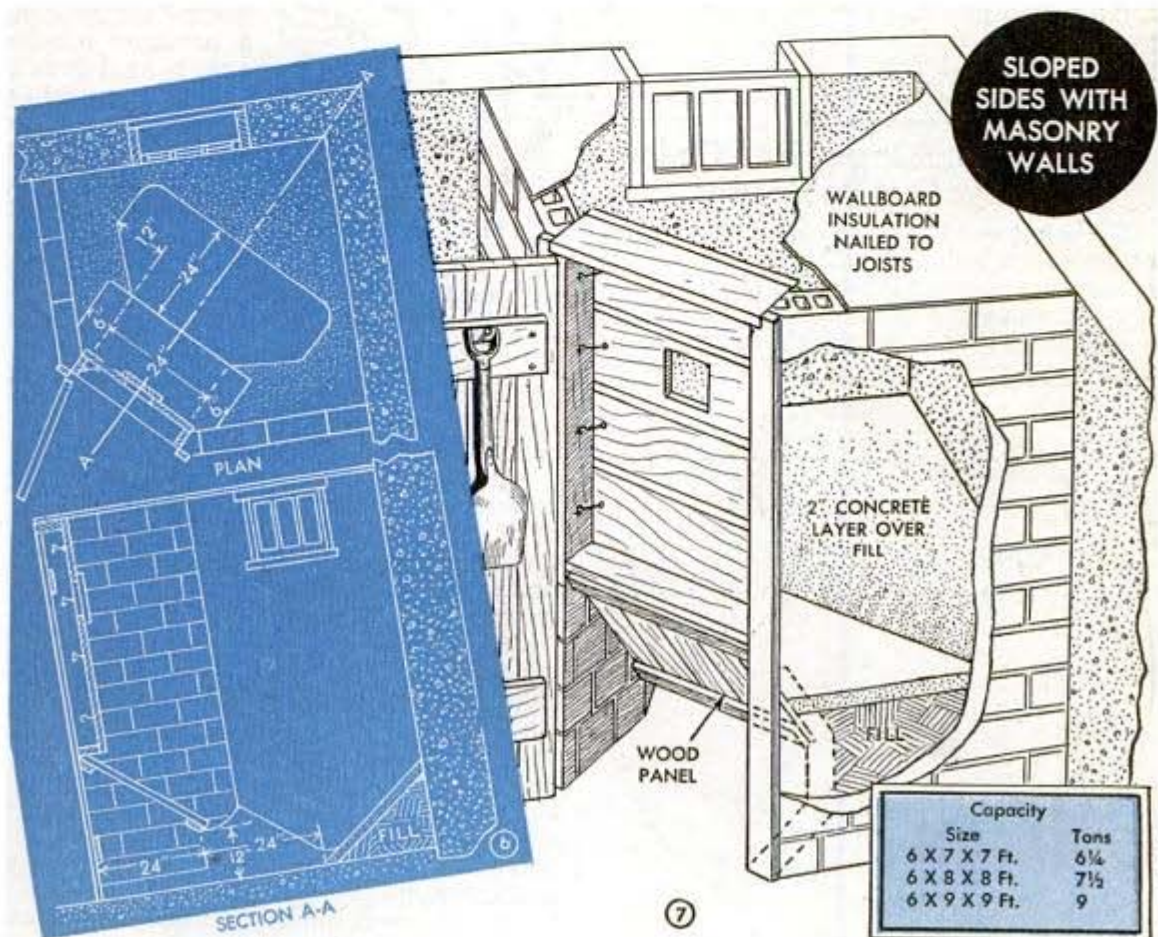

Emergency Marking Gage Made From Screen Wire and Block

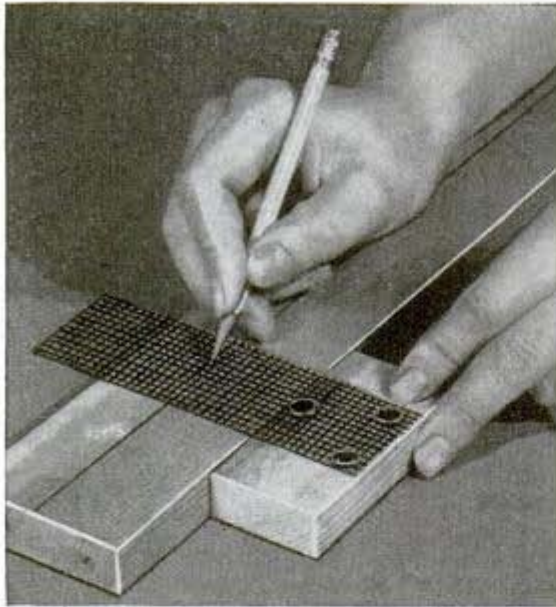

When a marking gage is not available, one may be improvised by tacking a scrap of screen wire onto a block at right angles. By placing the block against the board to be marked, with the screen on top, inserting a pencil point in the mesh to give the proper width and moving both gage and pencil down the board, a fairly accurate marking can be obtained.

Proper Matching of Red Cedar Brings Out Its Beauty

To bring out the attractive grain of red cedar closet lining, match the boards in a systematic manner instead of simply joining them at random. Do this by selecting a series of boards in which the veins of white appear as flowing units when the

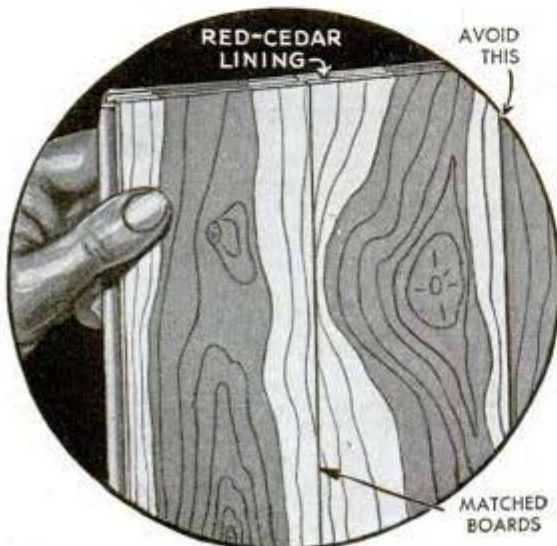

boards are joined. Avoid the severe straight line which is formed when a strip of white and a strip of red are joined together along the cut.

Easy Way to Clean Pipe Stem Having a Wide Hole

A pipe stem which has a wide, tapering hole can be cleaned easily with one insertion of the cleaner by kinking the latter as indicated. The kinks cause the cleaner to contact both sides of the hole at its widest part; then they straighten out as the cleaner is pulled through the narrower part.

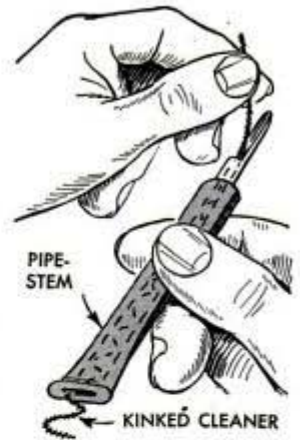

Twin Hacksaw Blades Reversed To Cut Thin Tubing Easily

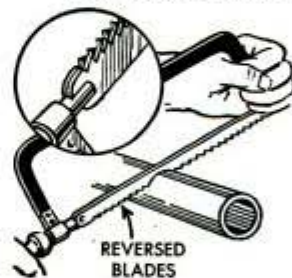

If you experience difficulty by having the teeth of a hacksaw blade catch and break off when cutting thin tubing, use two blades and put them in the saw frame so that the teeth of one

face opposite the teeth of the other. This will keep the teeth of one blade from digging in, and will permit the blades to cut on both strokes.

—H. D. Chapman, Mt. Rainier, Md.

Thumb Used as Thickness Gage

The distance between the end of your thumb and the cuticle of the nail makes a fairly accurate, short-scale measure by which to gage the thickness of lumber and other building materials, and it is one that is always with you. Simply measure this distance on your thumb and memorize it. Trimming the thumb nail does not, of course, alter the measurement.

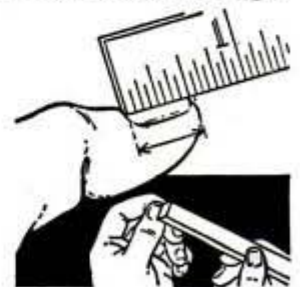

—J. Modroch, Danbury, Conn.

Holder Adjusts Itself to One or Several Letters

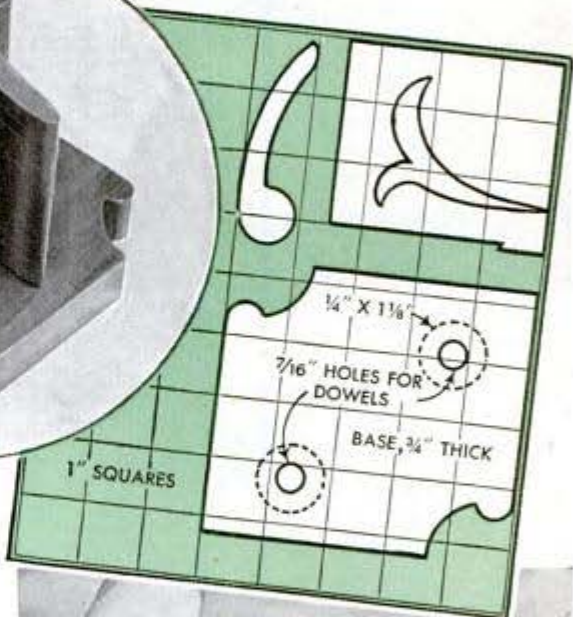
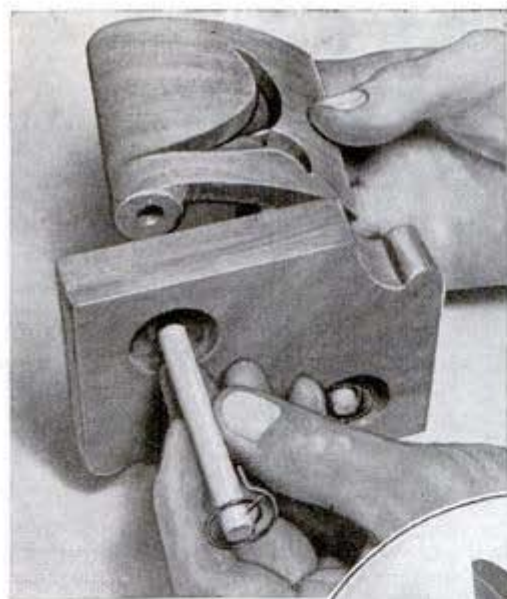

Besides being an attractive desk ornament, this letter holder will retain one letter just as firmly and neatly as it will several of them. This is because the sides or wings are pivoted and are under tension of springs, which keep them pressed firmly against the letters at all times. The holder looks best in walnut or maple, or a combination of the two, as for instance a walnut base and maple jaws. After jigsawing the base and wings to the size and shape indicated in the center right-hand detail, drill them to receive hardwood dowels as indicated in the upper left-hand photo. Before inserting the dowels, however, attach a spring to each one as indicated in the lower left-hand detail. The free end of each spring is slipped into a small hole drilled in the recessed portion of the base to keep it from turning. The wings must be attached firmly to the dowels which is best done with glue or small wooden pins, preferably the latter as the pins will permit dismantling a wing should a spring have to be replaced. If suitable springs are not available, you can make them easily from spring

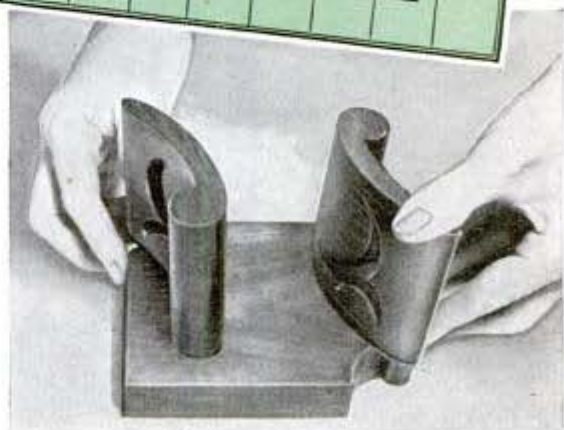

wire. Three coats of shellac well rubbed down between coats produces a nice finish on the holder. It is a good idea to glue a piece of thin felt or blotting paper to the bottom of the base to avoid scratching highly polished desk tops.

KEEP YOUR

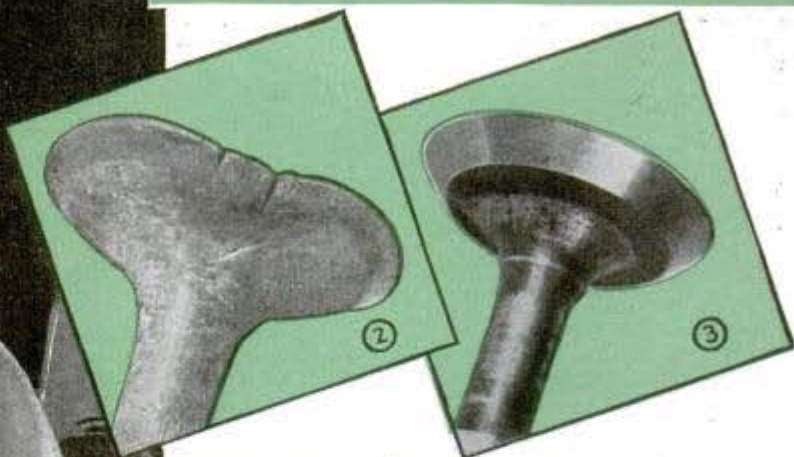

Left, valve burned because of insufficient tappet clearance. Right, refaced valve unfit for service because of thin, feather edge around the head

By C. E. Packer

THE DIFFERENCE between a car that needs constant repairs and one that rolls along trouble-free month after month often lies in the way they are driven and the way in which little things are taken care of before they develop into major troubles. The burned and warped valve in Fig. 2 is a good example of what happens when such a little thing as adjusting the tappets, Fig. 1, is neglected. This condition is caused by insufficient tappet clearance.

Engines are designed with definite clearance between the valve lifter and the valve stem to provide for expansion. When this clearance is reduced the valve is held open too long and, in the case of exhaust valves, burning is likely because the valve does not remain on its seat long enough to transfer the heat to the water jacket. When valves are not burned quite so badly as the one shown, attempts to restore them often are made

by refacing them like the one in Fig. 3. Such a valve may hold compression and appear to operate satisfactorily, but can be the direct cause of serious pinging on a hard pull due to the knifelike edge of the valve head, which becomes incandescent and causes the fuel charge to ignite before the spark occurs in the cylinder.

The ignition distribu-

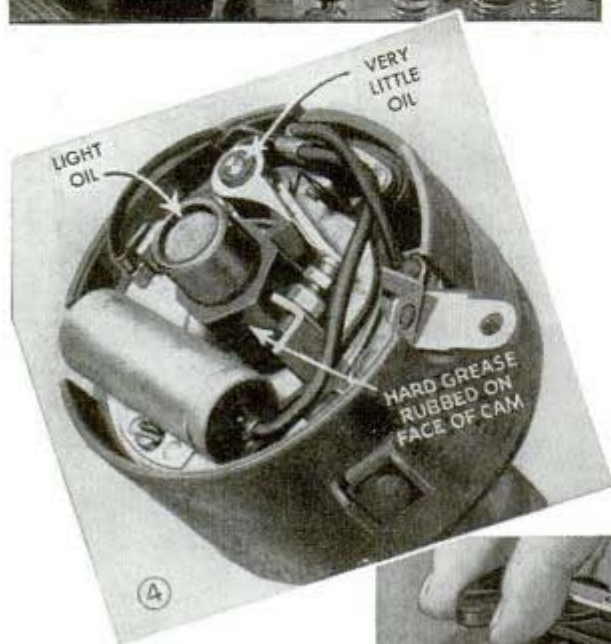

In addition to regular lubrication of the distributor, apply oil to the cam wick and the pivoted point, and hard grease to the cam face. Check the automatic spark control by turning the rotor first one way and then the other to see that it swings back to position freely

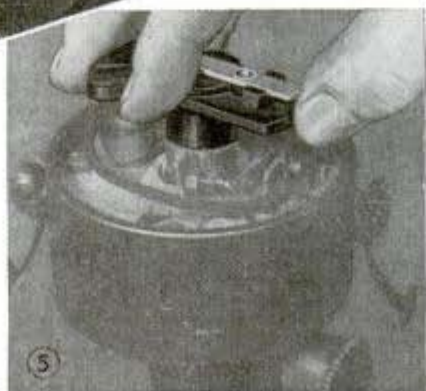

CAR ROLLING

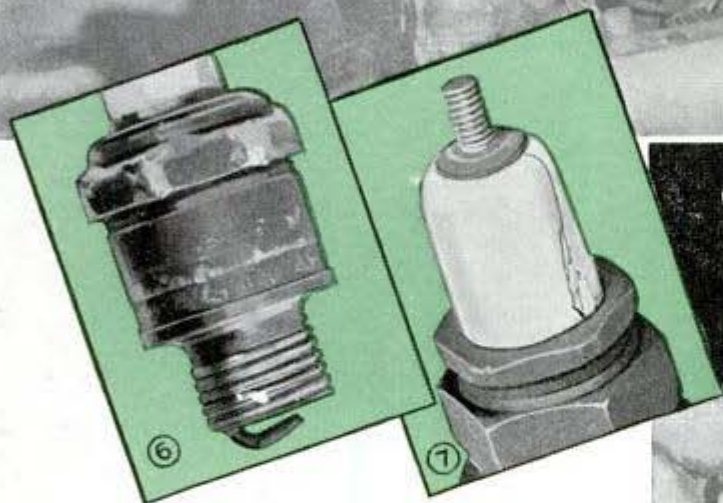

Spark plug at left was damaged by use of too large a wrench, which slipped and cracked porcelain insulator at the right

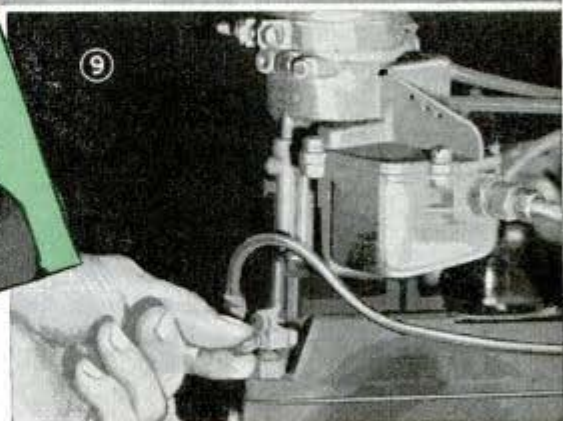

tor is another part often overlooked. In addition to the normal lubrication, it is important to keep the felt wick in the end of the breaker cam saturated with light oil. If this is not done, the cam may freeze to the shaft, making the automatic control inoperative. Increased life of the breaker points will result if a small amount of hard grease is applied to the cam, and a drop of oil is placed on the pivot of the moving point at thousand-mile intervals, Fig. 4. To check action of the automatic spark control, grip the rotor as in Fig. 5, gently twist it to one side and then release it. Any unusual stiffness or failure to return to its original position indicates faulty action which will

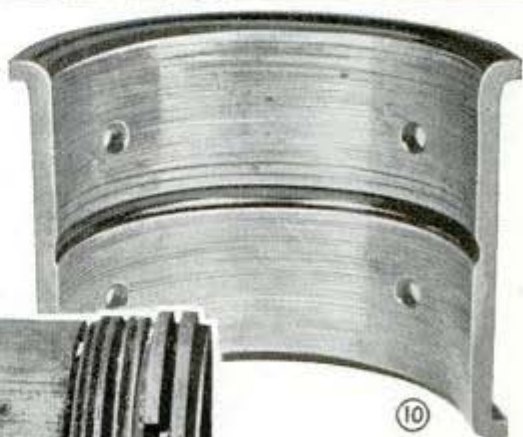

Bearing above was scored by foreign matter in diluted oil. Scored piston is result of gas washing oil from the surface of cylinder wall, allowing metal-to-metal contact

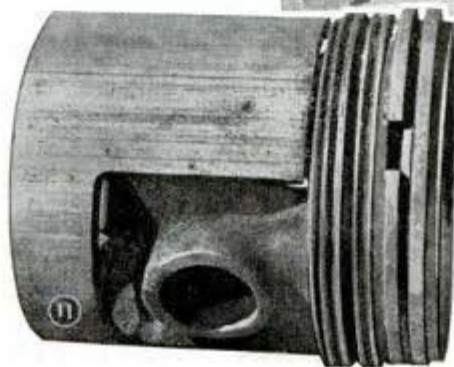



Condition of battery should be checked regularly with a hydrometer. Corroded battery at right indicates level of electrolyte is too high or charging rate is excessive, causing acid to overflow, thus reducing strength of electrolyte. Spring bolt below was worn and scored by lack of proper lubrication at regular intervals

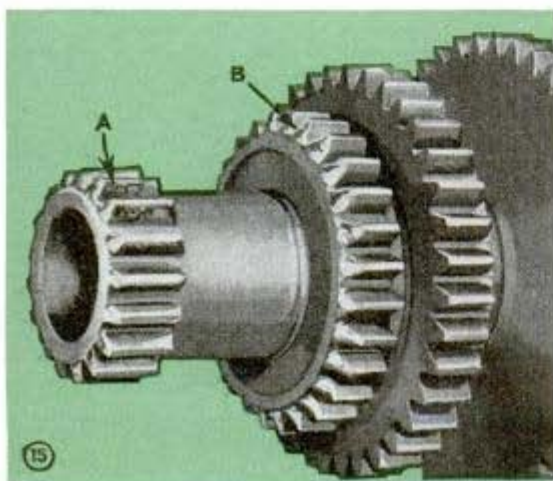
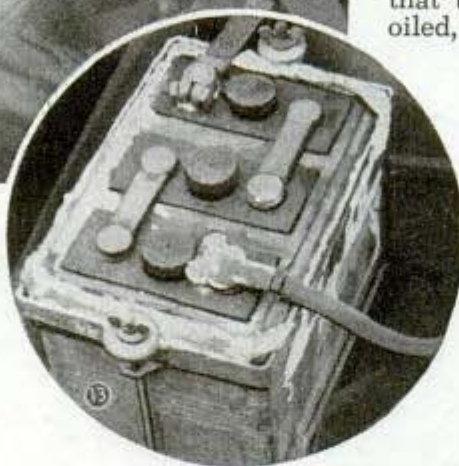

reduce engine performance, interfere with satisfactory gas mileage, and may even be the indirect cause of breaking the starter drive.

Use of anything but a well fitting socket wrench on spark plugs, Fig. 8, is likely to damage the plug bases or insulators as in Figs. 6 and 7. Dirt and moisture accumulating in the cracked porcelain will rob the engine of its spark. Spark plugs and cylinder heads can be ruined by pulling up a plug too tightly. It must be tight but threads on the small plugs can be stripped easily. Proper installation consists of tightening a plug with the fingers after checking that the threads are clean and oiled, and then giving it one-half

turn with a wrench to squeeze it down against a good copper gasket. Plugs that are too tight will be thrown out of adjustment, and those that are too loose will burn up as a result of hot gases escaping past the threads.

Finally, economical operation and smooth performance are obtained at lower speeds by careful carburetor adjustment. Most carburetors have a setting similar to the one

shown in Fig. 9. With the engine thoroughly warmed up and idling slowly, the setting is turned to the left until the engine begins to "lope" and "roll" noticeably. Then it is turned to the right very slowly until the engine smooths out and begins to lose speed, after which the adjustment is turned to the left again until the engine just begins to pick up speed.

Perhaps the greatest problem of present-day operation comes from running a car with the motor relatively "cold" due to frequent starts, slow speed, and reduced mileage. The result is that raw gasoline works down past the pistons into the crankcase, washes oil from polished surfaces, and invites destructive pitting. The gasoline also washes down abrasive metal particles, road dirt, and carbon which scratch bearing surfaces as in Fig. 10, and contribute to the scratching and scoring of pistons as shown in Fig. 11.

Infrequent lubrication of the chassis causes shackle bolts to wear like the one in Fig. 14. This in turn permits annoying

Chipped teeth of transmission gear at A are caused by improper lubrication, and worn teeth at B are caused by the gear spinning while shifting gears

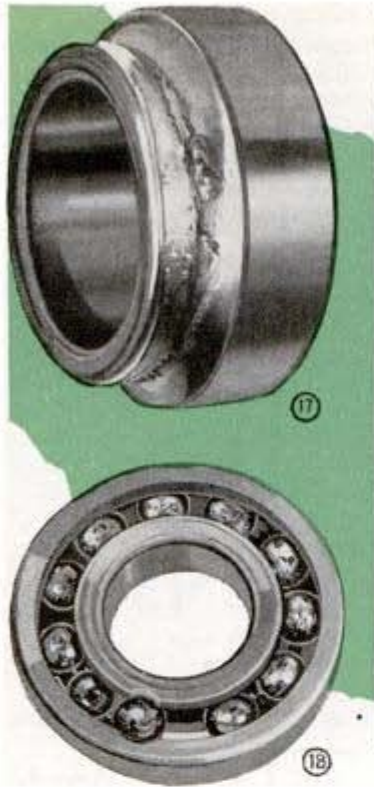

Cone and bearing at left show what happens when bearings are not adjusted and lubricated correctly

rattles and "chassis shake," which is injurious to tires and other parts. Often, failure to change to seasonal lubrication causes gear failure. The teeth of the transmission gear in Fig. 15 illustrate what takes place. Here the faces of the teeth of the gear (A) are deeply pitted and chipped, due to high pressures that cut through the lubricant. Continued whirling of this gear when shifting the transmission caused the worn condition of the teeth of gear (B).

Frequently, wheel bearings, Fig. 16, are neglected until the races are seriously damaged as shown by the cone in Fig. 17 which has been cut by broken balls of the bearing in Fig. 18. Unfortunately, when an owner discovers this damage he frequently overdoes the lubricating job and may completely "blow out" the grease seal in the rear-axle housing, which allows lubricant to work into the brakes. Grease in a brake has two opposite effects. When

first applied, the brake fails to hold, but as it heats up it "grabs," causing tire wear.

Being the very heart of the car, the electrical system should be checked regularly. When a battery is corroded like the one in Fig. 13, it may be that the water level is being carried too high in the cells, or that the charging rate is too high. When water is added, the level should never be brought more than $\frac{3}{8}$ in. above the plates. This will allow for expansion of the electrolyte when charging. It is best to check the battery at regular intervals with a hydrometer, as in Fig. 12. Keeping the specific gravity reading between 1.225 and 1.300 assures maximum battery life. If, however, the battery is constantly at the higher reading, perhaps the generator charging rate can be reduced. An excessive charging rate drives off the electrolyte and causes rapid wear and heating of the generator.

Saving Your Anti-Freeze Solution for Use Next Winter

Removing the anti-freeze solution from your car and storing it for use next winter assures you of some protection in case you are unable to obtain the required amount of new solution. Solutions that can be stored are those containing ethylene glycol (permanent anti-freeze solutions,) and those containing denatured ethyl alcohol, or ethanol, and methanol (wood alcohol.) Clean glass jugs or cans provide suitable containers. If cans are used, precautions

should be taken to prevent rusting, and the containers should be labeled and marked poison. Before the solution is used again, its strength should be checked, and it should be tested for acid content with blue litmus paper or similar indicator. If blue litmus paper turns red when immersed in the solution, an ounce or so of washing soda should be dissolved in the solution to neutralize the acid. Also, it is desirable to add a rust inhibitor.

Cutouts Made on Sewing Machine Using Altered Needle



Making cardboard cutouts on an ordinary foot-powered sewing machine is a fairly simple matter when the needle has been altered as shown. A heavy needle is cut to about 1 in. in length and the end ground to a sharp, chisel edge. When inserted, in the same manner as an ordinary needle, it should project far enough to penetrate about $\frac{1}{8}$ in. below the surface of the machine's table. With the design laid out on cardboard, proceed as if sewing along the lines. Soft cardboard up to about $\frac{1}{4}$ in. may be cut. Be careful in using heavier or tougher cardboard. Proceed slowly at first until sure the machine is cutting properly.

—Frank Shore, New York City

Moth Ball Usefulness Multiplied With "Pin-Up" Models

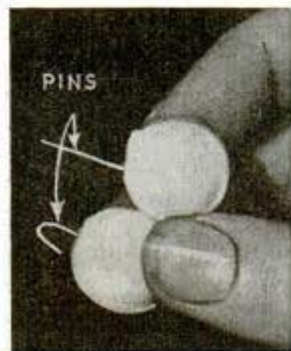

evergreen branches, moth balls discourage dogs. Pinned in this way, they also are

Moth balls can be put to many new uses if a pin, either straight or bent to form a hook, is heated and pushed into the moth ball to the center. After a few seconds cooling, the pin is permanently embedded. Hung by these pins on

much easier to place properly in clothing. They can be attached to portions of furniture which ordinarily would not be protected during storage, and are also handier in protecting collections kept in cases—in fact, wherever moth balls are used.

Glass Strip in Fish Aquarium Controls Floating Plants

To keep floating plants from covering the surface of your aquarium, and to provide a thick growth for concealing baby fish, wedge a strip of glass, 2 in. wide, across the width of the tank, with the top edge slightly above the water. An application of aquarium cement will make the installation permanent.

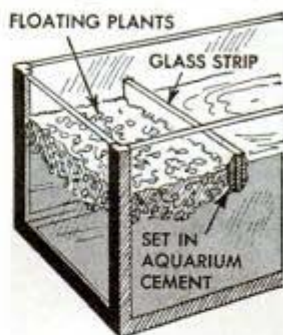

—S. P. Wiener, South Norwalk, Conn.

Hinge Stops on Castered Bench Prevent It From Moving About

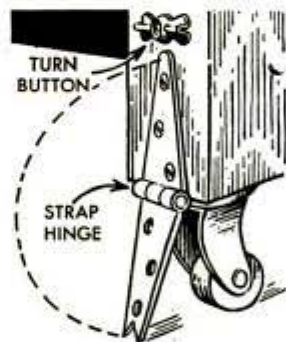

should rest at the angle indicated, when dropped down to the floor, and can be notched at the ends to provide points to engage the floor. Turnbuttons hold the hinge ends when they are swung up out of the way to move the bench.

If you have a heavy workbench that is provided with casters, and it is difficult to keep the bench from moving away from the wall, attach strap hinges to the front legs to serve as stops. The free ends of the hinges

Lock Washers From Coil Spring

The next time you need some small lock washers and there are none at hand, just take a small coil spring and cut off a few of the coils, which will serve nicely as washers.



The coils are cut off easily by inserting a small rod into the spring and using this as an anvil under a chisel.

PHOTO-PRINT STRAIGHTENER

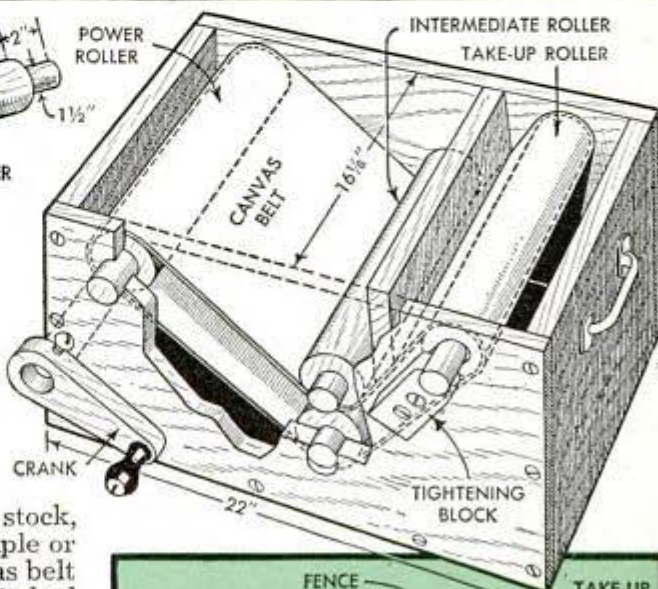
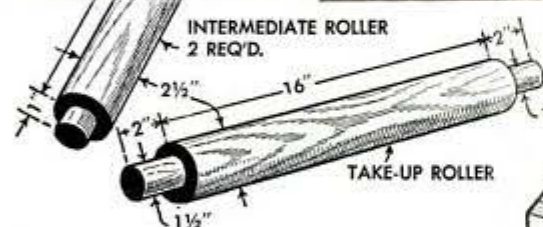
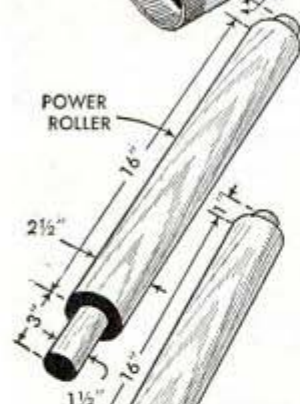
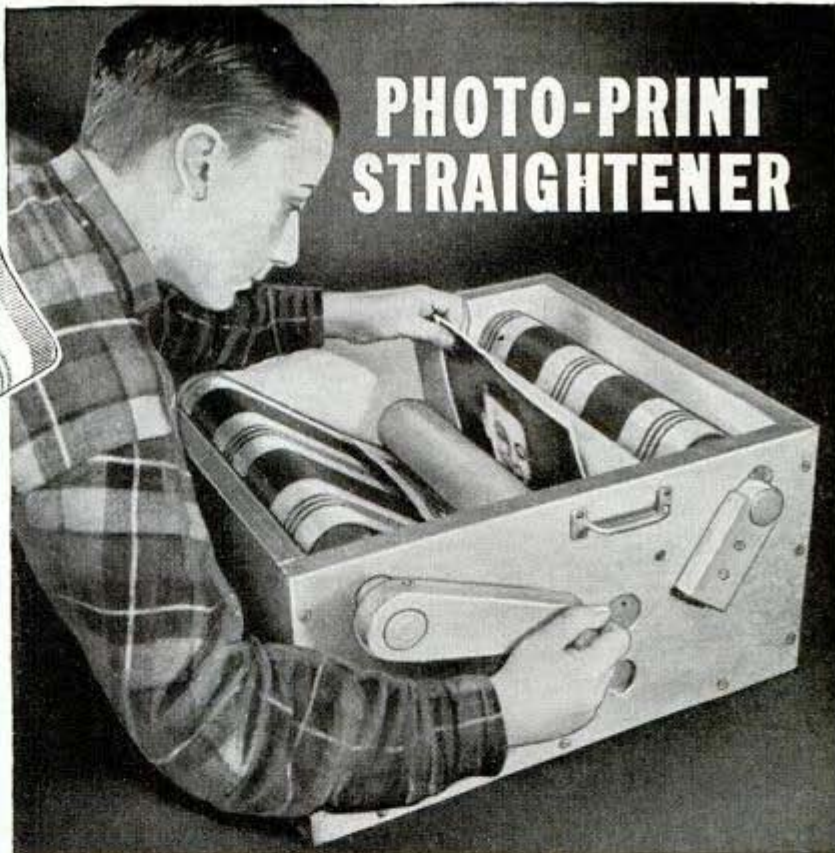

This inexpensive wood and canvas print straightener enables you to do a professional job on your photographs. The dimensions shown are for 8 by 10 in. or 11 by 14 in. prints. For smaller prints, the top intermediate roller should be smaller—about 1 1/4 in. in diameter for 4 by 5 in. prints. The outside housing, crank and fence are 1-in. stock, while the rollers are turned from maple or other close-grained wood. The canvas belt is cut diagonally and the seam is stitched down. As the canvas will stretch, tightening blocks, preferably having slots for adjustment, are installed to take up slack. Move the blocks up as far as possible so that the canvas is taut, then tighten the screws. If the canvas goes toward one side, lower the roller on that side. Some play must be left in the bearing ends of the lower intermediate roller. Prints to be straightened are inserted between the fence and the upper intermediate roller.

—Jack Mellinger, West Orange, N. J.

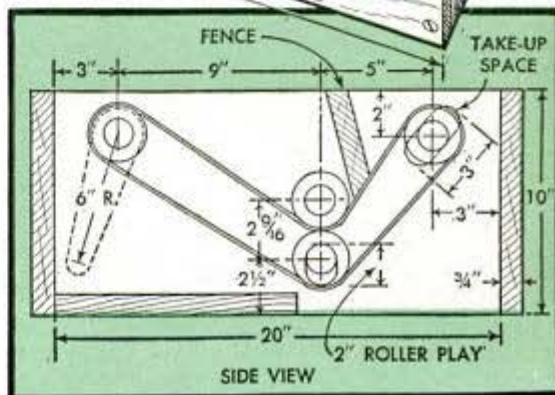

Using an Eraser on Photo Prints Reduces Local Shadows



Dark areas of prints often can be reduced to a lighter shade with the use of an ordinary pencil eraser. An ink eraser will do the work faster but requires more care since it is more abrasive. The method is especially suitable for smaller areas and is adaptable to matte and semimatte papers. After the print has been reduced, a light coating of oil medium is applied over the entire surface to prevent visible marks.

Closeups With Ordinary Cameras Taken by Switching Lenses

Closeup work can be taken without the use of an auxiliary lens with an ordinary No. 120 folding camera simply by changing the lens to a position in front of the shutter. This type of camera has a thread in front



of the shutter of exactly the same size as that in the rear, making it easy to switch the lens. With cameras in which both lenses are the same size, a similar technique can be applied. Shots can be taken as close as one foot. Proper distances are, of course, determined through the use of a ground glass.

Funnel Directs Water Properly While Washing Prints

You can direct the faucet water into your print-washing trays near the bottom to avoid damaging the photo papers by taping a clothespin to the spout of a funnel. This assembly, clamped to the tray under the faucet, will give

your prints thorough and safe washing. It is best to arrange the funnel so that the end of the spout will be located just slightly above the tray bottom.



Clothespin Handle on Reflector



Clipped to the rim of a photo-flood reflector, a spring-type clothespin provides a convenient handle for adjusting it without the risk of burning the fingers or getting fingerprints on the polished surface of the reflector.

Developer Cooled More Quickly With Salt in Tumbler of Ice

During hot weather when you find it necessary to use ice in a tumbler to cool a tray of developer, you can save time by applying salt to the ice to make it melt more rapidly. This takes up the heat from the developing solution, causing it to cool more quickly.

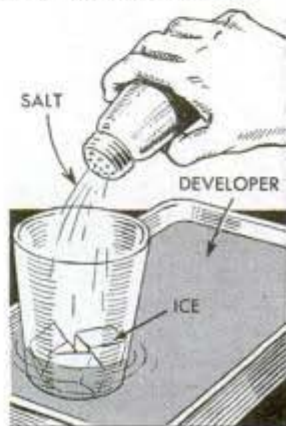

Swivel-head TRIPOD

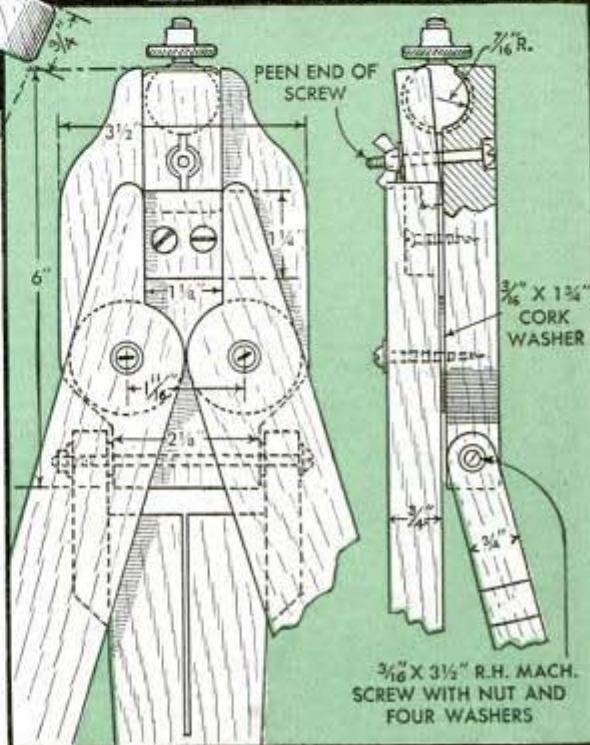
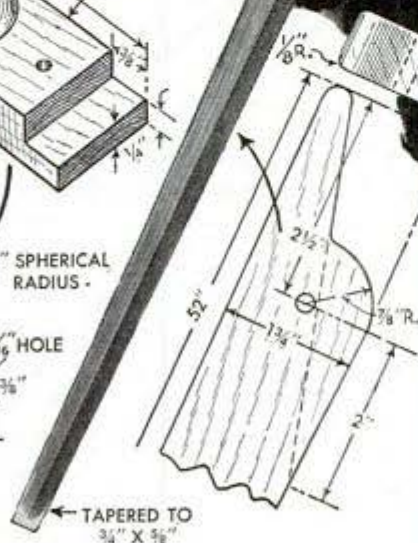
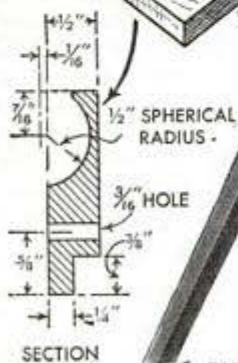
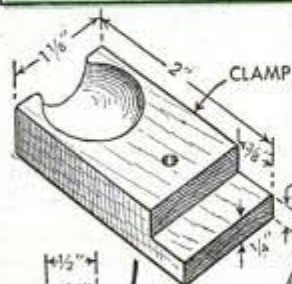
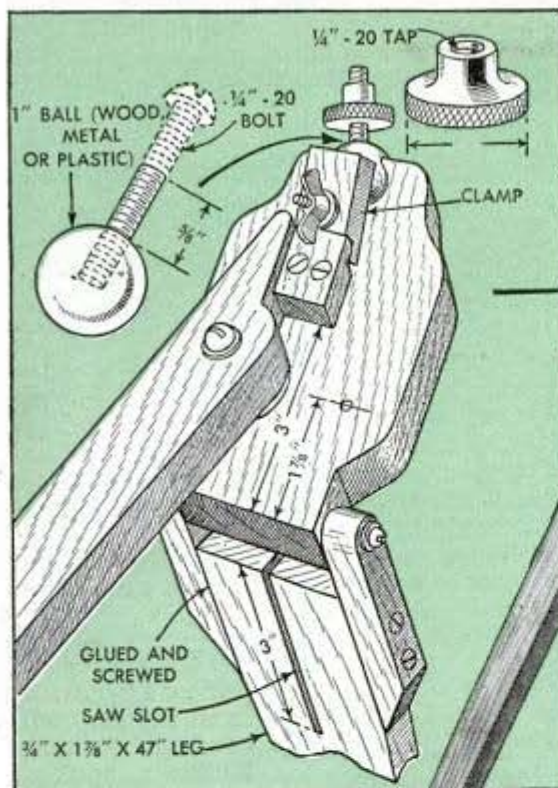

Although the legs of this rigid, all-wood tripod do not telescope, it can be adjusted for height to some extent by spreading the legs. The swivel head makes it possible to tilt the camera in practically any position for still shots and, with the clamp loosened slightly, action can be followed with a movie camera. Make the tripod of hardwood such as birch or maple. Leg fastenings should be tightened sufficiently to provide friction

Pan on Window Checks Damage Caused by Melting Frost

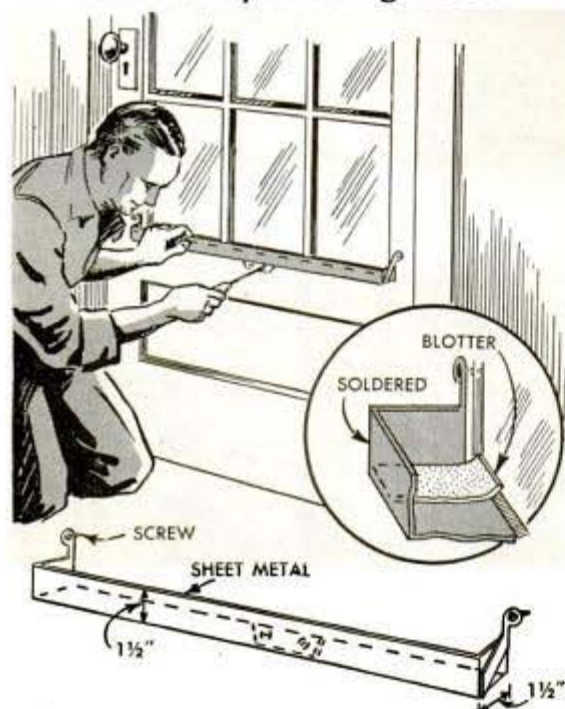

To check the water which melted from frosted door and window panes before it ran down and froze between the door and the tread or caused other damage, one man cut and bent a metal strip into a pan, soldered the joints and screwed it to the door just beneath the panes. Blotters to make a thickness of about $\frac{1}{2}$ in. are placed in the pan to absorb the moisture as it runs down. Similar pans may be attached to other doors and windows which cause the same trouble.

—Henry J. DeFreeuw, South Bend, Ind.

Altering Shackles on Padlocks To Suit Special Purposes

It's not difficult to alter the shape of a padlock shackle to suit some unusual locking job, such as locking oars to the side of a boat, a telephone receiver to its hook, etc. All you have to do is cut off the shackle close to the lock, and either reshape it to

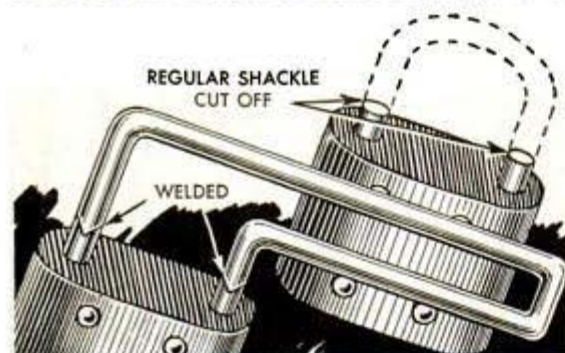

suit or else make a new shackle from small-diameter rod, and weld it to the shackle stubs at the lock. Before doing this, cut V-grooves in the stubs to receive the V-shaped ends of the new shackle, thus providing a good joint when welded.

Saddle Block Makes Safe Pusher For Work on Bench Saw

To assure the greatest possible safety to his hands and fingers when cutting small wooden blocks and strips on his bench saw, one carpenter uses a saddle-block type of pusher stick, which straddles the ripping fence.

An additional feature of the block is that it is not so easily mislaid as the usual type.

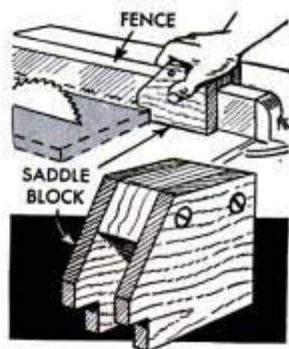

Nail Polish Protects Watch Strap

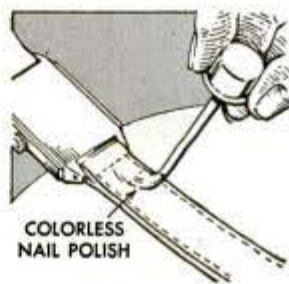

Perspiration from the arm will cause an ordinary leather strap for a wrist watch to rot within a few months, but it can be protected very easily with a couple applications of clear nail polish,

allowing the polish to dry between applications. The polish will seal the pores of the leather and make it practically waterproof. Additional applications of polish will give the strap a plastic-like appearance, although this is unnecessary except from a decorative standpoint.

—Kenneth Murray, Baltimore, Md.

Miniature Display Flags Stiffened By Ironing Under Waxed Paper

Small display flags that are stiffened with starch often become flimsy and wrinkled in damp weather. When this happens, just iron the flags smooth under sheets of waxed paper. Heat from the iron imparts some of the wax from the paper to the cloth, stiffening it and protecting it against moisture.





SHOP NOTES

Drilling DEEP HOLES in Metal

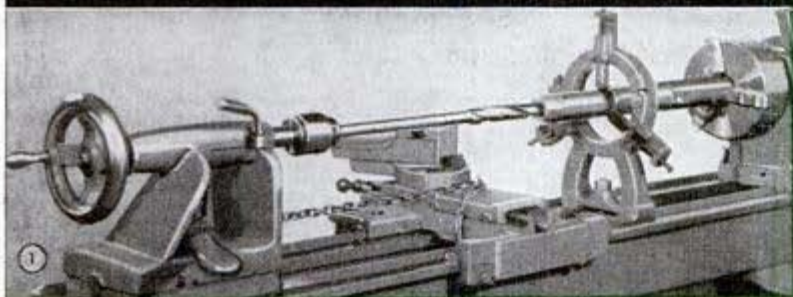

DRILLING FROM TAILSTOCK OF LATHE IS BEST METHOD OF WORKING WITH ORDINARY EQUIPMENT. POWER FEED CAN BE OBTAINED BY COUPLING TAILSTOCK TO CARRIAGE

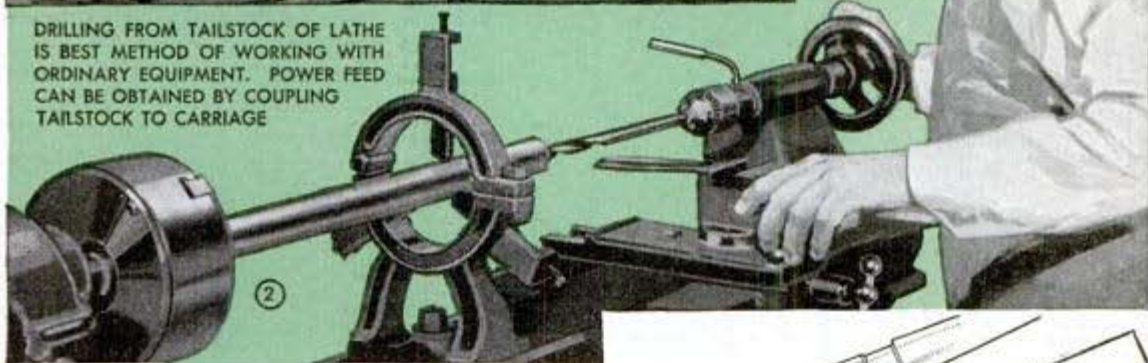

DRILLING cylindrical work from the lathe tailstock, as shown in Fig. 2, is practical for either shallow or deep holes. This method is accurate, easy to set up, and will handle the average job nicely. A power feed, if desired, can be obtained by coupling the tailstock with the carriage by means of a chain, as shown in Fig. 1.

The occasional job of deep-hole drilling can be done with a standard twist drill. For regular work of this kind, the drills shown in Figs. 4, 5 and 6 are preferable. Fig. 4 shows a high-spiral type of twist drill made

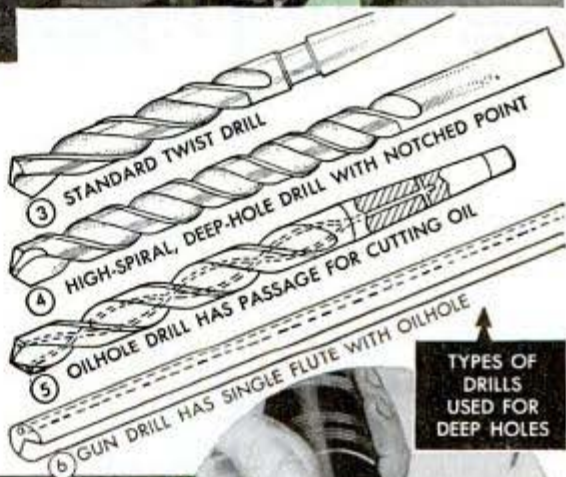

TYPES OF DRILLS USED FOR DEEP HOLES

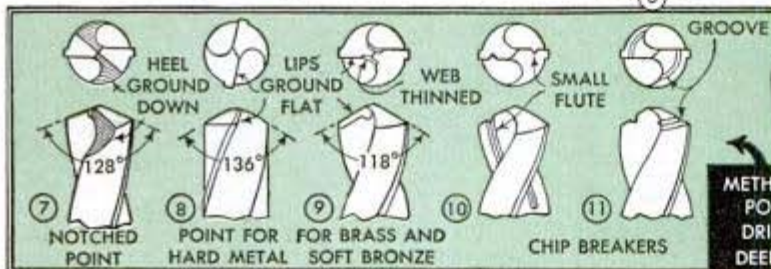

METHODS OF POINTING DRILLS FOR DEEP HOLES



★ ★ 13 DEEP-HOLE DRILLING PRACTICE WITH STANDARD TWIST DRILLS ★ ★

Material	F.P.M.*	Feed	Cutting Comp.	Style of Drill Point
Aluminum	250	Depends on drill size:	50:50 Kerosene and Lard Oil	Sharp point—90° to 110° included angle
Bronze and Soft Bronze	200	Under 1/8" — .001 to .002 in. per revolution	Dry or Soluble Oil	Standard 118° point with cutting lips flattened
Soft Cast Iron	120	1/8" to 3/4" — .002 to .004	Dry	90° to 118° included angle
Soft Steel	110	1/4" to 1/2" — .004 to .008	Soluble Oil, Mineral Lard Oil or Sulphurized Oil	Notched point, 118°
Tool Steel	60	1/2" to 1" — .008 to .015		125° to 135° included angle—angle increases with hardness
Cast Plastic	250	Over 1" — .015 to .025	Dry (withdraw drill frequently)	118°—Relieve heel as shown in Fig. 7 but without notching web

* For high-speed steel drills

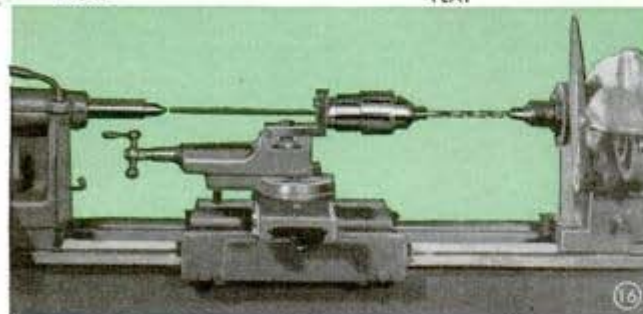
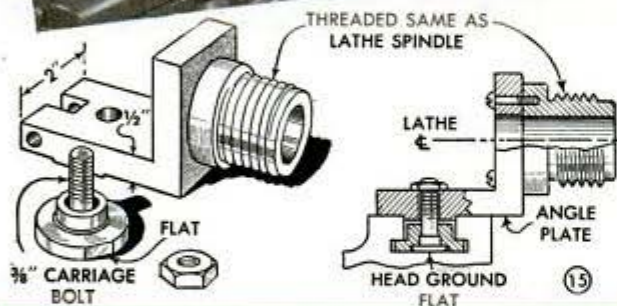
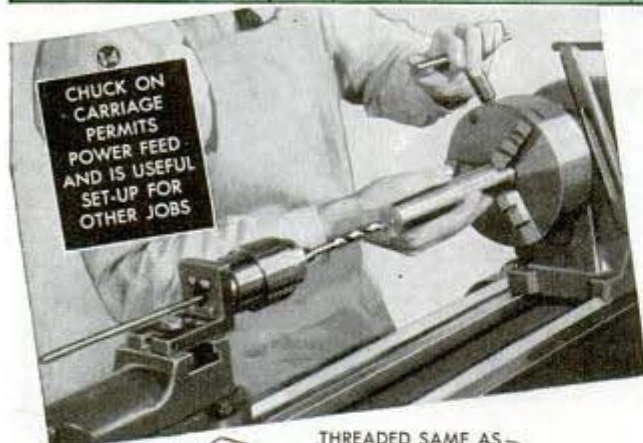

tracking of all drills used in deep-hole drilling.

You can drill to almost any depth with a standard type of twist drill by simply back-tracking the drill frequently. The hole should be drilled about one diameter or less, after which the drill should be withdrawn completely. This cycle of operations clears the hole of chips, allows the drill to cool, and gradually wears away any hard spots on the walls of the hole. If the drill is not long enough, a shank of suitable length and diameter can be welded on. One important thing to check is the margins of the drill. A high, clean margin is absolutely necessary—don't try deep-hole drilling with a drill that has margins worn away, especially within 1 in. of the lips.

Special pointing of the drill is sometimes helpful. Fig. 7 shows the best all-around point for deep-hole drilling. The included angle is 128 degrees, which is a bit sharper than the normal 118 degrees. The web is thinned by grinding away the heel, as shown. This drill penetrates easily, the notched point eliminating the non-cutting web of the standard twist drill. If the work is very hard, a blunt point, as in Fig. 8, with the cutting lips slightly flattened, will cut and hold up better. The same treatment of flattening the lips is required when drilling brass, Fig. 9,

especially for deep-hole work (sometimes called a crankshaft drill). Other than the fast twist, which gives better chip elevation, this drill differs from a standard twist drill in that it has a notched point. Fig. 5 shows a standard twist drill with oil holes through the solid metal. It requires a special socket which permits coupling to a force-feed oil line. The cutting oil cools and lubricates the drill, and washes the chips out through the flutes. The gun drill, Fig. 6, also works on the force-feed system, chips being washed out through the single flute. Properly supported, it is the truest

but in this case the included angle is the standard 118 degrees. Fig. 9 also shows web thinning by grinding with a round edge wheel. A moderate amount of this is good practice, especially on larger drills.

Figs. 10 and 11 show two styles of chip breakers. The purpose of a chip breaker is to divide and break up the chip so that it can be expelled readily through the flutes of the drill. In factory-made drills of this style, the chip breaker consists of one or more flutes within the main flute, as in Fig. 10. A simpler style for occasional work is shown in Fig. 11, where the chip-breaking

flute is ground on the end of the drill. Fig. 12 shows how the work is done with a hand grinder fitted with a cut-off wheel.

A summary of drilling practice with standard twist drills is given in Fig. 13. Power feed is sometimes a desirable feature because it keeps the chip uniform and unbroken. Besides the chain method shown in Fig. 1, power feed on the lathe can be obtained by drilling from the carriage, as shown in Figs. 14 and 15. This set-up is

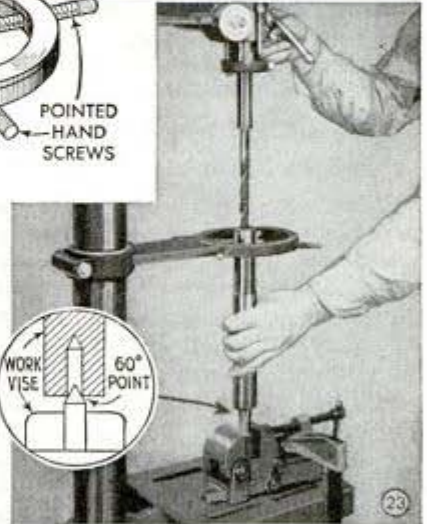
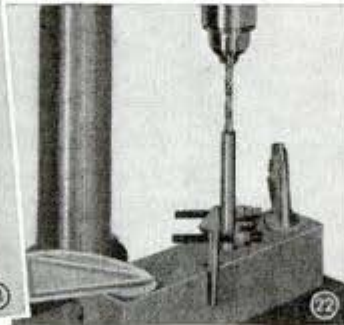
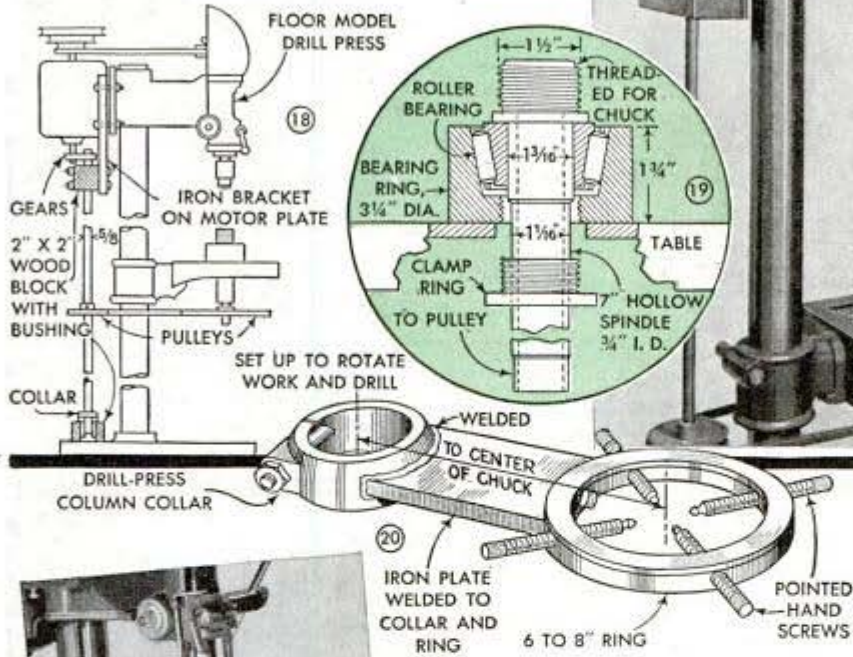
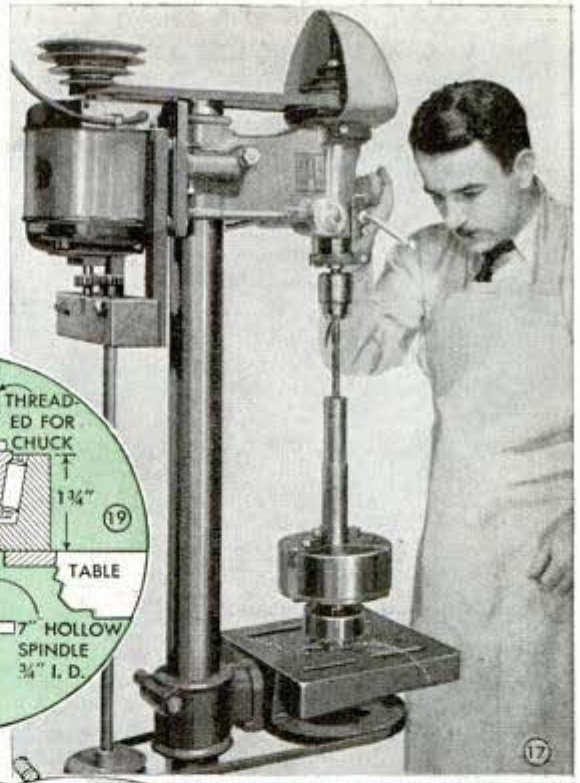

easily aligned by using a straight rod or the drill itself, as in Fig. 16.

When the work is done on the drill press, various methods can be used to assure an accurate hole. Many machinists rotate both work and drill, as shown in Figs. 17, 18 and 19. The diagram, Fig. 18, shows a 1:1 ratio from motor to pulley spindle, but a reduction of 2:1 is better as it decreases vibration and gear noise. A further reduction is obtained by the pulleys, so that the final speed of about 200 r.p.m. is obtained.

Figs. 21 and 22 picture one of the best methods of drilling round work of small diameter. A wood block is clamped to the

drill table and a drill of the same diameter as the work is used to run a hole into the block, as in Fig. 21. Then the work is mounted in the hole, with the actual work drill in the drill chuck as in Fig. 22. Note that the drill table and the wooden block remain in a fixed position.

In drilling long work on a drill press, the biggest difficulty is holding the work upright. For this purpose, the ring shown in Fig. 23 is excellent. The bottom end of the work is supported on a 60-degree point held in a drill vise, the point being aligned exactly below the drill point previous to the drilling operation.

Easy Way to Hold a Blowtorch While Filling the Tank



The problem of holding a blowtorch in an inverted position while filling the tank was solved by one workman who hooked it over a nail driven into the workbench top near one edge. To do this, a small hole was drilled through the rim of the torch tank as indicated. With this method of holding the torch, both hands are free to hold the gasoline can while filling the tank.

Shrinkage Space Avoids Bulge Above Steel Support

Whenever steel I-beams are used as supporting members for the ends of heavy wooden floor joists, an air space should be provided between the joist ends directly above the beam. If this is not done, shrinkage of the joists, or contraction and expansion, which is widely different between the wood and metal, may cause the floor boards to bulge. The air space allows for vertical movement of the floor above the beam, and is made by notching the ends of the joists

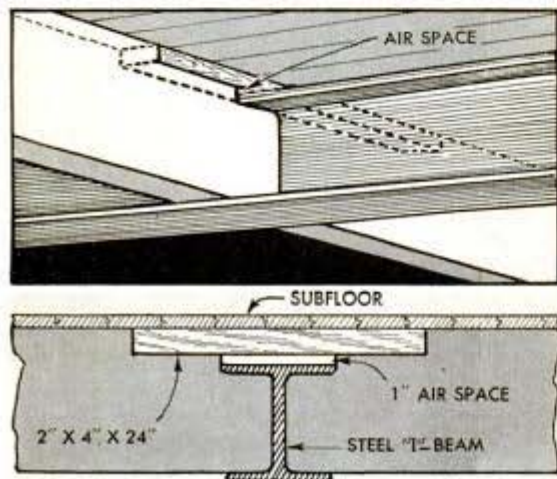

to form two recesses above the beam as indicated. One recess is about 1 in. deep and of the same width as the beam, and is bridged by a length of 2 by 4-in. stock, which sets in the longer second notch flush with the upper edges of the joists to support the floor boards.

Coupling Locked on Pump Rod

While on a job of repairing a well pump, the workman noticed that one of the couplings on the pump rod was loose and could not be tightened securely because of worn and rusted threads. As no new coupling was available, a good repair was made by sawing off one end of the coupling as indicated, and then using this as a lock nut to secure the connection.

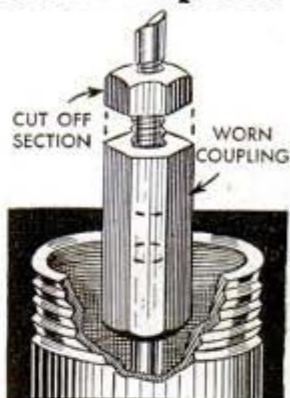

Wrench Loosens Oil-Drum Plug

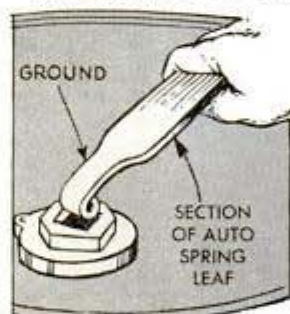

plugs. This served even better than the wrench formerly used as it would not get out of adjustment, and since it could not be used for other purposes, there was no reason for carrying it away.

Annoyed by having some of the workmen carry away a wrench used for loosening the plugs in oil drums, one garage mechanic ground down the eye end of an auto-spring leaf so that it would fit into the

Sandpaper Cone Lifts Eggs

To simplify the removal of eggs from the case fillers for candling, one merchant employs a cone made of coarse sandpaper. The cone is rolled with the rough side in and is held permanently in shape with strips of gummed paper tape. Pressed down over an egg, the cone lifts it easily, and may be detached by a slight pressure of the fingertips.



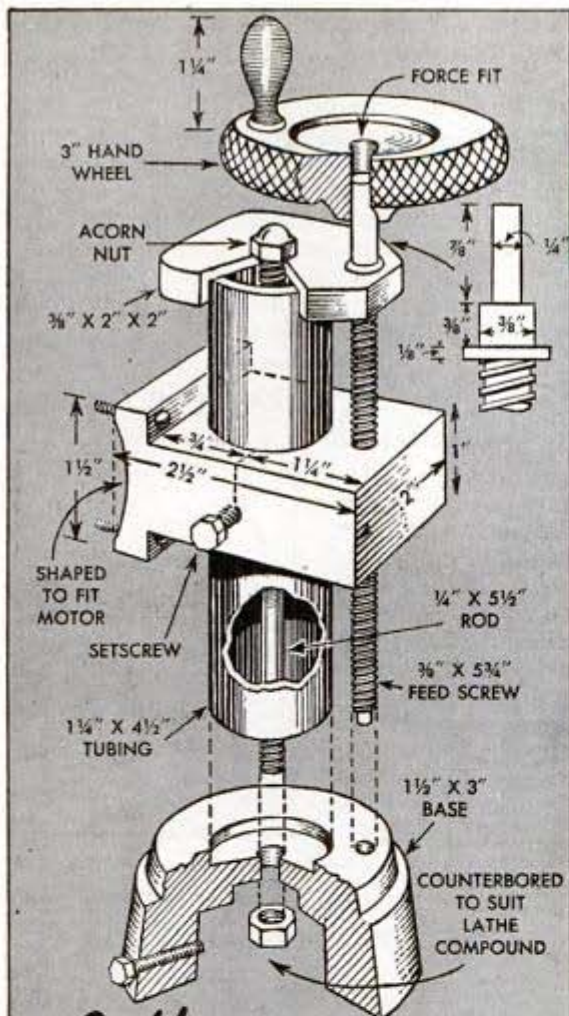

Lathe TOOL POST GRINDER

By R. Rosendahl

Inexpensive and easy to make, this grinder will handle most light tool-post work accurately, being especially suitable for finishing and for grinding recesses, keyways, etc. Vertical adjustment is made with a hand wheel on the grinder assembly and lateral feed or adjustment is made with the lathe-compound screw. Any small motor of $\frac{1}{8}$ hp. or more having a speed of 3,500 to 4,000 r.p.m. will do. Of course, the motor shaft must be threaded for attachment of a grinding wheel, and if desired, a chuck or sleeve can be used on the end to take a stub extension, thus lengthening the shaft for internal grinding. The grind-



er is made to be interchangeable with the lathe compound rest, and the base must be shaped to fit your particular lathe. Material for making the grinder can be found in most scrap boxes. The base can be turned from cast iron, and the vertical post can be machined from ordinary pipe if tubing is unavailable. The assembly is held together by a rod, which is threaded at both ends for nuts. As the grinding wheel must rotate in the direction opposite to that of the work, it may be necessary to reverse the rotating direction of the motor, which usually can be done by reversing the wires from the brushes to the field coils. Any electrician can do this if you are not familiar with the procedure.

Replacement of Clock Gears Aided by Paper Pattern

To simplify the replacement of parts in an alarm clock which has been taken apart for repairs, take a rather stiff sheet of writing paper; place it beneath the side of the frame that is removed and, with a pin, punch holes through it at the bearing points. It is then easy to slip the paper over the ends of the gear shafts to hold them in place while the frame is put back, after which the paper is easily torn away.

Improving Scaffold With Wheels Bracketed to Stirrups

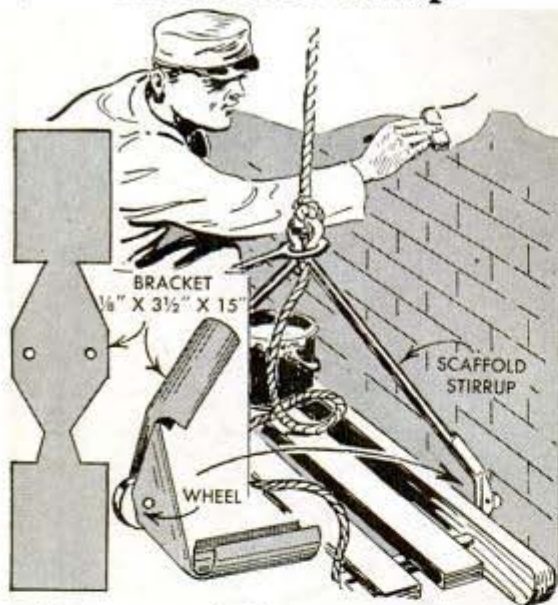

Wear on scaffold stirrups can be prevented, and the scaffold made easier to raise or lower if a bracket carrying a small wheel is attached to each stirrup at the spot where it ordinarily would rub against the wall of a building. The bracket is cut from $\frac{1}{8}$ -in. steel, with the center bent out as shown to take the wheel, which can be a roller-skate wheel or any other suitable one. The ends of the bracket are bent in the opposite direction and hammered around the stirrup.

Tap Wrench Made Into Pin Vise For Use With Large Stock

A pin vise capable of handling $\frac{1}{4}$ -in. round stock can be made from a standard tap wrench. After the handle bar is driven out, clamp a rod of maximum diameter in

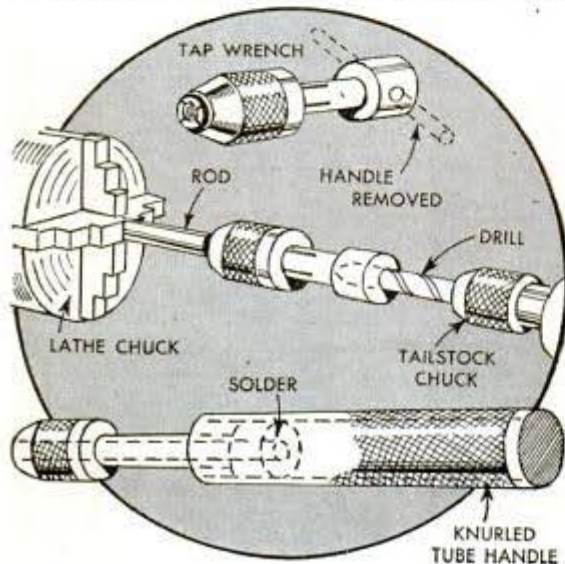

the wrench and chuck the other end of this rod in the lathe. Using a drill of the same diameter as the rod in the tailstock chuck of the lathe, complete the hole lengthwise through the tap wrench. A piece of steel tubing is knurled on the outside for a handle. With the head of the tap wrench turned down to the right size, it may be driven into the handle and soldered in place. Remove the rod, give the tool a careful cleaning, and the converted wrench is ready for use as a pin vise.

Printing-Ink Cans Open Easily When Block Is Tacked to Lid

To remove the covers of printing-ink cans without battering and pounding, one printer tacks the covers onto wood blocks. These blocks provide a firm grip for the fingers, by which the covers may be loosened and removed instantly.



Handle Is Held Securely on File By Hook Point on Tang



If you are troubled by having the handle of a file loosen, grind the tang end to a sharp point, then heat and bend it to form a hook as indicated. When the tang is forced into the handle, the hook will anchor firmly in the wood and hold the handle securely.

Tin Strip Provides Sharpener For Pointing Shop Crayon

For sharpening crayon or chalk for shop use, one workman twisted a strip of tin as shown and tacked it to the wall. The free end provides a blade and the crayon is pointed by inserting and turning it.



Two-Row Cornstalk Cutter From Scrap Material

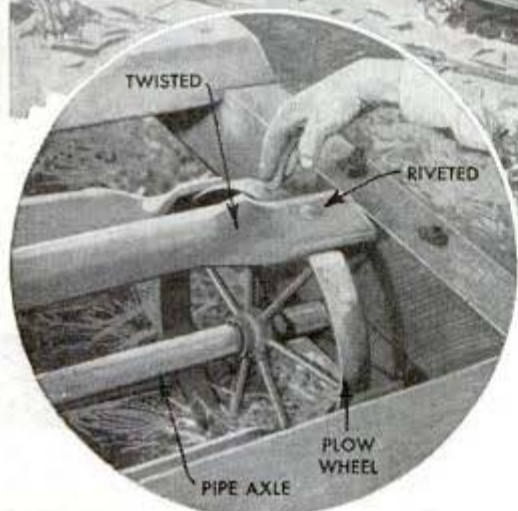
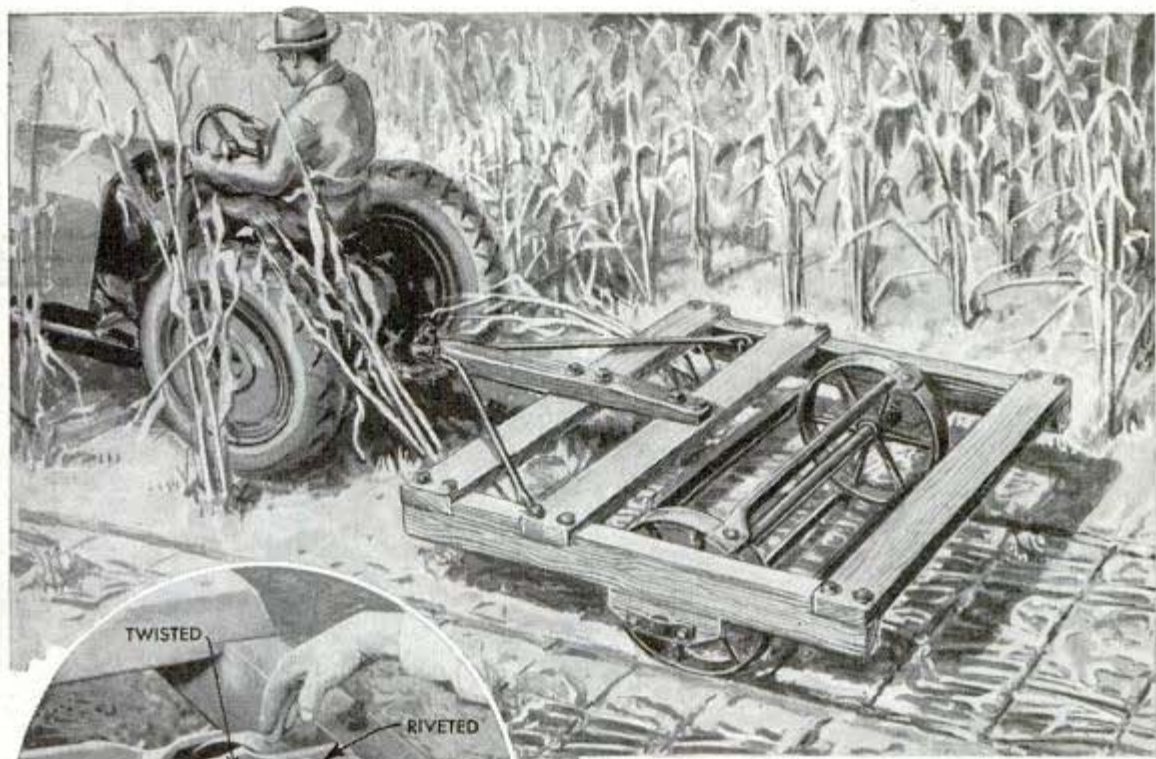

Covering two rows at a time, this cornstalk cutter will save time, and costs very little to make, especially if you have some scrap lumber and a couple of small implement wheels available. On the original, two plow wheels were used, and a length of pipe served as an axle. Old road-grader blades were used for the cutters, but other pieces of flat, scrap steel will do, provided they are tempered to hold a sharp edge. The cutters are given half twists near the ends by forging and then are riveted to the wheel rims, spacing them equally around the wheels. For the frame, use 4 by 4-in. stock or heavier at the sides and 2 by 6-in. stock for the crosspieces. Bearings are hardwood blocks, preferably maple, drilled to receive the axle, the bearing holes being capped at the outside with pieces of flat iron to keep the cutter assembly centered in the frame. With this arrangement the wheels are pinned to the axle. However, if it is desired to have the wheels turn on

the axle and thus provide bearing surfaces more resistant to wear than wood bearings, the axle is held rigidly in the frame and is drilled for large cotter keys at the inner sides of the wheel hubs to keep the assembly centered. Spring teeth from a hay tedder are fastened near each end of the front crosspiece to drag on the ground and turn all cornstalks at right angles to the cutter so they will be chopped into short pieces. Although the original cutter was fitted with a stub tongue for pulling with a tractor, horses can be used if a longer tongue is provided. If this is done, the tongue should be set to one side of the cutter center so that the horses can walk between the cornstalk rows instead of on them.

—A. M. Wettach, Mt. Pleasant, Ia.

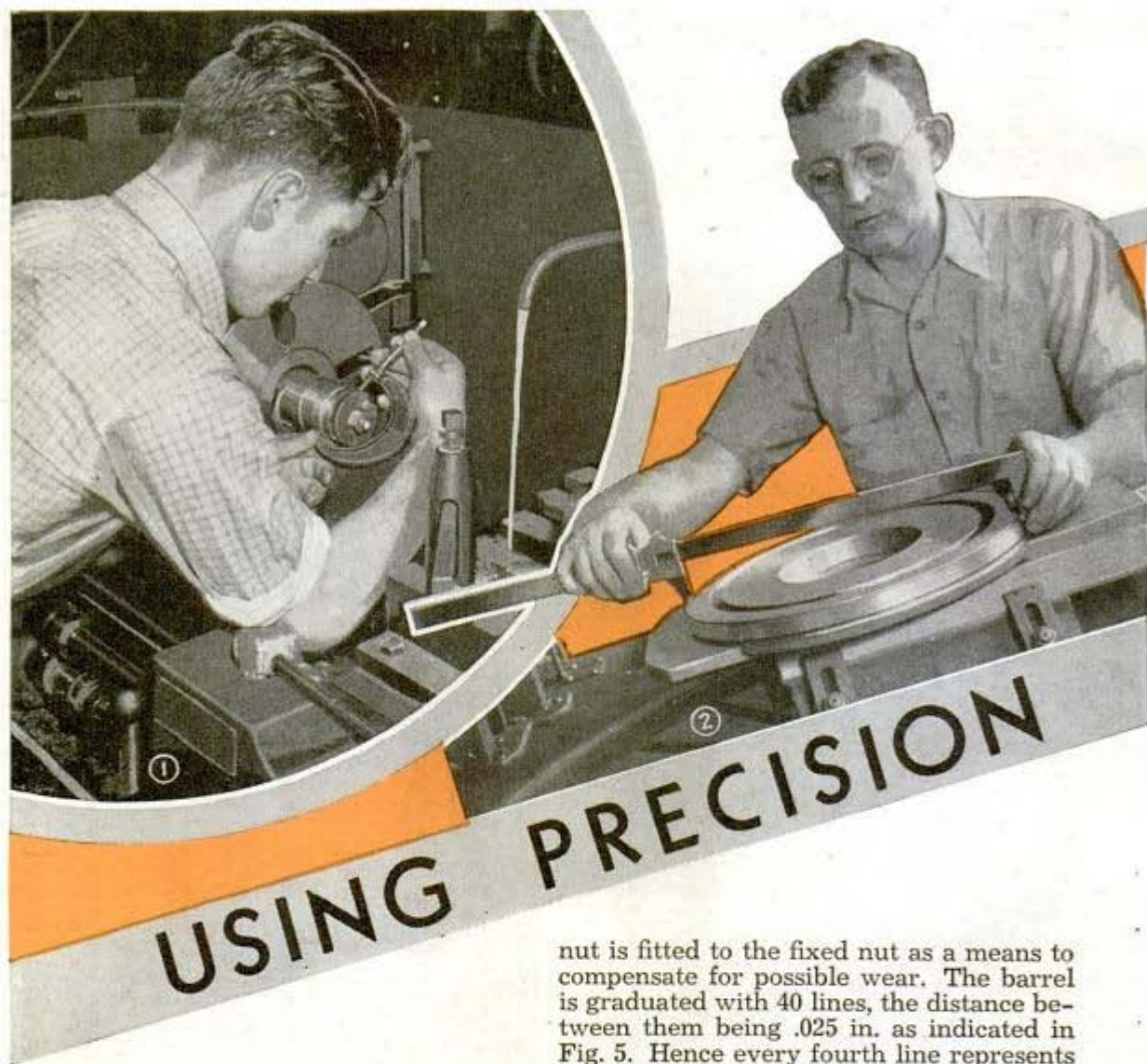

By H. J. Chamberland

WHEN speaking of precision measuring tools such as used by machinists, toolmakers and machine operators we usually refer to types graduated to read in thousandths and tenths of thousandths inch or in degrees and minutes. The four most outstanding and generally used precision measuring tools are the micrometer caliper, Fig. 1, vernier caliper, Fig. 2, universal bevel protractor, Fig. 4, and the combination square, Fig. 3, which is a precision measuring tool when used in connection with its attachments.

Micrometer caliper: This tool, commonly called a micrometer or "mike" measures one-thousandths of the standard inch. It consists of two engaging parts which can be separated when necessary. As shown in Fig. 6, one part consists of the frame and barrel which are integral. A fixed nut is fitted internally to the barrel and a slotted

nut is fitted to the fixed nut as a means to compensate for possible wear. The barrel is graduated with 40 lines, the distance between them being .025 in. as indicated in Fig. 5. Hence every fourth line represents .1 in., being marked 0, 1, 2, 3, etc. The 40th line is marked 0 as is the first. The total distance between the two 0 lines is therefore 40 times .025 in. or 1000 thousandths of an inch.

The other part of the micrometer consists of an accurate screw-spindle to which the thimble is fitted. The screw-spindle rotates inside the barrel and the thimble on the outside. The latter has 25 graduations on its beveled edge and every fifth graduation is marked 0, 5, 10, 15 and 20 with the 0 representing the 25th. One complete revolution of the thimble is equal to one spacing on the barrel, or .025 in., and as the thimble is divided into 25 equal parts, it follows that one of these parts represents .001 inch.

How to read a micrometer: First read the highest figure showing on the barrel, which in Fig. 5 is .2 in. To this you add .025 in. for every line visible between this figure and the edge of the thimble, which in the example makes a total of .225 in. To

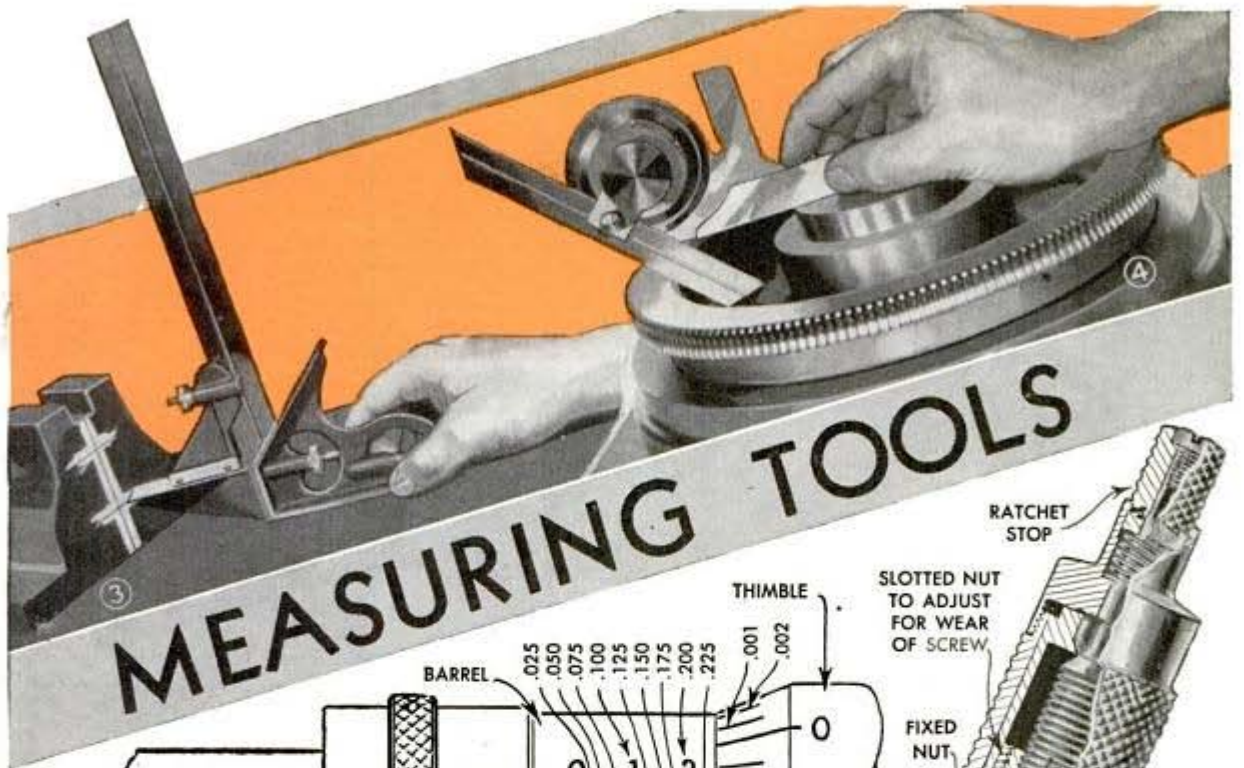

MEASURING TOOLS

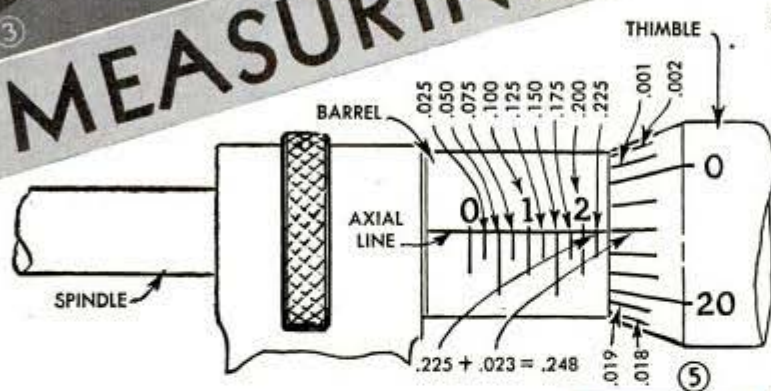

this total is added the number of lines on the thimble which coincide with or have passed the parallel or axial line on the barrel. In Fig. 5 the 23rd line coincides with the axial line. Thus the total reading is .248 inch.

For closer measurements many micrometers are graduated to divide a thousandth inch into ten parts each representing .0001 in. As shown in detail A of Fig. 8, the only difference between this and other micrometers is 10 horizontal lines on the barrel known as vernier divisions, which are marked as shown in detail B. Note that the axial line is lowered to permit this arrangement. To read in tenths, you first check the number of thousandths which in this case is .250 plus .020, as the 20th line on the thimble has passed the axial line on the barrel. Then you count the number of lines on the thimble that are above the vernier line 0 until you note a line on the thimble and one on the barrel coinciding. In this case it is the third line on the thimble and the .0003-in. line on the barrel, thus giving a compiled reading of .250 plus .020 plus .0003 or .2703 inch.

Method of using: Fig. 1 shows a very good way to use a micrometer on work in a machine but not held between centers.

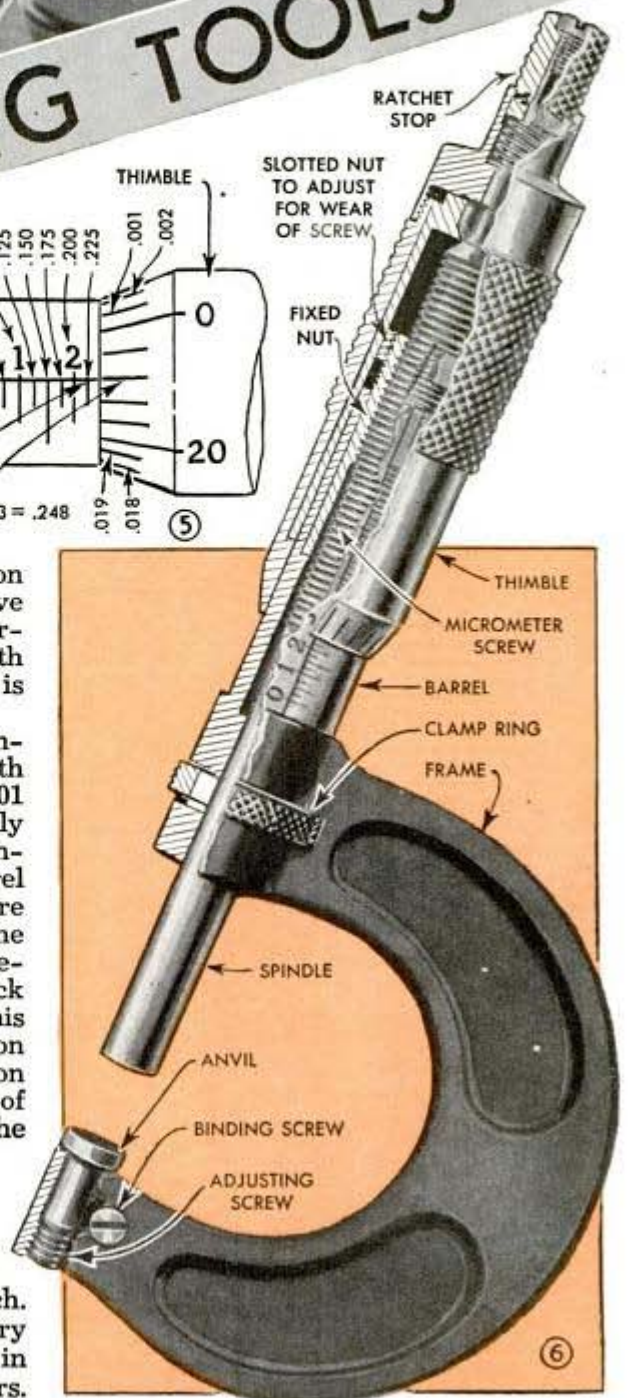



When possible the micrometer should be read before removing it from the work because a slight movement of the spindle while the mike is slid off the work might result in an incorrect reading. With the micrometer in this position the operator is facing the graduations, whereas in Fig. 9, when the work is between centers, the reading has to be observed from the left, or else the micrometer must be removed carefully from the work. Fig. 9 also shows the proper way to hold a micrometer on work mounted between centers. Its weight should be entirely supported with the hand holding the frame, leaving the other hand free to control the thimble for spindle contact without any undue pressure. Beginners will obtain closer readings and a micrometer will last much longer if it is equipped with a ratchet stop as shown in Figs. 6, 10 and 11. The ratchet stop prevents squeezing the work, which results in wear on the fine threads of the screw and also on the measuring faces. Fig. 11 shows how a micrometer is held in measuring small cylindrical parts. Note how the micrometer is supported in the palm of the hand and is held so it can be read easily.

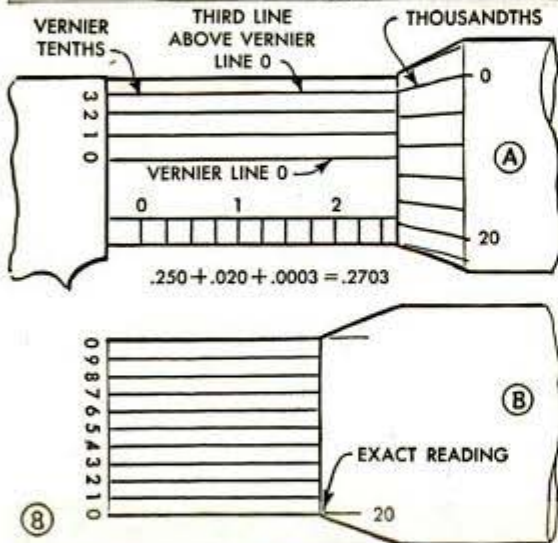

Although individual micrometers are available for measurements of 1 to 12 in., a set is rather expensive and therefore a micrometer as shown in Fig. 7 is economical. It consists of a frame and a set of interchangeable anvils varying 1 in. in length. Each anvil is also adjustable to compensate for wear, and measuring rods or "checks" are furnished to maintain over-all precision. The larger the micrometer, the more care must be exercised to hold it rigidly so that no pressure is transmitted to the spindle. When measuring large work, the micrometer must necessarily be moved back



and forth delicately while establishing spindle contact. All micrometers larger than 3 in. should be held as in Fig. 7. To get into narrow or deep slots, some micrometers have anvil ends as shown in Fig. 12.

Various types of micrometers: Fig. 15 shows a screw-thread micrometer, used to measure the pitch diameter of threads. The anvil is free to rotate into alignment. The tool shown in Fig. 14 is an inside micrometer used to replace plug gages for measuring holes from approximately $\frac{7}{32}$ to 1 in. diameter. The inside micrometer shown in Fig. 13 is the telescoping type and holes up to 12 in. in diameter can be measured to within .0005 in. This tool has interchangeable measuring rods, the measuring points adjusting themselves to the cylindrical surface automatically, after which they are locked by turning the knob on the end of the handle. Then the tool is carefully withdrawn from the hole, the thimble turned

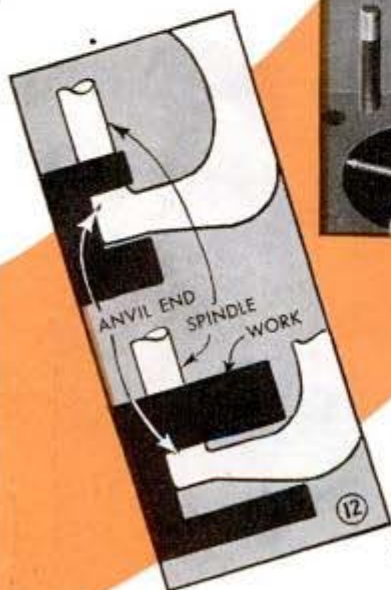
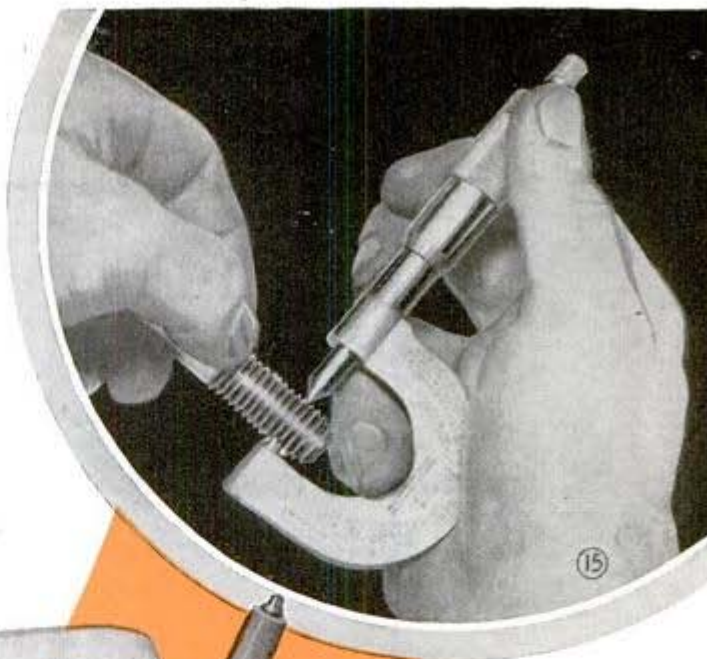

to which is precisely fitted a slide having an opening. The long scale is graduated somewhat like the barrel of a micrometer, having 40 divisions per inch, each being .025 in., and

every fourth line is a .1-in. division. To the slide is attached the vernier scale having 25 graduations numbered at every fifth line.

If the distances between the 25 lines on the vernier scale and 25 lines on the large scale were precisely alike, they could all be made to coincide simultaneously. However, the 25 divisions on the vernier scale equal in extreme length only 24 divisions on the large scale, meaning 24 times .025 or .6 in. Therefore the distance between the two lines of the vernier scale is .6 divided by 25, giving .024 in. or a difference of .001 in. between lines of the small scale and those of the large scale. When the 0 on the vernier scale is in line with a certain line on the large scale, the reading is exact.

To compute the reading as shown in Fig. 17 use a reading glass. Note that the 0 on the vernier scale has not reached the 6th figure of the second inch on the large scale. So, as with the micrometer, you add to the .5 in. the three preceding .025-in. divisions, which gives thus far 1.575 in. Now you start with the 0 on the small scale and, reading to the right, you find that the 14th line is the first line on the vernier scale

until making contact with the shoulder of the rod and the reading taken.

Vernier caliper: The vernier caliper

shown in Fig. 16 could be called a high-precision slide rule and described as a micrometer having graduations on flat rather than on cylindrical surfaces. The vernier caliper is intended to measure externally as in Fig. 2 and internally as in Fig. 16. As shown in Fig. 17, it consists of a long scale

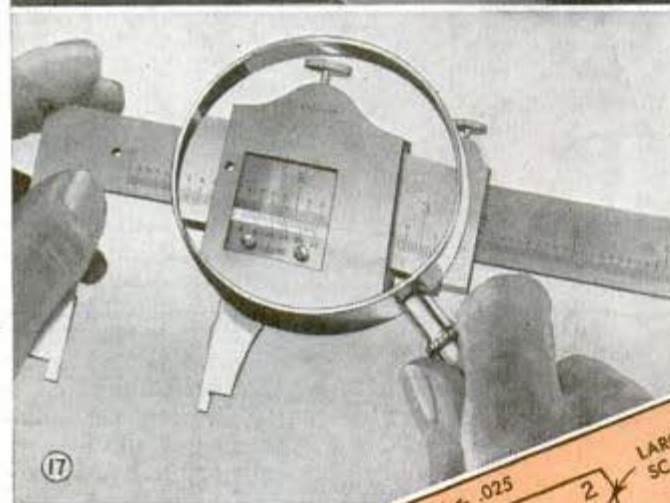
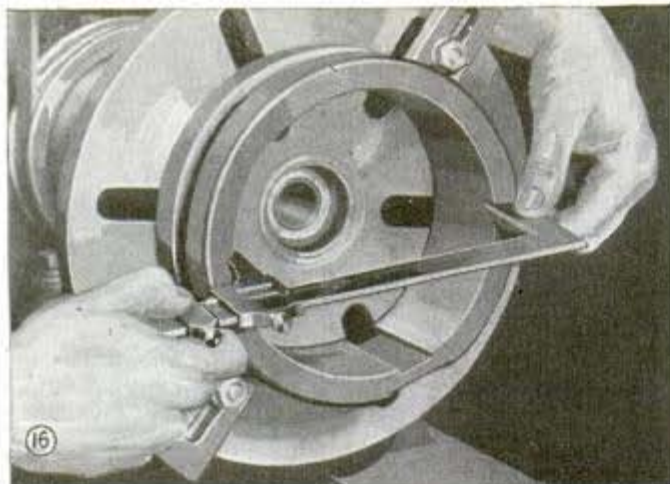

to coincide with a line on the large scale. Therefore the exact distance between the measuring faces is 1.575 plus .014 or 1.589 in. Fig. 18 is a closeup view of the reading in Fig. 17 between the .8 and the 2-in. lines of the large scale. Graduations on both scales are enlarged to show the coinciding of the 14th line of the vernier scale.

Fig. 2 shows how a vernier caliper should be used to check external measurements; the user holds the end measuring face against the work while the slide is adjusted by means of a fine thread screw to create the proper contact from this opposite measuring point. Precise measurements are obtained as with a large micrometer by simultaneous "feel" and delicate back-and-forth movement. As shown in Fig. 17, some vernier calipers are graduated on both sides so they can be read for both external and internal meas-

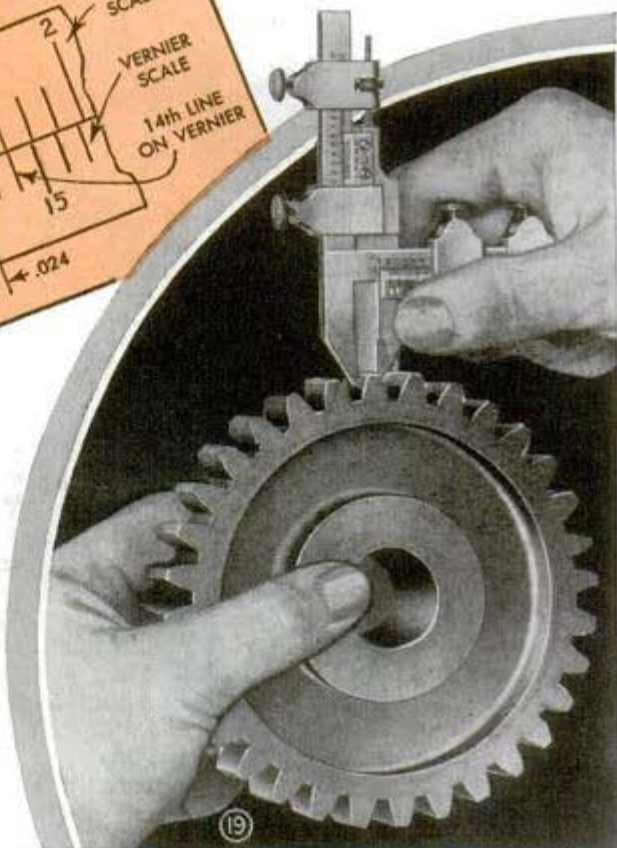
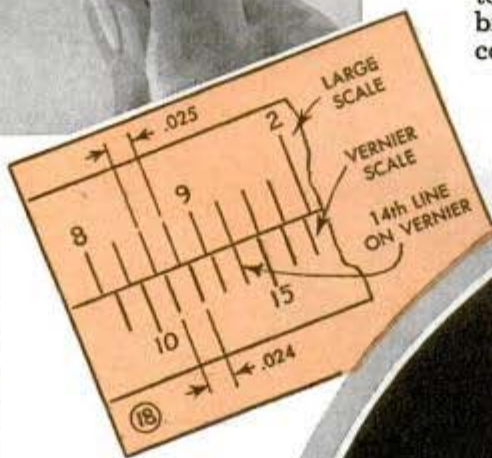

urements. When a vernier is graduated for external use only, the thickness of the measuring points must be added to the reading of the internal measurements.

The two-in-one vernier shown in Fig. 19 serves the same purpose as the micrometer shown in Fig. 15, but is used on gear teeth. Fig. 20 shows a universal surface gage being set to a desired height with the figures of the scale of a combination square, the purpose being to locate a plate or casting. An experienced machinist can work to close figures, but such an arrangement is not precise to the thousandth as when using a vernier height gage such as shown in Fig. 21. In Fig. 22 is shown another type of height gage which can be set to within .001 in. with a micrometer caliper. This tool is chiefly used to set up height of shaper and planer tools from table.

Plain and universal bevel protractors: Besides its use with a height-gage attachment, Fig. 3; with a surface gage, Fig. 20; as a depth gage, Fig. 23, and as a centering tool, Fig. 24, the combination square is used in connection with a plain pro-

tractor head as shown in Fig. 25. A bevel protractor of this type is quite accurate to obtain angular measurements in degrees but it is only graduated over an arc of 180 degrees reading from 0 to 90 degrees on each extremity of the arc. Closer precision demands a universal bevel protractor such as shown in Fig. 4, which has graduations over the entire dial. This protractor also incorporates the vernier system to divide a degree into divisions of 5 minutes or $\frac{1}{12}$ of a degree. As shown in Fig. 26, the dial is graduated in degrees and the vernier scale has 12 divisions on each side of the 0, each representing 5 minutes. With the protractor, each space on the vernier is 5 minutes or $\frac{1}{12}$ of a degree shorter than two spaces on the scale. When the 0 on the vernier coincides with a line or graduation on the dial, the reading is in exact degrees. If the 0 on the vernier does not coincide with one on the dial, as shown, the line that does coincide indicates the number of units of 5 minutes to be added to the number of degrees. In this case we find that when reading from 0 on the dial and to the right, the

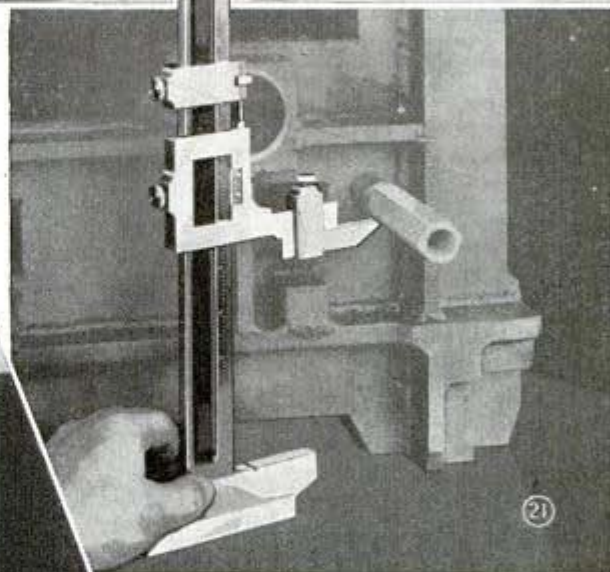
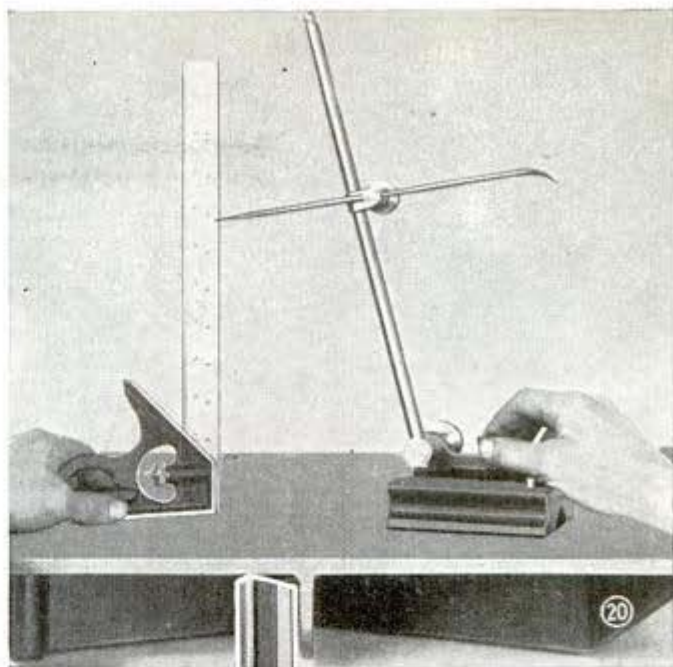

0 line on the vernier is between the 15th and 16th degree lines. We therefore have a primary reading of 15 degrees. Again reading to the right, but this time from the 0 line on the vernier, we note that the 8th line of the vernier coincides with one on the dial. As each line represents 5 minutes, we add 5 times 8 or 40 minutes to the previous reading which gives 15 degrees and 40 minutes as the exact measurement.

There are several other micrometer and vernier precision measuring tools which incorporate the principles outlined. Micrometers can be reset by experienced mechanics to compensate

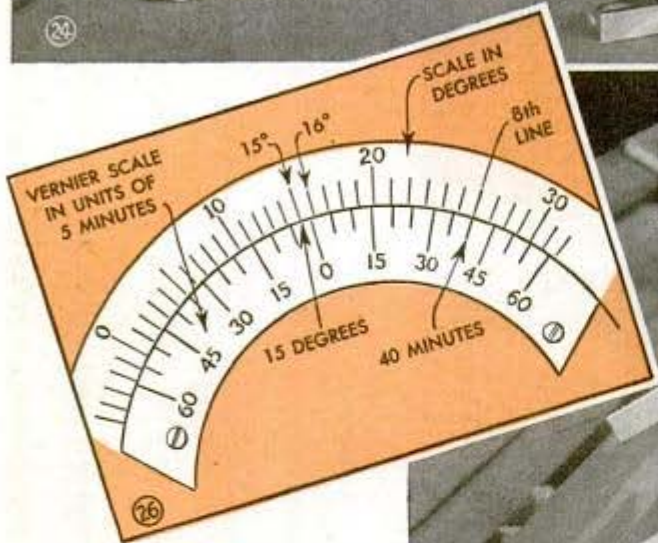
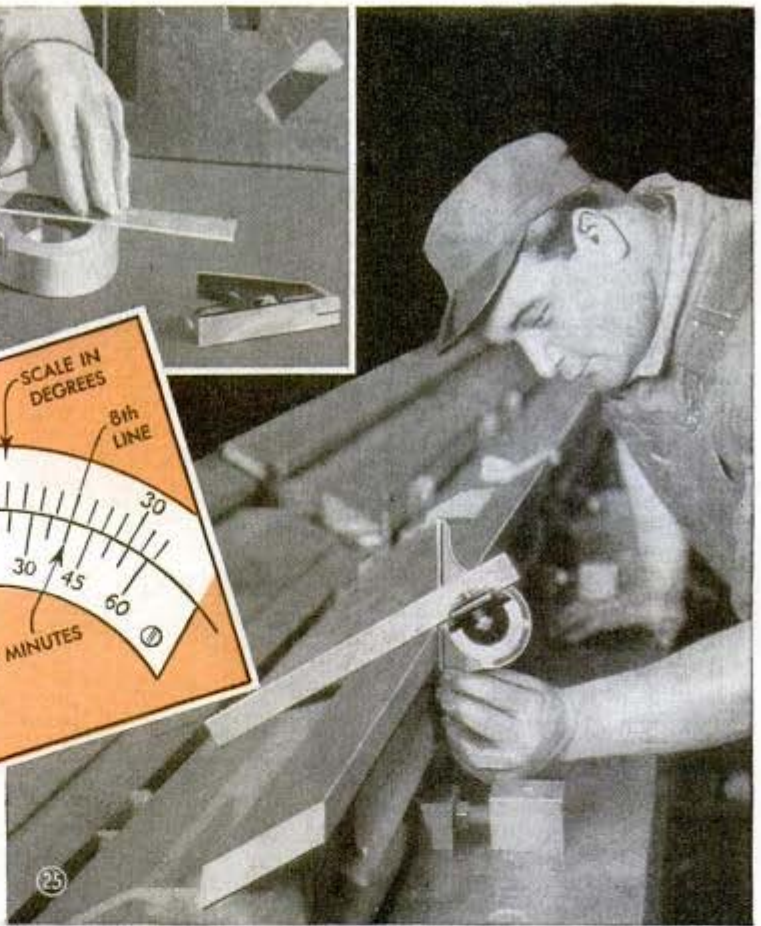

for wear, but this should not be attempted by apprentices. Vernier calipers, vernier height gages and vernier bevel protractors must be returned to manufacturers for repairs. Micrometers used on work being ground should be cleaned by dipping in naphtha at least twice a week, both integral parts being cleaned separately. Every machine operator should have a so-called "roughing" micrometer if possible,

keeping the best one to obtain final measurements. Vernier calipers should never lie on a bench or machine table unless resting on a piece of paper or, preferably, cloth. They should be wiped clean with cheesecloth after being used and given a light coat of very light oil. This also applies to universal bevel protractors.

Screwdriver Blades Sheathed to Carry Safely in Pocket

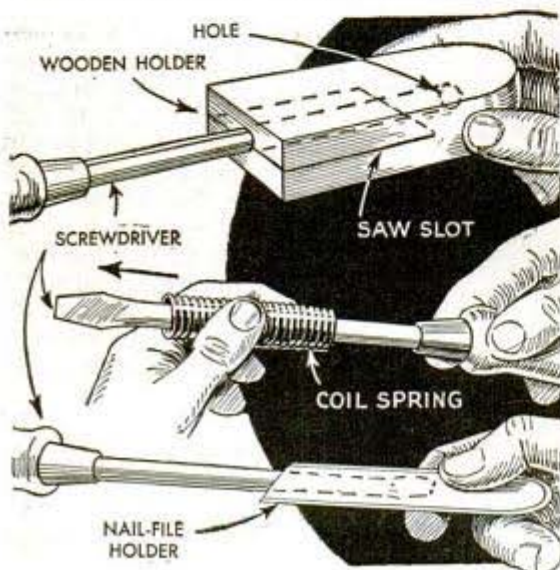

To cover the blade of a small screwdriver so that it can be carried safely in the pocket, drill a hole a little smaller than the diameter of the screwdriver in a wood block, rounded on one end. A slot sawed into the block almost the length of the hole will accommodate the screwdriver blade, and the natural spring of the wood will hold the block on. Another method of covering the point is to wind a coil spring around the shaft of the screwdriver so that it fits snugly. When the screwdriver is to be put in the pocket, simply push the spring up so that it covers the head. An ordinary nail-file holder also makes a good cover.

☐ Cotton gloves dipped in melted paraffin will protect the hands while cleaning a printing press and type. Excess paraffin should be wrung out before it hardens.

Welder's Table Tilts or Rotates to Any Position

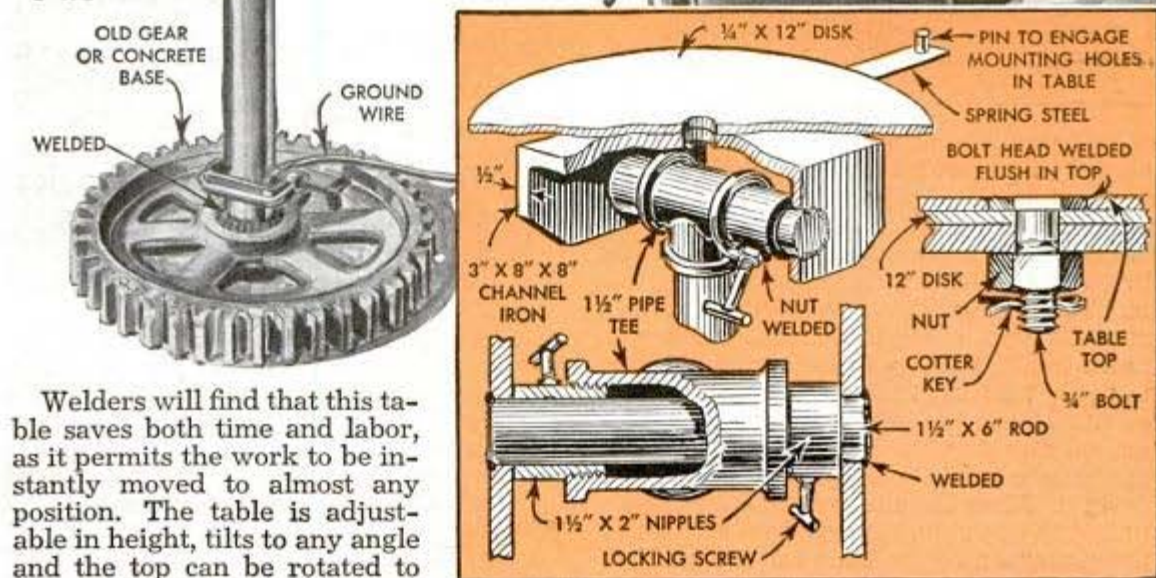
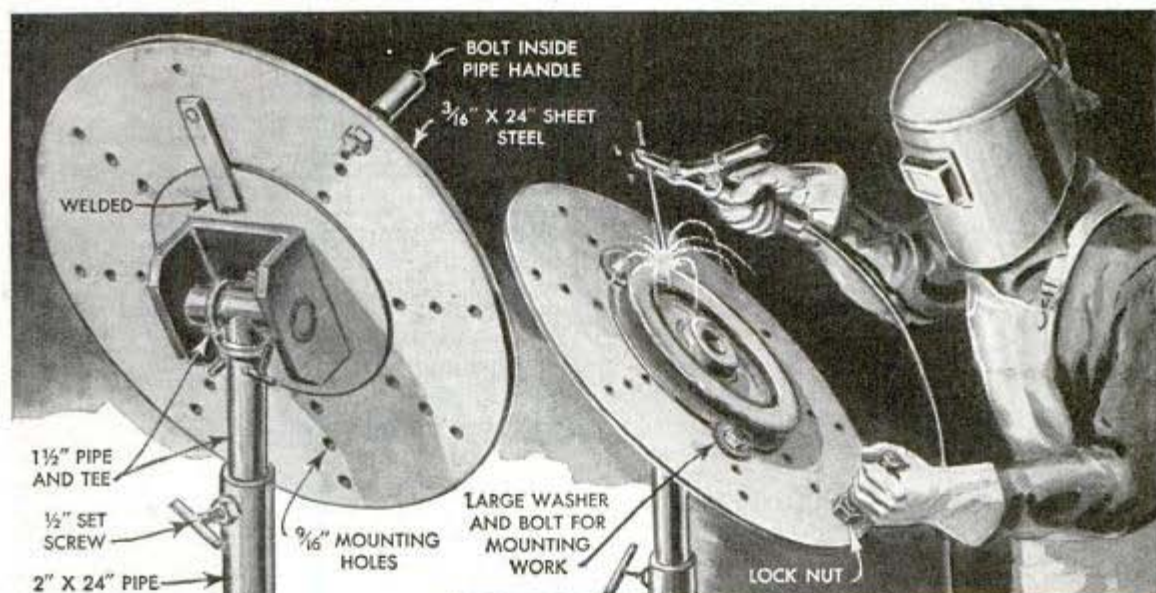

Welders will find that this table saves both time and labor, as it permits the work to be instantly moved to almost any position. The table is adjustable in height, tilts to any angle and the top can be rotated to bring the work to the most convenient position. An old gear or even a disk cast of concrete will serve as a base to which is attached a standard consisting of two lengths of pipe, one to slide inside the other. Height adjustment is held by a set screw fitted with a handle and threaded into a nut welded over a hole through the larger pipe. Short pipe nipples turned into a T-fitting at the upper end of the standard serve as bearings for an axle on which the table-top assembly rotates when tilted. The axle ends are welded into holes in a saddle of large channel iron to which the table top is pivoted. To hold the table in a tilted position, locking screws are threaded into nuts welded over a hole in each pipe nipple. The table top proper is a 24-in. disk of sheet steel, pivoted to the channel-iron saddle by a bolt, the head of which is

welded flush with the table surface. A 12-in. steel disk is placed between the table top and saddle and is welded to the latter to provide a wide bearing surface. Holes for mounting work are drilled through the table top, one being fitted with a handle. The table is locked in any position by a pin welded to a spring-steel strip, which is in turn welded to the 12-in. disk in a position that will permit the pin to engage holes in the table.—Bob York, Chicago.

Colors Identify Right Oil Can

To make sure the right oil is used for certain purposes, one plant enamels all oil-cans, using a different color for each type of oil. Drums from which the cans are filled are similarly identified, as are the oil holes and oil cups on machines.

Rotating Parts Bin Under Bench Is Easily Accessible

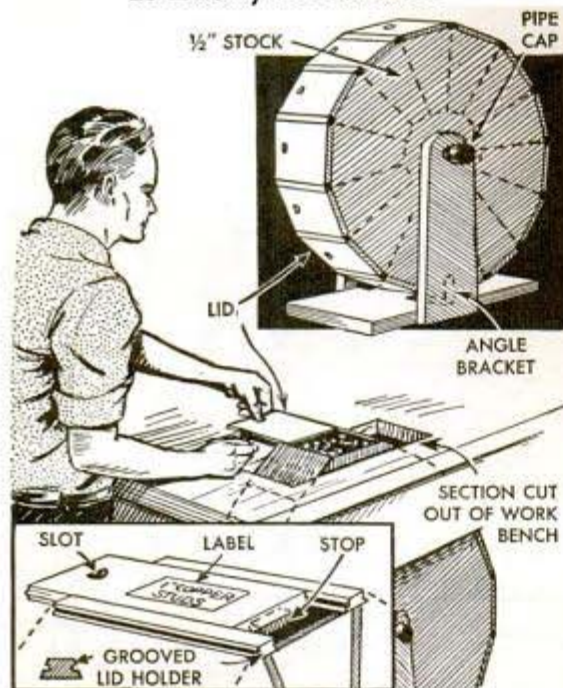

By merely rotating this bin, small parts stored in any of its compartments can be brought to the top of the bench for easy access. Supported on an axle of pipe between two heavy uprights, the bin is placed beneath the bench, through which a slot large enough to allow it to revolve has been cut. The bin should be of a diameter to permit only the top of each compartment to project through the slot above the level of the bench top. Side pieces of the required diameter are cut from 1/2 in. stock and marked off into as many equal parts as desired. After the bin partitions have been nailed to one side, a strip of tin or flexible fiber board may be bent around and attached to serve as a bottom for the compartments if it is not desired to fit in individual boards for this purpose. When the other side is nailed in place, holders are grooved to fit the lids and attached to the end of each partition. Washers of wood or leather between the uprights and the bin will keep the sides from scraping.

Using Hacksaw Blade in Places That Are Hard to Reach

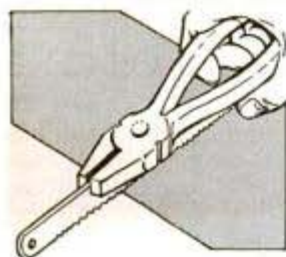

The next time you have to use a hacksaw in a place where there isn't room for the saw frame, try holding the blade as shown. Grip it near one end with

a pair of pliers, letting the thumb and index finger extend downward to grip the blade behind the pliers. This will enable you to hold the blade stiff enough to permit taking strokes several inches long.

Hook-Point Knife Brands Meat For Locker-Plant Patrons

Due to the fact that smoking of hams and bacon would obliterate rubber-stamp marks to identify the finished products for various patrons, one manager of a locker plant employs a sharp, hook-point knife to brand these meats before they are processed. The initials or locker number of the patron are quickly carved in the meat rind and remain visible after processing has been completed.



Pipe and Rod Are Cut at Angles In Channel-Iron Miter Box

Made from a length of 1 1/2-in. channel iron, this miter box for cutting pipe and rods does not even require the use of a vise. Slots are cut at the required angles, and thumb bolts to which curved metal shoes have been soldered or welded to hold the round pieces are placed at the ends of the unit. To use the miter box, clamp the pipe or rod in place and saw through it with a hacksaw in the proper slot.

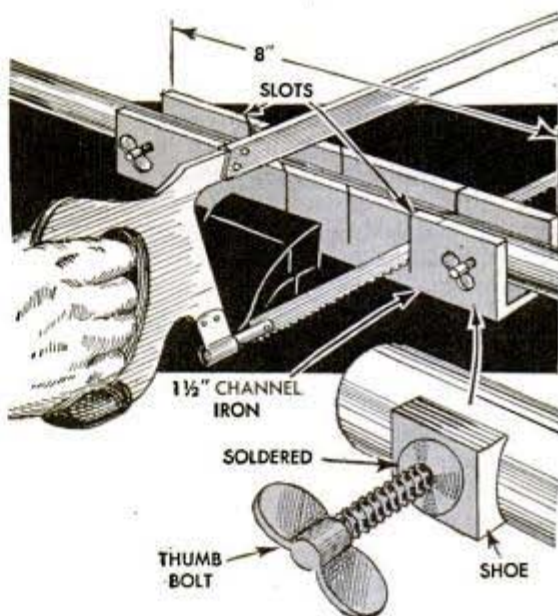

TWO PRODUCTION METHODS of MAKING CUTOUTS

SMALL cutouts used for bar pins, toys and novelties can be cut quickly and uniformly by using the strip or turned methods of cutting. In the turned method of cutting, the work is first turned as a ring, Fig. 1, using cardboard templates to check the shape. Then, the ring is sliced into individual cutouts on a circular saw, which is fitted with two blades separated by a spacing collar, as in Figs. 3 and 4. The jig for cutting consists of a sliding wooden table carrying a segment guide against which the ring is held. The strip method of cut-

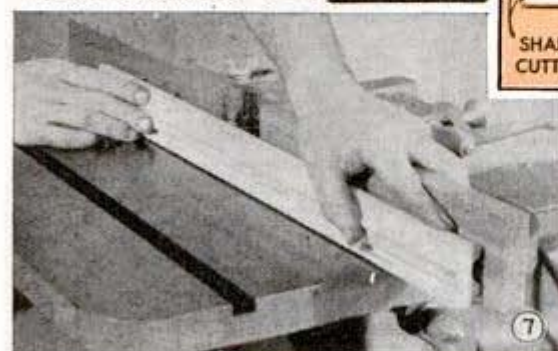
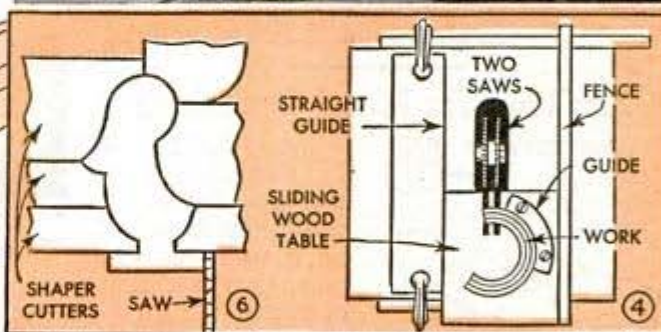
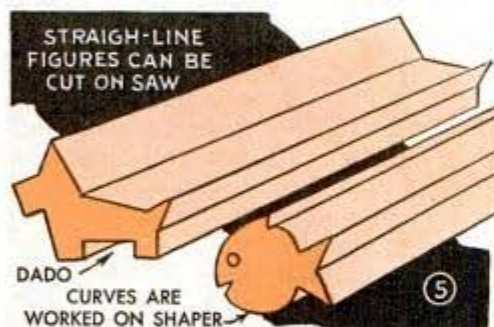
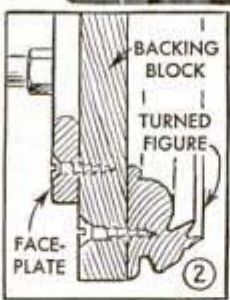
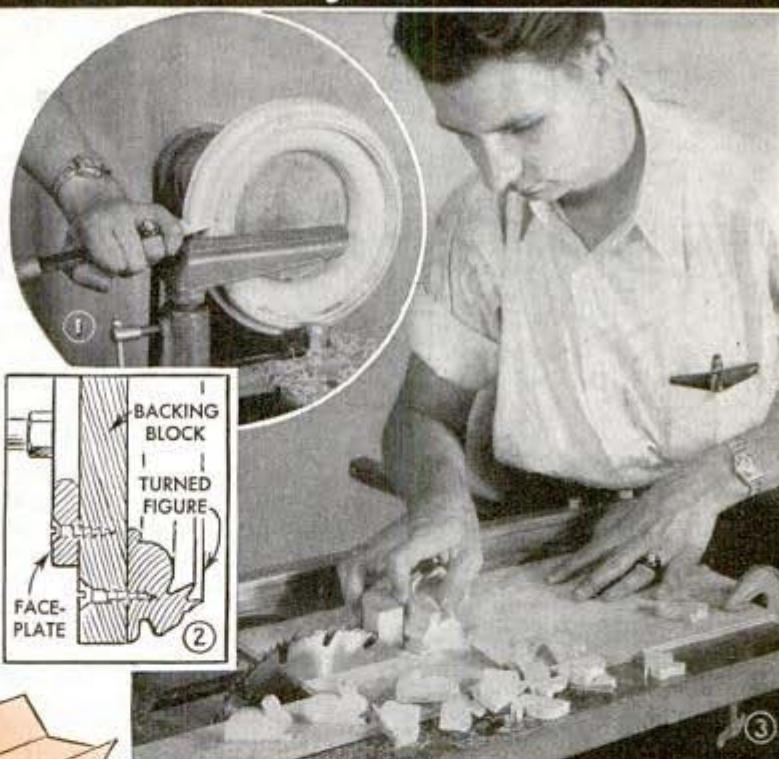

ting can be used where the shape is not too intricate. Some work, such as the dog shown in Fig. 5, can be cut entirely on a circular saw; other figures must be worked on a shaper. Fig. 6 shows an example of a simple shaped figure, cut in eight passes of the work. Some grinding of specially shaped cutters is unavoidable, but a surprising amount of the contour often can be cut with cutters of standard shapes. Several test strips should be run in order to locate the exact position of each cutter in turn. Fig. 7 shows the figure fully shaped while Fig. 8 shows the simple second operation of cutting the strips to thickness. These methods can be used for either wood or plastic cutouts. Plastic strips should be sanded and buffed before slicing. Wood cutouts are shaped preferably across the grain so that the figures will show face grain after sawing.

Produce Signs Hooked on Fence Are Changed Easily

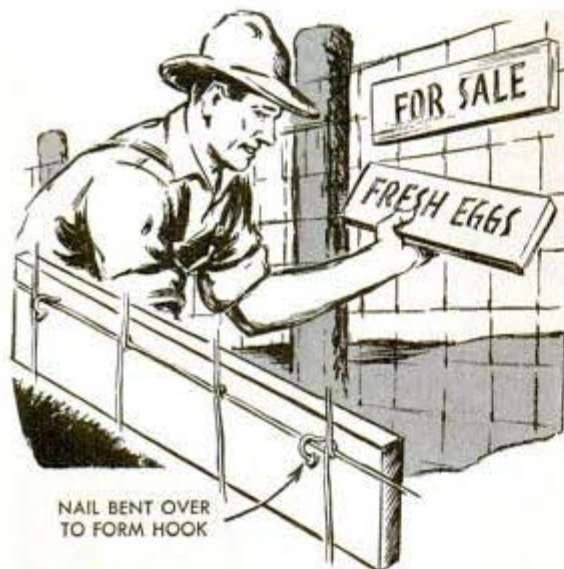

NAIL BENT OVER TO FORM HOOK

One farmer who often advertised produce for sale at his home, used signs like the ones shown, which are hooked to the fence wires near his house. The hooks, which were nails driven part way into the board signs, made it easy to put up or take down the signs as required.

—A. H. Waychoff, Phoenix, Ariz.

Air Vent for Metal Container

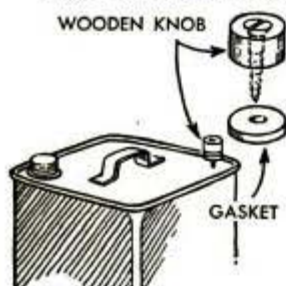

Instead of making a small hole in the top of a metal container to serve as a vent when pouring out the contents, make a simple screw-type vent like the one shown. It consists

of a wood screw driven through a small wooden knob for easy removal, and is driven down against a pliable gasket when sealed. There is no possibility of losing a vent of this type, and it takes only a twist of the wrist to seal a container or provide a vent.

Increasing Life of Scoop Shovel Used on Concrete Floor

A shovel used in a coal bin or other place where there is a concrete floor will soon be worn through by the abrasive action of the rough concrete unless the shovel

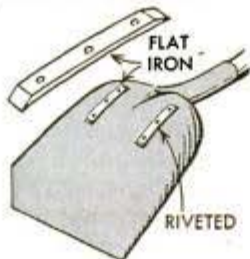

is thickened at the points of contact. A good way of increasing the thickness is to rivet two pieces of flat iron to the shovel as indicated. The ends of the two pieces should be beveled slightly and the rivet heads should be countersunk to prevent catching on the floor.

Funnel Suspends Plumb Bob For Setting Fence Posts

When setting or straightening fences, a funnel makes a good holder for the plumb bob sometimes used to aid in setting the posts vertically. With the plumb bob tied to its handle-loop, a large funnel can be inverted over the end of the post to hold the plumb in position.



How to Keep a Laboratory Hose From Slipping Off Wall Hook



The tendency of a length of rubber hose to slide off the wall hook in a laboratory, led one instructor to drive a couple of glass picture nails into the wall below the hook as indicated. These held the hose in place on the hook,

but still did not interfere with its removal when it was needed.

Straightening Linotype Matrix

If you have ruined a linotype matrix by trying to straighten it with a hammer, try the following: Place the matrix between a couple of linotype slugs and then straighten it with a hammer. Being soft metal, the slugs protect the matrix if the hammering is done lightly and very carefully. Naturally, this method is not recommended as regular practice, and should be used only in an emergency.

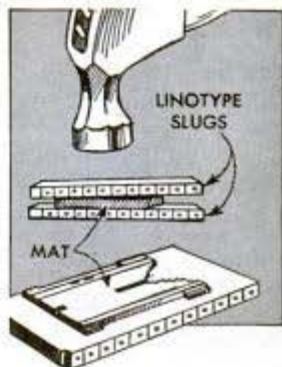



Wartime Tube Substitutions

By Robert Oelrich

ADAPTORS that any radio serviceman can assemble easily are now being used to combat tube shortages. These adaptors permit a radio tube of one base design to be used to replace a tube of equal electrical specifications of different base design. The substitute types are often available, but, without a suitable adaptor, the socket must be changed in the set itself.

No receiver wiring changes are necessary when using adaptors, except in a few unusual cases. They are very flexible; for example: a 5-prong tube may replace a 6-prong tube, or an 8-prong tube may replace a 6-prong tube, etc. The comparatively seldom used loctal-type tubes with specifications matching scarce types of octal tubes, are excellent substitutes when used with the adaptor illustrated.

To make this adaptor, clean an old octal (8-prong) tube base of all glass and cement and unsolder all old wire leads from the base pins. Clean the pins to allow the wires from the loctal socket to pass through. Cut wires, preferably No. 26 solid, 7 in. long, and insulate about 1 in. of each wire with "spaghetti" as shown in the photo of the wired socket in the adaptor assembly. The pin numbers are always designated in the manual charts with regard to the bottom view as detailed in Fig. 1. After soldering the wires in the pins following the chart data, cut off excessive wires and apply speaker cement to the edge of the socket and base. Charts Figs. 2, 3 and 4 are only a few of the practical wartime tube changeovers that can be worked out by radio servicemen and experimenters.

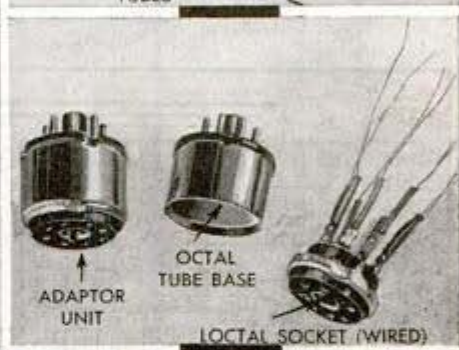
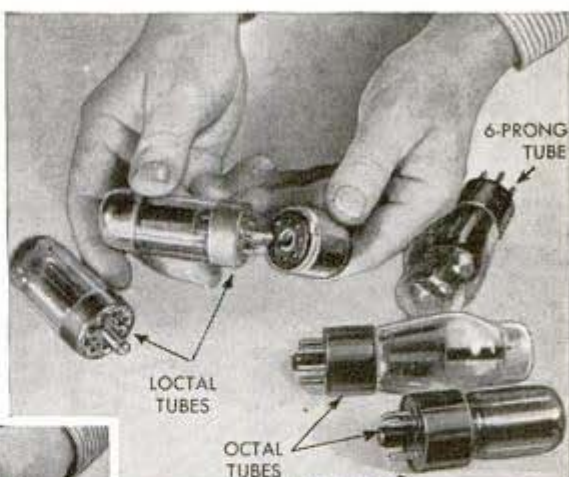
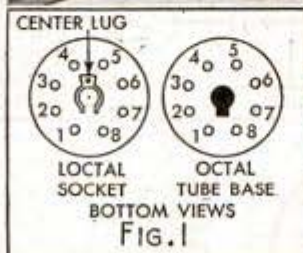

Substitute	To	Type
25Z5 (6 Prong)		25Z6GT (Octal)
Pin No. 1	2
2	3
3	4
4	8
5	5
6	7

FIG. 2

Substitute	To	Type
35A5 (Loctal)		35L6GT (Octal)
Pin No. 1	2
2	3
3	4
6	5
7	8
8	7

FIG. 3

Substitute	To	Type
7Q7		6SA7
14Q7 (Loctal)		12SA7 (Octal)
Pin No. 1	2
2	3
3	4
4	5
5	1
6	8
7	6
8	7

FIG. 4

Note: Center lug on loctal to No. 1 on octal-Adaptor.

PORTABLE PHONO-ATTACHMENT

By Arthur I. Rattray

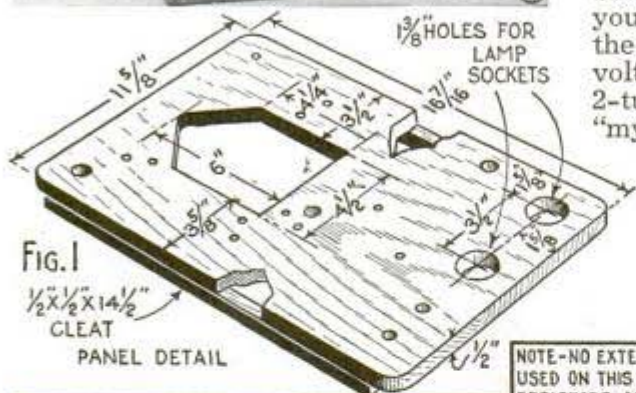

OPERATING through any radio receiver or amplifier, this portable combination a.c. unit provides high quality recorded music on short notice in friends' homes or in recreation centers. If a set with phono input jack is available, this unit can be connected directly by means of a short shielded lead with a phono plug on each end. When a radio receiver is to be used and there is no built-in phono jack, you merely insert two 60-watt lamps in the unit and these act as a line switch and voltage-dropping resistor to operate the 2-tube "wireless" phono oscillator, or "mystery" player so that records can be tuned in without wired connections.

The oscillator portion of this unit was made from non-critical materials salvaged from a discarded midget receiver, and built around an old phono motor and turntable. The plywood

panel is detailed in Fig. 1. Any bag or sample case about 12 in. wide, 17 in. long and 4 in. deep will house the unit, provided that the lid is about 2 in. high so it will clear the pickup arm and control knobs. Fig. 2 shows the schematic circuit diagram and resistor values. Photos A, B and C and the simplified wiring diagram Fig. 3 show all parts in their relative po-

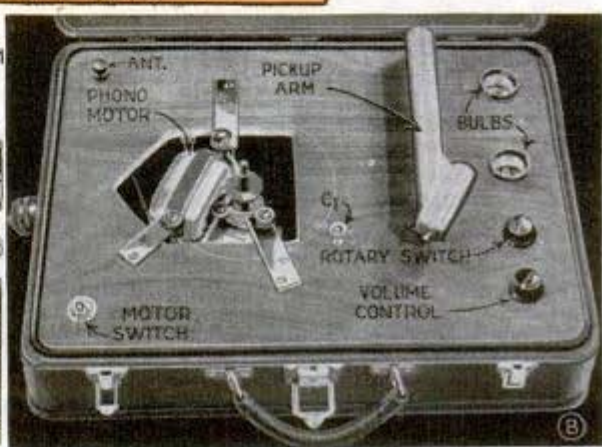
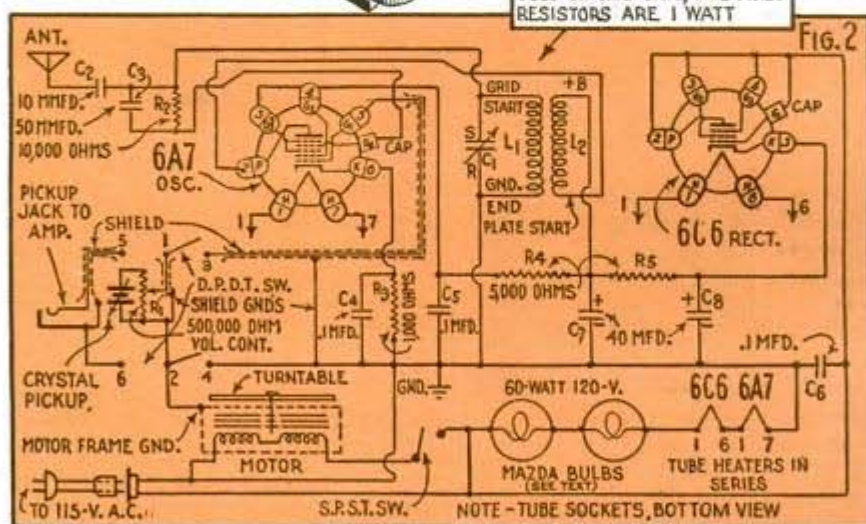

Flexible Five-Tube Demonstrator in Panel Form

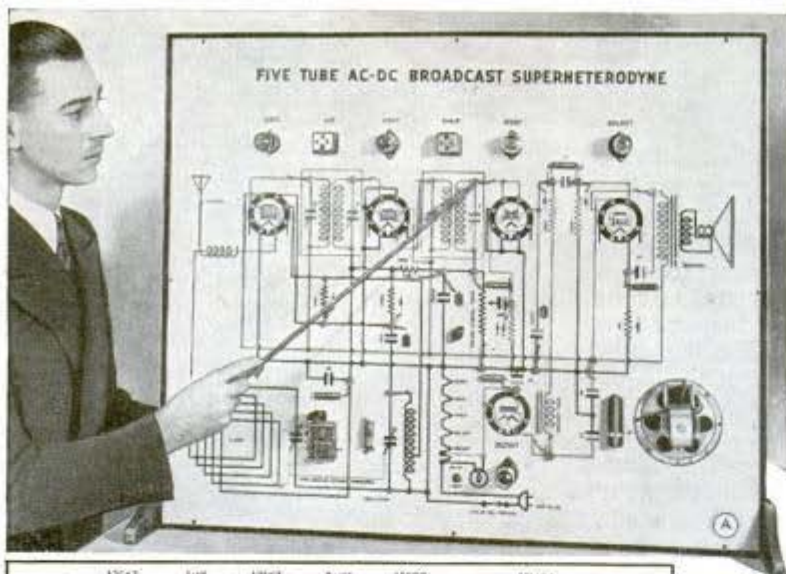

DESIGNED to simplify instruction in the theory of radio circuit design and operation, this flexible panel-type demonstrator unit is a complete 5-tube superheterodyne broadcast receiver. It is assembled on a 30 by 36-in. imprinted panel and mounted in a reinforced hardwood frame 3 in. deep. The unit may be hung on a wall or placed on a desk or bench in a vertical position. Two removable mounting feet provide the necessary support when used in this position as shown in photo A.

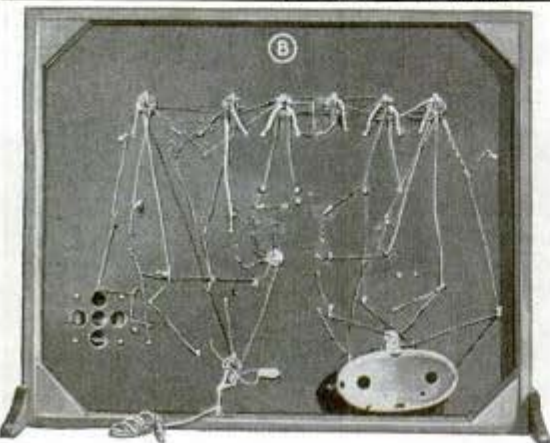
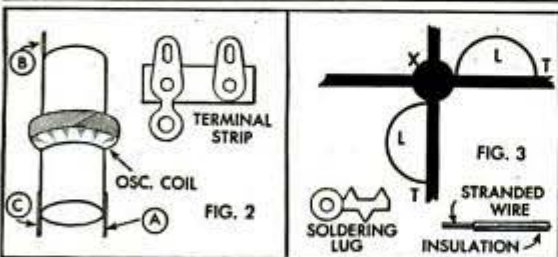
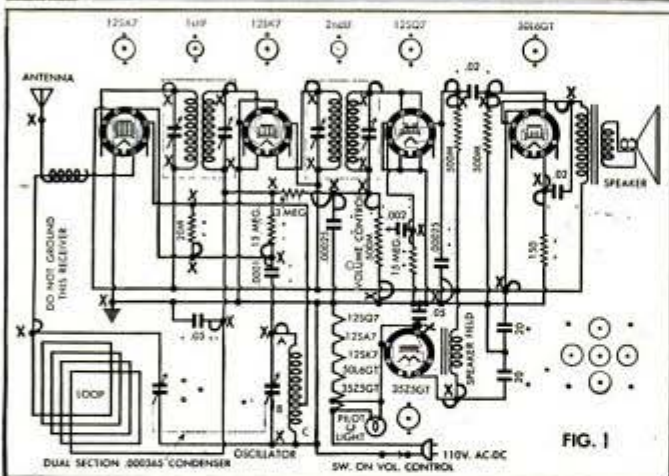

All parts except the loop are mounted in plain view adjacent to their schematic positions on the large diagram Fig. 1 which is printed in four colors on an off-white background. Grid circuits are in green, plate circuits are in blue, positive potential (B plus) leads are in red, and the balance of the circuit is in black in accordance with RMA standards. Multiple snap connectors are used on studs at points marked X on each tube element for signal and voltage measurement, also at circuit junctions so that each coil, condenser or resistor may be opened

or, where it will not damage the unit, shorted out to simulate actual conditions in defective receivers. This feature provides an excellent means for demonstrating trouble shooting and the proper use of test equipment in teaching repair work. All trimmers are easily accessible from the front of the panel for demonstration of alignment procedure.

Available to all schools and other institutions conducting educational programs, it comes with drilled panel in kit form or completely assembled and wired. Mounting and wiring details for the oscillator coil and multiple snap connectors appear in Figs. 2 and 3. Photo B shows all wiring back of the panel; the loop antenna is at lower right, and the holes that form the speaker grill appear at the left. Surprisingly good results are obtained with the small speaker due to the baffle effect of the large panel. The tubes are of the high voltage filament type and the circuit is for 110-volt a.c.-d.c. operation.

PIPE APPEAL*

WATCH IT WORK!

He—What's the big occasion, my love?

She—YOU, darling!

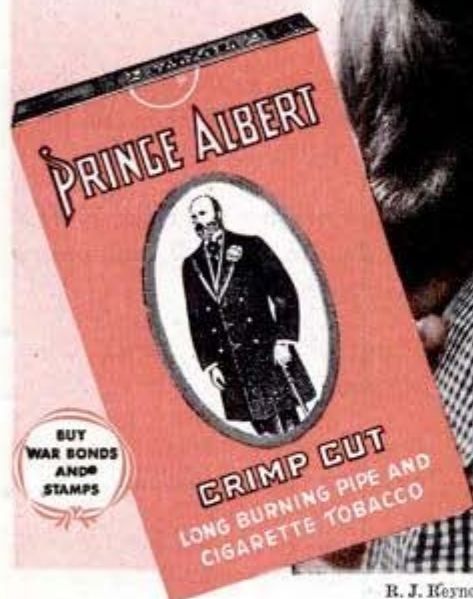

R. J. Reynolds Tobacco Company, Winston-Salem, N. C.

WHEN you see a woman retire...from the pipe she used to admire...get busy, brother...get Prince Albert in your bowl. Watch P. A.'s PIPE APPEAL—its *so-soothing* aroma—change hisses to kisses—fretting to petting. And see how P. A. peps up your personal pipe-joy. It's prize tobacco—no-bite treated—richer-tasting, yet SO MILD. Crimp cut...draws easy, packs right. World's largest seller—first puff tells you why.

50 pipefuls of fragrant tobacco in every handy pocket package of Prince Albert

70 fine roll-your-own cigarettes in every handypocket package of Prince Albert

TURN TO
TONGUE-EASE—
P.A.'S MILDERS.
RICH TASTE THAT'S
MELLOW



* **PRINCE ALBERT**
THE NATIONAL JOY SMOKE

WHY THE ELASTIC COLLAR?



ONE REASON YOU CAN'T BUY THEM NOW

This is the drive cog of a tank. It yanks the tread with as much as 1,000 horsepower. That, together with rough going, gives tank treads an awful beating. So, for security, they are fastened with Elastic Stop Nuts. The cog and each lug you see in the picture are held on with Elastic Stop Nuts.



You see here an Elastic Stop Nut.

The thing that makes it different from other nuts is the special collar in the top.

This collar is made of an elastic material.

It presses itself between the bolt threads. It grips and holds tight. The nut cannot turn by itself.

This means the nut locks anywhere on the bolt and won't work loose.

Even violent vibration won't budge it.

You can put an Elastic Stop Nut on and take it off, time and time again. It always locks.

That's because the collar is elastic. It does its job and comes back for more.

Many billions of Elastic Stop Nuts are in use.

And to our knowledge, not one in a million has ever failed.

When peace comes, Elastic Stop Nuts will be available for all the good things to come. They will make them safer, stronger, more dependable and free from frequent servicing. So expect to see many of these nuts you can identify by ESNA'S red collar.

ESNA

TRADE MARK OF

ELASTIC STOP NUT CORPORATION OF AMERICA

ELASTIC STOP NUTS

Lock fast to make things last

Union, New Jersey and Lincoln, Nebraska

AFTER THE WAR IS OVER...



AT fighting fronts or on production fronts — the desire for motorcycling thrills still lingers. And whether fellows wear campaign ribbons or Army-Navy "E" pins, their day dreams run about like this letter:

"In 1935 I bought my first '74' which I rode 5 years and turned over a good many miles of the best fun I ever had. After the war is over I've planned a trip that will take me over every state in the Union and will fulfill all my old dreams of a real outdoor trip!"

You bet! The days of long trips, race meets, hill-climbs and all other fun-packed motorcycling events will come again! Plan to be riding with the rest of the gang on a brand new Harley-Davidson — so Buy War Bonds NOW!

*Write for free copy of ENTHUSIAST MAGAZINE,
filled with motorcycle pictures and stories.*

HARLEY-DAVIDSON MOTOR CO.

Department PM, Milwaukee 1, Wisconsin

HARLEY- DAVIDSON MOTORCYCLES

HARLEY-DAVIDSON MOTOR CO.
Department PM, Milwaukee 1, Wisconsin

Please send at once free copy of 24-page
"Enthusiast" Magazine, filled with motor-
cycle action pictures and thrilling stories.

Name _____
Address _____
City _____ State _____



**SEND COUPON
NOW**

FREE!

Contrary to popular belief, today's slow driving dirties spark plugs quicker. Regular cleaning and adjustment are more necessary. When you need new plugs, get the longer life that is engineered into AC Spark Plugs.

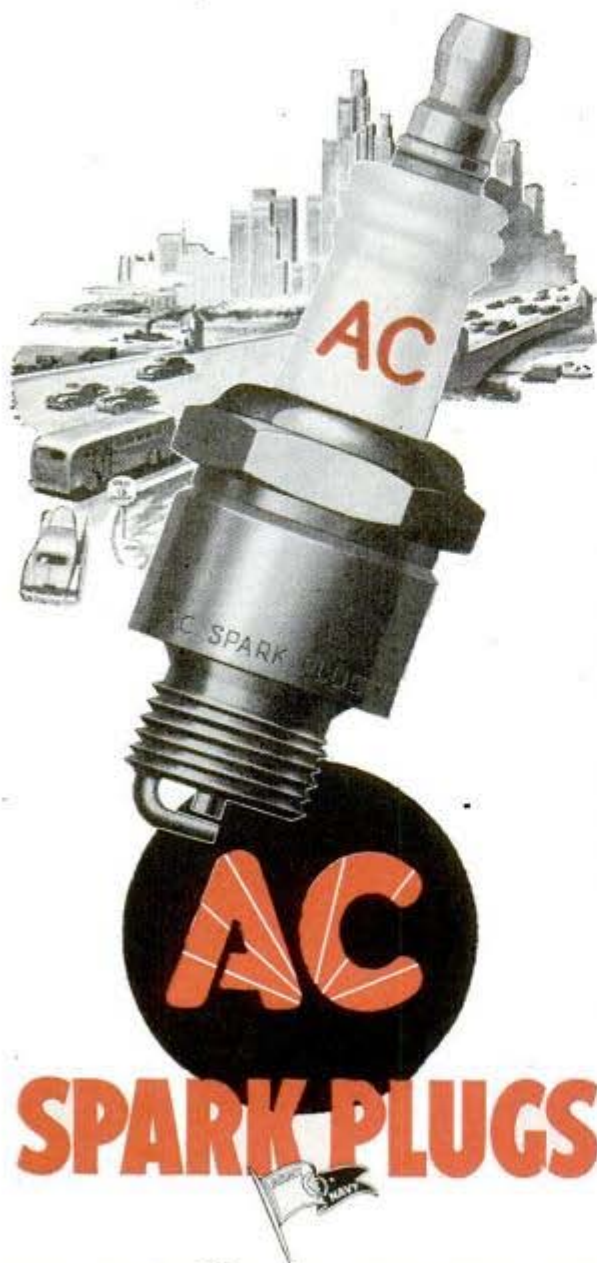

BUY ANOTHER WAR BOND THIS MONTH

The Camera Clicks for Uncle Sam

(Continued from page 38)

training and entertaining service men, probing the mysteries of explosives and projectiles, telling the grim story of the war at the fronts, surveying crops, protecting valuable records on microfilm, turning out millions of blueprints, and doing thousands of other odd jobs.

Photographs are even being used to sell furniture. Because of the shortage in transportation, the shipping of new models to some furniture shows has proved impractical. Instead, the pieces are artistically shot with the camera from all angles, the photos placed on display at furniture expositions and orders taken.

Probably the biggest single photographic project undertaken since the invention of the little black box with the lens is the snapping of portraits for identification badges and cards to be worn and carried by millions of American workers. Automatic focusing and quick developing and printing methods made this a quick job.

The portrait may bring wise cracks, but each worker accepts it as a badge of membership in the industrial army.

Flak, Unlimited

(Continued from page 80)

tively than that. Their motto runs: "If you hit him in the rudder, you only make him shudder; if you hit him in the prop, you always make him drop."

Hitting a fast airplane target is not as easy as you might think. It's about as hard as using a pea shooter to knock down a bumblebee across the street. At the beginning of his training a young gunner may be certain that he has chewed to bits a practice target towed by an airplane. But when he looks at the target after the plane drops it he may not find a single hole. Practice and lots of it as a team is what makes the individual gunner and the whole crew good marksmen. The men have to learn the idiosyncrasies of their weapons and to compensate for them.

Each gun crew gets plenty of instruction before it sees active combat. The men fire, both night and day, at sleeve targets that are towed at various altitudes. They learn to whip their guns around in a hurry and then steady them as they begin to lead the target. They fire bursts at radio-controlled miniature airplanes that are in effect scale models of full-sized aircraft flying at higher altitudes, and they fire at rocket targets that whiz past them overhead at speeds of up to 400 miles per hour.

The lamp that paints a bullseye on Axis planes!

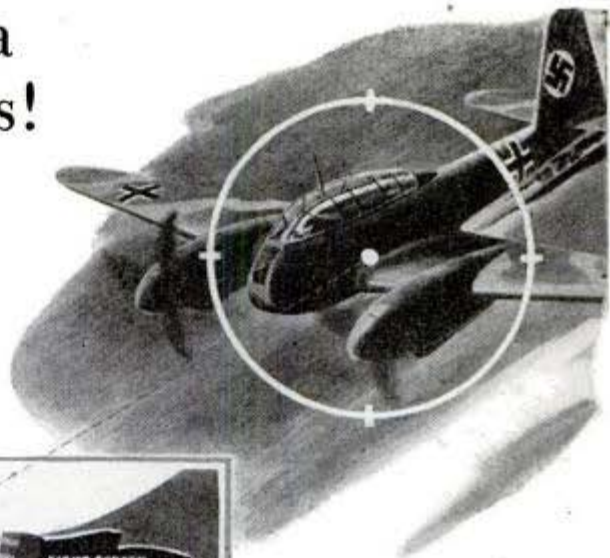

1. Ever wonder how our gunners can fire accurately at 400 m. p. h.? One reason is a new kind of gunsight. Instead of straining to hold the enemy in your sights as you would with a rifle, you see a "bullseye" of orange light ... apparently painted right on the enemy plane! Diagram below shows how it works.

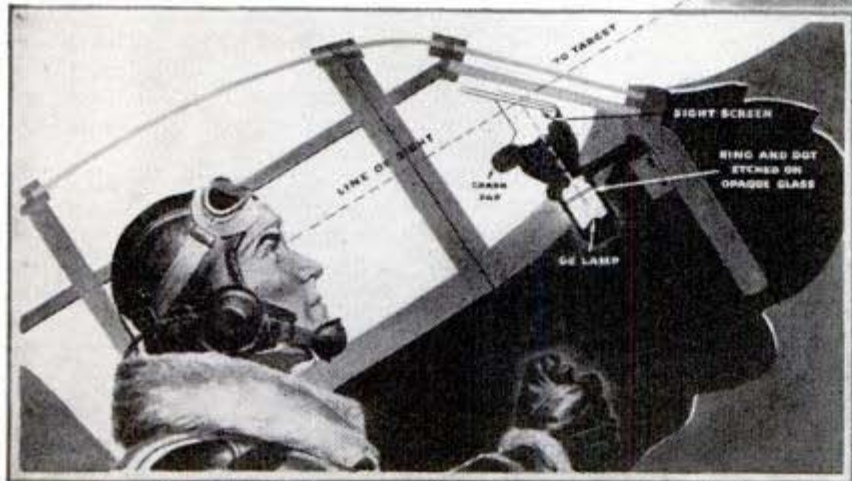

2. The problem G-E had was to develop a new lamp for greatly increased brightness. Combat experience showed that the image had to be bright enough to show up against Sahara sands or bright clouds. Gunsights now are being equipped with a lamp G-E developed especially to meet these conditions.

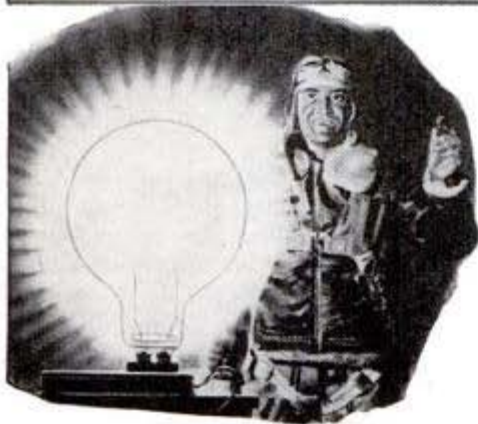

3. To design and produce this new lamp in a hurry was a tough problem...but no tougher than many which G-E research has had to solve since Edison's first lamp. Between the big 10,000-watt airport floodlight and the tiny "grain-of-wheat" lamp used for instrument illumination are hundreds of different G-E lamps working for victory.

4. The same research that produces G-E lamps used in war is your assurance that the G-E lamps you use will give you the most light for your money.

Hear the General Electric radio programs: "The G-E All-Girl Orchestra," Sunday 10 p. m. EWT, NBC; "The World Today" news every weekday, 6:45 p. m. EWT, CBS.

**MADE TO
STAY BRIGHTER
LONGER**



G-E MAZDA LAMPS

GENERAL  ELECTRIC

THE BEST INVESTMENT IN THE WORLD IS IN THIS COUNTRY'S FUTURE...BUY WAR BONDS



CRACKED WALLS

You don't have to be an expert to mend cracked walls with Rutland Patching Plaster. Just mix Rutland with water . . . wet the old plaster . . . and apply with knife or trowel. Rutland is the *original* ready-to-use patching plaster. Sets without shrinking or cracking. Extra fine and white. Makes a patch as smooth and lasting as the wall itself.



BROKEN CONCRETE

Don't let small breaks in cement floors, walks, walls, etc., get larger. Mend them promptly with Rutland Concrete Patcher. Just mix with water and apply with trowel.

RUTLAND

REPAIR PRODUCTS

Rutland Fire Clay Company, Rutland, Vt.

More Power for the Farmer

(Continued from page 54)

into a single-unit machine by means of ingenious linkage and hydraulic control of the implement. Instead of being merely dragged by the tractor, the implement becomes virtually a part of it.

Ferguson attachments make it possible to plow, cultivate, ridge; to aerate and prepare stubble land, haul a six-ton trailer, haul and operate a cross-cut saw—and an almost endless variety of other tasks. Standard tractor mowers, horse-drawn disc harrows, seed drills, combines, manure-spreaders and other wheeled implements can also readily be attached to the tractor. Chief benefit of the regular attachments, however, is that they can all be raised from the ground into carrying position by means of a hydraulic control located at the driver's hand.

"That the most basic industry of all has not heretofore been able to adopt the principles of mechanization which have made other industries prosperous is a challenge to everyone," says Harry Ferguson, who with Henry Ford has vowed to cut the cost of farming so that the farmer will make more without needing to raise his prices to the consumer.

They want to make farming attractive to youth, and start a new back-to-the-farm movement—and how vital this is is shown by these figures:

In three years, 1,200,000 young farm men turned in their blue jeans for uniforms.

Another 1,400,000 adults left the farms for war jobs in cities.

Still another 1,700,000 farm people, though not leaving the farms, abandoned tilling the soil in favor of jobs in nearby war plants, or other nonfarming pursuits.

"Unless we are successful in getting these young people back to farms where they will help nature create the basic wealth of this country we can well be concerned about our future stability," says a Ferguson spokesman.

It is this same challenge that is faced by Mr. McCaffrey of International Harvester:

"It used to be said that the effect of the mechanization of agriculture inevitably would be to increase the size of the individual farm and reduce the number of farmers. Actually, for the last 10 years the most striking development in our industry has been the rapid appearance of machines suitable for the smaller farms. We are certain that trend will continue, and we know that it is a healthy one. Only by doing that will the farms remain a great mass market for the products of American industry."



CASITE

CLEANS OUT MOTORS
KEEPS MOTORS CLEAN

● A dirty motor starts hard—jerks, sputters and wastes gasoline. With Casite in your crankcase your motor stays clean, runs smoothly, starts readily . . . you get longer motor life, added driving satisfaction, better gasoline mileage.

Casite is sold coast-to-coast by service stations, garages, and car dealers. The price is only 65¢ a pint. Start today cleaning out your motor, and keeping it clean . . . with Casite.

THE CASITE CORPORATION • HASTINGS, MICHIGAN

*A pint through the carburetor at regular intervals . . .
a pint in the crankcase with each oil change.*

LET'S GET GOIN'!

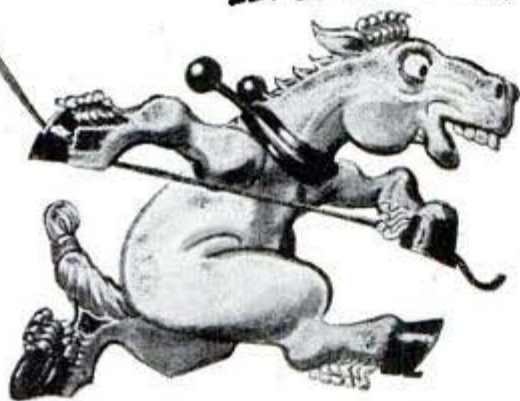

★ IT'S A PRIVILEGE TO BUY WAR BONDS ★



WILD TURKEY

"Here in West Virginia where we still hunt the native wild turkey, the terrain is rough and rugged, and our chances at game are often taken from one hill to another.

"My fondest recollections date back more than thirty years to the time I first came into possession of a Marlin rifle—a 32-20. Then followed a 25-20, a 30-30, and a Marlin lever action 22.

"All the Marlins I have owned were super accurate, efficient and trustworthy."

Thos. E. Knapp, Alderson,
West Virginia

★ ★ ★

Marlin thanks Mr. Knapp and the thousands of other sportsmen who have expressed appreciation for the accuracy and dependability of Marlin Guns. We are concentrating on war production until the war is won. After victory, however, Marlin will introduce new models and many improvements in its well-known line of rifles and shotguns.



No. 1 Enemy on the Home Front

(Continued from page 87)

H. L. Miner, manager of the Du Pont Company's Safety and Fire Protection Division. Paper, cloth and wood are among the materials that now can be chemically treated to make them incapable of spreading flames. Lumber is being treated chemically until its fire-retardant quality is closer to that of asbestos than to ordinary wood.

Chromated zinc chloride is deposited in the wood under pressure, in chambers big enough to accommodate long trains of narrow-gauge cars. Practically all kinds of cloth, also, including the sheerest, can be treated so that you can't burn it.

Still, Mr. Miner, like other fire authorities, emphasizes that every advance of science might as well have remained an idle dream, if personal carelessness is the order of the day. The best fire-fighting, and fire-preventing equipment in the world can't approach man's own caution. Educational campaigns are of first importance. In many war plants, for instance, new employees are not likely to know either where the alarms are, or how to set them off; much less will they know how to use emergency fire equipment, unless they are shown.

First lesson should be that, if all precautions fail and fire does take hold, the No. 1 thing to do is—not to grab the extinguisher—but to grab the telephone, or otherwise summon the professional firemen. Then grab the extinguisher. In one plant, for instance, well-meaning employees tried to fight a blaze for 20 minutes without once thinking of calling in the firemen. When they finally did, the flames were so out of control that what might have been a little flare-up caused \$400,000 damage.

In case of fire, call the firemen; learn how to turn in an alarm; learn also how to handle whatever emergency equipment is at hand. But above all, learn safety; keep fire from happening.

They Bring Themselves Back Alive

(Continued from page 61)

ing on the average Pacific island. Any volcanic isle or coral atoll furnishes fowl, fish and one or more fruit or vegetable like coconuts, pigweed, bananas, sugar cane, mangroves, limes, guavas, papaya and even oranges. The coconut tree not only furnishes food and drink but clothing, baskets, mosquito netting, cloth, rope, bedding, sandals, sunburn lotion, shingles, torches, and even beer, if you know how to use the materials.

(Continued to page 154)

Scourge of the Wolf-Pack!

FROM the blue waters of the Caribbean to the icy depths of the North Atlantic, Nazi U-boat packs are on the run. Speedy, hard-hitting Navy Destroyer-Escort ships, quantity-built in several American shipyards, have done their part to clear the convoy lanes of enemy submarines.

The men and women of Defoe—workers and management alike—are proud to be constantly ahead of schedule in the production of these famous DE fighting ships. The unique "roll-over" construction process has made this record possible.

Due to these accomplishments, the Navy now has called upon Defoe's engineering and production facilities to build fleets of LCI (L) Landing Craft. These large armor-sheathed ocean-going invasion vessels are today proving a potent force in the march to Tokyo and Berlin.

When Victory is won, the experience, skill and spirit of Defoe men and women—now devoted solely to helping meet the needs of the Navy—will be at the disposal of industry to provide products of better quality, greater value and lower cost for peacetime America.

BACK THE ATTACK—BUY WAR BONDS. Defoe workers take more than 10% of their pay in War Bonds



DEFOE SHIPBUILDING COMPANY,

BAY CITY, MICHIGAN

Defoe

Three White Star Renewal Citations now decorate the Navy "E" Award won by Defoe workers.

**Ships for Victory
Servants for Peace**

Tool Tips by **STANLEY**

VERTICAL CHISELING

Knowing how to use the wood chisel can save you many a piece of rare wood, and hours of lost time. Here is a point to remember:

In cutting vertically, across the grain, the chisel should be tilted slightly to one side to give it a shearing, or slicing, ac-

tion. If the surface is wider than the chisel, press part of the chisel against the portion just cut using it as a guide to cut the next portion.



Tools are Vital to Victory . . . Make them last



For complete information (with sketches) on vertical chiseling and dozens of other operations get a copy of the "Tool Guide". It's a must for every workshop.

**A Big Value
for only 25¢**



Write for your copy today.

STANLEY TOOLS

DIVISION OF THE STANLEY WORKS
105 ELM STREET

New Britain, Conn.

One of the first things to learn in the tropics is the art of camouflaging by the use of twigs, branches, leaves, mud, paint, vegetable dyes or whatever else the jungle affords locally. Success depends on ingenuity. Few Americans, however clever, equal natives at the art of concealment as one hungry, stranded aviator found out when he hurried up to a banana tree on a Pacific island, reached up for a tempting piece of fruit only to have the tree walk off into the jungle before he realized it was a camouflaged native who had been watching him all the time.

The Tube That Is Remaking the World

(Continued from page 25)

engineer employs the mass spectrometer to dissect a complicated gas molecule 1/25,000,000th of an inch long and automatically record the composition of the gas, mightily accelerating the analysis of gases in the production of butadiene synthetic rubber. Five to ten skilled chemists used to spend 15 hours to 3 days analyzing a cubic foot of gas. The electronic spectrometer weighs out the molecules and atoms of a thimbleful in just 15 minutes, and without error.

More sensitive than man? The human eye can detect 10,000 tints, the photoelectric spectrophotometer 2,000,000. It can discern one part of silver in a solution 250,000,000 times the volume of the silver. In a millionth of a second the X-ray can spot a flaw in the heart of inch-thick armor steel. A mercury vapor detector in a General Electric plant "smells" one part of mercury in 200 million parts of air. An electronic tuning fork "feels" the change of pace if a turbine steps up momentarily from 1,800 to 1,800.1 revolutions per minute. The electron microscope, window to a new world, makes visible particles as small as a millionth of an inch—the human hair divided into one-thousandth. The electronic tube is the eye and ear of television, and in the postwar world television "light-houses"—automatic relay stations—will bring you in full natural color the scenes and sounds occurring around the world.

War shrouds in secrecy many of the electronic wonders evolving in the research laboratories today. The wonders of radar, seeing the unseen bomber plane and battleship and submarine periscope. The wonders of the cyclotron, prying into the heart of the atom, and of the 100-million-volt X-ray machine already at work in a Gen-

(Continued to page 156)

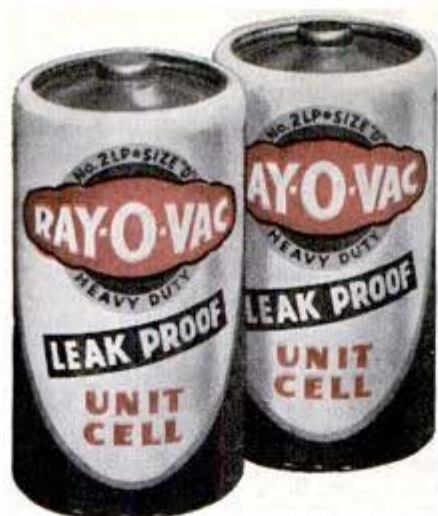

Actual photo of
LEAKPROOF
BATTERIES
picked at random
from 1939
manufacture.

THESE FLASHLIGHT BATTERIES ARE **4 YEARS OLD - and STILL FRESH**

Remember when you picked up a flashlight, long unused, and found the batteries dead? The fact is, most flashlight batteries die just lying around...but not Ray-O-Vac LEAKPROOF Batteries. LEAKPROOF'S patented sealed-in-steel construction seals the power in...it's there when it's needed!

RAY-O-VAC LEAKPROOF BATTERIES ARE
NOW GOING 100% TO OUR ARMED FORCES



FLASHLIGHTS • BATTERIES

BUY WAR BONDS  BUY WAR STAMPS

RAY-O-VAC COMPANY, MADISON 4, WISCONSIN
OTHER FACTORIES AT CLINTON, MASSACHUSETTS • LANCASTER, OHIO • SIOUX CITY, IOWA

How to

**MAKE
HAND SAWS
LAST LONGER**

See Your Hardware Dealer!



Tools are mighty important to the war effort. Your Hardware Dealer is cooperating with Uncle Sam by selling some types for essential uses only.

Perhaps you may not be able to purchase a new hand saw. Nevertheless, your Hardware Dealer can help.

If your old saw is a Disston—or other quality make—a good, inexpensive reconditioning job will put it in serviceable condition. See the Disston dealer in your community. Talk it over with him. At the same time he will tell you about the possibility of getting new tools for essential work.

Save your tools and serve your country. Fix 'em up and make 'em do!



HENRY DISSTON & SONS, INC.
411 Tacony, Philadelphia 35, Pa., U. S. A.



GOOD ADVICE AND PRACTICAL HELP
on tool use and care are yours for the asking in the Disston Saw, Tool and File Manual. FREE from your Hardware Dealer, or write for a copy.

eral Electric laboratory. Of electronic detectors locating buried mines or probing wounds for shrapnel fragments, radio transmitters in reconnaissance planes sending facsimile maps with the speed of light to an army base 100 miles away, electronic crewmen in our warplanes sensing ice formation on wing tips and warning of overheating engines, piloting bombers on unerring, level courses with superhuman accuracy as they make their target run.

After the war there will be time for stateless radio and true-color television, for short-wave chats between automobile and home, for flying and ocean travel made safe by electronics, for homes made light and radiantly warm and germ-free and for work made easy by vacuum tubes, time then for wresting the power from the atom.

Charles E. Wilson, executive vice chairman of the War Production Board, calls electronics "the fire of the future."

"Like fire," says Mr. Wilson, "it can be a savage foe or a powerful servant. Like fire, it is almost universal in its potential applications to our lives. Fire was a gift to the barbarians, which men have shaped to their uses. Electronics has been no gift. The men of science learned its secrets and earned its blessing during decades of unremitting toil, patience, trial and error, and brain work. . . The electronic tube, so innocent and so mysterious to a layman's eyes, will touch you, in the years to come, wherever and however you live—your sight, hearing and taste, the food you eat, the healing of your body, the safety of your home, and the tremendous progress of your business, whatever it may be."

Tenderfoot Skipper

(Continued from page 31)

many details of coming into port. We were all very pleased with ourselves that night. We had completed our first long trip safely, and even if we were disappointed not to have made contact with a sub on the way, we had made landfall "right on the nose."

The next few days were busy. Then one night a messenger came with "secret" orders. We were to be the guinea pig of an experiment. My ship was to tail a convoy and sneak into an attack position at night. Then we were to be fired on as if we were a sub. Careful plans were made so that we shouldn't be hit, but—it still made us nervous to think that a lot of guys with itchy trigger fingers were going to point a lot of guns in our direction.

A day or so later we "shoved off" and after tailing the convoy all day started to

(Continued to page 158)

Here's how your car FEELS...



... after

MARFAK

chassis

lubrication!

Car stiff in the joints? Hard to handle? A rattle here, a squeak there? Give it new riding comfort and driving ease with tough, long-wearing MARFAK chassis lubricant. Always applied by chart, never by chance. From king pins to rear shackles every point of lubrication is shown on the chart and the proper type of lubricant is plainly listed. And with each job your Texaco Dealer checks every point of wear, every point of adjustment, sends your car forth hale and hearty. Ask him to give your car that "MARFAK feeling"—tomorrow!



For Your Enjoyment... 2 Great Radio Programs

 **FRED ALLEN:** Every Sunday night. See your local newspaper for time and station.

METROPOLITAN OPERA: Complete broadcasts of great operas every Saturday afternoon. See your local newspaper for time and station.



Take the Br-r-r out of breakfast



KEEP WARMER WITH BALSAM-WOOL ATTIC INSULATION



A warmer house in the morning . . . more comfort all day long . . . that's what you get when you apply Balsam-Wool Insulation in your attic! And, while making your home more livable, Balsam-Wool actually saves fuel—as much as 20%, many householders find.

Easy to apply—laid like a carpet in your attic, Balsam-Wool is the original blanket insulation—windproof, moistureproof and fire resistant. It is sold under a money-back guarantee of complete satisfaction. Don't wait—see your lumber dealer now. Ask him about his monthly payment plan—or mail coupon for complete information.

Balsam-Wool

SEALED ATTIC INSULATION

Balsam-Wool . . . Products of Weyerhaeuser . . . Nu-Wood

WOOD CONVERSION COMPANY
Dept. 210-4, First National Bank Bldg.
St. Paul 1, Minnesota

Gentlemen: I want to know more about Balsam-Wool Double-Value Attic Insulation.

To assist us in giving you special information, please check: I am a home owner
renter architect contractor
student

Name.....

Address.....

City.....State.....



close in about sunset. Before we were on station, darkness fell. Never have I experienced the blackness of that night. As the zero hour neared I couldn't be sure where the convoy was. I hated to think what would happen if our ship was in the wrong place. Purely by "feel" we edged into position. I had sent all the men below except those necessary to run the ship. Those left "topside" were ordered to wear helmets and not expose themselves more than necessary. When zero hour arrived hell broke loose from the convoy. Shell fragments fell all about the ship, a few hitting the deck aft. We crouched on the flying bridge expecting momentarily that some guy would miscue and land one right on us. I guess those boys knew what they were doing for soon the firing ceased. From what was learned that night, I'm sure our convoys have been a bit safer on the seas.

At daybreak we received an order from the escort commander to relieve a PC having trouble with its sound gear. Around the convoy we steamed and drew up alongside the ship we were to relieve. They passed us a line and transferred their orders to us. We were on our first convoy.

Our first excitement in escorting convoys came months later when our sound operator called out in an excited voice: "CONTACT—bearing zero seven-five." I grabbed my glasses and pulled the general alarm. Men rushed to their stations as the siren wailed. The sub, if it was a sub, was only 600 yards away, and moving slowly toward the convoy. That wasn't going to give us much time to make a good attack. Knowing this was a vital convoy, troops for Africa and high-octane gasoline bound for Russia, I decided to make an "urgent" attack. In we went toward the sub at full speed. The team was clicking perfectly. The sound operator called out his bearings, the sound officer calmly called out the ranges and what little indications he could of our relative speeds. Then . . . "FIRE ONE" and a series of orders to the men on the fantail. Suddenly the sea astern exploded like a volcano and smacked the bottom of our ship.

No sub came popping to the surface, and we tried frantically to regain contact on our sound gear. We were disappointed but all felt better that we had at last made an attack. A few days later another convoy lost a couple of ships at that approximate position. We felt we had kept a sub from getting one of our ships.

It's hard to fight an enemy you never see—like fighting a ghost—but after this war is won the tenderfoot sailors on the sub-busters can hold up their heads in pride.

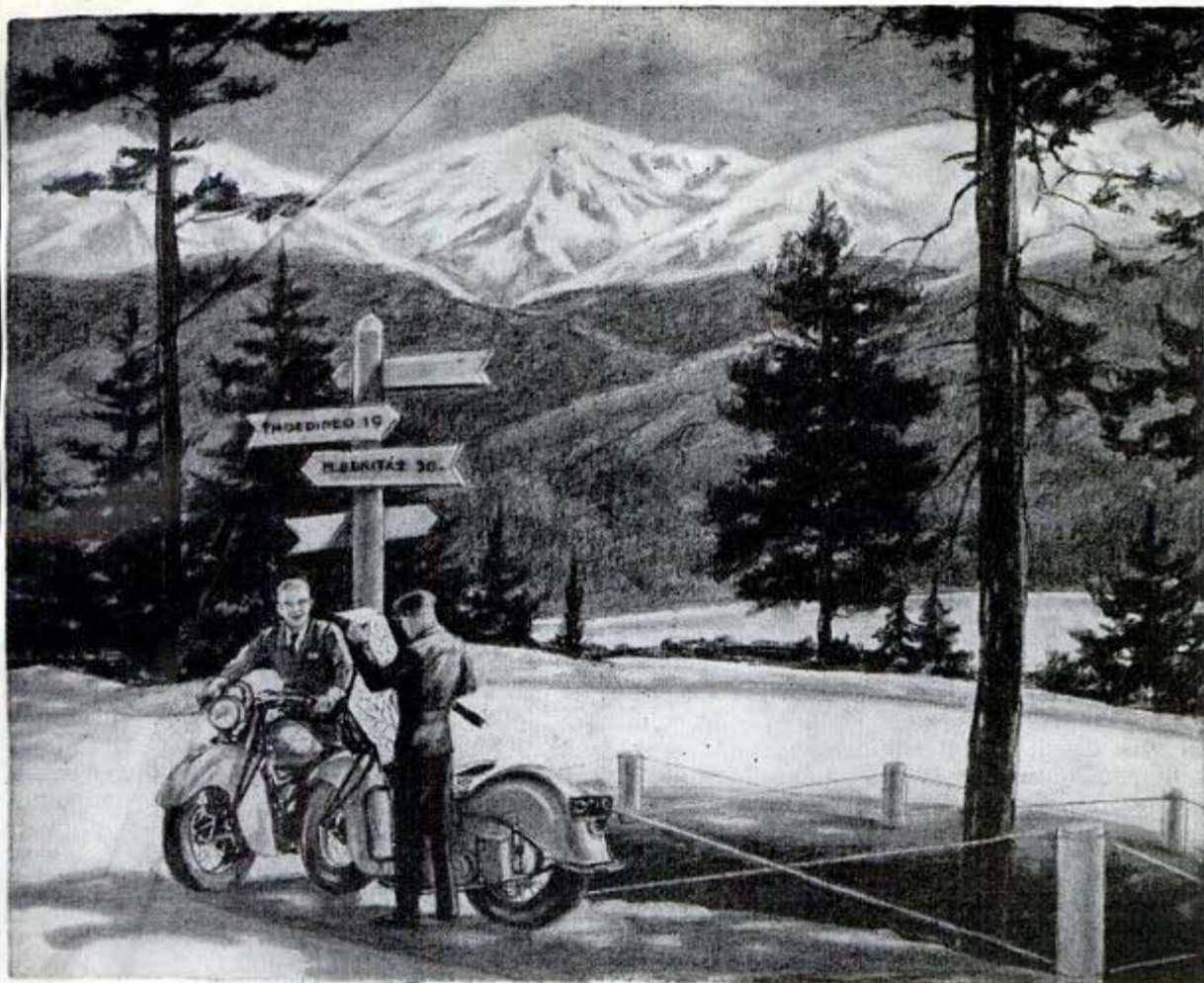

INDIAN
TRAIL BLAZERS



Which Way Adventure

Take the right fork... or the left... there's fun, fellowship and the greatest sport in the world just waiting for you when you own an Indian, America's most famous motorcycle. With an Indian, you'll enjoy a thrilling new freedom... away from plodding traffic lanes. You'll be able to explore those out of the way places no car can ever get to. On smooth highways or country roads... you'll find that your Indian ride will be incredibly smooth. You'll experience a feeling of safety and confidence you never believed possible. Make your plans now

so that when this war is won, you can enjoy motorcycling at its finest, astride an Indian.

INDIANS ON THE WARPATH

Right now, all new Indian Motorcycles go straight to war, and what a fighting record they're turning in! But new, improved, postwar Indians are already being blueprinted. *They're the motorcycles to wait for!*

BUY WAR BONDS NOW
TO BUY AN INDIAN LATER

Indian Motorcycle Company
Springfield, Massachusetts



Mail FREE copy of exciting Indian News.

Name.....

Address.....

City.....State.....

PM-4

Indian

MOTORCYCLES

Keeping 'em Flying

WITH CHAMPION SPARK PLUGS

The men who literally "keep 'em flying," the ground crew mechanics of the Army, Navy, Marine and Coast Guard Air Forces, are daily performing prodigies of maintenance, service and repairs. These unsung heroes, schooled and skilled in many crafts, keep their charges airworthy and in fighting trim at all times.

One of the first things the ground crew mechanics check is spark plugs, because they know how vital they are to the engine's performance and dependability. Outstanding performance and dependability are the principal characteristics of Champion Ceramic Aircraft Spark Plugs—qualities which have won for them an ever increasing demand from our Air Forces.

These same qualities are inherent in all Champion Spark Plugs, including those for your car. In fact, the Champions for your car are products of the same research and engineering, and many of their basic materials and patented features are embodied in Champion aircraft types.

Have your spark plugs tested and cleaned at regular intervals. This is vital to the times and will assure you of maximum economy and dependability.



CHAMPION SPARK PLUGS



"... Let Freedom Ring" BUY WAR BONDS

Say you saw it in *Popular Mechanics!*

New Magic in Black Gold

(Continued from page 75)

Research found a way to release oil that was imprisoned in rock formations, by sending acid down the well to dissolve the rock. Then the men turned around and found a way of creating rock instead of dissolving it, for a different purpose. You might call the result a super concrete. It comes in handy when a well that is being drilled encounters a flow of water. Rock-forming material is dumped down the well to harden and seal off the water, then the drill cuts a hole through the artificial plug and drilling continues.

The petroleum scientists have built up a giant industry based on the chemistry of crude oil and gases. Petroleum's multitudinous products have become part of our lives in more ways than might be dreamed. A woman at her dressing table and an American bomber over Berlin might seem to have nothing in common but each is dependent on petroleum in many disguises.

Petroleum products went into the cosmetics the woman uses, her soap, the lacquer on her dressing table contained a solvent synthesized from petroleum products. Her clothes were made with the aid of petroleum, and even her rubber heels, her plastic comb, and her shampoo.

Without petroleum we would be desperately in need of substitutes for building airplanes. Camouflage paint has a petroleum base, cloth control surfaces are coated with a petroleum substance, bomb bay doors are of a petroleum plastic, self-sealing fuel tanks and lines are of synthetic rubber derived from petroleum, and the liquid in the hydraulic system is a petroleum product. The bombardier sights through a window made from petroleum and drops bombs that depend for their explosive force on toluol from petroleum. The list is longer than that, even without considering the petroleum fuel and lubricants.

Model Builders Attention!

	V	V-2	V-3
Hex	1/2"	3/4"	5/8"
Thread	3/8"-24	1/4"-32	1/4"-32
Thread Length	7/32	7/32	5/32
Weight, Grams	8	3 1/2	2 1/2

Actual Size V-Plug

Champion spark plugs for model gas engines give the same dependable performance as their larger counterparts. Silliment sealed. Sillimanite insulator. Alloy needlepoint electrodes for easy starting. One-piece construction.

CHAMPION

SPARK PLUG COMPANY • TOLEDO, OHIO

Ingenious New Technical Methods

Presented in the hope that they will
prove interesting and useful to you.



New Saw-Gun Saws and Files in Hard-to-Get-At Places

Jobs of sawing and cutting that are inaccessible to ordinary tools, are now made possible with the recently developed Saw-Gun. It works equally well on wood, plastics, light and heavy gauge metals (corrugated or plain—stainless and monel), castings, rods and other materials. The Saw-Gun saves hours on panel notching and slotting operations, doing work ordinarily requiring the use of several tools.

It is propelled by electric power, compressed air or flexible shaft and provides an efficient portable power-saw or file, that can be carried from place to place.

The Saw-Gun is operated by placing cutting edge of saw blade against work and turning on power. Filing is accomplished in the same manner by inserting a file in the tool instead of a saw blade.

We hope this has proved interesting and useful to you, just as Wrigley's Spearmint Gum is proving useful to millions of people (much to their surprise) working everywhere for Victory.

*You can get complete information from the Mid-States
Equipment Co., 2429 S. Michigan Ave., Chicago 16, Ill.*



Permits sawing and filing in spots
inaccessible to ordinary tools.

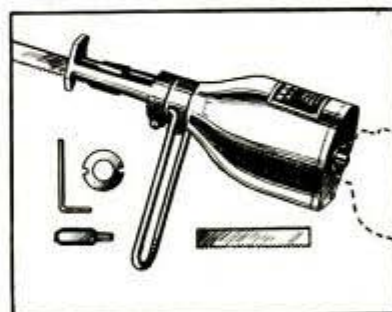

Can be directly connected to electric
drill, air drill, or flexible shaft.

Y-108

'INVISIBLE' LIQUID

proves great success for

SKIN and SCALP IRRITATIONS

**Promptly
Relieves
Itching—
Aids
Healing!**



Here's a Doctor's formula—Zemo—a remarkable liquid which appears invisible on your skin—yet so highly medicated that first applications relieve itching, burning of Eczema, Psoriasis, and similar skin and scalp irritations due to external cause. Zemo also aids healing.

Zemo positively won't show on skin all the time it is helping it. Apply any time. First trial convinces! 3 sizes. Buy Extra Strength Zemo for stubborn cases.

ZEMO

6" POCKET-SIZE A-B-C-DE-F-G-H-I-J-K-L-M-N-O-P-Q-R-S-T-U-V-W-X-Y-Z

SCALES

DURABLE PLASTIC

NEW 6 INCH
Lightweight, Laminated PLASTIC
SLIDE RULE

7 ADDED FEATURES

never before offered
Plastic, cannot warp or break, stays accurate, engine-turned calibrations can't rub off; handy size with all scales to figure any arithmetic, multiplication, division, geometry, engineering problem; 1000 other uses. Has 6" and metric rule; conversion tables for decimals, fractions, weights—quantity, liquids, BTU, HP, areas, linear-metric, etc.

79¢

Includes "Easy-to-Use" INSTRUCTIONS

EASY, QUICK, WITHOUT PENCIL OR PAPER

Mechanics, shipbuilders, draftsmen, technicians, engineers, tool and die makers speed work. Servicemen use for range finding, navigation, logistics, etc. Accountants, businessmen, clerks, figure mark-ups, profits. Housewives, students, anyone can be mathematical wizard. 8-page illustrated instruction folder shows how.

SEND NO MONEY

Pay postman 79¢ for one, \$1.50 for two, with instructions, plus few pennies postage and C. O. D. charges. **MONEY-BACK GUARANTEE**
Or send Money Order or ACADEMIC SLIDE RULE CO. Cash, and we pay postage. CARROLL OHIO DEPT. KM

WAR WORKERS
Increase efficiency; use the slide rule, keep job after War!

COMPLETE INSTRUCTIONS FOR ACADEMIC SLIDE RULE "Easy-to-Use"

THIS RULE HAS EVERYTHING

**Make it Last
LONGER!**

Heavy Body 3-IN-ONE Oil is MADE for electric refrigerators, washing machines, light electric motors! Heavier-bodied for heavier duty. Use it periodically to cut down repair bills. Try it!



"3-IN-ONE" OIL

The Navy's Tools of War

(Continued from page 13)

which follows the target and transmits the data electrically to a plotting room below decks, where complex instruments evaluate all variables, mostly automatically, and transmit them electrically to the turrets. With this system, it is not necessary for the men at the guns to see the enemy ship at all.

The heaviest U. S. Naval anti-aircraft gun is the 5-inch. With its accurate and rugged fire control system, it has been proven by battle results to be the best in the world, for rapidity and accuracy of fire and effectiveness of ammunition. Its high explosive shell, burst by a time fuse, takes good care of any horizontal bombers which come low enough for accurate bombing, and helps in the defense against dive bombers, torpedo planes, and strafers.

But the 40-millimeter and 20-millimeter are the better guns for infighting. Both use explosive ammunition, but with sensitive contact fuses. The 40 is mounted in twin and four-barreled mounts, the 20 in singles, and both are plastered all over the topsides of our ships.

I can't tell you the exact number of these guns a particular ship carries, but I am certain you would be astonished if I did. Together with the powerful 5-inch batteries, the collection of these guns on each of our new battleships and carriers constitutes the heaviest concentration of anti-aircraft guns in such a limited space found anywhere in the world. The new cruisers, destroyers, escort vessels, PT boats, subchasers, tenders, repair ships, transports, and even cargo ships, have powerful batteries which really knock planes down.

I don't want to give the impression that everything we have in Naval ordnance is perfect, and that production has always been up to requirements. When you must do all your designing and testing in time of peace, it would be a miracle if everything came through the acid test of battle with flying colors. And when you consider how late this country really got down to the business of arming, it's not surprising that we have not always had all we wanted of everything.

But, taking all types of Naval ordnance together, we do not have to take our hats off to any other Navy, for either quality or quantity.

We have made a most promising start; and we will continue to give the ships and planes of our Fleet the best naval ordnance in the world, so that they can give the Fleets of the Axis their half of the ocean—the bottom half.

THE HOW AND WHY OF

WILLIAMS DROP-FORGED TOOLS

DATA ON WILLIAMS' CUTTING-OFF TOOL HOLDERS (Data Sheet No. 12)



With Williams' Spring Cutting-Off Tool Holder, feed can be applied automatically leaving operator free to watch and thoroughly lubricate the work.

Williams' Spring Cutting-Off Tool Holder makes comparatively simple a lathe operation normally one of the most difficult. Several advantages result from the "goose-neck" design of this Holder which automatically provides relief from any sudden or excess pressure on the cutter blade. Even an inexperienced operator can cut off work considerably out-of-round without chatter, "climbing" or damage to either tool or work. The shock-absorbing qualities of this Spring Head, likewise, tend to protect lathe bearings and journals and will definitely improve the quality of work done on old and "loose"

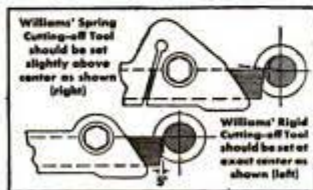

lathes. Only with this type of Spring Holder can the automatic cross feed be used for cutting-off operations.

In setting-up, the *spring* cutting-off tool should be set slightly above center. A *rigid* cutting-off tool, however, should always be set on exact center. See drawing at lower left. Cutters may be sharpened by grinding the end of the blade . . . usually to an angle of 5°. The sides of Williams' blades never need to be reground since they have sufficient taper throughout their length to provide side clearance. The work should be flooded with oil when cutting off steel. No lubricant is necessary with cast iron or non-ferrous metals.

Below are illustrated the two types of Williams' Cutting-Off Tool Holders. The rigid Holder accommodates either a cutting-off or side blade without any adjustment. Its cutting-off blade is interchangeable with Williams' Spring Holder. Both these types of Williams' Holders employ a positive cam lock to hold their blades in place, which is both quick-acting and rugged.

WILLIAMS' SPRING CUTTING-OFF HOLDER



Straight Shank Pattern. Also made with Right Hand Offset shank.

WILLIAMS' CUTTING-OFF & SIDE-TOOL HOLDER

Left Hand offset Pattern. Also made with Right Hand Offset and straight shank.



FREE DATA SHEETS

J. H. WILLIAMS & CO., BUFFALO 7, N. Y. ON USE OF SHOP AND HAND TOOLS

Your name and address in the margin below will bring 12 Tool Holder Data Sheets (punched for 3-ring binder) and a list of our complete Data Sheet series. Mail to above address, Dept. PM-4.

Some things haven't changed!

LHS

STERNCREST

STERLING

Every pipe produced from genuine imported Mediterranean briar of pre-war quality, and shaped by the skilled hands of master craftsmen to be "A thing of beauty and a (smoking) joy forever". Sterling Silver band; solid rubber bit. Every pipe numbered, and registered by LHS, as your guarantee of pipe perfection.

\$5

Smooth and
Antique
Finish.

Many hand-
some models.



"Perfection... in a Pipe"

LHS STERNCREST 14K

The custom craftsmen of LHS select the very choicest grains for these patrician pipes. They finish them by an exclusive process that brings out the full beauty of the briar,—circle them with a band of solid gold. Truly, "Perfection—in a Pipe" **\$7.50**

L & H STERN, Inc., Stern Bldg., Brooklyn, N.Y.

Makers of the famous

LHS Ultra-fine \$10 Certified Purer \$3.50 Superfine Purer \$1.50

Put this in your
pipe and smoke it!

BUY WAR BONDS

'Shot in Wing' With Hypo Needle Cures Airplane Blisters



Hypodermic needles loaded with adhesive are used to puncture blisters that sometimes form in the cloth stretched over ailerons. The blister collapses and the adhesive seals the cloth to the wood form. This process, discovered by a worker at the Consolidated-Vultee aircraft plant, eliminates peeling off the blisters and applying patches. *Vultee Field, Calif.*

Suction Tubes to Remove Trash Proposed by City Engineer

Underground pneumatic tubes which would suck household wastes and ashes to central stations may supplant the garbage truck in the cities of the future, according to Morris M. Cohn, sanitary engineer for Schenectady, N. Y. Cohn explained that the "subway" system would eliminate the storage and handling of wastes and their surface collection. It would consist of a network of pneumatic ducts under the streets, with a connection in every home, store and industry. An air-lock chamber would permit the property owner to discharge ground-up wastes into the city's refuse "veins," from whence they would be sucked to an incinerator.

☐ In 1943 four million fewer automobiles were registered than in 1941, the peak year, respective figures being 25.5 million and 29.5 million cars.



THERE'S BEEN A BIG CHANGE

ONE REASON why moderns wear fewer clothes is because they must move faster than folks did in the old days. The tempo of things has changed.

But changes haven't all been a matter of *subtraction*. In the case of tapered roller bearings, a new, faster-moving age called for *addition*—addition of rollers to stand heavier loads and shocks. Tyson Heavy-Duty Bearings answer that need.

Tyson actually added *thirty percent more rollers*, on the average, size for size! This single improvement has virtually doubled bearing life for Tyson users. For every heavy-duty job, Tyson "All-Rolls" Bearings are the most advanced . . . toughest . . . longest lived.

* * *

The big name in bearings today is . . . TYSON!



TYSON BEARING CORPORATION, MASSILLON, OHIO

COUNT THE ROLLS - THE ROLLS COUNT



Tyson

TODAY'S HEAVY-DUTY BEARING

★ LET'S ALL BACK THE ATTACK ★

Now ONE in Name

MILLERS FALLS
TOOLS

SINCE
1868

GOODSELL
PRATT
1500 GOOD TOOLS



THE QUALITY which has always been symbolized by the Goodell-Pratt trademark lives on under the Millers Falls name. One in quality for generations — one in production and management since 1931 — Goodell-Pratt precision tools now carry the company name — Millers Falls. Only the trademark is changed.

So when you buy, insist on the name Millers Falls.

MILLERS FALLS
TOOLS

SINCE
1868

MILLERS FALLS
COMPANY

Greenfield, Mass.
U.S.A.

77816
"Salt Shaker" Selects Right Rivet
By Twist of Rotating Top



Selection of the right size rivet from a number of sizes is made easy by use of a "salt shaker" dispenser, employed on aircraft construction in the Detroit plant of the Murray Corporation. Several cylindrical compartments hold the rivets separately, graded according to size. A rotating top with a hole through which the rivets pour like grains of salt is turned until the right compartment is reached. The compartments are labeled to indicate the size of the rivets in each. *Detroit, Mich.*

Anti-Typhus "Dust" for Vermin
Is Effective for a Month

Effective protection against typhus is offered by a chemical agent, DDT (dichlorodiphenyl-trichloro-ethane), just adopted by the War Department. A single application of it dusted on clothing gives protection from disease-carrying vermin for one month. It is considered such an effective insecticide that the army recently flew the first 500-pound cargo produced at a DuPont plant to an overseas base. DDT was largely used as a moth repellent and plant lice control until recently, when the United States Department of Agriculture announced it had successfully tested it against body lice.

POPULAR MECHANICS
*C. I. du Pont de Nemours & Co.
Wilmington, Del.*

LEADERS DO THINGS FIRST

Leadership rests upon the ability to foresee, to develop, and to achieve—first. ★ On that critical basis, weigh the position of the Allison engine. ★ Allison built the first aircraft engine in the world to receive official military rating of more than 1,000 horsepower. ★ Allison manufactured the first airplane engine in all the world to weigh less than one pound per horsepower. ★ These are only two of the thirteen major advances in aircraft - powering credited to Allison. ★ Leadership is earned by achievements at the forefront of development.

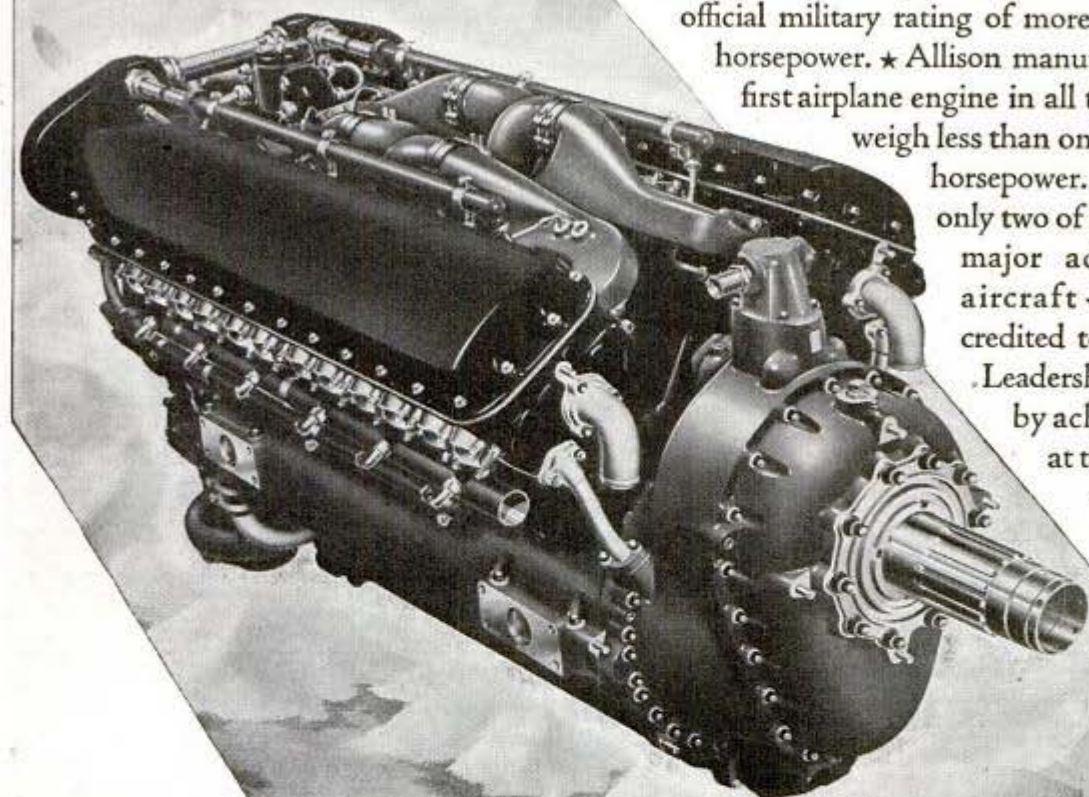

Every Sunday Afternoon
GENERAL MOTORS SYMPHONY
OF THE AIR—NBC Network

LIQUID-COOLED AIRCRAFT ENGINES

Allison

DIVISION OF

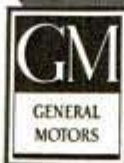

KEEP AMERICA STRONG
BUY WAR BONDS

POWERED BY ALLISON:

P-38—Lightning • P-39—Airacobra • P-40—Warhawk • A-36 and P-51—Mustang

PHOTOS SEE ALL-TELL ALL Prove What "Graf-Flox" Does

Scientific photography reveals why Burd "Graf-Flox" Piston Rings save money for car owners. Laboratory microphotos show (1) why Burd discarded old-type cupola iron in favor of electric furnace iron because of its finer, more uniform distribution of natural graphite (2) how abrasive metal particles left in machining are completely removed, and (3) how open pores of metal are sealed with deeply-penetrating, firmly-fixed colloidal graphite. That's why Burd "Graf-Flox" Piston Rings are self-lubricating, self-seating, and non-scoring—why they reduce friction and wear, add years of life to rings and motors.



OLD TYPE PISTON RING

Burd electric furnace iron assures finer, more even distribution of natural graphite in metal. Note how loose particles left in machining are removed and pores filled with colloidal graphite.



GRAF-FLOX TREATED PISTON RING

Photomicrograph shows "pearl layer" of abrasive metal particles left in machining rings. Also reveals uneven distribution of natural graphite in old-type cupola iron—long discarded by Burd.

BURD PISTON RING CO., Dept. PM, Rockford, Ill.

THIS COUPON BRINGS 2 FREE BOOKS

Burd Piston Ring Co., Dept. PM, Rockford, Illinois.

Gentlemen:

Please send me your Handy Hand Book on how to keep my car in good working order. Also Victory Car Economy Record Book to keep mileage costs and gas coupons safely.

Name

Address

City..... State.....





GERSTNER Tool Chests
Better-Built Chests for the more exacting mechanics. Free catalog for machinists and tool-makers.
GERSTNER TOOL CHESTS
444 Columbia St. Dayton 7, Ohio

Say you saw it in Popular Mechanics!

BRIGHT STAR FLASHLIGHTS and BATTERIES

NOW SERVING OUR MEN
ON EVERY FRONT!



BRIGHT STAR
BATTERIES

WHEN THE WAR IS
OVER THEY'LL SERVE
AT HOME AGAIN!

BRIGHT STAR BATTERY CO., CLIFTON, NEW JERSEY

STOP LEAKS IN BASEMENT WALLS, FLOORS

Stop-it



Stop those leaks! End that seepage through cracks in basement walls and floors. Use **STOP-IT**—amazing, quick-setting, water-proof material. INSTANTLY seals dripping cracks and openings. For interior and exterior use.

EASY TO USE Simply mix with water and apply on cracks. Sets hard and permanent. At amazing low cost, you can turn that damp, musty basement into a delightful playroom. Get **STOP-IT** at your dealer or write direct.

FREE BOOKLET Send for free "Household Hints in War-Time." Tells how to save money, conserve food, clothing, fuel.

ANOTHER TAMMS PRODUCT
TAMMS SILICA COMPANY
228 - EA N. La Salle St. - Chicago 1, Ill.

CRAFTSMEN—STOP RUST WITH FIENDOIL

Protect tools, clean and coat them with this anti-corrosive favored for years by gun and tackle users. Get it now at your Sports or Hardware Store.

2 oz. Bottle—35¢

MCCAMBRIDGE & MCCAMBRIDGE CO.
Baltimore

ON THE ROAD TO VICTORY

★ go thousands of HULL COM-PASSES. Wartime improvements will make available an even finer instrument for the Road to Vacationland—after Victory.

HULL MFG. CO.
P.O. Box 246-D4 • WARREN, OHIO



ANYONE CAN DO THIS IF

THEY HAVE
OUR CHART

Blue Print 27"x36" shows how to find length of any rafter; find any angle in degrees, frame any polygon 3 to 16 sides, read board foot and brace tables, octagon scale, rafter tables and many other uses. Can be scaled down for model work as well as full scale framing. Also Chart changing pitches to degrees for use with Radial Saws. Send 50c in Coin or M. O. No Checks or Stamps. **MASON & PARRISH ENGINEERS, 2106-B N. Burdick St., Dept. D, Kalamazoo, Mich.**

SPECIAL OFFER FOR AGENTS

CRESCENT TOOLS

Give Wings to Work

ASK YOUR
HARDWARE
DEALER

TRAILER AXLES, HITCHES, AND PARTS

● If you are interested in purchasing trailer axles, hitches, and other trailer parts, contact us promptly. Complete house trailer blue prints, \$1.00. Write for free literature.

HAMMER BLOW TOOL COMPANY, Dept. 104, WAUSAU, WIS.

SHAW and "Peppy-Pol" "DU-ALL" GARDEN TRACTORS

● 1 to 9 H.P. Circulars on request. War limits production—We supply repairs for all SHAW Tractors sold in our 40 years in business.

BUILD YOUR OWN RIDING TRACTOR—"WAR HORSE"

using old auto parts, powered by 2 H.P. or larger air-cooled engine; or walking type Garden Tractor 1/2 to 3 H.P. as shown; or convert truck or auto into Farm Tractor. SHAW will plow, cultivate. Plans for building, in one day, any one of above, postpaid for \$1.00 (state which wanted) or all 3 for \$2.00. Money Back Guarantee!

SHAW MFG. CO., 4504 Front St., Galesburg, Kansas
688Q North 4th St., Columbus, Ohio



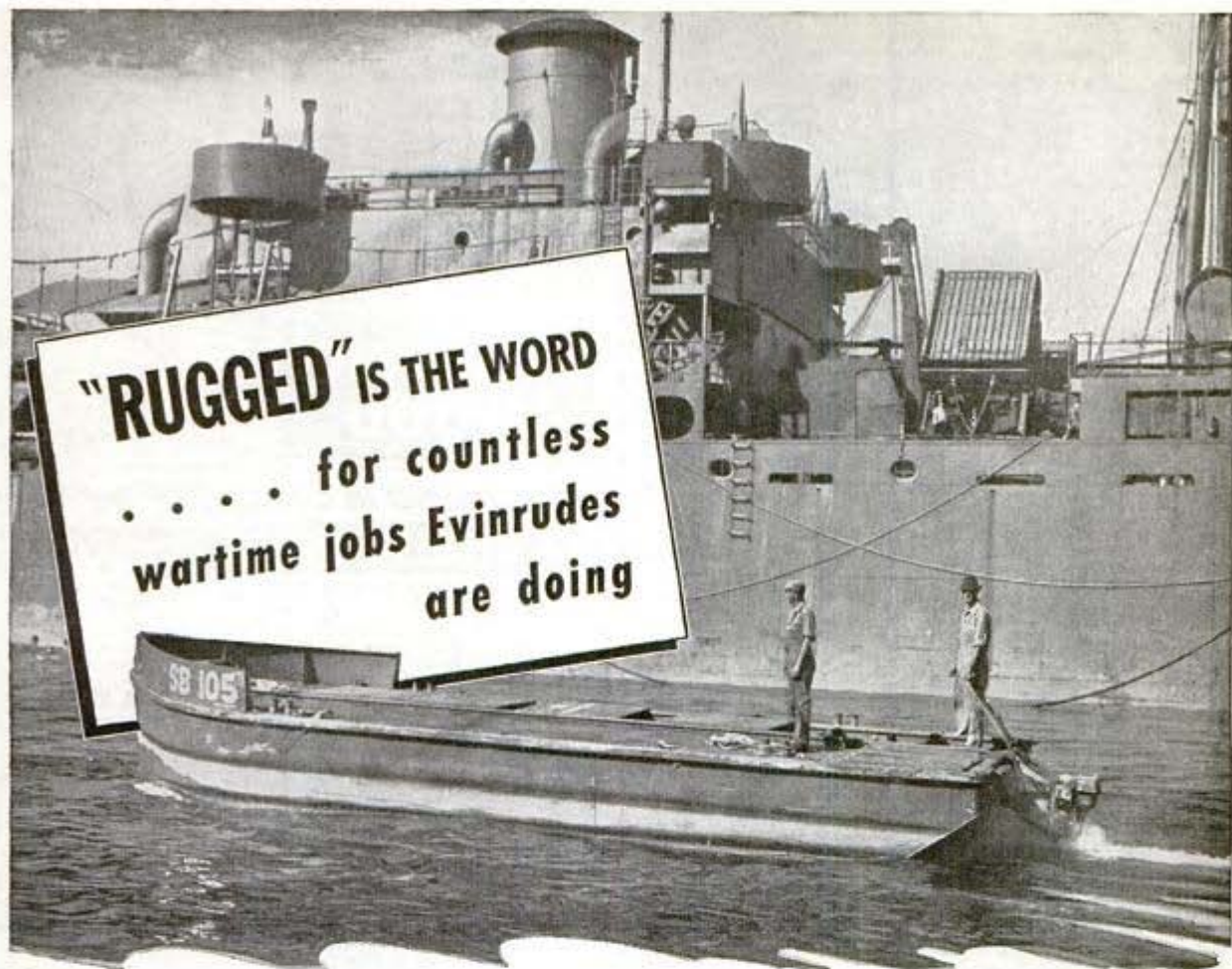

"RUGGED" IS THE WORD
 for countless
 wartime jobs Evinrudes
 are doing

"PLENTY RUGGED", say our fighting men, to sum up the tough jobs . . . to patly describe any grim task from long, forced march to furious battle action.

Rugged too are the assignments that Evinrudes are capably handling in every part of the world—from busy home ports to beachheads on distant fighting fronts.

Powering lighters, ferries, tenders, work boats . . . many Evinrudes are rolling up operating records equal to several lifetimes of ordinary duty.

On assault craft, swift and powerful "fighting" Evinrudes have proved their

stamina on many fronts. Evinrudes serve with England's famed Commandos. Great Evinrude "fours," specially developed for the purpose, drive many of the Army's speedy Storm Boats.

Motors for such service . . . motors of many types for our fighting forces . . . are the only kind we are building now. Some day new peacetime Evinrudes will follow down the production line. You can be sure they will be tops for "rugged" service . . . and that in every other characteristic, they will be sheer pleasure to own!

EVINRUDE MOTORS, Milwaukee, Wisconsin



KEEP BACKING THE ATTACK
 BUY MORE WAR BONDS

EVINRUDE
 OUTBOARD MOTORS

Does a busy day
make an OLD MAN
out of you?



● Maybe you're missing something, mister . . . maybe you could end that "old man" feeling *this* simple, scientific way . . . with a Bauer & Black self-adjusting Suspensory. Men everywhere in all walks of life, active or quiet, heavy or light . . . say the firm, comfortable, flexible support of a Suspensory makes them *feel years younger* . . . less tired . . . all the time.

Mail Coupon for FREE BOOK



This free illustrated book tells you how men claim to have found new vigor . . . helped to banish quitting-time fatigue . . . how they stay fit and energetic all day long . . . every day. Send for your free copy today.

BAUER & BLACK

Suspensories

Division of The Kendall Company

Dept. S305

2500 S. Dearborn St., Chicago, Ill.

Please send me your booklet about Suspensories.

Name _____

Address _____

City _____

State _____

My Occupation is Active Not Active

LOOK for New Post-War WITTE DIESELECTRIC PLANTS

The finest Dieselectric Plants ever to carry the WITTE name will be ready for you after victory . . . to supply power and light at amazingly low cost. Over 74 years manufacturing experience contributes to their reliability. Today, WITTE Units are serving the victory cause all over the world.



WITTE ENGINE WORKS

LARGEST BUILDER OF SMALL DIESELS
KANSAS CITY, MO., U. S. A.

SAVE THAT CHAIR!

Broken furniture can often be repaired permanently, quickly with **PLASTIC WOOD!** Handles like putty; hardens into wood. At Paint, Hardware and 10¢ Stores.



New Designs in FRANZITE GRIPS

Modernize Your Gun! Improve Your Score!

Most durable grips made. Positively unbreakable! For Colt, Smith & Wesson, Hi-Standard, Orgies, Luger & Mausers in a wide choice of beautiful designs in ivory, pearl, walnut, onyx, etc. Low prices. FREE CATALOG. Dealers Wanted.

SPORTS, INC., (Mrs.) 2850 N. Clark St., Dept. P-4, Chicago, Ill.

**\$20.00
COMPLETE**

ENGINES IN STOCK



The G. H. Q. miniature gasoline engine that really operates is still available. Over 100,000 sold to date. 1/5 H.P. Complete with flywheel and propeller, fuel, 15 accessories and full instructions. Fully bench tested and ready to run. For boats, planes, midget cars, etc. Send only \$1.00 — Shipped Collect C.O.D. same day. Send 25¢ for illustrated Catalog of hundreds of hobby items.

GHQ MOTORS, Dept. BV, 40 East 21 St., New York 10, N. Y.

NEW OTTAWA SAW

**BIG
FREE
BOOK**

World's Fastest
6 H.P.
EASY to MOVE



Fells trees.
Saws big logs, small logs, limbs. Pulley for belt work. Easy to handle, weighs less than lower powered units. FULLY GUARANTEED. Cash in on fuel shortage. Turn wood lots into cash.

OTTAWA MFG. CO., 427 PINE ST., OTTAWA, KANS.

Wonder-Tone NOISE ELIMINATOR

Just attach to your radio (long, short wave) and enjoy reception free from distracting noises. Send-No-Money Pay Postman 60¢ plus postage or send 60¢ and we'll send postpaid. Return in 3 days for refund if not delighted.

WONDER-TONE COMPANY, Dept. 39, 7078 N. Clark St., Chicago 26, Ill.



DO YOU

WANT a permanent business profession of your own? Then **BECOME A FOOT CORRECTIONIST.** Earnings in this greatly needed profession run as high as \$50-\$100 weekly after a few weeks home training—no medical or chiropody—no further capital needed, no goods to buy, 47th year. Write for free booklet.

Stephenson System of Foot Correction

28 Back Bay,

Boston, Mass.



AUTO ENGINE SPEED CONTROL GOVERNORS

Give constant speed to any auto or truck engine, when used for power. Fully guaranteed. Simple instructions. Oil ring bearing \$13.00. Ball bearing \$19.50. Prepaid. Also additional carburetor butterflies. In Montreal, 7546 Wiseman St. Latin Amer. East Asiatic Co. Free circulars.

CANDEE, 2641-P S. Hill, Los Angeles-7

FROM COAST TO COAST...GRATEFUL MULTITUDES HAIL

Zenith's Crusade to Lower the Cost of Hearing!

TO the hard of hearing men, women and children of America, a new world of happiness has been opened! At a cost which, for the first time, brings a fine type of hearing aid within reach of all, the new Zenith Radionic Hearing Aid is lifting the cloud of misunderstanding and missed opportunities from the lives of those who have suffered in silence.

As this mighty Zenith crusade sweeps ahead, it is revolutionizing the cost of hearing. It is enabling men and women to be restored to full usefulness in vital wartime work... children to be saved from failure and unhappiness... the hard of hearing, and their families and friends, to redis-

cover the enjoyment that comes when normal sounds are heard again.

From coast to coast, America has given this crusade an enthusiastic welcome. The proof is in the deluge of orders pouring in from every part of the nation... orders which continue to exceed all anticipation. Please accept our apology if you have been unable to secure a Zenith Radionic Hearing Aid. We are making every effort to supply the demand. Our production is increasing daily, but we shall never break faith with our hard of hearing friends by sacrificing quality for speed or quantity.

You have waited years for this crusade that lowers the cost of hearing.

Note carefully the advantages which the new Zenith Radionic Hearing Aid now brings you—and we feel sure you will decide never to pay more and get less in a hearing aid. You will find it worth your while to wait a little longer, if necessary, until Zenith's precision production facilities can meet the needs of your community.

In the meantime, you are invited to attend the demonstration now going on at local optical establishments franchised by Zenith. Let your ears decide—you will not be pressed to buy. No salesman will call at your home. Send

for our free booklet.
Zenith Radio Corporation,
Post Office Box 6490A,
Chicago 1, Ill. Dept. PM-4.

NEW ZENITH RADIONIC HEARING AID BRINGS YOU ADVANTAGES UNKNOWN BEFORE

Another Zenith "First"!

ONLY ZENITH GIVES YOU:

1 The fine precision quality that modern knowledge and engineering make possible in a hearing aid, yet priced at only \$40, complete, ready to wear. One model—no "decoys"... one price—\$40... one quality—our best. You need not pay more or accept less.

2 Four-Position Tone Control. The flick of your finger instantly adjusts it to the effective combination of low, medium and high tones for individual needs in varying surroundings, hearing deficiencies in any range. No further adjustments needed.

3 Special Battery-Saver Circuit. Insures economy in battery consumption... results in substantial saving of battery life and battery replacement expense.

4 Zenith Quality—Zenith Guarantee. Zenith, the world's leading manufacturer of radionic products exclusively, is fortunate in having the knowledge of precision production that makes possible this quality hearing aid at a remarkably low price. Guaranteed for a full year, with unique service insurance plan.

The Zenith Radionic Hearing Aid is available through reputable optical establishments franchised by Zenith.



Accepted by American
Medical Association Council
on Physical Therapy

\$40 READY
TO
WEAR

Complete with Radionic Tubes,
Crystal Microphone, Magnetic
Earphone and Batteries. One
model—no "decoys"... one price
—\$40... one quality—our best.
Covered by a liberal guarantee.



To Physicians: A detailed scientific description will be sent upon request. Further technical details will appear in medical journals.

*

There are cases in which deficient hearing is caused by a progressive disease and any hearing aid may do harm by giving a false sense of security. Therefore, we recommend that you consult your otologist or ear doctor to make sure that your hearing deficiency is the type that can be benefited by the use of a hearing aid.

COPYRIGHT 1944, ZENITH RADIO CORP.

BEFORE STARTING DIRTY WORK

Rub on "PRO-TEK" like a cold cream



When through work, grime and paint wash right off



It acts like an invisible glove



DU PONT
PRO-TEK
REG. U. S. PAT. OFF.
HAND PROTECTIVE CREAM

BURN YOUR NAME ON TOOLS WITH THE ARKOGRAF

PROTECT YOUR TOOLS FROM THEFT
Write with electricity any name or design on the hardest and finest tools and instruments or any metal, like writing on paper with pen or pencil. Thousands used by mechanics, garages, machine shops. Complete outfit \$3.50—Prepaid Anywhere. Interesting illustrated circular free. Write today. ARKOGRAF PEN CO., 3927 S.E. Stark, Portland 15, Ore.



ELECTRICITY FOR ANY JOB ANYWHERE



ONAN GASOLINE DRIVEN ELECTRIC PLANTS provide electricity in locations where it is not otherwise available, and for emergency standby service. Thousands of units are doing a winning job in the war.

Sizes from 350 to 35,000 watts. A.C. 50 to 800 cycles, 110 to 660 volts. D.C. 6 to 4000 volts. Also dual A.C. and D.C. output models. D. W. ONAN & SONS, 1092 Royalston Ave., Minneapolis, Minn. Details gladly furnished



DRILL PRESS OWNERS!

HERE'S 1 TOOL WITH 5 DISTINCT USES
THE BARRON MULTI-PURPOSE ROTARY WOOD PLANER



PLANES & SURFACES • PANELS & BEADS
ROUTS & GROOVES • RABBETS • TENONS **\$7.50** COMPLETE

Converts ANY drill press into a time saving, low cost planer, paneler, tenoner, etc. Surface finishes all types of tough grained and knotty surfaces to agate smoothness. Safe! Guaranteed harmless to drill press. Thousands now in use. **SOLD ON MONEY BACK GUARANTEE.** Full refund on 5 day trial. Shipped prepaid on receipt of \$7.50—or C.O.D. YOU RISK NOTHING. Free literature.

STEEL TOP AUXILIARY DRILL PRESS TABLE

Has 300 sq. in. smooth working surface. Equipped for shaper and many other important workshop uses—a real buy at **\$5.95**



Barron Tool Co., 369 Architects Bldg., Detroit 1, Mich.

BEES

Keep bees for honey and to pollinate the fruit blossoms.

Our 96 page book, "STARTING RIGHT WITH BEES," with 180 illustrations will help you get more honey. Only 50 cents postpaid. Our book "500 ANSWERS TO BEE QUESTIONS" is a valuable source of information. Contents classified and indexed, 104 pages. Only 50 cents. GLEANINGS IN BEE CULTURE, monthly magazine. Largest circulation of any bee magazine, \$1.00 per year (with either of the above books, \$1.25).

FREE BEE SUPPLY CATALOG, 40 pages. THE A. I. ROOT CO., Box 94, MEDINA, OHIO

SEE BEFORE YOU BUY



Diamond-dazzling Zircons from the Mines of far-away Mystic Siam. Effective and inexpensive. Stand acid; cut glass; full of FIRE! Thrilling beauty in exquisite mountings for Lady or Gent. Sent on trial. Write for catalogue now.

NATIONAL ZIRCON CO., Dept. 528, Wheeling, W. Va.

Catalog FREE!

MASCOT SLIDE RULE

Fits the pocket. Quickly solves any problem in multiplication, division, proportion. Gives the square, the square root, logarithm and reciprocals of all numbers. Trig scales give sines and tangents of numbers. Fine black graduations on white celluloid. Price in fabricoid case \$1.00, in leather case \$1.25. Money back if not satisfied. Special offer to agents and dealers.



MONITOR SLIDE RULE—6" Dia.

Made in white Vinylite. Same scales as Mascot Slide Rule. Without case, \$2.95. Leatherette case 75c additional. TAVELLA SALES CO., 19-D West Broadway, New York 7, N. Y.

GENUINE U.S. BARGAINS



O. D. WOOL BLANKETS (USED) . . . \$2.95
ALUMINUM MESS PANS (USED)35
U. S. ARMY PUP TENTS (USED) . . . 3.50
Slightly Used Army Caisson Wheels with Axles, 56" high, weight per pair with Axle, 322 lbs. \$37.50

Thousands of Other Bargains in Military, Outdoor & Sport Goods for Hunter, Farmer, Scout Send 10¢ for 32-page catalog returned with first order.

A and N SUPPLY CO.
4724 LESTER ST. RICHMOND, VA.

ONE-MAN SAWMILL LESS THAN \$100.00



Turn Trees Into Money with a BELSAW

Three capacities: 10, 14 and 20 feet. Accurate set works, positive gogs. Hand or power feed.

Runs on low power—Many owners use old auto engine. Pays for itself quickly—thousands in commercial service, everywhere. Write for free lumber handbook and catalog of mills, supplies, tools, saw blades and woodworking equipment. BELSAW MACHINERY CO. Dept. 1811-F, 3542 Main St., Kansas City 2, Mo.

AUTO-LITE SPARK PLUGS

IN SERVICE ON EVERY FRONT



"Rafe figgers his curve-pitchin' Bazooka zigs 'em when they're zaggin'!"

"PLUG-CHEK" HELPS KEEP 'EM FIRING!

Good spark plugs help deliver good mileage. Faulty or improper plugs can waste gas, cause excessive wear, and make engines hard to start. Cleaning and re-gapping may be all your present spark plugs need, and "Plug-Chek" Inspection Service can aid your service man in determining what should be done. Tests conducted by the American Automobile Association show Auto-Lite "Plug-Check" Inspection Service may increase gas mileage as much as 12%. Ask for a "Plug-Chek" today.

THE ELECTRIC AUTO-LITE COMPANY

TOLEDO, 1 • Merchandising Division • OHIO

BACK THE ATTACK—BUY WAR BONDS

Tune in
AUTO-LITE'S

GREAT RADIO SHOW
STARRING

RONALD COLMAN

IN

**"EVERYTHING FOR
THE BOYS"**

Tuesday Night . . . NBC Network
Featuring men and women at the
fighting fronts





A TORNADO IS A SPIRAL, TOO!

Standard the world over for nearly half a century, "Yankee" Spiral Ratchet Screw Drivers are now helping to produce a tornado of ordnance to flatten the Axis. Simple, compact, strong, and ingenious, they and other "Yankee" Fine Mechanics' Tools are saving time, trouble, and money in the Battle of Production. At war's end, of course, they will again be available where and when you want to buy them . . . and they'll have new war-tested skill behind them. Meanwhile, treat them right. Tools are weapons of war.



"YANKEE" SPIRAL SCREW DRIVER NO. 130A
A Size for Every Purpose

"YANKEE" TOOLS

make good mechanics better

North Bros. Mfg. Co., Phila. 33, U.S.A.
Established 1880

Makers, also, of "Yankee-Handyman" Tools

Test-O-Lite

the MODERN TROUBLE SHOOTER

← THE NEON GLOW

... LOCATES TROUBLE INSTANTLY in electric circuits, fuses, cut-outs, motors, radios, appliances. Tests everything electrical from 100 to 550 volts. Indicates hot or grounded wires. Tells AC from DC. Far superior to ordinary clumsy test bulb.

↑ PUTS "FINGER" ON THE TROUBLE SPOT -- QUICKLY

Gaves precious time. Indispensable in shop or home. Has patented safety features. Vest pocket size with clip. Lifetime guarantee. List \$1.50 (Priority A7 required) Purchase through regular electrical dealers.

FUSES

MOTORS

OUTLETS

L. S. BRACH MFG. CORP.
55 Dickerson St. Newark, N. J.

Amazing Handy ADDING MACHINE

Can Be Carried in Vest Pocket—

yet Handles Totals up to \$99,999.99

ONLY \$2.50 POSTPAID With Leatherette Case

ABSOLUTELY ACCURATE

Not only adds, but can be used to Subtract, Multiply, and Divide. STURDILY CONSTRUCTED, with metal front and back, yet weighs only 5 ounces—so that it can be conveniently carried in pocket, as well as used in office, shop and home. . . . Useful to business men, accountants, students, everyone . . . Worked with a touch of the finger.

SEND NO MONEY

Just send name and address. Then pay postman \$2.50 plus few cents postal charges on delivery. Or send \$2.50 with order, and we pay charges.

LEE'S SPECIALTY CO., Dept. PM, 1616 No. Ogden Chicago 14, Ill.

TOOLS TO FINISH THE JOB!

20 CARBON DRILL SET

Wafer-Thin Vest Pocket Case. No. 61 to 80. A craftsman's treasure! Indexed case! Easily \$4.50 value! **\$3.50** (By mail \$3.65) Case alone \$1.00

60 CARBON DRILL SET

No. 1 to No. 60 Complete. In new automatic General Index Case—complete tap machine screw and decimal equivalents at eye level beneath each drill. (Case alone—no files \$2.50). Complete outfit only 60 drills as above in 3 tier Indexed Bench Drill Stand—\$12.50.)

Needle Files	Carbon Drills	TAPS	Oculists	Pin Vises
Fine Swiss type, 4" or 6 3/4" Long, Round, Flat, Oval, Knife, Sq., Equaling, Bar-	81 to 80, each 15c 50 to 60, each 20c 40 to 49, each 25c 32 to 48, each 30c 1 to 31 each, 35c	0-80 65c, 1-72 65c, 2-56 90c, 3-45 50c, 4-40 55c, 6-32 45c, 8-32 45c, 10-24 50c.	.046 .055 ea. 40c	Leg. wood-handled \$1.25. 4 jaw double chuck. Takes 40 to 80. \$1.00. Small jaw brass handle closest zero, 25c.
U. S. Navy specific-rette, Joint, cationa, Hex, Swiv-Slitting, Mark-el Head, Threaded ing, ea. 40c. chuck. Screw Driver Complete Set with 3 Blades—12 files, in sizes .100, .080 and daxed holder, .070. Complete \$4.50. \$1.00 per set.				Self Locking Tweezers Holds small pins 50c. Larger Sure-grip 65c.

\$14.50 25¢ P.P. Pocket Scriber 1/2" Diameter, Positive Locking Chuck, Reversible Points, 75c each. 1/2 to 1" Combination Calipers—3" Can be used for inside or outside precision measuring micro setting \$1.75 each.

INTERNATIONAL MODELS, 254(N) W. 55th St., New York 19, N. Y.

Try Anti-Gray Hair Vitamins

Plus Wheat Germ Oil (E) Vitamins ON THIS MONEY BACK OFFER

RESTORING COLOR TO GRAY HAIR WITHOUT DYES IS SCIENCE'S LATEST MIRACLE

If your hair is gray, graying, streaked, faded or off-color, modern science offers new hope without dyeing. A lack of certain vitamins in your daily diet can cause hair to turn gray. Improve your diet, get extra supplies of these "anti-gray" hair vitamins by simply taking the original 2-way Panate Vitamin treatment. You too may be amazed and delighted to see the gray spread stopped, restoration of normal natural original color to the hair at roots, temples, parting, a great improvement in your hair beauty. You can now test Panates yourself on an iron clad guarantee that leaves no room for doubt. PANATES is different—it not only contains a powerful supply of "Anti-Gray Hair" Vitamins but "staff-of-life" Vitamin (E) Wheat Germ Oil as well. Panates is not a hair dye. You have nothing to fear . . . no mess, no fuss. You can test safe, beautiful Panates whether you now dye your hair or not, because Panates Vitamins work from within to check gray spread and literally feed natural color back into the hair roots.

When the blood does not provide the proper elements, the tiny laboratory that manufactures color shuts down and the hair grows gray. Perhaps you may need the vitamins in Panates. Make this test today.

SEND FOR THIS INTRODUCTORY TRIAL OFFER TODAY

The 30 day trial of the regular \$4.79 (90 day) Panates double action Vitamins is only \$1.79 if you act at once! **SEND NO MONEY** pay postman plus C.O.D. postage on arrival on guarantee of full satisfaction or money back. Send \$1.79 and we pay all postage. Or, if you want more of the amazing Panates Anti Gray Hair Vitamin story, write for **FREE Valuable Booklet**, "Vitamins and Gray Hair." No cost, no obligation. Whatever you send for put your letter or postcard in the mail today while Special Offer is available. Who knows perhaps the 2 vitamins in Panates may be the wonderful easy-way answer to your hair color worries!

PANATE CO. Dept. 49-D, 310 S. MICHIGAN AVENUE, CHICAGO 4, ILLINOIS

DELTA
MILWAUKEE
Power Tools

**Special, Money-Saving
Offer on DELTA
PLANS**
for more fun in your
Homecraft Shop

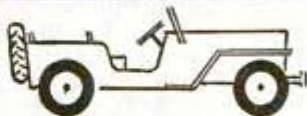

**TOY
JEEP**

A gift to thrill any youngster, 18" long — looks like a real jeep. Full-size plans, plus a sheet of assembly photos and detailed instructions. A lot of fun to make. Check the coupon — send today.

Price for the set..... **50¢**

Clear, detailed, large-scale plans for projects that provide many hours of healthful, enjoyable activity for you and delight your family and friends. Drastic price reductions made possible by grouping plans. • Every project shop-tested by Delta, world's largest peacetime maker of home power tools, now devoted to war work. • Plans range from simple cut-outs to ambitious furniture pieces. Send for yours. Mail coupon with check, money-order or stamps.



LOOM

A full-size loom which has been used to produce beautiful woven fabrics. Two big sheets of detailed plans, picture, parts list, and in-

structions. Include these loom plans in your order.

Price for the set..... **50¢**

Package "G"— 18 Furniture Plans

Handsome pieces to make your home more attractive or develop a profitable side-line. Includes:

- | | |
|----------------------|---------------------------|
| Child's Desk | Corner "What Not" Cabinet |
| Portlight Lamp | Corner China Cabinet |
| Spinet Desk | Spinning Wheel Lamp |
| Tilt-top Card Table | Windsor Smoking Stand |
| Butterfly Table | Small Modern Table |
| Wing Chair | Cricket Leg Bridge Lamp |
| Nested Coffee Tables | Revolving Book Stand |
| Davenport Table | Cobbler's Bench |
| Small Table | Chest of Drawers |

Check Package "G". 18 big, complete plans only... **75¢**

**Save 25¢
EXTRA**

Package "J"—31 Plans

The prices of all plans on this page add up to \$2.15. By ordering all 31, you get them for

\$1.90

Package "H"—Small Projects—11 Plans—63 Items

Attractive, useful small projects — almost all with full-size patterns, making their construction simple and easy. Grand money-makers. Order today. Package includes plans for:

7 Flower Box Designs	2 Action Toys
Doll Furniture	4 Wall Shelves
12 Hot-Pot Holders	9 Trellises
Wall Shelf and Door Stop	5 Bird Houses
7 Lawn Ornaments	8 Knitting Bag Handles
12 Wall Shelves	

Former price for 11 plans, 55¢. Now only..... **40¢**

*Tear Out and
Mail Coupon Today!*

Editor, Delta Craft Publications
THE DELTA MFG. CO.
681D East Vienna Avenue
Milwaukee 1, Wisconsin

I am enclosing.....in full payment for the plans checked below.

- | | |
|--|--|
| <input type="checkbox"/> Package "G" 18 Furniture Plans, 75c | <input type="checkbox"/> Toy Jeep, 50c |
| <input type="checkbox"/> Package "H" 11 Small Project Plans, 40c | <input type="checkbox"/> Loom, 50c |
| <input type="checkbox"/> Package "J" — all 31 Plans, \$1.90 | |

Name.....

Address.....

City.....(.....) State.....

The Many-Purpose
RULE
FOR ACCURATE
MEASURING



No matter what kind of linear measuring, the MASTER Streamline steel tape rule fits the job. Its adaptability for inside and outside measuring in addition to its use as a scribe or height gauge, makes this all-purpose rule a great time saver in the home workshop.

Its lever-lock holds all readings and its simple, sturdy construction makes it easy to insert the spare blade (an exclusive Streamline feature). Graduations on both sides and all edges of the blade.

Master Rule Mfg. Co., Inc.
815 E. 136th St., N. Y. C., Dept. F-4
Enclosed please find \$2.65
for 6 ft. Streamline with spare
blade.
Name _____
Address _____
City _____ State _____

MAIL THIS COUPON TODAY
Branch Office:
541 S. Spring St., Los Angeles, Cal., Dept. F-4
MASTER
WOOD AND TAPE RULES



BUY
BONDS

"The remarkable speed, stamina and convenience of CUSHMAN Auto-Glides are helping win the battle of production!"—say scores of great war-time factories!

There's nothing like a CUSHMAN to break "delivery" bottle-necks! A CUSHMAN, and only one operator, replaces many foot messengers—delivers big loads of mail, repairs, etc.—carries inspectors, messengers, etc. It moves throughout the factory easier than other transportation. It speeds deliveries . . . cuts costs . . . saves manpower.

CUSHMAN Floating Drive applies power as smoothly as Fluid Drive! Eliminates clutch pedal, gear shaft! Merely touch hand accelerator to start, travel any speed up to 35 mi. an hour. Flashy pick-up.

Knee-action with coil springs, long wheel base and balloon tires provide Smooth Riding. Low center of gravity, heavy brakes, excellent lights provide Safety.

WRITE The Army, Navy, Air Force and many large war plants take a large part of our output. However, you also may be able to qualify. See your dealer or write us.

CUSHMAN MOTOR WORKS, Dept. P-8, Lincoln, Nebr.

10¢ POSTPAID



**NEW BOOK OF LATHE AND
DRILL PRESS SET-UPS**

Gives practical, helpful information on unusual and varied uses for drill presses and lathes and Jacobs Chucks. Printed in color and containing 49 illustrations, it shows how the set-ups are made, illustrates the tools used, and in some instances tells you how to make the tools themselves. Helpful to shop owners and those planning shops. Send 10¢ to cover cost of handling and postage.

THE JACOBS MFG. COMPANY

5113 JACOBS ROAD, HARTFORD, CONN.



**SHIP
MODELS
ILLUSTRATED**
with a guide to
modeling



\$2
POSTPAID

is the first book of its kind ever published — of ship models, of real ships, of masts, of rigging, of furniture, of deck gear — covering many types of vessels from whale-boats to PT's from "Sloopers" to Corvettes. It incorporates many color plates, close-up photos, detailed drawings and actual construction plans, in addition to a salty text covering ship model building and a glossary of nautical terms. Send for it today. We'll include our catalogue of ship model kits and supplies.

29 WEST 15th STREET
MARINE MODEL CO. DEPT. M-6 NEW YORK CITY

REED PRECISION MICROMETERS

With Vernier 1/10000" Reading to



Illustrated is #901 Micrometer reading to 1/10000". Fully polished, fine finish, used by thousands of America's toolmakers and mechanics. Price \$9.23 net F. O. B. New York. MAIL YOUR ORDERS TODAY.

GEO. SCHERR CO.
128A LaFayette St., New York, N. Y.

BUILD YOUR OWN ARC-WELDER

For Light or Heavy Work

No rewinding necessary—use coils taken from old auto generators. Works on 110 or 220 A.C. Has 20 different heats. Complete plans and BIG Catalog 35c.

LEJAY MFG. CO., 3347 LeJay Bldg., Minneapolis, Minn.



The Dennison Handy Helper says:

KEEP TABS ON YOUR TIN...

TURN ALL OF IT IN

KEEP TABS ON YOUR FILES, TOO

Dennison
INDEX TABS

At Stationery Departments Everywhere



IT'S NEW!

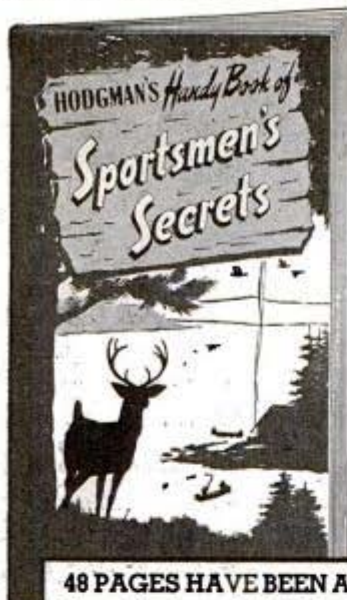

48 PAGES HAVE BEEN ADDED!

If you liked our 1943 "Secrets", you will like our 1944 edition even better. It's chock full of little known facts and hitherto unpublished secrets for getting those wary fish and crafty game. Contains page upon page of "how-to" and "what-to-do". Written by a well-known sportsman and author, it's a pocket guide every fisherman and hunter should have. Only 10c postpaid — and worth a hundred times that much. Send for your copy today.

HODGMAN RUBBER COMPANY
DEPT. P
FRAMINGHAM, MASSACHUSETTS



FINISHING TOUCH
...TO SPEED THE GOOD SHIP

HERE you see a ship's propeller blades being given a last-minute dressing—to add that fraction-of-a-knot speed which may mean the performance of some vital war errand in the nick of time.

As on thousands of equally unusual jobs, there is no substitute for the combination of human skill and *The right file for the job.*

With metals, alloys and other materials increasing in variety, the latter becomes a more and more important requisite—in shipyard, plane factory, industrial plant, machine shop, or tool room.

Nicholson and Black Diamond brands comprise literally *thousands* of kinds, cuts and sizes of files. Included are many special purpose files for such materials or operations as stainless steel, aluminum, brass, lead, plastics, foundry castings, die castings, die making, lathe filing, saw sharpening. Guarantee: *Twelve perfect files in every dozen.*

"FILE PHILOSOPHY," A 48-page Book, Free — Invaluable to shop foremen, machine and repair shop operators, mechanics, mechanical "trainees." Profusely illustrated, high-lighted with information on kinds, use and care of files. Address:

NICHOLSON FILE CO., 22 Acorn St., Providence 1, R. I., U. S. A.
(Also Canadian Plant, Port Hope, Ont.)

NICHOLSON
FILES FOR EVERY PURPOSE
NICHOLSON
U.S.A.
MADE IN U.S.A.

Say you saw it in *Popular Mechanics!*

ARMSTRONG TOOL HOLDERS

enabled American Industry to change to war production "over night." For they are the permanent, multi-purpose tools used by 96 per cent of the machine shops and tool rooms, on lathes, planers and shapers—the tools used to make dies and jigs, to build production machines. They are the tools you will want for your own shop after the war—ARMSTRONG TOOL HOLDERS for industry, ACE Tool Holders for home work shops.



ARMSTRONG BROS. TOOL CO.
"The Tool Holder People"
368 N. Francisco Ave., Chicago, U.S.A.

MENDS FURNITURE



Also dishes, glassware, toys and luggage. Good for models too.

DU PONT
DU CO CEMENT

BOOK of 100 BUILD YOUR OWN ITEMS

all for
\$150

Worth \$12.35
if plans bought
individually

MONEY-MAKING IDEAS

This remarkable series of plans will save money on your own jobs and help you make money on jobs for others in installing electrical equipment in Camps, Cottages, Garages, Farms and workshops, or making motors for Bikes, Scooters, etc.

NO EXPERIENCE OR SPECIAL TOOLS NEEDED

It doesn't take an experienced mechanic to interpret and work out these plans; they are clear and simple enough for any amateur to enjoy working with. Old auto generators and other pick-up material will be found handy in working them out.

THESE SIMPLE PLANS

show you how to construct electrical equipment that is scarce and valuable today, such as:

- 200 Amp. Generator Welders
- Large Transformer Welders
- Gunsmith's Carbon Welder
- Workshop Spot Welder
- 6, 12, 32, 110-Volt Motors
- Electric Outboard Motor
- Wind-Driven Light Plant
- Electric Fencers
- Electric Drills
- Bench Grinders
- Armature Rewinding
- Electric Scooter
- Insect Electrocutors
- Electric Bicycle Pusher
- and Many Other Things

SEND NO MONEY

Send a postcard with your name and address and it will bring you the complete LeJay Manual of over 100 build-your-own items. Just say "send it C.O.D." and the postman will deliver it to your door. If not entirely satisfied after 3 days, send it back and your money will be returned. If you prefer to save C.O.D. fees, send \$1.50 now, same guarantee.



3 DAY TRIAL

LEJAY MFG. CO

47 LeJAY BUILDING
MINNEAPOLIS - 8 - MINN.

HOW TO BUILD



SYN-FLO...

A NEW MAGIC LIQUID-PLASTIC ENAMEL

- ★ Finishes walls like TILE
- ★ Finishes woodwork like PORCELAIN

This is really it! Modern science has produced this new white PLASTIC coating you apply with a brush. It actually has the same chemical properties of genuine molded plastic products.

A BRUSH-ON PLASTIC

With an ordinary brush you flow this coating on your woodwork and it dries to a smooth porcelain finish—hard, water-proof, abrasion-resistant—stays brilliant white.

You won't have to wait until after the war for this new, scientific, plastic discovery. Limited quantities now available.

MONEY-BACK GUARANTEE

One gallon SYN-FLO Liquid Plastic will cover walls of average room. Send only \$5.95 for full Gallon SYN-FLO with Special Thinner, express prepaid. Will ship C.O.D. if desired.

LIMITED SUPPLY AVAILABLE
TO PUBLIC NOW. ORDER AT
ONCE! FREE ILLUSTRATED CIR-
CULAR ON REQUEST.

SUPERIOR PAINT and VARNISH WORKS
2256-2274 N. Elston Ave., Chicago 14

FORTY POWER TOOLS You Can Build at Low Cost

Now a NEW EDITION FEATURING TOOLS MADE OF WOOD

Power tools for your home workshop—at a cost anyone can afford. Make them yourself—lathes, drill presses, sanding machines, shaper, circular, band, and scroll saws and other power tools—from old auto, sewing machine, and other discarded parts that cost very little. Get the new edition, "Forty Power Tools You Can Make", and follow simple instructions, diagrams and photographs. Make yourself up to date, efficient machines that will do a good job for you and save you time, hard work, and many dollars. Send \$1.25 for "Forty Power Tools You Can Make" today or order on postal card and pay postman on delivery anywhere in U. S. A. Your money back if not satisfied.

POPULAR MECHANICS PRESS, Dept. 532, 200 E. Ontario, Chicago, 11



FUN AND PROFIT FROM YOUR HOME WORKSHOP

New 1944 "WHAT TO MAKE" is now ready. One of these books is issued each year and is a reprint of articles which have been published in our "Craftsman" Department. Hundreds of ideas that can be used around your home workshop in one handy, 224-page volume. Get book from your Newdealer or send 50c to

POPULAR MECHANICS PRESS
Dept. 529, 200 E. Ontario, Chicago 11

SIGNS EASILY AND EXPERTLY PAINTED WITH LETTER PATTERNS AND SHOWCARDS

MANLY SIZES & STYLES
WRITE FOR FOLDER!
JOHN F. RAHN
1330-31 N. Central Ave.
CHICAGO 51, ILL.

Say you saw it in Popular Mechanics!

Pipe-Smokers Urged to



READ THIS FREE BOOK

If you smoke a pipe, or would like to, we invite you to read "The Choice of Experience" . . . the fascinating story of John Middleton's Walnut pipe-tobacco and its beginnings in 1856 in old Philadelphia in the days of sail. Enclosed with the book will be an ample sample of Walnut . . . Middleton's master-blend of 7 superb, *naturally* aromatic tobaccos . . . mild, fragrant, and friendly. Just scratch your name and address on a penny postal and mail it to John Middleton, 1201 Walnut St., Philadelphia 7, Pa.



BUILD A BOAT

- Row Boat—12 Foot
- Dinghy—8 Foot
- Training Ship—6 Foot
- Sea Sled—9 Foot
- Outboard—12 Foot
- Cruiser—18 Foot
- Bicycle Boat—Kayak
- Row Boat—Sectional
- Dinghy—5 Sailing
- Canoe—16 Foot
- Sailing—12 Foot
- Outboard—Runabout
- Pontoon—Ice Yacht

FOR PLEASURE OR PROFIT DESCRIBES 17 LOW COST BOATS

Get this outstanding book and build a boat at home for your own use or to sell at a profit. You can do it. Just the boat you've always wanted—power, sail or row boat—17 different kinds and sizes.

Order BUILD A BOAT on postal card and pay only \$1.50 plus postage on delivery. Return in 5 days if not pleased and get money back. Or send \$1.50 with order. (Outside U. S. \$1.70 with order.) Order today.

POPULAR MECHANICS PRESS
Dept. 531, 200 E. Ontario, Chicago 11

Only 50c!

MAKES AND SAVES MONEY FOR YOU

NEW 1944 BOOK FOR EVERY MAN WHO USES TOOLS

One of these books is issued each year and is a reprint of articles published in our Shop Notes Department. It contains cream of experience of years, of hundreds of our country's most successful mechanics. Get this great book from your News Dealer, or send 50c to

POPULAR MECHANICS PRESS
Dept. 528 • 200 E. Ontario • Chicago 11



Say you saw it in POPULAR MECHANICS

Decorative Decalcomania

Transfers. Imported Designs of all Sizes and Types—

Flowers, Fruits, Figures, Dogs, Horse Heads, Ships, Juvenile, Tropical, Chinese, Peasant, Colonial, Inlay, Borders, Initials, etc., for Furniture, Doors, Walls, Trays and what not. **Catalog with 800 illustrations in Color sent for 25c.** Deductible on first order of \$1 up. **L. C. WELLS, Dept. PM-44, 25 East 26th Street, New York, 10.**



Atlas

MODERN SHOP EQUIPMENT

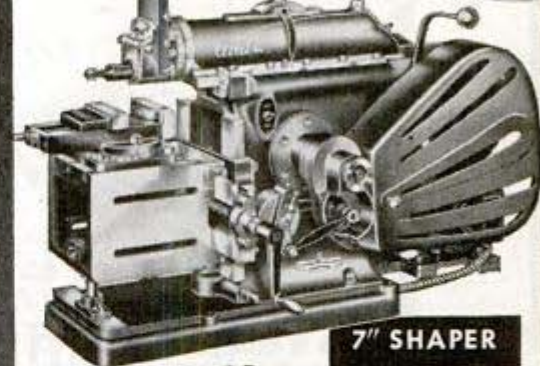

7" SHAPER

- Ram Stroke $\frac{1}{2}$ " to 7"
- Strokes per minute
45, 78, 122, 186
- Cutting Speeds . . .
. . . $2\frac{1}{2}$ to 116 fpm
- Table Travel, horizontal . . . 93"
- Table Travel, vertical . . . 47"
- Overall Dimensions . . .
36" x 17" x 26" high

PRECISION THAT WINS!

Precision gives our men the winning edge . . . in gunfire . . . in bombing . . . in all types of weapons and equipment. That's why we're proud to report that Atlas Machine Tools and their operators are delivering precision production that really counts! In hundreds of plants, Atlas Shapers turn out millions of vital small parts that turn up in key spots on weapons of all kinds on all fronts.

Remember Atlas . . . for lathes, milling machines, shapers, and drill presses for YOUR shop . . . after the war! **ATLAS PRESS CO., 443 N. Pitcher Street, Kalamazoo 13D, Michigan.**



**BUY
BONDS
NOW**

- FOR A NEW *Atlas* SHOP
AFTER THE WAR

Make Models with **KEENER, X-acto KNIVES!**
safer, FASTER
You, too,
will be an EXPERT modeler



The Navy—and the Army, too—need thousands and thousands of authentic, scale models of allied and enemy planes for teaching quick identification. Use X-acto knives to speed up this production.

Make Model Planes for Uncle Sam!

No other knife at any price has all the rich features that make X-acto the undisputed first choice of model makers. Its super-keen, surgical-steel blades (just re-blade-to-sharpen) and the scientifically shaped blades in eight styles, give the craftsman the most versatile tools of his whole outfit. With these amazing knives, you increase output and improve accuracy.

KIT NO. 62—Double set with 2 handles, 12 blades.... **\$2.00**
KIT NO. 82—Furnished with 3 handles, 12 blades and fitted wooden chest.... **\$3.50**

FREE—with your order 32 page Manual "How To Build Model Planes"



X-acto KNIFE
RE-blade to RE-sharpen

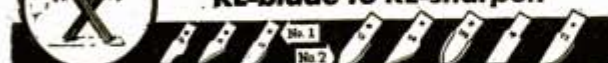

If your dealer had to send you X-actos direct to us

At Your Hobby Dealer's Hardware or Dept. Store

X-acto Crescent Products Co., 640-4th Avenue, New York 16, N. Y. Send X-acto checked. Enclose FREE 32 page Manual "How To Build Model Planes."
 Enclosed find \$..... X-acto desired:
 Chest No. 82—\$3.50 Set No. 62—\$2.00 No. 1 (light)—with one blade 50c No. 2 (heavy) with one blade 50c.
 No. 52—with 5 extra assorted blades 1.00.
 I will pay postman \$..... plus postage

Save postage and C.O.D. fees by remitting with order. (NO C.O.D.'S ON 50c ORDERS)
 Name.....
 Address.....

FREE CATALOG Pins and Rings and Rings
 Finest quality. Over 300 artistic designs. Write for our attractive free catalog and select a beautiful pin or ring for your class or club.
 Dept. N, Metal Arts Co., Rochester 5, N. Y.

Say you saw it in Popular Mechanics!

Handy Mail Order List
Little Library of Useful INFORMATION
5 for \$1.00
12 for \$2.00
25¢ Each

- Here at amazingly low cost is the practical help and information you have always wanted. Articles in previous issues of Popular Mechanics have been classified according to subject and are now available in these handy reprint booklets.
- How to Use Measuring Tools—Micrometers, Calipers, etc.—106.
 - Power Driven Saws—74.
 - Drill Presses, Grinders, Etc.—79.
 - Wood, Metal Turning—Lathes—81.
 - Filing Machine, Hacksaw, Cutoff Wheel, Shaper—82.
 - Lathe Tools You Can Make—101.
 - Workbenches—Tool Cabinets—47.
 - Spray Paints—91.
 - From Pattern to Casting—91.
 - Tool and Saw Sharpening—92.
 - Sharpening Drills, Wood Bits—90.
 - Successful Wood Turning—32.
 - How to Read Blueprint—71.
 - Metal Turning Lathe Kinks—99.
 - Operating a Metal Lathe—100.
 - Heat Treating, Hardening—102.
 - Working With Glass—103.
 - Servicing Elec. Motors—75.
 - Electromagnets & Solenoids—44.
 - Transformer Construction—41.
 - The Boy Electrician—43.
 - Soldering and Brazing—37.
 - Arc and Spot Welders—5.
 - Electroplating With Nickel, Chromium, Cadmium, Etc.—85.
 - Plating Leather, Wood, etc.—87.
 - Lower Your Fuel Costs—31.
 - Curing Leaky Basements—45.
 - Fitting Home Game Room—55.
 - Indoor & Outdoor Fireplaces—88.
 - Backyard Gardening—39.
 - Lawn and Garden Novelties—72.
 - Trellises, Pergolas, Fences—76.
 - Lawn and Garden Furniture—77.
 - Playground Equipment—73.
 - Concrete Garden Furniture—8.
 - Making Serving Trays—53.
 - Sanders—80.
 - House Wiring—89.
 - Treasure Finders—13.
 - Hanging Wallpaper—38.
 - Built-in Fixtures—78.
 - Bird Houses—7.
 - Magazine Racks—49.
 - Clock Cases—50.
 - Working With Plastics—61.
 - Simple Home Improvements—104.
 - Ridding Home of Insect Pests—107.
 - Children's Room Furniture—51.
 - Jigsawed Novelties—57.
 - Doll House & Doll Furniture—60.
 - 25 Shelves You Can Make—64.
 - Novelties Turned on Lathe—62.
 - Inlay Pictures—Veneering—63.
 - Wood, Soap Carving—65.
 - Windmills & Weather-vanes—68.
 - Lamps from Wood, Metal—69.
 - Home Work Opportunities—19.
 - Wood Finishing—40.
 - Boats—14 ft. Outboard—2.
 - Boats—14 ft. Sail Dinghy—26.
 - Boats—21 ft. Sloop—46.
 - Towboats, Small Dinghy—83.
 - Small Sail Boats—84.
 - Two Outboard Runabouts—85.
 - Build Own Canoe, Kayak—30.
 - Build Class-E Ice Yacht—22.
 - Auto Kinks, Shortcuts—10.
 - Building Trailers—27.
 - Motor-Driven Midget Cars—34.
 - Stop Auto Electrical Troubles—95.
 - Photo Printers and Dryers—25.
 - Photo Darkroom Equipment—96.
 - Trick and Table Top Photos—97.
 - Cosmetic Formulas—12.
 - Food Products Formulas—15.
 - Fair and Coloring—21.
 - Re-Silvering Mirrors—70.
 - Chemical Experiments—93.
 - Log Cabins, Tourist Houses—14.
 - Trapping Small Animals—23.
 - Farm Garden Tractors—8.
 - Building Extra Attic Rooms—23.
 - Attractive Basement Rooms—24.
 - Small Looms—37.
 - Gem Cutting—42.
 - Photo Enlargers—1.
 - Photo Kinks—98.
 - Cleaning Formulas—11.
 - Taxidermy—9.
 - Magic—29.
 - Training Dogs—35.
 - Small Furnaces—36.

Check Titles Wanted, Write Name and Address in Margin and Mail to **POPULAR MECHANICS PRESS, Dept. 527, 200 E. Ontario, Chicago, 11**

BOYS Ask Dad to Get this Great Book for You!



This new book tells and shows how to make over 450 things—useful articles for the home, toys, furniture, boats, novelties, photo equipment, electrical gadgets, etc. of the more simple, easy-to-make type. Only ordinary tools are needed. No special skill required. Tell Dad to send \$1.00 to address below NOW. We'll send Dad's money back if you and he don't think it's worth double the cost.

POPULAR MECHANICS PRESS
 200 EAST ONTARIO STREET
 DEPT. 534, CHICAGO 11, ILL.

NOW a DYNAMIC Saves **HEAVY DUTY** VALUABLE TIME and MONEY!
INDUSTRIAL WELDER

AMAZINGLY SIMPLE & EASY TO OPERATE
 This portable Dynamic Welder—easily carried right to the job—plugs into any convenient, properly wired 110 volt light circuit—works on Iron, Steel, Brass, Bronze and other metals—has eight metallic and carbon arc welding heat stages—does work you would think only possible with a larger, more expensive machine.

DESIGNED TO DO HIGH GRADE WELDING INEXPENSIVELY
 Maintenance Men; Farmers; Mechanics; Machine Shops; Foundries; Auto, General Repair and Job Welding Shops; using the Dynamic find it so indispensable and useful that they cannot afford to be without it.
 If inexperienced, you can easily learn to do a variety of high grade welding jobs by following the practical, simplified operating and welding instructions furnished.

DYNAMIC WELDER CO., 13-AH, East 23rd St., Chicago 16, Ill.

for Only \$23.50 COMPLETE

Once you see a Dynamic in operation you won't be without it. Its simplicity will amaze you. In a year the Dynamic only costs you about 6c a day.
 Comes complete with helmet, rods, cables, electrode holder and operating instructions, etc.
 Write today for free priority assistance and particulars on how to qualify for one of these amazingly low-priced welders. Act now while they are still available. Get details on our 10-day trial offer.

BOTTLENECK BUSTERS



Chicago Mounted Wheels—They're tough, long lived, dependable. Over 300 sizes, styles and grains.

Chicago Grinding Wheels—With full WPB approval, we specialize on wheels 3" in diam. and under for the duration.

AMERICA'S UNBEATABLES

Yes, all the wheels in our line are small, but powerful and swift tools of war doing their stuff day in and day out—making it possible to speed through everything that requires precision internal or external grinding, polishing and burring — bombsights, planes, tanks, guns, intricate instruments, etc.

Handed Tool of 1001 Uses and Hi-Power Grinders are still available to all who have priorities.

Send for Free Catalog

CHICAGO WHEEL & MFG. CO.

1101 W. Monroe St., Dept. PM, Chicago 7, Ill.



Make BIG MONEY AT HOME!

NEW Invention Electroplates by BRUSH



Now Plates CHROMIUM!

ALSO GOLD, SILVER, NICKEL, COPPER, ETC.

War Increases Demand—You Profit!

New, patented invention makes possible big earnings AT HOME. Replate auto-parts—worn articles in homes, stores, hotels, restaurants, etc., with durable, sparkling, new coat of metal—with stroke of brush. Easy, simple, quick. Genuine Gold, Silver, Nickel, Cadmium, etc. Everything furnished. Outfit complete, ready for use. No shop required. Clear from \$2 to \$5 an hour in lifetime business. Small investment starts you in business. Steady repeat. Machine can pay for itself in week. Send TODAY for FREE SAMPLE and illustrated BOOKLET how you can have a life income from a business of YOUR OWN built upon satisfied customers. Act at once!

WARNER ELECTRIC COMPANY

360 N. Michigan Ave., Chicago, Dept. 312

FREE BOOK & SAMPLE

WARNER ELECTRIC CO., 360 N. Michigan Ave., Chicago, Dept. 312
Gentlemen: Send me Free Sample and Illustrated Booklet.

Name _____
Address _____
City _____ State _____



YOUR WET CELLAR made dry From the INSIDE

DON'T tolerate cellar dampness another season. Once and for all seal up the cracks and holes and porous spots through which water or moisture seeps. Do it with Smooth-On No. 7 Iron Cement, made for water-proofing cellar walls and floors. You don't have to wait to get help—you can do it yourself—quickly, inexpensively.

Anyone who can handle a paint brush can apply Smooth-On No. 7. Goes on like paint, hardens in about 24 hours, on wet or dry surfaces.

Use Smooth-On No. 7 also to waterproof stable, garage, out-house, wash-room, cistern, swimming pool, fountains, troughs, septic tanks; to repair and even concrete floors. Ask at the nearest hardware store—if they haven't it, write us direct. Sold in 5-lb., 25-lb., 50-lb. and 100-lb. sizes.

FREE Smooth-On Repair Manual

Full directions for water-proofing cellars, floors, etc. 40 pages of information, clear instructions for making dozens of home repairs with Smooth-On Cements. Fits in pocket. Handy index. 170 diagrams. • Use the Coupon.



MAIL THIS TODAY

Smooth-On Mfg. Co., Dept. 37
570 Communipaw Ave., Jersey City 4, N. J.

Please mail me my copy of your Manual

Name _____

Address _____

4-44 _____

Free
Do it with **SMOOTH-ON**

WORKSHOP WISDOM

How to repair or assemble outdoor furniture



IF YOU GLUE all the joints on your outdoor furniture they will be stronger and more rigid than if you use nails or screws alone.

But be sure you use a *waterproof, moldproof* glue like **CASCAMITE Resin Glue**. Here's what to do:

1. Be sure that all joints fit snugly and that all joint surfaces are smooth.
2. Make a standard glue mixture with **CASCAMITE** powder and cold water. Directions are on the container.
3. Apply glue to joints and put under strong pressure using clamps, screws, or nails.

Why Cascamite does a better job

It's waterproof and moldproof. Rain or mildew cannot weaken the insoluble Cascamite bond.

It's stronger. By actual tests, joints made with Cascamite are strong as the wood itself—even after prolonged soaking in water.

It's stainfree. Cascamite doesn't stain or disfigure light woods. Remember this when you want to do some fancy veneer work.

Get Cascamite Resin Glue—and Casco Casein Glue, for *indoor* gluing—in 10¢, 25¢, and larger sizes, at hardware stores everywhere.

Send post card today for free Casco Project Booklets and free Gluing Guide containing 80 household gluing hints. Address: Casein Company of America, Dept. PM-44, 350 Madison Ave., New York 17, N. Y.



CASCAMITE

Plastic Adhesive

Say you saw it in Popular Mechanics!

**TAPE WORMS
ROUND WORMS
(Ascarids)
HOOK WORMS
WHIP WORMS**



...you can free your dog of all these worms

with **PULVEX**
COMBINATION TREATMENT **WORM CAPSULES**

Used by leading breeders. At leading pet, drug, department stores, 50¢ a package (double size, 75¢). Packed two ways: for puppies, for dogs.



Build: STEAM MARINE ENGINE

● A precision built and engineered single cylinder, 1/4" scale model, with clutch or reverse. Send \$2.50 for 14 pages scale drawings, 2 photos, instructions.

- 2 Photos and Description 25¢
- Rough Castings Kit \$12.50
- Horizontal Flash Boiler Drawings and Instructions... 1.00

THOMPSON ENGINEERING CO. 202 NO. DIVISION BLDG., GRAND RAPIDS 2, MICH.

Say you saw it in POPULAR MECHANICS

FREE! LATEST, MOST COMPLETE RADIO PARTS CATALOG



EVERYTHING in RADIO and ELECTRONICS for War Training, Maintenance or Repair

It's the most complete, up-to-date **BUYING GUIDE** available! It contains latest "supply data" on radio and electronic parts available without priority for repair and replacement—*plus* everything in war training kits, books and equipment! Whatever you need—you'll save time by getting in touch with **ALLIED first**. Send for this big free catalog today.

RADIO'S FINEST BOOK VALUES

Specially prepared to aid radio training in schools and industry. Full of valuable data. Send for all six!

- Radio Formulas and Data Book No. 37-752...10¢
- Dictionary of Radio Terms No. 37-751...10¢
- Radio Circuit Handbook No. 37-753...10¢
- Radio Builders' Handbook No. 37-750...10¢
- Simplified Radio Servicing No. 37-755...10¢
- Radio Data Handbook No. 37-754...25¢
- All Six Books No. 37-799...75¢

ALLIED RADIO CORP.

833 W. Jackson, Dept. 5-D-4, Chicago 7



6 BOOKS FOR 75¢

ALLIED RADIO

POPULAR MECHANICS



In the last war, outboard motors were in their infancy. Today Johnson Sea-Horses are doing man's work in the armed services. It took lots of development to bring them along so far...lots of experience in outboard design, metals, manufacture.

Johnson has this experience—22 years of it. It is being put to good use in a full schedule of production of Sea-Horses for the armed services and essential needs. It will be an even richer experience when it is again turned to the production of Sea-Horses for pleasure use.

JOHNSON MOTORS, WAUKEGAN, ILLINOIS

DO YOUR DUTY • BUY WAR BONDS

**JOHNSON
SEA-HORSES**
for Dependability



**THE
OUTBOARD MOTOR
THAT HAS COME
OF AGE**

ARMY NAVY
THERE IS NO SUBSTITUTE

FOR EXPERIENCE

there's a Real Story in the basically improved design of the

DURO Band Saw



Despite its unusually low price, this heavy DURO 16-inch production Metal Cutting Band Saw has many special features not found in machines costing several times as much. It is ideal for cutting tubing, extruded shapes, bar stocks, metal sheets, casting gates, plastics, brake linings, hard rubber, slate, fibre and many other materials. Can be adjusted to obtain standard wood cutting speeds by a flip of a lever. Some of its special features include: Heavy machined cast iron trunnion; special roller blade guides which reduce blade crystallization and lessen blade breakage; new design which permits all adjustments to be made from front while saw is in operation; New Departure Ball Bearings; machined dove-tailed ways with adjustable steel gibs; many other advantages. Metal cutting speeds: 236 and 596 R.P.M. Wood-cutting speeds: 2360 and 5960 R.P.M. Available on priorities only.

Send for New DURO Catalog

For full details and prices on the DURO 16" Metal Cutting Band Saw send for latest DURO CATALOG using coupon below. Also lists specifications and prices of complete line of DURO single and multi-spindle Drill Presses, Circular Saws, Jointers, Routers, Shapers, Grinders, Lathes, Scroll Saws, Flexible Shaft Units and Portable Electric Drills.

THE DURO METAL PRODUCTS COMPANY
2655 N. Kildare Ave., Chicago 39, Illinois

Gentlemen: Please send me FREE copy of latest DURO Catalog giving full specifications on new DURO 16" Metal Cutting Band Saw and other DURO Machine Tools.

Name.....

Address.....

City..... State.....

DURO TOOLS

MACHINE TOOL DIVISION

ALSO MAKERS OF DURO HAND TOOLS

APRIL, 1944

183

WHAT'S IN A NAME?

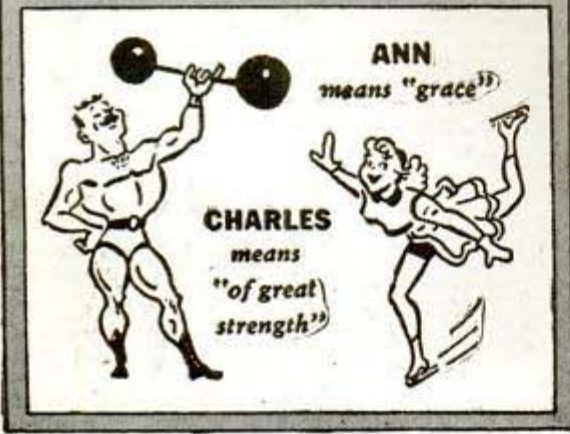

ANN
means "grace"

CHARLES
means
"of great strength"

You'll be surprised at the meanings of some of your friends' names. Have fun looking them up in "WHAT'S IN A NAME?" — the new cartoon-illustrated book that everybody's talking about.

The Ethyl Corporation would like to send you this fascinating booklet *free* because we think it will help you to remember *our* name and what it means:

Send the coupon below for free booklet that tells the meaning of nearly 1000 names.



"WHAT'S IN A NAME?"
Dept. PM3, Box 53, New York City.

Please send me a free copy of "What's in a Name?"

Name.....
(PLEASE PRINT)

Address.....

City & State.....

PALMGREN ANGLE VISES



Solve Difficult Angle Jobs
Quick, accurate setups at any angle. End makeshift methods—time loss—rejections. Ideal for tool rooms or home workshop. Accurately machined and graduated. Once set, it stays locked. Jaws hardened steel—plain or grooved. Sizes 1 1/2" to 8" Jaws. Orders filled on plant priority ratings only. You may qualify. Write.

Chicago Tool & Engineering Co.
8365 South Chicago Ave.
Chicago, Ill.

Send for Free Circular "101 ANGLE OPERATIONS" describes complete line, gives many uses.

for
Drilling
Milling
Grinding
Fitting
Filing

PRECISION WORK AT ANY ANGLE

Thompson BEATS the World on BOATS



Better Built Lower Prices

- Canoes \$75 and up
- Rowboats \$48 and up
- Outboards \$48 and up

Safe Boats With Full Length Spray Rails

Keep passengers perfectly dry—even at high speeds. Catalog also shows today's seven most popular models of sailboats. Two big factories. Prompt shipment.

CATALOG FREE
Write for your copy. State kind of boat in which you are interested.
THOMPSON BROS. BOAT MFG. CO. (110
213 Ann St. PESHIGO, Wis. (Write to either place.)
113 Elm St. CORTLAND, N.Y.

Light "Car-Top" Boat

Build This Scale Model JEEP



Here's the model of the hour! An authentic 1" to 1' scale replica of the U.S. Army Jeep. There's nothing more fascinating to assemble; nothing you'll be more proud to display. No special tools necessary. Kit contains everything—Full size, step-by-step plan. Completely Finished wood parts. Detailed printed parts in Color. Five finished scale wheels. Glue, Paint, Etc. Get your Jeep Kit today. Send check or money order to...

H. F. Auler Co., 165 N. Broadway, Milwaukee, 2, Wis.

Overall Length 9 3/4"
\$1.25
Post Paid



Have YOUR OWN Business

SAW FILING

You can have a good, steady, cash business of your own reconditioning saws with the Foley Automatic Saw Filer, which makes old saws cut like new again. The Foley is the ONLY machine that files all hand saws, also band and circular saws. Easy to operate—no eyestrain.

SEND FOR FREE PLAN—shows how to start in spare time—no canvassing. You can get a Foley Filer now—no special priority application required. Send coupon today—no salesman will call.

FOLEY Automatic SAW FILER

FOLEY MANUFACTURING CO.
416-4 Foley Bldg., Minneapolis 13, Minnesota
Send Free Plan on Saw Filing business, no obligation

Name.....
Address.....





**NEXT TIME, USE
WELDWOOD GLUE**

The tremendous holding power of Weldwood Glue is due to the strength of the bond it makes between woods. It actually welds them together.

You'll find Weldwood Glue remarkably simple to mix and use, too. Just mix the fine powder with ordinary tap water, spread with brush or stick, and the job's done. Clamps can be removed and the job can be light-worked in a few hours.

Your hardware store or lumber dealer has handy packages of Weldwood Glue in 10c, 25c, 50c and 85c (1 lb.) sizes. Get a can today or send 25c and your dealer's name for a trial 3 1/2 oz. sample. Supply limited, due to Uncle Sam's war needs.

UNITED STATES PLYWOOD CORPORATION
Weldwood Glue Dept. 26, 55 West 44th St., New York 18, N. Y.

Weldwood Glue has everything:

1. Tremendous strength.
2. Waterproof, bacteria- and rot-proof.
3. Quick and easy to use. No heating. No waiting.
4. Economical.
5. Applied cold, quick setting.
6. Stain-free.



"Makes the glue line the SAFETY line"

WELDWOOD
PLASTIC RESIN
WATERPROOF GLUE

110-VOLTS AC from DIRECT CURRENT

with KATO KONVERTERS. Furnish standard 110-v AC from 32, 110, or 220-v. DC. Good deliveries on sizes 350 through 1500 watts on priority orders. Good deliveries on 5, 7 1/2, 15 & 25 KW AC generators. Mfr's of motor generators, frequency changers and high frequency generators.

KATO ENGINEERING CO.
37 Elm Street, MANKATO, MINN., USA



BUILD THESE PROJECTS

For garden or lawn. Easy to build. Easy to sell. Detailed Blueprints Model B-25 Dutch Windmill 60c; Model O.M.-60 Old Mill, 85c. Lawn Figure Patterns—Sambonnat Girl, Dutch Boy, Tulip Girl, Holland Fair, 35c each, all 4—\$1.00. Catalog illustrating many models, send 15c today.

CRAFTSMAN'S MODEL CO., Dept. P-76, 2030 N. 41st St., Milwaukee, Wis.

BRUSH PLATING OUTFITS

for autoparts, reflectors, faucets, bicycles. No tanks necessary. Free particulars. **GUNMETAL CO., AVE. M., DECATUR, ILLINOIS**

STOP THEFT WITH NEW WONDER LOCK
No Screws—No Nails—No Holes to Drill



Slips on instantly and locks securely. Designed to fit every type of drawer or door. Has 4 adjustable positions. Locks two drawers at one time. Will not scratch furniture or woodwork. Has beautiful rust-proof finish. Theft proof. Thousands in daily use by leading firms, department stores and U.S. government agencies. Ideal for home, office, factory or hotel use. Splendid for locking work benches or store rooms. (Also made for glass or wood sliding show case doors.) Priced only \$2.50 each. Send check or money order today. Full satisfaction or money back guaranteed. (When ordering 3 or more, specify if keys are wanted alike.)

WONDER LOCK

54 W. Van Buren Street, Chicago 4, Ill., U. S. A.



KRW ARBOR PRESSES BENCH TYPE AND HYDRAULIC

NEEDED IN EVERY SHOP—SAVE TIME AND MONEY—DO BETTER WORK, QUICKER.

No shop is complete without a small arbor press. Pressing and squeezing operations can be done better and faster on a KRW Arbor Press. Stop using vise and sledge hammer methods—they generally deliver spoiled work in the end. KRW Factory-To-You Prices give you greater value for your money. Order today.

KRW Bench Type Arbor Presses, 3 sizes
No. 37-P 1/2 Ton, \$13.25*
No. 37-O 1 Ton, \$23.00*
No. 37-N 3 Ton, \$33.00*
*Prices F.O.B. Arcade, N. Y. Slightly higher west of Rockies. Stand illustrated extra.



KRW Hydraulic Presses are built in 25, 50, 60 and 75 ton sizes. Prices start at \$198.00*.



K. R. WILSON, 17 Lock St., BUFFALO 2, N. Y.
Builders of Shop Equipment for Ford Dealers Since 1916



HOW TO OBTAIN SHOP TOOLS

at the earliest possible moment and **PAY FOR THEM OUT OF PATRIOTIC SAVINGS IN WAR BONDS**

Own versatile, low-cost, sturdy

Boice-Crane
Band Saws - Saw Jointers
Jig Saws - Spindle Shapers
Belt Sanders - Spindle Sanders
Drill Presses - Lathes
Thickness Planers

Write today for folder on the

Boice-Crane PURCHASE PRIORITY PLAN

a safe, convenient plan for forward-looking shop men and home craftsmen.

With manufacturers now engaged 100% in war production, the pent-up demand for shop tools is tremendous. You can avoid prolonged waiting for your tools, or the necessity of buying something less satisfactory, by reserving a preferred delivery position now. Use this convenient coupon to get details.

BOICE-CRANE CO.
943 Central Ave., Toledo, Ohio

Please send, without obligation or cost, details of the Boice-Crane Purchase Priority Plan, together with a copy of your catalog on shop tools.

NAME _____
STREET _____
CITY _____



WORLD'S LOWEST PRICED ADDING MACHINE

FREE TRIAL ONLY \$2.50

IDEAL FOR BUSINESS OR PERSONAL USE. GUARANTEED ACCURATE.

Not a toy. Operates with only a finger flick. Adds, subtracts, multiplies, divides. Counts up to ten million. Pays for itself over and over. Ideal Gift—for Business, Income Tax and School use. **MONEY BACK GUARANTEE.** Send name and address. Pay postman only \$2.50 plus postage. (Send full cash if outside U. S.) Money back in 10 days if not delighted. **AGENTS WRITE.**

CALCULATOR MACHINE COMPANY (Mrs.)

DEPT. 152, P. O. BOX 1118

CHICAGO, ILLINOIS

PLASTI-COTE

THE AMAZING LIQUID PLASTIC PAINT

Beautiful your home this easy, practical, inexpensive way

Plasti-cote makes painting fun. Try it in any room... or even your brick-walled basement. One coat covers... even on stucco, clapboard, plasterboard, masonite, wood, brick, metal. Washes like tile!

MONEY BACK GUARANTEE

Use 25% of this paint. If not satisfied, return the rest and full price will be refunded. Order for cash, post-paid, or C. O. D. plus small expr. charge. Colors: White, Ivory, Cream, Buff, Dusty Rose, Peach, Black, Light, Med. or Dark green, grey, blue, brown.



\$5.95 PER GAL.

MAIL ORDER TODAY!
1 gal. covers 300 sq.-ft. Gloss, Semi-Gloss, Flat Finish

CELLO-NU PRODUCTS
56 W. RANDOLPH • CHICAGO 1



Say you saw it in Popular Mechanics!



PRACTICAL, PROFITABLE Low Cost BOOKS

POPULAR MECHANICS OWN PUBLICATIONS

Books for self improvement, to help you save money on repairs and alterations, for hobby enjoyment... and... way to earn extra money.

- How to Read Blueprints... \$1.50
- Forty Power Tools You Can Make (New Ed.)... \$1.25
- From old parts, scrap, etc.
- Concrete Handbook (new)... \$1.50
- Do work for yourself, others.
- Your Car. Save \$100 Yearly... \$1.25
- Simple repairs, shortcuts.
- Build a Boat... \$1.50
- 17 popular kinds. Easy.
- Shop Notes Library (1944 Volume)... \$.50
- 5 Volumes now \$2.50.
- Garden Book... \$1.00
- Make your own furnishings.
- Welding, Brazing, Soldering... \$1.25
- How to make and use equipment.
- What to Make (1944 Volume)... \$.50
- 5 volumes now \$2.50.
- Boy Mechanic... \$2.00
- Photo Guide... \$1.25
- Make own equipment, better pictures.
- Money Making Formulas... \$2.00
- Painting, Furniture Finishing & Repairing (new)... \$1.50
- The Young Craftsman (new) Over 450 easy-projects... \$1.00

POPULAR MECHANICS PRESS, Dept. 530, 200 East Ontario, Chicago, 11

New Accurate 10" Slide Rule

Instruction Book FREE



SPECIAL COMBINATION OFFER

Standard 10" Slide Rule and Instruction Book; Pocket Calculator for adding and subtracting up to 999,999; 6" Transparent Protractor and Graph Rule graduated in centimeters and inches.

—ALL 3 for \$1.00 cash (\$1.10 Foreign) POSTPAID.

New "TRIG" 10" Slide Rule, with Pocket Calculator and Transparent Protractor. **\$1.50 (\$1.60 Foreign) POSTPAID.**

Magnifying Indicator

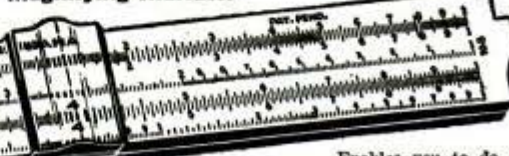

50¢

Enables you to do difficult calculations instantly without paper or pencil—multiplying, proportions, division, extracting roots, etc. Accurate, white composition face. Has standard A, B, C, D, CI and K scales.

For complete outfit, including slide rule, 28-page illustrated instruction book, carrying case, send 50¢ (60¢ Foreign). New "TRIG" 10" Slide Rule, with same six scales as above plus S, L, and T scales on Reverse of Slide for problems in Trigonometry; Gunmetal Finish Indicator; complete instructions—\$1.00. Mailed postpaid. Satisfaction Guaranteed or money refunded. (See Special Combination Offer.) Order NOW.

HEWIG CO., Box A-143, Grand Central Annex; New York City

KEEP OLD LAWNMOWERS CUTTING with the IDEAL LAWNMOWER SHARPENER

PERFORM A REAL SERVICE

Keep lawnmowers in service on the home front! Old lawnmowers, like other household equipment, must continue to last so that vital materials can keep flowing to our armed forces. You can keep 'em sharp . . . make old, dull lawnmowers cut like new, and make money too, with the Ideal Lawnmower Sharpener.

Easy to operate, no experience necessary—just set the mower in the sharpener, make a few simple adjustments, the machine does the rest. Sharpens like magic to perfect edge in just a few minutes. Write today for complete details.

- ★ NO EXPERIENCE NEEDED
- ★ EASY TO OPERATE
- ★ KEEN EDGE IN 20 MINUTES

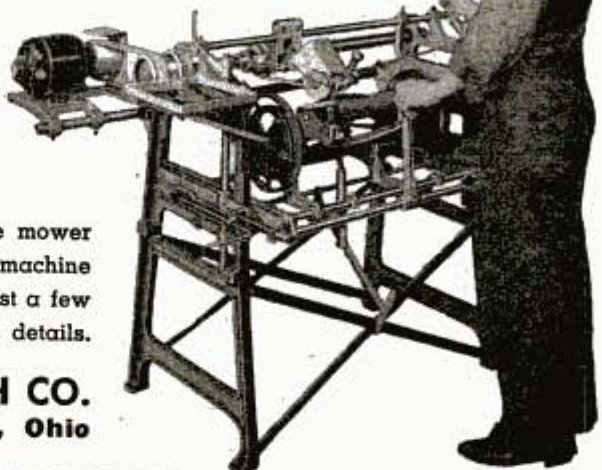

THE FATE-ROOT-HEATH CO.
1444 Bell Street, Plymouth, Ohio



SEND FOR COMPLETE CATALOG
BUY WAR BONDS . . . AND HOLD THEM!

"CLEVELAND MODELS" Now Bring You 4 More New War Models!



Grumman "AVENGER"
Heavily armored, carrier-based torpedo bomber of Midway Island fame. Span 39'-8 1/4". C-D Master Kit SF-93, \$4.00

Grumman Avenger! British Whirlwind! Jap Zero! German Focke-Wulf! All have now been added to the stellar array of realistic 3/4" war planes in "America's First Line of Models." For quick, easy economical pre-flight training build Cleveland Models—the Models the Men in the Air Forces Build. It's the easy way to learn Flight Theory, Design, Construction and Split-Second Recognition of War Planes.



British "WHIRLWIND"
Making spectacular bombing and strafing raids on Germany's merchant marine. Span 33'-6". C-D Master Kit SF-105 \$3.50



German Focke-Wulf 190
Germany's chief fighter against Allied bombing raids. Span 27'-3 1/4". C-D Master Kit SF-92, \$3.00



Mitsubishi "ZERO"
Japan's tricky, high speed, fast climbing fighter. Span 29'-3 1/4". C-D Master Kit SF-90 \$3.00



Lockheed P-38 "LIGHTNING"
Deadly interceptor due to its super-speed, high ceiling, and terrific diving power. Span 38'-4". C-D Master Kit SF-85 \$4.00



De Havilland "MOSQUITO"
World's fastest operational bomber. One of England's outstanding contributions to the aerial war. Span 40'-3 1/4". C-D Master Kit SF-145 \$4.50



Bell P-39 "AIRACOBRA"
Deadly "cannon-plane" Span 25'-1 1/4". C-D Master Kit SF-76 \$3.00

Build These Big 36" Industrial Training Models of War Planes

Build these big 3-ft. span models. Each a realistic beauty.



Kit T74: Messerschmitt ME-109
Kit T-76: Bell "Airacobra"
Kit T77: Curtiss P-40 "Warhawk" (shown)

Kit T78: Hawker "Hurricane"
Kit T85: Lockheed P-38 "Lightning"
Kit T91: P-51 "Mustang"

Each Complete Kit, only \$1.50



No. Amer. "MUSTANG" (P-51)
Tough, vicious fighter. First American fighter over Germany itself. 350 mph. Span 27' 3/16". C-D Master Kit SF-91 \$3.00

Send 5c for new No. 41 catalog (none free).

"Soars for Hours"
Build America's Biggest \$1 Model
SUPER CONDOR Soarer—Stronger, longer flights, more graceful lines, construction simplified. Easier than ever to build. Kit E-5019, only \$1.00



See your dealer first. If he can't supply you, order direct. Include 15c extra for packing—postage charge on all orders.

CLEVELAND MODEL & SUPPLY CO. "World's Largest Mfrs. of Quality Model Aircraft Since 1919" 4508D35 Lorain Ave., Cleveland 2, Ohio



BUILD A MODEL PLANE ON A TUBE . . . Easy

Now combined with time-saving OTT-O-FORMERS, the new OTT-O-TUBE construction is the up-to-date way to build the model war planes you want. Get the thrill of building a plane on a tube with WOOD parts that are all cut to shape.

AT YOUR DEALER

Good dealers everywhere have OTT-O-FORMER Kits. If no dealer near you mail order direct to address below. Minimum order by mail \$1.00. Send 15c (25c for Mosquito) extra to partly pay postage and packing.

MOSQUITO, DeHavilland DH-98

40 1/4 in. wing span. Kit \$3.00

HELLCAT, Grumman F6F

40 inch wing span kit. \$3.00

THUNDERBOLT, Republic P-47

25 inch wing span kit. 29 cts.

ZERO, Mitsubishi KI-001

25 inch wing span kit. 29 cts.

FOCKE-WULF Fw-190

25 inch wing span kit. 29 cts.

30 other thrilling Kits 15c to \$1.00

and OTT-O-TUBE
CONSTRUCTION

JOE OTT
MANUFACTURING CO.
405 West Superior Street CHICAGO

Ott-O-Former AIRPLANE KITS



Hospital Paid
Sickness or Accident
90 Days!

Surgeon's Fee
Sickness or Accident
up to **\$150.00**

Loss of Income
\$25.00 Wkly.

Loss of Limbs or Eyes
up to **\$750.00**

Accidental Death
\$1000.00

Also many extras

Hospital bills, surgeon's bills! . . . what a hole they put in savings! But today 10,000,000 people use their policies to pay these bills.

SICKNESS OR ACCIDENT

From the very first day you are hospitalized our 3¢ a-day plan pays hospital room, surgeon's fee, ambulance, many extras. Choose your own doctor and hospital. Individuals or families insured, age 1 to 60. No salesmen. Mail coupon now! You never can tell what tomorrow may bring!

Commonwealth Mutual Ins Co of America
206 E. Lexington St. Baltimore-2 Md. Dept P M 4
Send details & free book—no obligation.

Name.....

Address.....

City..... State.....

SEND FOR BIG FREE BOOK NOW!

Mortite

THE UTILITY TAPE OF MANY USES

A pliable plastic that comes all ready for use inside or outside. Unrolls like ribbon. Adheres to any clean, dry surface. Just press into holes and cracks with the fingers and it stays put. Will not crack, shrink or chip off. Can be painted.

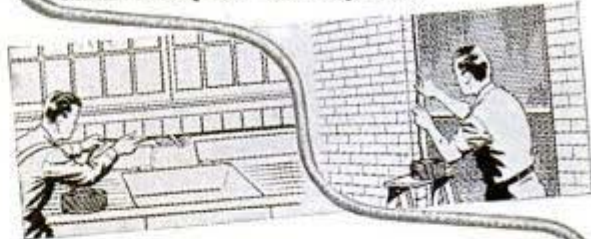

- A good plugger-upper.
- Seals cracks in plaster and woodwork, around screens, windows, casements, transoms, baseboards.
- Keeps out dirt, dust and vermin. Stops rattles.
- Permanent glazing for wood or metal sash.
- Plugs leaks around bathtubs, toilets, sinks, laundry tubs, etc.
- Makes good packing and gaskets.

About 80 feet of 1/4" Mortite to a roll. At your dealer's, or \$1.25 postpaid.

Send for Circular

J. W. MORTELL CO.

Also Makers of NoDrip, and other Technical Coatings since 1895
522 BURCH ST., KANKAKEE, ILL.



OTTAWA TRACTOR SAW

Falls Tree—Cuts Log

Uses Power Take-off any tractor. Direct drive. Long stroke. Saws fast. Easy on fuel. Thousands of satisfied users. Big labor saver. Low in Price.

Write for FREE
Book and Prices

OTTAWA MFG. CO., D-427 Forest Ave., OTTAWA, KANSAS

Urgent! If you're doing war or vital civilian work—get your

FREE COPY

America's No. 1 Catalog
RADIO AND ELECTRONIC
COMPONENTS AND EQUIPMENT

Covers the entire range of radio and electronics . . . a "tremendous" book to save you time, trouble and money.

NOTE: Lafayette Radio Corp. carries a supply of all standard replacement parts plus a wide variety of useful parts and equipment for non-critical consumer applications.

LAFAYETTE RADIO CORP.
901 W. JACKSON BLVD., CHICAGO 7, ILL., DEPT. P-4
Please send me a FREE copy of the new Lafayette Radio Corporation Catalog No. 94.

NAME

ADDRESS

CITY..... STATE.....

Make Your PAINT BRUSHES LAST!

How easy—with Dic-A-Doo Paint Brush Bath! Keeps *new* brushes soft, springy, flexible, ready for the next job. Restores *old* brushes to useful work. All the hard, caked paint dissolves. . . Buy 5¢ package, 10¢ box, at Paint Stores, Hardware Stores, Five and Ten Cent Stores. The Patent Cereals Co., Geneva, N. Y., makers of Dic-A-Doo Paint Cleaners.

DIC-A-DOO
PAINT BRUSH
BATH



COLOR CONCRETE WITH CHEMICALS

A business of your own. Big money making Hollywood style pottery and birdbaths without moulds. Washing-wells, stucco-rock, benches. Marbling and cement water-paints. 10c brings sample, literature, pictures. Hollywood CementCraft, 8529 Wonderland Ave., Hollywood 46, California



ANYONE, ANYTIME
CAN MAKE PHOTO-COPIES
QUICKLY

A-PE-CO
PHOTO-COPYER

\$5500

FAST, PHOTO-EXACT COPIES
'IN ANY OFFICE OR SHOP

Same-size, exact photo-copies of anything up to 18" x 22". Eliminates steno-copying, tracing, proof-reading. Photo-copies direct from letters, records, pictures, blueprints, tracings, receipts, shop orders—anything written, printed, drawn, photographed. Accepted as legal evidence. Copies from magazines or books. No end to the uses of A-PE-CO. Needed by all departments. Thousands in use. See Page 16, August Popular Mechanics.

No Camera—No Darkroom—Low Cost

Any office employee quickly becomes expert. Low cost per copy, lowest investment in equipment. Saves other equipment. Simple, fast. No focusing. Conserves man-hours. Put A-PE-CO on any available desk or table. Immediate delivery. Representatives in principal cities and Canada. Write for A-PE-CO folder.

AMERICAN PHOTOCOPY EQUIPMENT CO.
2849 N. Clark St. Dept. GF-44 Chicago 14, Illinois

Representatives in Principal Cities

In Canada: Railway & Power Engineering Corp., Ltd.

FIGHT WITH WAR BONDS

APRIL, 1944

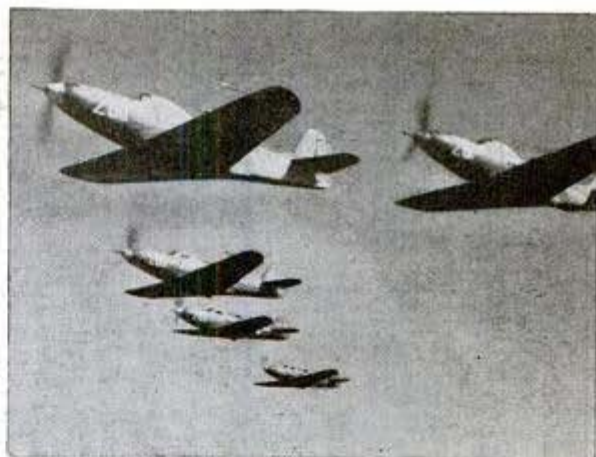

Snap-on Tools help build America's greatest fighter planes

In every inch and every ounce, our sleek and deadly fighter planes were developed to outmatch the finest the enemy can offer . . . in speed, battle-worthiness and devastating fire power! Then followed the miracles of production-in-volume . . . to the everlasting credit of America's aviation industry!



Snap-ons help build them! To speed countless operations on production and assembly lines, Snap-ons are standard tool equipment. In "tight" places and difficult applications, where working space is highly restricted, the superior flexibility, strength and powerful leverage of Snap-ons save precious time, produce better work.



. . . and
**Snap-ons help
keep 'em flying!**

Efficient maintenance on far-flung battle fronts call for extensive kits of tools identical with those used "on the line". At depots, hangars and bases around the world, Snap-on tools are on the job!

SNAP-ON TOOLS CORPORATION, Kenosha, Wis.



Always write your name and full address clearly when answering advertisements.

189

INVENTORS

Now

IS THE TIME TO PATENT & SELL YOUR INVENTION

Now, more than ever before, is the right time to patent your invention. Why? Because manufacturers presently engaged in war production are looking ahead to the future by buying up patent rights now, so they will have new and attractive items to make and sell for civilian consumption as soon as the war is over. This is what happened during and after the last war. Hence, the smart thing for you to do is to look ahead to the future too. Protect your invention by applying for a patent now, so you will be in position to cash in on an outright sale, or on the royalties your invention will bring.

"PATENT GUIDE" SHOWS WHAT TO DO

Our Free "Patent Guide" contains complete information about patent procedure and how to sell inventions. It tells you how to find out whether your invention is probably patentable; what steps to take in order to obtain patent protection for your invention; how to arrange for the profitable sale of your invention; and how to secure financial backing if necessary. Our "Patent Guide" also gives many illustrations of successful inventions; how many simple improvements on already existing inventions proved to be large commercial successes; contains countless other items of vital interest to all inventors including the illustration of over 150 basic mechanical movements. With our "Patent Guide" you also will receive free a "Record of Invention" form with instructions for making disclosure and establishing date of your invention.

TAKE FIRST STEP NOW

Send for your free "Patent Guide" today. Remember—action is important—delay may be costly. Mail the coupon in an envelope or paste it on a penny postcard NOW.

CLARENCE A. O'BRIEN & HARVEY B. JACOBSON

Registered Patent Attorneys

41R-D Adams Building, Washington 4, D. C.

CLARENCE A. O'BRIEN & HARVEY B. JACOBSON

Registered Patent Attorneys before the United States Patent Office

41R-D Adams Building, Washington 4, D. C.

Please send me your 48-Page "Patent Guide for the Inventor" and specially prepared "Record of Invention" FREE. This request does not obligate me.

Name

Address

City State

(Please write or print plainly)

Say you saw it in Popular Mechanics!

Fuse Puller — Circuit Tester

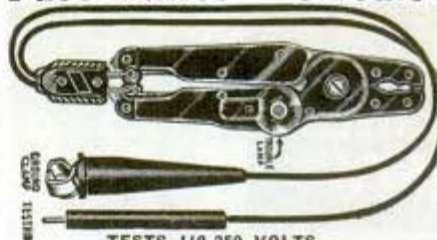

For
Home
or
Factory

TESTS 110-250 VOLTS

When motors stop and lights go out, this tool quickly **LOCATES DEAD CIRCUITS** and safely removes blown Fuse. The Star Test Pocket Plier is made of a Transparent Plastic having in one of the legs a small lamp in series with a resistance and can be used to test 110 to 250 volts circuit. The Plier will pull fuses from 10 to 100 Amperes. Thousands of Electricians find this tool handier than Test Lamps. Price \$2.75 each without Leads, \$1.50 additional for Leads, plus 10c postage. Can be obtained from General Electric or Westinghouse Stores or directly from us. Order NOW. **STAR PLIER CO., 233 Canal St., New York 13, N. Y.**

LEPAGE'S GLUE

LEPAGE'S GRIPSREADER MUCILAGE
LEPAGE'S WHITE PASTE

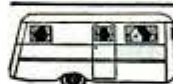

Complete Plans and
Building Instructions, 8c

TRAILER BUILDERS' PARTS CATALOG

We'll save you money on 'everything. Largest and most complete trailer builders' supply house in the United States. Member TRAILER COACH MFRS.' ASSOC. Send 10c for parts catalog.

NATIONAL TRAILER EQUIPMENT CO.
719 N. Seventh St. Milwaukee 3, Wis.

WOOD WORKERS

AMAZING BOOK FOR YOU

Harold Hunt wants to send revised No. 14 catalog. 124 pages of woodworking ideas. **UNEQUALED BARGAINS** in imported and American woods, supplies. Those already holding this catalog—send for revised sheets.

CRAFTSMAN WOOD SERVICE CO.
2729 S. Mary St., Dept. A-44, Chicago 8, Ill.

only
10¢

KIDNEYS MUST REMOVE EXCESS ACIDS

Help 15 Miles of Kidney Tubes Flush Out Poisonous Waste

If you have an excess of acids in your blood, your 15 miles of kidney tubes may be over-worked. These tiny filters and tubes are working day and night to help Nature rid your system of excess acids and poisonous waste.

When disorder of kidney function permits poisonous matter to remain in your blood, it may cause nagging backache, rheumatic pains, leg pains, loss of pep and energy, getting up nights, swelling, puffiness under the eyes, headaches and dizziness.

Kidneys may need help the same as bowels, so ask your druggist for Doan's Pills, used successfully by millions for over 40 years. They give happy relief and will help the 15 miles of kidney tubes flush out poisonous waste from your blood. Get Doan's Pills.



Motorists! up to 30% EXTRA MILEAGE

from EACH GAS STAMP with a

VACU-MATIC

CARBURETOR *Control*

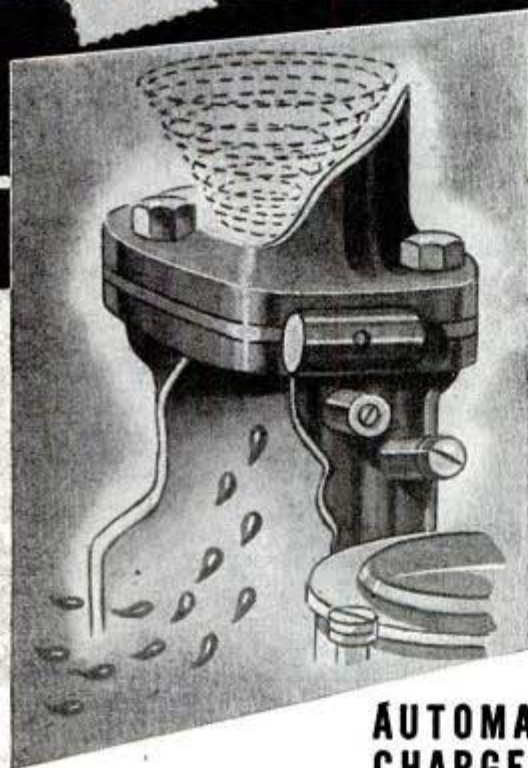

➔ You can't change gas rationing, but you can make sure that each precious gallon of gasoline is providing you with the maximum mileage of which your car is capable. Now you can get added mileage . . . plus quicker starting and more power! Make this free test. Install a Vacu-Matic on your car and get up to 30% extra mileage on a money-back guarantee.

FITS ALL CARS

• Vacu-Matic is constructed of six parts assembled and fused into one unit, adjusted and sealed at the factory. Nothing to regulate. Any motorist can install in ten minutes. The free offer coupon will bring all the facts. Mail it today!

AUTOMATIC SUPERCHARGE PRINCIPLE

• Vacu-Matic is entirely different! It operates on the supercharge principle by automatically adding a charge of extra oxygen drawn free from the outer air, into the heart of the gas mixture. It is entirely automatic and allows the motor to "breathe" at the correct time, opening and closing automatically.

PROVEN BY TEST

• In addition to establishing new mileage records on cars in all sections of the country, the Vacu-Matic has proven itself on thousands of road tests and on dynamometer tests which duplicate road conditions and record accurate mileage and horsepower increases. Thousands of motorists now enjoy extra mileage—improved performance with Vacu-Matic.

AGENTS FREE OFFER ➔

• Vacu-Matic offers a splendid opportunity for unusual sales and profits. Every car, truck, tractor and motorcycle owner a prospect. Valuable territories now being assigned. If you help us introduce it to a friend, you can obtain your own free. Check and mail coupon today.

Send this Free Offer Coupon

THE VACU-MATIC COMPANY
7617-911 W. State St., Wauwatosa 13, Wis.

Please send full particulars about VACU-MATIC, also how I may obtain one for my own car FREE. This does not obligate me in any way.

Name

Address

City State

Check here if interested in Agency Proposition.

SOUTH BEND LATHES

GIVE SKILLED
MANPOWER MORE
PRODUCING POWER

16" SOUTH BEND
TOOLROOM LATHE

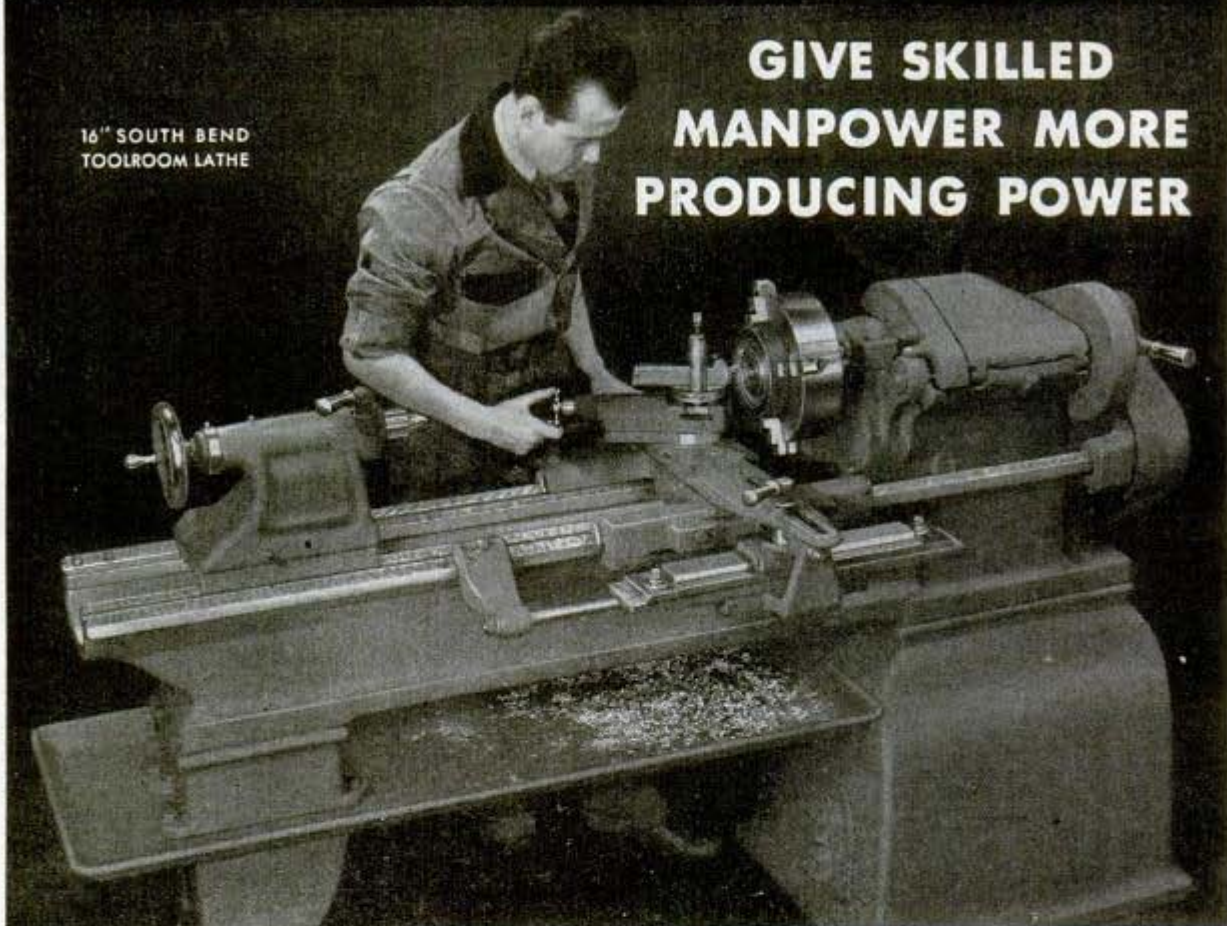

LATHE BOOKS AND FILMS



HOW TO RUN A LATHE

A helpful handbook on lathe operation and care. Contains 128 pages and 369 illustrations. Price 25c. Stamps accepted for single copies.

LATHE PROJECTS

Twelve practical lathe projects complete with detailed drawings and instructions for all operations. Price 50c.

TRAINING FILMS

Two 16 mm, 800 ft., sound films in color on lathe operation. Available on free loan basis for training purposes. Send for Circular No. 8-A.

FREE CIRCULAR

Write for Circular 21-C for additional information on Lathe Books and Films.

To give our fighting forces the increased striking power of more and better weapons, Industry's skilled manpower must have the increased producing power of fast, accurate tools.

South Bend Lathes squarely meet this requirement. Their rigidity and wide range of spindle speeds permit taking full advantage of the higher cutting speeds that are possible with carbide and diamond tipped tools. Their precision makes it possible to finish turn and bore with such accuracy that subsequent grinding and honing operations can often be eliminated.

South Bend Engine Lathes and Toolroom Lathes are made in five sizes—9" to 16" swings. The Turret Lathes are made in two models—Series 900 and Series 1000. Write for your copy of Catalog No. 100-C.

SOUTH BEND LATHE WORKS

SOUTH BEND 22, INDIANA

Lathe Builders for 37 Years



PRINTED BY POPULAR MECHANICS COMPANY, CHICAGO, ILL., U. S. A.

THEY PACK A ONE-TWO PUNCH



INSIDE THE WAIST of this "Fort," everything is strictly business. Outside of "office hours"—that's when Camels come into the picture (see right). You'll find Camels extra mild, full-flavored, and fresh everywhere... CAMELS are packed to go round the world, to stay fresh anywhere!

THEY'VE GOT WHAT IT TAKES!

• They're the waist gunners of a Flying Fortress; and come Zeros or Messerschmitts, you'll find them at the two 50-calibre guns at the left. And after that B-17 has set her wheels down, you're apt to find them lighting up a Camel... for, as the gunner below at the right puts it: "Camels have a full, round flavor that says 'welcome' from the first puff. And I know from experience, they're extra mild."

First

IN THE SERVICE

The favorite cigarette with men in the Army, the Navy, the Marines, and the Coast Guard is Camel.

(Based on actual sales records.)

CAMELS



Check Camels with your



Zone

R. J. Reynolds Tobacco Co., Winston-Salem, N. C.



"CAMELS SURE TASTE FRESHER"

"THEY SUIT ME TO A 'T'"

BUY WAR BONDS AND STAMPS

If you haven't smoked a Camel recently, give them a try today. Compare them for taste... for your throat... for your "T-ZONE." On the basis of the experience of millions of smokers, we believe you will like the extra flavor... we believe your throat will confirm the findings of other Camel smokers.