

It's Raining Soldiers

POPULAR MECHANICS



MAG

WRITTEN

REG'D TRADE MARK, GREAT BRITAIN, NO. 410420

REG. U.S. PAT. OFF.

APRIL
25 CENTS
30c IN CANADA



 **BUY UNITED STATES
WAR SAVINGS
BONDS AND STAMPS**

SEE PAGE 6

"FIRSTS" A ZENITH HABIT

A GOVERNMENT official was being shown a new idea in the Zenith laboratories. In passing, he commented upon the outstanding manner in which the radio industry was effecting the rapid and continuous changes necessitated by war requirements. A Zenith official replied—he said:

"... the answer is easy, Radio and Radionics represent a trigger-quick, fast moving business. Concerns that couldn't 'change over-

night' are out. In this industry, we're used to fighting with new ideas—only—now we're fighting Japs and Germans instead of each other."

In that statement is evidenced the condition that made possible Zenith's attainment of industry leadership. Ever increasing public acceptance of Zenith name and product resulted from a never ceasing stream of Zenith 'firsts'—new features—new devices and new sets which enable us to truthfully say to the public:

"ONLY ZENITH HAS THIS"

Today you find as commonplaces—essentials—of most radio sets—features first introduced to the public by Zenith—such as—

"FIRST" PUSH BUTTON TUNING

Years—yes, years ahead of the industry—(1928) a Zenith set embodied push button selection of the station desired. Our slogan in 1928 was "Push the button—there's your station."

For over seven years, Zenith Radio Corporation has advertised on our short wave sets—"Europe, South America or the Orient Every Day or your money back." It has never been called upon for a refund.

BELOW—A FEW NEW ZENITH "FIRSTS"—"FROZEN" BY ZENITH CHANGEOVER TO WAR PRODUCTION

"FIRST" LONG DISTANCE PUSH BUTTON PORTABLE

1942 saw the national introduction of a revolutionary new portable—the Zenith Trans-Oceanic. Without increase in size or weight it gave push button operation for foreign and U. S. short wave stations—tuned in the same way as locals—and standard broadcasts too. It contained a disappearing fish pole antenna plus dual Wavemagnets—operated from battery or house current—was born of Zenith pioneering in LONG DISTANCE RADIO RECEPTION.

—AND THESE ARE JUST A FEW OF THE MANY ZENITH "FIRSTS"—

"FIRST" HOUSE CURRENT SETS

"Way back when" (1926) home radios were operated from storage batteries until Zenith offered the first set run by house current.

"FIRST" SAFETY AUTO RADIO

The only auto radio you can operate WITHOUT TAKING YOUR EYES OFF THE ROAD—or—YOUR HANDS OFF THE WHEEL—the Zenith Safety Foot Control Auto Radio. This remarkable new radio was on the FORD, NASH, MERCURY, LINCOLN-ZEPHYR, HUDSON and WILLYS. Owners of these cars will gladly demonstrate their Zeniths—give you a "preview" of "tomorrow's radio today."

"MILITARY SECRET"

Today all Zenith production centers on war needs. What we are making is a military secret. But three things we can tell you. *First*... we are dealing with the thing we know—Radio—and Radionics exclusively. *Second*... we are learning every day—gaining new knowledge which will reflect itself in Zenith civilian products when the time arrives. *Third*... we now know—by first hand experience—that our Army and Navy are more than "up-to-date"—they are alert and progressive in thought and action—almost unbelievably so. This fact is a great reassurance to us here as citizens—it commands our complete confidence as it would yours if you knew what we know.



RADIONICS the New Miracle Industry

Four great industries are destined to lead this country back to normalcy after victory is won.

Planes and Radionics are two of the four. Radio—never a necessity on ship or train—is as essential as the engine itself to that great new form of individual and mass transportation—the airplane.

1917 WAR
RUN BY TELEPHONE

1943 WAR
RUN BY RADIO

BETTER
THAN CASH
U. S. War Savings Stamps
and Bonds

ZENITH
LONG DISTANCE
RADIO
RADIONIC PRODUCTS EXCLUSIVELY—
WORLD'S LEADING MANUFACTURER

— a Zenith Radio Dealer near you is giving reliable service on all radios—regardless of make.

ZENITH
RADIO CORPORATION
CHICAGO

This menace is in for a big surprise



Her name is *Anopheles*.

She is the mosquito that carries malaria.

From now on, she'll be much less of a menace to our fighting forces in Africa and the Pacific, and to all of us here in America... thanks to a new Westinghouse development in the field of insect control.

Insect control! Funny thing for an electrical manufacturer to be concerned with?

Not when you know that this new device—a small metal cylinder containing Aerosol, a development of the U. S. Dept. of Agriculture—was made possible by Westinghouse "know how" gained in building electric refrigerators.

With this device, soldiers in combat zones can destroy every deadly insect in barracks, dugouts, captured enemy positions, in an amazingly short time—with complete safety to themselves. Cargo and transport planes returning to America from malaria-infested areas can be rid of disease-laden insects *in flight*, long before there is any danger of bringing these unwelcome stowaways into the United States.

Is this so important? A high military authority has said that *this new Westinghouse device may save more American lives than any other single invention of the war to date.*

And it is only one of many Westinghouse products that are helping to bring Victory nearer. In addition to all the electrical products we are making—and there are literally thousands of them—we are turning out such things as precision Army binoculars, huge steam turbines and reduction gears for ships of the Navy and Merchant Marine, plastic linings for Army helmets, control pulleys for aircraft, anti-tank shot, mountings for big Navy guns.

In peacetime, our principal business is *electricity*.

But in wartime, our only business is Victory. And that means we are vitally concerned with anything—electrical or not—that our "know-how" can design or build to help win this war.

Westinghouse Electric & Manufacturing Company, Pittsburgh, Pennsylvania.

TUNE IN the Westinghouse Program starring John Charles Thomas—NBC Network, Sunday, 2:30 P. M., Eastern War Time.

Westinghouse

PLANTS IN 25 CITIES—OFFICES EVERYWHERE

This One



S4EA-R74-GTWG

"Thanks for helping"

We are grateful for your help in difficult times.

Here in the Bell System we have seen some 43,000 of our people go into the armed services.

Shortages of copper and other materials have made it impossible to add needed lines and equipment.

We have been unable to install telephones for all who want them and many of our lines are overcrowded.

Yet in spite of all this, telephone users have been tolerant and we have fewer complaints right now than at any time in the history of the business. Thanks a lot for understanding.

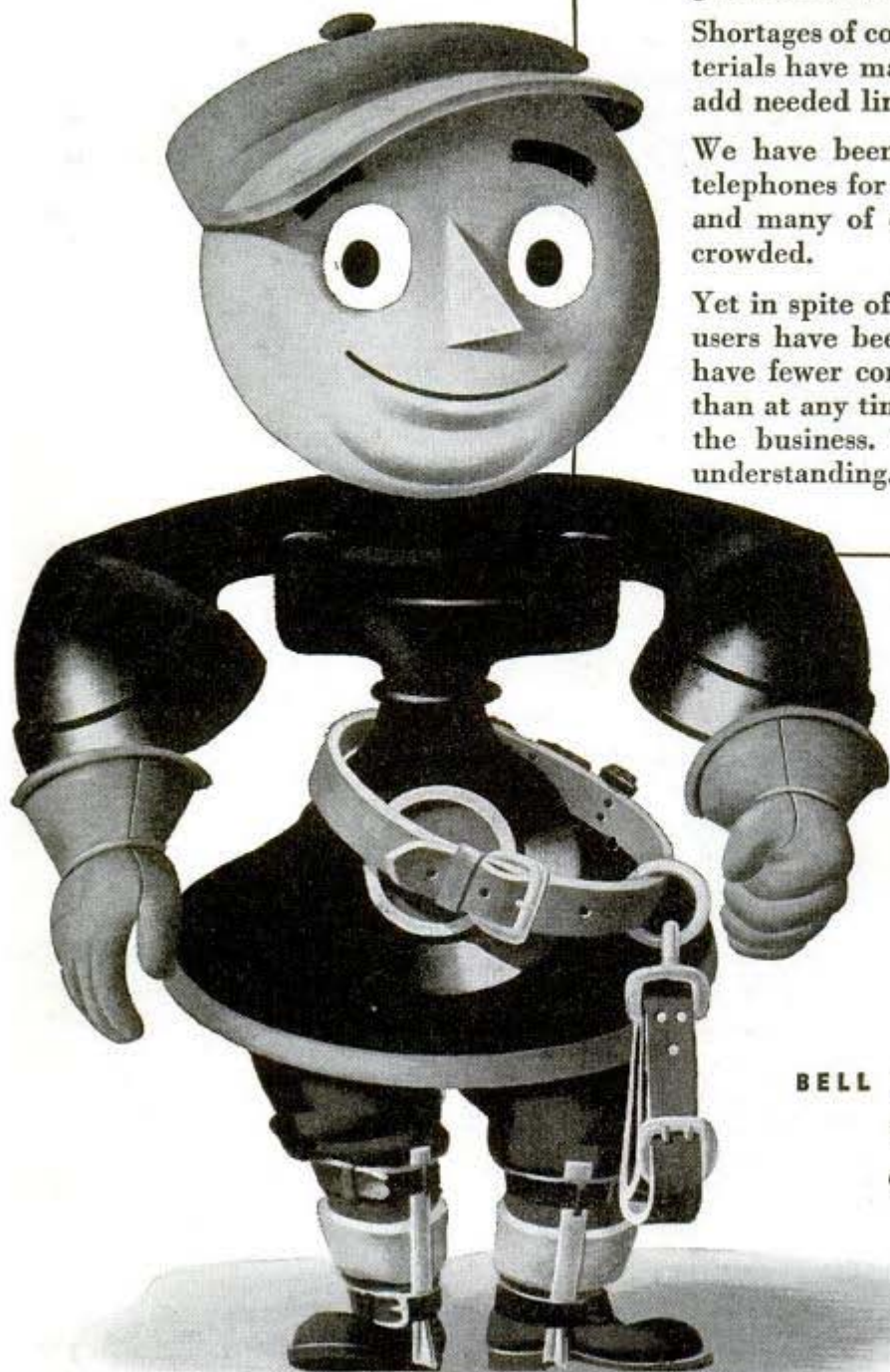

BELL TELEPHONE SYSTEM

**WAR CALLS
COME FIRST**



Popular Mechanics Magazine

Registered in U. S. Patent Office and Canada

H. H. WINDSOR, Founder

H. H. WINDSOR, Jr., Editor and Publisher

April, 1943

Vol. 79, No. 4

IN THIS ISSUE

Our New Schools of War	1
Keeping 'Em Flying	8
It's Raining Soldiers	19
Set 'Er Down in Your Back Yard	28
The Mystery of the Common Cold	34
Let Chickens Solve Your Meat Problem	40
Running the Ice Blockade	50
The Navy's Fighting "Seabees"	58
First Aid for Guns and Tackle	66
Shakedown Cruise	76
Soup's On at the Zoo	82
Movie Make Believe Made to Order	89

Where-to-Buy-It Index Starts on Next Page

Blasting Is Their Business

THE young engineer's job was to blow up a bridge at the last minute as enemy tanks approached. But when he made the contact with the electric exploder nothing happened. Through a hail of enemy fire he rushed to the bridge, readjusted the charge of TNT, regained his position and blew up the span. He was cited for bravery—but officers at Fort Belvoir, where U. S. Engineers are trained, tell their students he should have been censured for his mistake in setting the TNT. The first mistake is usually the last, says a May feature about the demolition school.

Paper Runs the World

WITHOUT paper, the war would end in 60 days. For it is the universal stuff of which army orders and food cartons, shell wrappings and folding money and War Bonds are made; and the recipe for a battleship calls for 37 tons of blueprints. The story of paper began in China nearly 1,900 years ago; it's brought up to date in an article scheduled for next month.

Next Month

GARDENS were a mere hobby to the average fellow a couple of years ago. Last year it was the patriotic thing. Right now it's an absolute necessity to raise your own food, for half of the entire 1943 production of canned vegetables will be needed for our soldiers and allies. And it's not a bright idea to grow enough radishes for the neighborhood in 10 days and not enough tomatoes and beans for yourself the rest of the summer. Get started right by reading: "18,000,000 Gardens for Victory," an important May article.

It Couldn't Be Done

DOUGLAS Aircraft is just one example of the miracle of American production. Its growth since the war began is fantastic. To train employees the company has a teaching staff larger than that of most universities. It spends \$15,000 a month hunting men in want ads. Its engineering department runs off 1,000 miles of blueprints a year. Next month the task this company has done is told in "The Job That Couldn't Be Done."

"Cat Crackers"

WE'RE not talking about food for the family mouser. No, cat crackers are those exclusively American industrial marvels which are producing enormous quantities of the highest-octane gasoline for our air fighters by catalytic cracking. What this means in added speed and power for our planes is told next month in "Cat Crackers—Nemesis of the Axis."

Published monthly by POPULAR MECHANICS COMPANY, 200 East Ontario Street, Chicago, U. S. A. Single copy in the United States, 25 cents; subscription rates in United States and possessions, and countries of the Pan-American Postal Union including Spain, \$2.50 a year. Single copy in Canada, 30 cents; subscription rates, \$3.00 a year. To all other countries add \$1.00 a year over United States prices for overseas postage. Changes in address must be reported to us immediately to eliminate delay. Entered as Second Class Matter, Sept. 15, 1903, at the Post Office at Chicago, Illinois, under Act of March 3, 1879. Entered as Second Class Matter at Post Office Dept. Canada.

Copyright 1943, by Popular Mechanics Company, Copyright under International Copyright Union. All rights reserved under Pan American Copyright Union. Printed in the United States of America



KEEP YOUR CAR SAFE AND FOOL THE JAP

Let your car deteriorate, and you will certainly please Tojo. Because new cars are out of the picture for some time to come.

Remember, idle cars gather rust and corrosion. Infrequent, short drives, scarcely warm the lubricants. Your car needs extra protection now if ever.

Pyroil gives your car extra protection. When idle. When in use. Protection above and beyond that of the regular lubricant you use. Pyroil protects your car against the troubles that start with sludge, gum, carbon, acid-corrosion, "varnish" and other contaminations.

Simply pour a few ounces of Pyroil in the gasoline tank and crankcase of your car. Then, keep a couple of containers of Pyroil always at hand in your garage. Use Pyroil every mile you drive. Mail coupon below for important facts of today. Manufactured and Guaranteed by Pyroil Company, W. V. Kidder, Founder, 54 Pyroil Bldg., La-Crosse, Wisconsin, U. S. A.



NEW CONTAINER.
3-OUNCE SIZE IN DARK
BROWN GLASS. ENOUGH
FOR 250 MILES OF DRIVING

**Buy War Bonds
Don't Stop Now**

**MAIL THIS
COUPON**

**DISTRIBUTORS:
CHECK AND MAIL
COUPON FOR FRANCHISE FACTS.**

PYROIL COMPANY
54 Pyroil Bldg., LaCrosse, Wisconsin

Please send me facts of today about Pyroil's protection to my semi-idle car.

Send details of your Plan for Distribution

Name

Address

City..... State.....

WHERE-TO-BUY-IT INDEX

Where no name and address appear directly under an item, the product is not believed by us to be commercially available

"Mikes" report accuracy in bombing practice.....	5
Asbestos-covered sheet for air ducts.....	5
Grant Wilson Co., 4101 W. Taylor St., Chicago	
Knife-edged locomotive	6
Bombproof shelter under palisades.....	7
Noiseless air gun fires 12,000 a minute.....	7
Flying ferry for tanks.....	12
Electronic "ear" tests anti-knock gasoline.....	12
Electro Products Lab., 549 W. Randolph, Chicago	
Shield for gunner in bomber "greenhouse".....	13
Keep the patient comfortable.....	14
Crewless convoy vessel made of concrete.....	16
Large globe in White House.....	16
Sun piped to lab for study.....	17
Camera car is steady at 70 m.p.h.....	18
Ceramic grates for fireplaces.....	27
Most department stores	
Sled equipped with ski runners.....	27
Strand Ski Co., New Richmond, Wis.	
Variable-pitch propeller controlled by ship's wake.....	27
Straightener reclaims crooked nails.....	32
Specialists on call for war duty.....	32
Home forecaster dials the weather.....	32
Kenyon Instrument Co., Huntington Sta., Long Island, N. Y.	
Hold-down tubes grip cargo in plane.....	33
Evans Products Co., Detroit, Mich.	
Minor adjustment needed for lower-octane gas.....	33
Pyramid trailer troop transport.....	38
Utility Trailer Mfg. Co., 3900 Medford St., Los Angeles, Calif.	
Staple remover does not tear paper.....	38
Metal Specialties Mfg. Co., 3200 Carroll Ave., Chicago	
Last known element photographed.....	38
Jeep spouts tear gas to train men.....	39
Wire "umbrella" sheds lightning.....	39
"Marine tractors" push fire barge.....	45
Trailer dumps at right angles to truck.....	45
Sailors of the air fly barrage balloons.....	46
Steam roller abandoned by Japs.....	48
Railroads haul record load.....	48
Webbed glove for swimmers.....	48
Fluid coal subs for fuel oil.....	49
Toys of war	54
Light cargo plane lands in small areas.....	55
Wrecked plane used as ground trainer.....	55
Railways double use of Diesels.....	55
"Club" propeller aids new-engine test.....	56
Hand-controlled dentist's drill.....	56
Garment hanger holds mothball supply.....	56
New furniture bounces on wooden springs.....	57
Demountable truck body speeds handling.....	61
Trans. Guarantee Co., Ltd., 35 Chelsey St., San Francisco, Cal.	
Warship lookouts use "bicycle" seats.....	61
Sky sweepers on the alert.....	62
Tree sniper in camouflaged suit.....	64
Joining of metals in alloy made visible.....	64
Wooden clamp with sliding jaw.....	64
F. J. Moncey Co., 209 S. State St., Chicago	
Adjustable "catwalk" for servicing planes.....	65
Wolfe & Mann Mfg. Co., 28th and Sisson Sts., Baltimore, Md.	
Mechanical cotton picker	65
Guard regulates traffic at plane plant.....	70
Pre-flight glider remains on ground.....	70
Tilting seat saves "blackout" of dive pilot.....	70
"Divining rod" locates land mines.....	71
Portable landing lights undergo inspection.....	71

(Continued to page 6A)

Illustrated by L. H. C. & M. M. M. Co.



CHAMPION SPARK PLUGS

are the dependable source of full, flowing engine performance, so vital to a Navy pilot at that crucial moment when an enemy ship—the never-to-be-forgotten prize—looms large in his sights. Champions are on active duty on every front.

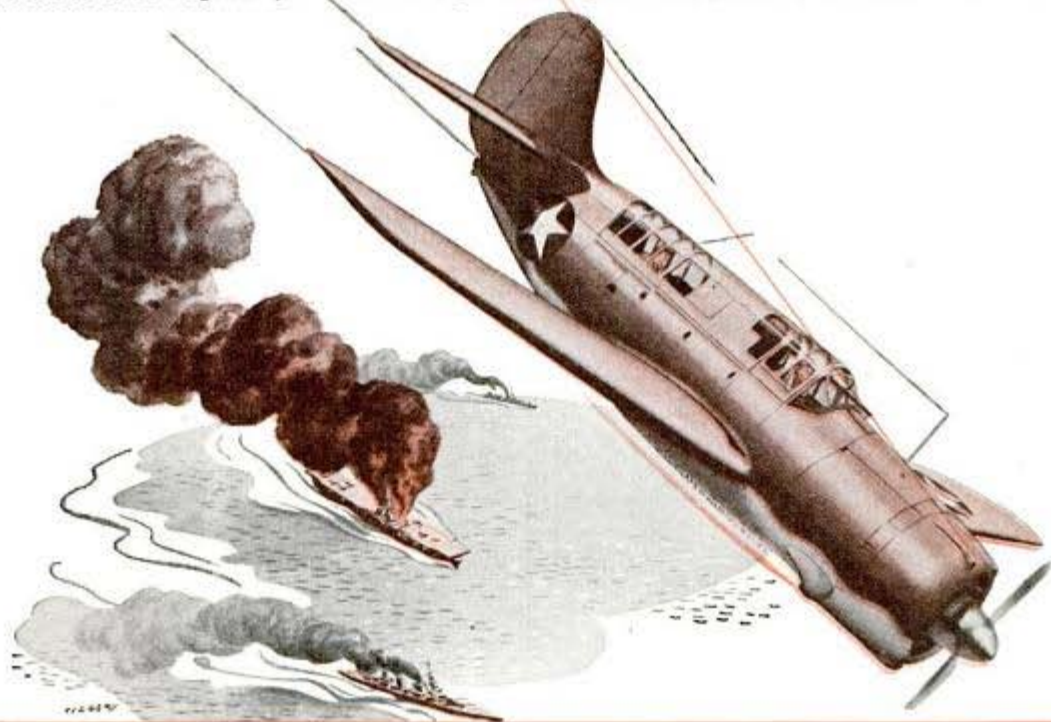

The furious assault on an enemy ship by a formation of Navy dive bombers is a magnificently awe-inspiring and intense moment. Already the record books are replete with glorious achievements on the part of the men who man these avengers of Pearl Harbor. The records likewise show that many of these Navy planes, as well as all other types of planes in use by our air forces, are powered by

engines equipped with Champion Spark Plugs. In performing their vital tasks, instantaneous response to the throttle is paramount and depends on the proper functioning of the all-important spark plugs. The characteristic dependability of all Champions, including those for your car, is directly due to research, engineering and precision manufacturing unequalled in the spark plug industry.

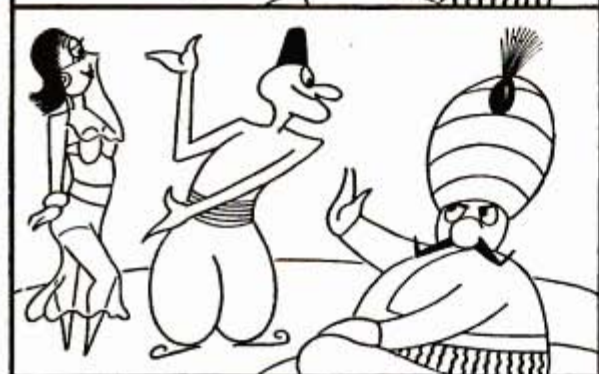

... the drink with
QUICK FOOD ENERGY

(Continued from page 4A)

Details of the Focke-Wulf plane.....	72
Rescue boat on Nile picks up flyers.....	74
Plane model equipped with controls.....	74
Comet Model Airplane & Supply Co., 129 W. 29th St., Chicago	
Aviation mechanics learn Commando tricks.....	75
Dog makes parachute jumps.....	80
Building material of cement and wood fiber.....	80
Hot lamps handled with air-cooled gloves.....	80
Sailors train at sights of gun mounting.....	81
Self-propelled tank destroyer.....	81
Snap-on hose clamp.....	81
Huntington Precision Products Co., Huntington, Va.	
Tank and gun "doctors" operate in field.....	88
Classroom demonstrator for radio training.....	152
Lafayette Radio Corp., 901 W. Jackson Blvd., Chicago	

Craftsman and Shop Notes Index

BOATS AND BOATING

Moving small boat on wheelbarrow.....	108
Getting the most from your boat.....	110
Skids shield outboard motor.....	130

CAMPING, HUNTING AND FISHING

Beach bag has folding legs.....	95
Tin-can shield for fishing reel.....	96
Attaching sinker to line.....	102
Window shade as picnic tablecloth.....	124
Emergency fly vise from battery clip.....	130

FARM

Chemicals dissolved in corn popper.....	137
Cleaning coils of weed burner.....	146

FURNITURE

Graceful whatnot tier.....	101
Old beds go modern.....	104

HAND TOOLS

Channel on bench guides shears.....	96
Holder to grip pieces of rod.....	96
Clamp avoids pinching of saw by plywood.....	102
Screw hook in end of yardstick.....	102
Storing coping-saw blades in bottle.....	123
Pointing tool for concrete blocks.....	124
Hammer holds rods for pointing.....	134
Keeping metal chips out of drill chuck.....	137
Marking duplicate holes with punch.....	142
Tool rounds edges of woodwork.....	143
Fitting clamps with sliding handles.....	144
Ratchet screwdriver adjusts lathe chuck.....	144
Soldering with welding torch.....	146

HOME IMPROVEMENTS

Child's wardrobe from orange crates.....	93
Preventing seepage under basement sash.....	116
Insulating built-in bathtub from cold wall.....	123

HOUSEHOLD

Repairing enamelware.....	96
Dinner gongs and napkin holders.....	97
Solving home problems.....	98
Shade attached to top sash.....	100
Basting cloth without pins.....	102
Marked shoe aids child in dressing.....	102
Knife holder from picture frame.....	118
Shoehorn holds mop upright in pail.....	124
Dial on bottle shows when to take medicine.....	124
Ant-killing solution.....	130

(Continued to page 8A)

WORK for YOURSELF as well as the Boss!

... Right now
is the **BIG CHANCE** for YOU

You've got a job—you're making money right now. Sure—but why don't you buckle down and put in the next three or four months' spare time in getting set for a better job—and more money? Plants need Foremen—and how—just build on what you've got and be a Foreman—on the road up.

Three or four short months give you Foremanship training. All you need do is to apply yourself, without interfering with your present job. Send for our FREE book. It tells how you can prepare—how you can be a successful FOREMAN through our "FOREMANSHIP FOR VICTORY" training.

This training is as streamlined as an armored division. It is interesting, concise, and right to the point. You need it right now.

What You Study Tonight—You Can Use Tomorrow

This is not merely "a set of books"—because we guide you step-by-step through each lesson of the course. Through our Problem Method you solve actual Foremanship problems—problems which the Foreman faces every day and which he has to take care of. And you can apply what you learn today on the job tomorrow. How long you take to complete this course is up to you—you can go as fast or as slowly as you choose.

In addition to ambitious men who want to be Foremen, lots of experienced production men and foremen who want to do a better job are taking this training. Our instructors are capable and experienced production men who understand Foremanship and its problems thoroughly.

You know as well as we do that the need for workers is today probably the greatest in our history. The Foreman—the boss in the shop or factory—the man who directs and sees that the work is turned out—that the production line is kept moving—he is the man who knows, and for that reason the man who gets the bigger pay.

Send for FREE booklet today. It places you under no obligation at all, and may be the means of your further success in business.

LASALLE EXTENSION UNIVERSITY A Correspondence Institution

Dept. 464-IF Chicago

Kindly send me your free booklet and details about your Foremanship Training for Victory.

Name.....Age.....

Position.....

Address.....

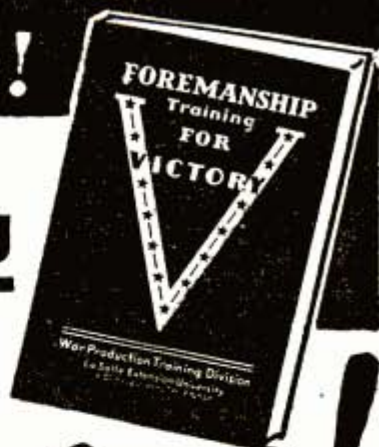

free!
Coupon will bring
a 48-page booklet
by return mail...

TRAINING COVERS 12 BASIC SUBJECTS

- The Foreman and His Job in the Victory Plan
- Training the Working Force
- Managing the Working Force
- Leadership and Handling Men
- Planning and Scheduling Production
- Getting the Work Out
- Greater Efficiency Through Job Analysis
- Greater Efficiency Through Time and Motion Study
- Greater Efficiency Through Elimination of Waste
- Handling and Safeguarding Material, Tools, and Equipment
- Cost and Record Control
- Handling Problems of Rights and Grievances



HOW'S YOUR HORSEPOWER?

● The big job today is to get every ounce of horsepower out of every drop of motor fuel.

A dirty motor cannot do this job... so clean yours out with Casite.

Casite dissolves the sludge and gum that keeps motors from performing at top efficiency... economically. It also acts as an oil-carrier... cuts friction and wear by leading oil to difficult places... in cold weather as well as hot.

Get top performance from your motor (gasoline or diesel) car, truck or tractor... by keeping it clean with Casite.

Keep Casite in your crankcase and use it regularly through your carburetor... a pint with every oil change; a pint through the carburetor twice a year.

THE CASITE CORPORATION, HASTINGS, MICHIGAN



CASITE

CLEANS OUT MOTORS
KEEPS MOTORS CLEAN

(Continued from page 6A)

LAWN AND GARDEN

Wire support for hose nozzle.....	108
Coat hanger holds lawnmower against wall.....	108
When, where and how to prune.....	119
Hotbed sash opens from either side.....	136

PAINT AND PAINTING

Painting sound-absorbing material.....	118
Preservative for paintbrushes.....	124
Check viscosity for better spray painting.....	147

POWER TOOLS

Crank operates drill press for tapping.....	116
Diamond design on turned work.....	125
Foot-powered scroll saw.....	131
Height gauge centers tool bits.....	135

RADIO AND ELECTRICITY

Tinned terminals reduce resistance.....	136
Operating horizontal motors in vertical position.....	145
First aid for home sets.....	149
Universal testing bridge.....	150
Seven-tube classroom demonstrator.....	152

SPORTS AND GAMES

Multiple game board.....	103
Portable target frame.....	109
Clamps to store skis.....	117
Tightening tennis net.....	129

STORE AND SHOP

Hanging drop cord on nail.....	96
Oilcloth pocket on clip board.....	100
Guides for printing deckle-edge paper.....	136
Printers' tools held on magnet.....	137
Repairing shop tools.....	138
Ferris-wheel display for cloth.....	144

WOODWORKING

Heavy-duty clamp from auto jack.....	118
Turnbutton makes handy bench stop.....	130
Wire lath reinforces bolted wood joints.....	143

MISCELLANEOUS

Caster unit moves large panels.....	95
Cleaner for smoking pipe.....	95
Garage doorstop from hinge.....	97
Earrings used as modelmaker's clamps.....	102
Individual book markers.....	108
Hinged tag for laundry case.....	108
Shoe-polish dauber cleans test tube.....	108
Transit made from carpenter's level.....	109
Insulating welding carbon for inside seams.....	118
Powder puff aids showcard writer.....	118
Knots improve lifeline.....	125
Copying table.....	126
Door wedge stabilizes typewriter shelf.....	130
Graphite rustproofs metal surface.....	136
More heat from carbon welder.....	136
Paperhanger's knife sharpener.....	137
Toolbox partition increases capacity.....	143
Powderpuffs in shoes rest feet.....	144
Tool kit serves as sawhorse.....	146
Easy way to join copper tubing.....	146
Anchoring bolts in concrete.....	146

IMPORTANT NOTICE

It is the intention of this magazine to provide its readers with information regarding the latest developments in the mechanical arts. We take no responsibility as to whether the disclosures contained in our articles are covered by patents and advise readers to investigate this subject before making, using, or selling any of the products, machines, or processes described in order to avoid possible liability for patent infringement.



PARTNERS IN THE BUSINESS OF VICTORY!

WHEN it comes to winning a war, one *trained man* is worth a dozen untrained men!

That's true of America's armed forces— which need chemists, mechanics, machinists, electricians, radio experts, accountants and a dozen other classifications of trained men. And trained men in America's armed forces get better pay and higher ranking!

It's true of America's victory-vital industry. Today, business and industry are crying for skilled, trained manpower! Never was opportunity greater for the alert,

ambitious man who has mastered his line of work through study and practice!

Yes, the *trained man in uniform* and the *trained man in industry* are "partners in the business of victory." Whether you're serving Uncle Sam in barracks or factory, farm or office, TRAINING can make you a more valuable citizen and a real asset to your country!

Before you turn this page—tear off this coupon, mark it and mail it—just as thousands of successful men have done!

INTERNATIONAL CORRESPONDENCE SCHOOLS

HELPING TO TRAIN AMERICANS FOR VICTORY

BOX 5659-J, SCRANTON, PENNA.

Without cost or obligation, please send me booklet and full particulars about the course *before* which I have marked X:

- | | | | |
|--|---|---|--|
| <input type="checkbox"/> Air Brake | <input type="checkbox"/> Contracting and Building | <input type="checkbox"/> Management of Inventions | <input type="checkbox"/> Sanitary Engineering |
| <input type="checkbox"/> Air Conditioning | <input type="checkbox"/> Cotton Manufacturing | <input type="checkbox"/> Marine Engines | <input type="checkbox"/> Sheet Metal Work |
| <input type="checkbox"/> Airplane Drafting | <input type="checkbox"/> Diesel Engines | <input type="checkbox"/> Mechanical Drafting | <input type="checkbox"/> Ship Drafting |
| <input type="checkbox"/> Architectural Drafting | <input type="checkbox"/> Electrical Drafting | <input type="checkbox"/> Mechanical Engineering | <input type="checkbox"/> Shipfitting <input type="checkbox"/> Shop Practice |
| <input type="checkbox"/> Architecture | <input type="checkbox"/> Electrical Engineering | <input type="checkbox"/> Mine Foreman | <input type="checkbox"/> Steam Electric <input type="checkbox"/> Steam Engines |
| <input type="checkbox"/> Auto Engine Tune-up | <input type="checkbox"/> Electrician | <input type="checkbox"/> Navigation <input type="checkbox"/> Patternmaking | <input type="checkbox"/> Steam Fitting |
| <input type="checkbox"/> Auto Technician | <input type="checkbox"/> Electric Lighting | <input type="checkbox"/> Plastics <input type="checkbox"/> Plumbing | <input type="checkbox"/> Structural Drafting |
| <input type="checkbox"/> Aviation <input type="checkbox"/> Aviation Mechanic | <input type="checkbox"/> Foundryman <input type="checkbox"/> Heating | <input type="checkbox"/> Public Works Engineering | <input type="checkbox"/> Structural Engineering |
| <input type="checkbox"/> Blueprint Reading | <input type="checkbox"/> Heat Treatment of Metals | <input type="checkbox"/> Pulp and Paper Making | <input type="checkbox"/> Surveying and Mapping |
| <input type="checkbox"/> Boilermaking | <input type="checkbox"/> Highway Engineering | <input type="checkbox"/> Radio, General | <input type="checkbox"/> Telegraphy <input type="checkbox"/> Telephony |
| <input type="checkbox"/> Bridge Engineering | <input type="checkbox"/> House Planning | <input type="checkbox"/> Radio Operating | <input type="checkbox"/> Textile Designing |
| <input type="checkbox"/> Chemistry <input type="checkbox"/> Coal Mining | <input type="checkbox"/> Industrial Metallurgy | <input type="checkbox"/> Radio Servicing | <input type="checkbox"/> Toolmaking <input type="checkbox"/> Tool Design |
| <input type="checkbox"/> Civil Engineering | <input type="checkbox"/> Locomotive Engineer | <input type="checkbox"/> R. R. Section Foreman | <input type="checkbox"/> Welding, Gas and Electric |
| <input type="checkbox"/> Concrete Engineering | <input type="checkbox"/> Machinist <input type="checkbox"/> Inspector | <input type="checkbox"/> R. R. Signalman <input type="checkbox"/> Refrigeration | <input type="checkbox"/> Woolen Manufacturing |
-
- | | | | |
|--|--|--|---|
| <input type="checkbox"/> Accounting <input type="checkbox"/> Advertising | <input type="checkbox"/> College Preparatory | <input type="checkbox"/> First Year College | <input type="checkbox"/> Railway Postal Clerk |
| <input type="checkbox"/> Bookkeeping | <input type="checkbox"/> Commercial | <input type="checkbox"/> Foremanship <input type="checkbox"/> French | <input type="checkbox"/> Salesmanship |
| <input type="checkbox"/> Business Correspondence | <input type="checkbox"/> Commercial Illustrating | <input type="checkbox"/> Good English | <input type="checkbox"/> Secretarial <input type="checkbox"/> Spanish |
| <input type="checkbox"/> Business Management | <input type="checkbox"/> Cost Accounting | <input type="checkbox"/> High School | <input type="checkbox"/> Showcard and Sign Lettering |
| <input type="checkbox"/> Cartooring <input type="checkbox"/> Civil Service | <input type="checkbox"/> C. P. Accounting | <input type="checkbox"/> Managing Men at Work | <input type="checkbox"/> Traffic Management |
-
- | | | |
|---|---|--|
| <input type="checkbox"/> Advanced Dressmaking | <input type="checkbox"/> Home Dressmaking | <input type="checkbox"/> Tea Room and Cafeteria Management, Catering |
| <input type="checkbox"/> Foods and Cookery | <input type="checkbox"/> Professional Dressmaking and Designing | |

Name..... Age..... Address.....
City..... State..... Present Position.....

Canadian residents send coupon to International Correspondence Schools Canadian, Limited, Montreal, Canada
British residents send coupon to I. C. S., 71 Kingsway, London, W. C. 2, England

SPECIAL
TUITION RATES
FOR MEMBERS
OF THE
ARMED FORCES
★

**AUDELS SHEETMETAL WORKERS
HANDY BOOK\$1**

Practical inside information. Fundamentals of Sheet Metal Layout Work. 388 pages. Fully illustrated. 11 sections. Clearly written. Essential and important facts, figures, pointers in everyday language. Ready Reference Index.

AUDELS WELDERS GUIDE.....\$1

A concise, practical text on operation and maintenance of all welding machines for all mechanics. Over 400 pages, fully illustrated. Covers all methods of electric and acetylene welding including airplane work. Every welder should own this guide.

**AUDELS ANSWERS ON
BLUE PRINT READING.....\$2**

Covers all types of blue print reading including ship and airplane for mechanics and builders. 376 pages, very fully illustrated. No other trade book like it—new, complete.

**AUDELS NEW MACHINISTS &
TOOLMAKERS HANDY BOOK.....\$4**

Covers modern machine shop practice in all its branches. 5 practical books in 1. New from cover to cover. Tells how to set up & operate lathes, screw and milling machines, shapers, drill presses and all other machine tools. 1600 pages, fully illustrated, 5 x 8 1/2 x 2. Indexed. 5 sections. 1—Modern Machine Shop Practice. 2—Blue Print Reading & How to Draw. 3—Calculations & Mathematics for Machinists. 4—Shop Physics. 5—How to Use the Slide Rule. 60 chapters. Easy to read and understand. A shop companion that answers your questions.

**AUDELS MATHEMATICS &
CALCULATIONS FOR MECHANICS.....\$2**

Mathematics for home study or reference. 700 pages, 550 illustrations. Practical mathematics from the beginning. How to figure correctly. New, easy, correct methods covering a complete review of practical arithmetic. Illustrated with examples. Includes mensuration—plane and solid geometry—trigonometry—algebra—calculus—electrical & mechanical shop calculation—practical tests—reference tables and data. How to use the slide rule. A real help.

AUDELS SHIPFITTERS HANDY BOOK.....\$1

288 pages of information, instruction, pictures and reference charts, together with many short cuts and trouble savers for shipfitters in their daily routine. No other trade book like it. Every shipfitter needs this book.

AUDELS AUTOMOBILE GUIDE.....\$4

A practical quick ready reference book for auto mechanics, service men, trainees and owners. Explains theory, construction and servicing of modern motor cars, trucks, buses & auto type Diesel engines. 1340 pages, fully illustrated. 55 chapters. Indexed. A standard book for mechanics and operators.

AUDELS RADIOMANS GUIDE.....\$4

A key to the practical understanding of radio including Frequency Modulation, Television, etc., Aircraft and Marine Radio. For radio engineers, servicemen, amateurs. 772 pages. 400 illustrations and Diagrams. Photos. Review Questions and Answers. Ready Reference Index. Authentic, clear, concise.

AUDELS MECHANICAL DICTIONARY.....\$4

950 pages. Over 17,000 new and standard mechanical terms, words, phrases, tables, formulas, helps, hints, short-cuts and practical suggestions. The right word when needed most.



**Information in a Handy Form!
AN AUDEL GUIDE IS A GOOD FRIEND!**

Use the brains and experience of others in these Guides of the Trades. Save time and money with right methods, short cuts, labor-saving ideas—"Learn more to earn more." Use our generous 7-day free examination privilege and our dollar a month payment plan. Become a Master in your Trade, and understand the Trades that tie into yours.

How to obtain these Guides for examination
Mark X on the order blank the Guides desired. Every Audel Guide is complete, up-to-date, easily understood with Questions and Answers, fully illustrated and indexed. They speak for themselves. Send for yours today at our risk and expense. Ask to see them.

AUDELS HANDY BOOK OF

PRACTICAL ELECTRICITY

For maintenance engineers, electricians and all electrical workers. 1440 Pages, 2600 Illustrations. Covers important electrical information in handy form—Including Marine Wiring, Radio Principles, Welding, Ready Reference Index. The key to a practical understanding of electricity.

\$4

AUDELS CARPENTERS & BUILDERS

GUIDES—4 Vols......**\$6**
A practical illustrated trade assistant on modern construction for carpenters, joiners, builders, mechanics and all woodworkers. 4 vols., 1600 pages, 3700 illustrations, flexible covers. Each volume pocket size. Sold separately \$1.50 a vol.

AUDELS DIESEL ENGINE MANUAL

.....**\$2**
A practical, concise treatise with questions and answers on the theory, operation and maintenance of modern diesel engines, including General Motors 2 cycle Diesel. 384 pages, fully illustrated, flexible binding, pocket size. All details plainly brought out, this book is of extreme value to engineers, operators & students.

AUDELS PLUMBERS & STEAMFITTERS

GUIDES—4 Vols......**\$6**
A Practical Trade Assistant & Ready Reference. Explaining in plain language & by clear Illustrations, diagrams, charts, graphs, pictures the principles of modern plumbing practice including Air Conditioning. 4 Vols.—1670 Pages—3642 Diagrams. Each Vol. Pocket Size. Sold Separately \$1.50 a Vol.

AUDELS WIRING DIAGRAMS

FOR LIGHT & POWER.....**\$1**
210 Pages, Illustrated. Gives practical facts on wiring of electrical apparatus. It explains clearly in simple language how to wire apparatus for practically all fields of electricity. Each diagram is complete and self-explanatory.

AUDELS ELECTRIC DICTIONARY

.....**\$2**
For Every Worker Who Has To Do With Electricity. Enables you to understand and explain electrical problems. Defines more than 9000 words, terms & phrases in plain, unmistakable language, compiled with accuracy & thoroughness. Valuable as an Encyclopedia of Electricity & as a Dictionary. Alphabetically arranged, ready reference index.

AUDELS MILLWRIGHTS & MECHANICS

GUIDE.....**\$4**
Practical up-to-date Information on Plant Installation, Operation and Maintenance. 1200 pages completely illustrated, fully indexed. 1000 facts at your fingertips in 6 convenient sections with ready reference.

GUETHS MECHANICAL DRAWING

.....**\$1**
A Concise Drawing Course. 150 pages, 50 plates. A complete instructor and reference work. Gives many helpful hints and suggestions on How to Draw.

AUDELS ELECTRONIC DEVICES

.....**\$2**
Tells What You Want to Know About the Electric Eye. Easily Understood. Covering photo-electric cells and their applications. Amplifiers, illumination, frequencies, voltage, photocell, tubes, Ohm's Law, wiring diagrams, etc.

AUDEL, PUBLISHERS, 49 W. 23 ST., N. Y.

CUT HERE

MAIL ORDER

THEO. AUDEL & CO., 49 West 23d Street, New York

Please mail me for 7 days' free examination the books marked (X) below. I agree to mail \$1 in 7 days on each book or set ordered, and to further mail \$1 a month on each book or set ordered until I have paid purchase price.

If I am not satisfied with Guides I will return them.

- | | | | |
|--------------------------|--|-------|-----|
| <input type="checkbox"/> | AUDELS SHEET METAL WORKERS Handy Book | | 51. |
| <input type="checkbox"/> | AUDELS WELDERS GUIDE | | 2. |
| <input type="checkbox"/> | AUDELS ANSWERS ON BLUEPRINT READING | | 4. |
| <input type="checkbox"/> | AUDELS MATHEMATICS & TOOLMAKERS Handy Book | | 1. |
| <input type="checkbox"/> | AUDELS SHIPPERS Handy Book | | 4. |
| <input type="checkbox"/> | AUDELS AUTO GUIDE | | 4. |
| <input type="checkbox"/> | AUDELS RADIOMANS GUIDE | | 4. |
| <input type="checkbox"/> | AUDELS MECHANICAL DICTIONARY | | 4. |
| <input type="checkbox"/> | AUDELS Handy Book of PRACTICAL ELECTRICITY | | 6. |
| <input type="checkbox"/> | AUDELS CARPENTERS and Builders Guides (4 vols.) | | 2. |
| <input type="checkbox"/> | AUDELS DIESEL ENGINE MANUAL | | 6. |
| <input type="checkbox"/> | AUDELS PLUMBERS and Steamfitters Guides (4 vols.) | | 1. |
| <input type="checkbox"/> | AUDELS WIRING DIAGRAMS | | 2. |
| <input type="checkbox"/> | AUDELS ELECTRIC Dictionary | | 4. |
| <input type="checkbox"/> | AUDELS MILLWRIGHTS and Mechanics Guide | | 1. |
| <input type="checkbox"/> | Gueths Mechanical DRAWING Course | | 2. |
| <input type="checkbox"/> | AUDELS ELECTRONIC DEVICES | | 2. |
| <input type="checkbox"/> | Rogers Mechanical DRAWING and Design | | 6. |
| <input type="checkbox"/> | AUDELS MARINE Engineers Guide | | 12. |
| <input type="checkbox"/> | Rogers MACHINIST GUIDE | | 1. |
| <input type="checkbox"/> | AUDELS MASONS and Builders Guides (4 vols.) | | 2. |
| <input type="checkbox"/> | AUDELS ENGINEERS and Mechanics Guides | | 2. |
| <input type="checkbox"/> | Nos. 1, 2, 3, 4, 5, 6, 7 and 8 complete | | 2. |
| <input type="checkbox"/> | AUDELS Answers on Practical ENGINEERING | | 2. |
| <input type="checkbox"/> | AUDELS ELECTRICAL POWER CALCULATIONS | | 2. |
| <input type="checkbox"/> | Hawkins ELECTRICAL Guides at \$1. each | | |
| <input type="checkbox"/> | Nos. 1, 2, 3, 4, 5, 6, 7, 8, 9 and 10 | | |
| <input type="checkbox"/> | AUDELS Answers on REFRIGERATION | | 2. |
| <input type="checkbox"/> | Hawkins Aids to ENGINEERS EXAMINATION | | 2. |
| <input type="checkbox"/> | Master PAINTER and DECORATOR | | 2. |
| <input type="checkbox"/> | AUDELS GARDENERS & GROWERS GUIDES \$1.50 a Vol. | | 4. |
| <input type="checkbox"/> | AUDELS Sheet Metal Pattern Layouts | | |
| <input type="checkbox"/> | AUDELS NEW ELECTRIC LIBRARY at \$1.50 a Volume | | |
| | Vols. I, II, III, IV, V, VI, VII, VIII, IX, X, XI, XII | | |

Name.....

Address.....

Occupation.....

Employed by.....

PM



Check

NOW!

You Can
Look Over
Any Guide
In Your
Own Home

—
Start the
Easy Pay-
ments If
Satisfied

MAIL THIS TODAY



Easy as A-B-C

Be Your Own MUSIC Teacher

LEARN AT HOME by wonderful improved method. Simple as A-B-C—a child can learn it. Your lessons consist of real selections, instead of tiresome exercises. Each of these delightfully easy lessons adds a new "piece" to your list. You read real notes, too—no "numbers" or trick music. Method is so thorough that many of our 700,000 students are band and orchestra leaders.

Be Popular

Everything is in print and pictures. First you are told what to do. Then a picture shows you how. In a few short months you may become an excellent musician—the life of every party!

Free Book and Print and Picture Sample Write at once for our illustrated Free Book and Free Print and Picture Sample. Please mention your favorite instrument. Instruments supplied when needed, cash or credit. (Forty-Fifth Year—Est. 1898).

U. S. SCHOOL OF MUSIC
74 Brunswick Bldg., New York City, N. Y.

Pick Your Course

Piano	Guitar
Hawaiian Guitar	Violin
Piano Accordion	Plain Accordion
Saxophone	Trumpet
Cornet	Reed Organ
Tenor Banjo	Ukulele
Drums and Traps	Trombone
Flute	Piccolo
Modern Elementary	Harmony
Mandolin	Practical Finger Control

AN INFANT INDUSTRY ... SUDDENLY MATURED PLASTICS

Get In at the Start—and Grow

Plastics is a new industry which the nation's war needs is forcing to quick maturity. Already Plastics are indispensable in practically every branch of the Service—Aircraft, Ordnance, Chemical, Marine, Signal Corps, etc. Opportunities? Nearly everything, from homes to clothing, from gadgets to tools, will be affected by Plastics.

Spare Time Training Now Ready

The time to get started is *now*. You can prepare at home, in your spare time, to take your place in an infant industry that even now is leaping into prominence. A new, practical training plan is now ready to help you realize your ambitions and build your future security. Act now. Don't delay. Mail this coupon today.

AMERICAN SCHOOL, Dept. P445,
Drexel Ave. at 58th St., Chicago, Ill.

Send me FREE information covering special training in subjects checked below. No obligation on my part.

- | | |
|--|--|
| <input type="checkbox"/> Plastics | <input type="checkbox"/> Cost Accounting for Manufacturing |
| <input type="checkbox"/> Electrical Engineering | <input type="checkbox"/> Automotive Engineering |
| <input type="checkbox"/> Drafting and Design for Men and Women | <input type="checkbox"/> Architecture & Building |
| <input type="checkbox"/> Diesel Engineering | <input type="checkbox"/> Shipbuilding |
| <input type="checkbox"/> Mechanical Engineering | <input type="checkbox"/> Business Management |
| <input type="checkbox"/> Aviation | <input type="checkbox"/> High School Course |
| <input type="checkbox"/> Radio | |

Name.....

Address.....

Quick! Get into DRAFTING now



All working tools, including drawing table, sent to you at once—furnished free with course.

ENGINEER DOBE, Division 3374 Libertyville, Illinois

Learn At Home From An Engineer

With industry working feverishly—the field for DRAFTSMEN is bigger than ever! Get into a better job with more pay and fascinating, pleasant work. I will train you at your home in your spare time until you are holding a better paying position as Draftsman. My practical training in drafting also includes a working course in Industrial Designing valuable on new products, improving, restyling and modernizing—all extremely important and profitable to draftsmen. Write for full illustrated details and booklet. Give your age.

LEARN WATCH REPAIRING



AT HOME. By our modern and original system of instruction you can learn every part of the WATCH REPAIRING TRADE AT HOME. Prepare yourself for a well-paying position or start in business after completing our course of instruction. Good watch repairers are in demand and generally earn very good salaries. For particulars apply to the Wisconsin School of Watch Repairing 524 E. Mason St., MILWAUKEE, WIS.

Learn Profitable Profession in 90 days at Home



Earnings of Men and Women in the fascinating profession of Swedish Massage run as high as \$40 to \$70 per week but many prefer to open their own offices. Large incomes from Doctors, hospitals, sanitariums and private patients come to those who qualify through our training. The Army and Navy need hundreds trained in massage. Write for Anatomy Charts and booklet—They're FREE.

THE COLLEGE OF SWEDISH MASSAGE
100 E. Ohio St., Dept. 464, Chicago

RADIO ENGINEERING, broadcasting, aviation and police radio, servicing, marine and Morse telegraphy taught thoroughly. 48 weeks' engineering course equivalent to three years' college radio work. School established 1874. All expenses low. Catalog free.
The Dodge Institute, Dept. D, Valparaiso, Ind.



Begin today. Write now for our Free Book, "How to Become a Good Penman." It contains specimens and tells how others learned to write in spare time. Enclose 10c for your name beautifully written and a pen point suitable for shaded writing. Write today.

THE TAMELYN SCHOOL OF PENMANSHIP
X442 Ridge Building, Kansas City, Mo.

Get into the BAKING BUSINESS Bakers make good money! Now 7th Industry in wages! Nearly depression-proof. New home study Baking Course qualifies you. Common school education sufficient. If you're ambitious, write for FREE BOOK, "Opportunities in Baking." National Baking Institute, 1315 Michigan, Dept. 1354, Chicago



THERE'S MONEY IN CARTOONS!

RAYE BURNS will teach you HOW TO CREATE ORIGINAL CARTOONS at home that you may SELL! Course contains 26 lessons and over 600 illustrations. All for Only..... **\$2.85**

Send name and address for free details.
RAYE BURNS SCHOOL, Dept. M, Box 1298, CLEVELAND, OHIO



EARN MONEY PAINTING PORTRAITS

No previous training or talent necessary. Unique Stuart System teaches you, by mail, in 10 simple, easy-to-follow lessons, to make excellent charcoal and oil likenesses. Detailed guidance for your every step. Send for free book today.

STUART STUDIOS,

121 Monument Circle, Room 643, Indianapolis, Ind.

Please send me free book and outline of lessons.

Name.....

Street.....

City..... State.....

Always write your name and full address clearly when answering advertisements.

FREE LESSON IN RADIO

GETTING ACQUAINTED WITH RECEIVER SERVICING

Here is a Partial List of Subjects this Lesson Teaches

WITH 31 PHOTOS, SKETCHES, RADIO DRAWINGS

How superheterodyne receivers work
 How to remove tubes, tube shields
 Three reasons why Radio tubes fall
 Electrodynamic loudspeaker:
 How it works
 Replacing damaged cone
 Reentering voice coil
 Remedies for open field coil

Output transformer construction, repair

Gang tuning condenser:
 Construction of rotor, stator
 How capacity varies
 Restrunging dial cord
 Straightening bent rotor plates

I.F. transformers—What they do, repair hints

How to locate defective soldered joints

Inside story of carbon resistors
 Paper, electrolytic, mica, trimmer condensers

How condensers become shorted, leaky

Antenna, oscillator coil facts
 Power transformer: construction, possible troubles
 Installing power cord
 Troubles of combination volume control, on-off switch
 Tone controls
 Dial lamp connections
 Receiver servicing technique:
 Checking performance
 Testing tubes
 Circuit disturbance test
 Isolating defective stage
 Locating defective part



J. E. SMITH, President
 National Radio Institute
 Established 28 Years

See For Yourself How I Train You at Home to BE A RADIO TECHNICIAN

send my 64-page illustrated book, WIN RICH REWARDS IN RADIO. It describes many fascinating jobs Radio offers, tells how you can train for them at home in spare time.

More Radio Technicians Now Make \$50 a Week Than Ever Before

There's a big shortage of capable Radio Technicians and Operators. Fixing Radios pays better now than for years. With new Radios out of production, fixing old sets, which were formerly traded in, adds greatly to the number of servicing jobs.

Broadcasting Stations, Aviation and Police Radio, Ship Radio and other communications branches are scrambling for Operators and Technicians. You may never see a time again when it will be so easy to get started. The Government needs hundreds of civilian and enlisted Radio men and women. Radio factories, with huge war orders to fill, have been advertising for trained personnel. And think of the NEW jobs Television, Frequency Modulation, and Electronics will open after the war! This is the sort of opportunity you shouldn't pass up.

Many Beginners Soon Make \$5, \$10 a Week Extra in Spare Time

There's probably an opportunity right in

your neighborhood to make money in spare time fixing Radios. I'll give you the training that has started hundreds of N.R.I. students making \$5, \$10 a week extra within a few months after enrolling. The N.R.I. Course isn't something just prepared to take advantage of the present market for technical courses. It has been tried, tested, developed, perfected during the 28 years we have been teaching Radio.

Find Out What N. R. I. Can Do for You

MAIL COUPON NOW for FREE Sample Lesson and 64-page illustrated book. You'll see the many fascinating jobs Radio offers and how YOU can train at home. If you want to jump your pay—mail Coupon at once in an envelope or paste on a penny postal.—J. E. SMITH, President, Dept. 3DP, National Radio Institute, Washington, D. C.



\$10 a Week Extra in Spare Time

"I repaired some Radio sets when I was on my tenth lesson. I really don't see how you can give so much for such a small amount of money. I made \$500 in a year and a half, and I have made an average of \$10 a week—just spare time." JOHN JERRY, 1337 Kalamath St., Denver, Colo.

Radio Service Manager of 4 Stores



"I was working in a garage when I enrolled with N.R.I. I am now Radio Service Manager for M. Furniture Co. for their 4 stores." JAMES E. RYAN, 119 Pebble Court, Fall River, Mass.



Lieutenant in U. S. Army Signal Corps

"I cannot divulge any information as to my type of work, but I can say that N.R.I. training is certainly coming in mighty handy these days." (Name and address omitted for military reasons.)

\$200 a Month in Own Business



"For several years I have been in business for myself making around \$200 a month. Business has steadily increased." ARLIE J. FROEHNER, 300 W. Texas Ave., Goose Creek, Texas.



Extra Pay in Army, Navy, Too



Men likely to go into military service, soldiers, sailors, marines, should mail the Coupon Now! Learning Radio helps Service men get extra rank, extra prestige, more interesting duties, MUCH HIGHER PAY. Also prepares for good Radio jobs after service ends. Over 1,700 Service men now enrolled.

GOOD FOR BOTH 64 PAGE BOOK **FREE**
 SAMPLE LESSON

**Mr. J. E. SMITH, President, Dept. 3DP
 NATIONAL RADIO INSTITUTE, Washington, D. C.**

Mail me FREE, without obligation, Sample Lesson and 64-page book, "Win Rich Rewards in Radio." (No Salesman will call. Write plainly.)

Age.....

Name

Address

City..... State..... 4FR-2

HOW TO TRAIN AT HOME AND

Win Rich Rewards in Radio



NEWS

Increased production means



More Jobs for MACHINISTS and bigger pay for men who know their work

This big home-study and reference course gives you the practical facts on machines and methods you need to advance in machine shop work. Take advantage of the other man's experience as found in books, to solve your problems, increase your efficiency, with

The AMERICAN MACHINISTS' LIBRARY

6 volumes—2368 pages—2516 illustrations

(A combined home-study course and reference library)

This library of machine shop practice was written for practical men. It gives you the best methods for every kind of machine shop work. It fully explains lathes, drills, and other machine tools and their operation, automatic screw machines, speeds and feeds, gear design and production, jigs and fixtures, punch and die work, metal surfacing, etc., etc. Plainly written—completely illustrated—the best kind of help to the machine shop man who wants to advance himself.

No money down—special price—easy payments.

EXAMINATION COUPON

McGraw-Hill Book Co., 330 W. 42nd St., New York

Send me for ten days' examination the American Machinists' Library. If satisfactory I will send you \$1.50 in 10 days and \$3.00 monthly until the price of \$10.50 is paid. If not wanted, I will return the books postpaid. (To insure prompt shipment write plainly and fill in all lines.)

Name.....
 Home Address.....
 City and State.....
 Position.....
 Name of Company..... PM-4-43

Say you saw it in Popular Mechanics!

AVIATION CAREER



Offers You
A GREAT FUTURE!

Complete Aeronautical Engineering or Master Aviation Mechanics training in the heart of the Aircraft industry. Graduates obtaining immediate employment. No flying involved. Aviation's foremost school, established in 1923. Located on Grand Central Air Terminal. For full information, address Department PM-4

CURTISS TECHNICAL WRIGHT INSTITUTE

GRAND CENTRAL AIR TERMINAL
GLENDALE (LOS ANGELES) CALIF.

THIS TOWER OVERLOOKS AVIATION'S MOST DISTINGUISHED SCHOOL OF AERONAUTICS

"YOU ARE UNDER ARREST!"



There's a Thrill in Bringing a Crook to Justice Through Scientific **CRIME DETECTION!**

I have taught thousands this exciting, profitable, pleasant profession. Let me teach you, too, in your own home. Learn Finger Printing, Firearms Identification, Police Photography and Secret Service Methods thoroughly, quickly and at small cost.

43% of All American Bureaus of Identification are headed by students and graduates of I. A. S. you, too, can fit yourself to fill a responsible crime detection job with good pay and steady employment. But don't delay—get the details now. Let me show you how easily and completely I can prepare you for this fascinating work, during spare time, in your own home. You may pay as you learn. Write today . . . Now . . . Be sure to state age.

Be A **FINGER PRINT Expert**

FREE!!!
Send for Thrilling "BLUE BOOK OF CRIME"

INSTITUTE OF APPLIED SCIENCE
1920 Sunnyside Ave., Dept. 1354, Chicago, Ill.

Learn TOOL DESIGN

Qualify quickly as a Machine or Tool Designer by home study in spare time. Entire defense program depends largely upon the machine and tool designer. After defense boom, machine and tool designers will be specially necessary for reconstruction. Many now making \$100 to \$125 a week. Rapidly expanding industry calling for more machine and tool designers than now available. Learn quickly with our step-by-step lessons supervised by a recognized professor of machine tool design. Rush name and address today for complete facts on Machine or Tool Design. Learn what these fields offer you and how quickly you can qualify for a big pay position. No obligation. State age. A penny postal will do—but hurry.



Ohio Institute of Technology, Box 98, Greenville, Ohio

BECOME AN EXPERT MEAT CUTTER



Greater opportunities! Thousands of firms are seeking expert Meat Cutters. Train in 8 weeks at famous National School. It's quick, easy to learn Meat Cutting by ACTUAL PRACTICE in big National cutting rooms and retail department. No previous experience or advanced education necessary. **FREE** U.S. Union card guaranteed. Employment service **FREE**. Train free. Pay later. Money terms. Write TODAY for **FREE** catalog and plans to help you get ahead.

National School of Meat Cutting, Inc., Dept. U-41, Toledo, Ohio

ELECTRICITY MEN NEEDED

Electricians are needed everywhere. Hollywood studios alone claim shortage 200 men. This is a live money making profession. Learn at home, spare time. Easy payments. Selective Employment service. Write for **FREE** Bulletin. No obligation.

AMERICAN SCHOOL

Dept. EE445 Drexel at 58 St., Chicago

LAW
STUDY AT HOME for PERSONAL SUCCESS and LARGER EARNINGS. 31 years expert instruction—over 106,000 students enrolled. LL.B. Degree awarded. All texts furnished. Easy payments. Send for **FREE** BOOK—"Law and Executive Guidance."

AMERICAN EXTENSION SCHOOL OF LAW
Dept. 28-M 5 East Huron St., Chicago, Ill.

FIBRE ARMS AND LEGS!

Light, correctly fitted, strong and comfortable. Natural appearance. Braces for all deformities. Scientific design. Fair Terms.

BUCHSTEIN-MEDCALF 610-3rd Av. S., Minneapolis, Minn.

MONEY IN RABBITS—CAVIES

WE BUY and put you in touch with other markets. Catalog and copy of magazine 10c. Or send 25c for Book Catalog and Price List and 6 mo.'s Subscription to the AMERICAN SMALL STOCK FARMER. **OUTDOOR ENTERPRISE CO., BV 54, PEARL RIVER, N. Y.**

MONEY for MEN ALL DATA FREE

THE PLASTEX Industry needs manufacturers on small scale and for big production of Lump and Clock Stamps, Art Goods and Novelties in Plastex and Marble imitation. Experience unnecessary. 1/2c material makes regular 10c store sellers. Rubber moulds furnished for speed production. Small investment brings good returns. WE ARE NOW PLACING BIG CHAIN STORE ORDERS WITH MANUFACTURERS. Ambitious men have chance for real prosperity. Our **FREE** booklet will interest and benefit you. **PLASTEX INDUSTRIES, Dept. P, 1055 Washington Ave., New York, N. Y.**

A million tons of rubber ...GOING TO WASTE!

You'd demand *action*—if you knew that a million tons of rubber were going to waste, when it's vital to our war effort.

And yet the fact is, a million *men* are "going to waste" in low-paid, unskilled jobs—when, with a few months of practical, spare-time *training*, they might be doing more important, better paid work in some victory-vital shop or factory!

And America needs *trained man-power* as much as she needs rubber and gasoline!

You can demand *action* on this matter, too—by mailing this coupon today, and learning how quickly a low-cost I. C. S. Course can fit you to be a better fighter on the business and industrial front!

Act right now—the world won't wait for slow-pokes!

INTERNATIONAL CORRESPONDENCE SCHOOLS

HELPING TO TRAIN AMERICANS FOR VICTORY

BOX 5660-J, SCRANTON, PENNA.

Without cost or obligation, please send me booklet and full particulars about the course *before* which I have marked X:

TECHNICAL AND INDUSTRIAL COURSES

- | | | | |
|--|---|---|--|
| <input type="checkbox"/> Air Brake | <input type="checkbox"/> Contracting and Building | <input type="checkbox"/> Management of Inventions | <input type="checkbox"/> Sanitary Engineering |
| <input type="checkbox"/> Air Conditioning | <input type="checkbox"/> Cotton Manufacturing | <input type="checkbox"/> Marine Engines | <input type="checkbox"/> Sheet Metal Work |
| <input type="checkbox"/> Airplane Drafting | <input type="checkbox"/> Diesel Engines | <input type="checkbox"/> Mechanical Drafting | <input type="checkbox"/> Ship Drafting |
| <input type="checkbox"/> Architectural Drafting | <input type="checkbox"/> Electrical Drafting | <input type="checkbox"/> Mechanical Engineering | <input type="checkbox"/> Shipfitting <input type="checkbox"/> Shop Practice |
| <input type="checkbox"/> Architecture | <input type="checkbox"/> Electrical Engineering | <input type="checkbox"/> Mine Foreman | <input type="checkbox"/> Steam Electric <input type="checkbox"/> Steam Engines |
| <input type="checkbox"/> Auto Engine Tune-up | <input type="checkbox"/> Electrician | <input type="checkbox"/> Navigation <input type="checkbox"/> Patternmaking | <input type="checkbox"/> Steam Fitting |
| <input type="checkbox"/> Auto Technician | <input type="checkbox"/> Electric Lighting | <input type="checkbox"/> Plastics <input type="checkbox"/> Plumbing | <input type="checkbox"/> Structural Drafting |
| <input type="checkbox"/> Aviation <input type="checkbox"/> Aviation Mechanic | <input type="checkbox"/> Foundryman <input type="checkbox"/> Heating | <input type="checkbox"/> Public Works Engineering | <input type="checkbox"/> Structural Engineering |
| <input type="checkbox"/> Blueprint Reading | <input type="checkbox"/> Heat Treatment of Metals | <input type="checkbox"/> Pulp and Paper Making | <input type="checkbox"/> Surveying and Mapping |
| <input type="checkbox"/> Boilermaking | <input type="checkbox"/> Highway Engineering | <input type="checkbox"/> Radio, General | <input type="checkbox"/> Telegraphy <input type="checkbox"/> Telephony |
| <input type="checkbox"/> Bridge Engineering | <input type="checkbox"/> House Planning | <input type="checkbox"/> Radio Operating | <input type="checkbox"/> Textile Designing |
| <input type="checkbox"/> Chemistry <input type="checkbox"/> Coal Mining | <input type="checkbox"/> Industrial Metallurgy | <input type="checkbox"/> Radio Servicing | <input type="checkbox"/> Toolmaking <input type="checkbox"/> Tool Design |
| <input type="checkbox"/> Civil Engineering | <input type="checkbox"/> Locomotive Engineer | <input type="checkbox"/> R. R. Section Foreman | <input type="checkbox"/> Welding, Gas and Electric |
| <input type="checkbox"/> Concrete Engineering | <input type="checkbox"/> Machinist <input type="checkbox"/> Inspector | <input type="checkbox"/> R. R. Signalman <input type="checkbox"/> Refrigeration | <input type="checkbox"/> Woolen Manufacturing |

BUSINESS COURSES

- | | | | |
|--|--|--|---|
| <input type="checkbox"/> Accounting <input type="checkbox"/> Advertising | <input type="checkbox"/> College Preparatory | <input type="checkbox"/> First Year College | <input type="checkbox"/> Railway Postal Clerk |
| <input type="checkbox"/> Bookkeeping | <input type="checkbox"/> Commercial | <input type="checkbox"/> Foremanship <input type="checkbox"/> French | <input type="checkbox"/> Salesmanship |
| <input type="checkbox"/> Business Correspondence | <input type="checkbox"/> Commercial Illustrating | <input type="checkbox"/> Good English | <input type="checkbox"/> Secretarial <input type="checkbox"/> Spanish |
| <input type="checkbox"/> Business Management | <input type="checkbox"/> Cost Accounting | <input type="checkbox"/> High School | <input type="checkbox"/> Showcard and Sign Lettering |
| <input type="checkbox"/> Cartooning <input type="checkbox"/> Civil Service | <input type="checkbox"/> C. P. Accounting | <input type="checkbox"/> Managing Men at Work | <input type="checkbox"/> Traffic Management |

HOME ECONOMICS COURSES

- | | | |
|---|---|--|
| <input type="checkbox"/> Advanced Dressmaking | <input type="checkbox"/> Home Dressmaking | <input type="checkbox"/> Tea Room and Cafeteria Management, Catering |
| <input type="checkbox"/> Foods and Cookery | <input type="checkbox"/> Professional Dressmaking and Designing | |

Name.....Age.....Address.....
City.....State.....Present Position.....

Canadian residents send coupon to International Correspondence Schools Canadian, Limited, Montreal, Canada
British residents send coupon to I. C. S., 71 Kingway, London, W. C. 2, England

SPECIAL
TUITION RATES
FOR MEMBERS
OF THE
ARMED FORCES



ELECTRICIANS

—and those who want to know Electricity!



Here at last is a 3-Volume Set of practical electrical books for the "beginner" or "old timer"

MAIL COUPON FOR 7 DAY FREE TRIAL

THE BOOKS YOU'VE BEEN WAITING FOR!

HUNDREDS OF PICTURES AND DIAGRAMS. HUNDREDS OF SUBJECTS AT YOUR FINGERTIPS!

A few of many branches of Electricity explained and pictured in this amazing set are:

- Radio - Television
- Air Conditioning
- Telephone
- Auto Electricity
- Talking Pictures
- Generators
- Refrigeration
- House Wiring
- Electric Signs
- Home Appliances
- Switchboards
- Power Plants
- Diesel Engines
- Motors - Armatures
- A.C. and D.C.

FREE—WITH BOOKS

Send for these reference books now, and I'll include a certificate entitling you to 1 full year of Technical Service—personal advice by mail from the Coyne staff of instructors on any Electrical subject.

Now! What every Electrician, service man, radio man, maintenance man—in fact, any man interested in Electricity—has long needed!

It's an amazing 3-volume set of Electrical books to help you solve your everyday problems in an easy, practical way, and to increase your knowledge of the electrical field.

WRITTEN SO YOU CAN UNDERSTAND IT!

The material is written so you don't have to wade through a lot of useless theory. It comes to the point and tells you in simple, understandable language about any electrical subject. Every subject is indexed so you can quickly locate it.

It is a course of Electricity in itself. Used by hundreds of Electricians on the job.

DON'T SEND A PENNY!

I'm so sure you'll never part with this set that I want to send it to you on 7 days FREE TRIAL. Mail coupon today. If satisfied with the books, send \$1.95 in 7 days and then \$2 a month until the total price of \$13.95 is paid. If not satisfied, send them back in 7 days and you won't owe me a cent.

H. C. LEWIS, Pres., Dept. 43-R6, COYNE ELECTRICAL SCHOOL, 500 S. Paulina St., Chicago, Ill.

Send me the big 3-volume NEW EDITION Coyne Electrical and Radio Reference Encyclopedia, postpaid. Within 7 days after receiving the books, I'll either return them or send you \$1.95 and then \$2 a month until the total price of \$13.95 is paid.



NAME

ADDRESS

CITY STATE

OCCUPATION AGE

SAVE 10%. Send cash price, \$12.55. with order if preferred—you save \$1.40. Same 7-day free trial and return privilege.

Always write your name and full address clearly when answering advertisements.

\$5, \$10, \$15 FOR ONE DRAWING

Be an ARTIST!

—Train at Home in Your Spare Time

The fascinating field of Art offers commercial opportunities to men and women. Trained Artists are capable of earning \$30, \$50, \$75 a week. Learn to draw step-by-step. COMMERCIAL ART, CARTOONING, ILLUSTRATING, all in one complete course. Two Art Outfits furnished. Write for full information in FREE BOOK, "Art for Pleasure and Profit." No obligation. State age.

WASHINGTON SCHOOL OF ART, Studio 124F 1115—15th St., N. W., WASHINGTON, D. C.

FREE BOOK gives details

TRI-STATE COLLEGE

B. S. Degree in 27 Months

Distinguished for technical 2 1/2-year courses in Civil, Electrical, Mechanical, Chemical, Radio, Aeronautical Engineering; Business Administration, Accounting, and Secretarial Science.

MEN AND WOMEN—3 yr. high school students with good record admitted. Special Preparatory Department. Short diploma courses (36 weeks) in Surveying, Drafting. Low tuition. Low living costs. Cosmopolitan student body. 60th year. Enter June, September, January, March. Write for catalog. 443 College Ave., ANGOLA, INDIANA.

TRAIN Your VOICE!

Results GUARANTEED

We build, strengthen the vocal organs—not with singing lessons—but by sound, scientifically correct silent and vocal exercises and absolutely guarantee complete satisfaction with results. Write for Voice Book, FREE. Sent to no one under 17 years old unless signed by parent.

PERFECT VOICE INSTITUTE, Studio 1354, 64 E. Lake St., Chicago, Ill.

AUDELS Carpenters and Builders Guides 4 vols. \$6



Inside Trade Information for Carpenters, Builders, Joiners, Building Mechanics and all Woodworkers. These Guides give you the short-cut instructions that you want—including new methods, ideas, solutions, plans, systems and money saving suggestions. An easy progressive course for the apprentice and student. A practical daily helper and Quick Reference for the master worker. Carpenters everywhere are using these Guides as a Helping Hand to Easier Work, Better Work and Better Pay. To get this assistance for yourself, simply fill in and send the FREE COUPON below.

Inside Trade Information On:

How to use the steel square—How to file and set saws—How to build furniture—How to use a mitre box—How to use the chalk line—How to use rules and scales—How to make joints—Carpenters arithmetic—Solving mensuration problems—Estimating strength of timbers—How to set girders and sills—How to frame houses and roofs—How to estimate costs—How to build houses, barns, garages, bungalows, etc.—How to read and draw plans—Drawing up specifications—How to excavate—How to use settings 12, 13 and 17 on the steel square—How to build hoists and scaffolds—skylights—How to build stairs—How to put on interior trim—How to hang doors—How to lay floor—How to paint



THEO. AUDEL & CO., 49 W. 23rd St., New York City

Mail Audels Carpenters and Builders Guides, 4 vols., on 7 days' free trial. If O. K I will remit \$1 in 7 days, and \$1 monthly until \$6 is paid. Otherwise I will return them. No obligation unless I am satisfied.

Name

Address

Occupation

Reference

15 Minutes a Day!

Give me just this
and I'll prove I can make you
A NEW MAN!

I'M "trading-in" old bodies for new! I'm taking men who know that the condition of their arms, shoulders, chests and legs—their strength, "wind," and endurance—is not 100%. And I'm making NEW MEN of them. Right now I'm even training hundreds of soldiers and sailors who KNOW they've got to get into shape FAST!

Only 15 Minutes a Day!

Are you ALL MAN—tough-muscled, on your toes every minute, with all the up-and-at-'em that can lick your weight in wildcats? Or do you need the help I can give you—the help that has already worked such wonders for other fellows, everywhere?

All the world knows I was ONCE a skinny, scrawny 97-lb. weakling. And NOW it knows that I am the holder of the title, "The World's Most Perfectly Developed Man." How did I do it? How do I work miracles with the bodies of other men in only 15 minutes a day? The answer is "Dynamic Tension," the amazing method I discovered and which changed me from a 97-pound weakling into the champion you see here!

In just 15 minutes a day, right in the privacy of your own home, I'm ready to prove that "Dynamic Tension" can lay a new outfit of solid muscle over every inch of your body. Let me put new, smashing power into your arms and shoulders—give you an armor-shield of stomach muscle—strengthen your legs into real columns of surging stamina. If lack of exercise or wrong living has weakened you inside, I'll get after that condition, too, and show you how it feels to LIVE!



Charles Atlas

—actual photo of the man who holds the title, "The World's Most Perfectly Developed Man."

Charles Atlas—America's Greatest "Builder of Men"

Among all the physical instructors and "conditioners of men" ONLY ONE NAME STANDS OUT. That name is Charles Atlas!

In every part of the country Charles Atlas is recognized as "America's Greatest Builder of Men." Thousands upon thousands have put their physical development into his capable hands!

And now that the call is for men capable of helping America meet and conquer any national emergency, many thousands of others (even those already in their country's Army and Navy) are calling upon Charles Atlas to build the kind of men America vitally needs!

MAIL THIS COUPON NOW!

FREE This Famous Book that Tells You How to Get a Body that Men Respect and Women Admire

My book, "Everlasting Health and Strength," tells you exactly what "Dynamic Tension" can do. And it's packed with pictures that SHOW you what it does. RESULTS it has produced for other men. RESULTS I want to prove it can get for YOU! If you want to learn how you can actually become a NEW MAN, right in the privacy of your own home and in only 15 minutes a day, then man!—get this coupon into the mail to me as fast as your legs can get to the letterbox! CHARLES ATLAS, Dept. 84, 115 East 23rd St., New York, N. Y.

**CHARLES ATLAS, Dept. 84,
115 East 23rd St., New York, N. Y.**

I want the proof that your system of "Dynamic Tension" will help make a New Man of me—give me a healthy, husky body and big muscular development. Send me your free book, "Everlasting Health and Strength."

Name

(Please print or write plainly)

Address

City..... State.....

Check here if under 16 for Booklet A.

SPRAYBERRY RADIO TRAINING *includes* FULL EQUIPMENT

Experience Easily Acquired
at Home



You Do Practice-Giving Experiments, Many Special Features... ALL Designed to Help You Make Fast Progress.

SPRAYBERRY Training starts right at the beginning of Radio... unfolds each subject in a simplified, logical, understandable style. You easily learn Television, Frequency Modulation, Signal Tracing,

Mobile Radio (Auto-Tank), Aviation Radio, Electronics, Facsimile Radio, Radio Set Repair and Installation work.

Training Prepares You for a Business of Your Own... or Good Radio Jobs—Civilian or Military

The important and fascinating field of Radio offers many opportunities to the man who wants to get ahead. My Training will help you win quick promotion in the Army or Navy... will fit you for a bright civilian career. SPRAYBERRY Methods are thorough and practical. Your training will not interfere with your present duties.

FULL RADIO SET

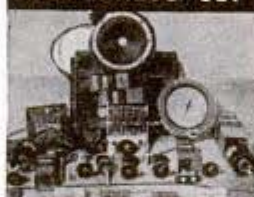

You Get a Dual-Purpose Radio Set

I supply you with Radio Parts which you use to gain experience in Repair work. These same Parts are used as a Modern Signal Generator and for Signal Tracing, etc. You'll find my Course and Equipment fully described in the catalog offered below.



No Previous Experience Needed

It makes no difference what your education has been. I can fit you quickly for a good-paying Radio job. I make it easy for you to grasp Radio principles and remember them. Your success is my full responsibility.

Earn While You Learn

My BUSINESS BUILDERS show you how to put your equipment to actual use in handling Money-making Radio Service Jobs shortly after you begin Training.

THE SPRAYBERRY COURSE IS SOLD UNDER MONEY-BACK AGREEMENT

RUSH COUPON for BIG FREE BOOK

SPRAYBERRY ACADEMY OF RADIO

F. L. Sprayberry, President
610-D University Place, N. W.
Washington, D. C.

Please rush my FREE copy of "HOW TO MAKE MONEY IN RADIO"

Name..... Age.....

Address.....

City..... State.....

(Mail in envelope or paste on penny postcard)

HOW DID THE ANIMALS GET THEIR NAMES?

Dinosaur

means literally a
"terrible lizard"



THE name *dinosaur* comes from the Greek words *deinos*, "terrible," and *sauros*, "lizard." Both you and your children will enjoy the hundreds of fascinating word origins in WEBSTER'S NEW INTERNATIONAL DICTIONARY, Second Edition. Its completeness makes it truly the foundation book for home education! 600,000 entries—122,000 more than in any other dictionary. 12,000 terms illustrated; 3,350 pages. Ask any bookdealer to show you the MERRIAM-Webster. Write for free illustrated booklet of interesting word origins to G. & C. Merriam Co., 227 Federal Street, Springfield, Mass. Advertisement Copyright, by G. & C. Merriam Co.

THE GENUINE WEBSTER

WEBSTER'S
NEW INTERNATIONAL
DICTIONARY
Second Edition



STUDY AT HOME

With A Chartered Educational Institution

Courses in **ENGINEERING**: Electrical, Civil, Mechanical, Drafting, Architectural, Steam, Aeronautical, Radio, Structural, Mining, Industrial, Highway, Petroleum, Marine, Chemical.
Courses in **ARTS AND SCIENCES**: Philosophy; Education; Letters; Public Health; Medical Jurisprudence; Psychology; Sociology; Physics; Chemistry; Geology; Pol. Science; Theology; Law; Business and Commerce; Accounting; Mathematics; Statistics; Agriculture.
McKinley-Roosevelt Incorporated, 4610-UC, Sheridan Road, Chicago

America Needs Men Trained for TOOL & DIE MAKING, MACHINIST & SCREW MACHINE TRADES

HARRY LEBESON
PRESIDENT & FOUNDER
ALLIED School offers you short intensive, Practical training courses in Our fully equipped Shops. Learn on Actual Jobs! Easily, Quickly. Learn Days or Evenings. Enter anytime. FREE Employment Service and opportunity to earn while learning. Write for FREE Book "Practical Machine Shop Training."
ALLIED SCREW MACHINE CO., (School Division)
609 West Lake Street, Dept. PM-4, Chicago, Illinois

Short-Cut Mathematics COMBINED WITH Practical Mechanics Simplified

NEW 2-in-1 reading course! Now you can learn the speedy, simplified system of calculation used by draftsmen, engineers, accountants, "master minds" on the stage. Learn easy way to multiply 4 figures by 4 figures without using old-fashioned multiplication; add long columns of figures this lightning short-cut method. Learn horsepower, slide rule, micrometer, logarithms, wood measure, puzzles, etc., etc. Large illustrated volume complete with answers, only \$1 postpaid. Satisfaction or refund.

FREE Complete details... mail coupon TODAY!

NELSON CO., 500 Sherman St., Dept. D-300, Chicago

Please send free details about "Short-Cut Mathematics and Practical Mechanics Simplified." No obligation.

Name.....

Address.....

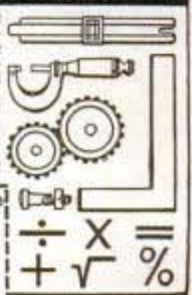

AUDELS HANDY BOOK OF PRACTICAL ELECTRICITY

FOR MAINTENANCE ENGINEERS, ELECTRICIANS AND ALL ELECTRICAL WORKERS. PRICE \$4

HERE IS ELECTRICAL INFORMATION IN A HANDY FORM

COVERING:

ELECTRICAL ENERGY
MECHANICAL ENERGY
Current Effects—Magnetism
MAGNETIC INDUCTION
D. C. Motors—Dynamos
A. C. Motors—Alternators
ALTERNATOR
CONSTRUCTION
Armature Winding
Armature Repairing
WIRING DIAGRAMS
Reverse Current Relays
Overload Relays
Differential Power Relays
Undervoltage Relays
Temperature Relays
ELECTRIC POWER
TRANSMISSION
Underground Wiring
Cable Splicing
Switches—Electric Bells
TRANSFORMERS
HOUSE WIRING
Diagram of Connections
Rectifiers—Converters
Power Factors
WATT-HOUR METERS AND CONNECTIONS
Watt-Hour Rules
Meters and Instruments
Circuit Breakers—Fuses
Rheostats and Starting Devices
STORAGE BATTERIES
Electrolysis—Insulators
Electric Lighting
FLUORESCENT
Sign Flashers
NEON SIGNS
Electro Plating
RADIO PRINCIPLES
RADIO QUESTIONS AND ANSWERS
Radio Tubes—Photo Electric Cells
Electric Cranes
POWER WIRING
Substations—Power Station Plans
Plant Management
AUTOMATIC TELEPHONE
Automatic Telephone Switchboards
The Telegraph, Relay System and Codes
ELEVATORS AND CONTROLLERS
Elevator Wiring and Operating Instructions
MARINE WIRING
Electric Ship Drive
ELECTRIC RAILWAYS
Electric Heating
AIR CONDITIONING
Motion Pictures
Domestic Refrigeration
Air Compressors
OIL BURNERS
Pumps—Wiring Calculations
Soldering—Brazing
WELDING
Electro-Therapeutics—X-Rays
Automobile Starting
Automobile Lighting Systems
Ignition
Electrically Operated Tools
Ready Reference Index

YOUR OPPORTUNITY!

"AUDELS HANDY BOOK OF PRACTICAL ELECTRICITY," endorsed by hundreds of experienced workers, you too can profit by the personal ownership of this good book, containing the practical information that every electrical man can use. Clear—concise—explaining the essential facts, figures and rules used in good general practice—and fully illustrated.

1440 PAGES
2600 ILLUS.

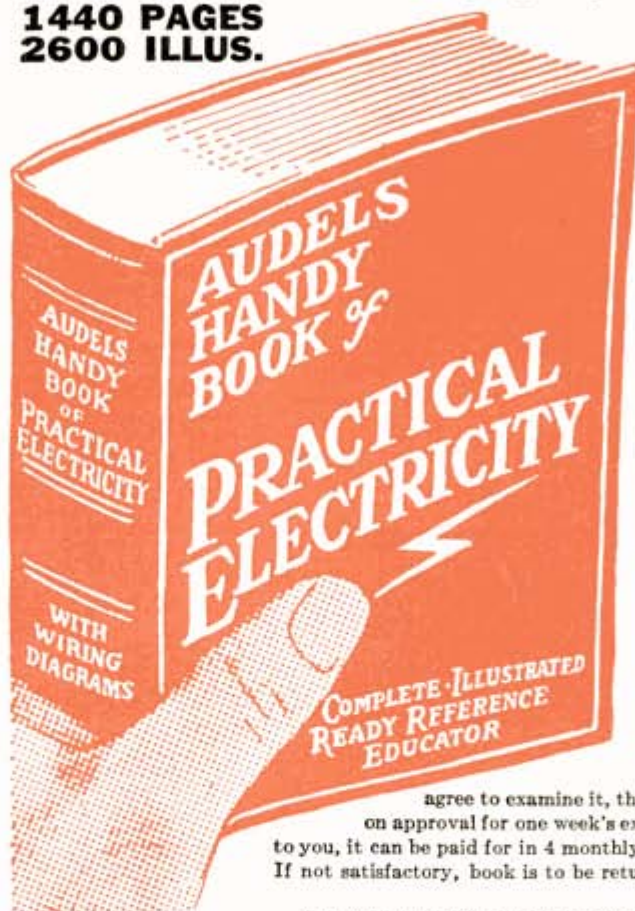

A Practical, Quick, Ready Reference. Gives complete instruction and inside information on electrical subjects. Every point clearly explained in plain language and with diagrams. Subjects arranged progressively for the student, and complete index makes information instantly available to professional workers for ready reference. A time and money saver. A competent and dependable guide and helping hand. Sooner or later this handy book will answer important questions and help you to handle efficiently all kinds of electrical problems.

"AUDELS HANDY BOOK OF PRACTICAL ELECTRICITY" is bringing a helping hand to hundreds of workers and if you will

agree to examine it, the book will be sent to you on approval for one week's examination. If found O.K. to you, it can be paid for in 4 monthly payments of \$1.00 each. If not satisfactory, book is to be returned in one week.

**TO GET THIS ASSISTANCE FOR YOURSELF
SIMPLY FILL IN AND MAIL COUPON TODAY**

ASK TO SEE IT!

THEO. AUDEL & CO., 49 West 23rd St., New York
Mail AUDELS HANDY BOOK OF PRACTICAL ELECTRICITY (Price \$4) on 7 Days' Free Trial. If O.K. I will remit \$1 in 7 days and \$1 monthly until \$4 is paid. Otherwise I will return it.

Name _____

Address _____

Occupation _____

Reference _____ P. M.



THEO. AUDEL & CO., 49 W. 23rd St., N. Y.

DRAFTSMEN NEEDED NOW



Industry is clamoring for more draftsmen for the job can't start until plans are drawn. Buildings, airplanes, machines, guns, tanks, bridges, all start on the drafting board, so it's no wonder that every good draftsman has a fine job. Yes, more draftsmen are needed NOW. The pay is good and the opportunities for advancement great.

Learn at Home in Spare Time

Begin now to turn spare hours into money. Be a draftsman, the connecting link between a mechanic and an engineer. Enjoy the wonderful opportunities for promotion that exist now. No experience or artistic talent is needed. You don't have to leave your present job while learning. Use spare time.

American School, Dept. DD445, Drexel Ave. at 58th St., Chicago, Ill.

Gentlemen: Send me FREE information covering special training in subjects checked below. No obligation on my part.

- | | |
|--|--|
| <input type="checkbox"/> Drafting and Design for Men and Women | <input type="checkbox"/> Electrical Engineering |
| <input type="checkbox"/> Cost Accounting for Manufacturing | <input type="checkbox"/> Diesel Engineering |
| <input type="checkbox"/> Architecture and Building | <input type="checkbox"/> High School Course |
| <input type="checkbox"/> Automotive Engineering | <input type="checkbox"/> Plastics |
| <input type="checkbox"/> Business Management | <input type="checkbox"/> Mechanical Engineering |
| | <input type="checkbox"/> Aviation <input type="checkbox"/> Radio |
| | <input type="checkbox"/> Shipbuilding |

Name.....

Address.....



Know Electricity as Experts Know It—and Get an Expert's Pay!

What about your future? Who is safe today? Surely not the man who is contented to stand still! Know your job thoroughly—prepare yourself for jobs ahead. To do just this thousands of men have used

The Croft Library of Practical Electricity

The Croft Library is a complete electrical educator. It is founded on practice—on 20 years of shirt-sleeve experience—on work as it is actually done. It is jammed from cover to cover with the kind of hard-headed facts you want. Written so that the beginner can easily understand it, yet so sound, so thorough, that it is the daily guide of 59,000 highly paid electrical workers and engineers. Croft tells you the things you need to know about motors, generators, armatures, commutators, transformers, circuits, switchboards, distribution systems—electrical machinery of every type—wiring for light and power—wiring of finished buildings—underwriters and municipal requirements—illumination in its every phase—the most improved methods of lighting—lamps and lamp effects, etc.—how to do a complete job, from planning it, to completion.

No money down—easy payments

Fill in and mail the coupon attached and we will send you the entire set of seven volumes for ten days' examination on approval. We take all the risk—you assume no obligation. If you decide to keep the books, send \$3.00 in ten days and the balance at the rate of \$3.00 a month. Send the coupon NOW and see the books for yourself.

EXAMINATION COUPON

McGraw-Hill Book Co., 330 W. 42nd St., New York

Send me for ten days' examination on approval the Croft Library of Practical Electricity, 7 vols. If satisfactory I will send you \$3.00 in 10 days and \$3.00 monthly until the price of \$18.00 is paid. If not wanted, I will return the books postpaid. (To insure prompt shipment write plainly and fill in all lines.)

Name.....

Home Address.....

City and State.....

Position.....

Name of Company..... PM-4-43

Look to... Your Future Be an AIRCRAFT INSTRUMENT TECHNICIAN

As an Aircraft Instrument Technician you're needed NOW ... AND TOMORROW. No matter what you're doing today ... in a war plant ... in Army or Navy ... you can prepare for better service, rapid promotion and FOR YOUR FUTURE ... through home study with America's oldest and largest instrument school. Same textbooks as resident course. Write for details.



This illustrated folder tells of opportunities.

SEND FOR YOUR COPY NOW

American School of Aircraft Instruments
Dept. M4
3903 San Fernando Rd., Glendale, Calif.

ENGINEERING DEGREE IN 27 MONTHS

INDIANA TECHNICAL COLLEGE

Courses in Aeronautical, Chemical, Civil, Electrical, Mechanical, and Radio Engineering. One-year courses in Radio and Drafting. Approved by C.A.A. Prep courses without added cost. Low tuition. Large industrial center. Opportunity to earn part living expenses. Enter June, Sept., Dec., March. Catalog. 543 E. Washington Blvd., Ft. Wayne, Ind.

LEARN MECHANICAL DENTISTRY

DENTAL TECHNICIANS are urgently needed by the ARMY, NAVY and 3,000 laboratories. Permanent career; Easy terms. State licensed, OLDEST school. Write NOW for FREE Bulletin P. N. Y. School of Mechanical Dentistry, 125 W. 31st St., New York, N. Y.

Learn CARTOONING

FREE TRIAL LESSON! Cash in on your sense of humor—AT HOME—BY MAIL! Have fun! Make money! No experience needed to start. Write today for FREE LESSON, mailed postpaid. No obligation. Moon Gag-Cartoon School, Dept. M, Argyle, Wisconsin.



Learn PHOTOGRAPHY at Home

Splendid opportunities. Prepare in spare time. Easy plan. No previous experience needed, common school education sufficient. Send for free booklet "Opportunities in Photography", particulars and requirements.

American School of Photography
1315 Michigan Ave., Dept. 1354, Chicago, Ill.

LEGS—ARMS—BRACES

The best money can buy—our 133 employees wear 174 appliances. Write us your needs. Mpls. Artificial Limb Co. 405-6th Ave. S. Minneapolis, Minn.



3 in 1 RADIO TUNER Only \$1.00 Postpaid



1. Aerial Eliminator
2. Antenna Tuner
3. Wave Trap

Eliminates hums, clicks, caused by static, rain, wind, etc. Replaces old, ineffective outside aeriels. Move your radio anywhere. The 3 in 1 improves the reception of weak stations, separates interfering stations, gives you greater volume and distance. Uses no power, lasts life of radio. Also works on battery radios. Takes minute to connect. 15 DAY FREE TRIAL. SEND NO MONEY. Simply pay Postman \$1.00 plus few cents postage or we will send postpaid for one dollar bill. Vogue Eliminator Co., 7759 S. Halsted, Dept. E-455, Chicago.

FIX Your TIRES

So-Lo SAVES RUBBER

Use "plastanoid" SO-LO to fix cuts, bruises, worn spots in tires. SO-LO also mends shoes, raincoats, boots—anything of rubber, leather, cloth.



MEND the HOLE for

SPREADS ON like butter. Dries tough overnight. Flexible. Non-skid. Waterproof. Won't come off—guaranteed. AT HARDWARE & 10c STORES



Learn **RADIO** COMMUNICATIONS—ELECTRONICS

Faster ... Easier ... With the Aid of

MOTION PICTURES *In Your Own Home*



DeFOREST'S TRAINING HELPS YOU TO GET AHEAD IN MILITARY SERVICE

Students and graduates are given a timely service that is aiding many to get into interesting, vital Radio Communications work in the armed forces—with opportunities for higher pay and better ranking. Thousands of our enrollees are now serving Uncle Sam, many of them enjoying important advantages because of their previous training.

CODE

An Important Feature

A demand exists for Radio Operators in both military and civilian life. DeForest's Training will prepare you for various Radio Operator's License examinations.

START A SERVICE AND REPAIR BUSINESS OF YOUR OWN

Trained men are needed to keep the millions of Radio sets in operation during the war years and afterwards.

DeFOREST'S TRAINING OFFERS YOU A VALUABLE FREE EFFECTIVE EMPLOYMENT SERVICE which has already started hundreds of students and graduates in the Radio and Electronics industry.

DeForest's Training offers you this unusual advantage to help you prepare quickly for today's many opportunities.

"One picture is worth ten thousand words"—states the old Chinese proverb—and probably few sayings are closer to the truth.

That is why DeForest's Training furnishes you with a 16 mm. motion picture projector together with a number of reels of film which are loaned to you for study purposes.

While war industries and the armed forces are now using movies more than ever to train men quickly and better, DeForest's Training has long been preparing men for Radio and Electronics with the aid of motion pictures.

It's so much easier . . . more interesting, too, when you can "learn by seeing", you owe it to yourself to get complete details about DeForest's Training valuable "film-way" aid to learning Radio and Electronics. Simply send the coupon below. There's no obligation.



Above: **DR. LEE DeFOREST**—who supervised the preparation of DeForest's Training—is one of the world's greatest scientists and inventors in Radio and Electronics.



DeFOREST'S TRAINING, INC.

occupies and owns this modern, well equipped building and laboratory in Chicago where residential training is also being given ambitious men and women. DeForest's Training is affiliated with the DeVry Corporation, internationally known manufacturers of high grade Sound Motion Picture and Electronic equipment. This affiliation is valuable from a practical industrial slant . . . helps keep training up to industry's needs and changes.

BUY U. S. WAR BONDS

PRACTICAL THREE-WAY METHOD Assures Better Training

You receive a time-tested proved combination of

- 1. Modern, loose-leaf lesson material.**
- 2. Visual training by means of motion pictures in your own home.**
- 3. The privilege of additional practical training on various types of commercial equipment in our Chicago Laboratory.**

WOMEN: Real opportunities also exist for you in Radio and Electronics. Write for descriptive literature on our specialized training for women.

**SEND TODAY FOR VALUABLE
NEW BOOKLET**

"Victory For You"
in **RADIO . . . Communications . . . Electronics.** This handsomely illustrated up-to-the-minute new book will bring you a timely picture of these many opportunities and show you how to make your start with the aid of valuable "Visual Training."



DeFOREST'S TRAINING, INC.

2531 North Ashland Avenue, Dept. **K** Chicago, Ill.

Please send me free illustrated book entitled "Victory for You" in Radio. No obligation, of course.

Name Age

Address

City State

Dept. K. Paste coupon on penny postcard or mail in envelope.

Do you want

- .. to go to College?
- .. or to enter a Profession?
- .. or get an Office Position?

(Such as Accounting, Architecture, Nursing, Dentistry, Teaching, Social Work, Osteopathy, Beauty Culture, Optometry, Embalming, Chiropraxy, Law, Medicine, etc.)

To get anywhere, you practically MUST finish High School FIRST. You can complete our simplified High School Course in SPARE time at home, as FAST as your time and abilities permit. Equivalent to resident school work—prepares you for college, pre-professional examinations, business, industry. Standard texts furnished. Diploma. Credit for H.S. subjects already completed. Single subjects if desired. Low tuition, easy terms. American School, Chicago, est. 1897—endorsed by educators. Finish your high school education NOW. Write TODAY!

High School Course at Home

Many Finish in 2 Years

American School, Dept. H445, Drexel Ave. at 58th St., Chicago, Ill.

Gentlemen: Send me FREE information covering special training in subjects checked below. No obligation on my part.

- | | |
|--|--|
| <input type="checkbox"/> High School Course | <input type="checkbox"/> Diesel Engineering |
| <input type="checkbox"/> Cost Accounting for Manufacturing | <input type="checkbox"/> Drafting and Design for men & women |
| <input type="checkbox"/> Architecture and Building | <input type="checkbox"/> Plastics |
| <input type="checkbox"/> Automotive Engineering | <input type="checkbox"/> Private Secretary |
| <input type="checkbox"/> Business Management | <input type="checkbox"/> Mechanical Engineering |
| <input type="checkbox"/> Electrical Engineering | <input type="checkbox"/> Aviation <input type="checkbox"/> Radio |
| <input type="checkbox"/> Elec. and Gas Refrigeration | <input type="checkbox"/> Salesmanship |
| <input type="checkbox"/> Air Conditioning | <input type="checkbox"/> Shipbuilding |

Name

Address

The last word on AIRCRAFT ELECTRICAL and IGNITION SYSTEMS

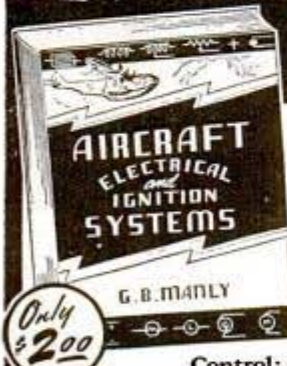

by G. B. MANLY
Asst. Chief Educational Dept.
Allison Engine Division

This latest up-to-the-minute book fully explains and illustrates operations and assemblies. Gives you all the information you need for big pay job at higher rating in the armed forces. Complete—easy to understand. Includes Elements of Electricity; Generation and

Control; Storage Batteries; Resistance Regulators; Trouble Shooting; Adjustment and Overhaul of Generators, Control Units, and Magnetos; Starting Systems; Ignition System Operation.

MONEY-BACK GUARANTEE

Order today. If not fully satisfied, return book in 5 days and we'll refund your money.

FRED'K J. DRAKE & CO.

Dept. P.M.-4, 600 W. Van Buren St., Chicago, Ill.
Drake's books sold at leading bookstores.

280 pages
131 illustr. and diagrams.

SEND NO MONEY

Send "Aircraft Electrical and Ignition Systems" at once, C.O.D. I will pay postman \$2.00 plus small carrying charges (if you send cash in advance we pay all postage). If not fully satisfied I will return book in 5 days and purchase price will be refunded.

Name

Address

City

State

ALL PURPOSE RATION SAFETY PURSE COUPON

POCKET SIZE 4 1/2 x 6 1/2



BIG SELLER

Protect all kinds ration book coupons and stamps with this pocket size Ration Stamps Purse. Long lasting. Genuine leather-ette. Four separate compartments for Gas Coupons, Point Ration Coupons, Tire Inspection Record, Driver's License, Insurance Cards, etc. Every car owner and ration coupon user a prospect. Ration records more precious than gold. Keep them safe. Urgently needed by all.



AGENTS: Big 35¢ seller. Send only 25¢ for your case and big profit opportunity.

EVER-HANDY PRODUCTS CO.
1706 Washington Ave., Dept. P, St. Louis, Mo.

AUCTION AUCTION AUCTION

2000 U. S. PATENT MODELS

If you would like to own an original U. S. Patent Model, make a bid for it NOW by mail. These Models are true and authentic originals which had to be furnished the Patent Office with every patent application made, up to 1890. 2,000 of these models will be auctioned April 26th to April 30th, 1943, at 115 East 40th Street, New York City. Send for catalog which gives patent number and complete description of each model . . . and YOUR BID SHEET.

O. Rundle Gilbert—Original Patent Models Company
Dept. P. M. 505 Fifth Avenue, N. Y.

CATALOGUE
25¢



Why It Pays To

LEARN PHOTOGRAPHY NOW

Never before so many job and career opportunities! Photographers needed in business, industry, science. N.Y.I. graduates winning promotion, higher pay in Armed Forces. Quality at America's largest, oldest school. Resident or home study. FREE catalog describes commercial, portrait, motion picture and color courses. Write today!



N. Y. INSTITUTE OF PHOTOGRAPHY, Dept. 48, 10 W. 33 St., New York, N. Y.

ARTIFICIAL ARMS—LEGS

WRITE FOR FREE BOOK showing how armless mechanics, office workers, farmers, carpenters, laborers hold regular jobs; how they feed, shave, dress themselves, pick up large and small objects, carry grips, etc. with the WORLD RENOWNED CARNES ARTIFICIAL ARM. Rehabilitation by CARNES LEGS too. BOOK SENT FREE—advise whether interested in leg or arm—no obligation, send for it now.

FREE BOOK



CARNES ARTIFICIAL LIMB CORP.

Dealers and Representatives Everywhere

908-D East 12th

Kansas City, Mo.

ARTISTS MAKE MONEY

Find out your ability. Send name, age, occupation and address for Free Vocational Art Test.

ART INSTRUCTION, INC. (Formerly Federal Schools)
4133 Art Instruction Building, Minneapolis, Minnesota

BRUSH PLATING OUTFITS

for autoparts, reflectors, faucets, bicycles. No tanks necessary. Free particulars.
GUNMETAL CO., AVE. M, DECATUR, ILLINOIS

Wonder-Tone NOISE ELIMINATOR

Just attach to your radio (long, short wave) and enjoy reception free from distracting noises. Send-No-Money Pay Postman 60¢ plus postage or send 60¢ and we'll send postpaid. Return in 5 days for refund if not delighted.



WONDER-TONE COMPANY, Dept. 27, 7078 N. Clark St., Chicago, Ill.

BUILD THESE PROJECTS

For garden or lawn. Easy to build. Easy to sell. Detailed Blueprints Model B-25 Dutch Windmill 50¢; Model OM-60 Old Mill, 55¢. Lawn Figure Patterns—Sunbonnet Girl, Dutch Boy, Teige Girl, Holland Pair, 35¢ each, all 4—\$1.00. Catalog illustrating many models, send 10¢, today.

CRAFTSMAN'S MODEL CO., Dept. P-69 2030 N. 41st St., Milwaukee, Wis.

FREE CATALOG Pins and Rings

Finest quality. Over 300 artistic designs. Write for our attractive free catalog and select a beautiful pin or ring for your class or club.

Dept. N, Metal Arts Co., Rochester, N. Y.

INVENTORS

NOW Is the Time to PATENT and SELL Your Invention

Get
**FREE
COPY**

Now, more than ever before, is the right time to patent your invention. Why? Because manufacturers everywhere presently engaged in war production are looking ahead to the future by buying up patent rights now, so they will have new and attractive items to make and sell for civilian consumption as soon as the war is over. This is what happened during and after the last war. Hence, the smart thing for you to do is to look ahead to the future too. Protect your invention by applying for a patent now, so you will be in position to cash in on an outright sale, or on the royalties your invention will bring.

Patent Guide Shows What To Do

Our "Patent Guide for the Inventor" answers many important questions concerning Patents that inventors constantly ask. It tells what facts, details, drawings, sketches, etc. are necessary to apply for a Patent; how to protect your invention through dated and witnessed disclosure; how to do this AT ONCE to safeguard your rights; how Patent Office Records can be checked to determine whether the invention is probably patentable before filing fees need be paid; discusses costs involved and a practical way these can be paid as the application progresses. It tells how some inventors secured financial backing; how many simple inventions have proved large commercial successes; how Patents covering improvements also can be profitably utilized and marketed; tells countless other facts of interest.

Why You Need Expert Assistance

The Patent Laws were enacted for your benefit—to give you protection for the features of your invention which are Patentable. But these features must be legally and concisely set forth in the form of "claims." This phase of the procedure is so complex that the Patent Office advises the Inventor to engage a competent Registered Patent Attorney. We maintain a large staff—carefully trained registered patent attorneys—expert draftsmen—experienced searchers—to serve you. We have been serving inventors for more than 20 years.

Take First Step Now

With the Patent Guide you will receive also Free a "Record of Invention" form which will enable you at once to establish the date of your invention, before you file your Patent application. This step costs you nothing yet may be vital to your success. Remember—in Patent Matters, ACTION is IMPORTANT. Delay can be costly. Mail the coupon in an envelope, or paste it on a penny postcard NOW.

CLARENCE A. O'BRIEN
and
HARVEY B. JACOBSON
"Worthy of Your Trust"
Registered Patent Attorneys
31-D Adams Building
Washington, D. C.



**48
PAGES**
Over 100
Illustrations



CLARENCE A. O'BRIEN
and **HARVEY B. JACOBSON**

CLARENCE A. O'BRIEN AND HARVEY B. JACOBSON
Registered Patent Attorneys before the United States Patent Office
31-D Adams Building, Washington, D. C.

Please send me your 48-Page "Patent Guide for the Inventor" and your specially prepared "Record of Invention" form FREE. This request does not obligate me.

Name

Address

City..... State.....

(Please write or print plainly.)

Get This
FREE BOOK
IMMEDIATELY MAIL COUPON TODAY!

WE ASKED 817 MEN TO NAME THE BEST RADIO TRAINING THEY KNOW!



Let Radio's foremost instructor guide you!

Unusual Survey Reveals What RADIO MEN Think of RADIO COURSES

Here's your chance to get started right in your study of Radio—without guesswork, and without investing a lot of money!

Recently we asked a mixed group of 817 Radio instructors, students, servicemen, Radio men in the U. S. Armed Forces, in manufacturing plants, etc. to tell us just what they think of the books and courses offered for Radio beginners. ONE OUT OF EVERY 218 to be exact—wrote that Gibraltar's RADIO PHYSICS COURSE is their FIRST CHOICE as the easiest-to-learn, most thorough and inexpensive Radio book!

Radio Physics Course Tops All Others

No wonder then that RADIO PHYSICS COURSE has given more people their basic radio training than any other! It takes no previous knowledge for granted. Step by step—at home, in spare time—it gives you the scope of 36 courses—combined in one big 972 page book, with 508 illustrations, and 856 self-testing review questions—for only \$5 complete!



The only book of its kind—972 big pages

Used and recommended in U.S. Signal Corps Pre-Induction Training Courses everywhere!

36 Courses in One for only \$5 Complete

Compare with any other at any price! You be the judge. Our 5-Day Money-Back Guarantee protects you fully.

5-DAY FREE TRIAL

Radio & Technical Publ. Co., Dept. PM-34, 45 Astor Place, New York, N. Y.

Rush me your RADIO PHYSICS COURSE BOOK. \$5 enclosed. Send C.O.D. for \$5 plus postage. In either case, if I am not fully satisfied, I may return the book within 5 days of receipt and get my money back.

NAME.....
ADDRESS.....
CITY.....STATE.....

TRAILER BUILDERS' PARTS CATALOG

We'll save you money on everything. Largest and most complete trailer builders' supply house in the United States. Member TRAILER COACH MFRS.' ASSOC. Send 10c for parts catalog. NATIONAL TRAILER EQUIPMENT CO., 719 N. Seventh St. Milwaukee, Wis.

INTRODUCING-New Victory Model HANDIWELD ELECTRIC ARC WELDER

RETAILS ONLY \$1.95 FULLY GUARANTEED



PLUGS INTO LIGHT SOCKET

Victory Model Handiweld Arc Welder operates from 110 volts, A.C. or D.C. current same as other arc welders higher priced; generates tremendous heat to weld all metals. Not a toy welder that uses carbons, but actually uses standard coated rods—sizes 1/16" and 3/32". However, due to Priorities a generous supply of 1/16" rods only are supplied with the welder. Guaranteed not to burn out. Repairs fenders, auto bodies, radiators, machinery parts, etc. Take Victory Model Handiweld anywhere to job, operate right from light socket. You'll find a thousand uses for this welder around your home, garage, workshop. Also in garages, factories, repair shops, tin shops; mechanics, inventors, blumbers, farmers, etc.

Order a "Victory Model" Handiweld now. SEND NO MONEY We'll rush one to you with rods, goggles, operating instructions, and all necessary parts with the exception of a large jar and a small piece of extension cord; these most every one has. Pay postman only \$1.95 plus a few cents postage. If not delighted return Victory Model Handiweld in 5 days from receipt and money paid for it will be refunded promptly. Rush your order now. KUMFY PRODUCTS INC., Dept. M-202, Cincinnati, Ohio.

"HERE'S HOW TO BECOME AN AIRCRAFT INSTRUMENT TECHNICIAN—RIGHT NOW!"

TAKE OUR NEW, SHORT WARTIME COURSE IN

AIRCRAFT INSTRUMENTS

Qualify for well paying positions with manufacturers and Airlines or Technician's Rating in U. S. Air Corps!

If you can't come to the school, write for information about our popular Home Study Course! Practical, complete training on actual instruments. Send for CATALOG today...

EASTERN AIRCRAFT INSTRUMENT SCHOOL

"Largest in the East"

DEPT. M-1 116 NEWARK AVENUE JERSEY CITY, N. J.

521 ITEMS TO HELP YOU MAKE MONEY!

With WORK UNIFORMS

You be our local dealer. Millions of war workers and EVERY type of business need Work Uniforms, Coveralls, Jackets, Pants, Shirts. Advertising embroidered. No experience necessary. We supply everything. Write for big money-making Outfit FREE.

GEO. MASTER GARMENT CO. Dept. D-74, Ligonier, Ind.

COLCHICINE!

Do you know about the chemical which creates all kinds of freak new mutant plants? Send 25c for Folder and copy 24 page Illustrated Booklet plus copy of Experiments Magazine, QUEST, WELLESLEY, MASS.

OTTAWA LOG SAW

Write for FREE BOOK

PUT THIS OTTAWA to work for you. MAKE MONEY! Wood is valuable. Does more than 10 men. Easily operated. Falls trees—and saws limbs. Use 5-hp. engine for other work.

SAW 10 to 20 CORDS A DAY

OTTAWA MFG. CO. 427 Wood St. Ottawa, Kans.

TOMBSTONES

\$10.95 UP FREIGHT PAID

High Quality Granite and Marble. Lettered. Guaranteed. Write for Free Catalog and samples of stone. Without Delay. Order By Mail. U. S. MARBLE & GRANITE CO., A-18, ONECO, FLA.

don't WORRY

Why put up with years of needless discomfort and worry? Try a Brooks Automatic Air Cushion. This marvelous appliance permits the opening to close, yet holds reducible rupture securely, comfortably—day and night. Thousands report amazing results. Light, neat-fitting. No hard pads or stiff springs to chafe or gouge. Made for men, women and children. Durable, cheap, Sent on trial to prove it. Never sold in stores. Beware of imitations. Write for Free Book on Rupture, no-risk trial order plan, and proof of results. All correspondence confidential. BROOKS COMPANY, 158-B State St., Marshall, Mich.



WATCH * * * * MIDWEST

AFTER THE WAR IS WON * * *
FOR SENSATIONAL ADVANCEMENTS
AND FEATURES SUCH AS - - -

SUPER BAND - SPREAD TUNING*



***A
MIDWEST
SENSATION IN
1942—BUT WAIT
TILL YOU SEE THE
MIDWEST OF
TOMORROW**

OUR ENTIRE PRODUCTION FACILITIES
ARE NOW DEVOTED TO MANUFACTURING
RADIO EQUIPMENT FOR OUR ARMED FORCES
BUT...WHEN VICTORY IS WON

**YOU'LL BE BUYING YOUR MIDWEST RADIO
DIRECT FROM THE FACTORY**



SAVING UP TO **50%**
WILL BE JUST AS POPULAR AS EVER

Yes, Sir. Thousands upon thousands of people all over the U. S. were buying super powerful Midwest Radios direct from our factory until "Pearl Harbor" and if the many letters we are still receiving every day is an indication, the direct-to-user-plan will be more popular than ever after the War is won.

**FREE
FOR A
LIMITED
TIME ONLY**



THIS comprehensive 20-page booklet on our Armed Forces absolutely free if you send 10¢ for a U. S. War Savings Stamp. Just send 10¢ in coin or postage stamps and your booklet and War Savings Stamp will be sent promptly.

MIDWEST RADIO CORPORATION
DEPT. 15-B CINCINNATI, OHIO

Here I am at Work
Making Good Money



as an
**AIRCRAFT
DRAFTSMAN**

This complete drawing outfit,—everything to work with,—including drafting table, drawing board, supplies, etc.—ALL SENT TO YOU AT NO EXTRA COST if you are a Chicago Tech Student.

MAIL COUPON
BELOW

AIRCRAFT DRAFTING,—a new field of opportunity,—calls for men to make detail drawings for all types of planes,—training and scouting planes, patrol bombers, fighters, gliders, torpedo carriers, dive bombers, and air transport planes. All of these must first be laid out on paper by draftsmen before work can proceed. Read the Help Wanted Ads for proof of the urgent demand for draftsmen.

**A War-Time Job,—a
Peace-Time Future**

Think of what Aviation will be after the War is over. Decide to "get aboard" now,—and help this great industry to win the War. Then you'll be in on the ground floor when peace comes.

Learn Drafting at Home
(or at the College in Chicago)

A few hours of pleasant home study every week,—that's all. No interference with your present job! Choose the line you like best (see coupon below). Make your start now towards a career in this great branch of Aviation. To prove to you how easy it is to learn Drafting,—any branch,—at home by the Chicago Tech method, we'll send you a Trial Lesson FREE. No charge for this Lesson either now or later. Send a post card or the coupon.



free
TRIAL LESSON
Send Coupon

CHICAGO TECHNICAL COLLEGE

D-204 Tech. Bldg., 2000 S. Michigan Ave., Chicago, Ill.

Yes,—please send me **FREE** Trial Lesson in **DRAFTING**.

- | | |
|---|--|
| <input type="checkbox"/> Aircraft Drafting | <input type="checkbox"/> Machine Drafting |
| <input type="checkbox"/> Electrical Drafting | <input type="checkbox"/> Structural Drafting |
| <input type="checkbox"/> Architectural Drafting | <input type="checkbox"/> Building Construction |

Name.....

Address.....

City..... State.....

Age..... Occupation.....



WELDERS WANTED!

**Men and Women
ELECTRIC ARC—
OXY-ACETYLENE**

Skilled Welders earn up to \$15 a day. The demand now greater than the supply. Learn this highly paid trade in 3 weeks by actual shop work. One of America's leading schools. Established 1902. 7 floors of shops. Endorsed by welding industry. Limited number of students. 3 weeks course in Electric Arc or Acetylene Welding, including room and board, only \$205. Course covers minimum requirements of U. S. Office of Education for War Production Workers, and the American Welding Society Code. Write or wire for reservation. Ask for "Welding Facts." State age.

GREER COLLEGE

DEPT. 143, 2024 SOUTH WABASH AVE., CHICAGO

Correspondence Courses in **RADIO and ELECTRICAL ENGINEERING** **LOW AS \$25**

ELECTRICAL ENGINEERING. Get good grasp of wide electrical field. Modern. Very understandable. Theory made easy.
RADIO ENGINEERING. Extra fine course in radio, public address, photo-electric work. Trains you to be super-service man, real vacuum tube technician. Tuition ONLY \$25, other course. Deferred payment plan. Experiment kits furnished. ONLY \$25. Write for free copies of school catalog, student magazines, etc.
FREE LINCOLN ENGINEERING SCHOOL, Box 331-P-52, Lincoln, Nebr.

LAW STUDY AT HOME for PERSONAL SUCCESS and LARGER EARNINGS. 31 years expert instruction—over 105,000 students enrolled. L.L.B. Degree awarded. All texts furnished. Easy payments. Send for FREE BOOK—"Law and Executive Guidance."
AMERICAN EXTENSION SCHOOL OF LAW
Dept. 28-M, 8 East Huron St., Chicago, Ill.

ATTENTION! RABBIT & GUINEA PIG RAISERS
Save Money—Build your hutches scientifically for as little as \$1.25 each. New design eliminates handling of animals, provides excellent ventilation, and can be added to as stock increases. New simplified method of cleaning. Send 50c in cash or Defense Stamps for complete drawings and instructions for building these unusual hutches. Write P. O. Box 426, BURLINGTON, WISCONSIN.

SHEET METAL INFORMATION ON LAYOUTS
NOW READY!



A practical, illustrated Encyclopedia covering all phases of Sheet Metal Work including Pattern Cutting, Pattern Development, and Shop Procedure—Developed by experts for Sheet Metal Workers, Layout Men, Mechanics, and Students.
1001 KEY FACTS AT YOUR FINGER ENDS
10 Big Sections, 350 Layouts, 1600 Illust. FULLY INDEXED FOR READY REFERENCE in answering your layout problems. Easy to read and understand. Well printed in clear type. Flexible covers.

\$4 COMPLETE • PAY ONLY \$1 A MO.
To get this assistance for yourself simply fill in and mail order today.

AUDEL Publishers, 49 West 23rd St., New York
Mail AUDEL'S SHEET METAL PATTERN LAYOUTS BOOK. Price \$4 on 7 Days Free Trial. If O. K. I will remit \$1 in 7 days and \$1 monthly until \$4 is paid. Otherwise I will return it.

NAME.....
ADDRESS.....
OCCUPATION.....
REFERENCE..... **PM**

INVENTORS

OF TODAY ARE PLANNING NOW FOR TOMORROW!



We've Helped Men Like You For Nearly Half a Century!

While you can secure a patent by yourself, please remember that the Supreme Court has stated that the assistance of a competent Patent Attorney is worth far more than the moderate fee paid for such assistance. Professional inventors invariably secure their patents in this manner. **WRITE US TODAY.** Our experience and training may mean the difference between your success and failure.

WHEN Peace comes at the end of this first completely mechanized war, most manufacturers will have to start **RIGHT FROM SCRATCH!** Amazingly efficient new tools, new methods, designs and war-inspired substitute materials will have a golden opportunity for immediate acceptance. No longer will the capable inventor with a good strong patent be balked by "I have too heavy an investment in my present set-up to spend the time and money to re-tool according to your plans." Manufacturers will be receptive as never before to devices that will *save them time, save them money and save them labor.* When Peace comes, are you going to be able to go to one of these manufacturers with your patent in your hand . . . and set it to work for you? You can! Other alert inventors are taking advantage of this "period of waiting" to have their patent applications prepared and prosecuted **TODAY** so they'll be ready **TOMORROW!**

SEND NO MONEY FOR THESE VALUABLE BOOKS!

We'll send them to you **ABSOLUTELY FREE** . . . with no obligation. 64 pages of facts which tell you in easy-to-understand language just what you must do to secure a strong patent. Illustrate 115 mechanical movements. With books we also send the multi-vital "Evidence of Invention" form, which helps establish date of disclosure. **SEND COUPON FOR BOOKS NOW!**



64 pages of facts for INVENTORS

... and the important Evidence of Invention Form!

COUPON BRINGS YOU THESE 2 BOOKS FREE!

VICTOR J.
EVANS & Co.

Merlin M. Evans

REGISTERED PATENT ATTORNEYS

**MAIN OFFICE: 730-D MERLIN BUILDING
WASHINGTON, D. C.**

Pittsburgh Office: 521-N Empire Building
Los Angeles Office: 738-N Security Building

Rush by return mail. Free copies of your books, "Patent Protection" and "When and How to Sell an Invention"—also important—"Evidence of Invention" form.

Name.....

Address.....

City and State.....

**HELP YOURSELF GET
THE JOB YOU WANT
IN THE ARMY!**

**PASS HIGH
ON THE
INDUCTION
"I.Q." TEST**



Everyone entering the Service must take a General Classification "Intelligence" Test. A high mark on this test helps you toward the **JOB YOU WANT** and **OFFICER TRAINING**.

"PRACTICE FOR THE ARMY TESTS"

is a book containing complete and simplified material along the lines of the questions given on the test . . . tells how to answer them quickly, easily—costs only \$1.50. Get a thorough preparation **RIGHT AWAY** if you're about to enter the Service.

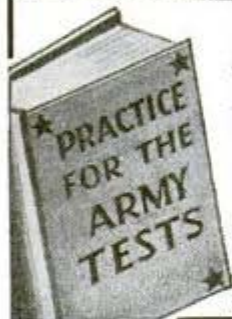

Free Trial Coupon

ARCO PUBLISHING CO.
480 Lexington Ave.
Dept. 1204, New York, N. Y.

Please rush copy of "Practice for the Army Tests" to me. If I am not satisfied after 5 days, I will return book for a full refund.

- I will pay postman \$1.50 plus postage, on arrival.
- I enclose \$1.50 (Postage is free)

NAME

ADDRESS

CITY..... STATE.....

LEARN AT HOME TO MOUNT BIRDS



Animals, Heads, Fishes, Pets; to TAN. Be a Taxidermist. Profit and FUN.

Hunters, save your valuable **TROPHIES**. Mount ducks, squirrels, everything. Learn to TAN for leather and furs. Wonderful **HOBBY** Have a **HOME MUSEUM**.—**BIG PROFITS** mounting for others. **INVESTIGATE NOW**.

FREE BOOK With 100 fine game pictures. **NOW** absolutely **FREE**. Write **TODAY**.

Send Postal **TODAY** for **FREE BOOK**. State **AGE**. **N.W. SCHOOL OF TAXIDERMY**, Dept. 3374, Omaha, Neb.



NOT ALL DO IT but I EARNED
350 IN A SINGLE WEEK GROSS
IN MY OWN BUSINESS

With New Electric Furniture Cleaner reports George Held. Make big money out of clubs, country estates, hotels, homes, every place which uses furniture, with new electric detergent which washes upholstered furniture right in your customer's home.

NO SHOP—NO STORE—NO RENT

You save this expense for you do the work right in your customer's home. Dozens of men have reported very large earnings. In reading these remember that they were in their busiest seasons and do not reflect continuous operations. These figures are not net, for you deduct the cost of materials which, however, is very small. Barrett says took in \$28 in 8 hours. J. S. Corbit \$279.50 his first month. J. N. Ankrum wrote he got two jobs the first day—one for \$11.50, the other for \$38.50. George Held reports \$350 in a single week. There are plenty of openings for more ambitious men. You make only a reasonable down payment, the balance on easy terms.

BOOK, Write today for this business building book, which points out a brand new opportunity and tells you how easy it is to get started in a business where you are your own boss and can stop worrying about just a job. Write today—**NOW**.



VON SCHRADER MFG. CO.
554 Pl. Racine, Wisconsin

Learn NAVIGATION

Easy, No Math, Home Study Courses. Pay as You Learn. Navy Publication Text Books. Navigators Urgently Needed.

PREPARE FOR GREAT POST-WAR FUTURE

Start Now—Write Today

COAST SCHOOL OF NAVIGATION

305 Bond Street, Asbury Park, N. J.

Burn Your Name On Tools **Electro Name Etcher** *Only*

PROTECT valuable tools from thieves and tool borrowers! **Electro Etcher** BURNS your name, any design, permanently on tools, instruments, dog collars, any metal. Easy! Simple as writing with pen or pencil. Rush order today—supply limited—no more when these are gone! **SEND NO MONEY!** Pay postman \$1.00 plus few cents postage on delivery. Use 5 days—money back if not delighted. **Electro Etcher**, Dept. L-600, Strader Ave., Cincinnati, O.

LEARN MONEY-MAKING CARTOONING

Same Simplified Method that has helped train creators of "Terry & Friends," "Wash, Tubbs," "Our 'Wif'," "Winnie Winkle," "Beglar Fellers," "Strange As It Seems," "Secret Agent X-9," and many others. Earn while learning. Rush 10c for Picture Chart (to test your ability), and full details. (State age.)

THE LONDON SCHOOL, 434 National Bldg., Cleveland, Ohio

LEARN A BIG PAY TRADE MAIL COUPON!

in 2 to 8 WEEKS!

We Pay Room and Board

To meet the great demand for men and women at high wages, we have inaugurated intensive training courses in the trades listed here. Learn in 2 to 8 weeks by actual shop work. One of America's leading schools. Established 1902. 7 floors of shops. Over 40,000 graduates. Many employers send their men and women here for intensive training. Free employment service. Mail coupon for "Shop Training Facts."

GREER SHOP TRAINING
Dept. 243, 2024 S. Wabash Ave., Chicago, Ill.

Send "Shop Training Facts" describing trade checked below:

- Auto-Diesel
- Welding
- Refrigeration and Air Conditioning
- Body-Fender
- Machine Shop
- Tool and Die
- Aviation

Name

Address

..... Age.....

A golden future awaits those who know *Plastics*

PREPARE TODAY FOR THE
FUTURE THAT LIES AHEAD

Get into
PLASTICS
now

THOUSANDS OF MEN, TRAINED IN
PLASTICS, ARE NEEDED *at once*
ON INDUSTRIAL FRONTS...



On all sides men are being "called" who know plastics, to fill important defense industry positions as designers, fabricators, molders, superintendents of plants. Now, more than ever, men are wanted in this new, interesting, essential industry that is a vital part of the war-program. If you want to take your place in this magic industry, which is growing by leaps and bounds, you should *make up your mind*... and start training, at home now.

Today's Developments Are Tomorrow's Realities

We have entered the Plastics Era... our major industries now consider plastics as one of the greatest developments of the decade... new ways of using plastics are uncovered each day, and in all parts of the country new opportunities for men have opened almost overnight. PLASTICS IS *almost a miraculous Industry*. Its future is so rich that some predictions seem exaggerated and fantastic... but the fact remains that plastics have proven themselves and are taking a vital place in the production of airplanes, radios, furniture, ships, electrical equipment and scores of other important products.

In the future entire houses... walls, doors, windows, stairs, hardware and furniture... can be made entirely from plastics. The first car you buy after the war may have a complete plastic body, besides scores of separate parts made from plastic materials. YOUR OWN JUDGMENT should tell you of the tremendous magnitude of plastics right now, and the even greater post-war opportunities—and that you should get into plastics now and plan a prosperous life-time career in a great new industry.

LEARN AT HOME

Make your increased time at home pay you dividends. Your training for a career in plastics can all be fitted into your spare time. You won't need to lose one minute from your present work—

simply devote a few hours each week to enjoyable home study, like thousands of other men and women who are helping their country while preparing for the future. The Plastics Institute course is an easy, practical tested method which will fit you for this promising and interesting career... if you are now working with plastics, it equips you for advancement. During the entire course your training is supervised by men well known in the plastics industry, in which they have been recognized as authorities for years.

Time Is Priceless—ACT NOW!

Find out how the Plastics Institute can help YOU. Mail the coupon for your copy of the large FREE booklet the "World of Plastics." It is crammed with valuable information about plastics, tells about the new plastic airplanes and other uses for this revolutionary new material... as well as about the opportunities for YOU in plastics. Decide NOW to let plastics point the way to YOUR success... send the coupon TODAY.

Plastics Training Can Help You In Many Industries...

There is hardly an industry that is not using more and more plastics every day... and when the war is won thousands of new products will be made from plastics. Here are just a few of our major businesses now using plastics—

Aircraft Automotive Railroad Home Building
Electrical Radio Shipbuilding Textile

Read What Students Say

"My enrollment... has already netted me unexpected results after only 2 months of study. I have been transferred... to the Research Department at Douglas... and incidentally, at an increased rate of pay."—R.P.C.

"The course is so thorough and efficient that I was able to step right into my position and carry on without difficulty."—E.I.V.

"Please accept my sincerest thanks... in providing a thorough and practical approach to the field of Plastics."—B.W.C.

INTERESTING
BOOK
"WORLD OF PLASTICS"
SENT FREE



Plastics INSTITUTE
626-E LaSalle-Wacker Bldg., Chicago, Illinois

AMERICA'S
ORIGINAL
PLASTICS
SCHOOLS

GET FULL DETAILS NOW

MAIL COUPON FOR FREE BOOK

Plastics Institute • 626-E LaSalle-Wacker Bldg., Chicago
GENTLEMEN: Please send me the booklet "World of Plastics" and information on your training program. I understand there is absolutely no obligation.

Name _____ Age _____

Street _____

City _____ State _____

SHIPBUILDING

Basic Training at Home in Spare Time



America needs ships, more ships, and men trained to build them. Thousands of good pay opportunities, in many trades are opening now in this vast, fast-growing industry. World events point to continued demand for trained shipbuilding workers.

New Training Courses Now Ready

Shipbuilding workers, and men who want to enter shipbuilding—grasp this opportunity. Help your country and fill a top-pay job. In spare time at home, even without previous experience, you can get your basic training in ship blueprint reading, general ship construction and related trade instruction. Fit yourself to start, or to win promotion and bigger income. Turn your free hours into money. Act now.

American School, Dept. S445, Drexel Ave. at 56th St., Chicago, Ill. Send me FREE information covering special training in subjects checked below. No obligation on my part.

- | | |
|--|--|
| <input type="checkbox"/> Ship Blueprint Reading | <input type="checkbox"/> Cost Accounting |
| <input type="checkbox"/> Shipfitting | <input type="checkbox"/> for Manufacturing |
| <input type="checkbox"/> Electrical Engineering | <input type="checkbox"/> Architecture & Building |
| <input type="checkbox"/> Drafting and Design for Men and Women | <input type="checkbox"/> Plastics |
| <input type="checkbox"/> Diesel Engineering | <input type="checkbox"/> Business Management |
| <input type="checkbox"/> Mechanical Engineering | <input type="checkbox"/> Aviation <input type="checkbox"/> Radio |
| | <input type="checkbox"/> High School Course |

Name.....

Address.....

SUPER JU JITSU

NOW—
YOU CAN Destroy Your Enemy Quick!

WHEN THIS HAPPENS TO YOU...



BE A ONE-MAN BLITZ! Strike with Command lightning! You don't need ox-like muscles to use Super Ju Jitsu, most powerful of all defense and attack methods. **Technique** is the deadly secret. Brains count—not size, not strength. Almost miraculously efficient.

Gain Self-Confidence
KNOW how YOU can lick brutes twice your size with your bare hands only, even when they are ARMED with gun, knife, club. Get ready now for any emergency—protect your loved ones. Amazing self-study course teaches you double-quick. No boring exercises needed.

Send for Exciting Details—Free!
Startling Low Price. Satisfaction Guaranteed or your money back. Mail coupon now.

FREE

NELSON CO., 500 Sherman Street
DEPT. D-502, CHICAGO, ILL.

Please rush me free the hard-hitting details about "Super Ju Jitsu." No obligation on my part.

NAME.....

ADDRESS.....

DO THIS



OR DO THIS



GET INTO AVIATION LINCOLN



Don't wait for the Government to FORCE you into essential war work. Start training NOW at this LINCOLN GOVERNMENT APPROVED SCHOOL for high-pay essential employment as Aeronautical Engineer, Government Licensed Airplane & Engine Mechanic, Airplane Assembly Mechanic, Airplane Draftsman. No previous experience necessary. We train you and assist Graduates in locating immediate essential employment with Airlines, Aircraft Factories and at Airports. Earnings range from \$140 to as high as \$300 a month to start with excellent opportunity for rapid advancement. WRITE TODAY for complete information stating which of the above courses interests you most.

LINCOLN AERONAUTICAL INSTITUTE
674 Aircraft Building, Lincoln, Nebraska

2100 NEEDED INVENTIONS

THE secret of successful inventing is in knowing what to invent! That's why this remarkable new book by Raymond Yates, noted science editor and inventor, should be yours. It not only proves you don't have to be a genius to be an inventor. It shows how some of the simplest ideas like the paper clip and clamp fruit jar top made huge fortunes. Mr. Yates gets you started by describing 2100 needed inventions—practical money-making suggestions that are crying to be invented—each group neatly classified, such as Radio, Electrical, Aviation, Chemical. Also describes 10 most needed inventions—39 inventions U. S. needs most to win war. Order 2100 NEEDED INVENTIONS now and KNOW what manufacturers want before you waste time on impractical inventions! Special chapters included on Uncle Sam's call for wartime inventors. Also shows how to develop and protect ideas! SEND NO MONEY. On delivery pay postman \$2.00, plus C.O.D. postage. Money back if not satisfied. Order today from WILFRED FUNK, Inc., Dept. 14, 354 Fourth Ave., New York, N.Y.

New York Established 1902

Electrical School

Ask for free illustrated booklet

44 West 17th St., N. Y. C.

ITALIAN ACCORDIONS

Hand Made. Very best. Lowest prices. Buy Direct from Factory and Save Money. Send name and address for FREE catalog.

ITALIA & P. SOPRANI ACC. MFG. CO.
323 W. POLK ST., DEPT. PM-4, CHICAGO, ILL.

Inventions Wanted Patented or Unpatented

Write us if you have a sound, practical invention for sale, patented or unpatented. It can now be safely sold without patenting expense.

Chartered Institute of American Inventors
Dept. 4, 631 Pa. Ave., N. W. Washington, D. C.

SEE MILES AWAY! 5-POWER TELESCOPE



Perfect for spotting planes, ships; watching sporting events, people, birds, etc. Genuine black, lifetime plastic tubes with scientific ground 33 mm. lens and metal eye piece! Enlarges everything 5 times size! Brings objects 5 times closer; simple, easy to use.

20 DAY FREE TRIAL OFFER

Try for 20 days at our risk! Return for refund if not completely satisfied. SEND NO MONEY. Just pay postman \$2.19 plus few cents postage. Don't wait—production of telescopes may be curtailed as it has been on binoculars. **VOGUE TELESCOPE CO., 7759 S. HALSTED, DEPT. R-116, CHICAGO.**

**AUDELS NEW
MACHINISTS
HANDYBOOK
NOW READY!**

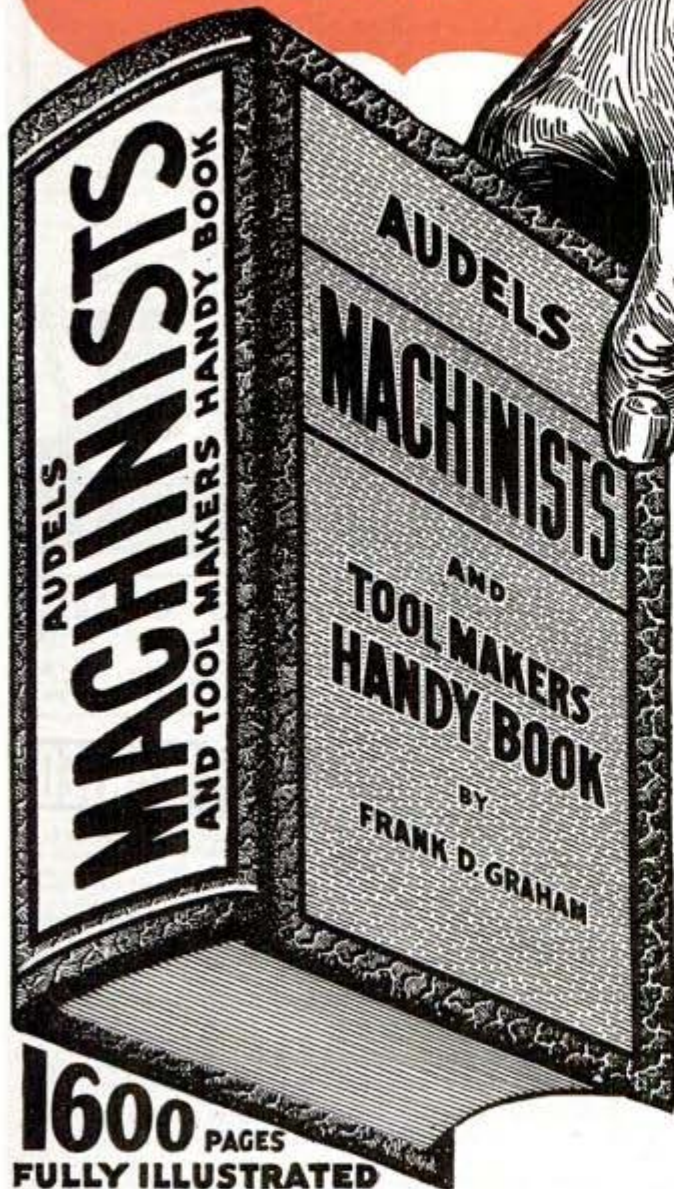

Prepare!

**A KEY TO
MODERN SHOP PRACTICE**

PRACTICAL INSIDE INFORMATION

For Every Machinist, Toolmaker, Engineer, Machine Operator, Mechanical Draughtsman, Metal Worker, Mechanic or Student. This 1600 Page Handy Book Covers Modern Machine Shop Practice in All Its Branches.

**A COMPLETE INSTRUCTOR WITH
READY REFERENCE INDEX**

New from Cover to Cover. Tells How to Operate and Set Up Lathes, Screw & Milling Machines, Shapers, Drill Presses & All Other Machine Tools.

**5 PRACTICAL BOOKS IN ONE!
60 FULLY ILLUSTRATED CHAPTERS**

Covering: **1**—Modern Machine Shop Practice. **2**—Blue Print Reading and How to Draw. **3**—Calculations & Mathematics for Machinists. **4**—Shop Physics. **5**—How to Use the Slide Rule.

ASK TO SEE IT!

THEO. AUDEL & CO., 49 West 23rd St., New York
Mail AUDELS MACHINISTS & TOOLMAKERS HANDY BOOK, Price \$4 on 7 Days Free Trial. If O. K. I will remit \$1 in 7 days and \$1 Monthly until \$4 is Paid. Otherwise I will return it.

Name _____
Address _____
Occupation _____
Reference _____ P.M.

1600 PAGES
FULLY ILLUSTRATED

A SHOP COMPANION THAT ANSWERS YOUR QUESTIONS
Easy to read and understand—flexible covers—Handy size 5 x 6½ x 2—a ready reference that answers your questions accurately.

TO GET THIS ASSISTANCE FOR YOURSELF SIMPLY FILL IN AND MAIL COUPON TODAY **\$4 COMPLETE PAY \$1 A MONTH ONLY!**

THEO. AUDEL & CO., 49 W. 23rd St., New York

INVENTORS



HOW TO PROTECT, FINANCE And SELL YOUR INVENTION

Our FREE BOOK and other literature available to our clients—gives you complete details on how to "ready" your invention for money-making. It tells you how others did it—who they went to for finances—how they arranged partnerships—how they made contacts with manufacturers—how they dictated royalty arrangements—how much money they made—how you can find a market. Our new FREE BOOK discloses sources of quick revenue if your invention is patentable and saleable with profit possibilities.

THE FIRST STEP

The first step in getting your invention ready for market is to make a dated record of it on our "Invention Record" Form. This Form properly filled out and witnessed will be invaluable to you later in establishing the date of your invention should need for such evidence arise. We will be glad to send you our "Invention Record" and have it witnessed in this office when you return it with disclosure of your device. This service costs you nothing—and it immediately puts you on record as the originator of your device.

Protect Your Invention NOW!

We have many letters in our files from manufacturers requesting inventions. Today's demand for new devices is tremendous—added to by emergency needs. Protect your invention now with a U. S. Patent. By acting promptly you may prevent another inventor getting in ahead of you at the Patent Office here in Washington. The first step is to make a sketch and description of your invention on our "Invention Record," have it witnessed and mail it to us. We will then make a Search of the U. S. Patent Office files to ascertain whether we can get patent protection for you. This is a step you should make NOW—before another steps in ahead of you and walks away with a patent.

MAIL

COUPON
TODAY!

McMORROW & BERMAN
REGISTERED PATENT ATTORNEYS BEFORE U.S. PATENT OFFICE
135-D Albee Building
Washington, D. C.

Send me your NEW FREE Book "How To Protect, Finance and Sell Your Invention" and specially prepared "Invention Record" form at once. I understand that this request does not obligate me.

NAME

ADDRESS

CITY..... STATE.....
Write or Print Name Clearly

POULTRY PAYS

IN
PATRIOTISM
PROFITS
PLEASURE

Learn at home, the EASY, SCIENTIFIC, and INEXPENSIVE way. Our course covers ALL phases of Poultry raising, including plans for buildings, breeding, hatching, culling, sexing, caponizing, marketing, judging, exhibiting, and many others, etc., as planned by Harry M. Lamon, former Senior Poultryman for the United States Department of Agriculture.

In the past twenty years, we have helped thousands of students to establish poultry farms, to increase profits on established plants, to secure positions in the many branches of the Poultry business, and many just to enjoy a small, profitable, breeding plant.

The Government needs your help for its huge requirements for Poultry and eggs. Sec'y. Wickard wanted 200,000,000 extra chickens this year. Later he called for 4 billion pounds of chicken for meat alone. 28% jump over 1942! And more eggs per bird—8% more eggs! We can teach you the EASY, SCIENTIFIC, and PROFITABLE way to assist this program.

Write TODAY for catalog "How to Raise Poultry For Profits." It fully explains courses and easy payment plan.

NATIONAL POULTRY INSTITUTE
Dept. 50-4, Adams Center, N. Y.



Send Today

LOOK! Baby Chicks
THOUSANDS WEEKLY ALL YEAR. Finest quality & Layers in 40 breeds. Hybrid Baby Pullets and Cockerels, B. W. D. Tested. Ducklings, Goslings, Baby Turkeys, Guineas. In business 30 years. Catalog free. ORDER NOW. Make BIG money raising NABOB QUALITY CHICKS.
NABOB HATCHERIES, BOX M, GAMBIER, OHIO

RADIO OPERATORS WANTED
Be a "key" man. Learn how to send and receive messages in code by telegraph and radio. Army, Navy and Commerce needs thousands of men. Good pay, adventure, interesting work. Learn at home quickly through famous Candler System. Write for FREE BOOK.
CANDLER SYSTEM CO.
Dept. 5-D, Box 928 Denver, Colo., U. S. A.

MATHEMATICS FOR RADIO
TWO VOLUMES covering the algebra, radio arithmetic, geometry; advanced algebra, trigonometry, complex numbers needed to read technical books on radio.

MAEDEL PUBLISHING HOUSE, Room 111
593 East 38 Street, Brooklyn, N. Y.

Send me MATHEMATICS FOR RADIO and COMMUNICATION as checked below. I enclose payment therefor with the understanding that I may return the book(s) within 5 days in good condition and my money will be refunded.

Name

Address

Book I at \$3.75 plus 6c postage Book II at \$4.00 plus 6c postage
Foreign and Canadian prices 25c per volume higher

"NOW Show me the AUTO REPAIR JOB I can't DO!"

Here's proof you CAN do it:
FREE 7-DAY OFFER

**How MoToR's NEW FACTORY SHOP MANUAL
Serves as Your Complete Repair, Tune-Up &
Service Guide for Every Car Built Since 1935!**

ANY expert mechanic can tell you that this is the ONE and ONLY book needed to know everything necessary to keep America's cars rolling today! Easy, step-by-step instructions anyone who can read can follow. Hundreds of photos, diagrams and drawings show exact how-to-do-it.

Packed full of short cuts, it saves time and money—even for the experts. Try it at our risk, and see for yourself!

It's a BIG BOOK, 8½ x 11 inches. More than 900 illustrations; over 600 pages. Special water-proof binding. Lies open at any page for work-while-

you-read. The only up-to-date book of its kind in all America!

Just Like 150 Official Shop

Manuals—But All in One Book!

MoToR's FACTORY SHOP MANUAL contains all essential information from each manufacturer's own official shop procedure manual. Just look up the job, the model, the make, and go to work! Quick index gives you page and job instantly. Clear instructions, detailed pictures give you the "dope" you want at once. PARTIAL Contents here can only give you an idea of the jobs this book covers!

used by
U.S.
Army



**Same FREE 7-Day Offer
Applies on MoToR's New**

TRUCK REPAIR MANUAL!

Just published, for truck specialists, service stations, fleet owners—the first complete TRUCK REPAIR MANUAL, covering EVERY job on EVERY truck made since 1936! 1400 pictures, 904 pages, 300,000 facts based on truck manufacturers' own official manuals. Used by U. S. Armed Forces. Every essential fact you need to know to do ANY job. Strong, water-proof binding, size 8½ x 11.

Covers all models, 1936-1942. All Gasoline Engines; ALL DIESELS, Hesselmans, Diesel Fuel Injection Systems. All basic adjustment and repair procedures described in easily-understood text and pictures: Fuel Systems, Governors, Lubrication Systems, Ignition Systems, Starters, Generators, Clutches, Transmissions, Front and Rear Axles, Torque Dividers, Transfer Cases, Brakes, etc.

Offered to you on the same FREE 7-Day TRIAL offer. Just check box in coupon at right—and mail us coupon.

Thousands Now in Use!

Now used by the U. S. Armed Forces, trade and technical schools all over the country, auto servicemen in nearly every town.

Right now—to see how this book can help you get at each job easier, do it better, and finish up with it faster—send coupon below for a FREE 7-DAY TRIAL.

SEND NO MONEY

When the postman brings you the FACTORY SHOP MANUAL, try it out on a few extra-tough jobs. See how the book can pay for itself the first few days you use it! And unless thoroughly satisfied, return book in 7 days and pay nothing. Send coupon without money. TODAY! Address: MoToR Book Dept., Desk 14, 572 Madison Ave., New York, N. Y.

Clear, Pictured, Job Facts on Every Car Built Since 1935!

Nearly 200,000 service and repair facts on all these makes:

American	Ford	Oldsmobile
Bantam	Graham	Overland
Auburn	Hudson	Packard
Austin	Hupmobile	Pierce
Buick	Lafayette	Arrow
Cadillac	La Salle	Plymouth
Chevrolet	Lincoln	Pontiac
Chrysler	Lincoln	Reo
Cord	Zephyr	Studebaker
De Soto	Mercury	Terraplane
Dodge	Nash	Willlys

600 pages; 50 pages of carburetor text, charts, illustrations, covering all models.

Over 450 charts, tables covering important specifications, clearances, measurements, arranged in handy form, including: Tune-up Chart; Valve Measurements; Compression Pressure; Torque Wrench Reading; Starting Motor; Engine Clearance; Main & Rod Bearing Journal Dimensions; Generator; Clutch & Brake Specifications; Front End Measurements, etc.

Detailed, pictured instructions on Engines; Electric, Fuel, Cooling, Lubricating Systems; Transmissions; Wheels; Front Ends; Universals; Rear Ends, etc., etc.

MAIL COUPON NOW FOR 7-DAY FREE TRIAL

MoToR BOOK DEPT., Desk 14, 572 Madison Avenue, New York, N. Y.

Rush to me at once: (check box opposite book you want).

MoToR's FACTORY SHOP MANUAL

If O.K., I will remit \$1 in 7 days, and \$1 monthly for 4 months, plus 35c delivery charge with final payment (\$5.35 in all). Otherwise I will return book in 7 days. (Foreign price, \$6, cash with order).

MoToR's TRUCK REPAIR MANUAL

(Described at left in the box.) If O.K., I will remit \$2 in 7 days, and \$2 monthly for 3 months, plus 35c delivery charge with final payment (\$8.35 in all). Otherwise I will return book in 7 days. (Foreign price, \$11, cash with order).

Name _____ Address _____

City _____ State _____ Age _____

Employer _____ Occupation _____

SAVE 35c! Check here if enclosing payment (check or money-order) WITH coupon. We will then pay 35c shipping costs. Same 7-day return privilege.

ARC WELDING NEEDS YOU!



Excellent Pay!

Offers a **BETTER FUTURE!** Get training in a trade that will always need experts regardless of world or local conditions.

NO BETTER PLACE TO TRAIN than this school, backed by one of the world's largest builders of arc welders; supervised by some of America's Finest Instructor-Operators.

NON-PROFIT INSTITUTION. Cost only for materials used. Individual machines, booths. Short, intensive course. **WRITE OR ENROLL TODAY!**

The HOBART SCHOOL OF ARC WELDING

Box M-43, TROY, OHIO

Costs but little to learn. ACT NOW!

One of the finest schools of its kind in the world.

FREE Literature... Write Today! Reservations are being made continually, **HURRY!**

60 ART LESSONS Only 2.95

Study art in privacy of your own home in spare time with this course by Alexander Murray, author and art instructor. Lessons deal with commercial art, cartooning, lettering, anatomy, perspective, layout, etc. No added expense or bother of correspondence. Over 815 instruction illustrations. Order now... get all 60 lessons plus 85 sheets of drawing paper. Send only \$2.95 for complete course postpaid—or if in U.S.A. pay postman plus postage. **MONEY BACK** if not delighted after inspecting.

EDUCATIONAL SUPPLY CO., Dept. 113-D, RACINE, WIS.

PATENTS AND TRADE MARKS

C. A. SNOW & CO.

Registered Patent Attorneys Since 1875

Write for Free Book and "Certification of Invention" form

427 SNOW BUILDING, WASHINGTON, D. C.

ELECTRICAL BOOKS

shipped FREE

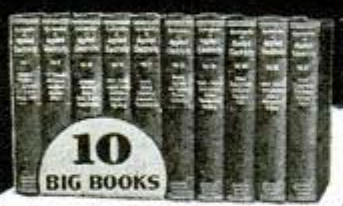

10 BIG BOOKS

FOR EXAMINATION MODERN ELECTRICITY INCLUDING RADIO AND REFRIGERATION

PATENT YOUR IDEAS

SEND FOR FREE BOOK

HOW TO OBTAIN A PATENT

Written by Former Member Examining Corps (1922-24) U. S. Pat. Office.

CARL MILLER, Registered Patent Attorney
Former Member Examining Corps U. S. Patent Office

Woolworth Bldg., Dept. 43-A, New York—Bond Bldg., Dept. 43-A, Washington, D. C.

BIG FIELD! Big Demand! Big Pay!

Men who understand electricity are urgently needed in thousands of War Production industries. Airplanes, ship building, arms plants, machine shops—practically every industry depends on electricity and men who know this subject make big money. Pleasant, fascinating work, easy to learn and do; learn with these books. Send coupon for a set for **FREE** examination and see for yourself.

SEND NOW [A year's consulting privileges with our engineers now given to all buyers of this famous Cyclopedic of Electricity.]

AMERICAN TECHNICAL SOCIETY
Vocational Publishers since 1898

JIU JITSU 3 LESSONS 10¢

Investigate the course experts buy. Authentic, complete. Send 10c today for 3 trial lessons, full details.

MODERN SCHOOL OF JIU JITSU, Box M-88, Forest Hills, N. Y.

SHORT WARTIME COURSES

UNCLE SAM NEEDS YOUR HELP in war industries and armed forces. A million technically trained men wanted—**Electro-Technicians, Aviation Mechanics, Aircraft and Arc Welders, Draftsmen, Radio Men.** Prepare now for bigger and better job opportunities in vital industries. Earn while you learn. Write for **FREE** illustrated book—"VICTORY MEN." Mention course desired.

MILWAUKEE SCHOOL OF ENGINEERING
PM-443 N. Broadway & E. State, Milwaukee, Wis.

SHEET METAL NEW LAYOUT INSTRUCTOR NOW READY!

At Last! Here is practical and usable instruction on **SHEET METAL LAYOUT** WORK so simplified that anyone can learn. Published to help train the men so badly needed for this big-pay work. Sheet Metal Men—Mechanics—get this new instructor and get into the easiest, cleanest and best paying part of all sheet metal work. Bound in book form with 143 complete jobs worked out in drawings and carefully explained.

SEND NO MONEY. Write today for "Simplified Methods in Sheet Metal Layout". Remit \$3 or pay postman \$3 plus postage on delivery. Money back in 5 days if not satisfied.

GOODHEART WILLOOX CO., INC.
Dept. 14, 2009 Michigan Avenue, Chicago



American Technical Society, Dept. E419, Drexel at 58th St., Chicago

Send for 10 days' free use. 10 volume set of New 18th Edition, Applied Electricity, including a certificate entitling me to consulting privileges for one year. I will pay the delivery charges only on the books. If I wish I may return them in 10 days and owe you nothing, but if I keep them, I will send \$2.00 after 10 days, then \$3.00 a month until the total price of only \$29.80 is paid.

NAME.....

ADDRESS.....

CITY..... STATE.....

Please attach letter stating age, occupation and name and address of employer and give at least one business man as reference.

To PROTECT Your INVENTION - Use this coupon, NOW

Delays are dangerous and may be very costly. My personal service assures prompt action, strict confidence, and a minimum of expense. I suggest that you send me a model or drawing, or sketch and description of your invention, and \$5.00. I will make a search and report promptly as to its patentability and send you a copy of my 72-page booklet. Or, if you prefer to read my booklet first, mail the attached coupon at once. I will also send my "Record of Invention" form. (Over 40 years experience as a Registered Patent Attorney.)

A PERSONAL CONFIDENTIAL PATENT SERVICE

L. F. Randolph, 302-D Columbian Bldg., Washington, D. C.

Please send me at once, free of charge, your 72 page booklet and "Record of Invention" form.

Name.....

Address.....



ACTUAL SIZE OF BOOK
5 1/4 x 8 1/4 Inches

This Book
FREE
to Every
STAMMERER
128 Pages
Interesting... Inspiring
Authoritative... Helpful
—
Write Today

THIS REMARKABLE BOOK TELLS YOU:
(Based on 41 Years' Experience)

- What causes stammering
- How stammering can be stopped
- Who can, and who can't, be freed from stammering
- How much time is required to stop stammering
- Whether stammering is ever outgrown
- Whether stammering can be stopped "by mail"
- Why stammering is actually contagious
- The meaning of the intermittent tendency and the progressive tendency
- Why you stammer worse at one time than another
- What parents should know about stammering
- How stammering affects your health and mind
- How you can gain new happiness and profit when your stammering ends

LOSE NO TIME in obtaining your copy of Benjamin N. Bogue's current authoritative book — "Stammering — Its Cause and Correction." It will come to you postpaid, promptly, with the author's compliments. There is no cost of any kind. Every stammerer owes it to himself to have this valuable book.

Avoid Disappointment — Act Today

Nine editions of Mr. Bogue's former books were required to meet the demand in this, and other, countries. It is hoped that the present supply of this vital, helpful book will permit the author to respond promptly to every request. But, to assure your copy, write today without fail.

Every phase of stammering

and stuttering is discussed fully and simply in this 128-page book. It contains five different parts—and a total of thirty-six chapters.

Written by a Man Who Stammered

Mr. Bogue, author of this book, was himself, a stammerer—and the facts he gives you are based on 41 years of experience in the correction of stammering. He knows and understands the stammerer's problems and unhappiness. His own life story is contained in his book. He helps you answer the many questions you have asked yourself—brings you facts you have sought but never found.

Comfort and Help for Stammerers

This helpful book is the latest and most thorough work on "Stammering," of which we have any knowledge. It is authoritative and complete and should bring comfort and hope to every stammerer. The book will be mailed postpaid to every stammerer who requests it promptly. To teachers and persons other than stammerers, copies of the book are available upon terms which Mr. Bogue will gladly state if you will write to him. But to stammerers it is free. It will come to you promptly, and post-paid.

WRITE FOR YOUR COPY TODAY BENJAMIN N. BOGUE, PUBLISHER, DEPT. A-13
CIRCLE TOWER, INDIANAPOLIS, INDIANA

LEARN RADIO

Home-Study Radio Course

AMAZING BARGAIN OFFER **\$2.50** COMPLETE

Here is your chance to get your radio training almost free. These simplified, well illustrated, interesting lessons cover every phase of radio work. You will find the training remarkably easy to grasp and use.

TRAIN AT HOME FOR A RADIO JOB

This home-study manual has helped others like you to secure high pay jobs in radio factories, service shops, War Industries, Navy and Army. These money-saving lessons will give you all the essential training needed. Includes extra information on recent radio developments. You may examine the complete course-manual, containing all the lessons and review questions, in your own home without any risk.



"You should get more money for the course. The first week I studied, I made \$10.00 repairing sets. I have repaired 100 radios to date." Robert Hammel, Davenport, Iowa.



"I started to repair radios when I was on the 12th lesson. It took me two months to master your course." Roger Langlois, Montreal, Canada.

PRACTICAL INSTRUCTIONS
The lessons are clear, practical, interesting, easy to master and use. No special education or previous experience required. You will enjoy learning important radio facts and doing real radio work after the 14th lesson.

SATISFACTION GUARANTEED
Take advantage of our "no-risk" trial offer. Send trial coupon. You will receive the complete Course for 10 days examination. Begin your radio study without any obligation. If you are pleased, the complete Course-Manual is yours to keep for only \$2.50, full price.

NO RISK TRIAL ORDER COUPON

SUPREME PUBLICATIONS, 328 S. Jefferson St., Chicago, Illinois
Ship the complete Radio Course book for 10 days use.

I am enclosing \$2.50, full price, send postpaid.
 Send C.O.D. I will pay the mailman \$2.50, and a few cents postage. I must be satisfied or you will refund my money in full.

Name:
Address:

MAGIC LIQUID MAKES PHOTOS APPEAR
On Scarfs, Ties, Stationery, Etc.

Reproduce any snapshot on cloth, leather, wood, paper. Simply apply liquid. Like magic photo appears within 2 minutes in broad daylight. Harmless to negative. Won't wash off. Full colors included. Complete kit for 300 photos only \$1. Send no money, just name. Pay postman \$1 plus few cents postage on delivery. (Canada, \$1.25 money order only.) Order today.

L & M Mfg. Co. Dept. 220, 104 W. Pearl St. Cincinnati, Ohio

Tough JIU-JITSU Holds

Jiu-Jitsu MILITARY MANUAL

For **SELF DEFENSE** and **COUNTER ATTACK**
Used by **United States Marines**

Amazing JIU JITSU MILITARY MANUAL packed from cover to cover with TOUGH HOLDS, chokes, throws and gun-disarming instructions. GRAPHIC ILLUSTRATIONS OF U. S. MARINES IN BAYONET DISARMING AND CLUB DEFENSE. A powerful defense and counter-attack system easy to learn. Makes you tough regardless of your size. Shows you how to handle brutes, even though armed, with your bare hands. Every Police Officer, Guard and every man and woman should have this book. Ideal for Service Men!

Leatherette Finish
\$1.00 Post-paid

SEND NO MONEY—Just send us your order and pay postman \$1.00 plus few cents postage. Or enclose dollar for postpaid delivery. To avoid delay men in camps should enclose dollar with order. Act now—prepare yourself for any emergency.

GORDY PUBLISHERS, 58 E. 18th St., Dept. 39, Chicago, Ill.

New 3 in 1 Policy Only \$1 a month!

Pays These BIG Benefits

- ACCIDENT Benefits** **\$5,000.00**
Accumulated Cash for Accidental Loss of Life, Limbs or Sight
- ACCIDENT Disability** **UP TO \$150.00**
A month for Loss of Time
- SICKNESS Benefits** **UP TO \$100.00**
A month for Loss of Time
- HOSPITAL Benefits** **UP TO \$7.50 EACH DAY**
For Hospital expenses

Policy pays liberal benefits from **FIRST DAY**. Even covers common sicknesses and ordinary accidents. No agents, no red tape, no medical examination. Mail-plan cuts expenses, gives you greater insurance value. Investigate at once. No obligation. Write for details today!

GEORGE ROGERS CLARK CASUALTY CO.
Dept. D-29 • Rockford, Ill.

MAKE YOUR OWN ELECTRICAL REPAIRS Locate quickly any Electrical Trouble—(A.C.)—(D.C.) Motors—Generators—Batteries—Circuits—Radio Interference—Electrical Devices. Amazing New Book. Written in Simple language anyone can understand. 132 pages—150 Diagrams. \$1.95. 28 years practical experience packed in this Volume. Money-Back Guarantee. Order your copy NOW! Details free. L. D. BEGGS, Box 780, Chicago, Illinois

SHORT METHOD ARITHMETIC

Mechanical calculator simplified, used by World's experts. 128 pages. Illustrated. Paper 50c postpaid. Send for catalogue. Drake Press & Bindery, 1132 North Wells Street, Chicago, Ill.

STUDY ENGINEERING AT HOME

With A Chartered Educational Institution

Courses in **ENGINEERING**: Electrical, Civil, Mechanical, Drafting, Architectural, Steam, Aeronautical, Radio, Structural, Mining, Industrial, Highway, Petroleum, Marine, Chemical.

Courses in **ARTS AND SCIENCES**: Philosophy; Education; Letters; Public Health; Medical Jurisprudence; Psychology; Sociology; Physics; Chemistry; Geology; Pol. Science; Theology; Law; Business and Commerce; Accounting; Mathematics; Statistics; Agriculture.

McKinley-Roosevelt Incorporated, 4610-TC, Sheridan Road, Chicago

NEW BOOK ON PLASTICS now ready

PLASTICS FROM FARM AND FOREST by E.F. Lougee

At Last! A non-technical Plastics book, written in a clear, practical, understandable way, by the well known authority E. F. Lougee, former Editor Modern Plastics Magazine. Profit by information in this intensely interesting and instructive book, entitled "PLASTICS from FARM and FOREST" No other like it anywhere Describes many fascinating and amazing experiments in Plastics; and tells of the big opportunities both now and in the future. Do you want to know

Only \$2.00

how blankets, hats and buttons are being made from skim milk, how corncobs and sugar cane waste is being turned into wall board and molded products; how soy beans are made into automobile parts, how walnut shells find their way into Plastics and dynamite? These subjects, and many others, are explained in Lougee's Book. Get the facts on Plastics. Order this important book **TO-DAY!** 10 Days Inspection FREE.

SEND NO MONEY
Don't delay—Book shipped C.O.D. anywhere in U.S.A. Simply pay postman \$2.00 plus small C.O.D. and postage charges. (If you send cash in advance we pay postage). In either case, if you are not fully satisfied, return the book in 10 days and we'll refund your money immediately. Mail your order NOW!

PLASTICS INSTITUTE
221 NO. LA SALLE ST., DEPT. M • CHICAGO, ILLINOIS



GET ON THE TECHNICAL FRONT

NOW, as never before, the urgent need for Trained Radio Men has created a tremendous shortage. Man-power is being mobilized for duty on the **TECHNICAL FRONT**: Radio Engineers, Service men and operators, Experts in shops, in laboratories and countless, undreamed-of other applications are on the "MUST HAVE" list. The war has stimulated demand in both Civilian and military fields. Regardless of whether you remain a civilian or enter Military Service, National Radio Training will qualify you for a real future, a good pay job, responsibility and marvelous opportunity for advancement.

LEARN AT HOME

NOW you can learn **AT HOME** in your spare time. National's **VICTORY** training plan speeds up your progress right from the start, yet omits absolutely nothing vital to your preparation.

FASCINATING WAY TO LEARN RADIO

Eliminating dry text books, National's plan of rapid Home Training actually brings you the proved **Shop-Studio-Field** service methods that are followed in National's resident training shops. This training is simplified so that you can easily grasp Radio step by step in a way that grows in its fascination every day. No previous experience needed. When you complete this Course you are prepared for a good radio job at excellent pay or may establish your own radio business.

Bear in mind that with the war-time curtailment of radio sets there is a huge increase in service work in homes. Radio manufacturing plants also need trained technicians to help produce over two billion dollars worth of military radio equipment. Factories are installing elaborate sound systems. Electronics is growing by leaps and bounds. Defense radio installations are without limit. All sound systems and innumerable defense hook-ups require **Trained men**. Prepare yourself for these job opportunities. **Enroll and Train by National's easy-to-grasp home method.**

National Graduates Win Good Jobs

RADIO INSPECTOR

An employed at General Electric plant in Bridgeport as Inspector on Radio for Army and Navy. I owe a great deal of my success to National Training.

Chas. Plunkett, Danbury, Conn.

SOUND ENGINEER

Since joining the Army my work has been both theatre and sound work, thanks to National Training. Radio training has helped me a great deal.

Pvt. F. M. Cary, Warren, Wyo.

Regardless of previous education or age, you can Train for Radio. Continue your present job. Earn while you learn. If subject to Military Service, all the more important that you get pre-training.

BE A RADIO TECHNICIAN

WITH PREPARATION FOR CIVILIAN OR U.S. GOV'T. SERVICE



TESTED HOME TRAINING BY PROVED SHOP-FIELD METHOD



For 33 years National Schools has trained ambitious men for Top Pay trades. Squarely behind your Home training are the modern, completely-equipped Training Shops of National Schools where we develop and prove every Shop Method Assignment sent to you. Every phase of your training is personally supervised by an established Faculty of practical, experienced instructors and engineers.

They have developed progressive methods of training you in your own home, based on actual shop practice. Unique training facilities give you Home Training based on Resident School Shop principles—methods not available from any other source, to our knowledge. You'll be amazed when you receive our Complimentary Lesson and full details.

MILITARY SERVICE

Prepare for Radio Service in Army and Navy. In U. S. Gov't. service you install, operate and maintain most technical equipment such as secret ultra-high frequency apparatus to locate airplanes. Get promotion in rank and increased pay almost from the start.

SPECIAL OFFER

So that you can demonstrate to yourself the ease and rapidity of learning Radio at home, National Schools will present to you one Complimentary Lesson free, accompanied by Opportunity Book of Facts and Details about all branches of Radio. Use the Coupon. Mail it today!

Qualify For These Jobs

**RADIO EXPERT
BROADCASTING
AIRCRAFT—MARINE
INDUST. ELECTRONICS
STUDIO TECHNICIAN
GOV'T. SERVICE
REMANUFACTURE**

More than 37,000 Graduates

NATIONAL SCHOOLS

Los Angeles California

ESTABLISHED 1905



MAIL OPPORTUNITY COUPON FOR QUICK ACTION

National Schools, Dept. PM-4 (Mail in envelope or 4000 So. Figueroa, Los Angeles, Calif. paste on penny postal)

Mail me FREE, without obligation, one Lesson and Opportunity Book, with full details about how I CAN become a RADIO Technician.

NAME _____ AGE _____

ADDRESS _____

CITY _____ STATE _____



REQUEST FULL DETAILS

**WORLD'S
BEST
WANT AD
MEDIUM**

CLASSIFIED Advertisements



Advertisements in this section, 35 cents per word, each insertion, minimum 10 words, payable in advance
To be inserted under proper classification in May issue, copy should be in our office March 8th
May issue on sale April 1st

Popular Mechanics Magazine, 200 East Ontario Street, Chicago, Illinois

YOU'LL PROFIT

By reading and answering the classified ads in this section. Hundreds of opportunities to make and save money.

AUTOMOBILES, MIDGET CARS

WHIRLGAS Superchargers, \$3, increase mileage 20%; power 10%. Perfect perpetual performance. Refund guarantee. University test. Any car; give make, year. Wrench installs 15 minutes. John Hanley, Manufacturer, 5719 Loraine, Detroit, Mich.

NEW Scientific tablet saves gas up to 30%! Results guaranteed. Positively harmless—\$1 box treats 180 gallons—C.O.D. or postpaid. (Liberal supply 25c.) Distributors wanted. Gas-O-Lubri Products, D-3338 Manderson, Omaha, Nebr.

AUTOMOBILE Racing book, fifth edition, well illustrated. Instructions on building bodies, frames, engines. Ford A and B conversions. Plans, AAA rules, specifications. Roadster racing, Indianapolis cars. \$1.00 postpaid, \$1.15 C.O.D. Ray Kuns, Dept. 47, Madisonville, Cincinnati, Ohio.

PROFESSIONAL Midget racers, motor-scooters, midget cars. Parts, plans. Handbook catalog—50 illustrations, plans—20c. Midwest, 2557 Charlestown, Toledo, Ohio.

AUTO SUPPLIES, EQUIPMENT

WANTED—McCulloch Ford V8 supercharger. Box 1344, Lake Charles, La.

RUBBER Preservative, cement, canvas waterproofer, soldering paste. Formulas 25c. Victory Sales, Box 5172, Chicago.

1943 **IGNITION** Supercharger \$2.50. Fast starting, mileage, pep. EG Sales Mfg. Co., 60 John St., New York.

PLATING Outfits for auto parts. Connect to a battery. No tanks used. Free particulars and proofs. Gunmetal Co., Ave. J, Decatur, Ill.

AUTO TRAILERS

BUILD Your own house trailer. Have exactly the kind and size you want, arranged and equipped the way you want it. Save money and have a better trailer. Thousands of smart people have built from Jim Dandy plans. Send 10c today for Jim's interesting trailer plan catalog illustrating 7 streamlined and conventional models of house trailers with floor plans, collapsible tent trailer and utility trailer any of which you can build yourself. The plan you select costs only \$1.00. Send time today for catalog. Jim Dandy, Box 125-A, Wausau, Wisconsin.

MOTORCYCLES, BICYCLES, MOTOR-SCOOTERS, SUPPLIES

BOYS Repair your own bicycles. All bicycle repair secrets revealed. "Bicycle Repair Manual." Send only 65c to R. G. Klausner, Shelbyville, Illinois.

MOTORCYCLISTS—New and used parts, accessories, all models. Catalog and decal 10c. Henderson catalog 10c additional. Triangle, 2157 Harrison, Chicago.

Popular Mechanics Magazine, Chicago, Ill.

Dear Mr. Johnson: I have just been looking over the results of my advertising in Popular Mechanics Magazine, and find that for every dollar I have invested in ads I have received a net profit of more than a dollar in just a few months. This profit is absolutely net, after every item of expense has been deducted, and is exactly the same to me as if someone were paying me interest on my money of more than 200% per annum. It is needless to say that I am satisfied, and that I will be using your columns for some time to come.

Yours very truly,

(Original letter on file in our office)

N. B. POSERA

"MODERN Motorcycle Mechanics and Speed Tuning," 436 pages, 200 illustrations. Extensively covers—Operating, maintenance, and complete reconditioning, American and British motorcycles. \$2.50 postpaid. Descriptive folder free. Nicholson Brothers, Saskatoon, Canada.

CONVERT Your bicycle to electric power-bike. Practical plans \$1.00. Lee Power Cycle, Watertown, Wis.

MOTORCYCLE Bags—\$5.20 and up. Allen Streamlined Bag Co., 216 Summit St., Elgin, Ill.

BUILD Electric bicycle. No chains, gears, welding. Plans \$1. Klaus, 1369 Missouri St., Pittsburgh, Penna.

26 X 2.125 **BICYCLE** Tires \$2.50, tubes \$1.50 postpaid. Reconditioned men's balloon bicycles, like new \$40.00. Pulver's Sporting Goods, Hudson, N. Y.

REBUILD Your Indian motor. Genuine Indian parts. Used motorcycle catalog 15c. Indian Motorcycle Sales, Kansas City, Mo.

SEND 10c For Handbook of Information. Lists new and used parts for Indian, Harley, Bootz, 622 East Grand, Des Moines, Iowa.

POWER Your bike with outboard motor. Plans, \$1.00 defense stamps. Donald Laverdiere, 21 Poulin St., Waterville, Me.

BICYCLES, Parts, tires. Also scooter tires, all sizes. Send dime for list. Cycle Transport Co., 1241 S. Michigan Ave., Chicago, Ill.

SAVE Gasoline, tires! Motor-scooters, motorcycles, bicycle motors, midget automobiles, gasoline engines. No priority necessary. Illustrated catalog one dime. Clymers, 307 West Pico, Los Angeles, Calif.

PISTONS, All sizes, for Harley-Davidson, Duckworth chain $\frac{3}{8}$ x $\frac{5}{8}$ for motorcycle. McCann's 2104 Texas Street, El Paso, Texas.

AVIATION

LOOK—World's best offer—Genuine Geodetic simplified, detailed plans complete, \$5.00 for the Baby Airliner, low wing, flight tested, sweet performance. Illustrated literature, Ford aircool conversion diagram 25c. Standard Aircraft, Ft. Worth, Texas.

PLANS, Flying Flea \$1.00, monoplane \$1.00. Circulars 20c. Craftsman Books, Box 1153-PM, Milwaukee, Wis.

PROPELLERS—We design, manufacture, sell, all types, sizes. Patent applied on our 3 blade Airliner. Factory prices. Quality, lists free. Standard Aircraft, Ft. Worth, Texas.

BATTERIES, GENERATORS, ETC.

EDISON Batteries. Light Power. Fifteen year life. Five year guarantee. Complete lighting plants. Free literature. See Jay Company, 321 Yonkers Avenue, Yonkers, New York.

EDISON Lifetime storage batteries for light and power. Eliminate acid battery diseases. Long guarantee. All kinds rebuilt generating plants, motors, and miscellaneous articles at bargain prices. Free interesting literature. T. Hawley Smith Co., Croton Falls, N. Y.

RENEW Dead car batteries inexpensively. Get wise. Instructions \$1.00. Popular Service, Racine, Wisconsin.

ELECTRICAL SUPPLIES, EQUIPMENT

ELECTRIC Pencil: Writes-engraves all metals. \$1.25 postpaid. Beyer Mfg., 4515-H Cottage Grove, Chicago.

FOR Motors, welders, generators, other electrical items. Write LeJay Mfg., 847 LeJay Building, Minneapolis, Minn.

ELECTRO-MAGNETS—Plans for building—\$1.00. Terry Sales, Central Station 1676, Toledo, Ohio.

SAVE Gasoline—Buy electric motors through mail. Alternating and direct current. Fractional horse power. Send dime for wholesale catalog. CMCO, 514 Van Buren, Chicago.

WELDING, SOLDERING, PLATING

MAKE Your own electric welder; complete kit, everything supplied, with full directions for assembly, \$5.95; will make a \$19.95 set. Marvel Electro Welder Mfg. Co., 193AB Center St., New York City.

ARC Welders wanted by the thousands. Learn with 516 page lessons manual. Over 500 how-to-do-it photos. \$2.00 copy. Money-back guarantee. Hobartweld, Box M-434, Troy, Ohio.

WELDING Outfits—Aircraft, sheet-metal, heavy duty soldering outfits. Superior Oxy-Acetylene Co., Hamilton, Ohio.

BUILD d.c. Arcwelder without rewinding armature. Plans \$1.00 each. 25 to 600 amperes from vehicle motors, light plant generators, automobile starter-generators. Welders Club, AB-3432 M-Mart, Chicago.

MACHINERY, TOOLS, SUPPLIES

INDEX Heads for sale. Very inexpensive. Sixty-two different divisions. Used on small lathes, drill press, milling machines, etc. Make gears, hobs, cutters, etc. Very accurate and durable. Not a toy. Used by defense schools and hobbyists. Write for free folder. 2117 East B St., Torrington, Wyo.

STEEL Beam trammels for draftsmen, engineers, mechanics. Circular free. Clair Company, Box 92M, Blythebourne Station, Brooklyn, N. Y.

NEW Tap grinding attachment. Grind taps like factory on small lathe or surface grinder. Free literature, 2312 S. Fern St., Arlington, Va.

NEW Caliper, direct reading, speeds up defense work, cheap. Free illustrated circular. Factory, 811-G East 31st, Kansas City, Mo.

IMMEDIATE Delivery of Lewis Castings and blueprints on low priority for building your own mills, shapers and other shop tools. Save delivery delays. These tools handle all war work within their capacity. Send 10c to cover mailing cost of new 32-page illustrated catalog. Lewis Machine Tool Company, P.O. Box 116, Sta. A, Department M-28, Los Angeles, California.

AT Last! A simple method for tempering chisels and punches. Send \$1.00 today for complete instructions. Money back guarantee. J. & E. Engineering Company, 703 Madison, Saginaw, Mich.

USED Wood and metal working power tools, bought, sold, exchanged. Details free. National Tool Mart, Ashburn, Ga.

RECLAIM Dull and broken drills with Nu-Way Drill Grinder. Circular free. Tractor-Lite Mfg. Co., Spirit Lake, Iowa.

LATHE Owners—Amazing new line attachments, chucks, turrets. Machine Supply, Newfane, Vermont.

BUILD Lathe grinding attachment. Castings. Building instructions \$2.50. Details 10c. Star Machine Co., Kingfisher, Okla.

CONCRETE Building block machines and molds. Easy payments. Catalog free. Concrete Machine Co., 3129 South Compton Ave., St. Louis, Mo.

13" x 5" WILLARD Lathe with gap. No. 2 Pratt & Whitney hand milling machine. four step cone drive. Write for full particulars. Cincinnati Machinery & Supply Company, 217 E. Second St., Cincinnati, Ohio.

GRIND Drills like factory: attachment for bench grinder. Cheap. Factory, 811-B East 31. Kansas City, Mo.

FOR Sale—New and used reamers and milling cutters—not catalogued—furnish your list of requirements for prices. Write P.O. Box 493, Flint, Mich.

ENGINES, MOTORS, DYNAMOS

BIG Pay jobs in welding. Complete welding lessons and reference book. 516 pages. 41 lessons. \$2.00 copy. Money-back guarantee. Hobartweld, Box 435-M, Troy, Ohio.

WINDING Data, 225 motors, single and three phase. \$1.00. Motor Data Co., Box 7631, Kansas City, Mo.

BOATS, OUTBOARD MOTORS, ETC.

FULL Size, cut to shape boat patterns, blueprints. 7½ - 38 feet. Illustrated "Build a Boat" catalog, 10c (coin). "How to Build Boats" book, \$1.00. Cleveland Boat Blueprint Co., Station A-66, Cleveland, Ohio.

12 FOOT Flat bottom rowboat, complete plans 25c. Catalog boat building plans 10c. The Rudder, 15 Murray Street, New York.

WANTED Small metal hull inboard speed boat, 3 or 4 passenger, 75hp. or more. Brown, 2580 Spaulding, Omaha, Nebr.

USED Outboard motor parts. Outboard Exchange, 1194 Remsen Ave., Brooklyn, N. Y.

REBUILT Outboard motors. Fully guaranteed. Hundreds to pick from. Send 10c for complete list. Boat design book 15c. Buy now before prices advance. Chicago's largest dealer. Masters & Son, 214 West Chicago Avenue, Chicago.

BOAT Designers are highly paid professionals. Complete course by mail. Catalog. Westlawn, Montville, N. J.

OUTBOARDS—Save ½. Good used parts, all makes and models. Bargains rebuilt motors. Crandall Hicks Co., 959 Commonwealth, Boston, Mass.

SPORTING GOODS, GUNS, FISHING TACKLE, ETC.

I'LL Trade guns and ammunition. Swap your guns or ammunition for other guns, other ammunition, for bargains in other equipment. I'll also pay cash (or trade) for modern used guns, ammunition, fishing tackle, outboards, golf balls, clubs, binoculars, cameras. Write immediately for liberal "cash or trade" offer. Also for free giant bargain list. Send 3c stamp. Milton Klein, Gun Trader Since 1885, 508HC South Halsted, Chicago.

ELEVEN Good box traps. Complete blueprints, 30c. Wesho-Uco, Box 51, Detroit, Mich.

ARCHERY Equipment: Catalogue free. Mid-West Archery, 2209-A East 75th, Chicago.

FREE Catalog. fly tying and lure making materials, flies, streamers, bugs, lures, wholesale prices. Supreme Mfg. Company, Amarillo, Texas.

75 TIN-CAN "Teluhov" plans. Silencers—Traps, hunting, fishing, camping. Circular 10c. Spencer Laboratories, Akron, Ohio.

I'LL Swap fishing tackle or pay cash. Also guns, ammunition, golf equipment. Describe what you have. Write for free complete bargain catalog. Send 3c stamp. Milton Klein, Gun Trader Since 1885, 508HC South Halsted, Chicago.

TURN Your spare guns into war bonds. Derryhoyle House, Natick, Mass., buys, sells, exchanges, or sells on commission. Circular free.

BOWS—Arrows for recreation, hunting, fishing. Beautiful archery instruction book, 90 pages. 50 illustrations, only 50c. Illustrated catalogue free. Archery, 617 South State, Chicago.

USED Guns, bought, sold, exchanged. List stamp. Howe Fur Company, Coopers Mills, Maine.

ATHLETIC EQUIPMENT, BODY BUILDING COURSES

SUPER System of natural physical training. Free booklet. Harry Good, 3261-PM Watson Road, St. Louis, Mo.

SUPER Ju-Jitsu—lightning defense and attack system. Sensational new home study course now ready! Learn to lick brutes twice your size with only your bare hands. Free details. Nelson Co., 500 Sherman, Dept. D-508, Chicago.

BE Strong, muscular, full of pep. Amazing new body-building course. Write Olympic System, Dept. M, Waterville, Maine.

FIELD GLASSES, MICROSCOPES, TELESCOPES

ASTRONOMICAL Telescopes, binoculars, cameras, microscopes, bought, sold, repaired. Send 10c for list of instruments desired. Rasmussen, Box 294, Amsterdam, N. Y.

MICROSCOPES! Research, industrial, amateur, accessories. We sell, buy, repair, exchange. Inquiries invited. National Microscope Exchange, 121 Chambers St., New York, N. Y.

LENSES—Build your own telescope, field glass, microscope, rifle scope, etc. Assortment of fifteen lenses—\$1.00 postpaid. Thirty lenses—\$2.00. Sixty different lenses—\$5.00. Slightly chipped on edge. Satisfaction absolutely guaranteed. American Lens Company, 1313-M Vine Avenue, Park Ridge, Illinois.

ANTIQUES, RELICS, INDIAN GOODS, CURIOS

ANTIQUE Firearms, swords, daggers, Indian relics, coins, papermoney, medals. Lists free. Nagy, 8-PM South 18th, Philadelphia, Penna.

1943 ANTIQUE Firearms catalog, 25c. "Young," Liberty Ave., Belleville, N. J.

SWORDS, Rapiers, daggers, pistols, armor, illustrated catalog 25c. Robert Abels, 860-A Lexington Ave., New York.

25 GENUINE Indian arrowheads, \$1.00. Catalog. Geo. Holder, Glenwood, Ark.

INDIAN Relics, coins, bills, gems, crystals, curios, etc. Illustrated catalog 5c. 100 ancient arrowheads \$3.00. H. Daniel, Hot Springs, Ark.

INDIAN Relics, beadwork, coins, curios, minerals, old glass. Catalog 6c. Indian Museum, Osborne, Kansas.

FARMS, FARM LANDS, REAL ESTATE

10 ACRES Fronting paved highway \$100, \$5.00 down \$5.00 monthly. R. W. Stewart, Inverness, Florida.

ORLANDO, Florida. 5 acres on main highway; good fruit and vegetable land; easy terms; free booklet. Department Y, Box 1944, Orlando, Florida.

CANADIAN Tax sale lands for a dollar an acre and up. Small monthly payments. Farms, timber, hunting and fishing camps, minerals. Limited number of properties. Write at once for free illustrated booklet. Tax Sale Service, Room 613, 72 Queen St., W. Toronto, Canada.

40 ACRES. Near White River, unimproved; poultry land. \$190, \$5 down, \$5 monthly. Free list and literature. Hubbard, 216 Grossman Bldg., Kansas City, Kans.

STROUT'S Big new catalog! 100 pages chock-full of bargains—farms, country homes, rural business opportunities in states east of the Mississippi; write today for your free copy of this money and time-saving guide. Strout Realty, 255-P 4th Ave., New York City.

VIRGIN Ozark poultry, fruit land, \$1 acre. Armstrong, Thornburg, Iowa.

ONTARIO, Money making farms, all sizes. Catalog 10c. Dominion Farm Agency, Queen W, Toronto, Canada.

SEE The Highlands of Louisiana where winter brings no idle acres. Choice cut-over land at low prices with terms. Send for descriptive book without obligation. Long-Bell Farm Land Corporation, 899 R. A. Long Bldg., Kansas City, Mo.

GOOD Farm bargains. Washington, Minnesota, Montana, Idaho, Oregon, North Dakota. Dependable crops, favorable climate. Write for literature, lists describing typical farms. Specify which state. J. W. Haw, 119 Northern Pacific Ry., St. Paul, Minn.

GOVERNMENT Land \$1.00 acre up. Information all states 25 cents. National Tax Service, 1037A Majestic Bldg., Detroit.

FARM MACHINERY AND SUPPLIES

BUY Tractor parts now! Large stock. New or used. Quick service; low prices. Free 52 page catalog. Irving's Tractor Lug Co., Galesburg, Illinois.

POULTRY AND FARM SUPPLIES

50 RARE And fancy breeds. Eggs, Stock. List 3c. Empire, Corono, New Mexico.

MORE Money from poultry by following latest discoveries reported by America's leading poultry magazine, operating own experimental farm. One year 25c; five years only \$1. Poultry Tribune, Dept. 22, Mount Morris, Ill.

RAISE Turkeys the new way. Make up to \$3000 yearly in your own back yard. Write for free information telling how. National Turkey Institute, Dept. B, Columbus, Kansas.

CHICKS And pullets champion mated. 52 varieties, 7 hybrids, licensed inspected, bloodtested. Rush postal, large colored book, low prices. Berry's Farm, Route 12, Clarinda, Iowa.

DOGS, PETS, BIRDS, RABBITS

PARRAKEETS Or Love Birds, Zebra Finches, Birds. Paul Duesterhoeft, Westfield, Wis.

REPORT On Chinchillas (not rabbits). Rarest domesticated animals. Opportunity. Book \$1.25. Bayfarms, 3606-C Brighton, Oakland, California.

ST. BERNARD Puppies. Champion sired beauties. Franklin Young, R4, Riverhead, Long Island, New York.

BIRDS? Get American Canary Magazine monthly. Year, \$1.00. 2839-P North Halsted, Chicago.

PROFITABLE OCCUPATIONS

YOUR Own profitable business! We help you to build up successful subscription agency in your community, making money year after year with new and renewal orders for all magazines published. No experience required. So turn your spare time into cash! Clip this ad now and mail with your name and home address to International Circulation Co., Inc., Dept. AB-4, 57th Street at 8th Ave., New York, N. Y.

WE Buy Angora wool. Our super woolers reasonably priced. Hazelwood Angora Farms, Route 1, Spokane, Wash.

WELDING Pays. Learn with 1942 trace school text manual. 516 pages. Over 500 photos. \$2.00 copy. Money-back guarantee. Hobartweld, Box M-433, Troy, Ohio.

MECHANICALLY Inclined men—Own and operate general appliance repair shop. Complete, illustrated course shows you how. Welding, refrigeration, motor repair, how to get business, etc., all phases covered. Free literature. Christy Supply, Dept. 427, 2835 N. Central Ave., Chicago.

RAISE Angora rabbits—wool brings \$5.00 pound, Particulars free. Grinstead's, Edwardsville, Illinois.

STANDARD Rabbit Journal, Milton, Pa. 3 years \$1.00, sample dime.

\$40.00 WEEKLY. Made growing mushrooms, fresh, dried. Dominion patent 331583. Free spaw. North American, 160P Yonge, Toronto, Canada.

BOOKS, PERIODICALS, PICTURES, POSTCARDS

EXQUISITE Kodachrome reproductions, postcard size, for mailing, framing. 85 subjects, military planes, Hawaii, western. Send 4c (postage) for free sample and list. Western Movie Supply, 254 Sutter, San Francisco.

ONE Book free with every book you buy. Your favorite magazines at lowest possible prices. The latest books rented at less than a penny and half per day. These advantages are yours, if you join this amazing club. No dues whatever. Book and Magazine Club, P.M., 315 Fifth Ave., New York.

CURRENT Single copies—Business, vocational, diversion magazines. Choose from 512 publications; 140 trades, professions, hobbies, sports, live stock, poultry, etc. List with prices free. Commercial Engraving Publishing Co., 34C North Ritter, Indianapolis, Indiana.

REBINDING: We bind magazines, old books, Bibles, hymnals. Heckman Bindery, Dept. D, North Manchester, Indiana.

SAVE 50% On best sellers. Send 3c stamp for catalog. Cavalier Enterprises, 5448 Stanton Avenue, Pittsburgh, Penna.

ANY Book (new, used, out-of-print, rare) promptly supplied! Lowest prices! Send for free bargain catalogues! Old Prof's Book Shop, M16 Arcadia Court, Pontiac, Mich.

BACK-DATED Magazines. Catalog 10c. Cicerone's, 863 First Ave., New York, N. Y.

FREE—Beautiful view card of Atlanta, Georgia, if you send 3c stamp for list of card exchange members. Thigpen, Box 97, Bolton, Georgia.

"SANTA Claus in Santa Land"—the new child's classic—autographed copies—\$1.25. Book-nook, Hemlock, New York.

FREE—100 Page catalog of new and used college and home study text and reference books at a saving. Est. 1902. College Book Co., Dept. M, Columbus, Ohio.

TRAINS. The picture magazine about railroads and railroad travel. Send 25 cents now for new issue. Trains, 1027-R North 7th, Milwaukee, Wisconsin.

ARTISTIC Girl pictures. Real models. 10 postcards 35c, 40—\$1.00. Scott's, Box 342, Covington, Ky.

17,000 WORD Dictionary, send 20c with order. Edwards Store, 1700 Locust, Quincy, Illinois.

MAGAZINE Bargains. 35 different back number detective, western, love, movie, comics or 15 different National Geographics, aviation, mechanics, science, photography; 10 Esquires; 7 Fortunes \$1.00 express charges collect. Retail or wholesale catalog 3c. Corey's Exchange, 355 North Clark, Chicago, Ill.

WHAT Every Mason wants. We have Masonic books for Blue Lodge, Chapter, Commandery, Scottish Rite and Shrine. Our rituals are used the world over. Send for free catalog of books and rituals for Masons, Odd Fellows, Knights of Pythias, Knights of Columbus, Elks, etc. Ezra A. Cook, Publisher, Inc., P.O. Box 796, P. Chicago, Ill.

TRAVEL Kodachromes 2"x2" in gorgeous colors by some of America's foremost color photographers. National parks, N. Y. and San Francisco fairs, scenic and historic spots, famous gardens. High in quality but moderate in price. Satisfaction or your money refunded. Request newest list of hundreds of subjects. Elk Studio, Department "C," Elkton, Maryland.

DRUNKENNESS Is a disease which responds to treatment. Medical skill plus human sympathy prove successful with liquor and drug cases. 60 years experience. Write for free booklet. P. M. Nelson, The Keeley Institute, Dwight, Ill.

MAKE Your own herb medicine. Beautiful illustrated recipe book 10c. Botanic, 3518 West 66th Place, Chicago.

BOOKS. (Out-of-print, new, used) quickly supplied. Many 35c bargains. Catalogue. T. Jankowski, 18870 Marx Ave., Detroit, Mich.

SELF-EXPLAINING Bible: Illustrated circular free. Box 446-P, Minneapolis, Minn.

MACHINIST'S Reference book \$1.00 postpaid. G. A. Knudsen, 523 - 48th St., Brooklyn, N. Y.

OUR Books will help you get a better job or start a business of your own. Catalog free. Popular Mechanics Press, (C-43), 200 E. Ontario, Chicago.

GAMES, ENTERTAINMENT

AMAZE Your friends! With clever professional party tricks. Learn fascinating paper cone balancing act. Climaxed by dramatic burning-cone-trick. Easy, simple! Takes very little practice. Complete instructions and illustrations, only 25c. Emil Knoff, 2154MN North 52nd St., Milwaukee, Wis.

MAGIC TRICKS, PUZZLES, JOKER NOVELTIES

CLOUDS Of smoke and many mystifying tricks from finger tips, empty hand, including 5 ft. ribbons from single indestructible long lasting dab of harmless mystic paste. It's amazing, unusual. See magic dealer or send 50c for 35 performance tube, 3 one dollar. Regan's Laboratories, DP, Calton, N. J.

LEARN Ventriloquism. Quick results. For free particulars state your age. Fred Maher, 1700-A Casgrain, Detroit, Mich.

DOLLAR Magic set free with gigantic catalog, 25c. Mysto, 4462 Germantown, Philadelphia.

JOIN Magicians' Fraternity! Monthly magazine of tricks, sample, 10c. International Magicians, Mount Morris, Illinois.

NEW! Simplified card tricks! Amazing self-working bafflers 50c postpaid, James W. Roundtree, 529 Elliott St., River Rouge, Michigan.

SEND One dollar for printed instructions telling how to do twelve new professional tricks. Thayer's, Box 1785, Wilshire-La Brea Station, Los Angeles, Calif.

62 TRICKS, Apparatus all included, \$2.50. Box 1373-A, Raleigh, N. C.

MAGICIANS' Headquarters. 216-page catalog, pocket, parlor, professional tricks. 25c. Kanter's, M-1311 Walnut, Philadelphia.

LEARN Ventriloquism. 3c stamp brings particulars. Smith, 801 Bigelow, Peoria, Illinois.

AMAZING Nectie trick! Yours for 25c! Magicart, Apt. 507, 624 Brady Ave., N., Dearborn, Michigan.

AMAZE Audiences! Become professional magician! Dollar trick, catalog, circulars, quarter. Nelmar, 2851 Milwaukee, Chicago.

MAGNET Trick instruction book—25c. Central Station Box 1676, Toledo, Ohio.

MAGIC Tricks, puzzles, books, cards, punch boards. Catalog 10c. Specialty, Box 671, St. Louis, Mo.

BE A magician. Large professional magic catalogue of latest tricks 25c. Ireland, C-109 North Dearborn, Chicago.

MYSTIFYING Tricks free. H. F. Willis, Box 1704, Cleveland, Ohio.

500 TRICKS You can do, only 10c! Brand new tricks for pocket, parlor, stage, with cards, coins, thimbles, balls, professional apparatus, books, illusions. Send 10c for Douglas' famous book of 500 tricks. Douglas Magic Shop, Box 274, Dallas, Texas.

WORLD'S Largest professional magic shop keeps you in touch with latest tricks. To receive mailings send 25c for 1943 catalog. Holden, 220 W. 42nd St., New York.

HOLLYWOOD Special! Magicians button, catalogue, ghost illusion and free trick for 25c. Magic House of Charles, Box 888, Hollywood, California.

NEW Vanishing key and catalog 25c. Sterling Magic, 345 John R, Detroit, Mich.

COINS, TOKENS, CURRENCY

OLD Money wanted. Will pay fifty dollars for nickel of 1913 with Liberty head (no buffalo). We pay cash premiums for all rare coins. Send 4c for large coin folder. May mean much profit to you. Numismatic Co., Dept. 20, Fort Worth, Texas.

SEND \$1.00. Receive assortment foreign, U. S. coins, price lists. Harry Bason, 24 Maple Drive, New Hyde Park, N. Y.

10 INDIAN Head cents, different dates, also price lists. 35c. Schultz, 1053 Richmond, Cincinnati, Ohio.

\$10, \$5, \$1 CONFEDERATE Notes, 25 cents each. Beffel, Box 37-E, Ottawa, Ill.

LORD'S Prayer, Ten Commandments, or Crucifixion, engraved on real pennies. 12c each. 3—25c. Lohman, 825 Lima, Burbank, Calif.

100 YEAR Old cent 25c, 10 different Indians 25c, 10 different Lincolns San Francisco mint with new silver copper nickel 35c, large illustrated coin book 50c. Coin Shop, Box 77, Alameda, Calif.

50,000 COINS, Medals, papermoney. Lists free. Nagy, 8-T South 18th, Philadelphia, Penna.

THREE Coins, Baroda, Borneo, Mexico, 10c. Oddehon, Box 44, Overland, Mo.

CASH Premiums for old coins, copper, nickel, silver and gold; catalogue 10c. Smith and Sons, 2287 Clybourn Ave., Chicago, Ill.

COMMEMORATIVE \$1¹/₂s. Columbus, Stone Mountain, Long Island \$1.00 each. Large illustrated catalogue 10c. Norman Shultz, Salt Lake Utah.

GET Profit and pleasure in collecting old coins. Send 10c for 56-page illustrated coin catalog. You'll be delighted with it. Send for it now. B. Max Mehl, 370 Mehl Building, Fort Worth, Texas. Largest rare coin establishment in U. S. Established 43 years.

OLD Money wanted. Big premiums paid. 1,000 quotations. Catalogue 10c. Allan Appell, Sedalia-6B, Missouri.

I MAY Have just the scarce U. S. coins you want. Send me list. "Meet me by mail." William H. Kenworthy, Waterville, Maine.

OLD STAMPS WANTED

UP To \$1,000.00 paid for rotary perforated eleven 1924 one cent green Franklin stamp. You may have this and many other valuable stamps at home on some old letters. Send 4c (stamps) for illustrated folder containing valuable information on recent and old stamps and amazing prices I pay. C. A. Jasperson, Beverly Hills, California.

WANTED: Good stamp collections, envelopes with stamps before 1875, stamps received by importers, etc., stamps directly from foreign countries. Money by return mail. Al Johnson, 727 North Foote, Colorado Springs, Colorado.

I WILL Pay \$100.00 each for 1924 1c green Franklin stamps, rotary perforated eleven (up to \$1,000.00 each unused). Send 6c today for large illustrated folder showing amazing prices paid. Vernon Baker, (34-PM), Eyriria, Ohio.

STAMP COLLECTING

LIBERIA Triangles No. 342-7 (6) 10c with 1/4 - 1/2 - 1c approvals. Carroll's, 745A W. 45th St., Los Angeles, Calif.

80c VALUE—U. S. exhibition sheet, telegraph stamp almost 60 years old, 25 more different U. S. Only 5c to new applicants for my U. S. approvals. Steger, 1165 Downing, Denver, Colorado.

25 STAMPS Of fighting Russia 5c, with my fine foreign approvals. Kealey Stamp Service, Box 104, Toluca Lake Station, North Hollywood, California.

POSITIVELY Greatest free offer—Latest Scott's International \$4.00 Stamp Album—covering entire world, contains 36,000 illustrated, descriptive spaces; Scott's 1943 Standard \$4.00 catalogues "Philately's Encyclopedia" — absolutely free to applicants for foreign approvals becoming customers. Bargain Stamp Service, Palm Springs, California.

WOW! \$10.00 Worth of fun for only 10c! 500 foreign stamps, unsorted and unpicked (mostly on bits of paper) just as received from the church missions and other sources. Africa, So. America, Australia, China, Philippines, Dutch Indies, and other countries are represented. Includes a few commemoratives, airmails, and stamps cataloging up to 25c or more each! The biggest package of fun in stampdom—and you might find something really valuable! Price only 10c to serious approval applicants! Money back if not delighted. Jamestown Stamp Co., Dept. No. 22, Jamestown, New York.

BREAKING Up a very large private collection into \$2, \$5 and \$10 packets. No telling what you will receive, except a good bargain, that will positively satisfy, for I have no rubbish. Be sure to enclose stamped self addressed envelope, with remittance. Sincerely Leon Block, 3116 Hudson Street, Baltimore, Md.

19th CENTURY U. S. commems, Civil War revenues, battleship, \$5 and \$10 stamps. Illustrated U. S. catalogue, free to U. S. approval applicants. Metropolitan Stamps, 198-X Broadway, New York.

LATIN-AMERICA — Commemoratives! Pictorials! Airmails! 50 different, only 5c to approval applicants. W. E. Thiem, 630 Gramatan Ave., Mt. Vernon, N. Y.

50 DIFFERENT Ships, railroads, etc., 10c. Approvals. Buchanan, 307 East 23rd, New York.

125 DIFFERENT Canada postage. Real bargain \$1. Douglas, Hawkesbury, Ontario.

EUROPE, 40 Years old—50 different 25c; 20, 10c. No approvals. Elsea, Bowling Green, Ohio.

MISSION Mix 50c lb. plus postage. Cash. Marist Missions Sodality, Brookland, D. C.

COMMEMORATIVES, 45 Different U. S. 25c. Eaton's, 618 Eaton Road, Rochester, N. Y.

COLOSSAL Bargain. Countries from Aden right through to Wurttemberg. Triangles, airmails, etc., all for 10c to approval applicants. Miller, 453 East 178 St., New York.

DESTROYER: Canada's dollar 25c. Scarce St. Pierre, two airmails 20c. Approvals? Dufort, 4402 Chateaubriand, Montreal, Canada.

APPROVALS. One cent each, etc. 3c postage. Creevey's, Berwick, Penna.

TRADE Duplicates with collectors everywhere. Details free. Stamp Traders Association, 4107B Osceola, Chicago.

U. S. Approvals only. Sample price—Parks 19c. Box 488, Minneapolis.

FREE! 25 Different Scandinavia for return postage. Approvals sent. Cline, 171P, Clifton, New Jersey.

220 U. S. Stamps on approval. We pay return postage. Southern Stamp Co., Box 70, Miami, Florida.

125 DIFFERENT 5c. Foreign pictorials, commemoratives, etc. Attractive approvals. Getche, 1040 N.E. Eighteenth, Minneapolis.

STAMPS, Superb selection sent on approval, attractive prices. Fred Herzberg, 168 Oak, Elmhurst, Ill.

FREE! Foreign coin, banknote and large 50 page illustrated coin catalogue to approval service applicants. Send 3c postage. Tatham Coinco, Springfield-125, Mass.

1000 MIXED Foreign, 25c. Well worth sorting for values. Plaza Stamp Co., Santa Fe, N. Mex.

SCARCE Countries: Baden, Mohell, Macao, Inhambane, Schleswig, etc., 5c. Approvals. Bayn Nielsen, Cornwall, Ontario, Canada.

ECUADOR, 100 Different, 60c. Free lists. Mayfield, Route 3, Chattanooga, Tenn.

U. S. Commemoratives—40 diff. only 10c with approvals. Harmil, Box 4314, Kansas City, Mo.

FINE Approvals, freshly mounted. Fast, personal service. Tell me what countries you prefer and I'll send their stamps. Skinner, 345 East Ocean, Long Beach, Calif.

BUY Approvals wanted, take same amount free. Feils, Delft, Minnesota.

PICTORIAL Packet 3c with attractive approvals. Paul Perkosky, R.1, Box 133, Rome, N. Y.

FREE Stamps with approvals, 3c postage. Robert Wilson Smith, McKeesport, Penna.

FREE! Bavarian railroad set; 14 varieties. Approvals. Benters', Burke, S. Dakota.

1, 2, 3c ATTRACTIVE Approvals. Theo. Marlin, 340 Irving, Toledo, Ohio.

20 COMMEMORATIVES—5c With approvals. Betts, 607 Wrightwood, Chicago, Ill.

BOTH Sets Army, Navy complete 10c. Herman Kleinman, Jenkintown, Penna.

BARGAINS In fine approvals! Write today! International Stamp Co., Hallettsville, Texas.

\$10.00 TO \$1,000.00 Paid for stamp collections. Keigwin Company, Vineland, N. J.

10 DIFFERENT Albania 12c. Approvals sent. Prall, Hackettstown, New Jersey.

FREE War Savings stamps to approval applicants. "Nuff said. Valley of the Moon Stamps, Fetters Hot Springs, Calif.

UNITED States 135 different postage 75c. Cal's Stamp House, Roseville, Mich.

LOWEST United States stamp prices. Free illustrated catalogue. Creevey's, Berwick, Penna.

FIFTY British Colonies and twenty U. S. commemoratives for 3c postage to approval applicants. Pan-Am Stamp Company, Box 1168, Miami, Fla.

BIG Bargain! 150 different stamps only 10c. Includes Latin America, U. S. commemoratives, Pacific regions, etc. To approval applicants. Geo. W. Emptage, Cordell, Okla.

WANTED. Collections, accumulations. Send description, Leslie Stamp Company, Haverhill, Mass.

MINT Clark five cents: United States and foreign approvals. Gobrecht, 205 Anderson, Joliet, Ill.

BETTER Value 1c approvals—10 stamps free—your choice. Excel, Box 1315, Chicago.

NEW Free French, 100 other stamps 10c, with approvals. Lon's, M-245, Owatonna, Minnesota.

WANT A firstday cover for your collection? For just one penny and request for approvals, we'll send cacheted firstday cover of new four-freedoms stamp Pittsco, Dept. 52A, Framingham, Mass.

GOYA Nudes (2 vs.) 8c. Approvals. Millhiser, 7724 Abbott, Pittsburgh, Penna.

SENSATIONAL Packet, Fiji, Niue, Bhopal, Borneo, Hyderabad, Ceylon, Set, 3c. Best approvals. Superior, 1019 Greyton, Cleveland Heights, Ohio.

EXCHANGE Duplicates, no high catalog necessary. Details 3c stamp. Will Colton, Sparks, Maryland.

FREE, Grabbag, 25c credit to applicants. Box 85, Delmar, Calif.

FREE! The Stamp Finder! Send today for the big new edition, fully illustrated, enabling you instantly to identify all difficult stamps! Also fine packet strange, fascinating stamps from Bosnia-Herzegovina, Monaco, Patiala, Cyprus, etc., including maps, ships, animals and strange scenes. All free to approval applicants including 3c postage. Garcelon Stamp Company, Box 900, Calais, Maine.

TEN Crazy-shaped stamps, 3c with approvals. Knopp, Box 1381, Bristol, Conn.

UNITED States stamps on approval! Large variety at lowest net prices in America. Stamp Co., Albany, N. Y.

15 AIRPLANE—War weapon stamps 10c. Approvals. Smith, 237 East 8th, Roselle, N. J.

1000 MIXED U. S. old and new 25c. Weatherby, Troy, Ohio.

1,000 MIXED Poster stamps and patriotic labels \$1.00. Rooney, 116 Prince Street, New York.

DEALERS—Wholesale list. Postage 3c. Frank's, 5031 Queensberry, Baltimore, Md.

FREE Your choice of any 10 stamps from our first U. S. approval selection. Illustrated list included. Cosmopolitan Stamp Company, Dept. 3M, 1457 Broadway, New York City.

WORLD'S Smallest airmail—diamond and triangle stamps, free stamp magazine, also magnifier to study your stamps, with large collections of stamps from scarce countries. A bargain, 5c with approvals. Capital Stamps, Dept. 2, Little Rock, Arkansas.

SMOKY Mountain commemorative sheet, largest U. S. stamp issued, and 33 U. S. including commemoratives, airmail, revenues, etc. Catalogs 75c—To approval applicants for 5c. Curhan Stamp Company, Gloucester, Mass.

206 DIFFERENT Stamps including Kedah, Haiti, Cochon, Albania, Johore, Perak, only 10c to approval applicants. Reich Stamp Co., 4647 Kenmore, Chicago, Dept. M3.

SERIOUS Approval applicants send 5c for six beautiful sets—plus extra gift. Manchester Stamp Company, Dept. P, Manchester, Connecticut.

SOLOMON Islands, Seychelles, Nejd, Caymans, Manchukuo, Brunei, Turks Caicos. Everything 3c with approvals. Viking, 130-Z Clinton Street, Brooklyn, N. Y.

20 DIFFERENT Foreign commemoratives 5c! Approvals. Benton Ryan, Middletown, Connecticut.

FREE! Western Hemisphere packet. Postage 3c. Owens, 806 Welsh, Bay City, Michigan.

FREE! Russia war set. Postage 3c. Williams, 606 Archer, Bay City, Michigan.

FREE! Pony Express set (facsimiles). Postage 3c. Roberts, 406 Building, Bay City, Michigan.

3 CUBA Sets 10c with approvals. Pertell, 1610 So. Third, Maywood, Ill.

LATIN-AMERICA—Nice packet, 100 different, only 10c with approvals. "Crescent Stamps," London, Canada.

FREE! Leeward Is., Cayman Is., Turks and Caicos plus 60 different mint Geo. VI coronation poster stamps, to approval service applicants sending 3c postage. Tatham Stampco, Springfield-30, Mass.

500 UNITED States for 10c! 500 U. S. A.—absolutely unpicked and unsorted—just as received from church missions. Many varieties, including commemoratives, airmails, high values up to \$5.00 denomination! Price only 10c to approval applicants! Money back if not delighted. Swan Stamp Co., Dept. 69B, Dunkirk, N. Y.

FREE! Complete "United States" stamp catalog with 1,000 illustrations! Send 3c for postage. Harris & Co., 137 Transit Building, Boston, Mass.

60 DIFFERENT United States 10c. Pricelist free. Seidenberg, Baroda, Mich.

VICTORY Packet free—Includes stamps from Tanganyika, British Cayman Islands, animal, scarce babyhead, coronation, early Victorian, airmail, map stamps, with big catalogue—all free. Send 5c for postage. Gray Stamp Company, Dept. PM, Toronto, Canada.

MEXICO Census commemorative set free with approvals. Pladon Stamps, 1717-M Idaho, Toledo, Ohio.

WHOLESALE Supplements to dealers for 10c postage. Hundreds of bargains. Grossman Stamps, 102 West 42nd, New York.

UNITED States approvals complete coverage, fine quality, attractive prices. Seminole Stamps, Box 436, Coconut Grove, Florida.

WEEKLY Stamp magazine, thirteen weeks, 10c. Stamp Journal, Kalamazoo, Mich.

A REAL Bargain. Specially prepared packet containing 150 different foreign and 65 different U. S. stamps; catalog value about \$5.00; pamphlet which tells you "How to Make Your Stamp Collection Properly" and large bargain lists, all for only 23c postpaid. Queen City Stamp Co., Room 36, 604 Race St., Cincinnati, Ohio.

PENNY Approvals, that satisfy. Neil Gronberg, Box 5441-P, Philadelphia, Penna.

SEND Postage for free United States price list. Stanley Gibbons, 38-P Park Row, New York.

CANADA 100 Different 25c—approvals all countries. Lists. Victoria Stamp Co., London, 4, Canada.

HOBBIES AND COLLECTIONS

GENUINE Arizona ruby and desert sapphire, send quarter for both. Mineral Specimens Company, Box 2651, Phoenix, Arizona.

20 DIFFERENT Cactus plants postpaid, \$1.00. Eulalia Turner, Azusa, Calif.

ADDRESS, 20 Big hobby clubs for 25 cent war stamp. Charles Fox, Argos, Ind.

EVERY Hobbyist should read "Collector-Dealer-Trader Magazine," 32 big pages, 15 departments on every major hobby—sample 20c, six issues \$1.00. Hobby Publications, La Porte, Indiana.

MATCH Hobby "Bulletin," membership blank, stamp, Box 1111, Rochester, N. Y.

UNUSED Book match covers, 100 all different, \$1.00. Free list. Charles Edelman, 1311C East 84, Cleveland, Ohio.

JOIN Matchbook club, 25c. Free covers. Box 101-B, Rochester, N. Y.

BEAUTIFUL Jewelry stones removed from rings, etc. 100 assorted \$2.00. Lowe's, Box 311, St. Louis, Missouri.

NEW—15 Different match covers 10c. Box 202, Rochester, N. Y.

DO You know ores? 24 beautiful identified mineral specimens, inch size, gold, silver, molybdenite, etc. Display carton—postpaid one dollar. Arizona Mineral Specimen Co., Cherry, Arizona.

CAMERAS AND PHOTO SUPPLIES

STILL Available at Central—Hundreds of bargains in cameras and supplies. Send for free illustrated catalog listing still and movie cameras, films, lenses, enlargers, meters, supplies—at tremendous savings—all guaranteed. Trade in your old camera or equipment. Write for our free copy of newest money-saving bargain book—just out! Limited edition. Hurry! Central Camera Co., (Photographic Headquarters since 1899), 230 S. Wabash Ave., Dept. D-16Z, Chicago, Illinois.

CAMERAS Bought, sold, traded, repaired. All makes. Darkroom equipment. Easy terms. Mogull's, 64 West 48th, New York.

HIGHEST Prices for cameras. Send yours in for free estimate. Bank references. 943 Pennsylvania Avenue, N. W., Washington, D. C.

BASS Says: War time proves Bass leadership. Amazing selection of finest still cameras—Leica, Contax, Korelle reflex, Argus, new and used still available. Write for quotations. Satisfaction guaranteed or your money refunded. Bass buys 'em, sells 'em, trades 'em. Bass Camera Company, Dept. AG, 179 W. Madison St., Chicago, Illinois.

MAKE Money in photography. Learn quickly at home. Easy plan. Previous experience unnecessary. Common school education sufficient. Booklet and requirements free. American School of Photography, 1315 Michigan, Dept. 3431, Chicago.

HAVE You a camera? Send ten cents for recent number of our big magazine, showing how to make better pictures and earn money. American Photography, 116 Camera House, Boston, Mass.

CAMERA Repairing. Bellows made to order. shutters repaired. Bellows made to fit all standard cameras! United Camera Co., Inc., A-1515 Belmont, Chicago.

CASH! Spot cash for cameras, lenses, binoculars, movie or still, sound projectors. Send full description by mail, or wire for prompt cash offer. Over 30 years of dependability insures honorable dealings. Bass Camera Company, 179 West Madison Street, Chicago, Illinois.

PHOTO FINISHING

EXCLUSIVE Introductory offer! 4 beautiful enlargements for 10c. Send any 4 negatives of the same size (up to 2 1/2" x 4 1/2") and we will return to you immediately 4 valuable enlargements—deckled and dated on Velox. Negatives returned with order. Send negatives, this ad and 10c coin today. This ad must accompany order. Mail-N-Save, Box 310-14, Quincy, Mass.

25 CENTS For roll finished with 16 regular negative size prints or 8 double size prints 30c. Fast, safe service from the old reliable, Pioneer Photo Co., Box 123, Wichita, Kansas.

FILMS—8 Exposure, enlarged to double size 30c. Or 8 exposures negative size only 25c. Finest quality. Fast service guaranteed. C-C Photo, Box No. 280, West Chester, Penna.

ROLL Film developed and 16 prints or 8 prints and 2 enlargements 25c. Crystal Photo Service, Box L, Crystal Lake, Ill.

FILMS Scientifically developed with 8 x 4x8 enlargements 30c. Send for price list and mailbag. Photo-Service, 107 Dewey St., Newark, N. J.

16 SPARKLING Lifetone prints, 2 beautiful Hollywood enlargements, free Leatherette frame and photo wallet only 25c. Free photo album with first order. Lifetone Studios, Dept. A-439, Des Moines, Iowa.

COLORED Lifelike enlargements from your snapshot negative 5x7, 25c; 8x10, 40c. Promenade Photos, 13 St. Marks Place, New York City.

TWO Beautiful 8 x 10" enlargements 25c. Five sparkling postcard enlargements—25c. Empire Photos, Adams Center, N. Y.

REPRODUCE Any snap shot on hankies, slips, wood, leather, etc. Outfit \$1.00 postpaid. Dissell, 4667 Rockwood Road, Cleveland, Ohio.

BIGGEST \$1.00 Value in 35 mm. finishing today. 36 exposure fine grain 3 1/4 x 4 1/2 enlargements; deckled, embossed margin and date. Eighteen exposures 75c; sixteen exposure splits 55c. Free mailers. 8 exposure rolls in beautiful deckled contact finish with embossed wide margin, 25c. Mailbag Film Service, Box 5440A, Chicago.

EIGHT Beautiful enlarged prints (nearly postcard size) or 16 regular prints 25c. 35mm. rolls enlarged 3 1/4 x 4 1/2 \$1.00. Burton Studios, 55M, Roscoe, N. Y.

PHOTOGRAPHY For pleasure and profit. Prepare at home. Common school education sufficient. Write for information and requirements. American School of Photography, 1315 Michigan, Dept. 3452, Chicago.

BEAUTIFUL Enlargement from each picture on roll 25c. Cut Rate Photos, Dept. B-4, Janesville, Wis.

SEND Your favorite negatives and dime for sample photo Easter card and sample photo Mother's Day card. Roll developed 8 prints and two enlargements 25c. Young Photo Service, 405-M, Albany, N. Y.

REPRINTS 2 1/2c Each, 100—\$2.00. 6 or 8 exposure rolls developed 2 prints each exposure 25c. 36 exposure 35mm rolls fine grain enlarged prints \$1.00. Mailing envelopes free. Mercury, A-109 North Dearborn, Chicago.

ONE 7x5 Enlargement. Send 10c. Hand colored, 15c extra. Prompt service. Send negative only. Photo Service, Dept. 100A, Des Plaines, Ill.

AMAZINGLY Beautiful hand colored prints 6-8 exposure roll developed, printed 25c trial. Reprints 4c each. National Photo Art, D-PM, Janesville, Wisconsin.

6-8 EXPOSURE Rolls developed and enlarged mammoth size 25c. Reprints 3c. Thrifty Photos, Box 46, South Gate, Calif.

DOUBLE Size 4x6 prints. Quality work. Guaranteed. Everlasting Hi-gloss finish. Overnight service. Your roll developed and 8 x 4x6 prints from 116 or 120, 30c. All other sizes in proportion. 12 exposure roll 40c; 16 or 18 exposure roll 55c, 36 exposure roll \$1.10. Reprints, 4x6—3 1/2c each. No order less than 25c. Get our low prices on enlargements, double weight, velvet finish copies made from new and old prints. Send for mail bags. Pacific Photo Service, Box 666, San Francisco, Calif.

35 MM. Fine grain developed 36 big sparkling 3 1/2 x 5 enlargements \$1.25. Re-load 35c. Photoshop, Linton, Ind.

EVERY Picture an enlargement! 8 sparkling deckle-edge enlargements and roll developed 25c coin; 116 size or smaller; enlarge reprints 3c. Enlarge Photo, Box 791D, Boston, Mass.

8 EXPOSURE Rolls, giant size 25c; 16 exposure rolls, 50c. Mayfair Photos, Box 261-K, Toledo, Ohio.

ROLLS Developed: Two prints each negative 25c. Reprints 2c each. Summers' Studio, Unionville, Mo.

THREE Prints each good negative, 6 to 8 exposure rolls, 30c. 12, 16, 18 exposure rolls, 50c. Reprints, 3c. Fred D. Eastman, Bode, Iowa.

ROLL Developed and 8 lustrous distinct finish permanent Velox glossy prints 25c—reprints 3c each. Fotoprint Service, Box L, Roanoke, Virginia.

8x10 SILK Finish enlargement—25c. Send negative. Irving Studio, 4066A Irving Park, Chicago.

MOTION PICTURES AND SOUND EQUIPMENT

16MM. Sound musicals. Lists free. Warrington, 1418 Knecht Ave., Hawthorne, Md.

BASS Says: Leadership in the cine field is apparent in war times. Here ready—your choice of 8 mm. and 16 mm. apparatus. Write for quotations. Your old equipment is worth real money in trade—describe please. Or we buy for cash and pay immediately on receipt. Write to headquarters. Bass buys 'em, sells 'em, trades 'em. Satisfaction guaranteed or your money refunded. Bass Camera Company, Dept. A, 179 W. Madison St., Chicago, Illinois.

READY-TO-FRAME 6x4 Enlargements, 5c; Hand colored 20c—from your negative. 16 reprints your negative, 25c. Kodak roll developed with 16 guaranteed deckle-edge Velox prints 25c; 36 exposure 35mm. roll developed, vaporated, enlarged to 3x4, \$1.00. 3x4 reprints, 3c each. Immediate service! Free mailers! American Studios, LaCrosse, Wisconsin.

LEARN Movie projection, management. Free catalog. Give age. Theatre Institute, Elmira, N. Y.

OUTSTANDING Sound 35mm. features! Shorts! Demsey, 1223 Berkley, Youngstown, Ohio.

SOMETHING New, movie screen coating. Free literature. Snow White Screen Company, Danville, Illinois.

DANDY 35mm. Films—List free! "Surprise" samples, 10c. Superior, 126 Fourth, Paterson, N. J.

FREE, 1943 Movie catalog, sample film, 10c. Goodwill Company, Jackson, Tenn.

WANTED: Used equipment for cash. Films, cameras, projectors, etc. Peters, 41-C South Fourth, Allentown, Penna.

100 FT. 8mm. Subjects 98c. Spring Films, Hopkinton, Mass.

35MM. 16MM. Sound silent projectors, films. Savarese, Woodcliff Lake, N. J.

WORLD War—35 mm. Positive. Negative. Elouhy, 31-27 - 43 St., Astoria, N. Y.

SPOT Cash waiting! 16mm. sound projectors; Rolliflex Cameras, Cine special (cameras-lenses). Mogull's, 64 West 48th, New York.

200 SEAT Movie theatre for sale. Summer proposition. Landow, Keansburg, N. J.

SILENT 35mm. Films. Bargains. Wm. Batt, 721 Main, Watsonville, Calif.

\$1 BRINGS "Surprise" assortment useful 8mm. colorful titles! LeMoine Films, Nevada, Missouri.

SOUND And silent films, cameras, projectors, and accessories, exchanged, bought, sold, rented. Bargain list free. Harvey Iris, Box 539, Brockton, Mass.

SEND Stamp for 16mm., 8mm. catalogue. Sterling's, 679 Northampton, Easton, Pennsylvania.

ESO-B Guaranteed 8mm. film ready for camera. Univex, \$2.00 six 30' spools, postpaid. Double 8mm. available. Particulars. ESO-S, 3945 Central, Kansas City, Missouri.

SOUND 35mm. Features \$10.00 up. Programs rented \$7.50 complete. Sound projectors \$275.00. 16mm. sound film lists. Simpson Films, Miamisburg, Ohio.

"THE World's Greatest Passion Play," 8mm., 16 and 35mm. Specify sound or silent. Rent or purchase, include stamp. Hemenway Film, 33 F Melrose St., Boston, Mass.

8MM.-16MM. Silent-sound film, all latest subjects. "Russia Strikes Back," "United States Carrier Fights for Life," "Casablanca Meeting With Roosevelt-Churchill." Films rented everywhere. Free catalogue—(sample film 10c). Garden Film, 317 West 50th, New York.

COMPLETE 16mm. Sound subjects, perfect, \$5.75. Odd sound reels \$2. All sizes film bought, sold, exchanged. Catalogues—sample film 10c. International-M, 2120 Strauss, Brooklyn, New York.

8MM.-16MM. Films. Free catalogue (sample film 10c). Parkway Exchange, 961 Eastern Parkway, Brooklyn, New York.

MUSIC AND MUSICAL INSTRUMENTS

CASH For your old musical instrument regardless of condition or age. Accordions, oboes, saxophones, bassoons, clarinets, English horns, trumpets and other horns. Look around your home now! Turn your old instruments into cash. Get our price. Write or send instrument express collect. Gretsch & Brenner, Inc., 42 East 20th Street, New York City, N. Y.

"PICTURED Piano Playing." No notes—sensational results guaranteed—10c sample. Picture Piano, Wallace, Idaho.

OVER 2000 Phonograph records played from one needle, state make of phonograph, postpaid \$1.00 each. Adrian Earl Thompson, Drawer 440, Tuscumbia, Ala.

SONGWRITERS! Amazing outstanding offer. Hibbeler, C5, 2157 No. Avers, Chicago.

NEW And used accordions bought and sold. \$25.00 up. Del Principe, 307 So. Wabash, Chicago.

CASH For used musical instruments. E. T. Evans, Westminster, Md.

LEARN Popular piano! Write Magic Key, 111-A Broadway, Glendale, Calif.

POEMS Wanted for musical setting. Send poem for immediate consideration. Five Star Music Masters, 630 Beacon Building, Boston.

SONGS. Lyrics wanted! Guaranteed publication. Free details and royalty contract. Pan-O-Ram, 1658 Broadway, New York, N. Y.

POEMS Wanted. Monthly publication. Annual anthology prize awards. The Poet, Box 864, Salisbury, Maryland.

SONGS—Song poems wanted. No charge for melodies. Marketing service. Hollywood Recording Studios, 87G26 Preuss St., Los Angeles.

MUSIC Printing \$5—100. Composing arranging. Auto-Litho Co. Jensen, Fla.

MORRIS Composing copyright service. Profit sharing. Details for stamp, 189 16th, Wheeling, W. Va.

SONGWRITERS. Write for free booklet profit sharing plan. Allied Music, 20 East Fourth, Cincinnati, Ohio.

SONGWRITERS: Send poems for offer and free rhyming dictionary. Phonograph records made. Vanderbilt Studios, Box 112-P.S., Coney Island, N. Y.

PUBLISHERS For new songwriters. Radio Music Publishers, 121 Harrison Chicago.

SONG Poems wanted: Write for free instructive booklet. United Music Corporation, Dept. 14, Salem, Indiana.

SONGS Composed, arranged and published. Siebenack Music Co., Kalida, Ohio.

GOOD Music composed to good words. Reginald Belcher, Chatham, New Jersey. Established 1910.

SONGWRITERS—Free book. Send poems. Variety, Dept. 2, Salem, Indiana.

SONGWRITERS—Get our plan quick! Rush poem—war, love, etc. Free rhyming pamphlet. Victor Studio, Box 278, Chicago.

\$275.00 DEAGAN Stand marimba, 3½ octaves, \$85.00. "Kenchal," 271 Madison, West Hempstead, New York.

SONGWRITERS—Get the facts. Free informative booklet, plan. Write today. Song Service, 331-C West 46th, New York.

SONGWRITERS—Send poem for immediate consideration and free rhyming dictionary. Richard Brothers, 24 Woods Building, Chicago.

MUSIC Composed to words. Rhyming pamphlet on request. Phonograph recording of completed songs. Send poem for consideration. Keenan's Studios, Dept. PM, Box 2140, Bridgeport, Conn.

WANTED! Lyrics, melodies for songs. We arrange, publish, sell. Superior Song Studios, Passaic, N. J.

MUSIC Composed to words. Wonderful proposition. Bauer Bros., Oakkosh, Wis.

LEARN Swing piano! Postal brings free folder. Christensen, 451 Kimball Hall, Chicago.

WRITE Songs. Big money and reputation. Write for information. J. Gordon Pub. Co., 201 N. Hoynes, Ave., Chicago.

RADIOS, SUPPLIES, INSTRUCTION

BUILD Radio condenser tester for \$2. Plans 25c. A. C. Lowe, 1104 Knight St., Lynchburg, Virginia.

REVISED Plans 18 long distance crystal sets, with "Radiobuilder"—year, 25c. Laboratories, 1406-C 77th Avenue, Oakland, Calif.

EARN More. Radio and electrical servicing simplified. Complete radio servicing course in one book. Details free. Hawkins Specialties, 537 So. Dearborn, Chicago.

RADIO Service men and experimenters send for our giant radio catalogue. Save dollars. United Radio Co. (1000M), Newark, N. J.

RADIO Communications courses qualifying for all federal licenses. Home study and resident courses. American Radio Institute, 1123 Broadway, New York, N. Y.

LOWEST Prices in America. Radio tubes, parts, condensers. Free bargain lists. Potter, 1314 McGee, Kansas City, Mo.

BUSINESS OPPORTUNITIES

WANTED County representatives—Sensational 100% profit 50c seller Storm-Proof Cigarette-Clear and Pipe Lighter, employing charcoal principle—"More wind blows—more lighter glows." Everybody wants one because everybody smokes. Men, here's that useful, non-competitive money-maker you have been looking for. Write—Storm-Proof Lighter Company, 126 Lexington Avenue, New York.

START Home business making statuary, plaques, art goods, novelties, souvenirs, concrete pottery, garden furniture, artificial marble flooring, liquid marble. Make your own flexible molds. Amazing profits. Valuable folder free. Creative Publishers, (PM), Glencoe, Illinois.

FREE—200 Clever mailorder, homework, local business offers—all snappy money-makers. Lewis Co., 828-M Carpenter, Oak Park, Illinois.

PROFITABLE Business by mail. Small investment. Particulars free. Walker Herrin, 818 S. Vermont, Hannibal, Mo.

THOUSANDS Of Time-O-Graphs will be sold by mail. Prospects. Thousands of teachers, millions of war news readers. Samples and sales plan \$1.00. Time-O-Graph Company, 1417 A State St., Schenectady, New York.

300 PROVEN Ways to make money. Only 25c and 5 names addresses. Supply limited. Get yours. R. Lewis, 70 East Lincoln, Delaware, Ohio.

MONEY Making business starter, circular free. Wayne Products, Pleasantville, New Jersey.

ESTABLISH Profitable business. Sno-Drift cleanser. Walters, M-830 West End, Detroit, Michigan.

TIRED Of working for others? Be your own boss! Dimes, quarters, dollars by mail! Free particulars! "Novel Enterprises," P.O. Box 457, Reno, Nevada.

MILLION Articles. Buy wholesale. Valuable directory 10c. Ideal Service, D-4, Park Ridge, Ill.

MAKE Your own Flexible Molds. Statuary, Art Goods, Novelties, Artificial Marble Flooring, Liquid Marble. Literature free. Kemico, 4-M, Park Ridge, Ill.

ONLY \$1.00 Monthly or \$7.50 for whole year, pays for branch-office under your own name. Co-operative Offices, 126 Lexington Avenue, New York.

FOR An extremely profitable lifetime business, operate a collection agency-credit bureau. Many make \$4,000 yearly, up. Write Cole Associates, Syracuse, N. Y.

HOW To publish books, magazines, inexpensively. Booklet covering: costs, distribution, advertising, financing, editing, etc. Complete 25c. Graphic, Box 131, St. Louis, Mo.

5 DIFFERENT Mail order magazines 10 cents. Loren Hollenberg, Roseville, Ill.

DON'T Be a job hunter—Start your own business on our capital. No hard times; no layoffs; always your own boss. Hundreds average \$3,000 to \$5,000 annual sales year after year. We supply stocks, equipment on credit, 200 home necessities. Selling experience unnecessary to start. Wonderful opportunity to own pleasant, profitable business backed by world wide industry. Write Rawleigh Co., Dept. D-U-PPMB, Freeport, Ill.

CAPITAL Seekers—Interested in raising \$25,000 or more for a legitimate project should write to Amster Leonard, Fox Theater Bldg., Detroit, Michigan.

MAIL Order business—Course in modern mail order methods. Learn how successful men sell by mail. Free details. John W. Foree, 4539 Chestnut Avenue, Kansas City, Mo.

300 MONEYMAKERS 25c. Details, stamp. Quality Distributors, 668 Fern, Yeadon, Penna.

GUARANTEED Income! Grinding lawn mowers. \$2.00 capital! Mowers, Janesville, Wis.

SELL By mail! Instructive folder free. Terrill, B-2X, Bogard, Mo.

MAIL Order business course shows you how to make money, spare or fulltime. Teaches professional mail order technique—not penny-catching schemes. Free details. Nelson Company, 500 Sherman, Dept. D-402, Chicago.

MAKE Imitation marble, granite, flexible molds. Details, stamp. Dykes, 5110 Kinghill, St. Joseph, Mo.

\$200.00 WEEKLY Traveling, short hours evenings. Box 682, Savannah, Georgia.

5 DIFFERENT Magazines 10c. Interesting mail stamp. Renick, Holland, N. Y.

RAISE Angora wool rabbits for wool and meat. Easy, profitable business. Booklet, prices, etc. 10c. Harder Farm, Route 2, Salem, Oregon.

SIGNS And showcards easily and expertly painted with letter patterns. Many sizes and styles. Write for descriptive folder. John Rahn, A1330 Central Ave., Chicago.

START Profitable business at home. We have complete details many successful enterprises. Illustrated broadside free. Crown Books, B-1, Charlotte, Mich.

MECHANICALLY Inclined men—Own and operate general appliance repair shop. Complete, illustrated course shows you how. Welding, refrigeration, motor repair, how to get business, etc., all phases covered. Free literature. Christy Supply, Dept. 127, 2835 N. Central Ave., Chicago.

SENSATIONAL Results reported! Need mailorder letters, literature, campaigns written reasonably? Investigate! Pinkel Advertising, 1109½ South Ogden, Los Angeles.

"HOW To Sell by Mail"—Amazing new booklet postpaid 25c, including pre-view today's success opportunities. General Publications, Ossining, New York.

MAILORDER Best seller—complete, authentic life story General Douglas MacArthur. Circulars available. Southern Books, Waynesboro, Georgia.

SELL Our latest exclusive books of instruction by mail. Publisher furnished snappy circulars. No bookstore competition. Bigger profits, Rush name! Financial Education, 435 Commonwealth Bldg., Denver.

COLOR Cement with chemicals. Make artistic cement garden ornaments Hollywood style. Sample 10c. Hollywood Cementcraft, 8527 Wonderland, Hollywood, Calif.

LIQUID Marble—Colorful, glazed! Mold, brush, spray! Composition floors, rubber-lastic molds. Particulars free. Marbleizing Service, Edwardsville, Illinois.

VITAMINS, Minerals, health books, wholesale. National Diet Company, Portland, Oregon.

DRUNKENNESS is a disease which responds to treatment. Medical skill plus human sympathy prove successful with liquor and drug cases. 40 years experience. Write for free booklet. P. M. Nelson, The Keeley Institute, Dwight, Ill.

\$10,000 **FIRST** Year making and selling dandy hand cleaner, powder form, from Schemer Magazine, Alliance, Ohio. Formula and "Schemer" 12 months just \$1.00.

\$50.00, \$100.00 **WEEKLY** Using sawdust. Stamp appreciated. Clement, 80R Gersline, Rochester, N. Y.

MAKE Extra money at home. Use your spare time. Literature free. Write now. Hodges, 321 E. 41st, Chicago, Ill.

EXTRA Income—Plenty mail selling opportunities. Write Katz, 4254 N. Kimball, Chicago.

"HOW To Make Simple Molds and Plaster Plaques." No rubber required! Booklet 25c. Plastercraft, 1406 E. 43rd St., Cleveland, Ohio.

AGENTS—To mail our literature. Good profits. Home business. Maywood, 1133 Broadway, New York.

FULL Or sparetime propositions galore in "Money Making Business Starters." A \$1.00 book you can have for 25c prepaid. Order today. I. W. Meeks Pub. Co., Box 792, Weed, Calif.

5 MOST Read mail order magazines 20c. Armand Cartier, 695A North, Pittsfield, Mass.

BRUSH Plating outfits connect to a battery, no tanks necessary. Almost as simple as painting. Your opportunity to make good income plating autoparts, bathroom fixtures, reflectors, mirrors. Get free proof and particulars that put you in a paying business of your own. Gunmetal Co., Ave. H, Decatur, Illinois.

WEBER Typewriter Mechanics School. Simplified homestudy-repairing increasing. Canton, Ohio.

PLASTEX Industries offers industrious men an opportunity to start a business of their own, manufacturing art goods, novelties, souvenirs, etc., in Plastex and marble imitation. 5c material makes \$1 articles. Rubber moulds furnished for speed production. Small investment brings good returns. We are now placing big chain store orders with manufacturers. Write for interesting booklet mailed free. Plastex Industries, Dept. A, 1085 Washington Ave., New York.

STATUARY: Make all kinds. Simple process. Make and install artificial stone flooring in color. Liquid marble. Other money-makers. Write promptly. Literature free. Compo-Tex, Box 786, St. Louis, Mo.

HOW And where to obtain capital. Fully explained, particulars free. Star Service, Wapakoneta, Ohio.

127 WAYS To make money, in home or office, business of your own. Full particulars free. Elite Co., 214 Grand St., New York.

SELL By mail—Particulars free. Harry Dean, 1828 Ave "L," Galveston, Texas.

COFFEELINE! Free imprint proposition! Unlimited possibilities. Dime assures complete information. Carey, 26 Thirteenth, Darby, Pennsylvania.

WANTED Capital. For immediate development and sale of good practical invention. Will assign you an interest. Offers an inflation proof investment for your post war dollars. Inventor, Box 1872, Oakland, Calif.

MONEYMAKING OPPORTUNITIES

RAISE Guinea pigs at home. Millions used, markets everywhere. My proposition, booklet free. Taylors Guinea Pig Farm, Hapeville, Georgia.

MONEY At home. Your own business; "Progressive Mailtrade" magazine (14th year), prints many small capital ideas. Read by thousands; you'll like it too. Copy 10c. Publishers, Box 115X, Gardenville, N. Y.

SEND \$2.00 For assortment of beautiful unpainted plastex novelties. Paint and resell for \$10.00. No answer, unless cash accompanies order. Doggy Gift Shop, 5708-W North Ave., Milwaukee, Wis.

MONEYMAKING Homework offers. Formulas. Literature free. Robert Arthur, 914A Pike St., Seattle, Wash.

MOLDMAKING—Plaster Casting. Complete formulas—fully illustrated. 25c. Ideal Service, RM-4, Park Ridge, Ill.

MAKE Money at home by mail. Pleasant, easy, doesn't require experience or huge capital. Jamesk, Box 1436, Long Beach, California.

REAL Cash instead of flimsy promises! Send dime for details profitable spare-time mail order business. Martin, 2417-P Jefferson Ave., St. Albans, W. Va.

YOUR Name printed in 10,000 "Big Mail" directories. 25c. Checking copies sent. Arlesse's, 15881 Log Cabin, Detroit, Michigan.

SPARETIME Homework—Many profitable mailorder and local business plans. Details and big magazine. 10c. Lewis, 828-H Carpenter, Oak Park, Ill.

GOGETTER: Money making home work plans; courses, mail order, commercial plan. Details 3c. Waltman's Service, 504 Mill St., Chester, Penna.

HELP Win the war first! Then man, you'll like silvering mirrors, reflectors! Making sparkling chipped glass nameplates. Outfit prices. Sprinkle, Plater, V60, Marion, Indiana.

PROFITABLE Homework. Fascinating sample, details 10c. Woodcraft Projects, 1320 Lindsay, Gainesville, Texas.

EARN Money evenings, copying and duplicating comic cartoons for advertisers. Adservice, Argyle, Wisconsin.

MECHANICALLY Inclined men — Own and operate general appliance repair shop. Complete, illustrated course shows you how. Welding, refrigeration, motor repair, how to get business, etc., all phases covered. Free literature. Christy Supply, Dept. 1127, 2835 N. Central Ave., Chicago.

ASTOUNDING Moneymaking plan exposed in \$1.00 folio. Order now. You'll be satisfied. M. Woelfel, 2029 Laurel Road, Upper Darby, Penna.

INCREASE Sparetime profits. Read National Mail Order Advertising & Selling magazine. Sample copy 10c. National, Ord, Nebraska.

EARN Money at home! Thousands do! "Home Worker Magazine" tells how. Sample, 25c. Sizemore, Box 7, 4917 North Kostner, Chicago.

LEARN Metascience. Remarkable drugless healing. No manipulation. No apparatus. Unbelievable simplicity and results. Inexpensive correspondence course. Write Metascience, De Land, Florida.

FORMULAS, PLANS, ETC.

MAKE Fast selling products. No machinery. "Chemist Approved Formulas." Literature free. Kemico, 15, Park Ridge, Illinois.

SIX Money making formulas, free. Send stamp. A. Veach, Palestine, W. Va.

PERSONAL Formula service, 20 years registered pharmacist, medicines, cosmetics, flavors, insecticides, flavors, bleaches, list 10c. McDaniel, 939 East Euclid, Detroit.

"LUMINOUS Paint" shines in dark. Easily made. 100 other formulas, plans—all 25c. Ideal Service, 304, Park Ridge, Ill.

FORMULA And method wanted for etching plastic to be used as printing plate. Address Hill, 243 Forest Ave., Glen Ellyn, Ill.

10,000 FORMULAS; Moneymakers. 924 page volume. \$1.75. Ideal Service, 179P, Park Ridge, Ill.

REAL Manufacturing formulas. Lists free. Cummings, Chemist, Gordon Ave., Syracuse, N. Y.

AUTHENTIC Formulary 924 pages (illustrated). 10,000 money making formulas, recipes, instructions, substitutes. \$1.75 postpaid or C.O.D. (foreign \$2.10). Catalog 3c. Adams Brown Company, Chestnut Hill, Massachusetts.

FORMULAS — Latest, best. Analysis. Literature free. Belfort, Engineering Building, Chicago.

CHEMISTRY

WINN'S New Idea Home Laboratory Chemical Kits and apparatus outfits for home experimenting. Send 5c for literature and retail supply catalogue. J. H. Winn Co., Dept. 504, 124 W. 23rd St., New York.

HANDBOOK For chemical experimenters, hundreds of experiments, illustrated. 50c. Experiment booklet 10c. Reading Scientific Company, Reading, Penna.

FREE Catalog: Chemistry, mineralogy, microscopes, biology. Tracey Laboratories, Evanston, Illinois.

FREE Chemical catalogue. Enclose 3c postage. Greenwood, 398 Broadway, New York.

EXCELLENT Emulsions instantly, at a piston's stroke—with the Jubilee Emulsifier. No failures, no separation, when ingredient ratio is sound. Saves time, materials. Small, compact, powerful. Easy to operate, and to clean. Suitable for experiments, test samples, small-batch production. \$3.00. Moneyback guarantee. Send for free particulars. International Emulsifiers, 2409 Surrey Court, Chicago, Illinois.

CHEMISTRY Laboratory apparatus and chemicals for industrial, analytical, and private experimental laboratories. Complete chemical laboratory supply service for correspondence school students. Send 3c for free 48-page catalog of chemicals and apparatus. Dept. M-43, Biological Supply Co., 1176 Mt. Hope Ave., Rochester, New York.

SPECTROSCOPE For quick chemical analysis \$2.50. Kutting Sons, Campbell, California.

HELP WANTED

WOMEN—Earn to \$23 weekly taking orders in home for dresses \$2.39. Just one of 140 wonderful values. No investment. Give age, dress size. Fashion Frocks, Desk 54140, Cincinnati, Ohio.

BIG Money taking orders; shirts, ties, hosiery, underwear, pants, jackets, sweaters, uniforms, etc. Sales equipment free. Experience unnecessary. Nimrod, 4922-BG Lincoln, Chicago.

WRITE For free fabric samples amazing stainproof tablecloths. Clean with damp cloth. Require no ironing. Beautiful patterns. Look expensive, long wearing, low priced. Commissions big. Also complete dress line. Melville Company, Dept. 3574, Cincinnati, Ohio.

WANTED—Men in metal working industries to sell at good profit important machine shop tool to co-workers. Write for details to Dickman, 330 W. 42nd St., New York City.

AGENTS WANTED

\$1.00 BRINGS Cook stove and range oil burner to your door. C.O.D. balance. Fits in your stove. Cook your meals and heat your kitchen with cheap oil. Life time guarantee. Big profits. Oil dealers sell oil for cooking. We have government priority. Write quick. Northwest Mfg. Co., Box 130-D, Mitchell, So. Dak.

FIRST Aid! Co-operate with national defense program. Build a steady flow of repeat business that will last for years. Highly dignified job selling Schaffner's "Little Doc" First Aid Kits and supplies. Everyone is a prospect. Send \$1.50 for sample kit and sales ammunition. Money back guarantee. Gus J. Schaffner Co., No. 6 Schaffner Bldg., Avalon, Pittsburgh, Penna.

SILVER Plating and polishing liquid. Apply with cloth. Cleans, silverplates, polishes, one rubbing. Makes silverware, jewelry, musical instruments, like new. NuSilver, Aurora, Ill.

EXCELLENT Sparetime sideline! Substantial profits! Pines, 144-34 70th Avenue, Flushing, N. Y.

SELL 50 For \$1.00 name imprinted stationery with matching envelopes—free samples. Odd cards 2/2c. Birthday, all occasion greeting card assortments 35c up. Cards for boys in service. Special offer. New England Art, North Abington, F-362, Mass.

"MAGIC Roach Box"—Handy, effective, economical. Carton twelve boxes \$1.00 post paid. Agents wanted. Nock Co., 1712 Valmont, New Orleans, La.

MEN And women wanted! Full or part time. We help you get started on Raleigh Route of 800 families. Large sales mean big profits. Write Raleigh Co., Dept. D-180-PPMA, Freeport, Ill.

GOLD Lacquered window sign letters. New styles. Absolutely beautiful. Free samples—catalogue. Atlas, 7941 Halsted, Chicago.

BIG Money taking orders; shirts, ties, hosiery, underwear, pants, jackets, sweaters, uniforms, etc. Sales equipment free. Experience unnecessary. Nimrod, 4922-AN Lincoln, Chicago.

NOVELTIES — Service banners, flags, pennants, pillow tops, military jewelry. Retail or wholesale—state which. Clover Novelty Co., 101K, Hollis, N. Y.

USED Men's shoes 14c, hats 12c, pants 28c, dresses 10c, winter coats 50c, spring coats 35c. Bargain catalog free. Portnoy, 566-V Roosevelt, Chicago.

AGENTS—300% Profit selling gold leaf window letters; stores and offices. Free samples. Metallic Letter Co., 438-B North Clark, Chicago.

BEAUTIFUL Oil paintings 75c up. Dis-sell, 4667 Rockwood Rd., Cleveland, Ohio.

Free Water and our concentrates, makes flavors, lotions, shampoos, 72 products, labels, bottles furnished. Qualco, E-20030 Russell, Detroit.

MAKE Money applying initials on automobiles. Also, sideline salesmen for short run decal name plates. "Ralco," 1483 Washington, Boston, Mass.

"CAR Watchman" prevents thieves from stealing tires—gas—equipment. Amazing invention. Whirlwind seller. Big profits. Write quick. Northwest Electric Co., D-10, Pukwana, So. Dak.

AGENTS Selling house to house send for details personal imprinted napkins and guest towels. Big profits. Quality Paper Products, Hollis, N. Y.

MILLIONS Of war workers will buy "Parisian Beauty Secrets," a 160-page illustrated book with 160 interesting chapters on health, diet, exercise and beauty care by the noted Parisian authority, Pierre Carrette. Price \$1.00. Sample 50c prepaid. Write for agent's discounts. Gold Shield Products, Dept. M, 350 Greenwich St., New York, N. Y.

AGENTS To sell men's neckwear. Eventide Neckwear Co., 4121 Fillmore St., St. Louis, Mo.

WHOLESALE Sources, 500,000 articles. Free directory. Maywoode, 1133 Broadway, New York.

LUMINOUS Paint, Profitable 50c seller. Details. Ward, 97-C, Saybrook, Conn.

ELITE Collection contains 127 plans for starting own business; home, office. Descriptive booklet free. Elite Co., 214 Grand St., New York.

SHAVE With feather-like touch; attachment for any 2-edge safety; agents outfit 10c; fifty postpaid \$1.50; retail 25c. Adjustrate, 35PM North Ninth, Columbus, Ohio.

ANTI-FREEZE Make-sell yourself. Many other manufacturing processes. Special sale. Thermocwks, Peoria, Ill.

SMALLEST Bible in the world. Fast sellers. Two Bibles 25c, doz. 70c., etc. Ray Inman, 615 Deerfield Ave., Highland Park, Ill.

GREETING Card distributors wanted. No personal selling. Others do it for you. Get free details. Dunbar Cards, New Brunswick, N. J.

READY-TIED Neckties. Big profits. Making money for our salesmen since 1934. Sample 30c, write Zip-On Neckwear, 425 Market, Philadelphia, Penna.

SCHOOL Seniors—Sell America's most beautiful distinctive graduation name cards. Positively highest commission. Lowest prices. Free sample kit. Printcraft, 1423 E. Elm Street, Scranton, Penna.

SELL By mail! Books, novelties, bargains! Big profits! Particulars free! Elko, 438 North Wells, Chicago.

AGENTS. Big line including food products. Fast selling premium and bargain deals. Low prices. Send card for big outfit with gift. Ho-Ro-Co, 2737 Dodder, St. Louis, Mo.

AGENTS: Stamping names on pocket-key protectors. Sample check with your name, address, 25c. Stamping outfits. Emblem checks, check-fobs, name plates. Hart Mfg. Co., 303 Degraw St., Brooklyn, N. Y.

DO You want agents for your proposition? Your ad in this space will place your message before hundreds of men seeking fast-selling products. My folder "How to Secure Agents," is filled with proof. I'll gladly send you a copy free. F. W. Johnson, Manager Classified Advertising, Popular Mechanics Magazine, 200 E. Ontario St., Chicago.

HIGH-GRADE SALESMEN

SALESMEN: Marvelous Magnetic Brush excels vacuum cleaner. 100 brushes, mops, chemicals. 5%—15% higher commissions. Neway Brush Co., Hartford, Conn.

BIG Commissions—selling to stores celluloid pricing tickets, metal shelf moulding. To restaurants, menu covers, signs. P. Pricing Press, 124 White St., New York.

BUSINESS SERVICE

MAIL Address, Receiving, Forwarding \$1 month. Haller, 436 N. Y. Ave., Brooklyn, N. Y.

HAWKINS Mail Service, Washington, D. C. receives, re forwards, business, personal mail. \$2.00 monthly. No. 7b Randolph Place.

TYPEWRITERS, DUPLICATORS, OFFICE DEVICES

TYPEWRITERS, Adder, mimeograph, multigraph, addressograph. Send for free lists of machines that will help you at half price. Pruitt, 28 Pruitt Bldg., Chicago.

RUBBER STAMPS, OFFICE SUPPLIES

BETTER, Cheaper, Quicker. 3 lines 35c. Mary Struble, Cupertino, California.

3 LINES 30c. Signatures \$1.50. 500 printed statements or envelopes, \$1.50, postpaid. Stamprite, Wauwatosa, Wis.

KNOB Handle, cushioned. 2 lines 30c, 3-40c. Stamp Works, Centerport, N. Y.

PRINTING, MULTIGRAPHING, MIMEOGRAPHING, GUMMED LABELS

250 LETTERHEADS Or envelopes \$1.50 prepaid. Planned layouts and type selections. Samples, estimates, quick service. General job printing. Decalcomanias. Fitzco, 49 Ranney, Springfield, Mass.

PRINTING—Excellent quality: 500 letterheads, envelopes, statements \$2.85 postpaid; cards \$1.60. California Press, Rosemead, Calif.

500 8 1/2 x 11 HAMMERMILL Letterheads and 500 6 3/4 envelopes printed your copy \$4.75 postpaid. Drew Press, Box 423-Y, Greensboro, N. C.

MIMEOGRAPHING That's different! Saves you money! Write for free samples and details. "Argenzio-for-Mimeo," Box 167A, Rutherford, N. J.

SPECIAL! 200 Bond letterheads, envelopes, 8c. Joseph Johnson, 1382 Fifth Ave., New York.

POSTPAID \$1.00. 225 Letterheads or envelopes. Evansprint, 44-NT, Reading, Pennsylvania.

FIRST Quality printing—Reasonable. Samples. Treaster Printing Service, Millroy, Pennsylvania.

CENTRAL West Printers—Leading mail-order printers and mailers—3226-P Jackson, Chicago.

\$1.00 POSTPAID—100 8 1/2 x 11 Bond letterheads and 100 envelopes. Benneville, 907 West Roosevelt, Philadelphia.

"GOD Bless America" stickers, 500 for 25c. Miss Rycza, 2385 Castle, Cleveland, Ohio.

CATALOGS, Booklets, magazines, our specialty. Page size, quantity? Number pages? Send sample. Miller Printshop, Lawrence, Kansas.

200 LETTERHEADS Or envelopes \$1.25. Fred Grissom, Rt. 3PM, Delhi, Louisiana.

500 PRINTED Letterheads and envelopes, good 20 lb. white bond, \$3.65 prepaid. Samples free. Quiz Print, Ord, Nebraska.

SPECIAL 500 8 1/2 x 11 Letterheads, 500 6 3/4 envelopes, good heavy white stock, postpaid \$4.50. Buttler, P.O. Box 54, Napa, Calif.

PERSONAL Stationery—200 6x7 bond letterheads, 100 8 3/4 envelopes, three or four lines printed, \$1.00 prepaid. Shirk, Printer, Lebanon, Penna.

MIMEOGRAPHING—Letters, pricelists, formulas, instructions. Lowest prices. Lem's Letter Shop, 5710 Stanton, Detroit.

5000 ELEGANT Envelope slips, \$3.75; postcards, \$8.75; 6x9 circulars, \$8.25. All printing low prices. Samples. Goodprint, Harrisonburg, Va.

500 3 1/2 x 2 1/4 FOUR Line gummed stickers, 25c. Meritz Printery, Saginaw, Mich.

PRINTING OUTFITS AND SUPPLIES

PRINTING Press, type, ink. Prints cards, etc. All postpaid \$3.00. Berent, 4300 Hampton Blvd., Norfolk, Va.

PRESSES, Type, cabinets, supplies. List for stamp. Lincoln Press, 220-L Hartwell, Fall River, Mass.

SILK Screen process instruction, supplies, service. Write Screen Process Company, 109 S. Capitol, Indianapolis.

COLUMBIA University Home Study Course in Machine Design. Best course of its kind at an/ price. Sent on receipt of \$5.00, money refunded in five days if not satisfied. Offer limited by few copies available. Ideal Co., 10 Hicks St., Brooklyn, N. Y.

DRUNKENNESS is a disease which responds to treatment. Medical skill plus human sympathy prove successful with liquor and drug cases. 60 years experience. Write for free booklet. P. M. Nelson, The Keeley Institute, Dwight, Ill.

"SLIDE Rule Simplified," 25 processes. Normal, inverted, SLT scales: "K," folded, separate. \$1.00. Copyright owner: Adrian E. Gerrits, 517 N. Durkee, Appleton, Wisconsin.

BECOME Finance man. Particulars free. Nebraska Finance Co., Lincoln, Nebraska.

LOCKSMITH Course. Lock picking, key fitting, etc. \$1.00 prepaid. Locksmith, Canadian, Texas.

CLINICAL Laboratory technic taught in your own home. Practice outfit supplied. Bulletin free. Imperial Technical Institute, Box 973-E, Austin, Texas.

LEARN Telegraphy! Splendid opportunities now prevail. All expenses low. Catalog free. Dodge Institute, Dept. M, Valparaiso, Indiana.

RADIO Engineering, broadcasting, aviation and police radio, servicing, marine and Morse telegraphy taught thoroughly. All expenses low. Catalog free. Dodge Institute, Dept. R, Valparaiso, Ind.

CARTOONING, COMMERCIAL ART, SHOWCARD WRITING, SIGN PAINTING

HOW To make money with simple cartoons—A book everyone, who likes to draw, should have. It is free; no obligation. Simply address Cartoonists' Exchange, Dept. 94, Pleasant Hill, Ohio.

CARTOONING Course—36 lessons—6 booklets—816 illustrations—only \$2.80. Free details. Templeton Studios, Elgin, Illinois.

7 AMAZING, Profitable cartoon businesses. Hartman, 2438 W. Lincoln, Nebr.

COMIC Pen and ink sketch made from your photograph. Picture returned unharmed. State hobby or pastime. Send photo and \$1 to Zimm, Alleman, Iowa.

CARTOONING Course—Newest methods, illustrations, gag-cartooning—\$1.00. Warren, Cartoonist, N7509 Smith, Spokane, Wash.

EARN Money evenings, copying and duplicating comic cartoons for advertisers. Ad-Service, Argyle, Wisconsin.

STUDY Art, cartooning. Book lists free. Box 592, Springfield, Ill.

CHALK Talks, Laugh producing program, \$1.00. Catalog 10c. Balda The Cartoonist, Oshkosh, Wisconsin.

CARTOONING Course—30 illustrated lessons, over 500 sketches. \$1.00 postpaid. Montes Studio, Box 892, Pasadena, Calif.

ADVERTISING AGENCIES, LETTER WRITERS, FOR ADVERTISERS

MAIL-ORDER Or agent ad reaching 1,000,000 families throughout United States \$15.40 inch. Newspaper, magazine, mailing-list, rate-book, free. Chicago Advertising Agency, 20-PM West Jackson, Chicago.

MAIL Order sales skyrocketing. Cash producing ads, letters, folders, etc., prepared. Best pullers, lowest rates. Free product analysis. Van De Mark, Times Star Tower, Cincinnati.

ADVERTISE: 24 Words, 149 newspapers, \$6.50. Lists free. Advertising Bureau, 4515-C Cottage Grove, Chicago.

24 WORDS, 35 Newspapers \$2.00. Goodall, 37 Gardner, Vallejo, California.

ADVERTISING Placed all magazines, newspapers U.S.A., Canada. Lowest rates. Free service. 64-page catalog free. Baker Advertising Agency, A-189 W. Madison, Chicago.

FREE—New Advertisers Rate Guide, 44 pages. Includes everything. Lowest rates. E. H. Brown Advertising Agency, Merchandise Mart, Chicago.

FREE—"Amazing New Book"—"Profits From Classified Advertising." Tells how and what to advertise. Be sure to read this book before you invest one cent in advertising. Remember—it's free! Write for your copy now. F. W. Johnson, Classified Advertising Manager, 300 East Ontario Street, Chicago, Illinois.

SELL Shoes—Everybody a prospect. Amazing new Commando military styles paying biggest profits in our 39 years of leadership to alert salesmen and women. Hundreds of fast-selling numbers for men and women. Dress, work, sport shoes. Sample outfit free. Write Mason Shoe Co., Dept. M125, Chippewa Falls, Wis.

VICTORY Tax calculator—not affected by priorities. Every employer a prospect. Prefer salesman handling stationery line, but not necessary. Big profit. Send 60c today for sample kit and complete, easy sales plan. Write today. The Backlin Company, Burlington, Wis.

ADVERTISING Book matches. America's largest manufacturer of union label book matches. Fast selling line. Large sales producing kit. Sample matches. Complete cut catalog, 17 color combinations makes selling easy. Commission in advance. Superior Match Company, 7530 Greenwood, Dept. M-4, Chicago.

HARVEST Hat salesman. Commission paid weekly. American Harvest Hat Company, St. Louis, Missouri.

SALESMEN: Have real money making opening. Fits into war program. Old progressive firm. Dept. "F," Box 392, Dallas, Texas.

EDUCATIONAL AND INSTRUCTION

"HOW To Break and Train Horses"—A book every farmer and horseman should have. It is free; no obligation. Simply address Beery School of Horsemanship, Dept. 1104, Pleasant Hill, Ohio.

WELDING—Electric arc. Learn profitable trade quickly through actual practice. Individual welder instruction at bare cost of materials. Full particulars free. Valuable welding lessons book 50c. Hobart Welding School, Box M-432, Troy, Ohio.

NEW Writers wanted to re-write ideas in papers, magazines, books. Splendid opportunity to "break into" profitable writing field. Rush postcard for free details. Comfort Writer's Service, Dept. F-149, St. Louis, Mo.

BLUEPRINT, Drafting, layout, accounting correspondence courses by single units. No binding contracts. Davison Tech, 7 Grand Avenue, Detroit.

FREE Paint lessons on plaque, book-ends. Burgermaier Arts, Brown-Oak St., Dayton, Ohio.

REFRIGERATION Extension course. Easy, Quick. Low cost. Free catalog. Highland Tech, 1141 North Highland, Los Angeles.

DRAFTING, Trigonometry courses \$1 each! Inquire Giles, Dept. PM-5, 1326 Myers, Burbank, Calif.

CODE Language—Everywhere invaluable. Conversation possible almost immediately. Instruction booklet 25c. Zendu, Burbank, California.

DETECTIVE Training. Phillips Secret Service, 1917-B North Kenneth, Chicago, Illinois.

IMPROVE Pronunciation. Learn phonetics, reading, writing in hour. 10c. Linford Upton, 2623 Burling, Chicago.

SECRET Investigation. Experience unnecessary. Detective particulars free. George Wagner, M-125 West 86th, New York.

CHESS Sets and books. Catalog free. George Wentz, San Marcos, Texas.

\$125 ALEXANDER Hamilton modern business course, 24 unused volumes, (Morrice), sacrifice \$38.50. "Kenchal," 271 Madison, West Hempstead, New York.

BECOME A Doctor of Psychology (Ps. D.) Teach secret of contentment, happiness. Solve mental worries. Free book. College of Universal Truth, 5651-B North Ashland, Chicago.

EARN Certified Grapho-Analyst degree in amazing new science. Students report earning up to \$1.00 an hour spare time, \$75.00 weekly full time. Graduates in employment and credit agencies, police departments, hotels, theaters, department stores, courts, doctor's offices, private practice. Free placement service. 3,000 word illustrated lesson free. Afga, Linn Creek, Mo.

PSYCHOLOGY Teaches about mind. Bio-Psychology teaches about power of mind over body. Why not learn to use powers of your subconscious mind? Study. Broaden your education. Invest in yourself. What other investment can yield better returns? Write Department J, Taylor School of Bio-Psychology, Chattanooga, Tennessee.

ZINC Etchings 50c. Proofs for stamp. Encoprint, B-31, Kokomo, Indiana.

WE Defy any duplicator to beat Screen-O-Press. Reproduces typewritten letters, halftones, printing. Lettersize \$2.99. Anthony Unis, Peoria, Ill.

INEXPENSIVE 6x8 Printing press. Details free. Novelty Shop, Downsville, Louisiana.

PRINT Your own cards, stationery, circulars, advertising. Save money. Simple rules furnished. Print for others, nice profit. Junior outfit \$8.25, senior outfits \$17.38. Details free. Kelsey, Inc., T-11, Meriden, Conn.

BARGAINS—Presses, type, supplies. Send stamp, 159 Harvard, Cambridge, Mass.

USED Presses, type, supplies. Lists 3c. Turnbaugh Service, Loysville, Penna.

PATENT ATTORNEYS

INVENTORS: Take first step toward protecting your invention—without obligation. Write for free "Record of Invention" form for establishing date of invention and free "Patent Guide for the Inventor"—telling about confidential search service; how to sell and market inventions; details of convenient payment plan. Send today for free "Patent Guide" and "Record of Invention" form. Clarence A. O'Brien & Harvey Jacobson, Registered Patent Attorneys, 31B-D Adams Building, Washington, D. C.

PATENTS Secured. Two valuable booklets, "Patent Protection" and "When and How to Sell an Invention," together with valuable "Evidence of Invention" form sent free. Write immediately to experienced patent counselors, Victor J. Evans & Co., 731-D Merlin Bldg., Washington, D. C.

"PATENT-Particulars" and blanks, free, airmailed. Sterling Buck, Park-North Avenues, Baltimore, Md. Government-registered 36 years.

"INVENTOR'S Guide," 100 mechanical movements, free; advises on patenting, selling inventions, Frank W. Ledermann, 154 Nassau Street, New York.

PATENTS—Trade marks. Preliminary advice, book and disclosure form free. Personal service. Irving L. McCathran, 315 McLachlen Bldg., Washington, D. C. Registered Patent Attorney.

I SELL Patents. Established in 1900, Charles A. Scott, 773PM Garson Ave., Rochester, N. Y.

PATENTS. Protect your idea by securing free "Proof of Invention" folder. Exceptional personal service. Established 1906. E. E. Vrooman, 871 Woodard Bldg., Washington, D. C.

L. F. RANDOLPH, 302-B Columbian Bldg., Washington, D. C. Low cost. Book and information free.

INVENTORS—Before disclosing your invention to anyone—send for form "Evidence of Conception"; "Schedule of Government and Attorneys' Fees" and instructions. Sent free. Lancaster, Allwine & Rommel, 411 Bowen Building, Washington, D. C.

FOR INVENTORS

INVENTORS: Learn now—without obligation—how to protect and sell your invention. Secure free "Record of Invention" form for establishing date of your invention—and new free book "Patent Guide for the Inventor" containing complete information about patent procedure and selling inventions. Don't delay. Write to—Clarence A. O'Brien & Harvey Jacobson, Registered Patent Attorneys, 31A-D Adams Building, Washington, D. C.

INVENTIONS Wanted—Plans for our post war output in a plant with exceptional manufacturing facilities make possible the production of one or more articles with its war enlarged equipment. Submit inventions with sketch or description for manufacturing offer. Write National Electrical Machine Shops, Inc., 2014-T Fifth Street, N.E., Washington, D. C.

PATENT Your idea! Write immediately for two free illustrated books, "Patent Protection" and "When and How to Sell an Invention." 68 pages of valuable information for inventors. No obligation. Address: Victor J. Evans & Co., 732-D Merlin Bldg., Washington, D. C.

INVENTORS: New military and commercial inventions urgently needed by manufacturers. Write for particulars, Chartered Institute, Dept. 4-A, Washington, D. C.

CASH For practical ideas and inventions. Mr. Ball, AB-9441 Pleasant, Chicago.

INVENTIONS WANTED

INVENTORS' Opportunity—Large Pacific coast manufacturer with iron, aluminum and magnesium, and permanent mold foundries, and large production machine shop (now 100% on war work) will consider, on royalty basis, mechanical inventions of volume sales possibilities for immediate or post-war sale and manufacture. National coverage. No engineering or tooling cost to you. Replies held confidential. Development Department, Kinney Engineering Company, 2021 Bay Street, Los Angeles, California.

INVENTIONS Wanted: By AAAA rated, long est. manufacturer to produce and sell new machines for aircraft or automotive maintenance. Royalty or outright basis. Lempro Products, Dunham Road, Bedford, Ohio.

SHOP Notes for 1943. 234 pages of time and labor-saving ideas for shop men, handymen. 50c. Popular Mechanics Press, (C-43), 200 E. Ontario, Chicago.

INVENTORS: Have you a sound, practical invention for sale, patented or unpatented? If so, write Chartered Institute of American Inventors, Dept. 4-D, Washington, D. C.

CASH For inventions, patented, unpatented. Mr. Ball, A-9441 Pleasant, Chicago.

WANTED—Meritorious patented, unpatented inventions. Booklet, references, free. Invention Reporter, 5B-11236 So. Fairfield, Chicago.

YOUR Ad in this space will bring amazing results. I'll prove it to you. Write at once for interesting information. F. W. Johnson, Room 300, 200 East Ontario St., Chicago.

PATENTS FOR SALE

SKATE Sharpening machine. Self feeding. Child can operate. Sharpens 12 pair per hour. Sell outright. J. O. Devau, Derby Line, Vt.

MANUFACTURERS Or financially responsible persons desiring to enter the manufacturing field, I have a patent of extremely high merit covered by patent No. 2,283,848 for sale on an outright or royalty basis. This device which is entirely automatic is designed for feminine personal hygiene and will have an excellent demand after the war. Requires stampings, brass work, some rubber, some electrical work and enameling. Let me send you full details and copy of patent. Simple construction and not expensive. A safe device to use. Do not pass this up and then regret it later. For details write or wire Donald M. Chapin, Box 224, Artesia, New Mexico.

AN Entirely new type of fuel injector for Diesel or gasoline engines. The coming method of carbureting. Even distribution of fuel to all cylinders. U. S. patent No. 2,286,928. Write Box 143, Martinsville, Va.

PATENTED, Auxiliary tread for dual wheel assemblies. Outright. H. J. Fisher, Crestline, Ohio.

FOR Sale or royalty—Patented novel and essential pull tab for all zippers—best offer considered. Samuel F. LaVerde, 932 Fairfield Ave., Niagara Falls, N. Y.

HANDY Electrical appliances connector, patent No. 2,253,668. W. A. Weddle, 303 Valley Avenue, Roanoke, Va.

I WANT To send you proof of the wonderful pulling power of Popular Mechanics Magazine's classified pages. What's your proposition? Write me today. F. W. Johnson, Manager Classified Advertising, 200 E. Ontario St., Chicago, Ill.

MODELS AND MODEL SUPPLIES

MODEL Railroading is fun if you know how. To find out all about this intriguing man's hobby send 25 cents for new issue of Model Railroad Magazine, 1027-R North 7th, Milwaukee, Wisconsin.

COMPLETE Construction kits for beautiful ship and coach models. All parts completely shaped and ready to assemble, with drawings and instructions. Some ready colored, requiring no painting. \$1.00 to \$6.00. Send 3c stamp for catalog. Miniature Ship Models, Dept. R, Perkasis, Penna.

SHIP Model kits and fittings. Complete line Fisher model yacht equipment. All Boucher, Fisher, Marine Model and Ideal kits, fittings and blueprints at catalog prices. Most complete stock in New England. James Bliss & Co., Inc., 220 State Street, Boston, Massachusetts.

MODEL Blueprints. Send for list. Swanson, 5510 64th Street, Chicago.

SHIP Models and yacht supplies complete. Large 56 page catalogue 15c. Bill Wild's, 510 East 11 St., New York City.

RAILWAY Models, complete line informative catalogs O gauge, 112 pages, 25c; HO, 48 pages 15c. Walthers, 247 Erie, Milwaukee, Wisconsin.

MANUFACTURING

EXPERT Precision lathe work and machining of small parts. Write Specialty Machine Shop, 2521 Mitchell St., Racine, Wis.

INVENTIONS, Models, machinists, dies. Quantities made. Baum's Metal Specialties, Kansas City, Mo.

MODELS—Small lot manufacturing. Metals, plastics, etc. Milburn, Burlington, Kentucky.

NOVELTIES Built to order. Details. Odum Engineering, Box 101, Crosbyton, Texas.

HOME CRAFTSMEN

28 LAWN Ornament patterns 25c. Other patterns; 15" - 20" high; Dutch girl, Dutch boy, pirate, bull terrier, Mexican girl, Mexican boy, dwarf, penguin, flower girl, 10c each; 3 for 25c. 25 novelty patterns 30c. All 62 full size patterns \$1.00 post-paid. Strother, Box 383-EL, Bellington, W. Va.

CATALOG—Patterns plywood novelties, lawn ornaments, silhouettes, letters and numerals. Decal transfers, handy hand tools, new power sander. Other lines, 500 articles finely illustrated. Write today. Wo-Met Shop, Ashburn, Georgia.

15 FULL Size what-not patterns 25c; 25 lawn ornament patterns 25c. Albright Service, M6901 Railroad Ave., Omaha, Nebr.

KNOCKDOWN Cedar chest, lumber, veneer. Free price list. Giles-Kendall Co., Decatur, Alabama.

1000 TELUHOW Plans tell homeworkers about building 1000 projects. List 10c. C. King, E. Kingston, N. H.

THE New Shebel Saw Filer produces saws that have no equal. Send for full information. A. P. Shebel, 730 S. 2nd St., Milwaukee, Wis.

USED Wood and metal working power tools, bought, sold, exchanged. Details free. National Tool Mart, Ashburn, Ga.

JIG Bore table adaptable to drill press or vertical mill. Prints \$1.00. Box 1304, Van Dyke, Mich.

LEATHERCRAFTSMEN: Send 10c for new handbook and catalogue of tools and supplies. E. A. Sweet Company, Inc., Leathercraft Division A-68, 148 State Street, Binghamton, N. Y.

WATCHES, OLD GOLD, JEWELRY, ETC.

AGATES, Opals, gems, minerals, woods. Bishops Agate Shop, North Bonneville, Wash.

ELGIN Wrist watches, 7 jewel. New style case. Reconditioned movement. Limited supply. Only \$19.75 plus tax. C.O.D. House of Marc, Kansas City, Mo.

DIAMONDS, Old gold wanted. Highest prices paid. Write Nebraska Finance Co., Lincoln, Nebraska.

WATCHES, Parts, tools, jewelry, diamonds—bought, sold. Catalogue. Gales, Box 1000, Chicago.

HIGHEST Prices for old gold—Mail your teeth, watches, jewelry. 100% full cash value mailed day shipment received. Satisfaction guaranteed or articles cheerfully returned. Information free. Chicago Gold Smelting Company, 300-P Champlain Building, Chicago.

GOLD \$35.00 Ounce. Mail old gold teeth, diamonds, jewelry, watches. Receive cash by return mail. Satisfaction guaranteed. Free information. Dr. Weisberg's Gold Refining Company, 1509-Q Hennepin, Minneapolis, Minn.

SURVEYING INSTRUMENTS

GUARANTEED Factory rebuilt transits and levels for sale (cash or terms) or rent (with purchase option). We will repair, trade, or buy old instruments. Ship pre-paid for estimate and valuation. For complete information write for list M81, Warren-Knight Co. (Manufacturers of Transits and Levels), 136 N. 12th St., Philadelphia, Penna.

POPULAR MECHANICS

**ELECTRIC SHAVERS, RAZORS,
BLADES, SHARPENING**

DOUBLE Edge razor blades—100 for \$2.00. Mark Specialty, 89 Westminster, Rochester, N. Y.

FOR SALE—MISCELLANEOUS

LUNCH Stand for sale. Living quarters. Summer. Landow, Keansburg, N. J.

WANTED—MISCELLANEOUS

WANTED: Automobile catalogs. Anything prior to 1930. Send list of what you have. D. Cameron Peck, 140 West Ontario, Chicago.

WANTED: Mercury (quicksilver) \$1.50 per pound. Western Metal Co., Bloomington, Illinois.

CASH For used optical, mechanical, scientific instruments. Gordon's, 162-2B Madison, Chicago.

WE Buy shop, scientific, photographic, office, equipment; jewelry. "Anything." Justice Jobbers, 190 North Wells, Chicago.

MERCURY (Quicksilver), tungsten, molybdenum, cadmium, high speed tool steel, bismuth, purchased in any quantity. Write for quotations. Metallurgical Products Co., 35th and Moore Sts., Philadelphia, Penna. Established 1909.

PERSONAL

MEXICAN Legal matters reliably handled, address Box 240, Juarez, Mexico.

AMAZING War prophecies. Startling, accurate. Write Charles Sierer Railroad, Ironton, Ohio.

BUY Vitamins direct. Save. Postcard. Matoska Products, White Bear, Minn.

ASTROLOGY! Trial reading. Send birthdate and dime. "Delmarr," Crescent Beach, B. C., Canada.

PSORIASIS Sufferers: Pixacol, used only as directed, has brought relief when everything else failed. Applied externally, dries quickly, convenient. Try regular \$1 bottle without investing a cent! Write: Pixacol, Box 1298, Cleveland, Ohio.

"GRUVED" Letters correct your penmanship in few hours. (Guaranteed). Write. Ozment, 9, St. Louis, Mo.

BIRTH Certificates, all ages, any state, ten day service. Enclose postage. Herndon J. Thompson D324, Davis, Oklahoma.

DRUNKENNESS is a disease which responds to treatment. Medical skill plus human sympathy prove successful with liquor and drug cases. 60 years experience. Write for free booklet. P. M. Nelson, The Keeley Institute, Dwight, Ill.

ATHLETE'S Foot sufferers—Learn how I and many others got rid of athlete's foot. Send 50c. Retca, 1912E Atlantic St., Philadelphia, Penna.

RUPTURE. Back, abdominal troubles reduced. Often cured. Free information. Earles Company, Flint, Michigan.

MISCELLANEOUS

SEW Upholstery tears professionally, furniture and automobile. Detailed instructions 25c. Penn-Homecrafts, Meadville, Penna.

CARPENTERS—We guarantee to teach the steel square in five easy lessons by mail, it's really fun this modern way. Write. Builders Topics, 606 Broadway North, Seattle, Washington.

KEEP 'Em knitting. Pikloom Speed Knitter, a modern marvel for beginners or experienced knitters. Simplifies knitting. Easier and quicker. Eliminates errors. Write for free literature. Edwin F. Russell, 13 1/2 East Montgomery St., Johnstown, New York.

HEATING Six rooms \$20.00 yearly. Circulars 10c. Rosenzweig, RR10-B3, Cincinnati.

MAKE Delicious Carmelcorn, formula, 35c. Frank Shilling, 1017-M Duerber, Canton, Ohio.

BIG Mail for you. Latest moneymaking offers, opportunities, catalogs, magazines. Name listed in directory 10c. Ideal Service, 137-M, Park Ridge, Ill.

GREAT Fun. Make believe you are in N. Y. Card mailed to you for writing and mailed again 25 cts. 3 for 50 cts. Haller, 436 N. Y. Ave., Brooklyn, N. Y.

FREE Catalog of Alaska novelties. Alaska Specialties Company, Ketchikan, Alaska.

COFFEE Shortage? No need worrying if you use Foremost method in making your own coffee substitute. Excellent quality. Inexpensive. Full and complete information sent postpaid for 50c. Foremost Formulas, Dept. 1A, 513 East 11, New York.

ANY Question answered. Where? Why? How? What? Any subject. Simple ones three day service \$1. Researcher, 4107B Osceola, Chicago.

SEEK Buried treasure. Methods, mysteries, devices explained. Circulars free. Century Press, Box 151B, Glen Ellyn, Ill.

"MAGIC Story"—Greatest success narrative all time; million sold. Leads men to fortune by unfalling ways. 19th edition, \$1. Digest free. General Publications, Ossining, N. Y.

RECEIVE Mails, magazines, samples. Your name in numerous mailing lists 10c. Howard, 396 Broadway, New York.

WALLPAPER Estimating book will help you save money when repapering—800 different room sizes. \$1.00 postpaid. Hampshire Decorating Co., 625 38th St., Des Moines, Iowa.

4 GIANT Living American silk cocoons 25c. Johnson, 912 Benton, Nashville, Tenn.

HELPFUL Books on hundreds of subjects. Catalog free. Popular Mechanics Press, (C-43), 200 E. Ontario, Chicago.

MEDICAL Laboratory technicians in great demand. We train you in your spare time, in your own home. You can practice while studying. Write for free catalogue. Imperial Technical Institute, Box 973-J, Austin, Texas.

PAINT Surprise package—\$1.00—24-1/2 pt. cans paints and enamels, assorted colors. (Equivalent to 1 1/2 gals.) This paint is the product of one of America's largest paint factories and is brand new, guaranteed paint. Express shipments only. Paint Shack, 58 Market St., Newark, N. J.

HUNDREDS Of helpful books. Catalog free. Popular Mechanics Press, (C-43), 200 E. Ontario, Chicago.

MACHINE SHOP MEN
Needed Now!

Learn to set up and run ANY kind of machine; MAKE MORE MONEY NOW by learning quickly HOW TO DO THINGS which usually take years of study and practice. The demand for SKILLED men is ALREADY ahead of the supply, then what WILL IT BE a month or two from now?

Bigger Pay Don't miss this chance to qualify for promotion, don't miss this Big Opportunity which is yours almost for the asking. Eight Big Books chockful of important mechanical facts told simply and clearly. Over 3000 pages, nearly 3000 illustrations cover every subject fully, including Tool Making, Pattern Making, Foundry Work, Mechanical Drawing, Forging, Machine Shop Practice and Management, and hundreds of other subjects.

8 Big Books (Up-to-date Edition) Sent FREE

to you for examination. With them we send a Big Binder of nearly 900 pages with 206 shop tickets and over 1300 illustrations. These show, step by step, how to set up and run almost any kind of job and are in addition to the 8 books. Decide in your own home or place of business whether or not you want to keep them, check up on any facts you want to. Note their great MONEY MAKING value, then, if you want them, pay on the easiest kind of payments. A year's consulting privileges with our engineers now given with these books without extra charge.

American Technical Society, Vocational Publishers since 1898.
American Technical Society, Dept. S419, Drexel at 58th St., Chicago
You may send me the 8 big books and binder of shop tickets for free examination. I will pay the delivery charges only, unless I decide to keep them in which case I will send \$2.00 in ten days and \$3.00 per month until the total price of only \$34.80 is paid. If I return them in 10 days I will owe you nothing. You also agree to send me a certificate entitling me to consulting privileges with your experts for one year without extra charge.

Name

Address
Please attach a letter stating age, occupation, employer's name and address and that of at least one business man as reference.

FLYING-MODEL BUILDING-NEWS
AIR-AGE
APRIL 1943

THE AIRPLANE AS A BATTLE WEAPON
BY N. R. SIBERT
MAJOR U. S. AIR FORCE

LUCCIN ZACHAROFF
JAMES L. H. PECK
CHARLES KENNETH

**LOOK AHEAD
YOUNG AMERICA**

A new thrill for air-minded readers... up-to-the-minute; real news; fine articles. The perfect 3-point landing - - - flying, model building, air news. Get all 3 in every issue of

AIR-AGE

Large size 8 1/2 x 11 3/4 inches. Crammed full of actual photographs — scoops that will excite you. Leading authorities on aviation tell you just what you want to know.

On Sale Now...
All Newsstands 15¢
Special subscription offer. **10 issues for \$1.00 a copy**

Clip a dollar to coupon and send now. **\$1**

SILCO PUBLISHING CORP., Dept. PM
160 West Broadway
New York, N. Y.

Send me the next 10 issues of AIR-AGE. My dollar enclosed (cash or money order.)

NAME

ADDRESS

Airport in the Sky

DIRIGIBLE CARRIERS
PROPOSED TO
LAUNCH WARPLANES

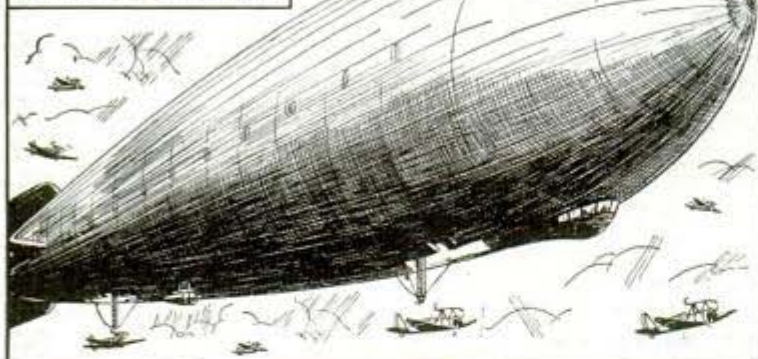

R. J. Reynolds Tobacco Company, Winston-Salem, North Carolina

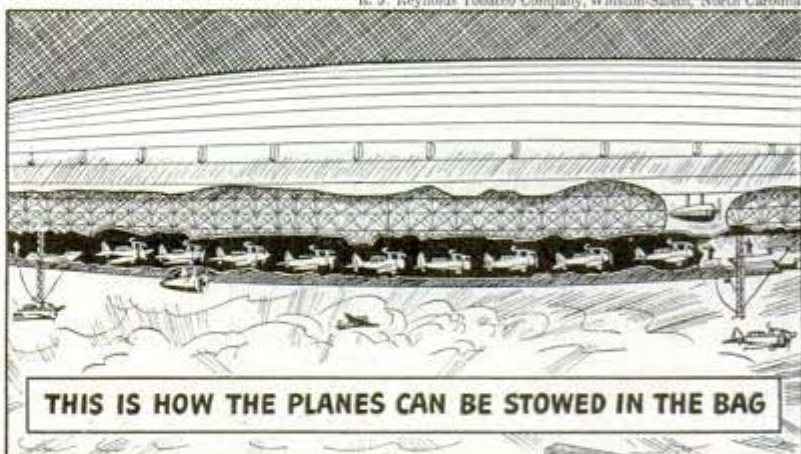

50
PIPEFULS
OF FRAGRANT
TOBACCO
IN EVERY
HANDY POCKET
PACKAGE OF
PRINCE ALBERT

PRINCE ALBERT
THE NATIONAL JOY SMOKE

son: Allen Warren Heath.
7 Park Ave NYC

Popular Mechanics Magazine

REGISTERED IN U. S. PATENT OFFICE AND CANADA

WRITTEN SO YOU CAN UNDERSTAND IT

Vol. 79

APRIL, 1943

No. 4

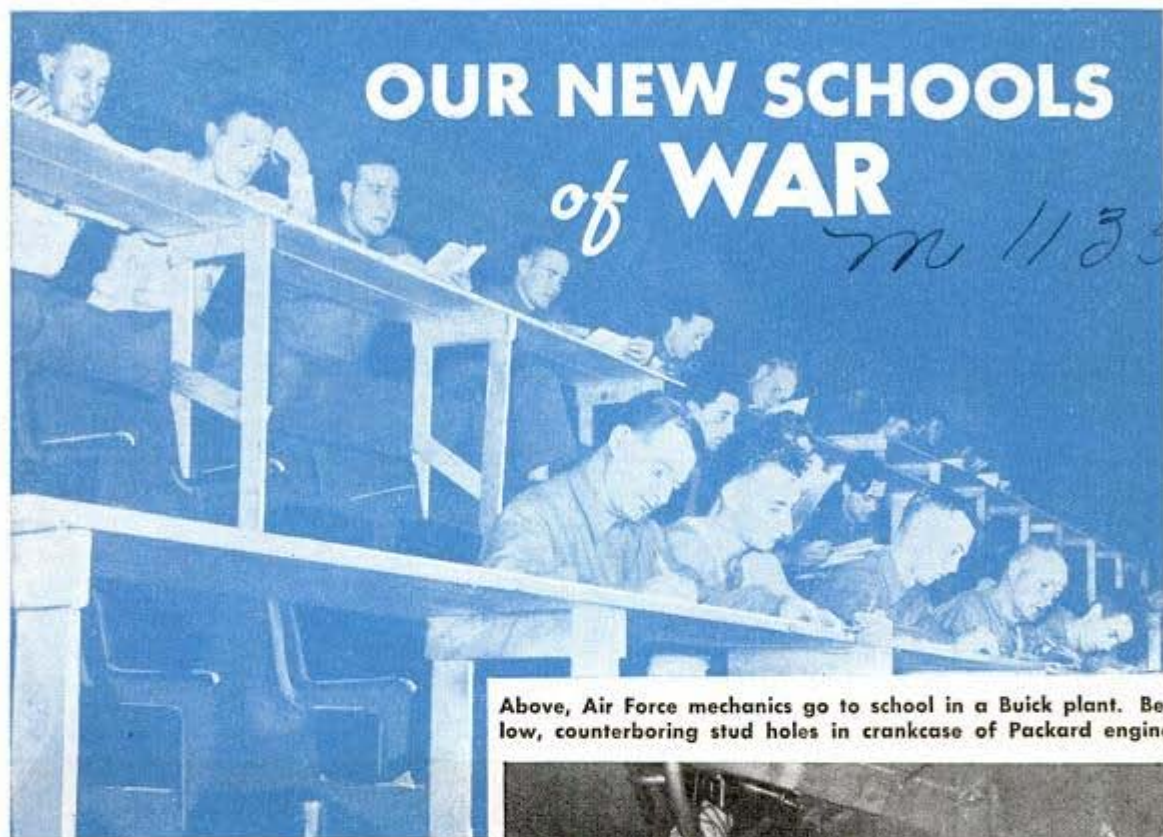

OUR NEW SCHOOLS of WAR

7M 1135

Above, Air Force mechanics go to school in a Buick plant. Below, counterboring stud holes in crankcase of Packard engine

THE old saying that an army travels on its stomach—that its movements are limited by its food supply lines—is only half the truth.

The modern mechanized army travels on its tool kit. Its operations are limited not by food supply problems, which have been solved by new methods of dehydration, refrigeration and scientific rations, but by its repair tools and men with the ability to use them. One damaged tank at the scene of combat, if it can be repaired, is worth a dozen new ones coming off production lines thousands of miles away.

The result is the growing trend toward sending servicemen to the production lines which turn out the machines. Soldiers, sailors, coast guardsmen, marines and air





Navy petty officers learn how armatures are wound at General Electric

corps men in uniform go to schools of production in industrial plants before departing for the firing line.

The gigantic airplane and automobile plants are being turned into new-style colleges of war. Barracks are springing up beside factory buildings. Uniformed men are drilling and toughening within earshot

of the humming machines of mass production. Overalls and uniforms mingle at huge assembly lines as a symbol that civilians and servicemen are fighting this war shoulder to shoulder.

Hundreds of thousands of American servicemen, thousands more from Great Britain and other United Nations, will "graduate" with honor from factories this year, and many of them will serve as instructors for other servicemen at the front until, it is estimated, more than 1,000,000 Americans in uniform will get up-to-the-minute mechanical training this year.

General Electric Company was one of the first corporations to open its doors to men in uniform. Navy men are given instruction in the repair of submarine propulsion. Air men are taught maintenance of equipment for high altitude flying. Both army and navy men are learning the care

A General Electric man explains a detail of bearing construction at a school for submarine petty officers



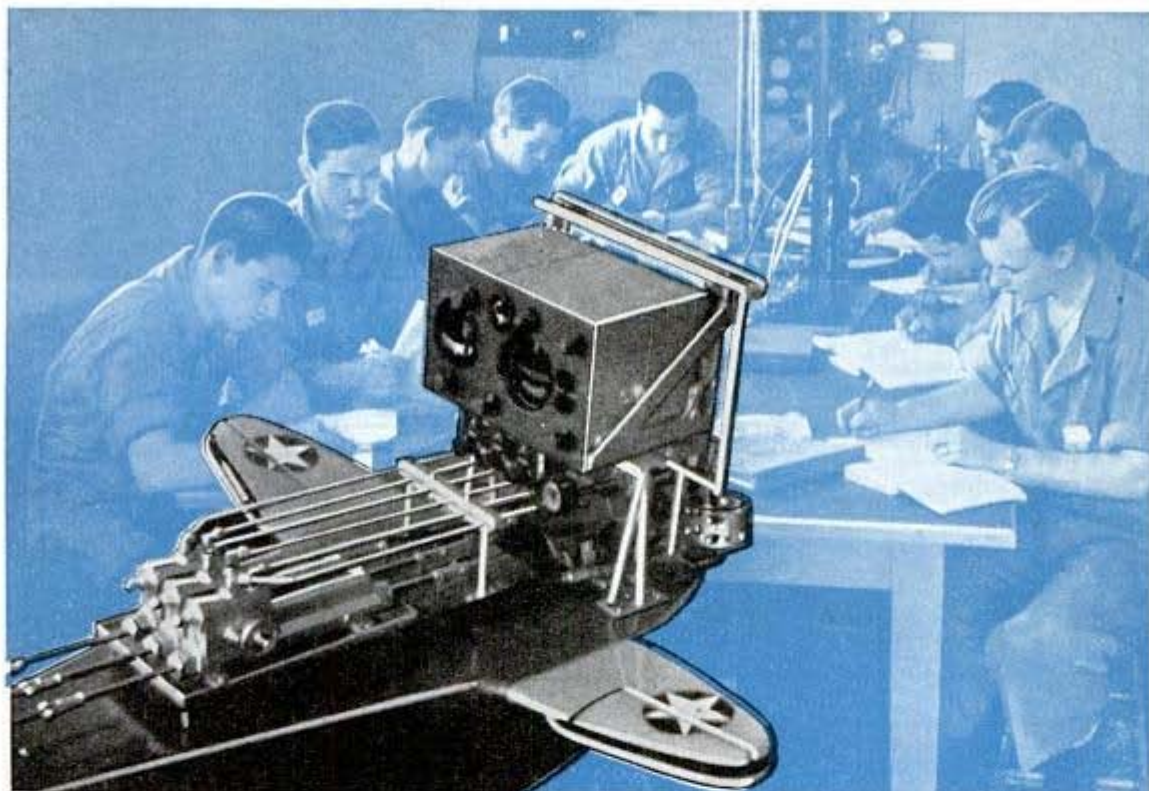

Army mechanics at United Air Lines' Training Center at Oakland study hydraulic operation of automatic pilot

of radio equipment, searchlights, gun controls, airplane locaters and other machines the company manufactures.

Graduates of this industrial college of war are already active as far off as England, Hawaii, Africa and India, not only repairing equipment, but training new groups of servicemen in uniform. The factory training program is teaching teachers whose importance is indicated by the fact that servicemen who have completed the courses are sped to active fronts in trans-Atlantic and trans-Pacific planes.

This is a war of science. Electrical machines and circuits must be co-ordinated with highly complex mechanisms, optical systems, and radio. All that has been learned in the last 20 years about electronics, frequency modulation, television, and high-frequency phenomena is now being ap-

plied to the airplane and warship. Electrification of a warship has become much more complete and complicated. Automatic controls, shockproof mounting, mine protection, radio communication, signaling, and aircraft and submarine detection require highly trained men.

The principal General Electric training courses are conducted in half a dozen of the company's plants where the products



Coast guardsmen learning to operate and maintain equipment at Westinghouse plant are shown coil system of generator stator

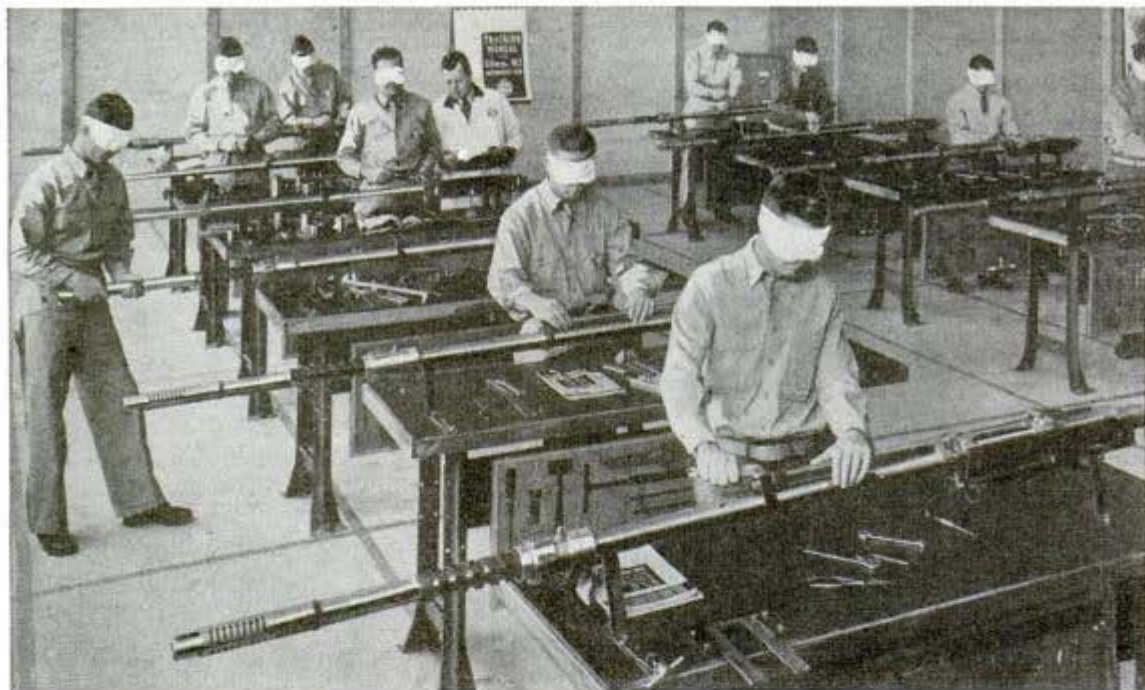

Blindfold assembly and disassembly of 20-mm. cannon is required for completion of Oldsmobile arms course

studied are manufactured. Smaller courses are under way at Navy yards, air fields, and aircraft factories. In space once used to store home appliances, an aircraft armament school is under way. Instruction has been given at another plant in the operation of the turbosupercharger which enables planes to maintain speed and power at high altitudes. The students learn the complete assembly and disassembly of the device studied. They are required to locate and correct faults intentionally placed in apparatus. Specially prepared texts, charts, and movies supplement oral instruction.

In Westinghouse plants, too, uniformed men of the United States, Canada and Great Britain mingle with factory workers. They attend classes six days a week, eight hours a day, working alongside the mechanics, learning to assemble and repair the company's war products. An average course runs two weeks or more. Many trainees are coast guardsmen getting first-hand knowledge of propulsion equipment before it is placed in small navy ves-

Navy trainees learning to service B-24 bombers march to class at the Willow Run Ford school

sels. This is to enable them to make repairs at sea, if necessary. Other groups include officers who are taught the assembly and care of ordnance equipment.

General Motors Corporation is "graduating" more than 500 selected servicemen a week in plants at Detroit, Lansing, Flint, Pontiac and Indianapolis. The men not only work on tanks, but on howitzers, mortars, tommy guns, planes, cannon and other weapons. At one plant, not only American uniforms are seen on assembly lines, but those of Canada, New Zealand, Great Britain, China, and Chile.

One General Motors "college of war" in

(Continued to page 168)

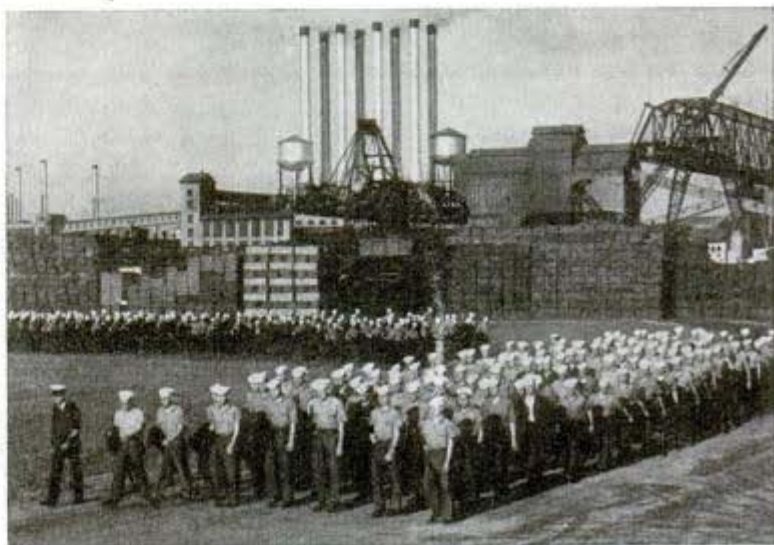

Army Air Forces Bombardier School, Midland, Texas
 "Mikes" Score Accuracy in Bombing Practice

7-12-43



Aerial view of target range (above) shows how four microphones are placed in square pattern. Top left, map model of range. At left, closeup of "pillbox" for microphone

Automatic and instantaneous scoring of accuracy in bombing practice is achieved by a "sonic method" installed at the Midland Bombardier School in Texas, which transmits reports to the bomb-scoring crew 20 to 60 miles distant. Developed under the supervision of Capt. Edward Peter McKaba from a somewhat similar method used for locating underground oil deposits, this new scoring system "listens" to the exploding bombs by means of four microphones arranged in a square pattern, each being placed 500 feet from the target center. By recording the time of arrival of the sound of a bomb explosion, these microphones plot the exact spot where each bomb strikes. If, for instance, a bomb hits in the center of the target, each microphone

will receive the sound at the same time. Sound from a bomb falling off center will arrive at the nearest "mike" first, and at the others in the order of their distance from the source of the explosion. At headquarters, the bomb's position is determined by applying these values to a unique hyperbolic plotting board devised for the purpose. Heretofore, the explosion of each of the 200 bombs dropped by a cadet during his 12 weeks of training was photographed from the bombing plane. The sonic method eliminates the need for these expensive cameras and the large quantity of film as well as the labor and materials required in the process. The new system may be wired back to the home base through leased telephone lines, so each bomb can be scored the instant it hits. This also saves the necessity of making many inspection trips to the target.

Rigid, Asbestos-Protected Sheet Used in Place of Metal in Air Ducts

Heating or air-conditioning ducts and fittings made of rigid, asbestos-protected sheets are offered by a manufacturer as "a full and unlimited substitute for sheet metal." The sheets may be rolled, bent, folded, die-cut or creased on regular metal-shop equipment, manufacturers assert.

Weighing only about one-half pound per square foot, the sheet will withstand a blow of over 200 pounds per square inch. Each sheet is about $\frac{3}{16}$ inch thick. Protected on both sides by asbestos, the sheets do not rust or corrode, and are said to have high insulating value, besides resisting water.

Frank Wilson, Inc.
 H.C. W. Taylor, Chicago

Knife-Edged Streamliner Hits 100-Mile Speed

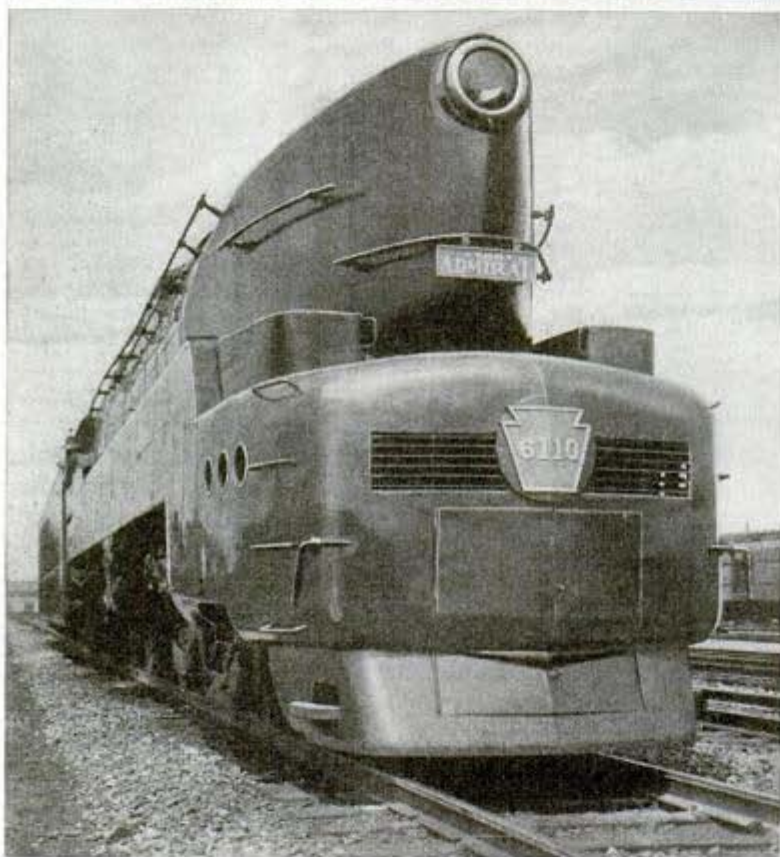
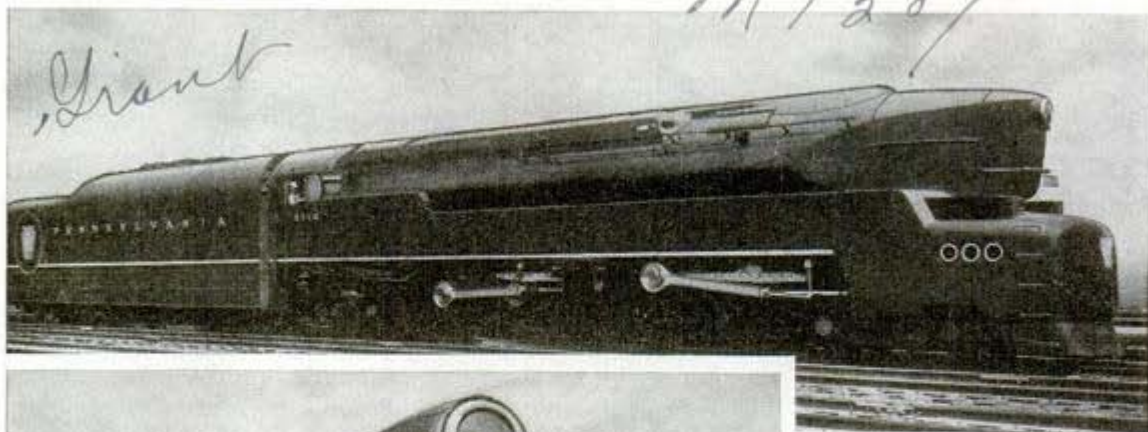

tractive force of 65,000 pounds, and one of the twins also has a booster unit which applies an additional 13,500-pound effort to the rear truck for starting. Similar in many respects to the world's largest passenger engine, the 6-4-4-6 giant which the Pennsylvania loaned for exhibit at the New York world's fair for two years before it ever saw service, the new locomotives are slightly shorter and more flexible and can be used in any part of the railroad, while the unique 6-4-4-6 is too long and rigid for the eastern mountains and curves. Both types were intended to pull heavy passenger trains at high speed

Twin steam locomotives of striking streamline design featured by knife-edge "prows" are hauling fast passenger trains over the Pennsylvania railroad between Harrisburg and Chicago. Built to make this 713-mile run with only one stop for fuel, these engines have a four-cylinder drive, with a poppet valve system, and can pull an 880-ton load—the equivalent of about 12 passenger cars—at 100 miles an hour. The vast tender carries 41 tons of coal and 19,500 gallons of water, the tanks being re-filled while running from pans between the rails. The wheels are of the 4-4-4-4 arrangement, the drivers being 80 inches in diameter. The locomotives develop a

where formerly double-headers were required. Use of the poppet valves instead of the conventional piston type permits separate control of intake and exhaust, produces greater horsepower with economy. Tests made previously with a standard Pennsylvania locomotive demonstrated that with poppet valves it could develop 44 percent more horsepower at the drawbar at 80 miles per hour than the conventional engine of the same type, and 54 percent more horsepower at 90 miles an hour. The poppet valve engine pulling a 1,000-ton train accelerated from 40 to 75 miles per hour in nearly five minutes less time than the standard locomotive.

6 Built by Baldwin Locomotive Works, Eddystone, Pa. POPULAR MECHANICS

*Acme Newspictures Inc
461 - 8 av, nyc.*

Hangar Under Palisades Seen as Bomb Shelter

m 1162

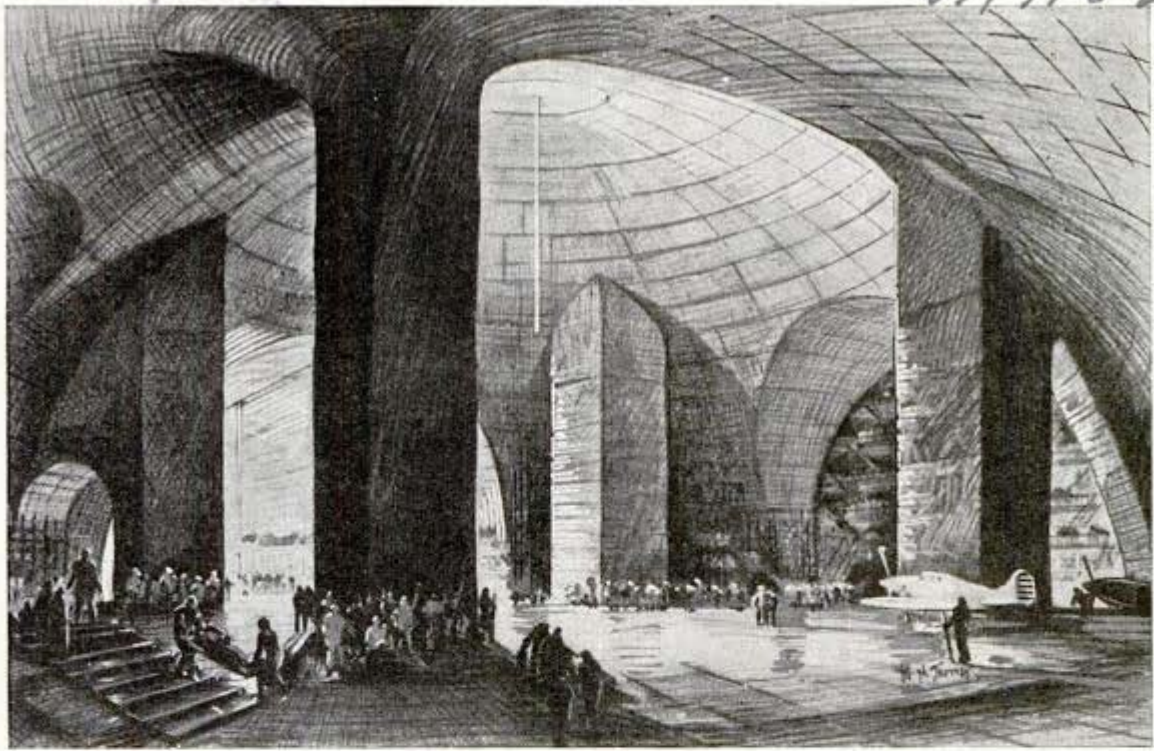

Chambers under deep mile and a half long tunnel would serve as air-raid shelters, hospitals and hangars

Huge bombproof tunnels dug out of the rocky palisades on the Hudson River are visualized as a possibility by George J. Atwell, who heads a construction company. He proposes a tunnel 200 feet wide, 100 feet

high and a mile and a half long. It would consist of a number of chambers serving as air-raid shelters, hospitals and airplane hangars that would be able to withstand the pounding of heavy bombs.

Silent, Non-Flashing Rifle Fires 12,000 Times a Minute

Outfiring the newest Nazi weapon four to one, an automatic, pneumatic gun developed by a Los Angeles inventor pours out 12,000 rounds a minute, compared with 3,000 a minute for Germany's latest weapon. No powder is necessary in the gun, compressed air provided by a cylinder be-

neath it supplying all the force needed to "blow" the equivalent of a .50 caliber bullet. There is no noise, no recoil and no flash, giving it special advantage for night fighting. Bullets, which require no shell casing, are fed into the firing chamber by vacuum from a hopper.

*out mfg co
Los Angeles Cal*



Pneumatic gun designed for night fighting requires no powder

Diesel Uses Vegetable Oil

Peanut, cottonseed, or palm oil have been found suitable for fuel in Diesel-motored trucks, and tests indicate such vehicles may burn these oils if mineral oil is not readily available. In a 300-mile road test, mileage per gallon on the regular mineral oil was 17 miles; with palm oil, 15.4 miles; peanut oil, 14.7 miles, and cottonseed oil, 14.5 miles. Mineral oil must be used for starting.

3-4

magazine clip

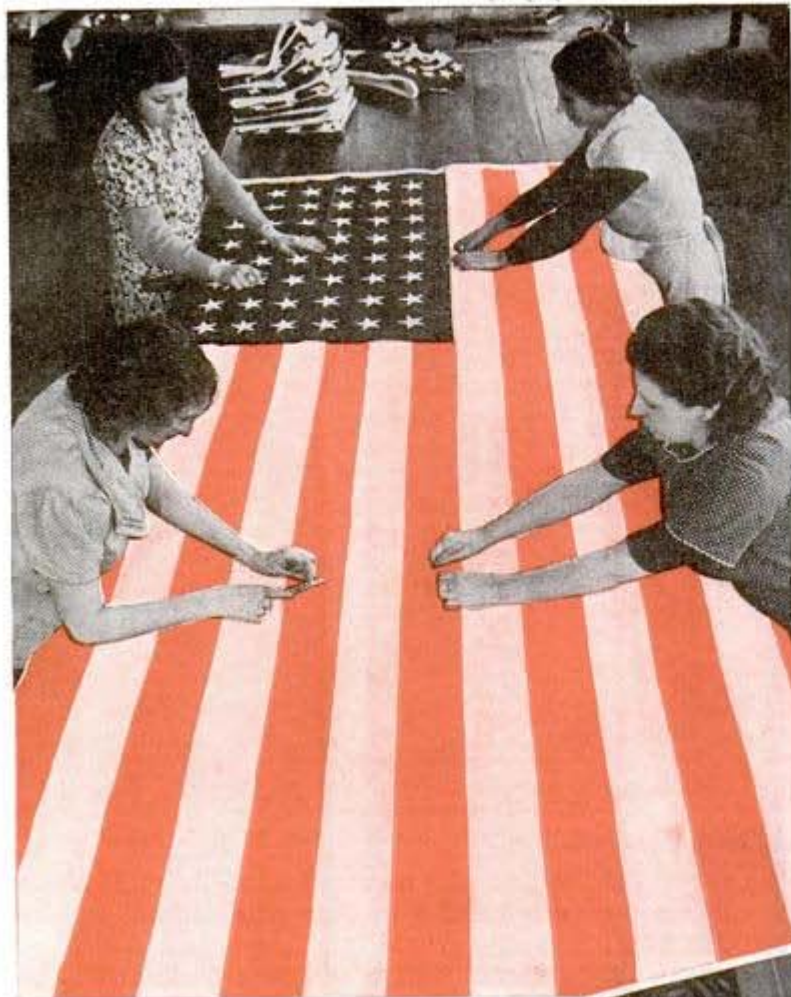

KEEPING

M1101
 that manufacturing plants "down under" are fashioning cloth into the Star Spangled Banner. In parts of England it is commonly flown as the British Royal Standard. Only one nation has suffered a major slump in the business of turning out American flags and this one is Japan, which, strange as it seems now, was America's chief competitor in making our own flags until Dec. 7, 1941.

At home, the demand for all varieties of American emblems has raised the annual flag output to

Old Glory (left) gets a final inspection on the assembly line

Below, storing printed flags in rolls to await cutter's shears



NEVER before in history have Old Glory and the other flags of the United States meant so much to so many people.

From the gray peaks of the Aleutians to the sands of Africa, the red, white and blue, together with our battle, ceremonial and signal flags, have become symbols of hope to hundreds of millions of allies, just as they are symbols of pride and confidence to Americans at home and abroad.

The result is the greatest demand for American emblems since the nation was founded—and the greatest production to keep 'em flying.

Factories have even been set up in distant lands, particularly those of the British Empire, to manufacture American flags—places where the flags were seldom seen in pre-war days.

Such far off continents as Australia will celebrate United States flag day in June and so great is the popularity of our flag

the almost incredible figure of 30,000,000.

Textiles for flag manufacture have as high a priority rating as many essential war products. Approximately 25,000,000 square yards of fabrics have been allocated per year to flag manufacture, including not only the Stars and Stripes, but service flags, marine signals, flags of other members of the United Nations, flags of states and mu-

Allen Warren Elliott
7 Park Av. N.Y.C.

'EM FLYING

nicipalities and insignia used by civilian defense organizations. Despite the fact that many new companies are manufacturing flags, deliveries are five weeks to three months behind orders.

The largest flag concern in the world, Annin and Company in New York City, finds that even with the huge increase due to the expansion of our armed forces, the American public is by far the biggest buyer. On the order books of this company, which is typical of the industry, the patriotic demand of the American public



Courtesy Annin & Co.

† While she sews, flag-maker is careful not to let flag touch the bare floor

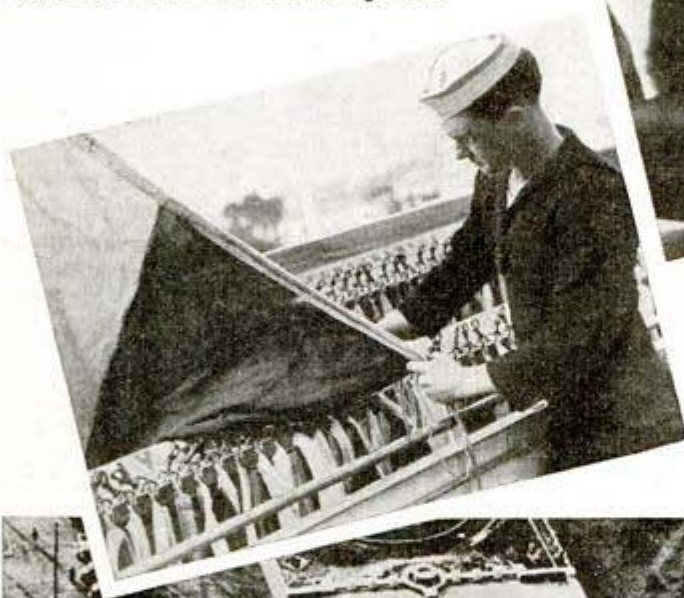

Left, signalman on ship prepares to hoist a flag—flags on board total 200

Giant flag (below) used for civic celebration at Verona, N. J., never flown

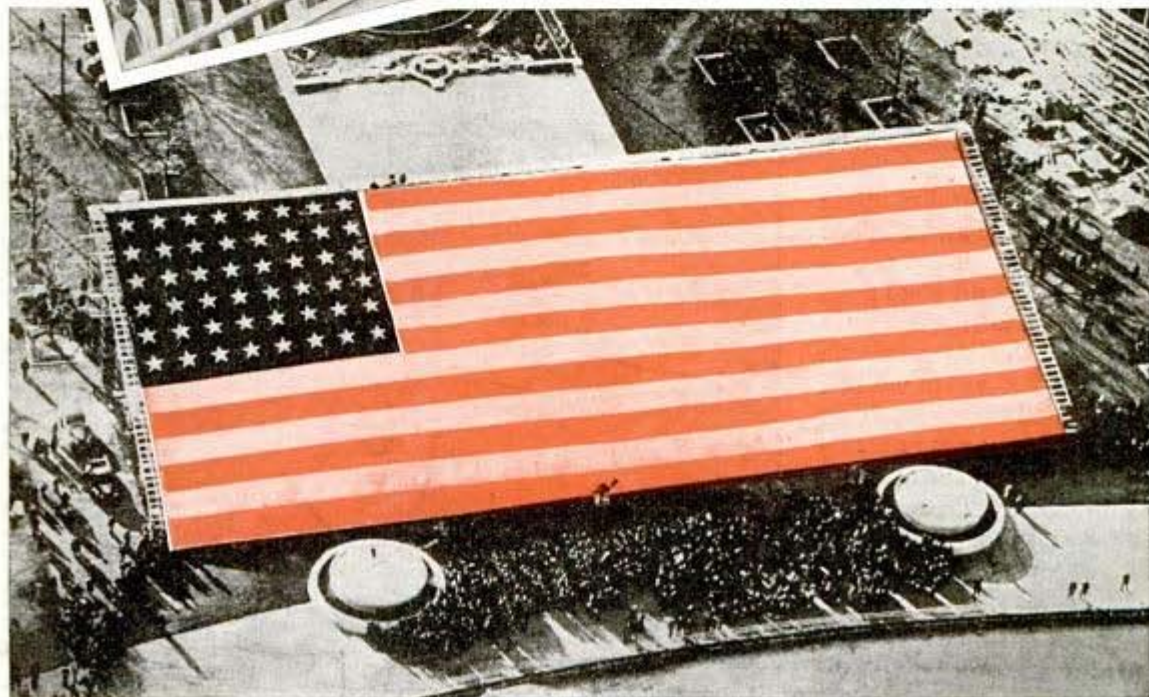

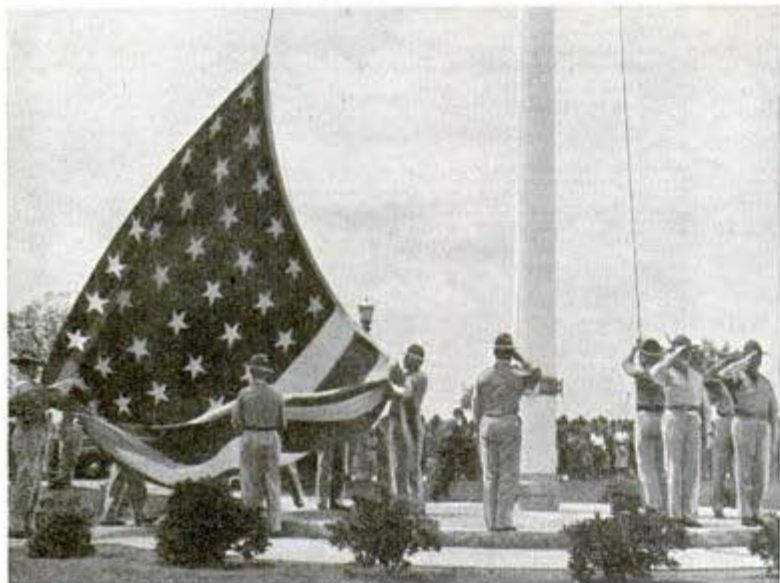

Soldiers at Fort Sam Houston stand at attention during flag-raising ceremony—for outdoor use flags are made of wool and silk to resist weather

ranks first in volume, the army second, the coast guard third, the navy fourth, the maritime commission fifth with demand for service-star flags and "E" flags making up the balance.

The red, white and blue furnishes all but a fraction of the number of flags made for the public and the army. The navy, coast guard and maritime commission also place large orders for signal flags and flags of friendly foreign nations, a total of some 200 of which are stowed aboard nearly every American ship.

Cotton and rayon are used for the bulk of the civilian flags, with rayon more or less limited to indoor or sheltered use. For all army and navy uses which require exposure to wind, rain and sun, wool and silk are necessary.

Even silk and wool flags are often whipped into tatters during a single cruise of a ship which meets bad weather. This requires constant replacements of badly damaged flags. These are never merely discarded, but are always burned. The American flag never

Joining blue field to stripes on an army flag made at the Philadelphia Quartermaster Depot



finds its way into the garbage heap.

Colors most often used in flag making are white and red because they go into the stripes and stars, with blue third. Yellow and black come next in demand.

The Stars and Stripes, the proper name for which is the United States Ensign, fits well into mass production methods in the popular sizes, but flags for the President, cabinet officers, army and navy commanders, regiments and battalions, the states and municipalities and foreign banners must be fashioned by experts in

an operation much like hand tailoring.

The slightest error becomes a glaring fault in the eyes of those who pledge allegiance to a flag. In South America, where the United States has displaced Germany in the flag business, a small mistake even in proportion would be viewed as an insult.

In the case of the cheaper and smaller American flags, the stars and stripes and fields of blue are printed on long strips of cotton and rayon which run through presses not unlike those used to print wallpaper. The ink, or dye, is dried and the strips are wrapped into rolls in which

form they are stored. The flags are hemmed and cut off one by one as needed.

For larger and more expensive flags, rolls of red and white material are sliced into strips of the correct dimensions. The strips are then sewn together by expert seamstresses. White stars are stamped out, usually with blunt points to be trimmed later, attached to blue fields and then the flag is assembled. It is given a canvas binding through which eyelets, called grommets, are punched to hold the rope or halyard.

To make stars, as many as 125 thicknesses of cloth are placed on a press so that a single die, directed by hand, punches through all of the layers of cloth at each stroke of the machine. One man can turn out thousands in a day.

The army and navy, which make most, but not all of their own flags, manufacture none of the printed flags which private companies turn out by the mile. While they use machines to cut out stripes, punch stars and sew, the work is of a highly specialized type requiring much instruction and long practice to keep pace with production lines. These lines, in the case of the navy plant in Brooklyn Navy Yard, the largest operated by the government, turn out one variety of precision-made U. S. emblems at a flag-a-minute clip. Altogether this Brooklyn loft turns out about 200 types of flags.

The largest army flag-making unit in the Phila-

(Continued to page 166)

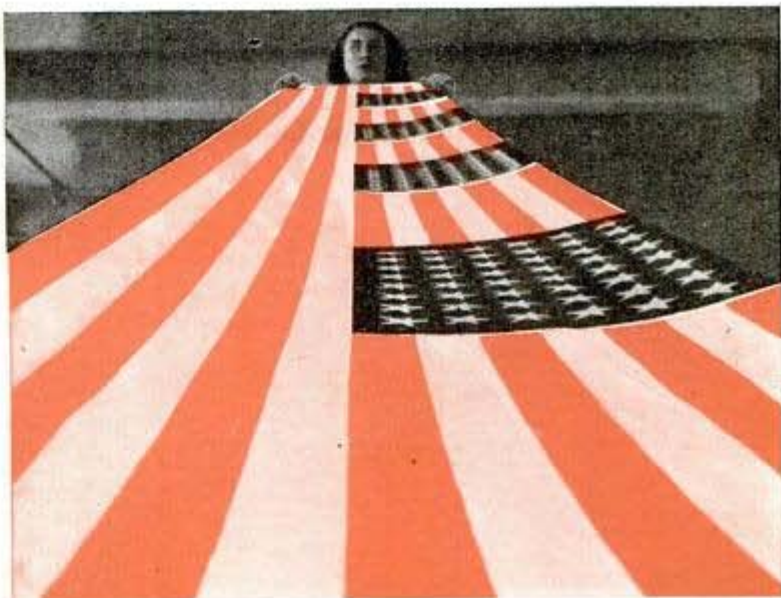

↑ Miles of flags are made in strips and then hemmed and cut off. They are printed on cotton and rayon on presses like those used to print wallpaper

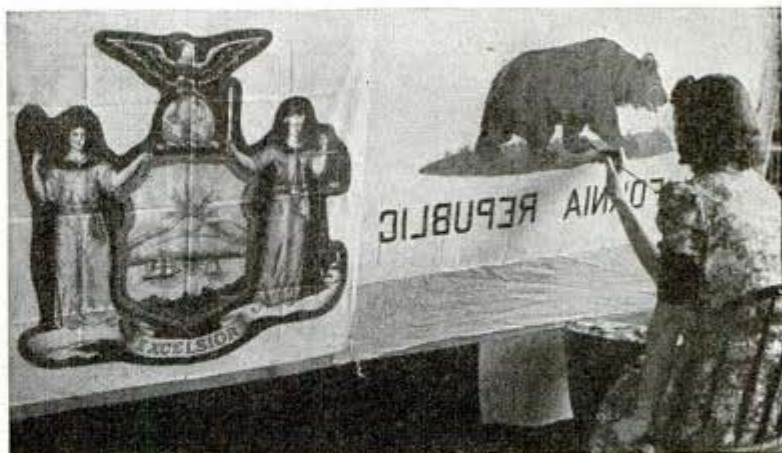

Worker painting figures on state flags—New York, left, California, right
“Star maker” (below) stamps out stars which are trimmed to point by hand



FLYING FERRY

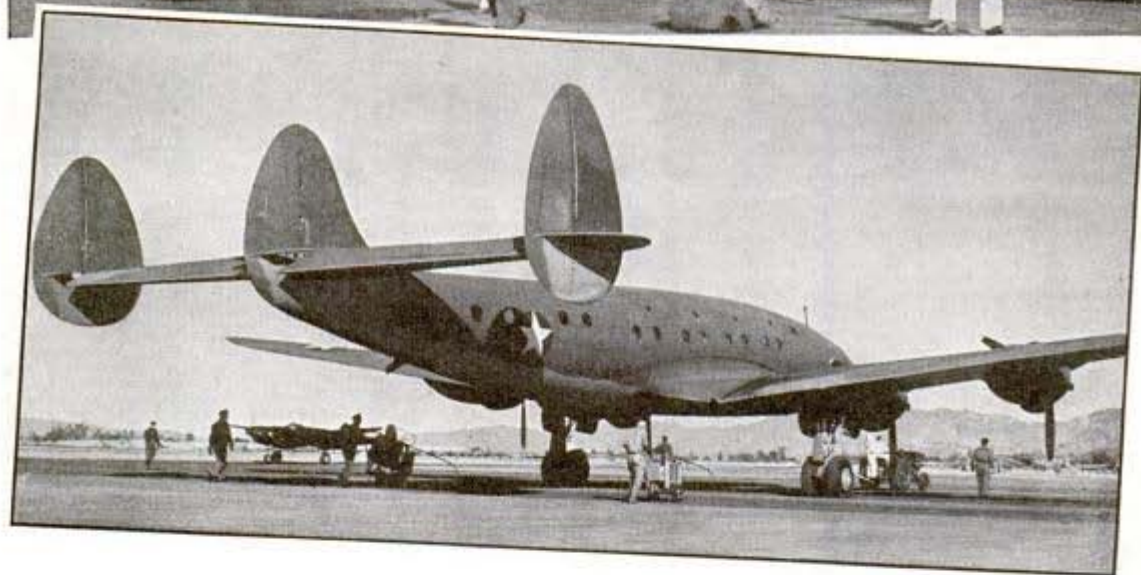

Electric "Ear" Tests Gasoline for Anti-Knock Quality

All guesswork in measuring the efficiency or octane rating of gasoline can be eliminated by using an electronic method that "listens" to the "knock" while an engine is running under test. Three instruments work together in analyzing the knock. First is a sound pickup that plugs into the engine by means of a cable. It "hears" two noises—the main explosion and the knock. The second is a sound filter whose job is to tune out the sound of the main explosion and feed only the knock noise into the third instrument—the cathode-ray oscillograph—which shows a wave

form on a screen corresponding to the intensity of the knock. The height of the cathode-ray wave form or deflection is noted when testing a standard octane rating gasoline, and then the unknown gasoline is substituted and adjustments are made on the engine to obtain again the same height of cathode-ray deflection. The engineer, by taking careful note of the engine adjustments, can determine immediately the octane rating of the unknown gasoline. Engineers can also rid an airplane engine of all knock with the aid of this instrument.

Intel News Photos, 326 W
Madison, Chicago

for TANKS

724

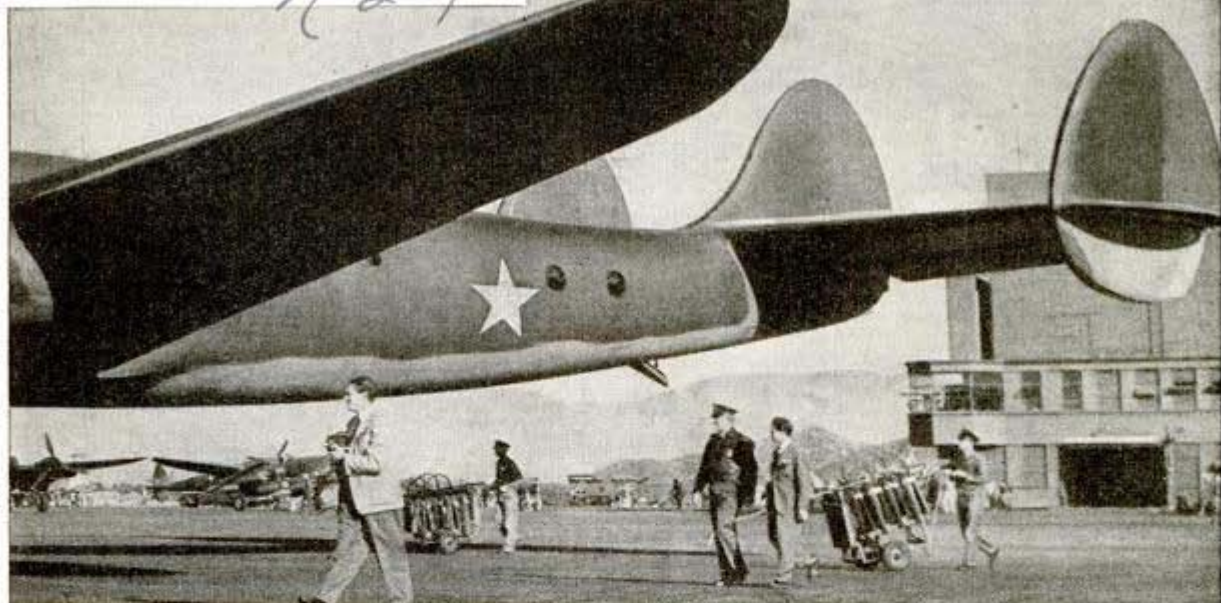

Combining high speed, long range and cargo capacity, Lockheed's "Constellation" transport plane can outspeed a Jap Zero or any four-motored bomber now in action, though it's the largest cargo plane in production. It is capable of ferrying across the ocean a light tank and its complement of men, or the equivalent weight in men and cargo. Designed as a peacetime transport for T.W.A., it can carry 55 passengers and a crew of nine nonstop from Los Angeles to New York, its makers assert. Its speed across the continent would be 9 hours; and it could make Honolulu in 12. Fully load-

ed, it uses only one gallon of gasoline a mile for its four 2,000-horsepower Cyclone 18's, which their manufacturer, Wright, calls the world's most powerful service engines. The "Constellation" cruises "above the weather" at 20,000 feet, but can rise to 35,000 and still maintain air density of the 8,000-foot level within its pressurized cabin. It can remain at 25,000 feet on three engines, and at 16,500 on only two. Exhaust heat from the motors de-ices the wings. Engines can be reached in flight through a passage in the wings, and can be removed and replaced in 45 minutes.

Armor Plate Protects Gunner in Bomber "Greenhouse"

Stationed in an exposed position where he would make an easy target for enemy fighter planes, the gunner in the blister turret of a PBY patrol bomber is protected from bullets by a special shield of heavy armor plate. One of a crew of eight aboard the long range raider, the aerial marksman aims his .50 caliber machine gun through a telescopic sight.

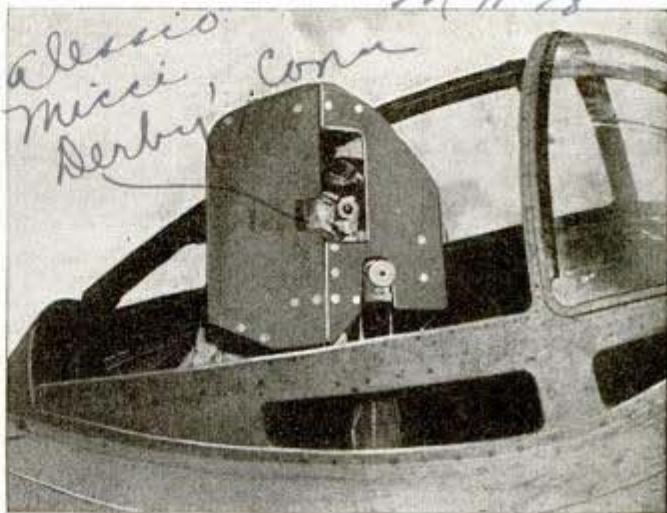

Twentieth century knight carries shield in turret of bomber

Write to the firms listed in the Where-to-Buy-It Index, to learn more about products described in this magazine. Say You Saw It in Popular Mechanics.

Intel News Photos
326 W Madison, Chicago

Chicago

Allen Warren Elliott, 7 Park av, N.Y.C.



You'd never recognize it, but the neat bed-tray (left) is a converted orange crate, sides torn off. Right, easing foot pains by binding pillow so the patient has something firm to press against



M 1128
KEEP the PATIENT

Ingenuity on the part of home nurses trained by American Red Cross makes up for shortage of registered nurses and sickroom materials. Among innovations are wood blocks (left) converting low bed into high hospital cot. Below, the bridge table is used to make a canopy for treating the patient with inhalants





COMFORTABLE

† Chair transforms ordinary bed into hospital type to support patient in reclining position. This is especially handy at mealtime



Three pieces of wire and wood (right) used to protect sore foot from sheet

Below, sheet tied around end of bed enables patient to pull herself up

Paper bag (below) with hole for the nose makes an excellent croup tent. It covers pitcher of steaming fluid set in pan for safety



Int'l News Photos, 326 W
Madison, Chicago

"Phantom" Convoy Vessel Has Remote Control

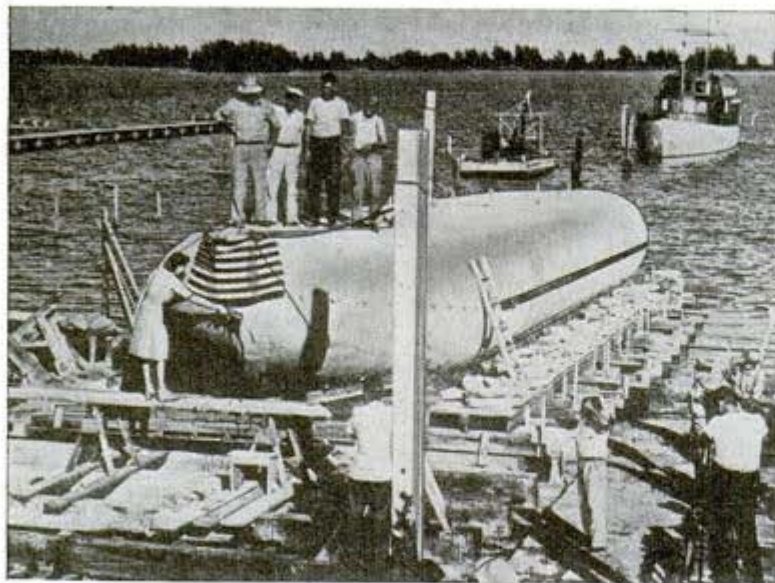

Called a phantom of the seas because it runs without a crew, a concrete vessel for convoy service operates by remote radio control from a master escorting vessel. Without the deckhouse, which is merely a temporary structure, the ship lies low in the water, making it difficult to sight from a submarine and to sink. Built in full size it will have a cargo capacity of 2,000 tons, being 260 feet long, 36 feet at the beam and 27 feet in depth. Ten or more can be operated from a single control station, and should one be destroyed by the enemy its loss would be comparatively small.



Top, launching a 90-foot model of vessel designed to travel in convoys operated by remote control. Left, boat on trial run has temporary deckhouse

Big-Scale Globe Helps President Mark Arenas of War

Presented by the U. S. Army, a huge world globe, 50 inches in diameter, aids the President in locating fighting fronts quickly. It occupies a prominent place in the Presidential offices in the White House.

Even from a distance of several feet, the 50-inch globe in the President's office in the White House has details of war fronts



*Ref: Fels Planetarium
The Franklin Inst, Philadelphia Pa.
m 1182*

Mirrors Pipe the Sun to "Lab" 90 Feet Below

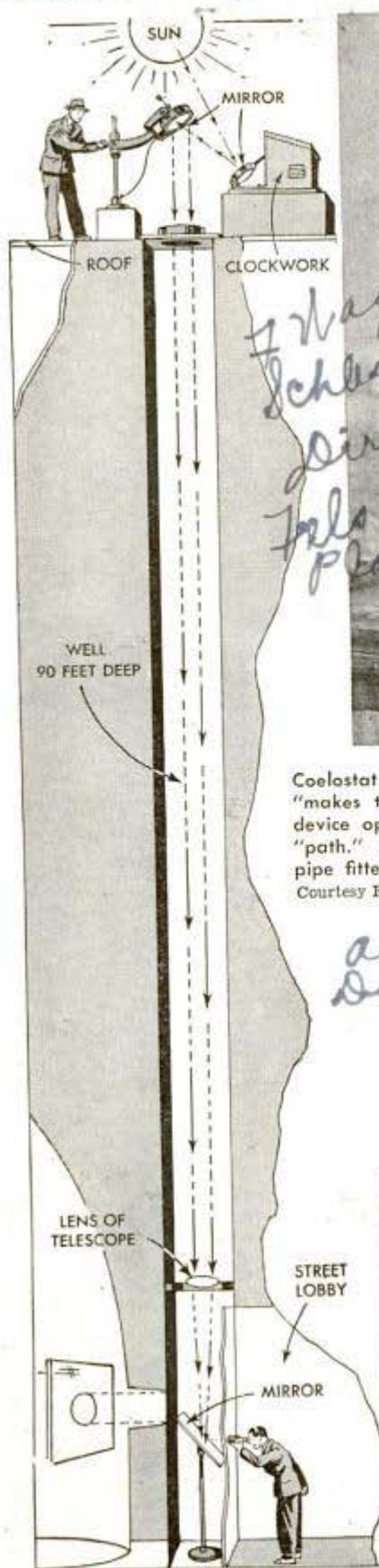

Coelostat on roof of the planetarium (above) "makes the sun stand still" with clockwork device operating mirrors following the sun's "path." Image is carried through a 90-foot pipe fitted with lens as shown in the sketch. Courtesy Fels Planetarium

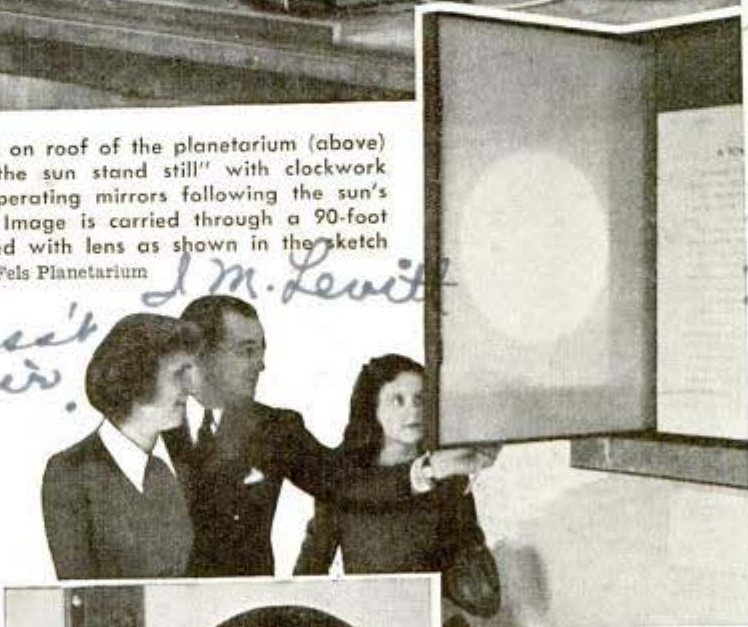

Left, using eyepiece of "stove pipe" telescope to study the sun in lieu of screen (above) at the Fels Planetarium, Franklin Institute, Philadelphia. For study by large groups of astronomy students, sun's image is projected on wall on which are drawn stars invisible in daytime. Navigation students can learn to "shoot" the sun indoors and speed wartime training

Camera Atop Car Shoots Wild Horse Stampede

m 1176



Keeping pace with wild horses, tanks, or planes taking off is no job at all for the camera car (left) that can shoot a scene while speeding at 70 miles an hour over rough terrain. The car is equipped with two sets of springs to hold even keel for the camera mounts and wheels have two shock absorbers. Generating units provide electricity to run six cameras and a battery of movie lights

5509 Klumpfen N. Hollywood, Cal

Photo from News



Young admirer looks on while car inventor, P. J. Grosso of Hollywood, operates hydraulic pump which controls auxiliary springs. Right, rear view of car shows various levels for mounting cameras in addition to top, front and side platforms. Below, the car gets a test shooting a wild horse stampede in "The Desperadoes"



IT'S RAINING SOLDIERS

m 85-1



The rain begins! Over Africa and New Guinea and the Solomon Islands, Yankee paratroopers like this man are pouring out of the skies to establish advance footholds for the ground forces and seize air bases

22007 av Hells ave
By Julian P. Leggett
Jokwood
Dayton, O.
Major, Air Corps

WHEN American parachute troopers "hit the silk" and floated to earth, then seized important airfields in North Africa a short time ago, military experts sat back and said, "I told you so."

For these experts, including commanding generals of various divisions of the Army Air Forces, had predicted that one of Uncle Sam's most powerful striking forces would be an air-borne army. And the invasion of Africa provided the occasion for the first real test of this force.

Not too many details of the North African campaign have been revealed, but hints of the paratroopers' role in the swift advance from the coast to the very gates of the Axis' last stronghold on that continent have appeared from time to time in com-

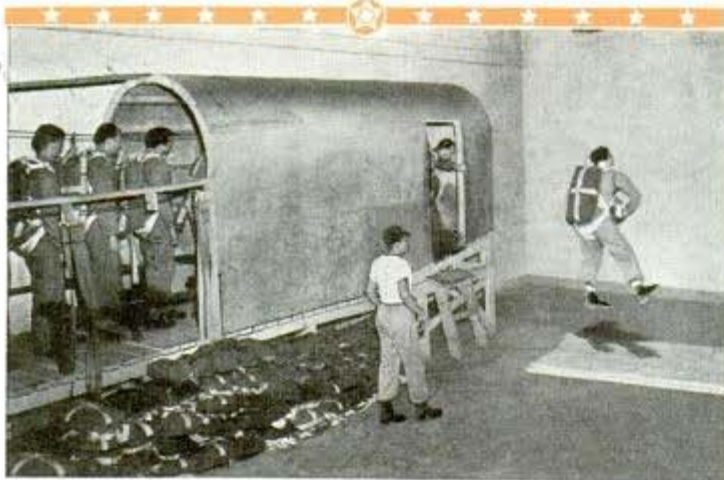

Looks easy—and at this stage, it is. Before a parachutist makes his first real jump, he goes through all the motions in a four-foot leap from the open door of a "mock-up" of a transport plane



This is how a glider pilot cuts loose from his tractor plane, releasing the tow line when his craft is ready for a glide to earth. Below, beginners get the feel of parachute and harness before they start the rigorous aerial course at Fort Benning, Ga.



muniques. Right from the start, it is evident, the paratroopers leaped from aircraft and quickly encircled a number of landing fields from which the defenders might have launched warplanes. So rapidly did these Yankee "Commandos of the sky," working in conjunction with the British, perform their missions, not a single defending plane rose from the ground. The paratroopers landed from their carrier planes, assembled their weapons and attacked "on the double." With the airport in their hands, the Yankee and British forces then waited until fighter and bomber aircraft began to land and ground troops moved up to relieve the paratroopers.

In the same manner, the paratroopers are employed in the seizure of important objectives behind the enemy lines. Dropped from the sky in advance of the Allies' ground forces, they can surprise a small defending unit, then hang on to the objective until their own men arrive.

Many details must be kept secret concerning the exact size, composition, tactics and objectives of these commandos of the sky, but it is a safe guess that many an American attack in the next few months will find them leading the way. Further, it can be told that in size, equipment and firepower, this airborne army ultimately will exceed anything of the kind that the world has ever seen.

This army-on-wings includes more than paratroopers. According to General Henry H. Arnold, Commanding General, Army Air Forces, it eventually will be composed of glider pilots and combat troops transported by aircraft, both airplanes and large gliders, as well as the already famous parachute

soldiers. It is contemplated that the paratroopers frequently will be transported in large airplanes which will tow troop- and equipment-carrying gliders in battle areas.

In announcing formation of the air-borne force not long ago, General Arnold said:

"Glider pilots and air-borne combat troops will be in the forefront of attacks; the importance of these swiftly moving fighting teams cannot be over-estimated. This will be a self-contained force whose soldiers, equipment and supplies all are transported by air. It will be able to strike the enemy where he is least prepared."

Tactical training of the aerial commandos for lightning offensive action has been in progress for many months at a number of stations, which were set up to augment preliminary and advanced glider pilot schools and paratroop training establishments. Upon graduation, the new glider pilots join other units of the air-borne army forces at the tactical stations to com-



Marine paratroopers training at a Naval Air Station hook ripcords to cable and are ready for the plunge

Three big army transport planes pour out chutists in an aerial parade, precise as if hung from one string



One a second, they pour into the sky while the jump-master stands by watchfully. Boots of one paratrooper are still visible outside the door as the next man is halfway out. Notice ripcords still attached to cable



The Yankee Commandos of the air are forming a huge glider army, too. Here airborne troops leap from glider to attack

Reactions of student paratrooper are tested on tower from which jumper falls for 20 feet before harness checks him

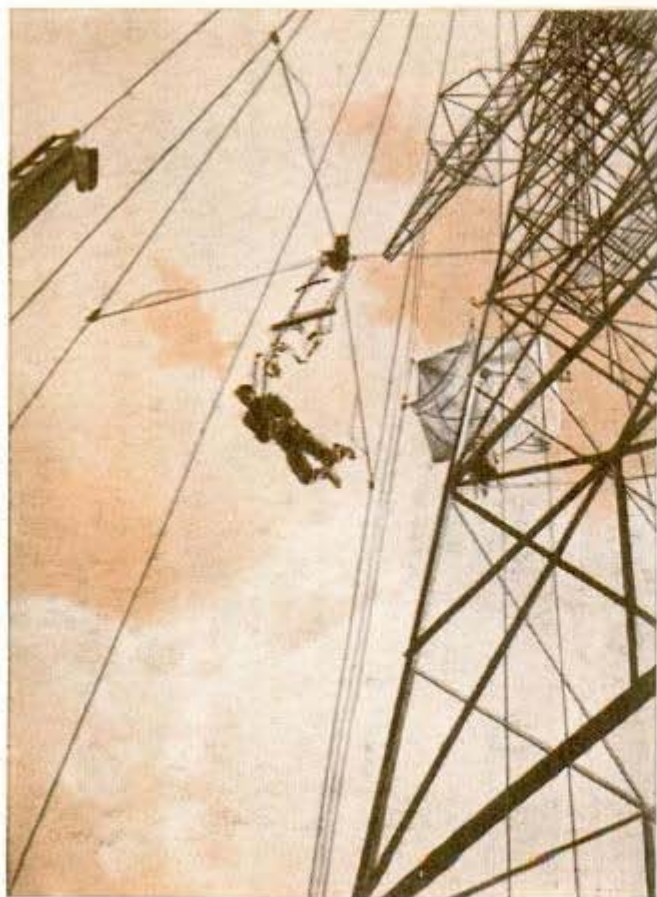

plete their training coordination with the combat groups.

When formation of this force was first announced, two complete airborne divisions had been organized. These air units included parachutists, transport-borne troops and glider-riding soldiers — all formed into a powerful striking force similar to the infantry and with approximately the same fire power.

Of the various phases of this program, which has progressed with even greater speed than its creators had anticipated, the glider development is the newest, as well as the fastest-moving. Not many months ago, the glider had no place in the American air forces; few glider pilots were to be found among the nation's flying officers. But the picture has changed at a dizzy rate. Its outlines had been laid prior to the Pearl Harbor attack by the Japanese and today every detail is in sharp focus. Hundreds of pilots have been trained and hundreds more are in training; many gliders have been built and hundreds more are in the building. Even the actual size of the glider has been increasing. First, there were only one- and two-



Parachutes are still billowing on the ground as the troopers from the sky consolidate quickly into fighting teams, seize the equipment and supplies dropped with them, and rush into position. Below, airborne infantry march up the ramp to board a Curtiss "Commando," the C-46. This twin-engine cargo plane is one of the largest aircraft in the world, being mass-produced for the Army Air Forces for transport service

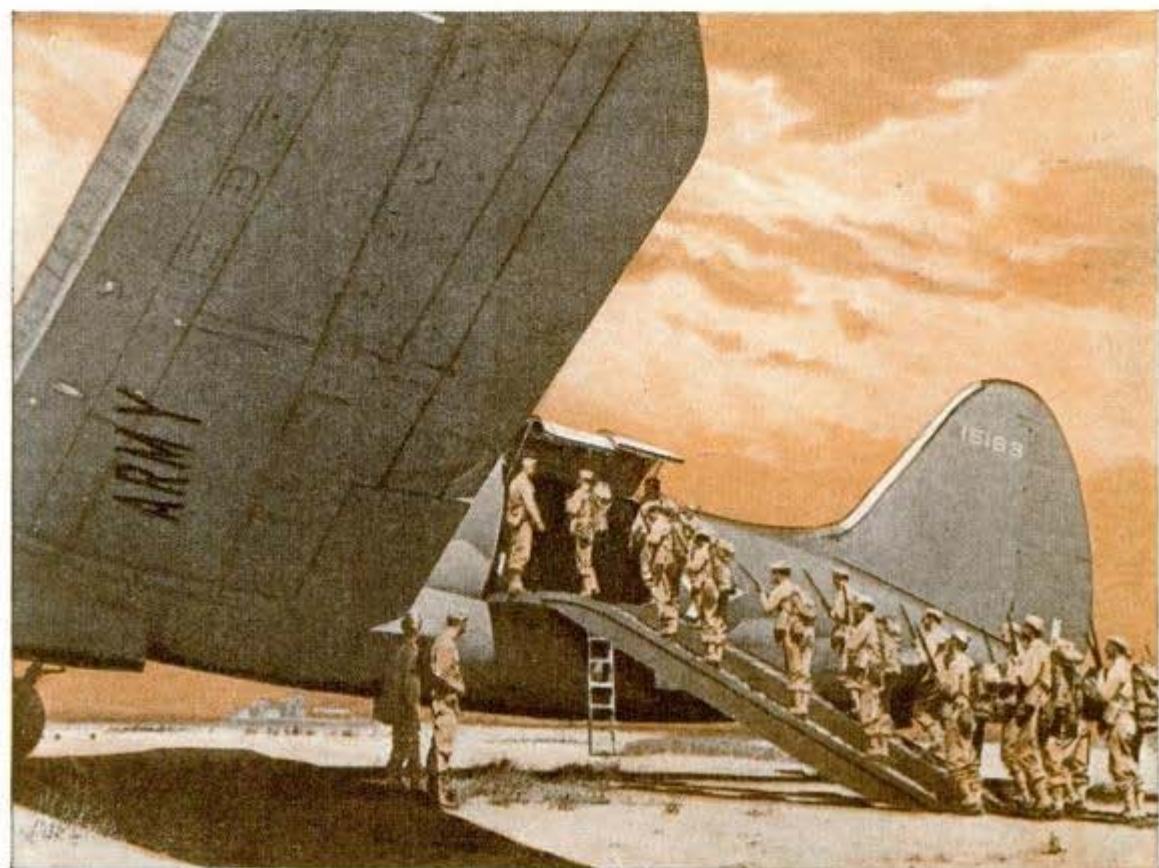



Marines watch the terrain as they come in for a landing. Their transport plane carries a new type midget car and a 37-millimeter antitank gun

purposes. Next came a glider capable of carrying nine fighting men of average weight; needless to say, it could be employed to advantage in transporting soldiers. Latest of the gliders to be announced is a 15-place ship; not only will it carry 15 aerial Commandos, but its weight-carrying ability is sufficient for transporting certain equipment as well.

And beyond the 15-place glider probably are ships of still greater capacity. Dispatches from the fighting fronts have told of German gliders large enough to transport "baby" tanks, five- or six-ton machines, in all likelihood. American engineers have not even hinted that any of their efforts may be pointed in this direction; the practicability of moving tanks of any size by this means may be questioned.

But it is a safe bet that if "super-glid-ers" can be used to advantage, Uncle Sam's engineers will provide them and they'll outperform anything the enemy can produce. General Arnold further revealed that the air-borne army is being equipped to perform missions of the now-familiar British Commando type. One phase of this development is the working out of some means by which army airplanes, while in flight, can pick up gliders from the ground. One has only to exercise the imagination a bit to realize the usefulness of such a development. It can be accomplished by a hook, which extends from the airplane in a downward direction, for engaging a pick-up device, similar to that used in airplane mail pickup service. Attached to the pick-up device is the tow line of the glider. Making the connection and hauling the glider into the air is only a matter of seconds, in contrast to the amount of time required for landing the plane, making the tow line connection and then getting both the airplane and the glider into the air. Too frequently, there is insufficient space for an airplane to land or take off, yet enough for the glider to be lifted into the air by means of this pickup system.

Of more appeal to the imagination of the layman is the parachutist's role in the aerial Commando force. Youth's never-ending quest for thrills is fully satisfied in the paratrooper's daily routine. Using newly developed equipment and launching technique, the 'chute troops drop from carrier aircraft at a rate of one per second; then additional supplies of ammunition, guns, food and water can be dropped at will in aerial delivery



A circle of parachute students hook on to the practice "flyway" chute at naval air station

containers developed and tested at Wright Field. Leaping, one after another, in a form of split-second aerial marching, the paratroopers land with almost uncanny precision on a predetermined area adjacent to a military objective. Often this is accomplished with no more than a few hundred feet of altitude in which to clear the carrier plane, open the 'chutes fully and maneuver them to the landing area.

Speed, surprise and controlled mobility are attained only after long, hard periods of practice formation jumps with full field equipment. After a period of learning how to pack his own parachute—highly important because his very life depends upon his skill—the student is physically conditioned for the rough-and-tumble work of parachute jumping. He is given 30 minutes of "double time"—twice the regular marching rate—each day, plus morning exercises which strengthen and toughen him for the job ahead. Next he places a dummy parachute on his back, to get the feel of it, and practices "landing" from a dummy airplane on the ground; he slides down an inclined beam on a suspended harness which releases him above the ground, thus accustoming him to landing from a height. Next, the student learns to tumble and fall correctly so as to avoid fractures or sprains; also how to come to his feet instantly after landing. He climbs ropes hand-over-hand and is taught balance and coordination.

Tower training is the next phase and here the student's reaction to "falling free" through the air for 20 feet are noted before he is allowed to descend from a 250-foot tower. First, he makes a controlled jump, with wires guiding his 'chute safely to earth, and then a "free" jump, in which the 'chute floats to earth with no control other than the student's manipulation of the shroud lines.

The fourth, and final phase is actual jumping. The student makes five classifi-

The dragline from a tractor plane has hooked a towline and in a few seconds will pull glider into air



Signaling with the "biscuit gun" at a glider school

cation jumps and must participate in at least two mass jumps of 12 men each. During this phase, the men are graded on their work. If the student declines to go aloft or to jump, he is disqualified. The paratroopers are volunteers.

Of his work a paratroop officer said recently:

"In our Army, a parachutist is not one who merely parachutes. Parachuting is a great sport. The tedious preparation pre-





Defenders were too quick for paratroopers in this army game and a chutist is stopped by a rifle behind his back as he lands in North Carolina

Knowing how to handle a wind-filled parachute after landing will save bruises and broken bones. Trick is to spill air immediately on landing

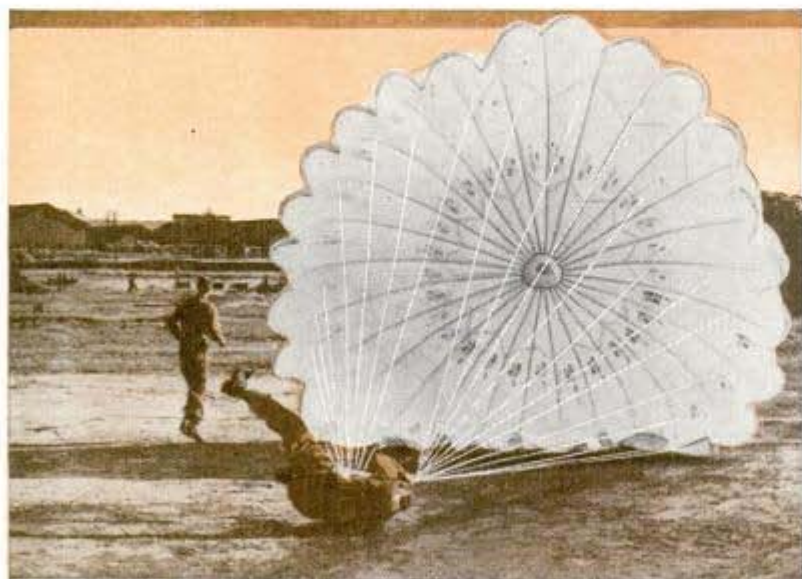

ceding the actual descent comes closer to being work. We parachutists are fanatically fond of our particular branch of the service; there has grown up among us a bond which the layman probably wouldn't understand."

Only a few short years ago, a handful of infantry officers and enlisted men gathered at Fort Benning, Ga., to form the nucleus of the first parachute group. Today, almost

below the exact spot where these inexperienced but willing pioneers first stepped to the open door of their airplane and jumped out into "nothing," a huge parachute school is in operation, training paratroopers by the hundreds for Uncle Sam's powerful aerial army.

But what about the danger? That is a question that the layman poses frequently, but one easy to answer. Fort Benning records show that in two years of training, approximately 100,000 jumps were made with only three fatalities—all the result of mis-

takes made by the men. And that record is better than most sports—baseball, football and basketball—can boast.

It's apparent that the paratroopers themselves think little of that side of their job. Not long ago, a group of these aerial commandos participated in a large-scale mock invasion of an airport. On the transport carrying them to the "jumping off place," there was a marked absence of glumness;

in contrast, they devoured oranges and cookies, cracked jokes and ribbed one or two of their group about landing on tree stumps or in a lake.

This same group had double-timed for two miles the day before in a bit of "warming up." And the day before that, they had marched 35 miles in less than eight hours at night under blackout conditions while carrying complete equipment.

Jumping from their aircraft and landing in a particular area is far from being the paratrooper's entire job. They are specialists of the first order, being trained in aerial photography, map reading, radio communication, compass orientation and the use of virtually every type of weapon, from the Garand automatic rifle to the trench mortar. And they know how to use some new—and still secret—weapons.

Being of the Commando type, the paratrooper also is taught how to operate all kinds of vehicles—armored equipment, trucks and motorcycles—as well as railroad trains. Such knowledge may be highly valuable in enemy territory. All this training, plus careful planning of each particular mission, makes the paratrooper one of the deadliest fighting men on earth.

Then there are the air-borne troops in this aerial striking force. They are transported to destination by glider and airplane, following closely on the heels of the paratroopers whose job it is to seize an airport where the aircraft may land. Their training is directed upon the importance of swift loading and unloading of their planes. One of the latest airplanes useful for this purpose is the Curtiss C-46, the Commando, which is capable of carrying some 50 men with full equipment. The Commando has a wide side door through which a jeep or a large gun can be loaded.

This, then, is the force which our military experts are confident will prove one of the most important in America's scheme of attack leading to victory.

m 1205
Ceramic Grates Save Cast Iron

Although new cast-iron grates are banned for the duration, flames will continue to flicker in American fireplaces because of ceramic grates now available. These nonmetallic grates, developed from clays, and other heat-resistant materials fired and hardened at extremely high temperatures, will save 30,000 tons of cast iron.

Science Service
 APRIL, 1943

Dec 24-42

Strand Ski Co
New Richmond, Wis
Sled With Ski-Like Runners

Glides on Ice or Snow

m 1163



"Go Devil"

Ski-like runners slide easily over snow, sleet or ice

Ski-runners have been found to be a welcome substitute for metal on children's sleds, as they give the gliding effect of skis and bring the thrills of coasting to areas of the country where metal runners are not practical. Treated with a special ski wax, the sled is said to ride straight and true over light or deep snow, sleet or ice, and it is easy to pull over deep snow even when it is heavily loaded.

Ship's Variable-Pitch Propeller Controlled by Its Own Wake

7731

Blades of a ship's propeller would be set automatically at the angle that will assure most efficient operation by an invention of John Hays Hammond, Jr., patented recently. Pitch of the propeller's blades is controlled constantly by the slipstream of the vessel itself. Activating the unit is a hinged strut projecting from the hull. Pressure upon this, varying with the ship's speed, operates an electrical device that gives a slipstream reading on a dial. If this reading indicates inefficient operation, an electric motor automatically increases or decreases the angle of the blades.

Gloucester 27
Mos.

SET 'ER DOWN *in* YOUR

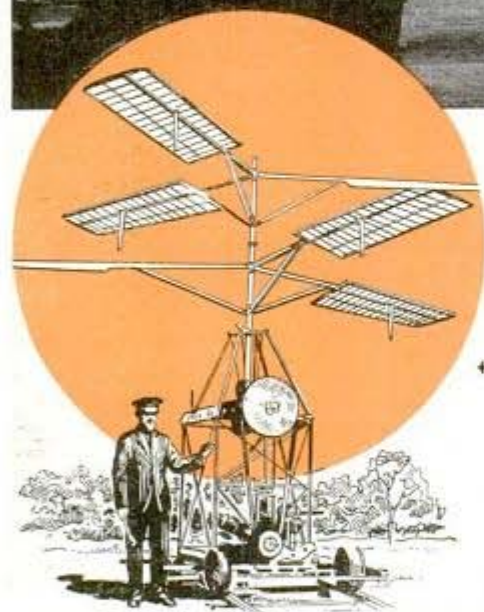
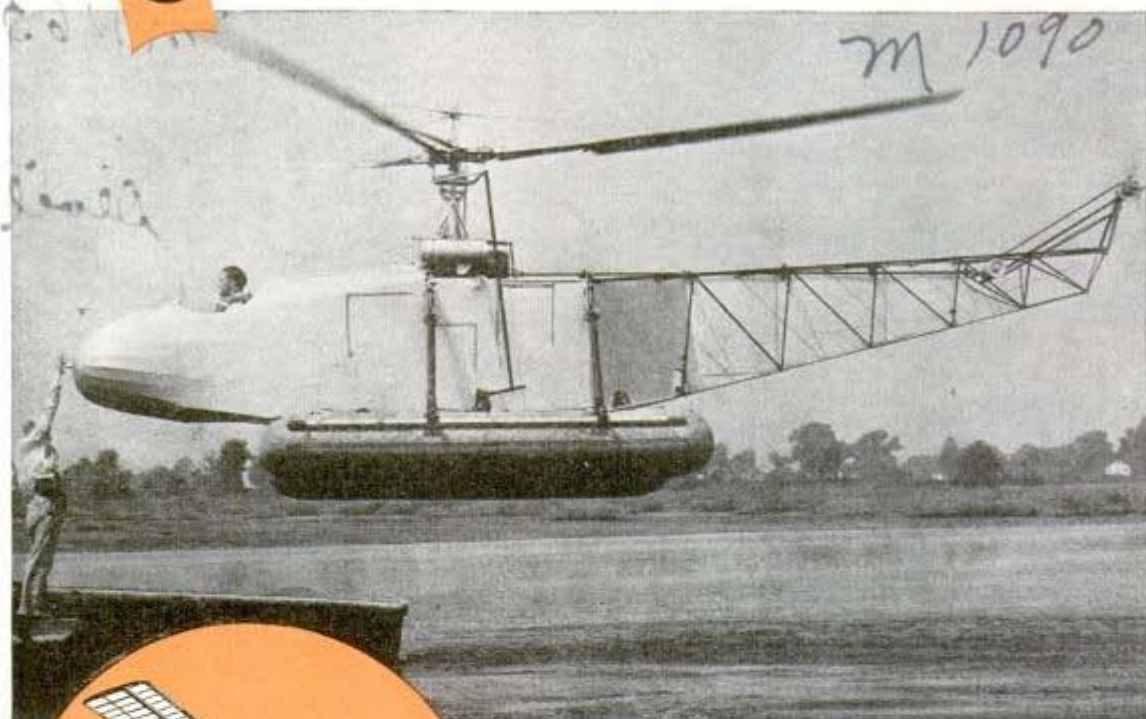

Fitted with pontoons for landing on water or land, the Sikorsky VS-300 helicopter hovers motionless in air before alighting

Igor Sikorsky beside one of his first helicopters at Kiev, 1908. ← It was a beginning, but it wouldn't fly

Demonstrating perfect control, the pilot pierces a paper target and gently lifts away a metal loop set in top of a pole

By Roderick M. Grant

THIS is no midsummer day's dream. Your next car may be a helicopter.

Pure poppycock, you'll say; the thing is fantastic. For 30 years, if you're that old, you have read tales of that crazy contraption that would hoist itself by its own bootstraps six feet off the ground and then come down to the good earth with a bonebreaking thump. Then you'd drive twelve miles to the airport and watch those \$100,000 sky liners climb away gracefully at 125 miles an hour, and if you thought of the helicopter again you wondered why crackpots went on wasting time with these impractical dancing dervishes when the sky was filling with Clippers and Stratoliners and Flying Fortresses.

You have been misled. Alone, since 1908, one man has been laboring to build a craft that you can lift safely



Wrought-Sikorsky did.
United Aircraft, Stratford, Conn

BACK YARD

from between the cherry trees and the Monday wash line in your urban back yard and set down as gently as a toy balloon between two parked cars.

And lo, the helicopter has arrived. You believe when you see it rise vertically to hover like the frozen motion of a hummingbird, swim backward in air as easily as forward, do a right-about-face with a doughboy's precision and swing from side to side as smoothly as a pendulum.

The thing still looks like the skeleton from an inventor's closet and you subconsciously search the sky for the invisible string from which it must be hanging. But it has arrived at its beginning, and the principal obstacles between the helicopter and your garage are lack of a nickname—helicopter is still a 25-cent word with controversial pronunciation—and lack of a production line.

The nickname is up to you. The production line is up to Igor Sikorsky, the unassuming genius who nursed the unbelievable craft for 31 years before he got it to work, and had time meanwhile to turn out some of the world's largest commercial transoceanic flying boats.

Mr. Sikorsky is a native Russian and today is a more passionate American than you or I. He built his first edition of the helicopter at Kiev in 1908. It looked like a Dutch windmill upended, and it wouldn't fly. That did not discourage Mr. Sikorsky. He built a second helicopter that also didn't fly. Then



In this panel are the three stages of the experimental helicopter, first of its breed to fly successfully. The original model, above, had outrigger structures extending from the tail, with twin rotors



The outriggers were dropped in the first major revision and a tower over the tail substituted (above), carrying a single rotor. In the present version the tower has been scrapped, pontoons replace wheels





Ingenious controls in main rotor mast permit sidewise, backward, forward or vertical maneuvers

chine again, and a flying generation had grown up before the Sikorsky helicopter first thrashed its great arms and rose into space.

That was 1939. In the four years since, 18 major changes have been made in the craft and more are in the making. The original helicopter of 1939 is the same steel dragonfly that darts over the bay at Stratford, Conn., today in absurd aerial evolutions. It is like the Model T Ford that entered its second

he began building fixed-wing craft, mostly multi-engine planes, until the tragedies of the bolshevik revolution drove him from his homeland. He translated his endeavors to America, building land planes and amphibions and flying boats. It was a long time before he tackled the wingless ma-

100,000 miles with none of its original parts.

Up to this moment Mr. Sikorsky has confined himself to a search for stability, control and smoothness of transmission and rotor operations. Those fundamentals having been solved, save for the refinements time and experience will bring, the inventor will be free after the war to attack the problems of production. They will be simple. Basically the helicopter is a framework of welded steel tubing with a main rotor and a tail rotor driven by a gasoline engine and operated by an ingenious set of controls; it should cost no more than a medium-priced automobile, and it presents much less difficulty than the automobile in mass production. Since the war's end will undoubtedly see a vastly expanded aviation plant seeking peacetime employment, the helicopter should find a home. There will remain the problems of stepping up performance beyond the present easy pace of 80 miles an hour, increasing the capacity of the experimental VS-300 to family size, and convincing you the helicopter is no neck-breaking aerial jungle gym for daredevils but the safest and most convenient aircraft invented for a cliff-dwelling kitchenette civilization.

So far as the neck-breaking proclivities of this flying machine go, it is significant that Mr. Sikorsky still has his own neck. True, in his pioneer experiments



Its arms thrashing just enough to counteract gravity, the helicopter waits upstairs while its "ground crew" attaches a can of gasoline to line to refuel

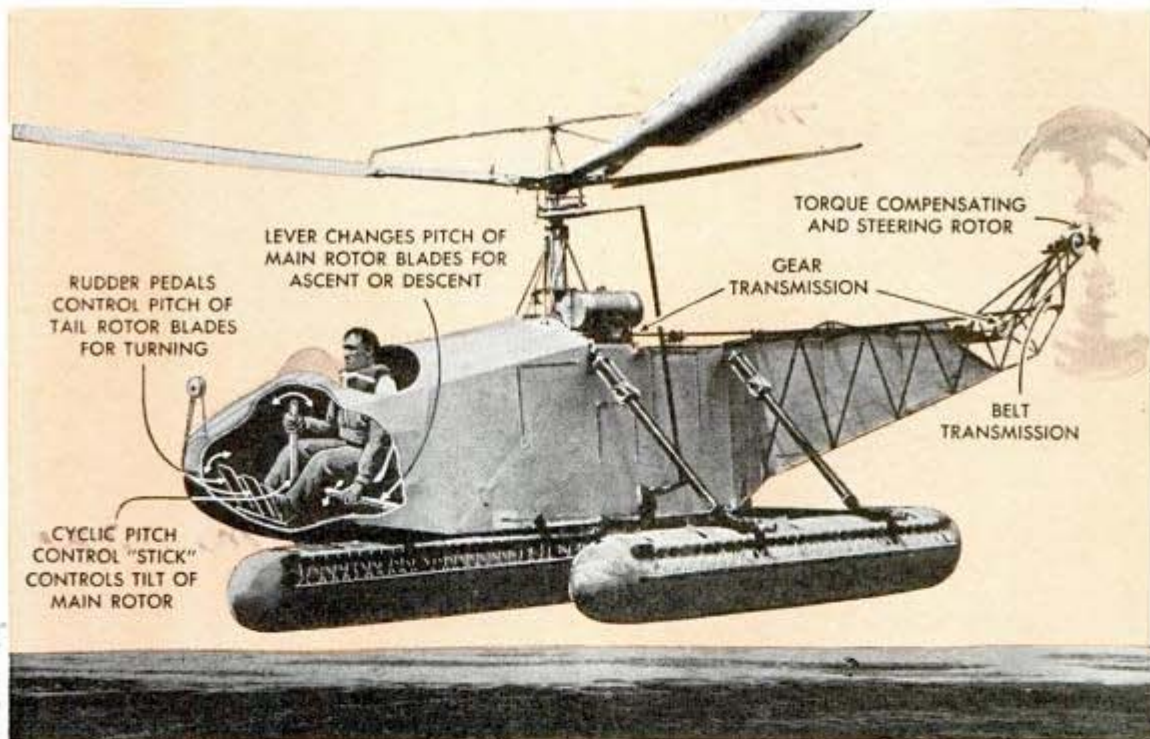

Photo-diagram shows the principal elements of control. After the war, you may learn to fly it in an afternoon

he took the precaution to fly his helicopter as a captive, maneuvering it over the factory yard while assistants restrained it within a safe distance of earth by rope. Now that the controls are perfected the VS-300 hops around as unfettered as a mosquito, which it resembles except for the sting.

"The helicopter can do what no eagle can," says Mr. Sikorsky. "Indeed, it can perform as no other thing on earth—fish, flesh, fowl or mechanical. No eagle can hover. No bird can fly backward. No ship can swim sideways. No plane can rise vertically from a standing start. But, to be quite humble about it, the helicopter can't do much that a mosquito can't do."

At the Sikorsky plant you may meet the only two Americans licensed to fly the only helicopter in the hemisphere. Igor Sikorsky holds No. 1 private license. Charles L. Morris, test pilot, holds No. 1 commercial license. It is the opinion of these two that you could learn to fly the helicopter in

two hours. You will learn more safely than the airplane pilot, for you need not roar across a field at 60 miles an hour to take off or alight. When the helicopter has its day, you can learn by maneuvering the craft through its three-dimensional repertoire while it hangs from its gyrating umbrella, anchored a few feet above the ground by ropes. If your engine fails, you drift to the ground under the restraining influence of the free-wheeling main rotor blades.

(Continued to page 161)

Mr. Sikorsky sets the VS-300 down between parked cars, in a space just wide enough to allow clearance of the fourteen-foot main rotor blades



Machine "Irons Out" Nails At Rate of 31,000 a Day



Straightener removes kinks to reclaim bent nails

Crooked nails, made valuable by the diversion of new production to war industries, can be given a new lease on life by straightening them in a machine that "irons out" 31,000 nails in a single day. Invented by George D. Hulburt at 20th Century-Fox film studio, the reclaiming apparatus removes the kinks by stamping the nails into a straight groove.

630,770 of Nation's Specialists On Call for Wartime Duties

Signed up for work wherever they may be needed in this technician's war are 630,770 scientists and professional men and women, who can be located instantly for vital and unusual war jobs. So great is the demand for persons of their skills that names of 140,000 of those registered have been sent to war agencies requesting them. A checklist of American brainpower, the list is termed the National Roster of Scientific and Specialized Personnel, and it was established before Pearl Harbor by the National Resources Planning Board and the U. S. Civil Service Commission. Its aims are to assure that the job is tailored to the person qualified to hold it, to provide a constant check on who is available and what jobs need filling, and to guarantee that immediate needs for skilled persons do

not halt research that has its sights trained on something more important for the future. Registration is voluntary. Included on the roster are 80,605 chemists; 11,054 physicists and astronomers, 5,933 psychologists; 34,053 civil engineers; 4,825 aeronautical engineers; 3,265 automotive engineers; 21,669 mechanical engineers; 7,967 chemical engineers; 22,027 electrical engineers; 5,630 radio engineers; 7,170 biologists; 9,028 geologists; 9,154 mathematicians, 7,990 economists and 1,221 naval architects.

Home Forecaster Dials Weather From Known Conditions

You can be your own weatherman with a dial forecaster that requires the operator to make four simple observations of the weather existing at the time and to set four rotating disks accordingly. The observations, each represented by a separate dial, include the present wind direction, barometric pressure, which way the barometer is changing, and a choice between "fair," "overcast" and "rain." The wind-direction dial includes an indication as to whether the wind is backing or veering, that is, whether the last change swung counterclockwise or clockwise. When the four disks have been arranged so the indicated weather conditions point toward the red arrow at the top of the dial, they line up three digits and a letter of the alphabet. The user then locates this reference in a table, which gives a definite weather prediction covering an area within a radius of 30 to 50 miles and a period from 12 to 24 hours. Accompanying the forecaster is a complete set of instructions.

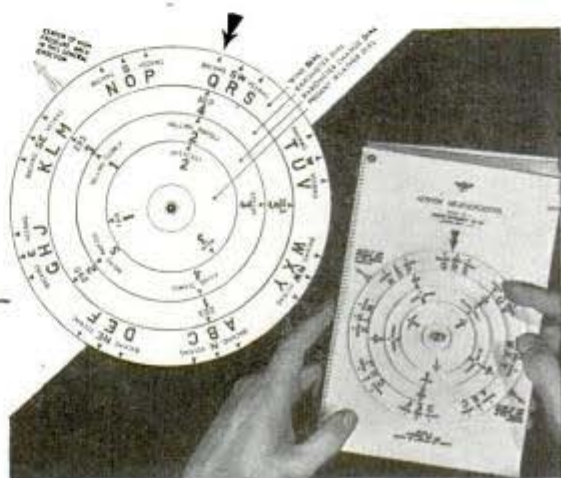

After disks are set (left) answer is found in table

POPULAR MECHANICS

washington. D.C.

*J. C. Kaldrick, 717 Evans Road
 Co. Fullerton at Greenfield,
 Detroit, Mich. 7/11/40*

Hold-Down Tubes Fasten Cargo in Airplane

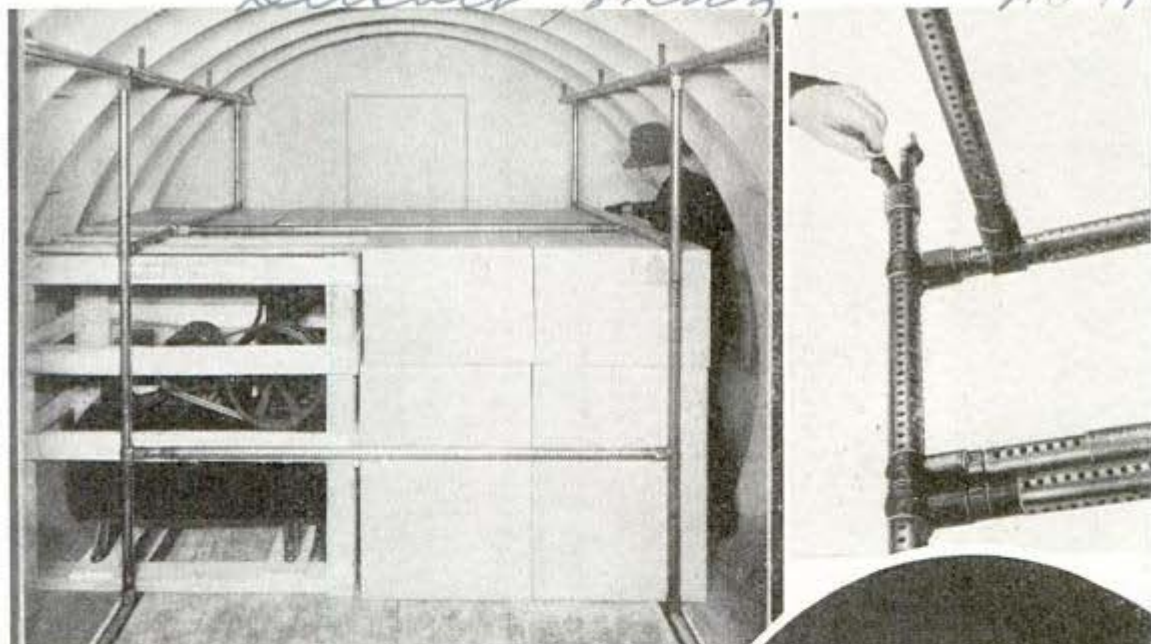

Flying level or banking (simulated above and right) adjustable bars (upper right) retain grip on cargo

To keep cargoes from shifting about in freight-carrying airplanes, hold-down equipment has been developed that serves the additional advantage of speeding the loading and unloading. A series of tubular bars, four of them installed permanently in the ship, combine to bear against the stowed material so motion of the ship can't budge it. Two of the tubes are installed lengthwise in the ceiling, two others parallel them in the floor. Removable telescoping bars may be attached to these in vertical or horizontal position by means of split jaws at the ends that are provided with dowel pins which "bite" into holes in the cross bars. The removable members can be placed to exert pressure downward, sidewise or endwise.

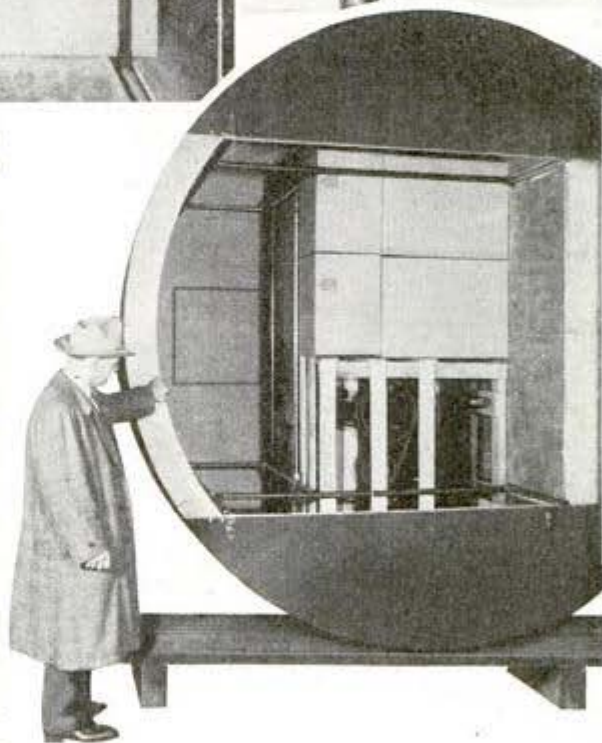

Tune-Up for Lower-Octane Gas Calls for Only Minor Adjustment

No major changes in the motors of busses, trucks and other commercial vehicles because of the reduced anti-knock value of gasoline will be necessary, driving tests have shown. Fuel consumption and power output are little affected if the spark timing is properly retarded. Only if the octane rating falls below 65 is performance likely to be noticeably altered, since truck drivers in road tests reported they could detect no difference in performance between gas-

olines of 65 and 72 octane. ^{71.30} Carburetor adjustment does not appear from these tests to be worth while. With the lower-octane fuel, engineers warn, closer maintenance will probably be necessary, and the proper spark adjustment should be made for each motor, since motors vary even though of the same model. Most passenger car owners have found they can adapt their driving to the fuel and avoid knocking just by easing up on the accelerator.

*Ref: E. P. Brenz, N. W
 Mitchell; A. B. Culbertson,*

Shell Oil Co.

The MYSTERY of the COMMON COLD



Measuring and comparing flow of blood in finger and nose (above) with a plethysmograph in the environment room. Below, influenza virus is transmitted to a mouse in Navy research laboratory

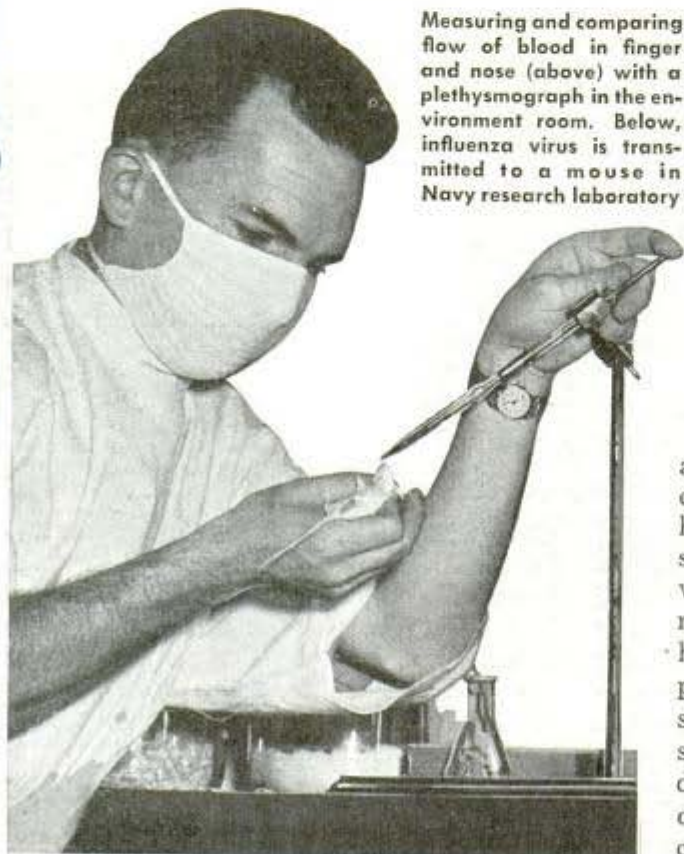

EVERYONE "knows" common colds are contagious. The chances are that you can trace your last cold directly to someone else who had a sneeze.

But can you?

Science can't. Science hasn't been able to find a germ or virus that causes colds, not even with the electron microscope that discovered the virus of influenza, a protein only 10 millimicrons in size, smaller than some molecules. Dr. Wm. J. Kerr and his associates at the University of California Medical School wanted to learn exactly how infectious the common cold is, so they placed healthy volunteers who catch cold easily in an environment room where temperature and humidity are controlled, then exposed them to other people who were suffering from colds. All slept in the same room, drank from the same drinking glasses, lived together for days. Not one of the 30 without colds caught the symptoms from those

Ref. Credo: Dr. Wm. J. Kerr, U. of Calif. Medical School, San Francisco, Cal.

Ref: Influenza! Commander Albert P. Krueger, Univ. of Calif., Berkeley, Calif.

Radio fever machine invented by Dr. Lee De Forest treats colds and respiratory infections

who were sneezing and coughing.

Such experiments are leading many authorities to the belief that many colds are merely mechanical upsets. Some of us are not always able to react properly to overheating, exposure to drafts, or changes in the weather. Abrupt weather changes appear to afflict many people with the symptoms of colds at about the same time, leading to the impression that one person can infect others. This apparently is the basis of the old story about the island of St. Kilda, whose inhabitants were said to suffer colds only when people from the outside arrived by boat. The truth seems to be that sailboats could reach the island only during a northeast wind, and it was the cold wind, not the visitors, which caused outbreaks of sneezing.



The latest explanation of colds has to do with the spongy tissue that covers the turbinals in the upper nose. Ordinarily the air we breathe is heated and moistened on its way to the lungs by this tissue. Now and then, depending on the severity of the exposure and the general resistance of the

Left, multiple temperature indicator used to check temperatures of different parts of body in research on common colds. Right, attaching the leads for measuring temperatures at various points on a subject's arm

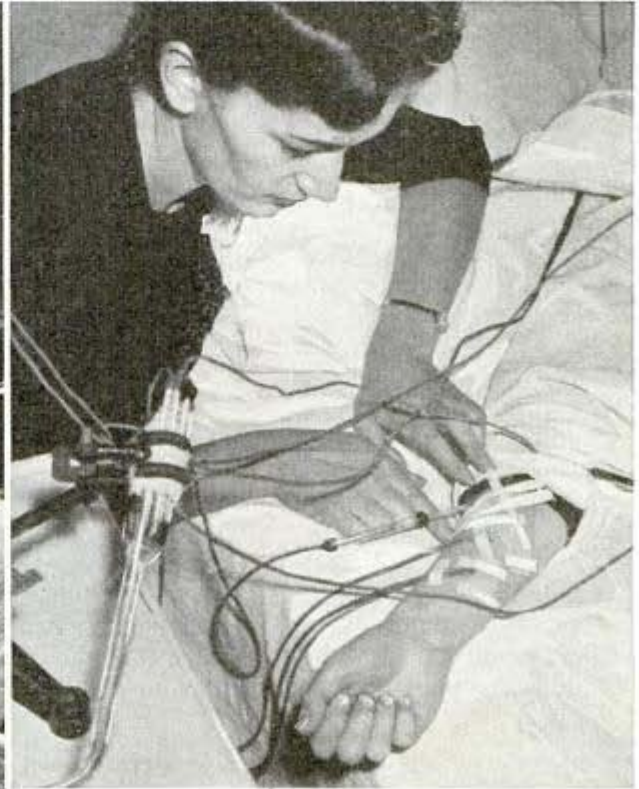



Combination stethoscope, called a symballophone, aids in locating and studying respiratory infections

person, this air-conditioning apparatus gets out of kilter. The unpleasant conditions we know as a cold result. There seems to be a connection between the temperature of the skin and the actions of the turbinals, and this may be the reason why exposure to drafts that cool the skin often give us colds.

Today Dr. Kerr and a team of physiologists and doctors are studying all such physical manifestations. They are using an environment room in which temperature and humidity can be controlled precisely. Any type of climate can be reproduced inside its four walls, and even the barometric pressure is regulated. The entrance is through an air lock. You close one door behind you before opening the door that leads into the environment room.

In this room the research team is studying the mechanism of the skin,

Moisture containing influenza virus is atomized and injected into test chamber containing mice

its temperature and blood circulation. Volunteers susceptible to colds are subjected to drafts and other adverse conditions, then their automatic reactions are studied. The research program will consider all respiratory diseases and will even investigate the possible effects of vitamins and diets on susceptible people.

No one ever died of a common cold, probably, yet colds can't be classed as mere annoyances. For one thing, they pave the way for many kinds of secondary infections that are often serious. The irritation is apt to result in such inflammations as sinusitis, tonsilitis, or bronchitis, and the micro-organisms that cause pneumonia and other respiratory diseases get a chance to go to work. These complications begin in the later stages of the cold and blend so well with it that most people simply think their cold is getting worse.

A survey made one spring week indicated that some 23,000,000 individuals in the United States were suffering the symptoms of colds at the same time. Another estimate is that the average worker loses eight days a year from illness, a considerable part of which loss is caused by colds. If such illness could be reduced by only one day per worker per year, the equivalent of the full time work of an additional 60,000 men would be gained.

To reduce colds among war workers, Douglas Aircraft Company last winter spent \$25,000 on an anti-cold program that included distribution of pills intended to increase resistance to the condition. Simi-

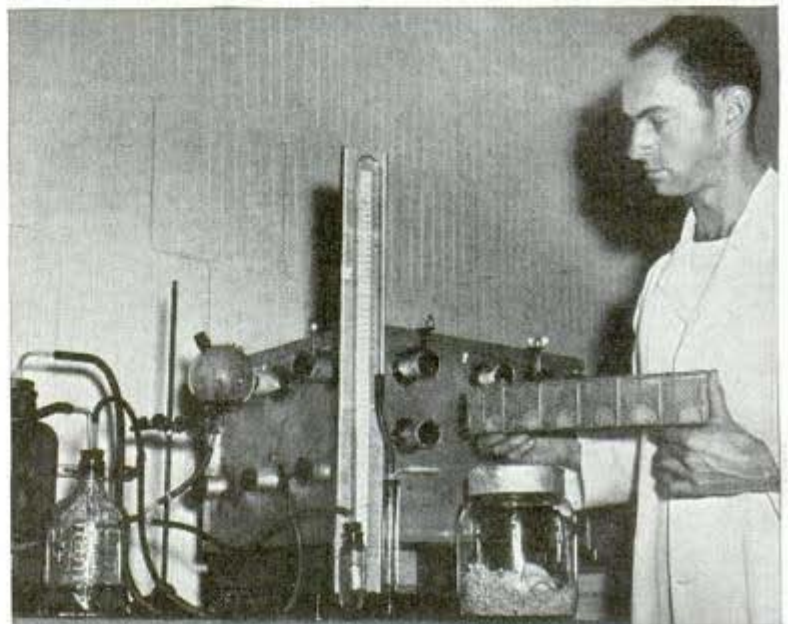

larly, 1,000 employees of Lockheed Aircraft Corporation are participating in a 6-month nutrition experiment in which their normal diets are supplemented with vitamin tablets. These are intended to improve their general health, reduce fatigue, and thus indirectly reduce susceptibility to colds.

Unlike the common cold, influenza has been proved to be a virus disease. It is marked by a sharp temperature rise, pains in the joints and muscles, is more debilitating than a cold, and requires longer convalescence. The virus is carried by droplets in the air. A minor epidemic of influenza occurs in the United States every other year. A small outbreak is expected in 1943. No one knows why major epidemics of flu occasionally sweep the world, the last of which, in 1918, resulted in millions of deaths.

But, if such a pandemic should occur again, the United States is in far better position than in the past to control the

Cold quartz ultraviolet light sterilizes air, killing germs and "flu" virus



Top, injecting influenza virus into eggs to prepare vaccine; below, air lock leading to environment room at University of California has double-pane windows



spread of the disease and to reduce its mortality. Various groups are engaged in intensive studies of influenza. Type A, Type B, and a probable Type Y have been distinguished. One of the research groups, the Navy's Laboratory Research Unit No. 1, on the Berkeley campus of the University of California, has been administering a virus-vaccine with promising results in some 50 percent of the vaccinated personnel. Indications are that more effective vaccines will be developed that will provide immunity to the disease to an even greater percentage of those who are vaccinated. Influenza can become a deadly enemy in wartime, hence the Navy's interest in conquering the disease. The laboratory re-

(Continued to page 154)

Rep
 graphed by scientists at the Radium Institute in Bern, Switzerland. Known both as helvetium and as alabamine, the element was not isolated until 1940 and then the discoverer, Dr. Walter Minder, extracted only one ten-thousandth of a milligram from a gram of radium. Besides being the last element whose existence is believed possible, helvetium is also the 10th and last radioactive element in the series whose existence was established when the Curies discovered radium in 1898.

Jeep Spouting Cloud of Gas Trains Men for Attack

7m 115
 Officers and men at Geiger Field, Wash., are subjected to occasional "friendly" attacks of tear gas spouted from an army jeep traveling around the field constantly. This keeps the personnel ever on the alert, teaching them to be quick in donning gas masks in the face of surprises, the idea being that when eventually they go into action they will be ready for real doses laid down by the enemy. The tiny car releases clouds of gas at unexpected times and places. It carries the fluid in a storage tank connected to the exhaust tail pipe. Pressing a lever sprays fluid into the pipe, where it changes to gas and shoots out with the exhaust.



Pressing lever by seat sprays fluid into the hot exhaust pipe

APRIL, 1943

*some newspaper
461 8 av, 7/1/43*

Wire 'Umbrella' Sheds Lightning Aimed at Explosives Plant

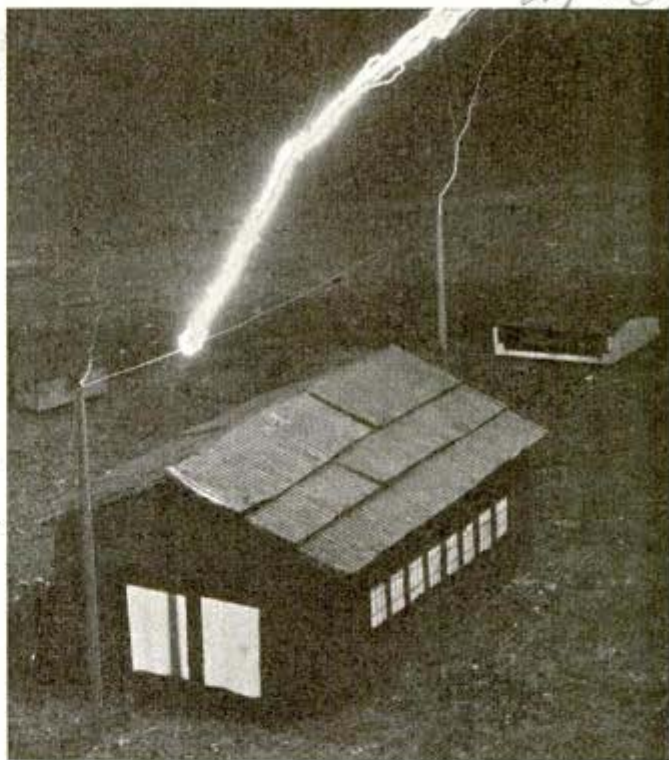

Steel wire catches bolt and carries it to rods in the ground

Lightning streaking toward munitions plants or oil storage centers at more than 11,000,000 miles a minute will hold no terror for workers if the structures are protected by a wire "umbrella" developed by Westinghouse Electric and Manufacturing Company. It is simply a steel wire strung above the building and anchored to a tall wood pole at each end, and from there connected to steel rods buried

in the ground. Lightning rods previously used required about 250 pounds of copper, whereas the same building can now be shielded with only 60 pounds of steel and the two wood poles. The new design eliminates the danger of lightning leaping to metal sections of the building and causing sparks, since the whole charge is caught by the wire and led harmlessly into the earth. The system was tested on models at Westinghouse high voltage laboratory.

Blankets made of layers of reinforced crepe paper, said to have warmth-retaining qualities comparable to some textiles, are appearing in department stores.

Edward Weston 1912
Victory Blvd Van Nuys Calif

Stinson

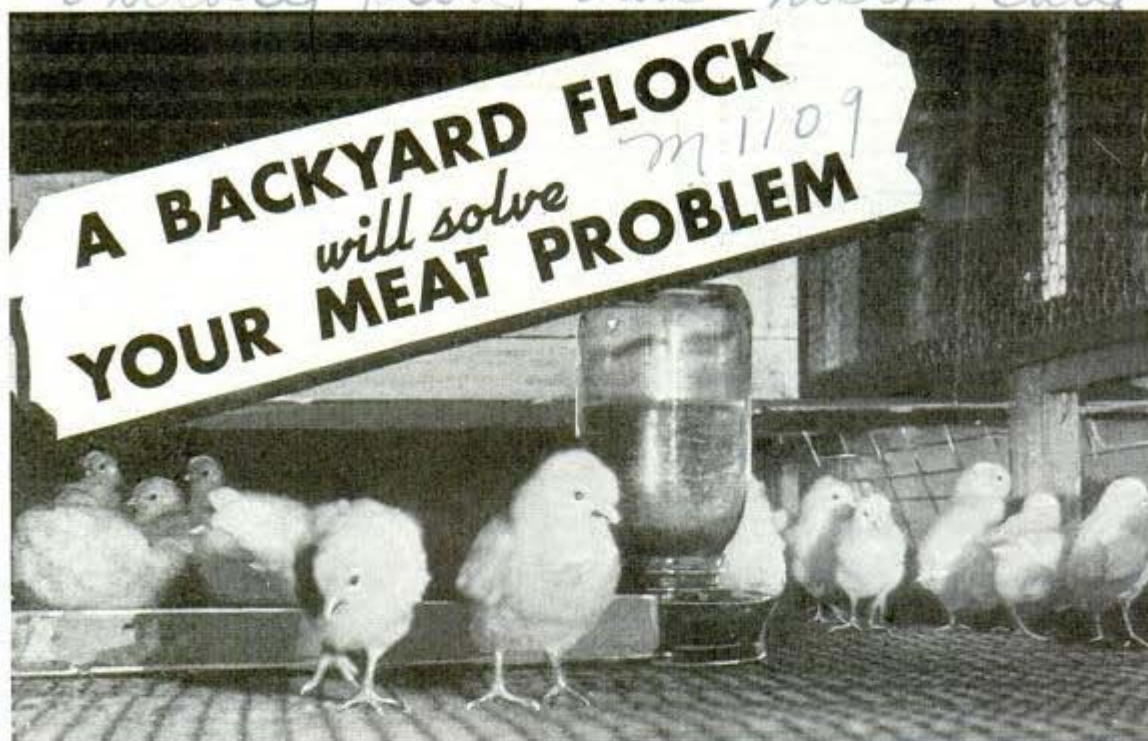

Chickens grown in backyard pen live out their lives on wire; their feet never touch the ground

A PEN 4 by 12 feet in size, small enough to tuck away in a corner of your backyard, is all the space you need for raising enough poultry to keep your family in meat and eggs.

Instead of allowing your flock to run loose you should copy the modern commercial "egg factory" method of raising them on wire. An elevated pen with a wire mesh floor keeps your flock healthy and sanitary.

It's cheapest to buy day-old chicks of good tested stock, from an accredited hatchery.

Most hatcheries have chicks available all year and will ship them to you in sturdy cardboard boxes. More expensive, but far less trouble, is to buy chickens that are from one to two months old. These are usually available in the spring and early summer, though possibly you will need to arrange with the hatchery ahead of time to rear them to this age. By doing so you avoid the need for a brooder.

Select a breed according to your needs. White Leghorns are good layers and five of them will feed on what four birds of a larger variety would consume. Barred Rocks and Rhode Island Reds are larger, plumper birds with more meat. They eat more than Leghorns, and are good layers. It's best to buy about two and a half times as many chicks as you will want for an egg flock. A few will die, and half of the rest will be cockerels. These make good fryers at three and four months, just as they begin to crow.

Of 50 day-old chicks, 18 or 20 will become laying hens.

Fowl raised on wire are healthier than those kept on the ground. Metal water trough on this pen is easily refilled

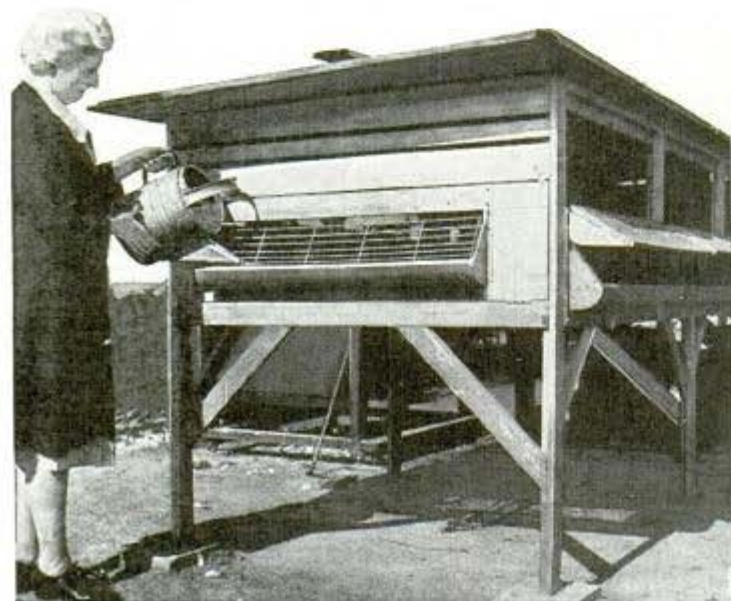

Eight or ten of these will lay more than enough eggs for a family of four, leaving up to a dozen for a chicken dinner. Keep the hens that lay the most eggs. If you buy partly grown chicks that are out of the brooder stage you can start with 35 or 40.

The recommended way to keep poultry is in batteries of individual wire cages. There isn't enough wire to go around, these days, and your next best bet is a wire runway, even if you have to straighten and patch secondhand wire.



Slanting wire floor of this single cage allows egg to roll into tray

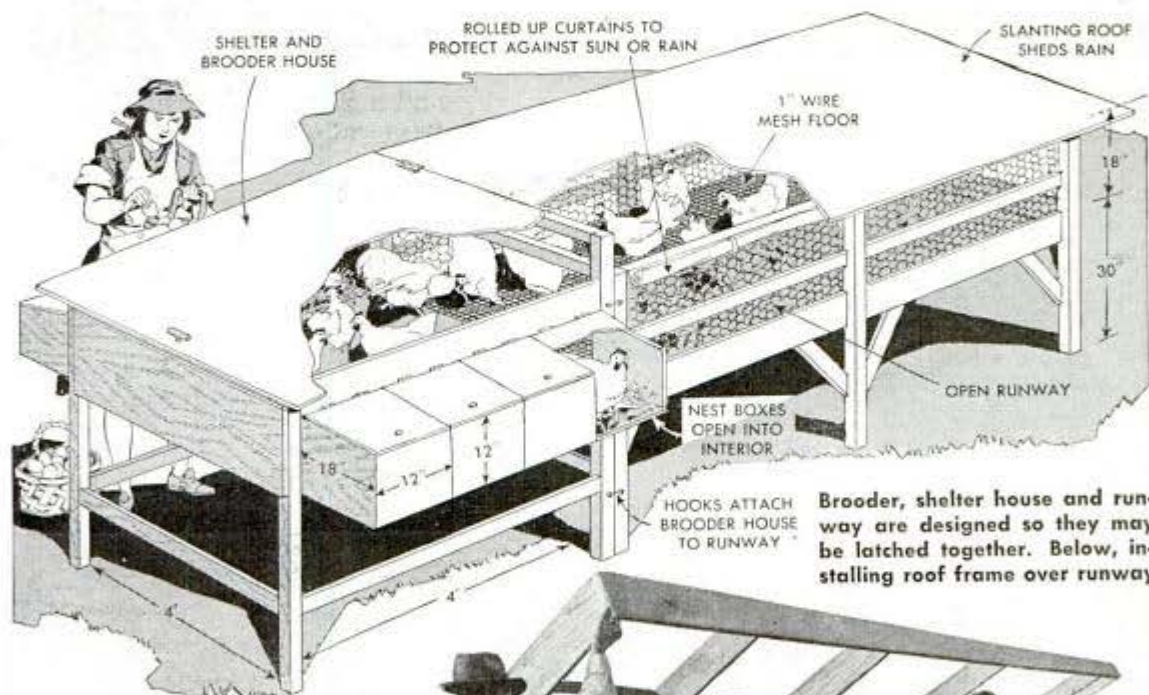

Brooder, shelter house and runway are designed so they may be latched together. Below, installing roof frame over runway

A good size runway for a flock of up to 24 mature birds is 4 by 8 feet in area, 2 feet high, and with a 4-by-4-foot shelter house at one end. The house and runway are supported on legs 30 inches off the ground. The floors of both the house and runway are of 1-inch wire mesh, and both are roofed with



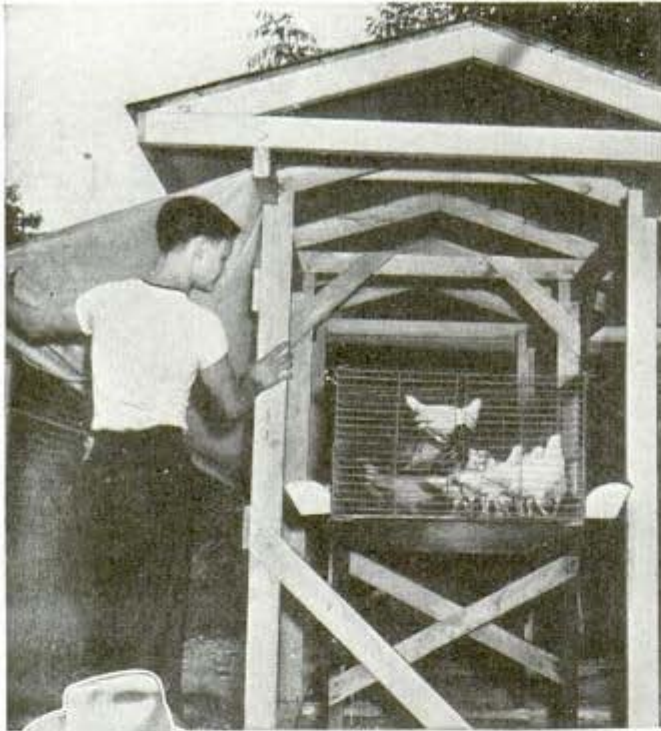

Canvas awnings at the sides of this runway protect chickens from rain and heat of sun

provide three or four nest boxes, 12 by 18 inches in area and 12 inches high. The slanting tops are hinged so that you can reach in to collect the eggs. Paint all woodwork with aluminum paint if it is still available. Next best is creosote paint and next, whitewash.

Housing chickens this way is a compromise between the old method of allowing them to run on the ground and the modern commercial battery method. Poultry raised on wire are healthier than if kept on the ground, and the confinement does the birds no harm. They remain clean because their droppings fall through the wire floor to the ground, which should be kept dry and unpaved. The droppings dry rapidly in the open air, create no odor problem, and make excellent garden fertilizer. A fly trap should be installed near the pen, preferably between the pen and your house. An electric flytrap, protected from the rain, is recommended.

Decide on one of the commercial feed mashes and stick with it, following directions. Keep the feed troughs at least half full. Stirring



Home-made brooder holding a dozen chicks is heated by light bulb (left). Day-old chicks (below) are shipped in boxes with air holes

boards covered with roofing paper. The runway walls are of chicken wire. Removable feed troughs may be hinged to the walls of the runway, or the troughs may be placed inside, on the wire mesh floor. There must be room at the troughs for all the birds to eat at the same time, without crowding. A water trough may be placed across the far end of the runway. The runway should face the south, with the house at the north end. The slanting roof of the house is hinged for ready access.

The poultry will roost on the wire floor in the house. Each side of the house should be built out to



the feed up occasionally in the troughs arouses the interest of the hens and causes them to eat more.

Chickens require plenty of fresh water, grit, and feed. They need sunshine but also need protection from the hot sun in the summer. Lath latticework may be placed on the sunny side of the runway; or canvas curtains will protect the birds against either sun or rain. Hens do best at a temperature of about 60 degrees. In the south and southwest the flock can be left outdoors all year, but in the north and east in winter the chicken house and runway should be moved under a shed or into the garage. Ordinary cold weather doesn't hurt chickens but drafts do. In cold, dark weather, hens lay less, so moving them into a heated garage, with lights burning in the daytime, will reduce the mid-winter egg-laying slump.

Chickens are inclined to peck one another unless confined individually. One tablespoonful of salt per gallon of drinking water is one remedy, but should be used as a cure and not as a preventive, since chickens can't stand much salt. There are also medicated salves that may be placed on the birds to stop the vice. Likewise, it is not advisable to run immature chickens and grown fowl in the same pen. If you wish to have fryers available all year it is best to build another runway. With combinations of equipment some people start 25 chickens four times a year, then have fryers and roasters always available.

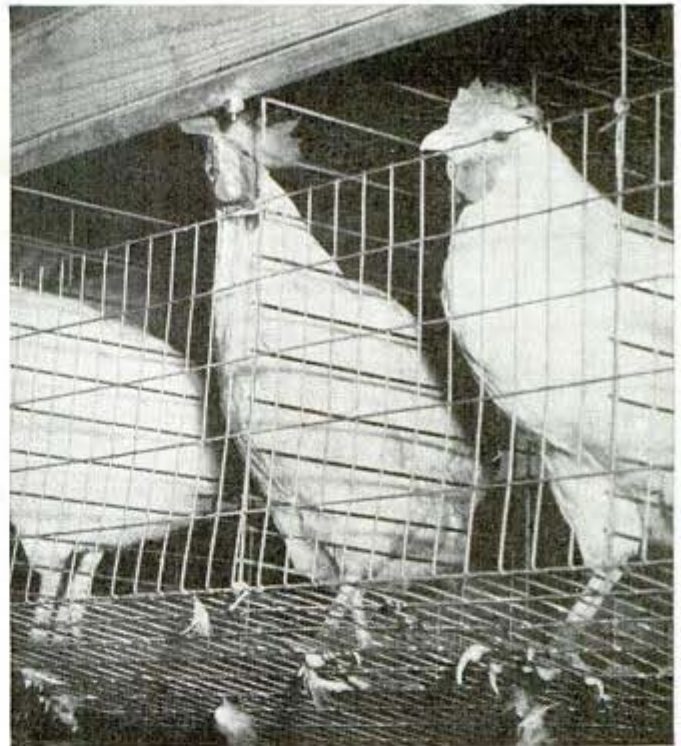

Overhead "dewdrop" on water pipe serves as drinking fountain

Raising young chickens in a brooder is more trouble than buying partly grown fowl, but it is a lot cheaper. Build the runway and shelter house described above as two units that can be locked together. Thus the shelter house can be removed and a brooder substituted at the end of the runway during the first month or five weeks.

The brooder is a box 3 by 4 feet in area, up to 18 inches high, mounted on 30-inch legs, with latches to lock it to the open end of the runway. The floor is of 1/2-inch wire mesh, with a wooden floor several inches

(Continued to page 160)



Garbage can with sliding door dispenses food. Pen at right takes up only a corner of the back yard



allen Warren Elliott
7 Park Ave, N.Y.

Mobile School Teaches Seamen to Fight Planes



7-10-76
In teaching merchant marine seamen to combat aerial attacks, the navy found it more practicable to take the classroom to the docks than to bring crews ashore for instruction. So buses like the one below were converted into mobile schools by fitting them with five kinds of machine guns. Left, within bus, an instructor demonstrates the loading of .50-caliber Browning machine gun



Members of an armed guard, left, are learning to sight a 20-mm. machine gun. However, man behind gun is a bit too close, as recoil would drive sight into his eye. Knowing the guns, merchant crews gain more confidence in protection against planes and are enabled to take a hand in repelling air raids instead of standing by

In the armed guard mobile training unit, right, merchant seamen are being taught how breech block and barrel of .50-caliber Browning gun are removed. Other machine guns carried are .30-caliber Lewis, .30-caliber Colt and .30-caliber Browning. Going from dock to dock, these mobile schools have trained thousands of men in the handling of guns. Members of the deck crews and even men from the engine room gang take instruction. Bus crews usually consist of an ordnance officer, chief gunner's mate, gunner's mate and the driver, and 10 students comprise an average size class

U. S. Navy photos



*News Photos 2764 Madison
Chicago 1943*

Floating "Marine Tractors" Push Fire Barge

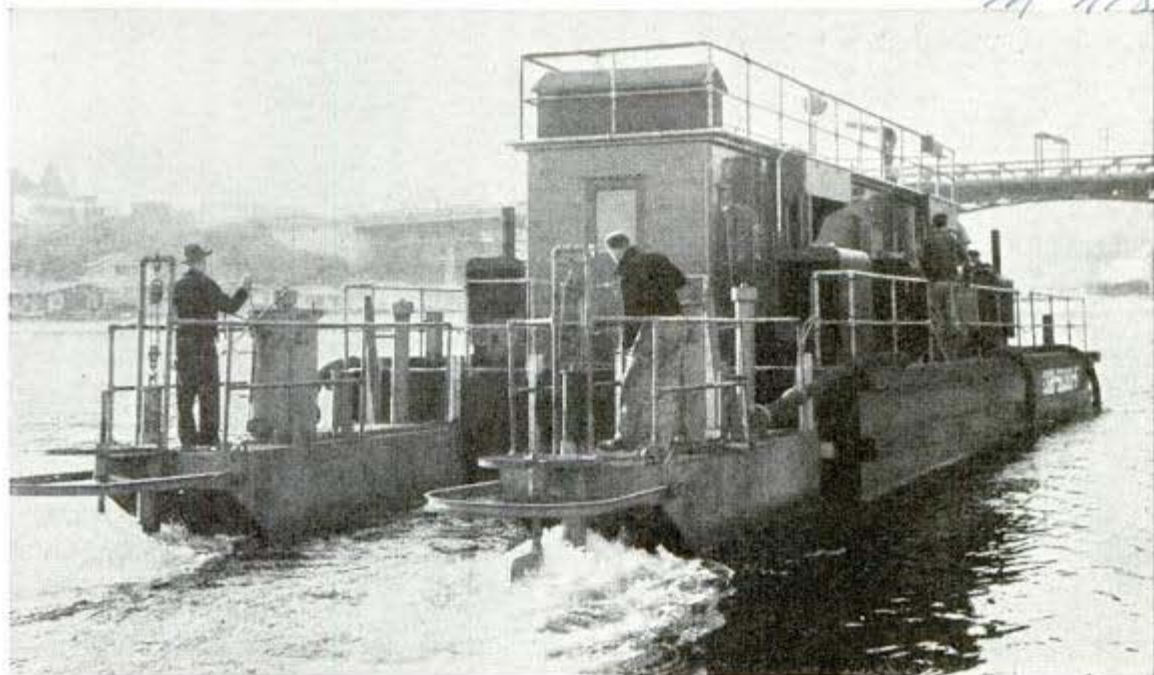

Driven by the floating outboards, fire barge carries eight 95-horsepower pumping units for fighting flames

Two "marine tractors," each floating on a pontoon of its own, provide propelling power for a fire fighting barge built for the Coast Guard to be used against dock and other marine fires. These new-type outboard engine units, produced by Chrysler Corporation, can be attached readily at the stern of any flat-bottomed cargo-carrier, doing the work of a tugboat and giving a

cheap source of power with speeds ample for ordinary commercial purposes. Each floating engine has its own deck and steering wheel, and each must be manned by a separate quartermaster while under way. Its use, however, is limited to smooth bodies of water such as rivers and inland seas where the men would not risk being swept overboard by heavy seas.

Sky-Scraping Dump Trailer Turns at a 90-Degree Angle

Rearing up on its tail wheels, a double-jointed truck-trailer unit used by General Electric Company for rubbish removal tilts to a maximum elevation of 19 feet 6 inches above the ground. At the same time the trailer, which is 17 feet 4 inches long, can dump at right angles to the truck. The unit saves 67 percent of the labor while accomplishing 25 percent more work than three 3-ton dump trucks it replaced.

☐ You can obtain additional information about products described in this magazine by writing to the firms listed in the Where-to-Buy-It index. Say You Saw It in Popular Mechanics.



Double-jointed truck-trailer is raised 19 feet to dump load

771123

SAILORS of the AIR

When the huge balloons that protect vital areas from low-flying bombers are brought down they're deflated and the gas is stored (right) in metal cylinders for re-use. It takes an expert crew of soldiers who "know the ropes" like sailors to handle barrage balloons



U. S. Army Signal Corps photos



↑ Gathered around "inflated octopus," soldiers at army balloon training center listen to instructor while crew in the background demonstrates correct method of launching gas bag

Below, rigging model of ballonet. This balloon has special chamber with wind scoop intake to keep pressure constant



Down she comes, as a motor-driven winch winds in the steel cable holding balloon

ny: Allen Thurman & Co. Inc.
7 Park Ave, NYC.

Fly BARRAGE BALLOONS



"Balloons aloft" call sends men rushing to posts, top left. Above, checking up on wind

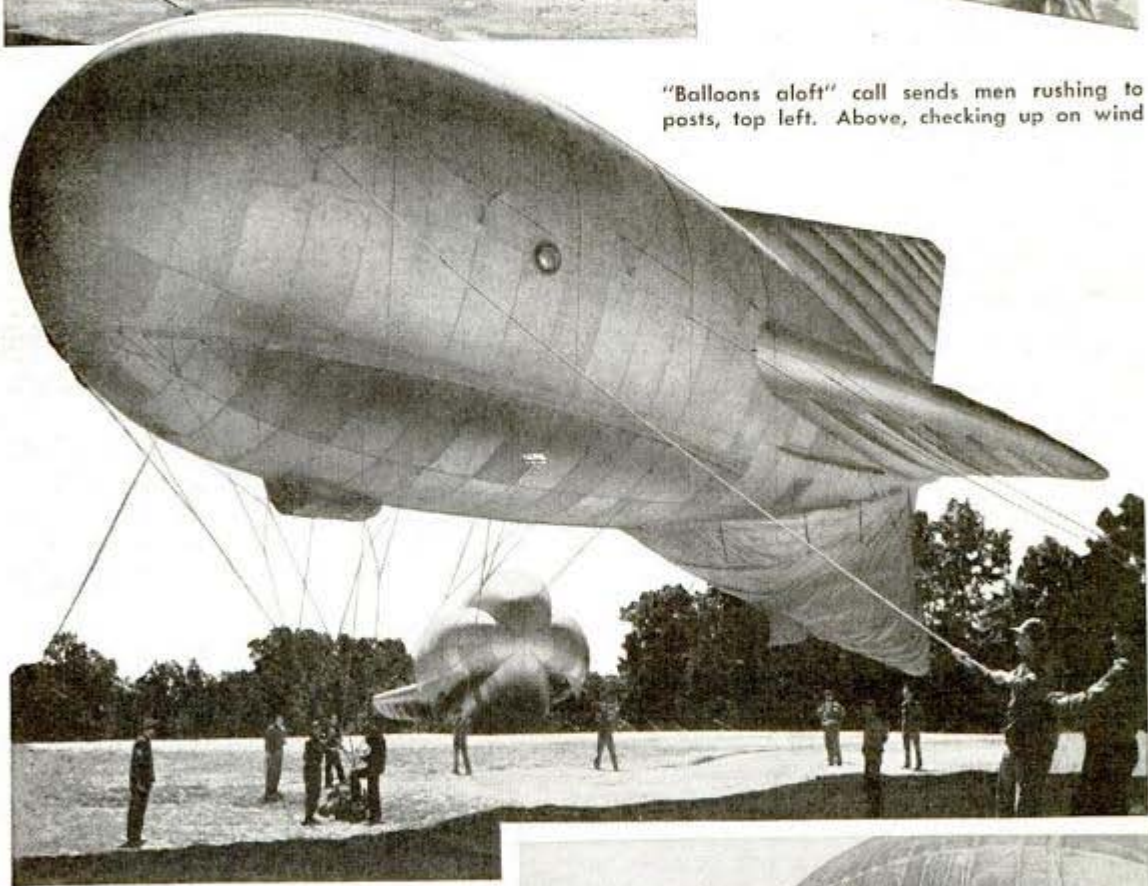

† Bedding down a balloon with ground mat to protect fabric before bag is deflated and stored. Outer covering is made of cotton impregnated with synthetic rubber which holds hydrogen gas better than natural rubber. For army training, a balloon 35 feet in diameter and 87 feet long is used on one steel cable

Right, barrage balloon "sailors" call this operation "feeding the baby"—inflating with gas from bottles, or cylinders. These balloons are capable of rising to high altitudes



1. 2. 3. 4. 5. 6. 7. 8. 9. 10. 11. 12. 13. 14. 15. 16. 17. 18. 19. 20. 21. 22. 23. 24. 25. 26. 27. 28. 29. 30. 31. 32. 33. 34. 35. 36. 37. 38. 39. 40. 41. 42. 43. 44. 45. 46. 47. 48. 49. 50. 51. 52. 53. 54. 55. 56. 57. 58. 59. 60. 61. 62. 63. 64. 65. 66. 67. 68. 69. 70. 71. 72. 73. 74. 75. 76. 77. 78. 79. 80. 81. 82. 83. 84. 85. 86. 87. 88. 89. 90. 91. 92. 93. 94. 95. 96. 97. 98. 99. 100.

Steam Roller Left Behind by Japs In Fight for Solomons



U. S. Marine guarding steam roller left by fleeing Japanese

In their hasty withdrawal from positions on Guadalcanal Island in the Solomons, the Japanese abandoned a steam roller which they had used for smoothing airfield runways. The slow-moving roller did not have the speed necessary to escape the offensive action of U. S. Marines who took over the island.

Railroads Abandon 2,500 Miles While Hauling Record Load

Freight carried by American railroads reached a record volume of 630,000,000,000 ton miles in 1942—the equivalent of 630 billion tons carried one mile—and paradoxically, in this record year more miles of track were abandoned than ever before. The cargo handled was 155 billion ton miles greater than in 1941, and was more than one and one-half times the volume moved in 1918. A new high in passenger traffic was also established at 53,000,000,000 passenger miles—up 80 percent from 1941 and 13 percent above the passenger peak set up in 1920. There were 74 miles of new line built during the year—the largest amount of construction since 1937. The United States railway system was expanding through almost exactly a century begin-

ning in 1830, new mileage reaching its zenith in 1887 when 13,081 miles of track were laid. Since 1931 the average annual construction of new lines has been about 70 miles. In Canada, except for the year 1938 when 101 miles of track were laid, only nine miles have been constructed since 1932. Abandonment of track went above 2,000 miles for the first time in 1942, when 2,516 miles of track were officially abandoned, including a 142-mile stretch in Utah where the golden spike ceremony linked the Union Pacific and Central Pacific in 1869 into the first transcontinental railroad. Since 1931 a total of 18,832 miles of railroad have been abandoned.

Webbed Swimming Glove Adds Power to Stroke

Greater forward pull for swimmers is possible with a webbed glove invented and patented by James F. Myers of Oakdale, Pa. Consisting of fingers and thumb with webs between them, the mitt is joined by reinforcing material at the base. A strap at the back is anchored around the wrist.

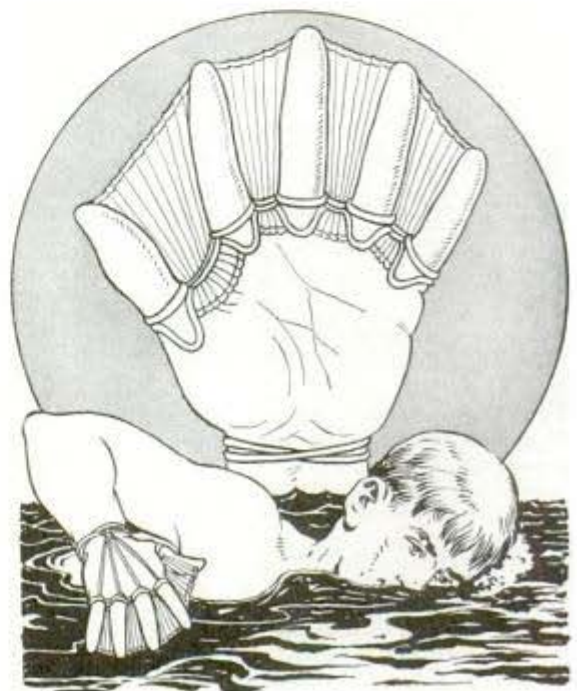

Webbing between fingers gives swimmer more power

48 Railway Age
1943

Ill. Tribune - 1/31-43

Equipment for Giant Dam Flown to Wilderness

Borrowing a page from the annals of U. S. Army transport, Canadian engineers are using airplanes to carry thousands of tons of equipment—even horses—to the wilderness site of the Shipshaw power development on the Saguenay River in Quebec. Big bulldozers, trucks, steam shovels and other bulky items are dismantled and loaded into planes, rushed to the site and put together in a jiffy. More than 850 workmen also have been transported by cargo planes. When the giant dam is completed it will be second in size only to the Grand Coulee on the Columbia River. The \$65,000,000 project will generate 1,200,000 horsepower which would be sufficient to light every home on the North American continent. The power, however, will be used to make aluminum for planes and other war uses. Construction of the dam, now more than half completed, has been pushed at top speed through two winters when temperatures dipped to 30 and 40 de-

grees below zero. Some 5,731,000 cubic yards of earth and rock were excavated, compared with 5,500,000 cubic yards for the building of Boulder dam. The last rock plug blown contained 18,000 cubic yards. Thirty thousand cubic feet of linear diamond drill holes were pierced to move this barrier of solid rock. When the explosive charge was set off, boulders weighing 400 pounds were hurtled 1,000 feet in the air. In the wilds above the main dam, smaller "storage dams" are being built to guarantee a minimum output of 970,000 horsepower. The storage dams conserve the waters of streams entering 400-square-mile Lake St. John from which the Saguenay flows. The main dam has a drop greater than that at Niagara Falls. Twelve steel headgates will control the rush of water as it is carried into the turbines through six tunnels 30 feet in diameter. Building the giant project has already taken a toll of 62 lives.

Radio "Ears" for Deaf Are Like Two-Way Police Sets

Miniature radio sets that enable the deaf to hear and send messages are being tested by the Illinois State Welfare Department. The "radio ears," which are compared to the two-way radio communication systems used by police, involve the use of low-watt, ultra-short-wave individual "transceivers." Sending and receiving messages are permitted within the wave band and limited power radius of each set. With this device, a deaf person "hears" by vibrations which are set up on both the ear drum and bone. If tests prove successful, the "trans-

ceivers" will be used in schools for the deaf. This is expected to speed up the education of afflicted children once they learn to associate the sounds they hear with objects already familiar through visual experience. This correlation process is expected to require about a year. Aside from opening up a new auditory world to the hard of hearing, the invention is expected to reduce the cost of educating deaf children which is now about twice that of educating normal children, according to Rodney H. Brandon, Illinois welfare director.

Fluid Coal That Flows in Pipe May Substitute for Fuel Oil

"Fluid" coal, so finely pulverized that when mixed with air it can be pumped through pipes a quarter-mile long, is being studied as an alternative for fuel oil in industrial heating processes, to relieve the oil shortage. It is produced by grinding coal to dustlike fineness in specially designed mills. A stream of air entering the mill picks up the particles and delivers them to collectors. When not impacted, the material flows through the fingers, and when mixed with air it will flow through pipes and spray out of jets. Pulverized coal

was widely used before the discovery of vast new sources of oil and gas brought sharp reductions in the costs of these fuels. In 1920, there were 690 furnaces in the United States known to be using the pulverized coal.

At Harvard University ice has been produced at 375 degrees Fahrenheit—far above the ordinary boiling point—by subjecting water to a pressure of 40,000 atmospheres, equal to that 1,000 miles below the earth's surface.

coll. history

Jacobson

RUNNING *the* ICE BLOCKADE

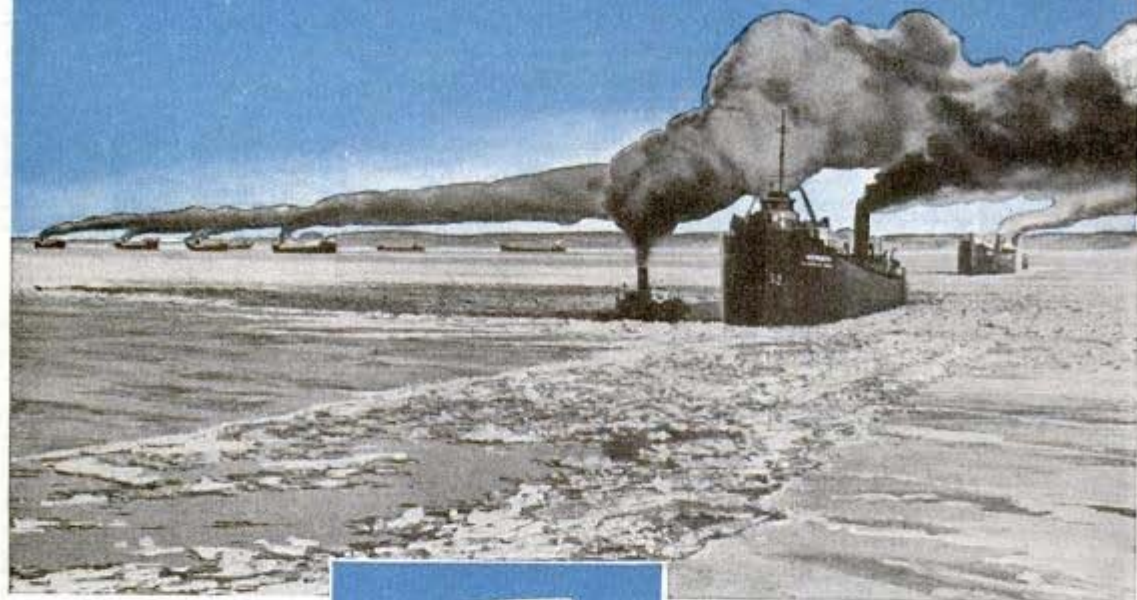

↑

To the rescue of ore boats caught in heavy spring ice in Whitefish Bay goes Coast Guard boat St. Marie (center)

Sketch (right) shows bow of cutter riding up over ice to break it with its weight instead of "cutting" by force

Below, measuring thickness of ice broken in Straits of Mackinac (24 inches) on ore route Duluth to Gary, Ind.



By Waring G. Smith

Ensign, U. S. Coast Guard Reserve

THE program of the United States Coast Guard to lengthen the navigation season on the vital Great Lakes shipping channels reaches a climax this year with the commissioning of the new "Manitowoc," probably the best ice breaker in the world.

It represents the culmination of decades of research and experience by the Coast Guard in ice-breaking operations, most of it in the Great Lakes region where hundreds of cargo ships carry the most concentrated shipment of ore in the world, and where the toughest ice-breaking problems exist.

Ore shipments originate in Lake Superior ports, meet the bottleneck of the St. Mary's River below Whitefish Bay, pass through the "Soo" locks and divide at Lake Huron. One third of the ship-

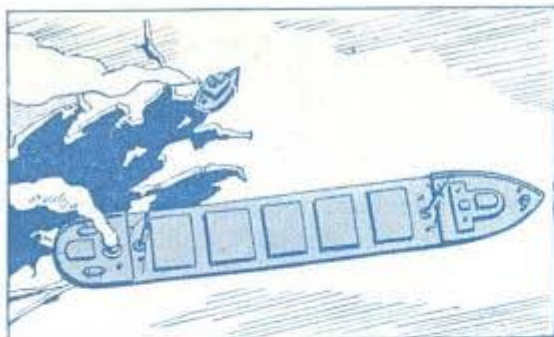

Ice-locked freighter in sketch is being freed by cutter circling ship. Right, the famous old three-masted Coast Guard cutter "Bear"

ments then pass through the tricky Straits of Mackinac to Lake Michigan; other shipments pass through the narrow St. Clair and Detroit Rivers to lower lake ports.

Some shipping experts claim it is possible, barring extreme winter weather, to keep Great Lakes channels usable practically the year around. But two factors prevent the attempt. First, a great part of the iron ore is mined by a hydraulic process not usable in sub-freezing conditions. Damp ore will freeze to the sides of a ship's hold, cannot be unloaded without passing the ship through a steam shed. Supplies of ore for winter shipments are limited to what is available from dry stock piles built up in summer months. Of course vessels han-

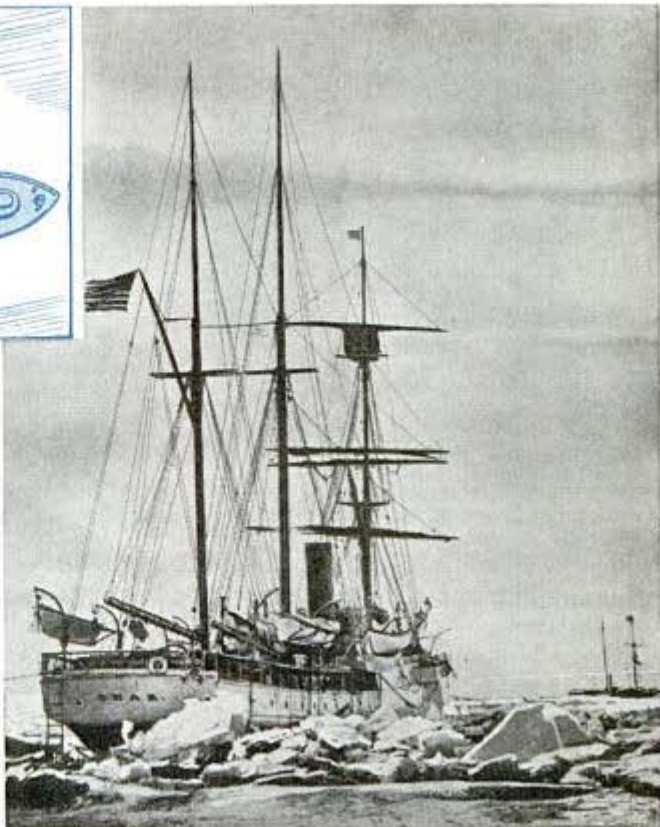

Official U. S. Coast Guard photos

dling oil, coal, timber, and scrap steel are not hindered by freezing weather. Sometimes they operate after ore boats have been laid up.

Second, and more important deterrent, is the law of diminishing returns. In winter

Plowing through a mountain of ice, the cutter St. Marie clears a channel through bottleneck of St. Mary's River below Whitefish Bay and above well-guarded locks of Sault Sainte Marie





Hard working crew clears ice from deck of cutter as the Coast Guard opens channel for boats on Hudson River in early spring

it becomes wasteful, even dangerous to carry on normal ship movements. More fuel and manpower would be spent keeping ice-bound channels open than the shipments justify. Danger of being grounded becomes greater. Ice damages the steel plates of freighter hulls.

Hence ice-breaking operations are intended to prolong the navigation season only when large fleet movements can be maintained. The ice-breaking program in 1941 was partly responsible for a total net tonnage of 89,730,000 in ore movements, surpassing previous records by 15,000,000 tons. In 1942 many new records were established. Soon after ice-breaking began on March 20 the ports at Escanaba and Marquette, Mich., opened at earliest-yet

dates. The first arrival in Cleveland, on March 28 cut 12 days off the earliest previous records.

The first spring operation is to break a channel in frozen harbors to coal docks where ships may refuel, then clear a path to open water. None of the Great Lakes freezes over entirely, except Lake Erie in severe weather. Huge ice fields form in shallow sections and bays, but a channel can be cleared.

Seldom does the ice get too thick to break. The *Sainte Marie*, one of the toughest ice breakers, can clear a path through four feet of solid ice. If a channel cannot be

broken or maintained through a large ice field, lake captains wait for a change of wind to move the field clear of the course, rather than attempt to skirt a shifting field which may drive the ship dangerously near shore.

Slush ice, jams and windrows where ice has packed up in jagged barriers are the big problems. Granular ice has a heavy drag like quicksand, is responsible for the majority of cases where vessels get stuck.

On March 24, 1942, the tug *Iowa* was stationed in Whitefish Bay to free vessels progressing through loose field ice and slush ice. While following about 100 yards behind a freighter, pan ice closed in and caught the *Iowa* on her port beam, forcing her up on the field ice as large pieces

Pride of the Coast Guard—the new streamline \$6,000,000 ice-breaking cutter *Manitowoc* which has cruising range of 6,000 miles and carries airplane with gear for raising and lowering



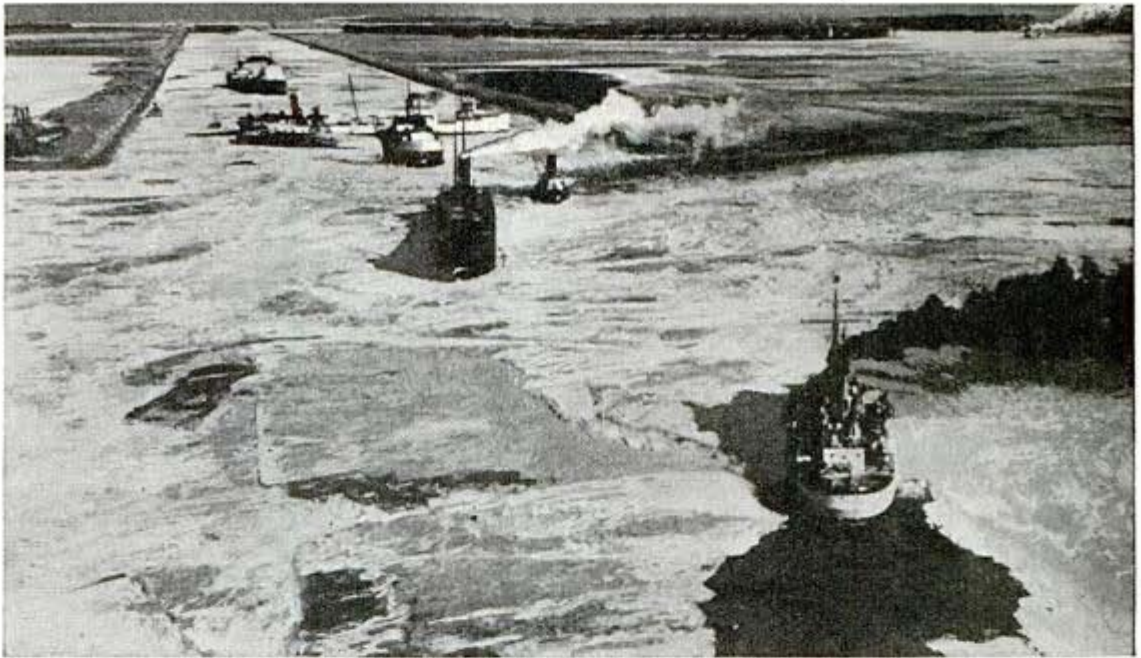

Egg-shaped hull of a new cutter at right guards against ice pressure better than vertical type, below

jammed against her hull and spilled over the gunwales onto her deck. She was freed by loosening the ice with the wash from the forward propeller of the *Sainte Marie*, a common method of freeing vessels.

Aerial reconnaissance often enables vessels to avoid windrows and large ice jams. Coast Guard amphibian planes radio reports on currents, large movements of ice fields, location of barriers. The plane's navigator indicates to the breaker the course where least resistance will be met.

Where windrows cannot be circumnavigated, brute force is used. The breaker will proceed into a windrow until the danger of getting stuck is imminent, then reverse and get a fresh start in another direction. By repeating this process, large pieces of ice can be broken off and washed astern by propeller action. The trick is to make progress but keep the stern free so a quick reverse can be made. As the breaker forges ahead, the captain must be ready for the moment when resistance nearly stops the vessel. If he fails to reverse her then, the bow will ride up high, then the ship will be stuck. Then another breaker

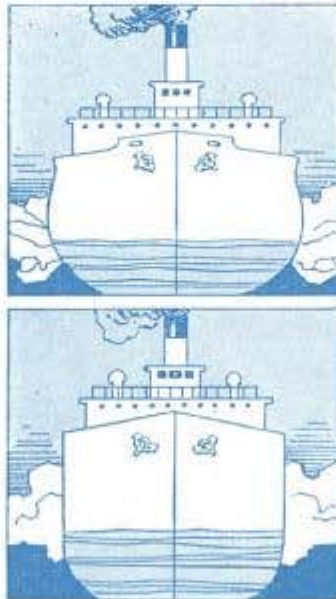

↑ Great Lakes freighters frozen in the narrow Detroit River are "rescued" by hardy Coast Guard cutters

must free her by cutting a semicircular channel alongside. In some cases, it may be necessary to use dynamite. The explosive charge is not so much to break up the ice as to create a sudden concussion which will momentarily free the hull. At this split second, the vessel can make a start to the rear and clear herself.

Ice jams present impregnable barriers. Fortunately they seldom develop entirely across a bay or channel but are driven to one side

or the other by prevailing winds. If the one navigable channel is blocked by a jam, the captain can only wait until a change of wind moves the ice aside.

Not always is it ice or storm that stops a ship. Great Lakes sailors still tell of the time when a horse and wagon held up navigation. A farmer had been traveling across an ice field at the north end of Lake Huron and became "mired" in the path of a freighter. It took several hours to free the wagon wheels before the command "full speed ahead" could be given on the freighter's bridge.

Prime requisites of an ice breaker are

(Continued to page 173)

Copy J. P. Sisset, 2200 Van Hells ave
Oakwood, Dayton, Ohio

TOYS of WAR

11
m50
1150
Toys representing tanks, ships, guns and airplanes teach Uncle Sam's fighters the game of war that is played for keeps. At an army air corps combat crew school, right, scale models familiarize bomber crews with Jap and American battleships so enemy craft may be identified quickly



Widespread army installations need traffic officers well trained for the job. Miniature buildings and vehicles, left, present problems in controlling the movement of traffic and aid instructors in demonstrating their solutions. Below is a midget cutaway copy of army barracks, where embryo carpenters, electricians and plumbers of the armed forces get a thorough knowledge in the fundamentals of repair and construction. Scale models work like the real thing and speed up instruction

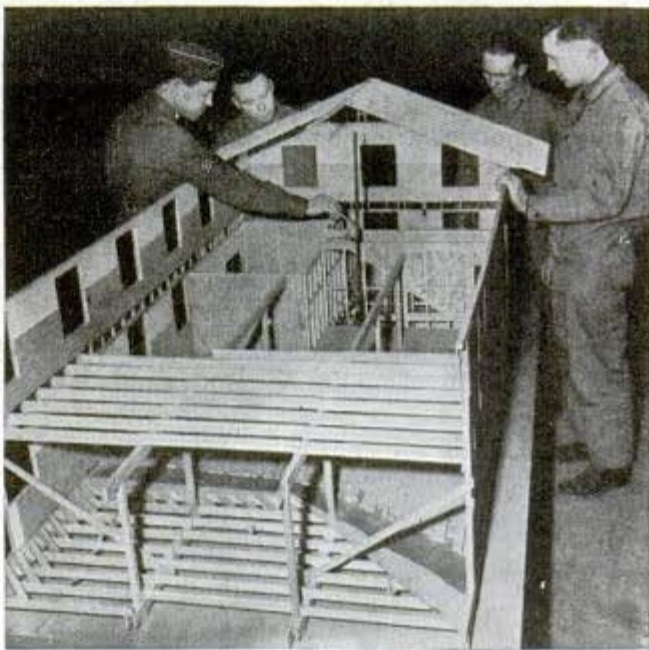

Among the "toys of war" is a tiny rifle range, complete in every detail and used for instructing gunners. Face of model rapid-fire target, left, is divided into 10 equal parts and the pointer is turned by handcrank as student practices firing. This helps the student when he goes to work on actual range

Photos, U. S. Army Signal Corps

Middletown, Ohio

Light Plane Flies Vital Cargo to Isolated Spots

Small vital cargoes can be carried swiftly to regions inaccessible by other means in a new light plane which proved successful in recent tests by the Aeronca Aircraft Corporation. Fully loaded with freight such as fuel, ammunition, food and medical supplies, the cargo plane can land, take off and maneuver in an area too small for the larger and faster ships.

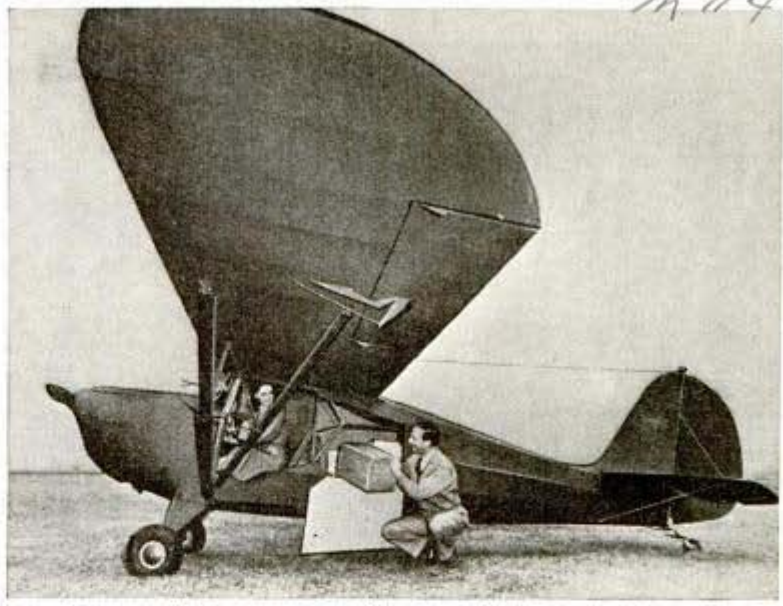

Small plane, capable of landing and taking off in small space, loads and unloads quickly through side panel

Skeleton of Disabled Trainer Teaches Use of Controls

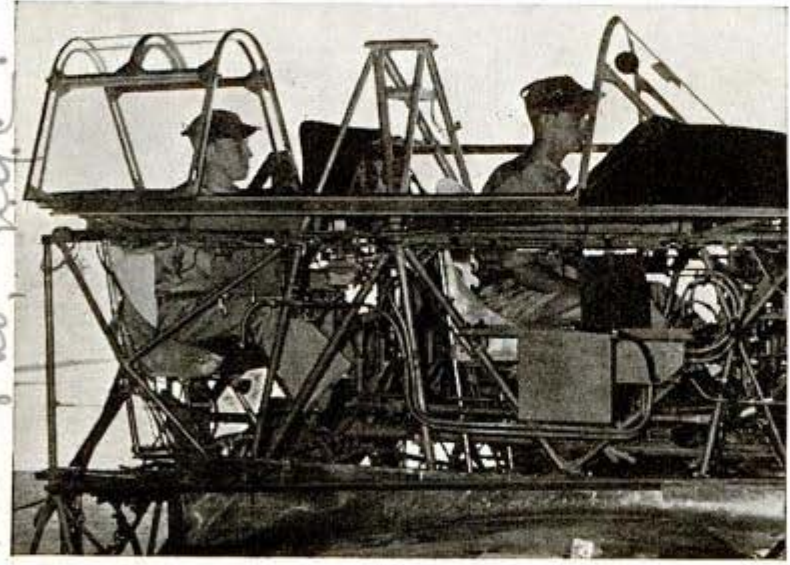

Although ^{m 1085} damaged badly enough to be retired from further flying duty, an advanced training plane was not allowed to relinquish its useful life. At Southwest Airways' Falcon Field, Phoenix, Ariz., this disabled ship, grounded permanently, gives a preliminary orientation course to Royal Air Force cadets. To serve as a teacher, the ship's fuselage was stripped of nearly everything except dual pilots' compartments, instrument panels and controls.

Remains of a damaged trainer do ground duty training cadets at controls

United States Railways Double Use of Diesels in the Last Two Years

Use of Diesel locomotives by American railroads has doubled in the past two years, while the number of steam and electric locomotives has decreased, according to year-end records of the Association of American Railroads. Moreover, the number of new Diesel locomotives on order was greater than the number of both steam and electric locomotives combined. Diesel locomotives in operation numbered 1,486, a two-year gain of 770, while the number

of electric locomotives, 775, was a two-year loss of 12, and the number of steam locomotives, 39,245, was a two-year decrease of 816. On order were 504 Diesels, 314 steam, and only 22 electric locomotives. Of the new locomotives placed in service during the year, 319 were Diesels and 256 were electric or steam.

Ⓛ Brake linings of large bombing planes must be renewed after only six landings.

acme newspaper
461-8 av. nyc.

Diesel Power + Transportation Jan 43

Acme Mfg. Co. Inc. 2. re
461-8 av. 1170

"Club" Propeller Aids in Test Of New Airplane Engine



Airplane engine spins this heavy-bladed propeller during test run at the factory; its blades are shaped to cool the engine

In running tests of new Wright Cyclone engines built at the Studebaker plant in South Bend, Ind., club-bladed propellers are used to give the same load capacity as a flight propeller. The diameter being smaller, it permits tests to be run in smaller cells. Propellers are shaped to cool the engine while under test. After a severe initial test, each engine is torn down and inspected thoroughly, then reassembled and given a final test before leaving the plant.

Fingertip Control of Dental Drill Eliminates Foot Pedal

Fingertip control for the dental drill engine invented by Dr. Maurice I. Blair of Chicago will relieve dentists of the discomfort of standing awkwardly on one foot as they do with the foot-controlled drill. Since it was found impossible to place the control button directly on the drill, the inventor hit upon the idea of mounting a sensitive electric button on the mirror handle, connecting it by aerial wire to the drill through a two-tube radio. This is simple

to manipulate, and safe to use. It will not be in production until after the war, and by that time Dr. Blair expects to offer also a low-voltage switch to start and stop the dental engine, for use in areas where electrical interference might cause trouble in the radio circuit.

Mothballs Held in Hanger Protect the Garment

Carrying its own supply of mothballs, a garment hanger for which a patent has been issued to Sidney M. Abbens of San Francisco permeates the garment with moth-repelling fumes. In the hanger are recesses that hold the mothballs, vents being provided for escape of the fumes. Additional mothball space can be included by suspending a crosspiece between the ends of the hanger and cutting tapered openings into it to receive the moth repellent. A sliding perforated cover may be used on this bar to keep the mothballs from falling out.



Coat hanger loaded with mothballs has vents which allow the fumes to escape and permeate the garment

New Furniture Bounces on Wooden Springs



Foregoing use of steel springs to conserve metal, the furniture makers have devised substitutes of noncritical materials, chiefly wood. Above, a double-conical coil, collapsing within itself, made from thin, laminated wood strips



"Bouncy" foundations for innerspring mattresses still in dealers' hands, and for the cotton felt mattresses coming into use, are achieved by a base made of wooden slats held in a bowed position by round wood blocks, shown installed on bed above

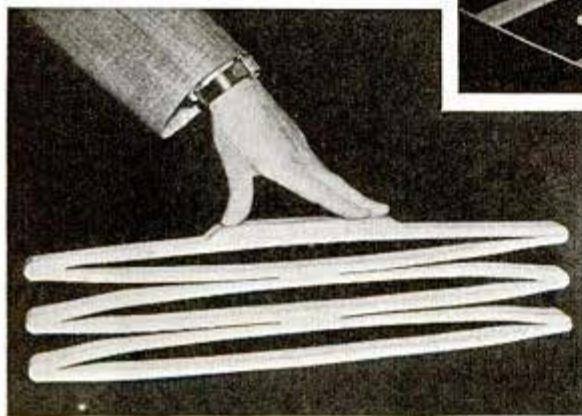

Several wooden springs like one above form the unit for a chair or sofa. To avoid steam bending, long ellipses are cut from a single plank, and narrow V's sawed from the ends. Ellipses are open at one end to relieve stress. "Individual spring action" of double-conical coils is claimed for spring at right. It is a series of ellipses, made of two pieces of bow-bent hardwood, held into a unit by strips of fiber. Waste bits of metal form the "joining hardware." Designers and inventors are constantly contriving new spring designs, in slats or laminations and a variety of shapes



con: Keith Vining, carpenter's mate
Seabees, 40 Battalion 20, N.C.T.C., Camp

The NAVY'S FIGHTING



^{m 1028}
TOUGHENED by years spent in the mechanical trades, molded into the Navy way of living by regular Naval officers, coached in the latest methods of construction by civil engineers, and schooled in combat tactics by hard-boiled Marine instructors, the Seabees are well named.

Their nickname is a derivation of the initials **C.B.**—**C**onstruction **B**attalions. Their slogan is "We Defend What We Build," and the inscription, picturing an angry bee, portrays their two-fold purpose. In the emblem, a busy bee wears a sailor's hat; in his forehead he carries a tommygun, midships hand a wrench and aft hand a hammer. On his corresponding sleeves are respectively: a Gunner's Mate rating badge, Machinist's Mate badge and a Carpenter's Mate badge.

Picked from among the best mechanics and technicians in civilian life, these men are becoming the unsung heroes of this war, for their work carries them right up to the battle fronts—and the nature of their achievements must necessarily be secret. They work right along with the Marines and begin construction before the smoke of battle has cleared away.

It is significant of the high cali-

The Seabees are builders, but they're taught to fight, too, during a basic training course

Their emblem is a busy bee in sailor hat, firing a tommygun and carrying wrench and hammer

Members of a navy construction regiment make practice landing from surf boats "under fire"



"SEABEES"

ber of mechanics accepted in the Seabees, that 60 percent of them are rated third class petty officers or higher. Physical requirements are nearly as exacting as in the regular Navy, only 50 percent of the applicants being acceptable. Already numbering many battalions, the Seabees only commenced organization after Pearl Harbor.

Yankee ingenuity is here reaching new high levels. Engineers and mechanics alike are encouraged to develop new ideas. Although details of their accomplishments must remain a military secret, among them are a "packaged roadway" that may be installed faster than ground can be cleared for it, instantly usable for landing even the heaviest planes; barges, or pontoons that are made up of sections and reassembled into many other practical types of equipment; an ingenious propulsion unit, and such items as combination refrigerators and life rafts!

Let's accompany an imaginary Construction Battalion in action. The problem is to establish an



Seabees defend a beach head from a hastily built foxhole

Right, a navy trainee learns to operate a steam shovel



Building a road through Virginia sand dunes. It is made of 20-foot wire mesh sections welded together
U. S. Navy photographs





Once the Marines have seized a beach, Seabees move in to fortify it. Above, towing 4-inch gun on skids with bulldozer



A landing party at the Seabee training center works ashore from a motor sailer, careful to keep their equipment dry

Pontoon barge is driven close to beach, and here anchor is being dropped before putting construction materials ashore

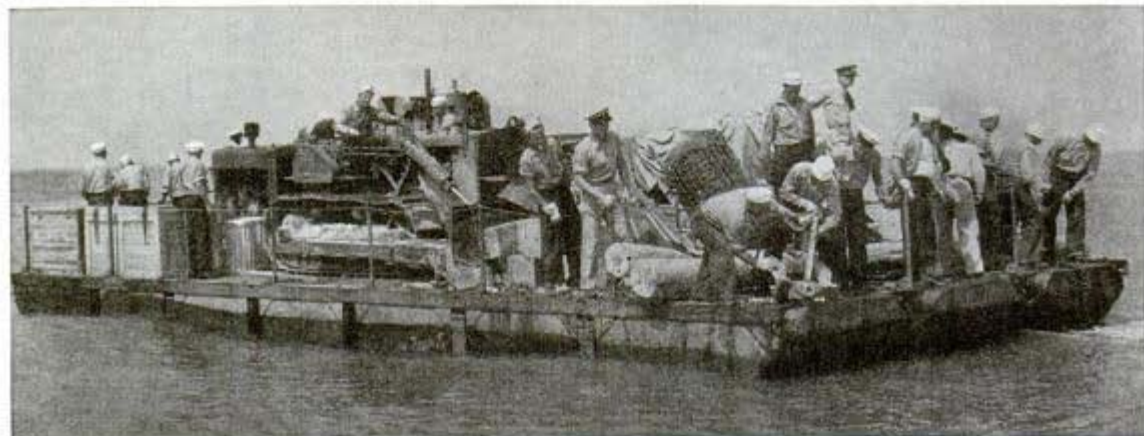

advance base on Island "X," recently wrested from the Japanese. The enemy has inconsiderately left this island in a deplorable state. What little water there was has been contaminated; wharves, dry-docks, buildings are a mass of burning rubble. Only shallow draft boats may land, for the single channel through the reef is wedged fast with a bomb-shattered destroyer.

As the last of the enemy are "mopped up," a Marine semaphore a message to the transports standing by. Even while a Seabee wigwags the answer, huge cranes begin lifting rapidly assembled pontoon barges over the side. Some of these vessels, loaded with diving and demolition equipment, head for the blocked channel, others point for the beach. Shallow draft admits them over the reef, and soon they nose up onto the sand.

Ramps are built and bulldozers landed. While roads are cleared and graded, carpenters swiftly build forms for gun emplacements at strategic locations. Concrete is mixing even before the mixers are unloaded, and guns will be mounted in a few hours.

Trained details are laying "packaged roadway" as fast as the ground is cleared. Electricians set up large generating equipment to provide light and power. Barges are re-assembled into wharves and dry-docks. Machine repair shops are set up, for some ships will require immediate attention.

A heavy concussion shakes the island, and men look up only long

*Transportation Quarantine
35 Chelsey St
San Francisco, Cal.*

Loading and Unloading Speeded By Demountable Truck Body

enough to see smoke, water and debris, rise in a mighty column over the blocked channel. Ships hoist anchor and head for the channel, for the sunken destroyer has been blasted away.

Ships tie up to the wharves and begin unloading heavy equipment. Huge stills are set up, and begin delivering hundreds of gallons of fresh water per hour from the sea. Well drillers go into action, and kitchen equipment hits the beach. A tent city mushrooms into being.

Camouflage experts disguise these operations as rapidly as they are completed. Not one bit of raw earth or one shiny tool will be left uncovered.

An air raid warning rings out. What was a beehive of activity, becomes in seconds a masterpiece of optical deception. The few enemy aircraft that evade our interceptors, look through their bomb-sights for a target. Suddenly they realize they are trapped, for cleverly concealed guns bracket them in a deadly ring of fire. More Japanese have discovered that Seabees sting.

A few days later "Quonset Huts," those portable barracks, begin replacing the tent city. Water flows from deep wells, is purified and replaces that from the stills. Permanent mess halls appear, and ice machines begin to freeze thousands of tons of ice.

The finest surgical and medical equipment accompanies the Seabees, and is set up in new buildings, to be used by top-notch physicians, commissioned officers from private life. Epidemic diseases will be unknown, and sickness at a minimum due to inoculation, and strictest hygiene. These men are valuable to Uncle Sam, and he really protects them.

In a surprisingly few weeks, the base has assumed the aspect of a small city. Heavy freight rumbles along its fine roads, and huge bombers line its runways. Softball diamonds and football fields,



Demountable body is moved on or off truck chassis by one man

Greater speed in loading and unloading war goods is possible with a demountable truck body that slides along two tracks and has two casters to facilitate slipping the load off the chassis and wheeling it across the floor of the plant or platform. The body can be adapted to any type chassis, and only one-fourth the usual time is required for unloading. With the unloading gear specially arranged, one man can mount or dismount the heaviest load.

Lookouts on Rotating "Bicycle Seats" Scan Sea and Sky for Enemy

Pressing field glasses to their eyes, lookout men aboard U. S. warships sit in chairs called "bicycle seats" that allow them to circle completely as they keep watch over the sea and sky. Upon their keenness depends the speed with which the gunners can get into action against enemy craft.



"Bicycle seats" give lookouts a clear view in all directions

(Continued to page 161)

Com: Rudy Donald, P.O. Box 60, Sheepshead Bay Sta. Brooklyn, N.Y. M 982

SKY SWEEPERS

on the ALERT



"Keep 'em falling" voices the grim task of our batteries engaged in raking enemy planes from the sky. An important weapon is the giant 90-mm. anti-aircraft gun, left. Its shells knock out high-flying enemy bombers, even crippling planes without direct hits because of their wide bursting zone. Above, loader of a 37-mm. rapid-firing gun carries clip of high-explosive shells effective against compara-

Searchlight operator, below, manipulates the controls that focus the beam on a plane

tively low-flying planes. "Ears," below, reveal approaching planes whether the visibility is good or bad, and help to "position" the searchlights at night



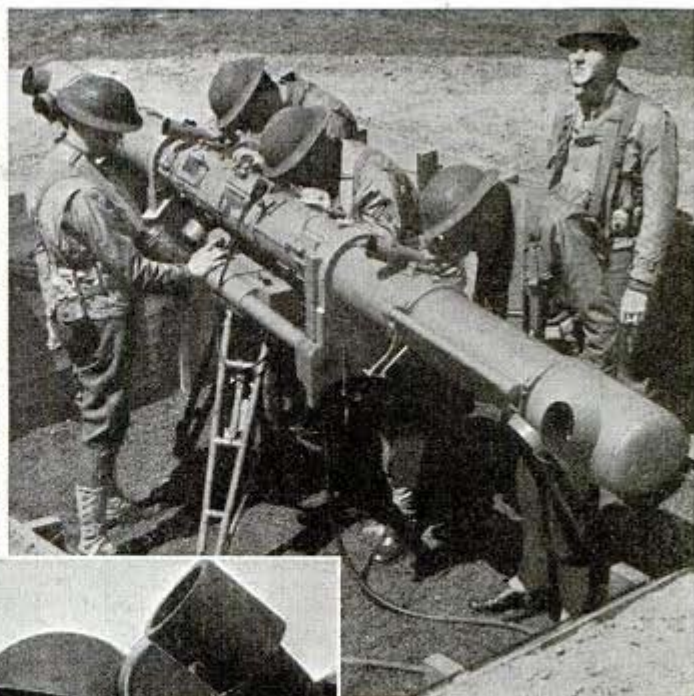

Wearing helmet and "stethoscope" attachments, above, specially trained man operates the "ears," or sound locator. All men in this branch must have binaural hearing so they can trace the origin of sounds. Through the battery commander's telescope, (center,) a constant watch is kept on the effect of the firing, enabling necessary corrections to be made quickly

Heightfinder, above, determines altitude of planes and is coordinated with the "director," which in turn transmits final firing data to guns after it has been calculated accurately. An important niche in a battery is filled by the .50-caliber heavy machine gun, below. It delivers potent wallops against low-flying enemy aircraft, such as dive bombers or planes on strafing missions



Int'l News Photos, 326
W. Madison, Chicago

Tree Sniper Is Almost Invisible In His Speckled Suit

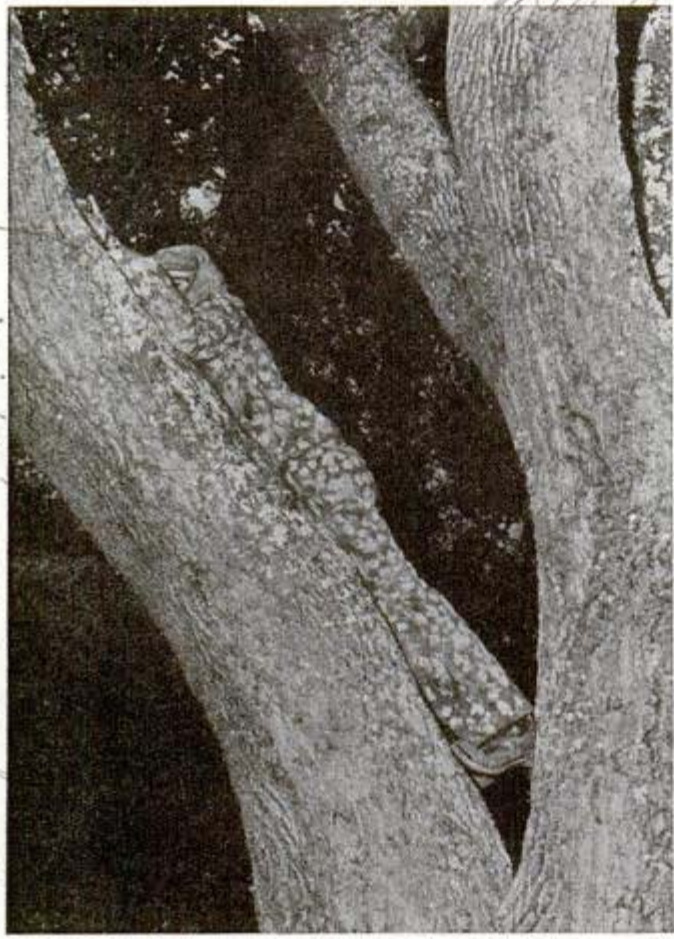

Even the sharp eye of the camera shows little distinction between this sniper's speckled suit and the bark of the tree

Trying to make themselves felt but not seen by the enemy, snipers training with an air depot camouflage group try out varicolored clothing to conceal their presence from the sharpest eyes. One motley suit worn by a tree sniper near McClellan Field makes him almost invisible by blending his form with that of the fungi-covered trunk.

Joining of Metals in Alloy Visible By "Thin Film" Process

Something never before seen—the actual mingling of two metals to form an alloy—has been made visible by a "thin film" process developed by Dr. Howard S. Coleman and Prof. Henry L. Yeagley of the Pennsylvania State College. The process shows in seconds, or minutes at most, what formerly took months to learn, namely, how rapidly one metal spreads through, or

diffuses into, another. In the new process, the metals that form the alloy are vaporized and condensed, one on top of another, in layers on a glass slide. With the metals deposited on the back, the obverse side becomes a mirror, just as a glass backed with silver or mercury shows a reflection. The slide is then reheated until diffusion begins, and the progress of one film of metal into the other is measured by a photoelectric cell, which records the change of light density upon a recording ammeter. The lowered reflection is a measure of the speed of diffusion of the two metals.

Clamp With a Sliding Jaw Slips Quickly on Work

Easy and fast to apply when gluing small parts together, a wooden clamp now available has a sliding jaw that holds tightly when squeezed by hand, and releases immediately on pulling the "trigger." Handy for home workshops, the clamp will not mar delicate work and saves time in making wooden articles, patterns, musical instruments and novelties. They come in five sizes from four to 12 inches long, giving from 40 to 100 pounds pressure.

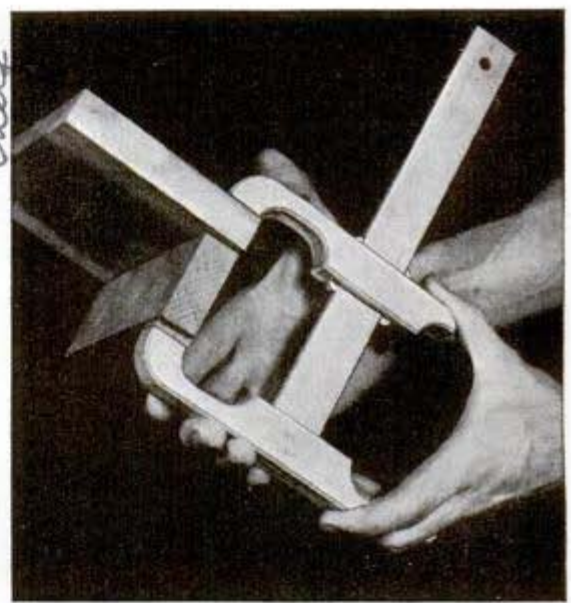

Alternate squeezes at top and bottom tighten clamp; a pull on the "trigger" releases pressure immediately

Pub. Clarence J. Hyatt
Waynesville, N.C.

3/11/27

3/11/27

valid

64 State College, Pa.

POPULAR MECHANICS
7. J. Moore, Co. 209
8. State, Chicago

*The Wolfe & Mann Mfg Co.
28th and Sisson Sts Baltimore Md*

Adjustable "Catwalk" Helps Service Airplanes

For the convenience of ground crews that service airplanes, an adjustable scaffold may be extended to form a straight "catwalk" from which an entire wing can be reached, or assembled in U shape for work on the engines. Mounted on casters, the platform is easily moved, but there are four "feet" which lock it immovably on the ground in working position. Sections of the platform floor are hinged so they may be opened to provide a well for the propeller, permitting the engine to be tested without removal of the entire scaffold. When it is to be stored, it folds compactly and takes little space.

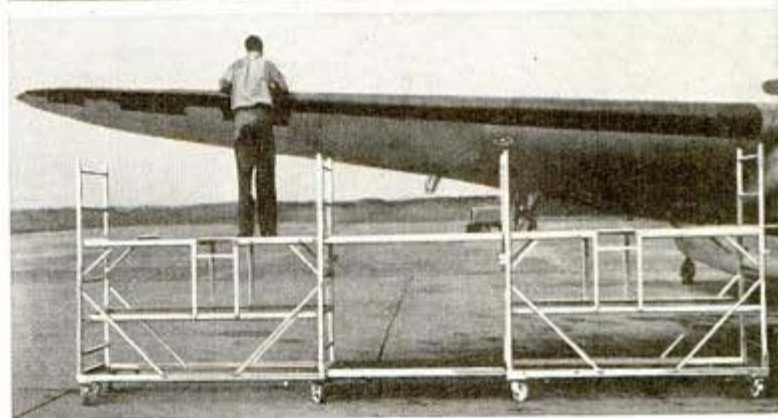
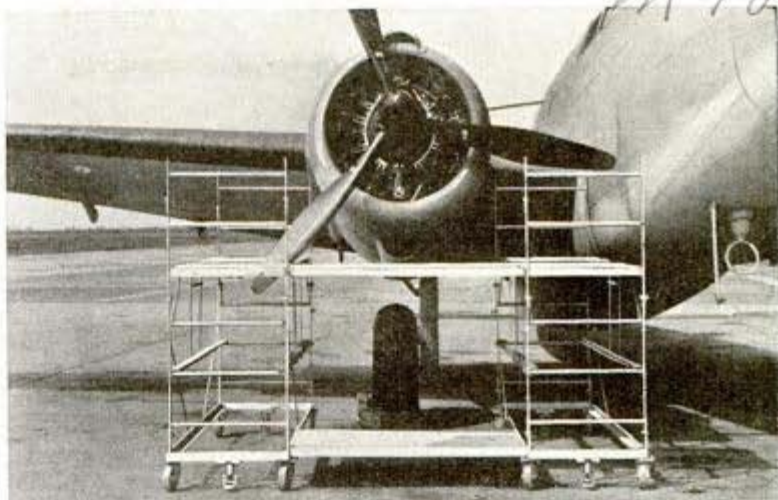

Folding scaffold, top, forms a catwalk at two sides and front of engine; bottom, it is adjusted in straight line along edge of a wing

Mechanical Cotton Picker Helps Conserve Manpower

After nearly 40 years in the development process, the newest type mechanical cotton picker is finding usefulness in the war effort

as an important labor saver. Two International Harvester pickers working on a plantation near Clarksdale, Miss., have

released many toilers for duty at both the fighting and production lines. At present the operation of these machines is limited to areas where cotton gins are equipped with special cleaners and driers which have been developed for processing the mechanically picked cotton.

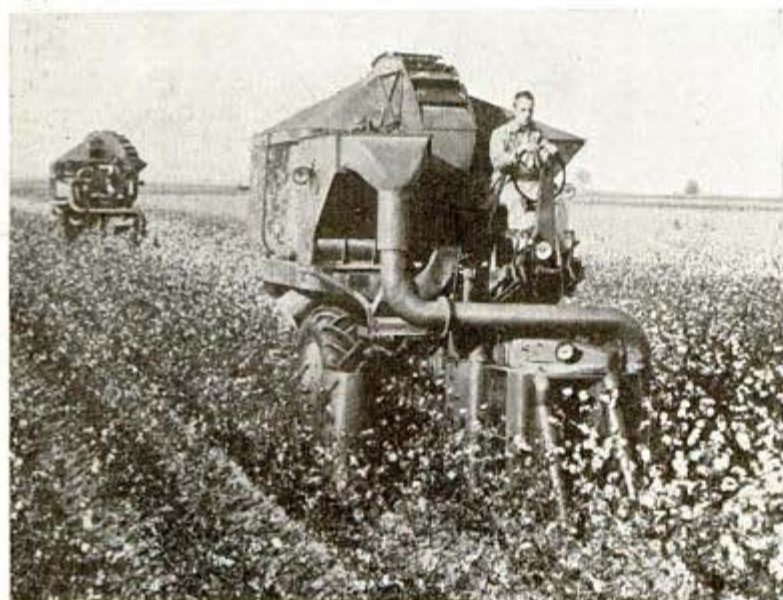

A pair of the latest type mechanical pickers heading through field in a recent test. The one in front, it is said, can do the work of 50 to 80 men. Portion of the field at left has been picked

Photo by Timmon ju
 38727 Franklin Av
 Los Angeles Cal.

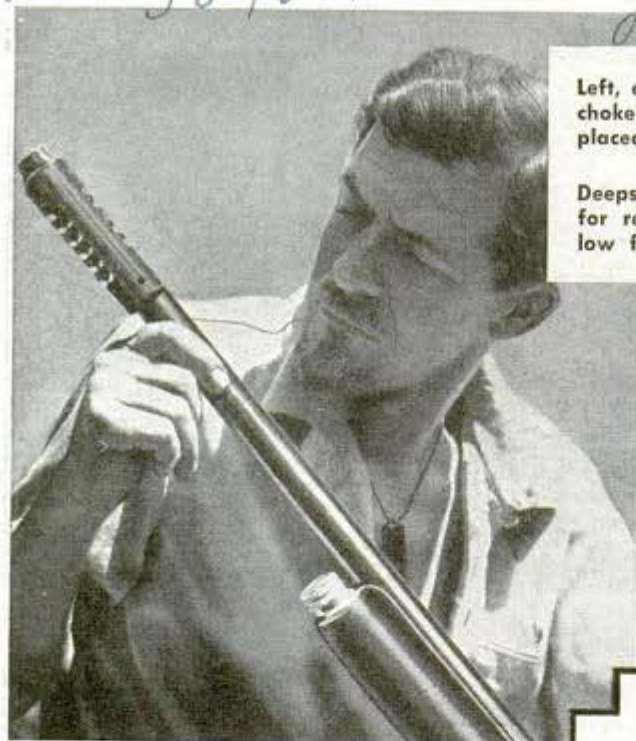

Left, examining a variable choke arrangement that is placed on shotgun muzzle



Deepsea reel has high gear for reeling line rapidly, low for pulling in slowly



FIRST AID

For GUNS and TACKLE

m1026

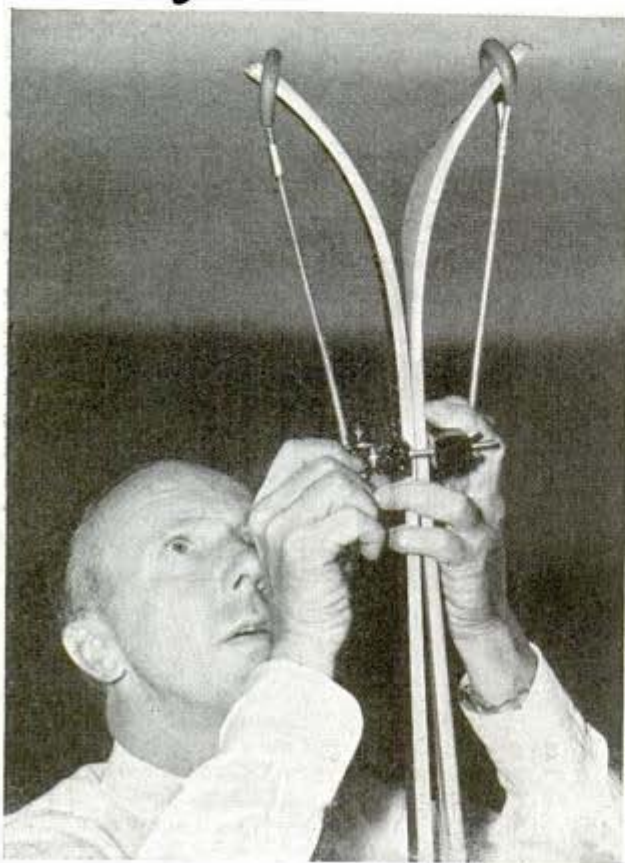

Ref: By C. B. Harrison

Outing Expert

Automobile Club of Southern California

2601 S Figueroa St

A GOOD JOB for you after dinner tonight would be to take your fishing lines off the reels and coil them loosely in a cardboard box for storage. Tie a piece of string around the end that comes off the reel first so you can reverse the line when you put it back on the reel.

Another after-dinner job is to take your gun apart, wipe it clean, and oil it. This should be done every month, not just once a year. Leave plenty of oil inside the barrel but don't plug the ends with oily rags. This common mistake promotes sweat and rust.

You won't be able to buy much in the way of sporting goods and tackle until after the war. Dealers are already sold out on many items. Now is the time to start taking extra care

Clamps are attached to the toes of skis to hold them at the proper curve when not in use

Los Angeles, Cal.

of what you own. Never allow a fishing line to dry on the reel. Strip off the wet line and let it dry thoroughly in the shade. If the line has been used in salt water, wash it several times in fresh water before drying. Hooks that have been used are sure to rust, so protect them with oil or grease when putting them away. Leaders should be dried and stored in loose coils. Rods should be hung by their tips. Don't lean them against a wall. It's a good idea to varnish them once a year. Your flies are safest when you put a mothball in among them. When you store away your reel, disassemble and clean it with kerosene, and after it has dried thoroughly, wipe all parts with an oily rag.

Guns are doubly valuable these days. When you go after game, make every shell count. Shells are scarce, and meat that you knock down yourself helps solve our food problem. Take a trained dog when you go bird hunting. A dog can nose out cripples that you would swear had gotten away. I got four fat pheasants one morning without firing a shot, simply by ranging across a field that had been shot over at daybreak by a group of hunters. They hadn't been able to find the birds they had crippled and my dog traced four of these.

A dog loses his power of scent in dry, dusty hunting. Carry water with you and give him a drink now and then. That keeps his nose wet and allows him to work better. Your



↑ Here is a compressed-air harpoon gun used for shark fishing. Air is discharged into barrel behind the harpoon by means of electromagnetic valve

← Ocean fisherman's chair and reel made of Lucite plastic on aluminum alloy base. Rod butt is integral with reel, has chuck at top for seating rod

↓ Spear head, feather jigs and the rubber fish with a hook in its tail are part of the tackle one fisherman uses to catch big game of the ocean





Battery-driven outboard engine has electric motor in streamline housing in front of screw. Crank is for slow speeds

dog may travel ten times farther than you do when hunting and his muscles are knotted and sore at the end of the day. Before feeding him, brush his coat and knead his legs and shoulders.

In the field, pick up all your used shells. Center fire cartridge cases can be reloaded. Even reloading materials are scarce, but many gun clubs have the equipment and some still have materials for reloading. If your local police department has a pistol range they probably reload their cartridges and may have tools and materials for your size as well. If not, they probably can tell you where to get the gear you need. Be sure to use the right materials. If you load shotgun shells with pistol powder, for instance, you are apt to blow up your gun.

A rifle or any other sort of gun can blow up with disastrous results if the barrel is plugged or stopped up. It's al-

ways a good idea to open the action and sight through the bore from the rear to make certain the gun is clean before taking it in the field. One man didn't know the barrel of his brand new gun was full of grease and he blew the gun to pieces and injured himself the first time he fired it. Snow has probably burst more gun barrels than anything else. A careless hunter gets a little snow packed in the muzzle, and another "hunting accident" occurs. Twigs or mud are just as dangerous.

If you are using old ammunition there is always a chance that a cartridge will hang fire. It may delay and not explode for 10

seconds or up to a minute after you have pulled the trigger. The best thing to do is to keep aiming at the target for at least 20 seconds. If it hasn't fired by then, point the gun at the ground and keep the breech closed a full minute before opening it up and extracting the cartridge. The big danger in a hang fire is that the shell may explode just as you are opening the breech. Another thing, never use modern high power shells in an old Da-

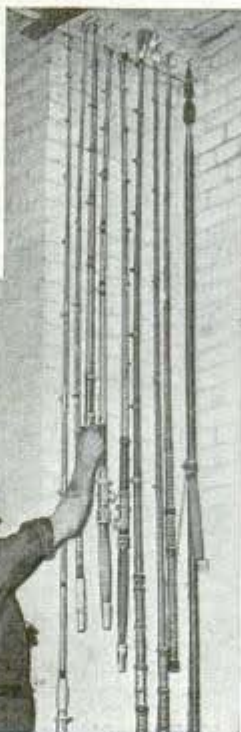

Left, fishing rods should be hung by tips instead of leaning against wall. Below, repaint decoys every season

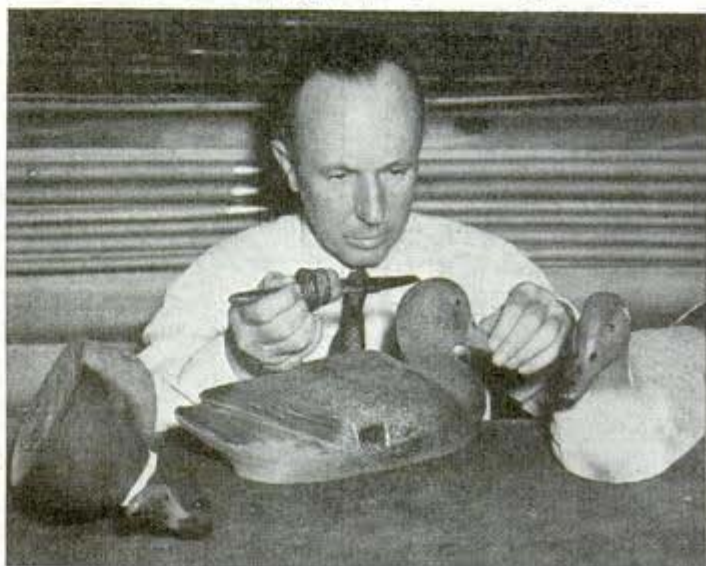

mascus twist shotgun. Those guns are works of art, but the barrels won't stand the pressures of modern powder. Such a shell may unwrap the barrel or blow it to pieces. Don't do any dry snapping, or trigger pulling, without a shell in the barrel of a rifle or shotgun. That's a good way to break the firing pin.

Few gun barrels are perfectly straight. That's the reason why, when you get a new gun, you should sight it in. Fire it a few times on a target range to learn just where it points and you can become familiar with how the sights should be set and held. This sighting-in is advised because it is impossible to keep the long drill straight when a barrel is being bored. The gunsmith first bores the barrel out, then machines the exterior away in the same line as the bore. After that he may sight through the bore and rap the barrel a few times with a mallet to help straighten it.

A rifle bullet can do more damage at, say 100 yards, than it can only 10 or 15 yards away from the muzzle. The reason



This rifle has a split barrel that burst because of stoppage. In this case the hunter was not injured, but proper care will prevent such mishaps

is that the bullet is unstable when it first leaves the gun and it takes considerable distance to settle down to straight flight. First the tail of the bullet wobbles around, describing a circle, then the whole bullet takes on a small corkscrew motion. Finally the spin imparted by the rotation grooves inside the barrel takes charge and the bullet settles down to straight, even flight.

Few hunters or fishermen have thought of canning the meat they bring home,

(Continued to page 154)

Left, a good rubdown with saddle soap will preserve leather goods. Right, reloading tool that seats new bullet on used cartridge case after new primer has been installed and powder poured in



Acme Newspictures Inc
461-8 40th St. N.Y.C.

"Traffic Cop" Directs Crossing at Plane Plant

M 1148



Vehicles scurrying between plants of airplane firm are aided by "traffic cop" at busy intersection

Traffic is so heavy at the Boeing Airplane Company's plant at Wichita, Kans., that a guard is posted to prevent tie-ups at the intersection of two busy lanes. Among the wide variety of riders and vehicles are

messengers toting light parcels, large semi-trailer trucks, smaller flat-bed trucks, and a sidecar motorcycle bearing a guard as he travels from one sentry post to another or does liaison work between plants.

Pre-Flight Glider Trains Student Without Leaving Ground



Student learns proper use of plane controls in pre-flight training glider which is towed around field by automobile

M 1092
Students learning the basic principles of flight can be spared the risk of a crackup by "flying" a glider that never leaves the ground. Seated at the controls, the beginner may acquire what amounts to experience in handling a plane in actual flight, while an automobile tows the pre-flight training glider on a level field in utmost safety.

Dive Bomber Seat Saves Pilot From "Blackout"

M 1193
Pilots in dive bombers will be able to pull out of their dizzying plunges with less chance of losing consciousness from violent and

sudden changes in blood circulation in their brains, if promises held out by an automatic pilot's seat, patented by Frederick P. Dillon of Los Angeles, are fulfilled. A hinged back tilts to let the pilot down to a supine position just before the plane reaches the most critical point in its dive. As the plane climbs out of the dive, a hydraulic cylinder automatically restores the seat to normal sitting position. The invention includes a gyroscopic mechanism that takes over control of the plane at the instant the pilot releases his bomb, maintaining automatic flight until the danger of "blackout" is past.

Sapper's "Divining Rod" Locates Buried Mines

Digging up land mines and rendering them harmless is the task of mine sappers whose work demands a high degree of skill and plenty of courage. First it is necessary to locate the hidden monsters. For this purpose the British army in Egypt and Africa has used a special detector, the construction of which is a guarded secret. Mounted on a long handle, the detector is swept over the ground ahead of the advancing troops, and when it comes within range of a bomb it sounds a warning in ear-phones worn by the user.

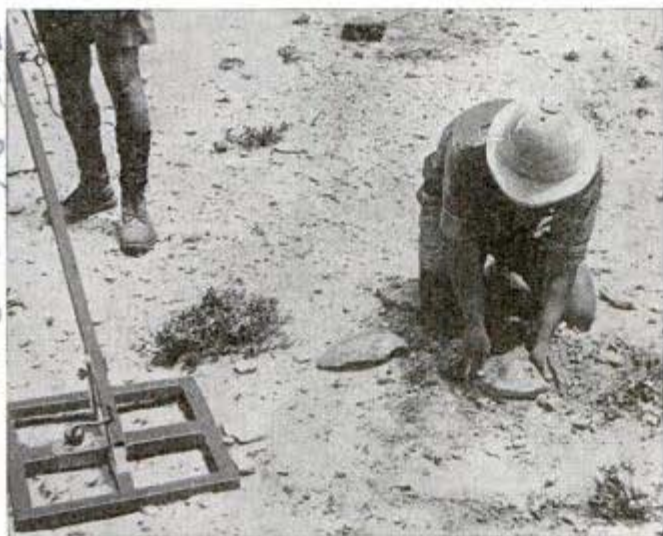

Detector, at left, finds mines, and sappers dispose of them

Portable Lights for Landing Field Made in "Backyard" Shops



Lights made in many small shops are assembled for inspection

Hundreds of portable landing lights produced for the Army Air Corps in garages and backyard machine shops are brought together at the plant of Lights, Inc., of Los Angeles for checking by army inspectors. Acting as a clearing house for production of small-size articles needed by the army and navy, this company has opened up vast untapped resources offered by 450 small sub-contractors in its vicinity—backyard plants, machine shops and garages. These small shops are capable of manufacturing materials that would require a single plant of from 10,000 to 15,000 workers and from five to ten million dollars worth of unobtainable machinery.

☐ A new 3,000-ton Danish freight ship is driven by a 950-horsepower Diesel engine using producer gas instead of oil, the gas being generated aboard ship by burning coal.

Int'l News Channel
 235 E 45th St
 NYC

1111 8th Avenue

*London Telegraph Agency
13 Fleet St London, England
M 1082*

R. A. F. Tries Out a Downed German Fighter

| SPEED | VERY FORMIDABLE AT THESE HEIGHTS |
|------------|-------------------------------------|
| 24,000 FT. | AT THESE HEIGHTS |
| 22,000 FT. | MAXIMUM SPEED 390 M.P.H. |
| 20,000 FT. | 375 M.P.H. |
| 18,000 FT. | |
| 16,000 FT. | |
| 14,000 FT. | SPEED DECREASES WITH LOSS OF HEIGHT |
| 12,000 FT. | |
| 10,000 FT. | |
| 8,000 FT. | |
| 6,000 FT. | SPEED AT 4,500 FT. 326 M.P.H. |
| 4,000 FT. | COMES IN TO LAND AT 125 M.P.H. |
| 2,000 FT. | TOUCHES AT 110 M.P.H. |

THE PILOT IS SEATED LEANING BACK WITH HIS KNEES HIGH TO REDUCE EFFECT OF GRAVITY WHEN VIOLENTLY ACCELERATING

Although a great fighting plane, tests of a German Focke-Wulf "F.W. 190," which landed intact in England, reveal it to be somewhat less than the phenomenal ship at first believed. At its best in altitudes between 20,000 and 24,000 feet, where it

reaches top speed, the sky fighter is formidable only above 16,000 feet. Drawings above indicate other interesting and outstanding features, and the inset, extreme lower righthand corner, shows some comparisons with Britain's Spitfire. Although

Pilot "Blows Up" Hood of Cockpit to Bail Out

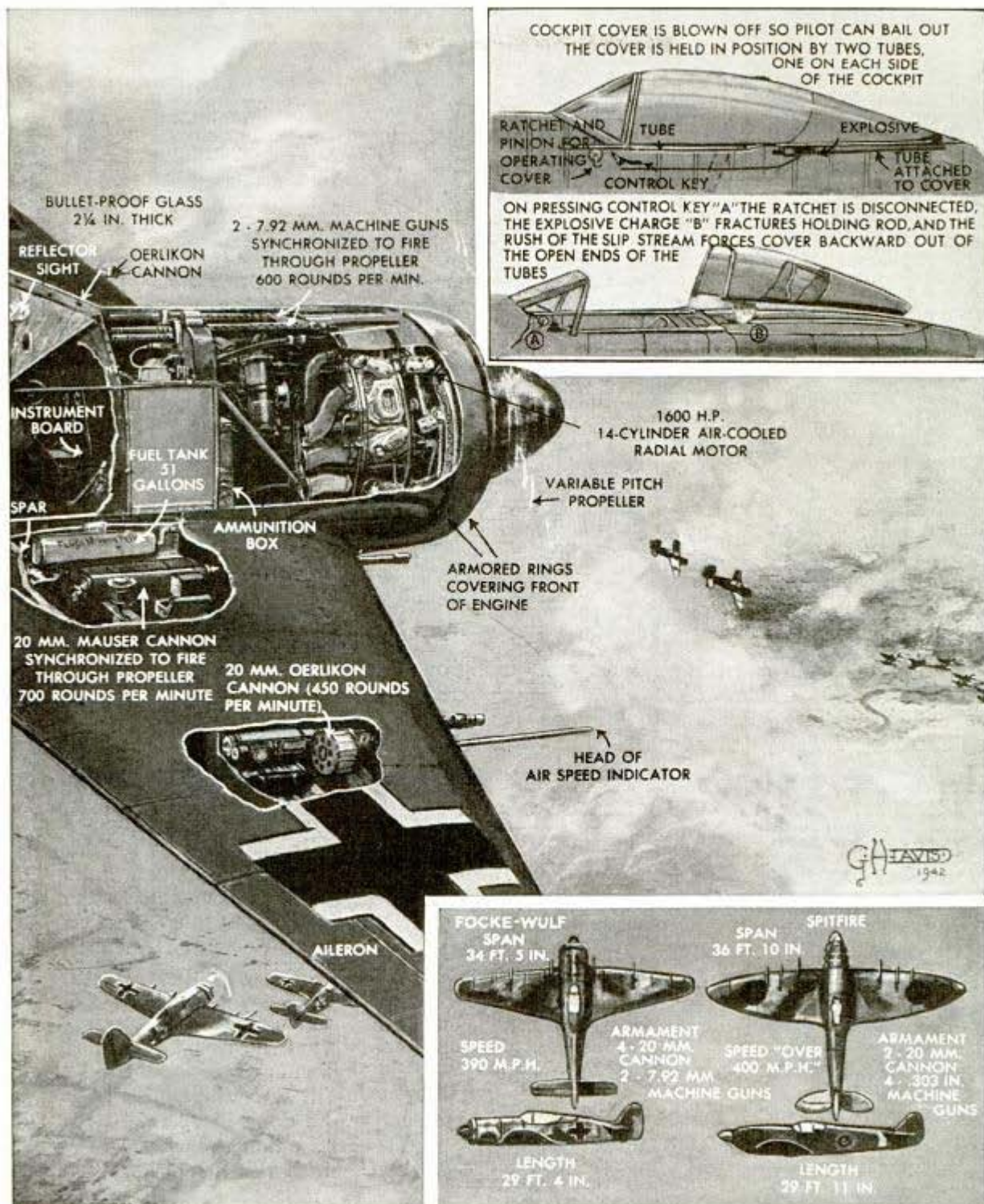

the electrically operated undercarriage is rated among the best, aerodynamically the ship is poor, being hard to fly owing to its high landing speed. Provisions for the pilot are good. He can bail out quickly by jettisoning the whole cockpit hood at pres-

sure of a key. Total weight of fire from the four cannon and two machine guns amounts to about 610 pounds a minute, but is less effective than might appear because of the short machine-gun range and poor hitting power of the Oerlikon cannon.

Acme Newsictures Inc

461-8 av. nyc

Air-Propelled Boat Rescues Flyers on the Nile

7/11/38



Driven by an air propeller and riding on pontoons, rescue boat is efficient in deep or shallow water

Sky fighters down on their luck and forced to land in waters of the Nile delta depend for quick rescue upon a hydroplane operated by the Royal Air Force. Skim-

ming over the surface on seaplane floats, the craft receives power from an airplane engine and an air propeller mounted at the stern. Top speed is about 15 knots.

Plane Model With Control Stick Shows How It Is Flown

Aviation students can now obtain a "build-it-yourself" airplane model of the P-39 Airacobra with cockpit controls that operate ailerons, rudder and elevator just

as on full-size craft. With it the builder interested in preflight training can "take the stick" and adjust the controls to the proper position for various maneuvers as shown in an illustrated booklet accompanying each kit. All of the parts, made of non-critical materials, are in finished form and need only to be fitted together, which can be done in 90 minutes. The tiny trainer has a 24-inch wingspan.

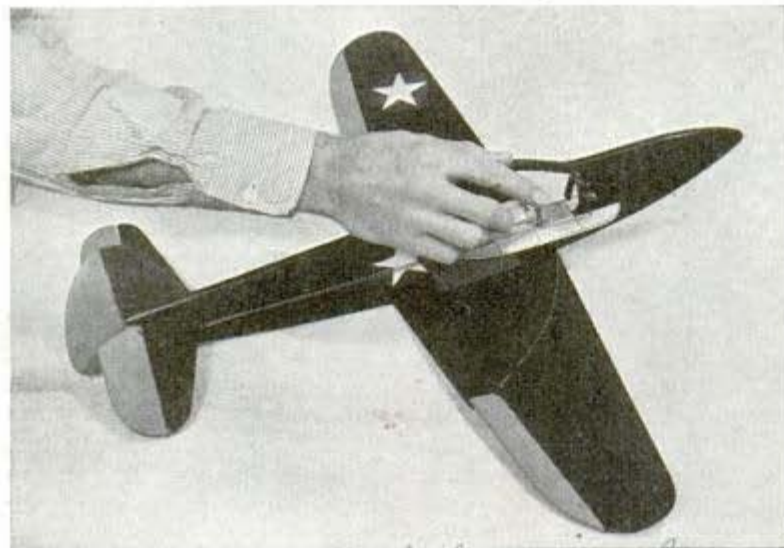

Wiggling control stick on airplane model, built from complete kit of parts, operates the rudder, elevator and ailerons as on an actual plane

Comet Model Airplane Supply Co
POPULAR MECHANICS Co
127 W 29 St, Chicago Illinois

Aviation Mechanics Learn Commando Tricks

M 1087



You won't find the exercise (above) in the mechanics' manual for the army air forces, but the men in training at United Air Lines' School of Aeronautics learn that excellent physical condition may play an important part in getting a plane aloft in a hurry. Soldier mechanics drill on a 100-yard obstacle course

News Bureau

Chicago



Army mechanics don't stop for anything like a wall (above) if it happens to be between them and their planes. It's up and over in drill at Oakland, Calif.

Above, three mechanics take a hurdle on the "commando" course which is laid out on rough terrain with plenty of loose rock and sand surfaces such as might be found at an air field in distant combat zone. The course boasts one seven-foot wall, barbed wire entanglement, maze of poles and a deep pit spanned by a single log. At end of course (right) mechanics swarm about planes getting them under a shelter or ready to take off. The record time for the course is 18 seconds



SHAKEDOWN CRUISE



Shipbuilding has undergone a revolution; vessels today are built in parts and then assembled. Here an entire deck section is lifted into its place by cranes

Propeller and rudder of a new Liberty ship ready for the launching. Soon the screw will be turning at full speed in a six-hour steam trial at the dockside



By Thomas E. Stimson, Jr.

LIKE to go aboard for the shakedown cruise on one of America's brand new Liberty ships?

All right. Here's one at the California Shipbuilding Corporation's yards at San Pedro. Steam is up and the propeller is already turning over slowly as we show our passes and climb the gangplank. A few weeks ago this ship didn't exist; today she is complete in every item. Tomorrow she will be loading cargo for our forces in Europe or the Orient

Right now the vessel is about to begin her steaming trial. Full speed ahead for six steady hours. The ship trembles a bit as her propeller thrashes over faster and she strains against the hawsers that hold her in the dock. When do we cast off? We don't. The ship will stay tied to the land for this sea trial. Ordinarily we would be making the run at sea but an officer explains that the Navy is too busy just now to furnish a protective escort.

Early tomorrow morning the vessel will make a harbor run to test her maneuverability. Inspectors will measure the time it takes to swing her head to port and star-

Ref: Public Relations Dept
Terminal Island Cal.

77 1035

board, both going ahead and going astern. She will drop her anchors and pick them up. Then will come the crucial "crash stop" test in which the engine is thrown from full speed ahead to full speed astern as fast as the engineer can wind down the throttle wheel. The purpose is to see in how short a distance the ship can be brought from full speed ahead to a dead stop. The superstructure shakes and groans as the propeller goes into reverse. White water piles up under the stern and the ship loses way and stops.

Later, an hour or so is spent adjusting the compasses and checking the radio installations and the ship is returned to a pier. Even while the experts of the trial board are filling out their reports, her brand new canvas hatch covers are pulled off and the cargo booms begin to bring war materials on board. Provisions for her first voyage are trucked to the wharf, the balance of her crew are signed on, and the old broom at her masthead that shows she has passed her trials is hauled down. The vessel is ready to sail.

The 10,500-ton Liberty ship Joseph N. Teal was delivered to the Maritime Commission, ready to go to sea, two weeks to the day from the time her keel was laid. Similar vessels since have been built in less than a week. These remarkable records were made at the Henry J. Kaiser yards at Portland, Ore., and were made possible by the prefabrication of large sections of the vessels that



Above, swinging a gun aboard a Liberty ship. Hundreds of American cargo vessels are being armed against the U-boat raiders that infest the sea lanes and enemy planes that sweep out from Europe. Navy-trained gunners man the weapons. Below, Liberty ships at California shipbuilding yard

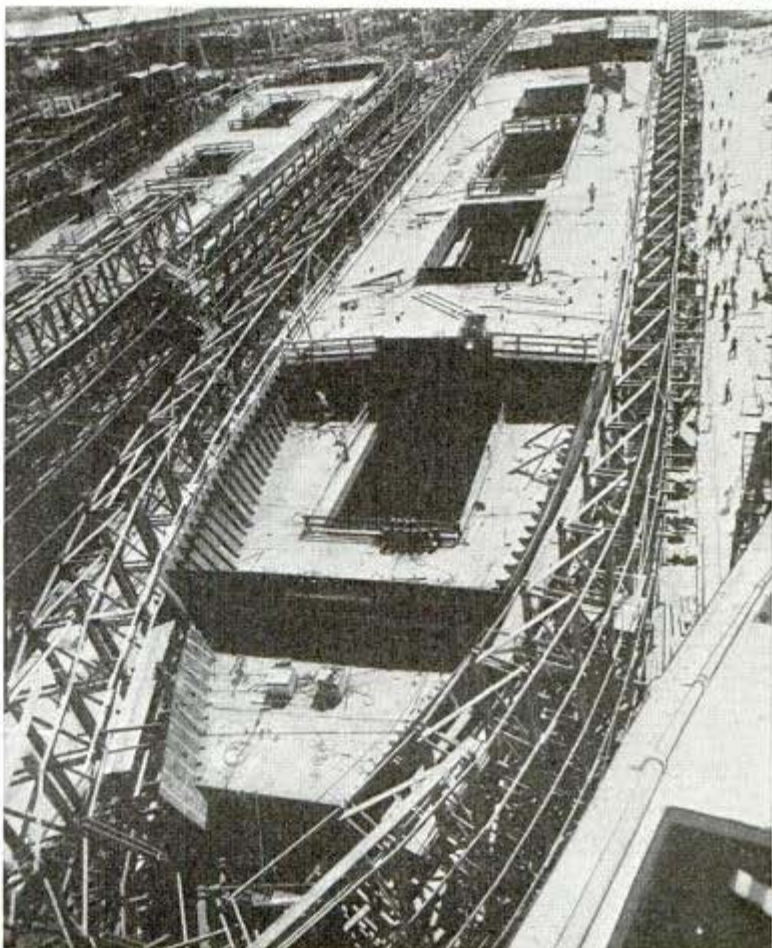

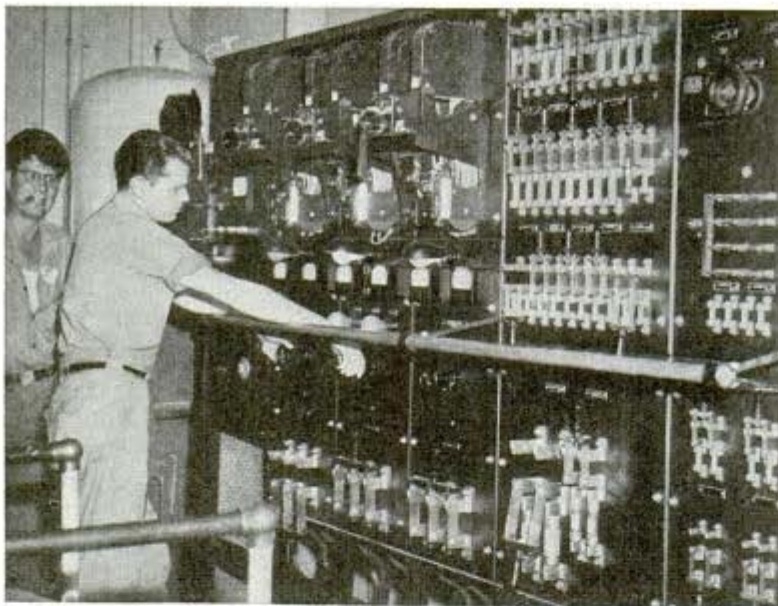

Above, the main switchboard in engine room of a Liberty ship

were then moved into place on the ways by tremendous cranes.

The technique of assembling ships by sections is still growing and the goal of shipbuilders is to prefabricate and preassemble even larger sections. For instance, the superstructure of a Liberty now takes a couple of days to move into place and assemble. The builders foresee the time when this entire amid-ships superstructure, consisting of armored bridge, navigation and radio quarters, offices, galley, and sleeping quarters, will be assembled on the ground in one huge complete unit, then picked up by cranes and dropped into place on deck. Then it will be necessary only to weld the great unit to the ship, paint over the fresh welds, and connect up the pipes and electric wiring.

A ship is far from complete on the day she is



Skid frame (left) holds life raft poised ready to slide into water at instant rope is cut. Below, outfitting engineers line up propeller shaft with boring of frame



launched. Most of her machinery, including the engine and boilers, is in place, but none of it is connected up. The launching ceremony is hardly over when tugs nose the new hull into the wet basin and the outfitters take charge. The outfitting crews have a million and one jobs to perform and each detail must be done just right even though the men are racing against time. The first big job is to line up the tail shaft with the boring of the stern frame. The shaft bearings are set up, chalked, and shimmed, the thrust bearing is lined up and adjusted and finally the main engine is lined up with the shaft.

Meanwhile, other outfitting crews are completing the installation of the water, steam, air and oil lines. Inspectors are right behind them, giving each tank and pipe line a hydrostatic test. Crews of

joiners are busy in the superstructure, finishing up the carpentry work, installing doors and bunks, running electric cables, and fitting out the galley. Electrical inspectors test each generator and switch-board as soon as it is connected up. Shipwrights meanwhile have been installing the anchors and anchor chains, and riggers have brought the booms and cargo handling equipment on board and are installing them in place. The life boats and life rafts are swung up on deck and tested for quick operation.

Now the navigation equipment is brought on board and attached to the ship. The radio, radio loop, depth finding equipment, compasses and binnacles, steering gear, navigation and signal lights, and flags are all made ready for use. The engine room telegraph is connected, the telephone system is installed, and the deck guns and other protective equipment are put in place. Twenty-four hours a day the work goes on. Has the typewriter been put in the radio shack? Has the rules-of-the-road chart been hung up on the bridge? Not one detail must be forgotten, from the installing of screens across the ventilators and the hooking up of the anti-magnetic-mine belt to the installation of the tiny davit on the bow to which the Suez light is to be attached any time the vessel goes through the Suez canal.

By the time bedding has been installed



Deck officers hoist an old broom to the masthead of a Liberty ship, signaling successful finish of sea trials

in the bunks, silverware and dishes have been placed in the galley, and the final painting is being completed, Calship's port engineer and his crew come on board. Members of the Maritime Commission trial board accompany him to test and prove the ship. The boilers are fired, steam is raised,

(Continued to page 156)

Beyond the aft gun platform of a Liberty ship, three other vessels of identical design are being completed

Photo from U. S. Maritime Commission



with News Photos
306 V. Madison, Chicago

"Para-Canine" Earns Wings By Repeated Jumps

M 1149

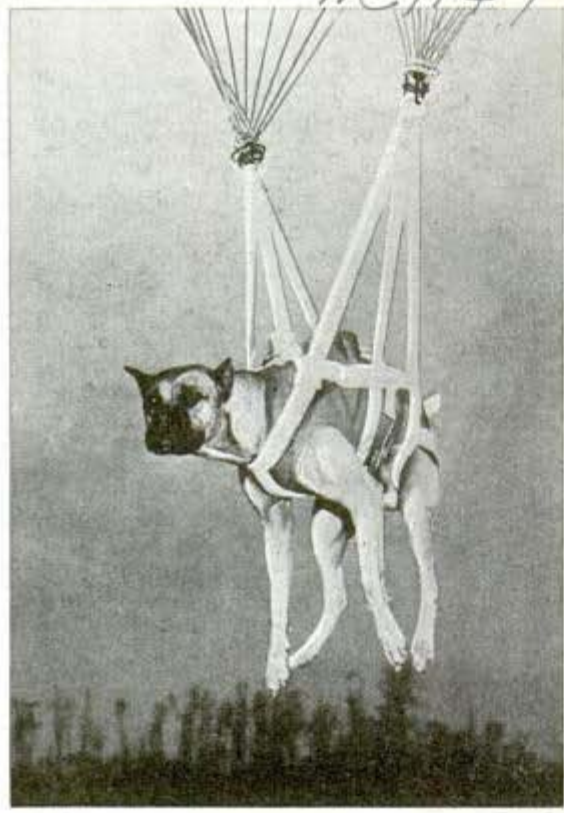

Mascot at Fort Benning making a "four-point" landing after leap from plane. He weighs ninety pounds

After making five regulation parachute jumps, Max—full-fledged mascot of the 505th parachute infantry at Ft. Benning—has been given his silver wings by Col. James M. Gavin. His first jump was taken in the number two position right behind Lt. Clyde Russell, who was jump master. It's said that all paratroopers sweat on the second leap, and, although he was no "door-freezer," the 90-pound canine toughie seemed to experience nervous reactions that were almost human. Ensuing jumps were taken in style, which qualified him for the 'chutist mascot rating.

Cement and Wood Fiber Mixture May Build Future Homes

M 1184

Building material made from a mixture of cement and a specially ground wood fiber is being studied by Robert C. Brown, Jr., director of the Chicago technical development section of the War Production Board, for possible use in building low-cost homes. The fiber, made from lumber

waste or inexpensive woods, is mixed with ordinary cement to form a material called "fibercrete," which weighs one-half to one-third as much as concrete and has two or three times its tensile strength. It can be sawed, is resistant to fire, is less brittle than concrete and absorbs less water than concrete. Most significant wartime application of fibercrete probably would be in runways for heavy bombers and for rapid construction of shelters at military bases.

Asbestos Gloves Are Air Cooled For Handling Hot Lamps

Sealed-beam headlamps carried out of an annealing furnace on a moving conveyor or at the Westinghouse Company's lamp division in East Pittsburgh are so hot they scorch hands even when protected by asbestos gloves, and something had to be done about it. One day a department employee, getting a permanent wave, noted the beautician using an air hose to cool her hair. Borrowing this "air-conditioning" idea, a low pressure air hose was extended into the gauntlet of each glove to provide circulation of cool air, which carries off the heat. Besides ending the scorched-hand hazard for operators who remove the lamps from the conveyor, air circulating inside the gloves gives less shrinkage in the lamp glass because it permits change in the pre-heat temperature.

306-4 Ave,

M 1097



Low pressure hose extends into each asbestos glove with cool air to prevent burns on hands of worker

clipping

Acrony 1161- Soc, 7412.

Sailors Ride Ack-Ack Mount to Learn Gunnery

In a four-month course ordinary seamen are turned out as anti-aircraft gunners at a naval training school in England for service on board merchant ships. They start their training at the sights of an anti-aircraft mounting, minus the gun, which has been erected at the seamen's school.

British seamen at sights of anti-aircraft mounting at naval training school where they learn to man guns on merchant vessels



*ordinary seaman
Merchant*

Self-Propelled Tank Destroyer Blasts 'Em With a "105"



Among the bad news for the Axis powers is a new self-propelled tank destroyer that has already gone into action for the U. S. Army. To rip the enemy's armored equipment it packs a vicious 105-millimeter gun, and also carries an anti-aircraft gun for defense against strafing planes.

Anti-aircraft gun gives this lethal machine protection against enemy planes while it trains big center gun on foe

arm

Wrap-Around Clamp for Hose Snaps Into Place With Leakproof Grip

Snapping easily into place with a twist of the wrist, a hose clamp now available saves bothering with nuts, threads and pivots. After a simple adjustment, the wrap-around clamp locks itself with a secure and uniform grip. Made of stainless steel resistant to erosion and material fatigue, the clamp is suitable for application to fluid supply hose that must be connected firmly to end assemblies, metal hydraulic lines, or even the garden hose. It may be left in place or used over and over again.

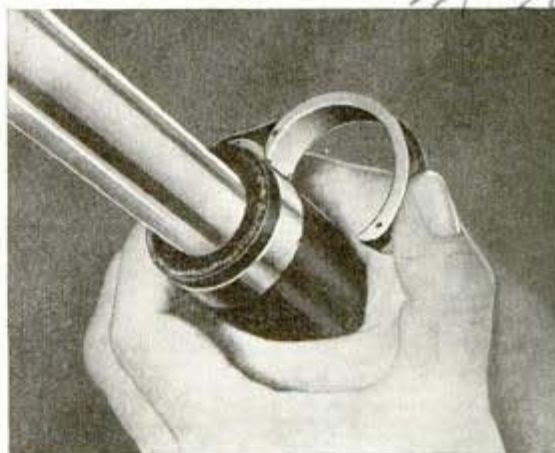

Connecting hose with steel clamp which snaps on in jiffy and locks with uniform pressure

APRIL, 1943

*Huntington Precision Products 81
Huntington, Va.*

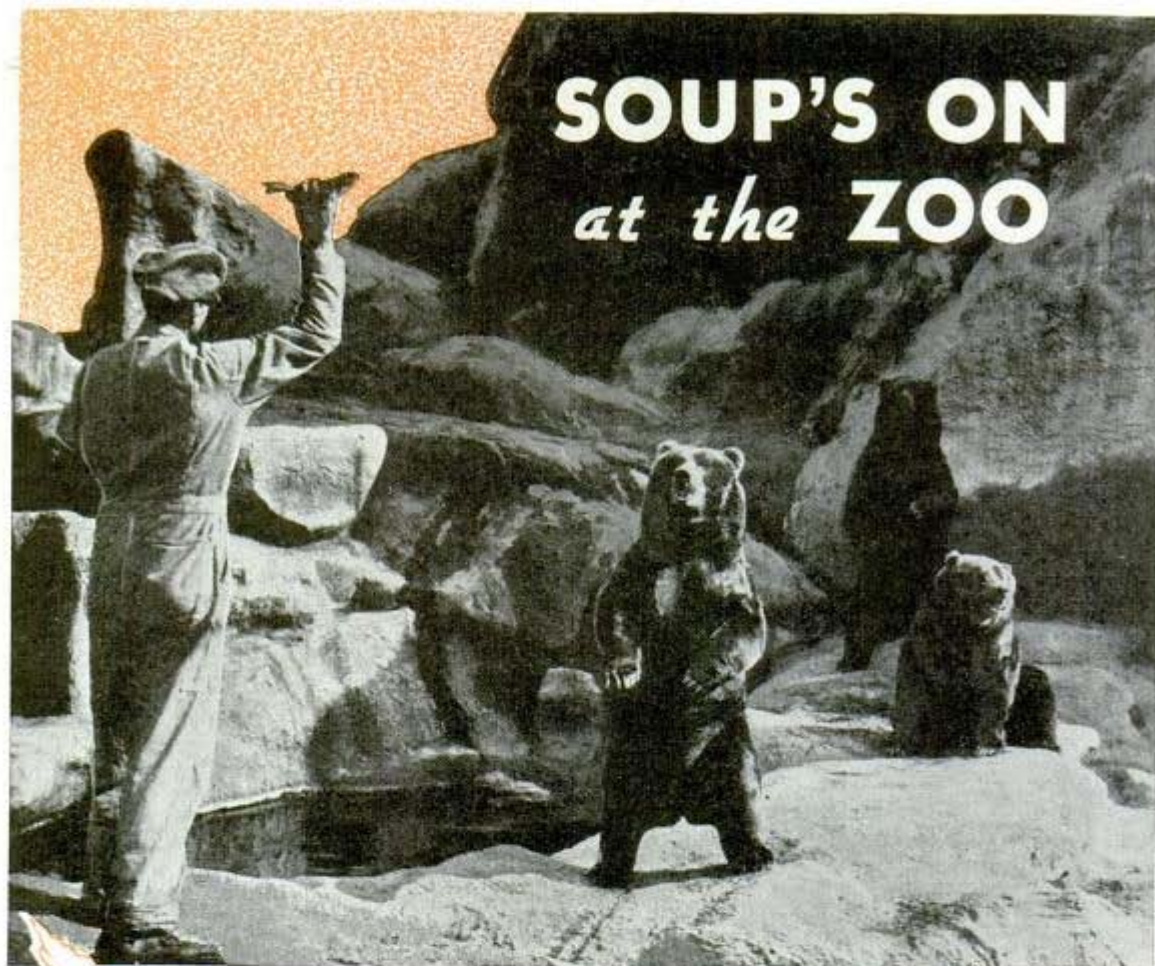

SOUP'S ON *at the ZOO*



Last call for breakfast (herring and dog food) brings trio of 1,800 pound kodiaks to attention

"Ah," roars Bebe, giant hippo at Chicago's Brookfield Zoo as keeper literally tickles her palate

741061

By

Wayne Whittaker



PALATES that must be tickled every day at the zoo range from gorilla to hummingbird; from the binturong of Sumatra and the giant panda of Szechwan Province, China, to the polar bear and the penguin.

A blueprint for feeding a zoo full of mammals, reptiles and birds from every corner and climate in the world is as intricate as plans for an ocean liner. When the curator makes out his menu it includes more than a hundred separate food items. Among the strange ones are blue clay for the kangaroos

and thistles for the camels. The anteater, whose name suggests a simple diet, won't touch ants. He prefers a porridge of milk, green bone paste, bananas, defibrinated blood, sweet potatoes, eggs, cod liver oil and almost everything within reach except the bars of his cage.

Other animals and reptiles have individual idiosyncrasies that complicate the bill of fare. Robert Bean, curator of mammals at Chicago's Brookfield Zoo and recognized in the zoo-keeping world as an authority on the care and feeding of wild animals and reptiles, recently had a python "personality and food problem" to handle.

The zoo was presented with a pair of valuable pythons, giant snakes of the earth, by a wealthy sportsman who had raised them on his estate.

"The only trouble with the pythons was that they wouldn't eat," said Mr. Bean. "After several months we became worried. We'd tried everything we could think of—choice fat rabbits, chickens, ducks and other poultry—but the pythons just pushed back their plates. Finally, I called the man who gave them to us. He told me the pythons had been raised on chickens and always had good appetites.

"Snatching at a straw, I asked him what kind of chickens he raised on the estate. He said White Leghorns. At that time we happened to be buying Plymouth Rocks and Rhode Island Reds. Well, I went out and rounded up some White Leghorns.



Leaning over a 14-foot fence, Jack the giraffe nibbles on a tasty leaf



Bottle-fed Joey (year old kangaroo) was tiny as mouse when "adopted"

This hungry resident of primate house, below, helps himself as keeper holds tray of fresh fruit and lettuce



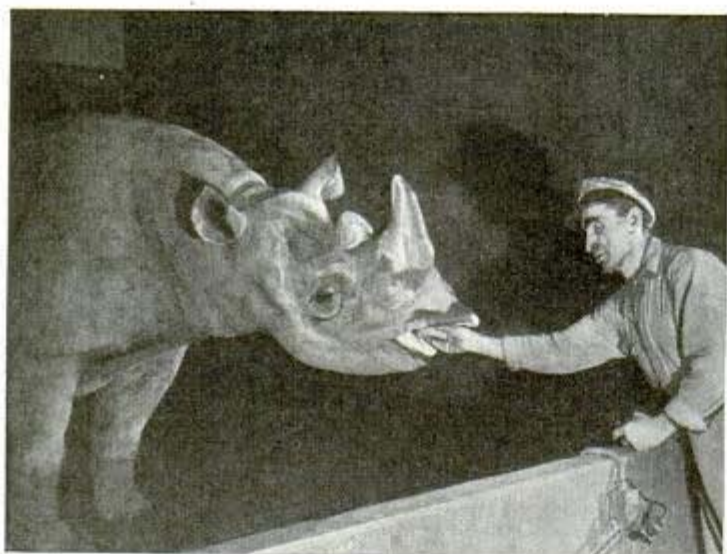

Karonga, believed to be the only tame rhinoceros in world, accepts rye bread from her Brookfield keeper. Most rhinos are ferocious



Five-day-old zebra colt (above) takes time out for dinner as its mother, Maude, pricks up her ears at cameraman. Below, anteater with elongated snout sips a bowl of porridge containing milk, bananas, green bone paste, eggs, etc. He turns up his nose and refuses ants



You should have seen the pythons gobble them up. What they were doing was holding out for their favorite leghorns and they've thrived ever since. The python, by the way, is a quiet and good tempered fellow. He sleeps most of the time, rousing himself every two or three months to shed his skin and eat a meal."

The poultry connoisseurs of the reptile house are a far cry from the bears and hippopotami—the easiest animals to keep and feed. The bear is the most omnivorous of all wild beasts, relishing and thriving on meats, fish, fruits and vegetables alike. He breakfasts on dog biscuits and carrots; supper consists of several loaves of whole wheat bread, apples, fresh fruit, more carrots, meat or fish. Between-meal snacks, provided by the public, may include a dozen boxes of candied popcorn and 10 bags of peanuts. Wild animals will never overeat like their domestic cousins, according to Mr. Bean, and that is why the public is permitted to feed them indiscriminately.

The huge 1,600-pound kodiak bear consumes about 35 pounds of food daily during the summer and averages less than three pounds a day in winter. Like other bears, he will sleep for two or three days at a stretch in winter. Mr. Bean belongs to the school of thought that says no bear hibernates.

The hippo lives on mountains of alfalfa, oat and bran mash, chopped roots and greens. A sick hippo is an unknown quantity—a quantity of some 4,000 pounds.

Another zoo giant with a tremendous appetite, but lacking the hippo's excellent health, is the elephant seal. This 3,200-pound aquatic can polish off 100 pounds of mackerel daily during the warm

months. Plague of the big seal is ulcers. Reggie, the late elephant seal at Brookfield, used to go on a voluntary three-week starvation diet every summer to clear up his ulcers.

A giant panda cub is fed like a baby on milk, strained vegetables, corn sirup, cereal, halibut oil and malt. As he grows older, spinach, chard, celery, carrots, apples, toasted whole wheat bread, green cornstalks, bamboo and corn meal are added to the diet. A panda will never touch meat or fish.

Of the few pandas exhibited in this country, the Brookfield Zoo has had three. Mr. Bean, who pioneered in concocting a diet for panda cubs with the famous Su-Lin, believes the reason pandas die in American zoos at an early age may be traced to the rarefied atmosphere of their native habitat. A panda's lungs are half again as large as those of an American bear the same size.

Zoo keepers had difficulty in raising kangaroos, too, until it was discovered that clay from deep tunnels or river banks is essential to their diet. Without it they

develop a jaw disease that is often fatal.

"Our group of 42 kangaroos eats 100 bushels of blue clay a year," said Mr. Bean. "I don't know why it is good for them, but it is—perhaps some mineral content."

Don't get the idea that kangaroos live on clay alone. Their hearty diet includes rolled oats, whole wheat bread, chopped apples, sugar beets, carrots, boiled pota-



Robert Bean, curator of mammals at Brookfield, offers four-year-old panda, Mei-Lan, a bouquet of bamboo which she eats like hay

"Every man for himself" is polar bears' motto as they line up while a keeper pitches food. Note deep pit





Shoebill stork opens up to receive his breakfast herring that will be followed by a few smelts and frogs. He's from the Sudan

toes, bananas and plenty of leafy clover.

Brookfield's 700 animals consume more than 100,000 pounds of frozen horse meat a year. Frozen meats and fish are considered the greatest safeguards to health. The biggest meat eaters are tigers and lions, each grown animal devouring between 12 and 15 pounds daily. Another member of the cat family with a fondness for meat is the binturong, or "bear cat," who spends his non-eating moments snoozing in a tree.

Among the hay and grain consumers are the zebras, elephants, camels and giraffes. The zebra is a lazy fellow who is content to chew his alfalfa quietly unless it happens to be snowing. Despite his African habitat, the zebra has a childish urge to romp in the snow. Camels prefer the coarsest kind of hay. Dried thistles, resembling bouquets of needles, are camel delicacies. The giraffes, browsers by nature, prefer leafy alfalfa and the leaves of oak and maple trees. Giraffes also are fed milk and a porridge of oatmeal, corn meal, molasses and salt. The rabbitlike hyrax, or

Friendly Miss Congo, eight-year-old gorilla, sniffs at offering of candy



coney, becomes nervous and anemic when dandelions are omitted from his feed box.

The daily ration for the monkey family—rhesus, chimpanzees, gorillas and some 30 other variations of the clan—includes fruits, cereals, vegetables, spinach, lettuce and soy beans. The smaller species also relish insects and a little meat, but the larger the animal the less carnivorous he is. Gorillas loathe the sight and smell of meat or fish. If a gorilla becomes obstreperous, a fish dangled on the end of a stick will send him quaking to his cage. Gorillas love coffee and fruit. When Suzette, a member of Brookfield's gorilla family of three, recently had pneumonia she existed on a mere three dozen oranges and a pint or two of coffee a day.

All zoo animals are given cod liver oil in winter. The monkeys receive it the year around—not because they need it, but because they develop an intense dislike for it if removed from their diet during the summer. The monkeys are notorious "apple shiners" and learn to ingratiate themselves with their feeders in the hope of an occasional tidbit.

The big snakes live mostly on rabbits and poultry. The two pythons with a taste for White Leghorns are not the only residents

of Brookfield's spacious reptile house with diet eccentricities. An anaconda once refused food for 11 months. One day a truck driver ran over a cat. Apparently it was what the big South American boa was waiting for, because his menu since that day has had only one item—dead cats.

The boa-constrictor, who seeks his natural prey in jungle treetops, has a preference for pigeons or any tree-roosting bird. The big cobras (Grandpa cobra is 18 feet long) are satisfied with a dozen rats about every six weeks. Their neighbors, the alligators, dine on fresh meat and fish.

Feeding 1,200 birds of some 400 species is the job of Curator Karl Plath at Brookfield. The small softbilled birds consume a great variety of seeds—hemp, millet, rape, sunflower—and grain as well as bananas, apples, boiled sweet potatoes and grapes. Satisfactory substitutes have been found for many seeds formerly imported.

The birds eat more in proportion to their weight than any other zoo creature. The expression "birdlike appetite" is a misnomer, says Mr. Plath. Some of the larger birds, shoebill storks and penguins, are fed fish. The penguins receive one drop of iodine a day which helps them fight mold particles in the air. The mold causes painful corns on their feet and that is why they walk with an exaggerated waddle.

More difficult to feed than the bird of paradise and the exotic birds of the tropics are the tiny North American hummingbirds. They are fed a mixture of butter, scraps of lean meat and defibrinated blood.

In a single year the zoo's big commissary handles 109,000 pounds of frozen meat, 106,000 pounds of bear bread, 3,510 dozen eggs, 72,000 pounds of bananas, 47,000 pounds of apples, 39,000 pounds of carrots, 18,000 pounds of spinach, 13,000 pounds of mackerel, 187 tons of alfalfa hay, 114 tons of timothy hay, 40,000 pounds of bran, and 79,000 pounds of oats. Among scores of other annual food totals are 405 skinks (small lizards), 214 chameleons, 1,285 frogs, 2,500 pounds of canary seed, 45 pounds of thistle seed, five quarts of worms, 7,000 mice, 15 pounds of ant eggs, 200 pounds of yeast, 4,000 pounds of grapes and 180 gallons of cod liver oil.

Another large item is peanuts—for the public. On a busy day, 1,800 pounds are sold on the bear "promenade" alone. Mr. Bean estimates the bears' share is less than 10 percent.

APRIL, 1943

acme
461-500 nyc
22-1123

Crystals Crated With Motor Show Moisture It Absorbs



Blue crystals mean moisture has not reached engine

To detect any moisture encountered by Wright Cyclone engines while in transit between factory and destination, a bag of silica gel crystals, pasted on a color chart, accompanies each one as it is shipped. When the case is unpacked, the color of the crystals is matched with the chart. If the hue is pink, inspectors examine the engine to learn whether the moisture has affected the power plant. However, if the crystals correspond with the dark blue portion of the chart, it is a sure sign that all is well within the engine.

Groove Cut in Nut Saves Steel Without Loss of Strength



m 1112

Much of the steel can be saved in making nuts by cutting a groove across the top of each one about two-thirds the depth of the nut. The threads remaining on the

uncut sides provide enough holding power and strength. A slight arch at the base of the nut adds a locking feature that causes the nut to bind under turning pressure.

Look in the index to find where to buy articles described in this magazine. Say You Saw It in Popular Mechanics.

Mac-Lean - Fogg Locking
26497 Kilar, Chicago
87

*Capt J. P. Lyell, 2205 Fair Hills Dr.,
Bakerswood Dayton Ohio*

Tank and Gun "Doctors" Operate in the Field

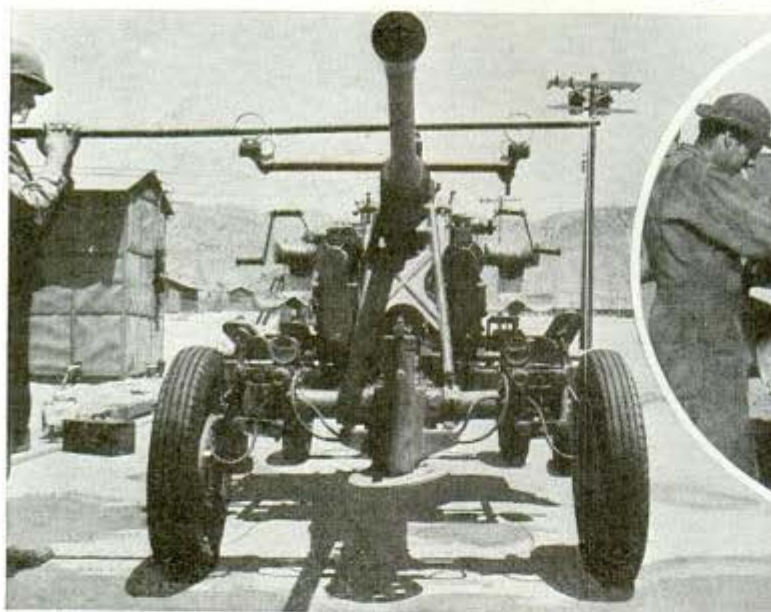

For want of a horseshoe nail a rider and a battle were once lost, according to legend. Horseshoe nails aren't so important in keeping modern mechanized units of the U. S. Army rolling, but crack repair crews and parts for tanks, guns, trucks and even jeeps are vital today. Much of the repair work is done in the field with members of the crews keeping an alert eye and ear for enemy bombs or bullets. The men, above, are repairing a 250 horsepower radial engine in tank. Upper left, using special instrument on anti-aircraft gun to reveal wheel misalignment. Army mechanics at front line bases are noted for speed, ingenuity

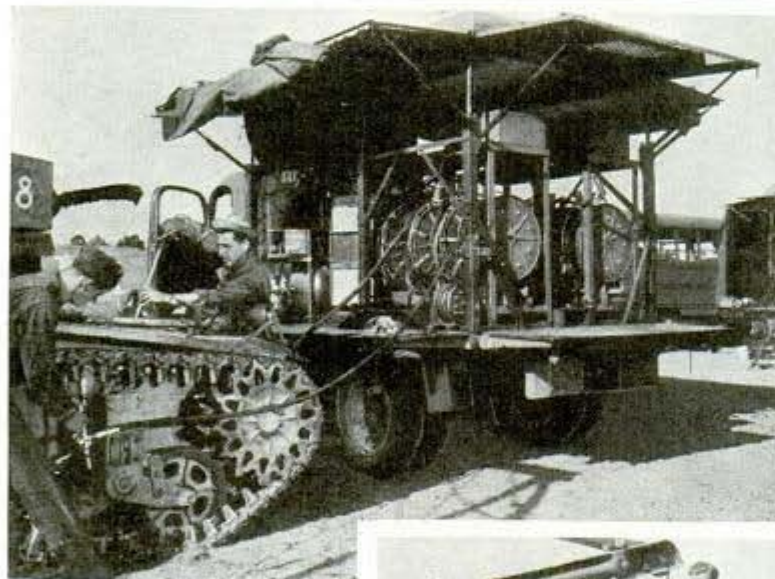

U. S. Army Signal Corps photos

Above, field lubrication car being used to grease a tank at advanced base. Frequent servicing of tanks, specially on hot desert battlefields, is essential to keep these iron fortresses in top fighting condition to blast the enemy

"Hold it!" shouts mechanic on top of tank as crew working with repair truck lifts 1,300-pound motor for quick repair job. Other equipment for field crew includes new mobile electric arc welder used to "heal" battle scars



Con: Thomas & Turner, Jr
3872 Franklin Ave, Los Angeles
Calif



HOLLYWOOD is making most of its movies indoors this year. Daytime exteriors are apt to be spoiled by the noise of bombers and fighter planes on patrol, and big out-of-doors night scenes are prohibited by dim-out regulations.

Pictures can't be made at sea or even along the beaches and headlands. For security reasons, not even water reservoirs can be used to double for the ocean.

Under those circumstances, how would you like to be asked to stage a full-size ocean battle for the screen? R.K.O. was faced with that problem when it decided to film "The Navy Comes Through." The script called for the firing of a big 5-inch gun on the deck of a ship, for near-misses by bombs alongside the ship, and for a storm and fog at sea.

First, the studio built a 125-foot section of a full-sized ship inside one of its sound stages. The ship's deck is complete even to anti-aircraft machine gun turrets and the big 5-inch naval gun. The gun does everything except fire a real shell, yet its materials cost only \$20. The near-misses that landed

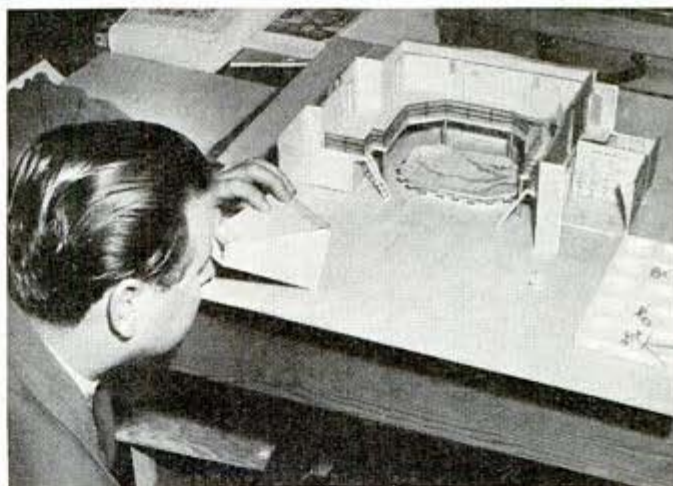

Inspecting scale model of plotting room for "Eagle Squadron." Below, filming action on deck of studio ship on sound stage



Jack Turner



Jack Otterson, Universal Studios art director, left, using periscope to study camera angles on set model of "Forever Yours." Right, big steel water tank used for filming undersea scenes

alongside the ship were simulated for the screen by dumping 850 gallons of water down a 40-foot chute built like a ski slide, allowing the water to land right beside the set and deluge the gun deck. The same water chute contributed the big waves of the indoor ocean storm. Ocean fog was manufactured simply by spraying quantities of mineral oil against electric hot plates that vaporized the oil into fine mist.

To make sure that the antiaircraft machine guns would fire perfectly, the studio technicians fitted a spark plug inside each and valved acetylene gas into the gun barrel. Making and breaking the spark circuit exploded the acetylene gas in a realistic imitation of gunfire.

Another problem was to show bullets from a German plane ripping into the concrete gun shield. This was done, not with real bullets, but by drilling out each bullet hole ahead of time, inserting a dynamite squib in each hole, then plastering them over. Set off rapidly one at a time by electricity, the squibs gave the effect of bullets slamming into the concrete shield.

In a sea picture, of course, the ship must roll and the horizon must rise and fall. In this case both the ship and the horizon were stationary, but you wouldn't know it on the screen. The horizon shots were made by pointing the camera at big glass slides that moved up and down and on which the horizon line and clouds were painted. A

huge sun arc light, mounted on a rocker arm, provided the illusion that the ship was rolling. When the arc was swung back and forth, shadows of the ship's rigging moved back and forth on deck.

All motion pictures, of course, are illusions. Sets and backdrops are mere imitations of the real thing, usually, yet the art directors who design them use them in a subtle



Water cascading over gun inside sound stage is poured down tall chute, to give effect of heavy sea

Copyright R. K. O.



Copyright R.K.O.

Preparing to shoot a scene centered about the big naval gun on deck of ship "far at sea"—actually on studio sound stage. The five-inch gun which looks like real article cost only \$20

way to do much more than an audience realizes. Jack Otterson, art director at Universal, explains that scenery or a set can be used to help tell the story or to establish a mood which in turn will heighten the effect that the actors are creating. The art director may even distort or exaggerate the furnishings of a set to help establish the feeling of a picture.

Thus none of the settings in a *Frankenstein* picture are quite normal. They are deliberately designed to symbolize the weird and fantastic. On the other hand, in a picture of the "Boys From Syracuse" type, the art department plays around with conventional scen-

ery and treats it lightly to help provide the humorous touch. Sometimes a set, such as the office of an important man, is made larger than it actually is, just to convey the feeling of importance.

Getting a set ready for the actors and



Machine gun on studio cruiser spits real fire made with spark plug and tank of acetylene gas
Copyright R.K.O.



Filming closeup of bomb explosion for "Wake Island," Paramount's cameramen work inside their specially designed bombproof booth

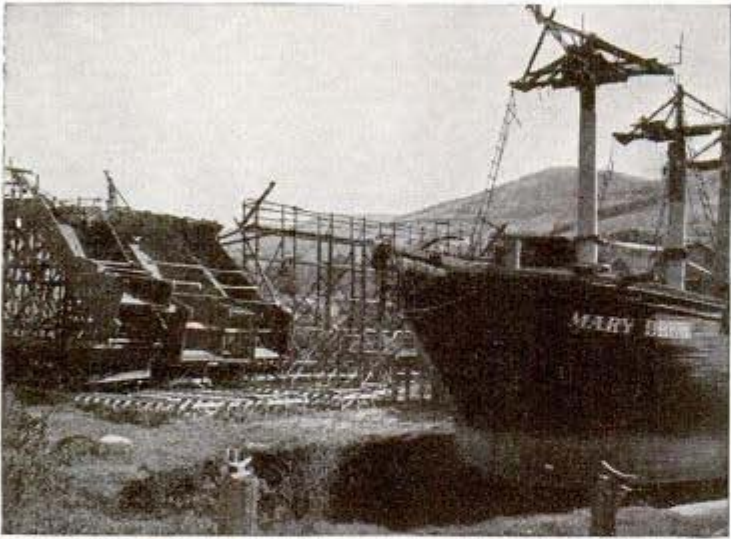

At "anchor" in Universal's back lot is this movie ship ready to buck the flood that will rush down water chutes at left. Below, adjusting the portable "windmaker" that produces South Sea hurricane or Chicago gale with its huge tunnel and airplane-type fan

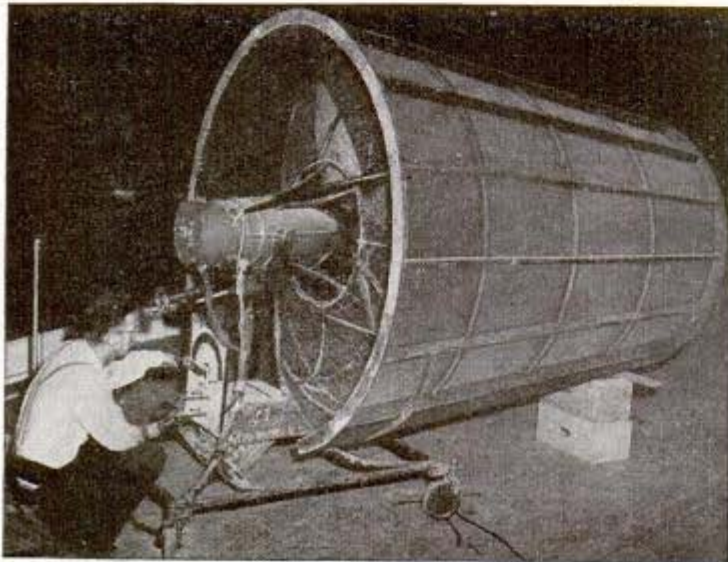

cameraman begins at the time a picture script is decided upon. First the art director and the producer break the script down into scenes, then the art department prepares sketches to show the appearance of each scene. Scale models of large, ornate sets may be built so that camera angles may be studied.

These sketches and models then go to the drafting room where actual plans are drawn. The plans show only two or three walls, braced from behind. If a ceiling is to be shown in the picture it will be made of muslin. A "hard" ceiling would bounce too many echoes back to the microphone.

Next, prints of the plan of each set are sent to the construction department and to all the other departments that will help prepare the set. A print may go to the drapery department if window drapes are needed, another print goes to the set-dressing department that will provide all the properties, such as furniture and fixtures. The plumbing department gets a print if plumbing must be provided to create a rainstorm. Fire, wind and thunder are handled by special-effects groups.

The construction department rarely builds up a set from brand-new material. It has a storehouse full of different kinds of fireplaces, for instance, and long racks of full-sized "flats" that represent various interior and exterior walls. Several of these flats, with door and window openings in the right places, may be just the ones needed for a scene after they have been repainted.

In the new Deanna Durbin picture "Forever Yours," one set consists of materials that were used in 11 previous films.

(Continued to page 158)



The CRAFTSMAN

Child's

WARDROBE

has space for toys

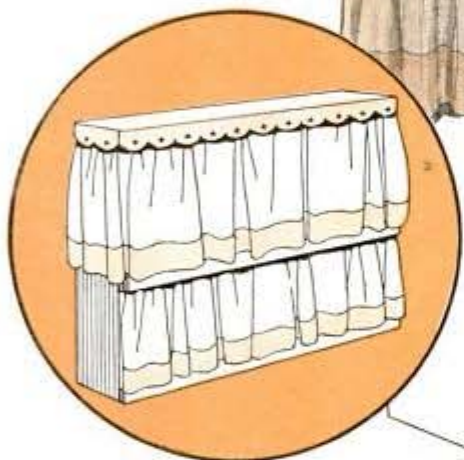

Portable "stowaway" to supplement closet-space shortage in compact living quarters. Orange crates provide pigeonhole compartments for toys below curtained wardrobe attached to wall

HERE'S a wardrobe that is of special value to families living in small apartments and rented homes, as it provides an inexpensive way to relieve crowded closet space and, being a knockdown affair, there's no problem at moving time. It can be improvised at practically no cost from a few orange crates, scrap lumber and some cloth. Whether as many as five crates can be used as shown in Fig. 1, depends, of course, on how large a wall space is available. Making the lower part is simply a matter of fastening the crates together, side by side, with strips across the top and bottom as



shown in Fig. 4, and then fitting draw curtains to the front. Note in Fig. 5 how the strip at the top is spaced with cleats to provide room for a strong cord or wire to be strung tautly between screw eyes for the curtains. Colored cardboard will do to cover the exposed ends of the crates, thus saving painting, or cloth can be used here to match the curtains.

The shelf board should be as wide as the orange-crate unit and cut a little longer than its length, so that the curtains will hang over the ends. Except where these are tacked in folds to cleats at each end of the shelf as in Fig. 2, they are hemmed to slide on a cord strung between the end brackets, after which a scalloped valance of matching or contrasting cloth is tacked to the edge of the shelf to add a finish.

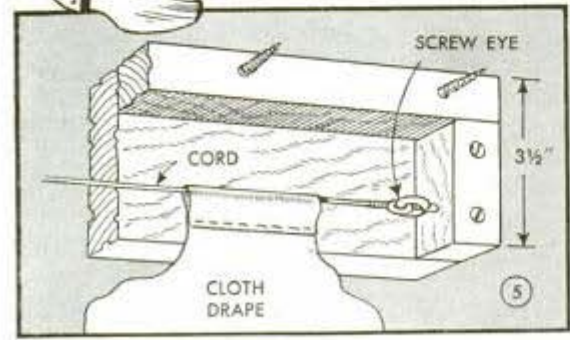
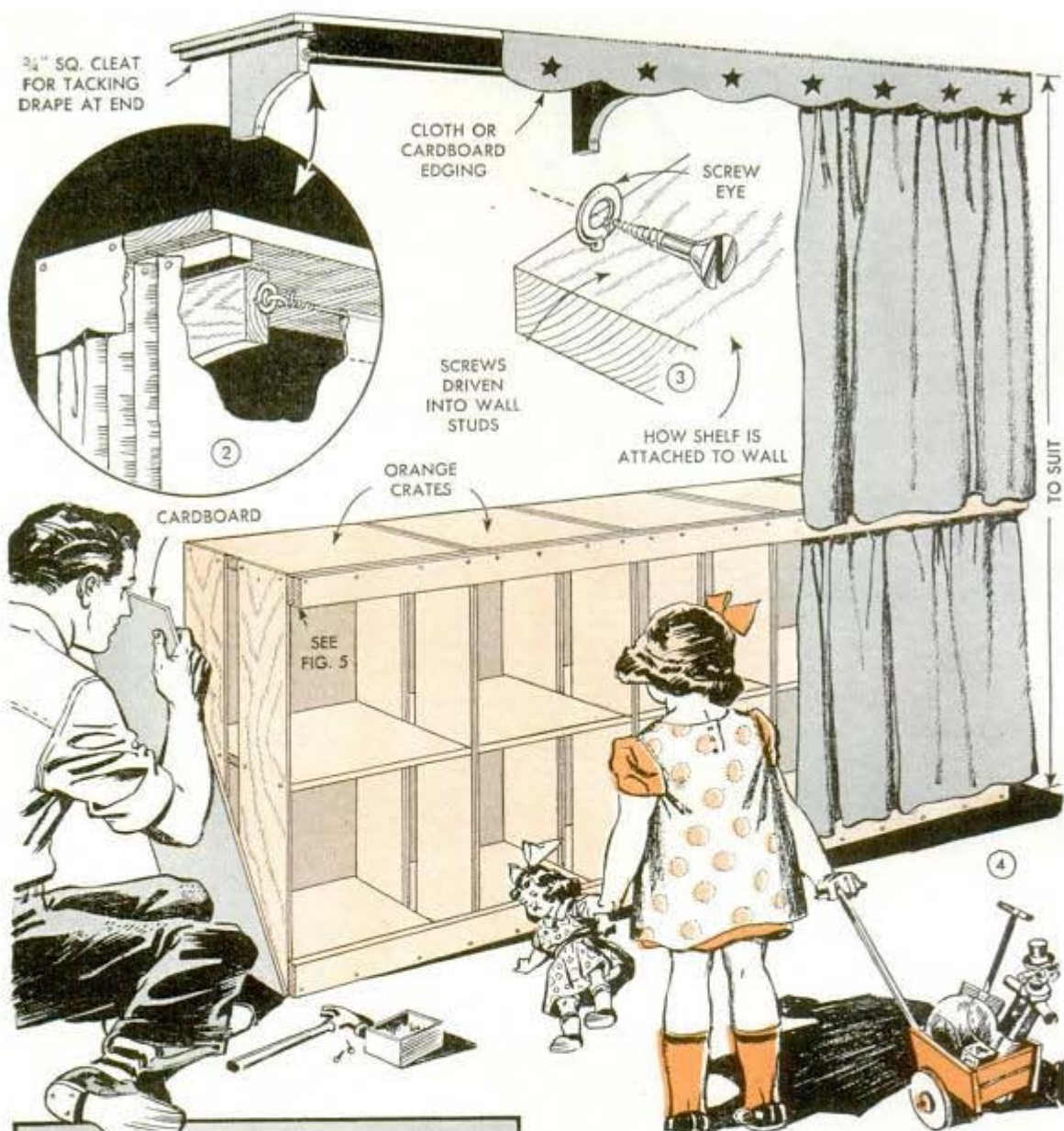

Screw eyes along the back edge of the shelf are spaced to permit screws to be driven through them and into wall studs as shown in Fig. 3. Additional support is provided by three wooden brackets which merely rest against the wall. Locating the studs is done by tapping the wall lightly with a hammer and noting where it sounds solid.

As the wall provides the back of the curtained enclosure, intervening wall studs within the space are used to support coat-hanger rods. Objection to marring the wall with these can be overcome by fastening wood strips vertically to the back edge of the shelf in which lengths of broomstick can be fitted in holes to project outward as hangers.

In rooms where there is insufficient wall space to permit using the wardrobe as shown, it could be made to fit waste corner space. Assembly would be quite similar, except of course, that the shelf board would have to be mitered at right angles over the center bracket and the orange crates assembled in an L-shaped unit to fit the corner.

Folding Legs Keep This Beach Bag Out of Sand

An excellent bag for carrying articles at the beach or while boating can be made from six wooden coat hangers, three dowels and about one yard of heavy cloth. The bag will fold flat and is large enough to hold several bathing suits, caps, a camera, sport glasses, etc. To make the bag, remove the wire hooks from the hangers and pivot four of them together in pairs with a single dowel to form the ends of the bag frame. The bottom dowel is held in place with two brass screws, one in each end, while the top two dowels, which help join the ends together, are fastened with upholsterer's tacks. Now, pin the cloth in place temporarily on the frame and mark the locations of the seams with a pencil. Then remove the cloth and

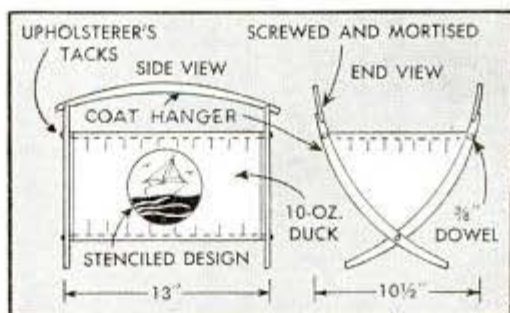

sew it to form the bag. Remove one of the frame ends from the dowels and slip the bag in place. Replace the end and mortise and screw the remaining two hangers into the upper ends of the end hangers to form handles.—G. E. Basich, San Diego, Calif.

Large Panels Are Moved Easily With Snap-on Caster Unit

One man can move large panels of wall-board, wood or other material by means of this simple caster unit, which snaps over the lower edge of the panel. The unit con-

sists of a hardwood block fitted with a caster and two pieces of flat spring, which are screwed to opposite sides of the block and bent to form a clip. In use, the unit is slipped over the lower edge of the panel near its center of balance, thus making it possible to push the panel along with ease.

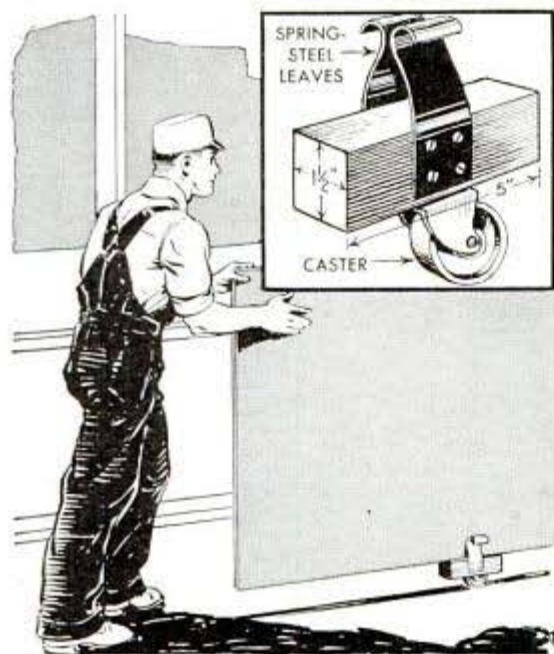

Cleaner for Pipe Smokers

You can clean and sweeten your pipes with materials from the kitchen—baking soda and vinegar. Place a pinch or two of soda in the bowl of your pipe and, as you stand over the sink, pour a little vinegar over the soda and quickly cover the pipe bowl with your thumb. The mixture effervesces and cleans the pipe thoroughly as it works through the stem. Repeat the process as often as you think necessary and then let the pipes dry.

—John B. Mitchell, Peoria, Ill.

When making peppermints, drop them onto a piece of waxed paper and they will be easy to remove when cool.

Channel Formed by Wood Strips Aids in Cutting Sheet Metal



SPACED STRIPS

If you have a heavy piece of sheet metal to cut and only a pair of light shears at hand, a channel formed by nailing two spaced wood strips to the floor or bench top will help. If one handle of the shears is placed in the channel, it will keep them from tipping when pressing down hard with one hand to operate the shears. Also, the channel will serve as a guide in cutting straight across the metal sheet.

Flying of Rod Pieces Prevented While Cutting Them Off

When a length of rod is gripped in a vise for cutting off short pieces with a cold chisel, you can keep them from flying about by using a short length of belting slit near

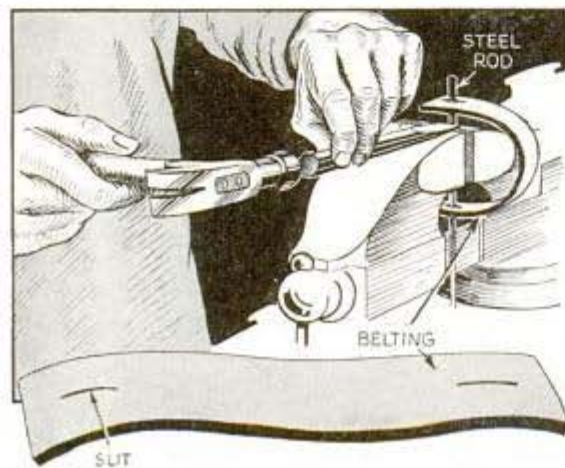

SLIT

each end. The rod is run through one slit and then clamped in the vise as indicated, after which the other end of the belt is slipped over the end of the rod to be cut.

Metal Shield for Fishing Reel Made From a Tin Can

Due to the shortage of rubber, which makes it impossible to use sections of rubber hose as protectors for fishing reels, some sportsmen are using screw-top cans for this purpose. The can is slotted along one side to slip over the reel and the cap is screwed on to hold the assembly in place.



CAN

CUT OUT

SCREW TOP

Drop Cord Kept From Slipping When Hooked Over Nail

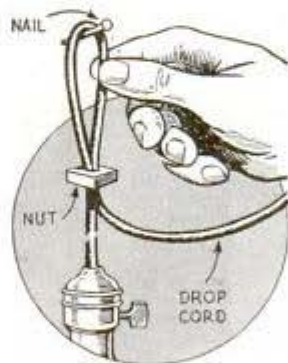

NAIL

NUT

DROP CORD

The next time you can't prevent a drop cord from slipping when hooked over a nail to keep the light in a convenient position, try doubling a portion of the cord and slipping a large nut over it, as shown.

The loop thus formed is then hung over the nail or hook to hold the light.

Repairing Chipped Enamelware

Once enamelware has become chipped, the metal underneath will rust rapidly unless it is protected. To do this, rub the metal with fine abrasive cloth until it is bright and clean. Then use a good flux and give the spot a good coating with solder. This gives added life to the ware and prevents rusting.

—John Krill, Youngstown, Ohio.



SOLDER

Colorful Dinner Gongs and Napkin Holders

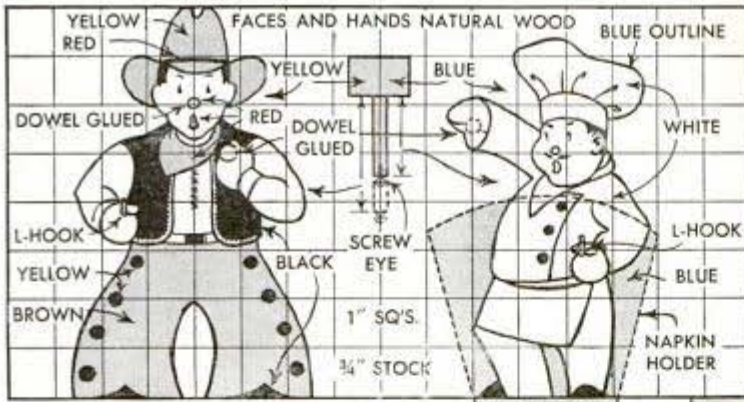

Standing pertly on round bases, with a mallet hanging from one hand and a dinner gong from the other, these gay little figures will add a touch of color to your table. If desired, they can be mounted on large, square bases and used in restaurants and tea rooms to hold napkins and menus as well as dinner gongs. Each figure is screwed to its base and has a short dowel in one hand on which to hang the gong and an L-hook in the other hand for the mallet,

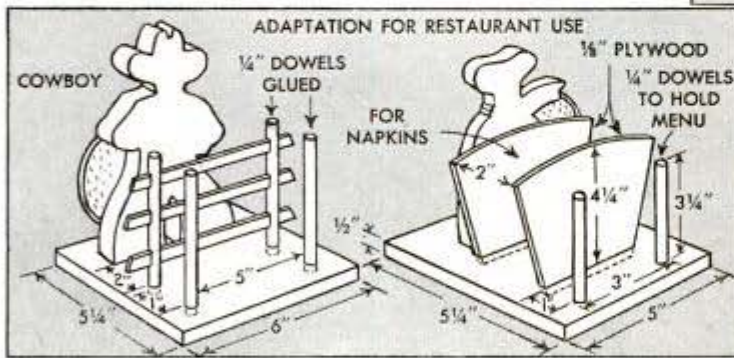

which has a screw eye in the end of the handle. The gongs are tin-can lids hammered to a concave shape, and the mallets are small wooden blocks fitted with dowel handles. On the cowboy figure, a napkin holder is provided by placing a miniature rail fence 2 in. behind the figure, while the menu holder consists of two dowels set into the base 1 in. behind the fence. For the chef, the napkin holder is made by mortising and gluing two pieces of thin wood into the base behind the figure as indicated, using two dowels to hold menus.

—R. L. Fairall, Los Angeles, Calif.

☞ To prevent cats scratching in a garden, sprinkle ground orange peel over the dirt.

Handy Stop for Garage Doors

Bent and screwed to a garage door as shown, a large strap hinge makes an excellent doorstop that can be operated with your foot. The addition of a small coil spring provides tension on the lower half of the hinge so that it will "bite" into the ground when in use. Also, this serves to keep the stop in a raised position when the door is closed.

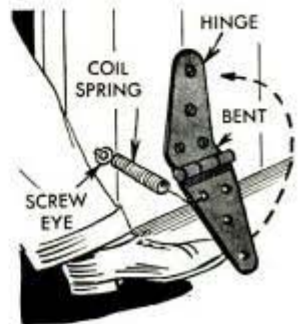

Solving HOME



1—Where coat hooks are so close to a door that garments get between it and the casing, drill two holes in the casing at an angle to take an umbrella rib, which provides a guard to prevent the trouble

2—Life of oilcloth shelf material is increased considerably by covering it with waxed paper, as this keeps dishes and bowls from sticking to the cloth and ruining the coating when they are removed

3—You can stop splashing of liquids from an electric mixer by slipping an oiled-silk or similar cover over the bowl. Of course, an opening with reinforced edges must be provided in the center for the beaters

4—The annoyance of having her silk stockings dry with streaks in them led one housewife to hang them between damp towels. This caused the moisture to evaporate evenly so that streaks were avoided

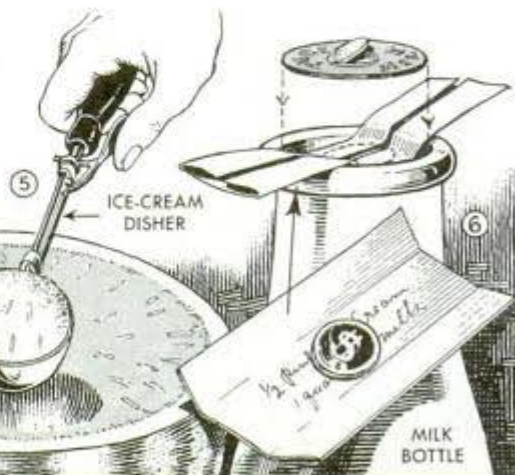

5—When serving small portions of watermelon, an ordinary ice-cream dipper provides a quick means of dishing it out in the form of small, appetizing pieces. This is much more attractive than the usual large pieces which include the rind. 6—To avoid displaying coins in a bottle set out for the milkman, fold them up in your order so that the paper can be laid across the bottle mouth and anchored securely with the cap

PROBLEMS



7—Small paper sacks are kept closed without tying them by rolling the top edges over pipe-stem cleaners and then bending the ends back. As the cleaners bend easily, they can be used many times

8—To prevent intruders from raising a window, a reliable stop is made quickly from a length of dowel, which is held in place by a pin or nail at the lower end while the top slides in a large screw eye

9—After being enameled in a variety of bright colors and strung on tape measures, empty thread spools lend themselves to additional usefulness in the sewing room by serving as tiebacks for drapes

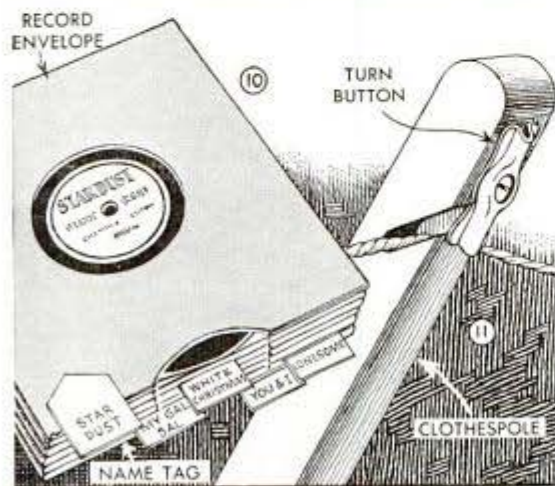

10—It's a simple matter to locate phonograph records when they are kept in individual envelopes, if each envelope is fitted with a name tag as shown. Note that the tags are spaced so they can be read easily when stacked or placed vertically. 11—If you have trouble keeping a clothes pole in place on windy days, cut a notch at an angle near the top of the pole for the line and then attach a turn button just above the notch to serve as a lock



12—To store a foiled card table in a crowded closet so that it will occupy little space, screw a door bumper to the baseboard near a convenient corner and slip the table between the bumper and wall

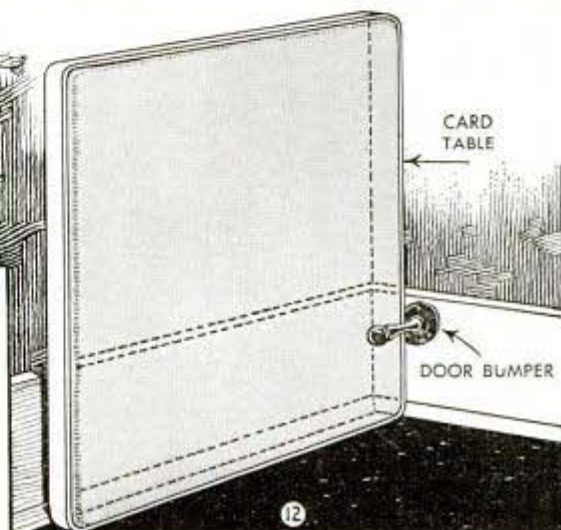

Oilcloth Envelope on Clip Board Stores Extra Papers



Shipping clerks and others who have use for a clip board will find that a large envelope or pocket made from oilcloth and fastened to the back of the board is handy for storing extra papers. This is especially true when invoices, bills, etc., are clipped to the board as they can be removed and slipped into the envelope as the items on them are checked off.

Window Shade Put on Top Sash To Prevent Damage by Wind

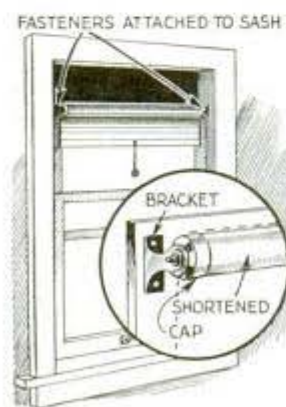

If you are in the habit of lowering the upper sash of a window to provide ventilation, mount the shade on the sash and it won't be damaged by the wind. To do this, you will have to put the shade brackets on the sash and shorten the roller to suit.

When shortening the roller, remove the cap and nail at one end, saw off the required length and then replace the cap. Be careful to saw straight so that the end of the roller will be square, otherwise the roller will not turn true between the brackets.

—Wm. L. Matthews, Kansas City, Mo.

How the Whatnot Tier Is Made

There's a corner in your living room waiting for this beautiful whatnot tier, which will show your favorite curios to excellent advantage. Needless to say, walnut, mahogany or cherry should be used for such a piece and finished with extra care. The manner in which it is put together assures exceptional sturdiness, as the slender uprights are not only glued and nailed securely in notches but are strengthened further by a molding on each shelf. All seven shelves are exactly alike, each having a tenon cut completely around it and a notch at each corner. The tenons can be cut on a saw if you do not have a shaper. In making the feet for the base, first draw a pattern, following the shape indicated by the dotted lines, and trace around it on one face of four 2 x 2 x 4 $\frac{1}{4}$ -in. blocks. Before this is sawed, the mortises in adjacent faces for the rail tenons should be cut. After sawing, tack the waste pieces back onto the block and trace the pattern in a reversed position on the face adjacent to the one just cut. Make sure, before cutting the second profile, that the nails holding the waste pieces are not in the line of cut. Follow the above procedure in cutting each foot and then sand them smoothly. The length of the rails should be cut to bring the feet even with the outer edge of the tenoned shelf.

Economy in laying out the scalloped uprights will be had by nesting the pattern as closely as possible, leaving sufficient space to saw apart. Bandsaw them carefully to line, with the table at right angle to the blade, and afterward draw a centerline down all four edges of each member, as represented by the dotted line. These serve as guide lines in sawing away the corners with the table tilted 45 degrees, as shown in the photo at the bottom of the opposite page. By sawing a little to the right of the line and giving the blade plenty of time to make each cut, the sanding required to remove the saw marks will not reduce the size of the pieces appreciably. Complete the job by attaching the uprights to the shelves in the manner shown in the circular detail, and screw the base from below to the bottom shelf. If you like, a narrow scalloped railing can be added to the top shelf as shown in the photo. This is mitered at the corners and kept even with the shoulder of the molding.

Graceful WHATNOT TIER

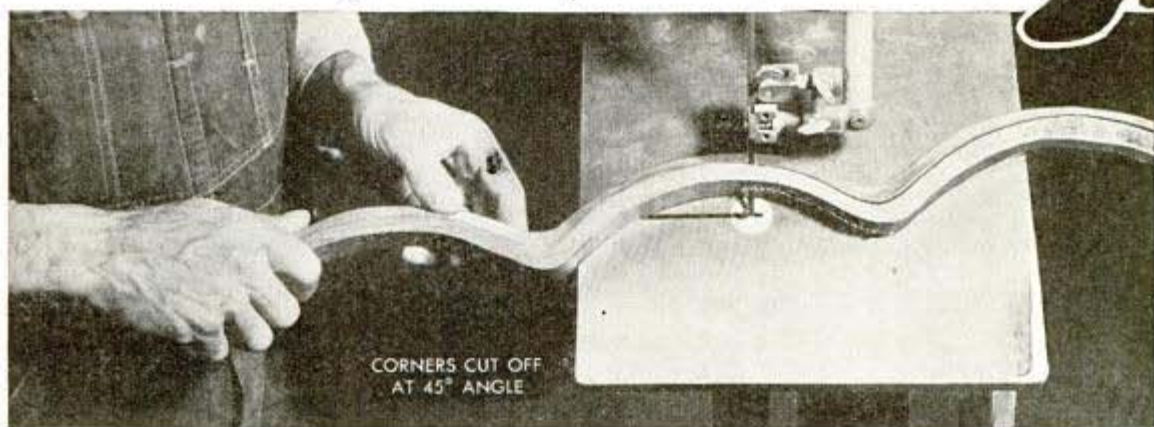
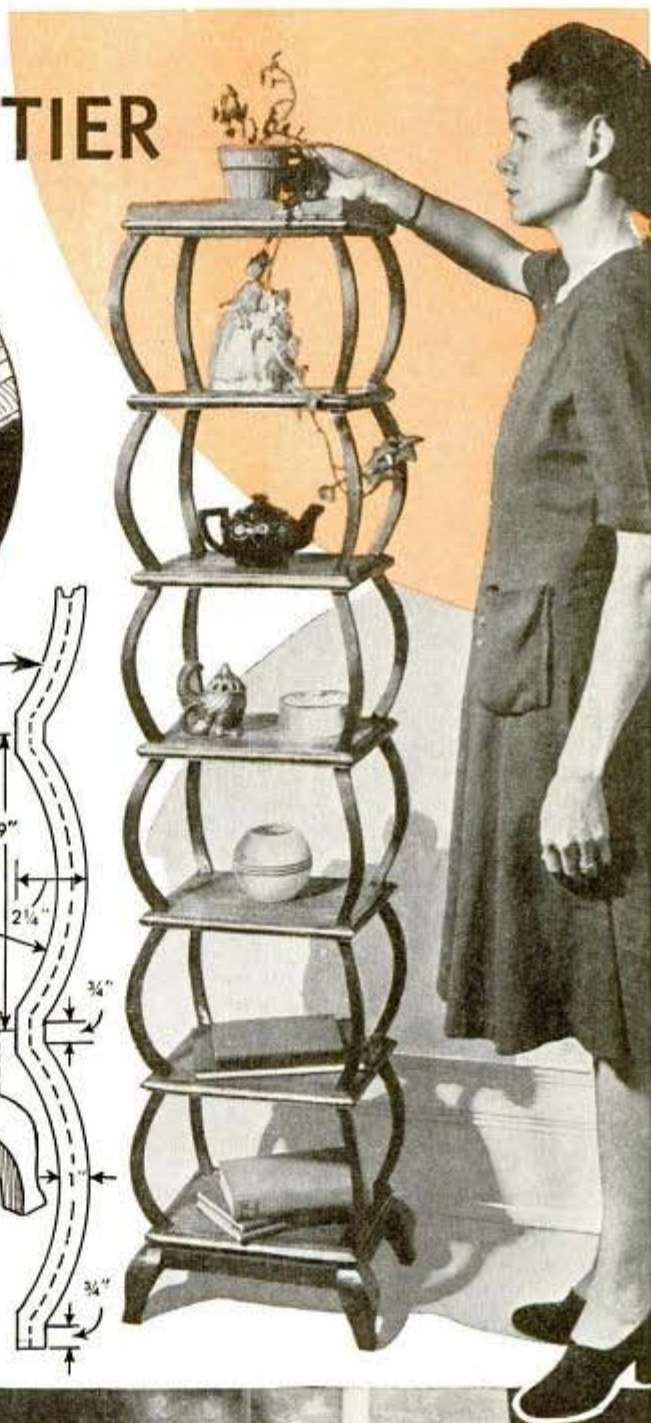
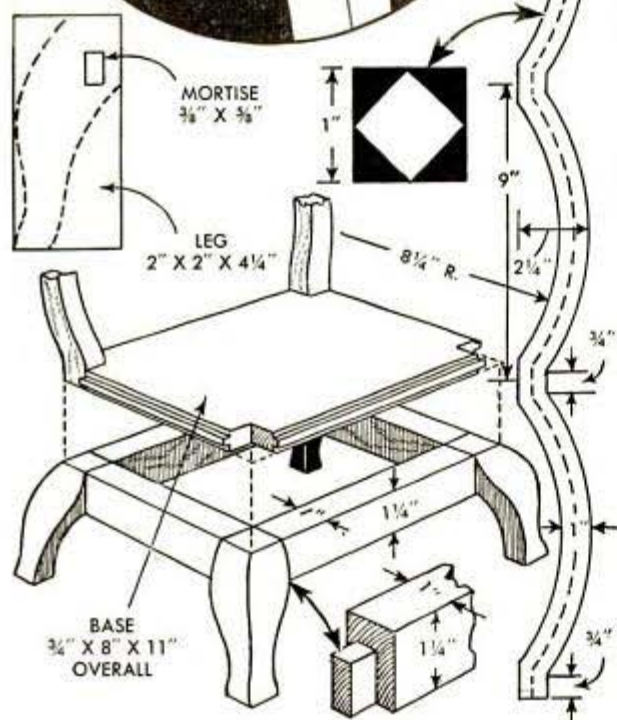
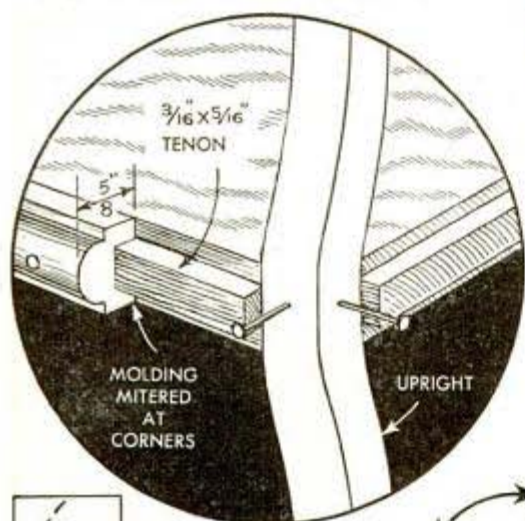

Clamp Prevents Pinching of Saw When Cutting Plywood Panels



When cutting a large panel of plywood, the severed edges can be prevented from pinching the saw by using a large paper clamp. After you have sawed into the panel a sufficient distance, the clamp is slipped over the edge of the panel so that it grips the wood on both sides of the saw cut, as shown in the detail.

—G. E. Hendrickson, Argyle, Wis.

Colored Adhesive Strip in Shoe Aids Small Child in Dressing



As a help to small children when putting on shoes, a colored strip of adhesive tape is put inside the shoe for the right foot. As a child that is right handed usually will try to put a shoe on his right foot first, he is simply taught to put the marked shoe on first. The tape may be colored with ordinary crayon and should be placed in the shoe where the child can see it easily.

Basting Cloth Without Pins

Cellulose tape often can be used for basting and arranging cloth to be sewed on a machine. First, however, a test should be made to see that the cloth will not be damaged when the tape is removed. This

method saves considerable time and is better than pinning, as the pressure foot of the sewing machine will ride over the tape.

—A. L. Mills, Chicago.

Sinker "Clamped" to Fishline

To attach a lead sinker to a fishline so that it can be held at any point on the line without using knots, one fisherman cuts the sinker half-way through at the center so that it can be opened like a hinge. The line is passed through the sinker loops, drawn through the cut and the lead closed over it.



Screw Hook in End of Yardstick Assures Accurate Measuring

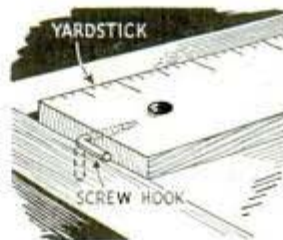

You can hold the end of a yardstick flush with the edge of boards for accurate measuring by driving a small screw hook into the end of it as shown. In this position, the hook can be turned parallel with the yardstick so it will be out of the way when not in use, or it can be removed entirely when taking inside measurements.

Small Clamps for Modelmakers From Inexpensive Earrings

When a light clamp is needed in gluing balsa strips, modelmakers will find ten-cent earrings suitable. They require no altering except to remove the ornaments.

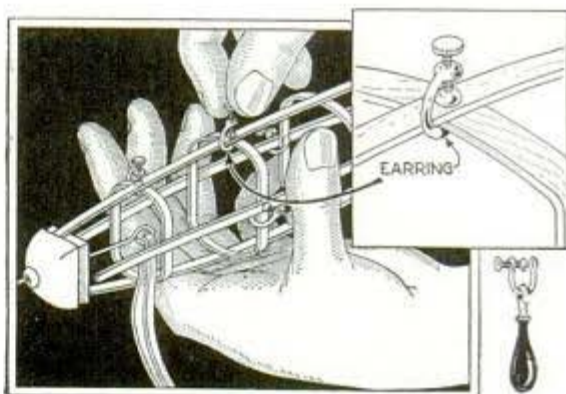

Several Children Play on Multiple Game Board

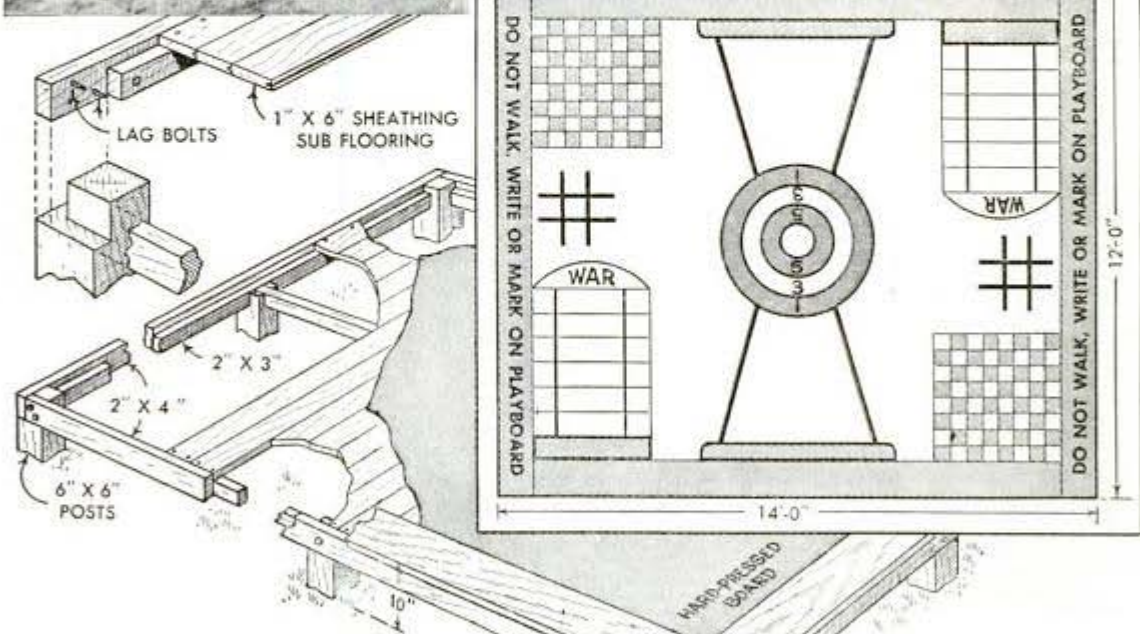

Set up in a playground in Union, N. J., the outdoor game board shown in the photo has painted on it several games of the type children usually mark off with chalk and play on streets and sidewalks. As more than sixteen can play at one time, the board has served in keeping them off the streets in a safe place. Such a board can be made as shown in the detail. It is built on creosoted posts, and consists of a 2 by 4-in. framework supporting a subfloor of 1 by 6-in. sheathing, which is topped with a covering of hard-

pressed board. A border of 1 by 10-in. boards provides seats for the children while playing. All joints and abutting surfaces should be set in white lead to help keep out moisture. To avoid splinters, all wood that the children come in contact with should be sanded, and the entire assembly should be painted. The subfloor should be painted before applying the hard-pressed-board top.

—Edward Biertuempfel, Union, N. J.



OLD BEDS go MODERN



SMART "Hollywood" styling in beds that has become popular involves the use of a box spring and mattress set on four or six short legs. The usual footboard is eliminated. In most cases the headboard is quite simple, often being a separate piece of furniture, such as the compartment headboard style in Fig. 7, which houses a small radio, books and has cabinet space for other items. Beds of this style are easily made from older beds provided the spring and mattress are in good condition.

In making the conversion the first job is to box the spring. The conventional platform spring has an iron rail all around the bottom, and this serves as a mounting for a wooden framework, as detailed in Fig. 1. The exact method to be followed in mounting the framework depends on the spring construction. The more common method of working, applicable to almost any style of spring, is to use a hardwood frame, as shown in Fig. 2, which is fastened in place by means of pieces of angle iron or wood blocks. A $\frac{7}{8}$ -in. hole should be bored in each corner to take the legs and if six legs are to be used, holes should also be drilled midway on each long side. Then the spring is ready to be covered with 10-oz. cotton duck or other suitable material. This is tacked to the wood at the bottom as in Fig. 4 and it should be sewed all around the wire edge of the spring at the top, as shown in Fig. 3. Two layers of felted cotton are applied over the cloth foundation, and then the casing material is stripped in place and tacked all around as in Fig. 5. The cotton should be applied

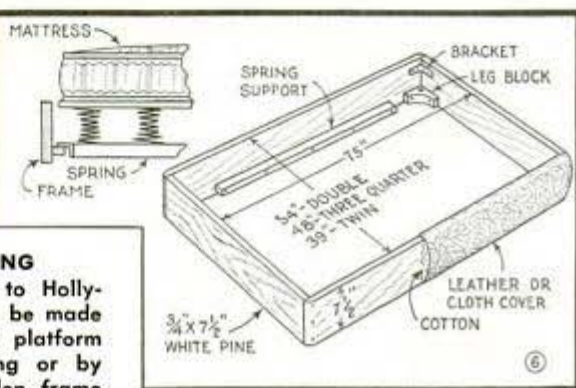

START WITH THE SPRING
Box spring essential to Hollywood bed styling can be made from conventional platform spring by upholstering or by using a simple wooden frame



with the spring right side up. The casing is slipped in place and temporarily tacked in several places, after which the spring is turned over on the floor for final tacking. The casing itself is not difficult to make, but if desired this part of the work can be turned over to an upholsterer. It should be 2 in. wider and longer than the spring, with sidewalls of sufficient depth to turn over and tack to the wooden frame. The cloth is standard mattress

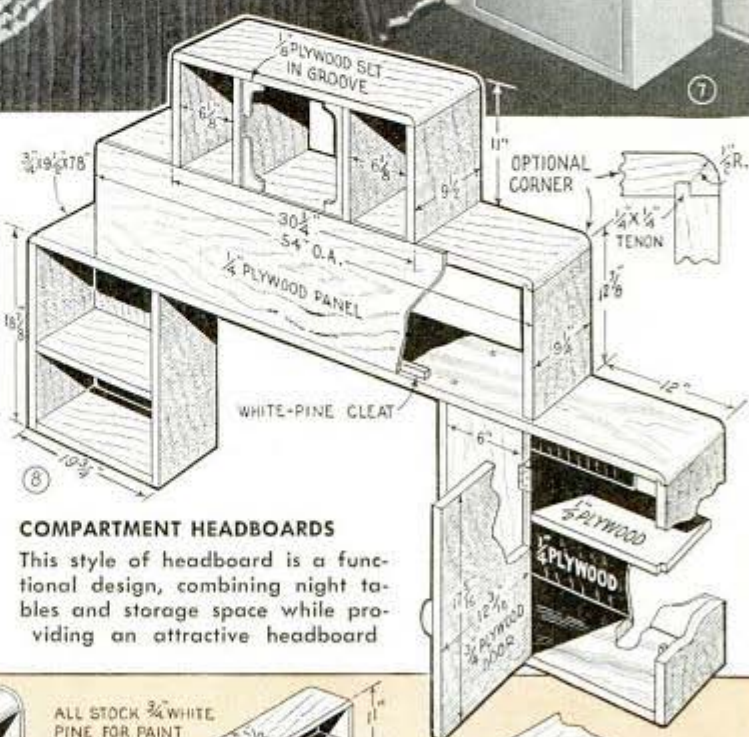

COMPARTMENT HEADBOARDS

This style of headboard is a functional design, combining night tables and storage space while providing an attractive headboard.

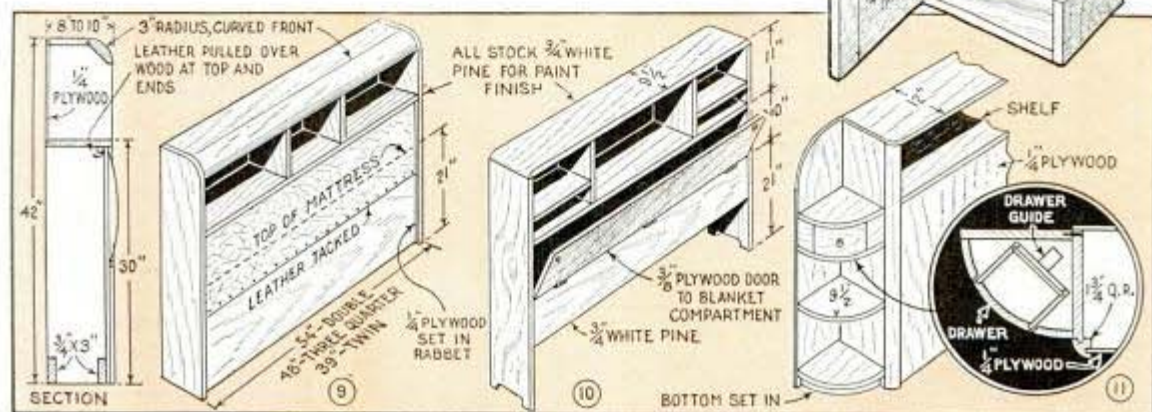

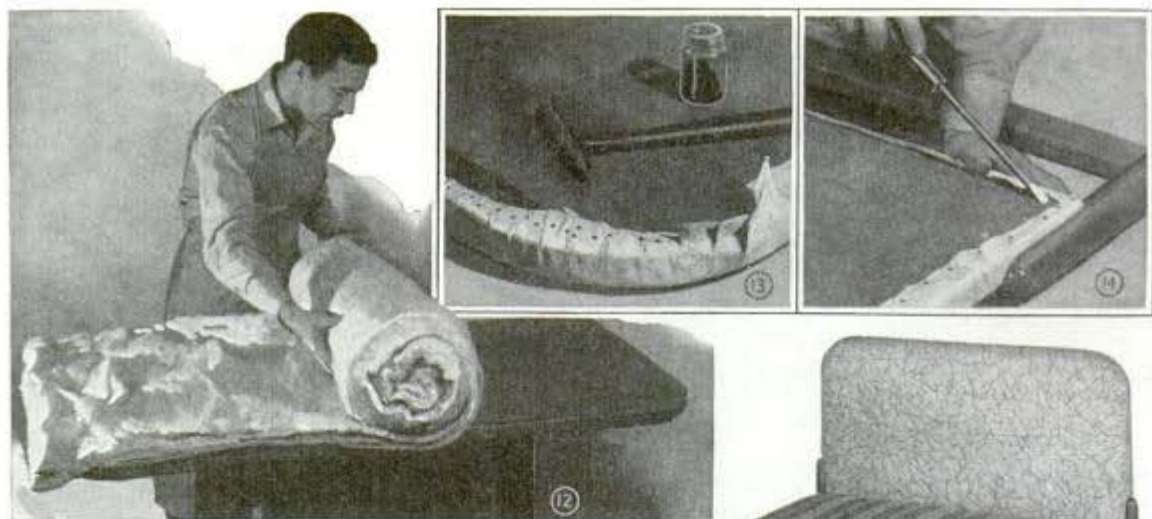

COVERED HEADBOARDS

Artificial leather in white, blue or cream color over $\frac{3}{4}$ -in. plywood makes an attractive headboard. Cloth, quilted or buttoned, also is attractive and can be used to advantage for matched units of bedspread, headboard and bedroom drapes

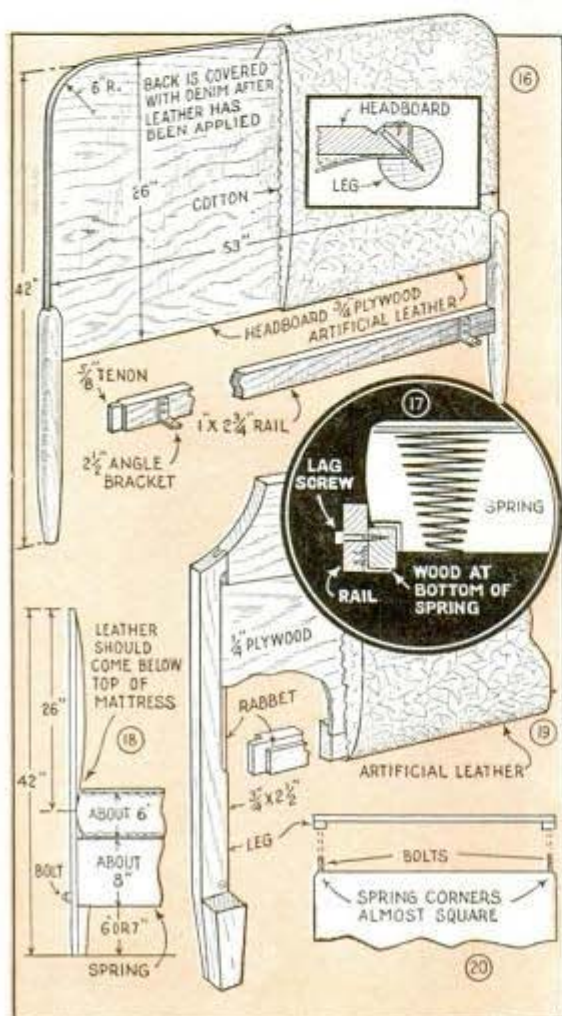

ticking, obtainable in a number of different colors and patterns. Finally, the open bottom of the spring is covered with inexpensive black cambric as a dust seal. Upholstering can be eliminated entirely by boxing the spring with wood, as shown in Fig. 6, but the wood can be covered with felted cotton and imitation leather or cloth if desired. The bed is completed by fitting four or six short legs in holes provided in the framework, although, if the framework is wide enough, the legs may be omitted.

Compartment headboards are good functional design and easy to make. Fig. 8 gives the details of the one shown in Fig. 7. It is made from $\frac{3}{4}$ by 10-in. white pine with glued and nailed joints and a lacquer finish. The bed is pushed up against the headboard to complete the ensemble. Other ideas for compartment headboards are shown in Figs. 9, 10 and 11.

Leather- or cloth-covered headboards are attractive, and often the lumber in the old headboard can be utilized. The work is quite simple—a slab of wood, then a layer of cotton, Fig. 12, and finally a cloth or leather cover. If the top of the headboard is rounded, the corners can be turned with minimum wrinkling by cutting the leather

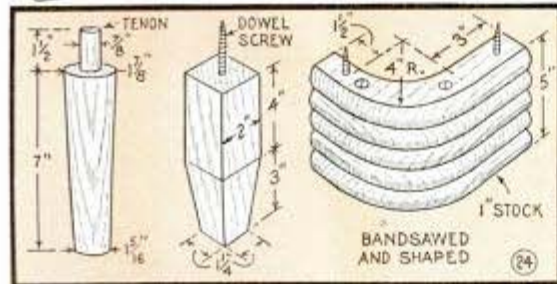
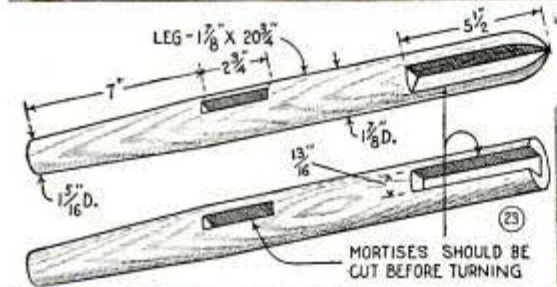
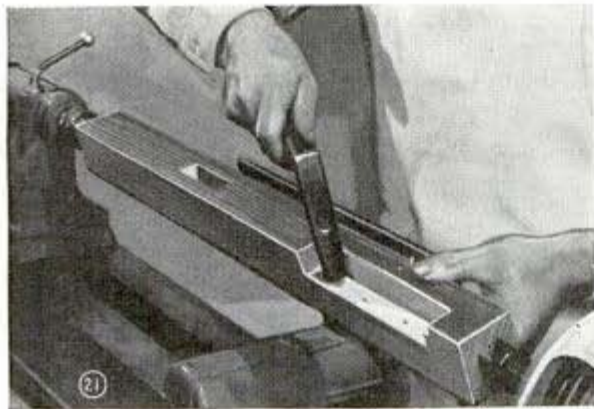

LEG STYLES

Stub legs should be 6 to 7 in. long to provide a mattress height of approximately 20 in. They may be round, square or built up from bandsawed pieces

general dimensions for this type of bed.

Stub legs may be round or square with a slight taper at the bottom, as shown in Fig. 24. The simplest method of mounting is to use a drive-fit tenon. If you have taps and screw boxes for cutting threads in wood, it is worth while to thread the tenons so that the legs can be removed. A less sturdy but quite satisfactory type of screw-on leg can be made by fitting the leg with a 2½-in. No. 10 dowel screw. The shaped type of leg shown in the right detail of Fig. 24 is very attractive. The sections are first bandsawed, then shaped and screwed together. Screws countersunk from the underside fasten the leg to the bed frame.

Two styles of round headboard legs are shown in Fig. 23. The top turning has a quarter section cut out to take the headboard, while the bottom design is grooved to take the headboard. In making turned legs with cutouts of this kind, the mortises should be cut while the work is in-the-square. In turning the pre-cut work, it is necessary to protect the leading edge of the cut by tacking a strip of wood in place as shown in Fig. 21. In turning a pair of legs, Fig. 22, calipers are used to check diameters so the legs will be duplicate turnings.

into tabs, as shown in Fig. 13. If the headboard has a panel set in a framework, it may be necessary to remove the framework to permit covering the panel, after which the framework is again fitted in place. Widening of grooves and rabbets may be necessary. In Fig. 14 the legs and cross rail had to be removed temporarily. Almost all headboards supply legs at the head, while the foot (and center if desired) is fitted with stub legs as before. Fig. 15 shows the box spring attached to a leather-covered headboard. Fig. 16 gives the essential dimensions and construction for this bed. Angle brackets at the cross rail provide support for the spring, but rigidity is obtained by means of the lag screws fitting through the rail and into the spring framework as shown in Fig. 17. The legs are detailed in Fig. 23. A similar style but in built-up construction is shown in Fig. 19. The leg style shown here also provides a land for the spring, which should be made with almost square corners at the head end, Fig. 20, to fit properly. Fig. 18 gives

Wheelbarrow Serves as a Dolly In Moving Small Boat



HANDLE SLIPPED THROUGH RING IN GUNWALE

For moving a boat a short distance to and from a beach, one sportsman attaches rings to the gunwales of the boat to slip over the handles of a garden wheelbarrow. With this arrangement, the inverted boat can be lifted at the stern end and wheeled easily.

Wire Makes Portable Sprinkler From Your Lawn Hose



It is a simple matter to convert your lawn hose into a portable sprinkler by bending a piece of heavy wire to support the hose in a vertical position as shown. The loop and hook bends in the wire

hold the hose so that it may be moved easily to different locations on the lawn.

Individual Markers When Several Persons Read the Same Book

Members of our family often read the same book over a given time and sometimes experience trouble because one or two of the book markers become dislodged. To avoid this, we now use three cards of different colors. A lip is cut in each card

so that it fits over a page of the book to keep it in place. On the edge projecting from the book, the person's name is printed as an aid in instant identification.

—W. F. Messenger, Ballston Spa, N. Y.

Hinged Tag on Laundry Case Reverses to Change Address

A reversible label to facilitate mailing a laundry case can be made by hinging an ordinary shipping tag to the case with a piece of adhesive tape as shown. In this position,

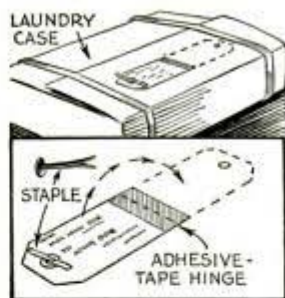

the tag can be swung from right to left to show the desired address. Holes through the case take a stationery staple which holds the tag in the desired position.

Coat Hanger Holds Lawnmower Against Wall in Garage



To keep your lawnmower from rolling when stored against a wall, twist the ends of a wire coat hanger and bend the resulting loops down. These are then slipped over the mower handle and the hanger is hooked on a nail.

Test Tubes Cleaned Thoroughly With Shoe-Polish Dauber

The problem of cleaning the inside surfaces of test tubes was solved by one chemist who used a shoe-polish dauber. It is just about the right size for most tubes and, when charged with a suitable cleaning material, will enable you quickly to remove stains and residue from the glass.



Rifle Target Bundled Easily to Fit in Car Trunk

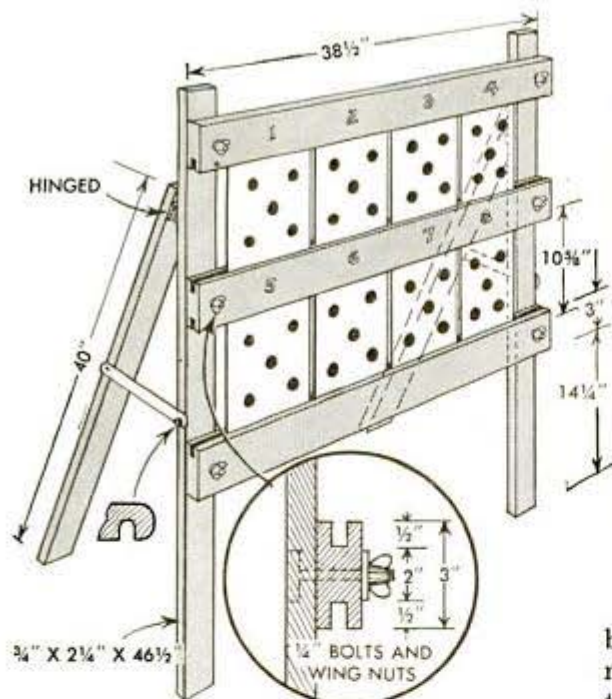

Ideally suited to anyone who wants an outdoor target frame, this one can be dismantled and bundled to store away or put into a car trunk. The frame consists of three crosspieces and two vertical mem-

bers fastened together with bolts and wing nuts and supported by a hinged brace. The targets slide between the crosspieces in grooves and are backed by heavy cardboard to stiffen them. A dull black finish on the frame prevents light reflection and helps to make the targets stand out clearly.

—W. C. Thayer, Sr., Latrobe, Pa.

Simple Hand Transit Made From Carpenter's Metal Level

By sawing an inexpensive metal level in half and pivoting the two parts together at one end with a machine screw, you can make a transit with which to determine the heights of objects, such as chimneys, flagpoles, etc., where extreme accuracy is not important. To use the transit, stand a known distance from the object and hold the lower arm of the transit a known distance above the ground. Sight along the top arm to the point, the height of which is to be determined, keeping the lower arm in a horizontal position by means of the level. Then trace the two sides of the instrument on paper and complete the lines of a right triangle as indicated. Knowing the lengths of the horizontal and vertical lines of the triangle and also the distance from the object, you compute the unknown height, adding to this the height of the transit from the ground. The horizontal and vertical lines of the triangle are proportional to the horizontal distance to the object and its height, respectively.

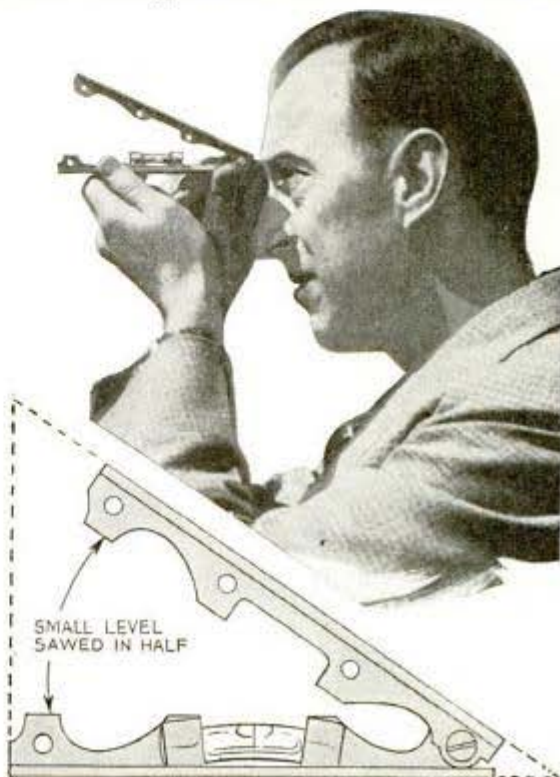

Getting the most from

By Thomas P. Lake

Important shortcuts that good sailors use automatically and the novice should master. Tells all about location of pivoting point, fullness of sails, trimming, and how the helm is a clue to sail balance

THERE are many shortcuts in getting the most from your boat, whether it is a 10-ft. dinghy, a 40-ft. racing sloop or a 50-ft. heavy cruising type. First in importance is the fullness of a sail, for if it is either as flat as a board or as full as a sack of flour, best results in sailing cannot be obtained. A sail gains power by causing the air to flow past it in smooth lines; air

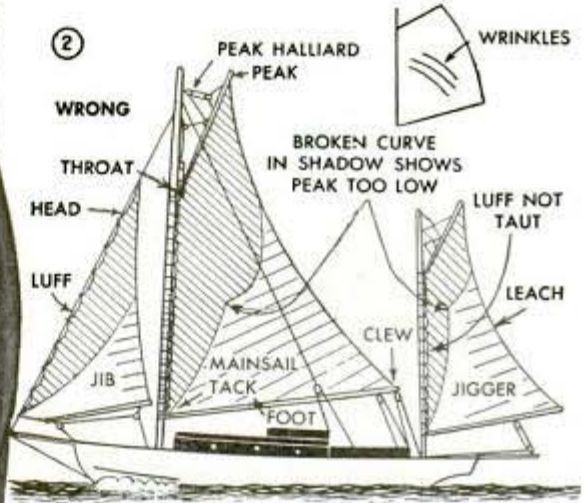
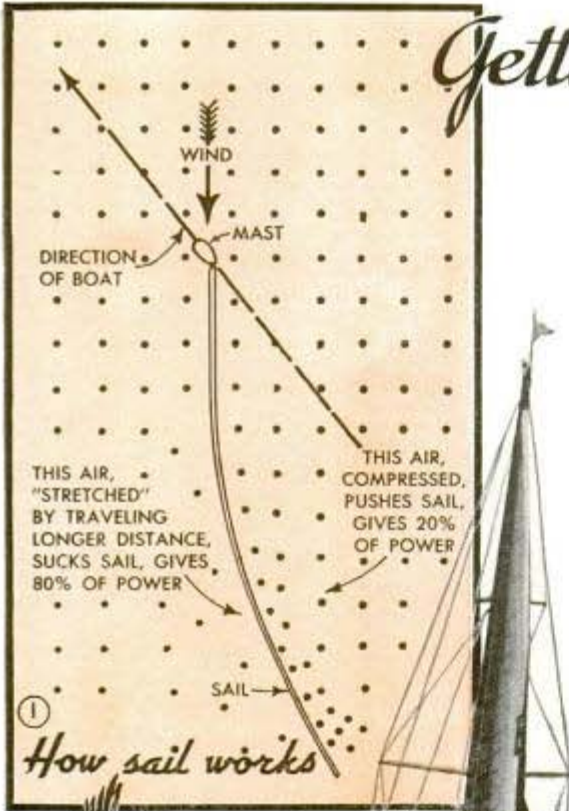

THESE ERRORS REDUCE POWER 50%

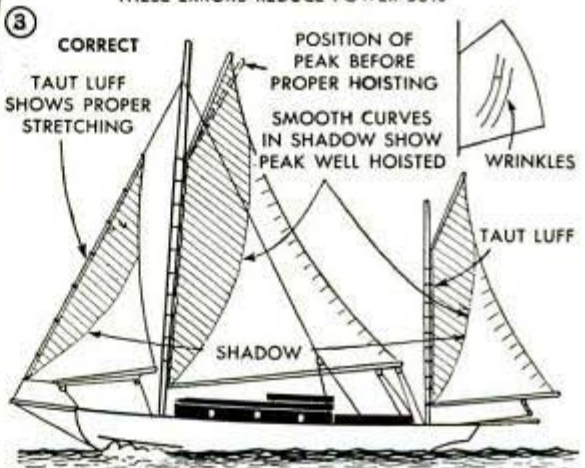

OBSERVE THESE POINTS TO GAIN FULL POWER

YOUR BOAT



on the leeward side (side away from the wind) travels a greater distance than that on the weather side (side toward the wind), as illustrated in Fig. 1. The leeward air is "stretched out" when it passes along the sail, and is at a lower-than-atmospheric pressure. The sail, in trying to move into this low-pressure area, transmits its pull to the boat. The air on the weather side is slightly compressed and adds its small effort to the total effect. The weather side supplies about twenty percent of the total, while the leeward side supplies about eighty percent.

Although the fullness of a sail is cut and sewed into it by a sailmaker, the sail must be set properly if it is to take its correct shape. This is especially true of a gaff-headed sail (sail with the gaff or spar at the head or top portion of sail). The shadow of the mast on a sail provides a good clue to how well a sail is hoisted. Fig. 2 shows a small cruising yawl with poorly hoisted gaff-headed sails. The broken curves indicate hard spots (taut areas), which break the smooth flow of air across

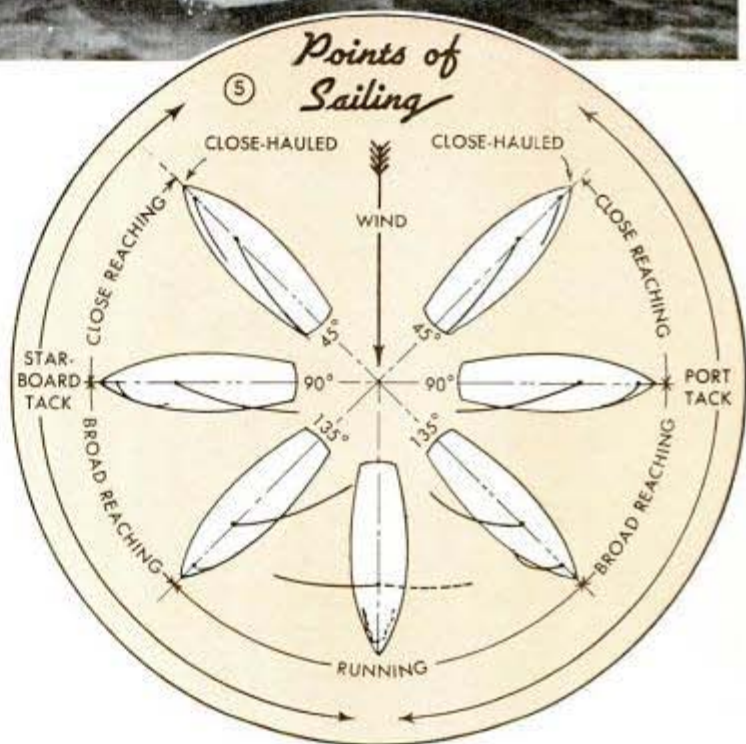

the sail, both windward and leeward as well. Such hard spots tend to cause little eddy currents that prevent the proper air flow over the sail and reduce its power. The smooth curves shown in Fig. 3 are the sign of well hoisted sails. Jibs (triangular sail forward of the foremast) and marconi mainsails (without a gaff) must be set properly also, and the shadows will help in determining this. Avoid hoisting a sail or stretching its foot (lower edge) any more



than just enough to make it set smoothly, free from wrinkles.

Fig. 5 gives the correct terms for the points of sailing. A close-hauled boat is sailing as close to the wind as is possible with advantage. When she is not as close to the wind as possible, even though only a few degrees from it, she is said to be close-reaching. When the wind frees (moves aft as seen from the boat), the reach changes from close to broad, and when the wind comes over the quarter (45 degrees

CAMBER — 1 FT TO 20 OR MORE
FLAT SAIL BEST IN HEAVY WIND

CAMBER — 1 FT IN 10 OR LESS. HAS GREAT DRIVE, AND MUCH DRAG
FULL SAIL BEST FOR RUNNING AND BROAD REACHING

CAMBER — 1 FT IN 15. HAS GREAT DRIVE AND LITTLE DRAG
MODERATELY FULL SAIL BEST FOR BEATING AND GENERAL USE

⑥ Judging sail fullness



⑦ Measuring sail fullness

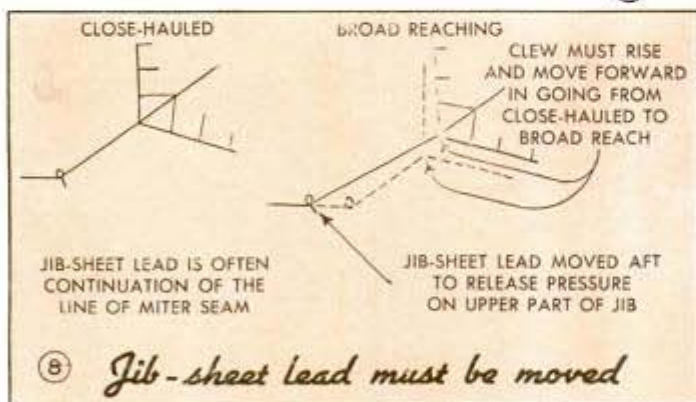

from astern), or from astern (over the stern), the boat is said to be running (going with the wind).

While there is wide difference of opinion concerning the fullness of sails, most American sailors seem to prefer a curve in a horizontal direction, with a depth of about 1 ft. in 15 ft., as indicated in Fig. 6. This curve is the camber of the sail. The fullness of a mainsail can be measured as shown in Fig. 7. If a mainsail is too flat, it can be given more camber by easing the outhaul (line to haul the corners of a sail to the end of a boom or gaff) and distributing slack of a few inches throughout the length of the foot. This is especially valuable when broad-reaching or running, and the results are well worth the trouble if such a course is to be held for even a short time. A flat mainsail is good for heavy weather because it is not efficient; there

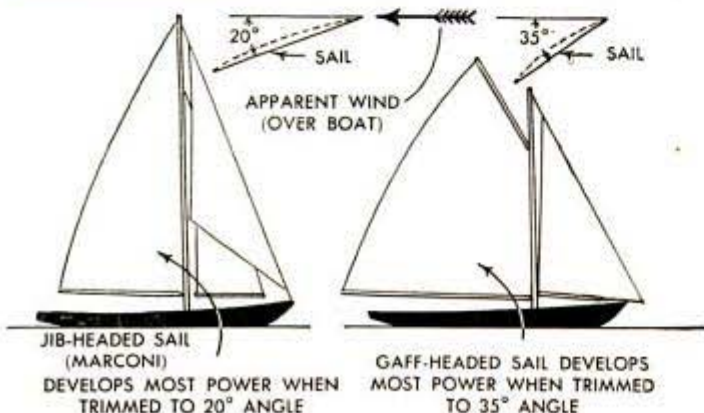

⑧ How mainsail is trimmed

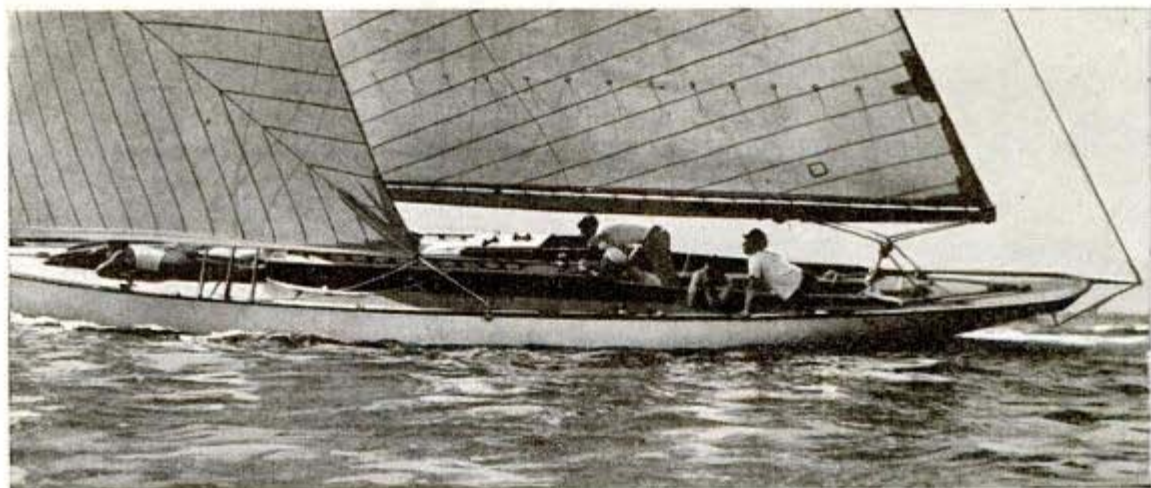

is then a surplus of wind and high efficiency is not desired. A flat sail may require less luffing (slight shaking while spilling wind out of sail) to enable the boat to stand up to the wind. A gaff-headed mainsail requires different trimming than a marconi mainsail as explained in Fig. 9. The angles given are for apparent wind (the angle made by the wind over the moving boat); not for the true wind.

The draft (air flow) of a jib can be altered by shifting the jib-sheet lead in combination with trimming the sheet. The effect of moving the lead is shown in Fig. 8. When close-hauled as in Fig. 4, the lead should be in its forward position in order to distribute more strain to the upper portions of the jib and to make it set somewhat flatter. When reaching, however, the mainsail twists much more than it does when sailing close-hauled, and the jib must be allowed to twist to match it. If the lead is not changed, the jib backwinds the mainsail (blows against its leeward side) unless the jib is eased off (sheet slacked) until the lower portion is not pulling properly. To obtain the twist without slacking away too much on the sheet, the lead is moved aft 2 or 3 in. on small boats and up to 2 or 3 ft. on larger ones. Fig. 10 shows how the jib must be matched to the angle of the mainsail at various heights above the deck for close-reaching and broad-reaching. Accuracy in following these directions will help to increase the speed of your boat.

Probably the least understood factor in good sailing is the location of the pivoting point or center of gravity, which should be about under the center of buoyancy. In loading a boat, serious changes may occur.

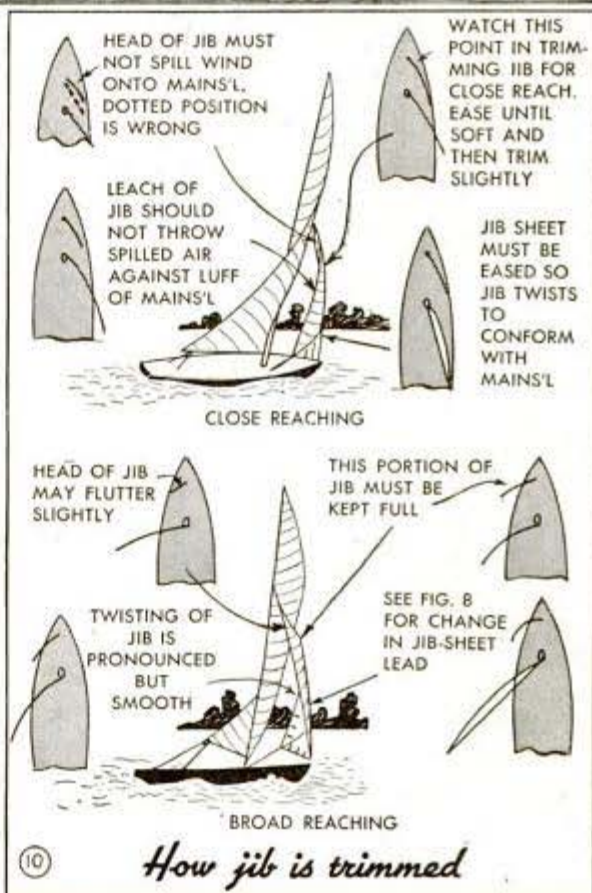

The center of gravity may be moved forward or aft by such things as installing a larger motor than was intended in the design of the boat, the addition of a larger water tank, the placing of food stores, the stowage of luggage or spare sails, etc. Fig. 12 shows the effects of correct and incorrect ballasting. The top details show what happens when there is too much weight at the stern, the center details show effects when ballast is too far forward, and the lower details show results with a correctly balanced boat. You can determine the pivot-

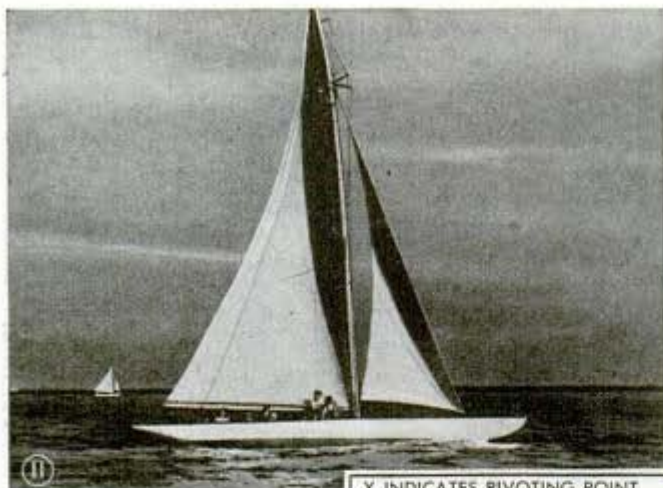

can be eased off slightly until only the jib is closely trimmed. The jib may be considered as being too weak to balance the mainsail, and the latter must be eased as the jib is actually well trimmed and working. Otherwise, the entire balancing force must come from the rudder, which comes into play when the tiller is held to the weather side.

There are times however, when a slight amount of weather helm is of great advantage. Fig. 16

ing point by looking across the deck and moving forward and aft until the point about which the boat seems to pitch is located. It is usually best to determine the pivoting point of a boat in a somewhat choppy sea. If the pivoting point is about one-third the length forward from the stern, the ballast is approximately correct. Fig. 13 shows the effects of various pivoting points on a small boat. Also, with proper weight distribution disturbing sail motion is reduced.

In the photo, Fig. 11, you can see a comparatively large bow wave. This large wave exists only on the lee bow, for the weather bow wave is much smaller. Fig. 15 shows how the bow shape of most boats produces a larger bow wave on the lee than on the weather side. The lee bow wave becomes in effect a large roll of water which tends to force the bow to turn into the wind and this wave becomes more pronounced as the angle of heel is increased. For this reason a squall, which heels a boat considerably, can be expected to create a very heavy weather helm quickly. Unless the thrust of the lee bow wave is met with an equal thrust at the stern, (from the rudder), the boat will turn to weather. Under such conditions however, the mainsail

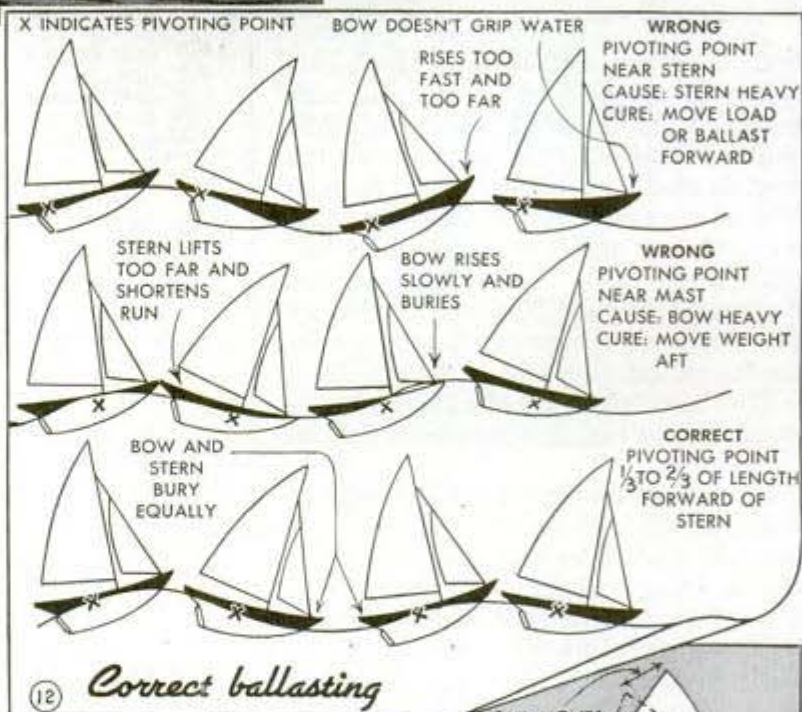

12 *Correct ballasting*

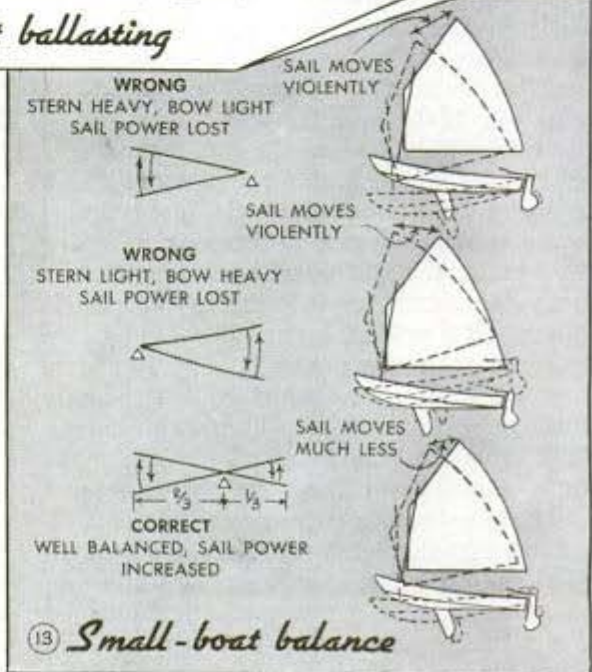









13 *Small-boat balance*

shows two common types of sailboat hulls—the fin keel and the deep keel. The fin keel should have its sails balanced very accurately because even a slight helm is a serious drag. The deep keel, on the other hand, becomes more effective than it is when the boat is sailing close-hauled with a slight weather helm. This is due to the fact that the keel and rudder are continuous and streamlined in a single unit, which forms a curve similar to the air-foil curve of an airplane wing, or of a sail. This curve is formed on the weather side of the keel-and-rudder assembly, (with slight weather helm), and makes it act somewhat like a wing or sail. The result is that there is a distinct tendency to draw the boat to windward. It becomes especially noticeable in the marked reduction of the leeway (sideslip), which is normally experienced when sailing close-hauled. With a deep-keel boat, you can determine the most advantageous position for the tiller when the boat is out of the water by laying a straightedge along the rudder and the after portion of the keel or false keel, and forcing the rudder over until a straight line is formed. Then carefully



14 *Watch helm for balance*

| FAULT | RESULT | CURE |
|---|--|--------------|
| 
JIB LUFFS | 
HEAVY WEATHER HELM | TRIM JIB |
| 
MAINS'L LUFFS | 
LEE HELM | TRIM MAINS'L |
| 
MAINS'L TOO FLAT | 
WEATHER HELM | EASE MAINS'L |
| 
JIB TOO FLAT | 
LEE HELM | EASE JIB |

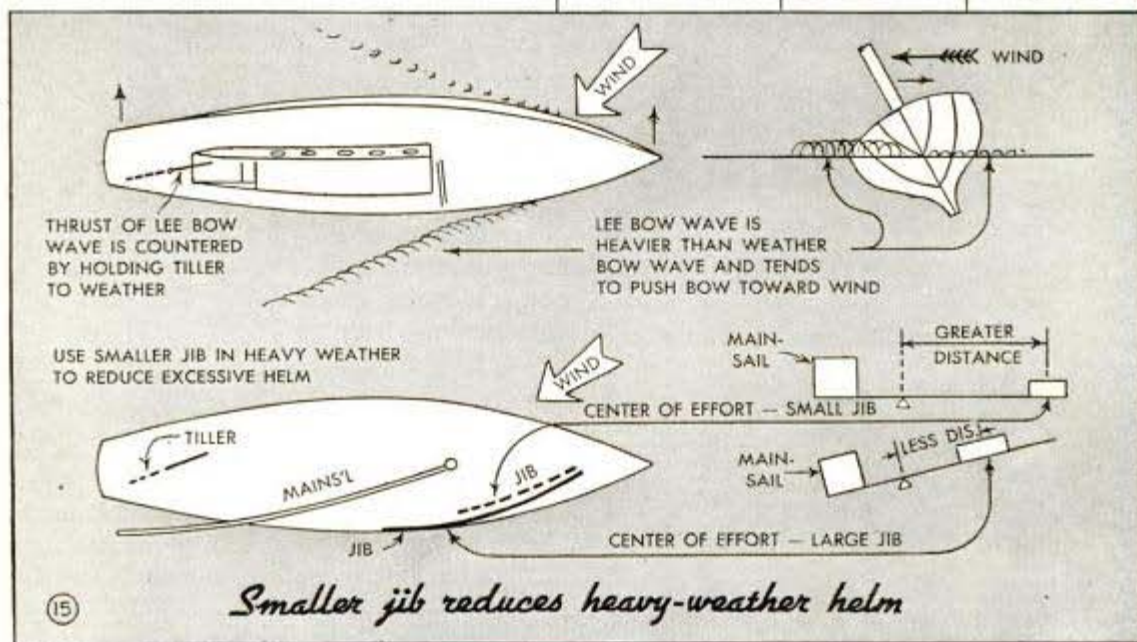

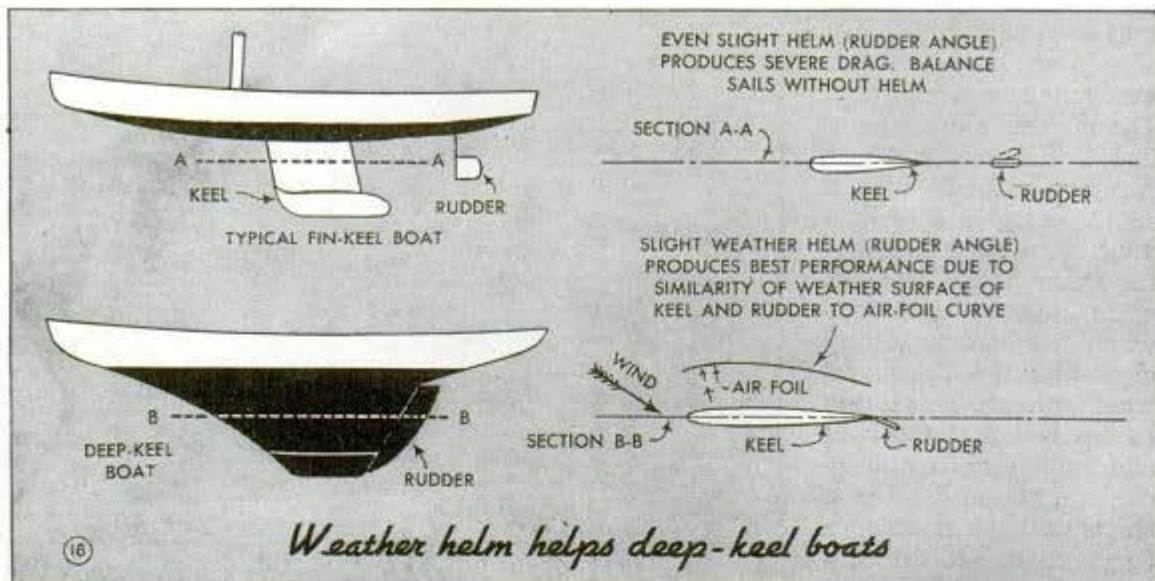

note the angle made by the tiller, and trim the sails when close-hauled or close-reaching so that this angle will hold the boat on a straight course. When this is done, a marked improvement in performance will

be observed. The helm is the clue to sail balance when reaching as well as when sailing close-hauled. Fig. 14 shows the four conditions of poor sail balance disclosed by pronounced weather or lee helm.

Drill Press Operated With Crank When Used for Tapping

Instead of pulling on the belt to rotate a power drill press when using it as an emergency tapping machine, use a crank like the one shown and the job will be faster and easier. The crank is made from a square block of wood, which fits over the top of the motor pulley. Strips are screwed to the underside of the block and shaped as shown to provide a groove to take one half the edge of the pulley. A tapered dowel

serves as a hand grip and also bears against the opposite edge of the pulley to hold the crank in place. Friction between the pulley and crank is sufficient to prevent it from slipping.

—E. R. Augustin, Jr., Livingston, Mont.

Drip Mold Prevents Seepage Under Basement Sash

Water seeping under basement sash during driving rains often causes considerable damage. This is true particularly where the sash are above the grade line. One simple way to avoid this trouble is to cut a length of window-stop strip to a snug fit in the frame and nail it to the sill. Then, above this, nail a length of quarter round to the bottom rail of the sash, allowing $\frac{1}{8}$ -in. clearance between the two parts so that the sash will close easily. Run calking compound in the corners as indicated.

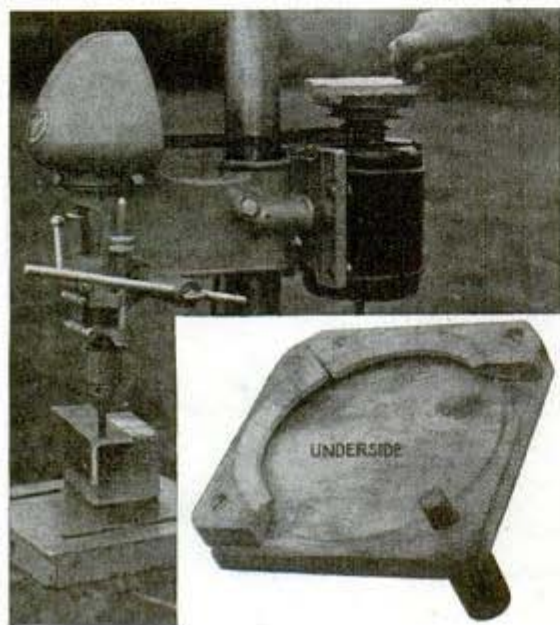
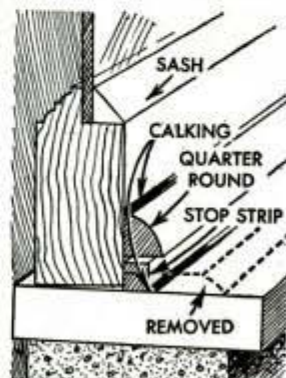

How to Prepare Your Skis for Summer Storage

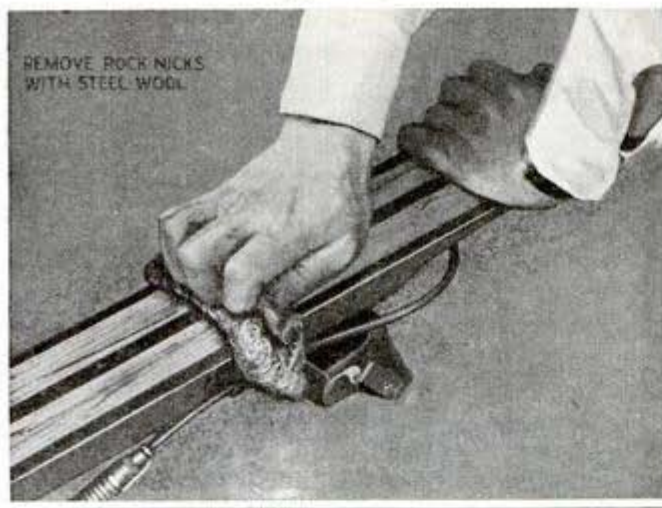

Skis should not be kept in a place that is too dry or too damp, or where they are exposed to sunlight. Usually a dark, well ventilated closet is the best place to keep them,—never in a humid basement or in a hot, dry attic. They must be protected against the absorption of moisture, and each one should be clamped separately in a suitable form to retain the correct shape. Before storing them, remove all wax or varnish from the top and bottom surfaces, and also the edges, down to the bare wood and carefully polish off any nicks with fine steel wool. When sanding the bottoms, use a sandpaper block, taking care to retain the smooth surface; always work with the grain of the wood from the tips to the heels. After the skis have been cleaned and sanded, remove all dust with a clean cloth dipped in carbon tetrachloride. Then apply two coats of waterproof varnish (marine varnish is preferable) to the top surfaces, and two or more coats of transparent lacquer to the bottom surfaces and to the edges, allowing each coat to dry thoroughly before applying the next one. Before using them next season apply two additional coats to the bottoms. If you use a pine-tar base wax instead of lacquer, linseed oil makes a good summer coating

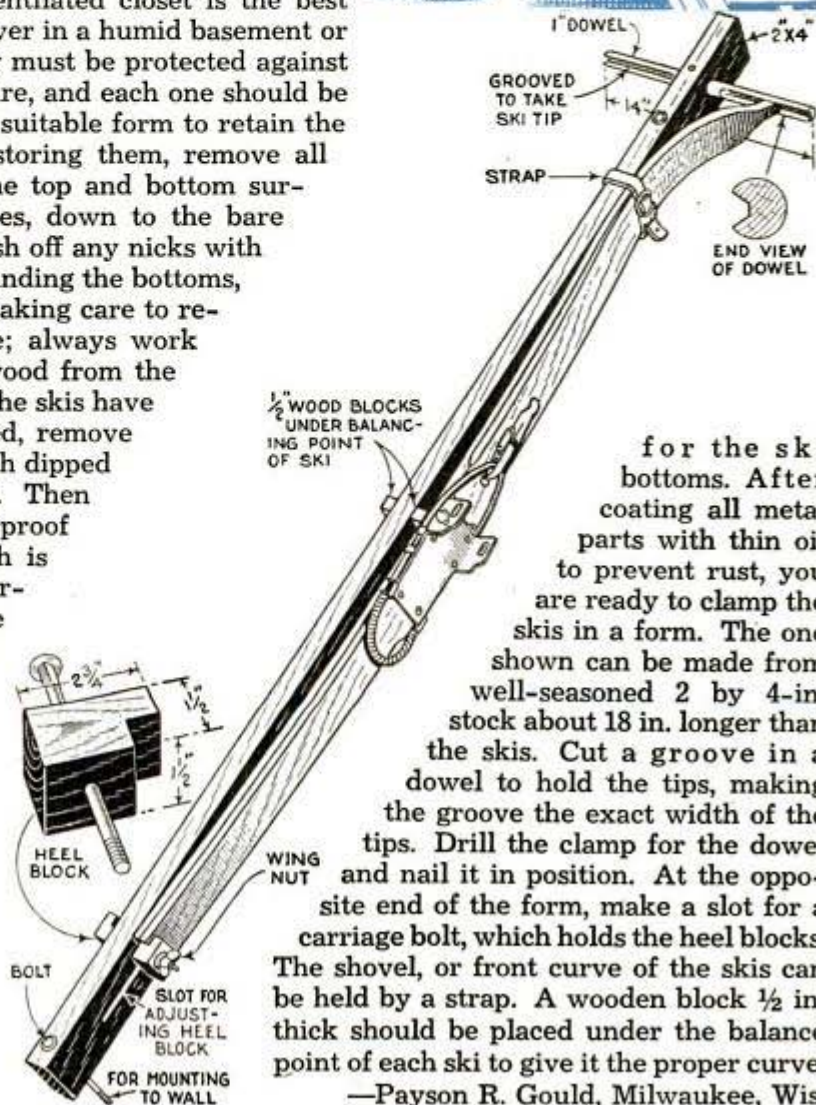

1/2" WOOD BLOCKS UNDER BALANCING POINT OF SKI

for the ski bottoms. After coating all metal parts with thin oil to prevent rust, you are ready to clamp the skis in a form. The one shown can be made from well-seasoned 2 by 4-in. stock about 18 in. longer than the skis. Cut a groove in a dowel to hold the tips, making the groove the exact width of the tips. Drill the clamp for the dowel and nail it in position. At the opposite end of the form, make a slot for a carriage bolt, which holds the heel blocks. The shovel, or front curve of the skis can be held by a strap. A wooden block 1/2 in. thick should be placed under the balance point of each ski to give it the proper curve.

—Payson R. Gould, Milwaukee, Wis.

Woodworker's Powerful Clamp Made From Auto Jack

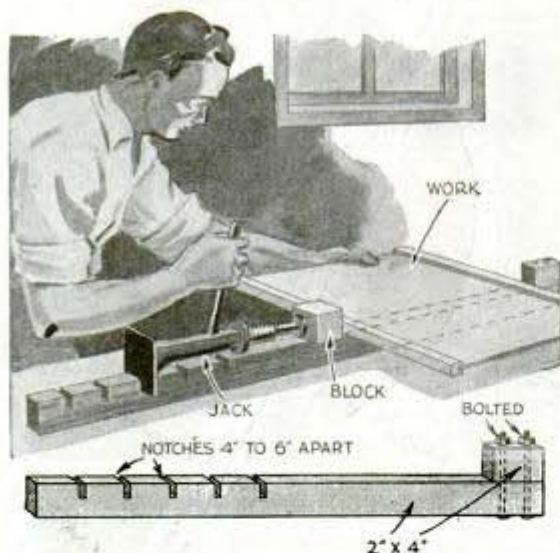

The next time you need a strong clamp with a wide jaw span and none is available, one can be made up to utilize your auto jack. Select a suitable length of 2 by 4-in. hardwood stock and bolt a block to one end to serve as one of the clamp jaws. Then cut several notches near the other end to take the base of the jack when it is laid on top of the stock as shown. It is likely that you will have to use a hardwood block at the end of the jack screw as the second jaw of the clamp. In use, just place the work between the two jaws and screw up the jack, using the notches to get the desired adjustment.

Powder Puff on Writer's Finger Provides Hand Rest

To avoid soiling show cards and to simplify the movement of his hand over them, one artist employs a small powder puff. A

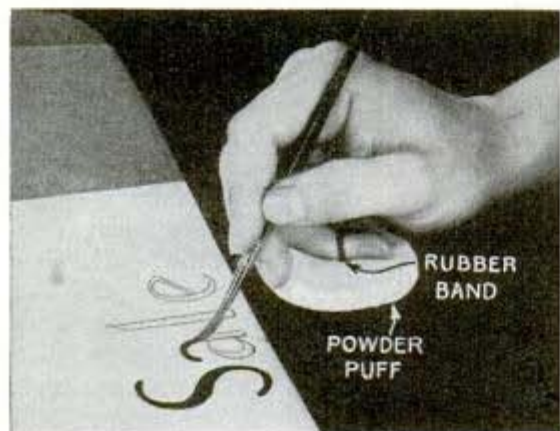

rubber band is stitched through the cover of the pad at the center, so that it will serve as a ring to hold the pad on his finger.

Carbon of Small Welder Shielded To Braze Inside Seams

Recently while brazing some inside seams on cylindrical containers that had diameters only slightly greater than the length of the torch carbon, I found that the upper end of the carbon often made accidental contact with the cylinders. To avoid this, I drilled a cork part way through and put it on the carbon, thus insulating it against accidental contact.

—W. C. Wilhite, Carlinville, Ill.



Picture Frame Serves as Holder For Kitchen Knives

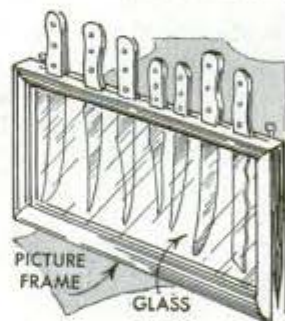

If you need a holder for kitchen knives, a handy one can be made from an old picture frame in a few minutes. Slots to accommodate the blades are formed in the top frame member by cutting notches along the back and then covering the entire back with a thin piece of plywood. Screw eyes can be used to hang the holder on the wall.

Helpful Suggestions on Painting Sound-Absorbing Material

When it is necessary to paint sound absorbing material, the porous surface must be covered without sealing it. Before painting, vacuum-clean the surface if possible. A solution of mild soap and water may be used on enameled material. The paint must be mixed carefully, used sparingly and applied uniformly. Soft paste white lead and a little more than an equal portion of thinner provides a good mixture. This thin mixture will not cover as well as paint intended for ordinary work. Therefore, three or more coats may be required.

When, Where and How TO PRUNE

INCORRECT pruning—or none at all—of young trees and shrubs often is one of the foremost causes of disappointing results when they mature. Future strength, shape and production of flowers or fruits of shade and fruit trees, particularly apple trees, and treelike shrubs are a matter of proper pruning at planting time and correct seasonal prunings for a few years thereafter. You must visualize the tree not as it is today, but as it will be several years hence. The immediate problem after planting is to shape a strong head (the juncture of the main branches to the trunk) and a compact frame (the main branches and their secondary branches).

When planting a one-year-old tree, reduce the root growth if too long, to balance the top growth after it has been shortened to spurs or stubs having one bud each, from which new growth starts. See Fig. 3. Select spurs in groups of fours, each group being 8 to 10 in. apart. If the tree is a "whip," that is, one having no side growth, rub off the unwanted long buds and cut through those that lie close with a sharp knife. When pruning, the location of the cut in relation to the buds is very important. In Fig. 2, the first sketch at the left shows an unpruned branch. The terminal bud is at the tip with cluster buds at the base of the tip; those farther down are axillary buds, which sometimes are found in pairs. The second sketch shows a cut made

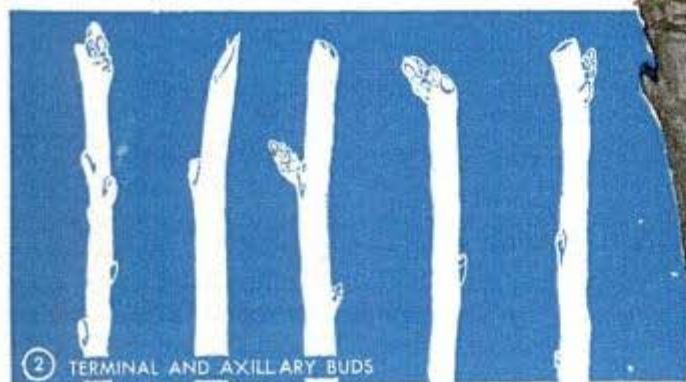
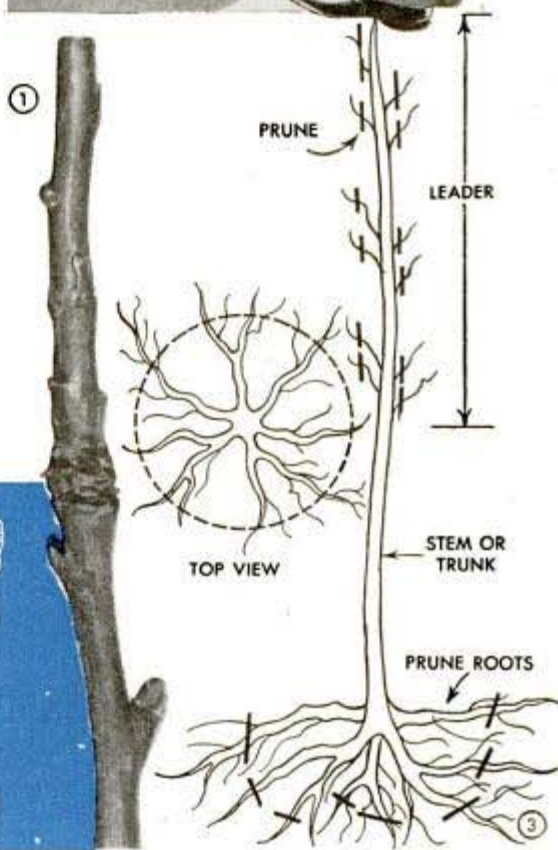



mainly of forming the head, Figs. 4, 5 and 6. Fig. 4 shows a mistake often made by pruning which causes the entire weight of the tree to be borne at one point on the trunk instead of being distributed uniformly as in Fig. 6. The head should have from three to five main branches (usually three for an apple tree). Prune so that the buds or spurs are spaced around the trunk and up its sides as in Figs. 5 and 6, cutting the selected branches back from eight to ten buds. During the third year, or the second year if two-year trees were planted, complete the frame as in Fig. 7, treating each main branch as if it were an individual tree, except that the buds on it are not spaced around the branch, but should lie fanwise and parallel to the ground as much as possible. Take care to avoid weak crotches. Remember that growing strength is concentrated in the terminal, cluster and adjacent buds. Fig. 8 shows how growth is likely to develop if not cut back. Cutting back forces the weaker buds below the cut

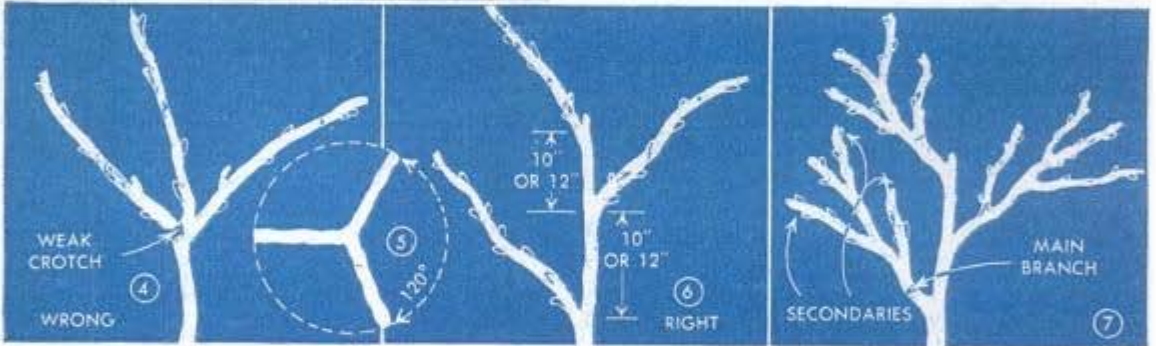

too long and slanting, causing the wound to dry too slowly, while the third sketch shows a cut so far above the bud that the stub is likely to rot. In the fourth sketch the cut is too close to the bud, which will dry and drop off. The correct way is given in the fifth sketch where the cut is slightly slanting and is about $\frac{1}{4}$ in. above the bud.

When the leader is taken, that is, when the unwanted vertical portion of the stem is removed, vertical growth of the trunk practically ceases. In commercial orchards the head is kept low, so that the lowest branch is about 2 ft. from the ground. On the home grounds you may want more height, however, and therefore the leader can be left until the second year. If a newly planted tree or shrub has developed two leaders, remove one, Fig. 10. On a tree that is two years old, whether it is being planted or is already set out, pruning consists

to grow and form a closely knit frame. As strong shoots start from the buds nearest the cut, you can control the direction of growth by cutting just above the buds pointing in the desired direction. Later pruning keeps the tree in shape, which requires cutting back about one third of the previous season's growth as indicated by a swelling of the branches where the new wood joins the old, see Fig. 1. When viewed in spring, the growth from the tip of a branch back to the first swelling is last season's wood.

Fruit trees should be pruned more thinly than shade and ornamental trees as an open center is necessary to admit light and air, which are essential to health of the tree and the color of its fruit. However, don't overdo this, for, as the tree develops, the weight will tend to move away from the center. Also do not remove short, stub-

by twigs that may develop on branches, as in Fig. 9, as they will bear fruit for many years. Different kinds of fruit trees require different pruning methods. A peach tree should have four main branches spaced a little closer and nearer the ground than an apple tree, which usually has only three. If a peach tree is not pruned, it produces fruit on year-old shoots growing from terminal and nearby buds. These grow fast and long, and can be cut back at least fifty percent. Rampant seasonal growth can be cut back during the summer. After the frame of a pear tree has formed, prune lightly and toward outside buds when possible as pear trees are inclined to vertical growth. New growth starting from the trunk and low down on the main branches should be removed. The cherry tree, like all fast growers, is rather weak. A good head and frame are essential. Later severe pruning is unnecessary as fruiting is little affected. Pruning when growth is dormant or just beginning in early spring is advis-

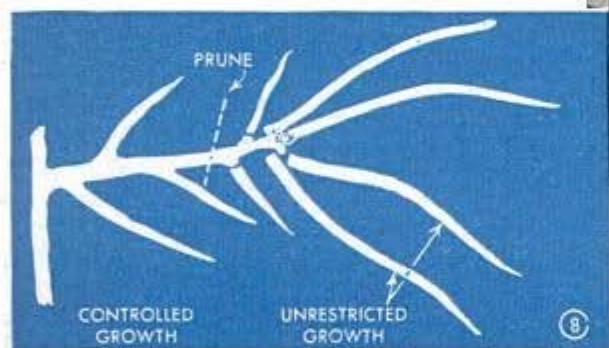
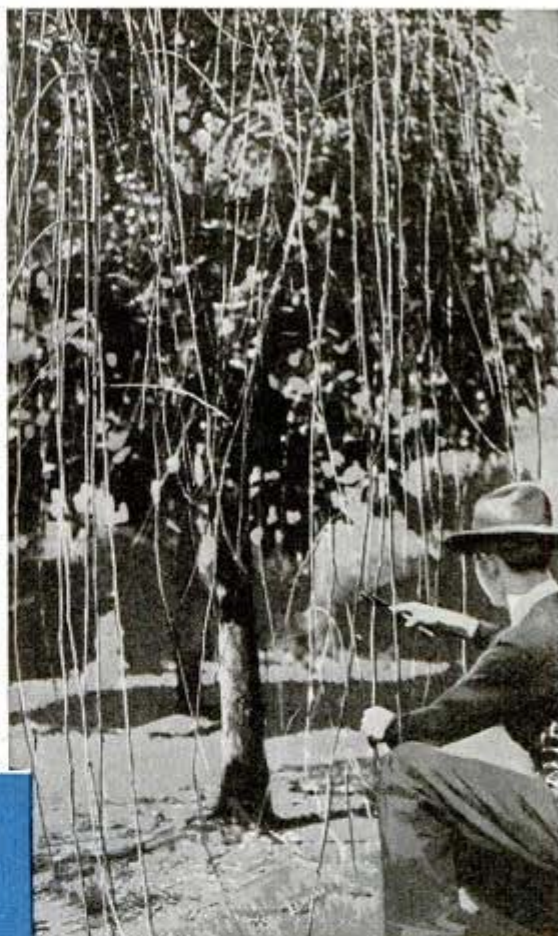

should be cut. Those that grow from heads should be framed as apple trees, but with four or five main branches, giving due consideration to height of the lower branches. For sidewalk plantings, you will want extreme

able for the trees mentioned. Don't prune in winter. When it is necessary to remove large limbs, proceed as shown in Fig. 11; not as shown in Fig. 12, which results in splitting off wood toward the trunk. Always start a cut from the underside of the limb several inches from the trunk or head. When the saw begins to bind, make a second cut on top about an inch from the first one as in Fig. 13. After the limb drops, cut as close to the trunk or branch as possible. The wound will heal more quickly and often will bark over, whereas stubs of any length will rot eventually. It is advisable to seal the exposed wood with asphaltum paint.

For shade trees, study growth habits. Some continue to branch from the leader, which never

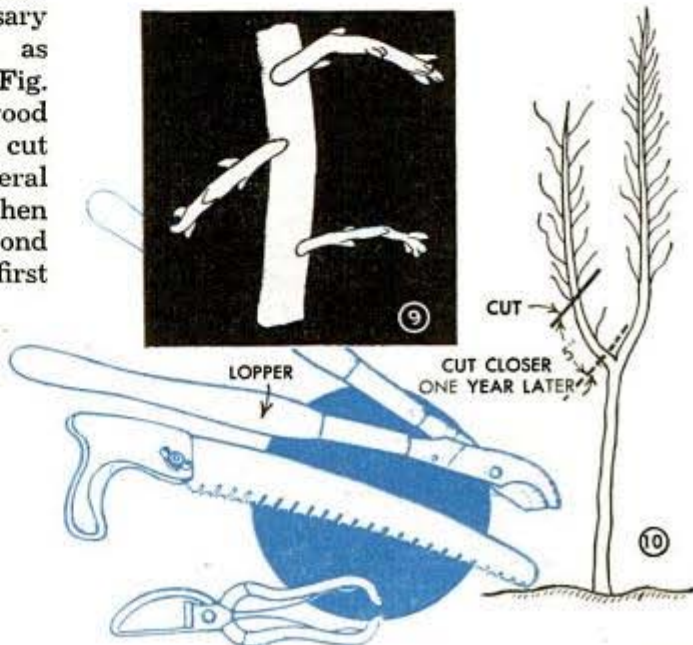
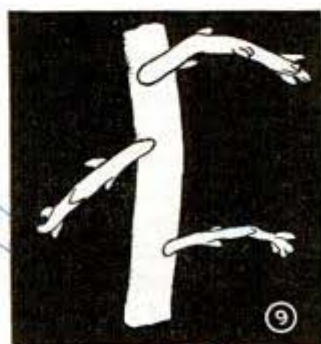



are kept in better flowering condition and within bounds not by pruning, but by encouraging new shoots to replace older ones which are cut back to the ground. This also is good practice on any shrub having growth habits like the familiar white spirea. All flowering trees and treelike shrubs can be divided into two classes: spring bloomers and summer-and-fall bloomers, each having different pruning seasons. White spirea, lilac, redbud, azalea, forsythia, dogwood, bush honeysuckle and pussy willow are among the many spring bloomers that, after flowering, grow new wood on which flower buds for the next season grow. If pruned in early spring much of their floral display is lost. It is best to prune them immediately after the blossoms have dropped.

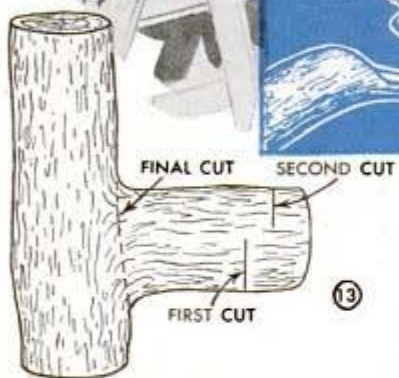

To prevent trunk injury when removing a large limb, make two cuts several inches from the trunk to drop the limb and then saw off the stub

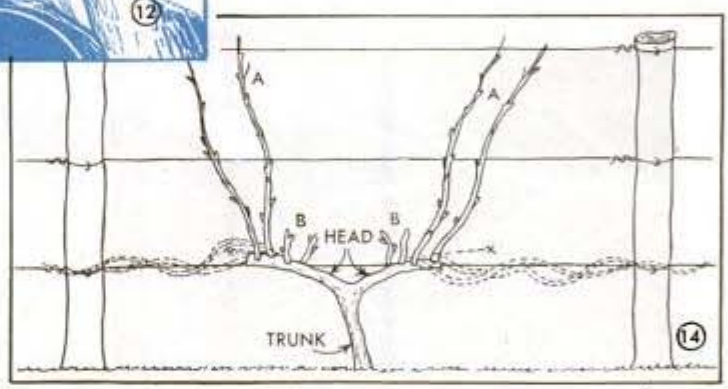

height before taking the leader. Flowering trees and treelike shrubs usually are treated similarly to fruit and shade trees. Heads of very dwarf trees and those inclined to an erect growth should be formed lower than those of fruit trees, and main branches can be much closer together. Dwarf trees growing taller and those having a wide spread can be framed higher. After the frame has formed, pruning should not be so severe as for most fruit trees, because the essential purpose of the latter is to bear large size fruit. Shrubs growing asunder (separate shoots coming from below ground) often are inclined to a vigorous and thick vertical growth, which can be corrected by removing some and pruning other shoots as in Fig. 15 to control growth in the direction desired. Matured shrubs of this kind and those growing from heads formed close to the ground

Among the summer and fall bloomers are false spirea, weigela, rose-of-Sharon, spirea and hydrangea, which are pruned in early spring. Tender tops growing on hardy roots like the butterfly bush are likely to be winter killed and should be cut back to the ground in the fall. Except for the removal of dead wood, evergreens need no pruning. Unlike deciduous (leaf shedding) trees, they

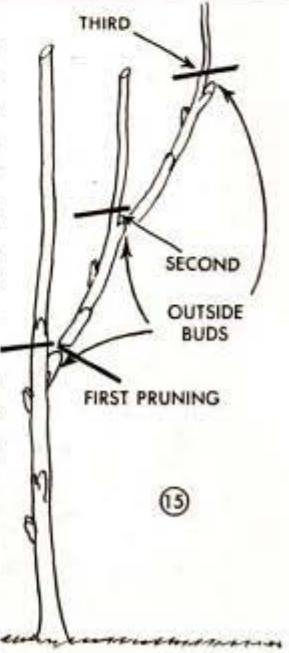

lack axillary buds, and therefore if cut back, they cannot grow replacements. However, if growth is a bit ragged, or if a certain shape is desired, soft-foliaged types such as arborvitae, juniper, hemlock and cypress can be sheared, but only after green growth has started in the spring, never in the winter, as the additional evaporation from the cut surfaces may kill them.

Among the several pruning systems for grape vines, the one illustrated in Fig. 14 is widely chosen because it is simple and produces renewal canes close to the head. During the latter part of each winter, but not when the vines are frozen, leave two or more long canes AA, having five to ten buds each, and cut a similar number of canes BB back to spurs having one or two buds each. Cut away all other growth. The long canes produce shoots that will grow the following summer's crop, while the short canes BB will become renewal canes that will bear crop of the second summer. Early in spring bring the long canes down and tie them as indicated by the dotted lines. Later reduce each short cane to a single strong shoot and tie to the upper supports. Repeat this procedure each season. Always select renewals on or as close to the head as possible. Often, these may be had coming from the trunk. The total number of buds that the long canes will carry depends on the soil, vigor of the plant, etc. If well established, the popular Concord grapes can carry fifty to sixty buds to a vine, whereas less vigorous varieties should be held to a maximum of twenty-five to thirty buds.

When planting young flowering vines, cut them back to induce more base shoots. Most matured varieties are handled much the same as shrubs. In summer, prune off straggling wisteria shoots, except those wanted for further climbing. Cut back new growth one third to induce flower-bearing spurs. In spring, cut back spring-and-summer blooming clematis as far as frost has killed the vines. Cut summer-blooming vines back to 2 ft. from the ground. Nearly all annuals and many perennials are improved by pinching off side shoots. Disbudding (removing surplus buds) produces specimen and show flowers. You need only a few pruning tools like those shown at the left of Fig. 10. Always use the tool that will do the job best, and keep them razor sharp as dull tools bruise the wood which is then likely to rot.

Insulating Between Built-In Tub And Cold Outside Wall

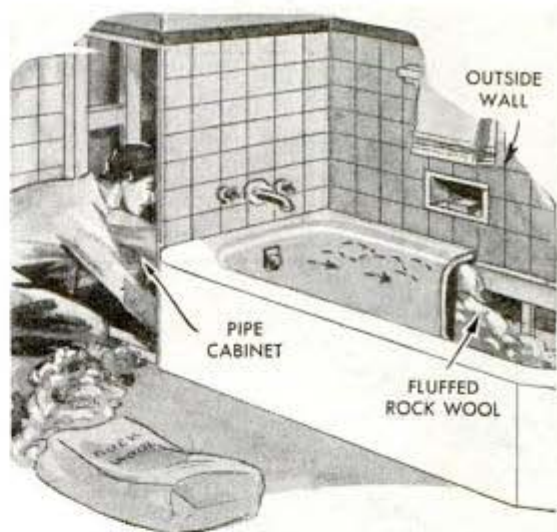

When a built-in bathtub is located against an outside wall, it should be insulated by packing the space between the tub and wall with a fluffed insulating material. In addition to protecting against danger of water pipes freezing during extreme temperatures, this also helps greatly in keeping the bath water at a uniform temperature. Frequently, tubs already installed can be insulated in this way simply by taking off the back of the pipe cabinet and forcing the material back of the tub.

Cork Supports Coping-Saw Blades In Bottle to Prevent Rusting

Where coping-saw blades are kept in a tall bottle to keep them from rusting, the cork provides an excellent means of supporting the blades so they can be removed quickly whenever

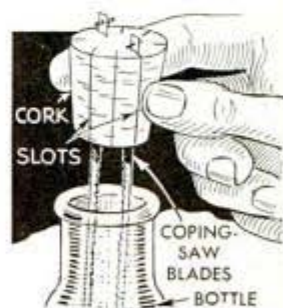

desired. Just cut or saw a number of slots in the side of the cork, insert the blades in them and then press the cork in place.

❑ Iodine stains can be removed from cloth by soaking it in photographer's hypo solution and then rinsing it thoroughly in running water. In the absence of hypo solution, a concentrated solution of potassium iodide in water can be used.

Joints Between Concrete Blocks Shaped With Improved Tool

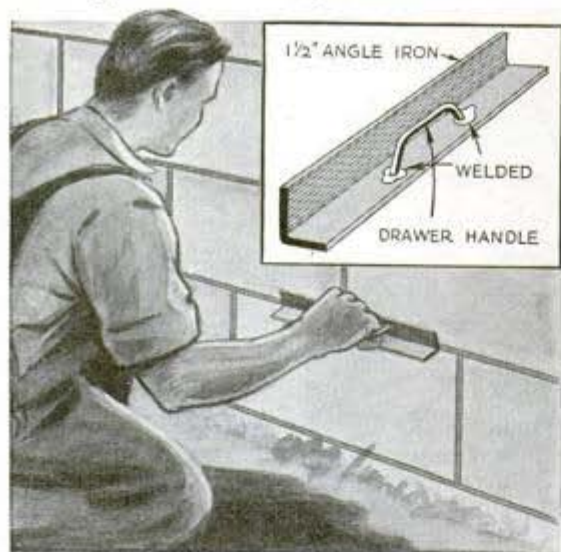

When pointing joints between concrete blocks, or laying up a new wall, and there is no regular tool for finishing the joints, one can be improvised from a length of angle iron. A drawer handle welded on the angle iron provides a good hand grip, although any suitable grip can be used if the tool is intended for only temporary use.

Roll-Up Table Cloth for Picnic From Shade on Suitcase

If you go on picnics frequently, an old suitcase with a window shade attached to it will be handy. The suitcase provides a carrier for food and other articles, and the shade serves as a table cloth when pulled



out on the ground and fastened down with a peg as shown. The shade roller is attached to the suitcase by means of the regular brackets, which are riveted in place.

Shoehorn Taped to Mop Handle Keeps It Vertical in Pail

Taped to the handle of a scrubbing mop, a shoehorn will slip over the edge of the scrub pail and keep the handle in a vertical position when the mop is not being used. Location of the horn will depend on the height of the pail. If the horn is bent to the contour of the mop handle, it will be easy to tape in place.



Numbered Paper Collar on Bottle Shows Time to Take Medicine



Anyone who experiences trouble in remembering the time to take medicine, can use a paper collar as shown to indicate the time. Number the collar from 1 to 12 and paint a small arrow on the neck of the bottle as indicated. Then

each time medicine is taken, turn the collar so that the arrow points to the hour it is to be taken again.

Oil Preserves Paintbrushes

A new paintbrush suspended in raw linseed oil for a few hours before using it will be easier to clean. The porous bristles will absorb the oil, sealing themselves from moisture and thinners which make them flabby. This process is good only for brushes to be used in paints that contain an oil ingredient. The brush should be cleaned thoroughly to remove the oil before using it in paints having no oil content.

Diamond Ornaments Turned on Spherical Work

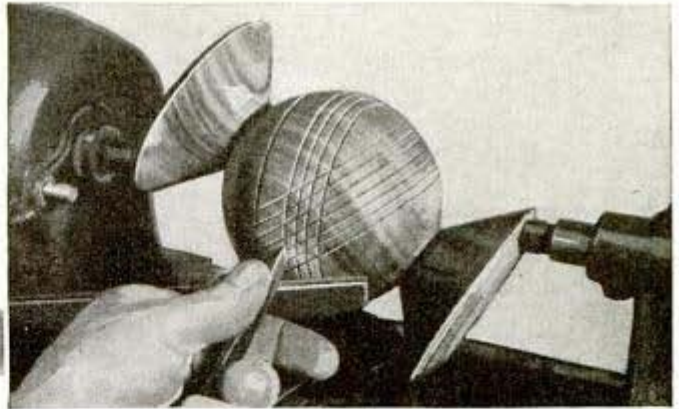

Turning diamond-shaped ornaments on opposite sides of spherical work, such as bowls, balls, etc., is not difficult and results in a beautiful job that shows outstanding craftsmanship. The bowl shown above is a good example. First, mount the stock between centers and turn the ball portion in the regular way, leaving waste stock at both ends shaped as indicated. Notice that the faces of the ends are beveled to provide flat surfaces for the lathe centers when the work is mounted at an angle between them as shown in the upper right-hand photo. Also, notice that a shallow groove is turned in each face as a guide in positioning the center. It is important that the groove be turned on each face in exactly the same position in relation to the center of the work so that the axis between lathe centers passes exactly through the center



of the ball. Now, with the work mounted at an angle and the lathe running at slow speed, turn a number of shallow grooves in the ball. Then reverse the work end for end and turn another series of grooves. Finally, the ball is turned down, removing the grooves, and leaving the diamond pattern in relief as shown in the lower photo.

—Benj. Nielsen, Aurora, Nebr.

Life Line Is Easy to Climb or Slide Down When Knotted

A life line will be improved if knots spaced 12 to 14 in. apart are tied in it to aid in gripping it with the hands. This is especially true of lines used on piers, large private boats, or as fire ropes in homes where persons inexperienced in rope climbing may have to use them. Even a child that might not be able to grip a smooth rope tightly enough to support its weight can use a knotted one with ease. It is well to remember that the upper end of a rope used for these purposes must be attached to a firm support so there is no possibility of it pulling loose while in use and allowing someone to fall.

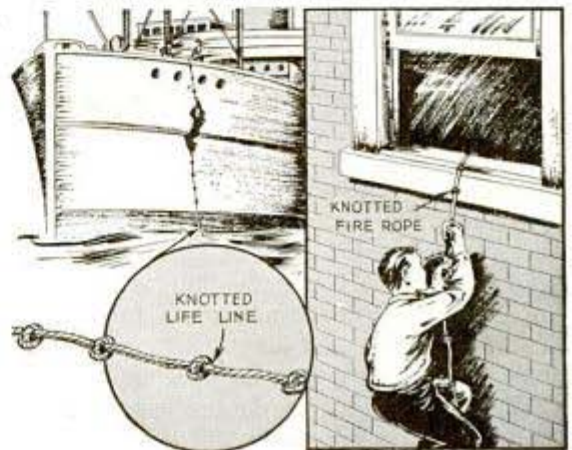

COPYING TABLE



Eliminates usual hand shadow by projecting image from below. Spring counterbalances equalize weight of projector to give a positive focusing action

By Edwin M. Love

THIS multi-purpose "drawing camera" throws enlarged views of small patterns and pictures in magazines on tracing paper placed over a horizontal window, where it is an easy matter to trace them. You just place the picture in the copy holder as in Fig. 3, slide the projector up or down to get a sharp focus and then copy the picture or pattern on the paper held on the tracing window with cellulose tape. The advantage of having the projector mounted under the window is that your hand, when tracing the image, does not cast a shadow to obscure the work, which would be the case if the picture were projected from above. Direct copy work can be done by placing the picture on the tracing window and using the special lights provided for this purpose. Of course, best results are had in a darkened room. Provision is made also to copy enlarged views from negatives. Besides, the outfit can be used as a post-card projector by replacing the tracing window with a mirror, which is tilted at a

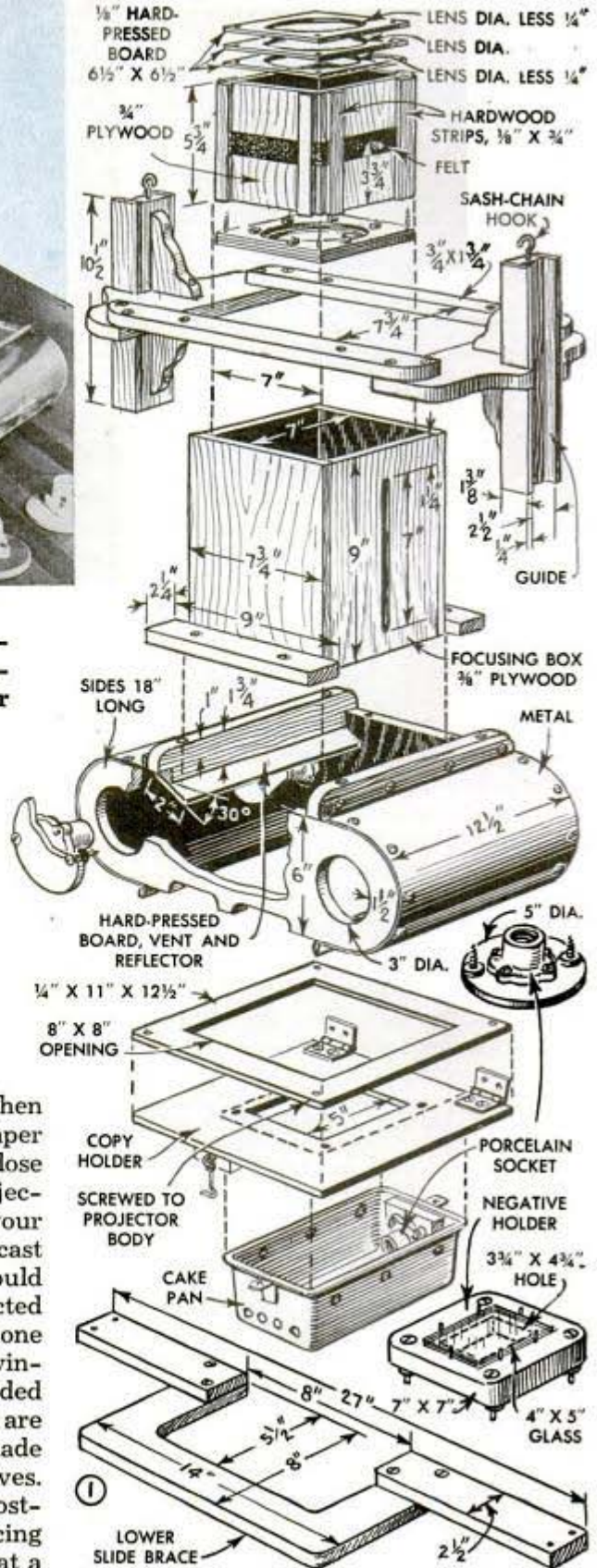

has built-in projector

45-degree angle to throw the picture on a wall or screen.

Construction centers around the projector itself, so start with this first. Fig. 1 shows the parts and their correct relation of assembly. If you cannot get plywood, use solid stock for the sides of the focusing box, lens holder and the lamp house. The latter, shown in the photo to the left of Fig. 1, has two beveled cleats across the top to which strips of hard-pressed board are fastened. These strips serve to deflect the light downward on the copy holder, and direct the heat out through the circular openings. Disks on which the porcelain sockets are mounted are spaced to stand out from the openings and provide vents. A few washers slipped over the screws will do the trick. Bright sheet metal salvaged from an oilcan

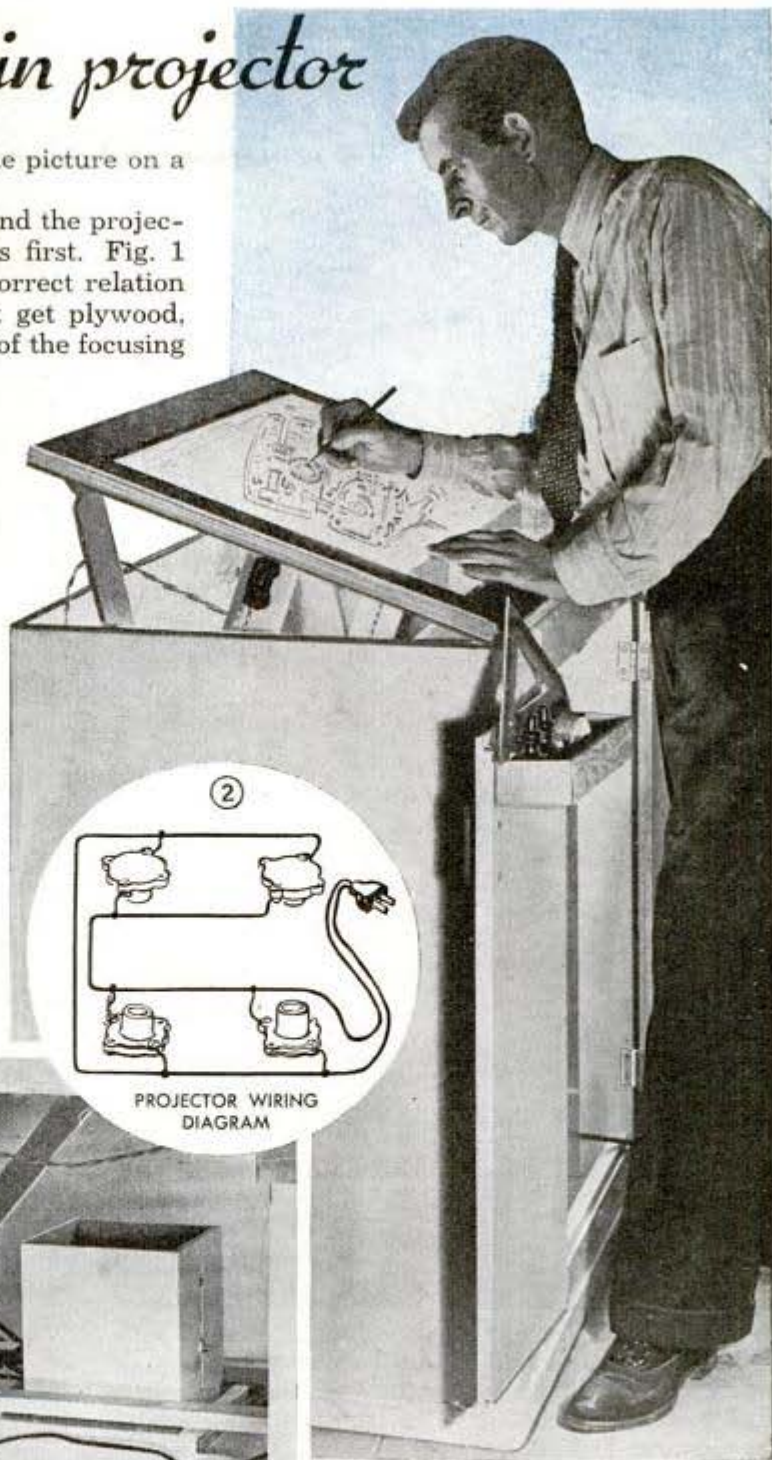

PROJECTOR WIRING DIAGRAM



or similar container, will do to cover the rounded ends. You will notice that flanges are formed along the top and bottom edges of the metal, the top ones to permit attachment to the beveled cleats and the lower ones to overlap the edges of the copy holder. Wire the sockets according to Fig. 2, after first applying aluminum paint to

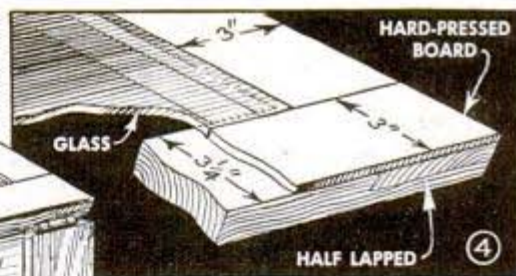
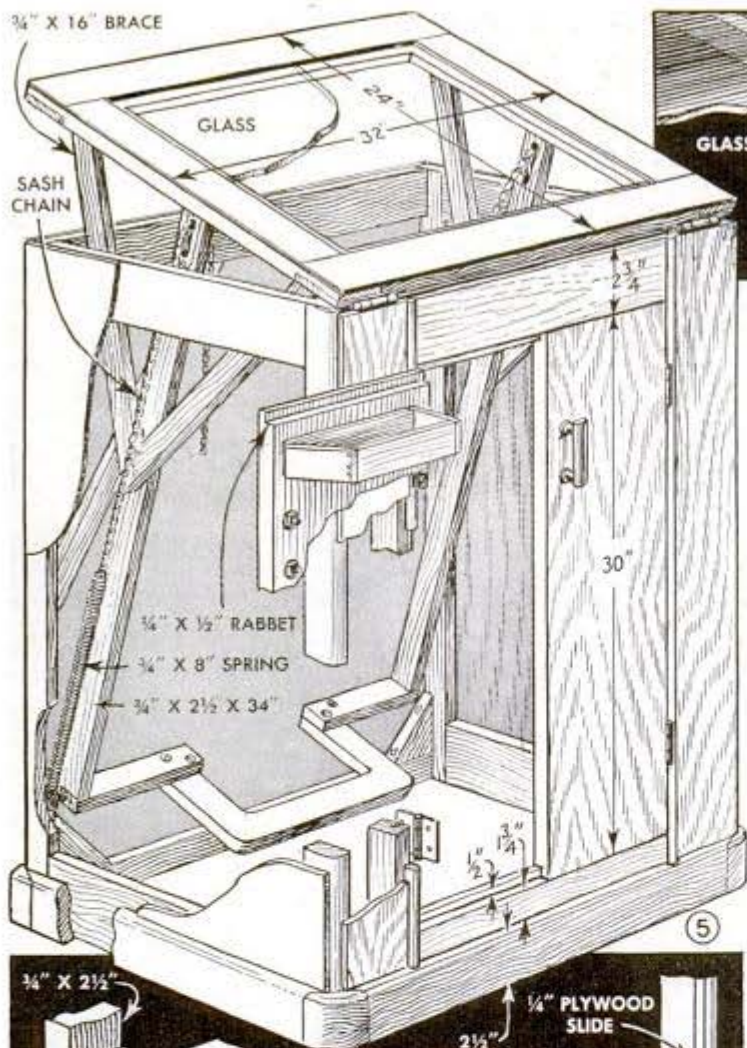

Although somewhat expensive, a corrected projector lens is the best. However, good definition can be had by using a camera lens. If you happen to have either a 4-by-5 Graflex or Speed Graphic camera lens with a focal length of about 5 in. and a speed of f:4.5 or better, it can be used in the projector by making a lens-board holder just like the one on the camera. Then you can use the lens from the camera on the projector, whenever needed. Sometimes a rapid rectilinear lens can be purchased reasonably from a pawn shop. A fourth choice would be the use of a pair of condensing lenses taken from an old lantern-slide projector. The upper detail in Fig. 1 shows how to mount a pair of these lenses. Each lens is sandwiched between two rings, the holes in

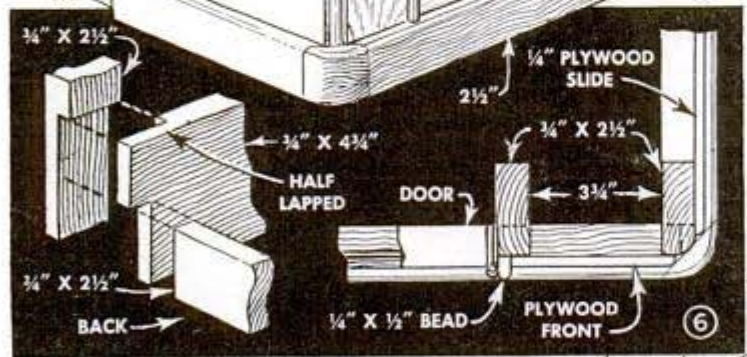

the inside of the lamp house. Next, you make the focusing box and the lens holder that slides inside of it. The latter is adjusted and locked by two wing nuts on bolts which project through slots in opposite sides of the box. After adding the hardwood strips at the corners of the lens holder, sand them down until a nice sliding fit is had and then wax both the strips and the inside corners of the box. Fill the space between the strips with felt as indicated, to stop light leakage.

The efficiency of the projector depends on the quality of the lens used, especially if negatives are to be projected for tracing.

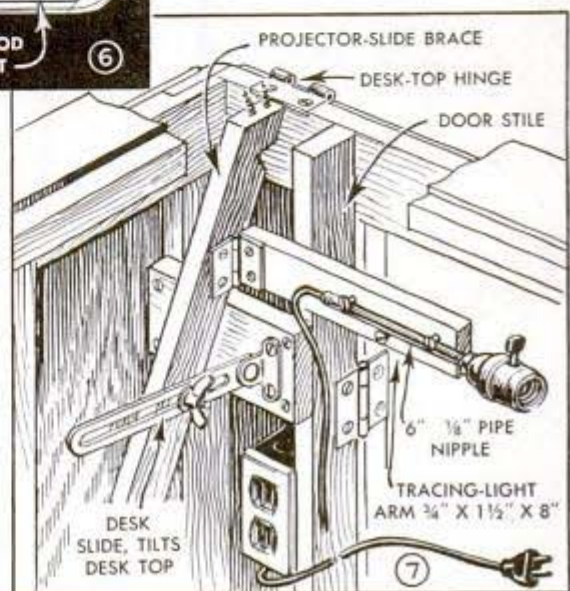

these being cut slightly smaller in diameter than a center one holding the lens. Usually these lenses have focal lengths of 6 and 8 in. Screw the 6-in. one to the bottom of the holder and the 8-in. one to the top, placing the convex faces outward.

Screws through the cleats on the focusing box are driven into the top edges of the lamp house and then the framework holding the channel-shaped guides is screwed to the top of the beveled cleats as shown in Fig. 8. Plywood is best for the two-piece copy holder. Screw the upper part of this to the bottom of the lamp house and hinge the lower part to it after you

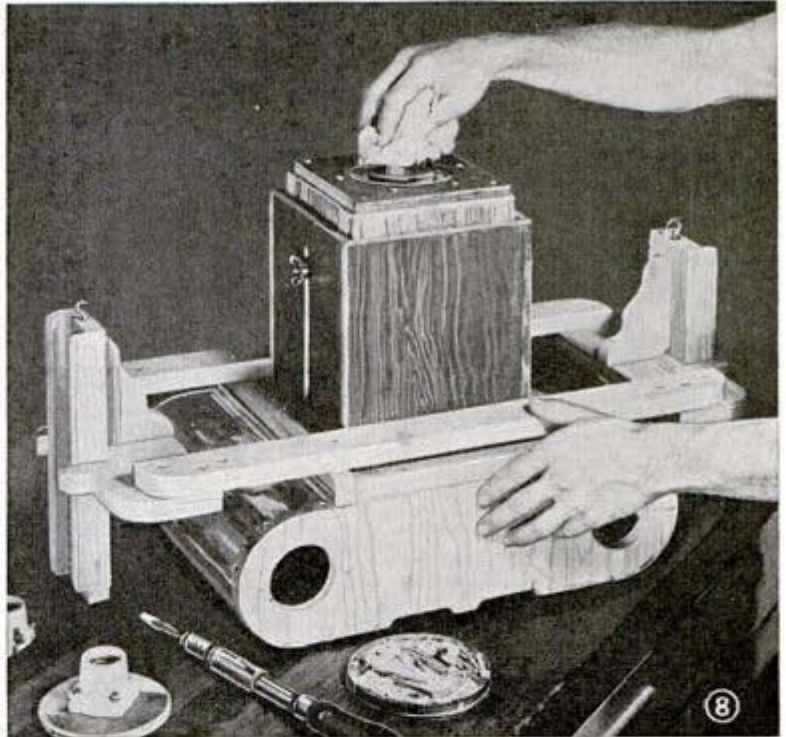

have attached the cake-pan reflector. Two or three screws are driven into the side of the lamp house to engage a hook on the lower part of the copy holder—one keeps the holder closed on a single sheet and the others provide space for magazines or catalogues. A holder for negatives is made to fit over the opening in the lower part of the copy holder as shown, four projecting bolts on the former engaging holes in the latter to keep it in place. Negatives are held between two pieces of glass which are centered over the opening with brads.

Now to make the cabinet: The cutaway view in Fig. 5 shows the vertical slides between which the projector travels. Being attached to the frame of the tracing window, they keep the projector at right angles to it, regardless of how much the top may be tilted. The brace joining the two slides at the bottom is U-shaped to permit further travel of the projector. Note in Fig. 5 how coil springs are used to counterbalance the projector. The springs are fastened to the outside lower ends of the slides and the chains, passing over standard sash pulleys fitted in the upper end of the slides, are hooked, under slight tension, to the channel-shaped guides of the projector. To work properly, the guides must fit the slides rather snugly. Desk slides, Fig. 7, lock the window at the desired slant. Fig. 7 also shows how two lights are in-

stalled, one at each side, on hinged arms to give illumination for direct tracing. On the original model 25-watt lamps were used here, a 150-watt lamp in the negative reflector and four of 100-watts in the lamp house. As shown in Figs. 5 and 6, the cabinet consists of a half-lapped framework fitted with doors at the front and covered with either 1/4-in. plywood or hard-pressed board. Strips of the latter are used around the top of the window frame to retain the glass as shown in Fig. 4.

Tennis Net Is Tightened and Held By Strong Anchor Hook

To tighten and hold a tennis net, where a ratchet adjustment is not provided, set one of the posts in a pipe socket and drill the post to receive a strong anchor hook. This hook is made by bending a length of iron rod to the shape indicated. It is used as a handle to turn the post and tighten the net ropes after which it is forced into the ground to hold the tension.

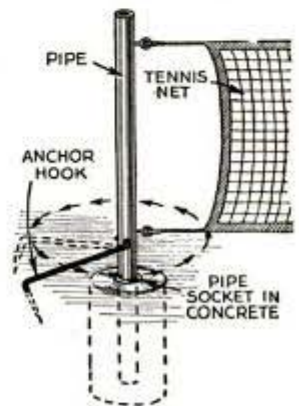

W.T.M. Concrete

Door Wedge Stabilizes Desk Slide To Hold Adding Machine

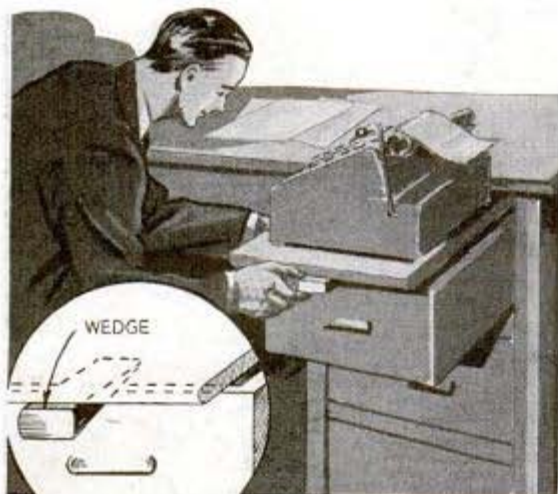

If you use an adding machine or typewriter on a desk slide, the latter can be supported rigidly by simply pulling out the top drawer of the desk and forcing a wedge between it and the slide. Where rubber doorstops are available, one of these will be ideal for the purpose. If the space between the slide and drawer is too great, a wooden block can be attached to the stop.

Fisherman's Emergency Fly Vise From Dry Cell Clip



Soldered to the edge of your tackle box as indicated, a clip from a dry cell provides a handy vise for holding a hook while tying a fly. Such a vise is always at hand and

ready for instant use, even when you are away from home on a fishing trip.

Keeping Ants Out of Your Home

After trying unsuccessfully for several years to keep ants out of our home, we found the following mixture highly satisfactory. It consists of sodium arsenate, $\frac{1}{2}$ oz., sugar, 1 lb., and sirup or honey, 1 tablespoonful stirred into water $1\frac{1}{2}$ pts. As this solution is poisonous it must be used in feeders or containers of a type that will prevent children and small animals from getting at it. Place the feeders in a safe

place near the ant trail and your home will soon be free of ants.

—C. L. Stevenson, North Hollywood, Calif.

Turnbutton Serves as Bench Stop

Needing a stop on his workbench to hold small work while planing it, one craftsman used a metal turnbutton for the purpose. This was screwed to the end of the bench top as shown, where it could be turned to a horizontal position parallel with the edge of the bench to keep it out of the way when not in use.

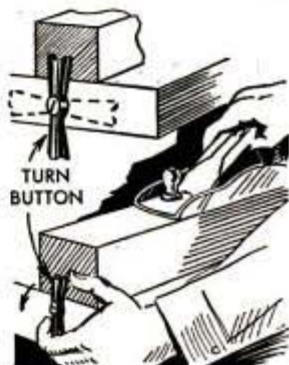

Flat-Iron Skids at Stern of Boat Shield Motor Against Logs

Damage to an outboard motor by having it strike submerged logs and rocks in a shallow lake, can be avoided by fitting it with these skids, which act like sled runners to raise the stern over any obstruction. Bolted to the bottom of the boat, the skids are thin enough to offer very little resistance to the forward movement of the boat. Also, if you drag your boat across a narrow strip of land from one lake to another, the skids will be helpful.

—Stanley K. Wood, Hot Springs, Ark.

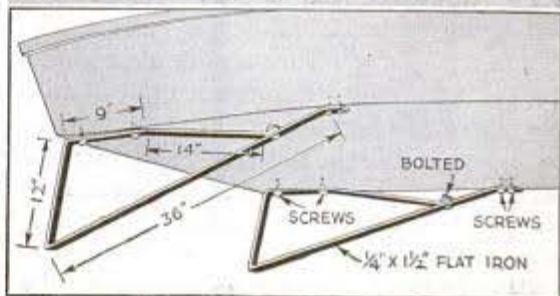



SHOP NOTES

Foot-powered SCROLL SAW

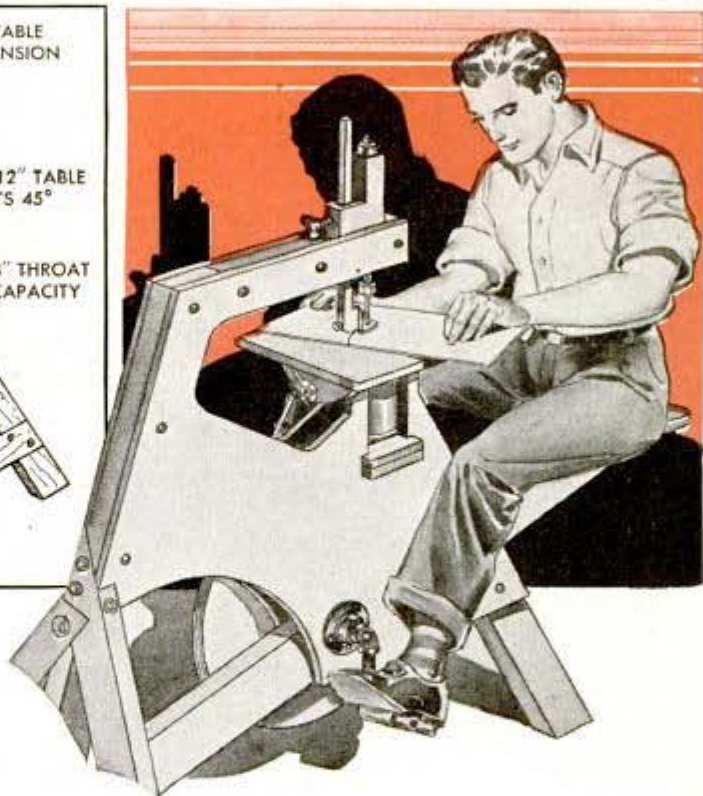
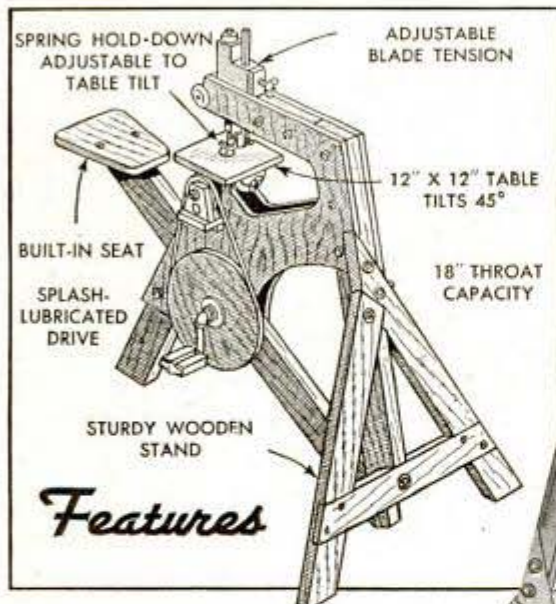

Although designed to be pedaled like a bicycle, you can use a motor to run this sturdy scroll saw. It is built almost entirely of wood, has splash-type lubrication, adjustable blade tension and other features as shown above

By **Wayne C. Leckey**

PART I

SCARCITY of metal need not keep you from having a scroll saw, as this one is made mostly of wood. Aside from the bolts and bushings required, the few other pieces of metal needed can be salvaged, in most cases, from odds and ends found in the junk box. If plywood is not available in your particular locality, you can resort to solid stock by gluing up panels of sufficient width. The crankshaft mechanism of the

drive head operates in a bath of oil and is sealed inside an ordinary 1-qt. paint can of the type having a press-fit lid. Fig. 4 will give you an idea of how it works. A crankshaft, entering the side of the can, engages a bar, which slides back and forth in a channel clamped to a vertical shaft. This produces a smooth reciprocating motion of the shaft, much like a piston, the stroke being 1 in. Oil in the bottom of the can is splashed by the crankshaft to keep the mechanism well lubricated.

The complete drive unit is shown in Fig. 1, partly cutaway so that you can get a better idea of its assembly. Bronze spindle bushings (Ford model-T type) are used as sleeves for the vertical shaft and also as

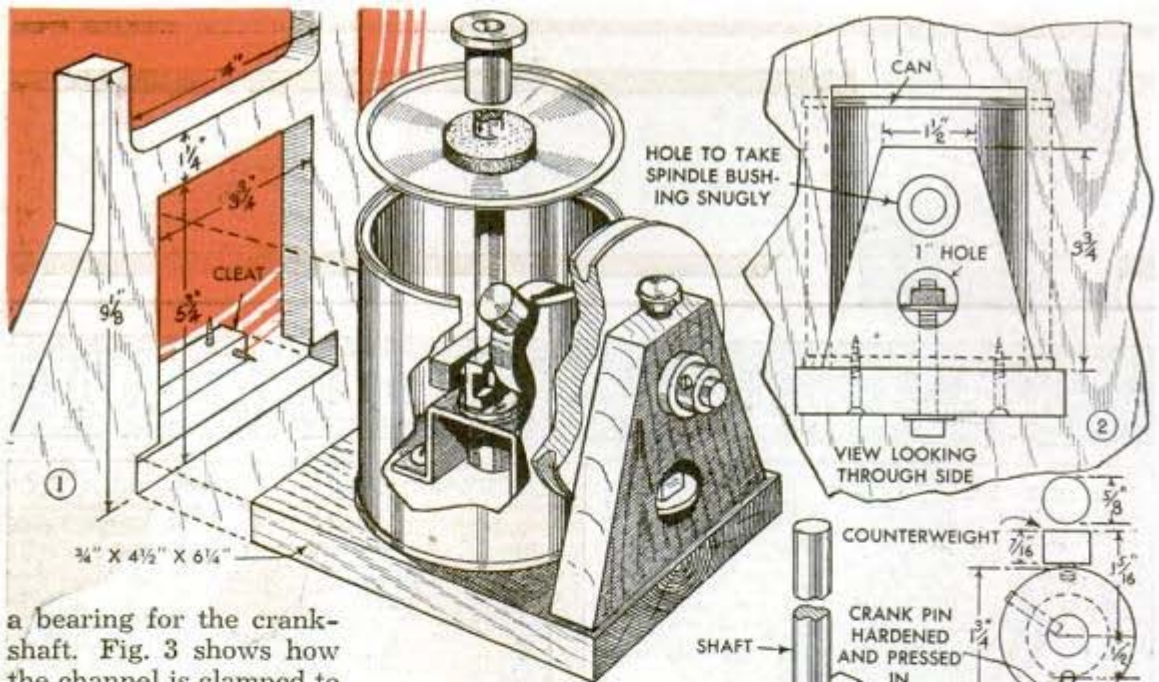

a bearing for the crankshaft. Fig. 3 shows how the channel is clamped to flattened places on the shaft, and how the lower bushing is mounted in a flat-iron bracket. Note from Fig. 4 that the bolts in the latter fasten both it and the can to the wooden base. You can work the channel to shape by hand using a hacksaw, chisel and file, or you can have the channel and crankshaft made. Thick felt washers prevent leakage of oil at points where the two shafts pass through the can. The oil level, of course, should be kept below the hole in the side of the can, as shown in Fig. 4.

It is important that the block holding the crankshaft bearing be rigid. Fig. 2 shows a way of bolting

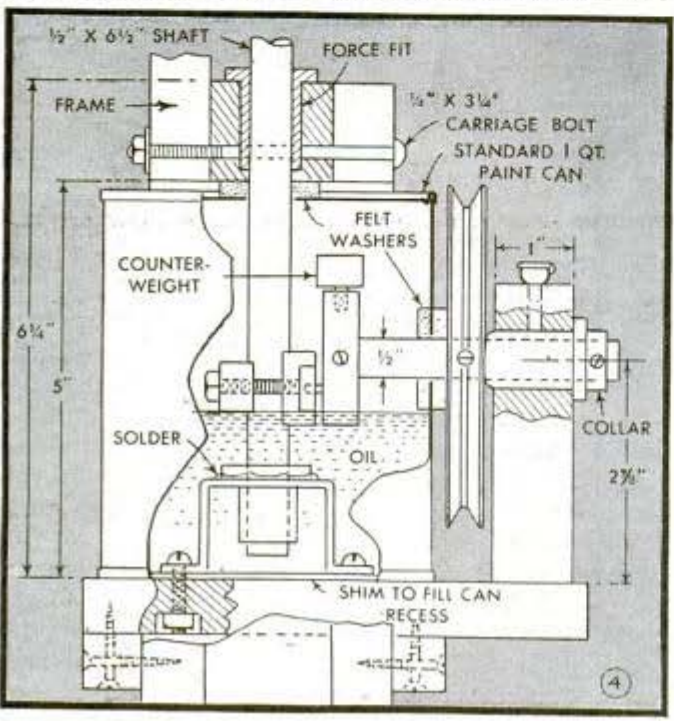
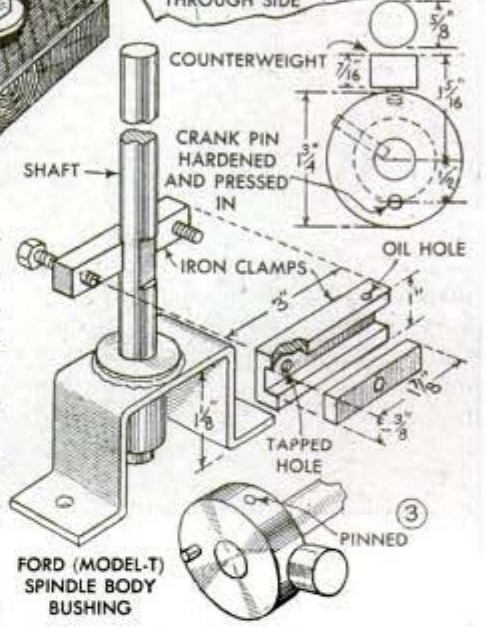

this, which allows it to be retightened easily if it should work loose. When installing the crankshaft there must be no end play, as the face of the disk, bearing slightly against the channel, keeps the bar engaged in the latter. It also prevents twisting of the shaft and saw blade, which would cause the latter to break. So, see that the setscrews in the pulley and the collar are tightened securely to the shaft on each side of the bushing, without side play. If desired, you can make the pulley of wood and pin it to the shaft. Before the lid can be pressed on the can, the upper end of the shaft must be threaded and slotted, so that a blade chuck like the one detailed in Fig. 7 can be fitted to it after the upper bushing and the filler block in which it

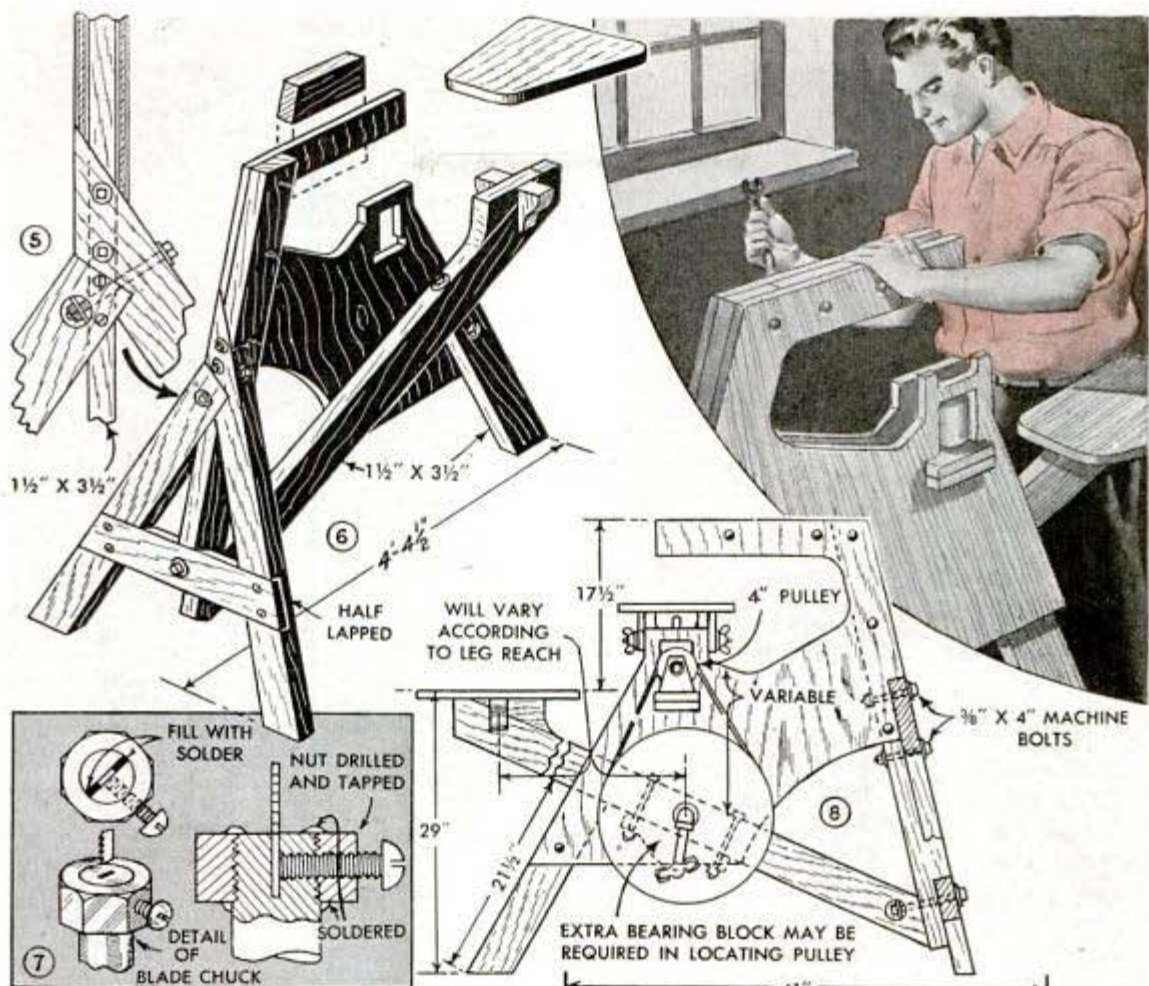

fits, have been slipped over the end.

You can set the drive-head unit aside for the time being, and proceed to make the wood stand. Plywood is preferred but solid stock can be used. Fig. 9 shows how both side pieces can be laid out economically on a 41 by 63½-in. panel, after which the two can be cut apart roughly with a compass saw and then trimmed to exact size. The size of the opening in which the drive head fits is given in Fig. 1. Note that the left-hand side has projections above the opening, which serve as stops for the tilting table. The frame or core to which the side pieces are glued and bolted is made up of common 2 by 4-in. material. Fig. 6 shows the arrangement of the pieces, while Figs. 5 and 8 detail how the rear legs are fastened rigidly with bolts and screws. The member which extends to form a seat is bolted to the front and rear legs in the same way as used in the drive head. As individual leg reach varies, the length of this piece will have to

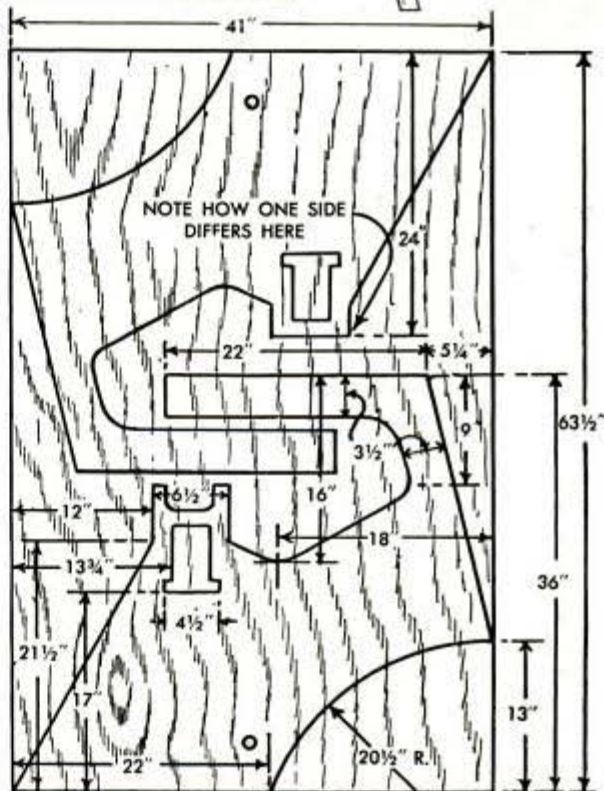

⑨ HOW SIDES CAN BE LAID OUT ECONOMICALLY

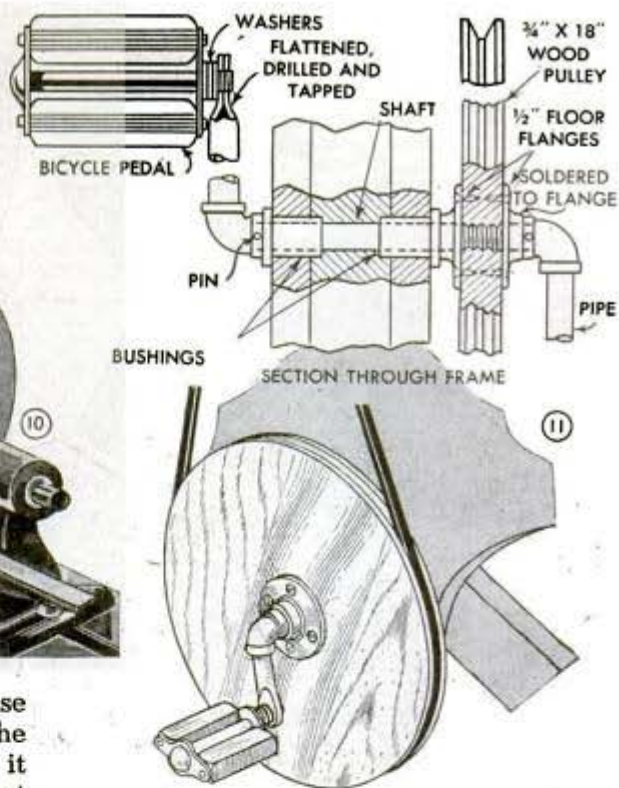

be determined by trial. This is likewise true in locating the bearing hole for the large drive pulley. For some persons it may be satisfactory if centered in the seat member as in Fig. 8; for others it may be necessary to fit an extra block as indicated to permit lowering the position of the pulley to a point where it is easy to pedal.

Assemble the stand as far as shown in Fig. 6 and then slip the drive unit into the opening provided for it before putting the opposite plywood side on the frame. This of course, will necessitate removing the pulley and the wood bearing block. In doing this, be careful that the pin in the crankshaft does not disengage the bar. Cleats are used in the manner shown in Figs. 1 and 4 to fasten the drive unit in place, after which the filler block containing the upper bushing of the shaft is bolted flush with the top of the plywood sides. With this filler block in place, you can go ahead and add the blade chuck to the slotted end of the shaft. This consists of a hexagon nut screwed and soldered to the end and then drilled and tapped crosswise for a setscrew to clamp the blade as shown in Fig. 7. The blade can be made self-centering in the chuck by filling the slot with solder on each side of a piece of wood that is the same width as the blade.

The sectional view in Fig. 11 shows how the large drive pulley is held to a 1/2-in. pipe shaft by two floor flanges which are centered and screwed opposite each other. One end of the shaft is threaded to pass

through the flanges far enough to permit a 1/2-in. elbow to be pinned to the projecting end and soldered to the flange. If you are unable to have the bushings turned of metal to fit the pipe shaft, satisfactory ones can be turned of hard maple and replaced at signs of wear. If metal bushings are used, they should be a press fit in the stand. Bicycle pedals attached to flattened ends of short pipe arms make a neat job. Owing to the size of the plywood drive pulley, you'll have to true it on the outer end of the lathe as shown in Fig. 10.

(To be continued)

Claw Hammer in Vise Holds Rods For Pointing With File

When pointing rods with a file, one mechanic uses a claw hammer as an improvised vise to hold the rods so they can be rotated easily as the work progresses.

The hammer is clamped in a regular bench vise for rigid support while the rods are held in the claws, one hand being used to turn the work as the other one operates the file.



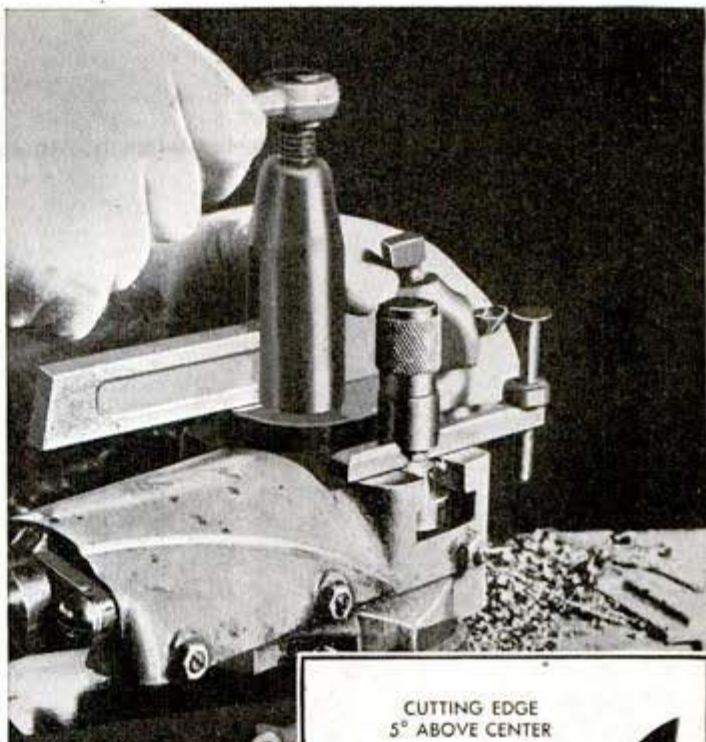
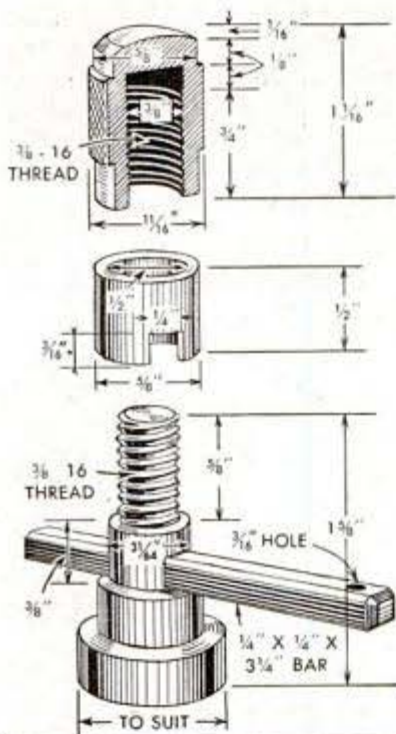

HEIGHT GAUGE *to center tool bits*

LOCKED in a lathe tool-post slot where it is ready for instant use, yet is out of the way when not needed, this gauge will enable an inexperienced lathe operator to center a tool bit accurately. Also, the gauge will save time for an experienced operator, for the gauge arm can be swung horizontally to the bit position for adjusting the latter, after which the arm is swung back out of the way. Requiring only a small amount of steel, the gauge can be made from scrap pieces, and consists of the four parts shown in the upper left-hand detail, plus a centering tip and collar as shown in the lower detail. A base turned to fit the tool-post slot and threaded at the upper end, has a hole through it to take an arm which carries the centering tip. Horizontal adjustment of the arm is held by a slotted collar, which is tightened against it by a turned nut or cap. The centering tip carries a movable collar, which is held by a setscrew so that the exact center of your lathe can be obtained from the headstock

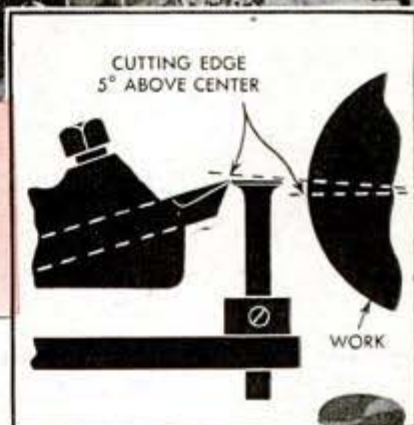

center, after which the collar is adjusted to hold the tip to the correct height. It is a good idea to check the tip against the headstock center occasionally to assure that it is in the correct position. As the original gauge was made for one particular lathe, it may be necessary to increase or decrease some of the dimensions proportionally, especially the diameter of the base, for a gauge to suit various lathes.

—W. T. Warde, San Francisco, Calif.

Hotbed Sash Lifted at Both Sides If Loose-Pin Hinges Are Used

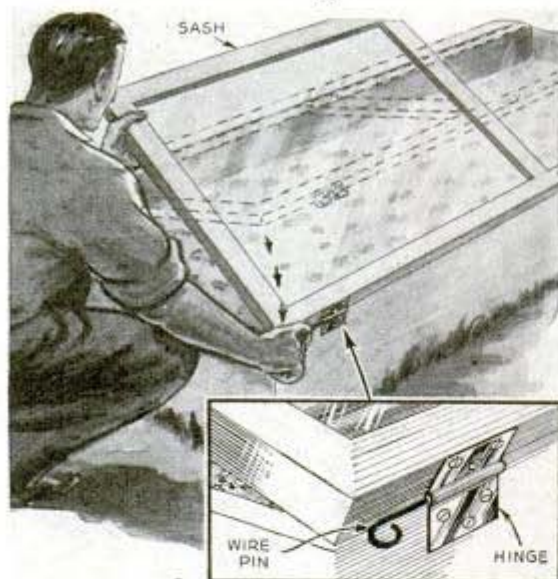

Being unable to raise his hotbed sash on some days because of chill winds blowing toward the opened side, one gardener hinged both sides of the sash so that either could be raised to deflect the wind. Loose-pin hinges were used, pieces of heavy wire with eyes formed on the ends being used as pins to permit easy removal.

Metal Surfaces Are Rustproofed By Polishing With Graphite

Polished steel surfaces that are exposed to the weather or to the action of coolants can be given a waterproof coating by sprinkling them lightly with finely powdered graphite, and then rubbing them briskly with a piece of carpeting glued to a block of wood. A surface that has already rusted should be scoured with coarse steel

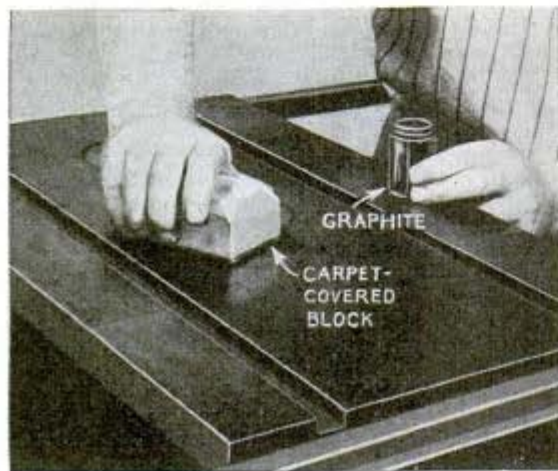

wool and dressed down with emery cloth used dry. Rub the surface until all tiny rust pits have been worn down. Then apply the graphite generously and rub it well into the surface with a hard felt pad. The resulting finish will be black and have a high luster.—Alexander Maxwell, Chicago.

Printing of Deckle-Edge Paper Speeded by These Guides

Feeding of deckle-edge paper stock on a job press is often difficult because the rough edges catch on the gauge pins and interfere with sliding the sheets

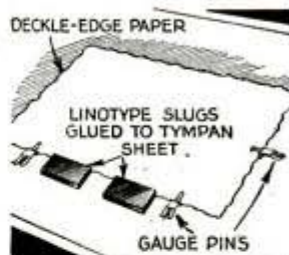

into position. One printer avoids this trouble by gluing a couple of linotype slugs onto the tympan sheet. These are placed so that they project slightly beyond the centers of the gauge pins yet allow the tongues of the pins to hold the stock. The rough sheets slide easily against the smooth edges of the slugs.

More Heat From Carbon Welder

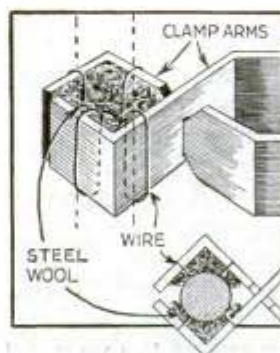

With most types of low-voltage carbon welding torches, the clamp for holding the carbon permits contact at only three or four points instead of all the way around, and when the contact areas become filmed or corroded, high resistance is set up against the passage of current. An improvement for a torch of this type is to bind a small quantity of steel or copper wool to the inside of each clamp arm, using small wire to fasten it securely. The wool allows contact all around the carbon, thus providing maximum heat at the tip.

Preventing Electrical Terminals Overheating and Annealing

I have found that trouble caused by friction terminals on toasters, electric irons, etc., becoming hot and annealing because

of high electrical resistance, due to rust and corrosion, can be eliminated by tinning (brazing) the terminals with bronze or brass. This makes a low-resistance connection and does away with rust and corrosion that is normally encountered on untreated pin terminals.

—R. K. Beal, Marion, Ohio.

Emery-Cloth Knife Sharpener On Paperhanger's Table



A convenient sharpener for a paperhanger's knife can be made by sawing slits in one end of the table top through which a strip of

emery cloth can be threaded as indicated. No tacks are necessary to hold the cloth, which may be changed easily when worn.

Printer's Tools Held by Magnet Above Imposing Stone

To keep his make-up rule, bodkins, tweezers, etc., conveniently at hand over the imposing stone in his shop, one printer uses a large magnet. This is suspended from the ceiling by a cord which passes through a screw eye and over to a window-shade roller attached to the wall. This arrangement permits the magnet to be pulled down where it is within easy reach or raised out of the way when not needed. If desired, a counterweight can be used instead of the window-shade roller.

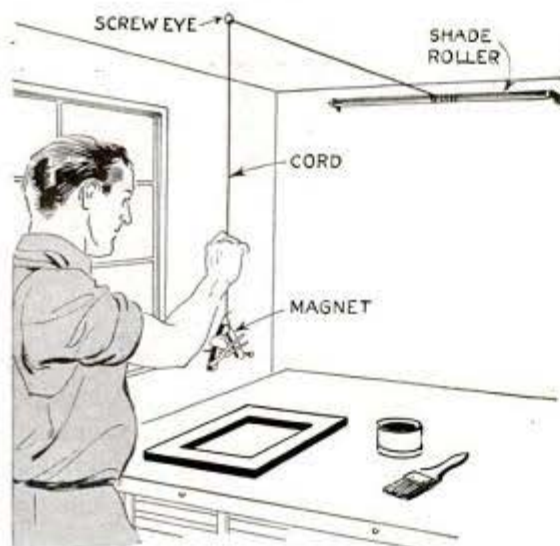

APRIL, 1943

Easy Way to Dissolve Chemicals In Spraying Solutions



One orchardist saves time when dissolving chemicals to make up his spraying solutions by putting the chemicals in a discarded corn popper and swishing them back and forth in the liquid. In this way, the chemicals are dissolved more rapidly than when dumped into the water and stirred with a paddle.

Fouling of Drill Chuck Prevented By Small Felt Disk

When using an electric drill in an inverted vertical position one mechanic experienced trouble by having chips work down the drill flutes and get into the chuck. To prevent this, he slipped a thin felt disk over the drill close to the chuck. The felt absorbed the excess lubricant, which runs down the flutes carrying the chips with it. It will be a good idea to have extra washers at hand so they can be changed when saturated with oil, otherwise centrifugal force will sling the oil around.—W. C. Lammey, Sandwich, Ill.



137

CONSERVE *by Repairing*

SALVAGE FOR VICTORY!

Every machine shop can help to divert more metal, time and equipment for use in essential war production by applying more stringent measures to assure the greatest possible amount of salvage of worn and broken tools and machine parts, instead of scrapping and replacing them with new parts.

By H. J. Chamberland

AMONG repair methods to renew worn and broken tools and machine parts so that they will give continued, useful service, are three outstanding processes, as follows: 1—Bronze welding with an oxy-acetylene torch to resurface or rebuild. 2—Hard chromium plating to replace worn surfaces and produce hard-wearing surfaces. 3—Regrinding cutting edges of high-speed tools, better known as cutter salvaging.

Bronze welding: This process is extensively used to build up worn or broken sections of steel, cast iron, malleable iron, copper, brass and other metal tools. Bronze welding differs from most other types of welding in that it produces welds of exceptional strength without fusion of base metal. Because of less heat required, bronze welding is faster and therefore gas consumption is reduced. Preheating cast iron is often unnecessary but if it is advisable, it need not be extended beyond a black heat so that expansion and contraction are minimized. A special bronze welding rod is used, which melts quickly and flows freely at 1600° Fahr. It tins easily, hardens rapidly and can be machined readily.

Tinning: The secret of bronze welding lies largely in the tinning or preparatory operation. The surfaces to be tinned must be cleaned thoroughly, as molten bronze will not flow on dirty metal. The appren-

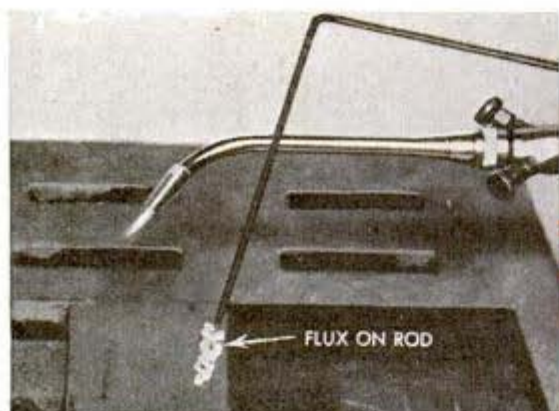

① FLAME ADJUSTMENT FOR SLIGHT OXIDATION



② HEAT SMALL SPOT TO BRIGHT RED

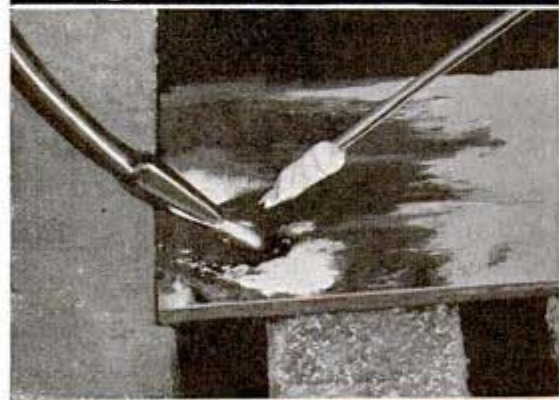

③ END OF ROD MELTED ON RED SPOT

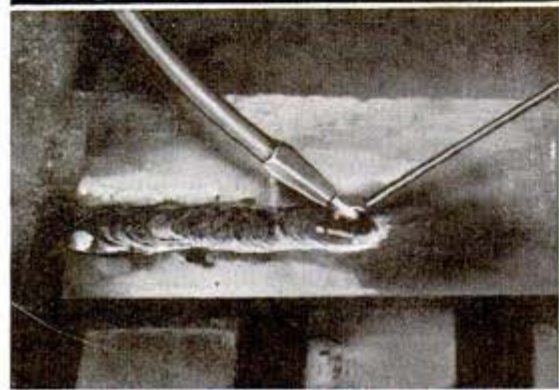

④ DEPOSITING A LAYER OF BRONZE

METAL Shop Tools

tice can practice tinning as follows: Get a couple of $\frac{1}{4}$ -in. low-carbon steel plates about 8 in. square. A section about 3 in. wide should be surface-ground or highly polished. Use a light blowpipe, recommended bronze and related flux. Adjust the flame for slight oxidation, bend the bronze rod for convenient handling, heat the end of the rod about 2 in. and dip it into the flux so that a sufficient amount will adhere to the rod as shown in Fig. 1. Next, as shown in Fig. 2, hold the flame near the edge of the plate and heat a small area about the size of a dime to a bright red. Then, as shown in Fig. 3, melt the flux end of the rod on the red area. The metal should now spread evenly in a thin film. The small dark spot readily seen under and ahead of the flame represents the tinned area. Keep working from left to right continually depositing a layer of bronze about $\frac{1}{8}$ in. thick and $\frac{3}{4}$ in. wide as shown in Fig. 4, alternately dipping and raising the rod from the puddle so you can get the flame under the rod to allow the deposit ahead to thin out.

Building up broken gear teeth: Building up broken or worn sections with bronze weld is known as surfacing. A common application is to renew broken teeth of a gear as shown in Figs. 5 and 6. With this method, thousands of costly cast-iron gears can be salvaged at slight cost. In doing this, the fractured surface is filed and polished, then heated to a cherry red and tinned. A tooth can

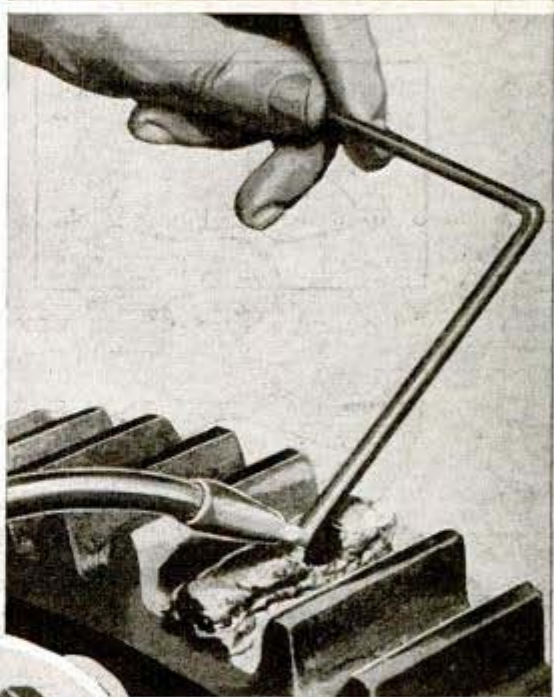

⑥ BUILDING UP NEW TOOTH

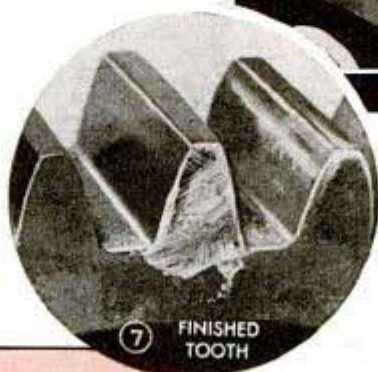

⑦ FINISHED TOOTH

be built up as shown by depositing the bronze in a series of ripples each about $\frac{1}{16}$ in. thick. Direct more heat to the rod than to the deposit. You can start with a $\frac{3}{16}$ -in. rod and finish with one $\frac{1}{8}$ in. in diameter to better accommodate the gradual narrowing of the tooth.

Fig. 7 shows the bronze-weld tooth after it has been machined to shape. It is stronger than adjacent teeth, having a tensile strength of 50,000 lbs. per square inch. When two or more large teeth have to be built up, the following procedure is advised: After filing the fractured surface

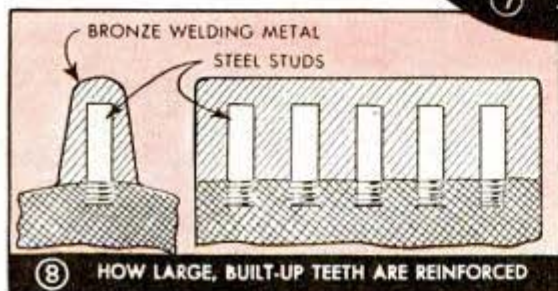

⑧ HOW LARGE, BUILT-UP TEETH ARE REINFORCED

REPAIRING CRACKED GEAR

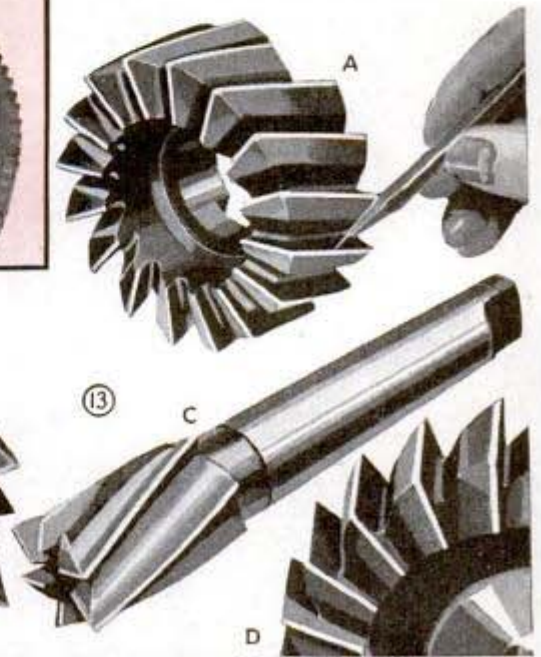
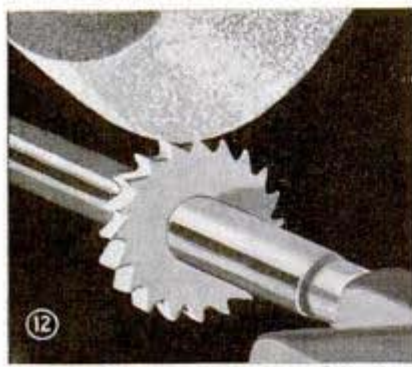
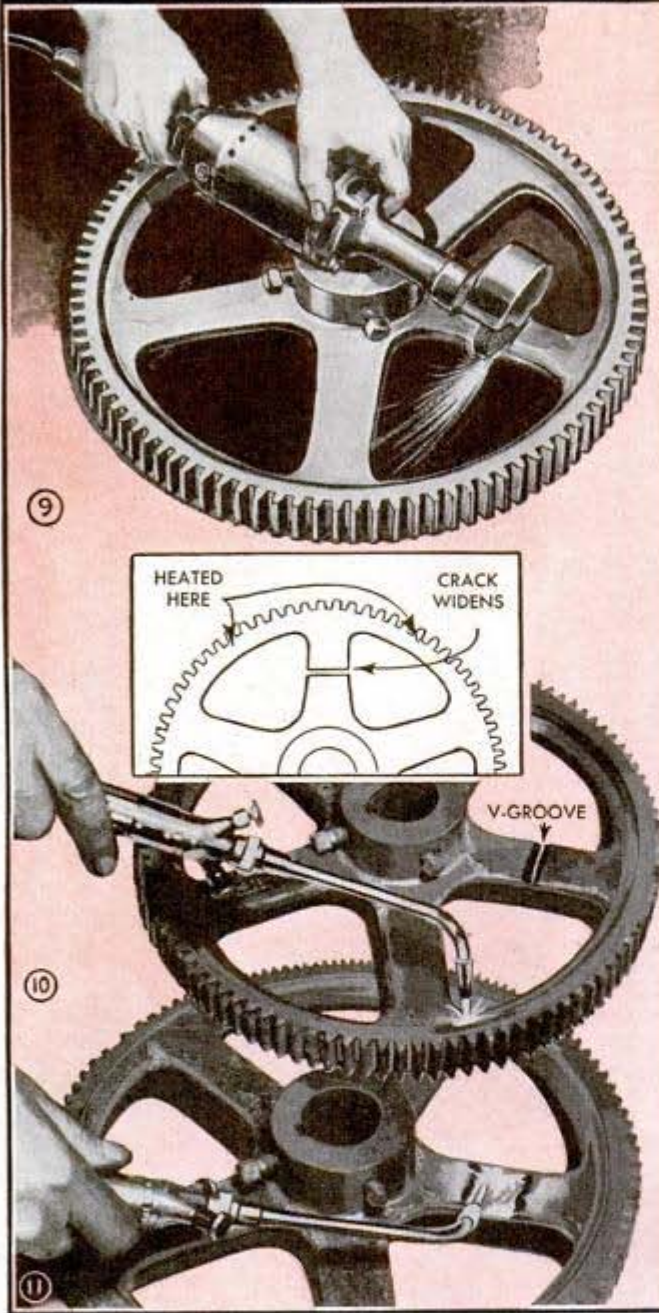

TYPES OF CUTTERS EASILY SALVAGED IN ANY MACHINE SHOP

smooth, the gear is drilled and tapped for reinforcing steel studs along the line of every missing tooth as shown in Fig. 8. Gear teeth so reconstructed may either be finish-shaped by milling, or by filing to template size.

Cracked gears: When a spoke of a cast-iron gear breaks, a bronze weld solves the problem of saving the part. Such a fracture is ground to a V-shape for increasing the strength of the weld, as shown in Fig. 9. Note that the rim of the gear is heated close to adjacent spokes, Fig. 10, which slightly opens the crack as shown in the insert. Then the metal adjacent to the crack is tinned and heated after which the bronze weld metal is applied as illustrated in Fig. 11. Then the gear is turned over and welded on the opposite side.

Hard chromium plating: Hard chromium plating differs from decorative plating in that the former requires but a perfectly smooth and clean surface of base metal, whereas the latter requires an intervening layer of nickel. Broaches, taps, reamers, facing tools, jig bushings, drills, files, dies of all kinds, most types of gauges, shaft bearings and other items are surfaced with this process. Plug

RECUTTING TEETH OF END MILLS

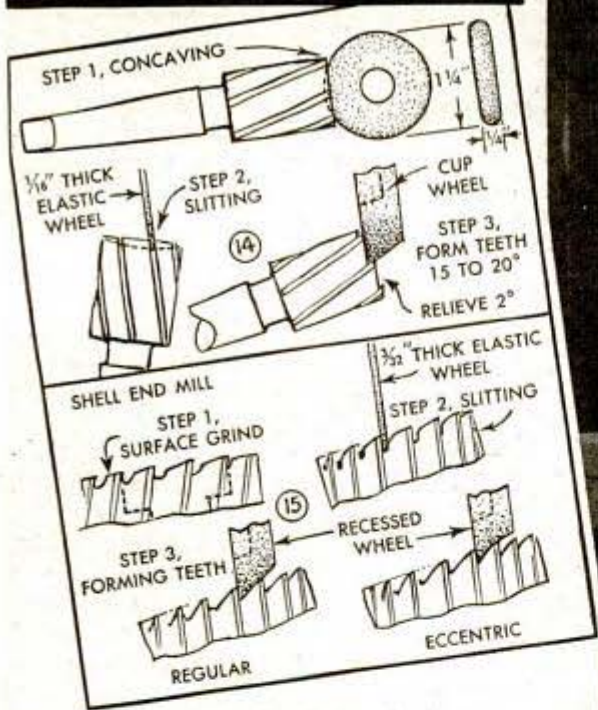

COUNTERBORE MADE FROM TAP

gauges that are worn undersize can be hard chrome plated at approximately 20 percent of the cost of new tools. The primary step is to true them cylindrically by grinding, the removal of .0015 to .002 in. of stock usually being sufficient. Then the tools are plated .0003 to .0005 in. oversize and lapped to exact dimensions. Motor-shaft bearings are often given a .004 to .006-in. plate to allow for finishing to size. Snap and journal gauges as well as reamers are the most economical chrome-plating applications. Many new tools such as files are chromium plated. It has been found that such files given a .0002-in. of hard chrome plate will last three or four times as long as the common unplated kind. Also chrome-plated drills and facing tools will last six to eight times longer between grinds than the usual kind.

Cutter salvaging: When depth of flutes of milling cutters, side mills, end mills and shell end mills, has been reduced one third from successive sharpening operations, the tools have lost approximately 25 percent of their original cutting efficiency. The reason is a gradual reduction of chip clearance besides feed and speed changes. Generally, cutters can be reground twice and only cutters made of high-speed steel can be ground because the steel is hardened all the way through. All the mills that are shown in Fig. 13, can be salvaged easily

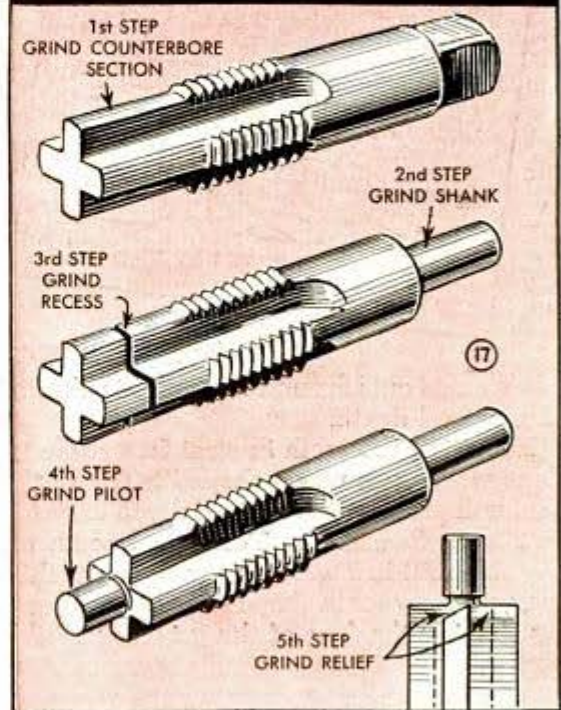

in any machine shop but cutters over 2 in. thick should be sent out to shops specializing in this kind of work. When done outside, the cost of regrinding is 50 percent of the prevailing price of new tools of the same type and recut diameter. Cutter salvaging in one shop is done for 20 to 30 percent of new tool costs. When the teeth of cutters originally are milled in a single traverse movement past the milling cutter, the salvaging procedure requires a series



18 DISK PLUG GAUGES MADE FROM OLD SLITTING SAWS

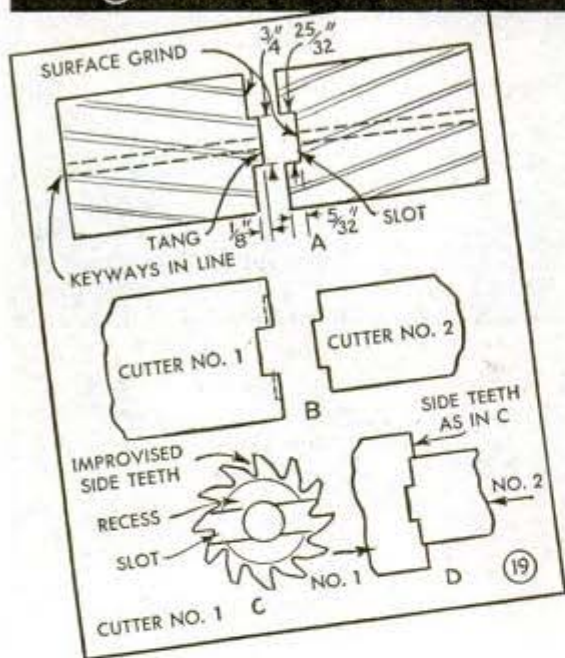

of repeated cuts around the circle to obtain the desired depth.

Recutting the teeth in straight cutters is done with a cup wheel shaped to the angle that will produce the desired depth of flute, as shown in Fig. 12. Peripheral teeth of the side mill in Fig. 13-D can be recut this way, and any tooth shape may be produced by shaping the face of the grinding wheel accordingly. The side mill shown in Fig. 13-B can be recut by setting the machine table at the correct angle and using two different wheels with different angles to reproduce the original shape of the teeth. The shell end mill in detail A and the end mill in detail C would never require recutting peripheral teeth if the end teeth were given constant attention. For recutting spirally milled teeth in any mill, it is necessary to use the same attachment as for sharpening spiral hobs to reproduce correctly the angle of spiral. The simple procedure of cutting new teeth in end mills as shown in Fig. 14 also applied to reshap-

ing end teeth in shell end mills as shown in Fig. 15. The reason for using the elastic or rubber-bonded wheel is that it spaces rapidly and saves the corners of the actual gumming wheel. To recut spiral teeth, a straight wheel having a 1/2- or 3/4-in. face is used. The diameter must not exceed 4 in. and the face must be

dressed to a compound angle to reproduce the original milling cutter used.

Tool transformations: After a metal-cutting tool has served its original purpose, it is not necessarily ready for the scrap pile. The high-speed counterbore shown in Fig. 16 has been made from a tap no longer of service. Steps to transform the tool are shown in Fig. 17, the work being mounted on centers. The grinding operations require less than 45 minutes.

Fig. 18 shows an assortment of disk plug gauges made from discarded high-speed 1/4-in. slitting saws. This set of gauges was made for approximately 20 percent of what new gauges of this type would cost. Holes are of one diameter for single-handle convenience.

Two milling cutters of identical diameters can be made interlocking in less than an hour's time, as described in Fig. 19A. This procedure has saved the cost of a new cutter to mill a wider surface. Cutters of different diameters are interlocked as in detail B. The larger mill requires side-cutting action as shown in details C and D.

Duplicate Holes Marked Easily With Acorn Nut and Punch

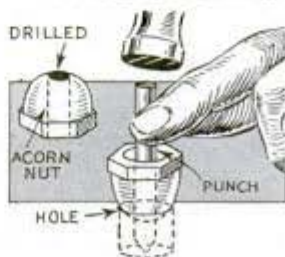

Where new work is being laid out from a pattern and suitable tools are not at hand for marking the metal to drill duplicate holes, these marks can be made easily with an acorn nut and an ordinary punch. All you need to do is drill the nut and slip it over the end of the punch to provide an attachment that will center the punch accurately when held vertically in the holes.

—A. H. Waychoff, Phoenix, Ariz.

This Tool Rounds Edges of Woodwork Quickly

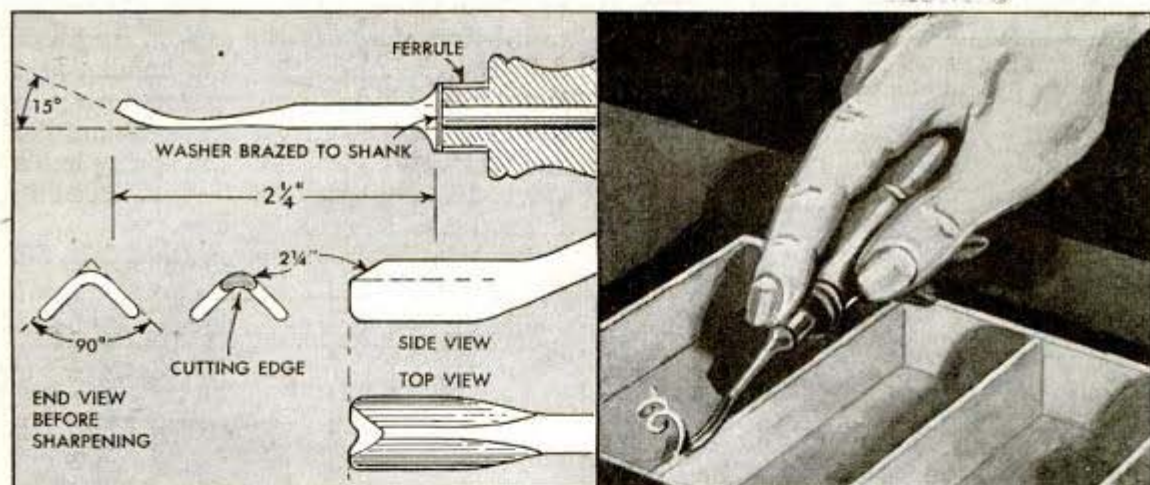

Woodworkers will find this tool a time-saver for rounding sharp edges, especially on work that has dead ends such as drawer sides, partitions, etc. The tool is made from two old twist drills welded together end to end. One drill is untwisted and the end is forged flat, after which the sides of the flattened portion are bent upward at about 90 degrees to form a trough shape slightly rounded on the inside bottom surface. This job is best done by using as an anvil a piece of steel with one edge rounded to the radius you desire to produce on the wood. Next, the end or tip is bent upward at an angle of about 15 degrees, and a collar or washer

is brazed on the shank part of the tool to rest against the handle when the latter is driven in place. The tip or cutting end of the tool is now hardened by heating it to a bright cherry red and plunging it into cold water. Then the tip is polished bright, reheated carefully to a straw color and then quenched quickly in water. After grinding the tip on the underside to form the cutting edge, a wooden handle drilled to take the shank tightly is driven in place. On some jobs it may be necessary to grind off the tip corners to keep them from catching on the work.

—Walter E. Burton, Akron, Ohio.

High Partition in Toolbox Increases Its Carrying Capacity

Instead of hunting through his small toolbox whenever he wanted a certain tool, a carpenter substituted a high partition for the regular one, and fitted it with racks for saws and other most-used tools. This arrangement made selection of tools easy, increased the capacity of the box and provided a carrying handle that could be reached without stooping low.

Reinforcing Bolted Wood Joints

A simple method of reinforcing bolted joints in wood framing is to insert a piece of metal lath or large mesh wire between the boards before bolting them together. The wires will sink into the surface of both pieces of wood, locking them together when the bolts are drawn up. A few hammer blows while tightening will help.

—Robert Hamilton, St. Joseph, Mo.



Ferris-Wheel Display on Counter Helps Customer Select Cloth

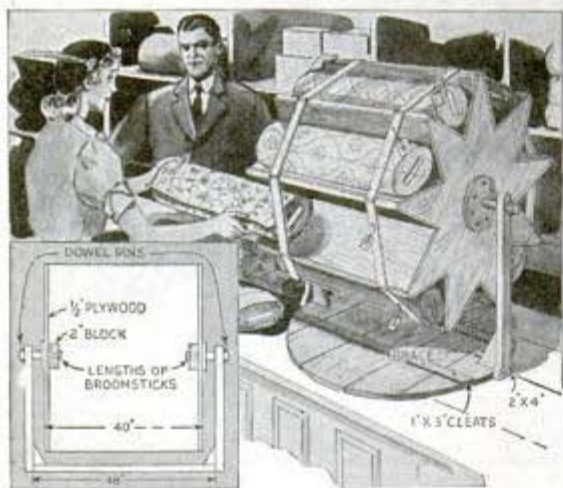

After installing this unusual counter display, one dry-goods merchant found that it not only pleased his customers by permitting them to select their purchases at their leisure, but it also saved time for the clerks by making it unnecessary for them to take down from the shelves several bolts of cloth to show each customer. The display can be made any size desired, although one 40 in. wide and 4 ft. high holds nine bolts of cloth which is about right for a counter. The sides are cut from $\frac{1}{2}$ -in. plywood and are pivoted to two supports by means of short lengths of broomstick. These turn in holes in the supports, and are a drive fit in holes in the side pieces, reinforcing blocks being used on the side pieces as indicated. The supports are screwed to a circular base and braced with corner blocks. Several boards glued together make up the base, which is reinforced with two horizontal cleats 1 in. thick and 3 in. wide.

Fitting Toolmakers' Clamps With Sliding Handles

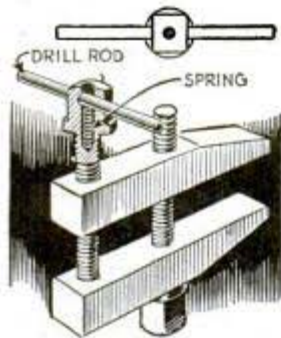

Small toolmakers' clamps that are made for use with a wrench can be improved by fitting them with sliding handles. For the small $1\frac{1}{2}$ or 2-in. sizes, this is best done by drilling a small

hole about $\frac{1}{2}$ in. deep in the squared end of the clamp screw, and then drilling a second hole through the end at right angles to the first one to take a $1\frac{1}{2}$ -in. length of drill rod. In assembling the handle, first insert a small coil compression spring in the blind hole so that it bears against the rod when it is inserted. The spring holds the rod in any position desired. Peening the rod ends keeps it in place.

—W. E. Jacobson, Riverdale, Ill.

Strain of Standing at Machines Eased by Powder Puffs

To lessen the strain of standing at a production machine for long hours, one operator places a powder puff in the heel of each of his



work shoes. As the puffs come in a variety of sizes, it is usually a simple matter to find a couple in a ten-cent store that will suit.

—William Swallow, Brooklyn, N. Y.

Lathe Chuck Is Adjusted Quickly By Spiral Ratchet Screwdriver

Lathe operators will find that much time can be saved in adjusting a chuck by using a spiral ratchet screwdriver instead of the regular T-wrench. The wrench will have



to be used in tightening the jaws after they come in contact with the work, but the screwdriver permits the jaws to be run down quickly to the work or backed away from it. A short piece of metal ground to fit the chuck-jaw sockets and substituted for the screwdriver blade will be handy.

Operating Horizontal Motor in Vertical Position

Almost any electric motor of fractional horsepower that is designed to operate in a horizontal position can be used in a vertical position if an adequate method of lubricating the bearings is provided and a thrust bearing is installed to keep the armature shaft from rubbing on the end-plates of the motor housing. The simplest method of lubricating the bearings is to install a grease tube as shown in Fig. 1. This consists of a suitable length of tubing, tapped at one end to take a screw plug, and filled with yarn or other packing. One end of the packing is held against the motor shaft by a small spring inside the tube. A special grease lubricant, such as comes in collapsible tubes for sewing machines, vacuum cleaners, etc., is used. Or, a mixture of finely flaked graphite and light petroleum jelly can be used.

To install the tube on very small motors having babbitt or thin bronze sleeve bearings that usually cannot be removed without damaging them, you enlarge the oil-hole to take the tube with a press fit. This is done by taking out the motor shaft and drilling through both the housing and the bearing. On the larger motors that are likely to have removable bronze bearings, you can remove them, enlarge the oilholes, and then insert the grease tube through the oil well in the housing.

After taking care of the lubricating problem, you are ready for a thrust bearing. On the smaller, single-end shaft type of motor, a steel bearing ball working in the countersunk center hole of the shaft end will suffice. This is shown in Fig. 3, the ball being retained in a shallow depression made in a Bakelite plate, which is held by screws tapped into the end plate of the motor. This arrangement permits tightening the screws to take up wear. The ball will eventually sink into the Bakelite to a depth that will necessitate replacing it. On larger motors having double-end shafts, regular ball thrust bearings will have to be installed. This can be done by turning a shoulder on the bearing, and then making up a shouldered fiber collar to fit between the bearing and the end of the armature as shown in Fig. 2. Usually, the cone type of bearing used on bicycle wheels, or the flat type used for lathe headstocks are small enough to fit into the space between the armature and the motor bearing.

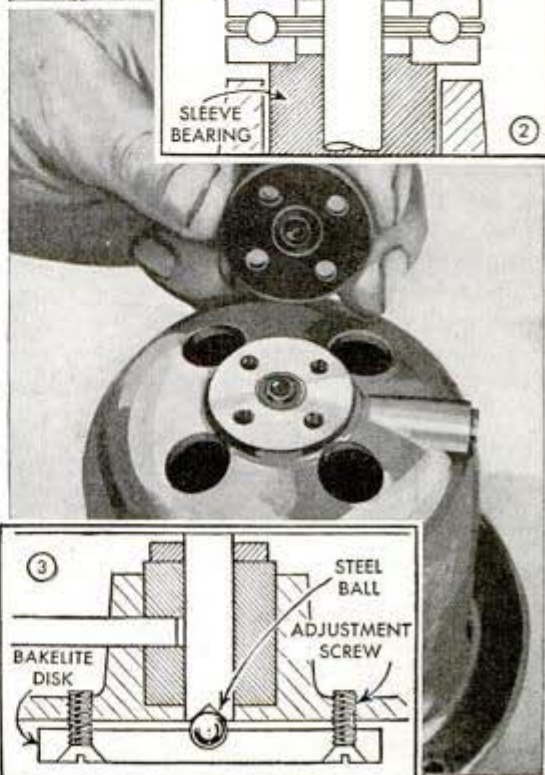
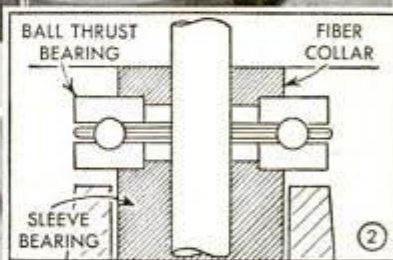
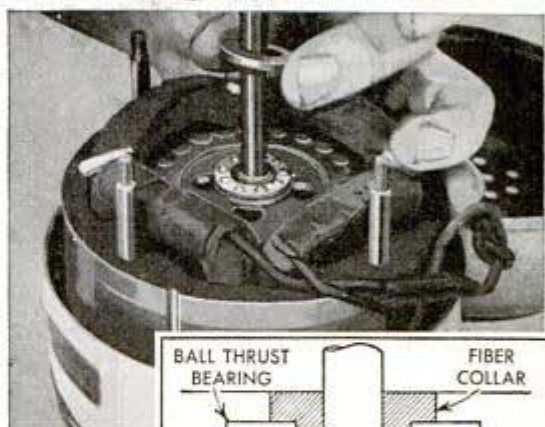
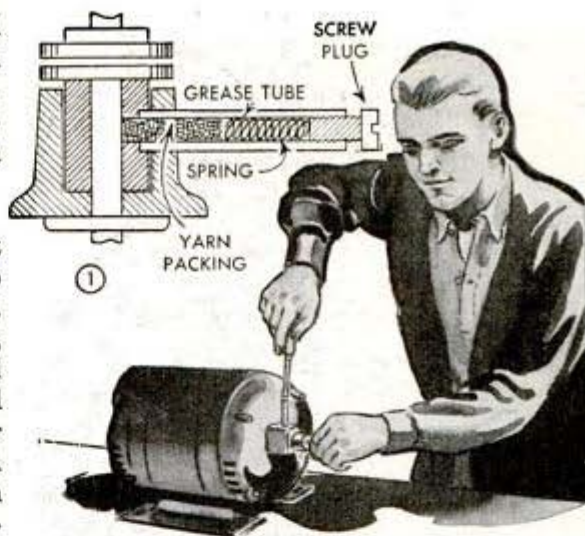

This Tool Kit Serves as Sawhorse When Handling Small Work

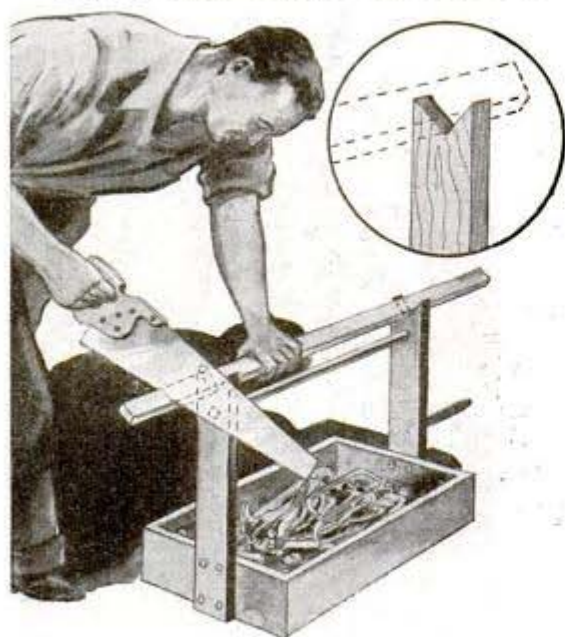

For small jobs away from the shop, one carpenter carries a tool kit like the one shown. The vertical members of the handle are notched at the upper ends to make a convenient sawhorse for cutting moldings and other small pieces.

Copper Tubing Joined Securely

The next time you have to join some copper tubing and have no regular tools at hand for the job, try the following: Enlarge the end of one tube with a file or screwdriver, and file down one end of the other tube to slip inside it. Then, after tinning the surfaces that are to contact, you can sweat-solder the joint.

—Harold Rupp, Florence, Ariz.



Welding Torch Used to Solder

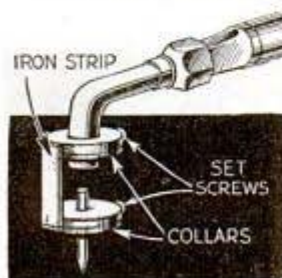

On a job of soldering several thousand floats, I used this simple attachment on a gas welding torch and did the job quickly. The attachment consist-

ed of two metal collars spaced with an iron strip to hold a piece of carbon so that the low flame of the torch was directed against the upper end of it as shown. This gave the desired heat at the lower end of the carbon so that the soldering could be done without discoloring the floats, which were made of brass.

—Marion L. Holsinger, Harrisonburg, Va.

W.T.M. Concrete Anchoring Bolts in Concrete To Prevent Turning

If bolts are anchored in concrete for the attachment of objects that must be removed and replaced at intervals, any tendency of the bolts to loosen because of these repeated operations can be avoided by bending the bolt as indicated. This idea is also handy when attaching objects that require the nuts to be drawn up exceptionally tight, as the bent bolts are anchored more firmly in the concrete than when straight bolts are used.

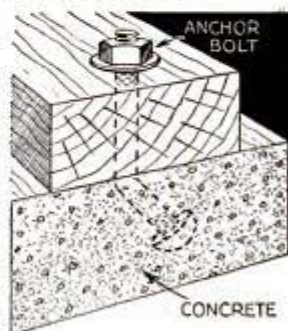

Coils of Weed Burner Cleaned With an Electric Drill

When the coils of a fire gun used for burning weeds became clogged with carbon, I cleaned them with a speedometer cable that was rotated inside the coils with a slow-speed electric drill. After removing the valve from one end of the coils and the elbow and tip from the other end, a speedometer cable was worked through them and one end chucked in the drill. Rotating the chain removed the carbon, after which kerosene was run through the coils to remove all loose particles of carbon. When reassembled, the fire gun worked as good as a new one.

—Blair Votaw, Phoenix, Ariz.

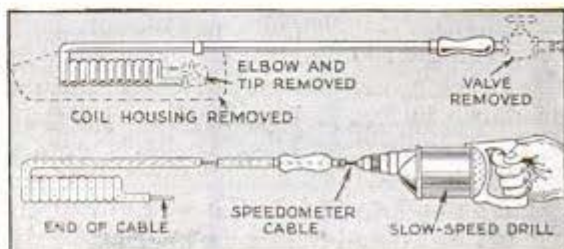

Check VISCOSITY

for Better Spray Finishing

WHEN using a spray gun, you probably have noticed that on one job the paint is applied just right for an even coat, while on the next job you may get runs, a sandy surface or excessive dusting. Chances are that the trouble is the viscosity of the paint or lacquer you are using. Viscosity indicates thick and thin liquids. For example, light, thin No. 10 automobile oil has a low

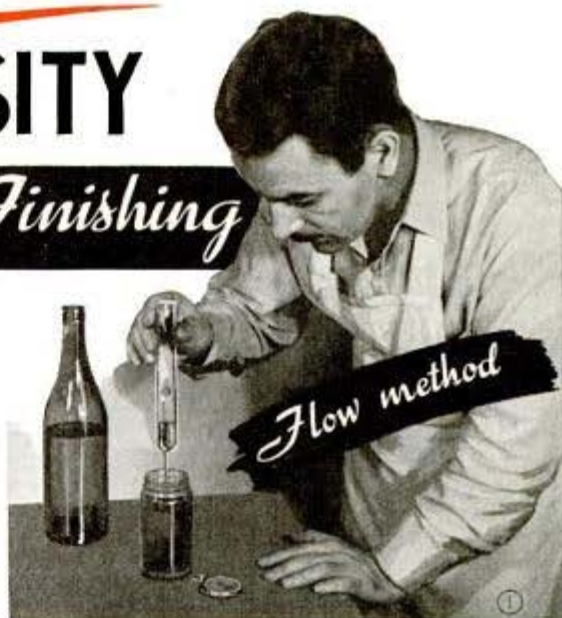

viscosity and the heavier and thicker No. 30 oil has a high viscosity. When using paint or lacquer of high viscosity in a spray gun, you get spatter and excessive orange peel; when the viscosity is too low, you get a thin, sandy finish, possible sags, and excessive dusting.

It is obvious that there is a right viscosity for every fluid and for every spray gun, and the trick is to get it just right when you spray. To do this, you need some device that will measure viscosity. A simple one is a glass tooth-brush tube or a test tube, at the bottom of which is drilled a $\frac{1}{16}$ -in. hole. Also, an opening is cut about $2\frac{3}{4}$ in. from the end, as shown in Fig. 2.

Both hole and opening may be cut in glass by using a silicon-carbide wheel mounted in a hand grinder. A guide mark is ground on the glass about $\frac{1}{2}$ in. from the end. To use, dip the tube in the fluid being checked so that the tube is filled to the lower edge of the opening. Then quickly lift the tube and allow the fluid to run out through the bottom hole as in Fig. 1, carefully noting the time that it takes. If you are checking a clear fluid, take the time when the fluid drops to the mark on the lower end of tube; if you are checking opaque fluid, take the time the instant the stream breaks. Results obtained by such timing give comparative viscosity figures for various liquids.

Another simple check is the falling-ball

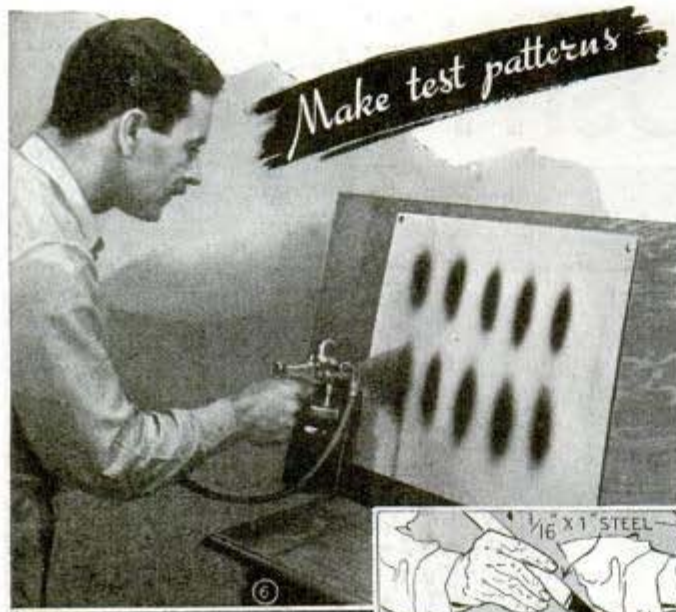

own gun and compressor, is a matter of checking with test patterns. Start out by filling the spray-gun jar about half full of a liquid, which you know is definitely too heavy, and spray a test pattern, as in Fig. 6. Then add a small amount of thinner and spray another test pattern. Continue in this way until you find the proper viscosity to use for your gun. Recheck by spraying a complete panel. Now, measure the viscosity of the most suitable fluid by any of the methods described. Fluids that are

method. You drop a small steel ball into the fluid and note the number of seconds required for it to hit the bottom of container as shown in Fig. 3. This is a handy way of checking if you use glass jars on your spray gun, as the ball or balls can be left in the jars. If you have a small compressor capable of spraying only light fluids, it will be necessary to use glass or plastic balls instead of steel ones. Obviously, the greater the drop, the more accurate the test; 5 in. is a good distance, but 10 in. is the professional standard. It will be apparent that this test cannot be used with opaque materials.



Still another method is the use of viscosity tubes, as shown in Figs. 4 and 5. Standard viscosity tubes are quite inexpensive (about ten cents each), but small vials of uniform size can be used. You will need six or seven. Each one is filled with the fluid being checked so that there will be an open space of about $\frac{1}{16}$ in. below the cork. When the tube is inverted so that the open air space becomes a bubble, it will travel to the upper end of the tube. The time required varies with the viscosity. The exact size of the bubble is not important, but the tubes must be the same inside diameter for good results. If the bubble travels too fast when checking thin fluids, the tube should be set at an angle instead of being turned upside down.

To correlate results obtained by any of these methods with the capacity of your

used in the spray gun should be brought to the same viscosity as that of the original test fluid. If you use the viscosity-tube method, seal a tube containing the "just-right" fluid, and use this tube for direct comparison.

Making these tests takes a little time, but it is well worth the effort. Just remember how long it took you to wash and sand off that last job you spoiled. However, if you persist in sticking to the crude paddle test, at least make a point of testing in a uniform manner. Use a piece of metal $\frac{1}{16}$ by 1 in., and always dip it into the liquid to a predetermined mark. Liquid that is too thin will immediately run off the end of the paddle, as shown in Fig. 7. A liquid that is too heavy will drop before it runs, as in Fig. 9. Liquid that is close to the right viscosity starts to run but has enough fluidity to finally flow to the end of the paddle in more or less wavy "gallops," as in Fig. 8. Sprayers get good results with this method, but in all cases the viscosity tests already explained permit greater accuracy.

☞ To do a good job of filling wood grain, use the heel of your hand in a circular motion to further pack the paste in the pores before wiping off with a cloth.



Radio

First Aid Hints for Home Sets

MOST "chairside" receivers present a mechanical problem to the average set owner when it becomes necessary to replace tubes, as the chassis base must be removed from the cabinet.

If your set is a phono-radio model, similar to the one shown in photo (A), and you are not familiar with the compact internal arrangement, it is best to leave tube replacements to a radio serviceman. On the other hand, if you have changed tubes in various types of sets, and your "chairside" receiver is one of the models without a record player, remove the line cord plug from the wall outlet first, then disconnect the antenna and ground leads.

Where the controls are on the side, the cabinet may be turned upside-down as illustrated in photo (B); in this assembly the chassis and speaker were all mounted on a sliding side panel that was easily removed. If the chassis

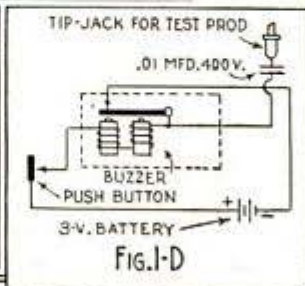

screws up, and place a book or block inside the cabinet under the top of the chassis so that it will not drop when the mounting screws are removed. The dial proper is usually a part of the chassis assembly.

A high-frequency "test buzzer" signal generator is a handy and efficient test unit for the radio student and experienced set owner. Battery operated, it generates both r.f.

and a.f. signals and provides a rapid method for determining what particular stage of a receiver is defective. A compact type appears in photo (C), and a homemade unit is shown in photo (D) and circuit diagram Fig. 1-D.

is screwed flat to one side of the cabinet, and the separately mounted speaker has a plug and cable arrangement, lay the cabinet on its side with the chassis-mounting

the short test prod of the signal generator is held close to the antenna to adjust trimmer condensers on t.r.f. sets; and grid of 1st detector tube in supers.

UNIVERSAL TESTING BRIDGE

By L. M. Dezettel

ASSEMBLED from standard radio parts that nearly every experimenter and serviceman has on hand, this test unit is capable of measuring resistors, condensers and chokes without the use of a meter. Identify, and put old parts to work in servicing home receivers and building useful emergency sets, student receivers, amplifiers and similar units.

It is based on the simple and widely known bridge circuit in which an unknown resistor, condenser or choke is measured as a ratio of a known resistor, condenser or choke. This ratio depends upon the ratio between two resistors within the instrument. The case is made of plywood, all dimensions of which are given in Fig. 1; the front panel may be of $\frac{1}{8}$ -in. Bakelite, hard-pressed wood or any similar material.

Photos A, B and E show front and rear views of the completed unit. The same general arrangement is illustrated in the simplified wiring diagram that appears in Fig. 2 in which all parts are shown in their relative positions on the rear of the front panel and as mounted on the inside of the case. A large round-hole lug is placed under the mounting nut of switch No. 1 for an added common ground connection.

The circuit consists of a bridge network, with variable resistors R_4 and R_5 , a constant tone source, and a pair of headphones. The tone is heard in the headphones and the resistors are balanced until no tone signal is heard. The value of the unknown resistor, etc., is then read on a calibrated scale. Since requirements of the power supply and oscillator are not critical, almost any tube combination can be used. In this case a type-56 tube is employed as a half-wave rectifier. Select several resistors, condensers and chokes of known values to act as your standards.

Practically any old power transformer can

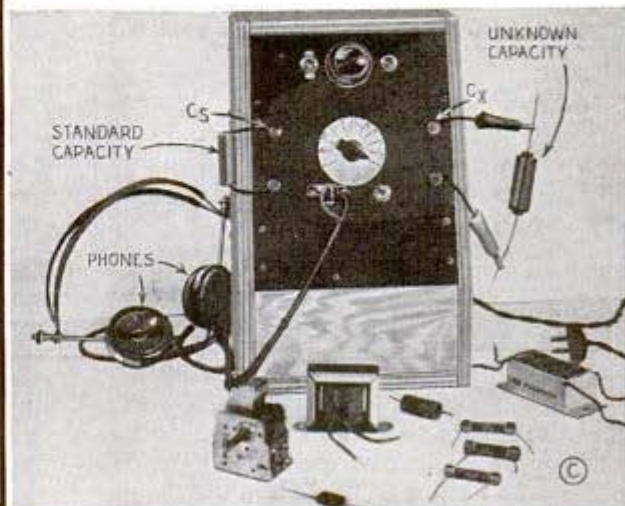
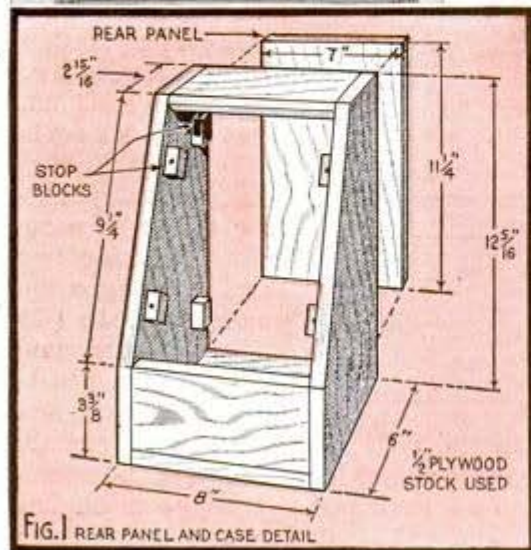
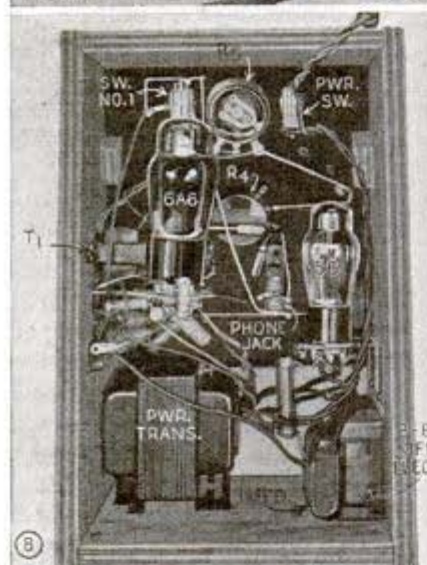
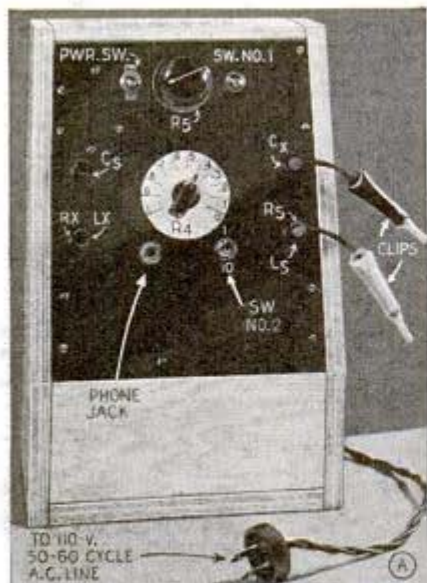

MEASURES UNMARKED PARTS

be used, as only about 50 volts are required for the oscillator. The transformer in this case was a common broadcast set variety with a 600-volt secondary high-voltage winding. Only one-half the high voltage secondary was used, the other high voltage end being clipped off. To further reduce the voltage, a 5,000-ohm 3-watt carbon resistor was used and also served for filtering. A 6A6 tube is used for the oscillator. This is a 6.3-volt tube but may be operated from the 5-volt winding, as the oscillator is not called upon to deliver much power.

The fed-back energy should be as little as possible and still be enough to maintain oscillation. The value of resistor R_1 should be experimented with to obtain this result. The output is fed to the bridge circuit through an ordinary 3-1 ratio audio transformer connected in reverse. Resistors R_2 and R_3 are $\frac{1}{4}$ -watt carbon types with a 2 percent tolerance, and potentiometer R_4 is a wire-wound unit. The headphones should be high impedance type; crystal if you have them. To measure a resistor, using a standard resistor of 1,000 ohms, connect the standard to terminals R_5 and the unknown resistor to R_x . A tone will be heard in the headphones; switch No. 1 should be in the No. 1 position, and potentiometer R_4 rotated until no signal is heard in the phones on one

(Continued to page 170)

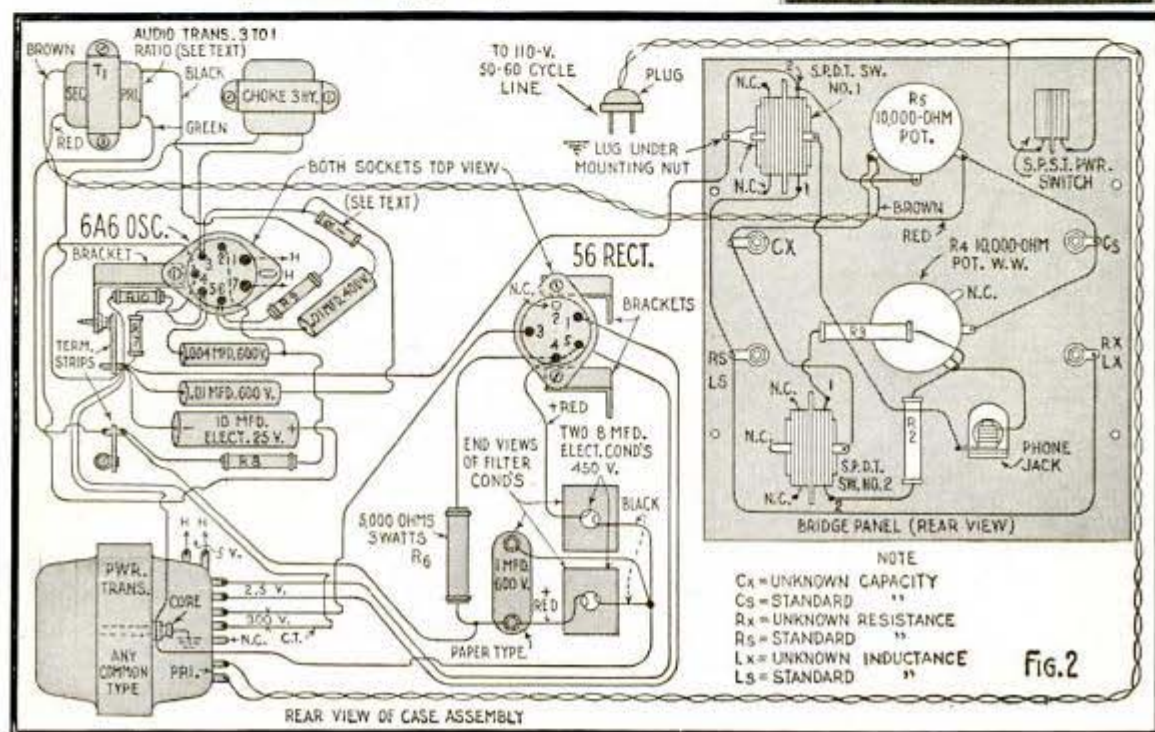
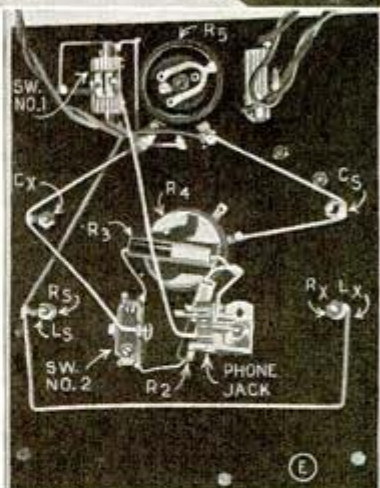

Classroom Demonstrator for Radio Training

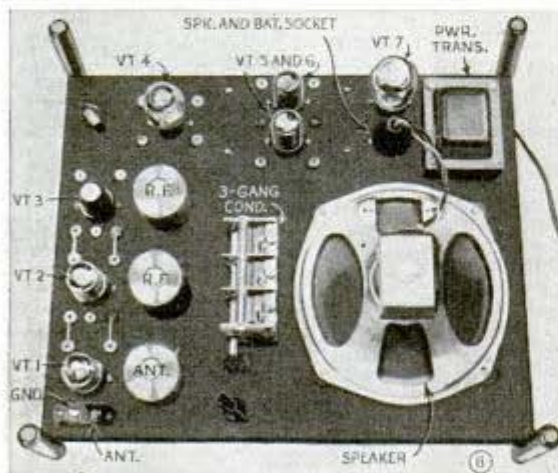
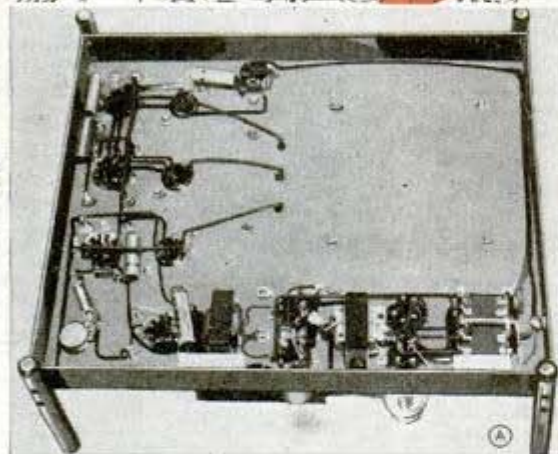
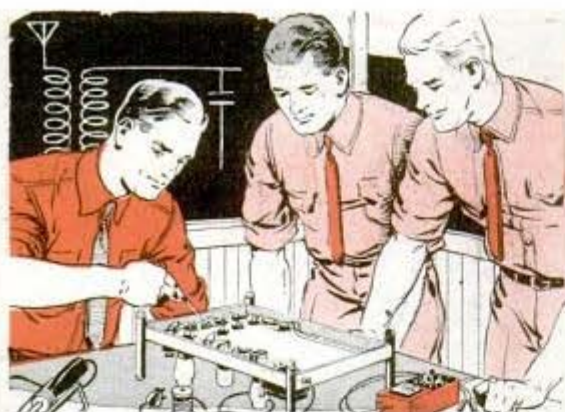

DESIGNED to provide an exceptionally flexible operating model of an a.c. receiver for schools training Army, Navy, aircraft and civilian radio students, this 7-tube demonstrator can be assembled, tested and dismantled at will. The tuned-radio-frequency circuit may be wired in stages so that the students can test and operate each stage individually, or in combinations, from the self-contained power supply or external batteries. The complete assembly with push-pull audio output stage provides ample volume and good quality for practical demonstrations.

The chassis layout and schematic circuit diagrams are given in Figs. 1 and 2. Four dowel rod rests are used, one on each corner of this kit chassis, to facilitate handling. By means of this handy arrangement the receiver can be placed on any of its six sides without damage to the parts or the table, desk or bench on which it is placed. This feature is illustrated in photos A and B. The metal chassis is 13 in. wide, 17 in. long and 1 3/4 in. high.

Combinations of pin jacks and jumper wires are used on top of the chassis in order to operate the set in stages. These pin jacks also provide a means for making electrical measurements at practically all parts of the circuit. The 8-in. dynamic speaker is mounted on 4 dowel rods that support it above the base at a height of about 2 inches, and is connected in the circuit by means of a short cable and a plug that fits into a socket on the base. Both a.f. and r.f. volume controls are provided, and nothing has been overlooked that would be helpful to the student and the instructor. The tube line-up is as follows: two 6SK7-GT's; one 6C5-GT; one 6L5G; two 6V6-GT's as output tubes, and a type-80 full-wave rectifier.

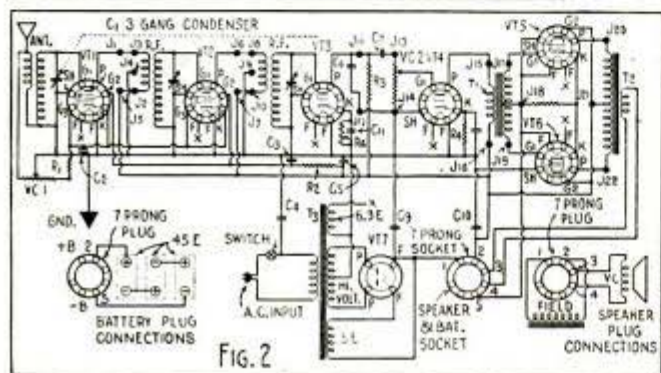

Fig. 2

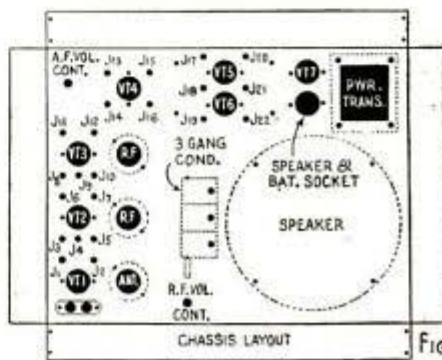

Fig. 1

AUTO-LITE SPARK PLUGS

IN SERVICE AT HOME AND ON EVERY FRONT



"Gran'maw—c'mere—the Army wants ter know if Willy is six feet tall!"

THIS YEAR ALL AMERICA MUST MEASURE UP

Today we must all measure up in our war effort. Even in little things like keeping our cars up to snuff—so they stretch every rationed gallon of gasoline miles farther.

That's the job Auto-Lite Spark Plug Dealers can help you do with "Plug-Chek" Inspection Service. Actual tests by the American Automobile Association show this new spark plug service can help increase gas mileage as much as 12%.

To make sure you get your full measure in miles, ask your nearest Auto-Lite Spark Plug Dealer for a "Plug-Chek" today.

THE ELECTRIC AUTO-LITE COMPANY
Toledo, Ohio • Merchandising Division • Sarnia, Ontario

Keep 'em Smiling!

... and help the U. S. O.

A big, new 24-page book of Paul Webb's "Mountain Boys" cartoons mailed by us to men in service. Send name and address with dime or War Savings Stamp which we will turn over to the U. S. O. in full.



First Aid for Guns and Tackle

(Continued from page 69)

mainly because they don't know how easy it is. I put up two deer last fall in Mason-type jars and the meat is in my cupboard now, tenderly cooked and ready to eat. A couple of weeks ago when I got back from a deep sea fishing trip I put up 48 pounds of tuna in glass jars. If you follow the directions that come with a case of jars you won't go wrong. Use the dry, hot oven process, cooking fish five hours at 250 degrees and meat two hours at 250 degrees. Tough deer shank makes good mince meat if you cut it up, add suet and raisins, then can it. You may add apples and other ingredients when you open the jar.

Keep your ammunition, rubber boots, and other rubber goods in a cool, dark, dry

place. Your tennis racket will last longer if you keep it in a press and shellac its strings lightly with white shellac now and then. Skis keep their shape best when tied against a spreader, with clamps to keep the toes bent out. When winter is over I scrape all the varnish off my skis, right down to the wood, then smooth them with steel wool. Let them lie unpainted all summer so that they lose all their moisture, then revarnish them in the fall. Never use a boot oil to preserve leather goods. That makes them heavy. Leather should be dressed with saddle soap.

Remember, you won't get much more sports equipment until the war is over, so take care of what you have right now.

The Mystery of the Common Cold

(Continued from page 37)

search unit was organized in 1934 by Commander Albert P. Krueger and has been on active duty since January of 1941. It is an integral part of the 12th Naval District medical activities under Captain E. U. Reed.

Aside from developing effective vaccines, the unit is studying means of controlling the air-borne infection. Work is being done on chemical agents that inactivate the virus in the air without harming it. Studies at the University of Chicago's Billings Hospital indicate propylene glycol vapor is one such agent. This cheap, odorless, tasteless, non-toxic substance in the future may be sprayed into the air in theaters and schools. One part of glycol in 2,000,000 parts of air is said to kill heavy concentrations of suspended bacteria in a few seconds. As is the case with common colds, one of the dangers of influenza is its wearing down of resistance to a point where other infections can take hold. Pneumonia has been a frequent and deadly secondary infection. The new sulfa drugs, which have no effect on influenza virus, are such a potent weapon against pneumonia that the pneumonia death rate last year was less than half as high as was its average during the 10 years ended in 1937.

With their improved understanding of respiratory upsets and infections, have medical authorities any new advice for treating colds? Unfortunately, there is no

specific cure—all information. They advise you to avoid abrupt changes of temperature and humidity as much as you can. That is, the nose should be given a chance to adjust itself to the new conditions when, for instance, you leave a dry warm room and go outside into a cold and moist atmosphere. Next, avoid overcooling or excessive heat loss, such as resting in a draft after exercise, or continuing to wear wet clothing. Third, keep up your resistance by avoiding fatigue, improper diet, and overindulgence, and by proper exercise.

When you do catch cold in spite of these precautions, warmth and rest are the best things for you. Staying in bed a few days helps avoid a more serious secondary infection. There are numerous preparations at the drugstore that may give some comfort, though no one preparation seems good enough for universal recommendation. Ephedrine preparations that help shrink the nasal passages give some relief. Oily substances may prove harmful. Hot baths and hot drinks also give relief provided you stay in bed to avoid a chill. Never "stuff a cold." You are better off by taking nothing but plenty of liquids for the first day or two. Most important—stay in bed if you can, and in all events, get plenty of rest and keep the room warm and moist. In fact, the more you take it easy, the easier the cold will be on you.

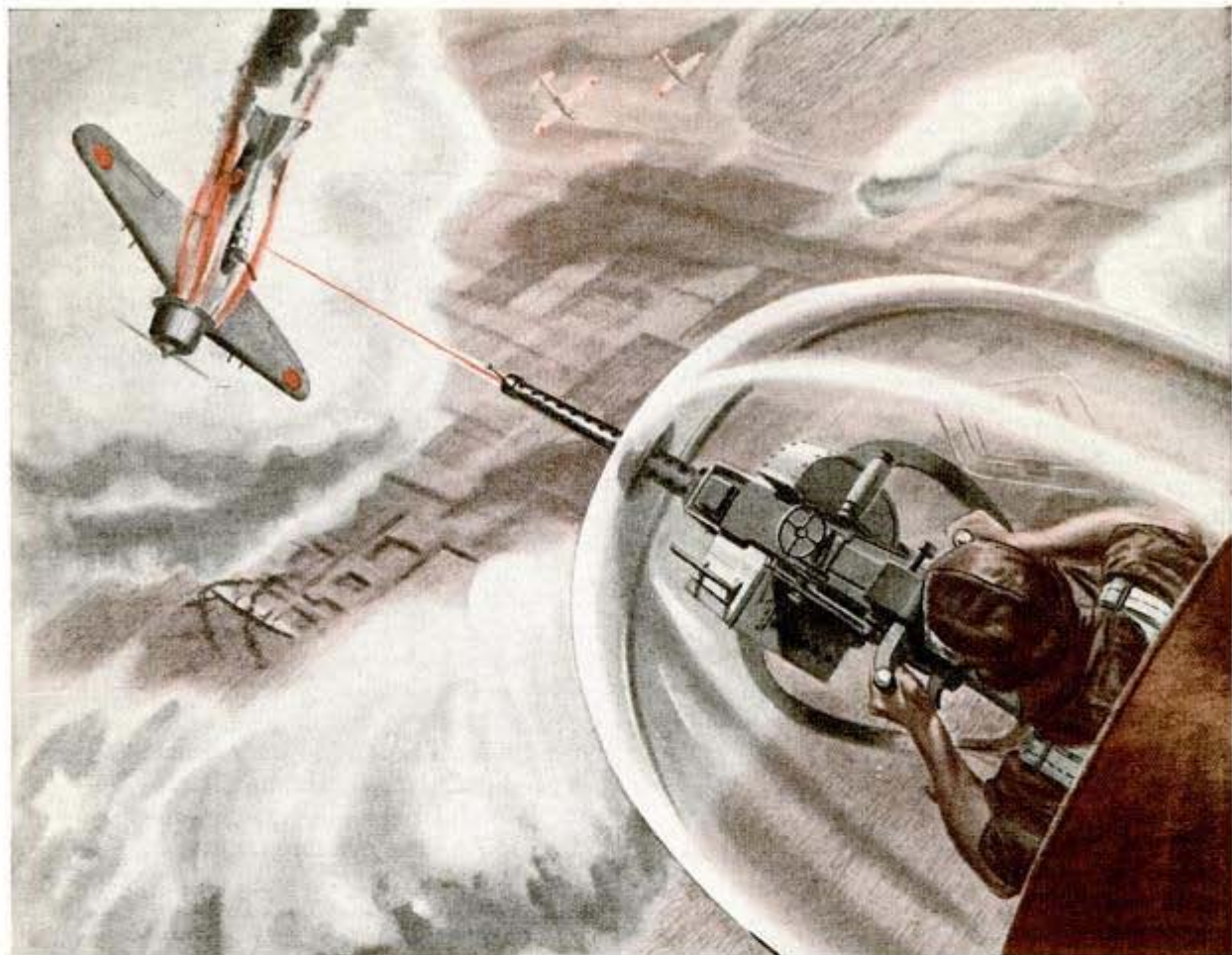

More fire power to 'em!

Our fighting men are showing the world the stuff of which America is made.

It's our job to back them with arms worthy of their skill and courage. So, for over a year, huge quantities of Savage-built Browning aircraft machine guns, Thompson submachine guns, and military rifles have moved in a steady stream to our forces on world-wide battle fronts. We're glad that the arms experience and

technical skills in our organization made it possible to get large quantities of military equipment into production quickly. Savage Arms Corporation, Utica, N. Y.



It was because of high achievement in production of War equipment that the Army-Navy Production Award was bestowed on the Utica Plant of the Savage Arms Corporation.

SAVAGE



SAVAGE MODEL 99

"Hammerless," streamlined — this famous rifle has been the dependable companion of big game hunters the world over. After Victory, it will continue to be the ideal, high-power hunting rifle.

WANT SOME TIPS ON TURNING TOOLS?



FREE! WILLIAMS' TOOL DATA SHEETS



● If you operate a lathe in a war plant or at home, you can profit by the factual information contained in Williams' Data Sheet No. 7. Like others in this series, designed to help mechanics and production men, it is punched to fit a standard 3-ring binder. Subjects covered to date are listed below. Indicate those you want on the coupon and we'll send your copies free.

- | | |
|--|--|
| 1. Characteristics of Williams' "Superior" Wrenches. | 6. Data on "Vulcan" Chain Pipe Vises. |
| 2. Data on Williams' Boring Tools. | 7. Data on Williams' Turning-Tools. |
| 3. Data on "Vulcan" Chain Pipe Tonges. | 8. Data on Williams' "Superior" Wrenches. |
| 4. Data on Williams' "Supersocket" Wrenches. | 9. Saving Time with Williams' "Supersockets" |
| 5. Data on "Vulcan" Lathe Dogs. | 10. Data on "Vulcan" Eye Bolts. |
| 11. Data on Williams' "C" Clamps. | |

MAIL THIS COUPON

J. H. Williams & Co., Dept. M-443, Buffalo, N. Y.

Please send Data Sheets circled below:

1 2 3 4 5 6 7 8 9 10 11

Name _____

Address _____

City _____ State _____

WILLIAMS

SUPERIOR DROP-FORGED TOOLS

Shakedown Cruise

(Continued from page 79)

the steam lines are blown out, generators started up, and the main engine is turned over. All the steam-operated equipment is tested and adjusted. Then the long steaming trial begins in the dock. Meanwhile the Maritime Commission experts are testing her fuel consumption, her horsepower, and are checking the operation of all the engineroom department equipment. Hundreds of ships like this one have been built already, but nothing can be taken for granted.

Next to come on board is the company's port captain with his crew of deck officers and men, together with more inspectors. The ship goes out on her harbor trials, testing for speed, maneuverability, and her ability to stand the strains of unusual maneuvering. For passengers she carries the deck and engineering officers who will operate the ship at sea. These men are already familiarizing themselves with the vessel and the way she handles.

The trial board is not the only agency that looks the new ship over. The American Bureau of Shipping has put men on board to determine that the hull is sound and the machinery safe and seaworthy. Men from the Bureau of Marine Inspection and Navigation try out the boilers, set and seal the safety valves, and test such safety devices as the life boats and rafts, the fire fighting equipment, and the navigation equipment. Representatives of the Public Health Service test out the drinking water and sanitary systems. One of the last inspections is made by the "rat man" of the Public Health Service, who goes over the whole ship looking for places where rats might be able to hide and build nests. Every such space must be accessible for inspection and easy cleaning.

American shipyards have attained their goal of three ships per day. Before the end of 1943, more than 1,600 Liberty ships alone will have been launched, aside from other vessels that are being constructed. This vast fleet is being built for the sole purpose of helping to win the war, but its usefulness will not end when the war is over. These ships are sturdy and economical. Decades after peace is signed they will be carrying the American flag along the trade routes of the world.



Announces

A NEW, NATION-WIDE CONSERVATION SERVICE

TO MAKE this new service available quickly, AC has placed trained men in the field to carry to all service organizations the latest and best methods of diagnosing trouble, testing, adjusting, and repairing AC products with a minimum of parts replacement. This will help to conserve material and shorten the time required for repairs.

For Your Car or Truck

Your car or truck is equipped with from one to nine of these AC devices. All are *important* to the conservation of your gasoline, oil, and tires. Some of them are so indispensable that, if they fail, you cannot drive at all.

For Yourself—and America

A list of the products covered by this new, wartime service; and a brief statement of what they require, and why; are given at the right of this page. For your own good, and for the conservation of America's gas, oil and tires, follow the suggestions given.

AC SPARK PLUG DIVISION—GENERAL MOTORS CORPORATION



SPARK PLUGS—Dirty or worn plugs waste up to 10% on gas. They also cause hard starting, weaken your battery. Have your plugs cleaned and adjusted every few months.



AIR CLEANERS—A dirty air cleaner restricts the flow of air into the carburetor, reduces gasoline economy. Have your air cleaner rinsed every time your car is lubricated.



FUEL PUMPS—Practically trouble free. However, if yours has been in use thirty or forty thousand miles, a check-up is probably due.



OIL FILTERS—Slow driving accelerates formation of soot and carbon in engine oil. This dirt will clog piston rings, cause increased consumption of oil and gas. Replace your oil filter element when AC Test Pad shows oil is dirty.



SPEEDOMETERS—Speedometers are very reliable, seldom give trouble. Keep them in good condition.



AMMETERS—Very reliable, seldom require service. Must be kept in good condition because they show whether the battery is being charged or drained.

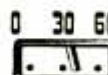

OIL PRESSURE GAUGES—If they stop functioning, SWITCH OFF THE ENGINE, call a competent service man at once. Usually, the trouble is in the oil supply system.



GASOLINE GAUGES need to be kept in reliable condition, although they seldom need service.



TEMPERATURE GAUGES—your only indicators of engine heat. Although very reliable, they should be kept in condition.

LIGHTER MOMENTS

with **fresh**

Eveready Batteries



"It's your wife, sir, she says to be sure and wear your ear muffs and rubbers."



One of the important uses of "Eveready" "Mini-Max" portable radio batteries by our armed forces is to furnish power for "walkie-talkies" (portable 2-way field radios). Because the armed forces are taking all we can make, there are none available for civilians.



The words "Eveready" and "Mini-Max" are registered trade-marks of National Carbon Company, Inc.

Movie Make Believe—Made To Order

(Continued from page 92)

The construction department transformed an old balloon hangar into a church, borrowed an old shack from "Lady in a Jam," salvaged a number of beams from "All Quiet on the Western Front," arches from "Tower of London," and stairways from "Eagle Squadron" and put them all together to create a Chinese mission.

Another department that helps in creating a set is the library of photographs and paintings that depict scenes in all parts of the world. Such a scene is enlarged to 16 by 20 feet and used as a background behind an open window.

Nowhere except at a studio, possibly, would you enjoy a breakfast that consists of a bowl of snow that has been sprinkled with broken glass and topped off with shaving lather. Such a dish is better than it seems, because motion picture snow consists of unbleached corn flakes. The broken glass is used for sweetening, for motion picture glass used for "breakaway" window panes and wine glasses is nothing but clear sugar candy. Even the shaving cream is palatable, being pure whipped cream that stands up better in pictures.

You would be disappointed if you tried a dish of motion picture ice cream. Real ice cream would melt too fast under the hot lights, so mashed potatoes are used instead. Likewise, cuts of meat such as lamb chops lose their fresh appearance during long rehearsals, so the lamb chop that you watch an actor eat on the screen may really be made of colored candy.

These are only a few of the substitutes that motion picture technicians have found to be better for picture purposes than the real articles. They use their ingenuity to provide practically anything that an imaginative script writer can demand. Sometimes the simplest ideas are best. At one studio some time ago thousands of dollars were spent in building a motion picture boat and in mounting it on rockers to create the effect of rolling in the waves. But the rockers were noisy and squeaked so loudly that the microphone picked up the sound in spite of several attempts to silence them with grease. The cameraman solved that one. He simply rocked his camera back and forth.

\$1,000 FOR YOUR IDEAS In the Big Marlin Gun Contest!

Now here's a chance for you hunters and target shooting fans, to *cash in* on your knowledge of guns! Marlin—always on the lookout for new ideas to improve sporting firearms—wants to hear from you. Sportsmen and gun dealers are cordially invited to join Marlin's big Gun Contest—with \$1,000 in cash prizes to shoot at. And remember, many a good idea is simple and easy to describe. Your chance is as good as the next fellow's to win a prize. It's easy to get in the contest—read the details below and send your entry in today! Contest ends July 1, 1943.

Jot down your ideas for improving any current model Marlin Gun. Follow the simple contest rules and send your entry in. If you wish, you may suggest new features, not at present in the line. A free catalog is yours for the asking, to review the features of Marlin Guns.

PRIZES IN THE BIG MARLIN CONTEST

The first prize is \$500.00 in cash; second prize \$100; third prize \$50.00; fourteen additional prizes of \$25.00 cash each. Seventeen prizes in all! (Marlin suggests the purchase of U.S. Savings Bonds with the prize money.)

JUDGING

Three famous gun editors—Bob Nichols of *Field & Stream*, Jack O'Connor of *Outdoor Life*, Maj. Chas. Askins of *Sports Afield*—will select the winning entries. All ideas for which prizes are given become the property of The Marlin Firearms Company and none will be returned. Prizes awarded for the seventeen ideas which are most valuable and practical, in the opinion of the judges. Duplicate prizes awarded in the event of a tie. WINNERS will be determined and prizes announced as soon as possible.

CONTEST RULES

The Marlin Gun Contest is open to all sportsmen and dealers in guns, with the exception of Marlin employees. Written suggestions must not exceed 300 words, the shorter the better. No limit to number of entries which may be submitted. Write name and address clearly on each suggestion. Mail entries to Dept. C, The Marlin Firearms Co., 17 E. 42nd St., New York City.

Entries must be received on or before July 1, 1943.

Win cash with your ideas! Enter the Marlin Contest today.

The Marlin Firearms plant is now 100% on war production.



Marlin's Over & Under Shotgun, in 12, 16 and 20 gauges and .410 bore, is hammerless, cocks on opening, has sturdy one-piece frame.



All Marlin rifles—lever action, clip and tubular magazine and .22 automatic, feature deep-cut, accurate, "Ballard" rifling.

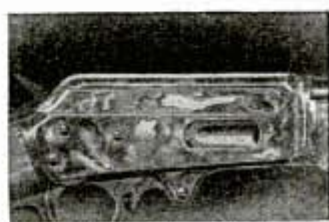

Marlin lever action rifles, in calibers .22, .30, .30 and .32 spec., have the solid-top, case-hardened receiver, with safe side ejection.



It lost a war!

"For the want of a nail . . ." the shoe, horse, rider, battle—and, consequently, the whole war—were lost. So goes the schoolbook legend whose moral points to the importance of little things in the achievement of big things.

It takes *millions* of details to arm a war-winning nation. Every industrial job has them. Where filing operations are concerned, production heads, shop foremen and mechanics can accomplish much through the proper *use, care and selection* of files. Each of these phases has a bearing on:

- Saving time in production or repair work;**
- Saving materials — including that used in the files themselves;**
- Increasing worker efficiency and reducing work spoilage.**

In addition to making top-quality files for every purpose, Nicholson is interested in every user getting the most out of them.

FREE BOOK, "File Philosophy"

It's new — 48 instructive, illustrated pages on file use and care, and how to select *The right file for the job.*
Address:

**NICHOLSON FILE CO., 22 Acorn St.
Providence, R. I., U. S. A.**

(Also Canadian Plant, Port Hope, Ont.)

• To obtain Nicholson or Black Diamond Files, see your hardware or mill-supply house.



NICHOLSON
FILES FOR EVERY
PURPOSE

NICHOLSON
U.S.A.
MADE IN U.S.A.

A Backyard Flock Will Solve Your Meat Problem

(Continued from page 43)

below this, on which newspapers should be spread to catch the droppings. The papers should be renewed daily. For the first several days, however, roofing paper should be spread over the wire mesh floor to retain the interior heat. For the first several weeks, the wire mesh floor of the open runway should also be covered with a 1/2-inch mesh screen. The slanting roof of the brooder, weather tight, is hinged so that it may be opened for inspection.

Chicks must be kept dry and warm, at just the right temperatures. The best way to provide heat is with an electric heater, attraction light, and thermostat, mounted from the roof of the brooder. Good units cost \$5.00 and up and are still available at most feed and supply stores. An electric light is another constant source of heat but the air temperatures around it must be carefully guarded. Such a light should be enclosed in a large tin can suspended from the roof of the brooder. Punch a few small holes around the diameter of the can, at the bottom, to provide a small amount of light inside the brooder. If you are raising only a few chicks it is possible to keep them warm with a cloth-wrapped earthenware jug kept full of hot water.

For baby chicks, the air temperature inside the brooder the first day should be from 90 to 95 degrees, to be reduced one degree a day for five to six weeks, depending on the weather. Then no heat is needed. The chicks will chill if the brooder gets too cool; they will literally cook if the temperature climbs above the recommended point. To be safe you should operate the brooder for several days before you obtain the chicks, watching inside temperatures closely. Drinking water in the brooder must be kept tepid for the first few weeks. A cloth drape across the entrance to the outside runway allows the chicks to go outside during the day yet holds the heat inside the brooder.

After the chicks are two months old the brooder may be replaced with the shelter house. The pullets won't start laying until they are about six months old, but in the meantime the cockerels will provide many delicious meals of fried chicken.

The Navy's Fighting "Seabees"

(Continued from page 31)

boxing rings and bowling alleys, movies and music from the battalion's own band, provide recreation.

Permanent buildings are nearly completed, and machinery commences moving onto the transports.

One night just as the bugle is blowing the last notes of "Taps," Jack the Carpenter's Mate rolls over on his bunk and addresses his buddy Olson, Shipfitter, First Class.

"Olson," he whispers, "it won't be long to shoving-off time, will it?"

"No," grunts Olson, half asleep. "It's getting pretty comfortable around here now, and it sure is quiet!"

Olson is right, for some hundreds of miles away the Marines have landed at another beach, and are mopping up. A base will be needed, and soon the Seabees will land and construction will be well in hand.

Set 'Er Down in Your Back Yard

(Continued from page 31)

When Mr. Sikorsky established a world's endurance record of 1 hour, 32 minutes and 26.1 seconds in the air on May 6, 1941, the VS-300 was an ungainly skeleton with four fans: a three-bladed main rotor mounted on its complex control tower aft of the pilot, who sat on the nose in quite as exposed a position as the Wright Brothers in their kite of 1905; two smaller horizontal rotors on opposite ends of outrigger structures jutting sidewise from the tail, and a vertical tail rotor with sidewise thrust for turning and torque compensation. The outrigger blades turned in opposite directions and provided lateral (sideways) and longitudinal (fore-and-aft) control.

In the next major stage the outrigger bridgework was shorn off and a tower installed over the tail with a single rotor. This was still crude and clumsy, and on the theory that the simplest structure works best the tower was scrapped after extensive and satisfactory experimentation. The VS-300 had reached substantially its present form. The cockpit was later covered with fabric, and a vertical fabric fin from midsection to tail improved stability. Surviving the innumerable changes are the

(Continued to page 163)



IN war or peace, Indian motorcycling builds character and manhood... brings together, in the healthy comradeship of clean, wholesome sport, husky, red-blooded youngsters eager for action and adventure. Today, Indian riders are in the thick of things on all the world's fighting fronts... carrying out their missions brilliantly on motorcycles unsurpassed in power, stamina and safety.

After the war, new thousands will thrill to the sport of motorcycling... and Indian will have new and greater machines to give every rider *motorcycling at its best*... machines that only Indian could build.

In the meantime, see your Indian dealer. He can't sell you a new motorcycle, but he may have a swell reconditioned "buy"... and he's the man to see for service on your present machine.

INDIAN MOTORCYCLE COMPANY, SPRINGFIELD, MASS.



**BUY WAR BONDS NOW
★ ★ TO BUY AN INDIAN LATER ★ ★**



Serving a Fighting America Everywhere ★★★



WITTE DIESEL ENGINES and DIESELECTRIC PLANTS

★ WITTE Diesel Engines and Die-selectric Plants are aiding our gal-lant fighting forces in many parts of the world . . . in Alaska, in Africa, in the Panama Canal Zone, out in the South Pacific area and many other places where depend-able auxiliary light and a vital wa-ter supply may be needed.

For 73 years WITTE has been serv-ing the world. Today, the large WITTE plant is devoted 100% to war production. After victory, WITTE will continue to build Diesel Engines and Dieselectric Plants that are outstanding for efficiency and economical operation.

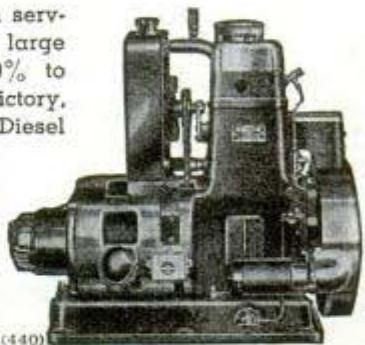

WITTE ENGINE WORKS 1744 OAKLAND AVENUE
LARGEST BUILDER OF SMALL DIESELS (440) KANSAS CITY, MISSOURI

BUILD THE BIGGEST \$1.00 PLANE IN U.S.

New, Redesigned 7-Ft. Super CONDOR Soaring Glider

Stronger, longer flights, more graceful lines, construction simplified. **\$1.00**
Easier than ever to build. Soars for hours. Kit VE-5019.....

4-Ft. Cleveland Eaglet
Unusually good model of a secondary type glider. Patterned after "Baby Bowius". Easily built. **50c**
Kit VE-5018, only.....



If your dealer can't supply you, order direct. Enclose 15c extra on orders for less than \$1.00.



Send 5c for new No. 40 Catalog (none free)

Be Sure to Build These Six New Big 3-Foot Famous War Models

Kit T74—Messerschmitt ME-109; Kit T76—Bell Airacobra P-39; Kit T77—Curtiss P-40 "Warhawk"; Kit T85—P-38 "Lightning"; Kit T78—Hawker "Hurricane"; Kit T91—P-51 "Mustang".....Each only **\$1.50**



CLEVELAND MODEL & SUPPLY CO., INC., 4508C35 Lorain Ave., Cleveland, Ohio

5 DAYS Free inspection

ARC WELDING!

516 Pages, 512 Illustrations. A New DAILY GUIDE for operators and managers doing vital war work. Explains NEWEST TECHNIQUES, METHODS, PROCEDURES and MATERIALS. With charts, diagrams, tables to show you best methods for metals and positions involved.

\$2.00

POSTPAID

Order Your Copies at Once!

This Complete and Authoritative book ANSWERS your every welding question. You'll actually use it as a daily guide because it's chucked full of valuable fast minute welding information. It'll put you straight, in words and pictures, on EVERY welding operation.

192 pages of Arc Welding Lessons This one section is a gold-mine within itself. Shows student correct methods of present day applications. Brings the expert up-to-date. You can't afford to waste a day, so get your copy NOW!

HOBART Bros., Box M-431, Troy, Ohio

"One of the World's Largest Builders of Arc Welders"

main rotor consisting of three 14-foot blades turning 260 revolutions per minute in hovering flight, and a single 7-foot 8-inch tail propeller rotating in a vertical plane. The blades of the tail rotor, controlled by rudder pedals, vary from positive to negative in thrust for directional control, and with the pedals neutral there is a slight positive angle in the blades to compensate for the torque of the main lifting rotor. By pressing on either pedal the pilot can turn the helicopter right-about-face in its own length.

In the cyclic pitch control which is the brain of the main rotor lies the greatest investment of genius. Within the last year this has been perfected to the point that the rotor blades, at the command of the conventional stick, change their angle of incidence progressively as they revolve. With the stick forward, for example, each blade increases its pitch as it swings to the rear, is feathered at the sides and is at lowest pitch when it swings in front; the result is to tilt the craft's nose slightly downward for forward flight. With the stick back, the cycle of pitch is reversed and the helicopter goes into retreat. The helicopter engineer, instead of speaking of the wing angle of attack, refers to the inclination of the disc described by the rotor. Tilt the disc to the right and the craft moves in that direction. Similarly, the weight carried is described as disc loading rather than wing loading; that of the VS-300 is 2.25 pounds per square foot of disc.

The stick, operating the cyclic pitch control, determines the direction of flight. At the pilot's left hand is a second control lever which increases or decreases the thrust of the main rotor blades simultaneously to control the rate of ascent or descent. The throttle is synchronized with this to provide automatic change of power as the angle of the blades changes, so that revolutions per minute remain constant. These two levers and the rudders are the controls, simple in operation as they are ingenious and complex in conception.

Recently Mr. Sikorsky has been trying a two-blade main rotor, which would simplify storage. The helicopter still flies with one less blade, but there is more vibration. The difference is that between a 4-cylinder and a 2-cylinder car. It may work yet. The VS-300 with its pilot weighs 1,300 pounds.

(Continued to page 165)

Keep 'em Firing



BUY
WAR BONDS

Atlas

America's
Compact
Modern
LATHE



Top producers of weapons for land, sea, and air are the modern Atlas 10" Lathes. You'll find them throughout the nation in the tool rooms and shops of large and small armament makers. You'll find them frequently in mobile maintenance outfits of the armed services.

Atlas Lathes are selected for this vital work because they combine all modern lathe operating features and meet the high precision standards of industry *at lower cost*. New performance demands . . . new materials to machine . . . new techniques in development . . . are contributing much to lathe advancement and assure you that the Atlas Lathe of tomorrow will be an even better one for you.

ATLAS PRESS CO.
443 North Pitcher Street
Kalamazoo • Michigan



VICTORY FIRST! -THEN Atlas TOOLS FOR YOU

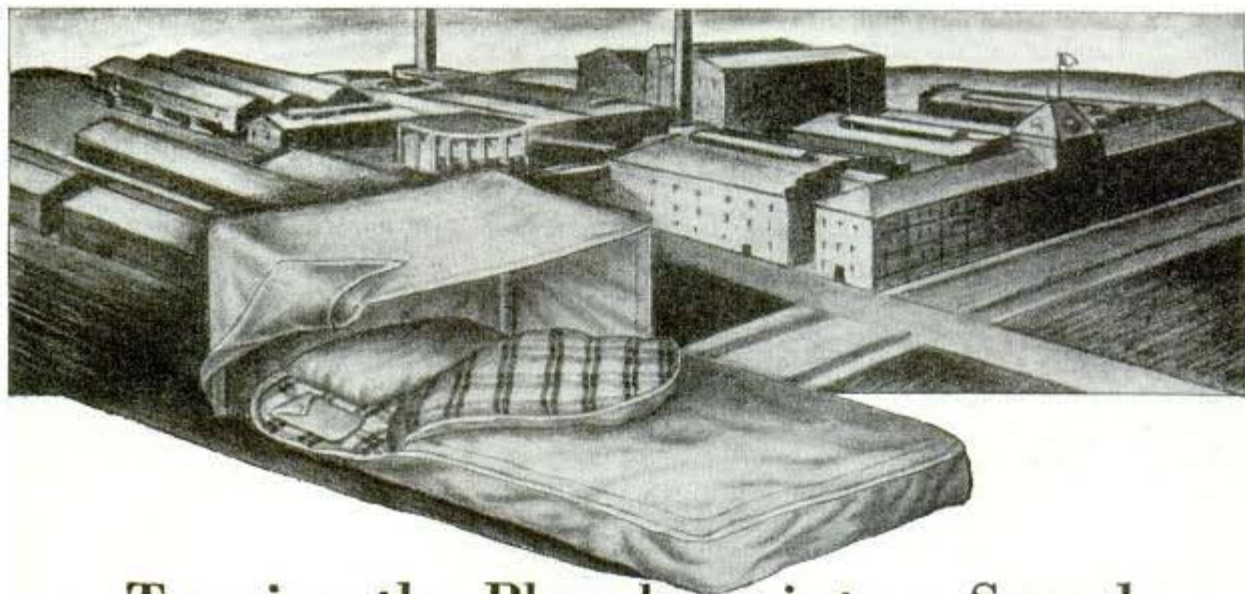

Turning the Plowshare into a Sword

Almost before the echo of cowardly Pearl Harbor bombs had died away, Ta-pat-co factories became an active unit of our nation's war industry.

Ta-pat-co sleeping bags, life preservers and other equipment dedicated to safety and comfort for lovers of outdoor sports in time of peace, now fulfill the same mission for our soldiers in time of war.

Ta-pat-co Sports equipment has become Ta-pat-co FIGHTING equipment—sleeping bags that give soldiers

warm beds in sub-zero temperatures—parkas that defy the cutting blasts of icy winds—life preservers that ride the crest of wave-tossed seas—on land, on sea and in the air—Ta-pat-co is in the war.

After victory is won, and the sword is beaten back into a plowshare, you will find your favorite Ta-pat-co equipment at your sporting goods dealer. Keep in touch with him. He will be the first to know when Ta-pat-co is again available for your outdoor sports enjoyment. 1-S-2

TA-PAT-CO Outdoor Sports Equipment
American Pad and Textile Company **FIGHTING** Greenfield, Ohio

Just You Two in Your Canoe



• THE rustle of leaves in a whispering breeze, with the light of a moon for your mood. An Old Town Canoe is a world of your own . . . your passage to peace and contentment.

The dip, dip, dip of a Redskin's paddle takes you through quiet enchantment. Paddling or resting, it's steady and strong. It's sturdy and easy to own.

FREE CATALOG shows all kinds of canoes for paddling, sailing or outboards. They're light in weight, perfectly balanced. Also outboard boats, Sailboats, Rowboats, Dinghies. Write today. Address Old Town Canoe Company, 934 Main Street, Old Town, Maine.

"Old Town Canoes"

Always write your name and full address clearly when answering advertisements.

U. S. MECHANIZED TROOPS RIDE WITH GUIDES



HULL STREAMLINE COMPASSES are used on U. S. Army motor vehicles to show direction of travel at all times. As Hull Streamline Auto Compasses have aided America's motorists in the past, so are Hull Compasses helping to guide our fighting men to their destinations today. Until victory, available for civilian purchase only so far as dealer stocking permit.

HULL MANUFACTURING CO.
P. O. Box 246-D4, WARREN, OHIO

Clean out car radiators thoroughly after draining anti-freeze. Use

Sani-Flush 10c and 25c sizes
Directions on can

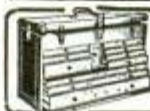

GERSTNER TOOL CHESTS

save valuable tools from loss and damage. Free Catalog to toolmakers and machinists. **GERSTNER TOOL CHESTS** 443 Columbia St. Dayton, Ohio

BURN YOUR NAME ON TOOLS WITH THE ARKOGRAF

PROTECT YOUR TOOLS FROM THEFT
Write with electricity any name or design on the hardest and finest tools and instruments or any metal, like writing on paper with pen or pencil. Thousands used by mechanics, garages, machine shops. **Complete Outfit \$3.50—Prepaid Anywhere** Interesting illustrated circular free. Write today. **ARKOGRAF PEN CO., 3927 S.E. Stark St., Portland, Ore.**



Mr. Sikorsky sees no reason why a helicopter of 10 tons gross weight, carrying 20 passengers and cargo, cannot be built. The VS-300 flies 70 to 80 miles an hour, 8 miles to the gallon with its 90-horsepower Franklin engine. They can improve those figures when they try.

Before this war is over the helicopter may be in it. It takes little imagination to see the helicopter as an ideal liaison craft, landing in a forest clearing or on a headquarters roof; or as an observation post hovering high above the ocean or battleground; or as an aerial machine-gun nest in lieu of barrage balloons. Rising vertically above a fort or factory it could meet enemy bombers halfway with a hail of bullets. The army tried an autogiro in mock battle against fighter planes and dive bombers some years ago, using cameras for guns. The autogiro got more photographic hits in its gunsights than either of its combatants. The dive bomber can't aim or evade; the pursuit plane is less accurate than the slower autogiro. The helicopter, which can sit still or dodge and keep firing, should out-perform the autogiro, which must keep flying forward for buoyancy.

After the war the helicopter surely will be the aerial runabout, climbing out of the back yard to fly to the grocery or the downtown office or the airport, settling gently into any space large enough to contain its structure. It is not designed for high-speed commercial air travel nor heavy cargo, but it should solve the problem of ferrying passengers from outlying airports into crowded cities.

Fitted with rubber pontoons, the VS-300 is at home, like the Marines, on land—on the sea—and in the air. It lands on your concrete driveway so tenderly the pilot might hold a cup of coffee without spilling. It alights on a back yard pond with scarcely a ripple. In the Sikorsky yard they nose it up to a post and lift a ring off its top, hang it three feet above ground while someone loads a suitcase into a luggage rack on the nose, or poise upstairs while an assistant hooks a can of gasoline on a rope to be hauled up.

The airplane, says Mr. Sikorsky—and he builds them—in spite of its excellent speed and carrying efficiency, is a very helpless machine with respect to points of takeoff and arrival. The helicopter is the most independent creature man has devised.

"Snap-on tools have been a part of United Air Lines' Equipment, used in the overhaul of our planes, for the past 15 years."

W. P. Hoare

UNITED AIR LINES

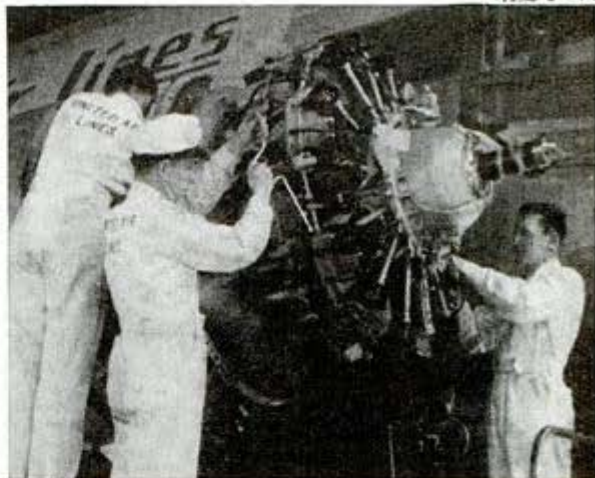

For Maintenance and Overhaul UNITED AIR LINES Uses Snap-on Tools

250,000,000 miles of swift and efficient flight... such a record could be attained only through rigid standards of maintenance, highly trained personnel, and finest equipment. Snap-on tools have served United for fifteen years! "Continual endorsement of these tools by our personnel speaks for itself," says Mr. W. P. Hoare, General Superintendent, Overhaul and Repair Base.

Fine mechanics work with fine tools... and America's vast aviation industry is developing the greatest army of fine mechanics the world has ever known! Everywhere in aviation... on famed assembly lines, teeming training schools, far-flung flying bases... Snap-on's superior speed, accuracy and durability have won outspoken preference.

SNAP-ON TOOLS CORPORATION, Kenosha, Wis.





WET CELLARS MADE DRY... from the inside!

If water or moisture seeps into your cellar through cracks or porous areas in the floor or walls, you can seal them permanently with Smooth-On No. 7. Applied with a brush to either wet or dry surfaces, this unique compound assures thorough water tightness . . . even in the wettest seasons. Smooth-On No. 7 is excellent for patching concrete floors, waterproofing garages, stables, washrooms, brick walls, cisterns, septic tanks, water troughs, fountains, fish ponds and swimming pools.



DO IT YOURSELF ... AT LOW COST

By waterproofing with Smooth-On No. 7 you will save a lot of money. It's easy to apply . . . all you do is mix with water and brush it on. 25 lbs. will cover about 100 sq. ft. of surface. Smooth-On No. 7 is sold in 1, 5, 25 and 100 lb. containers.

FREE INSTRUCTION BOOK SHOWS HOW

This handy 40-page repair book shows how to use Smooth-On No. 7 . . . and also tells you how to make hundreds of other money-saving, lasting repairs with other famous Smooth-On compounds. Everyone should have this practical guide on home, shop and auto repairs which shows how to stop leaks, seal cracks and tighten loose parts in metal, concrete, plaster and wood. It's FREE! Send for your copy today.



MAIL COUPON FOR *free* BOOK

Smooth-On Manufacturing Co., Dept. 37
570 Communipaw Ave.,
Jersey City, N. J.

Please send me the SMOOTH-ON Repair Handbook.

Name

Address

4-43

Do it with **SMOOTH-ON**

Keeping 'Em Flying

(Continued from page 11)

Philadelphia Quartermaster Depot rivals the navy establishment in size, though the army uses fewer flags in proportion to the number of men in the ranks. A tremendous amount of work goes into regimental standards and guidons, which, due to the danger of aerial observation, are left in the United States when troops sail. These regimental emblems are works of art requiring careful design, preliminary stenciling, retracing of complicated figures, and stitching or "painting with thread" which presents smooth work on both sides.

Particularly noticeable to a visitor in a flag factory is the fact that American flags are never permitted to touch the bare floor. Also obvious is that the manufacture of Old Glory is not just another day's work, but a task in which the experts take a genuine patriotic pride though they work in a sea of red, white and blue years on end.

Every war has produced a number of battle flags which have a special meaning to the nation. This war has already produced two and both are reverently guarded in glass cases in the museum at Annapolis, Md., the home of the U. S. Naval Academy.

One of these is the bomb-torn ensign of the U. S. Destroyer Shaw, one of the victims of Japanese treachery at Pearl Harbor. About half of the red and white area was torn away by the terrific blast which sank the ship, but when comparative quiet settled over the harbor the next morning, the flag was still flying on a mast which protruded above water. Navy men who have made a shrine of the glass case vow that it will fly again—on the topmast of the biggest Japanese battleship afloat.

Perhaps the fact that this flag survived and enabled the Shaw to come through with colors still flying had a special significance, for the Shaw was raised and refitted to fight against the Japs.

Nearby, in another case in the same museum, is the flag which flew over our naval base at Cavite. Brought back to the United States some months ago, it is a museum piece in the eyes of navy men for a limited time only. They say the day will come when the ensign will be rehoisted—at Cavite after the rising sun has set at this spot.

That's the spirit that will keep 'em flying.

OUTBOARD MOTORS GO *to War*



SOMEBODY ELSE is using your new Sea-Horse outboard motor. Somebody in America's armed forces.

He's not using it for fishin', either. He's giving it the gun on a dozen different jobs requiring guts—in engines as well as men.

It's not the first time Sea-Horses have served. Famous explorers who have ventured into the far reaches of the world know about Sea-Horse stamina. Men in the lumber and fishing industries are familiar with Sea-Horse power. Red Cross rescue squads, saving lives and administering relief in disastrous floods, have tested Sea-Horse ruggedness.

The Johnson Sea-Horse always has been noted for **DEPENDability**. The fact that Sea-Horses were qualified for war work without any basic change in design, speaks volumes for their quality.

JOHNSON MOTORS, Waukegan, Ill.

In addition to outboard motors, we are building important precision items for the armed forces—devoting all our effort to the war.



JOHNSON SEA-HORSES
for **DEPENDability**



HARLEY-DAVIDSON

for me after Victory



BUY WAR BONDS Now!
10% every pay-day will help Uncle Sam now — and help make you a Harley-Davidson owner when peace comes.

HARLEY-DAVIDSON

MOTORCYCLES

Out of the great experience gained in devoting our entire effort to the production of motorcycles that meet the grueling demands of war — will come the finer, more rugged and powerful Harley-Davidson of tomorrow. As always, it will be a world champion — a motorcycle red blooded Americans will be proud to own!

HARLEY-DAVIDSON MOTOR COMPANY
Department PM Milwaukee, Wisconsin

Our New Schools of War

(Continued from page 4)

the Allison engine plant, specializing in airplane equipment, has been furnishing, for months, training programs to a large number of United Nations air force depots and airfields. A student in the Allison school is taught to disassemble, overhaul, reassemble and time the engine. He is then taught the functions and overhauling of the accessories used in installations. Fuselages of all planes powered by the Allison engine have been set up for teaching installations, removal of engines, inspection, starting, warming up, ground tests, etc. Emphasis is placed on trouble shooting so that the trainee is thoroughly familiar with all phases of engine maintenance.

In the Oldsmobile gun school at Lansing, Mich., servicemen of practically every category are learning the servicing and operation of the cannon produced there. At the AC Spark Plug and Frigidaire plants of General Motors, machine guns are studied, and the courses include sound movies. One novel feature is the blindfolding of classes so that the men can learn to take apart and assemble these lethal weapons in the darkest night on a battlefield.

Six weeks will transform a mechanically minded recruit into an experienced overhaul mechanic handling Pratt and Whitney engines at the Buick college of war in Flint, Mich. Other classes study the same engine at the Chevrolet plant in Detroit and here special attention is given to the use of makeshift tools. It has been discovered that if an ingenious mechanic is deprived of all tools except a screwdriver he can make most of the necessary repairs and adjustments on the complex engine.

Classes of uniformed men at the Pontiac plant tackle two of the most complicated weapons in this war, the Oerlikon and Bofors guns.

Ford has an average of above 2,000 men constantly at its Rouge plant, most of them bluejackets acquiring the technical skill necessary for the operation of modern naval vessels. Uncle Sam is sending several hundred hand-picked flight mechanics to the Ford Willow Run plant for a post-graduate course in servicing the big Ford-built B-24 bombers. The men picked for duty with the B-24s will represent the top 20 percent of the graduating classes of Air Force training schools all over the country.

The mechanics go into camp just across the road from the big Willow Run plant. Barracks, mess halls and recreation facilities have been rushed to completion. Already skilled in their craft in the army schools, the mechanics will be given an intensive "finishing" course in the Ford school and plant. A crew will be ready for each bomber as it leaves the assembly line.

Most of the students at the Packard plant are navy recruits who specialize in the assembly, operation and repair of the motors for the deadly mosquito boats.

Not only do Army Air Force mechanics get mechanical training at United Air Lines Training Center at Oakland, Calif., but they are given intensive training in "Commando" tactics. At the call of "Air Raid!" the mechanics tumble out of hangars, shops and barracks, race to the nearby "Commando" course, scale a seven-foot wall, hurdle a fence, dive under a barbed wire entanglement, dart in and out through a maze of poles, race across a log spanning a deep pit. At the end, without stopping to take one restful breath, they spring to the task of getting airplanes under cover or ready to take off. It is all part of the job of preparing these men for alert, efficient action wherever they may be assigned. The theory is that an aviation mechanic is responsible for his airplane and, should it be threatened by enemy fire when on the ground, he must race to save it. He should be a superman as well as a technical expert.

About half of the servicemen who get production line training have had previous mechanical experience, working around automobiles, for example, but the other half includes men trained only as butchers, bus drivers, clerks, students or similar non-mechanical jobs. Before they are assigned for last-minute "college" education in the science of mechanical warfare, they have usually had mechanical courses offered by the army, and these have been preceded by tests which determine whether they have mechanical aptitude.

One thing is sure to result if the war continues long enough. This nation is going to lead the world by a widely increasing margin in mechanical manpower.

☛ To learn where to buy commercial products described in these pages, see the index.



ON Thursday the orders came in . . . 400 powerful outboards for immediate delivery to Lord Mountbatten's Commandos. All of them to be equipped with underwater mufflers. And all of them to be aboard an out-bound ship *on the following Monday!*

To meet the promise, there were neither motors enough nor parts enough at the factory. From dealer stocks extra motors were recruited to fill the requirement. Assembly lines were swiftly organized to build up new motors from spare parts. Army

officials gave unceasing cooperation to speed the job. Saturday night, loaded in express cars cut into a fast passenger train, the Commando's motors were on their way!

A small incident . . . in the vast dramatic panorama of America's Production-For-Victory. But a significant one to countless thousands of water-loving Americans. Again, their favorite motors are "in there pitching." And they can be confident that, where outboards can serve, no effort will be spared by Evinrude to produce *plenty enough, soon enough!*

EVINRUDE MOTORS

Milwaukee, Wisconsin

Evinrude Motors of Canada, Peterboro, Canada



★ Invest in America — Buy More Bonds

EVINRUDE
OUTBOARD MOTORS

JUST OUT!

NEW ALLIED 1943 RADIO CATALOG

FOR RADIO WAR TRAINING AND RADIO
REPLACEMENT PARTS

SEND FOR IT NOW! **FREE**

● This latest Allied Catalog places everything in Radio and Electronics at your fingertips—books, diagrams, training kits, replacement parts... more than 10,000 items for TODAY'S needs. Send for this new 1943 FREE Radio Catalog now! For dependable service... order from Allied.



SEND FOR THESE VALUABLE NEW BOOKS

- Dictionary of Radio Terms . . . 10c
- Radio Circuit Handbook . . . 10c
- Radio Formulas and Data Book 10c
- Radio Builder's Handbook . . . 10c
- Simplified Radio Servicing . . . 10c

Write for quantity quotations

ALLIED RADIO CORP.

833 West Jackson Blvd.
Dept. 5-D-3, Chicago



ALLIED RADIO

MAKE EXTRA MONEY

with **IDEAL** Lawnmower Sharpener

NO EXPERIENCE NEEDED!

Greater opportunity than ever! With few new lawnmowers available this year, servicing of old mowers becomes more important than ever. Sharpening and servicing lawnmowers is highly profitable full or spare time work. All you do is set mower in the Ideal Sharpener, make a few simple adjustments—the Ideal sharpens any mower to perfect edge in 15 to 20 minutes. Usual charge \$1 to \$1.50 for every job! Customers tell their friends. Remember, **NO EXPERIENCE NECESSARY!**



Send for **FREE PLAN BOOK** →

FREE 24-page Plan Book shows you how to get plenty of jobs—how to "open up shop" in your own basement or garage. Profits for either part or full time. **START NOW** when demand for **SERVICE** is greatest in years!



THE FATE-ROOT-HEATH COMPANY

1443 BELL STREET • PLYMOUTH, OHIO

Universal Testing Bridge

(Continued from page 151)

of the positions of switch No. 2. Switch No. 1 should then be thrown to position No. 2 and potentiometer R_5 varied until no signal is heard. This potentiometer balances out stray capacities that affect accuracy.

Switch No. 1 is again thrown to position 1 and R_4 is readjusted. If switch No. 2 is in the No. 1 position, the dial calibration reads in tenths. That is, if the dial pointer in photo (A) is at .4 with the switches in this position, the unknown resistor should be

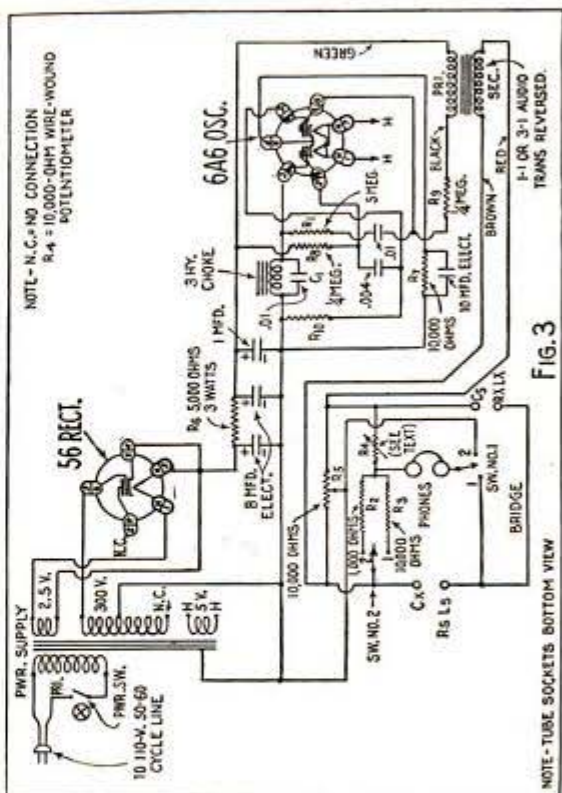

FIG. 3

four-tenths of the standard resistor, or 400 ohms. The 2¼-in. paper dial markers represent units when switch No. 2 is in the No. 2 position; therefore should the reading be 5 the unknown resistor would be 5,000 ohms, or, 5 times 1,000 ohms. A detailed material list is available if desired. Condensers are measured in the same way as resistors; connections are made as shown in photo (C). A true inductance reading will not be obtained on chokes at L_s and L_x because of d.c. resistance in the wire. This effect can be balanced out by connecting a 2,000-ohm variable resistor in series with the choke having the least d.c. resistance and adjusting this variable resistor at the same time that R_4 is adjusted.

Ah-h-h!...
that wonderful
BRIGGS!



You'll get a boost—in pipe enjoyment—the minute you load up with Briggs. When the old briar starts giving out the grand richness of this tobacco that's been cask-mellowed for years (longer than many costly blends), you'll discover you're "that way" about Briggs. But who *wouldn't* go for such gloriously ripe flavor—such full-bodied mellowness—such relaxing fragrance! Better get started *today*.



BRIGGS

The Smoke with
a Smile

PRODUCT OF P. LORILLARD COMPANY



KRW ARBOR PRESSES BENCH TYPE AND HYDRAULIC

NEEDED IN EVERY SHOP—SAVE TIME AND MONEY—DO BETTER WORK, QUICKER.

No shop is complete without a small arbor press. Pressing and squeezing operations can be done better and faster on a KRW Arbor Press. Stop using vise and sledge hammer methods—they generally deliver spoiled work in the end. KRW Factory-To-You Prices give you greater value for your money. Order today.

KRW Bench Type Arbor Presses, 3 sizes

- No. 37-P ½ Ton, \$13.25*
- No. 37-O 1 Ton, \$23.00*
- No. 37-N 3 Ton, \$33.00*

*Prices F.O.B. Arcade, N. Y. Slightly higher west of Rockies. Stand illustrated extra.



KRW Hydraulic Presses are built in 25, 50 and 75 ton sizes. Prices start at \$198.00*



K. R. WILSON, 17 Lock St., BUFFALO, N. Y.

Builders of Shop Equipment for Ford Dealers Since 1916



WAR WORKERS-WIN "PRODUCTION AWARDS"

Dremel Moto-Tools are used on hundreds of jobs, in thousands of war plants, because they are such great time and labor savers. Sharpening tools . . . cleaning dies, castings, cores and welding points . . . grinding, polishing, burring and finishing . . . these are but a few of Moto-Tool's many capabilities. Only Moto-Tool has all these features—27,000 r.p.m. (assures better work and lengthens life of cutters); shockproof (bakelite) case; oil-less (oil-sealed) bearings; fan-cooled motor (can't overheat). Order Moto-Tools and accessories at your dealer, or direct on 10-day trial. Money-back guarantee. Prompt shipment upon receipt of proper priority. Catalog FREE.

Kit No. 1 with 23 high grade accessories and Model 1 Moto-Tool in hard wood case \$17.50
Kit No. 2 same as above with Master Moto-Tool \$23.50

DREMEL MFG. CO., Dept. T-113-D, RACINE, WIS.

—Suggest—
MOTO-TOOLS
TO SAVE TIME—
CUT COSTS AND
SPEED PRODUCTION

\$100 MONTHLY FOR SICKNESS AND ACCIDENTS

**Plus Hospital Benefits—Pays Up
To \$1,000 If Killed!**

We have just issued a NEW sickness—accident—hospital policy that costs as little as 3c a day!

It pays up to \$100 a month for disability from sickness or accident—and hospital benefits in addition!

It pays your beneficiary up to \$1,000 if you are killed.

And most important—It covers ALL accidents from the very first day . . . ALL sickness from the very first day, except those specifically excluded in the policy. No waiting period of 7 or 14 days, as so many policies require.

It has other benefits—you will see them all for yourself when you send for a regular policy on FREE inspection without obligation. You can judge this important value for yourself!

Postal now is offering this protection, if desired, on a monthly payment plan of only \$1.00 a month—or on quarterly, semi-annual or annual payments.

BUT SEND NO MONEY. Write for policy on free inspection. No agents will call—no medical examination.

Don't delay—write today! Send full name, address, age, occupation, and name of beneficiary to Postal Life & Casualty Insurance Company, 5,001 Postal Life Building, Kansas City, Mo.

SHAW and "Peppy-Pal" GARDEN TRACTORS

• 1 to 9 H. P. Circulars on request. War limits production . . . We have repairs for all SHAW tractors sold in our 39 years in business. Write us for your needs.

YOU CAN BUILD YOUR OWN GARDEN TRACTOR

\$1.00 brings our plans, postpaid, telling how to build a garden tractor (Chiefly by welding and bolting up scrap steel), for cultivating, light plowing, etc.

SHAW MFG. CO., 4504 Front St., Galesburg, Kansas
668-G No. 4th St., Columbus, O.; 5812-G Magnolia Ave., Chicago, Ill.



NEW COMMANDO Military Style Shoes

Crash through to biggest shoe profits in years with sensational new soft-as-glove leather Military Shoes for Men of Action—also hundreds of other fast-selling styles for men and women, for dress, work, sport. Rush name and address for FREE SAMPLE OUTFIT, and Tested Sales Plans.



FREE SALES KIT

VICTOR THOMAS SHOE CO.
610 W. Van Buren St., Dept. V-94, Chicago, Ill.

REVIVES RIBBONS FOR 1/2 CENT

In a few seconds Sten-O-Aide makes old faded office machine ribbons work like new. Use them 3 to 5 times longer. Kit pays for itself in short time. Every typewriter owner needs one. Satisfied users everywhere. Money-back-guarantee. Write today for Free Folder.



STEN-O-AIDE INC.

4671 So. Division Grand Rapids, Michigan

NEW Grinding Attachment

For 8" to 16" Metal Lathes. Build It Yourself.

At last, a precision grinder within your means. You save 2/3 by finishing our semi-machined castings on your own lathe. HURON handles both internal and external grinding. Accuracy to .00025". Mirror finish easily obtained. Grinds holes, pistons, bushings, shafts, hard or soft, holes, lathe centers. Sharpens reamers, milling cutters. Does eccentric drilling; keys; pulleys; scores of other uses for home workshops, cranes, machine shops. Write for FREE illustrated folder and price list of supplementary items. Mention your lathe.



Huron Machine & Tool Co., Dept. B, Yale, Mich.

Semi-Machined Castings Only \$645

WINDOW SIGN LETTERS

For Store Fronts and Office Windows. Anyone can put them on. Free Samples. Liberal Offer to general agents.

METALLIC LETTER CO., 432 N. Clark St., Chicago

DO YOU

WANT a permanent business profession of your own? Then BECOME A FOOT CORRECTIONIST. Earnings in this greatly needed profession run as high as \$50-\$100 weekly after a few weeks home training—no medical or chiropody—no further capital needed, no goods to buy. 47th year. Write for free booklet.

Stephenson System of Foot Correction
28 Back Bay, Boston, Mass.

LEARN the SECRET of INDIAN COMFORT FREE

| | | | | |
|--|--|--|--|--|
| <p>BASS SPORTOCASINS
Royal road to par through perfect comfort.</p> | <p>BASS WEEJUNS
The favorite national leisure footwear.</p> | <p>BASS HUNTER
Here's foot comfort supreme for men who love the great outdoors!</p> | <p>BASS RANGER
Perfect high-cut boot for woods-comfort. True moccasin construction!</p> | <p>FREE booklet showing all styles of men's and women's outdoor footwear. Explains Indian-comfort construction. Mail postcard today. G. H. Bass & Co., 64 Main St., Wilton, Maine.</p> |
|--|--|--|--|--|

WEAR BASS MOCCASINS

Running the Ice Blockade

(Continued from page 53)

plenty of power and streamlined hull design. This combination was first utilized in small tugs like the wooden Algoma, an early lake ice breaker. Most tug boats have an egg-shaped hull which keeps them from sticking as they advance in ice packs, and enables them to reverse easily. But they lack the weight and size to tackle ice under heavy conditions or to break a single channel wide enough for a cargo ship. Tugs are most effectively used to keep previously cut channels open by breaking up floating pieces of ice and working against the sides of the channel.

They often work tandem ahead of a line of freighters, the first to clear the channel of ice that has slipped in from the sides, the second to widen the channel or tow the first freighter through slush ice. This avoids the situation where a towing tug might get stuck breaking a path and be run down by its tow. Once under way a line of loaded freighters can make steady progress through slush ice behind a breaker.

Mainstays of the initial attack on Old Man Winter are the Coast Guard's 165-foot ice-breaking cutters and car ferries, such as the Wawatan and Sainte Marie. Their greater weight, strength and beam enables them to cut a channel of sufficient width that cargo vessels may follow them through soft or "rotted" stretches. If a single breaker has to cut a channel alone in waters which have a swift current, she will begin downstream so that the current washes broken ice clear of her stern. To speed up operations and to free some vessels for other wartime activities, the Coast Guard charts additional tugs and ferry boats. Champ of the tugs is the Favorite, which often breaks ice with her stern piled high with coal. This provides extra fuel and helps raise the bow much as water ballast is used on other ships for the same purpose.

The car ferry Sainte Marie is one of the best all-around ice breakers on the Lakes. She is 258 feet long with a 62-foot beam, has a propeller both fore and aft. Her deck is square at both ends, her spoon-shaped prow reinforced at stem and forward ribs.

Similar, but longer, is the ferry "Chief Wawatan." Less maneuverable, the Wawatan cuts a straighter course in heavy ice.

(Continued to page 174)

how to **S-T-R-E-T-C-H** your "A" Coupons!



Make the most of your "A" coupons. Get better gas mileage by restoring compression, improving combustion and sealing leaks through Burd 3-Way Reconditioning Service. 1. Have Burd "Graf-Flox" Piston rings installed. They are self-lubricating; require no run-in period. 2. Stop piston slap and restore flexibility with Burd Piston Expanders. 3. Keep oil out of intake chamber and prevent carbon with Burd Valve Packing. Have all three jobs done at once at practically no extra cost for labor. For greater wartime economy . . . ask your garage-man for Burd 3-Way Reconditioning Service.

BURD
3-Way
RECONDITIONING
SERVICE

Burd Piston Ring Co.
Rockford, Ill.
Liberty Foundries Co.,
Associate Co., Mfrs. of
Madedes Heaters



COUPON BRINGS HANDBOOK FREE



Burd Piston Ring Co., Dept. PM., Rockford, Ill.
Please send information on advantages and economies of Burd 3-Way Motor Reconditioning Service. Also copy of "Auto Serviceman's Handy Handbook."

Name

Address

City State

BEFORE

AFTER

CONSERVE
Valuable
Paint Brushes

GOOD paint brushes are expensive and scarce! Keep new brushes soft, flexible and in good painting condition . . . restore hardened, discarded old brushes to service with DIC-A-DOO Paint Brush Bath. Easy to use. Preserves bristles; prolongs brush life by softening up and washing away dried out paint. 5¢ pkg. cleans several brushes. Ask for it by name at paint, hardware and 5 & 10¢ stores. The Patent Cereals Co., Geneva, N. Y., makers of the famous DIC-A-DOO Paint Cleaners.

DIC-A-DOO
PAINT BRUSH
BATH



Calling all "hands" to faster production

In the hands of skilled workmen, "Yankee" Fine Mechanics' Tools meet and match the need for speed in this year of America's supreme effort. In their very design, these tools are streamlined for action. They get things done . . . done fast and done right. On the production lines of a nation at war, they are "Yankee" clippers of vital minutes in the battle of production. "Yankee" Tools have had a half century's service in the shops and homes of America. They were ready for their big test when war came. And when war ends, they will again serve the needs of peace with unexcelled performance the world over.

"YANKEE" SPIRALS



Simple. Compact. Strong. A size for every purpose.

"YANKEE" TOOLS

make good mechanics better
North Bros. Mfg. Co., Phila., U. S. A.
Established 1880

Makers, also, of "Yankee-Handyman" Tools

NO MORE PRESSING BILLS!
WITH A PRES-KLOTH IT'S
EASY TO PRESS YOUR OWN
SUITS AND TIES!

No Stick!
No Slime!
No Lint!
No Scratch!

PRES-KLOTH

for a Perfect
STEAM PRESS
Right At Home Using Any
Kind of Iron

COSTS ONLY 69¢



This scientific pressing cloth makes any iron do the work of a steam pressing iron. Puts a professional knife-like edge in trousers, removes the most stubborn wrinkles without effort. Lasts for years.

AT MOST HOUSEWARE AND NOTION COUNTERS
If Your Dealer Can't Supply You, Write Direct To

WEAVER PRES-KLOTH CO., OMAHA, NEBR.

COLD WATER STAYS ON TOP
HOT STEAM GOES THRU

Top honors will go to the new Manitowoc. Slightly egg-shaped, the hull will offer least possible resistance to ice. Her bottom will curve up to present a wedge shape at the water line so that the vessel will rise when under ice pressure, preventing strain on her side plates. The bow is designed to ride up over heavy ice until the weight of the vessel breaks downward.

With a displacement of 5,000 tons and 10,000-horsepower Diesel engines, weight, strength and power will be combined for top-notch ice-breaking efficiency. Having two propellers aft and one forward will give her high maneuverability, and will help to keep ice broken up and washed clear of bow or stern. The Manitowoc will have a beam of 70 feet, greater than that of any regular lake cargo boat, so that she can cut a single channel large enough for other boats to follow in without delay.

On the deck will be storage space for a Coast Guard plane, with gear for raising or lowering it into the water. She will be as fine looking as the trimmest Coast Guard cutter, with long flowing lines and streamline design, modern radio and bridge instruments; she will be equipped for rescue, and have a cruising range of 6,000 miles.

To break ice in the Illinois waterway from Lake Michigan to the Mississippi, the Coast Guard is building a unique craft, a combination of tow boat, tender and ice breaker. It will be built in three separate units which can be joined to perform different functions. The power unit will have three Diesel engines directly connected to three propellers. Its welded steel hull will measure 30 by 114 feet with a draft of only 5½ feet and over 300 tons displacement. The power unit may push a barge for servicing buoys and other aids to navigation. For ice-breaking a plow-shaped third unit will be hooked in front. It will weigh 75 tons and have a beam of 49 feet.

Whether it's a weather-beaten barge going through the Illinois River, a tanker bringing oil to Buffalo's factories, or a long ore boat steaming through the St. Mary's River, all have important work to do. Hardy lake sailors and the persistent Coast Guard have joined hands to keep smashing records and deliver the raw materials for America's war plants. Old Man Winter will pull enough tricks to make the effort interesting but determined lake men will beat him at his own game.

THE GREATEST
POWER ON
EARTH !



The Magic of Mind

WERE the great personages of the past victims of a stupendous hoax? Could such eminent men of the ancient world as Socrates, Pericles, and Alexander the Great have been deluded and cast under the spell of witchcraft—or did the oracles whom they consulted actually possess a *mysterious faculty of foresight*? That *the human mind can truly exert an influence over things and conditions* was not a credulous belief of the ancients, but a known and demonstrable fact to them. That there exists a wealth of infinite knowledge just beyond the border of our daily thoughts, which can be aroused and commanded at will, was not a fantasy of these sages of antiquity, but a dependable aid to which they turned in time of need.

It is time you realized that the rites, rituals and practices of the ancients were not superstitions, but subterfuges to conceal the marvelous workings of natural law from those who would have misused them. Telepathy, projection of thought, the materializing of ideas into helpful realities, are no longer thought by intelligent persons to be impossible practices, but instead, *demonstrable sciences*, by which a greater life of happiness may be had.

One of America's foremost psychologists and university instructors, says of his experiments with thought transference and the powers of mind—"The successes were much too numerous to be merely

lucky hits and one can see no way for guessing to have accounted for the results." *Have you* that open-minded attitude of today which warrants a clear, positive revelation of the facts of mind which intolerance and bigotry have suppressed for years? *Advance with the times*; learn the truth about your inherited powers.

Let this free book explain

The Rosicrucians (NOT a religious organization) have been leaders in introducing the ancient wisdom of mental phenomena. Established throughout the world for centuries, they have for ages expounded these truths to those thinking men and women who sought to make the utmost of their natural faculties. Use the coupon below—avail yourself of a pleasing book of interesting information which explains how you may acquire this most *unusual and helpful knowledge*.

The ROSICRUCIANS (AMORC)

USE THIS COUPON

Scribe V.E.B.

The Rosicrucians, AMORC,
San Jose, California.

I am sincerely interested in knowing more about this unseen, vital power which can be used in acquiring the fullness and happiness of life. Please send me, without cost, the book, "THE MASTERY OF LIFE," which tells me how to receive this information.

Name _____

Address _____

State _____

Make BIG MONEY AT HOME!

NEW Invention Electroplates by BRUSH



Now Plates CHROMIUM!

ALSO GOLD, SILVER, NICKEL, COPPER, ETC.

War Increases Demand—You Profit!

New, patented invention makes possible big earnings AT HOME. Replate auto-parts—worn articles in homes, stores, hotels, restaurants, etc., with durable, sparkling, new coat of metal—with stroke of brush. Easy, simple, quick. Genuine Gold, Silver, Nickel, Cadmium, etc. Everything furnished. Outfit complete, ready for use. No shop required. Clear from \$2 to \$5 an hour in lifetime business. Small investment starts you in business. Steady repeat. Machine can pay for itself in week. Send TODAY for FREE SAMPLE and illustrated BOOKLET how you can have a life income from a business of YOUR OWN built upon satisfied customers. Act at once!

WARNER ELECTRIC COMPANY

215 W. Ohio St., Chicago, Ill., Dept. 209

FREE BOOK & SAMPLE

WARNER ELECTRIC CO., 215 W. Ohio St., Chicago, Ill., Dept. 209

Gentlemen: Send me Free Sample and Illustrated Booklet.

Name _____

Address _____

City _____

State _____

BEES 500 Questions and Answers..

Send for new 104-page book "500 Answers to Bee Questions." Information on honey production, swarming, feeding, transferring, uniting, wintering, etc., classified with over 800 references. The ideal book to help any beekeeper get more from his bees. Write today. ONLY 50 Cents Postpaid.

Also 6 months' subscription to 64-page monthly illustrated magazine, "Gleanings in Bee Culture." FOR ONLY 25c. (Offer good to new readers in United States, only.)

Price list on bee supplies FREE.

The A. I. Root Co., Box 51, Medina, O.

Get this Handy OHMITE Ohm's Law Calculator!



Figures Ohms, Watts, Volts, Amperes—Quickly, Easily!

Solves any Ohm's Law Problem with one setting of the slide. Requires no slide rule knowledge. All values are direct

reading. Scales on two sides cover the range of currents, resistances, wattages and voltages commonly used in Radio and Electrical Work. Size 4 1/8" x 9".

Send only 10c in coin to cover cost of handling.

OHMITE MFG. CO., 4931 Flournoy St., Chicago, Ill.

MAGNE-BLOX For USE On SURFACE GRINDERS

Magne-Blox have been developed for use on Magnetic Chucks for surface grinding operations. They are used for holding work that cannot be held directly on the chuck. Will save their cost by simplifying difficult grinding set-ups.

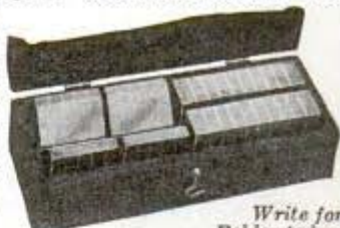

Write for Folder today.

GEO. SCHERR CO., 128A Lafayette St., New York

ANYONE CAN DO THIS IF THEY HAVE OUR CHART

Blue Print 27"x36" shows how to find length of any rafter; find any angle in degrees, frame any polygon 3 to 16 sides, read board foot and brace tables, octagon scale, rafter tables and many other uses. Can be scaled down for model work as well as full scale framing. Also Chart changing pitches to degrees for use with Radial Saws. Send 50c coin. No stamps. MASON & PARRISH ENGINEERS, 2106-B No. Burdick Street, Dept. D, Kalamazoo, Mich.

SPECIAL OFFER FOR AGENTS

ARMY-NAVY BARGAINS

| | | | |
|--------------------|--------|-----------------------|--------|
| Gun sling | \$.50 | Cart. belt | \$.60 |
| Hobbles | .50 | Rope lariat | .75 |
| Leather belt | .75 | Sword Bayonet | 1.75 |
| Short shovel | .85 | Model cannon 7" | 1.75 |

75th Anniversary Catalog 1865-1940, 308 pages, over 2,000 illustrations of pistols, rifles, daggers, medals, saddles, etc., mailed for 50c. 1943 circular for 3c stamp.

FRANCIS BANNERMAN SONS, 501 Broadway, New York

END DAMP AIR WITH "DRI-AIR"

New DRI-AIR Chemical draws excess moisture from air in damp basements, PROTECTS TOOLS and machinery against RUST, mold, mildew. Complete outfit, DRI-AIR Unit and 10 lbs. DRI-AIR Chemical, \$5.50 f.o.b. Chicago. Order now! DEALERS WRITE TODAY! TAMMS SILICA COMPANY, 228 N. LaSalle St., Chicago, Ill.

BUILD YOUR OWN ARC-WELDER

For Light or Heavy Work

No rewinding necessary—use coils taken from old auto generators.

Works on 110 or 220 A.C. Has 20 different heats. Complete plans and BIG Catalog 35c.

LEJAY MFG. CO., 3347 LeJay Bldg., Minneapolis, Minn.

PINS RINGS FOR YOUR CLUB!

Beautifully Styled—Low Prices!

Make your members more conscious of their membership. Write for free catalog. Shows 300 styles, sterling and gold plate on sterling. Choose a design suitable for your group. No order too small. Quality leader for 48 years. Write today!

BASTIAN BROS. Dept. 87, Rochester, N. Y.

TRAILER AXLES, HITCHES, AND PARTS

● If you are interested in purchasing trailer axles, hitches, and other trailer parts, contact us promptly. Complete house trailer blue prints, \$1.00. Write for free literature.

HAMMER BLOW TOOL COMPANY, Dept. 104, WAUSAU, WIS.

TOMBSTONES DIRECT TO YOU \$9.95 UP

● Genuine beautiful ROCKDALE Monuments, Markers. Satisfaction or Money Back. Free lettering. Free catalog. Freight paid. Compare our prices. Rockdale Monument Co., Dept. 751, Joliet, Ill.

BUILD YOUR GRANDFATHER CLOCK NOW

Send 35c for Simple SHOP TESTED COPYRIGHTED BLUEPRINT. The Simple Sensible Red-I-Kut way as thousands have. DIME brings PLANS and sixty pictures HOW to bring many fine brass weight Westminster, tube chime movements showing nice beautiful colonial grandfather cases. Build now. Avoid Govt. Freeze. Save half. HURRY!

KUEMPEL CHIME CLOCK CO., Bldg. 75, Guttenberg, Iowa

TOOLS TO MAINTAIN COMMUNICATIONS

Wherever modern armies march, they trail a vast network of wires for intercommunication. Much of this network goes overhead, on poles, crossarms, and other wood members that must be worked with Hand Tools.

For this, and for the thousands of other needs of our fighting forces, Stanley Tools are being used in unprecedented quantities. Tools for normal use are necessarily restricted.

Tools are vital to Victory. Buy them only for essential use. Stanley Tools, Division of The Stanley Works, New Britain, Conn.



Photo Courtesy U. S. Signal Corps

1843 **STANLEY** 1943

TRADE MARK



STANLEY TOOLS

"The Tool Box of the World"



Save Fingers

with **Steel-Grip Finger Guards**

Hundreds of factories are saving time and injuries in war production by protecting workers with Steel-Grip Finger Guards. Used for handling rough or sharp articles, for buffing, grinding, sanding, polishing, punch press work and hundreds of other jobs. Protect fingers or thumb, front or back, from cuts, abrasions or blisters. Made of durable leather with elastic web back for snug, cool, comfortable fit. Easy on and off. One size fits all, men or women. Send 10c each for samples or trial order box of 50 at 83¢ each, less 10%.

Catalog of Steel-Grip Safety Apparel free on request

INDUSTRIAL GLOVES CO.
651 Garfield Blvd., Danville, Ill.
Canada: Safety Supply Co., Toronto

New Designs in

FRANZITE GRIPS

Modernize Your Gun! Improve Your Score!
Most durable grips made. Positively unbreakable! For Colt, Smith & Wesson, Hi-Standard, Ortgies, Luger & Mausers in a wide choice of beautiful designs in ivory, pearl, walnut, onyx, etc. Low prices. FREE CATALOG. Dealers Wanted.

SPORTS, INC., (Mrs.) 2850 N. Clark St., Dept. P-4, Chicago, Ill.

OTTAWA TRACTOR SAW

Falls Tree—Cuts Log
Fits rear power take-off shaft.
Drive thru gear reduction. 18-in. stroke, 10-ga. blade. Economical, saws to profit.

FREE Circular and Price List

OTTAWA MFG. CO., 2027 Forest Avenue, OTTAWA, KANSAS

Better model-making— better arts and crafts—

WITH THIS **REVOLUTIONARY KNIFE**

The very knife-design makes you do a better job. The handles make your fingers deft. Super-keenness makes effortless cutting on hard woods, cardboards or plastics. Special blade-shapes make X-ACTOS



No. 1 X-ACTO knife for light, delicate work. 3 styles of blades. Complete with one blade. 50c. With 3 extra assorted blades. \$1.00

No. 2 X-ACTO knife for heavy carving—3 styles of blades. Complete with one blade. 50c. With 3 extra assorted blades. \$1.00

No. 42 Double Set 2 handles 12 blades. \$2.00.

No. 82 Fitted wooden chest 3 handles, 12 blades. \$2.50.

follow guide lines easily; and surgical sharpness minimizes splitting. NOW, at first sign of dulling, instant change to a new blade renews the surgical keenness. Re-blade to re-sharpen.

GET FREE BOOK, TELLS "HOW"

to build Model Planes prepared by experts. Profusely illustrated, simple, easy to follow instructions. Build solid models for Army and Navy spotter planes.

Write for FREE "How to build Model Planes." Send 5c to cover handling and postage. At your local Hobby Shop, Hardware or Department Store or order direct. Extra Blades 50c for pack of 5

X-ACTO
CRESCENT PRODUCTS CO.
440 Fourth Ave., New York, N.Y.
Dept. PM



X-ACTO knife
RE-blade to RE-sharpen



NEW PROJECT LIBRARY

Over 300 Outstanding Projects with Photos and Working Drawings



One of the greatest project library values ever offered—over 300 "cream of the crop" selections from past issues of the Delta—segregated in nine convenient books, with each book devoted to a specific type of project. No more searching through dozens of books to find the exact project you want. Photographs, working drawings and complete directions on each project. Every item shop-tested. In addition, you get the valuable "Practical Finishing Methods," a gold mine of information on latest finishing methods. Examine this remarkable value on our "no-risk" offer. Send TODAY!

ONLY \$2 COMPLETE

Here's What You Get:

Vol. I—21 Lovely Lamps including many modern designs. Vol. II—19 Charming Chairs. Vol. III—One Evening Projects that "look like a million." Vol. IV—Garden Furniture and Novelties. Vol. V—New and Unusual Toys, Games, Playground Equipment. Vol. VI—Furniture Designs—many original designs. Vol. VII—Interesting and Useful Novelties. Vol. VIII—40 Fine Tables. Vol. IX—Small Furniture Designs.

PLUS—"Practical Finishing Methods"

How to do every possible finishing operation—how to prepare the work—how to stain—fill—varnish—lacquer, etc. Proper use of spray gun and brush. How to mix your own low-cost materials. Silk screen process—how to finish metal—make decorations. Includes old secret methods.

FREE—Extra Gift

With every order a FREE copy of "How to Make Money with Power Tools." Gives numerous examples of successful money-making plans.

Examine Library at Our Risk!

Send only \$2 for complete Project Library, Finishing Methods and FREE Gift Book. On arrival, postpaid, examine thoroughly. If not fully satisfied, your \$2, plus return postage will be promptly refunded.

The Delta Manufacturing Company
68-D E. Vienna Ave., Milwaukee, Wis.



DRILL PRESS OWNERS!

HERE'S 1 TOOL WITH 5 DISTINCT USES
THE BARRON MULTI-PURPOSE
ROTARY WOOD PLANNER



PLANES & SURFACES • PANELS & BEADS \$7.50
ROUTS & GROOVES • RABBETS • TENONS COMPLETE

Converts ANY drill press into a time saving, low cost planer, paneler, tenoner, etc. Surface finishes all types of tough grained and knotty surfaces to agate smoothness. Safe! Guaranteed harmless to drill press. Thousands now in use. **SOLD ON MONEY BACK GUARANTEE.** Full refund on 5 day trial. Shipped prepaid on receipt of \$7.50—or C.O.D. YOU RISK NOTHING. Free literature.

STEEL TOP AUXILIARY DRILL PRESS TABLE

Has 300 sq. in. smooth working surface. Equipped for slaps and many other important workshop uses—a real buy at \$5.95



Barron Tool Co., 369 Architects Bldg., Detroit, Mich.



KAYAKS
Easy to Build
BOATS for Home Assembly
"U-MAK-IT"

KAYAKS, ROWBOATS, DINGHIES, INBOARDS, OUTBOARDS, RUNABOUTS. Cut-to-fit for quick assembly. Everything complete plus illus. Instructions. No Experience Necessary. Simple as A-B-C. SEND 10¢ POSTAGE (COIN) TODAY For Money-Saving Illus. Catalogs showing all latest Models.

AQUAMOBILE V-18

Designed for Automobile Engines. Adjustable Motorbeds. Open or with cab. Length 18 ft., width 6 ft. 7 in. Fast VEE Bottom Hull.



Encl. 10¢ (coin). Send all illus. Booklets at once.

Name
Address
MARINE DIVISION OF U-MAK-IT PRODUCTS
KAYAK BOAT CO., 154 P-EAST 129th ST., NEW YORK, N.Y.

DIE-LESS DUPLICATING

Many small parts can be formed without dies, to duplicated accuracy of .001" with DI-ACRO Precision Machines.—Benders, Brakes, Shears—saving Man Hours and Critical Materials. Require priority of A-1-A or higher. Write on business letterhead for catalog, or state if employed in War Production.

O'NEIL-IRWIN MFG. COMPANY
341 8th Avenue S., Minneapolis, Minn.



New Only \$15.00

REAL ENGINE VALUE



The G.H.Q. is a miniature gasoline engine that really operates. Over 15,000 sold in the last year. 1/8 H.P. Complete with flywheel (or propeller), fuel, many accessories and full instructions. Fully bench tested and ready to run. For boats, planes, midget cars, etc. Send only \$1.00—Shipped Collect C.O.D. same day. Send 6¢ for circular or 25¢ for Jumbo Hobby Catalog of hundreds of planes, boats and hobby items.

GHQ MOTORS, Dept. BT, 40 East 21 St., New York, N. Y.

ONAN ELECTRIC PLANTS

ALTERNATING AND DIRECT CURRENT



Used by U.S. ARMY, NAVY, and MARINES on all World Fronts for HOSPITALS, COMMUNICATION, LIGHTING and EMERGENCY ELECTRIC POWER.

MANY MODELS from 350 to 35,000 Watts
Any Voltage—Any Frequency—A.C. or D.C.

WRITE FOR DETAILS

D. W. ONAN & SONS
1080 Royalston Ave., Minneapolis, Minn.

IT'S FUN TO MAKE THINGS OF WOOD



CONSTANTINE'S MANUAL TELLS HOW TO DO IT

Beginner or expert will find many helpful hints and tips on veneering, woodfinishing, cabinet making, carpentry, etc. Describes and illustrates over 100 different kinds of wood and 980 different items for you. ALL AT MONEY SAVING PRICES. Includes Identification Panel & Chart of Over 60 Rare Woods in NATURAL COLOR. A source of supply for anything in wood regardless of quantity. Send only 25¢ in stamps or coin, 25¢ refunded or credited on first order so Manual costs you nothing.

ALBERT CONSTANTINE & SON, INC.
791J East 135th St. New York, N. Y.

Always write your name and full address clearly when answering advertisements.

MOTORISTS Wanted!



TO MAKE THIS UNIQUE GAS SAVING TEST

Will you permit us to send you at our risk the Vacu-matic a device which auto owners everywhere are praising? Install it on your car. Test it at our risk. Unless it trims dollars off your gas bills by saving up to 30% on gasoline consumption, gives more power, quicker pickup and faster acceleration, the test will cost you nothing.

Automatic Supercharge Principle
Vacu-matic is entirely different! It operates on the supercharge principle by automatically adding a charge of extra oxygen, drawn free from the outer air into the heart of the gas mixture. It is entirely automatic and allows the motor to "breathe" at the correct time, opening and closing as required. Saves up to 30% on gas costs, with better motor performance.

FITS ALL CARS
Constructed of six parts fused into a single unit, adjusted and sealed at the factory. Easily and quickly installed by anyone in a few minutes.

AGENTS Get Yours FREE

FOR INTRODUCING. Here's a splendid opportunity for unusual sales and profits. Every car, truck, tractor owner a prospect. Send name and address now for big money making offer and how you can get yours Free. The Vacu-matic Co., 7617-784 W. State Street, Wausatosa, Wis.

READY CUT HOMES

Still Available . . . Get one—

Really need a home? You can now—in many areas, necessary equipment included! We'll show you how to get government permission, and save \$500 average, on a modern production method home, easily assembled. Information on FHA financing. If you plan to build—now or later—send 25c now for Sterling Homes Catalog showing 75 modern low priced home plans; full color; and get on your way for government priority. Complete building plans ready now for filing with application at moderate cost. Write.

Dept. PM-43
INTERNATIONAL MILL & TIMBER CO.
Bay City, Mich.

NEW COLOR CATALOG FOR ONLY 25¢





Free Catalog

Just Off the Press

Fully illustrated, showing special footwear and clothing for fishermen and campers, also special fishing tackle.

L. L. Bean, Inc.

45 Main Street
Freeport, Maine
Mrs. Fishing and Camping Specialties

DOOR-EASE STAINLESS STICK LUBRICANT

EASES STICKING DRAWERS

Use Door-Ease—like a crayon—for things that stick or squeak . . . drawers, doors, windows, latches and friction catches, screws, zippers, etc. Clean, weather-proof, long lasting!—Door-Ease Mfrs., Muskegon, Mich.

10¢

In metallic container at Hardware, Auto Accessory, Dept., and Dime Stores.



RE-STRING RACKETS AT HOME—EARN MONEY

EASY—PLEASANT—PROFITABLE

FREE WRITE FOR 1943 CATALOG AND INSTRUCTION SHEET NOW

W. A. Bickel & Co., 137 N. Marion, Dept. M-43, Oak Park, Ill.



CRESCENT TOOLS

Give Wings to Work

ASK YOUR HARDWARE DEALER



GRAY HAIR VITAMIN NOW \$1.95

No dyes—No drugs—Hair grew out in Natural Color in almost nine out of ten test cases just taking one tablet Calcium Pantothenate Vitamin each day.

Why pay \$3.50 to \$5.00 for the famous "Gray Hair Vitamin"? SEND NO MONEY. Just send name and address. We will ship 100 10-mg. tablets (100 days' supply) genuine standard quality Calcium Pantothenate Vitamin C.O.D. for \$1.95 plus few cents postage. Guaranteed same quality as used in National Tests or money back.

LILEE PROD. CO., 2017 S. Michigan Ave., Dept. 94, Chicago, Ill.

PAY NO MORE

Please use CASCO GLUE for essential repairs only



One of hundreds of ways glue is going to war. Photo shows three of 500 giant CASCO-glued laminated wood beams built to Navy Specifications by Attwell Const. Co., Glue Fabricators, Seattle, Washington.

● Good industrial glues like CASCO and CASCAMITE are scarce. Uncle Sam needs them for jobs like those 5,000-lb. beams shown above—and for aircraft, life rafts, boats, plywood and all kinds of field equipment.

So use these glues only to repair your furniture, screens and necessary home equipment. Today it's *fight*. Plenty of time and plenty of glue for *fun*—tomorrow.



CASCAMITE Resin Glue for waterproof gluing. CASCO Casein Glue for water-resistant gluing. 10¢ and larger sizes at hardware stores.



FREE REPAIR GUIDE!

CASEIN COMPANY OF AMERICA, Dept. PM-443
350 Madison Avenue, New York, N. Y.

Send me the literature checked.
 "GLUING GUIDE". Complete directions for both glues. Over 80 home workshop and repair jobs.

NAME

ADDRESS

----- Save 2¢ — Stick coupon on penny postcard -----

Highest Approval for NEW GLUE!

U. S. Adopts it for
Boats and Planes*



Welds wood to wood in Uncle Sam's boats and planes. Holds in salt surf, tropic heat, sub-zero stratosphere. Fast acting WELDWOOD is foolproof. Add tap water to dry powder, stir—and glue is ready for instant use. Cold setting. Perfect for repair jobs. At hardware, chain stores, lumber yards—10¢, 25¢, 50¢. Or send 25¢ with your dealer's name for sample can. Supply limited due to Uncle Sam's war needs.

UNITED STATES PLYWOOD CORPORATION

World's Largest Producer of Plywood

Weldwood Glue Dept.

103 Park Ave., New York

Compare These
Amazing Qualities

1. Tremendous Strength
2. Waterproof
3. Rot and bacteria-proof
4. Economical
5. Stain-free
6. Quick and easy to mix

*"Makes the glue line
the SAFETY line"*

*APPROVED for aircraft
by U. S. Army, U. S. Navy
and Civil Aeronautics Auth-
ority when properly applied.



WELDWOOD
PLASTIC RESIN
WATERPROOF GLUE

The Dennison Handy Helper says:
"NO NEED LICKING, USE SELF STICKING

Dennison
PRES-a-PLY LABELS"

Transparent Mending Tape • Mailing Labels
Gummed Reinforcements • Index Tabs
Shipping Tags • Crepe Paper • Gummed Labels
DENNISON MFG. CO., Framingham, Mass.



Gay Color
AND *Charm* WITH
MEYERCORD DECALS

Add new zest to kitchens, bathrooms, play-
rooms or accessories at low cost. Washable.
Easy to apply. Fun to use. Sold at hard-
ware, paint, 5 & 10, department stores.

TRIMZ: Ask to see the new
Trimz wall borders!

FREE
Colorful booklet
tells where and
how to use decals.
Address Dept. E

MEYERCORD DECALS
5323 WEST LAKE ST., CHICAGO

Test-O-Lite the MODERN
TROUBLE SHOOTER



← THE NEON GLOW

... LOCATES TROUBLE
INSTANTLY in electric cir-
cuits, fuses, cut-outs, motors,
radios, appliances. Tests
everything electrical from
100 to 550 volts. Indicates
hot or grounded wires. Tells
AC from DC. Far supe-
rior to ordinary
clumsy test bulb.

↑ PUTS "FINGER" ON THE
TROUBLE SPOT -- QUICKLY

Saves precious time. Indispensable in
shop or home. Has patented safety fea-
tures. Vest pocket size with clip. Life-
time guarantee. List \$1.50

L. S. BRACH MFG. CORP.

55 Dickerson St. Newark, N. J.



FUSES



MOTORS



OUTLETS

Full Stock of Leather on
Hand
IDEAS for LEATHER
Projects



Send 10 cents for big 16-
page Idea Catalog. Full of
suggestions on materials,
tools, and projects in •
Leather • Wood Carving • Archery • Gifts. We have
plenty of Leather, Immediate Shipments for All Orders.

J. C. LARSON & CO.

180 No. Wacker Drive,

Dept. 180-D,

Chicago, Illinois



Wood
workers: Here it is! Harold

only
10c

Hunt's big revised No.
14 wood catalog! Latest UP-TO-DATE
IDEAS for experts and amateurs: SPECIAL
BARGAINS in rare woods, veneers, and
ALL kinds of supplies. 124 pages—12 of
rare woods in color. Get posted. Send only
10c to CRAFTSMAN WOOD SERVICE CO.
2729 S. Mary St., Dept. A-32, Chicago, Ill.

Make Your Own
KEYWAY CUTTER LATHE ATTACHMENT
Cut internal keyways, square holes, ream-broaching,
light broaching, press fitting, etc. EASY PLANS \$1.00
includes tips on how to cut off. Satisfaction Assured!
PAUL HOBSON, 422 So. Dearborn St. Chicago

**KIDNEYS
MUST REMOVE
EXCESS ACIDS**

Help 15 Miles of Kidney Tubes
Flush Out Poisonous Waste

If you have an excess of acids in your blood, your 15
miles of kidney tubes may be over-worked. These tiny fil-
ters and tubes are working day and night to help Nature
rid your system of excess acids and poisonous waste.

When disorder of kidney function permits poisonous
matter to remain in your blood, it may cause nagging
backache, rheumatic pains, leg pains, loss of pep and
energy, getting up nights, swelling, puffiness under the
eyes, headaches and dizziness.

Kidneys may need help the same as bowels, so ask your
druggist for Doan's Pills, used successfully by millions
for over 40 years. They give happy relief and will help
the 15 miles of kidney tubes flush out poisonous waste
from your blood. Get Doan's Pills.

Cushman



Cushmans
at Washington, D. C.
Airport

**...aiding
the war
effort**

The reason your dealer can't supply you with a new Cushman today, without high priority, is that our entire Cushman output—12 times greater than normal—is being called

into service by the Army, Navy, Air Forces and great defense plants. These Cushmans are greatly aiding the Victory program by speeding officers and key-men for inspection and check-up of bases, camps, forts and defense plants—speeding deliveries of orders, mail, prints, repairs, supplies, parts, etc. Their 35-miles-per-hour speed saves precious time. Their 100-miles-per-gallon economy reduces costs. Their easy-to-stop-and-park-anywhere convenience is invaluable.

And out of this rigorous war-time experience is coming a better Cushman—even more sturdy and dependable—a machine you'll delight to own when it is again available.

If you own a Cushman, lubricate and service it carefully and regularly so it may serve you for the duration. Your instruction book gives you complete directions. For a new copy see your Cushman dealer or write us for a free copy.

Cushman Motor Works, Dept. P-4, Lincoln, Nebr.

**Thompson
BEATS
the World
on BOATS**



**Better Built
Lower Prices**



Canoes \$75 and up

Rowboats \$48 and up

Outboards \$48 and up

**Safe Boats With
Full Length Spray Rails**
Keep passengers perfectly dry—even at high speeds. Catalog also shows today's seven most popular models of sailboats. Two big factories. Prompt shipment.

CATALOG FREE
Write for your copy. State kind of boat in which you are interested.

THOMPSON BROS. BOAT MFG. CO. (114)
213 Ann St. PESHIGO, WIS. Light "Car-Top" Boat 413 Elm St. CORTLAND, N.Y.

ARMSTRONG TOOL HOLDERS

enabled American industry to change to war production "over night." For they are the permanent, multi-purpose tools used by 96 per cent of the machine shops and tool rooms, on lathes, planers and shapers—the tools used to make dies and jigs, to build production machines. They are the tools you will want for your own shop after the war—ARMSTRONG TOOL HOLDERS for industry, ACE Tool Holders for home work shops.



ARMSTRONG BROS. TOOL CO.

"The Tool Holder People"

365 N. Francisco Ave., Chicago, U. S. A.

New Accurate 10" Slide Rule

Instruction Book
FREE



**SPECIAL
COMBINATION OFFER**

Slide Rule and Instruction Book; Pocket Calculator for adding and subtracting up to 999,999; 6" Transparent Protractor and Graph Rule graduated in centimeters and inches. **ALL 3 for \$1.00 cash** (\$1.10 Foreign) Postpaid.

Magnifying Indicator



50¢

Enables you to do difficult calculations instantly without paper or pencil—multiplying, proportions, division, extracting roots, etc. Accurate, white composition face. Has standard A, B, C, D, CI and K scales. For complete outfit, including slide rule, 28-page illustrated instruction book, carrying case, send 50¢ (60¢ Foreign). Mailed postpaid. Satisfaction guaranteed or money refunded. (See Special Combination Offer) **Order NOW!**

HEWIG CO., Box 143-L, Grand Central Annex, New York City

HOLES IN WALLS



**REPAIR THEM WITH
RUTLAND
PATCHING PLASTER**

says Uncle Ned,
the How-to-fix-it man



● Mending cracked walls with Rutland Patching Plaster is as easy as buttering a slice of bread. Just mix with water and apply with knife. Makes a smooth, firm patch as lasting as the wall itself. Rutland Fire Clay Company, Rutland, Vt.



Say you saw it in Popular Mechanics!



YOUR reputation as a sportsman will be safe when you get this 100 page book, ram-jam full of hitherto unpublished secret methods for cramming your creel and garnishing your game bag. No time worn tripe, but swell new success secrets.



Written by Mark W. Burlingame, famous sportsman, author, editor—specially for Hodgman Rubber Co., whose fine waterproof sporting specialties are known to thousands of American Sportsmen. No, we can't sell you any merchandise because it all goes to Uncle Sam, but we can send you this "reputation protector" if you will mail the coupon and only one thin dime.

HODGMAN RUBBER CO.
Dept. P, Framingham, Massachusetts
Here's my dime. Send me "Secrets".

Name.....
Address.....

MAIL IT TODAY!

Try Anti-Gray Hair Vitamins

Plus Wheat Germ Oil (E) Vitamins
ON THIS MONEY BACK OFFER

RESTORING COLOR TO GRAY HAIR WITHOUT
DYES IS SCIENCE'S LATEST MIRACLE

If your hair is gray, graying streaked, faded or off-color, modern science offers new hope without dyeing. A lack of certain vitamins in your daily diet can cause hair to turn gray. Improve your diet, get extra supplies of these "anti gray hair" vitamins by simply taking the original 2-way Panates Vitamin treatment. You too may be amazed and delighted to see the gray spread stopped, restoration of normal natural original color to the hair at roots, temples, parting, a great improvement in your hair beauty. You can now test Panates yourself on an iron clad guarantee that leaves no room for doubt.

PANATES is different—it not only contains a powerful supply of "Anti-Gray Hair" Vitamins but "staff-of-life" Vitamin (E) Wheat Germ Oil as well. Panates is not a hair dye. You have nothing to fear... no mess, no fuss. You can test safe, healthful Panates whether you now dye your hair or not, because Panates Vitamins work from within to check gray spread and literally feed natural color back into the hair roots.

When the blood does not provide the proper elements, the tiny laboratory that manufactures color shuts down and the hair grows gray. Perhaps you may need the vitamins in Panates. Make this test today.

SEND FOR THIS INTRODUCTORY TRIAL OFFER TODAY

The 30 day trial of the regular \$4.79 (90 day) Panates double action Vitamin is only \$1.79 if you set at once! SEND NO MONEY pay postman plus C.O.D. postage on arrival on guarantee of full satisfaction or money back. Send \$1.79 and we pay all postage. Or, if you want more of the amazing Panates Anti Gray Hair Vitamin story, write for FREE Valuable Booklet, "Vitamins and Gray Hair." No cost, no obligation. Whatever you send for put your letter or postcard in the mail today while Special Offer is available. Who knows perhaps the 2 vitamins in Panates may be the wonderful easy-way answer to your hair color worries!

Not in stores. Write

PANATES CO. Dept. A-240, 310 S. MICHIGAN AVENUE, CHICAGO, ILLINOIS



No More Damage from Condensation or Sweating Pipes, Water Softeners, Tanks, Walls, Ceilings and Air Ducts

NO Drip A SURE CURE—This sensational plastic cork coating prevents condensation drip from metal, concrete, brick, wood, plaster or composition surfaces. Permanently protects metal against rust and corrosion, thus prolonging life of pipes, tanks, etc. Forms a moisture-proof, insulation type coating. Apply with brush, trowel or spray.

Stucco-like finish requires no maintenance and can be painted any color. A gallon covers about 30 feet of 1" O.D. pipe. Comes in 1, 5 and 55 gallon drums. Get at Hardware, Plumbing, Mill Supply Dealers or send \$1.90 for 1 gal. prepaid. Write for Free Handbook. J. W. MORTELL CO., 522 Burch St., Kankakee, Ill.

ONE-MAN SAWMILL LESS THAN \$100.00

Makes Lumber Turn Trees Into Money with a BELSAW
Three capacities: 10, 14 and 20 feet. Accurate set works, positive dogs. Hand or power feed. Runs on low power—many owners use old auto engine. Pays for itself quickly—thousands in commercial service, everywhere. Write for free lumber handbook and catalog of mills, supplies, tools, saw blades and woodworking equipment. BELSAW MACHINERY CO. Dept. 1811-C, 3542 Main St., Kansas City, Mo.

FORTY POWER TOOLS You Can Build at Low Cost

USE OLD AUTO PARTS
SAVE HUNDREDS OF DOLLARS
Power tools for your home workshop—at a cost anyone can afford. Make them yourself—lathes, drill presses, sanding machines, shaper, circular, band, and scroll saws and other power tools—from old auto, sewing machines, and other discarded parts that cost very little. Get the new book, "Forty Power Tools You Can Make", and follow simple instructions, diagrams and photographs. Make yourself up to date, efficient machines that will do a good job for you and save you time, hard work, and many dollars. Send \$1.25 for "Forty Power Tools You Can Make" today or order on postal card and pay postman on delivery anywhere in U. S. A. Your money back if not satisfied.

POPULAR MECHANICS PRESS, Dept. 468, 200 E. Ontario St., Chicago

AUTO ENGINE SPEED CONTROL GOVERNORS

Give constant speed to any make of auto or truck engine, regardless of load changes, when used for power. No better governor can be made. Fully guaranteed. Complete, simple instructions. Oil ring bearing \$12.50. Ball bearing \$19.00. Montreal branch, 7546 Wiseman St. Free circulars. CANDEE, 129-34 Llewellyn St., Los Angeles

WORLD'S LOWEST PRICED ADDING MACHINE

Best Pocket Size FREE TRIAL ONLY \$258 TOTAL COST SEND NO MONEY
IDEAL FOR BUSINESS — GUARANTEED PERSONAL USE — ACCURATE. Not a toy. Operates with only a finger flick. Adds, subtracts, multiplies, divides. Counts up to ten million. Pays for itself over and over. Ideal Gift—for Business. Income Tax and School use. MONEY BACK GUARANTEE. Send name and address. Pay postman only \$2.50 plus postage. (Send full cash if outside U. S.) Money back in 10 days if not delighted. AGENTS WRITE. CALCULATOR MACHINE COMPANY (Mrs.) DEPT. 140, P. O. BOX 1118 CHICAGO, ILLINOIS

Say you saw it in Popular Mechanics!

Limited Supply - ORDER YOUR RADIO, ELECTRONIC AND SOUND TECHNICAL BOOKS - Now!

... while we have complete stocks. If it is a technical book in Radio, Electric or Sound LAFAYETTE has it—at special prices!

RADIO PARTS—Lafayette has some radio parts and sets available without priority. Write for new illustrated folder—it's FREE—address 901 W. Jackson Blvd., Chicago, Ill., Dept. 4P3.

LAFAYETTE RADIO CORP.

901 WEST JACKSON BLVD. CHICAGO, ILLINOIS 265 PEACHTREE STREET ATLANTA, GEORGIA

110-VOLT AC GENERATORS

& AC light plants. 1800 & 1200 rpm. Available for all standard voltages such as 110, 220 or 440 three phase; three phase, three wire or three phase four wire & 25, 30 or 50 cycles. 350 through 15,000 watts. Also rotary converters, motor generators, frequency changers, etc.

KATOLIGHT, 26 Elm St., Mankato, Minn.



EMPIRE "TORPEDO" LEVELS



HANDY HOUSEHOLD TOOL
Smallest and Handiest Accurate Level Made. "Cigar-shaped," can't tear pockets. Walnut stock. Has Level, Plumb, and 45° vials, 9" long. Light weight, strong, No. 44 only \$1.10. Order from local dealer. Write for literature.

EMPIRE LEVEL MFG. CO., DEPT. P-172 3142 1/2 SIXTH STREET MILWAUKEE, WISCONSIN



GENUINE U.S. BARGAINS

O. D. WOOL BLANKETS (USED) \$2.95
McCLELLAN SADDLES (USED) . 5.95
U. S. ARMY PUP TENTS (USED) . 3.50
BOYS' BLUE WOOL OVERCOATS (USED) SIZES 32 TO 38 . . . 3.95
Thousands of Other Bargains in Military, Outdoor & Sport Goods for Hunter, Farmer, Scout Send 10¢ for 32-page catalog returned with first order.

A and N SUPPLY CO.
4720 LESTER ST. RICHMOND, VA.

\$9.50 UP MONUMENTS

SEND FOR FREE CATALOG Enduring, strikingly beautiful GRANITUR TOMBSTONES of prices you can afford. Investigate our memorials before you buy. GUARANTEED.

ECONOMY MONUMENT CO., DEPT. A, 4145 W. KINZIE ST., CHICAGO, ILL.

Print Your Own

Cards, stationery, circulars, tags, labels, photo and movie titles, advertising, etc. Save money. **Print for Others. Good Profit!** easy rules sent. Raised Printing and Embossing too. Junior outfit \$8. Senior outfits from \$17.38. Send for free catalog and all details. **KELSEY INC., 5-37, Meriden, Conn.**



THE FOLEY SAW FILER is in use by U. S. Army, Navy, Air Force, hundreds of War and manufacturing plants.

Filing time, saves files and reduces saw breakage. Available on priority of A-9 or better. Write on business letterhead for literature.
FOLEY MFG. CO., 416-3 Foley Bldg., Minneapolis, Minn.

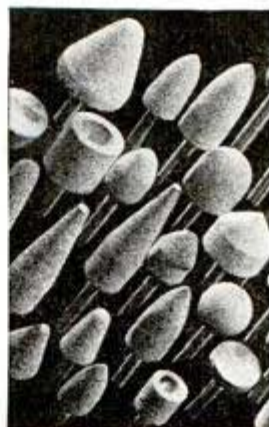

FINISH THE JOB RIGHT

Like setting the last rivet as the plane comes off the production line—burring, finishing and polishing to minute specifications mean the job is right.

CHICAGO MOUNTED WHEELS

Famous since their introduction 45 years ago for quality and long life. There is a "just right" Chicago Mounted Wheel for every operation.

PROMPT DELIVERIES—We are working 24 hours a day and due to our central location, can make prompt shipment on all Mounted Points and Grinding Wheels 3" in diam. and under. With the approval and endorsement of W P B, all our facilities are concentrated on these smaller sizes, enabling us to give the most potent service to the war program.

HANDEE TOOL OF 1001 USES and HI-POWER GRINDERS have gone to war—available to all who have priorities

FREE Catalog, shows actual sizes and colors of largest line of Mounted Wheels made.

CHICAGO WHEEL & MFG. CO.
America's Headquarters for Mounted Wheels
108 S. Aberdeen St., Chicago, Ill.



COMPARE THIS RULE

FEATURE FOR FEATURE

Check the MASTER STREAMLINE — value for value — against any other 6-ft. steel tape available for use at home or at work. This many-purpose rule serves you with precision as outside calipers, inside calipers, a depth gauge or a straight edge.

Its lever-lock holds the reading while you bring rule from work to eye. Its hook grips firmly for outside measuring. In cramped spaces, "STREAMLINE" makes measuring a one-hand job. Extra large, easily legible numbering gives accurate reading in poorly-lighted spots. Graduations are flush with work.

The handy-size MASTER STREAMLINE comes with an easy-to-insert extra blade, doubling its life. You can double its usefulness, too — when you specify that the extra blade be graduated in tenths of inches and hundredths of feet. See the MASTER STREAMLINE at your hardware dealer's. Or, send us the coupon today.

\$265 each Complete with spare blade

MAKE IT A RULE TO MAKE IT A MASTER

MASTER
WOOD AND TAPE RULES

MASTER RULE MFG. CO., 815E 136th St., N.Y.C. 17
 Send me MASTER "Streamline" with spare blade. I enclose \$
 Send more information on this superior rule.
 Name _____
 Address _____
 City _____ State _____

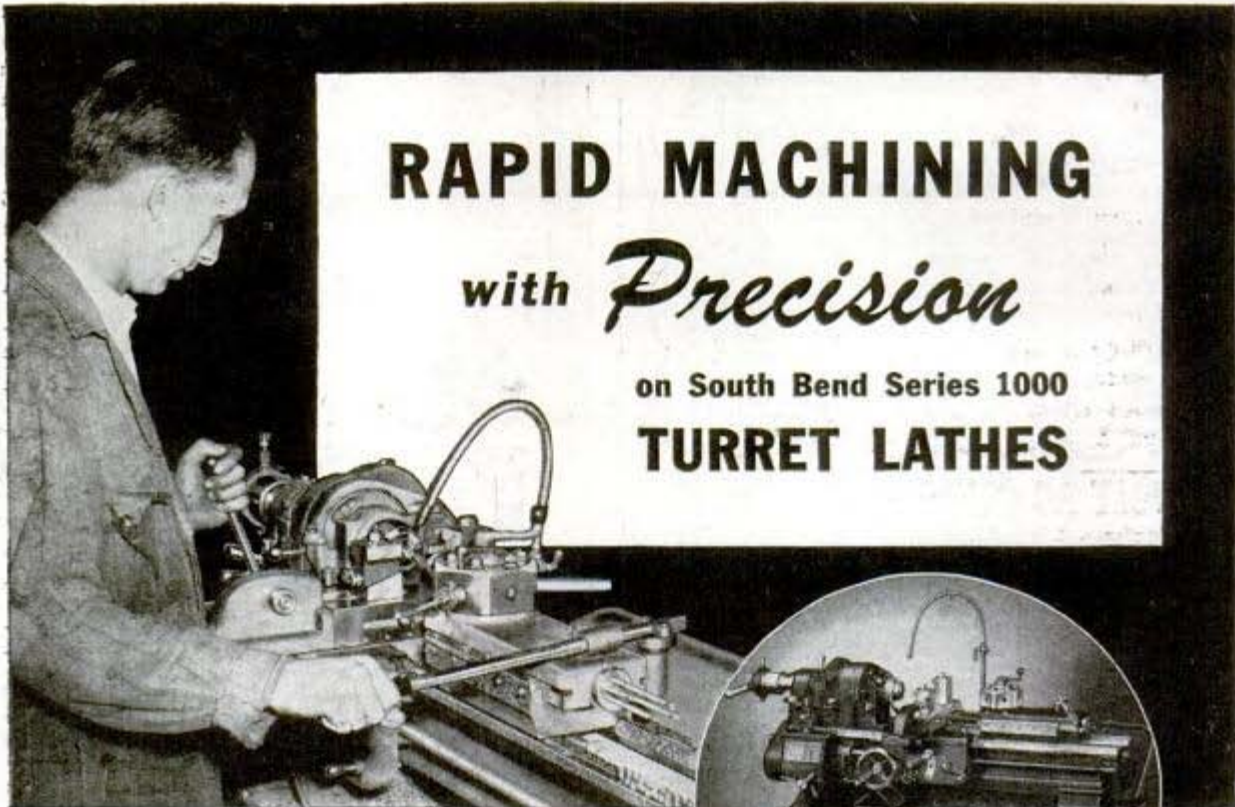

RAPID MACHINING

with *Precision*

on South Bend Series 1000

TURRET LATHES

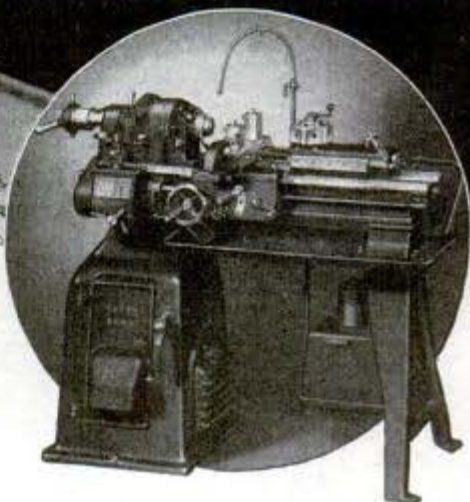

Rapid machining *with precision* is easily accomplished in shops that are equipped with the new South Bend Series 1000 Turret Lathes. Designed for manufacturing small accurate parts, they have the stamina to maintain exact tolerances on volume production without sacrificing speed or versatility.

These Turret Lathes are especially suitable for second operation work. The basic South Bend features that insure efficient production are supplemented by the handlever operation of the turret, cross slide, and collet attachment to speed up machine operation and lessen operator fatigue.

SPECIFICATIONS

Hole through spindle 1 3/8"
 Collet capacity, round 1"
 Swing over bed and saddle wings . 10 1/2"
 Spindle speeds, (12) 50 to 1357 r. p. m.
 Effective feed of turret slide 4"
 Thread cutting range, (48) 4 to 224 per in.

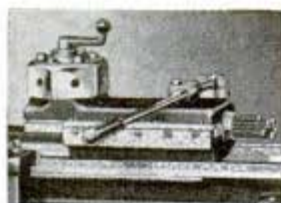

HANDLEVER TURRET

Permits rapid positioning of turret tools. Turret indexes automatically on return stroke. Equipped with adjustable stops.

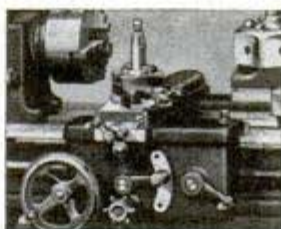

UNIVERSAL CARRIAGE

Provides wide range of feeds—48 power longitudinal feeds—48 power cross feeds—48 threading feeds, 4 to 224 per inch.



SOUTH BEND LATHE WORKS

SOUTH BEND, INDIANA

LATHE BUILDERS FOR 36 YEARS

MEN! Whether You are **16** or up to **50**
Serve Your Country Best... in a
GOOD WAR-TIME JOB
WITH A PEACE-TIME FUTURE!

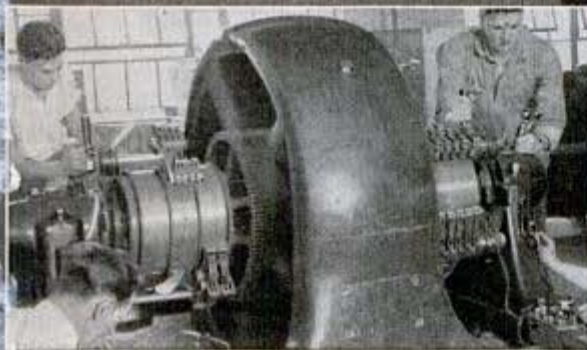

★ **ELECTRICITY** is one of the most important factors in our war effort. Thousands of trained Electricians are needed NOW. And after the war, Electricity will continue to be tremendously important! Why be satisfied with a narrow, no-future war job when I make it SO EASY to prepare for a good war-time job with a REAL PEACE-TIME FUTURE?

FIRST IN WAR! ELECTRICITY FIRST IN PEACE!

Learn By Doing in 12 Weeks

Get into the fascinating, fast-growing, well-paid field of Electricity—a field that offers you opportunities and a future—in good times or bad times—a field that is a permanent necessity in war or peace. Here is your chance to prepare yourself for a lasting permanent future.

Here at Coyne, in 12 weeks, you can train for your Big Opportunity by working on real electrical machinery. Here you learn airplane ignition, wind arm-

atures, learn power plant operation, do house and factory wiring, etc. Coyne training is easy to learn. You "Learn-By-Doing" in my great Shops. Not a correspondence course. You don't need previous experience or advanced education. You don't need much money to get my training. I have many plans to help the fellow who needs training but hasn't much money. Mail coupon for all the facts.

INSURE YOUR FUTURE—Send for Book!

Coyne has seen War and Peace—times of prosperity and times of national depression. During all these times Coyne has trained men for Good pay jobs. Coyne training is tested and proven. Mail coupon and let me send you the big, free Coyne book and my complete story about how I help you get the training you need for a good Electrical job. This does not obligate you. So act at once. Just mail coupon.



H. C. LEWIS, Pres.
COYNE ELECTRICAL SCHOOL
 500 South Paulina Street
 Dept. 43-72 Chicago, Illinois

H. C. LEWIS, President
COYNE ELECTRICAL SCHOOL, Dept. 43-72
 500 S. Paulina St., Chicago, Ill.

Send me your Free Book and tell me about your plans to help me good war-time job with a peace-time future.

NAME.....

ADDRESS.....

CITY..... STATE.....



H.C. Lewis

GET YOUR TRAINING NOW... PAY FOR IT LATER!

Coyne Training is EASY, PRACTICAL! You LEARN BY DOING on real, actual machinery and apparatus. Don't let lack of money stop you. You can get training first—then pay for it in easy monthly payments after you graduate. If you need part-time work to help out with living expenses, I'll help you get it.

LIFETIME JOB SERVICE
 Free to Coyne Graduates!

*"I'd walk many a mile
just to hand him
these Camels!"*



It's the most welcome gift
you can send him... a carton of Camels
— the soldiers' favorite

SURE, you'd rather *hand* them to him...
but you don't have to see him to know that
he'll appreciate a carton of Camels. For
with men in *all* the services, cigarettes are
the gift they want most from home.

And when you send him Camels—the
mild, slow-burning cigarette—you're send-
ing the brand men in the service prefer.
Army, Navy, Marines, Coast Guard—the
favorite is Camel.* Send him a carton today.

Send him

Camels

First in the Service

*The favorite cigarette with
men in the Army, Navy,
Marines, and the Coast Guard
is Camel. (Based on actual sales
records in Post Exchanges,
Sales Commissaries, Ship's
Service Stores, Ship's Stores,
and Canteens.)

R. J. Reynolds Tobacco Company
Winston-Salem, North Carolina



MAYBE HE WEARS the O.D. of the
Army—maybe the blue of the Navy and
Coast Guard—or the forest green of the
Marines—it's all the same: Camels, with
that "I'd walk a mile for—" flavor, will
be welcome as often as you send them.
So—send him a carton of Camels today.