

*Miracle on Wheels*

# POPULAR MECHANICS

**MAGAZINE**

WRITTEN SO YOU CAN UNDERSTAND IT

REG. TRADE MARK GREAT BRITAIN NO. 40476

REG. U.S. PAT. OFF.

NOV.  
25 CENTS  
30¢ IN CANADA

SEE PAGE 6





*"Gosh, conductor, I guess I left my  
commutation ticket in my other suit!"*

**Some day you'll commute by plane** to towns and factories that are now half a day's journey away. When you do, you'll very likely forget your commutation ticket more than once.

**Yes! Out of our victory** in this war will come a new America. An America which will again startle the world because of the way of life our people create.

**Let the "Doubting Thomas"** keep this in mind: American industry is already turning out planes by the thousands that dwarf our present transports. The men and machines are already on the job. The will and determination are already at work. But today they're devoted to winning the war. *Tomorrow* they'll be devoted to the creation of this new America.

**The skilled workman** in the B. F. Goodrich Aeronautical Division knows how close the new America really is. He's seen the miracles of the past few years *first hand*. He's worked on tires for aircraft that can smoothly land a 30-ton Flying Fortress. He's worked on brakes that bring to a safe, smooth stop, a ship that can dive as fast as sound travels—

on De-Icers which defy Old Man Weather.

**The 80 aviation products** B. F. Goodrich makes are serving the Army and Navy right now. Our Silvertown Tires, Expander Tube Brakes, De-Icers, Bullet Sealing Fuel Cells go into America's bombers, fighters, training planes, helping to make them the finest there are in the world!

**But some day we know** that our handiwork at B. F. Goodrich will equip the planes of Peace. And these are the planes that will create the new America! The B. F. Goodrich Co., Aeronautical Division, Akron, Ohio.



*Skyway or Highway*

**B.F. Goodrich**

**FIRST IN RUBBER**

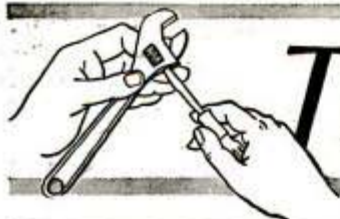

# TOOL NOTES

Maintenance  
and Repair  
Suggestions to  
Prolong Tool Life

## No. 3 GENUINE CRESCENT REPAIR PARTS PROLONG TOOL LIFE

Every tool user...from individual mechanic to large industrial plant ...can speed production and help the war effort by actively practicing tool conservation. With thousands upon thousands of new tools needed by our Army, Navy and Air Force, any effort which will prolong tool life now becomes doubly important.

Genuine Crescent parts are sold by Hardware Dealers everywhere. The only information necessary for ordering is the name of the tool, its size or type, and the name of the part needed. The illustrations on this page give you the proper names of all parts.

In addition to the parts illustrated above, parts are also available for Crescent Nail Pullers. The illustration below will enable you to identify the various nail puller parts. In ordering, give number of the nail puller and name the parts needed.

### PARTS FOR NAIL PULLERS

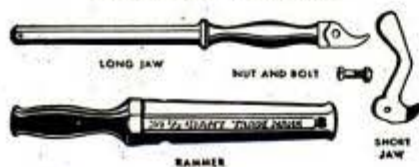

CRESCENT TOOL COMPANY, JAMESTOWN, N. Y.

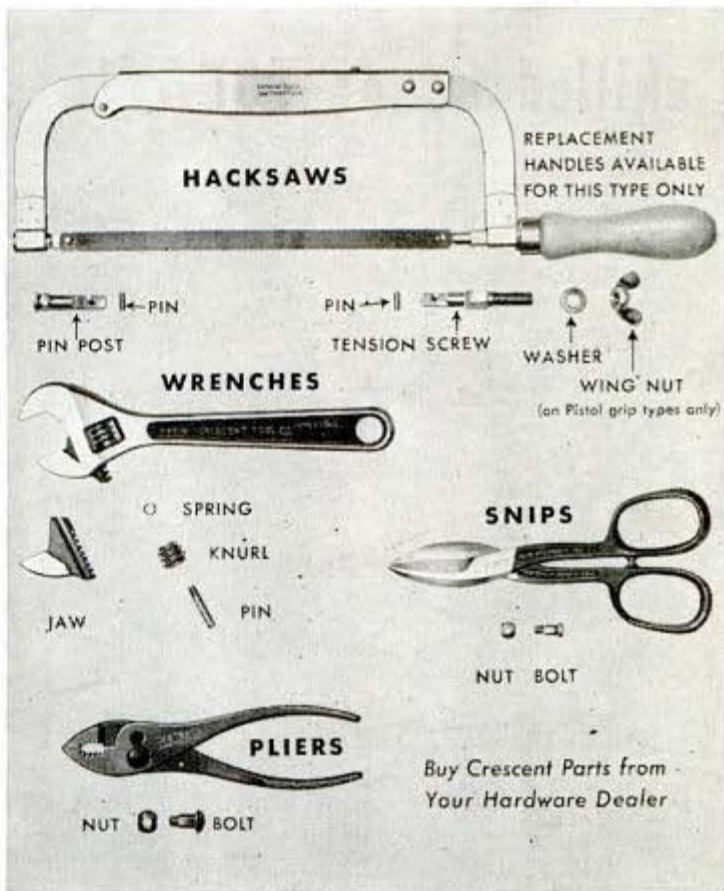

Buy Crescent Parts from  
Your Hardware Dealer

**CRESCENT TOOLS**  
*Give Wings to Work*



# The "Nerve Center of the Army" needs your skilled hands TODAY!

This is a war of speed—a radio war. Commands and messages must go through like lightning. Never have communications been so vital to victory, or have new devices meant so much.

The whole responsibility for "getting the message through" is in the hands of the U. S. Army Signal Corps. Hands that install and maintain countless thousands of radio sending and receiving sets—hands that adjust the marvelous mechanisms of America's newest and most secret weapons—hands that flash the orders to attack!

Now—today—the Signal Corps needs your skill in this thrilling branch of service. You may already be an expert in radio or another communications field. If so, there is no more worth-while service you can render your nation than as a Signal Corps soldier. You may have no more than ambition and a love of mechanics and electricity. In that case the Signal Corps is ready to give you thorough training—at good pay! It's the opportunity of a lifetime to serve your country and prepare for a future career.

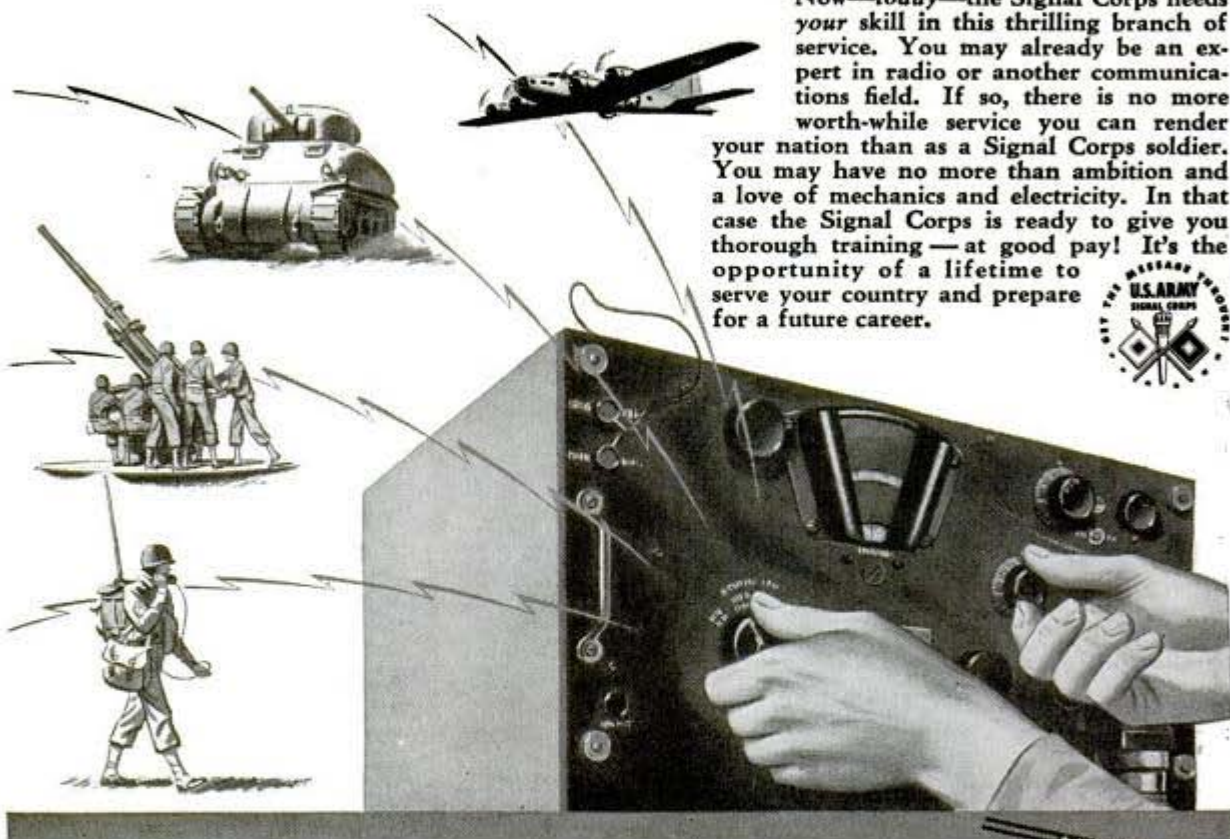

## HOW YOU CAN GET IN NOW

### 1. ENLISTMENT

If you are 18 to 45 and physically fit, you may apply for enlistment in the Signal Corps or in the Signal Corps Enlisted Reserve.

**Direct Enlistment:** Experience as a licensed radio operator, a trained radio repairman, a telephone or telegraph worker, will qualify you for active duty at once. From Private's pay you can advance rapidly as you earn higher technical ratings—up to \$138 a month, with board, shelter and uniforms.

**Enlisted Reserve:** If you are skilled with tools but lack qualifying experience, you may enter the Enlisted Reserve. You will be given training, with pay, in one of the many Signal Corps schools, and ordered to active duty when you have completed the course.

**Commissions:** Graduate Electrical Engineers may apply for immediate commissions in the Signal Corps. And spe-

cial opportunities for training and commissions are open to Juniors and Seniors in electrical engineering colleges.

### 2. CIVILIAN TRAINING

If you are over 16 years of age, and even though registered for Selective Service, have not received your order to report for induction, the Signal Corps offers you an outstanding opportunity.

If you have ability with tools—if you want to secure training in the vitally important field of communications—you may attend a school in or near your home city. You will be paid not less than \$1020 per year *while learning*. And when you have finished your training—in 9 months or less—you can advance to higher pay as your technical skill increases.

Even if you have a minor physical handicap, Signal Corps Civilian Training may give you the chance you've wanted to serve the Army of the United States.

**KEEP 'EM FLYING!**

# U.S. Army

• FOR FURTHER INFORMATION REGARDING ENLISTMENT—Call and talk this over at the nearest Army Recruiting and Induction Station, or write to: "The Commanding General," of the Service Command nearest you.

★

Or write to: Enlisted Branch, AB-1, A.G.O., Washington, D. C.

★

FOR CIVILIAN TRAINING INFORMATION—Call at any office of the U. S. Civil Service or U. S. Employment Bureau.

# Popular Mechanics Magazine

Registered in U. S. Patent Office and Canada

H. H. WINDSOR, Founder

H. H. WINDSOR, Jr., Editor and Publisher

November, 1942

Vol. 78, No. 5

## IN THIS ISSUE

The Mystery of Rubber . . . . .	1
The Navy's Seven-League Boots . . . . .	8
Color in Your Home . . . . .	17
Thrills of Mountain Railroading . . . . .	26
Precious Cargoes . . . . .	34
Patrolling Uncle Sam's Deadlines . . . . .	42
Boom Town in the Big City . . . . .	50
On the Night Shift . . . . .	57
Heroes of the Engine Rooms . . . . .	66
For Discomfort—No Place Like Home	72
Miracle on Wheels . . . . .	82
Liquid Gold for War and Peace . . . . .	92

Where-to-Buy-It Index Starts on Next Page

## Life Aboard a Battlewagon

INSIDE the gun turret gears are whirling, 16-inch shells come from the handling room, then powder bagged in silk. All is ready. The captain's finger presses a button and a terrific blast shakes the blue-jacket's bones. This is the critical moment toward which everything aboard ship is pointed. Years of tradition, months of training, days of routine swabbing of decks, target practice and collision drill all lead to this climax. Lt. Commander John T. Tuthill, Jr., gives you a taste of "Life Aboard a Battlewagon" in the December issue.

## Your Victory Car

LOOKING for something radical in your postwar car, perhaps a molded plastic body with rear engine and transparent top? You may be disappointed. Brooks Stevens, industrial designer, in an article next month says taxes may bring your car down to "jeep" size, with an aluminum body, less ornamental chrome. But the rear-engine car, he thinks, will come later.

## Next Month

WHEN you read about it, it seems very glamorous to raid enemy supply columns, plant TNT under bridges and ski along timberline trails. But it's not pure glamor to pour out of a plane in enemy territory with a pocket full of TNT, caps and fuses—one of the jobs they give the "paraskis." Uncle Sam's mountain troopers are getting ready, and when it's time to plant the Stars and Stripes on Fujiyama, "They'll Be Coming 'Round the Mountain." Read their story in the December issue.

## Lifesaving Plasma

THOUSANDS of American lives will be saved in this war by a new discovery. It is the discovery that blood plasma—the fluid that carries the blood cells through the body—can be dried, preserved as long as five years, and injected into the blood stream of a wounded, shocked or diseased patient regardless of his blood type. "Cheating Death With Blood," appearing next month, tells how your blood may save a soldier's life.

## Fooling Sky Spies

THIS may be a job you can do for the U.S.A. There are about 5,000 civilians studying and experimenting with camouflage to help conceal our military and industrial centers from enemy eyes in the sky. That's not enough. Only a beginning has been made. In the December issue an article, "Fooling the Spy in the Sky," sketches what has been and what must be done.

Published monthly by POPULAR MECHANICS COMPANY, 200 East Ontario Street, Chicago, U. S. A. Single copy in the United States, 25 cents; subscription rates in United States and possessions, and countries of the Pan-American Postal Union including Spain, \$2.50 a year. Single copy in Canada, 30 cents; subscription rates, \$3.00 a year. To all other countries add \$1.00 a year over United States prices for overseas postage. Changes in address must be reported to us immediately to eliminate delay. Entered as Second Class Matter, Sept. 15, 1903, at the Post Office at Chicago, Illinois, under Act of March 3, 1879. Entered as Second Class Matter at Post Office Dept. Canada.

Copyright 1942, by Popular Mechanics Company, Copyright under International Copyright Union. All rights reserved under Pan American Copyright Union. Printed in the United States of America

# PYROIL PROTECTS YOUR CAR



Get the protection of Pyroil for your car. Proper care and protection now—such as Pyroil enables you to provide—will pay you dividends later.

A dash of Pyroil added to crankcase and gasoline tank at intervals, gives you this protection. It quickly establishes a protective film throughout the internal parts of the engine. This Pyroil film is unlike that of other lubricants. Hard carbon, gum, sludge, and ruinous corrosive elements, are overcome by it.

The contaminations that get into the engine of your car are often responsible for its early wear-out. The use of Pyroil is a proved protection against these. With Pyroil, your car can last longer. You save money in its operation; in repairs.

Pyroil provides still another great advantage these days: users claim considerable extra mileage gained!

So, get Pyroil, today. Ride out this emergency in your car, safely. Pyroil is sold everywhere. Mail coupon for enlightening facts. Manufactured and Guaranteed by Pyroil Company, W. V. Kidder, Founder, 511 Pyroil Bldg., LaCrosse, Wisconsin.



**Give the Nation Your Scrap!**

ADD MERELY OUNCES TO GAS TANK & CRANK CASE

**DISTRIBUTORS:**  
CHECK AND MAIL COUPON FOR FRANCHISE FACTS.

**PYROIL COMPANY**  
511 Pyroil Bldg., LaCrosse, Wisconsin

Please tell me how Pyroil will help my car. I drive a

(make) (year)

Send details of your Plan for Distributors

Name .....

Address .....

City or Town.....State.....

## WHERE-TO-BUY-IT INDEX

Where no name and address appear directly under an item, the product is not believed by us to be commercially available

Rocket bomb and antitank gun.....	6
Warplane to battle U-boats.....	7
Dual control on Venetian blind.....	7
Nova Mfg. Co., 89 Bogart St., Brooklyn, N. Y.	
"Lay-up" kit for stored car.....	7
Parfax Sales, 266 Bryant St., Buffalo, N. Y.	
A roomful of furniture in a box.....	14
Abraham & Straus, 420 Fulton St., Brooklyn, N. Y.	
Log jam in soldier's obstacle course.....	16
Tin machines make fiber cans.....	16
Dentist's office on wheels.....	16
Wood substitutes for metal.....	25
Magnets used as thumbtacks.....	32
Dry-ice rifle.....	32
Manner Gun Co., 1026 17th St., Denver, Colo.	
Fertilizer spreader for lawns.....	32
Germaco Products, 747 Terminal St., Los Angeles, Calif.	
17-foot model of battleship.....	33
"Sky ride" across river for wounded.....	33
Cellar window greenhouse.....	40
Ickes-Braun Greenhouse Mfg. Co., 2320 Wabansia, Chicago	
Roof flashing uses no metal.....	40
Wasco Flashing Co., 86 Broadway, Cambridge, Mass.	
Wool may be baled like hay.....	40
Hand signal-light for police.....	40
Traf-O-Lite Co., Oak Park, Ill.	
American-built fighters fly for R.A.F.....	41
"Sand Sailer" boats.....	45
Pin cushion worn on arm.....	45
Sears, Roebuck & Co., State and Van Buren, Chicago.	
One way to get into a piggy bank.....	46
Automatic bucking bar silences riveter.....	48
Murray Corp., 7700 Russell St., Detroit, Mich.	
Snap-on plastic cap for screws.....	48
Empire Notion Co., 107 E. 29th St., New York City	
V-prong rake pulls crab grass.....	48
Vaughan's Seed Store, 10 W. Randolph, Chicago	
Tubeless tire for trucks.....	48
Giant wire-cutter for Army.....	49
Huge vulcanizing unit.....	49
Vitamin C averts heat prostration.....	49
Largest spray booth for bombers.....	56
Brush made from rat whisker.....	56
Vitamin pills in separate wrappings.....	56
Hi-V Vitamin Corp., 366 Madison Ave., New York City	
Lightweight plane body.....	61
Bomb shelters from cotton balloons.....	61
Commandos Anonymous.....	62
Fireproof blackout shade.....	64
Mandel Bros., State and Madison Sts., Chicago	
Cedar chest drawer slots aid circulation.....	64
Cavalier Corp., Chattanooga, Tenn.	
Truck delivers feed in bulk.....	64
Convoy ships use visible signals.....	65
"Sound shadows" cast by buildings.....	65
Stan gun called "Woolworth Tommy".....	70
Electric quiz game for Naval pilots.....	70
Stick measures grain in bin.....	70
Nock-On-Wood, Ltd., Bloomfield, Iowa	
Among new inventions.....	71
Tractor for Britain's farmerette.....	77
Airplane assembly line conveyor.....	77
Tommy gun for paratroops.....	77

(Continued to page 6A)

# AUTO-LITE SPARK PLUGS

**IGNITION ENGINEERED**



"SHET 'ER OFF WHILST THEY IS FIXIN' THAT BLOW-OUT, LUKE . . . AIN'T YOU HEERD THAT OIL IS AMMUNITION ?"

## "PLUG-CHEK" INSPECTION SERVICE HELPS STOP GAS WASTE

Jake's got the right idea. Today everybody's out to stop waste of vital materials. Here's a tip. Ask your service man for a "Plug-Chek," the inspection service that helps him spot gas and power wasting spark plugs, aids in restoring gasoline and oil economy. Often simply cleaning and regapping your present plugs puts an end to costly waste. Ask for a "Plug-Chek" today.

**THE ELECTRIC AUTO-LITE COMPANY**  
Toledo, Ohio • Merchandising Division • Sarnia, Ont.



Color and condition tell if plugs are operating properly. Matching your plugs with those illustrated on the "Plug-Chek" is the first step in getting new life for spark-wearied engines.



In its 26 Great Manufacturing Divisions, Auto-Lite Is Producing for America's Armed Forces on Land, Sea and in the Air



(Continued from page 4A)

All dressed up for war.....	78
Yardstick "weighs" paper.....	80
Richard E. Fox, Rm. 934, Merchandise Mart, Chicago	
Electronic tube for heat-treating furnace.....	80
Social security information dial.....	80
Earl B. Shields, 624 S. Michigan Ave., Chicago	
Bomb-fire wagon.....	81
Golf machine shows rhythm.....	81
Repairing bombed water mains.....	87
Plug-in filter for air tools.....	87
Filters, Inc., Glendale, Calif.	
Bomb protection painted on windows.....	88
Blackout hood for flashlight.....	90
Blossom Mfg. Co., 79 Madison Ave., New York City	
Puttyless window sash.....	90
Farley & Loetscher Mfg. Co., 7th and White Sts., Dubuque, Ia.	
Corrugated-paper dispenser.....	90
Sherman Paper Products Corp., Newton Upper Falls, Mass.	
Amphibian car, and other patents.....	91
Pipe holder for windshield.....	96
Continental Products, 2036 S. Michigan Ave., Chicago	
Rubber heel with wood core.....	96
Self-lighting blackout cane.....	96
Edgley Mfg. Co., 1409 Elm St., Dallas, Texas	
Five-tube a.c.-d.c. student kit.....	158
Allied Radio Corp., 833 W. Jackson Blvd., Chicago	
Air raid alarm unit for receivers.....	159
National Union Radio Corp., 57 State St., Newark, N. J.	
Compact antenna unit for portable sets.....	159
Taricone Mfg. Co., 125 Green St., New York City	
Tubular electrolytic condenser in plastic container.....	159
American Condenser Corp., 2508 S. Michigan Ave., Chicago	
Solderless wire connectors.....	159
Kresge's, 10 S. State St., Chicago	
Vacuum tube voltmeter.....	160
Radio City Products Co., 127 W. 28th St., New York City	
Electronic key is semi-automatic.....	160
Electro-Medical Laboratory, Inc., Holliston, Mass.	
Panoramic receiver.....	160
Hallcrafters, Inc., 2611 Indiana Ave., Chicago	
"Electric eyes" as traffic cops.....	164
Menthol from peppermint oil.....	164
Silver replaces other metals.....	170

## Craftsman and Shop Notes Index

### ART AND ARTISTS

Keeping ink bottle on drawing board.....	110
Spreader for tracing cloth.....	128
Tray for mixing water colors.....	128
Making light guidelines on cards.....	145

### AUTOMOTIVE

Adjustable bumper on truck bed.....	100
More mileage on less gas.....	140
Magnet prevents loss of wheel nuts.....	142
Marking inner tube puncture.....	142
Battery cables removed quickly.....	142
Cleaning motor commutator.....	143
Truck chock from old wheel rim.....	144

### CAMPING, FISHING, HUNTING

Making trap spring easily.....	100
Bumper for boat dock.....	100
Duck call from jar cover.....	112
Avoiding soot on utensils.....	128

### FARM

Signs made from flour sacks.....	105
Storing ladder under building.....	128

(Continued to page 8A)





## How Do You Use The Most Important Hours of Your Day?

The most important—and they can be the most profitable, too. Men—ordinary men in ordinary circumstances—have had returns of as high as \$5, \$10, \$25, even in exceptional cases \$50 per hour for these hours.

They are the hours of your leisure time—usually spent in recreation or odds and ends.

These can be your growth hours, the time when through training you can prepare for more efficient service on the job or for the job ahead. During your working hours, you are usually buried in routine details, growing slowly if at all. But in these spare hours, your mind can reach out to absorb the experience of others, to learn the principles and methods behind your job and behind your field. The next day on the job, you will find yourself using something of what you learned the night before to the benefit of your job and the pleasure of your boss.

Interestingly enough, this spare time study can be fascinating recreation, not drudgery. And the few minutes spent this way tone up the remaining hours of your leisure

—make them more interesting.

—make them more interesting.

### WHAT CAN THEY MEAN TO YOU?

We can't say exactly. But we can tell you what they have meant to thousands of others. They have brought to these men and women promotions, new jobs, more money and prestige, greater success and happiness, security for the future. If these are the things you want, we invite your investigation of LaSalle home study training.

For, from our 34 years' training, over a million men and women, we have learned what you need and how to give it to you. Our training is geared to the busy individual who is ambitious and earnest for better things. Check on

the coupon below the field in which you are interested. We'll send you—without obligation our free 48-page booklet, discussing the opportunities and requirements in that field and telling about our training for it. If not entirely sure which field to check, write us rather fully about your problem and let us counsel you.

**LaSalle Extension University**  
**A Correspondence Institution**

**DEPT. 1164-R** **CHICAGO, ILL.**

I am interested in knowing how I can use my spare time to advance myself. Please send your free booklet on the field I have checked below.

<input type="checkbox"/> Modern Foremanship <input type="checkbox"/> Accounting <input type="checkbox"/> Traffic Management <input type="checkbox"/> Executive Management <input type="checkbox"/> Salesmanship <input type="checkbox"/> Business Correspondence	<input type="checkbox"/> Industrial Management <input type="checkbox"/> Expert Bookkeeping <input type="checkbox"/> Law: LL.B. Degree <input type="checkbox"/> Business Law <input type="checkbox"/> Business English <input type="checkbox"/> Stenotypy
---	---

Name \_\_\_\_\_ Age \_\_\_\_\_

Position \_\_\_\_\_

Address \_\_\_\_\_

# DO IT BETTER



Speed, ease in use, safety—these are the qualifications of the Plumb Nail Hammer, qualifications that mean *good workmanship!*

See, for example, how the sharp vise-like claws grip—able to easily pull nails, even the heads, through wood.

Head and handle are perfectly balanced for easy, accurate swing. Flared end of handle prevents slipping. Head is secured by exclusive Take-Up Wedge kept tight by the turn of a screw driver.

Plumb Tools have been the choice of craftsmen for generations. Now, more than ever, it is important to own the best tools!

FAYETTE R. PLUMB, Inc. • PHILADELPHIA, PENNA.

# PLUMB

HAMMERS • HATCHETS • AXES • SLEDGES

(Continued from page 6A)

Taking strain off fence-post staples.....	136
Ring protects posts while driving them.....	138
How to get rid of gophers.....	139
Steps on wagon box.....	144
Small trees protected from rabbits.....	144
Snow fence from sunflower stalks.....	145
Horseshoe anchors outdoor feedbox.....	152
Plow protected from rust.....	153
Making a strong doubletree.....	153
Closing holes in grain sacks.....	153
Easing tractor engine exhaust.....	153

#### FURNITURE

Repairing torn upholstery.....	100
Keeping drawer knob tight.....	104
Pinning tidy on chair.....	113

#### HAND TOOLS

Jig to sand plastic rods.....	100
Foil grip for file.....	101
Magnet holds saw on sawhorse.....	112
Staple holds oilstone on bench.....	117
Barrel used as pipe vise.....	120
Using picture-framing vise.....	120
Heel improves L-clamp bolt.....	120
Circle gauge for irregular work.....	138
Preventing punch from sticking.....	138
Folding edges of screen wire.....	138
Log peeler made from shovel.....	145
Gun to form pattern fillets.....	152
Spike point in miter box holds work.....	152

#### HOME IMPROVEMENTS

Lawnmower stored between joists.....	117
Attic rooms (Part 2).....	122
Shelves conceal pipes.....	129

#### HOUSEHOLD

Solving home problems.....	102
Spacing quilt ties.....	104
Winter window gardens.....	112
Holding mop handle in bucket.....	117
Wringer rollers kept from sticking.....	117
Old broom as stovepipe cleaner.....	117
Heavy rugs held on line.....	118
Flower frog fitted with handle.....	118
Gum removed from fabric.....	120
Pot holder shaped to handle.....	120
Leveling large pictures.....	121

#### METALWORKING

Handy acid applicator.....	104
Tubing bent without kinking.....	129
Reamer for sheet metal.....	152
Applying machine finish to metal.....	154

#### OFFICE

Keep your typewriter young.....	114
Book ends hold letter file.....	128
Saving paper clips.....	136
Rubber band as book marker.....	136

#### PHOTOGRAPHY

Mounting camera on tilting head.....	130
Enlarging easel on tripod head.....	130
Black spots kept off print.....	130
Print-and-negative drier.....	131
Film kept submerged in developer.....	132
Wire hook curves ferrotype tin.....	132

(Continued to page 10A)

# America is building two great armies — YOU BELONG IN ONE OF THEM!

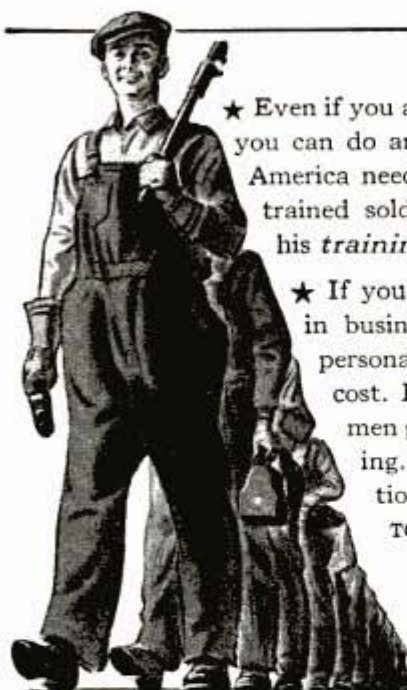

★ Even if you are not a member of Uncle Sam's armed forces, you can do an important job in defending your country! America needs *trained workers* as much as she needs trained soldiers and sailors! The man who neglects his *training*—neglects his *patriotism*!

★ If you can read and write, and are employed in business or industry, I. C. S. offers you a personalized, proved training program at low cost. Hundreds of thousands of successful men got their start through I. C. S. training. Mail coupon for further information on courses and low costs—**TODAY!** There's no time to waste!



## INTERNATIONAL CORRESPONDENCE SCHOOLS

HELPING TO TRAIN AMERICANS FOR VICTORY

BOX 5647-J, SCRANTON, PENNA.



Without cost or obligation, please send me a copy of your booklet, "Who Wins and Why," and full particulars about the course *before* which I have marked X:

### TECHNICAL AND INDUSTRIAL COURSES

- |   |   |   |  |
|---|---|---|--|
| <input type="checkbox"/> Air Brake              | <input type="checkbox"/> Contracting and Building | <input type="checkbox"/> Management of Inventions | <input type="checkbox"/> Sanitary Engineering      |
| <input type="checkbox"/> Air Conditioning       | <input type="checkbox"/> Cotton Manufacturing     | <input type="checkbox"/> Marine Engines           | <input type="checkbox"/> Sheet Metal Work          |
| <input type="checkbox"/> Airplane Drafting      | <input type="checkbox"/> Diesel Engines           | <input type="checkbox"/> Mechanical Drafting      | <input type="checkbox"/> Ship Drafting             |
| <input type="checkbox"/> Architectural Drafting | <input type="checkbox"/> Electrical Drafting      | <input type="checkbox"/> Mechanical Engineering   | <input type="checkbox"/> Shipfitting               |
| <input type="checkbox"/> Architecture           | <input type="checkbox"/> Electrical Engineering   | <input type="checkbox"/> Mine Foreman             | <input type="checkbox"/> Steam Electric            |
| <input type="checkbox"/> Auto Engine Tune-up    | <input type="checkbox"/> Electrician              | <input type="checkbox"/> Navigation               | <input type="checkbox"/> Shop Practices            |
| <input type="checkbox"/> Auto Technician        | <input type="checkbox"/> Electric Lighting        | <input type="checkbox"/> Plastics                 | <input type="checkbox"/> Steam Engines             |
| <input type="checkbox"/> Aviation               | <input type="checkbox"/> Foundryman               | <input type="checkbox"/> Public Works Engineering | <input type="checkbox"/> Steam Fitting             |
| <input type="checkbox"/> Blueprint Reading      | <input type="checkbox"/> Heat Treatment of Metals | <input type="checkbox"/> Pulp and Paper Making    | <input type="checkbox"/> Structural Drafting       |
| <input type="checkbox"/> Boilermaking           | <input type="checkbox"/> Highway Engineering      | <input type="checkbox"/> Radio, General           | <input type="checkbox"/> Structural Engineering    |
| <input type="checkbox"/> Bridge Engineering     | <input type="checkbox"/> House Planning           | <input type="checkbox"/> Radio Operating          | <input type="checkbox"/> Surveying and Mapping     |
| <input type="checkbox"/> Chemistry              | <input type="checkbox"/> Industrial Metallurgy    | <input type="checkbox"/> Radio Servicing          | <input type="checkbox"/> Telegraphy                |
| <input type="checkbox"/> Coal Mining            | <input type="checkbox"/> Locomotive Engineer      | <input type="checkbox"/> R. R. Section Foreman    | <input type="checkbox"/> Textile Designing         |
| <input type="checkbox"/> Civil Engineering      | <input type="checkbox"/> Machinist                | <input type="checkbox"/> R. R. Signaller          | <input type="checkbox"/> Toolmaking                |
| <input type="checkbox"/> Concrete Engineering   | <input type="checkbox"/> Inspector                | <input type="checkbox"/> Refrigeration            | <input type="checkbox"/> Welding, Gas and Electric |
|   |   |   | <input type="checkbox"/> Woolen Manufacturing      |

### BUSINESS COURSES

- |  |  |  |   |
|--|--|--|---|
| <input type="checkbox"/> Accounting          | <input type="checkbox"/> Advertising             | <input type="checkbox"/> College Preparatory     | <input type="checkbox"/> First Year College   |
| <input type="checkbox"/> Bookkeeping         | <input type="checkbox"/> Business Correspondence | <input type="checkbox"/> Commercial              | <input type="checkbox"/> Foremanship          |
| <input type="checkbox"/> Business Management | <input type="checkbox"/> Business Correspondence | <input type="checkbox"/> Commercial Illustrating | <input type="checkbox"/> Foremanship          |
| <input type="checkbox"/> Cartooning          | <input type="checkbox"/> Civil Service           | <input type="checkbox"/> Cost Accounting         | <input type="checkbox"/> Good English         |
|  |  | <input type="checkbox"/> C. P. Accounting        | <input type="checkbox"/> High School          |
|  |  |  | <input type="checkbox"/> Managing Men at Work |

### HOME ECONOMICS COURSES

- |   |   |  |
|---|---|--|
| <input type="checkbox"/> Advanced Dressmaking | <input type="checkbox"/> Home Dressmaking                       | <input type="checkbox"/> Tea Room and Cafeteria Management, Catering |
| <input type="checkbox"/> Foods and Cookery    | <input type="checkbox"/> Professional Dressmaking and Designing |  |

Name..... Age..... Address.....  
 City..... State..... Present Position.....

Canadian residents send coupon to International Correspondence Schools Canadian, Limited, Montreal, Canada  
 British residents send coupon to I. C. S., 71 Kingway, London, W. C. 2, England



★ **All out for Victory! Waste nothing—take care of everything you own! Watch your piston rings. At the first sign of oil-pumping, consult your motor service man. He will show you how to save oil—check dangerous cylinder wear and improve gasoline mileage.**

**HASTINGS MANUFACTURING CO., HASTINGS, MICH.**  
 Hastings Mfg. of Canada, Ltd., Toronto

➡ **HASTINGS** ➡  
**STEEL-VENT PISTON RINGS**  
TOUGH ON OIL-PUMPING   GENTLE ON CYLINDER WALLS

(Continued from page 8A)

**POWER TOOLS**

- Truing curves with jigsaw..... 99
- Auxiliary table on jointer..... 104
- Extension on saw table..... 110
- Small power tools carried easily..... 136
- Boring bits from piston rings..... 145
- Grinding and lapping..... 146

**RADIO AND ELECTRICITY**

- First aid for home sets (Part 6)..... 155
- Four-unit a.c.-d.c. student receiver (Part 1)..... 156
- Small kit sets used in schools..... 158
- Ganging variable condensers..... 159
- Telescoping antenna from camera tripod..... 159
- Homemade knob puller..... 159
- Chimney bracket for antenna..... 159
- Push-on knob made from spool..... 159
- Radio on tricycle carryall..... 160

**STORE AND SHOP**

- Holding cloth for cutting..... 104
- Putty holds ruler for glass cutter..... 110
- Place at table shown on check..... 136
- Shop uses for scrap linoleum..... 137
- Shoe-display racks..... 138
- Taking inventory of lumber..... 143
- Label scraper..... 144
- Chart helps customer select nails..... 151
- Sign held on screen door..... 152
- Wrapper for rolling coins..... 152
- Paint colors shown on can bottoms..... 153
- Truck weight painted on side..... 154

**TOYS AND NOVELTIES**

- Bird-like pipe holder..... 101
- Christmas toys..... 106
- Nautical tie rack..... 113
- Round cribbage board..... 118
- Novel salt and pepper shakers..... 121

**WOODWORKING**

- First-aid kit..... 97
- Roll front bread box..... 105
- Bending thin strips of wood..... 110
- Novel bookends..... 111
- Decorative wastebasket..... 119
- Woodturning lathe..... 133
- Luggage-type tool chest..... 139

**MISCELLANEOUS**

- Holder for pipe or rods..... 101
- Painting concrete floors..... 104
- Making small rubber belts..... 110
- Pump rods held for repairing..... 111
- Saddlebags for suitcase..... 112
- Bandage winder for Red Cross..... 118
- Breaking-in phonograph records..... 127
- Toggle bolts wired for easy removal..... 129
- Handling large cakes of ice..... 136
- Tinfoil as type spacer..... 143
- Keeping wall map rolled..... 144
- Holding tie wires on ladder..... 145

**IMPORTANT NOTICE**

It is the intention of this magazine to provide its readers with information regarding the latest developments in the mechanical arts. We take no responsibility as to whether the disclosures contained in our articles are covered by patents and advise readers to investigate this subject before making, using, or selling any of the products, machines, or processes described in order to avoid possible liability for patent infringement.

# AUDELS HANDY BOOK OF PRACTICAL ELECTRICITY

• FOR MAINTENANCE ENGINEERS, ELECTRICIANS AND ALL ELECTRICAL WORKERS. PRICE \$4 •

**HERE IS  
ELECTRICAL  
INFORMATION  
IN A  
HANDY FORM**

**COVERING:**

ELECTRICAL ENERGY  
MECHANICAL ENERGY  
Current Effects—Magnetism  
MAGNETIC INDUCTION  
D. C. Motors—Dynamos  
A. C. Motors—Alternators  
ALTERNATOR  
CONSTRUCTION  
Armature Winding  
Armature Repairing  
WIRING DIAGRAMS  
Reverse Current Relays  
Overload Relays  
Differential Power Relays  
Undervoltage Relays  
Temperature Relays  
ELECTRIC POWER  
TRANSMISSION  
Underground Wiring  
Cable Splicing  
Switches—Electric Bells  
TRANSFORMERS  
HOUSE WIRING  
Diagram of Connections  
Rectifiers—Converters  
Power Factors  
WATT-HOUR METERS AND  
CONNECTIONS  
Watt-Hour Rules  
Meters and Instruments  
Circuit Breakers—Fuses  
Rheostats and Starting Devices  
STORAGE BATTERIES  
Electrolysis—Insulators  
Electric Lighting  
FLUORESCENT  
Sign Flashers  
NEON SIGNS  
Electro Plating  
RADIO PRINCIPLES  
RADIO QUESTIONS AND  
ANSWERS  
Radio Tubes—Photo Electric Cells  
Electric Cranes  
POWER WIRING  
Substations—Power Station Plans  
Plant Management  
AUTOMATIC TELEPHONE  
Automatic Telephone Switchboards  
The Telegraph, Relay System and  
Codes  
ELEVATORS AND  
CONTROLLERS  
Elevator Wiring and Operating  
Instructions  
MARINE WIRING  
Electric Ship Drive  
ELECTRIC RAILWAYS  
Electric Heating  
AIR CONDITIONING  
Motion Pictures  
Domestic Refrigeration  
Air Compressors  
OIL BURNERS  
Pumps—Wiring Calculations  
Soldering—Brazing  
WELDING  
Electro-Therapeutics—X-Rays  
Automobile Starting  
Automobile Lighting Systems  
Ignition  
Electrically Operated Tools  
**Ready Reference Index**

**YOUR OPPORTUNITY!**

"AUDELS HANDY BOOK OF PRACTICAL ELECTRICITY," endorsed by hundreds of experienced workers, you too can profit by the personal ownership of this good book, containing the practical information that every electrical man can use. Clear—concise—explaining the essential facts, figures and rules used in good general practice—and fully illustrated.

**1440 PAGES  
2600 ILLUS.**

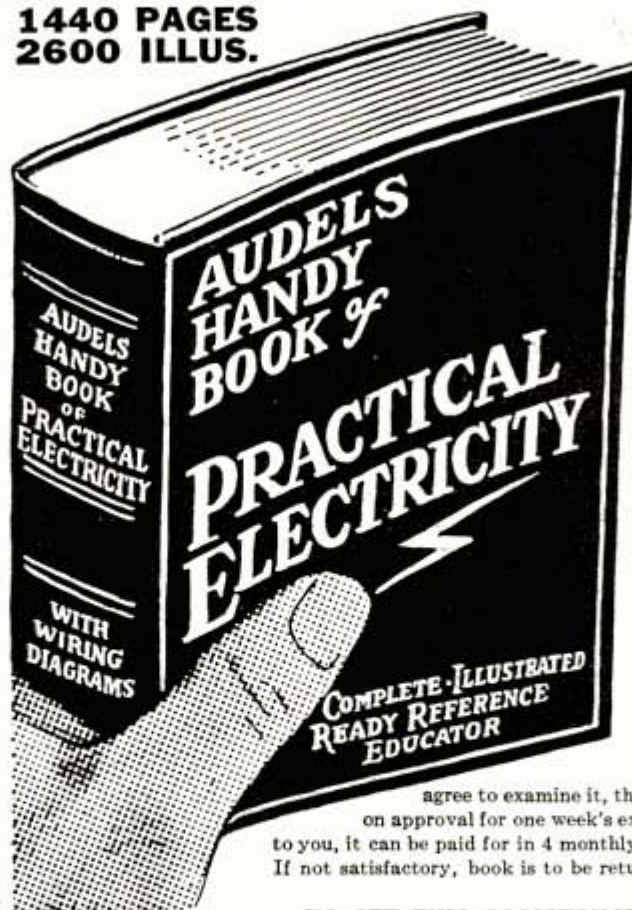

A Practical, Quick, Ready Reference. Gives complete instruction and inside information on electrical subjects. Every point clearly explained in plain language and with diagrams. Subjects arranged progressively for the student, and complete index makes information instantly available to professional workers for ready reference. A time and money saver. A competent and dependable guide and helping hand. Sooner or later this handy book will answer important questions and help you to handle efficiently all kinds of electrical problems.

"AUDELS HANDY BOOK OF PRACTICAL ELECTRICITY" is bringing a helping hand to hundreds of workers and if you will agree to examine it, the book will be sent to you on approval for one week's examination. If found O.K. to you, it can be paid for in 4 monthly payments of \$1.00 each. If not satisfactory, book is to be returned in one week.

**TO GET THIS ASSISTANCE FOR YOURSELF  
SIMPLY FILL IN AND MAIL COUPON TODAY**

**ASK TO SEE IT!**

**THEO. AUDEL & CO., 49 West 23rd St., New York**  
Mail AUDELS HANDY BOOK OF PRACTICAL ELECTRICITY (Price \$4) on 7 Days' Free Trial. If O.K. I will remit \$1 in 7 days and \$1 monthly until \$4 is paid. Otherwise I will return it.

Name \_\_\_\_\_

Address \_\_\_\_\_

Occupation \_\_\_\_\_

Reference \_\_\_\_\_ P. M.

**\$4 COMPLETE  
PAY \$1 A  
ONLY 1 MO.**



**THEO. AUDEL & CO., 49 W. 23rd St., N. Y.**



J. E. SMITH, President, National Radio Institute, Established 27 years. He has directed the training of more men for the Radio Industry than anyone else.

# I WILL SEND A SAMPLE to PROVE I can Train You BE A RADIO

## Men I Train at Home Win Good Jobs Like These



### \$10 a Week in Spare Time

"I repaired some Radios when I was on my tenth lesson. I made \$600 in a year and a half, and have made an average of \$10 a week—just spare time." JOHN JERRY, 1126 Mariposa St., Denver, Colorado.



### \$200 a Month in Own Business

"For several years I have been in business for myself making around \$200 a month. Business has steadily increased. I have N. R. I. to thank for my start." A. J. FROEHNER, 300 W. Texas Ave., Goose Creek, Texas.



### Lieutenant in Signal Corps

"I cannot divulge any information as to my type of work but I can say that N. R. I. training is certainly coming in mighty handy these days." (Name and address omitted for military reasons.)



### Chief Operator Broadcasting Station

"Before I completed your lessons, I obtained my Radio Broadcast Operator's license and immediately joined Station WMPC where I am now Chief Operator." HOLLIS F. HAYES, 327 Madison St., Lapeer, Mich.



Radio Servicing (illustration above) pays Technicians good money, spare or full time. Radio Operators (picture at right) find interesting work in the 915 U. S. Broadcasting Stations.

## ACT NOW! MORE RADIO TECHNICIANS ARE MAKING \$30, \$40, \$50 A WEEK THAN EVER BEFORE!

Mail the Coupon for a FREE lesson from my Radio Course. It shows you how N. R. I. trains you for Radio at home in spare time. And with this sample lesson I'll send my 64-page book, RICH REWARDS IN RADIO. It describes the many fascinating jobs Radio offers; explains how N. R. I. teaches you with interesting, illustrated lessons and SIX BIG KITS OF RADIO PARTS.

You'll see why my complete, practical Lessons offer a quick way to more pay. But even if you never go any farther, this sample Lesson is worth having. It is a real introduction to the wonders and opportunities of Radio. I will send it to you without obligation. MAIL THE COUPON!



### EXTRA PAY IN ARMY, NAVY, TOO



Men likely to go into military service, soldiers, sailors, marines, should mail the Coupon now! Learning Radio helps men get extra rank, extra prestige, more interesting duties, MUCH HIGHER PAY. Also prepares for good Radio jobs after service ends. Hundreds of service men now enrolled.

## A TESTED WAY TO

# LESSON FREE at Home in Spare Time to TECHNICIAN



## Beginners Quickly Learn to Earn \$5, \$10 a Week in Spare Time

Many N. R. I. students make \$5, \$10 a week extra money fixing Radios in spare time while learning. I send EXTRA MONEY JOB SHEETS that tell how to do it!

My "50-50 Method"—half building real Radio circuits like those illustrated at right and conducting fascinating tests and experiments with kits I supply, half learning from illustrated lessons—takes you step-by-step along the path others have followed to security and good pay. I begin at the beginning, explain things clearly.

Before you know it you find yourself "old friends" with Radio. You run your own "Spare Time Shop," get practice fixing friends' Radios, get paid while training!

## Big Demand Now for Trained Radio Technicians, Operators

Right now, probably in your own neighborhood, there's room for more spare and full time Radio Technicians. Many spare time Technicians are stepping into FULL time Radio jobs, or are starting their own shops, and making \$30, \$40, \$50 a week!

Other Radio Technicians and Operators take good-pay jobs with Broadcasting Stations. Hundreds more are needed for Government jobs as Civilian Radio Operators, Technicians. Radio Manufacturers rushing to fill Government orders, need trained men. Aviation, Police, Commercial Radio and Loudspeaker Systems are live, growing fields. And think of the NEW jobs Television, Frequency Modulation and other Radio developments will open after the war! I give you the Radio knowledge required for these fields. At left are just a few of the hundreds of men N. R. I. started on the road to good pay in Radio.

## START NOW Toward Radio's Rich Rewards!

MAIL THE COUPON. I'll send you the FREE Lesson and my valuable, 64-page illustrated book, RICH REWARDS IN RADIO. No obligation. They're packed with facts about Radio, things you never knew about Broadcasting, Radio Servicing, Manufacturing, Ship and Harbor Radio, Government, Aviation, Police, Commercial Radio, Television, Loud Speaker Systems.

They're crammed with photos of Radio Technicians and Operators at work. You'll see snapshots and letters from men I trained, so you can know what N. R. I. did for other fellows. Pictures of N. R. I. teachers, complete description of my Course and "50-50 Method"—Experimental Kits—Extra Money Job Sheets—Consultation Service—Graduate Service and Diploma. You'll see what Radio offers YOU. And you'll have my FREE lesson to keep. No salesman will call. Mail the Coupon NOW—get started today on the road to bigger pay! J. E. SMITH, President, Dept. 2MP, National Radio Institute, Washington, D. C.

TRAINING MEN FOR VITAL  
RADIO JOBS

GOOD PAY

## You Build These and Other Radio Circuits with 6 Big Kits I Send



**MEASURING INSTRUMENT** (above) you build early in Course. Use it in practical Radio work to make EXTRA money. Vacuum tube voltmeter and multimeter. Measures A. C., D. C. volts, D. C. currents, Resistance, Receiver output.



**SUPERHETERODYNE CIRCUIT** (above) Pre-selector, oscillator-mixer-first detector, i.f. stage, diode-detector-r.v.c. stage, audio stage. Bring in local and distant stations on this circuit you build yourself!

**A.M. SIGNAL GENERATOR** (above) Build it yourself! Provide amplitude-modulated signals for test and experimental purposes. Gives valuable practice!



GOOD FOR BOTH 64 PAGE BOOK SAMPLE LESSON FREE

Mr. J. E. Smith, President, Dept. 2MP  
NATIONAL RADIO INSTITUTE, Washington, D. C.

Mail me FREE, without obligation, your Sample Lesson and 64-page book, "Rich Rewards in Radio." (No Salesman will call. Please write plainly.)

Name..... Age.....

Address.....

City..... State..... 2FR

# NEWS

Increased production means



## More Jobs for MACHINISTS and bigger pay for men who know their work

This big home-study and reference course gives you the practical facts on machines and methods you need to advance in machine shop work. Take advantage of the other man's experience as found in books, to solve your problems, increase your efficiency, with

### The AMERICAN MACHINISTS' LIBRARY

6 volumes—2368 pages—2516 illustrations  
(A combined home-study course and reference library)

This library of machine shop practice was written for practical men. It gives you the best methods for every kind of machine shop work. It fully explains lathes, drills, and other machine tools and their operation, automatic screw machines, speeds and feeds, gear design and production, jigs and fixtures, punch and die work, metal surfacing, etc., etc. Plainly written—completely illustrated—the best kind of help to the machine shop man who wants to advance himself.

No money down—special price—easy payments.

#### EXAMINATION COUPON

McGraw-Hill Book Co., 330 W. 42nd St., New York

Send me for ten days' examination the American Machinists' Library. If satisfactory I will send you \$1.50 in 10 days and \$3.00 monthly until the price of \$19.50 is paid. If not wanted, I will return the books postpaid. (To insure prompt shipment write plainly and fill in all lines.)

Name.....  
Home Address.....  
City and State.....  
Position.....  
Name of Company..... PM-11-42

# AVIATION CAREER



## Offers You A GREAT FUTURE!

Complete Aeronautical Engineering or Master Aviation Mechanics training in the heart of the Aircraft industry. Graduates obtaining immediate employment. No flying involved. Aviation's foremost school, established in 1929. Located on Grand Central Air Terminal. For full information, address Department PM-11

CURTISS TECHNICAL WRIGHT INSTITUTE

GRAND CENTRAL AIR TERMINAL  
GLENDALE (LOS ANGELES) CALIF.



THIS TOWER OVERLOOKS AVIATION'S MOST DISTINGUISHED SCHOOL OF AERONAUTICS

## Be an ARTIST!

You Can Train at Home in Your Spare Time

The W. S. A. practical home study method has trained men and women of all ages since 1914. **COMMERCIAL ART, CARTOONING, ILLUSTRATING** all in one complete course. You learn to draw step-by-step. Trained Artists are capable of earning \$30, \$50, \$75 a week. Write for FREE BOOK, "Art for Pleasure and Profit"—describes course and service. 2 Art Outfits furnished. STATE AGE. **WASHINGTON SCHOOL OF ART, Studio 1211A 1115—15th St., N. W., WASHINGTON, D. C.**

\$5, \$10, \$15 FOR ONE DRAWING



### BECOME AN EXPERT MEAT CUTTER

Greater opportunities! Thousands of firms are needing expert Meat Cutters. Train in 2 weeks at famous National School. It's quick, easy to learn Meat Cutting by ACTUAL PRACTICE in big National cutting rooms and retail department. No previous experience or advanced education necessary. BIG PAY JOBS. Union card guaranteed. Employment service FREE. Terms first. Pay later. Easy terms. Write TODAY for FREE catalog and plans to help you get ahead.

National School of Meat Cutting, Inc., Dept. U-36, Toledo, Ohio

## ELECTRICAL TECHNICIANS URGENTLY NEEDED!

In industry—in Army and Navy—electrical technicians win better jobs and ratings. Learn fundamentals of electrical theory and practice—testing, drafting, machine shop, wiring, control. Course complete in one school year. Dormitory; dining hall; campus, 50th year. Send for catalog and Vocational Chart, 121 Takoma Ave., Washington, D. C.

### BLISS ELECTRICAL SCHOOL

## Regain Perfect Speech, If You STAMMER

Every stammerer should have the new 128 page book "Stammering, Its Cause and Correction." Sent free to stammerers. It describes the Bogue Unit Method for the scientific correction of stammering and stuttering. Method successfully used at Bogue Institute for 41 years—since 1901. Endorsed by physicians. Write for full information. No obligation. Benjamin N. Bogue, Dept. 1344 Circle Tower, Indianapolis, Indiana.

## LAW STUDY AT HOME for PERSONAL SUCCESS and LARGER EARNINGS. 31 years expert instruction—over 106,000 students enrolled. LL.B. Degree awarded. All texts furnished. Easy payments. Send for FREE BOOK—"Law and Executive Guidance."

AMERICAN EXTENSION SCHOOL OF LAW  
Dept. 23-M, 8 East Huron St., Chicago, Ill.

## TRAIN Your VOICE! Results GUARANTEED

We build, strengthen the vocal organs—met with singing lessons—but by sound, scientifically correct silent and vocal exercises and absolutely guarantee complete satisfaction with results. Write for Voice Book. FREE. Sent to no one under 17 years old unless signed by parent.

PERFECT VOICE INSTITUTE, Studio 1358, 64 E. Lake St., Chicago, Ill.

Say you saw it in Popular Mechanics!

## LEARN WATCH REPAIRING



AT HOME You can learn by our modern and original system of instruction every part of the Watch Repairing Trade at home. Prepare yourself for a well paying position or start in business after completing our course of instruction. Good watch repairers are in demand and generally earn very good salaries. For particulars apply to the Wisconsin School of Watch Repairing 524 E. Mason St., MILWAUKEE, WIS.



# Home Training helps YOU WIN!



DRAFTING

## Right Now

there is a tremendous shortage of skilled men in all branches of industry. Draftsmen, electricians, machine designers, tool makers, machinists are needed and the pay is big. Executives, too, foremen, superintendents, managers are wanted to help complete our tremendous production program.

### War Production Demands Better Men

It is a duty you owe your country, yourself, and your family. You should know more and more about your job. You should be prepared to advance and to accept the responsibilities of the men ahead of you so that they in turn may climb and, climbing take you with them. No matter what your present job, you should learn to do it better or learn how to do the job of the man ahead of you. You need to know both theory and practice to make our tremendous war plants more productive. Yes, indeed, you are needed and needed badly right now.

### Draftsmen, Electricians, Machine Designers, Machinists, Foremen, Superintendents, Managers Can All Profit by Home Study . . .

No matter what your trade or profession there is a better place for you in industry. You can get the training needed right in your own home.

**AMERICAN SCHOOL**  
Dept. G845, Drexel at 58th St.,  
CHICAGO, ILLINOIS

### Use Spare Time, Learn At Home

As little as one-half hour a day can produce surprising results in giving you a better education, more practical and theoretical training which will be reflected in your pay envelope. Never in the history of the world have there been so many opportunities for trained men, nor has it been so easy to get this training. The American School was founded over 40 years ago to provide home study for men and women who missed the opportunity to go to high school or college and to make it possible for you to LEARN AS YOU EARN.

### Rewards Are Great

Government figures show that graduates of specialized training of college grade, average over \$40 per week more than grade school graduates. If you missed this college training, then here is your opportunity to get specialized training at home. More than 150 noted educators, engineers, and executives helped to prepare American School Courses. This instruction is now available to you at a relatively low cost and on very easy monthly payments. Write now for details. Clip and mail the coupon—there is no obligation.



HIGH SCHOOL



ELECTRICITY



MECHANICAL ENG'R G

**MARK, CLIP AND MAIL THIS COUPON NOW!**

**Get facts FREE..**

(No Cost). All you have to do to find out about this type of training, to get the details and the outline of study, with histories of the successes of other men, is to send the coupon. There is no cost and no obligation of any kind. Let this great school, one of the pioneers in the home study field, explain the methods which can do so much for you. Get this information now so that you can get started quickly on the road to the fulfillment of a real ambition, and be of the greatest possible help in this present emergency.

**AMERICAN SCHOOL**

Dept. G845, Drexel at 58th St., Chicago

AMERICAN SCHOOL, Dept. G845, Drexel at 58th, Chicago.

Without obligation, Please send FREE and postpaid, bulletin and details of the Subjects checked.

- |   |   |  |
|---|---|--|
| <input type="checkbox"/> Air Conditioning           | <input type="checkbox"/> Accounting and C.P.A.              | <input type="checkbox"/> Drafting and Design for Men and Women |
| <input type="checkbox"/> Refrigeration              | <input type="checkbox"/> Cost Accounting                    | <input type="checkbox"/> Radio                                 |
| <input type="checkbox"/> Architecture and Building  | <input type="checkbox"/> Practical Bookkeeping              | <input type="checkbox"/> High School                           |
| <input type="checkbox"/> Plumbing and Steam Fitting | <input type="checkbox"/> Private Secretary                  | <input type="checkbox"/> Plastics                              |
| <input type="checkbox"/> Automotive Engineering     | <input type="checkbox"/> Diesel Engineering                 | <input type="checkbox"/> Liberal Arts                          |
| <input type="checkbox"/> Aviation Drafting          | <input type="checkbox"/> Surveying & Topographical Drafting | <input type="checkbox"/> Mechanical Eng.                       |
| <input type="checkbox"/> Aviation Engineering       | <input type="checkbox"/> Sheet Metal Pattern Drafting       | <input type="checkbox"/> Shop Management                       |
| <input type="checkbox"/> Business Management        | <input type="checkbox"/> Electrical Engineering             | <input type="checkbox"/> Tool Making                           |
|   |   | <input type="checkbox"/> Better Foremanship                    |
|   |   | <input type="checkbox"/> Engine and Boiler Work                |

Name..... Occupation.....  
Address..... Age.....  
City..... State.....



## MACHINE SHOP MEN

Learn to set up and run ANY kind of machine; **MAKE MORE MONEY NOW** by learning quickly **HOW TO DO THINGS** which usually take years of study and practice. The demand for **SKILLED men is ALREADY** ahead of the supply, then what **WILL IT BE** a month or two from now?

# Needed NOW!

**Bigger Pay** Don't miss this chance to qualify for promotion, don't miss this Big Opportunity which is yours almost for the asking. Eight Big Books chockful of important mechanical facts told simply and clearly. Over 3000 pages, nearly 3000 illustrations cover every subject fully, including Tool Making, Pattern Making, Foundry Work, Mechanical Drawing, Forging, Machine Shop Practice and Management, and hundreds of other subjects.

**8 Big Books (Up-to-date Edition) Sent FREE** to you for examination. With them we send a **Big Binder** of 867 pages with 293 original shop tickets and over 1300 illustrations. These show, step by step, how to set up and run almost any kind of job and are in **addition** to the 8 books. Decide in your own home or place of business whether or not you want to keep them, check up on any facts you want to. Note their great **MONEY MAKING** value, then, if you want them, pay on the easiest kind of payments. A year's consulting privileges with our engineers now given with these books without extra charge. American Technical Society, Vocational Publishers since 1898.

American Technical Society, Dept. 5819, Drexel at 58th St., Chicago  
You may send me the 8 big books and binder of shop tickets for free examination. I will pay the delivery charges only, unless I decide to keep them in which case I will send \$2.00 in ten days and \$3.00 per month until the total price of only \$34.80 is paid. If I return them in 10 days I will owe you nothing. You also agree to send me a certificate entitling me to consulting privileges with your experts for one year without extra charge.

Name .....

Address .....

Please attach a letter stating age, occupation, employer's name and address and that of at least one business man as reference.

## Learn this Profitable Profession



## in 90 Days at Home

Hundreds of men and women of all ages 18-50 make \$10.00 to \$20.00 in a single day giving scientific Swedish Massage and Hydro-Therapy treatments. There is a **big demand** from Hospitals, Sanitariums, Clubs, Doctors and private patients as well as opportunities for establishing your own office.

Learn this interesting money-making profession in your own home by mail, through our home study course. Same instructors as in our **NATIONALLY KNOWN** resident school. A diploma is awarded upon completion of the course. Course can be completed in 3 to 4 months. High School training is not necessary. Many earn big money while learning. The Army and Navy need hundreds of men and women trained in Massage and Physiotherapy.

## Anatomy Charts & Booklet FREE

Enroll now and we will include uniform coat, medical dictionary, patented reducing roller and Hydro-Therapy supplies without extra cost. The reducing course alone may be worth many times the modest tuition fee.

Send coupon now for Anatomy Charts and booklet of photographs and letters from successful graduates. These will all be sent postpaid—FREE.



**THE College of Swedish Massage**  
Dept. 864—30 E. Adams St., Chicago  
You may send me **FREE** and postpaid, Anatomy Charts, booklet containing photographs and letters from graduates, and complete details of your offer.

Name .....

Address .....

City..... State.....

## PARKS AIR COLLEGE

PARKS AIRPORT EAST ST. LOUIS, ILL.

## Offers YOU COLLEGE and PROFESSIONAL TRAINING Majoring in AVIATION

Accredited by the Illinois Superintendent of Public Instruction. Included since 1938 in The Directory of Colleges and Universities, issued by the U. S. Office of Education. U. S. approved as a Commercial Ground and Flying School and Mechanics' School. Accredited by and cooperating with the United States Army Air Corps in giving flight and mechanical training. Open to high school graduates.

**FOUR** courses lead to B.S. degrees in Professional Piloting, Aviation Operations, Maintenance Engineering, Aeronautical Engineering.

**TWENTY-TWO TRAINING PLANES** are used in professional flight training which prepares graduates for airline flight operations.

**FACULTY** of 104 specialists in various fields of aviation. Enrollment limited to a total of 300 commercial aviation students. Capacity enrollment of 870.

Airport, 25 buildings devoted to school purposes exclusively. Dormitories and dining hall at the College.

Winter term January 4. Send postcard for new 64-page catalog.

**16th YEAR** Registrar, Dept. PM-11  
**PARKS AIR COLLEGE, East St. Louis, Ill.**

## ENGINEERING DEGREE IN 27 MONTHS

INDIANA TECHNICAL COLLEGE

Courses in Aeronautical, Chemical, Civil, Electrical, Mechanical, and Radio Engineering. One-year courses in Radio and Drafting. Approved by C.A.A. Prep courses without added cost. Low tuition. Large industrial center. Opportunity to earn part living expenses. Enter December, March, June, September. Catalog, 5112 E. Washington Blvd., Ft. Wayne, Ind.



**FREE BOOKLET** answers the many questions bound to be in your mind about where you stand in relation to the war—about how you can serve your country well, and still plan for a secure, successful future. It tells why **YOU**—by entering the aircraft industry—can be **NECESSARY** to your country's victory. For your free copy of this helpful booklet, airmail your request **NOW** to

**AERO INDUSTRIES TECHNICAL INSTITUTE**  
5253 W. SAN FERNANDO RD., LOS ANGELES, CALIF.

## Learn PHOTO-ENGRAVING



We teach you quickly, at home in spare time. Earn while you learn. Establish your own profitable business with equipment we furnish, or work for others at good salary. Cuts in this magazine made by process we teach. Send for your copy of our big illustrated catalog. It's free!  
**THE AURORA SCHOOL OF PHOTO-ENGRAVING**  
Tasope' Bldg. (Dept. PM-46) Aurora, Mo.

## Learn Public Speaking

At home—in spare time. Many overcome "stage-fright," gain self-confidence and increase earning power, this easy way. Write for free booklet, *How to Work Wonders With Words* and requirements.  
North American Institute Dept. 1358  
1315 Michigan Ave., Chicago, Illinois

## LAW STUDY AT HOME

Legally trained men win higher positions and bigger success in business and public life. Greater opportunities now than ever before. Big corporations are headed by men with legal training.  
**More Ability: More Prestige: More Money**  
We guide you step by step. You can train at home during spare time. Degree of LL. B. Successful graduates in every section of the U. S. We furnish all text material, including 14-volume Law Library. Low cost, easy terms. Get our valuable 48-page "Law Training for Leadership" and business books FREE. Send for them NOW.  
LaSalle Extension University, Dept. 1164-L. Chicago  
A Correspondence Institution

## MONEY for MEN ALL DATA FREE

THE PLASTEX Industry needs manufacturers on small scale and for big production of Lamps and Clock Stands, Art Goods and Novelties in Plastex and Marble imitation. Experience unnecessary. Lgc material makes regular 10c store sellers. Rubber moulds furnished for speed production. Small investment brings good returns. **WE ARE NOW PLACING BIG CHAIN STORE ORDERS WITH MANUFACTURERS.** Ambitious men have chance for real prosperity. Our **FREE** booklet will interest and benefit you.  
PLASTEX INDUSTRIES, Dept. P. 1085 Washington Ave., New York, N. Y.

Pardon me for staring...

BUT JUST LOOK AT THAT

**HE-MAN BODY**



**I**MPOLITE or not—a girl just can't help staring at a man who's got a HE-MAN build! What about you? Does YOUR physique KEEP 'em staring—or do you suspect that girls may be snickering behind your back? If you're built like a blacksmith around the chest and arms—if you've got a spring in your step and a sparkle in your eye that just radiates physical health and strength—then watch the panic among the girls! Which man would YOU rather be—HE-MAN or WEAKLING? Charles Atlas puts it UP TO YOU!

**Let Me PROVE I Can Make YOU a NEW MAN of Might and Muscle!**

**W**ILL you give me just 15 minutes a day of your spare time? That's all I need to PROVE—regardless of how old or young you are, or how ashamed you may be of your present physique—that I can give you a body men envy and women admire. Biceps that can dish it out, and a muscle-ridged stomach that can take it. A full, deep barrel-chest. Legs that never tire. A tough, sinewy back. An all-around physique that can laugh at ANY kind of rough going.

We're ALL in the Army today! The heavy war-time demands on strength and endurance are no longer limited to front-line trenches. It's only a matter of time until EVERY citizen is called to shoulder his full share of the load. ALREADY the Army has enrolled men from 18 to 64. And whether you do your part in Uncle Sam's

Services or as a home-front civilian, you've GOT to be in 100% SHAPE. Every man, young or old, owes it to himself to get a body with the bulldog staying power that double shifts of working call for. HOW DO YOU STACK UP?

**Would You Believe I Was Once a 97-lb. Weakling?**

Yes, I was—a miserable 97-pound bag of skin and bones. But you'd never believe it to look at me now, would you? Through my discovery of "Dynamic Tension" I changed myself into "The World's Most Perfectly-Developed Man." I'm LIVING PROOF of the miracles "Dynamic Tension" can perform—right in the privacy of your own home! NOW—will you give my method 15 minutes a day to get the kind of HE-MAN build you have always longed to have?

**FREE BOOK "Everlasting Health and Strength"**

Just a postage stamp will bring you your copy of my famous book, "Everlasting Health and Strength," absolutely free. No wonder nearly 2,000,000 men have sent for this big 48-page story of "Dynamic Tension"—illustrated with action photos of myself and some of my pupils. You'll not only read about my secret of "Dynamic Tension"—but you SEE PROOF of it! CHARLES ATLAS, Dept. 8-ZA, 115 East 23rd Street, New York, N. Y.



**CHARLES ATLAS, Dept. 8-ZA**  
115 East 23rd Street, New York, N. Y.

I want the proof that your system of "Dynamic Tension" will help make a New Man of me—give me a healthy, husky body and big muscular development. Send me your free book, "Everlasting Health and Strength."

Name.....  
(Please print or write plainly)  
Address.....  
City..... state.....

**CHARLES ATLAS**  
An actual untouched photo of "The World's Most Perfectly Developed Man."

# SPRAYBERRY RADIO TRAINING includes FULL EQUIPMENT

Experience Easily Acquired  
at Home



You Do Practice-Giving Experiments, Many Special Features... ALL Designed to Help You Make Fast Progress.

SPRAYBERRY Training starts right at the beginning of Radio... unfolds each subject in a simplified, logical, understandable style. You easily learn Television, Frequency Modulation, Signal Tracing, Mobile Radio (Auto-Tank), Aviation Radio, Electronics, Facsimile Radio, Radio Set Repair and Installation work.

ing, Mobile Radio (Auto-Tank), Aviation Radio, Electronics, Facsimile Radio, Radio Set Repair and Installation work.

**Training Prepares You for a Business of Your Own... or Good Radio Jobs—Civilian or Military**

The important and fascinating field of Radio offers many opportunities to the man who wants to get ahead. My Training is designed to give you quick access to these opportunities. SPRAYBERRY Methods are thorough and practical. Your Training will not interfere with your present duties. No previous experience is needed.



## You Get a Dual-Purpose Radio Set

I supply you with Radio Parts which you use to gain experience in Repair work. These same Parts are used as a Modern Signal Generator and for Signal Tracing, etc. You'll find my Course and Equipment fully described in the catalog offered below. But in addition to this catalog, I am going to send you, without obligation, a valuable new manual.

## YOURS FREE! Just Off the Press Big 80-Page Book "RADIO SERVICE SHORT CUTS"

Don't miss it! It's a rich storehouse of practical tips and information. In keeping with the same plain, to-the-point language found throughout the Sprayberry Course, this handy volume tells how Radio break-downs occur... how to spot these defects... how to correct them quickly and efficiently. There is no fluff or ornamentation... simply the practical answers to the problems you meet as a busy, successful Radio man. If you ACT Now, you can get this book FREE... along with my descriptive Course Catalog. Use coupon below!

THE SPRAYBERRY COURSE IS SOLD UNDER MONEY-BACK AGREEMENT

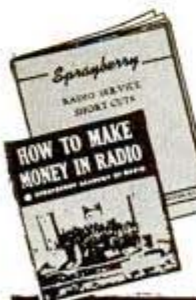

## RUSH COUPON for BOTH FREE BOOKS

### SPRAYBERRY ACADEMY OF RADIO

F. L. Sprayberry, President  
510-L—University Place, N. W.  
Washington, D. C.

Please rush my FREE copies of "HOW TO MAKE MONEY IN RADIO" and valuable 80-page "RADIO SERVICE SHORT CUTS".

Name .....

Address .....

City..... State.....

(Mail in envelope or paste on penny postcard)

Say you saw it in Popular Mechanics!

# Now is the Time for you to get into DRAFTING



All working tools, including drawing table, sent to you at once—furnished free with course.

**Learn At Home From An Engineer** With industry working feverishly—the field for DRAFTSMEN is bigger than ever! Get into a better job with more pay and fascinating, pleasant work. I will train you at your home in your spare time until you are holding a better paying position as Draftsman. My practical training in drafting also includes a working course in Industrial Designing valuable on new products, improving, restyling and modernizing—all extremely important and profitable to draftsmen. Write for full illustrated details and booklet. Give your age.

Engineer Dobe, Div. 3378, Libertyville, Ill.

## Free Booklet on PLASTICS

Your CAREER in Plastics

A great war-time industry, Plastics offers tremendously increasing possibilities in post-war developments already under way. Virtually every industry is using, or planning to use, Plastics. This booklet outlines the opportunities existing in this rapidly expanding industry, gives a history of plastic materials and indicates educational background necessary and employment possibilities in chemical, engineering, molding, fabricating, and other divisions of Plastics.

**Plastics Industries Technical Institute**

112 E. 42nd St.      221 N. LaSalle St.      186 South Alvarado  
New York City      Chicago, Ill.      Los Angeles, Calif.

## TRI-STATE COLLEGE

**B-S-Degree in 2 1/2 years**

**ENGINEERING**

Distinguished for technical 2 1/2-year courses in Civil, Electrical, Mechanical, Chemical, Radio, Aeronautical Engineering; Business Administration, Accounting, and Secretarial Science. Special preparatory department for those who lack required high school work. Short diploma courses (36 weeks) in Surveying, Drafting. Low tuition. Low living costs. Cosmopolitan student body. Enter January, March, June, September. Write for catalog. 4112 College Ave., ANGOLA, INDIANA.

## Learn to Write

Begin today. Write now for our Free Book, "How to Become a Good Penman." It contains specimens and tells how others learned to write in spare time. Enclose 10c for your name beautifully written and a pen point suitable for shaded writing. Write today.

**THE TAMBLYN SCHOOL OF PENMANSHIP**  
X461 Ridge Building, Kansas City, Mo.

## OWN A Printing Business

Cards, Tickets, Stationery, etc. Good profit in spare time. PRINT YOUR OWN greeting cards, movie titles, church work, etc. Save money. Easy rules supplied. Junior Press \$8. Senior Outfits from \$17.38. Have home shop. Raised printing and Embossing too. Sold direct from factory only. Write for free catalog and all details. **KELSEY, INC. X-37, MERIDEN, CONN.**

## THERE'S MONEY IN CARTOONS!

RAYE BURNS will teach you HOW to CREATE ORIGINAL CARTOONS at home that you may SELL! Course contains 26 lessons and over 600 illustrations. All for Only..... **\$2.85**

Send name and address for free details.

**RAYE BURNS SCHOOL, Dept. M, Box 1298, CLEVELAND, OHIO**

## Short-Cut Mathematics

COMBINED WITH  
*Practical Mechanics Simplified*

NEW 2-in-1 reading course! Now you can learn the speedy, simplified system of calculation used by draftsmen, engineers, accountants, "master minds" on the stage. Learn easy way to multiply 4 figures by 4 figures without using old-fashioned multiplication; add long columns of figures this lightning short-cut method. Learn horsepower, slide rule, micrometer, logarithms, wood measure, puzzles, etc., etc. Large illustrated volume complete with answers, only \$1 postpaid. Satisfaction or refund.

**FREE** Amaze friends with your magic-like mental powers!  
Complete details... mail coupon TODAY!

**NELSON CO., 500 Sherman St., Dept. L-300, Chicago**

Please send free details about "Short-Cut Mathematics and Practical Mechanics Simplified." No obligation.

Name.....  
Address.....

$$\frac{\div}{+} \quad \frac{\times}{\sqrt{}} \quad \frac{=}{\%}$$



Prepare TODAY for the

Victory-World of TOMORROW!



• There are two big reasons why you should start **TODAY** to become a trained specialist in some one line of work.

• **FIRST** — and most important right now — sound, practical training will make you a better fighter on the industrial front, and enable you to play a much more important part in outproducing our Axis enemies!

• **SECOND** — in the victory-world of

tomorrow, even more than yesterday and today, *trained men* will be in demand to fill the best, and highest paying, jobs in business and industry!

• Right now is the time for you to join the 100,000 American men who are studying low-cost, spare-time I. C. S. Courses in 400 different business and technical subjects. Mail this coupon for free booklet and complete information — and mail it today!

**INTERNATIONAL CORRESPONDENCE SCHOOLS**  
HELPING TO TRAIN AMERICANS FOR VICTORY

BOX 5648-J, SCRANTON, PENNA.

Without cost or obligation, please send me a copy of your booklet, "Who Wins and Why," and full particulars about the course *before* which I have marked X:



**TECHNICAL AND INDUSTRIAL COURSES**

- |  |   |   |  |
|--|---|---|--|
| <input type="checkbox"/> Air Brake   | <input type="checkbox"/> Contracting and Building                     | <input type="checkbox"/> Management of Inventions                               | <input type="checkbox"/> Sanitary Engineering                                  |
| <input type="checkbox"/> Air Conditioning                                    | <input type="checkbox"/> Cotton Manufacturing                         | <input type="checkbox"/> Marine Engines   | <input type="checkbox"/> Sheet Metal Work                                      |
| <input type="checkbox"/> Airplane Drafting                                   | <input type="checkbox"/> Diesel Engines                               | <input type="checkbox"/> Mechanical Drafting                                    | <input type="checkbox"/> Ship Drafting   |
| <input type="checkbox"/> Architectural Drafting                              | <input type="checkbox"/> Electrical Drafting                          | <input type="checkbox"/> Mechanical Engineering                                 | <input type="checkbox"/> Shipfitting <input type="checkbox"/> Shop Practice    |
| <input type="checkbox"/> Architecture  | <input type="checkbox"/> Electrical Engineering                       | <input type="checkbox"/> Mine Foreman   | <input type="checkbox"/> Steam Electric <input type="checkbox"/> Steam Engines |
| <input type="checkbox"/> Auto Engine Tune-up                                 | <input type="checkbox"/> Electrician                                  | <input type="checkbox"/> Navigation <input type="checkbox"/> Patternmaking      | <input type="checkbox"/> Steam Fitting   |
| <input type="checkbox"/> Auto Technician                                     | <input type="checkbox"/> Electric Lighting                            | <input type="checkbox"/> Plastics <input type="checkbox"/> Plumbing             | <input type="checkbox"/> Structural Drafting                                   |
| <input type="checkbox"/> Aviation <input type="checkbox"/> Aviation Mechanic | <input type="checkbox"/> Foundryman <input type="checkbox"/> Heating  | <input type="checkbox"/> Public Works Engineering                               | <input type="checkbox"/> Structural Engineering                                |
| <input type="checkbox"/> Blueprint Reading                                   | <input type="checkbox"/> Heat Treatment of Metals                     | <input type="checkbox"/> Pulp and Paper Making                                  | <input type="checkbox"/> Surveying and Mapping                                 |
| <input type="checkbox"/> Boilermaking  | <input type="checkbox"/> Highway Engineering                          | <input type="checkbox"/> Radio, General   | <input type="checkbox"/> Telegraphy <input type="checkbox"/> Telephony         |
| <input type="checkbox"/> Bridge Engineering                                  | <input type="checkbox"/> House Planning                               | <input type="checkbox"/> Radio Operating  | <input type="checkbox"/> Textile Designing                                     |
| <input type="checkbox"/> Chemistry <input type="checkbox"/> Coal Mining      | <input type="checkbox"/> Industrial Metallurgy                        | <input type="checkbox"/> Radio Servicing  | <input type="checkbox"/> Toolmaking <input type="checkbox"/> Tool Design       |
| <input type="checkbox"/> Civil Engineering                                   | <input type="checkbox"/> Locomotive Engineer                          | <input type="checkbox"/> R. R. Section Foreman                                  | <input type="checkbox"/> Welding, Gas and Electric                             |
| <input type="checkbox"/> Concrete Engineering                                | <input type="checkbox"/> Machinist <input type="checkbox"/> Inspector | <input type="checkbox"/> R. R. Signalman <input type="checkbox"/> Refrigeration | <input type="checkbox"/> Woolen Manufacturing                                  |

**BUSINESS COURSES**

- |  |  |  |   |
|--|--|--|---|
| <input type="checkbox"/> Accounting <input type="checkbox"/> Advertising   | <input type="checkbox"/> College Preparatory     | <input type="checkbox"/> First Year College                          | <input type="checkbox"/> Railway Postal Clerk                         |
| <input type="checkbox"/> Bookkeeping                                       | <input type="checkbox"/> Commercial              | <input type="checkbox"/> Foremanship <input type="checkbox"/> French | <input type="checkbox"/> Salesmanship                                 |
| <input type="checkbox"/> Business Correspondence                           | <input type="checkbox"/> Commercial Illustrating | <input type="checkbox"/> Good English                                | <input type="checkbox"/> Secretarial <input type="checkbox"/> Spanish |
| <input type="checkbox"/> Business Management                               | <input type="checkbox"/> Cost Accounting         | <input type="checkbox"/> High School                                 | <input type="checkbox"/> Showcard and Sign Lettering                  |
| <input type="checkbox"/> Cartooning <input type="checkbox"/> Civil Service | <input type="checkbox"/> C. P. Accounting        | <input type="checkbox"/> Managing Men at Work                        | <input type="checkbox"/> Traffic Management                           |

**HOME ECONOMICS COURSES**

- |   |   |  |
|---|---|--|
| <input type="checkbox"/> Advanced Dressmaking | <input type="checkbox"/> Home Dressmaking                       | <input type="checkbox"/> Tea Room and Cafeteria Management, Catering |
| <input type="checkbox"/> Foods and Cookery    | <input type="checkbox"/> Professional Dressmaking and Designing |  |

Name.....Age.....Address.....  
City.....State.....Present Position.....

Canadian residents send coupon to International Correspondence Schools Canadian, Limited, Montreal, Canada  
British residents send coupon to I. C. S., 71 Kingway, London, W. C. 2, England

# DRAFTSMEN NEEDED Now



Industry is clamoring for more draftsmen for the job can't start until plans are drawn. Buildings, airplanes, machines, guns, tanks, bridges, all start on the drafting board, so it's no wonder that every good draftsman has a fine job. Yes, more draftsmen are needed NOW. The pay is good and the opportunities for advancement great.

## Learn at Home in Spare Time

Begin now to turn spare hours into money. Be a draftsman, the connecting link between a mechanic and an engineer. Enjoy the wonderful opportunities for promotion that exist now. No experience or artistic talent is needed. You don't have to leave your present job while learning. Use spare time.

**American School, Dept. DD845, Drexel Ave. at 58th St., Chicago, Ill.**

Gentlemen: Send me FREE information covering special training in subjects checked below. No obligation on my part.

<input type="checkbox"/> Drafting and Design for Men and Women	<input type="checkbox"/> Electrical Engineering
<input type="checkbox"/> Accounting and Auditing	<input type="checkbox"/> Diesel Engineering
<input type="checkbox"/> Architecture and Building	<input type="checkbox"/> High School Course
<input type="checkbox"/> Automotive Engineering	<input type="checkbox"/> Plastics
<input type="checkbox"/> Business Management	<input type="checkbox"/> Mechanical Engineering
<input type="checkbox"/> Aviation	<input type="checkbox"/> Radio
	<input type="checkbox"/> Retail Merchandising

Name.....  
Address.....

# QUICK WAY TO LEARN MUSIC

## — play any instrument

GET A REAL thrill out of music! Play the musical instrument you like best. Start right in with simple tunes. No tedious, old-fashioned drills and exercises.

It's easy! Everything is in print and picture. You see every position and move. Thousands have been amazed at their progress in just a few short weeks. Now they're sought-after guests for every party! Don't miss out on the popularity that is rightfully yours!

Mail coupon today for free illustrated Booklet and Print and Picture sample that show how easily and quickly you can learn music at home. Just check instrument that interests you. (Instruments supplied when needed, cash or credit). U. S. School of Music, 711 Brunswick Bldg., New York City.

### FREE PRINT and PICTURE SAMPLE

U. S. School of Music, 711 Brunswick Bldg., N.Y.C.

Please send me Free Booklet and Print and Picture Sample. I would like to play instrument checked below. (Do you have instrument.....)

<input type="checkbox"/> Piano	<input type="checkbox"/> Guitar	<input type="checkbox"/> Saxophone	<input type="checkbox"/> Trumpet	<input type="checkbox"/> Ukulele
<input type="checkbox"/> Violin	<input type="checkbox"/> Accordion	<input type="checkbox"/> Mandolin	<input type="checkbox"/> Tenor Banjo	<input type="checkbox"/> Other Instrument

Name.....  
Street.....  
City..... State.....

# Do You Make Mistakes in English?

EVERY time you speak or write you show just what you are. Mistakes in English reveal you as a person who lacks education and refinement. Lack of language power prevents you from presenting your thoughts in the strongest possible way. No matter what you do, real command of English will help you to your goal. Stop making mistakes in spelling, punctuation, pronunciation. Increase your vocabulary.



### WONDERFUL INVENTION

Only 15 minutes a day with Sherwin Cody's new invention—and you can actually SEE your English improve. It teaches by HABIT—makes it easier to do the RIGHT way. Wonderful self-correcting lessons include spelling, punctuation, grammar and expression.

### FREE BOOK ON ENGLISH

Lack of language power may easily be costing you thousands of dollars every year. See what Mr. Cody can do for you; it costs nothing to find out. Mail a postal card or letter this very minute for free book, "How You Can Master Good English in 15 Minutes a Day". It will prove a revelation to you. WRITE NOW. Address:

**Sherwin Cody School of English, 511 Searle Bldg., Rochester, N. Y.**

## New York Electrical School

Established 1902

Ask for free illustrated booklet

### School

44 West 17th St., N. Y. C.

## Learn PLASTICS

Get into Plastics! Your big opportunity. Enter a New Industry. Plastics is thrilling, profitable, uncrowded. Learn Now! First Plastics School in the East with complete Study and Lab. courses. Write Dept. M Today! State age.

### BOSTON TECHNICAL INSTITUTE SCHOOL OF PLASTICS

170 COMMONWEALTH AVENUE, BOSTON, MASS.



## ARTISTS MAKE MONEY

Find out your ability. Send name, age, occupation and address for Free Vocational Art Test.

**ART INSTRUCTION, INC.** (Formerly Federal Schools)  
11132 Art Instruction Building, Minneapolis, Minnesota

## Learn PHOTOGRAPHY at Home

Splendid opportunities. Prepare in spare time. Easy plan. No previous experience needed, common school education sufficient. Send for free booklet "Opportunities in Photography", particulars and requirements.

**American School of Photography**  
1315 Michigan Ave., Dept. 1358, Chicago, Ill.

## EARN THE DEGREE

Doctor of Psychology (Ph.D.), Doctor of Divinity (D.D.), many others. Courses in business, accounting, law, etc. Low fees. Send for large Bulletin and student picture-folder AT ONCE. No obligation whatever.

**TEMPLE BAR EXTENSION COLLEGE**  
1411 Fourth Avenue, Dept. 4-R, Seattle, Washington, U. S. A.

## RADIO ENGINEERING

aviation and police radio, servicing, marine and Morse telegraphy taught thoroughly. 48 weeks' engineering course equivalent to three years' college radio work. School established 1874. All expenses low. Catalog free.

**The Dodge Institute, Dept. D, Valparaiso, Ind.**

## PLAYS

Send for FREE catalog of 144 plays, copiously illustrated. Non-royalty plays, also tested plays on a percentage-royalty basis. Playbook exchange. Row, Peterson plays are nationally famous for their high quality. Ask for live drama newspaper, "Landscape"—it is free.

**ROW, PETERSON & COMPANY**  
1309 Ridge Ave. Evanston, Ill.

## FIBRE ARMS AND LEGS!

Light, correctly fitted, strong and comfortable. Natural appearance. Braces for all deformities. Scientific design. Fair Terms.

**BUCHSTEIN-MEDCALF**  
610-3rd Av. S., Minneapolis, Minn.



## MONEY IN RABBITS — CAVIES

**WE BUY** and put you in touch with other markets. Catalog and copy of magazine 10c. Or send 25c for Book Catalog and Price List and Year's Subscription to the **AMERICAN SMALL STOCK FARMER, OUTDOOR ENTERPRISE CO., BV 919, PEARL RIVER, N. Y.**





# WANTED!

# Aviation-PILOTS and MECHANICS

## THESE AMAZING DRAKE BOOKS GIVE YOU THE FACTS YOU NEED FOR FLYING OR GROUNDWORK



**SEND NO MONEY**

### Prepare Yourself Quickly, Easily, Economically

The U. S. Air Force Needs Thousands of trained men—the aviation industry needs thousands more. The call is vital, urgent, necessary—that's where you can forge yourself a highly paid career and secure a real future for peacetime work as well. Start studying today—get a headstart toward a better rating—a commission. Don't wait for long class drills—read these books now and get into the advanced groups.

**Recommended by the U. S. Office of Education For Pre-Flight Training**

**Especially Compiled to Help You Pass Those Tough Examinations**

Each volume is authoritative, giving you the results of years of experience by famous flyers and brilliant engineers. Careful study of them can be a tremendous factor in your aviation success.

### Complete—Concise—Easy to Understand

A study of these books gives you the actual feel of flying, diving, landing. You can quickly and easily grasp the principles of navigation. And the mysteries of motors, overhauling, and repairing are made simple and understandable even to the inexperienced. That's why Drake's Books are chosen by leading schools—why they will give you everything you need to pass your examinations.

### 5 DAYS EXAMINATION

You can't risk a penny—see them for 5 days—then if you don't agree they are the most valuable aviation books ever written, return them and your money will be refunded. Send immediately to Fred'k J. Drake & Co., Dept. PM 11, 600 W. Van Buren St., Chicago, Ill.

## DRAKE'S BOOKS—A Sure Way to Better Pay!

**AVIATION FROM THE GROUND UP.** By Lt. G. B. Manly, U. S. Air Corps., Ret. 400 pages, 250 illustrations make up this fundamental treatise on all phases of Aviation. Theory of flight, aerodynamics, construction, engines, weather, navigation, etc. **Used as text book in flying schools.** Also valuable terms and definitions. Beautiful cloth binding. Price..... **\$300**

**WIN YOUR WINGS.** By Col. Roscoe Turner and Major Jean Dubuque. 2 volumes—more than 1,000 pages—over 600 illustrations. Covers primary training. Follows C.A.A. requirements. Study of these books should qualify anyone to pass written examination for private pilot's certificate. Advanced Aviation Instruction with up-to-minute information for securing a commercial or instructor's rating. Probably the greatest works ever written on aviation. Everyone should read this set. **\$300**  
Size 6 x 9—Cloth Cover—Price Per Vol. ....

**AIRCRAFT POWERPLANT MANUAL.** By G. B. Manly. 760 pages—more than 300 illustrations. Fully covers the subject. Easy to understand, clearly explains maintenance and step-by-step overhauling procedure. Here's a guide for periodic engine inspection work. Gives you a perfect understanding of timing, lubrication, ignition, fuel systems, etc. You'll want this book handy wherever you go. Cloth bound..... **\$400**

**AIRCRAFT SHEET METAL CONSTRUCTION AND REPAIRS.** By M. P. Harrold. 158 pages—123 illustrations. Fully explains repair processes of aircraft sheet metal parts. Instructions for scores of actual jobs. Includes cutting, soldering, welding, spinning. Complete—concise—easy to understand. Valuable to both beginner and experienced worker. Cloth Bound..... **\$150**

### DRAKE'S BOOKS SOLD AT LEADING BOOKSELLERS

### Free Catalog—Don't Delay—Mail Today!

Fred'k J. Drake & Co., Dept. PM 11, 600 W. Van Buren St., Chicago, Ill.

Please rush me the books checked. Send COD. I will pay postman plus charges. If not fully satisfied, I will return the books within 5 days and my money will be refunded in full. (If cash is enclosed, we pay all postage.)

- Aviation from the Ground Up ..... \$3.00
- Win Your Wings—Vol. 1 ..... \$3.00
- Win Your Wings—Vol. 2 ..... \$3.00
- Aircraft Powerplant Manual ..... \$4.00
- Aircraft Sheet Metal Construction and Repairs..... \$1.50
- Send Free Catalog

Name .....

Address .....

City..... State.....

★  
Recommended by  
U. S. Office  
of Education

★  
Written by  
Authorities

★  
Thousands  
of  
Illustrations

★  
Easy to  
Understand

★  
They Cover  
the Subjects  
Completely

Send  
NO  
MONEY



**Hurry  
Free  
Inspection  
Offer.  
Limited!**



# DRAFTING

**BOOKS SENT FREE!**  
ON APPROVAL—5 VOLUMES  
BRAND NEW EDITION

## For Beginners or Experts

Written so you can understand every word, by well known engineers. De Luxe modernistic, washable cloth binding, over 1600 pages, hundreds of blueprints, charts and diagrams; prepares you for a good drafting job in mechanical lines. Sent for 10 days' free use if you mail coupon immediately.

### Big Field • Big Demand • Big Pay

Competent draftsmen are urgently needed in all manufacturing lines at \$30.00 to \$75.00 a week. That's just the beginning—FOR DRAFTSMEN HAVE GOOD CHANCES FOR ADVANCEMENT. Pleasant, fascinating work, easy to learn and do. Learn quickly with these books—send coupon for a set and see for yourself.

[ A year's consulting service now given to all buyers of this famous cyclopedia of drafting. ]

**AMERICAN TECHNICAL SOCIETY**  
Vocational Publishers since 1898

American Technical Society, Dept. DB19, Drexel at 58th St., Chicago, Ill. Send for 10 days' trial, Brand New 5 volume set of "Drafting for Machine Trades." I will pay the delivery charges only. If I wish, I may return books in 10 days and owe you nothing, but if I decide to keep them, I will send \$2.00 after 10 days, then only \$3.00 a month until \$19.80, the total price, is paid. Send Brand New edition and include Consulting Service Certificate.

Name.....

Address.....  
Please attach letter stating age, occupation, employer's name and address and that of at least one business man as a reference.

# SUPER JU JITSU

**NOW—**  
**YOU CAN DESTROY**  
**YOUR ENEMY QUICK!**

WHEN THIS  
HAPPENS  
TO YOU...



**BE A ONE-MAN BLITZ!** Strike with Command lightning! You don't need ox-like muscles to use Super Ju Jitsu, most powerful of all defense and attack methods. **Technique** is the deadly secret. Brains count—not size, not strength. Almost miraculously efficient.

**Gain Self-Confidence**  
KNOW how YOU can lick brutes twice your size with your bare hands only, even when they are ARMED with gun, knife, club. Get ready now for any emergency—protect your loved... OR DO THIS



**Send for Exciting Details—Free!**  
Startling Low Price. Satisfaction Guaranteed or your money back. Mail coupon now.

**FREE**

**NELSON CO., 500 Sherman Street**  
**DEPT. L-502, CHICAGO, ILL.**

Please rush me free the hard-hitting details about "Super Ju Jitsu." No obligation on my part.

NAME.....

ADDRESS.....



# GET INTO AVIATION Train Now at LINCOLN



Opportunities of a lifetime now open to men trained at this LINCOLN GOVERNMENT APPROVED SCHOOL of Aviation. Our Graduates taking immediate employment in Airplane Factories, with Airlines, and at Airports at salaries up to \$3600 a year to start. Draft age men also taking Lincoln Training to prepare themselves for enlistment in Army and Navy Air Services. You can train at this Lincoln School for positions as Commercial Pilot, Flight Instructor, Aeronautical Engineer, Government Licensed Airplane & Engine Mechanic, Airplane Assembly Mechanic, Airplane Draftsman. We train you and assist our Graduates in locating positions. New classes starting weekly.

**WRITE TODAY** for complete information.  
**LINCOLN AERONAUTICAL INSTITUTE**  
5911 AIRCRAFT BUILDING, LINCOLN, NEBRASKA



# WELDERS WANTED!

## Men and Women ELECTRIC ARC— OXY-ACETYLENE

Skilled Welders earn up to \$15 a day. The demand now greater than the supply. Learn this highly paid trade in 4 weeks by actual shop work. One of America's leading schools. Established 1902. 7 floors of shops. Endorsed by welding industry. Limited number of students. 4 weeks course in Electric Arc or Acetylene Welding, including room and board, only \$306. Course covers minimum requirements of U. S. Office of Education for War Production Workers, and the American Welding Society Code. Write or wire for reservation. Ask for "Welding Facts." State age.

**GREER COLLEGE**  
DEPT. 1112, 2024 SOUTH WABASH AVE., CHICAGO

# STUDY AT HOME

With A Chartered Educational Institution

Courses in **ENGINEERING**: Electrical, Civil, Mechanical, Drafting, Architectural, Steam, Aeronautical, Radio, Structural, Mining, Industrial, Highway, Petroleum, Marine, Chemical.

Courses in **ARTS AND SCIENCES**: Philosophy; Education; Letters; Public Health; Medical Jurisprudence; Psychology; Sociology; Physics; Chemistry; Geology; Pol. Science; Theology; Law; Business and Commerce; Accounting; Mathematics; Statistics; Agriculture.

McKinley-Roosevelt Incorporated, 4610-UC, Sheridan Road, Chicago

# FREE BARGAIN CATALOG of BOOKS

25,000 books of all publishers listed in our 48th Annual Bargain Catalog of 320 pages. Old-time favorites—latest "best sellers." Reference, Fiction, Juvenile, History, Scientific, etc. Supplying schools, colleges, libraries and thousands of individual customers. Send postcard today for our new 1943 catalog, "Bargains in Books."

**THE BOOK SUPPLY COMPANY, Dept. 136**  
564-566 West Monroe Street Chicago, Illinois

# Stop Working for Others We Start Men in Business—

supply stocks and equipment on credit—teach Sales Methods that have enabled inexperienced people to acquire wealth, fine homes, farms, automobiles. Many in same locality over 25 years—hundreds average \$3000-\$5000 annual business year after year. People buy Rawleigh's 200 Home Necessities because they give big values for the money. Our 50 years reputation and "try-before-you-buy" plan helps to make easy sales. Over 41 million sold last year proves enormous market. Now openings for more new Dealers. First come, first served. Only reliable men selected. First send for convincing proof.

**The W. T. Rawleigh Co., Dept. K-35-PPM** Freeport, Ill.







**ELECTRICIANS**  
**URGENTLY NEEDED NOW!**  
**MEN** *whether you are* **16 or 50**

**"LEARN BY DOING"—in 12 Short Weeks**  
**You don't need much money. I'll Finance Your Training!**

**WANTED: TRAINED MANPOWER!**

Vital Defense jobs are waiting for men of all ages who know Electricity. Even men with physical handicaps can qualify. Trained electricians who are drafted can apply for higher ratings and bigger pay. All over America, you will be able to find steady, well-paid work that will help win the War—when you are trained as a SKILLED ELECTRICIAN.

**START NOW, PAY LATER**

Come to Coyne in Chicago—the heart of vast war industries. Learn Electricity quickly, in only 12 weeks of practical training on real motors, generators, switchboards. No books, no reciting—you "Learn by Doing" in the great Coyne shops. That's why my students learn so quickly.

Just think! Three months from today you may be ready to take your place as an essential war worker—prepared, too, for a good job after the war. Don't let lack of money hold you back. We'll help you get a part-time job so you can "earn while learning". You can get training first—then pay for it in easy monthly payments after you graduate.

**LIFETIME JOB SERVICE**

Every Coyne graduate receives Lifetime Employment Service, without charge. Make sure of your future. Thousands of successful men rely on Coyne Training in Practical Electricity—tested and proven for 43 years.



**TIME IS SHORT!**  
**ACT NOW!**

Don't delay. Mail the coupon for my big, free Coyne book. It's full of pictures and proof that I can help you get the training you need for a good job in Electricity. This does not obligate you. No salesman will call. So act now. Get the facts—MAIL COUPON TODAY.

**EXTRA! 4 Weeks course in RADIO now included**

**HUNDREDS NOW TRAINING**  
**on Real Electrical Apparatus**  
**IN THE BIG COYNE SHOPS**



Right now, today, men from all walks of life . . . men as young as 16 and as old as 50 . . . men with no more schooling or experience than you have . . . are busy training at Coyne. Join them for the opportunity you have always wanted. Write today for details. You couldn't be starting at a better time!

**H. C. LEWIS**  
 President  
**COYNE ELECTRICAL SCHOOL**  
 500 So. Paulina St., Dept. 82-72, Chicago, Ill.

**H. C. LEWIS, Pres., COYNE ELECTRICAL SCHOOL**  
 500 S. Paulina Street, Dept. 82-72, Chicago, Ill.

Without obligating me in any way, send me your FREE BOOK and explain your plans to help me get into Electricity.

NAME.....

ADDRESS.....

CITY.....STATE.....

OCCUPATION.....AGE.....

**"Position 'X' evacuated!  
TRAINED MEN  
advance now!"**



**BE A  
RADIO  
TECHNICIAN**

**GET READY FOR YOUR OPPORTUNITY. . .** It's HERE! Radio technicians are needed everywhere; afield in action, and at home in industry! Trained men are needed in the Army, Navy and Air and Signal Corps, Government Defense Service and Civilian fields. Now, in answer to repeated demands for Trained Radio Technicians, National Schools has extended its famous *Shon Methods* so you can qualify right at home. You can quickly prepare to be of greatest service to your country and yourself. Yes, right at home, in your spare time. National's time-tested plan of Home Training will definitely establish you, in a short time, so you can hold a good job in this fascinating field. Furthermore, you become equipped for an even bigger career in the years of reconstruction after the war. Learn Radio in all its practical branches by National's proven methods.

**FASCINATING WAY TO LEARN RADIO**  
You will receive actual extension of same study and training as you would receive if you attended school in person. Not a dull moment. Easy-to-grasp methods that quickly qualify you.

**FREE LESSON & OPPORTUNITY BOOK**  
So that you may actually demonstrate your own ability to learn RADIO quickly and easily, we will send you one free complimentary Lesson, with Big Opportunity Book that gives full details—without obligation to you. Mail the Coupon TODAY!

**TESTED  
HOME  
TRAINING**

**Quality For  
These Jobs**  
RADIO EXPERT  
BROADCASTING  
AIRCRAFT—MARINE  
INDUST. ELECTRONICS  
STUDIO TECHNICIAN  
GOV'T. SERVICE  
REMANUFACTURE

**NATIONAL SCHOOLS**

**Los Angeles  
California  
ESTABLISHED  
1905**



**MAIL OPPORTUNITY COUPON FOR QUICK ACTION**

**National Schools, Dept. 11-M** (Mail in envelope or paste on penny postal.)  
**4000 So. Figueroa, Los Angeles, Calif.**

Mail me FREE, without obligation, one Lesson and Opportunity Book, with full details about how I can become a RADIO Technician.

NAME \_\_\_\_\_ AGE \_\_\_\_\_

ADDRESS \_\_\_\_\_

CITY \_\_\_\_\_ STATE \_\_\_\_\_

**"MY JOB'S IMPORTANT! IS YOURS?  
AIRCRAFT INSTRUMENT  
MEN NEEDED AT ONCE!"**

**PREPARE in AVIATION'S  
MOST VITAL BRANCH**

**AIRCRAFT  
INSTRUMENTS**

**HOME STUDY—LEARN BY DOING!**

Practical, complete training—on actual instruments furnished by the school—qualifies you for well-paying positions with manufacturers, airlines and instrument service and repair stations. Send for CATALOG today . . .

**EASTERN AIRCRAFT INSTRUMENT SCHOOL**  
"Largest in the East"

DEPT. (M) 116 NEWARK AVENUE JERSEY CITY, N. J.

**MAKE MONEY FROM  
POULTRY**



with a business of your own. How to start small way, spare time, grow from profits, or prepare for good job in large poultry plant. Harry M. Lamon, nationally known Poultry Expert, shows latest scientific methods, money-making secrets in poultry raising. His system of home study training used by thousands. Endorsed by many colleges and leading Poultrymen. Established 20 years. Write Today for his big FREE BOOK "How To Raise Poultry For Profit." Shows way to real business opportunity.

**NATIONAL POULTRY INSTITUTE**  
Dept. 50-15 Adams Center, N. Y.

★ ★ ★

**MAKE YOUR OWN  
POWER TOOLS  
at Low Cost**  
*from old Auto Parts, etc.*

**New Book Will Save Hundreds of Dollars  
Shows How to Make Forty Tools**

Now you can have a good lathe, drill press, circular and band saw and other power tools in your home workshop, at a cost of only a few dollars each. Make them yourself from old auto parts, discarded sewing machines and other odds and ends that cost little or nothing. Get this new book—"Forty Power Tools You Can Make." Costs only \$1.25 postpaid. This book gives every detail in plain language you can understand and follow. Hundreds of pictures and plans show every step to follow in making the power tools you want. Actual photographs of finished machines included. Send \$1.25 today. Money back if not satisfied.



**MAKE EVERY POWER TOOL NEEDED IN YOUR  
HOME WORKSHOP**

- Some of the power tools you can make are:
- |                    |                              |
|--------------------|------------------------------|
| 2 Band Saws        | 2 Drill Presses              |
| 9 Sanding Machines | 1 Scroll Saw                 |
| 2 Circular Saws    | 2 Wood Turning Lathes        |
| 1 Metal Lathe      | 3 Grinders                   |
| 1 Power Hack Saw   | 1 Shaper or Moulding Machine |
| 1 Jig Shears       | 1 Vibrating Pencil           |
| 1 Cut-Off Wheel    | and others                   |

Information too, about pulleys, belts, motors and drive methods. Just published. No other book like it. Order today.

**POPULAR MECHANICS PRESS**

Dept. 437 • 200 E. Ontario Street, Chicago

# INVENTORS

## NOW Is the Time to PATENT and SELL Your Invention

Now, more than ever before, is the right time to patent your invention. Why? Because manufacturers everywhere presently engaged in war production are looking ahead to the future by buying up patent rights now, so they will have new and attractive items to make and sell for civilian consumption as soon as the war is over. This is what happened during and after the last war. Hence, the smart thing for you to do is to look ahead to the future too. Protect your invention by applying for a patent now, so you will be in position to cash in on an outright sale, or on the royalties your invention will bring.

### Patent Guide Shows What To Do

Our "Patent Guide for the Inventor" answers many important questions concerning Patents that inventors constantly ask. It tells what facts, details, drawings, sketches, etc. are necessary to apply for a Patent; how to protect your invention through dated and witnessed disclosure; how to do this AT ONCE to safeguard your rights; how Patent Office Records can be checked to determine whether the invention is probably patentable before filing fees need be paid; discusses costs involved and a practical way these can be paid as the application progresses. It tells how some inventors secured financial backing; how many simple inventions have proved large commercial successes; how Patents covering improvements also can be profitably utilized and marketed; tells countless other facts of interest.

### Why You Need Expert Assistance

The Patent Laws were enacted for your benefit—to give you protection for the features of your invention which are Patentable. But these features must be legally and concisely set forth in the form of "claims." This phase of the procedure is so complex that the Patent Office advises the inventor to engage a competent Registered Patent Attorney. We maintain a large staff—carefully trained registered patent attorneys—expert draftsmen—experienced searchers—to serve you. We have been serving inventors for more than 20 years.

### Take First Step Now

With the Patent Guide you will receive also Free a "Record of Invention" form which will enable you at once to establish the date of your invention, before you file your Patent application. This step costs you nothing yet may be vital to your success. Remember—in Patent Matters, ACTION IS IMPORTANT. Delay can be costly. Mail the coupon in an envelope, or paste it on a penny postcard NOW.

**CLARENCE A. O'BRIEN**  
and  
**HARVEY B. JACOBSON**  
"Worthy of Your Trust"  
Registered Patent Attorneys  
21-L Adams Building  
Washington, D. C.

*Get This*  
**FREE BOOK**  
IMMEDIATELY MAIL COUPON TODAY!

*Get*  
**FREE  
COPY**



**48  
PAGES**  
*Over 100  
Illustrations*



**CLARENCE A. O'BRIEN**  
and **HARVEY B. JACOBSON**

**CLARENCE A. O'BRIEN AND HARVEY B. JACOBSON**  
Registered Patent Attorneys before the United States Patent Office  
21-L Adams Building, Washington, D. C.

Please send me your 48-Page "Patent Guide for the Inventor" and your specially prepared "Record of Invention" form FREE. This request does not obligate me.

Name .....

Address .....

City..... State.....

(Please write or print plainly.)

# POPULAR INVENTIONS

For Your Home



## Electric Vaporizer Hooks on Edge of a Glass



Quick relief from colds is said to be offered by an electric vaporizer that produces steam instantly which in turn picks up vapors from benzoin, oil of Eucalyptus, camphor or similar medicines. The vaporizer is hung on the edge of a tumbler of water, while the medicine, soaked in cotton, is placed in the small porcelain cup at the top of the vaporizer.

## Handy Stick to Hold Knitting Ball Rotates as Yarn Unreels

For convenience in knitting, the ball of yarn can be anchored on a plastic rod equipped with a loop that slips over the arm. Dangling freely, the yarn unwinds as you knit. A rule embossed on the stick is handy for measuring stitches.



## Door Lock Made Burglarproof By Guard in Keyhole

M 667



Ordinary door locks can be made burglarproof with a simple guard that holds the key fast, preventing it from being turned or pushed from the keyhole. With the key turned sidewise in the

lock, the flat metal guard slips beneath it into the keyhole. The outer end of the guard, bent into U-shape, engages the key head and a cotter pin is inserted to hold the guard and key together.

### WHERE-TO-BUY-IT INDEX OF POPULAR INVENTIONS

#### Electric vaporizer

The Hanksraft Co., Madison, Wis.

#### Stick to hold knitting yarn

Frederick O. Sanford, Inc., 220 Fifth Ave., New York City

#### Key guard

McKay Bros., 917 Chicago Ave., Evanston, Ill.

# ELECTRICIANS

**Earn More Money. Know Your Job Better. Serve Your Country. Get this...**

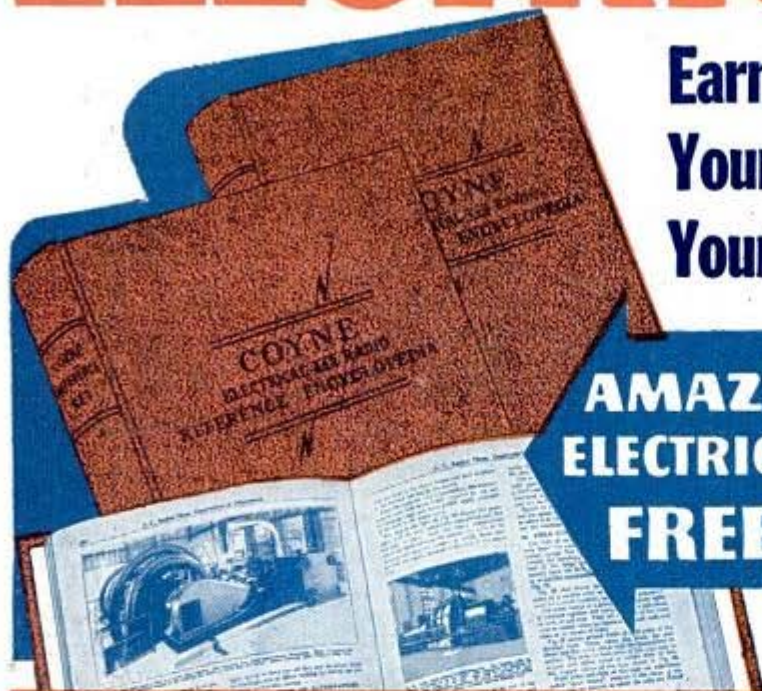

**AMAZING 3 VOLUME  
ELECTRICAL ENCYCLOPEDIA  
FREE 7 DAY TRIAL**

**AUTHORITATIVE - PRACTICAL**  
Prepared by Experts

**1200 Pages. 8½x11 in. OVER 2000 PICTURES and DIAGRAMS. 2000 subjects listed in handy index. Handsomely bound in Harvard Red and Gold Leatherette**

## **RADIO-TELEVISION INCLUDED**

Invaluable to radio men. Includes electronics, auto radios, short wave, F.M., television, P.A. systems, etc.

## **NOT A CORRESPONDENCE COURSE**

No written lessons or examinations or tests to be sent in. You study at home when you have time, and this great set will always serve as a reference encyclopedia when you want to look up any electrical problem.

## **FREE WITH ENCYCLOPEDIA**

One year of personal advice by mail. ACT NOW and we'll include Technical Service by mail on any special electrical or Radio problem for one year after you purchase encyclopedia.

**H. C. LEWIS**  
President  
**COYNE ELECTRICAL SCHOOL**  
500 South Paulina Street  
Dept. 82-R1, Chicago, Illinois

## **BRAND NEW 1942 EDITION**

Covers everything electrical: Armature winding, A.C. and D.C. Motors, generators, Electronics, automotive electricity, refrigeration, etc., etc. Answers your electrical questions quickly, clearly, completely. Helps you get ready for BIGGER OPPORTUNITIES in the Good-Pay Field of Electricity—now and after the war. A practical study-at-home reference set. Used regularly on the job by hundreds of Electricians, service men, radio men, air cadets, students, maintenance men, etc. EASY. COMPLETE.

## **SEE THEM RISK FREE**

You don't have to risk a penny. To get your set promptly, just mail coupon. Examine books 7 days risk free. Mail coupon now.

**H. C. LEWIS, Pres., COYNE ELECTRICAL SCHOOL**  
500 South Paulina Street, Dept. 82-R1, Chicago, Ill.

Send me the big Coyne Electrical Reference and Instruction Encyclopedia. Within 7 days after receiving the books, I'll either return them or send you \$3, and \$3 a month until advertised price of \$12.00 is paid. We pay shipping charges.

NAME \_\_\_\_\_

ADDRESS \_\_\_\_\_

CITY \_\_\_\_\_ STATE \_\_\_\_\_

OCCUPATION \_\_\_\_\_ AGE \_\_\_\_\_

# RADIO

Basic principles of all radio OPERATION RECEPTION

Radio is more important NOW than ever. Thousands will be needed in aviation, army, navy, and commercial work. Our latest course gives you basic instruction in radio operation and reception. Airway Weather Service, Aeronautic Radio, Servicing, Frequency Modulation are all covered.

## Complete HOME TRAINING in spare time

Make use of spare time to master the principles of this interesting and profitable profession. Fit yourself for an important part in the tremendous affairs now taking place. Help to win this war quicker. Learn all about our plan, send for this bulletin—it's FREE.

American School, Dept. R845, Drexel at 58th St., Chicago

**SEND FOR THIS BULLETIN FREE**

American School, Dept. R845, Drexel Ave. at 58th St., Chicago, Ill.

Gentlemen: Send me FREE bulletin covering special training in subjects checked below. No obligation on my part.

- |  |   |
|--|---|
| <input type="checkbox"/> Drafting and Design For Men and Women | <input type="checkbox"/> Diesel Engineering     |
| <input type="checkbox"/> Accounting and Auditing               | <input type="checkbox"/> High School Course     |
| <input type="checkbox"/> Architecture and Building             | <input type="checkbox"/> Liberal Arts           |
| <input type="checkbox"/> Automotive Engineering                | <input type="checkbox"/> Mechanical Engineering |
| <input type="checkbox"/> Aviation                              | <input type="checkbox"/> Radio                  |
| <input type="checkbox"/> Electrical Engineering                | <input type="checkbox"/> Plastics               |
|  | <input type="checkbox"/> Retail Merchandising   |

Name.....

Address.....

## "YOU ARE UNDER ARREST!"



There's a Thrill in Bringing a Crook to Justice Through Scientific **CRIME DETECTION**

I have taught thousands of men and women this exciting, profitable, pleasant profession. Let me teach you, too, in your own home. Prepare yourself in your leisure time to fill a responsible, steady, well-paid position in a very short time and at very small cost. What others have done, you too, can do.

## 43% of All American Identification Bureaus

Are headed by students and graduates of I.A.S. This fascinating work is easy to learn and the training is inexpensive. You, too, can fit yourself to fill a responsible crime detection job with good pay and steady employment. But don't delay—get the details now. Let me show you how easily and completely I can prepare you for this fascinating work, during spare time, in your own home. You may pay as you learn. Write today for free Crime Book.

## FREE! "THE BLUE BOOK OF CRIME"

It's a thriller. Tells about some of the most interesting crimes ever perpetrated and how they were solved through the very methods taught by I.A.S. Send now—be sure to state age.

**INSTITUTE OF APPLIED SCIENCE**  
Dept. 1358, 1920 Sunnyside Ave., Chicago, Illinois

Be A **FINGER PRINT** Expert

## "LANGUAGE IS A WEAPON"

Forge ahead, win special assignments, in global war and the ultimate peace, through ability to speak a foreign language.

### MASTER ANOTHER LANGUAGE quickly, easily, correctly by LINGUAPHONE

The world-famous Linguaphone EAR-EYE Conversational Method brings voices of native teachers INTO YOUR OWN HOME. No English is spoken. You learn the new language by LISTENING.

Home-Study Courses in 29 Languages:  
RUSSIAN JAPANESE SPANISH  
PORTUGUESE CHINESE NORWEGIAN  
and 23 others

Send for FREE book  
**LINGUAPHONE INSTITUTE**  
83 RCA Building, New York - Circle 7-0830

## MAKE MONEY

Learn Painting at Home by the NEW, Easy Stuart System

• Previous art training or talent NOT necessary. This Stuart System is radically new and simple. It will REALLY TEACH PORTRAIT PAINTING. Cost is unusually low. Write for free booklet. Start your career NOW!

STUART STUDIOS, Room 6112  
121 Monument Circle - Indianapolis, Indiana

### TRAIN FOR VICTORY



## SPARTAN SCHOOL OF AERONAUTICS

Train at SPARTAN for a place in America's war program, and for a lifetime aviation career. \$2,000,000 worth of new buildings, new equipment. Government Approved. Personalized instruction—Sheet Metal, Aircraft or Engine Mechanics, Flight, Engineering, Radio, Instruments, Meteorology. Qualified SPARTAN graduates quickly employed. Spartan factory, contractor to U. S. Army and Navy, directly connected. Next semester starts

Aug. 2. Write for new 64-page free catalog. Give age and education. Captain Maxwell W. Balfour, Director—Dept. PM-112, Tulsa, Okla.

## Get Your Share of U. S. Defense BONDS \* STAMPS

## ANY BOOK IN PRINT!

Delivered at your door. We pay postage. Standard authors, new books, popular editions, fiction, reference, medical, mechanical, children's books, etc.—all at guaranteed savings. Send card now for Clark's 1943 Catalog.

**FREE** Write for our great illustrated book catalog. A short course in literature. The buying guide of 300,000 book lovers. The answer to your Christmas gift problem. **FREE** if you write NOW—TODAY!

CLARKSON PUBLISHING COMPANY  
Dept. PM-2, 1253 So. Wabash Ave., Chicago, Ill.

## GET INTO THE BAKING BUSINESS!

National Baking Institute announces a new home study course in commercial baking. Baking now America's fifth industry in wages. Nearly a depression-proof business. Good field for ambitious men. Common school education sufficient. Send for free booklet "Opportunities in Commercial Baking" and requirements.

NATIONAL BAKING INSTITUTE  
1315 Michigan Ave., Dept. 1358, Chicago, U. S. A.

## America Needs Men Trained for TOOL & DIE MAKING, MACHINIST & SCREW MACHINE TRADES

**HARRY LEBESON** PRESIDENT & FOUNDER  
ALLIED School offers you short intensive, Practical training courses in our fully equipped Shops. Learn on Actual Jobs! Easily, Quickly. Learn Days or Evenings. Enter anytime. **FREE** Employment Service and opportunity to earn while learning. Write for **FREE** Book "Practical Machine Shop Training."  
**ALLIED SCREW MACHINE CO., (School Division)**  
609 West Lake Street, Dept. PM-11, Chicago, Illinois

# 2100 NEEDED INVENTIONS

THE secret of successful inventing is in knowing what to invent! That's why this remarkable new book by Raymond Yates, noted science editor and inventor, should be yours. It not only proves you don't have to be a genius to be an inventor. It shows how some of the simplest ideas like the paper slip and clamped fruit jar top made huge fortunes. Mr. Yates gets you started by describing 2100 needed inventions—practical money-making suggestions that are crying to be invented—such groups as neatly classified, such as Radio, Electrical, Aviation, Chemical, also describes 10 most needed inventions—39 inventions that S. Needs most to win war. Order 2100 NEEDED INVENTIONS now and KNOW what manufacturers want before you waste time on impractical inventions! Special chapters included on Uncle Sam's call for wartime inventors. Also shows how to develop and protect ideas! SEND NO MONEY. On delivery pay postman \$2.00, plus C.O.D. postage. Money back if not satisfied. Order today from WILFRED FUNK, Inc., Dept. M, 354 Fourth Avenue, New York, N. Y.



## Be Really Comfortable with CLEAN OIL HEAT

NO FUEL RESTRICTIONS in Alabama, Arizona, Arkansas, California, Colorado, Idaho, Louisiana, Mississippi, Montana, Nevada, New Mexico, Texas, Utah, Wyoming. YOU CAN BUY A LACO HEATER if you have no other means of heating or your heater is worn out. (This subject is still further restrictions.) No more heaters after present stock—BUY WHILE YOU CAN! • Enjoy uniform temperature—“Oven Door” heat by opening dual doors. Economical—“Two Stage” burners, large-surfaced steel “Inner-Heating Units”, create, deliver more heat from less fuel. Beautiful heavy steel cabinet.



## LACO

FREE Send for free LACO book, low prices, facts on HOW YOU CAN BUY! Write NOW! LACO OIL BURNER CO., 1211 Union Ave., Griswold, Iowa

## FREE! \$5.00 Full Size FOOD & HOUSEHOLD PRODUCT ASSORTMENT

SEND NO MONEY! Rush name and address for big Assortment of FOODS, GROCERIES, SOAPS, ETC.—full size packages, worth \$5.00. Yours ABSOLUTELY FREE! Show these products to friends and neighbors. Take orders for sensational values, more than 200 quality products used in every home. Earn big profits, full or spare time. No experience necessary. Write for FREE \$5.00 Assortment of Products NOW. ZANOL, 5212 Monmouth, Cincinnati, O.



## LEARN MONEY-MAKING CARTOONING

Some Simplified Method that has helped train creators of “Terry & Pirates,” “Wash, Tubs,” “Out Our Way,” “Winnie Winkle,” “Boxer Fellers,” “Strange As It Seems,” “Secret Agent X-9,” and many others. Earn while learning. Rush 10c for Picture Chart (to test your ability), and full details. (State age.) THE LONDON SCHOOL, 4211 National Bldg., Cleveland, Ohio



## ITALIAN ACCORDIONS

Hand Made. Very best. Lowest prices. Buy Direct from Factory and Save Money. Send name and address for FREE catalog. ITALIA & P. SOPRANI ACC. MFG. CO. 323 W. POLK ST., DEPT. PM. 11, CHICAGO, ILL.

## Correspondence Courses in RADIO and ELECTRICAL ENGINEERING

LOW AS \$25 ELECTRICAL ENGINEERING. Get good grasp of wide electrical field. Modern. Very understandable. Theory made easy. RADIO ENGINEERING. Extra fine course in radio, public address, photo-electric work. Trains you to be super-service man, real vacuum tube technician. Tuition ONLY \$25, either course. Deferred payment plan. Experiment kits furnished. FREE Write for free copies of school catalogs, student magazines, etc. FREE LINCOLN ENGINEERING SCHOOL, Box 931-P-47, Lincoln, Nebr.

# More GOOD JOBS in DRAFTING

in AIRCRAFT and other War Industries!



Calls for Draftsmen Are Increasing! . . . Read the want-ads for proof of this urgent demand.

This complete drawing outfit,—every thing to work with,—including drafting table, drawing board, supplies, etc.— ALL SENT TO YOU AT NO EXTRA COST if you are a Chicago Tech Student.

MAIL COUPON BELOW

The War Production program has increased the demand for Aircraft Draftsmen, Machine Draftsmen, Architectural Draftsmen, Electrical Draftsmen, and Structural Draftsmen. The Draftsman always comes first on any new project in manufacturing and industry—peace or wartime.

## The Draftsman—“The Key Man” in War or Peacetime Industry

No new machines can be built, no airplanes constructed, no bridges or buildings erected, no ships or submarines launched until the draftsman has completed his work. Real immediate opportunities exist in Drafting—the profession upon which all construction is vitally dependent. Drafting is clean, interesting, well paid work. Steady employment. Investigate today what Drafting offers you! Help your country in a vital War production job on the important Home Front—and help yourself to a well paid job in Drafting.

## Learn in Spare Time,—at Home!

(or at the College in Chicago)

With our easy step-by-step lessons, (and the tools we furnish), you can learn in your spare time at home. Convenient terms. To prove to you how easy it is to learn Drafting by the Chicago Tech Method we'll send you a Trial Lesson FREE. No charge for this lesson either now or later.

Send a post card or the coupon now for

**free TRIAL LESSON**  
Send Coupon

## CHICAGO TECHNICAL COLLEGE

P-203 Tech. Bldg., 2000 S. Michigan Ave., Chicago, Ill.

Please send me FREE Trial Lesson in DRAFTING showing how to learn at home by C. T. C. plan for good job in aircraft and other war industries. No obligation of course.

Name.....  
Address.....  
City.....State.....  
Occupation.....Age.....

Say you saw it in POPULAR MECHANICS

# Helpful · Pay Raising · Extra Money

## BOOKS

INCLUDING NEW TITLES!

Use these books to prepare for a better job—bigger pay—to start a profitable business of your own. Watch these listings. Popular Mechanics specializes in outstanding books on many subjects. As new books of merit appear we will revise this list.



**Photo Guide**  
Construct own equipment, gadgets. Make better photos. \$1.25  
**Chevrolet Car & Truck**  
How to repair all models. \$3.00  
**Easy-to-Make Toys**  
..... \$1.85  
**Welding, Electric** \$1.25  
**Welding, Oxy-Acetylene**  
Welding, cutting..... \$1.25  
**Metallurgy**..... \$1.50  
**Fluorescent Lighting**  
New manual on construction, installation, repair..... \$3.00  
**Sign Painting**..... \$3.00  
**Audels Diesel Engine Manual**..... \$2.00  
**Get Tough**  
How to win in hand to hand fighting. \$1.00

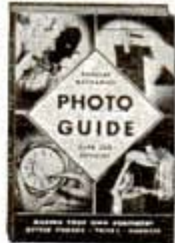

**Modern Welding Practice**  
Very latest information on all kinds of welding..... \$3.50  
**How to Read Electrical Blueprints**  
New self-study book..... \$3.00  
**Garden Book**  
Build own trellises, lawn furniture, fireplaces, ornaments, etc..... \$1.00  
**Forty Power Tools**  
Build own saw, drill, lathe, sander, etc. from scraps—save money.... \$1.25  
**Shop Notes Library**  
Four big volumes including new 1943 edition (224 pages—28 in color); over 1900 articles on money-making & money-saving ideas..... \$1.95  
**Welding, Brazing and Soldering**  
How to build and use arc, spot welders; tricks of soldering..... \$1.25  
**Running a Milling Machine (new)**..... \$1.50  
**How to Train Shop Workers (new)**..... \$1.25  
**Autopower**  
Convert old auto generators into motors, welders, etc..... \$1.00  
**Practical Ship Production (new ed.)**..... \$3.00  
**Tool Design**  
New book on production tools.... \$4.50  
**Tin Smith's Helper**  
Seams, piping, gutters, etc..... \$3.00  
**Modern Refrigeration**  
Electric, gas. Be service expert.... \$5.00  
**Auto Body and Fender Repairs**  
Shows how to do professional job... \$3.00  
**Dyke's Auto Encyclopedia (includes Diesels, airplane engines)**  
World's greatest book for mechanics. \$6.00  
**Sheet Metal Work**  
Self instruction in all phases..... \$2.50  
**Armature Winding**  
Construction, winding, repairing AC & DC Motors, generators..... \$2.00  
**Build Your Own Boat**  
Describes 17 popular boats—rowboats, sailboats, plywood outboard, etc., 192 pages..... \$1.25  
**Forging Practice**..... \$1.50  
**High School Self Taught**  
4 yr. course in one vol..... \$1.89  
**Carpentry & Joinery**  
Learn modern methods... \$2.00  
**Foundry Work**  
..... \$2.00  
**What to Make**  
4 Big Books, including New 1943 issue, 588 pages of popular handicraft projects. De Luxe Cloth... \$5.50  
Paper... \$1.95  
**Practical Furniture Finishing** \$1.25  
**Machine Shop Work**  
Modern methods, use of tools, machines... \$2.75  
**Blueprint Reading**  
For machine trades..... \$1.50  
**Blueprint Reading**  
For building trades..... \$1.25  
**Painting & Decorating**..... \$1.50  
**Plastics**  
New book on manufacture and use. \$3.00  
**Pattern Making**  
Wood, metal..... \$2.00  
**Milling-Machine Indexing (new)**..... \$1.50  
**Tool Making**  
For beginners, advanced workers... \$3.50  
**Five Acres and Independence**  
How to make money on small farm. \$2.50  
**Knots, Ties, Splices**  
For everyone who uses rope..... \$1.00  
**Lathe Training**  
New book..... \$1.35  
**Electric Wiring**  
Includes estimating and new code... \$2.50  
**House Construction**  
Gives every step in House construction..... \$2.89  
**Marinists' and Tool Makers Hand Book**  
New 1600-page book..... \$4.00  
**Your Car**  
Hundreds of simple car repairs, shortcuts, how to operate car economically... \$1.25  
**Elementary School Subjects**  
For home study..... \$1.89

**Ford V8 Car and Truck**  
Repairing, operating..... \$3.00  
**Modern Radio Servicing**..... \$5.00  
**1001 Ways to Use Concrete**  
Do work for yourself, others, save, make money..... \$1.98  
**Oil Burner Handbook**  
New book takes guess work out of servicing..... \$2.50  
**Steel Square Pocket Book**  
Best methods of using..... \$1.00  
**De Luxe Small Homes**  
New plan book shows 210 popular designs..... \$1.00  
**Modern Homecraft**  
New 250 page book on modern furniture..... \$3.00  
**Architectural Details**  
For every type of building..... \$1.50

## Little Library of Useful INFORMATION

Here is the information and practical help you have always wanted at amazingly low cost. Only simple tools needed to make and enjoy many things you might not otherwise afford. Order by number.

**WORKSHOP EQUIPMENT**  
Power-Driven Saws—74.  
Drill Presses, Grinders—79.  
Sanders—80.  
Wood—Metal-Turning Lathes—81.  
Filing Machine, Hacksaw, Cutoff Wheel, Shaper—82.  
Lathe Tools You Can Make—103.  
Workbenches—Tool Cabinets—47.  
Spray Painting—94.  
From Pattern to Casting—91.

**SHARPENING— USING TOOLS**  
Tool and Saw Sharpening—92.  
Using & Sharpening Drills and Wood Bits—90.  
Successful Wood Turning—32.  
How to Read Blueprints—71.  
Metal Turning Lathe Kinks—99.  
Operating a Metal Lathe—100.  
Heat Treating and Hardening—102.  
Working with Glass—103.

**ELECTRICAL**  
Rewinding & Servicing Electric Motors—75.  
House Wiring—89.  
Electromagnets & Solenoids—44.  
Transformer Construction—41.  
The Boy Electrician—43.  
Soldering & Brazing—17.  
Arc & Spot Welders—5.  
Treasure Finders—13.

**ELECTROPLATING**  
Electroplating with Copper, Nickel, Chromium, Cadmium—86.  
Plating Leather & Other Non-Metallic Objects—87.  
**HOME IMPROVEMENTS**  
Building Extra Attic Rooms—23.  
Attractive Basement Rooms—24.  
Lower Your Fuel Cost—31.  
Hanging Wallpaper—38.

Curing Leaky Basements—45.  
Fitting Home Game Room—55.  
Built-In Fixtures—78.  
Indoor & Outdoor Fireplaces—88.

**GARDENING**  
Backyard Gardening—39.  
Lawn & Garden Novelties—72.  
Trellises, Pergolas, Fences—76.  
Lawn & Garden Furniture—77.  
Playground Equipment—73.  
Concrete Garden Furniture—6.  
Bird Houses—7.  
Farm & Garden Tractors—8.

**CRAFT WORK—HOBBIES**  
Complete how-to-make-it instructions  
Magazine Racks—49.  
Clock Cases—50.  
Making Serving Trays—53.  
Children's Room Furniture—51.  
Book Ends—52.  
Small Tables—54.  
Smoking Stands—56.  
Jigsawed Novelties—57.  
Desk—58.  
Book Cases—59.  
Doll House & Doll Furniture—60.  
25 Shelves You Can Make—84.  
Novelties Turned on Lathe—62.  
Inlay Pictures—Veneering—60.  
Whittling, Wood, Soap Carving—65.  
Action Toys—66.  
High Flying Kites—67.  
Windmills & Weathervanes—68.  
Lamps in Wood, Metal—89.  
Home Work Opportunities—19.  
Telescopes—20.  
Metalcraft—28.  
Small Looms—37.  
Wood Finishing—40.  
Gem Cutting—42.

**5 for \$1.00**  
**12 for \$2.00**  
**25¢ Each**

### BOAT BUILDING

Build a boat at home—you can do it  
14 Ft. Outboard Runabout—2.  
14 Ft. Sailing Dinghy—26.  
21 Ft. Sloop—46.  
Rowboats, Bicycle Boat, Small Dinghy—83.  
Small Sail Boat—84.  
Two Outboard Runabouts—85.  
Build Your Own Canoe, Kayak, Surfboard—30.  
Fast Class-E Ice Yacht—22.  
**AUTOMOBILES**  
Auto Kinks & Shortcuts—10.  
Building Trailers—27.  
Motor-Driven Midget Car & Scooter—34.  
Stop Auto Electrical Troubles—95.

**PHOTOGRAPHY**  
Save Money—make your own photo equipment  
Photo Enlargers—1.  
Photo Printers & Dryer—25.  
Photo Darkroom Equipment—96.  
Picture Projector, Trick & Table Top Photography—97.  
Photo Kinks—98.

**FORMULAS**  
Simple Ingredients—  
Make Useful Products  
Cleaning Formulas—11.  
Cosmetic Formulas—12.  
Food Products Formulas—15.  
Metal Plating & Coloring—21.  
Re-Silvering Mirrors—70.  
**MISCELLANEOUS**  
Chemical Experiments—93.  
Taxidermy—9.  
Log Cabins, Tourists Cottages—14.  
Magic for Everybody—29.  
Trapping Small Animals—33.  
Training Your Dog—35.  
Building Small Electric and Gas Furnaces—36.

## Books Sent C.O.D. Anywhere in United States

Just check the books and bulletins you want (minimum C.O.D. order \$1.00), write your name and address below, and mail this advertisement. It is your order blank. When postman hands you books, pay him the price and few cents postage. Outside U. S. A. enclose remittance and include 15% additional for shipping charges. Ask for big FREE catalog of helpful books.  
(If you send payment with order we pay postage. Same return privilege)

Name.....  
City..... State.....  
Address.....  
Mail to Popular Mechanics Press, Dept. 430—200 East Ontario St., Chicago, Ill.



**110,000 ENTRIES**  
**1800 ILLUSTRATIONS**

**DEFINES** all the most commonly used words, selected from WEBSTER'S NEW INTERNATIONAL DICTIONARY, Second Edition, "The Supreme Authority." 1300 pages; \$3.50 to \$8.75, depending on bindings. Purchase at bookdealers or direct from publishers. Write for FREE Quiz and Picture Game to G. & C. Merriam Co., 162 Federal St., Springfield, Mass.

**The BEST Handy-Size DICTIONARY**

*A Merriam-Webster*

# Foremen!

## Increase Your Pay

No matter how many years you've been on the job, you'll find LaSalle home-study training in Modern Foremanship a real money-maker for you. Here's why: Hugo Diemer, Meyer Bloomfield and a number of other experts who had won distinction in the field of production engineering gathered, analyzed and organized for LaSalle the experience of **more than 5,000 practical foremen and production men in every line of industry.** Upon this basic material they built a truly remarkable training course covering every phase of the foreman's job. "Have received two promotions and a 'raise' in salary of \$75 a month"—"Have increased the production of my department 20%"—"My monthly salary is now \$310—a 'raise' of \$125 a month"—these are but a few of the many tributes paid LaSalle home-study training in Modern Foremanship. Low-cost; easy terms. Complete details in an attractive 48-page book, "Modern Foremanship," sent you free upon request. Write for it today.

**LASALLE EXTENSION UNIVERSITY**  
 A Correspondence Institution  
 Dept. 1164-MF CHICAGO

**AN INVENTOR LOOKS INTO THE FUTURE**

**Now IS THE TIME INVENTORS SHOULD PREPARE TO CASH IN!**

Many times IN THE PAST, big manufacturers have hesitated to buy a worthwhile patent because it might mean re-tooling and a new set-up of their entire plants. TODAY, those same manufacturers have scrapped their expensive dies, their intricate machines to convert to war work. TOMORROW, they'll be receptive as never before to devices which will save them time, save them money and save them labor. Far-sighted inventors are right now preparing for a vast patent-buying era by having their patent applications prepared and prosecuted NOW. These times offer an absolutely unique opportunity for YOU MEN WITH IDEAS.

Send today for  
**FREE BOOKS**

Plainly written books which tell you, step by step, how to safeguard your invention, how to sell it. With books we also send important "Evidence of Invention" form.

**44 YEARS' EXPERIENCE**  
**HELPING MEN LIKE YOU!**

No matter how good your invention may be, its commercial value depends upon the careful preparation of the patent covering it. This strong firm of Registered Patent Attorneys has helped and wisely advised individual inventors for almost half a century. WE CAN HELP YOU!

**SEND COUPON NOW!**

**VICTOR J. EVANS & Co.**

Registered Patent Attorneys  
 630-M Merline Building,  
 Washington, D. C.



Please rush books and "Evidence of Invention" form, without cost or obligation.

Name.....  
 Address.....  
 City and State.....

Say you saw it in Popular Mechanics!

# TRAVEL FOR UNCLE SAM



## RAILWAY POSTAL CLERKS

City and Rural Carriers—Postoffice Clerks—Office Clerks—Accountants—Stenographers—Typists—Many other Government Jobs

**\$1260 to \$2100 First Year**

Hundreds appointments now being made

FRANKLIN INSTITUTE Dept. R-174 Rochester, N. Y.

Sirs: Rush to me, without charge, copy of 32-page book, "How to get a U. S. Government Job," list of positions, and full particulars telling how to qualify for them.

Name.....

Address.....

# ELECTRICAL BOOKS

shipped FREE

**10 BIG BOOKS**

FOR EXAMINATION  
**MODERN ELECTRICITY INCLUDING RADIO AND TELEVISION**

Here's great news for anybody interested in Electricity. NEW 18th, edition of Applied Electricity brought right down to date with NEW Electrical subjects fully covered, including Electrical Blue Print Reading. 10 big Volumes and all shipped FREE for examination.

**1942 Edition For Beginners and Experts**

over 3000 pages—hundreds of illustrations—the most complete work of its kind we have ever published. Dynamos, motors, power stations, Radios, television, everything electrical explained so anyone can understand it.

**BIG FIELD! Big Demand! Big Pay!** Men who understand electricity are urgently needed in thousands of War Production Industries. Airplanes, ship building, arms plants, machine shops—practically every industry depends on electricity and men who know this subject make big money. Pleasant, fascinating work, easy to learn and do; learn with these books. Send coupon for a set for FREE examination and see for yourself.

**SEND NOW** [ A year's consulting privileges with our engineers now given to all buyers of this famous Cyclopedia of Electricity. ]

AMERICAN TECHNICAL SOCIETY  
Vocational Publishers since 1898

American Technical Society, Dept. E819, Drexel at 58th St., Chicago  
Send for 10 days' free use, 10 volume set of 1942 Edition, Applied Electricity, including a certificate entitling me to consulting privileges for one year. I will pay the delivery charges only on the books. If I wish I may return them in 10 days and owe you nothing, but if I keep them, I will send \$2.00 after 10 days, then \$3.00 a month until the total price of only \$29.80 is paid.

NAME .....

ADDRESS .....

CITY ..... STATE .....

Please attach letter stating age, occupation and name and address of employer and give at least one business man as reference.

**10' ACCURATE SLIDE RULE only 50¢ COMPLETE**

Complete with 32-page illustrated instructions and black leather-like case. Easy to learn to make lightning calculations without pencil and paper. You can multiply, divide, square, cube, extract square and cube root just by reading the figures on the rule. Accurate white composition face. Plastic magnifying indicator makes numbers easy to read. Standard A, B, C, D, CI and K scales, 100% American made.

**RUSH ORDER TODAY**—Send 50c in coin, stamps, or War Stamps. (Canada, 60c money order only.) Complete outfit mailed postpaid. Satisfaction guaranteed or money refunded. (Special quantity prices to schools and dealers.) Rush cash today for this great slide rule value.

**FRANKLIN PRODUCTS CO., 256-L Maple Grove Ave., Ft. Wayne, Ind.**

BOOK & CASE FREE of Extra Cost

**STUDY ENGINEERING AT HOME**  
With A Chartered Educational Institution

Courses in **ENGINEERING**: Electrical, Civil, Mechanical, Drafting, Architectural, Steam, Aeronautical, Radio, Structural, Mining, Industrial, Highway, Petroleum, Marine, Chemical.

Courses in **ARTS AND SCIENCES**: Philosophy; Education; Letters; Public Health; Medical Jurisprudence; Psychology; Sociology; Physics; Chemistry; Geology; Pol. Science; Theology; Law; Business and Commerce; Accounting; Mathematics; Statistics; Agriculture.

**McKinley-Roosevelt Incorporated, 4610-TC, Sheridan Road, Chicago**

# YOU CAN SUCCEED IN AVIATION

**STUDY AT HOME** and win out in the fight for future security by becoming a well-informed expert in the field of aircraft construction and maintenance.

Full information and costs of the practical, up-to-the-minute Ryan Home Study training will be sent without obligation. Mail this ad and begin your spare time study.

**RYAN AERONAUTICAL INSTITUTE**  
4211 Lindbergh Field, San Diego, Cal.

**\$5 FOR YOUR PICTURE!** Universal-trained men and women everywhere selling their photographs for \$5 and more each—earn \$15 to \$50 EXTRA every month! Home Study photo-journalism course teaches you what to take, how, and where to sell photographs. FREE Book gives details. **UNIVERSAL PHOTOGRAPHERS, Inc., Dept. 7, 10 W. 33 St., New York City**

**413 Pages Profusely Illustrated**

# FIVE ACRES and Independence

**A PRACTICAL GUIDE TO THE SELECTION AND MANAGEMENT OF A SMALL FARM**

**By M. G. Kains**  
B. S., M. S., formerly Special Crop Culturist of U. S. Dept. of Agriculture.

**ALL OF US** long some day to own a small farm, whether it be for permanent residence or as a weekend haven where we may enjoy the relaxation of rural life. With war upon us, inflation, depression, strikes, high rents, high cost of food and shortages threatening, we may find the solution in a properly operated small farm where we can eat regularly and abundantly, sleep soundly, have no money worries and live a healthy outdoor life. You don't have to own a large farm, but it is important to have practical advice from one who knows all about how to farm. There are many pitfalls which may easily be avoided. And there are many tried and proved methods which can lead to success.

We have found a practical book that starts at the beginning and takes you step by step into successful farming. This book takes nothing for granted. It tells what kind of farm to buy; how to choose it; how to finance it; what and how to plant, choice and care of livestock, poultry, bees, etc.; especially essentials of fruit and vegetable growing, fertilizers, irrigation, spraying, cultivation, harvesting, storage, sale of products and by-products. Every page is packed with proved ways to make the small farm self-supporting and profitable. Whether you have a farm now or are planning to purchase one, get this book by Mr. Kains and prepare yourself. Don't miss "Five Acres and Independence"; it might change your whole life, it may bring you the independence and security you are now striving so hard to obtain!

**Only \$2.50, Postpaid in U.S.A. (Outside U.S. \$2.75). Order Today**

**POPULAR MECHANICS PRESS** Room 436 • 260 East Ontario St., Chicago

# LEARN A BIG PAY TRADE in 2 to 8 WEEKS!

**We Pay Room and Board**

To meet the great demand for men and women at high wages, we have inaugurated intensive training courses in the trades listed here. Learn in 2 to 8 weeks by actual shop work. One of America's leading schools. Established 1902. 7 floors of shops. Many employers send their young men here for intensive training. Free employment service.

**MAIL COUPON!**

**GREER SHOP TRAINING**  
Dept. 2112, 2024 S. Wabash Ave., Chicago, Ill.  
Send "Shop Training Facts" describing trade checked below:

<input type="checkbox"/> Auto-Diesel	<input type="checkbox"/> Body-Fender
<input type="checkbox"/> Welding	<input type="checkbox"/> Machine Shop
<input type="checkbox"/> Refrigeration and Air Conditioning	<input type="checkbox"/> Tool and Die
	<input type="checkbox"/> Aviation

Name .....

Address .....

..... Age

# INVENTORS. INDUSTRY NEEDS YOUR IDEAS NOW!

YOU NEED *This*



**FREE BOOK**

**TWO REASONS—1.** Manufacturers are getting ready NOW for post war sales and production—

**2.** Right now, manufacturers are seeking products their expanded facilities can handle; factories must have products to take up the slack after war orders stop. Your chance comes with patent protection now—delay may endanger your chance. Get our **NEW FREE Inventor's Book** today and valuable "Invention Record" form. This request does not obligate you. **Act now. Write today.**

## McMORROW & BERMAN

Registered Patent Attorneys Before U. S. Patent Office, 1358 Barrister Building, Washington, D. C.  
Send me your **NEW FREE** Book and specially prepared "Invention Record" form at once. I understand that this request does not obligate me.

NAME.....  
ADDRESS.....  
CITY.....STATE.....  
**WRITE OR PRINT NAME CLEARLY**

### SPECIAL MAIL ORDER LIST!

#### PRACTICAL, PROFITABLE Low Cost BOOKS

Popular Mechanics own publications including books for self advancement, saving money on improvements, hobby enjoyment and ways to earn extra money.

#### Select and Order Now

- How To Read Blueprints.** New. Complete. Get this valuable knowledge from this one book. \$1.50.
  - Forty Power Tools You Can Make.** All of the wanted power tools for the home workshop. Make them from old auto parts, etc., at low cost. \$1.25.
  - 1001 Ways to Use Concrete.** Covers all concrete uses. Shows how to start a paying business. Reduced to \$1.98.
  - Your Car.** Save up to \$100 a year. Describes hundreds of simple repairs, shortcuts, etc. \$1.25.
  - Build a Boat.** For pleasure or profit. Shows how to make 17 low-cost boats at home. \$1.25.
  - Shop Notes.** Money-making, money-saving help for every man who uses tools. 1943 volume 50 cents. 4 volume Library \$1.95.
  - Garden Book.** Build your own trellises, fences, lawn furniture, etc. \$1.00.
  - Welding, Brazing and Soldering.** Including how to make welding equipment and use it effectively. \$1.25.
  - What To Make.** What to make and how to make it for fun or profit. 1943 volume (de luxe cloth) \$1.25, (paper) 50c. 4 volumes (de luxe cloth) \$5.00, (paper) \$1.95.
  - Boy Mechanic.** The best book for every boy. Hundreds of pictures. \$2.00.
  - Photo Guide.** The guide to better pictures with money-saving articles on making equipment at home. \$1.25.
  - Money Making Formulas.** Over 3000 formulas. Tells how to convert simple ingredients into saleable products. \$2.00.
- SEND NO MONEY**—Books shipped C.O.D. anywhere in U.S.A. at listed price plus delivery cost. We pay postage when remittance accompanies order. Mail your order today.

**POPULAR MECHANICS PRESS**  
Dept. 434, 200 E. Ontario St., Chicago

**CHECK TITLES WANTED AND MAIL**



**Train AT HOME for an ESSENTIAL WAR INDUSTRY**

America's "Blueprint for Victory" requires the greatest army of tool designers, design engineers, aircraft designers and draftsmen in history. Men in these big key positions are essential in producing the tools for the armed forces of all the allied nations. Plant production will be doubled in 1942 and 1943 figures will be still higher. This is an all-out war of production. It's the opportunity of a life-time to enter a skilled profession where paychecks are reaching up to \$100.00 or more weekly for competently trained men. Ohio Institute of Technology home instruction enables you to obtain thorough training that should start you earning in the shortest possible time. Many students find jobs long before completing course. All instruction geared to war-time needs. No useless theoretical studies. No outdated instructions. Special military and naval drafting instruction also available. Personal Attention given every student under direction of a former Naval Aviation and university instructor whose ability in his field has been recognized by the U. S. Government.

#### IMMEDIATE ACTION IS URGENT

Send today for **FREE** Book describing our complete courses in Tool Design, Design Engineering, Drafting, etc. Send no money. Just rush name and age. Our Free Book will open your eyes to a future in one of the most rapidly expanding industries in America.

#### OHIO INSTITUTE OF TECHNOLOGY

A Pioneer Home Study School in Design Engineering and Tool Design

**BOX 79 GREENVILLE, OHIO**

# AUDELS MATHEMATICS AND CALCULATIONS FOR Mechanics

**\$2**  
A **HANDY BOOK**

## MATHEMATICS AND CALCULATIONS FOR HOME STUDY AND REFERENCE

**GOOD NEWS! PRACTICAL MATHEMATICS ILLUSTRATED.** How to figure correctly. **EVERY MECHANIC** can use the new, correct, easy methods, covering a complete review of practical arithmetic—with examples including mensuration—plane and solid geometry—trigonometry—algebra—calculus—**ELECTRICAL and MECHANICAL SHOP CALCULATIONS**—practical tests—reference tables and data—how to use the slide rule—700 pages—550 illustrations—pocket size.

Highly endorsed. Let us mail you copy for free trial. Price \$2, postpaid.



**FREE EXAMINATION COUPON**

**THEO. AUDEL & CO.**  
49 W. 23rd St., N. Y. C.  
Mail Audel's Mathematics on 7 days' free trial. If O. K. I will remit \$2, otherwise I will return it.

Name.....  
Address.....  
Occupation.....P. M.

NOVEMBER, 1942

33A

**ARC WELDING NEEDS YOU!**

**Excellent Pay!**

**Costs but little to learn. ACT NOW!**

Offers a **BETTER FUTURE!** Get training in a trade that will always need experts regardless of world or local conditions.

**NO BETTER PLACE TO TRAIN** than this school, backed by one of the world's largest builders of arc welders; supervised by some of America's Finest Instructor-Operators.

**NON-PROFIT INSTITUTION.** Cost only for materials used. Individual machines, booths. Short, intensive course. **WRITE OR ENROLL TODAY!**

One of the finest schools of its kind in the world.

**The HOBART SCHOOL OF ARC WELDING**  
Box M-112 TROY, OHIO

**FREE Literature... Write Today! Reservations are being made continually, HURRY!**

**INVENTORS PATENT YOUR IDEAS SEND FOR FREE BOOK**

**HOW TO OBTAIN A PATENT**

Written by a Former Member of the Examining Corps (1922-24) of the U. S. Patent Office. If you want to profit by your idea, you should take steps to apply for a U. S. Patent at once. Your first step is to get this Free Book. This interesting illustrated book contains valuable information you should have. It tells you fully how to obtain a patent on your idea in the quickest way. With this Free Book you will also receive a "Record of Invention" form on which you can easily record your idea. Personal and Confidential Service: Your case will be personally handled only by a Registered Patent Attorney who is also a Former Member of the Examining Corps of the U. S. Patent Office. All communications confidential.

MAIL COUPON TODAY for FREE PATENT BOOK and RECORD OF INVENTION Form.

**CARL MILLER**  
REGISTERED PATENT ATTORNEY  
FORMER MEMBER EXAMINING CORPS U. S. PATENT OFFICE

Woolworth Bldg., 35th Floor, Dept. 112-A, New York City  
BOND BUILDING, Dept. 112-A, WASHINGTON, D. C.

Please send me your Free Book, "How to Obtain a Patent," and your "Record of Invention" form.

NAME.....

ADDRESS.....

**PATENTS**

Booklet Free • Highest References  
Promptness Assured • Best Results  
Send drawing or model

**All Business Given Prompt and Proper Attention**

**WATSON E. COLEMAN**  
Registered Patent Lawyer  
635 F Street, N. W. Washington, D. C.

**PATENTS AND TRADE MARKS**

**C. A. SNOW & CO.**

Registered Patent Attorneys Since 1875  
Write for Free Book and "Certification of Invention" form  
427 SNOW BUILDING, WASHINGTON, D. C.

**ELECTRICITY MEN NEEDED**

Electricians are needed everywhere. Hollywood studios alone claim shortage 200 men. This is a live money making profession. Learn at home, spare time. Easy payments. Selective Employment service. Write for FREE Bulletin. No obligation.

**AMERICAN SCHOOL**  
Dept. EE845 Drexel at 58 St., Chicago

**Learn PROFITABLE PHOTOGRAPHY**

Modern, practical training. You "learn by doing." For pleasure or career. Unusual wartime opportunities. Black & White, Motion Picture, or Color photography. 32nd year. Free Booklet.

**NEW YORK INSTITUTE OF PHOTOGRAPHY**  
10 West 33 St. (Dept. 49) New York City

**RAISE GUINEA PIGS**

**MAKE MONEY.** Thousands needed—War demand great. We supply breeders and buy the young. Write today for FREE illustrated bulletin. **RESEARCH SUPPLY CO., Dept. F-2, 2436 W. York St., Phila., Pa.**

Say you saw  
it in . . .

**POPULAR MECHANICS**

**To PROTECT YOUR INVENTION. Use this coupon, NOW**

Delays are dangerous and may be very costly. My personal service assures prompt action, strict confidence, and a minimum of expense. I suggest that you send me a model or drawing, or sketch and description of your invention, and \$5.00. I will make a search and report promptly as to its patentability and send you a copy of my 72-page booklet. Or, if you prefer to read my booklet first, mail the attached coupon at once. I will also send my "Record of Invention" form. (Over 40 years experience as a Registered Patent Attorney.)

**L. F. Randolph,** 302-D Columbian Bldg., Washington, D. C.  
Please send me at once, free of charge, your 72 page booklet and "Record of Invention" form.

Name.....

Address.....

**A PERSONAL CONFIDENTIAL PATENT SERVICE**

# WAR OPPORTUNITIES IN ACCOUNTING

War needs call for many new bookkeepers and accountants. Taxes and governmental regulations demand many extra for government and for industry. Enlarged plants need more. Also, many present accountants are being called to armed services. This opens unusual opportunity to women and to men not subject to military call. This opportunity will persist after the war.

You can prepare for these opportunities in spare time, at home, at moderate cost. 34 years of training accountants—over 2,000 C. P. A.'s among our alumni—have developed condensed, practical, interesting training. Write—today—for free booklet, "Accountancy, the Profession That Pays."



**LASALLE EXTENSION UNIVERSITY**  
A Correspondence Institution  
Dept. 1164-H CHICAGO, ILL.

## 60 ART LESSONS

Only **\$1.95** POST PAID

Study art in privacy of your own home in spare time with this course by Alexander Murray, author and art instructor. Lessons deal with commercial art, cartooning, lettering, anatomy, perspective, layout, etc. No added expense or bother of correspondence. Over 815 instruction illustrations. Order now—get all 60 lessons plus 65 sheets of drawing paper. Send only \$1.95 for complete course postpaid—or if in U.S.A., pay postman plus postage. MONEY BACK if not delighted after inspection.

EDUCATIONAL SUPPLY CO. Dept. 112-L RACINE, WIS.

## RUN CARS WITHOUT GAS

Use other cheap fuels and drive away gas rationing "blues." Convert your car with used and discarded parts. Keep 'em rolling. Famous engineer has worked out entire method and simplified it so that anyone can do it. Complete, simple, guaranteed instructions only \$1. SEND NO MONEY. Pay postman on delivery. Order today.

WAYNE ENGINEERING CO. Box 15 Greenville, Ohio

## MAKE MONEY AT HOME!

Learn to color photos and miniatures in oil. No previous experience needed. Good demand. Send for free booklet, "Make Money at Home!" and requirements.

NATIONAL ART SCHOOL  
1315 Michigan Ave. Dept. 1358 Chicago

## HANDY MAIL LIST ORDER Little Library of USEFUL INFORMATION

5 for \$1.00 • 12 for \$2.00 • 25c Each

- |                       |                                   |                                |  |                               |                               |                    |                             |                             |                                     |                             |                           |                               |                              |                               |                         |                                 |                                |                              |                         |                           |                         |   |                                 |                           |                            |                            |                                 |                        |                               |                                 |                               |                          |                              |                          |             |                  |                      |                       |                       |                |                    |                 |                               |                        |                                 |                             |                               |                              |                                  |                               |                            |                             |                    |                          |                              |                        |                            |                      |                            |                            |                             |                           |                       |                              |                                   |                               |                              |                                |                       |                            |                                |                          |                          |                                |                            |                             |                                |                               |                 |                 |                    |                 |                       |              |           |                   |                    |
|-----------------------|-----------------------------------|--------------------------------|--|-------------------------------|-------------------------------|--------------------|-----------------------------|-----------------------------|-------------------------------------|-----------------------------|---------------------------|-------------------------------|------------------------------|-------------------------------|-------------------------|---------------------------------|--------------------------------|------------------------------|-------------------------|---------------------------|-------------------------|---|---------------------------------|---------------------------|----------------------------|----------------------------|---------------------------------|------------------------|-------------------------------|---------------------------------|-------------------------------|--------------------------|------------------------------|--------------------------|-------------|------------------|----------------------|-----------------------|-----------------------|----------------|--------------------|-----------------|-------------------------------|------------------------|---------------------------------|-----------------------------|-------------------------------|------------------------------|----------------------------------|-------------------------------|----------------------------|-----------------------------|--------------------|--------------------------|------------------------------|------------------------|----------------------------|----------------------|----------------------------|----------------------------|-----------------------------|---------------------------|-----------------------|------------------------------|-----------------------------------|-------------------------------|------------------------------|--------------------------------|-----------------------|----------------------------|--------------------------------|--------------------------|--------------------------|--------------------------------|----------------------------|-----------------------------|--------------------------------|-------------------------------|-----------------|-----------------|--------------------|-----------------|-----------------------|--------------|-----------|-------------------|--------------------|
| Power Driven Saws—74. | Drill Presses, Grinders, Etc.—79. | Wood, Metal Turning—Lathes—81. | Filing Machine, Hack Saw, Cutoff Wheel, Shaper—82. | Lathe Tools You Can Make—101. | Workbenches—Tool Cabinets—47. | Spray Painting—94. | From Pattern to Casting—91. | Tool and Saw Sharpening—92. | Sharpening Drills and Wood Bits—90. | Successful Wood Turning—32. | How to Read Blueprint—71. | Metal Turning Lathe Kinks—99. | Operating a Metal Lathe—100. | Heat Treating, Hardening—102. | Working With Glass—103. | Rewinding, Servicing Motors—75. | Electromagnets & Solenoids—44. | Transformer Construction—41. | The Boy Electrician—43. | Soldering and Brazing—17. | Arc and Spot Welders—5. | Electroplating With Nickel, Chromium, Cadmium, Etc.—86. | Plating Leather, Wood, etc.—87. | Lower Your Fuel Costs—21. | Curing Leaky Basements—45. | Fitting Home Game Room—55. | Indoor & Outdoor Fireplaces—88. | Backyard Gardening—39. | Lawn and Garden Novelties—72. | Trellises, Pergolas, Fences—76. | Lawn and Garden Furniture—77. | Playground Equipment—73. | Concrete Garden Furniture—6. | Making Serving Trays—53. | Sanders—80. | House Wiring—89. | Treasure Finders—13. | Hanging Wallpaper—38. | Built-in Fixtures—78. | Bird Houses—7. | Magazine Racks—49. | Clock Cases—50. | Children's Room Furniture—51. | Jigsawed Novelties—57. | Doll House & Doll Furniture—60. | 25 Sneives You Can Make—64. | Novelties Turned on Lathe—62. | Inlay Pictures—Veneering—63. | Whittling—Wood, Soap Carving—85. | Windmills & Weather vanes—88. | Lamps from Wood, Metal—69. | Home Werk Opportunities—19. | Wood Finishing—40. | Boats—14 ft. Outboard—2. | Boats—14 ft. Sail Dinghy—26. | Boats—21 ft. Sloop—46. | Rowboats, Small Dinghy—83. | Small Sail Boats—84. | Two Outboard Runabouts—85. | Build Own Canoe, Kayak—30. | Build Class-E Ice Yacht—22. | Auto Kinks, Shortcuts—10. | Building Trailers—27. | Motor-Driven Midget Cars—34. | Stop Auto Electrical Troubles—95. | Photo Printers and Dryers—25. | Photo Darkroom Equipment—96. | Trick and Table Top Photos—97. | Cosmetic Formulas—12. | Food Products Formulas—15. | Metal Plating and Coloring—21. | Re-Silvering Mirrors—70. | Chemical Experiments—93. | Log Cabins, Tourist Houses—14. | Trapping Small Animals—33. | Farm and Garden Tractors—8. | Building Extra Attic Rooms—23. | Attractive Basement Rooms—24. | Small Looms—37. | Gem Cutting—42. | Photo Enlargers—1. | Photo Kinks—98. | Cleaning Formulas—11. | Taxidermy—9. | Magic—29. | Training Dogs—35. | Small Furnaces—36. |
|-----------------------|-----------------------------------|--------------------------------|--|-------------------------------|-------------------------------|--------------------|-----------------------------|-----------------------------|-------------------------------------|-----------------------------|---------------------------|-------------------------------|------------------------------|-------------------------------|-------------------------|---------------------------------|--------------------------------|------------------------------|-------------------------|---------------------------|-------------------------|---|---------------------------------|---------------------------|----------------------------|----------------------------|---------------------------------|------------------------|-------------------------------|---------------------------------|-------------------------------|--------------------------|------------------------------|--------------------------|-------------|------------------|----------------------|-----------------------|-----------------------|----------------|--------------------|-----------------|-------------------------------|------------------------|---------------------------------|-----------------------------|-------------------------------|------------------------------|----------------------------------|-------------------------------|----------------------------|-----------------------------|--------------------|--------------------------|------------------------------|------------------------|----------------------------|----------------------|----------------------------|----------------------------|-----------------------------|---------------------------|-----------------------|------------------------------|-----------------------------------|-------------------------------|------------------------------|--------------------------------|-----------------------|----------------------------|--------------------------------|--------------------------|--------------------------|--------------------------------|----------------------------|-----------------------------|--------------------------------|-------------------------------|-----------------|-----------------|--------------------|-----------------|-----------------------|--------------|-----------|-------------------|--------------------|

Check Titles Wanted, Write Name and Address in Margin and Mail to POPULAR MECHANICS PRESS, Dept. 435, 200 E. Ontario St., Chicago

# Read the Want-Ads INSPECTORS

## ★ WANTED ★

By Aircraft and Other War Production Plants



## MEN --- all Ages and WOMEN!

**MEN** needed as inspectors in aircraft and other War Production plants. Good pay and chances for promotion.

**WOMEN** The nation's war industries are calling for women inspectors. Base pay and overtime same as for men.

### A War-Time Job With a Peace-Time Future

One inspector required for every 12 to 20 employees in aircraft and other war plants employing from 15000 to 40000 workers. Help win on the home front.

### Unique Training Plan. Quick results

By the Chicago Tech plan you complete in your spare time at home the major part of your training which includes blue print reading. Keep your present job while learning. Then when your training obligations at home have been met, you come to Chicago Tech (round trip transportation and room furnished) for a short practical training in our Inspection Dept., shops and laboratories, with gauges, calipers, and other measuring instruments. This prepares you for a good job as an inspector.

### Employment Help When Ready

When you are ready we help you find a job as a mechanical precision inspector. Just now we have more calls for qualified inspectors than we can fill.

### Send Coupon or Post Card

Mail the coupon or a post card for free information. There's no time to lose. Battles are lost by delay,—so are opportunities like this one. Act now.

## CHICAGO TECHNICAL COLLEGE

P-1200 Tech Bldg., 2000 So. Michigan Ave., Chicago, Ill.

Please send me Free information about how I can qualify for a good job as an Inspector.

Name..... Mr., Mrs. or Miss.  
Address.....  
City..... State.....  
Occupation..... Age.....

Always write your name and full address clearly when answering advertisements.

Now . . . One Low Cost Policy  
**Insures Your Family  
 for Life!**

**MOTHER, FATHER, CHILDREN, GRANDPARENTS,  
 AS LONG AS THEY MAY LIVE**

**Insurance Stays in Force for the  
 Entire Life of All Members and . .**

**COSTS only \$1 for all**

Monthly premium is divided equally among the group. Cash death benefits are graded according to the attained age. W. W. Pederson and family, of Chicago, Ill., are protected by an "American Family" Policy. His "American Family" Life Insurance Policy will provide cash for bills—doctors, nurses, medicines and the many other bills that come with unexpected tragedy. Included are his children, wife, and their grandfather. You, too, should protect your family. Send the coupon.

**This "Life-time" family insurance pays as plainly  
 stated in the policy — \$1,000.00 for natural death,  
 pays \$2,000.00 for auto accidental death, and . . .**



**Pays UP TO \$3,000.00 MAXIMUM CASH  
 FOR TRAVEL  
 ACCIDENTAL DEATH**

Only \$1.00 a month is all you ever have to pay for this low cost Triple Cash Benefit "American Family" Life Insurance Policy with cash benefits up to \$3,000.00 for the entire family. Each and every member of your family—mother, father, children, aunts, uncles, even grandparents—may be included in one policy.

**NO MEDICAL EXAMINATION**

Each and every member of your family from the baby to grandparents—may be included in your application if you wish—no medical examination for anyone. We take your word regarding their good health. The Interstate Reserve Life Insurance Company is an old reliable Company writing insurance continuously for 34 years under strict supervision of Illinois Insurance Department where over \$100,000.00 is on deposit for protection of policyholders. You deal direct with the Company; that is why we can offer you this better kind of insurance with its large cash death benefits for your entire family at such a low rate. Only \$1.00 a month is all you ever have to pay for all this life insurance.

In the event of one death the rest of the family remain insured. The "American Family" Policy pays for ordinary or natural death, double benefits for automobile accidental death, and triple benefits for travel accidental death.

**10 DAYS' FREE OFFER to the  
 readers of POPULAR MECHANICS**

The "American Family" Life Insurance Policy for each and every member of your family is probably the most amazing policy ever written at such a low cost. That is why we want to send you this policy on our 10-day free "read it in your own home" offer. Then you decide for yourself. No agents or collectors to bother you at any time. Any average family can afford the small premium and no family can afford to be without life insurance to cover the bills that come with sudden tragedy. Send coupon today for full information.

**SEND NO MONEY...  
 Just Mail this Coupon**

We want you to carefully examine in your own home the wonderful "American Family" Policy on our 10-day free examination offer. You are under no obligation to keep it. If you do not agree that it is the best insurance for your family then you can send it back at our expense on our written guarantee. You decide for yourself. No agents or collectors will call on you and you have full 10 days to decide. Don't delay. Send the coupon right away.

**INTERSTATE RESERVE LIFE INSURANCE CO.  
 10 East Pearson Street, Chicago, Illinois**

Interstate Reserve Life Insurance Co.  
 10 E. Pearson St., Dept. 66  
 Chicago, Ill.

**NO AGENT  
 WILL CALL**

Please send me 10-day Free Examination offer and full details of "American Family" Group Life Policy without obligation. Send No Money.

Name.....

Address.....

City.....State.....

**WORLD'S  
BEST  
WANT AD  
MEDIUM**

# CLASSIFIED Advertisements



Advertisements in this section, 35 cents per word, each insertion, minimum 10 words, payable in advance  
To be inserted under proper classification in December issue, copy should be in our office October 8th  
December issue on sale November 1st  
Popular Mechanics Magazine, 200 East Ontario Street, Chicago, Illinois

## YOU'LL PROFIT

By reading and answering the classified ads in this section. Hundreds of opportunities to make and save money.

F. W. Johnson,  
Popular Mechanics Magazine, Chicago, Ill.  
Dear Sir:

I have been advertising with Popular Mechanics at intervals for fourteen years, and can whole-heartedly say that the results have been more than satisfactory, drawing business from every corner of the globe.

Thanking you for past services, I remain

Respectfully,  
WESTERN CHEMICAL COMPANY.

(Original letter on  
file in our office)

### AUTOMOBILES—MIDGET CARS

**AUTOMOBILE** Racing book, fifth edition, well illustrated. Instructions on building bodies, frames, engines. Ford A and B conversions. Plans, AAA rules, specifications. Roadster racing, Indianapolis cars. \$1.00 postpaid. \$1.15 C.O.D. Ray Kuns, Dept. 47, Madisonville, Cincinnati, Ohio.

**NEW Scientific** tablet! Increases mileage 20%-40%. \$1 box treats 180 gallons. Results guaranteed. Details free. Gas-O-Lubri, M3338 Manderson, Omaha, Nebr.

**PROFESSIONAL** Midget racers, motor-scooters, midget cars. Parts, plans. Hand-book catalog—50 illustrations, plans—20c. Midwest, 3622A North Troy, Chicago.

**WHIRLGAS Superchargers**, \$3. Increase mileage 20%; power 10%. Refund guarantee. University test. Any car; give make, year. Wrench installs 15 minutes. Good results with 30% fuel oil mix. John Hanley, Manufacturer, 5719 Loraine, Detroit, Mich.

**PHOTOGRAPHS**, World's finest automobiles. List free. Automobiles, Box 534, St. Cloud, Minnesota.

**MIDGET Motors**, \$5.00 up. Used motors, midgets, motorscooters, parts. Latest lists, 20c. Shipp's Midgets, Box 543-H, Zanesville, Ohio.

### AUTO SUPPLIES—EQUIPMENT

**NO Drag wax**. Felspar car wax powder, cleans, waxes, sun or shade, removes haze. Quick, easy, 2-pints (about 8 cars) \$1.00 postpaid. Money back guarantee. 1723-S-W-Madison, Portland, Ore.

1942 **IGNITION Supercharger** \$1.75. E. G. Sales Mfg. Co., New York.

**TIRE Care** and maintenance, new book just out, tells how to repair your own tires, make rubber cement, reclaim scrap rubber for 1c per pound, 12 tire maintenance trade secrets disclosed, \$1.00 postpaid, money back guarantee, air mail delivery. The Harris Co., Boaz, Wis.

**LEARN** How to get up to 30% more power and 50% more mileage out of practically any car with our Vacuum-Cool Method. Not a gadget. We send easy-to-understand diagram instructions showing how to quickly hook up the vacuum to cool the motor, cool the oil (eliminating dilution and overheating) and circulate the radiator water after disconnecting both water-pump and fan to save power. Also uses gas vapors from top of gas tank. Make the gallons stretch! Make money charging other motorists for installing! Mail \$1.00 today to Vacuum-Cool Company, 210 Transportation Bldg., Los Angeles, California.

**RECLAIM** Used oil without cost. Particulars. F. Gerwin, Alva, Okla.

**PLATING** Outfits for auto parts. Connect to a battery. No tanks used. Free particulars and proofs. Gunmetal Co., Ave. J, Decatur, Ill.

### AUTO TRAILERS

**READY Now**—Plans for nine new Jim Dandy Trailers including six modern house trailers. Catalog 10c. Also new edition of Trailer Builders Manual and catalog of parts, supplies and equipment. Price 25c. Both 35c postpaid. Trailer Supply Co., 5120-A Fulton St., Wausau, Wis.

### MOTORCYCLES—BICYCLES—MOTOR-SCOOTERS—SUPPLIES

**ELECTRIC Bikes** use no gasoline! \$2.00 buys plans and instructions to build your own easily and cheaply. This model was featured in the New York Sunday News. These bikes built in our shop sell for \$150.00 and up. Paul Dunn, 2207 Elmwood Ave., Buffalo, N. Y.

**SAVE** Tires and gas. Ride to work on an electric bicycle. Low initial and operating cost. A few hours work will build an attachment for your bike. Complete plans \$2.00. Murray Bevis 1942 Inc., Columbus, Ohio.

**MOTORCYCLE Bags**—\$3.90 pair and up. Allen Streamlined Bag Co., 216 Summit St., Elgin, Ill.

**PARTS**, New and used. Catalogue and wings pin 10c. Ballak, 811 N. 9th, St. Louis, Mo.

**BICYCLES**, Parts, tires. Also scooter tires, all sizes. Send dime for list. Cycle Transport Co., 1241 So. Michigan Ave., Chicago, Ill.

**MOTOR Scooters**, motorcycles, 100 mile gallon, save gasoline, tires. No priority necessary but supply limited, hurry! Illustrated catalog one dime. Clymer's 307 W. Pico, Los Angeles, California.

### AVIATION

**A & E Mechanics** Manual prepares for "multiple choice" examinations. \$3.00 postpaid or C.O.D. Aviation Publishers, Box 503, Studio City, California.

**HUNDREDS** of airplanes grounded on coasts and small airports. Send 25c for new directory of war-bargains. Super Heath Parasol, complete less motor, \$35. Motors \$20 up. Used Aircraft Directory, Athens, Ohio.

**MOTORCYCLE Engines** with air propellers \$45. Storms, 199 Broadway, Asheville, N. C.

**AVIATION** Cadet examination preparation by home study course. Rutherford Preparatory School, Long Beach, Calif.

### BATTERIES—GENERATORS— ETC.

**EDISON** Lifetime storage batteries for light and power. Eliminate acid battery diseases. Long guarantee. All kinds rebuilt generating plants, motors, and miscellaneous articles at bargain prices. Free interesting literature. T. Hawley Smith Co., Croton Falls, N. Y.

**NEW** Inexpensive method puts failed batteries back into car, truck and farm-lite service. No magic fluid. No lead burning. Complete instructions \$1.00. Popular Service, Dept. C, Racine, Wis.

### ELECTRICAL SUPPLIES—EQUIPMENT

$\frac{1}{2}$  **HORSE**, 3450 Speed, repulsion induction alternating motors \$12.50; 500 watt, alternating current generators \$29.50; other sizes. Butler Electric, 1885 Milwaukee, Chicago.

**ELECTRIC**—Fence chargers, fly traps, insect killers, screens, calf weaners, stock prods, fire detectors, burglar alarms. Gardenhour Mfg., Waynesboro, Penna.

**ELECTRO-MAGNET** Plans, Circulars 5c. Terry Sales, Central Station 1676, Toledo, Ohio.

**FREE!** 1942 Catalog—1000 electrical bargains. LeJay Manufacturing, 847 LeJay Building, Minneapolis, Minn.

$\frac{1}{6}$  **H. P. Westinghouse** 115 volt direct current electric motors, \$4.75. Will easily pull  $\frac{1}{4}$  h.p. loads on pumps, churns, milkers, shredders, shears. Send check or money order to CMCO Electric, 514 Van Buren, Chicago.

**ELECTRIC Pencil**: Writes-engraves all metals. \$1.00 postpaid. Beyer Mfg., 4515-H Cottage Grove, Chicago.

### WELDING—SOLDERING—PLATING

**ARC Welders** wanted by the thousands. Learn with 516 page lessons manual. Over 500 how-to-do-it photos. \$2.00 copy. Money-back guarantee. Hobartweld, Box M-1124, Troy, Ohio.

**BUILD** d.c. Arcwelder without rewinding armature. Plans \$1.00 each. 25 to 600 amperes from vehicle motors, light plant generators, automobile starter-generators. Welders Club, AB-3432 M-Mart, Chicago.

### MACHINERY—TOOLS—SUPPLIES

**CONCRETE** Building block machines and molds. Easy payments. Catalog free. Concrete Machine Co., 5129 South Compton Ave., St. Louis, Mo.

**MACHINE** Shop power tools from scrap. Book \$1.00. Simplex, Box 260-P, Pontiac, Michigan.

**SHAPERS**, Milling machines, etc.—Save up to 5/8ths the cost of practical machine tools by building them yourself from Lewis castings. Foundry castings supplied with or without major machining operations. These tools handle commercial jobs that pay profits. Send 10c for new catalog showing low-cost castings for 24 projects. Lewis Machine Tool Company, Box 116, Station A, Dept. M22, Los Angeles, Calif.

**PLANS** For making internal keyway cutter lathe attachment. \$1.00. Cut square holes, broaching, etc. Hobson, 422 So. Dearborn, Chicago.

GRIND Drills like factory: attachment for bench grinder. Cheap. Factory, 811-B East 31, Kansas City, Mo.

RECLAIM Dull and broken drills with Nu-Way Drill Grinder. Circular free. Tractor-Lite Mfg. Co., Sidney, Iowa.

13" x5" WILLARD Lathe with rap. No 2 Pratt & Whitney hand milling machine, four step cone drive. Write for full particulars. Cincinnati Machinery & Supply Company, 217 E. Second St., Cincinnati, Ohio.

#### ENGINES—MOTORS—DYNAMOS

BIG Pay Jobs in welding. Complete welding lessons and reference book. 516 pages. 41 lessons. \$2.00 copy. Money-back guarantee. Hobartweld, Box 1125-M, Troy, Ohio.

ELECTRIC Light and power system. Wittle full Diesel engine "V" belted to 3500 watt a.c. generator. Very good condition. Price \$625.00. Will ship C.O.D. anywhere. H. L. Phillips, Glen Moore, Penna.

1/2 HORSE, 110 Volt, induction motors. Rebuilt, guaranteed \$9.75; other sizes. Wilmot Auto Supply, 2247 St. Paul Ave., Chicago.

WINDING Data, 225 motors, single and three phase. \$1.00. Motor Data Co., Box 7631, Kansas City, Mo.

#### BOATS—OUTBOARD MOTORS—ETC.

REBUILT Outboard motors. Fully guaranteed. Over 300 to pick from. Send 10c for complete list. Boat design book 15c. Buy now before prices advance. Chicago's largest dealer. Masters & Son, 214 West Chicago Avenue, Chicago.

TEN Plywood boat plans 50c. Catalog boat building plans 10c. The Rudder, 15 Murray Street, New York.

OUTBOARD Motors, used parts. Outboard Exchange, 1194 Remsen Ave., Brooklyn, N. Y.

FULL Size, cut to shape boat patterns, blueprints. 7 1/2 - 38 feet. Illustrated "Build a Boat" catalog, 10c (coin). "How to Build Boats" book, \$1.00. Cleveland Boat Blueprint Co., Station A-66, Cleveland, Ohio.

BOAT Designers are highly paid professionals. Complete course by mail. Catalog. Westlawn, Montville, N. J.

OUTBOARDS — Save 1/3. Good used parts, all makes and models. Bargains rebuild motors. Crandall Hicks Co., 959 Commonwealth, Boston, Mass.

FORD-Mercury-Zephyr marine conversions. Catalog 10c. Lehman Engineering Company, Dept. D, Newark, N. J.

#### ATHLETIC EQUIPMENT—BODY BUILDING COURSES

SUPER Ju-Jitsu—lightning defense and attack system. Sensational new home study course now ready! Learn to lick brutes twice your size with only your bare hands. Free details. Nelson Co., 500 Sherman, Dept. L-508, Chicago.

LEARN Handbalancing quickly. Glorious fun! W. Power, 923 W. Vine, Kalamazoo, Michigan.

BAR-BELLS. Exercise equipment. Courses. Special offers! Free booklet. Good Barbell Co., 3261-PM Watson Rd., St. Louis, Mo.

#### SPORTING GOODS—GUNS—FISHING TACKLE—ETC.

SEND 10c For list 100 used guns. Frayseth's, Willmer, Minn.

ARCHERY Equipment: Catalogue free. Mid-West Archery, 2209-A East 75th, Chicago.

BUCKSKIN Tan by genuine Indian method. Instructions plus buckskin shirt pattern for 50c. E. Evans, 30 West Washington, Chicago.

WHOLESALE Prices, flies, streamers, bugs, lures, fly tying and lure making materials, complete stocks, catalog free. Supreme Mfg. Co., Amarillo, Texas.

USED Guns, bought, sold, exchanged. List stamp. Howe Fur Company, Coopers Mills, Maine.

TIN-CAN 22 Silencer, sounds like air-gun. "Teluhov" plans \$1.00. Spencer Laboratories, Akron, Ohio.

"RAISE Earthworms for Profit." Information free. Stamp appreciated. Bureau Zoological Research, 106 "P" Broadway, Peoria, Ill.

#### FIELD GLASSES—MICROSCOPES—TELESCOPES

BINOCULARS—All makes, domestic and foreign binoculars repaired, replacements made and accurately collimated. Prices reasonable. Three days service. Maryland Precision Optical Co., 1 and 3 North Carey St., Baltimore, Md.

LENSES—Build your own telescopes, field glass, microscope, rifle scope, etc. Assortment of fifteen lenses—\$1.00 post-paid. Thirty lenses—\$2.00. Slightly chipped on edge. Satisfaction absolutely guaranteed. American Lens Company, 1313 Vine Avenue, Park Ridge, Illinois.

#### ANTIQUES—RELICS—INDIAN GOODS—CURIOS

RELICS, Minerals, coins, miniatures. Catalog 5c. June's Antiques, Northbranch, Kansas.

25 GENUINE Indian arrowheads. \$1.00. Catalog. Geo. Holder, Glenwood, Ark.

INDIAN Relics, coins, bills, gems, crystals, curios, etc. Illustrated catalog 5c. 100 ancient arrowheads \$3.00. H. Daniel, Hot Springs, Ark.

INDIAN Relics, beadwork, coins, curios, minerals, old glass. Catalog 6c. Indian Museum, Osborne, Kansas.

#### TAXIDERMY

RUGS—Grizzly, polar, black or brown bear, tiger, mountain lion, bobcat, coyote, leopard. Game heads—Deer, elk, sheep, antelope, moose. Hundreds of choice specimens at unusually low prices. Sent on approval to reliable persons anywhere. Write today for selection and price list. Jonas Bros., 1049 Broadway, Denver, Colorado.

#### DOGS—PETS—BIRDS—RABBITS

ST. BERNARD Puppies. Champion sired beauties. Franklin Young, R4, Riverhead, Long Island, New York.

GREAT Dane pups on approval. Time payments. Kalmir Dania, Stone-Mountain, Georgia.

BOXERS, Pugs, Cocker, Kerry Blue, Pyrenees, Dachshunde, Chows. Keegan Kennels, Saco, Me.

FERRETS—Kill your rats with ferrets. Henry Hainline, Creston, Iowa.

PUPPIES. Many breeds—particulars free! Book 108 colored pictures, descriptions recognized breeds, 35c. Royal Kennels, No. 91, Chagy, N. Y.

ANIMALS, Birds, reptiles. All kinds. Send stamp for lists. Snake King, Brownsville, Texas.

#### TREES, SHRUBS, PLANTS, HERBS

25 VARIETIES, Cactus plants postpaid \$1.50. Mixed seed 25c. Art Glover, San Dimas, Calif.

#### FARMS—FARM LANDS—REAL ESTATE

SPORTSMAN'S Camp; 100 acres—In Catskill Park Game Preserve—excellent hunting, fishing in nearby lake and streams; 2000 sugar maples, evaporator house; 8-room furnished dwelling, barn, hennery, \$1800, \$800 down; picture page 30 big catalogue, write for free copy. Strout Realty, 256-P 4th Ave., New York City.

CATALOG New Mexico real estate 10c. Box D, New Mexican, Santa Fe, New Mexico.

GOVERNMENT Land \$1.00 acre up. Information all states 25 cents. National Tax Service, 1037A Majestic Bldg., Detroit.

10 ACRES Good Florida land \$50.00. \$5.00 down, \$5.00 monthly. R. W. Stewart, Inverness, Florida.

GOOD Farm bargains. Washington, Minnesota, Montana, Idaho, Oregon, North Dakota. Dependable crops, favorable climate. Write for literature and lists describing farms for sale. Specify state. J. W. Haw, 119 Northern Pacific Ry., St. Paul, Minn.

40 ACRES. Near White River, unimproved; poultry land, \$190, \$5 down, \$3 monthly. Free list and literature. Hubbard, 216 Grossman Bldg., Kansas City, Kans.

SEE The Highlands of Louisiana. Choice cut-over land selling at low prices on liberal terms. Descriptive book sent upon request. Long-Bell Farm Land Corp., 878 R. A. Long Bldg., Kansas City, Mo.

INVERNESS, Florida, has great activity contemplated. Small farms very reasonable. Buy now before boom. Fort Dearborn Realty, 905 W. 87 Street, Chicago.

#### POULTRY AND FARM SUPPLIES

MAKE Poultry profits the American way. Monthly helps and suggestions cost less than 3c. One idea may net many dollars. Only 25c year, coin or stamps. American Poultry Journal, 533 S. Clark, Chicago.

POULTRY Profit-making. Monthly tips on raising, laying, feeding. New ideas. Get America's leading poultry magazine. One year 25c; five years \$1. Poultry Tribune, Dept. 22, Mount Morris, Ill.

#### PROFITABLE OCCUPATIONS

MAN. You'll like silvering mirrors, making chipped glass nameplates, signs, markers, mottoes. Outfit prices. Sprinkle, Plater, M288, Marion, Indiana.

WELDING Pays. Learn with 1942 trade school text manual. 516 pages. Over 500 photos. \$2.00 copy. Money-back guarantee. Hobartweld, Box M-1123, Troy, Ohio.

RAISE Angora rabbits—wool brings \$5.00 pound. Particulars free. Grinstead's, Edwardsville, Illinois.

MECHANICALLY Inclined men — Own and operate general appliance repair shop. Complete, illustrated course shows you how. Welding, refrigeration, motor repair, how to get business, etc., all phases covered. Free literature. Christy Supply, Dept. 422, 2835 N. Central Ave., Chicago.

RAISE Nutria, fur like beaver, vegetarians, write Specialty Farm, Rockford, Minn.

ANNOUNCING New home study course in commercial baking. Good field. Nearly depression proof. Common school education sufficient. Send for free booklet "Opportunities in the Baking Industry" and requirements. National Baking Institute, 1315 Michigan, Dept. 3433, Chicago.

STANDARD Rabbit Journal, Milton, Pa. 3 years, \$1.00, sample time.

RAISE Chinchilla rabbits for us. We pay up to six dollars each. Catalog and contract 10c. Book catalog. Year subscription Rabbit Magazine 25c. Stahl's, Box 10, Holmes Park, Mo.

\$40.00 WEEKLY. Made growing mushroom, fresh, dried. Dominion patent 331583. Free spawn. North American, 169Y Yonge, Toronto, Canada.

#### BOOKS—PERIODICALS—PICTURES—POSTCARDS

BUSINESS, Trade and diversion magazines. Current copies, 438 different publications, representing 122 vocations, to choose from—mechanical, electrical, building, plumbing, live stock, poultry, printing, journalism, photography, advertising, music, hobbies, stamp collecting, patents, mail order, radio, aviation, sports, etc. Free price list. Commercial Engraving Publishing Company, 34C North Ritter, Indianapolis, Indiana.

FREE—100 Page book catalog. New and used college and home study text and reference books at a saving. Est. 1902. College Book Co., Dept. M, Columbus, O.

EXCELLENT Sparetime profits taking subscriptions—2500 magazines. Complete starting supplies free! Pines, 583 Monroe, Brooklyn, N. Y.

BUSCH Press. 200 magazines free. 15 or more each month. Many carry no advertising—all meat. Timely—informative. Busch Press, P-2405 South Karlov, Chicago.

BOOKS On every sport. Catalog free. Dare, 670E42, Brooklyn, N. Y.

BACK Number magazine bargains. Complete year Readers Digests 1937-1941, choice 60c postpaid. Catalog 3c. Corey's Exchange, 355 N. Clark St., Chicago, Ill.

REBINDING: We assemble and bind magazines. Have your old books, Bibles, and hymnals rebound. Durable! Attractive! Prices are reasonable. Heckman Bindery, Dept. D, North Manchester, Ind.

WARPLANE Photographs. Specimen and list (1,000 titles) send 25c. Real Photographs, Ltd., Southampton, England.

MAKE Your own herb medicines. Beautiful illustrated recipe book 10c. Botanic, Box 1109, Evergreen Park, Illinois.

ANY Book (new, used, out-of-print, rare) promptly supplied! Lowest prices! Send for free bargain catalogues! Old Prof's Book Shop, M16 Arcadia Court, Pontiac, Mich.



## MAGIC TRICKS—PUZZLES—JOKER NOVELTIES

**MAGICIANS**—One dollar brings book on Miracle Magic. Guaranteed to produce these results: It will make miracle of our magic, open a new field in magic, be of interest to the entire show business, create audience thrills and applause, and be of service to our country and to the magic profession. Special deals for clubs and companies. Send to Charles Polk, Arcadia, Florida.

**MAGIC Tricks, apparatus, illusions, luminous paints and articles, joker's novelties, new catalog 10c.** Mac's Magic Shop, 506-B Main, Ft. Worth, Texas.

**BECOME Master magician.** Write Harry X. Willis, Box 1704, Cleveland, O.

**WORLD'S Cleverest magical tricks.** Delux catalogue 10c. Magicraft, Heights Station, Houston, Texas.

**FREE Trick and professional magic catalogue 25c.** St. Louis Magic Studio, 418 Olive, St. Louis.

**MYSTIFY Friends!** Type notes on dishes, windows, etc., as if you ran them through your typewriter. Directions 25c. Mathrix Co., P.O. Box 1707, Boston, Mass.

**LEARN Ventriloquism.** Send for free folder. State age. Fred Maher, 1700 N. Casgrain Avenue, Detroit, Michigan.

**NEW Vanishing key and catalog 25c.** Sterling Magic, 345 John R, Detroit, Mich.

**DOLLAR Magic set free with colossal catalogue 25c.** Magex, 4462 Germantown, Philadelphia.

**DOUGLAS' Famous 1942 catalog of 500 tricks you can do!** Brand new effects for pocket, parlor or stage. Send 10c for year's biggest catalog value. Douglas Magic Shop, Box 274, Dallas, Texas.

**HOLLYWOOD Special! Magicians button, catalogue, ghost illusion and free trick for 25c.** Magic House of Charles, Box 888, Hollywood, California.

**WORLD'S Largest professional magic shop keeps you in touch with latest tricks.** To receive mailings send 25c for 1942 catalog. Holden, 220 W. 42nd St., New York.

**MAGICIANS' Headquarters.** 216-page catalog, pocket, parlor, professional tricks. 25c. Kanter's, M-1311 Walnut, Philadelphia.

**FREE—Big list of helpful books.** Popular Mechanics Press, 200 E. Ontario St., Chicago.

## COINS—TOKENS—CURRENCY

**OLD Money wanted.** Do you know that coin collectors pay up to \$100.00 for certain U. S. cents? And high premiums for all rare coins? We buy all kinds. Send 4c for large coin folder. May mean much profit to you. Numismatic Co., Dept. 20, Fort Worth, Texas.

**THREE Coins and lists 10c.** Oddehon, Overland Station, Saint Louis, Mo.

**WE Buy Indian cents, Lincoln cents, old money.** Send 10c today for 1942 catalogue of prices. We pay for all wanted U. S. coins. American Rare Coin Co., Dept. 1, Transportation Bldg., Chicago.

**CENTS 100 Years old 25c.** 10 different Indians 25c, large illustrated coin book 50c, list 3c. Coin Shop, Alameda, Calif.

**COMMEMORATIVE 1/2s.** Columbus, Stone Mountain, Long Island \$1.00 each. Large illustrated catalogue 25c. Norman Shultz, Salt Lake Utah.

**10 INDIAN Head cents, different dates, also price lists 35c.** Schultz, 1053 Richmond, Cincinnati, Ohio.

**30 DIFFERENT Indian cents \$1.50.** Sales list free. Wittlin, 1681 Broadway, New York City.

**FREE! Foreign coin, banknote and large 50 page illustrated coin catalogue to approval service applicants.** Send 3c postage. Tatham Coinco, Springfield-125, Mass.

**OLD Money wanted.** Big premiums paid. 1,000 quotations. Catalogue 10c. Allan Appell, Sedalia-6B, Missouri.

**I MAY Have just the scarce U. S. coins you want.** Send me list. "Meet me by mail." William H. Kenworthy, Waterville, Maine.

**GET Profit and pleasure in collecting old coins.** Send 10c for 56-page illustrated coin catalog. You'll be delighted with it. Send for it now. B. Max Mehl, 370 Mehl Building, Fort Worth, Texas. Largest rare coin establishment in U. S. Established 42 years.

## OLD STAMPS WANTED

**I WILL Pay \$100.00 each for 1924 1c green Franklin stamps, rotary perforated eleven (up to \$1,000.00 each unused).** Send 6c today for large illustrated folder showing amazing prices paid. Vernon Baker, (211-P.M.), Elyria, Ohio.

## STAMP COLLECTING

**16 PAN American sets 10c.** To attract approval applicants of the better type we are making the following amazing offer: From our good neighbors in the Western Hemisphere 16 sets from 16 countries: Mexico 729-33 complete. Canadian Royal Visit complete, Puerto Rico 85-86, Jamaica George 2 values, Ecuador map, Guatemala birds 2 val., Venezuela 80, British Guiana new waterfalls, Old Newfoundland, Bolivia postal tax complete, Peru map and pictorials, Colombia 2 RA pictorials, Chile transportation pictorials 3 val., Paraguay commemoratives 2 val., Brazil 5 val. We will send all these for only 10c to sincere approval applicants. Kindly state whether you wish "on approval" United States, foreign or both. Approval Headquarters, Globus Stamp Company, 268 Fourth Avenue, New York City, Dept. 201.

**FREE—F. D. Roosevelt complete mint Brazilian Pan-American Union set picturing our Commander-in-Chief, Vargas and map of Americas with 114 different up-to-date values from: South America, our good neighbors United Nations, heroic Russia and war-torn Europe in commemoratives, pictorials, airmail and new issues—cataloging \$2.54 to new approval applicants only 10c.** Intercity Co., Dept. V, Port Washington, N. Y.

**GIVEN! Albums, hinges, ten commemorative sets, including U. S. artists, musicians, fair; British coronation, jubilee, Rumanian aviator; triangle, diamond, others including \$1, \$2 and \$5 U. S. to approval applicants—5c.** Baldwin Stamps, Haworth, N. J.

**\$40 PORTUGUESE! \$10 U. S.!** Austrian war set! New Zealand centennial set! Cuban tobacco set! Four Estonia Perforation gauge! Watermark detector! Only 5c with approvals. Elk Stamps, 2-1113 Smith, Charleston, W. Va.

**POSITIVELY Greatest free offer—Latest Scott's International \$4.00 Stamp Album—covering entire world, contains 36,000 illustrated, descriptive spaces; Scott's 1942 Standard \$3.50 Catalogue "Philately's Encyclopedia"—absolutely free to applicants for foreign approvals becoming customers.** Bargain Stamp Service, Palm Springs, California.

**SENSATIONAL Combination offer! Big packet 105 different including Iceland, Manchukuo, Ecuador (American flag in full colors), Danzig; airmails, commemoratives, triangle stamp, \$4 United States; complete set United States telegraphs, cataloging 20c.** Packet British Colonies, including Gwallor, Hyderabad, Burma (new country) jubilee and coronations, Scarce Far Eastern republic cataloging 50c. Big illustrated lists of other bargains. Total catalog price over \$3.00! All for only 5c to approval applicants! World-Wide Stamp Company, Department 600-N, Camden, New York.

**FREE Outfit! Album, stamps, hinges, gauge, detector, lists, to serious approval applicants.** 5c postage. Manchester Stamp Company, Manchester, Connecticut.

**UNPICKED Mixtures; large variety: 5000 U. S. 1870-1939, \$1.50. 6000 British, \$1.25. 2000 foreign, \$1.00.** Satisfaction guaranteed. Kuhn, 3712 - 85th, Jackson Heights, N. Y.

**FINE Approvals, freshly mounted.** Fast, personal service. Tell me what countries you prefer and I'll send their stamps. Skinner, 345 East Ocean, Long Beach, Calif.

**FREE.** Twenty-six beautiful, different, unused Russian stamps to sincere approval applicants sending 3c postage. Bridger, New Windsor, Illinois.

**FREE 25 Different Canada; approvals.** Knight, Box 3780, Portland, Oregon.

**U. S. \$5.00 (No. 573) 25c with approvals.** Ruthandaie, 569 Staples, San Francisco.

**ARGENTINE 100 Different 40c.** R. Provost, 32 Gloucester, Boston, Mass.

**FREE French stamps—free.** 1/2c and 1c. Lists. Utoch, Columbia, Penna.

**U. S. Commemoratives—78 different, 25c.** Crystal Stamp Co., Racine, Wis.

**YOU Get better stamps on approval from Kardasz & Co., 1575 W. Holt Ave., Milwaukee, Wis.**

**U. S. Mixture, 2 lb. \$1.00.** Zipper, 3220 Parade, Erie, Penna.

**SEYCHELLES, Neid, Caymans, Manchukuo, Brunei, Turks Caicos, British Solomons (Cannibaland), Everything 3c with approvals.** Viking, 130-Z Clinton St., Brooklyn, N. Y.

**ALBUM \$1.00, Stamps 25, 10c; 100, 25c.** Estes Stamps, 265 Alexander St., Atlanta, Ga.

**50 DIFFERENT Ships, railroads, etc.** 10c. Approvals. Buchanan, 307 East 23rd, New York.

**EXCELLENT Pictorial approvals ranging from 1c.** Crown Stamp Co., Box 331, Toronto, Canada.

**3c DEFENSE Errors.** Imperforate between pairs, blocks. Riedell, Greensburg, Penna.

**WAR Set! South African nurse, soldiers, RAF pilot.** 6 values, only 15c with approvals. Liberty Stamp Co., Rutland Heights, Mass.

**50 HYDERABAD, Travancore, Charkhari, British Colonies 3c.** Approvals. Cymerman, 177 Huron, Brooklyn, N. Y.

**5 SETS Western hemisphere 5c.** Approvals. Post Horn Stamps, Dept. A, Los Alamitos, Calif.

**4,000 U. S. Foreign \$1; approvals 1c; sets 10c.** Grist, 409 Oak, Davenport, Iowa.

**100 U. S. Catalog \$3.00 and bargain price list.** Al. Johnson, 727 North Foote, Colorado Springs, Colorado.

**STAMP Cat. \$3.00 free.** Approvals. R. Augsburg, 432 W. Maumee, Adrian, Mich.

**60 DIFFERENT United States 10c.** Pricelist free. Seidenberg, Baroda, Mich.

**OUTSTANDING U. S. values.** Free list. Ewing, 109 North Dearborn, Chicago.

**UNPICKED! 100 Revenues on documents—10c.** (700-50c). Vanvoorhis, Hyndman, Penna.

**DISPENSING Japanese stock! 3c stamp brings approvals and large free portion.** Romayne Case, East Rutherford, New Jersey.

**FORTY Countries, including Fiji in this packet, 100 different stamps, 10c.** Elesa, Bowling Green, Ohio.

**1000 STAMPS, Prize packet, 25c.** Nagle Stamp Shop, North Judson, Indiana.

**MINT Clark 5 cents; United States and foreign approvals.** Gobrecht, 205 Anderson, Joliet, Ill.

**20 AIRMAILS 5c With approvals.** Elm Stamp Company, Dept. A, E. Providence, R. I.

**SWAP Duplicates with collectors everywhere.** Dime brings Swappers' Guide. Stamp Swappers, R.1102, 480 Lexington, New York.

**MEXICAN Stamps.** New extensive price list just out. Free upon request. Julio Fabian, Bajio 343, Mexico D.F., Mexico.

**FREE! Russia war set.** Postage 3c. Williams, 606 Archer, Bay City, Michigan.

**19th CENTURY U. S. commems.** Civil War revenues, battleship \$5 and \$10 stamps, 1942 illustrated U. S. catalogue. Free to U. S. approval applicants. Metropolitan Stamps, 198-P Broadway, New York.

**SELL Stamps.** \$44.75 retail for \$10.00. Sets, singles, hinges, etc. Ellis, 55-P Reade Street, New York.

**U. S. Mixture.** \$1 presidential guaranteed. 50c lb., 3 lbs. \$1.25. Stamphouse, 3042 Warwick, Chicago.

**BIG Packet, commemoratives, pictorials, Eastern Roumelia, Bhopal 5c.** Approvals. Superior, 1019 Greyton, Cleveland Heights, Ohio.

**50 FREE.** Kwangchowan, etc. Illustrated album 3c. Bullard, Newcastle, Me.

**U. S. Parks complete 12c.** Better grade approvals. Box 488, Minneapolis.

**FREE Your choice of any 10 stamps from our first U. S. approval selections, plus illustrated 1942 U. S. price check list.** This generous offer made to introduce one of the finest selections of U. S. approvals ever offered. Cosmopolitan Stamp Co., Dept. M, 1457 Broadway, New York.

**UNUSED Mexican airmail set, cat. 75c.** Free, with our economical approvals. Saguro Stamps, Yuma, Arizona.

**FREE! 15 Brazil.** Request approvals. Send postage. Lucky, 745 Josephine, Glendale, Missouri.

**LIQUIDATING Dealer's stock into 50c or \$1.00 lots.** No junk. No approvals. Block, 2850 Clafin, Bronx, N. Y.

**INTERESTING** Mixtures: Pound U. S. \$1.15; foreign \$1.40. Hermes Stamp Company, Box 276, Hempstead, N. Y.

**BEAUTIFUL** Embossed air-mail cover with Alaska photo-stamp. Send 20c stamps or coin. Alaska Sportsman, Ketchikan, Alaska.

**LOWEST** United States stamp prices. Free illustrated catalogue. Creevey's, Berwick, Penna.

**1000 MIXED** U. S. old and new 25c. Weatherby, Troy, Ohio.

**40,000 VARIETIES** Available on approvals 1/4c up. We buy collections, pay \$5.00 to \$1000.00 cash. PKEigwin Stamp Co., Vineland, N. J.

**TEN Crazy-shaped stamps**, 3c with approvals. Knopp, Box 1381, Bristol, Conn.

**BRITISH** Empire collection! Burma, Cyprus, Gwalior, Sarawak, Tasmania; also 50 other British only 5c with pictorial and commemorative approvals. Lyman, 95 Nassau, New York City.

**ALL Different**, 9 Plume, 5 Palestine only 7c to approval applicants. Wonder Lake Stamp Co., Ringwood, Ill.

**FREE!** Western Hemisphere packet. Postage 3c. Owens, 806 Welsh, Bay City, Michigan.

**1000 U. S. Mixed**, dime and 4c postage. Jem Stamps, Port Jefferson, N. Y.

**FREE!** Complete "United States" stamp catalog with 1,000 illustrations! Send 3c for postage. Harris & Co., 137 Transit Building, Boston, Mass.

**VICTORY** Packet free—Includes stamps from Tanganyika, British Cayman Islands, animal, scarce babyhead, coronation, early Victorian, airmail, map stamps, with big catalogue—all free. Send 5c for postage. Gray Stamp Company, Dept. PM, Toronto, Canada.

**MEXICO** Census commemorative set free with approvals. Pladon Stamps, 1717-M Idaho, Toledo, Ohio.

**WHOLESALE** Supplements to dealers for 10c postage. Hundreds of bargains. Grossman Stamps, 102 West 42nd, New York.

**15,000 VARIETIES** 1c, 2c each! Davison, Box 31A, Wollaston, Mass.

**FREE!** Pony Express set (facsimiles). Postage 3c. Roberts, 406 Building, Bay City, Michigan.

**FREE!** Leeward Is., Cayman Is., Turks and Caicos plus 60 different mint Geo. VI coronation poster stamps, to approval service applicants sending 3c postage. Tatham Stampco, Springfield-30, Mass.

**UNITED STATES** approvals complete coverage, fine quality, attractive prices. Seminole Stamps, Box 436, Coconut Grove, Florida.

**WEEKLY** Stamp magazine, thirteen weeks, 10c. Stamp Journal, Kalamazoo, Mich.

**A REAL Bargain**. Specially prepared packet containing 150 different foreign and 65 different U. S. stamps; catalog value about \$5.00; pamphlet which tells you "How to Make Your Stamp Collection Properly" and large bargain lists, all for only 23c postpaid. Queen City Stamp Co., Room 36, 604 Race St., Cincinnati, Ohio.

**PENNY Approvals**, that satisfy. Neil Gronberg, Box 5441-P, Philadelphia, Penna.

**\$1.00 (CAT. Price)** for 1c! Two mint U.S.A., cat 20c; "queer countries" packet (Djibouti, Manchuria, etc.); scarce set Russia, cat. 75c. Everything for only one cent to approval applicants! Garcelon Stamp Company, Box 400, Calais, Maine.

**GIANT** Packet 136 all different from Africa, South America, South Sea Islands, etc. Includes Nicaragua airmail, two scarce unused United States cataloging 20c, triangle and animal stamps; many others. Also includes fine collection 25 different British Colonies—Charkari, Jamaica, Johore, etc. and United States \$4 and \$5 high values. Total catalog price over \$4.00! Everything for only 5c to approval applicants! Mystic Stamp Company, Department 80-A, Camden, New York.

**SEND** Postage for free United States price list. Stanley Gibbons, 38-P Park Row, New York.

**CANADA** 100 Different 25c—approvals all countries. Lists. Victoria Stamp Co., London, 4, Canada.

**SMOKY** Mountain commemorative sheet, largest U. S. stamp issued, and 33 U. S. including commemoratives, airmail, revenues, etc. Catalogs 75c—To approval applicants for 5c. Curhan Stamp Company, Gloucester, Mass.

U. S. \$2.00 stamp No. 572 (perf. init.) 10c to approval applicants for U. S. approvals. M. Haycock, 61A O'Brien Place, Brooklyn, N. Y.

**UNUSUAL** Packet free with approvals. Stampdom, 3808 - 12th Avenue, Brooklyn, N. Y.

**EXCHANGE** Better duplicates with collectors. Particulars—3c. Rubin, 148 Chestnut, Liberty, New York.

U. S. 1/2c; 1 1/2c; Overprinted Canal Zone, 5c. Approvals. Dargis Stamp Service, 2226 Falls, Niagara Falls, N. Y.

### HOBBIES AND COLLECTIONS

**SPECIAL** Albums for match books. Albums, also, for photographs, phonograph records, etc. Free booklet. Matchless Album Co., Dept. P. Long Branch, N. J.

**"STRIKE 'Em Dead"** (Japs), new match sensation 50c carton of 10. San Francisco and famous bridge set of 12, 50c. Kiwert Cliff House, San Francisco.

**20 DIFFERENT** Cactus plants postpaid, \$1.00 seed, 25c. Eulalia Turner, Azusa, Calif.

**WANTED:** Old cigarette cards. Write Charles Bray, East Bangor, Penna.

**20 DIFFERENT** Cactus plants \$1.00 postpaid. Lida Delap, Azusa, Calif.

**POSTCARDS**, Music records, Lists 10c. Songwriting, Fore's, (Dept. R), 3151 High, Denver.

**20 DIFFERENT** Cactus plants postpaid, \$1.00. Eulalia Turner, Azusa, Calif.

**BEAUTIFUL** Abalone shells, brilliant finish—make beautiful gifts and decorations. 12 assorted prepaid \$1.00. Abalone Shells, Box 66, Rockport, California.

**BEAUTIFUL** Jewelry stones removed from rings, etc. 100 assorted \$2.00. Lowe's, Box 311, St. Louis, Missouri.

**NEW—15** Different match covers 10c. Box 202, Rochester, N. Y.

**EXCHANGE** Your duplicate stamps, match covers, etc. with collectors everywhere. List swappers, dime. (Mention hobby.) Secretary, Box 2166, Denver, Colo.

**75 THOUSAND** Political buttons, rare kind, 40—\$2.00 postpaid. S. Hoffman, 929 Locust St., Philadelphia.

### CAMERAS AND PHOTO SUPPLIES

**CAMERAS** And supplies. Free illustrated catalog listing everything photographic—still and movie cameras, films, lenses, enlargers, meters, supplies—at tremendous savings. Hundreds of bargains. All guaranteed. We take your old camera or equipment in trade. Write now for your free copy of our newest money-saving bargain book—just out! Limited edition. Hurry! Central Camera Co. (Photographic Headquarters since 1899), 230 S. Wabash Ave., Dept. K-16Z, Chicago, Illinois.

**SPEED-O-COPY** Groundglass focusing attachment for Leica, Contax, Argus C-2 and C-3. Send for literature. D. Paul Shull, Dept. PM-10, 240 So. Union Ave., Los Angeles, California.

**OIL** Coloring photographs a fascinating hobby or profitable business. Learn at home. Easy simplified method. Previous experience unnecessary. Send for free information and requirements. National Art School, 1315 Michigan, Dept. 3447, Chicago.

**HAVE** You a camera? Send ten cents for recent number of our big magazine, showing how to make better pictures and earn money. American Photography, 116 Camera House, Boston, Mass.

**BASS** Says: Astounding buy, exclusive here, latest Argus C3 with coupled range finder, synchro flash, 50 mm. F:3.5 lens, also 75 mm. Bausch & Lomb telephoto F:5.6 also coupled to range finder, \$82.50 value; price \$60.50, unconditionally guaranteed. Cowhide Eveready case, \$4.75. V. P. Hagee Deluxe, F:4.5 lens, Prontor shutter, big value at \$18.75. Send for yours quick while they are available. Write for quotations and advise what you have to trade. We pay cash for good cameras, lenses, binoculars. Don't trade until you write Bass Camera Company, Dept. AG, 179 W. Madison St., Chicago.

**MAKE** Money in photography. Learn quickly at home. Easy plan. Previous experience unnecessary. Common school education sufficient. Booklet and requirements free. American School of Photography, 1315 Michigan, Dept. 3432, Chicago.

**CAMERA** Repairing. Bellows made to order, shutters repaired. Bellows made to fit all standard cameras! United Camera Co., Inc., A-1515 Belmont, Chicago.

**CASH!** Spot cash for cameras, lenses, binoculars, movie or still, sound projectors. Send full description by mail, or wire for prompt cash offer. Over 30 years of dependability insure honorable dealings. Bass Camera Company, 179 West Madison Street, Chicago, Illinois.

### PHOTO FINISHING

**8 EXPOSURE** Films developed—all prints enlarged to post card size, 25c plus 3c stamp. Picture Man, Dept. 100, Park Ridge, Illinois.

**EMBOSSD** Deckled edge Christmas cards including envelopes from your own negative, 25 for \$1.25; 12 for 75c. Sample order 4 for 25c. Film Capitol Service, Box 504, Rochester, N. Y.

**BIGGEST** \$1.00 Value in 35 mm. finishing today. 36 exposure fine grain 3 1/4x4 1/2 enlargements; deckled, embossed margin and date. Eighteen exposures 75c; sixteen exposure splits 55c. Free mailers. 8 exposure rolls in beautiful deckled contact finish with embossed wide margin, 25c. Mailbag Film Service, Box 5440 A, Chicago.

**16 SPARKLING** Lifetone prints, 2 beautiful Hollywood enlargements, free Leathertone frame and photo wallet only 25c. Free photo album with first order. Lifetone Studios, Dept. A-1139, Des Moines, Iowa.

**ROLL** Developed, eight snappy 4x6 enlargements, or sixteen sparkling prints 25c. Crystal Studios, Box 159-F, Rushford, Minnesota.

**ROLLS** Developed: Two prints each negative 25c. Reprints 2c each. Summers' Studio, Unionville, Mo.

**ROLLS** Developed two sets prints 25c. Reprints 25c dozen. Eshlemans Studios, Box 331, Perth Amboy, N. J.

**PHOTOSTAMPS**, Latest Xmas comics, you'll want more. Quarter, Studios, 82-29 60th Road, Elmhurst, N. Y.

**BIG 5x7** Enlargement only 10c. In set up frame 25c. Colored 30c. in frame 49c. Special quantity prices. Winholt Photo, Box 5, Woodbine, Penna.

**REPRINTS** 2c Each, 100—\$1.50. 6 or 8 exposure rolls developed 2 prints each exposure 25c. 36 exposure 35mm. rolls fine grain enlarged prints \$1.00. Mailing bags free. Mercury, A-109 North Dearborn, Chicago.

**16 SPARKLING** Lifetone prints, 2 beautiful Hollywood enlargements, free Leathertone frame and photo wallet only 25c. Free photo album with first order. Lifetone Studios, Dept. A-1139, Des Moines, Iowa.

**FREE!** Best snapshot on attractive photo button with 16 prints each roll 25c. Beautiful novelty premiums. Novel-Ad Co., B.M.-3327 North Ave., Chicago.

**OIL** Coloring photographs a fascinating hobby or profitable business. Learn at home. Easy simplified method. Previous experience unnecessary. Send for free information and requirements. National Art School, 1315 Michigan, Dept. 3437, Chicago.

**8 EXPOSURE** Rolls, giant size 25c; 16 exposure rolls, 50c. Mayfair Photos, Box 261-K, Toledo, Ohio.

**ROLL** Developed and 4x6 oversize glossy Velox prints, 8 exposure 30c; 12 exposure 45c; 16 exposure 60c. Overnight service. Clemet Photo Service, 1318 W. Columbia Ave., Philadelphia, Penna.

**IDEAL** Photos beautifully finished wide border—deckle-edge, 25c per roll of eight. Fade-proof, superior quality. Write for free mailers. Ideal Photos, Box 2255, Paterson, N. J.

**THE** Photo Mill. Immediate service! No delay! Eight exposure roll developed, printed and coupon for your choice of two beautiful 5x7 professional enlargements, one tinted enlargement, eight reprints or other premiums for 25c coin. Developing and eight Jumbo prints 30c coin. The Photo Mill, Box 629-12, Minneapolis, Minnesota.

**EVERY** Picture an enlargement! 8 sparkling deckle-edge enlargements and roll developed 25c coin; 116 size or smaller; enlarge reprints 3c. Enlarge Photo, Box 791D, Boston, Mass.

**3 1/4x4 1/2 ENLARGEMENTS** From 36 exposure roll \$1.00, 18 exposure roll 75c. Double size prints, 8 exposure 828-127-120 rolls 25c. 8 exposure 116-129-130 rolls 30c. Split rolls 45c. Write for complete price list. Village Film Laboratories, Box 4046, Dept. M, Village Station, Los Angeles, California.

**IMMEDIATE Service!** Pictures returned same day order received. Sixteen guaranteed deckled-edge Velox prints from roll, 25c. One colored or two plain enlargements plus 8 deckled-edge Velox prints, 25c. Free! Coupon for 8x10 enlargement free with each 25c order. Any 36 exposure 35mm. film fine-grain developed, "Magic-Eye" timed, vapo-rated and each good negative enlarged to 3x4 on deckled-edge Velox paper, \$1.00. 18-exposure, 60c! Reloads: 36 exposure, 50c; 18 exposure, 35c. 3x4 deckled-edge reprints, 3c each! Write for free mailers, free premium offers. American Studios, Dept. 406, LaCrosse, Wis.

**BEAUTIFUL Enlargement** from each picture on roll 25c. Cut Rate Photos, Dept. B-4, Janesville, Wis.

**THREE Prints** each good negative, 6 to 8 exposure rolls, 30c. 12, 16, 18 exposure rolls, 50c. Reprints, 3c. Fred D. Eastman, Bode, Iowa.

**ROLL Developed** and 8 lustrous distinct fish permanent Velox glossy prints 25c—reprints 3c each. Fotoprint Service, Box I, Roanoke, Virginia.

**8x10 SILK Finish enlargement—25c.** Send negative. Irving Studio, 406A Irving Park, Chicago.

**DOUBLESIZE Prints.** Your roll developed and 8 doublesize prints 25c; from 116 or 120 size negatives you receive 4x6 inch prints. All other size negatives printed in proportion. 16 exposure rolls 50c; 12 exposure rolls 35c. Reprints 3c each. "Our guarantee." Everlasting hi-gloss finish. Overnight service. Pacific Photo Service, Box 666, San Francisco, Calif.

**16 BEAUTIFUL Oversize deckled prints** and two enlargements with first order 25c. Owiphot M1, Weatherford, Oklahoma.

**PHOTOGRAPHY** For pleasure and profit. Prepare at home. Common school education sufficient. Write for information and requirements. American School of Photography, 1315 Michigan, Dept. 3451, Chicago.

#### MOTION PICTURES AND SOUND EQUIPMENT

**DEVELOP** Your own 8-16mm. movies. Save 60%. Bulk films—developers. Write Genera Company, Davenport, Iowa.

**FREE:** New movie rental library catalog. (Please specify model projector). Sale 16mm. sound projectors; 8-16mm. movie equipment, films, cameras, screens, trades accepted; easy payments. Mogull's, 64 West 48th, New York.

**CAMERAS, Projectors, films.** Lists free. (Film sample, 10c). Box 337, Valley Stream, N. Y.

**35MM. Films, Projectors, Sound, Silent.** Demsey, 1223 Berkley, Youngstown, Ohio.

**LATEST Film lists** and equipment. New film exchange. Paramount Mfg. Company, G-108, Box 224, Back Bay, Boston, Mass.

**SELECT Productions—(Catalog-sample 10c).** Midwest Cine Shop, Hannibal, Mo.

**FREE.** Movie catalog. Sample film, regular and Kodachrome, 10c. Goodwill Company, Jackson, Tennessee.

**ESO-S Univex** and double 8mm. spooled movie films save you 50%. Particulars. PM catalog. Eso-S, 3945 Central, Kansas City, Missouri.

**KODACHROME, BW, film subjects** for grownups, 8-16mm. Lists, color sample, dime. Jenkins, 392K, Elmira, N. Y.

**100' 16MM.** Used sound films, \$1.00 postpaid. Blackhawk Films, Dept. PM2, Davenport, Iowa.

**100 FT. 8mm. Subjects 98c.** Spring Films, Hopkinton, Mass.

**WANTED:** Used equipment for cash. Films, cameras, projectors, etc. Peters, 41-C South Fourth, Allentown, Penna.

**COMPLETE 8-16mm. Silent-sound subjects, \$1.** Need slicing. All sizes film, bought, sold, exchanged. Catalogue-sample film—10c. International-M, 2120 Straus, Brooklyn, N. Y.

**RENT—Buy—Sell.** 8mm.-16mm. movie equipment films. Save 50%. Catalogues for 10c. Don Elder's, M-739 Boylston, Boston, Massachusetts.

**8-MM.-16MM. Silent-sound; all latest subjects.** Films rented everywhere. Free catalogue (sample film 10c). Garden Film, 317 West 50th, New York.

**LEARN** Movie projection, management. Free catalog. Give age. Theatre Institute, Elmira, N. Y.

**8MM.-16MM. Films.** Free catalogue (sample film 10c). Parkway Exchange, 961 Eastern Parkway, Brooklyn, New York.

**"THE World's Greatest Passion Play"** Large rental library 16mm. sound or silent. Write Hemenway Film Co., 33-F Melrose St., Boston, Mass.

**BASS Says:** War time means Bass as the logical supply center for hard to get cine equipment. We have it. Write for latest condensed Cine price list, 8 mm. and 16 mm., and sound. New Revere double 8 with F:3.5 lens, \$38.50. RCA 16 mm. S.O.F. newsreel camera, \$325.00. Spot cash for good used movie equipment and sound projectors. Bass Camera Company, Dept. A, 179 W. Madison St., Chicago, Ill.

#### MUSIC AND MUSICAL INSTRUMENTS

**LEARN Popular piano!** Write Magic Key, 111-A Broadway, Glendale, Calif.

**SONGS—Song poems wanted.** No charge for melodies. Marketing service. Hollywood Recording Studios, 87G22 Preuss Sta., Los Angeles.

**SONGS Composed, arranged.** Excellent beginners proposition. Basil Alt, Ottonville, Ohio.

**SONGWRITERS—Write today for free,** explanatory booklet, plan. Song Service, 331-C West 46th, New York.

**SWING—Trumpet, sax, clarinet** choruses copied from records. Two \$1.00. Burrows Music, 86 Verdale, Brookline, Mass.

**SONGWRITERS—Special offer.** Send your poems to Siebenek Music Co., Kalida, Ohio.

**SONGWRITERS:** Know where and how to sell your songs or poems? Ask Ken Rasmussen, PM-1, Box 481, Hollywood, California.

**SONGWRITERS:** Send poems for offer and free rhyming dictionary. Phonograph records made. Vanderbilt Studios, Box 112-E.B., Coney Island, N. Y.

**SONG Poems** wanted for musical setting. Send poem for immediate consideration. Five Star Music Masters, 630 Beacon Building, Boston.

**SONGWRITERS:** We offer complete service. Melody writing, recording, radio broadcast, marketing. Screenland Records, 1501E Vine St., Hollywood, Calif.

**ORIGINAL Music** composed to your words. Reginald Belcher, Chatham, New Jersey. Established 1910.

**ATTENTION Songwriters!** Send us your song poems, lyrics, song titles, songs and melodies for our offer. No obligation in submitting your work. Beehive Music Company, P.O. Box 146, Sugarhouse Station, Salt Lake City, Utah.

**WANTED—Piano accordions—any condition.** Send description. Immediate cash. Chaton, 600 Blue Island, Chicago.

**MELODY Composed** for poem with complete pianoscore. Sent "on approval" no down payment. Investigate. Ben Mannus, Box 342, Syracuse, N. Y.

**NEW And used accordions** bought and sold. \$25.00 up. Ace-Music, 307 So. Wabash, Chicago.

**SONGWRITERS!** Amazing outstanding offer. Hibbler, C5, 2157 No. Avers, Chicago.

**SONGWRITERS.** Write for free booklet, profit sharing plan. Allied Music, 204 East Fourth, Cincinnati, Ohio.

**SONGWRITERS:** Write for free instructive booklet concerning song poems. United Music, Dept. 14, Salem, Ind.

**SONGWRITERS—Send poem** for immediate consideration and free rhyming dictionary. Richard Brothers, 24 Woods Building, Chicago.

**MUSIC Composed** to words. Rhyming pamphlet on request. Phonograph recording of completed songs. Send poem for consideration. Keenan's Studios, Dept. PM, Box 2140, Bridgeport, Conn.

**WANTED!** Lyrics, melodies for songs. We arrange, publish, sell. Superior Song Studios, Passaic, N. J.

**MUSIC Composed** to words. Wonderful proposition. Bauer Bros., Oshkosh, Wis.

**LEARN Swing piano!** Postal brings free folder. Christensen, 451 Kimball Hall, Chicago.

**WRITE Songs.** Big money and reputation. Write for information. J. Gordon Pub. Co., 201 N. Hoyne, Ave., Chicago.

#### RADIOS AND SUPPLIES

**RADIO Kits** ready to wire. Factory quality. All kinds. Latest catalog—free. McGee Radio, SW-22, Kansas City, Mo.

**CRYSTAL Set, earphone, antenna.** Instructions—all postpaid \$3.50. Berent Radio, 4300 Hampton Blvd., Norfolk, Va.

**RADIO Service men** and experimenters send for our giant radio catalogue. Save dollars. United Radio Co. (1000M), Newark, N. J.

**MAKE** Your own simple long distance crystal radio. Illustrated instructions 25c. Alva Allen, PM427, Clinton, Missouri.

**RADIO Communications** courses qualifying for all federal licenses. Home study and resident courses. American Radio Institute, 1123 Broadway, New York, N. Y.

**RADIO Books—Latest—Bargain catalog** free. Popular Mechanics, 633 St. Clair, Chicago.

#### BUSINESS OPPORTUNITIES

**SALESMEN.** Amazing patented urgently-needed labor-saving screw-holding screw drivers! Removes, holds, inserts screws instantly inaccessible places; defense plants buy quantities, fast sales, big repeats, large commissions. Free trial offer! Mfg'r, 1018 Journal Bldg., Boston, Mass.

**FREE Literature!** Guaranteed mail-order letters, literature, campaigns written. Wonderful results! Finkel Advertising, 1013-P South Los Angeles Street, Los Angeles.

**START** Home business making statuary, plaques, art goods, novelties, souvenirs, concrete pottery, garden furniture, artificial marble flooring, liquid marble. Make your own flexible molds. Amazing profits. Valuable folder free. Creative Publishers, (PM11), Glencoe, Illinois.

**SELL** By mail—authentic life story General Douglas MacArthur. Attractive circulars. Southern Books, Waynesboro, Georgia.

**FOR** An extremely profitable lifetime business, operate a collection agency-credit bureau. Many make \$4,000 yearly, up. Write Cole Associates, Syracuse, N. Y.

**START** Your own business on your capital. No hard-times; no layoffs; always your own boss. Hundreds average \$3000 to \$5000 annual sales year after year. We supply stocks, equipment on credit, 200 home necessities. Selling experience unnecessary to start. Wonderful opportunity to own pleasant, profitable business backed by world wide industry. Rawleigh Co., Dept. K-U-PPMB, Freeport, Ill.

**MILLION Articles.** Buy wholesale. Valuable directory 10c. Ideal Service, D-11, Park Ridge, Ill.

**PERMIT** To publish. Bridgehead to mail order success. Opens new era. Details free. Maupin, LaFayette, Indiana.

**FREE Literature** describing many money making plans. Krach Service, 9901 Union Ave., Cleveland, Ohio.

**BIG Opportunity** mail write Mailers, 730 West Gift, Peoria, Illinois.

**SALES Letters** that produce business. S. Hahn, 233 E. 32nd, New York City.

**SELL** By mail—Suggestions free. Harry R. Dean, 1828 Ave. L, Galveston, Texas.

**MAKE** Artificial marble, glazed tiles, plaques, flooring, pottery, novelties, cement secrets, uncanny. Beautiful samples free. Payn, 945 Grande Vista (Room 101), Los Angeles, Calif.

**LETTERSHP.** The versatile business. Operate anywhere. Tremendous profit. Professional Products, Madisonville, Cincinnati.

**WANTED—Mail order business** or plan. Box 844, St. Louis, Mo.

**AMAZINGLY Successful mailorder plan.** Work at home. Pays well. Literature free. Leonard Publishers, 255 West 93rd Street, New York, N. Y.

**MAKE** Money collecting money. Good income; quick results. National Collectors, Newark, Ohio.

**MAKE** Your own Flexible Molds. Statuary, Art Goods, Novelties, Artificial Marble Flooring, Liquid Marble. Literature free. Kemico, 111-M, Park Ridge, Ill.

**A FORTUNE** For you by manufacturing a line of your own. Sensational new plan and formula of the fastest seller on the market today. Demand exceeds the supply. Rush \$1.00 for plan and formula. Be wealthy. Rothschilds Company, 1804 Woodbine Avenue, Knoxville, Tenn.

**MAKE Money** by mail, the way we do. Free information. Maywood, 1133 Broadway, New York.

**SELL Books** by mail on commission. No stock to carry. Orders come to you. Maywood Publishers, 1133 Broadway, New York.

**LIQUID Marble**—Colorful, glazed! Mold, brush, spray! Composition floors, rubber-lastic molds. Particulars free. Marbleizing Service, Edwardsville, Illinois.

**COLLECT** Those slow accounts. Write now! Stephens Service, Box 703, Athens, Georgia.

**DEFINITELY** New unique mail order plan. Free details. Box 353, Macon, Georgia.

**MAKE \$5000 Year** spare time! Pyre-Pruf makes clothing, rugs, roofs, etc. fire-resistant. Great "air-raid" item. Send \$1 for trial, details. Lustre Products, DuBois, Penna.

**MECHANICALLY** Inclined men—Own and operate general appliance repair shop. Complete, illustrated course shows you how. Welding, refrigeration, motor repair, how to get business, etc., all phases covered. Free literature. Christy Supply, Dept. 122, 2835 N. Central Ave., Chicago.

**START Your own** magazine agency at home. No capital required. Write for particulars and supplies. American Readers' Service, Hatfield, Penna.

**2c DAILY** Operates New York office under your own name. Co-operative Offices, 126 Lexington Avenue, New York.

**FIRE Detector** unit, patented. Underwriters labeled. Complete manufacturing equipment. Sell outright. Distributors wanted. High priority rating. A. Moss, 4046 Chouteau Ave., St. Louis, Mo.

**SWISS Music** box works—\$1.85 to \$2.25. Suitable for many novelties. Mermod Manufacturers, 147 West 46th Street, New York.

**4 MOST** Read mail order magazines, 15c. Armand Cartier, 695A North, Pittsfield, Mass.

**EXTRA Income**—Plenty mail selling opportunities. Write Katz, 4254 N. Kimball, Chicago.

**FREE Booklet.** How to manufacture many products. Western, 201 Climax Bldg., Cleveland, Ohio.

**BRUSH Plating** outfits connect to a battery, no tanks necessary. Almost as simple as painting. Your opportunity to make good income plating autoparts, bathroom fixtures, reflectors, mirrors. Get free proof and particulars that put you in a paying business of your own. Gunmetal Co., Ave. H, Decatur, Illinois.

**COLOR Cement** with chemicals. Make artistic cement garden ornaments Hollywood style. Sample 10c. Hollywood Cementcraft, 8527 Wonderland, Hollywood, Calif.

**STATUARY:** Make all kinds. Simple process. Make and install artificial stone flooring in color. Liquid marble. Other money-makers. Write promptly. Literature free. Compo-Tex, Box 786, St. Louis, Mo.

**PLASTEX Industries** offers industrious men an opportunity to start a business of their own, manufacturing art goods, novelties, souvenirs, etc., in Plastex and marble imitation. 3c material makes \$1 articles. Rubber moulds furnished for speed production. Small investment brings good returns. We are now placing big chain store orders with manufacturers. Write for interesting booklet mailed free. Plastex Industries, Dept. A, 1085 Washington Ave., New York.

**WEBER Typewriter Mechanics School.** Simplified homestudy-repairing increasing. Canton, Ohio.

**HOW** And where to obtain capital. Fully explained, particulars free. Star Service, Wapakoneta, Ohio.

**POPCORN** And potato chip machines. We help start men and women in business. Long-Eakins, 1960 Hign, Springfield, Ohio.

**CHARTERS:** Delaware; best, cheapest; free forms. Colonial Charter Co., Wilmington, Del.

**127 WAYS** To make money, in home or office, business of your own. Full particulars free. Elite Co., 214 Grand St., New York.

**\$50.00, \$100.00 WEEKLY** Using sawdust. Stamp please. Clement, 943 Arthur St., Rochester, N. Y.

**START Home** business making concrete garden furniture, pottery, bird bath, flower boxes. Amazing profits. Illustrated instruction book 25c. Popular Mechanics, 200 E. Ontario, Chicago.

## MONEYMAKING OPPORTUNITIES

**WRITE For** trade journals and earn easy full-time or side money if mechanical, technical or mercantile minded. Capitalize on your knowledge. Instructions, markets. Send \$1 bill. Don Wimmer, Trade Journal Consultant, 149 Belaire, Louisville, Ky.

**BE A** professional scrapbooker. Big fees. Unlimited opportunities. Can be done at home. No competition. No capital needed. Write to Scrapbookers Guild, 59 Park Place, New York, New York.

**JUST Released!** 3 moneymaking home-plan formulas, showing you how, what to do. Guaranteed results! 25c (coin) buys complete business setup! McDougle, Box 564, Birmingham, Alabama.

**HUNDREDS** Moneymaking opportunities, free information, magazine, Gale, 14646 Roselawn, Detroit.

**MOLDMAKING**—Plaster Casting. Complete formulas—fully illustrated. 25c. Ideal Service, RM-9, Park Ridge, Ill.

**MAILORDER** Income. Boundless opportunities. Particulars free. MacMillen, 273B, Lancaster, Ohio.

**\$24,500 RICHER;** Used schemes from "Schemer" Magazine, Alliance, Ohio. Get next! Three months just 30c.

**EARN Money** evenings, copying and duplicating comic cartoons for advertisers. Adservice, Argyle, Wisconsin.

**MAN,** You'll like silvering mirrors; making chipped glass nameplates, signs, markers, motos. Outfit prices. Sprinkle, Plater, M287, Marion, Indiana.

**WANT Sparetime** dollars? Read Mail Order Advertising and Selling, 36-84 pages monthly. Year \$1.00, two valuable folios free. Sample 10c. National, Ord, Nebr.

**INVESTIGATE** "War Money in Mail Order." Publisher Outler, Reading, Pennsylvania.

**WHOLESALE Sources.** 500,000 articles. Free directory. Maywoode, 1133 Broadway, New York.

**RAISE Guinea** pigs, make money. War demand great. Free details telling how. Research Supply, 2436 W. York St., Philadelphia, Penna.

**1000 WAYS** To make more money, 25c. John Guthrie, R2, Bardstown, Ky.

**START Your own** business with few dollars in sparetime and build as big as ambition demands. No experience. No canvassing. Not a trashy offer but something worthwhile. Details for 10c. One of our best 25c moneymaking plans free if you act quickly. Master Novelties, 1517 First Avenue, New York.

**MONEY** By mail—no investment. Send name. O'Brien, 71 Main, Meriden, Conn.

**"MY-PLAN"** Brought me over \$5,000.00. Started with \$1.25. Information free. Taylor, Box 383-P, Hapeville, Georgia.

**THE Knack** of making money in any job, business easily mastered if you know how. For details write Leo Adams, 492 Barrett St., Elgin, Ill.

**LEARN Metascience.** Remarkable drug-less healing. No manipulation. No apparatus. Unbelievable simplicity and results. Inexpensive correspondence course. Write Metascience, De Land, Florida.

**EARN Money** at home! Thousands do! "Home Worker Magazine" tells how. Sample, 25c. Sizemore, Box 7, 4917 North Kostner, Chicago.

## FORMULAS—PLANS—ETC.

**ANALYSIS.** Duplication guaranteed. Valuable formulas. Write. Associated Chemists, Indianapolis, Indiana.

**MAKE Fast** selling products. No machinery. "Chemist Approved Formulas." Literature free. Kemico, 15, Park Ridge, Illinois.

**24 FORMULAS** And trade secrets, 35c postpaid. H. Tooker, 630 Chestnut, Hamilton, Ohio.

**FLEXIBLE Molds** for plaster casting. Newest sensation. Details free. D. Dykes, 918 Alabama, St. Joseph, Mo.

**"LUMINOUS Paint"** shines in dark. Easily made. 100 other formulas, plans—all 25c. Ideal Service, 311, Park Ridge, Ill.

**SINGLE-INGREDIENT** Formulas. No manufacturing! Information free. A. Kinford, Wayne, Penna.

**23 YEARS** Supplying authentic formulas. Catalog free. Grinstead, Edwardsville, Illinois.

**REAL Manufacturing** formulas. Lists free. Cummings, Chemist, Gordon Ave., Syracuse, N. Y.

**AUTHENTIC** Formulary 924 pages (illustrated). 10,000 money making formulas, recipes, instructions, substitutes. \$1.75 postpaid or C.O.D. (foreign \$2.00). Catalog 3c. Adams Brown Company, Chestnut Hill, Massachusetts.

**FORMULAS**—Latest, best. Analysis. Literature free. Belfort, Engineering Building, Chicago.

## CHEMISTRY

**WINN'S** New Idea Home Laboratory Chemical Kits and apparatus outfits for home experimenting. Send 3c for literature and retail supply catalogue. J. H. Winn Co., Dept. 511, 124 W. 23rd St., New York.

**FREE Catalog:** chemistry, mineralogy, biology. Special: 28 piece chemistry set, send \$1.00. Tracey Laboratories, Evanston, Illinois.

**CHEMISTRY** Laboratory apparatus and chemicals for industrial, analytical, and private experimental laboratories. Complete chemical laboratory supply service for correspondence school students. Send 3c for free 48-page catalog of chemicals and apparatus. Dept. M-43, Biological Supply Co., 1176 Mt. Hope Ave., Rochester, New York.

**SPECTROSCOPE** For quick chemical analysis \$2.50. Kutting Sons, Campbell, California.

## HELP WANTED

**AMAZING** Profits with free outfit. Country wild about growing fruit trees! Sell farmers, victory-gardeners, suburbanites, others. Sensational earnings right now. Spare or full time. Oldest, biggest nursery. Write quick. Stark, Dept. C-127, Louisiana, Missouri.

**HOTEL** Positions waiting. Supervised home training. National placement service—free. Florence Utt Hotel School, PM-5, Kansas City, Mo.

**CALL** On friends with sensational personal Christmas cards from 50 for \$1.00 up. Stationery. Also magnificent 21 card \$1.00 assortment. Profit 50c. Experience unnecessary. Samples on approval. Wallace Brown, 225 Fifth Ave., Dept. O-34, New York.

**BIG Money** taking orders; shirts, ties, hosiery, underwear, pants, jackets, sweaters, uniforms, etc. Sales equipment free. Experience unnecessary. Nimrod, 4922-BG Lincoln, Chicago.

**STEADY Work**—Good pay. Reliable man or woman wanted to call on farmers. No experience required. Pleasant work. Home every night. Make up to \$15.00 in a day. Wonderful new proposition. Particulars free. McNess Co., Dept. 627, Freeport, Illinois.

## AGENTS WANTED

**\$1 STARTS** You in business selling men's ties, ready tied Slide-On-Ties and boxed novelties. Write today for descriptive wholesale catalog, free sample materials. Phillip's Neckwear, 20 West 22nd St., Dept. P-11, New York.

**AGENTS**—Whirlwind profit opportunity. Finest silk Nylon, and Rayon hosiery. Big selection. Very latest styles and colors. Replacement guarantee. Your own hose free with large outfit. Rush hose size, name today. Wilknit, Dept. CR-37, Greenfield, Ohio.

**LORD'S Prayer.** Ten Commandments, or Crucifixion, engraved on real pennies. Individually carded. Fastest 10c sellers in years. \$5.25 gross. Trial order, generous assortment, sent prepaid for \$1.00. Perkins, 4745 Broadway, M-11, Chicago.

**NEW Air** raid shoe sweeps country. Zips on—zips off. No fumbling or breaking of laces in blackouts or when alarm sounds. Huge profits for direct salesmen and women. Hundreds of other fast-selling shoe styles. Write for free sample shoe outfit. Victor Thomas Shoe Co., 610 W. Van Buren St., Dept. V-64, Chicago, Ill.

**WINDOW Letters**—Better quality, cut prices. Free samples. Metropolitan, 316 West 42nd Street, New York.

**MEXICAN** Feather, straw, pictures; sandals, tablecloths, etc. Quick sellers! 100%-300% profit! Free particulars. Samples 10c stamps. Marquez, PE Apartado 1176, Mexico City.

**MAGIC Shopping bag.** Sells like wild. Magically turns purse into roomy shopping bag. Handy, compact. Samples sent on trial. Krstee, 122, Akron, Ohio.

**PATRIOTIC Photo card:** Mothers, wives, sweethearts of service men grab it. Write Art Supply, Box 617-M, Louisville, Ky.

**MEXICAN Bird pictures** handmade with real feathers. Free particulars. Sample 10c. Importer C. Staff, 14960 Evanston, Detroit, Michigan.

**AGENTS.** Big line including food products. Fast selling premium and bargain deals. Low prices. Send card for big outfit over with gift. Ho-Ro-Co, 2737 Dodier, St. Louis, Mo.

**MAILING Lists** (salespeople only) all states, 500 names \$3.00. Guaranteed 100%.—Free Agents Registry, 628 Stimson Bldg., Los Angeles, Calif.

**BIG Opportunity** for independent income. Make and sell made-to-measure arch supports. Lowest priced instructions. Jul Carssen, 3609 Texas, St. Louis, Mo.

**BIG Clothing bargains** for big profits. Used dresses 10c, men's suits \$1.00, shoes 12½c. Over 100 sensational values. Experience unnecessary. Free wholesale catalog. Superior, 1250-CF Jefferson, Chicago.

**SELL Midget Bibles.** Size of postage stamp. Contains 64 pages of New Testament. Sample 10c. H. Tooker, 630 Chestnut, Hamilton, Ohio.

**FREE Assortment** of actual packages foods, groceries, household products worth \$5.00, if you promise to show to friends and neighbors and try to take orders. Fine profits. Spare time. Experience unnecessary. Zanol, 6321 Monmouth, Cincinnati, Ohio.

**MEN And women wanted!** Full or part time. We help you get started on Raleigh Route of 800 families. Large sales mean big profits. Write Raleigh's, Dept. K-180-PPMA, Freeport, Ill.

**SELL Christmas card sensation!** New "prize" 21-card assortment leads in value, appeal. Sells \$1—pays up to 50c. 11 fast-selling assortments. Christmas cards with name 50 for \$1, up. Samples on approval. Chilton Greetings, 147 Essex, Dept. 2-T, Boston, Mass.

**FREE Literature** on new Line Phonograph Scratch Filter and Tone Equalizer, also on radio wavetrap and signal booster. Send \$2 for both samples and make profits immediately. Goldshield Products, Dept. M, 350 Greenwich St., New York.

**FREE Water** and our concentrates, makes flavors, lotions, shampoos, 72 products, labels, bottles furnished. Quailco, E-20030 Russell, Detroit.

**"CAR Watchman"** prevents thieves from stealing tires, gas, equipment. Amazing invention. Whirlwind seller. Big profits. Write quick. Northwest Electric Co., N-10, Pukwana, So. Dak.

**POWERFUL Mile stretcher.** More miles—power. Reduces costs. Guaranteed. Free offer. Thermox, Peoria, Ill.

**SCHOOL Seniors**—Sell graduation name cards. America's largest, fastest-selling, low-priced display. 35% commission. Free cards. Universal Engraving & Printing, Box 745-PM, Pittsburgh, Penna.

**MAKE Money!** Selling collection system. Free details. Stephens Service, Box 703, Athens, Georgia.

**USED Men's shoes** 14c, hats 12c, pants 28c, dresses 10c, winter coats 50c, fall coats 35c. Bargain catalog free. Portnoy, 566-V Roosevelt, Chicago.

**AMBITIOUS School seniors**—Sell classmates the "tops" in graduation name cards. Best commissions. Free cards. Agencies going like wildfire. Hurry! Craftcards, Box 235-L, Pittsburgh, Penna.

**MEXICAN Feather pictures.** Prettiest Christmas novelty, 50c (stamps) bring \$2.00 worth samples. Refunded if unsatisfied. Mexicanart, Apartado 1593, Mexico City.

**SELL New-used clothing** from home, auto, store. Men's suits 82c, leather jackets 45c, overcoats 51c, dresses 9c, ladies' coats 33c. Other bargains. Catalog free. S&N, 565A Roosevelt, Chicago.

**BIG Money taking orders:** shirts, ties, hosiery, underwear, pants, jackets, sweaters, uniforms, etc. Sales equipment free. Experience unnecessary. Nimrod, 4922-AN Lincoln, Chicago.

**MAKE Money** applying initials on automobiles. Also, sideline salesmen for short run decal name plates. "Ralco," 727 Atlantic, Boston, Mass.

**MAKE Easy money** selling foremost line Christmas cards. "Leader" assortment 21 gorgeous folders going like "wildfire." Sells for \$1.00, costs as low as 50c. Actual retail value \$3.00. Other bargain assortments. Also, 50 Christmas cards imprinted with name for \$1.00. Finest low-priced imprints in America. Write for sample "Leader" assortment on approval, also two portfolios imprint cards and free gift offers. Silver Swan Studios, Inc., 320 Fifth Avenue, Dept. 47, New York.

**COMIC Clever Xmas greeting cards.** List 10c. Straley, 1015 Mulberry, Springfield, Ohio.

**SEND For free copy** of illustrated wholesale Christmas catalog! Forty profitable lines! Elfco, 438 North Wells, Chicago.

**AGENTS—300% Profit** selling gold leaf letters; stores and offices. Free samples. Metallic Letter Co., 438-B North Clark, Chicago.

**AGENTS:** Stamping names on pocket-key protectors. Sample check with your name, address, 25c. Stamping outfits. Emblem checks, check-fobs, name plates. Hart Mfg. Co., 303 Degraw St., Brooklyn, N. Y.

**AGENTS—To mail** our literature. Good profits. Home business. Maywood, 1133 Broadway, New York.

**RELIABLE People** wanted to place eggine in stores and appoint agents. Used the same way as eggs in baking and cooking at 10 cent dozen. Full size package and particulars 10 cents postpaid. Morrissey, 4417-21 Madison St., Chicago, Ill.

**DO You want agents** for your proposition? Your ad in this space will place your message before hundreds of men seeking fast-selling products. My folder "How to Secure Agents" is filled with proof. I'll gladly send you a copy free. P. W. Johnson, Manager Classified Advertising, Popular Mechanics Magazine, 200 E. Ontario St., Chicago.

#### HIGH-GRADE SALESMEN

**SALESMEN.** Amazing patented urgently-needed labor-saving screw-holding screw drivers! Removes, holds, inserts screws instantly inaccessible places; defense plants buy quantities, fast sales, big repeats, large commission. Free trial offer! Mfg'r, 1017 Journal Bldg., Boston, Mass.

**MAKE More money** selling advertising to businessmen, calendars, signs, specialties, souvenirs, desk items, executive gifts, etc. Sideline or full time. Good repeat business. Newton Mfg. Co., Dept. P-11, Newton, Iowa.

**BIG Commissions**—selling to stores celluloid pricing tickets, metal shelf moulding. To restaurants, menu covers, signs. P. Pricing Press, 124 White St., New York.

**RELIABLE Man** wanted by nationally-known manufacturer-jobber to contact merchants in own town. Steady, big pay; opportunity to develop own independent business. Start full or part time. Sales experience unnecessary. Laymon, Dept. 10-X, Spencer, Ind.

**CALENDARS**—Sell full or part time. One of nicest lines in the country. Big commission for men and women producers. Gem Match, 74 West Washington, Chicago.

**ADVERTISING Book matches.** America's largest manufacturer of union label book matches. Fast selling line. Large sales producing kit. Sample matches. Complete cut catalog, 17 color combinations makes selling easy. Commission in advance. Superior Match Company, 7530 Greenwood, Dept. N-11, Chicago.

**PERMANENT Opportunity.** A-10 priority plumbing repair materials nationally known to plumbers. Exclusive territory. Responsible, hardworking, star salesman required living near large city. For full information, sell yourself in first letter. Box 7, Long Island City, N. Y.

**ADVERTISING Book matches**—World's largest "direct selling" book match factory offers advance cash earnings calling on every type of business. Experience unnecessary; full, part time; low prices; high quality; quick deliveries; powerful patriotic display, repeats. Free kit, instructions. Match Corp. of America, 3433 West 48th Pl., Dept. E-11, Chicago.

**CALENDARS, Fans, novelties**—Beautiful complete lines all sizes, including jumbos, samples free. Start now, be first in field. Fleming Calendar Company, 6539 Cottage Grove, Chicago.

**EARN Money** in your spare time taking subscriptions to Popular Mechanics. Unlimited possibilities, every family a prospect. Easy to sell. Bonus paid in addition to liberal commission. Send postcard for further details today. Circulation Dept., Popular Mechanics Magazine, 200 E. Ontario St., Chicago.

#### EDUCATIONAL AND INSTRUCTION

**"HOW To Break and Train Horses"**—A book every farmer and horseman should have. It is free; no obligation. Simply address Berry School of Horsemanship, Dept. 11011, Pleasant Hill, Ohio.

**DRAFTING And mathematics** courses. Each \$1 complete! Free circular. Write J. R. Giles, 1326 Myers, Burbank, Calif.

**FREE Illustrated lesson** handwriting analysis. Examination free. Afga, Linn Creek, Mo.

**NEW Writers** wanted to re-write ideas in papers, magazines, books. Splendid opportunity to "break into" profitable writing field. Rush postcard for free details. Comfort Writer's Service, Dept. FW-149, St. Louis, Mo.

**LOVERS Of artistically effective, unusual, yet inexpensive and easy hobbies** write for free details. Weidner, 11711 Wilshire, Los Angeles, California.

**WELDING**—Electric arc. Learn profitable trade quickly through actual practice. Individual welder instruction at bare cost of materials. Full particulars free. Valuable welding lessons book \$5c. Hobart Welding School, Box M-1122, Troy, Ohio.

**WANT A U. S. gov't job** \$105 to \$175 month. Men—women. Hundreds Victory program appointments being made. Big opportunity. Prepare now for examinations. 32 page book—full particulars list positions free. Write today. Franklin Institute, Dept. S2, Rochester, N. Y.

**HOW To write short stories** that sell. 64 pages. 12c postpaid. Smyth, 4721 California, Omaha, Nebr.

**BELIEVE It or not** Pitman shorthand made easy. Ten lessons, then speed practice. Lesson free. Elliott, 4426 Carrollton, New Orleans, La.

**BECOME A finance man.** Particulars free. Nebraska Finance Co., Lincoln, Nebraska.

**FINGER Print experts** earn big pay! Learn easily at home. Low cost! "Crime Book" free. Write stating age. Dept. 26, Inst. Applied Science, 1920 Sunnyside, Chicago.

**SECRET Investigation.** Experience unnecessary. Detective particulars free. George Wagner, M-2640 Broadway, N. Y.

**BECOME A Doctor of Psychology** (Ps. D.) Teach secret of contentment, happiness. Solve mental worries. Free book. College of Universal Truth, 20-B East Jackson, Chicago.

**LOCKSMITH Course.** Lock picking, key fitting, etc. \$1.00 prepaid. Locksmith, Canadian, Texas.

**CLINICAL Laboratory technic** taught in your own home. Practice outfit supplied. Bulletin free. Imperial Technical Institute, Box 973-E, Austin, Texas.

**LEARN Telegraphy!** Splendid opportunities now prevail. All expenses low. Catalog free. Dodge Institute, Dept. M, Valparaiso, Indiana.

**RADIO Engineering,** broadcasting, aviation and police radio, servicing, marine and Morse telegraphy taught thoroughly. All expenses low. Catalog free. Dodge Institute, Dept. R, Valparaiso, Ind.

**LETTERING** Easily learned. No knowledge of art necessary. New, self-taught system. Complete \$1.00. Sample free. B. C. Rinehart, 332 South Michigan, Chicago.

**TOOL Dienmakers,** apprentices, students, learn "trig" to serve your country better. Get The Shopman's Trigonometry, \$1.00, supply limited. Clarence J. Turcotte, 202 Hastings, Flint, Mich.

#### CARTOONING, COMMERCIAL ART, SHOWCARD WRITING, SIGN PAINTING

**CARTOONING Course**—30 illustrated lessons, over 500 sketches, drawing paper, pens and pencils, complete, \$1.00 postpaid. Montes Studio, Box 892, Pasadena, Calif.

**CHALK Talk stunts.** 20 patriotic, \$1.00, Catalog 10c. Balda The Cartoonist, Oshkosh, Wisconsin.

**CARTOONING** Course—36 lessons—6 booklets—816 illustrations. \$2.80. (Satisfaction guaranteed.) Templeton Studios, Wellington, Elgin, Illinois.

NEW Cartoon plans, markets, etc. Hartman, 2438 W. Lincoln, Nebr.

EARN Money evenings, copying and duplicating comic cartoons for advertisers. Ad-Service, Argyle, Wisconsin.

#### INFORMATION

**WHAT? When? Where? How? Who? Why?** All questions answered. Formulas, problems, dates, methods, people. Any subject! Send questions—no money! Pay \$1.00 when answered. 3 day service. Satisfaction guaranteed. Information Research Institute, Box 8725, Pittsburgh, Penna.

#### ADVERTISING AGENCIES, LETTER WRITERS, FOR ADVERTISERS

**MAIL** Order sales are skyrocketing. Back your product with our 30 years of successful mail order experience. Costs nothing. Write Van De Mark, Times Star Tower, Cincinnati.

2000 **SPORTSMEN** Names. Write for prices. Sargent Smith, Seneca, Penna.

**RURAL**, Small town, women buyers—2,000 \$5.48. Lederer, 17 Guilford Avenue, Baltimore.

**ADVERTISE** Profitably: \$15 reaches 5,000,000 Sunday newspaper readers with 24-word ad. Newspaper, magazine, mailing-list ratebook, free. Chicago Advertising Agency, 20-PA West Jackson, Chicago.

**ADVERTISE**: 24 Words, 149 newspapers \$6.50. Lists free. Advertising Bureau, 4515-C Cottage Grove, Chicago.

24 **WORDS**, 35 Newspapers \$2.00. Goodall, 37 Gardner, Vallejo, California.

**FREE**—New Advertisers Rate Guide. 44 pages. Includes everything. Lowest rates. E. H. Brown Advertising Agency, Merchandise Mart, Chicago.

**ADVERTISING** Placed all magazines, newspapers U.S.A., Canada. Lowest rates. Free service. 54-page catalog free. Baker Advertising Agency, A-189 W. Madison, Chicago. Established 29 years.

**FREE**—"Amazing New Book"—"Profits From Classified Advertising." Tells how and what to advertise. Be sure to read this book before you invest one cent in advertising. Remember—it's free! Write for your copy now. F. W. Johnson, Classified Advertising Manager, 200 East Ontario Street, Chicago, Illinois.

#### RUBBER STAMPS, OFFICE SUPPLIES

**QUALITY**, 3 Lines 35c. signatures \$1.50. Federich Mfg., East Pittsburgh, Penna.

**SUPERIOR** Quality, two lines 25c. three 35c. four 50c. signatures \$1.50. Slocum, 814 Bradley, Peoria, Illinois.

**SUPERB** Quality, cushioned, indexed two lines 25c. three lines 35c. Lentz, Box 402, Youngstown, Ohio.

3 **LINES** 30c; Cushioned, indexed, 35c. Signatures \$1.50. Stamprite, Wauwatosa, Wis.

2 **LINES** 25c. 3 Lines 35c. Stamp Works, Auburn, Nebr.

**KNOB** Handle, cushioned, 2 lines 25c. 3—35c. Stamp Works, Centerport, N. Y.

#### TYPEWRITERS, DUPLICATORS, OFFICE DEVICES

**TYPEWRITERS**, Adder, mimeograph, multigraph, addressograph. Send for free lists of machines that will help you at half price. Pruitt, 28 Pruitt Bldg., Chicago.

#### BUSINESS SERVICE

**SOUTHERN** Mail address. Receiving, forwarding, \$1 month. Exchange, Box 66, Atlanta, Georgia.

**FIVE** Reasons how collect delinquent accounts, keeping customers. One dollar. General Adjustment Co., Jordan Bldg., Waco, Texas.

**NEW** York mail address, office service, from \$2 monthly. Special commissions executed. Paramount Offices, 140 West 42nd, New York.

**CHICAGO** Mail address: \$1 monthly—Receiving, reforwarding your business, personal mail. General, 30 West Washington, (Established 1919).

#### PRINTING OUTFITS AND SUPPLIES

**PRESSES**, Type, supplies. List free. Catalog ten cents. Model Press Co., York, Penna.

**WE** Defy any duplicator to beat Screen-O-Press. Reproduces typewritten letters, halftones, printing. Letterize \$4.89. Anthony Unis, Peoria, Ill.

**INEXPENSIVE** 6x9 Printing press. Details free. Novelty Shop, Downsville, Louisiana.

**AMAZING** Savings in job printing and supplies. Literature free. Quality Shop, 1356 North Carolina Avenue, N. E., Washington, D. C.

**PRESSES**, Complete supplies. Bulletins. Send stamp. Bradshaw, 3214-P Huron, Chicago.

**PRINT** Your own cards, stationery, circulars, advertising. Save money. Simple rules furnished. Print for others, nice profit. Junior outfit \$8.25, senior outfits \$17.38. Details free. Kelsey, Inc., T-11, Meriden, Conn.

**PRINT** At home. 10c will bring a complete catalog of presses, type and supplies. F. Peiffer & Company, 6 Columbia St., Newark, N. J.

**BARGAINS** — Presses, type, supplies. Send stamp. 159 Harvard, Cambridge, Mass.

**USED** Presses, type, supplies. Lists 3c. Turnbaugh Service, Loysville, Penna.

#### PRINTING, MULTIGRAPHING, MIMEOGRAPHING, GUMMED LABELS

**HAMMERMILL** Letterheads, envelopes, any color. 39 type styles. Free particulars. Woodruffs, 217-A4 Lewis, Duluth, Minn.

**LETTERHEAD** Specialists. Original artist designs. Gill Art Service, Huntsville, Alabama.

**SAFETY** Coin carriers 65c—100, samples 3c. Economic Press, Leonia, N. J.

125 8½x11 **HAMMERMILL** Letterheads, 125 envelopes, 4 lines, both \$1.35. Gooch, 202PM, Hernando, Miss.

**ENGRAVED** Process letterheads. 8½x11" white bond. Engraving—blue, black, 1000—\$1.00 with order, balance \$3.25 C.O.D. Goheso, PM7, Omena, Mich.

\$1.00 **POSTPAID** 110 8½x11 Letterheads, 110 envelopes. W8JHP, Pottsville, Penna.

**MILITARY** Stationery—75 sets \$1. Morlin, 194 Henry Street, New York.

500 **STICKERS**, ½x2½. Four lines, 25c. Catalog free. Reed's Press, Box PM-326, Spiro, Okla.

250 **LETTERHEADS**, Envelopes, or statements, \$1.00 postpaid. List for stamp. Holmc, Celeste, Texas.

250 **DISTINCTIVE** Bond letterheads or envelopes printed \$1.50 postpaid. Lumco, Kimball, Nebraska.

**PATRIOTIC** Stationery, two colors, 100 noteheads and envelopes, \$1.00. United Sales, Aberdeen, So. Dak.

\$1.00 **POSTPAID**: 100 8½x11 Bond letterheads and 100 envelopes, Benneville, 907 West Roosevelt, Philadelphia.

**CENTRAL** West Printers, Leading mail order printers. 3226-P Jackson, Chicago.

**MIMEOGRAPHING**—Letters, pricelists, formulas, instructions. Lowest prices. Lem's Letter Shop, 8710 Stanton, Detroit.

**HAMMERMILL** Letterheads, envelopes, billheads, statements. Samples free. Drew Press, Box 423-G, Greenboro, N. C.

100 **BOND** 8½x11 Letterheads and 100 envelopes \$1.00 postpaid. Benneville, 907 West Roosevelt, Philadelphia.

500—\$1.95, 1000—\$2.95. **LETTERHEADS**, Envelopes, billheads, cards. Studios, Incorporated, 1724 Monroe Street, Madison, Wisconsin.

5000 **ELEGANT** Colored envelope slips, \$3.75. 5000 6x9 circulars, \$8.25. Folders, \$1.60 thousand. Samples. Goodprint, Harrisonburg, Va.

**JOB** Printing, circulars, letterheads, envelopes. Bell Press, PM, Winton, Penna.

500 ¾x2¼ **FOUR** Line gummed stickers, 25c. Moritz Printery, Saginaw, Mich.

**JOB** Printing, Quick, reasonable. Samples. Atlantic, Box 653-H, Rock Hill, S. C.

1000 **LETTERHEADS** Or envelopes \$2.95. Catalogue. Davis Press, Webster, Mass.

**WANTED** Printing of all kinds by thousands of our readers. Your ad in this space will bring you some nice orders. Write for positive proof. F. W. Johnson, Classified Advertising Manager, Room 304, 200 East Ontario Street, Chicago.

#### PATENT ATTORNEYS

**PATENT** Your ideas. Write immediately for two free books. "Patent Protection" and "When and How to Sell an Invention." Fully explain many interesting points to inventors and illustrate important mechanical principles. With books we also send "Evidence of Invention" form. Prompt service, reasonable fees. 43 years' experience. Avoid risk of delay. Address: Victor J. Evans & Co., Registered Patent Attorneys, 631-M Merilin Building, Washington, D. C.

**PATENTS** Procured: Procedural instructions free. Frederick J. Larson, Registered Patent Attorney since 1905. 7346 Forsythe Boulevard, St. Louis, Missouri.

**INVENTORS**: Take first step toward protecting your invention without obligation. Write for free "Record of Invention" form for establishing date of invention. We also send free—48 page book, "Patent Guide for the Inventor"—telling about confidential search service; how to sell and market inventions; details of convenient payment plan. Send for free "Patent Guide" and "Record of Invention" form today. Clarence A. O'Brien and Harvey Jacobson, Registered Patent Attorneys, 21B-L Adams Building, Washington, D. C.

"**PATENT-Particulars**" and blanks, free, airmailed. Sterling Buck, Park-North Avenues, Baltimore, Md. Government-registered 36 years.

**PATENTS**, Booklet free. Highest references. Best results. Promptness assured. Watson E. Coleman, Patent Lawyer, 635 F Street N.W., Washington, D. C.

"**INVENTOR'S** Guide." 100 mechanical movements, free; advices on patenting, selling inventions. Frank W. Ledermann, 154 Nassau Street, New York.

**L. F. RANDOLPH**, 302-B Victor Bldg., Washington, D. C. Low cost. Book and information free.

**INVENTORS**—Before disclosing your invention to anyone send for form "Evidence of Conception"; "Schedule of Government and Auctioneers' Fees" and instructions. Sent free. Lancaster, Allwine & Rommel, 411 Bowen Building, Washington, D. C.

#### FOR INVENTORS

**ATTENTION** Inventors. Old established Pacific Coast manufacturing company is interested in acquiring patented or patentable items for manufacture on either outright purchase or royalty basis. American Pipe & Steel Corp., 230 Date Ave., Alhambra, Calif.

**NOTICE!** War inventions!—New government agency — National Inventors Council—now functioning. Made up of industrial executives experienced in development and utilization of inventions. Purpose is to study and recommend military or naval adoption of inventions submitted by civilian inventors and valuable to country's defenses. We are prepared to expedite preparation of patent application on any war invention. Send at once for our two free advisory books on patent procedure. Act now to insure prompt disposition of your invention by this new board. Write today—Victor J. Evans & Co., Registered Patent Attorneys, 632-M Merilin Building, Washington, D. C.

**INVENTORS**: Take first step toward protecting your invention without obligation. Write for free "Record of Invention" form for establishing date of invention, and free "Patent Guide for the Inventor"—telling about confidential search service; how to sell inventions; convenient payment plan. Send for "Patent Guide" and "Record of Invention" form today. Clarence A. O'Brien and Harvey Jacobson, Registered Patent Attorneys, 21A-L Adams Building, Washington, D. C.

**INVENTORS**—Industry needs your ideas now! Manufacturers are getting ready now for post-war sales and production. Factories must have products to take up the slack after war orders stop. Get our new free inventor's book today and valuable "Invention Record" form. Act now. McMorro and Berman, 134-K Barrister Building, Washington, D. C.

**FREE** Booklet "Why Invent?" shows sure way to success. Don't attempt selling or patenting your invention before you have read it! Invention-Service Company, Dept. A, Professional Arts Building, Hagerstown, Md.

**PROTECT** Your ideas without patent—Full particulars and plan—All you need for one dollar. Charles D. Hevenor, Lincoln Building, Buffalo, N. Y.

**COLCHICINE**—Evolution chemical creates new, mutant plants. Illustrated booklet—plus experiments magazine 25c. Questok, Wellesley, Massachusetts.

**INVENTORS**—Entirely new products are urgently needed for the drastic changes in our every-day needs. If you have a practical, useful non-military invention it can now be sold safely, without patenting expense. Write today for complete details. Chartered Institute of American Inventors, Dept. 4A, Washington, D. C.

**CASH** For practical ideas and inventions. Mr. Ball, AB-9441 Pleasant, Chicago.

**SELL** Your patent through a small classified ad in Popular Mechanics. Many inventors have found buyers in this way. Ask me for proof—I'll gladly send it to you. F. W. Johnson, Manager Classified Advertising, 200 E. Ontario St., Chicago.

#### INVENTIONS WANTED

**INVENTIONS** Wanted:—Now assembling line to present after "the duration." Do you have an item of merit with volume distribution possibilities? We have capital to manufacture and contacts to market items selected. Have successfully sold under Heco Trademark to 10c store chains and catalog houses for years. If you have invention with chain store appeal communicate with us at once. Address New Products Dept., Heckethorn Mfg. & Supply Company, Littleton, Colorado.

**PATENTS** Wanted—Assignments quickly arranged if meritorious. Direct connections with large manufacturers. Listing forms free. Universal Guaranty Company, Box 772-M, Lancaster, Penna.

**WANTED**—Small practical article, state price. Box 844, St. Louis, Mo.

**INVENTORS!** Have you good patentable ideas? Write Mr. Metzler, 11 West 42nd, New York.

**MANUFACTURER** Wants new invention or idea. Nelson, P.O. Box 626, St. Paul, Minn.

**INVENTORS**—Manufacturers urgently need new ideas for drastically altered civilian markets. If you have a useful new invention, or a practical improvement on an already established product, you can now sell it safely without patenting expense. Complete details, free. Chartered Institute of American Inventors, Dept. 4-D, Washington, D. C.

**WANTED**—Meritorious patented, unpatented inventions. Booklet, references, free. Invention Reporter, 5B-11236 So. Fairfield, Chicago.

**CASH** For inventions, patented, unpatented. Mr. Ball, A-9441 Pleasant, Chicago.

**YOUR** Ad in this space will bring amazing results. I'll prove it to you. Write at once for interesting information. F. W. Johnson, Room 300, 200 East Ontario St., Chicago.

#### PATENTS FOR SALE

**PATENTED** Electrical connector for bus bars reduces bends. Bernie Cox, 1010 N. Main St., Harrisburg, Ill.

**NEW** Tool for painters, plasterers, masons, carpenters and glaziers. Inexpensive—million needed now. Willie J. Brabham, Paint Shop, Navy Yard, S. C. X71224.

**I WANT** to send you proof of the wonderful pulling power of Popular Mechanics Magazine's classified pages. What's your proposition? Write me today. F. W. Johnson, Manager Classified Advertising, 200 E. Ontario St., Chicago, Ill.

#### MANUFACTURING

**MODELS**—Small lot manufacturing. Metals, plastics, etc. Milburn, Burlington, Kentucky.

#### MODELS AND MODEL SUPPLIES

**CATALOG** 50 Engines, model railroad supplies, 25c refunded. Howardco, A3417 North Ashland, Chicago.

**RAILWAY** Models, complete line informative catalogs O gauge, 112 pages, 125c; HO, 48 pages 15c. Walthers, 247 Erie, Milwaukee, Wisconsin.

**"CONSTELLATION"** Carved hull construction set, separate fittings, blueprints, 152 page illustrated catalog 20c, listing hundreds of ship and yacht model fittings. A. J. Fisher, 1002-7 Etowah Ave., Royal Oak, Mich.

**SHIP** Models and yacht supplies complete. Large 56 page catalogue 15c. Bill Wild's, 510 East 11 St., New York City.

**SHIP** Model kits and fittings. Complete line Fisher model yacht equipment. All Boucher, Fisher, Marine Model and Ideal kits, fittings and blueprints at catalog prices. Most complete stock in New England. James Bliss & Co., Inc., 230 State Street, Boston, Massachusetts.

**FREE**—Big list of helpful books. Popular Mechanics Press, 200 E. Ontario St., Chicago.

#### HOME CRAFTSMEN

**28** LAWN Ornament patterns 25c. Other patterns: 15"-20" high; Dutch girl, Dutch boy, pirate, bull terrier, Mexican girl, Mexican boy, dwarf, penguin, flower girl, 10c each; 3 for 25c. 25 novelty patterns 30c. All 63 full size patterns \$1.00 postpaid. Strother, Box 383-DY, Belington, W. Va.

**LEATHERCRAFT** Headquarters. Leather, tools and instructions for you to make most anything in leather. Also archery and wood craft supplies. Send for catalog. J. C. Larson Co., 180 No. Wacker Drive, Chicago, Ill., Dept. 180-D.

**GET** Free leathercraft instruction pamphlets, prices of leathers, tools, projects. Fascinating hobby. Make beautiful gifts. Leather samples 5c. Wilder & Company, 1938 Crosby, Dept. 11P, Chicago, Illinois.

**LUCITE**—Transmits light around curves—beautiful clear plastic. Bargain 1 lb. assortment of odd pieces (approximately 2 rods and 6 flat sheets). \$1.00 postpaid. Craft Service, 337 University Avenue, Rochester, New York.

**LEATHERCRAFTSMEN:** Send 10c for new handbook and catalogue of tools and supplies. E. A. Sweet Company, Inc., Leathercraft Division, A-63, 148 State Street, Binghamton, N. Y.

**SQUAREKNOTTERS!** Make belts, handbags, etc. Quality cord samples with catalog, free. Beginners book, catalog and samples 10c. Special! Regular \$1 book with 50c beginners outfit, all for \$1. P. C. Herwig Co., Dept. J-36, 121 Sands St., Brooklyn, N. Y.

**KNOCKDOWN** Cedar chest, lumber, veneers, illustrated catalog 10c. Giles Kendall Co., Decatur, Ala.

**CATALOG**—Patterns plywood novelties, lawn ornaments, silhouettes, letters and numerals. Decal transfers, handy hand tools, new power sander. Other lines, 500 articles finely illustrated. Write today. Wo-Met Shop, Ashburn, Georgia.

**WOODWORKING** Power tools—Make them yourself. Lathe, scroll saw, saw table, drill press, portable sander, bandsaw, motorized plane. Complete details only 25c. Popular Mechanics Press, Dept. 401, 200 E. Ontario Street, Chicago.

#### WATCHES, OLD GOLD, JEWELRY, ETC.

**OPALS**—Collectors' parcels \$5.00. Lapidaries' parcels \$5.00. Catalogue free. Norman Seward, Melbourne, Australia.

**CASH!** Gold, jewelry, teeth, coins, diamonds, mercury, etc. Ship! Simon's, 353 Old Arcade, Cleveland, Ohio.

**ELGIN**, Waltham watches. Attractive buys. Make big money. Free watch and jewelry catalog. Plymouth Jewelry Co., 163-F Canal St., New York.

**AGATES**, Fossil woods, three pounds \$1.50 postpaid. Jay Ransom, Aberdeen, Wash.

**WATCHMAKERS'** Materials, tools, jewelry—bought, sold. Best prices for old gold, diamonds. Free catalog. Ben Segal Company, Box 150, Chicago.

**HIGHEST** Prices for old gold—Mail your teeth, watches, jewelry. 100% full cash value mailed day shipment received. Satisfaction guaranteed or articles cheerfully returned. Information free. Chicago Gold Smelting Company, 300-P Champlain Building, Chicago.

**GOLD** \$35.00 Ounce. Mail old gold teeth, diamonds, jewelry, watches. Receive cash by return mail. Satisfaction guaranteed. Free information. Dr. Weisberg's Gold Refining Company, 1500-Q Hennepin, Minneapolis, Minn.

#### FOR SALE—MISCELLANEOUS

**UNPAINTED** Wall plaques 5c each, 24 different samples \$1.00. Ommann, 642 Broadway, St. Paul, Minn.

#### WANTED—MISCELLANEOUS

**MANUFACTURER** Wanted for home window washer. D. Jones, 716 Waveland, Chicago, Ill.

**MERCURY**—Quicksilver, \$1.25 to \$1.50 per pound. Western Metal Co., Bloomington, Illinois.

**MERCURY** (Quicksilver), tungsten, molybdenum, cadmium, high speed tool steel, bismuth, purchased in any quantity. Write for quotations. Metallurgical Products Co., 35th and Moore Sts., Philadelphia, Penna. Established 1909.

**HIGHEST** Prices for used cameras, binoculars, microscopes, drawing sets, tools, any optical or scientific instrument. Satisfaction guaranteed. Gordon's, 162-M Madison, Chicago.

**CASH** For anything. Justice Jewelry Jobbers, 190 North Wells, Chicago.

#### PERSONAL

**WIN** Prize money: Booklet—"Successful Contesting" shows how. 10c postpaid. Bulletin listing \$100,000.00 prizes included. World Publishing, 4515-D Cottage Grove, Chicago.

**PSORIASIS** Sufferers: Pixacol, used only as directed, has brought relief when everything else failed. Applied externally, dries quickly, convenient. Try regular \$1 bottle without investing a cent! Write: Pixacol, Box 1298, Cleveland, Ohio.

**MEXICAN** Legal matters. Wm. Cocke, Amer. Atty., 1736 EIPaso, Texas.

**SONGWRITERS**, Write for free booklet, profit sharing plan. Allied Music, Dept. 85, 204 East Fourth, Cincinnati, Ohio.

**NEW**, Money making formulas book tells how to go into business for yourself. Send for free details. Popular Mechanics, 200 E. Ontario, Chicago.

#### MISCELLANEOUS

**MODERNWAY** Shaving liquid. No soap or cream. Rub on beard and shave. Use Modernway for after shaving application. Antiseptic, refreshing, cool. Modernway is new. Large size sixty cents, tax other costs included. Satisfaction assured. Wm. Crawford, M1042, Box 743, Plainfield, N. J.

**INFORMATION** For treasure seekers. Write, Wyss, 104½ Francis, St. Joseph, Mo.

**MEDICAL** Laboratory technicians in great demand. We train you in your spare time, in your own home. You can practice while studying. Write for free catalogue. Imperial Technical Institute, Box 973-J, Austin, Texas.

**INTERESTED** In real plastics? Send stamped envelope, Box 498, Gainesville, Texas.

**"FOLD** Away Table" tilts top, adjusts height to fit you in any position to work in comfort or relax in ease for more effective work or more reading pleasure. Send check for \$5.95 (express extra) or ask for free folder. Franklin Table Co., 2020 Village Drive, Louisville, Ky.

**BIG** Mail for you. Latest moneymaking offers, opportunities, catalogs, magazines. Name listed in directory 10c. Ideal Service, 132-M, Park Ridge, Ill.

**BIBLE** Tracts, "Heaven and How to Get There." God's way made plain. John 14:6. Write for free samples, folder. John W. Peterson, Route 1, Galesburg, Ill.

**CHRIST'S** Coming! Get 30 positively reliable proofs, free. Sheall, 263-X Duluth, Minnesota.

**SAMPLES**—Papers, circulars, cards, etc., 10 cents. Brewster, Eastport, Maine.

**HEATING** Six rooms \$20.00 yearly. Circulars 10c. Rosenzweig, RR10-A10, Cincinnati.

**RECEIVE** Gigantic mails, magazines, samples. Your name in numerous mailing lists 10c. Howard, 396 Broadway, New York.

**MECHANICAL** Information for inventors, experimentalists, model builders, students, mechanics, regarding materials, shop practice, formulas, manufacturing methods, sources of supply, etc. Send 25c for 225 mechanical facts and our plan. J. C. Irwin, Box 823, Minneapolis, Minn.

**1001** WAYS to Use Concrete. Send for large free illustrated folder describing new Popular Mechanics book covering every known use of concrete for the home, farm, building, business and industry. Popular Mechanics Press, Room (C40), 200 E. Ontario St., Chicago.

**For FUN and PROFIT learn to MOUNT BIRDS**



**AND ALL KINDS OF ANIMALS**

**SPORTSMEN, SAVE YOUR TROPHIES!** Learn at home in spare time to mount all kinds of birds and animals. Decorate your den with trophies of field and stream. We teach you this **FASCINATING SPORTSMEN'S HOBBY**. Quickly, easily learned. Wild game is growing **scarcer**. Trophies now more valuable than ever! Shoot **FEWER** and **MOUNT** them true to life. **IT'S PROFITABLE!** Many report earning \$25 to \$75 a month mounting specimens for hunters. Why not **YOU?** Learn to make **USEFUL** articles from mounted specimens such as book ends, lamps, etc., etc. (See squirrel lighter to left.)

**WILD GAME NOT NEEDED.** If you don't hunt you can mount **COMMON** specimens: Owls, crows, pigeons, hawks, rabbits, even frogs. **Real FUN.**

**LEARN TANNING** We also teach you to tan fur soft and pliable and new method to **TAN GENUINE LEATHER** from all kinds of hides. Great spare time money maker.

**FREE BOOK** Send right now for beautiful free 48-page booklet, illustrated, telling how easily **YOU** can learn to be a Taxidermy Artist. Contains many fine pictures, intensely interesting. Get **YOUR** copy today. No cost or obligation. **Send now!** State **AGE**. H. W. SCHOOL of TAXIDERM, 3378 Elwood Bldg., Omaha, Neb.

**Do you want**

- ➔ .. to go to College?
- ➔ .. or to enter a Profession?
- (Such as Accounting, Architecture, Nursing, Dentistry, Teaching, Social Work, Osteopathy, Beauty Culture, Optometry, Embalming, Chiropractic, Law, Medicine, etc.)
- ➔ .. or get an Office Position?

To get anywhere, you practically **MUST** finish High School **FIRST**. You can complete our simplified High School Course in **SPARE** time at home, as **FAST** as your time and abilities permit. Equivalent to resident school work—prepares you for college, pre-professional examinations, business, industry. Standard texts furnished. Diploma. Credit for H.S. subjects already completed. Single subjects if desired. Low tuition, easy terms. American School, Chicago, est. 1897—endorsed by educators. Finish your high school education **NOW**. Write **TODAY!**

**High School Course at Home Many Finish in 2 Years**

American School, Dept. H845, Drexel Ave. at 58th St., Chicago, Ill.

Gentlemen: Send me **FREE** information covering special training in subjects checked below. No obligation on my part.

- |  |  |
|--|--|
| <input type="checkbox"/> High School Course          | <input type="checkbox"/> Diesel Engineering                  |
| <input type="checkbox"/> Accounting and Auditing     | <input type="checkbox"/> Drafting and Design for men & women |
| <input type="checkbox"/> Architecture and Building   | <input type="checkbox"/> Liberal Arts                        |
| <input type="checkbox"/> Automotive Engineering      | <input type="checkbox"/> Private Secretary                   |
| <input type="checkbox"/> Business Management         | <input type="checkbox"/> Mechanical Engineering              |
| <input type="checkbox"/> Aviation                    | <input type="checkbox"/> Radio                               |
| <input type="checkbox"/> Electrical Engineering      | <input type="checkbox"/> Salesmanship                        |
| <input type="checkbox"/> Elec. and Gas Refrigeration | <input type="checkbox"/> Retail Merchandising                |
| <input type="checkbox"/> Air Conditioning            |  |

Name \_\_\_\_\_  
Address \_\_\_\_\_

**READY CASH HOT POTATO CHIPS**



Has the war wiped out your business? Are you about to lose your job on account of the war? Here's a booming business. Potato chip sales and profits are reaching an all-time high. Potato chip producers are rushed to the limit. Food sales are skyrocketing. Shortage of sugar boosts potato chip sales. Stores frantic for merchandise to sell do your retailing for you. Plenty of good, vacant stores near center of almost every town, village or city. You can start in store or own home. We still have a few complete famous Long Eakins Potato Chip Outfits ready for immediate shipment. No previous experience required. Follow simple instructions we furnish. We have cash or credit terms. Plenty of bags, advertising helps, etc.

**FREE**—Complete details how to get into potato chip business. Rush name. **LONG EAKINS CO., 1120-S High St., Springfield, Ohio**

**INVENTIONS WANTED** Practical new ideas

are urgently needed to meet the rapidly changing conditions of warfare and commerce. If you have a useful invention for sale your country needs it **now**—and it can be safely marketed without patenting expense! Write for complete details, today. Chartered Institute of American Inventors Dept. 4, Barrister Building, Washington, D. C.

**AIRCRAFT CONSTRUCTION**

STUDY AT HOME QUICKLY AND EASILY SELF-TAUGHT NO HIGH SCHOOL EDUCATION NECESSARY **MEN AND WOMEN—MAKE BIG MONEY**

Industry is Clamoring for Help Complete Course—Thoroughly Illustrated **Only \$10** HOME STUDY INSTITUTE, 236 W. 55th St. (Dept. A-22), N. Y. C.

**LEARN SELF-DEFENSE QUICKLY**



**AUTHENTIC JIU JITSU**

For men, women. Learn to subdue, control any aggressor, no matter how strong, vicious, or armed. A highly-practical, amazingly-effective system by one of world's best-known, most thorough teachers. Course evolved from 35 years' teaching thousands including police, military. Everything signed, authentic, confidential to Jiu Jitsu. Instructed, described in detail, step by step. In these times it may save your life. Money-back guarantee. Send only \$1 for Session 1 today.

The MODERN SCHOOL OF JIU JITSU, BOX 88, FOREST HILLS, N.Y.C.

**LAW** STUDY AT HOME for PERSONAL SUCCESS and LARGER EARNINGS. 31 years expert instruction—over 100,000 students enrolled. LL.B. Degree awarded. All texts furnished. Easy payments. Send for **FREE BOOK**—"Law and Executive Guidance." **AMERICAN EXTENSION SCHOOL OF LAW** Dept. 23-M, 8 East Huron St., Chicago, Ill.

**TIME & MOTION STUDY** **The Vital War Profession** Prepare to help your nation through cost reduction and methods improvement. 40 intensive weekly home study sessions. Big pay jobs await trained engineers. Write at once for descriptive folder. **INDUSTRIAL TI-MO CLINIC, 4000 W. Washington Blvd., Chicago**



**YOU CAN HELP** SHOES, TIRES, RUBBER GOODS Last Longer.

Fix them with new plastanoid "putty." **MENDS** holes and worn spots in leather, cloth, rubber. Spreads on like butter. Dries tough overnight. Flexible, non-skid, water-proof. Won't come off—guaranteed. 25 repairs—29 cents. **So-Lo THE HOLE MENDER**

AT HARDWARE AND 10c STORES



# FREE 7-DAY OFFER to AUTO MECHANICS

## Shows Every Mechanic, Even Experts, How to DO REPAIR JOBS EASIER, QUICKER!

HERE, in one amazing volume, is ALL that anyone needs to know to do practically EVERY repair, tune-up, replacement job on every American car made since 1935, including 1942's—as well as major data for servicing 405 trucks! So clear are its pictures and step-by-step instructions a child can almost understand it. Gives exact how-to-do-it on engines, lubrication, electric, fuel, cooling systems. Covers every service operation on

clutch, transmission, universals, rear-end, wheels, brakes, knee action, shock-absorbers, springs, body, free-wheeling, etc., etc. Try it at our expense for 7 days, and see for yourself!

### THE MOST COMPLETE REPAIR GUIDE PUBLISHED

Every job, from wheels to windshield wipers is covered. 50 pages of text, charts, cross-section diagrams on carburetors alone! Nearly 200,000 essential facts, each available on a second's notice through the Quick Reference Index. Sturdy waterproof binding that lasts for years.

### ALMOST LIKE PERSONAL INSTRUCTION!

Contains the Official shop procedure manuals prepared by the car manufacturer's own engineers. Open the manual to the car you are working on, and everything you'll want to know is there before your eyes. Easy as A-B-C.

Published by MoToR, Leading Automotive Business Magazine

### THOUSANDS NOW IN USE

This is the exact same shop guide used by the U. S. Army, trade and technical schools all over the country for training auto mechanics. They long ago learned that no other book can compare with it.

### SEND NO MONEY

Simply fill out and mail coupon below today and a copy of MoToR's up-to-the-minute 1942 Factory Shop Manual will be sent to you at once for 7 days' Free Trial. ACT NOW. While we still have plenty on hand for quick shipping.

Explains Every Repair Job on Every Model of All These Cars — 1935 through 1942!

American	La Salle
—Bantam	Lincoln
Auburn	Lincoln
Austin	—Zephyr
Buick	Mercury
Cadillac	Nash
Chevrolet	Oldsmobile
Chrysler	Overland
Cord	Packard
De Soto	Pierce Arrow
Dodge	Plymouth
Ford	Pontiac
Graham	Reo
Hudson	Studebaker
Hupmobile	Terraplane
Lafayette	Willys

And major data needed to service 405 models of trucks. Nearly 200,000 Vital Facts on Every Phase of Tune-Up and Repair.

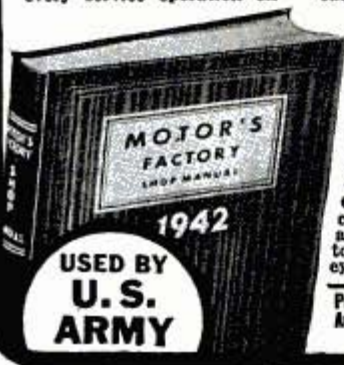

## FREE 7-DAY TRIAL

MoToR BOOK DEPT., Desk 111, 572 Madison Ave., New York, N.Y.

Rush me MoToR's 1942 Factory Shop Manual. If O. K. I will remit \$1 plus 35c shipping charge in 7 days, and \$1 monthly for 4 months. (\$5.35 in all.) Otherwise I will return book in 7 days. (Foreign price \$6, cash with order.)

NAME \_\_\_\_\_ AGE \_\_\_\_\_  
ADDRESS \_\_\_\_\_  
CITY \_\_\_\_\_ STATE \_\_\_\_\_

### OCCUPATION & EMPLOYER

Save 35c Check here if you enclose \$5.00 (\$6.00 Foreign). We then pay costs. Same 7-day return privilege.



## Know Electricity as Experts Know It—and Get an Expert's Pay!

What about your future? Who is safe today? Surely not the man who is contented to stand still! Know your job thoroughly—prepare yourself for jobs ahead. To do just this thousands of men have used

## The Croft Library of Practical Electricity

The Croft Library is a complete electrical educator. It is founded on practice—on 20 years of shirt-sleeve experience—on work as it is actually done. It is jammed from cover to cover with the kind of hard-headed facts you want. Written so that the beginner can easily understand it, yet so sound, so thorough, that it is the daily guide of 20,000 highly paid electrical workers and engineers. Croft tells you the things you need to know about motors, generators, armatures, commutators, transformers, circuits, switchboards, distribution systems—electrical machinery of every type—wiring for light and power—wiring of finished buildings—underwriters and municipal requirements—illumination in its every phase—the most improved methods of lighting—lamps and lamp effects, etc.—how to do a complete job, from planning it, to completion.

### No money down — easy payments

Fill in and mail the coupon attached and we will send you the entire set of seven volumes for ten days' examination on approval. We take all the risk—you assume no obligation. If you decide to keep the books, send \$3.00 in ten days and the balance at the rate of \$3.00 a month. Send the coupon NOW and see the books for yourself.

### EXAMINATION COUPON

McGraw-Hill Book Co., 330 W. 42nd St., New York

Send me for ten days' examination on approval the Croft Library of Practical Electricity, 7 vols. If satisfactory I will send you \$3.00 in 10 days and \$3.00 monthly until the price of \$18.00 is paid. If not wanted, I will return the books postpaid. (To insure prompt shipment write plainly and fill in all lines.)

Name.....  
Home Address.....  
City and State.....  
Position.....  
Name of Company..... PM-11-42

## Serve Your Country as a TECHNICIAN in Vital War Industries



WELDING TECHNICIAN



AIRCRAFT TECHNICIAN



ELECTRO TECHNICIAN

Every airplane, tank, ship or other war machine now fighting for Uncle Sam was built by specially trained men. Yes, Trained Technicians, and our country's wartime industries need millions more. Whether you are drafted or not you can serve your country better if you are a Trained Technician—and you'll be in line for better pay.

### 6 WEEKS—6 MONTHS WARTIME COURSES

We train you in our modern, completely equipped shops. Special wartime courses prepare you in 6 weeks to 6 months for ELECTRO TECHNICIANS, AVIATION MECHANICS, AIRCRAFT and ARC WELDERS, DRAFTSMEN, RADIO OPERATORS and TECHNICIANS.

### EARN \$1,040 WHILE LEARNING

Ask about Special Cooperative Courses and opportunity to earn \$1,040 while learning. Don't be content with hit-or-miss jobs with poor pay when in a short time you can become a trained specialist, with an expert's pay, for war or peace—and get a better rating if drafted. Send coupon today.

## MILWAUKEE SCHOOL OF ENGINEERING Institute of Electrotechnics

PM-1142 North Broadway and E. State, Milwaukee, Wis.

Without obligation send Free Booklet, "Golden Opportunities in Defense Work." Also tell me how to Become an

- |   |   |
|---|---|
| <input type="checkbox"/> Are Welding Operator | <input type="checkbox"/> Electrical Engineer B. S. Degree |
| <input type="checkbox"/> Aircraft Welder      | <input type="checkbox"/> Radio Operator                   |
| <input type="checkbox"/> Welding Technician   | <input type="checkbox"/> Radio Technician                 |
| <input type="checkbox"/> Aircraft Technician  | <input type="checkbox"/> Student Loan Plan                |
| <input type="checkbox"/> Electro Technician   | <input type="checkbox"/> Earn Part Expense Plan           |
| <input type="checkbox"/> Aircraft Draftsman   | <input type="checkbox"/> "Earn \$1040 while learning"     |

Name..... Address.....  
City and State..... Age..... PM-1142

★ Five of the first fifty-three Army-Navy Production Award pennants . . . for plants with the highest achievement in the production of war equipment . . . have been awarded to Westinghouse.

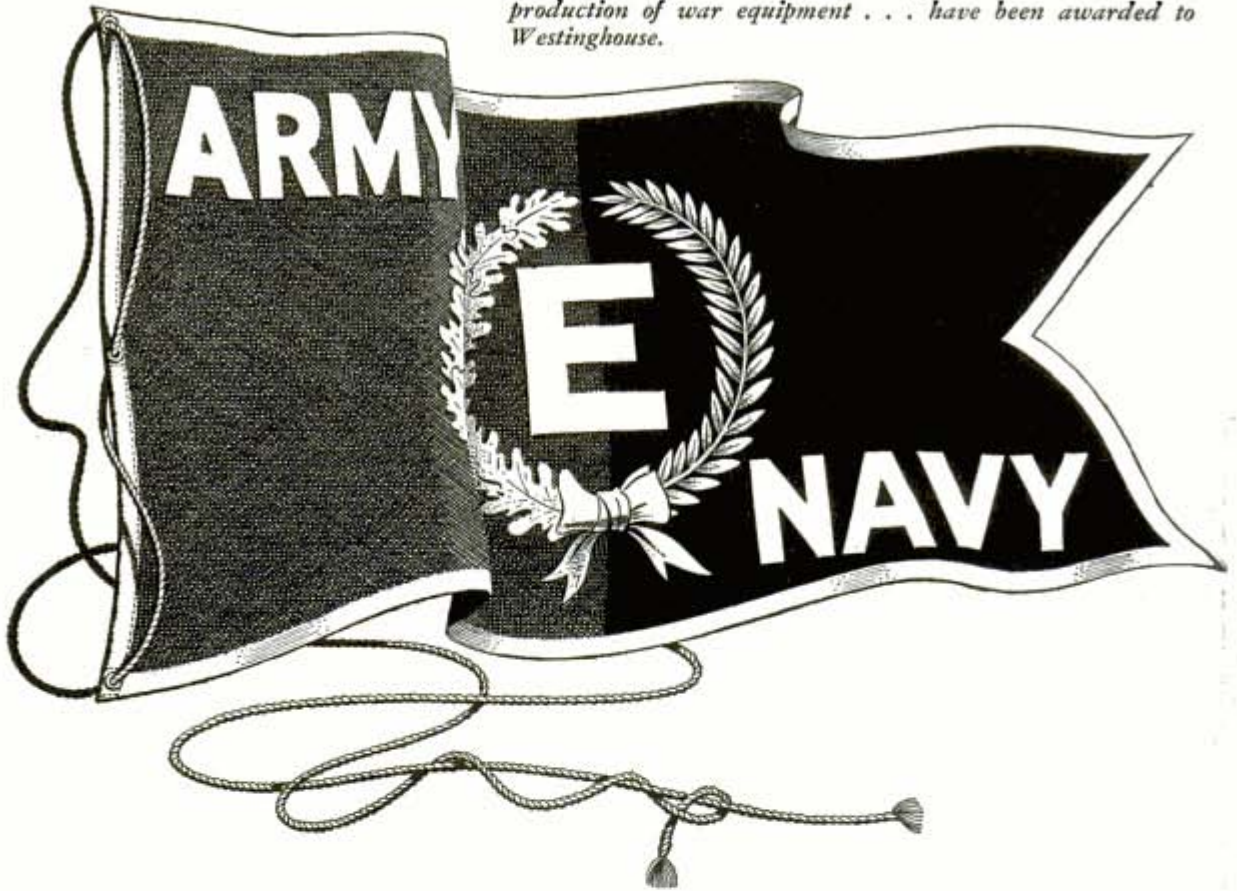

## To Westinghouse men and women, for "an outstanding contribution to victory"

**I**N ANNOUNCING that five of the first fifty-three Army-Navy Production Awards go to Westinghouse, James Forrestal, Undersecretary of the Navy, said, "The men and women in these plants are making an outstanding contribution to victory. Their practical patriotism stands as an example to all Americans and they have reason to be proud of the record they have set."

Westinghouse, one of the world's leading manufacturers of electrical equipment, is now producing war materials at the

rate of 4000 carloads per month . . . enough to fill a freight train 37 miles long every 30 days.

To this effort, we are applying the full extent of Westinghouse "know how" in scientific research, in engineering, and in production. As a result, production, on a man-hour basis, is 95% ahead of the mid-1940 rate. In some divisions, production is up more than 300%.

This is the record to date. We hope to make it still better tomorrow.



# Westinghouse

Westinghouse Electric and Manufacturing Company,  
Pittsburgh, Pa. • Plants in 25 cities—Offices Everywhere

# Popular Mechanics Magazine

REGISTERED IN U. S. PATENT OFFICE AND CANADA

WRITTEN SO YOU CAN UNDERSTAND IT

Vol. 78

NOVEMBER, 1942

No. 5

71775

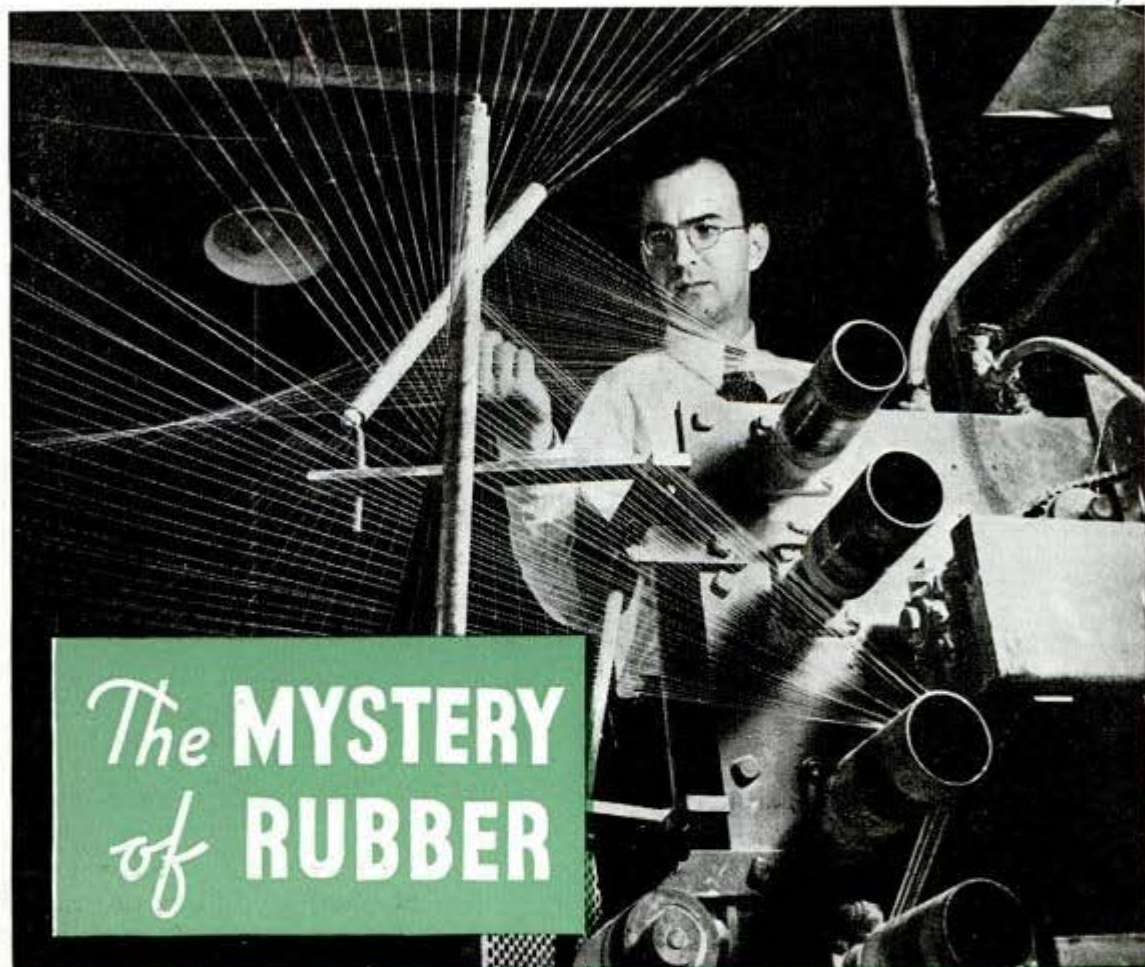

## The MYSTERY of RUBBER

This weblike pattern is created by latex rubber thread recently made of synthetic rubber for first time

**T**HE present mounting emergency over our rubber supply has proved one fact in a hurry. Rubber is not only one of Nature's most useful gifts to mankind, but one of the most mysterious. With most of the civilized world stripped of the source of rubber from the rubber tree, some inventive genius, perhaps in a home workshop, may solve part of the mystery and produce rubber quickly and cheaply.

The truth is that with all of his scientific achievements, man has never created an ounce of rubber.

Fossils of rubber plants show that man

has had access to rubber for approximately 3,000,000 years. Archaeologists have dug up rubber balls 900 years old in Inca and Mayan ruins. Since the first written report on rubber was made to the French Academy in 1746 describing it as the astounding "tears of the weeping tree" of French Guiana in South America, millions of words have been written about rubber.

Yet the average person learns virtually all he ever knows about rubber by the time he reaches kindergarten—that it bounces, compresses, stretches and bends.

This might be excused by the compara-

NOVEMBER, 1942  
Cont: Allen Warren Elliott, 7 Park Ave 1  
N. Y. C.



Pouring neoprene, synthetic rubber developed by Du Pont, into a vat. Basic raw materials are coal, limestone and salt



Above, testing samples of synthetic and natural rubber for their resistance to sunlight with a machine that produces ultraviolet light in laboratories of the U. S. Rubber Co. Synthetics show a high rate of resistance

Bullet-sealing hose is tested with machine gun on grounds of B. F. Goodrich Co. Small gauge at top shows loss of gas. Closeup, far right, shows size of holes made in hose and the 50 caliber bullet used for the tests

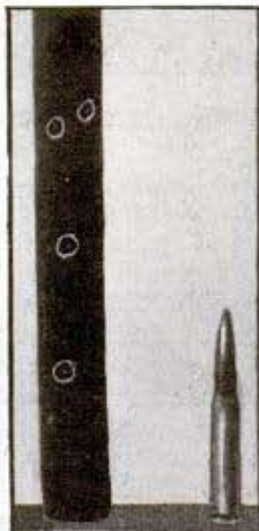
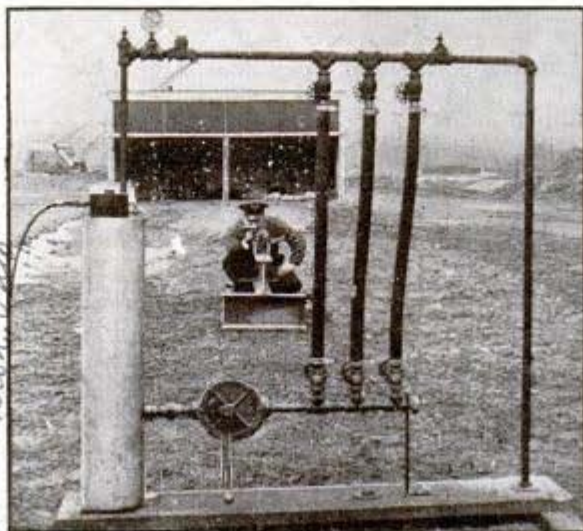

ble fact that there is not a scientist alive who can prove in simple language why rubber acts the interesting way it does. The nearest thing to an explanation is a theory, which sounds reasonable but may be untrue, that the molecules of rubber are shaped in spirals, something like bedsprings. Perhaps the resilient characteristics of rubber are caused by the tendency of these molecules to remain in the shape of bedsprings. Why they should want to, if they really do, is another mystery.

Perhaps some bright young mind knowing nothing about hydrocarbons, monomeric isoprene, polymerizing, protective colloids, antioxidants and other scientific rubber terms will find the key in a brand new application of heat. This solution might be based on the strange fact that Nature stubbornly grows rubber trees only in a torrid region of hot sunlight about 10 degrees on either side of the equator.

He will have to explain why the same heat is so destructive that automobile tires wear out more rapidly in summer than in winter, and why the same sunlight necessary to grow the tree will rot a rubber glove.

Another paradox he can tackle is the fact that a rubber tree must have plenty of air to live, yet air slowly destroys rubber; that rubber is impervious to soap and

sheds water, yet it is reprocessed with soap and water.

He will have plenty of company in seeking his solution, for several hundred crack scientists and leading industrialists of America are devoting their energies in four directions: To produce real rubber by some quick method in a test tube. To discover means of rushing substitute rubber-bearing plants to maturity with increased yields. To find new, easily made synthetics and expand production on the good ones we have. And to make better rubber from rubber.

This last effort deals with the reclamation of scrap rubber. The puzzling problem here is that in made-over rubber the molecules lose some of their bounce every time they are processed. They become much less efficient, in contrast to reclaimed metals. This is because crude rubber is compounded with sulphur, carbon black, zinc oxide, and other chemicals when it is made into products. When the products are treated in the reclaiming process, a certain amount of the chemicals are retained. Further processing raises the percentage of foreign content instead of resulting in pure crude rubber.

Some of the factors in the rubber situation which seem to be mysteries are not mysteries at all.

Why should wealthy America be without sufficient rubber? Because we did not lay up enough before the war, relying on our navy to keep trade routes open. Why don't we get our rubber from South America? Because scientific cultivation on plantations in the Far East cut prices until South

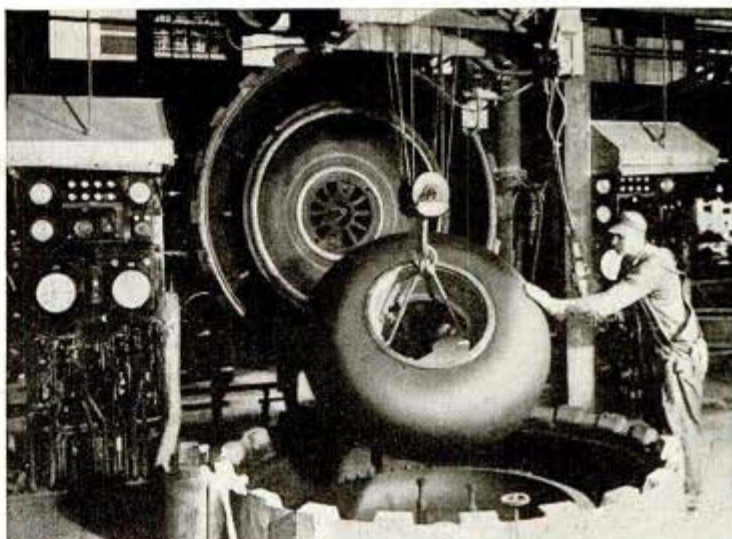

The rubber—300 pounds of it—in this bomber tire being lifted from the vulcanizer is one of the reasons there is none left over for civilians



Check and double check—this huge rubber pontoon float made for the U. S. Army must be flawless for its future role under hail of shells  
Workmen removing a "cake" of Chemigum, synthetic developed by the Goodyear Co., from a press. Cakes are converted into war materials

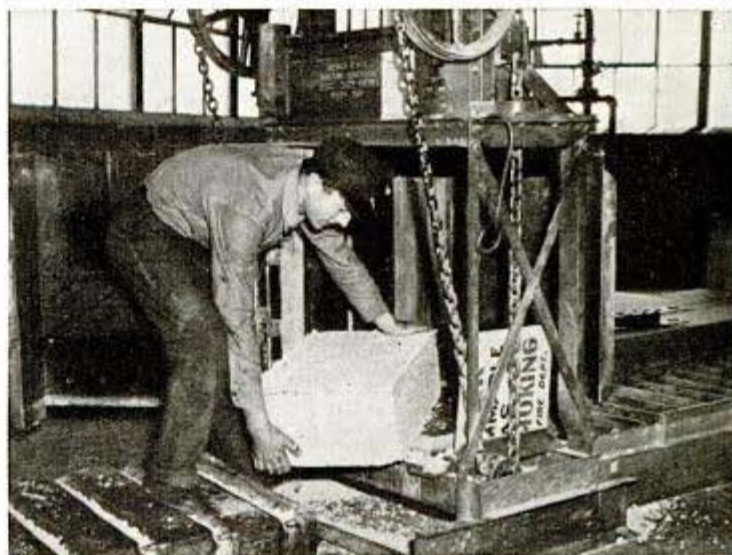

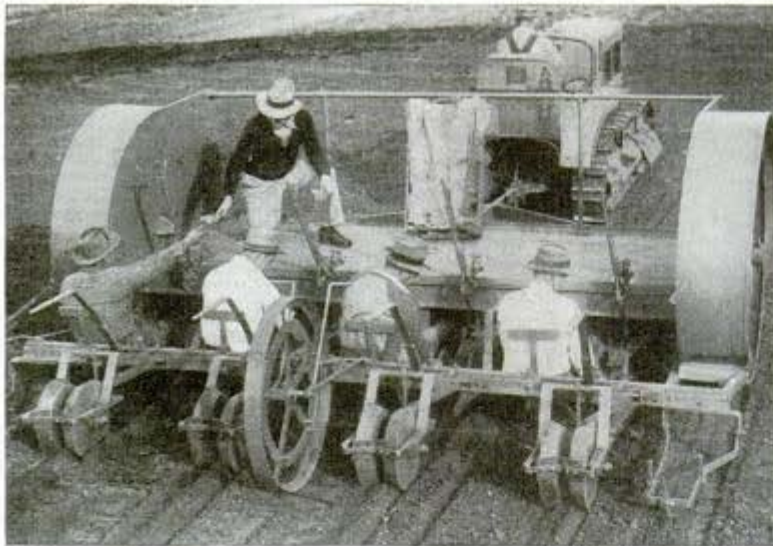

The four men seated at this machine can plant 240 guayule seedlings a minute. The machine prepares the hole and covers the new "rubber" plant

American rubber could not compete. Why can't we get raw rubber from wild trees as the Indian did before the white man cultivated it? Because wild trees grow far in the jungle hardly accessible by either cart or boat. Experimental boat-trucks which plow through water like tugs and clamber over banks like tanks are being manufactured in large numbers in New Orleans to negotiate the Orinoco and Amazon rivers seeking rubber from the estimated 300,000,000 trees.

Why don't we find other growing plants which produce rubber? We have and they flourish all around us. Edison tested 17,000 plants and found 250 useful ones. There are probably 150 more, some of them so common that you probably pass them on the way to work or to the store. Two are dandelions and goldenrod. Even milkweed exudes a rubbery fluid. But they must be tested, cultivated, improved, processed.

The latest sensational find bears the name *Cryptostegia Grandiflora*, which is being rushed into cultivation by the United States Rubber Company. It is found in Florida, California and Arizona and X-ray tests reveal it has a structure very much like that of *Hevea*, which is the familiar rub-

**Making artificial rubber in 10 seconds by coagulating latex with some acetic acid**

ber tree. Also being tested by the same company is *Fosteronia Floribunda*, a plant native to Central America. Both of these will yield an annual crop of rubber. Sources of both are limited at present.

Promising, too, is the shrub guayule, which grows in the Southwest. The Intercontinental Rubber Company and General Tire and Rubber Company have sponsored this development. But it takes about four years for the cultivated plant to grow to maturity and then it must be harvested

—plant, root and all—instead of yielding sap. It will help later on. Dozens of other plants are being examined by rubber companies and private investigators. A real find will bring a fortune and help the nation win the war.

Why have we failed to produce synthetic rubber in large commercial quantities?



U.S. Rubber Co.  
Providence, R.I.

**Marking thousands of re-processed golf balls moving along final conveyor line**

Because there was no need to. Natural rubber was plentiful and, in recent years, not too expensive.

Why were synthetics developed at all? Because they were better for many purposes than natural rubber, just as Du Pont's nylon is better than Japanese silk. One important feature of synthetics is that they resist deterioration from oil, sunlight and oxygen.

Why didn't synthetics replace natural rubber before the war? Because they were too costly to compete with it for general use, such as tires.

What are the basic ingredients of various synthetics? Coal, petroleum, natural gas and alcohol. The Department of Agriculture recently announced the addition of soy bean oil and corn oil substitutes which have already been developed to one-third the stretch of rubber and one-sixth the strength.

What are the leading synthetics? Ameripol, made by the B. F. Goodrich Co. Hycar, made by the Hycar Chemical Company, jointly owned by the B. F. Goodrich Co. and Phillips Petroleum Co. Butyl, developed by the Standard Oil Co. of New Jersey. Thiokol, made by the Dow Chemical Co.

(Continued to page 170)

Resembling the mythical "Man from Mars" is the sandblaster at right whose equipment requires plenty of rubber. Below, gathering guayule seeds with vacuum process. Bin is behind driver

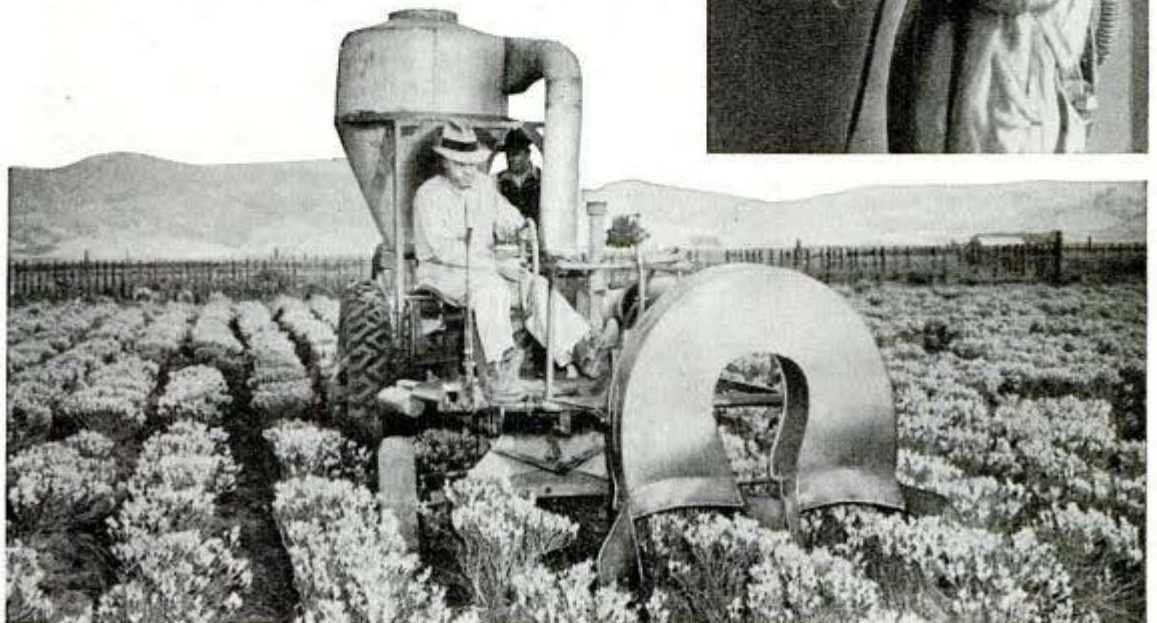
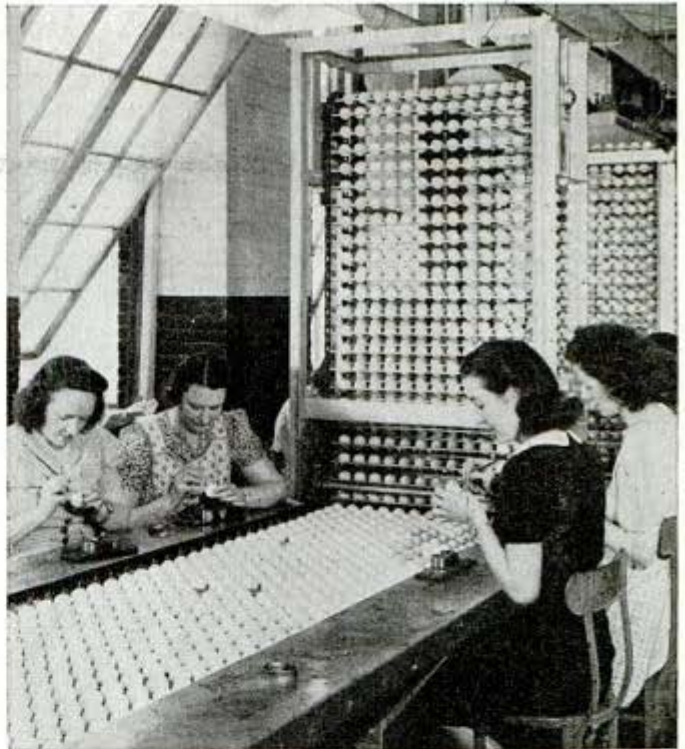

# Rocket Bomb, Antitank Shotgun Enter Air War

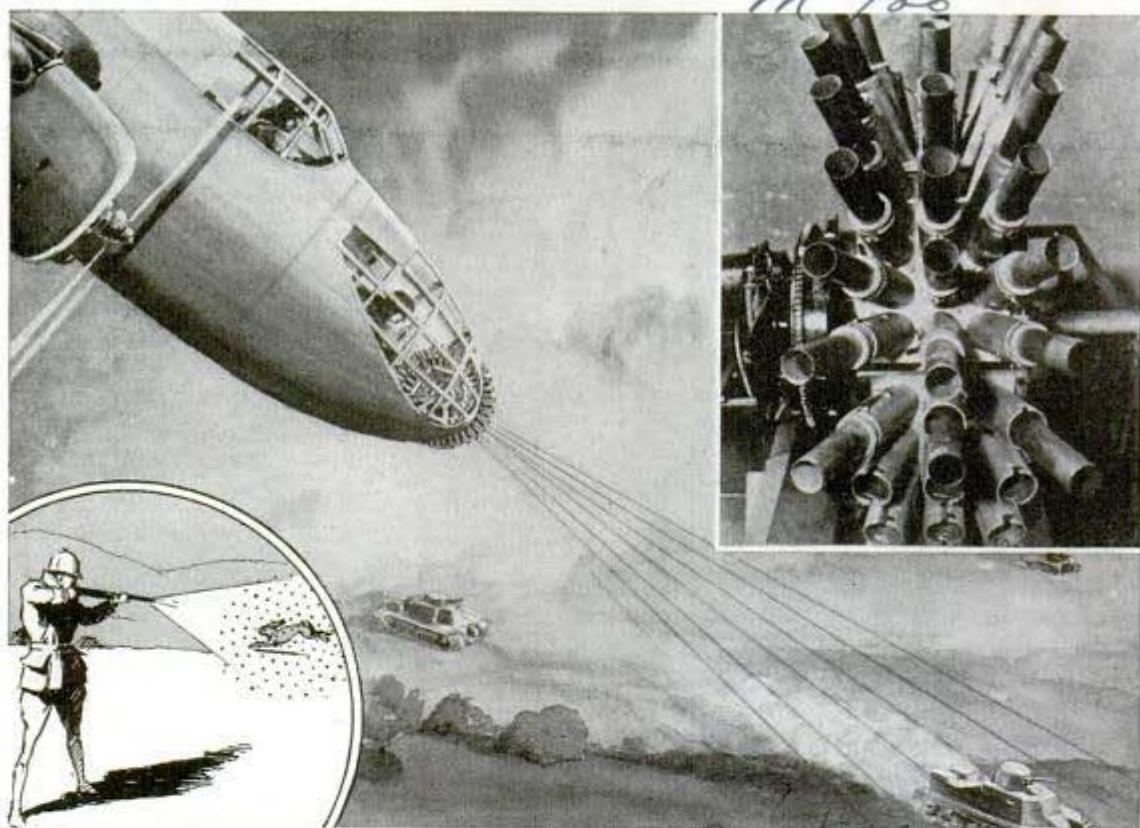

*R. M. Grant*

With a shotgun's effectiveness, multiple projector above sprays target with many shells at once; drawing shows how it may be used against tanks. Rocket bombs (left) dropped by German and Russian planes attain armor-piercing velocity, may replace the dive bomber

the ordinary gravity bomb. German planes used these rocket bombs in attacks on British ships in the Mediterranean, and the Russian air force is reported also to have used rocket bombs and several other rocket-type weapons. Aimed simply by pointing the plane at the target, the rocket bomb is understood to be quite accurate and may render the dive bomber obsolete. Another aerial weapon already in action is a multiple shell projector which sprays up to 20 or 30 big shells at once, with the effectiveness of a shotgun fired at a rabbit. Firing armor-piercing projectiles, it would be deadly against tanks and similar mobile targets. One "spray gun" of this type is adapted for firing solid shot, shrapnel, gas shells or flares; another rotary bomb thrower can fling 5,000 incendiaries a minute.

One of the really new weapons of this war, which made its appearance only recently, is the Fourth of July rocket in reverse. Instead of being fired into the sky, it is a rocket bomb dropped by a warplane, its self-propelling jet driving it earthward at a terrific velocity that gives it an armor-piercing force not attained by



*acme newspaper Inc. 461 Ave. M 867*

# Helium-Buoyed Plane Could Hover Over "Sub"

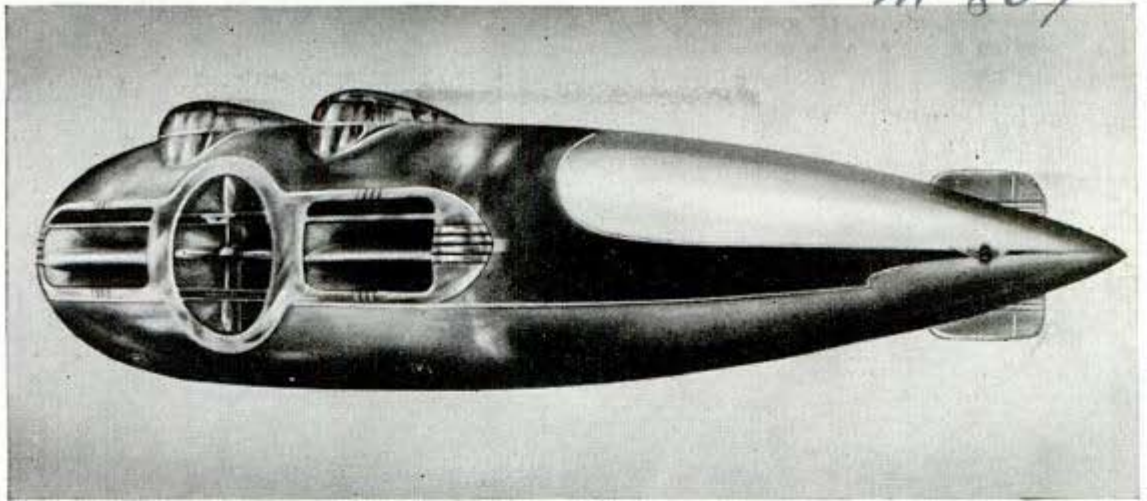

U-boats may be stalked by a plane like this, buoyed by helium so it could hover at 10 miles an hour

Among the many designs for warplanes submitted to a United States Senate Committee seeking means to end the submarine menace is the "Airwing," a plane 250 feet long, 250 feet wide and 69 feet deep. The craft would have its propellers buried

within an interior wind tunnel and carry helium containers to give it buoyancy. This would permit cruising at 10 miles an hour and it could hover over enemy submarines for better accuracy in bombing. Top speed of the ship would be 190 miles per hour.

# Dual Control on Venetian Blind Leaves One Section Shut

If you wish ventilation or need only partial privacy afforded by one section of a

Venetian blind, a new adjustable blind opens or closes in sections. The tape and cord are placed outside the wooden strips instead of in holes within the slats. Pinning the cord to the tape at any point when the slats are closed, "freezes" the slats shut above that point. Jerking the pull cords at the side opens only the lower section.

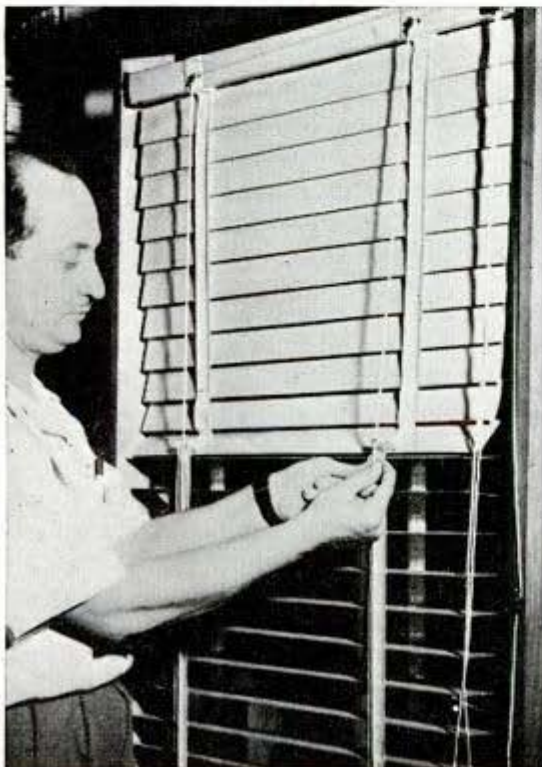

Pinning cord to tape locks one section of the blind

# 'Lay-Up' Kit Guards Stored Auto Against Deterioration

In laying up his car for the duration, the owner is confronted with the problem of protecting the finish and working parts against the ravages of rust, corrosion and disintegration. This job has been simplified by a handy kit containing essential materials to guard from damage 12 important parts of the car, including the radiator, engine, battery, starter, transmission, differential, gas tank, springs, chromium trim, generator, moving parts and steering apparatus. The kit provides anti-corrosion grease, anti-corrosion liquid to be mixed with the oil, rust inhibitor for the gas tank, rust preventive for the radiator, and a preservative coating for the chromium.

NOVEMBER, 1942  
*Nova Drfg Co, 89  
Bozart St. Brooklyn, N.Y.*

*Parfay Sales  
266 Bryant St  
Buffalo, N.Y.*

Takeoff signal officer waves the "go" sign to a fighter on a carrier's deck  
U. S. Navy photos

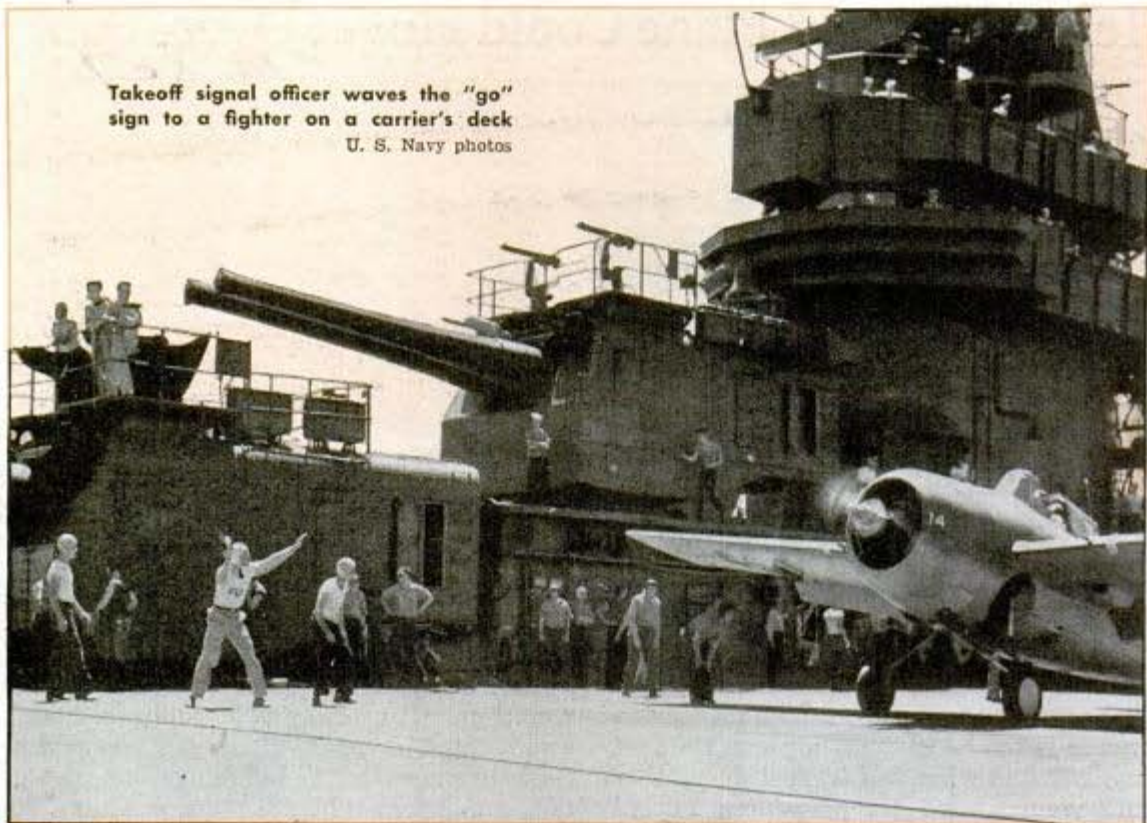

## The NAVY'S SEVEN-LEAGUE BOOTS

208 876  
By C. H. Woodward

Rear Admiral, U. S. Navy

**D**URING the days of John Paul Jones the speedy frigate, with her heavy spars and billowy spread of canvas, was used both for fleet scouting and on important independent and daring "take-a-chance" missions. Her guns were always ready and her horny-handed sailors, with cutlasses in their teeth, were ever prepared to board and strike down the hull-scraping enemy.

Today America's naval picture is quite different. We now have, employed in similar service, huge powerful mobile airports steaming through the seas at express-train speed, with younger men on board operating aircraft destined to strike the enemy hundreds of miles away with bomb or torpedo.

A converted carrier's derrick retrieves a seaplane after flight launched by catapult





**Torpedo bombers taxi to the starting line on flight deck of an American carrier, ready for takeoff signal**

The modern aircraft carrier is both the far-seeing eye and the far-shooting gun of the Admiral who commands the fleet. With her planes she is able not only to obtain and report vital information, but also because of her advanced position, to strike swift blows early in the conflict. With balanced groups of aircraft on board, the carrier is veritably the striking fist of the fleet's air arm.

Carriers not only augment and support fleet gun power when heavy surface forces

meet, but long before the major units come into tactical contact, their scouting planes are sent out in advance to locate the enemy and maintain a constant flow of indispensable information to their respective fleet commanders regarding the composition, bearing, distance, course and speed of the opposing forces.

The air force which is able to gain control of the air (its principal mission) not only can deny similar information to the enemy air force, but also is in position to



Flaps down and propeller humming, a navy plane heads away for battle



After a snowstorm in northern waters a tractor plow and shovel gang have a big job clearing the deck. Runway and deck gear must be ready always

Along the deck rolls a navy dive bomber while another circles overhead awaiting a rendezvous with the mother ship when landing officer signals



attack enemy major ships with bombs and torpedoes while preventing similar attacks on his own main body. This requires aircraft in overwhelming numbers. Frequently there may be an exchange of blows between opposing fighting planes while the two main bodies are still hundreds of miles apart.

Among the more important strategic uses to which carriers have been put most frequently—and successfully—so far, are surprise raids against enemy shore installations at various far-flung Pacific outposts, and as striking forces against enemy ships. Anyone who looks at a map of that vast ocean can see the need for many carriers, as land-based planes do not have the range to be effective. It is for this reason the Navy Department obtained from Congress the authority and funds to more than double the carrier construction program.

The tremendous striking power of carriers has been fully demonstrated

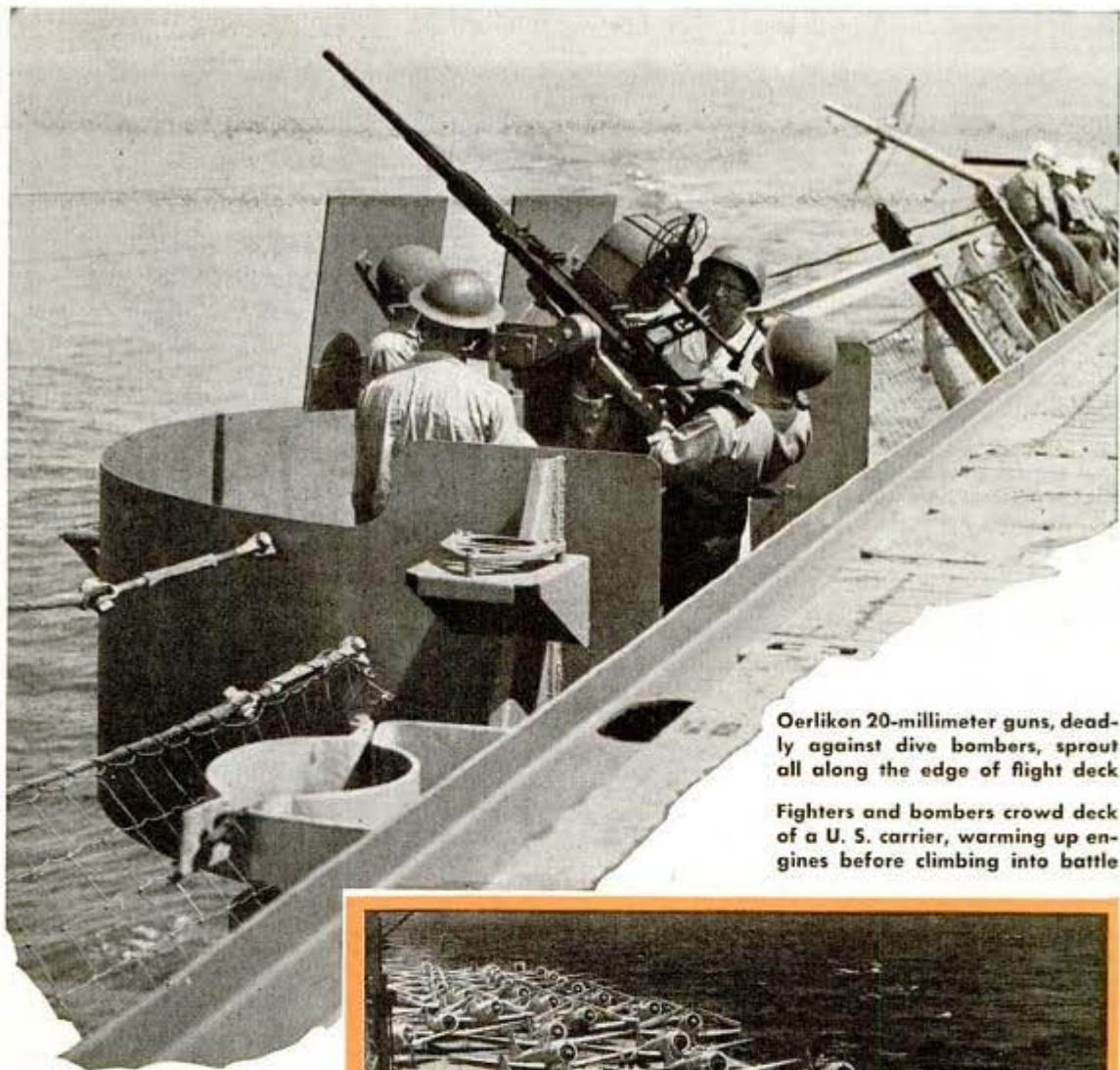

Oerlikon 20-millimeter guns, deadly against dive bombers, sprout all along the edge of flight deck

Fighters and bombers crowd deck of a U. S. carrier, warming up engines before climbing into battle

in the present war. In several spectacular naval actions they have accomplished dramatic results and proved to be the most effective among the weapons used to date.

The Navy has never underestimated the importance of air power in sea warfare, where it plays an increasingly vital part, and has found ample confirmation of its views in the events of the past two years. This is particularly so since the attack on Pearl Harbor. From its inception naval aviation has been an indispensable and integral part of the fleet, working in conjunction with surface craft. The principal concentration of air striking power is



found in the Carrier Divisions, and our carriers have developed an efficiency of operation not yet attained abroad, even under pressure of war.

Admiral Nimitz, Commander-in-Chief of the Pacific Fleet, in a recent address, stated that air power played the leading



Above, tense-faced navy airmen watch the fatal dive of a Japanese bomber that has just plunged into the sea after attempting a suicide crash on the carrier's deck. At right, the flight deck of the U.S.S. Ranger

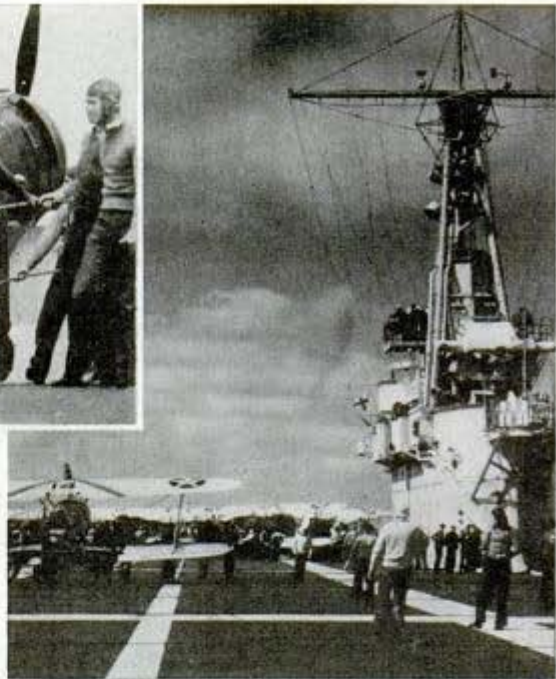

role in both the epic Coral Sea and Midway actions and prophesied that they "will continue to do so as the war progresses." He emphasized that enemy personnel losses in these two engagements were at least ten times greater than ours, and that plane losses were more or less in the same proportion.

A most amazing account of the Midway battle by Ensign G. H. Gay, a wounded eyewitness who participated in the attack, was released by Admiral Nimitz recently. Ensign Gay was pilot of one of the 15 planes belonging to Torpedo Squadron No. 8, which was operating on June 4. Prior to taking off, the Squadron Commander (Lt. Comdr. Waldron) announced that he was determined to "push home" the attack, which he did most effectively, though at

great cost. The squadron encountered heavy fighter opposition at a point 15 miles distant from three Japanese carriers and outside the enemy screen, there being three to four Japanese Zero planes to each American torpedo plane—more than could be handled.

As the attack proceeded the Japanese carriers maneuvered brilliantly, putting their sterns to the attack so that our planes were under both fighter attack and terrific anti-aircraft fire for approximately half an hour. Five of our planes succeeded in launching torpedoes, the others being shot

Converted into an aircraft carrier since the start of the war, the U.S.S. Charger was formerly a freighter

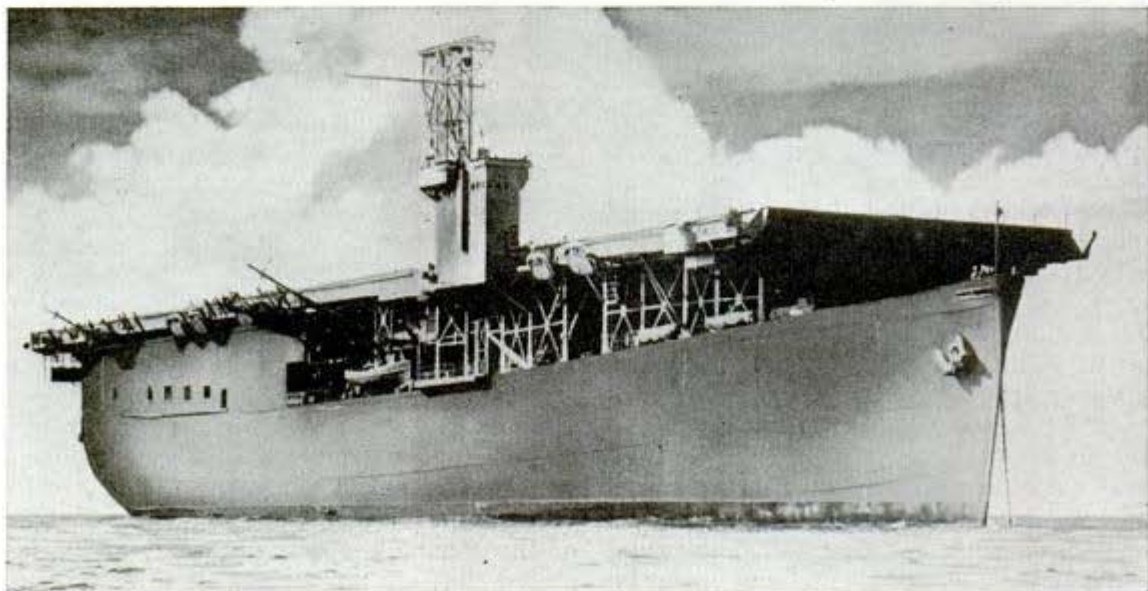

down before arriving at the firing point. Later the remaining five met a similar fate.

Ensign Gay—the only surviving officer of his squadron—scored one hit on one of the larger carriers before he was shot down (his rear seat man having been killed). So close was he to the Japanese ships, when he hit the water, he knew that if he inflated his rubber boat he would be spotted and strafed immediately. So he blew up his life preserver and clung to his rubber boat. Grabbing a seat cushion which floated by, he placed it over his head for concealment whenever enemy planes were near.

Ensign Gay witnessed the blowing up of the carrier Kaga and saw a Japanese cruiser shell the already heavily damaged carrier Akagi to sink her. In addition to seeing other wounded ships pass by, he also had a "fish-eye" view of several aerial



Banking astern its "flattop," a plane heads for home aboard the Ranger

combats between Japanese and American fighter planes. At twilight, Ensign Gay inflated his boat and, after drifting for ten hours, was picked up next morning by a PBY seaplane. Two rear-seat men from the same squadron were later rescued. The losses to this squadron were 14 officers and 13 enlisted men.

(Continued to page 178)

Hiding beneath a cushion lest enemy planes spot him, Ensign G. H. Gay, U. S. N., witnessed this dramatic sight in the Midway battle—the Japanese carrier Kaga blowing up, while "orphaned" Jap planes wheeled helplessly around. Gay was the sole survivor of U. S. Torpedo Squadron No. 8



*Col. Allen Warren Elliott - 78 Ark Ave. N.Y.C.*

# A ROOMFUL of FURNITURE

*M 810*



Houdini, the magician, might have inspired the designer of the box, above, which holds a whole roomful of furniture including a five-drawer chest, three tables, two chairs, a desk, rugs and bric-a-brac

Above, one of the collapsible twin chairs that are packed into drawers of chest along with pictures, lamps, rugs, slip covers, draperies, cushions and table legs. All articles, except the chest, fold into a minimum of space. Below, "moving" out of the chest into the one-room home



The Army officer and his wife have tea in their cheerful new home that was a bare room containing only bed frame and mattress when they moved in with their "magic" box a couple of hours before. The top of the coffee table in the foreground forms part of the original box, as shown in the diagram. The back and sides of the desk form the left part of framework for the packing box. The two end table tops also fit into the frame. All of the tops face inward

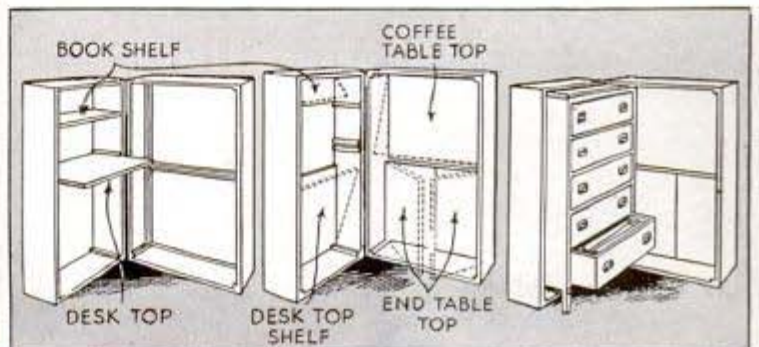



# in a **BOX**



The furnishings for this attractive room, with the exception of the chair at left, bed frame and mattress, were contained in a box 25 by 41½ by 52½ inches weighing 430 pounds. Out of view of the camera is the "carry-all" chest. The desk with a handy bookshelf hardly is recognizable as one side of packing box. Left, assembling lamp with a collapsible shade that fits into the chest. "Box" furniture is made in varied styles

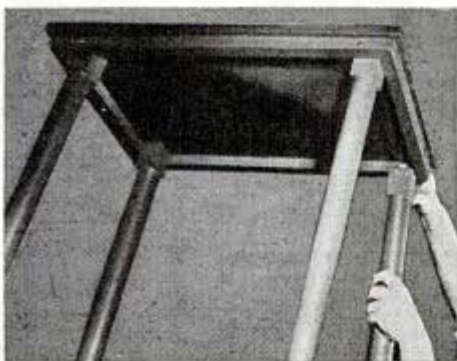

Rugs are supplied in three pieces to facilitate packing them into the chest drawers. They can be used separately or sewed together. Left, fitting legs to the end table top to form a sturdy piece of furniture. This revolutionary method of packing furniture into a box which, itself, is part of the furnishings is expected to be a boon to military officers, college students, defense workers or others who move about on the job

*Int'l. News Photos, 326  
W. Madison, Chicago*

## "Log Jam" in Obstacle Course Toughens Army Trainees

*m 678*



Log maze helps make fighters by building muscle and brawn

No ordinary obstacles will stump soldiers trained at Selfridge Field, Mich., for they repeatedly thread their way through a 220-yard course beset with obstacles to develop lithe and nimble bodies. Part of the obstacle course consists of a tangle of upright and crisscross logs that must be climbed over, squeezed through or crawled under to get into the clear, requiring the agility of a monkey. The course is dotted with hurdles, tunnels and broad jumps, and at many places a missed footing might mean a mud bath.

## Tin Machines Make Fiber Cans For Packing Dry Products

*37786*

Cans with fiber instead of tin bodies now can be turned out with the same machines that have been manufacturing metal containers. The fiber cans, produced by a new method being tested in actual operations by American Can Company, will be used for packing dry products heretofore put up in tins. In the manufacturing process, the fiber, cut into sheets of tin plate size

and lithographed on regular presses formerly used for lithographing designs on tin plate, is sheared and formed into container bodies. Machines now in use will seam the ends on the containers, and firms using the fiber cans will be able to run them through existing packaging machinery.

## Army Dentist Rolls 'Office' To Bedridden Patients

*See what a...*  
Soldiers in the station hospital at Fort Benning, Ga., are receiving dental attention with the aid of a compact cart equipped like a modern dental office. The "dentist's office on wheels" can be rolled from bed to bed or building to building by one man. Mounted on top of the cart is an electric drill, spotlight, sterilizer, air syringe and two spray bottles with plenty of space to spare for use as a work table. The interior contains compartments and drawers that hold the necessary instruments and supplies, including cement for fillings and clean linen. The cabinet is made of wood, Masonite and angle iron. It was designed by Maj. R. D. Watkins, chief of dental service at the hospital, after he noticed that many bedridden soldiers needed dental care.



Pushing dental cart along street on round of call's

*clip  
Chgo Sun, July 10 42*

*Station Hospital  
Ft. Benning, Ga.*

M 579

# COLOR in Your HOME

*Leant*



Photographed at Marshall Field & Co., Chicago

Warmly colorful is this treatment of a room with leather wall panels and fireplace border and leather chairs, especially suited for a playroom or lounge. Sketches above and below suggest decorative use of color around a window and wall cabinet, the latter dropping open to lead a double life as breakfast table





To add a dash of color to the bedroom, this housewife has fashioned a fabric border for the mirror.

Transfers furnish bright patterns for many spots in the home. Here they are applied to kitchen linoleum

Meyercord Co. photo



## By Dr. Matthew Luckiesh

Director, Lighting Research Laboratory  
General Electric Company

COLOR VISION is more of a gift than a necessity. It represents the heaping measure in our marvelous heritage of vision. It bestows upon our surroundings—upon all creation—a magical drapery to be enjoyed. Our eyes are optical organs which reveal things to us. But they are also doorways of impressions which—if the doorway of our consciousness is open—make the world about us colorful or demand that it be colorful. Unfortunately many persons are mentally color-blind much of the time and as a consequence live in a colorless world. Color vision is useless unless we are color-conscious. Color is useless unless used. It is a complex subject but it can be mastered—but not without much conscious observation and many trials and perhaps many errors.

Color is the play and colors are the players. All the world's a stage—for color—and in our homes we have a free hand to produce the plays. These assume a variety of forms as extensive and as complex as human interpretations and responses. In casting the play one has myriad colors from which to choose suit-



able players. A cast may be large or small depending upon the purpose or opportunity. No part of a color play is without a suitable player or a group of them if need be. Dignity is available with an infinite variety of other characters. Frivolity, brilliancy, cheerfulness, mystery, sadness, quietude and a multitude of other parts are easily filled by a knowing producer from the myriad players available. And it is interesting and enjoyable to learn to become such a producer in your own home.

The power of a given color depends upon its area as well as upon its purity. Generally for restful environments, appropriate objectives for the rooms in which we spend much time intimately, the colors of areas such as walls should be subdued into tints or light shades of tints. The floor areas should be subdued into somewhat deeper shades and the ceilings should be very light in color. This is the distribution of brightnesses or values outdoors in Nature which are satisfying because they are natural. Against these extensive backgrounds more colorful objects, such as paintings, vases, draperies, rugs, furniture, are the furnishings. A great variety of colors may be harmoniously blended so as to be full of interest in detail and as a whole. What a relief such a room is from drabness of the Taupe Age which persisted for a century!

Upper left, a gay frame for bookcases—for mirror, window or closet shelf, too—is offered in adhesive "Trimz." Right, a screen of tinted glass. The table will help in selecting paints for light or dark room

**PERCENT OF LIGHT REFLECTED  
BY VARIOUS STANDARD COLORS**

WHITE (CASEIN)	90%
WHITE (FLAT)	84%
WHITE (EGGSHELL)	82%
WHITE (GLOSS)	81%
IVORY WHITE	79%
CREAM	74%
ALUMINUM	73%
IVORY TAN	67%
LIGHT GREEN	62%
YELLOW	60%
LIGHT GRAY	59%
BUFF	55%
LIGHT BLUE	52%
MEDIUM GREEN	49%
TAN	48%
MEDIUM BLUE	43%
ORANGE	40%
FRENCH GRAY	32%
DARK RED	14%
DARK GREEN	10%
DARK BLUE	9%
BLACK	2%

Courtesy of American-Marietta (Paints) Co.

43 E. Ohio  
St., Chicago.



In choosing fabrics, remember the light source in your home. The same drapery material here changes tint under four types of electric lamps

Concealed lights throw warmth on draperies and Chinese screen, below

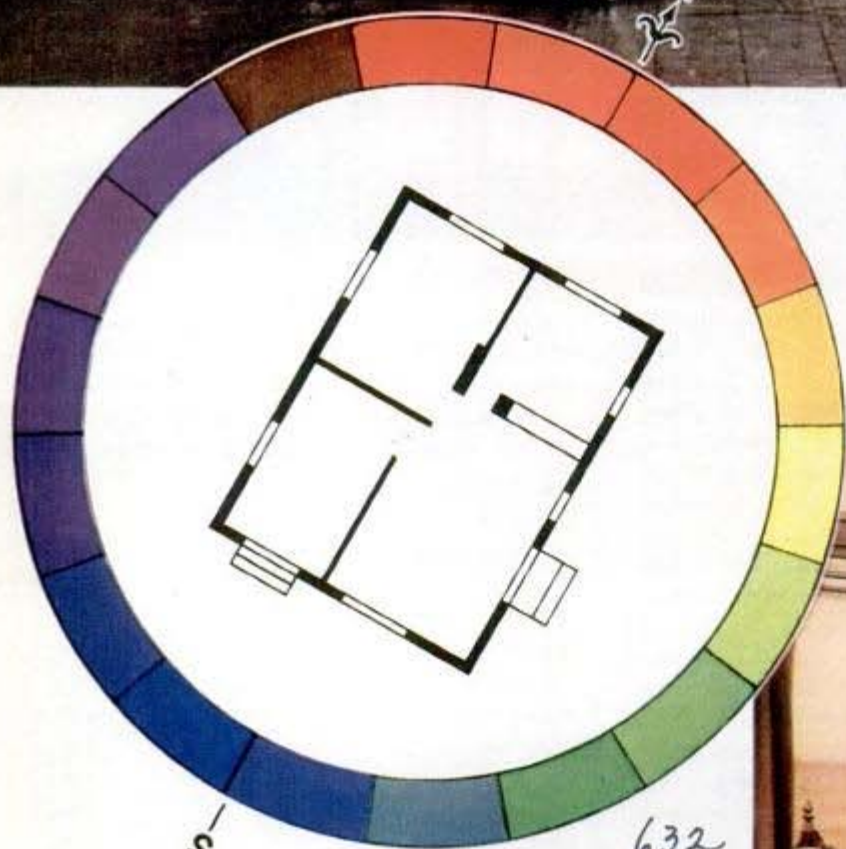

Chart from Pittsburgh Plate Glass Co.  
*Augustine Way, Pittsburgh*

Place a sketch of your house in the color wheel, its south end toward the "S." This will guide you in selecting the best color for each room



Light plays strange tricks with color. At the Chicago Lighting Institute this flag was first photographed under ordinary incandescent lighting (top), then its luminous fabric was excited by the rays of an ultraviolet lamp (below)

There is nothing to fear in color. Look at an Oriental rug and note that the variety of color is both harmless and appealing. But even this apparent maze of color is seen to possess system and a more or less defined background of color or colors. So should a home have a color system — perhaps vaguely as a whole but definitely in each room. The walls should be backgrounds for more colorful objects and furnishings. In a living room it may be a subdued color without pattern but with vague texture. Pattern has its place in rooms where less time is spent but even in these the walls and floors are primarily backgrounds to furnish the mood or atmosphere.

Although many colors have dual natures just as many human beings have, depending upon the situation, a few generalizations are possible. The most exciting color is orange bordering on red and this exciting influence extends throughout the regions of red-purple, crimson, scarlet, orange and yellow. The most cheerful

*Eds. by Paul R. MacAriston, Inc. 16, 53 St. N.Y.C.*

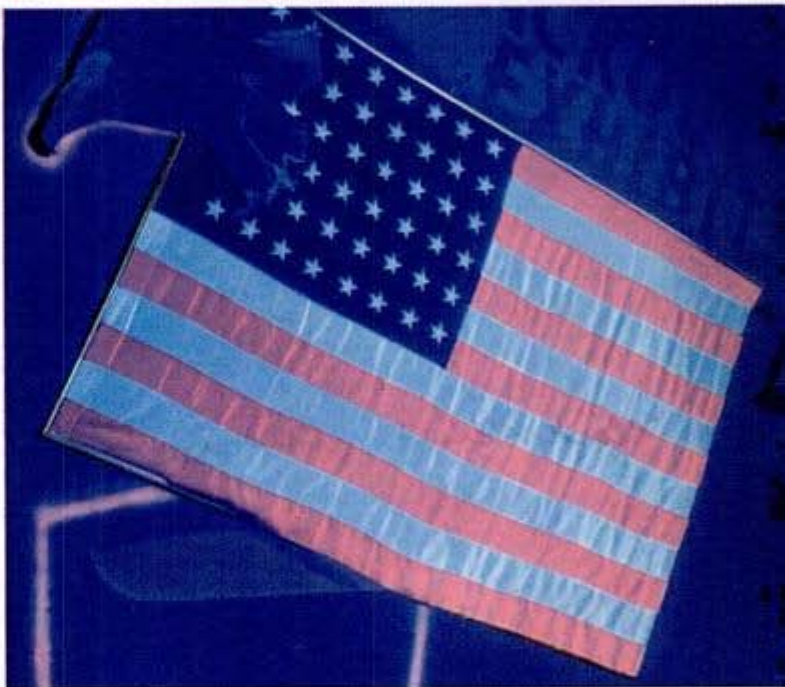

“Plan-a-Room,” <sup>kit</sup> a miniature decorating kit, assists the home maker in visualizing furnishings in color

Examining samples of Flexglass in various colors. The twin columns, too, are of this sparkling glass



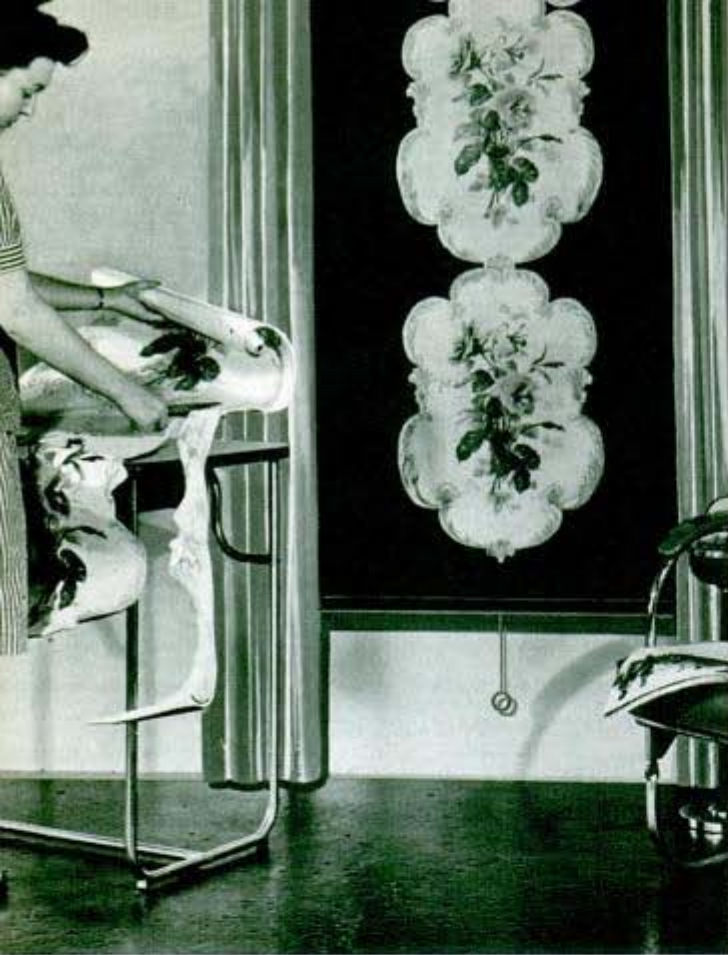

There can be color even in the blackout. Above, a black window shade is decorated by applying floral panels cut from a roll of wallpaper. Venetian blinds (below) can be had with attractive patterns in color

Remien & Kuhnert Co., Chicago

63 21 Clark & Board, Chicago



color is yellow and this cheerful influence extends throughout the region from yellowish green to yellowish orange. The most tranquil color is green and this tranquilizing influence extends from yellow-green to blue or even to violet-blue. Violet is the region of subduing influence which extends into the purples but, of course, as all colors are reduced more and more into shades they are subdued and are of more subduing influence. Conversely as all colors are reduced more and more into tints their individual powers are diluted but a cheerful influence remains owing to their lightness. These powers or influences increase as their area increases. The purest colors can be used safely in small areas—a vase, or other relatively small ornament.

(A tint is produced by diluting a color with white which also lightens the color. A shade is produced by darkening the color with black. Reducing the amount of light on the color also produces a shade of the color.)

Two kinds of harmonies may be considered for a room as a whole. One is the harmony of approximate complementaries such as blue and yellow or blue-green and coral. The other is the harmony of colors more nearly alike such as yellow and orange, red and orange, green and yellow-green or blue and blue-green. The latter kind of harmony is generally less interesting or less lively than the former. For a home a complementary color scheme such as subdued blue-green and slightly subdued coral is more likely to result in an interesting colorful environment.

In choosing colors for the greater areas with which to live it is essential to distinguish between an inherent liking or preference for a color as considered by itself and our liking or preference for a color when it is associated with something and with other colors. A large group of young men and women were tested carefully in regard to their preference for various colors when not associated with anything else. Six principal colors of the spectrum ranked in this order: red, blue, violet, green, orange and yellow. Actually the men preferred blue most but red was a close second. The reverse was true of the women. However, it may be said that both men and women preferred the colors near the ends of the spectrum to those near the middle. This





CARPET COLOR	WALL COLOR	DRAPERY COLOR	DOMINANT UPHOLSTERY COLOR	SECONDARY UPHOLSTERY COLOR
BEIGE TO BROWN	Beige or Ivory	Peach	Brown	Green
	Blue	Rose	Burgundy	Blue
	Green	Gold or Beige	Cedar	Green
	Peach	Green	Cedar	Gold or Beige
	Rose	Turquoise	Burgundy	Beige
BLUE	Beige or Ivory	Rose	Burgundy	Beige
	Blue	Peach	Brown	Beige
	Peach	Beige	Cedar	Blue
	Rose	Blue	Mauve	Beige
	Grey	Rose	Burgundy	Gold or Beige
WINES	Beige or Ivory	Green	Gold	Wine
	Blue	Oyster	Blue	Gold
	Green	Wine	Gold	Green
	Rose	Turquoise	Gold	Beige
	Grey	Rose	Blue	Mauve
GREEN	Beige or Ivory	Green	Cedar	Beige or Gold
	Green	Peach	Cedar	Beige or Gold
	Peach	Beige	Brown	Cedar
	Rose	Green	Mauve	Grey
	Grey	Peach	Green	Gold
PEACH	Beige or Ivory	Green	Brown	Cedar
	Blue	Beige	Cedar	Gold
	Green	Cedar	Green	Beige
	Peach	Beige	Blue	Gold
	Grey	Peach	Green	Brown
ROSE	Beige or Ivory	Mauve	Turquoise	Beige
	Blue	Oyster	Mauve	Blue
	Green	Rose	Mauve	Gold
	Rose	Blue	Burgundy	Oyster
	Grey	Mauve	Turquoise	Oyster
TURQUOISE	Beige or Ivory	Peach	Brown	Beige
	Rose	Beige	Mauve	Blue
	Peach	Turquoise	Cedar	Beige
	Turquoise	Gold	Mauve	Beige
	Grey	Rose	Burgundy	Beige

United Wall Paper Factories-

33307 *all money*  
*Chicago*

A strip of patterned wallpaper laid on the back of a whatnot or china cabinet furnishes a gay background for amusing figures or china. The table (from Bigelow-Sanford Carpet Co.) suggests harmonious colors for decorating

*140 Madison Ave, N.Y.C.*

remained true for tints and shades of the same colors. How contrary this fact is to the preference of colors when used in decorative schemes to live with! Almost the reverse is true where good taste dictates the colors to be used for large areas in the home. In other words our absolute color preference may safely guide us in the selection of an ornament such as a vase or painting but this primitive innate liking must be replaced by a relative color preference when selecting the colors to live with intimately and which are dominating in area.

In considering a color for an important area of a room such as walls or floor covering or even for an important item of furnishing such as draperies, a large painting, or a dominating piece of furniture one might have in mind the following characteristics of color: stimulating, subduing, vividness, attractiveness, appropriateness, distinctiveness, innate appeal, warmth, coolness, neutrality,

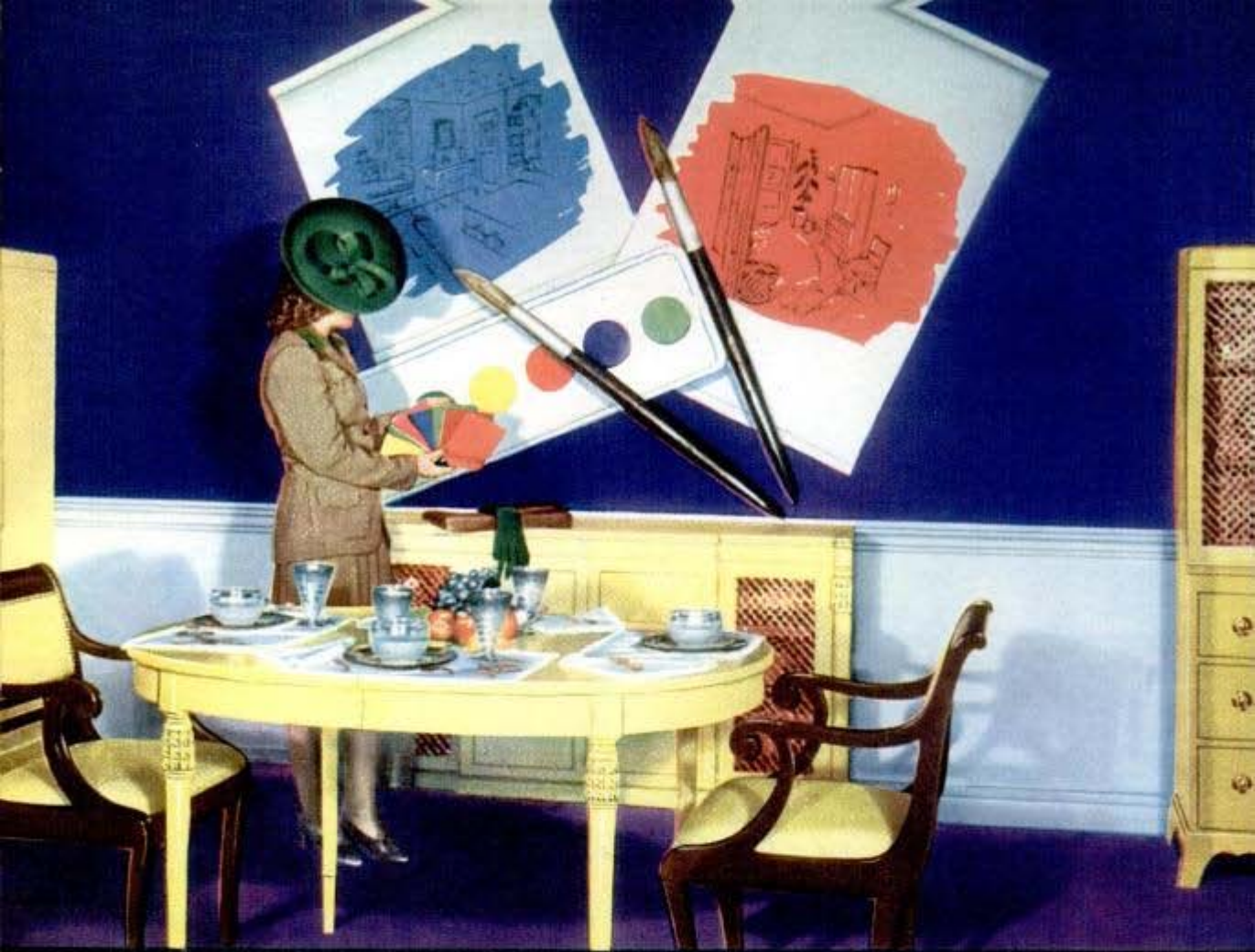

Photographed at Marshall Field & Co., Chicago

Colors must be blended in the home to please the eye, to add warmth or coolness, gaiety or quiet, to create the mood desired. Here a housewife studies color charts and samples of bright leathers

This is another method of quenching the gloom of the blackout—black drapery with pattern inside



novelty, realism, symbolism, usefulness, surface finish, practicability, and established usage. These characteristics overlap more or less but if a given color for a given purpose is diagnosed in this manner one is not very likely to make a great mistake in the selection of the color to suit the purpose in mind. Always remember in dealing with a decorator that you must live with the color and he does not. Good decorators put themselves in your position but some do not. Do not mistake temporary sensationalism and novelty for enduring satisfaction.

The appropriate color scheme for a home depends upon climate, exposure, character of the home and rooms, personality of the individuals and many other secondary factors. Often compromises are necessary. Generally north rooms should have warmer colors—shades and tints of colors on the yellow side of the middle of the spectrum. Southern exposures may well have cooler colors—tints and shades of green, blue-green, blue, violet, etc. As to personality, alert, conscious sparkling persons are quite in place in colorful environments.

Bernice Bowser and her associates have divided women into five color types: blond, brunette, redhead, brown hair and silver-gray. They have developed color-charts showing the range

(Continued to page 176)

Wilen & son. co  
mace mart, Chicago

# Wood Bats for Metal Around Your Home Plate

1488

Mutcher 1300. 14115 mace mart  
Chicago

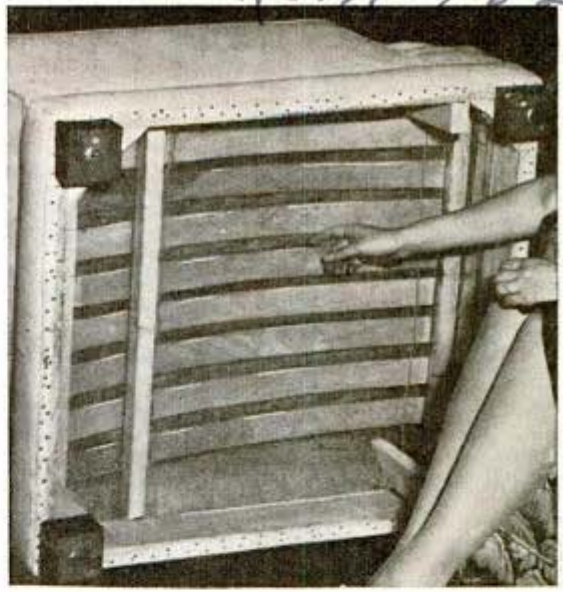

There wasn't much chrome available when America was getting its start, but there was plenty of wood. And America can do very nicely with wood today, now that chrome and other metals are on the "precious" list. The sink (upper left) has a counter of wood and a basin of porcelain, its only metal parts being the spout and piping and door hinges. One furniture manufacturer solved the problem of springs for a living room chair (upper right) by using highly resilient curved wooden slats instead of metal coils. The bent-tube chrome leg was so popular that furniture makers were loath to abandon it, so when the metal famine came, a wooden chair was designed (lower left) retaining the lines of the chrome chair. The wooden wagon can serve as a scooter and for shopping.



C. L. Bradford  
1488 mace mart, Chicago

NOVEMBER, 1942 *Salmonson & Co Inc*  
*American Furniture Mart*  
*666 Lake Shore Dr. Chicago*

# THRILLS of MOUNTAIN RAILROADING

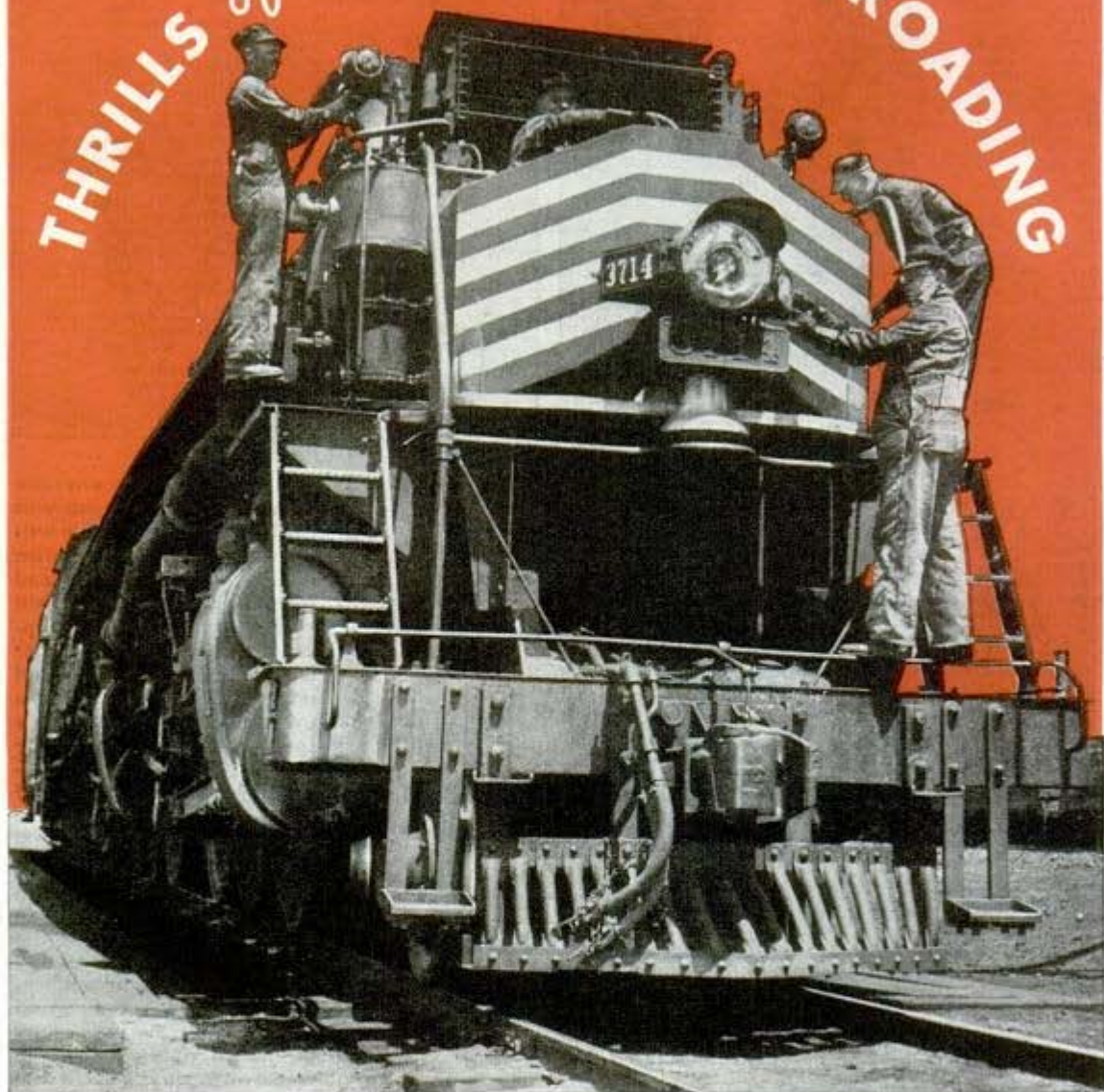

Grooming the mountain giant for its 2,500-mile run over snow-covered passes, through gorges and tunnels

M 685

By Thomas E. Stimson, Jr.

3872 Franklin Ave Los Angeles, Cal.

**E**VER hear of an electric slide detector fence?

High in the Rockies, a chunk of granite the size of an automobile plunges down a mountainside and lands on a railroad track. A train is due around the curve in a few minutes but the engineer already knows that the rails are obstructed. When it fell, the rock automatically told the engineer to stop his train. It had plunged

through an electric slide detector fence, breaking a circuit that set the signals against the oncoming engine.

This device is one of the weapons that the Denver & Rio Grande Western railroad uses in its never-ending fight against the mountains. Operating "through the Rockies and not around them," the D. & R. G. W. winds along the bottoms of narrow mountain gorges, crawls over

**Roaring through the Royal Gorge, which would hold Empire State Building under suspension bridge**

passes nine and ten thousand feet high, and crosses the continental divide through the six-mile Moffat Tunnel. Advertised in peacetime as the world's most scenic route, the railroad is now concentrating on the fast movement of war materials. Its main lines from Denver and Pueblo to Salt Lake City form vital links in our central transcontinental railroad system. About three quarters of all the molybdenum mined in the world moves over its rails from the mountain of ore in central Colorado.

In spite of the country through which it operates it is a high speed, heavy duty railroad, using special engines and equipment for hauling big loads up steep grades. Its engines include great steam locomotives of 132,000 pounds tractive effort, and 5,400 horsepower Diesel engines that are specially supercharged for high altitude operation. It used to take 54 hours to haul a train of freight from Denver to Salt Lake City; now the same load is moved in 24 hours.

This line, too, is a connecting link between the past and present of railroading.

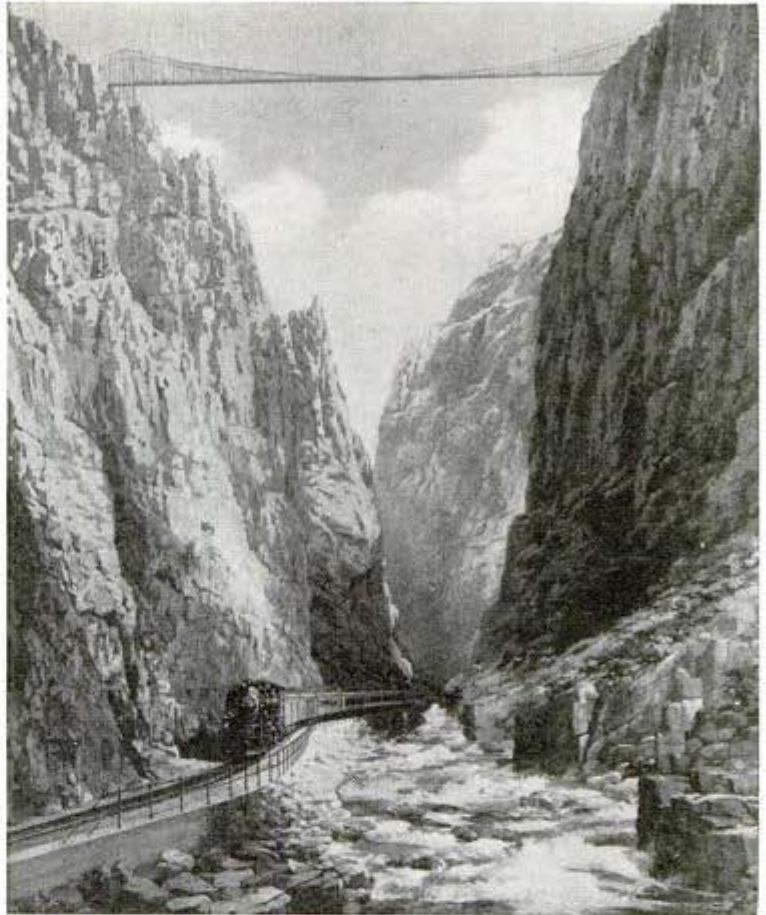

Seventy years ago it was a narrow gauge system and some of its feeder lines that crawl up to isolated mountain mining communities still use 3-foot narrow gauge track. Some of the original rails were manufactured in England, and some of the narrow gauge bridges are built of wrought iron instead of steel. On this railroad you can ride on a brand new Diesel-electric

Dispatcher attaching message on stick for crew; right, two engines pulling train before days of "giants"

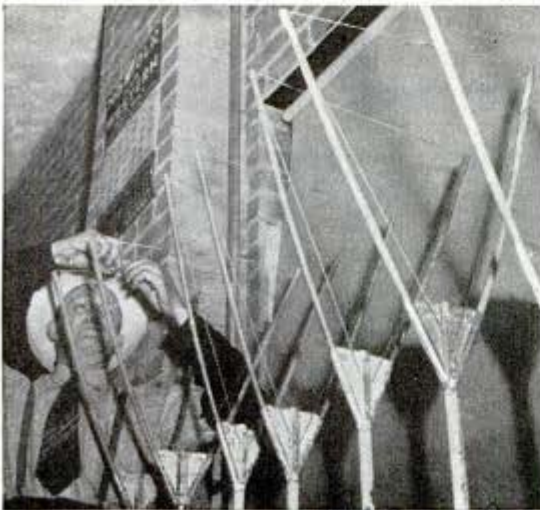

NOVEMBER, 1942  
*Director of Public Relations, Ry.*  
*Attn: George F. Dodge*  
*Denver, Colo.*  
*Dr. R. G. G.* 27  
 Материал, защищенный авторским правом

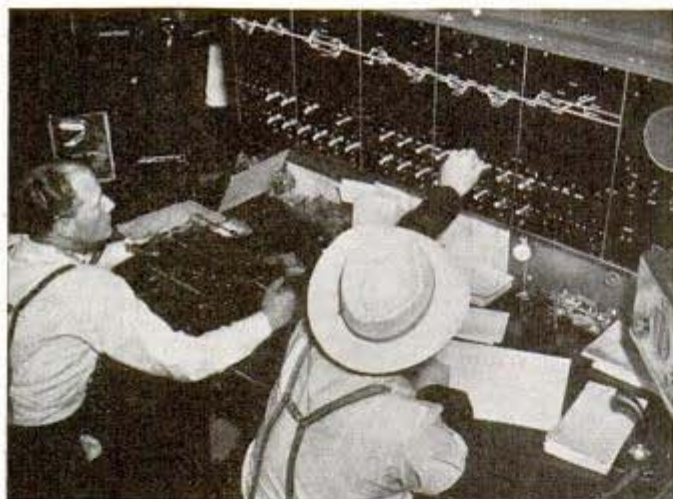

Lights on control board show train positions in mountain area



↑ Electric slide detector fence warns the engineer of landslide

Left, examining signals interlocked with the electric fence

The old-type narrow gauge engine, below, has cinder collector

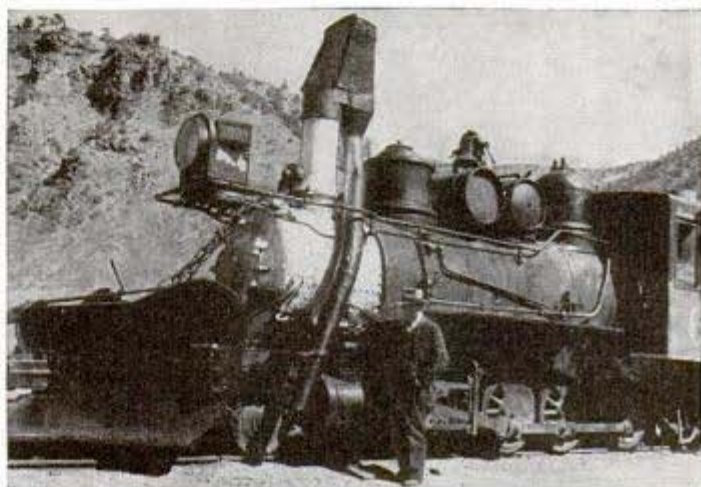

luxury streamliner and transfer from it to a puffing narrow gauge train. The narrow gauge coaches, built in 1880, have been modernized and even carry 110-volt current for your electric shaver. Some of the roadbed has three rails so that both narrow gauge and standard gauge equipment can use it. Over some parts of its route the line travels over solid beds of coal and oil shale. All but a short stretch of track on an entire division is ballasted with gold ore worth \$1,000 a mile, the slag from old mining smelters.

As much as 40 feet of snow a year falls on one mountain pass that the narrow gauge crosses, yet out in the desert on the main line to Salt Lake City summer temperatures rise as high as 110 degrees. The road fights the snow with big plows and with miles of snow sheds and snow fences. Some of the canyons have walls 1,000 feet high and in all such places where slides or falling rocks might cause trouble the roadbed is protected with electric slide detector fences.

Washouts in the mountains must always be guarded against. It has even happened, when miles of track have been rebuilt after a storm, that another washout tears the new track away even before the first train can cross. Out in the desert regions, "washins" are another difficulty. A cloudburst far away in the hills may wash sev-

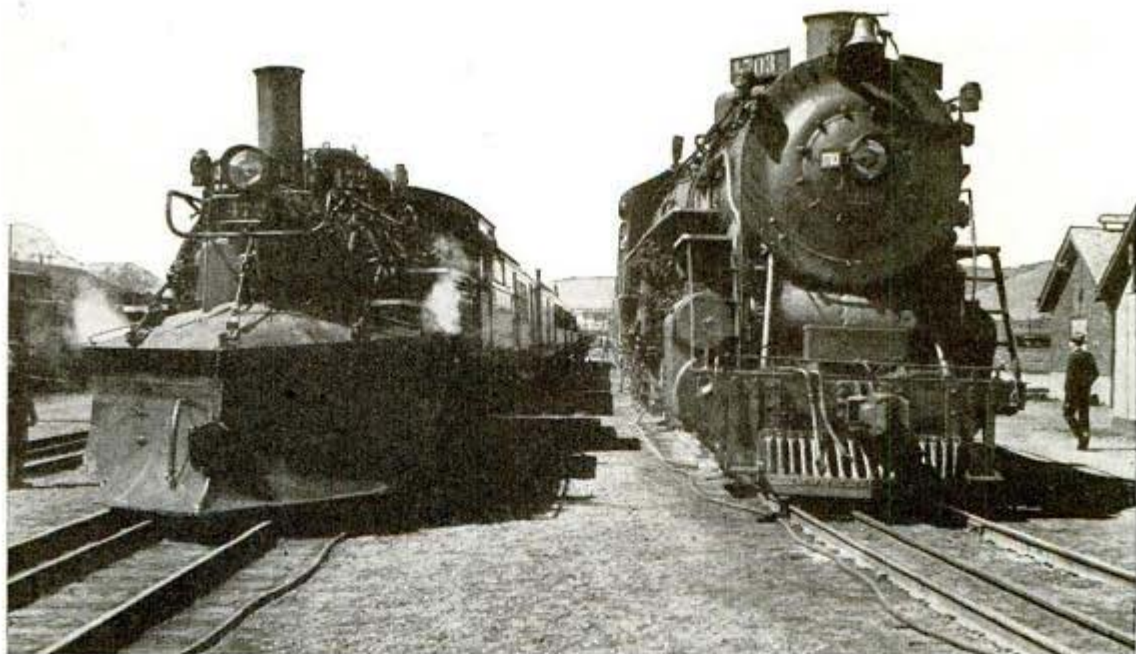

**Narrow gauge engine, left, pauses beside a standard gauge locomotive. Three-rail tracks accommodate both**

eral feet of dirt and debris over the rails, even though the weather along the railroad remains warm and clear. So when ominous clouds gather in some quarters, track patrolmen automatically make extra rounds. Without warning, desert creek beds that have been dry for five years may fill with a roaring flood of water. Some of the culverts under the roadbed are 15 feet in diameter to carry off such flash floods.

Repeated cloudburst trouble led the railroad men to build a long sturdy bridge right on top of the ground at one point. Then, when everything was completed and trains were moving across the bridge, they excavated a channel underneath the structure so that future flood waters could pass without doing harm. Such safety work as this has led to a record of 16 years of operation without a single passenger fatality. There are more than 2,000 bridges, as well as many miles of tunnels, in the 2,500 miles that the system covers.

Keeping the great Moffat Tunnel in operation is a special job in itself. Instead of being level, the

tracks in the tunnel climb 50 feet from one portal, then descend 20 feet on the other slope. Passenger coaches, of course, are completely air conditioned, yet breathing respirators are issued to the engine crews for the six-mile trip through the heart of the mountain.

Condensation of engine steam precipitates the smoke and soot on passenger car windows, so these are automatically washed clean again by high power sprinklers as the train emerges from either portal. After a train has passed through, large ventilating fans go into operation

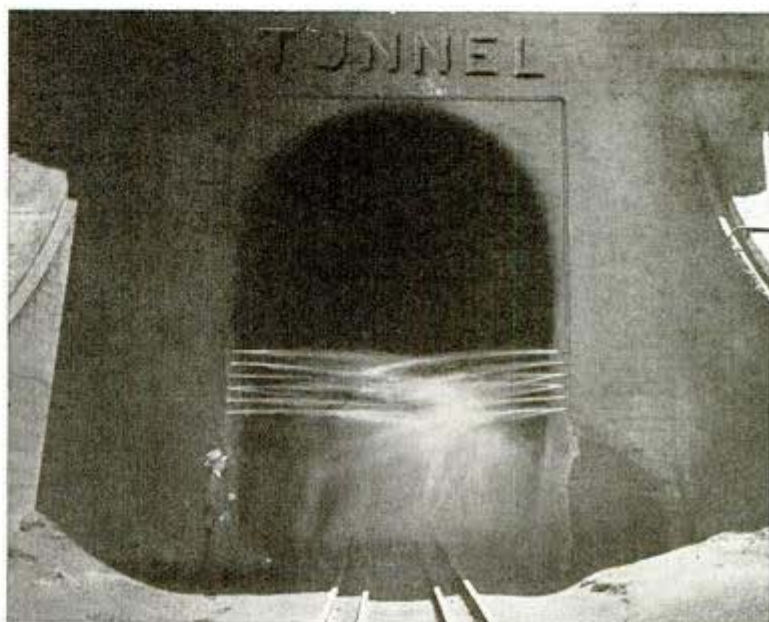

**Water jets wash dirt from cars as they leave the Moffat Tunnel**

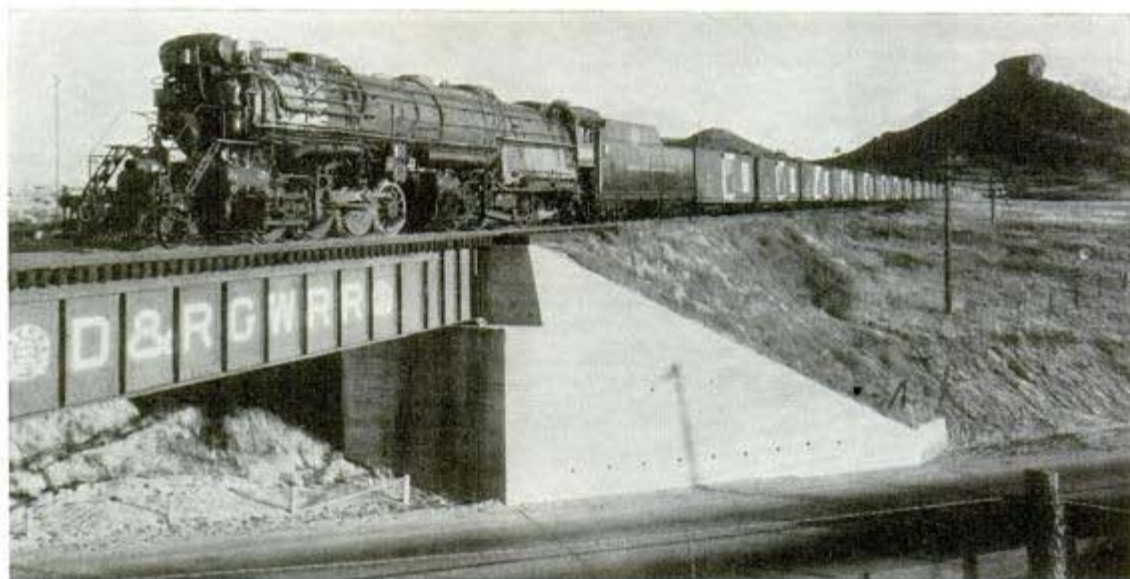

**A big new mountain climber hauling a load of freight that would have required from three to five engines 20 years ago**



**Engineer opening the inspection door of fire box in cab of steam locomotive boasting 132,000 pounds of tractive effort**

**Making careful inspection of engine before setting out from Denver for Salt Lake City via lofty passes, tunnels, desert**



and remain on until the atmosphere clears to a point where an electric eye shuts the fans off. It may take 20 minutes to clear the tunnel of smoke.

Tons of cinders must be removed from the floor of the tunnel each year. Rail replacement is another job, since the tops of the rails are worn down a quarter of an inch a year, due to the corrosive action of the high humidity and the engine gases.

You rarely see a long stretch of straight track in the mountains. On one of its lines in southern Colorado the tracks wind in and out of New Mexico 18 times. One of the narrow gauge routes passes the same station three times as it winds back and forth up the side of a mountain. At one horseshoe curve, when the train is a long one, it almost seems that the engineer in front and the brakeman in the caboose can shake hands.

Half a century ago the narrow gauge engineers used the "smoke telegraph" to keep track of each other. That is, they slowed down when they saw the smoke of an approaching train. Today the D. & R. G. W. uses centralized traffic control systems at various points along its lines where traffic is heavy. Train orders that are passed to the engineers govern train movements over some parts of the system but



**In the cab of a huge steam locomotive, engineer guards lives of his passengers**

when an engineer moves into one of the C. T. C. areas he moves his train according to the block signals alone. These in turn are operated electrically from a central point. The dispatcher in charge has a track diagram in front of him with lights on the diagram that show the location of all trains. He controls all signals and movements with a few switches.

No other line in the United States operates under such a variety of extreme conditions. To help itself maintain "on schedule" performance the D. & R. G. W. has its own complete railroad laboratory where new designs are studied and where new materials and equipment are tested before they are put into service. Its metallurgical research men constantly look for better materials for fireboxes, its chemists study water, fuels and oils, and other engineers are steadily at work on equipment that will last longer under heavy use. In a sense, the entire D. & R. G. W. system is a laboratory for the rest of the country's railroads, since all the lines profit by what the mountain railroad learns in its laboratory and tests on its system.

**This hanging bridge, entirely unsupported from below, was built in Royal Gorge due to the steepness of the canyon wall**

**Below, four-power-car locomotive of the Diesel-electric type that cut 30 hours off the trip from Denver to Salt Lake City**

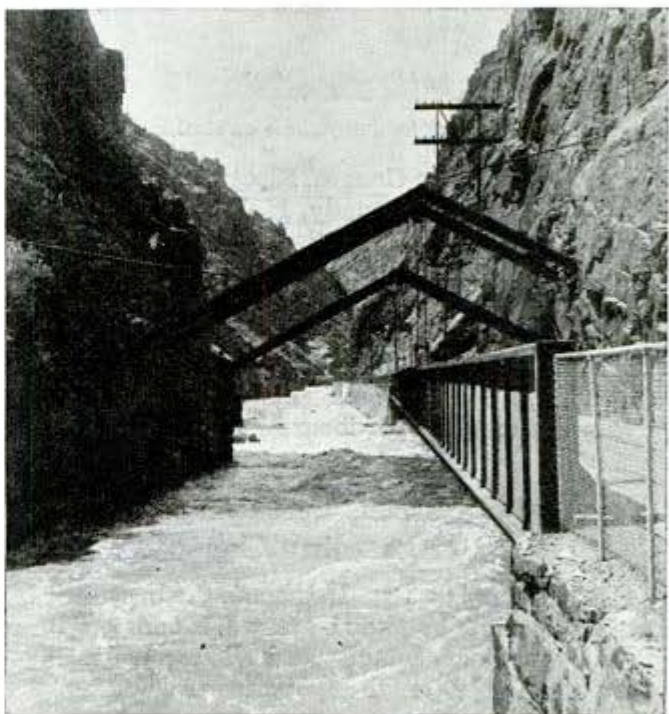

## Magnets Tack Up Notices On Steel Bulletin Board



Magnetic "thumbtacks" hold anywhere on steel board

In an office of the General Electric works laboratory, at Schenectady, N. Y., a steel partition serves as a bulletin board, but in place of the familiar thumbtack, small alnico magnets are used. Alnico—an alloy of aluminum, nickel, cobalt and iron—is the most powerful permanent magnet known, and the tiny magnets hold large pieces of paper and cardboard in place.

## 'Dry-Ice' Rifle Gets Cheap Power From Expanding Gas

Gas given off by Dry-Ice shoots the bullets from a rifle invented by Ray J. Monner of Denver, Colo., which the inventor has made available to the government. In



One load of Dry-Ice fires gun about 2,000 times

32 *Monner Gun Co*  
*1026-17th St. Denver,*  
*Colo.*

crushed form, carbon dioxide exerts a constant pressure of about 1,170 pounds per square inch, and one magazine fires the gun about 2,000 times. With suitable modifications, the inventor says he can use this force in a way that will match the fire-power of any gun using powder for ammunition. On a single charge the gun is good for several days of shooting, the cost of which is estimated to be 20 percent of the cost of shooting with an orthodox weapon.

## Automatic Fertilizer Spreader Rolled on Lawn by Hand

Fertilizer may be spread evenly over the lawn with a perforated drum mounted on wheels which is rolled back and forth by



Insets show how spreader is put together and filled

hand. The fertilizer, loaded through a capped opening in one of the wheels, sifts through the perforations as the many-sided drum turns. The drum consists of heavy cardboard, while the wheels are of light-weight metal. A handle, attached to a wire frame, is used for pushing the spreader.

### AMERICAN RED CROSS PHOTO CONTEST

War Savings Bonds with a total value of \$5,125 at maturity are offered as prizes in a photo contest sponsored by the American Red Cross. The competition opens Oct. 1, closing Dec. 31. Entries must be hitherto unpublished photographs of Red Cross activities or symbolic of its spirit. For details write American Red Cross National Photographic Awards, 598 Madison Ave., New York.

*Dist. POPULAR MECHANICS*  
*Vaughan's Seed Store*  
*10 N. Randolph, Chicago*

# 17-Foot Battleship Model Has Crew of Three

It was a real launching, even though only in miniature, when a 17-foot model of the U.S.S. Oklahoma rode out onto Sunapee Lake in New Hampshire. Built from U. S. Navy photographs by John A. Sargent of Littleton, Mass., the model is complete in all exterior details. The "battleship" has a beam of four feet,

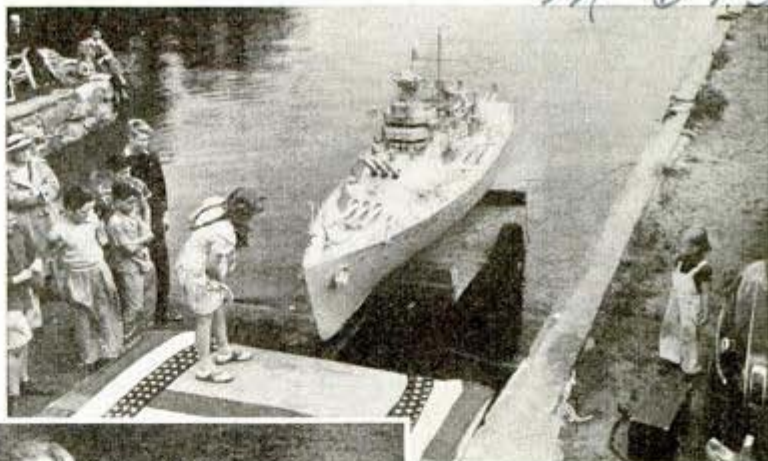

*M 645*



Ceremony attended the launching of model of U.S.S. Oklahoma. Left, lifting top for entry

turrets controlled from within, small anti-aircraft guns mounted about the ship, and a catapult that can launch a model seaplane. It carries a crew of three at five miles an hour, driven by its own 1½-horsepower gasoline engine. Members of the crew lift away a section of the superstructure in order to enter the ship.

# "Sky Cradle" Carries Wounded Soldiers Across a River

British soldiers have a simple way to transport casualties across rivers where there is no bridge nor boat available. On a wire rope stretched across the water, the wounded man, cradled in a stretcher, is whisked to the far shore by means of pulleys and ropes, somewhat in the manner of a breeches buoy. The whole outfit is easy to carry, after it has been folded and packed, and can be assembled in 15 minutes.

British troops pulling stretcher across stream with pulleys and ropes



*M 736*

*acme newspictures  
461-8 av, n.y.c.*

Cont: Alley, Warren Elliott, 7 Park Ave, NYC

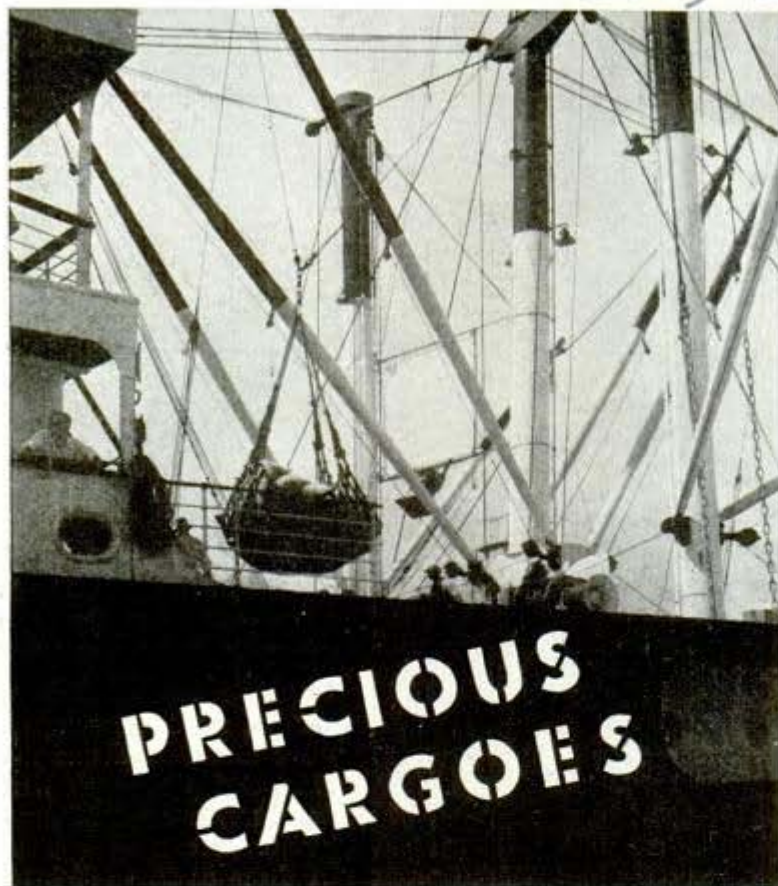

A net filled with cargo is lifted from hold of Grace Line ship

the night behind the blackout shades of the coastal dimout. There they scheme to get precious cargoes to far-flung battlefields. Some are in uniform and some in civilian garb—but they are servicemen all.

Our great unsung army is a relative handful of grim, overworked British and American shipping experts from steamship line executives down to stevedores and longshoremen. It is also an army of weather-beaten and sharp-eyed ship officers and their brave crews; pier superintendents and workers to whom an inch of cargo space is as valuable as a battlefield sector; gunners whose specialty is blasting submarines out of

ocean lanes. In Washington, it is the Navy, the Maritime Commission and Army Transportation Service, the War Shipping Administration and the Office of Defense Transportation, drawn in large part from the personnel which kept the United Nations' cargo and passenger ships plowing the oceans in peace.

71809  
**By Philip B. Iglehart**

Vice-President of the Grace Line

**T**HE most critical phase in the greatest war mankind has ever seen has been reached.

The battle of production is shaping up as a victory for the United Nations, thanks to America's industrial strength, mechanical ingenuity and assembly line technique.

Now the battle of transportation is on in deadly earnest.

Victory, defeat, or a stalemate depends on thin lines of drab cargo ships stretched across the restless wastes around the globe. And on thin lines of shipping specialists aboard the vessels, in the offices and on the piers where lights burn far into

Street cars for South America are loaded at a New York pier  
Grace Line photos

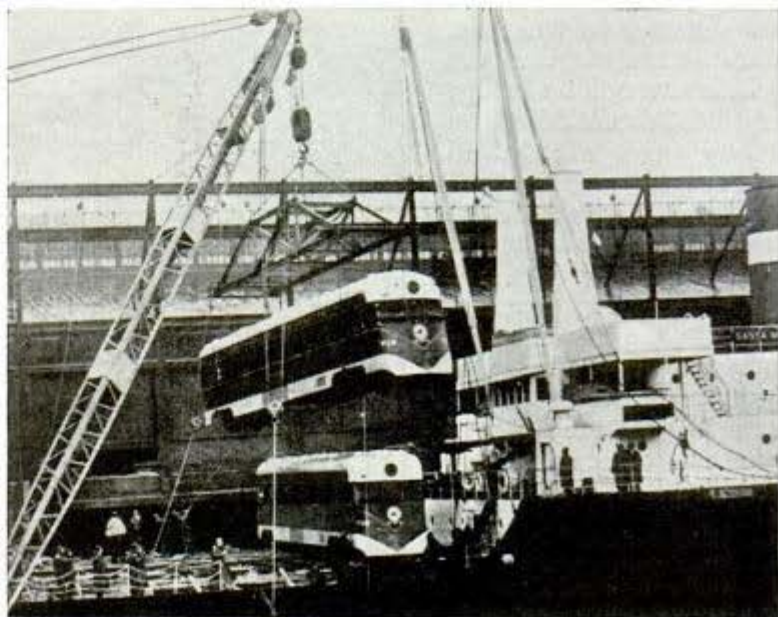

For America's war policy is to go to sea, to search out the enemy wherever he may be and fight him there, rather than on our own land.

Efficient ship operation is as important as the more spectacular angles of ship protection and shipbuilding in this vast global war. Guns, tanks, food, supplies, fighter planes and troops cannot fly to widespread battlefronts. Production may surpass all expectations, but unless cargo space is built, protected and, finally, efficiently used, victory may be tragically delayed.

And one key phrase in this gigantic transportation struggle is a phrase the average American has never even heard—"quick turn-around." In everyday language this means cutting down the time the ship is in port between arrival and departure. Now that the

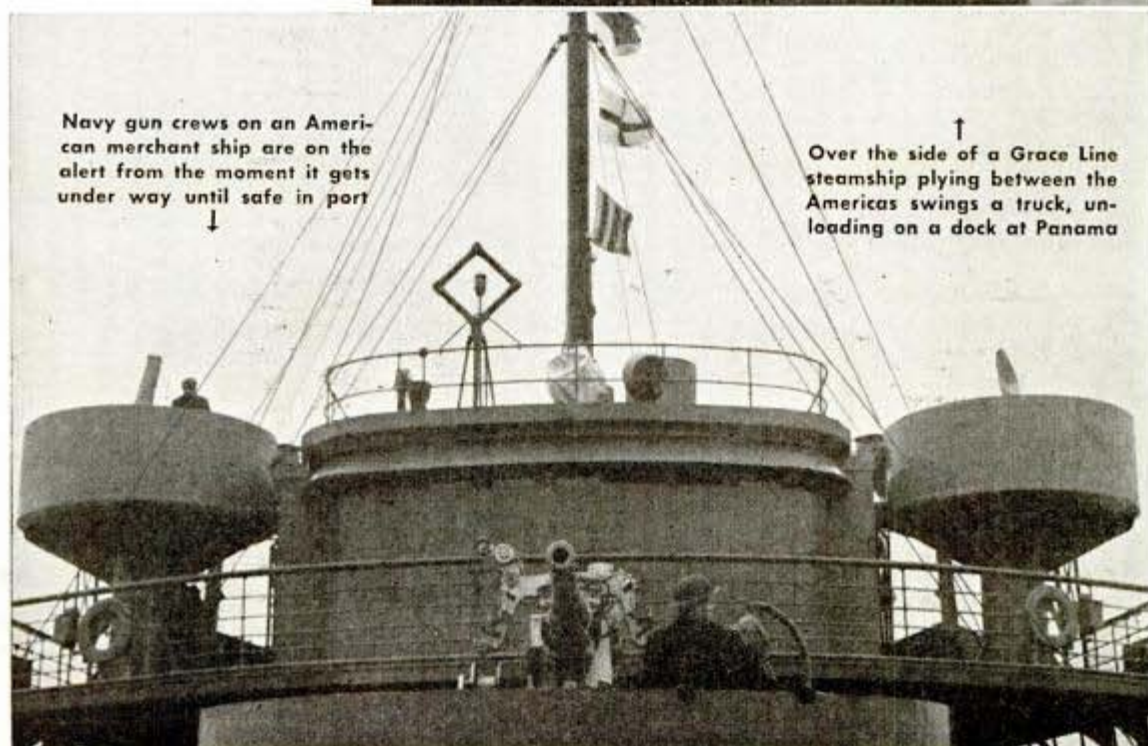
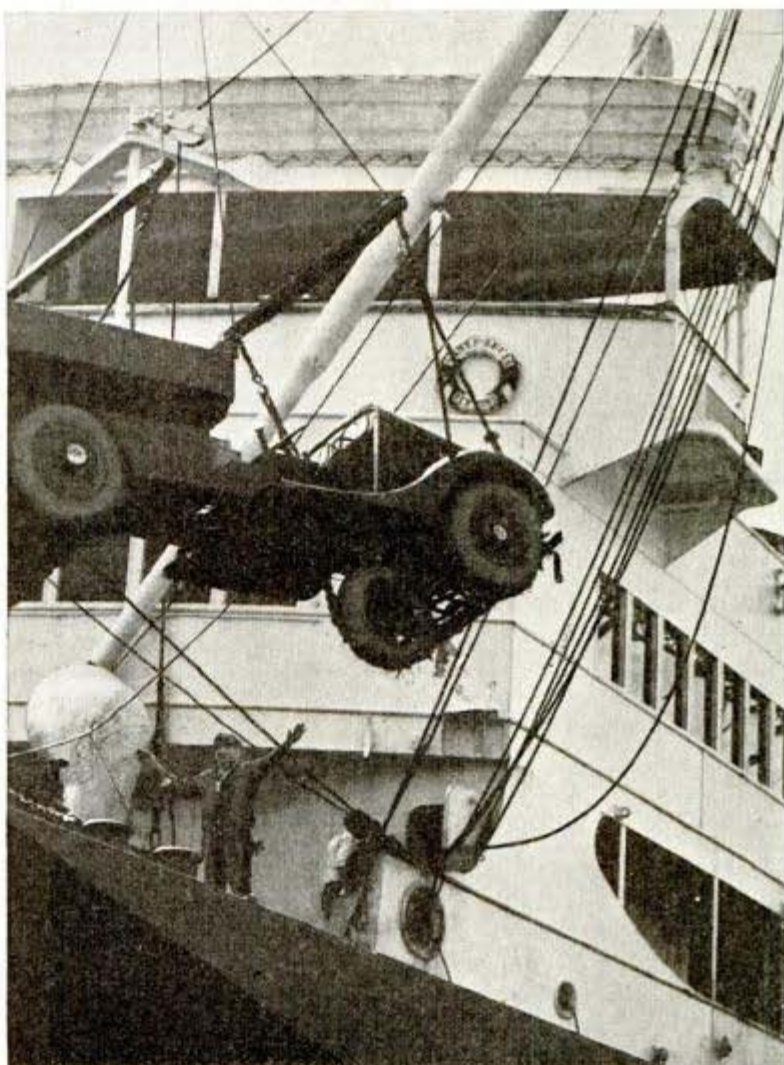

Navy gun crews on an American merchant ship are on the alert from the moment it gets under way until safe in port



↑  
Over the side of a Grace Line steamship plying between the Americas swings a truck, unloading on a dock at Panama



Crates of fruit from tropical America roll down the conveyor at New York, speeding a ship's turn-around

A camel in a sling joins a circus sailing from Peru

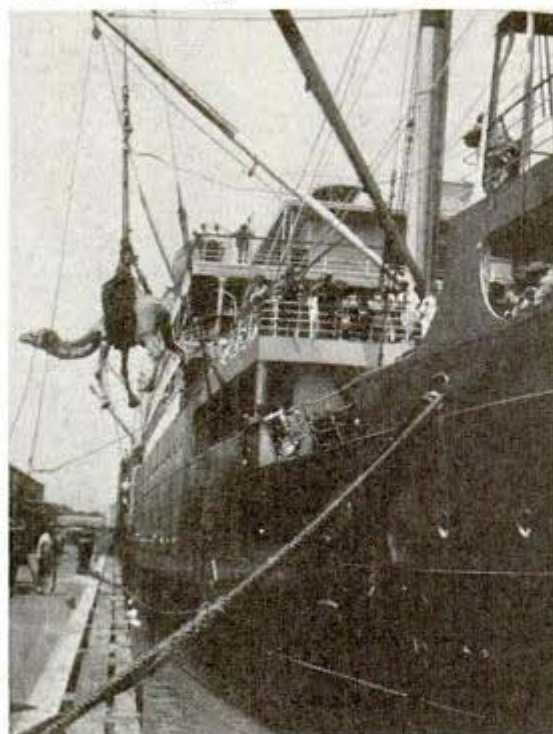

United States is the arsenal of democracy and must pour from its ports a great flow of vital material to its many allies, this commonplace phrase "quick turn-around" has great significance.

Day and night, in every port, cargo of every type swings aboard the drab freighters. It's a race against time. Men work long, hard, and feverishly. To the uninitiated, cargo seems to be dumped in pell-mell, helter-skelter. But in that seeming confusion there is a system as smoothly operated as the assembly line in a modern

aircraft plant. Ships arrive at an embarkation port. Long before they reach the dock, cargoes for distant war fronts—guns, tanks, planes, food-stuffs, clothing, machinery, munitions—have arrived by rail or truck at the embarkation port, where all are stored awaiting shipment.

At this point, the shipping executives, longshoremen, stevedores and mates, take over.

The actual unloading and loading are done by the stevedore; he is no unskilled laborer doing his job by rule of thumb, but an important cog in the business of ocean shipping. Upon his skill depends, to a certain extent, the safety of the ship at sea. The stevedore directs the loading and unloading of the ship and has charge of positioning the cargo. On the other hand, longshoremen are laborers who work in the holds, on the pier, or on lighters, and who stow away the cargo.

The problem is not what comes out of a ship, but what goes in. Practically everyone in the organization has some part in solving this problem and the solution in essentials finally reaches the stevedore whose work then begins.

On the pier he must separate valuable

Net is stretched on dock to be filled with freight

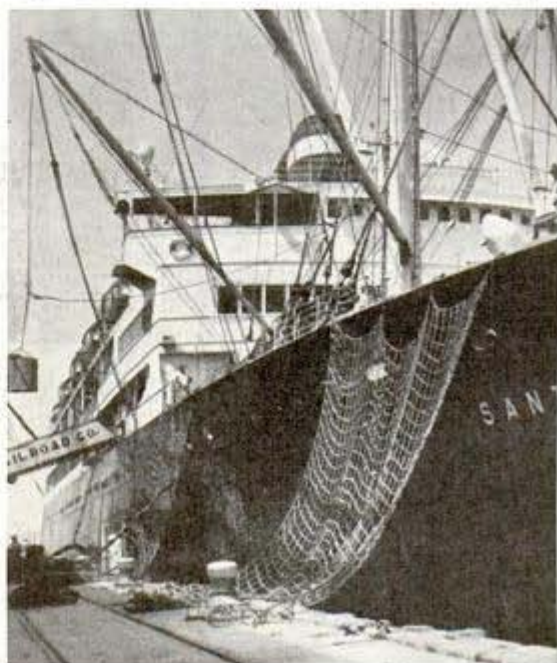

cargo and perishable shipments from the rest of the freight. The cargo is further divided into heavy and light cargo, into character cargo, such as "reefer" cargo which is freight kept under refrigeration, and according to port. Then the cargo is ready for loading.

Looking down into the hold of a ship is almost a dizzying stunt. As though in a deep well, men are working far below, swinging bulky machinery, copper ingots, or boxed automobile parts into position while the derrick booms swing high overhead. Each hold aboard Grace Line ships is divided into three sections: lower hold; next, 'tween deck; and last, next to the hatch, the cover of the hold, or the shelter deck. This is the general American below-deck plan. The English is: lower hold, orlop deck, 'tween deck, shelter deck.

Definite rules for loading ships have evolved from experience and common sense. Cargo is loaded with two requirements in mind—safety and accessibility. Cargo is a ballast, and improper loading will affect, dangerously, the balance of the ship. Poor loading will make the ship sluggish in rough weather, cause the ship to list dangerously in choppy seas because of shifting cargo, make the ship too heavy forward so that she buries herself in high seas, or too light and thus put an undue strain on the ship's hull. Heavy cargo goes into the lower hold, but some heavy cargo is also distributed between 'tween deck and shelter deck so that the ship will be neither too tender nor too stiff in rough weather.

For certain light cargo, rope or wire net slings are used for lowering; box and crate slings for heavier cargo; wire cables and chain for machinery and steel rails; canvas slings for bags and flour; barrel hooks for kegs, and so on. In some cases, automobiles are driven right into

**Gunners aboard a merchant ship get the range on a hostile craft**  
U. S. Navy photo

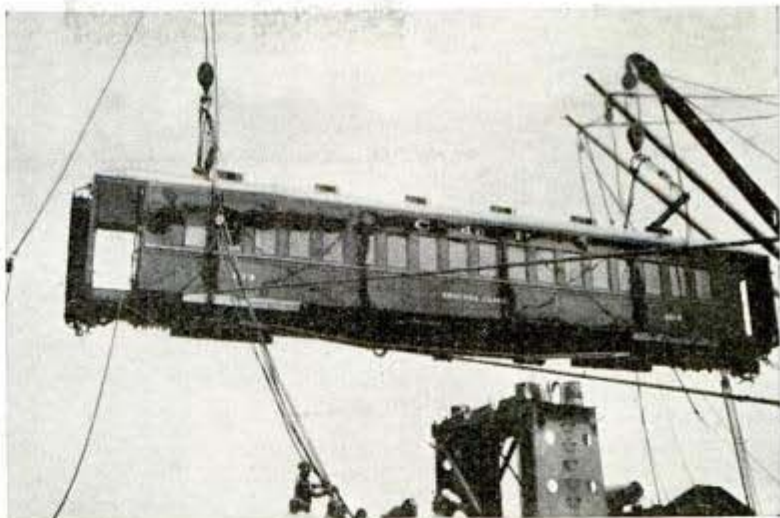

**Powerful cranes hoist a new railway car into ship**

**Colombian coffee for your table goes into a hold**





A ship's stability depends greatly on skill of the loaders. Here is an electric hoist working in the hold

the ship's hold through side ports; in other instances they are hoisted aboard by the ship's derricks.

In a ship loaded in New York for Valparaiso, Chile, cargo for the last port is loaded first, and that for the first port last. But not all shipments for one port are loaded into one hold, for this would slow up loading and discharging. Instead, shipments for Callao, Peru, will be distributed among as many holds as possible so that the maximum number of holds can be worked at one time, thus facilitating the unloading of the ship and reducing the number of man-hours of work.

But regardless of the orderly loading of cargo according to ports of call, there are other trials and tribulations to vex the stevedore. Certain types of cargo cannot be placed together, certain cargoes must be isolated. The stevedore may tear his thinning hair, but these rules are inflexible.

All moist freight—or liquid—must be separated from dry goods, since moist freight tends to cause injury to cargo which must be



Special lights are rigged on a vessel putting out to sea in a convoy

A crated automobile emerges from a Grace Liner's hold at Chilean port

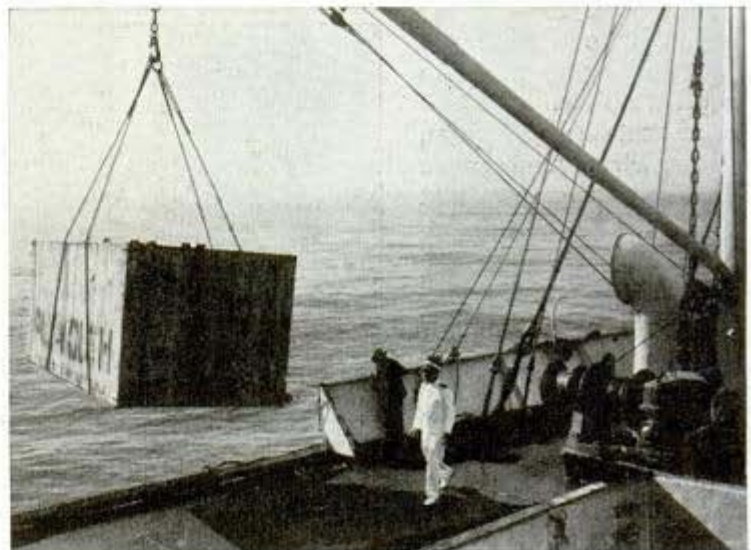

shipped dry. Oil and turpentine are never stowed in the same compartment with wool, flour, or sugar. However, cotton, a dry cargo, must be segregated from all other shipments and is usually protected with 'tween deck hatches, thoroughly secured. When damp, cotton is subject to spontaneous combustion. All freight of combustible nature is placed far from passenger and crew quarters, boilers and bulkheads.

Other freight also must be given special compartments. Certain moist cargo doesn't exude the pleasantest of odors, and must be stowed far away from green fruits, foods, and similar freight.

Aside from proper distribution to protect cargo from spoiling, mechanical precautions are taken. Certain freight, including foods, must be kept at fixed temperatures to prevent spoilage. Modern cargo ships are equipped with the finest of mechanical refrigeration so that perishables can be kept at the required temperatures throughout the



voyage. In the Chief Engineer's log room are gauges which keep a continual record of the temperatures in the ship's massive refrigerators and these data are regularly checked by assistant engineers in charge of the cooling apparatus.

As cargo is swung into place and stowed by longshoremen, the strictest precautions must be taken against shifting during rough weather. Listing, dangerous to ship and passengers, can result from two causes directly laid to loading—improper distribution of cargo; shifting of cargo during rough weather. The first cause is eliminated by proper loading at the pier, and the second is counteracted by correct stowage.

Simple devices are used to keep cargo in place. Carpenters make bulky cargoes solid. On top of the lower tiers of freight, "dunnage"—wood planking—is laid down as a flooring upon which the next tier is stowed. In empty spaces between articles are placed blocks of wood, "chocking," so that empty places are filled and each tier of freight becomes a solid mass. Freight such as barrel goods, rolls of paper, newsprint, and roofing are stowed in "head-up" position, which prevents sliding and acts as "dunnage" for other material.

Safeguarding ship and cargo by proper

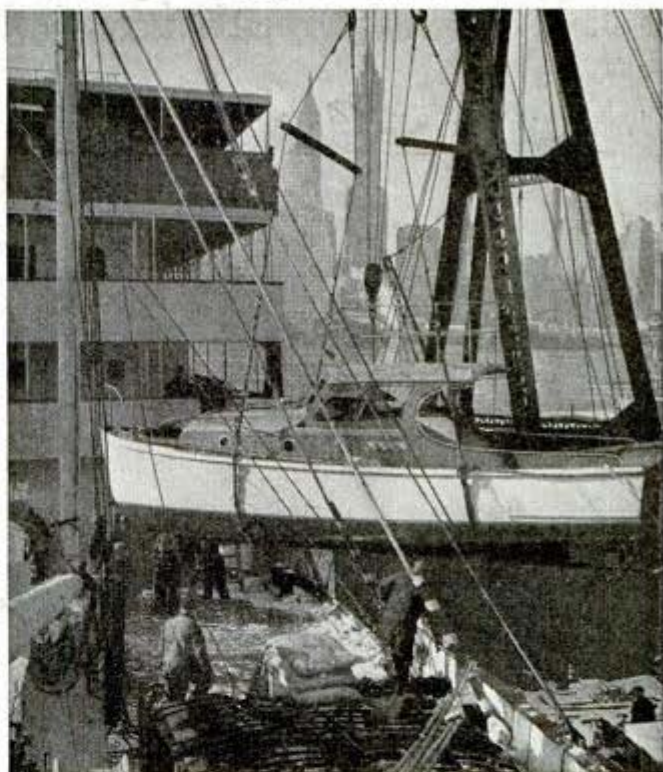

A small fishing cruiser goes for a cruise aboard a big sister

stowage does not end the precautions against accident. There is ever present the fire hazard, and against this most dangerous of threats the modern cargo ship has arrayed a formidable variety of equipment. The most effective method of fighting such a fire today is by use of carbon dioxide. After closing all hold ventilators, the gas

(Continued to page 183)

Boxed electrical apparatus jolts down 15 steps to test its bracing before shipping



Westinghouse photo

Sailors of the U. S. Navy man their 50-caliber machine guns while their warship patrols the ship lanes off Atlantic coast



U. S. Navy photo

*Lehco-Braun Greenhouse Mfg Co  
23 20 Wabancie Ave, Chicago*

## Cellar Window Greenhouse Grows Plants in Winter

*M 560*

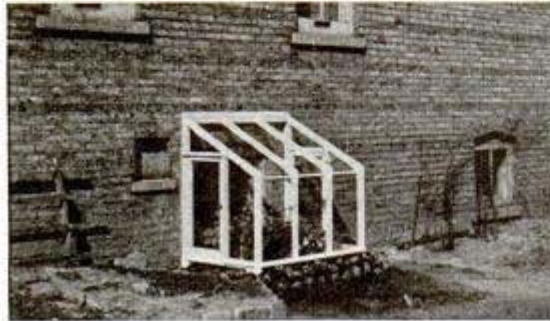
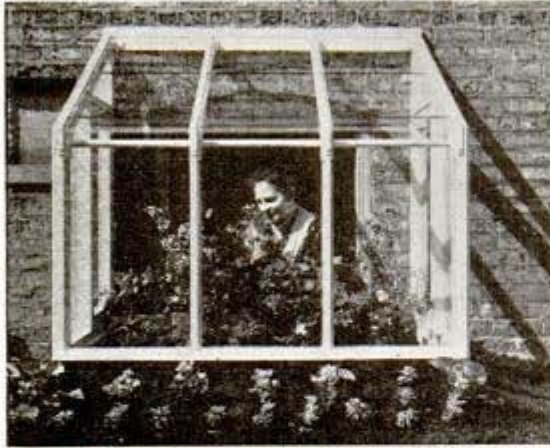

Caring for flowers or vegetables in the window conservatory is accomplished without stepping outdoors

You can grow flowers, a few choice vegetables or early seedlings outside a basement window of your home in winter with an attractive conservatory that requires no foundation. The home greenhouse, which fits around a window is accessible from the basement or through a small door on the outside. An inexpensive kerosene stove or electric heater may be used to maintain the proper temperature.

## Roof Flashing Using No Metal Escapes Wartime Restraint

*M 644*



No priority rating is required for production of flashing for roofs that is made with a felt center instead of copper, and hence contains no strategic material. Bonded

on both sides by asphalt-saturated fabric to make it waterproof, tough and durable,

*Waco Flashing Co  
86 Broadway  
Cambridge, Mass*

the flashing is flexible and may be shaped by hand to fit the job without tearing or cracking. Its rough surface readily forms an adhesive bond with the mortar.

## Wool Put Up in Bales Like Hay To Solve Burlap Shortage

*M 670*

Wool growers in the west, threatened with an impending shortage of burlap, are experimenting with substitutes for the wool bags used at present. One of the most ingenious is a baling method tried at Deer Lodge, Mont. Six fleeces of the 1942 clip were successfully pressed into bales with an ordinary power hay baler, according to reports of Don Tavenner of the Williams and Pauly sheep ranch.

*cont. Glen Perrins, 1030 Darling St, Ogden Utah*

## Hand Signal-Light for Police Stands on Suction Base

*M 258*

Used as a hand signal or set up as a warning light, a flashlight fitted with a translucent plastic tube glows red when the bulb is turned on. One light may be held in each hand by an officer directing traffic after dark, making his signals plainly visible to drivers. At the base is a large rubber suction cup which will hold the light firmly on the body of a truck or car, or on the pavement beside it. Squad cars carry the lights for use as emergency warning signals on stalled or wrecked vehicles. The battery case is rubber covered, making the unit waterproof.

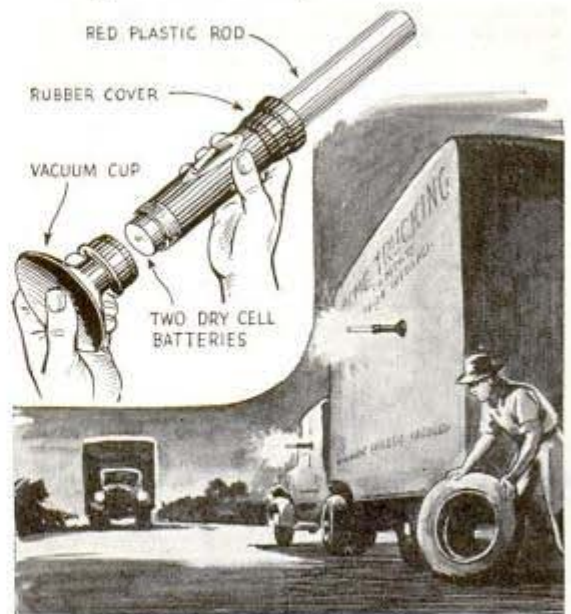

Red warning light is easily attached to stalled car

POPULAR MECHANICS

*Traf-o-lite  
Oak Park, Ill*

The London Electatype Agency Ltd.  
 134 Fleet St, London E.C. 4, England  
**Fast American-Built Fighters Fly for the R. A. F.**

72699

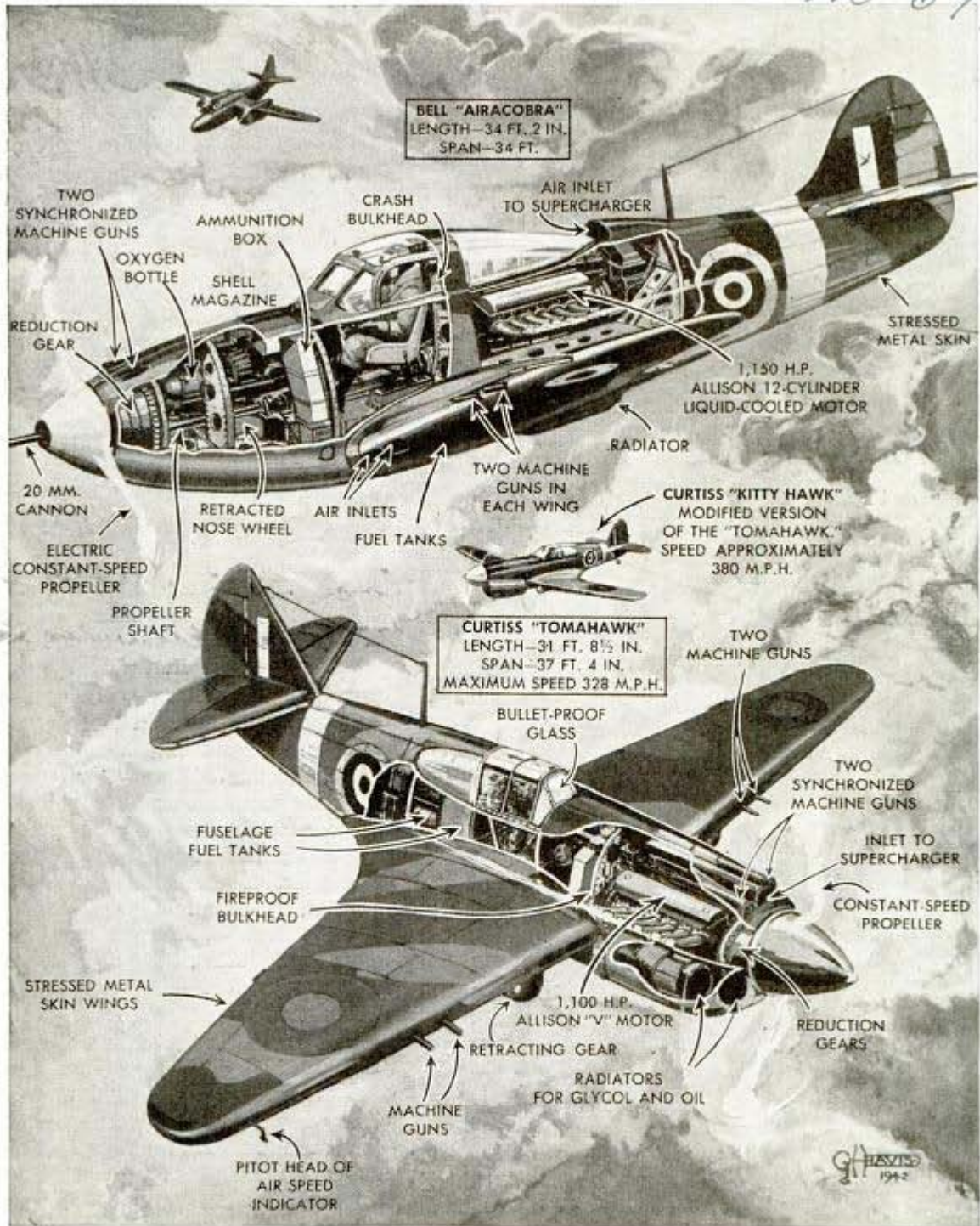

Some of the outstanding features of two outstanding fighter planes "made in America" for the Royal Air Force are shown here. Both the Bell "Airacobra" and the Curtiss "Tomahawk" are powered by liquid-cooled Allison engines. The "Tomahawk" has four Browning machine guns in the wings and two guns synchronized to fire through the propeller; the "Kitty-

hawk," a later version, faster and more heavily armed, is sketched at the center. The "Airacobra" has a similar gun arrangement, plus a 20-mm. cannon in the nose. Its engine is behind the pilot, delivering power to the propeller by a shaft some 10 feet long and weighing 40 pounds. Its seven guns can fire 387 pounds of projectiles per minute.



*Thomas E. Stinson Jr.  
3872 Franklin Ave. No.  
Camden, Cal.*

**PATROLLING  
UNCLE SAM'S  
DEADLINES**

*m 6/9*



ARMED men in autogiros, in boats, patrol cars, on horseback, on foot, and in tall watch towers are guarding our borders night and day.

In the northern woods a band of Border Patrol men may be cruising along the boundary. On the Great Lakes small boats are patrolling against smugglers. Along the Mexican border an autogiro may be hovering over a patch of mesquite; from a tower that overlooks the Rio Grande a guard dressed in the same uniform worn by the horsemen and aviators has his field glasses trained on a bend in the river. Someone is trying to cross, he decides and he picks up his radio microphone.

"T 3 to C 21. There's something going on down at the west end of the island. Look it over." Within a couple of minutes he sees the car that he called from its usual patrol racing down to the spot.

Today the Border Patrol, which was organized primarily to prevent aliens from entering the United States illegally, is also

Top, guarding a Mexican train at the border while Customs inspectors examine it. Below, patrolmen leave a sign on the desert to inform other trackers they have captured three aliens

*Ref: Senior Inspector, Border Patrol, Immigration Service*

doing its part to prevent spies and saboteurs from crossing our borders and to keep information of interest to the enemy from being carried out of the country. Hardly ever before in its colorful history, even during rum-running days when a gunfight a week was less than average, have members of the patrol been so busy.

Entering the United States by stealth looks easy on the map. Part of our southern border, for instance, is nothing but a shallow river that you can wade across in most seasons. From El Paso to San Diego the border is almost imaginary, marked only by a monument every few miles. The border is fenced only through the infrequent villages.

But a spy learns that it isn't as easy as it looks. Immigration men must find everything in order before a visitor can cross at a regular port of entry. Undercover men may have investigated him beforehand. Wading across the river or simply walking into the United States at some inland point seems easy but the sands of the south give him away. He can't conceal his tire prints or footprints. Some have tried walking only on stones or weeds but they haven't been able to fool the expert trackers of the Patrol. "Cutting sign" is a daily chore from coast to coast on the border and some of the Patrol trackers are so expert that they can tell you, from the footprints, at what point a man shifted his pack from one shoulder to the other.

One favorite stunt has been to cross the border



Border Patrol pilot and observer can fly slowly along their beat in an autogiro, hovering if necessary to make a close scrutiny of the ground



The international boundaries are fenced off in the more populated areas such as El Paso, where the guard at left is on watch at border fence

Below, the operator at El Paso central radio station listens to a report from the field. All patrol cars, airplanes and towers are radio-equipped





**Telegraph key on patrol-car instrument board is used for radio communication when car is too far from station for voice radio**

as soon as it gets dark and to head north at full speed, thus getting a 12-hour start over the trackers. All that means, usually, is that the trackers may have to camp out while they are on the trail because they won't return to headquarters until they have found their man. Even if he has managed to reach a road and has been picked up by a car he still isn't safe, because Border Patrol groups blockade all roads for miles behind the border, examining all strangers who come by.

The men on desert patrol use cars with big tires that will carry them across rough country and in some sections they use horses as well. On an ordinary day they start out before daybreak, possibly patrolling the border itself or possibly working the country a few miles this side of the

border. Occasionally an alien walks backward for a mile or two as he comes across in the expectation that his footprints, pointing the wrong way, will fool the patrol. But the patrolmen know all the tricks. The cars used on desert patrol are equipped with radio keys for code communication because frequently they prowl so far from their substations that ordinary voice radio won't carry.

Border guarding is a little different in populated areas such as El Paso where the Mexican town of Ciudad Juarez lies just across the river. Here a series of observation towers is used to watch for illegal activities. Some smart

stunts have been tried, but the watchmen know what to look for, such as the old trick of trying to get across while parties of swimmers are enjoying the river on a hot summer day. In the general confusion a swimmer from the Mexican side may cross the river with one shoe and lay it on the American bank. The other shoe comes over on the next trip, and gradually all his clothes are lying in a heap in the United States. All he has to do, when the rest of the swimmers come in and dress, is to join them, dress, and walk off. But anyone who tries this stunt walks right into the arms of a couple of Border Patrol men who have been tipped off by one of the tower guards.

Most of the people who try to cross our southern border are Mexican laborers in

(Continued to page 164)

**Two mounted patrolmen, armed and dressed for rough work, scan the sands along the border for footprints**



# Sand Sailors Get Thrills at 40 Miles an Hour

*M. Whittaker*

*M 698*

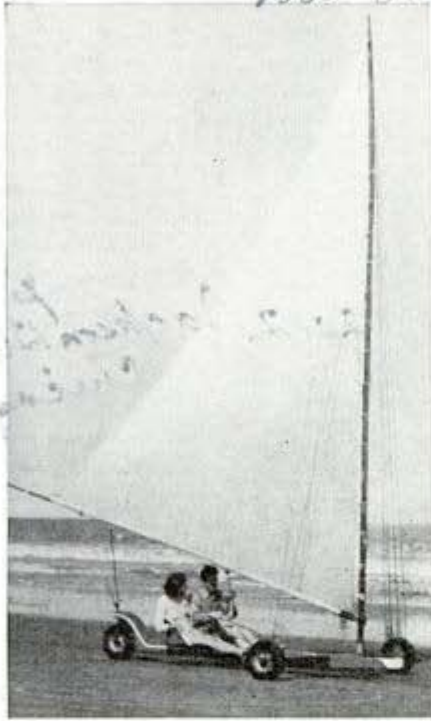

Racing along the beach at Sea Island, Ga., these two-seater sailboats on wheels require a good man at the tiller if the wind is stiff and the sand is hard-packed

With submarines lurking off shore, some salt water sailors have tied up their old boats and are finding excitement in the new sport of sand sailing. Lightweight boats, resembling ice boats more than the regulation sailing craft, can speed along a hard packed beach with the aid of a stiff breeze at 40 miles per hour. The boats have

a metal frame, three wheels, a seat for two and a single sail. A certain amount of skill is required at the tiller, for when the boats "come around" after a race down the beach an unwary sailor may find himself in the ocean or scraping up sand. At Sea Island, Ga., one of the centers of the sport, a fleet of eight boats thrills visitors with races.

## Handy Pincushion Is Held on Arm by Two Elastic Tapes

*M 377*

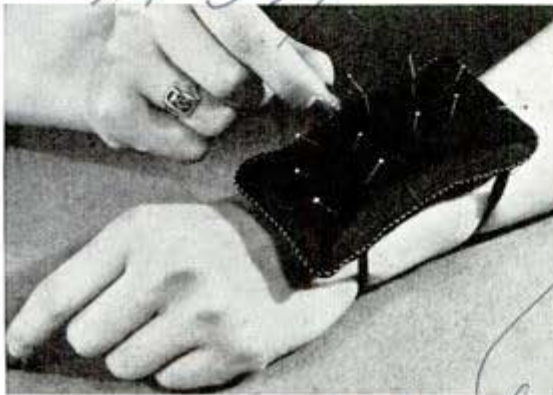

Worn on the forearm by means of two pieces of elastic tape, a pincushion is always within reach and leaves both hands free. It provides a convenient place to keep pins while fitting a dress, and can even be worn over the shoe when adjusting the length of another's dress. It may also be fastened to the sewing machine or sewing basket.

Look in the index to find where to buy articles described in this magazine. Say You Saw It in Popular Mechanics.

NOVEMBER, 1942

*Dist: Sears Roebuck & Co. 45  
State & Van Buren  
Chicago*

*Mary N. H. Hedges, Dir. of Publicity*

# ONE WAY

When the radiographer—that's the man who operates an X-ray unit—turns his attention from bones and tissue to such familiar articles as a piggy bank, left, or toy train, below, he gets some unusual and artistic effects called "shadowgraphs." These pictures were made in the General Electric X-ray studios

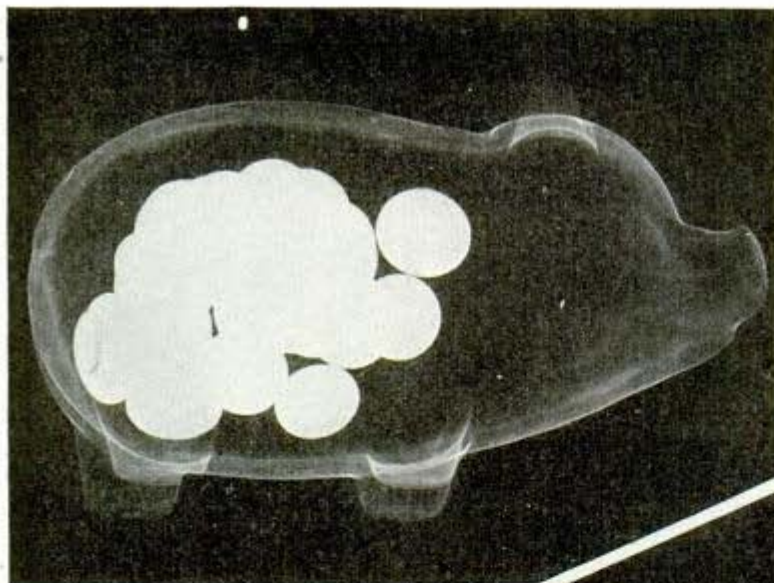

*2012 Jackson Blvd  
Chicago*

To make the shadowgraphs, a sensitized film in a light-tight holder is placed under the object with the X-ray tube above it. Some objects require a high voltage. The toy train took 95,000 volts, enough power to make a six-inch spark, for good results

*M536*



Left, flower shadows and various densities were recorded with only 17,000 volts. In the vase are three lilies, an orchid and fernery. Pictorial X-ray work is not easy for an amateur for no fixed rules or charts are available. The principal requirement is an experimental approach and the expert operator, familiar with densities of bone and tissue, must develop a new technique for materials such as pottery, steel, leather or cloth

Here is a .45 caliber automatic pistol in shadow form showing the inside mechanism. Note cartridge in the firing chamber, the six bullets in the clip reproduced in varying degrees of shadow. It took more than 180,000 volts to penetrate the steel in the gun. The voltages required here are small compared to that used by some huge X-ray units in use in war plants that can stab their rays through five-inch steel

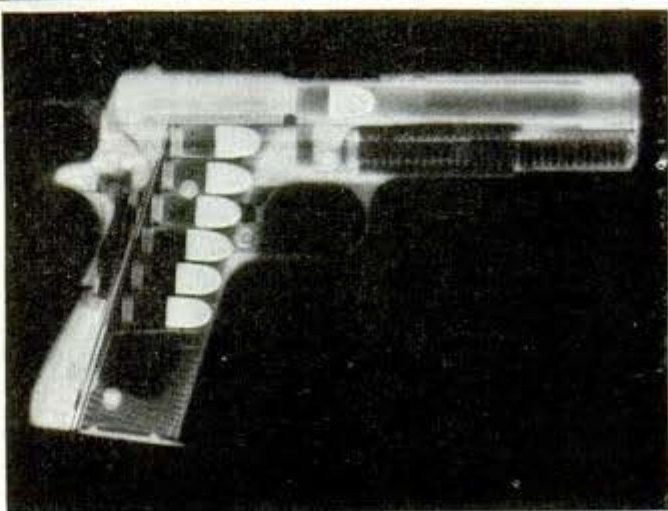



# to GET into JUNIOR'S PIGGY BANK

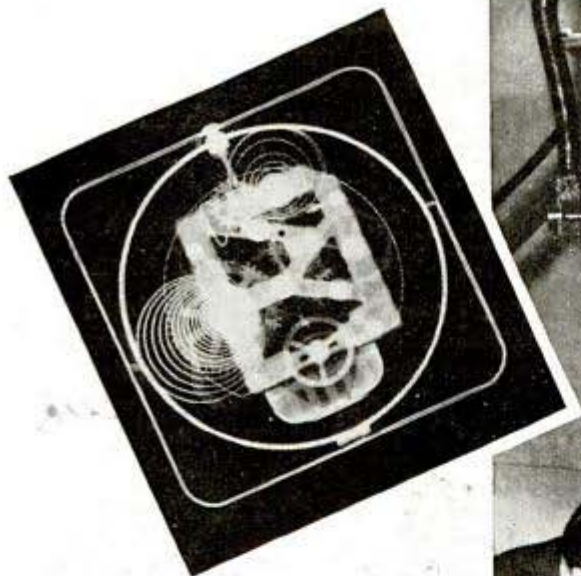

If you had "X-ray" eyes your alarm clock would look like the one shown above. All the large and small wheels and springs are plainly visible. The curved object at the bottom of the mechanism is the bell. Right, General Electric technicians are aligning an industrial X-ray unit to radiograph the gun pictured on the opposite page

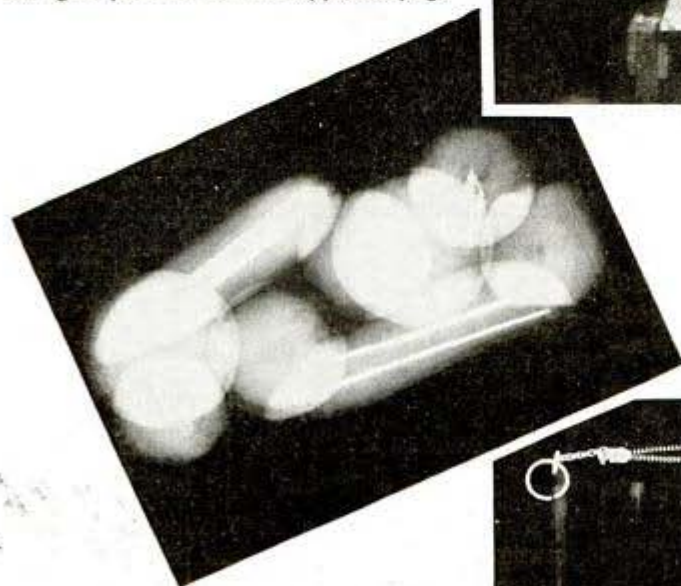

Nothing is sacred from the all-revealing X-ray—even the heterogeneous contents of milady's purse revealed in shadowgraph at right. Look close and you'll see hairpins, open safety pins, ear rings, keys, a belt buckle, nail file, coin purse, compact, mirror and lipstick. When the rays were discovered in 1895 by Prof. Wilhelm Konrad Roentgen, he named them for the unknown quantity—X. The wave lengths are shorter than space between atoms in steel

Left, this surrealistic effect was produced by X-raying a package such as might be mailed by confederates to a criminal seeking to escape from prison. The package shows saw blades and a file concealed in two bananas and a razor blade inserted in an apple. Many prison authorities use the X-ray for examining incoming packages, which saves opening boxes and reveals items hidden from human eyes

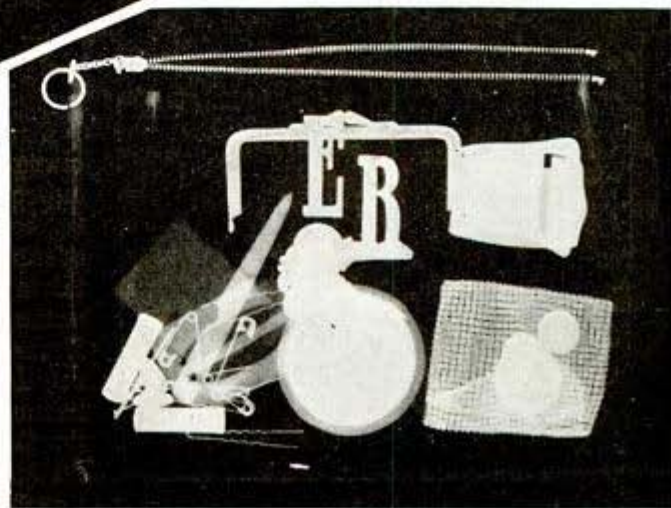

Murray Corp. of Amer.  
7700 Russell St. Detroit, Mich

## Racket of Riveter Is Silenced By Automatic Bucking Bar

M 702

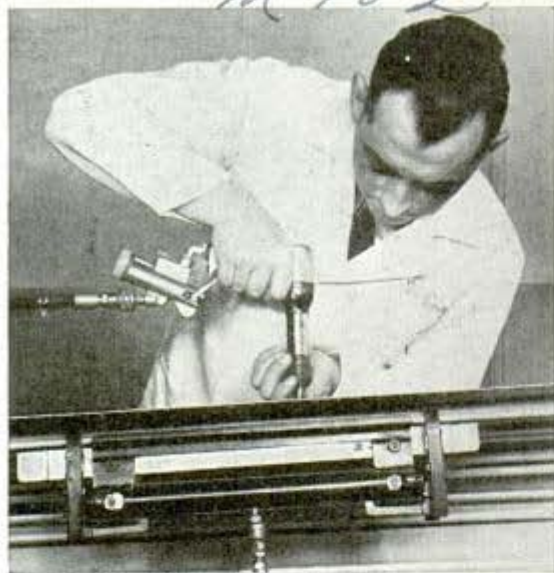

One-man machine speeds riveting in armament plant

Armament work is speeded and noise of riveting is eliminated by an automatic bucking bar that bucks and aligns rivets without the services of a second person. Said to increase riveting efficiency by 52 percent, the automatic bucking bar permits several riveters to work simultaneously on the same assembly without removing the device from the fixture.

## Snap-On Cap for Screw Heads Made in Colored Plastic

Snap-on plastic caps to fit screw and nail heads may be obtained in colors to match woodwork or harmonize with any decora-

M 474

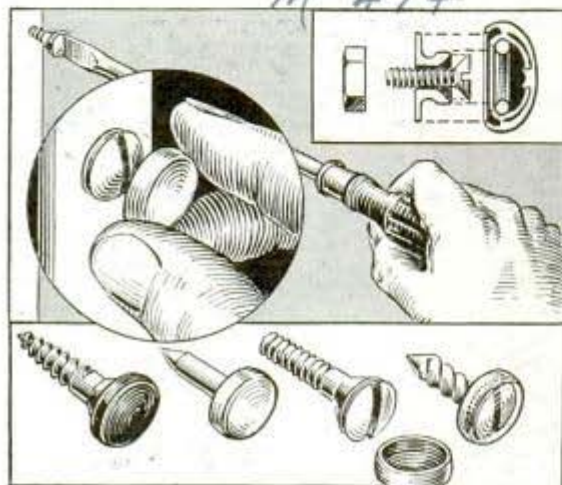

Plastic cap snaps on screw head to prevent tampering

48 Empire Nation Co  
107 E 29 St, N.Y.C.

tive scheme. Metal caps with a silver finish are also available. Larger metal covers resembling a rivet or bolt head are made for wood or machine screws. They are said to be useful in preventing the theft of equipment in public places for they spin around when tampered with and are not easily pried off.

## V-Prong Rake Pulls Crab Grass Without Injuring Lawn

M 640

Tough crab grass may be removed with a special rake having V-shaped tines with V-shaped slots between them, designed to



Blades of lawn grass slip through the V-shaped slots

grasp the crab grass blades and yank them out but letting the lawn grass slip through undamaged. The harder the pull, the tighter are the grass blades held, yet its use does no injury to the lawn, according to the manufacturer.

## Tubeless Tire for Big Trucks Has Special Air Lock

M 796

Development of a revolutionary pneumatic tire that requires no inner tube is expected to save vast amounts of priceless rubber. Air is held in the casing with a specially designed locking member that takes the place of the tube and flap combination. The new tire, invented by Frank Herzegh of the B. F. Goodrich Company, requires no special tools for mounting. If it becomes deflated it can be repaired quickly. Tests conducted by the company under all sorts of road conditions reveal that the tire is adaptable to war or civilian use.

Akron, Ohio

*press assen. 50 Rockefeller Plaza, N.Y.C.*

# Giant Wire-Cutters Snip Path to Speed Infantry

*M 306*

United States Army engineers use special wire-cutters to clear a path through barbed wire entanglements for the infantry. They handle the big steel clippers with heavy riveted gloves. The wire-cutters were added to the engineers' equipment after their successful operation during maneuvers.



Big steel clippers bite their way through barbed wire as Army engineers clear a path for advancing troops. Note the heavy gloves and rifles within easy reach

# Huge Vulcanizer Closes Its Jaws to "Cook" Rubber Tank

*M 541*

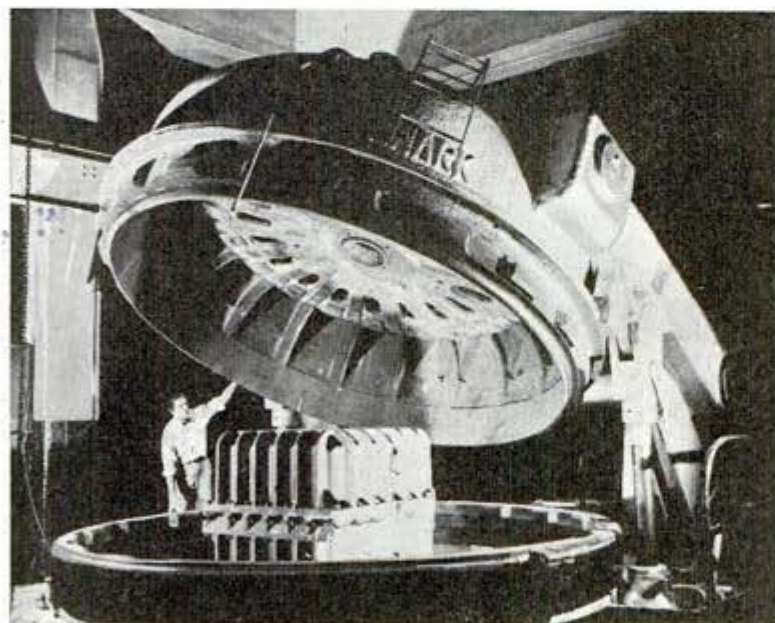

Looking like a huge clam, the world's largest vulcanizing unit is turning out selfsealing gasoline tanks for America's combat planes. Molds containing the rubber tanks are placed in the mouth of the vulcanizer, the big cover is closed and heat is then applied. Before the war this giant machine was used to vulcanize tires for earth-moving machinery.

*Army - New pictures are 461. 8 am. N.Y.C.*

Raising the cover of this big vulcanizing unit—the world's largest—reveals mold containing selfsealing gas tank for bombers

# "Beat the Heat" Pills Taken by Workers Contain Essential Vitamins

*M 672*

By taking doses of vitamin C in tablet form, workmen can stave off attacks of heat prostration and thus save many hours and days now lost to industry. These "beat the heat" pills, physicians of the Du Pont company's medical division have found, effectively protect against heat cramps and prostration even in temperatures above 100

degrees and oppressively high humidity. The procedure is to give, twice each day, a tablet consisting of 50 milligrams of vitamin C and 250 international units of B-1, plus other B vitamins. The tablets replace vitamin C drained from the body in perspiration in the same way that salt is sometimes taken to replace salt likewise lost.

*Wilmington, Del*

# BOOM TOWN *in the* BIG CITY



This was Boom Town—New York's Rockefeller Center—before the dim-out. Now all's dark above 15th floor *in 563*

• Roots wrapped in burlap, a 50-foot elm moves into the Center



By Allen Warren Elliott

*343 7 Park Ave, NYC*

**T**O FEEL the throb of Uncle Sam's war pulse, step into that towering stone and steel wonder of the business world, Rockefeller Center in New York City.

Here in this twelve-acre "city within a city" something new has developed in the business life of civilians. White collar work and executive ability have gone on a 24-hour-a-day basis. Typewriters click the clock around, just like shell-loading machines in an arsenal. Twelve o'clock is still lunch time for hungry throngs, but it's twelve midnight as well as noon. After the "dim out" which screens telltale night lights from the fifteenth floors up, hundreds of workers hit the street, homeward bound at dawn.

The result of this expansion is that the most daring real estate venture in the world's history—a

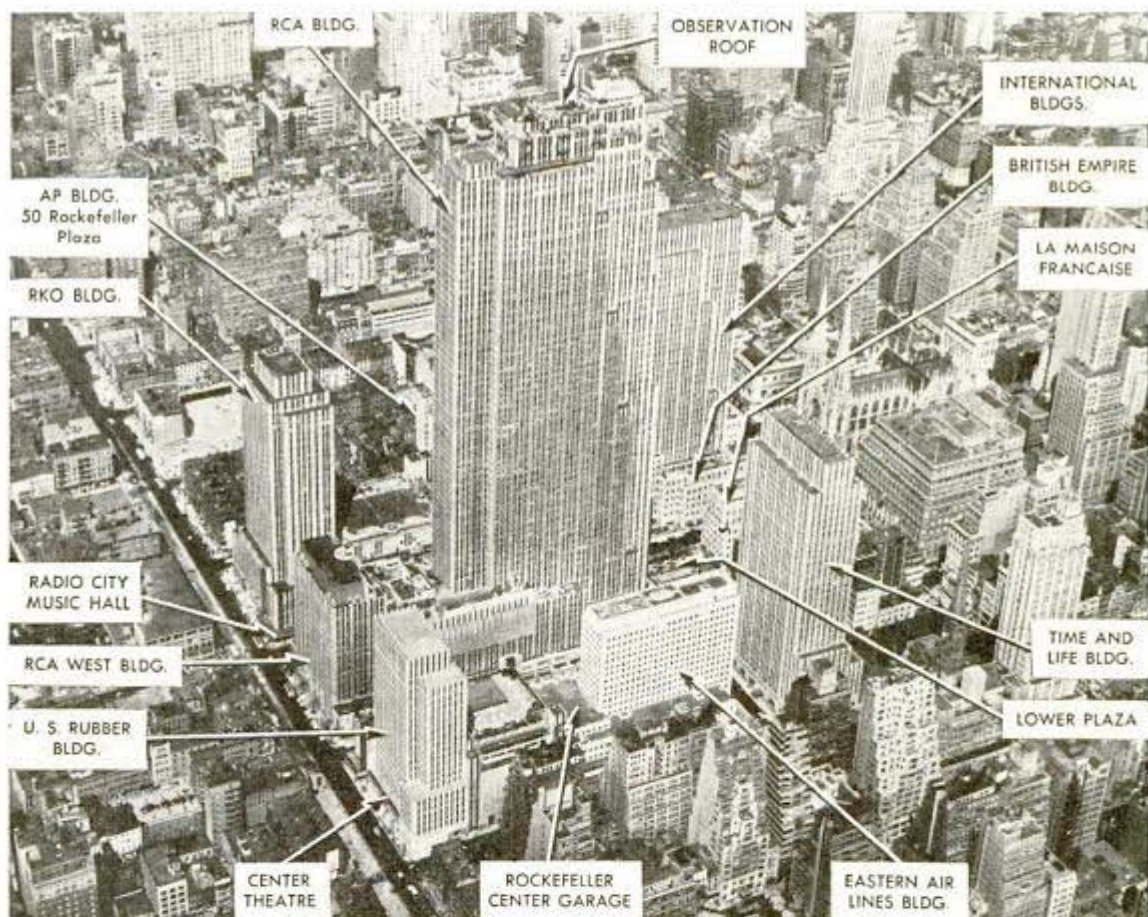

Thomas Airviews photo

These are the principal buildings in Boom Town, looking northeast, with Sixth Avenue on the left side

\$100,000,000 project started in the midst of the depression—has proved to be one of the most successful. The fourteen office buildings are now nearing the bulging point.

Rockefeller Center is a veritable boom town in the big city.

So essential are the commodities and services handled on the 5,290,717 square feet of floor space piled on the twelve precious acres that the nation's war effort would be measurably slowed if the great community of commerce were wiped out—which is impossible, of course, unless New York City were leveled by the enemy.

Rubber? One rubber corporation alone occupies more than ten floors of a 20-story skyscraper. Railroads? Thirteen have offices in the Center. Oil companies? Twelve. Foreign consulates? There are nineteen

Looking aloft, just off Fifth Avenue, at a flight of bombers



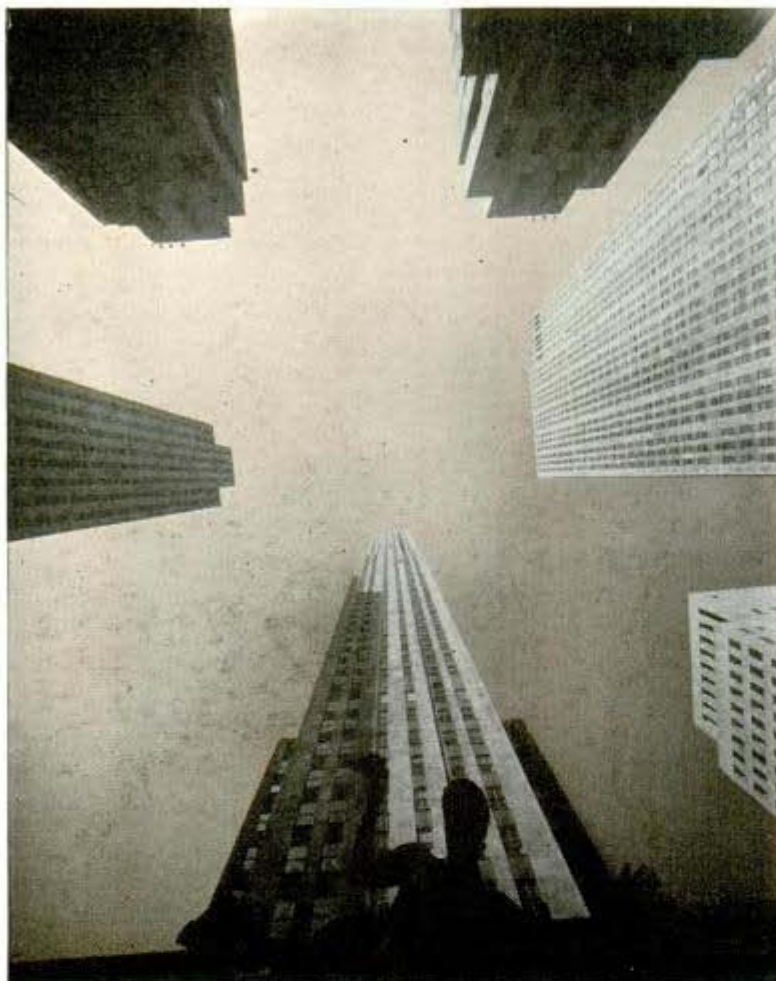

A special lens captured this unusual view of Rockefeller Center

listed. Air lines? Four. Banks? Eight. And so the list continues with broadcasting stations, world-wide news services, magazine publishers and a host of others adding to their rent, payrolls and light bills as war adds to their problems and hours of operation. Their rent notices alone total about \$12,000,000 a year.

In the most up-to-date three square blocks in the world, 26,000 tenant and building employes use more electricity than cities like Omaha. The electrical load is equivalent to the pulling power of an army of horses filling a wide street, six teams abreast, for a distance of  $4\frac{3}{4}$  miles. In Rockefeller Center there are over 21,000 telephones, more than enough for a community like Kansas City, Kans. There are more than 125,000 visitors daily to the fourteen buildings, bringing a novel transportation problem, because it is vertical instead of horizontal. That means elevators.

This special nozzle was developed at the Center to speed up the vacuum-cleaning of the Venetian blinds



There are 200 elevators in Boom Town. They handle approximately 270,000 passenger rides a day. At peak service, as high as 67 passengers a minute are taken care of in a bank of eight elevators. The high rise elevators in the RCA Building, the largest, travel 1,400 feet a minute and can cover the distance from the street floor to the 65th floor in 37 seconds. Going at full speed it takes  $3\frac{1}{2}$  floors to start them and seven floors to stop them. It is estimated that, when operating on a full schedule, the elevators in the RCA Building alone cover a total of 1,500 miles daily—a distance equal to that between New York City and Fort Worth, Tex.

The 200 Rockefeller Center cars could carry 4,000 persons at once. If the shafts of all these elevators were stacked on top of one another they

would reach ten miles into the air. They require about 300 operators and 50 mechanics.

Fortunately, in the event of enemy air raids Boom Town is one of the safest places in New York City. Experts who have studied the effect of bombing raids agree that the exteriors of the steel and stone office buildings offer exceptional factors of protection. But the management of Rockefeller Center has not been resting on that. For many months, under the guidance of the Office of Civilian Defense, it has been making an intensive study of the most effective air raid precautions and their application to the Center, which has been set apart by the authorities as a separate air raid protection zone.

Within the employe ranks, air raid wardens have been appointed and have been receiving thorough instructions. Many materials to aid in the protection of Rockefeller Center have been bought. In addition to 9,000 bags, filled with sand, these include stirrup pumps, metal water containers and metal pails. Despite the Center's more than ample water supply system, with strategically located tanks, as well as tap connections throughout office, shop and other areas—at least one emergency container has been placed on every floor and filled with water. This water is to be used in stirrup pumps in case of emergency.

In the event of actual air raids, occupants of the four top floors in any building are instructed to proceed immediately by way of the building stairways to various floors somewhat lower, and assemble as close to the central part of these floors as possible. Occupants of all floors below the four top ones are told to assemble in the central areas, each on his own floor. They must remain there until the "all clear" signal is sounded.

Shop keepers on street and mezzanine levels, at the time of an air raid alarm, have been cautioned to turn out all lights, close their

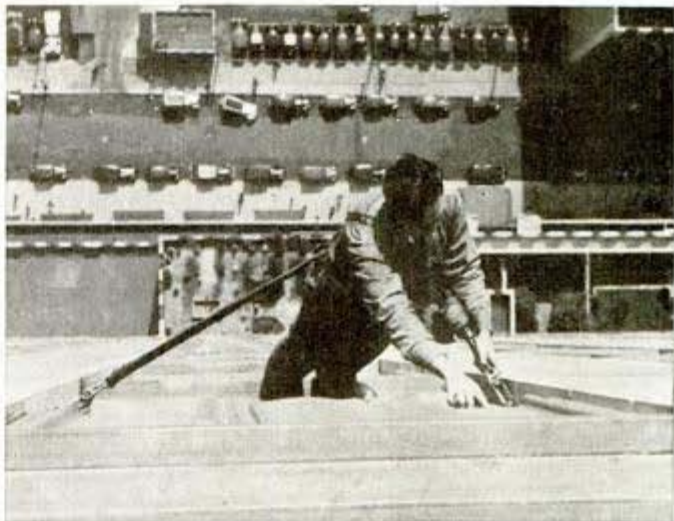

It takes 25 cleaners to shine the 21,292 windows twice a month



Above Prometheus, god of fire, rises the 853-foot RCA building

Looking down one of the 800-foot elevator shafts in the 70-story RCA tower. These elevators travel at 1,400 feet per minute





A guard rolls one of the canvas curtains installed on all Boom Town shop windows to stop flying fragments in case of bombing. Below, every floor has an "A.R.P." station with sand bags, a large can of water and lanterns. There are 9,000 sand bags ready



Every one of the 1,850 employes of Rockefeller Center has been fingerprinted and photographed as protection against sabotage and for possible identification as war casualties



premises and go to the Concourse level, below ground, where they are told to stay away from all exposed exterior walls.

Every pane of window glass in the two miles of shops has been provided with a special canvas curtain to stop fragments if bomb blasts crash through the lower floors. Larger windows have heavy fabric screens. Hospital windows have steel curtains. The Rockefeller Center hospital has been selected by the Emergency Medical Service of the Office of Civilian Defense as a casualty station, which will function as an intermediate station between medical field units and hospitals in the event of emergency needs for medical services.

All air raid alarms will be given by means of existing fire alarm gongs located on each floor of the Center's office buildings. The air raid signal is approximately 50 rapid, continuous, evenly spaced gong strokes over a 30-second period. The all-clear signal, marking the end of the alarm is a series of two gong strokes, with a marked pause between each pair of strokes.

Should some special condition due to the war confine one of these crowds of daily visitors to the boundaries of Boom Town, they would find available every convenience any modern city affords, except for a place to sleep. One rule of Rockefeller Center is that no one sleeps on these twelve acres.

The throngs would have access to 22 restaurants, three theaters, a post office and telegraph center, a gymnasium, and four barber shops, three beauty salons as well as a steam bath. There are even sixteen bootblacks to shine their shoes.

A maze of underground passages and



rooms, which even include a bonded storage warehouse, would not only provide additional air raid protection, but would enable them to pass freely from one building to another during an emergency.

In fact, Boom Town could probably take care of thousands of refugees from the surrounding fashionable neighborhood for the group of buildings really deserves the adjective "colossal," as these statistics show:

More than 300,000,000 pounds of steam are used each year to heat and cool Rockefeller Center. This amount of steam would heat 2,000 six-room houses for one year.

The air-conditioning system is the largest for comfort in the world. Its total tonnage of nearly 8,000 tons would be sufficient to provide almost three million square feet of surface for ice skating. It would be valuable in case of a gas attack. There are 21,292 windows in the Center. A crew of 25 window



Above the Information Desk at RCA Building entrance is a mural by Jose Maria Sert depicting man's triumphs through mental and physical labors



cleaners and two foremen clean all windows and ventilators twice a month, spending an average of eight minutes on each.

Every night 800,000 square feet of carpet are cleaned. Every month the cleaning division uses 600 razor blades to remove paint from glass and chewing gum from floors, 1,000 pounds of alkaline cleaner, 2,800 pounds of liquid soap, 180 gallons of disinfectant, 110 gallons of brass polish, one ton of rags and 100 pounds of steel wool. Nine hundred bags, weighing 150 tons, of waste paper are gathered from various offices in a month.

Rockefeller Center's exterior and interior decorations include more than a hundred murals and sculptures by world-famous artists and sculptors. No comparable assembly of large-scale works of art can be found elsewhere outside of museums or government buildings.

(Continued to page 172)

On observation roof a guide explains the astrophane, miniature planetarium and model of the universe

1934.7 Feature Service  
 1705 Republic bldg  
**Spray Booth for Bombers**  
 Is Largest in World  
 Cleveland, Ohio

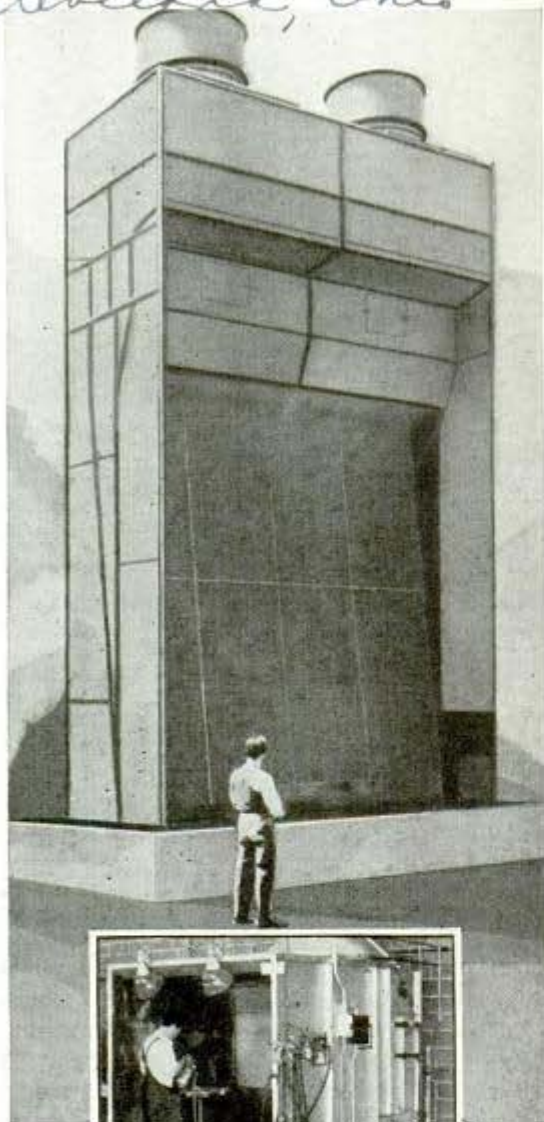

One section of new booth, top; ordinary booth, below

Mass production of large bombers will get another boost with the completion of the world's largest spray booth in one of the aircraft plants. It will be 152 feet long, 100 feet wide and 31 feet high. Big bombers can be wheeled into the booth for painting. The booth is made of eight compartments assembled in pairs with movable partitions between them. This sectional construction provides for one booth with 15,200 square feet of floor space or for several smaller booths large enough to accommodate a bomber's fuselage. Each com-

partment is equipped with a wash curtain with huge fans to draw air through a waterfall. With the entire installation in operation 192,000 gallons of water will fall in one hour and fans will move 496,000 cubic feet of air per minute to protect workmen against spray vapors.

### One Rat Whisker Makes Brush Used for Fine Painting

Among oddities about brushes are the following: A single rat whisker is used to make brushes for fine oil painting; "camel's hair" brushes are generally made from squirrel's hair because camel's hair would make a mediocre brush; hog bristles make the finest paint brushes because they split into "flags" at the tips and as the brush wears down they travel down the bristle holding the paint and spreading it evenly. Unusual materials from which brushes are made include nylon, rice root, bamboo, rubber, hair from the inner side of an ox's ear, and ordinary grass, according to G. O. Rowland of the Osborn Manufacturing Company in Cleveland.

5401 Hamilton Ave.

### Cellophane Sheets Lock Pills In Separate Safety "Cells"

Vitamin capsules are protected from contamination with a Cellophane wrapping that provides individual containers which can be torn off one at a time. The wrapper is made by pressing two sheets of Cellophane together with a rough die so that the sheets become meshed around each capsule. The meshed surface, like the perforations around a postage stamp, keeps the capsule enclosed after it is detached for individual servings.

M 730

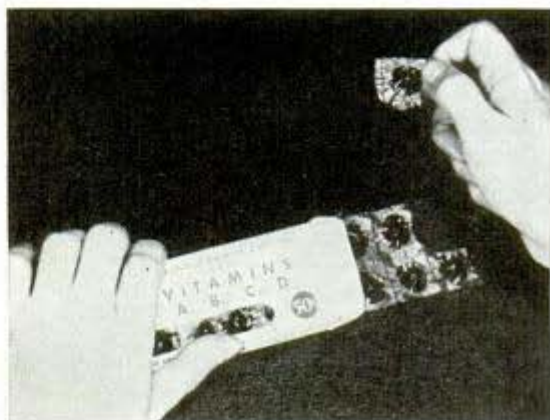

Vitamin capsules are torn off like postage stamps

Ni-V Vitamin caps  
 366 Madison Ave, N.Y.C.



**T**HIS land of the free and home of the brave will soon be a three-shift nation. The brave—America's soldiers, sailors and marines—are already fighting 24 hours a day somewhere on the globe. The free—that includes the rest of us—will soon be making industry click around the clock, pouring out weapons, ammunition and supplies for the armed forces.

By the end of the year there will be about 4,200,000 armed fighters wearing Uncle Sam's colors. This will require some 17,500,000 war contract workers alone, a recent government survey showed. The survey also indicated that approximately 9,000,000 more Americans would have to go into war work next year. This may land you on the night shift.

In other words, if you are a man able to work and are not already in a war job, or a civilian job necessary in wartime, or on a farm, you may be working in a war plant in 1943.

The chances are conservatively

Airacobras for the Army roll by night along the assembly line at the Bell Aircraft plant

21592  
Below, a worker on the night shift inspects mighty gears in the General Electric factory

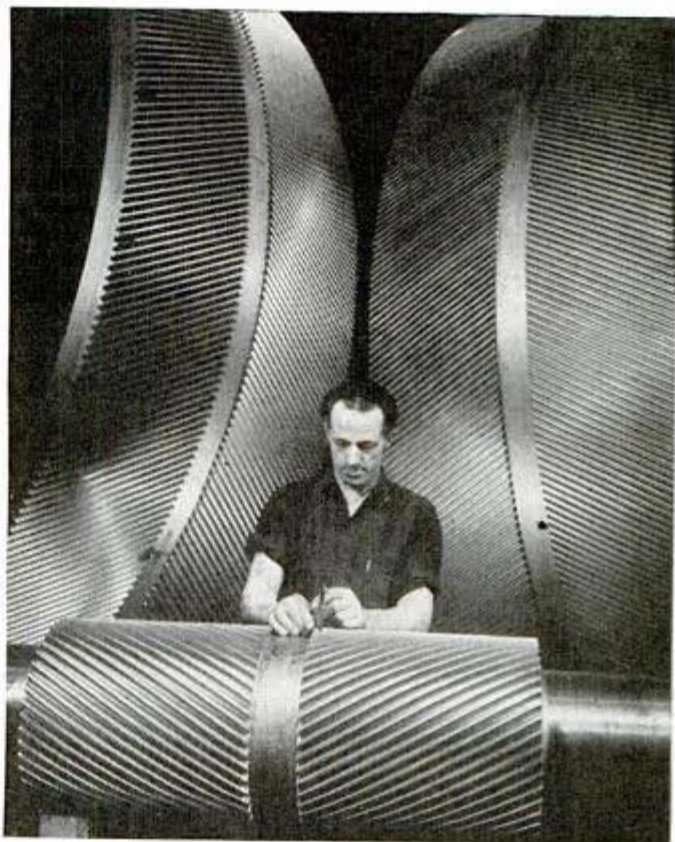

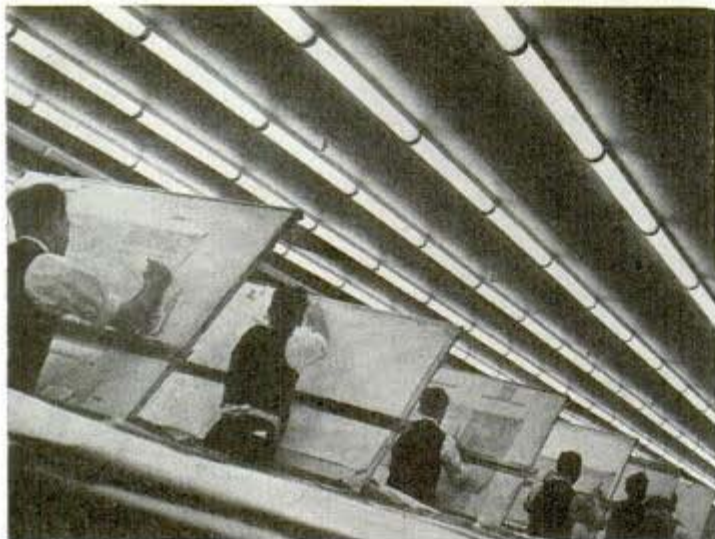

"Daylight" around the clock is supplied by one-third of a mile of fluorescent lamps in large drafting room of a Westinghouse plant.



Two members of the shift whose day starts at midnight are assembling landing field floodlights—beacons for the "night shift" fliers. War traffic keeps airline offices humming at night. Below, United Air Lines pilots conferring with a dispatcher at LaGuardia Field



one in ten that you will be on a night shift at least part of the time because some plants rotate shifts. Even if you are now a daytime worker in a defense plant you may be shifted to the night crew so a woman can take your daytime task.

There are not enough machines to keep all of the workers on a single shift, eight-hour-day basis. There are not enough roads, automobiles, street cars, buses and subways to handle two great traffic jams, morning and evening. There are already more than 51,000,000 wage earners moving back and forth every day.

Millions of us will have to go on the night shift.

This means breakfast around 3 p.m. or 11 p.m. It means supper around 1 a.m. or 9 a.m. It means learning to sleep amid daytime noises. It means getting accustomed to that strange and often melancholy feeling of being out of step with the rest of the world which every night worker experiences. It brings new problems affecting the eyes, the nerves, family life, the accident rate. It can bring a lot of fun, too, among other things.

And it already affects hundreds of thousands of workers who have no connection with war industries. Storekeepers, restaurant employes, theater men, physicians, teachers, radio station staffs, trolley and bus operators, railroad and airline personnel have also added to the "graveyard crews," "swing shifters" and "night owl" gangs.

In cities like Los Angeles, scores of stores, even groceries, operate 24 hours a day and housewives complain that "swing shift wives," who have adjusted their schedule to that of their husbands, are getting the pick of fruits and vegetables by being early birds.

In communities like Buffalo,

the biggest radio stations operate all night and speeches and daytime events are re-broadcast for war workers during the early morning hours. In Schenectady and other cities, bowling alleys and billiard rooms run all night and movies open at 10 a.m.

Railroads and air lines are feeling the pressure of war traffic. Businessmen and government officials are packing night trains and planes. Forty additional Pullman cars carry about 1,000 more businessmen every night than were carried before the war on the New York-Washington run.

Employment experts are just learning how important and complex the mass night shift problem really is. It's all so new that some angles are still mysteries of cause and effect.

They are sure of one thing: that you probably won't like the idea when it is first suggested to you. Few do. The reasons given are always indefinite, but mostly stem from the average man's habit psychology and the vague feeling that it is better to go along with the crowd. After a few months on the night shift it won't make much difference to about half of the workers. Some prefer a late "trick" on the job, especially in summer.

The group that likes night work consists of those active persons who have learned that every day can be a holiday with opportunities to hunt, fish, golf, play baseball or tennis, and hike in the open. They have also found that theaters are cheaper and less crowded in the afternoons. They have discovered that seats are easier to find on trolleys and buses. Restaurants are not so packed. Some have started gardens and others raise chickens. They say that the topsy-turvy arrangement of eating and sleeping hours be-



These 315-pound bolts will join two sections of a steel shaft for a giant generator. The night workman just finished painting bolts



Doctors of the night shift working in the first-aid station at the Lockheed Aircraft Corporation. Some call it the "MacArthur shift." Below, this pistol team of General Electric employees prefers the night shift because it gives them plenty of time for daylight practice





Testing 16-inch searchlight, above, the Westinghouse engineer uses glass shield to protect his eyes as he adjusts filaments of the powerful lamp

Right, guard at Bell Aircraft plant stops a night employe at the gates for a look at his photo pass and the company button workers must wear

Pattern makers of the night shift in the Westinghouse foundry at Trafford, Pa., execute a blueprint design before shaping mold for steel casting



comes routine after a while. But they claim you never lose that eerie feeling of loneliness when you find yourself on a deserted street after midnight, or at dawn. They miss long evenings with the family.

Insurance companies report that you are more likely to be injured on the night shift, but National Safety Council experts examined the accident frequency rates in 12 war industry plants and found no large variation between night and day figures.

Any increase in accidents is traced to upset nerves, eye strain and fatigue which often plague members of the night shift. The general cause is lack of sound sleep which can be temporary, while life is being readjusted, or permanent if the worker finds too many pleasant things to do in the daytime or "overworks" at play. Several companies have given their night shift employes posters to hang on their doors

which read: "Quiet—War Worker Asleep."

Some companies find more men report at the first-aid room on the night side. In the order of frequency, their complaints are stomach disorders, headaches and eye strain. Investigation revealed that many of these symptoms were the result of overwork by men who had picked up part-time day jobs.

Production records usually show a slight let-down in efficiency figures on the night shift. Much of this in the past has not been the fault of the workers, but comes from the fact that executives and veteran employes prefer day jobs. This leaves the night shift with less competent direction, more new employes and ragged working plans.

Westinghouse Electric and Manufacturing Company was one of the first to recog-

(Continued to page 168)

Ref: The Vidal Research Co.  
Camden, N.J.  
m 744

## Molded "Shell" Makes Lightweight Plane Body

Airplane fuselages so light that a girl can pick up the shell of a completed half-section are molded of thin wood-veneer strips laminated with plastics, which can be bent or curved into virtually any shape possible with metal. The process starts with a wooden mold made in the dimension of the fuselage, into which slots are cut where ribs are wanted. Strips of plywood are placed in these slots, and the whole surface is covered with thin layers of veneer which is then treated with thermo-setting glue. This form goes into a pressure tank where it is "cooked" with steam while the pressure is exerted equally at every point of surface. The process is said to be fast and cheap.

Lightness of "half-shell" for a plane fuselage, molded of wood and plastic, is evidenced by girl carrying it overhead



## Cotton Replaces Rubber Balloon in Making Bomb Shelter

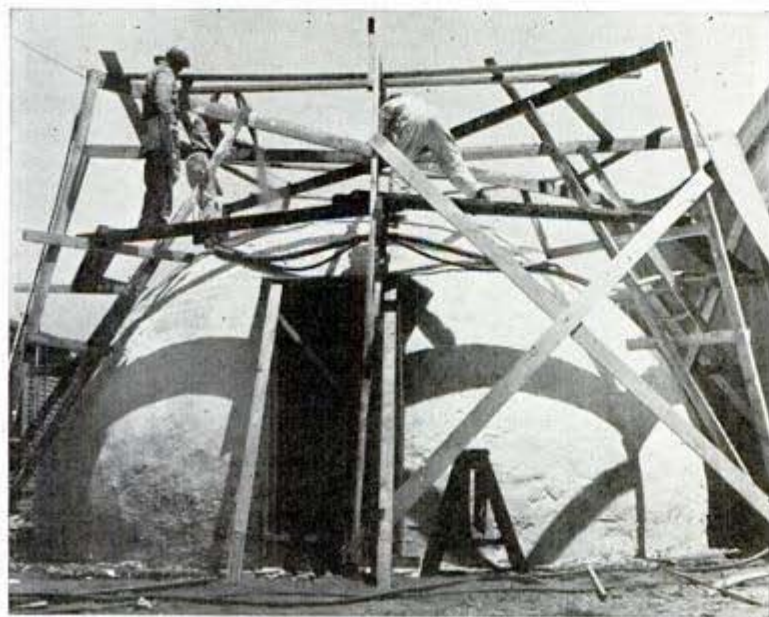

m 754  
Cotton muslin is being substituted for rubber in making balloons used in forming cement "igloos" for bomb shelters. The balloon is inflated with air to the size desired and then the outside is sprayed with successive layers of asphalt, gypsum, balsam wool and several inches of gunite, an extremely tough cement.

Balloons used as forms in erecting cement domes for bomb shelters are now made of cotton muslin so rubber can be saved for vital war needs

Some newspaper  
461-500-1000



Deepest secrecy surrounds the identities and activities of members of America's only civilian "commandos" composed of professional and business men expertly trained to handle any variety of uprising or disaster. Always at the call of the sheriff of a county in Ohio, these "commandos anonymous" are armed and kept in readiness to strike swiftly, seize an objective and guard it until United States Army units or other authorities take over. At top and right, men demonstrate how they take cover in approaching a stronghold to wrest it from the grasp of saboteurs, or to surprise an enemy military unit



Individual members of the organization supply their own equipment and they drill at irregular intervals so their operations may be conducted free from spying eyes. They can be summoned speedily by secret methods of communication, thus making it extremely difficult for fifth columnists and saboteurs to disrupt or interfere with their strategical plans. Group, left, is receiving instructions from leader before moving into a make-believe attack. Faces of men in pictures have been redrawn in order to baffle any attempt at identification

cont. J. P. Leggett, Capt. Air Corps, Air Service Command, Wright Field, Dayton



Right, member of the comandos anonymous pointing to hits on target made by his comrades, all of whom must be crack shots, as well as proficient wielders of the bayonet. They know, too, from repeated practice, the fine points of stepping into an emergency and swiftly interrupting the plans of vandals and saboteurs. If an explosion occurs, they leave that scene to the control of police and firemen, moving to other points of danger to cut off any hostile maneuvers bent on crippling defense factories, power systems or other vital centers. Thus, while local officers are engaged in one sector, the secret "army" halts spread of terrorism elsewhere



At maximum alert, the comandos advance with rifles at high port in position to fire or use bayonets (below), and begin to form a skirmish line (right) as they jump ditch preparing to close in upon their objective. This illustrates their unity of action in protecting important points in the county



Below, a member of this new link between the civil and military authorities has taken cover to look down the sights of his rifle at the enemy



*Dist: Mandel Bros  
State & Madison, Chicago*

## Fireproof Blackout Shade Hangs Over Curtains

*M 519*



Shade is put up by fastening end cords over nails

Made of heavy, black paper which is flameproof, a blackout shade is designed to hang over curtains. Wooden rods attached to either end have cords to be fastened on hooks or nails above and below the window. The shades are made in sizes to cover completely curtains and windows of average measurement.

## Slots in Cedar Chest Drawers Circulate Moth-Repellant

Moth-repellant odor in a cedar chest fitted with drawers is given a better chance

*M 758*



Cedar drawer with slots permits circulation of air

64 *Cavalier Corp  
Chattanooga, Tenn.*

to circulate by patented slots cut in the bottom of each drawer. Cedar drawers of ordinary design, when their surfaces are covered by the contents, prevent free circulation and thus lower the efficiency. A three-drawer "stow-away" chest, with a lock on the side that controls all the drawers, has six slots in each drawer-bottom that permit the cedar odor to pervade all parts of the chest.

## Poultry Feed Flows From Truck Like Water From Spigot

Besides saving the work of handling poultry feed in sacks, a special feed truck developed by a poultryman of Modesto, Calif., provides a sanitary method of haul-

*M 742*

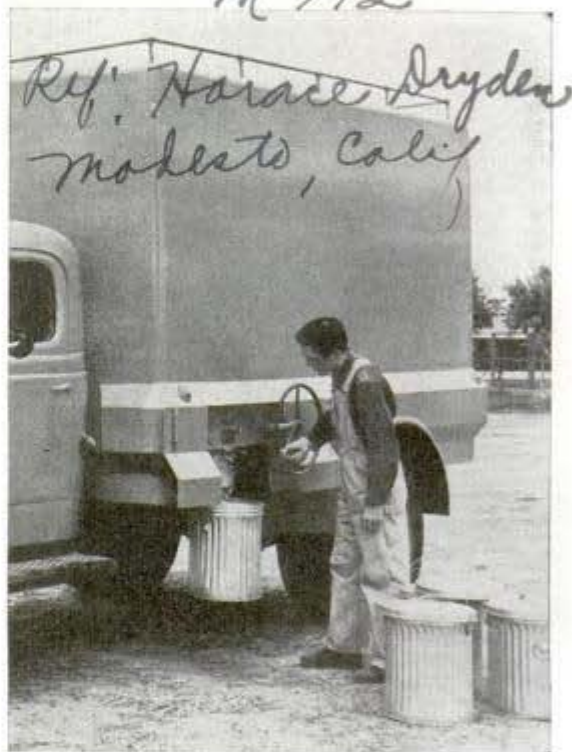

Worm gear in truck help draw feed into metal cans

ing from the mill to poultry houses on the ranch. A worm gear in the truck body makes it possible to draw out the entire five tons of poultry feed as from a spigot. In making periodical rounds of the poultry houses with a truck, the feed is run into clean galvanized containers from which it is used for direct feeding. This does away with carting 100 sacks of grain on each trip from the mill.

☞ To learn where to buy commercial products described in these pages, see the index.

## Ships in Convoy Quit Radio for Sign Language

Visible signals instead of radio with its telltale ether waves are used for communication between ships in a convoy. The man on signal duty sends a message via sign language, "reads" the answer from the signal man on another ship and relays it by means of a microphone to officers' headquarters on his own ship.

Shielding his eyes from the sun, the man on signal duty reads a message sent from nearby ship in convoy and relays it by microphone to officers' headquarters — almost as quick as telltale radio



*H 63 West et.*

## Air Raid Signals Test "Sound Shadow" Cast by Building

To chart the "sound shadows" created by tall buildings when the blast of an air raid siren reverberates among them was the aim of recent investigations at the Bell Telephone laboratories in New York City. For the sound source, investigators placed

a tone generator, a power amplifier and a "bull horn" on the roof of the laboratories building. Crews observing the sound reception were stationed at various nearby points. Results showed the sound intensity on top of the National Biscuit building was

about 100 decibels, and in the street below about 10 decibels lower. A drop of six decibels means that the sound has lost about one-half its intensity or loudness. In the "acoustic shadow" of one tall building in the vicinity the intensity was reduced about 15 decibels, but behind another building it was found the level was raised by reflected sound.

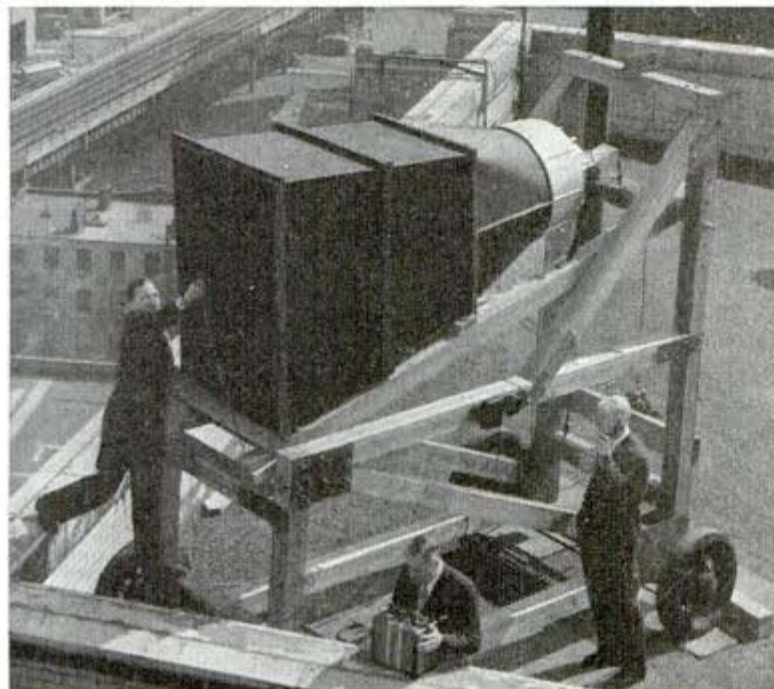

Loud blast from "bull horn" on roof of Bell Telephone laboratories building reverberated among New York buildings in tests to determine the effect of tall structures on siren signals used in giving air raid warnings

# HEROES of the ENGINE ROOMS

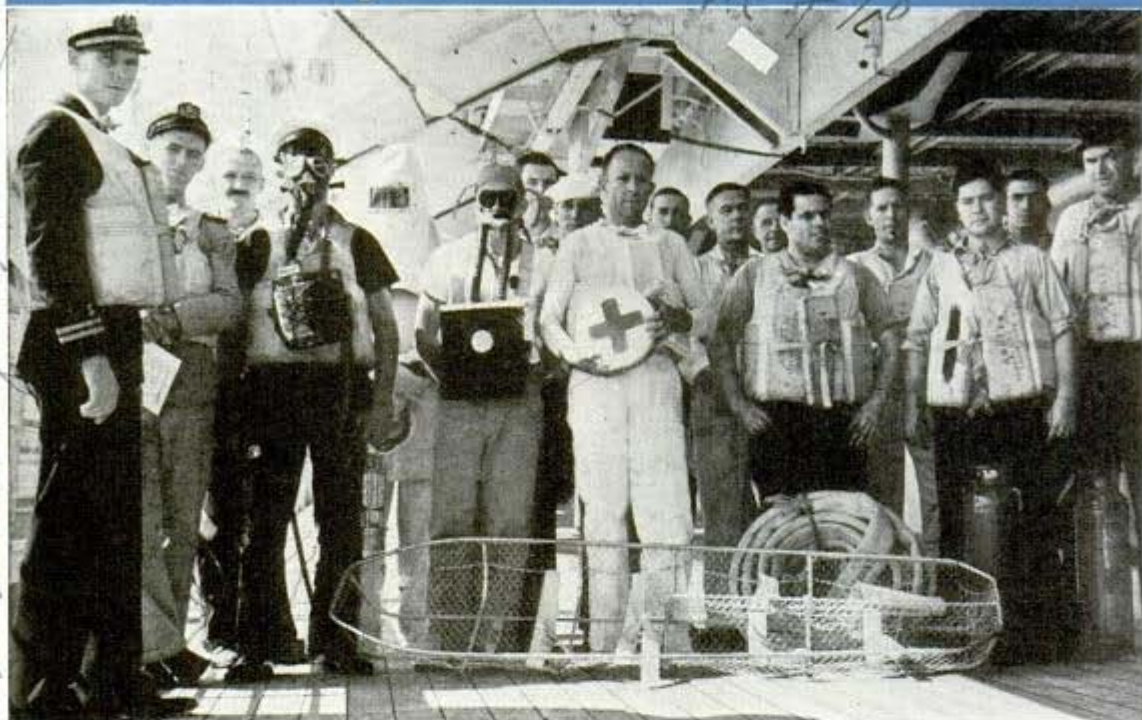

An emergency squad ready to battle disaster at sea

Entering engine room through double-door air lock



**T**HERE'S no warning, down in the engine room, when a torpedo strikes home. Everything collapses in a sudden, frightful concussion.

Hull plates rip apart, iron rivets fly through the air like bullets, and gratings and ladders tumble down on the engines. Steam lines and the fuel and water lines snap and burst. The engineers and firemen on duty rarely have a chance to save themselves. They are caught in the middle, between the deadly, scalding steam, and the tons of water that pour in through the hole in the ship's side. A torpedo travels under water and makes a hole that may be 20 feet across. The engine room fills up almost instantly.

The men who operate the engines of our merchant ships are among the unsung heroes of the war. There are from 15 to 30 men in the engine room department of a ship and a minimum of three or four are always on duty. A torpedo may never hit, or one may strike without warning in the next moment, yet the firemen and oilers must perform their duties as calmly as if they were in port. More than ever before, they must maintain the engines at full efficiency. No one knows when the telegraph needle will swing over to "full speed" and

cont: Thomas E. Stinson, Jr., 3872 Franklin Ave., Los Angeles, Cal



**Tugs rescuing lumber boat that has been torpedoed by an Axis submarine, but manages to stay afloat with bilge pumps working at full capacity. After repairs in port it will again brave the U-boats**

the voice tube from the bridge will beg for every extra revolution they can get.

Ship sinkings have been running at a high rate but the totals are low compared to the hundreds of American vessels that are operating in all parts of the world.

Even on an uneventful voyage the engine room crew takes a beating these days. Ordinary temperatures in the fire rooms and engine rooms run up to 110 degrees, but now at night the men work in temperatures that range up to 125 degrees. Sky lights must be battened down and portholes closed at dusk to prevent light escaping from the ship. The reduced ventilation increases the temperature down below.

A submarine aims its torpedoes at the engine room space because such a hit usually dooms the ship. Even a vessel that is entirely loaded with lumber may sink if the engine room is struck. The lumber may be so green that its buoyancy isn't enough to float the weight of the hull and engines. A

hit in one of the cargo spaces isn't always so bad. As long as the pumps can operate, the ship may float. Then, if the deck gunners can chase the submarine away or sink it, the ship may make port. Usually this will call for superhuman work by the engi-



**Happy engine room officer answers bridge signal marking end of a successful voyage**

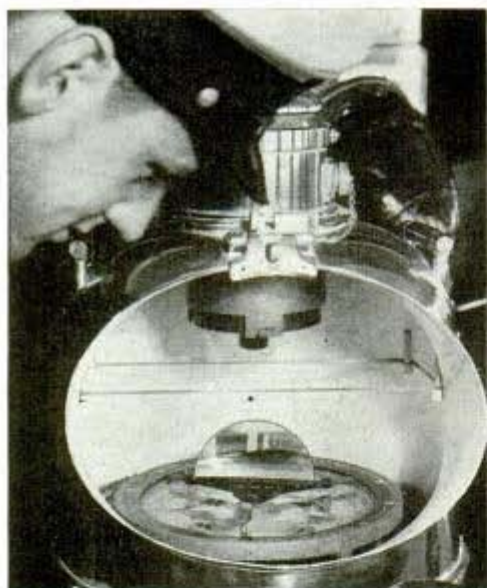

Studying the magnetic compass installed in the wheelhouse of an American merchant ship



One of Uncle Sam's merchant mariners makes sure that the reduction gear at end of propeller shaft is "ship shape"

neers because the propeller shaft may have been bent and the engines may be pushed out of line. Valves and fittings will probably leak and sea water may be mixed with the fuel oil. The rest of the trip will be a battle against big odds.

Some of our newest and largest merchant ships have pressure fire rooms that you enter through an air lock, closing one door behind you before opening another to prevent the air pressure from dropping. These fire rooms are cool to work in but they have their own special danger. Any sort of puncture, even from a shell, lets the air rush out through the hole so fast that the flames in the boiler furnaces are sucked out into the working spaces.

An underwater mine is rarely as damag-

ing as a torpedo, but a bomb may be worse. Even a "near miss" can put a ship out of service. Exploding in the water 100 feet away, the bomb's force may spring the plates on one side of the ship, bend the shaft out of line, and crack some of the machinery. Maybe the damage can be repaired, maybe not. A bomb that hits the vessel may penetrate several decks before exploding, turning the ship's interior into a wreck. There is at least one instance in which a bomb dropped from high altitude crashed through a ship's decks, pierced the bottom, and exploded in the water under the ship, caving the ship's bottom upward and sinking it without loss of life.

Oil tankers are the special prey of the U-boats. But such ships don't always catch fire when hit. One may even stay afloat because of its buoyant cargo. Once a torpedo blast broke a tanker in two and later on the after end, including the engine room, was safely towed to port.

Even though our merchant seaman escape from a sinking ship with their lives they may be in for a rough time. There may have been no time to



Antiaircraft crew on transport in convoy is ready to give enemy planes a hot reception. Man at right phones: "Foe Sighted"

launch the lifeboats, or the boats may have been damaged by shell-fire. Many ships now carry life rafts, built up of oil drums and scaffolding, suspended in the rigging. One slash of a knife and the raft slides over the rail. Then the men jump overboard and swim to it. They may be rescued in a few hours, or a few days, or a few weeks. Even a few hours is a tormenting hardship because the rafts have no protection from the elements. Waves sweep over the improvised structures and the sun and rain beat down on the men.

Still, the fight to carry precious cargoes across the oceans isn't as one-sided as it has been. Our merchant ships are now armed and can defend themselves with half a chance. One gun crew blew up a U-boat's periscope before a second torpedo struck their ship, and another gun crew caught a submarine when it was surfacing and sank it. Submarines like to strike at night when the gun crews can't sight them. In the daytime they get between their targets and the sun so that the gun crews find it hard to sight the periscope on the glistening waves. A ship is safest in convoy and now that the Navy is receiving more new fighting ships it has been able to increase its convoy protection with the result that more and more merchant ships are being guarded by destroyers that can detect and locate enemy submarines under water and either destroy them or make it so hot that their torpedoes go astray.

In the meantime the engineers of the merchant vessels are doing all they can ahead of time to minimize the damage that might be caused if a torpedo should strike. Rope ladders are hung down into the engine and fire rooms for emergency use if the permanent ladders are carried away. Such a hit might spring bulkheads, jamming watertight doors so that they could not be closed, so all watertight doors are now kept closed at all times except when someone must pass through.

(Continued to page 183)



**Danger is the business of these officers in the wheelhouse of a Standard Oil tanker. Torpedoes may strike any moment**



**Lighting the fire in steam boiler in ship's fire room. The firemen are ever alert for the word: "Full speed. Sub sighted"**

**Man with the oxygen mask is coming up from engine room through escape hatch. He's a member of emergency squad**



*Acme Newspapers Inc*  
*461-8 av, N.Y.C.*

## "Woolworth" Tommy Gun Built at Low Cost

*M 7 35*



Sub-machine gun produced at high speed for British

"The Woolworth Tommy Gun" is what British soldiers call the Sten sub-machine gun, which earned its nickname from the high speed and low cost at which it is being mass-produced. This gun is being issued at a fast rate to the British Home Guard and men in the army.

## Pilots Play Electric Quiz Game Scoring Their Accuracy

*M 703*

Naval aviation cadets can test their ability to identify ships and aircraft with a push-button quizzer patterned after the popular pinball game. Developed by the



Push-button quizzer for naval aviation cadets tests speed and accuracy in identifying ships and aircraft

Bureau of Aeronautics, the "automatic rater" may be rigged up to give instruction in aerology, nomenclature and navy regulations, as well as providing certain types of psychological tests. At pressure of a certain button, the machine displays a card containing a question, which the player studies carefully. Then he chooses one of a variety of answers shown and presses the corresponding button. Following each answer the panel flashes either the word "correct" or "incorrect." On completion of the test, the player is scored automatically on the accuracy of his answers and the speed of his decisions. He is allowed a certain number of seconds to give each answer, and for each extra second thereafter the machine deducts a point from his score. There are ten questions, each one correctly answered allowing 20 points.

## 'Yardstick' Measures Grain in Bin And Computes It in Bushels

*M 598*



Special measuring stick, marked in tenths, reveals bushels in bin by multiplying the three dimensions

The number of bushels of grain in a given bin can be calculated quickly with a special stick, graduated into tenths. To find its capacity, the bin is measured in length, breadth and depth, counting the full length of the stick as one unit and the fractions in tenths. The product obtained by multiplying these three dimensions gives the number of bushels of ear corn in the bin. If the contents are shelled corn or small grain, the product should be multiplied by two to get the number of bushels.

POPULAR MECHANICS

*Rock-on-Wood, Ltd*  
*Bloomfield, Iowa*

*Acme Newspapers Inc*  
*461-8 av, N.Y.C.*



Ref: Nelson & Frey, 347  
Madison Ave, NYC  
m 687

# "Hole-in-One Club" Appears at Hobby Show



The feat that most golfers dream about—a hole in one—is made easy by the practice club, above, that carries a "cup" in the head of the stick. If the swing is perfect the ball lodges in the cup. When the swing is out of line, a stout cord keeps the ball from going far.

Left, market basket made of a paper bag and a supporting device that can be carried in pocket



Welcomed by persons troubled with raising and lowering windows, is a simple pulley arrangement, above, that does job quickly



A "mystery server" rises from the top of the tipless table, right, when you press a button, eliminating the need for waiters. Food may be placed on the shelves of the server from an aperture in the wall, or the server can be operated from a basement kitchen. The inventions on this page were exhibited in New York at an exposition given by the American Hobby Federation

# FOR REAL DISCOMFORT..



From stone age cave to modern home is a long distance, yet the 1942 house is a far from perfect machine for living. It isn't the cost, it's the upkeep. Why, for example, must floors be continually waxed? Why not a permanent finish?

which will help to shape and improve the conditions in the new world which is to be.

The home of tomorrow can be designed as a unit, and now is the time to start working on the blueprints. Present-day houses grew like Topsy in an age-long progression of refinements and changes from the days of the caveman. We used to have bare floors to stand on, but then we made some money and somebody invented a nice, soft carpet which somebody else had to vacuum clean every day and then clean the vacuum cleaner. We used to wear hair shirts and homespun pants, but now we have to have fresh linen once a day—somebody has to wash it and iron it.

Thus, through our great industrial efficiency, we have greatly increased our standard of living, meaning the quantity of consumer goods available—but, we have also greatly increased the effort of living at home. For a while this was supportable because we could get servants cheaply. But with the decrease in the higher income brackets and increases in lower income brackets, we find the servants disappearing. Tomorrow there will be no servants, so let us design for this and be prepared.

At my own modern house, when you drive up to the front door, the first thing

## By Houlder Hudgins

President, Sloane-Blabon Corp.

597 Madison Ave., N.Y.C.

EACH of us in his own way is preoccupied with only one thought—let us win this war. But some day this war will end.

When peace comes we will have progressed more than halfway through a world revolution and yet we have no plans for accommodating ourselves to the new world in which we will most certainly be living. It is up to America's designers to start work now on the design of material things

# "THERE'S NO PLACE LIKE HOME"



you notice is that the house needs a coat of paint. Can't we design an exterior finish that won't require new paint every two or three years?

The roof on my house is like most roofs; it's in pretty good condition, but there are a few shingles missing. To replace them is a major project requiring skill and time. Can't we design a roof that will perform just as well, but either stick together longer or grow old more gracefully and not cost so much to replace? To get into my house, you have to have a key which allows you to push open a door fitted



Home is really too dangerous a place to live in. Step into the livingroom and you're in peril of taking a header on a loose rug

Electric wires trailing on the floor to trip you are no credit to our efficiency. And why not abolish dust? Someone will find a way





with elaborate and highly polished brass fixtures. Some mysterious person keeps this brass polished. Can't we design door knobs that work a little easier and make them of a material that doesn't have to be polished like your Sunday go-to-meeting shoes?

Walk in my front door and start turning on the lights. One of the first things you do is trip over the floor lamps with which we have all replaced the gaudy gingerbread wall fixtures of the previous decade. Can't we design illumination that will be part of the house itself and which at the



**You spend a couple of hundred dollars for a roof; in a few years shingles need replacing or patching. They should last longer**



**Many modern kitchens are so tiny you knock a kettle off the stove every time you turn around. The old-fashioned kitchen was so big you walked for miles**

flick of a switch, or better still, by self-operation, flood a room with scientific light? Perhaps in certain rooms we can so accurately simulate daylight as to give us all the benefits of a winter in Florida right in our house. I shave by the light of a sun lamp—it is good, and good for you.

The next thing we do is sit down on a chair. At last we are comfortable; that is, we were until we felt a draft. Why do we have to build a house as a shell and then fill it with insulation and weatherstripping? It seems to me that we ought to be able to design a house of materials which already exist that have structural building strength and high insulation qualities in themselves. Why do we have to have windows that open, creating a draft? Can't we design a simple system of air-flow which will give us all the fresh air we need?

If we sit on the chair and look around, we see that the place needs dusting. Where did the dust come from? Most of it comes in the window, so let us do away with windows that open, and cut down the dust. It is cold, so we light a fire in the fireplace and turn up the thermostat. The fire makes us red hot, even though most of the heat goes up the chimney. Can't we design a fireplace that gets more heat value out of the fire—because firewood is expensive? And, the heat from the fireplace shuts off the

Windows have become a habit that we tolerate despite the inevitable drafts and the heat loss in winter

thermostat so that the rest of the house is cold. Can't we solve this problem?

I shudder to think of the problem of assembling a full meal in a modern house. If it is a big house, you walk miles in the process. If it is a small house, you bruise your hips and scrape your shins dodging the myriad mechanical gadgets that clutter up a kitchen. The more efficient the house, the worse off you are. You neatly sidestep the new home-size commercial laundry only to receive a full body block thrown at you by the dishwashing machine which causes you to trip and fall, throwing both hands and the contents thereof into the new garbage disposal unit. Can't we design a system of home utilities which are part of the house and constitute a single unit which takes care of all the heating,

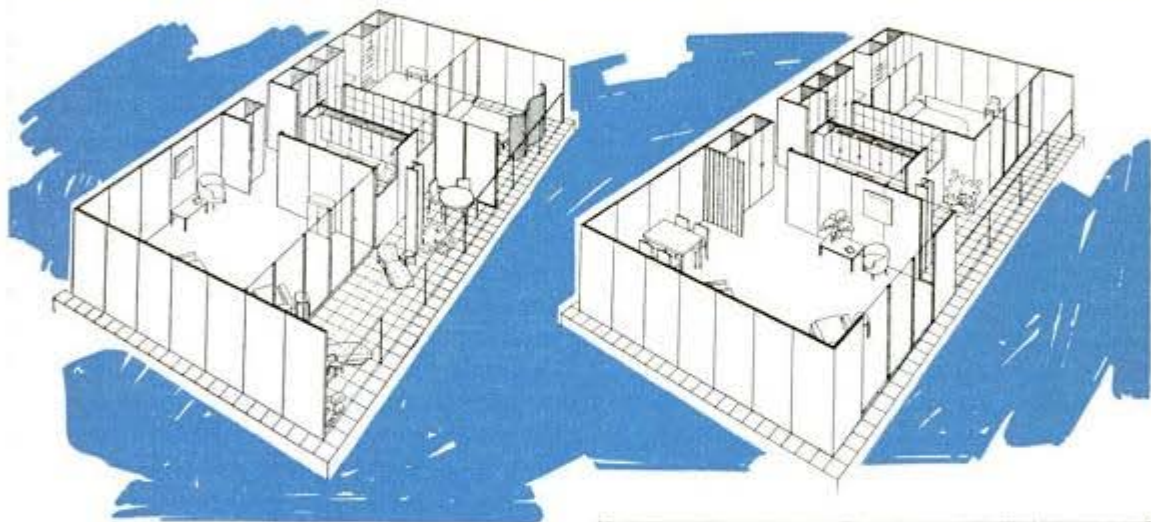

Future homes may consist of room units that can be interchanged. In the apartment above, exterior walls are moved inward (left) for the summer. Another job that should be abolished is the polishing of brass

cooking, cleaning, washing, bathing and toiletries?

For my money, I would like to find a house at any price which is a real satisfactory machine to live in. We have 99 and 44/100 percent of all the materials on hand with which to create such a scientific and completely designed establishment.

The only two things we definitely know about the houses of the future are that they must be low priced and we will need millions of them.

The processes of redistribution of income which have been going on for over ten years will continue—by which we mean,





**Draperies make frequent and regular trips to the wash, and Venetian blinds catch an appalling amount of dirt. Can't someone plan a better way to live?**

in specific terms, that tomorrow and until further notice the market for all products will be concentrated in what is now the \$2,000 to \$5,000 annual income bracket. It is a reasonable opinion that the war, with its heavy taxation, will speed the process of cutting down top incomes and raising bottom incomes so that the \$2,000—\$5,000 bloc will represent the mass income.

At the same time we are involved in a process of geographic redistribution of people. Here in the United States, long before the war was even thought of, our cen-

**Dusting and scrubbing must give way to time for living in an efficient home. All building materials should have inherent insulating qualities**



**A thermostat is a wonderful thing if left alone. You warm up by the fireplace, turn down the thermostat and the rest of the folks in the house are chilled**

ter of population was moving south and west. Now, with the impetus of war, we are continuing this trend and beginning a process of decentralization. The war may teach us the lesson that it is unsafe to live in concentrated cities. So we should think in terms of designing for a decentralized mass market.

So now we come to a more concrete idea of the designer's assignment. It is something like this: Go design a house for a mass market to meet the demands of the people in today's two thousand to five thousand dollar a year income bracket that does the following things:

First, it will be a machine to live in that will be a thing of satisfaction; a house to

(Continued to page 166)



*Int'l News Photos, 326 W  
Madison, Chicago*

## "Pint-Size" Tractor Handles Like Baby Carriage

One of the non-military groups vital to England's war effort is the women's land army helping to produce crops for food at home as well as on the battle fronts of its far-flung empire. To lighten her task, the farmerette operates "pint-size" tractors for plowing, towing and countless other farm duties. The tractor uses very little fuel and is said to handle as easily as a baby carriage.

Heavy work in the field for England's farmerettes is performed by small-size tractors that operate at the touch of levers, requiring little energy of women who drive them



*m 756  
olive willis*

## Planes Move in Endless Stream on Assembly Conveyor

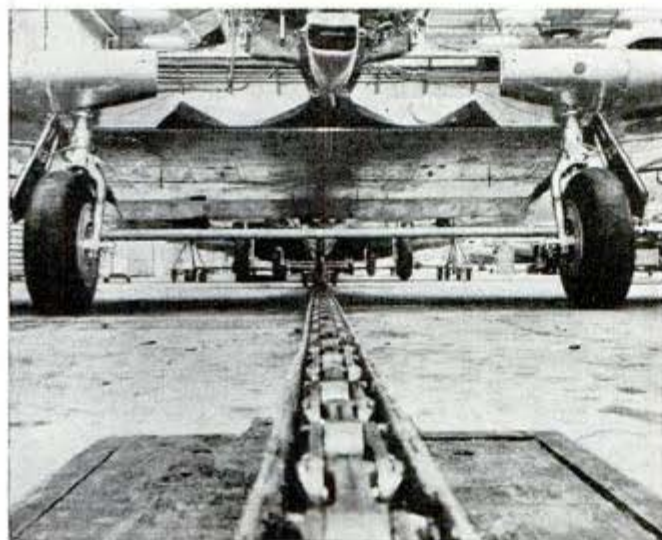

Airplanes entering the last lap of their "growing up" process at a plant of North American Aviation, Inc., are towed backward for best working convenience by a power driven conveyor moving near the floor level. In this final phase of assembly, reached by the planes only after they have received fuselages and center sections, the last electrical equipment and engines and propellers are installed. Then the ships are delivered to the flight-test ramp.

*Dallas Tex  
usm*

Airplanes nearing completion are pulled backward along assembly line by conveyor moving near floor level

## "Tommy Gun" for Canadian Paratroops Weighs Only Seven Pounds

Already in mass production, Canada's newest weapon is an all-metal sub-machine gun that weighs only seven pounds. It is designed for use by parachute troops. The gun, which proved to be accurate and deadly on the testing grounds, is somewhat similar to the American "tommy gun."

Names and addresses of makers or sellers of commercial products described in this magazine are listed in the Where-to-Buy-It index. Write to them for additional information and be sure to Say You Saw It in Popular Mechanics.



Canadian soldier takes aim with newest weapon for parachute troops—"featherweight" sub-machine gun

*Int'l News Photos, 326 W. 77  
Madison St., Chicago*

# ALL DRESSED UP for WAR

M 663

Westinghouse  
40 wall of, nyc.



You're not only wrapped up pretty thoroughly in this war, but because of it you and your household effects and war goods are wrapped up in new materials. Shipping space is at a premium and packaging must be compact. Metal packaging, especially tin, must be replaced by glass or fiber. On these pages are a few examples of the changes taking place. At the left, Westinghouse research men put a new container to a test of strength. It is made of a reinforced corrugated paperboard, and saves twenty percent in weight as compared with the box previously used. In many instances, the war has given the incentive for development of new materials and methods that are proving to be better than the old

Kraft paper stock expanded into a honeycomb pattern as shown at right was developed by the Research Products Corporation at Madison, Wis., for shipment of fragile articles, especially glass. To provide a tight seal for fiber can replacing metal container the airtight string-under-label arrangement below was devised

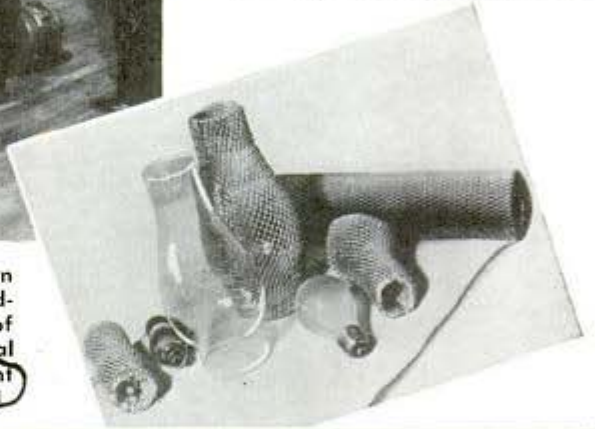

Right, screwing a cap over the composition-lined inner lid which permits the use of an ordinary coffee jar for preserving fruits or vegetables. No rubber rings are necessary



Thrifty Lid  
Dwens. Illinois glass co  
Toledo Ohio



Allen Warren Elliott  
7 Park Ave, N.Y.C.

A.P. Stores

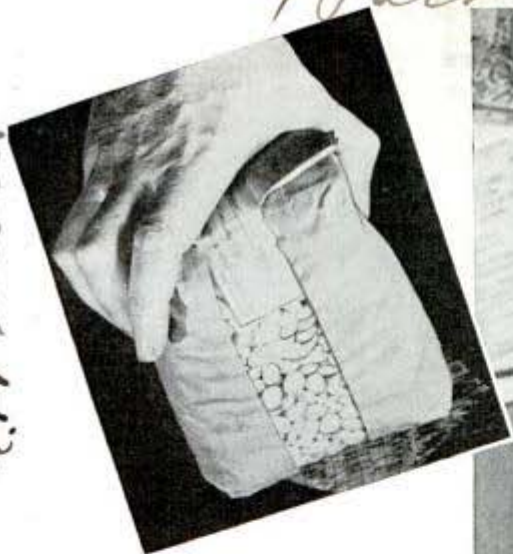

Your dried beans may not come home in the fancy cardboard package you are accustomed to, but for a while at least they will be available in the "goldfish" container shown above, a paper bag with transparent window that permits the buyer to inspect the goods—which is, incidentally, a sales help for the grocer

The leatherette package worn over the arm, at right, won a prize in an All-America Package Competition. It is economical in use of materials, for it serves originally as a sales package for beauty preparations, and afterward as a purse. And in a season of small hats, it can even serve as a hat box for traveling



Modern Packaging

The growing demand for diversified foods was back of the packaging innovation shown below. The half wrapped in dark paper is a small loaf of whole wheat bread, while a similar loaf of white bread comes in the light wrapper at the left. The twin loaves are wrapped separately and sold as one in two-color outer wrapping

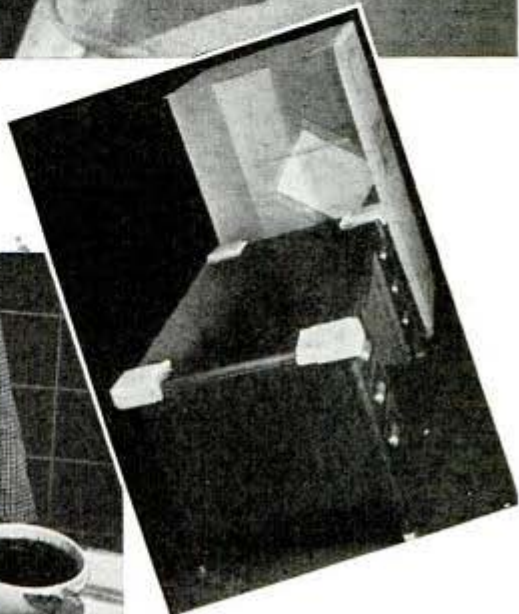

The corrugated case for shipping desks, above, has cotton wadding on the corners. The fiber package prevents marring finish or breaking legs, saves 10 percent in packing costs, cuts packing time from 24 to 8 minutes, reduces fire hazard



Modern Packaging  
122 E 42nd  
N.Y.C.

*Richard E. Fox  
934 Merchandise Mart  
Chicago, Ill.*

## Yardstick for "Weighing" Paper Tells Pounds by Depth of Pile



Handy stick 'weighs' either newspapers or magazines

Stacked magazines and old newspapers can be "weighed" with a yardstick which provides a graduated scale relative to height. One edge is calibrated for magazines, the other for newspapers. The yardstick is held upright beside a stack of papers to read the weight. On the opposite side the ruler gives information for your "victory" garden. Fifty-six vegetables are listed with instructions for spacing the rows and depth of planting.

## 'Weatherman' Warns of Moisture In Heat-Treating Furnace

Standing watch over the moisture content of gases 1,000 times as dry as the air of an average sunny day, an electronic "weatherman" records as little as 4/1,000 of one percent water vapor in furnace gases used in heat-hardening tough steel parts for airplanes, tanks and guns. In the heat-treating process close check of moisture is essential because the flow of wet gas for only a few minutes might ruin a whole batch of carefully machined parts by softening and rusting their surfaces. The "automatic dew-point recorder," developed at Westinghouse Research Laboratories, contains a new electronic tube similar to a radio rectifier tube which transforms al-

ternating current to direct current, except that the radio tube contains no gases, while gas from the furnace flows continuously through the recorder's tube. As long as the gas remains dry, electrons flow steadily from the tube's filament to a metal plate and produce an unvarying electric current; but when water vapor enters, the electric current is reduced by electrons adhering to the water's oxygen atoms. A meter measuring the flow of current indicates the moisture in the gas.

## Dial Tells Monthly Payments Of Social Security Benefits

Quick calculation of social security benefits is possible with a chart that shows at a glance the amount of cash payable after 5, 10, 20 and 30 years on incomes averaging \$100, \$125, \$150, \$175, \$200 and \$250 per month over these periods. For instance, if a worker retires at the age of 65 after earning an average of \$200 for 10 years, a pointer on the dial is turned to the 10-year period under the \$200 bracket. A window in the dial then indicates that the worker would receive \$38 per month, he and his wife, both 65, would receive \$58, his widow (at 65) \$29, his widow (at any age) and one child \$48, or his widow and two children would receive \$67 per month. In the same way, information regarding monthly payments can be found under each wage bracket. Figures are adjusted to the nearest dollar.

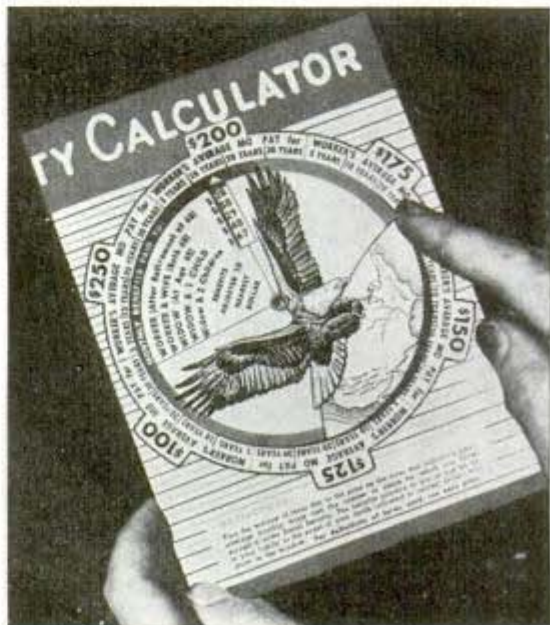

Dial calculates monthly social security payments

80 *Elec. & Mfg. Co. Inc.  
E. Pittsburgh, Pa.* *POPULAR MECHANICS  
Earl B. Shields 624  
S. Michigan, Chicago*

Ref: Chief Engineer

State & Madison

# Bomb-Fire Wagon Is "Tailored" to Fit Building

M 601

Getting ready for incendiary bombs, should enemy flyers break through, mechanics in the maintenance department of Carson Pirie Scott and company, one of Chicago's large department stores, have built and outfitted a fire wagon that can negotiate any passageway, doorway or elevator in the store. Balanced on two wheels from an Austin car, the cart can be moved about easily by one man. It has a Ford front axle cut down to the desired size, and a couple of tin cans make hub caps. Despite its small size, the vehicle has its own 30-gallon water tank and a compressor supplying five to 65 pounds pressure, for spraying fire bombs. The spraying hose, 50 feet long, uses a nozzle adjustable from a fine foglike spray to a concentrated stream. There is also a 50-



Two wheeled cart completely equipped to fight fires and aid the injured

foot filling hose. Among equipment carried in pairs are stretchers, gas masks, asbestos gloves, fire extinguishers, sand buckets and electric lanterns. Other equipment includes a first aid kit and tools.

# Perfect Swing of Golf Machine Reveals Need for Rhythm

M 647

Good golfers develop as great a rhythmic sense as accomplished pianists, according to Robert Winthrop Adams, Boston engi-

neer, who has invented a machine with a perfect golf swing to prove it. The machine is enclosed in a wooden box with a white cardboard face against which a small club, like the hand on a clock, swings in rhythm and at perfect angles. The club is controlled by cogs and levers run by a small motor. In making the machine—a six-year job—the inventor studied slow motion pictures of Bobby Jones' swing and had an artist trace the position of Jones' club at various key points during the swing.

R. 1318, 140 Federal St



The golf machine mounted on the table does everything a good golfer should do except shout "Fore!" Small club on face traces a perfect swing

# MIRACLE *on* WHEELS



Here's Uncle Sam's blitz buggy, errand boy, maid-of-all-work, the jeep; its four-wheel drive takes any dare

With flanged wheels, a jeep patrols and performs scout duty on railways

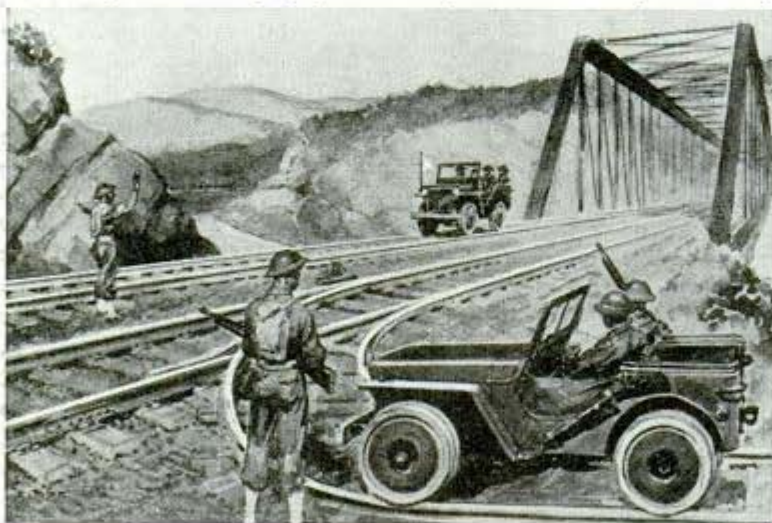

the eyes of leg-weary soldiers, hurrying officers and harassed technical men, its drab and insignificant outlines are as beautiful as the swan's.

Army men call the jeep a miracle on wheels. Already the jeep has undergone its baptism of fire and has emerged with combat service stripes. That's the word that has filtered in from the United Nations forces around the globe, from India, from Burma, from Libya, from Iceland and from Australia, tucked away

**W**HEN the final score of this war of wings and wheels is added up, one large item on the credit side where America's gains are listed will be that fast-moving, hard-hitting blitz buggy—the jeep.

So versatile has this automotive jack-of-all-trades become that another use for the squat little cross between an automobile and a mule is probably being thought up by some army technician while you are reading this.

Call it an ugly duckling if you will; in

in official communiques, or in the statements of men who have returned. These read like a citation of valor for the little car which started out under the undignified title of "belly-flopper," a mere platform on wheels driven by a gasoline engine and intended to carry two soldiers lying prone with a machine gun.

They say it can scramble over rough country better than a horse. Cross streams. Climb rocky terrain. Beat down barbed wire entanglements. Dodge through for-

Cont: Allen Warren Ellworthy, 7 Park Ave. N.Y.C. M.C.

**It really can't fly, but on rough terrain  
the jeep spends considerable time in air**

ests. Hit more than 60 miles an hour on any solid road.

Its eight speeds and four-wheel drive can carry a full load up a 65-degree grade, turn in a circle 30 feet in diameter, tilt sidewise to an angle of 55 degrees without turning over, and raise a merry rumpus with anything that gets in sight of its machine guns. And it has a low silhouette which, together with camouflage and army lusterless paint, makes it easy to conceal in almost any terrain.

Reports from Chungking say a jeep was the first motor vehicle to conquer the towering heights and dense jungles of a new India-China route supplanting the Burma road.

In Australia our soldiers were given the difficult task of laying an underground cable at an airdrome without interrupting field operations. It should have taken several days. But the jeep sped in, hitched to a plow and the ditch was dug at 10 miles an hour. Behind it came another jeep, towing a reel of cable, and next a third jeep pulling a roller that covered the cable and flattened the ground. The job was finished in two hours while Australians gaped.

In China the British forces are using them for liaison work behind the lines. With their four-wheel drive, it is reported, the jeeps can bounce over the roughest rice paddies and plunge across irrigation

**Right, model of the "miracle on wheels"; below, jeep with wheelbase extended a foot is ambulance for four**

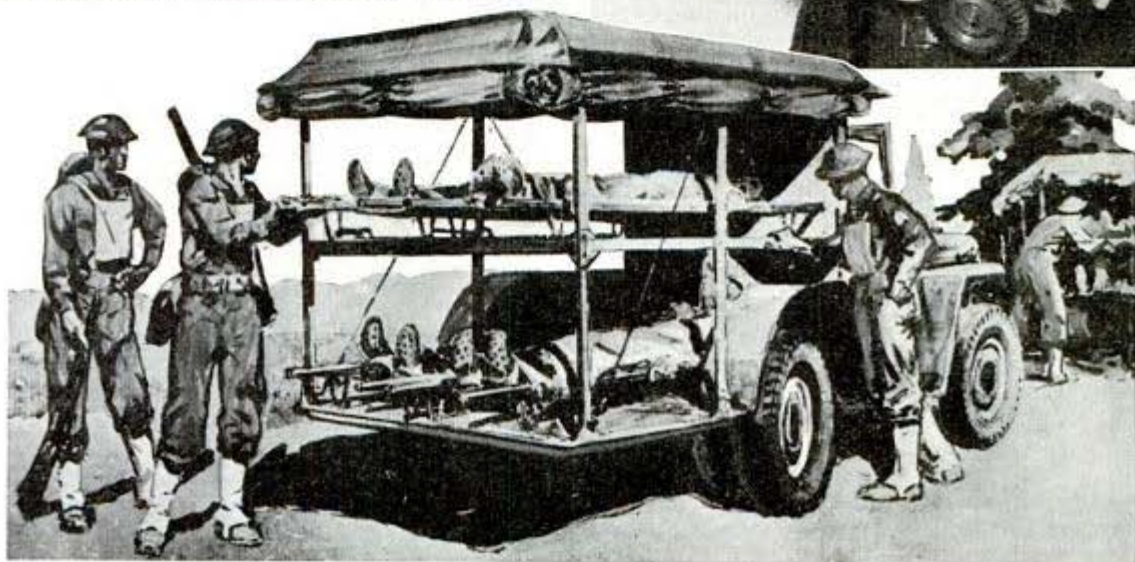



Willys-Overland Motors, Inc.

Doing a bit of sand-blasting on a Florida dune in maneuvers

ditches. They are excellent for night patrol work and for towing smashed planes from bomb-pocked airfields.

The rear guard at Rangoon was evacuated to Lashio in jeeps. They rolled along the bumpy roads at 40 to 50 miles per hour, and pulled many a three-ton lorry from the ditches along the way.

They say it will transport up to seven soldiers and its engine hood makes a swell place to sleep. It is used by soldiers to run errands and by generals to run battles. With a few additions, it makes an excellent field ambulance that will haul four wounded men. It can operate closer to the front line than regular ambulances because of its very low silhouette.

In a battle the jeep is used as weapon carrier. With a .30- or .50-caliber machine gun mounted on it, it becomes a mobile and effective weapon against ground troops or planes. It will pull a 37-mm. antitank gun around

While tanks make a frontal advance on a village, jeeps dart in for surprise attack on flank

without a groan. It can be carried around on the back of a truck like a papoose, or inside a plane, like a baby kangaroo.

Known variously as "jeep," "peep," as "reconnaissance car" or "quad car," the new unit is officially "a quarter-ton, 4-by-4 truck" and was intended to replace motorcycle-sidecar pieces and enable military strategists to bridge the gap between heavy advance units and infantry. It is built from a design by Willys-Overland.

Basic in the design is the Willys commercial car power plant, with special carburetor and manifold, developing 61 horsepower at 3,800 r.p.m. The engine's cooling capacity has been highly developed. The radiator is protected by an extra heavy grill. The engine is protected from mud and dust by a special heavy duty oil bath air cleaner.

Application of the engine's power through four-wheel-drive mechanism gives the car unusual pulling ability on slippery roads and in deep mud, snow or sand. The regular transmission gears, three forward and one in reverse, are operated from the remote control gearshift lever on the steering column. A special gear box giving an additional 2 to 1 reduction is brought into operation when a special transmission lever is thrown forward, so it is possible to obtain a total of six forward speeds and 2 in reverse. Another lever on the transfer case permits selection of either 4 wheel drive or rear wheel drive only.



The special levers are so arranged that it is impossible to use rear wheel drive alone when the 2 to 1 reduction is in use, preventing the wheel slippage which would occur if this increased power were applied to rear wheels only.

Designed to use either low grade or high grade gasoline, the car's 12-gallon fuel tank under the rear seat provides a high speed cruising radius of 175 miles or better on a single tankful of gas.

Employing a short wheelbase of only 80 inches, it has exceptional road clearance, and at the same time an exceptionally low center of gravity. A heavy steel plate protects the oil pan from contact with rocks and hummocks; a similar plate protects the transmission.

The body, built of heavy gauge steel throughout, provides two folding seats in front and a rear single seat which can on occasion accommodate two persons. Two side seats, over the rear wheels, and sturdy flat topped front fenders can carry additional passengers in an emergency. In addition to regular headlamps the car has special black-out headlamps such as were developed for use on Army trucks. The headlamps are provided with steel brush guards to protect them against contact with brush and tree branches. A compartment in the dash accommodates light tools. Two special compartments beside the rear seat are available for chains and tools or ammunition. The car carries a fire extin-



Another member of the jeep family is the Crosley "bull pup," 1,000-pound scout car here being lifted aboard cargo plane for a ride to Marine post

Jaunty jeeps sprint across the battleground to lay a smoke screen for a tank attack. The little buggies can take an amazing lot of punishment



A young fellow with a future, the jeep hopes to take up farming after the war. Below, it pulls a lime spreader at six miles an hour in a test



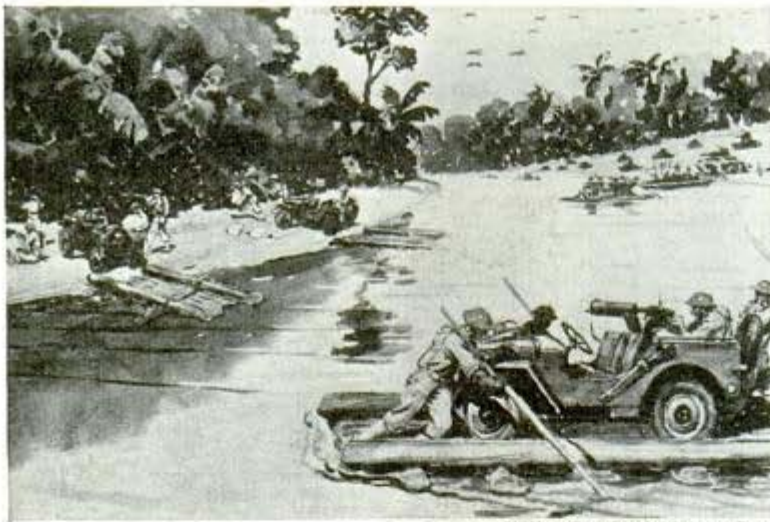

Willys-Overland Motors, Inc.

Helping to establish a bridge-head at a river crossing, blitz buggies are ferried on rafts

car provide convenient hand grips for manual assistance in case the car gets into difficulties.

Variable rate rear springs provide comfortable riding qualities when the car is running light. Their supplementary spring leaves automatically come into action to pick up the added weight when a load is increased.

The reconnaissance car

has heavy disk wheels and tires of special Army design, and heavy duty, double action adjustable shock absorbers. Both axles are full floating type with special universal joints.

Because this setup differs considerably

guisher, and has brackets for other emergency equipment.

A railing around the rear gives passengers a means of holding on in rough travel. The same railing can be adjusted to a vertical position to provide a rear support for a waterproof canvas that may be attached to the top of the windshield for cover in bad weather. The windshield itself can be folded forward over the hood permitting a clear field of fire in all directions for rifles or machine gun.

Two hooks on the front and a sturdy pintlehook at the rear equip the car for haulage jobs. Two handles on each side of the

**Doughboys in Iceland converted the jeep at right into a snug sedan for the winter. Below, the other extreme—a jeep used as supply car refuels a tank on the desert**



from an ordinary automobile, the Army is training a special crew of "trouble shooters" to keep its speedy and tough jeeps in top condition. Road service men from auto plants have been dispatched to Army training centers throughout the country to conduct special courses among soldiers assigned to mechanized units.

Engineers at the huge Willys plant, where thousands of these iron

(Continued to page 174)



*shown at Exhibition Hall, Lower Level, Stevens Hotel, American Water Works Convention.* M 738

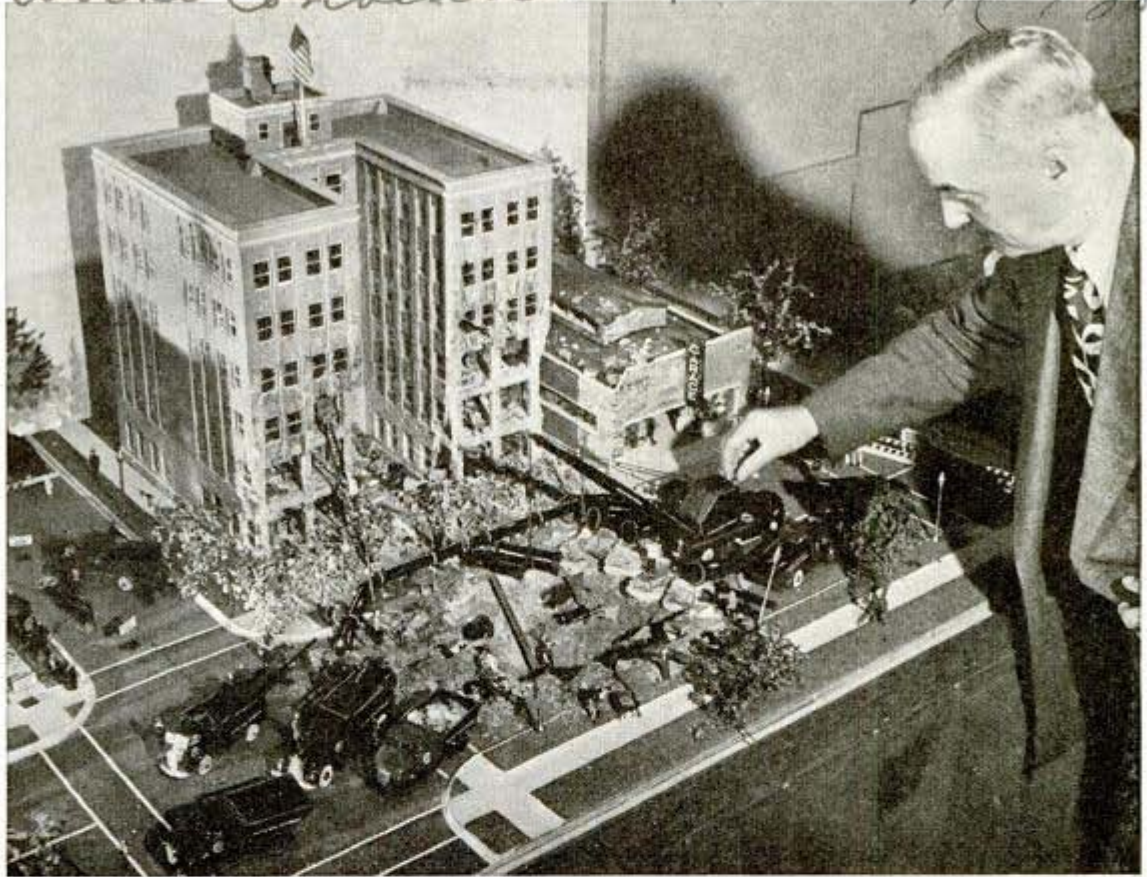

Model of a Chicago street after an air raid shows how water mains would be routed around deep bomb crater

If a 2,000-pound bomb should fall in a Chicago street, causing damage to the water supply system and the underground network of sewers, electric conduits and gas lines, city crews will be on the job in a jiffy making emergency repairs. Engineers in the division of waterworks design, Department of Public Works, built a scale model of a street scene showing a crater dug by a ton of TNT that landed on a boulevard before a six-story apartment building

which was partly demolished. Maintenance crews from the water pipe extension division are shown making permanent repairs after they have cleaned the debris from the crater and installed a by-pass main above the street level. Gas lines are plugged and sewer pipes clogged with sand bags. The model also shows that a gas bomb has exploded near the apartment building and a decontamination squad is neutralizing and mopping up poison gas.

### Plug-In Filter for Pneumatic-Tool Line Keeps the Dirt Out of Tools

Excessive wear to pneumatic tools can be prevented with an air filter that keeps dust, rust, scale, oil and water from entering the mechanism of the tools. It is connected to the compressor air line, and centrifugal action of the air within the filter throws off  $\frac{9}{10}$  of the dirt and moisture, and the other  $\frac{1}{10}$  is filtered out by a special glove. Besides cleaning the air, the filter provides a plug-in feature for the tools as convenient as electrical outlets, serving several tools at one time.

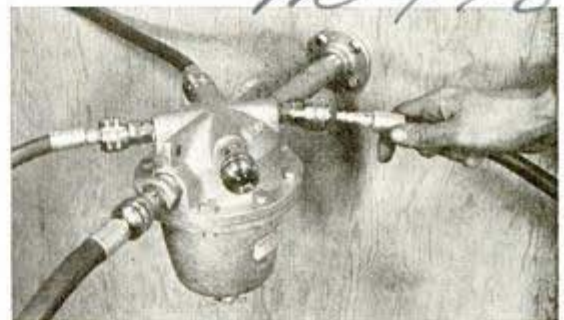

Plugging in filter to serve several tools at once

*Filters, Inc.  
Glendale, Calif.*

# BOMB PROTECTION



7m 784  
There's little difference between flying glass and bullets, as the English people discovered in the early days of the Nazi aerial blitz when 82 percent of the casualties were caused by broken glass instead of direct bomb hits. To combat the hazard, a London druggist developed a transparent plastic that is painted on glass like varnish and prevents shattering. The product, called Garinol, is made with a secret formula including a synthetic resin base. When applied to glass, the surface of the plastic dries, but the underlayer that has contact with the glass remains soft and sticky. This rubbery underlayer holds the pieces of glass together when a window is broken. The photographs on these pages, made at the speed of 1/30,000 second, were taken during a demonstration at the Museum of Science and Industry in New York City. The young lady at the left is painting one side of a pane of glass with Garinol which will become firm in about two days. For heavy plate glass, two coatings are required

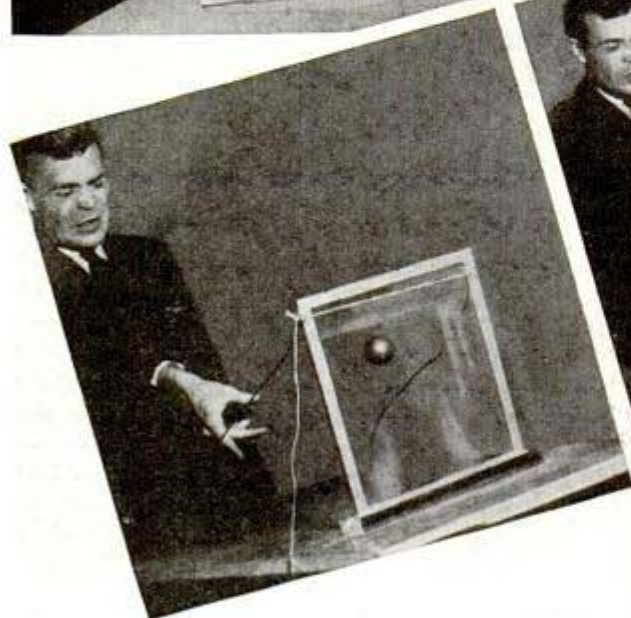

The two center pictures show what happens when a metal ball is hurled against a pane of untreated glass mounted in a frame. The ball penetrates the pane, shattering it into thousands of flying pieces. At right, the demonstrator hurls the same ball through a similar piece of glass that has been coated with the protecting plastic. The speed camera has caught the ball at the split second of penetration. Cracks in the glass appear and the pane bulges as if it were made of rubber. The ball goes through the glass, but the plastic prevents shattering and the broken pieces snap back into place. Just across the way on the next page the same pane of glass is shown after the ball has gone through. The broken bits have snapped back together intact and still transparent

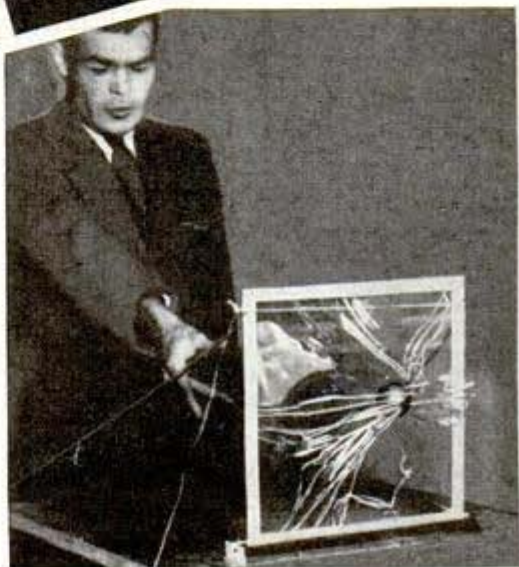

*Garinol, Inc, 522-5 ave  
nyc*

# PAINTED on Your WINDOW

Cracking down on an electric light bulb with a hammer produces a "pop" and a shattering of fine particles of glass—as the uncomfortable demonstrator, at right, discovers. When a light bulb is treated with the "brush on" protection first and then struck with a hammer, the result, below, is less sensational, but safer. Bulbs can be crushed safely in the hands after coating

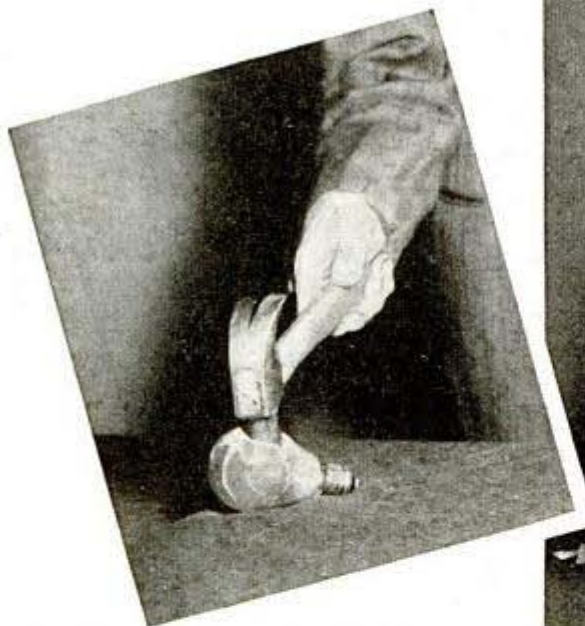

Picking up treated globe that has been crushed (lower right) shows that no pieces have scattered. It can be wadded up like a handkerchief for safe disposal. Other experiments with the plastic revealed that an incendiary bomb can be dropped on a piece of treated glass without breaking it. The glass only cracks and bends. In treating windows, the plastic is applied only on the inside. Scores of uses for Garinol, in peacetime as well as in war, were seen in tests



## Cloth Hood Dims Flashlight For Use in Blackout



Hood slips over end of any flashlight and is held in place with an elastic band; cloth prevents glare

To dim the bright beam of an ordinary flashlight so it may be used safely during a blackout, a diffusing hood made of a fabric slips over the lens. An elastic band sewed into the edge of the hood stretches to fit easily over the end of any size lamp.

## Puttyless Sash Has Built-In Spring To Snap Glass in Place

New window glass can be snapped into place quickly without the use of putty or any tools, in a puttyless sash now available. The sash has grooves in the upright

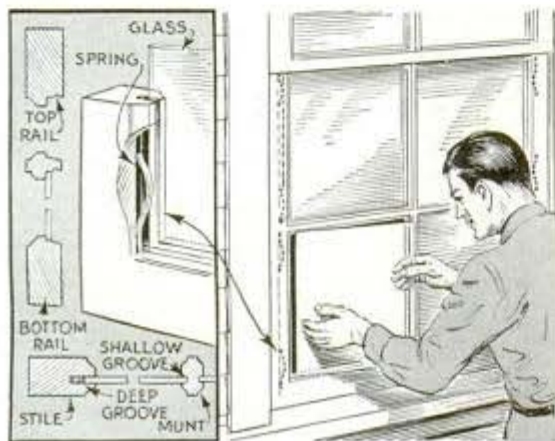

Grooved sash has a spring in one side to hold pane

members at both sides, one of which is equipped with springs to receive and hold the glass firmly. To insert a pane of glass, it is pushed against the springs until deep enough to slide into the opposite groove, which is a bit shallower, and the back pressure of the springs then forces it into the shallow groove. At the top and bottom, the glass rests firmly against wood rails so water and wind cannot penetrate easily. Sash of this type is recommended for garages and farm buildings such as barns, and may be used on cottages where the climate is not too cold.

## Dispenser of Corrugated Paper Cuts Wrapping to Fit

Products of various sizes may be wrapped for mailing in packages that need no "fill" with the aid of a dispenser for corrugated paper recently introduced. The dispenser supplies the shipper with the

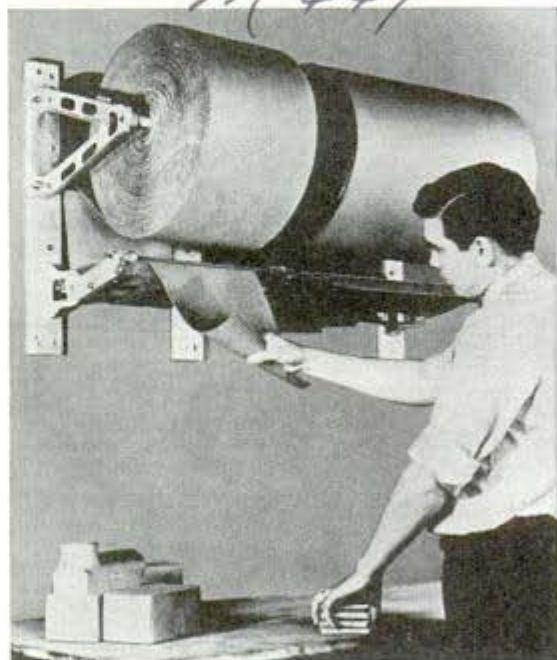

Machine eliminates need for large stock of cartons

correct lengths of paper, eliminates the need for keeping a large assortment of different-sized cartons on hand and saves thousands of pounds of paper formerly used for stuffing. An automatic brake prevents tangling or slipping and holds the paper at the edge of the cutter.

Look in the index to find where to buy articles described in this magazine. Say You Saw It in Popular Mechanics.

Blossom mfg. Co  
79 Madison Ave. N.Y.

m. 597

m 447

m 585

auth: Wendelin P. Grabbie, Hays, Kans.  
 assignor to Magic Life Boat Co, Denver.  
**Buoyant Amphibian Car Is Among New Patents** *Cal*

*M 420*

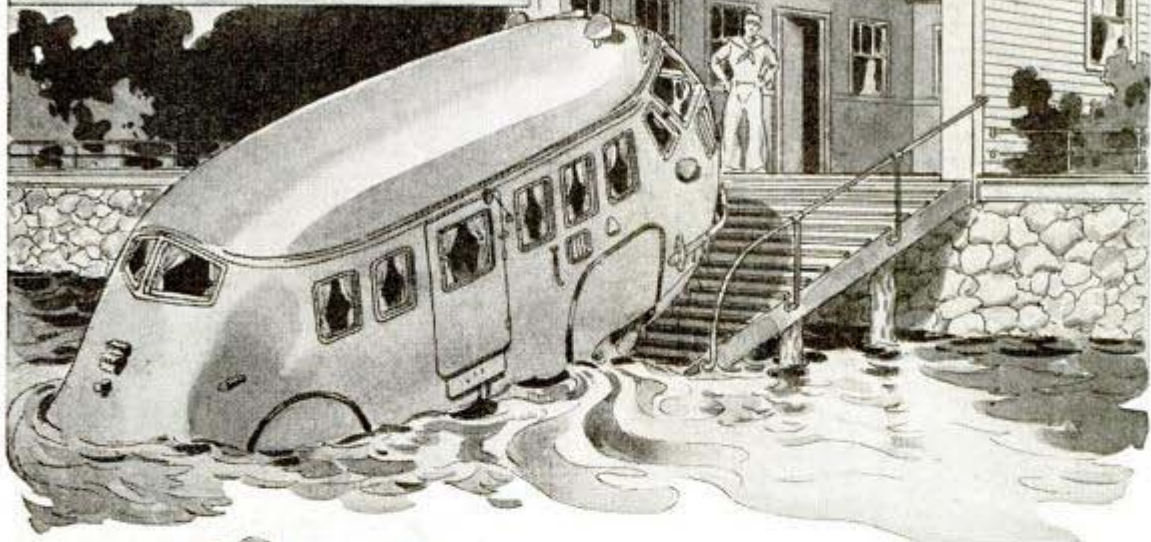
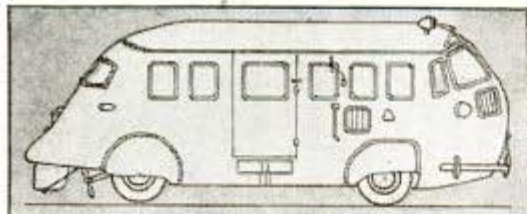

The amphibian car, above, was patented by a Kansas inventor; its propeller can be seen just behind the rear wheels in the inset sketch. When driven into the water it is kept afloat by its buoyant tanks. At left, a convertible tandem bicycle with two sets of pedals driving the rear wheel, over which is an extra seat. Like the other articles on this page, the bike is newly patented and no information as to its availability can be furnished interested purchasers

*David G. Swan engc.*

*P.O. Hayzelle*



To record transactions, such as cashing a check, and identify persons involved, an automatic-starting motion picture camera is positioned to film scene including date, time and indicator showing number of the transaction

*Jos. Allen Madden, 91  
 Vancouver, B.C., Canada*

Материал, защищенный авторским правом

# LIQUID GOLD *for* WAR *or* PEACE

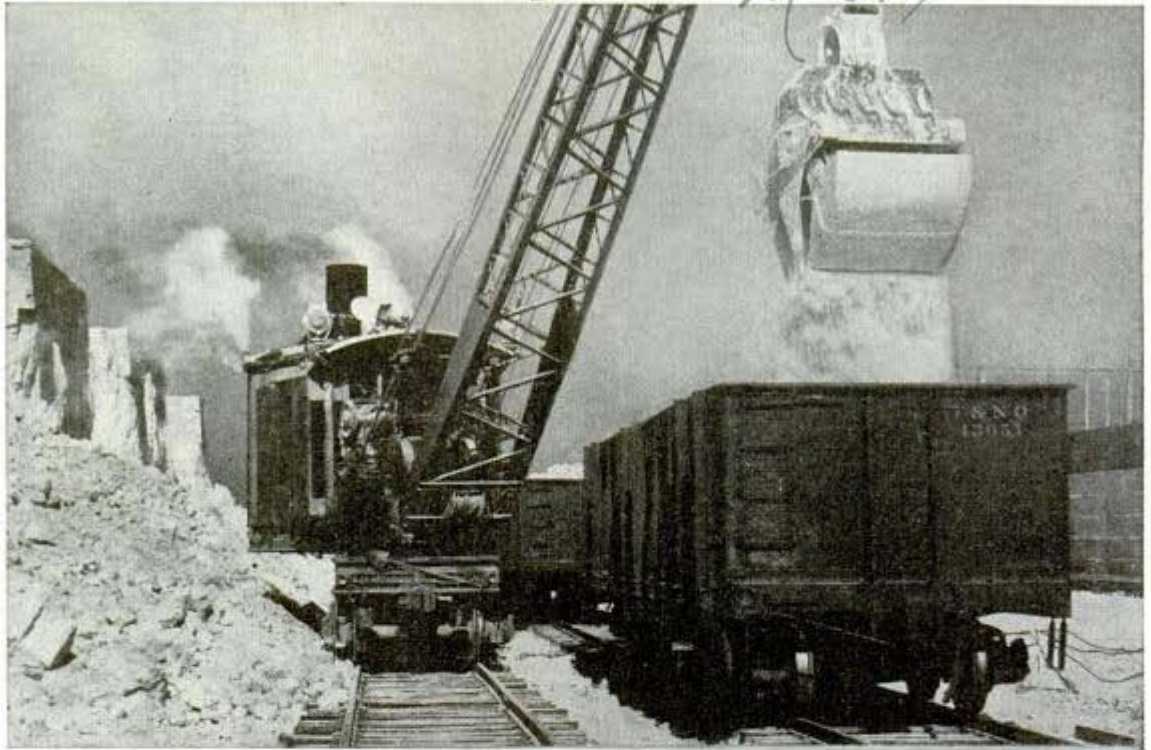

Loading sulphur onto railroad cars from a million-pound "brick" for shipment to plants where it will be converted to sulphuric acid, the lifeblood of war industries turning out planes, ships, guns

By Wayne Whittaker

THE pilot banks his plane, points downward to what looks like three giant gold bricks glistening in the Texas sunshine and shouts over his shoulder:

"That's sulphur!"

The passenger drops his magazine, glances down at the yellow "bricks" a quarter of a mile in length and shouts back:

"Must be a million tons of the stuff there.

Enough to last us a hundred years."

The passenger is understating it. The exact figures on American sulphur production and ready stockpiles are a close military secret. But the public would be pleasantly surprised by them, for the United States, dependent during the first World War on foreign sources of this vi-

Seventy miles of pipe carry hot water, steam and air into deep sulphur mine in Texas

tal raw material, has since developed a great source of its own.

Sulphur is taken as much for granted as free matches with a package of cigarettes. But it is as vital to both war and peace as are zinc, aluminum, copper and tin.

Without sulphur, Uncle Sam's "big four" in war production—ships, planes, tanks and guns—would stop sliding down the



Texas Sulphur Co Inc  
75 E 45 St. NYC

deposit + plant at  
Newgulf, Texas



Hot molten sulphur flowing from mine into six-acre vat to form solid "cliffs" like those in background

ways and rolling from assembly lines, for sulphur is one of the primary raw materials of industry in war and peace. It is vital for the production of steel, rubber, all types of petroleum products including high octane gasoline, explosives and hundreds of other articles from the casing for a sausage to the miracle drug, sulfanilamide.

Two thirds of the crude sulphur produced is consumed in the form of sulphuric acid and the total amount used each year is an unflinching "barometer" for American industry. Requirements of industry in 1941 were 11,040,000 tons of the acid.

A big American bomber roaring its way through the sky to strike at Jap bases in the Pacific or a concentration of German tanks in the African desert owes much of its effectiveness to sulphur. Far fetched?



Conveyor belt carrying sulphur into "weigh house" at a gulf port where thousands of tons are shipped

The varied uses of sulphur in the crude form, as sulphur dioxide or sulphuric acid are shown in chart prepared by Du Pont company showing peace and war needs

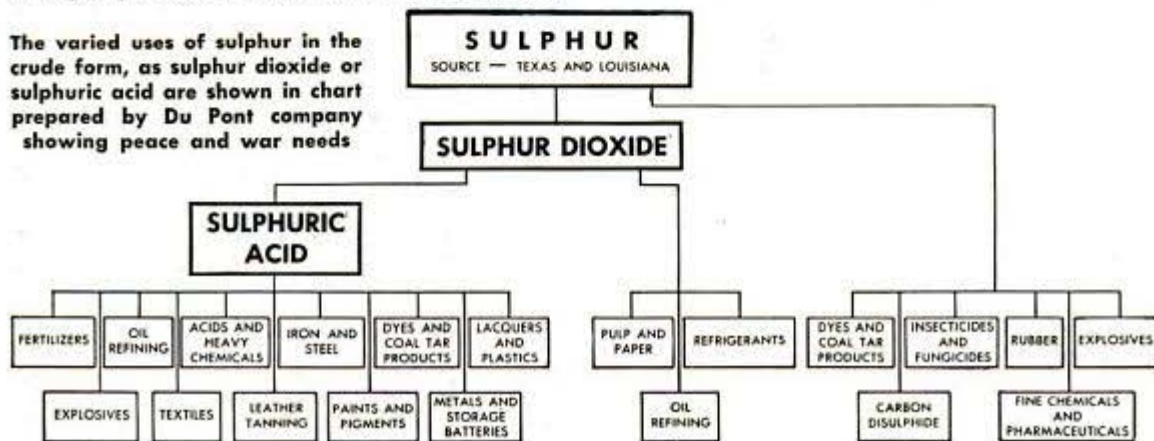

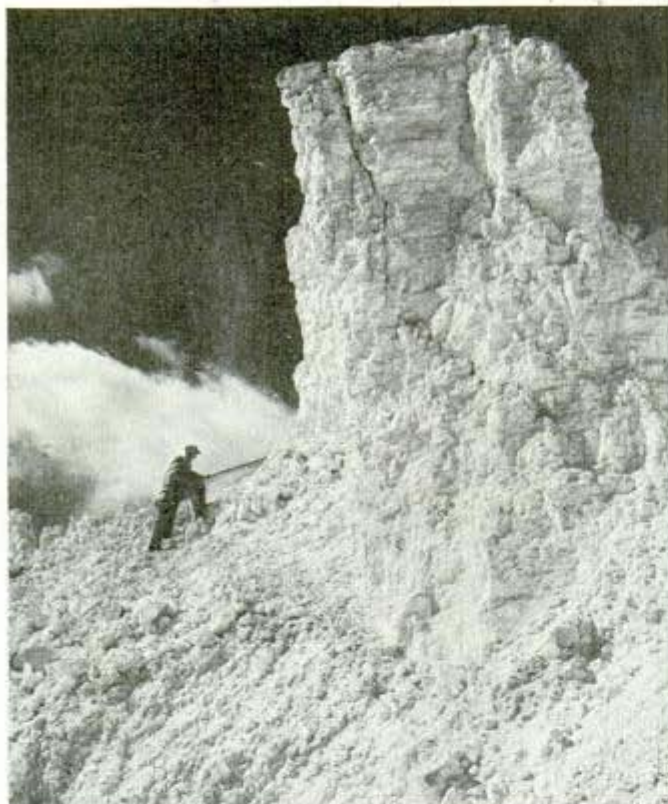

Drilling a hole for a charge of explosive that will break up the storage pile so it can be loaded in cars by huge shovels. Below, a golden stream of sulphur dust flows through spout from weigh house to load a Mississippi River barge in Louisiana.

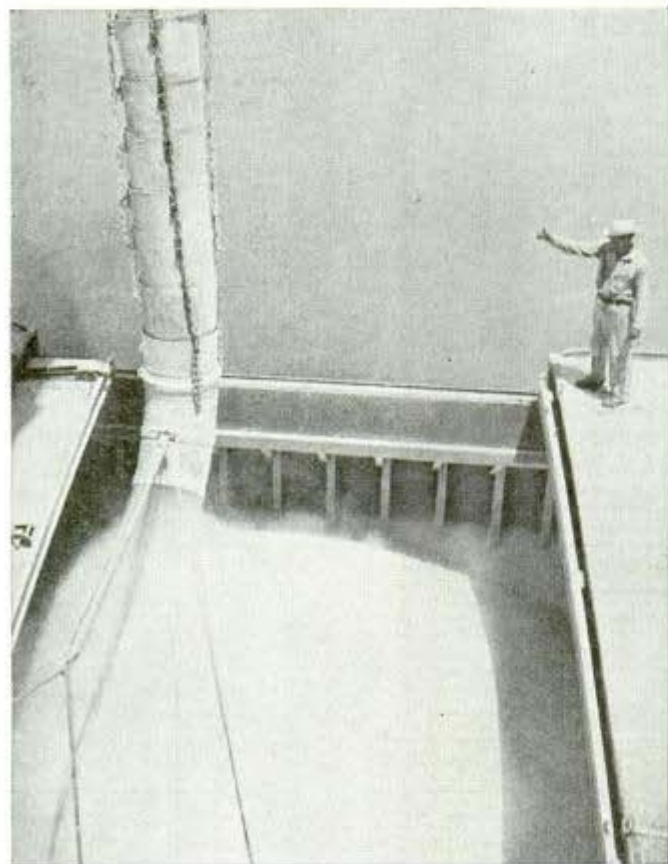

Not if you consider that every ounce of steel in the plane was "pickled" or de-scaled by sulphuric acid; that engine castings and crucial parts demanding lightness were molded of magnesium with the help of sulphuric acid; that the engine's mountings, hose, and tires on the plane were made of rubber that can only be vulcanized into a tough product with crude sulphur; that the heavy plane would never have been able to rise a foot off the ground without the high octane fuel produced by the cracking of petroleum with sulphuric acid.

These are only a few of the uses of sulphur in a bomber, fighter or patrol plane. Those glistening yellow "bricks" along the gulf coast helped put the kick in those deadly "eggs" resting in the bomb bay. Film for the telescopic cameras, special fabric for the pilot's suit, gas masks, medicinals, lubricants that flow smoothly in the stratosphere, and even the paper on which the map of enemy territory is drawn—all are stepchildren of sulphur and chemical genius.

When the sulphur industry boasts that it helps run all mechanized war equipment—in fact, everything that rolls, floats or flies—it isn't fooling.

Helping win wars and amazing mankind with its multitude of uses has been a habit of sulphur during its recorded history of 4,000 years. Ancient writings reveal that pagan priests used it in ceremonies—probably for its ethereal blue flame and pungent odor—and that one of its first practical uses was as a bleaching agent for cloth. It was also used centuries ago for making gunpowder, fumigants, paints and medicine.

Early conquerors were willing to risk the lives of their men to obtain sulphur to mix with saltpeter and charcoal for gunpowder. In 1519, Cortez sent a party of 10 men to climb the 17,500-foot crater of Popocatepetl near Mexico City in quest of the prized mineral. They found great quantities of it



Control center at a power plant for a Texas mine governs all operations—heating, and pumping water, forcing air in pipes

sublimated along the rim. Sulphur's rare quality of sublimation—its vapor turns into a solid when cooled—is the reason for many volcanic deposits. Popocatepetl is a source of sulphur today, but for some strange reason the deposit was neglected for 300 years after the mining expedition organized by Cortez.

Uncle Sam could chuckle at the predicament of Cortez if he were to fly over our rich sulphur mines, or wells, on the gulf coast of Texas and Louisiana. There is plenty for every need, both military and civilian. He would shiver a little, too, at the recollection of the desperate plight of American industry in World War I when we depended largely on foreign supplies.

Although the yellow mineral was first discovered in the United States in 1865 by prospectors drilling for oil in Calcasieu Parish, La., it was many years before American ingenuity devised a way of bringing it to the surface. Most foreign deposits are shallow and lend themselves to conventional mining methods. American deposits that cap salt domes were found to be from 500 to 1,500 feet deep and guarded by layers of quicksand and pockets of deadly gases.

(Continued to page 162)

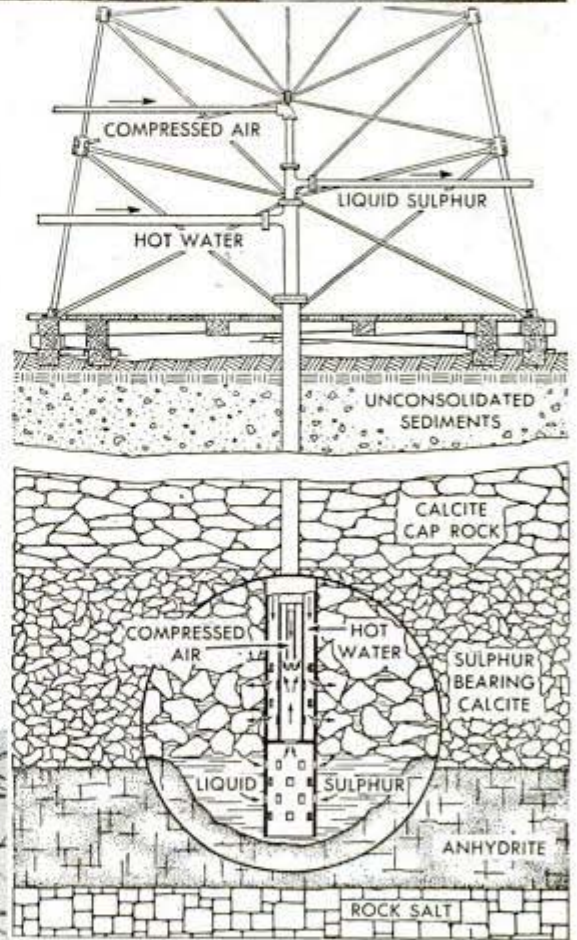
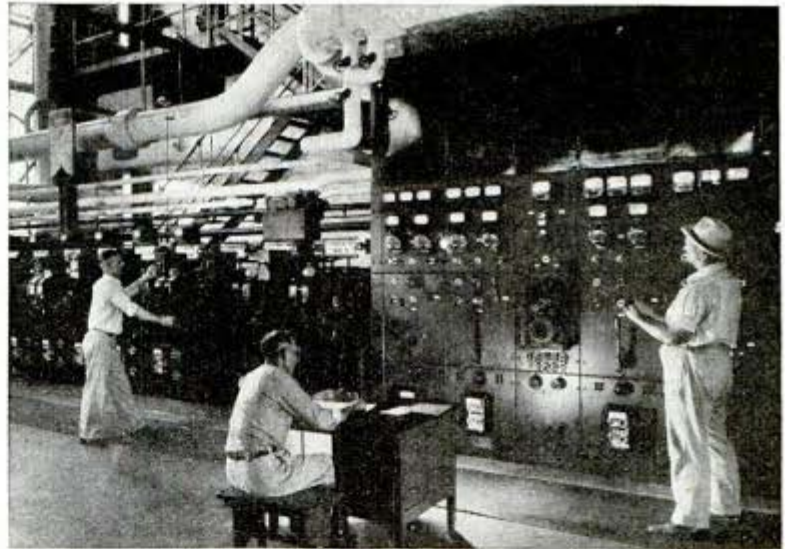
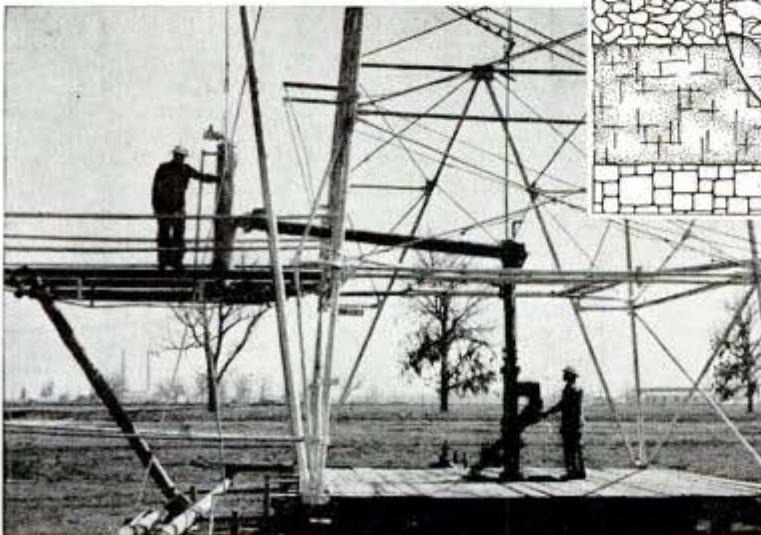

Diagram shows intricate Frasch process of mining of sulphur as a liquid by melting it far below the surface and pumping it out

Surface equipment at a sulphur mine gives it the appearance of an oil field with derricks and pumps. Compressed air helps to raise sulphur after it is melted by water heated to 325 degrees F.



*Continental Products Inc  
2036 So. Michigan, Chicago*

## Vacuum Cup Supports Pipe On Windshield or Dash

*cannot furnish*



Rubber holder for pipe or cigar is handy while driving a car, or at work requiring use of both hands

If you need a convenient holder for pipe or cigar while motoring, a small rubber holder can be firmly attached to the windshield or dashboard with a vacuum cup. The holder has a rubber lip which opens to grip the object to be held.

## Heels Made With Wooden Cores Save Rubber and Steel

At an enormous saving of rubber, as well as steel, heels hereafter may be fashioned with a core of wood, requiring about one

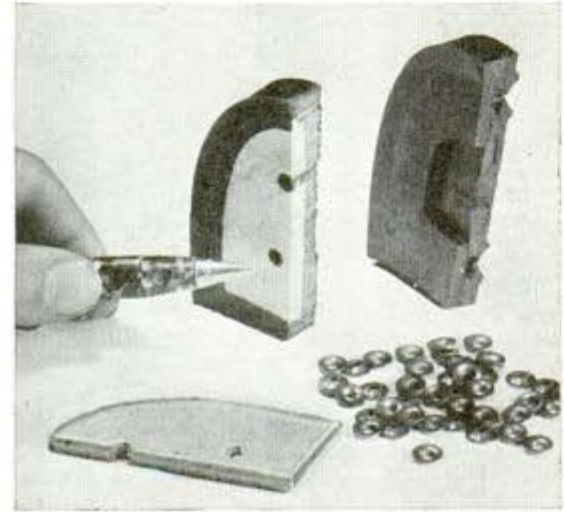

Wooden insert in heel saves rubber needed for war

and one-quarter ounces less rubber compound per pair for the standard one-half inch size. The wood insert is a good grade of maple which is plentiful, and the manufacturing process is inexpensive. Officials of B. F. Goodrich Company estimate that this heel, if used on all the 150,000,000 pairs of men's and boys' shoes produced annually, would save more than 5,000 tons of compounded rubber, besides about 850 tons of steel which has been used in the metal washer inserts necessary in the former types.

*Akron, Ohio*

## Self-Lighting Cane for Blackouts Cannot Throw Light Upward

Lighting automatically <sup>M 590</sup> only when inverted, a blackout cane meets the need of civilian defense workers since it cannot be made to throw a beam of light upward. In-



Inverting cane turns on light in handle which automatically turns off when the stick is held upright

stalled in the handle, the flashlight makes contact by means of a sliding battery. When the stick is carried in walking position, the bulb remains unlighted, but invert the cane, pointing the handle downward, and the battery slides into contact with the bulb and on goes the light. A frosted lens softens the glow. Theater ushers can use the cane in their work. **\$1.50**

To learn where to buy commercial products described in these pages, see the index.

*Edley mfg co  
POPULAR MECHANICS  
1409 Elm St. Dallas Tex*



# The CRAFTSMAN

## Civilian Defense Workers' +FIRST-AID KIT+

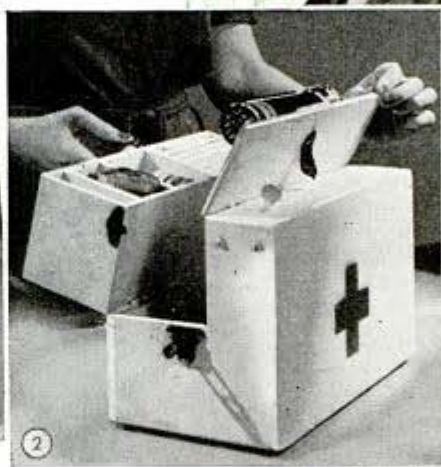

ANYONE whose duties in civilian-defense work require administration of first aid should have a compact, easy-to-carry kit with sufficient space for all recommended supplies, arranged most conveniently for instant use. This one, made of  $\frac{1}{4}$ -in. plywood, was designed especially to meet such requirements, and has a number of added features such as an adjustable clip, which holds a flashlight in any position to throw light on a patient or into the case, as in Fig. 1; a built-in warning or call bell, Fig. 7, which is useful during blackouts, and a removable tray for small items, as shown in Fig. 3. As you can see from Figs. 1 to 3, the construction of the case is such that the partitioned sections permit an orderly arrangement, and the method of opening the case prevents the contents from falling out.

Dimensions of the case shown in the photos are given in Fig. 6, but these may differ somewhat depending on the equipment and supplies used. For this reason

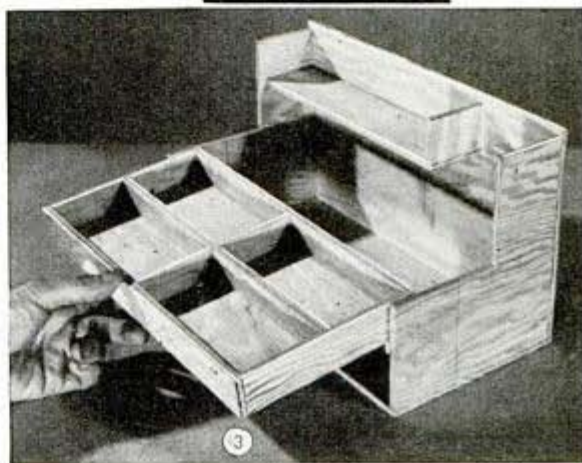



As the dimensions of your kit may vary, depending on the equipment available, it is advisable to get these first. The adjustable clip enables the worker to direct the flashlight in any direction and it can be left in the clip when the case is closed

it is best to purchase your supplies first. The following list was obtained from both Red-Cross manuals on first aid and from experienced first-aid instructors: Twelve 1-in. compresses on adhesive; two or more 3-in. bandage compresses; sterile gauze, 1 sq. yd.; 3-in. gauze squares; one triangular bandage; a roll of adhesive tape; six iodine ampoules, or mild tincture of iodine in rubber-stoppered bottle; a tube of tannic-acid jelly; aromatic spirits of ammonia; a medicine dropper, preferably in a stoppered vial; tweezers; scissors; small drinking glass; needles and matches for sterilizing same; forceps; thermometer (clinical); olive oil; sodium bicarbonate; alcohol.

After cutting to size the pieces of plywood, preferably of the waterproof variety, they are put together with a few brads and waterproof plastic glue for maximum strength. A number of hinges, clasps and a handle with fastening plates will be needed, which may be stripped from an old piece of luggage that is no longer in use.



BINDING HINGES PERMIT FLASHLIGHT COVER TO REMAIN IN ANY SET POSITION

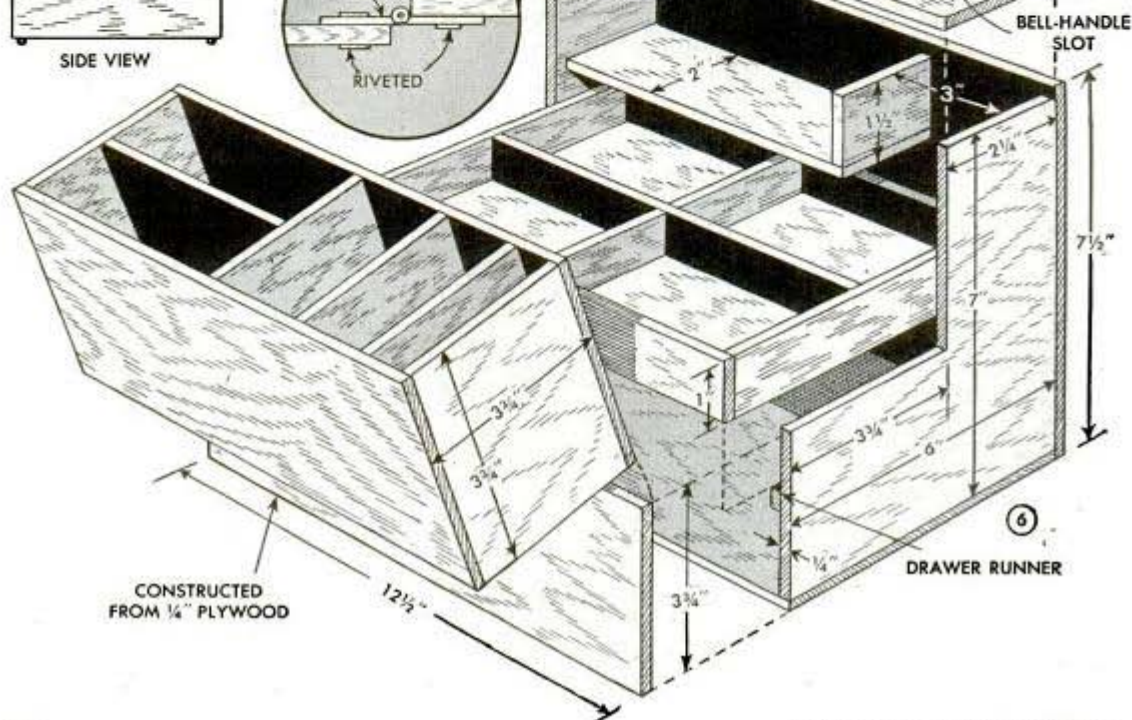
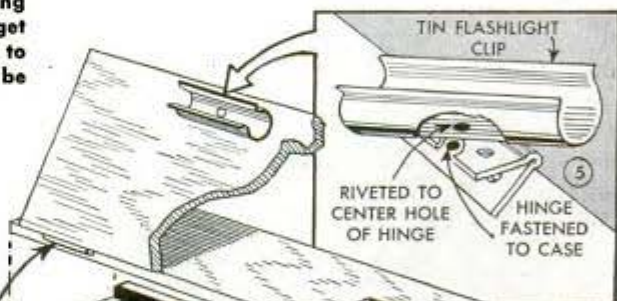
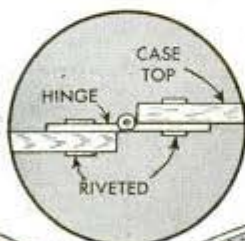

CONSTRUCTED FROM 1/4" PLYWOOD

DRAWER RUNNER



The hinged parts are attached with tubular rivets and washers as shown in Fig. 8, before the case is finished, but the locking clasps and handle plates are added after finishing. In attaching the clasps, the rivets can be squeezed down tightly by means of a C-clamp as shown in Fig. 9. Note from Fig. 4, that the partitioned top is hinged to the side piece before the latter is attached permanently to the rest of the case.

An ordinary bicycle bell is mounted tightly against the side of the case so that the latter will act as a sounding board to intensify the sound, Fig. 7. The thumb lever of the bell projects through the top of the case to be available at all times. A piece of sheet metal or a broom clip can be used as a flashlight holder, the clip being riveted to turn on a small butt hinge, which in turn is riveted to the partition as detailed in Fig. 5. The rivet that holds the flashlight clip to the hinge, as well as the hinge itself and the hinges on which the partition swings, should be made to bind so that the parts remain in the position in which they are adjusted. Hinges can be made to bind by simply squeezing them in a vise. A small leather tab is riveted to the partition as can be seen in Fig. 2, so that it can be lifted conveniently after opening the case. The flashlight can be turned, raised or lowered in any direction, or it can be removed from the clip. However, it can be left in the clip when the case is closed. It may be advisable to cement one

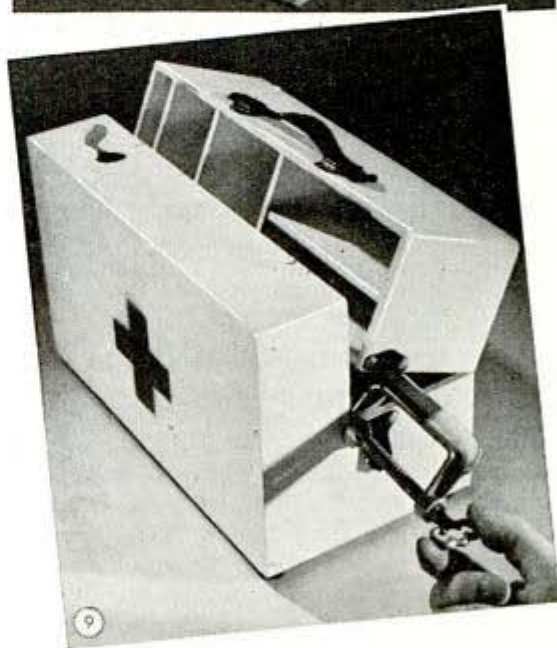

or two thicknesses of red Cellophane to the lens of the flashlight to reduce the intensity of illumination during blackouts.

## Pencil Mark on Finger Guide of Jig Saw Aids in Cutting True Curves

If you have difficulty in cutting true curves with a jig saw, try this simple method of guiding the work: First, insert the widest blade practical before starting to cut pieces such as chair rockers, which have long sweeping curves. Next, make a pencil mark on the wire finger guard of

the saw directly in front of the blade. If the saw lacks such a guard, an improvised wire pointer  $\frac{1}{2}$  in. in front of the blade will serve the same purpose. Now, saw as usual, but keep the guide line on the work directly under the guard mark or pointer.

—E. C. Henthorn, Norfolk, Nebr.

## Belting Used as Shock Absorber On Edge of Boat Dock



After attaching a strip of canvas belting to the edge of your boat dock in wave-like fashion, you won't have to worry about receiving a stiff jolt or scratching the planking on a small craft when bringing it up to the dock. In addition to providing a better cushioning effect than sections of auto tires commonly used for the purpose, such bumpers also give a neater finish.

—Dale R. Van Horn, Lincoln, Nebr.

## Adjustable Bumper on Truck Bed Protects Ends of Long Loads

If you haul lumber or pipe, here's an adjustable rear bumper that will help prevent shifting of the load as well as warn other drivers of their length. The bumper is made of two pieces of pipe which fit into flanges screwed to a 2-in. board that is striped with black and white paint. Pipe

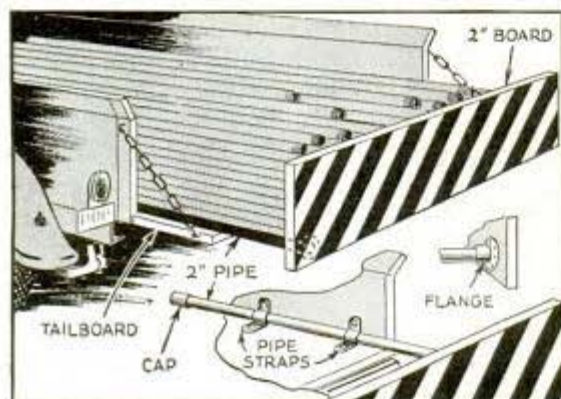

straps fastened securely to the truck body serve as guides while a cap on the end of each pipe prevents the assembly from being pulled entirely out.

## Cotton Wad Under Pan of Trap Aids in Quick Tripping

When making dry-land sets where a steel trap is to be covered with loose soil, leaves, or other fine material, the covering is likely to work under the pan of the trap and prevent its closing when tripped. To avoid this, one trapper places a piece of loosely wadded cotton under the pan as indicated. This allows the trap to spring easily under the animal's weight.



## Jig to Sand Plastic Rods

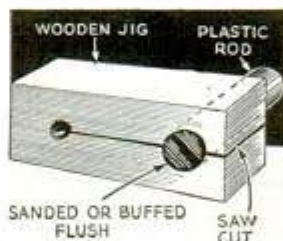

In order to avoid difficulty in buffing the ends of plastic rods without having them chip along their edges, one craftsman made up this simple jig which eliminates the trouble. It is made from a block of wood as indicated, and when the rods are gripped in it they can be held squarely and with uniform pressure against the sanding or buffing wheels.

—Paul H. Smith, Norfolk, Mass.

## Tongs Close Tear in Upholstery And Grip It for Sewing

To close a tear in upholstery and hold it for sewing, one workman employs a pair of tongs made from stout spring wire. These have small hooks formed on the ends to engage the fabric at either side of the tear so that the latter can be closed. The sliding loop on the tongs is then pushed down to hold them securely.

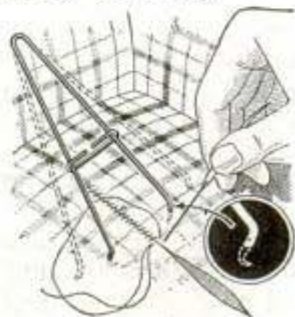

# Birdlike Pipe Holder Utilizes Stem as Tail

Made of walnut, this pipe holder is neat enough to grace any desk. The body is made from a 2 by 2 by 2½-in. piece of stock, which is glued to a wood faceplate for turning to shape. The finished body should be 2 in. in diameter and 2½ in. deep. It is bored out to fit the individual pipe. A similar procedure is followed in turning the removable head, which is 1¾ in. in diameter and 1¾ in. deep, while the neck, which is turned as an extension of the head, is ¾ in. long. A section is cut out of the back of the body to take the pipe stem as indicated. Feet are jigsawed from ¾-in. walnut, and the legs are walnut dowels set in holes drilled into the body at a slight angle. The beak is whittled and sanded to shape, and is doweled to the head. If desired, the holder can be weighted by recessing the underside of the feet to take a piece of lead.

—Elma Waltner, Hurley, S. Dak.

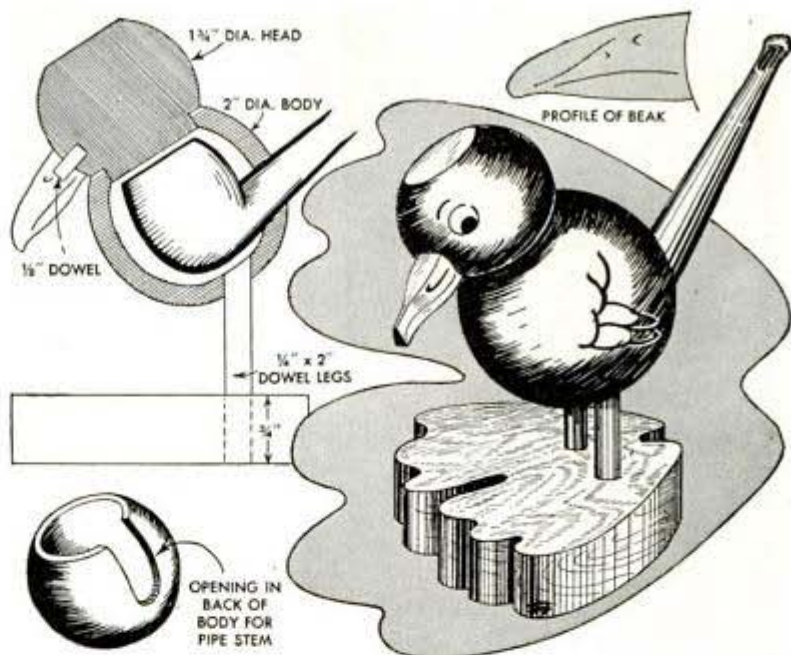

## Foil Grip on End of Rasp or File Protects Your Hand

Wrapped tightly around the end of a file or wood rasp, a strip of lead foil serves as a comfortable hand grip when using the tool for long periods of time. It is unnecessary to tie or wire the foil in place as the soft metal presses firmly into the file teeth, which hold it in place when the grip of your hand is released.

—W. C. Wilhite, Carlinville, Ill.

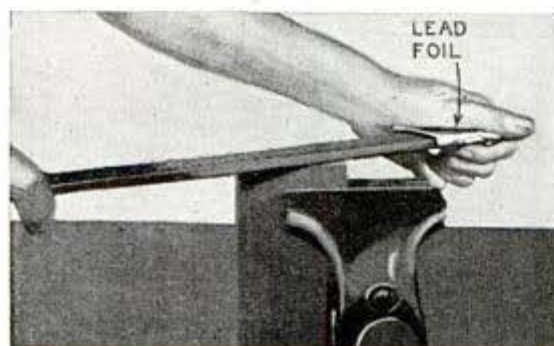

## Demountable Rims Form Cradle For Pipe or Long Rods

Storing pipe or long rods neatly can be done inexpensively by using two demountable auto rims to form adjustable holders. The rims are first cut as shown, after which the parts are drilled for carriage bolts to

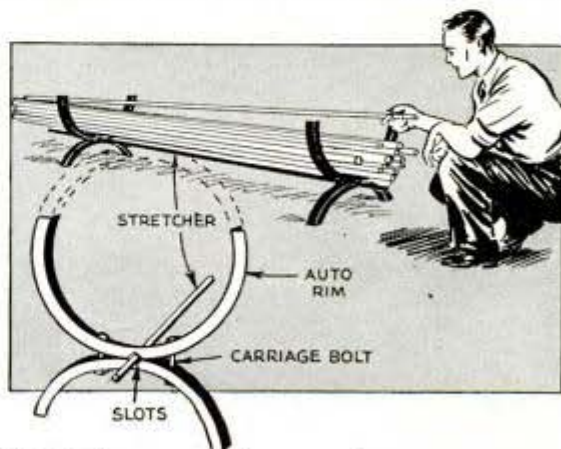

hold them together so that one section serves as the legs and the other provides a circular holder for the pipe. A loose-fitting stretcher keeps the ends of the holder in alignment and permits adjustment to accommodate stock of various lengths.

☐ For your extra guest room put a shelf with a mirror above it on the back of the door. Also put hooks to hang clothes on the same side.

# Solving HOME

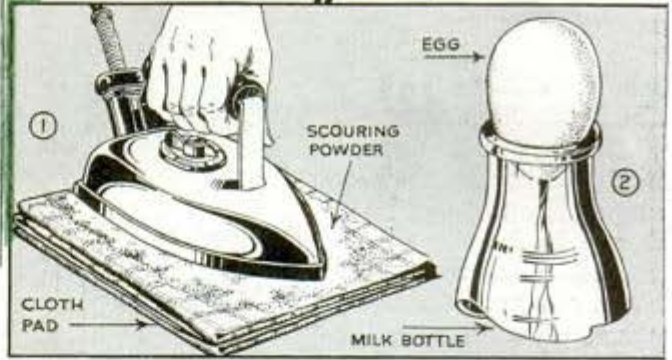

1. While ironing, the bottom of an iron can be kept smooth if you get into the habit of frequently rubbing it over a cloth pad that has been sprinkled with scouring powder. This method is better than using a wad of steel wool to remove accumulated coatings

2. Those who have occasion to "blow" eggs to use the shells for making novel party favors and similar articles will find an ordinary milk bottle especially handy as the mouth is just the right size to hold the eggs in the right position while they are draining

3. A couple of screw hooks in a washboard, engaging holes punched just below the rim of a washtub, will keep the board at hand yet permit it to be swung out of the way between jobs. The hooks also prevent the board from slipping while being used

4. When cleaning a bread or cake pan, avoid using the point of a knife to dislodge particles from the corners, which is hard on both the knife and the pan. It's better to use a wooden skewer or any small stick that is similarly pointed, for this purpose

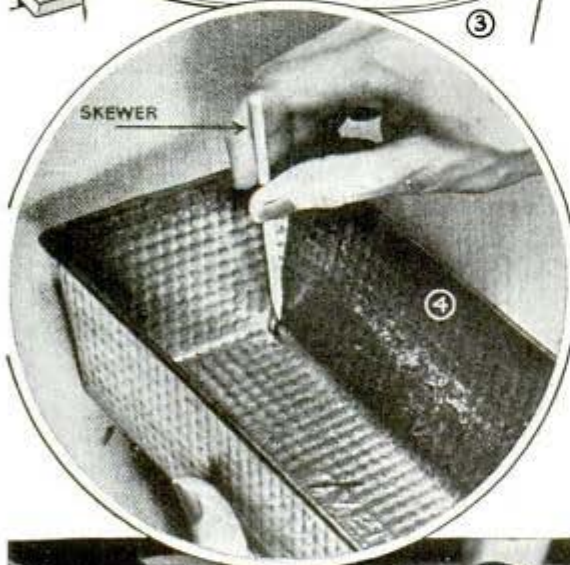

5. It's easy to distribute French dressing uniformly over salad by using a ten-cent clothes sprinkler of the type shown. When finished, the sprinkler can be inserted in a hot-water faucet and cleaned quickly



6. Half of a rubber ball, which is punched and slipped on a nail-polish bottle provides a non-tipping base. You then can insert the brush with one hand without holding the bottle with the other



# PROBLEMS

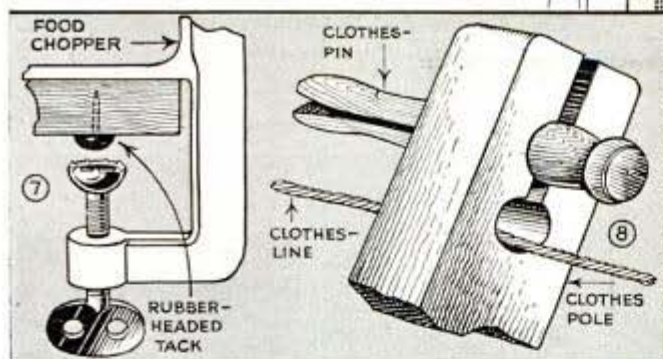

7. If the clamping screw of your food chopper has a cupped end, a rubber-headed tack on the underside of a table will prevent it from working loose. Locate the tack so that it will engage the cupped end when the chopper is in contact with the table edge

8. Clothesline props that have the ends notched and drilled as shown to accommodate ordinary clothespins can be "locked" on the line, which will effectively prevent them from falling on the ground and becoming soiled on a windy day

9. A good way to prevent a door mat from being kicked out of place and still make it easy to remove for cleaning, is to use a couple of large battery clips. These are attached directly to the door sill by means of screw eyes as shown in the detail

10. Where a number of windows are to be fitted with curtain rods, you'll save considerable time in locating the exact position of the curtain-rod brackets so they will be mounted uniformly on all of the windows, if you use a simple cardboard template

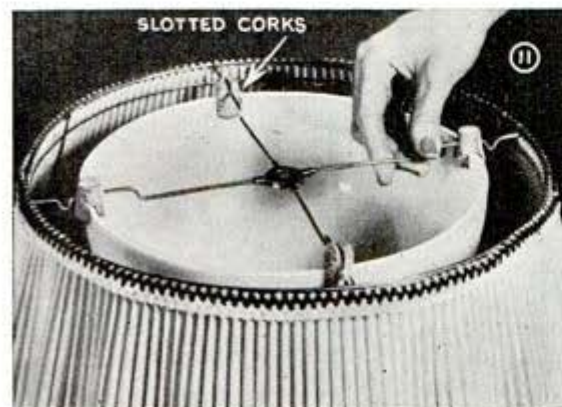
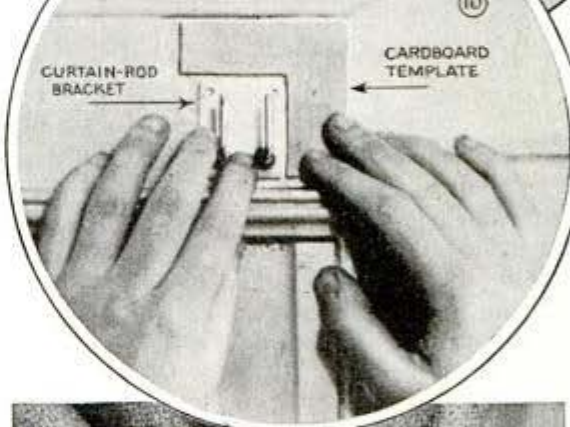

11. To keep a lamp shade of the type shown securely on an inverted reflector, slot the top and bottom of four corks and press them on the reflector rim and also on the wire cross members of the shade



12. Unusual drapery tiebacks can be had by making up chains from celluloid poultry leg bands, which are available in a number of sizes and bright colors, enabling you to make an appropriate selection

## Small Table on Side of Jointer Holds Pieces of Work

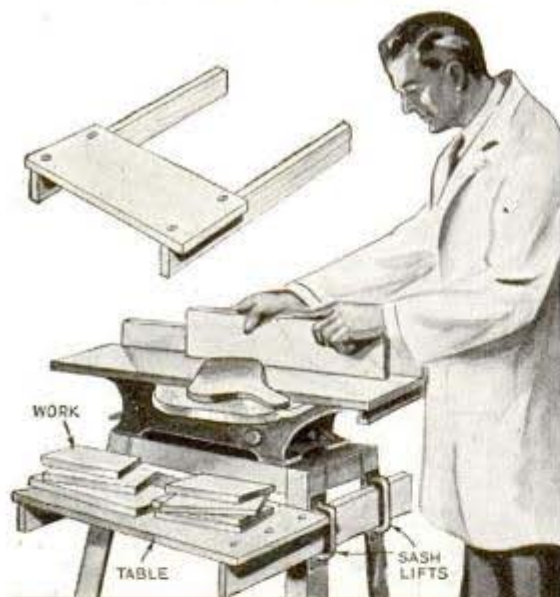

You'll find this small table handy to hold small pieces of work to be finished on your jointer. It slips into four sash lifts, which are bolted to the legs of the jointer stand.

## Preparing Concrete for Painting

To neutralize lime salts in new or untreated concrete floors, apply a solution of zinc sulphate, 3 lbs., per gallon of water. If the floor has a hardened surface so paint cannot anchor, apply an etching solution of muriatic acid, 1 part and water, 10 parts (by volume). This is put on after the neutralizing application. After allowing the acid to act for a couple of hours, wash the concrete thoroughly in order to remove all traces of acid. When dry, apply thin paint. It is better to put on two thin coats than one heavy coat. Use special concrete paint.

## Knotted String Spaces Quilt Ties

In order to space ties when making quilts or comforters, one housewife uses a knot-



ted string with rubber bands and barbless hooks at the ends. The hooks engage the cloth to stretch the string across the quilt and are easy to move ahead as each row of ties is completed, the ties being spaced according to the knots.

## Mucilage Brush on Oilcan Spout Serves as Acid Applicator

A handy applicator for soldering acid on roofing or eavestrough jobs can be made by forcing a mucilage brush over an oilcan spout so that it fits in place snugly. If too long, the brush handle can be cut off, after which the seam in it is closed by soldering so that the acid will flow out through the bristles.



## Sandpaper Holds Ruler on Cloth While Cutting With Razor

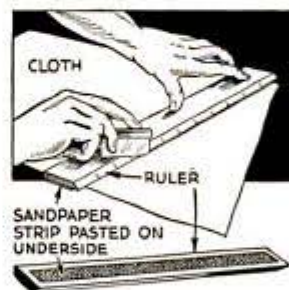

Cutting a large quantity of cloth into pennant-shaped pieces for printing advertising banners was a slow and costly process for one workman who was using a pair of scissors for the purpose. To speed up the job, he cut a strip of sandpaper and glued it onto a ruler. This was then used as a straightedge to guide a razor blade in cutting the cloth quickly and with little effort.

## Keeping a Drawer Knob Tight

If a drawer knob has a tendency to loosen, it can be kept tight by slipping a washer formed of steel wool over the bolt between the knob and the drawer front. When the knob is tightened against the wool, it will provide enough friction and tension to keep the knob from turning and loosening.

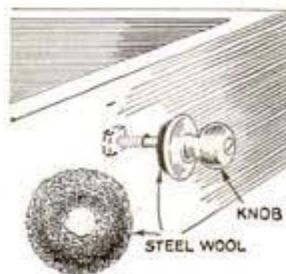

# "Roll Front" Bread Box Has Dividing Shelf

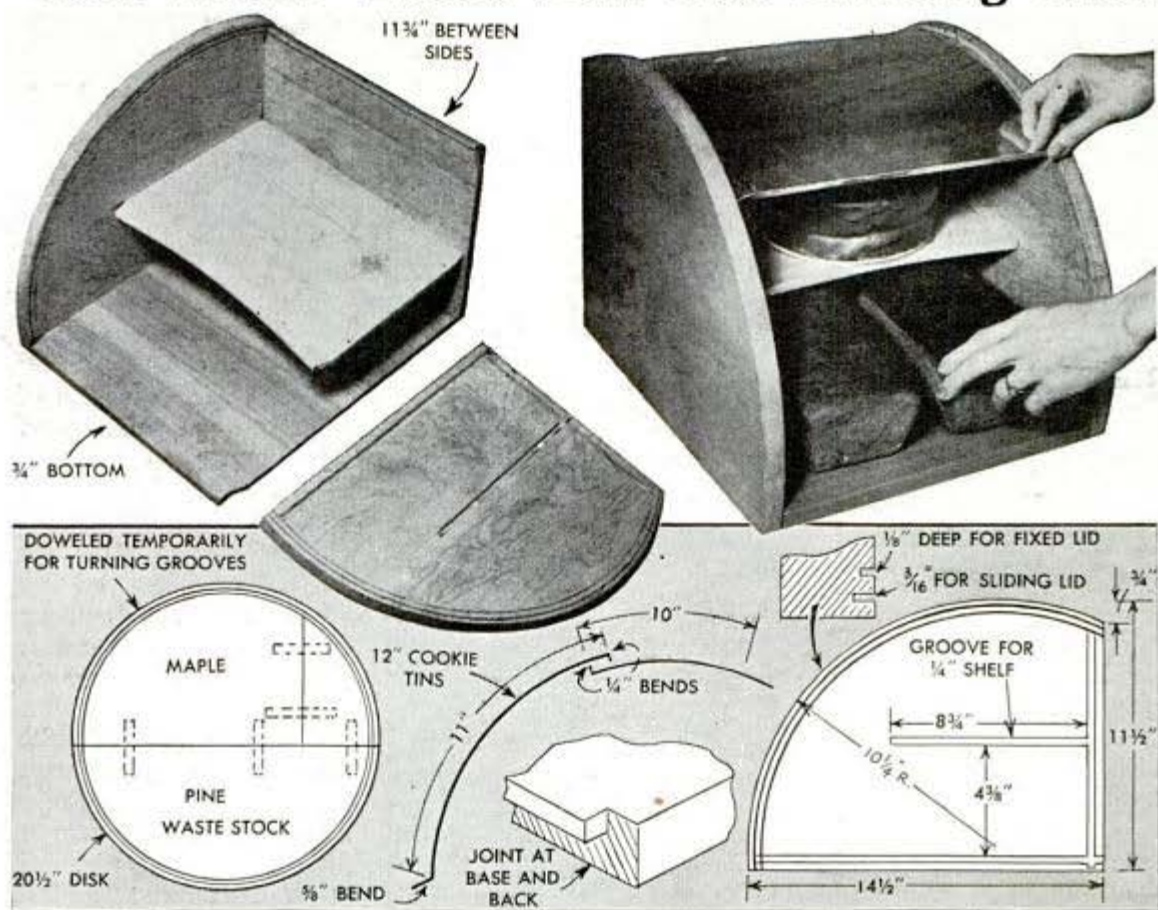

Here is a bread box that may be placed on a shelf or fastened directly to a wall. Its unusual construction makes it an interesting lathe-and-saw project. Maple is the best wood to use, with birch as a second choice. A side for the box is made by doweling the stock to pieces of scrap pine as shown, then roughly sawing the assembly to a circular shape, and finally mounting it in the lathe to turn the groove for the two-part metal cover. This produces a right-hand side. To obtain a duplicate left-hand or facing side requires reversing the second disk on the faceplate for grooving. A piece of hacksaw blade ground to a chisel edge will produce a suitable groove. The grooves for the bottom, back and shelf are made blind at the curved edge by stopping the dado cuts and finishing with a chisel. In fitting the  $\frac{1}{4}$ -in. shelf, leave an opening at the back so that crumbs may drop to the bottom and facilitate cleaning. A couple of cookie sheets, if available, can be utilized to form the top and sliding cover, or bright tin salvaged from a large can will do. By placing the metal on a thick cloth pad, a

common rolling pin, or other round object, will be found helpful in curving it to fit the grooves. A coat or two of shellac, applied inside and out, will make it possible to clean the box by wiping it with a damp cloth without raising the grain.

## Flour Sacks Slipped Over Posts Make Quickly Removed Signs

A cheap and efficient roadside sign that may be erected or removed in a moment can be made from a discarded flour sack. The lettering is painted on the sack after it is slipped over the top of a couple of small stakes driven into the ground at the desired location. The stakes should be spaced far enough apart so that the sack will be fully spread.



# 7 CHRISTMAS



SCRAPS of wood, a few brads, screws, bits of tubing and paint are about all you need to make these interesting wooden toys. Any boy will feel like a real soldier when he knocks out the enemy with the howitzer shown in Figs. 1 and 2. The gun shoots a wooden projectile which has a rounded nose, so that it does little damage even in a direct hit. Rubber bands are attached to a plunger or firing pin and work in grooves along the side of the barrel where they straddle brads at the forward end that hold the imitation recoil cylinders in place. If drills available are not long enough for boring out the barrel, it can be made in two pieces, slotting each half through the center with a gouge, then smoothing and truing the bore with sandpaper wrapped on a dowel. When these operations are finished, the two pieces are glued together so that the two slots form a round hole through which the shell passes.

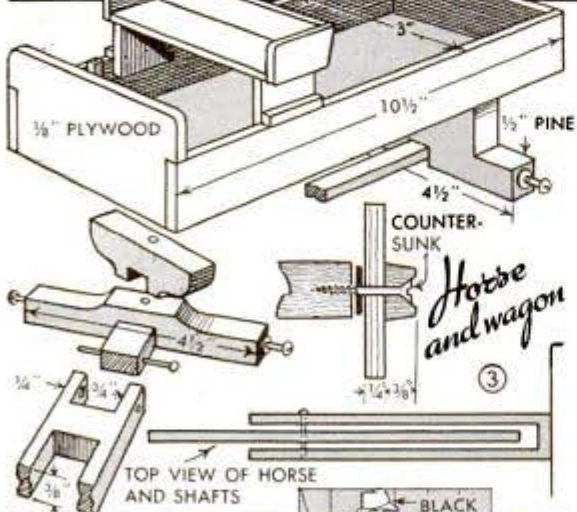
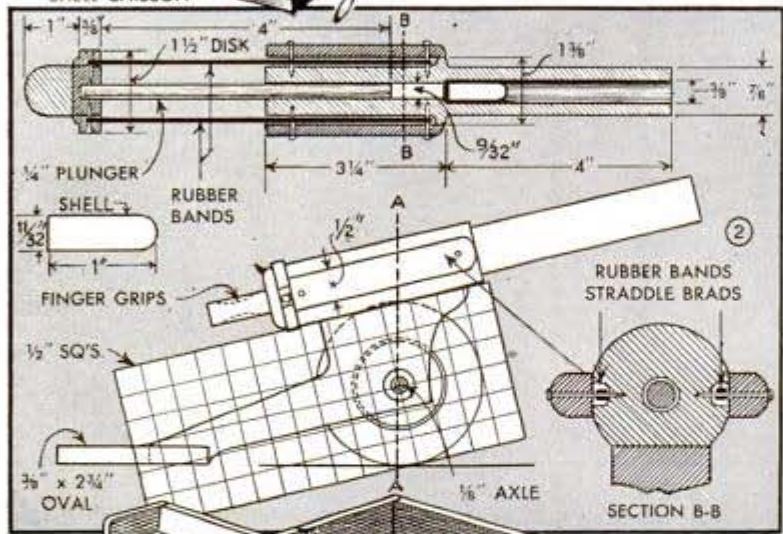

With the collection of scrap materials now so important, the junk collector's horse and wagon in Figs. 3 and 4 will be appropriate in teaching the children to gather these materials. It can be made

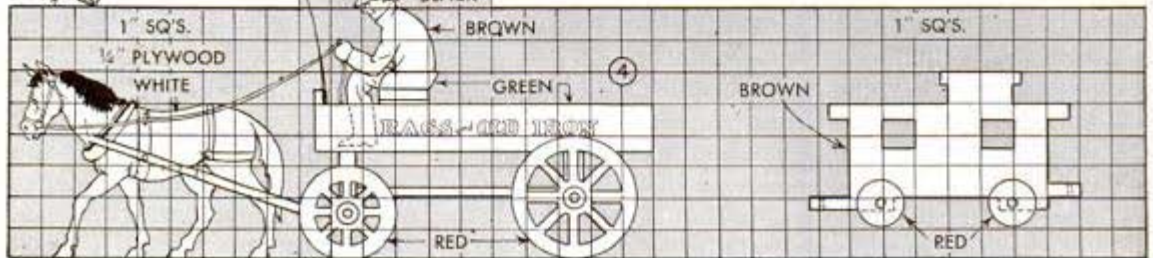

# TOYS of wood

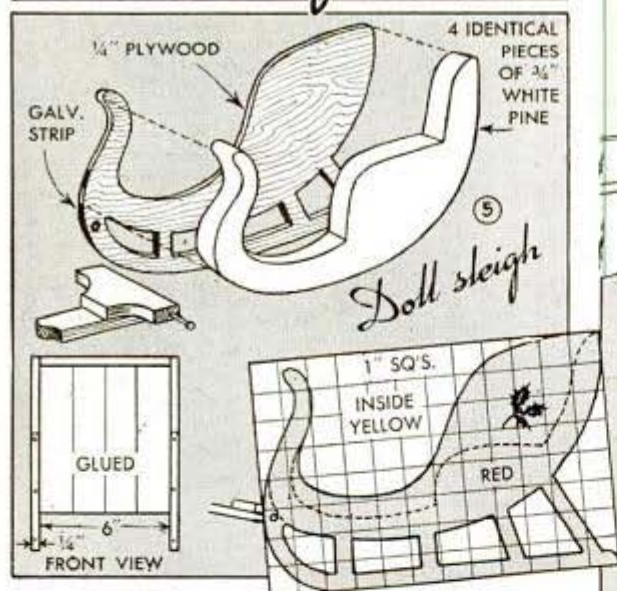

quite appealing to the eye as the toy lends itself to a lively color scheme as indicated.

A doll sleigh like the one in Fig. 5 will thrill the young feminine members of your family. A coping or jigsaw will enable you to cut the six pieces that form the sleigh. Sides are complete with runners, and the seat, floor and dash are built up of four pieces, which are glued together. A tongue for pulling the sleigh is pivoted between the runners at the front end. If available, strips of thin metal can be used as shoes for the runners.

Designed after models of Civil-war time, the train in Figs. 6 and 7 will stand a lot of rough handling. Making it is a job for the jigsaw and by stacking your stock, you can cut out material for two or three trains at one time. Be sure to cut the wood so that the grain runs lengthwise of the train as this will help prevent parts from splitting off easily. By duplicating passenger cars, a long express train can be made. The wheels are best turned in a lathe, although you can make them with a saw and sand-

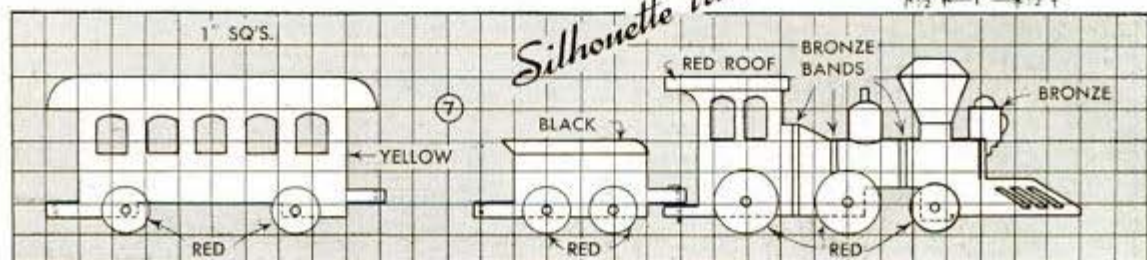
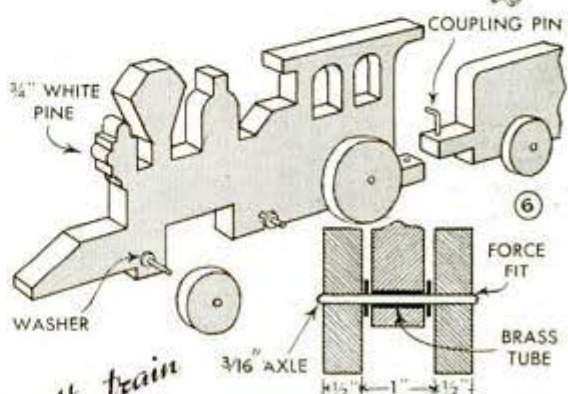

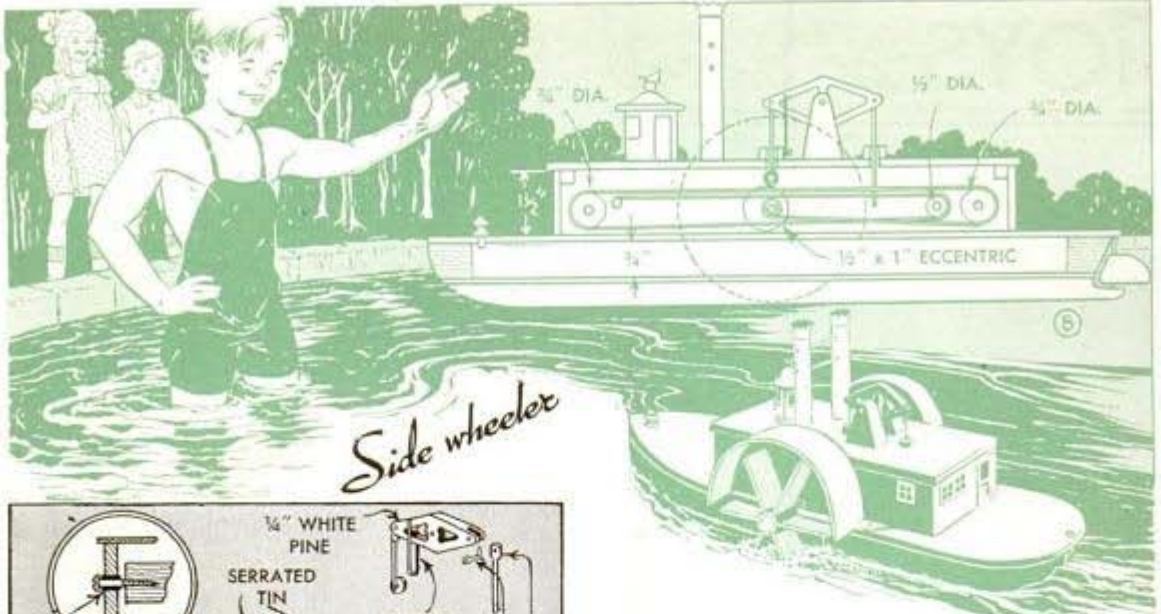

# Side wheeler

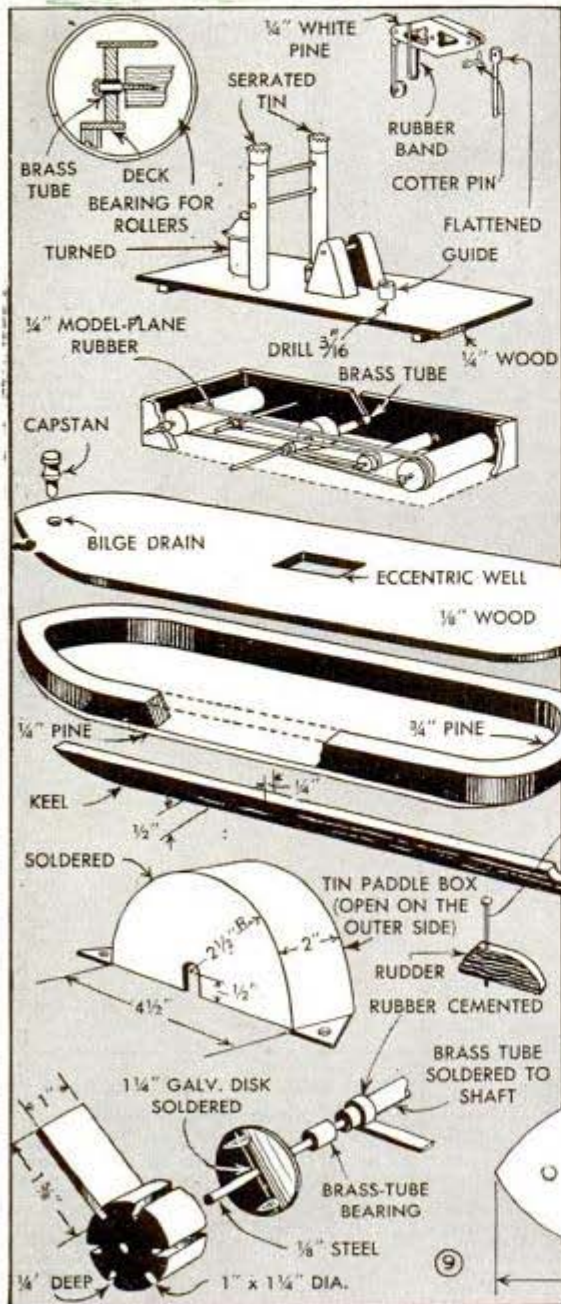

paper. They are fixed to an axle which passes through a tube in the car body to serve as a bearing. The simple couplings between cars can be manipulated by a very young child.

Figs. 8, 9 and 10 show a side-wheeler river boat that will delight the heart of the young sailor in your family. It is powered by rubber bands, which exert a direct pull on a drive shaft instead of being twisted as in a model airplane. The cutaway view shows how the bands are run over rollers to reduce friction and to get the maximum power to the drive shaft. For lightness, the central section of the hull is sawed out, and a deck and bottom of thin material are glued on. Paddle-wheel hubs are wood turnings slotted to take the paddles. They are screwed to metal disks which are soldered to the wheel shaft. A good color scheme consists of making the hull and cabin

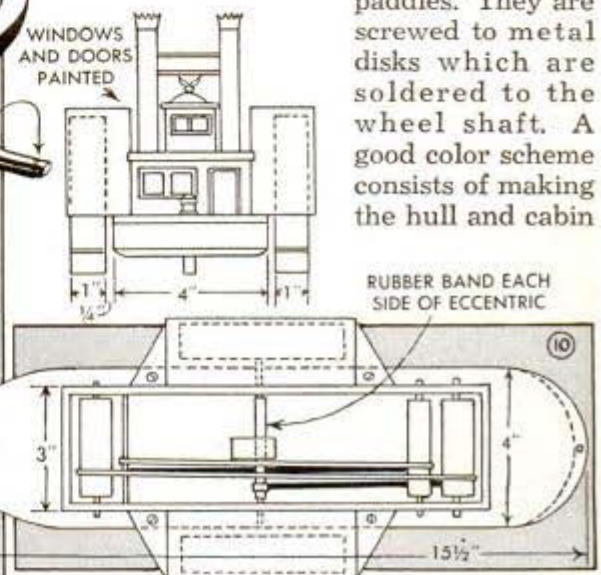

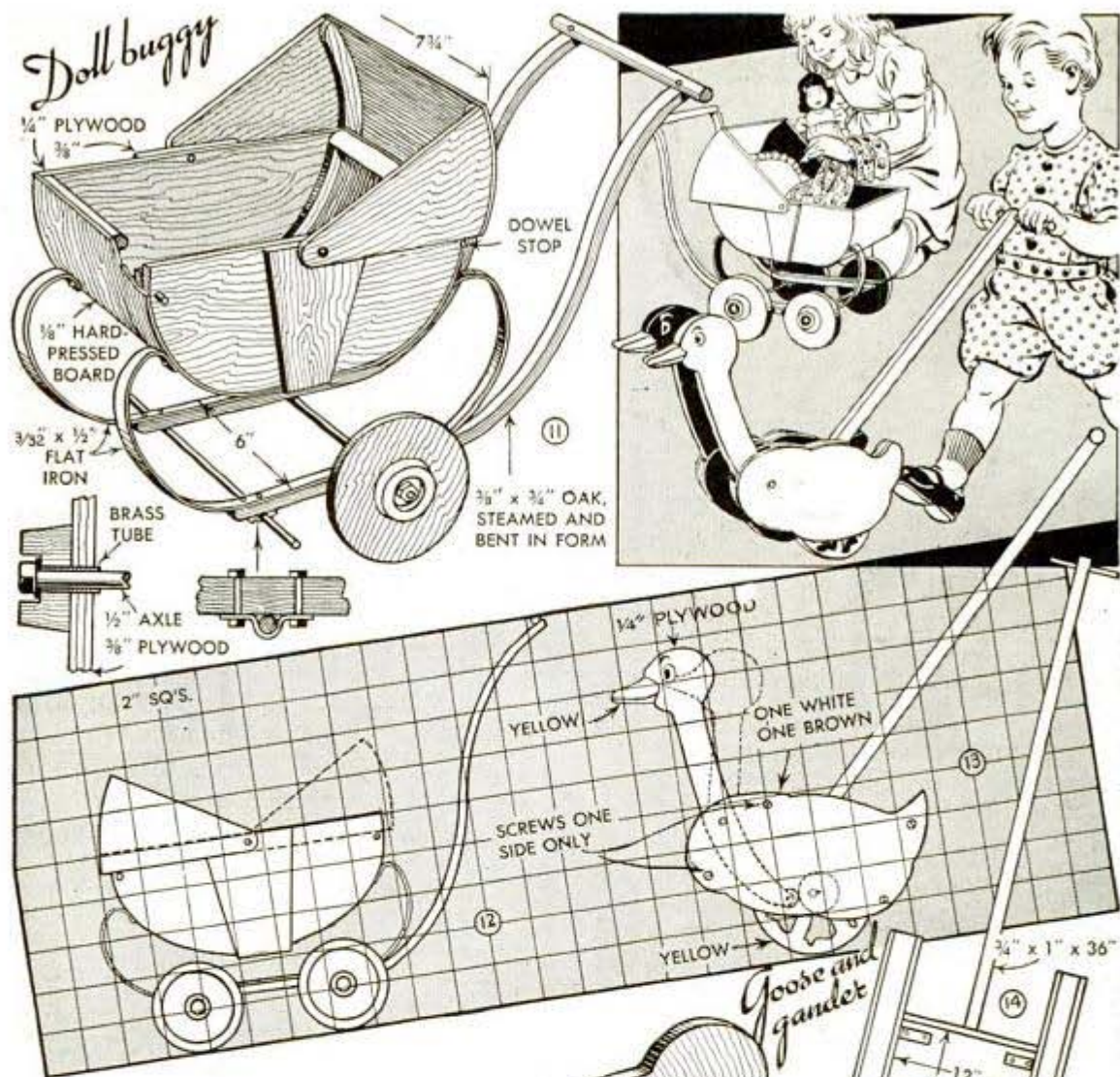

white with red below the water line and on the rudder, paddle boxes and walking beam. If the deck is varnished in natural wood with the top of the cabin painted gray, and the smokestacks black with bronze on the fluted tops, you will have a pleasing combination.

Designed along the lines of an English perambulator, the doll carriage in Figs. 11 and 12 can be made almost any size desired by enlarging the dimensions given. Wooden wheels are shown, but some taken from a discarded scooter or other toy can be used. The springs are shaped from light flat iron and the handles are steamed and bent to shape over a wooden form. The entire job can be made of plywood or hard-pressed board if a wood framework is made heavy enough to receive small screws. Note that the hubs are counterbored so that the projecting axles or nuts cannot damage furniture or woodwork in the home.

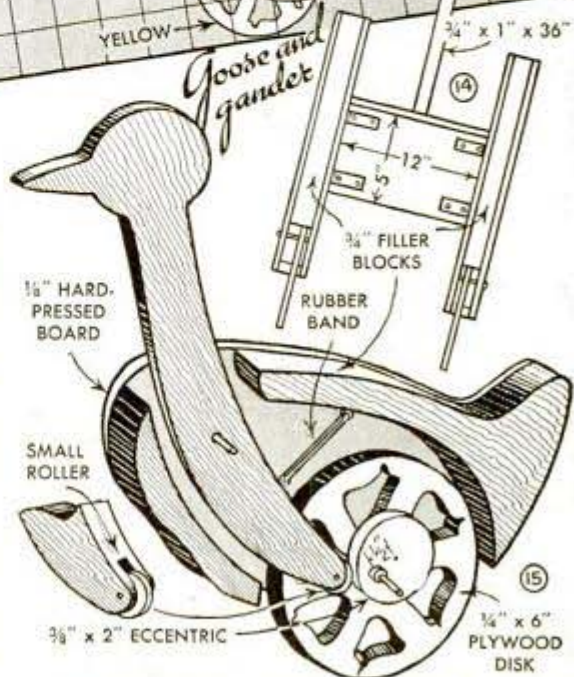

When pushed along a sidewalk or over a floor, the pair of geese in Figs. 13, 14 and 15 move their heads back and forth in a realistic manner, while bright yellow legs keep stepping along briskly. The latter are circular to avoid a bumping motion.

## Extension on Saw Table to Rip Large Plywood Panels

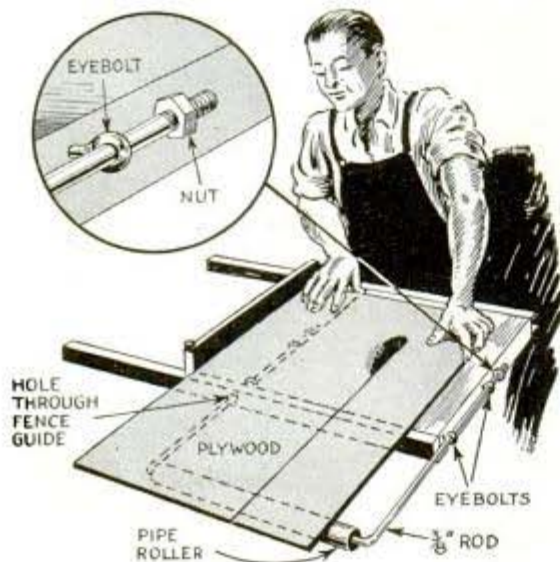

The difficulty of supporting a large piece of work on the table of a small circular saw can be overcome by using this simple table extension. It consists of a length of  $\frac{3}{8}$ -in. rod bent to a wide U-shape and fitted with a pipe roller at the closed end. Eye bolts at opposite edges of the table provide guides in which to slide the extension in or out to reduce or increase its length.—Robert Clark, Chicago.

## Ruler Anchored by Dabs of Putty When Cutting Glass Panes

After trying several methods to keep a ruler or straightedge from slipping while cutting panes of glass, one glazier found

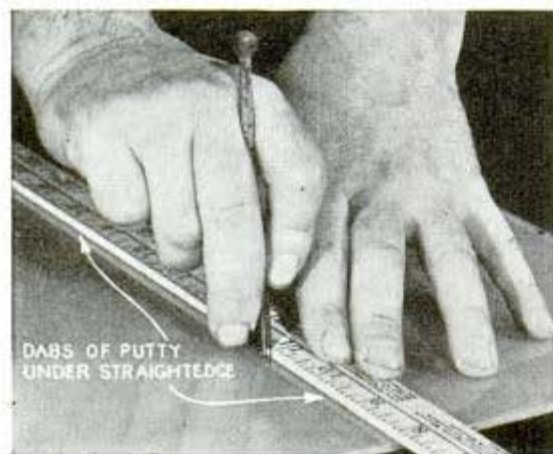

that the simplest one for all practical purposes is to use dabs of putty. A very small piece placed at either end will provide all

the friction necessary to keep the ruler in place while operating the cutter.

—G. E. Hendrickson, Argyle, Wis.

## Make Your Own Rubber Belts To Drive Models

Inability to purchase small rubber belts for toys and models led one hobbyist to make his own by the following method: First, a belt core is made



by wrapping several turns of string or thread over the pulleys to be belted, tying the ends together with silk thread at different locations to avoid producing a large knot. Then the core is dipped into a thick paste of plastic rubber putty such as is sold for mending shoes, thinning the putty with benzol to make a semi-liquid paste.

—Roger Dunwell, Freeport, Ill.

## Drawing Board Bottle Holder



A simple holder for an ink bottle on your drawing board can be made in a jiffy by bending a short length of wire to the shape shown. It is

inserted into a hole drilled near one of the upper corners of the board. The looped wire fits over the neck of the bottle to hold it in place.

## Soldering Iron Helps in Bending Thin Strips of Wood

Modelmakers and others who often have thin pieces of wood to bend can adapt the method used by a violin maker for shaping thin wood.

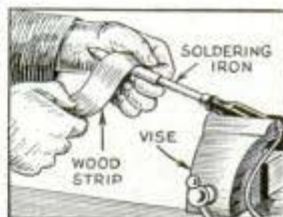

A heavy-duty soldering iron, clamped in a vise, provides heat for bending. The wood strips are moved back and forth over the element part of the iron, gradually exerting downward pressure on the work until it takes the desired shape.



# Weighted Wood Rollers Make Novel Bookends

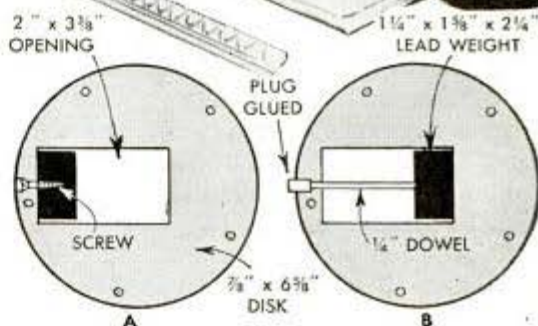

These bookends look like they would roll off a table, but a counterbalancing weight cleverly concealed in each one prevents this and causes the rollers to exert a strong push against the books to keep them in position. It is necessary, of course, to place the weighted portion next to the books. For each roller, four wooden disks are turned to the dimensions given, after which compartments for the weights are jigsawed in the two inner ones. Each compartment should be large enough to take a 2-lb. weight, lead if available, and permit the weight to slide freely. The latter is secured temporarily in the center of the inside disks with a dowel as at B to facilitate sanding and finishing of the bookends in the lathe. After assembling the roller, a chuck is made from a disk 9 in. in diameter and 2 in. thick by turning a recess in it large enough to take the assembly, yet fitting snugly enough to hold it for turning the edges uniformly, and for sanding and shellacking. One side of the roller is finished, after which it is reversed and the remaining side sanded. Now, the plug that holds the dowel is bored out and the dowel is removed, allowing the weight to slide

toward the outer surface where it is secured by a screw as at A. This is counter-sunk and hidden by a plug, which is sanded down and finished to match the roller.

## Spring Clip Holds Pump Rods

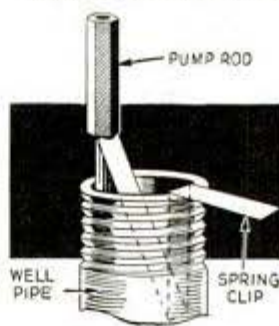

When a well pump has to be pulled for repairing the cylinder, one mechanic uses spring clips to keep the pump rods in place as the pipe lengths are taken apart. Each clip is bent to the shape shown and placed in the pipe with one end under the pump-rod coupling.

## Winter Garden Between Window And Storm Sash

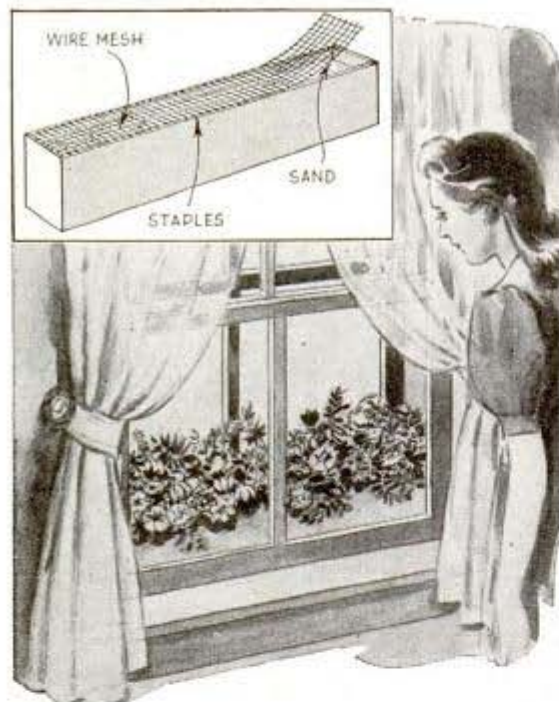

To brighten your windows during the winter months, you can have "flower gardens" between the storm sash and windows. Dried blossoms, berries, seed pods, grasses and sprays of silvery leaves will remain intact throughout the season and, unlike green plants, need no attention. To install a garden, make a box 6 or 8 in. high to fit between the window and sash. Paint it, fill it with sand and then fasten coarse wire mesh on top. Run the flower stems through the wire and into the sand to keep them in a vertical position. Many attractive compositions may be worked out.

—Bess Livings, Batavia, Ill.

## Duck Call From Jar Cover

I have had excellent results in hunting ducks by using a call consisting of an ordinary fruit-jar cover and a bolt. In use, the



threaded portion of the bolt is moved back and forth over the edge of the lid as shown in the photo, keeping the lid cupped in your palm to amplify the sound. With a little practice, you will be surprised how closely you can imitate a duck call.

—Wm. Guschl, Milwaukee, Wis.

## Magnet Holds Saw on Sawhorse

Stapled to one leg of sawhorse as indicated, a large magnet taken from an old discarded magneto keeps the saw conveniently at hand. Instead of leaning the saw against a sawhorse as is often done when not in use, it is leaned against the leg on which the magnet is attached, the latter keeping it from being knocked down accidentally.

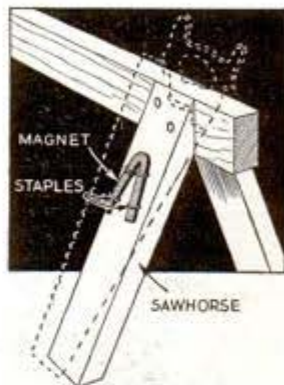

## Oilcloth Saddlebags on Suitcase Provide Extra Carrying Space

After packing his suitcase with clothing for a few days' vacation, one college student found that there was no room for stationery and other articles he wished to take. He solved the problem by making saddlebags from a piece of oilcloth. These were cut to hang over the sides of the suitcase, a hole being made in the center section to slip over the handle and prevent slipping. All edges were taped and the pockets were fitted with snaps.

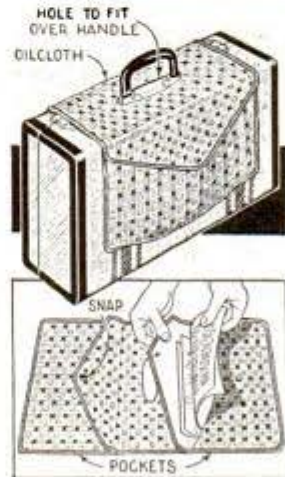

☛ If you are setting out hardy chrysanthemums this fall remember that they prefer a rich, well-drained garden soil. To have the best of success with these plants they should have a pint of liquid manure or nitrate-of-soda solution each week after the buds are formed.

## Neckties Are "Belayed" to This Nautical Rack

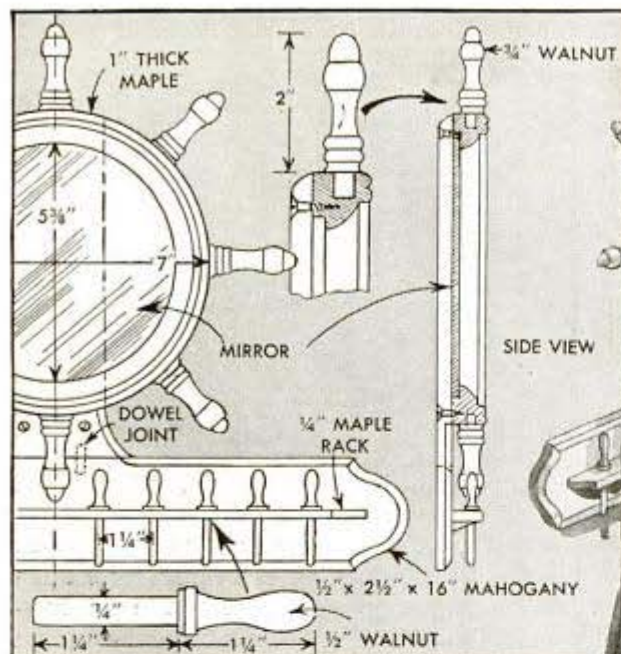

Combining maple with walnut gives pleasing contrast to this novel tie rack. The backing piece to which the turned mirror frame and the belaying-pin rack are attached, can be shaped from a single piece of plywood, or two pieces of solid stock doweled together as indicated. Turning the rabbet in the back of the mirror frame will require the work to be chucked, after shaping and beading the front. Such a chuck consists of a scrap block recessed on the lathe to permit the frame to be pressed snugly into it. A disk of cardboard placed behind the mirror glass when fastening the

frame to the backing piece, will protect the silver. Finish the rack natural by first filling the grain of the walnut parts, then shellacking the complete job and finally applying a coat or two of wax or varnish. —Chas. Lincoln, Jr., Morehead City, N. C.

## Spiral Pins Hold Tidy Sets on Your Upholstered Furniture



Fastening a tidy securely to an upholstered chair is no problem if you use a pin that has been bent spirally so that it can be turned into the fabric. Pins with colored heads add a decorative effect; and a pair of pliers is used to bend the pin around a nail, thus making a coil, as indicated in the detail. The turns of the spiral part of the pin can be stretched to space them as desired after the pin has been bent to shape. —Opie Read, Jr., Chicago.

☐ Examine the carving carefully when you buy carved-mahogany furniture. Smoothly finished carving, clean cut and fine in detail is a sign of careful workmanship and superior furniture.

# KEEPING YOUR



Simple typewriter upkeep so your old machine will do during suspension of production. Tells importance of cleaning, where to lubricate, ways to save the vital platen and other parts; also, how minor repairs are made to keep the machine in tip-top working order

**Y**OUR typewriter can be made to last for a long time if you will give it some regular attention to keep it clean and in serviceable condition. Dust is an abrasive that will increase the wear at all moving points besides clogging narrow passages and making the moving parts work harder and slower or causing them to stick. If the typewriter is in constant use, a daily brushing as in Fig. 5 is advisable to avoid this trouble. Be sure to remove the accumulation of dirt from erasures, which falls on the keys and gets into the working parts. A narrow bottle-cleaning brush is handy for this purpose. A more thorough cleaning is recommended once a week. Then, in addition to the usual brushing, dirt and gum should be removed from between the type bars with a pipe-stem cleaner as in Fig. 2. Dirt from the type faces can be lifted out by type



as a bellows, holding a small cardboard or metal tube in the gathered mouth of the bag to concentrate and direct the stream of air. When the typewriter is not in use, the cover always should be replaced as in Fig. 4.

Old age will cause a rubber platen shell to become smooth, but it also may be glazed due to an accumulation of gum and dirt. Carbon tetrachloride or ordinary rubbing alcohol applied with a soft cloth will re-

# TYPEWRITER YOUNG

move dirt and fine sandpaper will roughen a platen, when the rubber is hard and smooth. Sometimes a platen shell becomes loose on the core, which is generally made of wood. This can be cured by driving a short, headless brad through the shell and into the wood, as in Fig. 1. Do this near the end of the roll where it will not interfere with typing. Aged and hardened platens quickly wear both ribbons and type faces. To preserve a platen, make it a practice to use an extra sheet of paper underneath the typing paper.

Slipping of paper may be due to the habit of repeatedly jerking the paper from the machine, which wears the rollers and platen smooth. Another cause is lack of lubrication of the feed rollers—the small rubber rollers under the platen. Apply a little nongumming oil to the end bearings, being careful not to let it get on the rubber as oil will rot it. A good applicator is a pipe-stem cleaner used as in Fig. 9. Lubricate the platen bearings, the ribbon advance ratchet and other points where wear can be expected.

When two keys are struck at one time, the type bars jam in the guide. If this is repeated frequently the bars may be bent so that the type faces will be out of align-



ALWAYS REPLACE THE COVER



USE BOTTLE BRUSH FOR HARD-TO-REACH PLACES

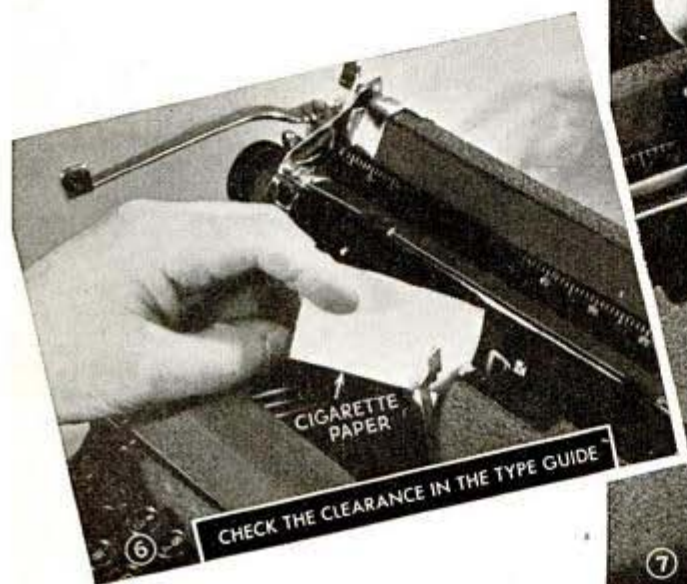

CIGARETTE PAPER  
CHECK THE CLEARANCE IN THE TYPE GUIDE



BE CAREFUL IN ALIGNING BENT TYPE BARS



ment. To check if the type crowds over toward either side of the guide, hold a piece of cigarette paper in place as shown in Fig. 6; the type should just clear it on each side. If the type has been bent sideways it will be necessary to bend it back carefully, using two pairs of pliers as in Fig. 7. However, unless you are a fairly good mechanic, it would be best to have troubles of this nature remedied by a trained typewriter repairman. This is particularly true if some of the letters are out of line vertically, as a special tool is required to correct this condition.

Check to make sure that the ribbon

moves at each stroke of a key, as a new ribbon can be ruined quickly if this is not the case. The ribbon-forwarding mechanism is operated by means of a small ratchet as indicated in Fig. 10. If it does not operate, it may be bent slightly. Adjust it with a pair of long-nose pliers until satisfactory operation is obtained. The newer typewriters are provided with key-tension control—"touch control"; if your machine does not have this, and if the tension is too loose or too tight, look underneath the machine for adjusting screws. There is usually one for each type bar. Each one must be loosened or tightened exactly the same as the others in order to maintain evenness of touch.

When the rubber feet of a typewriter become hard and smooth, and you cannot replace them, it may be advisable to cut disks from composition stick-on shoe soles and cement them over the smooth feet as shown in Fig. 8.

## Dustpan Provides Handy Holder For Paint Cans and Brushes

You won't have to worry about spilling paint or varnish on the rug or floor when touching up woodwork, if a holder of the type shown is used. It consists of an old dustpan to which are soldered two can lids that the paint cans are placed in to prevent them from slipping. Also, the surface of the pan provides plenty of space to lay brushes when not in use and the handle makes it a simple matter to pick up the paint and brushes and carry them safely from one room to another.



## Bucket Bail Holds Mop Handle



It is a simple matter to keep your mop handle in a vertical position in a scrub bucket when the mop is not in use if the bail is bent in the center as indicated. Bending the bail permits it

to be lowered with the mop handle between it and the side of the bucket.

## Oilstone Is Held in Position By Wide Staple

You can have both hands free to hold a tool while sharpening it on an oilstone if you provide the stone with a wide wire staple inserted through the base.

When using the stone, the legs of the staple are inserted in small holes drilled the proper distance apart in your bench top.

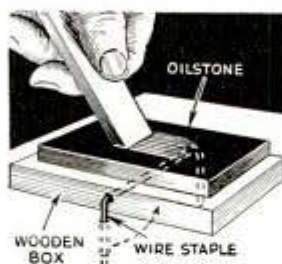

## Old Broom Cut Off at Binding Makes Good Stovepipe Brush

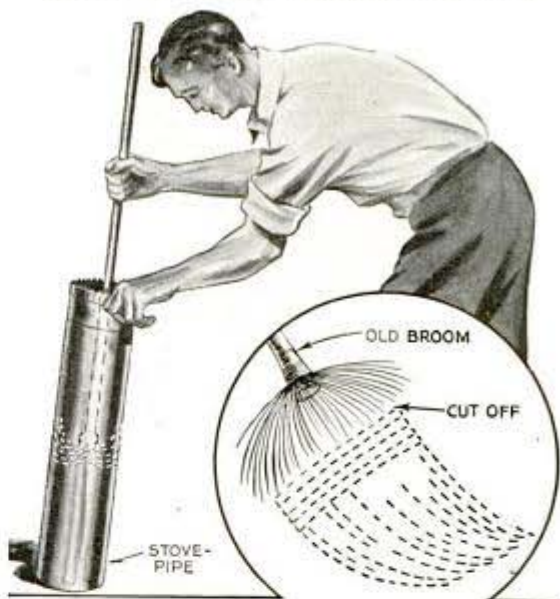

When you have some stovepipe to clean, just take an old broom and cut it off above the binding so that the straws can spread. The remaining part of the broom can be used as a swab to remove the soot.

## Lawnmower Stored Under Floor Removed From Outside House

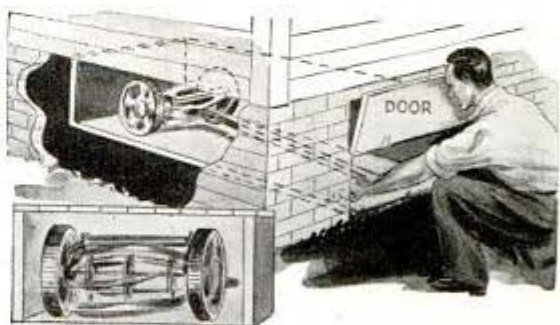

Instead of taking my lawnmower up and down basement steps every time it was used, I rigged up the storage arrangement shown. This was done by boxing-in between the floor joists and then cutting an opening in the foundation directly in front of the box so that the mower could be put in or removed from outside.

—Roy O. Nupp, Cleveland, Ohio.

## Sticking of Wringer Rollers Avoided With Cardboard

Just before you stop the washing machine, cut a piece of cardboard to a length approximating that of the wringer rollers and run it between them as indicated. This will prevent the rollers from sticking. This precaution is especially helpful if the machine must stand idle for some time. Also, don't forget to release the pressure on the rollers.—W. C. Lammey, Sandwich, Ill.



Remove grease and grime from mahogany furniture with a cloth wrung out in lukewarm water to which a little pure soap has been added. Dry with a soft cloth, wiping lightly with the grain of the wood.

## Heavy Rugs Held on Clothesline By Two Trouser Hangers

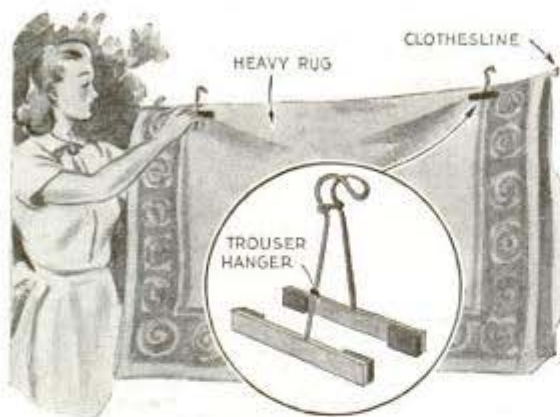

If you have found common clothespins too small for holding heavy rugs on the clothesline, try a couple of trouser hangers of the type shown. These not only hold the rug securely, but the felt pads with which they generally are provided eliminate the usual marks made on the pile by tight-fitting clothespins.

## Simple Winder Speeds Production Of Bandages by Red Cross

A simple bandage winder used by a California Chapter of the Red Cross has enabled four women to do the work of twelve in less than half the time. Made from scrap parts, it is assembled quickly by first attaching a supporting upright to the base.

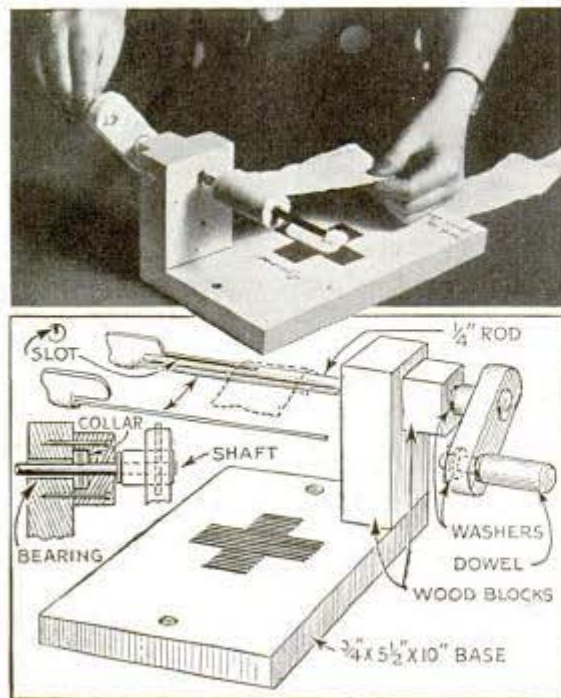

This is then drilled to receive a  $\frac{1}{4}$ -in. spindle which is slotted and fitted with a handle as shown. Note that the spacer block between the handle and support is counter-bored to receive a pinned collar that must be in place before the block is attached permanently. Although this is a neat way of keeping the spindle from sliding from one side to the other, a washer and pin on the opposite side of the support would also serve the same purpose.

—A. C. Morden, Azusa, Calif.

## Short Dowel in Flower Frog To Lift It From Bowl

When cut flowers are displayed in a frog, the entire assembly can be lifted easily without disarranging the flowers when you wish to change the water or clean the bowl, by providing the frog with a handle. This can be made by driving a length of wood dowel tightly into a hole in the center of the frog. The dowel can be painted green or stained green to make it inconspicuous among the leaves and stems of the flowers.



## Round Cribbage Board Stored In Small Space

Here's a novel cribbage board that is easy to read, and every fifth hole is numbered to help avoid errors when totaling the points. It can be made any thickness or diameter desired, and makes a very attractive board when inlaid. There are two rings of 60 holes each near the outer edge to mark scores, and four holes in the center to serve as peg holders. Felt is glued to the bottom of the board to protect the varnished surface of the table.

—J. O. Devau, Derby Line, Vt.

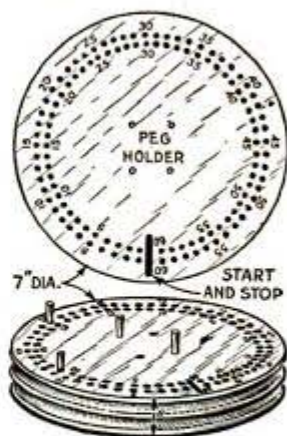





THE long neglected wastebasket comes into its own in this well-designed style, which makes it a thing of beauty as well as utility. Furthermore, it can be made of material to match the room furnishings, thus giving the basket the appearance of a piece of furniture instead of just a container to receive waste paper. It is composed of ten turnings, ten thin panels which fit into grooves dadoed into the sides of the turnings at an angle of  $73^\circ$ , a ring for the top and a scalloped disk for the bottom. When forming the turnings, the stock is mounted slightly off center. This results in each turning having one flat side, which is placed on the inside of the basket so that the inner surfaces of the turnings carry out the flat appearance of the panels. Tenons formed on the ends of the turnings fit into holes bored in the top ring and bottom disk. The ring is strengthened by sawing it into four thin layers, which are glued together with the grain of alternate layers running in opposite directions. As the basket is assembled without nails or screws, be sure all joints fit snugly and are glued carefully.

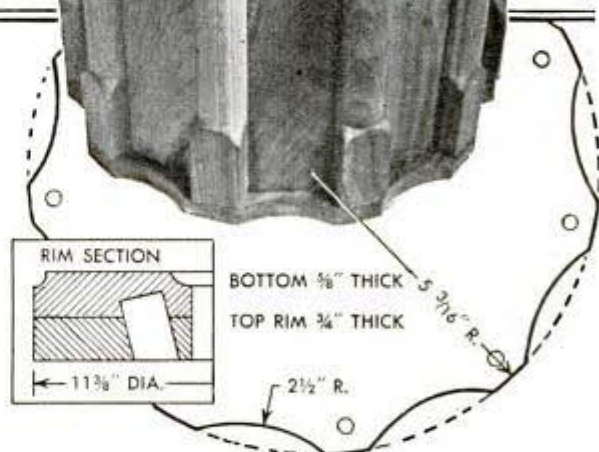

RIM RESAWED AND PIECES GLUED BACK TO BACK AT RIGHT ANGLES

## Barrel Used as Pipe Holder On an Emergency Job



When I was called on an emergency plumbing job, I had some pipe to thread and no pipe vise was available for holding it. I solved the problem by laying the die stock across the top of an open barrel as shown. The pipe was inserted into the die and then was turned with a pipe wrench to thread it. Any barrel with one end removed will do for this purpose.

—Arthur Wentzell, Halifax, N. S., Can.

## Picture-Framing Vise Has Block To Clamp It in Bench Vise

An easy way to handle a picture-framing vise when it is not used often enough to warrant fastening it permanently to the workbench, is to bolt it to a wood block, such as a piece of 2 by 4-in. stock, which can be clamped in your bench vise. In this way, the framing vise can be held securely,

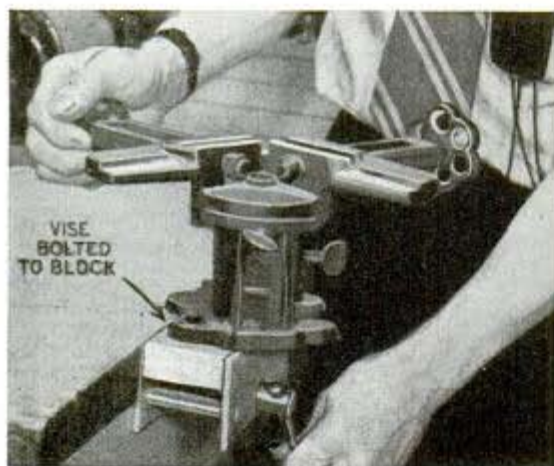

yet it can be set up or removed in a minute for storage, thus saving bench space.

—W. F. Messenger, Ballston Spa, N. Y.

## Wire Inside Cloth Pot Holder Shapes It to Handle

To make a cloth pot holder stay in place on the handle of a utensil where it would be convenient when needed, one lady stitched a square of screen wire between the cloth thicknesses of the pad. In this way, the wire will make the holder remain in the desired shape.

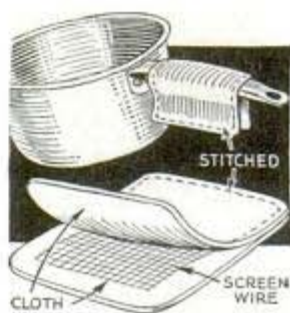

## Heel Improves L-Clamp Bolt



An L-clamp bolt used on a drill press and face-plate can be improved by the addition of a Y-shaped heel of the type shown. This helps prevent any tendency of the bolt to spring away from the work. The heel is an easy fit on the

bolt; the upper edge of the hole is chamfered.—Chas. H. Willey, Penacook, N. H.

## Gum Removed From Clothing By Using an Ice Cube

While ice often is used to chill and harden chewing gum on clothing, it is impractical to use the ice on fabrics that may be stained by water. For such fabrics,

one cleaner places the ice in a tin cup and applies this to the gum. Care should be taken to wipe moisture from the cup before placing it on the garment. If moisture collects rapidly, place a sheet of wax paper between the cup and the gum.



## Novel Salt and Pepper Shakers for Your Table

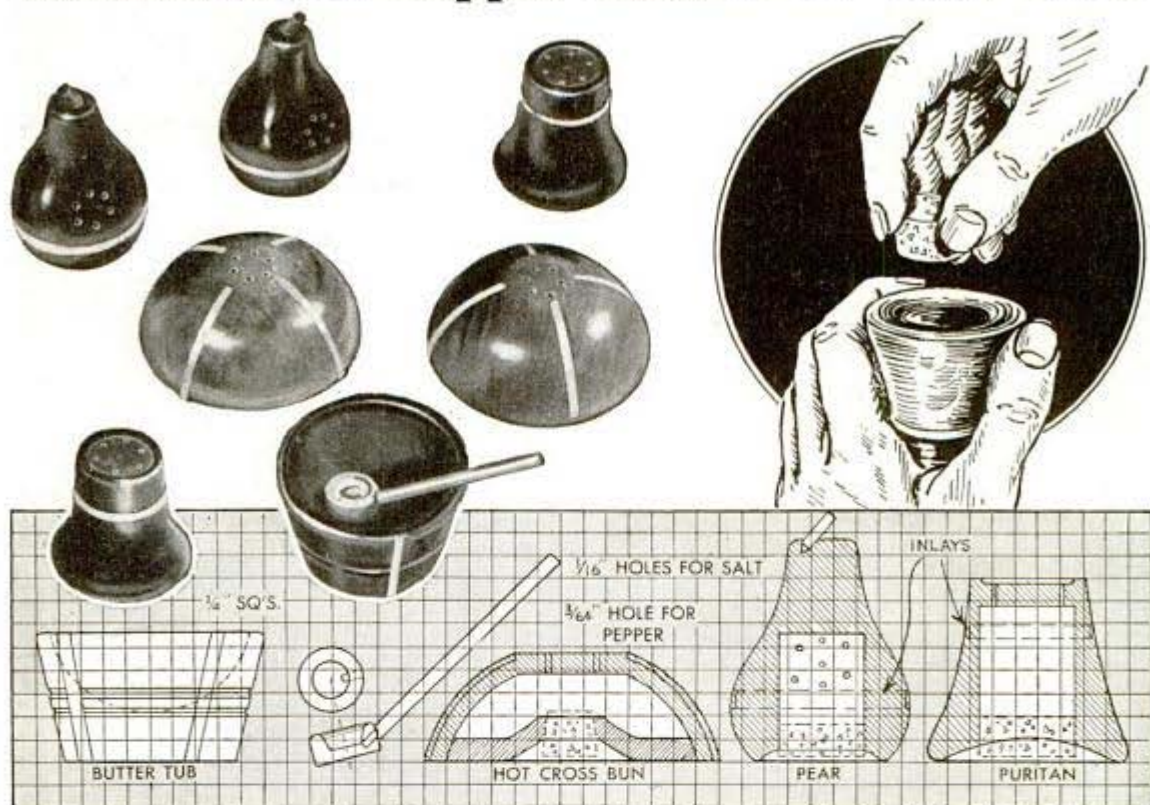

Reminiscent of the charm and simplicity of early New England, these novel salt and pepper shakers can be turned from mahogany or other hardwood. Note that the pear set is complete even to the stems, and contrasting inlay strips provide a neat touch to all pieces. Sugar or salt can be kept in the "butter tub" and taken out with a little ladle, which is also detailed. Openings for cork stoppers in the shakers are tapered slightly to assure a tight fit, and

holes for salt and pepper can be drilled in S and P shapes for quick identification, if desired. Inlay grooves are made in most pieces when in the lathe, but those in the hot-cross bun and butter-tub designs are filed, chiseled or cut with a motorized hand tool. If the material is available, clear plastic can be used for the inlay strips, or the job can be simplified by filling the grooves with plastic wood.

—Bruce MacIntosh, S. Braintree, Mass.

## Turnbuckles Provide Quick Method of Leveling Picture

When hanging large pictures from molding by means of two cords or wires, the trouble of getting them to hang level led one home owner to use small turnbuckles. One eye of each turnbuckle is opened to hook on a screw eye on the frame, and the picture wire is tied to the other eye. Adjusting the turnbuckles quickly levels the picture, and being directly behind the picture, they are almost concealed from view.

Women faced with the problem of wearing low shoes in high-heeled galoshes can solve it by having a shoemaker cut leather lifts to fit into the heels of the galoshes.

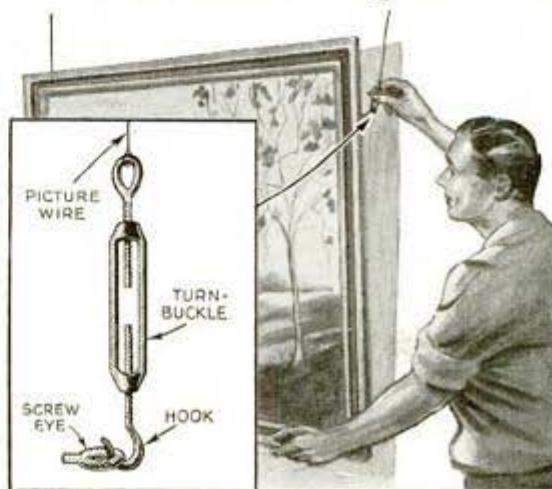

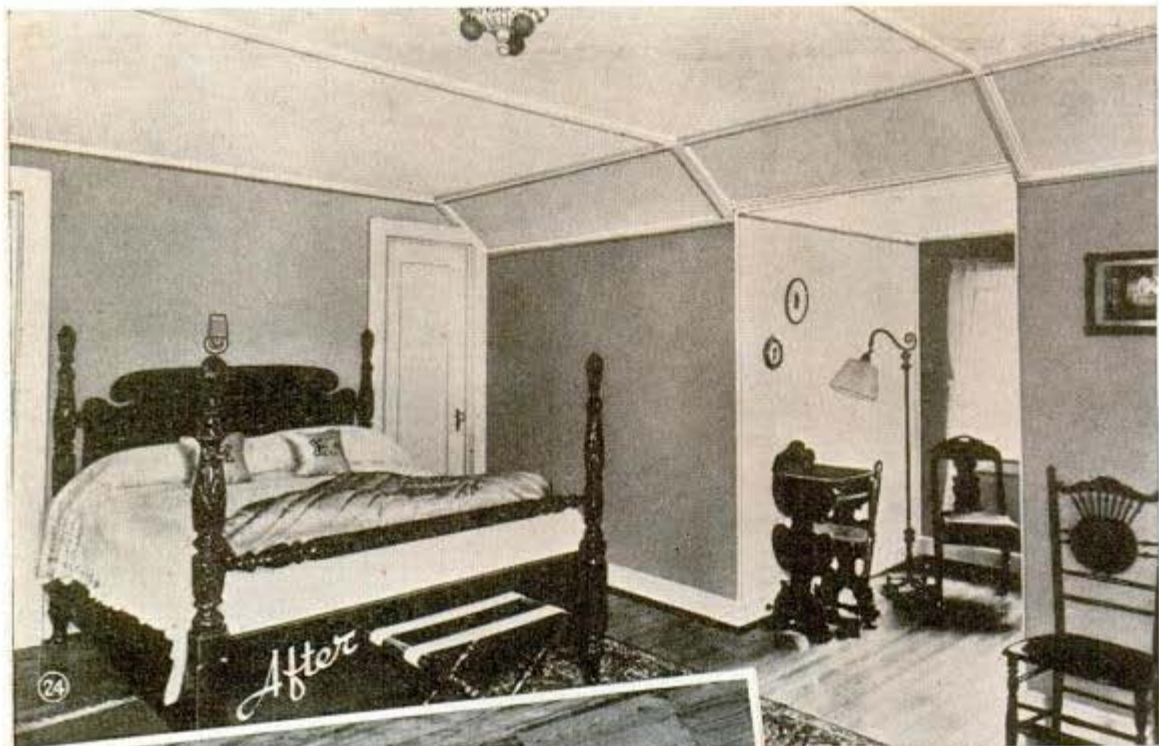

# SPARE

Bedrooms built in wasted attic space at relatively low cost relieve crowded quarters for large families and provide extra income for small families. In most cases only readily available materials are used, and the work can be done by any handyman

Courtesy The Upson Co.

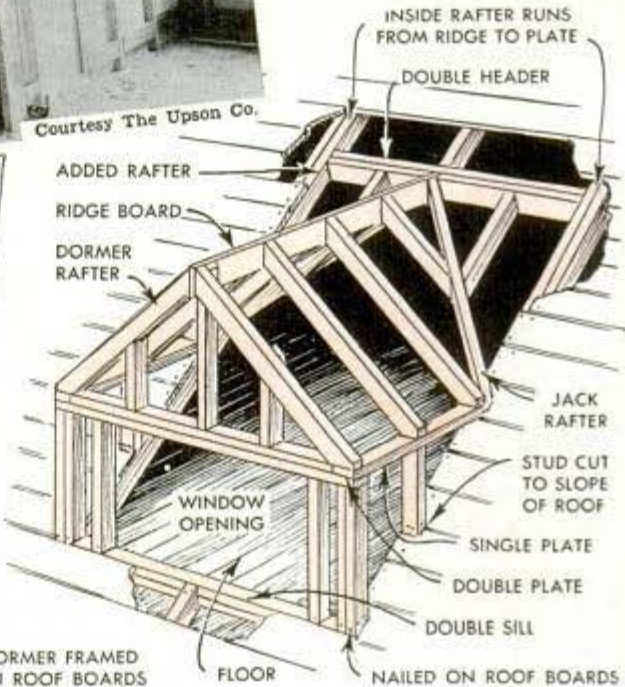
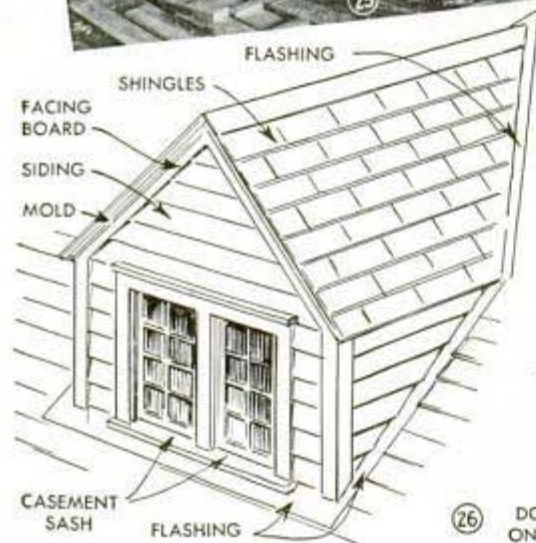

26 DORMER FRAMED ON ROOF BOARDS

(27) SECTION THROUGH CORNICE AT SIDE OF DORMER

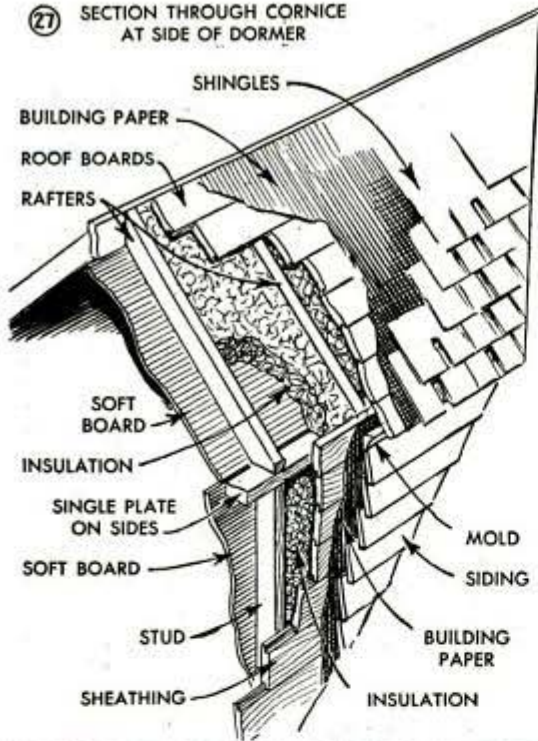

## ROOMS *in the* ATTIC

TO ASSURE adequate light and ventilation for spare rooms finished in an attic as described last month, often it is necessary to install dormers in the roof. Even when the house already has dormers, they may have to be enlarged to make the rooms livable. An example of what can be done in building a spacious attic room is shown in Fig. 24; the framing, before wall coverings were added, is shown in Fig. 25.

**Gable-roof dormers:** The addition of two or more dormers to a house is not difficult, and is only a relatively expensive job. They are of two general types, gable and shed roof. Gable dormers usually are only one or two windows wide, while shed-roof dormers, in effect, raise part of the roof and may be used to provide additional vertical wall space as well as several windows. The dormers should conform to the general style of the house, have similar eaves and window divisions and, if possible, the ridges should strike at least 1 ft. below the ridge of the main roof. Also, window sills should be at least 20 in. above the floor. Fig. 26 shows a common type of gable-roof dormer and the method of framing. It is general practice in remodeling to frame dormers right on the roof. Width of

By R. O. BUCK  
Part II

the dormer usually is determined by the location of the rafters which come down at the sides. These are doubled by spiking timbers of the same size from the plate to the ridge. After this has been done, a scaffold is erected to the eaves and the shingles are removed carefully from the roof over an area about 1 ft. wider than the proposed dormer. Then the roof boards are sawed out along the inside line of the doubled rafters.

Next, the corner posts, studs and plates are spiked into place on the roof boards, directly over the timbers, followed by the rafters and ridge. Note that the rafters under the dormer are sawed off and replaced by a double header at the top and bottom. Fig. 27 shows a section through the side of the finished dormer with the usual siding, paper and sheathing on the outside, insulation in the walls and ceiling, and one of the types of wallboards, in lieu of plaster, on the inside. A hip-roofed house should have dormer roofs to match as shown in Fig. 28. If the dormer is only a single window wide, double corner posts often are omitted and the studs set flat. Ceiling joists are optional, as explained later. The framing, except for the hip at

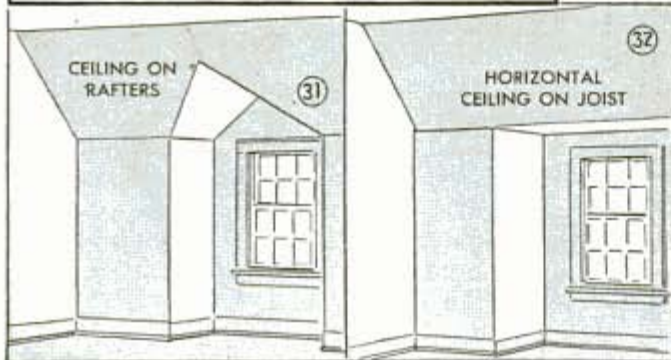
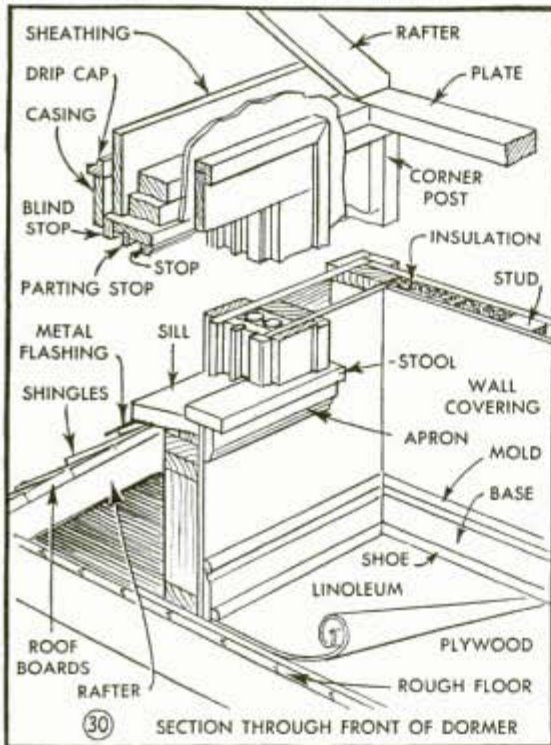
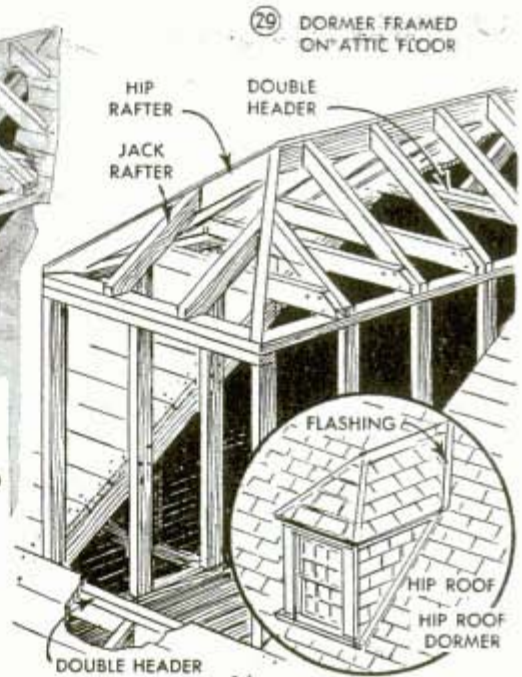
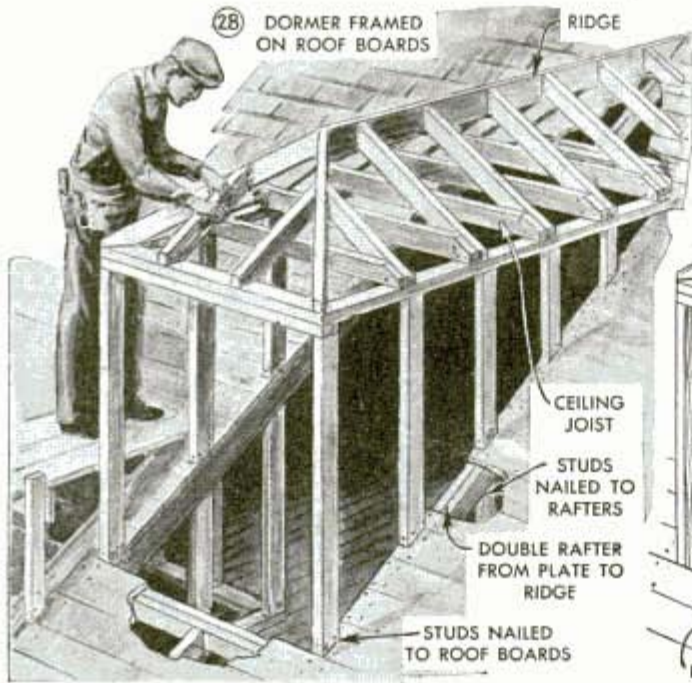

the front of the roof, is similar to the gable type in other respects. Fig. 29 shows an alternate method in which the dormer is framed inside the opening and spiked to the rafters.

**Shed-roof dormers:** These are simple to frame and generally are made large. They may be used on any house, especially at the back where they do not detract from an attractive roof line. Fig. 35 shows a typical four-window dormer. These dormers may be framed on the roof as previously described, but because they usually are large, most builders frame them inside, as in Fig. 34. In most cases they are high enough on the roof so that the dormer ceiling is on a level with the ceiling of the room as shown in Fig. 36. This is quite an advantage as it makes the area covered by the dormer actually part of the room. Fig. 37 shows a section of a typical shed-roof dormer framed with a plate and with the studs set on edge. This method is preferred by some builders, especially for large dormers. Also, setting the studs on edge provides more space for insulation. Fig. 30 shows a typical window section in a dormer, giving the relation between the rough framing, window frame, walls, floor, casing and baseboard. The ceiling of gable and hip-roof dormers may be finished directly on the underside of the rafters, Fig. 31, or may be

### 33 STOCK WINDOW SIZES

#### Two-light, check-rail type

Glass size	Opening size
20 x 24 in.	2 ft.-0 in. x 4 ft.-6 in.
24 x 24 in.	2 ft.-4 in. x 4 ft.-6 in.
24 x 26 in.	2 ft.-4 in. x 4 ft.-10 in.
26 x 26 in.	2 ft.-6 in. x 4 ft.-10 in.
28 x 26 in.	2 ft.-8 in. x 4 ft.-10 in.
28 x 28 in.	2 ft.-8 in. x 5 ft.-2 in.
30 x 28 in.	2 ft.-10 in. x 5 ft.-2 in.

#### Casement type

Average-size openings for sash in pairs	
2 ft.-8 in. x 2 ft.-6 in.	3 ft.-0 in. x 3 ft.-6 in.
2 ft.-8 in. x 3 ft.-0 in.	3 ft.-0 in. x 4 ft.-0 in.
2 ft.-8 in. x 3 ft.-6 in.	3 ft.-4 in. x 3 ft.-0 in.
3 ft.-0 in. x 3 ft.-0 in.	3 ft.-4 in. x 3 ft.-6 in.
3 ft.-4 in. x 4 ft.-0 in.	

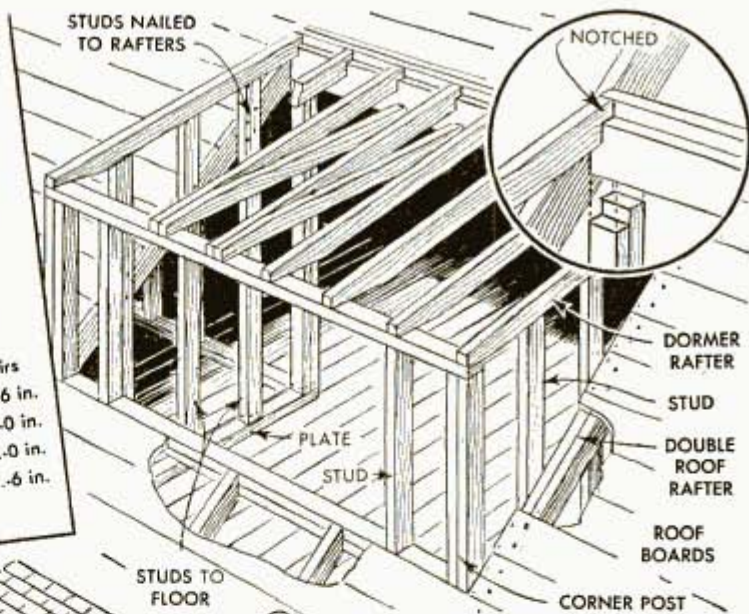

34 FLAT-ROOF DORMER

dropped and made horizontal by means of ceiling furring, Fig. 32.

**Windows:** Two types of windows are in common use, the check-rail or two-sash type and the casement or hinged window.

Windows generally are listed by the size of the panes of glass and the number of panes in both sash. For example a 2L-20 by 24 window would have a single pane of 20 by 24-in. glass in each sash. The first dimension for the glass is the width, the second the height. Windows come in standard sizes based on the glass, which is cut in even inches. Both or only the upper sash may be divided vertically, or both may be divided vertically and horizontally by means of muntins or dividing bars. Two or more complete windows in a single frame are called mullion windows. Fig. 33 lists the stock sizes of windows that are most suitable for dormers. Because of variations in millwork practice, it is advisable to purchase the frames in advance and from them determine the size of the stud opening. Closets, storage cupboards, chests of drawers, book shelves, built-in beds, etc., can be worked in under the eaves and at the ends of dormers as in Fig. 39, and thus further increase the usable space.

**Insulation:** Adequate insulation of the attic is essential for year-round utilization of attic space. Fig. 40 shows the two common methods of insulating an attic in which

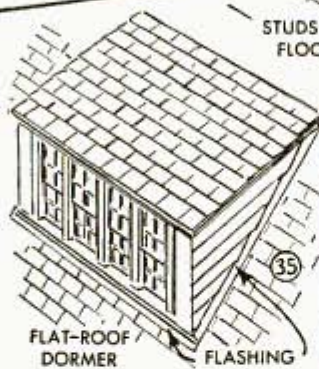

35 FLAT-ROOF DORMER FLASHING

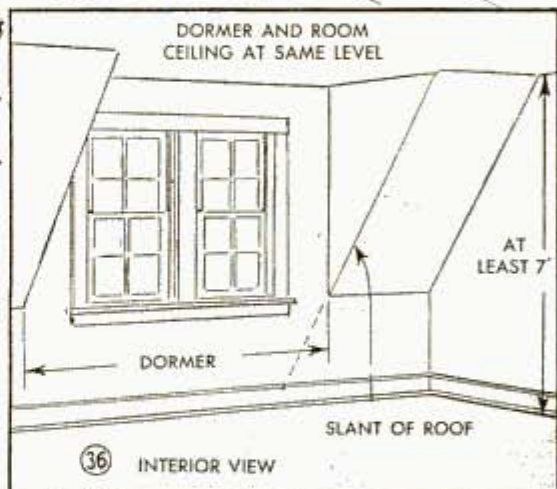

36 INTERIOR VIEW

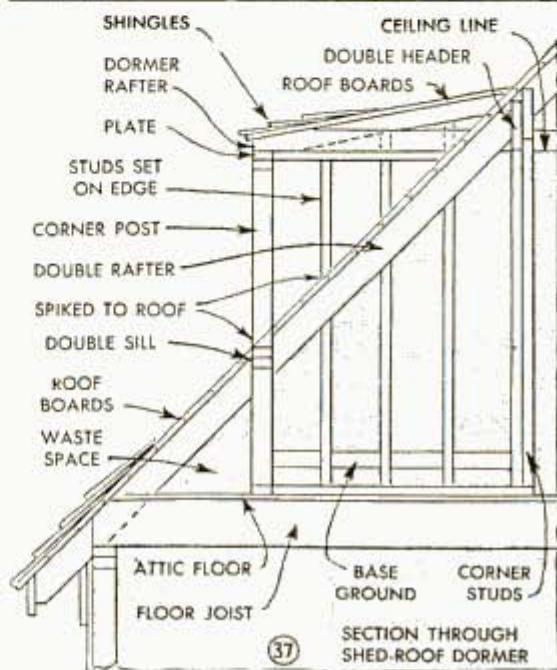

37 SECTION THROUGH SHED-ROOF DORMER

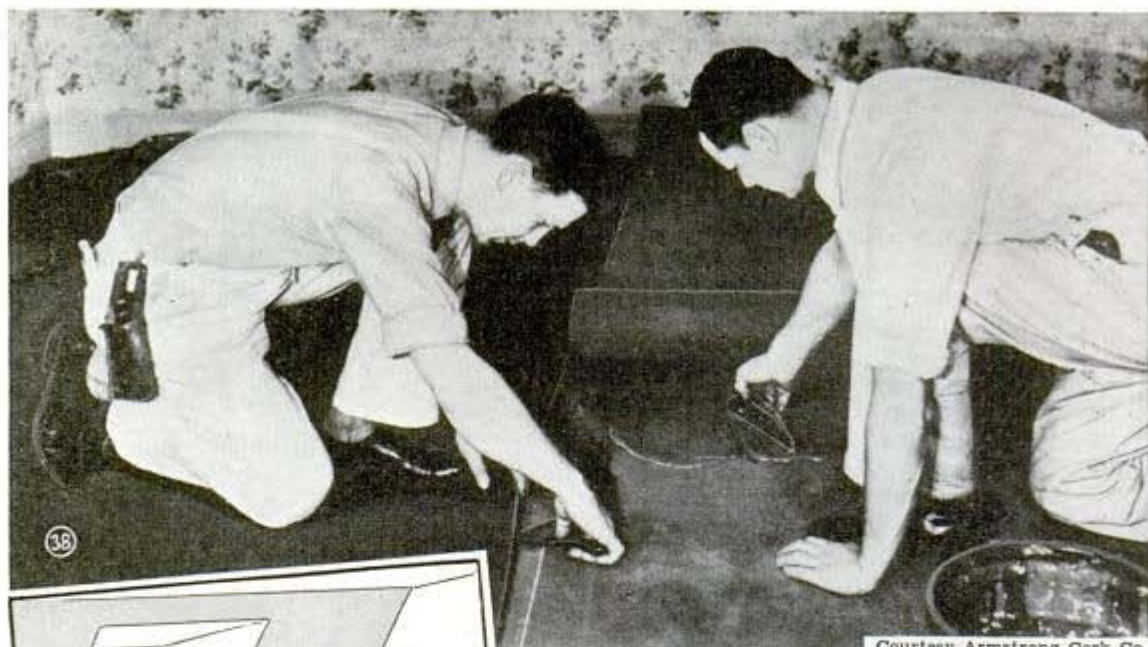

Courtesy Armstrong Cork Co.

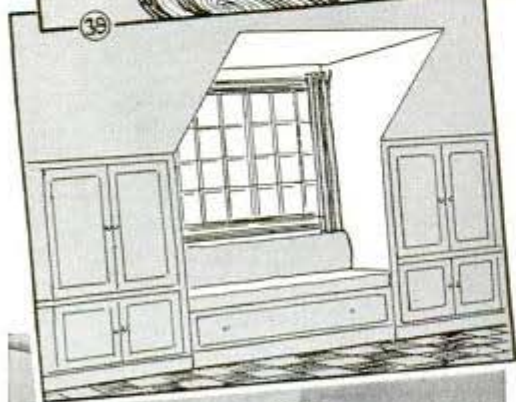

rooms are finished off. Insulating the area indicated at B provides for ventilation above the ceiling. For hip roofs, ventilators cannot be provided, so the usual practice is to insulate as shown at A and provide for ventilation in the area above the ceiling by means of a grill or indirect opening in the room ceiling. Insulation material put up in bats is the most convenient and effective for this type of job as in Fig. 41.

**Heating:** Most heating plants are adequate to provide for one or two additional sleeping rooms, especially after the attic has been insulated. Pipes for hot-water or steam radiators generally can be run up through some inside partition wall. The usual practice is to make the pipe in two or more lengths and start one up before coupling on the next. The expansion tank of a hot-water system will have to be moved above the radiator level in the attic. Hot-air ducts can be carried up through a partition from the basement, as they are made in convenient sections which fit between the studs. The use of gas heating appliances in bedrooms and bathrooms is forbidden in the building codes of many cities because of the danger from suffocation should the flame be extinguished accidentally.

**Flooring:** Most attics are floored with second or third grade softwood, which if reasonably smooth and level, may be painted. Linoleum, however, makes an ideal floor covering for this purpose. It is less expensive than good quality hardwood flooring, avoids the hazardous vibration caused by nailing the flooring down and produces a beautiful, one-piece floor. Assuming that the wood floor is reasonably smooth, the first step is to put down a layer



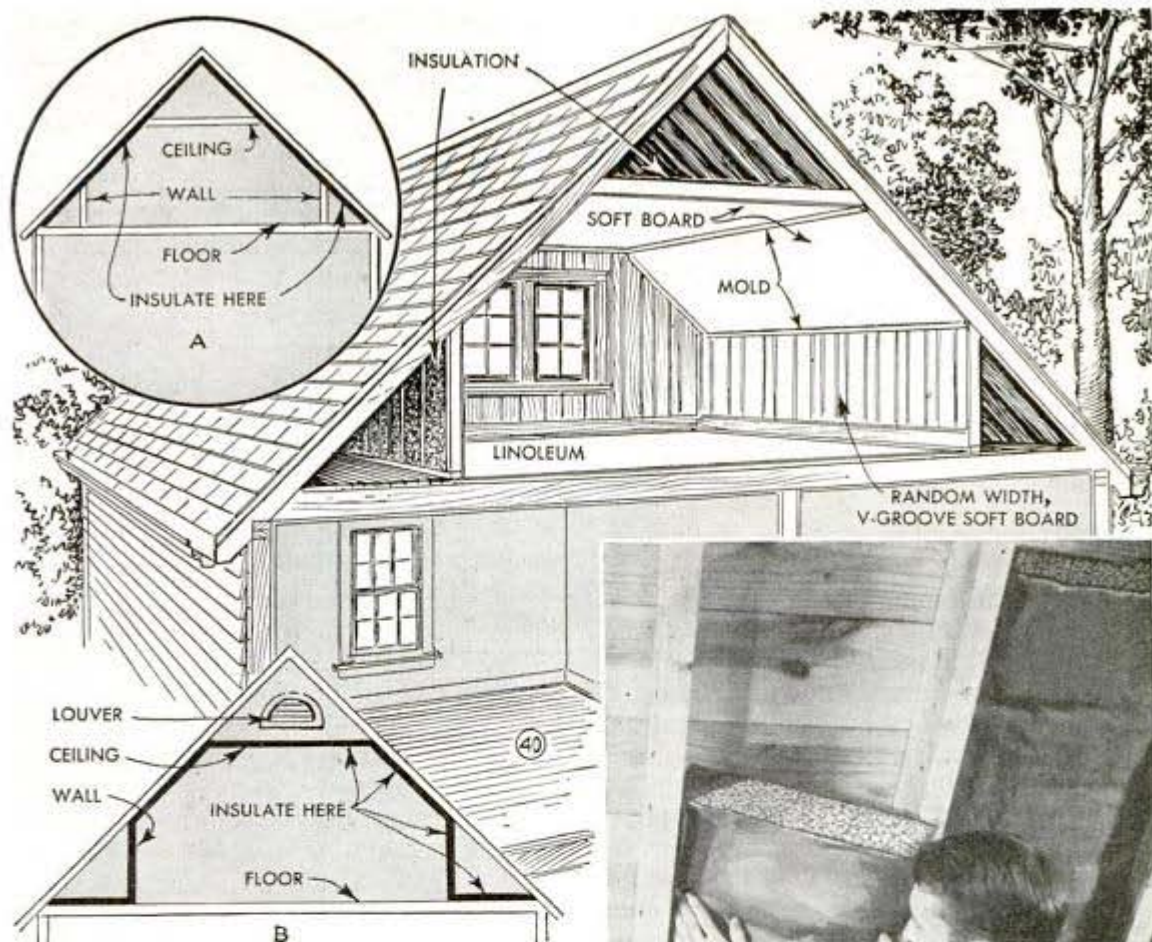

of lining felt over the entire area, cementing it with linoleum adhesive. The felt is covered with a layer of the same adhesive and the linoleum applied over it as shown in Fig. 38. Sandbags, or other heavy objects should be used to hold the linoleum down at the joints and edges until dry, and care must be taken to roll the entire surface to assure contact at all points. The lining felt takes up the expansion and contraction of the wood floor, and also provides additional warmth, quiet and cushioning between the boards and linoleum. The latter is available in a wide variety of beautiful colors, patterns and grades, and if it is of good quality and is laid correctly and cared for properly, it will last for many years. Should your floor be rough and un-

even it may be necessary to cover the surface before applying linoleum. Plywood panels are ideal and inexpensive for this purpose, although you can use other materials, such as hard-pressed boards. Use the material in as large panels as obtainable and thus have the minimum number of joints under the linoleum.

## Hints on How to Care for Phonograph Records to Make Them Last

To get the best results and prolong the life of phonograph records, "break-in" all new ones by using a new steel needle each time the record is played for at least the first three times. Always wipe the record with a brush before and after using it. This prevents dust from collecting in the grooves

and damaging them. Keeping the records in an album or in the envelopes in which they are purchased provides protection against scratching and the collection of dust. If you like organ recordings, try using only fiber needles on them after the breaking-in period.

## Drum Roller Simplifies Storing Of Ladder Under Building

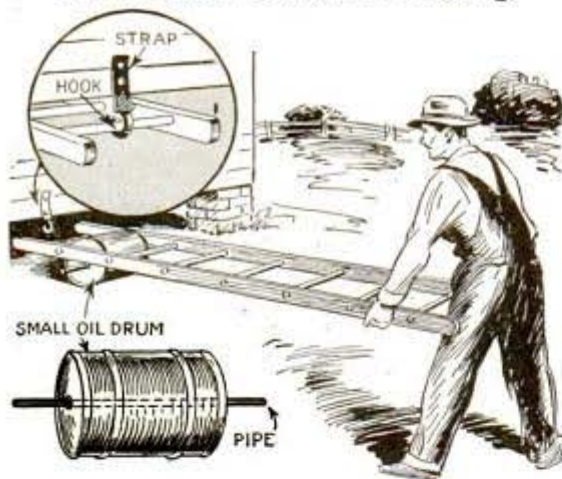

Farmers and others who store long ladders under a building, will find they can be slid into place easily by using a roller. This consists of a small oil drum, the ends of which are provided with holes to receive a pipe or broomstick axle. In use, one end of the ladder is dropped over the drum so that both sides rest on the pipe, which permits the ladder to be rolled in place. A strap-supported hook fastened to the side of the building holds the projecting end off the ground.

## Letter File Is Held on the Desk By Bookends



A letter file can be kept conveniently in a vertical position on your desk by placing it between a couple of bookends. A strong rubber band slipped over the bookends as shown, will keep them pressed

tightly against the sides of the file yet permit it to be inserted or removed quickly.

## Simple Spreader for Tracing Cloth

A spreader that will automatically keep tracing cloth stretched taut while lettering, can be made from a length of clock-

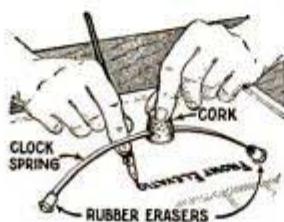

spring, a cork and a couple of pencil erasers of the slip-on type. The spring is inserted through the cork, which serves as a finger grip, and the erasers are impaled on the ends. In use, the spreader is placed over the desired position on the tracing cloth, after which downward pressure on the cork grip causes the erasers on the end of the spring to spread outward and pull the cloth taut.

## Avoiding Soot on Utensils

If you dislike using your kitchen utensils over an open fire outdoors because soot collects on them and is difficult to remove, rub soap on the outside of each utensil before using it. When this is done, any accumulation of soot on the soap can be rubbed off easily.—Benj. Nielsen, Aurora, Nebr.



## Vacuum Cups Provide Containers For Mixing Water Colors

Small vacuum cups of the type shown will serve nicely as auxiliary mixing trays



for water colors. If the closed ends of the cups are slit, they can be slipped over the edges of the water-color box. When not needed, the cups take very little space.

Ⓚ A good, natural antiseptic is the soft, liquid pitch of the fir and pine trees. It is easily collected with an eye dropper from the blisters and pitch pockets of the trees.

# Exposed Pipe Concealed by Attractive Shelves

In a large living room, an exposed pipe was concealed effectively by boxing it with a three-sided wooden trough which was used as the "backbone" of an attractive book or whatnot shelf. In addition to being useful for holding books and bric-a-brac, the unit also helps to improve the appearance of a stretch of unbroken wall space. Two pieces of  $\frac{1}{4}$ -in. plywood were used for the back, which was nailed to the shelves and pipe boxing. After assembling the entire unit on the floor, it was set in place and held securely by four long screws driven through the back and into the wall studs. Finishing consisted of two coats of paint in harmony with the color scheme of the room and its furnishings. However, the unit could be stained and varnished to match woodwork, if desired. In small rooms where storage space is limited, hinging the front of the base would also provide a handy place to keep small items.



## Wire Attached to Toggle Bolt Permits Removing It Later

As toggle bolts are designed without regard to their future removal, either you must damage the wall to remove the toggle or leave it inside. A practical means of removing such a bolt after it has served its purpose is to attach a length of thin wire

to the toggle. This extends through the hole and is tucked under the work being held. To remove the bolt, it is unscrewed completely after which the toggle can be withdrawn endwise by pulling on the wire that prevented it from falling down inside.

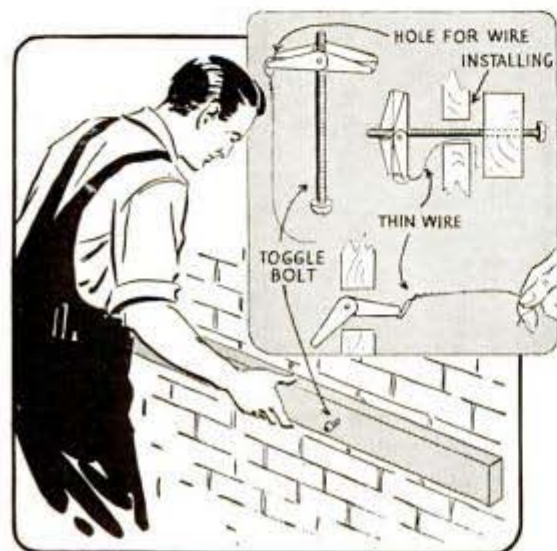

## Solder Aids in Bending Tubing Without Kinking It

When it is necessary to make a sharp bend in copper tubing, the danger of kinking it shut can be avoided by wrapping the tube with wire solder. For a  $90^\circ$  bend in  $\frac{1}{2}$ -in. dia. tubing, at least 5 in. of it should be wrapped and held tight while bending, after which the solder can be either unwound or slipped off the end and saved for future use.

☐ To make tulips and other bulbs, that require freezing, bloom in warm climates, keep them in the freezing compartment of a mechanical refrigerator for a few days before setting them in the ground.

## Angle Bracket on Tilting Head Gives Greater Flexibility

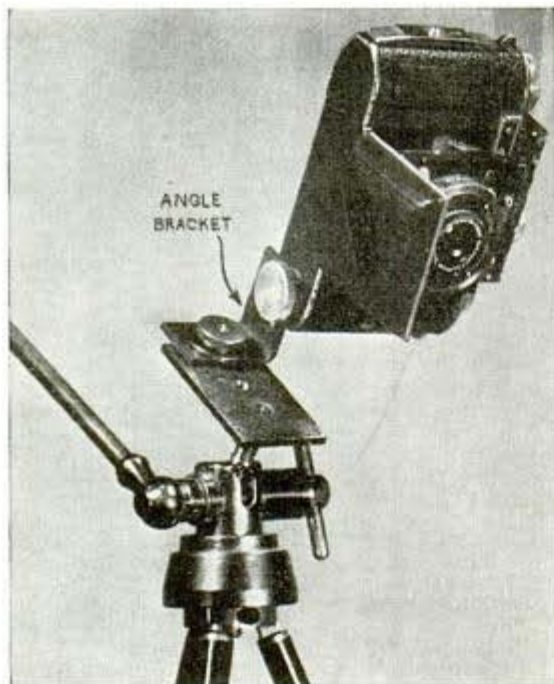

As there is no means on my tilting tripod head to hold a camera vertically, I use a small angle bracket which makes this possible. One leg of the bracket is attached to the tilting head and the camera is fastened to the other leg as shown in the photo.—Louis Hochman, Brooklyn, N. Y.

## Enlarging Easel on Tripod Head Tilts to Correct Distortion

Distortion in negatives often can be corrected by tilting the easel while an enlargement is being made. A way to make it easy to tilt the easel at an angle and hold it there is to mount it on a tilting tripod head. A small tilting head like the one shown can be fastened to two pieces of wood joined together at the centers to form a base. The tripod socket on the easel is mounted flush with the bottom surface so it will not interfere with its normal use.

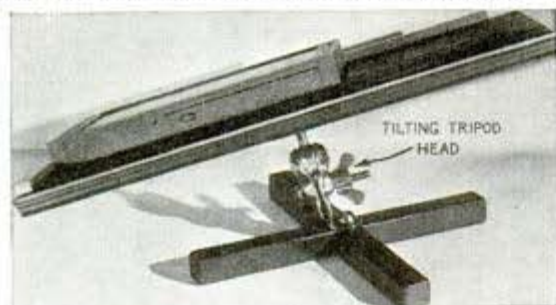

## Photo Print and Negative Drier Is Easy to Make

Utilizing standard ferrotype plates for the sides of this drier makes it possible to dry both negatives and prints at the same time, as the heated air, which is circulated in order to dry negatives on the inside, also warms the metal sides to hasten the drying of prints that are squeegeed to the outside. The cutaway view in Fig. 1 and the diagram in Fig. 4 show how the asbestos-lined heating compartment is wired to a small fan and an element of the toaster type, which is supported by insulators attached to a vented metal or plywood partition. If the latter is used, it should be set flush in rabbets to permit the hinged compartment to butt tightly. The fan is wired independently of the element so that when the temperature rises above 160 degrees, as indicated by a thermometer provided at the bottom of the negative compartment, the element can be switched off. The fan blades may have to be cut down somewhat to fit within the space. Muslin drop curtains serve the double purpose of absorbing water and preventing the prints from falling off. Small paper clamps slipped on curtain rods or dowels as shown in Figs. 2 and 5, are used to hold negatives. Spring clothespins could also be used. A friction cupboard catch mortised in abutting edges keeps the case closed tightly and a check chain prevents breakage of the dairy-type thermometer, which protrudes through the side of the case as shown in Fig. 3. U-shaped brackets attached to overhang the curved sides of the case serve as feet to support the drier horizontally when applying prints.—Myron Levee, Chicago.

## Black Spots Kept Off Enlargement By Stippling With Pencil

Black spots on photographic enlargements, caused by minute pinholes in the negative, can be made to blend with the surrounding parts of the print by stippling the spot on the paper with a soft lead pencil while the enlargement is being exposed. The pencil marks hold back some of the light, making the spot gray instead of black. The stippling should be done rapidly and from all sides to make sure that no impression of the hand or the pencil is left on the print.

—Mae Blacker Freeman, Chicago.

*Fan circulates air in this . . . . .*

# PRINT-and-NEGATIVE DRIER

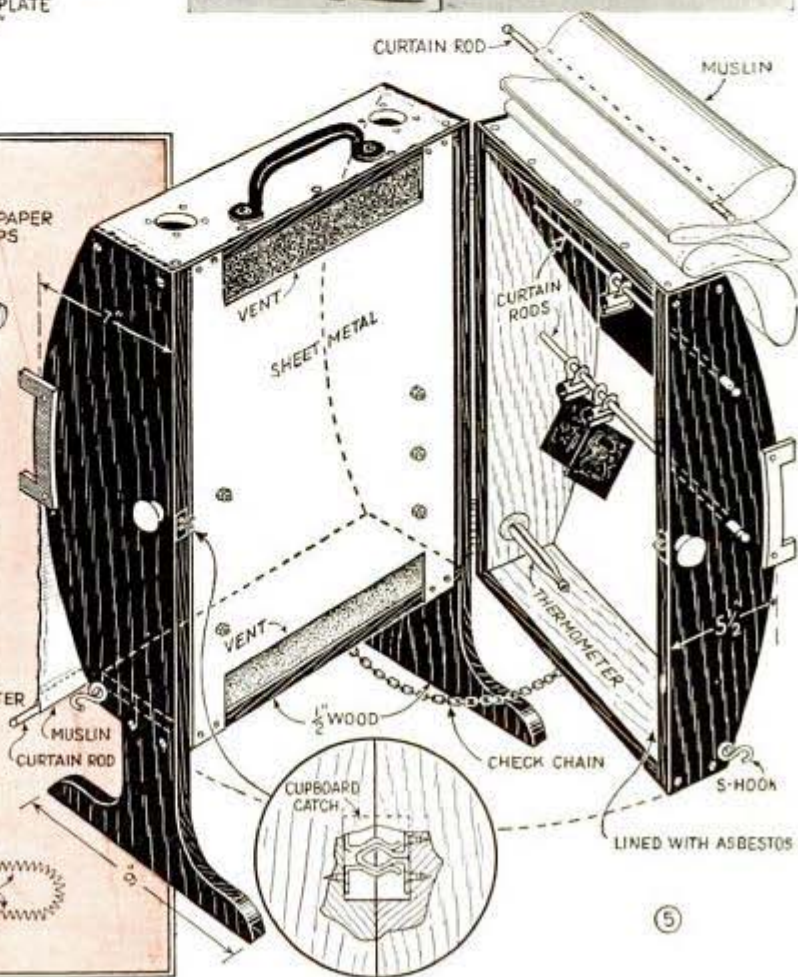
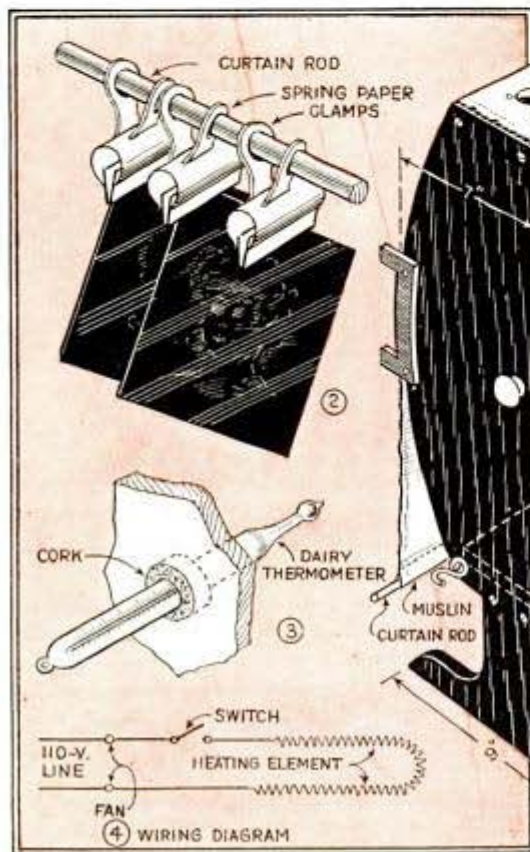
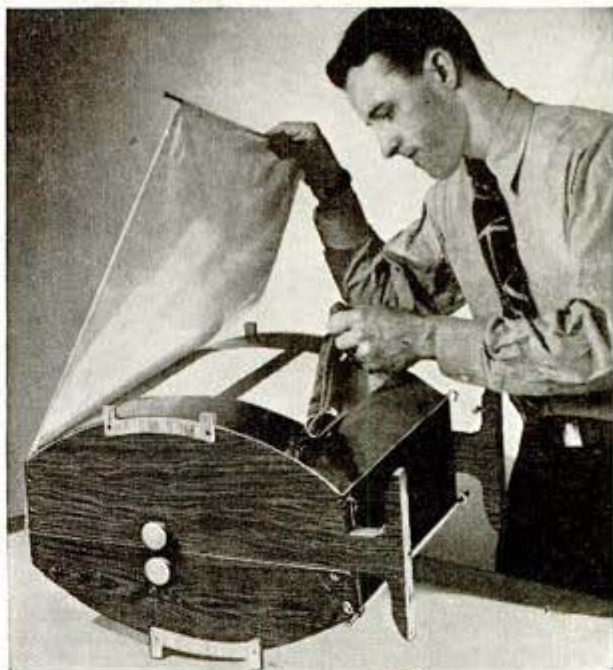
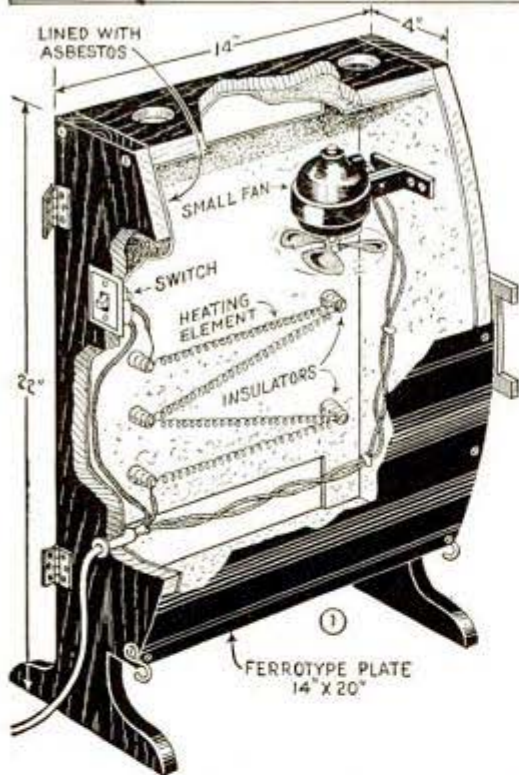

## Dowel and Clothespin Keep Film Submerged in Solution



A length of dowel rod glued in a hole in one leg of a spring clothespin, which can be clamped to the side of a tray, will hold roll film submerged in the developing solu-

tion. This makes it possible to use a small amount of developer in a shallow tray and it is easy to remove the assembly when the tray is used for another purpose.

## Wire Hook Curves Ferrotyping Tin So It Will Stand on Edge

Ferrotyping plates will stand upright while prints are drying if each plate is provided with a wire hook, as shown. The distance between the hooks is slightly less than the length of the ferrotyping plate, holding it in a slight curve. For a 14-in. plate, the hooks should be about 12½ in. apart.

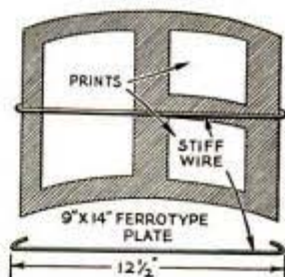

## WHAT KIND OF BOAT DO YOU WANT?

Whether it's a simple rowboat, an outboard runabout or a family cruiser, you'll find something you want among our plans. Build your boat now for the coming season



"Banta," 12-Ft. Runabout—1080-1081

"Banta," 12-Ft. Plywood Runabout—1080 and 1081: Simplified construction makes this plywood runabout easy to build. Here's the boat to take along on that weekend trip. 2 prints 50c.

"Falcon"—1070-1079 Incl.: Trim, sturdy 18-ft. inboard runabout or cabin cruiser. 66 in. beam, 42 in. total depth, 7 or 8 passengers. Makes a speed of about 17 m.p.h. with a 20 h.p. motor. 10 prints, material list and procedure \$2.50.

### CATALOGUE OF PLANS

If you have a home workshop and want some new ideas on things to build, just send your name and address with a 3c stamp for our new 32-pp. illustrated plan catalogue. Lists plans on workbenches, motor-driven machines, garden furniture, models of all kinds, boats, radio equipment, juvenile articles, etc.

Address—Dept. 423, Popular Mechanics Magazine, 200 E. Ontario St., Chicago

"Arrowhead" Sloop—944 to 951: 21-ft. sailboat that can be built by average craftsman. Accommodates up to 10 passengers. Set of 8 prints \$2.00.

"Hi-Ho," 14-Ft. Family Runabout—840 to 845: Powered by 11 to 22 hp. outboard or light inboard motor. Beam 58 in. Set of six prints \$1.50.

"Roamer"—765 to 770: Outboard cabin cruiser. 16 ft. long, 66 in. beam. Requires outboard motor of 20 to 36 hp. Set of six prints \$1.50.

"Skipper"—1018 to 1023: Low-cost, outboard runabout. Can be built for \$30 to \$40. 14 ft. long, 54 in. beam, weighs about 275 lbs. Set of six prints \$1.50.

12-Ft. Rowboat—707: Flat bottom. Can be used with small outboard motor. 25c.

"Sea Saucer"—893: Lightweight sailboat. Length 9½ ft. Planked with 3/16-in. plywood. 25c.

16-Ft. Canoe—811 and 812: Cedar planking covered with canvas. Two prints 50c.

Canvas-Covered Kayak—928 and 929: Light framework covered with canvas. 17 ft. in length and accommodates single passenger. Two prints 50c.

7½-Ft. Plywood Rowboat—1068: Made from waterproof plywood this boat is easily transported on top of car. Complete instructions and material list included. 25c.



# SHOP NOTES

## Treadle-driven, ball-bearing WOODTURNING LATHE

You need not go without a lathe as you can make this sturdy one of wood. Swings 12 in. over bed and 30 in. between centers. A heavy, balanced countershaft provides uniform spindle speed with moderate pedaling

By W. C. Leckey

WITH the exception of turned wooden pulleys and the form to cast a flywheel, you can build this efficient treadle lathe with a few hand tools. Distance between centers can be increased to accommodate turnings more than 30 in. long, but in doing so, the treadle, which must be correspondingly lengthened, is apt to twist when pedaling is done at the tailstock end. Spindle height is such to enable one to pedal the lathe from either a standing or sitting position. Approximately 100 downward strokes of the treadle per minute will give a spindle speed recommended for turning. Common 2-by-4-in. fir stock is satisfactory for the stand. Side and front views in Fig. 8 give the correct length to cut each member. Note how the headstock is incorporated in the twin front legs. Except for fastening the bed pieces, the type of assembly shown to the right of Fig. 3 is used throughout, which permits tightening joints that may become loose. The small pin indicated is provided to keep the members in line when drawing up the bolts. Endless V-beltting or round leather

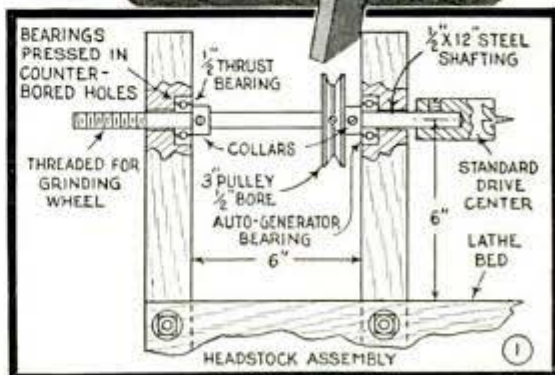
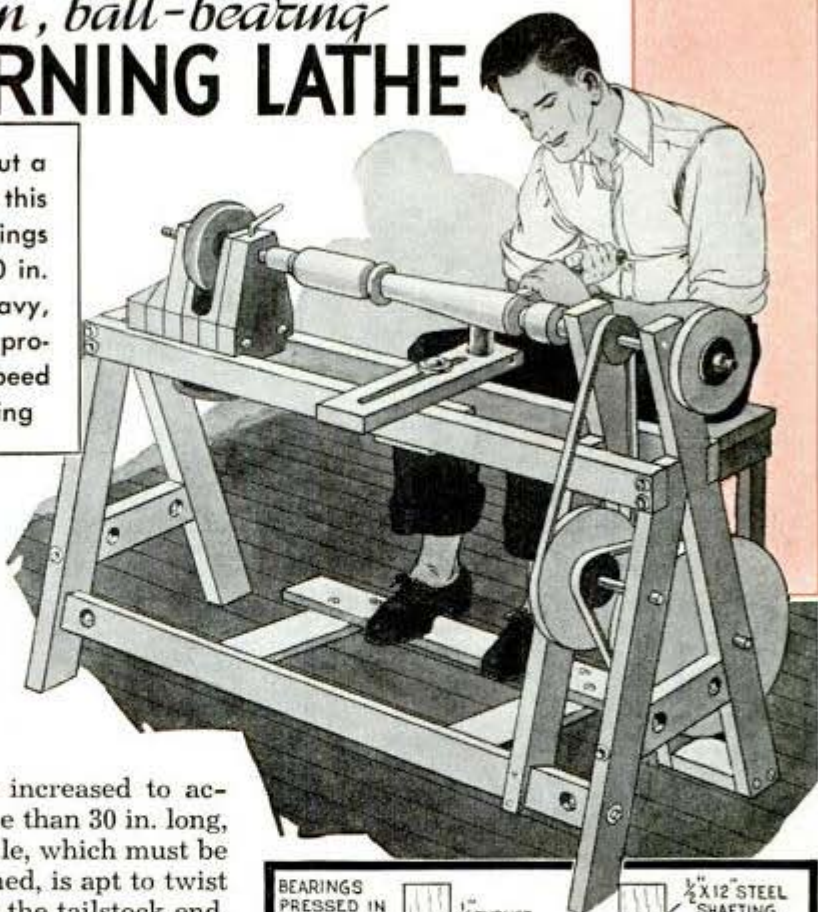

belting, joined, will do to rig the countershaft. As no tension adjustment is provided, it will be necessary, if an endless belt is used to drive the headstock spindle, to vary the position of the rear countershaft pulley to be able to stretch the belt snugly

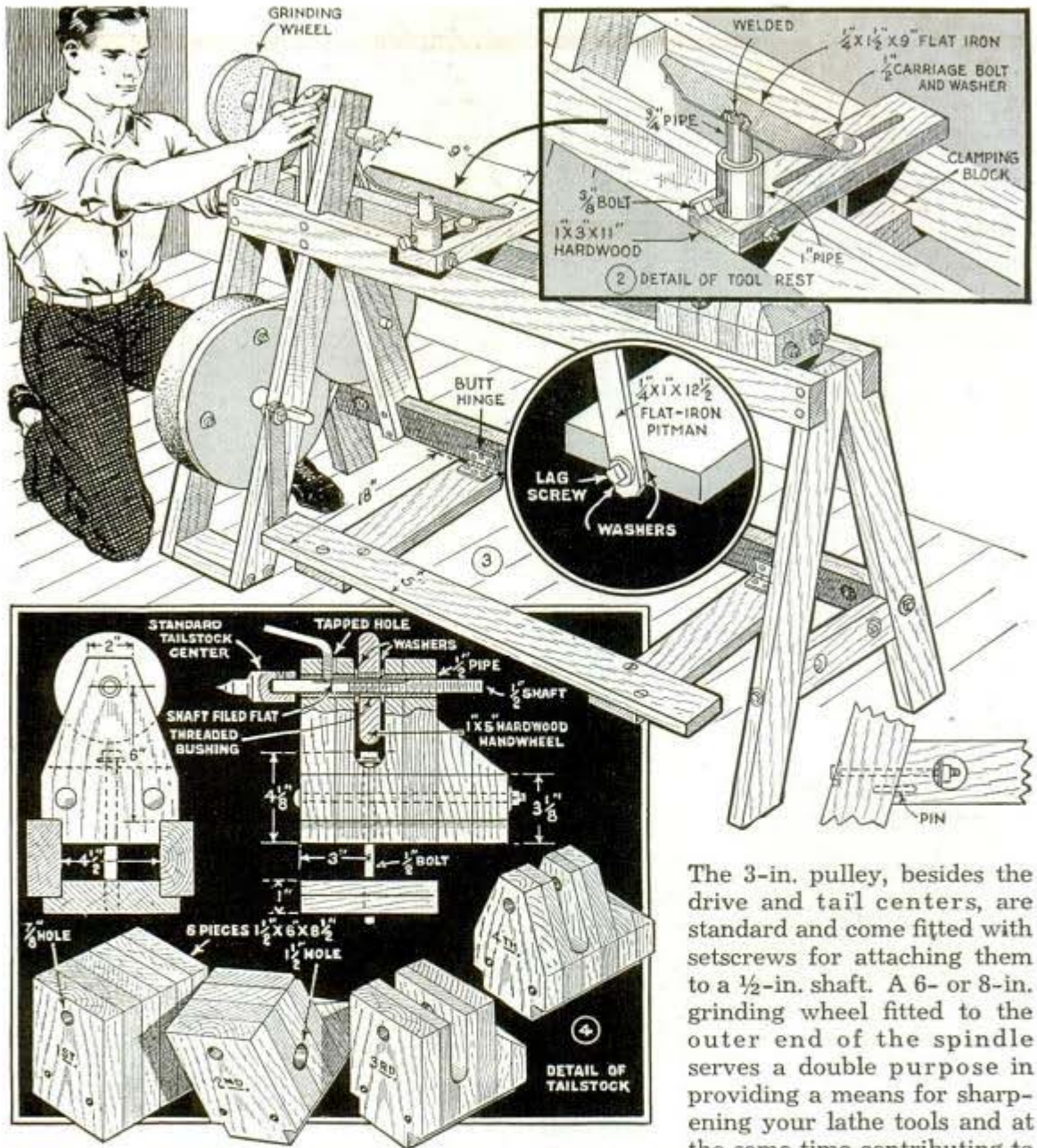

over it. Belt dressing can be used if slip-page develops.

Ball bearings in both the headstock and countershaft make the lathe exceptionally smooth running and are preferred to bronze bearings, although Ford model-T spindle body bushings can be used if you are unable to secure ball bearings. Fig. 1 details the headstock. The holes for the bearings must be centered an equal distance above the bed and counterbored on facing sides to provide a press fit for the bearings. An auto-generator bearing will do for the inner bearing, but the outer one should be of the type to take end thrust when pressure is applied by the tailstock.

the momentum. Collars are used against each bearing to take up end play.

The flywheel detailed in Figs. 5 and 6 provides the necessary momentum to keep the spindle turning at a uniform speed. Extra care must be used in centering the hub to have the flywheel run fairly true. About the easiest way to do this is to first mark a 17-in. circle on the plywood bottom of the form by which it can be centered when fastening it in place with screws. Then a hole is drilled in the exact center to take the 1/2-in. pipe hub snugly. A cleat across the top of the form holds the upper end of the pipe in position, while at the bottom a small block and a coupling



are used. The pipe should extend about  $\frac{1}{2}$  in. above the top of the form. As the drive pulley is fastened directly to the flywheel, greased dowels are placed in the form to provide bolt holes for this in the casting. Use a fairly rich aggregate consisting of cement, 1 part, sharp sand, 3 parts, and place pieces of wire mesh in the form as the pouring progresses to reinforce the work. Allow the concrete to set several days until fully cured. The flywheel is fastened to the pitman crank by a setscrew tapped in the coupling. Note in Fig. 8 that the point of fastening the pitman to the treadle should be directly in line with the flywheel shaft. Bearings for the countershaft assembly are fitted the same as those in the headstock. Plywood is best for the countershaft pulleys, the two rear ones being turned and grooved separately, screwed together and pinned to their shaft. Here collars are used as before to take up end play.

Fig. 4 details the tailstock and shows the progressive steps to follow in shaping the glued-up block. The spindle hole, which is bored while the block is still square, is bushed on each side of the handwheel opening with a  $\frac{1}{2}$ -in. pipe nipple to receive a  $\frac{1}{2}$ -in. threaded shaft. Note that one side of the shaft is filed flat for the end of the lock lever which keeps the spindle from turning when being advanced or withdrawn by the handwheel. The latter is of wood and has a threaded bushing imbedded in its center to fit the spindle. Washers center it in the opening. Both tailstock and tool rest clamp in place by handwheels fitted below the bed as shown in Figs. 7 and 8. The tool rest and holder are made according to Fig. 2. The post socket, which consists of a 1-in. pipe nipple inside a coupling, is anchored to the base by boring a hole in the latter to take the coupling snugly and then drilling crosswise through both for a  $3\frac{1}{2}$ -in. carriage bolt.

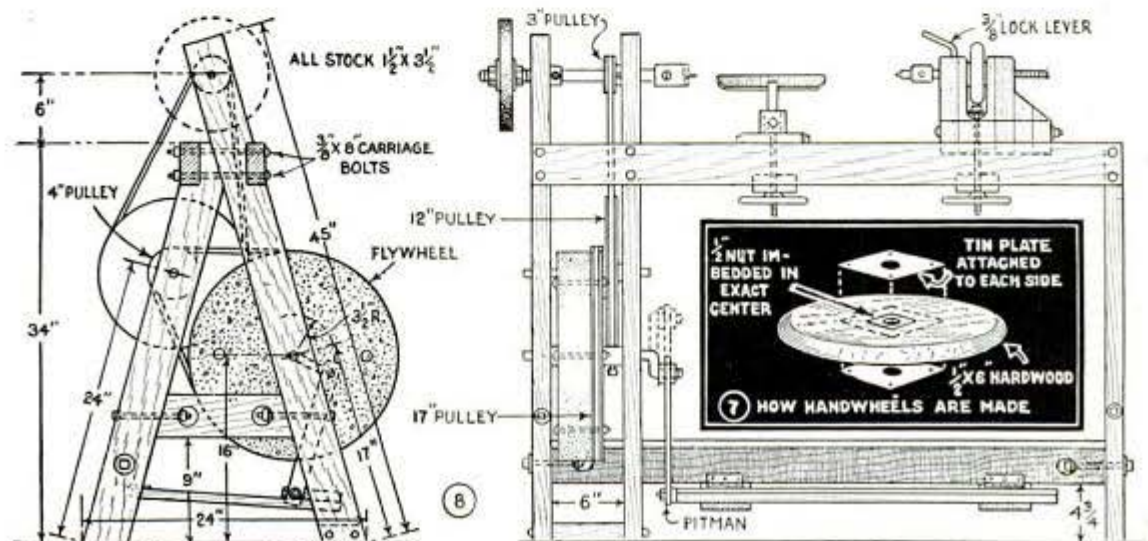
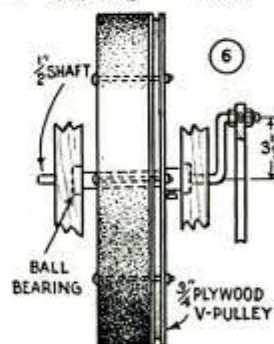
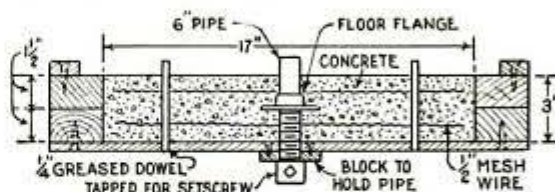

## Handles on Legs of Power Tools Make Them Easy to Carry



One workman who wanted to use small power tools on various jobs away from the shop, devised this simple method of carrying them. Sash lifts were bolted to the legs of each tool stand so that wooden strips could be slipped through them to provide handles as indicated.

## Eliminating Use of Paper Clips

A number of large offices are making carbon copies of answers to letters on the backs of the original letters. This saves staples and paper clips and greatly increases the amount of space in the files.

## Ice Cakes Centered on Gangplank By Length of Angle Iron

To avoid building a wide, heavy gangplank for loading large cakes of ice from a storage building, one workman used a single narrow plank, which was strength-

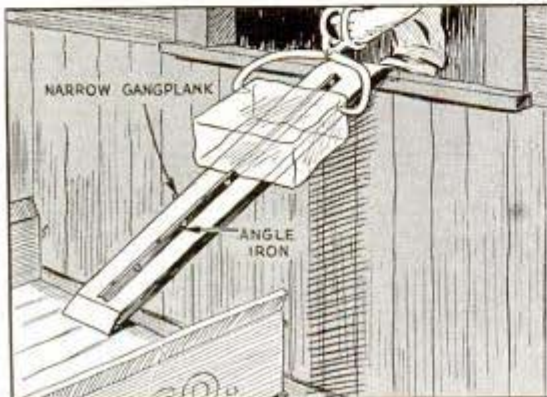

ened with a brace of angle iron. When centered on this incline, any large cake may be handled safely as the iron cuts into the ice to keep it from shifting.

## Slots in Hilltop Fence Posts Take Strain Off Staples

When a wire fence runs up over the top of a hill, and difficulty is experienced in keeping staples in the posts because the tightly-stretched wire pulling downward tends to remove them, try the following method of preventing this trouble. Slot the sides of the post and put the wires in them, driving the staples over the wires. The downward pull of the wires comes on the slots instead of the staples.

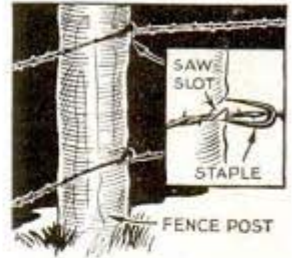

## Rubber Band Used as Book Mark

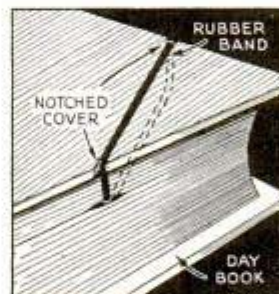

In order to mark a certain page of a day book so that it can be closed and opened at the same page repeatedly, one clerk notched the cover and snapped a rubber band over the notches. The

band can be slipped over the corner of the pages to mark the desired location.

## Diagram on Restaurant Check Shows Position of Patron

Noticing that his waitresses sometimes served the wrong orders when more than one patron was sitting at one table, a restaurant owner had squares printed on the order checks, marking the four sides



by directions as indicated. Then, when a waitress took an order, the patron's place at the table was checked on the square.

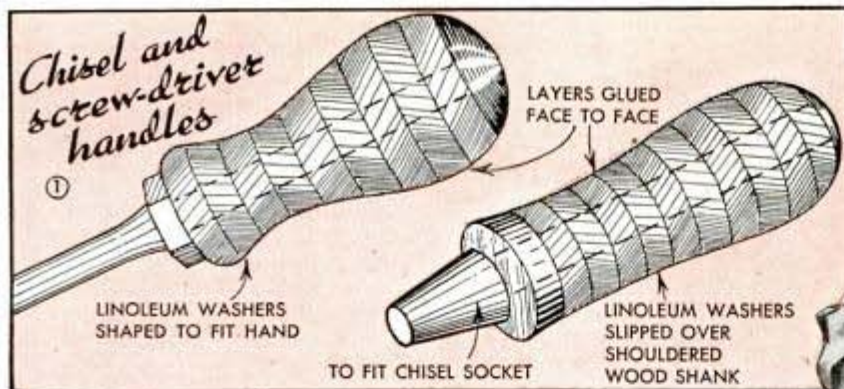

## Shop uses for SCRAP LINOLEUM

SCRAP pieces of thick linoleum, that can be had for little or nothing, provide an excellent material which lends itself to many useful applications in the home shop. For example, wood hand clamps can be made non-marring by facing the jaws with linoleum. These "pads" may be glued to the jaws, or simply kept handy for insertion when the work requires their use. Such slip-on pads may also be used on vise jaws. Serviceable screwdriver and chisel handles, custom shaped to fit the hand, can be built up from linoleum "washers" as shown in Fig. 1, coating them with cement and slipping them over a shouldered wooden shaft. By retaining the centering marks on the ends of the shaft, the handle can be remounted for shaping in the lathe with a sharp chisel, or with a medium rasp, if done by hand.

Specially shaped buffing and polishing wheels, suitable for use on work requiring hard felt or walrus-hide buffers, can be built up in both disk and spindle types as shown in Figs. 2 and 4. Here it is best to shave off the burlap backing before gluing the layers together, so that it will not later produce a ridge which would scratch the work. For polishing, the periphery of the wheel is coated with hot hide glue and rolled in abrasive grains; whereas in buffing, the wheel is charged, while under power, with pumice, tripoli or other cake polishing rouge. For sanding concave or convex moldings, as in Fig. 3, sanding blocks of built-up linoleum will be found superior to wood. Being softer and somewhat flexible, they reduce paper wear considerably.—Clyde Baker, Kansas City, Mo.

GLUED UP TO DESIRED THICKNESS

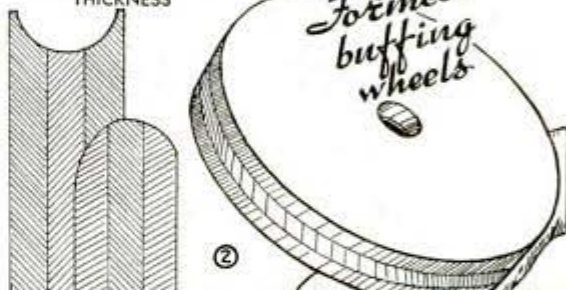

SHAPED TO FIT CONTOUR OF WORK

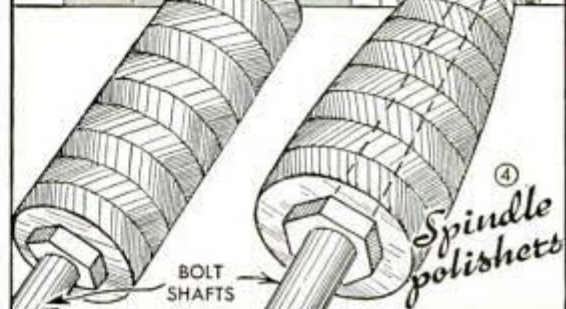

## Shoe-Display Racks on Shelves Hold a Sample of Each Style

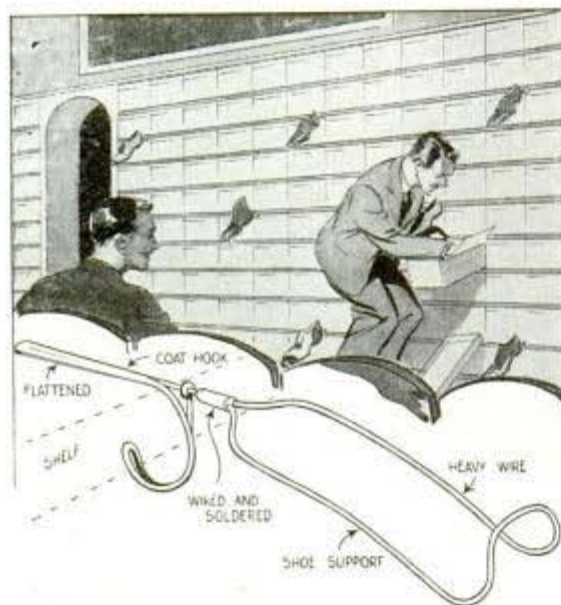

To aid his customers in selecting shoes, one merchant displays a sample of each style on the shelves directly in front of his fitting seats. The shoes are set on individual racks made from coat hooks and wire coat hangers, bent and soldered together as shown. The racks slip on the shelves and require no special framework.

## Circle Gauge Measures Radii Of Irregular Work

It is often necessary in our shop to make drawings, layouts or new patterns from old castings. To facilitate determining the radii of the work, we use a circle gauge of the type shown. It consists of a transparent celluloid disk which is scribed with concentric circle lines spaced  $\frac{1}{16}$  in. apart. The lines are made visible by rubbing a drop or two of black paint over the disk and then

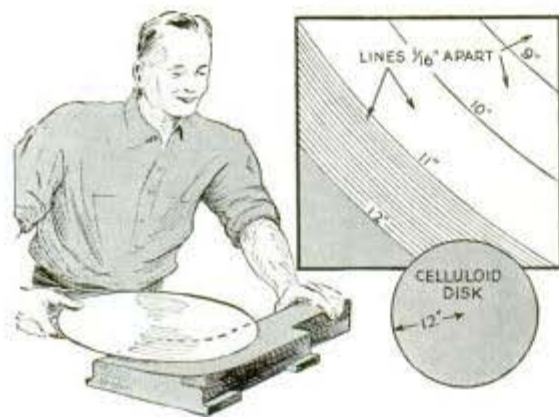

immediately wiping it off. This procedure makes the lines black but leaves the remaining part of the disk transparent. By placing the gauge in position on the work, it is easy to match the radius of the work with one of the scribed circles.

—Arthur Jennings, Derry, Pa.

## Punch Prevented From Sticking By Rubber Depth Gauge

In order to keep his metal punch from sticking, a workman ground the tapered end to provide a shoulder at the point indicated, and then drilled a rubber stopper to fit over the end.

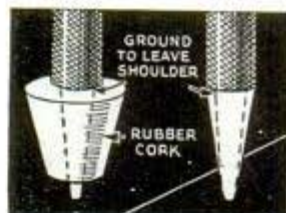

Resting against the shoulder, the stopper gauges the depth to which the punch may be driven, and the rebound of the rubber keeps the punch from sticking in the hole.

## Tool Folds Edges of Screen Wire To Avoid Injuring Hands

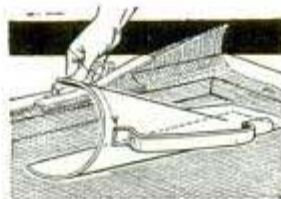

When making door and window screens, one carpenter uses this simple tool to fold over the ragged edges of the screen

wire to make them smooth and avoid injuring the hands. The tool is made from a piece of sheet metal bent as shown and provided with a handle. In use, the edge of the wire is rolled slightly, then started into the tool, after which pulling the tool along folds the wire over tightly.

—Fred W. Schneider, Towaco, N. J.

## Adjustable Ring at Top of Posts Prevents Damage When Driving

Wishing to keep sharpened posts and stakes from splitting at the top when they are driven into hard ground with a sledge, one farmer uses a ring clamp of heavy flat iron.

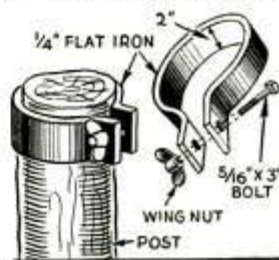

This slips over the post and tightens with a wing nut as shown.

# A Luggage-Type Tool Chest for Woodworkers

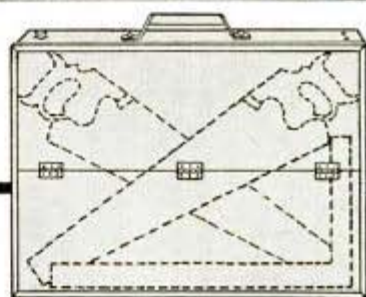
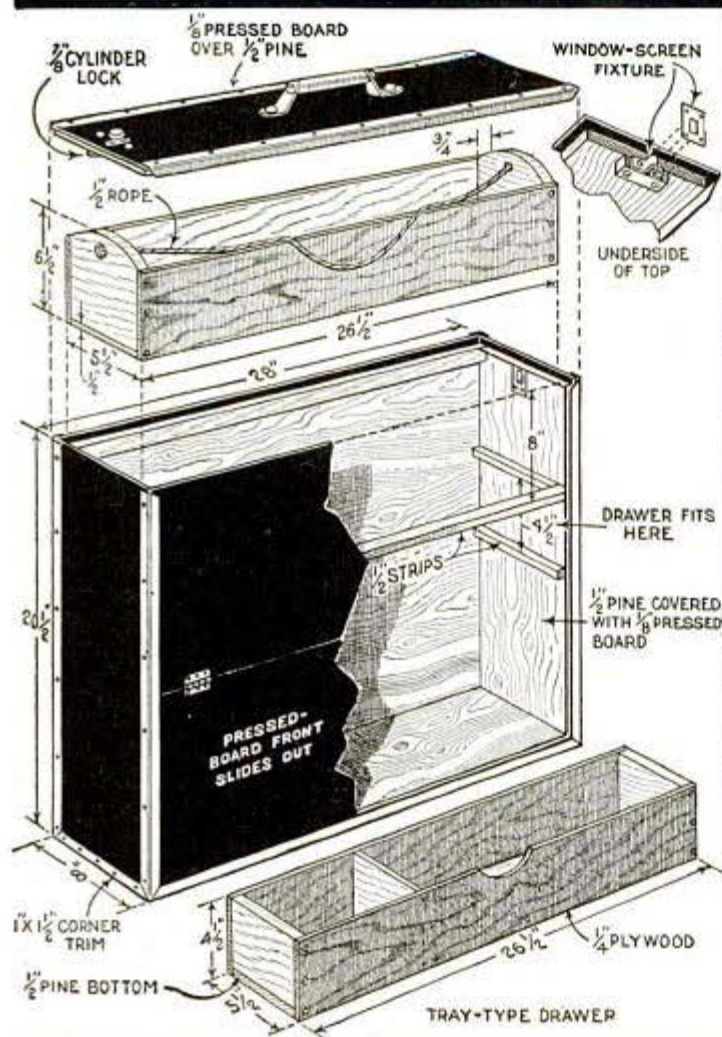

Carried like a suitcase, this rugged tool chest is especially suitable for carpenters who must ship their tools from job to job. The chest is long enough to take several hand saws diagonally across the back behind the trays, and is high enough to take the tongue of a full-size carpenter's square. Where it is necessary to check your tools a long distance by bus or train, be sure to tie the heaviest ones with strong cord attached to screw eyes in the bottom. Construction of the chest is more or less conventional except for the front. After the bulk of the chest has been assembled, the trim is set so that the front panel may be slid into place. Being hinged in the center, the panel may be half removed, turned over and rested on the partly opened tray. This makes all tools readily accessible. The upper tray can be used to carry around on

the job with the various tools needed. All joints should be reinforced with waterproof glue and metal corner trim should be applied to outside edges.

—Keith Vining, Daytona Beach, Fla.

## How to Eliminate Gophers Easily

After traps, water and poison had failed to get rid of a number of gophers, I used moth balls, which eliminated them entirely. In using these, I found it important to open the hole carefully and clean it as far down as possible. Six or seven moth balls are then dropped in, after which the hole is covered so that no light will be admitted.

—E. L. Camp, Los Angeles, Calif.

# MORE MILEAGE

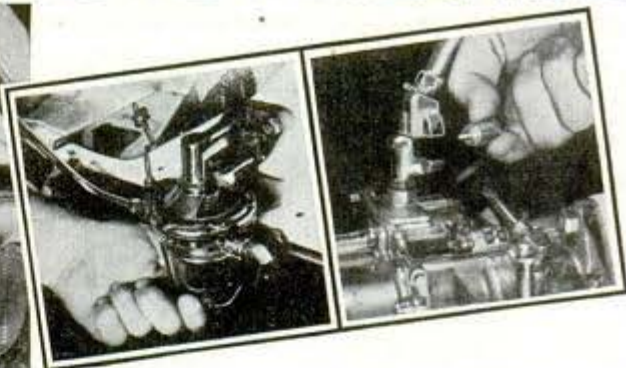

Keeping the sediment bowl and strainers in the fuel line clean helps assure easy starting and saves gasoline. Over-choking delivers raw gas into the motor where it is unburned and is ejected out the exhaust

By James R. Ward

**A**LTHOUGH any of the gas-saving ideas presented here may not mean much individually, the total savings effected by all of them may mean thirty or forty extra miles of driving for each tank of gas. For instance, driving at speeds under 50 m.p.h., and avoiding the habit of accelerating rapidly from a standstill will go a long way toward conserving gas. Rapid acceleration may consume enough gas to have moved the car twice a given distance had acceleration been slow. Likewise, sudden stopping wastes momentum that took gas to build up. Excessive use of first and second gears consumes gas unnecessarily because the motor runs faster and uses more gas per mile than when driven in third or high speed. This is especially true

A battery that is kept in good condition starts the motor quickly and gives a hot ignition spark to fire the fuel charge without waste. In some cases, an air chamber, consisting of an airtight can in the fuel line between the carburetor and pump, has been found to save gas by smoothing out pump pulsations so uniform fuel pressure is maintained at the carburetor

Maximum gas mileage depends a lot on a correctly adjusted spark, which is controlled on most cars by a device known under various names, such as "Gaselector," "Octane Selector," etc. A setting as close as possible to the "advance" end of the scale without causing a knock or ping in the motor is the most economical. On some cars, lowering the fuel-pump pressure aids in saving gas. Often this can be accomplished by shortening the pump stroke, by adding a 1/16-in. gasket at either A or B as shown below

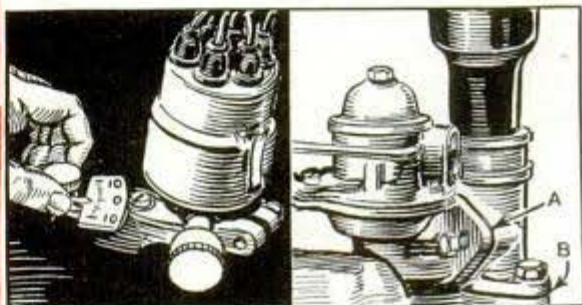
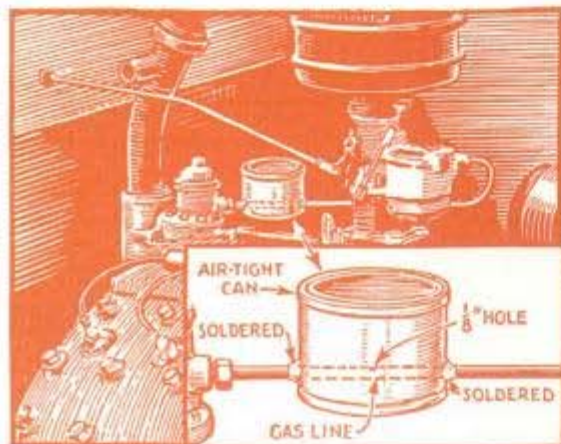

# on LESS GAS

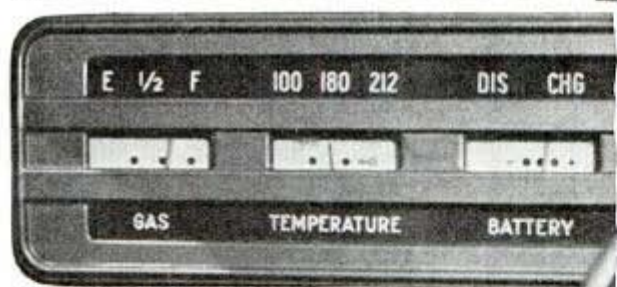

You can't "drive by your instruments," of course, but an occasional glance at them may forewarn you of a condition that will result in excessive gas consumption, such as incorrect motor temperature, oil pressure, charging rate, and the amount of fuel in the tank. A full tank may spill fuel and one with only a few gallons in it allows excessive vaporization

of "stop-and-go" driving in a city where gears must be changed frequently, often several times in a few blocks.

Besides these driving habits there are other things to keep in mind, such as filling the tank to a point where gas may leak out the vent when the car is in motion. On the other hand, keeping too little gas in the tank allows it to vaporize and escape through the vent. Over-choking of the motor and excessive use of the starter as well as "pumping" the accelerator pedal are all habits that result in wasting gas.

Then there is the mechanical condition of the car to consider. It is not the major breakage of parts or misadjustments that waste gas, because we make the necessary repairs immediately. Instead, the gas robbers are the hidden things that affect the car's operation very little. For example, crankcase oil that is heavier than required causes unnecessary drag on the moving parts. The same is true of an incorrectly lubricated chassis, dragging brakes and incorrect wheel alignment. All mean extra power that requires gas to produce.

The condition of the motor, fuel, cooling and electrical systems also has a bearing on gas consumption. A motor with worn piston rings, or valves that do not seat correctly, loses much of its power through the crankcase or exhaust system, thus requiring a larger fuel charge to produce the required power. A carburetor that is adjusted incorrectly may waste several ounces out of every tank of gas consumed. Or, a carburetor with the float level too high may cause an excessively rich fuel mixture. Similarly, a fuel pump that delivers



One way to save gasoline, especially in cold weather, is to depress the clutch pedal before cranking the motor. With the clutch disengaged, the motor will start more easily and less gas will be wasted

the gas under too great a pressure will cause too rich a mixture.

Many of us would be greatly surprised if we realized the amount of fuel wasted by an electrical system that was not in top condition, yet seemed to be working all right. It requires a hot, fat spark inside the combustion chamber to fire the fuel charge efficiently. Corroded or misadjusted spark-plug electrodes may cause sluggish firing of the fuel, which results in loss of power and high gas consumption. The same is true of burned and pitted distributor points, worn distributor rotors, loose or corroded wire connections, weak ignition coils or batteries, etc. All these affect the



Gas lost through leaky fuel-line joints does not produce power

strength of the spark in the combustion chamber.

Remember that the condition of the cooling system of the car has a definite bearing on the amount of gas it consumes. Every motor operates most economically at a certain temperature. If the cooling system is not working properly, permitting the temperature to raise or lower, motor efficiency is reduced and an excessive amount of gas is consumed. Keep the cooling system clean and be sure that the thermostats are set correctly.

## Magnet Hooks on Bumper of Auto to Hold Wheel Nuts

There is no possibility of a wheel nut being misplaced when removing a tire if you use this simple holder. It consists of a magnet from an old magneto which is fitted with a wire hook to hang on the car bumper. As the nuts are removed from the wheel they are placed against the magnet which holds them until they are needed.

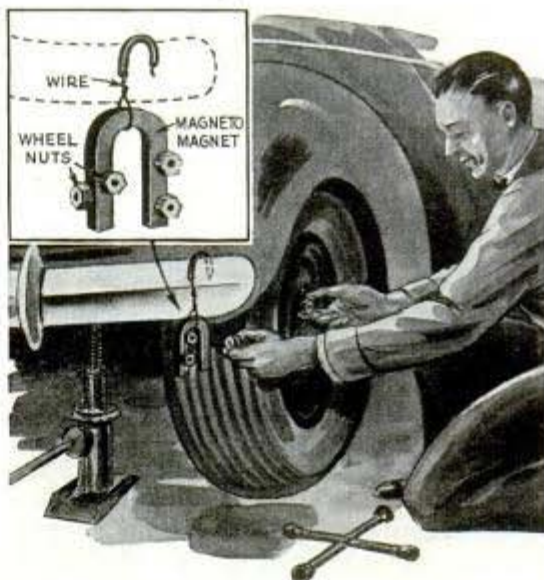

## Puncture in Inner Tube Marked With Indelible Pencil

After locating a puncture in an inner tube by submerging it in water, one mechanic marks the position of the hole with an indelible pencil by circling it and then drawing a cross over it. The wet tube causes the mark to stand out sharply. The pencil is kept in a coil spring soldered to the end of the water tank.



## Battery Cables Removed Quickly With This Simple Puller

If you have trouble removing corroded battery cables, here's a simple puller that will do the trick easily. It consists of a  $\frac{3}{8}$ -in. bolt and wing nut to which are fitted two small hooks that slip under the cable clamp. In use, the wing nut is held stationary with one hand while the other hand is used to turn the bolt by means of a short rod which is welded to the head of the bolt as shown.

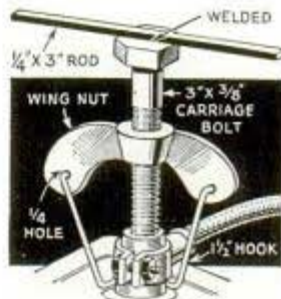



# Motor Commutator Cleaned With Canvas Wiper

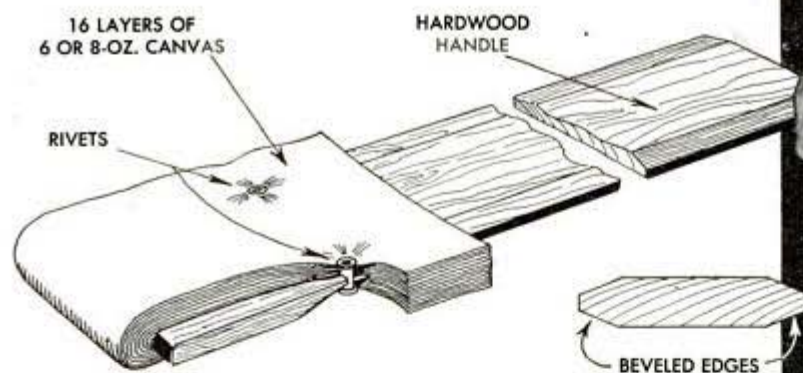

Use of a canvas wiper of the type shown has been found to be one of the best ways of maintaining the surfaces of motor or generator commutators, especially where large motors or generators are operated continuously. If applied at regular periods, the wiper will keep a commutator free of dust and grease indefinitely. The wiper is made by riveting several layers of canvas over the end of a length of thin hardwood, which serves as a handle. The first three or four layers can be removed as they become dirty, after which all the canvas should be renewed.



# Measuring Pole Aids in Taking Inventory of Lumber Yard

To save time in determining the amount of stock on hand, a lumber company uses this pole to measure large stacks of lumber quickly. It consists of a long piece of 3 by

3-in. stock, which is attached to a strong base and has small pulleys at the ends. The pole is marked off in 3-in. graduations, starting 2 ft. from the underside of the base. Measuring is done by a small rope, which is run over the pulleys and the ends tied to a wooden disk, thus making the rope endless. In use, the pole is held vertically against a stack of lumber, and the disk is moved down snugly on top of the stack. Then, holding the rope tightly against the pole so that the disk cannot move, the pole is lowered and the height of the stack noted as indicated by the position of the disk against the calibrated surface of the pole. From this data, the number of pieces or the number of board feet in the stack can be computed quickly.

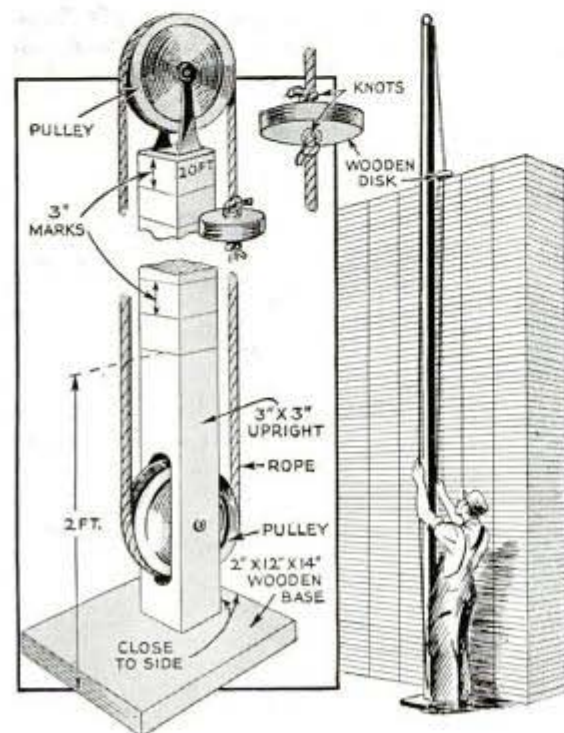

## Tinfoil as Spacing Material

Printers will find that tinfoil, folded into strips about  $\frac{1}{2}$  in. wide, is excellent material for spacing out irregular forms of type. The foil molds itself into any irregularities, providing a firm lockup and helping prevent workups on the press.

—George A. Dagnall, Syracuse, N. Y.

## Angle-Iron Steps on Wagon Box Make Climbing in Easy



Anyone whose work makes it necessary to climb in and out of a high wagon box repeatedly, knows how tiring it can become. To make this easier, one farmer cut two 8-in. lengths from a piece of 2 by 2-in. angle iron and bolted them to the center or "second" box, one being placed inside and one length outside the box. In this position, the steps do not interfere in any way with the removal of the sideboards.

## Auto Wheel Rim Used as Chock To Hold Truck on Hill

The driver of a milk truck who often had to leave his truck parked on a hillside avoided any possibility of the truck moving by using a chock made from a quarter section of an old auto wheel. Such a chock is light in weight and much easier to handle than a wood block or a stone of suffi-

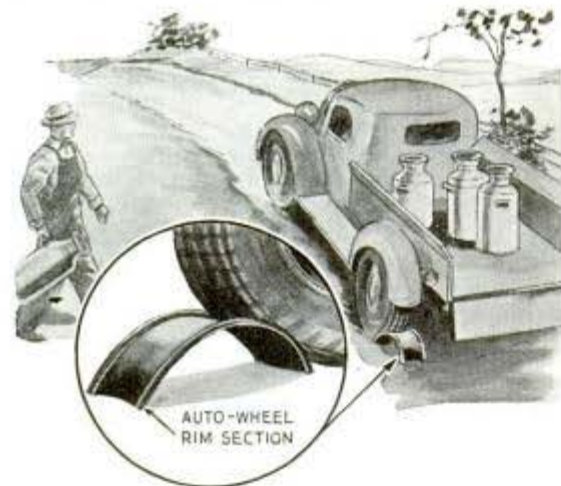

cient size. The chock can be carried in the truck conveniently where it takes little space and is ready for instant use.

## Map on Wall Is Kept Rolled Up By Cord and Slotted Ferrules

To keep wall maps or charts rolled up out of the way, yet available for instant use, one school teacher drilled the ferrule ends of the upper roller for

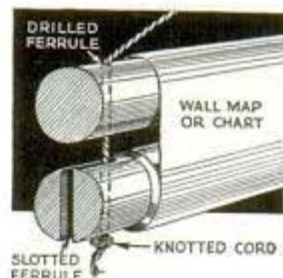

hanging cords and slotted the ferruled ends of the lower roller so that the knotted cord ends could be pulled into them. Thus the map could be rolled up and the cord slipped into the slots of the lower roller.

## Label Scraper for Shipping Clerk

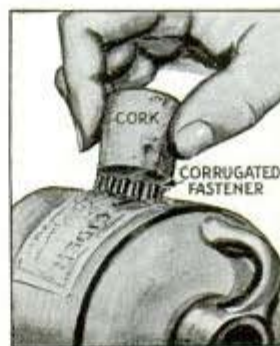

A shipping clerk who often had to scrape off old labels from boxes and other containers, found that a corrugated fastener was ideal for the purpose. The fastener is merely pushed into the small end of a large cork which then serves as a handle. The fastener is better than a knife for this purpose because it will make several deep scratches with one swipe across the label.

## Trees Protected Against Rabbits

One orchardist claims that it is unnecessary to wrap small trees to keep rabbits and other animals from damaging them. Instead, he applies liberal coatings of fish oil to the tree trunks. The oil should be applied in cool weather when it is thicker so that a heavier coating can be applied.



## Screw Eye and Staple on Ladder Hold Eavestrough Tie Wires

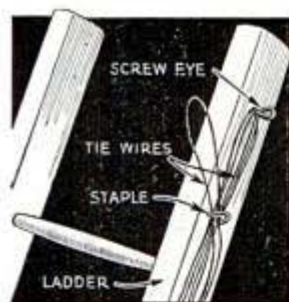

When putting new eavestroughs on a home, one tinsmith keeps tie wires for them conveniently at hand by fastening them to one side of his ladder. This is done by driving

a staple part way into the ladder and then just above it driving in a screw eye. In use the lacquered tie wires are run through the staple and slipped over the screw eye thus making them easy to remove.

## Light Guidelines on Showcards Made With Mimeograph Stylus

Instead of using a pencil to outline lettering and designs on showcards and then being obliged to erase them, one artist uses a ball-pointed mimeograph stylus in place of the pencil.



This scores the card stock with smooth grooves which are sufficiently visible for the artist to follow, yet scarcely apparent to a casual observer.

## Boring Bits From Piston Rings

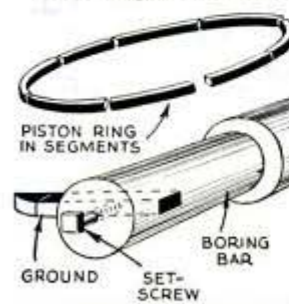

Broken into sections as indicated, an old autopiston ring can be converted into several boring bits for use on small lathes. The rings are very hard, and when ground to shape will stand

up well. Other worn out parts of a car can be used too, such as valves, stems, etc.

—Private Erwin Plavec, Ft. Lewis, Wash.

☐ Solid wood desk or table tops can be prevented from warping by making saw kerfs 6 in. apart on the underside.

## Cultivator Shovel Used as Tool For Peeling Green Logs



Needing a tool to remove the bark from a number of green logs, a workman fashioned one from a discarded cultivator shovel and a length of pipe as indicated. The pipe served as a handle for the shovel, the point of which was forced easily between the bark and the log.

## Sunflower Stalks Left Standing To Provide a Snow Fence

To keep snow from drifting and blocking his yards and drives, one farmer plants sunflowers in strips along the ends of the fields near the barn. The strips consist of three rows, the plants alternating 20 in. apart each way. In the fall when the ripened heads are harvested the stalks are left standing, providing an effective snow fence.



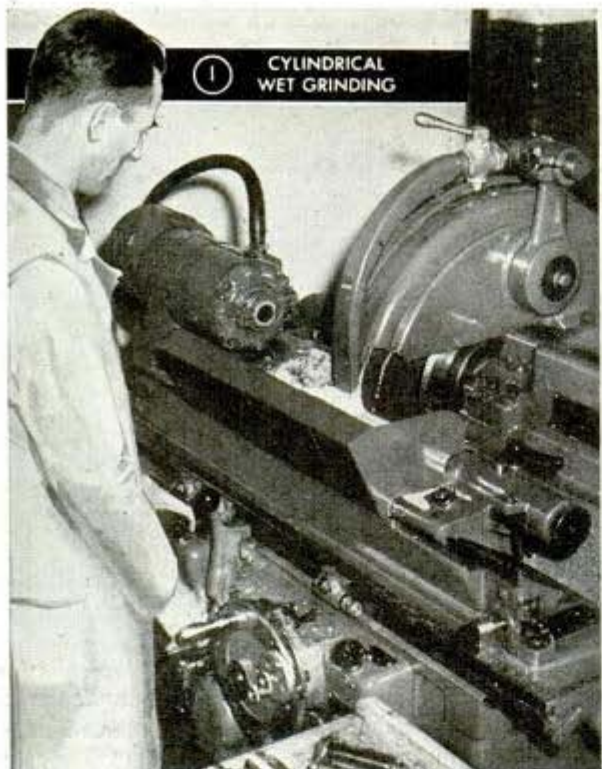

# Basic Hints on

By H. J. Chamberland

IN A PREVIOUS article on the subject of precision grinding, various types of grinders, their purposes, and their methods of operation were covered so that the average machine-shop apprentice could obtain the highlights of grinding practice. This article is intended to give the apprentice information so that he can get some experience in small grinding and lapping jobs, besides furnishing him with some basic data of value in grinding and lapping procedure.

**Grinding as a finishing process:** Originally, grinding machines were used principally to true work that had been distorted by hardening; but today grinding is the most economical process of finishing parts with extreme

accuracy, largely because it takes less time than any other method. Cylindrical grinding machines, of which an example is shown in Fig. 1, are used to grind cylindrical and tapered work, having provisions for depth of feed, automatic stop, control of cutting speed, automatic crossfeed, application of cutting oil or coolant on the work while grinding, etc.

**Wet-grinding set-up for lathe:** Considerable experience in cylindrical grinding can be obtained by any apprentice who can rig up and use a tool-post grinder on an ordinary bench metal-turning lathe as shown in Fig. 2. As a coolant is helpful and often essential, it is advisable to provide a nozzle and splash guard over the wheel, and a drainage pan below the wheel as shown in Fig. 3. Exact sizes of the parts, of course, are variable and depend on your particular type and make of lathe. The pan is slipped over the tool post of the cross-feed slide, and a water-tight assembly is provided when the compound swivel is tightened in position. Fig. 2 shows a view of the set-up with the wheel guard removed. The nozzle is held on the front of the grinder vertical slide. The coolant is carried to the nozzle through a rubber tube, which connects to a container, such as a 5-gal. can, placed behind the lathe at a suitable height above

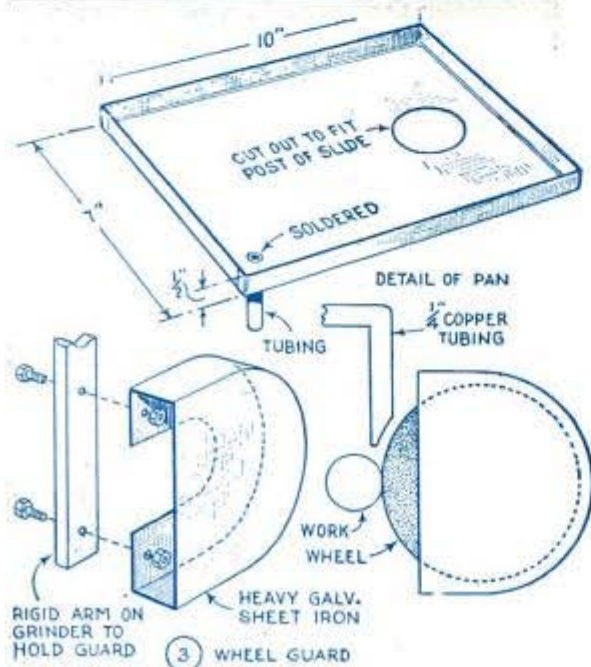
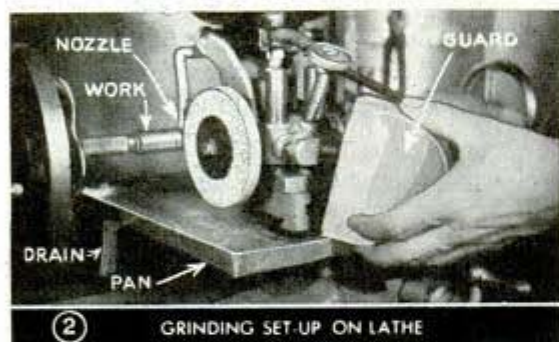

# GRINDING *and* LAPPING

the work. A valve at the container, or other device to constrict the rubber tubing is necessary to control the flow of the coolant and to be able to shut off the stream when necessary. A good coolant for grinding on such a set-up is made by dissolving sal soda, 4 oz., coal-tar disinfectant, 1 oz., and water, 4½ gal. The flow can be regulated so that this amount of coolant will last from 1 to 1½ hrs. before the supply container runs empty. Then, after the coolant has served its purpose, and has run out of the tray into another container placed in the rear or under the lathe, it can be used over and over again. However, a suitable filter or screen should be provided in the drainage line to keep particles of metal out of the liquid that runs to the lower container. Or, the liquid can be siphoned out of the lower container after standing undisturbed for 24 hrs., which enables the metal particles to settle to the bottom. If this is done, the lower portion of the liquid containing the metal should be discarded.

**Making plug gauges:** As every machinist should have a set of plug gauges for checking internal diameters of holes, the job of making a set of these is an ideal project for the apprentice as this gives him an opportunity to become familiar with grinding and lapping technique. Figs. 5 and 6 give the shape, size and dimension of ten plug gauges, which will fill the average needs. The correct grinding wheel for the job is important and as no single wheel can answer all purposes, the chart, Fig. 16, pertaining to the selection of grinding wheels, should be consulted freely.

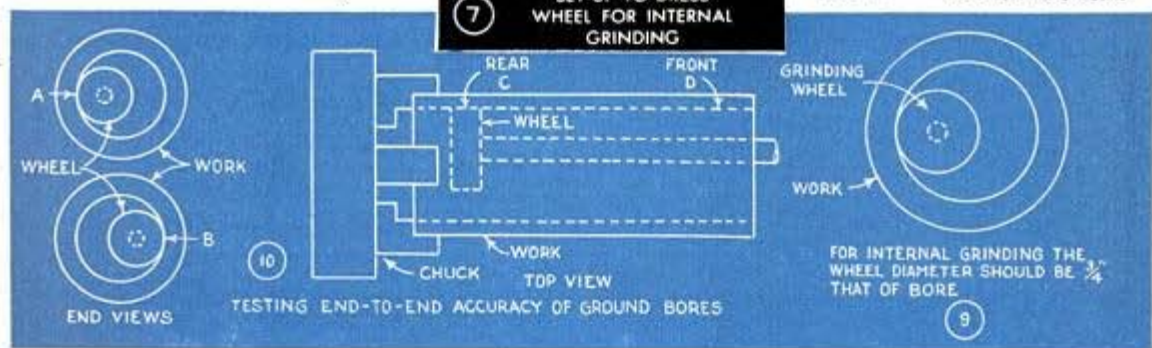
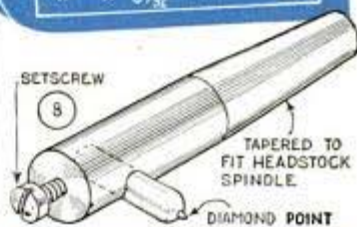
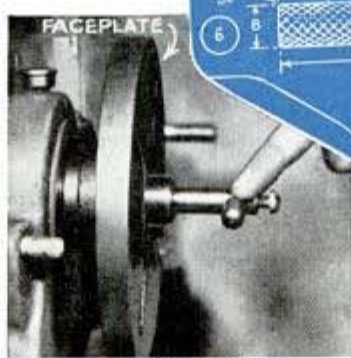
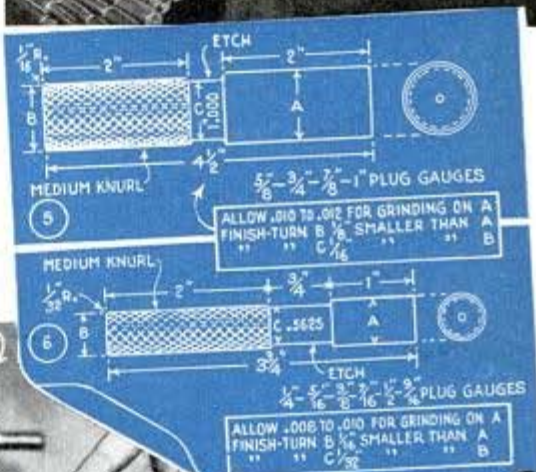

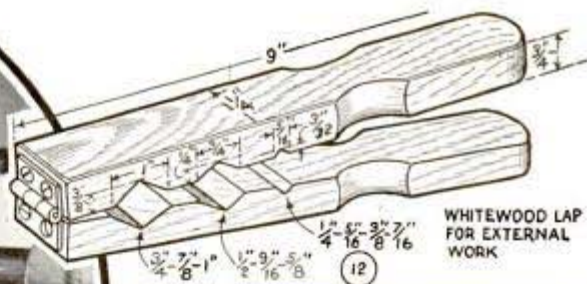

**Gauges are rough-ground:** After the gauges have been turned to approximate size, they are hardened and then the holes to take the centers are polished, after which the centers of the lathe are reground—the tailstock center last. To grind the surface of the gauges, the wheel must be dressed

properly because in tool-post grinding, there must be complete parallelism between the wheel face and the surface of the work. You should dress the wheel by means of a diamond nib set crosswise into a length of  $\frac{3}{4}$ -in. stock, mounted between centers. This is the most efficient method of dressing a wheel for grinding work held between centers. In proceeding to rough-grind the gauges, use just enough coolant to prevent heat. Grind to plus (a little over) .003 in. over the finish sizes. In this operation, the primary object is to grind straight and concentric rather than to produce a very fine finish.

**Aging the gauges artificially:** Unlike other machine-shop tools, gauges must undergo a certain treatment called aging or seasoning. This is highly important in order to assure that, regardless of any change in temperature, the tools will return to their finish dimensions at a temperature of 68 to 70 degrees F. In cases where it is impossible to allow a period of from 3 to 6 months for aging, tool steel can be aged artificially. The procedure is to dip the gauges into ice water first and then into boiling water as illustrated in Fig. 4. Each immersion should last about 30 sec-

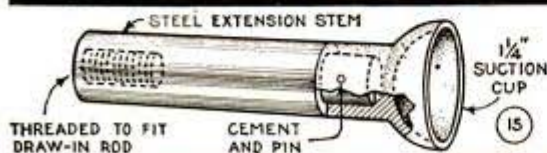
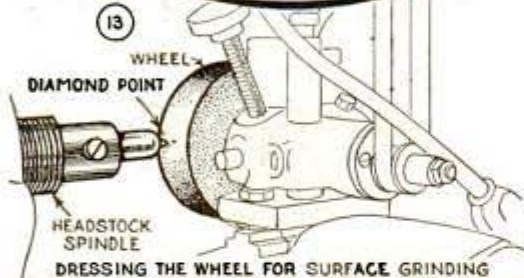

(16) SELECTION OF GRINDING WHEELS TO SUIT WORK FOR GENERAL SHOP USE

Grinding Operation	Hardened Steels	Soft Steel	Cast Iron	Brass	Bronze	Aluminum	Glass	Hard Woods
Cylindrical	38-46-L	38-46-N	37-36-J	37-36-K	37-46-K	37-30-J	37-36-J	37-24-K
Internal	38-60-J	38-46-L	37-46-J	37-36-J	38-60-J	37-46-K	37-60-H	37-24-K
Surface	38-36-H	38-36-L	37-30-J	37-24-H	37-24-H	38-46-H	37-100-N	37-24-K

PERIPHERAL SPEEDS—4500 TO 5000 S.F.P.M.

NOTE: Above recommendations given by one manufacturer. Similar combinations are available in other makes. For surface grinders having direct-drive, ball-bearing spindles, select wheel one grade harder than given in chart. Grinding wheels are harder in alphabetical order.

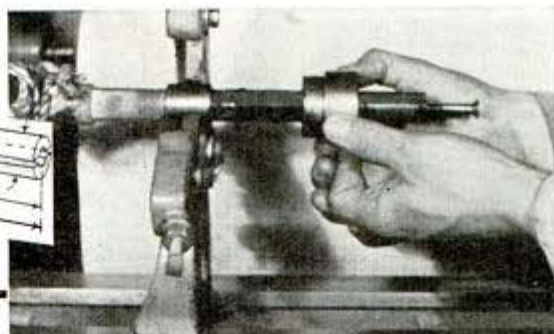
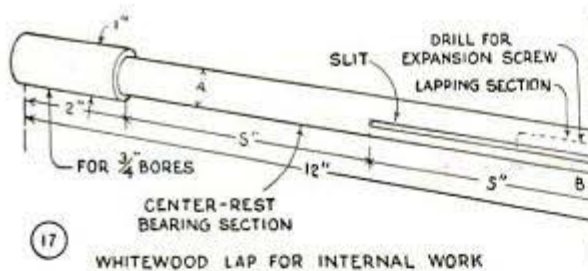

18 LAPPING BORE OF DRILL BUSHING



19 LAPPING SIDE OF PARALLEL BLOCK

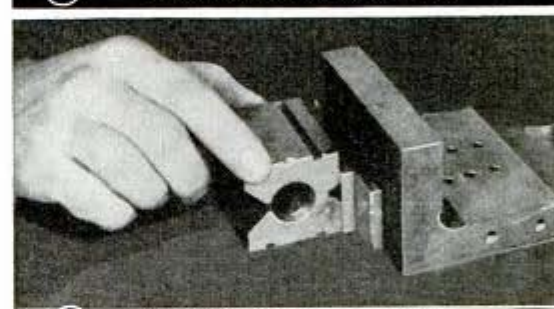

20 BLOCKS ARE LAPPED TOGETHER



21 WELL-LAPPED SIZING BLOCKS WILL ADHERE TO EACH OTHER

onds and the cycle should be repeated twenty or thirty times. Then the work should be set away for 48 hrs., in a place where the temperature is constant between 68 and 70 degrees F.

**Gauges are finish-ground:** When finish-grinding the gauges, the speed should be slow and the feed light, allowing no more than .0005 in. and no less than .0003 in. for lapping. See that the temperature of the coolant and the air in the workshop is about 65 degrees F. while finish-grinding.

**Tips on internal grinding:** Before continuing with the procedure of lapping the gauges, a few miscellaneous tips about grinding in general will be given here, rather than return to this subject later. For internal grinding no coolant is used. Best results are obtainable when the wheel diameter is close to three-quarters that of the bore, and there is sufficient wheel-to-work contact surface. See Fig. 9. The wheel should be dressed properly from the headstock as in Fig. 7, with the tool shown in Fig. 8. After removing a small amount of stock from surface A, Fig. 10, check the bore to see if the cut is straight. Then feed the wheel across to surface B, barely contacting the center of the bore to spark slightly, after which the wheel is traversed the entire length of the work. If there is a heavier spark at front D, the bore is tapered, being large at location C. This condition can be vice versa.

**Rotary surface grinding:** For surface grinding on a faceplate as in Fig. 14, where the grinding wheel travels parallel to the surface of the faceplate, you should dress the wheel as shown in Fig. 13. This is similar to the arrangement shown in Fig. 7, except that the diamond nib is held in the

22 SELECTION OF FINISHING COMPOUNDS FOR GENERAL SHOP USE

MATERIAL	TYPES OF COMPOUND		
	NO LIMIT SIZE	TO REMOVE .0005 to .001 in.	TO REMOVE .0005 in. or less
Hardened Steels	1st R.7-Coarse 2d R.7-Medium 3d R.7-Fine	1st R.7-Medium 2d R.7-Fine	R.7-Fine only
Soft Steels	1st W.7-Coarse 2d W.7-Medium 3d W.7-Fine	1st W.7-Medium 2d W.7-Fine	W.7-Fine only
All Soft Metals	1st G.7-Coarse 2d G.7-Medium 3d G.7-Fine	1st G.7-Medium 2d G.7-Fine	G.7-Fine only
For Extra-Fine Finish on Any Surface	Remove last .0001 in. with H-41-Medium and obtain mirror-like finish with A-50-Medium		

Note: Above recommendations are given by one manufacturer. Similar mixtures are available in other makes.

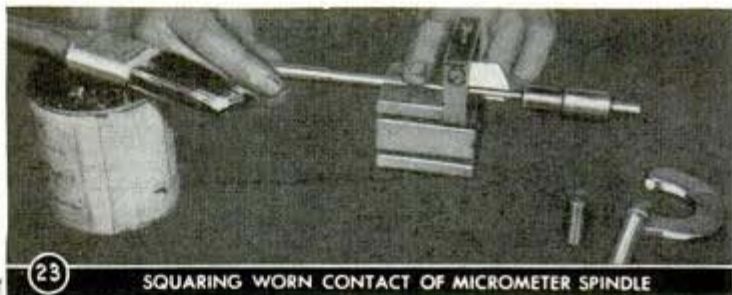

23

SQUARING WORN CONTACT OF MICROMETER SPINDLE



24

SQUARING WORN CONTACT OF ANVIL WITH IMPROVED ALIGNING SLEEVE

opposite plane. Fig. 15 shows how a suction cup is used to hold work on a faceplate when other methods of holding it are neither available nor advisable. You simply fit a steel stem to a vacuum cup such as used to lap automobile-motor valves. Insert the assembly into the spindle and pull in with the draw-in rod. By pressing the cup against a smooth surface and using a common household spring scale, you will discover a resisting pull of 10 lbs. for a 1¼-in. cup. Always spot-grind the plate lightly before proceeding, and if the work is rather heavy, adjust it and flow a dash of quick-setting liquid solder on all four sides.

**Lapping methods:** At its best a ground finish looks like a series of hills and valleys when magnified. While not so apparent to the naked eye, these minute imperfections can be removed by lapping, which can be done as well in the basement as in any well-equipped tool room. The requirements are a good lapping tool or lap, a compound suitable for the job, and some patience. The compound must be about

the same hardness as the material to be lapped, but, the lap must be considerably softer than the material. Finishing compounds are scientifically prepared and homemade concoctions should be avoided. A single mixture will not serve all needs and therefore the data chart on the selection of finishing compounds for general shop use, Fig. 22, should be followed carefully. Whitewood makes the best and most economical lap. Amateurs should use only fine compounds until they are acquainted with their rapid-cutting properties.

**Cylindrical lapping:** A universal lap that will serve for the entire set of plug gauges is shown in Fig. 12. Start with a large gauge, apply the compound generously to it and also to the lap, and proceed as shown in Fig. 11. The speed should be about 300 r.p.m. and the lap should traverse the work slowly and with light pressure. Check frequently for size and finish, and use a hot, strong solution of washing powder to clean all surfaces, wiping them with a piece of cheesecloth.

**Internal lapping:** Fig. 17 shows a white-wood lap for internal lapping. It should be a snug fit in the bore. One end is slit and fitted with a wood screw to expand it. In use the lap is mounted between centers being driven by a dog and supported by a center rest, using a steel bushing for a bearing as shown in Fig. 18. Then the compound is applied to both the lap and bore. The work is fed slowly, using an oscillating movement and constantly changing the position of the bore with relation to the lap. In Fig. 18, a drill bushing is being lapped with a spindle speed of 300 r.p.m.

**To lap two parallel surfaces:** It's an easy matter to lap the surfaces of two parallel blocks by first lapping one side of each on a surface plate. Most of the plate is covered with compound and one side of each block is lapped as shown in Fig. 19. Use a circular movement and keep changing the location of contact. Then the two blocks are lapped together with their previously



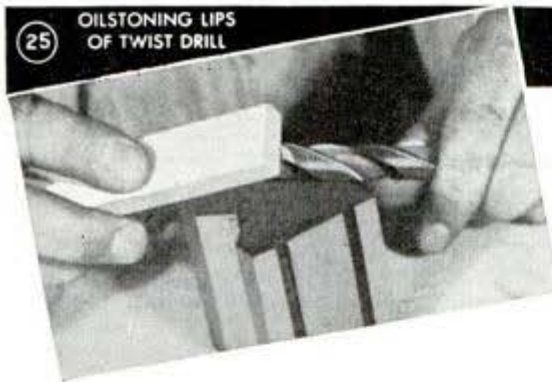

25 OILSTONING LIPS OF TWIST DRILL

lapped surfaces set against a V-block and an angle plate respectively as in Fig. 20. In this way both surfaces of each block will be parallel. When small blocks are well lapped, they can be wrung together so that they will adhere to each other as in Fig. 21.

**Lapping worn micrometer contact points:** A micrometer may be adjusted to read correctly but this does not mean that it will measure accurately, as the contacts on the spindle and the anvil may be worn. You can easily correct this error as follows: Remove the spindle and clamp it to a V-block as shown in Fig. 23. Use a thin piece of paper to raise the spindle slightly and then lap the end to the squared end of a piece of drill rod. Replace the spindle in the micrometer frame, and with a small sleeve bored blind to fit on the spindle, lap the end of the anvil as in Fig. 24. Use sufficient pressure and oscillating movement in each case.

**Oilstoning metal-cutting tools:** Oilstoning is really another form of lapping. By oilstoning the lips of twist drills as in Fig. 25, you can increase the feed and speed, and get more holes between grinds. If the chamfered corners of reamers are oilstoned

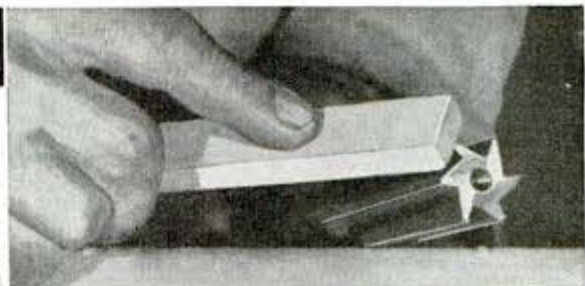

26 —THE CHAMFER CORNERS OF A REAMER,

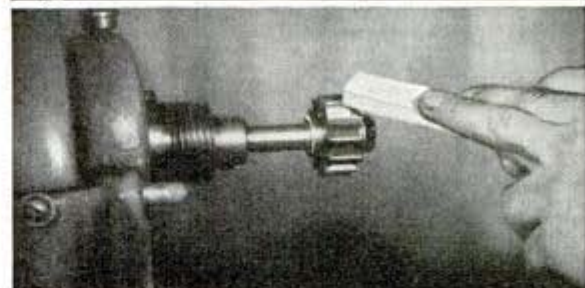

27 —THE EDGES OF MILLING CUTTER,

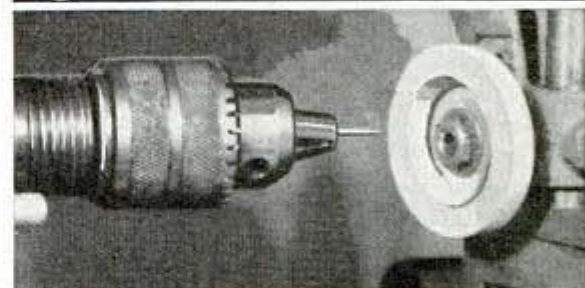

28 —AND, THE POINT OF A SCRIBER

as in Fig. 26, they will produce a mirror-like finish when reaming in brass or bronze. An oilstone also will remove fine, impregnated chips from the edges of a milling cutter as shown in Fig. 27. The best way to smooth down a sharp point, such as that of a scriber, is to make use of a grinder and a wheel oilstone as shown in Fig. 28.

**Next Month: Machining With Turrets**

## Chart Aids Customer in Selecting the Correct Size of Nail

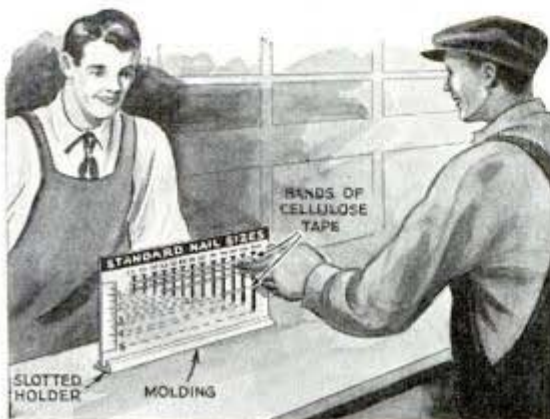

To enable inexperienced customers to select quickly the correct sizes of nails needed for their work, one hardware dealer uses a display chart of the type shown. Nails of the most common sizes are taped to a cardboard with the penny size marked directly above them. At the left end of the chart is a scale marked off in divisions of  $\frac{1}{4}$  in. with dotted lines running from the lower ends of the nails to the scale. In this way, the customer can glance at the chart and order the correct size of nail for the job he plans to do.

## Horseshoe Pivoted to Fence Post Anchors Outdoor Feedbox

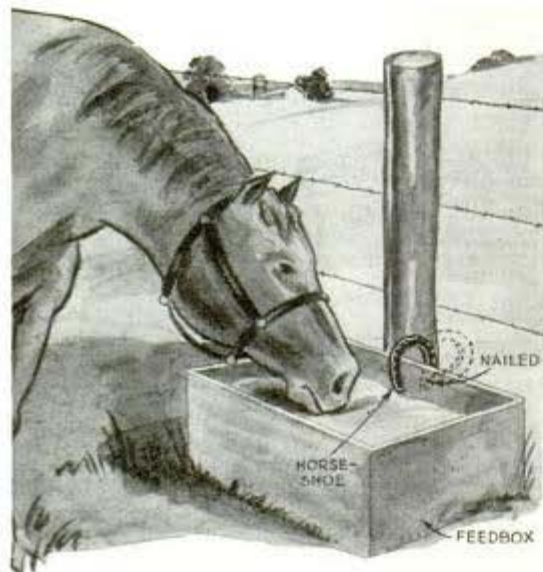

When an animal is fed in an open box outdoors, it can be kept from upsetting the box by using a horseshoe pivoted at one end to a post or stake. This permits the box to be removed easily for cleaning, yet keeps it securely in place when turned over the box edge.

## Simple Reamer for Sheet Metal



four sharp edges. One end of the tool serves as a handle while the other is being used.

This reamer is just the thing for enlarging holes in sheet metal. Made from a 12-in. length of  $\frac{1}{2}$ -in. tool steel, the reamer is tapered at both ends, each one being of a different size. The tapered portions should be ground square to provide

## Safety Pins Hold Sign on Screen

Owners of markets, stores and shops who have frequent occasion to display small signs on their screen doors will



find that ordinary safety pins provide ideal fastening devices. When pinned to the screen in the positions indicated, they hold each corner of the sign securely.

## Spike Point in Back of Miter Box Keeps Work From Slipping

Small strips of wood will not slip out of position when cutting them in a miter box if you drill and tap a small hole through the back of the box and insert a

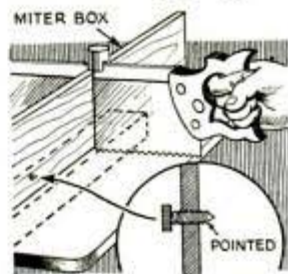

small pointed screw as indicated. The pointed end should just project through the back. By pressing the positioned work against the point of the screw, it will not slip when the cut is started.

## Creased Wrapper Holds Coins For Easy Rolling

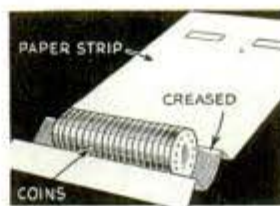

To avoid the difficulty of holding a stack of small coins together for rolling them in a paper strip, one cashier suggests that the strip be creased at the end as shown. This provides a stiff trough in which the coin stack may be held in correct alignment.

## Gun to Form Pattern Fillets

Wax for pattern fillets is best prepared in the form of slender sticks from  $\frac{1}{16}$  to  $\frac{1}{8}$  in. according to the work at hand. The wax sticks are made easily in a pressure gun assembled from a pipe nipple and two caps. The nipple is reamed smooth inside and a steel piston or plunger is fitted inside to force the wax out. Cartridges of wax can be prepared for quick insertion into the gun by melting it into paper tubes of suitable size.



## Paint Color Shown on Container

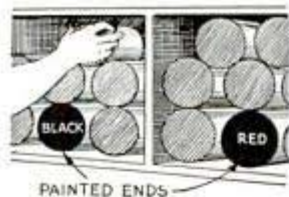

To aid his customers in selecting the color of paint they desire, one dealer stacks the various colors in different piles on his shelves and then paints the bottom of one can in each pile. In this way, a customer can pick the color desired without the dealer taking the time to show a color chart and wait while the customer makes his selection.—John Krill, Youngstown, O.

## 'Megaphone' on Tractor Exhaust Eases Throb of Engine

After enduring the pounding exhaust of a heavy tractor engine for long intervals, one driver welded a sheet-metal funnel to the top of a high exhaust stack. This eased the pounding throb of the engine and at the same time caused no back pressure, which is an objectionable feature of a conventional muffler on a heavy-duty engine. The flaring top of the tall exhaust stack deflects the sound upward and away from the driver.

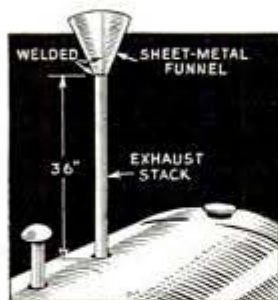

## Oiled Paper Protects Plow Against Rusting



Experiencing the usual trouble in removing heavy grease used to protect a plow moldboard against rust, one farmer coated the polished surface with light machine oil and then pressed sheets of oiled paper into contact with the surface. The paper adheres tightly to the metal, yet is stripped off easily when the plow is to be used again.

When papering a room, cut the paper about 2 in. beyond the corners, then either butt or lap the next piece, and you will have no trouble with wrinkles.

## Paper Stapler Closes Small Holes In Filled Grain Sacks



Operators of grinding mills and others who handle large quantities of sack feed will find an ordinary paper stapler handy to close small holes in sacks without emptying them. This quick repair is made by bringing the torn edges together and then turning a portion of them under, after which several staples are clinched along the opening to close it effectively as shown.

—Pio Panieri, Roslyn, Wash.

## Strong Doubletree Is Assembled From Model-T Front Axle

When hauling large logs and other heavy loads over mountainous roads, my team broke many doubletrees, which led me to assemble one from an old car axle that has lasted over three years. Being approximately the same length as an ordinary doubletree, all I had to do was slip the singletree links over the axle ends and bend them down after heating. A U-shaped rod flattened at the ends and welded to the axle holds the pin in place.

—Joe W. Back, Dubois, Wyo.

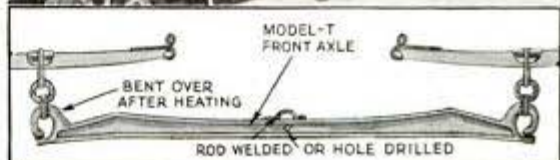

## Weights Painted on Hand Trucks Save Time in Checking Loads

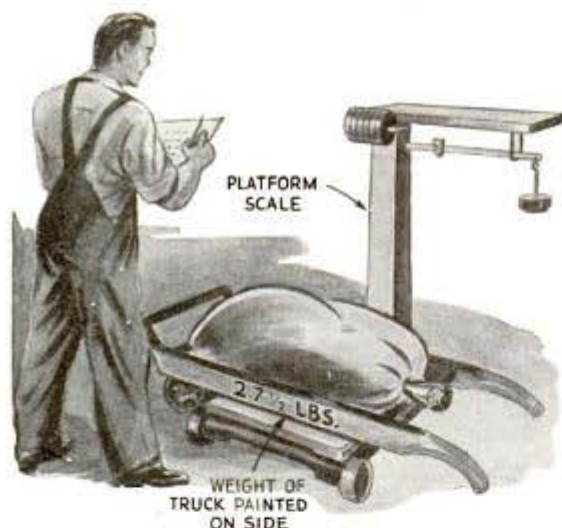

In a warehouse where hand trucks of various sizes were used, one merchant saved the labor of lifting the load onto and off platform scales by simply painting the weights of the empty trucks on the side rails. This permitted the workman to lower the truck on the scale platform, deduct its

weight from that shown on the scale and thus quickly determine the weight of the load on the truck.

## Easy Way to Put Machine Finish On Metal Surface

To put a machine finish on metal, try using a rubber stopper instead of a wood dowel or brass rod. The stopper should be about  $\frac{5}{8}$  in. in diameter at one end and tapered at the other end to fit into the chuck of the drill press. Another method is to use a short length of broomstick, turned down

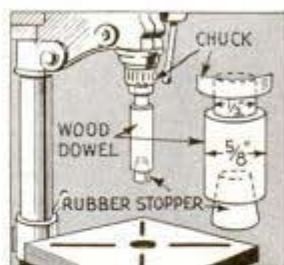

with a tapered hole at the other end to take the stopper. Silicon carbide of about 120 grain is mixed with light machine oil and applied to the end of the stopper. You will find that the flexible rubber stopper enables you to produce a better pattern.

## 1943 SHOP NOTES AND MECHANICS GUIDE NOW READY

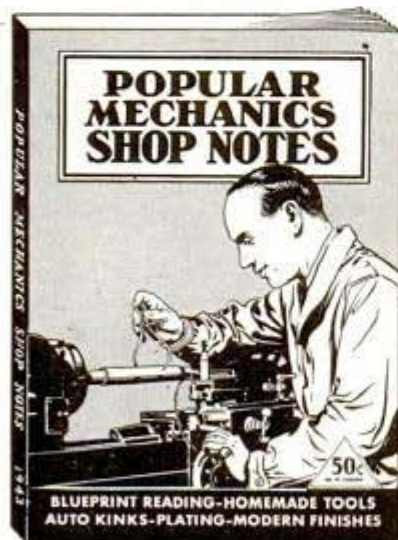

Here is the new 1943 Shop Notes with 449 articles, 224 pages of time and labor-saving ideas for everyone who uses tools—metal workers, carpenters, plumbers, electricians, auto mechanics, repairmen, etc. Send 50c for your copy now.

### Other Helpful Books

**Photo Guide.** Over 200 articles on making at low cost, your own camera and darkroom equipment; getting better photos; tricks; gadgets. \$1.25.

**Forty Power Tools You Can Make**—Shows how to make forty different machines, such as lathes, drill press, jig, band and circular saws, sanders from pipe fittings, auto parts, etc. \$1.25.

**Your Car**—Add thousands of miles of life to your car and operate it economically. 192 pages of money and labor-saving ideas, short cuts. For motorists, service men. \$1.25.

**1001 Ways to Use Concrete**—Do work for yourself, others. Save, make money. \$1.98.

**Garden Book**—Build your own trellis, fences, lawn furniture, outdoor fireplaces, attractive ornaments, etc. \$1.00.

**Welding, Brazing and Soldering**—How to construct equipment and use it efficiently. \$1.25.

**The Boy Mechanic**—For any boy. Tells how to build midget auto, boats, models, games, craftwork. \$2.00.

**Build a Boat for Pleasure or Profit**—17 low-cost boats—power, sail, row. No experience needed. \$1.25.

**What to Make**—Shows how to make hundreds of things in spare time for fun or profit. Furniture, craftwork novelties, etc. Set of four books, Volumes 1, 2, 3 and 4 (812 interesting pages) \$1.95. Single volumes 50c each.

Order from this list. Ask for **FREE** book catalog.  
Money refunded if you're not satisfied

Popular Mechanics Press, Dept. 424, 200 East Ontario Street, Chicago, Illinois

# RADIO



## First Aid Suggestions for Your Radio Sets

### PART VI

**F**IRST aid suggestions should always deal with the prevention of accidents. If your set is an a.c.-d.c. type, a ground lead never should be connected directly to the chassis of the receiver. If an external ground is considered necessary with a set of this type, a .1 mfd. 400-volt paper-type condenser must be connected in series with the ground lead. In sets that already include such a condenser, this second series condenser will add extra safety. Never ground any set on a gas pipe.

Antenna leads should not be connected to a radiator or water pipe; to do so probably will mean a burned-out antenna coil. Even though a protective series condenser is used it is bad practice and the slightly raised volume does not compensate for the greatly increased background noise.

Slipping dial cords are a common source of trouble that can be correctly quickly with a little crushed rosin or by applying a dial-cord dressing stick as shown in photo No. 1. All portable dry batteries such as illustrated in photos 2 and 3 should be tested under proper load, with a battery tester and voltmeter specially designed for that purpose in order to obtain a correct reading. All dealers and servicemen use a meter similar to

(Continued to page 182)

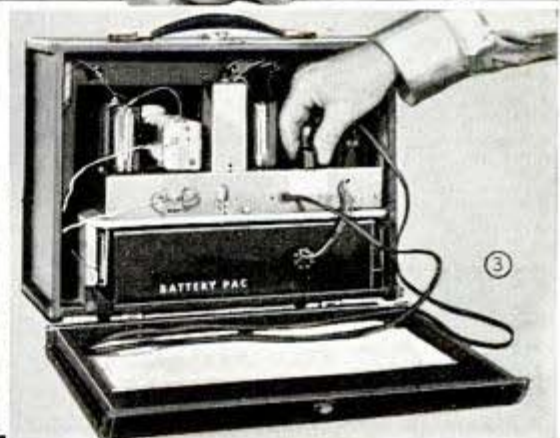
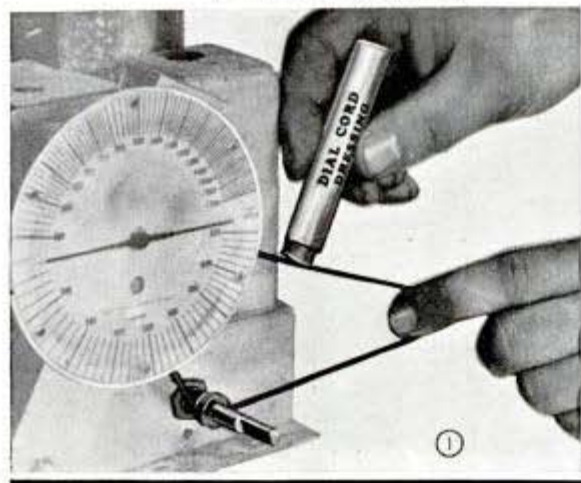



# FOUR-UNIT A.C.-D.C.

By M. N. Beitman

THIS is a practical progressive layout built in four distinct sections which plug together to make a good inexpensive 4-tube T.R.F. broadcast receiver. It consists of an a.c.-d.c. power unit which may be built first and used as a B-eliminator in connection with other sets, for classroom experiments, and for tests, or, combined with the audio unit it makes a phono amplifier. If you plan to construct the additional sections, the tubes used in the audio, detector and R.F. sections will serve to reduce the 110-volt line supply for the 25Z6-GT/G tube used as a rectifier in the power unit. If you wish to build the power unit only, a single 300-ohm, 25-watt wire-wound resistor can be used to replace all of the extra tubes including the ballast tube L-49-B. As this is primarily a construction article for the student and experimenter, the parts values are not critical.

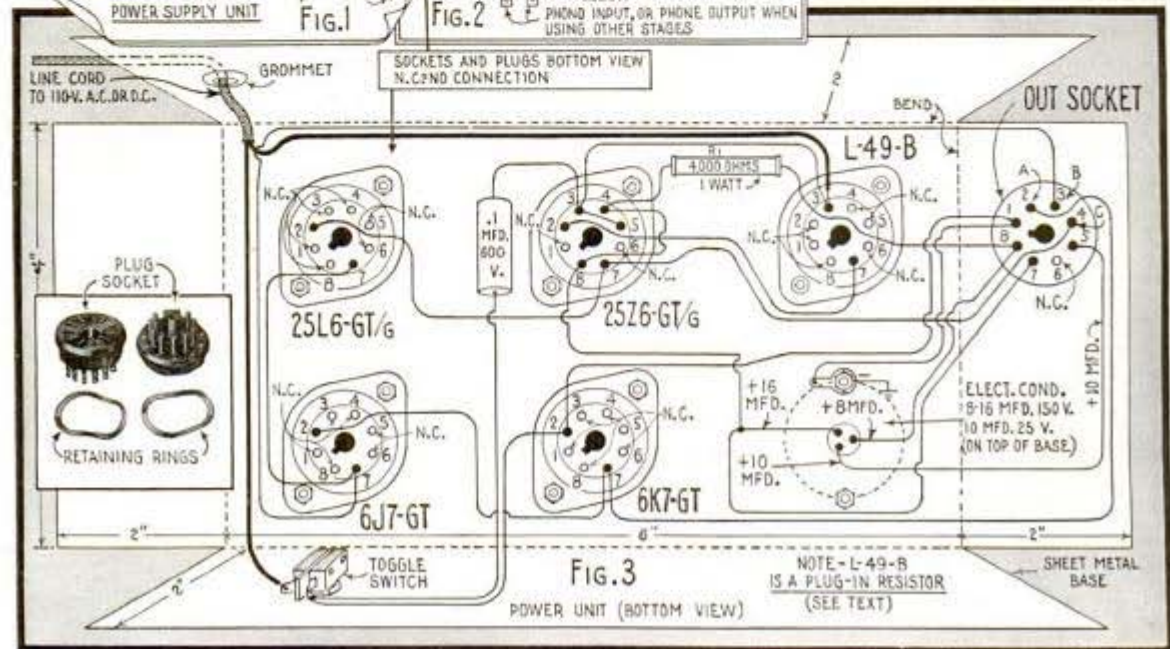
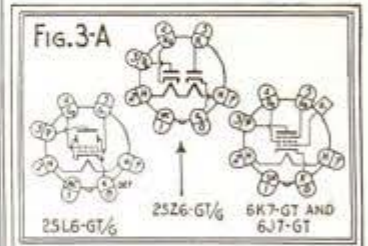
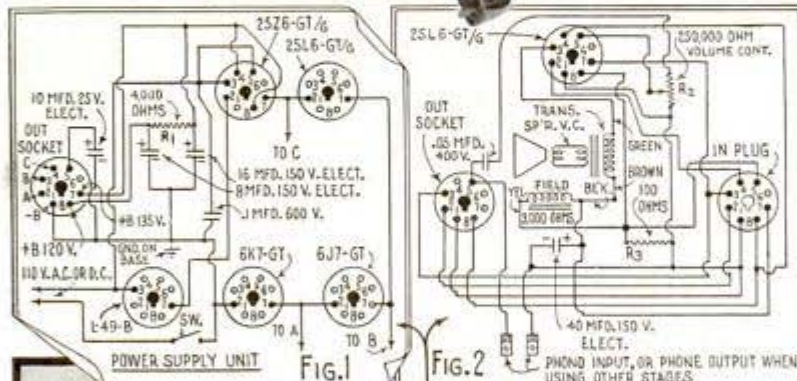
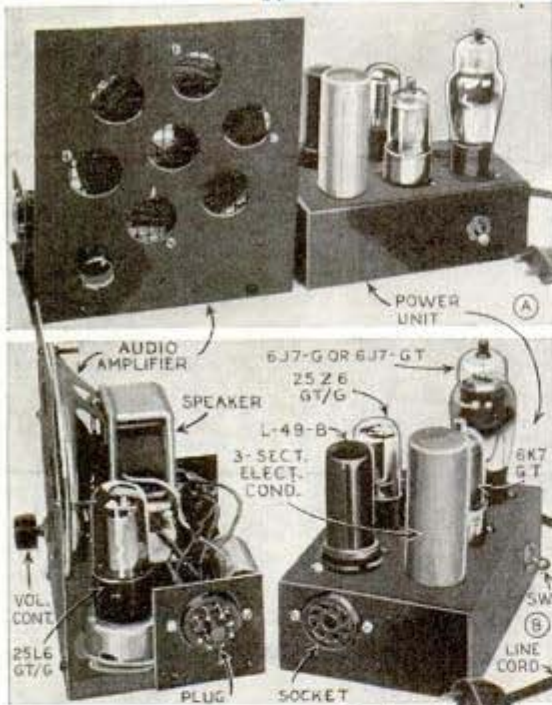

# STUDENT RECEIVER

## PART I—POWER SUPPLY AND AUDIO AMPLIFIER UNITS

Condensers may vary to twice the indicated values, or a junk box condenser of half the specified capacity will serve.

The schematic circuit diagram for the power unit appears in Fig. 1, and the simplified wiring diagram is shown in Fig. 3. It will be noted that the various voltages are brought out to an octal socket mounted on one side of the scrap metal base detailed in Fig. 3; all socket holes are  $1\frac{1}{8}$  in. in diameter. Care must be taken that the connections made to this "out" socket are just as shown as the same continuity is maintained in the additional units by means of plug and socket connectors. The audio, amplifier, detector and R.F. units are assembled on small wood baseboards, with the plug and socket connectors mounted on metal brackets screwed to the sides of the baseboards, the connectors being mounted at a uniform height so that the units may be plugged together as shown in photos A, B and C. Fig. 3-A shows bottom views of the standard tube socket connections for the tubes specified.

(Cont'd to page 180)

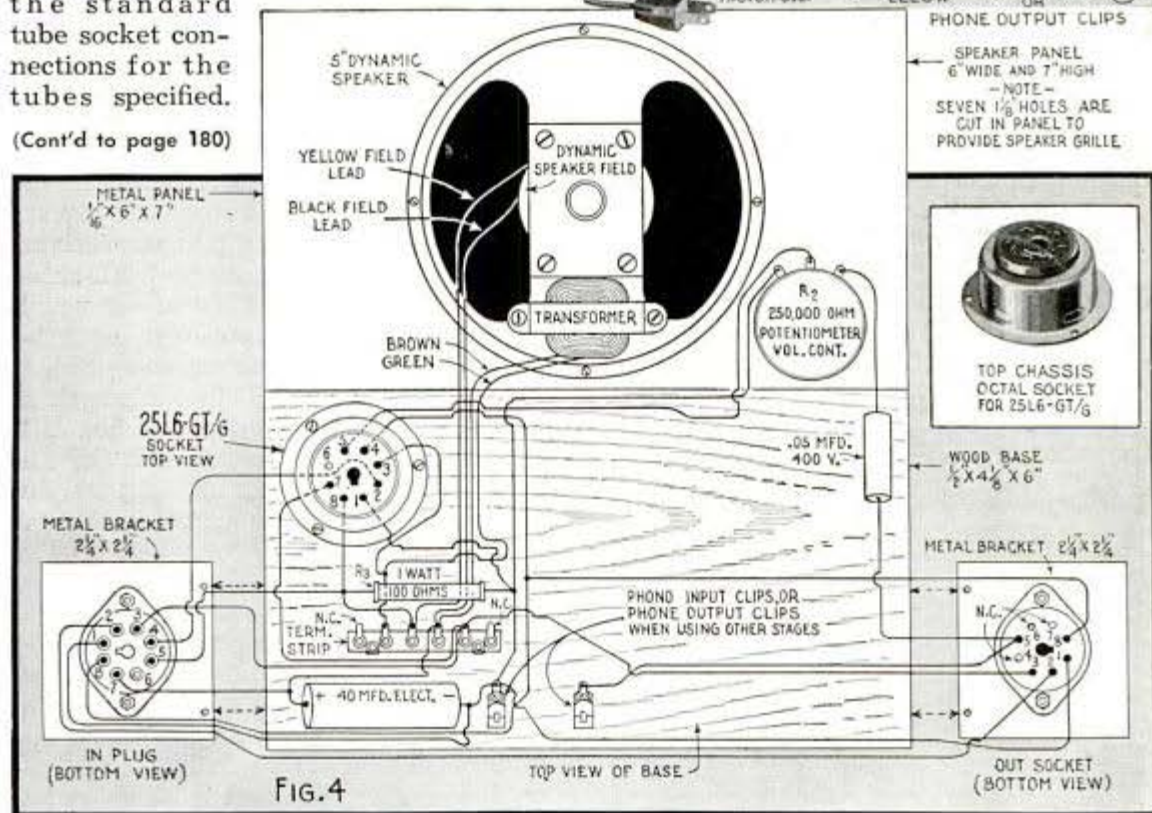
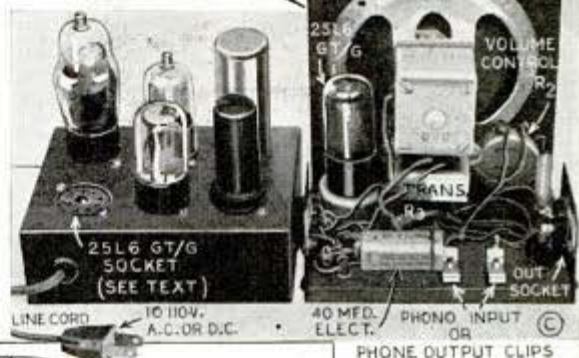

FIG. 4

# Compact A.C.-D.C. Set in Kit Form for Schools



ANY a.c.-d.c. super of the ultra-compact midget type provides an inexpensive means for practical classroom study and service training. Small receivers of this type have been made by the million and are used in many homes as a personal or auxiliary set. They therefore constitute a large portion of the average serviceman's "patients." However, when properly designed they do give long and satisfactory performance, considering their low cost.

Although a large number of discarded sets of this type are available for student use, the circuit data is not always obtainable and they usually find their way into the junk box of used parts. The 5-tube kit illustrated is one of several student kits, available from radio mail order houses, that include circuit diagrams, assembly details and notes on operation that are useful to advancing students and classroom instructors. This unit includes a loop antenna, beam-power output, automatic volume control and a 10 to 1 ratio tuning dial. The frequency range is from 540 to 1730 kilocycles and it operates on 105-125 volts either a.c. or d.c.. Photo A shows the completed chassis, and the general layout details appear in Fig. 1.

Photo A shows the completed chassis, and the general layout details appear in Fig. 1.

Although this is a modern and unusually well designed midget receiver in every respect, it is subject to most of the usual midget a.c.-d.c. set ailments due to space saving and parts limitations, thus making it a practical

"guinea pig" for the student and experimenter. Necessary confining of parts in small space means excessive generation of heat, and this is the principal enemy of any a.c.-d.c. set of the so-called "midget" or "compact" variety. Knowing this, the student or serviceman looks for defective filter condensers that have dried out. Other parts, such as carbon resistors, may warm up and change value to an extent where they become useless; these defects however, are easily remedied with standard replacement parts.

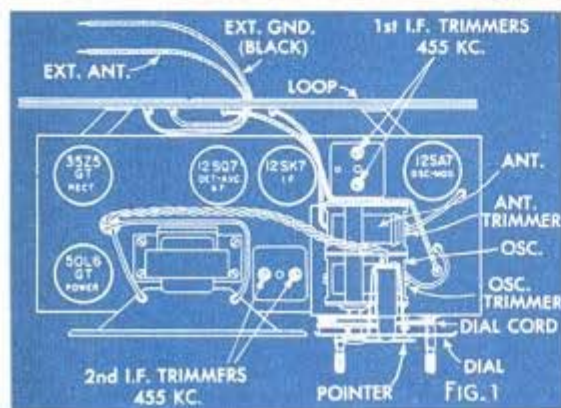
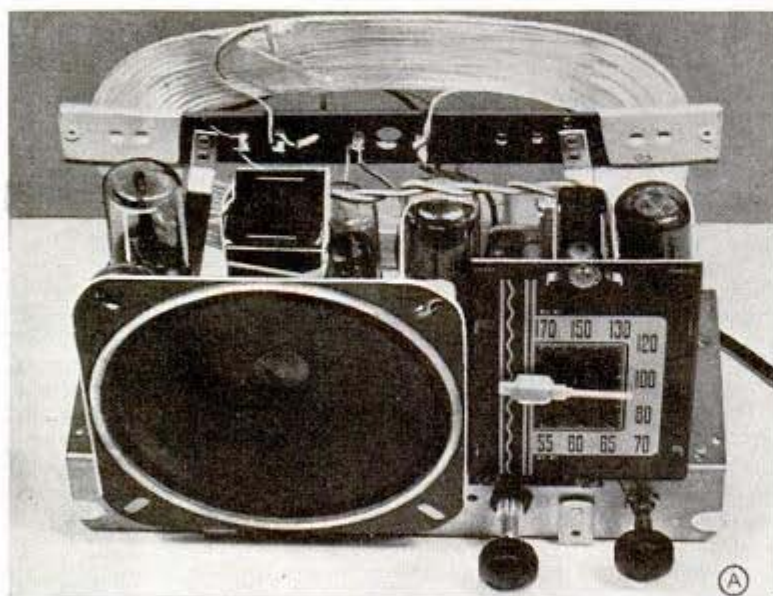



# Helpful RADIO SUGGESTIONS

(A) Air raid alarm unit easily installed in any type of radio set, table model or console, automatically sounds a loud siren-like tone when the radio station to which the set is tuned goes off the air at the first warning of attack. Switched on or off as required, it does not interfere with the operation of the receiver and no changes in wiring are necessary



(B) When no coupling is available, variable condensers may be ganged as shown; select condensers with right and left rotation and file the shafts as indicated. Further capacity matching is done with the usual padding condensers. (C) Handy antenna unit in compact form that may be placed behind the set or under a rug. It is 1/2 in. thick, 3 in. wide and 7 1/4 in. long. A 5-ft. lead wire connects to the antenna post on the set. Eliminates long flexible "roll up" antenna commonly used with older midget and small table models

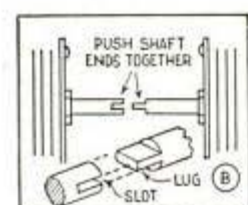
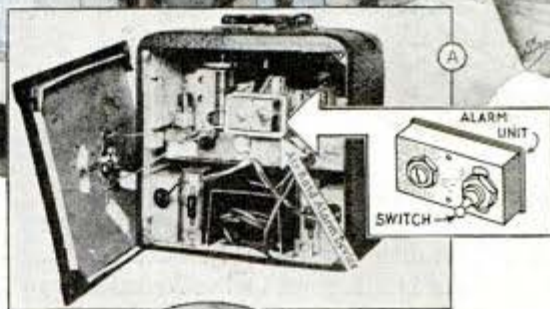

(D) One leg from a metal telescoping camera tripod makes a good antenna for portable radio equipment where an adjustable rod antenna is required. Porcelain stand-off insulators may be used for mounting



(E) Plastic replaces the metal shell in this inverted type chassis mounting tubular electrolytic condenser supplied single or multiple in a wide range of capacities and working voltages



(F) Sturdy chimney bracket for supporting a receiving antenna; paint to match bricks. (G) Homemade knob puller removes tight-fitting "push-on" control knobs. (H) Half of spool used as an emergency substitute for a lost or broken "push-on" knob; the piece of spring metal bears against the flat side of the shaft. (I) "Screw-on" wire connectors join twisted wires without solder or tape

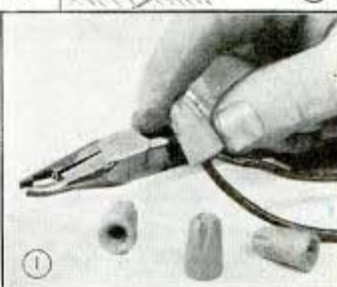
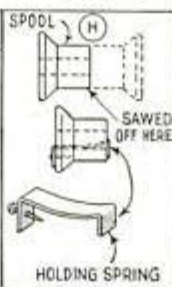
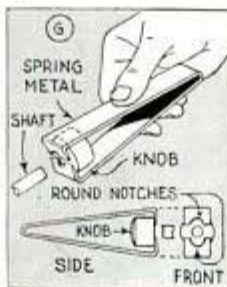
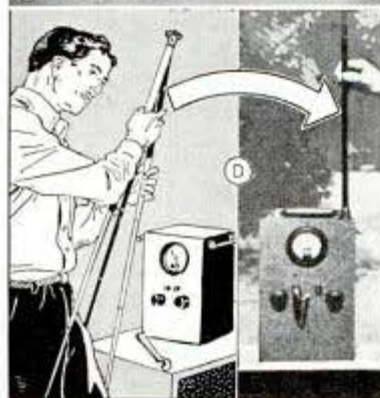
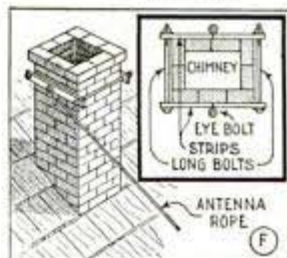

## Radio on Tricycle Carryall



In addition to a headlight, spotlight, bell, siren, rear-view mirror and carryall compartment this utility tricycle for delivering groceries and merchandise is equipped with an auto radio powered by a small 6-volt storage battery fastened behind the seat. A fish-pole auto antenna is mounted on one side of the carryall compartment at left rear but does not appear in the photo. The receiver is attached to the handlebars and front fender by means of metal strips.

## Electronic Key Is Semi-Automatic



Electronically operated, this "bug" key of advanced design is manipulated by the operator in the same manner as mechanical keys of the "bug" type. However, with this electronic key

the speed of sending is continuously adjustable even during the course of transmission by a single control knob on the front panel. Pressing the paddle to the right produces a continuous series of dots and to the left a continuous series of dashes.

At all speeds the correct proportion between dots, spaces and dashes is preserved regardless of operating peculiarities.

## Portable Vacuum Tube Voltmeter

Rugged and in convenient portable form, this test meter is claimed to give accurate measurements throughout the entire audio frequency range, including the ultra-high audio frequencies. It operates on a.c. or batteries.



## Panoramic Short-Wave Reception

Panoramic reception will be introduced when short-wave equipment is again available for civilian use. Combined with communications receivers such as this SX-28, traffic density is visual 50 kc. each side of a station to which the set is tuned.



Blueprints covering simplified radio construction articles in this and past issues are available for 25c each. Many popular tested circuits for beginners, students and experimenters may be built with used parts. Detailed material lists can be obtained from Popular Mechanics Radio Department upon receipt of postage.

**NEXT MONTH—Four-Unit A.C.-D.C. Student Receiver—Part 2.** Detector and R.F. amplifier stages are added to the power supply unit and audio-amplifier stage described for construction in this issue, completing the 4-tube T.R.F. set. Also—**A Pure Tone A.C.-D.C. Safety Code Oscillator;** and **First Aid for Home Receivers.**

A Suggestion to the Millions  
of .22 cal. Rifle Owners

# SHARE YOUR RIFLE WITH YOUR NEIGHBOR

HELP MAKE AMERICA NOW, AS IN THE PAST, A NATION OF MARKSMEN



Right now, more thousands than ever want a Mossberg .22—the military type sporting rifle—because in these stirring times they feel the natural American urge to have and use a gun.

We cannot supply that demand. Our efforts and facilities are 100% on War Production.

So we respectfully make this suggestion to owners of .22 cal. rifles of all makes—"Share your rifle with your neighbor. Explain the rules of safety. Show him how to handle and operate a rifle, how to "draw a bead" on the target. Let him experience the thrill of shooting. Use ammunition sparingly, and share the expense. You'll be making a real contribution to the war effort . . . for a nation of marksmen is unconquerable!"

To every owner who agrees to share his rifle—regardless of the make of the rifle—we will send, absolutely free, an authoritative, illustrated booklet "The Guidebook to Rifle Marksmanship," prepared by the National Rifle Association of America—a book every shooter will want.



## JOIN A GUN CLUB, OR START YOUR OWN

The National Rifle Association Cooperates

To every owner of a gun and to every patriot—another suggestion. Right now is the time to apply for membership in the Rifle or Gun Club in your community. You'll find the members are the nicest, friendliest folks in town. And,

though small arms ammunition may be scarce, reasonable quantities are available to such recognized clubs. Or, start your own shooting club. We will be glad to supply free, through The National Rifle Association, a helpful and interesting book on how to establish and conduct such a club.



**O. F. Mossberg and Sons**  
INC.

Manufacturers, in normal times, of  
.22 cal. RIFLES • SHOTGUNS • TELESCOPE SIGHTS • TARGO GUNS and Equipment

O. F. Mossberg and Sons, Inc. 26511, St. John St.,  
New Haven, Conn.

Sirs, I agree to "Share my .22 cal. rifle" and will invite a neighbor to shoot with me. Please send my copy of "The Guidebook to Rifle Marksmanship."

Please send me the N. R. A. booklet on how to organize and conduct a shooting club.

Please put my name on your list to receive the Victory Catalogue of postwar Mossbergs as soon as possible after the war is won.

Check  
booklets  
desired

Name \_\_\_\_\_ PLEASE PRINT

Street \_\_\_\_\_

City \_\_\_\_\_ State \_\_\_\_\_



A dull tool is a shirker on any job—but it is doubly at fault when its work is war-essential.

Making things last longer on the home fronts—building or repairing needed buildings and equipment—training in the important wood-working arts . . . millions of jobs call for *keen* saws.

Nicholson makes all kinds of files for keeping saws sharp. For filing hand-saws, Nicholson offers a helpful folder on

**"HOW TO SHARPEN A SAW"**

**FREE** to carpenters, mechanics, wood-workers, farmers, industrial arts students. Simply mail us your request (a post-card will do) for this interesting saw-filing instruction sheet.

**NICHOLSON FILE CO., 21 ACORN STREET  
Providence, R. I., U. S. A.**

*(In Canada, send your request for instruction sheet to Nicholson File Co., Port Hope, Ont.)*



**NICHOLSON FILES** FOR EVERY PURPOSE  
NICHOLSON U.S.A. MADE IN U.S.A.

**Liquid Gold for War or Peace**

*(Continued from page 95)*

Early efforts to mine the sulphur met with disaster. Shafts caved in and daring miners lost their lives. Scores of unorthodox methods—including freezing quicksand with ammonia pipes—were tried, but the sulphur remained locked in the earth.

America seemed destined for dependence on foreign supplies—supplies which today adequately care for the needs of our enemies—until Dr. Herman Frasch, a scientist prominent in the early history of the petroleum industry, conceived the revolutionary idea of mining sulphur as a liquid.

They—the scientific "they" of the early 1890's—laughed at him. Dr. Frasch ignored their ridicule and went ahead with his scheme to melt the mineral under ground with superheated water and then pump it to the surface through pipes. In 1895 the first melted sulphur flowed from the earth.

Virtually all American sulphur is produced by the Frasch process. Derricks of the Texas Gulf Sulphur Company and the Freeport Sulphur Company, the largest producers, give the mines the appearance of oil fields. The mining equipment includes a "nest" of pipes, placed one within the other, extending down to the sulphur deposit. Water brought to a temperature of 300 degrees Fahrenheit, under pressure, is forced into the mine. The sulphur melts and sinks to the bottom of the well. Water and air pressure lift it to the surface where it is discharged into steam-heated vats and pumped to huge bins where it hardens into mountainous bricks.

The development of the sulphur industry is allied with the growth of the petroleum and steel industries. Sulphuric acid was first used to refine kerosene in 1859. Since then the acid, sulphur dioxide and even crude sulphur have been used as purifying agents in cracking processes.

The great demand for sulphuric acid by the steel industry started in 1890 with the production of tin plate and the galvanizing of metal. Last year the industry used 1,450,000 tons of the acid as a cleaning and de-scaling agent. The rapid growth of the automobile industry had a tremendous effect on the production of oil products and sheet steel with corresponding demands on the sulphur industry. There are many other peacetime uses of sulphur. In 1941,

Freeport, Tex. 75645

about 2,500,000 tons of sulphuric acid were used in the manufacture of phosphate fertilizers. Farmers also depend on crude sulphur as a source of various insecticides.

Sulphur entered the pulp and paper industry in 1866 when it was discovered that wood pulp could be made by cooking chips in water containing calcium or magnesium bisulphite. Today about 250 pounds of sulphur are consumed in the production of one ton of sulphite pulp. The pulp, a standard raw material for the paper industry, is also used in the manufacture of Cellophane, related materials including casing for sausages, and such synthetic fibers as rayon. The manufacture of plastics, synthetic rubber or safety glass is dependent on chemicals with a sulphur base.

Other articles sulphur helps to produce, long accepted in everyday life, are photographic film, matches, celluloid, paint and varnish, glycerin, sugar, soda, ink, shoe polish, food preservatives, dye stuffs, rat poison, fire extinguishers, cements, resin, refrigerants and scores of others. It is estimated that the rubber industry alone manufactured 32,000 articles containing sulphur before production was curbed.

As distant as the poles are the uses of sulphur in TNT and sulfanilamide on the battlefields. Sulphur drugs are saving lives and limbs by the hundreds every day on both the war and home fronts. At Pearl Harbor alone scores of lives were saved by the prompt administration of sulfanilamide and sulfathiazole to the wounded.

This year American industry is consuming more sulphur than was ever used by one nation in 12 months. Meanwhile, the giant yellow bricks in Texas and Louisiana are growing daily as powerful pumps pour forth a golden stream that is the lifeblood of war production.

# CHAMPION SPARK PLUGS



Cargo ships of the highways, the transport trucks of this nation, are actively in the service of their country 24-hours a day, 7 days a week. Thus they play their vital, indispensable part equally with the trucks that transport troops and munitions of the armed forces. Unfailing dependability is the watchword of both, and in this service Champion Spark Plugs are maintaining their reputation for the unfailing ignition which has made "Champion" and "dependable" synonymous.



Champion's patented Sillment seal is but one of many exclusive features which make them equal to any emergency. This compressed dry powder seal permanently banishes troublesome gas or compression leakage common to ordinary spark plugs—which causes them to overheat, pre-ignite and results in rough, wasteful engine operation. You can depend on Champion Spark Plugs in every engine in any emergency.

*More Vital-  
More Dependable  
than ever!*



TO SAVE GASOLINE • KEEP YOUR SPARK PLUGS CLEAN



**Model Builders  
Attention!**

	V	V-2	V-3
Hex	1/2"	3/4"	5/16"
Thread	3/8"-24	1/4"-32	1/4"-32
Thread Length	7/32	7/32	5/32
Weight, Grams	8	3 1/2	2 1/2

Actual Size V-Plug

Champion spark plugs for model gas engines give the same dependable performance as regular Champions. Sillment sealed. Sillimanite insulator. Alloy needlepoint electrodes for easy starting. One piece construction.

**CHAMPION**

SPARK PLUG COMPANY • TOLEDO, OHIO

# Patrolling Uncle Sam's Deadlines

(Continued from page 44)

search of better jobs. Even these must be prevented from entering, otherwise other aliens and smugglers would take advantage of the laxity. In an effort to seal the borders against all traffic the Patrol has been doubled in size during the last several years, the result being that few aliens now try to cross the border because of the virtual certainty that they will be caught. Those who do try it, these days, are likely to be smugglers or enemy aliens who have worked out their plans carefully ahead of time. Such plans rarely succeed. In the true desert areas such a person can hardly carry water and food enough to carry him to safety. In the more populated areas, ranchers and cattlemen are on the lookout, ready to report strangers who have no business in the district.

Members of the Border Patrol can tell thrilling stories of their adventures but there is a lot of hard work attached to their jobs. Many people wouldn't last a week on the border. Long hours of horseback riding under the hot sun, days or nights "staked out" in the brush waiting for a suspected smuggler to cross, possibly pitched battles after dark with the patrolmen using tracer bullets to help find their targets, are all part of their life. In spite of the heat, sometimes, they must wear thick underwear and protective netting around their heads to ward off mosquitoes while on river duty. They may return in a few

hours when they go on patrol, or it may be a couple of days before they report back.

You could pass the physical examination of any airplane pilot and still not be physically eligible for the patrol, so stiff are the requirements for the service. Your personal history and background must stand the sharpest scrutiny. Then you must go to school for 30 days, at the El Paso headquarters. Included among the subjects studied by the men undergoing training at the school are Spanish, radio code, criminal investigation, "sign cutting" and tracking, self defense and methods of disarming an opponent, and mastery of the numerous weapons that the Patrol uses, including revolvers, rifles, carbines, riot guns, and submachine guns.

Once you go on active duty it will be months or years before you acquire all the abilities of a veteran of the border. For a long time you will travel in company with an experienced man who knows how to handle every sort of situation. And you'll learn to grin at yourself when, as has happened a couple of times, you spend long hot hours carefully following some vague footprints leading north from the border, only to find that they pass within a few yards of the corral where you saddled your horse before daybreak that morning, and that if you had only sat on the corral fence for a while the alien would have walked right into your hands.

## "Electric Eyes" Serve as Traffic Cop in Mile-Long Utah Tunnel

Traffic is controlled in a single-lane 6,000-foot tunnel in Utah with electronic tubes, better known as "electric eyes." They allow traffic to enter at one end for three minutes and, when the tunnel is clear, from the other end for the same time. If a laggard lingers in the tunnel, or a car

breaks down, an alarm sounds. The eye at one end counts the cars that go in and the eye at the other end "checks" them out. Before reversing traffic flow, the two eyes must register equal numbers of cars. The system was designed and installed by the General Electric company.

## Peppermint Oil Supplies Menthol Formerly Imported From the Orient

Menthol, the medicinal chemical formerly imported from China and Japan, is being extracted from American peppermint oil. New methods of refining the oil have opened up a large domestic market. Last year 500,000 pounds of menthol were used in this country and it is estimated that it would require at least 1,000,000 pounds

of oil to yield that amount of menthol. Farmers in Indiana and Michigan produced 80 percent of last year's crop and the balance was grown in Oregon and Washington. One refining plan calls for the extraction of only the excess menthol, leaving the residual oil for use as flavoring by toothpaste and chewing gum manufacturers.

# "I'd GO BATTY-

## if I didn't have my HOME WORKSHOP"



**W**HETHER you're the big boss or just one of the 'deck hands'... industrialist, professional man, military brass hat, bookkeeper or draftsman... there comes a time when you've got to get away from the strain of modern life—or go nuts!

"As for myself, I'd go batty if I didn't have my home workshop! My doctor tells me that working with my hands has a 'therapeutic value'. My friend who's a psychologist says he's been turning out gadgets in his own workshop for

years because that's nature's way of obtaining 'release'."

Creating things by hand has been a normal part of human routine ever since the first Neanderthal man began chipping flint arrows. That's why thousands of industrial leaders, professional men, army officers and desk slaves are finding new happiness and relief from desk jitters by adopting a creative hobby.

### Send for FREE Booklet—

"Happiness is in Your Hands." It gives full details of how happiness can be obtained through creative hand work—and contains practical suggestions for hobbies within the reach of all.

# DELTA MILWAUKEE



The Delta Manufacturing Company  
680-M E. Vienna Ave., Milwaukee, Wis.

Please send me FREE copy of your booklet "Happiness is in Your Hands".

Name .....

Address .....

City.....State.....



**Protect your anti-freeze —  
clean out with Sani-Flush first**

Don't waste precious anti-freeze in a dirty radiator. Rust and sediment cause dangerous overheating. Clean out first with Sani-Flush. It's quick and complete. Costs only a few cents.

Don't take chances on just flushing with water. Sani-Flush is thorough. Use it yourself, or ask your service station. *Sani-Flush is absolutely safe in auto cooling systems, when used according to directions on can.* It's in most bathrooms for cleaning toilets. Sold in grocery, drug, hardware and 10c stores. The Hygienic Products Co., Canton, O.

## Sani-Flush

### CLEANS OUT RADIATORS



#### GERSTNER TOOL CHESTS

Choose yours from our free catalog for machinists and toolmakers.

GERSTNER TOOL CHESTS  
442 Columbia St. Dayton, Ohio



### AUTO ENGINE SPEED CONTROL GOVERNORS

Give constant speed to any make of auto or truck engine, regardless of load changes, when used for power. No better governor can be made. Fully guaranteed. Complete, simple instructions. Courtesies to garages and established agencies. Montreal branch, 7546 Wiseman St. Free circulars. CANDEE, 129-10 Llewellyn St., Los Angeles.

## For Real Discomfort—"There's No Place Like Home"

(Continued from page 76)

which we can return after a day of work and in which we will be able to relax and really live.

Let us build that house as a unit with all the utilities included as part of the house and not additions to it. For instance, let us make the house have, as a part of it, a central utility unit built in, which, in one plant, provides heat, hot water, refrigeration, bath and toilet facilities, dishwashing and laundry, and perhaps communications. All this sounds like the old prefabricated home idea again. Our house may be—we can't guess—but prefabrication is a result, not a cause for design.

We may eliminate work through the use of materials and utilities which don't require work. Eliminate polishing, dusting, scrubbing and waxing, and the need for constant refinishing. Let us concentrate on this factor because if we don't we will be all worn out with the work of living.

Let us do some original designing in the field of illumination and make this a part of the house—as much a part of the house itself as the front door.

We should be able to build a house like a Thermos bottle so that without effort you can keep it warm in winter and cool in summer, and keep out dust all year 'round.

Some original research in the use of materials must be done. One of my designer friends has inspired me to this thought by his use of the phrase "materials that grow old gracefully." This is a valuable idea because it means eliminating work. Let us see if we can't design and specify materials which are impervious to the minor wear and tear of daily living.

Finally, having designed this "satisfactory machine to live in" and tested it and proved to our own satisfaction that it represents a real advance in the design of dwelling units, let us start designing it all over again to take in three more important elements—

The designed use of the latest developments in raw materials such as light stainless metals, inert plastics, resin-bonded plywoods, malleable plastic pipes and conduits, Plexiglas and innumerable other things which are being developed now for war purposes.



Then, let us design houses in "appearance packages" along lines which have been proven to be irresistible to the consumers' eyes.

Then, let us work out whole community plans based on the development of complete community centers with all the social and marketing utilities so necessary to the business of living a pleasant life. Let us work out the design of our future communities so that a fellow can grow a few flowers if he wants to and maybe have a tiny patch of radishes or other vegetables so that he can indulge in man's favorite dream of being a farmer, but let us design this so that the hobby of having a few flowers and radishes doesn't entail all the labor of a forty-hour week.

And for those who would prefer to design interiors, let us design home furnishings along traditional, friendly lines but let us make them:

First, do the job; after all, a chair is a chair and ought to look like one and ought to sit like one.

Let us eliminate simulated eye appeal. For years we have kept ourselves busy designing furniture that appealed purely because it had a concealed ash tray or some other useless contraption that wouldn't work. Let us, for the love of Mike, get away from "waterfall front." The world is sick of picking up things that have slipped to the floor.

And, finally, let us design draperies that drape and at the same time let us eliminate draperies that look like Grandmother's wedding dress warmed over for breakfast. Let us make hangings to conceal things like window shades mechanically perfect and, "just in case," let us make them provide a perfect blackout.

### Rubber-Mounted Plane Engine Reduces Vibration in Ship

Several valuable advantages for war-planes have resulted from a new type rubber suspension mount, developed by engineers of Goodyear Aircraft corporation, which cushions the engines and lessens the vibrational stresses in the craft's structure and other parts. Rubber is used in somewhat the same manner as in mounting automobile engines. Besides lengthening the life of a plane, decreased vibration permits truer aiming of bombs.

*Truet Rubber Co  
Akron, Ohio*



**NOW! You Can Afford \$10,000 Life Insurance**

**THESE LOW RATES MAKE IT POSSIBLE**

● Here is a long-term policy that protects you for the expectancy of life based on your age, according to the American Experience Table of Mortality. It has cash and loan values.	Age	Monthly Rate Per \$1,000
	20	\$.90
	25	.99
	30	1.12
	35	1.28
	40	1.54
	45	1.89
50	2.43	

AT AGE 35 a \$10,000 policy costs you only \$12.80 per month and will, should you die during the expectancy period, pay your beneficiary \$10,000 or a monthly income for life. This low-cost policy cannot be issued in amounts less than \$2,500. Write for full details, stating date of birth. Use coupon below.

*More Than A Billion Dollars of Insurance In Force*

**THE LINCOLN NATIONAL LIFE INSURANCE COMPANY**

Fort Wayne, Indiana

ITS NAME INDICATES ITS CHARACTER

**THE LINCOLN NATIONAL LIFE INSURANCE COMPANY**

Dept. PM-11, Fort Wayne, Indiana

Send full details about your Low Cost Plan, which provides ample protection at low cost.

Name \_\_\_\_\_  
 Street Address \_\_\_\_\_  
 City and State \_\_\_\_\_  
 Date of Birth \_\_\_\_\_

## NEW WATERPROOF GLUE GETS UNCLE SAM'S O.K.\*

APPROVED FOR  
AIRCRAFT

by U.S. Army U.S.  
Navy and Civil  
Authority when  
properly applied

So good it is used in Uncle Sam's planes\* and ships! Yet WELDWOOD GLUE is simple as A-B-C to use! No heating, waiting or special equipment. Just add tap water to dry powder and it's ready for instant use. At hardware, chain stores and lumber yards in 10c, 25c, 50c cans; or send 25c with your dealer's name for sample can. Supply limited due to Uncle Sam's war needs.

**UNITED STATES PLYWOOD CORPORATION**  
World's Largest Producer of Plywood

Weldwood Glue Dept.  
103 Park Ave., New York

Compare These  
Amazing Qualities

1. Tremendous Strength
2. Waterproof
3. Rot and bacteria-proof
4. Economical
5. Stain-free
6. Quick and easy to mix



"Makes the glue line the SAFETY line"

# Save your tools!



Get this FREE  
**DISSTON  
MANUAL**

from your

**HARDWARE DEALER**



**48 Pages • 200 Illustrations**

Packed with useful workshop advice, instructive pictures, practical helps and hints. Contains this statement from George T. Weymouth, Bureau of Industrial Conservation, War Production Board: "TOOLS ARE WEAPONS. CONSERVE THEM. USE THEM PROPERLY TO AVOID BREAKAGE AND THE WASTE OF CRITICAL MATERIALS NEEDED TO WIN THIS WAR." . . . Make your tools last longer. Get your FREE copy of the Disston Saw, Tool and File Manual from your Hardware Dealer.

**HENRY DISSTON & SONS, INC., 1111 Tacony, Phila., Pa., U.S.A.**

## On the Night Shift

(Continued from page 60)

nize the need for top flight brains on the night shift after its motor division plants went from 20 to 45 percent on night work.

"Night shifts previously had been operating as auxiliaries to the day forces, carrying out instructions left by day supervisors," says R. W. Owens, manager of this division.

"We did four things to maintain smooth-running production in the expanded night shifts. The percentage of older, experienced workers on the night crews was increased; supervisors were provided in each section where the increased personnel necessitated that procedure; production organization assistants were assigned to aid the supervisors, and the number of night shift inspectors was stepped up."

The unexpected part of the change was that when veteran employes were asked to upset their habits and take the night shift to help win the war they seemed to be happy to do so, feeling that if they couldn't fight, at least they could sacrifice something for the war effort. One company posted a sign: "Men Wanted to Work the MacArthur Shift—Midnight to 8 a.m."

General Electric Company, also a pioneer in all-out war production, found that whatever discomfort the night shift brought to employes, it affected principally the second shift which goes to work around 3 p.m. This shift lost the evening recreational opportunities. To counteract this, the company's \$400,000 clubhouse was thrown open at 8 a.m., movies were encouraged to open at 10 a.m. Opportunities for baseball, basketball, tennis, boxing, wrestling, bowling, and other sports were increased for the night shifts.

In recognition of the problems of the up-to-about-midnight shift, a Buffalo movie theater was induced to give a special weekly show every Wednesday morning at 2 o'clock.

In the same city, many night workers are permitted to operate radios on the job. Bell Aircraft Corporation is encouraging night workers to go to school in the daytime. Municipally operated vocational schools are working three shifts, too, and hundreds of men on the night shift are taking courses. Bell Aircraft employes also have their own daytime flying club, while

others belong to the Buffalo Soaring Society. Pullman-Standard plant employes in Hammond, Ind., hold dances which run from 8:30 p.m. to 5 a.m. so that all three shifts can attend.

The Caterpillar Tractor Company of Peoria has increased its personnel, and much of the expansion was made on the night shifts. Many employes have felt that expansion of night shifts provides more jobs and greater opportunity. Night employes have the same medical, safety and cafeteria facilities that day employes enjoy. Second and third shift employes have their own basketball and softball leagues, playing three mornings a week. They also have several bowling leagues which operate during the morning hours, and a roller skating organization.

Plant managers are making a special effort to provide good food for the night shifts. Westinghouse has "calorie carts" which provide snacks for night workers. At the Wright Aeronautical Corporation plant, 17 mobile lunch wagons trundle through the aisles at night with hot lunches. North American Aviation handles its night shift feeding problem with a "travelunch" cafeteria system of mobile canteens that take hot, nourishing food through the plant.

The Springfield, Mass., American Red Cross chapter has set up a hot lunch canteen service for plants lacking such facilities. In the dark hours before dawn—when efficiency is lowest—volunteer Red Cross canteen service workers are on duty at four o'clock serving hot soup, milk, sandwiches and coffee to workers on the midnight shift at the huge government arsenal.

Westinghouse has tackled the eye strain problem with research on fluorescent lighting. Du Pont has worked out a system of painting which cuts accidents, eliminates errors and eases eye strain by what is called "three dimensional seeing" which highlights the important parts of a machine and subdues the rest.

Research is under way along dozens of lines to make life easier for millions of Americans when they go on the night shift.

¶ You can obtain additional information about products described in this magazine by writing to the firms listed in the Where-to-Buy-It index. Say You Saw It in Popular Mechanics.

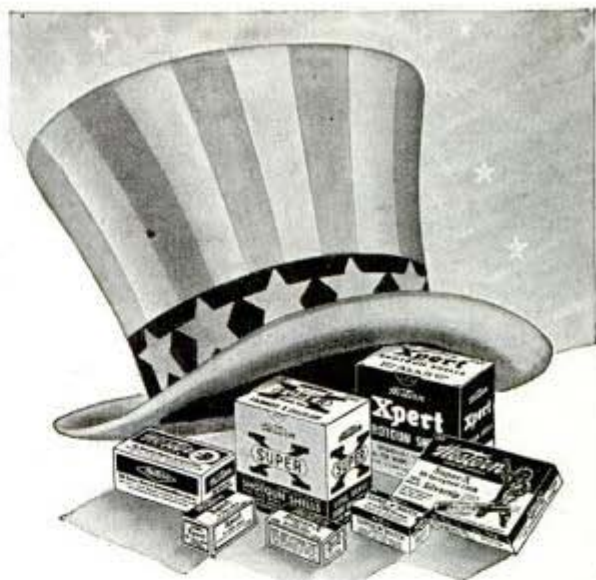

*...until Victory!*

WHILE the mammoth Western plants are serving the Stars and Stripes—working night and day producing millions of military cartridges—the names SUPER-X, XPERT, SILVERTIP and SUPER-MATCH remain symbols of outstanding service to the shooters of America.

All of the ingenuity of the now greatly augmented Western technical staff, which developed this famous line of World Champion Ammunition, is focused on giving our fighters the benefits of its skill and long experience.

Western ammunition—and our entire facilities—yes, and the many thousands of loyal Western workers—are proudly in the service of Uncle Sam...until Victory!

WESTERN CARTRIDGE COMPANY  
East Alton, Ill.

*Western*  
WORLD CHAMPION  
AMMUNITION



HOW TO ...

# Save Fuel THIS WINTER WITH SMOOTH-ON



Air leaks . . . below or above the furnace, or in the flue . . . are a frequent cause of fuel waste.

Stop these leaks . . . reduce your fuel bills . . . help to conserve fuel . . . by one application of SMOOTH-ON . . . easily and quickly, without dismantling any parts. The expansive property of SMOOTH-ON tightly fills all openings and makes an iron-hard seal which is not loosened by expansion or contraction.



SMOOTH-ON is equally effective for stopping leaks of steam, water or air due to cracks in boilers, heaters, pumps or piping . . . makes low-cost lasting repairs of equipment that you cannot replace because of war-time conditions.



This many-purpose iron repair cement also stops leaks in automobile radiators or engine cylinders, and tightens loose fixtures, tool handles and hardware. Be sure to buy a can today and be prepared for repair emergencies.



## SMOOTH-ON USERS!

Write us how YOU have used Smooth-On for repairs, so that we can tell others about your experiences. Your co-operation will help to save much-needed metal and parts, thereby aiding the Nation's war effort. WRITE TODAY.

Buy SMOOTH-ON in 1 1/2-oz., 7-oz. or larger cans from your hardware dealer or, if necessary, from us.

## FREE BOOK



Get your copy of our latest 40 page illustrated handbook. Shows how to make repairs quickly, economically. Just send the coupon.

Smooth-On Manufacturing Co., Dept. 37  
570 Communipaw Ave., Jersey City, N. J.  
Please send the FREE Smooth-On Handbook.

Name .....  
Address .....  
11-42 .....

Do it with SMOOTH-ON

## The Mystery of Rubber

(Continued from page 5)

Neoprene, made by the Du Pont Co. Chemigum, made by the Goodyear Tire and Rubber Co. Buna-S and Buna-N, made by the United States Rubber Co. and the Firestone Tire and Rubber Co.

Are synthetics good enough to replace real rubber entirely when volume is adequate to supply all needs? As yet, there isn't enough absolute laboratory or service test evidence to support an unqualified "yes" to that, but the speedup that the war pressure has given to rubber technology gives every evidence of solving the remaining problems in short order.

The Ameripol tire that B. F. Goodrich brought out in June, 1940, used that synthetic to replace 50 percent of the natural rubber content. Thousands of these tires were bought by car owners and more than 200 American corporations willing to pay the necessarily higher price to help speed the development of synthetic rubber as a "national insurance policy."

Reports from these operators, and from the company's own testing program, show that these tires gave service comparable to tires made entirely of natural rubber.

With all these companies producing synthetic rubber, why is there a shortage? Because of the tremendous difficulties in getting the necessary steel, chemicals and trained manpower to expand plants.

Will the shortage be felt severely? It certainly will unless rigid conservation of rubber is practiced by everyone. Army tanks have been switched back from rubber to steel treads, cutting their speed and boosting vibration. One spare tire is being removed from each army truck. Soldiers are getting oil treated raincoats instead of rubber. There will be no more tires for ordinary civilian use until late in 1944 or early in 1945.

Every plane, ship, train, and every vehicle which forms a part of the mechanized force needs rubber or a synthetic. A medium tank needs 500 pounds, a small pontoon bridge 1,000 pounds, the gas tank for a flying fortress 500 pounds, a battleship 75,000 to 150,000 pounds, a bomber's tire 300 pounds, a gas mask three-quarters of a pound, and a large bomber 1,250 pounds. Huge excavation truck tires used on army

projects stand 9½ feet in height and weigh nearly 3,500 pounds without tubes.

Some of the vital products containing rubber are blimps and barrage balloons, oxygen masks for fliers, bullet-sealing gasoline hose for bombers, life vests for navy fliers, rubber boats, life belts, surgeons' gloves, and de-icers for airplanes. There are hundreds more.

The obvious stop-gap to provide these is reclaiming scrap rubber and several dozen plants are busy at this.

For this purpose an average tire weighing 28.7 pounds yields 25 pounds of rubber, and 1,494,375,000 pounds came from this source in a somewhat normal year, 1941. About 100 pounds of rubber can be reclaimed from 140 pounds of inner tubing, or 175 pounds of hot-water bags, or 165 pounds of such articles as bathing caps and shoes. Fifty feet of garden hose will make an inflatable life raft; a month's supply of baby pants would provide enough rubber for 2,800 rubber rafts; seven car tires will make one bomber tire; two old tires will make a new one for a jeep; two old inner tubes will make three army gas masks, and three discarded rubbers will make an overshoe for a soldier.

The rubber shortage has naturally stimulated the minds of inventors and thousands of suggestions flood the rubber, oil and chemical companies every week, as well as government bureaus. Not one in a hundred is practical. Some recent developments hold promise, like a tire shoe of carpetlike texture, or the substitution of beef bladders for rubber bags in gas masks.

Some lucky inventors are likely to strike it rich in rubber. The greatest single advance in the history of rubber—vulcanizing—came about through the combination of a forgetful experimenter, a pot of rubber latex and a hot kitchen stove.

### Silver Replaces Scarce Metals In Electrical Apparatus

Almost every motor, generator, transformer and other apparatus made by the General Electric Company now contains a small amount of silver. The precious metal is used in place of tin, copper and other scarce materials. In 1940 the company used 1,000,000 pounds of tin; this year, despite doubled production, the amount will be the same due to increased use of silver.



## America May Well be Thankful

For its ancestry of hardy pioneers who cultivated the art of good marksmanship and, by its aid, opened a vast wilderness to law, order and opportunity.

And for the great body of sportsmen, hunters and target shooters who since have strengthened this tradition of familiarity with arms and straight shooting, so essential to the nation at war.

Deeply rooted in this phase of American life, Stevens takes pride in the fact that the accuracy and dependability of its sporting arms have earned the endorsement of such a vast army of those sportsmen. And for the fact that its technical skill and facilities were immediately available to our nation in need and are found so useful now in producing arms for the winning of a great war.

Supply of Stevens sporting arms today naturally is limited. But time will bring victorious peace, and with it abundant Stevens rifles and shotguns bearing new developments for the further improvement of shooting for sport in America.

J. Stevens Arms Company  
Division of Savage Arms Corporation  
Chicopee Falls, Mass.

# STEVENS



# Make BIG MONEY AT HOME! NEW Invention **Electroplates** by BRUSH



## Now Plates CHROMIUM!

ALSO GOLD, SILVER, NICKEL, COPPER, ETC.

**War Increases Demand—You Profit!**

New, patented invention makes possible big earnings AT HOME. Replate auto-parts—worn articles in homes, stores, hotels, restaurants, etc., with durable, sparkling, new coat of metal—with stroke of brush. Easy, simple, quick. Genuine Gold, Silver, Nickel, Cadmium, etc. Everything furnished. Outfit complete, ready for use. No shop required. Clear from \$2 to \$5 an hour in lifetime business. Small investment starts you in business. Steady repeat. Machine can pay for itself in week. Send TODAY for FREE SAMPLE and illustrated BOOKLET how you can have a life income from a business of YOUR OWN built upon satisfied customers. Act at once!

**WARNER ELECTRIC COMPANY**  
215 W. Ohio St., Chicago, Ill., Dept. 204

## FREE BOOK & SAMPLE

WARNER ELECTRIC CO., 215 W. Ohio St., Chicago, Ill., Dept. 204  
Gentlemen: Send me Free Sample and Illustrated Booklet.

Name \_\_\_\_\_

Address \_\_\_\_\_

City \_\_\_\_\_

State \_\_\_\_\_



\*WITTE has been serving America for 72 years.

## WAR VOLUNTEERS

Materials to build famous WITTE Log Saws and Engines are now needed for war equipment. America's victory program has first call at the large WITTE factory. After victory these money-makers will again be available. They're worth waiting for. . . .

## WITTE ENGINE WORKS

Kansas City, Missouri



## WITTE LOG SAWS and ENGINES

# IT'S FREE!

Don't Miss This  
up-to-the-minute  
**NEW BOOK!**

## THE AGE OF CHEMISTRY

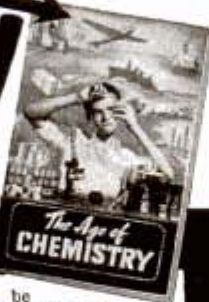

This age of chemistry may well be called "the age of opportunity" for boys and girls who become interested in chemistry. Every industry and home in America uses new and better products produced by our big chemical plants and made possible by the discoveries of Modern Chemistry. This new book describes many mystifying experiments you can perform to amaze your friends and tells you about the wonders of Chemistry. Write today—it's FREE.

THE PORTER CHEMICAL CO., 45 PROSPECT AVE., HAGERSTOWN, MD.

## Boom Town in the Big City

(Continued from page 55)

More than sixty basic materials were used in the construction of Rockefeller Center. The largest single item, measured by volume was not steel, concrete, limestone or granite—but cinders. Measured by weight the largest construction material was sand.

Sometimes people are worried that the weight of its skyscrapers will overburden Manhattan Island. Instead, they lighten it. The rock and earth excavated from the site of Rockefeller Center weighed approximately 400,000 tons more than the buildings themselves.

The number of companies or individuals leasing space is approximately 1,300; including the subsidiaries of some of these companies, the number of tenants would be at least double. These leases vary from 200 to 300,000 square feet. The average space occupied by a Rockefeller Center tenant is slightly more than 3,000 sq. ft.

Boom Town is the sightseeing center of the world. In a year, nearly 1,100,000 persons took the Rockefeller Center and NBC guided tours or visited the Observation Roofs. Add to this the number who visited the New York Museum of Science and Industry, the Rockefeller Home Center, and other exhibits, and you have approximately 4,000,000 people. Nearly five and one-half million individuals attended the Radio City Music Hall, largest and perhaps most interesting theater in the world.

Sightseeing also brings many visitors to the Rainbow Room, the Rainbow Grill, the Center Theater, and other activities, and 1,000,000 persons attend the programs broadcast from the studios of the National Broadcasting Company in a single year.

Rockefeller Center's annual Christmas tree, decorations, and choral programs, as well as the spring flower shows, are among the outdoor events that have attracted millions of people to the Center. As many as 300,000 men, women and children have come to the Center on Easter Sunday alone to see the spring flowers and shrubs.

Boom Town is really the Main Street of the biggest city in the best country in the world.

☞ To learn where to buy commercial products described in these pages, see the index.

FAMOUS  
**Marlin**  
FEATURES



Deep-cut "Ballard" rifling was first introduced in 1875 by Marlin in a single shot rifle. The superiority of this new type rifling was so marked that Marlin's 1875 model soon became recognized as the world's outstanding target arm.

For many years, Marlin rifles have featured Ballard type rifling for accuracy and long life. Before ship-

ment, all Marlin rifles have been thoroughly tested and targeted.

Marlin recently introduced a new chemical treatment for barrel bores which resists rust and corrosion. This new improvement adds to the long life and trouble-free use of Marlin rifles.

These famous Marlin rifles are worth remembering after the war is won.

Since early in 1942, engaged solely in war production.

1870 \* THE MARLIN FIREARMS CO. \* 1942  
NEW HAVEN, CONN., U. S. A.



**Something New! MECHANICS' TELESCOPE GAUGE**

A REAL 20th CENTURY TOOL. These small instruments measure by the thousandths the exact size of holes and slots using an outside caliper or micrometer to determine measurement and making either shrink or loose fit. Four measuring rods with lock adjustment measuring from 3/8" to 2 1/8". Guaranteed accurate and durable. ACT NOW! One set packed in box. Postage prepaid. Delivery C.O.D. Direct from factory to you. Send for booklet.

SEABOARD TOOL CO.

Pat. Applied For—Price \$5.25 P. O. Box No. 1214 Baltimore, Md.

**U. S. ARMY MOVES WITH HULL COMPASSES**  
\*HULL STREAMLINE COMPASSES assure the right direction of travel for the U. S. Army. Known by America's motorists as the modern means to efficient, direction-wise driving. \*Only available to public so far as dealer stocks permit.



HULL MANUFACTURING CO., P. O. Box 246-D11, Warren, Ohio

**PINS  
RINGS**

**FOR YOUR CLUB!**

Beautifully Styled—Low Prices!

Make your members more conscious of their membership. Write for free catalog. Shows 300 styles, sterling and gold sets on sterling. Choose a design suitable for your group. No order too small. Quality leader for 48 years. Write today!

BASTIAN BROS. Dept. 82. Rochester, N. Y.



**Wood workers: Here it is!**

only **10c**

Harold Hunt's big No. 14 wood catalog! Latest UP-TO-DATE IDEAS for experts and amateurs; SPECIAL BARGAINS in rare woods, veneers, and ALL kinds of supplies. 148 pages—20 of rare woods in color. Get posted! Send only 10c to CRAFTSMAN WOOD SERVICE CO. 2729 S. Mary St., Dept. A-27, Chicago, Ill.

★ ★ ★ ★ ★  
**SOME ARMY OR NAVY MAN'S USING IT NOW!**

● Some Army or Navy man's probably using the Powerlite you would like to buy today—thousands are in use in the Armed Forces. Delta's two plants are producing entirely for war. But, when the war is won there'll be Powerlites again—better if there's a way to make 'em better.

DELTA ELECTRIC CO.  
Marion, Indiana

**Delta POWERlite**



Say you saw it in Popular Mechanics!

"I'LL TAKE THE WHITE ONE EVERY TIME"



## ... EASY TO READ

—easy to clean—unconditionally guaranteed for one year. The crack-proof white surface is bonded to the steel—protects it from rust. 25, 50, 75, 100 ft. lengths. Sold by hardware, building material, mill supply dealers everywhere. Write for folder.

KUEFFEL & ESSER CO., Hoboken, New Jersey



LOOK FOR THIS DISPLAY



**K&E WYTEFACE**  
STEEL MEASURING TAPES

## BRUSH PLATING OUTFITS

for autoparts, reflectors, faucets, bicycles.  
No tanks necessary. Free particulars.

GUNMETAL CO., AVE. M, DECATUR, ILLINOIS

## ONAN ELECTRIC PLANTS

ALTERNATING AND DIRECT CURRENT



Produce Current, same as City Power Lines, for FARMS, SCHOOLS, THEATRES, PUBLIC BUILDINGS . . . Operate Lights, Radios, Motors, All Appliances.

Over 40 STOCK MODELS—150 to 50,000 Watts.  
Any Voltage—Any Frequency.  
Combination A. C. - D. C. Types.

Manual, Full Automatic and Self-Starting, \$99 up.

Shipped—COMPLETE, READY for OPERATION.  
THOUSANDS IN USE IN ALL PARTS OF THE WORLD

Write for Complete Details.

D. W. ONAN & SONS  
1075 Royalston Avenue - MINNEAPOLIS, MINN.



The FOLEY SAW FILER

is in use by U. S. Army, Navy, Air force, hundreds of War and manufacturing plants.

FOLEY MFG. CO., 1116-2 Foley Bldg., Minneapolis, Minn.

Saw filing pays up to \$2 or \$3 an hour. A FOLEY Automatic Saw Filer files hand, circular and hand saws better than the best hand filer. Cash business, no canvassing, no eyestrain. No experience needed. Send for FREE PLAN, no obligation.

## Miracle on Wheels

(Continued from page 86)

broncos are rolling down assembly lines once devoted to automobiles, believe the jeep's uses are still relatively unexplored. Some of the uses proposed are: a portable power-plant for aircraft searchlights; a smoke screen spreader to cover a tank attack; a mobile dump truck for filling holes made by enemy bombers on airfield runways; a field radio car; a field telephone exchange; a mobile anti-aircraft unit to protect land convoys and combat parachute troops; a water supply car to service desert outposts; a medical unit for front-line surgery and first-aid; a fuel supply car for tanks; a food supply unit for front-line fighters; a mobile combat unit for protecting bridges and railroad junctions; an auxiliary fire fighting unit; and a mobile air-compressor to pump up deflated tires.

"Although the 'belly-flopper' may be considered the forerunner of the jeep," says Joseph W. Frazer, president of Willys-Overland Motors, "it actually was similar only insofar as it was a light, low-slung vehicle, but it provoked thought and we were asked to bid on an entirely new type of vehicle. We never saw anything like it before and it only existed in a 1/8-in. size sketch, which called for a gross weight not to exceed 1,400 pounds and must be capable of carrying a 625 pound load.

"That was practically impossible. We finally constructed a pilot model for testing. It made a wonderful showing—but it weighed 2,450 pounds. The Quartermaster Corps then asked for a vehicle with full equipment that would weigh not over 2,175 pounds.

"Every bolt, every piece of metal, was studied and tested and the final model weighed 2,154 pounds—exactly 21 pounds less than the specifications called for."

Thus the jeep was launched.

Already this military marvel has become a part of the American scene as familiar as the hamburger stand. After the war, its designers see it as a prime farm tool, taking the place of the automobile, the truck, the tractor and the horse—even being jacked up to supply power for lights, portable saws, and so on.

Right now, however, it has a wartime job to do alongside the fighting men. They'll do it, too, these jeeps and Yanks.



Now \$9.95  
Only

### REAL ENGINE VALUE



The G. H. Q. is a miniature gasoline engine that really operates. Over 15,000 sold in the last year. Now is your chance to buy the *New Improved* 1943 model for \$9.95. Absolutely complete with coil, condenser, plug, instructions, etc. Fully bench tested and ready to run. For boats, planes, midget cars, etc. Send only \$1.—Shipped Collect C. O. D. same day. Send for *FREE* circular or 6c for Jumbo catalog of hundreds of plane, boat and hobby items.

GHQ MOTORS, Dept. B, 40 East 21 St., New York, N. Y.

### BURN YOUR NAME ON TOOLS

WITH THE

## ARKOGRAF

**PROTECT YOUR TOOLS FROM THEFT**  
Write with electricity any name or design on the hardest and finest tools and instruments, or any metal, like writing on paper with pen or pencil.

**Complete Outfit \$3.50—Prepaid Anywhere**  
Interesting illustrated circular free. Write today. Agents wanted.  
ARKOGRAF PEN CO., 3927 S.E. Stark St., Portland, Ore.



### Class Pins and Rings

Artistic pins, rings and emblems.  
Finest quality. Reasonable prices  
from 55c up. Write today. Dept. N.  
Metal Arts Co., Rochester, N. Y.

**FREE  
Catalog**

How long since you made movies  
of your family?

—Load up your **CINÉ-KODAK** today—

### FREE LITERATURE FOR TRAILER BUILDERS

New up to date facts on world's most reliable parts, axles, hitches, draw bars. Used by U. S. Gov't. and largest trailer Mfrs. Easy to build in spare time. Complete working Blue Prints only \$1.00. Write for Free Literature.

HAMMER BLOW TOOL COMPANY

Dept. 111

Wausau, Wis.



# NOW READY!

# LIONEL CATALOG

Just off the press — big, new full-color Lionel Catalog. Send for your free copy at once. Use the coupon below.

**FREE! FREE! FREE! FREE!**

LIONEL, Dept. 2, 15 East 26th St., New York, N. Y.

Please rush me free copy of new 1942 Lionel Catalog.

Name \_\_\_\_\_

Address \_\_\_\_\_

City \_\_\_\_\_

State \_\_\_\_\_

## ALL OUT FOR

# Victory

## WITH

## HARLEY-DAVIDSON

Motorcycle clubs all over the country are serving in civilian defense duty. Members proudly use their rugged, dependable Harley-Davidsons for messenger and errand service, escort and patrol duty, and render valuable aid to other volunteer branches. Harley-Davidsons' greater flexibility makes them the ideal vehicles for this type of service, and their unmatched economy conserves gas, oil and rubber for the nation's Victory Drive.

See your Harley-Davidson dealer — learn about the superior performance of these world champion motorcycles. Also look over his special values in reconditioned models.

### MAIL COUPON NOW

HARLEY-DAVIDSON MOTOR CO., Dept. P, Milwaukee, Wisconsin

Send **FREE** copy of big 24-page "Enthusiast" magazine filled with thrilling motorcycle pictures and stories. Also literature on the latest Harley-Davidsons. Stamp is enclosed for mailing cost.

Name \_\_\_\_\_

Address \_\_\_\_\_

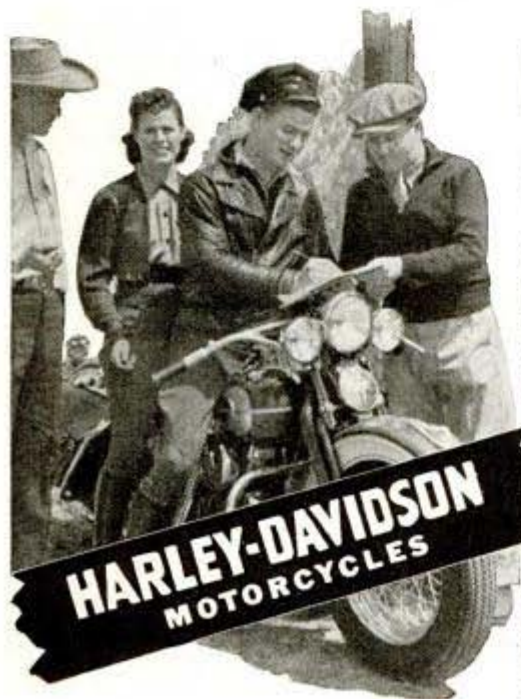

# Color in Your Home

(Continued from Coloroto Section)

of the color spectrum suitable for each type. This approach is exceedingly useful to women in helping them to understand color and to choose color for cosmetics, clothes and their own boudoir. Some companies dealing in home furnishings are applying this approach for decoration and furnishing of the home. Perhaps a husband will say that the home has other purposes besides being a setting for a wife of a certain color type. The question is very pertinent and legitimate. In such cases the best solution is to try to produce a colorful environment which is as appropriate as a suitable compromise of all factors can be—and give the wife all the concessions possible in doing so. After all the woman is more important than the man in relation to color in the home. In a sense, the woman wears a room.

Incidentally, artificial illuminants are now available which simulate natural daylight. The woman should apply make-up for use in the daytime under an artificial daylight if natural light is unavailable. Make-up for night-time offers no problem.

Light and lighting have powerful overall influences upon the color scheme of a home and they possess mobility which fixed color schemes do not. Great mistakes are made in selecting colors under natural daylight which are to be lived with more generally under artificial light. These teach the lesson that actually the "color is in the light and not in the object." Artificial light produces subtle effects, many of which are felt rather than seen. Now there is available a variety of artificial illuminants from the coldness of daylight-fluorescent lamps to the extreme warmth of fluorescent-tungsten lamps. Generally the "warmer" light of tungsten-filament lamps satisfies the entrenched association of a warm yellowish tint with artificial light. However, a gradual shift is taking place toward whiter light and less colorful lamp shades as whiter artificial light has become available. But there is little excuse for choosing shades for portable lamps and for fixtures on the cold side of white such as bluish or greenish. They are far more suitable if they are on the warm side of white such as eggshell, ecru, peach, etc.

In indirect lighting subtle tints are imparted to the light by the reflection from

colored surfaces. Thus a cream-tinted ceiling imparts warmth to the color of the light. However, this method of coloring the light need not stop at subtle effects. Here and there in a room, an alcove or a niche more colorful ceilings and walls can color the reflected light markedly—and if appropriate—with interesting effects. Concealed reflecting surfaces can be used in this manner to tint the light.

In special lighting effects of tints and colors, artificial light reveals its unique characteristic of mobility. The lighting effect, however subtle or colorful, can be created instantly with the snap of a switch. For a special occasion or for as long a period as desired the lighting effect may radiate interest and charm. When it is no longer desired it disappears with the snap of a switch. This mobility is not only unique but highly desirable for it permits the use of powerful, theatrical, and even exotic color and lighting effects which would not be tolerated if they had to be lived with continually. On the other hand many appropriate subtle effects of tinted and colored lighting can be superposed upon the regular lighting and be lived with continually.

Lamps may be placed behind cornices over windows and a shower of glorified sunlight (straw color) or of glorified moonlight (rich blue) may be showered down the draperies. Windows in basement rooms or imitation windows elsewhere may be covered with grills, shutters or venetian blinds behind which artificial light sources are installed. A niche in a wall or on the stairway may be covered with a stained glass or may contain a statue, vase or crystal ornament. An aquarium becomes more fascinating under concealed light ingeniously applied. Concealed sources of light bring them to life. Beautiful plaques of crystal glass set in the wall become gems of light and color. In many such applications the new fluorescent lamps which produce "daylight," "white," "soft-white" and various colors efficiently are particularly useful.

Small spotlights are now available by placing a reflector tungsten lamp in a socket. Colored lenses readily snap on these lamps. A variety of lighting tools is avail-

(Continued to page 178)

KEEP 'EM  
FLYING



BUY  
WAR  
BONDS

# Atlas

## MODERN SHOP EQUIPMENT



LATHES

DRILL  
PRESSES

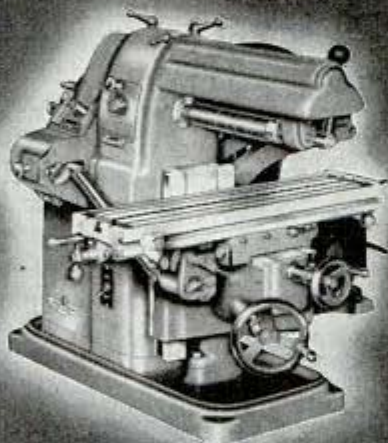

MILLING MACHINES

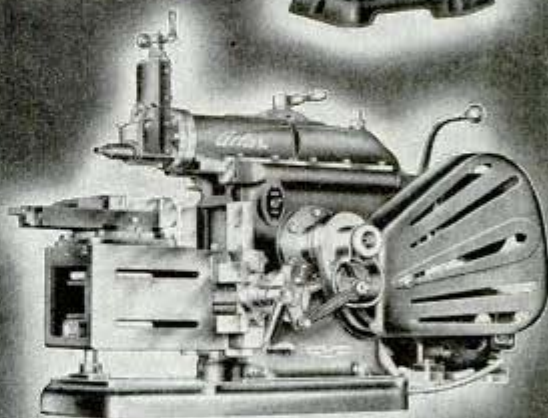

SHAPERS



HISTORY is being made today by American industry. Every industrial craftsman can take pride in the weapons he helps produce. They are the best in the world! Here at Atlas we are glad of our opportunity for service — making the tools for building so many of Uncle Sam's effective war machines. Planes, ships, tanks, guns — in nearly all industrial plants on the honor rolls of the nation you will find one or more Atlas Machines helping speed production. Someday, again, you will be buying machine tools for your shop. Then, you can be sure that our experience in meeting today's intensive demands, will make Atlas Equipment better than ever. Atlas Press Company, 1143 N. Pitcher St., Kalamazoo, Michigan.

**VICTORY FIRST!** - THEN *Atlas* TOOLS FOR YOU

## WHEN LIVES ARE AT STAKE, A GLUE HAS TO BE GOOD!



### CASCAMITE meets Navy Glue Specifications for Wood Life Rafts

Uncle Sam is hard-boiled about glues for his life rafts. These resin glues must stand shear tests of 2800 lbs. per square inch on maple blocks; 340 lbs. per square inch on thin, dry plywood; 280 lbs. per square inch on thin plywood *after 48 hours water soaking!* CASCAMITE stands these tests with strength to spare, just as CASCO Powdered Casein Glue passes all casein glue specifications.

That's why you know these glues will do your homecraft and repair jobs *once and for all!* They meet Uncle Sam's toughest requirements.



**CASCAMITE Powdered Resin Glue**—Meets Army and Navy specifications for aircraft assembly cold press resin glue. Also specifications for life floats, truck bodies, other field equipment. Waterproof. Moldproof. Stainfree. Mixes instantly in cold water. 10c to 85c.



**CASCO Powdered Casein Glue**—Meets Army, Navy and Federal casein glue specifications.

Highly water-resistant. Cold water mix. A "self-bonding" type glue; makes strong bonds with but moderate pressure—even on imperfectly fitted joints. 10c to 65c.

Both sold at Hardware, Paint and Lumber Dealers'. Every 25c or larger can includes coupon good for free project plan for one of 36 furniture and water sports projects.

### FREE HOME AND INDUSTRIAL GLUING DATA:

CASEIN COMPANY OF AMERICA, Dept. PM1142  
350 Madison Avenue, New York, N. Y.

Send me the literature checked.

- "Gluing Guide." Complete mixing directions for all glues. Over 80 home workshop jobs.
- "Project Folders." Describe free project plans.
- Technical Information on the industrial gluing of

(fill in)

(Be sure to give your name and address clearly printed or typed.)

able to make it easy for anyone who will give some thought and feeling to the possibilities of tinted and colored light in making a home interesting. These lighting effects may flood the entire room, the windows or a portion of a wall or they may be confined to an ornament or group of them. They may extend as far as desired or be confined to a night light. And they may extend outdoors into the garden.

Everywhere there is opportunity for taste, interest, charm, mystery, and symbolism covering the entire range from the realistic to the abstract and from the subtlest effects which are merely felt, to those which are subtly seen, and to those powerful ones which surprise and fascinate. Light is a master sculptor. Artificial light supplies crystals and jewels with their brilliance. The painter's palette is drab compared with the purity and brilliance of colored light. Many new light sources and lighting tools are now available. Artificial light as a powerful medium of expression should help in the rescue of civilization from the drabness of the century-long Taupe Age which only recently has been appreciably invaded by color and colors.

### The Navy's Seven-League Boots

(Continued from page 13)

To show Ensign Gay's mettle, upon returning to his ship he requested of his commanding officer that Torpedo Squadron No. 8 be reorganized and that he be ordered back to duty with it. This may be done. At any rate, that famous but ill-fated squadron is still officially in commission.

The design of every naval vessel is necessarily a compromise between conflicting factors, among which the most important are: protection (armor), armament (guns), speed and cruising radius (fuel capacity). In the case of carriers, two other points which must be fully considered are: the varying mission of carriers and the number of planes to be carried together with the necessary aviation facilities.

In a general comparison between American and Japanese carriers we find the capacity of the latter to be less, per ship, while speed is about the same. Though little is known of Japanese armor protection, because of the reinforced flight decks and heavier side plating along the waterlines,

our carriers are considered to be tougher. According to "Jane's Fighting Ships" the Japanese had, at the start of the war, 9 carriers with the following characteristics:

No.	Tonnage	Speed	Normal Capacity
2	17,000	30 knots	45 aircraft
3	10,500	30 knots	30-40 aircraft
1	7,000	25 knots	24 aircraft
2	26,900	23-28 knots	50-60 aircraft
1	7,400	25 knots	25 aircraft

The Akagi and Kaga (26,900 tons) were originally designed as a battle cruiser and a battleship, respectively, but as result of the Washington Limitation of Arms Treaty (1921) were converted to aircraft carriers as were our Lexington and Saratoga (both originally designed as battle cruisers). The Asage underwent a complete overhaul 1937-39.

Because of the smaller size of Japanese ship-borne planes, it is believed that the carrying capacities of the various carriers are considerably more than indicated in the above table, perhaps almost equal to the capacities of American carriers.

The seven American carriers, at the beginning of the war, and their characteristics, as reported by Jane, are:

No.	Tonnage	Speed	Normal Capacity
1	14,500	29 knots	72 aircraft
3	19,900	34 knots	81 aircraft
1	14,700	30 knots	72 aircraft
2	33,000	33 knots	83-90 aircraft

Counting out the Lexington, lost in the Coral Sea, and the Yorktown, put out of action at Midway, this leaves five carriers in service. However, a new 25,000-ton carrier (Essex), first to be launched since December 7, 1941, slid down the ways on July 31. Ten others of this type are under construction. These latter are in addition to those recently authorized in the 200,000-ton expansion carrier program.

In addition several merchant ships of the Maritime Commission C-3 type ("Mormacmail," now U.S.S. Long Island) were taken over last year for conversion into auxiliary "escort" carriers, for use primarily in convoy duty. These are vessels of 7,800 tons with speed of 16 knots, carry-

(Continued to page 185)

## What a difference, when you smoke the *Imperial* honeyed pipe



YES, THERE'S REAL HONEY in Imperial. Good enough to eat! Dear to the hearts of smokers everywhere because it entirely eliminates "breaking-in"!

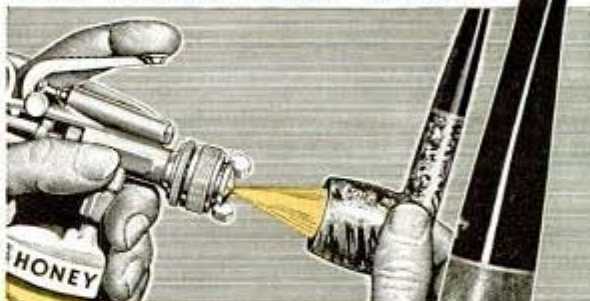

HERE'S HOW THE HONEY IS SPRAYED in the pipes. It coats walls of pipe-bowl permanently. It mingles with tobacco and forms a beautifully-cured "cake." A sweet, satisfying smoke, mild and smooth, no matter what tobacco you use.



Billiard Shape

\$1<sup>50</sup>

... and everybody knows that for \$1, **YELLO-BOLE** is the finest pipe you can buy

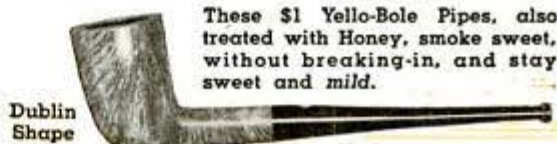

Dublin Shape

These \$1 Yello-Bole Pipes, also treated with Honey, smoke sweet, without breaking-in, and stay sweet and mild.

© 1942, Kaufmann Bros. & Bondy, 630 Fifth Avenue, N. Y.

FOR OUTDOOR  
**THRILLS!**



## Indian SPRING FRAME MOTORCYCLES

Only Indian offers "Spring Frame" smooth-riding comfort and safety, plus new streamlined beauty. National Defense may mean a wait for one of these great Indians, but your Indian dealer will gladly help you get more service out of your present machine.

ASK YOUR DEALER FOR THIS  
NEW **FREE** BOOKLET

Jam-packed with ideas to help you get more out of any make of motorcycle. Ask your local Indian dealer for a free copy, and Indian literature.



INDIAN MOTORCYCLE CO., SPRINGFIELD, MASS.

**FREE RADIO CATALOG!**

You'll want this Big FREE 1942 Book that shows Everything in Radio! Here's everything you need for radio servicing, for experiment, for instruction in the science of modern Radio! More than 15,000 quality radio items—replacement parts, books, tools, lab and experimental equipment—all at the lowest prices! Send for this FREE Catalog now—and don't miss the two big book values described below—They're a "must" for Everyone in Radio!

**Radio Builders' Handbook.** Everyone in radio needs it 10¢

**Radio Dictionary.** Complete, valuable, defines all terms 10¢

**FREE**  
Send for it NOW

**ALLIED RADIO CORP.**

833 WEST JACKSON DEPT. 5-L-2 CHICAGO

**PHOTO ENLARGEMENTS**

Is Photography your hobby? Do you want a profitable business at home? Make **PHOTO ENLARGEMENTS** for yourself and others. Your cost 5¢ each and less. The Ideal Photo Enlarger is **AUTOMATIC**. No experience required. Also **COPIES** any picture 37-94 COMPLETE. Interesting circular **FREE**.

**5¢ ANY SIZE**

Ideal-O, 148 West 23rd St., New York City

**HOLD-E-ZEE AUTOMATIC GRIP SCREWDRIVERS**

Hold, start and set-up screws in unhandy places. Gripper instantly released by spring action, sliding up out of way when not in use. Finest materials thru-out, chrome vanadium blades; many have transparent, insulating unbreakable handles. (Illustr.)

No more expensive than ordinary screw drivers. Models for recess-head screws. Handiest, ever. Get one today. At auto-supply, hardware or electrical stores.

UPSON BROS., INC. 86 EXCHANGE ST. ROCHESTER, N. Y.

## Four-Unit A.C.-D.C. Receiver

(Continued from page 157)

When the power unit is completed it is a good idea to test the output if a suitable B-eliminator voltmeter is available. Referring to schematic circuit diagram Fig. 1, it will be noted that the 120-volt positive B output is filtered, and positive B 135 volts is not. Photos D and E show top and bottom views of the completed power unit.

The schematic circuit diagram for the audio unit appears in Fig. 2, and the simplified wiring diagram in Fig. 4. Dimensions are given in Fig. 4 for the wood base-

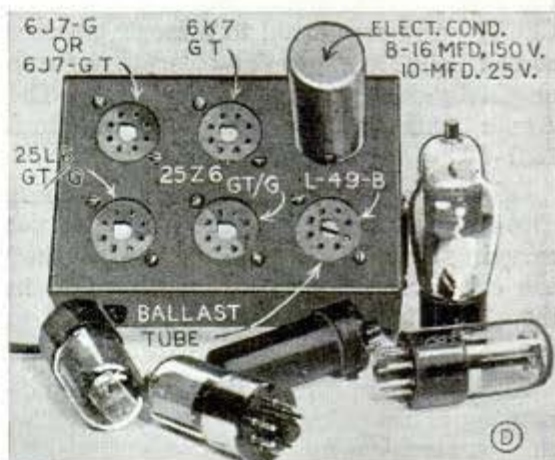

board and metal front panel. The top chassis type octal socket for the 25L6-GT/G audio tube is the Amphenol type ACS8; however, any octal wafer-type socket may be used instead merely by mounting it on  $\frac{3}{4}$ -in. bushings to support it above the baseboard. The connections are shown looking directly down on the top of the socket. The "out" socket is a bottom view looking directly at the terminal connections on the underside. The "in" plug is also shown as a bottom view, with this important difference: the connections are shown looking at the ends of the prongs and considering the prongs as on the bottom side. A 5-in. dynamic speaker with a 3,000-ohm field and output transformer to match a type 25L6 tube, is mounted on the front panel together with the volume control  $R_2$  which is an audio taper type. The speaker grill is formed by cutting seven  $1\frac{1}{8}$ -in. holes in the pattern shown; this is backed with a piece of large mesh screen wire. The blueprint number will be R-309 but this blueprint will not be available un-

(Continued to page 182)

POPULAR MECHANICS

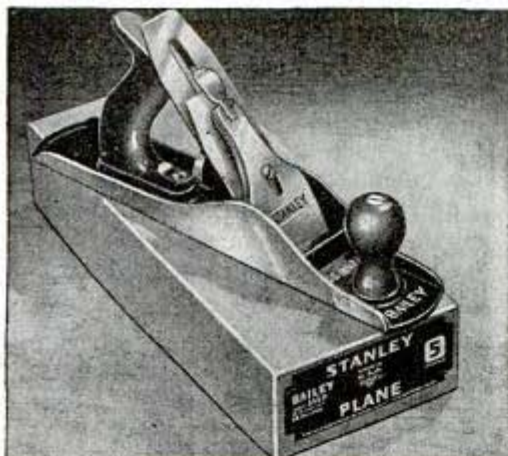

**STANLEY "BAILEY" Plane**—famous throughout the world for over fifty years, for its quality construction, balance and "feel."

**STANLEY OPEN THROAT Router Plane No. 71.** With adjustable fence which makes it easy to rout the exact distance from an edge.

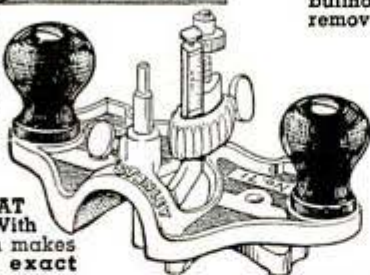

**STANLEY RABBIT Plane, No. 78** has two cutter seats for regular and bullnose work. Fitted with Spur, removable Depth Gauge and Fence.

**STANLEY SIDE RABBIT Plane No. 79.** Both right and left hand, for side rabbeting in trimming dados, mouldings and grooves.



**STANLEY**  
Trade Mark

## STANLEY TOOLS

DIVISION OF THE STANLEY WORKS

NEW BRITAIN, CONN., U. S. A.

**THE TOOL BOX OF THE WORLD**

**BOYS!** More boys have won fame and big awards with Gilbert Chemistry Sets than any other kind. Send for **FREE** 24-page book "Fun and Action for Boy Chemists." **GILBERT HALL OF SCIENCE** 206 Erector Square, New Haven, Conn.



### END DAMP AIR WITH "DRI-AIR"

New DRI-AIR Powder draws excess moisture from air in damp basements. **PROTECTS TOOLS** and machinery against **RUST**, mold, mildew. Complete outfit, DRI-AIR Unit and 10 lbs. DRI-AIR Powder, \$3.70. Order now! **DEALERS WRITE TODAY!**

**TAMMS SILICA COMPANY**

228 N. LaSalle St., Chicago, Ill.



**8 Mile Range-Wide Vision BINOCULARS \$4.75**  
**15 Days FREE TRIAL**  
Postpaid or C. O. D.

Comes complete with case and straps. Well ground powerful lens. Easily focused for all distances and ideal all-weather binoculars. Guaranteed. If not satisfied after 15 days trial, money refunded. **AGENTS WANTED.**

**Vogue Binocular Co., 7759 S. Halsted, Dept. 1108, Chicago**

## WINDOW SIGN LETTERS

For Store Fronts and Office Windows. Anyone can put them on. Free Samples. Liberal Offer to general agents. **METALLIC LETTER CO., 430 N. Clark St., Chicago**

## Build the Biggest \$1.00 Plane in the U. S.—Giant 7-Foot Glider

Famous **CLEVELAND CONDOR**. Soars for hours. Easily built. Complete Kit, only \$1.00



Big 48" **EAGLET** Glider (Baby Bowler type) 50c. At dealers or direct. Send 5c for catalog of all C-D models. (None free.)

**CLEVELAND MODEL & SUPPLY CO., INC., 4508B 105 Lorain Ave., Cleveland Ohio**



On orders less than \$1.00 add 15c for packing and postage.

## REMODEL AND BEAUTIFY with Air Pressure

Renew old buildings. Make new construction more permanent and attractive. **COLORCRETE** in a mortar-like consistency fuses with any masonry surface—exterior or interior—when applied with air gun. **COLORCRETE** is waterproofed and can be sprayed in any thickness and in 30 colors and shades. Fully proven by over 15 years' actual use.

With the **COLORCRETE** machine, you can supply big waiting market at amazingly low cost. Some present operators report earnings that have paid for their equipment from first few jobs. Machine capacity up to 1,000 sq. ft. per hr.

Get the facts. Send for Free Books while your territory is still open. Write today.

**COLORCRETE INDUSTRIES, INC.**  
570 Ottawa Ave., Holland, Michigan



## WHEN YOU BUY FLASHLIGHT BATTERIES DEMAND "EVEREADY" FRESH DATED BATTERIES

The word "Eveready" is the registered trade-mark of National Carbon Co., Inc.

**GUARANTEED**  
**5 POWER TELESCOPE**

For Civilian Defense...  
for Sports



**GROUND, POLISHED LENS**

● Here is real efficiency in a man-sized telescope. Brings you close to everything. Air-raid wardens, sports fans... use them everyday.

Every home should have one or more

**Send Order Today**

**50¢** each  
**POSTPAID**  
No C.O.D.

**FREE!** Silhouette identification chart showing United Nations fighters, bombers and Axis bombers. Know them by name and shape.



**IWAN RIES & Co.** Established 1898  
73 W. Monroe St., Chicago, Ill.

**NEW! FREE CATALOG**

**RADIO · SOUND ELECTRONICS PARTS · SUPPLIES**



**FAST EMERGENCY SERVICE**

**WRITE TODAY**

The BIG book of BIG values! Standard Radio and test equipment, thousands of parts for Radio, Electrical and Electronic assemblies. Nation wide service with Teletype connections for speed and dependability. Engineers, laboratory workers, servicemen and industrial plants look to Lafayette for everything in radio. Write for catalog PM-11 today.

**Lafayette RADIO CORP.**  
901 W. JACKSON, CHICAGO  
265 PEACHTREE ST. ATLANTA

## CARBURETORS REBUILT LIKE NEW

We can rebuild your old carburetor or will send original exchange carburetor. No delay—1 day service. Send for full particulars today. United Carburetor Service, 4720 N. Kimball, Chicago, Illinois

**WORLD'S LOWEST PRICED ADDING MACHINE**

**IDEAL FOR BUSINESS OR PERSONAL USE**

**GUARANTEED ACCURATE.** Not a toy. Operates with only a finger flick. Adds, subtracts, multiplies, divides. Counts up to ten million. Pays for itself over and over. Ideal Gift—for Business, Income Tax and School use. **MONEY BACK GUARANTEE.** Send name and address. Pay postman only \$2.50 plus postage. (Send full cash if outside U. S.) Money back in 10 days if not delighted. **AGENTS WRITE.**

**ONLY \$2.50**  
**TOTAL COST SEND NO MONEY**

**CALCULATOR MACHINE COMPANY (Mrs.)**  
DEPT. 135 P. O. BOX 1118 CHICAGO, ILLINOIS

til the 4-unit receiver is completed in the December issue. A detailed list of materials for all four units is available from Popular Mechanics radio department without charge at once, if desired. After the audio amplifier unit is wired, it may be plugged in with the power stage. The 25L6-GT/G tube is removed from the power unit and placed in the audio stage tube socket; all necessary circuit changes

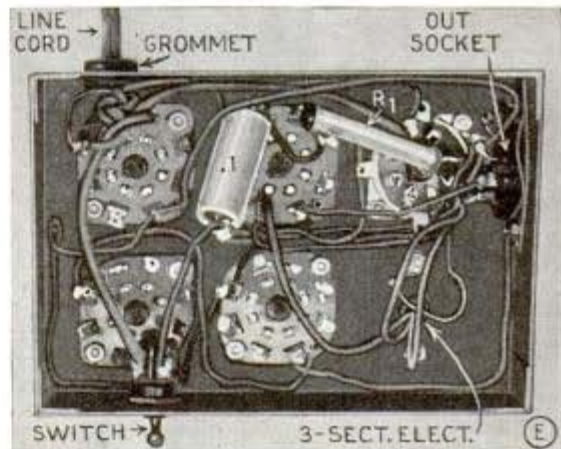

are made automatically. To test, advance the volume control and touch the Fahnestock clips with a finger; a loud buzz should be heard. A phonograph pick-up (crystal or magnetic) may be connected to these clips and the two units will serve as a complete phono amplifier.

(To be concluded)

## First Aid for Radio Sets

(Continued from page 155)

the one shown in photo No. 2; older heavy-duty test meters may shorten the life of these batteries.

Portable sets, like the one shown in photo 3, designed to operate either from batteries, 110-volt a.c. or 110-volt d.c. electric circuits, shift from batteries to all electric operation either by means of a switch or by plugging the line cord plug in or out of a receptacle on the rear of the chassis as indicated in the photo. If this type of receiver is to be operated on battery be sure that the power cord plug is pushed all the way down in the receptacle. When not in operation for any length of time it is a good idea to remove the plug so as to protect the life of the batteries in case the set should be turned on accidentally.

(To be continued)



## Precious Cargoes

(Continued from page 39)

valves are opened from the engine room or the bridge and the carbon dioxide pours into the holds, smothering the fire.

Fortunately for the nation in time of stress, shipping companies installed modern mechanical devices for cargo handling on piers and ships in time of peace.

These devices include lift trucks which carry, pile and lift merchandise, platform and towing trucks, modern electric cranes, platform skids, chutes which slide cargo downward to pier or into vessel, and conveyor belts for handling cargo like bananas.

Cargo ships have also been improved with more booms per ship and heavier lifts, up to 50 tons on Grace Line ships, longer booms, reaching 63 feet, which place cargo more nearly where it belongs, bigger hatches and better-planned refrigeration.

For these improvements and for the serious, hard-working, efficient men who pioneered them in times of peace, America will have cause to be more and more thankful as the grim lines in the battle of transportation grow tighter and tighter in the perilous months to come.

## Heroes of the Engine Rooms

(Continued from page 69)

Cast iron fittings, pipe connections, and valve bodies might be cracked or broken in an enemy attack, and a helpful remedy has been to encase such fittings in boxes that are poured full of concrete. On some ships cargo nets are hung over the sides at all times so that the crews can escape over them to the rafts in case of an "abandon ship" order, and on most ships, all crew members are required to wear life belts.

Whenever an enemy craft of any sort is sighted, orders go down to the engine room to start the fire pumps going. Thus the crew can immediately battle any fire that starts on board. If the ship is hit, the bilge pumps are brought to full capacity at once.

Our seagoing engineers are carrying on just as they did during peace. Because they are exhibiting the same gallant bravery in the face of danger that our armed forces display, Congress, at the urging of the Maritime Commission, recently passed a law providing for the award of medals to heroes of the Merchant Marine.

# HOW AND WHY WILLIAMS' TOOLS AID WAR PRODUCTION

## DATA ON WILLIAMS' BORING TOOLS

★ For lathe operations involving boring and internal threading, Williams' Tools incorporate features which conserve man-hours, improve output, and reduce rejects.



**WILLIAMS' BORING-TOOL HOLDERS** (80 series) accommodate several sizes of bars. Commercial forms of bar steel are also adaptable for either bars or cutters without machining. Adjusting sleeves or bushings are not used with this holder so there are no loose parts to become misplaced or lost. A "V" Block clamping arrangement grips even under-size or out-of-round bars firmly at four points, thus preventing tool chatter.

The Sleeve Bar regularly furnished accommodates either a straight or angle cutter in the one head. A Plain Bar, as illustrated, can also be supplied. Made in 5 sizes covering bar diameters from 3/16" to 1-1/8".

### WILLIAMS' LIGHT BORING

**TOOL HOLDER** incorporates certain distinctive features. In boring and internal threading operations each holder will take several sizes of bars. Easy, rapid adjustment is assured with the knurled adjustment screw. When used as a Turning Tool Holder the offset shank makes it reversible for right and left hand work. Made in 3 sizes for bars from 1/8" to 7/16" in diameter.



**WILLIAMS' ADJUSTABLE BORING-TOOL POST** is designed to accommodate many sizes of bars on various types of lathes. Quick, vertical adjustment is accomplished by selecting the proper bar recess in slotted collar and then rotating the knurled ring which raises or lowers the bar to the correct height. Tightening the set screw in the head tightens the whole device instantly. For boring and internal threading this vertical adjustment permits proper centering and assures perfect performance. The "V" block bar clamping construction grips the bar at four points, eliminating vertical or horizontal movement. Made in 4 sizes for bars 1/2" to 2-1/4" diameter.

J. H. WILLIAMS & CO. BUFFALO, N. Y.

**WILLIAMS**  
SUPERIOR DROP-FORGED TOOLS  
Headquarters  
for over half a century for  
**DROP-FORGINGS and DROP-FORGED TOOLS**

# SEE FAR AWAY!

**SEND NO MONEY TEST 10 DAYS AT OUR RISK**

Now on priority, remaining stock being closed out quickly at only \$1.00. If C. O. D. postage is extra. Satisfaction on 10 days' trial or moneyback. Act, write now:  
**MILLER TELESCOPES, Dept. 630, 225 N. MICHIGAN AVE., CHICAGO, ILLINOIS**

Get This Brand New "LATHE MANUAL"

This manual will enable you to understand the modern metal-cutting lathe, its parts and their functions... to teach the proper care of a lathe... to explain the grinding of cutters; modern lathe tools and how they should be set-up; methods of holding work, and the performance of the basic lathe operations. This manual is exceptionally complete in its tool grinding charts.



ONLY 50c

The Care and Operation of a Lathe

50c

**SHELDON MACHINE CO., Inc.**  
4266 N. Knox Ave.  
CHICAGO ILLINOIS

Send for LATHE CATALOG

## SHAW and "Peppy-Pal" "DU-ALL" GARDEN TRACTORS

\* 1 to 9 H. P. Circulars on request. War limits production... We have repairs for all SHAW tractors sold in our 39 years in business. Write us for your needs.

**YOU CAN BUILD YOUR OWN GARDEN TRACTOR**

\$1.00 brings our plans, postpaid, telling how to build a garden tractor (Chiefly by welding and bolting up scrap steel), for cultivating, light plowing, etc.

**SHAW MFG. CO., 4511 Front St., Galesburg, Kansas 668-G No. 4th St., Columbus, O.; 5812-G Magnolia Ave., Chicago, Ill.**



## MOTORISTS Wanted!



**TO MAKE THIS UNIQUE GAS SAVING TEST**

Will you permit us to send you at our risk the Vacu-matic, a device which auto owners everywhere are praising? Install it on your car. Test it at our risk. Unless it trims dollars off your gas bills by saving up to 30% on gasoline consumption, gives more power, quicker pickup and faster acceleration, the test will cost you nothing.

**Automatic Supercharge Principle**  
Vacu-matic is entirely different! It operates on the supercharge principle by automatically adding a charge of extra oxygen, drawn free from the outer air into the heart of the gas mixture. It is entirely automatic and allows the motor to "breathe" at the correct time, opening and closing as required. Saves up to 30% on gas costs, with better motor performance.

**FITS ALL CARS**  
Constructed of six parts fitted into a single unit, a limited and sealed at the factory. Easily and quickly installed by anyone in a few minutes.

**AGENTS Get Yours FREE**  
FOR INTRODUCING. Here's a splendid opportunity for unusual sales and profits. Every car, truck, tractor owner a prospect. Send name and address now for big money making offer and how you can get yours Free.  
**The Vacu-matic Co., 7617-757 W. State Street, Wauwatosa, Wis.**

# Increase Your Earning Power

Apply time and labor-saving kinks to your work. Your efficiency will soon be recognized and you will be in line for advancement.

If you do machine shop work of any kind, sheet-metal work, painting, carpentry, auto repairing, farming, concrete work, plumbing, electrical work, welding, building-glass work, general repairing, tool-making, poultry raising, masonry or home repair work, get this

## LIBRARY OF 1700 TIME AND LABOR SAVING IDEAS FOR SHOPMEN AND HANDYMEN



**SHOP NOTES**  
for  
**1943**

449 Articles  
560 Illustrations  
224 Pages  
Price 50c  
See partial list of contents below

Including the new 1943 issue illustrated above, there are four volumes in the Shop Notes Library of 1700 easily understood short cuts to every-day jobs. Here are just a few of the subjects taken from the latest issue.

- how to read blue-prints
- color designs in mirrors
- helpful hints for the motorist
- sheet-metal brake from old auto parts
- lathe indexing attachment
- five handy tool boxes
- tool grinding
- joints easily cut with jig
- electroplating, plating by dipping
- tricks of using cold chisels
- saw-sander unit with tilting tables
- centering fixtures for drill press
- ideas that improve drawing table
- constructing thickness sander
- drill-press clamp handles irregular work
- making spray guns and compressor
- lathe dial shows cutting speed
- solenoid pendulum operates displays
- welder's drill and grinder from old auto starter
- quick-acting clamps
- shop forge with electric blower
- turning and polishing plastic balls
- knurling tool prevents bending small work
- drilling at an angle
- restoring antique furniture
- a lustrous oil finish
- servicing auto generators and starters
- precision drill press
- metal spinning
- buying used power tools
- good concrete
- sewage disposal made safe

Each volume contains approximately 400 articles and 400 illustrations and has 184 or more pages. This unrivaled library of shop helps may be secured for a limited time only. After the present supply of books is exhausted the offer must be withdrawn.

**\*Send No Money**

**POPULAR MECHANICS PRESS, 200 E. Ontario St., Dept. 438, Chicago, Ill.**

Send me, as per your offer, the following books. I will pay postman price and small amount of postage. My money will be refunded if I am not satisfied. (Check what you want.)

1943 Shop Notes 50c.

Shop Notes Library (4 vols.—1943, '42, '41, '40) \$1.95.

Name.....

Street and No.....

City.....State.....

\* C. O. D. applies to U. S. A. only. If you reside elsewhere, remittance must accompany order.

Say you saw it in Popular Mechanics!

ing an undisclosed number of combat planes.

Aircraft carriers are organized internally, as are other naval vessels, and with the same ship departments of Navigation, Gunnery, Engineering, Construction and Repair, Medical and Supply. In addition, there is the important Air Department, the entire officer personnel of which is composed of naval aviators assisted by the necessary subordinate ratings and seamen. The Commanding Officer, Executive Officer and Navigator are also naval aviators.

Although squadrons embarked on a carrier retain their individual identity, nevertheless while on board they become a part of the Air Department, and as such operate as an integral part of the ship. The squadron personnel in nonflying status is utilized as necessary in forming the Air Department organization such as crews for handling planes, fuel squads, plane directors, ordnance men, fire-fighting crews, servicing, gunnery, etc. A high degree of cooperation, skill and dexterity is required of "all hands." Safety precautions are so rigidly adhered to that damage or injury through carelessness is almost unknown.

The Air Department of the ship is directly responsible for all aviation activities on board, and for the maintenance and upkeep of aircraft. One of the principal duties in this connection is performed by the Air Officer who is in charge of flight deck operations. He is assisted by the Forward and Rear Flight Deck Officers who supervise, respectively, the taking off and landing of planes.

When planes are to be landed on deck the carrier heads into the wind to reduce relative landing speed of planes. During this period a gong summons plane-handling, fire-fighting and medical crews to their alert stations. Because of their close proximity to whirling propeller blades, these jobs are dangerous and require specially trained men.

The Signal Officer (a pilot) is stationed at the after edge of the landing deck to inform pilots, by flag movements, whether approaches are too high, too low or too fast. He makes the final decision as to whether landing shall be attempted or another try made, in which latter case another circling approach is begun. When finally waved to come "in" the pilot eases his throttle and

(Continued to page 186)



## PROTECT THAT SPARK OF LIFE!

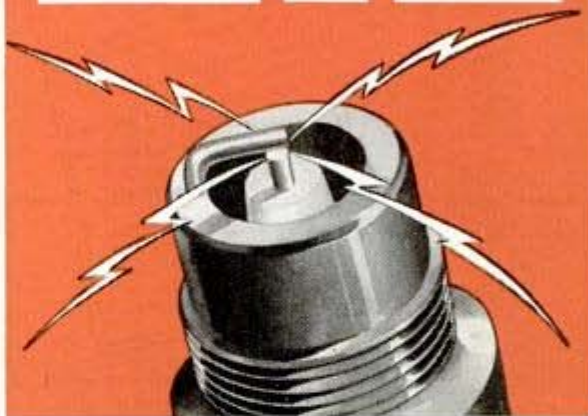

Your spark plugs will last longer—your engine will perform better—and your gas mileage will hold higher—if you will do these three simple things *regularly*:

- 1 Have your spark plugs cleaned and regapped every 4,000 miles.
- 2 Replace worn plugs promptly.
- 3 Change to a "hotter" plug if you are troubled with excessive fouling; or to "cooler" plug if preignition, rapid wear, cracking, or splitting are chronic.

Clearly, proper care for that "spark of life" for the engine is a wartime *must*,—and a worthwhile factor in reducing motoring costs, also. So, give your spark plug equipment this 3-way care—always.



**AC PRODUCES FOR VICTORY**  
Machine guns, aircraft spark plugs, standard spark plugs, oil filters, and many other products are being supplied to our armed forces.



**AC SPARK PLUG DIVISION**  
General Motors Corporation

**Unmatched  
Features . . .  
Many Found Only In Big Machines!**

**in this Fine New  
PORTER-CABLE  
7" SHAPER**



**PROMPT  
DELIVERY**

Fast-cutting—versatile—tough, this fine little shaper makes heavy cuts with ease. No chatter, no backlash! Get faster set-up, greater precision, easier operation . . . a wealth of power—all in compact space! Ask your local Porter-Cable man—or write us today!

**PORTER-CABLE MACHINE CO.**  
2000-11 N. SALINA ST. SYRACUSE, N. Y.

- LOOK AT THEM**
- 6 automatic cross-feeds.
  - Table traverse 10 1/2".
  - Vertical travel 5 1/2", by handwheel.
  - Ram travels in dovetail ways; phosphor bronze slide block.
  - 64 to 175 reciprocations per min.
  - Micro-Set adjusts stopping point exactly.
  - Toolhead turns 360°; has tapered locating pin.
  - Heavy crank-pin plate gives flywheel action.
  - Chain-and-sprocket drive.
  - Table mounted on dovetail, tapered locating pin.
  - Steel and cast-iron parts.

**New Accurate 10" Slide Rule**

Enables you to do difficult calculations instantly without paper or pencil—multiplying, proportions, division, extracting roots, etc. Accurate, white composition face. Has standard A, B, C, D, CI, and K scales. Special magnifying indicator.

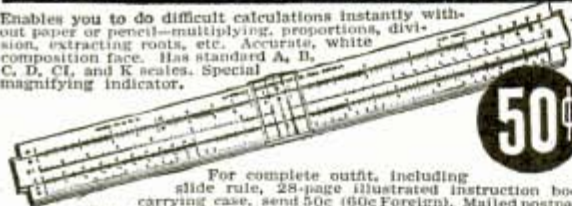

**50¢**

For complete outfit, including slide rule, 28-page illustrated instruction book, carrying case, sent 50c (60c Foreign). Mailed postpaid. Satisfaction guaranteed or money refunded.

**SPECIAL COMBINATION OFFER**—Slide Rule and Instruction Book; Pocket Calculator for adding and subtracting up to 999,999; 6" Transparent Protractor and Graph Rule graduated in centimeters and inches—ALL 3 for \$1.00 cash (\$1.10 Foreign). Order NOW **HEWIG CO., Box 143-D, Grand Central Annex, New York City**

**Technician Inspection Mirrors**—Ideal Xmas gift for aircraft mechanics, shipbuilders, inspectors, engineers, etc. Adjustable—metal construction, 2 1/2" circle mirror. Little as 89c at your dealer or write direct. Free particulars. Guaranteed satisfaction. **GENERAL AIRKRAFT PRODUCTS** 601 So. Vermont Ave., Los Angeles, Calif. Patents Pending

**PAINT STRIPING TOOL**

*Try it! See the Added Beauty*

**ONLY \$1.00 POST PAID**

With this NEW TOOL (not a brush) everyone can now draw lines with paint. Used on autos, models, toys, tiled walls, cabinets, furniture, linoleum floors and all home workshop projects.

**As easy to use as a pencil**



Send only \$1.00 for complete tool for painting a 1/16" wide stripe, including adjustable guide, operating instructions, etc. C. O. D. price \$1.25. Tool uses paint, enamel, lacquer, etc. Patented interchangeable tips are available for wider or narrower stripes.

**Every Painter and Craftsman Should Own One**  
Send for your tool today. Use it. If you are not satisfied that you have added character as well as beauty to your work, return the tool and we'll refund your money promptly.

Dealers: Write for literature, etc.  
**WENDELL MFG. CO.**  
2531 N. Ashland Ave. Chicago, Ill.

lands on deck where a secret arresting gear quickly brings his plane to a stop. In order to withstand this shock plane structures have been strengthened.

Carriers normally carry fighters, scouts, bombing and torpedo planes. While each plane is adapted to its own primary task, it is also adapted to that of each other type should the situation demand it. Maximum possible air aid is thus provided to the fleet.

Before proceeding on a mission, the squadron leaders, after conference with the commanding officer (or Task Commander) call their pilots together and describe the plan of attack. This includes such details as timing, directions, flying speeds and individual targets, fuel and bomb loads. The Air Group Commander is the senior flying officer and the captain's representative at the scene of action.

Prior to getting under way, the planes to be used are assembled on deck and arranged in the order of take-off. Immediately on the bugle call to "flight quarters," the whole ship springs into action, every man on board proceeding immediately to his station.

The navigator having determined the course and speed of the ship to reach the desired position at the time decided upon, the ship is gotten under way as soon as the engineer reports ready. Meanwhile, plane crews are busy warming up their engines, and the gunners take station at their anti-aircraft and machine guns. All pilots, having previously proceeded to the "ready" room, await the order to "man planes," upon receiving which they jump to their planes and give them a last minute check prior to launching.

When the captain gives the order, planes begin to take off, in succession and on signal, at fixed intervals—long enough to clear preceding planes—and rendezvous in squadrons, circling in the air to gain formation. Each squadron commander then, on signal by interplane phone, proceeds with his squadron toward the objective. Some fighters are retained on board and in the vicinity of the carrier for protection of the ship and for patrol.

Upon completion of the mission, or when bombs, torpedoes and munitions are exhausted, such planes as are left reform and return to the carrier where they form a landing circle. From this they peel off, one

(Continued to page 188)



### GENUINE U.S. BARGAINS

O. D. WOOL BLANKETS (USED) . \$2.95  
 MCCLELLAN SADDLES (USED) . 5.95  
 U. S. ARMY PUP TENTS (USED) . 3.50  
 ALUMINUM MESS PANS (USED) .35  
 Thousands of Other Bargains in Military, Outdoor  
 and Sport Goods for Hunter, Farmer, Scout Send 10¢  
 for 32-page catalog returned with first order.

**A and N SUPPLY CO.**  
 EST. 1868 4720 LESTER ST. RICHMOND, VA.



### END GUN RUST WORRIES

**RIG**—Universal stops rust when others fail. Protects chemically dirty surfaces. Quick, easy to use. Used by gun experts—Mfrs., Labs., etc. Unexcelled for **TOOLS**, chrome, battery terminals or anything that rusts! Write **RIG**, 5646 Lake Park Ave., Chicago, Ill.



### METAL AND WOOD WORKING MACHINE TOOLS

Send for new **FREE** catalog of complete line of **Machines, Motors and Accessories**  
**WALKER-TURNER CO., INC.** • 1112 Berkman St., Plainfield, N. J.



### ATTENTION HIGH SCHOOL SENIORS!

Sell America's Most Beautiful and Distinctive Graduation Name Cards! Positively highest Commission. Lowest Prices. Representative cards **FREE!** Limited supply of agencies. Send **NOW** for free sample kit to **PRINTCRAFT**, 1423 E. Elm St., Scranton, Penna.

### Wonder-Tone NOISE ELIMINATOR

Just attach to your radio (long, short wave) and enjoy reception free from distracting noises. Send-No-Money Pay Postman 60¢ plus postage or send 60¢ and we'll send postpaid. Returns in 5 days for refund if not delighted.

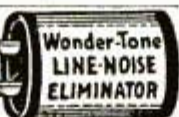

**WONDER-TONE COMPANY**, Dept. 22, 7078 N. Clark St., Chicago, Ill.



### BUILD A MOSQUITO BOAT!

**CARVED HULL INCLUDED!** Famous Ideal 12 1/2" Super-Detail model. Perfect building easy with our complete kit. \$2.50, p.p. (Catalog 10¢)  
**IDEAL MODELS**, 26 W. 19 St., NEW YORK

## DO YOU

WANT a permanent business profession of your own? Then **BECOME A FOOT CORRECTIONIST**. Earnings in this greatly needed profession run as high as \$50-\$100 weekly after a few weeks home training—no medical or chiropody—no further capital needed, no goods to buy. 47th year. Write for free booklet.

**Stephenson System of Foot Correction**  
 28 Back Bay, Boston, Mass.



### MONUMENT

Genuine Granite or Marble. \$10.95 U.P. Order Direct by Mail and save. Don't wait. **U. S. MARBLE & GRANITE CO., A-18**, Oneco, Fla.



### BUILD YOUR GRANDFATHER CLOCK NOW

Send 35¢ for Simple **SHOP TESTED** COPYRIGHTED BLUEPRINT. The Simple Sensible Real-It-Kut way as thousands have. **DIME** brings **PLAN** and sixty pictures "HOW" Book pricing many fine brass weight Westminster, tube chime movements showing also beautiful colonial grandfather names. Build now. Avoid Govt. Freeze. Save half. **HURRY!** **KUEMPEL CHIME CLOCK CO.**, Bldg. 78, Guttenberg, Iowa

Always write your name and full address clearly when answering advertisements.



## NEW POPULAR MECHANICS BOOK CATALOG

Give yourself the lift you need with pay-raising, extra money books. Every man who reads Popular Mechanics will want this new, big illustrated catalog of the world's **BEST** practical books on trades, professions, opportunities, crafts and hobbies. You must see it to appreciate its value. Send your name and address on penny post card. Do it today.

**Helpful BOOKS**  
**SEND YOUR NAME TODAY**

**POPULAR MECHANICS PRESS**  
 Dept. 433, 200 E. Ontario St., Chicago



## SHARP KNIVES



**JUST A TWIST OF THE WRIST** and your favorite knife is safely HONED TO A KEEN, RAZOR-SHARP EDGE.

Guide slots automatically hold knife at the proper angle for correct sharpening, by fine **TRU-BALANCED CORUNDUM HONE**. All Steel with Self-lube Bearing. Compact, beautifully plated—easy to attach and operate. Satisfaction or Money Refunded

"**MAKE CARVING A PLEASURE**"  
 Mail Coupon TODAY!

**HONE-RITE, BOX 388A, PARK RIDGE, ILL.**

Kindly send me one of these guaranteed "**HONE-RITE**" Knife Sharpeners postpaid, for which I enclose \$1.50.

Name \_\_\_\_\_  
 Address \_\_\_\_\_

## FREE TO ALL PIPE SMOKERS!

A year's subscription to our illustrated catalogs read by over 90,000 enthusiastic smokers. Collectors, connoisseurs and pipe club members will enjoy fascinating facts about briar, meerschaum, corncob, clay, odd pipes, tobaccos, blending, smokers' accessories, etc. All famous nationally advertised brands. Send for your Free copy today to

**GEORGE YALE**  
 Dept. P-11 1083 Sixth Avenue New York City

## WHY WEAR DIAMONDS?

When Diamond-Dazzling Blue-White genuine Zircons from the Mines of far-away Mystic Siam are so effective and inexpensive. Thrilling beauties that stand acid; cut glass and are full of diamond FIRE! Exquisite mountings! Write for **FREE** Catalogue. Address:



**NATIONAL ZIRCON CO.**, Dept. 27, Wheeling, W. Va.

## IT'S FUN TO MAKE THINGS OF WOOD



### CONSTANTINE'S MANUAL TELLS HOW TO DO IT

Beginner or expert will find many helpful hints and tips on veneering, woodfinishing, cabinet making, carpentry, etc. Constantine Master Manual for Woodworkers and Big Bargain Book describes and illustrates over 100 different kinds of wood and 980 different items for you. **ALL AT MONEY SAVING PRICES**. A source of supply for anything in wood regardless of quantity. Send only 25¢ in stamps or coin, 25¢ refunded or credited on first order so Manual costs you nothing.

**ALBERT CONSTANTINE & SON, INC.**  
 791-F E. 135th St. New York, N. Y.

## OTTAWA LOG SAW \$39



**PUTS THIS OTTAWA** to work for you. **MAKE MONEY!** Wood is valuable. Does more than 10 men. Easily operated. Falls trees—saws limbs. Use 8-hp. engine for other work. Write for **FREE** Book.  
**OTTAWA MFG. CO.**  
 6127 Wood St., Ottawa, Kans.

## DOOR-EASE STAINLESS STICK LUBRICANT



**EASES STICKING WINDOWS**  
 Use Door-Ease—like a crayon—for things that stick or squeak... windows, doors, drawers, latches and friction catches, zippers, screws, etc. Clean, weather-proof, long lasting!—Door-Ease Mfrs., Muskegon, Michigan.





## Galileo WAS A 17th CENTURY ARGUS

When Galileo realized the value of his first telescope for use in warfare, though it was a crude hand-made instrument built of an old organ pipe, he presented it to his government in 1610 and made military history. For modern warfare, a 20th century Argus is building large quantities of greatly improved lightweight telescopes, fire-control instruments and other vital optical and electrical units for use by the United Nations.

**argus**  
SUBSIDIARY  
OF  
**INTERNATIONAL INDUSTRIES, INC.**  
ANN ARBOR MICHIGAN

Fine American Made Cameras • Aviation Radio Equipment

## GS TOOL CHESTS

GS Tool Chests are used by thousands of mechanics to safeguard their valuable precision tools. Illustrated is Solid Oak Chest 20" x 9" x 13 1/4" with 7 drawers and TWO LOCKS for complete safety. Price \$13.50 plus shipping charges. QUICK DELIVERY to workers in war plants. Extra discounts on quantity orders. INQUIRE. SEND YOUR ORDER IN TODAY.

Write for four page folder.

**GEO. SCHERR CO.**

128A LAFAYETTE ST. - NEW YORK



## PAINT BRUSHES SCARCE! Keep NEW brushes soft RENEW old brushes

Conserve valuable Paint Brushes! Save them by using DIC-A-DOO PAINT BRUSH BATH after every use. Amazingly efficient in loosening, washing away paint from bristles. Brush remains good as new for long time. . . . Restores old hardened brushes to usefulness. Enough to clean several brushes. Costs only 5 cents. Get it at hardware or 5-&-10¢ stores. You'll want to keep several packages on hand. The Patent Cereals Co., Makers of Dic-A-Doo Paint Cleaner, Geneva, New York.

**DIC-A-DOO**  
Brush Bath



at a time and land on signal, according to a standard plan, with the same precision with which they took off. This operation involves flying at low speeds and low altitudes, and requires great skill.

Once on board, all planes are refueled, thoroughly checked and made ready for the next task. Like their eagle prototypes, this brood of far-seeing, steel-taloned, swift-flying planes impatiently wait in their aerie for a call to action.

(Note: The opinions expressed and the assertions made herein are the author's and are not to be construed as official or reflecting, in any way, the views of the Navy Department or the Naval Service at large.)

## Proper Placement of Feed Hopper In Poultry House

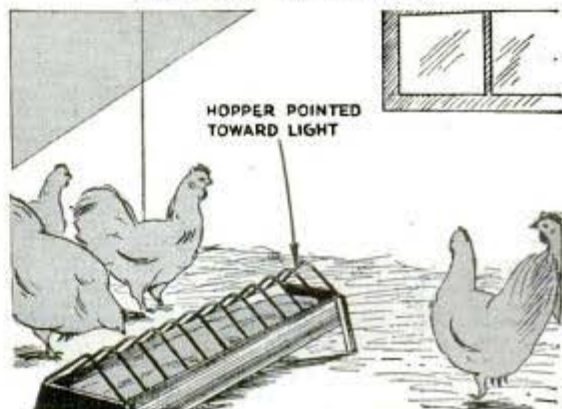

According to one experienced poultryman, it's good practice to see that feed hoppers in laying houses are always pointing toward the light. This prevents the hens from scratching litter into the feed as they usually scratch with their heads toward the light, thus throwing straw past the hoppers instead of into them.

## Electric "Nerves" of Airplane Control 150 Instruments

Electricity plays a vital and little-known part in the operation of modern commercial and military airplanes. In the early days of aviation the engine ignition, generating system and a flashlight composed the electrical equipment, but today an airplane has about 150 electrically operated devices. Each plane contains from seven to 20 miles of electrical wiring depending on its size, according to technicians in the equipment laboratory of the Army Air Corps at Wright Field, who are responsible for many of the developments.



## KRW ARBOR PRESSES BENCH TYPE AND HYDRAULIC

NEEDED IN EVERY SHOP—SAVE TIME AND MONEY—DO BETTER WORK, QUICKER.

No shop is complete without a small arbor press. Pressing and squeezing operations can be done better and faster on a KRW Arbor Press. Stop using vise and sledge hammer methods—they generally deliver spoiled work in the end. KRW Factory-To-You Prices give you greater value for your money. Order today.

### KRW Bench Type Arbor Presses, 3 sizes

No. 37-P ½ Ton, \$13.25\*  
 No. 37-O 1 Ton, \$23.00\*  
 No. 37-N 3 Ton, \$33.00\*  
 \*Prices F.O.B. Arcade, N. Y.  
 Slightly higher west of Rockies.  
 Stand illustrated extra.



KRW Hydraulic Presses are built in 25, 50 and 75 ton sizes. Prices start at \$198.00\*



**K. R. WILSON 17 Lock St., BUFFALO, N. Y.**  
 Builders of Shop Equipment for Ford Dealers Since 1916



### Fastest Sighting Combination Known

#### MARBLE'S Flexible Rear Sight and Sheard Gold Bead Front Sight

Look through peep to gold bead and center instantly on target. Coil spring keeps rear sight in true shooting position. Can be locked down. Interchangeable discs. Price, \$4. Gold front sight that never blurs. Price, \$1.50. Give make, model and rifle cal. 578 Delta Ave., Gladstone, Mich., U.S.A.



### Powerful Vision—8 Mile Range BINOCULARS

20 Days Free Trial \$4.75 Postpaid or C.O.D.

Scientifically ground, powerful lens that give sharp, clear vision of 110 yds. at 1000 yds. distance! Adjustable for all distances and eye widths. Binoculars come with handsome case and straps. GUARANTEED. 30 days free trial money refunded. American Binocular Co., 7759 S. Halsted, Dept. F-862, Chicago.

If not satisfied after 30 days free trial money refunded. American Binocular Co., 7759 S. Halsted, Dept. F-862, Chicago.



### OTTAWA TRACTOR SAW

**Falls Tree—Cuts Log**  
 Fits rear power take-off shaft. Drive thru gear reduction, 18-in. stroke, 10-ga. blade. Economical, saws to profit. FREE Circular and Price List  
 OTTAWA MFG. CO., 1527 Forest Avenue, OTTAWA, KANSAS

### NEW Grinding Attachment

For 8" to 16" Metal Lathes. Build it Yourself.

At last, a precision grinder within your means. You save 2/3 by finishing our semi-machined castings, on your own lathe. HURON handles both internal and external grinding. Accuracies to .00025". Mirror finish easily obtained. Grinds valves, pistons, bushings, shafts, hard or soft. Aides, lathe centers, Sharpen, resizers, milling cutters. Does eccentric drill-bit taper; polishes; scores of other uses, for home workshops, garages, machine shops. Write for FREE illustrated folder and price list of supplementary items. Mention your lathe.



Semi-Machined Castings Only \$6.45

Huron Machine & Tool Co., Dept. B, Yale, Mich.

## Feel the pride of professional results in your own shop

Many master craftsmen find our STREAMLINE Steel Tape is the biggest little helper in their kits. You, too, can benefit by its advantages.

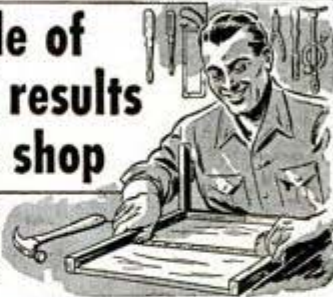

Can be used as a caliper—inside or outside—a straight edge, or a depth gage.



Graduations flush with work.



Finger Lock secures your measurement.



Extra blade insures double life and double usefulness.



Great legibility.

• See the Master STREAMLINE at your hardware dealer's or send us this coupon today.

## MASTER WOOD AND TAPE RULES

\$2.65 Each Complete with spare blade

Master Rule Mfg. Co., Inc., Dept. F-11, 815 E. 126th St., N.Y.C. Please send postpaid one "Streamline" 6-ft. steel tape rule complete with push-button lock and spare blade. I enclose \$2.65 (check, cash, or money order).

Name \_\_\_\_\_  
 Address \_\_\_\_\_  
 City \_\_\_\_\_ State \_\_\_\_\_

### Answers your every welding question

516 Pages; 512 Illustrations  
 Get this big volume packed full of sound advice with detailed diagrams and charts. Get expert training at

The HOBART Trade School ONE OF AMERICA'S FINEST!



Only \$2.00 POSTPAID

## Easy to Read and Understand

# ARC WELDING

Manual and Ready-Reference Text

A Daily Guide for Today's War Work. You'll use it constantly to help improve your weld quality, speed and efficiency.

Latest Techniques, Methods, Procedures... explained and illustrated. You'll be a top-notch operator holding down the big-pay war jobs;

HOBART trained in a valuable post-war trade. "One of the World's Largest Builders of Arc Welders"

HOBART BROS. CO., Box M-1121, TROY, OHIO

Send \_\_\_\_\_ copies of "Practical Arc Welding" @ \$2.00 ea.  C.O.D.  Check enclosed.

Send information on  Welders  Trade School  
 NAME \_\_\_\_\_  
 ADDRESS \_\_\_\_\_

Most Complete, Concise and Authoritative Book on Arc Welding ever published

5 DAYS Inspection FREE!

USE THIS Coupon TO ORDER ACT NOW!

## PROTECT YOUR WHEELS AND TIRES FROM THIEVES!

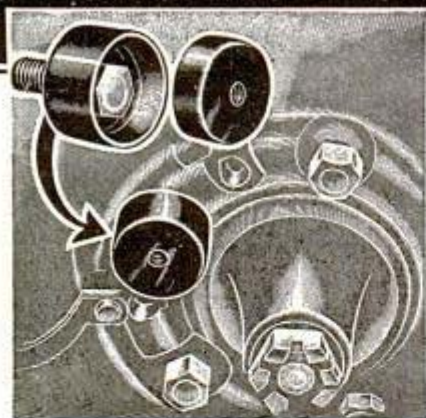

You can't buy new tires, so it's wise to safeguard your present ones. Send a dollar bill, today, for a set of five safety Wheel Nut Locking Caps and Special Key. Made of steel, cadmium plated; fits all cars. Will not affect wheel balance. Easy to install, only your key will unlock them. Sent postpaid on receipt of one dollar—you'll say best buy you ever made.

SAFE-T-LOCK CO., 6839 Normandale Ave., Normandy, Mo.

## DRILL PRESS OWNERS!

HERE'S 1 TOOL WITH 5 DISTINCT USES  
THE BARRON MULTI-PURPOSE  
ROTARY WOOD PLANER



PLANES & SURFACES • PANELS & BEADS  
ROUTS & GROOVES • RABBETS • TENONS **\$7.50** COMPLETE

Converts ANY drill press into a time saving, low cost planer, paneler, tenoner, etc. Surface finishes all types of tough grained and knotty surfaces to agate smoothness. Safe! Guaranteed harmless to drill press. Thousands now in use. **SOLD ON MONEY BACK GUARANTEE.** Full refund on 5 day trial. Shipped prepaid on receipt of \$7.50—or C.O.D. **YOU RISK NOTHING.** Free literature, Barron Tool Co., 369 Architects Bldg., Detroit, Mich.

STEEL TOP AUXILIARY  
DRILL PRESS TABLE  
Has 300 sq. in. smooth working surface. Equipped for shaper and many other important workshop uses—a real buy at **\$5.95**



## MEN MADE TO ORDER



Fit Your Abilities  
To The Opportunities

You have unused talents and mental powers. Learn to develop those faculties of mind which today's world of business demands. Start life anew—without changing your affairs. Write the Rosicrucians for free Sealed

Book telling how you may receive age-old teachings to achieve personal power.

Address: Scribe P.P.K.

The ROSICRUCIANS, (Amorc) • San Jose, Calif.

## Wire Solder Is Shaped Quickly To Form Fishline Sinkers



One fisherman makes small sinkers of various weights by wrapping a length of wire solder around a nail to make a tight spiral. The solder is then removed from the nail and cut into individual sinkers of any length desired.

## Extra Gasoline Carried in Auto May Explode Like Dynamite

Motorists who are trying to beat the rationing of gasoline by carrying extra cans of it in their cars are warned that one gallon of gasoline and 100 pounds of dynamite have almost the same explosive power. The greatest danger, according to the National Board of Fire Underwriters, is in pouring gasoline from the can into the automobile tank. Tank inlets are designed for the delivery of gasoline through a nozzle attached to a hose. In pouring from a can a spark of static electricity may be produced by striking the can against the lip of the inlet. Many explosions were caused in this manner in the early days of automobiles when car owners frequently carried extra quantities of gasoline in specially designed containers. Motorists are also warned against hoarding gasoline in any enclosed or poorly ventilated space, particularly a cellar. Gasoline vaporizes to more than 100 times its bulk and converts more than 1,500 times its volume of air into an explosive mixture readily ignited by a spark or carelessly flipped match or cigarette.

The Traveler's Co.  
W. Hartford, Conn.  
POPULAR MECHANICS



# GRAY HAIR VITAMIN

NOW  
**\$1.95**  
PAY  
NO  
MORE

No dyes—No drugs—Hair grew out in Natural Color in almost nine out of ten test cases just taking one tablet Calcium Pantothenate Vitamin each day.

Why pay \$3.50 to \$5.00 for the famous "Gray Hair Vitamin" that gave such amazing results?

**SEND NO MONEY.** Just send name and address. We will ship 100 10-mg. tablets (100 days' supply) genuine standard quality Calcium Pantothenate Vitamin C.O.D. for \$1.95 plus few cents postage. Guaranteed same quality as used in National Tests or money back.

**LILEE PROD. CO.,** 2017 S. Michigan Ave., Dept. 99, Chicago, Ill.

## ARMY-NAVY BARGAINS

Haversacks .....	\$.75	Cart. belt .....	\$.60
Hobbles .....	.50	Rope lariat.....	.75
Helmet eagle.....	.35	Sword bayonet.....	1.75
Europ. cutlass .....	2.50	Model cannon 7".....	1.75

75th Anniversary Catalog 1865-1940, 308 pages, over 2,000 illustrations of pistols, rifles, daggers, medals, saddles, etc., mailed for 50 cents. 1942 circular for 3c stamp.

Francis Bannerman Sons, Dept. P. 501 Broadway, New York

**BUILD YOUR OWN ARC-WELDER**  
For Light or Heavy Work

No rewinding necessary—use coils taken from old auto generators. Works on 110 or 220 A.C. Has 20 different heats. Complete plans and BIG Catalog 35c.

**LEJAY MFG. CO.,** 3347 LeJay Bldg., Minneapolis, Minn.



**BARRELO' FUN**  
32 Articles PLUS 12 Party Games!  
Real fun-provoking articles—Daffy Diplomas, Nutty Novelties, Funny Favors, Goofy Gags, Belly-Laff Business Cards, Prizes and Surprises, Gags Galore—stunts that slay 'em.

**Roll Out the Barrel at your next party!**  
Send 50c and we'll send you BARRELO' FUN, postage prepaid. Or better still—send \$1.00 and we will mail one to you, and one to a friend, whose name and address you will send us. **SURPRISE A SERVICE MAN WITH ONE.** Your money refunded if you are not satisfied.

**SKILCRAFT CO.,** Dept. 112, GENEVA, ILL.



## 4000 BARGAINS IN FREE 260 Page CATALOG

Shows money makers for dealers, agents and salesmen. Articles desirable for the home, office, factory or store are displayed for your selection. Satisfaction guaranteed or your money back. Get your copy, now, as supply is limited.

**SPORS CO.,** 9-42 National, LE CENTER, MINN.

## don't WORRY

Why put up with years of needless discomfort and worry? Try a Brooks Automatic Air Cushion. This marvelous appliance permits the opening to close, yet holds reducible rupture securely, comfortably—day and night. Thousands report amazing results. Light, neat-fitting. No hard pads or stiff springs to chafe or gouge. Made for men, women and children. Durable, cheap, **Sent on trial** to prove it. Never sold in stores. Beware of imitations. Write for Free Book on Rupture, no-risk trial order plan, and proof of results. All correspondence confidential.

**BROOKS COMPANY, 158-B State St., Marshall, Mich.**



**NO Drip** A SURE CURE—Use this plastic cork coating to stop sweating and condensation drip. Easy to apply with brush or trowel to pipes, tanks, walls, ceilings, air ducts—any surface of metal, concrete, brick, wood, plaster, etc. Insulates and prolongs life of metal by preventing rust and corrosion. A gallon covers about 30 ft. of 1" O.D. pipe. The permanent, stucco-like finish can be painted any color. Comes in 1, 5 and 55 gal. drums.

Get at Hardware, Plumbing, Mill Supply Dealers or send \$1.90 for 1 gal. prepaid. **CIRCULAR FREE.**

**J. W. MORTELL CO.,** 522 Burch St., Kankakee, Ill.

## GOOD NEWS!

For Future SYNCRO SAW Owners!



SYNCRO now produces parts for tanks, submarines, planes, guns and precision machine tool parts—for VICTORY! Syncro Electric Jig Saws will be even better after the war due to continuing laboratory research! See Dealer for available SyncroSaws.

**SYNCRO** WORLD'S SAFEST SAWS

**SYNCRO DEVICES, INC.**  
3265 Bermuda, Dept. PH-112, Ferndale, Michigan

## WITTE DIESELECTRIC PLANTS

★ **Out On the Victory Front** — WITTE Dieselectric Plants are aiding America's war effort. War needs come first at WITTE. Prompt shipment given to high priority orders. After peace these money-makers will again be ready for all. A WITTE Diesel is worth waiting for . . .

**WITTE ENGINE WORKS, 1748 Oakland Ave., Kansas City, Mo.**



## LEATHERCRAFT HEADQUARTERS!

**We have plenty of leather**

Make useful leather items for yourself OR gifts for others.

Belts, Purses, Gloves, Moccasins, Desk Sets, Book Binders . . . easy to assemble. 101 practical suggestions in 16-page catalog. Send 10 cents. Write today.

**J. C. LARSON CO.**  
Great Lakes Bldg., No. Wacker Drive, Chicago, Illinois

# HOW TO GET THE MOST OUT OF YOUR LATHES

*No. 1 in a series of suggestions made by the South Bend Lathe Works in the interest of more efficient war production.*

## Keep Your Lathes Clean

Yes, it's as simple as that. Just by keeping your lathes (and other machine tools) clean, you can increase production, reduce scrap, and lengthen the life of your equipment.

This will not only benefit you, but it will be a definite contribution to our total war effort. For every available machine tool must be kept going. The combined output of all machine tool builders cannot supply enough equipment to keep pace with the rapidly expanding war production program, so there can be no unnecessary replacements.

### Dirt Is Abrasive

Unless brushed away frequently, the scale, grit and fine chips produced by the cutting tool mix with the oil on the bed ways, dovetails and other bearing surfaces, forming a dirty sludge. Because this dirt is abrasive, it increases friction and causes wear wherever it is allowed to collect.

Obviously, this retards production, shortens machine life, and makes it hard for the operator to maintain exacting tolerances. And when chips work under the tailstock or saddle, or into the spindle taper, the accuracy of the lathe may be seriously impaired.

### Encourage the Operator

A good way to keep your lathes clean is to encourage each operator to take care of his own machine. Let him know that you appreciate his interest and effort. Explain how easy it is to spot a good machinist by the way he takes care of his lathe. Urge him to take pride in keeping his lathe clean, free from dirt and chips. He will have greater respect for his job and will unconsciously become a more careful workman.

A small paint brush is convenient

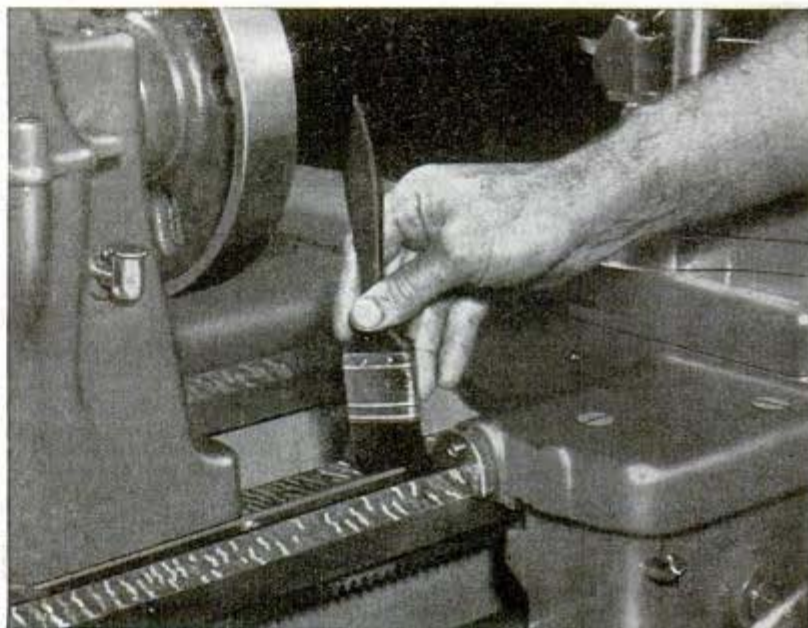

**A small paint brush is convenient for brushing away dirt and chips**

for brushing away loose dirt and chips. Compressed air is not so good because it may blow dirt and chips into oil holes and bearings. Pliers are handy for pulling long steel shavings away from the machine. A clean cloth can be used, after brushing, to remove the last traces of dust and grit. A little oil on the cloth will prevent rust from forming on the finished surfaces of the machine.

The felt wipers on the ends of the saddle wings should be removed and cleaned in kerosene occasionally. An experienced machine tool service man should periodically inspect the lathe and remove any grit or chips that may have worked under the saddle or tailstock. The bed ways can be badly scored by a small steel chip imbedded in the saddle or tailstock base.

### Don't Let Chips Collect

Adequate chip disposal should be

provided to prevent chips from piling up underneath or around the lathe. Dirt and chips should not be allowed to work into the threads of the lead screw or the gearing of the apron or quick change gear box.

At a time like this, when most machine tools are operating 24 hours a day at speeds and feeds far beyond those for which they were designed, a small amount of carelessness may cause excessive wear—even a breakdown. Certainly an ounce of prevention is now worth far more than a pound of cure.

### Write for Bulletin H1

Bulletin H1 giving more detailed information on the cleaning and care of the lathe will be supplied on request. Reprints of this and other advertisements in this series can also be furnished. State number of copies wanted.



## SOUTH BEND LATHES WORKS

Dept. 623 • South Bend, Ind., U. S. A. • Lathe Builders for 35 Years

PRINTED BY POPULAR MECHANICS COMPANY, CHICAGO, ILL., U. S. A.

POPULAR MECHANICS

**AUDELS NEW  
MACHINISTS  
HANDYBOOK  
NOW READY!**

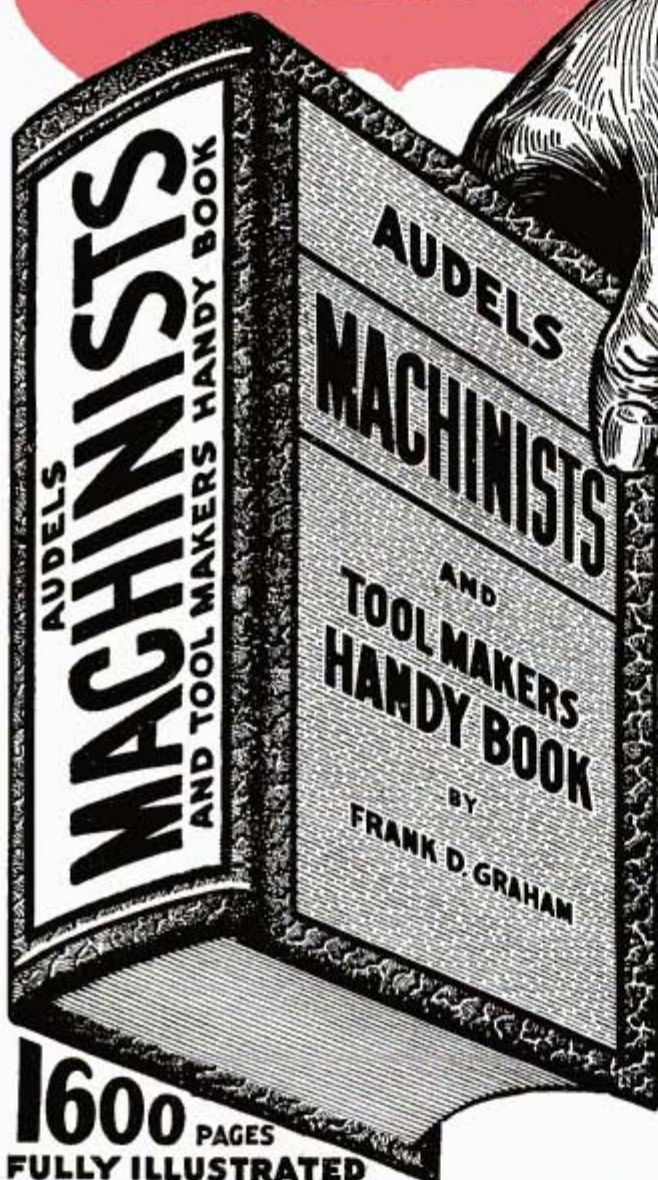

*Prepare!*

**A KEY TO  
MODERN SHOP PRACTICE**

**PRACTICAL INSIDE INFORMATION**

For Every Machinist, Toolmaker, Engineer, Machine Operator, Mechanical Draughtsman, Metal Worker, Mechanic or Student. This 1600 Page Handy Book Covers Modern Machine Shop Practice in All Its Branches.

**A COMPLETE INSTRUCTOR WITH  
READY REFERENCE INDEX**

New from Cover to Cover. Tells How to Operate and Set Up Lathes, Screw & Milling Machines, Shapers, Drill Presses & All Other Machine Tools.

**5 PRACTICAL BOOKS IN ONE!  
60 FULLY ILLUSTRATED CHAPTERS**

Covering: 1—Modern Machine Shop Practice. 2—Blue Print Reading and How to Draw. 3—Calculations & Mathematics for Machinists. 4—Shop Physics. 5—How to Use the Slide Rule.

**ASK TO SEE IT!**

**THEO. AUDEL & CO., 49 West 23rd St., New York**  
Mail AUDELS MACHINISTS & TOOLMAKERS HANDY BOOK, Price \$4 on 7 Days Free Trial. If O. K. I will remit \$1 in 7 days and \$1 Monthly until \$4 is Paid. Otherwise I will return it.

Name \_\_\_\_\_  
Address \_\_\_\_\_  
Occupation \_\_\_\_\_  
Reference \_\_\_\_\_ P.M.

**1600 PAGES  
FULLY ILLUSTRATED**

A SHOP COMPANION THAT ANSWERS YOUR QUESTIONS  
Easy to read and understand—flexible covers—Handy size 5 x 6½ x 2—a ready reference that answers your questions accurately.

TO GET THIS ASSISTANCE FOR YOURSELF SIMPLY FILL IN AND MAIL COUPON TODAY **\$4 COMPLETE PAY \$1 A MONTH ONLY**

**THEO. AUDEL & CO., 49 W. 23rd St., New York**

"TIN FISH"—that means torpedo in submarine language. The phrase, "the smoking lamp is lit" means Camels are in order—for with men in the Navy, the favorite cigarette is Camel. (See below.)

You want  
**STEADY NERVES**  
to launch a "tin fish"  
or make one!

**H**IDE-AND-SEEK. A deadly game of it with the T.N.T. of depth charge and torpedo—a game only for steady nerves!

But, then, what isn't in these days—with all of us fighting, working, living at the highest tempo in years. Yes, and smoking, too—perhaps even more than you used to.

For the sake of your own smoking enjoyment, try Camels. Put them to the "T-Zone" test described below and make your own comparisons.

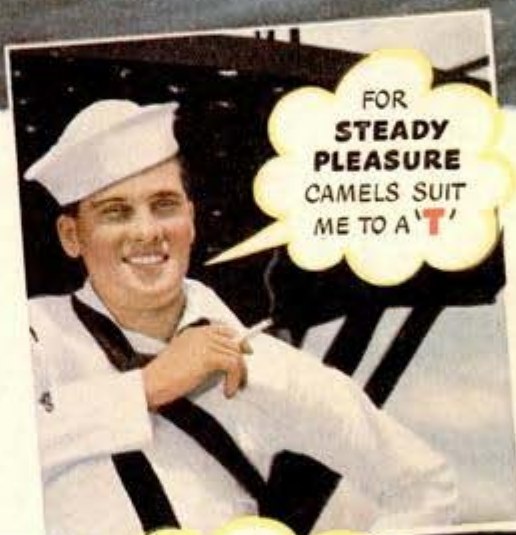

**FIRST IN THE SERVICE**

In the Navy—in the Army—in the Marine Corps—in the Coast Guard—the favorite cigarette is Camel. (Based on actual sales records in Ship's Service Stores, Ship's Stores, Sales Commissaries, Post Exchanges, and Canteens.)

**THE CIGARETTE OF COSTLIER TOBACCOS**

R. J. Reynolds Tobacco Co., Winston-Salem, N. C.



The "T Zone" where cigarettes are judged

The "T-ZONE"—Taste and Throat—is the proving ground for cigarettes. Only your taste and throat can decide which cigarette tastes best to you . . . and how it affects your throat. For your taste and throat are absolutely individual to you. Based on the experience of millions of smokers, we believe Camels will suit your "T-ZONE" to a "T." Prove it for yourself!

CAMELS WIN WITH ME ON EVERY COUNT. THEY'RE EASY ON MY THROAT AND THEY DON'T TIRE MY TASTE



**GYROSCOPE GIRL**—Rosemary Gregory (above) calibrates automatic directional devices at a Sperry Gyroscope Co. plant, and she's just as partial to Camels as the fighting men who depend on her precision. She says: "Camels suit me better all ways—for taste and my throat."

*Camel*