

Frozen Billions

POPULAR MECHANICS

★

MAGAZINE

WRITTEN SO YOU CAN UNDERSTAND IT

OCT.
25 CENTS
30c IN CANADA



SEE PAGE 55



BUY UNITED STATES
WAR SAVINGS
BONDS AND STAMPS

How to make your

FLASHLIGHTS and BATTERIES LAST LONGER

These Wartime Suggestions have been Reviewed
and Passed by the Office of Price Administration
and the Office of Civilian Defense



1 DON'T USE FLASHLIGHT CONTINUOUSLY. Snap it on when you *need to see*—then snap it off. *Needless use of flashlight merely wastes "juice."*



2 WHEN STARTING A TRIP, don't toss your flashlight *loaded* into your suitcase, haversack or toolbox. Unscrew, or remove batteries—then switch can't "catch" and waste batteries.



3 KEEP FLASHLIGHT OUT OF CHILDREN'S REACH. It is not a toy—but a tool for your convenience and safety. *Know* where it is at all times—so you can put your hand on it quickly when you *need it*.



4 DON'T THROW AWAY A BROKEN FLASHLIGHT until you're sure it can't be fixed. Minor repairs can quickly be made, lens or bulb may be replaced.



5 DON'T "HOARD" BATTERIES — keep one extra set for each flashlight in case of long-continued use. Others want and need batteries too. *Do your share* in conserving the nation's battery supply.

BUY FRESH DATED BATTERIES

Fresh batteries last longer. Dependable "Eveready" *fresh* DATED batteries will give long life and reliable service.

NATIONAL CARBON CO., INC.
30 East 42nd Street, New York
Unit of Union Carbide and Carbon Corporation



The word "Eveready" is a registered trademark of National Carbon Company, Inc.



FRESH BATTERIES LAST LONGER...

Look for the DATE-LINE



EVEREADY

TRADE-MARK

FLASHLIGHTS AND BATTERIES

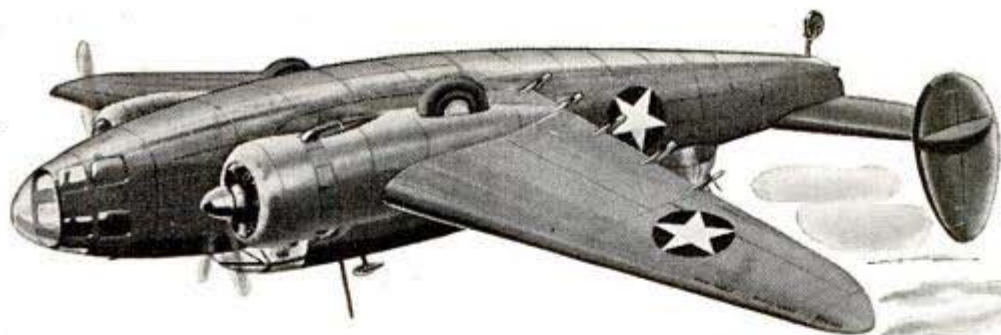

Upside down or right side up . . .



at 20° below or 100° above

Without electricity, no modern bomber could ever leave the ground.

Electricity starts the motors, retracts the landing gear, changes the propeller pitch, works the wing flaps, opens the bomb doors, powers the radio and inter-communication system, operates the instruments, gives light for the crew to work by.

No ordinary electrical apparatus can handle these jobs in a bomber.

The whole complicated system must work as well upside down as right side up. It must function in a tropical thunderstorm and in 20° below zero altitudes. And it must be designed to save every precious fraction of an ounce and inch.

Developing electrical equipment for bombers—and producing that equipment in quantity—is a job made to order

for Westinghouse “know how.”

Here are some of the Westinghouse products that are going into American bombers today:

- Instruments designed so one instrument does the work of two.
- Radio equipment and special blind-flying devices.
- Electric motors that develop more horsepower per pound than any other motors ever built.
- Instrument lights that cast invisible rays on dial markings.
- Electric generators which weigh only 42 pounds, yet produce as much electricity as 35 standard automobile generators weighing 23 pounds each.

In making these things, the long-range work of Westinghouse Research and Engineering Laboratories has played a significant part. Discoveries in many fields—in electronics, physics, chemistry, mechanical and electrical engineering—are now bearing fruit in the production of better and more powerful weapons of war.

Many of these discoveries, we believe, will someday help to make a better peacetime world.

★ ★ ★

This advertisement has been reviewed by Government authorities, and contains no information of military value to the enemy.



Westinghouse

PLANTS IN 25 CITIES—OFFICES EVERYWHERE

WESTINGHOUSE ELECTRIC & MANUFACTURING COMPANY, PITTSBURGH, PA.

★ ★ ★ ★ ★ ★ ★ ★ ★ ★

★ Clear the Lines for the War ★

★ Before you make a Long Distance telephone ★
★ call today, ask yourself these questions: ★

★ 1. Is it necessary? ★

★ 2. Will it interfere with war calls? ★

★ The weight of war on the telephone lines is ★
★ heavier every day. We can't build the new lines ★
★ to carry it because sufficient materials aren't ★
★ available. We've got to make the most of the ★
★ service we now have. ★

★ Please give a clear track to the war effort by ★
★ confining your Long Distance calls to those ★
★ that are really necessary. ★

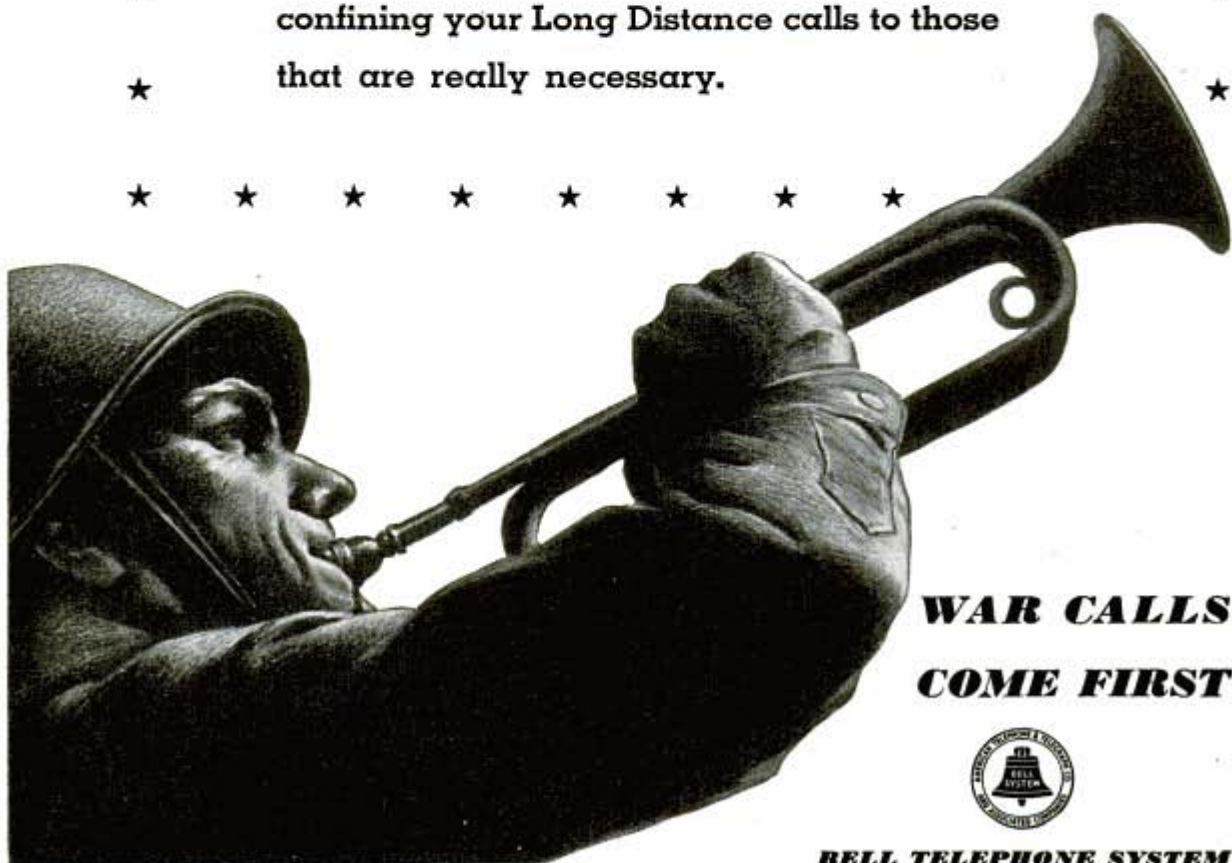

**WAR CALLS
COME FIRST**



BELL TELEPHONE SYSTEM

Popular Mechanics Magazine

Registered in U. S. Patent Office and Canada

H. H. WINDSOR, Founder

H. H. WINDSOR, Jr., Editor and Publisher

October, 1942

Vol. 78, No. 4

IN THIS ISSUE

Uncle Sam's Trump Card	1
The Commandos are Tough	8
Frozen Billions	17
The Most Dangerous Man in the World	26
Keep the Home Fires From Burning .	34
Sister Ships—or Are They?	42
Yachtsmen on Patrol	50
Minute Men of 1942	56
Radio Traffic Control	66
Your Home of the Future	72
Smoke Gets in Their Eyes	82
Win Your Golf Games on the Greens	92

Where-to-Buy-It Index Starts on Next Page

Wanted—A Machine to Live In

THERE'S always something. The roof needs shingling, the house needs paint, the doorknobs stick and the chimney is ready to topple. The plumbing is out of order twice a year, and someone is always having to polish the brass fixtures. All this irks Houlder Hudgins, president of the Sloane-Blabon Corporation, who thinks it's high time to do something original in designing homes and furnishings. He suggests someone produce a home that takes care of itself—"a machine to live in." Read his article in November—"For Real Discomfort, 'There's No Place Like Home'."

Affectionately Yours, the Jeep

UGLY little puddle jumper, the jeep. But the boys in khaki love it like a puppy. It rides like a bronco that's been to West Point, but it rides—across rivers, through barbed wire or jungle, over Australian desert or Chinese mountain. Take a ride next month in this "Miracle on Wheels" that privates use to run errands, generals to run battles.

Next Month

ONE of the last narrow-gauge railroads is the Denver & Rio Grande Western, but don't get the idea it's old-fashioned. You can step from its puffing narrow-gauge train to a broad-gauge Diesel-electric streamliner; you can ride over ancient wrought-iron bridges, rails made in England, and track ballasted with gold ore worth \$1,000 a mile. Its peacetime boast is of the "world's most scenic route," but just now it's busy hauling a war load at top speed. Read the November feature, "Thrills of Mountain Railroad."

Precious Cargoes

IT'S much more delicate than it appears, this business of loading a ship. Oil and turpentine don't mix with sugar and powdered eggs; cotton has a flair for spontaneous combustion; some foods require constant temperatures. If the stevedores do the job badly, the cargo may shift and give the ship a dangerous list. Next month Philip B. Iglehart, Vice President of the Grace Line, tells of the business of loading ships.

Color in Your Home

SKETCH the floor plan of your home inside the color wheel that appears in the November Coloroto section. From it you can tell the appropriate colors for any room. The story, illustrated in natural color, is about "Color in Your Home," written by a leading authority—Dr. Matthew Luckiesh, Director of General Electric's Lighting Research Laboratories.

Published monthly by POPULAR MECHANICS COMPANY, 200 East Ontario Street, Chicago, U. S. A. Single copy in the United States, 25 cents; subscription rates in United States and possessions, and countries of the Pan-American Postal Union including Spain, \$2.50 a year. Single copy in Canada, 30 cents; subscription rates, \$3.00 a year. To all other countries add \$1.00 a year over United States prices for overseas postage. Changes in address must be reported to us immediately to eliminate delay. Entered as Second Class Matter, Sept. 15, 1903, at the Post Office at Chicago, Illinois, under Act of March 3, 1879. Entered as Second Class Matter at Post Office Dept., Canada.

Copyright 1942, by Popular Mechanics Company, Copyright under International Copyright Union. All rights reserved under Pan American Copyright Union. Printed in the United States of America

Your Car is in the Fight, too..



fighting to survive Semi-Idleness

Idleness can do harm to your car. While you're saving on tire wear, idle valves get sticky. Crankcase oil gets sludgy. Corrosive elements attack and endanger metal surfaces. You'll be wise to guard against this. For your car must last—and give you dependable service—for the duration.

Running or idle, the way to be sure of dependable protection for your car, is to use Pyroil. Pyroil prevents corrosion of internal parts. It keeps valves free. It disperses sludge, sticky gum and hard carbon. Users claim considerably increased mileage, too, when Pyroil is used. More mileage for every gallon of gasoline—plus better performance.

So, guard your car every mile it functions, every day it rests. Get Pyroil, today. All you need are a few ounces at a time. Your service salesman will add it to the crankcase and to the gasoline tank. You may purchase it in convenient size containers to have always at hand.

Mail coupon for a list of Pyroil Protection Service Stations located in your vicinity. Manufactured and Guaranteed by Pyroil Company, W. V. Kidder, Founder, 510 Pyroil Bldg., LaCrosse, Wisconsin.



**Guard it
with Pyroil**

ADD
MERELY
OUNCES TO
GAS TANK &
CRANK CASE

**DISTRIBUTORS:
CHECK AND MAIL
COUPON FOR FRAN-
CHISE FACTS.**

PYROIL COMPANY
510 Pyroil Bldg., LaCrosse, Wisconsin

Please send me a list of Pyroil Protection Service Stations in my vicinity where I may obtain Pyroil regularly.

Please send details of your Plan for Distributors.

Name.....

Address.....

City..... State.....

WHERE-TO-BUY-IT INDEX

Where no name and address appear directly under an item, the product is not believed by us to be commercially available

Furnace built in chimney.....	5
Round Oak Furnace Co., Dowagiac, Mich.	
Secret belt pocket holds money.....	5
V. L. & A., 9 N. Wabash Ave., Chicago	
Freak German monoplane.....	6
Gun fired by gas.....	6
Wire-tailed antiaircraft rocket.....	7
Switchboard of Jap plane.....	7
Fluorescent extension light.....	7
Hygrade Sylvania Corp., Lighting Div., Ipswich, Mass.	
Army bridge of rubber and steel.....	12
Roller does work of paintbrush.....	12
The Sherwin-Williams Co., Cleveland, Ohio	
"Bomb" explodes mercury in lamp tubes.....	12
Machine reclaims used bottle caps.....	13
Heileman Brewing Co., La Crosse, Wis.	
Sandblasting renews typewriter roller.....	13
Sky hook to launch gliders.....	14
Runways built along highways.....	16
Miles left in tires measured easily.....	16
Plastic holders for cut film.....	16
Nicholson Photo Co., 5208 Wilshire Blvd., Los Angeles, Calif.	
Fuel tanks of synthetic rubber.....	25
Dummy planes and guns to fool enemy.....	25
Lifesaving suit donned quickly.....	31
Watertight Fastener Corp., 15 Whitehall St., New York City	
Electric iron shapes plywood hull.....	31
Plastic plug for leaking lifeboat.....	31
"Anchor watch" for small boat.....	32
Pleasure Craft Supplies, 1110 Bailey St., Seattle, Wash.	
Nazi's advanced plane engine.....	32
Microfilm record projector.....	32
Schoolboys' model planes aid cadets.....	33
Culvert used to trap bears.....	33
Army machine shop on rails.....	38
Cat converts sedan to ambulance.....	38
A. B. Stoves, Inc., Battle Creek, Mich.	
Testing lamps for defense.....	39
Stretcher shapes metal sheets.....	40
Hydraulic Press Mfg. Co., Mt. Gilead, Ohio	
Bomb snuffer and shovel.....	40
Wilshire Sheet Metal Co., 8708 Wilshire, Beverly Hills, Calif.	
Spider web pattern in balloon.....	41
Torque stand tests plane engine.....	41
Non-recoil gun for warplane.....	45
How a ship is launched.....	46
Robot beats time to record.....	48
Three developments for future planes.....	48
Steel casting for huge press.....	48
Target barrier prevents accidents.....	49
Sketch shows rubber used in bomber.....	49
Self-fastening wall strip.....	54
Julius Blum & Co., 532 W. 22nd St., New York City	
Fan chases flies from doorway.....	54
Reynolds Electric Co., 2650 Congress St., Chicago	
Rubber and gas made in one process.....	54
Soil-test ribbon changes color.....	54
Fisher Scientific Co., 711 Forbes St., Pittsburgh, Pa.	
Steel net traps submarine.....	55
Carbon-dioxide clouds smother fire.....	61
Cardox Corporation, 307 N. Michigan Ave., Chicago	
Propeller to push rocket plane.....	61
Steam engines haul plow on cable.....	62
Five-in-one garden tool.....	64
Swartzbaugh Mfg. Co., Merchandise Mart, Chicago	

(Continued to page 6A)

"No, Junior, you can't have the plane tonight... Dad and I are using it!"



DON'T feel too sorry for Junior. Life in the America that lies ahead has other compensations. In fact, it will be so far superior to what his parents had at his age, their fondest hopes will seem meagre, their deepest dreams will seem trivial.

It's not hard to imagine a family plane. Many were flown before the war. American manufacturers have blueprints of them for larger production when peace comes. It's not hard to conceive of hourly air travel to distant continents. Our ferry command is doing just that today. It's not hard to believe in fleet upon fleet of flying freighters when we're turning out gigantic bombers by the thousands right now.

Is this new America a dream? Yes, in the sense that its wonders reach into the depths of man's imagination. No, in the sense that it is real and inevitable. For the men who are planning and building the planes of Victory *now* will soon be planning and building the planes of Peace.

Out here at B. F. Goodrich our Aeronautical Division has been making dreams come true for over 30 years. We've played our part in the miracles of aviation with Silvertown Tires that make a plane's landings safer and smoother, with Expander Tube

Brakes that give pilots greater ground-control, with De-Icers that defy the elements.

Naturally, most of the 80 B. F. Goodrich aviation products we turn out today are being used by Uncle Sam. We're proud of this. Every B. F. Goodrich employee knows that what he makes goes to create a plane that is the world's best. One reason he's doing his job today faster and better than ever is that he too wants to get started building the new America. The B. F. Goodrich Co., Aeronautical Division, Akron, Ohio.



1917 WAR TELEPHONE

RUN BY



1942 WAR RADIO

RUN BY



For Instance ...

"We would like to have tarried [over Tokyo] and watched the later developments of fire and explosion, but even so we were fortunate to receive a fairly detailed report from the excited Japanese radio broadcasts. It took them several hours to calm down to deception and accusation."
 (Brig. Gen. James H. Doolittle in news reports of Tokyo bombing)

Interesting!

Watch for radio use in the war news—you'll find it in the air—on the ground—and at home!

WITHOUT radio, the movement of war would still be anchored by telephone lines—the physical hazards of the courier and visual signals.

Now war moves swiftly over the whole face of the earth—instantaneous radio communication thru the ether instead of over copper wires has blasted the barriers of space and time.

So today all our radio production centers on war use.

But what of tomorrow—what effect will this have upon the future—after victory?

One thing is certain—it will revolutionize and speed the great new future form of transportation.

Radio has never been universally necessary in transportation before. In automobiles—on trains—it has been entertainment—in boats it has been a great aid but not an essential.

But today for the future, in that great, new universal transportation that is forming itself—the airplane—radio is essential as the engine itself.

And—mark this well—airplanes and radio are two of the four great industries destined to lead this country back to business normalcy after the peace is won.

Zenith's leadership in the radio industry has been established by a constant achievement of "firsts." Repeatedly, ideas "brand new" when Zenith "first" introduced them, later became essentials on all radios. And that same "forward thinking" of engineers and factory and organization now concentrates on war production of the thing we know—radio—exclusively radio. We are progressing—we learn every day—and this new experience will inevitably reflect itself when Zenith again produces for peace.

—a Zenith Radio Dealer near you is giving reliable service on all radios—regardless of make.

ZENITH RADIO CORPORATION—CHICAGO

(Continued from page 4A)

Adjustable screen for car radiator.....	64
Sears Roebuck & Co., State and Van Buren Sts., Chicago	
Fly spray made from pine oil.....	64
Transparent plastic coil spring.....	64
Swartzbaugh Mfg. Co., Merchandise Mart, Chicago	
Among the new patents.....	65
Rifle sights sooted for better aim.....	71
Motorized pushcart.....	71
Blackout microphone.....	78
General Electric Co., Schenectady, N. Y.	
New engines work on test stands.....	78
Westinghouse Electric & Mfg. Co., E. Pittsburgh, Pa.	
Soap cup on hose to wash car.....	78
Stebbins Hardware Co., 11 W. Van Buren St., Chicago	
Huge models of insects.....	79
Operating table built of wood.....	80
Tip of screwdriver holds screws.....	80
Stebbins Hardware Co., 11 W. Van Buren St., Chicago	
Tool loosens glass bottle stoppers.....	80
Central Scientific Co., 1700 Irving Park, Chicago	
Self-gripping screen patch.....	80
Screen Patch Co., 1249 Commercial Trust Bldg., Philadelphia	
Combined viewer and projector.....	81
Novex Corp., 307 W. Monroe St., Chicago	
Seaman learn code on land.....	81
Staple holder and driver.....	86
Stebbins Hardware Co., 11 W. Van Buren St., Chicago	
Tube loads tobacco into pipe.....	86
Oxford Products, 343 S. Dearborn St., Chicago	
Wardens learn war gas odors.....	86
Sea gliders carry troops.....	87
"Fall guys" smash barbed wire.....	87
Play it safe.....	88
Glass blowing for radio experiments.....	90
Pump tanks put out bomb fires.....	90
Starch speeds recovery of aluminum.....	90
First-aid kit worn as belt.....	90
Mine Safety Appliances Co., 230 N. Braddock, Pittsburgh, Pa.	
Guns on platforms train crew.....	91
Emergency switchboard on trailer.....	91
Cellophane hood for store light.....	96
Nation seeking war inventions.....	96
Viewer for color slides or strip film.....	96
Craftsmen's Guild, 5773 W. Olympic Blvd., Los Angeles, Calif.	
Three-in-one radio tuner.....	159
Insuline Corp., 30-30 Northern Blvd., Long Island City, N. Y.	
Soldering iron designed for speed.....	159
Weller Bros., 510 Northampton St., Easton, Pa.	
Screwdriver has illuminated shaft.....	159
Vinco Products Co., 3901 Arthington St., Chicago	
Antenna encircles rear of console cabinet.....	160
The Crosley Corp., Cincinnati, Ohio	
Vertical air-raid siren.....	160
Federal Electric Co., Inc., 8700 S. State St., Chicago	
Terminal blocks in kit form.....	160
Curtis Development & Mfg. Co., 1 N. Crawford Ave., Chicago	
Battery power unit for audio amplifiers.....	160
Electro Products Laboratories, 549 W. Randolph St., Chicago	
Liquid coating prevents glass shattering.....	169
The Wilbur & Williams Co., Park Square Bldg., Boston, Mass.	

Craftsman and Shop Notes Index

ART AND ARTISTS

Monogram guide.....	115
Mechanical artist.....	117
Pipe stem used as stylus.....	138

AUTOMOTIVE

Saving your car's electrical system.....	140
Starting car when key is lost.....	144

(Continued to page 8A)

How Big Is YOUR PAY-CHECK?

*If you earn under \$3,000,
Higher Accountancy may
be the answer for you*

"THE size of my pay-check? What business is it of yours?" Perhaps that's the first reply that comes to your mind.

But—stop a moment. It really is our business—to help men just like you. In fact, it's been our business here at LaSalle for 33 years.

If your pay-check isn't all that you'd like it to be, why not consider accountancy? Why not become a member of this well-paid and respected field? Why not, in short, prepare yourself to earn real money—insure a good home for your family—a new car—an education for the growing youngsters—a bank account for a rainy day . . . these and many more of the precious things in life?

Maybe you're one of those ever hoping for "breaks" that will give you a higher standard of living. Yet that's precisely what most of 30,000,000 other employees in this country are doing.

Not all of them, of course. Here and there you find ambitious men who aren't depending on luck to carry them ahead. They're following a tested path to increased earnings—leaving nothing to mere chance. They're *training* themselves for better jobs—every week spending a few hours in serious but interesting study at home.

Some day, as expert bookkeepers and later as accountants, these determined men will have standing and a considerably larger income—in a profession that pays and pays well.

Why don't *you* do as they are doing—take advantage of LaSalle training? Even though you do not know the fundamentals of bookkeeping now—you nevertheless may have an excellent opportunity to master accountancy. Many others have done it.

Perhaps you're asking yourself, "But don't these others possess natural ability that I lack? Don't I need a special talent for all this?"

Ask rather, "If I do my part, won't I get results, too?"

You will! What it takes is intelligence, serious study and work—not genius. Under the LaSalle system you solve problems by simple steps . . . from day to day, as an expert accountant does. You use the same basic principles. And when these problems become difficult and puzzle you, you get counsel that could be matched only through personal coaching by a battery of experts in a big accounting house.

In a comparatively short time, you train yourself in Elements of Accounting, Principles of Account-



ing, Auditing, Cost Accounting, Business Law, Organization, Management and Finance. The training—complete and intensive all the way—takes you right into C.P.A. coaching if you desire.

Later, when you're an accountant, it may be possible to go into business for yourself as a public accountant and be independent. Or, if you choose to work for someone else as an executive accountant, it will may be for a salary several times that which you draw now.

Write for this FREE book

If you're tired of pinching pennies, investigate accountancy and LaSalle training. There isn't a faster, less expensive or more convenient method to master accountancy. Fill in the coupon and mail. We'll send you our 48-page book, "Accountancy, The Profession That Pays."

Then, when you read all the facts, you yourself will be able to judge best whether you have the will to study and apply your best efforts—toward a more secure future.

LaSalle Extension University A Correspondence Institution

Dept. 1064-H

Chicago, Ill.

I want to earn a bigger salary—through accountancy training. Send me, without cost or obligation, your 48-page book, "Accountancy, The Profession That Pays."

Name.....

Present Position..... Age.....

Address..... City.....

EVERY WORD CONTAINS
A HIDDEN STORY OF ITS ORIGIN

Alert!

Once meant,
*On the
watch-
tower!*



ALERT, now meaning "air raid alarm!", comes from early French *à l'erte*, "on the watch." This, in turn, came from Italian *all'erta*, "on a watchtower or height." When the first field hospital was organized to follow an army, the French called it *hôpital ambulante*, "walking hospital," from the Latin *ambulare*, "to walk." Eventually *hôpital* was dropped and *ambulante* became *ambulance*, a vehicle for conveying casualties. *Sabotage*, now the malicious hindrance of production, comes from French *saboter*, "to work carelessly"—originally, "to tread with wooden shoes, or *sabots*."

Both you and your children will enjoy the hundreds of fascinating word origins in WEBSTER'S NEW INTERNATIONAL DICTIONARY, Second Edition—The Merriam-Webster.

These colorful word histories are just one feature of this greatest of all knowledge books. Its completeness makes it truly *the Foundation Book for Home Education!* The more questions you and your children bring to it, the more you will be amazed at the range and scope of the information furnished by its hundreds of encyclopedic articles, by over 200 outstanding authorities. It seems almost unbelievable that such a vast fund of knowledge could be packed into one book! And, in addition, you learn everything you want to know about words, 600,000 of them, 122,000 more than any other dictionary.

You have long wanted this great question answerer; now is the time to get it. Ask any bookdealer to show you *the Genuine Webster*—The MERRIAM-Webster—identified by the *Circular Trade-Mark*. Write for free illustrated booklet of interesting word origins to G. & C. Merriam Co., 123 Federal St., Springfield, Mass.

Advt. Copyright, 1942, by G. & C. Merriam Co.

the Genuine Webster

WEBSTER'S
NEW INTERNATIONAL
DICTIONARY
Second Edition



(Continued from page 6A)

Clip holds trouble light.....	144
Detachable foot-scraper on car.....	144
Polisher for commutator bars.....	144
Used anti-freeze solutions tested.....	144
Wedge relieves cylinder compression.....	144
Avoiding breakage of oil line.....	145
Birds prevented from roosting in garage.....	145
Sign held on top of car.....	153

CAMPING, HUNTING, FISHING

Holder for camp candle.....	101
Damp grass in creel.....	104
Wiener fork has six prongs.....	104
Fish-bait jar held on belt.....	118

FARM

Torch to start fires.....	126
Barbed wire carried on steel post.....	136
Chickens dusted automatically.....	145
Hauling pump rods safely.....	153
Tractor wheel measures crop rows.....	153
Banking outdoor forge fire.....	154
Effective spear for mice.....	154

HAND TOOLS

Hammer head anchored tightly.....	100
How to make clamping blocks.....	100
Starting nut in difficult place.....	100
Holes bored in glass quickly.....	106
Jointed ruler used as protractor.....	106
Gauge on level finds roof pitch.....	107
Rubber band holds tape line.....	107
Comb on trash box cleans brush.....	114
Pocket scraper to clean metal.....	120
Tray on cotter pin can.....	122
Emergency level.....	128
Breakage of small dies reduced.....	138
Rapid-acting welders' clamp.....	152

HOME IMPROVEMENTS

Storm sash for basement windows.....	101
Water kept from gable ends.....	106
Attic rooms (Part I).....	108
Using insulation bats.....	127
Holes patched in composition roof.....	128

HOUSEHOLD

Solving home problems.....	102
Holding bed clothes on baby.....	104
Adjusting skirt length.....	105
Gloves made from woolen socks.....	106
Modern clothes hamper.....	107
Oilcloth pockets hold change.....	114
Bucket bail bent to hold brush.....	116
Sewing aids.....	121
Make them last longer.....	123
Bracket lamps.....	125

LAWN AND GARDEN

Croquet wickets placed easily.....	114
Reel holds row-marking line.....	114
Child's swing braced underground.....	119
How to stake tomato plants.....	138

OFFICE

Cutting board on ruler.....	120
Container for rubber cement.....	122
Tape protects magazine covers.....	122
Ink pad kept moist.....	128

(Continued to page 12A)



PARTNERS IN THE BUSINESS OF VICTORY!

WHEN it comes to winning a war, one *trained man* is worth a dozen untrained men!

That's true of America's armed forces—which need chemists, mechanics, machinists, electricians, radio experts, accountants and a dozen other classifications of trained men. And trained men in America's armed forces get better pay and higher ranking!

It's true of America's victory-vital industry. Today, business and industry are crying for skilled, trained manpower! Never was opportunity greater for the alert,

ambitious man who has mastered his line of work through study and practice!

Yes, the *trained man in uniform* and the *trained man in industry* are "partners in the business of victory." Whether you're serving Uncle Sam in barracks or factory, farm or office, TRAINING can make you a more valuable citizen and a real asset to your country!

Before you turn this page—tear off this coupon, mark it and mail it—just as thousands of successful men have done!

INTERNATIONAL CORRESPONDENCE SCHOOLS

HELPING TO TRAIN AMERICANS FOR VICTORY



BOX 5645-J, SCRANTON, PENNA.

Without cost or obligation, please send me a copy of your booklet, "Who Wins and Why," and full particulars about the course *before* which I have marked X:

TECHNICAL AND INDUSTRIAL COURSES

- | | | | |
|--|---|---|--|
| <input type="checkbox"/> Air Brake | <input type="checkbox"/> Contracting and Building | <input type="checkbox"/> Management of Inventions | <input type="checkbox"/> Sanitary Engineering |
| <input type="checkbox"/> Air Conditioning | <input type="checkbox"/> Cotton Manufacturing | <input type="checkbox"/> Marine Engines | <input type="checkbox"/> Sheet Metal Work |
| <input type="checkbox"/> Airplane Drafting | <input type="checkbox"/> Diesel Engines | <input type="checkbox"/> Mechanical Drafting | <input type="checkbox"/> Ship Drafting |
| <input type="checkbox"/> Architectural Drafting | <input type="checkbox"/> Electrical Drafting | <input type="checkbox"/> Mechanical Engineering | <input type="checkbox"/> Shipfitting <input type="checkbox"/> Shop Practice |
| <input type="checkbox"/> Architecture | <input type="checkbox"/> Electrical Engineering | <input type="checkbox"/> Mine Foreman | <input type="checkbox"/> Steam Electric <input type="checkbox"/> Steam Engines |
| <input type="checkbox"/> Auto Engine Tune-up | <input type="checkbox"/> Electrician | <input type="checkbox"/> Navigation <input type="checkbox"/> Patternmaking | <input type="checkbox"/> Steam Fitting |
| <input type="checkbox"/> Auto Technician | <input type="checkbox"/> Electric Lighting | <input type="checkbox"/> Plastics <input type="checkbox"/> Plumbing | <input type="checkbox"/> Structural Drafting |
| <input type="checkbox"/> Aviation <input type="checkbox"/> Aviation Mechanic | <input type="checkbox"/> Foundryman <input type="checkbox"/> Heating | <input type="checkbox"/> Public Works Engineering | <input type="checkbox"/> Structural Engineering |
| <input type="checkbox"/> Blueprint Reading | <input type="checkbox"/> Heat Treatment of Metals | <input type="checkbox"/> Pulp and Paper Making | <input type="checkbox"/> Surveying and Mapping |
| <input type="checkbox"/> Boilermaking | <input type="checkbox"/> Highway Engineering | <input type="checkbox"/> Radio, General | <input type="checkbox"/> Telegraphy <input type="checkbox"/> Telephony |
| <input type="checkbox"/> Bridge Engineering | <input type="checkbox"/> House Planning | <input type="checkbox"/> Radio Operating | <input type="checkbox"/> Textile Designing |
| <input type="checkbox"/> Chemistry <input type="checkbox"/> Coal Mining | <input type="checkbox"/> Industrial Metallurgy | <input type="checkbox"/> Radio Servicing | <input type="checkbox"/> Toolmaking <input type="checkbox"/> Tool Design |
| <input type="checkbox"/> Civil Engineering | <input type="checkbox"/> Locomotive Engineer | <input type="checkbox"/> R. R. Section Foreman | <input type="checkbox"/> Welding, Gas and Electric |
| <input type="checkbox"/> Concrete Engineering | <input type="checkbox"/> Machinist <input type="checkbox"/> Inspector | <input type="checkbox"/> R. R. Signalman <input type="checkbox"/> Refrigeration | <input type="checkbox"/> Woolen Manufacturing |

BUSINESS COURSES

- | | | | |
|--|--|--|---|
| <input type="checkbox"/> Accounting <input type="checkbox"/> Advertising | <input type="checkbox"/> College Preparatory | <input type="checkbox"/> First Year College | <input type="checkbox"/> Railway Postal Clerk |
| <input type="checkbox"/> Bookkeeping | <input type="checkbox"/> Commercial | <input type="checkbox"/> Foremanship <input type="checkbox"/> French | <input type="checkbox"/> Salesmanship |
| <input type="checkbox"/> Business Correspondence | <input type="checkbox"/> Commercial Illustrating | <input type="checkbox"/> Good English | <input type="checkbox"/> Secretarial <input type="checkbox"/> Spanish |
| <input type="checkbox"/> Business Management | <input type="checkbox"/> Cost Accounting | <input type="checkbox"/> High School | <input type="checkbox"/> Showcard and Sign Lettering |
| <input type="checkbox"/> Cartooning <input type="checkbox"/> Civil Service | <input type="checkbox"/> C. P. Accounting | <input type="checkbox"/> Managing Men at Work | <input type="checkbox"/> Traffic Management |

HOME ECONOMICS COURSES

- | | | |
|---|---|--|
| <input type="checkbox"/> Advanced Dressmaking | <input type="checkbox"/> Home Dressmaking | <input type="checkbox"/> Tea Room and Cafeteria Management, Catering |
| <input type="checkbox"/> Foods and Cookery | <input type="checkbox"/> Professional Dressmaking and Designing | |

Name..... Age..... Address.....
City..... State..... Present Position.....

Canadian residents send coupon to International Correspondence Schools Canadian, Limited, Montreal, Canada
British residents send coupon to I. C. S., 71 Kingway, London, W. C. 2, England



Be a Radio

MANY MAKE \$30,

J. E. SMITH
President
National Radio
Institute
Est. 27 Years

I Train BEGINNERS at Home for Good Spare Time and Full Time Radio Jobs

Men I Train Win Success Like This

\$10 a Week in Spare Time



"I repaired some Radio sets when I was on my tenth lesson. I really don't see how you can give so much for such a small amount of money. I made \$600 in a year and a half, and I have made an average of \$10 a week—just spare time." **JOHN JERRY**, 1126 Mariposa St., Denver, Colorado.

Salary Increased \$1,800 Year in Radio

"I have been regularly employed in Radio since my graduation. I have been Chief Engineer of three broadcast stations, and at present time am Chief Engineer of WDDO. My salary has increased \$1,800 per year since entering Radio and credit is given you for your excellent training." **JULIUS C. VESSELS**, Station WDDO, Chattanooga, Tenn.



\$200 a Month in Own Business



"For several years I have been in business for myself making around \$200 a month. Business has steadily increased. I have N. R. I. to thank for my start in this field." **ARLIE J. FROEHNER**, 300 W. Texas Ave., Goose Creek, Texas.

Here's your opportunity to get a good job in a field with a big peacetime future! There is a shortage today of trained Radio Technicians and Operators. If you're in a rut, worried because your present job has no future—find out about RADIO!

Mail the Coupon. I will send you FREE my 64-page, illustrated Book, **RICH REWARDS IN RADIO**. It describes many fascinating types of Radio jobs; tells how N. R. I. trains you at home in spare time; how you learn by building fascinating Radio Circuits with **SIX BIG KITS OF RADIO PARTS** I send!

ACT NOW! Many Beginners Quickly Make \$5, \$10 Extra a Week

Many N. R. I. Students make \$5, \$10 EXTRA MONEY in spare time while learning. I send EXTRA MONEY JOB SHEETS that tell how to do it!

Right now, probably in your neighborhood, there's room for a spare and full time Radio Technician. Many spare time Technicians are starting their own FULL time shops . . . making \$30, \$40, \$50 a week!

Others take good-pay jobs with Radio Broadcasting Stations. Many more are needed for Government jobs as Civilian Operators, Technicians. Radio Manufacturers employ trained Technicians to help fill Government wartime orders. Aviation, Commercial, Police Radio and Loudspeaker Systems continue to be live, growing fields. And think of the NEW jobs Television, Frequency Modulation, and other Radio developments will open up after the war! I give you the Radio knowledge required for jobs in these fields.

Build These Radio Circuits With Parts I Send!



SUPERHETERODYNE CIRCUIT. Receives Local and Distant Stations. Build it with parts I supply. Use it to make fascinating tests, experiments, prove what you learn from my illustrated lessons!

MEASURING INSTRUMENT. Built early in Course. Use it to locate defects, service Radios in your neighborhood, earn EXTRA MONEY while you learn!



A. M. SIGNAL GENERATOR. Build it yourself. It provides amplitude-modulated signal for testing and experimental purposes. I send all parts, instructions, for building these and other Radio Units!

By the time you've conducted 60 sets of Experiments with Radio Parts I supply—have made hundreds of measurements and adjustments—you'll have valuable PRACTICAL experience.

FIND OUT ABOUT THIS TESTED WAY

Technician

\$40, \$50 A WEEK

How My "50-50 Method" Paves the Way to Bigger Pay

My "50-50 Method"—half building and testing Radio Circuits, half learning from illustrated lessons—is a tested, proved method. Think how much you'll learn by building the "Super-het" and Measuring Instrument illustrated below—by conducting 60 sets of experiments on these and other circuits you build with parts I supply! Before you know it you are "old friends" with the miracle of Radio. You run your own Spare Time Shop, fix the Radios of your friends and neighbors—get paid while learning!



Extra Pay in Army, Navy, Too

Men likely to go into military service, soldiers, sailors, marines, should mail the Coupon Now! Learning Radio helps men get extra rank, extra prestige, more interesting duties, MUCH HIGHER PAY. Hundreds now in service are N. R. I. students. Also prepares for good Radio jobs, after service ends.



A Great School Helps You Toward the Rich Rewards of Radio

In 27 years since N. R. I. pioneered the home study of Radio, I've seen my method help thousands jump their pay. It's not a "miracle cure" nor a "long chance" operation. It is a time-tested, practical way to prepare for a full time Radio job paying up to \$50 a week. Instead of struggling along by yourself, you "team up" with an organization that knows how to help beginners get started.

Find Out What N. R. I. Can Do For YOU

MAIL THE COUPON for my FREE 64-page book. It is packed with Radio facts, things you never knew about opportunities in Broadcasting, Radio Servicing, Manufacturing, other Radio fields.

You'll read a complete description of my Course—"50-50 Method"—6 Experimental Kits—Extra Money Job Sheets. You'll see the fascinating jobs Radio offers and how YOU can train at home. No obligation. If you want to JUMP YOUR PAY—Mail Coupon AT ONCE! **J. E. SMITH, President, Dept. 2KP, National Radio Institute, Washington, D. C.**

Set Servicing pays many N. R. I. trained Radio Technicians \$30, \$40, \$50 a week. Others hold their regular jobs and make \$5 to \$10 extra a week in spare time.

Training Men for Vital Radio Jobs

Broadcasting Stations employ N. R. I. trained Radio Technicians as operators, installation, maintenance men and in other capacities and pay well.



THIS Free Book HAS HELPED HUNDREDS OF MEN MAKE MORE MONEY



TO BETTER PAY

Mail this to get 64 page book FREE

**J. E. SMITH, President, Dept. 2KP
National Radio Institute, Washington, D. C.**

Dear Mr. Smith: Mail me FREE, without obligation, your 64-page book, "Rich Rewards in Radio," which points out Radio's opportunities and tells how you train men at home to be Radio Technicians. (No salesman will call. Please write or print plainly.)

Age.....

Name.....

Address.....

City..... State.....

KNOWLEDGE
THAT HAS
ENDURED WITH
THE PYRAMIDS

A SECRET METHOD FOR THE MASTERY OF LIFE

WHENCE came the knowledge that built the Pyramids? Where did the first builders in the Nile Valley acquire their astounding wisdom that started man on his upward climb? Did their knowledge come from a race now submerged beneath the sea? From what concealed source came the wisdom that produced such characters as Amenhotep IV, Leonardo da Vinci, Isaac Newton, and a host of others?

Today it is known that they discovered and used certain *Secret Methods* for the development of their inner power of mind. They truly learned to master life. This secret art of living has been preserved and handed down throughout the ages and today is extended to those who dare use its profound principles to meet and solve the problems of life in these complex times.

This Sealed Book -- FREE

Has life brought you that personal satisfaction, the sense of achievement and happiness that you desire? If not, it is your duty to yourself to learn about this rational method of applying natural laws for the mastery of life. To the thoughtful person it is obvious that everyone cannot be entrusted with an intimate knowledge of the mysteries of life, for everyone is not capable of properly using it. But if you are one of those possessed of a true desire to forge ahead and wish to make use of the subtle influences of life, the Rosicrucians (not a religious organization) will send you A Sealed Book of explanation without obligation. This Sealed Book tells how you, in the privacy of your own home, without interference with your personal affairs or manner of living, may receive these secret teachings. Not weird or strange practices, but a rational application of the basic laws of life. Obtain your complimentary copy by addressing your inquiry to Scribe D.I.O.

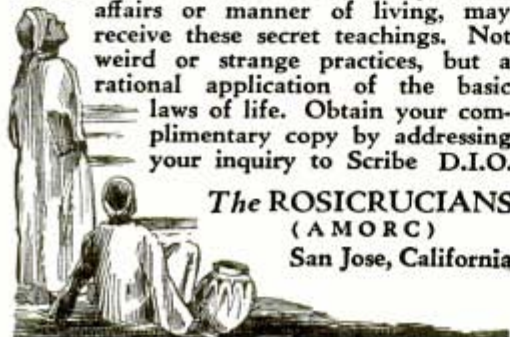

The ROSICRUCIANS
(A M O R C)
San Jose, California

(Continued from page 8A)

PAINT AND PAINTING

C-clamp holds paint-pail.....	116
Removing paint from bricks.....	116
Color wheel	135

PHOTOGRAPHY

Case for small camera.....	129
Spot reflector for flash bulbs.....	129
Adjustable view camera	130
Extra weights for photo scales.....	134
Name clip identifies print on tin.....	134

POWER TOOLS

Floating drive for lathe.....	100
Handwheels adjust lathe parts.....	125
Drill chuck made smaller.....	137
Stop prevents rip fence from sliding off.....	153

RADIO AND ELECTRICITY

String pull on extension cord.....	122
First aid for receivers (Part 5).....	155
Three-tube all-wave super ("V" series set No. 3).....	156
Two-ampere tungar battery charger.....	158
Adding tip to old iron for radio soldering.....	159
Auto set mounted on a bicycle.....	159
Burring reamer to enlarge holes in chassis bases.....	159
Connector for checking resistors.....	159
Meter stand for experimenters.....	159

SPORTS AND GAMES

Repairing cracked tennis ball.....	116
Cloth rack for guns.....	120
Hanging a punching bag.....	125

STORE AND SHOP

Sorting tray for small parts.....	106
Metal sleeve on tack carton.....	120
Rug used as sawhorse pad.....	122
Paper clips hold screws in place.....	126
Holder for rug display.....	138
Mounting paper signs in window.....	138
Lapel pincushion for tailor.....	145
How to read blueprints.....	146
Protector for bench vise.....	153

WOODWORKING

Decorative wall trees.....	97
Bric-a-brac shelf.....	105
Sawhorse holds board on edge.....	113
Short work held in vise.....	116

MISCELLANEOUS

Wing nut locked in place.....	100
Wire knives cut soap blocks.....	101
Bait held on mousetrap.....	104
Magnet keeps door hasp open.....	104
Warning board on guy wire.....	106
Splash board for boat.....	114
Novel match holders.....	119
Extra drawer in large drawer.....	126
Magnets used as glue clamp.....	126
Repairing fountain pen threads.....	128
Laboratory stand	137

IMPORTANT NOTICE

It is the intention of this magazine to provide its readers with information regarding the latest developments in the mechanical arts. We take no responsibility as to whether the disclosures contained in our articles are covered by patents and advise readers to investigate this subject before making, using, or selling any of the products, machines, or processes described in order to avoid possible liability for patent infringement.

Home Training helps YOU WIN!



Right Now

there is a tremendous shortage of skilled men in all branches of industry. Draftsmen, electricians, machine designers, tool makers, machinists are needed and the pay is big. Executives, too, foremen, superintendents, managers are wanted to help complete our tremendous production program.

War Production Demands Better Men

It is a duty you owe your country, yourself, and your family. You should know more and more about your job. You should be prepared to advance and to accept the responsibilities of the men ahead of you so that they in turn may climb and climbing take you with them. No matter what your present job, you should learn to do it better or learn how to do the job of the man ahead of you. You need to know *both theory and practice* to make our tremendous war plants more productive. Yes, indeed, you are needed and needed badly right now.

Draftsmen, Electricians, Machine Designers, Machinists, Foremen, Superintendents, Managers Can All Profit by Home Study . . .

No matter what your trade or profession there is a better place for you in industry. You can get the training needed right in your own home.

AMERICAN SCHOOL
Dept. G745, Drexel at 58th St.,
CHICAGO, ILLINOIS

Use Spare Time, Learn At Home

As little as one-half hour a day can produce surprising results in giving you a better education, more practical and theoretical training which will be reflected in your pay envelope. Never in the history of the world have there been so many opportunities for trained men, nor has it been so easy to get this training. The American School was founded over 40 years ago to provide home study for men and women who missed the opportunity to go to high school or college and to make it possible for you to LEARN AS YOU EARN.

Rewards Are Great

Government figures show that graduates of specialized training of college grade, average over \$40 per week more than grade school graduates. If you missed this college training, then here is your opportunity to get specialized training at home. More than 150 noted educators, engineers, and executives helped to prepare American School Courses. This instruction is now available to you at a relatively low cost and on very easy monthly payments. Write now for details. Clip and mail the coupon—there is no obligation.

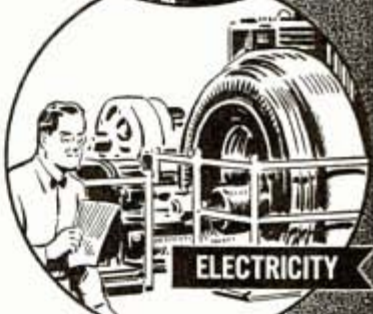

MARK, CLIP AND MAIL THIS COUPON NOW!

Get facts FREE..

(No Cost). All you have to do to find out about this type of training, to get the details and the outline of study, with histories of the successes of other men, is to send the coupon. There is no cost and no obligation of any kind. Let this great school, one of the pioneers in the home study field, explain the methods which can do so much for you. Get this information now so that you can get started quickly on the road to the fulfillment of a real ambition, and be of the greatest possible help in this present emergency.

AMERICAN SCHOOL

Dept. G745, Drexel at 58th Street, Chicago

AMERICAN SCHOOL, Dept. G745, Drexel at 58th, Chicago

Without obligation, please send FREE and postpaid, bulletin and details of the Subjects checked.

- | | | |
|---|---|--|
| <input type="checkbox"/> Air Conditioning | <input type="checkbox"/> Accounting and C.P.A. | <input type="checkbox"/> Drafting and Design for Men and Women |
| <input type="checkbox"/> Refrigeration | <input type="checkbox"/> Cost Accounting | <input type="checkbox"/> Radio |
| <input type="checkbox"/> Architecture and Building | <input type="checkbox"/> Practical Bookkeeping | <input type="checkbox"/> High School |
| <input type="checkbox"/> Plumbing and Steam Fitting | <input type="checkbox"/> Private Secretary | <input type="checkbox"/> Plastics |
| <input type="checkbox"/> Automotive Engineering | <input type="checkbox"/> Diesel Engineering | <input type="checkbox"/> Liberal Arts |
| <input type="checkbox"/> Aviation Drafting | <input type="checkbox"/> Surveying & Topographical Drafting | <input type="checkbox"/> Mechanical Eng. |
| <input type="checkbox"/> Aviation Engineering | <input type="checkbox"/> Sheet Metal Pattern Drafting | <input type="checkbox"/> Shop Management |
| <input type="checkbox"/> Business Management | <input type="checkbox"/> Electrical Engineering | <input type="checkbox"/> Tool Making |
| | | <input type="checkbox"/> Better Foremanship |
| | | <input type="checkbox"/> Engine and Boiler Work |

Name..... Occupation.....

Address..... Age.....

City..... State.....



Know Electricity as Experts Know It—and Get an Expert's Pay!

What about your future? Who is safe today? Surely not the man who is contented to stand still! Know your job thoroughly—prepare yourself for jobs ahead. To do just this thousands of men have used

The Croft Library of Practical Electricity

The Croft Library is a complete electrical educator. It is founded on practice—on 20 years of shirt-sleeve experience—on work as it is actually done. It is jammed from cover to cover with the kind of hard-headed facts you want. Written so that the beginner can easily understand it, yet so sound, so thorough, that it is the daily guide of 50,000 highly paid electrical workers and engineers. Croft tells you the things you need to know about motors, generators, armatures, commutators, transformers, circuits, switchboards, distribution systems—electrical machinery of every type—wiring for light and power—wiring of finished buildings—underwriters and municipal requirements—illumination in its every phase—the most improved methods of lighting—lamps and lamp effects, etc.—how to do a complete job, from planning it, to completion.

No money down — easy payments

Fill in and mail the coupon attached and we will send you the entire set of seven volumes for ten days' examination on approval. We take all the risk—you assume no obligation. If you decide to keep the books, send \$3.00 in ten days and the balance at the rate of \$2.00 a month. Send the coupon NOW and see the books for yourself.

EXAMINATION COUPON

McGraw-Hill Book Co., 330 W. 42nd St., New York

Send me for ten days' examination on approval the Croft Library of Practical Electricity, 7 vols. If satisfactory I will send you \$3.00 in 10 days and \$3.00 monthly until the price of \$18.00 is paid. If not wanted, I will return the books postpaid. (To insure prompt shipment write plainly and fill in all lines.)

Name.....
Home Address.....
City and State.....
Position.....
Name of Company..... PM-10-42



U.S. GOVERNMENT JOBS.

START \$1260 to \$2100 Year

Thousands War Appointments Now Being Made

FRANKLIN INSTITUTE
Dept. P195
Rochester, N. Y.

Rush to me, entirely free of charge, 32 page book with: (1) a full description of U. S. Government jobs; (2) a list of U. S. Government Jobs; (3) tell me how to qualify for a job.

Name.....
Address.....

32 Page Civil Service Book FREE

Mail Coupon today—SURE

★

PARKS AIR COLLEGE

PARKS AIRPORT EAST ST. LOUIS, ILL.

Offers YOU COLLEGE and PROFESSIONAL TRAINING Majoring in AVIATION

Accredited by the Illinois Superintendent of Public Instruction. Included since 1938 in The Directory of Colleges and Universities, issued by the U. S. Office of Education. U. S. approved as a Commercial Ground and Flying School and Mechanics' School. Accredited by and cooperating with the United States Army Air Corps in giving flight and mechanical training. Open to high school graduates.

FOUR courses lead to B.S. degrees in Professional Piloting, Aviation Operations, Maintenance Engineering, Aeronautical Engineering.

TWENTY-TWO TRAINING PLANES are used in professional flight training which prepares graduates for airline flight operations.

FACULTY of 104 specialists in various fields of aviation.

Enrollment limited to a total of 300 commercial aviation students. Capacity enrollment of 870.

Airport, 25 buildings devoted to school purposes exclusively. Dormitories and dining hall at the College.

Fall term September 28. Send postcard for new 64-page catalog.

16th YEAR Registrar, Dept. PM-10
PARKS AIR COLLEGE, East St. Louis, Ill.



TRAIN Your VOICE!

Results GUARANTEED

We build, strengthen the vocal organs—not with singing lessons—but by sound, scientifically correct silent and vocal exercises and absolutely guarantee complete satisfaction with results. Write for Voice Book, FREE. Sent to no one under 17 years old unless signed by parent.

PERFECT VOICE INSTITUTE, Studio 1356, 64 E. Lake St. Chicago, Ill



TRI-STATE COLLEGE

B-S-Degree in 2 1/2 years

Distinguished for technical 2 1/2 year courses in Civil, Electrical, Mechanical, Chemical, Radio, Aeronautical Engineering; Business Administration, Accounting, and Secretarial Science. Special preparatory department for those who lack required high school work. Short diploma courses (36 weeks) in Surveying, Drafting, Low tuition. Low living costs. Cosmopolitan student body. 59th year. Enter January, March, June, September. Write for catalog. 4102 College Ave., ANGOLA, INDIANA.



Learn Profitable Profession in 90 days at Home

Earnings of Men and Women in the fascinating profession of Swedish Massage run as high as \$40 to \$70 per week but many prefer to open their own offices. Large incomes from Doctors, hospitals, sanitariums and private patients come to those who qualify through our training. The Army and Navy need hundreds trained in massage. Write for Anatomy Charts and booklet—They're FREE.

THE COLLEGE OF SWEDISH MASSAGE
30 E. Adams St., Dept. 764, Chicago



Learn PHOTO-ENGRAVING

We teach you quickly, at home in spare time. Earn while you learn. Establish your own profitable business with equipment we furnish, or work for others at good salary. Cuts in this magazine made by process we teach. Send for your copy of our big illustrated catalog. It's free!

THE AURORA SCHOOL OF PHOTO-ENGRAVING
Tasape' Bldg. (Dept. PM-45) Aurora, Mo.



Learn CARTOONING

FREE TRIAL LESSON! Cash in on your sense of humor—AT HOME—BY MAIL. Have fun! Make money! No experience needed to start. Write today for FREE LESSON, mailed postpaid. No obligation.

MOON Gag-Cartoon School, Dept. K, Fall Creek, Wis.



MONEY for MEN ALL FREE

THE PLASTEX Industry needs manufacturers on small scale and for big production of Lamp and Clock Stands, Art Goods and Novelties in Plastex and Marble imitation. Experience unnecessary. 1-gc material makes regular 10c store sellers. Rubber moulds furnished for speed production. Small investment brings good returns. WE ARE NOW PLACING BIG CHAIN STORE ORDERS WITH MANUFACTURERS. Ambitious men have chance for real prosperity. Our FREE booklet will interest and benefit you.

PLASTEX INDUSTRIES, Dept. P, 1085 Washington Ave., New York, N. Y.

BILL, YOU SURE HAVE A SWELL BUILD! DID YOU TRAIN FOR A LONG TIME?

ABSOLUTELY NOT! THE ATLAS DYNAMIC TENSION SYSTEM MAKES MUSCLES GROW FAST!



Here's the Kind of MEN I Build!

Charles Atlas

An actual untouched photo of Charles Atlas, holder of the title, "The World's Most Perfectly Developed Man."



J. G. O'BRIEN
Atlas Champion Cup Winner
This is an ordinary snapshot of one of Charles Atlas' California pupils.



Will You Let Me PROVE I Can Make YOU a New Man?

I DON'T care how old or young you are, or how ashamed of your present physical condition you may be. If you can simply raise your arm and flex it I can add **SOLID MUSCLE** to your biceps—yes, on each arm—in double-quick time! Only 15 minutes a day—right in your own home—is all the time I ask of you! And there's no cost if I fail.

I can broaden your shoulders, strengthen your back, develop your whole muscular system **INSIDE** and **OUTSIDE!** I can add inches to your chest, give you a vise-like grip, make those legs of yours lithe and powerful. I can shoot new strength into your old backbone, exercise those inner organs, help you cram your body so full of pep, vigor and red-blooded vitality that you won't feel there's even "standing room" left for weakness and that lazy feeling! Before I get through with you I'll have your whole frame "measured" to a nice, new, beautiful suit of muscle!

What's My Secret?

"Dynamic Tension!" That's the ticket! The identical natural method that I myself developed to change my body from the scrawny, skinny-chested weakling I was at 17 to my present super-man physique! Thousands of other fellows are becoming marvelous physical specimens—my way. I give you no gadgets or contraptions to fool with. When you have learned to develop your strength through "Dynamic Tension" you can laugh at artificial muscle-makers. You simply utilize the **DORMANT** muscle-power in your own God-given body—watch it increase and multiply double-quick into real, solid **LIVE MUSCLE.**

Only 15 Minutes a Day

My method—"Dynamic Tension"—will turn the trick for you. No theory—every exercise is practical. And, man, so easy! Spend only 15 minutes a day in your own home. From the very start you'll be using my method of "Dynamic Tension" almost unconsciously every minute of the day—walking, bending over, etc.—to **BUILD MUSCLE** and **VITALITY.**

FREE BOOK "Everlasting Health and Strength"

In it I talk to you in straight-from-the-shoulder language. Packed with inspirational pictures of myself and pupils—fellows who became **NEW MEN** in strength, my way. Let me show you what I helped **THEM** do. See what I can do for **YOU!** For a real thrill, send for this book **today.** AT **ONCE.** **CHARLES ATLAS,** Dept. 8-Z, 115 East 23rd Street, New York City.



CHARLES ATLAS, Dept. 8-Z, 115 East 23rd Street, New York, N. Y.

I want the proof that your system of "Dynamic Tension" will help make a New Man of me—give me a healthy, husky body and big muscular development. Send me your free book, "Everlasting Health and Strength."

Name.....
(Please print or write plainly.)
Address.....
City..... State.....

Do you want

- .. to go to College?
- .. or to enter a Profession?

(Such as Accounting, Architecture, Nursing, Dentistry, Teaching, Social Work, Osteopathy, Beauty Culture, Optometry, Embalming, Chiropractic, Law, Medicine, etc.)

- .. or get an Office Position?

To get anywhere, you practically MUST finish High School FIRST. You can complete our simplified High School Course in SPARE time at home, as FAST as your time and abilities permit. Equivalent to resident school work—prepares you for college, pre-professional examinations, business, industry. Standard texts furnished. Diploma. Credit for H.S. subjects already completed. Single subjects if desired. Low tuition, easy terms. American School, Chicago, est. 1897—endorsed by educators. Finish your high school education NOW. Write TODAY!

High School Course at Home

Many finish in 2 Years

American School, Dept. H745, Drexel Ave. at 58th St., Chicago, Ill.

Gentlemen: Send me FREE information covering special training in subjects checked below. No obligation on my part.

- | | |
|--|--|
| <input type="checkbox"/> High School Course | <input type="checkbox"/> Diesel Engineering |
| <input type="checkbox"/> Accounting and Auditing | <input type="checkbox"/> Drafting and Design for men & women |
| <input type="checkbox"/> Architecture and Building | <input type="checkbox"/> Liberal Arts |
| <input type="checkbox"/> Automotive Engineering | <input type="checkbox"/> Private Secretary |
| <input type="checkbox"/> Business Management | <input type="checkbox"/> Mechanical Engineering |
| <input type="checkbox"/> Aviation | <input type="checkbox"/> Radio |
| <input type="checkbox"/> Electrical Engineering | <input type="checkbox"/> Salesmanship |
| <input type="checkbox"/> Elec. and Gas Refrigeration | <input type="checkbox"/> Retail Merchandising |
| <input type="checkbox"/> Air Conditioning | |

Name _____

Address _____

SUPER JU JITSU

NOW—WHEN THIS HAPPENS TO YOU...
YOU CAN DESTROY Your Enemy Quick!

BEA ONE-MAN BLITZ! Strike with Command lightning! You don't need ox-like muscles to use Super Ju Jitsu, most powerful of all defense and attack methods. **Technique** is the deadly secret. Brains count—not size, not strength. Almost miraculously efficient.

Gain Self-Confidence

KNOW how YOU can lick brutes twice your size with your bare hands only, even when they are ARMED with gun, knife, club. Get ready now for any emergency—protect your loved ones. Amazing self-study course teaches you double-quick. No boring exercises needed.

Send for Exciting Details—Free!

FREE Startling Low Price. Satisfaction Guaranteed or your money back. Mail coupon now.

NELSON CO., 500 Sherman Street DEPT. K-502, CHICAGO, ILL.

Please rush me free the hard-hitting details about "Super Ju Jitsu." No obligation on my part.

NAME _____

ADDRESS _____



DO THIS



OR DO THIS



ARREST HIM, OFFICER! I'LL HAVE COMPLETE FACTS ON THE OTHER FELLOW TONIGHT!



Secret Service Operator No. 38 is on the job... FOLLOW HIM through all the excitement of his chase after the counterfeit gang. Write NOW for

FREE Confidential Reports No. 38 Made to His Chief!

It may open your eyes to the great opportunity for YOU as a well paid Finger Print Expert. The kind of work you'd like. Excitement! Travel! Thrills! A REGULAR MONTHLY salary. REWARD MONEY. Graduates of this school HEAD 43% of all Identification Bureaus in U. S.! Write for Free Reports, Finger Print Book, low prices. Easy Terms Offer.

Literature will be sent only to persons stating their age.
INSTITUTE OF APPLIED SCIENCE
1920 Sunnyside Ave., Dept. 1357 Chicago, Illinois

ENGINEERING DEGREE IN 27 MONTHS

INDIANA TECHNICAL COLLEGE

Courses in Aeronautical, Chemical, Civil, Electrical, Mechanical, and Radio Engineering. One-year courses in Radio and Drafting. Approved by C.A.A. Prep courses without added cost. Low tuition. Large industrial center. Opportunity to earn part living expenses. Enter December, March, June, September. Catalog. 5102 E. Washington Blvd., Ft. Wayne, Ind.



FREE BOOKLET answers the many questions bound to be in your mind about where you stand in relation to the war—about how you can serve your country well, and still plan for a secure, successful future. It tells why YOU—by entering the aircraft industry—can be NECESSARY to your country's victory. For your free copy of this helpful booklet, airmail your request NOW to

AERO INDUSTRIES TECHNICAL INSTITUTE
5253 W. SAN FERNANDO RD., LOS ANGELES, CALIF.

LEARN WATCH REPAIRING



AT HOME You can learn by our modern and original system of instruction every part of the Watch Repairing Trade at home. Prepare yourself for a well paying position or start in business after completing our course of instruction. Good watch repairers are in demand and generally earn very good salaries. For particulars apply to the Wisconsin School of Watch Repairing 524 E. Mason St., MILWAUKEE, WIS.



BECOME AN EXPERT MEAT CUTTER

Greater opportunities! Thousands of firms are needing expert Meat Cutters. Train in 8 weeks at famous National School. It's quick, easy to learn Meat Cutting by ACTUAL PRACTICE in big National cutting rooms and retail department. No previous experience or advanced education necessary. BIG PAY JOBS. Union card guaranteed. Employment service FREE. Train first. Pay later. Easy terms. Write TODAY for FREE catalog and plans to help you get ahead.

National School of Meat Cutting, Inc., Dept. U-35, Toledo, Ohio

RADIO ENGINEERING, broadcasting, aviation and police radio, servicing, marine and Morse telegraphy taught thoroughly. 45 weeks' engineering course equivalent to three years' college radio work. School established 1874. All expenses low. Catalog free.
The Dodge Institute, Dept. D, Valparaiso, Ind.



EARN MONEY PAINTING PORTRAITS

No previous training or talent necessary. Unique Stuart System teaches you, by mail, in 10 simple, easy-to-follow lessons, to make excellent charcoal and oil likenesses. Detailed guidance for your every step. Send for free book today.

STUART STUDIOS,

121 Monument Circle, Room 6102, Indianapolis, Ind.

Please send me free book and outline of lessons.

Name _____

Street _____

City _____

State _____

Get this amazing New ENCYCLOPEDIA OF ELECTRICITY For 7 DAYS FREE TRIAL!



3 BIG VOLUMES TO HELP YOU EARN MORE MONEY

You don't have to risk a penny. See this remarkable set in your own home. Read through it. THEN YOU MAKE YOUR OWN DECISION!

1200 big pages, 8½ x 11 in.
2000 subject listings
2000 pictures and diagrams
Handsomely bound in
Harvard Red and Gold
Leatherette.

AUTHORITATIVE—Prepared by experts who know how to tell you about Electricity in plain, understandable words.
PRACTICAL—Used regularly on the job by Electricians,

Service Men, Radio Men, Air Cadets, Students, Maintenance Men, etc. **EASY**—How-to-do-it pictures and easy-to-follow words. **COMPLETE**—A world of Electrical knowledge.

If You Are In Any of These Classifications—You Need This Electrical Encyclopedia
NO AMOUNT OF MONEY can replace today's precious electrical devices—refrigerators, toasters, irons, professional equipment, light and heating equipment, etc. **Keep them running** with the help of these great books. **EASY, PRACTICAL, SAVE TIME, MONEY, EQUIPMENT.** Invaluable to—
HOME OWNERS—Save DOLLARS on household repairs. Easy to understand.
DOCTORS, DENTISTS—Know how to make repairs on your precious equipment.
TEACHERS—A handy guide that answers every student's questions.
HANDI-CRAFTSMEN—Know how to wire your own handicraft.
ELECTRICIANS—Helps you earn more money. Explains ALL electrical jobs.
SOLDIERS, SAILORS—Train yourself to be eligible for higher ratings.
WAR INDUSTRY WORKERS—Helps you prepare for good-pay electrical jobs.
PART-TIME ELECTRICIANS—Know how to make more difficult repairs.
WOMEN—With many Electricians in vital war work, you can learn to make many of your OWN repairs.
LIBRARIANS—Every well-equipped technical shelf requires these guides.
FARMERS—Keep your equipment running. Save money.
Whatever your line of work, you may at times have to make electrical repairs. You can't afford to be without this **Electrical Workers' Encyclopedia.** NOT AVAILABLE IN BOOK STORES. Mail coupon NOW!

RADIO-TELEVISION INCLUDED

Covers EVERYTHING ELECTRICAL from magnetism and signal systems to armature winding, A.C. and D.C. motors, generators, electronics, automotive electricity, refrigeration, Diesel electricity, telephones, etc. . . . also includes **Radio and Television.** Tells how to build, troubleshoot, make repairs. Easy-to-understand words TELL how each job is done. Plenty of pictures and simple diagrams SHOW how it's done. YOUR ELECTRICAL AND RADIO QUESTIONS answered quickly, completely, clearly and in simple language.

This is not a correspondence course. No written lessons or examinations or tests to be sent in. You study at home when you have the time and it will always serve as a reference set when you want to look up any electrical problem.

FREE WITH ENCYCLOPEDIA

One year of personal advice by mail. IF YOU ACT NOW, we'll include a Certificate entitling you to 1 year of Technical Service. This means you have the privilege of writing to us for technical advice on any Electrical subject, for one whole year after you purchase this Electrical encyclopedia.

ASK TO SEE THEM

To get your set promptly, just mail coupon. Examine the three big volumes for 7 days. If at the end of that time you don't agree they're the best practical electrical set you ever saw regardless of price, then return the books and YOU WON'T OWE A CENT. If you decide to keep them, just send \$3 after 7 days and \$3 a month until the advertised price of \$12.00 is paid. We prepay shipping charges. Mail the coupon now. THIS OFFER IS LIMITED. Act Today!

LEWIS, 500 S. Paulina St.,
Dept. 72-R1, Chicago, Ill.

Send me your big 3-volume Electrical Reference and Instruction Encyclopedia. Within 7 days after receiving the books, I'll either return them or send you \$3, and \$3 a month until advertised price of \$12.00 is paid. We prepay shipping charges.

NAME.....
ADDRESS.....
CITY.....STATE.....
OCCUPATION.....AGE.....

LEWIS 500 So. Paulina Street
Dept. 72-R1, Chicago, Ill.

Do You Make these Mistakes in ENGLISH?

Sherwin Cody's remarkable invention has enabled more than 100,000 people to correct their mistakes in English. Only 15 minutes a day required to improve your speech and writing.

MANY persons say, "Did you hear from him today?" They should say, "Have you heard from him today?" Some spell "calendar" "calender" or "calander." Still others say "between you and I" instead of "between you and me." It is astonishing how often "who" is used for "whom," and how frequently the simplest words are mispronounced. Few know whether to spell certain words with one or two "c's" or "m's" or "r's," or with "ie" or "ei." Most persons use only common words—colorless, flat, ordinary. Their speech and their letters are lifeless, monotonous, humdrum. Every time they talk or write they show themselves lacking in the essential points of English.



SHERWIN CODY

Wonderful New Invention

For many years Mr. Cody studied the problem of creating instinctive habits of using good English. After countless experiments he finally invented a simple method by which you can acquire a better command of the English language in only 15 minutes a day. Now you can stop making the mistakes which have been hurting you. Mr. Cody's students have secured more improvement in five weeks than previously had been obtained by other pupils in two years!

Learn by Habit—Not by Rules

Under old methods rules are memorized, but correct habits are not formed. Finally the rules themselves are forgotten. The new Sherwin Cody method provides for the formation of correct habits by calling to your attention constantly only the mistakes you yourself make. One of the wonderful things about Mr. Cody's course is the speed with which these habit-forming practice drills can be carried out. You can write the answers to fifty questions in 15 minutes and correct your work in 5 minutes more. The drudgery and work of copying have been ended by Mr. Cody! You concentrate always on your own mistakes until it becomes "second nature" to speak and write correctly.

FREE—Book on English

A new book explaining Mr. Cody's remarkable method is ready. If you are ever embarrassed by mistakes in grammar, spelling, punctuation, pronunciation, or if you cannot instantly command the exact words with which to express your ideas, this new free book, "How You Can Master Good English—in 15 Minutes a Day," will prove a revelation to you. Send the coupon or a letter or postal card for it now. No agent will call. SHERWIN CODY SCHOOL OF ENGLISH, 510 Searle Building, Rochester, N. Y.

SHERWIN CODY SCHOOL OF ENGLISH
510 Searle Building, Rochester, N. Y.

Please send me, without any obligation on my part, your new free book, "How You Can Master Good English—in 15 Minutes a Day."

Name Please print plainly

Address

If 18 years or under check here for Booklet A

See you saw it in Popular Mechanics!

AIRCRAFT DRAFTING TOOL DESIGN

Tool designers, aviation and mechanical draftsmen are the key men urgently needed for the Army and Navy armament aircraft program. This is your opportunity to help in the biggest production job America has ever faced. Learn quickly to qualify for good pay drafting position. Former naval aviation instructor will teach you at home, through individual home study lessons. Want ads full of openings for aviation draftsmen and tool designers waiting to be filled. Great shortage of trained men. Industry crowding us for men. Salaries highest in history. Rush name and address for catalog. Please state age.

THE OHIO INSTITUTE OF TECHNOLOGY
BOX 75, GREENVILLE, OHIO

New York Established 1902
Electrical
Ask for free illustrated **School** booklet
44 West 17th St., N. Y. C.

LAW STUDY AT HOME
Legally trained men win higher positions and bigger success in business and public life. Greater opportunities now than ever before. Big corporations are headed by men with legal training.
More Ability: More Prestige: More Money
We guide you step by step. You can train at home during spare time. Degree of LL. B. Successful graduates in every section of the U. S. We furnish all text material, including 14-volume Law Library. Low cost, easy terms. Get our valuable 48-page "Law Training for Leadership" and "Exhibitors" books FREE. Send for them NOW.

LaSalle Extension University, Dept. 1064-L. Chicago
A Correspondence Institution

Regain Perfect Speech, If You

STAMMER

Every stammerer should have the new 128 page book "Stammering, Its Cause and Correction." Sent free to stammerers. It describes the Bogue Unit Method for the scientific correction of stammering and stuttering. Method successfully used at Bogue Institute for 41 years—since 1901. Endorsed by physicians. Write for full information. No obligation. Benjamin N. Bogue, Dept. 1343 Circle Tower, Indianapolis, Indiana.

FORGE AHEAD

The Mind Stimulator is a copyrighted system for Rapid Mind Training, Creative Thinking and Self Advancement. Free Mind Power Test and Literature.
SELF ADVANCEMENT INSTITUTE, 33 BERN ST., PHILADELPHIA, PA.

AMAZING NEW ELECTRIC ARC WELDER

RETAILS ONLY \$2.95 COMPLETE
FULLY GUARANTEED



PLUGS INTO LIGHT SOCKET

Amazing new HANDIWELD Electric Arc Welder—operates from 110 volt A.C. or D.C. same as other arc welders. Generates tremendous heat to weld all kinds of metal. Not a toy welder that uses carbons, but actually uses standard coated rods—sizes 1/16" and 3/32". Generous supply furnished with welder. Guaranteed not to burn out. Repairs fenders, auto bodies, radiators, pre-bent small castings and machinery parts. Take HANDIWELD anywhere to job, operates from light socket. Sturdily built of finest materials to last years. Fully guaranteed by Big Manufacturer.

SEND NO MONEY! You'll find a thousand uses for the HANDIWELD around your home, garage, work shop. Also by garage, factories, repair shops, mechanics, farmers, inventors, linemen, plumbers, etc. Order HANDIWELD now. Send no money. We'll rush one to you complete with rods and goggles. Pay postman only \$2.95 plus few cents postage. If not satisfied, return HANDIWELD in 5 days from receipt and money paid for it will be refunded instantly. Rush your order now.
KUMFY PRODUCTS INC., Dept. L-202, Cincinnati, Ohio

You can't ration **BRAINS!**

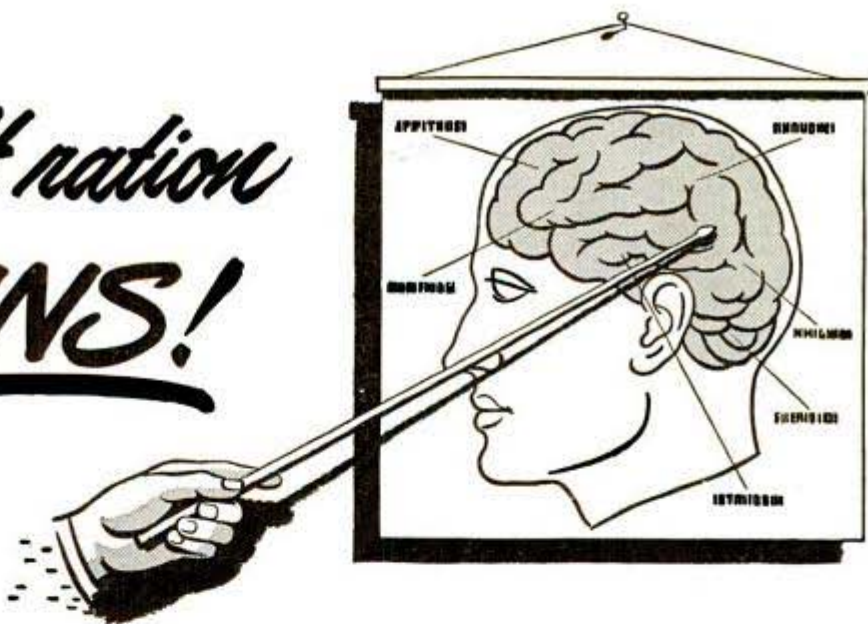

EVEN the brutalitarian dictators can't ration *brains!*

But, unfortunately, millions of individuals never make *all-out* use of the brains that God gives them. They go through life on one or two mental cylinders. Because the smartest man in the world can't operate a lathe, or read a blueprint, or design a new dive-bomber unless he has acquired TRAINING in a particular line of work.

How about *your* mental machinery— is lack of practical, modern training the monkey-wrench in the gears? Are you "just as smart" as men making two or three times your income in better jobs? Then mail this coupon, and learn how a low-cost I. C. S. Course can make you a trained man in a few months—without interfering with your present job!

Join the thousands of *successful* men who got their training the I.C.S. way!

INTERNATIONAL CORRESPONDENCE SCHOOLS

HELPING TO TRAIN AMERICANS FOR VICTORY



BOX 5646-J, SCRANTON, PENNA.

Without cost or obligation, please send me a copy of your booklet, "Who Wins and Why," and full particulars about the course *before* which I have marked X:

TECHNICAL AND INDUSTRIAL COURSES

- | | | | |
|---|---|---|--|
| <input type="checkbox"/> Air Brake | <input type="checkbox"/> Contracting and Building | <input type="checkbox"/> Management of Inventions | <input type="checkbox"/> Sanitary Engineering |
| <input type="checkbox"/> Air Conditioning | <input type="checkbox"/> Cotton Manufacturing | <input type="checkbox"/> Marine Engines | <input type="checkbox"/> Sheet Metal Work |
| <input type="checkbox"/> Airplane Drafting | <input type="checkbox"/> Diesel Engines | <input type="checkbox"/> Mechanical Drafting | <input type="checkbox"/> Ship Drafting |
| <input type="checkbox"/> Architectural Drafting | <input type="checkbox"/> Electrical Drafting | <input type="checkbox"/> Mechanical Engineering | <input type="checkbox"/> Shipfitting <input type="checkbox"/> Shop Practice |
| <input type="checkbox"/> Architecture | <input type="checkbox"/> Electrical Engineering | <input type="checkbox"/> Mine Foreman | <input type="checkbox"/> Steam Electric <input type="checkbox"/> Steam Engines |
| <input type="checkbox"/> Auto Engine Tune-up | <input type="checkbox"/> Electrician | <input type="checkbox"/> Navigation <input type="checkbox"/> Patternmaking | <input type="checkbox"/> Steam Fitting |
| <input type="checkbox"/> Auto Technician | <input type="checkbox"/> Electric Lighting | <input type="checkbox"/> Plastics <input type="checkbox"/> Plumbing | <input type="checkbox"/> Structural Drafting |
| <input type="checkbox"/> Aviation <input type="checkbox"/> Aviation Mechanics | <input type="checkbox"/> Foundryman <input type="checkbox"/> Heating | <input type="checkbox"/> Public Works Engineering | <input type="checkbox"/> Structural Engineering |
| <input type="checkbox"/> Blueprint Reading | <input type="checkbox"/> Heat Treatment of Metals | <input type="checkbox"/> Pulp and Paper Making | <input type="checkbox"/> Surveying and Mapping |
| <input type="checkbox"/> Boilermaking | <input type="checkbox"/> Highway Engineering | <input type="checkbox"/> Radio, General | <input type="checkbox"/> Telegraphy <input type="checkbox"/> Telephony |
| <input type="checkbox"/> Bridge Engineering | <input type="checkbox"/> House Planning | <input type="checkbox"/> Radio Operating | <input type="checkbox"/> Textile Designing |
| <input type="checkbox"/> Chemistry <input type="checkbox"/> Coal Mining | <input type="checkbox"/> Industrial Metallurgy | <input type="checkbox"/> Radio Servicing | <input type="checkbox"/> Toolmaking <input type="checkbox"/> Tool Design |
| <input type="checkbox"/> Civil Engineering | <input type="checkbox"/> Locomotive Engineer | <input type="checkbox"/> R. R. Section Foreman | <input type="checkbox"/> Welding, Gas and Electric |
| <input type="checkbox"/> Concrete Engineering | <input type="checkbox"/> Machinist <input type="checkbox"/> Inspector | <input type="checkbox"/> R. R. Signaller <input type="checkbox"/> Refrigeration | <input type="checkbox"/> Woolen Manufacturing |

BUSINESS COURSES

- | | | | |
|--|--|--|---|
| <input type="checkbox"/> Accounting <input type="checkbox"/> Advertising | <input type="checkbox"/> College Preparatory | <input type="checkbox"/> First Year College | <input type="checkbox"/> Railway Postal Clerk |
| <input type="checkbox"/> Bookkeeping | <input type="checkbox"/> Commercial | <input type="checkbox"/> Foremanship <input type="checkbox"/> French | <input type="checkbox"/> Salesmanship |
| <input type="checkbox"/> Business Correspondence | <input type="checkbox"/> Commercial Illustrating | <input type="checkbox"/> Good English | <input type="checkbox"/> Secretarial <input type="checkbox"/> Spanish |
| <input type="checkbox"/> Business Management | <input type="checkbox"/> Cost Accounting | <input type="checkbox"/> High School | <input type="checkbox"/> Showcard and Sign Lettering |
| <input type="checkbox"/> Cartooning <input type="checkbox"/> Civil Service | <input type="checkbox"/> C. P. Accounting | <input type="checkbox"/> Managing Men at Work | <input type="checkbox"/> Traffic Management |

HOME ECONOMICS COURSES

- | | | |
|---|---|---|
| <input type="checkbox"/> Advanced Dressmaking | <input type="checkbox"/> Home Dressmaking | <input type="checkbox"/> Tea Room and Cafeteria |
| <input type="checkbox"/> Foods and Cookery | <input type="checkbox"/> Professional Dressmaking and Designing | Management, Catering |

Name..... Age..... Address.....

City..... State..... Present Position.....

Canadian residents send coupon to International Correspondence Schools Canadian, Limited, Montreal, Canada
British residents send coupon to I. C. S., 71 Kingsway, London, W. C. 2, England



DRAFTING

BOOKS SENT FREE!
ON APPROVAL—5 VOLUMES
BRAND NEW EDITION

Only 15 minutes a day with these WONDER BOOKS can prepare you for a good drafting job. Drafting from simple straight lines to important complex plans. A step at a time! Built especially for beginners, for men with only grammar schooling. Drafting room practice, PLUS ENGINEERING, made easy and clear. 400 pages on tool design, over 300 pages on machine design. Includes special volume on blueprint reading with full size actual production blueprints, some 20"x30", as well as question and answer sheets.

For Beginners or Experts

Written so you can understand every word, by well known engineers. De Luxe modernistic, washable cloth binding, over 1600 pages, hundreds of blueprints, charts and diagrams; prepares you for a good drafting job in mechanical lines. Sent for 10 days' free use if you mail coupon immediately.

Big Field • Big Demand • Big Pay

Competent draftsmen are urgently needed in all manufacturing lines at \$30.00 to \$75.00 a week. That's just the beginning—FOR DRAFTSMEN HAVE GOOD CHANCES FOR ADVANCEMENT. Pleasant, fascinating work, easy to learn and do. Learn quickly with these books—send coupon for a set and see for yourself.

[A year's consulting service now given to all buyers of this famous cyclopedia of drafting.]

AMERICAN TECHNICAL SOCIETY Vocational Publishers since 1898

American Technical Society, Dept. D719, Drexel at 58th St., Chicago, Ill. Send for 10 days' trial, Brand New 5 volume set of "Drafting for Machine Trades." I will pay the delivery charges only. If I wish, I may return books in 10 days and owe you nothing, but if I decide to keep them, I will send \$2.00 after 10 days, then only \$3.00 a month until \$19.50, the total price, is paid. Send Brand New edition and include Consulting Service Certificate.

Name

Address
Please attach letter stating age, occupation, employer's name and address and that of at least one business man as a reference.

AVIATION CAREER



Offers You
A GREAT FUTURE!

Complete Aeronautical Engineering or Master Aviation Mechanics training in the heart of the Aircraft industry. Graduates obtaining immediate employment. No flying involved. Aviation's foremost school, established in 1929. Located on Grand Central Air Terminal. For full information, address Department PM-10

**CURTISS WRIGHT
TECHNICAL INSTITUTE**

GRAND CENTRAL AIR TERMINAL
GLENDALE (LOS ANGELES) CALIF.



THIS TOWER OVERLOOKS AVIATION'S MOST DISTINGUISHED SCHOOL OF AERONAUTICS

A Marvel for HEAT and Economy!



LACO

Here's your kind of heat—your kind of heating economy! Costs little to own, little for fuel. Has super-heating capacity! Purchasable on need in states without oil restrictions.

Free Book explains why the LACO is so unusually economical. Shows the special "2-Stage" burners—unusual "Inner Heating Unit." These features combine to produce utmost heat from low priced oil—deliver it into your room with maximum efficiency.



FREE Send for LACO book, low prices, facts about your eligibility to buy!

LACO OIL BURNER CO., 1210 Union Ave., Griswold, Iowa

INVENTIONS WANTED

Practical new ideas are urgently needed to meet the rapidly changing conditions of warfare and commerce. If you have a useful invention for sale your country needs it now—and it can be safely marketed without patenting expense! Write for complete details, today. Chartered Institute of American Inventors Dept. 4, Barrister Building, Washington, D. C.

Learn PLASTICS

Get into Plastics! Your big opportunity. Enter a New Industry. Plastics is thrilling, profitable, uncrowded. Learn Now! First Plastics School in the East with complete Study and Lab. courses. Write Dept. M Today! State age.

BOSTON TECHNICAL INSTITUTE SCHOOL OF PLASTICS

478 COMMONWEALTH AVE., BOSTON, MASS.

EARN THE DEGREE

Doctor of Psychology (Ps.D.), Doctor of Divinity (D.D.), many others. Courses in business, accounting, law, etc. Low fees. Send for large Bulletin and student picture-folder AT ONCE. No obligation whatever.

TEMPLE BAR EXTENSION COLLEGE
1411 Fourth Avenue, Dept. 4-R, Seattle, Washington, U. S. A.

THERE'S MONEY IN CARTOONS!

RAYE BURNS will teach you HOW to CREATE ORIGINAL CARTOONS at home that you may SELL! Course contains 26 lessons and over 600 illustrations. All for only..... **\$2.85**

Send name and address for free details.

RAYE BURNS SCHOOL, Dept. M, Box 3583, CLEVELAND, OHIO

LAW

STUDY AT HOME for PERSONAL SUCCESS and LARGER EARNINGS. 31 years expert instruction—over 106,000 students enrolled. LL.B. Degree awarded. All texts furnished. Easy payments. Send for FREE BOOK—"Law and Executive Guidance."

AMERICAN EXTENSION SCHOOL OF LAW
Dept. 22-M, 8 East Huron St., Chicago, Ill.

Get into the BAKING BUSINESS

Bakers make good money! Now 7th Industry in wages! Nearly depression-proof. New home study Baking Course qualifies you. Common school education sufficient. If you're ambitious, write for FREE BOOK, "Opportunities in Baking."

National Baking Institute, 1315 Michigan, Dept. 1357, Chicago

Burn Your Name On Tools Electro Name Etcher

Protect valuable tools from thieves and tool borrowers! Electro Etcher BURNS your name, any design, permanently on tools, instruments, any metal. Easy! Simple as writing with pen or pencil. SEND NO MONEY! Rush order today. Pay postman only \$1.00 plus few cents postage on delivery. Use 5 days—money back if not delighted. Electro Name Etcher, Dept. J-600, Strader Ave., Cincinnati, O.

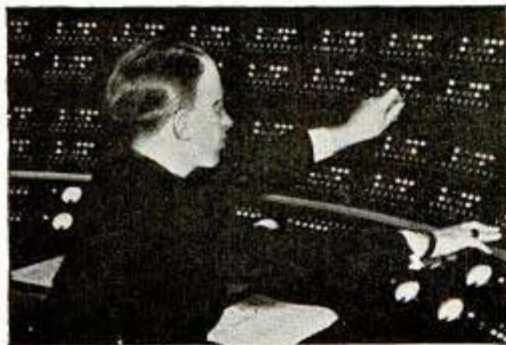

MASTER ALL BRANCHES OF RADIO NOW, as never before, the urgent need for Trained Radio Men has created a tremendous shortage. Man-power is being mobilized for duty on the **TECHNICAL FRONT**: Radio Engineers, Service men and operators, Experts in shops, in laboratories and countless, undreamed-of other applications are on the "MUST HAVE" list. The war has stimulated demand in both Civilian and military fields. Regardless of whether you remain a civilian or enter Military Service, National Radio Training will qualify you for a real future, a good pay job, responsibility and marvelous opportunity for advancement.

LEARN AT HOME

NOW you can learn **AT HOME** in your spare time. National's **VICTORY** training plan speeds up your progress right from the start, yet omits absolutely nothing vital to your preparation.

FASCINATING WAY TO LEARN RADIO

Eliminating dry text books, National's plan of rapid Home Training actually brings you the proved Shop-Studio-Field service methods that are followed in National's resident training shops. This training is simplified so that you can easily grasp Radio step by step in a way that grows in its fascination every day. No previous experience needed. When you complete this Course you are prepared for a good radio job at excellent pay or may establish your own radio business. Bear in mind that with the war-time curtailment of radio sets there is a huge increase in service work in homes. Radio manufacturing plants also need trained technicians to help produce over two billion dollars worth of military radio equipment. Factories are installing elaborate sound systems. Electronics is growing by leaps and bounds. Defense radio installations are without limit. All sound systems and innumerable defense hook-ups require Trained men. Prepare yourself for these job opportunities. Enroll and Train by National's easy-to-grasp home method.

National Graduates Win Good Jobs

Radio Lab. Specialist

"I got a job with International Telephone & Radio Co. Am working in their laboratory developing new Radio equipment, ultra-high frequency receivers and transmitters. It's a good, straight salary job."
Douglas Nielsen, Jamaica, N. Y.



U. S. CIVIL SERVICE

"Am now employed by Civil Service as Junior Aircraft Radio-Electrician at McClelland Field. There are several other National Schools graduates employed by this Dept."
Milton H. Ross, No. Sacramento, Calif.



National Training Helps
"Promoted to Instructor in Circuit Analysis at U. S. Army Air Corps here at Scott Field. Your Course has helped me very much and am sure it is responsible for my success."
Island Gillum, Scott Field, Illinois.



FREE LESSON & OPPORTUNITY BOOK

MEN WANTED: AGES—16 to 50
In Radio, age is not a factor. Training is the main requirement.

More than 37,000 Graduates

USE THIS COUPON

BE A RADIO TECHNICIAN WITH PREPARATION FOR CIVILIAN or U.S. GOVT. SERVICE



Draft age men: TRAIN BEFORE ENTERING SERVICE

TESTED HOME TRAINING BY PROVED SHOP-FIELD METHOD

For 37 years National Schools has trained ambitious men for Top Pay trades. Squarely behind your Home Training are the modern, completely-equipped Training Shops of National Schools where we develop and prove every Shop Method Assignment sent to you. Every phase of your training is personally supervised by an established Faculty of practical, experienced instructors and engineers. They have developed progressive methods of training you in your own home, based on actual shop practice. Unique training facilities give you Home Training based on Resident School Shop principles—methods not available from any other source, to our knowledge. You'll be amazed when you receive our Complimentary Lesson and full details.

KEEP PRESENT JOB WHILE LEARNING

Regardless of previous education or age, you can Train for Radio. Continue your present job. Earn while you learn. If subject to Military Service, all the more important that you get pre-training.

MILITARY SERVICE

Prepare for Radio Service in Army and Navy. In U. S. Gov't. service you install, operate and maintain most technical equipment such as secret ultra-high frequency apparatus to locate airplanes. Get promotion in rank and increased pay almost from the start.

SPECIAL OFFER

So that you can demonstrate to yourself the ease and rapidity of learning Radio at home, National Schools will present to you one Complimentary Lesson free, accompanied by Opportunity Book of Facts and Details about all branches of Radio. Use the Coupon. Mail it today!

Qualify For These Jobs
RADIO EXPERT
BROADCASTING
AIRCRAFT—MARINE
INDUST. ELECTRONICS
STUDIO TECHNICIAN
GOV'T. SERVICE
REMANUFACTURE

NATIONAL SCHOOLS

HOME TRAINING HEADQUARTERS

Los Angeles

California

ESTABLISHED 1905



MAIL OPPORTUNITY COUPON FOR QUICK ACTION

National Schools, Dept. 10-M (Mail in envelope or 4000 So. Figueroa, Los Angeles, Calif. paste on penny postal)
Mail me FREE, without obligation, one Lesson and Opportunity Book, with full details about how I CAN become a RADIO Technician.

NAME _____ AGE _____
ADDRESS _____
CITY _____ STATE _____

NATIONAL SCHOOLS
SHOP PLAN
Home Training
COMPLIMENTARY
LESSON

DRAFTSMEN NEEDED



NOW

Industry is clamoring for more draftsmen for the job can't start until plans are drawn. Buildings, airplanes, machines, guns, tanks, bridges, all start on the drafting board, so it's no wonder that every good draftsman has a fine job. Yes, more draftsmen are needed NOW. The pay is good and the opportunities for advancement great.

Learn at Home in Spare Time

Begin now to turn spare hours into money. Be a draftsman, the connecting link between a mechanic and an engineer. Enjoy the wonderful opportunities for promotion that exist now. No experience or artistic talent is needed. You don't have to leave your present job while learning. Use spare time.

American School, Dept. DD745, Drexel Ave. at 58th St., Chicago, Ill.

Gentlemen: Send me FREE information covering special training in subjects checked below. No obligation on my part.

- | | |
|--|---|
| <input type="checkbox"/> Drafting and Design for Men and Women | <input type="checkbox"/> Electrical Engineering |
| <input type="checkbox"/> Accounting and Auditing | <input type="checkbox"/> Diesel Engineering |
| <input type="checkbox"/> Architecture and Building | <input type="checkbox"/> High School Courses |
| <input type="checkbox"/> Automotive Engineering | <input type="checkbox"/> Plastics |
| <input type="checkbox"/> Business Management | <input type="checkbox"/> Mechanical Engineering |
| <input type="checkbox"/> Aviation | <input type="checkbox"/> Radio |
| | <input type="checkbox"/> Retail Merchandising |

Name.....
Address.....



Increased production
means



More Jobs for MACHINISTS and bigger pay for men who know their work

This big home-study and reference course gives you the practical facts on machines and methods you need to advance in machine shop work. Take advantage of the other man's experience as found in books, to solve your problems, increase your efficiency, with

The AMERICAN MACHINISTS' LIBRARY

6 volumes—2368 pages—2516 illustrations
(A combined home-study course and reference library)

This library of machine shop practice was written for practical men. It gives you the best methods for every kind of machine shop work. It fully explains lathes, drills, and other machine tools and their operation, automatic screw machines, speeds and feeds, gear design and production, jigs and fixtures, punch and die work, metal surfacing, etc., etc. Plainly written—completely illustrated—the best kind of help to the machine shop man who wants to advance himself.

No money down—special price—easy payments.

EXAMINATION COUPON

McGraw-Hill Book Co., 330 W. 42nd St., New York

Send me for ten days' examination the American Machinists' Library. If satisfactory I will send you \$1.50 in 10 days and \$3.00 monthly until the price of \$19.50 is paid. If not wanted, I will return the books postpaid. (To insure prompt shipment write plainly and fill in all lines.)

Name.....
Home Address.....
City and State.....
Position.....
Name of Company..... PM-10-42

Always write your name and full address clearly when answering advertisements.

"LANGUAGE IS A WEAPON"

Forge ahead, win special assignments, in global war and the ultimate peace, through ability to speak a foreign language.

MASTER ANOTHER LANGUAGE quickly, easily, correctly by LINGUAPHONE

The world-famous Linguaphone EAR-EYE Conversational Method brings voices of native teachers INTO YOUR OWN HOME. No English is spoken. You learn the new language by LISTENING.

Home-Study Courses in 29 Languages:
RUSSIAN JAPANESE SPANISH
PORTUGUESE CHINESE NORWEGIAN
and 23 others

Send for FREE book
LINGUAPHONE INSTITUTE
83 RCA Building, New York • Circle 7-0830

10" ACCURATE SLIDE RULE only 50¢ COMPLETE



Complete with 32-page illustrated instructions and black leatherette case. Easy to learn to make lightning calculations without pencil and paper. Multiply, divide, square, cube, extract square and cube roots exactly the same way as any professional engineer. Accurate white composition face. Plastic magnifying indicator makes numbers easy to read. Standard A, B, C, D, CI and K scales. 100% American made.

RUSH ORDER TODAY—Send 50¢ in coin or War Savings Stamps. (Canadians and others send 50¢ money order.) Complete outfit mailed postpaid. Satisfaction guaranteed or money refunded. (Special quantity prices to schools and dealers.) Rush cash today for this great value.

FRANKLIN PRODUCTS CO., 256-K Maple Grove Ave., Ft. Wayne, Ind.

BOOK & CASE
FREE of Extra
Cost!

LOANS FOR DEFENSE JOB TRAINING

Trained men and women are earning big wages in war industries. Thousands of new workers needed every month. Many schools can train you nights for big pay job. Choose your own school. We lend up to \$300 to pay for course. Repay in small, monthly instalments. Send for FREE booklet. Tells how to get a loan—quickly, privately—to pay for defense training. No red tape. Write today. Send no money.

HOUSEHOLD FINANCE, Dept. DFM, 919 N. Michigan Ave., Chicago

ARTISTS MAKE MONEY

Find out your ability. Send name, age, occupation and address for Free Vocational Art Test.

ART INSTRUCTION, INC. (Formerly Federal Schools)
10132 Art Instruction Building, Minneapolis, Minnesota

Time & Motion Study WINS PROMOTION—RAISES PAY

Urgent need in War and Post-war Industries for cost reduction and methods improvement. Experts in demand. Fascinating work, big pay. Train now. Graduates report up to 50% and 100% pay increases in record time.

Learn at Home in Spare Time
New streamlined course permits quick qualification for placement and opens the way to rapid advancement. Previous experience unnecessary.

FREE DETAILS—Send for free folder and details of guaranteed, low-cost course. No obligation. Write

Industrial Ti-Mo Clinic, Dept. 10
4000 Washington Blvd., Chicago, U.S.A.

Free Book

MOUNT BIRDS, ANIMALS, FISH
See FREE. Explains Taxidermy. Tells how to learn at home by mail to mount birds, animals, heads, skins and furs. Great for MEN and BOYS. Also earn money in spare time. WRITE TODAY—NOW for free book containing 100 game pictures. State AGE. N.W. School of Taxidermy, Dept. 3377, Omaha, Neb.



WELDERS WANTED!

ELECTRIC ARC—OXY-ACETYLENE
Skilled Welders earn \$8 to \$15 a day. The demand now greater than the supply. Learn this highly paid trade in 2 weeks by actual shop work. One of America's leading schools. Established 1902. 7 floors of shops. Endorsed by welding industry. Limited number of students. 3 weeks course in Electric Arc or Acetylene Welding, including room and board, only \$108. Write or wire for reservation. Ask for "Welding Facts." State age.



GREER COLLEGE, Dept. L102, 2024 S. Wabash Ave., Chicago

MECHANICS-STUDENTS- Here's the book you've waited for-

MATHEMATICS

For Ready Reference

(By H. M. PHILLIPS)

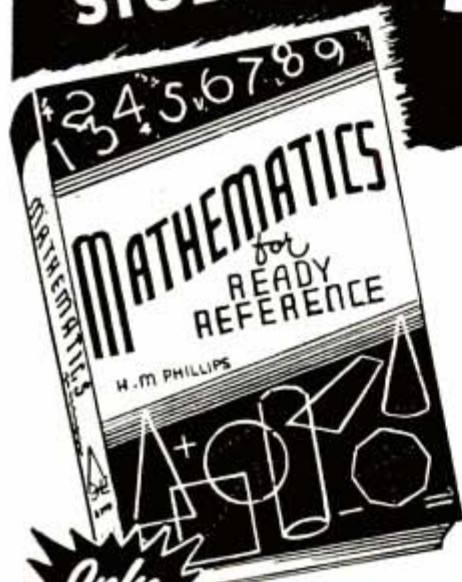

Only \$2.00

Over 200 pages
Over 100 illustrations

SEND NO MONEY 5 DAY EXAMINATION

DON'T DELAY. Order the book you want. We'll send it by return mail. Simply pay postman the purchase price plus small COD and postage charges. (If you send cash in advance we pay postage.) In either case, if you are not fully satisfied, return the book in 5 days and we'll refund your money immediately.

FRED'K J. DRAKE & CO., Dept. PM10, 600 W. Van Buren St., Chicago, Ill.

Now—for the first time—a book which presents all branches of mathematics in a practical, easy-to-understand way. It's new—yet it has already been enthusiastically endorsed. Planned and written by one of the country's foremost authorities, it provides:

A READY REFERENCE BOOK FOR EVERYDAY USE. No matter how good you may be at mathematics, there are always some things easily forgotten. This book is so thoroughly indexed and cross-indexed that any method, formula, or table can be instantly located. In many cases the cross-index refers you also to other sections in order to make the matter entirely clear to you. Nothing has been overlooked in making this the handiest, most complete mathematics reference book ever compiled. No time is wasted—you go direct to the subject wanted and find the way to solve your problem whether it's simple arithmetic or the most complex trigonometry.

A SHORT COURSE FOR STUDENTS and a REFRESHER FOR THOSE WHO NEED TO "BRUSH UP". Subjects are presented in their proper order so it can be used as a text book or instructional manual. At the end of each section are test problems showing how each method is applied to actual daily work.

COMPLETE—EASY TO UNDERSTAND

Here's the book you'll keep always within reach—as useful as one of your tools. Whatever your problem may be—figuring the cubical content of a circular tank or dividing a decimal number by a whole number, this book shows you how to get the right answer. And it is so easy to understand. Technical terms and unfamiliar phrases have purposely been avoided. Even the beginner will have no difficulty in understanding it.

MATHEMATICS IS THE BASIS OF ALL MECHANICAL WORK

With this book as a ready reference you need never be afraid of any problem. And think how much that means to any student or mechanic. Use it in your daily work—study it for advancement to better paying jobs.

DON'T DELAY — ORDER YOUR COPY — NOW

DRAKE'S BOOKS - a sure way to better pay!

THE SLIDE RULE, by J. J. Clark, M.E. Every mechanic, engineer, draftsman, electrician, and student needs this book. Explains fully the use of slide rule—how to solve complicated problems quickly—accurately. Complete—easy to understand. Includes 16-place tables. Cloth bound, over 200 pages, illustrated **\$1.50 ONLY**

AIRCRAFT SHEET METAL CONSTRUCTION AND REPAIRS, by M. P. Harrold. This book explains fully the methods and processes used in the repair of aircraft sheet metal parts. Gives detailed instructions for scores of actual jobs. Includes cutting, soldering and welding; spinning; seams and joints; tanks, floats, and cowling; etc. Complete—concise—easy to understand. Equally valuable to beginner and experienced worker. Cloth bound—123 illust. **\$1.50 ONLY**

Thousands of **BIG PAY** jobs are now open and this is your opportunity to qualify for one of them. Drake's Books cover the leading trades and crafts—provide the information you need for rapid advancement in defense plants or in the armed forces.

Here are a few of the more popular Drake's books now being used by thousands. If you don't see what you want, ask for our

COMPLETE DESCRIPTIVE CATALOG

DRAKE'S BOOKS ARE SOLD AT LEADING BOOK STORES

AIRCRAFT POWERPLANT MANUAL, by G. B. Manly. Earn big money—be an aircraft mechanic. This book fully covers the subject. Written in non-technical language easily understood by anyone mechanically inclined. Includes hundreds of illustrations. Gives step-by-step procedure for servicing and overhauling as practiced on aircraft powerplants in actual use. 700 pages—size 6" x 8" **\$4.00 ONLY**

CARPENTRY, by H. H. Siegele. Explains and illustrates hundreds of solutions to carpentry problems—makes it easy for you to handle difficult jobs. Authoritative—concise—easy to understand. Practical for both amateur and professional. Cloth bound—over 300 pages—700 illus. **\$2.00 ONLY**

Check the books you want Mail Today

FRED'K J. DRAKE & CO., Dept. PM10, 600 W. Van Buren St., Chicago, Ill.

Please send books checked herewith. Send COD. I will pay postman plus charges. If not fully satisfied I will return the book within 5 days and my money will be refunded. (If you send cash in advance we pay all postage.)

- Mathematics for Ready Reference, \$2.00
- The Slide Rule, \$1.50
- Aircraft Sheet Metal Construction and Repairs, \$1.50
- Carpentry, \$2.00
- Aircraft Powerplant Manual, \$4.00
- SEND FREE CATALOG

Name

Address

City State

SPRAYBERRY RADIO TRAINING *includes* FULL EQUIPMENT

Experience Easily Acquired
at Home



You Do Practice-Giving Experiments, Many Special Features... ALL Designed to Help You Make Fast Progress.

SPRAYBERRY Training starts right at the beginning of Radio... unfolds each subject in a simplified, logical, understandable style. You easily learn Television, Frequency Modulation, Signal Tracing (Auto-Tank), Aviation

ing, Mobile Radio, Radio, Electronics, Facsimile Radio, Radio Set Repair and Installation work.

Training Prepares You for a Business of Your Own... or Good Radio Jobs—Civilian or Military

The important and fascinating field of Radio offers many opportunities to the man who wants to get ahead. My Training is designed to give you quick access to these opportunities. SPRAYBERRY Methods are thorough and practical. Your Training will not interfere with your present duties. No previous experience is needed.



You Get a Dual-Purpose Radio Set

I supply you with Radio Parts which you use to gain pre-experience in Repair work. These same Parts are used as a Modern Signal Generator and for Signal Tracing, etc. You'll find my Course and Equipment fully described in the catalog offered below. But in addition to this catalog, I am going to send you, without obligation, a valuable new manual.

YOURS FREE! Just Off the Press
Big 80-Page Book
"RADIO SERVICE SHORT CUTS"

Don't miss it! It's a rich storehouse of practical tips and information. In keeping with the same plain to-the-point language found throughout the Sprayberry Course, this handy volume tells how Radio break-downs occur... how to spot these defects... how to correct them quickly and efficiently. There is no fluff or ornamentation... simply the practical answers to the problems you meet as a busy, successful Radio man. If you ACT Now, you can get this book FREE... along with my descriptive Course Catalog. Use coupon below!

THE SPRAYBERRY COURSE IS SOLD UNDER MONEY-BACK AGREEMENT

RUSH COUPON for BOTH FREE BOOKS

SPRAYBERRY ACADEMY OF RADIO

F. L. Sprayberry, President
510-K—University Place, N. W.
Washington, D. C.

Please rush my FREE copies of "HOW TO MAKE MONEY IN RADIO" and valuable 80-page "RADIO SERVICE SHORT CUTS".

Name

Address

City..... State.....

(Mail in envelope or paste on penny postcard)

Say you saw it in Popular Mechanics!

FOREMEN, SUPERINTENDENTS PRODUCTION MEN

Study INDUSTRIAL MANAGEMENT

Millions of men pouring into new or expanded factories require thousands more production executives to supervise them. That spells real opportunity for you if you are ambitious. You can step up to a better job. Your present experience and ability may need only a fuller knowledge of production and management principles and methods. LaSalle training in *Industrial Management* will help you greatly. It is interesting, condensed, practical—planned for men like you. You can study it in your spare time, at home—and at moderate cost. If you want to get ahead, ask for our free 48 page booklet on *Industrial Management*—it gives full details. Send this ad or write today.

LASALLE EXTENSION UNIVERSITY A Correspondence Institution

Dept. 1064-IF, CHICAGO

LEARN Electricity
I'll Finance Your Tuition

Learn by Doing, in 12 weeks, in big shops of Coyne—Not home study or correspondence. Earn while learning. Free employment service after graduation. Write for details of my Pay after Graduation Plan and Free book.

COYNE ELECTRICAL SCHOOL, Dept. 72-72
500 South Paulina Street - Chicago, Illinois

Free Booklet on **PLASTICS**

Your CAREER in Plastics

A great war-time industry. Plastics offers tremendously increasing possibilities in post-war developments already under way. Virtually every industry is using or planning to use Plastics. This booklet outlines the opportunities existing in this rapidly expanding industry, gives a history of plastics materials, and indicates educational background necessary and employment possibilities in chemical, engineering, molding, laminating, and other divisions of Plastics.

Plastics Industries Technical Institute
112 E. 42nd St. New York City 211 N. LaSalle St. Chicago, Ill. 461 South Alvarado, Los Angeles, Calif.

Serve Your Country as a TECHNICIAN in Vital War Industries



**WELDING
TECHNICIAN**



**AIRCRAFT
TECHNICIAN**



**ELECTRO
TECHNICIAN**

Every airplane, tank, ship or other war machine now fighting for Uncle Sam was built by specially trained men. Yes, Trained Technicians, and our country's wartime industries need millions more. Whether you are drafted or not, you can serve your country better if you are a Trained Technician—and you'll be in line for better pay.

**6 WEEKS—6 MONTHS
WARTIME COURSES**

We train you in our modern, completely equipped shops. Special wartime courses prepare you in 6 weeks to 6 months for **ELECTRO TECHNICIANS, AVIATION MECHANICS, AIRCRAFT and ARC WELDERS, DRAFTSMEN, RADIO OPERATORS and TECHNICIANS.**

**EARN \$1,040
WHILE LEARNING**

Ask about Special Cooperative Courses and opportunity to earn \$1,040 while learning. Don't be content with hit-or-miss jobs with poor pay when in a short time you can become a trained specialist, with an expert's pay, for war or peace—and get a better rating if drafted. Send coupon today.

MILWAUKEE SCHOOL OF ENGINEERING Institute of Electrotechnics

PM-1042 North Broadway and E. State, Milwaukee, Wis. Without obligation send Free Booklet. "Golden Opportunities in Defense Work." Also tell me How to Become an

Are: Welding Operator Electrical Engineer B. S. Degree
Aircraft Welder Radio Operator
Welding Technician Radio Technician
Aircraft Technician Student Loan Plan
Electro Technician Earn Part Expense Plan
Aircraft Draftsman "Earn \$1040 while learning"

Name..... Address.....

City and State..... Age... PM-1042

INVENTORS

NOW Is the Time to PATENT and SELL Your Invention

Get
**FREE
COPY**

Now, more than ever before, is the right time to patent your invention. Why? Because manufacturers everywhere presently engaged in war production are looking ahead to the future by buying up patent rights now, so they will have new and attractive items to make and sell for civilian consumption as soon as the war is over. This is what happened during and after the last war. Hence, the smart thing for you to do is to look ahead to the future too. Protect your invention by applying for a patent now, so you will be in position to cash in on an outright sale, or on the royalties your invention will bring.

Patent Guide Shows What To Do

Our "Patent Guide for the Inventor" answers many important questions concerning Patents that inventors constantly ask. It tells what facts, details, drawings, sketches, etc. are necessary to apply for a Patent; how to protect your invention through dated and witnessed disclosure; how to do this AT ONCE to safeguard your rights; how Patent Office Records can be checked to determine whether the invention is probably patentable before filing fees need be paid; discusses costs involved and a practical way these can be paid as the application progresses. It tells how some inventors secured financial backing; how many simple inventions have proved large commercial successes; how Patents covering improvements also can be profitably utilized and marketed; tells countless other facts of interest.

Why You Need Expert Assistance

The Patent Laws were enacted for your benefit—to give you protection for the features of your invention which are Patentable. But these features must be legally and concisely set forth in the form of "claims." This phase of the procedure is so complex that the Patent Office advises the Inventor to engage a competent Registered Patent Attorney. We maintain a large staff—carefully trained registered patent attorneys—expert draftsmen—experienced searchers—to serve you. We have been serving inventors for more than 20 years.

Take First Step Now

With the Patent Guide you will receive also Free a "Record of Invention" form which will enable you at once to establish the date of your invention, before you file your Patent application. This step costs you nothing yet may be vital to your success. Remember—in Patent Matters, ACTION is IMPORTANT. Delay can be costly. Mail the coupon in an envelope, or paste it on a penny postcard NOW.

CLARENCE A. O'BRIEN
and
HARVEY B. JACOBSON
"Worthy of Your Trust"
Registered Patent Attorneys
21-K Adams Building
Washington, D. C.

Get This
FREE BOOK

IMMEDIATELY MAIL COUPON TODAY!



**48
PAGES**
Over 100
Illustrations

**CLARENCE A. O'BRIEN
and HARVEY B. JACOBSON**

CLARENCE A. O'BRIEN AND HARVEY B. JACOBSON
Registered Patent Attorneys before the United States Patent Office
21-K Adams Building, Washington, D. C.

Please send me your 48-Page "Patent Guide for the Inventor" and your specially prepared "Record of Invention" form FREE. This request does not obligate me.

Name

Address

City..... State.....

(Please write or print plainly.)

POPULAR INVENTIONS

For Your Home

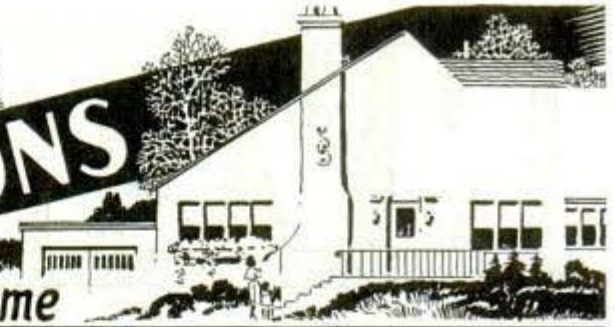

Non-Sag Clothesline Holder Has Pulley in Frame



Double clotheslines, such as are stretched across the courts of apartment buildings, are kept from sagging under heavy loads with a metal holder that has two pulleys. One engages the top line, the other the bottom one. The holder can be moved back and forth to bolster the line where needed.

Bottle Spout Locks the Sparkle In Carbonated Drink

Carbonated beverages can be poured from bottles without losing their sparkle and zip if the bottles are opened with a special spout, or siphon, now available. It is placed on a bottle by piercing the cap and screwing it down tightly, and a rubber collar helps provide a seal between the spout and bottle.



Insulated Can and Fruit Jar Make a Vacuum Bottle



Foods packed in a common quart-size fruit jar can be kept hot or cold for several hours when stored in an insulated can designed to be used when a vacuum bottle is not available. The inexpensive container keeps beverages cold for ten hours, salads cold four to six hours, and

cooked foods are kept hot for from five to eight hours. Ice cubes and ice cream put up in jars can also be kept in the holder.

WHERE-TO-BUY-IT INDEX OF POPULAR INVENTIONS

Non-sag clothesline holder

Acme Metal Goods Co., 2 Orange St., Newark, N. J.

Hot or cold fruit-jar jacket

Lawrence A. Lockwood Co., 232 E. Erie St., Chicago

Spout for carbonated beverage bottle

Carson Pirie Scott & Co., State and Monroe Sts., Chicago



A pocket-size booklet of help for better pictures
NEW G-E PHOTO DATA BOOK

TELLS how to use your meter to get more out of every shot.

..how to make prints and enlargements easier.
 ..how to make metered-flash shots, and how to control photo backgrounds.

GIVES in handy, compact form, many other helpful facts: film speeds, developing formulas, flash exposure data. Fifty cents at your dealer's. Get a copy and get more out of your picture-taking. *General Electric, Schenectady, N. Y.*

If your dealer cannot now supply you with a G-E exposure meter, here's the reason: Materials and facilities are needed to produce equipment for our armed forces and vital war industries. Our efforts are being expended to speed VICTORY for the United Nations. We know you'll understand.

GENERAL ELECTRIC

606-125-6386

ELECTRICAL BOOKS shipped *FREE*

FOR EXAMINATION MODERN ELECTRICITY INCLUDING RADIO AND TELEVISION

Here's great news for anybody interested in Electricity. NEW 18th. edition of Applied Electricity brought right down to date with NEW Electrical subjects fully covered, including Electrical Blue Print Reading. 10 big volumes and all shipped FREE for examination.

1942 Edition For Beginners and Experts

over 3000 pages—hundreds of illustrations—the most complete work of its kind we have ever published. Dynamos, motors, power stations, Radios, television, everything electrical explained so anyone can understand it.

BIG FIELD! Big Demand!

Big Pay! Men who understand electricity are urgently needed in thousands of War Production industries. Airplanes, ship building, arms plants, machine shops—practically every industry depends on electricity and men who know this subject make big money. Pleasant, fascinating work, easy to learn and do; learn with these books. Send coupon for a set for FREE examination and see for yourself.

SEND NOW [A year's consulting privileges with our engineers now given to all buyers of this famous Cyclopedia of Electricity.]
AMERICAN TECHNICAL SOCIETY
 Vocational Publishers since 1898

American Technical Society, Dept. E719, Drexel at 58th St., Chicago
 Send for 10 days' free use, 10 volume set of 1942 Edition, Applied Electricity, including a certificate entitling me to consulting privileges for one year. I will pay the delivery charges only on the books. If I wish I may return them in 10 days and owe you nothing, but if I keep them, I will send \$2.00 after 10 days, then \$3.00 a month until the total price of only \$29.80 is paid.

NAME.....
 ADDRESS.....

CITY..... STATE.....
 Please attach letter stating age, occupation and name and address of employer and give at least one business man as reference.

Read the Want-Ads
INSPECTORS
 ★ **WANTED** ★

By Aircraft and Other War Production Plants

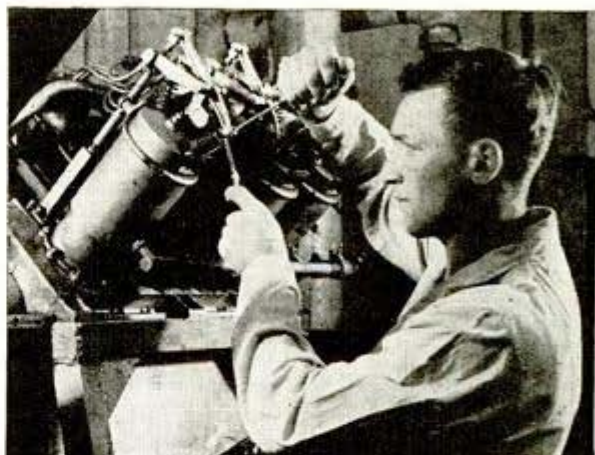

MEN ---all Ages and WOMEN!

MEN needed as inspectors in aircraft and other War Production plants. Good pay and chances for promotion.

WOMEN The nation's war industries are calling for women inspectors. Base pay and overtime same as for men.

A War-Time Job With a Peace-Time Future

One inspector required for every 12 to 20 employees in aircraft and other war plants employing from 15000 to 40000 workers. Help win on the home front.

Unique Training Plan. Quick results

By the Chicago Tech plan you complete in your spare time at home the major part of your training which includes blue print reading. Keep your present job while learning. Then when your training obligations at home have been met, you come to Chicago Tech (round trip transportation and room furnished) for a short practical training in our Inspection Dept., shops and laboratories, with gauges, calipers, and other measuring instruments. This prepares you for a good job as an inspector.

Employment Help When Ready

When you are ready we help you find a job as a mechanical precision inspector. Just now we have more calls for qualified inspectors than we can fill.

Send Coupon or Post Card

Mail the coupon or a post card for free information. There's no time to lose. Battles are lost by delay,—so are opportunities like this one. Act now.

CHICAGO TECHNICAL COLLEGE

N-1200 Tech Bldg., 2000 So. Michigan Ave., Chicago, Ill.

Please send me Free information about how I can qualify for a good job as an Inspector.

Name.....
 Mrs. Mrs. or Miss.

Address.....

City..... State.....

Occupation..... Age.....

Say you saw it in *Popular Mechanics!*

AUTO REPAIRMEN

Examine this big, how-to-do-it guide to EVERY car repair job—yours to use for 7 days

FREE!

THE MOST COMPLETE REPAIR GUIDE Ever Published!

Shows How to Do Any Repair Job on Any Model Car Made since 1935, including 1942's!

American	La Salle
—Bantam	Lincoln
Auburn	Lincoln
Austin	—Zephyr
Buick	Mercury
Cadillac	Nash
Chevrolet	Oldsmobile
Chrysler	Overland
Cord	Packard
De Soto	Pierce Arrow
Dodge	Plymouth
Ford	Pontiac
Graham	Reo
Hudson	Studebaker
Hupmobile	Terraplane
Lafayette	Willys

And major data needed to service 405 models of trucks. Nearly 200,000 Vital Facts on Every Phase of Tune-Up and Repair • Over 450 Charts, Tables • More than 900 Photos, Drawings, Diagrams • Over 600 Big Pages—Size 8 1/2 x 11 inches.

Published by MoToR, The Leading Automotive Business Magazine, 572 Madison Ave., New York, N.Y.

Mail coupon today for the world-famous MoToR's Factory Shop Manual. Shows every mechanic, even experts, just how to do repair and tune-up jobs easier, quicker.

Here, in one amazing volume, is ALL that anyone needs to know about EVERY repair, tune-up, replacement job on every American car made since 1935, including 1942's—as well as major data for servicing 405 trucks! So clear are its pictures and step-by-step instructions a child can almost understand it. Gives exact how-to-do-it on engines, lubrication, electric, fuel, cooling systems. Covers every accident to clutch, transmission, universals, rear-end, wheels, brakes, knee action, shock-absorbers, springs, body, free-wheeling, etc., etc. Try it at our expense for 7 days, and see!

Almost Like Personal Instruction!

Contains the Official shop procedure manuals prepared by the car manufacturer's own engineers. Open the manual to the car you are working on, and everything you'll want to know is there before your eyes. Easy as A-B-C.

Hundreds Now In Use

This is the exact same shop guide used by the U. S. Army, trade and technical schools all over the country for training auto mechanics. No other book can compare with it.

SEND NO MONEY

Simply fill out and mail coupon below today and a copy of MoToR's up-to-the-minute 1942 Factory Shop Manual will be sent to you at once for 7 days' Free Trial.

MAIL COUPON

MoToR BOOK DEPT., Desk 110, 572 Madison Ave., New York, N.Y.

Rush me MoToR's 1942 Factory Shop Manual. If O. K. I will remit \$1 plus 35c shipping charge in 7 days, and \$1 monthly for 4 months. (\$5.35 in all.) Otherwise I will return book in 7 days. (Foreign price \$6, cash with order.)

NAME _____ AGE _____

ADDRESS _____

CITY _____ STATE _____

OCCUPATION & EMPLOYER _____

SAVE 35c! Check here if you enclose \$5.00 with coupon. We will then pay 35c postage and packing costs. Same 7-day return privilege applies.

Say you saw it in Popular Mechanics!

MAGIC PHOTO LIQUID

Prints Pictures on—

CLOTH LEATHER PAPER WOOD

Amazing discovery permits you to print pictures from any of your snapshot negatives on wood, cloth, leather or paper. Like magic, your pictures will show on ties, handkerchiefs, purses, cards, letterheads. Takes only few minutes in broad daylight. Won't rub off or harm negative.



NATURAL COLORS TOO! Imagine having your favorite snapshots—your sweetheart's, baby's or your own, shown in natural colors—in artistic shapes and designs on whatever material used. **SEND NO MONEY!** Just rush your name and address for introductory outfit. Enough material to print and color 300 average size pictures, only \$1.00. But don't send a penny. Pay the postman when it arrives—plus a few cents postage. You risk nothing. It's guaranteed to work. Send today.

FOTO-COLOR, 104 W. PEARL ST., CINCINNATI, O.

BECOME AN AIRCRAFT DRAFTSMAN THROUGH HOME STUDY

A lifetime of fascinating, well paid work. A real future and an opportunity to apply your own inventiveness and talents in the essential field of aviation. Ryan will train you through simple, thorough, practical home study courses prepared by active leaders of the aviation industry. Here is the field you want to enter. Here is the way for you to prepare successfully at home. Mail this ad now for full information and costs.

RYAN AERONAUTICAL INSTITUTE
4210 LINDBERGH FIELD • SAN DIEGO, CALIF.



Learn to Speak SPANISH FRENCH, GERMAN OR ITALIAN This Easy Way



Know a second language for better business or social position; read foreign books; really enjoy travel. Speak like a native.

Now FUN to learn quickly, easily at home as thousands have! Write today for free book "The Cortina Short-Cut." State language interested in.

CORTINA ACADEMY, SUITE 6410, 105 WEST 40th STREET, NEW YORK CITY

Learn PHOTOGRAPHY at Home

Splendid opportunities. Prepare in spare time. Easy plan. No previous experience needed, common school education sufficient. Send for free booklet "Opportunities in Photography", particulars and requirements.

American School of Photography
1315 Michigan Ave., Dept. 1357, Chicago, Ill.

Short-Cut Mathematics COMBINED WITH Practical Mechanics Simplified

NEW 2-in-1 reading course! Now you can learn the speedy, simplified system of calculation used by draftsmen, engineers, accountants, "master minds" on the stage. Learn easy way to multiply 4 figures by 4 figures without using old-fashioned multiplication; add long columns of figures this lightning short-cut method. Learn horsepower, slide rule, micrometer, logarithms, wood measure, puzzles, etc., etc. Large illustrated volume complete with answers, only \$1 postpaid. Satisfaction or refund.

Amaze friends with your magic-like mental powers. **FREE Complete details... mail coupon TODAY!**

NELSON CO., 500 Sherman St., Dept. K300, Chicago

Please send free details about "Short-Cut Mathematics and Practical Mechanics Simplified." No obligation.

Name _____

Address _____



$$\frac{\div}{+} \quad \frac{\times}{\sqrt{}} = \%$$



Be Your Own MUSIC Teacher

LEARN AT HOME by wonderful improved method. Simple as A-B-C—a child can learn it. Your lessons consist of real selections, instead of tiresome exercises. Each of these delightfully easy lessons adds a new "piece" to your list. You read real notes, too—no "numbers" or trick music. Method is so thorough that many of our 700,000 students are band and orchestra LEADERS.

Be Popular

Everything is in print and pictures. First you are told what to do. Then a picture shows you how. In a few short months you may become an excellent musician—the life of every party!

Free Book and Print and Picture Sample If interested, write at once for our illustrated Free Book and Free Print and Picture Sample. Please mention your favorite instrument. Instruments supplied when needed, cash or credit. (Forty-Fourth Year—Est. 1898).

U. S. SCHOOL OF MUSIC
710 Brunswick Bldg., New York City, N. Y.

Pick Your Course

Piano	Flute
Violin	Guitar
Organ	Saxophone
Cornet	Mandolin
Trombone	Ukulele
Piccolo	Cello
Hawaiian Steel Guitar	Trumpet
	Piano Accordion
	Plain Accordion
	Drums and Traps

ELECTRICITY MEN NEEDED

Electricians are needed everywhere. Hollywood studios alone claim shortage 200 men. This is a live money making profession. Learn at home, spare time. Easy payments. Selective Employment service. Write for FREE Bulletin. No obligation.

AMERICAN SCHOOL

Dept. EE745 Drexel at 58 St., Chicago



Be an ARTIST!

—Train at Home in Your Spare Time

The fascinating field of Art offers commercial opportunities to men and women. **COMMERCIAL ART, CARTOONING, ILLUSTRATING** all in one complete course. Learn to draw step-by-step. **TWO ART OUTFITS** furnished. Trained Artists are capable of earning \$30, \$50, \$75 a week. Write today for full information in FREE BOOK, "Art for Pleasure and Profit." No obligation.

FREE BOOK gives details!

Washington School of Art, Studio 1210A
1115—15th St., N. W., Washington, D. C.

Yes! I am interested in learning to draw. Please send me your Free Book, "Art for Pleasure and Profit."

Name..... Age.....
Address.....
City..... State.....

68 Pages of facts for INVENTORS

These books were prepared for men of ideas—men who have an article in mind that will make money, save money, save labor or give pleasure. Leading thinkers agree that the world of a few years from now will be radically different because of the contributions to progress that inventors will make. Now is the time—if you have an idea—to see about protecting it.

Many Little Ideas May Have Big Commercial Possibilities

Don't think that to be profitable an idea needs to be complicated. Simple articles—just a person's hunch—have often proved profitable. The crinkly hair pin, the metal tip for shoe laces, the paper clip are good examples. Also improvements on patented articles sometimes prove more profitable than the original article itself.

Don't Delay—Send for These Free Books Now

Many a man has waited until too late to protect an idea by a United States Patent. Remember someone else may be thinking along the same lines that you are, and the Patent Laws favor the man who files his application for a patent first. Delays of even a few days can sometimes mean the loss of a patent. So learn the important facts about Patent Protection at once.

44 Years of Proven Service

For forty-four years, this capable organization has served inventors from all over the country. Our large staff of patent specialists gives you expert and prompt service. Our fees are reasonable; we also help with deferred payments.



VICTOR J. EVANS & Co.

Merlin M. Evans
REGISTERED PATENT ATTORNEYS

MAIN OFFICE: 630-L MERLIN BUILDING WASHINGTON, D. C.

Pittsburgh Office: 521-N Empire Building
Los Angeles Office: 738-N Security Building

Send me free copies of your books "Patent Protection" and "When and How to Sell an Invention"—also important "Evidence of Invention" form.

Name.....
Street and No.....
City or Town..... State.....

Say you saw it in Popular Mechanics!

MAIL COUPON TODAY FOR YOUR COPIES



THIS SIGN HAS BEEN SCRAPPED!

If you are over 40, you know that this unwritten policy formerly faced you in many cases. Youth was preferred.

But not now.

War has placed a premium on you. You have advantages to offer an employer. You can get jobs—you can win promotion with your present employer. Today is your day to build yourself into greater responsibility and larger pay—for both war and post-war times.

You need, perhaps, only a little more specialized ability—a little more knowledge for the better job. And we can help you—that has been our business for 34 years.

Ask about our training in the field of your choice. The information is free and it may help insure your success and happiness now and when peace comes.

LASALLE EXTENSION UNIVERSITY

A Correspondence Institution

Dept. 1064-R Chicago

I want to know whether—and how—you can help me to more ability and success. Please send me—without obligation—your free 48-page booklet on the business field checked below.

- | | |
|--|--|
| <input type="checkbox"/> Bookkeeping | <input type="checkbox"/> Accounting |
| <input type="checkbox"/> Foremanship | <input type="checkbox"/> Industrial Management |
| <input type="checkbox"/> Business Law | <input type="checkbox"/> Traffic Management |
| <input type="checkbox"/> Business Management | <input type="checkbox"/> Law: LL. B. Degree |
| <input type="checkbox"/> Salesmanship | <input type="checkbox"/> Business Correspondence |

Name.....Age.....

Address.....

Present Position.....

GET INTO AVIATION LINCOLN

Train Now at

Opportunities of a lifetime are open now to men trained at this **LINCOLN GOVERNMENT APPROVED SCHOOL of Aviation.**

Our Graduates taking immediate employment in War Industries, with Airlines and at Airports at salaries up to \$3600 a yr. to start. Lincoln Training also a big advantage to men seeking to qualify for Army and Navy Air Service. You can train at this Lincoln School for positions as Commercial Pilot, Flight Instructor, Aeronautical Engineer, Government Licensed Airplane & Engine Mechanic, Airplane Assembly Mechanic, Airplane Draftsman. We train you and assist our Graduates in locating positions.

WRITE TODAY for complete information.

LINCOLN AERONAUTICAL INSTITUTE
5910 Aircraft Building, Lincoln, Nebraska

MAKE MONEY FROM POULTRY

with a business of your own. How to start small way, spare time, grow from profits, or prepare for good job in large poultry plant. Harry M. Lamon, nationally known Poultry Expert, shows latest scientific methods, money-making secrets in poultry raising. His system of home study training used by thousands. Endorsed by many colleges and leading Poultrymen. Established 20 years. Write Today for his **FREE BOOK "How To Raise Poultry For Profit."** Shows way to real business opportunity.

NATIONAL POULTRY INSTITUTE
Dept. 50-14 Adams Center, N. Y.

ELECTRICAL TECHNICIANS URGENTLY NEEDED!

In industry—in Army and Navy—electrical technicians win better jobs and ratings. Learn fundamentals of electrical theory and practice—testing, drafting, machine shop, wiring, control. Course complete in one school year. Dormitory; dining hall; campus. 50th year. Send for catalog and Vocational Chart. 120 Takoma Ave., Washington, D. C.

BLISS ELECTRICAL SCHOOL

TAKE THIS PROVEN SHORTCUT TO SUCCESSFUL PHOTOGRAPHY

Enroll now at country's largest school. Men—women—profit by our 32 years experience in training students for photographic success. Big opportunities NOW in military and industrial photography. Individual coaching by experts. for Commercial, News, Portrait, Motion Picture, Color Photography. Resident or home study. Free booklet.

N. Y. INSTITUTE OF PHOTOGRAPHY
DEPT. 49, 10 WEST 33 ST., NEW YORK, N. Y.

\$ \$ IN WET BASEMENTS

Spare or full time profits in a business of your own. Exclusive territory. No experience needed. Waterproof your own. Simple—no digging. Details free.

SEAL SEEP CO., 1010 Dawson Road, Cincinnati, O.

Learn Public Speaking

At home—in spare time. Many overcome "stage-fright," gain self-confidence and increase earning power, this easy way. Write for free booklet, *How to Work Wonders With Words* and requirements.

North American Institute, Dept. 1357
1315 Michigan Ave. Chicago, Illinois

America Needs Men Trained for TOOL & DIE MAKING, MACHINIST & SCREW MACHINE TRADES

HARRY LEBESON
PRESIDENT & FOUNDER

ALLIED School offers you short intensive, Practical training courses in Our fully equipped Shops. Learn on Actual Jobs! State Approved. Learn Days or Evenings. Enter anytime. **FREE** Employment Service and opportunity to earn while learning. Write for **FREE** Book "Practical Machine Shop Training."

ALLIED SCREW MACHINE CO., (School Division)
609 West Lake Street, Dept. PM-10, Chicago, Illinois

INVENTORS. INDUSTRY NEEDS YOUR IDEAS NOW!

YOU NEED This



FREE BOOK

TWO REASONS — 1 Manufacturers are getting ready NOW for post war sales and production—

2 Right now, manufacturers are seeking products their expanded facilities can handle; factories must have products to take up the slack after war orders stop. Your chance comes with patent protection now—delay may endanger your chance. Get our NEW FREE Inventor's Book today and valuable "Invention Record" form. This request does not obligate you. *Act now. Write today.*

McMORROW & BERMAN

Registered Patent Attorneys Before U. S. Patent Office, 1357 Barrister Building, Washington, D. C.
Send me your NEW FREE Book and specially prepared "Invention Record" form at once. I understand that this request does not obligate me.

NAME.....
ADDRESS.....
CITY.....STATE.....
WRITE OR PRINT NAME CLEARLY

Quick! Get into DRAFTING now



Learn At Home From An Engineer
With industry working feverishly—the field for DRAFTSMEN is bigger than ever! Get into a better job with more pay and fascinating, pleasant work. I will train you at your home in your spare time until you are holding a better paying position as Draftsman. My practical training in drafting also includes a working course in Industrial Designing valuable on new products, improving, restyling and modernizing—all extremely important and profitable to draftsmen. Write for full illustrated details and booklet. Give your age.

ENGINEER DOBE, Division 3377 Libertyville, Illinois

LEARN SHOP MATHEMATICS

Every machinist, inspector, tool maker, etc. should take this quick course. Covers all types of shop mathematics. Quickly taught at home by mail. Low price. This Mathematics Course free if you decide to take advanced studies for key war position. Write for complete facts.

OHIO INSTITUTE OF TECHNOLOGY, Box 76, Greenville, Ohio

STUDY ENGINEERING AT HOME

With A Chartered Educational Institution
Courses in ENGINEERING: Electrical, Civil, Mechanical, Drafting, Architectural, Steam, Aeronautical, Radio, Structural, Mining, Industrial, Highway, Petroleum, Marine, Chemical.
Courses in ARTS AND SCIENCES: Philosophy; Education; Letters; Public Health; Medical Jurisprudence; Psychology; Sociology; Physics; Chemistry; Geology; Pol. Science; Theology; Law; Business and Commerce; Accounting; Mathematics; Statistics; Agriculture.

McKinley-Roosevelt Incorporated, 4610-TC, Sheridan Road, Chicago

PLAYS

Send for FREE catalog of 144 pages, copiously illustrated. Non-royalty plays, also tested plays on a percentage-royalty basis. Playbook exchange. Row, Peterson plays are nationally famous for their high quality. Ask for live drama newspaper. "Lagniappe."—it is free.
ROW, PETERSON & COMPANY
1909 Ridge Ave. Evanston, Ill.

RADIO Basic principles of all radio OPERATION RECEPTION

Radio is more important NOW than ever. Thousands will be needed in aviation, army, navy, and commercial work. Our latest course gives you basic instruction in radio operation and reception. Airway Weather Service, Aeronautic Radio, Servicing, Frequency Modulation are all covered.

Complete HOME TRAINING in spare time

Make use of spare time to master the principles of this interesting and profitable profession. Fit yourself for an important part in the tremendous affairs now taking place. Help to win this war quicker. Learn all about our plan, send for this bulletin—it's FREE.
American School, Dept. R745, Drexel at 58th St., Chicago

SEND FOR THIS BULLETIN FREE

American School, Dept. R745, Drexel Ave. at 58th St., Chicago, Ill.

Gentlemen: Send me FREE bulletin covering special training in subjects checked below. No obligation on my part.

- Drafting and Design
- Accounting and Auditing
- Architecture and Building
- Automotive Engineering
- Aviation
- Electrical Engineering
- Diesel Engineering
- High School Course
- Liberal Arts
- Mechanical Engineering
- Radio
- Plastics
- Retail Merchandising

Name.....
Address.....

★ WANT A GOVERNMENT JOB ? ★

Hundreds War Service Appointments Being Made
\$1260 TO \$2100 FIRST YEAR

BECOME Railway Postal Clerks, Postal Clerks, Mail Carriers, Border Patrolmen, Stenographers, Typists, Junior Clerks, Ass't Statistical Clerks, Junior Custodial Officers.
32 Page Civil Service Book—FREE

FRANKLIN INST., Dept. P174, Rochester, N. Y.
Gentlemen: Rush to me, without charge, 32 page book with list of U. S. Government big paid positions. Advise me also regarding salaries, hours, work, vacation, etc. Tell me how to qualify for a position.
Name.....
Address.....

ARC WELDING NEEDS YOU!

Excellent Pay!

Costs but little to learn. ACT NOW!

Offers a **BETTER FUTURE!** Get training in a trade that will always need experts regardless of world or local conditions.

NO BETTER PLACE TO TRAIN than this school, backed by one of the world's largest builders of arc welders; supervised by some of America's Finest Instructor-Operators.

NON-PROFIT INSTITUTION. Cost only for materials used. Individual machines, booths. Short, intensive course. **WRITE OR ENROLL TODAY!**

The HOBART SCHOOL OF ARC WELDING
Box M-102 TROY, OHIO

FREE Literature... Write Today! Reservations are being made continually, HURRY!

INVENTORS PATENT YOUR IDEAS
SEND FOR FREE BOOK

HOW TO OBTAIN A PATENT

Written by a Former Member of the Examining Corps (1922-24) of the U. S. Patent Office. If you want to profit by your idea, you should take steps to apply for a U. S. Patent at once. Your first step is to get this Free Book. This interesting illustrated book contains valuable information you should have. It tells you fully how to obtain a patent on your idea in the quickest way. With this Free Book you will also receive a "Record of Invention" form on which you can easily record your idea. Personal and Confidential Service: Your case will be personally handled only by a Registered Patent Attorney who is also a Former Member of the Examining Corps of the U. S. Patent Office. All communications confidential.

MAIL COUPON TODAY for FREE PATENT BOOK and RECORD OF INVENTION Form.

CARL MILLER
REGISTERED PATENT ATTORNEY
FORMER MEMBER EXAMINING CORPS U. S. PATENT OFFICE

Woolworth Bldg., 35th Floor, Dept. 102-A, New York City
MILLER BUILDING, Dept. 102-A, WASHINGTON, D. C.

Please send me your Free Book, "How to Obtain a Patent," and your "Record of Invention" form.

NAME.....

ADDRESS.....

PATENTS

Booklet Free • Highest References
Promptness Assured • Best Results
Send drawing or model

All Business Given Prompt
and Proper Attention

WATSON E. COLEMAN
Registered Patent Lawyer
724 Ninth Street, N. W. Washington, D. C.

PATENTS AND TRADE MARKS
C. A. SNOW & CO.
Registered Patent Attorneys Since 1875
Write for Free Book and "Certification of Invention" form
427 SNOW BUILDING, WASHINGTON, D. C.

INVENTORS AND DESIGNERS

We have manufacturing facilities now entirely engaged in defense work. Anticipating postwar markets, we are interested to develop for manufacture new devices and products of non-military character. Recommend consultation with patent counsel before submission of material. Send copies of description to be retained by us.

MICHIGAN PATENTS CORP., Reynolds Bldg., Jackson, Mich.

Correspondence Courses in **RADIO and ELECTRICAL ENGINEERING** **LOW AS \$25**

ELECTRICAL ENGINEERING. Get good grasp of wide electrical field. Modern. Very understandable. Theory made easy.

RADIO ENGINEERING. Extra fine course in radio, public address, photo-electric work. Train you to be super-service man, real vacuum tube technician. Tuition ONLY \$25, either course. Deferred payment plan. Experiment kits furnished.

FREE Write for free copies of school catalogs, student magazines, etc.

FREE LINCOLN ENGINEERING SCHOOL, Box 931-P-46, Lincoln, Nebr.

Learn to Write

Begin today. Write now for our Free Book, "How to Become a Good Penman." It contains specimens and tells how others learned to write in spare time. Enclose 10c for your name beautifully written and a pen point suitable for shaded writing. Write today.

THE TAMBLYN SCHOOL OF PENMANSHIP
X441 Ridge Building, Kansas City, Mo.

MAKE MONEY AT HOME!

Learn to color photos and miniatures in oil. No previous experience needed. Good demand. Send for free booklet, "Make Money at Home" and requirements.

NATIONAL ART SCHOOL
1315 Michigan Ave. Dept. 1357 Chicago

Always write your name and full address clearly when answering advertisements.

MONEY IN RABBITS — CAVIES

WE BUY and put you in touch with other markets. Catalog and copy of magazine 10c. Or send 25c for Book Catalog and Price List and Year's Subscription to the **AMERICAN SMALL STOCK FARMER**.

OUTDOOR ENTERPRISE CO., BV 919, PEARL RIVER, N. Y.

FIBRE ARMS AND LEGS!

Light, correctly fitted, strong and comfortable. Natural appearance. Braces for all deformities. Scientific design. Fair Terms.

BUCHSTEIN-MEDCALF
610-3rd Av. S., Minneapolis, Minn.

To PROTECT Your INVENTION - Use this coupon, NOW

Delays are dangerous and may be very costly. My personal service assures prompt action, strict confidence, and a minimum of expense. I suggest that you send me a model or drawing, or sketch and description of your invention, and \$5.00. I will make a search and report promptly as to its patentability and send you a copy of my 72-page booklet. Or, if you prefer to read my booklet first, mail the attached coupon at once. I will also send my "Record of Invention" form. (Over 40 years experience as a Registered Patent Attorney.)

L. F. Randolph, 302-D Columbian Bldg., Washington, D. C.

Please send me at once, free of charge, your 72 page booklet and "Record of Invention" form.

Name.....

Address.....

A PERSONAL CONFIDENTIAL PATENT SERVICE



**"MY JOB'S IMPORTANT!
IS YOURS???"**

**PREPARE in AVIATION'S
MOST VITAL BRANCH**

AIRCRAFT INSTRUMENTS

HOME STUDY—LEARN BY DOING!

* Practical, complete training on actual instruments furnished by the school—qualifies you for well paying positions with manufacturers, airlines and instrument service and repair stations. Send for CATALOG today... *

EASTERN AIRCRAFT INSTRUMENT SCHOOL

"Largest in the East"

DEPT. M J 116 NEWARK AVENUE JERSEY CITY, N. J.

STUDY AT HOME

With a Chartered Educational Institution

Courses in **ENGINEERING**: Electrical, Civil, Mechanical, Drafting, Architectural, Steam, Aeronautical, Radio, Structural, Mining, Industrial, Highway, Petroleum, Marine, Chemical.
Courses in **ARTS AND SCIENCES**: Philosophy; Education; Letters; Public Health; Medical Jurisprudence; Psychology; Sociology; Physics; Chemistry; Geology; Pol. Science; Theology; Law; Business and Commerce; Accounting; Mathematics; Statistics; Agriculture.

McKinley-Roosevelt Incorporated, 4610-UC, Sheridan Road, Chicago

LEARN MONEY-MAKING CARTOONING

Some Simplified Method that has helped train creators of "Terry & Fitzmaurice," "Wash Tubbs," "Out Our Way," "Winnie Winkle," "Reg'lar Fellers," "Strangers As It Seems," "Secret Agent X-9," and many others. Earn while learning. Rush 10c for Picture Chart (to test your ability), and full details. (State age.)

THE LANDON SCHOOL, 4210 National Bldg., Cleveland, Ohio



MACHINE SHOP MEN

Learn to set up and run ANY kind of machine; MAKE MORE MONEY NOW by learning quickly HOW TO DO THINGS which usually take years of study and practice. The demand for SKILLED men is ALREADY ahead of the supply, then what WILL IT BE a month or two from now?

Needed NOW!

Bigger Pay Don't miss this chance to qualify for promotion, don't miss this Big Opportunity which is yours almost for the asking. Eight Big Books checkfull of important mechanical facts told simply and clearly. Over 3000 pages, nearly 3000 illustrations cover every subject fully, including Tool Making, Pattern Making, Foundry Work, Mechanical Drawing, Forging, Machine Shop Practice and Management, and hundreds of other subjects.

8 Big Books (Up-to-date Edition) Sent FREE

to you for examination. With them we send a Big Binder of 867 pages with 293 original shop tickets and over 1300 illustrations. These show, step by step, how to set up and run almost any kind of job and are in addition to the 8 books. Decide in your own home or place of business whether or not you want to keep them, check up on any facts you want to. Note their great MONEY MAKING value, then, if you want them, pay on the easiest kind of payments. A year's consulting privileges with our engineers now given with these books without extra charge. American Technical Society, Vocational Publishers since 1898.

American Technical Society, Dept. 3710, Drexel at 58th St., Chicago
You may send me the 8 big books and binder of shop tickets for free examination. I will pay the delivery charges only, unless I decide to keep them in which case I will send \$2.00 in ten days and \$3.00 per month until the total price of only \$34.80 is paid. If I return them in 10 days I will owe you nothing. You also agree to send me a certificate entitling me to consulting privileges with your experts for one year without extra charge.

Name.....
Address.....
Please attach a letter stating age, occupation, employer's name and address and that of at least one business man as reference.

More GOOD JOBS in DRAFTING

in AIRCRAFT and other War Industries!



Calls for Draftsmen Are Increasing! . . . Read the want-ads for proof of this urgent demand.

This complete drawing outfit,—every thing to work with,—including drafting table, drawing board, supplies, etc.—
ALL SENT TO YOU AT NO EXTRA COST if you are a Chicago Tech Student.

MAIL COUPON
BELOW

The War Production program has increased the demand for Aircraft Draftsmen, Machine Draftsmen, Architectural Draftsmen, Electrical Draftsmen, and Structural Draftsmen. The Draftsman always comes first on any new project in manufacturing and industry—peace or wartime.

The Draftsman—"The Key Man" in War or Peacetime Industry

No new machines can be built, no airplanes constructed, no bridges or buildings erected, no ships or submarines launched until the draftsman has completed his work. Real immediate opportunities exist in Drafting—the profession upon which all construction is vitally dependent. Drafting is clean, interesting, well paid work. Steady employment. Investigate today what Drafting offers you! Help your country in a vital War production job on the important Home Front—and help yourself to a well paid job in Drafting.

Learn in Spare Time,—at Home!

(or at the College in Chicago)

With our easy step-by-step lessons, (and the tools we furnish), you can learn in your spare time at home. New short courses at new low prices. Convenient terms. To prove to you how easy it is to learn Drafting by the Chicago Tech Method we'll send you a Trial Lesson FREE. No charge for this lesson either now or later.

Send a post card or the coupon now for

FREE TRIAL LESSON
free TRIAL LESSON
Send Coupon

CHICAGO TECHNICAL COLLEGE

N-203 Tech. Bldg., 2000 S. Michigan Ave., Chicago, Ill.

Please send me **FREE Trial Lesson in DRAFTING** showing how to learn at home by C. T. C. plan for good job in aircraft and other war industries. No obligation of course.

Name.....

Address.....

City..... State.....

Occupation..... Age.....

**WORLD'S
BEST
WANT AD
MEDIUM**

CLASSIFIED Advertisements



Advertisements in this section, 35 cents per word, each insertion, minimum 10 words, payable in advance
To be inserted under proper classification in November issue, copy should be in our office September 8th
November issue on sale October 1st
Popular Mechanics Magazine, 200 East Ontario Street, Chicago, Illinois

YOU'LL PROFIT

By reading and answering the classified ads in this section. Hundreds of opportunities to make and save money.

Popular Mechanics Magazine
Chicago, Illinois
Attention: F. W. Johnson

Gentlemen: Since 1920 I have spent many thousands of dollars for classified advertising space, and, in checking up, I find that for results your publication leads the field with a wide margin to spare.
A recent advertisement, costing \$7.00, produced a net profit of more than \$200 in thirty days.

(Original letter on file in our office)

Yours very truly,
AMSTER LEONARD

AUTOMOBILES—MIDGET CARS

AUTOMOBILE Racing book, fifth edition, well illustrated. Instructions on building bodies, frames, engines. Ford A and B conversions. Plans, AAA rules, specifications. Roadster racing. Indianapolis cars. \$1.00 postpaid, \$1.15 C.O.D. Ray Kuns, Dept. 46, Madisonville, Cincinnati, Ohio.

WHIRLGAS Superchargers. \$3. Increase mileage 20%; power 10%. Refund guarantee. University test. Any car; give make, year. Wrench installs 15 minutes. Good results with 30% fuel oil mix. John Hanley, Manufacturer, 5719 Loraine, Detroit, Mich.

SEAL-MATIC Substitutes new rings, rebore! Details. Devereaux, Box 212-J, Battle Creek, Michigan.

PHOTOGRAPHS, World's finest automobiles. List free. Automobiles, Box 534, St. Cloud, Minnesota.

MIDGET Motors, \$5.00 up. Used motors, midgets, motorscooters, parts. Latest lists. 20c. Shipp's Midgets, Box 543-H, Zanesville, Ohio.

AUTO SUPPLIES AND EQUIPMENT

TUNE-UP Your own engine. Small, compact machine, easily operated by amateur, frees rings and valves, restores power, reduces carbon, increases gas mileage, reduces "ping," aids starting, quiets motor, saves oil. Tests spark plugs under load, tests coils, condensers, ignition wiring, distributor points, valve action. Machine with two quarts of solvent, costs less than one, professional, engine tune-up. Used successfully by hundreds of service stations. Now available, for the first time, to private owners, at amazingly low price. Write for complete details and proof of performance. Agents wanted. Waverly Petroleum Products Co., Drexel Bldg., Philadelphia, Penna.

LEARN How to get up to 30% more power and 50% more mileage out of practically any car with our Vacuum-Cool Method. Not a gadget. We send easy-to-understand diagram instructions showing how to quickly hook up the vacuum to cool the motor, cool the oil (eliminating dilution and overheating) and circulate the radiator water after disconnecting both water-pump and fan to save power. Also uses gas vapors from top of gas tank. Make the gallons stretch! Make money charging other motorists for installing! Mail \$1.00 today to Vacuum-Cool Company, 210 Transportation Bldg., Los Angeles, California.

AUTO Alarm. Prevents theft of car, tires, etc. Easily installed. \$2.95 prepaid. Knipp, Long Beach, California.

RECLAIM Used oil without cost. Particulars. F. Gerwin, Alva, Okla.

PLATING Outfits for auto parts. Connect to a battery. No tanks used. Free particulars and proofs. Gunmetal Co., Ave. J, Decatur, Ill.

PUNCTURE Preventive, vulcanizing cement. Ten other auto wartime secrets. Rush \$1.00. Money back guarantee. Auto Savers, JK-125, Station M, Cincinnati, Ohio.

REPLATE Your auto parts, bath fixtures, silverware with beautiful "Sterling Silver"! Inexpensive, no-electricity method. Fuller Sales Co. (495) Kalamazoo, Michigan.

PUNCTURE Proof! Five tire treatment \$1.00. Duffy, PD-14, Covington, Ky.

REPAIR Your own tires, newly developed methods, 12 tire maintenance trade secrets disclosed including how to reclaim and devulcanize scrap rubber for 1c per pound. Complete instructions \$1.00, money back guarantee, free literature. The Harris Co., Boaz, Wis.

AUTO TRAILERS

ALL About trailers, construction, parts, supplies, etc. 64 pages vital information for anyone interested in home trailers. Send 25c. Stepha Co., 2801PM 14th, Kansas City, Mo.

READY Now—Plans for nine new Jim Dandy Trailers including six modern house trailers. Catalog 10c. Also new edition of Trailer Builders Manual and catalog of parts, supplies and equipment. Price 25c. Both 35c postpaid. Trailer Supply Co., 5120-A Fulton St., Wausau, Wis.

MOTORCYCLES, BICYCLES, MOTOR-SCOOTERS AND SUPPLIES

BICYCLE News! A "break" for adults! Glidacycles at last available to the public. Solve your wartime transportation problem and keep fit by riding the only rational bicycle ever designed especially for adults. Ideal exercise and recreation for both sexes. New, modern, unique—the Glidacycle has more exclusive features than all others combined. New patented drive principle—less effort, more comfortable, safer, speedier—marvelous coaster. Easier for beginners. A smart, low-slung, streamlined beauty. Limited number. Send dime (stamps or coin) for illustrated brochure. Better hurry! Glidacycle Sales Company, Dept. C, Box 362, New Orleans, La.

BICYCLES, Parts, tires. Also scooter tires, all sizes. Send dime for list. Cycle Transport Co., 1241 So. Michigan Ave., Chicago, Ill.

PARTS—New and used. Catalogue and wings pin 10c. Ballak, 811 N. 9th, St. Louis, Mo.

MOTOR Scooters, motorcycles, 100 mile gallon, save gasoline, tires. No priority necessary but supply limited, hurry! Illustrated catalog one dime. Clymer's 307 W. Pico, Los Angeles, California.

BUILD Electric power bicycle, low cost, easily built, operate cheaply, practical. Detailed plans 50 cents. Leland Hoke, 312 Market Street, Watertown, Wisconsin.

AVIATION

AVIATION Cadet examination preparation by home study course. Rutherford Preparatory School, Long Beach, Calif.

BATTERIES, GENERATORS, ETC.

GENUINE Edison batteries for light, power. Non-acid. Fifteen year life. Five year unconditionally guaranteed. Low prices. Complete lighting plants. Free literature. See-Jay Company, 82 Sterling Avenue, Yonkers, New York.

EDISON Lifetime storage batteries for light and power. Eliminate acid battery diseases. Long guarantee. All kinds rebuilt generating plants, motors, and miscellaneous articles at bargain prices. Free interesting literature. T. Hawley Smith Co., Croton Falls, N. Y.

ELECTRICAL SUPPLIES—EQUIPMENT

ELECTRIC—Fence chargers, fly traps, insect killers, screens, calf weaners, stock prods, fire detectors, burglar alarms. Garden-hire Mfg., Waynesboro, Penna.

FREE! 1942 Catalog—1000 electrical bargains. LeJay Manufacturing, 847 LeJay Building, Minneapolis, Minn.

ELECTRO-MAGNET Plans, Circulars 5c. Terry Sales, Central Station 1676, Toledo, Ohio.

1/2 HORSE, 3450 Speed, repulsion induction alternating motors \$12.50; 500 watt, alternating current generators \$29.50; other sizes. Butler Electric, 1885 Milwaukee, Chicago.

DEALERS, Sell alternating and direct current motors. Fans, exhaust, attic and circulating. Air compressors and paint spraying equipment. Wholesale catalog, 10c. CMCO, 514 Van Buren, Chicago.

ELECTRIC Pencil: Writes-engraves all metals. \$1.00 postpaid. Beyer Mfg., 4515-H Cottage Grove, Chicago.

WELDING—SOLDERING—PLATING

WELDING Opportunities. Send name, postal. I. T. I., 741-45 W. 70th St., Chicago, Ill.

ARC Welders wanted by the thousands. Learn with 516 page lessons manual. Over 500 how-to-do-it photos. \$2.00 copy. Money-back guarantee. Hobartweld, Box M-1024, Troy, Ohio.

BUILD d.c. Arcwelder without rewinding armature. Plans \$1.00 each. 25 to 600 amperes from vehicle motors, light plant generators, automobile starter-generators. Welders Club, AB-3432 M-Mart, Chicago.

SPOT Welder inexpensive. Plans, photographs \$1. Lynnpeitcher, 4772 Del Monte, San Diego, California.

WELDING Outfits, immediate delivery. \$37.33, \$45.67 to \$78.06. Welding torches \$6.88 to \$22.58. Cutting attachment \$13.79 up. Regulators and gauges, acetylene generators, accessories and supplies. Superior Machine Co., Hamilton, Ohio.

MACHINERY, TOOLS AND SUPPLIES

PLANS For making internal keyway cutters and arbor press lathe attachment. \$1.00. Hobson, 422 South Dearborn, Chicago.

USED Rubber covered conveyor belting, 20", 24", 121 Fairview, Saginaw, Mich.

SHAPERS, Milling machines, etc.—Save up to 5/8ths the cost of practical machine tools by building them yourself from Lewis castings. Foundry castings supplied with or without major machining operations. These tools handle commercial jobs that pay profits. Send 10c for new catalog showing low-cost castings for 24 projects. Lewis Machine Tool Company, Box 116, Station A, Dept. M22, Los Angeles, Calif.

CONCRETE Building block machines and molds. Easy payments. Catalog free. Concrete Machine Co., 5129 South Compton Ave., St. Louis, Mo.

INDEX Heads for sale. Very inexpensive. Sixty-two different divisions. Used on small lathes, drill press, milling machines, etc. Make gears, hobbs, cutters, etc. Very accurate, and durable. Not a toy. Used by defense schools and hobbyists. Write for free folder, 2117 East B St., Torrington, Wyo.

BUILD Your own drill grinding attachment. Simple, inexpensive, accurate. Patterns, instructions \$1.00. 2113 Channing, Berkeley, Calif.

WANTED: Electric saw filing machine, electric drills, Skill saw, bench grinders, shapers, bench and floor lathes. Bench drills, wood working machine tools, micrometers, depth gauges, vernier calipers and other precision tools. Can use complete kits of machinist and toolmakers equipment. Please send full description and price to Allen Electric Co., 3201 Grand Ave., Detroit, Mich.

BRAND-NEW One inch micrometer, \$3.95 C.O.D. Equipment Manufacturing Co., Box 5955, Kansas City, Mo.

13" x 5" WILLARD Lathe with gap. No 2 Pratt & Whitney hand milling machine. Four step cone drive. Write for full particulars. Cincinnati Machinery & Supply Company, 217 E. Second St., Cincinnati, Ohio.

RECLAIM Dull and broken drills, with Nu-Way Drill Grinder. Circular free. Tractor-Lite Mfg. Co., Sidney, Iowa.

ENGINES, MOTORS, DYNAMOS

BIG Pay jobs in welding. Complete welding lessons and reference book. 516 pages, 41 lessons. \$2.00 copy. Money-back guarantee. Hobartweld, Box 1025-M, Troy, Ohio.

1/2 HORSE, 110 Volt, induction motors. Rebuilt, guaranteed \$9.75; other sizes. Wilmet Auto Supply, 2247 St. Paul Ave., Chicago.

WINDING Data, 225 motors, single and three phase. \$1.00. Motor Data Co., Box 7631, Kansas City, Mo.

AC And DC generators, motors, exhaust fans. State your needs. Queen City Electric, 519 South California, Chicago.

BOATS, OUTBOARD MOTORS, ETC.

MARINE Power—Easily convert any Ford motor (domestic and foreign) with Oeco parts and kits. Complete catalogue 25c (coin). Osmithson, 3644 Lawrence St., Philadelphia, Penna.

REBUILT Outboard motors. Fully guaranteed. Over 300 to pick from. Send 10c for complete list. Boat design book 15c. Buy now before prices advance. Chicago's largest dealer. Masters & Son, 214 West Chicago Avenue, Chicago.

TEN Plywood boat plans 50c. Catalog boat building plans 10c. The Rudder, 15 Murray Street, New York.

WELCH Boats—America's finest. Two thirds saving. Build your favorite boat by the Welch System. 10c brings you a complete catalog showing 32 designs. Welch Boat Company, Station K-1, Milwaukee, Wisconsin.

OUTBOARD Motors, used parts. Outboard Exchange, 1194 Remsen Ave., Brooklyn, N. Y.

FULL Size, cut to shape boat patterns, blueprints 7 1/2 - 38 feet. Illustrated "Build a Boat" catalog, 10c (coin). "How to Build Boats" book, \$1.00. Cleveland Boat Blueprint Co., Station A-86, Cleveland, Ohio.

BOAT Designers are highly paid professionals. Complete course by mail. Catalog. Westlawn, Montville, N. J.

OUTBOARDS — Save 1/2. Good used parts, all makes and models. Bargains re-build motors. Crandall Hicks Co., 959 Commonwealth, Boston, Mass.

FORD-Mercury-Zephyr marine conversions. Catalog 10c. Lehman Engineering Company, Dept. D, Newark, N. J.

ATHLETIC EQUIPMENT—BODY BUILDING COURSES

BAR-BELLS, Exercise equipment. Courses. Special offers. Free booklet. Good Barbell Co., 3261-PM Watson Rd., St. Louis, Mo.

SUPER Ju-Jitsu—lightning defense and attack system. Sensational new home study course now ready! Learn to lick brutes twice your size with only your bare hands. Free details. Nelson Co., 500 Sherman, Dept. K-508, Chicago.

BE Strong, muscular, full of pep. Amazing new body-building course. Write Olympic System, Dept. M, Waterville, Maine.

SPORTING GOODS, GUNS, FISHING TACKLE, ETC.

WHOLESALE Prices, flies, streamers, bugs, lures, fly tying and lure making materials, complete stocks, catalog free. Super Mfg. Co., Amarillo, Texas.

"TACKHOLE Dot." floating center reticules for target scopes \$5, hunting scopes \$10. Send scope. Accurate, speedy. Free literature. T. K. Lee, PO Box 2123, Birmingham, Ala.

BUY Hunting, trapping equipment where professional hunters, trappers buy. Lowest prices. Write for free catalog. Hill Bros. Fur, Dept. 355, St. Louis, Mo.

USED Guns, bought, sold, exchanged. List stamp. Howe Fur Company, Coopers Mills, Maine.

TIN-CAN 20 Silencer, sounds like air-gun. "Teluhov" plans \$1.00. Spencer Laboratories, Akron, Ohio.

GOLF Clubs. Five club matched set \$3.75. Lincoln Surplus, 220 East Stephenson, Freeport, Ill.

ARCHERY Equipment: Catalogue free. Mid-West Archery, 2309-A East 75th, Chicago.

"RAISE Earthworms for Profit." Information free. Stamp appreciated. Bureau Zoological Research, 106 "P" Broadway, Peoria, Ill.

FIELD GLASSES, MICROSCOPES, TELESCOPES

LENSES—Build your own telescopes, field glass, microscope, riflescope, etc. Assortment of fifteen lenses—\$1.00 postpaid. Thirty lenses—\$2.00. Slightly chipped on edge. Satisfaction absolutely guaranteed. American Lens Company, 324-M North Mayfield, Chicago.

ASTRONOMICAL Telescopes, binoculars, cameras, microscopes; bought, sold, repaired. Send 10c for list of instruments desired. Rasmussen, Box 294, Amsterdam, N. Y.

ANTIQUES, RELICS, INDIAN GOODS, CURIOS

25 GENUINE Indian arrowheads, \$1.00. Catalog. Geo. Holder, Glenwood, Ark.

COLUMBIA River gem birdpoint 50c. Catalog 5c. Sistershop, Northbranch, Kansas.

ANTIQUE Firearms, swords, daggers, powderhorns, Indian curios. Lists free. Nagy's, 8 South 18th, Philadelphia, Penna.

INDIAN Relics, coins, bills, gems, crystals, curios, etc. Illustrated catalog 5c. 100 ancient arrowheads \$3.00. H. Daniel, Hot Springs, Ark.

INDIAN Relics, beadwork, coins, curios, minerals, old glass. Catalog 6c. Indian Museum, Osborne, Kansas.

DOGS, PETS, BIRDS, RABBITS

FERRETS—Kill your rats with ferrets. Henry Hainline, Creston, Iowa.

ST. BERNARD Puppies. Champion sired beauties. Franklin Young, R4, Riverhead, Long Island, New York.

MONEY Raising rabbits. Investigate. Folder 10c. Close Rabbitry, Tiffin, Ohio.

PUPPIES, Many breeds—particulars free! Book 108 colored pictures, descriptions recognized breeds, 35c. Royal Kennels, No. 91, Chazy, N. Y.

ANIMALS, Birds, reptiles. All kinds. Send stamp for lists. Snake King, Brownsville, Texas.

TAXIDERMY

RUGS—Grizzly, polar, black or brown bear, tiger, mountain lion, bobcat, coyote, leopard. Game heads—Deer, elk, sheep, antelope, moose. Hundreds of choice specimens at unusually low prices. Sent on approval to reliable persons anywhere. Write today for selection and price list. Jonas Bros., 1049 Broadway, Denver, Colorado.

TREES, SHRUBS, PLANTS, HERBS

25 VARIETIES, Cactus plants postpaid \$1.50. Mixed seed 25c. Art Glover, San Dimas, Calif.

FARMS, FARM LANDS, REAL ESTATE

IMPROVED Farms, unimproved lake-shore tracts. Free list. Theo. Gau, Pierz, Minn.

STROUTS Catalog just out! Farms, country homes, rural business opportunities; 64 pages chock-full of bargains described in states east of the Mississippi; write today for this money-saving time-saving guide. Free. Strout Realty, 255-P 4th Ave., New York City.

GOVERNMENT Land \$1.00 acre up. Information all states 25 cents. National Tax Service, 1037A Majestic Bldg., Detroit.

10 ACRES Good Florida land \$50.00. \$5.00 down. \$5.00 monthly. R. W. Stewart, Inverness, Florida.

GOOD Farm bargains. Washington, Minnesota, Montana, Idaho, Oregon, North Dakota. Dependable crops, favorable climate. Write for literature and lists describing farms for sale. Specify station. J. W. Haw, 119 Northern Pacific Ry., St. Paul, Minn.

40 ACRES Near White River, unimproved; poultry land. \$190. \$5 down. \$5 monthly. Free list and literature. Hubbard, 216 Grossman Bldg., Kansas City, Kans.

SEE The Highlands of Louisiana. Choice cut-over land selling at low prices on liberal terms. Descriptive book sent upon request. Long-Bell Farm Land Corp., 878 R. A. Long Bldg., Kansas City, Mo.

POULTRY AND FARM SUPPLIES

YOUR Greatest poultry problem will look simple when you read American Poultry Journal regularly. 500,000 poultrymen do. why not you? Only 25c year, 5 years \$1.00. American Poultry Journal, 532 S. Clark, Chicago.

MORE Profits from poultry—Learn how others get big daily income. Read America's leading poultry magazine. Five years \$1, one year 25c. Poultry Tribune, Department PB-3, Mount Morris, Ill.

PROFITABLE OCCUPATIONS

RAISE Angora rabbits. Wool sells \$5.00 pound. Booklet free. Taylors Rabbitry, Hapeville, Georgia.

BECOME Master magician. Write—Harry P. Willis, Box 1704, Cleveland, O.

SMALL Commercial Animals Magazine. Badaxe, Michigan. Three years, \$1.00; sample, 10c.

WELDING Pays. Learn with 1942 trade school text manual, 516 pages. Over 500 photos. \$2.00 copy. Money-back guarantee. Hobartweld, Box M-1023, Troy, Ohio.

MECHANICALLY Inclined men—Own and operate general appliance repair shop. Complete, illustrated course shows you how. Welding, refrigeration, motor repair, how to get business, etc., all phases covered. Free literature. Christy Supply, Dept. 421, 2835 N. Central Ave., Chicago.

ANNOUNCING New home study course in commercial baking. Good field. Nearly depression proof. Common school education sufficient. Send for free booklet "Opportunities in the Baking Industry" and requirements. National Baking Institute, 1315 Michigan, Dept. 3433, Chicago.

STANDARD Rabbit Journal, Milton, Pa. 3 years \$1.00, sample dime.

RAISE Chinchilla rabbits for us. We pay up to six dollars each. Catalog and contract 10c. Book catalog. Year subscription Rabbit Magazine 25c. Stahl's, Box 10, Holmes Park, Mo.

\$40.00 WEEKLY. Made growing mushrooms, fresh, dried. Dominion patent 331583. Free spawn. North American, 169Y Yonge, Toronto, Canada.

**BOOKS, PERIODICALS, PICTURES,
POSTCARDS**

BUSINESS. Trade and diversion magazines. Current copies. 403 different publications, representing 115 vocations to choose from—mechanical, electrical, building, plumbing, live stock, poultry, printing, journalism, photography, advertising, music, hobbies, stamp collecting, patents, mail order, radio, aviation, sports, etc. Free price list. Commercial Engraving Publishing Company, 34C North Ritter, Indianapolis, Indiana.

FREE—100 Page book catalog. New and used college and home study text and reference books at a saving. Est. 1902. We also buy books. College Book Co., Dept. 4, Columbus, O.

100 NAME Imprinted bookplates, \$1.00. Samples free. Carey Sales, 46-Y, Station "S," Brooklyn, N. Y.

SELF-EXPLAINING Bible: Illustrated circular free. Box 446-P, Minneapolis, Minn.

OUTDATED Magazines. Catalog 10c. Cicerone's, 863 First Avenue, New York, N. Y.

ART Pretty girl pictures fifty new series. Each picture full post card size 5 1/4" x 3 1/4". Grade AA series 18 pictures \$1.00. Grade B, 30 for \$1.00 wholesale. 3 sets \$2.00. Color cards—same prices. Harl Co., Box 10, Station Jay, New York, Dept. A25. (Address 309 West 125th St.)

POST Cards—8 historical views Philadelphia—25c. Lokes, 2725 W. Selitzer Street, Philadelphia, Penna.

EXCELLENT Sparetime profits taking subscriptions—2500 magazines. Complete starting supplies free! Pines, 583 Monroe, Brooklyn, N. Y.

MAGAZINE Bargains back dated mystery, movie, detective, western, comics 35 different choice or mixed \$1.00. 15 different Popular Science, Mechanics, Aviation, Photography, National Geographics, or 10 Esquires \$1.00. Magazines wholesale express charges collect. Retail, wholesale catalogs 3c. Largest stock vocational, business, technical magazines. Corey's Exchange, 355 N. Clark, Chicago, Ill.

WHAT Every Mason wants. We have Masonic books for Blue Lodge, Chapter, Commandery, Scottish Rite and Shrine. Our rituals are used the world over. Send for free catalog of books and rituals for Masons, Odd Fellows, Knights of Pythias, Knights of Columbus, Elks, etc. Extra A. Cook, Publisher, Inc., P.O. Box 796, P. Chicago, Ill.

REBINDING: We assemble and bind magazines. Have your old books, Bibles, and hymnals rebound. Durable! Attractive! Prices are reasonable. Heckman Bindery, Dept. D, North Manchester, Ind.

WARPLANE Photographs. Specimen and list (1,000 titles) send 25c. Real Photographs, Ltd., Southport, England.

ANY Book (new used, out-of-print, rare) promptly supplied! Lowest prices! Send for free bargain catalogues! Old Prof's Book Shop, M16 Arcadia Court, Pontiac, Mich.

MAKE Your own herb medicines. Beautiful illustrated recipe book 10c. Botanicals, Box 1109, Evergreen Park, Illinois.

FREE Books and magazines. Your name and address will bring you information how to get any national magazine for one year free. How you can get one book free with each book you buy. Book and Magazine Club, 315 Fifth Avenue, New York, N. Y.

**MAGIC TRICKS, PUZZLES,
JOKER NOVELTIES**

JOIN Magicians' Fraternity! Free tricks. Monthly magazine, sample 10c. International Magicians, Mount Morris, Ill.

MAGIC Tricks. Deluxe catalogue 10c. Magcraft, Heights Station, Houston, Tex.

BOOKS, Cards, novelties, catalog. Samples 10c. Eastern Sales, 32 West Randolph, Chicago.

LEARN Ventriloquism. Send for free folder. State age. Fred Maher, 1700-0 Casgrain, Detroit, Michigan.

STAMP Brings "Sensational Card Mystery!" Surprise waiting! Conaway, 123-M, Champaign, Illinois.

SENSATIONAL Card tricks. New, different. Baffles experts, 18 for \$1.00. Satisfaction guaranteed. Frank E. (Old Man) Lumley, 4530 North Hermitage, Chicago.

NEW Vanishing key and catalog 25c. Sterling Magic, 345 John R, Detroit, Mich.

DOLLAR Magic set free with colossal catalogue 25c. Magex, 4462 Germantown, Philadelphia.

DOUGLAS' Famous 1942 catalog of 500 tricks you can do! Brand new effects for pocket, parlor or stage. Send 10c for year's biggest catalog value. Douglas Magic Shop, Box 274, Dallas, Texas.

BE A magician. Large professional magic catalogue of latest tricks 25c. Ireland, C-109 North Dearborn, Chicago.

HOLLYWOOD Special! Magicians button, catalogue, ghost illusion and free trick for 25c. Magic House of Charles, Box 888, Hollywood, California.

WORLD'S Largest professional magic shop keeps you in touch with latest tricks. To receive mailings send 25c for 1942 catalog. Holden, 220 W. 42nd St., New York.

MAGICIANS' Headquarters. 218-page catalog, pocket, parlor, professional tricks, 25c. Kanter's, M-1311 Walnut, Philadelphia.

COINS, TOKENS, CURRENCY

OLD Money wanted. Will pay fifty dollars for nickel of 1913 with Liberty head (no buffalo). We pay cash premiums for all rare coins. Send 4c for large coin folder. May mean much profit to you. Numismatic Co., Dept. 20, Fort Worth, Texas.

10 **INDIAN** Head cents, different dates, also pricelists 35c. Schultz, 1053 Richmond, Cincinnati, Ohio.

30 **DIFFERENT** Indian cents \$1.50. Sales list free. Wittlin, 1681 Broadway, New York City.

WANTED—Coin approval applicants. Gorsline, 738 George, South Bend, Ind.

CENTS 100 Years old 25c, 5 different \$1.00, 10 different Indians 25c, 10 different San Francisco mint Lincolns 25c, large illustrated coin book 50c. Coins bought, List 3c. Coin Shop, Alameda, Calif.

50,000 **COINS,** Medals, papermoney. Lists free. Nagy, 8-P South 18th, Philadelphia, Penna.

COLLECTION Of \$150.00 in genuine C.S.A. currency, no duplicates, all for only \$1.48. McPherson Collection Agency, Branch, Mich.

FREE! Foreign coin, banknote and large 50 page illustrated coin catalogue to approval service applicants. Send 3c postage. Tatham Coinco, Springfield-125, Mass.

MORGAN Dollars—1878-79-80-81-82-86-87-88-90-91-97-1900—All S. mint uncirculated, \$2.00 each. Illustrated catalogue 10c. Norman Shultz, Salt Lake, Utah.

OLD Money wanted. Big premiums paid. 1,000 quotations. Catalogue 10c. Allan Appell, Sedalia-6B, Missouri.

I MAY Have just the scarce U. S. coins you want. Send me list. "Meet me by mail." William H. Kenworthy, Waterville, Maine.

GET Profit and pleasure in collecting old coins. Send 10c for 56-page illustrated coin catalog. You'll be delighted with it. Send for it now. B. Max Mehl, 370 Mehl Building, Fort Worth, Texas. Largest rare coin establishment in U. S. Established 42 years.

STAMP COLLECTING

POSITIVELY Greatest free offer—Latest Scott's International \$4.00 Stamp Album—covering entire world, contains 36,000 illustrated, descriptive spaces: Scott's 1942 Standard \$3.50 Catalogue "Philately's Encyclopedia"—absolutely free to applicants for foreign approvals becoming customers. Bargain Stamp Service, Palm Springs, California.

CENTRAL And South American stamps, air mails, commemoratives, postage, on approval. A handy stamp wallet with your name printed on it, free. Eppes, Madison, Fla.

INVEST 1c—A penny postal means dollars to you! "Treasure Island" gift offer—latest Scott's big \$4.00 1200 page (or \$7.00 loose-leaf) International Stamp Album—Scott's 1942, 2 volume, Standard \$4.00 Catalogue—choose other albums; free stamps—Given entirely free to purchasing applicants of foreign approvals! "Treasure Island" Service, Vista, Calif.

50 **HYDERABAD,** Travancore, Charkhari, British Colonies 3c. Approvals. Cymerman, 177 Huron, Brooklyn, N. Y.

PREMIUM—To approval applicants. Redding Stamp Shop, 1254 Rose, Redding, Calif.

WOW! \$10.00 Worth of fun for only 10c! 500 foreign stamps, unsorted and unpicked (mostly on bits of paper) just as received from the church missions and other sources. Africa, So. America, Australia, China, Philippines, Dutch Indies, and other countries are represented. Includes a few commemoratives, airmails, and stamps cataloging up to 25c or more each! The biggest package of fun in stampdom—and you might find something really valuable! Price only 10c to serious approval applicants! Money back if not delighted. Jamestown Stamp Co., Dept. No. 22, Jamestown, New York.

INTERESTING Approvals—United States—foreign. Hermes Stamp Company, Box 276, Hempstead, N. Y.

SENSATIONAL Combination offer! Big packet, 105 different including Iceland, Manchukuo, Ecuador (American flag in full colors), Danzig; airmails commemoratives, triangle stamp \$4 United States; complete set United States telegraphs, cataloging 20c. Packet British Colonies, including Gwalior, Hyderabad, Burma (new country) jubilee and coronations. Scarce Far Eastern republic cataloging 50c. Big illustrated lists of other bairains. Total catalog price over \$3.00! All for only 5c to approval applicants! World-Wide Stamp Company, Department 600-N, Camden, New York.

STAMP Dealers! Sell "Eagle Album Pages." Samples 10c. Mango, 568 So. 18th, Newark, N. J.

UNPICKED! 100 U. S. revenues on documents—10c! (700—50c.) 'Vanvoorhis, Hyndman, Penna."

BEAUTIFUL Embossed air-mail cover with Alaska photo-stamp. Send 20c stamps or coin. Alaska Sportsman, Ketchikan, Alaska.

CORONATIONS. One complete Crown Colony 8c. Approvals. Millihiser, 7724 Abbott, Pittsburgh, Penna.

JUMBO Approvals. Books of 500. Beaumont Stamp Exchange, 2667 McFaddin, Beaumont, Texas.

4,000 **U. S.** foreign \$1. Approvals 1c up. Free stamps. Grist, 409 Oak, Davenport, Iowa.

LOWEST United States stamp prices. Free illustrated catalogue. Creevey's, Berwick, Penna.

APPROVAL Sheets. Frederick B. Driver, 401 Finance Bldg., Philadelphia, Penna.

FOREIGN Approvals. References, H & P Burger, Rhinebeck, N. Y.

SHIPS! Stamps depicting battleships, schooners, catboats, etc. 50 different 50c. \$0—\$1.00, 100—\$1.50. Liberty Stamp Co., Rutland Heights, Mass.

BETTER Value 1c approvals—10 stamps free—your choice. Excel, Box 1315, Chicago.

1000 **MIXED** U. S. old and new 25c. Weatherby, Troy, Ohio.

40,000 **VARIETIES** Available on approvals 1/2c up. We buy collections, pay \$5.00 to \$1000.00 cash. P. Kelgwin Stamp Co., Vineland, N. J.

FINE Approvals, freshly mounted. Fast, personal service. Tell me what countries you prefer and I'll send their stamps. Skinner, 345 East Ocean, Long Beach, Calif.

APPROVALS. Prompt service. R. K. Augsburg, 432 W. Maumee, Adrian, Mich.

FREE 10 Cent war stamp with each \$1.00 purchase, approvals. Tradesman Stamp & Coin Co., P.O. Box 1256, Bristol, Conn.

BEAUTIFUL Complete set 10c with approvals. Ute Stamps, 1012 W. Cucharas, Colorado Springs, Colo.

U. S. And foreign penny approvals. Lenatt Stamp Company, Oxford, Maryland.

UNITED States—Bargain list free. Ewing, 109 N. Dearborn, Chicago.

BIG Lot for little! Includes triangles, old and recent U. S. commemoratives, mint British Colonies, free French Colonies and over 100 different others. Everything only 10c to approval applicants. Flax, P.O. Box 45, Long Island, N. Y.

TEN Crazy-shaped stamps. 3c with approvals. Knopp, Box 1381, Bristol, Conn.

U. S. Mixture. \$1 presidential guaranteed 50c lb., 3 lb. \$1.25. Stamphouse, 827 Agate, Chicago.

BRITISH Empire collection! Burma, Cyprus, Gwalior, Sarawak, Tasmania; also 50 other British only 5c with pictorial and commemorative approvals. Lyman, 95 Nassau, New York City.

SUPERB Approvals, net prices. Stamps 1/3 to 1/8 catalogue. P. G. Beals, 170A Tremont St., Boston, Mass.

25 DIFFERENT Greece 5c with approvals. Pinehurst Stampco, 90 Pinehurst Ave., New York.

FREE Your choice of any 10 stamps from our first U. S. approval selections, plus illustrated 1942 U. S. price, check list. This generous offer made to introduce one of the finest selections of U. S. approvals ever offered. **Cosmopolitan Stamp Co., Dept. M, 1457 Broadway, New York.**

19th CENTURY U. S. commems, Civil War revenues, battleship 55 and 110 stamps, 1942 illustrated U. S. catalogue. Free to U. S. approval applicants. Metropolitan Stamps, 198-P Broadway, New York.

LIQUIDATING Dealer's stock into 50c or \$1.00 lots. No junk. No approvals. Block, 2850 Clafin, Bronx, N. Y.

A STAMP Collectors dream!—To exchange duplicates leisurely at home against stamps he really needs selected from thousands of fine and different booklets. This service offers to all adults without dues. **Liberty Stamp Exchange Circle, 30 East 92nd Street, New York. Free information M.**

FREE 20 Different British Colonies, pictorials, jubilees, to approval applicants. Stamp Exchange, Brewer, Maine.

MIXTURES, United States, 40c lb. 3 for \$1.00. Canada 70c lb. 3 for \$2.00. Mission, 4512 North Racine, Chicago.

TRY Our jumbo penny approval books. O. K. Stamps, Centralis, Ill.

ALL Different, 9 Flume, 5 Palestine only 7c to approval applicants. Wonder Lake Stamp Co., Ringwood, Ill.

SEYCHELLES, Nejd, Caymans, Manchukuo, Brunel, Turks Caicos, British Solomons (Cannibal), Everything 3c with approvals. Viking, 130-Z Clinton St., Brooklyn, N. Y.

ADULTS! Free! "Treasure packets" Unpicked, mission mixture, off paper, highest grade, not cheap bulk mixture. Quality, not quantity. 1200, \$1.95; 2400, \$3.75; 3600, \$5.50; 4800, \$8.00. **Pioco Co., P.M.O. 134-4 Tanforan, San Bruno, Calif.**

BEST Approvals. Low prices. Write Melbee, 149-36 Beech Ave., Flushing, New York.

750 MIXED U. S. 10c, 200 mixed revenues 13c postpaid. Potter, 1314-P McGee, Kansas City, Mo.

FREE! Western Hemisphere packet. Postage 3c. Owens, 806 Welsh, Bay City, Michigan.

AUSTRALIA! The "Land Down Under." 25 diff. 5c. Coleman, North Wales, Penna.

1000 U. S. Mixed, dime and 4c postage. Jem Stamps, Port Jefferson, N. Y.

FREE! Complete "United States" stamp catalog with 1,000 illustrations! Send 3c for postage. Harris & Co., 137 Transit Building, Boston, Mass.

AIRMAILS! 25 Different, 25c; 50 different, 50c; 100 different, \$1.00. Ernie Phillips, Azusa, Calif.

PRINTING—Stock forms. Samples for stamp. Keelerprint, 3822-W Ogden, Chicago.

VICTORY Packet free—Includes stamps from Tanganyika, British Cayman Islands, animal, scarce babyhead, coronation, early Victorian, airmail, map stamps, with big catalogue—all free. Send 5c for postage. Gray Stamp Company, Dept. PM, Toronto, Canada.

MEXICO Census commemorative set free with approvals. Pladon Stamps, 1717-M Idaho, Toledo, Ohio.

WHOLESALE Supplements to dealers for 10c postage. Hundreds of bargains. Grossman Stamps, 102 West 42nd, New York.

15,000 VARIETIES 1c, 2c each! Davison, Box 31A, Wollaston, Mass.

60 DIFFERENT U. S., including commemoratives, airmail 10c. No approvals. Seidenberg, Cassopolis, Mich.

FREE! Austria war set. Postage 3c. Williams, 606 Archer, Bay City, Michigan.

FREE! Pony Express set (facsimiles). Postage 3c. Roberts, 406 Building, Bay City, Michigan.

FREE! Leeward Is., Cayman Is., Turks and Caicos plus 60 different mint Geo. VI coronation poster stamps, to approval service applicants sending 3c postage. Tatham Stampco, Springfield-30, Mass.

DEALERS—Wholesale list. Postage 3c. Frank's, 4900 Chalmers, Baltimore, Md.

NEW 1942 Bargain packet—Over 100 different stamps; includes strange "mystery stamp" now prohibited in United States mail; stamps you'll treasure from Aserbaljan, Georgia, Transcaucasia, etc. Complete packet for only 5c to approval applicants. Cactus Jr. Approvals, Box 1870-M, Tucson, Arizona.

UNITED States approvals complete coverage, fine quality, attractive prices. Seminoles Stamps, Box 436, Coconut Grove, Florida.

WEEKLY Stamp magazine, thirteen weeks, 10c. Stamp Journal, Kalamazoo, Mich.

A REAL Bargain. Specially prepared packet containing 150 different foreign and 65 different U. S. stamps; catalog value about \$5.00; pamphlet which tells you "How to Make Your Stamp Collection Properly" and large bargain lists, all for only 23c postpaid. Queen City Stamp Co., Room 36, 604 Race St., Cincinnati, Ohio.

PENNY Approvals, that satisfy. Neil Gronberg, Box 5441-P, Philadelphia, Penna.

\$1.00 (CAT. Price) for 1c! Two mint U.S.A., cat 20c; "queer countries" packet (Djibouti, Manchuria, etc.); scarce set Russia, cat. 75c. Everything for only one cent to approval applicants! Garcelon Stamp Company, Box 400, Calais, Maine.

GIANT Packet 136 all different from Africa, South America, South Sea Islands, etc. Includes Nicaragua airmail, two scarce unused United States cataloging 20c, triangle and animal stamps; many others. Also includes fine collection 25 different British Colonies—Charkari, Jamaica, Johore, etc. and United States \$4 and \$5 high values. Total catalog price over \$4.00! Everything for only 5c to approval applicants! Mystic Stamp Company, Department 80-A, Camden, New York.

SEND Postage for free United States price list. Stanley Gibbons, 38-P Park Row, New York.

CANADA 100 Different 25c—approvals all countries. Lists. Victoria Stamp Co., London, 4, Canada.

SMOKY Mountain commemorative sheet, largest U. S. stamp issued, and 33 U. S. including commemoratives, airmail, revenues, etc. Catalogs 75c—To approval applicants for 5c. Curhan Stamp Company, Gloucester, Mass.

U. S. Approvals. Complete stock. Big cash discounts. Box 488, Minneapolis.

U. S. \$2.00 stamp No. 572 (perf. init.) 10c to approval applicants for U. S. approvals. M. Haycock, 61A O'Brien Place, Brooklyn, N. Y.

HOBBIES AND COLLECTIONS

SPECIAL Albums for match books. Albums, also, for photographs, phonograph records, etc. Free booklet. Matchless Album Co., Dept. P, Long Branch, N. J.

BEAUTIFUL Abalone shells, brilliant finish—make beautiful gifts and decorations. 12 assorted prepaid \$1.00. Abalone Shells, Box 66, Rockport, California.

FOR Genuine desert ruby and sapphire send quarter to Mineral Specimens, Box 2651, Phoenix, Arizona.

75 THOUSAND Political buttons, rare kind, 40—\$2.00 postpaid. S. Hoffman, 929 Locust St., Philadelphia.

POSTCARDS, Old music, records. Lists 10c. Songwriting. Fore's, (Dept. R), Denver, Colorado.

STEER Horns for sale, six foot spread, free photo. Lee Bertillon, Mineola, Tex.

BEAUTIFUL Jewelry stones removed from rings, etc. 100 assorted \$2.00. Lowe's, Box 311, St. Louis, Missouri.

NEW—15 Different match covers 10c. Box 202, Rochester, N. Y.

EXCHANGE Your duplicate stamps, match covers, etc. with collectors everywhere. List swappers, dime. (Mention hobby.) Secretary, Box 2164, Denver, Colo.

CAMERAS AND PHOTO SUPPLIES

FILING Viewing systems, 35 mm., larger colored films. Filmdex, Mount Kisco, New York.

SPEED-O-COPY Groundglass focusing attachment for Leica, Contax, Argus C-2 and C-3. Send for literature. D. Paul Shull, Dept. PM-9, 240 So. Union Ave., Los Angeles, California.

NATIONAL Graflex II Sunshade and P.3.5 Tessar \$69.00. Contax II with case and P.3.5 Tessar, like new, \$170.00. Leica F with case and P.3.5 Elmar \$120.00, worth \$268. Dollina II with case and 2.9 Radionar \$85.00. Many other bargains. Send your camera in trade—or we buy for liberal cash price. Mail your outfit to us. We send check same day received and hold outfit 10 days for your acceptance. Barbeau's, Oswego, N. Y.

CAMERAS And supplies. Free illustrated catalog listing everything photographic—still and movie cameras, films, lenses, enlargers, meters, supplies—at tremendous savings. Hundreds of bargains. All guaranteed. We take your old camera or equipment in trade. Write now for your free copy of our newest money-saving bargain book—just out! Limited edition. Hurry! Central Camera Co., (Photographic Headquarters since 1899), 230 S. Wash Ave., Dept. J-16Z, Chicago, Illinois.

OIL Coloring photographs a fascinating hobby or profitable business. Learn at home. Easy simplified method. Previous experience unnecessary. Send for free information and requirements. National Art School, 1315 Michigan, Dept. 3447, Chicago.

THIRD-DIMENSION Camera very cheap, easily made, excellent results, plan 30c. Dolan, 237 Elm, S.W. Grand Rapids, Mich.

HAVE You a camera? Send ten cents for recent number of our big magazine, showing how to make better pictures and earn money. American Photography, 116 Camera House, Boston, Mass.

BASS Says: Astounding buy, exclusive here, latest Argus C3 with coupled range finder, synchro flash, 50 mm. F:3.5 lens, also 75 mm. Bausch & Lomb telephoto F:5.8 also coupled to range finder, \$82.50 value; price \$60.50, unconditionally guaranteed. Cowhide Eveready case, \$4.75. V. P. Ihagee Deluxe, F:4.5 lens, Prontor shutter, big value at \$18.75. Send for yours quick while they are available. Write for quotations and advise what you have to trade. We pay cash for good cameras, lenses, binoculars. Don't trade until you write Bass Camera Company, Dept. AG, 179 W. Madison St., Chicago.

MAKE Money in photography. Learn quickly at home. Easy plan. Previous experience unnecessary. Common school education sufficient. Booklet and requirements free. American School of Photography, 1315 Michigan, Dept. 3432, Chicago.

CAMERA Repairing. Bellows made to order, shutters repaired. Bellows made to fit all standard cameras! United Camera Co., Inc., A-1515 Belmont, Chicago.

CASH! Spot cash for cameras, lenses, binoculars, movie or still, sound projectors. Send full description by mail, or wire for prompt cash offer. Over 30 years of dependability insures honorable dealings. Bass Camera Company, 179 West Madison Street, Chicago, Illinois.

PHOTO Enlarger—Make it yourself. Costs little. Simple to make. Illustrated instruction book 25c. Popular Mechanics, 200 E. Ontario Street, Chicago.

PHOTO FINISHING

FILMS—8 Exposure, enlarged to double size 30c. Or 8 exposures negative size only 25c. Finest quality. Fast service guaranteed. C-C Photo, Box No. 280, West Chester, Penna.

OUTSTANDING Pictures because individual attention given each negative. No mass production methods. Roll developed and 8 guaranteed prints only 25c. 8 beautiful full size 4x6 enlargements 35c. Immediate service. Write for mailing bags. Minicam Photo Labs., Dept. 90, LaCrosse, Wisconsin.

ENLARGEMENT 4x6 in colors and film developed 8 Velox deckled-edge prints, 25c. Free film mailers 1-day service. Mail films to Joy-Photos, Dept. 28, GPO Box 606, New York, N. Y.

35 MM., Argus, Leica, etc. (except "Mercury") 36 exposure rolls, fine grain developed (Eastman DK-20) and beautifully enlarged to 3"x4" glossy prints, 90c. Cartridge reloaded with Eastman Plus X, 35c. 18 exposure rolls, 55c, reload 20c. Films permanently protected by revolutionary Cryolyte process. 24-hour service. Satisfaction guaranteed. Free mailing bags, sample print. Write Technifinish Laboratory, 606 Brown St., N. W., Rochester, N. Y.

SIXTEEN Guaranteed Velox prints, enlargement coupon, roll developed, 25 cents. Laurent, Box 116, Eastwood Sta., Syracuse, N. Y.

20c FILM Developed, 8 Velox Microtone prints, guaranteed workmanship. Wilson's, GPO Box 202, New York.

OIL Coloring photographs a fascinating hobby or profitable business. Learn at home. Easy simplified method. Previous experience unnecessary. Send for free information and requirements. National Art School, 1315 Michigan, Dept. 3437, Chicago.

16 SPARKLING Lifetone prints, 2 beautiful Hollywood enlargements, free Leathertone frame and photo wallet only 25c. Free photo album with first order. Lifetone Studios, Dept. A-1039, Des Moines, Iowa.

8 EXPOSURE Rolls, giant size 25c; 16 exposure rolls, 50c. Mayfair Photos, Box 261-K, Toledo, Ohio.

"SUPERFINE" — 35mm. 36 Exposure rolls developed, chemically hardened and enlarged semi-matt or glossy with exclusive "Exposurequalizer," to 3 1/4 x 4 1/2, \$1.00. Your cartridges respooled 35c. Our laboratory head pioneered 35mm. photography. Send for free mailing. Superfine Laboratories, 113 Court Street, Newark, N. J.

EMBOSSED Deckled-edge Christmas cards including envelopes from your own negative, 25 for \$1.25, 12 for 75c. Sample order 4 for 25c. Film Capitol Service, Box 504, Rochester, New York.

NO Free offers! No automatic printers! Individual attention to each negative. Roll developed and eight sparkling prints 25c. Immediate service. Write for free mailing bags. Universal Photo Service, La Crosse, Wisconsin.

ENLARGEMENTS On beautiful portrait paper—Four 8x10 \$1.00; six 5x7 \$1.00; ten 4x6 \$1.00. From photograph 50c extra. Miniservice, PMO2, Box 318, GPO, New York.

EIGHT Beautiful enlarged prints (nearly postcard size) or 16 regular prints 25c. 35mm. rolls enlarged 3 1/4 x 4 1/2, \$1.00. Burton Studios, 443M, Roscoe, N. Y.

16 SPARKLING Lifetone prints, 2 beautiful Hollywood enlargements, free Leathertone frame and photo wallet only 25c. Free photo album with first order. Lifetone Studios, Dept. A-1039, Des Moines, Iowa.

FREE Colored enlargement, 8-16 exposure, 25c. Send color data. Midwest Laboratories, 1153 S. Cuyler, Oak Park, Ill.

COLORS Lifelike enlargements from your snapshot negative 5x7, 25c; 8x10, 40c. Promenade Photos, 13 St. Marks Place, New York City.

ANY 35 mm. 36 Exposure film fine grain developed; 36 3 1/2" x 5" enlargements \$1.25; 18 exposures 95c. If you don't think these prints the best you ever bought, return film and prints and receive double your money back. Write for sample print and free mailing bags. Prime Photo Labs., Dept. A, Box 1283, Milwaukee, Wis.

BIGGEST \$1.00 Value in 35 mm. finishing today. 36 exposure fine grain 3 1/4 x 4 1/2 enlargements; deckled, embossed margin and date. Eighteen exposures 75c; sixteen exposure splits 55c. Free mailers. 8 exposure rolls in beautiful deckled contact finish with embossed wide margin, 25c. Mailbag Film Service, Box 5440 A, Chicago.

WITH Every 6 or 8 exposure roll, 2 full sets prints, 25c. Skyland Studios, Box 411-M, Asheville, North Carolina.

ROLL Developed and 4x6 oversized glossy Velox prints, 8 exposure 30c; 12 exposure 45c; 16 exposure 60c. Overnight service. Clemet Photo Service, 1318 W. Columbia Ave., Philadelphia, Penna.

IDEAL Photos beautifully finished wide border—deckle-edge, 25c per roll of eight. Fade-proof, superior quality. Write for free mailers. Ideal Photos, Box 2255, Paterson, N. J.

ROLL Developed, eight snappy 4x6 enlargements, or sixteen sparkling prints 25c. Crystal Studios, Box 159-F, Rushford, Minnesota.

THE Photo Mill. Immediate service! No delay! Eight exposure roll developed, printed and coupon for your choice of two beautiful 5x7 professional enlargements, one tinted enlargement, eight prints or other premiums, for 25c coin. Developing and eight Jumbo prints 30c coin. The Photo Mill, Box 629-12, Minneapolis, Minnesota.

EVERY Picture an enlargement! 8 sparkling deckle-edge enlargements and roll developed 25c coin; 116 size or smaller; enlarge reprints 3c. Enlarge Photo, Box 791D, Boston, Mass.

IMMEDIATE Service! Pictures returned same day order received. Sixteen guaranteed deckle-edge Velox prints from roll, 25c. One colored or two plain enlargements plus 8 deckle-edge Velox prints, 25c. Free! Coupon for 8x10 enlargement free with each 25c order. Any 35 exposure 35mm. film fine-grain developed. "Magic-Eye" timed, vaporated and each good negative enlarged to 3x4 on deckle-edge Velox paper, \$1.00. 18-exposure, 60c! Reloads: 36 exposure, 50c; 18 exposure, 35c. 3x4 deckle-edge reprints, 3c each! Write for free mailers, free premium offers. American Studios, Dept. 406, LaCrosse, Wis.

ROLLS Developed; two prints each negative 25c. Reprints 2c each; 100 or more, 1 1/2c. Summers Studio, Unionville, Mo.

3 1/4 x 4 1/2 ENLARGEMENTS From 36 exposure roll \$1.00, 18 exposure roll 75c. Double size prints, 8 exposure 828-127-120 rolls 25c. 8 exposure 116-129-130 rolls 30c. Split rolls 45c. Write for complete price list. Village Film Laboratories, Box 4046, Dept. M, Village Station, Los Angeles, California.

SIXTEEN Beautiful Holly-tone prints with eight exposure roll developed—25c. Hollytints, P-1350, Hollywood, California.

BEAUTIFUL Enlargement from each picture on roll 25c. Cut Rate Photos, Dept. B-4, Janesville, Wis.

TWO Beautiful prints from each picture on roll 25c. Twenty-two years of satisfied customers. Quick service. Lens Photos, Dept. J-4, Janesville, Wis.

THREE Prints each good negative, 6 to 8 exposure rolls, 30c. 12, 16, 18 exposure rolls, 50c. Reprints, 3c. Fred D. Eastman, Bode, Iowa.

ROLL Developed and 8 lustrous distinct finish permanent Velox glossy prints 25c—reprints 3c each. Fotoprint Service, Box I, Roanoke, Virginia.

8x10 SILK Finish enlargement—25c. Send negative. Irving Studio, 4006A Irving Park, Chicago.

DOUBLESIZE Prints. Your roll developed and 8 doublesize prints 25c; from 116 or 120 size negatives you receive 4x6 inch prints. All other size negatives printed in proportion. 16 exposure rolls 50c; 12 exposure rolls 35c. Reprints 3c each. "Our guarantee." Everlasting hi-gloss finish. Overnight service. Pacific Photo Service, Box 666, San Francisco, Calif.

16 BEAUTIFUL Oversize deckled prints and two enlargements with first order 25c. Owlphoto M.I. Weatherford, Oklahoma.

PHOTOGRAPHY For pleasure and profit. Prepare at home. Common school education sufficient. Write for information and requirements. American School of Photography, 1315 Michigan, Dept. 3451, Chicago.

MOTION PICTURES AND SOUND EQUIPMENT

100' 16MM. Used sound films. \$1.00 postpaid. Blackhawk Films, Dept. PM1, Davenport, Iowa.

\$1 BRINGS "Surprise" assortment 8mm colorful titles! LeMoine Films, Nevada, Missouri.

LATEST Film lists and equipment. New film exchange. Paramount Mfg. Company, G-106, Box 224, Back Bay, Boston, Mass.

EXCHANGE 8mm, 16mm. film subjects (silent) 25c, (sound) 50c. Application and sample film 3c. B-49, 2209 Main Street, Bridgeport, Conn.

FREE, 1942 Movie catalog; sample films 10c. Goodwill Company, Jackson, Tenn.

12 FILMS, Roundrobin, \$1.00. Movie Amateurs, 2521 Upham, Madison, Wis.

35MM. Films. Projectors. Silent. Sound. Demsey, 1223 Berkley, Youngstown, Ohio.

16MM. Silent sound sales. Lists free! Sound rental catalog 10c. Waverly, 5119-P South St. Louis, Chicago.

100 FEET 8-16mm. silent-sound 59c. Castle official films, bought-sold-exchanged. Catalogue-sample film 10c. International, 2120 Strauss, Brooklyn, N. Y.

FREE: New movie rental library catalog. (Please specify model projector). Sale 16mm. sound projectors; 8-16mm. movie equipment, film, cameras, screens, trades accepted; easy payments. Mogull's, 64 West 48th, New York.

RENT—Buy—Sell. 8mm.-16mm. movie equipment, films. Save 50%. Catalogues for 10c. Don Elder's, M-739 Boylston, Boston, Massachusetts.

LEARN Movie projection, management. Free catalog. Give age. Theatre Institute, Elmira, N. Y.

"THE World's Greatest Passion Play." Large rental library 16mm. sound or silent. Write Hemenway Film Co., 33-F Melrose St., Boston, Mass.

BASS Says: War time means Bass as the logical supply center for hard to get cine equipment. We have it. Write for latest condensed Cine price list, 8 mm. and 16 mm., and sound. New Reverse double 8 with F:3.5 lens, \$38.50. RCA 16 mm. S.O.F. newsreel camera, \$325.00. Spot cash for good used movie equipment and sound projectors. Bass Camera Company, Dept. A, 179 W. Madison St., Chicago, Ill.

SEVEN Emulsions for all 8mm. movie cameras! Spooled ready for use, or bulk. Save 30%. ESO-S, 3945 Central, Kansas City, Missouri.

8-MM.-16MM. Silent-sound; all latest subjects. Films rented everywhere. Free catalogue (sample film 10c). Garden Film, 317 West 50th, New York.

8MM.-16MM. Films. Free catalogue (sample film 10c). Parkway Exchange, 991 Eastern Parkway, Brooklyn, New York.

MUSIC AND MUSICAL INSTRUMENTS

WANTED—Piano accordions—any condition. Send description. Immediate cash. Chaton, 600 Blue Island, Chicago.

MELODY Composed for poem with complete pianoscore. Sent "on approval," no down payment. Investigate. Ben Mo-manus, Box 342, Syracuse, N. Y.

THE Ideal gift to music lovers; "cross-note puzzles." Entertaining, instructive. 40 pages. \$1.00. Charles D'Alco, 190 Sackman St., Brooklyn, New York.

SONG Writers—My plan gets results. Cash in on your song. Write, Clayton E. Wills, Box 404, Prestonburg, Ky.

SONGWRITERS: Send poems for offer and free rhyming dictionary. Phonograph records made. Vanderbilt Studios, Box 112-D.N., Coney Island, N. Y.

SONGS—Song poems wanted. No charge for melodies. Free examination. Hollywood Recording Studios, 87G21 Preuss St., Los Angeles.

SONG Poems wanted for musical setting. Submit poem for immediate consideration. Five Star Music Masters, 630 Beacon Building, Boston.

SONGS, Song poems, wanted. Work with Hollywood studio composer and arranger. Publication royalty basis. Radio Music Co., 6912 Hollywood Blvd., Hollywood, Calif.

SONGS, Poems wanted. Newart Song Publications, 1207 Carbon, Syracuse, N. Y.

NEW And used accordions bought and sold. \$25.00 up. Ace-Music, 307 So. Wabash, Chicago.

LEARN Popular piano! Write Magic Key, 111-A Broadway, Glendale, Calif.

SONGWRITERS! Have us compose music to your words. Write for information about Rhythm Patterns. Melody Music Publishers, Box 928, Dayton, Ohio.

SONGWRITERS! Amazing outstanding offer. Hibbeler, C5, 2157 No. Avers, Chicago.

SONGWRITERS. Write for free booklet, profit sharing plan. Allied Music, 204 East Fourth, Cincinnati, Ohio.

SONGWRITERS: Write for free instructive booklet concerning song poems. United Music, Dept. 14, Salem, Ind.

SONGWRITERS—Send poem for immediate consideration and free rhyming dictionary. Richard Brothers, 24 Woods Building, Chicago.

GOOD Music composed to good words. Reginald Belcher, Chatham, New Jersey. Established 1910.

MUSIC Composed to words. Rhyming pamphlet on request. Phonograph recording of completed songs. Send poem for consideration. Keenan's Studios, Dept. PM, Box 2140, Bridgeport, Conn.

WANTED! Lyrics, melodies for songs. We arrange, publish, sell. Superior Song Studios, Passaic, N. J.

MUSIC Composed to words. Wonderful proposition. Bauer Bros., Oshkosh, Wis.

LEARN Swing piano! Postal brings free folder. Christensen, 451 Kimball Hall, Chicago.

WRITE Songs. Big money and reputation. Write for information. J. Gordon Pub. Co., 201 N. Hoynes, Ave., Chicago.

RADIOS AND SUPPLIES

CASH For used radio test instruments and meters. Wanted: Oscilloscopes, volt-ohm-milliammeters, vacuum-tube volt-meters—RCA, Hickok, Supreme, Precision or equivalent makes. Also 0-1 milliammeters and 0-5, 0-10, 0-25 AC or DC ammeters, 3-inch size. Required in war training. Send equipment for liberal appraisals to Allied Radio Corporation, Dept. 5-K-C, 833 West Jackson, Chicago.

RADIO Service men and experimenters send for our giant radio catalogue. Save dollars. United Radio Co. (100M), Newark, N. J.

MAKE Your own simple long distance crystal radio. Illustrated instructions 25c. Alva Allen, PM427, Clinton, Missouri.

RADIO Communications courses qualifying for all federal licenses. Home study and resident courses. American Radio Institute, 1123 Broadway, New York, N. Y.

BUSINESS OPPORTUNITIES

START Home business making statuary, plaques, art goods, novelties, souvenirs, concrete pottery, garden furniture, artificial marble flooring, liquid marble. Make your own flexible molds. Amazing profits. Valuable folder free. Creative Publishers, (PM10), Glencoe, Illinois.

DON'T Be a job hunter—Start your own business on our capital. No hard-times; no layoffs; always your own boss. Hundreds average \$3,000 to \$5,000 annual sales year after year. We supply stocks, equipment on credit. 200 home necessities. Selling experience unnecessary to start. Wonderful opportunity to own pleasant, profitable business backed by world wide industry. Write Rawleigh Co., Dept. J-U-PPMB, Freeport, Ill.

FOR An extremely profitable lifetime business, operate a collection agency-credit bureau. Many make \$4,000 yearly, up. Write Cole Associates, Syracuse, N. Y.

PERMIT To publish. Mail selling "natural." Gives better odds. Write. Maupin, LaFayette, Ind.

LIFETIME Business. Steady income. Repairing sewing machines. Book instructions \$1.00. Connan, 114 S.E. 74, Portland, Ore.

HOME Work business. Many propositions. Suggestions free. McPherson Stamp Works, Middletown, Connecticut.

U. S. Unused postage stamps wanted; small discount. Advance Stamp Co., 24 East 23rd Street, New York.

START Sideline mail order business. Small capital. Legitimate. Choose from several propositions. Details free. Gasser, 4908 West 21st, Los Angeles, California.

EXTRA Money—Operate sideline. Home—sparetime. One plan free. Stamp please. Bates, 10 Forsyth Crescent, Toronto, Can.

JOIN The mail order inner circle. Send stamp for details. Charles Hansen, 7603 60th Place, Argo, Illinois.

MONEY Maker. Formula for making the best penetrating oil on the market. Only 50c. Wm. A. Farnsworth, 801 West Main St., Bellevue, Ohio.

RECEIVE Gigantic mails and samples. Your name on many mailing lists 10c. Edgington, 631 East 2nd, Casper, Wyo.

MAKE Your own Flexible Molds. Statuary, Art Goods, Novelties, Artificial Marble Flooring, Liquid Marble. Literature free. Kemico, 109-M, Park Ridge, Ill.

SWISS Music box works—\$1.25 to \$2.10. Suitable for many novelties. Mermod Manufacturers, 147 West 46th Street, New York.

MILLION Articles. Buy wholesale. Valuable directory 10c. Ideal Service, D-9, Park Ridge, Ill.

FIRE Detector unit, patented. Underwriters' labeled. Complete manufacturing equipment, sell outright. Distributors wanted. A. Moss, 4046 Chouteau Ave., St. Louis, Mo.

CHRISTMAS Cards: Earn money easily, quickly. Regulars, Catholics, olettes, humorous, etc. Also four outstanding personal lines. Free samples. Evers, Elmhurst, N. Y.

FREE—200 clever mailorder, homework, local business offers—all snappy money-makers. Lewis Co., 828-M Carpenter, Oak Park, Illinois.

MAKE Artificial marble, glazed tiles, plaques, flooring, pottery, novelties. Beautiful samples 3c. Payn, 945 Grande Vista (Room 101), Los Angeles, Calif.

4 MOST Read mail order magazines, 15c. Armand Cartier, 695A North, Pittsfield, Mass.

GO After the job you've dreamed of. Our guidance will help you. Gatto Associates, Trenton, N. J.

MECHANICALLY Inclined men—Own and operate general appliance repair shop. Complete, illustrated course shows you how. Welding, refrigeration, motor repair, how to get business, etc. all phases covered. Free literature. Christy Supply, Dept. 121, 2835 N. Central Ave., Chicago.

DOUBLE Your money back—if not delighted with amazing new folio. "Handsome Profits Without Merchandise." Rush only 8c (stamps accepted) for this eye opener today! Challenge Association, 10, Cincinnati.

SELL Books by mail on commission. These books appeal to everybody desiring financial improvement. Circulars furnished. Orders come to you. No stock to carry. Maywood Publishers, P 1133 Broadway, New York.

START A small business of your own. Big 150 page bound book contains 1000 ideas for making money. No capital needed. Price \$1.00 C.O.D. Money back guaranteed. Wineholt Co., Box B5, Woodbine, Penna.

SIGNS And showcards easily and expertly painted with letter patterns. Many sizes and styles. Write for descriptive folder. John Rahn, A1330 Central Ave., Chicago.

EXTRA Income—Plenty mail selling opportunities. Write Katz, 4254 N. Kimball, Chicago.

EXCELLENT Local opportunity developing upholstery cleaning business through our own successful methods. Enormous profits! Or sell our special repeat product by mail. Free literature. Shinnette, 2621D Atlantic Ave., Brooklyn, N. Y.

2c DAILY Pays for New York office under your own name. Co-Operative Offices, 126 Lexington Avenue, New York.

YOUR Sparetime, my ideas, worth cash. Possibly quick fortune. Positively no selling, soliciting, embarrassment or "bunk." Sreka, North Hollywood, California.

FREE Booklet. How to manufacture many products. Western, 201 Climax Bldg., Cleveland, Ohio.

COLLECT Your own accounts. Money-back guarantee. Creditors Service, Moorcroft, Wyoming.

BRUSH Plating outfits connect to a battery, no tanks necessary. Almost as simple as painting. Your opportunity to make good income plating autoparts, bathroom fixtures, reflectors, mirrors. Get free proof and particulars that put you in a paying business of your own. Gunmetal Co., Ave. H, Decatur, Illinois.

OPERATE Route used 1c, 5c candy bar, peanut, popcorn, gum vendors. Lowest prices. Northside Company, Indianola, Iowa.

COLOR Cement with chemicals. Make artistic cement garden ornaments Hollywood style. Sample 10c. Hollywood Cementcraft, 8527 Wonderland, Hollywood, Calif.

STATUARY: Make all kinds. Simple process. Make and install artificial stone flooring in color. Liquid marble. Other money-makers. Write promptly. Literature free. Compo-Tex, Box 786, St. Louis, Mo.

PLASTEX Industries offers industrious men an opportunity to start a business of their own, manufacturing art goods, novelties, souvenirs, etc., in Plastex and marble imitation. 5c material makes \$1 articles. Rubber moulds furnished for speed production. Small investment brings good returns. We are now placing big chain store orders with manufacturers. Write for interesting booklet mailed free. Plastex Industries, Dept. A, 1085 Washington Ave., New York.

WEBER Typewriter Mechanics School. Simplified homestudy-repairing increasing. Canton, Ohio.

HOW And where to obtain capital. Fully explained, particulars free. Star Service, Wapakoneta, Ohio.

POPCORN And potato chip machines. We help start men and women in business. Long-Eakins, 1960 High, Springfield, Ohio.

CHARTERS: Delaware; best, cheapest; free forms. Colonial Charter Co., Wilmington, Del.

127 WAYS To make money, in home or office, business of your own. Full particulars free. Elite Co., 214 Grand St., New York.

\$50.00, \$100.00 WEEKLY Using sawdust. Stamp please. Clement, 943 Arthur St., Rochester, N. Y.

MONEYMAKING OPPORTUNITIES

SCHOOL Seniors—Sell America's most beautiful distinctive graduation name cards. Positively highest commission. Lowest prices. Free sample kit. Printcraft, 1423 E. Elm Street, Scranton, Penna.

THE Battery emergency is here!—Represent "The Recuperator" Long Life Battery Service registered U. S. Patent Office, 1934. Thousands of satisfied customers. Sells to fleet owners, private car owners, boats, trucks, tractors, etc. This is the most timely product we know of today. Get full details. Alpha Distributing Co., 1025 N. Highland Ave., Hollywood, Calif.

MAN, You'll like silvering mirrors! Making chipped glass nameplates, signs, grave-markers. Outfit prices. Sprinkle Plater, 42, Marion, Indiana.

MOLDMAKING—Plaster Casting. Complete formulas—fully illustrated. 25c. Ideal Service, RM-9, Park Ridge, Ill.

MONEY By mail—no investment. Send name. O'Brien, 71 Main, Meriden, Conn.

CO-PUBLISH For profit! "For a Better America." Details, sample magazine, 10c. Lee Bell, 402 Grand, Oakland, California.

"MY-PLAN" Brought me over \$5,000.00. Started with \$1.25. Information free. Taylor, Box 363-P, Hapeville, Georgia.

MONEY Making opportunities for you in mail order business. Free details. Krach Service, 9901 Union Ave., Cleveland, Ohio.

EARN Money, copying and duplicating comic cartoons for advertisers. Ad-Service, Argyle, Wisconsin.

BOOKKEEPERS—Profitable opportunity for efficient bookkeepers. Ralph Lee, Vicksburg, Michigan.

OPERATE Profitable business in your home. Very little capital required. Particulars free. Lumco, Kimball, Nebr.

THE Knack of making money in any job, business or profession easily mastered if you know how. Send 3c stamp, I'll tell you how. Campbell, R 3, Sherwood, Oregon.

START Your own business with few dollars in sparetime and build as big as ambition demands. No experience. No canvassing. Not a trashy offer but something worthwhile. Details for 10c. One of our best 25c moneymaking plans. Free if you act quickly. Master Novelties, 1517 First Avenue, New York.

MAKE Money at home by mail. James, Box 1430, Long Beach, Calif.

SPARE Time income. Details, including profitable 25c plan, 10c. Maggard, Box 864-P, Wadsworth, Kansas.

BE Notary public, make money. School, H-30 W. Washington, Chicago.

MAKE Money in your sparetime. Interesting business. Stamp brings valuable information. McDougle, Box 564, Birmingham, Ala.

UNDOUBTEDLY One of the best mail order plans. Definitely new. 25c brings sample and complete details. Start small, grow big. Unusual, inexpensive product profitably and easily sold. Box PM-353, Macon, Ga.

MIGHT Consider financing chemist able to perfect tarnish-proof container for silver-ware. Address P.O. Box 1275, Milwaukee, Wisconsin.

THE Knack of making money in any job, business easily mastered if you know how. For details write Leo Adams, 492 Barrett St., Elgin, Ill.

HUNDREDS Moneymaking opportunities, information, circulars, magazine, free. Gale, 14646 Roselawn, Detroit.

"MAIL Order Digest" offers profits to co-publishers; free information. Mako Sales, 5226 Tennessee, St. Louis, Mo.

LEARN Metascience. Remarkable drugless healing. No manipulation. No apparatus. Unbelievable simplicity and results. Inexpensive correspondence course. Write Metascience, De Land, Florida.

FORMULAS, PLANS, ETC.

FLEXIBLE Molds for plaster casting. Newest sensation. Details free. D. Dykes, 918 Alabama, St. Joseph, Mo.

MAKE Fast selling products. No machinery. "Chemist Approved Formulas." Literature free. Kemico, 15, Park Ridge, Illinois.

SINGLE-INGREDIENT Formulas. No manufacturing! Information free. A. Kinford, Wayne, Penna.

"LUMINOUS Paint" shines in dark. Easily made. 100 other formulas, plans—all 25c. Ideal Service, 309, Park Ridge, Ill.

MECHANIC'S Waterless soap 2c pound. Formula 10c. Gerwin, Alva, Oklahoma.

23 YEARS Supplying authentic formulas. Catalog free. Grinstead, Edwardsville, Illinois.

FORMULA Messenger describing America's leading, latest chemical specialties. Miller's Chemists, Tampa, Florida.

AUTHENTIC Formulary 924 pages (illustrated), 10,000 money making formulas, recipes, instructions, substitutes. \$1.75 postpaid or C.O.D. (foreign \$2.10). Catalog 3c. Adams Brown Company, Chestnut Hill, Massachusetts.

FORMULAS—Latest, best. Analysis. Literature free. Belfort, Engineering Building, Chicago.

ICELESS Ice! Colder; cleaner; cheaper. Instructions 25c. Duffy, Covington, Ky.

REAL Manufacturing formulas. Lists free. Cummings, Chemist, Gordon Ave., Syracuse, N. Y.

CHEMISTRY

WINN'S New Idea Chemical Kits for high school and college students. Send 5c for literature and chemical supply catalog. Winn Co., Dept. 500, 124 W. 23rd St., New York.

COLCHICINE—Evolution chemical creates new, mutant plants. Illustrated booklet—plus experiments magazine 25c. Questok, Wellesley, Massachusetts.

CHEMICAL Magic set, performs mystifying experiments, 50c. Chem-Lab, Harvey, Ill.

FREE Catalog: chemistry, mineralogy, biology. Special: 28 piece chemistry set, send \$1.00. Tracey Laboratories, Evans-ton, Illinois.

CHEMISTRY Laboratory apparatus and chemicals for industrial, analytical, and private experimental laboratories. Complete chemical laboratory supply service for correspondence school students. Send 3c for free 48-page catalog of chemicals and apparatus. Dept. M-43, Biological Supply Co., 1176 Mt. Hope Ave., Rochester, New York.

SPECTROSCOPE For quick chemical analysis \$2.50. Kutting Sons, Campbell, California.

HELP WANTED

MEN! U. S. Government's urgent "Grow More Food" campaign your opportunity for big cash earnings, even spare time, selling famous Stark Fruit Trees to farmers, gardeners, home owners. Equipment free. Stark, Dept. B-127, Louisiana, Missouri.

BIG Money taking orders; shirts, ties, hosiery, underwear, pants, jackets, sweaters, uniforms, etc. Sales equipment free. Experience unnecessary. Nimrod, 4922-BG Lincoln, Chicago.

CALL On friends with sensational personal Christmas cards from 50 for \$1.00 up. Stationery. Also magnificent 21 card \$1.00 assortment. Profit 50c. Experience unnecessary. Samples on approval. Wallace Brown, 225 Fifth Ave., Dept. N-34, New York.

STEADY Work—Good pay. Reliable man or woman wanted to call on farmers. No experience required. Pleasant work. Home every night. Make up to \$15.00 in a day. Wonderful new proposition. Particulars free. McNess Co., Dept. 627, Freeport, Illinois.

AGENTS WANTED

EVERY Auto owner, garage and service station is a prospect for this amazing machine that tunes up motors in one application. Increases gas mileage! Saves oil! Reduces "ping." Anyone can operate. Small and compact. Plenty of other sales points. At least \$5 profit per sale for you. Write for details. Waverly Petroleum Products Co., Drexel Bldg., Philadelphia, Penna.

ALL Embossed Christmas cards, 50 with name \$1.00. Fast sellers—big profits. Leader \$1 box pays 50c profit. Stationery, many others. No investment. Approval samples. Empire Card, 525, Elmira, N. Y.

SELL Friends 50 name imprinted Christmas cards only \$1.00—free sample. 30 assortments 50c up. Patriotic cards. Famous 21 assortment on approval. Special offer. Hedenkamp, 343 Broadway, Dept. MP-10, New York.

MAGNETIC Sponge draws dirt from clothing. Used like brush. Saves dry-cleaning. Slick discovery. Samples sent on trial. Write "Inventor," 121 Kristee Bldg., Akron, Ohio.

STEADY Employment for reliable men, selling mineral mixtures to farmers and livestock feeders. Write for information. Lucas Mineral Company, Castanea, Penna.

LORD'S Prayer, Ten Commandments, or Crucifixion, engraved on real pennies. Individually carded. Fastest 10c sellers in years. \$5.25 gross. Trial order, generous assortment, sent prepaid for \$1.00. Perkins, 4745 Broadway, M-10, Chicago.

\$1 STARTS You in business selling men's ties, ready tied Slide-On-Ties and boxed novelties. Write today for descriptive wholesale catalog, free sample materials. Philip's Neckwear, 20 West 22nd St., Dept. P-10, New York.

CHRISTMAS Card money makers. Free samples outstanding 50 for \$1 name imprinted cards. Quick selling \$1 assortments cost 50c. Other boxes 25c up. Howard P. Ellis, Dept. MP, Pitman, N. J.

MEXICAN Feather pictures. Prettiest Christmas novelty, 50c (stamps) bring \$2.00 worth samples. Refunded if unsatisfied. Mexicanart, Apartado 1593, Mexico City.

CHRISTMAS Cards—Sell 50 for \$1 with sender's name imprinted. Amazing values get quick easy orders. 15 fast-selling box assortments. Generous cash profits. No experience needed. Samples on approval. Cardinal Craftsmen, Dept. 560, Cincinnati, Ohio.

FREE Water and our concentrates, makes flavors, lotions, shampoos, 72 products, labels, bottles furnished. Quaioco, E-20030 Russell, Detroit.

DON'T Be a job hunter—Start your own business on our capital. No hard times; no layoffs; always your own boss. Hundreds average \$3,000 to \$5,000 annual sales year after year. We supply stocks, equipment on credit, 200 home necessities. Selling experience unnecessary to start. Wonderful opportunity to own pleasant, profitable business backed by world wide industry. Write Rawleigh Co., Dept. J-U-PPMA, Freeport, Ill.

ELEVEN Big soap deals make sales easy and a good steady income for live agents. Full cooperation and sales helps supplied. Write immediately. Midwest Drug Company, Columbus, Ohio.

EXTRA Cash! Sell Christmas cards—50 for \$1 with name imprinted. New silver printing. 21-card assortment \$1—pays up to 100%. Complete line. Samples on approval. Colonial Studios, 642 S. Summer, Dept. V-11, Holyoke, Mass.

QUICK Cash earnings easy. Show friends, others finest value Christmas cards with name, 50 for \$1. Also famous "HertelArt" 21-card \$1 Christmas assortment. Up to 100% profit. 11 assortments—Gift wraps, etchings. Samples on approval. HertelArt, 308 Adams, Dept. 419, Chicago.

BIG Profits. Sell latest auto specialty, 100%-200% profits. Wildfire repeater. Owen Kofoid, West Branch, Iowa.

MEXICAN Feather, straw, pictures; sandals, tablecloths, etc. Quick sellers! 100%-300% profit! Free particulars. Samples 10c stamps. Marquez, PD Apartado 1176, Mexico City.

HUSTLERS Needed to supply new miracle product to home and industry. Norris, 1108 Madison, St. Louis.

I WILL Give you \$5.00 worth full size packages foods, groceries, soap, etc., free if you agree to show friends and others. Amazing spare time money making opportunity. Write Zanel, 6306 Monmouth, Cincinnati, Ohio.

AT Last! Something new and sensational in Christmas cards. Amazing "Oilette" cards. Like costly oil paintings. Never before offered. Gets orders fast. Beautiful 50 for \$1 cards, name imprinted. 10 other assortments. Big profits. Bonus. Samples on approval. Puro Co., 3043 Locust, Dept. 220, St. Louis, Mo.

SELL New, different kind of Christmas cards. Embossed designs, name-imprinted, 50 for \$1. Quick cash profits. 21-card \$1 assortment pays you 50c. Other fast sellers. Samples on approval. Friendship Studios, 497 Adams, Elmira, New York.

SELL New-used clothing from home, auto, store. Men's suits \$2c. leather jackets 45c, overcoats 51c, dresses 9c, ladies' coats 35c. Other bargains. Catalog free. S&N, 565A Roosevelt, Chicago.

100 POST Cards, remit \$1.50. Carlos Gonzalez, Box 7166, Mexico City.

BIG Profits selling famous Waltham Christmas cards. 21-card \$1 assortment pays you 50c. Christmas cards with name, 50 for \$1. Complete line. Samples on approval. Waltham Art Publishers, 160 N. Washington, Dept. 628, Boston, Mass.

CHRISTMAS Card leaders bring you quick cash earnings. Name-imprinted Christmas cards, 50 for \$1, up. Sensational "prize" 21-card assortment sells \$1.00. Up to 100% profit. 11 fast-selling assortments. Samples on approval. Chilton Greetings, 147 Essex, Dept. 2-S, Boston, Mass.

AGENTS—Whirlwind profit opportunity. Finest silk Nylon, and Rayon hosiery. Big selection. Very latest styles and colors. Replacement guarantee. Your own hose free with large outfit. Rush hose size, name today. Wilknit, Dept. CO-37, Greenfield, Ohio.

MAKE Extra money easy. Show smart personal Christmas cards with name, 50 for \$1 up. Outstanding values. Also 21-card assortment, \$1; others. Big profits. Samples free. Wetmore & Sugden, 749 Monroe, Dept. 76, Rochester, New York.

BIG Money taking orders; shirts, ties, hosiery, underwear, pants, jackets, sweaters, uniforms, etc. Sales equipment free. Experience unnecessary. Nimrod, 4922-AN Lincoln, Chicago.

MAKE Money! Show exclusive Christmas cards with name, 50 for \$1, up. Large selection. 21-card "Janex Art Box" \$1; other big profit assortments. Samples on approval. Janex Art Studios, 1225 Clifford, Dept. 520, Rochester New York.

SELL Ties; free kit. Eureka, 307 W. 38, New York.

STYLOGRAPH Fountain pen. Guaranteed \$1.50 sample \$1. Stylograph, B120M, Arkansas, Wis.

PATRIOTIC Photo card mothers, wives, sweethearts of service men grab it. Write Art Supply, Box 617-M, Louisville, Ky.

BIG Clothing bargains for big profits. Used dresses 10c, men's suits \$1.00, shoes 12½c. Over 100 sensational values. Experience unnecessary. Free wholesale catalog. Superior, 1250-BW Jefferson, Chicago.

CHRISTMAS Cards—America's finest assortments. Big profits. Samples on approval. Robinson Cards, Dept. 218, Clinton, Mass.

ANTI-FREEZE Shortage! Make-sell! Simplified manufacturing processes. Guaranteed. Thermowka, Peoria, Ill.

RELIABLE People wanted to place eggine in stores and appoint agents. Used the same way as eggs in baking and cooking at 10 cent dozen. Full size package and particulars 10 cents postpaid. Morrissey, 4417-21 Madison St., Chicago, Ill.

PROFITABLE Home business. Make fast-selling products: soaps, cleaners, flavors, others. Hire agents. Free details. Maywood, P 1133 Broadway, New York.

SCHOOL Seniors—Sell graduation name cards. America's largest, fastest-selling, low-priced display, 35% commission. Free cards. Universal Engraving & Printing, Box 745-M, Pittsburgh, Penna.

USED Men's shoes 18c, hats 12c, pants 28c, dresses 10c, winter coats 50c, fall coats 35c. Bargain catalog free. Portnoy, 566-V Roosevelt, Chicago.

MEXICAN Bird pictures handmade with real feathers. Free particulars. Sample 10c. Importer C. Staff, 14960 Evanston, Detroit, Michigan.

MAKE Money applying initials on automobiles. Also, sideline salesmen for short run decal name plates. "Ralco," 727 Atlantic, Boston, Mass.

MAKE Easy money selling foremost line Christmas cards. "Leader" assortment 21 gorgeous folders going like "wildfire." Sells for \$1.00, costs as low as 50c. Actual retail value \$3.00. Other bargain assortments. Also, 50 Christmas cards imprinted with name for \$1.00. Finest low-priced imprints in America. Write for sample "Leader" assortment on approval, also two portfolios imprint cards and free gift offers. Silver Swan Studios, Inc., 320 Fifth Avenue, Dept. 47, New York.

COMIC Clever Xmas greeting cards. List 10c. Straley, 1015 Mulberry, Springfield, Ohio.

SEND For free copy of illustrated wholesale Christmas catalog! Forty profitable lines! Elfco, 438 North Wells, Chicago.

SELL Fortune telling cards by mail. Big profits. 10 cts. brings samples and information. Thornburgh Service, 1206 Monroe, Wichita Falls, Texas.

WHOLESALE SOURCES, 500,000 articles. Free directory. Maywoode, 1133 Broadway, New York.

BIG PROFITS selling Shelton Dust Absorbers. Sample 6—\$1.00 prepaid. Shelton Mfg. Company, Colorado Springs, Colorado.

CHRISTMAS CARDS. Earn \$2 an hour. Take orders galore from friends. 50 exquisite folders with name \$1. Free samples 20 designs. America's fastest selling 21 Christmas folder box. Costs 50c. Sells \$1. Request samples today. Sunshine Art, Dept. E, 115 Fulton St., New York City.

AGENTS—300% Profit selling gold leaf letters; stores and offices. Free samples. Metallic Letter Co., 438-B North Clark, Chicago.

POPULAR 8"x10" Prizefighter photographs, Famous Knockouts. Tremendous field! Big profits! Price Sports Photos, 1210PM South Kolin, Chicago.

AGENTS. Big line including food products. Fast selling premium and bargain deals. Low prices. Send card for big outfit offer with gift. Ho-Ro-Co, 2715 Dodier, St. Louis, Mo.

AGENTS: Stamping names on pocket-key protectors. Sample check with your name, address, 25c. Stamping outfits. Emblem checks, check-fobs, name plates. Hart Mfg. Co., 303 Degraw St., Brooklyn, N. Y.

AGENTS—To mail our literature. Good profits. Home business. Maywood, 1133 Broadway, New York.

DO YOU WANT AGENTS for your proposition? Your ad in this space will place your message before hundreds of men seeking fast-selling products. My folder "How to Secure Agents" is filled with proof. I'll gladly send you a copy free. F. W. Johnson, Manager Classified Advertising, Popular Mechanics Magazine, 200 E. Ontario St., Chicago.

HIGH-GRADE SALESMEN

WANTED—Unusual salesmen for an unusual job. It's permanent, practically a business of your own, becoming more and more valuable. It's selling but selling largely by counseling. You are backed by strong national advertising and by many user-boosters. No priority troubles and war conditions work with you in many ways. Requirements: good personality and character, a will to work. Liberal commission arrangement. LaSalle Extension University, nationally-famous correspondence institution. Write fully about yourself to John D. Morris, 4103 S. Michigan, Chicago.

SALESMEN—Sell auto necessity; dealers, jobbers. Box 169, Spencer, Iowa.

BIG COMMISSIONS—selling to stores celluloid pricing tickets, metal shell moulding. To restaurants, menu covers, signs. P. Pricing Press, 124 White St., New York.

RELIABLE Man wanted by nationally-known manufacturer—jobber to contact merchants in own town. Steady, big pay; opportunity to develop own independent business. Start full or part time. Sales experience unnecessary. Laymon, Dept. 100, Spencer, Ind.

MEN—Women—Producers. Sell full or part time, the most beautiful calendar line. Big commission. Gem, 74 West Washington, Chicago.

ADVERTISING Book matches. America's largest manufacturer of union label book matches. Fast selling line. Large sales producing kit. Sample matches. Complete cut catalog, 17 color combinations makes selling easy. Commission in advance. Superior Match Company, 7530 Greenwood, Dept. N-10, Chicago.

ADVERTISING Book matches offer liberal earnings—full, spare time. Experience unnecessary. Factory direct. Low prices, high quality, quick deliveries, powerful patriotic display, repeats. All business firms prospects. Free kit, instructions. American Match & Printing Co., Dept. 68, 4822 South Trumbull Ave., Chicago.

ONLY \$4.62 Starts you in your own lucrative business distributing Long-Life Plus typewriter ribbons, carbon paper. Easy sales all offices, business concerns. Steady repeats, big profits. Excellent sideline. Sholes Co., Dept. PM-1, Short Hills, N. J.

CALENDARS, Fans, novelties—Beautiful complete lines all sizes, including jumbos, samples free. Start now, be first in field. Fleming Calendar Company, 6539 Cottage Grove, Chicago.

NEW Air raid shoe sweeps country. Zips on—zips off. No fumbling or breaking of laces in blackouts or when alarm sounds. Huge profits for direct salesmen and women. Hundreds of other fast-selling shoe styles. Write for free sample shoe outfit. Victor Thomas Shoe Co., 610 W. Van Buren St., Dept. V-58, Chicago, Ill.

EARN Money in your spare time taking subscriptions to Popular Mechanics. Unlimited possibilities, every family a prospect. Easy to sell. Bonus paid in addition to liberal commission. Send postcard for further details today. Circulation Dept., Popular Mechanics Magazine, 200 E. Ontario St., Chicago.

EDUCATIONAL AND INSTRUCTION

BELIEVE It or not Pitman shorthand made easy. Ten lessons, then speed practice. Lesson free. Elliott, 4426 Carrollton, New Orleans, La.

MATHEMATICS Without figuring. Only the ability to locate the intersection of a vertical and a horizontal scale. 7 tables 6x12". 200,000 problems solved: Multiplying, dividing, adding, and subtracting, fractions, and decimals, and whole numbers in 64ths, 32nds, 10ths, 9ths, 8ths, 7ths, 6ths 5ths, 4ths, 3rds, 1/2s, etc. Price \$2.00. Write C. M. Beaver, 1016 So. Westlake Avenue, Los Angeles, Calif.

NEW Writers wanted to re-write ideas in papers, magazines, books. Splendid opportunity to "break into" profitable writing field. Rush postcard for free details. Comfort Writer's Service, Dept. FV-149, St. Louis, Mo.

DRAFTING And mathematics courses. Each \$1 complete! Inquire J. R. Giles, 1326 Myers, Burbank, Calif.

BE Radio announcer, actor, writer, producer. Complete home study course. Radio Arts Academy, Studio D, 3819 Wilshire Boulevard, Hollywood, California.

GOVERNMENT Jobs. Hundreds appointments now being made. \$24.23-\$40.38 week. Men-women. Prepare now for examinations. Full particulars—list positions, free. Write today. Franklin Institute, Dept. R2, Rochester, N. Y.

WELDING—Electric arc. Learn profitable trade quickly through actual practice. Individual welder instruction at bare cost of materials. Full particulars free. Valuable welding lessons book 50c. Hobart Welding School, Box M-1022, Troy, Ohio.

LEARN Business paper writing. Make extra money regularly, spare time. Write, Institute of Writing, 5711 Chicago Avenue, Chicago.

BECOME A finance man. Particulars free. Nebraska Finance Co., Lincoln, Nebraska.

LEARN Physical culture, physical training, body building methods. Correspondence course. Booklet. Training Institute, 4753-P Broadway, Chicago.

EVERY Normal person has the potential power to be or to do what he desires to be or to do. Write for our free treatise: "Creative Power is available to you." Creative Thought Studio, P.O. Box 1, Greendale Station, Worcester, Mass.

AIRCRAFT Electricity instructors—Complete ten weeks lesson outline 300 lessons—blueprints—teaching aids. Prepared by government instructor. Free sample lesson. 331 SW 23, Oklahoma City, Okla.

FINGER Print experts earn big pay! Learn easily at home. Low cost! "Crime Book" free. Write stating age. Dept. 26, Inst. Applied Science, 1920 Sunnyside, Chicago.

HOME Study course, drugless therapy. Free literature. Inst. of Drugless Therapy, Tama, Iowa.

SECRET Investigation. Experience unnecessary. Detective particulars free. George Wagner, M-2640 Broadway, N. Y.

BECOME A Doctor of Psychology (Ps. D.) Teach secret of contentment, happiness. Solve mental worries. Free book. College of Universal Truth, 20-B East Jackson, Chicago.

LOCKSMITH Course. Lock picking, key fitting, etc. \$1.00 prepaid. Locksmith, Canadian, Texas.

CLINICAL Laboratory technic taught in your own home. Practice outfit supplied. Bulletin free. Imperial Technical Institute, Box 973-E, Austin, Texas.

LEARN Telegraphy! Splendid opportunities now prevail. All expenses low. Catalog free. Dodge Institute, Dept. M, Valparaiso, Indiana.

RADIO Engineering, broadcasting, aviation and police radio, servicing, marine and Morse telegraphy taught thoroughly. All expenses low. Catalog free. Dodge Institute, Dept. R, Valparaiso, Ind.

CARTOONING, COMMERCIAL ART, SHOWCARD WRITING, SIGN PAINTING

SIMPLIFIED Free-hand sign painting 50c for library. Indorsed. Complete course. It's easy. Get today—Use tomorrow. Haines System, Sabina, Ohio.

EARN Money, copying and duplicating comic cartoons for advertisers. Ad-Serv-ice, Argyle, Wisconsin.

CREATE Cartoons, 11,000 word book of instruction on comic drawing. Hundreds of illustrations. \$1.00 postpaid. Details stamp. Roy Hetzler, Dept. P10, Box 407, Rochester, N. Y.

AMAZING Cartoon business plans. Hartman Studios, 2438 W. Lincoln, Nebraska.

CHALK Talks. Laugh producing program, \$1.00. Catalog 10c. Balda The Cartoonist, Oshkosh, Wisconsin.

FREE—Big list of helpful books. Popular Mechanics Press, 200 E. Ontario St., Chicago.

ADVERTISING AGENCIES, LETTER WRITERS, FOR ADVERTISERS

CHANGE To Judkens. Low cost! Results guaranteed! 3329 Iowa, Fresno, California.

MAIL-ORDER Or agent ad reaching 1,000,000 families throughout United States \$14.00 inch. Newspaper, magazine, mailing-list, rate-book, free. Chicago Advertising Agency, 20-PM West Jackson, Chicago.

RURAL, Small town, women buyers—2,000 \$5.48. Lederer, 17 Guilford Avenue, Baltimore.

ADVERTISE: 24 Words, 149 newspapers, \$8.50. Lists free. Advertising Bureau, 4515-C Cottage Grove, Chicago.

FREE—New Advertisers Rate Guide. 44 pages. Includes everything. Lowest rates. E. H. Brown Advertising Agency, Merchandise Mart, Chicago.

ADVERTISING Placed all magazines, newspapers U.S.A., Canada. Lowest rates. Free service. 54-page catalog free. Baker Advertising Agency, A-189 W. Madison, Chicago. Established 29 years.

FREE—"Amazing New Book"—"Profits From Classified Advertising." Tells how and what to advertise. Be sure to read this book before you invest one cent in advertising. Remember—It's free! Write for your copy now. F. W. Johnson, Classified Advertising Manager, 200 East Ontario Street, Chicago, Illinois.

RUBBER STAMPS, OFFICE SUPPLIES

SUPERB Quality, cushioned, indexed. Two lines 25c. Three lines 35c. Four lines 45c. Lentz, Box 402, Youngstown, Ohio.

SUPERIOR. Cushioned, indexed, three lines 35c, four 50c. Signatures \$1.50. Siocum, 814 Bradley, Peoria, Illinois.

QUALITY, 3 Lines 35c. Federich Manufacturing, Box W-412, E. Pittsburgh, Penna.

3 LINES 30c; Cushioned, indexed, 35c. Signatures \$1.50. Stamprite, Wauwatosa, Wis.

2 LINES 25c, 3 Lines 35c. Stamp Works, Auburn, Nebr.

KNOB Handle, cushioned, 2 lines 25c, 3—35c. Stamp Works, Centerport, N. Y.

TYPEWRITERS, DUPLICATORS, OFFICE DEVICES

TYPEWRITERS. Adder, mimeograph, multigraph, addressograph. Send for free lists of machines that will help you at half price. Pruitt, 28 Pruitt Bldg., Chicago.

BUSINESS SERVICE

PHILADELPHIA, Pa., business, personal mail receiving, reforwarding. Graham, Real Estate Trust Bldg.

CHICAGO Mail address: \$1 monthly—Receiving, reforwarding your business, personal mail. General, 30 West Washington. (Established 1919).

SOUTHERN Mail address. Receiving, forwarding, \$1 month. Exchange, Box 66, Atlanta, Georgia.

PRINTING OUTFITS AND SUPPLIES

INEXPENSIVE 6x9 Printing press. Details free. Novelty Shop, Downsville, Louisiana.

AMAZING Savings in job printing and supplies. Literature free. Quality Shop, 1356 North Carolina Avenue, N. E. Washington, D. C.

PRINTERS Idea Package. 25c. Tried, workable ideas. Box 6, Chelsea, Oklahoma.

PRESSES. Complete supplies. Bulletins. Send stamp. Bradshaw, 3214-P Huron, Chicago.

PRINT Your own cards, stationery, circulars, advertising. Save money. Simple rules furnished. Print for others, nice profit. Junior outfit \$8.25, senior outfits \$17.38. Details free. Kelsey, Inc., T-11, Meriden, Conn.

PRINT At home. 10c will bring a complete catalog of presses, type and supplies. P. Peiffer & Company, 6 Columbia St., Newark, N. J.

BARGAINS — Presses, type, supplies. Send stamp. 159 Harvard, Cambridge, Mass.

USED Presses, type, supplies. Lists 3c. Turnbaugh Service, Loysville, Penna.

PRINTING, MULTIGRAPHING, MIMEOGRAPHING, GUMMED LABELS

HUNDRED Letterheads and envelopes, printed, dollar. Beautiful 15x20 patriotic picture free. Wickens, West Lafayette, Ohio.

1000 WHITE Bond 8 1/2 x 11" process engraved letterheads, blue or black ink, \$1.39 with order. Balance \$3.25 C.O.D. Goheso, Omena, Michigan.

HAMMERMILL Letterheads, envelopes, billheads, statements. Samples free. Drew Press, Box 423-G, Greensboro, N. C.

2500 ADVERTISING Book matches \$8.95. Otho DeWitt, 54 Lafayette, Pontiac, Michigan.

100 BOND 8 1/2 x 11 Letterheads and 100 envelopes \$1.00 postpaid. Benneville, 907 West Roosevelt, Philadelphia.

GREATER Printing values! Stationery, folders, booklets, circulars. Free samples, estimates. Reporter, Chelsea, Oklahoma.

500—\$1.95, 1000—\$2.95, LETTERHEADS, Envelopes, billheads, cards. Studios, Incorporated, 1724 Monroe Street, Madison, Wisconsin.

5000 ELEGANT Colored envelope slips, \$3.75. 5000 6x9 circulars, \$8.25. Folders, \$1.60 thousand. Samples. Goodprint, Harrisonburg, Va.

100—8 1/2 x 11 LETTERHEADS And 100 envelopes \$1.00 postpaid. General printing. Yankee Printing Co., 4701 Sheridan Road, Chicago, Ill.

JOB Printing, circulars, letterheads, envelopes. Bell Press, PM, Winton, Penna.

PRINTED Business cards 60c M. Envelopes \$1.60. Maloney Sales, 36 St. Paul, Rochester, N. Y.

LETTERHEAD Specialists, forms, artwork, etc. Gill Art Service, Huntsville, Alabama.

MIMEOGRAPHING. Good clean copies. No lineage limit. 300 letters or postcards \$1.00. Manuscript, legal typing specialists, lowest prices. Corey's Exchange, 355 N. Clark, Chicago, Ill.

500—\$1.95, 1000—\$2.95, LETTERHEADS, Envelopes, billheads, cards. Studios, Incorporated, 1724 Monroe Street, Madison, Wisconsin.

MORE Good printing for less money. Springer Press, Miami, Oklahoma.

CENTRAL West Printers—Headquarters for dollar specials. 3226-P Jackson, Chicago.

1000 DISTINCTIVE Letterheads, envelopes \$5.50. Catalogue. Davis Press, Webster, Mass.

HAMMERMILL Letterheads, envelopes, any color. 39 type styles. Free particulars. Woodruffs, 217-A4 Lewis, Duluth, Minn.

500 2x3 1/4 FOUR Line gummed stickers, 25c. Moritz Printery, Saginaw, Mich.

JOB Printing, Quick, reasonable. Samples. Atlantic, Box 653-H, Rock Hill, S. C.

WANTED Printing of all kinds by thousands of our readers. Your ad in this space will bring you some nice orders. Write for positive proof. F. W. Johnson, Classified Advertising Manager, Room 304, 200 East Ontario Street, Chicago.

PATENT ATTORNEYS

INVENTORS: Take first step toward protecting your invention—without obligation. Write for free "Record of Invention" form for establishing date of invention and free "Patent Guide for the Inventor"—telling about confidential search service; how to sell and market inventions; details of convenient payment plan. Send today for free "Patent Guide" and "Record of Invention" form. Clarence A. O'Brien and Harvey Jacobson, Registered Patent Attorneys, 21B-K Adams Building, Washington, D. C.

68 PAGES Of facts for inventors. Two valuable advisory books specially prepared for men with ideas. "Patent Protection" tells you steps to take quickly without cost. "When and How to Sell an Invention" gives you six basic ways to commercialize your patent rights. Both books sent free. Write us today in confidence. Victor J. Evans & Co., Registered Patent Attorneys, 631-L Merlin Building, Washington, D. C.

"PATENT—Particulars" and blanks free, airmailed. Sterling Buck, 637 W. North Ave., Baltimore, Md.

WESTERN Inventors, save time; employ C. L. Drew, Atty. Registered in U. S. Patent Office, Central Tower, San Francisco, Calif. 32 years practice.

"INVENTOR'S Guide," 100 mechanical movements, free; advises on patenting, selling inventions. Frank W. Ledermann, 154 Nassau Street, New York.

L. F. RANDOLPH, 302-B Victor Bldg., Washington, D. C. Low cost. Book and information free.

PATENTS, Booklet free. Highest references. Best results. Promptness assured. Watson E. Coleman, Patent Lawyer, 724 Ninth St., Washington, D. C.

INVENTORS—Before disclosing your invention to anyone send for form "Evidence of Conception"; "Schedule of Government and Attorneys' Fees" and instructions. Sent free. Lancaster, Allwine & Rommel, 411 Bowen Building, Washington, D. C.

FOR INVENTORS

INVENTORS—Take first step toward protecting your invention—without obligation. Secure free "Record of Invention" form—and free "Patent Guide" explaining how to patent and sell inventions; details of search service; convenient payment plan. Write today. Clarence A. O'Brien and Harvey Jacobson, Registered Patent Attorneys, 21A-K Adams Building, Washington, D. C.

CAN Inventors make money today? In 1941 alone over 4,000 assignments of patents a month were made by inventors to manufacturers or individuals. This shows today's demand for new patented inventions. Write for our free book, "Protect, Finance and Sell Your Invention." Special form "Invention Record" also mailed free. No obligation. McMorro & Berman, 134-H Bristler Building, Washington, D. C.

115 MECH. Movements—Just what you may need to complete your invention. 48-page illustrated book contains valuable information for inventors. Yours—free. Write today. Victor J. Evans & Co., 632-L Merlin Building, Washington, D. C.

MANUFACTURER Wants new invention or idea. Nelson, P.O. Box 626, St. Paul, Minn.

INVENTORS—Entirely new products are urgently needed for the drastic changes in our every-day needs. If you have a practical, useful non-military invention it can now be sold safely, without patenting expense. Write today for complete details. Chartered Institute of American Inventors, Dept. 4A, Washington, D. C.

CASH For practical ideas and inventions. Mr. Ball, AB-9441 Pleasant, Chicago.

SELL Your patent through a small classified ad in Popular Mechanics. Many inventors have found buyers in this way. Ask me for proof—I'll gladly send it to you. F. W. Johnson, Manager Classified Advertising, 200 E. Ontario St., Chicago.

INVENTIONS WANTED

MANUFACTURER With 10,000 direct-to-wearer shoe salesmen wants an additional item to distribute. Must be novel. Practical, reasonably priced. Write 610 Wrigley Bldg., Chicago.

PATENTS Wanted—Cash and, or royalty assignments arranged quickly on meritorious inventions. Direct connections with large manufacturers. List your patent now! Free forms. Universal Guaranty Company, Box 772, Lancaster, Penna.

MANUFACTURER Wants new invention or idea. Nelson, P.O. Box 626, St. Paul, Minn.

ONE Of our clients, a midwest manufacturer, AAAA rating, desires to purchase patented inventions of outstanding products, or small company having products with unusual post-war future. Must have good sales possibilities for a wide market. Cash. Not interested in foundries, job or parts shops, etc. Write—Carter, Jones & Taylor Advertising Agency, Associates Building, South Bend, Indiana.

INVENTORS—Manufacturers urgently need new ideas for drastically altered civilian markets. If you have a useful new invention, or a practical improvement on an already established product, you can now sell it safely without patenting expense. Complete details, free. Chartered Institute of American Inventors, Dept. 4-D, Washington, D. C.

WANTED—Meritorious patented, unpatented inventions. Booklet, references, free. Invention Reporter, 5B-11236 So. Fairfield, Chicago.

CASH For inventions, patented, unpatented. Mr. Ball, A-9441 Pleasant, Chicago.

YOUR Ad in this space will bring amazing results. I'll prove it to you. Write at once for interesting information. F. W. Johnson, Room 300, 200 East Ontario St. Chicago.

PATENTS FOR SALE

TOY Automobile assembly line. Stewart D. Long, Hotel Victoria, Chicago.

INVENTION Needed by all defense workers. 50c seller. Outright or royalty or salaries. M. J. S., 340 Newport, Long Beach, California.

ATTENTION Manufacturers: Sensational warlike invention for sale, pat. pend. Kuhne, 829 Eaton, Hammond, Ind.

ULTRA Ingenious shoe patent for aching feet. Surprisingly, simple and effective. Rabenold, Owassa, Iowa.

EV-RON Pencil sharpener for sale. A good 10c or mail order item. Frank J. Bambach, 29 Conn. Blvd., East Hartford, Conn.

ROTARY Air compressor, patent 2064635. Ben Stern, 6220 Ellis, Chicago.

NEW Tool for painters, plasterers, masons, carpenters and glaziers. Inexpensive.—million needed now. Willie J. Brabham, Paint Shop, Navy Yard, S. C. X71224.

I WANT To send you proof of the wonderful pulling power of Popular Mechanics Magazine's classified pages. What's your proposition? Write me today. F. W. Johnson, Manager Classified Advertising, 200 E. Ontario St., Chicago, Ill.

MANUFACTURING

MODELMAKERS, Diemakers, brassworkers, machinists, turnstiles, circulars. Baum's Specialties, Kansas City, Mo.

MODELS—Small lot manufacturing. Metals, plastics, etc. Milburn, Burlington, Kentucky.

MODELS AND MODEL SUPPLIES

1942 FORD Cars in miniature. All makes. Send stamp. Melvin Model Autos, P.O. Box 133, Hemingway, S. C.

CATALOG 50 Engines, model railroad supplies, 25c refunded. Howardco, A2417 North Ashland, Chicago.

RAILWAY Models, complete line informative catalogs O gauge, 112 pages, 25c; HO, 48 pages 15c. Walthers, 247 Erie, Milwaukee, Wisconsin.

"CONSTELLATION" Carved hull construction set, separate fittings, blueprints. 52 page illustrated catalog 20c, listing hundreds of ship and yacht model fittings. A. J. Fisher, 1002-7 Etowah Ave., Royal Oak, Mich.

SHIP Models and yacht supplies complete. Large 56 page catalogue 15c. Bill Wild's, 510 East 11 St., New York City.

MINIATURE Steam locomotives, new catalog listing all builders' needs 25c. Little Engines, Wilmington, California.

SHIP Model kits and fittings. Complete line Fisher model yacht equipment. All Boucher, Fisher, Marine Model and Ideal kits, fittings and blueprints at catalog prices. Most complete stock in New England. James Bliss & Co., Inc., 220 State Street, Boston, Massachusetts.

FREE—Big list of helpful books. Popular Mechanics Press, 200 E. Ontario St., Chicago.

HOME CRAFTSMEN

15 FULL Size what-not patterns 25c. 25 lawn ornament patterns 25c. Albright Service, M-6901 Railroad Ave., Omaha, Nebr.

GET Free leathercraft instruction pamphlets, prices of leathers, tools, projects. Fascinating hobby. Make beautiful gifts. Leather samples 5c. Wilder & Company, 1938 Crosby, Dept. 9F, Chicago, Illinois.

KNOCKDOWN Cedar chest, lumber, veneers. Illustrated catalog 10c. Giles Kendall Co., Decatur, Ala.

28 LAWN Ornament patterns 25c. Other patterns; 15"-20" high; Dutch girl, Dutch boy, pirate, bull terrier, Mexican girl, Mexican boy, dwarf, penguin, flower girl, 10c each; 3 for 25c. 25 novelty patterns 30c. All 62 full size patterns \$1.00 postpaid. Strother, Box 383-DW, Belington, W. Va.

MAKE Retreadable wood tires. Instructions \$1.00. Michael Schumacher, Westhampton Beach, N. Y.

LEATHERCRAFTSMEN: Send 10c for new handbook and catalogue of tools and supplies. E. A. Sweet Company, Inc., Leathercraft Division, A-62, 148 State Street, Binghamton, N. Y.

CATALOG—Patterns plywood novelties, lawn ornaments, silhouettes, letters and numerals. Decal transfers, handy hand tools, new power sander. Other lines. 500 articles finely illustrated. Write today. Wo-Met Shop, Ashburn, Georgia.

WOODWORKING Power tools— Make them yourself. Lathe, scroll saw, saw table, drill press, portable sander, bandsaw, motorized plane. Complete details only 25c. Popular Mechanics Press, Dept. 401, 200 E. Ontario Street, Chicago.

WATCHES, OLD GOLD, JEWELRY, ETC.

GEMS, Crystals, minerals, jewelry. Complete gem and mineral establishment. Specials: Six rough gemstones \$1.00, 10 strategic mineral specimens \$2.00. Postpaid. Catalog. Hill Co., Route 7, Salem, Oregon.

ELGIN, Waltham watches. Attractive buys. Make big money. Free watch and jewelry catalog. Plymouth Jewelry Co., 163-F Canal St., New York.

CASH! Gold, jewelry, teeth, coins, diamonds, mercury, etc. Ship! Simon's, 353 Old Arcade, Cleveland, Ohio.

ZIRCONS—Diamond-cut, low as \$1.00 per carat. Leuthold, 2227½ N. Alabama, Indianapolis, Ind.

AGATES, Fossil woods, three pounds \$1.50 postpaid. Jay Ransom, Aberdeen, Wash.

WATCHMAKERS' Materials, tools, jewelry—bought, sold. Best prices for old gold, diamonds. Free catalog. Ben Segal Company, Box 150, Chicago.

HIGHEST Prices for old gold—Mail your teeth, watches, jewelry. 100% full cash value mailed day shipment received. Satisfaction guaranteed or articles cheerfully returned. Information free. Chicago Gold Smelting Company, 300-P Champlain Building, Chicago.

GOLD \$35.00 Ounce. Mail old gold teeth, diamonds, jewelry, watches. Receive cash by return mail. Satisfaction guaranteed. Free information. Dr. Weisberg's Gold Refining Company, 1500-Q Hennepin, Minneapolis, Minn.

SURVEYING INSTRUMENTS

GUARANTEED Factory rebuilt transits and levels for sale (cash or terms) or rent (with purchase option). We will repair, trade, or buy old instruments. Ship prepaid for estimate and valuation. For complete information write for list M710. Warren-Knight Co. (Manufacturers of Transits and Levels), 136 N. 12th St., Philadelphia, Penna.

FOR SALE—MISCELLANEOUS

INVENTION—Ideas of real value. Reasonable. Write, Clayton E. Willis, Box 404, Prestonsburg, Ky.

UNPAINTED Wall plaques 5c each. 24 different \$1.00. Oman, 642 Broadway, St. Paul, Minn.

WANTED—MISCELLANEOUS

WANTED—New and used tanglefoot diffusers. Mears, Hallwood, Va.

WANTED: Mercury \$1.50 per pound. Western Metal Co., Bloomington, Illinois.

MERCURY (Quicksilver), tungsten, molybdenum, cadmium, high speed tool steel, bismuth, purchased in any quantity. Write for quotations. Metallurgical Products Co., 35th and Moore Sts., Philadelphia, Penna. Established 1909.

HIGHEST Prices for used cameras, binoculars, microscopes, drawing sets, tools, any optical or scientific instrument. Satisfaction guaranteed. Gordon's, 162-M Madison, Chicago.

CASH For anything. Justice Jewelry Jobbers, 190 North Wells, Chicago.

PERSONAL

OUTCOME Of present war foretold in 85 famous prophecies. Free prospectus. Write Hagen, 1418 Peden, Houston, Texas.

MEXICAN Legal matters. Wm. Cocke, Amer. Atty., 1736 ElPaso, Texas.

FEET Hurt Arch supports custom made \$3.95 pair. Write for free impression material. National Foot Health Center, 1476 Broadway, New York City.

CHURCH Workers! Free samples personalized illustrated tract. Gwynn Printers, Adrian, Michigan.

WIN Prize money—Booklet, "Successful Contesting," shows how 10c postpaid. Bulletin listing \$100,000.00 prizes included. World Publishers, 4515-B, Cottage Grove, Chicago.

"CHARACTER-X-RAY" Through new psychographical method. Reveals intensely valuable, often surprising information about yourself and others. Individual analysis regularly \$1.00. Special, limited time: Two analyses for this one price. Send dollar, handwritings (half-page each), ink on unruled paper. Act today. Taylor-Adams Associates, Dept. PM, 6331 Kimbark Ave., Chicago, Illinois.

BREATHE Nature's way. It works wonders, broadens chest, gives erect carriage, improves health, it's priceless. Learn how 25 cts. Martin, 955 E. Colorado, Pasadena, Calif.

BIRTH Certificates, all ages, any state, ten (10) day service. Enclose postage. Herndon J. Thompson, Dept. (D324), Davis, Oklahoma.

SONGWRITERS. Write for free booklet, profit sharing plan. Allied Music, Dept. S5, 204 East Fourth, Cincinnati, Ohio.

NEW Money making formulas book tells how to go into business for yourself. Send for free details. Popular Mechanics, 200 E. Ontario, Chicago.

MISCELLANEOUS

CHRIST'S Coming. Get absolute proofs today. Scheall, 263-X, Duluth, Minnesota.

TATTOOING Outfits. Write today. Zeis Studio, 728 Lesley, Rockford, Illinois.

HITLER'S Finish! America's future. Foretold in many famous prophecies. Free literature. Ellis, Cedar Grove, North Carolina.

HEATING Six rooms \$20.00 yearly. Circulars 10c. Rosenzweig, RR10-B8, Cincinnati.

BIG Mail for you. Latest moneymaking offers, opportunities, catalogs, magazines. Name listed in directory 10c. Ideal Service, 130-M, Park Ridge, Ill.

ASSURED Flat rates. Shipment household goods anywhere. Write United, 243 W. 60 St., New York, N. Y.

EVERYBODY Wants this. Literature free. 710 - 5 Street, Devils Lake, N. Dak.

RECEIVE Gigantic mails, magazines, samples. Your name in numerous mailing lists 10c. Howard, 396 Broadway, New York.

ASSAYS: Analyses of ores, minerals, \$1.00 up. Buskett, Joplin, Mo.

SAMPLES. Papers, circulars, cards, etc., 10 cents. Brewster, Eastport, Maine.

WE Train you to become medical laboratory technician at home in spare time. Free catalogue. Imperial Technical Institute, Box 973-J, Austin, Texas.

1001 WAYS to Use Concrete. Send for large free illustrated folder describing new Popular Mechanics book covering every known use of concrete for the home, farm, building, business and industry. Popular Mechanics Press, Room (C40), 200 E. Ontario St., Chicago.

Special Offer to INVENTORS!
Two valuable books for 25c—115 mechanical movements illustrated and explained—You get \$1 credit on usual Patent Search Charge. Victor J. Evans & Co., 671-L—1503-21st Street, N. W., Washington, D. C.

LAW
STUDY AT HOME for PERSONAL SUCCESS and LARGER EARNINGS. 31 years expert instruction—over 100,000 students enrolled. LL.B. Degree awarded. All texts furnished. Easy payments. Send for FREE BOOK—"Law and Executive Guidance."
AMERICAN EXTENSION SCHOOL OF LAW
Dept. 22-0, 8 East Huron St., Chicago, Ill.

LEARN A BIG PAY TRADE in 2 to 8 WEEKS!
We Pay Room and Board

To meet the great demand for men at high wages, we have inaugurated intensive training courses in the trades listed here. Learn in 2 to 8 weeks by actual shop work. One of America's leading schools. Established 1902. 7 floors of shops. Many employers send their young men here for intensive training. Free employment service.

GREER SHOP TRAINING
Dept. 2102, 2024 S. Wabash Ave., Chicago, Ill.
Send "Shop Training Facts" describing trade checked below:

Auto-Diesel Welding
 Refrigeration and Air Conditioning
 Body-Fender Machine Shop
 Tool and Die Aviation

Name.....
Address.....
Age.....

WONDERS OF AMERICA

War Clouds!

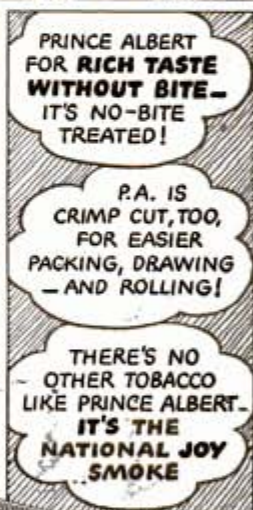
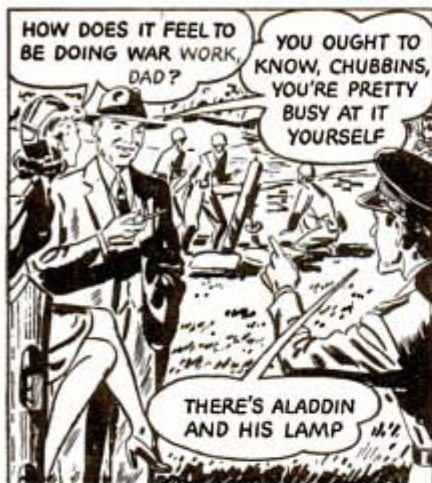

50
PIPEFULS OF FRAGRANT TOBACCO IN EVERY HANDY POCKET CAN OF PRINCE ALBERT



IN RECENT LABORATORY "SMOKING BOWL" TESTS, PRINCE ALBERT BURNED **86 DEGREES COOLER** THAN THE AVERAGE OF THE 30 OTHER OF THE LARGEST-SELLING BRANDS TESTED— COOLEST OF ALL!

PRINCE ALBERT

Popular Mechanics Magazine

REGISTERED IN U. S. PATENT OFFICE AND CANADA

WRITTEN SO YOU CAN UNDERSTAND IT

77 653

Vol. 78

OCTOBER, 1942

No. 4

UNCLE SAM'S TRUMP CARD

By E. E. Wilson

President, United Aircraft Corp.

(In collaboration with

Julian P. Leggett, Captain, AAC)

IT IS not at all impossible that when the history of this period is written, it will be recorded that American aeronautical engineering was our country's salvation.

Just what goals have been attained to justify such a statement? First, we know that it was the object of aeronautic engineers to have designs of aircraft that were superior to those of an enemy available upon the outbreak of the war. It is a well-recognized fact that in this objective, we have succeeded. Daily reports

Aeronautical engineers conducting a test in the Pratt & Whitney engine plant help keep U. S. aircraft superior to those of foe

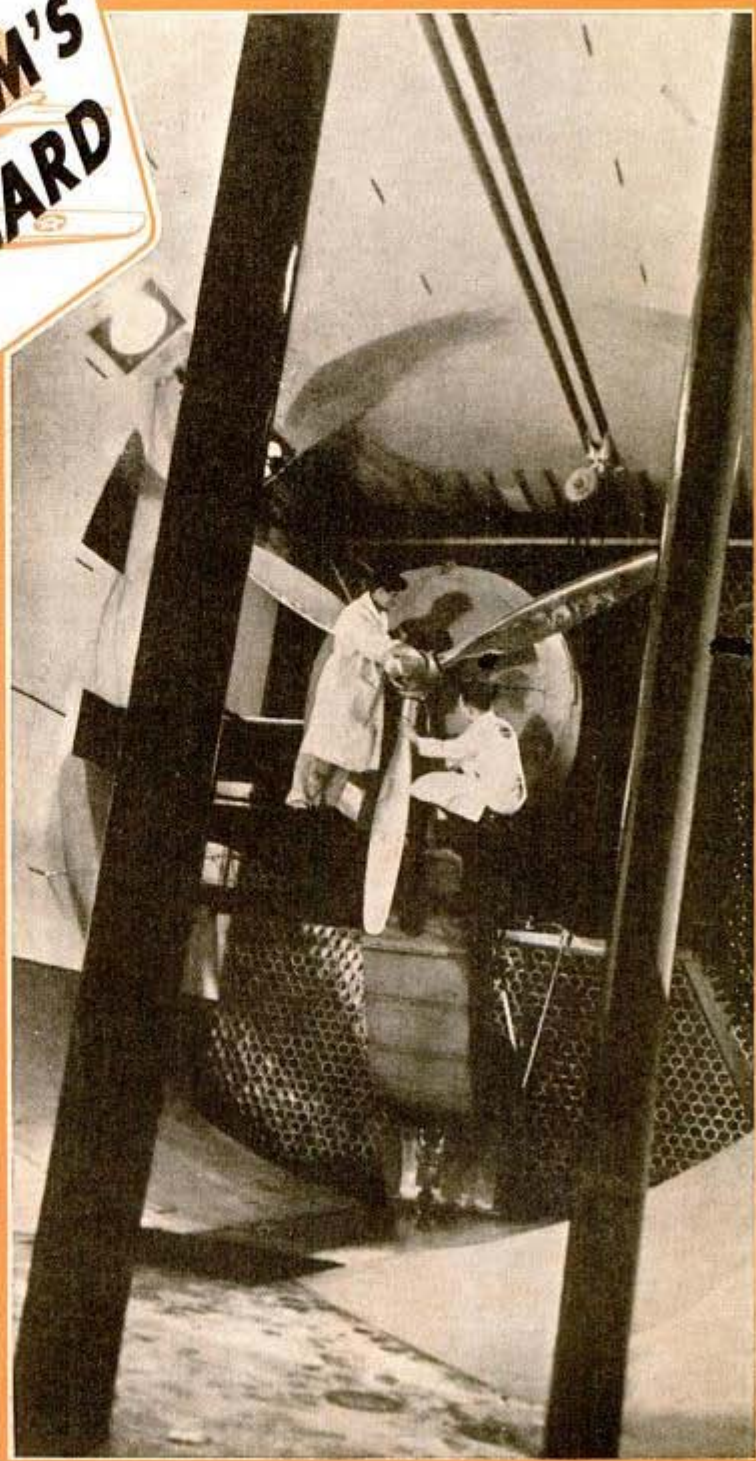

OCTOBER, 1942

1



Inspecting parts for engines protects pilots against failure in the strain of battle



Into a propeller factory flows this river of propeller domes, bushings and blade forgings — precision is industry's keyword



from the front confirm it. And these designs have now been turned over to automobile manufacturers and others, who already are supplementing the production performance of the aircraft industry.

Interestingly enough, this advantage in aeronautical design was attained in a country long committed to a policy of peace, or even pacifism. Any trials or tribulations we may have suffered under this policy are of minor importance; the important fact is that we have excelled, engineering-wise, the most intensive efforts of competitors whose national effort was directed toward war.

The history of aviation has been the history of the accomplishment of the "impossible." Many of us recall our inauspicious beginnings. There was Donald Douglas in the shed at Santa Monica, Glenn Martin in the abandoned church at Santa Ana, Claire Egtvedt in the Boeing furniture factory at Seattle and Igor Sikorsky creating long distance transports in a chicken yard at College Point. Perhaps no better illustration of the long way our art has come can be found than in the contrast between the physical facilities then and now.

Our engineering has progressed along fundamental lines. Here was no clever trick or invention, but steady and continuous testing and ex-

Conveying a group of engines—the heart of Uncle Sam's aircraft—to a test house where experts find any flaws in motor

perimenting, working always toward the same end, namely, an advanced technology against a declaration of war. With the passage of time, the complexity has increased tremendously. A few weeks before Tony Fokker died, he commented upon the fact that in his creative years, one man could know all there was to know about airplane design, while now it takes a dozen specialists in any organization.

Another important element is production engineering. It is well known that in the automotive field, production engineering reached a high degree of development. It is not so well known that aeronautical production engineering has attained an even higher degree of excellence and that its methods are being used by automobile manufacturers building aircraft and aircraft engines.

In the automobile, people came to take performance for granted, so there was less incentive to radical improvement in performance. Automotive engineering focused, instead, on reduction in cost. The situation in aeronautical engineering was different; style was of little importance, performance the thing that counted. In air transport the criterion was cost-per-ton-mile; in the military field the standard was speed and climb and ceiling. This emphasis on performance established a different



That's frost on the propeller mechanism being tested for 50 degrees below zero



Balancing propeller blade with counterweight to determine the static balance of a propeller

Left, rolling along the production line are observation scout planes made by Vought-Sikorsky



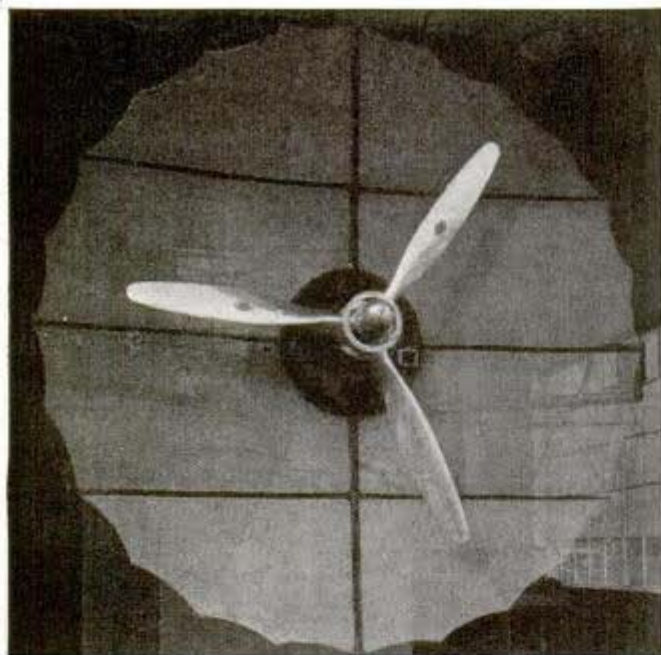

The wire mesh back of this propeller reveals errors in balance by fluttering; if it's perfect the mesh does not move

criterion for aeronautical production engineering. The machine tools had to be capable of quantity production, yet they had to be flexible and permit frequent and rapid changes in design. Beyond this, the precision requirements were much more exacting because of the high stresses involved. This called for the use of standard precision tools, but with special jigs and fixtures. It tended to place a premium on the use of automatic controls, making the machine more foolproof and less dependent on skilled operation.

So aeronautical engineering grew up around this flexible-tool philosophy. It has two important results—first, when the expansion program was initiated, the requirements were for standard tools and the machine tool industry was able to go into

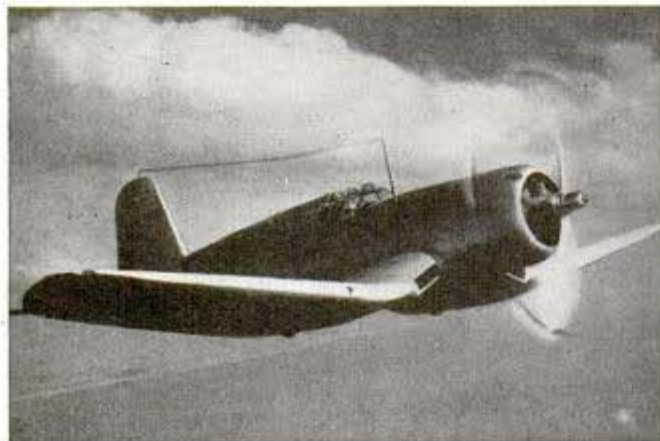

quantity production on standard or semi-standard tools, instead of limited production on special machines; and, second, in the training of operators, the use of automatic equipment greatly simplified the problem. Thus, the aircraft industry was enabled to expand with great rapidity. In the same way, it has decreased the time required for the automotive and other industries to convert their shops to aircraft production. The degree to which the aircraft industry has met the extraordinary expansion requirements is characterized by Charles Sorenson, of Ford Motor Company, as "the modern industrial miracle."

No one recognizes more clearly than the aeronautical engineers that we are just on the threshold. Design and development must continue at an accelerated pace.

Engineering organizations have been expanded in numbers almost as rapidly as plant facilities have increased. Technical schools have been combed for promising young men.

Extraordinary things are happening before our eyes. An aggressive enemy has denied us access to critical materials which have been the very foundation of our engineering and economy. The shortage of rubber changed the automotive industry overnight. Other material shortages are well known; engineering is focusing attention upon the development of substitutes. It is entirely possible that developments along this line may create new industries, to the ultimate benefit of our economy.

Take rubber, for instance. We have been living for years on Far Eastern sources because natural materials were cheaper. We were, in reality, exploiting the cheap labor of that part of the world. An artificial shortage of these materials bids fair to force the investment of capital in the development of new industries of vast importance. It is said that synthetic rubber is being produced in Germany today at a lower price than natural rub-

(Continued to page 178)

Searching out the enemy goes a high speed fighter—proof of U. S. engineering genius

POPULAR MECHANICS

Furnace Built in Chimney Gives "Forced" Heat

Built entirely inside a chimney, a furnace designed for low-cost houses and war economy saves space and materials. The fire box is built into the base of a conventional chimney, usually on the first floor or at basement level, and a porcelain enameled smoke stack (inside the chimney) carries off smoke and gases. The top of the chimney is partly capped so that the air between the smoke stack and the chimney may be heated. Cold air is drawn in



Photo courtesy Practical Builder

Round Oak Furnace Co
Dawagie, Mich

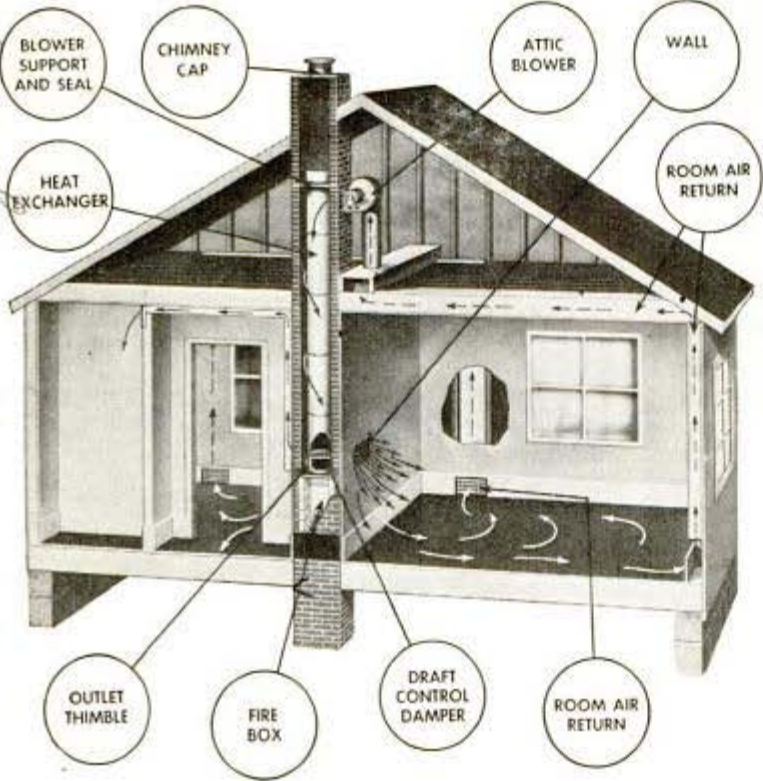

Applying finishing touches, above, to the heating unit built into an ordinary chimney at the basement level. The sketch shows inner stack that carries off smoke, the hot air chamber around stack and how cold air is drawn in, heated and forced out through vents

with a suction fan and a blower forces it through the heated chamber and out hot air registers into the rooms. A coil within

the fire box supplies hot water for the home. The furnaces are built to burn coal or gas, or for oil-burning combustion.

Secret Pocket Inside of Belt Holds Money Safe Against Pickpockets

Money can be carried secretly in what appears to be an ordinary dress belt having a built-in compartment extending nearly its full length and closed by two slide fasteners on the underside. Folded banknotes and other valuables that lie flat may be inserted easily and protected against accidental loss or easy theft. When the belt is worn it gives no hint of a hidden pocket.

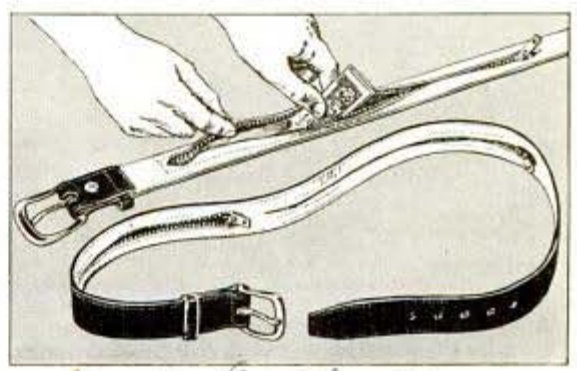

Folded banknotes are placed in the hidden pocket which closes with a slide fastener

OCTOBER, 1942. Von Leugnerke & Antoine
9. 77 N. LaSalle, Chicago 5

73673

Plane With Half a Tail Has Engine in One Wing

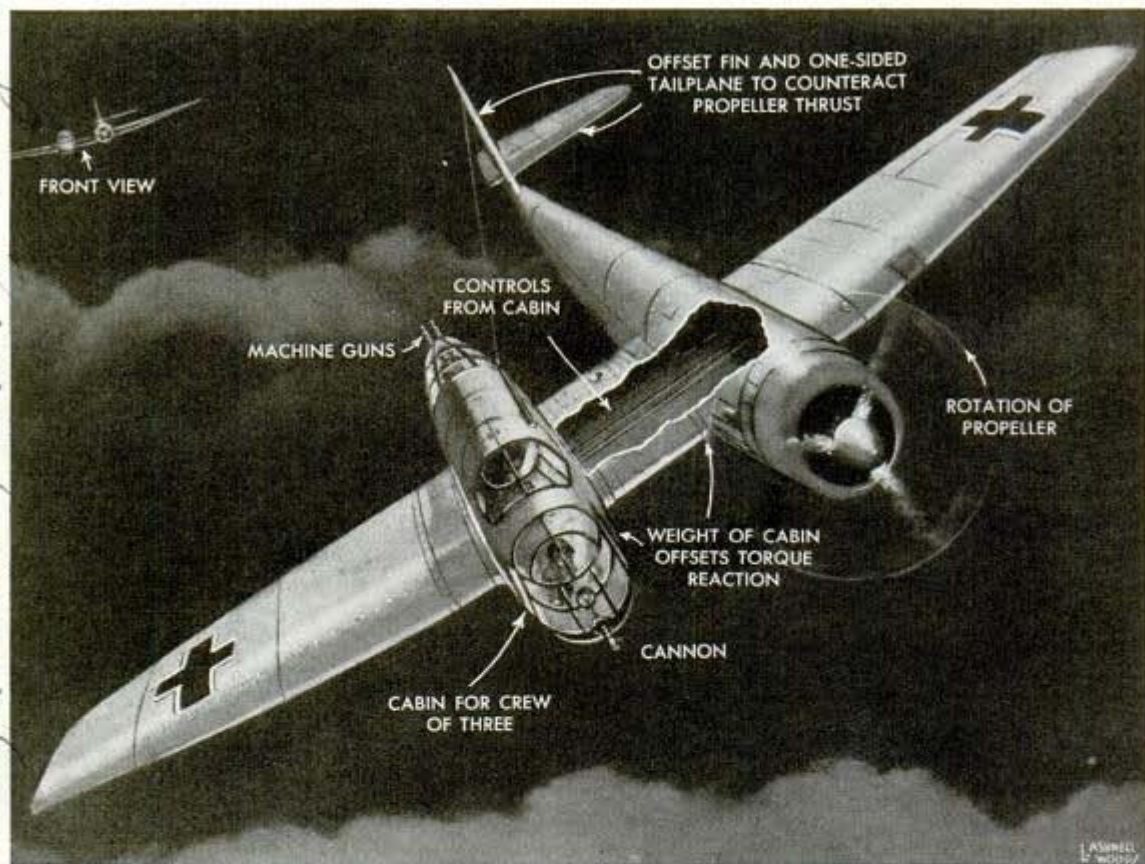

High speed and maneuverability are claimed for this German monoplane with "sightseeing" cabin at one side

The first time an American or R.A.F. pilot encounters one of the new freak monoplanes of the German Luftwaffe he probably cleans his goggles in a hurry and then doubts if he is seeing correctly. The craft has a lopsided appearance with the engine and controls on the right wing, a cabin for three on the left wing and only half a tail to balance the ship. The cabin, much short-

er than the nacelle holding the engine, looks like a sightseeing side car and is situated to insure a better view. Other special qualities claimed for the plane are high speed and maneuverability. Armament consists of fixed guns in the nose and a cone turret in the tail of the cabin. It is 49 feet long, has a wing span of 66 feet and will fly 220 miles per hour at 17,000 feet.

Gun Fired by Gas Explosion Has Spark Plug and Pump

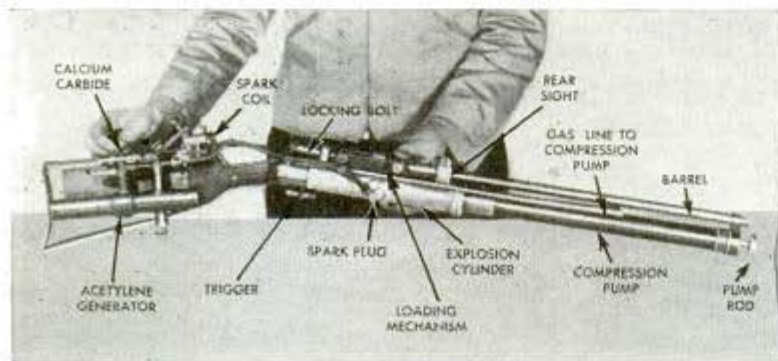

Dropping calcium carbide in generator holding alcohol and water produces enough acetylene gas to fire this economical gun about 10 times

Acetylene gas is used to fire a gun invented by Benton Whiteman of Parkesburg, Pa., which is equipped with a gas generator, explosion cylinder, spark plug and compression pump. First, four or five pieces of calcium carbide are dropped in the generator which contains a mixture of alcohol and water. This produces enough acety-

6 P. 8th Armored Div. main. Battalion. Ft. Knox, Ky. A.P.O. 258

London Electrotype Agency Ltd. 134 7 bet St. London, E.C. 4 England.

73477

M 771

lene gas to fire the gun about 10 times. A line carries the gas to a compression pump which forces it into the explosion cylinder. Special valves release hot gases into the barrel to propel the bullet when the trigger is pressed. The gun has a rear sight which is adjusted for windage and elevation.

Wire-Tailed Antiaircraft Rocket Entangles Enemy Planes

Great Britain's latest antiaircraft weapon is a rocket that trails in its wake long tentacles of entangling wires intended to disable enemy planes. However, the idea is not a new one. It made its appearance late in the first World War as a "spaghetti shell" that would spin out wires at high altitudes, but the war ended before it was fully developed. Since then other inventors have incorporated the idea into shells, rockets, balloons and airplanes. One proposed to string small bombs at intervals on the wires so they would explode when the aircraft struck them or pulled them into contact by winding the wire on its propeller.

Science fiction

M 785

Jap Zero Fighter Downed Intact Scrutinized by U. S. Experts

American aviation experts were presented with a fair sample of a Japanese Zero fighter plane when one of the ships was shot down intact by a U. S. pilot in combat over the island of New Guinea. The plane, which suffered little damage in landing, has been inspected thoroughly.

M 783

acme

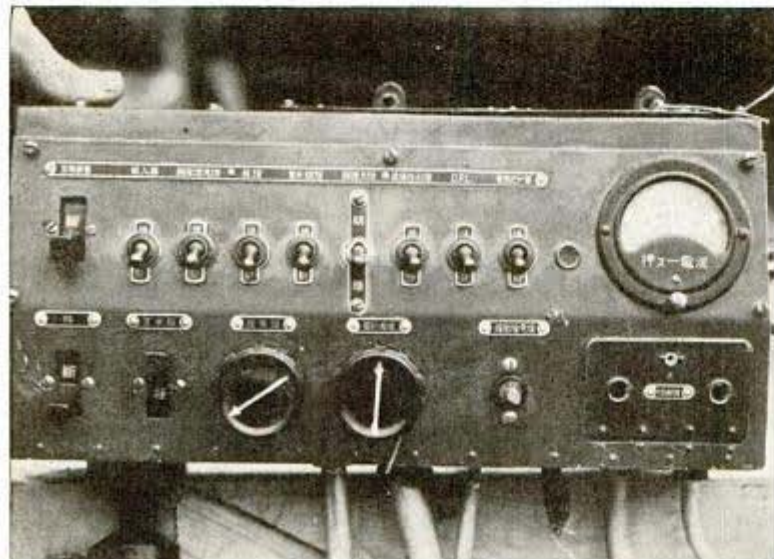

This switchboard was removed from a Japanese plane shot down by a U. S. pilot and shipped here for study. Note Jap characters on instruments

Fluorescent Utility Lamp Used on Extension Cord



Extension light is cool and easy on the eyes of war workers and may be clipped to the belt or coat lapel

Handy for close inspection work in confined places, a fluorescent extension cord light is now available for use in war plants. Designed at the request of a bomber parts manufacturer, the lamp is readily adaptable to all kinds of extension cord service.

The light source is so cool that the lamp may be clipped to the belt or coat lapel of the worker, leaving both hands free. It throws a glareless beam that reduces eye fatigue and results in effective illumination on the work. The grill protecting the fluorescent lamp is constructed of heavy gauge steel, and a burned-out lamp can be replaced in a few seconds.

One manufacturer of synthetic rubber is reported to have produced and investigated 8,000 varieties.

*Hygrade by Hyoma Corp
500-5 Ave. N.Y.C.*

M 416

7/20/41
L. M. H.

The **COMMANDOS** are TOUGH



Picked volunteers, the Commandos get toughened by rigorous training with all the realism of combat conditions

COMMANDOS are three-dimensional warriors. They strike by air or by sea, and they fight on land with the paralyzing swiftness and stealth of an Indian.

They're a tough team to beat. They've got to be, for they do their fighting on the home grounds of the enemy; the chances are they will be heavily outnumbered and outgunned on every raid, and there's a wide moat to cross before they are safely back in England.

Months before they were officially introduced to the world as Commandos,

thrilling stories began to leak out. There were reports of British motorcyclists landing on the French coast for night raids within the German lines. Some were said to have pushed inland as far as Amiens. Then British naval units dashed up to the Lofoten islands off Norway, and while loudspeakers informed the Norwegian populace, landing parties went ashore in barges to seize 200 German soldiers, burn a fish-oil factory and wreck a radio station. Still later, a raiding party stole ashore at Bardia, behind the Nazi army in Libya,

climbed the coastal escarpment without detection and blasted a vital bridge, coast-defense batteries and supply dumps. Sixty men lost their way in the blackness, but the rest rowed back to the ships lurking several miles off shore. In another Libyan raid, a small group of Britons actually penetrated Gen. Erwin Rommel's headquarters and narrowly missed capturing the Nazi commander, who

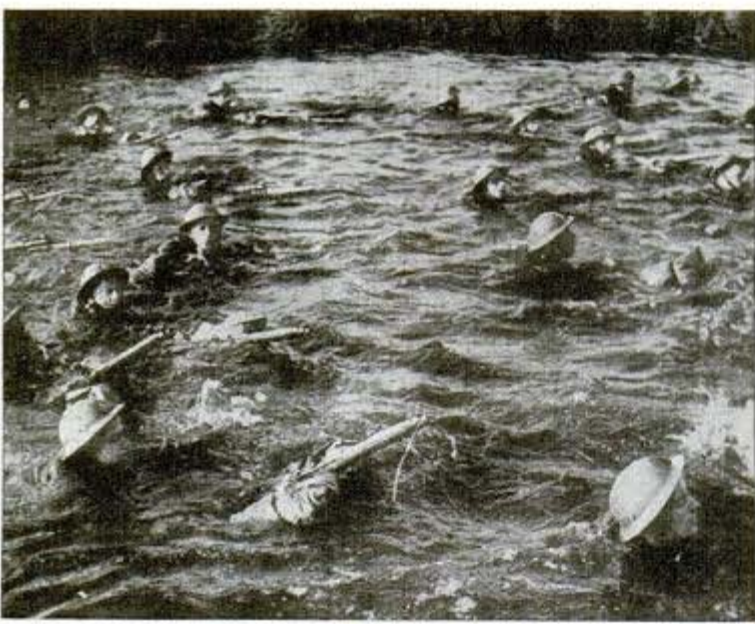

British soldiers with full kits swim across a river, resting rifles on bundles in front so that they can fire while swimming

happened to be attending a party.

About that time they began to be known as Commandos, so named for the bold guerrillas who made spectacular forays against the British in the Boer War. And the stories of their expeditions multiplied. They told of Commandos lying in ambush on a French coastal road to wipe out with tommy guns a squad of German troops whistling as they bicycled down to relieve a pillbox crew already subdued. They told of a Commando party stealing up to a French dance hall to kidnap Reichsmarshal Goering, who was expected there. He missed the abduction by a change of plans, but the Germans at the dance were captured or shot.

Commandos are black face—but they're no comedians. Their faces, even their teeth are blackened to prevent detection as they slip ashore and stalk the enemy sentry, throttling him with wire or rope or silencing him with a knife. They carry condensed rations, if any; they subdue the enemy silently if possible, but if guns are necessary they prefer



"Every man a Commando" is the slogan in the British training camps. Here two Scots Guardsmen flip one of their comrades, fully equipped, over a high wall

Six candidates for Commando assignments limber up their muscles by exercising with heavy logs. It takes months of muscle and brain work to equip a man

Before they raided Nazi-occupied Channel shores the Commandos made many a practice attack on beaches like this, crossing wire barriers with ladders





With fixed bayonets, trainees cross a pole hung over a trench

the light and murderous tommygun. Since theirs is most dangerous duty they are picked volunteers, toughened by rigorous training in assault tactics. They must be able to fight all night and all day without food if need be. They must be experts in demolition, able to march 30 or 40 miles a day, ready to fight with any weapon—or their hands, and feel at home in a parachute or swimming out to a boat. In training they practice landings and maneuvers with live bullets.

Several months ago a Commando unit was assigned the destruction of a Nazi plane-detection post on the Channel coast. Royal Air Force planes carried the men over, and they parachuted from low altitude—probably with the planes in a dead-engine glide to escape detection. The men crept almost to their objective, the radio tower, before they were challenged. In a sharp fight they subdued the defenders, wrecked the detector and made for the beach where

naval craft waited to take them off. They had to overcome outposts on the beach, then signal the boats, and as they pushed out into the Channel they saw headlights of German armored cars approaching. At dawn, fighter planes came from the English shore to protect the returning ships. It was perfectly timed teamwork from start to finish.

Maj. R. V. Boyle, a British officer, tells of one exploit in which the element of surprise carried the objective. The Commandos were to capture the German commander of a post in Norway.

They landed at night, cut the communication lines, and a detachment commandeered a car and drove to the home of the officer, several miles out of town. At 8:15 a.m. they "liquidated" the guard without a sound, then rang the front door bell. A servant responded and found himself facing

a battery of weapons. The Commandos, placing a gun at his back, ordered him to lead them to the German officer's room.

They knocked on the study door. The Nazi commander called "Come in" and continued writing. When he looked up, he was surrounded with guns. He and his papers were abducted to England without any other occupants of the house knowing he had left.

Boulogne, battered Channel city of occupied France, was the site of another pre-dawn dash. For two hours the Commandos swarmed over the dunes and stud-



Oarsmen row a big barge in practice for silent night landings

ied fortifications around Boulogne, then were taken off in warships without the loss of a man.

Long after the assault on the Nazi submarine base at St. Nazaire, which was of the proportions of a battle, stories of the Britons' heroism were coming out. That engagement lasted for two days. The Commandos rammed a former American destroyer into the drydock gates, and leaped ashore to storm the German strongholds. The commander of the raid, Lieut. Col. A. C. Newman, led a small headquarters staff into St. Nazaire and was last seen disappearing behind burning buildings. He is missing, a casualty or prisoner of war. Other units captured the Nazi field headquarters and held it for 48 hours before they were dislodged.

Principal hero of the attack, however, was an unnamed British officer whose sacrifice afterward was related by eyewitnesses who reached Sweden. This officer jumped to the dock from the old, dynamite-laden destroyer and surrendered. A few minutes later he agreed to conduct a party of German officers aboard the vessel on a tour of inspection. He knew it was loaded with explosives, that a time fuse would set off a terrific blast in a matter of minutes. He died, and the German officers died with him as the ship blew apart and wrecked the dock gates.

The Commandos didn't all come back from St. Nazaire. But they killed perhaps 400 Germans, many of them officers; they destroyed important military facilities, and gave the German occupying forces a fresh case of frayed nerves.



Slipping through barbed wire entanglements, a group of soldiers scales a ten-foot wall in preparation for a job across the Channel



Above, American Marines, trained in the style of Britain's Commandos, engage in patrol and landing operations. Below, British Bren gun carriers roll ashore from barges in a practice invasion



M 722

Rubber and Steel Bridge Spans River for Army



Tank moving across bridge made of heavy steel treadways supported by big rubber pontoons inflated with air

Bridges over rivers and streams are erected with utmost speed by army engineers using a series of large rubber pontoons inflated with air to support heavy steel treadways. Tanks, trucks and other vehi-

cles crawl over the bridges, the pontoons protruding far beyond the sides so they will not heel over. This type of bridging was developed by officers of the 16th Engineers of the First Armored Division.

Roller Does Work of Paintbrush With Water-Mixed Paint

Scarcity of paintbrushes is responsible for the development of a paint roller of-

fered by a paint manufacturer for use in applying water-mixed paint to walls and ceilings. The handle is set at right angle to the roller which has an outer surface of porous cloth. The paint container should be a flat-bottomed pan that may be tilted to expose a portion of the bottom where the roller is run to pick up an even supply. After paint has been applied to a section of wall, the roller is pulled back and forth until the surface is smooth. After using, the roller may be washed in soap and water and the edges of the woodwork cleaned.



Cloth-covered roller is "loaded" in flat-bottom pan

Mercury "Bomb" Explodes Metal Within Fluorescent Lamp

About 50 percent of the mercury formerly used in making fluorescent lamps, which was lost or wasted, is now being saved by injecting the mercury into the lamp tubes by means of "bombs" instead of the dispensing device they replace. Besides eliminating waste, the bombs im-

Pres. Mason
The Sherwin-Williams Co
101 Prospect Ave, 77th St, Cleveland, O

M 745

M 689

POPULAR MECHANICS
Nygade-Sylvania Corp
500-520 N.Y.

prove lamp performance because they deliver the exact amount of mercury needed, which is essential for long life and efficient operation. The mercury is "wrapped up" in a tiny metal tube affixed to a support lead of one cathode. When the current is first turned on in the lamp, during the exhaustion process, the heat expands the mercury, exploding the tiny tube and releasing the free mercury.

M 767
**Old Bottle Caps Given New Life
 By Cleaning and Stamping**

Used bottle caps are given a new lease on life with a reclaiming machine plus a sterilizing process that makes the second-hand steel crowns safe, sanitary and leak-proof, on a mass production basis. The machine's purpose is not to restore the cap to its original shape, but instead the cap is deformed by stamping two concentric circles in the top. These circles form a new seat that conforms with the seal-ring at the top of the bottle upon which it is pressed. They also serve to identify the reclaimed caps as such. Reclaiming begins by removing all paint and cork from the cap and sterilizing it for 15 minutes in live steam and boiling water. After its trip through the stamping machine, the cap travels on a belt to a painting machine for enameling inside and out, and immediately passes under infrared heat lamps to bake the enamel. A new disk is inserted to make sure that only new material comes in contact with the contents of the bottle.



Machine making caps leakproof by stamping two concentric circles which form a new seat of contact with bottle top

OCTOBER, 1942

**'Bicycle' for Shopping Bags
 Folds When Not in Use**



Inspired by the wartime curtailment of home delivery service, a small collapsible cart is designed to carry shopping bags. It consists of a V-shaped metal frame, two small wheels with rubber tires, and a handle like a cane for balancing and pushing. Bags are held on hooks on either side. When not in use it can be folded and carried over the

M 759
**Glass Bubble Deposited as F
 Guards Plastic Lenses**

Plastic lenses, made more rapidly and cheaply than glass, have had one drawback—they are too easily scratched. This weakness has been solved by the invention of Frederick J. Binda of Boston, who deposits a film of glass on the lens surface by blowing a bubble of hard glass in a way that brings it into contact with one side of the lens. This molten film, as thin as a few ten-thousandths of an inch, cools, hardens and sticks tightly to the plastic, cc
 Polaroid Corp. Cam-
 bridge, Mass. 13
 for resurfacing rollers.

Rel. Bell Telephone
 Labs, 465 West St
 N.Y.C. 13

Law. A. G. Lacey, President
 Heileman Brewing Co, La Crosse, Wis

SKY HOOK to LAUNCH

Androglaco. July 42 issue

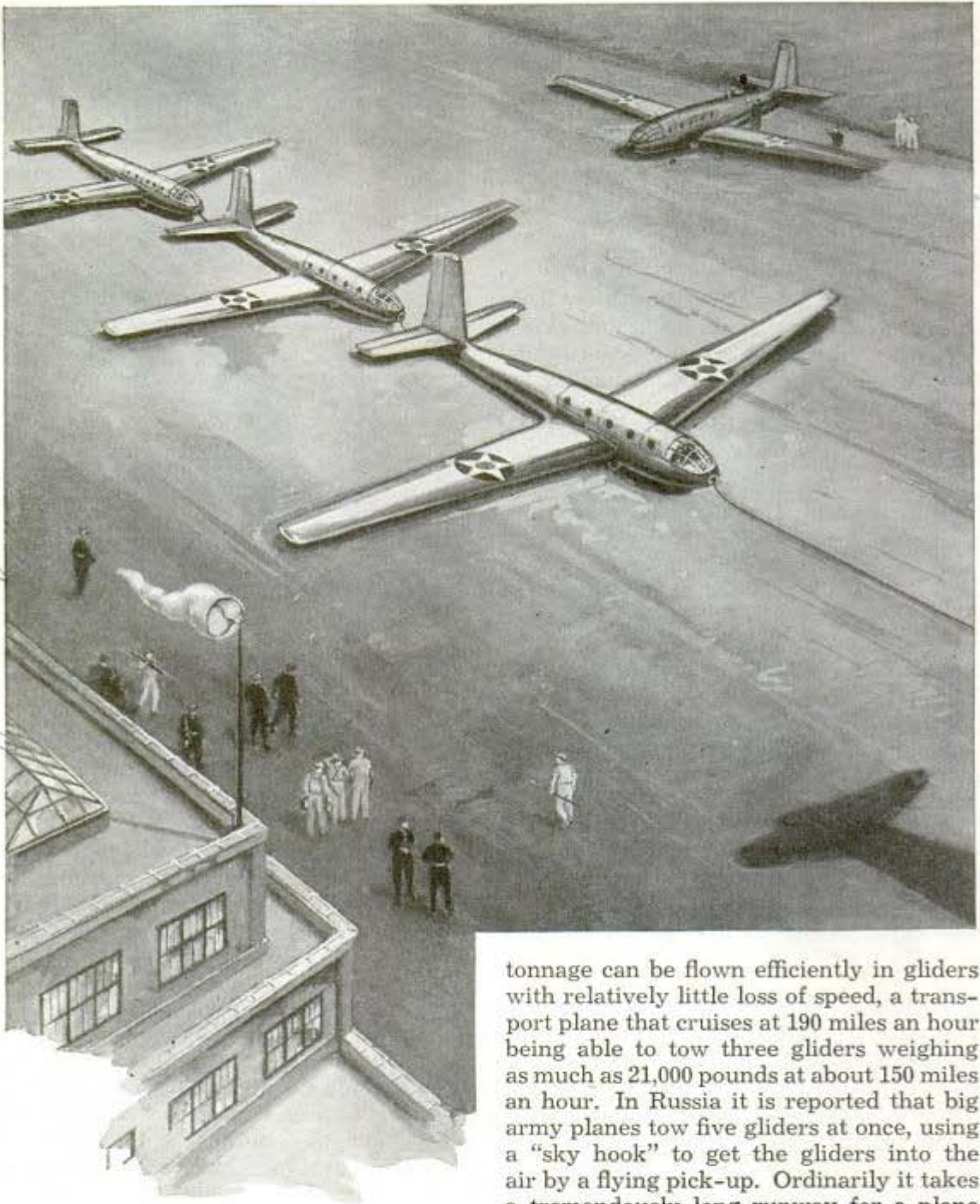

GLIDERS were once the sporty surfboards of the sky. Today they are carriers of aerial infantry and war freight; glider trains towed by transport planes are turned loose to slip silently down into enemy territory at night. Tomorrow the glider train may carry vast amounts of freight across the states. Considerable

tonnage can be flown efficiently in gliders with relatively little loss of speed, a transport plane that cruises at 190 miles an hour being able to tow three gliders weighing as much as 21,000 pounds at about 150 miles an hour. In Russia it is reported that big army planes tow five gliders at once, using a "sky hook" to get the gliders into the air by a flying pick-up. Ordinarily it takes a tremendously long runway for a plane to drag several gliders into the air and lift itself too. With the sky hook, however, the gliders can be parked almost nose to tail and literally yanked into the air by a grappling hook suspended from the rear of the tow plane's fuselage.

From the forward glider, a towing cable extends about 200 feet forward to form a

GLIDER TRAINS

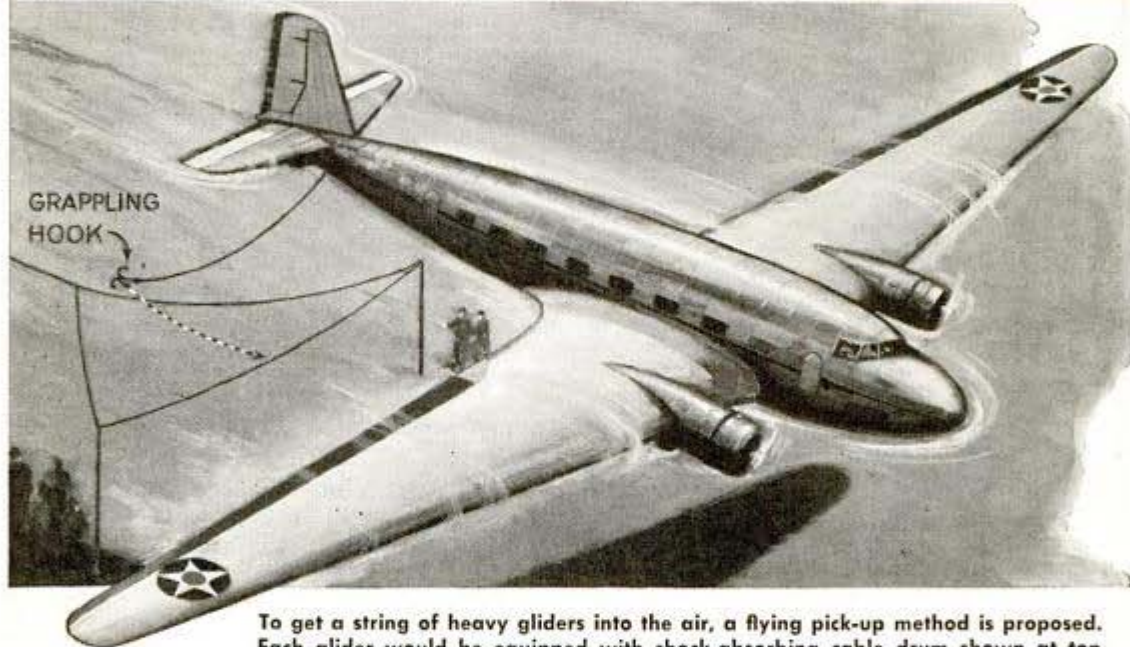
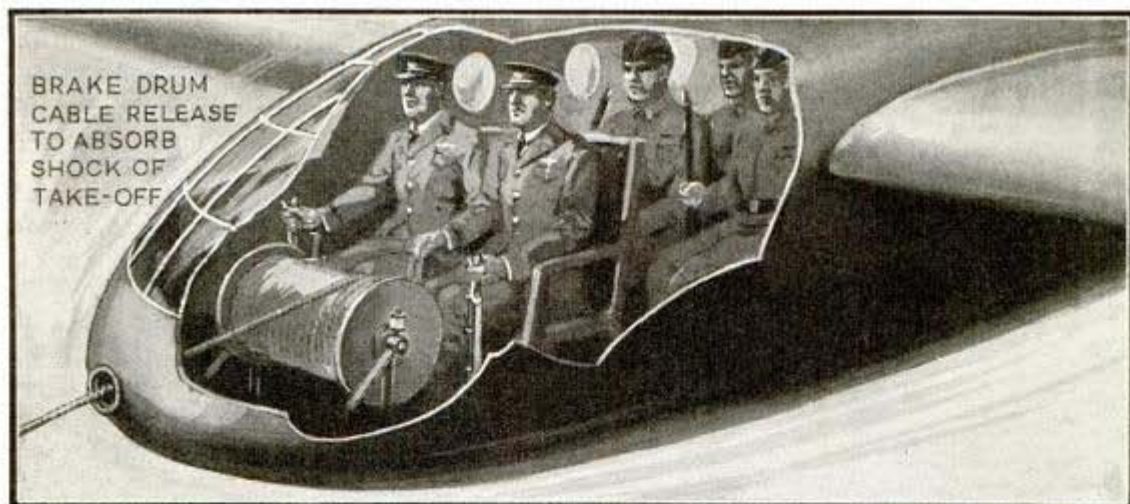

To get a string of heavy gliders into the air, a flying pick-up method is proposed. Each glider would be equipped with shock-absorbing cable drum shown at top

triangular loop, the base of which stretches between two "goal posts." The tow plane maneuvers over the gliders and the grappling hook seizes the cable between the posts, which fall to the ground. The posts are about 15 feet apart.

In the nose of the glider, the cable is wound around a revolving drum, which pays out the towline as the plane gives its initial yank. Immediately, then, the pilot of the glider begins applying brakes to the drum, using more and more pressure until the cable is no longer unwinding and the glider is in motion.

This same technique is employed in each glider of the train, the brakes on each ca-

ble drum acting as shock absorbers to ease one glider after another into the air. The glider, of course, can drop its towline to make a landing. Using this system in commercial freight carrying, a glider with freight destined for some point along the airway could drop off from the train just as a boxcar is set off on a railway siding. Later this glider could be retrieved by the sky hook of a passing air freight train.

A beginning on this technique was made the other day at Wright Field, where a Stinson plane swooped at 100 miles an hour to engage with its hook a line strung between two posts and attached to a motorless plane, which it pulled into the air.

International News Photos

M768

Highways Made Into Runways For U. S. Army Planes



Planes land on runway made by widening highway with strips of paving

Airplanes soon will be able to land and take off on flight strips being constructed parallel to highways at strategic points throughout the country. The first one completed, opened recently by the Army Air Corps and Public Roads Administration of the Federal Works Agency, is a strip 8,000 feet long and more than 500 feet wide, the runway being 7,000 feet by 150 feet.

Mileage Left in Your Auto Tires Can Be Measured Easily

You can measure the approximate number of miles left in your automobile tires, if the tires are wearing evenly and have no signs of undue wear caused by misalignment, unbalance, or loose and worn wheel parts. For a first line tire, each 1/32 inch of rubber in the non-skid portion of

the tread represents 2,500 miles of wear, according to studies made by tire engineers. For instance, if the tire shows 1/32 inch left, you can expect at least 12,500 miles before the tread is gone, provided you drive with utmost care. Tire experts say also that there is a possible 15,000 miles in the basic treadless rubber covering, but these last miles are the most dangerous because the tires are smooth. If your tires are second line (less expensive than first line), the mileage figures would be about 15 percent less.

Plastic Film Holder Is Unaffected by Developer

Plastic holders unaffected by photographic solutions and virtually unbreakable are now offered for suspending cut film in tanks during the developing process. It is said that the new holders load easily and they are perforated to permit rapid drainage of liquids.

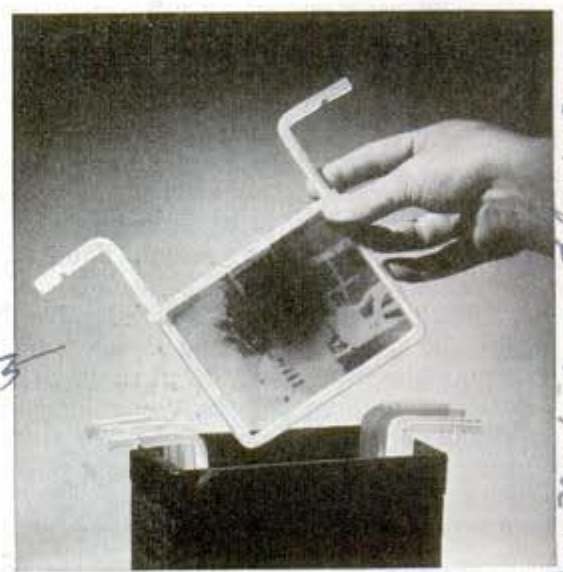

Easy loading holders are not harmed by photo bath

16 Bear mego
Rock Island, Ill

POPULAR MECHANICS
Los Angeles, Calif
Copyright, 1953, by Popular Mechanics Co.

By: Michaelson Photo Co
P.O. 208 Wilshire Blvd

FROZEN BILLIONS



One of man's most precious minerals, radium is of greater value than ever in a world at war. It is indispensable in therapy, in radio-photography and in research into nuclear physics; and today it finds use in the blackout. Here a General Electric scientist experiments with luminous pigments for blackout paints

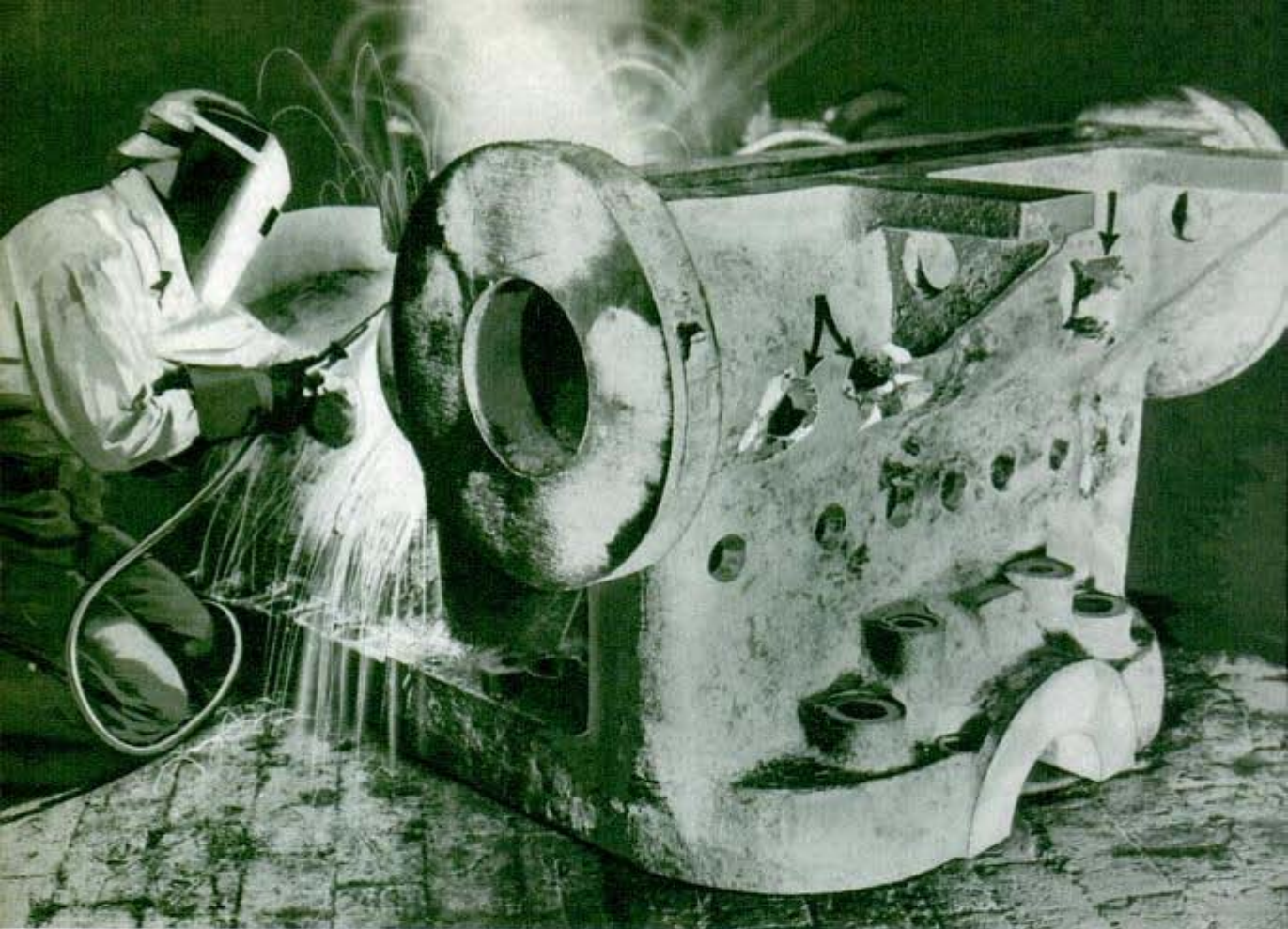

A welder fills in areas chipped from steel turbine casting (note arrows) after gamma rays had detected air-bubble flaws in steel

White crystals of radium bromide appear in colorless liquid during final stage of refining by Canadian Radium & Uranium Co.



m 533

By Allen Warren Elliott

3436.33 St. N. Y. C.

IF YOU could stuff your pockets full of hundred-dollar bills, fill your hat, grab two handfuls and then stagger around with a huge bundle under each arm, it is possible that you could carry a million dollars. If you could slip a little pellet of radium into your pocket, a ball about the size of a large garden pea, weighing around an ounce and a half, you would also be carrying a million dollars.

You wouldn't haul this precious load around very long. First, because radium plays tricks on the human body. And, second, because Uncle Sam would probably grab it in a minute and give you 10,000 crisp hundred dollar bills in exchange. For radium is now a vastly important war material.

The planes which fill the skies, the ships which plow the sea, the tanks, the guns, even the shells and bombs, all require radium somewhere along the line.

If regular nightly blackouts come to your community, you will probably require it too, for radium is the luminous paint factor which needs no light to make it shine in the dark year after year. Radium may even conceivably save your life before the war is over, since being hit by a blacked-out automobile is just as likely to be fatal as being struck by a bomb fragment.

Timed as if to meet the emergency need, a fantas-



Ever play "spook golf?" It's a game invented, as a stunt, by General Electric engineers experimenting with luminous paint for use in blackouts. At the right the golfer is photographed by flashlight; at left, he's in a blackout

tic stroke of luck has placed practically all of the world's supply of available new radium in the control of the United Nations.

Providential, too, was the whim of fortune by which the mine that disgorges 99% of this radium was discovered through two pairs of human eyes, one pair sharp and curious, the other pair swollen and snowblinded. Else the anti-Nazi world would have practically no new radium right now when it is needed.

The chain of fortunate circumstances held together, however, and today in a 10,000-acre spot of bleak ground in northern Canada, only 26 miles from the Arctic Circle, deep in the frigid rocks, men are mining this critical supply of radium ore. It is worth many, many millions, and for all anyone can say with certainty, this treasure is likely to prove to be literally frozen billions.

By dog sled, tractor train, plane, boat and rail huge supplies of this fascinating substance are being rushed from the Arctic Circle to New York City, from where the radium trickles in pin-point quantities throughout the United Nations. So scattered is the product in its natural state and so thinly can it be spread when purified that a huge supply of the ore, say 500 tons, finally becomes a quantity which could be hidden under a fingernail if unadulterated. And still this remains a huge supply.

Night and day in the depths of the radium mine on a rocky point extending into Great Bear Lake in the Northwest Territories, miners dig the black and brittle pitchblende. Night and day at Port Hope, near Toronto, On-

Radium sulfate, the source of the powerful gamma rays, is never handled directly. When needed for inspecting metals, it is brought from its sunken, lead-lined safe in this carrier, also lead-lined

Westinghouse photo

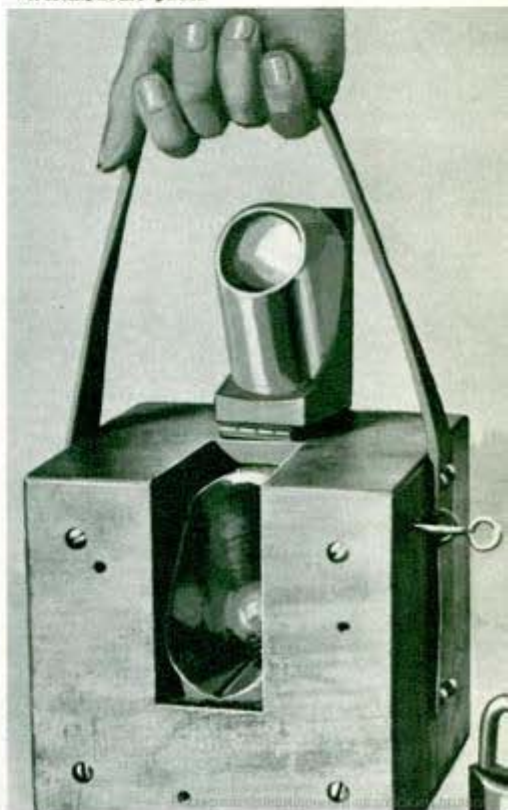

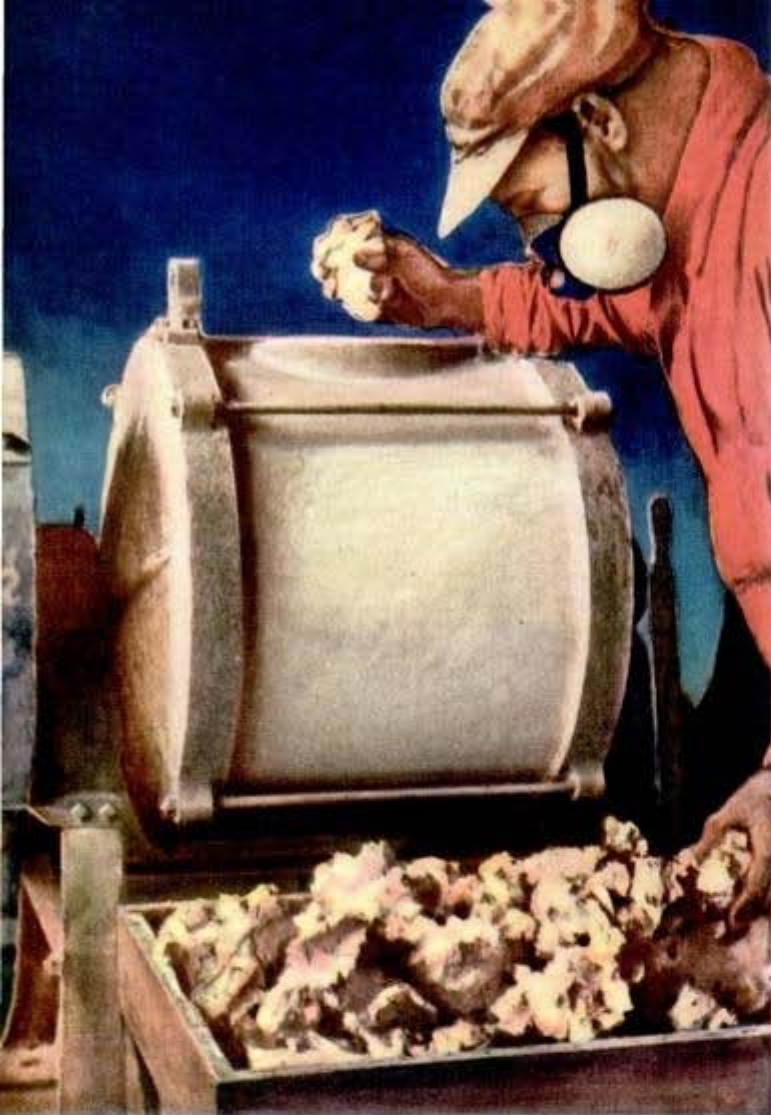

Grinding sodium uranate, a heavy, bright yellow, clay-like substance to be used as pigment. This is a common form of uranium, heaviest element and parent of radium

The first step in refining radium, as in treating many other ores, is to roast out impurities in the furnace. This is a scene at Eldorado refinery, Port Hope, Ont.



tario, experts refine the concentrated ore. And night and day in New York City chemists complete the processes bringing the radium down to a point of purity where a thimbleful, still heavily diluted, might fill dozens upon dozens of industrial war orders.

It all goes back 12 years to a romantic episode concerning the two pairs of eyes and a twist of fate which attracted little attention outside Canada at the time. Only now has it grown to world importance.

The hero who found this richest piece of rock in the world is a hardy French-Canadian prospector, Gilbert LaBine, who searched the snowy wastes year after year for "pay dirt." Not only his sharp eyes led to the strike, but also his honesty.



† Mining radium-bearing ore 500 feet under the earth, a stope in the Eldorado Mine on the edge of the Canadian Arctic. The ore vein which contains the radium is pitchblende—a dull heavy, black and brittle rock

LaBine finally struck silver in sufficient quantities to make a stake, took this money, interested a group of investors and formed the Eldorado Gold Mines, Ltd., to work some claims in the Long Lake District of Manitoba. One day, while the investors were all waiting for word which would make them wealthy, LaBine called them together and laid his cards on the table. The property, he confessed, was a failure. They would have to make another strike. Disappointed, his backers told him to try.

Hiring a plane and a pilot, he flew to the Great Bear Lake region. It had only been visited by Arctic explorers, a few Indians and Eskimos and an occasional white fur trapper, but somehow had become the focus of a tale of vast mineral wealth. He tramped across the snow and ice, questioned



One important use of radium in war is in the making of luminous compounds. Here a worker paints aircraft instrument dials with a radium compound which makes them easily read in a dark cockpit

The airplane and the dog sled, the new and the old, provide the only means of reaching the outside world during the long winter at Eldorado on Great Bear Lake, "world capital" of radium production





Hundreds of luminous chemicals are being studied at the General Electric laboratories for possible blackout use

A teaspoon about two-thirds full represents an average pre-war year's supply of radium salts in the United States

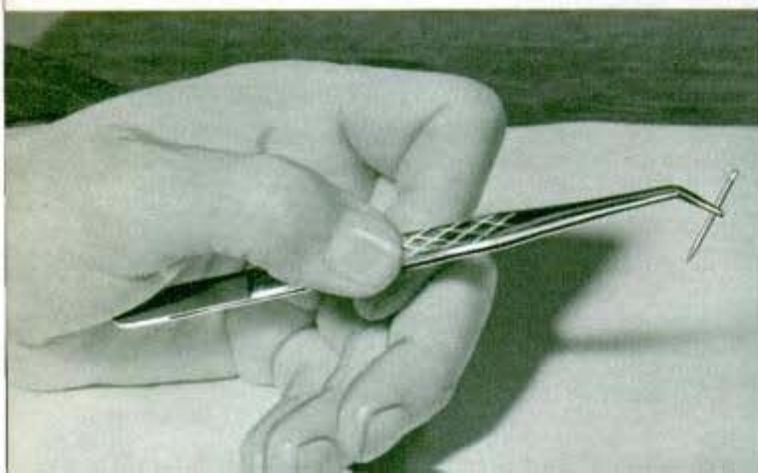

an Indian and his squaw who had camped on the lake shore, found nothing definite and soon returned to civilization. There might be fabulous veins of metal around Great Bear Lake, as the tales said, but unfortunately the lake was one of the world's largest.

Waiting a year, he tried again, taking another prospector with him, Charlie Saint Paul. Landing their plane on the frozen lake, they rigged up a sled and began exploring the shores, hauling 1,200 pounds of food and equipment in terrific cold, 20 to 45 degrees below zero.

Finally they reached a promontory that is now LaBine Point. They were thinking of giving up the search even though they had found outcroppings of silver. Silver was too cheap to be transported back to civilization from the top of the world. They would have traded a million tons of the silver ore on the spot for a hot apple pie.

It might have ended there, except that Saint Paul awoke one morning blinded by the glare of snow and ice. While waiting for his companion's eyes to heal, LaBine remembered a strange black streak which had caught his eye while flying over the promontory. Working his way over the ice and rocks, picking at the outcroppings, LaBine came upon a patch of what looked like coal, but was infinitely harder. He recognized it for pitchblende, the parent ore containing radium, uranium, silver and a number of other valuable minerals.

Before long the pair were winging south with ore samples. Chemists confirmed its value. The Canadian government sent an air expedition to the site of the strike. They verified the huge extent of the ore field.

Still, Gilbert LaBine and his investors had to wait for their riches.

While radium was then selling for \$1,960,000 an ounce there were many tantalizing factors. It was so costly that only the biggest institutions could buy minute quantities for its principal use, cancer treatment. The Belgians had a stranglehold on the world mar-

A needle of this size, used in radiotherapy and particularly for cancer treatments, usually contains \$600 to \$1,000 worth of radium

ket with easily accessible ore in the Congo and refineries in Belgium.

The nearest railroad ended 765 miles from Great Bear Lake. The only water route was open six weeks to two months of the year and rapids forced two overland portages. Huge quantities of ore had to be hauled to the nearest available coal or oil for concentrating, or the fuel had to be transported into the Arctic.

The jump from Great Bear Lake to the logical refining point was about 4,000 miles. To refine each ton of pitchblende even after it is concentrated requires five tons of chemicals. And to top it all, no one could be found on this continent to tell them how to extract the precious product, radium, from this particular ore.

"Then began a struggle which lasted years before results began to show," says Boris Pregel, president of the Canadian Radium and Uranium Corporation. "Gradually the machinery was shipped up there, largely by plane. The mine was dug. A mining town was built. A water transportation company was established. A plane service was inaugurated. A refinery was built near Toronto. A Frenchman named Marcel Pochon was located in the mines of Cornwall, in the British Isles, who knew what to do with the ore.

"As soon as the money started to come in, we cut the price approximately in half to broaden the market. Then the war struck and Germany took over the Belgian refineries while the Allies kept the Congo mines. This blocked the former principal source of radium and soon we found the entire civilized world depending upon us.

"Now, with this responsibility, we are no longer working for money. We are working to win the war."

Radium is being used more widely than ever for therapy, including cancer treatment, for research into nuclear physics which change the whole pattern of future living and for luminous pigments necessary for airplane, submarine and warship dials as well as blackouts. But its value for radiography, or photography by means of its radiations, is its key purpose right now.

Remarkable enough is its ability to bombard zinc sulphide with 183,000,-



Frank Hartman, Philadelphia "radium detective," hunts lost radium in ashes from hospital incinerator with his "electric bloodhound." Below, making a radiograph of a metal casting with radium encased in aluminum "bomb"

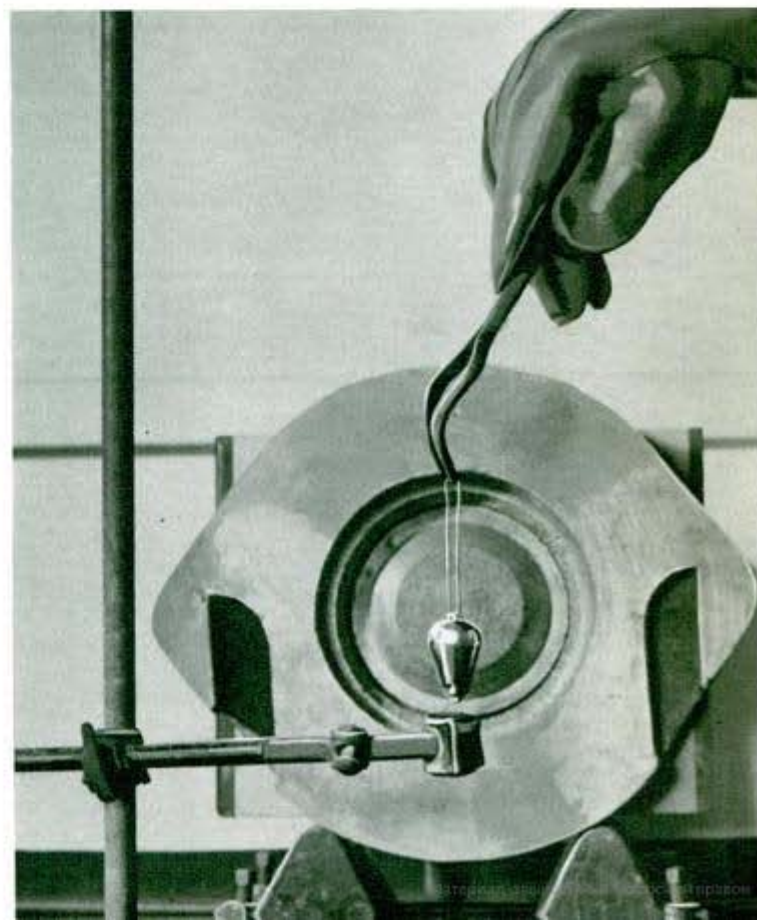



Crystals in this quartz bowl are barium-radium—all that remains after refining many tons of ore from the sub-arctic. Impurities have been removed, and barium is being separated out

Concentrated radium ore, ready for refining, is packed in bags like this at Port Radium—airport a few miles from the mining community—to await air shipment to refinery near Toronto



000 particles a second and thus give off a glow in luminous pigments that lasts an average of 10 years, or till the zinc is exhausted.

Even more fortunate for the war effort is the fact that the gamma rays of radium will penetrate eleven inches of toughest steel and make an impression on a film in which a flaw, such as an air hole, will show up black on the film and white on a photograph.

Great corporations like General Electric, General Motors and Westinghouse, and hundreds of others, are soaking up the supply in increasing volume, to take radiographs of castings, boilers, plates, etc., to correct hidden flaws so the final product may be perfect. Munitions factories use radium bombs to see through shell casings and eliminate duds from the munitions on which American troops and sailors will depend in

(Continued to page 176)

71708

Rubber Bags Convert Boxcars Into Oil Tanks

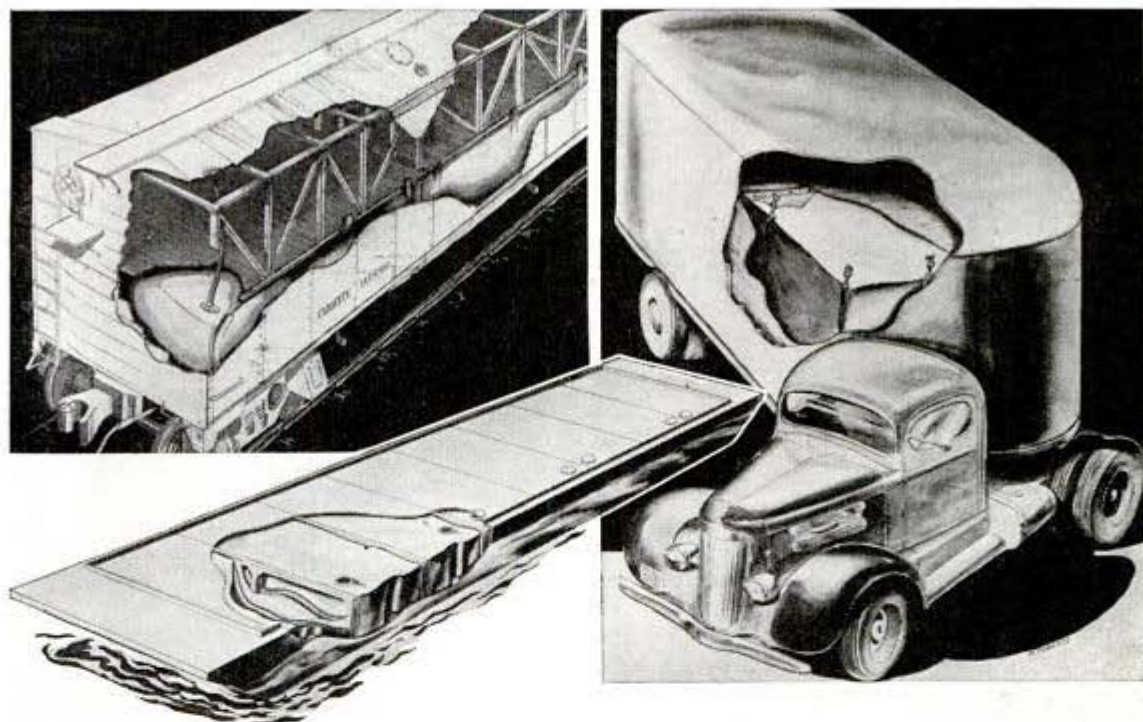

Collapsible rubber tanks can be placed in boxcar, wooden barge or truck to carry full or partial load of oil

Fuel tanks made of synthetic rubber are being developed by the Glenn L. Martin Company of Baltimore as a possible solution to the oil transportation problem. The collapsible rubber tanks would convert railroad box and gondola cars into tank cars, wooden barges and other boats into tankers and ordinary freight trucks into carriers of gasoline and oil. After delivering fuel, the tanks could be rolled into compact packages and expressed back to the refinery, making the boxcar, truck or

barge available for return freight. The transport tank is an adaptation of the rubber fuel tanks for airplanes developed by the Martin company, makers of the famous Martin bombers. The tanks can be made in various sizes to fill an entire boxcar or truck or for less-than-carload space that might otherwise remain empty. All that is required is proper support at the sides. There are adequate materials and manufacturing capacity to supply the tanks quickly, according to Mr. Martin.

Dummy Planes and Guns Are 'Bait' for Enemy Bombers



Engineers of the U. S. Army are designing dummy planes and guns to place on the ground at likely spots as "bait" for enemy raiders to waste their valuable bombs upon. From the air these dummies look so much like the real thing that a bombardier seeing them might readily yield to the urge to blast away at them and thus let himself be diverted from an important military target.

The wooden gun and plane would look like the real thing to a bombardier several thousand feet up in the air

Acme

71620

The MOST DANGEROUS MAN

Cont: Shaw & Stinson Jr

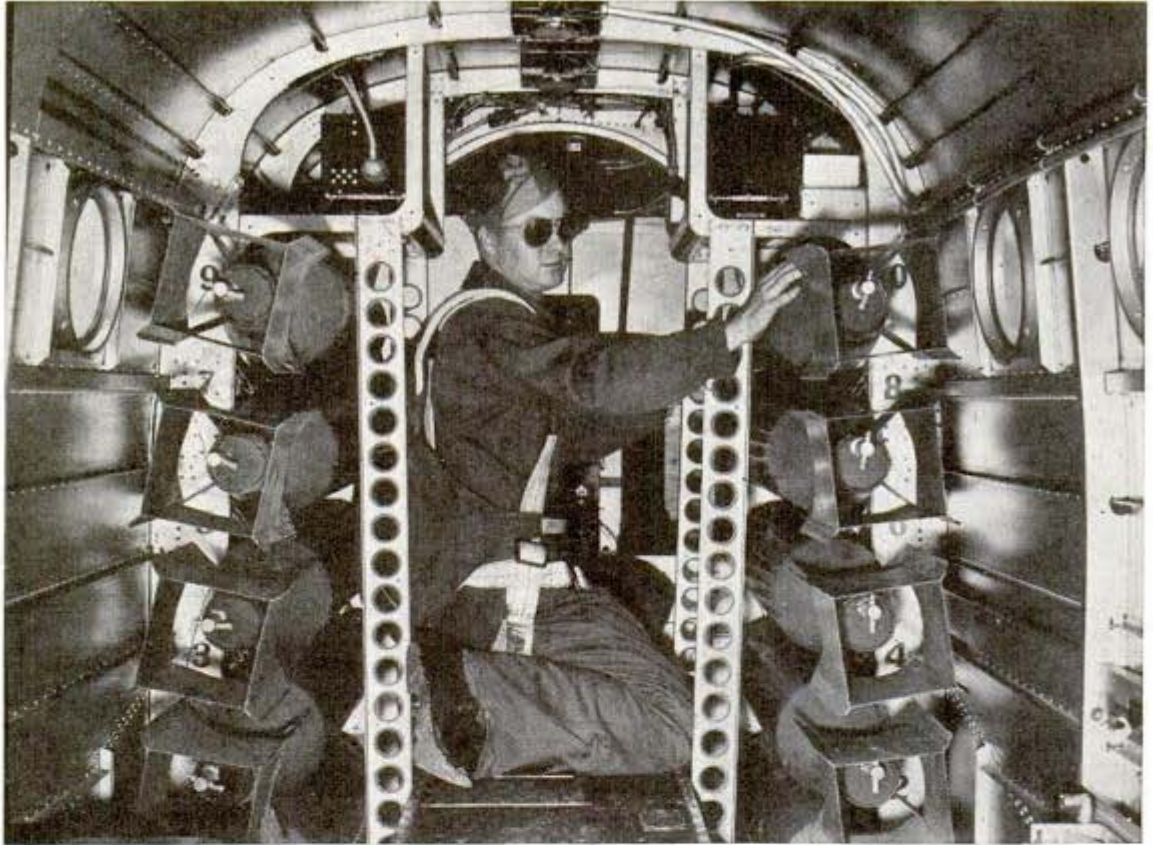

The bombardier checks arming wires on 100-pound practice bombs in racks of a training plane, above. Left, putting the precious bombsight into the "greenhouse" while an armed guard stands by

second to release his deadly load so that it will curve down and strike the center of an enemy warship or munitions factory that sometimes is still miles ahead of him.

At the moment that the pilot announces "On course and level. Your plane." the bombardier takes charge of the ship. He has already opened the bomb-bay doors, armed the

MET the bombardier, the "most dangerous man in the world."

He is in charge of one of the world's greatest military secrets, the American bombsight. He does his work, cool and unflustered, in the transparent nose of a flying battleship while antiaircraft explosions rock the plane and enemy interceptors dive toward it. His whole job is compressed into picking the one exact split

seconds, and has turned switches that select the bombs that will be dropped. Now he makes last minute adjustments to the big bombsight in front of him.

The speed and altitude of the bomber and the direction and velocity of the wind must be considered. Even the temperature of the air and the weight of the bombs will affect their trajectory.

The rest of the crew may be busy fight-

Ref: Public Relations office, Midland Army Flying School, Midland, Tex.

in the **WORLD**

ing off enemy attacks but they can tell, from the slight upward bounce, when their load of destruction is released. The pilot needs hardly wait for the confirming phone call "Bombs away. Okay to turn." from the bombardier. It will be long seconds yet before the bombs reach their target and the crew gets busy at once with the task of getting back to their base.

The aerial bomb is one of the most destructive weapons of the war and today the United States is producing vast fleets of bomb-carrying airplanes and thousands of trained bombardiers to man them. The Army Air Corps needs applicants for its bombardier schools, yet not everyone can meet the rigid qualifications. A good pilot is said to be easier to find than a good bombardier. These hand-picked men, between 18 and 26, preferably with an aptitude for mathematics, need an intense power of concentration and a high emotional reserve so that they can carry on their meticulous duties right in the face of danger.

From the time he swears the bombardier's oath never to reveal the details of his secret bombsight, to guard it with life itself, and to destroy it in case of need, the bombardier student lives a life apart from that of other military men. His bombsight is never left unguarded. The ground crew protects it in a special vault when not in use, moves it to the



Carrying two "eggs" to be dropped on some Texas range, a cadet marches between long rows of bombs in Sloan Field's "bomb dump." Below, pilot and bombardier instructor sit side by side in an AT-11 trainer





Cadets learn to handle dangerous tools of the trade

airplane under armed guard, and the bombardier attaches it to the plane while it is still shrouded in canvas. After the plane leaves the ground he uncovers it.

He studies his deadly, devastating science at such a field as the Midland Army Flying School in Texas. This is the greatest bombardier training base in the world. Its bombing range is larger than the state of New Jersey. From the school's maze of



It's simple, but it still works. A bombardier student examines a 1918 bombsight

airport runways an endless procession of two-engined training planes roar off on practice missions 20 hours a day, seven days a week.

Much of what the student learns is secret. He makes no notes in the lecture halls during the 12 weeks of training for fear the information might fall into the wrong hands. He carries no textbooks away from class. He learns how bombs are made, how they work, and what they do. He also studies meteorology, gunnery and navigation. He is trained in mathematics and physics. He learns to detect camouflage from the air and studies maps and aerial photographs of such cities as Berlin and Tokyo. He must be able to recognize enemy ships and to aim at their most vulnerable points.

He and his fellow students, every day, drop as many bombs in practice as the German air force was able to drop on London during the worst night of the London blitz. Thus the German's greatest effort is simply routine at this one American school.

The bombardier student learns and proves that his bombsight is so accurate that he can practically "drop a bomb into a barrel" from almost any altitude. He learns the advantage of such precision bombing over the "pattern" bombing that the Germans and Japs sometimes have used. He learns that against a warship a "near miss" is often more destructive than a direct hit on the superstructure, so great is the tremendous underwater blasting effect of the bomb explosion.

He practices first on the "bug" before he drops bombs from airplanes. The bug, a small carriage, has on its top a scale drawing of a typical target. It creeps across the floor under remote control when it is being used to represent a moving ship.

In dropping theoretical bombs against this miniature target the student sits on top of a bombing trainer that resembles a large high chair on wheels. His bombsight is in front of him and he peers through it as the trainer moves toward the bug. The final adjustments are made and he waits for the one moment at

which he can score a hit.

Soon he progresses to actual bombing. His flying classroom is a specially designed training plane that carries a pilot, bombardier instructor, and two students. Its racks are loaded with blue 100-pound practice bombs. These are filled with sand and contain a 5-pound spotting charge of black powder to create puffs of smoke when they hit. Accuracy of the practice bombing is judged by observers in towers near the targets, spread like plates across the 80-mile bombing range, and the hits are also recorded on motion picture film.

The first sighting runs are made at low altitude. As the student's proficiency increases the plane increases its altitude until finally the student is using his oxygen mask on every flight. Night bombing against flare targets is one of the final steps and a good bombardier can bomb as accurately from high altitude at night as



Watching the wheels go 'round—bombardiers study action of a gyroscope on a wooden model in classroom

Bombardiers occasionally double as gunners, so they must recognize all types of planes. Here they study model of PB2Y flying boat

Skimming low over a 30-foot target "shack" the bombardier releases one in the circle and finishes off the shack

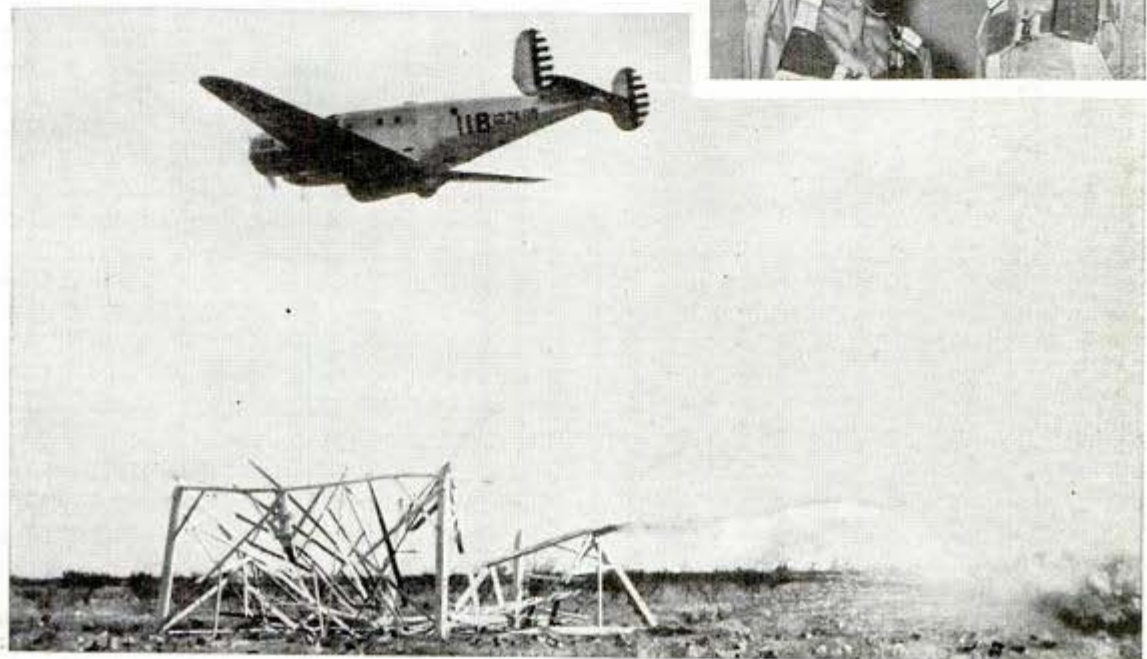

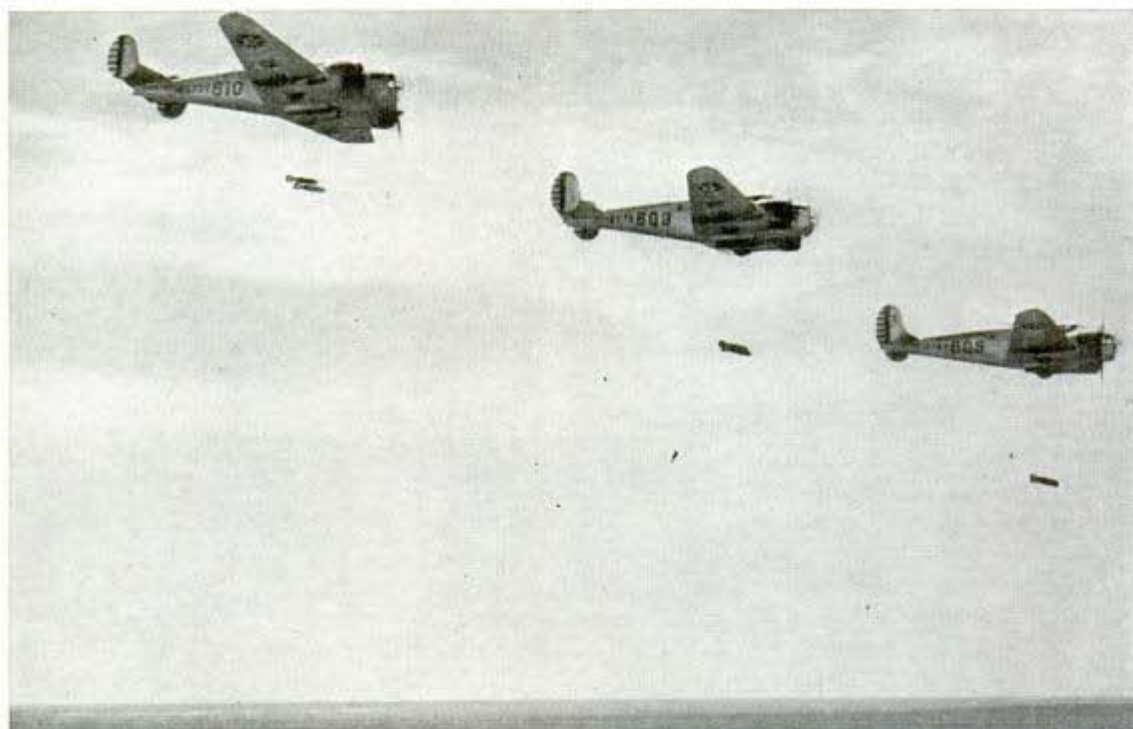

Trainers in formation drop two bombs each, simultaneously—a type of pattern bombing used against warships

he can in the daytime. He drops at least 200 bombs during some 35 day flights and 25 night flights. When he graduates, as a second lieutenant in the Army Air Corps, he is assigned to operate a Flying Fortress or one of the other new types of heavy bombardment planes.

From the military standpoint a bombing

plane is simply a long-range rifle. Ordinary heavy artillery is accurate up to ranges of 20 or 30 miles or so. The big bomber is a tremendous improvement on this because it can drop its "shells" 1,500 miles or more away from its base. One recent development in getting heavily loaded bombers into the air is the so-called "assisted take-off" for which rocket engines are attached to the plane. The backward blasts from the rockets help the plane's main engines pull the load up off the ground and into the air, at which point the main engines can keep it aloft.

Recently the British, with American help, have been trying a new technique. They are trying the effect of suddenly obliterating a military area all at once instead of pecking away at it week after week with small flights of bombers. In blasting the railroad and factory concentrations at Cologne in Germany late in May, British bombers dropped more than 6,000,000 pounds of high explosives within a 90-minute period, using 1,250 bombers and 6,000 air men in the gigantic attack.

Badly as more bombardiers are needed, you can't qualify for bombardier training simply because you wish to. Before you

(Continued to page 178)



This animated "high chair" is used for practicing aim with bombsight on mobile ship silhouettes on floor

7 M arner

Rubber Lifesaving Suit "Zips" on in 30 Seconds

7 M 719

When the cry of "Torpedo!" is raised by the crew on tanker, freighter or transport, there is little time to launch rafts or get into lifesaving equipment. A two-piece rubber lifesaving suit designed for speed has a zipper fastener that enables the wearer to put it on in about 30 seconds. An inner kapok vest and weighted rubber boots keep the victim in an upright position with head and shoulders out of the water. Boots, mittens and hood are attached to the suit. Food can be carried in watertight pockets high on the chest and the air space within the suit provides protection from the cold by holding the body heat. Even if the suit should become filled with water the kapok vest will keep a man afloat.



Located high on the chest of this watertight rubber suit is a pocket for food or valuables. Rubber hood, gloves and built-in overshoes are part of suit which has vest of kapok to support wearer

*Water-tight suit
Two-piece cap 15 white -
Hood
Con: Andrew M.
Larich, 1434 Harvard 77th, Washington, D.C.*

Plywood Is Bent for Boat Hulls With Electric-Steam Iron

7 M 694

Rowing shells are being built at one-tenth the usual cost by Coach E. A. Stevens, of Oregon State College, who presses sheets

of plywood for the hull into shape with an ordinary electric-steam iron. The rigid three-ply panels are soaked in water before the heat is applied and stout rubber bands made from inner tubes help pull them in shape. With this method the sheets can be shaped into compound curves, bent in two or three directions.

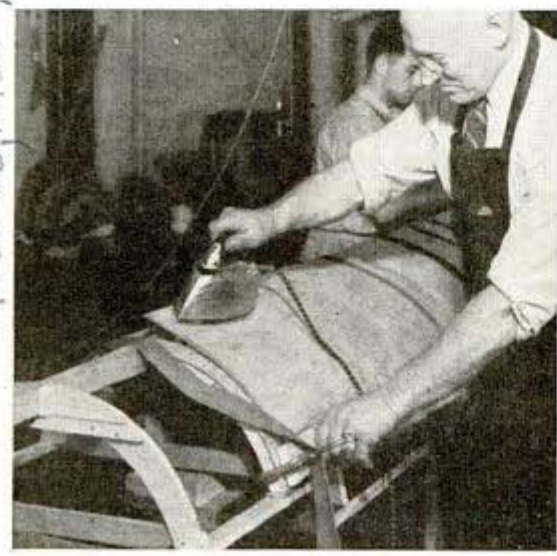

Pressing water-soaked plywood to form rowing shell

Plastic 'Plug' for Sinking Lifeboat Stops Leak Instantly

7 M 690

Leaks in sinking lifeboats can be plugged as soon as they occur, with a new plastic after kneading it briefly in the hands. The plastic has a binding effect, setting and hardening in water. Lifeboats in the British Merchant Service have been equipped with the pliant substance, and it is expected to prove useful in pontoons also. Officials of the U. S. Coast Guard are experimenting with a similar substance, which may be adopted for American lifeboats.

*Pleasure Craft
Supplies, 1110 Collier St.
Seattle, Wash.*

Anchor Watch Rings Bell If Boat Drifts Shoreward

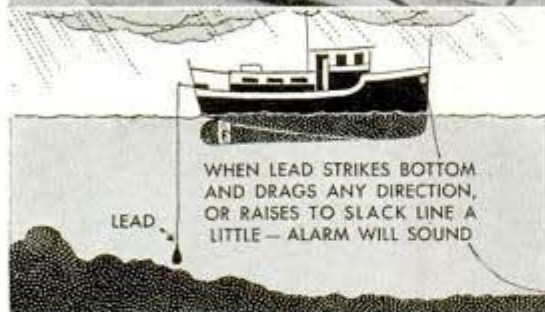

Small box attached to rail houses unit which rings bell in cabin if suspended lead-line strikes bottom

Owners of small boats carrying anchors too light to hook firmly unless the holding ground is soft enough, can equip their craft with an automatic "watchman" that will awaken the crew during the night should the water become shallow due to drift or other reasons. The alarm unit, consisting of two dry cells and a bell is installed in the cabin, being connected by wires with the control unit which is housed in a small mahogany box. The latter, attached to the deck or rail by a small cleat, overhangs the edge of the boat to allow a lead-line to be suspended freely into the water and permit the extended contact arm to swing without interference. With the lead-line set at a depth allowing a safe margin of clearance under the keel, the control unit rings the alarm as soon as the lead-line

drags on the bottom or rises to cause slack. The unit is handy also for feeling the way to anchorage in strange waters or fog.

Nazi Engine With Less Drag Gives Plane Extra Power

Apparently stealing a march on the world, according to a report from London, Germany is now using what is described as the most advanced airplane engine of today. It owes its success to a special cowling design that greatly reduces wind resistance. Installed in the Focke-Wulf 190, the BMW-801, as the engine is known, produces 1,580 horsepower on takeoffs and 1,460 horsepower at 16,300 feet.

Microfilm "Reader" Casts Image On Self-Contained Screen

Records on microfilm are read easily with a projector, or "reader," which reproduces the image on its self-contained screen. Some documents can be reproduced in almost natural size. Aside from saving storage space, film records indirectly aid the war economy by reducing the number of steel cabinets required. One of the biggest industrial microfilming projects is under way at the Westinghouse Electric & Manufacturing Company's East Pittsburgh Works where 2,000,000 plans, drawings and charts are being transferred to 16 millimeter film.

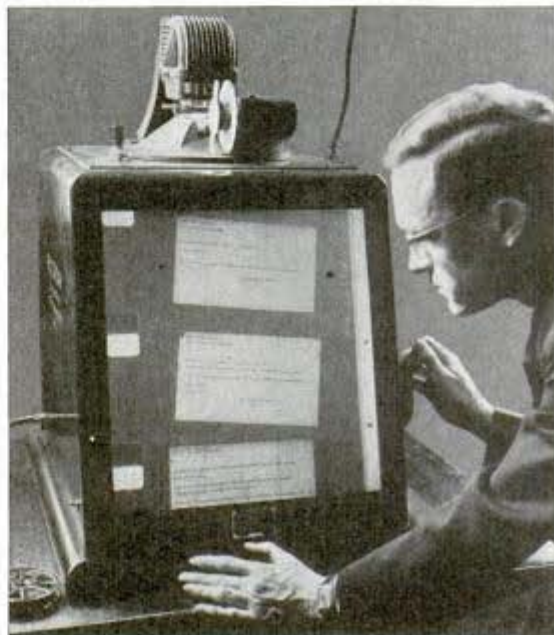

Filmed records are easily read with the projector

at Lubbock Army Flying School
Lubbock Texas
Schoolboys' Planes Aid Cadets in Flying Class

71 4 95



some

A cadet class at the Lubbock Army Flying School in Texas identifying types of aircraft with model planes

Flying cadets in training schools throughout the United States are learning to identify planes of all types with the aid of models made by thousands of high school boys. The models, carved from plans furnished by the Army and Navy, must meet exacting standards before they are approved for use in the training classes.

Culvert Is Used to Trap Bears for "Moving Day" in Park

71 4 48

Rangers in Yosemite National Park have devised a trap for bears that become "bad actors"—camp robbers that tear off kitchen doors—from a section of culvert pipe mounted on an auto front axle assembly. The corrugated steel pipe, closed on one end and with a trap door on the other, will hold the huskiest bear while he is being transported behind a ranger patrol car to the park's "concentration camp" for bruins in a more isolated part of the park—the high country back of Yosemite Valley.



"And don't come back," says the park ranger to his late prisoner as he lifts the steel door of the homemade trap made to order for unruly bears

Cont! Yosemite Natl Park, Calif.
Arthur Halme

Gen. Info:
 S. L. Friedman City
 Defense Council
 Los Angeles City
 Los Angeles, Cal.

If Japs or Nazis start dropping incendiaries, the five volunteers on this fire truck will know what to do



KEEPING *the* HOME FIRES *from* BURNING



Auxiliary "fire eaters" practicing with heavy stream of water

Cont. Stinson

out such bombs, fog nozzles that confine their action, and long handled tools for removing them were developed. One inventor devised a shovel with a hollow handle full of sand. After the sand had been poured on the bomb it could then be scooped up with the shovel.

Battalion Chief James L. Danks of the Los Angeles Fire Department wasn't satisfied with these ideas. Some material for quenching an incendiary and then fighting the fire it might have started should be universally available, he decided. Water is available almost everywhere and will put out most fires, yet a solid stream of water makes a magnesium incendiary explode, scattering its fire. If he could overcome this objection he would have a practical answer to the fire bomb threat, Danks thought. He perfected a perforated metal cone with a long hollow pipe for a handle. The end of this pipe in turn is attached to a garden hose or portable water container. With this device Danks walks up to a raging magnesium incendiary, drops the cone

VOLUNTEER fire brigades, blitz buggies, and new ways to fight incendiary bombs are some of the American developments in preparation for possible air raids.

American ingenuity wasn't long in finding better ways to fight incendiaries after it was first thought that dry sand or a fine water spray were the only materials that could control them. Chemicals that snuff

*Dank: Western Fire Protection Co
 611 E. 3 St. Los Angeles, Calif*

*Bomb
 shovels*



Extinguishing an incendiary by pouring chemically treated sand on it from a long handled holder

over the bomb, and turns on the water. The bomb explodes in a burst of fire, naturally, but the cone confines the action and protects the surroundings. Ten or 20 seconds later the bomb is dead, part of its material unconsumed. Then, if a fire has already been started, Danks directs his stream of water at the base of the flames. With five gallons of water he can extinguish five incendiaries. The "dunker" is to be made available at nominal cost.

The most common incendiary is a small 2-pound bomb having a thick magnesium wall and a thermit core, materials that are chosen for their fierce fire and their resistance to ordinary extinguishing methods. They are by no means the only incendiaries used.

The Japs, for instance, have a thermit bomb that ranges in weight from 10 to 132 pounds. This is almost impossible to extinguish but is used principally against important military objectives. Against defenseless civilian populations the Japs use lighter, cheaper bombs in order to start many separate fires. One of these is an acid-reaction type that causes a

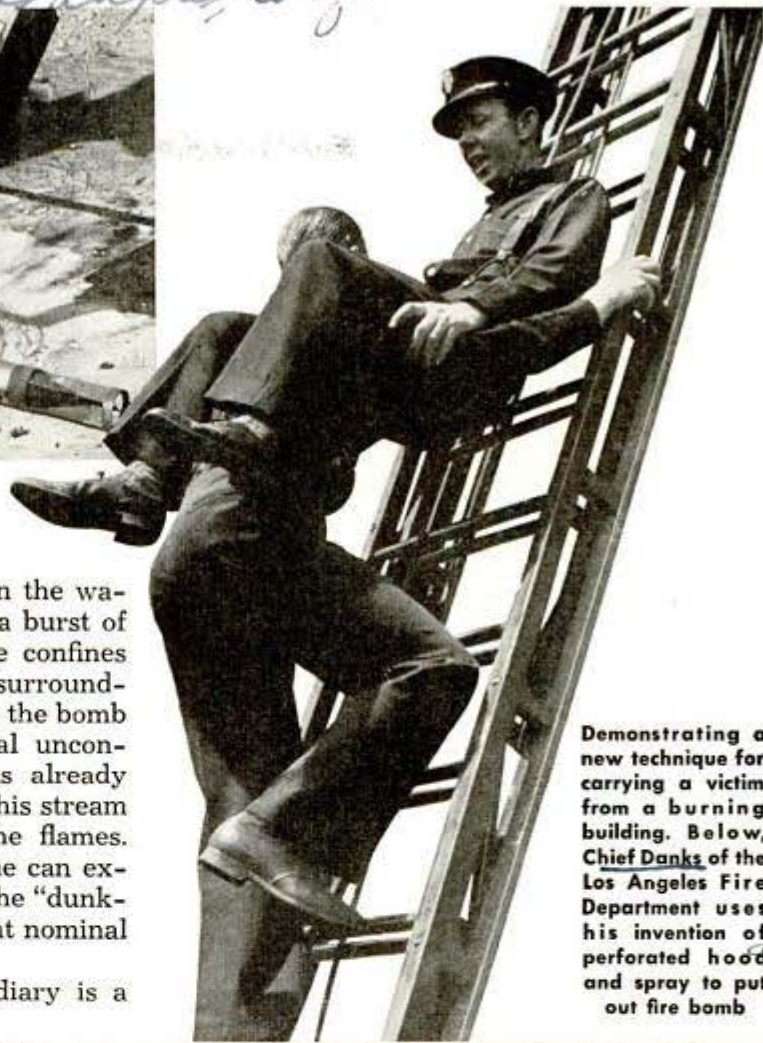

Demonstrating a new technique for carrying a victim from a burning building. Below, Chief Danks of the Los Angeles Fire Department uses his invention of perforated hood and spray to put out fire bomb

perforated hood



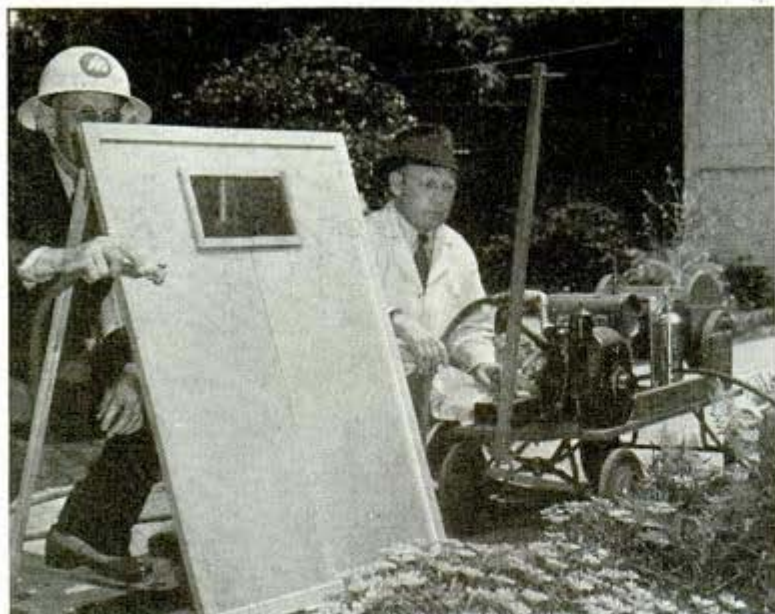

Shield protects firemen from heat; "blitz buggy" carries pump and hose

small explosion and a small fire. These may be extinguished with water.

The Japs also employ a dual-purpose demolition and incendiary bomb that destroys as it explodes and that also scatters numerous rubber pellets that have been impregnated with phosphorus. These ignite upon contact with the air but may be extinguished with water. They may reignite up to 10 hours later if allowed to dry out. A scatter-type phosphorus bomb is hazardous against dry shingles, dry grass, and wooded areas. It sets up a dense white smoke but may be quenched with water. In exploding, all such phosphorus bombs are apt to shower the area with particles of phosphorus that will inflict painful and malignant burns. Such burns must be kept under water until even microscopic bits of the material can be removed.

Another favorite of the Japs is a fire bomb that has a steel nose, allowing it to penetrate several floors before it explodes and scatters a number of small magnesium bombs. These units then ignite, but may be controlled by any of the usual methods of handling magnesium incendiaries.

The purpose of fire bombs, broadcast from airplanes, is to start scores or hundreds of small fires that might grow to major proportions if not extinguished at

once. No municipal fire department can take care of so many fires, all occurring at the same time.

To help combat such fires, certain to occur if our enemies try an aerial raid, volunteer fire fighters are being trained in the cities and towns of each coast. In case of an air raid they have special jobs. Some will watch for the fall of incendiaries, spot the locations of the fires and extinguish them. The Office of Civilian Defense has been promising that these neighborhood groups, affiliated with the air raid warden system, will be supplied with hel-

nets, axes, water pumps, and other necessary equipment.

But the civilian volunteers haven't waited. They might need the promised equipment tonight, or tomorrow. In city after city, scores of fire fighting groups have put their heads together and devised amateur equipment to do the job. Every outfit is different but every one is ready for instant use. Push carts, automobile trailers, camping trailers, station wagons, and even toy wagons have been put to work. In some cases volunteers who didn't have or who couldn't buy the gear they needed have built the equipment from materials they

This fire fighting trailer carries along its own water supply



had on hand. Stirrup pumps can't be bought, so one air raid warden made his own, larger and more powerful than most, in his own home workshop. Toy wagons are outfitted with a reel of hose and small gasoline-driven pumps for throwing water in case the regular water supply fails and the only available supplies of water are from fish ponds or bath tubs. One amateur builder produced a special nozzle for his group's equipment. A flick of the thumb delivers a solid stream for fighting ordinary fires or makes available a fine spray for confining an incendiary bomb. Wives of the wardens and fire watchers are being trained to operate the apparatus in case their men are away during a raid.

Even thousands of fire watchers may not be able to combat the fires that start during a big raid. Some of the bombs might start fires that couldn't be fought with light equipment. Volunteer fire brigades are being trained for such emergencies. These groups are being organized in many parts of the country and are auxiliaries of the regular fire departments. In a way they are a return to the old days when all fire fighting was on a volunteer basis. Fifty percent of the volunteers in one city failed to pass the rigid physical examination and were rejected. In some cases the brigades are equipped with spare municipal apparatus, in other cases they create their own equipment under fire department direction. Some groups buy apparatus with their own funds. They train on week ends, using public apparatus until their own "rigs" are completed.

An example of such an organization is Brentwood Fire Fighters, Inc., consisting of business men whose homes are in one community near Los Angeles. The group is organized into three companies of eight men each, plus three full relief shifts. The men raised \$2,500 by public subscription and with

(Continued to page 171)

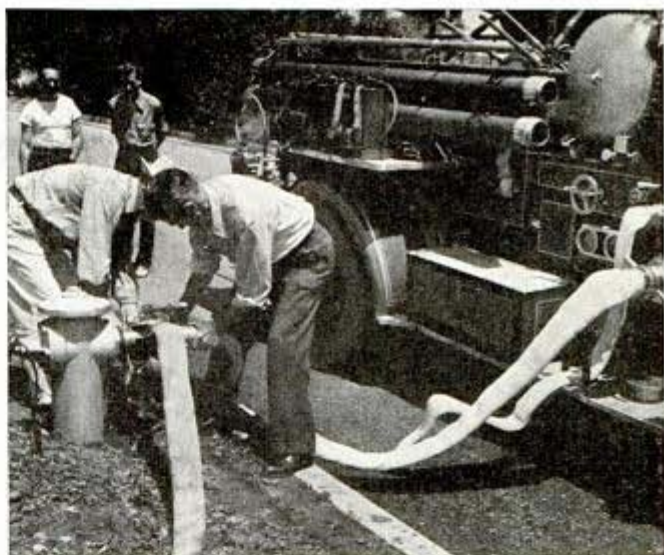

Volunteer fire brigade attaching hose to hydrant during practice run with city fire truck under the supervision of "regulars"



Mounted on the wheels of a toy wagon are two stretchers, blankets, splints, a medicine chest and other first-aid equipment

Unloading fire fighting paraphernalia from the rear of a station wagon recently converted into an emergency "blitz buggy"



Army's Machine Shop on Rails Repairs Any Weapon

M 564

to take advantage of knowledge gained by experience in far-flung battlefields, hence they incorporate everything needed in a modern shop to perform the highly specialized service required of them. Either car, with its crew of experts, is adequate to serve a full battalion of railway guns. The cars weigh more than 50 tons each.

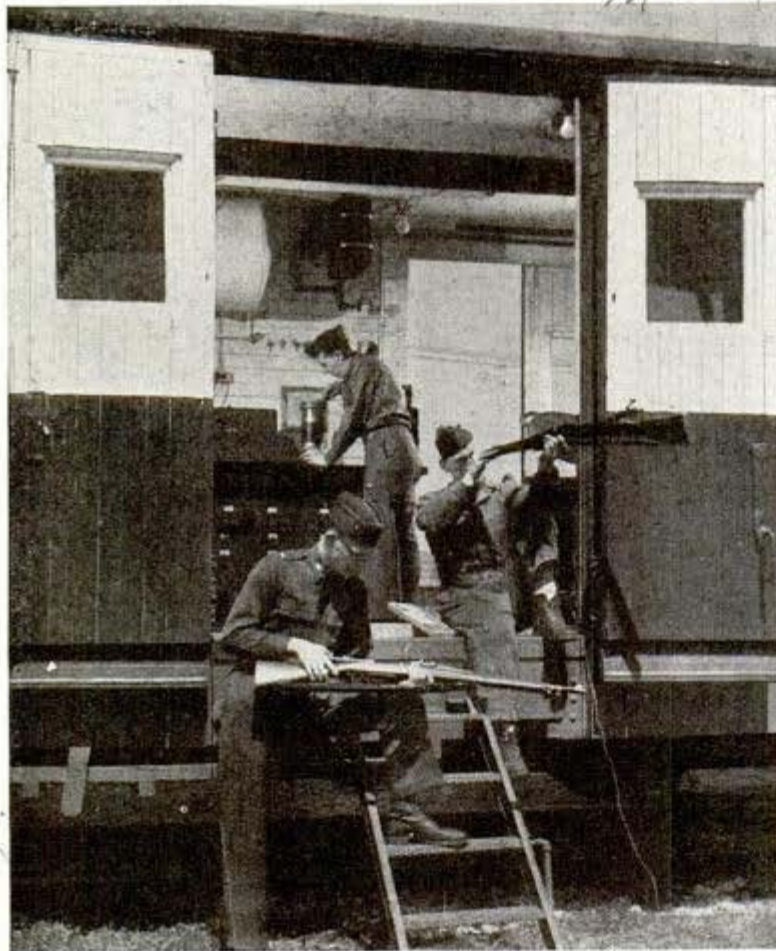

Railroad car, housing shop, repairs all kinds of weapons at front lines

Army weapons of all types can be repaired in the new rolling machine shops built into railway cars. Each completely equipped with a huge milling machine, shaper, grinders, drill presses and blacksmith shop, as well as thousands of precision instruments, tools, gauges and micrometers, the cars contain their own power plants in the form of two generators, one 15 kw. capacity and the other 5 kw. Housed near the latter are a large welding unit and an air compressor. Although designed primarily for maintenance of railway artillery, the shops can service and repair any army weapon from a .45 caliber automatic pistol to huge coast defense guns. While the cars were under construction, their design and equipment were altered from time to time in order

Folding Rack Holds Stretcher in Sedan As in Ambulance

M 349

Any two-door sedan can be converted instantly into an emergency ambulance in case of an air raid by fitting it with a turntable that receives a special cot. The only permanent installation is an unobtrusive plate to which the removable base may be anchored. The full-length cot, resting on a railing and loaded on the turntable which swings it into place, can be placed into or removed from the car in a matter of seconds. When it is not in use, the unit folds to a size small enough to be carried in the trunk.



Stretcher rack for sedan folds for loading into trunk, inset

Cont: A Eric
 Experiments by Advance Dept.
 U.S. Army

A. B. Stone, Inc.
 Battle Creek, Mich.

Westinghouse Elec. & Mfg. Co.
Lamp Div. Bloomfield, N. J.
Lamps for Defense Tried in "Proving Ground"

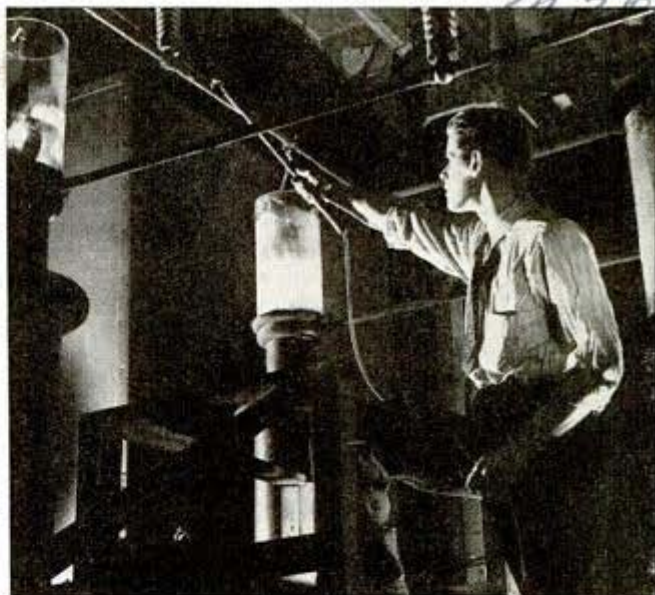
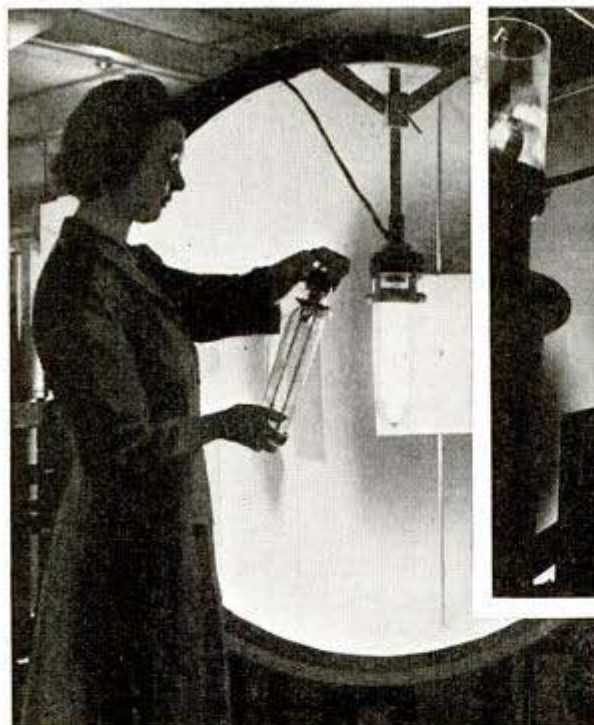

To keep their high degree of efficiency and reveal possible improvements, lamps for defense make regular trips to "testing lanes" as they leave Westinghouse production lines. Rectifiers, above, used in converting a.c. into d.c. for big industrial X-ray units, are jolted with 155,000 volts for 15 minutes. Excess voltage is discharged through an insulated "grounding stick" after the test

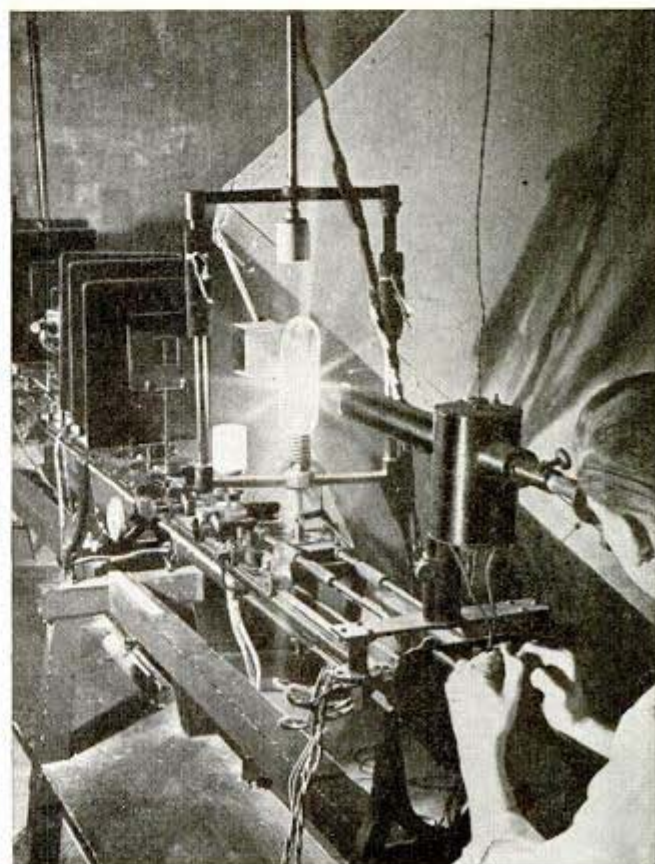

Top, candlepower of sodium vapor flood-lamp is measured by tiny beam that escapes through a small opening in large sphere. Bottom, 600-watt airplane headlights, mounted on test truck, ride laboratory "railroad" while photocells chart their breadth and candlepower. Optical lenses, right, aid in determining temperatures of the filament of an airway beacon lamp; image of the filament is enlarged by the lenses and compared in viewer with image of a test filament of known temperature

Skin Stretcher Shapes Metal for Airplane Panels

*Hydraulic Pressing of a
Throat Guard, etc.*

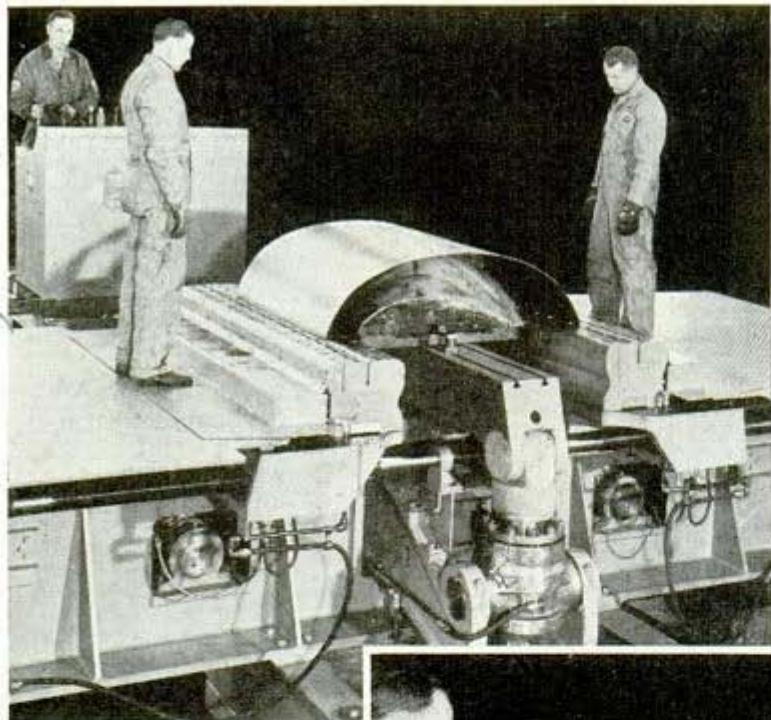

^{on 555}
Efforts to speed production of war planes produced a "skin stretcher" for metal which accurately shapes panels for airplane fuselages and pontoons. The hydraulically operated machine holds a metal sheet between two massive jaws while a die is pushed upward to form the desired shape. Although the machine is now used exclusively by the aviation industry, it is expected to find wide use in the manufacture of all kinds of automobile parts after the war is over.

The man at left, above, is operating the levers of a powerful press that shapes parts for planes with a die that is pushed up against a metal sheet held in place by two iron jaws on top of the machine. Right, the finished product designed to speed production



Shovel Dumps a Bomb Snuffer From Paper Bag on Inside

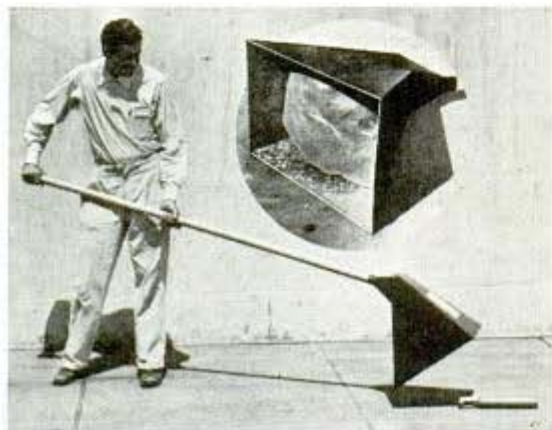

¹⁰⁵³⁷
Suspended inside a boxlike shovel is a paper bag filled with specially treated insulation material which quickly smothers incendiary bombs. A long wooden handle attached at a convenient angle enables the user to protect his face with the metal box when approaching a sputtering bomb. When the shovel is placed over the incendiary the paper bag burns, releasing the extinguishing material called "snuff" by its inventors. Four pounds of "snuff" are sufficient to smother a bomb in about two minutes. After the bomb is put out, the shovel may be turned over and used as a scoop. When loaded it weighs only 14 lbs.

Placing shovel over bomb. Inset shows bag of "snuff"

40 *Wilshire Sheet Metal Co.* POPULAR MECHANICS
8708 Wilshire Blvd., Beverly Hills, Calif.

Seam Pattern Forms "Spider Web" in Balloon

Workmen and inspectors engaged in the making of huge barrage balloons find themselves surrounded by a mighty spider web pattern when they toil inside the "sausages" at an eastern plant of General Tire and Rubber Company. This pattern is created by seams in the gigantic bags. The similarity to the spider web does not stop here, since these balloons, filled with helium, are sent aloft to ensnare Axis fliers on raiding expeditions, thus protecting our armed forces and war factories from air-borne attack.

"Balloon tailors" crouching at work on balloon's seams while the inspector stands silhouetted against "spider web" backdrop that symbolizes the balloon's mission to entangle enemy airplanes

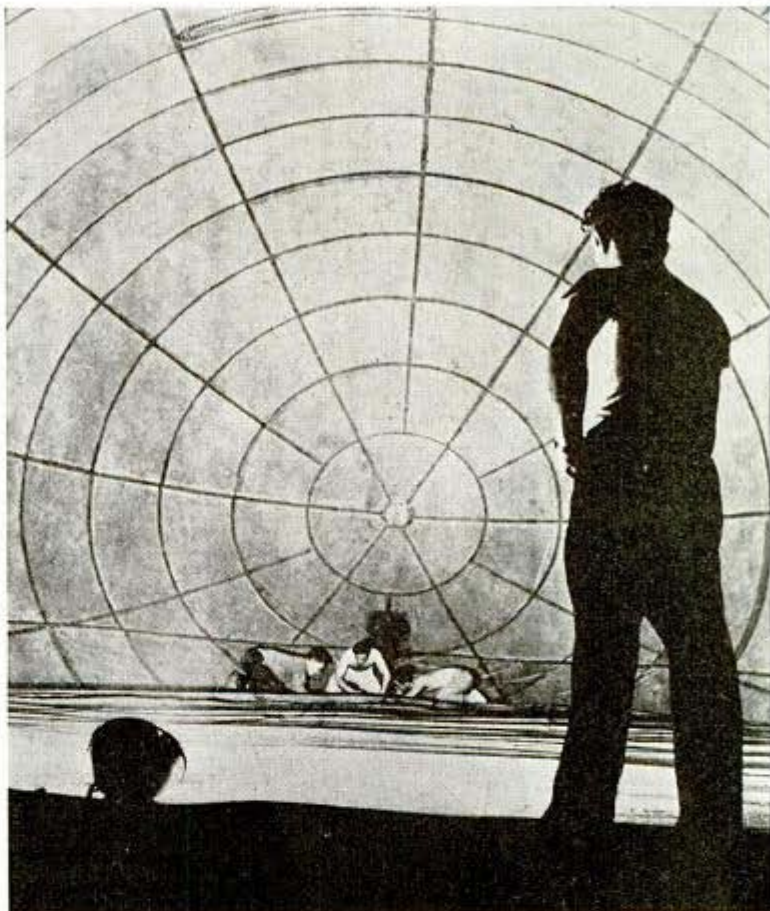

M 572
Little news photo

Engines Test Torque on Rack Before They Take to Air

Airplane engines, lashed to a test stand, grind out a hard day's work just to show

what they can do in actual flight service. This engine mount is one of the two installed in the propeller

research building, part of an aircraft engine laboratory being built by the National Advisory Committee for Aeronautics at Cleveland, O. The special purpose of these two test stands is to determine the amount of torque delivered by all types of aviation engines at different speeds. A total of \$18,000,000 will be spent in erecting the laboratory.

M 566
Press photo

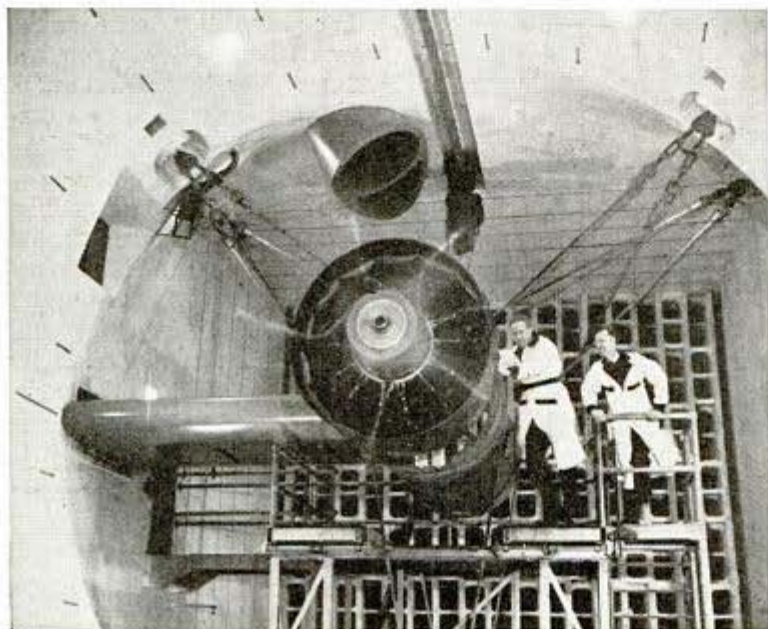

Aircraft engine undergoing test on one of the torque stands with two technicians on balcony watching results

Ref: De Rodas Calship Los
California Shipbuilding Corp, San Pedro,
SISTER SHIPS - or are they?

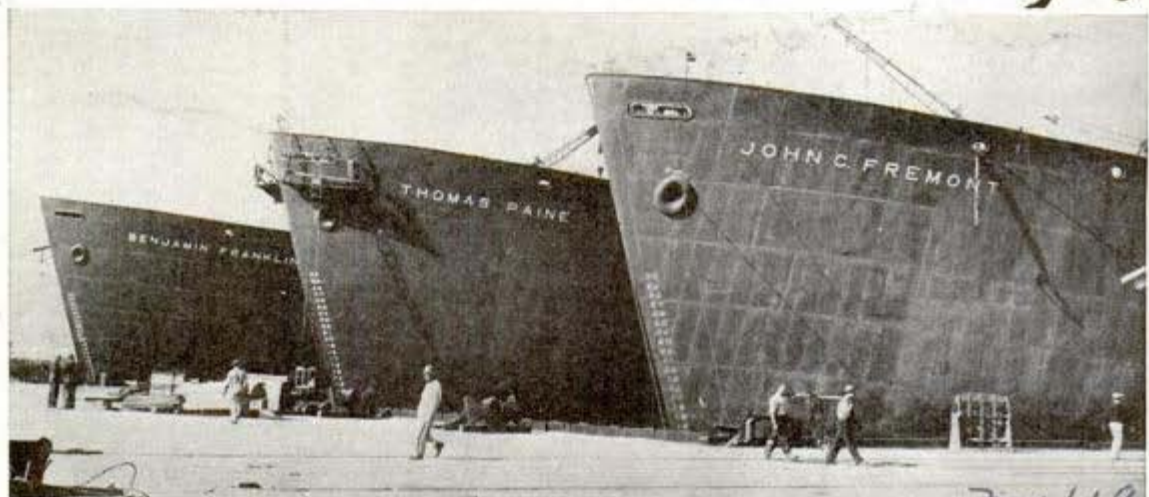

↑ Three freighters being equipped at outfitting dock

← The lead man of the gantry crane signals the operator to hoist away one of the prefabricated sections

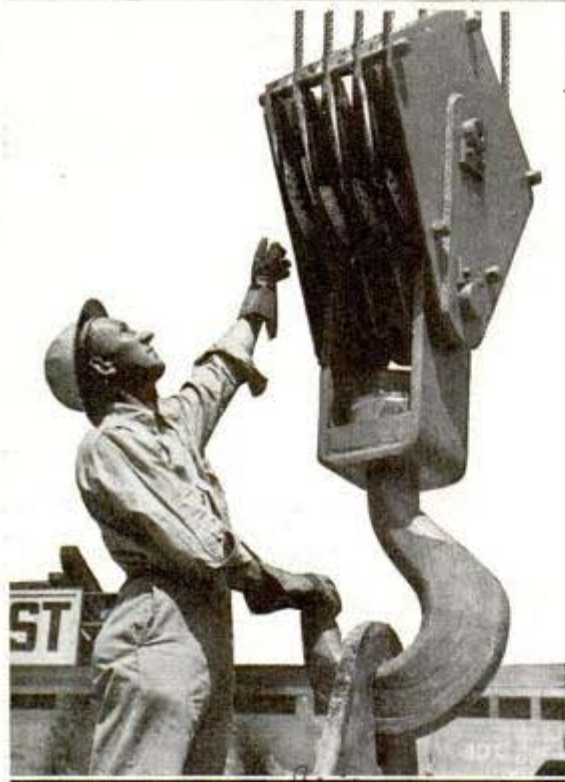

BUILT to the same exact specifications, of identical materials, hundreds of sturdy American freighters are being outfitted for service on the seven seas.

Sister ships?

To the eye they are as alike as pods on a vine. Yet seamen know that each ship will have a personality that is not quite the same as any other vessel in the world. One ship will steer differently than her sisters, another's compass must be adjusted more often, a third will have an easy buoy-

ant motion while a duplicate ship in different service will be stiff and cranky.

The fact is that no two ships are identical. The little details that make them different are unavoidably built into their hulls. Almost every ship, for instance, turns easiest toward the side that got the most shade while it was being built. The side exposed to the sun during construction is a little fatter. Expansion from the heat may have even pushed the bow and stern frames out of line an inch or so.

Changes in the weather during the construction period also seem to affect the steering. This is especially true of welded hulls. Such vessels have slight inequalities in their lines, due to variations in welding shrinkage apparently caused by fluctuations in weather.

The hundreds of "Liberty" class freighters being built are of practically all-welded construction. The bows and sterns of many rise 3 or 4 inches higher than the plans specify because the heat of welding has expanded the metal. One shipyard is said to have tried to counteract this by changing the lines of a test ship so that the bow and stern hung slightly down. The expectation was that heat expansion would bring the ends up to specifications. But for some reason the ship stayed that way.

Riveted ships, too, tend to sag at the ends. Rivet holes are always $\frac{1}{32}$ -inch or so larger than the rivets and these slight clearances



Cranes lowering the completed forepeak in place on ways

add up in a ship that is 500 or 600 feet long. As the ship takes form, the shipwrights use the decks and bulkheads to pull up the sagging ends and to help regulate the hull's shape.

To a certain extent a metal ship is a permanent magnet. The earth's lines of force magnetize the structure during the time it is being built. Shipwrights try to lay out their ways so that the ends of a ship under construction will point toward the magnetic poles. Thus when the ship is commissioned, compass corrections will be equal for each side of the ship. But this is hardly necessary today because merchant ships are launched so rapidly that they don't have a chance to acquire much magnetism. At the California Shipbuilding

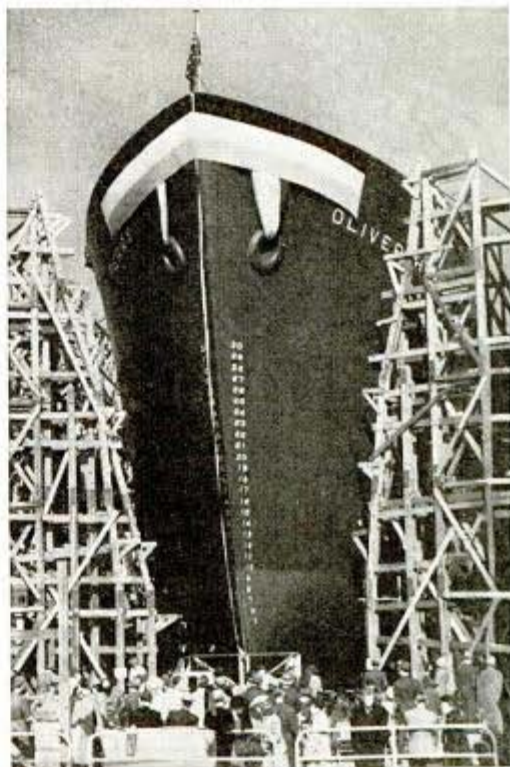

Photos courtesy Calship Log

One of America's new fleet is about to be launched. Wartime ceremonies are brief, for in a few minutes a new keel will be laid in the ways just vacated

The cutting torch burns through steel with a shower of sparks, finishing shaping of deck section





Welders on night shift complete the forepeak section in shipyard

Model of wooden ship designed to ride low and carry warplanes



Corporation's yards at San Pedro, for instance, ships are being launched in 80 to 100 days instead of six months after their keels are laid. Outfitting time is reduced to no more than a month and a half. Usually a ship at the outfitting dock is turned around to point opposite to the direction in which it was built, to help dissipate magnetism picked up during construction.

The way a ship rides in the water depends principally on her cargo. Loaded with light bulky material that provides a high center of gravity, the ship is lively and handles easily. But load the same ship with the same weight of ore and it becomes a stiff ship that is awkward to maneuver.

Any ship operates best in the service for which it was designed. The naval architects consider the type of cargo, length of voyage, desired speed, and other requirements in laying out their plans, and then produce a ship that is most economical for that special service. Place it in a different sort of service and

it won't do as well. The best example of this is a big transatlantic liner that is built for speed and comfort. Her bulbous forefoot is a stabilizing feature and in effect improves the ship's length-speed ratio, making for less resistance through the water at her regular speed. Yet if the same ship were to be put in coastwise service, going in and out of many ports at slower speed, her bulbous forefoot would be a hindrance to economy.

Early this year America was launching one ship a day. Now that rate has been stepped up to two ships a day and before the year is over our shipyards will be launching three ocean going vessels every 24 hours. This is one of the miracles of modern times and is possible partly because of an efficient prefabrication system. It takes too long today to build up

a ship plate by plate. Instead, whole sections are assembled as units. A 30-ton section of inner bottom, with all frames and piping installed, is prefabricated in the yard, then picked up by a crane and set down ready to be welded to the shell plating and to its neighboring sections of inner bottom. The forepeak, complete with stringers and bulkheads, is put in place

(Continued to page 182)

A Liberty freighter makes her trial trip under wartime convoy



Buckshot Backfire Absorbs Recoil of Big Gun

M 470



Cont. London Electrotype agency

Warplanes of the future may fire three-inch and larger shells, if development of the Davis nonrecoil gun, proposed in England, proves successful. Its barrel extends to front and rear of the plane, and the shell, with its charge at the center, provides for a "backfire" of buckshot to absorb the shock. Such guns, tried years ago, developed a muzzle velocity of 1,200 feet per second

HOW A SHIP IS LAUNCHED

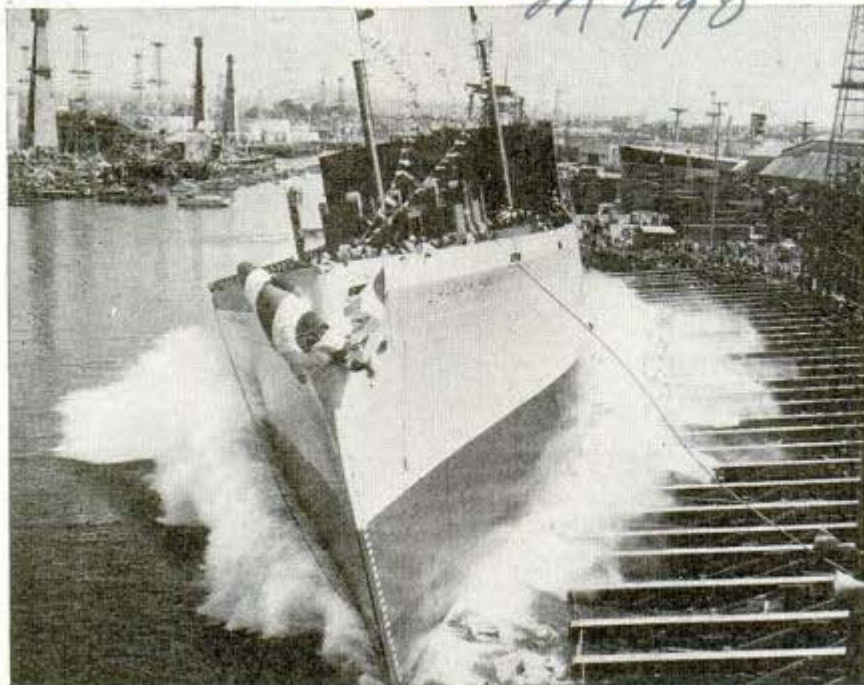

Below, workmen wielding acetylene torches to cut through one of the two steel "burn off" plates that hold the ship from sliding down the ways after the shoring, the bilge cribs and keel blocks are removed. The diagram shows the plates with a row of holes drilled through the center. At the command: "Burn one!" the workmen cut from the outside to the first hole on both plates. "Burn two" calls for cutting from the inside edge to the nearest hole. This process, synchronized with the launching ceremony, is kept up until weight of ship snaps plates and it begins to move down the ways

It takes a lot more than a smashed bottle of champagne and a few cheers to launch a new ship. Hours of careful preparation are required, not only to free the vessel from the land but to stop it after it is afloat. Often in a narrow channel a ship must be stopped in several lengths. Most ships are launched stern first, but in yards where the channels are too narrow the boats are built parallel to the channel and launched sideways like the new vessel shown above during a launching at the Consolidated Steel company yards



Plunging past the spectators, left, during a side launching goes the stern of a new vessel. It looks simple to the onlookers, but preparations started the day before with the greasing of the ways at low tide. Supporting blocks drop as button is pushed

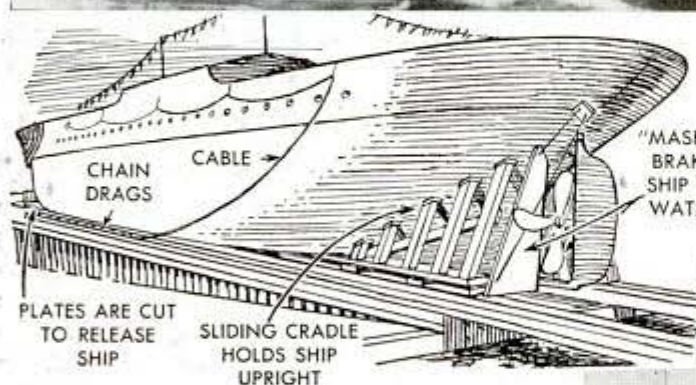
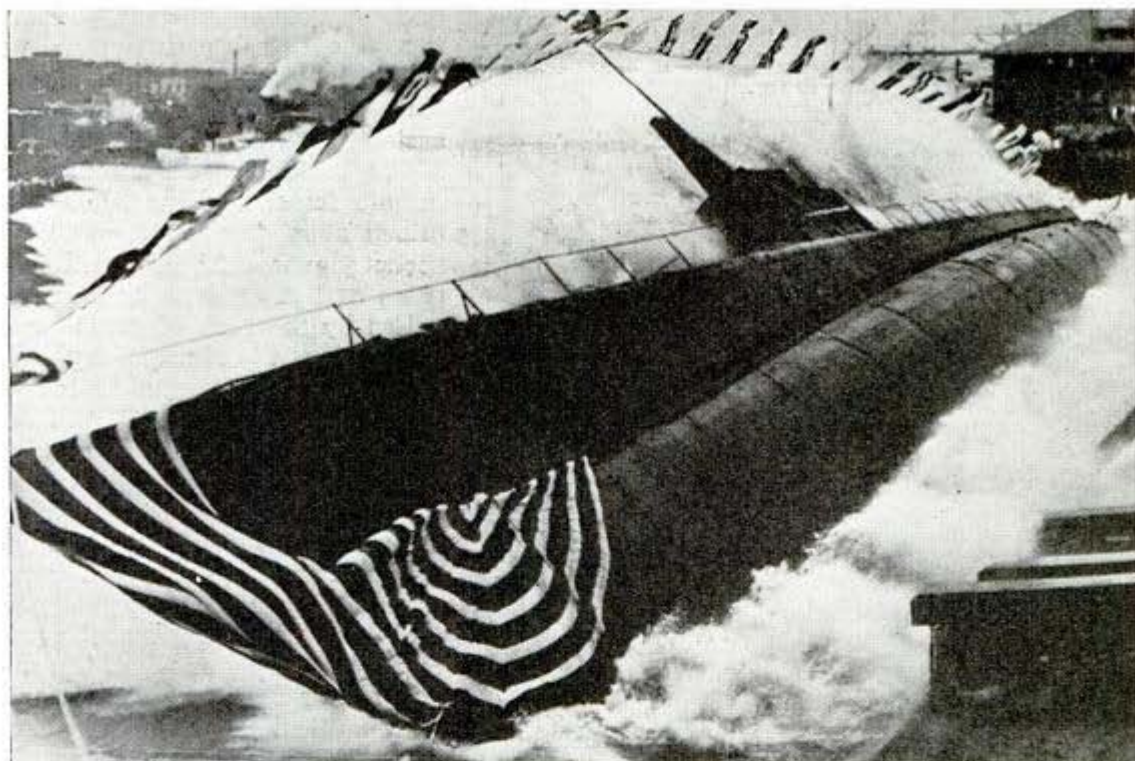

One of Uncle Sam's new submarines, above, the U.S.S. Peto, takes to the waves at a Wisconsin shipyard far from the smell of salt water. It's the first undersea fighter launched on the Great Lakes. Below, launching one of the new Liberty ships at the California Shipbuilding Corp. yards

The diagram shows a vessel ready to be launched stern first. Flat wooden "masks" act as brakes when the ship slides into the water. A sliding cradle holds the boat upright as it moves down the ways and 50 tons of drag chain laid in troughs on either side check the vessel's speed. Below, workmen applying a heavy coat of grease to ways

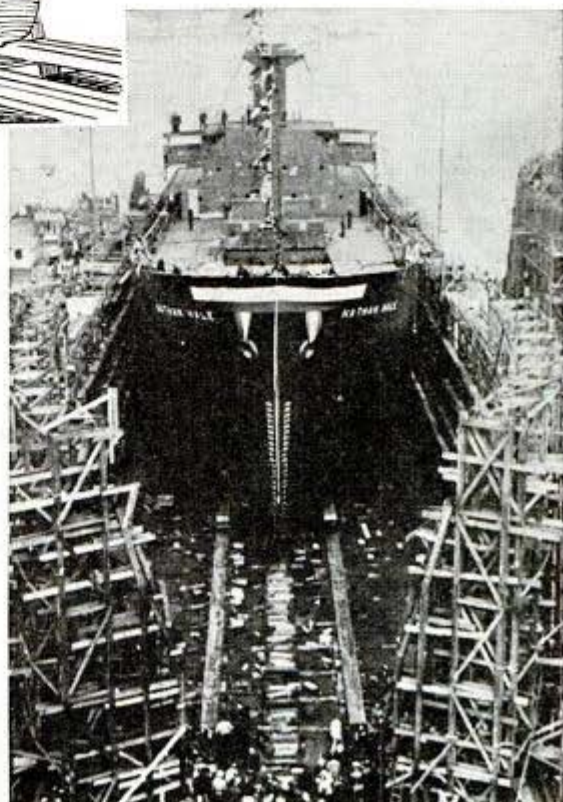

Tiny Figure Hits Bell in Rhythm With Phonograph Music

m. 556



*Westinghouse
Pittsburgh Pa*

Little "Sambo" has rhythm, striking bell in time with music

Turtle Creek

In his home workshop, Joe Kovalsky, a design engineer for Westinghouse, makes a hobby of producing electrical oddities to amuse his friends and to perform services in the home. One brain child, called Sambo, is a six-inch rhythm master carved out of wood. Seated on a chair with a hammer in his right hand, the little figure beats time to music from a phonograph record by striking a bell. The musical notes send electrical impulses through wires telling him when to swing the hammer.

Three New Developments Could Lift Plane Limits

m. 632

Achievement of three possible developments in aviation which were described by Dr. Jerome C. Hunsaker, chairman of the National Advisory Committee for Aeronautics, would result in lessening certain limitations now affecting airplanes, and might very well give to the nation leadership in the present world-wide race for superiority in military flying. The first development, a successful gas

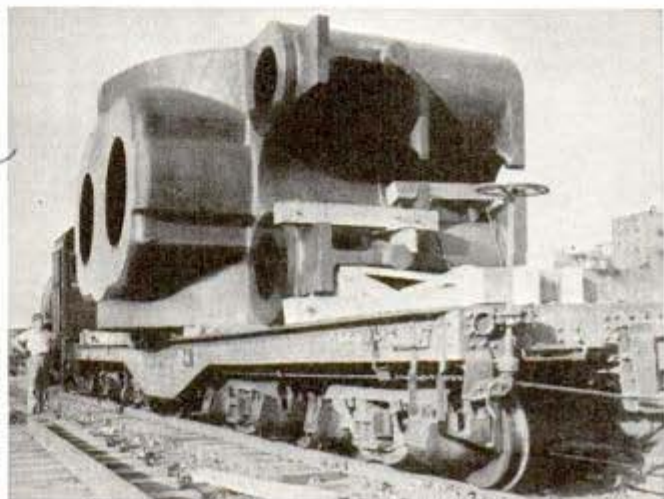

Flatcar dwarfed by one-piece steel cap for 12,000-ton press

turbine, would permit escape from the difficult task of lubricating present engines at high temperatures, would eliminate the cooling system, and allow operation at 10,000 to 12,000 revolutions per minute instead of the 3,000 obtained now. Second, a practical rocket plane would discard all engines and propellers, being propelled by the rush of gases from an orifice at the rear of the plane. Since air is not essential in its operation, the rocket idea would be particularly useful at high altitudes where the air is rare. The third concerns a new-type wing structure that would prevent the air becoming turbulent in flowing over it. If air could be made to flow over the wing smoothly it might reduce by one-half the resistance or drag felt by the ship. Aeronautical engineers in many parts of the world are giving attention to all three developments.

Casting for Heavy Press Is Load for a Flatcar

m. 624

Bedded down on a flatcar for shipment, a massive steel casting—one of the largest ever produced, according to officials of the Mesta Machine company at Pittsburgh—made a full carload. In making this top cap for a 12,000-ton armor plate press, 600,000 pounds of metal were poured.

*Massachusetts
Inst of Technology
Cambridge, Mass*

Cont! Don N. Wright, Chicago
argues, Rock Island Ill.

Shooting-Barrier Guards Workers on Range

m 593

To end the risk of accidental shootings at the pistol range used by police at Rock Island, Ill., a fool-proof barrier has been installed to halt target practice while workmen enter the range to adjust or change the targets. Heretofore attendants depended on verbal notice of their intention to go into the range area, but such notices were not always properly received or heeded, resulting in accidents. The new barrier, installed by Patrolman Willis Lucas, consists of upright boards fastened to a sliding bar extending across the range. In shooting position the uprights stand in front of the separations between pits, where they are out of the way. But when an attendant enters the range he must shove the bar away from the passageway, which automatically moves



Barriers are shown in front of booths to warn shooters against firing

the uprights sidewise until they stop in front of the shooters so they cannot take aim. As an additional warning, a string from one of the uprights is attached to the pull-chain which turns on a red light.

Bomber's "Skeleton" of Rubber Includes 8 Miles of Wire

In building a war machine to outblitz the Axis powers, rubber assumes an important role among the indispensable materials.

For aeronautical uses alone 80 items are produced by B. F. Goodrich company. The large quantity of natural and synthetic rubber needed in an American medium bomber has been illustrated by shading portions of a drawing to indicate the points where the commodity is used. A bomber of this size and type contains more than eight miles of rubber-covered wire and cable.

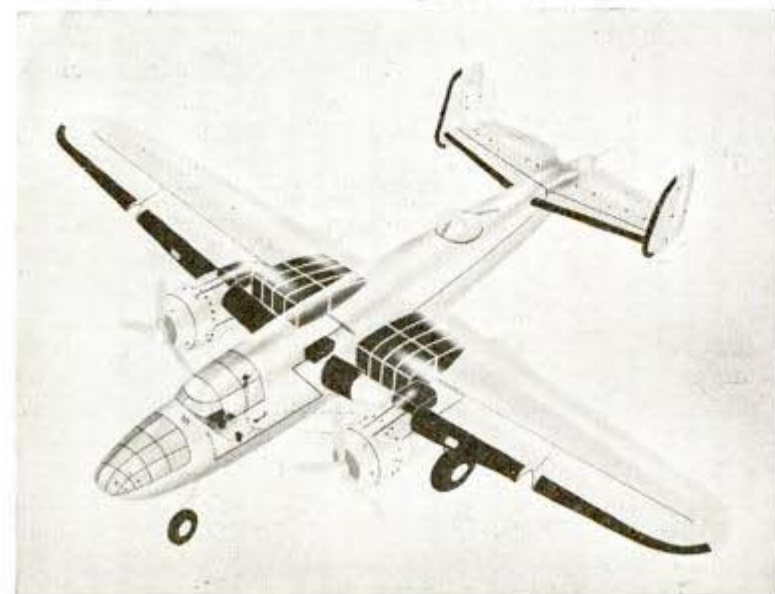

Black shading in drawing of American medium bomber marks parts of the ship where rubber must be used in its construction and its accessories

Of the 44,189,669 telephones in the world, the United States has 21,928,000, Germany 4,226,000, Great Britain 3,348,000; but on a basis of telephones per 100 population, the United States, Sweden, New Zealand and Canada lead.

m 665
Bomber's Skeleton of Rubber
Includes 8 Miles of Wire

Cont. Andrew Hamilton
1179 1/2 S. W. Belmont Ave M 422

YACHTSMEN Los Angeles on PATROL

small-boat operators. Several thousand private sail and power-driven craft are helping to guard the 40,000 miles of shoreline along America's two coasts. They are the flotillas of the Coast Guard Auxiliary, a volunteer organization which has taken over many of the peacetime duties of the regular Coast Guard.

One of the world's truly unique naval outfits, the Coast Guard Auxiliary patrols our harbors, rivers and coastlines from the rocky inlets of Maine to the palm-fringed keys of Florida, and from Puget Sound to San Diego. You'll find the Auxiliary on the job at San Francisco, Los Angeles, New Orleans, Philadelphia, New York, Boston and a score of smaller harbors.

They are the eyes and ears of our coastal defense. Long familiar with the ships and anchorage in our harbors, the Auxiliaries spot suspicious craft instantly. Twenty-four hours a day they

watch for spies, saboteurs, fires. They supervise the loading and unloading of ammunition and carry supplies to off-shore stations. A goodly part of their work cannot be discussed for reasons of military security.

The idea for the Auxiliary grew out of the fertile brain of Admiral Russell R. Waesche, Commandant of the Coast Guard, who has been called "the greatest idea man in the history of the service."

Several years ago this far-sighted Coast Guard officer noted the storm clouds on the international horizon. He decided that in time of war a well-trained, volunteer, civilian organization of small boat operators could be of great help to the regular Coast Guard—freeing it from its harbor police duties for more important tasks.

He knew where to get this organization. Pleasure boating in the United States before the war was a \$100,000,000 industry



One of the many jobs performed by the Coast Guard Auxiliaries is to deliver men and supplies to the lighthouses and other off-shore stations

THE ten days between May 26 and June 4, 1940, will live gallantly in history. After a series of smashing blows by German plane-tank teams, the British Army had retreated to the beach at Dunkirk. The Nazi generals were certain the British were licked.

Then the miracle happened.

Through the thick fog which blanketed the channel came thousands of small boats—trim yachts, sturdy tugs, sleek cabin cruisers, fishing smacks, holiday excursion boats, ferry boats. They were manned by schoolboys, by amateur yachtsmen and fishermen, by grey-haired oldsters. Into the hell of bullets and bombs of Dunkirk they went and brought 335,000 weary British Tommies back to England.

Here in the United States in 1942, Uncle Sam's own "putt-putt" Navy is doing a job as important, if not as spectacular, as that performed by the stout-hearted British



Because of their military status, members of the "putt-putt navy" are welcome at all Coast Guard stations. At upper right, enlisted men on duty with Auxiliary boats are given gunnery training at Naval Training Stations

A Coast Guard enlisted man poises on deck of a small boat, ready for action with a Lewis gun

which involved about 300,000 small power boats and something like a million enthusiasts. He thought that if war should come, up to 100,000 of these small boats could be utilized.

So Admiral Waesche drew up plans for his "putt-putt" Navy. It was established on June 23, 1939, and originally called the Coast Guard Reserve. Eighteen months later, the Reserve became a military organization and the "putt-putt" Navy became the Coast Guard Auxiliary on February 19, 1941.

Originally it was set up with four main purposes: (1) to further interest in safety at sea and upon navigable waters, (2) to promote better understanding of the laws and

Flagship of Flotilla 22 at San Pedro, Calif., is 50-foot, \$50,000 cabin cruiser "Warwynne"





The skipper stands at the helm of one of the Auxiliary boats

regulations relating to motorboats and yachts, (3) to provide a wider knowledge of navigation and operation of vessels, and (4) to co-operate with the regular Coast Guard in certain of its duties.

It now does all these things and more—since the regular Coast Guard's 267 cutters, ranging from 65 to 327 feet in length, have been armed with anti-aircraft guns, machine guns, depth charges and sound detectors for war on the high seas. While the regular Coast Guard is out looking for bigger game, the Auxiliary guards against poachers at home.

Because it is a voluntary organization,



the Auxiliary is composed of men in all walks of life. There may be a millionaire playboy with a \$50,000 cabin cruiser; a fisherman with his weatherbeaten boat, or perhaps a college student with his trim little sailboat. There are lawyers and lobster fishermen, mechanics and movie stars, doctors and drug store owners.

They are civilians who, because of families, jobs, physical disabilities or age cannot get into the Army or Navy. But this is their way of helping to beat the Axis.

Basic unit of the Auxiliary is the flotilla, consisting of at least ten members and ten boats. It is a relatively autonomous body, headed by a Commander, a vice Commander and a junior Commander. These officers are elected on a democratic basis and are usually wise old yachtsmen or fishermen. Flotillas are grouped into divisions and divisions are grouped according to Coast Guard districts.

To be eligible for membership, an Auxiliaryman must be a citizen of the United States, at least 18 years of age, and must have 25 percent interest or more in a motorboat or yacht.

The Coast Guard classifies a motorboat as a documented or numbered vessel, propelled by machinery, and not more than 65 feet in length. A yacht is defined as a documented or numbered vessel used exclusively for pleasure or any sailboat used exclusively for pleasure over 16 feet in length, measured from end to end over the deck excluding sheer.

A candidate must prove his seamanship by demonstrating a thorough knowledge of the handling and operating of vessels, the rules of the road, the buoyage system of the United States and navigation laws applicable to his vessel. In addition, his boat must be competently operated, well found, ship-shape and equipped in accordance with the law, with ground tackle, signal devices and safety equipment.

Surf boats meet in rendezvous before taking troops ashore. Some Auxiliarymen have been called to help in surf operations

The Auxiliaryman donates both his time and his boat. He serves when he can get away from his job—usually 24 hours at a stretch. This may be once a week or once a month. While on active service, he and his boat are under military orders of the Coast Guard and are operated at the expense of the government. Many of the larger and more seaworthy boats have been turned over to Uncle Sam for the duration. A careful inventory is taken of the condition of these boats and at the end of the war they will be turned back to the owner in as good a condition as when taken over, normal wear considered.

Auxiliary boats may be painted a dull gray when in service of the Coast Guard and the red and white striped flag of the Coast Guard flies from their masts. Some of the craft are equipped with Lewis guns and the crew members wear side arms when trouble is expected. Enlisted men are trained in



Landings in surf are no trick for small boat men. Shallow-draft boat runs up sand and drops gangplank



gunnery at U. S. Naval training stations.

While on duty, the Auxiliaryman serves in a capacity comparable to a Coast Guard Reservist. He wears a khaki work uniform similar to that of regular Coast Guard officers, except that it has no shoulder or cap insignia. According to age and experience, deck officers are rated as navigators, senior navigators and master navi-

(Continued to page 164)

Coast Guard flag is run up on an Auxiliary boat getting under way

Gunnery crews of the Coast Guards practice loading at a Naval Station



Self-Fastening Plastic Strip Seals Joints and Seams



Plastic molding holds firmly when pounded into seam

Unsightly seams and joints in walls can be finished neatly with a plastic strip requiring no nails, adhesives or other means outside itself for attachment. Made of resilient Tenite, the shatterproof strip is so shaped that it automatically secures itself to the wall when forced into the seam. The strips require no painting and are available in various colors.

"Wind Curtain" Over Doorway Sweeps Away Flies

Flies run into difficulty when they try to enter a doorway guarded by a gentle flow of air directed downward from an

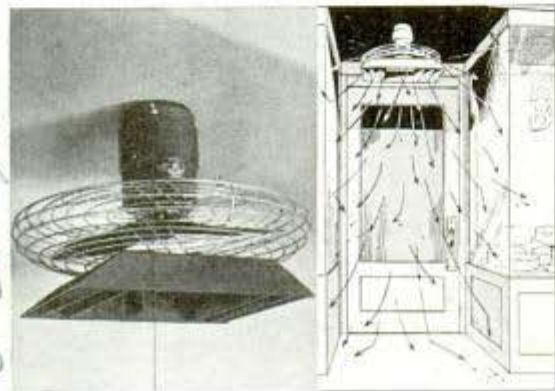

Breeze from fan, left, blows flies away from door

overhead fan, called a fly chaser. The breeze is not strong enough to distract persons going in and out, yet it wafts away insects hovering nearby when the screen door opens. The electric fan is mounted above doorways of stores, offices, dairies, restaurants and other buildings where doors are opened frequently.

Rubber and 'Gas' Made From Oil In a Single Process

Raw materials for producing synthetic rubber and an improved quality of aviation gasoline can now be obtained simultaneously from petroleum, by a new method worked out by scientists of the Standard Oil Development company. It is expected that the process will increase by two and one-half to three times the potential capacity of plants being built for the production of butadiene, a synthetic rubber material. A Standard Oil plant under construction, which will apply the new process, is scheduled to turn out butadiene at the rate of 13,000 to 17,000 tons a year.

Soil-Test Ribbon Changes Color To Gauge Plant Needs



Paper ribbon shows whether soil is acid or alkaline

Soil can be tested quickly to determine if it is "sweet," "medium" or "sour" with a tester that consists of a roll of paper ribbon and a color chart. When the ribbon is dipped into a sample of soil it changes color. A glance at the chart shows the condition of the soil. Accompanying the tester is a table of soil preferences for more than 300 plants and instructions on treating the soil if it is too acid or too alkaline for the desired planting.

Fisher Scientific Co.
POPULAR MECHANICS

711 Forbes St. Pittsburgh

Julius Rehm & Co. Inc.
 532 N. 22 St. N. Y. C.
 Chicago
 Reynolds Elec. Co.
 2660 Congress St.

Mrs. J. J. Clarke

711 005

711 589

711 517

711 586

London Electrotape Agency Inc
134 Fleet St, London, E.C.4, England
Steel Net to Trap Submarine by Its "Gills"
M 594

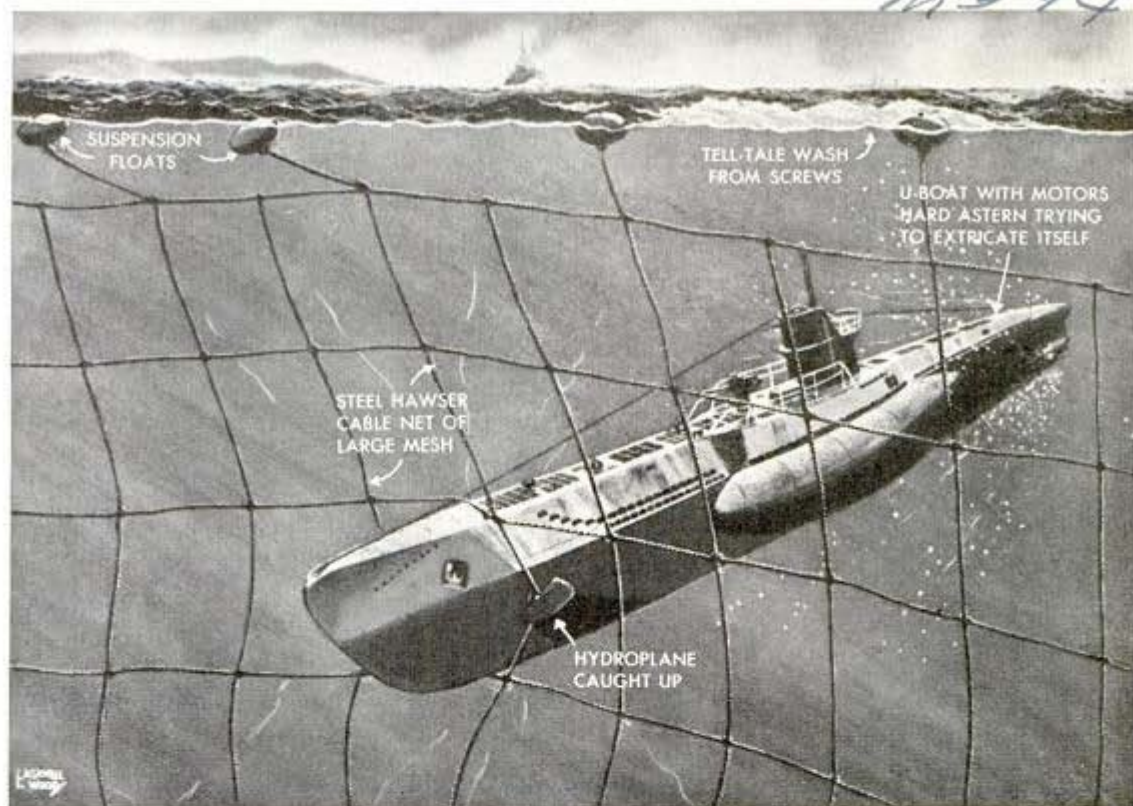

One of the defensive weapons developed during this war is a gigantic steel net devised to ensnare an enemy submarine by its "gills." The antisubmarine net itself is not an innovation; it was used in World War I to shut German U-boats out of the British, French and Italian harbors and naval bases. One British plant turned out 597 miles of these nets! The new type, however, is designed not merely to halt a submarine at the harbor mouth but to trap it. The heavy steel wire is laid in squares at least six feet wide, allowing the prow of the submarine to penetrate it until the vessel's hydroplanes—its "gills"—or other projections are caught in the net and it is impossible to free the ship by backing out. Telltale bubbles and the wash from the propellers would betray to patrol ships any attempt of a sub to escape. The huge net is supported by floats

These submarine nets are laid out on a vast rectangular pier of concrete near a point of embarkation, and when completed it is an easy matter to transfer them aboard the special net-laying vessels for removal to their strategic spot

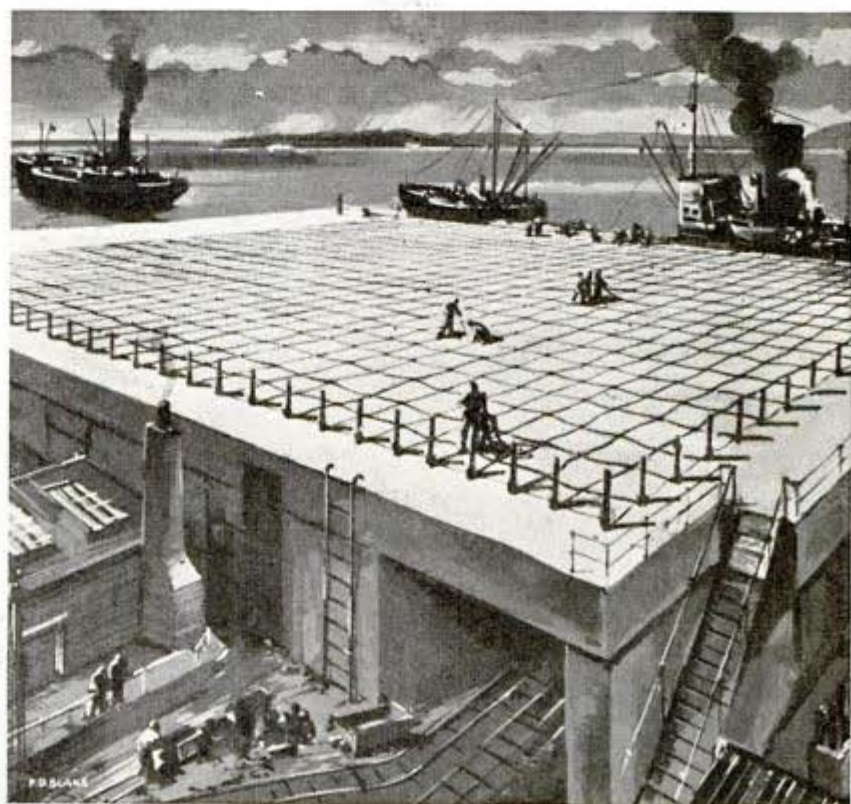

Con. Stinson, Dr. 3872 Franklin Ave, Los Angeles Calif

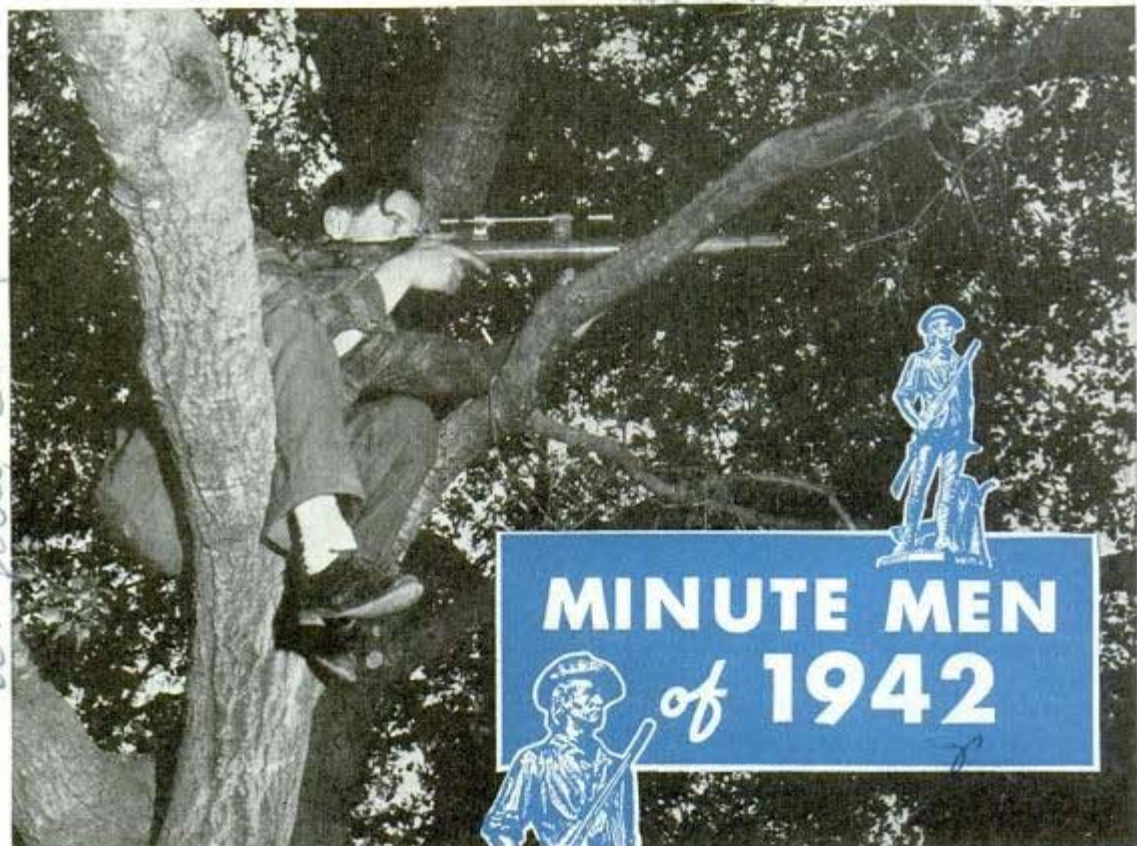

Hidden in the dense branches of a tree, with a few twigs pulled aside to give him a field of fire, a western "Minuteman" sights his rifle on a highway to help stop an approaching force of invaders

IF THE Japs should ever try to raid our Pacific coast they would find the west just as wild as it used to be.

Cow punchers, hard rock miners, farmers, even business men and factory workers have oiled their rifles and are keeping them handy. Good hunters make good snipers and crack shooting is a tradition in the west. Right after America entered the

war a spontaneous movement to put their rifles in good shape swept the western population. Armed men began to band together in many communities. Now efforts are being made to organize the groups into official home guard units.

Occasionally one of these guerrilla outfits holds a practice maneuver on a week end. Possibly they will infiltrate the hills that command a stretch of major highway. But the chances are you won't see a man unless you are a member of the group. Dressed in old clothes and armed with a variety of old and new guns of assorted calibers, they will be taking advantage of every bush and contour to get to their positions. Each has killed his share of big game and knows how to remain hidden. Each knows his gun and just where to place his shots.

He knows, too, that modern smokeless powder won't give his position away. Even after dark his



A deputy sheriff brings a new target to the practice range; back of old target is well chewed by bullets of practice rounds

gun makes only a tiny flash. In hilly country his shots echo back and forth in a confusing way. It would take a lucky shot to wipe him out, while he can aim and fire at will. Half a dozen men in ambush could account for scores of enemy soldiers.

After he has settled down where he has a good view of the road he lays out his water bottle and cartridges, and gets ready for business. First he makes a careful estimate of the range to help turn his first sighting shot into a hit. He will remember to place his shots low, to avoid the common tendency to hit over the target in down-hill shooting. Next he makes certain that he is invisible both from the target area and from above. If he doesn't have all the camouflage he wants he may even put on an improvised cardboard mask, mottled dull brown and green to blend with the background, to hide the whiteness of his face.

Most of the guerrillas would operate on foot in an emergency. Some groups are mounted on horses, others have motorcycles.

How valuable are such irregulars? The Army has thousands of men on the west coast but these soldiers have to be concentrated in the main defense areas. The guerrillas are everywhere, anywhere they



This hunter is molding his own bullets to reload his shells



Wearing a cardboard mask that matches a protecting stone wall, a rifleman snipes at the enemy with a high-powered sporting rifle. Below, civilian motorcyclists train for guerrilla war





Members of a western mounted posse assemble under a sheriff's leadership for a training ride. These horsemen are all experienced cow punchers

happen to live. They can operate alone or in groups. They don't need maps. They have camped out enough to know how to take care of themselves. No matter where paratroops might try to land, expert riflemen would try to kill them in the air. No matter where a beach landing might be attempted, snipers in the brush would be picking off some of the troops while others spread the alarm.

The Russian irregulars have been a constant irritation to Hitler's troops, and the British homeguardsmen expect to fight from behind every stone wall if their island is invaded. The modern American Minutemen, too, would fight a delaying action until reinforced. If not badly outnumbered they expect to win any skirmish, even against armored forces.

That's where the miners come in. Powder men who have been using dynamite for years, some of them so expert that they can "split kindling wood and stack it by the door with half a stick," have been studying ways to use their explosives. Tanks and armored cars can be stopped with a few sticks of dynamite rightly used. Some super-high-velocity hunting rifles will penetrate the armor of light tanks and smash the motors of other vehicles.

In Washington, a newly organized state home guard is uniformed and to some extent is armed with bayoneted rifles. This group is drilling under Army supervision and would operate on a guerrilla basis instead of as a massed force in time of need.

Armed men in many Oregon communities have held organization meetings, 1,000 armed civilians having been rallied at the small town of Tillamook alone.

In California the call has gone out for an army of snipers 100,000 strong. Men between 16 and 65 are wanted and those who haven't done much shooting will be trained in sniper's tricks by experienced sharpshooters. There are more than a quarter of a million licensed hunters in the state and practically all of them have their own weapons. The present

plan calls for authorizing these men to use their arms by swearing them in as deputy sheriffs.

Two examples illustrate the organizations that have been formed. Ed Lucas, a California Shipbuilding employee, is rounding up the motorcycle riders in the plant for guerrilla service. Eugene Bis-

Masked sniper takes a post in the crotch of a tree



cailluz, sheriff of Los Angeles county, has expanded his mounted posse to 350 men, consisting of small bands of rough riding horsemen with headquarters in their own communities. The Calabasas auxiliary of this outfit, for instance, consists of 30 trained cow punchers who are accustomed to working cattle in rough country. Their horses must stand the blast of a 30-30 from the saddle and the men practice their marksmanship by shooting at running coyotes. They have added first aid, handling of incendiaries, and sniping tricks to their training.

It's hard to find a revolver or rifle for sale in the west today. Practically everything available has been bought up. Standard calibers of ammunition are just as scarce. Few shells will be wasted on game this fall, now that it's open season all year round on Jap invaders, though the cartridge situation isn't as bad as it might be because hunters are learning to reload used shells.

Not everyone knows that used rifle shells can be reloaded and reused, 10 or 20 times or more, at much less expense than the cost of new shells. Many hunters reload them by hand, buying jacketed bullets or pouring their own bullets from a mold. Primers cost 40 cents a hundred. Powder must be weighed on an accurate balance. A loading tool that recaps the shell, seats the bullet in the neck, and reshapes the neck to size, costs \$5.50 and up. It costs \$2

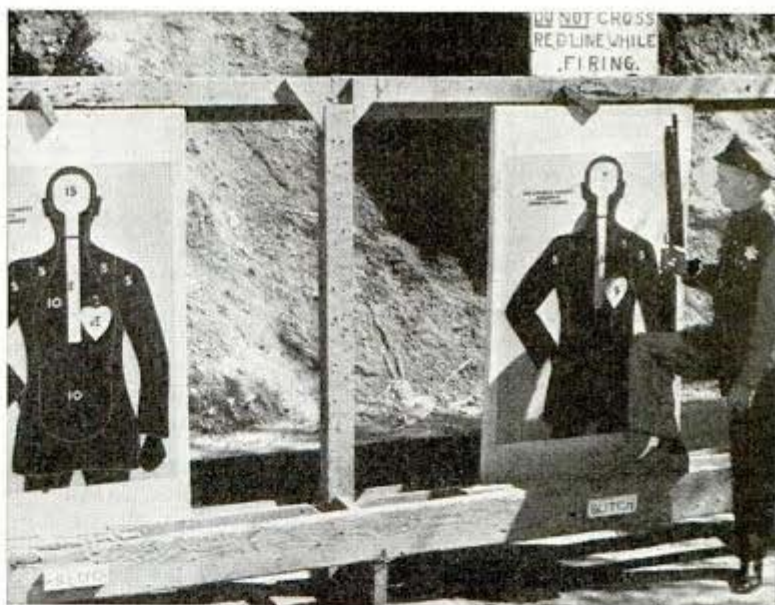

Members of the sheriff's posse improve their aim on this practice range



One of the motorcycle guerrillas takes a prone firing position over his "mount." Below, a marksman is crouched behind a tree in command of a mountain road. Wire cable is strung across road to slow the advance guard





These guerrillas of the ranchlands are a reminder of the pioneer days of "hoss thieves" and Indian wars

Lying in ambush on a ridge commanding a canyon road, a hunter awaits the enemy with shells and range-finding telescope beside him



to \$5 per hundred to reload 30.06 shells, depending on type of bullet and size of powder charge, as compared to \$11 per hundred for new cartridges.

If you have an old rifle, look it over carefully before you shoot it. Give it a thorough cleaning and oiling. If the action is slow and gummy, take it to a capable gunsmith. Inspect the bore for stoppages and be sure you can see all the rifling inside. It's never safe to shoot a gun that doesn't look perfect inside. If you have a stock of old shells, wipe them off with an oily rag. Don't use them if their necks have split. They may still shoot but in some guns they will be dangerous.

Tin 'Washed' From Inferior Ores With 'Electrical Spray'

Demonstrated with success in the Westinghouse laboratories, an "electrical spray" was used in "washing" tin and other metals such as gold and iron from low-grade ores. In one case, the ore contained only one and one-half percent tin, and the device produced a concentration containing about 70 percent tin, suitable for smelting. The separation principle is similar to the attraction of iron filings to an ordinary magnet. Since tin particles are good conductors of electricity, the sprayed electrical charges seep through them and into the foot-wide metal drum of the separator turning with a surface speed of 12 miles an hour. The tin particles, losing their charges before the drum has made more than one-half turn, let go and fall off the drum. However, the poorer conducting sand and rock

particles retain their charges and cling to the drum until pulled off by a series of oppositely charged wires when they reach the second half of the revolution. In this way the particles are deposited in two neat piles, one containing nearly all the tin mixed with a small amount of rock and sand, and the other rock and sand with only a very small percentage of tin. Ores must be dried thoroughly before the separator will handle them properly, but it is believed that the method will prove more efficient than present ones which do not require drying. The electrostatic separator can separate mixtures of any two materials, provided one part is a conductor of electricity and the other a very poor conductor. It is considered possible that the machine may even be used to purify foods.

*Cardox Corp. 307 N. Michigan
Chicago*

Truck Emits "Cloud" to Smother Burning Plane

One ton of liquid carbon dioxide per minute can be sprayed on an airplane that has crashed and burst into flames by a fire truck developed at Wright Field, materiel center of the Army Air Corps at Dayton, Ohio. Clouds of carbon dioxide thrown out by the truck permit it to approach close to a burning plane. The flames are driven back and smothered and the hot metal is

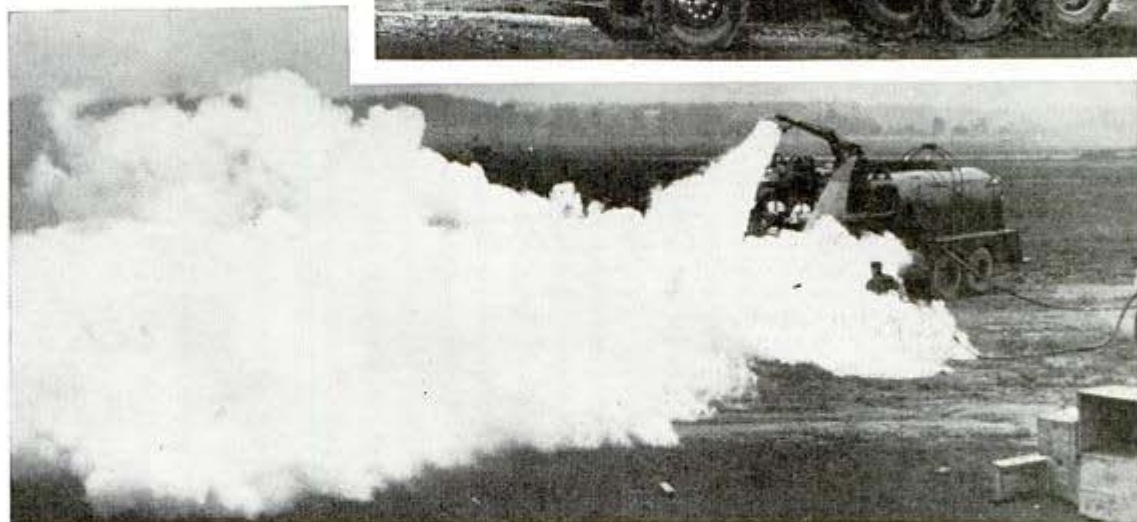

Approaching a burning plane, the truck sprays carbon dioxide from nozzles on front. Inset, control panel

cooled sufficiently to allow rescue crews to pull out the occupants. Two large nozzles are attached to the front of the truck. One is mounted on the end of a long boom that can be raised or lowered, and the other in front of the radiator. A ground sweep nozzle stretches the full width across the front of the truck. All are controlled from a panel in the driver's cab. In addition, two

hose reels are mounted on either side of the truck, each holding 100 feet of hose. A storage tank holds three tons of liquid carbon dioxide which is kept at zero temperature by an electrical refrigerator. This makes it possible to store the liquid in a comparatively light pressure tank. Airport firemen can handle the apparatus with the ease of a small hand extinguisher.

Propeller to Push Rocket Plane Through Dense Lower Atmosphere

Auxiliary turbine-driven propellers will be used to lift the rocket plane of the future through the dense lower atmosphere into the stratosphere, according to Dr. Robert H. Goddard of Roswell, N. M., an authority on rocket aircraft. He recently patented a turbine that can be attached to a rocket plane and cut loose in the stratosphere. The auxiliary unit would be float-

ed back to earth on parachutes while the plane roars on its way pushed by the blast of rocket jets. Propulsion by propellers is more efficient and less wasteful of fuel in dense atmosphere, Dr. Goddard reports.

Look in the index to find where to buy articles described in this magazine. Say You Saw It in Popular Mechanics.

Steam Engines Haul Plow on Mile-Long Cable

m. 587

Mr. Grant

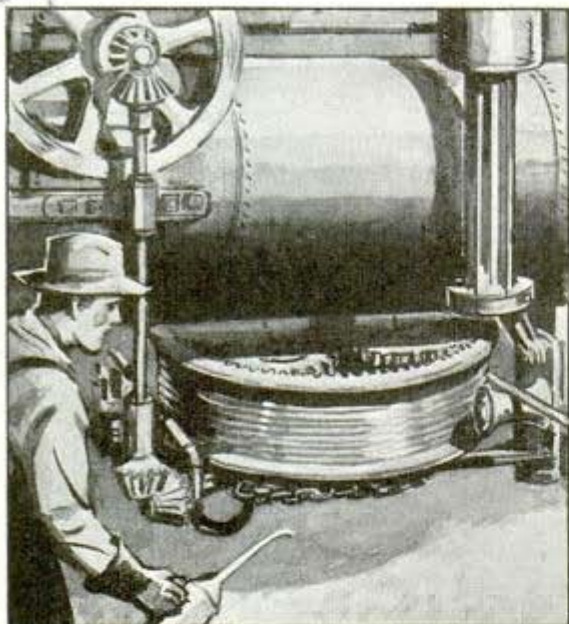

Gang plows that cut 16 furrows are crossing and recrossing the fields of hungry Europe, drawn back and forth by cables wound on the windlass of twin steam engines stationed at opposite ends of a field a mile wide. Invented in England, this steam plow is now in use in Germany, where its 230-horsepower engine burning coal or wood is economical in an oil-poor land. The reversible plow frame is triangular; reaching the end of the field, the 16 blades which have just finished their furrows tilt upward and 16 others facing the opposite direction dig into the ground for the return trip. The two steam engines, which somewhat resemble our familiar steam road rollers, move along the two edges of the field as the plowing progresses.

Below is the 230-horsepower steam engine winding up the mile-long cable on its drum, which has a vertical axis. This drum, as is indicated in the sketch at top, is propelled by a system of cog wheels that grip the teeth inside the windlass. The two engines, of course, work alternately hauling the 16-share plow

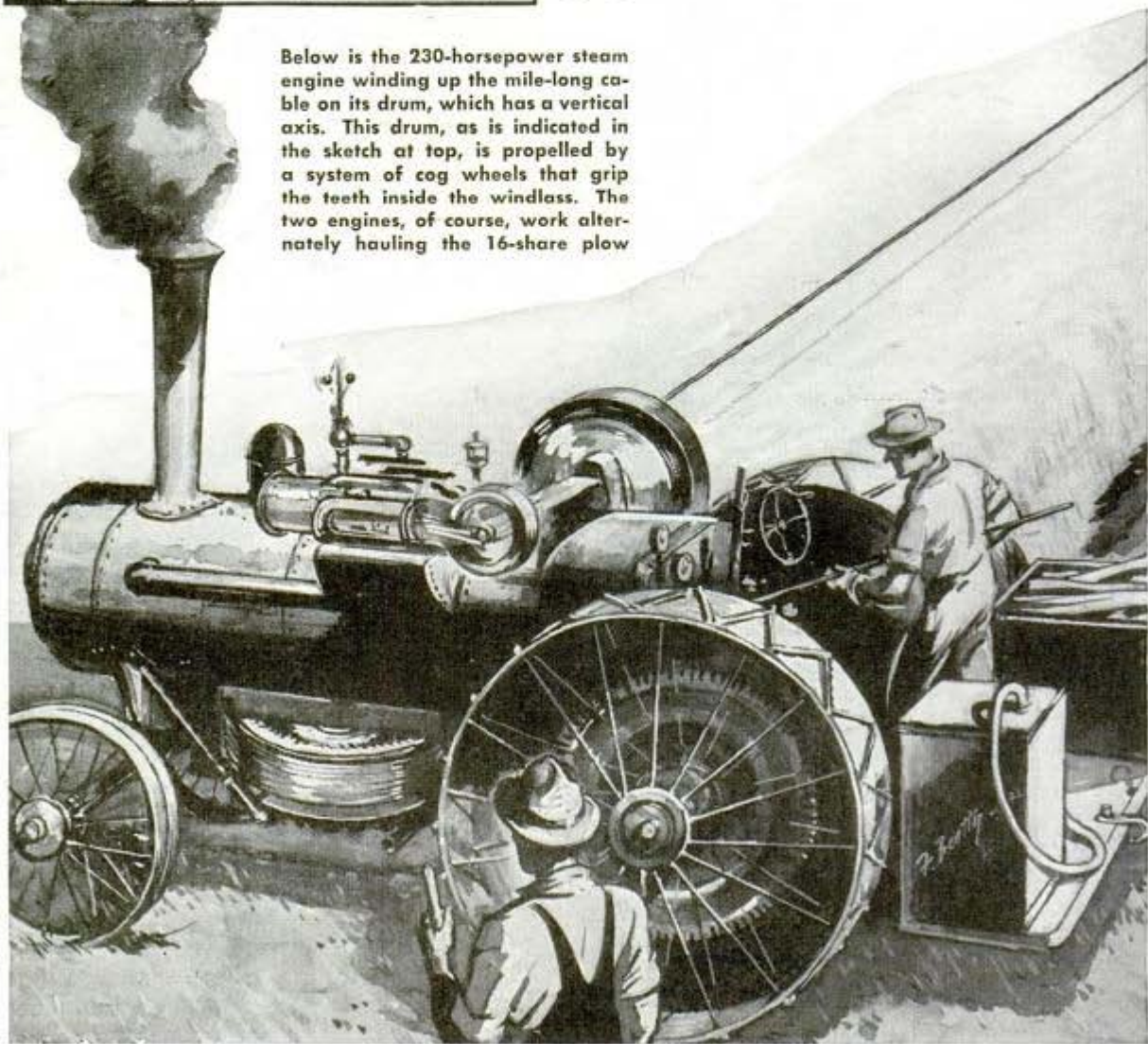

Reversible Shares Cut 16 Furrows Each Way

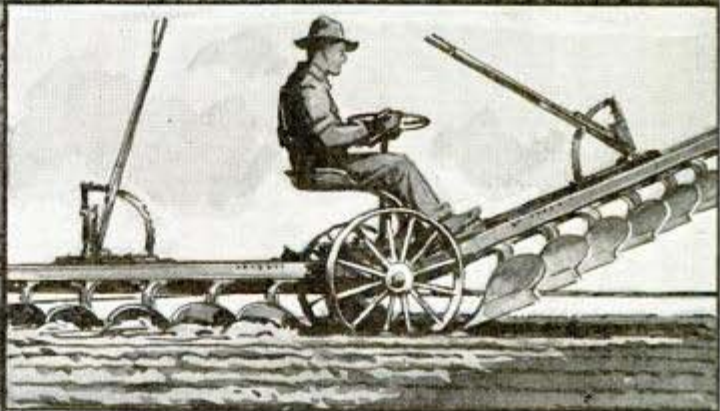
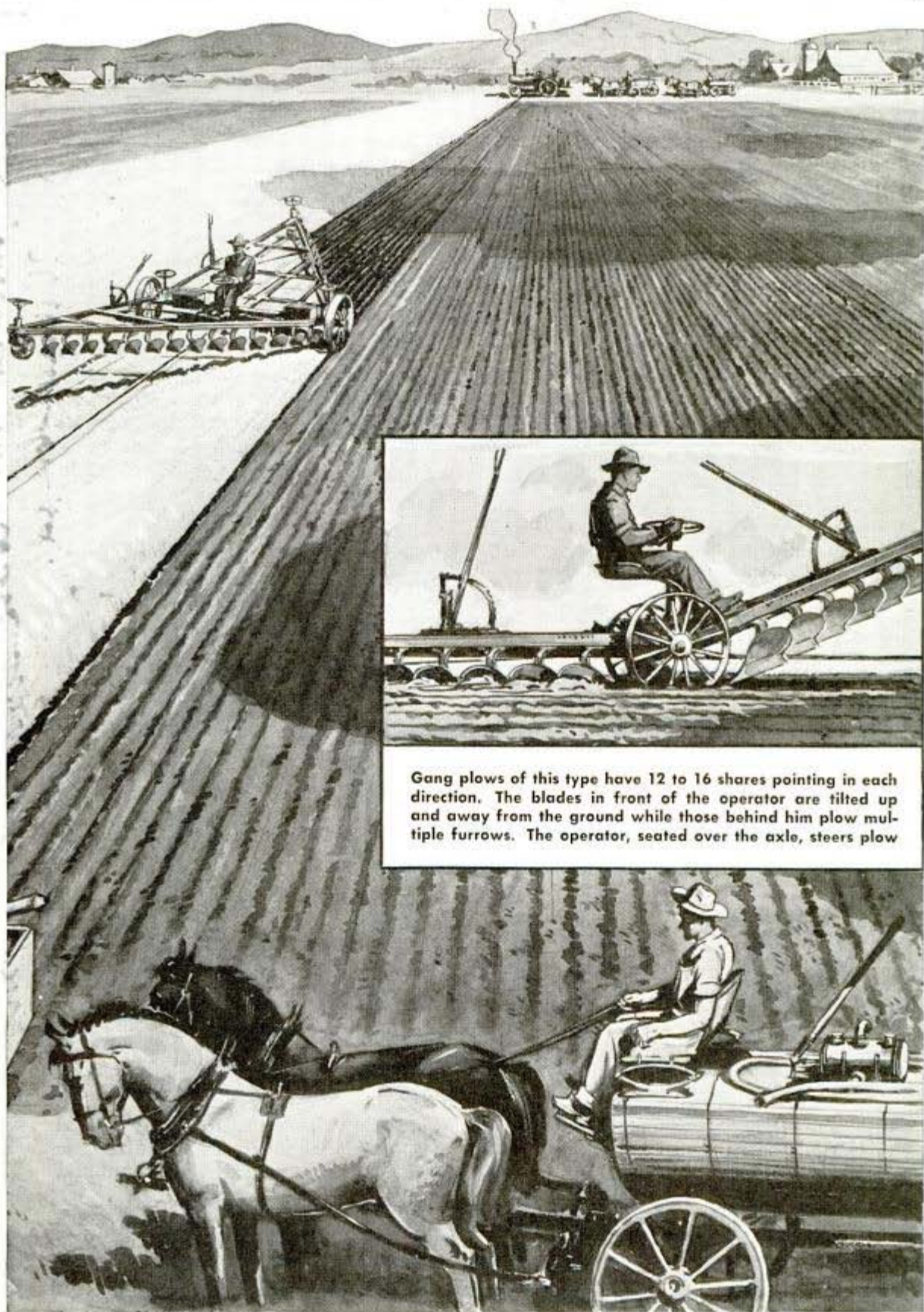

Gang plows of this type have 12 to 16 shares pointing in each direction. The blades in front of the operator are tilted up and away from the ground while those behind him plow multiple furrows. The operator, seated over the axle, steers plow

*Dist: Swartzbaugh, Mfg Co
 12121 North Chicago*

Five-in-One Garden Tool Has Adjustable Head



Three adjustments of the same implement reveal how the head can be tilted for many uses in the garden

Rake, hoe, plow, spade and weeder are combined in one garden tool with an adjustable head. One side is a rake, the opposite side a hoe; one end is a plow, the opposite end a spade. By tipping the head to the desired angle it may also be used as a weeder. The head is mounted on a notched disc at the base of the handle and is adjusted by pulling a spring crosspiece.

Adjustable Screen for Radiator Fits Most Automobiles

Out of sight behind the grill when installed, a new automobile radiator insect screen is adjustable to fit almost any car.

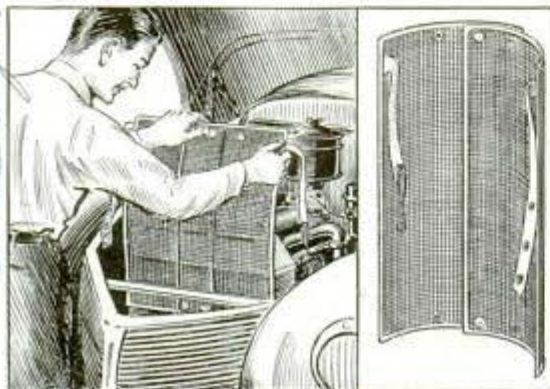

Bug screen, right, easily fitted to auto radiator

It consists of two parts fitted with button clasps permitting adjustment of the screen to three widths for narrow, medium and broad front radiators. Straps fastening about the radiator are provided with eyelets and a coil spring hook allowing for radiators of various thicknesses.

Fly Spray Made From Pine Oil Replaces Jap Pyrethrum

Made from southern pine extracts, an insect-killing chemical can be substituted for pyrethrum and rotenone ordinarily used in fly sprays. It is effective against flies, moths, mosquitoes, roaches, bedbugs, spiders and other insects. Experiments in the laboratory of the Hercules Powder Company at Wilmington, Del., reveal that the new chemical kills female flies as well as male. Pyrethrum sprays—for some unknown reason—have been chiefly effective against male flies.

Transparent Plastic Coil Spring Snaps Back Like Steel

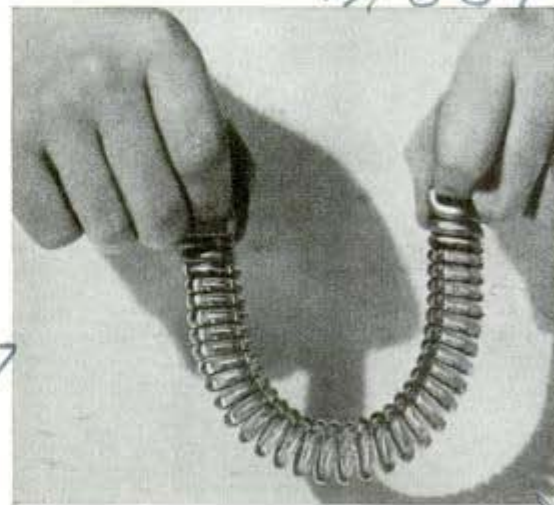

"Glass" spring can be pulled and stretched like metal

Made of transparent plastic, a coil spring with the resiliency of the steel product has the advantage of being rustproof. This plastic spring, developed to conserve vital war materials, is handy for home use for it is easily cleaned, will stand constant and rough usage and is decorative.

(Tungsten filament wire used in Mazda lamps is measured on scales accurate within 40 billionths of a pound, sensitive enough to weigh a penciled signature.

*Dist: Swartzbaugh, Mfg Co
 12121 North Chicago
 W.ilmington, Del.*

*Dist: Swartzbaugh, Mfg Co
 State & Van Buren
 Chicago, Ill.*

Trip Bar for Jumper Is Among New Patents

m 524

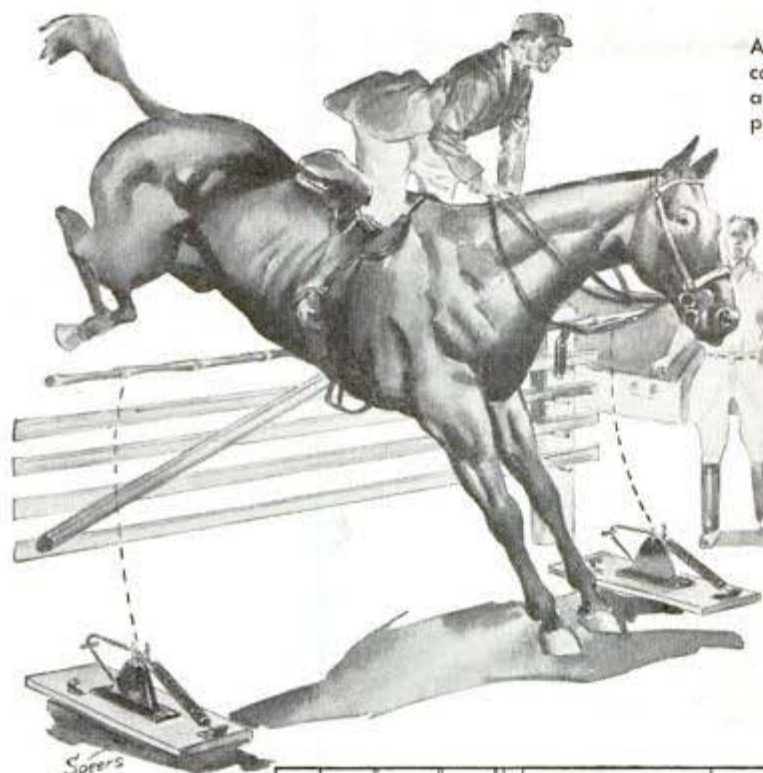

Among the new patents is one for a comb with a hollow handle that holds a container for fluid that runs along a passageway to grooves in the teeth

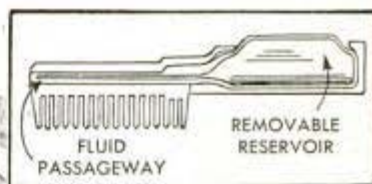

An automatic "whip" for training horses to jump hurdles consists of a light rod which is laid across two springs. If the horse knocks a pole from the hurdle top the rod is hurled upward against the under side of the horse



Left, combined bassinet and dressing table for infants opens up like a telescope. The frame supporting the basket slides back to reveal a table top with protecting rim and a depressed space on one end to hold toilet articles. Below is a catcher attachment for power-driven hedge trimmers, the cutter blade mounted on a bar. (All articles on this page were among recent patents, but there is no other information available for prospective purchasers)

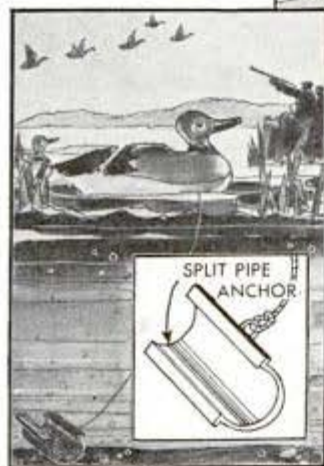

Duck hunters would welcome this anchor for decoys that prevents them from drifting too far from a blind. It is made of a split pipe of heavy material and attached with a line



RADIO TRAFFIC CONTROL

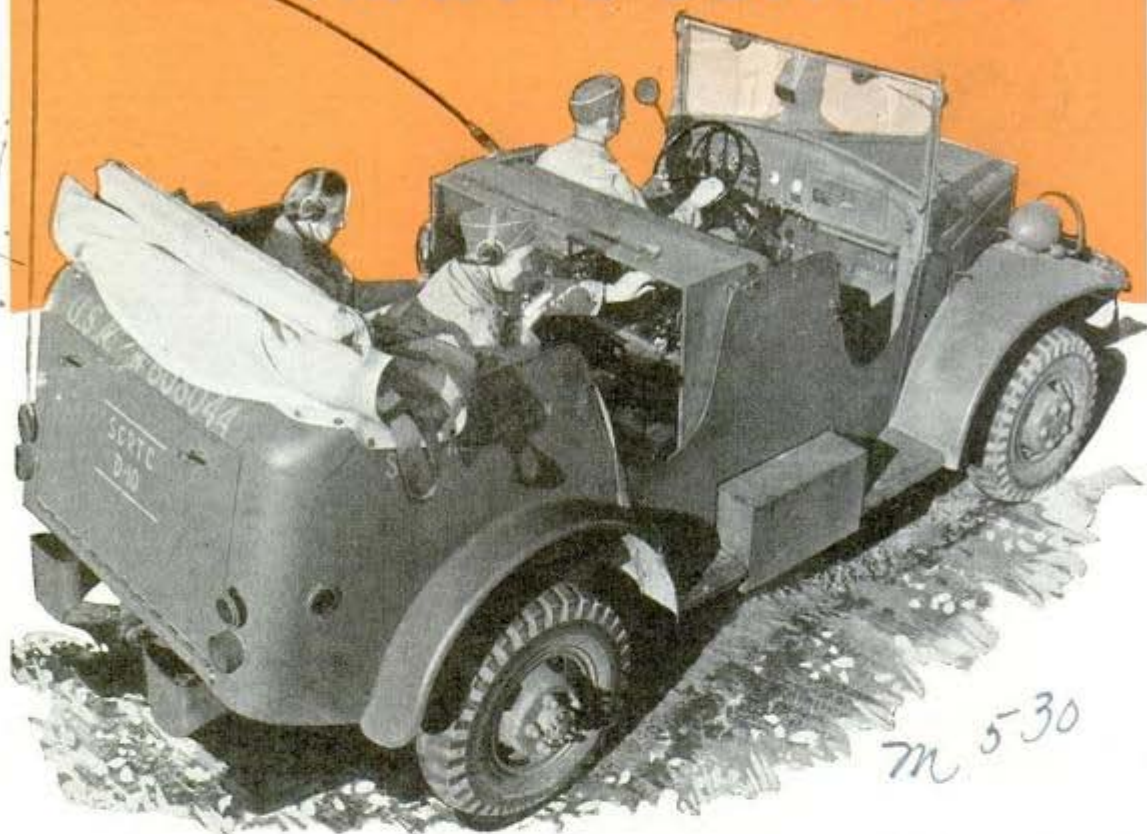

Ready to push into the "battle" zone during maneuvers, this radio crew will make the short waves hum. Below, radio traffic patrol car used in Brooklyn, N. Y.



IF YOU think that radio is something that can be tuned in and out of your life according to your momentary interest in music and news, radio engineers are winding up to hand you a few jolts in the not-too-far-off future.

Perhaps in two years, probably in five, but almost certainly at the close of the war, you are likely to have a radio traffic cop in the instrument panel of the family auto.

Somewhere on the dial of your auto radio you probably will have a notch or mark—a stranger among the channels already allocated to your favorite broadcasting stations—and if you are a law-abiding citizen you will watch for signs along the highway which might read: "Tune in for highway radio."

You might tune in and hear:

"Urgent . . . all cars . . . military convoy approaching at high speed . . . pull off the road immediately . . . urgent . . . all cars . . ."

Or the message might be:

"Caution . . . all motorists . . . bad traffic accident two miles south . . . road blocked . . . approach with caution . . . watch out for

Cont: Allen Warren Clark; 243 E. 33 St
nyc

Sitting in his locomotive cab, a railroad engineer talks to the crew farther back in the train

speeding police cars and ambulances . . .”

Or a wartime warning might come:

“Danger . . . all motorists driving south . . . detour at nearest right turn . . . highway under attack . . . stop and take advantage of first shelter. . .”

Washington officials have already discussed the advisability of setting aside a radio channel for motorists so that all roads could be patrolled by radio traffic cops. They would regulate civilian traffic to eliminate interference with troop and military supply movements and transmit air raid warnings. This innovation is only a makeshift compared to what is being planned for you in the postwar period.

If these plans mature, your car will have a two-channel type radio with one channel for ordinary broadcasting and the other pre-tuned to what will be known as a standard national highway frequency. There will be two receivers, one for entertainment and the other for the radio traffic cop. At certain zones, the policeman on roadside duty will push a button and your music or news will automatically fade to a whisper. His voice will come booming out of the other receiver with such admonitions as:

“Slow down, dangerous curve 500 yards ahead—”

“Public school being dismissed in the town to the south . . . watch out for the children.”

And you won't need to strain your eyes for road markers to identify state lines. Leaving

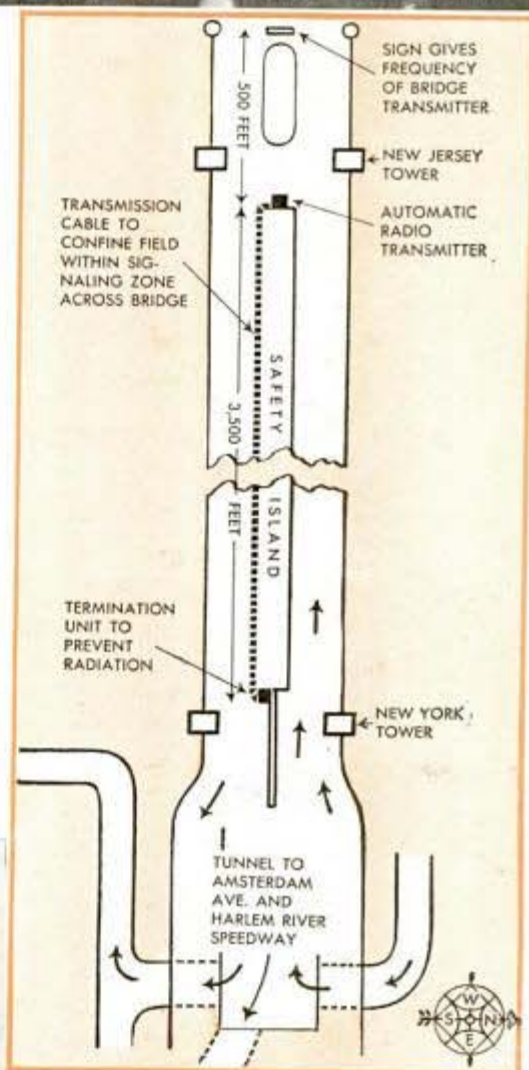

Diagram shows the radio traffic control installations used in a test on the George Washington Bridge in New York City. A sign on the bridge, left, tells motorist where to set his auto radio dial to receive the broadcast





Above, interior view of the "broadcasting station on wheels" (below) used by the Signal Corps. Trailer carries radio receiver, also motors to supply power for a transmitter in the tractor



The instrument panel on your postwar auto may look like the one above equipped with a Link short wave set. Note microphone, top

Reel on the back of peep holds cable to be laid along a road for transmission of secret orders by radio to passing troops

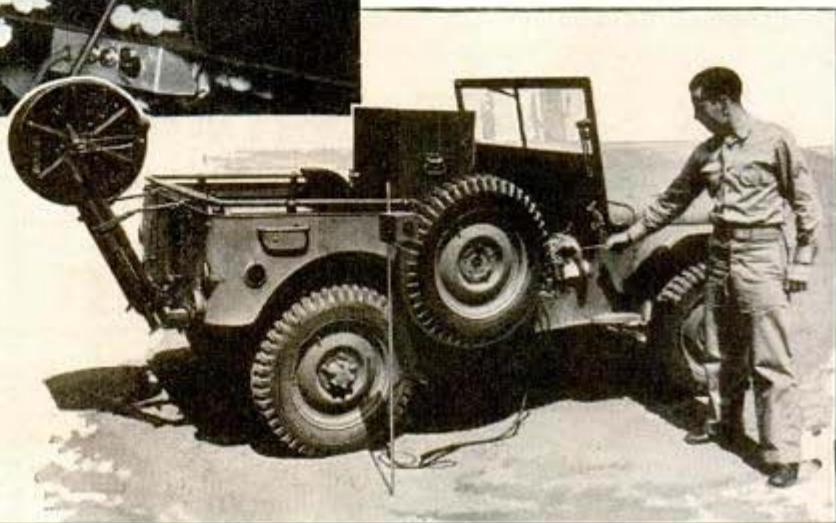

Pennsylvania, you may suddenly hear the strains of "Maryland, My Maryland—" and you will know where you are unless you are deaf. State songs would be followed with a friendly lecture on state highway safety regulations and speed limits.

Several methods of low-power, limited-area broadcasting might be used, but the most satisfactory one sends its frequency modulation waves from a cable stretched on the ground alongside the road. The unique feature of this system, perfected by a New York communications engineer, William S. Halstead, is that it can be confined to a band 150 feet on either side of the road and within the length of highway where the cable is installed.

It has already been tested by the Army Signal Corps at Fort Monmouth, N. J., and on George Washington Bridge and in the Queens-Midtown Tunnel in New York City and was found to give excellent results.

Halstead is the authority for startling predictions as to what the motorist may expect from the postwar radio.

"Not only will dozens of refinements too radical to have been engineered into your prewar car make their appearance," he says, "but the competition from huge plane factories to sell you a sky car as cheap as an automobile will

change the emphasis on the automobile to the safety angle. There will be a cat and dog fight between the airplane and the automobile. The automobile manufacturers will naturally stress safety.

"State authorities have done a great deal to make roads safe. Auto makers have made the car safe. The postwar emphasis will be on making the driver safe. The most likely method to be used will be highway radio broadcasts which will feed caution and common sense into the ears of the driver and relieve his already strained eyes. The road marker of the future will be the radio."

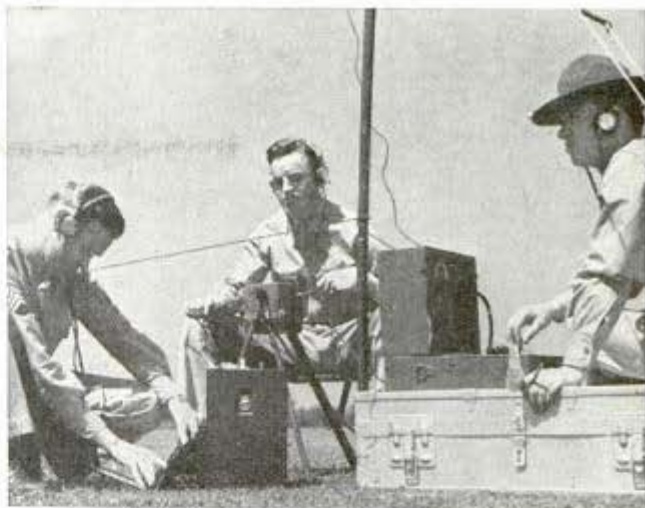

Operating portable radio transmitter and receiver at the Signal Corps School, Fort Monmouth, N. J. Trunk at right holds set

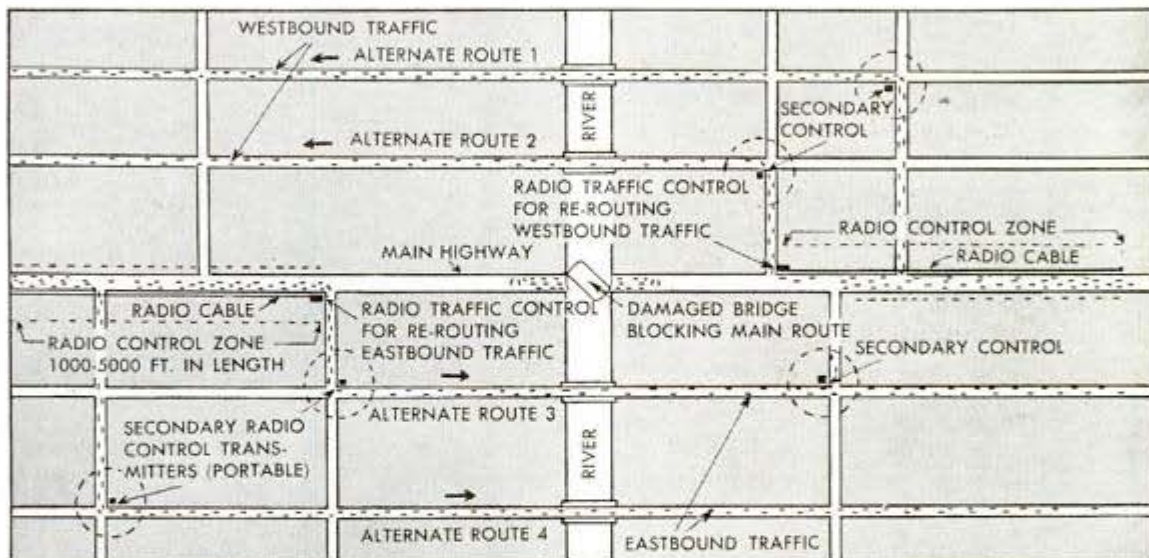

It is only necessary to use devices already invented and to look ahead five or 10 years, he says, to see the time when a traveling salesman on a highway in Iowa can push a button on his auto radio, get a clear channel in the roadside two-way broadcasting system, ask the policeman for a telephone operator, reverse the charges and talk to his wife in Chicago. And at the same time they can both be tuned in to the same radio program, the family favorite, and discuss the music or laugh at the jokes.

By the time the war ends transcontinental trucking and bus companies will be able to keep in almost constant communication with their drivers, rerouting trucks and buses

If a bomb should fall on bridge, center of diagram, severing main highway, traffic could be rerouted by radio cables. Below, moving antenna to focus beams in the desired direction

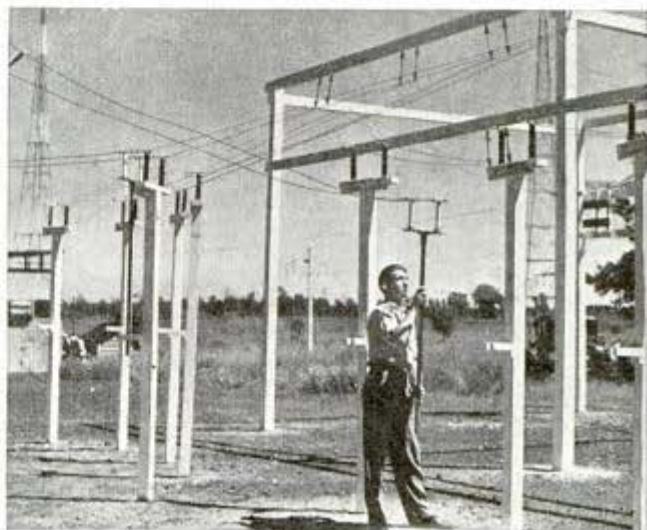



Army's famed "walkie-talkie"—portable two-way radio set—weighs less than regular infantry pack

by frequency-modulation networks, Halstead says, just as airplanes today are held enmeshed in a network of radio beams.

One proposal by Engineer Halstead is so sensible and cheap as to cause one to wonder why it has not already been adopted for all flying fields around the globe. Ex-

perience has shown that the first bombs which strike a raided airport quickly shatter microphone diaphragms, disrupt loud speaker systems and wreck telephone installations. The result is confusion at a critical moment.

Using the same cable-guided broadcast system already tested on roadways, stretching the cables alongside the runways or under them, would give a single control operator the convenience of talking to the pilot of any plane on any runway without their conversation being audible on the next runway—or to the enemy. By extending the network and overlapping the broadcasts, any part of the field could be reached even if bombs destroyed part of the cables, transmitters or receivers. Orders could be transmitted to officers equipped with "walkie-talkies" anywhere on the airport. Such portable radios are in widespread military use already.

More spectacular and alarming is a possible use of cable guided "FM" broadcasts for submarines, especially by Axis nations which tend to use the "wolf pack" method of operating subs.

It is only necessary to suspend a cable two or three hundred feet down into the water from a "mother ship" or a flagship submarine to create a limited broadcast area in which a squadron commander can

Airport with many radio zones could maintain communications if main control unit were struck by a bomb

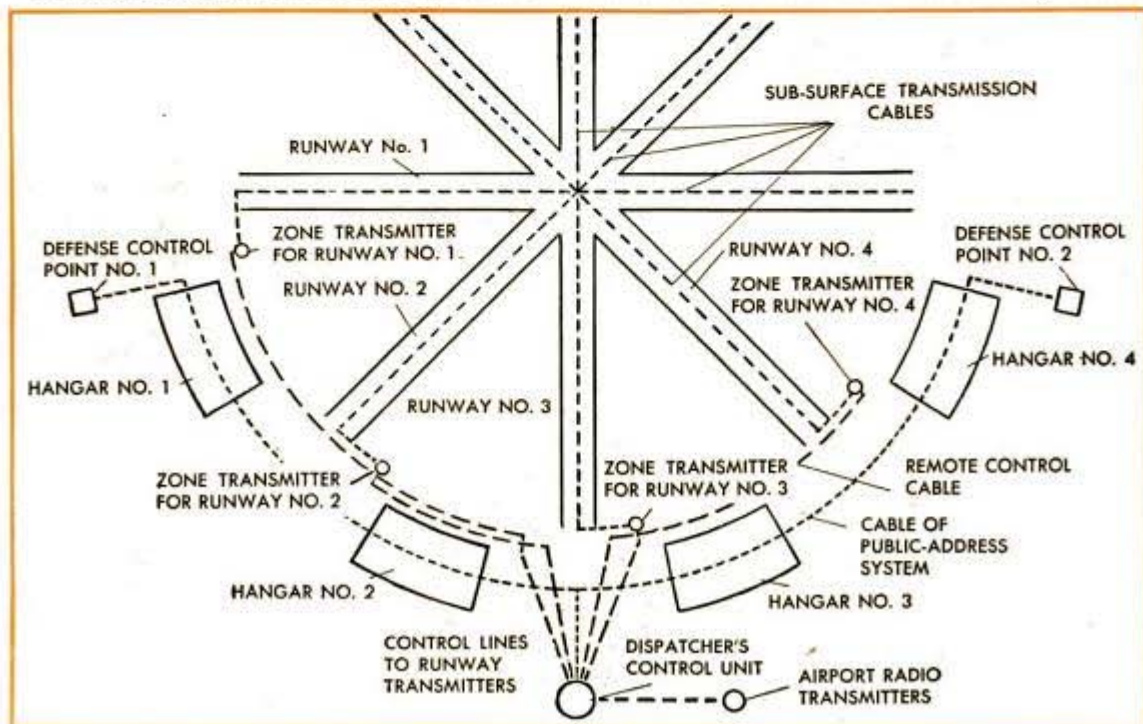

Int'l news photo

talk freely but secretly to the officers in charge of the other subs during an engagement, directing each undersea vessel to an appointed station and even giving the order to fire torpedoes.

One of the peculiarities of such an "FM" setup is that not only will there be a minimum of interference from electrical devices, but the conversations cannot be picked up on the surface of the water, the beams spreading out horizontally like the waves set up by a pebble dropped into a lake. The depth of the broadcast field depends on the length of the cable and the width upon the power used in the transmitter.

Another obvious possibility is the direction of landing parties, such as Commando units, from destroyers and transports. Officers equipped with walkie-talkies would be in a position to get direction from superiors stationed on ships where they could get a sweeping view of offensive and defensive operations. They would be able to report details from beachheads to the ships standing by, spotting guns and strong points which might be blasted by naval guns.

Still another practical use which is no secret, since it has been publicly proposed, is low-power radio direction of parachute troops from planes carrying officers in charge. After hundreds of troops have been dropped, the officer in a circling plane could direct the landing parties, warn them of enemy movements and practically conduct a battle from the air.

It is feasible to install radio traffic cops in the air to control the movement of vehicles during an air raid and it probably has already been done in some parts of the world. A plane broadcasting at a limited range could circle above such a point as a bombed road junction, sending terse directions to men on foot with walkie-talkies, to radio equipped jeeps and armored cars, to trans-

(Continued to page 168)

OCTOBER, 1942

Coating of Soot Over Rifle Sights Eliminates Annoying Glare



Holding rifle over oil flare aids Marine in firing practice

Before using his rifle in firing practice, Sergeant D. L. Ray, of the U. S. Marines at Quantico, deposits a sooty film on the sights. The dull surface thus formed eliminates glare and reflection, and enables him to draw a better bead on the target. Soot is obtained by holding the sights over an oil flare of the type used to mark highway obstructions.

M. 688

Wheeler, M. 79

Tricycle Pushcart With Small Motor Is Steered by Bike Handlebars

Three wheels, a box, a one-cylinder engine from a washing machine and bicycle handlebars are the main parts of a pushcart built and ridden by Mark Mansell of Detroit, Mich. The gasoline-driven oddity gives its owner 50 miles on one gallon.

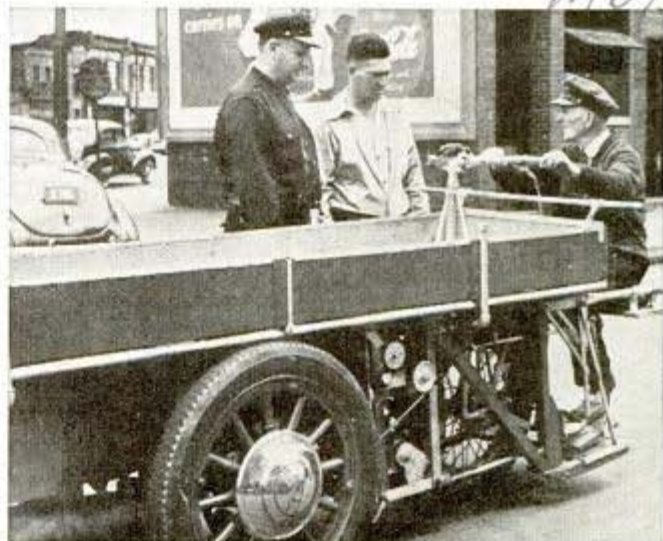

One-cylinder engine from a washing machine supplies the power

Press icon

W. Norman: See Models & Co - 50
Rockefeller Plaza, N.Y.C.

YOUR HOME of the FUTURE

cont: Allen Warren
Elliott, 3476 33rd St.
7 Park Ave, N.Y.C.

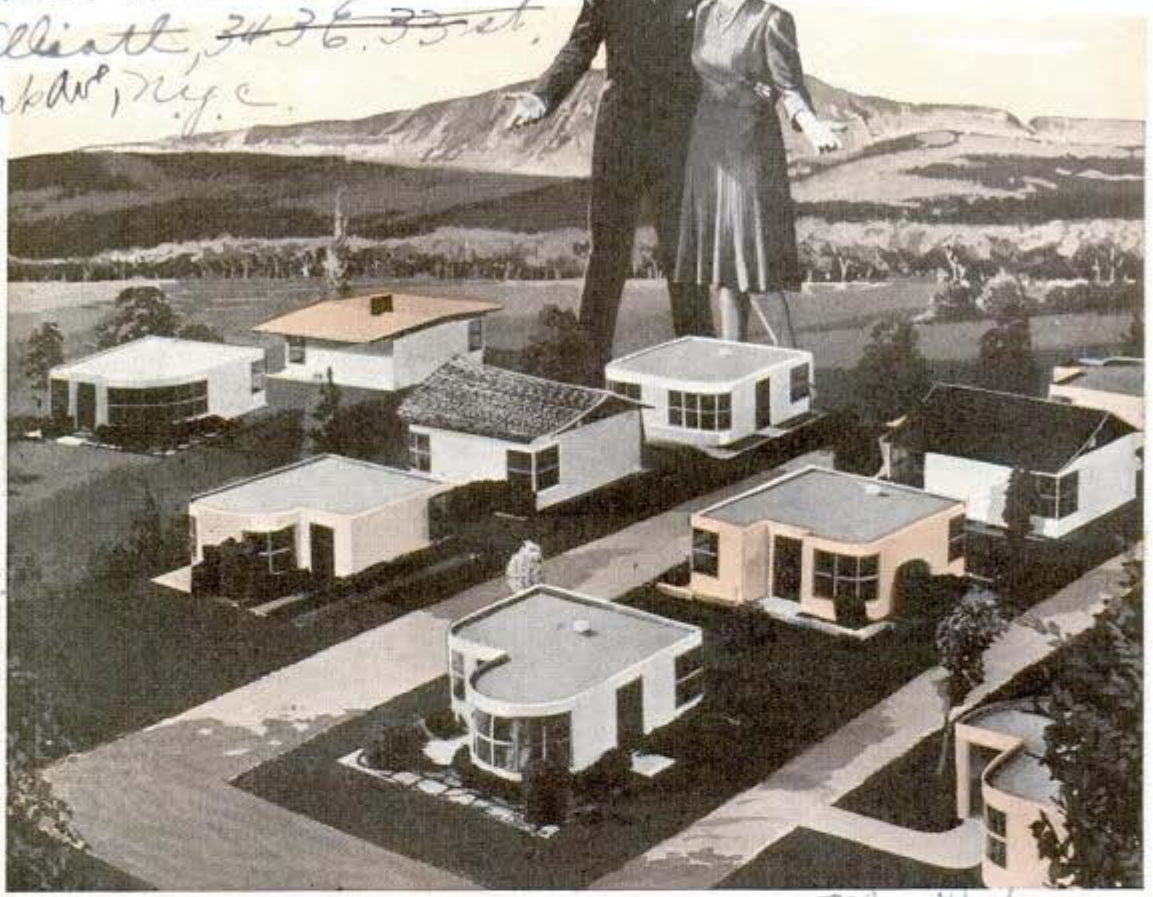

Shopping for future homes will be easy with a group of models arranged in a village. Below, model shows how prefabricated house is packed in special "van"

76 H64

WAR makes incredible changes in our daily habits and modes of living, but history shows civilization always takes a step forward when peace comes because we profit by lessons learned the hard way.

For example, take your home of the future.

Some of the changes being planned for your postwar dwelling border on the fantastic. They might be waved away as visionary if they were the idle dreams of dreamers instead of the practical proposals of the world's leading designers and architects. And the research is being fostered by one of America's leading industrial concerns. Indeed, some of the theories are already being put into use for war purposes.

It is necessary only to look ahead five or 10 years to picture possibilities like these:

Some Sunday morning you decide you would like to live on a piece of land which has caught your fancy. It is a bare plot in a developed real estate area with sewage, water, electricity and gas connections.



The "invisible" kitchen will be a part of the dining or livingroom with all equipment artfully concealed when not in use

The family spends the remainder of the day on the livingroom floor crawling on hands and knees, perhaps, in a village of tiny model houses supplied by a mass-production corporation which turns dwellings out just as automobile companies rolled cars from the assembly lines before the war.

Lifting off the bright little roofs, you examine bedrooms, bathrooms and livingrooms until you find the layout that suits your family.

Having narrowed the selection down to a few models, just as you would pick among automobiles, you turn the models upside down and find prices and specifications printed on the bottoms. Sunday night you make a final decision.

Your decision, strange as it may seem, is not only upon a prefabricated exterior, but a prefabricated interior, selected room by room according to function.

Monday morning you close the deal with the real estate company and turn over the small model of the home you have selected so that preconstructed foundation piers may be set into the bare plot and utility

pipes extended to the proper points. By Monday noon you have signed up for the house for Tuesday delivery.

Tuesday morning a truck or two pulls up to the site with half a dozen men. While you are downtown selecting whatever new furniture you may need, for Wednesday



Lifting off the roof and tipping back the walls of the model at left shows a prefabricated bathroom unit. Right, examining a Norman Bel Geddes model home featuring a roof that comes complete in just six sections

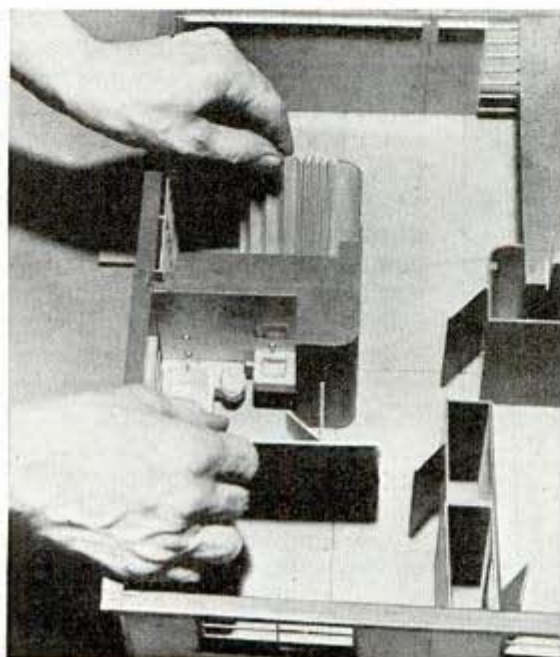

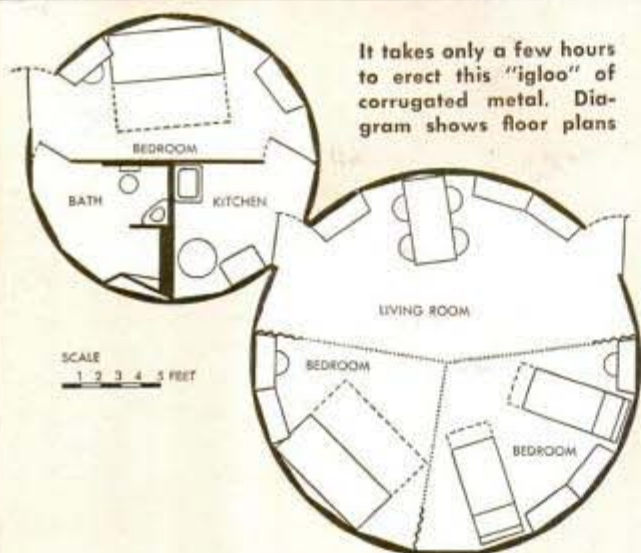

Erecting the circular house starts with the roof, made of metal sheets and dome shaped, which is assembled on the ground (below). It is hoisted to position up a mast

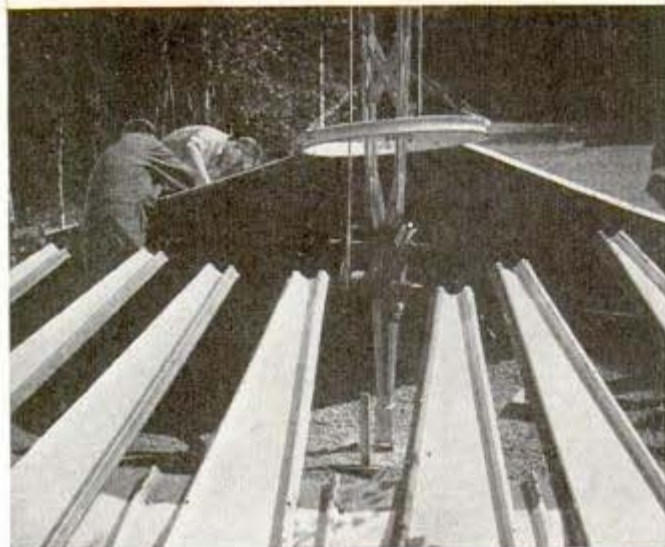

afternoon delivery, the small construction crew is setting up your new home.

Wednesday, surely by noon, you can move in your old furniture before the truck comes with the new and if you have found time to shop for food, Wednesday's evening meal can be eaten in the new abode.

Fantastic? It sounds so, but wait—

A few months later a shift occurs in the family setup. A son or daughter leaves home to be married. And at the same time, a member of the family decides to take up photography. This leaves an extra bedroom which might be converted to a darkroom.

You advertise in a newspaper: "Wanted to exchange one bedroom, style X2-A, of the Jones Home Corporation line, for a darkroom."

Someone who has a darkroom but who would prefer a bedroom answers your ad. A deal is made. A truck brings the prefabricated darkroom interior, pulls out the prefabricated bedroom interior and the home has changed to fit the change in the family—unlike today when we accommodate the family to the dwelling.

Should you fail to find someone who wants to make the proper swap, it is only necessary to go back to the Jones Home Corporation and trade in your spare bedroom for a darkroom. Or a darkroom for a nursery. Or a nursery for a home workshop. Or a workshop for a billiard room. Or a billiard room for a laundry. Each comes in a number of standardized sizes with a variety of interior finishes.

Implausible? Yes, but see what else these leading designers have in mind for you:

After a couple of years, you look out the window some morning and find that another family has moved a new house on the plot next door. A week later when you come home from the office, the brown house up the street near the cor-

ner is gone and there is a white colonial cottage in its place. You begin to feel that the old house is getting a bit shabby—the state of mind you used to get when your neighbors bought new cars and outdated the bus back in your garage.

You are likely to call up the Jones Home Corporation and say: "I have been thinking about a new house—one of those super-duper white colonial cottages with the built-in flower boxes and the green shutters. Model Y6-B. I was wondering what I could get on a trade-in. The old shack is in pretty good shape—"

The next day, a truck pulls up. Your furniture is moved out on the lawn. The old house is taken apart. The new one is set up and you move in.

Even more startling, perhaps, is the trend already indicated by the fact that hundreds of thousands of Americans now live in trailers and move from one defense area to another, changing their locality with their job.

In the future, the typical American family may rent the ground, instead of the house—a custom for generations in certain cities, like Baltimore—and on moving day a truck picks up the home along with the furniture.

"Why have a house exactly like that of your neighbor?" says one of the world's leading architects, Cass Gilbert, of New York City. "Why be tied to one place when your job or jobs may take you to different parts of the country? Why own a lot and house you don't live in, and live in a house you don't own? Why not own a home you like that is different from your neighbor's, and rent the lot at the land rent only? In this way, you could buy the house on a credit-rent plan, rent the lot, own your home—and move it to your job. Questions like these have been running through the heads of thoughtful architects and engineers for doz-

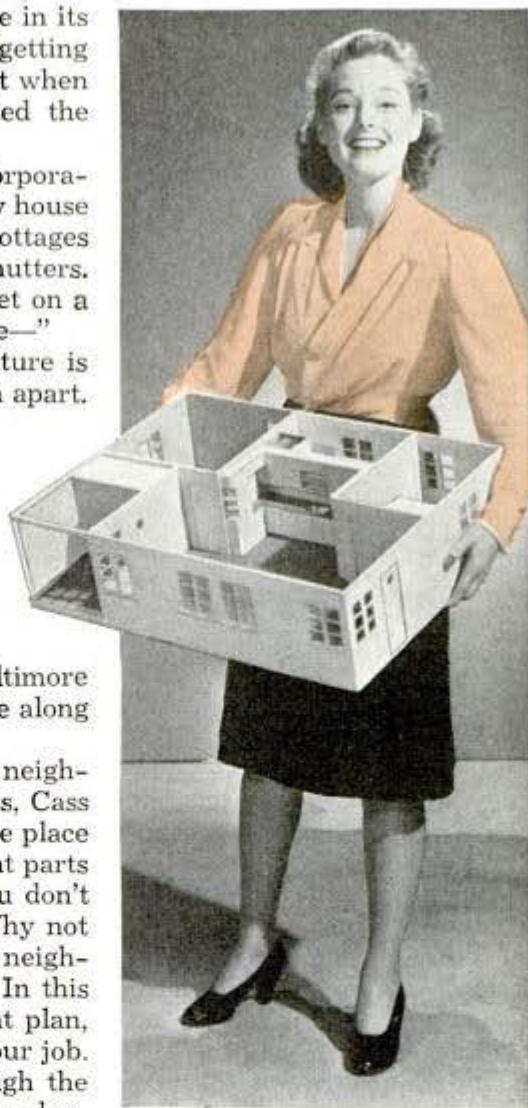

"Sounds like a good buy," says the customer of the Walter Teague model in her hands. It would sell for \$2,000 or less and—unlike Rome—this prefabricated unit could be built in a day

The three houses on adjoining lots face different directions, lending variety and eliminating the drab, slum-like effect of small houses of similar design often erected in rows, all facing in the same direction on street

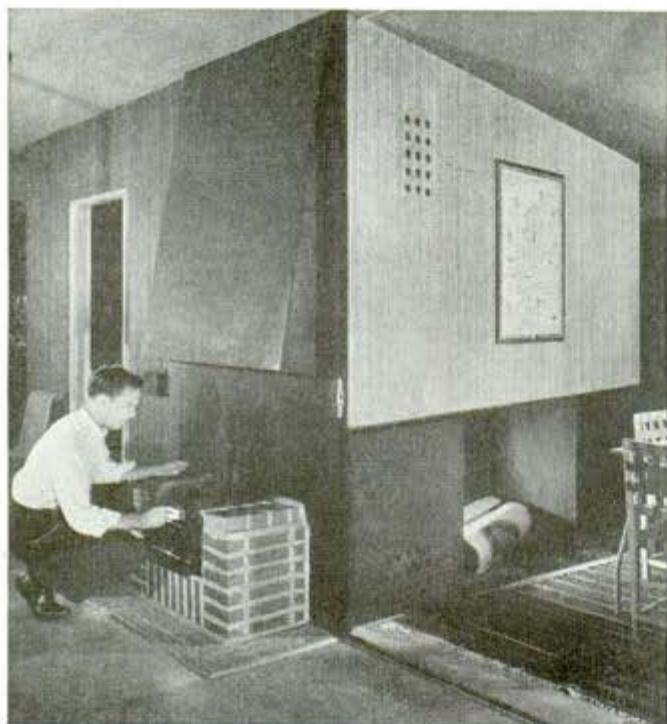

The charcoal grill and fireplace use one flue in this prefabricated "sportshack" for week ends designed by Donald Deskey

ens of years." Architect Gilbert is only one of a number of famous designers who have been retained by Revere Copper and Brass, Inc., one of the American industrial giants turning the wheels of our war effort, to look past the clouds of war into the calm days of peaceful progress.

"These architects and designers," says C. Donald Dallas, president of the corporation, "are planning homes for tomorrow that can bring, not housing, but living, within reach of the great majority."

Gilbert envisions millions of demountable American homes constructed by what is known as the plank panel method of long-lasting wood and fitted with copper and brass for piping, hot water tanks, sinks, fittings and valves. He describes the plank panel method as follows:

"Random-width planks of dry, suitable lumber two inches thick and eight, 10 or 12 feet long are run through machines that double tongue and groove the edges and rout out the ends.

"By modern methods of assembly with modern glues, these planks are made into strong, solid panels four feet wide and eight,

10 or 12 feet long. Each panel represents a four-foot width of wall or a four-foot width of floor. They are the 'building blocks' out of which the house is constructed.

"Provision is made within the body of each panel for internal metal rods to run horizontally through the wall at top and bottom, and also vertically at regular intervals. The rods pull all members together—roof, walls and floor—as tightly as bolts can hold wood. Self-contained window and door panels are manufactured in the same size, and are an equally strong part of the structure.

"This then becomes a wall two inches thick that has been solidly pulled together by steel rods to steel corner members. These panels are so weather-tight that five of them could be bolted together by the same method to form a water tank. For each plank is not only double tongued and grooved, but is glued tightly to its neighbor with modern waterproof glue."

Under this method of construction, he points out, you can add to your home by undoing a corner, adding extension rods and erecting an extra bedroom.

Paul Nelson, famed architect, sees the trend toward prefabricated interiors. He

Architect's conception of apartment building of the future

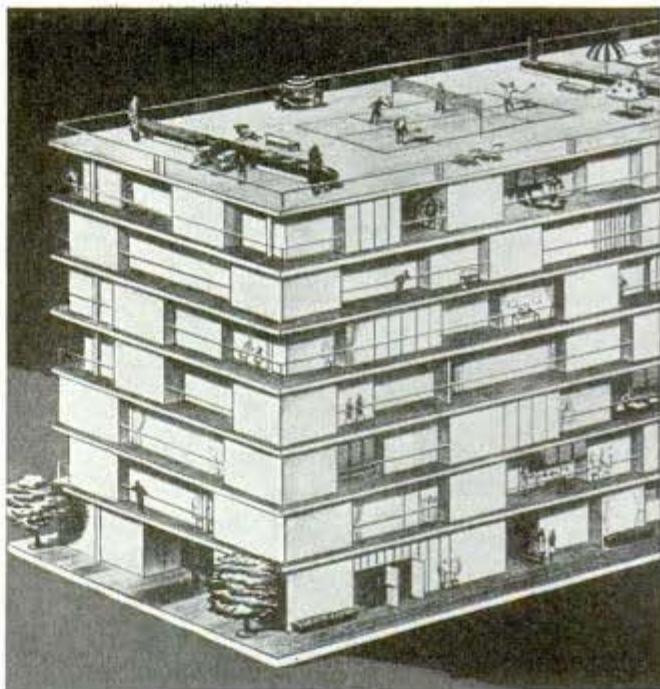

123456789
M. Y. C.

envisions a prefabricated shell in which prefabricated interiors can be placed, or changed. He says:

"The interior would contain prefabricated unit rooms adapted to the needs of eating, cooking, sleeping, washing and leisure. There could be rooms for hobbies, such as a photographic dark-room, home laboratories and special acoustical rooms for radio and television concerts. The reason we could have such seeming luxuries is that mass production could provide them at a cost almost unbelievably low.

"The same evolution would surely occur with mass-produced rooms that occurred with the automobile. There would be the possibility of buying and selling second-hand rooms. This would bring these superior living units within the reach of even the lowest income groups.

"In the house-of-the-future, as I envision it, your unit rooms would arrive by truck, once the exterior of your house was finished by local workers. You would have selected your units at your dealer's, after poring over catalogues with your family, and arguing about interior arrangement, furnishings, decorations and color schemes.

"Similar rooms, called 'roomettes,' are now made for Pullman cars, so it is only a short step from this to the mass production of rooms for your own home. A truck would back up to your house and a complete sleeping room, bath room or eating room, for example, would be unloaded and set in place in your home. The process would be almost as simple as plugging in the connections of your refrigerator or washing machine."

In this house designed for mass production, wall panels come with windows in place



Another view of the circular metal house showing the roof being lifted on the steel mast and some of the wall sections bolted in position

Buckminster Fuller, architect and inventor, has already constructed "your home of the future," a house built around a mast. Says he:

"Suppose you have bought or rented a building lot and have ordered one of these homes. The next morning a truck arrives and workmen begin unloading a lot of strange looking metal sheets and parts. Many of them are shaped like giant flower petals. Others are large curved panels of corrugated metal. You notice flooring sections, bathroom and kitchen appliances, and a very small heating plant. And you see a structural steel contrivance that looks

(Continued to page 166)

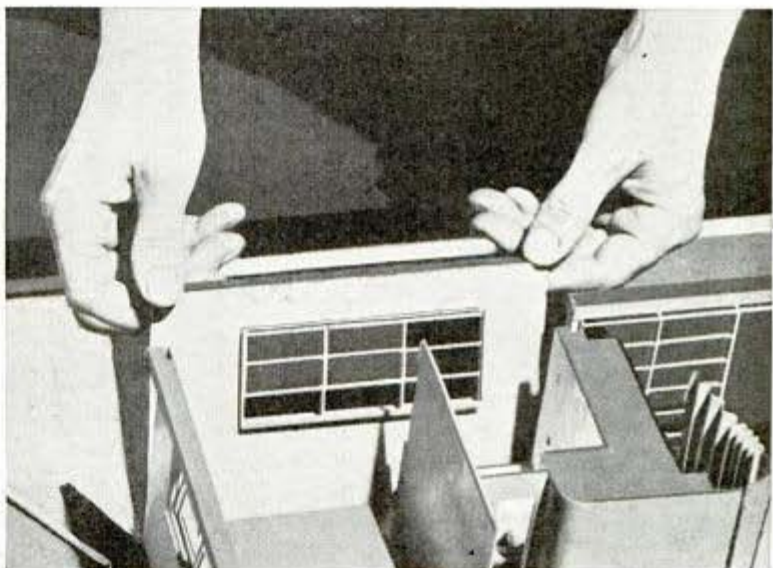

*General Electric
Schenectady 7/7*

Luminous "Mike" Lights Script When Studio Blacks Out



Luminous microphone and fluorescent script visible in blackout

No lights will be needed to continue broadcasting in a blackout if the radio studio coats a microphone with phosphorescent paint as General Electric engineers have done. In daylight, the paint stores up light energy, and continues to glow for some time after the room lights are extinguished, even supplying enough surplus light for the announcer to see his script. Script also can be made visible in the dark by printing in fluorescent ink which becomes luminous under invisible "black" or ultraviolet rays.

Energy Wasted in Engine Tests Now Generates Electricity

After years of idle running on test stands for the breaking-in process, new airplane engines have been given useful work to do. Hooked up with an ordinary electric generator of the type normally driven by a Diesel engine, one engine can produce about 2,000 kilowatt-hours of electrical energy during its test run. Every newly

completed aircraft engine is given what engineers call a "green" run in a special test cell, then it goes back to the factory to be taken apart, inspected and reassembled for the final break-in run. Generators thus used in one factory produce more than 4,000,000 kilowatt-hours, worth about \$24,000, which is enough to drive the factory's lathes, drills, grinders, boring machines and other tools used in manufacturing the engines, as well as to light the factory. They also aid in the tests, since by measuring the electricity generated engineers can tell whether the engine is running properly.

Soap Cup Fastens to Hose For Washing Automobile

Washing the family car is made easy with a soap-containing plastic cylinder that is screwed onto the garden hose. As the water rushes through the cylinder it mixes with the cartridge of cleaning substance to be sprayed on the car. This will remove any ordinary accumulation of dirt; to remove heavy dirt, the spray may be followed with a soft cloth or sponge. After the soap spray, the cartridge is removed and clear water used as a rinse.



Cartridge in plastic holder is removed to rinse car

*W. T. Hopkins Hardware Co.
117 W. Van Buren, Chicago*

*Westinghouse Electric
Mfg. Co., Pittsburgh, Pa.*

Gigantic Insects Reveal What Eye Cannot See



If a vote were taken to nominate the world's most unpopular insect, the fly, mosquito and flea might well vie for first place. Yet, despite frequent, albeit unwanted, contact with this trio of pests, few have ever beheld the remarkable combination of tiny parts, unseen by the unaided eye, which go to make up their bodies. That others might view the wonders revealed to them through microscopes, students of entomology have created models, magnified to 100 times the natural size. In all its intricacies, a common housefly becomes a "pincushion" of bristles and prickles, as shown at left. To produce this model required making 15,000 minute parts and fitting them in place

You may never have thought of the mosquito as covered with scales, but that's just what it is. The reproduction, right, called for 19 different shapes of scales, and there are about 35,000 of them covering all parts of the body. Six kinds of bristles, of which there are about 6,000, also had to be "planted." Fashioning of the mosquito's head alone (below) was an exacting task, because of the vast amount of delicate hand work required

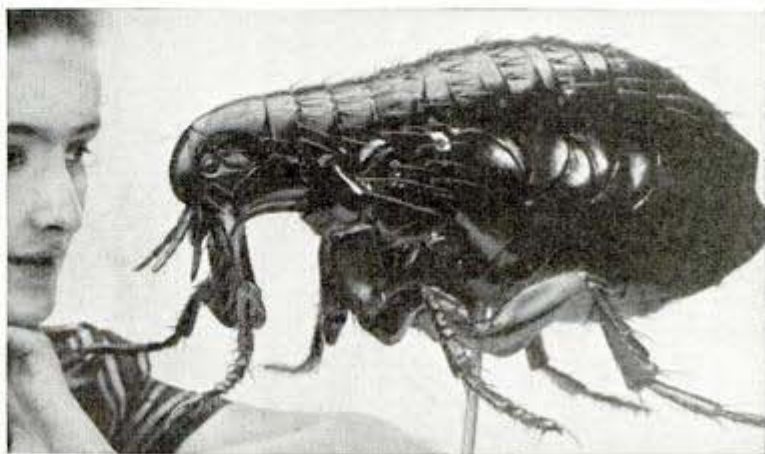

Not quite so common, but more intimate in its conduct, is the human flea, a bigger-than-life-size model of which has also been completed (above). Its body is protected by a shell of overlapping plates, with bristles jutting from between them. A large variety of materials went into the construction of the models, including metal, wood and synthetic products, according to the need for each part. In some cases a plaster body was molded from the handmade pattern and the separate external parts fitted into it to complete the lifelike figure

Wooden Operating Tables Built for War Hospitals



Balanced at the center, the table locks at any angle

Doctors in San Diego, Calif., are taking no chances with government priorities that might restrict the production of metal operating tables. They are having adjustable tables built of wood for their war emergency hospitals. Sturdy and inexpensive, the table is balanced at the center and locked at any desired angle with a thumbnut working in a quarter-circle piece. A footboard and slots for straps help to hold the patient in position.

Split Tip on End of Screwdriver Holds Screws for Starting

Screws are held firmly in place before they "take hold" with a screwdriver that has a special tip made of two steel leaves. The leaves are compressed to slip into the

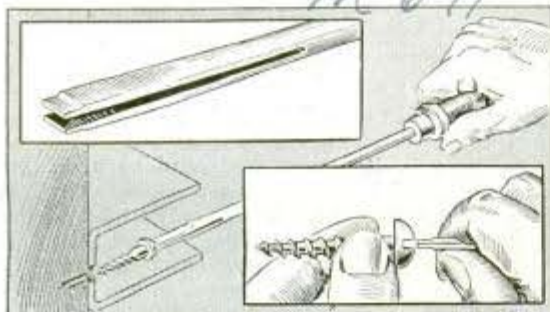

Steel leaves on driver are pressed into screw slot

screw slot where they expand to hold it securely for starting. Screws of ordinary size may be driven in all the way with this tool, but changing screwdrivers is simply a matter of pulling the screwdriver off after the screw is well started.

Steel Jaws Free Glass Stoppers "Frozen" in Bottle Tops

Glass stoppers that are stuck in bottle tops are removed without danger of breaking the glass with an extractor that has two pairs of adjustable steel jaws. One fits the head of the stopper and the other holds the extractor to the rim of the bottle neck. A top bar is turned to exert a steady pull on the stopper.



Screen Patch Grips Old Wires With Many Tiny Hooks

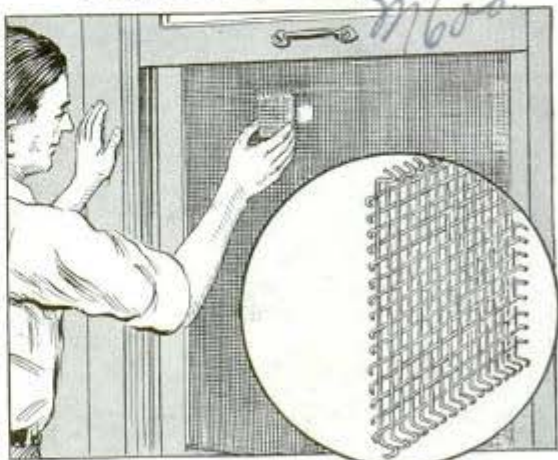

Inset reveals hooks that anchor patch in screen wire

Made of bronze wire cloth, a neat screen patch, equipped with fine wire hooks at two sides, snaps firmly into the old screen when repairing a torn section. Wire-ends along the other two sides of the patch are shaped especially to nest into the screen so no rough edges protrude on either side. Patches are 1½ inch square, and they can be fitted without removing the screen.

Screen Patch Co. 1249
POPULAR MECHANICS
Commercial Travel
Chicago Bldg, Philadelphia, Pa.

Cont. Floyd McGucken
#246-48th St San Diego, Cal

Discontinued

No-Vac Cop, 307 W Monroe St
Chicago

Automatic Viewer Feeds Slides for Projection

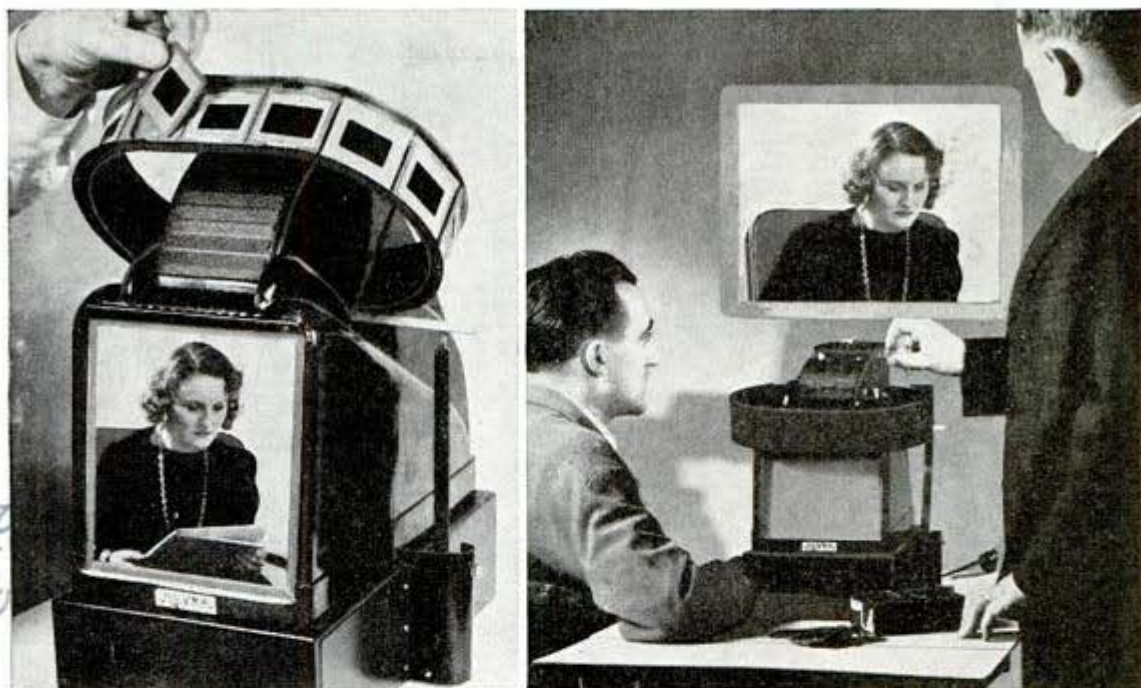

Rear view, left, shows viewing glass and the slide carrier. Right, projecting picture onto a screen

Continuous projection of black and white or color transparencies is provided by an automatic projector which doubles as a viewer, casting the picture on a seven-by-seven-inch built-in viewing glass. An automatic carrier shows 14 slides consecutively, at eight-second intervals, without attention of the operator. It is suitable equally for use in the home, in pictorial presentation of manufactured products, in

schools for educational subjects, and in window displays. A three-inch focus projection lens of f:2.9 aperture provides a large image at a short throw. Hand operation of the slide feed is possible in lecture work where it is desired to vary the duration of individual slides. The machine is complete with motor, cords, switches and a carrying case measuring 15 by 17½ by 11¾ inches.

Ship's Mast Set Up on Land Teaches Language of the Sea

To help teach visual communications to cadets, a mast for hoisting signal flags has been erected on dry land at the U. S. Merchant Marine Academy at Great Neck, L. I. The seamen of the future, training to be officers in the merchant marine, use the "transplanted" mast to gain much-needed experience in sending and reading code messages.

Signals flags hoisted on dry-land mast give practical lessons to cadets learning code messages in language of the sea

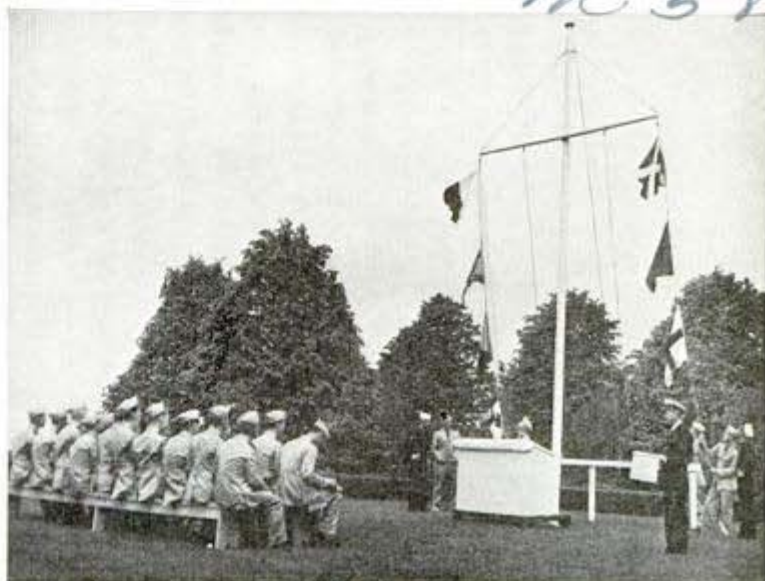

SMOKE GETS IN THEIR EYES



U. S. Army Signal Corps photo

Tin-hatted and masked soldiers of 13th Infantry charge through a heavy smoke screen generated by smoke pots

per Leggett

FAR in advance of friendly forces, a small reconnaissance unit was confronted suddenly by an armored column of immensely superior fire power. Withdrawal, at the same time delaying the enemy, was the only course open. But how could this be accomplished?

The answer lay in smoke—just common smoke—which American military and naval forces are finding extremely useful

both in offensive and defensive actions. Here is the way the reconnaissance unit used it to advantage:

Bridges on all side roads had been demolished, forcing the enemy column to stick to the main highway, where they encountered frequent road blocks. These were the points where smoke was called into play. A few smoke pots carried in each vehicle of the reconnaissance organization

provided the means of laying down smoke screens at the road blocks, forcing the enemy column to move very cautiously, then stop to remove the barriers. At the same time, the column was subject to machine gun fire from weapons planted on either side of the highway at the barriers, their locations concealed by the smoke. These delaying tactics were so successful that it took the armored column five hours to travel six miles, by which time the



Hard-working destroyers lay a smoke screen to protect the battle fleet or to shield a convoy

U. S. Navy photo

reconnaissance unit was able to call up heavy reinforcements which were concentrated on the main highway and which drove back the enemy with heavy losses.

All this actually happened, not in warfare, it is true, but in maneuvers of American forces. Under conditions of warfare, however, the enemy would move even slower, because the smoke might conceal a concentration of weapons capable of wiping out the column. In contrast, the units in maneuvers had only to fear a theoretical setback imposed by the umpires.

Another instance in which the usefulness of smoke was emphasized is reported by the Chemical Warfare Service, which directs the supply of gases, smoke mixtures and incendiaries to the United States Army and also the training of men to use these chemicals effectively. A smoke detail mounted in bantam automobiles hurriedly laid a thin smoke screen, about one-half mile long, at the edge of a town being approached by a tank column. This slowed the tanks so much that 37-mm. guns and 50-caliber machine guns could be moved to better defensive positions. Other smoke details at the same time placed a dense, wide screen 100 yards ahead of the position to which the guns were moved. Upon encountering the second screen, the tank commander halted, evidently

Here is the situation described in the article: smoke pots, road obstacles and bridge demolition delay an enemy armored division

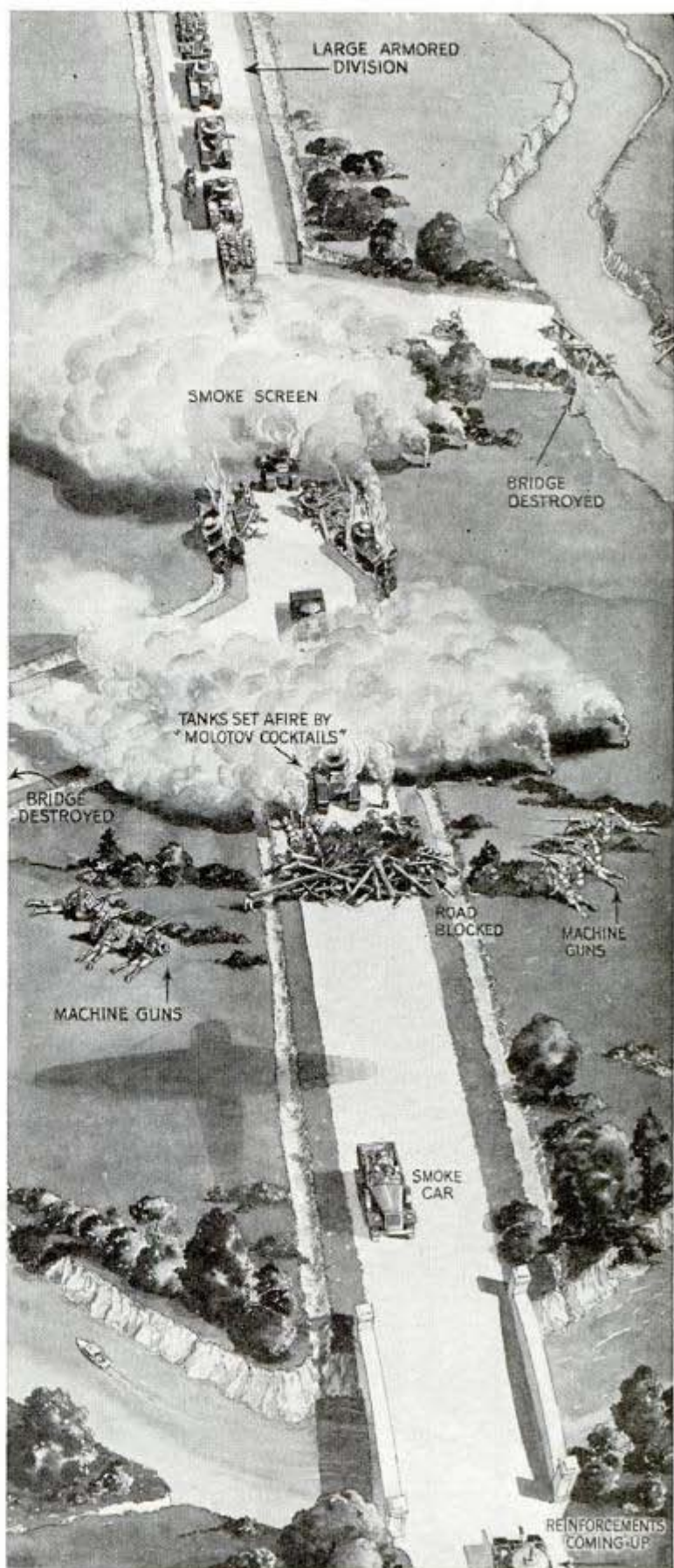



Chemical warfare men spray a curtain to shield troops preparing an advance. They must be ready for a counterattack by gas-masked defenders



Here three Navy planes hurriedly lay down a screen to conceal location of two warships, one of them just visible in thin screen previously laid

Smoke pots cover men landing from assault boats to establish bridgehead



to gather force. While he waited, the first screen dispersed and all the tanks moved up for the attack. Having had little difficulty with the first, but much thinner smoke screen, the tanks approached the second at high speed, moving in close formation. But the second screen was dense and wide, so each driver evidently reacted differently to the effect on his vision. Some slowed to a snail's pace, others gunned their motors, a few lost their sense of direction, resulting in collisions with each other and with obstacles which they were unable to see. Many tanks were immobilized and the mass attack broke down completely. Only a fraction of the original force was able to come through the screen and then one tank at a time, widely separated and hence easy targets for anti-tank gunners who could see the emerging tanks before the tank crews could see the guns.

This, another incident in maneuvers, is regarded as good evidence that smoke is one means of combatting tanks effectively. The Chemical Warfare Service reports:

"Anti-tank units have been quick to adopt smoke as a means of slowing up, to cause loss of direction, to paralyze tank movement momentarily. Whenever desired, smoke can be lifted to provide a better target of approaching tanks, since they would be silhouetted against the smoke background."

It might, indeed, be feasible to arm foot troops

with smoke pots and "Molotov cocktails" to combat tanks, especially where the operations are among large trees or other natural obstacles. Men on foot can operate in the smoke and are able to hear and see tanks long before being observed. Too, in a dense screen, tank movement is so slow that the men may dodge them easily while advancing from one tree to another. In this manner, the men could approach near enough to hurl the "Molotov cocktails"—bottles filled with gasoline—against the tanks, setting them on fire and forcing the crews to abandon all except hand weapons.

Experience has proved that smoke very sharply reduces the effectiveness of aimed gunfire, to the greatest extent when the gunners actually are enveloped in smoke because then they lose to a large extent the ability to maintain direction, elevation and control while firing. The next best move is to place the smoke over or around the target. Tests have shown that only one-fourth as many hits are registered on a smoke-covered target as on a target fully visible.

Since reconnaissance cars constantly are in danger of running into hidden machine gun nests, it has been suggested that the cars be equipped to provide a cloud of smoke in which they may hide from enemy gunners. One device has been tested to accomplish this end. Using a

(Continued to page 162)



Their view of the "enemy" batteries ahead obscured, two tanks grope slowly through a pall of smoke during tactical maneuvers of armored force



Gas masks are worn whether the smoke is a harmless screen or a poison gas, for the men must be accustomed to fighting and running with masks

Scouts hide behind fence posts as they prepare to advance behind screen



'Cold Chisel' Staple Driver Eliminates Flattening



Grooved end prevents driver slipping from staple

If you are troubled in driving staples by having them flatten out, here is a handy driver made of solid metal like a cold chisel with a grooved, moon-shaped end that holds any staple. The groove prevents the tool from slipping from the staple, while the curved end eliminates the danger of flattening the staple.

Metal Tube Measures Tobacco And Packs It in Pipe

Tobacco may be measured and loaded into a pipe with a metal cylinder that eliminates handling and spilling of tobacco. The tube is loaded by pressing with a re-

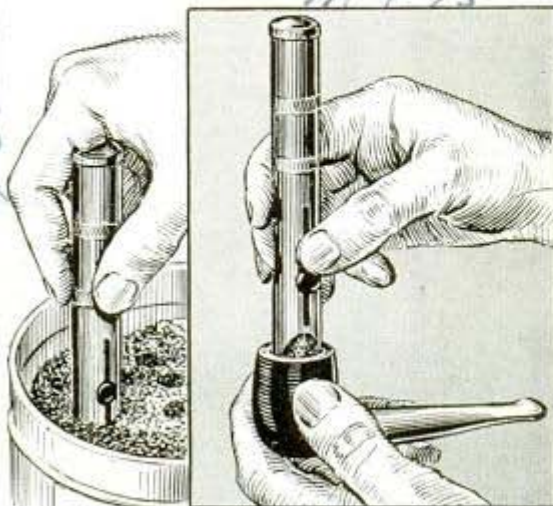

PIPE TOBACCO

Pressing button down fills the pipe without spilling

volving motion into a tobacco container. A red button on the side moves up to indicate the amount in the loader. After the loaded cylinder is inserted in the pipe bowl, the button is pressed downward packing the tobacco into the pipe.

Wardens Sniff War Gas Samples To Learn Their Odors

Wearing a gas mask, gloves and full protective clothing, Rev. Frederick C. Hickey, head of physical chemistry at Providence (R. I.) College, has prepared "sniff bottles" containing poison gas as an aid to student wardens learning to identify various war gases by their odors. Lewisite, one of the poisons, may smell like geraniums, but



Making up "sniff bottle" under complete protection

contacting it with the skin or inhaling the vapor causes burning and irritation severe enough to require hospitalization. The same is true of mustard gas, which smells like a combination of garlic, horseradish and mustard. In putting up five different gases, Mr. Hickey used an eye-dropper when adding the pure chemical agent to a bottle containing activated charcoal which retains the gas. Students may sniff these samples without suffering harmful effects.

To learn where to buy commercial products described in these pages, see the index.

Glider Alights on Sea to Launch Beach Attack

M 532

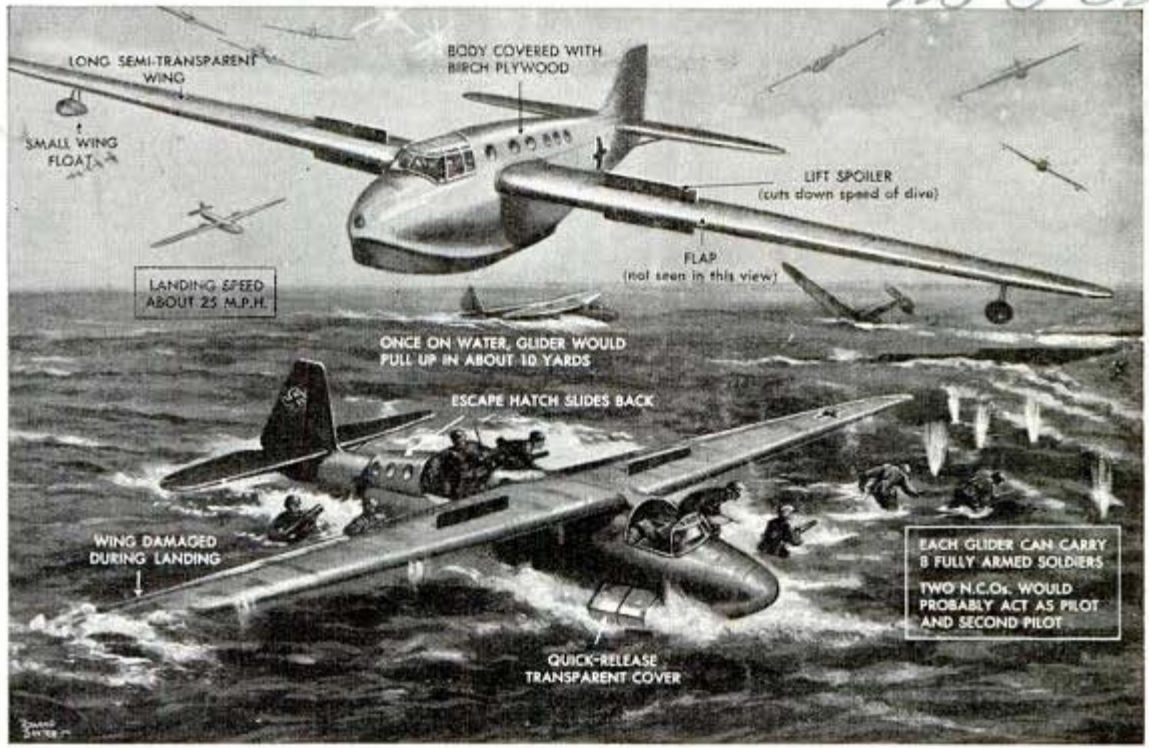

Eight fully armed soldiers leap from the sea glider and wade ashore after silent approach to enemy coast

Sea gliders that carry eight fully armed soldiers are reported under construction in Germany. The troop-carrying gliders, designed for invasion purposes, can land silently within wading distance of shore. Escape hatches slide back for quick exit. The glider body is covered with birch plywood and the long wings are made of semi-

transparent material that makes it difficult for them to be spotted in the air. On either wing are "lift spoilers" which cut down the speed of a dive and help control the craft when coming in low to land at a speed of about 25 miles per hour. Several gliders would be towed by a plane and released at high altitudes miles from their objective.

"Fall Guys" Smash Barbed Wire So Buddies May Cross

M 569

Performing what appears to be a tough assignment, trainees of the Australian military forces act as "fall guys" in flattening down barbed-wire barriers. Two leaders, throwing their full bodily weight against the wire, force it to the ground and thus create a gap in the entanglement through which the rest of the troops can jump without delay.



Two soldiers flinging themselves against barbed wire barricade to level it so others may rush through

Acme Magazine

cont.
 Allen Warren
 Elliott, 3436 33rd
 Ave.

PLAY IT SAFE

711574

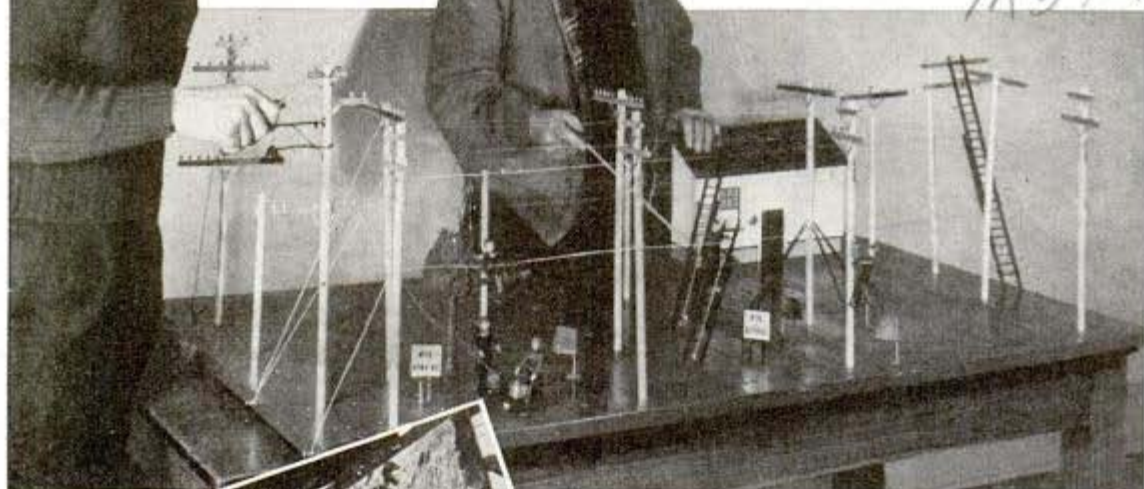

Man hours are "Victory hours" in the production race to defeat the enemy, and every industrial accident postpones ultimate victory. Safety schools, like those operated by the Bell Telephone Company, are being established in plants throughout the nation. Above is the safety demonstration board used to re-enact all manner of accidents that occur to telephone men. It includes telephone and power lines, ladders, cable car and figures of workmen built to scale. Some of the poles and men are wired so that when a workman touches a power wire there's a flash and he falls to the ground. Set was built by Al Bringer, cable-maintenance man, of Decatur, Ill.

"Toe-saver," above, teaches men how to handle cumbersome objects. If the board is dropped it is caught in slot

Shifting of the lead weight, simulating a person climbing a ladder, at right, reveals that if the base is placed more than one-third of the ladder's length from the wall it may slip; if placed less than one-quarter length from the wall the balance is changed so the ladder has a tendency to topple backward





Telephone company drivers encounter knotty traffic problems as part of their daily routine, and the class above is studying a complex problem at a busy intersection. They may even learn who has the right of way if a city fire engine, city police car and U. S. postal truck should meet at a corner during an emergency run.

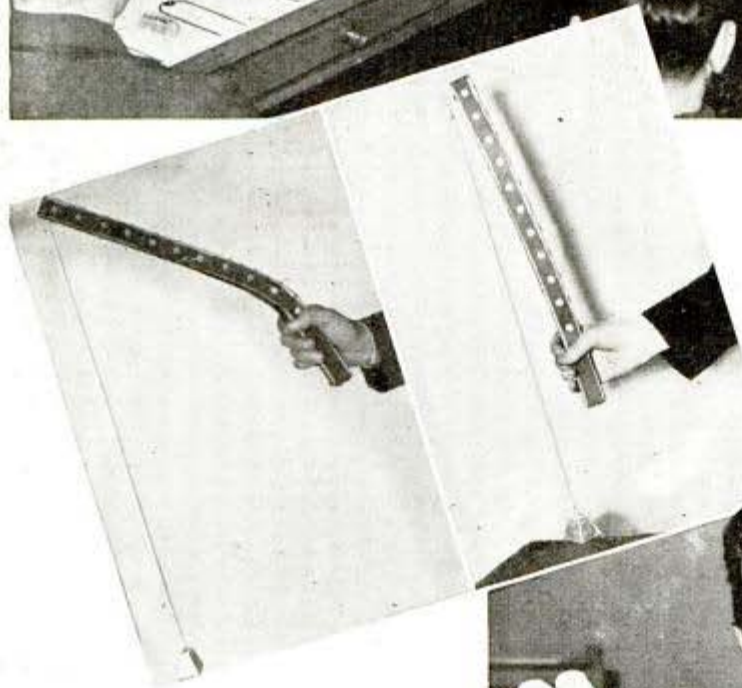

Above, jointed flexible model of the human spine shows why heavy load should be lifted with the legs and not the back, which is easily strained if legs are not properly used. The picture at left illustrates the wrong system with the model spine bending. When strain is taken with "legs" (right) the spine remains straight

Holding up his gloved hands, this workman reveals how he protects his wrists from hot metal with small patches of leather sewed on the long wristlets. A simple trick, yet it saves many burns that might occur while soldering or wiping a lead joint. In the safety schools the men also learn how to saw off limbs of trees with the use of a guide rope and how to make a splint for a broken arm with a kitchen broom and pieces of bandage



Glass Blowing Art Enlisted For Radio Experiments



Experimental radio tube made by expert glass blower

Although machines have taken over the task of making standard glass bulbs for radio tubes, the ancient art of blowing glass by hand is finding a role vital in the war effort. At the Westinghouse laboratories, a veteran of 20 years' service with the company blows glass globes and tubes into weird shapes for experimental military radio apparatus.

Pump Tanks for Bomb Defense Distributed in Danger Areas



Civilians within the target area of bombers based on enemy aircraft carriers and in certain strategic cities will be supplied with more than 2,000,000 fire extinguishers by the Office of Civilian Defense. The extinguishers are four-gallon pump tanks that carry their own

supply of water. Materials not on government priority lists, such as porcelain-coated steel, synthetic rubber, simple cast lead and plastics are being used in their construction. Four extinguishers will be distributed to each city block.

Pinch of Starch in Aluminum Vat Speeds Recovery of Metal

Ordinary starch speeds the recovery of aluminum from its ores by hastening the settling of impurities and preventing premature flowing of the metal. Only $\frac{5}{100}$ gram of starch is needed for each quart of caustic alkali used to dissolve the aluminum in bauxite ore. After the aluminum dissolves, the next step is to separate it from the insoluble particles in the ore.

First-Aid Kit Worn Like Belt Leaves Both Hands Free

Made in belt form, a first-aid kit of waterproof canvas can be worn about the waist, freeing both hands to attend the injured. This handy kit may be slipped quickly over outer clothing and adjusted by an air-raid warden while running to the scene of disaster. Its pockets, under a snap-fastened flap, contain triangular and compress bandages, shell-wound dressing, ointment for burns, scissors, note pencil and pad, adhesive plaster and other essential materials.

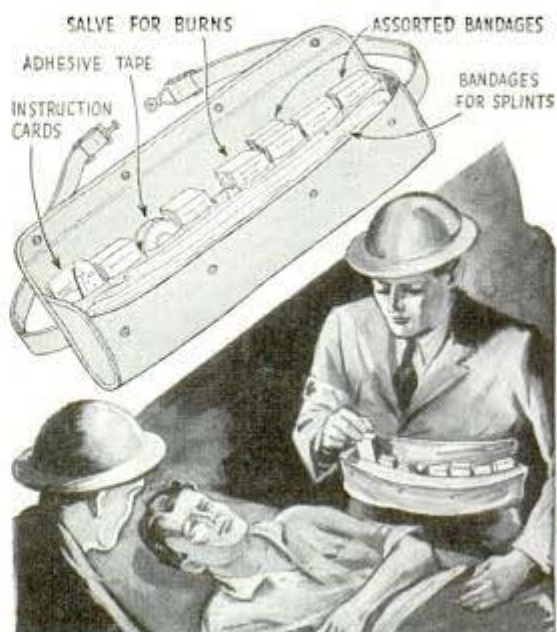

Waterproof kit holds necessary first-aid materials

Gun Mount Pitches Like a Ship to Train Crew



When the going is rough at sea it will be old stuff to these gunners trained on a "Leaping Lena" platform

Naval gunners are accustomed to the rolling and pitching of a ship at sea by practicing with guns mounted on moving platforms. The sailors adjust their sights

and blaze away with pompoms at targets towed by airplanes, just as they would go into action on the deck of a ship when enemy bombers attack.

Switchboard Built on a Trailer Is Ready to Serve in Raid

If enemy bombers or saboteurs should disrupt telephone service at a vital point, such as a war industry, the damage can be circumvented quickly with an emergency switchboard on wheels built by the Southern California Telephone Company. Trucks will speed the switchboard trailer to the scene of trouble, connect it to a main cable line and in a few minutes service will be resumed. The board can serve 400 phones.

Ⓛ Bicycle accidents cost the lives of 1,100 persons in 1941—an increase of 25 percent over 1940.



If enemy bombs disrupt lines, this switchboard can serve 400 telephones

Ref: Austin Lee McRae, Director Professional Golf Course, Los Angeles
 Park Municipal Golf Course, Los Angeles
 Cal



**WIN YOUR
 GOLF GAMES**
on the **GREENS**
 m 773

On short approaches (top) the ball is tossed in air as if by hand. Diagram shows three types of approach: slicing under ball for high trajectory and short roll (upper shot); normal approach (middle); holding club face almost vertical gives ball short flight, long roll (lower)

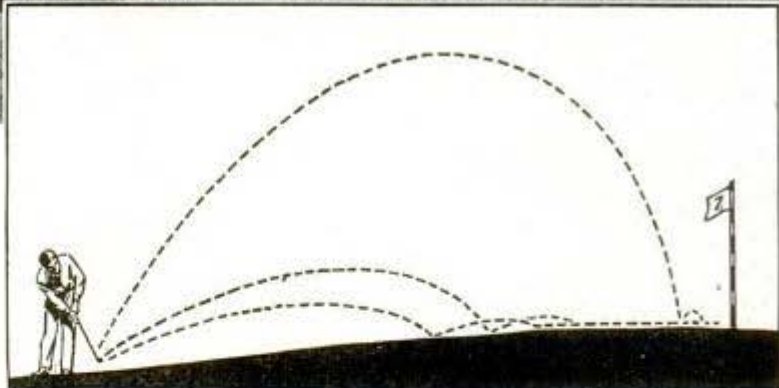

By Austin Lee McRae
 Los Angeles Professional Golfer

Steinson

NEXT time you have an hour for golf practice, spend it on the putting green instead of the driving range. Ability to hit long drives is satisfying, of course, but a good player reaches for his driver only 14 times during a game. He uses his putter possibly 30 times. And a little 6-inch putt counts as much as a 300-yard drive on the score card.

Experts figure that the drive is 20 percent of golf, that the long, medium, and short irons are 40 percent, and that putting

is also 40 percent of the game. Now you can see why good putting is important.

It breaks down something like this: par on the standard golf course is 72 strokes. The golf architect assumes that an ideal player will need one shot to get on the green of a par 3 hole, two shots to reach the green of a par 4 hole, and three shots to reach a par 5 green. Two putts are allowed for each green. The result is that this ideal player should make 14 drives, use his fairway woods four times, his long

irons three times, his medium irons five times, the short irons 10 times, and his putter 36 times.

Actually, many good players need an extra shot to reach some greens. They make up for this by sinking their first putt. Years ago Jerry Travers, one of the greatest putters in history, won several national championships without using a wood. He beat the long hitters at the putting green, rarely missing a 20-foot putt.

You don't need to be that good to play exceptional golf. But if you will think back over your last few games and count the number of times you three-putted a green, and the number of approach shots that you dubbed, you will realize the importance of the chip shots as well as the putts. The fact is that the average golfer plays worse as he gets close to the pin, though approach shots and putts are the easiest to improve by practice.

When you can consistently sink 5-foot putts you will be on your way to low scores. You will be able to hole out in one putt when your approach shot lands within a 5-foot radius of the pin. Sinking five-footers will almost automatically guarantee that you will never need more than



Most players roll ball toward one side, in path of straight tape, to overcome hump in green. Player instead should try to roll ball along curved path as indicated by curved tape. McRae is demonstrating

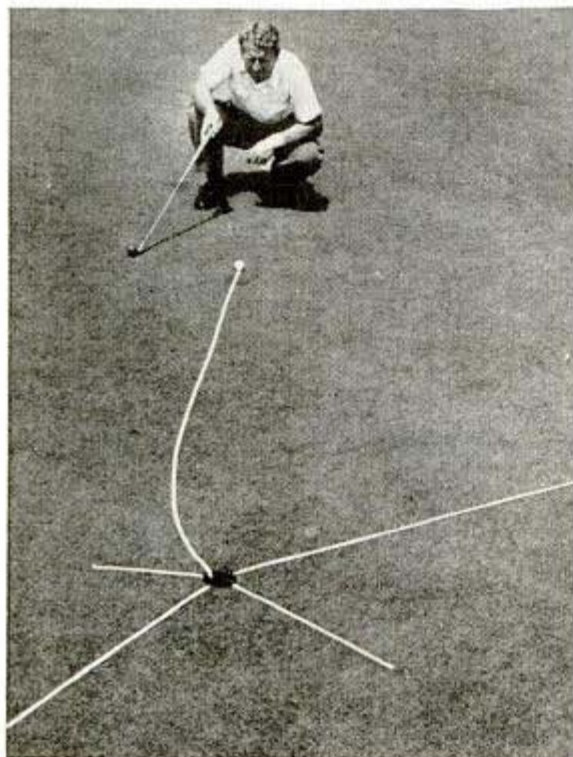

Tape lines above represent paths that should be taken by balls putted from different distances, curved line from player allowing for contour. Right, various styles of putters favored by different players





Measuring angle between blade and shaft of a putter

two putts per hole because you should roll the ball from any part of the green to within that distance of the hole.

Start practicing two feet away from the cup. When you never miss at that distance, putt from three feet away, then four feet, until you are ready to practice the long

Somewhat exaggerated curve indicates path the club head should make in putting; shaft is held near top



Two practice cups that are used for putting on a rug

five-foot putts. A straight-line putt on a level green is the hardest to sink so do your practicing on a level green.

All you are trying to do is to roll the ball across the grass so that it drops into a 4½-inch-wide cup. Pick the ball up with your hand and roll it in with a bowling motion. This gives you the feel of what you must attempt with the club.

Many players have their own styles of putting but you will notice that most of the best ones use a steady easy stroke that is essentially a swing. They never jab, just as a good bowler or billiard player never jabs. Swing the putter so that the club-head describes a slight arc in front of you instead of a pendulum-like straight line. This is necessary because the sole of the club is not at a right angle with the shaft.

There is no particular way for you to stand. Just walk up to the ball, put the clubhead behind it, and stand comfortably with your weight evenly spread on your feet. Hold the putter near the upper end of the shaft. If you shorten your hold you are bound to lean over, then you are apt to jab at the ball instead of swinging at it. Hit the ball with the center of the blade. Hitting it with the toe may turn the blade and spoil the shot. Make sure that the clubhead and swing are lined up to roll the ball straight to the hole.

The more you practice, the more you will improve. Your living-room rug is a good substitute for a golf green and there are several gadgets on the market that will do for a practice cup. If you want to practice on your lawn, keep the grass cut short so that it has as much as possible the feel and "speed" of a good green.

Some greens are faster than others. If you roll the ball too hard on a fast green

it may hop right over the hole. The appearance of the grass and the way it feels under your feet will tell you a lot about its speed. A green that has dew or moisture on it is always slower than a dry green.

On a flat, level green you should try to stroke the ball so that it rolls in a straight line. But many greens are on a slant or have humps in them. Kneel down behind the ball and sight toward the cup so that you can study the contours. Visualize the curved path that the ball must take to reach the hole, always remembering that the ball will break downhill. Then try to roll the ball along that curve. Don't make the mistake of trying to compensate for a contour by aiming the ball a few inches to one side of the cup. You are apt to misjudge how hard the ball should be hit when you do that. Make up your mind that you are rolling the ball along the curve.

Easy as they are, fairly short approach shots to the green also are missed too often. A 7 iron is the best all-round club for getting up on the green and close to the pin from as far as 75 or 100 yards away. You should feel that you are trying to pick the ball up with the club to toss it on the green just as you would do if you were tossing it by hand. Such a straight-forward pitch shot as that will carry you over traps and obstacles and will drop on the green with enough roll to get up close to the pin.

There are a couple of variations of this pitch that might be called trick shots and that you can master with practice. One of these, the cut shot, consists of putting underspin on the ball so that it has a high flight and then stops dead a little way from where it lands on the green. This is an advantage when the green is small or where you will be in

(Continued to page 169)

Upper right, how three balls at varying distance from cup are played to allow for slight rise at left. Lower right, a good grip near end of shaft. Hit ball with center of club face or slightly inside, as below. Hit with toe, it may roll to right

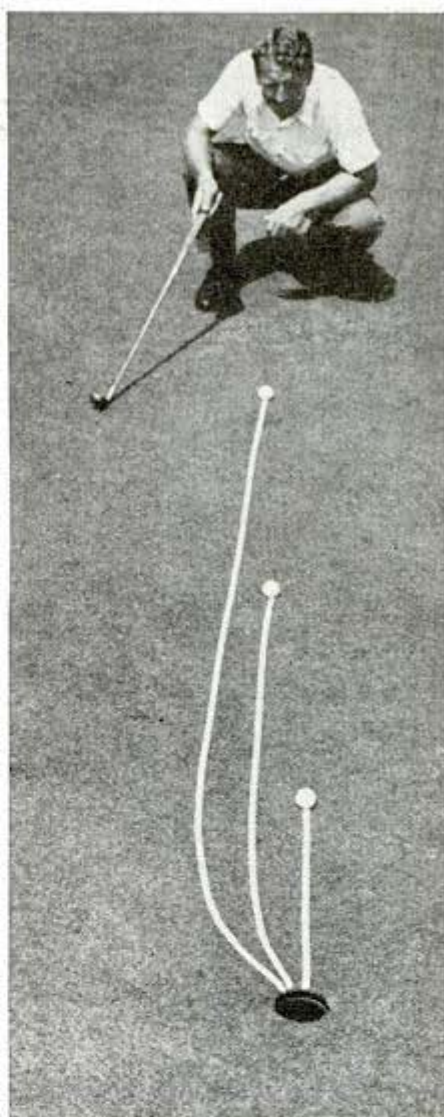

Cellophane Hood for Light Hides It From Enemy



Lowering blue "dimout" shade in store on the coast

Marian Rizzo
One Atlantic City merchant has complied with the "dimout" order for coastal areas by suspending a dark blue Cellophane shade above a light in his store. The shade is raised and lowered with cords and is always ready for quick adjustment.

War Department Seeking Ideas From American Inventors

If you wish to apply your talents toward the development of a new invention that might help win the war, the United States War Department has outlined the fields in which new ideas are wanted. The list includes fifteen different subjects, as follows: hydrocarbon vapors as an explosive; rocket-propelled projectiles; air, centrifugal and electromagnetic guns; automatic mines for land and sea; searchlights, mobile landing-field floodlighting; special automotive equipment for simplifying the servicing of motor vehicles and aircraft, and

improved motorized repair-shop equipment; improved tank design; better aircraft brakes; light, protective armored clothing; improved automatic anti-aircraft guns and small arms; aircraft catapults and retarding devices; ice-prevention devices; refueling equipment; remote-controlled aerial and marine torpedoes, land vehicles and ships, and remote control for other combat weapons; improved gunsights and bombsights, optical and otherwise. Important inventions that come within these fields should be submitted to the National Inventors Council, Department of Commerce, at Washington, D. C. During the past year the council has examined more than 35,000 inventions and suggestions, several of which, it is said, have proved of great value in the nation's war effort.

Enlarging Viewer for Color Slides Also Shows Strip Film

m 602
Color slides and 35-millimeter strip film alike are magnified and given a lifelike appearance when seen through a simple viewer now on the market. Made of Tenite, it is designed to take slides of any thickness, whether mounted in paper, glass or metal. For convenience in placing strip film in the slot, the front section containing the diffusing window can be removed by pressure at the sides to release the catch.



Viewing film while drawing it slowly past eyepiece



The CRAFTSMAN



Decorative WALL TREES

Revamped hall tree makes use of waste wall space. Five unusual designs to enliven a hall, playroom or bedroom

By Bess Livings

DESIGNED to supplement small-home wardrobes by providing extra facilities for guests, these novel versions of the outmoded hall tree require no space, as they are attached directly to the wall. Besides being useful, they provide an unusual touch of decoration to bare walls. The wall tree shown in Fig. 1 comes honestly by its name. For economy and to facilitate sawing, each limb is cut out separately from $\frac{1}{2}$ -in. plywood and glue-doweled together at the points indicated on the pattern given in Fig. 2. Marking and numbering each joint will aid in placing

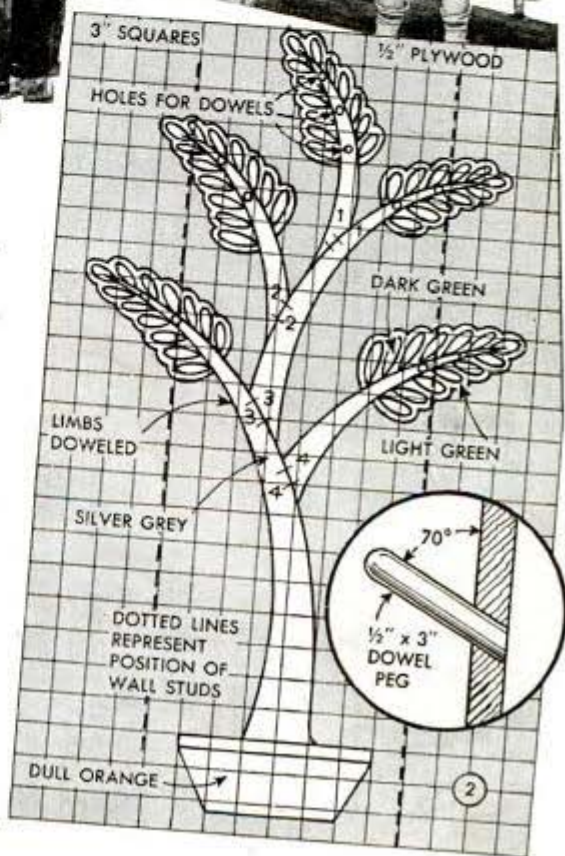

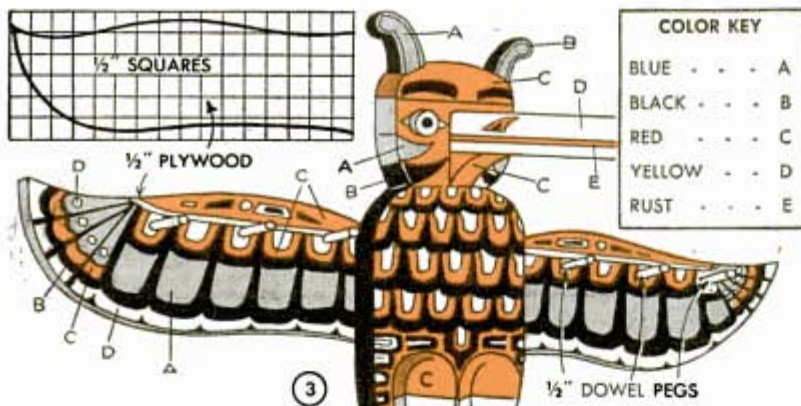

the limbs at their respective points. The tub from which the tree "grows" may be simulated by painting it directly on the baseboard, or it can be applied in relief by adding a separate piece cut to the shape outlined in the pattern. Each leaf is bored and fitted with dowel pegs according to

3

1/2" DOWEL PEGS

the circular detail and then painted, following the color scheme given. One or two screws through each leaf will do to fasten the tree securely to the wall studs, which can be located by tapping the wall lightly with a hammer.

Stimulating tidiness in the habits of youngsters, the Indian totem-pole wall tree shown in Fig. 3 will find appeal in a boy's room, or possibly in the basement recreation room. Instead of being carved from a single solid plank, each grotesque face and figure is sawed out separately from 1/2 and 1-in. pine, following the pattern given in Fig. 4, then shaped slightly as indicated and fastened to a 10-in. back board with screws and glue. The effect is practically the same as if carved. Besides the hangers incorporated in the design, such as the bird's beak and the grotesque nose, additional pegs are provided in the wings, and also midway up the pole within reach of youngsters. The separate wing piece is screwed to the back of the bird, after which a screw, placed in each end of the wing, is used to fasten the totem to the wall. It is attached to the baseboard at the bottom. Painting of the parts will be found easier if done before assembling. Where no color is indicated the wood is left natural and shellacked. The more weird and fantastic

the characters are the better. Limit the carving to a more-or-less hacking method, as the totem should be quite crude to look real.

A trellis wall tree like the one shown in Fig. 7, on which "bloom" colorful wooden flowers, lends a

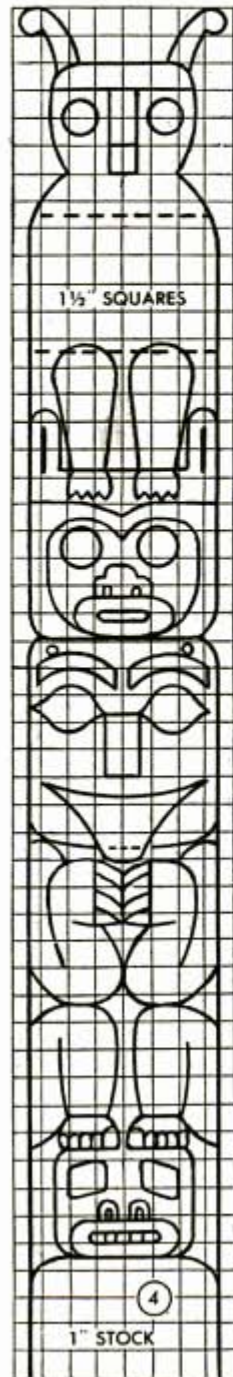

SIDE VIEW

4"

12"

3/4" STOCK

1"

1/2"

1/2"

5"

1/2"

1"

1"

1"

1"

1"

1"

1"

1"

1"

1"

1"

1"

1"

1"

1"

1"

1"

1"

1"

1"

1"

1"

1"

1"

4

1" STOCK

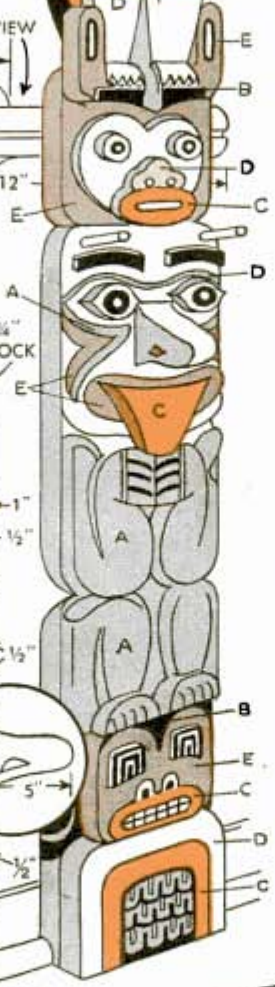

1/2" DOWELS

5

1/4" PLYWOOD

1" SQUARES



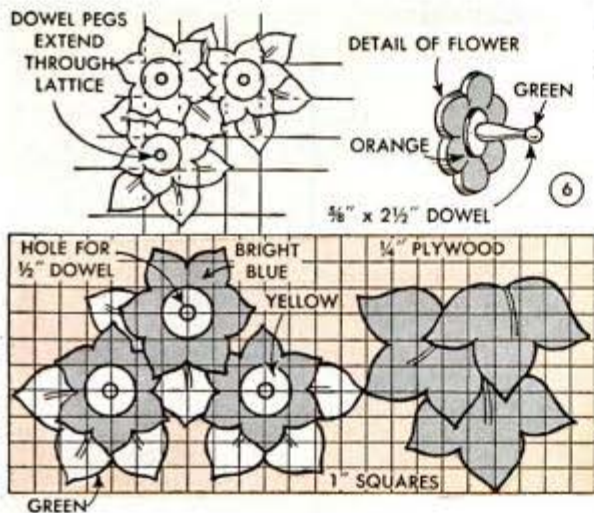

gay, informal touch to a bedroom or hallway. The center of each flower is provided with a shaped peg made from a dowel as in Fig. 6. Standard lattice stock is used in assembling the trellis, the cross strips being spaced apart about the distance shown for strength. A 1-by-2-in. piece is used at each side and at the center to bring the trellis about flush with the baseboard. A few screws driven through the center strip and into a wall stud will do to hold the trellis securely. The flowers, cut in groups of three, are arranged as shown, each flower straddling the center of a cross. Then the leaves are applied in an entwining pattern down to the baseboard. The flowers may be sawed out separately and glued in relief on top of the leaves, or they may be merely painted on. Green lamp cord is used for the stem and is held in place with staples. Finally, the flower box is attached to the baseboard at the bottom.

Unlike the others, the scroll-sawed bird and Mexican designs shown in Figs. 5, 8 and 9 are much easier to make. The bird overlay is glued and screwed to a background of identical size and fitted with dowel pegs. Suggested colors are: white birds, pale green or silver scrolls, yellow butterfly, orange flower and a deep green, blue or black background. The jolly Mexican holds clothes pegs in his hands and wears one for a nose, while the adobe shack provides three more. The figure, house, cactus and foreground are cut out separately and glued to a plywood background. Note that the width of the background is sufficient to overlap two wall studs for fastening with two screws.

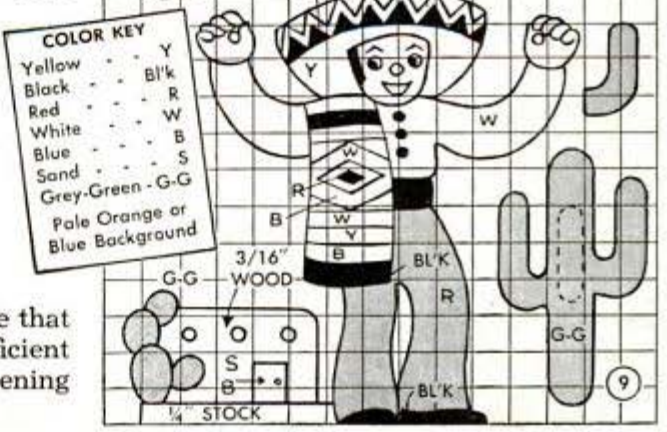

Floating Motor Mount on a Lathe Keeps the Belt Tight

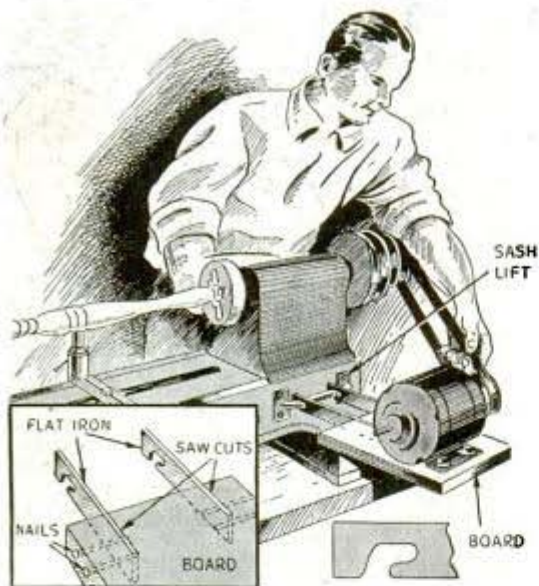

If you would like a floating drive for your woodturning lathe, here is one that attaches directly to the lathe bed. Materials needed for the drive are a sash lift, a board for the base and two short pieces of flat iron. One end of each iron is slotted as shown to slip over the sash lift, which is bolted to the side of the lathe. The other ends of the flat irons are fitted into the slots cut in the baseboard where they are held by long screws or nails driven into the edge of the base and through holes in the irons as shown in the detail. This drive can be removed from the lathe merely by tilting up the outer end and then lifting it off.—Robert Clark, Chicago.

How to Make Clamping Blocks

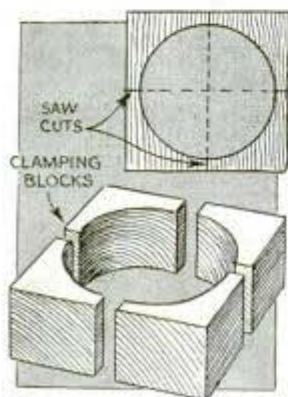

I have found the method shown a handy way of making clamping blocks for gluing up small radial cornered work such as chests, cabinets, etc. A block of the desired size is bored with an expansive bit set to cut a radius equal to that of the work. The block is then quartered by sawing. If the bit is tilted at the proper angle, angular faced

blocks will result for use on surfaces joined at angles other than 90 degrees.

blocks will result for use on surfaces joined at angles other than 90 degrees.

—Wm. Larken, Shannock, R. I.

Hammer Head Anchored Tightly With Ground-Pipe Wedge

Anyone having trouble keeping hammer handles from working loose should try this wedge, which is nothing more than a $\frac{3}{4}$ -in. length of pipe with one end ground sharp as indicated. When driven in place, the wedge spreads the handle end tightly against the sides of the head and the top and bottom of the opening.

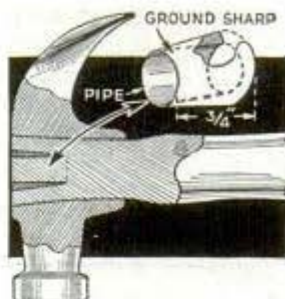

—William J. Pauser, Park Falls, Wis.

Wing Nut Locked by Wire Loop Anchored Under Washer

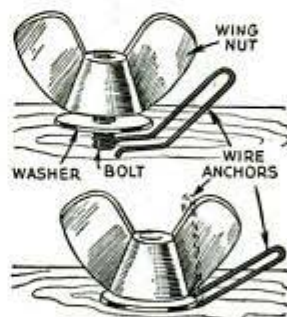

Wing nuts can be locked in place securely, where the bolts are through wood, by bending a short length of wire as shown and inserting it under the washer. When the nut is tightened,

the short wire ends are pressed into the wood and the loop may then be bent over one wing of the nut.

Starting Nut in Difficult Place

The next time you have a nut to start on a bolt that is in a hard-to-reach place, try this stunt. Wrap cloth around the nut so that it is a fairly tight fit in the wrench. In this way, you can hold the nut in the wrench and reach back to the bolt for starting it on the threads.



Wire Knives Cut Out Soap Blocks for Carving

When carving soap novelties, much time can be saved by cutting the block forms from cakes of soap with these cutters. One of them, A, has a length of fine wire stretched horizontally across a wooden block to shave off the lettering from a bar of soap, while the other one, B, makes vertical cuts. Note how the wire of each cutter is kept taut by means of a screw that is drilled to take the end of the wire. Circular insert shows how wire is attached to base of cutter B. Talcum powder should be sprinkled on the base of each cutter, which permits the soap to slide easily.—Stephen Kramerich, Detroit, Mich.

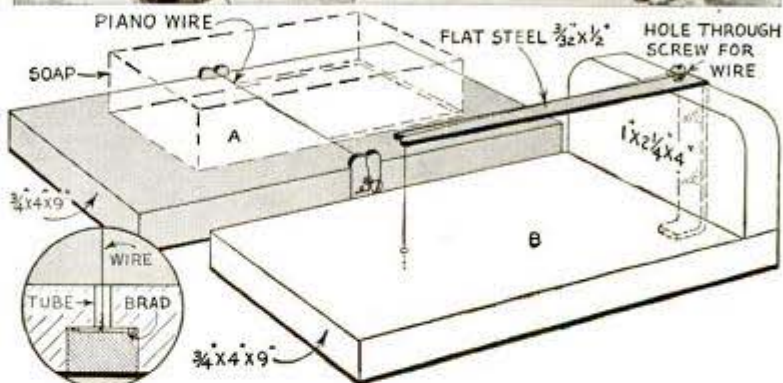

Storm Sash Fitted to Areaways of Basement Windows

Desiring storm sash for the areaways of basement windows of the type that are sunken below grade level, I made some to rest on top of the window wells as shown in the photo. The frames are made from $\frac{3}{4}$ -in. stock and the end pieces are cut diagonally with the narrow sides placed toward the fronts to admit as much light as possible. Before assembling the frames, the upper edges were rabbeted to take the

panes, which are wire glass. If desired, thick hair-felt weatherstripping can be put around the lower edges of the frames to provide a good air seal between them and the surfaces of the wells.

—Lowell S. Monroe, Shaker Heights, Ohio.



Simple Holder for Camp Candle

The problem of supporting a candle in the camp is solved by this simple holder which can be made from a tin can if desired. Just cut out a piece of the can and form it into a sleeve about $1\frac{1}{2}$

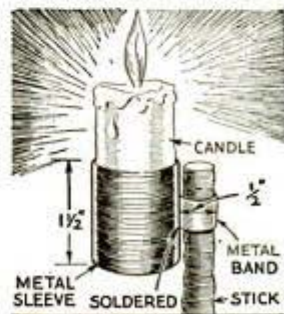

in. long and of sufficient inside diameter to take a candle snugly. To this sleeve, solder a metal band to slip over the end of a stick. The stick should be pointed at one end so that it can be stuck into the ground at any desired position.

Solving HOME

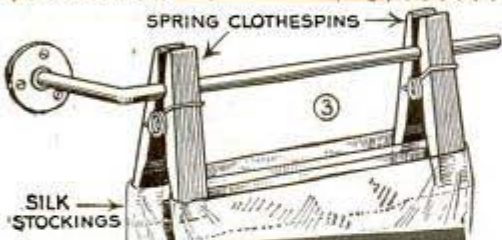
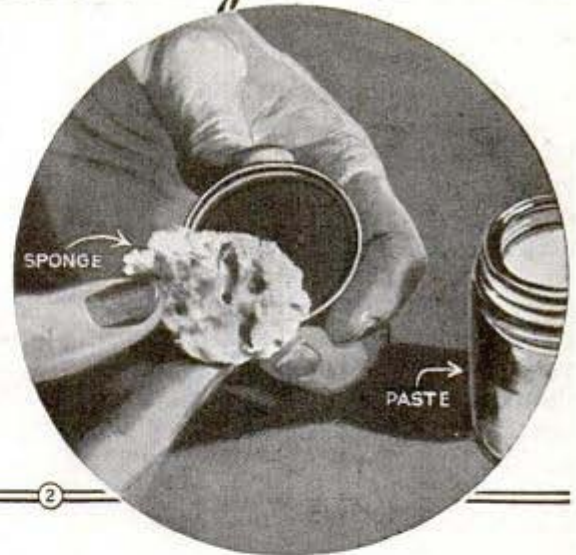

1. Sewed to the inside surface of your hat at the back, a small piece of hair comb will serve as an anchor to help keep it from blowing off your head in a wind. The comb is placed with the teeth downward so that it can be pushed into your hair. 2. A moist sponge placed inside the lid of a jar of paste will prevent the contents from drying out and hardening when the paste is not in use

3. To dry a pair of silk stockings indoors without creases or pin marks, clip a couple of clothespins over a towel rack and then slip the stocking tops over them, sliding the pins apart to stretch and spread them smoothly. 4. When washing delicate lace wrap it around a milk bottle, fasten the ends and dip the bottle up and down in soapy water. Rinse by dipping in clear water

5. Small children can be prevented from removing the laces from their shoes and losing them if knots are tied in the centers of the laces between the two lower eyelets. 6. Slipped over the end of a mop or broom handle, a hollow rubber ball with a hole in one side to fit snugly over the handle makes a good tip to prevent marring walls or woodwork if leaned against them

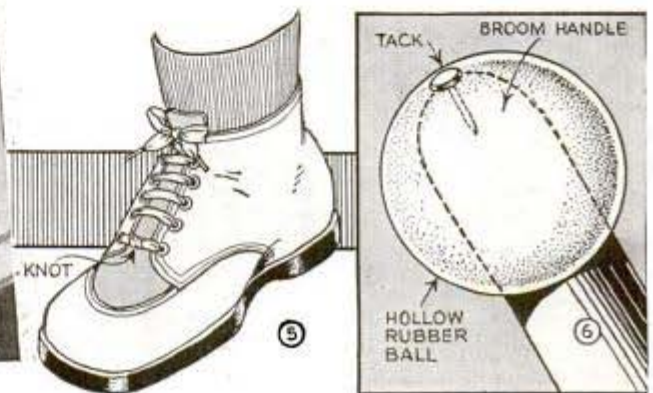

PROBLEMS

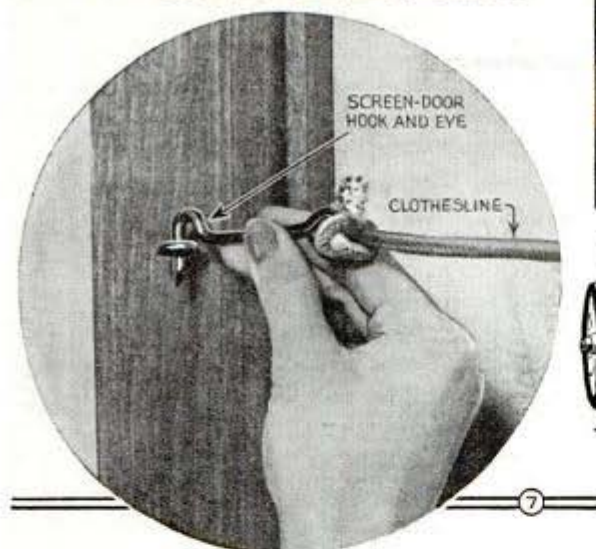

7. Screen-door hooks tied to the ends of an indoor clothesline provide a quick method of putting up or taking down the line when screw eyes are driven into opposite walls or supports to engage the hooks. 8. The next time you have a small can of paint to mix, first stir it to loosen the pigment from the bottom of the can and then use an egg beater to mix the paint thoroughly

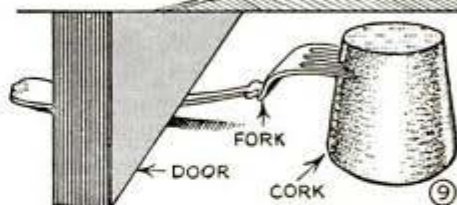

9. An emergency doorstop can be made in a jiffy by merely inserting the tines of a table fork into a large cork and then slipping the handle of the fork underneath the door. 10. A coil spring slipped inside the socket of a door knob will help keep the setscrew that holds the knob in place from loosening by holding it snugly against the screw

11. If the rubber grip on the handle of a vacuum cleaner loosens, it can be tightened by wrapping a band of adhesive tape around the handle to increase its diameter. A little glue applied to the tape will help also. 12. When crocheting a large piece, it can be kept clean by inserting it into a cloth bag, leaving the top of the work projecting so that you can get at it. Two or three safety pins hold the sack to the work

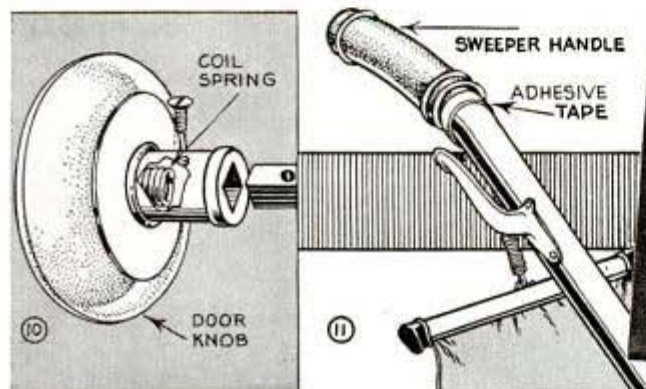

Clothes on Baby's Bed Held Down By Pair of Suspenders

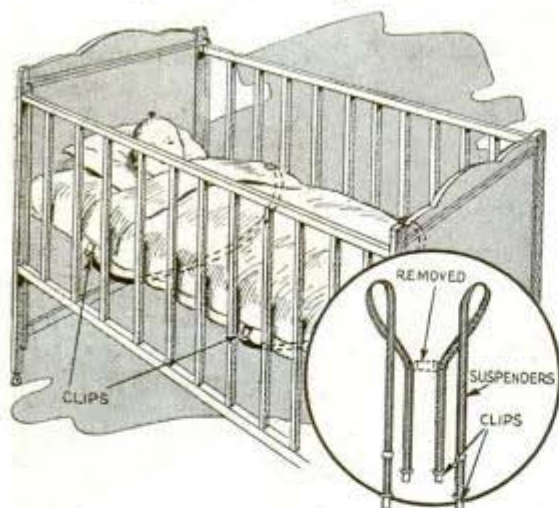

If you have trouble keeping the bedclothes on a baby at night, and do not want to use pins for this purpose because of the possibility of tearing the clothes or smothering the child, try long pieces of elastic such as a pair of old suspenders. A pair of the type shown in the circular detail are highly suitable when the center crosspiece at the back is removed. In use, the straps are run underneath the springs and mattress and clipped to the edges of the clothing. The elastic allows the child to move about freely yet keeps the clothes in position.—Eric R. Planitzer, Fitchburg, Mass.

Six-Prong Fork of Twisted Wire Roasts Wieners Uniformly

Roasting six wieners at a time is easy for one camper who uses a fork shaped like the spokes of a wheel. It is made by twisting six lengths of wire together, fit-



ting a wooden handle on one end and bending the opposite ends at right angles to the handle. By rotating the fork, all wieners are roasted uniformly as the escaping liquid flows down on the opposite ones and bastes them. It's a good idea to kink the prongs to prevent the wieners from slipping off into the fire.

Magnet Keeps Door Hasp Open

Use a small magnet to keep a door hasp from swinging outward where it might injure someone or catch on clothing. Locate the magnet so that the end of the hasp will come in contact with it when the latter is swung around, and then mount it with three small nails as shown.

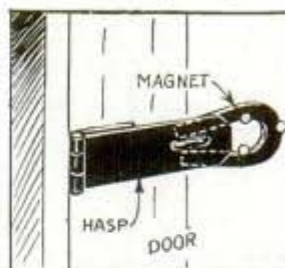

Damp Grass in Bottom of Creel Helps Preserve Fresh Trout



As the delicate flesh of trout spoils rapidly, it's a good idea to line the bottom of your creel with damp grass before placing any fish in it. The grass keeps them from lying on the bottom of

the creel where the slimy coating of the fish could become warm and start spoiling. In many cases, it is advisable to kill and clean a fish immediately, as failure to take this precaution often causes trout to fade, as well as give them an unsavory taste.

Fishhook Holds Mousetrap Bait

When you have trouble keeping bait on a mousetrap, fasten a small fishhook to the bait pan of the trap, and hook the bait onto it. The hook also makes it possible to use bits of meat or other articles of food for bait, and attach it easily and firmly to the trap.

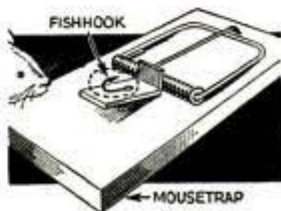

Colonial Bric-a-brac Shelf Has Three Sections

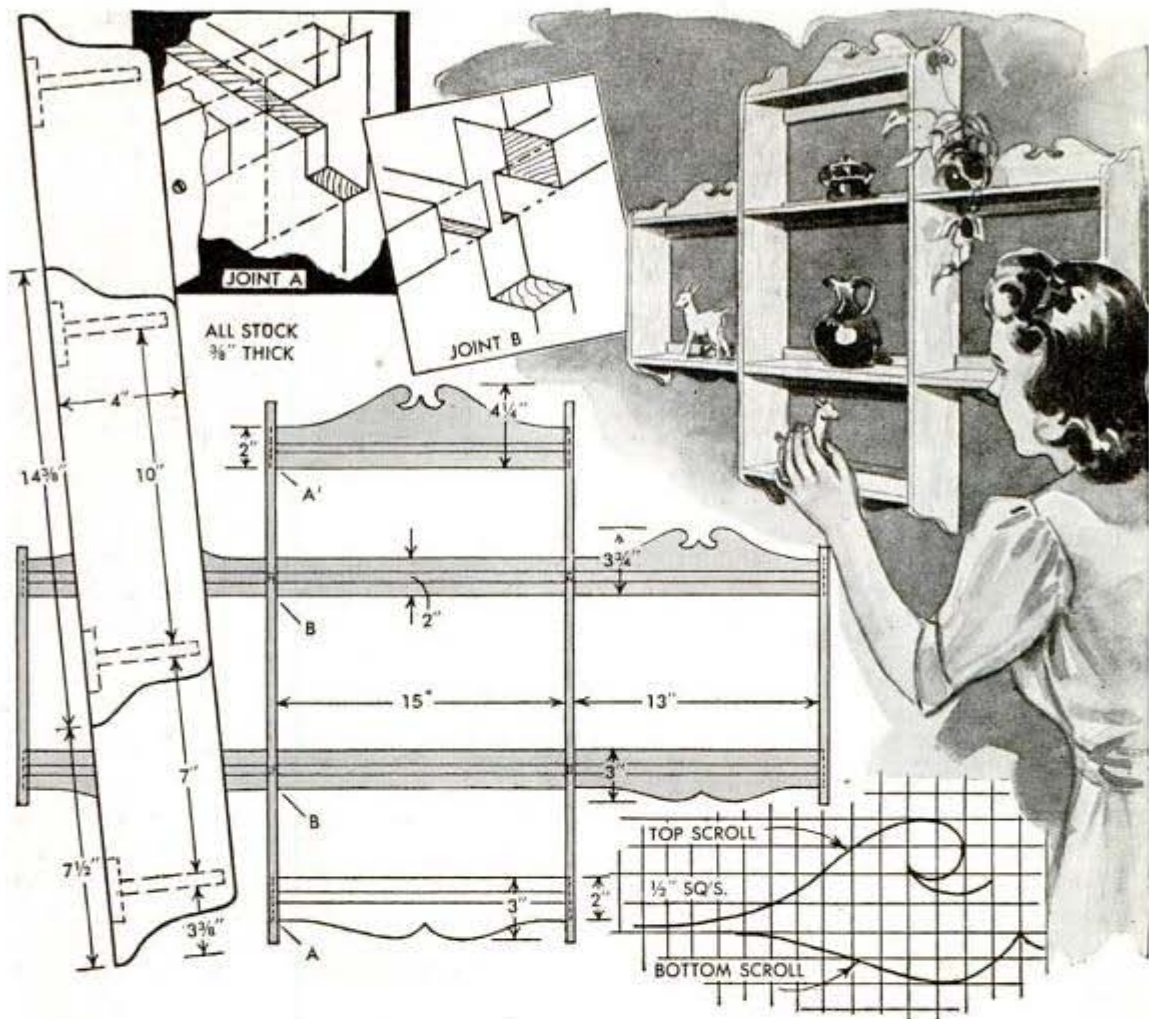

Differing from the usual type of whatnot shelf, this one has three sections, the center being about twice as high as the two side sections, and projecting both above and below the latter. In making this shelf, you can use $\frac{3}{8}$ -in. wood throughout. All sections have duplicate top and bottom scrolls, the design being given in the cross-hatched drawing, which you can enlarge on a sheet of cardboard marked off in $\frac{1}{2}$ -in. squares. Cutting out the design provides a template from which the outlines can be traced on the work. The ends of the four uprights are cut off at top and bottom to the same curvature as shown in the left-hand detail. Rigidity of the shelf, which does not have a solid back, is obtained by the horizontal crosspieces to which the shelves are screwed. Notice the details of the joints A and B, which interlock the shelves, uprights and backing pieces. When assembling the parts after

cutting and fitting, the surfaces are thoroughly sanded and then stained, after which glue is used at the joints. Finish can be obtained by merely waxing, by shellacking and varnishing, or by painting.

—George Martin, Downers Grove, Ill.

Bobby Pins Hold Hem of Skirt While Checking for Length



To eliminate any possibility of injury from common pins when using them while turning and fastening the hem of a skirt to adjust the length for sewing, use a number of bobby pins bent to the shape shown. These clips will hold the cloth securely.

Holes Are Bored in Glass Quickly With Dental Drill

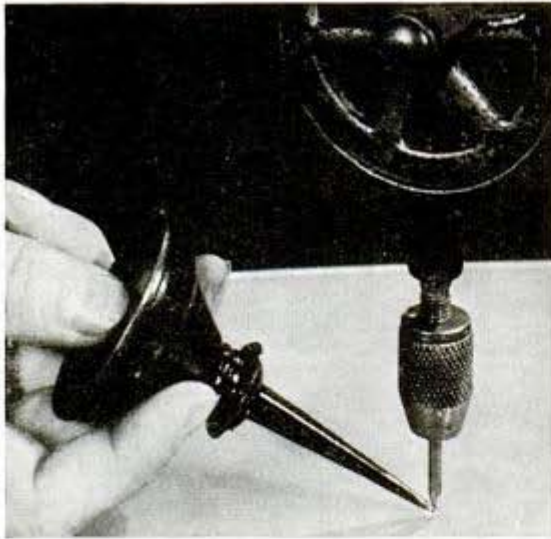

The next time you have some holes to make in a piece of glass, try using a dental drill for the purpose. In most cases, your local dentist will probably let you have some discarded ones for the asking. These can be chucked into a hand drill and will make holes in glass quite rapidly. While drilling, lubricate the glass with a solution of lard, 1 part, and kerosene, 2 parts.

Warning Board on Guy Wire Helps to Prevent Accidents

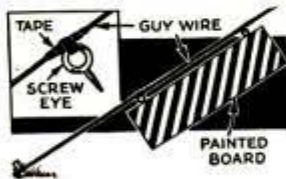

If you have any guy wires in locations where someone might accidentally run into them, boards painted with black and white stripes and hung on the wires will help to make them noticeable. Screw eyes driven into the edges of the boards will permit them to be hung on the wires, using tape or short pieces of small wire.

Gloves Made of Woolen Socks

A pair of gloves can be made from old discarded woolen socks. To do this, turn the sock wrong side out and stretch it on the left hand as shown, allowing



about $\frac{1}{2}$ in. for the cuff. Baste between the fingers, remove the sock, and stitch closely. Then cut away the excess material and remove the basting thread, after which the glove is turned right side out. The same method is used for making both gloves as they can be worn on either hand.

—Frank Shore, New York, N. Y.

How to Avoid Water Dripping From Gable Ends of Building

To prevent water from dripping off a roof edge at the gable and causing the cornice to rot, raise the roof edge slightly as shown.

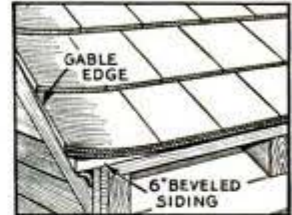

Just slip a length of beveled siding under the shingles or other roof covering and nail it in place. This produces a slant so drainage will be away from the gable edge.

Sorting Tray for Small Parts



This tray is just the thing for sorting screws, nails and other small parts because it has a spout on one side for pouring them into a container. The tray is simply a pan of

the desired size having a spout formed from sheet metal and soldered over a notch cut in the side of the pan.

Jointed Ruler Used as Protractor

In an emergency, you can use a folding ruler as a substitute for a protractor where the angles are not too critical. Just scribe lines on the metal hinge as indicated so that the end of the ruler points at a given angle when a line at the hinged end coincides with the corresponding angle line scribed on the hinge.



Distinctive Clothes Hamper in Modern Design

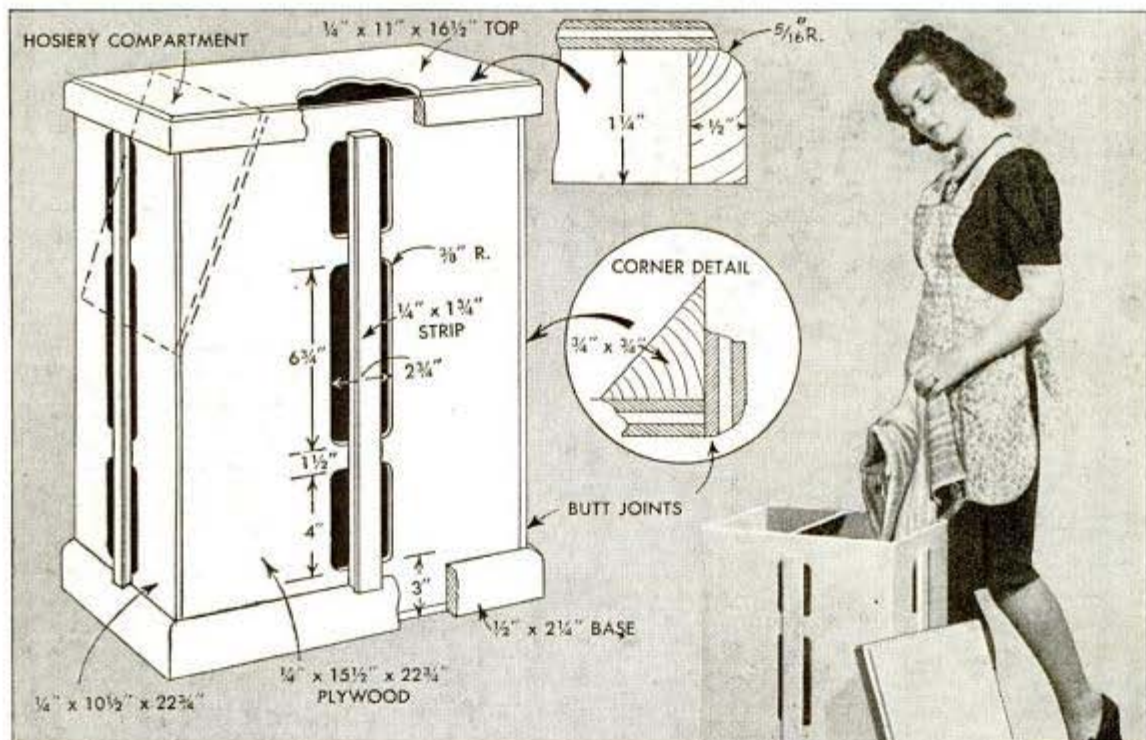

Assembled with glue and brads, this modernistic clothes hamper can be built entirely with hand tools and finished to match bathroom accessories. An inclined partition at one end provides a separate compartment for hosiery, while vents in both sides and ends permit plenty of ventilation.

Gauge on Carpenter's Level Helps Determine Roof Pitch

To determine the roof pitch of buildings while standing on the ground, one carpenter fitted his level with a simple, self-

adjusting gauge. This consists of a length of wire inserted into a hole drilled through the level at the point shown, after which the ends are bent down to hold it in place, but loose enough to swing easily. The side of the level is calibrated to indicate the various pitches. In use, the level is held to line up with the pitch of the roof as you sight across the top edge.

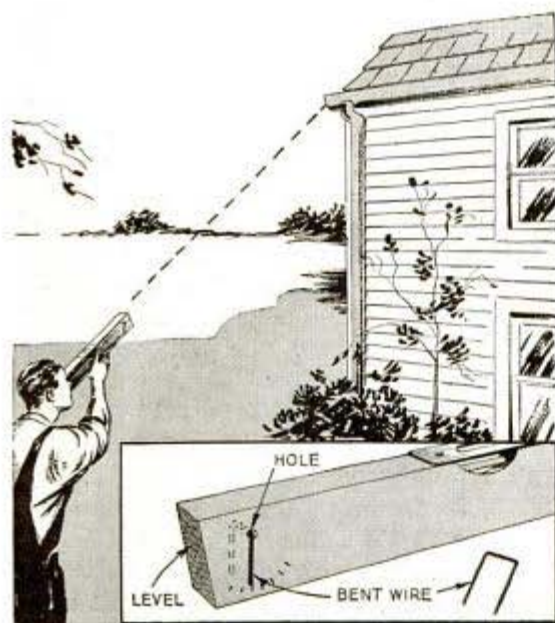

Rubber Band Holds Tape Line At Any Length Desired

To avoid having his tape line pulled out farther than desired on certain jobs, a workman used a split rubber band as shown. This is slipped over the line reel so that it may be pulled over the opening to grip the tape at any point.





Courtesy Armstrong Cork Co.

IF YOU need an extra room or two in your home, the unused attic space often may be utilized. When designed properly, attic rooms can be made as livable and attractive as those on the first floor. Figs. 1, 3 and 4 show good examples. Every house presents special problems, of course, because of the type of roof, location or absence of windows, stairway, etc., but generally a solution can be worked out and comfortable rooms provided.

Is the space usable? The first step is to determine whether or not the attic space in your home is usable. Roofs are usually $\frac{1}{4}$, $\frac{1}{3}$ or $\frac{1}{2}$ pitch, which is found by measuring the rise and span as shown in Fig. 2. Unless the rise is at least 8 ft. there will be insufficient headroom to make the use of the space practical. Roofs of $\frac{1}{4}$ pitch usually are too low unless the house is exceptionally wide. From the table, Fig. 5, you can determine the usable space avail-

By R. O. BUCK Part I

able for various widths of houses. Generally, attics are not floored unless the joists are of sufficient size to carry a normal load without undue springing, which might crack the plaster below. Laying an attic floor, if none has been provided, over an old plaster ceiling is impractical.

Room planning: The arrangement of rooms depends somewhat on the type of house and the location of the stairway and chimney. For a bungalow, a floor plan similar to that shown in Fig. 4 is suggested for the maximum of usable space. If your house has a hip roof, the available space is reduced somewhat at the sides of the dormers, but the same plan may be used. The attics of Cape Cod and other cottage-type houses in which the stairway generally is at one end, are best arranged as shown in Fig. 7. If the house is sufficiently wide, a hallway may run from the top of the stairs to connect with a second bed-

SPARE ROOMS *in the attic*

room, and a bath can be added opposite the closet. Other types of houses may require special planning.

A bathroom is very desirable, especially if two or more rooms are to be provided. Many houses have the plumbing roughed in for an upstairs bathroom when the house is built. If not, your plumber can suggest a method for bringing up the pipes. If sufficient plumbing fixtures cannot be obtained when making the rooms, provision can be made for installing them later. It is best to have the second-floor bath directly above the one on the main floor.

Partition framing: After determining the size to make your rooms, the sidewall and ceiling heights should be laid out on the floor with a chalk line exactly at right angles or parallel with the plate. Fig. 22 shows one end of an attic with wall studs and plate installed. To avoid undue vibration and possible damage to plaster, it is advisable to secure the plates to the joist with lag screws spaced at 32-in. intervals. Note the blocking between the original studs in the gable end, also the strips on which to nail the baseboard. Fig. 16 shows



Courtesy Armstrong Cork Co.

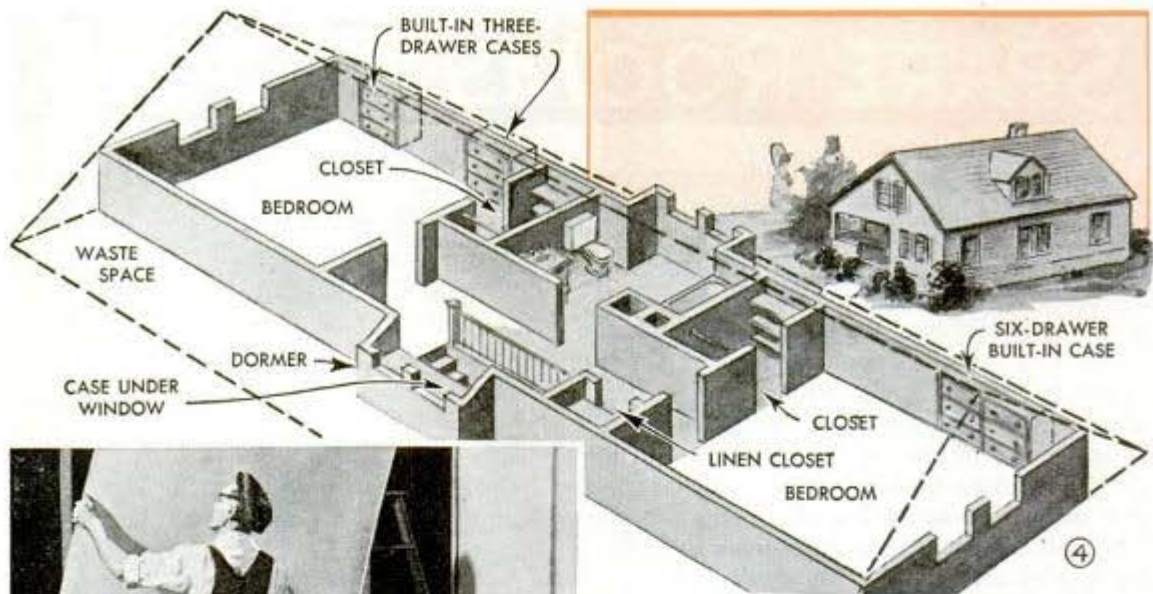

⑤ **USABLE ATTIC SPACE**

One-Third Pitch Roof		Horizontal ceiling when ceiling height is:					
Width of attic in feet	Usable floor space when vertical side wall is:						
	4 ft.	5 ft.	6 ft.	7 ft.	8 ft.	9 ft.	
24 ft.	12 ft.	9 ft.	0 ft.	3 ft.	0 ft.	0 ft.	
26 ft.	14 ft.	11 ft.	8 ft.	5 ft.	2 ft.	0 ft.	
28 ft.	16 ft.	13 ft.	10 ft.	7 ft.	4 ft.	1 ft.	
30 ft.	18 ft.	15 ft.	12 ft.	9 ft.	6 ft.	3 ft.	
One-Half Pitch Roof							
20 ft.	12 ft.	10 ft.	8 ft.	6 ft.	4 ft.	2 ft.	
22 ft.	14 ft.	12 ft.	10 ft.	8 ft.	6 ft.	4 ft.	
24 ft.	16 ft.	14 ft.	12 ft.	10 ft.	8 ft.	6 ft.	
26 ft.	18 ft.	16 ft.	14 ft.	12 ft.	10 ft.	8 ft.	
28 ft.	20 ft.	18 ft.	16 ft.	14 ft.	12 ft.	10 ft.	

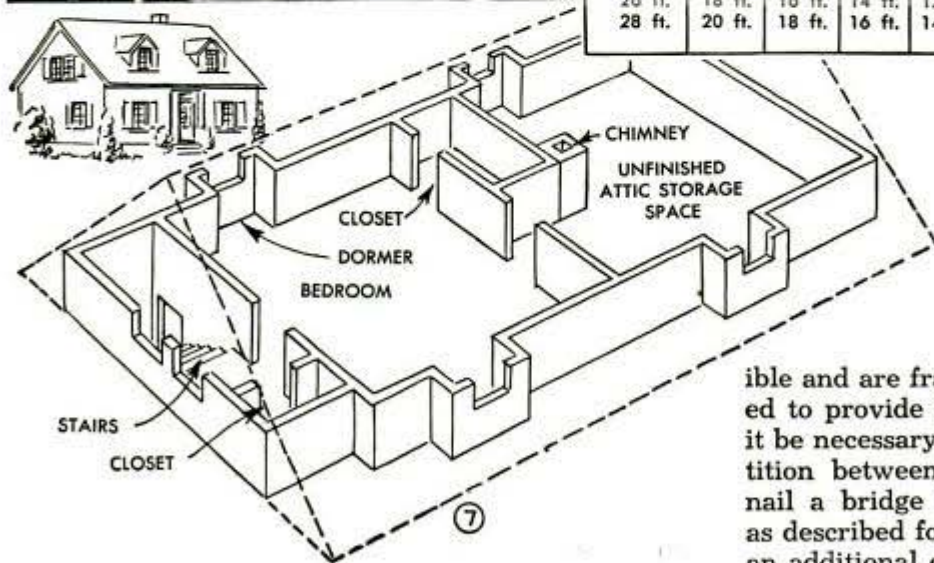

The table above will enable you to determine usable space in your attic, while the drawing at left shows neat arrangement for two rooms

ible and are framed as indicated to provide rigidity. Should it be necessary to locate a partition between joists, simply nail a bridge between rafters as described for studs, and add an additional ceiling joist over

the most practical way to frame up walls around a dormer. The studs usually can be placed so that they line up with the rafters, but if intermediate studs are required, a bridge may be used as shown in Fig. 15. The method for framing cross partitions, doorways and corners is given in Figs. 19, 20 and 21. Partitions should be located under a ceiling joist where fea-

the partition.

Electric wiring: The installation of the wiring for lights, switches and receptacles should be done while the framing is open. As wiring codes vary in different localities it would be well to determine just what the local requirements are if you do the work yourself. Conduit and armored cable are acceptable in most codes. Wiring must

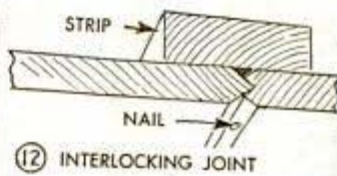
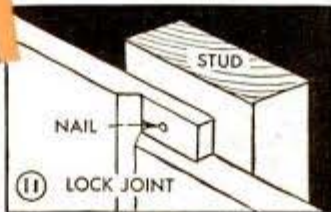
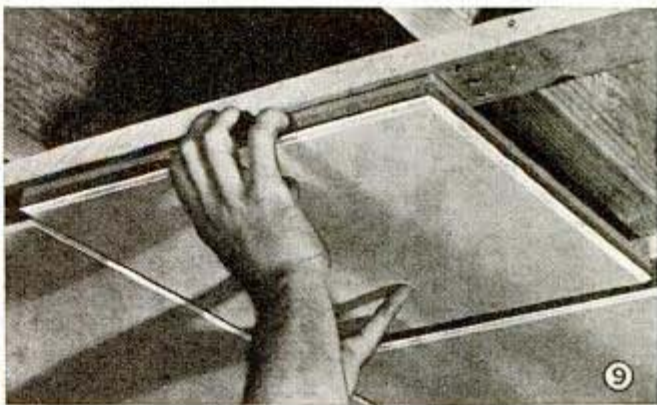
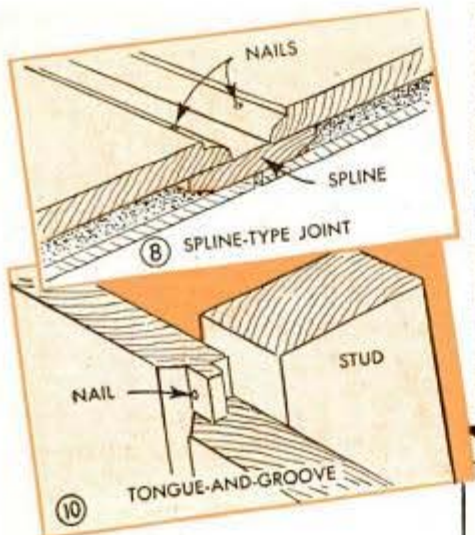

be done carefully, and all connections must be mechanically and electrically sound. This is accomplished by scraping the ends of the wires, twisting them tightly together and soldering the joint, preferably in a soldering cup. A ½-in. pipe cap with a twisted wire handle provides a good cup for melting the solder and dipping the joint. Soldering paste should be used as a flux, and the connections taped.

Armored cable should never be spliced because of the danger of a short circuit if the sharp metal covering happens to work through the insulation on the wires. A metal box should always be used with suitable bushing so that the insulation is protected and the joint is enclosed. In most modern electrical installations white and black covered

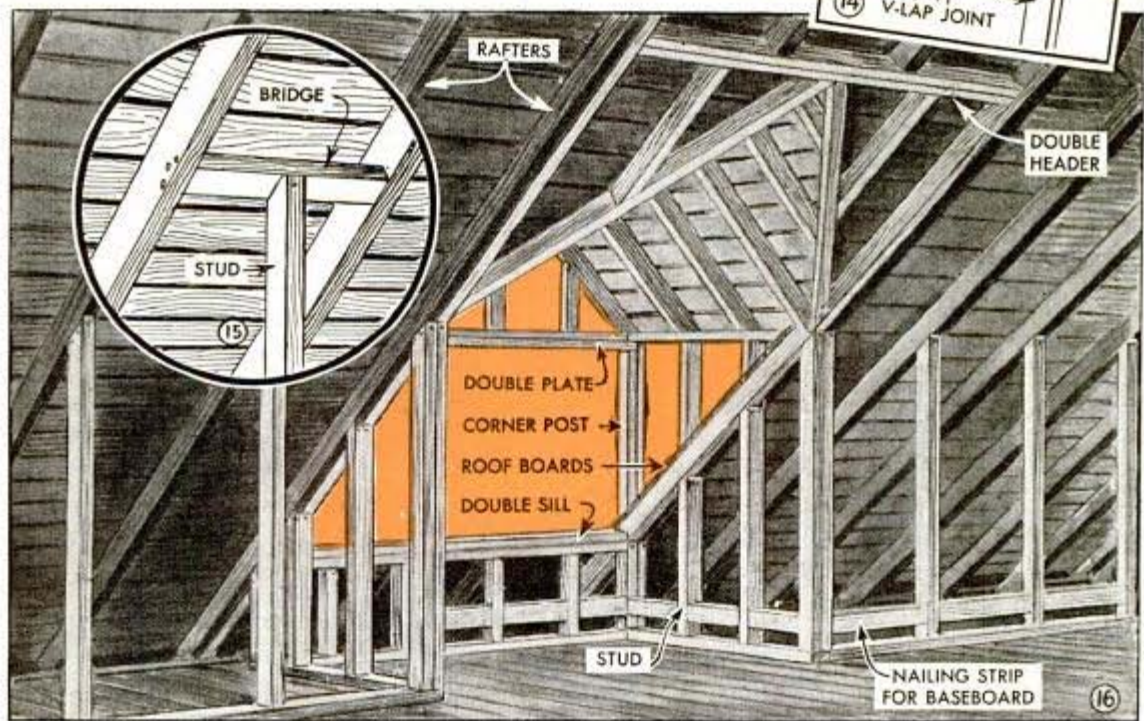
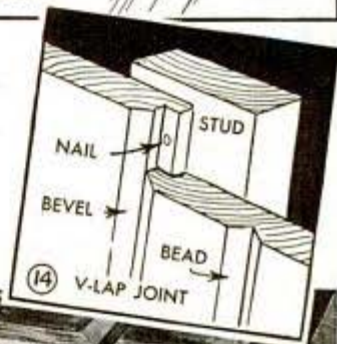
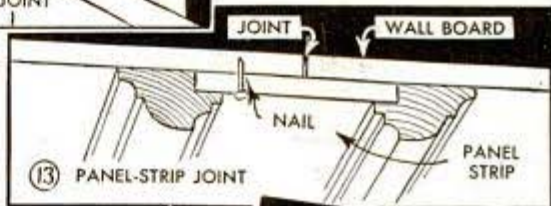



Courtesy Armstrong Cork Co.

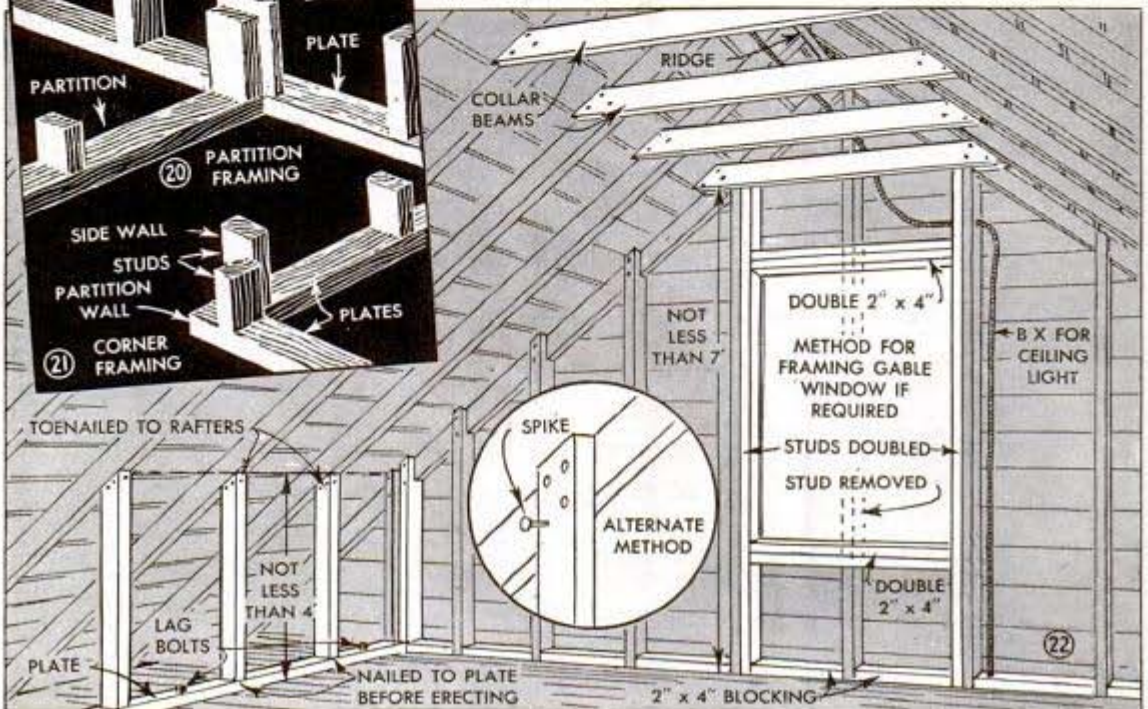
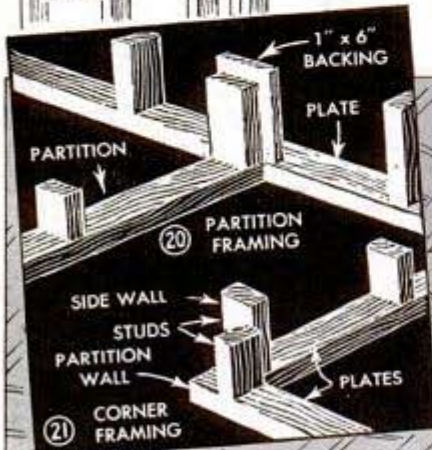
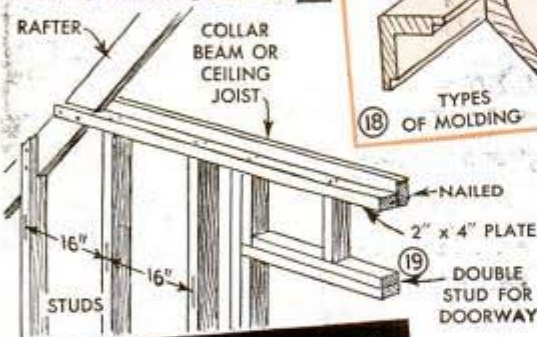

wires are used in the circuits to designate the "live" and grounded or "dead" sides of the circuit. The white is the "dead" side and the black the "live." Switches are connected to the live side while fixtures are on the dead. Thus when the switch is off the fixture circuit is dead. Most receptacles, fixtures, etc., have brass and tin plated screws for connecting the wires properly. The tinned screw is connected to the dead side of the line. Bathroom lights should always be provided with wall switches because of the extra hazard presented by the well-grounded plumbing fixtures.

To provide a source of current for the attic rooms, locate a box containing a line (not controlled by a switch) in the attic, or if necessary, run a line up from the basement. Generally there is some wall or partition where this can be accomplished easily. If there is more than one circuit that can be tapped conveniently, choose the one that carries the lightest load. This can be determined by removing all but one set of fuses in the basement fuse box, and turning on lights to determine how many outlets are on that cir-

cuit. Repeat this process with other circuits. Install all boxes for switches, receptacles and fixtures before starting the wiring so that you can plan the shortest runs to cut in all of the boxes. Put in plenty of baseboard receptacles to fill future needs as the cost is smaller while the walls are still open.

Wall treatments: The walls may be finished with sheets of wallboard tacked over the studs, as shown in Fig. 23. Metal fasteners, like the one shown or similar, are available and are used for the intermediate fastening of panels so that nailing need only be done at the edges. When using materials $\frac{1}{4}$ or $\frac{3}{8}$ in. thick it is customary to toenail nailing strips between the studs at breaks in the wall and under the baseboard. This makes a level joint and prevents warping at the edges.

Soft-pressed boards also are excellent material for finishing walls and provide considerable insulation value. The boards are available in wide sheets, random-width planks, tiles, etc., so that many beautiful effects are possible. Tile and random-width planks usually are nailed on 1 x 2-in. furring strips which, in turn, are nailed to studs or joists. The spacing of the furring will depend on the size of the boards or tiles. Fig. 9 shows how the tiles are applied to a ceiling, using metal clips to lock each one in place.

Plaster board makes an excellent wall for either a painted or papered room, Fig. 6. The manufacturers of this material have a good method for making a smooth joint between the boards. Several types of joints for wallboards are shown in Figs. 8, 10, 11, 12, 13 and 14. Plaster and lath ap-

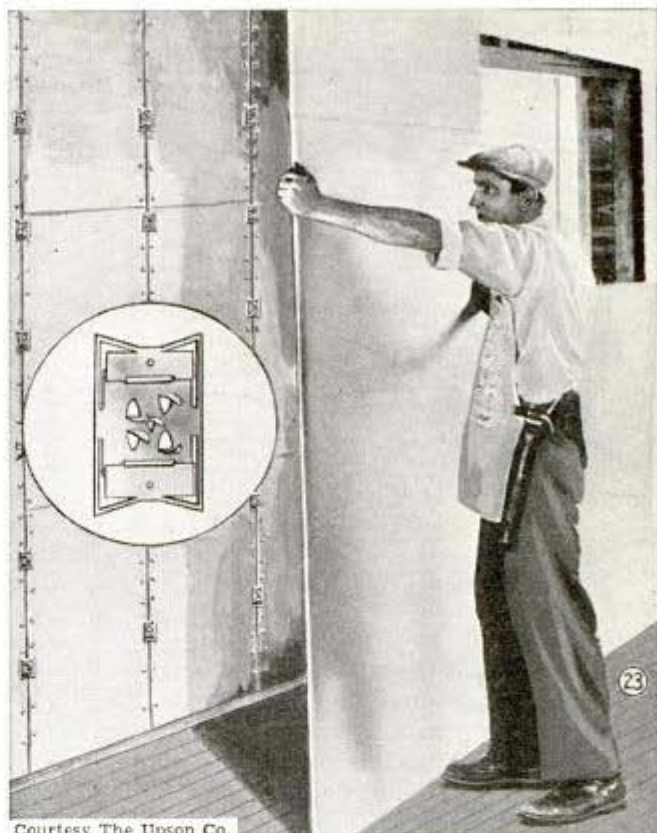

Courtesy The Upson Co.

plied in the usual way also are to be considered. Bathroom walls should be covered with some prefinished and moisture-resistant material. One of the most satisfactory and economical types is shown in Fig. 17. It is made of either hard board or asbestos fiber board and usually is squared off in a tile effect and enameled at the factory. Batten strips for nailing over joints in wall coverings have given place to a variety of attractive moldings in wood, metal and hard and soft board materials. Beautiful panel and molding effects such as shown in some of the photos can be worked out. Fig. 18 shows a few of the designs available.

(To be continued)

Two-Piece Top of Sawhorse Holds Boards Upright for Edge Planing

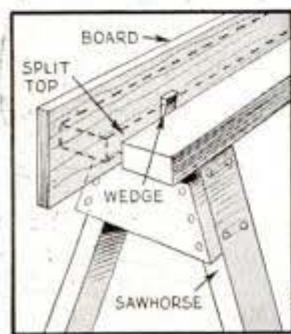

Next time you make a pair of sawhorses, why not use a two-piece top on one of them as shown to provide a groove in which to set boards for edge planing? This does not interfere with using the sawhorse in the regular way and may save considerable time when working on jobs where a bench and vise are not available. Thin boards can be held securely by driving a couple of wooden wedges alongside them.

Exact Change to Pay Tradesmen Kept in Pockets With Bills

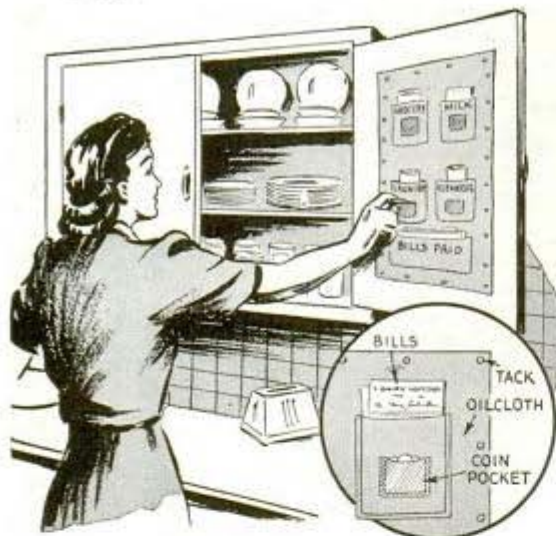

Placed inside a cupboard door, several oilcloth pockets are convenient for holding bills and the correct change to pay them with when various tradesmen call to collect. This avoids the confusion of trying to make correct change or of hunting around over the house when a collector arrives. The pockets are made by sewing pieces of oilcloth to a larger piece of oilcloth or other suitable material, the entire assembly being tacked to the inside surface of a cupboard door.

Splash Boards Protect Occupants Of Small Motorboat

When the water is choppy, I have found that passengers in my small motorboat invariably get soaked by water splashing over the bow. To remedy this, I made removable splash boards that can be slipped and locked in place whenever necessary.

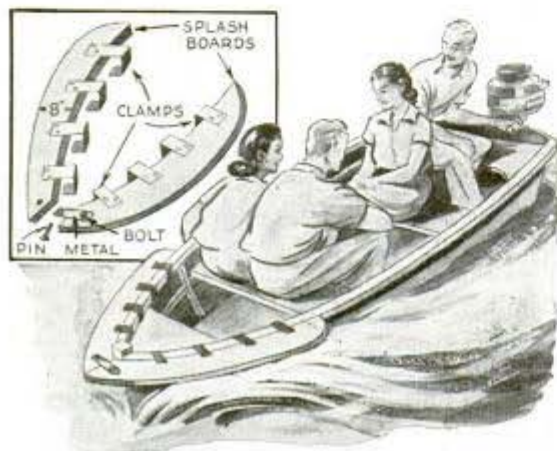

These are cut from softwood to the contour of the boat after which they are fitted with flat-iron clamps that fit over the gunwales. The boards are locked together with a pin, and painted the same color as the planking.

—Grant W. Howell, Hamilton, Ont., Can.

Reel and Hook on Garden Stake To Adjust Marking Line

You can adjust the length of a garden row marking line quickly and hold the adjustment if one of the stakes is fitted with a reel of the type shown. A screw hook at the outer edge of the reel prevents the line from unwinding once it has been adjusted to the desired length.

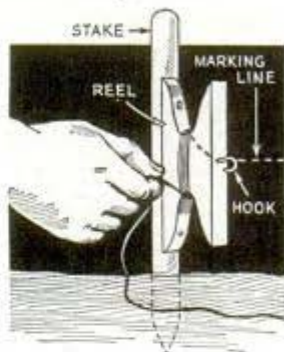

'Comb' on Edge of the Trash Box Removes Shavings From Brush

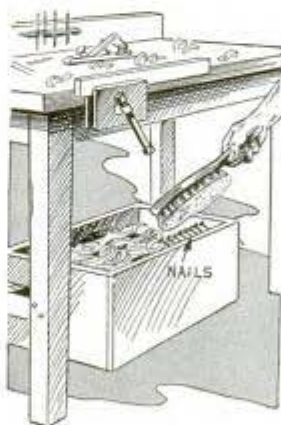

To remove steel or wood shavings and other small particles from the brush with which you clean your bench, drive a few short nails in the edge of your trash box. The nails will remove foreign particles when the brush is pulled across them.

Legs of Croquet Wickets Offset For Easy Pushing Into Ground

The difficulty of forcing the ends of croquet wickets into hard ground can be overcome by bending them so they can be forced in with the foot. When the offsets of the wicket are pressed down flush with the ground surface, they do not interfere when shooting a ball through the wicket.

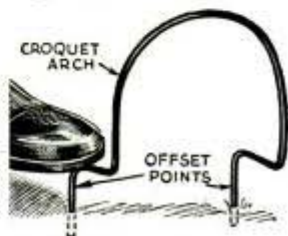

MONOGRAM GUIDE

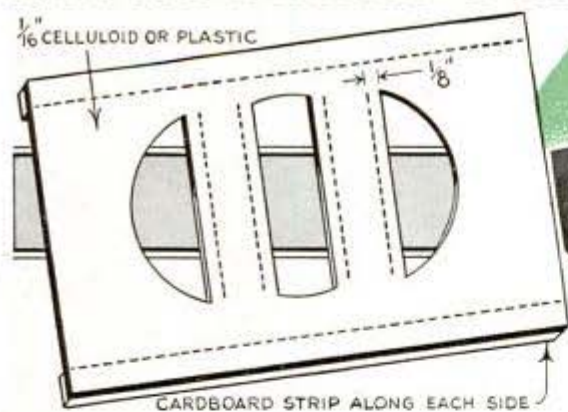

WITH this celluloid guide, it is an easy matter to monogram note paper, photographs, etc. To make a guide, scribe a circle of the desired diameter on a sheet of transparent celluloid and divide it into three equal parts. By bending the celluloid sharply at the scribed lines the waste will break off, leaving openings with smooth edges. Then about 1/8 in. from each straight cut, draw parallel lines with waterproof ink to serve as guides in spacing the initials. Narrow pieces of thick cardboard cemented to the top and bottom edges of the guide will raise it from the surfaces to be monogrammed to prevent smearing of ink. The alphabet reproduced here shows how easy it is to monogram any set of initials. Use a ruler as a straight-edge, sliding the guide along it as you draw each initial. If you wish the monogram to be raised or embossed, make the letters with job-printing ink thinned with oil of wintergreen, or use slow drying ink. As soon as the monogram has been drawn, dust the initials with powdered sealing wax of the color desired, blow off the surplus and warm the surface until the wax melts and becomes glossy.

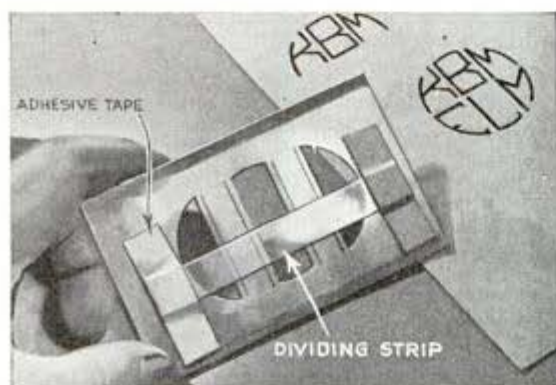
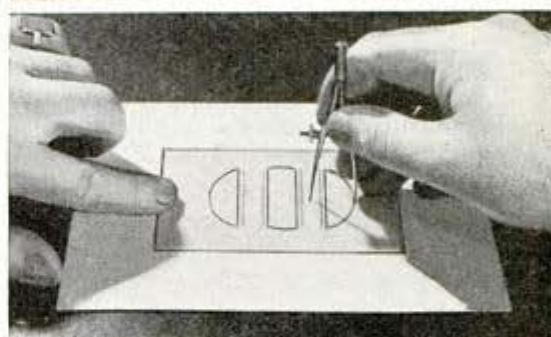

Paint Spots Removed From Brick With Caustic Soda Solution

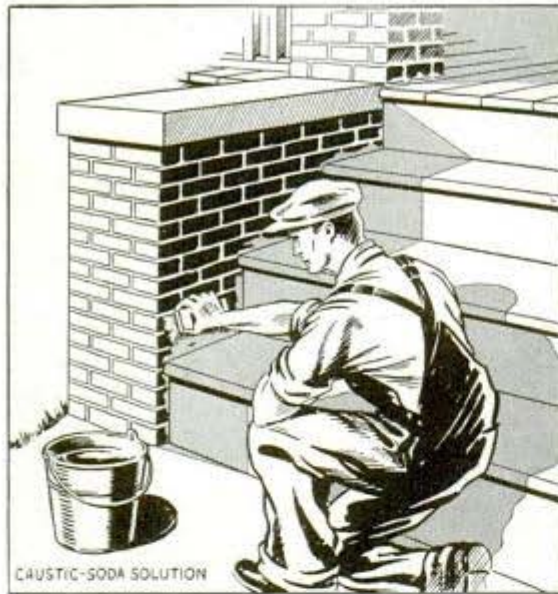

If you accidentally get paint on a brick surface when painting wood, here's an easy way to remove the paint. Mix a solution consisting of caustic soda, 1½ lbs. and hot water, 1 gal. Apply this solution to the paint to be removed and then wash it off with clear water, repeating the operation until the paint disappears. In handling this solution, be careful that none of it gets on your skin as it causes severe burns. Also, it is a good idea to use an old brush as the solution is very hard on the bristles.

Repair for Table-Tennis Ball That Has Been Cracked

A cracked table-tennis ball can be repaired and used again. First clean the ball around the crack with a pencil eraser. Then cut a strip of thin cotton cloth, preferably across the weave, about ¾ in. wide and long enough to allow about ¼ in. overlap at each end of the break. Next apply a coat of cellulose cement and press the cloth into place, smoothing out any wrinkles carefully. After the cement has dried for a few hours, apply a second coat of cement, working it gently into the weave of the

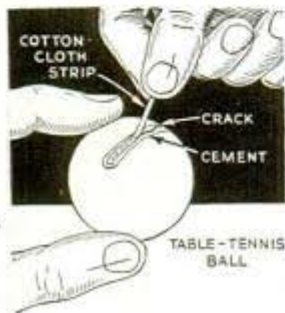

cloth. When this coat has dried, sand the patch lightly to remove the excess cement, but not enough to cut into the cloth.

C-Clamp Serves as Handy Hook For a Paint Pail

Instead of using an ordinary wire hook to hold your paint pail while working from a ladder or other elevated surface, just slip a small C-clamp on the bail. This can be used in the same way as a wire hook besides having the added advantage of being easy to clamp onto shelves, the side of a ladder and other edges where a hook might slide off.



Short Work Held in Bench Vise While Ripping It

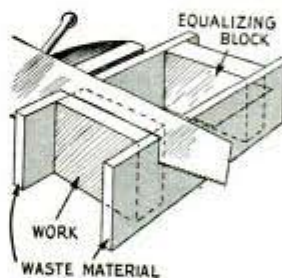

The next time you have a short piece of work to saw lengthwise, try this method of holding it. Place two pieces of scrap wood in your vise so that they extend beyond it at one end. Then put the work between them, at the projecting ends, placing a block of equal length between the scrap pieces at the other end. Now, by sawing through both the work and the scrap pieces, the job is done easily.

Whitewash Brush Held on Bucket By Bending Bail

One workman keeps his whitewash brush conveniently at hand on the bucket by bending the wire bail so it will rest on top of the bucket rim. When not in use, the brush is laid across the edge of the bucket and the bail.

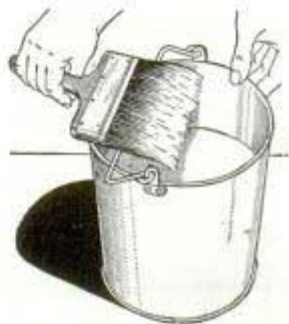

MECHANICAL ARTIST

draws endless designs

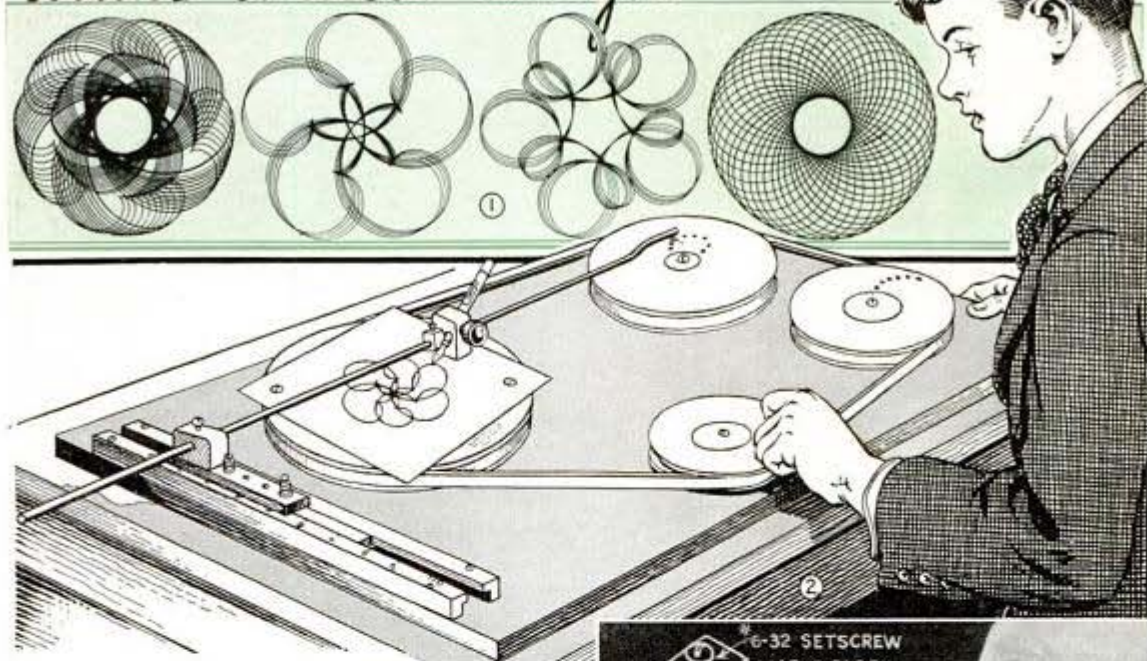

By Walter E. Burton

BY MAKING simple adjustments on the position of the writing arm of this drawing device, you can produce circular designs without limit, some examples of which are shown in Fig. 1. The parts you need to build this gadget, and their arrangement, are shown in Figs. 2 and 6. Four wooden pulleys are mounted on a large baseboard, which may be a drawing board or a piece of plywood. These should be grooved to take a V-belt, leather belting or any kind of homemade belt about 72 in. long. The largest pulley, which is 10 in. in diameter, provides the writing surface, paper being fastened to it with thumbtacks. The smallest pulley, 5 in. in diameter, is provided with a knob so that it can be used as a crank. The other two pulleys, A and B, Fig. 6, are used to guide the writing arm and for this purpose a number of holes are drilled in one side of each as indicated, to take a small pin on the end of the writing arm.

Although the drawings indicate a length of $\frac{3}{8}$ -in. steel rod for use as a writing arm, you can substitute a piece of maple dowel of larger diameter, which will be fully as serviceable and just as rigid. One end has a pin, as already mentioned, to engage

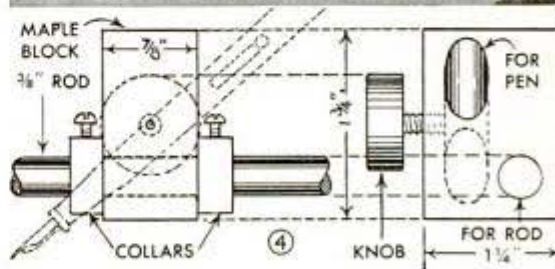
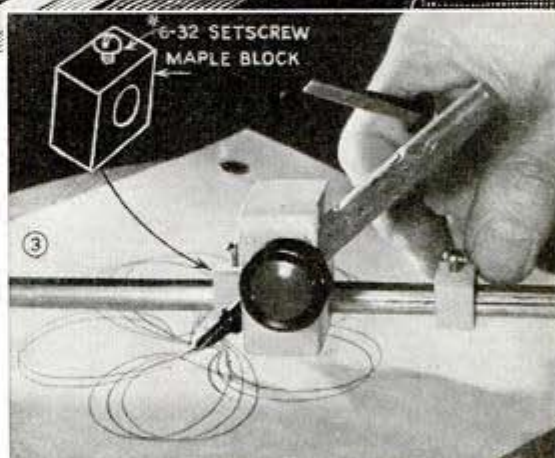

guide wheels A and B, and the other end is fitted to a pivot block which is carried on a rocker arm mounted on a strip of wood that slides back and forth between two guides, and can be locked in any position. A fountain-pen holder, detailed in Figs. 3 and 4, is mounted on the arm and is held in place, after being adjusted to position, by means of two collars of maple. Drilling a hole to take the fountain pen

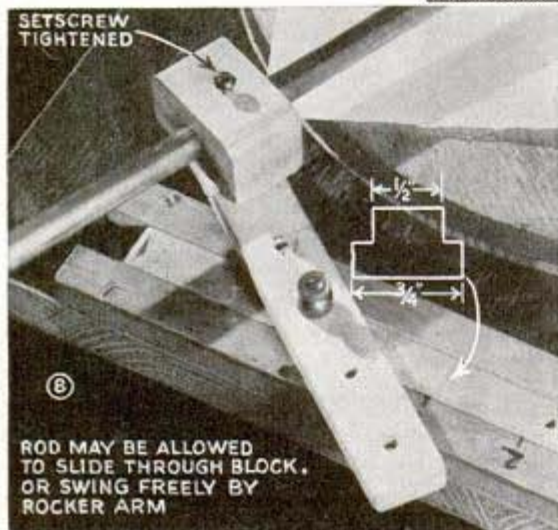
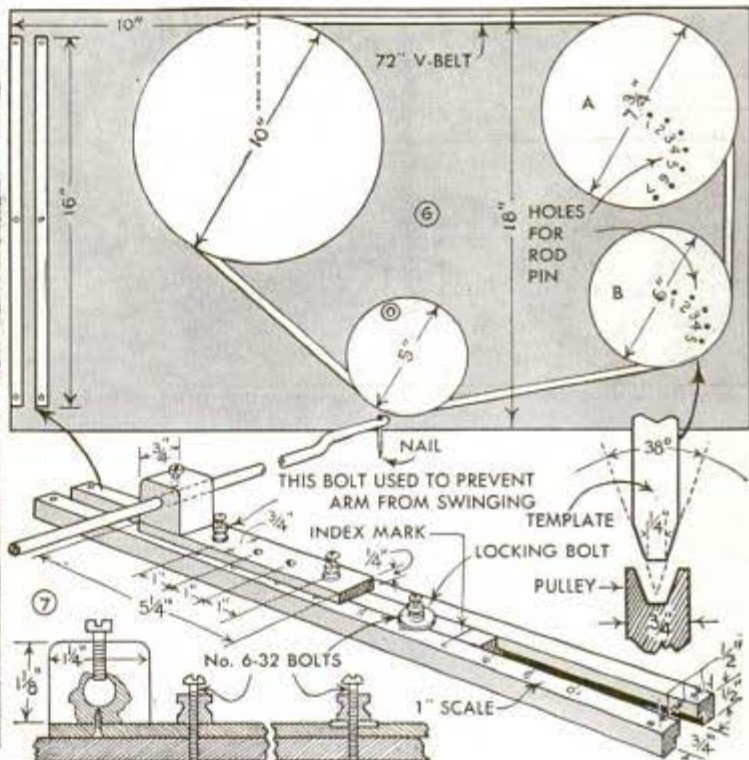
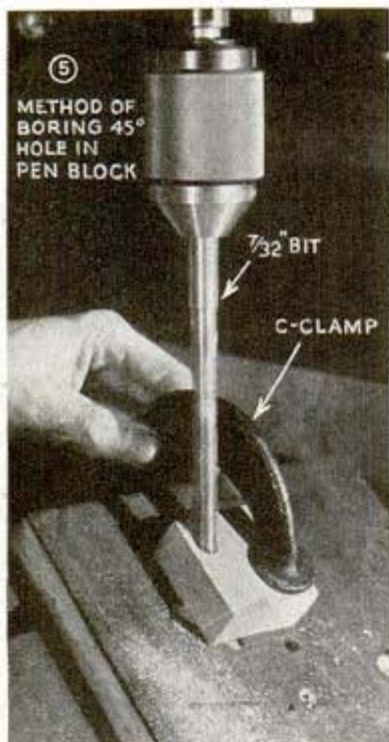

design drawn. The rocker arm is attached to a guide that moves between two strips to which it can be clamped by means of a locking screw. There is practically no limit to the number of adjustments that can be made at this end of the writing arm, which in conjunction with the holes in the guide wheels, provide still further possibilities.

Holder for Jar of Salmon Eggs Slips Over Trouser Belt

The problem of carrying a jar of salmon egg fish bait so that it is easy to get at is solved with this simple holder, which slips over your trouser belt. Take an ordinary clothespin and

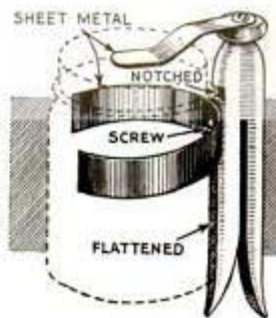

and screw a couple of strips of heavy sheet metal or spring steel to it as indicated, making the top one so that it pivots easily. Then cut a notch in the pin just above the circular metal strip to take the edge of the jar lid. When you want to remove some of the eggs, just swing the pivoted metal piece to one side and remove the jar lid.—Lamar Ferguson, Camas, Wash.

can be done by hand with a wood auger, or on a drillpress as shown in Fig. 5, the size hole being determined by the size of the fountain pen to be used. A thumb-screw can be provided to hold the pen tightly in place.

Details of the writing-arm pivot block, rocker arm, slide and guides are contained in Figs. 6, 7 and 8. Notice that the rod should be allowed to slide in the pivot block if the rocker arm is not arranged to swing as in Fig. 7. However, the rod may be held securely in the block if the rocker arm is pivoted as in Fig. 8. Either arrangement will make a difference in the

Novel Match Holders Turned on Your Lathe

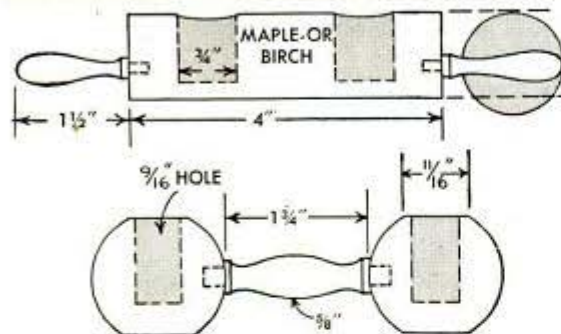

Here are a couple of clever little match holders that you can make in one evening. One represents a rolling pin and the other a miniature dumb-bell, each providing room for two rolls of matches. The rolling-pin holder is made by first turning the center section to $1\frac{1}{4}$ in. in dia., after which a flat is planed on one side to serve as the



bottom. Two holes are then bored in the top to provide match wells, the handles being made separately and glued in place. For the dumb-bell design, two $1\frac{5}{8}$ -in. dia. balls are turned and bored to accommodate the matches and handle. Striking surfaces from match books are glued on the side of each holder.

Child's Swing Has No Diagonal Braces Above Ground

Bolted securely across the two 4 by 4-in. vertical members of a child's swing, a 2-in. plank below the ground surface was found highly effective as a substitute for diagonal bracing, which was not desired both on account of the possibility of tripping over the braces and because of its appearance. Side pull exerted on the vertical members is distributed over the entire area of the plank, preventing the vertical members from working loose. All wood underground should be creosoted.

Reset Early Perennials in Fall

The fall is the time to divide and reset early spring perennials such as bleeding hearts, peonies, pyrethrums and Shasta daisies. Also, lilacs may be transplanted in the fall. Because they bloom during May, it is often advisable to plant them in the fall in preference to the early spring.



Pocket Scraper to Clean Metal Before Soldering It

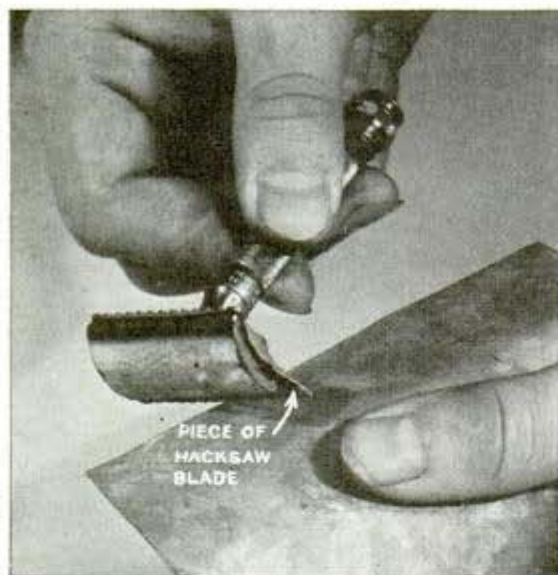

Instead of using your pocketknife or other small tool to clean metal for soldering, try this simple tool. It consists of an old safety-razor frame in which is clamped a piece of hack-saw blade so that the teeth project slightly beyond the edge of the comb of the razor.

Board on Ruler Protects Desk Top When Cutting Cardboard

Attach a piece of wood to one end of an ordinary ruler and you can use it as a straightedge for cutting cardboard without marring desk or table tops. The strip of

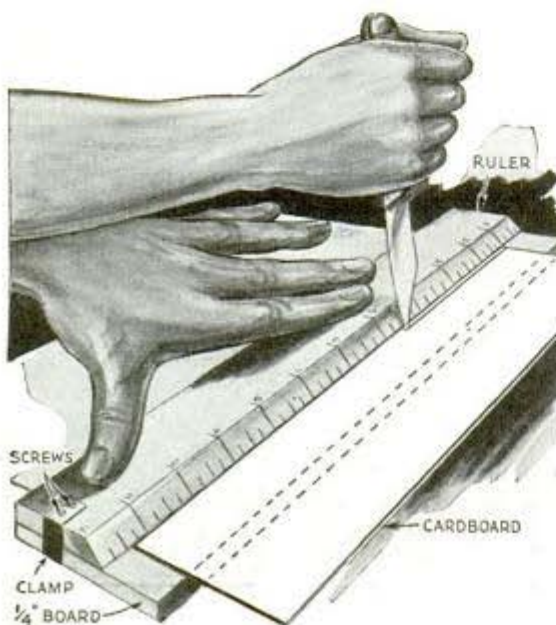

wood is held at one end by a metal clamp, bent and screwed to the ruler as shown, which leaves the other end free so it can be lifted up for insertion of the cardboard.

Cloth Rack for Guns Hangs On Back of Closet Door

Living in a small apartment where space was very limited, one housewife whose husband had several guns, saved space in the closet by making a cloth rack for the guns and hanging it on the back of the closet door. The rack was made by sewing two pieces of strong, heavy cloth together so that long pockets were formed.

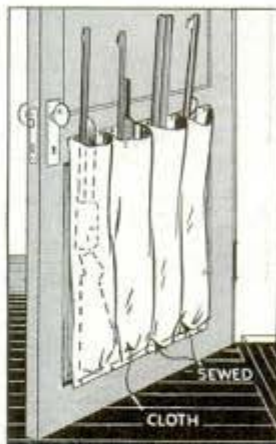

—Kathryn Shupe, Huntsville, Utah.

Sleeve That Slips Over Carton Makes Tacks Easy to Remove

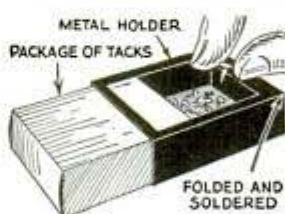

When you need only a few tacks, this metal sleeve that slips over the carton will enable you to select them and pour the remaining tacks back into the carton easily. It is made from thin sheet metal to a size that the tack carton will slip into easily, one side of the sleeve being cut out as indicated. In use, the sleeve is pulled part way off the carton, allowing the tacks to slide into it. When finished, tipping the carton upward causes the unused tacks to slide back into it.

WHAT HAVE YOU DONE?

Have you solved some troublesome everyday problem of a mechanical nature pertaining to your home, work or occupation, your hobby, play or recreation? If so, why not send us a short description accompanied by a sketch or a photograph? Many other readers may benefit from what you have done. We pay promptly for accepted material and return that which we cannot use. Address Homecraft Editor, Popular Mechanics Magazine, 200 E. Ontario Street, Chicago, Illinois.

SEWING AIDS

Designed for efficiency as well as decorative and amusing features, these sewing aids are made from simple materials. Empty spools assembled on a dowel and base in totem-pole fashion at the right, make a colorful ornament for a simple sewing outfit. Various faces and figures can be represented by a little carving and painting. The bird atop the pole has a clothespin beak, and scrollsawed wings are attached to a flat surface on the top spool. Five short dowels in the base hold thread spools, and half a round cork forms a pincushion. Concealed in the hollow pot of the pincushion plant below are small spools of darning cotton and a thimble. Needles "grow" like grass from a sheet-cork pincushion around the plant, and pins adorn the center of the cork flower. On the comedy side is a pincushion depicting a pathetic little figure that has backed into a cactus. Round and oval corks are cut in half and glued to the sides of both cutouts to give body to the cactus and figure. The flowers, made of leather, felt or oilcloth, are attached with colored thumb tacks

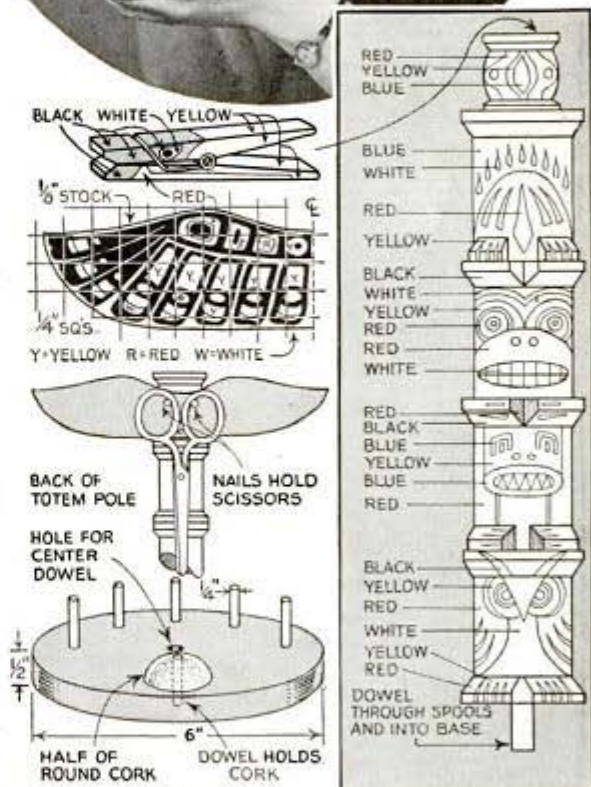
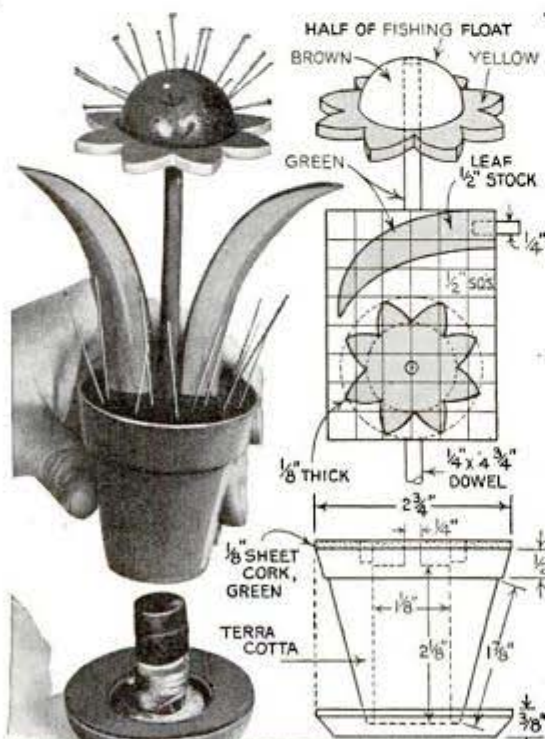

String Pull on Extension Cord Helps Prevent Short Circuit

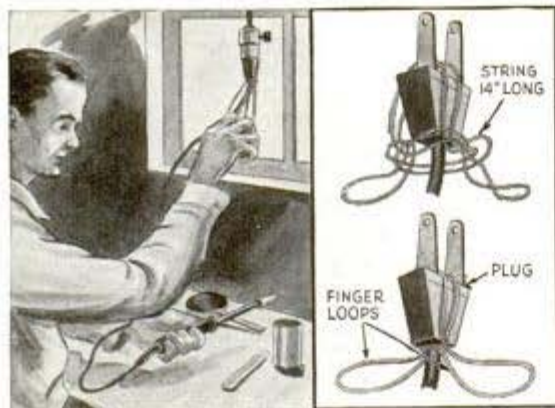

When using tools and appliances that are provided with extension cords that are to be plugged into outlets, try the pull shown for removing the plug. In this way there is no strain put on the cord where it enters the plug with the result that there is no possibility of breaking the insulation so that a short circuit may develop.

—Donald Richard, Manchester, N. H.

Cellulose Tape Increases Life Of Magazine Covers



tape also can be applied lengthwise along the bound edge to provide additional protection without hiding the printing.

If you keep a permanent file of magazines for future reference, the covers will remain intact much longer if strips of cellulose tape are applied on the corners as shown. Being transparent, a strip of such

Flat Container for Rubber Cement Holds Large Amount

An ideal container for rubber cement can be made by soldering two tin pie plates together as shown. Then cut a hole in the top plate, remove the spout

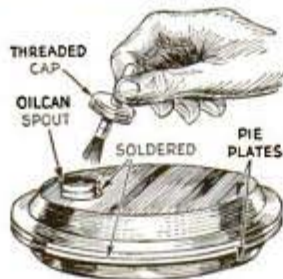

from a 5-qt. oilcan and solder this over the hole. A small brush is next fitted in the oilcan cap so that it can be screwed on the spout to close the container tightly when not in use to reduce evaporation.

Scrap Piece of Rug Used as Pad On Top of Sawhorse

Instead of searching for something to pad his sawhorses each time he works on varnished furniture or boards of fine finish, one carpenter tacked weighted pieces

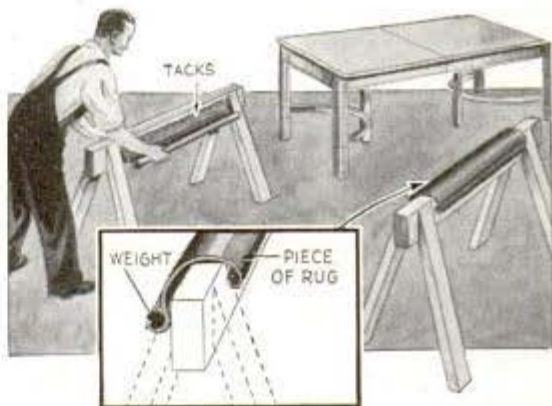

of an old rug on the horses as shown. These pads are not in the way when the horses are used for ordinary work, and may be swung up over them in a jiffy when needed.

Cotter-Pin Can Has Metal Tray To Select Contents Quickly

You won't have to pour cotter pins out on a flat surface to select the ones desired if the can is fitted with a tray of the type shown. It can be made easily by bending a piece of sheet metal to the contour of the can



and then soldering this onto the lid. In use, the lid is opened, which automatically draws the tray into position so the pins can be selected quickly. When finished, it takes only a second to pour the pins back into the can and close the lid.

☛ To preserve fine pieces of mahogany furniture, keep them away from open windows and sources of artificial heat.

MAKE THEM LAST LONGER!

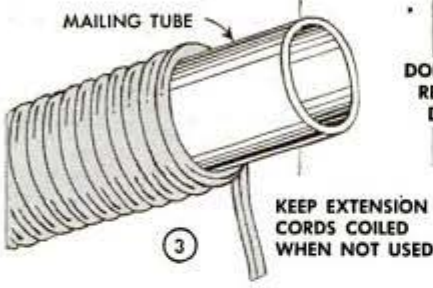
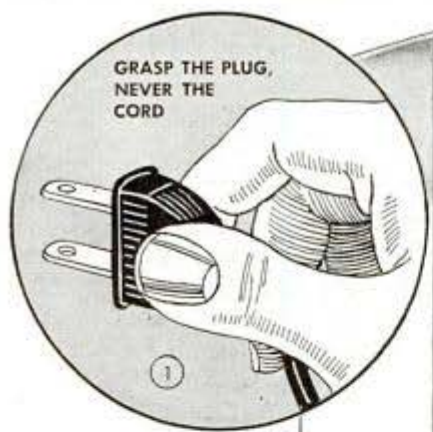

IT'S more important now than ever before to make equipment used around your home last as long as possible. Regular attention to simple precautions often will double the useful life of accessories and appliances. For example, cut in half the number of times you open the refrigerator by removing all the things you need at one time and you'll be surprised at the saving of both wear and operating expense of the vital mechanism. Leaving the door standing open as in Fig. 2, and infrequent defrosting are costly habits. Don't neglect the rubber door gasket. A weekly washing and dusting with talcum, to prevent sticking, will go a long way to make it last.

Never allow an electric extension cord to lie about doubled in a series of short bends which are the cause of breaks in the rubber covering. If you store the cord, wrap it loosely around a large mailing tube, as in Fig. 3, and place it in a drawer or dark closet. When you remove a cord from a wall receptacle, grasp the plug as in Fig. 1.

Paint the inside surfaces of eave gutters, Fig. 4, with ordinary house paint over a metal primer, or an asphalt roof coating. A galvanized wire clothesline will stay bright years longer if you wipe it with an oily rag after using, Fig. 5. The oil is wiped off

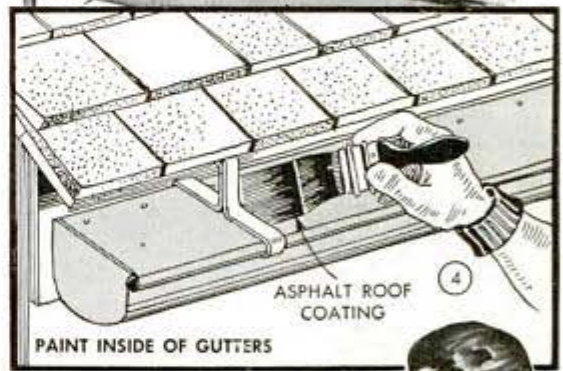



BE CAREFUL WHEN RESEATING FAUCETS



STORE PAINT "LEFTOVERS" IN FRUIT JARS

easily when you're ready to use the line. After the firing season has passed, take down the smokepipe of your heating plant and give it a thorough cleaning. Use a wire flue brush to loosen the soot and scale as in Fig. 6. Then store the pipe in a dry place. Be extra careful when you reseal compression faucets, Fig. 8. The bibb seat may have become worn from long use or cut thin from previous reseatings. Salvage all used nails and screws which are still serviceable, put them in a can or fruit jar and pour oil over them, Fig. 12.

A dust bag half full of dirt makes your vacuum cleaner far less efficient. The bag should be kept clean, Fig. 9, and the motor bearings should be lubricated at regular intervals. Be sure to release the pressure on the rolls of a washing-machine wringer, even if it stands idle for only a short time, Fig. 10. There is always the danger that the rubber rolls will stick together.

Garden sprayers and other appliances having a direct-attached hose or cord often are fitted with a spring to protect the cord or hose from sharp bends at the point where it is attached. If the spring is broken or missing renew it, Fig. 11. Leftover paint, Fig. 7, can be kept for a long time if you seal it in small glass fruit jars.

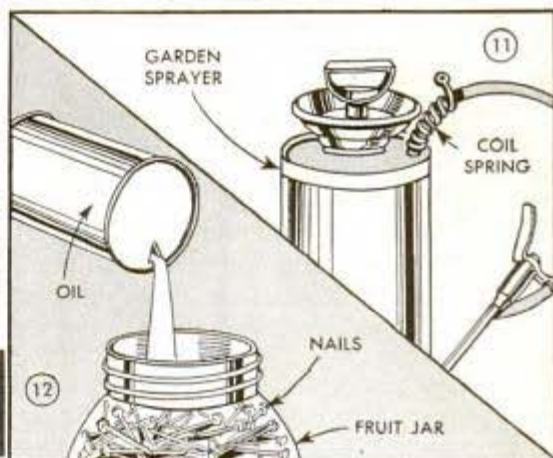

Pair of Sconce Lamps at Vanity Give Soft Glow

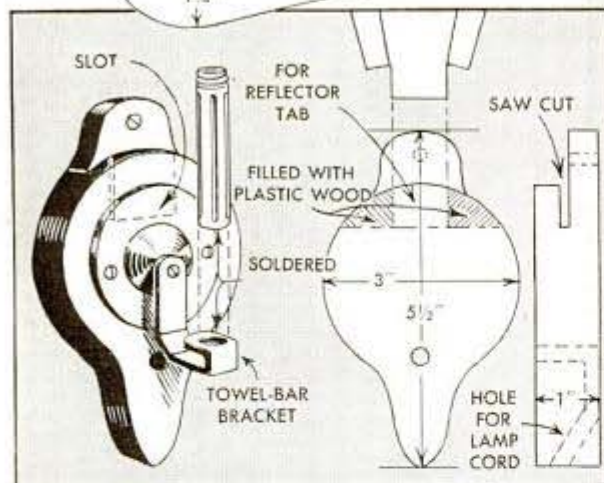
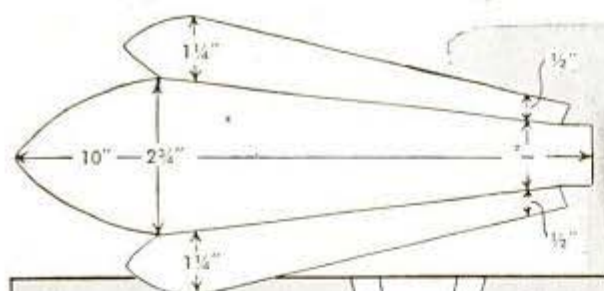

Incorporating parts of an ordinary chrome or nickered towel bar simplifies making a pair of these attractive wall lamps. Reflectors of highly polished metal are cut to the pattern shown and shaped concave by bending over a round object of suitable diameter. Short lengths of towel bar or pipe nipples will do to support the sockets which are fitted with candle-type bulbs. The base blocks may be varnished or enameled

Handwheels to Adjust Tool Rest and Tailstock on Lathe

Substituted for the nuts that tighten or loosen the clamping blocks that lock the tailstocks and tool rests of some types of woodturning lathes, a couple of handwheels will be timesavers when adjusting these parts. If possible, use wheels large enough to project beyond the lathe bed for ease of operation. And if desired, the wheel

rims can be filed or ground to make good gripping surfaces. On lathes having the nuts on top of the tool rest and tailstock, the bolts can be turned with the threaded ends down. Braze the lathe nuts over the holes in the handwheels, enlarging the holes if necessary.

—R. W. Arbogast, Glacier Park, Mont.



Hanging a Punching Bag

Here is a method of hanging a punching bag which should interest the physical culturist whose daily practice shakes and rumbles the house. First make a frame 4 ft. square of 2 by 4-in. stock, and cover it with tongued and grooved hardwood flooring laid closely and toenailed. In the center of this flooring, on the side opposite the frame, the regular punching bag swivel is fastened. Then a staple is driven into each corner of the frame and the platform suspended from the ceiling by four pieces of rope passed through the staples.

Torch for Starting Brush Fires Made From Length of Pipe



Igniting piles of brush or starting fires to burn off prairies is a simple matter with this torch. To make it, a length of $\frac{3}{4}$ -in. pipe is plugged at one end with a cork and is packed at the other end with wicking material, the latter extending down into the pipe for a distance of 3 or 4 in. In use, the cork is removed from the pipe which is then filled with kerosene and the cork replaced. The kerosene works up through the wicking, which can be ignited.

Extra Drawer Holds Small Tools At End of Bench Drawer

Instead of storing small tools and other items in a large workbench drawer where they often are difficult to locate, why not keep them in a small drawer which slides in the large one? All you need to do is cut an opening in the drawer front near one

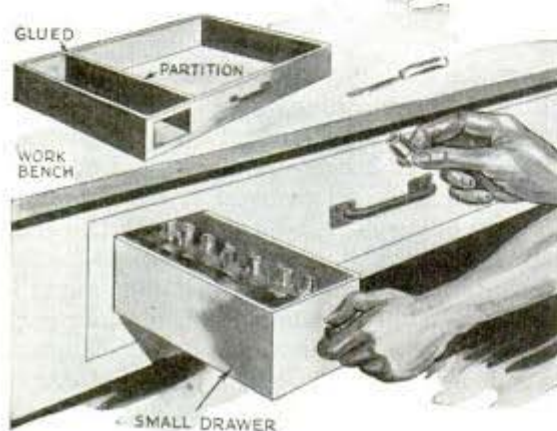

end and install a partition. Then a small drawer is made to fit, which provides a place for small items where they can be reached without opening the large drawer.

Oil Drum With Burlap Over End Keeps Spring Water Clean

If you dislike to use water from a spring because of insects that frequent such places, cut the top and bottom from an oil drum, wire a double thickness of burlap over one end and lower this into the spring.



The burlap permits clean water to filter in while a cover fitted over the drum top keeps out dust and leaves.

Magnets Serve as Glue Clamps For Small Model Parts



The next time you have a number of small model parts to glue together, try a couple of small, strong magnets of the type shown as clamps. These magnets have an exceptionally strong attraction

for each other, and will hold the parts firmly together until the glue sets.

An Easy Method to Hold Screws In Their Proper Places

When dismantling any object where the screws must be returned to their original holes, a good way to prevent mixing them is to slip them through the unthreaded hole of the part removed and turn on a paper clip to keep them in place. Spread the clip just enough so that it can be turned onto the threads of the screw.

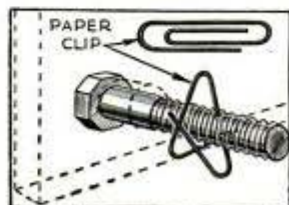

New Jobs for INSULATION BATS



NORMALLY, an uncovered hot-water tank radiates considerable heat, requiring more fuel to maintain the required amount of hot water than would be necessary if the tank were completely covered with an insulating jacket. If such a jacket is not available, you can substitute ordinary insulation bats, wrapping them around the tank and holding them in place by means of 1-in. cloth tape, or other banding. In one case where the water was heated by a coil in the furnace and additional gas heat was required to provide sufficient hot water, wrapping the tank in the manner described made auxiliary gas heating unnecessary and saved about 70 cents per month.

In basements where the temperature is higher than desired during the winter months, much of the heat radiated from the top of a furnace or boiler can be retained and a saving of fuel effected by covering the heating plant with insulation bats as shown. When doing this, care must be taken to avoid installing any inflammable material in contact with, or too close to the smoke pipe.

If your basement is too cool for comfort during winter, and you do not have storm sash on the basement windows, a few insulating bats will help to keep it warmer, if you care to cover the windows. In one case where all windows of a basement were so covered, the temperature was raised 6 degrees above that possible with uncovered windows. When working with insulation bats, keep in mind that they should not be compressed, as this reduces their effectiveness, but be sure to keep them in the fluffy state as they are when purchased.



Hot-water tanks



Casement windows



Heating plants

Surface of an Ink Pad Kept Moist By Tacking Cover to Board



The surface of an ink pad will always be moist so that a rubber stamp can be inked quickly and evenly if the pad is kept in an inverted position when not in use. To be sure that his helpers would follow this practice, one shipping clerk tacked the cover of his ink pad securely to a small board. In this way, the pad is always upside-down when the box is closed.

Emergency Level Easy to Make

If you are in need of a level and none is available, you can improvise one that can be made any size desired. With three wood strips, or even poles if a large level is needed, form a triangle.

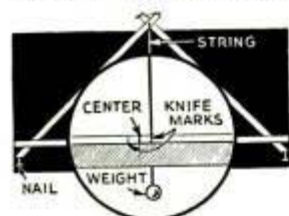

ed, form a triangle. The angles do not have to be exactly the same; rigidity is the main thing. Drive a nail into the lower end of each leg of the triangle, letting the heads project about 1 in. Then attach a plumb bob from the top of the triangle. Now set the legs on two solid objects and mark the position where the plumb bob crosses the horizontal bar of the triangle. Next, reverse the positions of the legs, being sure that the nail heads rest in the same locations as before, and again mark the position of the plumb bob on the horizontal bar. You will now have two marks on the bar. Measure one half the distance between the two and mark as before. When the low leg is raised

so the plumb bob cuts this center mark, the nail heads are resting on the same level plane.

—W. K. Dodge, Sr., Fort Bragg, Calif.

Repairing Fountain-Pen Threads

When the threads on your fountain pen have become so worn that the cap will not stay in place, try this simple repair. Apply a thin coat of shellac to the threads inside the cap, and after 10 min. or so, press a cigarette paper firmly against the tacky surface. After trimming off the surplus paper, screw the cap onto the pen and then remove it. Exam-



ine the paper to see if it has been pressed into close contact with the threads. If not, screw the cap onto the pen again. When the paper makes good contact with the threads, lay the cap aside until the shellac has dried thoroughly.

Small Holes in Composition Roof Patched With Calking Gun

In patching small holes in a composition roof, I found that a very good job can be done by applying the regular plastic for this purpose with a calking gun. The nozzle of the gun is inserted through the hole in the roofing and the plastic is applied between the roofing and the sheathing. Then the roofing is pressed down firmly, after which a little of the plastic is applied over the hole. You will find this method much better than merely applying the plastic to the exposed surface of the roof.

—A. W. Osborne, Tulsa, Okla.

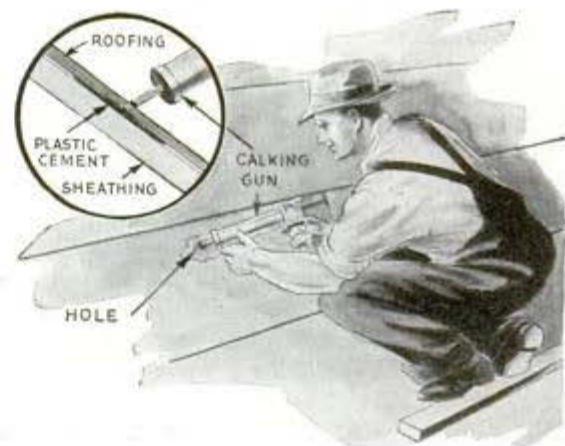

Spot Reflector for Small Photo-Flash Bulbs

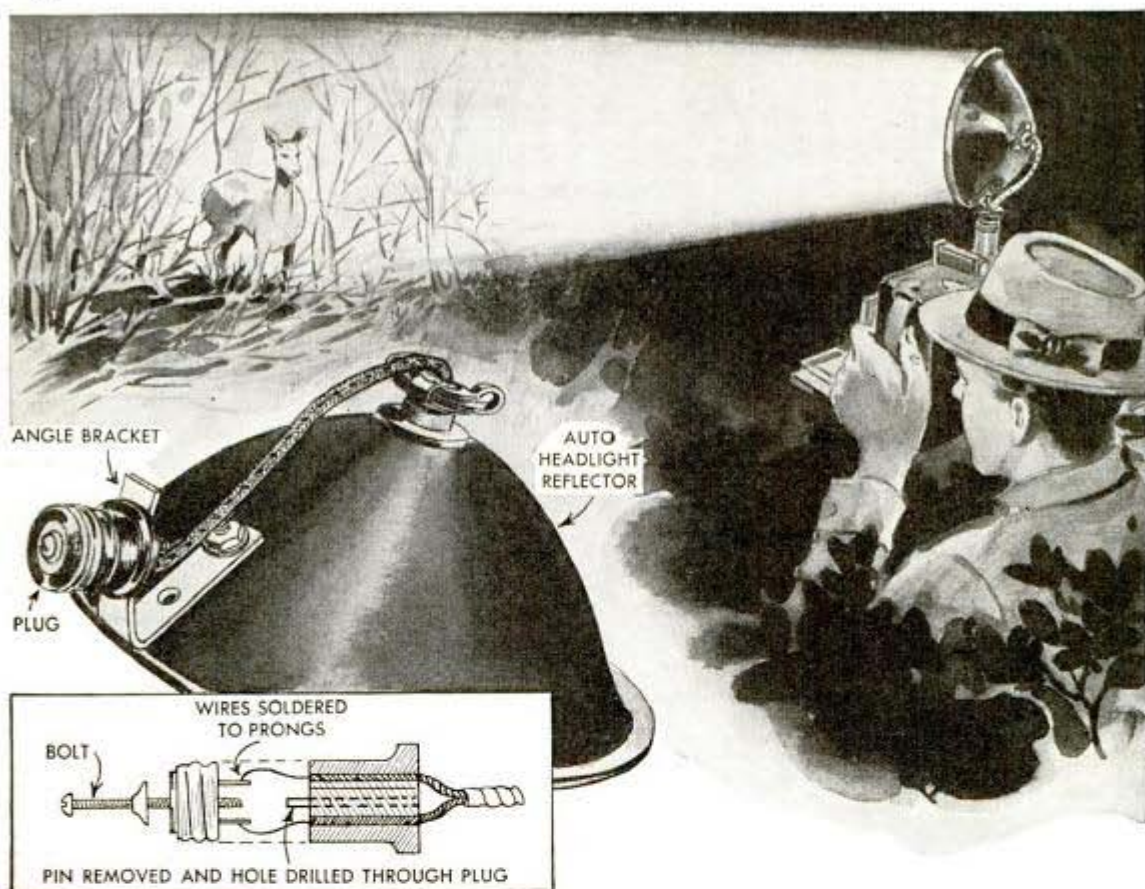

Flashlight photographs can be taken of subjects 50 to 200 ft. from the camera with this "spot reflector." Stage scenes can be "shot" from the rear of a theater; birds and animals can be caught in their natural surroundings without approaching close enough to frighten them and athletic events can be photographed from a spectator's seat. Costing less than a dollar, the reflector consists of an auto headlight reflector, an angle bracket and an electric plug. The plug is altered as shown for the attachment of wires and so that it can be fastened to the bracket with a bolt, the latter being substituted for the center contact. The assembly is screwed into the bulb socket of the regular flash equipment and operated in the usual way, except at much greater distance. Light from a midget flashbulb is concentrated in a comparatively narrow beam, just as is thrown from a car's headlight. This makes it necessary to aim the beam carefully at the subject being photographed. The approximate size and shape of the beam can be determined by inserting a regular car bulb in

the reflector and attaching it to a storage battery. The reflector should be given a coat of clear lacquer to protect the silvering. The midget flashbulb used has a single-contact bayonet base and the reflector must be one with a socket to accommodate this.—E. F. Whiteside, Wilmette, Ill.

Handy Case for Small Camera

A smart-looking and inexpensive case for a miniature camera can be made from a leather pouch designed to hold a small manicure set. These cases usually are fitted with a slide fastener around three sides, making it easy to remove the camera. By cutting two slots in the back and adding a belt, the case can be carried conveniently over the shoulder.



Fully-adjustable

New mono-rail type having front and rear focusing with rise, fall, tilt, swing and shift adjustments. Only parts to buy are lens, shutter, bellows plus used pinions and rack

By E. M. Love

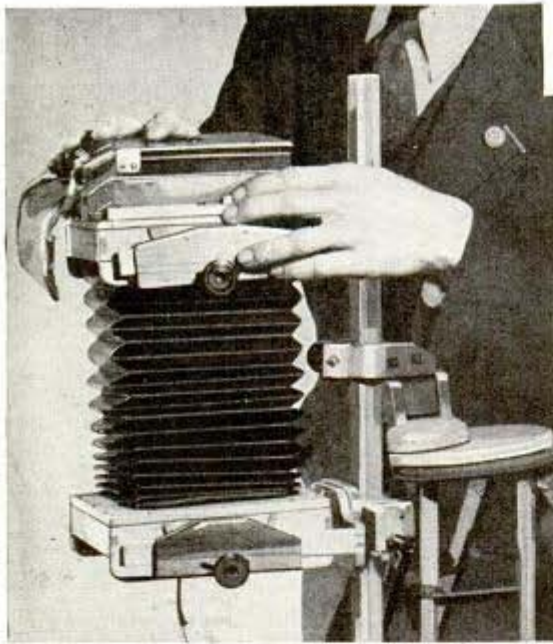

① SET VERTICALLY FOR FLOOR SHOTS

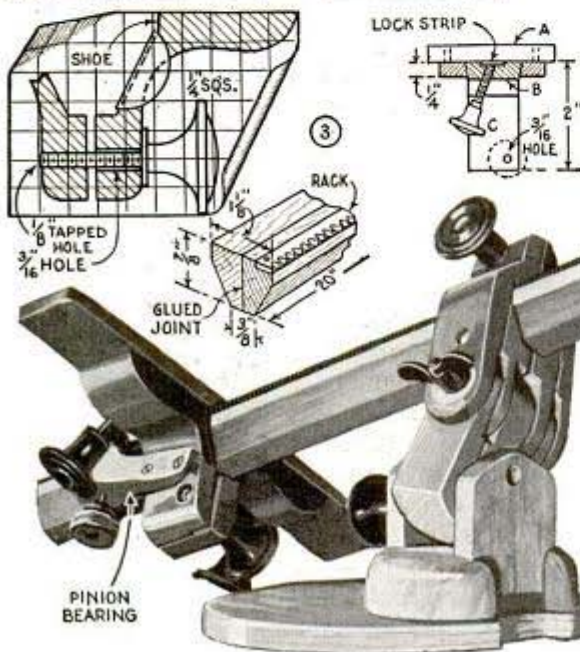
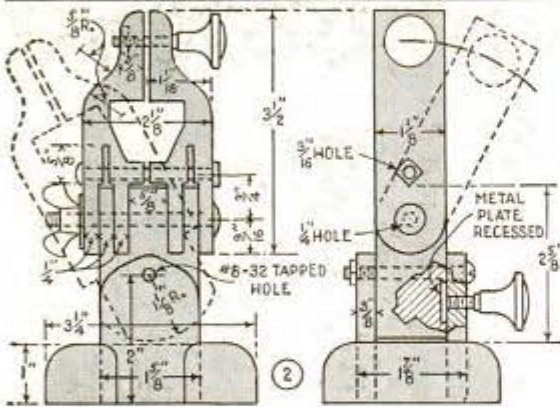

IF IT'S a view camera you want, here's an excellent one, embodying features of expensive commercial models. The cost will not be excessive if you already have a suitable lens on hand, especially one of a Graflex or a Speed Graphic camera. A further saving can be had by making the bellows yourself.

Maple is the best wood to use, although any hardwood will do. Fig. 2 details the two-part swivel head that carries the rack-fitted rail. Matching slots in the upper and lower parts interlap to permit rigid locking in one direction, while a metal bearing plate recessed flush in the side of the lower part as indicated, allows a drawer-knob thumbwheel to be tightened to lock it in the opposite direction. Note the saw kerfs in the upper slots to give a spring action to the joint. An auxiliary base fitted to the swivel head as shown in the photo above Fig. 4, may be added for attaching the unit

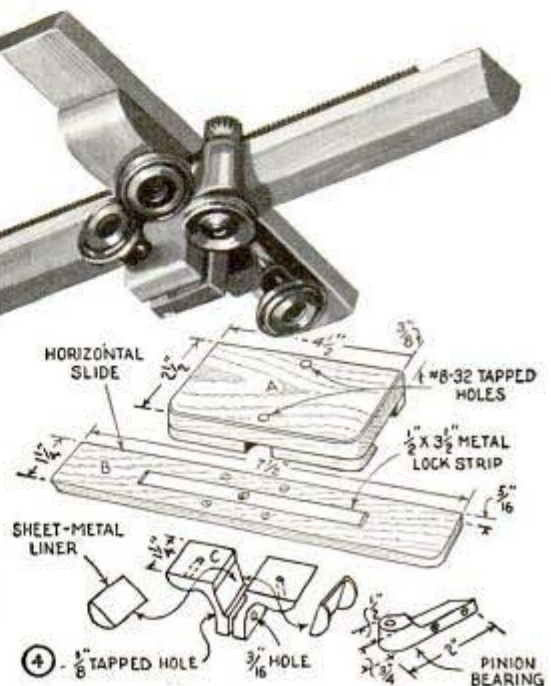

4-by-5 VIEW CAMERA.....

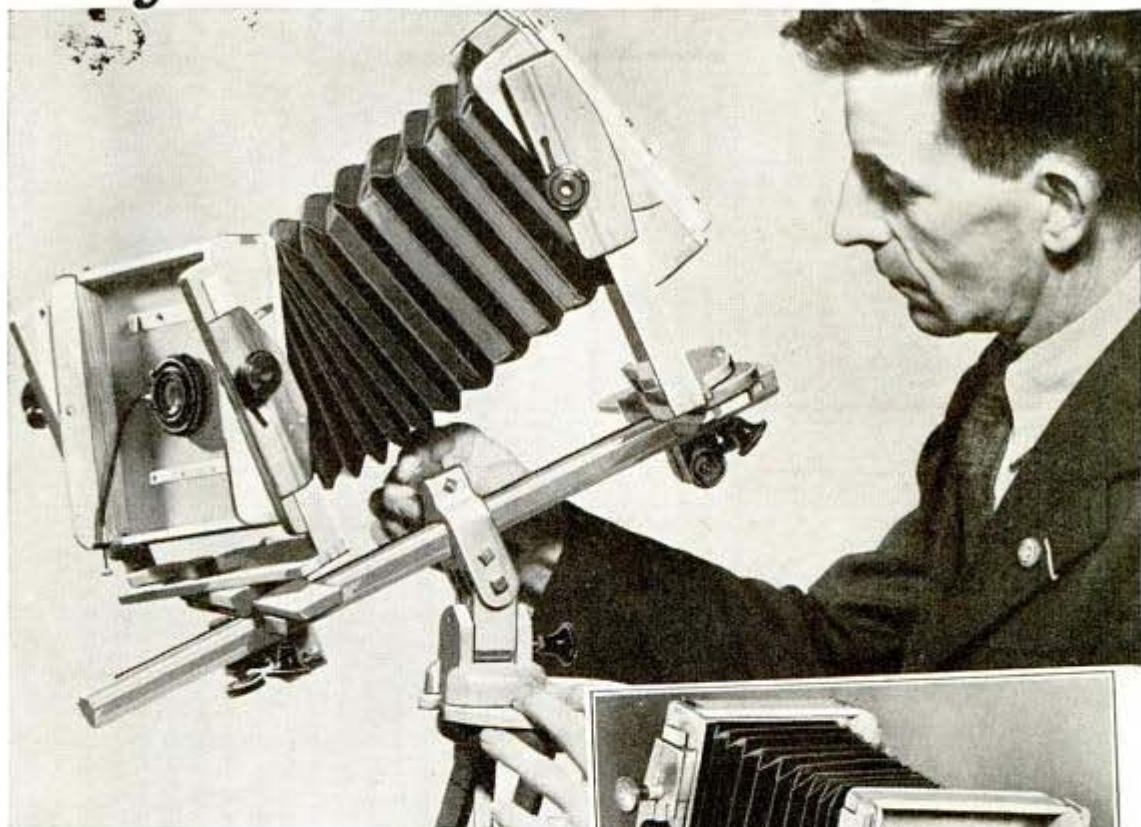

to the tripod screw with a wingnut, or the swivel head itself can be tapped to receive the tripod screw direct. The detail below Fig. 3 shows how warping of the rail is checked by gluing two pieces back to back, so that the grain runs opposite. A rabbet along one edge is made to receive the focusing rack flush. The front and rear jaws that clamp the lens and the film units to the rail, are laid out according to the squared drawing in Fig. 3. Sufficient clearance should be allowed to accommodate the little metal liners that bear against the sides of the rail when pressure is applied. You will notice in the detail to the right of Fig. 3 that the thumbwheels, controlling side shift, enter the shoes at an angle. Note also that the shafts of these handwheels make contact with a metal lock strip set flush in the horizontal slide pieces, B, to which the shoes are fastened. Part B provides a dovetail track on which part A slides. The pinion bearing blocks detailed in Fig. 4, fasten to the sides of the shoes with small screws and glue at such an angle to permit the pinions to engage the racks. Setscrews or small cotter pins may be used to attach the pinions to their shafts.

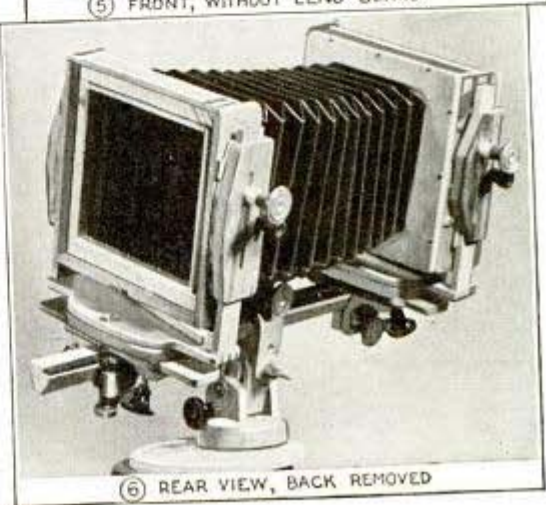
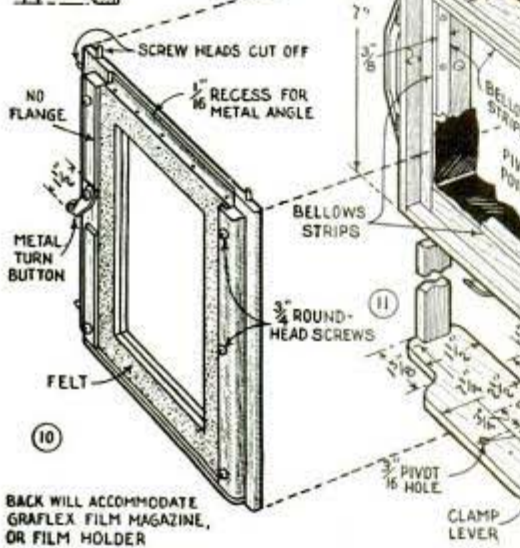
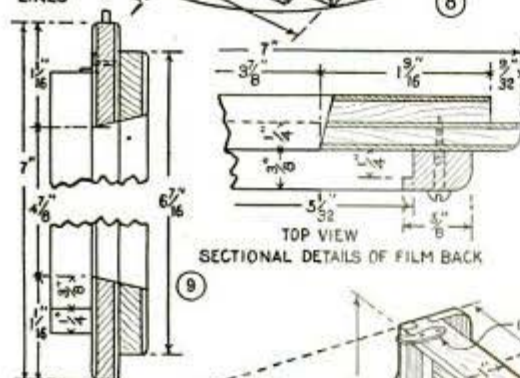
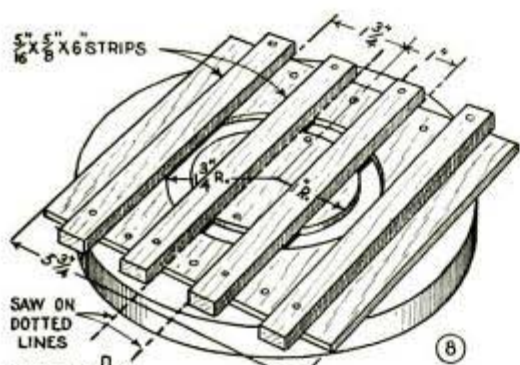
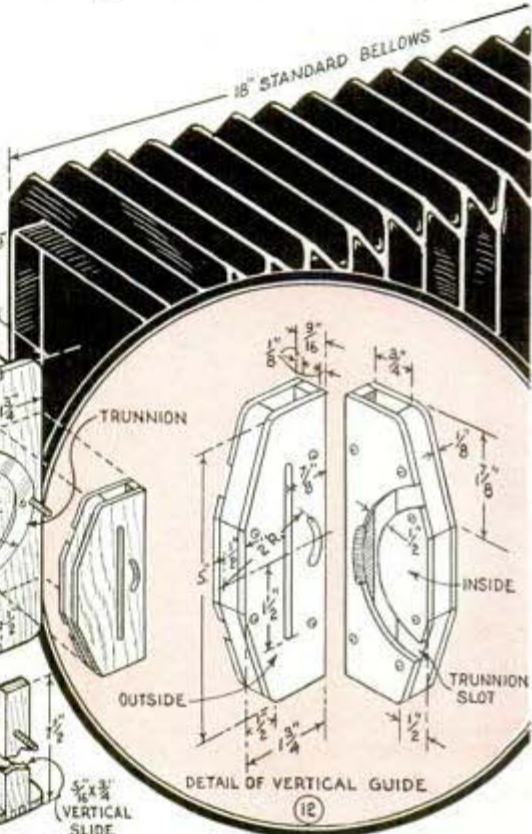



Fig. 11 details the construction of the boxes and vertical slides that pivot to part A. Both boxes, front and rear, are practically duplicates, except for the manner of attaching the bellows. Typical box-joint construction is used at the corners, allowing the tenons to extend for trimming flush after gluing. Trunnions, which engage the rise-and-fall guides detailed in Fig. 12, permit smooth tilt movement to the boxes. To make the trunnions and guides, a piece of plywood is tacked temporarily to a wood faceplate and the center is turned as in Fig. 7, to equal the radius given in Fig. 8. Then a $\frac{1}{2}$ -in. trunnion ring is turned to fit nicely inside the plywood recess and finally, a center disk is cut to fit within the ring. This disk is tacked to the wood faceplate, using the ring as a guide to get it in the exact center, and seeing that the nails are placed so as not to interfere in sawing later. Now the ring is removed and strips are applied as shown, gluing the two center ones equidistantly from a center line. The two outer strips are located to move freely on the vertical slides, a piece of paper being inserted for clearance. A pair of right and left guides are produced by sawing the assembly apart along the dotted lines, applying outer covers and trimming to the shape and size shown in Fig. 12. To



BACK WILL ACCOMMODATE GRAFLEX FILM MAGAZINE, OR FILM HOLDER



route the $\frac{3}{16}$ -in. curved slot in each guide, the method shown in Figs. 13 and 14 is used, while the rise-and-fall slot is cut similarly along a fence. The bolts engaging the latter slots are headless, threaded into underside holes and cemented with liquid solder. A twist drill may be used to cut the slot, if you do not have a router bit, by drilling a series of holes and passing the work slowly back and forth to clear the waste. A scrap board to which one half of a trunnion ring is fastened, serves as a guide to assure the curved slot equalling the trunnion arc.

Figs. 15 and 16 show front and rear views of the lens-board back, which is rabbeted and screwed to its box before attaching the bellows. The rabbeted opening in the face side is dimensioned to take a Graflex lens board, but the size may be altered to accommodate another lens. Needless to say, the bellows must be lightproof where it joins the boxes. A light bulb placed inside the assembly in a darkroom is a good way to test for leakage. Details of the film back

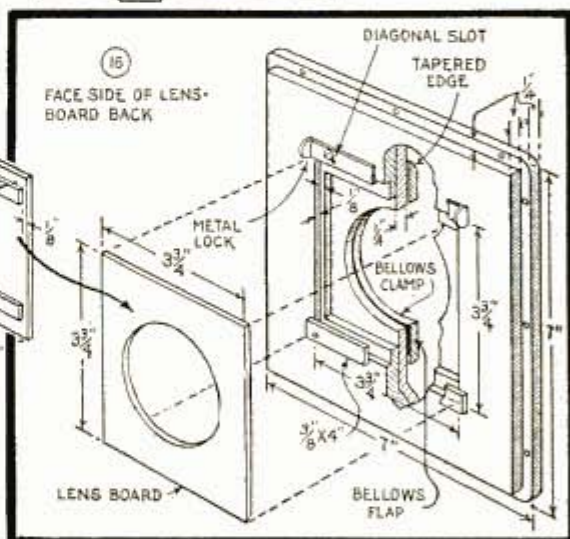
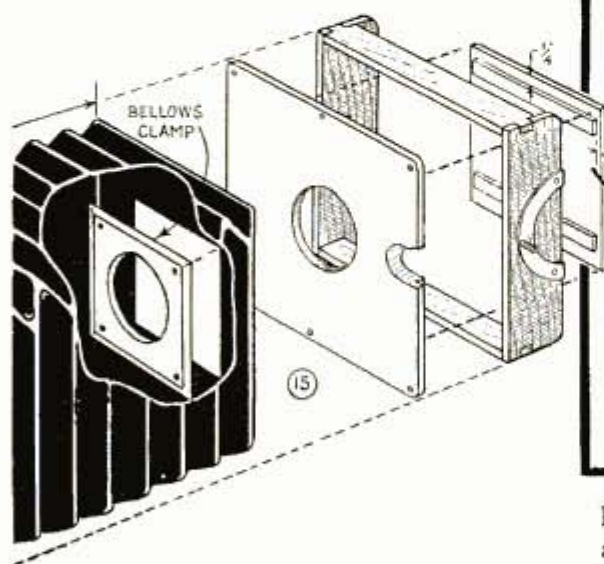
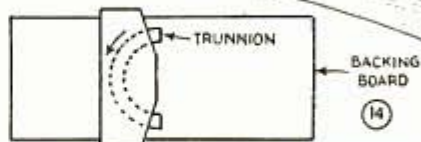
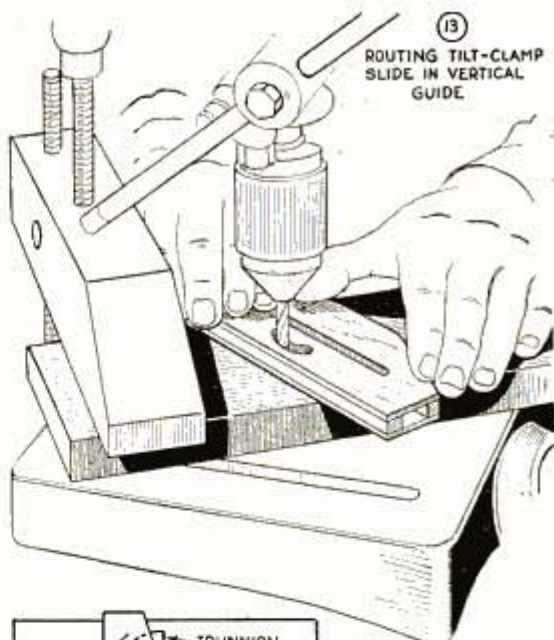

are given in Figs. 9 and 10. This is made especially for a Graflex film magazine, but a similar arrangement will take film holders. Spring clips provided at the top and bottom edges hold the back in place. Plastic drawer knobs make neat thumbwheels. Where these are required to have a fixed shaft, headless bolts can be soldered to the threaded bushing in the knob. Studying photos 1, 5 and 6 will help clarify points of construction which may not be readily apparent from the drawings. In assembling the parts, the front and rear vertical and

horizontal slides, when clamped, should be at right angles to the rail. Marks are scored on the fronts of the boxes and vertical guides to indicate zero points. Similar marks are located on the side wings.

Plastic-resin glue makes an excellent waterproof, non-scratching finish for the camera. The wood is dampened first to raise the grain, sanded off, and a coat of creamy glue is applied. This is allowed to dry until it becomes tacky, and then a second coat is applied. When dry, it is scraped, sanded and rubbed to a velvety finish with water and split 6-0 garnet paper. Do not let the first coat dry before applying the second, as flaking will result later.

Extra Weights for Photo Scales Made From Film Containers



Some small metal containers in which 35-mm. film is packed, a few washers and a candle, are all you need to make extra weights for your darkroom scales. In making the smaller weights, place the lid of a film container on one side of the scales and

the weight to be duplicated on the other side and drop wax from the burning candle into the container lid until it balances the known weight. For heavier weights, use the containers themselves, placing washers in them until they nearly balance and using wax to complete the balance.

—Willard Brown, Monroe, Wis.

Name-Clip Identifies Photograph Placed Face-Down on Tin

These name-clips enable a commercial photographer to pick out certain prints for quick drying from a large number that have been placed face-down on ferrotype tins. Each clip has a short piece of a curtain rod soldered to one side, in which can be slipped a card bearing a name or number.

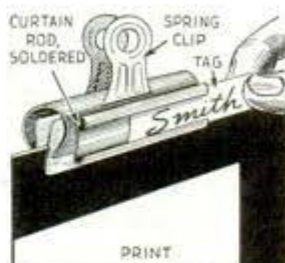

Dutch Windmill, Lawn Furniture, Trellises

BUILD-IT-YOURSELF PLANS



Dutch Windmill Plan—1059

Two Cedar Chests—795, 25c
 Gun Cabinet—991, 25c
 Queen Anne Coffee Table—526, 25c
 Dutch-Style Breakfast Set—822, 25c
 Priscilla Sewing Cabinet—617, 25c
 Corner Book Shelves—1029, 25c

Dutch Windmill—1059 (illustrated at left) 25c
 Lawn Chair—1058, 25c
 Jigsawed Ornaments—1051, 25c
 Porch Chair and Table—1028, 25c
 Two Barrow Chairs—924, 25c
 Lawn and Garden Furniture—920 to 922, collection of seats, swings, arbor-and-seat combinations, 75c
 Artistic Dog Houses—826, 25c
 Dutch Windmill Tool House—890, 25c
 Bird Houses—884 to 886, 20 designs, 75c
 Five Wren Houses—1065, 25c
 Trellis Suggestions—639, 25c
 Lawn Arbor and Trellis—715, 25c
 Sunbonnet Girl Cutout—35c
 Keep Off Grass Policeman—35c
 Humped Cat Cutout—30c
 Tulip Girl—35c
 Dutch School Boy—35c
 Ornamental Wood Fences—798, 99, 50c
 Circular Arbor and Gate—637, 25c
 Flower Boxes—1061, 25c
 Sand Box and Wading Pool—708, 25c
 Outdoor Fireplaces—917, 25c
 Log Cabin Construction—916, 25c
 12-Ft. Utility Rowboat—707, 25c

Order plans by number and title. Send 3 cent stamp for catalog describing complete list of 364 easy-to-follow plans

Popular Mechanics Plan Service, Dept. 417, 200 East Ontario Street, Chicago, Ill.



SHOP NOTES

COLOR WHEEL *takes guesswork out of* PAINT MIXING

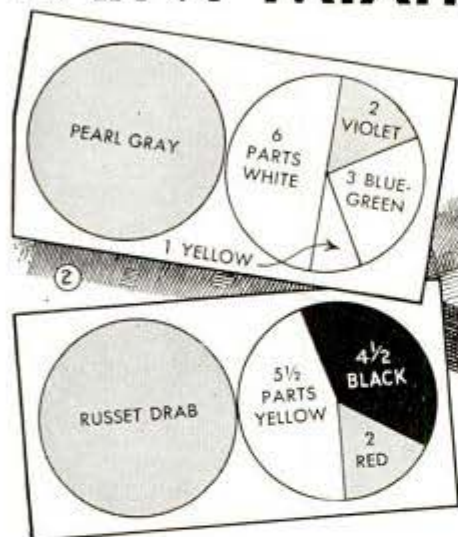

EACH DIVISION MARKED OFF IN 4 PARTS ON FACE OR EDGE

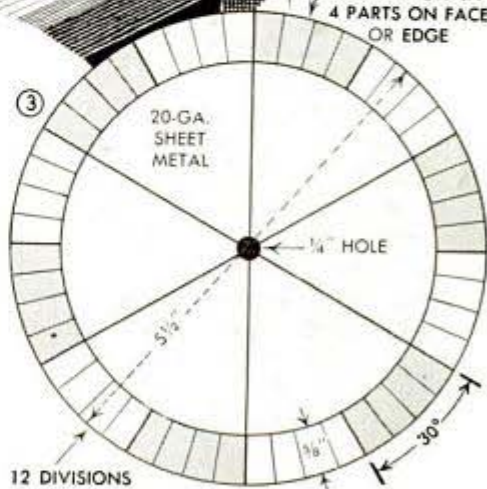

NEEDLESS experimenting and considerable waste of time and paint can be eliminated in solving your paint-mixing problems by letting a color wheel assist you in determining the correct amounts of various colors that are required to produce any desired shade of color. Besides this shop use, such a color wheel can be of help in art classes, interior decorating work and in automobile touchup jobs.

The fundamental idea of the color wheel is to rotate concentrically mounted disks of various colors, arranged to overlap each other so that a certain proportion of the color of each disk shows. The color produced by rotating will be the same as that produced by mixing together paints matching the disks in exactly the same proportions as the areas that are exposed. Rotation can be accomplished by a hand, or motor-driven shaft such as a little fan motor as in Fig. 1. It is provided with a threaded shaft extension as detailed in Fig. 5, and a wood or metal disk to give rigidity to the paper disks. All the disks have a 1/4-in. hole at the exact center, and the

paper ones have a slit cut radially from the center to the edge as in Fig. 4, which permits them to overlap each other. A thumbnut is provided so that the disks can be tightened together securely in whatever position they are arranged, in order to prevent them from shifting while being rotated. The backing disk, shown in Fig. 3, is divided into six

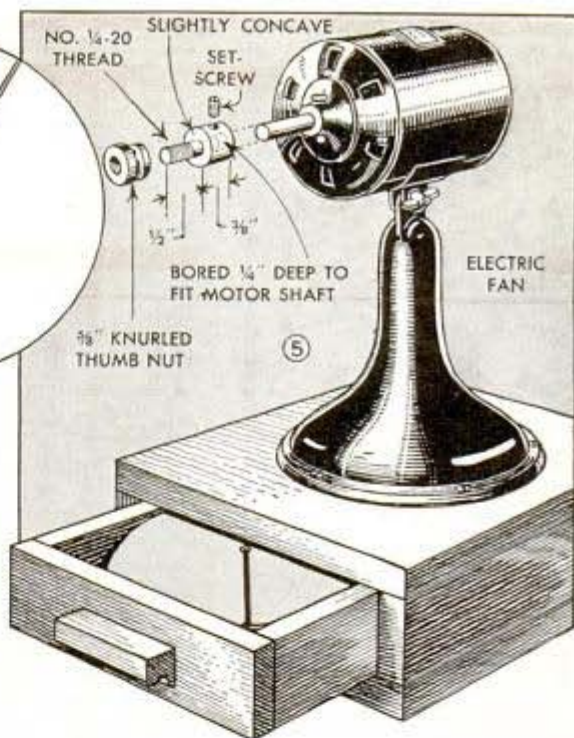
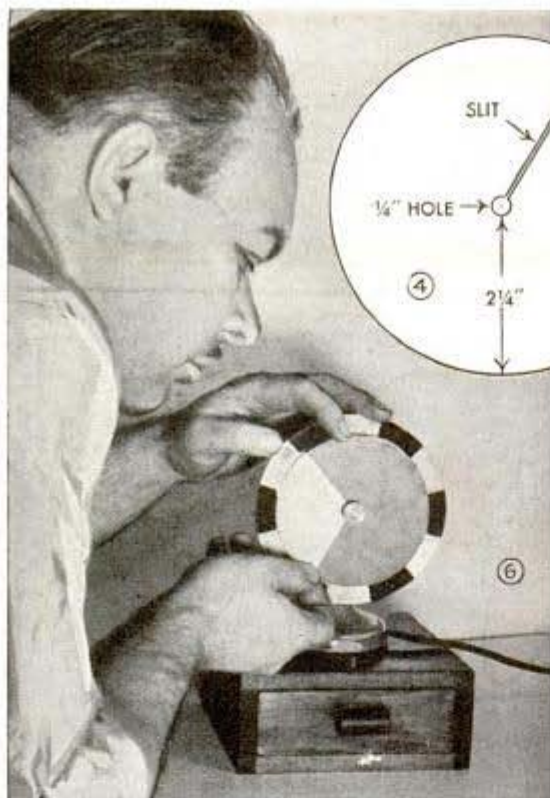

divisions, each of which is divided at the edge into eight equal parts, four being painted white and the other four black, producing twelve equal divisions that are alternately white and black. These divisions serve to measure the amount of each disk showing.

Inasmuch as the primary colors, blue, red and yellow, in addition to white and black, are contained in various proportions in all others, any shade can be matched if you have five white paper disks, one unpainted, another black, and the remaining three painted with the three primary colors that you are to use in painting. However, this

method of blending need not be restricted to the use of primary colors only, but works equally well with any colors with which you are working. In matching, you arrange the disks as in Fig. 6, and rotate them until a satisfactory result is obtained. You can keep a handy record by using cards similar to those shown in Fig. 2, daubing the resulting paint on one circle and dividing the other circle into as many parts as colors used, together with data regarding the amount or proportion of each color. For convenience, the fan may be mounted on a small box fitted with a drawer for storing a number of disks.

Steel Post Provides Safe Handle to Carry Barbed Wire

Carrying a spool of barbed wire and unrolling it without help when putting in a fence is done safely by one farmer who slips the spool onto a steel post. This makes carrying easy as the cross blade keeps the spool from sliding off and, when driven into the ground temporarily, the post also provides a handy holder for the spool while it is being unwound.

Grinding off one corner of a lathe spur center makes it easy to relocate work in case further turning is necessary.

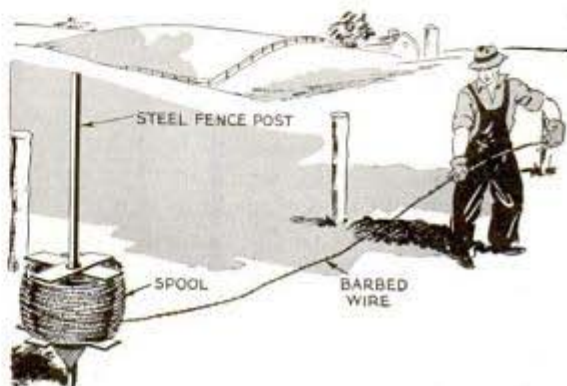

Drill Chuck Altered to Fit Small Metal Lathe

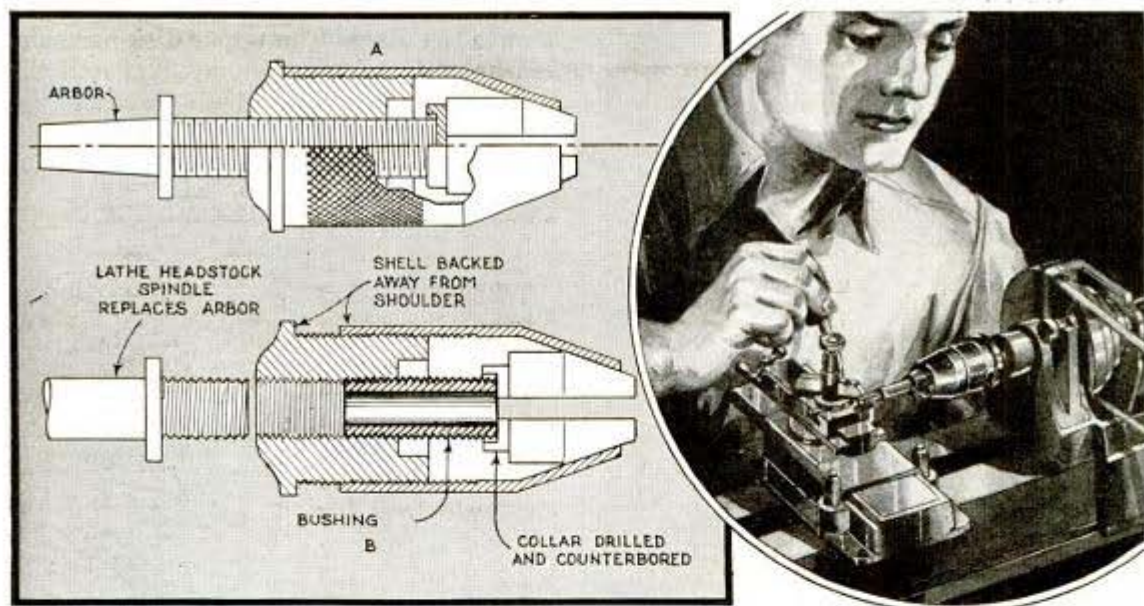

Owners of small metal lathes having spindles of $\frac{1}{2}$ -in. diameter, can equip them with a serviceable chuck at a fraction of the cost of a special one, by altering an inexpensive $\frac{1}{2}$ -in. drill chuck. The chuck, of course, must have the same size thread as the lathe spindle. First of all, the chuck is dismantled by unscrewing the shell from the core. Cutaway view A shows how the chuck looks before altering, it being necessary to turn the whole chuck body to open and close the jaws. As the lathe spindle, which supplants the original arbor, is

too short to engage the jaws, insertion of a threaded bushing is required as shown in detail B. Now only the shell of the chuck is turned to operate the jaws. The length of the bushing must be determined by trial, so that the shell does not quite touch the shoulder of the core when the jaws are closed. If a jaw opening is desired clear through the chuck, the cup collar is bored about $\frac{1}{8}$ in. larger than the size of the spindle bore. If it is hardened, it will be necessary to anneal it first.

—J. W. Naylor, Niagara Falls, N. Y.

Window Adjuster and Metal Ring Form Laboratory Stand

If you need a small laboratory stand, here's one that can be made almost entirely from a casement-window adjusting rod. It is screwed to a suitable wooden base after which the adjuster is soldered or wedged in a vertical position. Then a metal ring, 4 in. in diameter, is bent as indicated and drilled so that it can be bolted permanently to the sliding plate. After placing a vessel in the ring, its height above the flame is adjusted quickly by loosening the thumbscrew.

PASSING UP AN OPPORTUNITY?

Have you ever said "That's a good idea for Popular Mechanics" but you failed to send it in? Next time, don't pass up an opportunity—write a short description, include a clear photo or drawing, and mail it to the Homecraft Editor. If your idea is accepted, a check will be sent promptly.

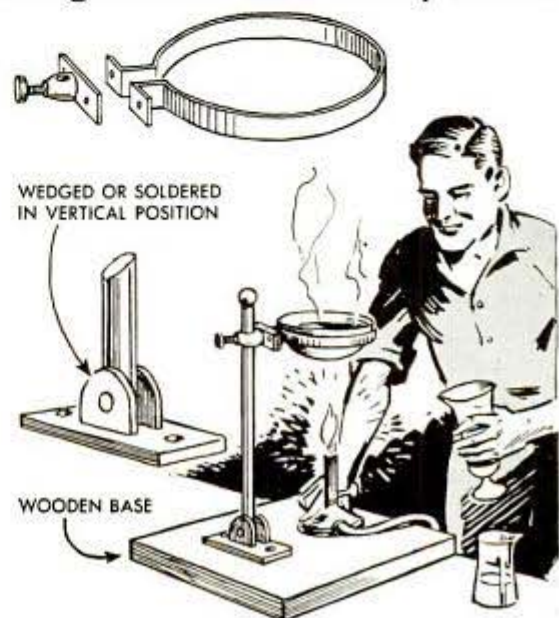

Pipe Stem Serves as Ball Stylus For Shading on Stencil



Needing a ball stylus with which to do screen-shading work on a duplicator stencil, I found that the aluminum filter tip of a discarded pipe stem was highly suitable. The pipe stem is used in exactly the same way as a stylus made especially for this work.—G. E. Hendrickson, Argyle, Wis.

Rugs in This Holder Unrolled Easily for Inspection

Supporting rolled rugs vertically in slotted holes so that they can be unrolled partially for inspection, this holder is used by a large department store for the conven-



ience of its customers. The holder consists of two large wood disks spaced by a post or standard, which is braced top and bottom to the disks. The upper disk has slotted holes in which the rugs rest and the lower disk is provided with wooden pegs to fit into the ends of the rug rolls.

Neat Way to Mount Paper Signs In a Show Window

When mounting paper signs in a window you can attach them with tape so that the latter does not show from outside the window by using the following method: Make an opening at each corner of the paper and then strip the tape across it, pressing the tape into contact with the window at each opening.

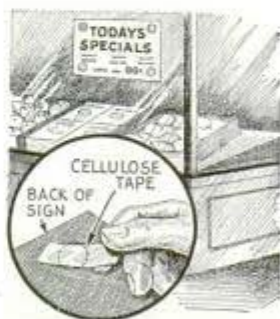

Breakage of Small Dies Reduced By Keeping Them Clean



A bottle brush of the type shown is handy for keeping very small dies clean. This is necessary if breakage is to be minimized. The small cutting edges of such dies cannot stand too much pressure, and will chip off if chips are forced between them.

How to Stake Tomato Plants

If you stake your tomato plants, the crop is usually reduced, but the quality and size is much better because staked plants are less likely to be attacked by insects or diseases. The most common method of staking consists in setting posts at the ends of the rows and stringing two wires between them. The small plants are trimmed to one or two stems, after which cords are tied at the bases of the plants and attached to the top wire. The plants are trained up the cords and onto the wires.

Crane-Type Clamp Holds Parts for Welding

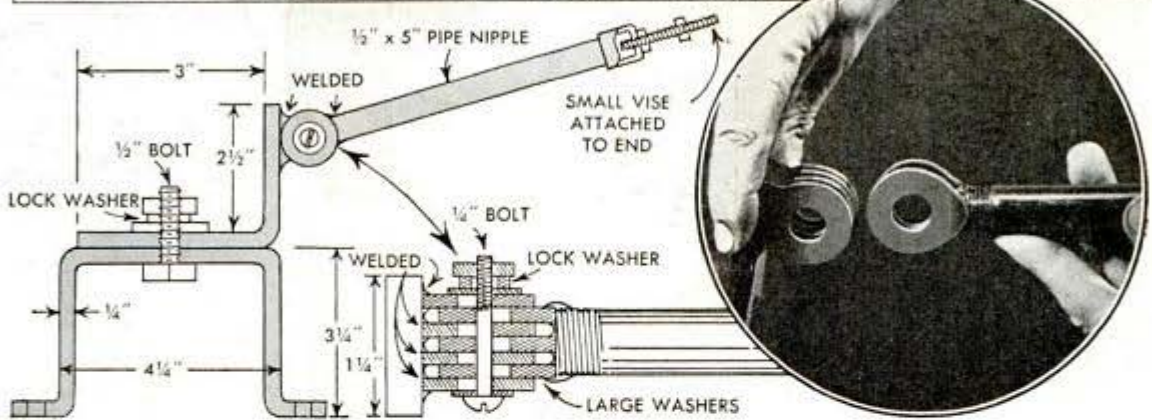
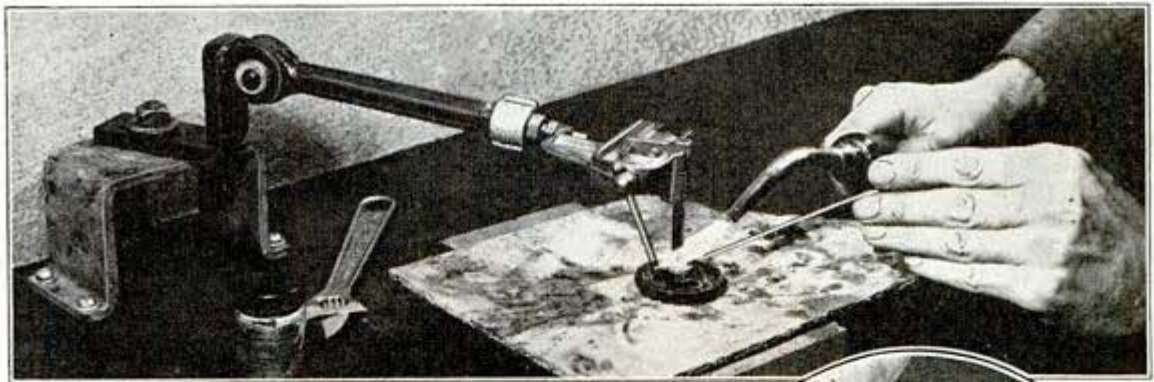

Resembling a crane in miniature, this unusual clamp can be tilted, turned, and swung to almost any position, which makes it ideal to hold parts while welding them. The base of the clamp is a U-shaped piece of iron to which an L-shaped piece is pivoted to support the crane arm. This is a pipe nipple hinged to the L-piece by a fric-

tion joint made by welding washers to the parts as shown. The outer end of the nipple is fitted with a cap, which is drilled in the end and a nut welded over it to take a stud bolt for attachment of a small vise. The vise serves as a clamp, which can be turned to any angle for holding the work.
—Walter E. Burton, Akron, Ohio.

Coil Springs in Stakes Anchor Excavator's Guide Lines

To save time in tying guide lines on stakes and to prevent the lines from being dislodged accidentally, one excavating contractor places the lines between the coils of springs. These are set tightly in holes in the stake tops so that two or three coils of each spring project to take the lines. The springs will compress when driving the stakes so they will not be damaged.

—A. H. Waychoff, Phoenix, Ariz.

❏ Soft woods such as fir and cypress are not suitable for making forms for use in spinning metal as woods of this type have a tendency to reproduce a grain pattern on the metal that is very difficult to remove. Best results are obtained by using hard maple for the forms in this type of work.

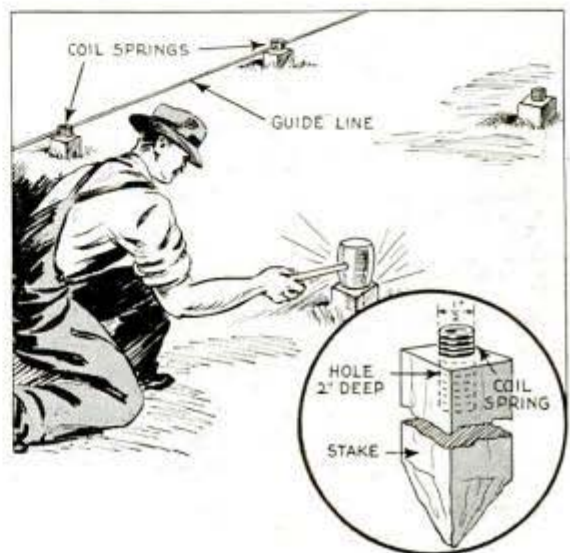

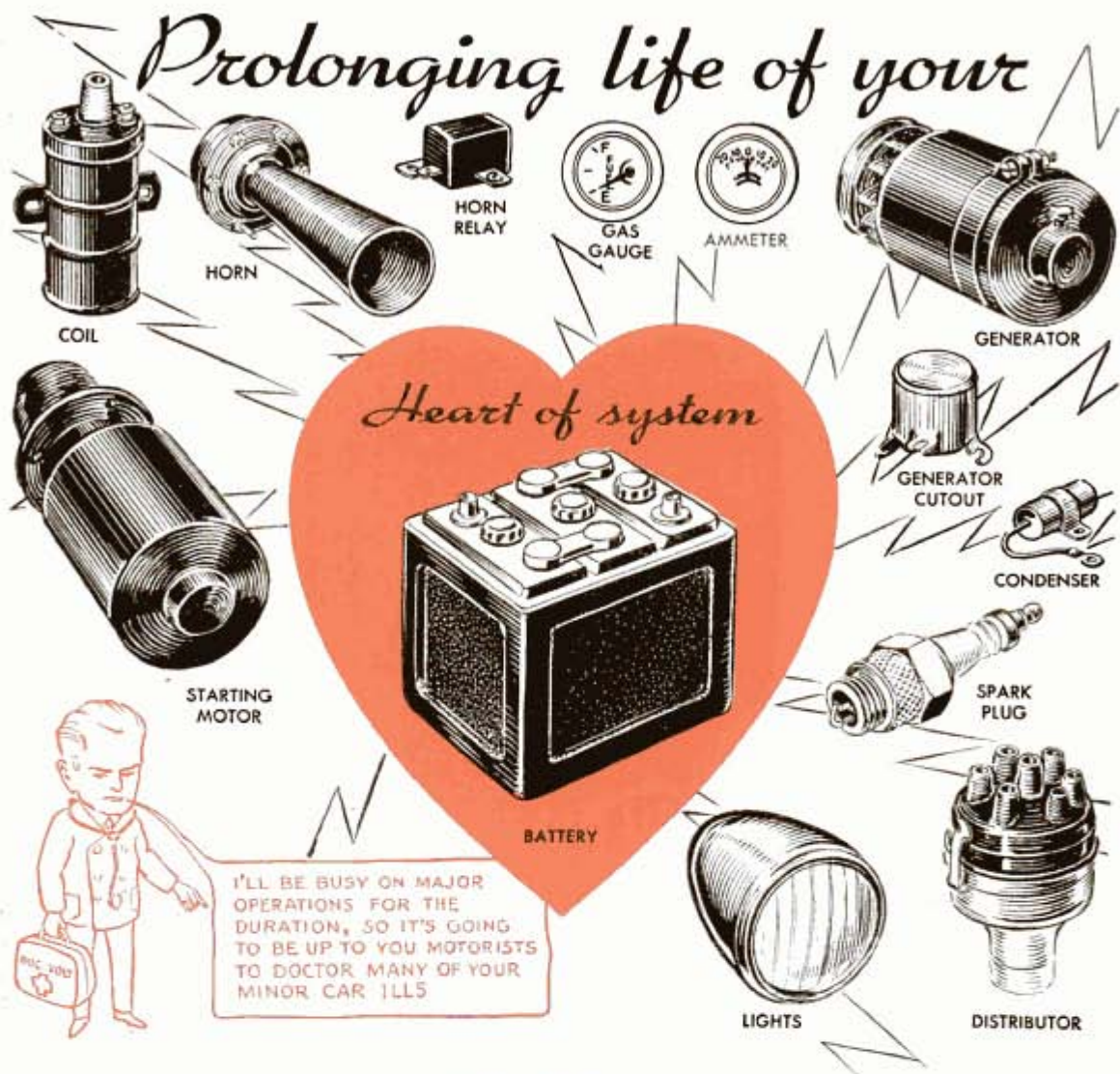

By C. E. Packer

BURNED-OUT lights, a "dead" starter or a stalled motor not only inconvenience a motorist, but are often the cause of serious accidents that, in many cases, could have been avoided by keeping the electrical system of the car in good condition. On most cars, this is neither expensive nor difficult, requiring only regular checkups and minor replacements.

As the battery is the heart of the electrical system, it should be given frequent attention, such as the addition of distilled water at regular intervals. Since it is highly sensitive to temperature, water must be added more often in hot weather. In doing so, however, you must guard against over filling. Water brought to a level higher than indicated in Fig. 1 will corrode the terminals and carrier, and cause serious damage to the cables and other parts on

which the acid is spilled. In addition to its corrosive action, acid on the top of the battery forms a path for electricity from terminal to terminal, and is a common cause of run-down batteries. Even with the best of attention some acid will be deposited on top of the battery and should be neutralized by pouring a cup of soda water or diluted ammonia over it as in Fig. 3, being careful not to get any inside the cells. After this, the battery should be rinsed with warm water and dried. To get all of the corrosion out of the terminals it is well to remove them, brush or scrape off the corrosion, Fig. 2, and then give them a coating of vaseline.

While the battery is the heart of the system, it is the generator that supplies the energy. Therefore all wiring must be in good condition and the various connec-

CAR'S ELECTRICAL SYSTEM



tions kept clean and tight. Should unusual resistance due to corrosion or loose connections interfere with the flow of electricity, current intended for the battery will be forced into the accessories with the result that breaker points will be burned, condensers overloaded, ignition coils overheated, and similar harm done. Burned out lights and similar damage do not always result from one loose terminal, but from the cumulative effect of the resistance resulting from a little looseness or a little corrosion in many terminals. Be sure especially to keep the generator wire tight at the cutout, Fig. 10.

A most common neglect in the electrical system is the fan belt which also runs the generator. If this is allowed to run too loosely it may result in undercharging the battery. Correct adjustment of the fan belt should permit a movement between the center of two pulleys of from $\frac{1}{2}$ to $\frac{3}{4}$ in. as shown in Figs. 4 and 5. A belt that is too tight is hard on the generator bearings.

Over-oiling is one of the most common causes of generator failure. A drop or two of oil every thousand miles on the bearings, in absence of specific instructions from the manufacturer, is about right, Fig. 6. Excess lubricant coats the commutator with an insulating film, which results in arcing and pitting of the commutator as the brushes attempt to cut through to make contact with the commutator segments. Temporary relief may be had by sanding the surface of the commutator with the generator running, using No. 00 sandpaper, Fig. 8, also reversing the sandpaper and working it back and forth under the brushes, as in Fig. 9, is a good idea. If the mica between the generator segments is flush, or almost so, it should be undercut as in Fig. 7. A hack-saw blade on which the teeth have been ground down slightly from side to side will enable you to do the undercutting. Also, over-oiling may damage the rubber insulation on the wires

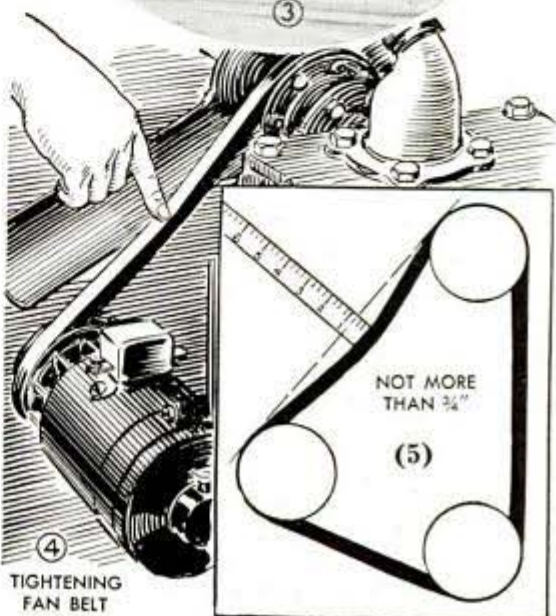

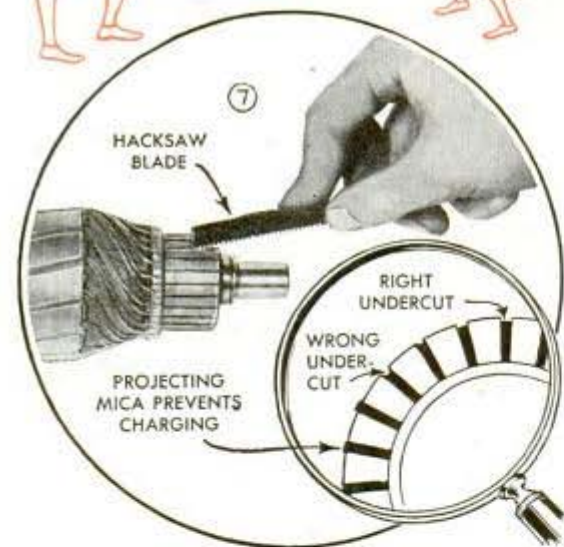

that connect the brush holders to the terminals. If a generator has been over-oiled the best cure is to disassemble it and wash all parts thoroughly in gasoline, using a paint brush to scrub out the accumulated oil and dirt. Before making any electrical tests or assembling, all parts should be dried carefully. Generator brushes that have become oil-soaked should be discarded and new ones installed.

Overloading and breaking down of ignition coils and condensers commonly results from excessive resistance in the secondary circuit. This resistance may develop at a number of points. The high-tension voltage generated in the coil may encounter excessive resistance due to neglect of the spark plug electrodes, which in the absence of factory information, should have a gap of .025 of an inch, Fig. 11. One place where leakage is likely to result is from the high-tension cables, Fig. 12, as they are continually exposed to high temperatures and oil vapors and should be kept clean. The combined action of heat and oil plus the extra resistance of wide plug gaps is destructive to the insulation. Other points of resistance are found where the ignition wires enter the distributor cap, Fig. 13. Sandpaper on the end of a pencil should be used to provide a clean contact for the secondary wires. As the rotor revolves within the distributor the high tension contacts of the rotor and the cap burn away. In the absence of new parts, the contacts can be built up with solder which will serve satisfactorily for a good many thousand miles.

Nothing need be said about servicing lights and other accessories as these will give very little trouble provided they are protected against excessive voltage. Modern cars use a regulator which has three units, Fig. 15. The first unit is the electrical cut-out which is nothing more than

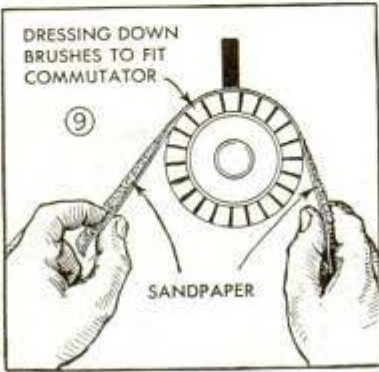

an automatic switch, allowing current to flow from the generator into the battery when the generator voltage exceeds that of the battery. On the other hand, when the generator stops, the cut-out switch opens and prevents the battery from discharging through the generator. The other two units of the regulator are the voltage unit which proportions the generator output to the need of the battery, and the current regulator, which limits the output of the generator to a certain safe maximum determined by the generator manufacturer. The regulator unit is somewhat complicated and most car owners will do well to limit themselves to seeing that the contact points are clean and faced squarely.

Starting motors, Fig. 14, require little attention. In those using the inertia-type weight on a spiral threaded shaft, the most common cause of failure is spring breakage. Another cause of failure is the use of lubricant on the threaded shaft, which should be kept clean and dry. If the pinion does not travel smoothly, a little graphite may be used on the shaft. The other popular type of starting motor gearing incorporates a pinion which is shifted by spring tension just before the starter switch is closed. If this spring breaks, the starter spins but does not crank the engine.

Like the generator, the starting motor may be damaged by over-oiling. Consequently, when removed for any other purpose it is well to disassemble the starter and wash it out thoroughly, drying all parts before assembling. A little light cup grease applied in the bearings will give long service, and is well worth applying since many starters are manufactured with no oil cups on their bearings. Jamming of the starter pinion against the flywheel is commonly due to looseness of the starter on its mounting. To free a jammed pinion, place the car in high and rock it back and forth.



KEEP HIGH-TENSION CABLES CLEAN AND CHECK CONDITION OF TERMINALS IN DISTRIBUTOR CAP

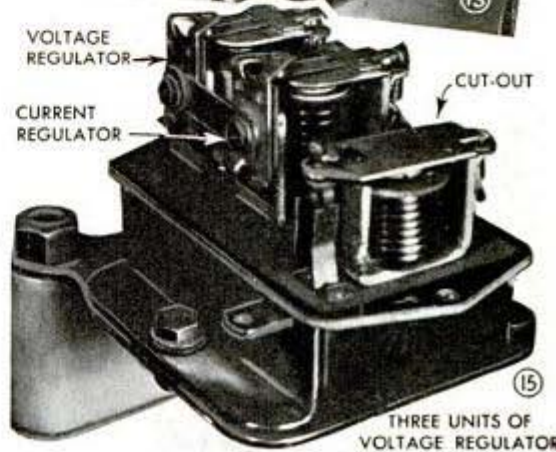
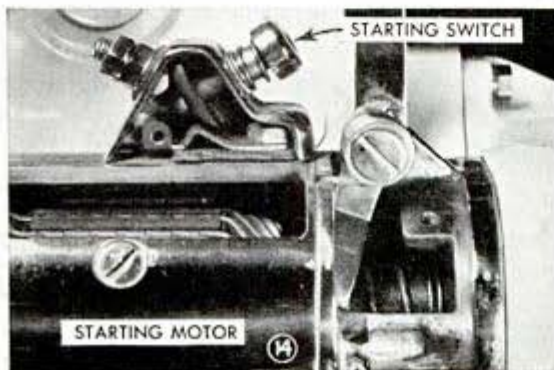

Jumper Wire 'Shorts' Out Switch To Drive Car When Key Is Lost



One motorist who lost his ignition key was able to get his car home by running a jumper wire from the live side of the horn relay to the coil as shown. The jumper wire could be connected to any terminal where current can be picked up. With this arrangement, the motor must be choked to stop it.

—Nelson Todds, St. John, N. B., Can.

Polisher for Commutator Bars

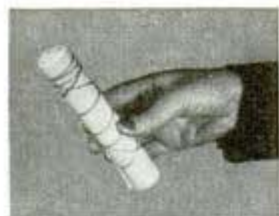

After turning down a commutator in our shop we polish it by pressing a canvas roll against it as it rotates. This imparts a high polish and cleans the bars of all grit, carbon, metal and mica particles. A roll will last for months of service, and is made by rolling a strip of canvas tightly to a diameter of about 1 in., using rubber bands to hold it.

—Herman R. Wallin, New York, N. Y.

Detachable Foot Scraper on Car Helps Keep Interior Clean

If your car has running boards of the type shown, this simple foot scraper will help to keep the interior clean, especially during win-

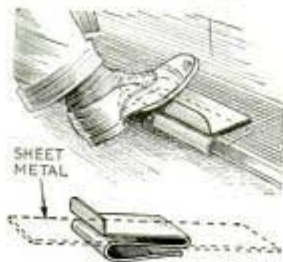

ter months. Only a few minutes are required to bend the scraper from a piece of sheet metal, and it can be slipped in place easily or removed and stored in the trunk or under a seat when not needed.

Clip on a Radiator Brace Rod Holds Trouble Light

By loosening one end of a radiator brace rod and slipping a large paper clip over it, you have a handy place to hold a trouble lamp while making motor repairs. The clip is also handy for cards containing data of oil changes, radiator solutions, etc.

—Everett Hanson, Argyle, Wis.



Compression Relieved by Wedge While Checking Motor

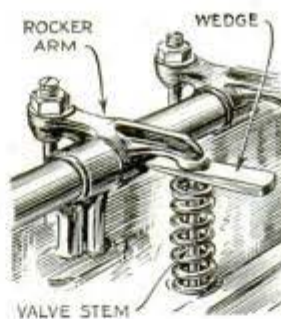

When adjusting bearings on an overhead-valve motor, it is a simple matter to relieve the compression on each cylinder as desired by using a wedge. This is inserted between the tappet and the end of the valve stem so that the valve cannot close completely. This method is quicker than removing and replacing a spark plug.

Used Anti-Freeze Solutions Tested To Determine Presence of Acid

Due to a possible shortage of anti-freeze solutions, many motorists using solutions of the ethylene glycol, denatured ethyl alcohol and ethanol types drained and saved them for use this coming winter. However, before returning the solution to your radiator, it should be tested with blue litmus paper or some similar indicator that shows whether or not it is free from acidity. If the paper shows red when immersed into the solution, acid is present, and should be

neutralized by dissolving about 1 oz. of washing soda in the solution, or just enough to prevent the paper from turning red when immersed into it. If the acid is not neutralized, it will damage the metal parts of the cooling system. It is a good idea to add sodium chromate, 1 oz. as a corrosion inhibitor, which is desirable in summer as well as winter. Also, the solution should be tested for strength before using it again. In this way, you can pour enough anti-freeze solution into the radiator to bring it up to the desired strength before pouring in the used solution. This will make it unnecessary to drain off and waste some of the solution later so that the new solution can be added to increase the strength. In order to avoid losing any of the anti-freeze, be sure that your cooling system is tight so that there will be no leaks. Check over the heater, hose connections and water pump, and inspect the radiator carefully for leaky places that might waste the anti-freeze solution.

Wire Mesh on Beams of Garage Prevents Birds Roosting

Disliking to have birds roost on the tie beams above my car in the garage, I discourage this practice by nailing wire mesh to the upper edges of the beams. The wire was cut and bent as shown in the photo to provide sharp points.

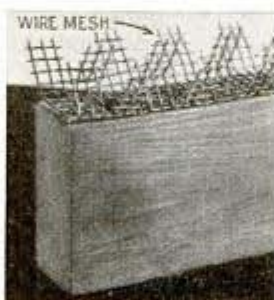

—L. F. Waitzman, Dayton, Ohio.

Avoiding Breakage of Oil Line



When replacing an oil line on your car, a little caution in pulling up the fittings may prevent future leakage. These fittings should be drawn up by hand, and no wrench

should be applied to them until the motor is started. If the fittings are then tightened just sufficiently to prevent leaks, there will be less danger of pulling them up too tight.

Lapel Pincushion for the Tailor Made From Cork and Badge

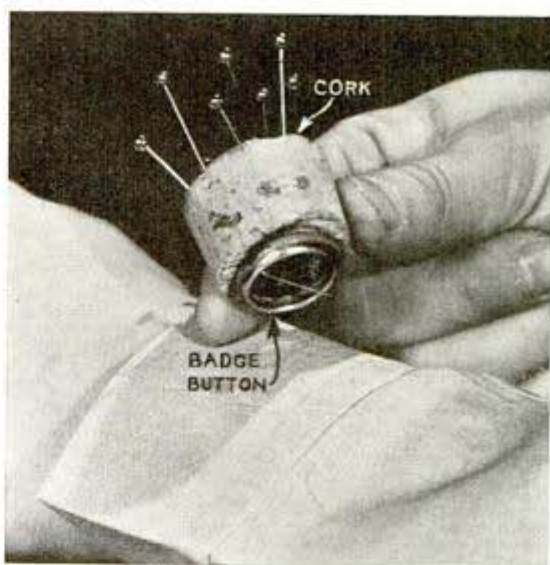

A handy pincushion for use of window trimmers or tailors may be made by cementing a large cork to a celluloid badge. The badge can then be worn on the coat lapel or sleeve within easy reach, sticking the pins into the cork.

Chickens Dusted Automatically

To assure that his hens would be dusted with louse powder at frequent intervals, one poultryman uses a folded curtain of burlap which is suspended above the nest entrances. The curtain is formed into pockets as indicated, which are kept partially filled with the powder. This sifts onto the hens as they push under the curtain when entering or leaving the nests.

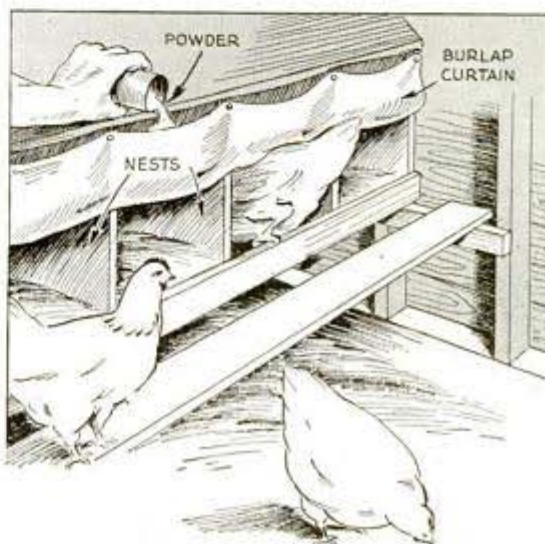



How to Read

Do you want to be a step ahead of the average machine-shop apprentice who merely operates a machine? Then learn how to read blueprints correctly because a skilled machinist must be able to translate the lines and symbols of the draftsman into measurements and operations that are required to produce the finished parts. And, as a skilled machinist you can make yourself more valuable in the production of war orders

By W. Clyde Lammey

ONE general definition of a blueprint is that it's simply an orderly arrangement of a number of lines which define and dimension the shape or outline of an object in such a way that one more or less unacquainted with the constructional details could set about building the unit or part in the machine shop without any further information. But to interpret accurately the "language" of the blueprint you must first know the "alphabet" of lines as indicated in Fig. 1, that is, the meaning and function of each line and how it is used by the draftsman. The simple drawing in the sample blueprint in Fig. 2 makes use of these lines. Although it does not represent any particular mechanical device and is not even a complete drawing, it does show common usage of the line alphabet as you will find it on the average machine-shop blueprint. There are exceptions, of course, sometimes made necessary by special requirements, but common practice is to standardize usage as much as possible to avoid confusion and error so that any one familiar with the standard practices can read and interpret correctly any blueprint no matter who made the original detailed drawings. Of

course, changes often are made, and new practices are being approved.

In Fig. 2, first note the dimension lines. There are two, one vertical and one horizontal. Both are located beyond the outline of the object by means of extension lines. However, notice that the center lines also serve as extension lines for the horizontal dimension line, an example of how certain designated lines serve other purposes on occasion. This horizontal dimension line also includes a short break in the pitman connecting the moving parts, which means that the pitman is really longer than it is actually shown and, also that the centers spanned by the dimension line actually are farther apart than shown. The draftsman shows the break merely for convenience and a saving of space. Unless otherwise noted on the blueprint, one thing to remember about a dimension line in such a position is that it always shows the full distance between the parts as they are or will be when made up. Cutting-plane lines A-A and B-B, Fig. 2, mean that figuratively the parts have been cut in two at the points crossed by the lines and that elsewhere on the print you will find sectional views showing the shape and size of the parts when viewed endwise. See sections A-A and B-B. Ordinarily those would be fully dimensioned except in cases where it is necessary to show only the sectional shape or contour of the part. In this case, the long-break line means that the part would run off the print were it drawn in detail, and the fact that it is broken away in this manner without detail would indicate that full detailing would be of

MACHINE-SHOP BLUEPRINTS

no importance on this particular print.

Lines denoting visible outlines of parts should be proportional to the size of the drawing. Usually, the draftsman makes these slightly heavier so that the essential outlines of the part or of the whole machine are easy to see. Fig. 3 shows eighteen of the symbols in common use for section lining. You are sure to run into them sooner or later on blueprints detailing machine parts and machine installations of various kinds, so it's well to study the characteristics of each one carefully. You also should become familiar with the various abbreviations used. For example, the diameter of a hole or shaft is often followed by the abbreviation D; radius by the abbreviation R, unless, of course, it is

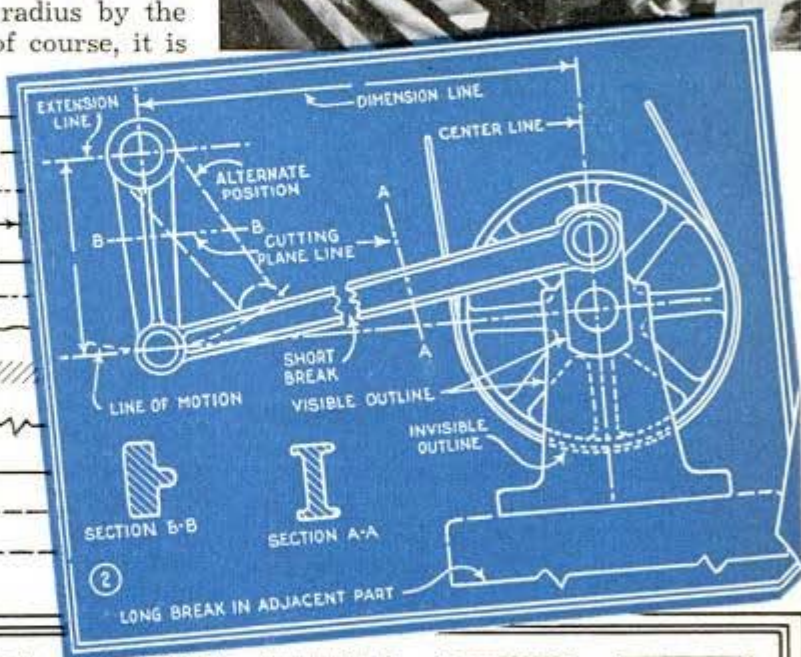
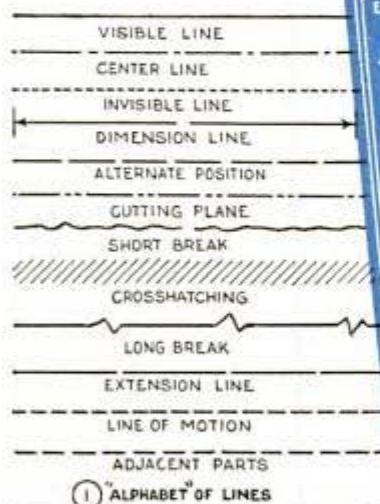
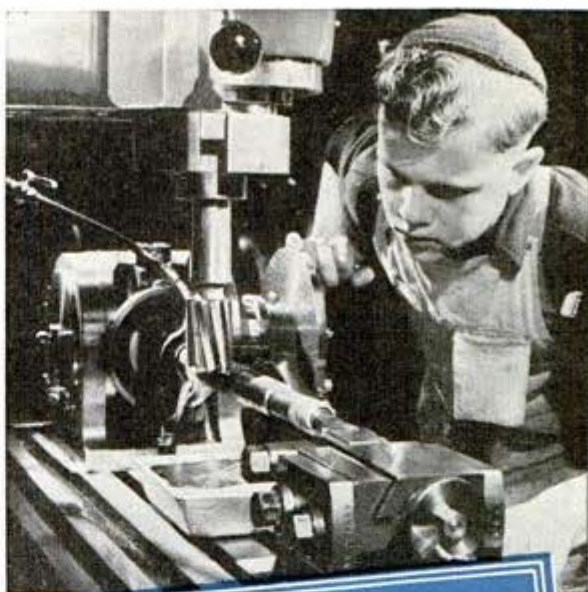

CAST IRON	WHITE METAL, ZINC, LEAD, BABBITT AND ALLOYS	SOUND OR HEAT INSULATION, CORK, HAIR-FELT, WOOL, ASBESTOS, MAGNESIA, PACKING, ETC.	ELECTRIC WINDINGS, ELECTROMAGNETS, RESISTANCE, ETC.	MARBLE, SLATE, GLASS, PORCELAIN, ETC.	SAND
STEEL	ALUMINUM AND ALUMINUM ALLOYS	FLEXIBLE MATERIAL, FABRIC, FELT, RUBBER, ETC.	CONCRETE	EARTH	WATER AND OTHER LIQUIDS
BRONZE, BRASS, COPPER AND COMPOSITIONS	ELECTRIC INSULATION, VULCANITE, FIBER, MICA, BAKELITE ETC. SHOW SOLID FOR NARROW SECTIONS	FIRE BRICK AND REFRACTORY MATERIAL	BRICK OR STONE MASONRY	ROCK	ACROSS GRAIN, WITH GRAIN } WOOD

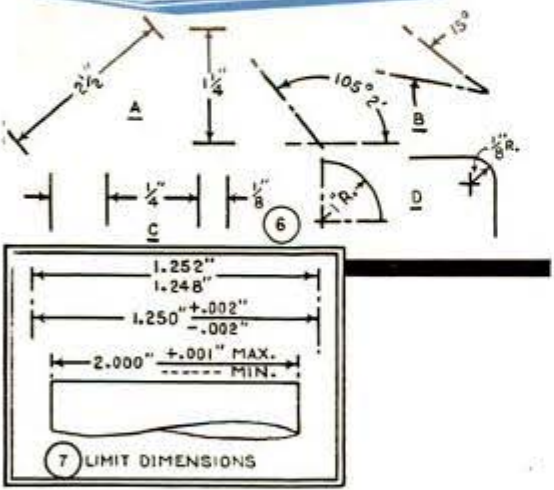
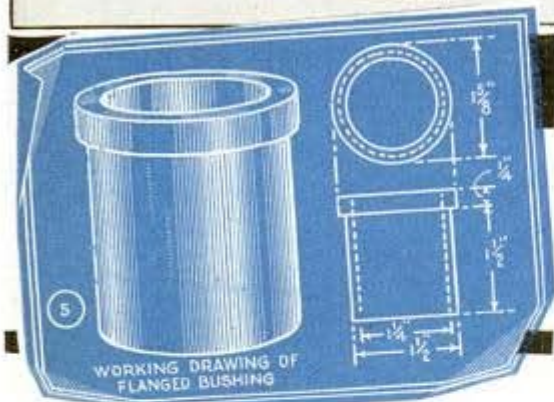
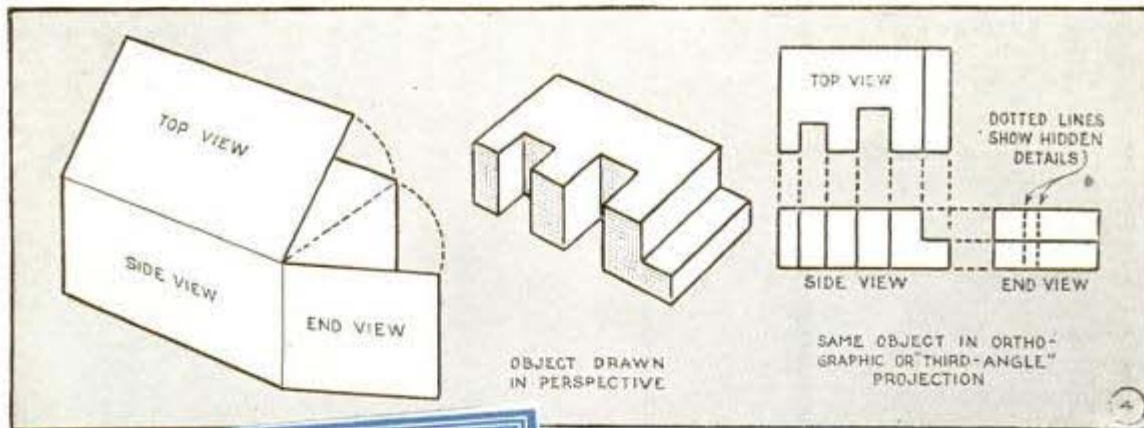

apparent from the drawing. A machine screw labeled as "6-32" indicates a screw of No. 6 size having 32 threads per inch. Where the size of a screw thread is given as 1"-8NC-1, the meaning is that the threaded part is 1 in. in diameter, has 8 threads per inch, and is a class 1 fit, according to the American National coarse-thread series. Previous to the adoption of the American National thread series, this particular size and thread was designated as 1"-8USS, referring to United States Standard thread. Besides the American National coarse-thread series, the American National fine-thread series NF, is rec-

ommended for general use in automotive and aircraft work, where special conditions require fine threads. Complete information regarding symbols and markings of screw-thread standards can be obtained from the National Bureau of Standards Handbook, No. H 28.

There are many other abbreviations that have become common usage on machine-shop blueprints, which the machinist should be able to recognize at once. A few examples of these are as follows: 20°10' indicating a bevel of 20 degrees, 10 minutes; csk. for countersink; cl. for center-line; f.h. m.s. for flat-head machine screw; lh. and rh. for left hand and right hand; ch. for chamfered; p for pitch; c.r. steel for cold-rolled steel. Also, the machinist should know sizes of tools such as drills, reamers, etc., referred to in drawings. Where abbreviations found on a drawing are uncommon, a handbook that completely covers the subject of machine-shop practice should be consulted. Of course, individual manufacturers sometimes use a number of abbreviations for their own convenience, in which case the meanings cannot be obtained from a general handbook, but must be had from the foreman or other well-informed worker.

In Fig. 4 we have the simple fundamentals of what draftsmen call orthographic or "third-angle" projection. One can visualize easily the essentials of the thing by thinking of a box, with an imaginary hinged top and right-hand end opened out as shown. This gives you the top, side or front, and end views. Some objects are of such a nature that only two views are needed. For example, suppose that the sides, ends, top and bottom of the box were the same. Then only two views ordinarily would be needed, side and end view. But

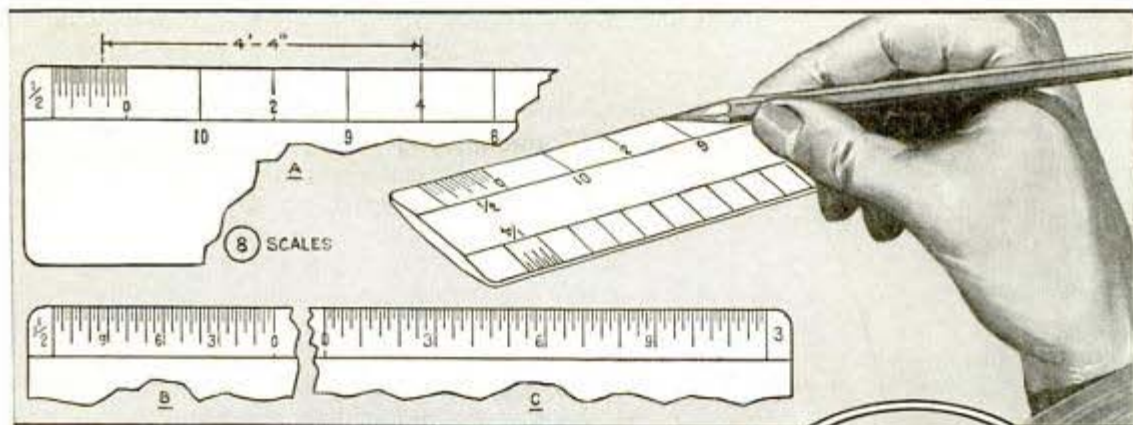

if the box were a solid and there were some characteristic of detail such as a groove or vee on the back, invisible side, front or end, three views would be needed to detail and dimension the object fully. Drawing at the right in Fig. 4, shows what is meant by this. First the object is shown in perspective and this particular part could perhaps be dimensioned fully just as it is, but the many extension and dimension lines necessary might tend to make the whole thing rather hard to read even when the object is comparatively simple in outline. So the draftsman makes a side view of the object as it would appear at eye level, directly above it a top view, and at the right, an end view as shown in the right-hand details. Then he has the part projected into three views which makes it easier to detail and dimension all the characteristics. Although this is a common method it should be remembered that there are several ways of projecting views. Where necessary, the side view is placed directly to the right of the top view and when shapes or machining operations are on the underside of the part, a bottom or "view looking up" usually is shown. In any usual arrangement the views are generally titled to aid in the reading.

Fig. 5 shows what engineers and machinists call a working drawing. This one is very simple but it contains all the information necessary to the machinist when making the part, except the material specification which would be shown on the regular print. The practice of including a perspective view or sketch of the object along with the flat views is becoming more widely used as an aid to clarity. The flanged bushing shown in the drawing is an example of where only two detail views are needed, a top or plan view and a side

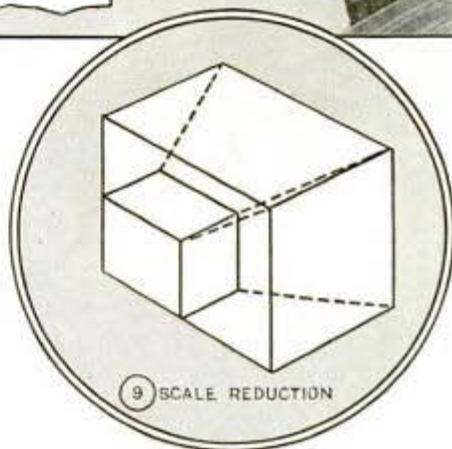

view. Many cylindrical objects of simple outline can be detailed in this way. In Fig. 6, A, B, C and D show how dimension lines on more or less intricate parts are placed. Ordinarily the draftsman locates the dimensions so that they can be read from either the bottom or right edge of the print. Where dimension lines scale down so closely together that the dimension cannot be written conveniently between the lines, they are written outside the line as indicated at C. Detail D shows how dimensions of radii usually are indicated.

Where dimensions are more critical than can be indicated by the common fractions of an inch, they are shown as decimals to three or four places as the nature of the work requires, and a minimum or maximum limit or tolerance, is indicated as in Fig. 7. Reading from the top to bottom in Fig. 7 the first two show a tolerance of .004 in., that is, to pass inspection the part can be .002 over or .002 in. under the required diameter. Likewise the third dimension shows that the part can be .001 in. oversize but must not be under the specified diameter of 2.000 in.

Many parts of machines are so large that it would not be possible or practical to draw them full size on a blueprint sheet.



So, for convenience, and also to keep the blueprint sheets of uniform size for easy handling and filing, the draftsman makes the drawings smaller than the actual part. He reduces the drawing of the part or parts uniformly by means of a scale, Fig. 8. The faces of the scale show a number of distances which represent 1 foot. These distances are graduated into 12 parts, each representing an inch. Then where halves and quarters of an inch are required the

twelfths are graduated again into halves and quarters, and so on, until the graduations become so small that they would be of no practical use. Detail A shows a reduction where $\frac{1}{2}$ in. equals 1 foot, and how the scale is used to take a reading of 4 ft. 4 in. Detail B shows a reduction where $1\frac{1}{2}$ in. equals 1 foot, and detail C a reduction of 3 in. equals 1 foot. Fig. 9 will perhaps make it easier to visualize just what happens when a scale reduction is used in making a drawing. The smaller part is exactly the same in every detail but it is greatly reduced in size from the original. One thing to remember in connection with dimensions on scale drawings is that the dimension always indicates the actual measurement of the part in the feet and inches of the common foot rule. Never otherwise, unless an unusual exception is noted on the drawing.

The drawing in Fig. 10 details the parts of a complete project all on one sheet, differing in this respect from the average run of shop blueprints, which usually are separate working or assembly drawings in a set consisting of a number of sheets. Each sheet rarely carries the drawings of more than two or three parts; more often only a single part will be shown. Figs. 11 and 13 are examples of practical working shop drawings which detail a single part. Going

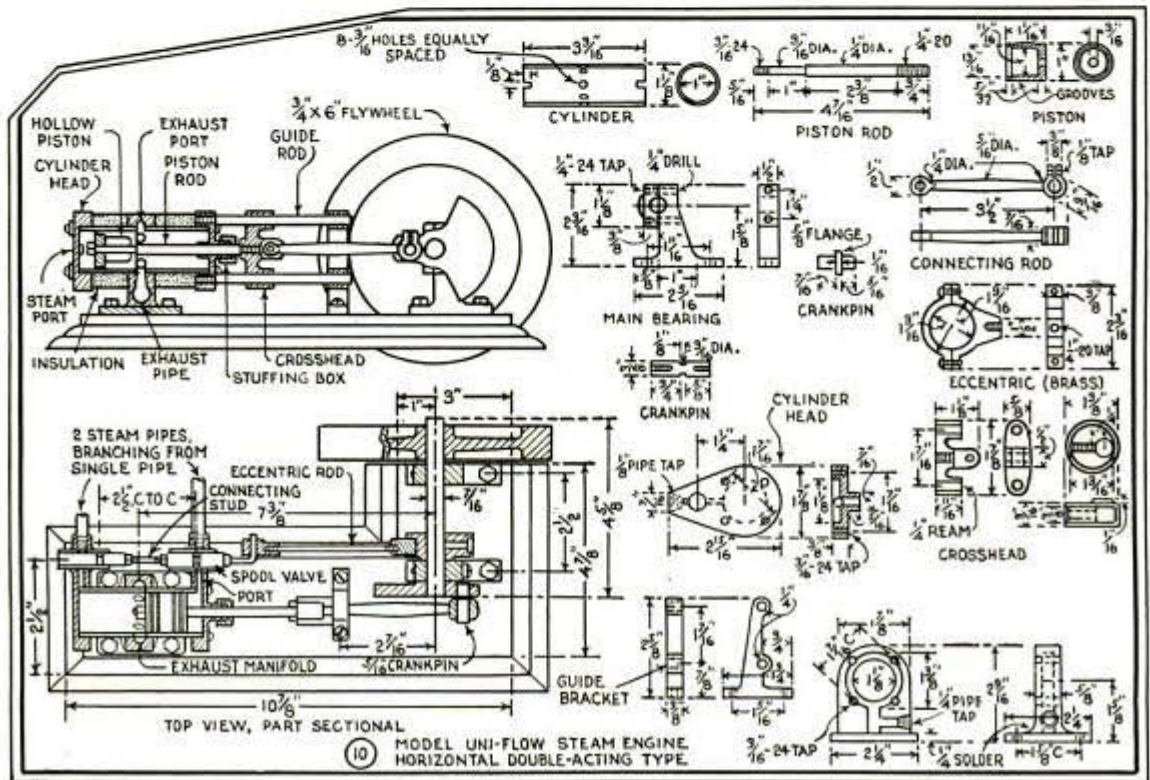

over Fig. 11, notice that the diameters of the three steps of the spindle are given in four-place decimals and that the allowable error or tolerance is held within the critical limit of only .0005 in. on each of the three steps. In Fig. 13 notice the use of the symbol "f" which means that all surfaces so marked are to be finished by machining. Another symbol, lately approved for universal use, is the 60-degree "V" with a code letter, which generally is made to refer to a note or table on the drawing giving the type of finish required as in Fig. 12.

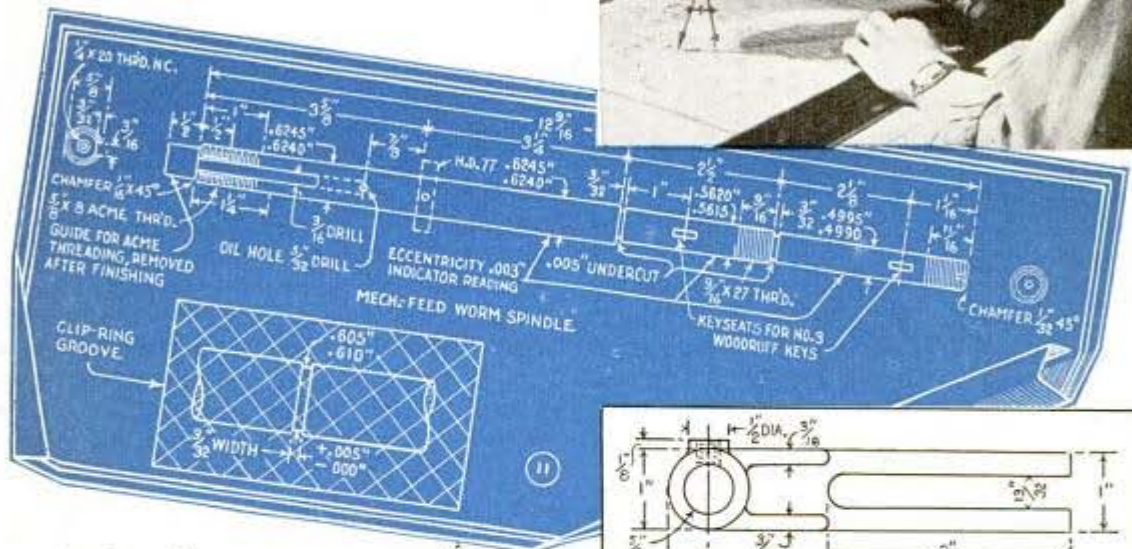

Another thing you are likely to find even on very elementary prints is the method of indicating breaks in the various materials and parts. Fig. 14 shows a few of the methods commonly used. An example of a break on round stock is shown in the lower left-hand detail of Fig. 11. Along with methods of showing breaks comes the manner of indicating sections of parts which must, of course, vary with the nature of the work. A section may be merely for the purpose of designating by symbol the kind of material, or to indicate the shape and size of parts irregular in shape or contour. Hence for convenience the draftsman locates the sections within the outlines as in Fig. 15, and thus gives the machinist a clear idea of the appearance and size of such parts. A short-cut method of sectioning parts, sometimes referred to as "conventional" sectioning, is shown in Fig. 16. Here you will notice that the side view of a pulley is cut along a

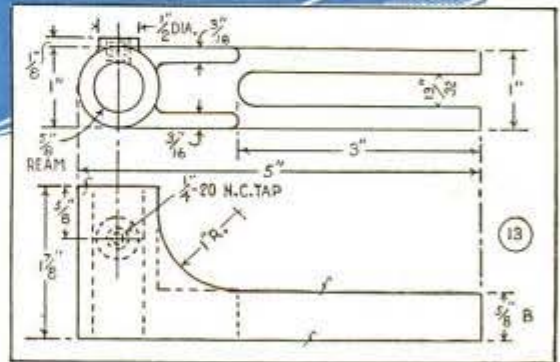
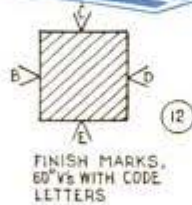

horizontal center line and the sectional view is shown at the right-hand side.

Sometimes only a partial or broken-out section is shown on a drawing. Such incomplete sections often are used instead of a full section when the latter is unnecessary, and especially when a partial section makes the drawing easier to understand. In the case of some shafts, bolts and other parts that are so long it would be inconvenient or impossible to show the entire length on a drawing, only the ends are shown, the center section being omitted and so indicated by a break in the drawing. Sectional views usually represent parts as they would appear if cut straight through on one continuous plane, which may or may not intersect the center

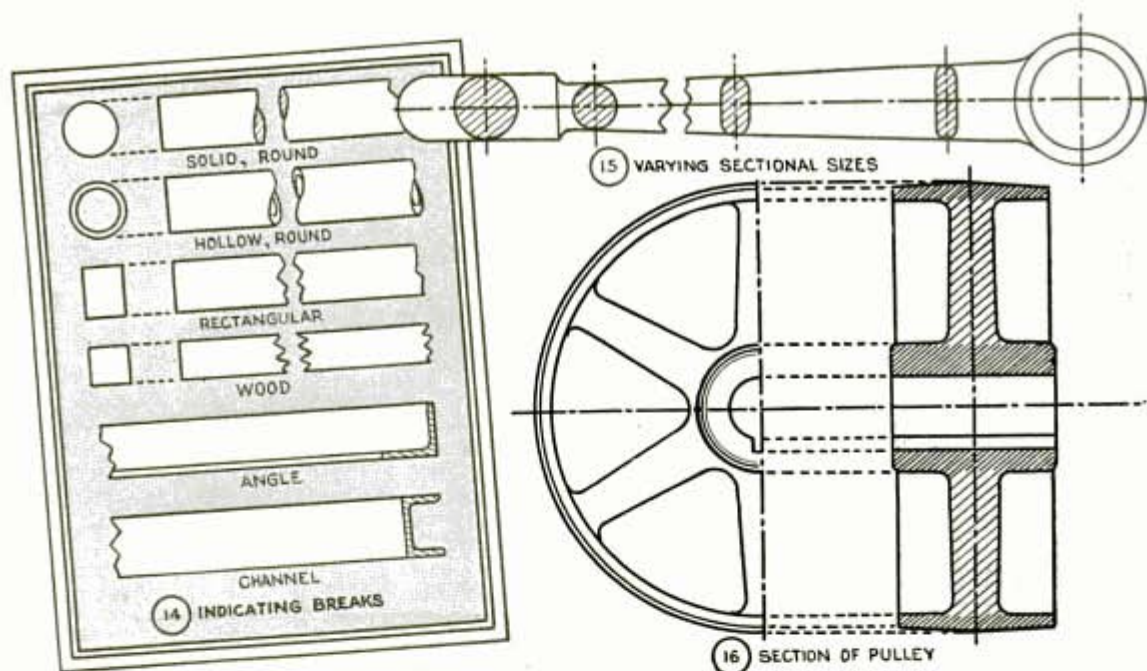

line. Arrows at the ends of the cutting-plane line show the direction in which the section is viewed. When more than one sectional view is required, the letters A-A, B-B, C-C, etc., are used to mark different cutting-plane lines and their corresponding views, thus definitely locating each

section. In other cases both exterior views and interior sections are combined. This is done to make a single view on a drawing reveal both the outer and inner construction of a part, the interior part being indicated by what is known as a phantom or dotted section.

Rapid-Acting Welder's Clamp Assembled From Odd Parts

Instantly adjustable for height, this efficient welder's clamp saves considerable time in clamping irregular-shape work in position for welding, as a single turn of the handwheel is all that is required to hold the work securely. The throat capacity is

limited only by the height of the pipe standard on which the upper jaw travels. For the base, a $\frac{1}{2}$ or $\frac{5}{8}$ -in. steel plate will do, but if a thicker piece, such as $\frac{3}{4}$ in., is available, heat will not tend to warp it. A pipe coupling to fit the standard and welded securely to the base will serve as a stop collar. The nipple supporting the upper jaw should be of a size to slide freely on the pipe, while the nipple welded to the opposite end of the jaw should be selected to accommodate a $\frac{1}{2}$ -in. bolt. Here a threaded pipe nipple could be used, or the bolt nut may be brazed to the top of the nipple as shown. A discarded valve wheel makes an excellent handwheel, but if you cannot secure one, a suitable one can be turned from wood and attached with a nut on each side. Point the lower end of the bolt so that there will be no chance of it shifting the work when it is turned by the handwheel.—G. F. Coughlin, Garfield, N. J.

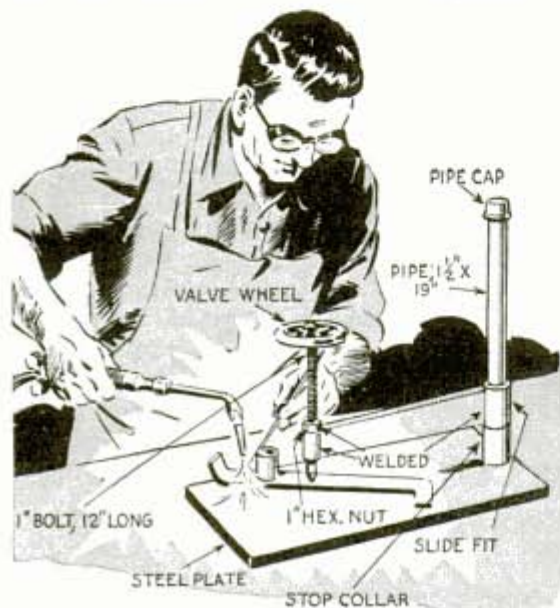

Often rubber insulation can be slipped off wires easily if it is first soaked in lacquer thinner for about 15 minutes.

Protector Sleeve for Bench Vise

Noticing that his men often used the projecting guides of the bench vises as anvils, a shop foreman had the vises fitted with sheet-metal protectors, which served as reminders to the men not to hammer on the guides. When the guides were used as anvils, they were often bent so that the vises were hard to open and close.



as anvils, they were often bent so that the vises were hard to open and close.

Stop on Rip-Fence Guide Rail Prevents Fence Sliding Off

Before I fitted a stop at the end of the rip-fence guide rail on my saw, the fence would slide off the end of the rail when the saw table was tilted at an angle of 45 degrees. For the stop I used a small friction catch of the type shown, and pressed it in a hole drilled in the top part of the rail. This allowed the fence to be removed for crosscut work, yet kept it from sliding off by its own weight.

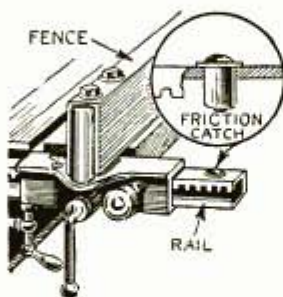

—Robert Clark, Chicago.

Burlap Sack Keeps Pump Rods In Pipe While on Truck

Instead of taking the time to prepare and drive wooden wedges into the ends of pump pipe to keep the rods in place while in transportation, try using burlap sacks for the purpose. These are slipped over the ends of several lengths of pipe containing the rods and tied in place as shown. It takes but a minute to remove or put a sack in place.

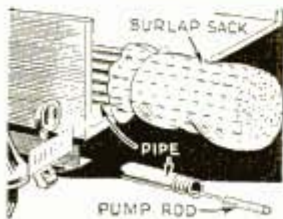

☐ A good lubricant for use when spinning most metals is made by mixing equal parts of No. 30 motor oil and soft soap.

Length of Contour Crop Rows Measured by Tractor Wheel

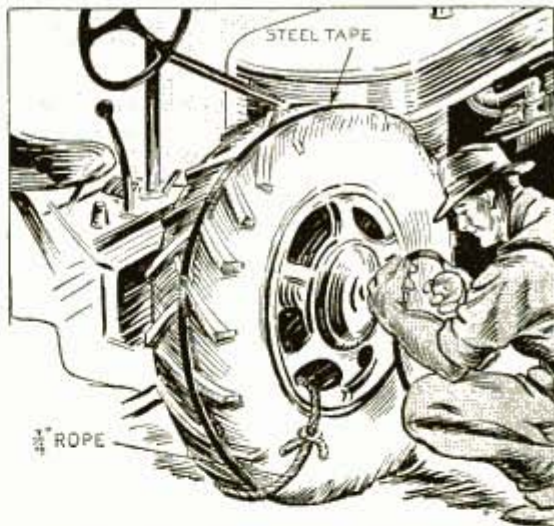

Where contour crop strips follow the level on terraced or strip-cropped land, the curving rows make it difficult to determine the length of rows and the number of acres in any one crop. One farmer solved this problem by tying a piece of rope around a tractor tire as shown. By counting the revolutions of the wheel as the tractor travels the length of the strip and then measuring the circumference of the tire he calculates the length of the rows. Then by measuring the width of the strip he can determine the number of acres in it.

Large Vacuum Cups Hold Sign On Top of Delivery Car

If you use a pleasure car to make occasional deliveries in a city where it is necessary to carry a sign on the car, just paint the sign on a piece of plywood or hard-



pressed board and attach this to two large vacuum cups. A piece of flat iron on each cup is bolted to the sign permanently so that it can be pressed on the car top or removed whenever desired without marring the finish.

Fire in Outdoor Forge Banked By Using Harrow Disk



To bank the fire in his outdoor forge so that the fuel will not be consumed rapidly when the forge is not in use, a mechanic uses a discarded harrow disk. This is

placed over the fire or removed in a jiffy with a pair of long-handle tongs, as indicated. The small hole in the center of the disk affords just sufficient draft to keep the fire alive.

Effective Spear for Field Mice

Troubled with field mice and other small rodents, a caretaker of a large estate uses this spear to eradicate them. It consists of a piece of oak 1½ in. by 8 in. in which 36 holes are drilled to take spikes 6 in. long. A second piece of wood nailed over the heads of the spikes keeps them in place and provides a means of attaching a handle.



SAVE MONEY BY MAKING YOUR OWN PHOTO EQUIPMENT

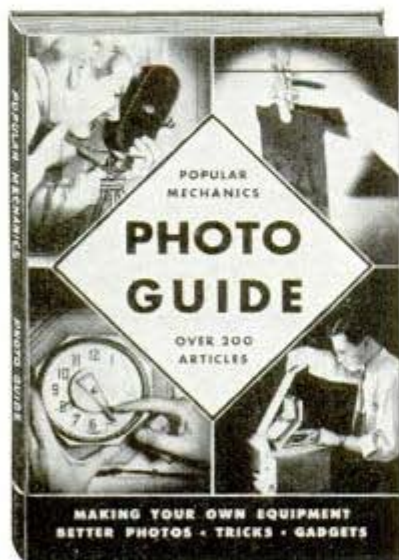

Here, in one handy volume, is a reprint of the best of the photo articles published in Popular Mechanics. This Guide tells how you can make camera and darkroom equipment and numerous time-saving gadgets. Included also are articles by successful photographers on color photos, speed shots, use of shadows, lighting, composition, water and snow scenes, retouching, trick and tabletop photography. Price \$1.25.

Other Helpful Books

Forty Power Tools You Can Make—Shows how to make forty different machines, such as lathes, drill press, jig, band and circular saws, sanders from pipe fittings, auto parts, etc. \$1.25.

Your Car—Add thousands of miles of life to your car and operate it economically. 192 pages of money and labor-saving ideas, short cuts. For motorists, service men. \$1.25.

1001 Ways to Use Concrete—Do work for yourself, others. Save, make money. \$1.98.

Garden Book—Build your own trellises, fences, lawn furniture, outdoor fireplaces, attractive ornaments, etc. \$1.00.

Welding, Brazing and Soldering—How to construct equipment and use it efficiently. \$1.25.

The Boy Mechanic—For any boy. Tells how to build midget auto, boats, models, games, craftwork. \$2.00.

Build a Boat for Pleasure or Profit—17 low-cost boats—power, sail, row. No experience needed. \$1.25.

What to Make—Shows how to make hundreds of things in spare time for fun or profit. Furniture, craftwork novelties, etc. Set of three books, Volumes 1, 2 and 3 (588 interesting pages) \$1.47. Single volumes 50c each.

Shop Notes—The mechanic's guide. Lathe operation, drafting, shop practice, using tools, welding, autos, electricity, etc., time and money-saving shortcuts. Set of 4 books (Shop Notes for '43, '42, '41, '40) \$1.95. Single volumes 50c.

Order from this list. Ask for FREE book catalog.
Money refunded if you're not satisfied

Popular Mechanics Press, Dept. 414, 200 East Ontario Street, Chicago, Illinois



First Aid for Receivers

PART V

MANY unnecessary radio service calls can be avoided by resisting the natural impulse to use a dust cloth to clean out the back of your radio. Dust will not do the set any harm, and you are the only one who knows that it is there. It is almost impossible to wipe dust out of the inside of a set with a cloth without loosening tubes in their sockets or disturbing some of the delicate electric wiring. If you feel that it must be removed, take the set line-plug out of the wall socket and then blow the dust out with your vacuum cleaner.

Interchangeable tube chart No. 2 lists additional tubes that the serviceman or dealer may suggest to replace the types specified in your old receiver when some of the original types are no longer available. However, in the interest of conserv-



INTERCHANGEABLE TUBE CHART No. 2

TYPE	REPLACE WITH	TYPE	REPLACE WITH	TYPE	REPLACE WITH
1A50	1A50T/G	6N60	6N60T/G	6S07	6S07T/G
1A70	1A70T	6J5	6J50T/G	6S07G	6S07T/G
1C50	1C50T	6J5G	6J50T/G	6V6	6V60T/G
1G40	1G40T/G	6J7	6J70T	6V6G	6V60T/G
1G60	1G60T/G	6J7G	6J70T	6X5	6X50T/G
1H50	1H50T	6K60	6K60T/G	6X5G	6X50T/G
1H5G	1H50T	6K7	6K70T	12SA7	12SA70T/G
1Q50	1Q50T/G	6K7G	6K70T	12SA70	12SA70T/G
3Q50	3Q50T/G	6K8	6K80T	12SK7	12SK70T/G
5T4	5T40	6K8G	6K80T	12SK7G	12SK70T/G
5W4	5W40T/G	6L6	6L60	12SQ7	12SQ70T/G
5W4G	5W40T/G	6L7	6L70	12SQ7G	12SQ70T/G
5Y30	5Y30T/G	6N7	6N70	25A6	25A60T
5Z4	5Y30T/G	6P50	6P50T	25A6G	25A60T
6A8	6A80T	6Q7	6Q70T	25A70	25A70T
6A8G	6A80T	6Q7G	6Q70T	25A050	25A050T
6AC50	6AC50T	6R7	6R70T	25L6	25L60T/G
6AE50	6AE50T/G	6R7G	6R70T	25L6G	25L60T/G
6B8	6B80	6S7	6S70	25Z6	25Z60T/G
6C5	6C50T	6SA7	6SA70T/G	25Z6G	25Z60T/G
6C5G	6C50T	6SA70	6SA70T/G	35L6G	35L60T/G
6F5	6F50T	6SF5	6SF50T	35Z50	35Z50T/G
6F5G	6F50T	6SJ7	6SJ70T	50Y60	50Y60T/G
6F6	6F60	6SK7	6SK70T/G	117Z60	117Z60T/G
6H6	6H60T/G	6SK7G	6SK70T/G		

* Shields Necessary in some cases.

† Space Limitations are the only factor limiting the interchange of "G" Type for Metal.

‡ Grid-Cap Lead may need lengthening. Base may need slight filing in few instances.

ing time and materials, these replacement types should not be used as long as stocks of the original tubes last; especially in view of the fact that in order to use some of these replacement tubes certain changes may be required in the set, as indicated by the foot notes, and these changes should be avoided until necessary. If your regular dealer or serviceman cannot supply the original type, shop around and you may find one that can, as there is a good supply of no longer manufactured types still in stocks of many dealers and servicemen. Faulty tubes can cause: no reception, distortion, hum, lack of sensitivity, microphonics, intermittent reception and fading.

(To be continued)

Three-Tube All-Wave Super

By Stanley Johnson



HERE is No. 3 "Special" in the series of "V" sets for students and experimenters. No. 1 appeared in the July issue, No. 2 in September and now we complete this series with No. 3 which is an easy-to-build 3-tube super "DX-er" that features a non-critical circuit which requires no aligning.

Although these 1, 2 and 3-tube receivers are complete and entirely different, they all employ the same parts, with a few simple additions. Those who built the 2-tuber will note that it is turned into this simple 5-band super by making minor changes in the detector circuit, rewinding the coils, and adding the 1A7-GT "mixer" stage; however, it should be entirely rewired to avoid errors. The detector, fixed-tuned to approximately 450 kilocycles by condenser C_{11} and the I.F. coil, is capacity coupled to the 1A7-GT mixer. Keeping the oscillator on one frequency eliminates antenna "dead spots," tunable hum and similar troubles.

Only 6 of the hand-wound plug-in coils are required to cover the broadcast band

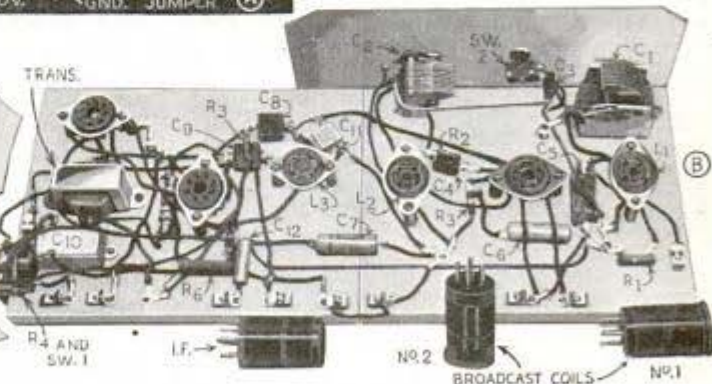
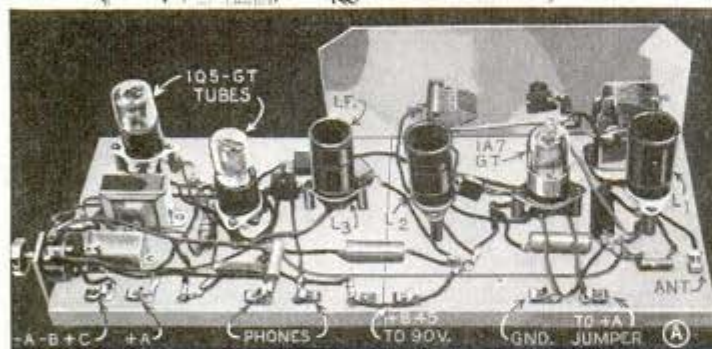

NOTE-ALL COILS ARE CLOSE WOUND WITH NO.36 ENAMELED WIRE ON 1 1/4" FORMS

I.F. COIL

TICK COIL 62 TURNS

GRID COIL 100 TURNS

SOLDERED

39-T.

100-T.

NO. 1 COIL

28-T.

75-T.

NO. 2 COIL

15-T.

34-T.

NO. 3 COIL

9-T.

15-T.

NO. 4 COIL

6-T.

7-T.

NO. 5 COIL

5-T.

5-T.

NO. 6 COIL

5-T.

5-T.

BAND	COIL IN L ₁ SOCKET	COIL IN L ₂ SOCKET
BROADCAST	# 1	# 2
160 METERS	# 2	# 3
80 "	# 3	# 4
40 "	# 4	# 5
20 "	# 5	# 6

T-TURNS
COIL FORMS I.F. AND NOS. 1, 2, AND 3 ARE STANDARD RIM TYPES.
COIL FORMS NOS. 4, 5, AND 6 ARE BASES SALVAGED FROM 4-PRONG TUBES

Fig. 1

I.F. COIL IS NEVER SHIFTED FROM ITS SOCKET L₃

Is Easy Project for Students

"V" Series Set No. 3

down to 14 megacycles owing to the fact that 4 of them do double duty, serving as either "first detector" or "oscillator" coils, depending upon the band being tuned. The coil-winding details and tuning chart appear in Fig. 1; all coils are wound in the same direction. The simplified wiring diagram is shown in Fig. 2 and the schematic circuit diagram in Fig. 3. The baseboard dimensions are given in two sections in Fig. 2 for the benefit of those who are progressing from the 2-tube set, the metal strip being used to connect the two sections at rear.

The placement of parts should be followed by referring to photos A, B and C. Wind all coils in the same direction; solder every circuit terminal carefully. The shaft of tuning condenser C_1 must clear the metal panel; condenser C_2 mounts directly on the panel as its rotor is grounded.

Referring to schematic diagram Fig. 3, you will note that condenser C_3 is connected directly to common ground just as shown in Fig. 2. However, condenser C_5 and resistor

(Continued to page 172)

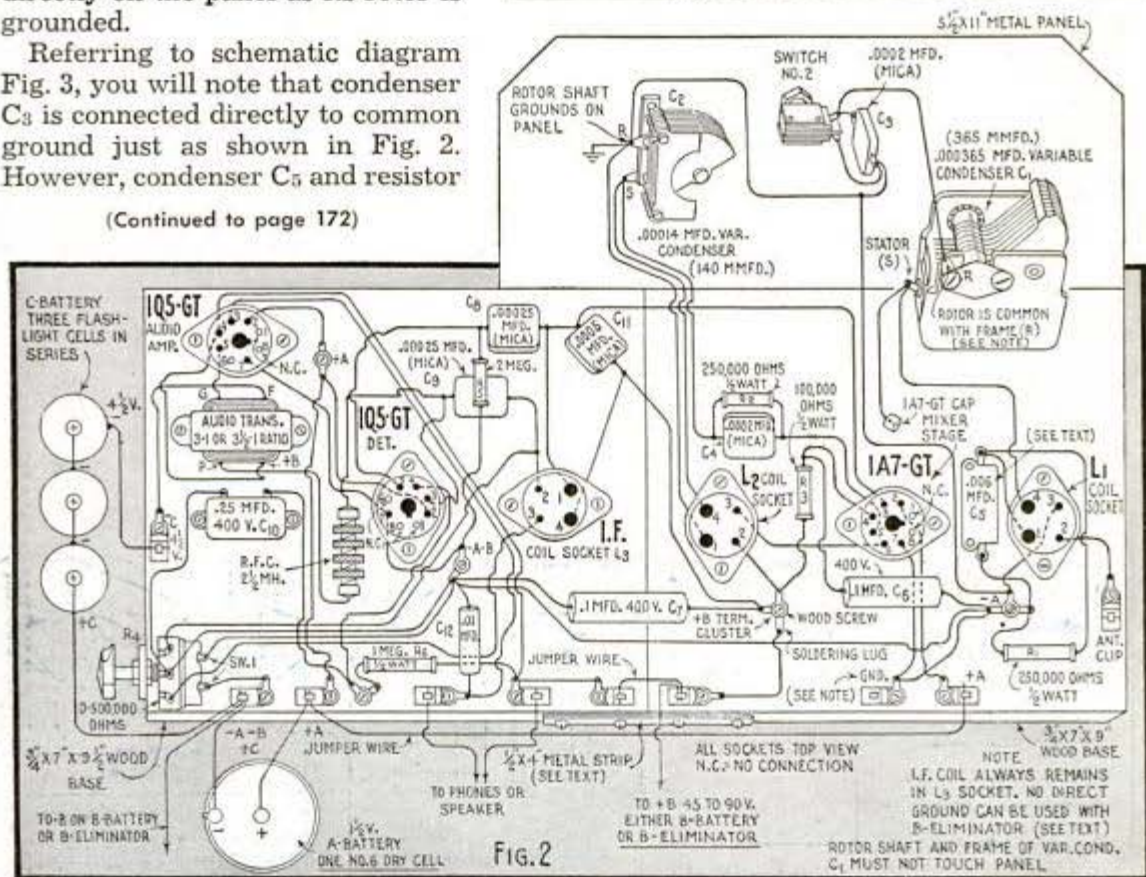
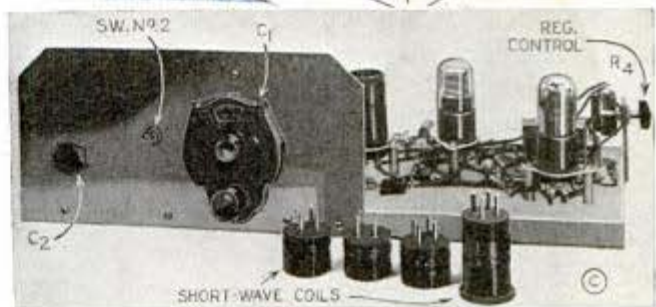

FIG. 2

Low-Cost Two-Ampere Tungar Battery Charger



SHOULD it become necessary to store your car, this tungar battery charger will keep a 6-volt storage battery fully charged so that you can operate your auto radio indoors. This is only one of many timely civilian defense uses for an efficient and inexpensive battery charger.

It consists of a homemade stepdown transformer and a G.E. type 195528 2-ampere tungar bulb that screws into an ordinary porcelain lamp socket. Laminations for the transformer are cut from common black stovepipe iron and stacked as shown in Fig. 1. The transformer is wound to supply 2 volts at 10 amps. for lighting the filament, and 15 volts at 2 amps. to be rectified for the battery.

Pile the strips in a 5-in. hollow square, the ends of alternate strips overlapping $1\frac{1}{4}$ in. Now build up the primary and secondary legs in the cigarbox arrangement Fig. 2, piling strips for one leg of the core

(Continued to page 174)

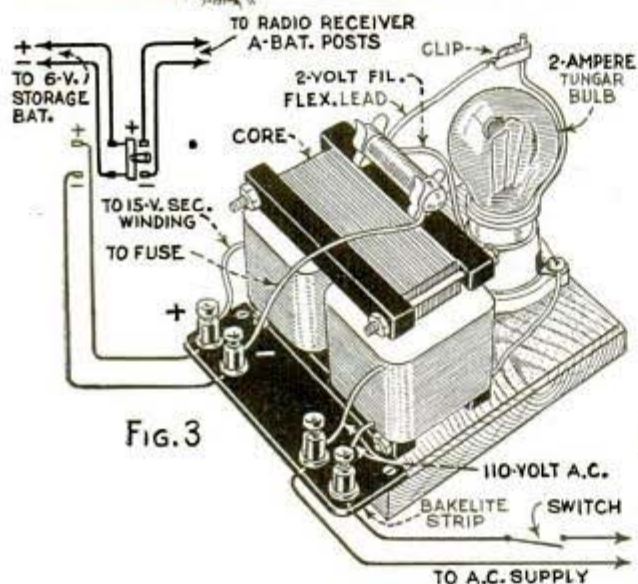

FIG. 3

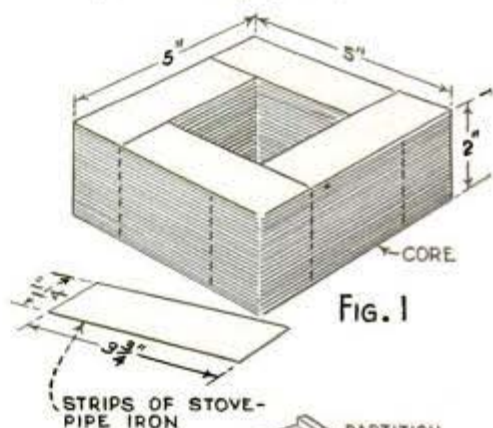

FIG. 1

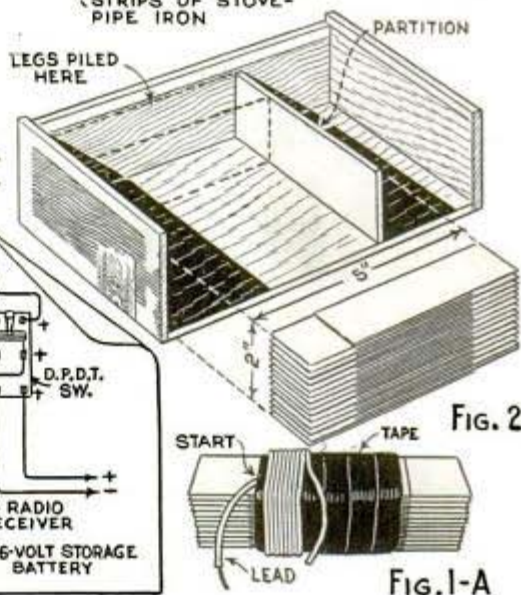

FIG. 2

FIG. 1-A

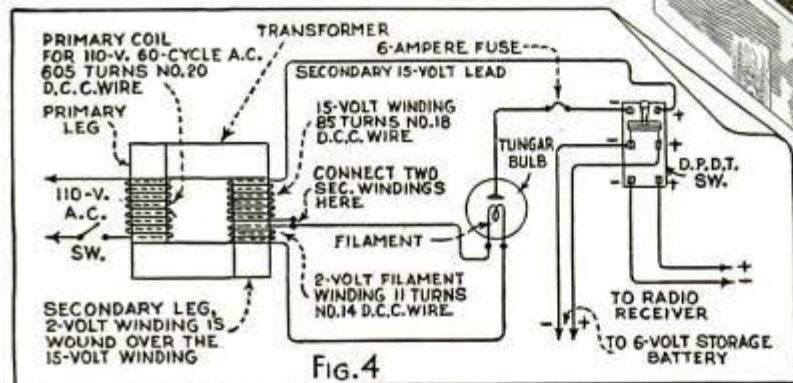

FIG. 4

Hints for RADIO EXPERIMENTERS

(A) Any single-unit auto radio and a small 6-volt storage battery will fit snugly in the luggage carrier on your bicycle to provide emergency news and entertainment on outings in locations remote from power lines when gas rationing ties up the family car, and dry battery packs are difficult to obtain for your portable battery receiver



(B) Adjustable tuning coil serves as antenna tuner, wave trap or antenna eliminator depending upon the manner in which it is connected to a receiver. Shown as an antenna tuner to improve sensitivity and selectivity. (C) White arrow and square painted on basement wall for quickly locating electric outlets in emergency

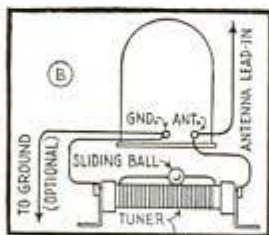

(D) Handy jig for checking pig-tailed resistors in a circuit before soldering them in position. This saves time if the resistor should differ in actual value from that indicated by its marked rating. A strip of Bakelite or fiber, 2 Fahnestock clips and 2 terminals of an octal socket provide the necessary materials for the gadget. (E) Meter stand for checking or demonstrating experimental work around the bench. The metal strip meter legs are bent to permit placing the meter at an angle for easy reading, and the extended terminals are in a good position for quick circuit connections

(F) Fast action soldering iron is ready to operate in 5 seconds; saves time and current

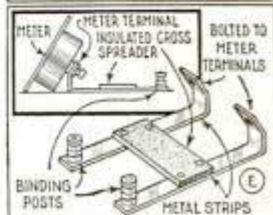

(G) Plumber's burring reamer may be used to enlarge holes in chassis bases for mounting tube sockets. The tool costs less than a good hole cutter and can be used with a bit-brace, drill chuck or turning handle. (H) Adding a radio service point to an old soldering copper. Grind down old point to a flat surface; drill and tap to take a short length of 1/4-in. threaded copper rod as shown. (I) Screwdriver has illuminated shaft for working in dark corners

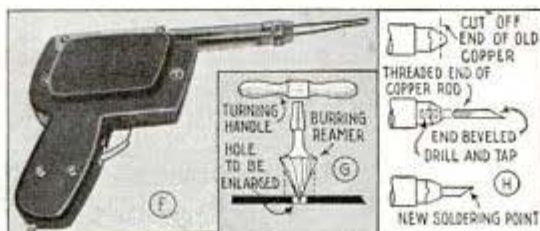

Antenna Encircles Rear of Set



One of the last 10-tube combination radio-phonograph consoles to come off the production line, this one has a tubular type loop antenna that encircles the rear of the cabinet as indicated by the arrows. Reduced noise and increased sensitivity are claimed. A master tone control is an additional feature.

Vertical Air-Raid Siren

Available in 3, 5 and 7½-horsepower ratings, this vertical siren is designed for



mounting on roof tops and on poles. Although local conditions modify results, the ranges determined by test are claimed to be 1 to 1½ miles, 1½ to 2 miles and 2 miles or better.

A and B From Six-Volt Battery

This A and B voltage vibrator power supply unit will provide 6 volts A and 300 volts B at 100 milliamperes from a 6-volt storage battery, to operate your portable public address system in any location. R.F. and A.F. filters are included with proper shielding to provide a hum-free and "hash-free" source of power.



Terminal Blocks in Kit Form

These build-up terminal blocks are easy to assemble and solve the problem for manufacturers and experimental laboratories where terminal block requirements

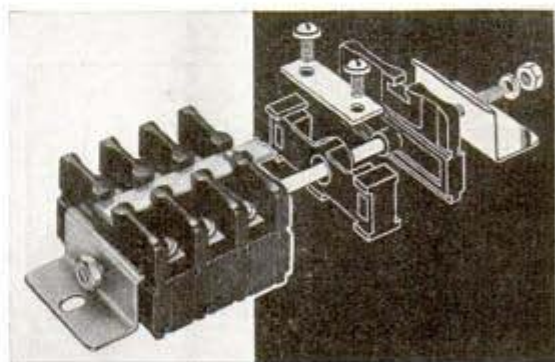

are varied. The kit contains end barriers, marking strip, mounting brackets, threaded rod and other necessary hardware.

Blueprints covering simplified radio construction articles in this and past issues are available for 25c each. Many popular tested circuits for beginners, students and experimenters may be built with used parts. Detailed material lists can be obtained from Popular Mechanics Radio Department upon receipt of postage.

NEXT MONTH—Four-Unit A.C.-D.C. Student Receiver—Part I. A practical progressive layout in 4 small junk-box units that plug together to make either a power unit, phono amplifier or a 4-tube receiver with a wave trap. Simple, but not intended to be too "easy to build." Also—**First Aid for Home Sets, Part 6.**



● Diesel Engine Assembly Line in the WITTE factory



WITTE Diesel Engines and Diesel Electric Plants are available for the defense needs or war efforts of all United Nations. Prompt shipment on high priority orders.

WITTE Diesel Engines and Dieselelectric Plants are out on the victory front . . . serving America and her allied nations all over the world . . . aiding the war effort.

Today, the war needs of the United Nations come first at the large WITTE factory. **We are 100% in war production!** Every piece of modern machinery and every skilled Diesel engineer in this busy plant is devoted to freedom's cause. WITTE has been serving America and other leading nations for 73 years . . . will continue to serve the Democratic world in war and peace.

After victory, our increased production facilities, skilled personnel and improved engineering developments will bring you even better WITTE Dieselelectric Plants—ready to produce extra power at lower cost.

A WITTE Diesel is worth waiting for . . .

★ WITTE ENGINE WORKS ★

LARGEST BUILDERS OF SMALL DIESELS

★ ★ 1747 OAKLAND AVE., KANSAS CITY, MISSOURI, U.S.A.—Cable Address: "WITTEKCMO" ★

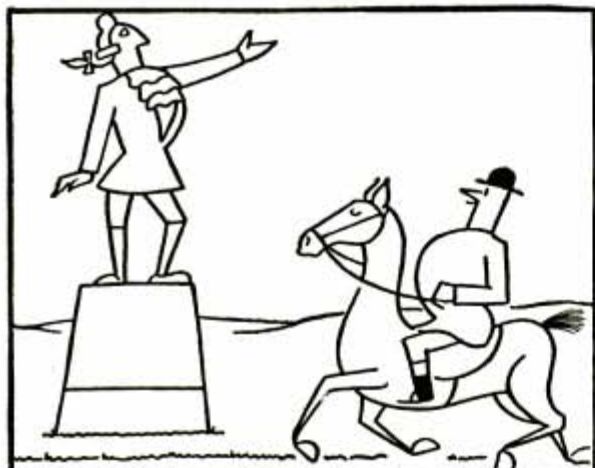

O. SOGLOW



Smoke Gets in Their Eyes

(Continued from page 85)

chemical mixture that when vaporized or atomized produces tiny droplets which give the appearance of a smoke cloud, the device may be installed on the scout car to provide protection for surprise contacts with the enemy.

Upon encountering an enemy machine gun unit, the leading vehicle of the reconnaissance unit would halt immediately and a member of the crew put the smoke generator into action. Under cover of this smoke, the car is put into reverse and rapidly backed, spreading the smoke cloud as it goes, then turns and seeks cover.

The Chemical Warfare Service includes units for the offensive use of smoke on the largest scale. Screening smoke has been used by all the European combatants to protect the advance of attacking infantry and tanks against aimed fire. Lately, large-area smoke screens have been used over many of the German industrial cities, as well as some of the factories in England, as protection against enemy bombers. Such installations cover many square miles.

But the usefulness of smoke is not confined to land operations. Recall the escape of two German warships, one a battleship and the other a large cruiser, from their refuge in a French port, in a sweep that took them through the English Channel. News dispatches tell us that a heavy smoke screen, probably poured from the funnels of speeding destroyers, was a major factor in the success of the maneuver, although surface craft and an "umbrella" of fighting planes also were employed to protect the escaping ships. However, the smoke played an important role in limiting the efforts of British air units to sink the German vessels.

Smoke rings, or squares, have been used in Europe as means of identifying land targets for following bombing pilots. First a reconnaissance plane appears, spots the target and then expels heavy rings of smoke that hang in air to guide the bombing planes to the target. Naturally the bombers must be close behind the smoke plane for the operation to succeed.

For many years, Uncle Sam's Navy has recognized the value of smoke and has employed it in all kinds of fleet maneuvers. Destroyers and planes provide the screens, pouring smoke from funnels and from

spray devices to shroud warcraft in both offensive and defensive movements. Behind a heavy bank of smoke, a battleship or smaller craft can execute quickly any of a score of turning maneuvers, either to gain a more advantageous position for attacking enemy fleet units or to move out of range of enemy guns. In the same manner an escorting destroyer lays down a smoke screen behind which merchant ships may scatter to escape from an approaching enemy raider.

The use of chemicals in warfare goes back to ancient and medieval days. Burning pitch and sulphur were catapulted over the walls of besieged cities and incendiary arrows and a kind of slow-burning powder were used centuries ago in naval engagements. However, chemical warfare, as we understand the term today, began in 1915 during the first World War. Modern large-scale production of chemicals made possible their extensive use.

A part of the Regular Army, the Chemical Warfare Service is charged with research in and development of chemical warfare; procurement and supply of chemical warfare material to the Army; training in offensive and defensive procedure, and the organization and operation of special gas troops. The chemicals employed in war are useful either to produce physiological effects on enemy soldiers, to generate dense volumes of smoke for screening operations or to act as incendiaries.

Solids, liquids and gases are all employed for these purposes, although the term "gas" is popularly associated with chemical warfare because of the primary use of the gas chlorine on April 22, 1915. Another reason for the popular use of the term "gas" is that the injurious agents are disseminated in the atmosphere as gases or powders, which cause injury when breathed and hence necessitate the use of gas masks as protection against them. New chemical warfare agents may appear in the future, but the discovery of any new gas, against which modern protective equipment would be ineffective, is considered unlikely by experts of the Chemical Warfare Service.

The United States is not a party to any treaty, now in force, that prohibits or restricts the use in warfare of poisonous or nonpoisonous gases, smoke and incendiary materials.

HOW AND WHY WILLIAMS' TOOLS AID WAR PRODUCTION



Williams' "SUPERIOR"
(Carbon Steel) WRENCHES

COMPARISON OF CARBON
AND ALLOY STEEL WRENCHES
HAVING SAME OPENINGS

★ Today, material shortages and the need for critical economy makes a close examination of the relative merits of carbon and alloy steel wrenches particularly timely. Since we manufacture *both* types, we can present the following facts without bias or prejudice.

"Superior" Wrenches are forged from carbon steel, specially processed to exacting specifications. They are substantially twice as strong as our earlier carbon steel wrenches. Comparative tests demonstrate that they average (throughout all patterns and sizes) 93% as strong as our corresponding alloy wrenches. In the popular Double-Head Engineers' pattern, "Superior" (carbon steel) Wrenches are *actually stronger* than the corresponding alloy wrenches which are of thinner design. Other Williams' patterns are forged from identical dies whether of carbon or alloy steel — thus the *average* shows a slight strength advantage in favor of alloy steel.

Against this slight advantage are the following practical considerations: Alloy steel wrenches cost nearly twice as much as "Superiors"; critical alloys are needed in many items of war production; in the Double Head Engineers' pattern, the thicker design of "Superior" Wrenches affords a more comfortable hand grip and a better bearing on the nut; the usual finish supplied on "Superior" Wrenches involves no critical material (such as chrome), since they are finished in baked-on enamel rather than plating.

In view of today's conditions, we strongly recommend the use of "Superior" (carbon steel) Wrenches for most industrial applications. Write for "How to Select and Use Wrenches" for complete information.

J. H. WILLIAMS & CO.

BUFFALO, N. Y.

WILLIAMS
SUPERIOR DROP-FORGED TOOLS
Headquarters
for over half a century for
DROP-FORGINGS and DROP-FORGED TOOLS

Yachtsmen on Patrol

(Continued from page 53)

gators; engineering officers are rated as engineers, senior engineers and master engineers.

Crews of Auxiliary boats are, in most cases, made up of regular enlisted Coast Guardsmen or reservists. They may be youngsters just out of high school who don't know a bowline from a bowsprit, or grizzled Chief Boatswains Mates who have spent a lifetime "in the service."

One of the important duties of the "putt-putt" Navy is to supervise the loading and unloading of munitions. In World War I, before America entered the conflict, stevedores sometimes smuggled "cigar bombs" aboard ships they were loading. The bombs did not go off until the ship was at sea.

The Auxiliary has been entrusted with the important job of seeing that this doesn't happen in World War II. So today while Allied ships are being loaded, the Auxiliaries stand guard.

Auxiliaries investigate every stray wisp of smoke on the waterfront. In harbors like San Pedro or Galveston, fire could do great damage to oil storage tanks. Every Auxiliary boat is equipped with fire-fighting equipment and short-wave radio.

Ferrying supplies and equipment to lighthouses and lightboats is another chore of the Auxiliary. Food, fuel, ammunition, gas masks, equipment and mail are carried to men on lonely lookout duty. In their frequent trips in and out of harbors, the Auxiliary boats inspect buoys and other navigational aids.

When great convoys steam into San Francisco or New York, it is the Auxiliary's job to meet them. Immigration officials must be taken out to board the vessels as they make port and the Auxiliaries see that they are delivered safely aboard. And as any seaman can tell you, it's no easy trick to put a small motorboat alongside a huge, wallowing transport—especially if a strong sea is running. But the Sunday skippers of the Auxiliary, who know their small boats intimately, can do it and do it well.

The quiet inlets, the specks of islands and the lonely stretches of uninhabited shoreline on both sides of the United States are perhaps better known to the Auxiliary than any other class of men. In peacetime these waterways were their playgrounds.

But now they are war-time beats to be patrolled day and night.

Off the southern tip of Florida, for example, are hundreds of little palm-fringed islands. These would make excellent hideaways for German and Japanese agents to set up short-wave radio sets and submarine fueling depots—if they weren't inspected regularly by the Auxiliary.

The regular Army and Navy have commissioned some of the Auxiliaries to supervise troop landing operations. Because of their skill in handling small craft, surf boats are "duck soup" to them.

You don't have to be within the smell of salt water, though, to find the Auxiliary. When the great Tennessee Valley projects suddenly dotted the map with power dams and lakes, flotillas of motorboats appeared just as suddenly. It fell to the lot of the Auxiliary to police the lakes and guard dams and power installations against sabotage. The Auxiliary is also found on the Great Lakes and the Mississippi River.

In addition to its many war-time duties, the Auxiliary is carrying on the "mercy" tasks of the Coast Guard, rescuing exhausted swimmers and occupants of overturned boats, and giving storm warnings.

The reason for the efficient and workmanlike job the Auxiliary does is the "big brotherly" interest taken in it by the regular Coast Guard. Special correspondence courses for Auxiliaries are offered by the U. S. Coast Guard Institute, New London, Conn. When duties permit, Coast Guard officers give instruction to Auxiliary groups. An order from the Coast Guard Commandant, Admiral Waesche, makes Auxiliaries welcome at Coast Guard depots, lighthouses, lifeboat stations and Coast Guard bases.

This is the third war within the memory of men now living in which small boat owners have played their part—having served in the Spanish-American War and World War I.

One Auxiliaryman summed up the reason for it this way: "We owners of sailing and pleasure craft aren't going to be able to pursue our peacetime hobby again until Japan and Germany are crushed. The sooner we get this thing over, the sooner we'll be able to enjoy the freedom of the seas for our own small craft!"

CHAMPION SPARK PLUGS



A vast army of volunteer workers are enlisted under the Red Cross, Civilian Defense and other service organizations, eager to play their vital part in time of emergency. Reliable transportation is an essential part of their activities. Champion Spark Plugs are playing their vital part by providing dependable ignition in the motorized equipment of these organizations as well as that of all branches of the armed services.



Check your spark plugs! Check them as a patriotic duty, and a personal, self service. When spark plugs are tested, cleaned and adjusted at regular intervals, they will remain economical and efficient throughout their useful life—and you will know when new ones are needed. Old, worn-out or inferior quality spark plugs can be exceedingly wasteful, and inefficient.



Champion Spark Plugs have won world recognition for better performance, due directly to many exclusive and patented features. One of these, which means most to motorists today, is the patented Sillment seal which banishes troublesome leakage, common to ordinary spark plugs. This exclusive feature prevents overheating, and pre-ignition, a cause of rough, wasteful engine operation.

*More Vital -
More Dependable
than ever!*



TO SAVE GASOLINE • KEEP YOUR SPARK PLUGS CLEAN

Your Home of the Future

(Continued from page 77)

like a tall mast. It is, and it is used only to support the house while under construction. This house is built from the top down, and laying the foundation is one of the last things to be done.

"The mast is placed at the exact center of your house-to-be, and is anchored with guy wires so that it is firm as a rock. On the ground surrounding the mast, the petal-shaped metal sections are bolted together to form a domed roof with a hole in the center through which the mast projects. The completed roof is hoisted up the mast a few feet by a one-man winch. Curved wall panels are bolted on so that they hang from the roof. This process is repeated until the wall reaches its full height of nearly 8 feet.

"Then the foundation is laid—a circle of bricks flat on the ground under the wall. The house is lowered onto the bricks. The mast is removed. A water- and bug-tight sectional steel floor is bolted to the lower rim of the wall, and all that remains is to install the sections of finished flooring, the lining, interior equipment, appliances and fixtures. The entire operation from placing the mast to moving in your furniture takes only a few hours."

In the home of the future designed by William Hamby, noted architect, drudgery now associated with kitchen work would vanish because there would be no kitchen as such, but a spacious area combined with the dining room, in which all kitchen appliances would be concealed. Food would be cooked and served in the same utensils.

Walter Dorwin Teague and Norman Bel Geddes, well known industrial designers, are also co-operating on plans for your home of the future. Teague sees a panel-type dwelling that can be fitted to any desired pattern with preconstructed service units for bathroom and kitchen, a dwelling costing from \$1,000 to \$2,000, easily remodeled. Geddes has a proposed house with 27 basic units, consisting of five different wall sections, doors, windows, floors and roof sections which will produce eleven different houses. One eight-hour day is sufficient for building, he says.

So the world, though it takes a step backward in wartime, is facing a brighter living in days of peace to come.



"General he say — send Sani-Flush to clean out car radiator"

Every one is taking extra precautions to keep cars in first-class condition. Be sure rust and sediment don't clog your radiator—cause dangerous overheating. Clean out with Sani-Flush for positive protection. Costs only a few cents.

Don't take chances on just flushing with water. Sani-Flush is thorough. Use it yourself, or ask your service station. *Sani-Flush is absolutely safe in auto cooling systems, when used according to directions on can.* It's in most bathrooms for cleaning toilets. Sold in grocery, drug, hardware and 10c stores. The Hygienic Products Co., Canton, O.

Sani-Flush

CLEANS OUT RADIATORS

SLEEP OUTDOORS ON YOUR VACATION!

Send for "Outdoors With Ta-pat-co"—telling famous camp tricks and trail secrets to make your outdoor vacation more comfortable, pleasant, and safe. See styles of Ta-pat-co sleeping bags and other outdoor equipment in beautiful colors. Write today—it's FREE! Address . . .

The American Pad & Textile Co.
Dept. 51, Greenfield, Ohio



THE
OUTDOOR
BED



FOR THE
OUTDOOR
MAN

444 Madison Ave. N.Y.C.

Preserving Thread in Awnings



Often the thread used in seams of an awning rot out and allow the seams to open before the awning cloth has reached the end of its usefulness. To avoid this, paint the seams of new awnings with melted paraffin. If care is taken to confine the paraffin to the thread as much as possible there will be little evidence of its presence.

—Raymond F. Yates, Lockport, N. Y.

U. S. Can Make 65% More Steel Than All of Axis Europe

Comparison of the relative steel-producing capacities of the United States and European countries reveals that we can make nearly 65 percent more steel in a year than all the plants in Germany and Axis-controlled Europe. Steel plants here can produce 88,570,000 tons, while Axis Europe's limit is said to be 53,800,000. The latter figure includes Germany's 24,700,000 tons together with 29,100,000 flowing from 11 other nations under the Axis thumb. Add to the American output the British Empire's 20,600,000 tons and Russia's 21,800,000 tons, and the total capacity of the United Nations becomes impressive. Japan is given a rating of 7,200,000 tons. Although some European plants have been damaged by bombing and other war causes, such losses doubtless have been offset by new construction. It is possible that European plants have difficulty in operating at capacity on account of the heavy burden of carrying on constant military campaigns, as well as to shortage of certain raw materials brought about largely by the sea blockade maintained by Great Britain.

☐ To learn where to buy commercial products described in these pages, see the index.

DOUBLE CHECK

SHOWS EXPERTS SPECIFY

AUTO-LITE BATTERIES

ENGINEERING experts for years have specified Auto-Lite Batteries as original equipment for 1 out of every 3 makes of cars. What's more, these famous batteries are used on giant ocean-spanning clippers where power and dependability count most. Get the longer life, extra power, thousands of car owners find Auto-Lite Batteries deliver. Auto-Lite Batteries are priced with the lowest.

USL BATTERY CORPORATION
(A Subsidiary of The Electric Auto-Lite Company)
NIAGARA FALLS • NEW YORK

Double Check for Extra Battery Life

✓ Every 1,000 miles use this 4-way service—test charge, add water, remove corrosion, tighten battery in place.

✓ Auto-Lite Battery service men can advise you on the size and type of battery for best service, longest life.

AUTO-LITE MEANS AUTO LIFE



IN ITS 26 GREAT MANUFACTURING DIVISIONS, AUTO-LITE IS PRODUCING FOR AMERICA'S ARMED FORCES ON LAND, SEA AND IN THE AIR

IF YOU'RE IN THIS FIX..

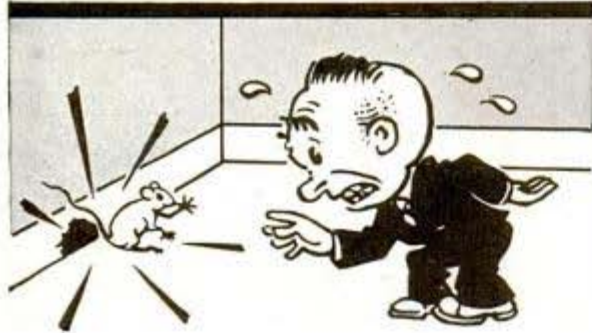

P. W. WILL FIX IT

HOLES AND CRACKS in floors, base-board, or woodwork can be easily and quickly repaired with **PLASTIC WOOD!** Takes a finish like the original wood. Get it at Paint, Hdwe., and 10¢ Stores.



HANDLES LIKE PUTTY—HARDENS LIKE WOOD

BE PREPARED! LEARN TO SHOOT WITH BENJAMIN

MADE IN
U. S. A.



HARD ACCURATE SHOOTING WITH CHAMBERED AIR

You can use new model BENJAMIN AIR RIFLES WITH LEVER HAND PUMP anywhere, for practice firing or just plinking, around the house or camping, fishing, hunting, etc., at lowest cost. Shooting force is adjustable with amazing maximum power and accuracy—no recoil or forward lunge to disturb your aim. Soft Action—Hammer Fire—Hair Trigger—Safety Lock—Hand Pump. Single Shot BB with 1 lb. shot \$9.00; Single Shot Cal. .177 or .22 rifled—with 500 pellets \$10.50. Also a complete line of improved BENJAMIN GENUINE COMPRESSED AIR TARGET PISTOLS. "No License Required." Write for details and FREE TARGETS. BENJAMIN AIR RIFLE CO., 895 Marion St., St. Louis, Mo., U. S. A.



8 Mile Range-Wide Vision

BINOCULARS \$4.75

15 Days FREE TRIAL
Postpaid or C. O. D.

Comes complete with case and straps. Well ground powerful lens. Easily focused for all distances and eye widths. Latest features. Ideal all-weather binoculars. Guaranteed. If not satisfied after 15 days trial, money refunded. AGENTS WANTED.

Vogue Binocular Co., 7759 S. Halsted, Dept. 1008, Chicago



AUTO ENGINE SPEED CONTROL GOVERNORS

Give constant speed to any make of auto or truck engine, regardless of load changes, when used for power. No better governor can be made. Fully guaranteed. Complete, simple instructions. Courtesies to garages and established agencies. Montreal branch, 7546 Wiseman St. Free circulars. CANDEE, 129-9 Llewellyn St., Los Angeles.

Radio Traffic Control

(Continued from page 71)

port trucks and even to the locomotives and cabooses of railroad trains if the point happened to be a railroad junction, too.

Nearly every wartime possibility has its practical example already written on the pages of radio history. The Army and Navy are absorbing low-power sets for soldiers afoot, for motorcycles, jeeps, trucks, gun mounts and ships as fast as they can be produced. The airplane as the charger of a mounted radio traffic cop has already been tested for handling large crowds at the Indianapolis motor races. Police short-wave networks exist not only in cities, but in entire states such as Connecticut which has 11 integrated stations.

In railroad yards near Chicago, switch signals and wire-carried messages have been eliminated in favor of radio control from tower to engine cab. Locomotive engineers can talk by radio to trainmen in the caboose. Ordnance plants control all traffic by radio.

Westinghouse engineers have installed a two-way radio system which controls buses and trolleys carrying 1,200,000 passengers a day in Brooklyn, operating between a central station and 20 patrol cars.

Already tested and approved is a device which will take the red and green traffic signal from the street corner and place it right on the instrument panel of your automobile. Instead of sending out colored light waves, or perhaps in addition to the light waves, the traffic signal box will send low-powered radio waves which will cause your individual "traffic lights" to flash off and on.

There is one more logical step to follow the establishment of these radio traffic cops. This is the creation of the radio patrolman. The engineers say he will be with us one of these days, carrying a walkie-talkie on his back and swapping sour quips with the gruff desk sergeant in the police station as he makes his rounds, keeping peace in a more peaceful world to come.

Names and addresses of makers or sellers of commercial products described in this magazine are listed in the Where-to-Buy-It index. Write to them for additional information and be sure to Say You Saw It in Popular Mechanics.

Win Your Golf Games On the Greens

(Continued from page 95)

trouble if the ball rolls off. Swing the iron in the usual manner but twist the blade slightly to the right as the ball is hit. This lays the blade over and helps you slice under the ball, chopping it high in the air.

The pitch and run is the opposite of the cut shot. It is useful when you want a short low flight and an extended roll, as for reaching the pin at the far end of a long green. You get this result by turning the blade toward the vertical as the ball is hit, moving the right hand over the left to close the face of the club. That gives the ball a lot of overspin and it rolls a long way after a short flight.

An hour a day spent in practicing putts and approach shots should take ten strokes off your score in a month or less. Such an improvement more than doubles your ability as a player. A couple of years ago a national survey showed that the average golfer makes a score of from 100 to 103 in 18 holes. Only three percent of all golfers can break 90 consistently, the survey found, and of that three percent, only one percent can break 70. That shows you what a great difference a few strokes can mean. If you shoot 100 regularly, an improvement of only 10 strokes puts you up with the few players who average 90 strokes.

Glass Made to Resist Shattering With Transparent Coating

Window glass can now be given protection against bomb explosions by coating it with a new transparent material claimed to prevent shattering. The liquid coat may be brushed or sprayed on the glass by anyone. It dries quickly to a tough film with a tensile strength of 3,000 to 5,000 pounds per square inch. The film passes sunlight with little absorption, weathering well without discoloration. However, it is not intended for long service on exterior surfaces exposed to weather, although an inside coating will last indefinitely. Excellent protection is given at temperatures up to the boiling point of water, the film's actual melting-point being a little over 390 degrees Fahrenheit. For use on factory windows where glare reduction is desired, specially colored liquid is available.

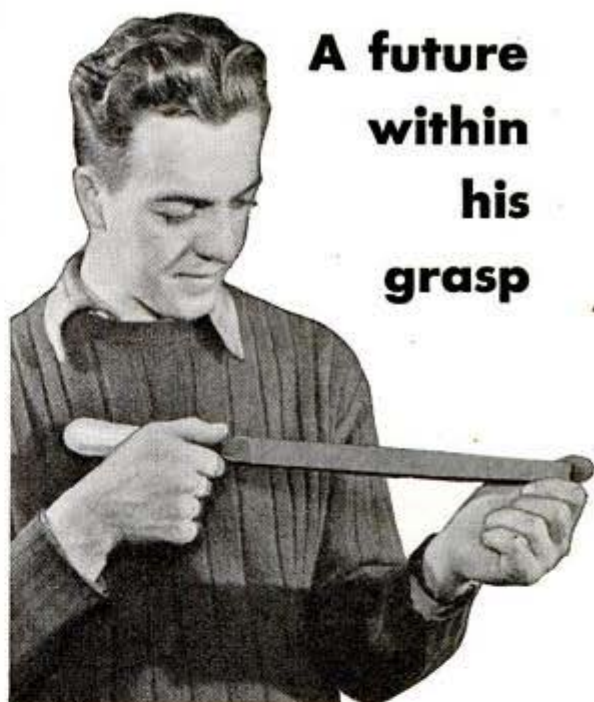

A future
within
his
grasp



Machines are doing many marvelous things today. Nevertheless, there are more opportunities for the skilled human hand than ever before. The mechanic who can use a file expertly—and who knows *The right file for the job*—is one whose skill usually commands excellent pay.

Nicholson—manufacturer of more than 3000 kinds, cuts and sizes of files for every imaginable kind of work—offers many helps to the mechanic or mechanical student who aspires toward a *career* in this vast field of opportunity. Our interesting **FREE BOOK, "A File for Every Purpose,"** offers a solid foundation for the study of files, their uses and care. Illustrated—28 interesting pages. **SEND FOR YOUR COPY.**

• **Free Technical Bulletins** also for advanced information on Special Purpose Files for Stainless Steel, Brass, Plastics, Die Castings, Die Making, Aluminum, Lathe Filing. Name ones wanted.

NICHOLSON FILE CO., Providence, R.I., U.S.A.
(Also Canadian Plant, Port Hope, Ont.)

NICHOLSON
FILES FOR EVERY
PURPOSE

NICHOLSON
U.S.A.
MADE IN U. S. A.

★ When buying files, buy the world's best—Nicholson or Black Diamond. Twelve perfect files in every dozen—guaranteed. At hardware and mill-supply houses.

The Welburn & Wellington Co
OCTOBER, 1942
Boston, Mass



**Move
Anywhere**
**UNCLE SAM
NEEDS WAR WORKERS**



Schult, the Mobile Housing Unit, moves to jobs where needed. Thousands have already been mobilized and housed in key centers in Schult Trailers, the nation's top trailer value... Now larger, roomier, more luxurious than ever. Interiors have private bedrooms, dinettes or davenports—super insulation for maximum year round comfort. Rugged construction assures long life. Move anywhere, cut costs, live comfortably. Write for complete information. Schult Trailers, Inc., Dept. 3210 Elkhart, Indiana.

Write
FOR NEW
CATALOG

Schult Trailers

**Make
BIG MONEY AT HOME!**
**NEW
Invention**
**Electroplates
by BRUSH**



Now Plates CHROMIUM!
ALSO GOLD, SILVER, NICKEL, COPPER, ETC.
War Increases Demand—You Profit!

New, patented invention makes possible big earnings AT HOME. Replate auto-parts—worn articles in homes, stores, hotels, restaurants, etc., with durable, sparkling, new coat of metal—with stroke of brush. Easy, simple, quick. Genuine Gold, Silver, Nickel, Cadmium, etc. Everything furnished. Outfit complete, ready for use. No shop required. Clear from \$2 to \$5 an hour in lifetime business. Small investment starts you in business. Steady repeat. Machine can pay for itself in week. Send TODAY for FREE SAMPLE and illustrated BOOKLET how you can have a life income from a business of YOUR OWN built upon satisfied customers. Act at once!

WARNER ELECTRIC COMPANY
215 W. Ohio St., Chicago, Ill., Dept. 203

FREE BOOK & SAMPLE

WARNER ELECTRIC CO., 215 W. Ohio St., Chicago, Ill., Dept. 203
Gentlemen: Send me Free Sample and Illustrated Booklet.

Name _____

Address _____

City _____

State _____

New
Only \$6.95

REAL ENGINE VALUE



The G. H. Q. is a miniature gasoline engine that really operates. Over 15,000 sold in the last year. Now is your chance to buy the New Improved 1942 model kit for \$6.95. Absolutely complete with coil, condenser, plug, instructions, etc. Only a screwdriver needed. For boats, planes, midget cars, etc. All parts guaranteed. Send only \$1.—Shipped Collect C. O. D. same day. Send for FREE circular or 6c for Jumbo catalog of hundreds of plans, boat and hobby items.

GHQ MOTORS, Dept. B, 40 East 21 St., New York, N. Y.

BURN YOUR NAME ON TOOLS

WITH THE
ARKOGRAF

PROTECT YOUR TOOLS FROM THEFT

Write with electricity any name or design on the hardest and finest tools and instruments, or any metal, like writing on paper with pen or pencil. Complete Outfit \$3.50—Prepaid Anywhere. Interceding illustrated circular free. Write today. Agents wanted. ARKOGRAF PEN CO., 3927 S.E. Stark St., Portland, Ore.



**WHY WEAR
DIAMONDS?**

When Diamond-Dazzling Blue-White genuine Zircons from the Mines of far-away Mystic Siam are so effective and inexpensive. Thrilling beauties that stand acid; cut glass and are full of diamond FIRE! Exquisite mountings! Write for FREE Catalogue. Address: NATIONAL ZIRCON CO. Dept. 27 Wheeling, W. Va.



only
10c

**Wood
workers: Here it is!** Harold Hunt's big No. 14 wood catalog! Latest UP-TO-DATE IDEAS for experts and amateurs! SPECIAL BARGAINS in rare woods, veneers, and ALL kinds of supplies. 148 pages—20 of rare woods in color. Get posted! Send only 10c to

CRAFTSMAN WOOD SERVICE CO.
2729 S. Mary St., Dept. A-26, Chicago, Ill.

OTTAWA LOG SAW \$39 **BIG BOOK FREE**



PUTS THIS OTTAWA to work for you. **MAKE MONEY!** Wood is valuable. Does more than 10 men. Easily operated. Falls cross-axes limbs. Use for FREE Book. **OTTAWA MFG. CO.** 6027 Wood St., Ottawa, Kans.

**BUILD
YOUR
OWN**

ARC-WELDER

For Light or Heavy Work

No rewinding necessary—use coils taken from old auto generators. Works on 110 or 220 A.C. Has 20 different leads. Complete plans and BIG Catalog 35c. **LEJAY MFG. CO., 3347 LeJay Bldg., Minneapolis, Minn.**



Wonder-Tone NOISE ELIMINATOR

Just attach to your radio (long, short wave) and enjoy reception free from distracting noises. Send-No-Money Pay Postman 60c plus postage or send 60c and we'll send postpaid. Return in 5 days for refund if not delighted. **WONDER-TONE COMPANY, Dept. 21, 7078 N. Clark St., Chicago, Ill.**



OWN A Printing Business

Cards, Tickets, Stationery, etc. Good profit in spare time. **PRINT YOUR OWN** greeting cards, movie titles, church work, etc. Save money. Easy rules supplied. Junior Press \$8. Senior Outfits from \$17.50. Have home shop. Raised printing with any Kelsey press. Sold direct from factory only. Write for free catalog and all details. **KELSEY, INC. X-37. MERIDEN, CONN.**

WINDOW SIGN LETTERS

For Store Fronts and Office Windows. Anyone can put them on. Free Samples. Liberal Offer to general agents. **METALLIC LETTER CO., 430 N. Clark St., Chicago**

Get Your Share of U. S. Defense BONDS ★ STAMPS

Keeping the Home Fires From Burning

(Continued from page 37)

this have purchased two good used trucks. With fire department help, these are being equipped with heavy duty pumping units, more than 1,000 feet of hose each, nozzles, brush hooks, and various sorts of extinguishers. One of the trucks has its own 200-gallon water supply. In addition, two private trucks and trailers carrying supplementary equipment are available, and a 30-horsepower tractor and bulldozer has been donated for hauling equipment up steep grades in the adjacent Santa Monica mountains.

All of the volunteer groups are receiving thorough training in first-aid. Garages have been cleaned out and spare rooms in homes have been prepared as emergency first-aid centers with cots in place and windows and entrances blacked out. One volunteer has equipped his bicycle with a complete first-aid outfit.

As fire fighters, all of the volunteers have learned that their most important duty is to get to the scene of a fire as soon as they can and extinguish it before it can spread. A gallon of water or a bucket of sand may extinguish a fire that might rage for days, once it got out of control.

All such precautions as these can't prevent or reduce the destruction that might be caused by heavy demolition bombs, but with the brave examples of the civilian fire fighters of London before them, the American volunteers will protect their homes as well as they can.

Toothpaste Tubes Made of Lead Lined With Indium

Users of toothpaste and shaving cream may soon be introduced to one of the rarest of metals—indium—which probably will make its appearance as a shiny lining in collapsible tubes made of lead instead of tin. As a commercial metal, indium is so new that few persons except chemists have ever seen it, and up to 1924 only one gram had been prepared in pure form. Since that year, however, an American corporation has been extracting it from a large deposit of ore discovered in Arizona. The metal still is expensive, but only a very thin coating is used inside the lead tube.

Ref. Crown Cork & Seal Co

OCTOBER, 1942

Baltimore Md

A WAR-TIME NECESSITY IN EVERY HOME



Seals Cracks



Stops Leaks



Tightens Loose Parts



Get SMOOTH-ON in 1 3/4-oz., 7-oz., 1-lb. or 5-lb. can from your hardware store or from us.

Don't worry because war requirements make it difficult or impossible to obtain new boilers, radiators, heaters, tools, fixtures, utensils, etc. With a can of SMOOTH-ON No. 1 in the house, you can stop leaks, tighten loose parts, and keep your plumbing and heating systems, hardware, tools, etc., in first class condition. SMOOTH-ON will also stop leaks and tighten loose parts all over the car, too.

Smooth-On is easy to use, because this many-purpose iron cement requires no heat, no dismantling of parts, and no special tools. It is economical, because a few cents worth will do most repair jobs, and the unused part of the can does not deteriorate.

For 45 years Smooth-On has helped householders save time and money on repair work, and today, it's more of a household necessity than ever before.

FREE

40-Page Repair Handbook chock full of practical repair hints that will help you to keep household, car, and shop equipment in good condition and enable you to repair what you can't replace. Your copy sent free on request.

MAIL THE COUPON

Smooth-On Manufacturing Co., Dept. 37
570 Communipaw Ave.,
Jersey City, N. J.

Name

Address

10-42



Free

Do it with SMOOTH-ON



noDrip **A SURE CURE**
 Use this plastic cork coating to positively stop sweating and condensation drip. Easy to apply with brush or trowel to pipes, tanks, walls, ceilings, air ducts—any surface of metal, concrete, brick, wood, plaster, composition. Insulates and prolongs life of metal by preventing rust and corrosion. A gallon covers about 30 ft. of 1" O.D. pipe. The permanent, stucco-like finish can be painted any color. Comes in 1, 5 and 55 gal. drums. Get at Hardware, Plumbing, Mill Supply Dealers or send \$1.90 for 1 gal. prepaid. **CIRCULAR FREE.**
J. W. MORTELL CO., 522 Burch St., Kankakee, Ill.

FREE RADIO CATALOG!

You'll want this Big FREE 1942 Book that shows Everything in Radio! Here's everything you need for radio servicing, for experiment, for instruction in the science of modern Radio! More than 15,000 quality radio items—replacement parts, books, tools, lab and experimental equipment—all at the lowest prices! Send for this FREE Catalog now—and don't miss the two big book values described below—They're a "must" for Everyone in Radio!

Radio Builders' Handbook, Everyone in radio needs it 10¢
Radio Dictionary, Complete, valuable, defines all terms 10¢

FREE
 Send for it NOW

ALLIED RADIO CORP.
 833 WEST JACKSON DEPT. 5-K-2 CHICAGO

PHOTO ENLARGEMENTS

Is Photography your hobby? Do you want a profitable easy business at home? Make **PHOTO ENLARGEMENTS** for yourself and others. Your cost 4¢ each and less. The Ideal Photo Enlarger is **AUTOMATIC**. No experience required. Also **COPIES** any picture \$7.34 **COMPLETE**. Interesting circular **FREE**.

5¢ ANY SIZE

Ideal-O, 148 West 23rd St., New York City

CRESCENT TOOLS
Give Wings to Work

ASK YOUR HARDWARE DEALER

FREE LITERATURE FOR TRAILER BUILDERS

New up to date facts on world's most reliable parts, axles, hitches, draw bars. Used by U. S. Gov't. and largest trailer Mfrs. Easy to build in spare time. Complete working Blue Prints only \$1.00. Write for Free Literature.

HAMMER BLOW TOOL COMPANY Dept. 110 Wausau, Wis.

BUY! Engel
Pocket Art Corners

The real thing for mounting Snapshots, Cards, Stamps, etc. No paste needed. Neat, easy to use for mounting prints tight or loose. Sold at photo supply and album counters or send 10¢ today for pkg. of 100 and free samples.

10¢ BUYS 100

Engel Art Corners Co., Chicago, Ill., Address Dept. 19K 4717 North Clark St.

Three-Tube All-Wave Super

(Continued from page 157)

R₁ may be brought into action, to prevent overloading, if necessary, by merely removing the C₃ connection from ground and connecting it to terminal 1 on the L₁ coil socket. If the "Junk-Box B-Eliminator" described in the August, 1942, issue is used with this receiver, no direct ground can be

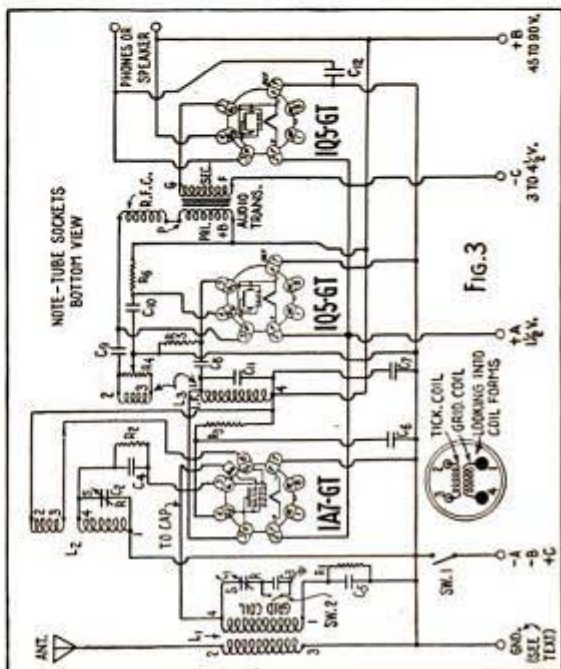

used on the set. If a ground is necessary, use a .1 mfd. 400-volt condenser in series with the ground lead. A detailed list of material is available from Popular Mechanics Radio department without charge, if desired.

Try out the set first on the broadcast band, with coil No. 1 in the L₁ socket and coil No. 2 in the L₂ socket. Switch No. 2 should be in the closed position so that condenser C₃ is not in the circuit, and the full capacity of C₁ is used. Advance regeneration control (R₄) to "full on" position and tune C₁ until a whistle is picked up, then immediately back off the regeneration control until the station comes in clearly, after which, adjust C₁ for strongest signal. Tuning on the short-wave bands is similar but more critical; tune in the stations with the small variable C₂ and use the larger one to "peak up" the signal and make it stronger. Switch No. 2 is opened for all short-wave bands. The blueprint number for this article is R-308.

So Much for So Little!

Scores of New Projects Guaranteed to Keep Any Craftsman Happy... Every One Shop-Tested



for
only
50¢

Furniture, Models, Novelties, Tops, Puzzles, Bird Houses, Games, Carvings, Gifts

6 BIG ISSUES of this Craftsman's Magazine Crowded with New Projects, Plans, Ideas, Shop Helps

This unique craftsman's magazine is published 6 times a year—from October to March—during the months that every home workshop owner can best use it. It is crowded with exclusive new and different plans and ideas—plus hundreds of helpful, practical shop suggestions. Read this brief outline of the high spots—and mail the coupon below today! Here's what the Deltagram gives you in each issue:

New Designs and Plans—with complete working drawings and material specifications on the latest ideas in the wood, metal and plastic fields. The latest styles in furniture, picture frames, novelties, toys... and hundreds of other new and different motifs of design and construction. Easy to work out, accurate and carefully tested, these projects enable you to try your hand at a great variety of work.

One Evening Projects—specially designed to be completed in one evening. Hundreds of handy little objects usable in the home, office or shop. You get the complete story, layout and specifications so that you can start right in and with no trouble

at all, progress step by step to the finished project. Ideal for the beginner, for children, or for the man who sells his work.

Special Shop Kinks—numerous shop kinks, and stories give you a world of ideas on how to get the most out of your tools. Short cuts to efficiency in the use of your tools, and much valuable information on technical subjects, a real service to the owner of a Delta equipped or other shop, are found in every issue of the Deltagram.

Shop Ideas—Job set-ups—machine set-ups—new and interesting ways of doing work. How to paint turnings on the lathe—how to do shaping with a double edge form—French Polishing—saw gumming with a grinding wheel—direct grinding of jointer knives—the cutting of Dentils. Ideas that will help you to do better work, and to overcome the many problems. Every story, every shop idea is aimed at your needs and demands.

Shop Activities—what are others doing—has some section a pet, new idea? What is going on in the North, South, East and West? Trade ideas with others. Keeps you in touch with current events in the craft field.

Whether you are a beginner or experienced shop man, you will get a lot of help from the

Deltagram. Join with your friends in working on projects. Many a profitable and pleasant hour can be spent with ideas from the Deltagram. Trade ideas with others—Do new and better work—learn quick, easy methods of doing things. Get new plans and designs. Don't miss these six big issues of the Deltagram. Bigger and better than ever. Mail the coupon today.

DELTA MILWAUKEE

MAIL THIS COUPON TODAY

THE DELTAGRAM, Published by
The Delta Manufacturing Company
680-L E. Vienna Ave., Milwaukee, Wis.
Gentlemen: I enclose 50¢ (coin or stamps) for the biggest 50¢ worth in the craft field—6 big issues of the Deltagram.

Name.....

Address.....

City.....

Check here and enclose \$1 if you wish 2 years' subscription (12 issues) of the Deltagram.



In pounding seas, humid tropics or sub-zero stratosphere, WELDWOOD GLUE holds.

It's foolproof—just add tap water to the dry powder, stir and the glue is ready instantly. No heating. No waiting. Cold setting . . . PERFECT FOR REPAIR JOBS.

Ask your dealer. If he's "just out" be a little patient, for WELDWOOD GLUE is playing an important part in the drive for Victory.

UNITED STATES PLYWOOD CORPORATION
World's Largest Producer of Plywood
616 West 46th Street, New York, N. Y.

Compare These Amazing Qualities

1. Tremendous Strength
2. Waterproof
3. Rot and bacteria-proof
4. Economical
5. Stain-free
6. Quick and easy to mix

"Makes the glue line the SAFETY line"

*APPROVED for aircraft by U. S. Army, U. S. Navy and Civil Aeronautics Authority when properly applied.



WELDWOOD
PLASTIC RESIN
WATERPROOF GLUE

DEFENSE WORKERS
Show Your Colors..!

"Tell the world"—with your own company emblem on Universal garments that you are proud to be doing your part in the vast Production Army. New—attractive—different lettered garments—shirts, jackets, service coats, etc. Many styles. Many kinds of emblems from which to choose. Low factory prices—sold direct.



Write for **FREE Folder!**
No obligation. Want to make EXTRA MONEY? Then ask for agent's special offer. Write:
UNIVERSAL UNIFORM CO.
Dept. D-1, Van Wert, Ohio



GERSTNER TOOL CHESTS
Outstanding in every way. Free Catalog to machinists and toolmakers.
GERSTNER TOOL CHESTS
442 Columbia St. Dayton, Ohio

TEST-O-LITE

Tests Everything Electrical From 100 to 550 Volts



A real necessity for electricians and home because it has 1001 uses. Equipped with a Neon light which tells instantly where trouble lies in electric circuits, fuses, cut-outs, motors, radios, all kinds of electric appliances, etc. Tells A. C. from D. C. Far superior to ordinary clumsy test bulb. Fountain pen size with clip for carrying in vest pocket. Lifetime guarantee.

PATENTED

L. S. BRACH MFG. CORP.
55 Dickerson St., Newark, N. J.



Low-Cost Two-Ampere Charger

(Continued from page 158)

and shoving the alternate strips to opposite ends to keep the ends even and square. Coat each strip with shellac; when the pile is 2 in. high clamp a wood block on it until dry, then remove the leg and tape it as shown in Fig. 1-A. Winding details are given in Fig. 4. About 1½ pounds of No. 20 d.c.c. wire and about ½ pound of No. 18 d.c.c. were required; this was obtained from burned-out transformers. Leave long start and finish winding leads on each coil, binding starting end under first layer of turns. Coat each layer with shellac as wound. When completed place the legs in

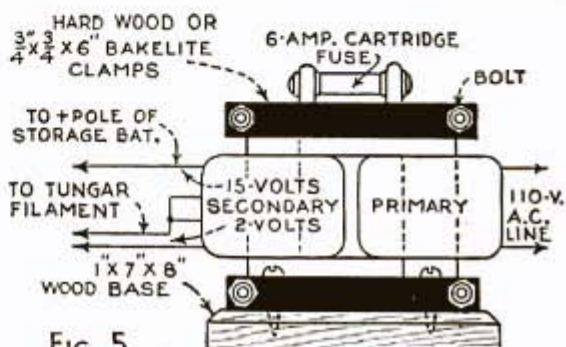

FIG. 5
END VIEW

a moderate oven and bake until dry. The primary is wound directly over the tape, but the secondary is wound over 2 layers of tape and one layer of empire cloth, available from electric shops. Solder, tape and shellac all splices and connections.

The 15-volt winding is wound on first and then 11 turns of No. 14 d.c.c. wire is wound over it for the 2-volt winding. When completed stand both legs on end and insert the side laminations, then coat completely with shellac and dry. Clamp top and bottom ends of the core with 4½-in. bolts to prevent hum and then complete all of the terminal connections shown in Figs. 3 and 5. Connect the battery to the charger and turn on the line switch; if bulb does not glow, turn off current and disconnect the end of the 15-volt winding where it is connected to the 2-volt coil and connect it to the other end, reversing the 2-volt connections. If bulb still refuses to glow it may be necessary to add 1 or 2 turns to the 2-volt winding or 5 or 6 turns to the 15-volt winding. Do not enclose the charger in a box; provide plenty of air circulation when charging.

IT'S FREE Don't Miss This NEW BOOK

"The Age of Chemistry"

New 1942 Chemcraft Chemistry Book describes many amazing experiments you can perform; and tells of the big opportunities, both now and in the future, for boys with a knowledge of chemistry. . . . Send Today.
THE PORTER CHEMICAL COMPANY
 26 Prospect Ave. Hagerstown, Md.



Powerful Vision—8 Mile Range BINOCULARS

20 Days Free Trial \$475 Postpaid or C.O.D.

Scientifically ground, powerful lens that give clear vision equal to 110 yds. at 1000 yds. distance! Adjustable for all distances and eye widths. Binoculars come with handsome case and straps. **GUARANTEED.**



If not satisfied after 20 days free trial money refunded. American Binocular Co., 7759 S. Halsted, Dept. F-762, Chicago.



OTTAWA TRACTOR SAW

Falls Tree—Cuts Log

Fits rear power take-off shaft. Drive thru gear reduction. 18-in. stroke, 10-ga. blade. Economical, saws to profit. **FREE Circular and Price List**
OTTAWA MFG. CO., 1427 Forest Avenue, OTTAWA, KANSAS

ANYONE CAN DO THIS IF THEY HAVE OUR CHART

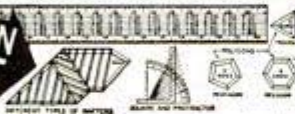

SPECIAL OFFER FOR AGENTS

Blue Print 27"x36" shows how to find length of any rafter, and any angle in degrees, frame any polygon 3 to 16 sides, read board foot and brace tables, octagon scale, rafter tables and much other information. Can be scaled down for model work as well as full scale framing. Also Chart changing pitches to degrees for use with Radial Saws. Send 50c coin. No stamps. **MASON AND PARRISH, ENGINEERS, PM-2105 North Burdick St., Kalamazoo, Mich.**

Save your tools!



Get this **FREE DISSTON MANUAL**

from your

HARDWARE DEALER



48 Pages • 200 Illustrations

Packed with useful workshop advice, instructive pictures, practical helps and hints. Contains this statement from George T. Weymouth, Bureau of Industrial Conservation, War Production Board: **"TOOLS ARE WEAPONS. CONSERVE THEM. USE THEM PROPERLY TO AVOID BREAKAGE AND THE WASTE OF CRITICAL MATERIALS NEEDED TO WIN THIS WAR."** . . . Make your tools last longer. Get your **FREE** copy of the Disston Saw, Tool and File Manual from your Hardware Dealer.

HENRY DISSTON & SONS, INC., 1011 Tacony, Phila., Pa., U.S.A.



HARLEY-DAVIDSON
Economy AID THE NATION'S VICTORY PROGRAM

Thousands of riders have enlisted their Harley-Davidson Motorcycles for duty on the home front. Many are riding in the service of Civilian Defense. Others are motorcycling to and from their war jobs, eliminating additional burden on overcrowded buses and streetcars. And because Harley-Davidsons use so little gas and oil, they conserve these vital war needs—and rubber, too!

While there are no new Harley-Davidsons available now for civilian use, your dealer may have some good values in reconditioned models.

See him today.

HARLEY-DAVIDSON



ON AMERICA'S FRONT

LINE OF ACTION

HARLEY-DAVIDSON MOTOR CO., Dept. P, Milwaukee, Wis.

Send **FREE** copy of big 24-page "Enthusiast" magazine filled with thrilling motorcycle pictures and stories. Also other literature. Stamp is enclosed for mailing cost.

Name

Address

PAIN BRUSHES SCARCE! Keep NEW brushes soft RENEW old brushes

Conserve valuable Paint Brushes! Save them by using DIC-A-DOO PAINT BRUSH BATH after every use. Amazingly efficient in loosening, washing away paint from bristles. Brush remains good as new for long time. . . Restores old hardened brushes to usefulness. Enough to clean several brushes. Costs only 5 cents. Get it at hardware or 5-&-10¢ stores. You'll want to keep several packages on hand. The Patent Cereals Co., Makers of Dic-A-Doo Paint Cleaner, Geneva, New York.

DIC-A-DOO
Brush Bath



Handsome TREASURE CHEST and other useful chests and boxes. Made easily—plans in Stanley Set No. 9. List of 14 sets of interesting plans sent free.

STANLEY TOOLS

Division of The Stanley Works,
1910 Elm St., New Britain, Conn.

EACH SET OF 5 PLANS ONLY **10c**

ONAN ELECTRIC PLANTS ALTERNATING AND DIRECT CURRENT



Produce Current, same as City Power Lines, for FARMS, SCHOOLS, THEATRES, PUBLIC BUILDINGS . . . Operate Lights, Radios, Motors, All Appliances.

Over 40 STOCK MODELS—150 to 50,000 Watts.
Any Voltage—Any Frequency.
Combination A. C. - D. C. Types.
Manual, Full Automatic and Self-Starting. \$99 up.
Shipped—COMPLETE, READY FOR OPERATION.
THOUSANDS IN USE IN ALL PARTS OF THE WORLD

Write for Complete Details.

D. W. ONAN & SONS
1074 Royalston Avenue - MINNEAPOLIS, MINN.

DO YOU

WANT a permanent business profession of your own? Then BECOME A FOOT CORRECTIONIST. Earnings in this greatly needed profession run as high as \$50-\$100 weekly after a few weeks home training—not medical or chiropody—no further capital needed, no goods to buy. 47th year. Write for free booklet.

Stephenson System of Foot Correction

28 Back Bay.

Boston, Mass.

BUILD A MOSQUITO BOAT!



CARVED HULL INCLUDED! Famous Ideal 12 1/2" Super-Detail model. Perfect building easy with our complete kit. \$2.50, p.p. (Catalog 10c) IDEAL MODELS, 26 W. 19 St., NEW YORK

IN STEP WITH UNCLE SAM

SYNCRU Electric Jig Saws enlist with Uncle Sam for the duration . . . making parts for tanks, submarines, planes, guns—producing precision machine tools, fixtures, gauges, production parts. Laboratory research guarantees BETTER SynCRU Saws for you after Victory! See Dealer for available SynCRU Saws.



SYNCRU WORLDS SAFEST **SAWS**

SYNCRU DEVICES, INC.

3265 Bermuda, Dept. PM-102, Ferndale, Michigan

Frozen Billions

(Continued from Coloroto Section)

battle. Shipbuilding corporations and steelmakers examine their war products by this method. A radium bomb the size of a small walnut can replace a roomful of machinery necessary for X-rays and the radiations flow in all directions, not merely in one.

Typical is the Westinghouse Steam Division Works at Lester, Pa., where these "pin point power plants," minute grains of radium sulfate, are at work inspecting war equipment as it is produced. Radium sulfate is used especially to examine parts of steam turbines, propulsion gears and auxiliary apparatus for our fighting ships. This plant has a supply of 825 milligrams of radium sulfate, about half the size of a boy's small marble, sufficient to test propulsion turbines and gears for more than 100 destroyers, cruisers, battleships and aircraft carriers, and a lot of other things.

N. L. Mochel, manager of the Metallurgical Engineering Department at the Westinghouse Works, termed radium sulfate "nature's most efficient power plant."

"The compound resembles slightly discolored table salt," Mr. Mochel explained. "The atoms split spontaneously. This perpetual disintegration generates gamma rays which pierce the hardest steel. Flaws in the metal appear on the film as dark areas. The rays are able to reach the film with greater intensity during an exposure period through flaws than through solid metallic structure.

"Even though it decays to produce energy, radium sulfate is a constant power source. Had a scientist of the fourth century isolated a bit of radium sulfate, it would have reduced itself only to half strength by 1942."

When a piece of equipment is brought into the laboratory for inspection, a technician fishes a radium capsule out of a sunken safe. The walls and bottom of the safe are four-inch slabs of lead. Inside is a block of lead with small wells to hold the radium sulfate containers. A lead lid locks into place over the safe. Radium sulfate must be handled with extreme care. The laboratory is lined with lead. Workmen never remain more than a minute or so in the vicinity when a capsule is exposed.

Displaying a small pear-shaped alumi-

num shell, Mr. Mochel explained that four particles of radium sulfate were enclosed in similar containers. The shells contain tiny silver kernels in which the substance is sealed. The four metal "nuts" would fit easily in the palm of one hand.

"The capsules are suspended within or beside the metal being tested," he continued. "As many as 20 films have been taken in the Westinghouse laboratories at the same time. A belt of film can be placed around circular pieces of metal, such as pipe. These plates register gamma rays from a single radium sulfate source fixed in the center."

Exposure times vary from a few minutes to 48 hours, Mr. Mochel said. Time of the exposure is gauged by using a special slide rule, developed by Navy engineers. It is estimated that each gram of the substance has 2,680 billion billions of atoms which can be kept working for about 20,000 years, the substance losing half of its life every 1690 years. It can't be burned by 2,000 degrees of heat, it can't be broken down by pounding, it won't freeze and it is pretty hard to lose. Electric "radium bloodhounds" have been invented to trace it by its radiations. Lost capsules have been found in a pig's stomach and inside a cement sidewalk.

Gilbert LaBine's mine will be working for America a long time, and the experts who once thought in milligrams are now thinking in grams. Soon they will be thinking in terms of ounces and eventually perhaps pounds of radium.

It's nice to think about a pound of radium. It would be quite a bit smaller than a tennis ball and would be worth nearly eleven and a half million dollars, f.o.b. New York City.

Japanese Beetles Prefer Yellow

Yellow is the favorite color of Japanese beetles, at least in their choice of traps. This was learned through experiments conducted by Federal entomologists when yellow traps captured 50.8 percent more beetles than the green and white ones in common use. Even the addition of yellow to other pigments had the effect of increasing their drawing power. Other colors used in the tests included aluminum, blue, pink, red, orange and green.

OCTOBER, 1942



**...FOR TABLES
OR TROOP CARRIERS...**

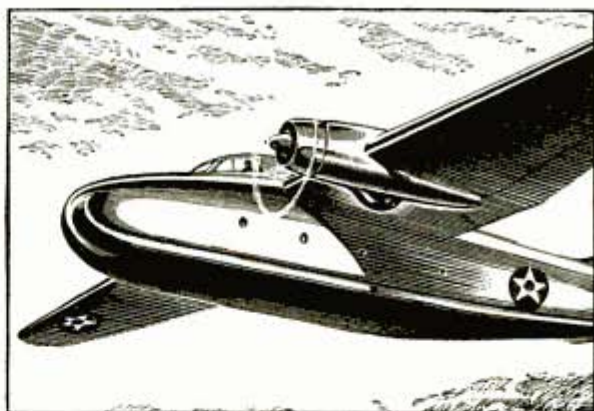

CASCO and CASCAMITE meet U. S. Army-Navy glue specifications!

Army and Navy experts wrote their toughest gluing specifications when they planned Uncle Sam's new wood planes, gliders, truck bodies, life rafts and other wood war equipment. But CASCO and CASCAMITE do the job with strength to spare!

That's why these modern glues are best for your home repair and hobby work. *There are no better gluing standards than these U.S. Gov't Specifications!*



CASCAMITE Powdered Resin Glue—Meets Army and Navy specifications for aircraft assembly cold press resin glue. Also specifications for life floats, truck bodies, other field equipment. Waterproof. Moldproof. Stainfree. Mixes instantly in cold water. 10¢ to 85¢.



CASCO Powdered Casein Glue—Meets Army, Navy and Federal casein glue specifications. Highly water-resistant. Cold water mix. Makes strong bonds with but moderate pressure—even on imperfectly fitted joints. 10¢ to 65¢.

Both sold at Hardware, Paint and Lumber Dealers'. Every 25¢ or larger can includes coupon good for free project plan for one of 36 furniture and water sports projects.

FREE HOME AND INDUSTRIAL GLUING DATA:

CASEIN COMPANY OF AMERICA, Dept. PM1042
350 Madison Avenue, New York, N. Y.

Send me the literature checked.

- "Gluing Guide." Complete mixing directions for all glues. Over 80 home workshop jobs.
- "Project Folders." Describe free project plans.
- Technical Information on the industrial gluing of

(fill in)

(Be sure to give your name and address clearly printed or typed.)

E. J. du Pont de Nemours
Wilmington, Del.

Uncle Sam's Trump Card

(Continued from page 4)

ber once brought in the German market. If this can be done, and since it is an engineering problem there seems no reason why it shouldn't, then we may create in this country a new industry with new employment and add to our national wealth. Wherever natural substitutes for rubber can be grown, a corresponding benefit should result to the farmer.

The same thing applies to other materials, especially metals, many of which are available in the Western Hemisphere, but have not been utilized from pure consideration of cost. If new processes can be found to extract these metals, then new territories and new industries will be opened up—and one of the most important factors in the development of new ventures will be the airplane.

So far, we have only scratched the surface of the possibilities of the use of the airplane in transport. In direct competition with highly developed forms of transportation, such as rail, motor and water, the airplane is able to operate successfully on a sound economic basis. In the opening up of undeveloped territory, the use of the airplane has almost unlimited possibilities as a freight-carrier. This alone would justify the investment of huge sums in engineering.

To a great degree, the engineering and

research being concentrated on military things can be adapted readily to postwar commercial fields. The time required to effect the transition from war to peace economy is extremely critical. Figuratively speaking, if the war stopped on Friday, and we could get into production, say much-needed washing machines, the following Monday, the benefits to our people would be immeasurable.

Here then is clearly the task of the aeronautic engineer. He must accelerate development to the highest possible rate; he, and every other engineer, must expand research in the direction of new products. To a great extent, the winning of the peace rests in the capable hands of the engineers.

These, then, may be listed as the accomplishments of the aeronautic engineer, as well as his new objective:

Superior design and development, resulting in better equipment for our fighting men; flexibility, permitting rapid expansion to mass production; transfer of design and production methods to the automotive industry; improvement of combat material, and research looking to the winning of the peace. Our engineering, which has flourished in the clear atmosphere of freedom, now pays its debt in the defense of freedom. Aeronautical engineering is America's trump card.

The Most Dangerous Man in the World

(Continued from page 30)

are accepted you will be tested by psychologists who will decide whether you have the precise mental and physical capabilities that are required. To make the start, you apply first to your local aviation cadet examining board. The examiners might find that you would make a better pilot or navigator than bombardier, or they may decide that you are just the type of man who is needed.

The instructors who are training young

bombardiers today believe that one of their students may be the one man who will turn the final tide of the war. It might well be, they reason, that it will be an American bombardier who, releasing his giant bombs at the right instant, will swing the course of a decisive sea battle or will change an enemy campaign into final defeat by destroying a vital supply dump or factory just when the enemy is desperate for munitions.

Moths Can't Digest Wool "Toughened" by Rearranging Its Atoms

Wool is chemically "toughened" so that it is indigestible to moths by a process developed by research workers of the Textile Foundation at the National Bureau of Standards. The treatment rearranges sul-

phur atoms inside the fiber, leaving the outside soft and pliable. The process makes the sulphur structure, ordinarily vulnerable to digestive juices in moths' stomachs, resistant to any kind of chemical attack.



THE MEN and the planes of the Army Air Forces carry a mighty responsibility. Victory or defeat—freedom or slavery—can depend on the strength of our air squadrons and *the skill of the crews who keep them in fighting trim.*

Today one of the most pressing needs of the Army Air Forces is for men, 18 to 45, who can handle tools—men with experience as automobile, truck or tractor mechanics, radio operators or repairmen, sheet metal workers, welders, service repairmen, or related skills.

If you have experience or training in any of these fields *you can now enlist directly in the Air Forces.* Here you'll have a chance to work with the finest equipment, on the newest and fastest planes, preparing yourself for a career in the limitless future of aviation. You'll get the world's best training—at good pay. And you'll be in line for rapid promotion. A man

who rises to Master Sergeant in his first enlistment receives \$138 a month, with board, housing, uniforms and medical care free, plus additional allowances if married.

This is your opportunity to serve your country where you're needed most. Sooner or later you'll say, "It's up to me." Why not NOW?

The nearest Army Recruiting and Induction Station will gladly give you full details, without obligation.

U. S. ARMY **"KEEP 'EM FLYING!"**

RECRUITING AND INDUCTION SERVICE

• Visit or write the nearest U. S. Army Recruiting Station or write to: "The Commanding General," of the Service Command nearest you.

Or write to:
Enlisted Branch, Dept. Y-1, A.G.O., Washington, D. C.

NOW READY! LIONEL CATALOG

Just off the press — big, new full-color Lionel Catalog. Send for your free copy at once. Use the coupon below.

FREE! FREE! FREE! FREE!

LIONEL, Dept. 2, 15 East 26th St., New York, N. Y.

Please rush me free copy of new 1942 Lionel Catalog.

Name _____

Address _____

City _____ State _____

DRILL PRESS OWNERS!

HERE'S 1 TOOL WITH 5 DISTINCT USES
THE BARRON MULTI-PURPOSE
ROTARY WOOD PLANER



PLANES & SURFACES • PANELS & BEADS
ROUTS & GROOVES • RABBETS • TENONS **\$7.50** COMPLETE

Converts ANY drill press into a time saving, low cost planer, paneler, tenoner, etc. Surface finishes all types of tough grained and knotty surfaces to agate smoothness. Safe! Guaranteed harmless to drill press. Thousands now in use. **SOLD ON MONEY BACK GUARANTEE.** Full refund on 5 day trial. Shipped prepaid on receipt of \$7.50—or C.O.D. **YOU RISK NOTHING.** Free literature.

Barron Tool Co., 369 Architects Bldg., Detroit, Mich.

STEEL TOP AUXILIARY
DRILL PRESS TABLE

Has 300 sq. in. smooth working surface. Equipped for shaper and many other important workshop uses—a real buy at **\$5.95**



LEATHERCRAFT HEADQUARTERS!

We have plenty of leather

Make useful leather items for yourself OR gifts for others.

Belts, Purses, Gloves, Moccasins, Desk Sets, Book Binders . . . easy to assemble. 101 practical suggestions in 16-page catalog. Send 10 cents. Write today.

J. C. LARSON CO.

Great Lakes Bldg., No. Wacker Drive, Chicago, Illinois

Thumbtacks Soldered Together Make Good Dowel Centers

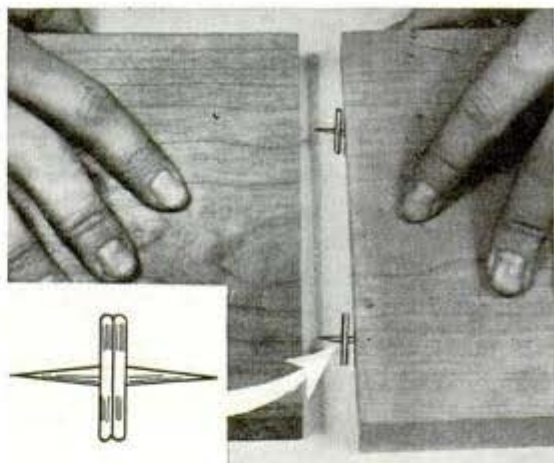

The home craftsman who does not wish to invest in a set of dowel centers, or who does not have one at hand when needed, can improvise suitable ones from thumbtacks. For each center, two tacks are soldered, head to head, so that their shanks are exactly in line with each other.

Glass Jewels for Tiny Bearings Replace Swiss Sapphires

Although the supply has been cut off, the lack of Swiss sapphires for tiny jeweled bearings will not hold up production of the millions of small electrical instruments needed by our armed forces and war industries. This is because a substitute jewel, composed of special hard glass which has been developed and found satisfactory, is now in mass production. As a matter of fact, about 25 years ago the General Electric company used hard glass bearings in its small instruments, but abandoned them when the synthetic sapphire was introduced in Europe, principally in Switzerland. Now, with the sapphires unavailable, the company again has explored the possibilities of the hard glass bearing. The inferior hardness of the glass, it is claimed, offers some advantages. In shaping them, for instance, it is sometimes less difficult to produce minutely accurate dimensions with the glass than with the hard sapphire. Also, the glass is of about the same hardness as the steel pivot it bears, so if the instrument is dropped both will be equally injured, which may affect the performance of the instrument but little.

Switch to Frank
MEDICO
FILTERED SMOKING



GENUINE FILTERS FOR MEDICO PACKED ONLY IN THIS RED & BLACK BOX

66 Baffle Filter Thrills Smokers

USED IN MEDICO PIPES, CIGAR, AND CIGARETTE HOLDERS

New York—The scientific, absorbent filter has contributed mightily to the smoking pleasure of millions of men and women who have switched to Medico Filtered Smoking. Actually, the smoke must travel through 66 "baffles" before reaching the mouth. Flakes and slugs are trapped; and the smoke is whirl-cooled as it winds its way through the filter.

\$1.00

★ *It's Small but it's* **TOUGH!**

PORTER-CABLE
CHAIN DRIVE
7" SHAPER

Strong and powerful for handling heavy cuts with real speed and accuracy. Smooth, chatter-free. Has chain and sprocket drive plus an extra-heavy cast-iron crank pin plate that reduces shock, gear backlash... preserves true alignment. Exclusive "Anyspeed" control—64 to 175 strokes p.m. Available now for your war jobs! Write today for full information.

PORTER-CABLE MACHINE CO., 2000-10 N. Salina St., Syracuse, N.Y.

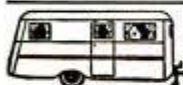

Complete Plans and Building Instructions, 85c

TRAILER BUILDERS' PARTS CATALOG

We'll save you money on everything. Largest and most complete trailer builders' supply house in the United States. Member TRAILER COACH MFRS. ASSOC. Send 10c for parts catalog. NATIONAL TRAILER EQUIPMENT CO. 719 N. Seventh St. Milwaukee, Wis.



METAL AND WOOD WORKING MACHINE TOOLS

Send for new FREE catalog of complete line of Machines, Motors and Accessories

WALKER-TURNER CO., INC. • 1102 Berckman St., Plainfield, N.J.

OUTDOOR FUN!

Indian

SPRING FRAME MOTORCYCLE

Exclusive "Spring Frame" smooths out roughest country roads. New comfort, safety. Brilliant streamlined beauty. See your Indian dealer.

INDIAN MOTORCYCLE CO., SPRINGFIELD, MASS.

See you saw it in Popular Mechanics!

Answers
your every
welding question

516 Pages; 512 Illustrations

Get this big volume packed full of sound advice with detailed diagrams and charts. Get expert training at

The HOBART Trade School
ONE OF AMERICA'S
FINEST!



Only \$2.00
POSTPAID

Easy to Read and Understand

ARC WELDING
Manual and Ready-Reference Text

Most Complete, Concise and Authoritative Book on Arc Welding ever published

5 DAYS Inspection FREE!

USE THIS
COUPON
TO ORDER
ACT NOW!

A Daily Guide for Today's War Work. You'll use it constantly to help improve your weld quality, speed and efficiency.

Latest Techniques, Methods, Procedures... explained and illustrated. You'll be a top-notch operator holding down the big-pay war jobs;

HOBART trained in a valuable post-war trade.

One of the World's Largest Builders of Arc Welders

HOBART BROS. CO., Box M-1021, TROY, OHIO

Send _____ copies of "Practical Arc Welding"

@ \$2.00 ea. C.O.D. Check enclosed.

Send information on Welders Trade School

NAME _____

ADDRESS _____

FOR WARTIME ECONOMY USE BURD PISTON RINGS

A "Graf-Flox" is not just a plating process... it's a treatment of the metal itself.

B "Graf-Flox" rings eliminate the run-in period. Friction is cut to a fraction... fuel saved... pep and power added.

C "Graf-Flox" guards against scuffing, scoring and seizing.

Motorists know that it is poor economy, even unpatriotic, to permit worn out piston rings to waste gas and oil. That's why car owners are having their motors rebuilt with Burd "Graf-Flox" Piston Rings. These revolutionary rings are self-lubricating to prevent scoring, sticking and seizing. They are self-seating, require no "run-in" period, no delay in hitting the road. Install Burd "Kure-Slap" Piston Expanders and Burd Valve Packing too. For real wartime economy—"Rebuild with Burd!"



BURD

"Graf-Flox"

PISTON RINGS

COUPON BRINGS HANDBOOK FREE

BURD PISTON RING CO., Rockford, Ill.

Please send Folder on BURD "Graf-Flox" Piston Rings and a copy of the Automotive Serviceman's "Handy Handbook."

NAME.....
ADDRESS.....
CITY..... STATE.....



POCKET TOOL

Handy, useful, something you need many times during the day. Regardless of where you work—in the factory—around the home—on the farm—this patented "Lucky 7" pocket tool will be worth its small cost many times over. Made of case-hardened steel— $\frac{1}{8}$ " thick— $1\frac{1}{2}$ " wide and $3\frac{1}{4}$ " long. Screw driver, rule, square, wrench, wire splicer, tack puller, bottle opener, friction top can opener, wire insulation stripper and other uses. Send only 25c in coins at once—and get yours, postpaid, while they last. Satisfaction guaranteed or your money back. YATES MFG. CO., 1131 ASHLAND AVE., WILMETTE, ILL.

BUILD THESE PROJECTS
For garden or lawn. Easy to build. Easy to sell. Detailed blueprints Model B-25 Dutch Windmill 50c; Model GM-60 Old Mill, 85c. Lawn Figure Patterns—Sunbonnet Girl, Dutch Boy, Tulip Girl, Hollandi Pair, 35c each, all \$1.00. Catalog illustrating many models, send 10c, today.

CRAFTSMAN'S MODEL CO., Dept. P-66, 2039 N. 41st St., Milwaukee, Wis.

CARBURETORS REBUILT LIKE NEW

We can rebuild your old carburetor or will send original exchange carburetor. No delay—1 day service. Send for full particulars today. United Carburetor Service, 4716 N. Kimball, Chicago, Illinois

I WISH I HAD SOME SPENDING MONEY
HERE'S MY CHANCE TILL I WIN THE COUPON
BRING A COLLIER'S EVERY WEEK
NOW I HAVE MONEY AND MANY BIG PRIZES

G-MAN OUTFIT

Boys, earn a G-Man set, microscope, movie, athletic equipment, or any of 200 other prizes. Make MONEY, too. It's easy. Deliver Collier's to customers you obtain near home. Do it in spare time. To start, write TODAY giving your age, to Jim Thayer, Dept. 963, The Crowell-Collier Publishing Co., Springfield, Ohio.

Sister Ships—or Are They?

(Continued from page 44)

with cranes after being built up as a unit, and deck sections are installed similarly.

If the demand for ships and more ships continues, small wooden freighters may be built again. Wooden ship architects point out that wooden vessels of the last war were built much stronger than necessary, with sides and strengthening partitions so thick that cargo spaces were reduced. With today's knowledge, wooden ships can be built much more economically. Wooden truss systems such as one designed by Harvey D. Sandstone, naval architect, make possible inexpensive wooden vessels that promise to be just as satisfactory as steel ships. Some of the 300-foot wooden ships built in the last war are still in use.

Taking advantage of the many improvements in naval architecture, Sandstone has designed a "ship of the future" that could easily be built today. The design is for a 350-foot 7,000-ton wooden vessel with a low streamlined silhouette. The midships portion of the whaleback deck would be awash in rough weather as is the case with loaded oil tankers. The vessel is designed for continuous tensile strength throughout, and is compartmented with fore-and-aft and thwartship bulkheads. The interior would be air conditioned if used as a troop transport. Cargo masts are stowed on deck and would be raised hydraulically for working cargo. The engine is aft, similar to oil tanker design. The ship is equipped with a retractable forward rudder that can be lowered for increased maneuverability in close quarters such as turning basins.

Proposed armament includes groups of anti-aircraft pompoms and 6-inch guns for use against surface raiders and submarines. One feature of the design is a pair of rams on the bow. The clear sweep of deck provides room for an aircraft runway or a catapult, with a boom at the stern for retrieving the planes from the sea.

Meanwhile, contracts have been let for the construction of a number of large reinforced concrete barges principally for coastwise oil transport. With capacities of 5,000 tons or more, the 350-foot barges will be towed by tugs or other vessels. The ships should be far more satisfactory than the experimental concrete vessels that were launched during the first world war.

Los Angeles, Cal.
Commercial Exchange/2509

THE KNIFE THAT MAKES THOSE



NAVY *plane* MODELS

QUICKER, EASIER, At Your Dealer's or Direct

Sets \$1 to \$3.50. Extra blades, 50c for pkt. of 5.

50c Each

X-ACTO CRESCENT PROD. CO., INC. Dept. PM 140-43 Ave. New York City

X-acto

Refill-blade KNIFE

Send 10c for booklet "HOW TO MAKE SCALE MODELS FOR DEFENSE"

EMPIRE LEVELS

Preferred by MASTER CRAFTSMEN . . .



EMPIRE TORPEDO LEVEL . . . Smallest and Handiest Accurate Level made. "Cigar-shaped," no sharp corners to tear pocket. Walnut stock. Has level, plumb and 45° vials. 9" long, only 3 oz. No. 44 . . . \$1.10. Order from local dealer. Write for literature.

EMPIRE LEVEL MFG. CO., Dept. P-220, 717 S. Sixth St., Milwaukee, Wis.

Only 50c

MAKES AND SAVES MONEY FOR YOU

NEW 1943 BOOK FOR EVERY MAN WHO USES TOOLS

New SHOP NOTES is biggest and best ever issued. 224 Pages, 18 in colors, 560 pictures and plans. Will help on your job. Get this great book today from your news dealer or send 50c to address below. Profit by its facts, ideas, shop kinks, short cuts. No other book like it anywhere.

POPULAR MECHANICS PRESS
Dept. 428 • 200 E. Ontario Street • Chicago



SPECIAL MAIL ORDER LIST!

PRACTICAL, PROFITABLE Low Cost BOOKS

Popular Mechanics own publications including books for self advancement, saving money on improvements, hobby enjoyment and ways to earn extra money.

Select and Order Now

How To Read Blueprints. New. Complete. Get this valuable knowledge from this one book. \$1.50.

Forty Power Tools You Can Make. All of the wanted power tools for the home workshop. Make them from old auto parts, etc., at low cost. \$1.25.

1001 Ways to Use Concrete. Covers all concrete uses. Shows how to start a paying business. Reduced to \$1.98.

Your Car. Save up to \$100 a year. Describes hundreds of simple repairs, shortcuts, etc. \$1.25.

Build a Boat. For pleasure or profit. Shows how to make 17 low-cost boats at home. \$1.25.

Shop Notes. Money-making, money-saving help for every man who uses tools. 1943 volume 50 cents. 4 volume Library \$1.95.

Garden Book. Build your own trellises, fences, lawn furniture, etc. \$1.00.

Welding, Brazing and Soldering. Including how to make welding equipment and use it effectively. \$1.25.

What To Make. What to make and how to make it for fun or profit. 1943 volume (de luxe cloth) \$1.25, (paper) 50c. 4 volumes (de luxe cloth) \$5.00, (paper) \$1.95.

Boy Mechanic. The best book for every boy. Hundreds of pictures. \$2.00.

Photo Guide. The guide to better pictures with money-saving articles on making equipment at home. \$1.25.

Money Making Formulas. Over 3000 formulas. Tells how to convert simple ingredients into salable products. \$2.00.

SEND NO MONEY—Books shipped C.O.D. anywhere in U.S.A. at listed price plus delivery cost. We pay postage when remittance accompanies order. Mail your order today.

POPULAR MECHANICS PRESS
Dept. 427, 200 E. Ontario St., Chicago

CHECK TITLES WANTED AND MAIL



HOW TO Conserve ON SPARK PLUGS and Gasoline Cost

What to do-

Have your spark plugs cleaned and adjusted every 4,000 miles. (Costs only 5c a plug.)



Replace all badly worn plugs promptly.

Why-

Dirty or worn spark plugs waste as much gas as 1 gallon in 10. They also cause hard starting (bad for batteries!) and loss of power.

Where-

Go to your neighborhood Registered AC Spark Plug Cleaning Station. Look for this Sign.

"Keep 'em Rolling"

Do Your Part
Buy Defense Bonds

AC SPARK PLUG DIVISION • General Motors Corporation

SALESMEN WANTED!

Capable salesmen make good incomes calling on industrial plants. No experience of welding necessary.

IMMEDIATE DELIVERY

TRINDL SUPER INDUSTRIAL ARC WELDERS

The handy portable welding equipment all war industries are looking for. Easy to operate. Handles 5/32" rods—110 and 220 volt 60 cycle AC with 10 to 125 amp. output—16 heat ranges—excellent for heavy production or maintenance work... ONLY \$58.00 COMPLETE.

TRINDL PRODUCTS, LTD. 2227-B CALUMET AVE. CHICAGO, ILL.



\$58 BUYS ALL! Welder, Head Shield, Electrode Holder, Ground Cable and Welding Rod.

"YANKEE" TOOLS
MEAN MORE THAN EVER NOW!



This "Yankee" vise (#1993) speeds production. It is detachable from its swivel base. The V-block holds round stock.

If your dealer can't deliver your favorite "Yankee" spiral screw driver—or vise, brace, drill or tap-wrench—just remember that we're making more "Yankee" Tools than ever. But, most of them are building planes, ships, tanks and guns!

The "Yankee" ingenuity that makes screw driving easier, that gives your vise the utility of a jig—is speeding the day of victory. The reliability which makes your "Yankee" tool a friend at home, makes America more productive.

The day will come when you can again buy "Yankee" Tools anywhere. Meanwhile, take good care of those you have.

"YANKEE" TOOLS

make good mechanics better
North Bros. Mfg. Co., Phila., U. S. A.
Established 1880

Makers, also, of "Yankee-Handyman" Tools



*In War.
In Peace*
**HULL COMPASSES
LEAD THE WAY**

• America's fighting men drive the right direction with Hull Streamline Compasses—the dependable instruments which have long kept civilian motorists on the right road at all times.

HULL MANUFACTURING CO., P. O. Box 246-D10, Warren, Ohio



New Accurate 10" Slide Rule

Enables you to do difficult calculations instantly without paper or pencil—multiplying, proportions, division, extracting roots, etc. Accurate, white composition face. Has standard A, B, C, D, CI, and K scales. Special magnifying indicator.

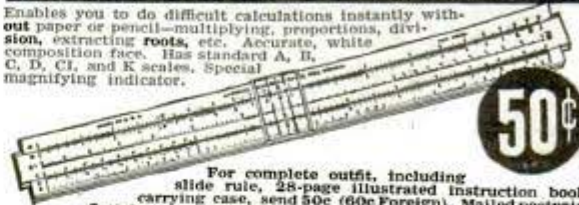

50¢

For complete outfit, including slide rule, 28-page illustrated instruction book, carrying case, send 50c (60c Foreign). Mailed postpaid. Satisfaction guaranteed or money refunded.

SPECIAL COMBINATION OFFER—Slide Rule and Instruction Book; Pocket Calculator for adding and subtracting up to 999,999; 6" Transparent Protractor and Graph Rule graduated in centimeters and inches—ALL 3 for \$1.00 cash (\$1.10 Foreign). Order NOW HEWIG CO., Box 143-B, Grand Central Annex, New York City



WAR VOLUNTEERS

Materials to build famous WITTE Log Saws and Engines are now needed for war equipment. America's victory program has first call at the large WITTE factory. After victory—these money-makers will again be available. They're worth waiting for.

*WITTE has been serving America for 72 years.

WITTE ENGINE WORKS
Kansas City, Missouri



WITTE LOG SAWS and ENGINES

How long since you made movies of your family?

Load up your CINE-KODAK today

PINS 55c UP **FREE CATALOG** **RINGS \$1.50 UP**

Finest quality. Over 300 artistic designs. Write for our attractive free catalog and select a beautiful pin or ring for your class or club.
Dept. N, METAL ARTS CO., Inc., Rochester, N. Y.

Send for **FREE CATALOG \$9.50 UP**

MONUMENTS

Enduring, strikingly beautiful GRANDUR Memorials direct, at prices you can afford. GUARANTEED. Investigate our memorials before you buy.
ECONOMY MONUMENT CO. (Dept.) 327 So. Dearborn St. Chicago, Illinois

GENUINE U.S. BARGAINS

- O. D. WOOL BLANKETS (USED) . \$2.95
 - MCCLELLAN SADDLES (USED) . 5.95
 - U. S. ARMY PUP TENTS (USED) . 3.50
 - ALUMINUM MESS PANS (USED) .35
- Thousands of Other Bargains in Military, Outdoor & Sport Goods for Hunter, Farmer, Scout Send 10¢ for 32-page catalog returned with first order.
- A and N SUPPLY CO.**
4720 LESTER ST. RICHMOND, VA.

Say you saw it in Popular Mechanics!



BURNS ANY COAL

ONE LEVER DOES IT ALL

AMERICAN "Self-Cleaning" Hand Operated STOKERS

Industrial Oil Burner Users, Heating Plants Get QUICK DELIVERY!

HERE is the quick, inexpensive solution for the problem of changing over from oil to **DEPENDABLE COAL FIRING!** Schools, factories, stores, institutions report excellent results with cheapest coal. No power cost, no fans, no motors. Sizes from 100 lbs. to 4,000 lbs. coal per hour. Write for full details.
AMERICAN COAL BURNER CO., ENGINEERS, 14-18 East Erie St., CHICAGO, ILL.

OPPORTUNITIES FOR SALES ENGINEERS

Some territories are open for experienced sales engineers familiar with steam plant boilers and furnaces. Information on request. Please furnish record of your experience and references.

FAMOUS *Marlin* FEATURES

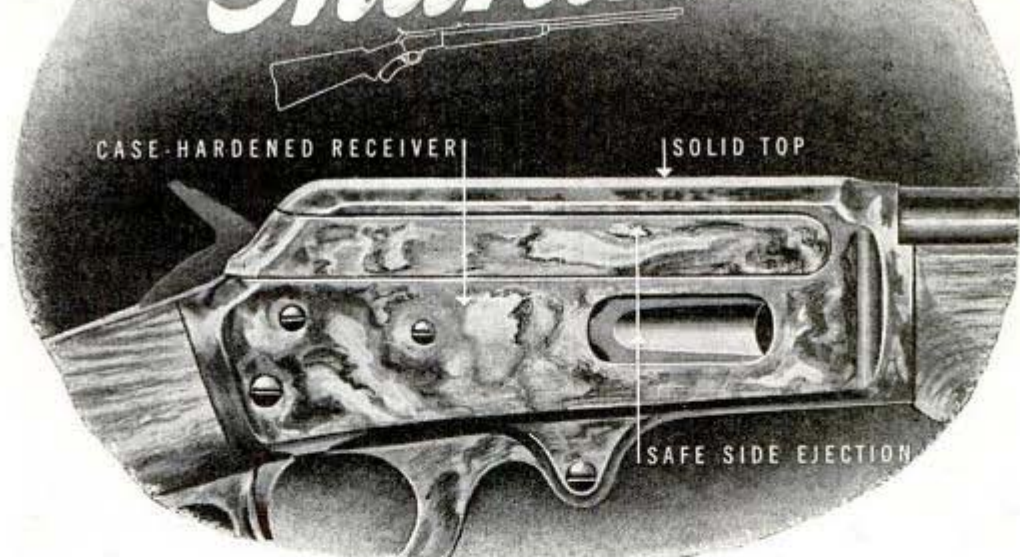

Marlin big game rifles—as well as the famous lever action .22—have featured the solid top receiver and side ejection since their introduction by Marlin a half century ago.

Marlin's solid top receiver permits *low mounting* of telescope sights, for convenience

and accuracy. Case hardening adds to wear and beauty. Side ejection is safe and permits undistracted attention to your aiming.

These Marlin features have proved their value over the years. They are worth remembering after the war is won.

1870

THE MARLIN FIREARMS CO.
NEW HAVEN, CONN., U. S. A.

1942

4000 BARGAINS IN FREE 260 Page Wholesale CATALOG

Shows money makers for dealers, agents and salesmen. Articles desirable for the home, office, factory or store are displayed for your selection. Satisfaction guaranteed or your money back. Get your copy, now, as supply is limited.

SPORS CO., 8-42 National, LE CENTER, MINN.

Get This Brand New "LATHE MANUAL"

This manual will enable you to understand the modern metal-cutting lathe, its parts and their functions . . . to teach the proper care of a lathe . . . to explain the grinding of cutters; modern lathe tools and how they should be set-up; methods of holding work, and the performance of the basic lathe operations. This manual is exceptionally complete in its tool grinding charts.

ONLY 50c

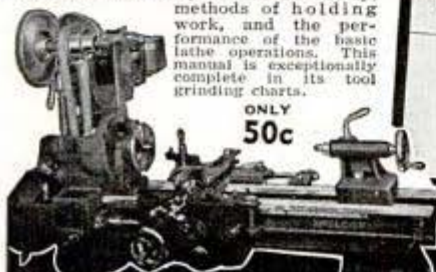

Send for LATHE CATALOG

SHELDON MACHINE CO., Inc.
4266 N. Knox Ave.
CHICAGO ILLINOIS

GS TOOL CHESTS

GS Tool Chests are used by thousands of mechanics to safeguard their valuable precision tools. Illustrated is Solid Oak Chest 20" x 9" x 13 1/4" with 7 drawers and TWO LOCKS for complete safety. Price \$13.50 plus shipping charges. QUICK DELIVERY to workers in war plants. Extra discounts on quantity orders. **INQUIRE. SEND YOUR ORDER IN TODAY.**

Write for four page folder.

Geo. Scherr Co.

128A LAFAYETTE ST. - NEW YORK



Always write your name and full address clearly when answering advertisements.

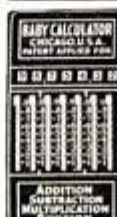

WORLD'S LOWEST PRICED ADDING MACHINE

FREE TRIAL ONLY \$250
Vest Pocket Size
FREE TRIAL
TOTAL COST SEND NO MONEY
MONEY BACK GUARANTEE. Send name and address. Pay postman only \$2.50 plus postage. (Send full cash if outside U. S.) Money back in 30 days if not delighted. **AGENTS WRITE.**

CALCULATOR MACHINE COMPANY (Mrs.)
DEPT. 134 P. O. BOX 1118 CHICAGO, ILLINOIS

Keep 'em Firing



BUY
WAR BONDS

Atlas

America's Compact Modern LATHE



Top producers of weapons for land, sea, and air are the modern Atlas 10" Lathes. You'll find them throughout the nation in the tool rooms and shops of large and small armament makers. You'll find them frequently in mobile maintenance outfits of the armed services.

Atlas Lathes are selected for this vital work because they combine all modern lathe operating features and meet the high precision standards of industry at lower cost. New performance demands . . . new materials to machine . . . new techniques in development . . . are contributing much to lathe advancement and assure you that the Atlas Lathe of tomorrow will be an even better one for you. Atlas Press Company, 1043 N. Pitcher St., Kalamazoo, Michigan.

VICTORY FIRST! - THEN Atlas TOOLS FOR YOU

NEW! **FREE CATALOG**
**RADIO·SOUND
ELECTRONICS
PARTS·SUPPLIES**

**FAST
EMERGENCY
SERVICE**

**WRITE
TODAY**

The BIG book of BIG values! Standard Radio and test equipment, thousands of parts for Radio, Electrical and Electronic assemblies. Nation wide service with Teletype connections for speed and dependability. Engineers, laboratory workers, servicemen and industrial plants look to Lafayette for everything in radio. Write for catalog PM10 today.

Lafayette RADIO CORP.
901 W. JACKSON, CHICAGO
265 PEACHTREE ST. ATLANTA

110-VOLT AC GENERATORS

& AC light plants, 1800 & 1200 rpm. Available for all standard voltages such as 110, 220 or 440 three phase; three phase, three wire or three phase four wire & 25, 30 or 50 cycles. 350 through 15,000 watts. Also rotary converters, motor generators, frequency changers, etc.

KATOLIGHT, 25 Elm St., Mankato, Minn.



MOTORISTS Wanted!



TO MAKE THIS UNIQUE
GAS SAVING TEST

Will you permit us to send you at our risk the Vacu-matic, a device which auto owners everywhere are praising? Install it on your car. Test it at our risk. Unless it trims dollars off your gas bills by saving up to 30% on gasoline consumption, gives more power, quicker pickup and faster acceleration, the test will cost you nothing.

Automatic Supercharge Principle
Vacu-matic is entirely different! It operates on the supercharge principle by automatically adding a charge of extra oxygen, drawn free from the outer air into the heart of the gas mixture. It is entirely automatic and allows the motor to "breathe" at the correct time, opening and closing as required. Saves up to 30% on gas costs, with better motor performance.

FITS ALL CARS
Constructed of six parts fused into a single unit, adjusted and sealed at the factory. Easily and quickly installed by anyone in a few minutes.

AGENTS Get Yours **FREE**

FOR INTRODUCING. Here's a splendid opportunity for unusual sales and profits. Every car, truck, tractor owner a prospect. Send name and address now for big money making offer and how you can get yours Free-The Vacu-matic Co., 7617-756 W. State Street, Wauwatosa, Wis.

In answering an advertisement with a coupon, be sure to write name and complete address clearly.

don't WORRY

Why put up with years of needless discomfort and worry? Try a Brooks Automatic Air Cushion. This marvelous appliance permits the opening to close, yet holds reducible rupture securely, comfortably—day and night. Thousands report amazing results. Light, neat-fitting. No hard pads or stiff springs to chafe or gouge. Made for men, women and children. Durable, cheap, **Sent on trial** to prove it. Never sold in stores. Beware of imitations. Write for Free Book on Rupture, no-risk trial order plan, and proof of results. All correspondence confidential.



BROOKS COMPANY, 158-B State St., Marshall, Mich.



KRW ARBOR PRESSES BENCH TYPE AND HYDRAULIC

NEEDED IN EVERY SHOP—SAVE TIME AND MONEY—DO BETTER WORK, QUICKER.

No shop is complete without a small arbor press. Pressing and squeezing operations can be done better and faster on a KRW Arbor Press. Stop using vise and sledge hammer methods—they generally deliver spoiled work in the end. KRW Factory-To-You Prices give you greater value for your money. Order today.

KRW Bench Type Arbor Presses, 3 sizes
 No. 37-P ½ Ton, \$13.25*
 No. 37-O 1 Ton, \$23.00*
 No. 37-N 3 Ton, \$33.00*
 *Prices F.O.B. Arcade, N. Y. Slightly higher west of Rockies. Stand illustrated extra.



KRW Hydraulic Presses are built in 25, 50 and 75 ton sizes. Prices start at \$198.00*



K. R. WILSON 17 Lock St., BUFFALO, N. Y.
 Builders of Shop Equipment for Ford Dealers Since 1916

BRONZE FOUNDRY Schools and Home Workshops

Make your own castings of aluminum, copper, bronze, silver. Foundry sets are available in three sizes including 2400 Deg. F. blast Furnaces. \$17.50, \$24.00, \$34.50, f.o.b. Kansas City. Free Circular.

KANSAS CITY SPECIALTIES CO.
 P. O. Box 6022, Dept. P-23 Kansas City, Mo.

BUILD YOUR GRANDFATHER CLOCK NOW

Send 35c for Simple SHOP TESTED COPYRIGHTED BLUEPRINT. The Simple Sensible Red-a-Kut way as thousands have. DIME brings PLANS and sixty picture "HOW" Book pricing many fine brass weight Westminster, tube chime movements showing nine beautiful colonial grandfather cases. Build now. Avoid Govt. Freeze. Save half. **HURRY!** KUEMPEL CHIME CLOCK CO., Bldg. 69, Guttenberg, Iowa



Machinist's Tool Chest 20" x 12 1/4" x 8 1/2"
 Popular top till chest. High grade material used throughout. Tough long wearing Fabrikoid Black seal grain leather with white metal trimmings. Drawers felt lined. Also men open top with 3 1/2" drawer. Immediate Delivery. Send for price list.
JOHN WILLIAM MFG. CO., 710W. Jackson Blvd. Chicago, Ill.

ACE LATHE TOOL SET

\$14.50



Be permanently tooled-up for every operation on your Metal Cutting Lathe

The ACE Set is complete—there's nothing more to buy. Drop forged by the manufacturers of cutting tools used by 90 per cent of the plants and shops in industry they are correctly designed, are of special steel, are finely finished, are stronger—will last a lifetime. You can cut easier, faster and more accurately with ACE TOOLS.
 At your Hardware Store—Circular FREE.
ARMSTRONG BROS. TOOL CO.
 "The Tool Holder People"
 268 N. Francisco Ave., CHICAGO, U.S.A.

BRUSH PLATING OUTFITS

for autoparts, reflectors, faucets, bicycles. No tanks necessary. Free particulars.
GUNMETAL CO., AVE. M, DECATUR, ILLINOIS

TOMBSTONES \$10.95 UP FREIGHT PAID

High Quality Granite and Marble. Lettered. Guaranteed. Write for Free Catalog and samples of stone. Without Delay. Order By Mail.
U. S. MARBLE & GRANITE CO., A-18, ONECO, FLA.

SHAW and "Peppy-Pal" GARDEN TRACTORS

* 1 to 9 H. P. Circulars on request. War limits production . . . We have repairs for all SHAW tractors sold in our 39 years in business. Write us for your needs.

YOU CAN BUILD YOUR OWN GARDEN TRACTOR \$1.00 brings our plans, postpaid, telling how to build a garden tractor, for cultivating, light plowing, etc., chiefly by welding and bolting up scrap steel.



SHAW MFG. CO., 4510 Front St., Galesburg, Kansas
 668-G No. 4th St., Columbus, O.; 5812-G Magnolia Ave., Chicago, Ill.

Figure Faster—Easier with OHMITE

OHM'S LAW CALCULATOR



OHMS WATTS, VOLTS AMPERES QUICKLY CALCULATED
 Simple! Easy!
 Solves any Ohm's Law problem with one setting of the slide. Requires no slide rule knowledge. All values are direct reading. Scales on two sides cover the range of currents, resistances, wattages and voltages commonly used in Radio and Electrical work. Size 4 1/2 inches x 9 inches.

Send only 10c in coin to cover cost of handling
OHMITE MFG. CO., 4931 Flournoy St., Chicago, Illinois



Just Off the Press Free Fall Catalog

Showing Hunting Footwear, Clothing, and forty-three other leather and canvas specialties of our own manufacture for campers and hunters.

L. L. Bean, Inc.
 299 Main St., Freeport, Me.

FILING SAWS for FACTORY



The FOLEY SAW FILER
 is in use by U. S. Army, Navy, Air force, hundreds of War and manufacturing plants.
FOLEY MFG. CO., 1016-2 Foley Bldg., Minneapolis, Minn.

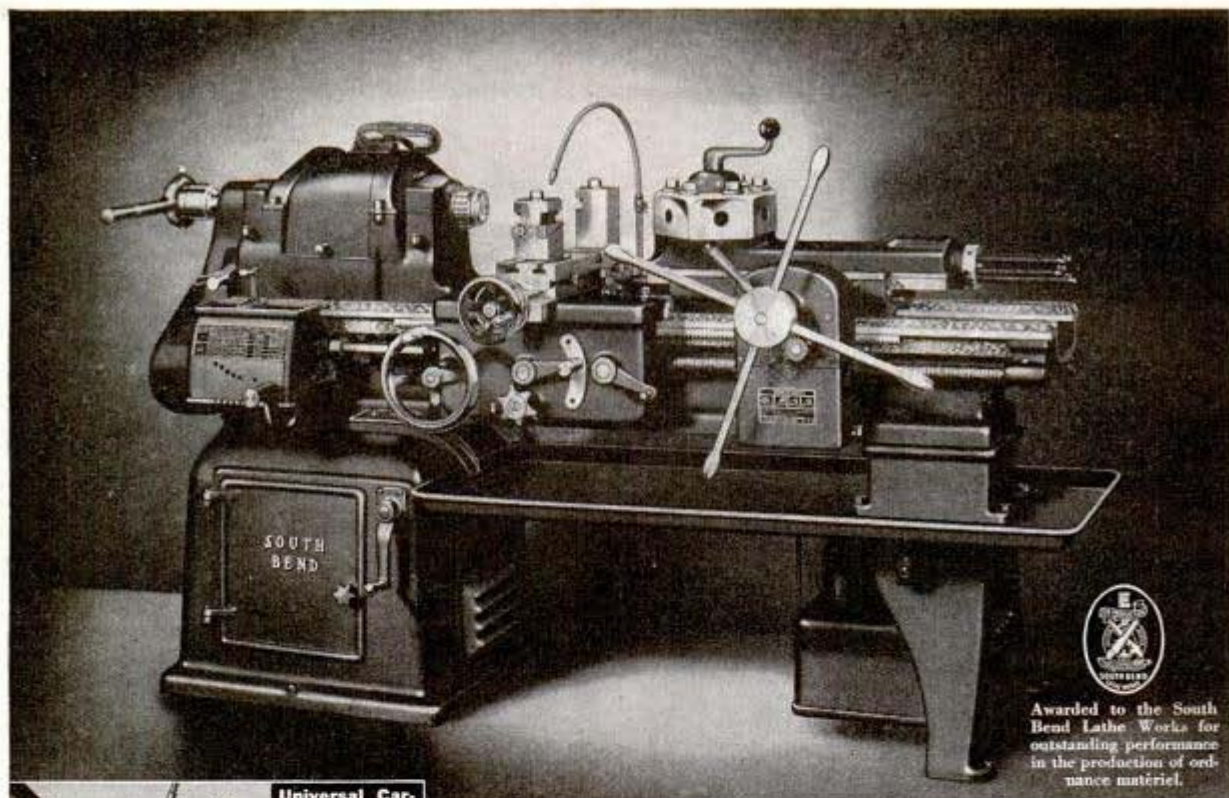

 Awarded to the South Bend Lathe Works for outstanding performance in the production of ordnance matériel.



Universal Carriage—Crossslide has front and rear tool blocks and adjustable stops.



Quick Change Gear Box—Provides 48 power cross and longitudinal feeds.



4-Way Turret Tool Block—Permits greater number of operations per set-up.

SOUTH BEND TURRET LATHES

Designed for the efficient production of duplicate parts, the South Bend No. 2-H Turret Lathe has the precision for exacting, close-tolerance operations—smooth power for producing a fine finish—versatility that reduces set-up time to a minimum.

The universal carriage has 48 power cross feeds, 48 power longitudinal feeds, and 48 thread cutting feeds. All changes are made through the quick change gear box. The ram-type turret indexes automatically and has an adjustable feed trip and stop for each of the six turret faces. The quick change gear box provides 48 changes of turret power feeds. Change gears in the turret apron provide an additional change of turret power feed, independent of universal carriage feeds in both rate and direction. Full advantage can be taken of the higher cutting speeds possible with tungsten carbide tools as a result of the wide range of available feeds and speeds.

Investigate the possibilities of South Bend Turret Lathes, especially for second operation work.

SOUTH BEND LATHE WORKS

Dept. 622

South Bend, Indiana

Lathe Builders For 35 Years



**AUDELS NEW
MACHINISTS
HANDYBOOK
NOW READY!**



Prepare!

**A KEY TO
MODERN SHOP PRACTICE**

PRACTICAL INSIDE INFORMATION

For Every Machinist, Toolmaker, Engineer, Machine Operator, Mechanical Draughtsman, Metal Worker, Mechanic or Student. This 1600 Page Handy Book Covers Modern Machine Shop Practice in All Its Branches.

**A COMPLETE INSTRUCTOR WITH
READY REFERENCE INDEX**

New from Cover to Cover. Tells How to Operate and Set Up Lathes, Screw & Milling Machines, Shapers, Drill Presses & All Other Machine Tools.

**5 PRACTICAL BOOKS IN ONE!
60 FULLY ILLUSTRATED CHAPTERS**

Covering: **1**—Modern Machine Shop Practice. **2**—Blue Print Reading and How to Draw. **3**—Calculations & Mathematics for Machinists. **4**—Shop Physics. **5**—How to Use the Slide Rule.

ASK TO SEE IT!

THEO. AUDEL & CO., 49 West 23rd St., New York
Mail AUDELS MACHINISTS & TOOLMAKERS HANDY BOOK, Price \$4 on 7 Days Free Trial. If O. K. I will remit \$1 in 7 days and \$1 Monthly until \$4 is Paid. Otherwise I will return it.

Name _____
Address _____
Occupation _____
Reference _____ P.M.

**1600 PAGES
FULLY ILLUSTRATED**

A SHOP COMPANION THAT ANSWERS YOUR QUESTIONS
Easy to read and understand—flexible covers—Handy size 5 x 6½ x 2—a ready reference that answers your questions accurately.

TO GET THIS ASSISTANCE FOR YOURSELF SIMPLY FILL IN AND MAIL COUPON TODAY **\$4 COMPLETE PAY \$1 A MONTH ONLY**

THEO. AUDEL & CO., 49 W. 23rd St., New York

CLAUDETTE COLBERT is doing a grand job in the Volunteer Army Canteen Service (VACS to the boys)
☆ You should see her starring in the new Paramount Picture "PALM BEACH STORY" ☆



KEEP 'EM SATISFIED WITH *Chesterfield*

Milder.. Cooler.. Better-Tasting Cigarettes

... that's what smokers ask for .. and that's CHESTERFIELD. *Milder* when you smoke a lot .. *Cooler* when the going's hot .. and *Better-Tasting* all the time! Buy CHESTERFIELDS by the carton and treat the boys and yourself to more smoking pleasure than you've ever known ...

They Satisfy

