

*Planes of Tomorrow*

By Glenn L. Martin

# POPULAR MECHANICS

## MAGAZINE

WRITTEN SO YOU CAN UNDERSTAND IT



REG. U.S. PAT. OFF.

SEPT.  
25 CENTS  
30¢ IN CANADA

BUY UNITED STATES  
WAR SAVINGS  
BONDS AND STAMPS

SEE PAGE 1





*"Now, mother, don't be a back-seat pilot . . . I'm only going 150!"*

**W**ILL ordinary folks own a family plane? No question about it! You could buy one today but for the war. That's only part of the story. There'll be super-luxury liners for air travel. Fleets of flying freighters! You'll see them all in the new America that is just around the corner.

This will be a land that's even more wonderful than the one we're all fighting for today. Its birth is scheduled for the day after Victory. From blueprints already drawn . . . from factories already producing . . . from the hearts and minds of men already building toward it, will come a way of life to dwarf anything we've ever known.

If you had been as close to aviation as we of B. F. Goodrich have been for three decades, you too would realize that miracles are becoming commonplace. From our own laboratories, we've seen developments which helped to give a new concept to flying. Developments such as the first low-pressure airplane tire, a Silvertown that could take the impact of a plane's landing again and again. The first De-Icer, which makes possible year-round flying. Brakes to bring giants-of-the-air to safe, smooth stops. The list of B. F. Goodrich aviation products numbers 80 now . . . and it's still

growing, still improving, still probing the future.

Right now, of course, we have that other job to do. The planes we equip today must destroy before they can create. Uncle Sam's bombers, fighters, and trainers have first call on our Silvertown Tires, Expander Tube Brakes, De-Icers, Bullet Sealing Fuel Cells. But, when that famous birthday arrives, the planes of peace will also be supplied with B. F. Goodrich equipment. The B. F. Goodrich Company, Aeronautical Division, Akron, Ohio.





## Bombers from the bottom of the Deep Blue Sea

**T**HERE'S a fabulous amount of magnesium in every cubic mile of sea water.

Enough magnesium for more than *four million* Flying Fortresses. Enough to lay a continuous ceiling of bombers . . . a hundred miles wide and stretching all the way from London to Berlin!

Now magnesium can't be dredged out of the ocean . . . for every ounce of this rare metal must be produced by electrolysis. This necessitates the conversion of vast amounts of alternating current to direct current, at the very water's edge.

The best means of converting power is the mercury arc rectifier. As long as ten years ago, Westinghouse Research Engineers began experimental work on a *new type* of mercury arc rectifier which would be more efficient . . . more economical . . . less costly to install and maintain than existing types.

These Westinghouse scientists realized that new untapped fields in metallurgy would be opened

by the perfection of an improved mercury arc rectifier. In 1937, they brought forth the *Westinghouse Ignitron*.

The Ignitron operates on the radically new principle of *starting* and *stopping* the mercury arc with each cycle. This means that electrodes can be placed much closer together . . . grids and shields reduced . . . arc drop voltage decreased . . . voltage control simplified . . . arc-back practically eliminated. And all of this assures higher efficiency and greater reliability.

More than 1,000,000 kw of Ignitrons are now at work . . . in magnesium, aluminum and chlorine plants, in electric railway systems, in mines, in war industries of many types.

*And so, the germ of an idea . . . born ten years ago in the Westinghouse Electronics Laboratories . . . is now contributing its important share in winning the war today.*



# Westinghouse

WESTINGHOUSE ELECTRIC AND MANUFACTURING COMPANY, PITTSBURGH, PENNSYLVANIA

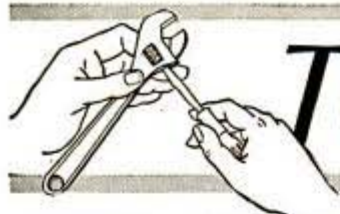

# TOOL NOTES

Maintenance  
and Repair  
Suggestions to  
Prolong Tool Life

## No. 2 HOW TO USE, AND KEEP CRESCENT SCREWDRIVERS IN GOOD WORKING ORDER

The common screwdriver is one of the most mistreated tools we have. You see inexperienced hands using it as a chisel, prybar, punch and, sometimes, the handle as a hammer. This kind of abuse will quickly ruin the best screwdriver made. Moral: Use screwdrivers only for the purpose for which they are made, driving screws.

### USE THE CORRECT SIZE SCREWDRIVER PROPERLY

The first rule is to use the *right* size screwdriver for the job. In other words, a screw with a large head requires a large screwdriver. Don't use a small screwdriver to drive a large screw. For example, you'll quickly ruin a cabinet screwdriver if you try to drive #10 screws with it. Don't try to use one corner of a large screwdriver to sink a small screw. In this case, the screw is usually damaged.

### USE CARE IN REGRINDING

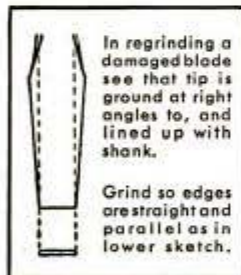

When the blade tip of a screwdriver becomes damaged, it should be re-ground to its original shape (see diagram). Grinding must be done carefully to prevent overheating and drawing the temper out of the blade.

### CRESCENT FERRULES STAY TIGHT

The ferrules on Crescent Screwdrivers are turned from solid bar steel and are forced on the blade under high pressure. They will not come loose. On most types of Crescent Screwdrivers, the blade rod goes clear through the seasoned hardwood handle and can be loosened only by breaking the handle. Remember, always treat your Crescent Tools well—they're worth it.

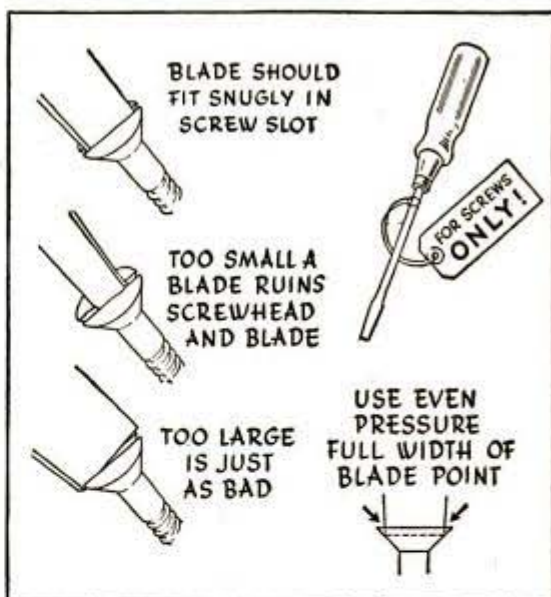

CHARACTERISTICS OF A GOOD SCREWDRIVER



## CRESCENT TOOLS

*Give Wings to Work*

CRESCENT TOOL COMPANY, JAMESTOWN, N. Y.

CRESCENT & CRESTOLOY WRENCHES, PLIERS, SCREWDRIVERS, SNIPS, HACK SAWS, ETC.

# Popular Mechanics Magazine

Registered in U. S. Patent Office and Canada

H. H. WINDSOR, Founder

H. H. WINDSOR, Jr., Editor and Publisher

September, 1942

Vol. 78, No. 3

## IN THIS ISSUE

Planes of Tomorrow . . . . .	1
Modern Miracle . . . . .	8
Big Machines for the Big Task . . . . .	17
Shortcut to Tokyo . . . . .	28
New Wealth From Black Gold . . . . .	34
Girls in Overalls . . . . .	40
Tin Fish for Nippon . . . . .	50
It's the Spares That Count . . . . .	56
Battle of the Deep-Sea Monsters . . . . .	66
The Last Roundup . . . . .	72
Let's Keep 'Em Healthy . . . . .	82
Dust the Destroyer . . . . .	88
New Crops for America . . . . .	92

Where-to-Buy-It Index Starts on Next Page

## Frozen Billions

**I**F YOU could slip into your pocket a little pellet of radium about the size of a pea, you'd be carrying a million dollars. You couldn't, of course. Radium is too dangerous to handle, too precious. It is precious to war industries for photographing flaws in steel, to medical science fighting cancer, to fliers reading luminous dials. "Frozen Billions," the October Colorado feature with eight pages of color pictures, tells the fantastic story of the discovery in arctic Canada of the ore that providentially gives the United Nations a radium monopoly.

## Uncle Sam's Trump Card

**I**T IS a tribute to our engineers that American war-planes—built in a land committed for years to a policy of peace while other nations directed their full national effort to war—are superior to those of the enemy. Aeronautical engineering is America's "trump card," writes E. E. Wilson, president of United Aircraft Corporation, in an article next month.

## Next Month

**S**UNDAY morning after the war, you decide to move to that new subdivision. You spend that day choosing exteriors and interiors from an array of model houses shown by a mass-production builder. Monday the pre-constructed foundation piers are set in and utility pipes extended. Tuesday a truck delivers your house and a half dozen workmen erect it. Wednesday you move in. A year later you can trade in an unused bedroom for a darkroom if you like. That's a taste of "Your Home of the Future," an October article.

## Minutemen of 1942

**T**HE West is still wild. Cow punchers and hard rock miners, ranchers and aircraft workers are out in the woods and hills along the Pacific, their rifles oiled and ready for a guerrilla ambush. A thousand armed "minutemen" rally in one Oregon town. California is calling for 100,000 snipers to prepare a welcome for any Japanese suicide ventures on our shores. An October feature pictures these American guerrillas.

## Meet the Bombardier

**A**T THE instant the pilot announces "On course and level; your ship"—the bombardier takes over the plane. Antiaircraft may be exploding outside his glass window, interceptors swirling around. He is absorbed in picking the split second to drop his deadly load. "The Most Dangerous Man in the World," in October, takes you up with the bombardier.

Published monthly by POPULAR MECHANICS COMPANY, 200 East Ontario Street, Chicago, U. S. A. Single copy in the United States, 25 cents; subscription rates in United States and possessions, and countries of the Pan-American Postal Union including Spain, \$2.50 a year. Single copy in Canada, 30 cents; subscription rates, \$3.00 a year. To all other countries add \$1.00 a year over United States prices for overseas postage. Changes in address must be reported to us immediately to eliminate delay. Entered as Second Class Matter, Sept. 15, 1903, at the Post Office at Chicago, Illinois, under Act of March 3, 1879. Entered as Second Class Matter at Post Office Dept., Canada.

Copyright 1942, by Popular Mechanics Company, Copyright under International Copyright Union. All rights reserved under Pan American Copyright Union. Printed in the United States of America



**Until Victory is Ours . . .**

## KEEP YOUR CAR WELL PROTECTED WITH PYROIL

- **Get Extra Mileage per Gallon of Gasoline**
- **Get Protection from Scuffing Wear on Metal Parts**
- **Get Safer, Better Operation**

Until Victory is ours, America's transportation system must not break down. Your automobile is a part of this. Use it wisely. Keep it well protected, with Pyroil.

Each time you buy gasoline and oil, tell the service salesman to add a little Pyroil. Just a few ounces at a time are necessary. But, what **extra protection** to engine parts—what **extra benefits** of operation—you get from this!

Pyroil users tell of the extra mileage they get using Pyroil. You can gain this, too. You will be amazed at the benefits of driving and of car conservation that Pyroil gives you.

So, until the victory is ours and you can then buy a new car, take the best possible care of the one you now have. That means, use **Pyroil every mile you drive!** Manufactured and Guaranteed by Pyroil Company, W. V. Kidder, Founder, 59 Pyroil Bldg., LaCrosse, Wisconsin, U. S. A.



ADD MERELY 3 OUNCES TO GAS TANK & CRANK CASE

MAIL COUPON FOR A LIST OF "PYROIL PROTECTION SERVICE STATIONS" IN YOUR LOCALITY.

DISTRIBUTORS: CHECK AND MAIL COUPON FOR FRANCHISE FACTS.

**PYROIL COMPANY**  
59 Pyroil Bldg., LaCrosse, Wisconsin

Please send me a listing of Service Stations in my locality, where I may obtain Pyroil Protection for my car, regularly.

Send Details of Plan for Distributors.

Name.....

Address.....

City..... State.....

**"KEEP 'EM ROLLING!"**

## WHERE-TO-BUY-IT INDEX

Where no name and address appear directly under an item, the product is not believed by us to be commercially available

Lightplane ambulance .....	6
Forged cylinder head cuts engine weight.....	6
Chutes jerk open in mass jump.....	7
Animated "Sprinkling Sambo".....	7
<small>Firestone Tire &amp; Rubber Co., Akron, Ohio</small>	
Train runs on rails or highways.....	12
Post-war auto made of plastic.....	12
Mountains of old auto tires.....	13
Auto carrier converted into bus.....	13
That's all there is—there isn't any more.....	14
Bantam sub-machine gun.....	16
Wheel lock clamps over hub.....	16
<small>Winkenweder &amp; Ladd, Inc., 1421 S. Michigan Ave., Chicago</small>	
Screw anchor for any wall.....	16
<small>Crossant Machine Works, 39 Moss, Reading, Penna.</small>	
Saving the Normandie .....	25
Barrage balloon like aerial octopus.....	26
Army trailer carries 30 cadets.....	26
Blower trains parachutists.....	27
Flame thrower attacking pillbox.....	27
Boring lathe hollows out huge gun forging.....	32
"False nose" hides gun's flash of fire.....	32
Pigeons "spy" for Nazis.....	33
Electric dial on riveting gun.....	33
War factories built underground.....	33
Special tester for truck tires.....	37
Folding pipe locks ashes in.....	37
<small>The National Briar Pipe Co., 45 Morris, Jersey City, N. J.</small>	
Cushions for typewriter legs.....	38
<small>Holder's, Inc., Merchandise Mart, Chicago</small>	
Plastic tips for open-toe shoes.....	38
<small>Sears, Roebuck &amp; Co., State and Van Buren, Chicago</small>	
Animals use carbon dioxide for growth.....	38
Postal scale shows mailing rate.....	38
<small>Beverly Craft, Beverly Hills, Calif.</small>	
Actor's features changed by plastic makeup.....	39
Transformer hum tested.....	44
Vibrator for drying concrete.....	44
<small>Whiteman Mfg. Co., 3249 Casitas Ave., Los Angeles, Calif.</small>	
Highway police train for war duty.....	45
Sky high and a state wide.....	46
Sand bag filler .....	48
<small>Spinks Scale Co., 422 Hillside Drive S. W., Atlanta, Ga.</small>	
Gauge measures butter stick.....	48
<small>Carson Pirlie Scott &amp; Co., State and Monroe, Chicago</small>	
Paper press for home use.....	48
<small>E. A. Vandy, Merchandise Mart, Chicago</small>	
Rivers diverted to speed rail building.....	49
Lawn mower motor on bicycle.....	54
Holder for filing papers.....	54
<small>The Co-Collater Co., 16½ N. 9th St., Richmond, Va.</small>	
Pencil on reel held by vacuum cup.....	54
<small>Ketcham &amp; McDougall, Inc., Upper Montclair, N. J.</small>	
High cost of fast driving.....	54
Bunks near battle stations on sub.....	55
Homebuilt motorbike saves gas.....	61

(Continued to page 6A)

You may worry  
about your  
old garden hose



...but here is one worry you can avoid

**Y**OU can still use a worn-out, patched-up hose . . . but *not* a broken-down automobile!

That's why king pins, tie rods, drag links, bearings and other vital friction points require the *extra* care, the *superior protection* of stem-to-stern Marfak chassis lubrication every 1,000 miles.

Marfak helps add miles to your car's life because it's super-tough. Applied by chart—not by chance—it resists wear-out, wash-out and squeeze-out.

For your peace of mind, don't say "grease job." Insist on genuine Marfak 40-point Lubrication Service. At Texaco and other good dealers everywhere.



Tune in the **TEXACO STAR THEATRE**  
every Sunday night—CBS



*You're Welcome at* **TEXACO DEALERS**

SEPTEMBER, 1942

This One



A8J1-KZH-57L9

5A

**Simoniz Saves  
the Value of  
What You Have!**



**IN YOUR HOME.** Use Simoniz to protect your furniture, woodwork, linoleum, refrigerator, and kitchen equipment. The deep, luxuriant lustre Simoniz gives . . . lasts! Besides, it makes the finish wear longer.



**IN YOUR SHOP**

Protect your tools with Simoniz. It keeps them in perfect condition. Stops rusting. Makes sliding tools work easier. Also use Simoniz on everything you make . . . for a beautiful lasting lustre.

**SIMONIZ YOUR CAR**

*It's More Important Now Than Ever!*

Use Simoniz Kleener to quickly restore the lustre. Simoniz to protect and preserve the finish . . . so your car's beauty lasts through to Victory. Buy them today!



THE SIMONIZ COMPANY, CHICAGO, U.S.A.

(Continued from page 4A)

Long-shank cutter and retriever.....	61
Pack-Rite Machine Corp., 828 N. Broadway, Milwaukee, Wis.	
Family car is potential fire engine.....	62
Portable acetylene-oxygen torch.....	62
Flexible hone for brake cylinder.....	62
Thermoid Co., Whitehead Rd., Trenton, N. J.	
Railroads operate in blackout.....	63
Army optical shops on wheels.....	64
Lacquer made from milk.....	64
Plastic pontoons speed plane takeoff.....	64
Ladders with handrails are fire escapes.....	65
Tiny radio "bomb" tells plane altitude.....	65
Wrench jaws adjusted by sliding band.....	65
Pack-Rite Machine Corp., 828 N. Broadway, Milwaukee, Wis.	
Workman beautifies face of dam.....	70
More Diesel locomotives built than steam.....	70
Canvas "board" keeps dough from sticking.....	70
Sears, Roebuck & Co., State and Van Buren, Chicago	
Broom used as splint in first-aid.....	71
Two planes tow squads of gliders.....	77
Big rocket projectors used by Russians.....	77
Saving the shavings.....	78
Dining table converted into seat.....	80
Virginia Lincoln, Rm. 1001, Furniture Mart, Chicago	
Jacket guards young trees.....	80
Servicised Products, 6051 W. 65th St., Chicago	
Lawn mower sharpener.....	80
Stebbins Hardware Co., 15 W. Van Buren, Chicago	
Plane gunner rides turntable.....	80
Dam builders risk lives.....	81
Sugar may be made from sorghum.....	81
Trick movie gun.....	86
Oversize model of rifle.....	86
Six-way table.....	87
Steinmetz & Kelly, Merchandise Mart, Chicago	
Fire cart fitted for air raids.....	87
Chicago Fire Equipment Co., 546 W. Lake St., Chicago	
Plastic cup frees "frozen" studs.....	91
Anti-Rust Corp., 340 Central St., New York City	
Frying pan made of pottery.....	91
Joaquin Potteries, P.O. Box 522, Stockton, Calif.	
Plastic disks glow in dark.....	95
Lumelite Corp., 261 Fifth Ave., New York City	
Mitten brush for grooming dog.....	95
Vaughan's Seed Store, 10 W. Randolph St., Chicago	
Homemade "ear" spots plane.....	96
Ash trays hold playing chips.....	96
Mandel Bros., State and Madison, Chicago	
Polarized light assembly.....	159
Drake Mfg. Co. 1713 W. Hubbard St., Chicago	
Power unit replaces batteries in portable sets.....	159
Electro Products Laboratories, 549 W. Randolph St., Chicago	
Screwdriver for recessed cross slot screws.....	159
Vaco Products Company, 1603 S. Michigan Ave., Chicago	
Soldering units for emergency connections.....	159
Jiggers, Inc., 215 W. Illinois St., Chicago	
Unidirectional crystal microphone.....	159
Shure Brothers, 225 W. Huron St., Chicago	
Giant screen oscillograph.....	160
Allen B. Du Mont Laboratories, 2 Main Ave., Passaic, N. J.	
Illumination blackout control.....	160
Photoswitch, Inc., 21 Chestnut St., Cambridge, Mass.	
Ultra-short-wave transceiver.....	160
Abbott Instrument, Inc., 8 W. 18th St., New York City	

(Continued to page 8A)



**Do you really Want to  
get ahead in business?**



## Then here is a valuable tip for you . . .

The problem of winning promotion—of achieving the better job and better pay—is not easy. Competition is keen and the demands are high. But it is much easier—simpler—if you understand one important fact.

Business and industry always need men and women who can take on larger responsibilities—give more valuable service. Those who step up into the bigger jobs are those who have an objective and definitely prepare for it—who not only give their best to today's job, but who also plan and prepare for the jobs on ahead and train themselves to meet the greater responsibilities of the bigger job.

### **Pick Some Growing Field and Prepare**

If you really want to get ahead, pick some field of opportunity—either your present field or some other. Find out its opportunities, and its requirements—decide whether you are fitted for it—then get busy.

Train thoroughly for it. Make yourself expert in it. Then you can compel success.

For 32 years, LaSalle has been helping ambitious men and women prepare for advancement. Hundreds of thousands now in good jobs and on the way up to better ones, owe their success to LaSalle training.

### **Investigate—Then Decide**

Out of that long and wide experience we have compiled a wealth of knowledge about various fields of business. That knowledge is freely at your disposal. Tell us—in a letter or in the coupon below—what you want to be. We will tell you—without cost or obligation—of the opportunities and requirements in that field. We will tell you also of our complete training program for that job. Then you can decide.

The coupon below lists a number of opportunity jobs. Check the one in which you are interested—or write in some other job on the blank line. Then mail the coupon today. It can be your first step toward the success you want.

## **LASALLE EXTENSION UNIVERSITY** **A Correspondence Institution**

Department 964-R

Chicago, Illinois

I am interested in winning to the career I have checked below. Please send me the facts about the opportunities in that field and about your training for that job.

- |  |  |   |
|--|--|---|
| <input type="checkbox"/> Business Manager            | <input type="checkbox"/> Cost Accountant           | <input type="checkbox"/> Collection Manager |
| <input type="checkbox"/> Industrial Manager          | <input type="checkbox"/> Statistician              | <input type="checkbox"/> Credit Manager     |
| <input type="checkbox"/> Factory Superintendent      | <input type="checkbox"/> Bookkeeper                | <input type="checkbox"/> Rate Clerk         |
| <input type="checkbox"/> Production Manager          | <input type="checkbox"/> Cashier                   | <input type="checkbox"/> Shipping Clerk     |
| <input type="checkbox"/> Foreman                     | <input type="checkbox"/> Salesman                  | <input type="checkbox"/> Traffic Manager    |
| <input type="checkbox"/> Inspector                   | <input type="checkbox"/> Sales Manager             | <input type="checkbox"/> Export Manager     |
| <input type="checkbox"/> Certified Public Accountant | <input type="checkbox"/> Correspondence Supervisor | <input type="checkbox"/> Legal Counsellor   |
| <input type="checkbox"/> Comptroller                 | <input type="checkbox"/> Sales Correspondent       | <input type="checkbox"/> Office Manager     |
| <input type="checkbox"/> Chief Accountant            | <input type="checkbox"/> Collection Correspondent  | <input type="checkbox"/> Secretary          |
| <input type="checkbox"/> Auditor                     |  |   |

.....  
(Any other)

Name.....Age.....

Occupation.....

Address.....

City.....State.....

## Craftsman and Shop Notes Index

### ART AND ARTISTS

Traceograph aids in sketching.....	97
Profiles drawn on mirror.....	101
Water colors pulverized quickly.....	118
Tennis racket helps student proportion work.....	128
Finger rest for showcard writer.....	144

### AUTOMOTIVE

When storing your car.....	140
Air hose protected on driveways.....	143

### CAMPING, HUNTING, FISHING

Button aids in tying flies.....	100
Burlap bag locates lost fish lures.....	112
Improving a fish stringer.....	114
How to smooth a fishing-rod tip.....	114
Scouring rusty gun barrels.....	118
Funnel aids in waxing fishline.....	118
Fish can't swallow this hook.....	128

### FARM

Easily stacked vegetable crates.....	138
Herding chicks into coop.....	138
Beef hung on axle while butchering.....	144
Holding steel posts while driving them.....	145
Hogs' feed trough will not upset.....	153
Barrel holds harness for oiling.....	154

### FURNITURE

Kitchen stool opens into ladder.....	101
Stains in wood finishing.....	106
Bachelor chest.....	115

### HAND TOOLS

Clamp holds bandsaw blade.....	100
Sliding gauge on tape measure.....	104
Rivets set with C-clamp.....	104
Nut centers dividers in hole.....	112
Repairing steel tape measure.....	114
Screwdriver shielded to prevent shucks.....	114
Using worn auger bits.....	114
Socket wrench holds nuts for rethreading.....	128
Pipe bender made from jack.....	145

### HOUSEHOLD

Snap-on skirt for sewing box.....	100
Solving home problems.....	102
Pen point reversed to avoid accident.....	117
Watering flower box from inside house.....	118
"On" position of light switch shown.....	118
Razor blades kept from rusting.....	119
Yarn holder on stand.....	125

### LAWN AND GARDEN

Portable lawn shower.....	99
Joggle wheel marks off tennis court.....	104
Anchoring flagstone steps on hill.....	125
Long-handled shrubbery tool.....	128

### OFFICE

Dotted lines made with comb.....	100
Index tabs reinforced with clips.....	145
Re-inking typewriter ribbons.....	153

### PHOTOGRAPHY

Convenient safelight mounting.....	129
Holding bulbs on closet shelf.....	129

(Continued to page 10A)

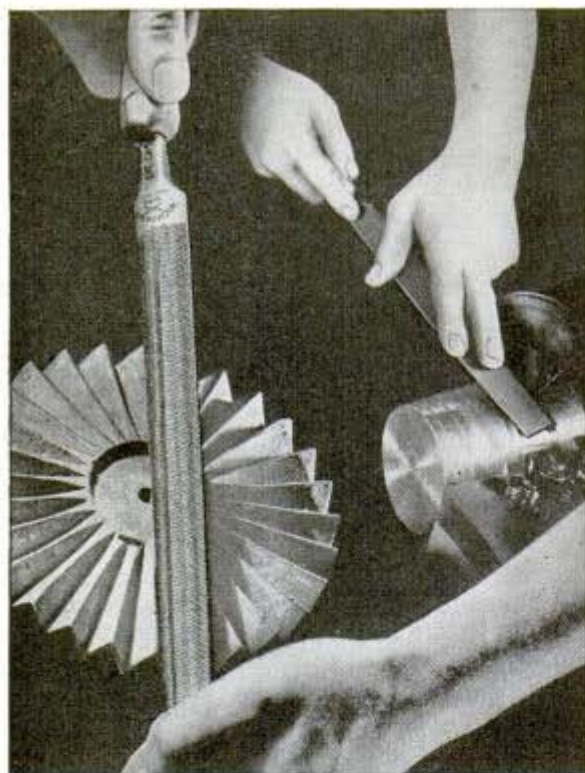

## Educated Hands...

WE HAVE long been the greatest mechanically talented nation on earth. And war industry is increasing the competition among skilled workers. Take filing. New hands are becoming adept in the use of files. Older ones are obtaining still more efficient filing results.

In Nicholson and Black Diamond brands, Nicholson makes every practical kind of file—more than 3000 types, cuts and sizes. And in the highest quality. Nicholson is also interested in helping to "educate" the hands that use files. Two of the many Nicholson aids are:

- **FREE BOOK, "A File for Every Purpose,"** to laymen, farmers, apprentices, industrial training students. Illustrated—28 pages.

- **Free Technical Bulletins** to machine-shop foremen and advanced mechanics on Special Purpose Files—for stainless steel, aluminum, brass, plastics, die castings, die making, lathe filing. Name ones wanted.

**NICHOLSON FILE CO., Providence, R. I., U. S. A.**

(Also Canadian Plant, Port Hope, Ont.)

# NICHOLSON

FOR EVERY

# FILES

PURPOSE

NICHOLSON  
U.S.A.  
MADE IN U. S. A.

Twelve perfect files in every dozen is the sweeping Nicholson guarantee. Your hardware or mill-supply house is the place to get them.



# A million tons of rubber ...GOING TO WASTE!

You'd demand *action*—if you knew that a million tons of rubber were going to waste, when it's vital to our war effort.

And yet the fact is, a million *men* are "going to waste" in low-paid, unskilled jobs—when, with a few months of practical, spare-time *training*, they might be doing more important, better paid work in some victory-vital shop or factory!

And America needs *trained man-power* as much as she needs rubber and gasoline!

You can demand *action* on this matter, too—by mailing this coupon today, and learning how quickly a low-cost I. C. S. Course can fit you to be a better fighter on the business and industrial front!

Act right now—the world won't wait for slow-pokes!

## INTERNATIONAL CORRESPONDENCE SCHOOLS

HELPING TO TRAIN AMERICANS FOR VICTORY

BOX 5643-J, SCRANTON, PENNA.

Without cost or obligation, please send me a copy of your booklet, "Who Wins and Why," and full particulars about the course *before* which I have marked X:

### TECHNICAL AND INDUSTRIAL COURSES

- |  |   |   |  |
|--|---|---|--|
| <input type="checkbox"/> Air Brake   | <input type="checkbox"/> Contracting and Building                     | <input type="checkbox"/> Management of Inventions                               | <input type="checkbox"/> Sanitary Engineering                                  |
| <input type="checkbox"/> Air Conditioning                                    | <input type="checkbox"/> Cotton Manufacturing                         | <input type="checkbox"/> Marine Engines   | <input type="checkbox"/> Sheet Metal Work                                      |
| <input type="checkbox"/> Airplane Drafting                                   | <input type="checkbox"/> Diesel Engines                               | <input type="checkbox"/> Mechanical Drafting                                    | <input type="checkbox"/> Ship Drafting   |
| <input type="checkbox"/> Architectural Drafting                              | <input type="checkbox"/> Electrical Drafting                          | <input type="checkbox"/> Mechanical Engineering                                 | <input type="checkbox"/> Shipfitting <input type="checkbox"/> Shop Practice    |
| <input type="checkbox"/> Architecture  | <input type="checkbox"/> Electrical Engineering                       | <input type="checkbox"/> Mine Foreman   | <input type="checkbox"/> Steam Electric <input type="checkbox"/> Steam Engines |
| <input type="checkbox"/> Auto Engine Tune-up                                 | <input type="checkbox"/> Electrician                                  | <input type="checkbox"/> Navigation <input type="checkbox"/> Patternmaking      | <input type="checkbox"/> Steam Fitting   |
| <input type="checkbox"/> Auto Technician                                     | <input type="checkbox"/> Electric Lighting                            | <input type="checkbox"/> Plastics <input type="checkbox"/> Plumbing             | <input type="checkbox"/> Structural Drafting                                   |
| <input type="checkbox"/> Aviation <input type="checkbox"/> Aviation Mechanic | <input type="checkbox"/> Foundryman <input type="checkbox"/> Heating  | <input type="checkbox"/> Public Works Engineering                               | <input type="checkbox"/> Structural Engineering                                |
| <input type="checkbox"/> Blueprint Reading                                   | <input type="checkbox"/> Heat Treatment of Metals                     | <input type="checkbox"/> Pulp and Paper Making                                  | <input type="checkbox"/> Surveying and Mapping                                 |
| <input type="checkbox"/> Boilermaking  | <input type="checkbox"/> Highway Engineering                          | <input type="checkbox"/> Radio, General   | <input type="checkbox"/> Telegraphy <input type="checkbox"/> Telephony         |
| <input type="checkbox"/> Bridge Engineering                                  | <input type="checkbox"/> House Planning                               | <input type="checkbox"/> Radio Operating  | <input type="checkbox"/> Textile Designing                                     |
| <input type="checkbox"/> Chemistry <input type="checkbox"/> Coal Mining      | <input type="checkbox"/> Industrial Metallurgy                        | <input type="checkbox"/> Radio Servicing  | <input type="checkbox"/> Toolmaking <input type="checkbox"/> Tool Design       |
| <input type="checkbox"/> Civil Engineering                                   | <input type="checkbox"/> Locomotive Engineer                          | <input type="checkbox"/> R. R. Section Foreman                                  | <input type="checkbox"/> Welding, Gas and Electric                             |
| <input type="checkbox"/> Concrete Engineering                                | <input type="checkbox"/> Machinist <input type="checkbox"/> Inspector | <input type="checkbox"/> R. R. Signalman <input type="checkbox"/> Refrigeration | <input type="checkbox"/> Woolen Manufacturing                                  |

### BUSINESS COURSES

- |  |   |  |   |
|--|---|--|---|
| <input type="checkbox"/> Accounting <input type="checkbox"/> Advertising   | <input type="checkbox"/> College Preparatory                    | <input type="checkbox"/> First Year College                          | <input type="checkbox"/> Railway Postal Clerk                         |
| <input type="checkbox"/> Bookkeeping                                       | <input type="checkbox"/> Commercial                             | <input type="checkbox"/> Foremanship <input type="checkbox"/> French | <input type="checkbox"/> Salesmanship                                 |
| <input type="checkbox"/> Business Correspondence                           | <input type="checkbox"/> Commercial Illustrating                | <input type="checkbox"/> Good English                                | <input type="checkbox"/> Secretarial <input type="checkbox"/> Spanish |
| <input type="checkbox"/> Business Management                               | <input type="checkbox"/> Cost Accounting                        | <input type="checkbox"/> High School                                 | <input type="checkbox"/> Showcard and Sign Lettering                  |
| <input type="checkbox"/> Cartooning <input type="checkbox"/> Civil Service | <input type="checkbox"/> C. P. Accounting                       | <input type="checkbox"/> Managing Men at Work                        | <input type="checkbox"/> Traffic Management                           |
| <input type="checkbox"/> Advanced Dressmaking                              | <input type="checkbox"/> Home Dressmaking                       | <input type="checkbox"/> Tea Room and Cafeteria Management, Catering |   |
| <input type="checkbox"/> Foods and Cookery                                 | <input type="checkbox"/> Professional Dressmaking and Designing |  |   |

Name.....Age.....Address.....

City.....State.....Present Position.....

Canadian residents send coupon to International Correspondence Schools Canadian, Limited, Montreal, Canada  
British residents send coupon to I. C. S., 71 Kingsway, London, W. C. 2, England



Added Power, Greater Accuracy  
from

*Balance!*



**NAIL HAMMER**  
(HF81—1 lb.  
head). Also fur-  
nished in four  
other sizes, 5  
oz. to 1½ lb.

It's *balance* that does it—crowned face, vise-like claws, supple hickory handle perfectly engineered as a unit into a striking, pulling tool of mechanical perfection! That's Plumb! Nothing of quality is spared. Safety is assured by the Plumb Patented Take-Up Wedge that keeps heads TIGHT. Plumb Hammers are universally recognized as a mark of real craftsmanship. Look for the Red Handle and Black Head—at your hardware dealers.



**PLUMB HALF HATCHET** (2962—  
3½" cut). Also furnished  
in 3¼" and 4" cuts.



**PLUMB MACHINIST HAMMER** (HF375—  
1½ lb. head). Available in twelve  
weights from 2 oz. to 3 lbs.

FAYETTE R. PLUMB, INC. • PHILADELPHIA, PA.

**PLUMB**

**HAMMERS • HATCHETS • AXES • SLEDGES**

(Continued from page 8A)

Audible timer for electric clock.....	129
Making emergency ground-glass.....	129
Photo-electric exposure meter.....	130

**POWER TOOLS**

Reshaping pins on grinder.....	110
Four-way tool turret.....	135
Adjustable tool rest for grinder.....	139
Flapping of roller-chain drives avoided.....	144
Cutting oils.....	146
Making scratch brush last longer.....	152

**RADIO AND ELECTRICITY**

Electrical outlet boxes mounted diagonally.....	139
First aid for radio receivers (Part 4).....	155
Experimenters "special" 5-band two-tube.....	156
Crystal-tube receiver from junk-box parts.....	158
Using headphones with your receiver.....	159
Short-wave adapter for broadcast set.....	159
Plastic call letters for your car.....	159
Color code for mica fixed condensers.....	159

**STORE AND SHOP**

Counter sign shows rope sizes.....	136
Estimating the board feet of scrap wood.....	137
Tricks of cutting glass.....	137
Circle stamp from vacuum cup.....	138
Pigeonhole shortened for short envelopes.....	138
Turntable for autographic register.....	139
Printing rollers cleaned easily.....	144
Delivery slip holder on basket.....	153

**WOODWORKING**

Taxi scooter.....	105
Inlaid bread tray.....	111
Hammer head padded to protect work.....	112
Chopping-bowl cookie jar.....	113
Ship model "Constellation".....	120
Weighted chalkline marks panels.....	126
Silverware chest.....	126
Drill-press sander.....	128

**MISCELLANEOUS**

Making grips stay on handlebars.....	99
Tricycle wheels on bicycle.....	99
Papering calcimined walls.....	100
Pencil clip held on pocket.....	104
Emergency tips for crutches.....	104
Simple shelter for newsstand.....	105
Holding wall paper on paste table.....	111
Bell on cane aids blind man.....	112
Emergency pestle for chemicals.....	112
Shield aids control of fire bombs.....	119
Cleats on plank prevent feet slipping.....	126
Holder for identification badge.....	138
Cable kept from slipping off logs.....	145
Water glass spread uniformly.....	145
Hitching post holds rope easily.....	153
Hooks replace wires on concrete forms.....	154

**IMPORTANT NOTICE**

It is the intention of this magazine to provide its readers with information regarding the latest developments in the mechanical arts. We take no responsibility as to whether the disclosures contained in our articles are covered by patents and advise readers to investigate this subject before making, using, or selling any of the products, machines, or processes described in order to avoid possible liability for patent infringement.



**J. E. SMITH, President**  
National Radio Institute  
Established 27 Years

# I WILL SEND A SAMPLE LESSON FREE to PROVE I can Train You at Home in Spare Time to BE A RADIO TECHNICIAN

## I Trained These Men



**\$200 a Month in  
Own Business**

"For several years I have been in business for myself making around \$200 a month. Business has steadily increased. I have N. R. I. to thank for my start in this field."  
—**ARLIE J. FROEHLER**, 300 W. Texas Ave., Goose Creek, Texas.

**\$5 to \$10  
Week in  
Spare Time**

"I am engaged in spare time Radio work. I average from \$5 to \$10 a week. I often wished that I had enrolled sooner because all this extra money sure does come in handy."  
—**THEODORE K. DUBREE**, Hordsham, Penn.



**Sergeant in Signal  
Corps**

"I am now a Sergeant in the U. S. Army Signal Corps. My duties cover Radio operating, maintenance of Army Transmitters and Receivers, operating Teletypes, handling duties of the Chief Operator in his absence."  
—**SERGEANT RICHARD W. ANDERSON**, U. S. Army (Address omitted for military reasons.)

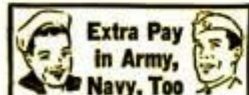

**Extra Pay  
in Army,  
Navy, Too**

Men likely to go into military service, soldiers, sailors, marines, should mail the Coupon Now! Learning Radio helps men get extra rank, extra prestige, more interesting duty at pay up to several times a private's base pay. Also prepares for good Radio jobs after service ends. It's Smart to Train for Radio NOW!

HERE is a quick way to better pay. Radio offers you the opportunity to make \$5, \$10 a week extra in spare time a few months from now and to prepare for good full time Radio jobs paying up to \$50 a week. **MAIL COUPON.** Get my Sample Lesson FREE. Examine it, read it—see how easy it is to understand. See how I train you at home in spare time to be a Radio Operator or Radio Technician.

### Real Opportunities for Beginners To Learn Then Earn Up to \$50 a Week

Broadcasting stations (882 in the U. S.) employ thousands of Radio Technicians with average pay among the country's best paid industries. The Radio repair business is booming due to shortage of new home and auto Radio sets, (there are 57,400,000 in use) giving good jobs to thousands. Many other Radio Technicians take advantage of these opportunities to have their own Radio Service businesses. The Government needs many Civilian Radio Operators, Technicians. Think of the many good-pay jobs in connection with Aviation, Commercial, Police Radio and Public Address Systems. N. R. I. gives you the required knowledge of Radio for those jobs. N. R. I. trains you to be ready when Television opens new jobs. Mail the **COUPON, NOW!**

### I'll Show You How To Make \$5, \$10 a Week Extra in Spare Time While Learning

Nearly every neighborhood offers opportunities for a part time Radio Technician to make good money fixing Radio sets. I give you special training to show you how to start cashing in on these opportunities early. You get Radio parts and instructions for building test equipment, for conducting experiments that give you valuable, practical experience. My fifty-fifty method—half working with Radio parts, half studying my Lesson Texts—makes learning Radio at home interesting, fascinating, practical.

### Find Out How I Train You at Home for Good Pay in Radio

**MAIL THE COUPON.** I'll send you a Sample Lesson and my 64-page book FREE. Learn about my Course; the types of jobs in different branches of Radio. Read letters from more than 100 men I have trained so you can see what they are doing, earning. **MAIL THE COUPON** in an envelope or paste it on a penny postal.

**J. E. SMITH, President**  
Dept. 2JP, National Radio Institute  
Washington, D. C.



**BROADCASTING STATIONS** (top illustration) employ Radio Technicians as operators, installers, maintenance men and in other fascinating, steady, well-paying technical jobs. **FIXING RADIO SETS** (bottom illustration), a booming field today pays many Radio Technicians \$30, \$40, \$50 a week. Others hold their regular jobs and make \$5 to \$10 a week extra in spare time.

**Mail Coupon  
Now!**

**TRAINING MEN  
FOR VITAL  
RADIO JOBS**

## GOOD FOR BOTH 64 PAGE BOOK SAMPLE LESSON FREE

Mr. J. E. Smith, President, Dept. 2JP  
NATIONAL RADIO INSTITUTE, Washington, D. C.  
Mail me FREE, without obligation, your Sample Lesson and 64-page book "Rich Rewards in Radio." (No Salesman will call. Please write plainly.)

Name ..... Age .....

Address .....

City..... State..... 2FR





# DRAFTING

**BOOKS SENT FREE!**  
ON APPROVAL—5 VOLUMES  
BRAND NEW EDITION

Only 15 minutes a day with these WONDER BOOKS can prepare you for a good drafting job. Drafting from simple straight lines to important complex plans. A step at a time! Built especially for beginners, for men with only grammar schooling. Drafting room practice, PLUS ENGINEERING, made easy and clear. 400 pages on tool design, over 300 pages on machine design. Includes special volume on blueprint reading with full size actual production blueprints, some 20"x30", as well as question and answer sheets.

## For Beginners or Experts

Written so you can understand every word, by well known engineers. De Luxe modernistic, washable cloth binding, over 1600 pages, hundreds of blueprints, charts and diagrams; prepares you for a good drafting job in mechanical lines. Sent for 10 days' free use if you mail coupon immediately.

### Big Field • Big Demand • Big Pay

Competent draftsmen are urgently needed in all manufacturing lines at \$30.00 to \$75.00 a week. That's just the beginning—FOR DRAFTSMEN HAVE GOOD CHANCES FOR ADVANCEMENT. Pleasant, fascinating work, easy to learn and do. Learn quickly with these books—send coupon for a set and see for yourself.

*A year's consulting service now given to all buyers of this famous cyclopedia of drafting.*

**AMERICAN TECHNICAL SOCIETY**  
Vocational Publishers since 1898

American Technical Society, Dept. D619, Drexel at 58th St., Chicago, Ill. Send for 10 days' trial, Brand New 5 volume set of "Drafting for Machine Trades." I will pay the delivery charges only. If I wish, I may return books in 10 days and owe you nothing, but if I decide to keep them, I will send \$2.00 after 10 days, then only \$3.00 a month until \$19.80, the total price, is paid. Send Brand New edition and include Consulting Service Certificate.

Name .....

Address .....  
Please attach letter stating age, occupation, employer's name and address and that of at least one business man as a reference.

# AVIATION CAREER



Offers You  
**A GREAT FUTURE!**

Complete Aeronautical Engineering or Master Aviation Mechanics training in the heart of the Aircraft industry. Graduates obtaining immediate employment. No flying involved. Aviation's foremost school, established in 1929. Located on Grand Central Air Terminal. For full information, address Department PM-9

**CURTISS WRIGHT TECHNICAL INSTITUTE**

GRAND CENTRAL AIR TERMINAL  
GLENDALE (LOS ANGELES) CALIF.



THIS TOWER OVERLOOKS AVIATION'S MOST DISTINGUISHED SCHOOL OF AERONAUTICS



# Follow This Man!

**Secret Service Operator No. 38 is On The Job!**

Follow him through all the excitement of his chase after the counterfeit gang. See how a crafty operator solves a murder with tell-tale finger prints! Thrills! Mystery!

## FREE! The Confidential Reports No. 38 Made to His Chief

**Earn a Regular Monthly Salary**

Write for reports and free "Blue Book of Crime." Learn how YOU can become a Finger Print Expert, at home, in spare time, at small cost. Our graduates run 43% of all

the Identification Bureaus in America! Send for list of over 840 bureaus employing our graduates. Write today! Literature sent only to persons stating their age.

**INSTITUTE OF APPLIED SCIENCE**  
1920 Sunnyside Avenue, Dept. 1356, Chicago, Ill.

## ENGINEERING DEGREE IN 27 MONTHS

INDIANA  
TECHNICAL  
COLLEGE

Courses in Aeronautical, Chemical, Civil, Electrical, Mechanical, and Radio Engineering. One-year courses in Radio and Drafting. Approved by C.A.A. Prep courses without added cost. Low tuition. Large industrial center. Opportunity to earn part living expenses. Enter September 8, December, March, June. Catalog. 592 E. Washington Blvd., Ft. Wayne, Ind.

# LAW

## STUDY AT HOME

Legally trained men win higher positions and bigger success in business and public life. Greater opportunities now than ever before. Big corporations are headed by men with legal training.

**More Ability: More Prestige: More Money.**

We guide you step by step. You can train at home during spare time. Degree of LL. B. Successful graduates in every section of the U. S. We furnish all text material, including 14-volume Law Library. Low cost, easy terms. Get our valuable 48-page "Law Training for Leadership" and "Lifeline" books FREE. Send for them NOW.

LaSalle Extension University, Dept. 964-L, Chicago  
A Correspondence Institution

## BECOME AN EXPERT MEAT CUTTER



Greater opportunities! Thousands of firms are needing expert Meat Cutters. Train in 8 weeks at famous National School. It's quick, easy to learn. Meat Cutting by ACTUAL PRACTICE in big National cutting rooms and retail department. No previous experience or advanced education necessary. **BIG PAY JOBS.** Union card guaranteed. Employment service FREE. Train FREE. Easy terms. Easy teach. Write TODAY for FREE catalog and plans to help you get ahead.

National School of Meat Cutting, Inc., Dept. U-34, Toledo, Ohio

## Learn CARTOONING

FREE TRIAL LESSON! Cash in on your sense of humor—AT HOME—BY MAIL. Have fun! Make money! No experience needed to start. Write today for FREE LESSON, mailed postpaid. No obligation.

Moon Gag-Cartoon School, Dept. J, Fall Creek, Wis.

## Learn PHOTO-ENGRAVING



We teach you quickly, at home in spare time. Earn while you learn. Establish your own profitable business with equipment we furnish, or work for others at good salary. Cuts in this magazine made by process we teach. Send for your copy of our big illustrated catalog. It's free!

**THE AURORA SCHOOL OF PHOTO-ENGRAVING**  
Tasape' Bldg. (Dept. PM-44) Aurora, Mo.

## MONEY MEN ALL DATA FREE

THE PLASTEX Industry needs manufacturers on small scale and for big production of Lamp and Clock Stands, Art Goods and Novelties in Plastex and Marble imitation. Experience unnecessary. Lac material makes regular 10c store sellers. Rubber moulds furnished for speed production. Small investment brings good returns. WE ARE NOW PLACING BIG CHAIN STORE ORDERS WITH MANUFACTURERS. Ambitious men have chance for real prosperity. Our FREE booklet will interest and benefit you.

PLASTEX INDUSTRIES, Dept. P. 1085 Washington Ave., New York, N. Y.



# Will You Let Me PROVE I Can Make YOU a New Man?



## LET ME START SHOWING YOU RESULTS LIKE THESE

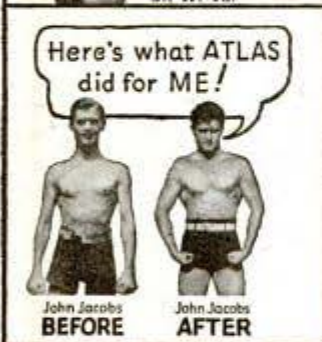

**CHARLES ATLAS**  
 Awarded the title of "The World's Most Perfectly Developed Man" in international contest—in competition with ALL men who would consent to appear against him.  
 This is a recent photo of Charles Atlas showing how he looks today. This is not a studio picture but an actual untouched snapshot.



## Here's What Only 15 Minutes a Day Can Do For You

I DON'T care how old or young you are, or how ashamed of your present physical condition you may be. If you can simply raise your arm and flex it I can add SOLID MUSCLE to your biceps—yes, on each arm—in double-quick time! Only 15 minutes a day—right in your own home—is all the time I ask of you! And there's no cost if I fail.

I can broaden your shoulders, strengthen your back, develop your whole muscular system INSIDE and OUTSIDE! I can add inches to your chest, give you a vise-like grip, make those legs of yours lithe and powerful. I can shoot new strength into your old backbone, exercise those inner organs, help you cram your body so full of pep, vigor and red-blooded vitality that you won't feel there's even "standing room" left for weakness and that lazy feeling! Before I get through with you I'll have your whole frame "measured" to a nice, new, beautiful suit of muscle!

### What's My Secret?

"Dynamic Tension!" That's the ticket! The identical natural method that I myself developed to change my body from the scrawny, skinny-chested weakling I was at 17 to my present super-man physique! Thousands of other fellows are becoming marvelous physical specimens—my way. I give you no gadgets or contraptions to fool with. When you have learned to develop

your strength through "Dynamic Tension," you can laugh at artificial muscle-makers. You simply utilize the DORMANT muscle-power in your own God-given body—watch it increase and multiply double-quick into real solid LIVE MUSCLE.

My method—"Dynamic Tension"—will turn the trick for you. No theory—every exercise is practical. And, man, so easy! Spend only 15 minutes a day in your own home. From the very start you'll be using my method of "Dynamic Tension" almost unconsciously every minute of the day—walking, bending over, etc.—to BUILD MUSCLE and VITALITY.

### FREE BOOK "Everlasting Health and Strength"

In it I talk to you straight-from-the-shoulder language. Packed with inspirational pictures of myself and pupils—fellows who became NEW MEN in strength, my way. Let me show you what I helped THEM do. See what I can do for YOU! For a real thrill, send for this book today. AT ONCE, CHARLES ATLAS, Dept. 8-Y, 115 East 23rd St., New York, N. Y.

CHARLES ATLAS, Dept. 8-Y  
 115 E. 23rd Street, New York, N. Y.

I want the proof that your system of "Dynamic Tension" will help make a New Man of me—give me a healthy, husky body and big muscular development. Send me your free book, "Everlasting Health and Strength."

Name .....  
 (Please print or write plainly)

Address .....

City..... State.....

# LEARN MUSIC in Your Own Home This EASY Way

**THINK OF IT!** Now you can actually learn to play your favorite instrument, right in your own home, by this amazing new short-cut method. What's more, learning music this way costs less than SEVEN CENTS a day! No expensive private teacher . . . not a penny extra for sheet music or anything else. It doesn't take years of practice, either. You'll pick up your instrument and play sooner than you probably ever thought you could.

## Play a Tune in One Lesson

Surprising enough you start playing a familiar melody in the very first lesson. No wasted time . . . no lost motion. That's because your lessons are in print and picture form. Big, clear diagrams and pictures show you what position to take . . . every move to make. And the text is like a teacher at your side, explaining as you go along. You can't go wrong!



**FREE BOOK** Mail coupon today for fascinating free booklet and Print and Picture Sample. These fully explain our wonderful home study course. Instrument supplied when needed, cash or credit.

**Learned Quickly at Home** I learned more music in a few months than I hoped to in two years. Your lessons are practical. \*W. S., Johnson City, Ill.

U. S. School of Music, 79 Brunswick Bldg., N. Y. C.  
Please send me FREE Print and Picture Sample and Illustrated Booklet. I am interested in the instrument checked below.

(Do you have instrument?)

Piano	Mandolin	Tenor Banjo	Piano Accordion
Violin	Saxophone	Ukulele	Plain Accordion
Guitar	Trumpet	Cornet	Hawaiian Guitar
Cello	Trombone		Other Instruments

Name.....  
Street.....  
City..... State.....

\*Actual pupil's name on request. Picture by professional model.



**START**

**\$1260 to \$2100 YEAR  
MEN — WOMEN**

**Hundreds War Service  
Appointments Now  
Being Made.**

**Common Education  
Often Sufficient**

**Mail Coupon  
Today—  
SURE**

Name.....

Address.....

**Franklin Institute,  
Dept. N195  
ROCHESTER, N. Y.**

Gentlemen: Rush to me, FREE of charge, list of U. S. Government big pay jobs. Send me FREE 32-page book describing salaries, vacations, hours, work, and full particulars telling how to qualify for one of these jobs.

## PARKS AIR COLLEGE PARKS AIRPORT EAST ST. LOUIS, ILL.

Offers YOU COLLEGE and PROFESSIONAL TRAINING  
Majoring in AVIATION

Accredited by the Illinois Superintendent of Public Instruction. Included since 1938 in The Directory of Colleges and Universities, issued by the U. S. Office of Education. U. S. approved as a Commercial Ground and Flying School and Mechanics' School. Accredited by and cooperating with the United States Army Air Corps in giving flight and mechanical training. Open to high school graduates.

FOUR courses lead to B.S. degrees in Professional Piloting, Aviation Operations, Maintenance Engineering, Aeronautical Engineering.

TWENTY-TWO TRAINING PLANES are used in professional flight training which prepares graduates for airline flight operations.

FACULTY of 104 specialists in various fields of aviation.

Enrollment limited to a total of 300 commercial aviation students. Capacity enrollment of 870.

Airport, 25 buildings devoted to school purposes exclusively. Dormitories and dining hall at the College.

Fall term September 28. Send postcard for new 64-page catalog.

16th YEAR PARKS AIR COLLEGE, East St. Louis, Ill.

## get the story of PLASTICS

See the important place of plastics in virtually every industry—in War as well as Peace. Learn what a knowledge of plastics can mean to your future career. Write today for interesting, illustrated literature.

### PLASTICS INDUSTRIES TECHNICAL INSTITUTE

1221 Chemin Bldg.  
NEW YORK CITY

Room 625-E LaSalle-Walker Bldg.  
CHICAGO, ILLINOIS

190 S. Alameda Street  
LOS ANGELES, CALIF.

## Regain Perfect Speech, If You STAMMER

Every stammerer should have the new 287 page book "Stammering, Its Cause and Correction." Sent free to stammerers. It describes the Bogue Unit Method for the scientific correction of stammering and stuttering. Method successfully used at Bogue Institute for 41 years—since 1901. Endorsed by physicians. Write for full information. No obligation. Benjamin N. Bogue, Dept. 1342 Circle Tower, Indianapolis, Indiana.

## THERE'S MONEY IN CARTOONS!

RAYE BURNS will teach you HOW to CREATE ORIGINAL CARTOONS at home that you may SELL! Course contains 26 lessons and over 600 illustrations. All for Only..... **\$2.85**

Send name and address for free details.

RAYE BURNS SCHOOL, Dept. M, Box 3583, CLEVELAND, OHIO

**RADIO ENGINEERING**, broadcasting, aviation and police radio, servicing, marine and Morse telegraphy taught thoroughly. 48 weeks' engineering course equivalent to three years' college radio work. School established 1874. All expenses low. Catalog free.

The Dodge Institute, Dept. D, Valparaiso, Ind.

## MAKE MONEY

Learn Painting at Home by the NEW, Easy Stuart System

• Previous art training or talent NOT necessary. This Stuart System is radically new and simple. It will REALLY TEACH PORTRAIT PAINTING. Cost is unusually low. Write for free booklet. Start your career NOW!

**STUART STUDIOS, Room 692  
121 Monument Circle • Indianapolis, Indiana**

## KNOCK-EM-COLD!

THE BIGGER THEY ARE, THE HARDER THEY FALL. LEARN JIU JITSU!

36 secret knock-out blows without fists by 25c world famous Police Jiu Jitsu Instructor

A little jab with tip of fingers, or strike with edge of hand to right spot and tough guys go out like a light. Also many one fingered headlock breaks. Northwest "Mocnties" use Jorgensen's system. G-Men must be Jiu Jitsu experts. He has personally taught many in U.S. Army, Navy, Marines, National Guard, Coast Guard, Immigration, Border Patrol, Police, etc. and performed for the Movies. Whether you are young or old, man or woman, send now for new illustrated course. Full Price 25c Size or strength mean nothing. Fear no man, gun, knife, club.

S. J. JORGENSEN, 775 Maritime Bldg., Seattle, Wash.





# Home Training helps YOU WIN!



DRAFTING

## Right Now

there is a tremendous shortage of skilled men in all branches of industry. Draftsmen, electricians, machine designers, tool makers, machinists are needed and the pay is big. Executives, too, foremen, superintendents, managers are wanted to help complete our tremendous production program.

### War Production Demands Better Men

It is a duty you owe your country, yourself, and your family. You should know more and more about your job. You should be prepared to advance and to accept the responsibilities of the men ahead of you so that they in turn may climb and, climbing take you with them. No matter what your present job, you should learn to do it better or learn how to do the job of the man ahead of you. You need to know both theory and practice to make our tremendous war plants more productive. Yes, indeed, you are needed and needed badly right now.

### Draftsmen, Electricians, Machine Designers, Machinists, Foremen, Superintendents, Managers Can All Profit by Home Study . . .

No matter what your trade or profession there is a better place for you in industry. You can get the training needed right in your own home.

**AMERICAN SCHOOL**  
Dept. G645, Drexel at 58th St.,  
CHICAGO, ILLINOIS

### Use Spare Time, Learn At Home

As little as one-half hour a day can produce surprising results in giving you a better education, more practical and theoretical training which will be reflected in your pay envelope. Never in the history of the world have there been so many opportunities for trained men, nor has it been so easy to get this training. The American School was founded over 40 years ago to provide home study for men and women who missed the opportunity to go to high school or college and to make it possible for you to LEARN AS YOU EARN.

### Rewards Are Great

Government figures show that graduates of specialized training of college grade, average over \$40 per week more than grade school graduates. If you missed this college training, then here is your opportunity to get specialized training at home. More than 150 noted educators, engineers, and executives helped to prepare American School Courses. This instruction is now available to you at a relatively low cost and on very easy monthly payments. Write now for details. Clip and mail the coupon—there is no obligation.



HIGH SCHOOL

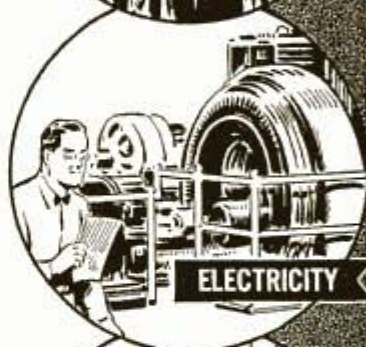

ELECTRICITY



MECHANICAL ENGR'G

**MARK, CLIP AND MAIL THIS COUPON NOW!**

**Get facts FREE..**

(No Cost). All you have to do to find out about this type of training, to get the details and the outline of study, with histories of the successes of other men, is to send the coupon. There is no cost and no obligation of any kind. Let this great school, one of the pioneers in the home study field, explain the methods which can do so much for you. Get this information now so that you can get started quickly on the road to the fulfillment of a real ambition, and be of the greatest possible help in this present emergency.

**AMERICAN SCHOOL**

Dept. G645, Drexel at 58th Street, Chicago

**AMERICAN SCHOOL, Dept. G 645, Drexel at 58th, Chicago**

Without obligation. Please send FREE and postpaid, bulletin and details of the Subjects checked.

- |   |   |  |
|---|---|--|
| <input type="checkbox"/> Air Conditioning           | <input type="checkbox"/> Accounting and C.P.A.              | <input type="checkbox"/> Drafting and Design for Men and Women |
| <input type="checkbox"/> Refrigeration              | <input type="checkbox"/> Cost Accounting                    | <input type="checkbox"/> Radio and Television                  |
| <input type="checkbox"/> Architecture and Building  | <input type="checkbox"/> Practical Bookkeeping              | <input type="checkbox"/> High School                           |
| <input type="checkbox"/> Plumbing and Steam Fitting | <input type="checkbox"/> Private Secretary                  | <input type="checkbox"/> Plastics                              |
| <input type="checkbox"/> Automotive Engineering     | <input type="checkbox"/> Diesel Engineering                 | <input type="checkbox"/> Liberal Arts                          |
| <input type="checkbox"/> Aviation Drafting          | <input type="checkbox"/> Surveying & Topographical Drafting | <input type="checkbox"/> Mechanical Eng.                       |
| <input type="checkbox"/> Aviation Engineering       | <input type="checkbox"/> Sheet Metal Pattern Drafting       | <input type="checkbox"/> Shop Management                       |
| <input type="checkbox"/> Business Management        | <input type="checkbox"/> Electrical Engineering             | <input type="checkbox"/> Tool Making                           |
|   |   | <input type="checkbox"/> Better Foremanship                    |
|   |   | <input type="checkbox"/> Engine and Boiler Work                |

Name.....Occupation.....

Address.....Age.....

City.....State.....



## Know Electricity as Experts Know It—and Get an Expert's Pay!

What about your future? Who is safe today? Surely not the man who is contented to stand still! Know your job thoroughly—prepare yourself for jobs ahead. To do just this thousands of men have used

### The Croft Library of Practical Electricity

The Croft Library is a complete electrical educator. It is founded on practice—on 20 years of shirt-sleeve experience—on work as it is actually done. It is jammed from cover to cover with the kind of hard-headed facts you want. Written so that the beginner can easily understand it, yet so sound, so thorough, that it is the daily guide of 29,000 highly paid electrical workers and engineers. Croft tells you the things you need to know about motors, generators, armatures, commutators, transformers, circuits, switchboards, distribution systems—electrical machinery of every type—wiring for light and power—wiring of finished buildings—underwriters and municipal requirements—illumination in its every phase—the most improved methods of lighting—lamps and lamp effects, etc.—how to do a complete job, from estimating it, to completion.

### No money down — easy payments

Fill in and mail the coupon attached and we will send you the entire set of seven volumes for ten days' examination on approval. We take all the risk—you assume no obligation. If you decide to keep the books, send \$3.00 in ten days and the balance at the rate of \$3.00 a month. Send the coupon NOW and see the books for yourself.

#### EXAMINATION COUPON

McGraw-Hill Book Co., 330 W. 42nd St., New York

Send me for ten days' examination on approval the Croft Library of Practical Electricity, 7 vols. If satisfactory I will send you \$3.00 in 10 days and \$3.00 monthly until the price of \$18.00 is paid. If not wanted, I will return the books postpaid. (To insure prompt shipment write plainly and fill in all lines.)

Name.....  
 Home Address.....  
 City and State.....  
 Position.....  
 Name of Company..... PM-9-42



WHEN THIS HAPPENS TO YOU...



### YOU CAN DESTROY Your Enemy Quick!

**BE A ONE-MAN BLITZ!** Strike with Commandlightning! You don't need ox-like muscles to use Super Ju Jitsu, most powerful of all defense and attack methods. **Technique** is the deadly secret. Brains count—not size, not strength. Almost miraculously efficient.



### Gain Self-Confidence

KNOW how YOU can lick brutes twice your size with your bare hands only, even when they are ARMED with gun, knife, club. Get ready now for any emergency—protect your loved ones. Amazing self-study course teaches you double-quick. No boring exercises needed.

**Send for Exciting Details—Free!** Startling Low Price. Satisfaction Guaranteed or your moneyback Mail coupon now.

**FREE**  
 NELSON CO., 500 Sherman Street  
 DEPT. J-502, CHICAGO, ILL.  
 Please rush me free the hard-hitting details about "Super Ju Jitsu." No obligation on my part.  
 NAME.....  
 ADDRESS.....



## Prepare For AVIATION'S MOST VITAL BRANCH AIRCRAFT INSTRUMENTS

### HOME STUDY—Learn By Doing!

Practical—complete training on Actual Instruments furnished by the school, qualifies you for well-paying positions with manufacturers, airlines and instrument service and repair stations. WRITE FOR CATALOG today. EASTERN AIRCRAFT INSTRUMENT SCHOOL "The Largest In The East" Dept. M-J, 116 Newark Ave. Jersey City, N. J.

## TRI-STATE COLLEGE

### B-S-Degree in 24 years

Distinguished for technical 2 1/4-year courses in Civil, Electrical, Mechanical, Chemical, Radio, Aeronautical Engineering; Business Administration, Accounting; Secretarial Science. Special preparatory department for those who lack required high school work. Short diploma courses (3 1/2 weeks) in Surveying, Drafting. Tuition, living costs low. Cosmopolitan student body. 59th year. Graduates successful. Enter September, January, March, June. Write for catalog. 492 College Ave., ANGOLA, IND.

## TRAIN Your VOICE!

### Results GUARANTEED

We build, strengthen the vocal organs—not with singing lessons—but by sound, scientifically correct silent and vocal exercises and absolutely guarantee complete satisfaction with results. Write for Voice Book, FREE. Sent to no one under 17 years old unless signed by parent. PERFECT VOICE INSTITUTE, Studio 8135, 64 E. Lake St, Chicago, Ill.

## Learn Profitable Profession in 90 days at Home

Earnings of Men and Women in the fascinating profession of Swedish Massage run as high as \$40 to \$70 per week but many prefer to open their own offices. Large incomes from Doctors, hospitals, sanitariums and private patients come to those who qualify through our training. The Army and Navy need hundreds trained in massage. Write for Anatomy Charts and booklet—They're FREE. THE COLLEGE OF SWEDISH MASSAGE 30 E. Adams St., Dpt. 664, Chicago

## Learn to Write

Begin today. Write now for our Free Book, "How to Revolve a Good Penman." It contains specimens and tells how others learned to write in spare time. Enclose 10c for your name beautifully written and a pen point suitable for shaded writing. Write today. THE TAMBLYN SCHOOL OF PENMANSHIP X441 Ridge Building, Kansas City, Mo.

## EARN THE DEGREE

Doctor of Psychology (Ps.D.), Doctor of Divinity (D.D.), many others. Courses in business, accounting, law, etc. Low fees. Send for large Bulletin and student picture-folder AT ONCE. No obligation whatever. TEMPLE BAR EXTENSION COLLEGE 1411 Fourth Avenue, Dept. 4-R, Seattle, Washington, U. S. A.

## Get into the BAKING BUSINESS

Bakers make good money! Now 7th Industry in wages! Nearly depression-proof. New home study Baking Course qualifies you. Common school education sufficient. If you're ambitious, write for FREE BOOK, "Opportunities in Baking." National Baking Institute, 1315 Michigan, Dept. 1356, Chicago

## America Needs Men Trained for TOOL & DIE MAKING, MACHINIST & SCREW MACHINE TRADES

HARRY LEBESON PRESIDENT & FOUNDER ALLIED School offers you short intensive, Practical training courses in Our fully equipped Shops. Learn on Actual Jobs! State Approved. Learn Days or Evenings. Enter anytime. FREE Employment Service and opportunity to earn while learning. Write for FREE Book "Practical Machine Shop Training." ALLIED SCREW MACHINE CO., (School Division) 609 West Lake Street, Dept. PM-9, Chicago, Illinois

# ... AND INDUSTRIAL WARFARE HAS ITS "COMMANDOS," TOO!

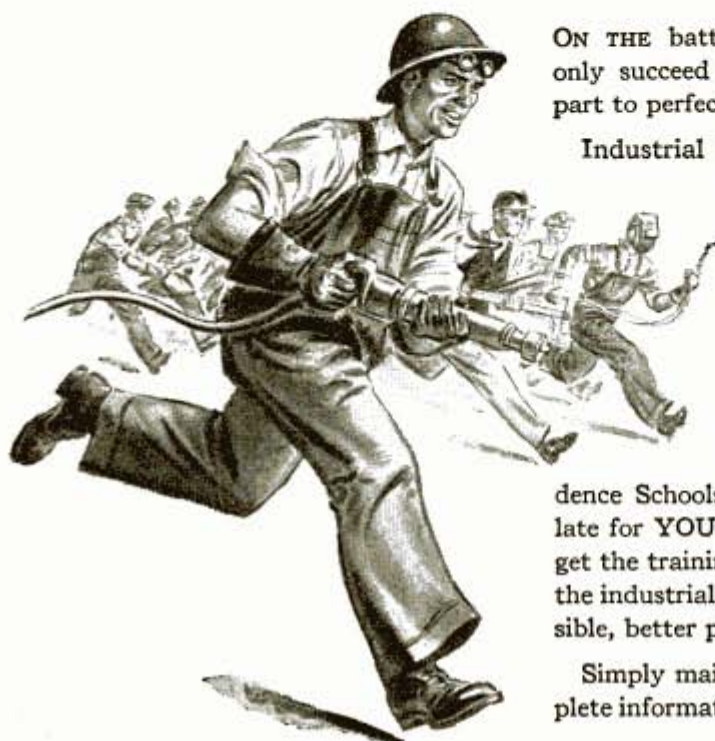

ON THE battlefield, daring "hit-and-skip" raids can only succeed when every man is *trained* to do his part to perfection.

Industrial warfare, too, has its "commandos"—workers whose skill and experience are backed by sound, practical, up-to-the-minute *training!* These are the men who were Johnny-on-the-spot when the nation called on industry to outproduce the Axis!

Many of these "shop commandos" got their basic and specialized training through the International Correspondence Schools—at surprisingly low cost! It's not too late for YOU to join their ranks—by starting now to get the training that will make you a better soldier on the industrial front, and qualify you for a more responsible, better paid job!

Simply mail this coupon, and we will send you complete information on I.C.S. Courses in your line of work.

## INTERNATIONAL CORRESPONDENCE SCHOOLS HELPING TO TRAIN AMERICANS FOR VICTORY



BOX 5644-J, SCRANTON, PENNA.

Without cost or obligation, please send me a copy of your booklet, "Who Wins and Why," and full particulars about the course *before* which I have marked X:

### TECHNICAL AND INDUSTRIAL COURSES

- |  |   |   |  |
|--|---|---|--|
| <input type="checkbox"/> Air Brake   | <input type="checkbox"/> Contracting and Building                     | <input type="checkbox"/> Management of Inventions                               | <input type="checkbox"/> Sanitary Engineering                                  |
| <input type="checkbox"/> Air Conditioning                                    | <input type="checkbox"/> Cotton Manufacturing                         | <input type="checkbox"/> Marine Engines   | <input type="checkbox"/> Sheet Metal Work                                      |
| <input type="checkbox"/> Airplane Drafting                                   | <input type="checkbox"/> Diesel Engines                               | <input type="checkbox"/> Mechanical Drafting                                    | <input type="checkbox"/> Ship Drafting   |
| <input type="checkbox"/> Architectural Drafting                              | <input type="checkbox"/> Electrical Drafting                          | <input type="checkbox"/> Mechanical Engineering                                 | <input type="checkbox"/> Shipfitting <input type="checkbox"/> Shop Practice    |
| <input type="checkbox"/> Architecture  | <input type="checkbox"/> Electrical Engineering                       | <input type="checkbox"/> Mine Foreman   | <input type="checkbox"/> Steam Electric <input type="checkbox"/> Steam Engines |
| <input type="checkbox"/> Auto Engine Tune-up                                 | <input type="checkbox"/> Electrician                                  | <input type="checkbox"/> Navigation <input type="checkbox"/> Patternmaking      | <input type="checkbox"/> Steam Fitting   |
| <input type="checkbox"/> Auto Technician                                     | <input type="checkbox"/> Electric Lighting                            | <input type="checkbox"/> Plastics <input type="checkbox"/> Plumbing             | <input type="checkbox"/> Structural Drafting                                   |
| <input type="checkbox"/> Aviation <input type="checkbox"/> Aviation Mechanic | <input type="checkbox"/> Foundryman <input type="checkbox"/> Heating  | <input type="checkbox"/> Public Works Engineering                               | <input type="checkbox"/> Structural Engineering                                |
| <input type="checkbox"/> Blueprint Reading                                   | <input type="checkbox"/> Heat Treatment of Metals                     | <input type="checkbox"/> Pulp and Paper Making                                  | <input type="checkbox"/> Surveying and Mapping                                 |
| <input type="checkbox"/> Boilermaking  | <input type="checkbox"/> Highway Engineering                          | <input type="checkbox"/> Radio, General   | <input type="checkbox"/> Telegraphy <input type="checkbox"/> Telephony         |
| <input type="checkbox"/> Bridge Engineering                                  | <input type="checkbox"/> House Planning                               | <input type="checkbox"/> Radio Operating  | <input type="checkbox"/> Textile Designing                                     |
| <input type="checkbox"/> Chemistry <input type="checkbox"/> Coal Mining      | <input type="checkbox"/> Industrial Metallurgy                        | <input type="checkbox"/> Radio Servicing  | <input type="checkbox"/> Toolmaking <input type="checkbox"/> Tool Design       |
| <input type="checkbox"/> Civil Engineering                                   | <input type="checkbox"/> Locomotive Engineer                          | <input type="checkbox"/> R. R. Section Foreman                                  | <input type="checkbox"/> Welding, Gas and Electric                             |
| <input type="checkbox"/> Concrete Engineering                                | <input type="checkbox"/> Machinist <input type="checkbox"/> Inspector | <input type="checkbox"/> R. R. Signalman <input type="checkbox"/> Refrigeration | <input type="checkbox"/> Woolen Manufacturing                                  |

### BUSINESS COURSES

- |  |  |  |   |
|--|--|--|---|
| <input type="checkbox"/> Accounting <input type="checkbox"/> Advertising   | <input type="checkbox"/> College Preparatory     | <input type="checkbox"/> First Year College                          | <input type="checkbox"/> Railway Postal Clerk                         |
| <input type="checkbox"/> Bookkeeping                                       | <input type="checkbox"/> Commercial              | <input type="checkbox"/> Foremanship <input type="checkbox"/> French | <input type="checkbox"/> Salesmanship                                 |
| <input type="checkbox"/> Business Correspondence                           | <input type="checkbox"/> Commercial Illustrating | <input type="checkbox"/> Good English                                | <input type="checkbox"/> Secretarial <input type="checkbox"/> Spanish |
| <input type="checkbox"/> Business Management                               | <input type="checkbox"/> Cost Accounting         | <input type="checkbox"/> High School                                 | <input type="checkbox"/> Showcard and Sign Lettering                  |
| <input type="checkbox"/> Cartooning <input type="checkbox"/> Civil Service | <input type="checkbox"/> C. P. Accounting        | <input type="checkbox"/> Managing Men at Work                        | <input type="checkbox"/> Traffic Management                           |

### HOME ECONOMICS COURSES

- |   |   |   |
|---|---|---|
| <input type="checkbox"/> Advanced Dressmaking | <input type="checkbox"/> Home Dressmaking                       | <input type="checkbox"/> Tea Room and Cafeteria |
| <input type="checkbox"/> Foods and Cookery    | <input type="checkbox"/> Professional Dressmaking and Designing | <input type="checkbox"/> Management, Catering   |

Name..... Age..... Address.....  
City..... State..... Present Position.....

Canadian residents send coupon to International Correspondence Schools Canadian, Limited, Montreal, Canada  
British residents send coupon to I. C. S., 71 Kingway, London, W. C. 2, England

# DRAFTSMEN NEEDED

## Now



Industry is clamoring for more draftsmen for the job can't start until plans are drawn. Buildings, airplanes, machines, guns, tanks, bridges, all start on the drafting board, so it's no wonder that every good draftsman has a fine job. Yes, more draftsmen are needed NOW. The pay is good and the opportunities for advancement great.

### Learn at Home in Spare Time

Begin now to turn spare hours into money. Be a draftsman, the connecting link between a mechanic and an engineer. Enjoy the wonderful opportunities for promotion that exist now. No experience or artistic talent is needed. You don't have to leave your present job while learning. Use spare time.

American School, Dept. DD645, Drexel Ave. at 58th St., Chicago, Ill.

Gentlemen: Send me FREE information covering special training in subjects checked below. No obligation on my part.

- |  |   |
|--|---|
| <input type="checkbox"/> Drafting and Design       | <input type="checkbox"/> Diesel Engineering     |
| <input type="checkbox"/> Accounting and Auditing   | <input type="checkbox"/> High School Course     |
| <input type="checkbox"/> Architecture and Building | <input type="checkbox"/> Plastics               |
| <input type="checkbox"/> Automotive Engineering    | <input type="checkbox"/> Mechanical Engineering |
| <input type="checkbox"/> Business Management       | <input type="checkbox"/> Radio and Television   |
| <input type="checkbox"/> Aviation                  | <input type="checkbox"/> Business Law           |
| <input type="checkbox"/> Electrical Engineering    | <input type="checkbox"/> Retail Merchandising   |

Name.....  
Address.....

# INVENTIONS WANTED

Practical new ideas are urgently needed to meet the rapidly changing conditions of warfare and commerce. If you have a useful invention for sale your country needs it now—and it can be safely marketed without patenting expense! Write for complete details, today. Chartered Institute of American Inventors Dept. 4, Barrister Building, Washington, D. C.

## New York Electrical School

Established 1902

Ask for free illustrated booklet  
44 West 17th St., N. Y. C.

### AIRCRAFT Designing & Engineering

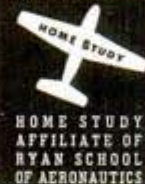

You can learn to design airplanes. A Ryan Home Study Course in Aeronautical Engineering will prepare you quicker for a job with good pay and a future. Easy to understand. No previous training necessary. Write today for free literature.

RYAN AERONAUTICAL INSTITUTE  
429 Lindbergh Field • San Diego, California

Always write your name and full address clearly when answering advertisements.

## Learn RADIO quickly for BIG PAY JOBS

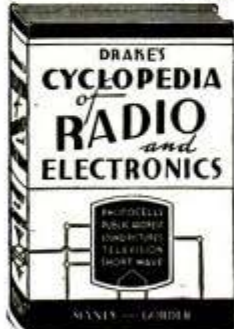

Thousands of Radio Technicians needed for Industry and our armed Forces—NOW. This home study book—the "Radio Man's Bible"—will enable you to qualify for advancement and big pay.

### 5 DAY EXAMINATION . . . SEND NO MONEY Pay as You Learn

Here is a complete course in Radio and Electronics—written in simple, non-technical language—easy to understand.

#### Completely Revised—Includes Frequency Modulation

Covers radio transmission and reception—sound pictures—short wave—public address systems—television—photo cells. More than 500 articles, complete in themselves—over 1100 additional definitions and references. Each section divided with cross-references to all related subjects. 1000 pages—1178 illustrations—130 tables—105 graphs.

Pay only \$1.00 a month and . . .

START TODAY to qualify for a bigger, better job and real money. MAIL THE COUPON NOW.

Drake Pub. Co., 604 W. Van Buren St., Chicago, Ill.  
Send me Drake's Cyclopaedia of Radio and Electronics, price \$5.00. I will pay postman \$1.00 plus charges (postage paid if cash in advance) and remit \$1.00 per month until full price, \$5.00, is paid. If not satisfied, I will return book within 5 days and my \$1.00 will be refunded.

Name.....  
Address.....  
City..... State..... PM9  
Position.....  
Company.....



Now's the time to get set for a good paying job. Today's industries are calling for more trained men. You can get practical experience under actual production conditions—in our modern, completely equipped shops. Moderate training fee—assistance given in securing employment. A few "Service Scholarships" offered by Milwaukee industries still available to qualified men who want to earn real money while learning.

**AIRCRAFT WELDING** "We need more planes!" That's the demand on every side. No wonder there's a big shortage of aircraft welders. Other industries need trained welders, too. Milwaukee School of Engineering trained welders get top pay because they know the "how and why" of Welding, Metallurgy, Drawing, Blueprint Reading, Set-up Work and Metal Fabrication—and they enable manufacturers to cut production time and costs. Remember—industries everywhere need practical trained Aircraft Welders, Arc Welding Operators, Aircraft Technicians and Engineers. Don't be content to struggle along on ordinary hit-or-miss jobs with poor pay—when in a short time you can become a trained specialist—an essential worker in a vital industry—with an expert's pay, and a better rating if drafted. Send coupon today—classes begin within a month.

## MILWAUKEE SCHOOL of ENGINEERING

Institute of Electrotechnics

PM-942 North Broadway and E. State, Milwaukee, Wis.

Without obligation send Free Booklet, "Golden Opportunities in Defense Work." Also tell me How to Become an  
Arc Welding Operator (3 mo.) . . . Electrical Engineer B.S. Degree.  
Aircraft Welder (3 mo.) . . . Commercial Radio Engineer . . .  
Welding Technician (1 yr.) . . . Armature Winder . . .  
Aircraft Technician (1 yr.) . . . STUDENT LOAN PLAN . . .  
Electro Technician (1 yr.) . . . EARN PART EXPENSE PLAN . . .  
Aircraft Draftsman (1 yr.) . . . "Earn \$1000 while learning."

Name..... Address.....  
City and State..... Age..... PM-9-42

# Be an ENGINE TECHNICIAN!

many good jobs await you in:

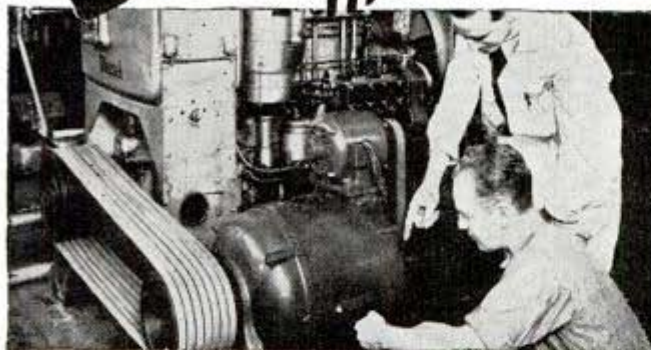

- DIESEL,
- GASOLINE ENGINES,
- MECHANICAL SERVICING,
- ENGINE RE-MANUFACTURE

Take your place as an Engine Technician in America's Victory Program NOW;—also be ready for continued advancement in industrial rebuilding when the War is over.

## SHOP METHOD HOME TRAINING BRINGS YOU RICH OPPORTUNITIES TO EARN MORE MONEY

"TRAINED MEN NEEDED," cry the Want Ad Columns of every newspaper, in every city. That's proof of the need today! And after the war, too, Trained Technicians will continue to be in demand, with permanent jobs, for the vital work of industrial reconstruction. National Schools now offers YOU a new opportunity to train quickly right in your own home, for these better jobs, in the active Diesel, Gasoline Engines, Mechanical Servicing and Engine Re-manufacturing fields. Trained Engine Technicians are needed in the Army, Navy, Civilian war production plants, Government Shipyards, in Industrial Engine Re-manufacturing, and many other similar spots—and will be so needed for years to come.

### MEN SUBJECT TO MILITARY SERVICE AIDED

National Schools' Diesel and Mechanical Training helps men get extra rank, extra pay, in war service, to repair tanks, tractors, road equipment, generating sets; also in Diesel Motor Marine operations. Many service men have enrolled.

### NATIONAL GRADUATES SUCCEED INCREASES PAY

"I am happy to say I have been able to earn more than \$200 a month; National training helped me."  
H. A. LONG,  
Spencer, N. C.

### DIESEL EXPERT

"It's a pleasure to express my appreciation for training I received at National. I am now with Coast Guard as Diesel Expert."  
WILLIAM BLISS,  
U. S. Coast Guard,  
Massachusetts

### RUNS BIG DIESELS

"Am employed in operation of two 2500 h. p. Diesel engines at Standard Oil Co."  
RONALD DUNN,  
New Jersey



## GET YOUR HOME TRAINING FROM AN ESTABLISHED RESIDENT SCHOOL

For 37 years National Schools has trained ambitious men for Top Pay trades. Squarely behind your Home Training are the modern, completely-equipped Training Shops of National Schools where we develop and prove every Shop Method Assignment sent to you. Every phase of your training is personally supervised by an established Faculty of practical, experienced instructors and engineers. They have developed progressive methods of training you in your own home, based on actual shop practice. Unique training facilities give you Home Training based on Resident School Shop principles—methods not available from any other source, to our knowledge. You'll be amazed when you receive our Complimentary Lesson and full details.

Regardless of age, Draft classification, or previous experience, mail the Opportunity Coupon, RIGHT NOW! Just put this Coupon in an envelope or PASTE IT ON A PENNY POSTAL.

## NATIONAL SCHOOLS

Los Angeles, California

Established 1905.



"I will train you in your spare time to qualify as Engine Expert."  
J. A. ROSENKRANZ  
President

### MAIL OPPORTUNITY COUPON FOR QUICK ACTION

National Schools, Dept. 9-M  
4000 So. Figueroa, Los Angeles, Calif.

(Mail in envelope or paste on a Penny Postal.)

Mail me FREE, without obligation, one Lesson and Opportunity Book, with full details how I can become an Expert Engine Technician.

NAME \_\_\_\_\_ AGE \_\_\_\_\_

ADDRESS \_\_\_\_\_

CITY \_\_\_\_\_ STATE \_\_\_\_\_

**REQUEST FULL DETAILS**

# More GOOD JOBS in DRAFTING in AIRCRAFT and other War Industries!



**Calls for Draftsmen Are Increasing! . . . Read the want-ads for proof of this urgent demand.**

This complete drawing outfit,—every thing to work with,—including drafting table, drawing board, supplies, etc.—**ALL SENT TO YOU AT NO EXTRA COST** if you are a Chicago Tech Student.

MAIL COUPON BELOW

The War Production program has increased the demand for Aircraft Draftsmen, Machine Draftsmen, Architectural Draftsmen, Electrical Draftsmen, and Structural Draftsmen. The Draftsman always comes first on any new project in manufacturing and industry—peace or wartime.

## The Draftsman—"The Key Man" in War or Peacetime Industry

No new machines can be built, no airplanes constructed, no bridges or buildings erected, no ships or submarines launched until the draftsman has completed his work. Real immediate opportunities exist in Drafting—the profession upon which all construction is vitally dependent. Drafting is clean, interesting, well paid work. Steady employment. Investigate today what Drafting offers you! Help your country in a vital War production job on the important Home Front—and help yourself to a well paid job in Drafting.

## Learn in Spare Time,—at Home! (or at the College in Chicago)

With our easy step-by-step lessons, (and the tools we furnish), you can learn in your spare time at home. New short courses at new low prices. Convenient terms. To prove to you how easy it is to learn Drafting by the Chicago Tech Method we'll send you a Trial Lesson FREE. No charge for this lesson either now or later.

Send a post card or the coupon now for

**FREE TRIAL LESSON**

# Free TRIAL LESSON

Send Coupon

### CHICAGO TECHNICAL COLLEGE

M-203 Tech. Bldg., 2000 S. Michigan Ave., Chicago, Ill.

Please send me **FREE Trial Lesson in DRAFTING** showing how to learn at home by C. T. C. plan for good job in aircraft and other war industries. No obligation of course.

Name.....  
Address.....  
City..... State.....  
Occupation..... Age.....

Say you saw it in Popular Mechanics!



## DRAW for MONEY Be An ARTIST! Trained Artists Are Capable of Earning \$30 - \$50 - \$75 A WEEK Use your spare time to prepare for a profitable Art Career!

NOW is the time to prepare for a pleasant, profitable future. **COMMERCIAL ART, ILLUSTRATING, CARTOONING**—all in ONE complete course. No previous Art experience necessary—hundreds have profited by our practical home study method since 1914. Write today for information in FREE BOOK, "Art for Pleasure & Profit"—tells all about our course, service—and commercial opportunities for you in Art. State age.

**WASHINGTON SCHOOL OF ART**  
STUDIO 129A, 1115-15th St., N. W.,  
Washington, D. C.

## ELECTRICITY MEN NEEDED

Electricians are needed everywhere. Hollywood studios alone claim shortage 200 men. This is a live money making profession. Learn at home, spare time. Easy payments. Selective Employment service. Write for FREE Bulletin. No obligation.

### AMERICAN SCHOOL

Dept. EE645

Drexel at 58 St., Chicago

Burn Your Name On Tools **Electro Name Etcher** Only

Protect valuable tools from thieves and tool borrowers! Electro Etcher **BURNS** your name, any design, permanently on tools, instruments, any metal. Easy! Simple as writing with pen or pencil. **SEND NO MONEY!** Rush order today. Pay postman only \$1.00 plus few cents postage on delivery. Use 5 days—money back if not delighted. **Electro Name Etcher, Dept. H-600, Strader Ave., Cincinnati, O.**

## NEWS

Increased production means

## More Jobs for MACHINISTS and bigger pay for men who know their work

This big home-study and reference course gives you the practical facts on machines and methods you need to advance in machine shop work. Take advantage of the other man's experience as found in books, to solve your problems, increase your efficiency, with

### The AMERICAN MACHINISTS' LIBRARY

6 volumes—2368 pages—2516 illustrations  
(A combined home-study course and reference library)

This library of machine shop practice was written for practical men. It gives you the best methods for every kind of machine shop work. It fully explains lathes, drills, and other machine tools and their operation, automatic screw machines, speeds and feeds, gear design and production, jigs and fixtures, punch and die work, metal surfacing, etc., etc. Plainly written—completely illustrated—the best kind of help to the machine shop man who wants to advance himself.

No money down—special price—easy payments.

### EXAMINATION COUPON

**McGRAW-HILL BOOK CO., 330 W. 42nd St., New York**

Send me for ten days' examination the American Machinists' Library. If satisfactory I will send you \$1.50 in 10 days and \$3.00 monthly until the price of \$19.50 is paid. If not wanted, I will return the books postpaid. (To insure prompt shipment write plainly and fill in all lines.)

Name.....  
Home Address.....  
City and State.....  
Position.....  
Name of Company..... PM-9-42

# INVENTORS

## Get Expert Advice on HOW to PROTECT and SELL Your Invention

Get  
**FREE COPY**

"Why I thought of that years ago!" How many persons have said that, when they found later that somebody else had thought of the same thing, had it patented, sold it, and were profiting from it? Too many, sad to say. These unfortunates did not know what to do about their inventions, in order to protect and profit from them. Some thought elaborate working models were necessary to secure a patent—others felt their idea wasn't "worth much." They failed to realize that a good practical invention, plus prompt action in securing a Patent, and locating a buyer or a good market, have proved the secrets of success for thousands of inventors.

### Patent Guide Shows What To Do

Our "Patent Guide for the Inventor" answers many important questions concerning Patents that inventors constantly ask. It tells what facts, details, drawings, sketches, etc. are necessary to apply for a Patent; how to protect your invention through dated and witnessed disclosure; how to do this AT ONCE to safeguard your rights; how Patent Office Records can be checked to determine whether the invention is probably patentable before filing fees need be paid; discusses costs involved and a practical way these can be paid as the application progresses. It tells how some inventors secured financial backing; how many simple inventions have proved large commercial successes; how Patents covering improvements also can be profitably utilized and marketed; tells countless other facts of interest.

### Why You Need Expert Assistance

The Patent Laws were enacted for your benefit—to give you protection for the features of your invention which are Patentable. But these features must be legally and concisely set forth in the form of "claims." This phase of the procedure is so complex that the Patent Office advises the inventor to engage a competent Registered Patent Attorney. We maintain a large staff—carefully trained registered patent attorneys—expert draftsmen—experienced searchers—to serve you. We have been serving inventors for more than 20 years.

### Take First Step Now

With the Patent Guide you will receive also Free a "Record of Invention" form which will enable you at once to establish the date of your invention, before you file your Patent application. This step costs you nothing yet may be vital to your success. Remember—in Patent Matters, ACTION is IMPORTANT. Delay can be costly. Mail the coupon in an envelope, or paste it on a penny postcard NOW.

**CLARENCE A. O'BRIEN**  
and  
**HARVEY B. JACOBSON**  
"Worthy of Your Trust"  
Registered Patent Attorneys  
21-J Adams Building  
Washington, D. C.

Get This  
**FREE BOOK**

**IMMEDIATELY MAIL COUPON TODAY!**



**48**  
**PAGES**  
Over 100  
Illustrations

**CLARENCE A. O'BRIEN**  
and **HARVEY B. JACOBSON**

**CLARENCE A. O'BRIEN AND HARVEY B. JACOBSON**  
Registered Patent Attorneys before the United States Patent Office  
21-J Adams Building, Washington, D. C.

Please send me your 48-Page "Patent Guide for the Inventor" and your specially prepared "Record of Invention" form FREE. This request does not obligate me.

Name .....

Address .....

City..... State.....

(Please write or print plainly.)

# POPULAR INVENTIONS

For Your Home

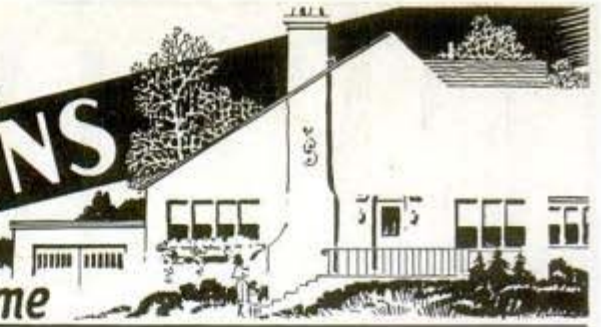

## Wire 'Cage' Holds Salad Vegetables for Washing

M 558

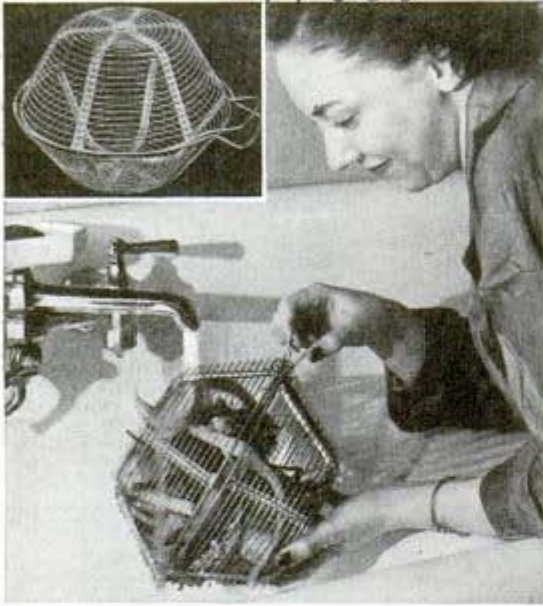

Salad vegetables can be washed quickly by placing them in a handy wire container and shaking them under a faucet. The container is shaped like a ball and has hinges for easy opening and closing.

## Light in Decorative Plant Tray Brightens Picture or Mirror

L 1261

Light lends a cheerful glow among the flowers and leaves of plants growing in a decorative metal tray fitted with an elongated electric light bulb. The tray can be placed near the wall where its beams will brighten a painting or mirror above it.

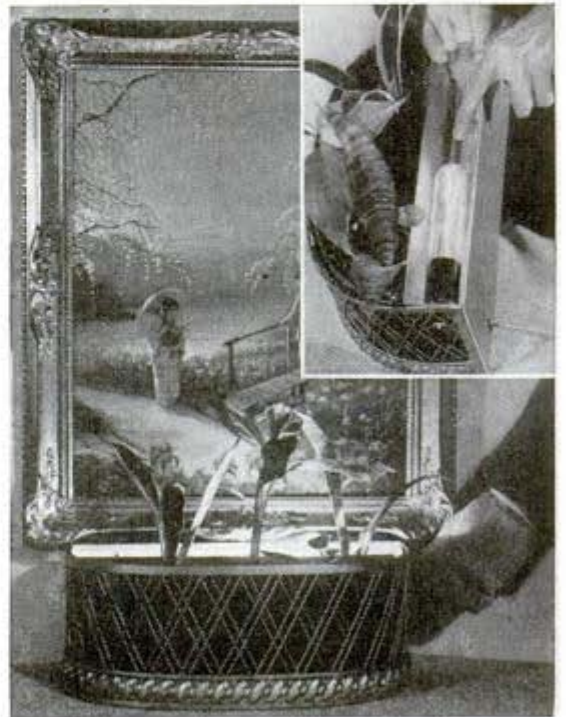

## Thumb-Operated Cherry Pitter Speeds Handling of Fruit

M 260

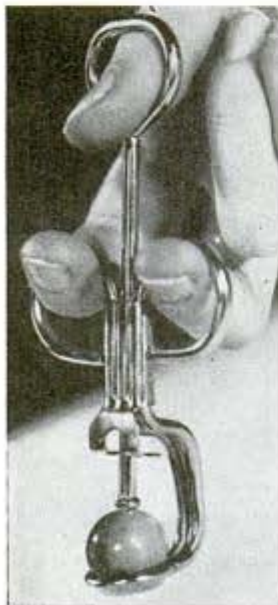

Held by two fingers through rings and the thumb in another ring to operate the plunger, a cherry pitter provides fast action in stoning cherries. The device may be held in the right hand while the left feeds cherries into it. Pressing the plunger forces the pits through, and releasing it withdraws the plunger so the fruit may fall into a bowl.

### WHERE-TO-BUY-IT INDEX OF POPULAR INVENTIONS

**Wire cage for washing vegetables**  
Mandel Brothers, State and Madison Sts., Chicago

**Thumb-operated cherry pitter**  
Goldblatt Bros., State and Van Buren Sts., Chicago

**Plant tray with light**  
Oliver Eldridge, Merchandise Mart, Chicago



# MEN *whether you are* 16 or 50 YOU ARE VITALLY NEEDED

Trained ELECTRICAL men needed now. It's not how young you are, or how old you are. The question is—have you the training to hold a particular job that must be filled.



Electricity is the mighty power behind our Victory Program. Trained Electrical men are needed. PREPARE FOR YOUR PLACE this amazingly easy way. "Learn By Doing" in 12 weeks. You don't need much money—I'll finance your training. READ EVERY WORD OF MY MESSAGE ON THIS PAGE AND SEE HOW YOU CAN DO YOUR PART EITHER IN THE ARMED FORCES OR INDUSTRY.



## ELECTRICITY *Learn By Doing in 12 Weeks*

Get into the fascinating, fast-growing, well-paid field of Electricity—a field that offers you opportunities and a future—in good times or bad times—a field that is a permanent necessity in war or peace. Here is your chance to prepare yourself for a lasting permanent future.

Here at Coyne, in 12 weeks, you can train for your Big Opportunity by working on real electrical machinery. Here you learn airplane ignition, wind armatures, learn power plant

operation, do house and factory wiring, etc. Coyne training is easy to learn. You "Learn-By-Doing", not by books. Not a correspondence course. You don't need previous experience or advanced education. With this brief description of my school I want to bring out this important fact—you don't need much money to get my training. I have many plans to help the fellow who needs training but hasn't much money. Mail coupon for all the facts.



**GET YOUR TRAINING  
NOW... PAY FOR  
IT LATER!**

Coyne Training is EASY, PRACTICAL! You LEARN BY DOING on real, actual machinery and apparatus. Don't let lack of money stop you. You can get training first—then pay for it in easy monthly payments after you graduate. If you need part-time work to help out with living expenses, I'll help you get it.

**EXTRA  
4 WEEKS  
COURSE IN  
RADIO  
INCLUDED**

### Get the Facts

This school is 43 years old—Coyne training is tested and proven. Mail coupon and let me send you the big, free Coyne book and my complete story about how I help you get the training you need for a good Electrical job. This does not obligate you. So act at once. Just mail coupon.

**H. C. LEWIS, COYNE ELECTRICAL SCHOOL**  
President  
500 S. Paulina St. Dept. 62-72 CHICAGO, ILLINOIS

H. C. LEWIS, President  
COYNE ELECTRICAL SCHOOL, Dept. 62-72  
500 S. Paulina St., Chicago, Ill.

Send me your Free Book and tell me about your plans to help me.

NAME.....

ADDRESS.....

CITY STATE

# AUTO MECHANICS!

**FREE 7-Day Offer!**

BIG ILLUSTRATED MANUAL MAKES IT EASY TO

## REPAIR ANY MAKE CAR-

**TODAY!**

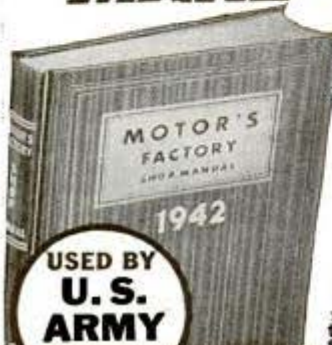

**USED BY U.S. ARMY**

**Explains Every Repair Job on Every Model of All These Cars—1935 through 1942!**

- |           |              |
|-----------|--------------|
| American  | La Salle     |
| —Bantam   | Lincoln      |
| Auburn    | Lincoln      |
| Austin    | —Zephyr      |
| Buick     | Mercury      |
| Cadillac  | Nash         |
| Chevrolet | Oldsmobile   |
| Chrysler  | Overland     |
| Cord      | Packard      |
| De Soto   | Pierce Arrow |
| Dodge     | Plymouth     |
| Ford      | Pontiac      |
| Graham    | Reo          |
| Hudson    | Studebaker   |
| Hupmobile | Terraplane   |
| Lafayette | Willys       |

And major data needed to service 405 models of trucks Nearly 200,000 Vital Facts on Every Phase of Tune-Up and Repair • Over 450 Charts, Tables • More than 900 Photos, Drawings, Diagrams • Over 600 Big Pages—Size 8 1/4 x 11 inches.

Published by MoToR, The Leading Automotive Business Magazine, 572 Madison Ave., New York, N.Y.

**Helps EVERY Mechanic, even experts, do repair jobs easier, quicker**

Explains every auto repair operation **STEP-BY-STEP**. Easy-to-use! Hundreds of photographs, diagrams, drawings, show exact "how to do it" of repairs, adjustments, replacements. All jobs on every truck model! Engine; Electric, Fuel, Cooling, Lubrication Systems; Clutch, Transmission; Universals; Rear End; Wheels, Brakes; Knee Action, Shock Absorbers, Springs; Body; Free Wheel, Overdrive, Fluid Coupling!

### 150 FACTORY BOOKS IN ONE!

Imagine a **COMPLETE COLLECTION** of ALL official shop procedure manuals, prepared by each car manufacturer's own engineers! That's what you **GET** in this book! Open the manual to the car you want—you'll find everything to show the right way to do the job.

### AUTO MECHANICS, INSTRUCTORS AND STUDENTS:

This is the factory shop manual used by the U. S. Army, trade, technical, and vocational schools for training auto mechanics.

### SEND NO MONEY

Simply fill out coupon below. Mail it today and a copy of MoToR's up-to-the-minute 1942 Factory Shop Manual will be sent to you at once for 7 days Free Examination.

**7 DAY TRIAL**

**MoToR BOOK DEPT., Desk 19, 572 Madison Ave., New York, N. Y.**  
Rush me MoToR's 1942 Factory Shop Manual. If O. K. I will remit \$1 plus 35c shipping charge in 7 days, and \$1 monthly for 3 months. (4.35 in all) Otherwise I will return book in 7 days. (Foreign price \$6, cash with order.)

NAME \_\_\_\_\_ AGE \_\_\_\_\_  
ADDRESS \_\_\_\_\_  
CITY \_\_\_\_\_ STATE \_\_\_\_\_  
OCCUPATION & EMPLOYER \_\_\_\_\_

SAVE 35c! Check here if you enclose \$4.00 with coupon. We will then pay 35c postage and packing costs. Same 7-day return privilege applies.

## Be a GOVERNMENT LICENSED AIRPLANE & ENGINE MECHANIC

Train Now at **LINCOLN**

Prepare now at this **LINCOLN GOVERNMENT APPROVED SCHOOL** to earn as high as \$2400 to \$3600 a year as Government Licensed Airplane & Engine Mechanic. Big demand! Airport Flight Training Centers, Civilian Schools training Air Corps Cadets, Airplane Factory, Flying Fields urgently calling on us for more "A & E" Mechanics. Graduates interested in civilian positions at foreign Repair Bases paid up to \$5000 a year to start. Lincoln Training prepares not only for immediate civilian employment **ESSENTIAL** to national defense, but for a **REAL CAREER** in Aviation **AFTER** the war. Men 17 to 48, not immediately subject to draft, with high school or equivalent education, accepted. We train you and assist Graduates in locating positions.

**WRITE TODAY** for complete information  
**LINCOLN AERONAUTICAL INSTITUTE**  
599 Aircraft Building, Lincoln, Nebraska

## MATHEMATICS FOR RADIO

Two volumes covering algebra, radio arithmetic, geometry; advanced algebra, trigonometry, complex numbers. Write for circular giving details of contents and prices.

**MAEDEL PUBLISHING HOUSE, Room 111**  
593 East 38 Street Brooklyn, N. Y.



Photography made easy at oldest, largest school. Qualify under full time experts for once-in-a-lifetime opportunities. U. S. victory program swelling demand for photographers. Resident or home study courses. Booklet **FREE**. N. Y. Institute of Photography, Dept. 49, 10 West 33 St., New York, N. Y. (32nd Year)

## PHOTOGRAPHY

### Free Book

**MOUNT BIRDS, ANIMALS, FISH**  
You **FREE**. Explains Taxidermy. Tells how to learn at home by mail to mount birds, animals, bees, etc. to TAN skins and furs. Great for MEN and BOYS. Fun! Also earn money in spare time. **WRITE TODAY—NOW** for free book containing 100 game pictures. State AGS, N.W. School of Taxidermy, Dept. 3376, Omaha, Neb.



## Learn PLASTICS

Get into Plastics! Your big opportunity. Enter a **NEW** industry. Plastics, the miracle material! Revolutionize design and construction. Plastics is thrilling, profitable, uncrowded. Learn Now! First Plastics School in the East with complete Study and Lab. courses. Write Dept. M. Today! State agn. **SCHOOL OF PLASTICS**



**LAW**  
**STUDY AT HOME** for PERSONAL SUCCESS and LARGER EARNINGS. 31 years expert instruction—over 106,000 students enrolled. LL.B. Degree awarded. All texts furnished. Easy payments. Send for **FREE BOOK!**  
**AMERICAN EXTENSION SCHOOL OF LAW**  
Dept. 21-M, 8 East Huron St., Chicago, Ill.

## RADIO REPAIR HINTS

"Introduction to Radio" explains circuit tracing and radio trouble-shooting. Gives many service hints. Tells how to find radio faults and make repairs quickly. New 32 page book. Price only **5¢**  
**SUPREME PUBLICATIONS, 3727 W. 13th St., Chicago, Ill.**

## LEARN WATCH REPAIRING



**AT HOME** You can learn by our modern and original system of instruction every part of the **Watch Repairing Trade** at home. Prepare yourself for a well paying position or start in business after completing our course of instruction. Good watch repairers are in demand and generally earn very good salaries. For particulars apply to the **Wisconsin School of Watch Repairing** 524 E. Mason St., MILWAUKEE, WIS.

## FOREMEN, SUPERINTENDENTS PRODUCTION MEN

### Study INDUSTRIAL MANAGEMENT

Millions of men pouring into new or expanded factories require thousands more production executives to supervise them. That spells real opportunity for you if you are ambitious. You can step up to a better job. Your present experience and ability may need only a fuller knowledge of production and management principles and methods. LaSalle training in *Industrial Management* will help you greatly. It is interesting, condensed, practical—planned for men like you. You can study it in your spare time, at home—and at moderate cost. If you want to get ahead, ask for our free 48 page booklet on Industrial Management—it gives full details. Send this ad or write today.

### LASALLE EXTENSION UNIVERSITY A Correspondence Institution

Dept. 964-IF, CHICAGO



### Time & Motion Study

#### WINS PROMOTION—RAISES PAY

Urgent need in War and Peacetime Industries for cost reduction and methods improvement. Experts in demand. Fascinating work, big pay. Train now. Graduates report up to 50% and 100% pay increases in record time.

#### Learn at Home in Spare Time

New streamlined course permits quick qualification for placement and opens the way to rapid advancement. Previous experience unnecessary.

**FREE DETAILS**—Write now for free folder and complete details of guaranteed, low-cost course. No obligation. Send name and address to

Industrial Tl-Mo Clinic, 106 N. Pulaski Rd., Chicago

## STUDY AT HOME

With A Chartered Educational Institution

**Courses in ENGINEERING:** Electrical, Civil, Mechanical, Drafting, Architectural, Steam, Aeronautical, Radio, Structural, Mining, Industrial, Highway, Petroleum, Marine, Chemical.

**Courses in ARTS AND SCIENCES:** Philosophy; Education; Letters; Public Health; Medical Jurisprudence; Psychology; Sociology; Physics; Chemistry; Geology; Pol. Science; Theology; Law; Business and Commerce; Accounting; Mathematics; Statistics; Agriculture.

McKinley-Roosevelt Incorporated, 4610-UTC, Sheridan Road, Chicago

## Do you want

- ➔ .. to go to College?
- ➔ .. or to enter a Profession?
- (Such as Accounting, Architecture, Nursing, Dentistry, Teaching, Social Work, Osteopathy, Beauty Culture, Optometry, Embalming, Chiroprody, Law, Medicine, etc.)
- ➔ .. or get an Office Position?

To get anywhere, you practically MUST finish High School FIRST. You can complete our simplified High School Course in SPARE time at home, as FAST as your time and abilities permit. Equivalent to resident school work—prepares you for college, pre-professional examinations, business, industry. Standard texts furnished. Diploma. Credit for H.S. subjects already completed. Single subjects if desired. Low tuition, easy terms. American School, Chicago, est. 1897—endorsed by educators. Finish your high school education NOW. Write TODAY!

## High School Course at Home Many Finish in 2 Years

American School, Dept. H645, Drexel Ave. at 58th St., Chicago, Ill.

Gentlemen: Send me FREE information covering special training in subjects checked below. No obligation on my part.

- |  |   |
|--|---|
| <input type="checkbox"/> High School Course          | <input type="checkbox"/> Diesel Engineering     |
| <input type="checkbox"/> Accounting and Auditing     | <input type="checkbox"/> Drafting and Design    |
| <input type="checkbox"/> Architecture and Building   | <input type="checkbox"/> Liberal Arts           |
| <input type="checkbox"/> Automotive Engineering      | <input type="checkbox"/> Private Secretary      |
| <input type="checkbox"/> Business Management         | <input type="checkbox"/> Mechanical Engineering |
| <input type="checkbox"/> Aviation                    | <input type="checkbox"/> Radio and Television   |
| <input type="checkbox"/> Electrical Engineering      | <input type="checkbox"/> Salesmanship           |
| <input type="checkbox"/> Elec. and Gas Refrigeration | <input type="checkbox"/> Business Law           |
| <input type="checkbox"/> Air Conditioning            | <input type="checkbox"/> Retail Merchandising   |

Name .....

Address .....

# INVENTORS

READ THIS BULLETIN  
and send 25c for these books

## EVANS CURRENT REPORT

### ALIEN PROPERTY RIGHTS NOT REVOKED BY U. S. GOVERNMENT

Since the principal publications throughout the country have been giving front page space to articles having to do with the seizure of alien property rights, patents, etc., many inquiries have been received by us regarding the advisability of proceeding with patent applications in the face of such seizures.

In the instance of the seizure of the patent rights of an enemy alien residing in their own countries, an evaluating agreement will be reached between the Alien's Government and the United States Government and the enemy patent holder may look to his Government for compensation. The resident aliens may appeal to a special claims committee set up in this country and after due proceeding had, compensation will be awarded on the basis of use and value of patent rights to the United States.

### PATENT PLANNING COMMISSION ANNOUNCED (BUSINESS WEEK OF JANUARY 24, 1942)

The Patent Planning Commission is now being set up to create a reservoir of new inventions as well as improvements upon known devices, which will be the primary productive aim of the 30,000 war production plants to be converted for industrial manufacture during the post war period.

Far sighted inventors should have their patent applications prepared now in preparation for a vast patent-buying era.

### WHY DON'T THEY . . . AMERICAN MAGAZINE

Provide change making machines in all public telephone booths, so that you won't have to go chasing all over the lot for a nickel.

Make all door knobs so they can be pushed either up or down to open and shut the door when your hands are wet.

The two valuable books below may be worth hundreds of dollars to you. Tell steps to take to safeguard your idea—advise against mistakes—illustrate 115 mechanical movements, among which you may find just the one needed to make your invention practical!

SEND 25c ..  
It's good for \$1.00

In order to secure your patent, your first step is a search of U. S. Patent Office records. Our regular search fee is \$5. Your 25c earns you a \$1 credit against this charge . . . and in addition brings you the valuable books and "Evidence of Invention" form. Don't delay. Enclose 25c for this vital material TODAY.

MAIL COUPON Now!

VICTOR J.  
EVANS & Co.

Registered Patent Attorneys

630-K — Merlin Bldg.  
Washington, D. C.

Send me copies of your Two Books and "Evidence of Invention" form for which I enclose 25c.

NAME .....

ADDRESS .....

CITY AND STATE .....

# "It is the BEST Handy-Sized Dictionary!"

ACTUAL use proves that WEBSTER'S COLLEGIATE defines all the most commonly used words—IS the BEST. 1,300 pages; 110,000 entries; 1,800 pictures. \$3.50 to \$8.75 depending on bindings. Buy of your dealer or direct from publishers. Mail coupon for FREE Quiz and Picture Game. G. & C. Merriam Company, 161 Federal Street, Springfield, Massachusetts.



G. & C. Merriam Co., 161 Federal St., Springfield, Mass.  
Please send me FREE Quiz and Picture Game, also full information about Webster's Collegiate Dictionary, Fifth Edition.

Name.....  
Address.....

## Do You Make Mistakes in English?

EVERY time you speak or write you show just what you are. Mistakes in English reveal you as a person who lacks education and refinement. Lack of language power prevents you from presenting your thoughts in the strongest possible way. No matter what you do, real command of English will help you to your goal. Stop making mistakes in spelling, punctuation, pronunciation. Increase your vocabulary.

### WONDERFUL INVENTION

Only 15 minutes a day with Sherwin Cody's new invention—and you can actually SEE your English improve. It teaches by HABIT—makes it easier to do the RIGHT way. Wonderful self-correcting lessons include spelling, punctuation, grammar and expression.



**FREE BOOK ON ENGLISH** Lack of language power may easily be costing you thousands of dollars every year. See what Mr. Cody can do for you; it costs nothing to find out. Mail a postal card or letter this very minute for free book, "How You Can Master Good English in 15 Minutes a Day". It will prove a revelation to you. WRITE NOW. Address:

Sherwin Cody School of English, 59 Searle Bldg., Rochester, N. Y.

Correspondence Courses in **RADIO and ELECTRICAL ENGINEERING** LOW AS \$25

**ELECTRICAL ENGINEERING.** Get good grasp of wide electrical field. Modern. Very understandable. Theory made easy.  
**RADIO ENGINEERING.** Extra fine course in radio, public address, photo-electric work. Trains you to be super-service man, real vacuum tube technician. Tuition ONLY \$25, either course. Deferred payment plan. Experiment kits furnished.

Write for free copies of school catalogs, student magazines, etc.  
**FREE LINCOLN ENGINEERING SCHOOL, Box 931-P-45, Lincoln, Nebr.**

# BROOKLYN YMCA TRADE SCHOOL



**Short Trade Courses, including War trades, offered day or evening. 5 to 10 week courses qualify you for Essential Jobs. Full Shop Equipment. Unexcelled Instruction. Fireproof Dormitories. Special Privileges. Check your interests on coupon to receive free literature.**

- Aircraft Construction
- Machinist
- Mechanical Pre-Engineering
- Diesel Engines
- Diesel Pre-Engineering
- Mechanical Drafting
- Auto Mechanic
- Refrigeration
- Television and Radio Mechanic
- Machine Design
- Armature Winding
- Welding
- Tool and Die Making
- Talking Pictures
- Electrical

**MAIL COUPON**  
1123 Bedford Ave., Dept. P. M. Brooklyn, New York City, N. Y.

Name.....  
Address.....

# Now is the Time for you to get into DRAFTING



All working tools, including drawing table, sent to you at once—furnished free with course.

## Learn At Home From An Engineer

With industry working feverishly—the field for DRAFTSMEN is bigger than ever! Get into a better job with more pay and fascinating, pleasant work. I will train you at your home in your spare time until you are holding a better paying position as Draftsman. My practical training in drafting also includes a working course in Industrial Designing valuable on new products, improving, restyling and modernizing—all extremely important and profitable to draftsmen. Write for full illustrated details and booklet. Give your age.  
Engineer Dobe, Div. 3376, Libertyville, Ill.

## ARTISTS MAKE MONEY

Find out your ability. Send name, age, occupation and address for Free Vocational Art Test.  
**ART INSTRUCTION, INC.** (Formerly Federal Schools)  
9132 Art Instruction Building, Minneapolis, Minnesota

**FIBRE ARMS AND LEGS!**  
Light, correctly fitted, strong and comfortable. Natural appearance. Braces for all deformities. Scientific design. Fair Terms.  
**BUCHSTEIN-MEDCALF** 610-3rd Av. S., Minneapolis, Minn.

**\$5 FOR YOUR PICTURE!** Universal-trained men and women everywhere selling their photographs for \$5 and more each—earn \$15 to \$50 EXTRA every month! Home Study photo-journalism course teaches you what to take, how, and where to sell photographs. FREE Book gives details. **UNIVERSAL PHOTOGRAPHERS, Inc., Dept. 7, 10 W. 33 St., New York City**

## Print Your Own

Cards, stationery, circulars, tags, labels, photo and movie titles, advertising, etc. Save money. Print for Others. Good Profit! easy rules sent. Raised Printing with any Kelsey press. Junior outfit \$8. Senior outfit \$17.38. Send for free catalog and all details. **KELSEY INC., 5-37, Meriden, Conn.**

Say you saw it in Popular Mechanics!

## HANDY RADIO Watch Size Complete Only \$1.99



No TUBES—No BATTERIES I BUILT-IN SPEAKER

At last! Amazing Handy Radio with built-in speaker! No bigger than a dollar watch! Weighs only 2 ozs. Fits vest pocket or purse. All standard broadcasts. Sensitive-super-audio crystal—no tubes, no batteries. Easy, accurate tuning. GUARANTEED. SEND ONE AS A GIFT TO YOUR FAVORITE "BUCK PRIVATE" (Son, Brother, Sweetheart) He'll enjoy it.

### Send No Money

Handy Radio comes complete, ready to listen in, with instructions and miniature built-in phone for enjoying programs in private without disturbing others. Complete, 100-foot aerial included FREE for extra loud volume. Operates anywhere—no electric connections! Just snap wires to bed spring or any metal connection. SEND NO MONEY! Mail order and pay postman only \$1.99 plus few cents postage on delivery. Use 5 days. Your money back immediately if not delighted! Rush your order today!  
Kumfy Products, Inc., Dept. H-911, Cincinnati, O.



# INVENTORS. INDUSTRY NEEDS YOUR IDEAS NOW!

YOU NEED

This



FREE BOOK

**TWO REASONS — 1** Manufacturers are getting ready NOW for post war sales and production—

**2** Right now, manufacturers are seeking products their expanded facilities can handle; factories must have products to take up the slack after war orders stop. Your chance comes with patent protection now—delay may endanger your chance. Get our NEW FREE Inventor's Book today and valuable "Invention Record" form. This request does not obligate you. *Act now. Write today.*

**McMORROW & BERMAN**

REGISTERED PATENT ATTORNEYS BEFORE U.S. PATENT OFFICE, 1356 BARRISTER BUILDING, WASHINGTON, D. C.

## ELECTRICAL TECHNICIANS

**URGENTLY NEEDED!**

In industry—in Army and Navy—electrical technicians win better jobs and ratings. Learn fundamentals of electrical theory and practice—testing, drafting, machine shop, wiring, control. Course complete in one school year. Dormitory; dining hall; campus. Send for catalog and Vocational Chart, 119 Takoma Ave., Washington, D. C.

**BLISS ELECTRICAL SCHOOL**

TRAIN FOR VICTORY

**SPARTAN SCHOOL OF AERONAUTICS**



Train at SPARTAN for a place in America's war program, and for a lifetime aviation career. \$2,000,000 worth of new buildings, new equipment. Government Approved. Personalized instruction—Sheet Metal, Aircraft or Engine Mechanics, Flight, Engineering, Radio, Instruments, Meteorology. Qualified SPARTAN graduates quickly employed. Spartan factory, contractor to U. S. Army and Navy, directly connected. Next semester starts

Aug. 3. Write for new 64-page free catalog. Give age and education. Captain Maxwell W. Balfour, Director—Dept. PM-92, Tulsa, Okla.



**A Marvel for HEAT and Economy!**

**LACO**



Our LACO Oil Heaters are sold only subject to Victory priority plans. But, in states without fuel restrictions you may purchase a heater on need. Write for Free Book describing this remarkably improved model. Unusually economical. Heats lower levels of room—provides super "Green-Door" heat when double doors swing open! Special 2-Stage burner gets tremendous heat from low-priced oil. Special "Inner Heating Unit" delivers utmost heat into room.

**FREE** Send for LACO book, low prices, facts about your eligibility to buy!

LACO OIL BURNER CO., 129 Union Ave., Griswold, Iowa



## MACHINE SHOP MEN

Learn to set up and run ANY kind of machine; MAKE MORE MONEY NOW by learning quickly HOW TO DO THINGS which usually take years of study and practice. The demand for SKILLED men is ALREADY ahead of the supply, then what WILL IT BE a month or two from now?

**Needed NOW!**

**Bigger Pay** Don't miss this chance to qualify for promotion, don't miss this Big Opportunity which is yours almost for the asking. Eight Big Books chockful of important mechanical facts told simply and clearly. Over 3000 pages, nearly 3000 illustrations cover every subject fully, including Tool Making, Pattern Making, Foundry Work, Mechanical Drawing, Forging, Machine Shop Practice and Management, and hundreds of other subjects.

**8 Big Books (Up-to-date Edition) Sent FREE**

to you for examination. With them we send a Big Binder of nearly 800 pages with 267 original shop tickets with 1200 illustrations. These show, step by step, how to set up and run almost any kind of job and are in addition to the 8 books. Decide in your own home or place of business whether or not you want to keep them, check up on any facts you want to. Note their great MONEY MAKING value, then, if you want them, pay on the easiest kind of payments. A year's consulting privileges with our engineers now given with these books without extra charge. American Technical Society, Vocational Publishers since 1898.

American Technical Society, Dept. 5619, Drexel at 58th St., Chicago

You may send me the 8 big books and binder of shop tickets for free examination. I will pay the delivery charges only, unless I decide to keep them in which case I will send \$3.00 in ten days and \$3.00 per month until the total price of only \$34.50 is paid. If I return them in 10 days I will owe you nothing. You also agree to send me a certificate entitling me to consulting privileges with your experts for one year without extra charge.

Name.....

Address.....  
Please attach a letter stating age, occupation, employer's name and address and that of at least one business man as reference.

# WANT A GOVERNMENT JOB?



**RAILWAY POSTAL CLERKS**

City and Rural Carriers—Postoffice Clerks—Inspectors — Accountants — Stenographers — Typists—Many other Government Jobs

**\$1260 to \$2100 First Year**

Hundreds appointments being made

FRANKLIN INSTITUTE Dept. N-174 Rochester, N. Y.

Sirs: Rush to me, without charge, copy of 32-page book, "How to get a U. S. Government Job," list of positions, and full particulars telling how to qualify for them.

Name.....

Address.....

# INVENTORS PATENT YOUR IDEAS SEND FOR FREE BOOK



## HOW TO OBTAIN A PATENT

Written by a Former Member of the Examining Corps (1922-24) of the U. S. Patent Office. If you want to profit by your ideas, you should take steps to apply for a U. S. Patent at once. Your first step is to get this Free Book. This interesting illustrated book contains valuable information you should have. It tells you fully how to obtain a patent on your idea in the quickest way. With this Free Book you will also receive a "Record of Invention" form on which you can easily record your idea. Personal and Confidential Service: Your case will be personally handled only by a Registered Patent Attorney who is also a Former Member of the Examining Corps of the U. S. Patent Office. All communications confidential.

MAIL COUPON TODAY for FREE PATENT BOOK and RECORD OF INVENTION Form.

## CARL MILLER

REGISTERED PATENT ATTORNEY  
FORMER MEMBER EXAMINING CORPS U. S. PATENT OFFICE

Woolworth Bldg., 35th Floor, Dept. 92-A, New York City  
MILLER BUILDING, Dept. 92-A, WASHINGTON, D. C.

Please send me your Free Book, "How to Obtain a Patent," and your "Record of Invention" form.

NAME.....

ADDRESS.....

# PATENTS

Booklet Free • Highest References  
Promptness Assured • Best Results  
Send drawing or model

All Business Given Prompt  
and Proper Attention

## WATSON E. COLEMAN

Registered Patent Lawyer

724 Ninth Street, N. W. Washington, D. C.

# PATENTS

## AND TRADE MARKS

### C. A. SNOW & CO.

Registered Patent Attorneys Since 1875  
Write for Free Book and "Certification of Invention" form  
427 SNOW BUILDING, WASHINGTON, D. C.

# AMAZING NEW ELECTRIC ARC WELDER

RETAILS  
ONLY  
**\$2.95**  
COMPLETE

FULLY GUARANTEED

**PLUGS INTO LIGHT SOCKET**

Amazing new HANDIWELD Electric Arc Welder—operates from 110 volt A.C. or D.C. same as other arc welders higher priced—generates tremendous heat to weld all kinds of metal. Not a toy welder that uses carbons, but actually uses standard coated rods—sizes 1/16" and 3/32". Generous supply furnished with welder. Guaranteed not to burn out. Repales fenders, auto bodies, radiators, pre-bested small castings and machinery parts. Takes HANDIWELD anywhere to job, operates from light socket. Sturdily built of finest materials to last years. Fully guaranteed by Big Manufacturer.

**SEND NO MONEY!** You'll find a thousand uses for the HANDIWELD around your home, garage, work shop. Also by garages, factories, repair shops, mechanics, farmers, inventors, tin shops, plumbers, etc. Order HANDIWELD now. Send no money. We'll rush one to you complete with rods and goggles. Pay postman only \$2.95 plus few cents postage. If not delighted, return HANDIWELD in 6 days from receipt and money paid for it will be refunded instantly. Rush your order now, KUMFY PRODUCTS INC., Dept. K-202, Cincinnati, Ohio

# BECOME A DENTAL REPAIR SPECIALIST STUDY AT HOME

Dental Repair Specialists are needed all over the world for the duration, and forever after.  
**MAKE BIG MONEY AT ALL TIMES**  
COMPLETE COURSE THOROUGHLY ILLUSTRATED  
**ONLY \$10.00 SEND MONEY ORDER MAILED SAME DAY.**  
HOME STUDY INSTITUTE, 236 W. 55th St., (Dept. C-102), N. Y. C.

# Learn PLASTICS

A great War industry today—greater in Peacetime tomorrow—important throughout Industry. Learn what a knowledge of plastics can mean to you. Write for interesting, illustrated literature.

## PLASTICS I. T. INSTITUTE

HOME STUDY + FORUM CLASSES + RESIDENT ENGINEERING

1221 Chasin Bldg. NEW YORK CITY      616-I LeBoeuf-Walker Bldg. CHICAGO, ILLINOIS      150 S. Alameda St. LOS ANGELES, CALIF.

# Learn GLIDING

The amazing sport that has swept America over night. Holds tremendous commercial possibilities for carrying freight. Offers the greatest opportunity in the well-paid field of aviation. Low-priced course prepared by nationally-known glider authority taught by mail. Covers fundamentals of design, construction and operation of gliders. Write for Booklet.

**BOWLUS AVIATION CO., 12680 Greenfield, Detroit, Mich.**

**PRACTICAL ARC WELDING**  
A TEXT BOOK  
HOBART

You'll PROFIT by using this  
**VALUABLE NEW**  
**ARC WELDING MANUAL**

Full of lessons, charts, diagrams, tables. Worth hundreds to you. **\$2.00** POSTPAID

1942 edition, gives latest information all welders need. 5 day free inspection. Write. Hobart Bros., Bx. M-921 Troy, O

# HOBART

"Simplified"  
**ARC WELDERS**  
With the Absolute Remote Control

**ORDER YOUR COPY NOW!**

*"One of the World's Largest Builders of Arc Welders"*

# To PROTECT YOUR INVENTION - Use this coupon, NOW

Delays are dangerous and may be very costly. My personal service assures prompt action, strict confidence, and a minimum of expense. I suggest that you send me a model or drawing, or sketch and description of your invention, and \$5.00. I will make a search and report promptly as to its patentability and send you a copy of my 72-page booklet. Or, if you prefer to read my booklet first, mail the attached coupon at once. I will also send my "Record of Invention" form. (Over 40 years experience as a Registered Patent Attorney.)

**L. F. Randolph,** 302-D Columbian Bldg., Washington, D. C.

Please send me at once, free of charge, your 72 page booklet and "Record of Invention" form.

Name.....

Address.....

## A PERSONAL CONFIDENTIAL PATENT SERVICE

# MAKE MONEY FROM POULTRY



with a business of your own. How to start small way, spare time, grow from profits, or prepare for good job in large poultry plant. Harry H. Lamont, nationally known Poultry Expert, shows latest scientific methods, money-making secrets in poultry raising. His system of home study training used by thousands. Endorsed by many colleges and leading Poultrymen. Established 20 years. Write Today for his big FREE BOOK "How To Raise Poultry For Profit." Shows way to real business opportunity.

**NATIONAL POULTRY INSTITUTE**  
Dept. 50-13 Adams Center, N. Y.



**FREE BOOKLET** answers the many questions bound to be in your mind about where you stand in relation to the war—about how you can serve your country well, and still plan for a secure, successful future. It tells why YOU—by entering the aircraft industry—can be NECESSARY to your country's victory. For your free copy of this helpful booklet, airmail your request NOW to

**AERO INDUSTRIES TECHNICAL INSTITUTE**  
5253 W. SAN FERNANDO RD., LOS ANGELES, CALIF.



## TRAIN FOR TECHNICAL RADIO WORK

I'll train you at home . . . or at camp for a good-paying Radio job, or a business of your own. I give you Radio Parts to build a complete 8-Tube Receiver. You learn quickly by doing many practice-giving experiments. You gain Radio repair experience right in your own home.

**FREE:** Write for complete details in new catalog "HOW TO MAKE MONEY IN RADIO." **SPRAYBERRY ACADEMY OF RADIO, 510-J University Place, N. W., Washington, D. C.**



## WELDERS WANTED!

**ELECTRIC ARC-OXY-ACETYLENE**  
Skilled Welders earn \$8 to \$15 a day. The demand now greater than the supply. Learn this highly paid trade in 2 weeks by actual shop work. One of America's leading schools. Established 1902. 7 floors of shops. Endorsed by welding industry. Limited number of students. 2 weeks course in Electric Arc or Acetylene Welding, including room and board, only \$108. Write or wire for reservation. Ask for "Welding Facts," State age.

**GREER COLLEGE, Dept. 192, 2024 S. Wabash Ave., Chicago**

## ELECTRICAL BOOKS



shipped  
**FREE**

FOR EXAMINATION  
**MODERN  
ELECTRICITY  
INCLUDING RADIO  
AND TELEVISION**

Here's great news for anybody interested in Electricity. NEW 18th. edition of Applied Electricity brought right down to date with NEW Electrical subjects fully covered, including Electrical Blue Print Reading. 10 big Volumes and all shipped FREE for examination.

**1942 Edition  
For Beginners  
and Experts**

over 3000 pages—hundreds of illustrations—the most complete work of its kind we have ever published. Dynamos, motors, power stations, Radios, television, everything electrical explained so anyone can understand it.

## BIG FIELD! Big Demand!

**Big Pay!** Men who understand electricity are urgently needed in thousands of War Production industries. Airplanes, ship building, arms plants, machine shops—practically every industry depends on electricity and men who know this subject make big money. Pleasant, fascinating work, easy to learn and do; learn with these books. Send coupon for a set for FREE examination and see for yourself.

**SEND NOW**

A year's consulting privileges with our engineers now given to all buyers of this famous Cyclopedia of Electricity.

**AMERICAN TECHNICAL SOCIETY**  
Vocational Publishers since 1898

American Technical Society, Dept. E619, Drexel at 58th St., Chicago  
Send for 10 days' free use, 10 volume set of 1942 Edition, Applied Electricity, including a certificate entitling me to consulting privileges for one year. I will pay the delivery charges only on the books. If I wish I may return them in 10 days and owe you nothing, but if I keep them, I will send \$2.00 after 10 days, then \$3.00 a month until the total price of only \$29.80 is paid.

NAME .....

ADDRESS .....

CITY .....

STATE .....

Please attach letter stating age, occupation and name and address of employer and give at least one business man as reference.

# Read the Want-Ads INSPECTORS WANTED

By Aircraft and Other War Production Plants

## MEN - - - all Ages and WOMEN!



### MEN

needed as inspectors in aircraft and other War Production plants. Good pay and chances for promotion.

### WOMEN

The nation's war industries are calling for women inspectors. Base pay and overtime same as for men.

## A War-Time Job With a Peace-Time Future

One inspector required for every 12 to 20 employees in aircraft and other war plants employing from 15000 to 40000 workers. Help win on the home front.

## Unique Training Plan. Quick results

By the Chicago Tech plan you complete in your spare time at home the major part of your training which includes blue print reading. Keep your present job while learning. Then when your training obligations at home have been met, you come to Chicago Tech (round trip transportation and room furnished) for a short practical training in our Inspection Dept., shops and laboratories, with gauges, calipers, and other measuring instruments. This prepares you for a good job as an inspector.

## Employment Help When Ready

When you are ready we help you find a job as a mechanical precision inspector. Just now we have more calls for qualified inspectors than we can fill.

## Send Coupon or Post Card

Mail the coupon or a post card for free information. There's no time to lose. Battles are lost by delay,—so are opportunities like this one. Act now.

## CHICAGO TECHNICAL COLLEGE

M-1200 Tech Bldg., 2000 So. Michigan Ave., Chicago, Ill.

Please send me Free information about how I can qualify for a good job as an Inspector.

Name.....

Mr., Mrs. or Miss.

Address.....

City..... State.....

Occupation..... Age.....

Say you saw it in Popular Mechanics!

**WORLD'S  
BEST  
WANT AD  
MEDIUM**

# CLASSIFIED *Advertisements*



Advertisements in this section, 35 cents per word, each insertion, minimum 10 words, payable in advance  
To be inserted under proper classification in October issue, copy should be in our office August 8th  
October issue on sale September 1st

Popular Mechanics Magazine, 200 East Ontario Street, Chicago, Illinois

## YOU'LL PROFIT

By reading and answering the classified ads in this section. Hundreds of opportunities to make and save money.

Popular Mechanics Magazine,  
Chicago, Illinois.

Dear Mr. Johnson:

It may interest you to know that I have used space in Popular Mechanics since 1909. That is nearly thirty-three years ago.

Of all advertising mediums employed, I could not afford to pass up a single issue of Popular Mechanics.

Very cordially yours,

JOHN D. PAYN.

(Original letter on file in our office)

### AUTOMOBILES—MIDGET CARS

**WANTED**—Stanley Steamer car or truck. James Bernardi, % Harry French, R. No. 2, Elmira, N. Y.

**AUTOMOBILE** Racing book, fifth edition, well illustrated. Instructions on building bodies, frames, engines, Ford A and B conversions. Plans, AAA rules, specifications. Roadster racing, Indianapolis cars. \$1.00 postpaid, \$1.15 C.O.D. Ray Kuns, Dept. 45, Madisonville, Cincinnati, Ohio.

**SEAL-MATIC** Substitutes new rings, rebore! Details. Devereaux, Box 212-J, Battle Creek, Michigan.

**WHIRLGAS** Superchargers, \$3, increase mileage 20%; power 10%. Refund guarantee. University test. Any car; give make, year. Wrench installs 15 minutes. John Hanley, Manufacturer, 5719 Loraine, Detroit, Mich.

### AUTO SUPPLIES AND EQUIPMENT

**LEARN** How to get up to 30% more power and 50% more mileage out of practically any car with our Vacuum-Cool Method. Not a gadget. We send easy-to-understand diagram instructions showing how to quickly hook up the vacuum to cool the motor, cool the oil (eliminating dilution and overheating) and circulate the radiator water after disconnecting both water-pump and fan to save power. Also uses gas vapors from top of gas tank. Make the gallons stretch! Make money charging other motorists for installing! Mail \$1.00 today to Vacuum-Cool Company, 210 Transportation Bldg., Los Angeles, California.

**AUTO Alarm**. Prevents theft of car, tires, etc. Easily installed. \$2.95 prepaid. Knipp, Long Beach, California.

**MAKE** Sell gasoline savers. Cost cent to make. Write Mechanic, Box 741, Worland, Wyo.

**REPAIR** Your own tires, newly developed methods, 12 tire maintenance trade secrets disclosed including how to reclaim and devulcanize scrap rubber for 1c per pound. Complete instructions \$1.00, money back guarantee, free literature. The Harris Co., Boaz, Wis.

**INCREASE** Gas mileage, reduce oil consumption, eliminate sticky valves. Complete treatment takes only thirty minutes. Retail \$1. Two trial cans \$1. Salesmen write for proposition. Welmaid, 5552 Broadway, Chicago.

**1942 IGNITION** Supercharger \$1.75. E. G. Sales Mfg. Co., New York.

**RECLAIM** Used oil without cost. Particulars. F. Gerwin, Alva, Okla.

**PLATING** Outfits for auto parts. Connect to a battery. No tanks used. Free particulars and proofs. Gunmetal Co., Ave. J. Decatur, Ill.

### AUTO TRAILERS

**READY Now**—Plans for nine new Jim Dandy Trailers including six modern house trailers. Catalog 10c. Also new edition of Trailer Builders Manual and catalog of parts, supplies and equipment. Price 25c. Both 35c postpaid. Trailer Supply Co., 5120-A Fulton St., Wausau, Wis.

### BATTERIES, GENERATORS, ETC.

**GENUINE** Edison batteries for light, power. Non-acid. Fifteen year life. Five year unconditionally guaranteed. Low prices. Complete lighting plants. Free literature. See-Jay Company, 82 Sterling Avenue, Yonkers, New York.

**EDISON** Lifetime storage batteries for light and power. Eliminate acid battery diseases. Long guarantee. All kinds rebuilt generating plants, motors, and miscellaneous articles at bargain prices. Free interesting literature. T. Hawley Smith Co., Croton Falls, N. Y.

### AVIATION

**AVIATION** Cadet examination preparation by home study course. Rutherford Preparatory School, Long Beach, Calif.

**WAR-BARGAIN** Airplanes located everywhere. Cubs \$125 up. Crackups \$25 up. Complete catalogue 25c. Aircraft Directory, Athens, Ohio.

### ELECTRICAL SUPPLIES, EQUIPMENT

**DEALERS**, Sell alternating and direct current motors. Fans, exhaust, attic and circulating. Air compressors and paint spraying equipment. Wholesale catalog, 10c. CMC Co., 514 Van Buren, Chicago.

$\frac{1}{2}$  HORSE, 3450 Speed, repulsion induction alternating motors \$12.50; 500 watt, alternating current generators \$29.50; other sizes. Butler Electric, 1885 Milwaukee, Chicago.

**ELECTRIC** Pencil: Writes-engraves all metals. \$1.00 postpaid. Beyer Mfg., 4515-H Cottage Grove, Chicago.

### MACHINERY, TOOLS AND SUPPLIES

**WANTED**: Electric saw filing machine, electric drills, Skil saw, bench grinders, shapers, bench and floor lathes. Bench drills, wood working machine tools, micrometers, depth gauges, vernier calipers and other precision tools. Can use complete kits of machinist and toolmakers equipment. Please send full description and price to Allen Electric Co., 3201 Grand Ave., Detroit, Mich.

**BUILD** Your own lathe grinder, castings, building instructions \$2.50. Particulars 10c. Star Machine Shop, Kingfisher, Okla.

**BROKEN** Steel tapes spliced, 50c. Not shortened. Capps, 1008 Bertsch, Waterloo, Iowa.

**BUILD** Your own machine tools. Lewis furnishes semi-finished castings for bench milling machine and shaper; rough castings for 23 metal and woodworking tools. Shop-tested materials and professional blueprints. Never a complaint on quality, design or price! Send 10c—New 1942, 32 page illustrated catalog. Lewis Machine Tool Co., Dept. M-21, Box 116, Station A, Los Angeles.

**BUILD** Air compressor, 120 cubic foot, from Ford A motor. Thousands in use. Parts easily obtainable. Complete plans and instructions \$3.00. Myers Portable Compressors, Box 211, Palma Station, Los Angeles, California.

**BRAND-NEW** One inch micrometer, \$3.95 C.O.D. Equipment Manufacturing Co., Box 5955, Kansas City, Mo.

**13"x5"** WILLARD Lathe with gap. No. 2 Pratt & Whitney hand milling machine, four step cone drive. Write for full particulars. Cincinnati Machinery & Supply Company, 217 E. Second St., Cincinnati, Ohio.

**GRIND** Drills like factory; attachment for bench grinder. Cheap. Factory, 811-B East 31. Kansas City, Mo.

**"BRINKS"** Bargain Bulletin. New-used machines, motors, tools for all shops. Brinkerhoff, 33 Walker St., New York City.

**RECLAIM** Dull and broken drills, with Nu-Tray Drill Grinder. Circular free. Tractor-Lite Mfg. Co., Sidney, Iowa.

### WELDING—SOLDERING—PLATING

**ARC** Welders wanted by the thousands. Learn with 516 page lessons manual. Over 500 how-to-do-it photos. \$2.00 copy. Money-back guarantee. Hobartweld, Box M-924, Troy, Ohio.

**WANTED**—Any ideas for improving arc welders or welding rods. Box 1652, Milwaukee, Wis.

**D.C. Arc-welder**. Build it yourself from automobile starter-generators, vehicle (automotive) motors, light plant generators. Plans \$1.00 each. Welders Club, AB-3432 M-Mart, Chicago. For sale: vehicle motors, \$35.00 each.

**GOVERNORS**—Auto engine speed control. Candee, 129-W '8' Llewellyn, Los Angeles.

### ENGINES, MOTORS, DYNAMOS

**MAYTAG** Gasoline motors rebuilt, re-conditioned, guaranteed. For washing machines, lawn mowers, cultivators, power tools, sheep shears, midget cars, pumps, etc. Rated  $\frac{3}{4}$  h.p. Single cylinder model \$17.50, twin cylinder model \$25.00. Specifications on request. Wilson Electric Co., Washington, Penna.

**BIG** Pay jobs in welding. Complete welding lessons and reference book. 516 pages. 41 lessons. \$2.00 copy. Money-back guarantee. Hobartweld, Box 925-M, Troy, Ohio.



**1/2 HORSE, 110 Volt, induction motors.** Rebuilt, guaranteed \$9.75; other sizes. Wilmot Auto Supply, 2247 St. Paul Ave., Chicago.

**WINDING DATA,** 225 motors, single and three phase, \$1.00. Motor Data Co., Box 7631, Kansas City, Mo.

**AC AND DC generators, motors, exhaust fans.** State your needs. Queen City Electric, 519 South California, Chicago.

**GOVERNORS—Auto engine speed control.** Candee, 129-X "8" Llewellyn, Los Angeles.

#### **BOATS, OUTBOARD MOTORS, ETC.**

**MARINE Power—Easily convert any Ford motor (domestic and foreign) with Oso parts and kits. Complete catalogue 25c (coin). Osmithson, 3644 Lawrence St., Philadelphia, Penna.**

**OUTBOARD Motors,** used parts. Outboard Exchange, 1194 Remsen Ave., Brooklyn N. Y.

**FULL Size,** cut to shape boat patterns, blueprints. 7 1/2 - 38 feet. Illustrated "Build a Boat" catalog, 10c (coin). "How to Build Boats" book, \$1.00. Cleveland Boat Blueprint Co., Station A-68, Cleveland, Ohio.

**TEN Plywood boat plans 50c.** Free catalog boat building plans. The Rudder, 15 Murray Street New York.

**REBUILT Outboard motors.** Fully guaranteed. Over 300 to pick from. Send 10c for complete list. Boat design book 15c. Buy now before prices advance. Chicago's largest dealer. Masters & Son, 214 West Chicago Ave., Chicago.

**BOAT Designers** are highly paid professionals. Complete course by mail. Catalog. Westlawn, Montville, N. J.

**OUTBOARDS—Save 1/2.** Good used parts, all makes and models. Bargains rebuilt motors. Crandall Hicks Co., 959 Commonwealth, Boston, Mass.

**FORD-Mercury-Zephyr** marine conversions. Catalog 10c. Lehman Engineering Company, Dept. D, Newark, N. J.

#### **ATHLETIC EQUIPMENT, BODY BUILDING COURSES**

**SUPER Ju-Jitsu—lightning defense and attack system.** Sensational new home study course now ready! Learn to lick brutes twice your size with only your bare hands. Free details. Nelson Co., 500 Sherman, Dept. J-508, Chicago.

**BE Strong, muscular, full of pep.** Amazing new body-building course. Write Olympic System, Dept. M, Waterville, Maine.

**TUMBLING Easily learned.** Write for details. W. Power, 923 W. Vine, Kalamazoo, Michigan.

**BAR-BELLS.** Exercise equipment. Courses. Special offers! Free booklet. Good Barbell Co., 4676APM, So. Grand, St. Louis, Mo.

#### **SPORTING GOODS, GUNS, FISHING TACKLE, ETC.**

**GOLF Clubs.** Five club matched set \$3.75. Lincoln Surplus, 220 East Stephenson, Freeport, Ill.

**ARCHERY Equipment;** Catalogue free. Mid-West Archery, 2209-A East 75th, Chicago.

**BOWS—Arrows;** Construction-instruction book 50c. Catalog free. Archery, 617 South State, Chicago.

"**RAISE Earthworms for Profit.**" Information free. Stamp appreciated. Bureau Zoological Research, 106 "P" Broadway, Peoria, Ill.

#### **FIELD GLASSES, TELESCOPES AND MICROSCOPES**

**LENSES—Build your own telescopes,** field glass, microscope, rifle scope, etc. Assortment of fifteen lenses—\$1.00 postpaid. Thirty lenses—\$2.00. Slightly chipped on edge. Satisfaction absolutely guaranteed. American Lens Company, 324 North Mayfield, Chicago.

#### **ANTIQUES, RELICS, INDIAN GOODS, CURIOS**

**GLASS, Books, minerals, curios,** catalog 5c. Junes Antiques, Northbranch, Kansas.

**GUNS, Swords, armor, war relics** catalog, 20c. Thomas Woronicki, Roslyn, N. Y.

**15 FLINT Relics 50c,** catalog free. Allen Brown, 54 W. Illinois, Chicago.

**INDIAN Relics, coins, bills, gems, crystals, curios, etc.** Illustrated catalog 5c. 100 ancient arrowheads \$3.00. H. Daniel, Hot Springs, Ark.

**INDIAN Relics, beadwork, coins, curios, minerals, old glass.** Catalog 6c. Indian Museum, Osborne, Kansas.

#### **DOGS, PETS, BIRDS, RABBITS**

**BASSET Hound puppies.** Sired by Champion Kelly's Chief Hareman, AKC registered. Belbay Kennels, Reg., New Alexandria, Pennsylvania.

**DACHSHUND, Fox Terrier, Shepherds.** No cards. Dog Clinic, Stockertown, Penna.

**MONEY Raising rabbits.** Investigate. Folder 10c. Close Rabbitry, Tiffin, Ohio.

**FREE TO owners** of scratching dogs: If your dog scratches constantly, loses hair, has sores, relieve his misery with Money Back Mange Remedy. Extra heavy 1/4 braided leather leash given free just to get you to try this marvelous discovery. Guaranteed quick relief or money back. Mail \$1 for jumbo 12-oz. \$1 bottle and \$1 leash—both for \$1—to Pet Remedies Co., Winnetka, Ill.

**PUPPIES.** Many breeds—particulars free! Book 100 colored pictures, descriptions recognized breeds, 35c. Royal Kennels, No. 91, Chazy, N. Y.

**ANIMALS, Birds, reptiles.** All kinds. Send stamp for lists. Snake King, Brownsville, Texas.

**KITTENS—Beauties, registered Persians, creams, blue creams, blues.** State wants. Tucker, 117-65 142nd Street, South Ozone, Long Island, New York.

#### **FARMS—FARM LANDS—REAL ESTATE**

**EQUIPPED 50-Acre farm** near big city; \$1800—Fertile cropland, creek-watered pasture, 100 apple trees; 9-room dwelling, barn, housing for 500 hens; cow, chickens, some crops, machinery included; terms; page 34 big free catalog 1384 bargains many states. Strout Realty, 255-P 4th Ave., New York City.

**10 ACRES Good Florida land \$50.00.** \$5.00 down, \$5.00 monthly. R. W. Stewart, Inverness, Florida.

**GOOD Farm bargains.** Washington, Minnesota, Montana, Idaho, Oregon, North Dakota. Dependable crops, favorable climate. Write for literature and lists describing farms for sale. Specify state. J. W. Haw, 119 Northern Pacific Ry., St. Paul, Minn.

**40 ACRES.** Near White River, unimproved; poultry land. \$190. \$5 down. \$5 monthly. Free list and literature. Hubbard, 216 Grossman Bldg., Kansas City, Kans.

**SEE The Highlands of Louisiana.** Choice cut-over land selling at low prices on liberal terms. Descriptive book sent upon request. Long-Bell Farm Land Corp., 878 R. A. Long Bldg., Kansas City, Mo.

#### **POULTRY AND FARM SUPPLIES**

**100 CHICK \$3.25—200, \$6.00 postpaid.** Empire Hatchery, Seward, N. Y.

**MORE Profits from poultry—Learn** how others get big daily income. Read America's leading poultry magazine. Five years \$1, one year 25c. Poultry Tribune, Department PB-3, Mount Morris, Ill.

#### **PROFITABLE OCCUPATIONS**

**ANNOUNCING New home study course** in commercial baking. Good field. Nearly depression proof. Common school education sufficient. Send for free booklet "Opportunities in the Baking Industry" and requirements. National Baking Institute, 1315 Michigan, Dept. 3433, Chicago.

**WELDING Pays.** Learn with 1942 trade school text manual, 516 pages. Over 500 photos. \$2.00 copy. Money-back guarantee. Hobartweld, Box M-923, Troy, Ohio.

**MAKE Statuary, Booring, etc.** Imitation marble formula 25c. Ideal Service, 9M, Park Ridge, Ill.

**STANDARD Rabbit Journal,** Milton, Pa. 3 years, \$1.00, sample dime.

**RAISE Chinchilla rabbits** for us. We pay up to six dollars each. Catalog and contract 10c. Book catalog. Year subscription Rabbit Magazine, 25c. Stahl's, Box 10, Holmes Park, Mo.

**RAISE Angora rabbits—wool** brings \$5.00 pound. Particulars free. Grinstead's, Edwardsville, Illinois.

**\$40.00 WEEKLY,** Made growing mushrooms, fresh, dried. Dominion patent 331583. Free spawn. North American, 169Y Yonge, Toronto, Canada.

#### **BOOKS, PERIODICALS, PICTURES, POSTCARDS**

**BUSINESS, Trade, professional and diversion magazines.** Current copies, 403 different publications—representing 115 callings, to choose from. Free price list. Commercial Engraving Publishing Company, 34C North Ritter, Indianapolis, Indiana.

**REBINDING:** We assemble and bind magazines. Have your old books, Bibles, and hymnals rebound. Durable! Attractive! Prices are reasonable. Heckman Bindery, Dept. D, North Manchester, Ind.

**WARPLANE Photographs.** Specimen and list (1,000 titles) send 25c. Real Photographs, Ltd., Southport, England.

**ANY Book (new, used, out-of-print, rare) promptly supplied! Lowest prices!** Send for free bargain catalogue! Old Prof's Book Shop, M16 Arcadia Court, Pontiac, Mich.

"**RARE Book Guide for Beginners.**" 25c postpaid. Doherty, 5322 Ludlam, Chicago.

**MAKE Your own herb medicines.** Beautiful illustrated recipe book 10c. Botany, Box 1109, Evergreen Park, Illinois.

**EXCELLENT Sparetime profits** taking subscriptions—2500 magazines. Complete starting supplies free! Pines, 583 Monroe, Brooklyn, N. Y.

**BACK Number magazines—We have** one of the largest stocks—Retail and wholesale. Send 6c for new price list. James G. Anderson, Broad and Stanton Sts., Trenton, N. J.

**BACK Dated magazines 5c.** Used, new books. (Foreign, domestic). Catalog 10c. Ciceron's, 863 First Avenue, New York City, New York.

**FREE Books and magazines.** Your name and address will bring you information how to get any national magazine for one year free. How you can get one book free with each book you buy. Book and Magazine Club, 315 Fifth Avenue, New York, N. Y.

#### **MAGIC TRICKS, PUZZLES, JOKER NOVELTIES**

"**SENSATIONAL Telephone Mystifier!**" 3c stamp! Surprise waiting! Conaway, M-123, Champaign, Illinois.

**CLEVER Card trick baffles experts.** Details free. Harry H. Willis, Box 1704, Cleveland, Ohio.

**DOLLAR Magic set** free with gigantic catalog 25c. Mysto, 4462 Germantown, Philadelphia.

**DOUGLAS' Famous 1942 catalog of 500 tricks you can do!** Brand new effects for pocket, parlor or stage. Send 10c for year's biggest catalog value. Douglas Magic Shop, Box 274, Dallas, Texas.

**NEW Vanishing key and catalog 25c.** Sterling Magic, 345 John R, Detroit, Mich.

**BE A magician.** Large professional magic catalogue of latest tricks 25c. Ireland, C-109 North Dearborn, Chicago.

**HOLLYWOOD Special! Magicians' button,** catalogue, ghost illusion and free trick for 25c. Magic House of Charles, Box 888, Hollywood, California.

**EARN Money in any crowd.** Call names of strangers, tell unspoken questions. Professional course mind reading, spirit writing, etc., \$1. Henderson, Box 341, San Bernardino, Calif.

**WORLD'S Largest professional magic shop** keeps you in touch with latest tricks. To receive mailings send 25c for 1942 catalog. Holden, 220 W. 42nd St., New York.

**MAGICIANS' Headquarters.** 216-page catalog, pocket, parlor, professional tricks, 25c. Kanter's, M-1311 Walnut, Philadelphia.

#### **COINS—TOKENS—CURRENCY**

**FREE! Foreign coin, banknote and large 50 page illustrated coin catalogue** to approval service applicants. Send 3c postage. Tatham Coinco, Springfield-125, Mass.

**OLD Money wanted.** Will pay \$100.00 for 1894 dime, S. mint, \$50.00 for 1913 Liberty head nickel (not buffalo). Big premiums paid for all rare coins. Send 4c for large coin folder. May mean much profit to you. Numismatic Co., Dept. 20, Fort Worth, Texas.





## MUSIC AND MUSICAL INSTRUMENTS

**YOU Can't lose on this one!** Free copy of "Tips to Song Writers" with my new patriotic song "Let This Freedom Ring." Autographed copy 35 cents; refunded if not satisfied. Composer, Box 481, Hollywood, California.

**LEARN** Popular piano! Write Magic Key, 111-A Broadway, Glendale, Calif.

**SONG** Poems wanted for musical setting. Submit for immediate consideration. Five Star Music Masters, 630 Beacon Building, Boston.

**SONGWRITERS:** Send poems for offer and free rhyming dictionary. Phonograph records made. Vanderbilt Studios, Box 112-D.F., Coney Island, N. Y.

**SONGWRITERS!** Have us compose music to your words. Write for information about Rhythm Patterns, Melody Music Publishers, Box 928, Dayton, Ohio.

**SONGPOEM** Writer! Hold everything 'til you get my offer! Ahlstrand, Comptor, Lake Stevens, Washington.

**LYRICISTS!** You can benefit by criticism. Postal sends you my personal letter on lyric criticism. Gordon Solle, Omena, Michigan.

**SONGS—**Song poems wanted. No charge for melodies. Free examination. Hollywood Recording Studios, 87G20 Preuss St., Los Angeles.

**SONGS,** Poems wanted. Newark Song Publications, 1207 Carbon, Syracuse, N. Y.

**SONGWRITERS!** Amazing outstanding offer. Hibbler, C5, 2157 No. Avers, Chicago.

**SONGWRITERS.** Write for free booklet, profit sharing plan. Allied Music, 204 East Fourth, Cincinnati, Ohio.

**SONGWRITERS:** Write for free instructive booklet concerning song poems. United Music, Dept. 14, Salem, Ind.

**SONGWRITERS—**Send poem for immediate consideration and free rhyming dictionary. Richard Brothers, 24 Woods Building, Chicago.

**GOOD** Music composed to good words. Reginald Belcher, Chatham, New Jersey. Established 1910.

**MUSIC** Composed to words. Rhyming pamphlet on request. Phonograph recording of completed songs. Send poem for consideration. Keenan's Studios, Dept. PM, Box 2140, Bridgeport, Conn.

**WANTED!** Lyrics, melodies for songs. We arrange, publish, sell. Superior Song Studios, Passaic, N. J.

**MUSIC** Composed to words. Wonderful proposition. Bauer Bros., Oshkosh, Wis.

**LEARN** Sing piano! Postal brings free folder. Christensen, 451 Kimball Hall, Chicago.

**WRITE** Songs. Big money and reputation. Write for information. J. Gordon Pub. Co., 201 N. Hoynes Ave., Chicago.

## RADIOS AND SUPPLIES

**MAKE** Simple long distance crystal radios. 2 regular 25c supersensitive crystals and complete illustrated instructions 25c. Alva Allen, A427, Clinton, Mo.

**RADIO** Communications courses qualifying for all federal licenses. Home study and resident courses. American Radio Institute, 1123 Broadway, New York, N. Y.

**RADIO** Service men and experimenters send for our giant radio catalog. Save dollars. United Radio Co., (1000 M.), Newark, N. J.

## MONEYMAKING OPPORTUNITIES

**MAKE** A good living in the mail order business. 64 pages of money-making plans and simple, workable instructions—\$1.00 postpaid; \$1.15 C.O.D. Reagan, 2720-M Broadway, New York City.

**INTERESTING** Mail of opportunities 10c (coin). Heck, Branchland, W. Va.

**MILLION** Articles. Buy wholesale. Valuable directory 10c. Ideal Service, D-9, Park Ridge, Ill.

**MAN,** You'll like silvering mirrors! Making chipped glass nameplates, signs, grave-markers. Outfit prices. Sprinkle Plater, 31, Marion, Indiana.

**THE** Knack of making money in any job, business or profession easily mastered if you know how. For particulars write Leo Adams, 492 Barrett St., Elgin, Ill.

**"MY-PLAN"** Brought me over \$5,000.00. Started with \$1.25. Information free. Taylor, Box 363-P, Hapeville, Georgia.

**OPERATE** Profitable business at home. Plans 25c. Lumco, Kimball, Nebr.

**NEWEST** Greatest moneymaker. Anti-axis novelty sells on sight. 200% profit. Send quarter for five. Wheaton Novelty Co., Box 435, Wheaton, Ill.

**EARN** Money, copying and duplicating comic cartoons for advertisers. Ad-Service, Argyle, Wisconsin.

**LEARN** Metascience. Remarkable drug-less healing. No manipulation. No apparatus. Unbelievable simplicity and results. Inexpensive correspondence course. Write Metascience, De Land, Florida.

**MOLDBAKING**—Plaster Casting. Complete formulas—fully illustrated. 25c. Ideal Service, RM-9, Park Ridge, Ill.

## BUSINESS OPPORTUNITIES

**YOURS** Free for five days—greatest gold-mine of business facts, rules, laws, tables, forms, ideas ever crammed into one volume! No man or woman—young or old—who wants to get ahead should be without new 1942 Business Encyclopedia! Everything you want to know about taxes, letters, money, salesmanship, marriage laws! Short-cuts, correct forms, money methods! Do you know laws governing bankruptcy, slander, debt? Every day people sign leases, mortgages, contracts—and are swindled because they "didn't know." Now you can be sure! For your own business success get this great book today! Send no money now—pay nothing to postman. Read—use—5 days! Return without cost or obligation unless you can't do without it. Otherwise send only \$1 plus postage. Rush free-examination order (without money) now to: Garden City Publishing Co., Dept. 109, Garden City, N. Y.

**START** Home business making statuary, plaques, art goods, novelties, souvenirs, concrete pottery, garden furniture, artificial marble flooring, liquid marble. Make your own flexible molds. Amazing profits. Valuable folder free. Creative Publishers, (PM9), Glenoco, Illinois.

**SPARETIME** Dollars—Make them sure! Read National Mail Order Advertising & Selling 36-84 pages monthly. Sample 10c, year \$1.00. Write National, Ord, Nebr.

**ARCHERY** Ranges earn \$100 weekly. Prices, plan. Stanley Johnson, Salamanca, N. Y.

**\$1.00 MAKES** Dead-beats pay up! Buy these 12 persuasive letters that without expensive legal fees, have produced money, even from hardened dead-beats. Copy on your own letterhead—then mail-collections will amaze you! \$1.00 postpaid; \$1.15 C.O.D. Reagan, 2720-O Broadway, New York City.

**HUSTLERS** Needed to supply new miracle product to home and industry. Norris, 1108 Madison, St. Louis.

**MAN** Wanted to supply Raleigh's household products to consumers. We train and help you. Good profits for hustlers. No experience necessary to start. Pleasant, profitable, dignified work. Write today. Rawleigh Co., Dept. I-53-PPM, Freepost, Ill.

**PATRIOTIC?** Invest! Fifty cents coin—stamps brings two patriotic songs and partnership coupon. Cooperative Music Writers, Box 1281, Montgomery, Alabama.

**MAKE** Artificial marble, glazed tiles, plaques, flooring, pottery, whetstones. Brilliant samples 3c. Payn, 945 Grande Vista (Room 101), Los Angeles, Calif.

**4 MOST** Read mail order magazines. 15c. Armand Cartier, 695A North, Pittsfield, Mass.

**RESILVER** Mirrors. Fast simple process. Profitable homework. Free details. Sornson, Box 126, Elk Horn, Iowa.

**MAKE** Your own Flexible Molds. Statuary, Art Goods, Novelties, Artificial Marble Flooring, Liquid Marble. Literature free. Kemico, 109-M, Park Ridge, Ill.

**KLENU** Dollars! Extraordinary formulas producing quickest-selling "war time" necessities! Details—stamp. Millers Chemists, Tampa, Florida.

**2c DAILY** Pays for New York office under your own name. Co-Operative Offices, 126 Lexington Avenue, New York.

**SNO-DRIPT** Cleanser, quality product, establish own business. Walters, 14861 Greenfield, Detroit, Michigan.

**AMBITIOUS** People! Operate mail order business at home. Free details. Hodges, 321 E. 41st, Chicago, Ill.

**SAVES** Tires—gasoline. Sample and proposition 25c. A. W. Winterfield, St. Paul, Minn.

**FREE—**200 clever mailorder, homework, local business offers—all snappy moneymakers. Lewis Co., 838-M Carpenter, Oak Park, Illinois.

**WIN** With "Schemer" schemes, mail-order tips, formulas. Twelve months, 288pp, just \$1.00; quarterly, 30c. (44th year). Schemer Magazine, Alliance, Ohio.

**MECHANICALLY** Inclined men—Own and operate general appliance repair shop. Complete, illustrated course shows you how. Welding, refrigeration, motor repair, how to get business, etc., all phases covered. Free literature. Christy Supply, Dept. 420, 2835 N. Central Ave., Chicago.

**FREE** Booklet. How to manufacture many products. Western, 201 Climax Bldg., Cleveland, Ohio.

**COLLECT** Your own accounts. Money-back guarantee. Creditors Service, Moorcroft, Wyoming.

**BRUSH** Plating outfits connect to a battery, no tanks necessary. Almost as simple as painting. Your opportunity to make good income plating auto parts, bathroom fixtures, reflectors, mirrors. Get free proof and particulars that put you in a paying business of your own. Gunmetal Co., Ave. H, Decatur, Illinois.

**OPERATE** Route used 1c, 5c candy bar, peanut, popcorn, gum vendors. Lowest prices. Northside Company, Indianola, Iowa.

**COLOR** Cement with chemicals. Make artistic cement garden ornaments Hollywood style. Sample 10c. Hollywood Cementcraft, 8527 Wonderland, Hollywood, Calif.

**YOUR** Own business. 66 page book, 40 plans; 64 page magazine 10c. De Selms, 250-P, North 9th, San Jose, Calif.

**STATUARY:** Make all kinds. Simple process. Make and install artificial stone flooring in color. Liquid marble. Other money-makers. Write promptly. Literature free. Compo-Tex, Box 786, St. Louis, Mo.

**PLASTEX** Industries offers industrious men an opportunity to start a business of their own, manufacturing art goods, novelties, souvenirs, etc., in Plastex and marble imitation. 5c material makes \$1 articles. Rubber moulds furnished for speed production. Small investment brings good returns. We are now placing big chain store orders with manufacturers. Write for interesting booklet mailed free. Plastex Industries, Dept. A, 1085 Washington Ave., New York.

**WEBER** Typewriter Mechanics School. Simplified homestudy-repairing increasing. Canton, Ohio.

**\$50.00, \$100.00 WEEKLY** Using sawdust. Stamp please. Clement, 943 Arthur St., Rochester, N. Y.

**MAKE** Money by mail, the way we do. Free information. Maywood, 1133 Broadway, New York.

**HOW** And where to obtain capital. Fully explained, particulars free. Star Service, Wapakoneta, Ohio.

**POPCORN** And potato chip machines. We help start men and women in business. Long-Eakins, 1960 High, Springfield, Ohio.

**CHARTERS:** Delaware; best, cheapest; free forms. Colonial Charter Co., Wilmington, Del.

**127 WAYS** To make money, in home or office, business of your own. Full particulars free. Elite Co., 214 Grand St., New York.

**SELL** Books by mail on commission. No stock to carry. Orders come to you. Maywood Publishers, 1133 Broadway, New York.

**LIQUID** Marble—Colorful, glazed! Mold, brush, spray! Composition floors, rubber-lastic molds. Particulars free. Marbleizing Service, Edwardsville, Illinois.

## FORMULAS, PLANS, ETC.

**AUTHENTIC** Formulary 924 pages (illustrated), 10,000 money making formulas, recipes, instructions, substitutes. \$1.75 postpaid or C.O.D. (foreign \$2.10). Catalog 3c. Adams Brown Company, Chestnut Hill, Massachusetts.

**MAKE** Fast selling products. No machinery. "Chemist Approved Formulas." Write Kemico, 15, Park Ridge, Illinois.

**FORMULAS**—Latest, best. Analysis. Literature free. Belfort, Engineering Building, Chicago.

**"LUMINOUS** Paint" shines in dark. Easily made. 100 other formulas, plans—all 25c. Ideal Service, 309, Park Ridge, Ill.

**ICELESS** Ice! Colder; cleaner; cheaper. Instructions 25c. Duffy, Covington, Ky.

REAL Manufacturing formulas. Lists free. Cummings, Chemist, Gordon Ave., Syracuse, N. Y.

FORMULAS And plans literature free. Krach Service, 9901 Union Ave., Cleveland, Ohio.

### CHEMISTRY

**MAKE Chemistry Your Hobby**—book tells how! Given free with chemistry magazine, 15c. Popular Chemistry, 6204 North Hermitage, Chicago.

WINN'S New Idea chemical kits for students; apparatus and chemicals, retail. Free catalog, send 3c return postage. J. H. Winn, Dept. 509, 124 W. 23rd Street, New York.

AMATEUR Chemist's handbook 25c. Catalog included. Colonial Chemical, Brockton, Mass.

FREE Catalog: chemistry, mineralogy, biology. Special: 28 piece chemistry set, send \$1.00. Tracey Laboratories, Evanston, Illinois.

CHEMISTRY Laboratory apparatus and chemicals for industrial, analytical, and private experimental laboratories. Complete chemical laboratory supply service for correspondence school students. Send 3c for free 48-page catalog of chemicals and apparatus. Dept. M-43, Biological Supply Co., 1176 Mt. Hope Ave., Rochester, New York.

SPECTROSCOPE For quick chemical analysis \$2.50. Kutting Sons, Campbell, California.

### HELP WANTED

**STEADY Work**—Good pay. Reliable man or woman wanted to call on farmers. No experience required. Pleasant work. Home every night. Make up to \$15.00 in a day. Wonderful new proposition. Particulars free. McNeess Co., Dept. 627, Freeport, Illinois.

**WOMEN Earn** to \$23 weekly taking orders in home for dresses at \$2.29. One of 110 wonderful values. No investment. Give age, dress size. Fashion Frocks, Desk 43140, Cincinnati, Ohio.

CALL on friends with sensational personal Christmas cards from 50 for \$1.00 up. Stationery. Also magnificent 21 card \$1.00 assortment. Profit 50c. Experience unnecessary. Samples on approval. Wallace Brown, 225 Fifth Ave., Dept. M-34, New York.

**WRITE For free fabric samples** amazing stainproof tablecloths. Clean with damp cloth. Require no ironing. Beautiful patterns. Look expensive, long wearing, low priced. Commissions big. Also complete dress line. Melville Company, Dept. 3354, Cincinnati, Ohio.

**AVAILABLE** At once, nearby Rawleigh route. Good opportunity. Trade well established. Route experience helpful but not necessary to start. Write at once. Rawleigh Co., Dept. 1-102-PPM, Freeport, Ill.

**500% PROFIT.** Business necessity. Dignified presentation. "Clicks." Write Howlett, Huntington Station, New York.

**SELL** Dresses at low prices. Hundreds sensational bargains. Actual samples free. Send dress size, age. Harford, Dept. L-354, Cincinnati, Ohio.

### AGENTS WANTED

**NEW Air raid shoe sweeps country.** Zips on—zips off. No fumbling or breaking of laces in blackouts or when alarm sounds. Huge profits for direct salesmen and women. Hundreds of other fast-selling shoe styles. Write for free sample shoe outfit. Consolidated Factory, Dept. S-54, Chippewa Falls, Wisconsin.

**MAKE Easy money selling foremost line Christmas cards.** "Leader" assortment 21 gorgeous folders going like "wildfire." Sells for \$1.00, costs as low as 50c. Actual retail value \$3.00. Other bargain assortments. Also, 50 Christmas cards imprinted with name for \$1.00. Finest low-priced imprints in America. Write for sample "Leader" assortment on approval, also two portfolios imprinted cards and free gift offers. Silver Swan Studios, Inc., 320 Fifth Avenue, Dept. 47, New York.

**CHRISTMAS Card money makers.** Free samples outstanding 50 for \$1 name imprinted cards. Quick selling \$1 assortments cost 50c. Other boxes 25c up. Howard P. Ellis, Dept. PM, Pitman, N. J.

**COMIC Clever Xmas greeting cards.** List 10c. Straley, 1015 Mulberry, Springfield, Ohio.

**EXTRA Money quick!** Sell super-value personal Christmas cards, 50—with name—\$1. Finest 21-card assortment, \$1. You make 50c. Complete line. Samples on approval. Waltham Art Publishers, 160 N. Washington, Dept. 587, Boston, Mass.

**FREE Water** and our concentrates, makes flavors, lotions, shampoos, 72 products, labels, bottles furnished. Quico, E-20030 Russell, Detroit.

**4 SALES Daily net over \$1000.00 monthly!** Prospects everywhere. Fast-selling business necessity. Write for details. National Claim Bureau, 20 West 43rd, New York City.

**SELL Christmas cards**—Make extra money. 50 gorgeous folders with name, \$1. Sensational selling 21-card box. 12 other big value assortments. Up to 100% profit. Experience unnecessary. Free samples. Southern Greetings, Dept. 758, Memphis, Tenn.

**MEXICAN Feather, straw, pictures; sandals, tablecloths, etc.** Quick sellers! 100%-300% profit! Free particulars. Samples 10c stamps. Marquez PC Apartado 1176, Mexico City.

**MAKE**—Sell your own products. Vanilla, Fly Spray, Hand Soap, Amazing Cleaner, hundreds other fast-sellers. Our formulas tell how. Write, Kemico, 129, Park Ridge, Ill.

**SELL Season's Christmas card hit!** America's finest 21-card assortment, \$1. Up to 100% profit. Big selection assortments; personal Christmas cards 50 for \$1, up. Free samples. Wetmore & Sugden, 748 Monroe, Dept. 75, Rochester, New York.

**AGENTS—Whirlwind profit opportunity.** Finest silk Nylon, and Rayon hosiery. Big selection. Very latest styles and colors. Replacement guarantee. Your own hose free with large outfit. Rush home size, name today. Wilknit, Dept. CK-37, Greenfield, Ohio.

**AT Last!** Something new and sensational in Christmas cards. Amazing "Oilette" cards. Like costly oil paintings. Never before offered. Gets orders fast. Beautiful 50 for \$1 cards, name imprinted. 10 other assortments. Big profits. Bonus. Samples on approval. Puro Co., 3043 Locust, Dept. 229, St. Louis, Mo.

**BIG Clothing bargains for big profit business.** Used dresses 10c. Men's used shoes 15c. Other sensational values. Experience unnecessary. Free wholesale catalog. Superior, 1250-BC Jefferson, Chicago.

**CHRISTMAS Cards**—America's finest assortments. Big profits. Samples on approval. Robinson Cards, Dept. 203, Clinton, Mass.

**SEND For free copy of illustrated wholesale Christmas catalog!** Forty profitable lines! Elco, 438 North Wells, Chicago.

**SELL Christmas card sensation!** New "prize" 21-card assortment leads in value, appeal. Sells \$1—pays up to 50c. 11 fast-selling assortments. Christmas cards with name 50 for \$1, up. Samples on approval. Chilton Greetings, 147 Essex, Dept. 2-R, Boston, Mass.

**GROCERIES Free.** Just agree to show friends, neighbors, others and I'll give you \$5.00 assortment foods, groceries, etc. Free. Amazingly simple way to make good money. Send no money—just name and address. Zanol, 6305 Monmouth, Cincinnati, Ohio.

**AGENTS:** New line religious, patriotic, scenic pictures and mottoes—20c to \$2.75. Liberal discounts. Old Rugged, 603 So. Main St., Telford, Penna.

**MAKE Money!** Show exclusive Christmas cards with name, 50 for \$1, up. Large selection. 21-card "Janet Art Box," \$1; other big profit assortments. Samples on approval. Janet Art Studios, 1225 Clifford, Dept. 529, Rochester, New York.

**AMAZING Magic purse unfolds** into roomy shopping bag. Sensational seller. Samples sent on trial. Kristee, 120, Akron, Ohio.

**SELL Christmas cards.** Outstanding selection smart designs with name imprinted—low as 50 for \$1. Amazing values get orders easily—pay quick cash profits. 11 lovely assortments. Up to 100% profit. Experience unnecessary. Samples on approval. HertelArt, 305 Adams, Dept. 319, Chicago.

**WE Pay you \$5 for selling ten \$1 boxes.** 50 beautiful assorted name imprinted Christmas cards. Sell \$1. You make 50c. Free samples. Cheerful Card Co., 49 White Plains, N. Y.

**DON'T Be a job hunter**—Start your own business on our capital. No hard times; no layoffs; always your own boss. Hundreds average \$3,000 to \$5,000 annual sales year after year. We supply stocks, equipment on credit, 200 home necessities. Selling experience unnecessary to start. Wonderful opportunity to own pleasant, profitable business backed by world wide industry. Write Rawleigh Co., Dept. I-U-PPM, Freeport, Ill.

**SELL Fortune telling cards** by mail. Big profits, 10 cts. brings samples and information. Thornburgh Service, 1206 Monroe, Wichita Falls, Texas.

**SELL Welder's gloves** and mittens, sample pair \$2.20 postpaid. Big agents discount. Kriewaldt Mfg. Co., Oconto, Wis.

**NEED Money quick?** Sell friends 50 for \$1.00 personal Christmas cards—free samples. Also 17 box assortments 30c up. Sensational 21 box on approval. Up to 100% profit. Special offers. Tom-Wat Studios, PM, Bridgeport, Conn.

**CHRISTMAS Card salespeople**—Sell most complete line. New embossed name-imprinted Christmas cards, 50 for \$1. "Leader" 21-card assortment—sensational \$1 seller pays 50c. Stationery; many others. Samples on approval. Artistic, 165 Way, Elmira, New York.

**CHRISTMAS Cards**—Sell 50 for \$1 with sender's name imprinted. Amazing values get quick easy orders. 15 fast-selling box assortments. Generous cash profits. No experience needed. Samples on approval. Cardinal Craftsmen, Dept. 569, Cincinnati, Ohio.

**REPRESENTATIVE** Every county. county map advertising cards. Unique plan, big returns. Hevenor Map Company, Buffalo, N. Y.

**LORD'S Prayer** on a real penny. Sells on sight. Full particulars and samples 25c. Perkins, 4745 Broadway, M-9, Chicago.

**BIG Profits** in luminous articles for blackouts. Circular free. Samples 10c. F. G. Sales Co., 3170 Redwood Rd., Cleveland Heights, Ohio.

**BIG Money** taking orders; shirts, ties, hosiery, underwear, pants, jackets, sweaters, uniforms, etc. Sales equipment free. Experience unnecessary. Nimrod, 4922-AN Lincoln, Chicago.

**WHOLESALE Sources.** 500,000 articles. Free directory. Maywoode, 1133 Broadway, New York.

**BIG Profits** selling Shelton Dust Absorbers. Sample 6—\$1.00 prepaid. Shelton Mfg. Company, Colorado Springs, Colorado.

**CHRISTMAS Cards.** Earn \$2 an hour. Take orders galore from friends. 50 exquisite folders with name \$1. Free samples 20 designs. America's fastest selling 21 Christmas folder box. Costs 50c. Sells \$1. Request samples today. Sunshine Art. Dept. E, 115 Fulton St., New York City.

**AGENTS—300% Profit** selling gold leaf letters; stores and offices. Free samples. Metallic Letter Co., 438-B North Clark, Chicago.

**POPULAR 8" x 10"** Prizefighter photographs. Famous Knockouts. Tremendous field! Big profits! Price Sports Photos, 1210PM South Kolin, Chicago.

**AGENTS.** Big line including food products. Fast selling premium and bargain deals. Low prices. Send card for big outfit offer with gift. Ho-Ro-Co, 2715 Dodier, St. Louis, Mo.

**AGENTS:** Stamping names on pocket-key protectors. Sample check with your name, address, 25c. Stamping outfits. Emblem checks, check-fobs, name plates. Hart Mfg. Co., 303 Degraw St., Brooklyn, N. Y.

**AGENTS—To mail** our literature. Good profits. Home business. Maywood, 1133 Broadway, New York.

**BIG Money** applying initials on automobiles. Easiest thing today. Free samples. If you sell printing and advertising specialties we have an excellent sideline featuring Decalcomania name plates in small quantities. "Ralco," 727 Atlantic Ave., Boston, Mass.

**SOLVEX** Cleans hands clean. Sample free. E. Podhaski, Monticello, Iowa.

**DO You want agents** for your proposition? Your ad in this space will place your message before hundreds of men seeking fast-selling products. My folder "How to Secure Agents" is filled with proof. I'll gladly send you a copy free. P. W. Johnson, Manager Classified Advertising, Popular Mechanics Magazine, 200 E. Ontario St., Chicago.

## HIGH-GRADE SALESMEN

**SALESMAN** With book or educational sales experience. Splendid opportunity. Leads furnished. Liberal commission. Write, giving experience and references, E. S. Smith, Art Instruction, Inc. (formerly Federal Schools, Inc.), Minneapolis, Minn.

**WE TRAIN YOU**, establish you in your own business, send check for large part of profit of each order immediately although customer makes no advance payment. No capital required. Biggest season starting now. Winona Monument Co., Winona, Minn.

**ADVERTISING** Book matches, America's largest manufacturer of union label book matches. Fast selling line. Large sales producing kit. Sample matches. Complete cut catalog, 17 color combinations makes selling easy. Commission in advance. Superior Match Company, 7530 Greenwood, Dept. N-9, Chicago.

**NEW Air raid shoe sweeps country.** Zips on—zips off. No fumbling or breaking of laces in blackouts or when alarm sounds. Huge profits for direct salesmen and women. Hundreds of other fast-selling shoe styles. Write for free sample shoe outfit. Victor Thomas Shoe Co., 610 W. Van Buren St., Dept. V-50, Chicago, Ill.

**BIG Commissions**—selling to stores celluloid pricing tickets, metal shelf mousing. To restaurants, menu covers, signs. P. Pricing Press, 124 White St., New York.

**CALENDARS** Fans, novelties—Beautiful complete lines all sizes, including jumbos, samples free. Start now, be first in field. Fleming Calendar Company, 6539 Cottage Grove, Chicago.

**SELL** Signs, calendars, thermometers, stationery. Write, Box 174, Huntington Station, New York.

**RELIABLE** Man wanted by nationally-known manufacturer—jobber to contact merchants in own town. Steady, big pay; opportunity to develop own independent business. Start full or part time. Sales experience unnecessary. Layton, Dept. 109, Spencer, Ind.

**CALENDAR** Salesmen—sideline, full time. Big money with country's leading 1943 line. Sensational values. Liberal commissions advanced. Free samples. Consolidated Inc., 1133-A Roosevelt, Chicago.

**ADVERTISING** Book matches—World's largest "direct selling" book match factory offers advance cash earnings calling on every type of business. Experience unnecessary; full, part time; low prices; high quality; quick deliveries; powerful patriotic display repeats. Free kit, instructions. Match Corp. of America, 3433 West 48th Pl., Dept. E-9, Chicago.

## EDUCATIONAL AND INSTRUCTION

**PROTECT** Yourself from attack in any emergency, with American Jiu-Jitsu! Brand new, easy-to-learn method shows how to throw stronger, heavier opponent; break holds; overcome threat of fist, club, knife, gun; attack with dangerous skill. 328 photos make every step clear. Send no money. Examine book 5 days free. Then send only \$1 plus postage. Order your copy now. Garden City Publishing Co., Dept. 109-A, Garden City, N. Y.

**MATHEMATICS** Without figuring. Only the ability to locate the intersection of a vertical and a horizontal scale. 7 tables 6x12", 200,000 problems solved: Multiplying, dividing, adding, and subtracting, fractions, and decimals and whole numbers in 64ths, 27ths, 12ths, 9ths, 8ths, 7ths, 6ths, 5ths, 4ths, 3rds, 1/2s, etc. Price \$2.00. Write C. M. Weaver, 1016 So. Westlake Avenue Los Angeles, Calif.

**DRAFTING** Course \$1 complete! Write J. R. Giles, 1326 Myers, Burbank, Calif.

**WELDING** Opens the way to good pay and future in important industries. Growing need for trained welders. Prepare now. Practical, personal training spare time at home and Chicago. Write for free facts. Utilities Engineering Institute, 1314 Belden, Dept. 129, Chicago.

**RADIO** Announcer, director, actor, writer. Learn how. Free book. Write Studio B, Radio Arts Academy, 3819 Wilshire Blvd., Hollywood, California.

**FINGER** Print experts earn big pay! Learn easily at home. Low cost! "Crime Book" free. Write stating age. Dept. 26, Inst. Applied Science, 1920 Sunnyside, Chicago.

**HOME** Study course, drugless therapy. Free literature. Inst. of Drugless Therapy, Tama, Iowa.

**LEARN** Drugless therapeutics. Practice Naturopathy and Metaphysical healing. Write Dr. Manks, DeLand, Florida.

**WELDING**—Electric arc. Learn profitable trade quickly through actual practice. Individual welder instruction at bare cost of materials. Full particulars free. Valuable welding lessons book 50c. Hobart Welding School, Box M-922, Troy, Ohio.

**U. S. Government jobs.** War causing hundreds appointments. \$1260-\$1620 first year. Men-women. Prepare immediately for examinations. Full particulars and list positions, free. Write today. Franklin Institute, Dept. P2, Rochester, N. Y.

**BECOME** A registered real estate broker! Profitable career. Jack Stein, Sarasota, Florida.

**SECRET** Investigation. Experience unnecessary. Detective particulars free. George Wagner, M-2640 Broadway, N. Y.

**BECOME** A Doctor of Psychology (Ps. D.) Teach secret of contentment, happiness. Solve mental worries. Free book. College of Universal Truth, 20-B East Jackson, Chicago.

**LOCKSMITH** Course. Lock picking, key fitting, etc. \$1.00 prepaid. Locksmith, Canadian, Texas.

**CLINICAL** Laboratory technic taught in your own home. Practice outfit supplied. Bulletin free. Imperial Technical Institute, Box 973-E, Austin, Texas.

**LEARN** Telegraphy! Splendid opportunities now prevail! All expenses low. Catalog free. Dodge Institute, Dept. M, Valparaiso, Indiana.

**RADIO** Engineering, broadcasting, aviation and police radio, servicing, marine and Morse telegraphy taught thoroughly. All expenses low. Catalog free. Dodge Institute, Dept. R, Valparaiso, Ind.

## CARTOONING, COMMERCIAL ART, SHOWCARD WRITING, SIGN PAINTING

**SIMPLIFIED** Free-hand sign painting 50c for library. Indorsed. Complete course. It's easy. Get today—Use tomorrow. Haines System, Sabina, Ohio.

**EARN** Money, copying and duplicating comic cartoons for advertisers. Ad-Service, Argyle, Wisconsin.

**EARN** Money. New patriotic chalktalk course 50c. Gross, 67-70 Yellowstone Blvd., Forest Hills, N. Y.

## ADVERTISING AGENCIES, LETTER WRITERS, FOR ADVERTISERS

**ADVERTISE** Profitably: \$15 reaches 5,000,000 Sunday newspaper readers with 24-word ad. Newspaper, magazine, mailing-list ratebook, free. Chicago Advertising Agency, 20-PA West Jackson, Chicago.

**24 WORDS,** 40 Newspapers \$2.00. Good-all, 37 Gardner, Vallejo, California.

**ADVERTISE:** 24 Words, 149 newspapers, \$6.50. Lists free. Advertising Bureau, 4515-C Cottage Grove, Chicago.

**FREE**—New Advertisers Rate Guide. 44 pages. Includes everything. Lowest rates. E. H. Brown Advertising Agency, Merchandise Mart, Chicago.

**ADVERTISING** Placed all magazines, newspapers U.S.A., Canada. Lowest rates. Free service, 54-page catalog free. Baker Advertising Agency, A-189 W. Madison, Chicago. Established 29 years.

**FREE**—"Amazing New Book"—"Profits From Classified Advertising." Tells how and what to advertise. Be sure to read this book before you invest one cent in advertising. Remember—it's free! Write for your copy now. F. W. Johnson, Classified Advertising Manager, 200 East Ontario Street, Chicago, Illinois.

## BUSINESS SERVICE

**SOUTHERN** Mail address. Receiving, forwarding, \$1 month. Exchange, Box 66, Atlanta, Georgia.

**CHICAGO** Mail address: \$1 monthly—Receiving, reforwarding your business, personal mail. General, 30 West Washington, (Established 1919).

## RUBBER STAMPS AND OFFICE SUPPLIES

**SUPERB** Quality, cushioned, indexed, 2 lines 25c, 3 lines 35c. Signatures \$1.50. Lentz, Box 402, Youngstown, Ohio.

**2 LINE 25c, 3 Line 35c.** M. Struble, Cupertino, California.

**ARMY, Navy, air service.** Three lines 35c, four 50c. Slocum, 814 Bradley, Peoria, Illinois.

**KNOB** Handle, cushioned, 2 lines 25c, 3-35c. Stamp Works, Centertown, N. Y.

**2 LINES 25c, 3 Lines 35c.** Stamp Works, Auburn, Nebr.

## TYPEWRITERS, DUPLICATORS, OFFICE DEVICES

**CARBON** Paper, typewriter paper, ribbon, envelopes, labels, paper clips, etc. Large assortment. Over \$13.00 value—only \$6.85. Write. Okay Company, Martins Ferry, Ohio.

**DEXSTONE** Prevents finger slip when leading papers, bowling, etc. Postpaid 25c. Defense stamp preferred. Dextstone Distributors, 1128 California, Butte, Mont.

**ADDING** Machines, \$21.95. Why pay more? Carl Klingensmith, Georgetown Road, Leeburg, Penna.

**TYPEWRITERS,** Adder, mimeograph, multigraph, addressograph. Send for free lists of machines that will help you at half price. Pruitt, 28 Pruitt Bldg., Chicago.

## PRINTING OUTFITS AND SUPPLIES

**RE-NU** Make ready knife with retractable blade. Sharp! Safe! Handy! Only 50c. Reliable, Mark Specialty Co., Temple Bldg., Rochester, N. Y.

**ROLLERS** Recast. Small sizes our specialty. Ship old rollers with composition on cores for proper size. Satisfaction guaranteed. Print Masters Specialties, 4533 Montrose, Chicago, Illinois.

**PRESSES** Complete supplies. Bulletin. Send stamp. Bradshaw, 3214-P Huron, Chicago.

**PRINTERS** Idea package. 25c. Tried, workable ideas. Box 6, Chelsea, Oklahoma.

**INEXPENSIVE 6x9** Printing press. Details free. Novelty Shop, Downsville, Louisiana.

**PRINT** Your own cards, stationery, circulars, advertising. Save money. Simple rules furnished. Print for others, nice profit. Junior outfit \$8.25, senior outfits \$17.38. Details free. Kelsey, Inc., T-11, Meriden, Conn.

**PRINT** At home. 10c will bring a complete catalog of presses, type and supplies. P. Peiffer & Company, 6 Columbia St., Newark, N. J.

**BARGAINS**—Presses, type, supplies. Send stamp. 159 Harvard, Cambridge, Mass.

**USED** Presses, type, supplies. Lists 3c. Turnbaugh Service, Loysville, Penna.

## PRINTING, MULTIGRAPHING, MIMEOGRAPHING, GUMMED LABELS

**STATIONERY,** Folders, booklets, post cards, circulars, register forms, etc. 4154-P Fifth Street, Philadelphia.

**MIMEOGRAPHING,** Reasonable. Samples free. Speed-O-Print, R No. 2, Box 104M, Greenfield, Mass.

**250 BOND** Letterheads or envelopes \$1.50 prepaid. Lumco, Kimball, Nebraska.

**100 GOVERNMENT** Postcards (already stamped) imprinted with your name and address on correspondence side. Only \$1.49 postpaid. Goheso, Omena, Michigan.

**\$1.00 POSTPAID:** 100 8 1/2 x 11 Bond letterheads and 100 envelopes. Benneville, 907 West Roosevelt, Philadelphia.

**FORMS,** Stationery, music, anything printed. Lowest prices; write, Stout's Printery, Pholi, Indiana.

**100 8 1/2 x 11 LETTERHEADS,** 6 3/4 Envelopes, \$1.00. Samples, Farleyprint, Woodway, Virginia.

**250 LETTERHEADS** Or envelopes \$1.50 postpaid. The Review, Westfield, Illinois.

**PRINTING** List for small users. Davis Press 2968 Central, Indianapolis.

**BUSINESS** Cards; noteheds; envelopes. 250-\$1.00. Schultco, Box 41, Irwin, Penna.

**250 HAMMERMILL** Letterheads (8 1/2 x 11), 250 envelopes—\$2.00. Samples. Treasurer Printing Service, Milroy, Pennsylvania.

**PRINTING** Of all kinds—Reasonably priced. Samples. Reporter, Chelsea, Oklahoma.

THOUSANDS Pleased! 200 sheets, any color, 100 matching envelopes, \$1.00. Special printing for servicemen. Vinmar Paper Co., Thompsettown, Penna.

HAMMERMILL Letterheads, envelopes, any color. 32 type styles. Free particulars. Woodruff's, 217-A4 Lewis, Duluth, Minnesota.

YOUR Name, address, printed, 500 each—Stickers  $1\frac{1}{2}'' \times 2''$  and memorandums  $4'' \times 5''$  \$1.50 postpaid. Miniature label specialties—700 designs, 10c. Arrowprint, PM942, Waterbury, Connecticut.

COMPLETE Printing. Free cuts, estimates, proofs. Longstone, R4, Dayton, Ohio.

GOOD Printing reasonably priced. 500 letterheads, statements, envelopes, cards \$1.50 box. Service stationery \$1.50 box. Ask for low estimates on your printing. Write for samples today! Birchwood Printers, E. Paterson, N. J.

500  $3\frac{1}{2} \times 2\frac{1}{4}''$  FOUR Line gummed stickers, 25c. Moritz Printery, Saginaw, Mich.

JOB Printing. Quick, reasonable. Samples. Atlantic, Box 653-H, Rock Hill, S. C.

WANTED Printing of all kinds by thousands of our readers. Your ad in this space will bring you some nice orders. Write for positive proof. F. W. Johnson, Classified Advertising Manager, Room 304, 200 East Ontario Street, Chicago.

#### PATENT ATTORNEYS

**INVENTORS:** Take first step toward protecting your invention—without obligation. Write for free "Record of Invention" form for establishing date of invention and free "Patent Guide for the Inventor"—telling about confidential search service; how to sell and market inventions; details of convenient payment plan. Send today for free "Patent Guide" and "Record of Invention" form. Clarence A. O'Brien and Harvey Jacobson, Registered Patent Attorneys, 21B-J Adams Building, Washington, D. C.

**PATENT** Your idea—New, useful ideas often very valuable. Two books—Free—tell how to apply for patent protection—give six basic ways to sell your invention. Experienced patent counselors. Fees reasonable; deferred payments. Write today. Victor J. Evans & Co., 631-K Merlin Building, Washington, D. C.

WESTERN Inventors, save time: employ C. L. Drew, Atty. Registered in U. S. Patent Office, Central Tower, San Francisco, Calif. 32 years practice.

"INVENTOR'S Guide." 100 mechanical movements, free; advises on patenting, selling inventions, Frank W. Ledermann, 154 Nassau Street, New York.

L. F. RANDOLPH, 302-B Victor Bldg., Washington, D. C. Low cost. Book and information free.

**PATENTS** Booklet free. Highest references. Best results. Promptness assured. Watson E. Coleman, Patent Lawyer, 724 Ninth St., Washington, D. C.

**INVENTORS**—Before disclosing your invention to anyone—send for form "Evidence of Conception"; "Schedule of Government and Attorneys' Fees" and instructions. Sent free. Lancaster, Allwine & Rommel, 411 Bowen Building, Washington, D. C.

#### FOR INVENTORS

CAN An inventor make money today? In 1941 alone over 4,000 assignments of patents a month were made by inventors to manufacturers or individuals. This shows today's demand for new patented inventions. Write for our free book, "Protect, Finance and Sell Your Invention." Special form "Invention Record" also mailed free. No obligation. McMorrow & Berman, 134-G Barrister Building, Washington, D. C.

**IDEAS** For sale. List 10c. Svitak, 1877 Riverside Drive, Los Angeles, California.

**INVENTORS**—Protect your idea with a patent. Secure "Patent Guide" and "Record of Invention" form—free. No charge for preliminary information. Write Clarence A. O'Brien and Harvey Jacobson, Registered Patent Attorneys, 21A-J Adams Building, Washington, D. C.

**DON'T** Take chances. Establish invention date before showing anyone. Forms, instructions \$1.00. Box 10, 167 West 80 Street, New York City.

**SPECIAL Offer** to inventors—Two valuable books for 25c—115 mechanical movements illustrated and explained—gives you \$1 credit against usual \$5 patent search charge. Victor J. Evans & Co., 632-K, 1503 - 21 St., N.W., Washington, D. C.

**INVENTORS**—Entirely new products are urgently needed for the drastic changes in our every-day needs. If you have a practical, useful non-military invention it can now be sold safely, without patenting expense. Write today for complete details. Chartered Institute of American Inventors, Dept. 4A, Washington, D. C.

**CASH** For practical ideas and inventions. Mr. Ball, AB-9441 Pleasant, Chicago.

**SELL** Your patent through a small classified ad in Popular Mechanics. Many inventors have found buyers in this way. Ask me for proof—I'll gladly send it to you. F. W. Johnson, Manager Classified Advertising, 200 E. Ontario St., Chicago.

#### INVENTIONS WANTED

**INVENTIONS Wanted:**—Now assembling line to present after "the duration." Do you have an item of merit with volume distribution possibilities? We have capital to manufacture and contacts to market items selected. Have successfully sold under Heco Trademark to 10c store chains and catalog houses for years. If you have invention with chain store appeal communicate with us at once. Address New Products Dept., Heckethorn Mfg. & Supply Company, Littleton, Colorado.

**MANUFACTURER** Wants new invention or idea. Nelson, P.O. Box 626, St. Paul, Minn.

**INVENTORS!** Have your good, patentable ideas? Write—Mr. Metzler, 11 West 42d, New York.

**INVENTORS**—Manufacturers urgently need new ideas for drastically altered civilian markets. If you have a useful new invention, or a practical improvement on an already established product, you can now sell it safely without patenting expense. Complete details, free. Chartered Institute of American Inventors, Dept. 4-D, Washington, D. C.

**WANTED**—Meritorious patented, unpatented inventions. Booklet, references, free. Invention Reporter, 5B-11236 So. Fairfield, Chicago.

**CASH** For inventions, patented, unpatented. Mr. Ball, A-9441 Pleasant, Chicago.

**YOUR Ad** in this space will bring amazing results. I'll prove it to you. Write at once for interesting information. F. W. Johnson, Room 300, 200 East Ontario St., Chicago.

#### PATENTS FOR SALE

**PATENTED** And pat. pend. "Roll-On" (T.M.) curtain pinner. Dies and jigs for manufacturing. Excellent post war chain store product. Proven sales. Outright. M. R. Yarger, Morgantown, W. Va.

**PRIME** Your postwar dollar. Plastics compound tool, delivers continuous, uniform strip. Pasanen, Franklin Mine, Mich.

**INVENTION** For sale: Outright or royalty—suitable for carpenter trade, established and developed. Stench, 423 Sprague, Dedham, Mass.

**SNOW** Scrapper fastens to car bumper. Sell U. S. and Canadian patent. 340 43rd, Des Moines, Iowa.

#### MANUFACTURING

**MODELS**—Small lot manufacturing. Metals, plastics, etc. Milburn, Burlington, Kentucky.

#### MODELS AND MODEL SUPPLIES

**CATALOG** 50 Engines, model railroad supplies, 25c refunded. Howardco, A2417 North Ashland, Chicago.

**RAILWAY** Models, complete line informative catalogs O gauge, 112 pages, 25c; HO, 48 pages 15c. Walthers, 247 Erie, Milwaukee, Wisconsin.

**"CONSTELLATION"** Carved hull construction set, separate fittings, blueprints. 52 page illustrated catalog 25c, listing hundreds of ship and yacht model fittings. A. J. Fisher, 1002-7 Etowah Ave., Royal Oak, Mich.

**SHIP** Models and yacht supplies complete. Large 56 page catalogue 15c. Bill Wild's, 510 East 11 St., New York City.

**MINIATURE** Steam locomotives, new catalog listing all builders' needs 25c. Little Engines, Wilmington, California.

**SHIP** Model kits and fittings. Complete line Fisher model yacht equipment. All Boucher, Fisher, Marine Model and Ideal kits, fittings and blueprints at catalog prices. Most complete stock in New England. James Bliss & Co., Inc., 220 State Street, Boston, Massachusetts.

**FREE**—Big list of helpful books. Popular Mechanics Press, 200 E. Ontario St., Chicago.

#### HOME CRAFTSMEN

28 **LAWN** Ornament patterns 25c. Other patterns: 15"-20" high; Dutch girl, Dutch boy, pirate, bull terrier, Mexican girl, Mexican boy, dwarf, penguin, flower girl, 10c each; 3 for 25c. 25 novelty patterns 30c. All 62 full size patterns \$1.00 postpaid. Strother, Box 383-DU, Belington, W. Va.

**SQUAREKNOTTERS!** Make belts, handbags, etc. Quality cord samples with catalog, free. Beginners book, catalog and samples 10c. Special! Regular \$1 book with 50c beginners outfit, all for \$1. P. C. Herwig Co., Dept. J-35, 121 Sands St., Brooklyn, N. Y.

15 **FULL** Size what-not patterns 25c coin. Albright Service, M-6901 Railroad Ave., Omaha, Neb.

**TAXIDERMISTS** Supplies. New large catalog 10c. Nowotny's, 1401 Broadway, San Antonio, Texas.

**GET** Free leathercraft instruction pamphlets, prices of leathers, tools, projects. Fascinating hobby. Make beautiful gifts. Leather samples 5c. Wilder & Company, 1938 Crosby, Dept. 9F, Chicago, Illinois.

**LEATHERCRAFT** Headquarters. Leather, tools and instructions for you to make most anything in leather. Also archery and wood craft supplies. Send for catalog. J. C. Larson Co., 180 No. Wacker Drive, Chicago, Ill., Dept. 180-D.

**PATTERNS**, Decal transfers, tools and many other homecraft supplies. Catalog finely illustrating 500 articles, 6c stamps. Wo-Met Shop, Ashburn, Georgia.

**LEATHERCRAFTSMEN:** Send 10c for new handbook and catalogue of tools and supplies. E. A. Sweet Company, Inc., Leathercraft Division, A-61, 148 State Street, Binghamton, N. Y.

**WOODWORKING** Power tools—Make them yourself. Lathe, scroll saw, saw table, drill press, portable sander, bandsaw, motorized plane. Complete details only 25c. Popular Mechanics Press, Dept. 401, 200 E. Ontario Street, Chicago.

#### WATCHES, OLD GOLD, JEWELRY, ETC.

**CASH!** Gold, jewelry, teeth, coins, diamonds, mercury, etc. Ship! Simon's, 353 Old Arcade, Cleveland, Ohio.

**ZIRCONS**—Diamond-cut, low as \$1.00 per carat. Leuthold, 2227 1/2 N. Alabama, Indianapolis, Ind.

**ELGIN**, Waltham watches. Attractive buys. Make big money. Free watch and jewelry catalog. Plymouth Jewelry Co., 163F Canal St., New York.

**AGATES**, Fossil woods, three pounds \$1.50 postpaid. Jay Ransom, Aberdeen, Wash.

**WATCHMAKERS'** Materials, tools, jewelry—bought, sold. Best prices for old gold, diamonds. Free catalog. Ben Segal Company, Box 150, Chicago.

**HIGHEST** Prices for old gold—Mail your teeth, watches, jewelry. 100% full cash value mailed day shipment received. Satisfaction guaranteed or articles cheerfully returned. Information free. Chicago Gold Smelting Company, 300-P Champlain Building, Chicago.

**GOLD** \$35.00 Ounce. Mail old gold teeth, diamonds, jewelry, watches. Receive cash by return mail. Satisfaction guaranteed. Free information. Dr. Weisberg's Gold Refining Company, 1500-Q Hennepin, Minneapolis, Minn.

#### RAZORS—BLADES—SHARPENING

**ELECTRIC** Razors repaired like new by factory experts. Any make. Pharnacal Products Co., 480 Lexington Avenue, New York City, N. Y.

#### WANTED—MISCELLANEOUS

**MERCURY** (Quicksilver), tungsten, molybdenum, cadmium, high speed tool steel, bismuth, purchased in any quantity. Write for quotations. Metallurgical Products Co., 35th and Moore Sts., Philadelphia, Penna. Established 1909.

HIGHEST Prices for used cameras, binoculars, microscopes, drawing sets, tools, any optical or scientific instrument. Satisfaction guaranteed. Gordon's, 162-M Madison, Chicago.

CASH For anything. Justice Jewelry Jobbers, 190 North Wells, Chicago.

**PERSONAL**

INDIVIDUAL Arch supports—made to impression, from work bench to you. \$3.95 pair, material and booklet free. National Foot Health Center, 1472 Broadway, New York.

HANDWRITING Reveals much, let me read yours, helpful, 35 cts. coin. Lockett, 627 Gerard, Long Branch N. J.

BIRTH Certificates, all ages, any state, ten (10) day service. Enclose postage. Herndon J. Thompson, Dept. (D324), Davis, Oklahoma.

SONGWRITERS. Write for free booklet, profit sharing plan. Allied Music, Dept. 85, 204 East Fourth, Cincinnati, Ohio.

MEXICAN Legal matters, Wm. Cooke, Reliable American Attorney, El Paso, Tex.

**MISCELLANEOUS**

ASSAYS; Analyses of ores, minerals, \$1.00, up. Buskett, Joplin, Mo.

UNPAINTED Wall plaques 5c each. 24 different \$1.00. Oman, 642 Broadway, St. Paul, Minnesota.

PAINT—Famous nationally advertised brand—3½ gal. pail \$2.69. Send stamp for catalogue. United, Box 1000, Newark, N. J.

BIG Mail for you. Latest moneymaking offers, opportunities, catalogs, magazines. Name listed in directory 10c. Ideal Service, 130-M. Park Ridge, Ill.

MILK Goats—free literature—sample magazine. Goat World, Vincennes, Ind.

SAMPLES. Papers, circulars, cards, etc., 10 cents. Brewster, Eastport, Maine.

CASH For discarded spectacles. Highest prices. Chas. Crone, Emporium, Penna.

RECEIVE Gigantic mails, magazines, samples. Your name in numerous mailing lists 10c. Howard, 396 Broadway, New York.

STEREOSCOPIC (Three dimensional) art photos. Particulars for stamp. Oddity House, St. Petersburg, Fla.

HEATING Six rooms \$20.00 yearly. Circ-lars 10c. Rosenzweig, RR10-B4, Cincinnati.

AVOID Sleeplessness. Brew coffee cheaper. Recipe 25c. Walka, 4545 Bartlett, Milwaukee.

FREE Pamphlet—Nostradamus foretells time and manner of Hitler's death. Send your name to C. Ellis, Cedar Grove, North Carolina.

WE Train you to become medical laboratory technician at home in spare time. Free catalogue. Imperial Technical Institute, Box 973-J, Austin, Texas.

CHRIST'S Coming. Get absolute proofs today. Scheall, 263-X, Duluth, Minnesota.

1001 WAYS to Use Concrete. Send for large free illustrated folder describing new Popular Mechanics book covering every known use of concrete for the home, farm, building, business and industry. Popular Mechanics Press, Room (C40), 200 E. Ontario St., Chicago.

**COMPLETE Victory Drawing Set**

Ideal for draftsmen, engineers, salesmen, artists and students

Just out! A new kind of drawing outfit consisting of large drawing board, T-square and 2 triangles, made of life-time Mionite Tempered Prodwood. Will give efficient, long-lasting service. Guaranteed not to warp. The first new development in drawing equipment in years. Every man and boy should own one.



**Make Your Own Layouts Design Hobby Projects**

Ideal for every drawing purpose. Just the thing for home work-shop, office, school or for outdoor sketching.

**MONEY BACK** Victory Drawing Sets will never warp, loosen or get out of line.

**GUARANTEE** Will outlast two or three ordinary sets. **PRICE POST PAID \$1** Send only \$1.00 for yours now. If not satisfied after 3 days' examination, return for full refund. Rush name, address and \$1.00 and your Victory Drawing Set will be sent postage prepaid by return mail. Send order to The LADON Co., 302 S. Wabash Ave., Chicago, Ill.

**RADIO Basic principles of all radio OPERATION RECEPTION**

Radio is more important NOW than ever. Thousands will be needed in aviation, army, navy, and commercial work. Our latest course gives you basic instruction in radio operation and reception. Airway Weather Service, Aeronautic Radio, Servicing, Frequency Modulation are all covered.

**Complete HOME TRAINING in spare time**

Make use of spare time to master the principles of this interesting and profitable profession. Fit yourself for an important part in the tremendous affairs now taking place. Help to win this war quicker. Learn all about our plan, send for this bulletin—it's FREE.

American School, Dept. R645, Drexel at 58th St., Chicago

**SEND FOR THIS BULLETIN FREE**

American School, Dept. R645, Drexel Ave. at 58th St., Chicago, Ill.

- Gentlemen: Send me FREE bulletin covering special training in subjects checked below. No obligation on my part.
- Drafting and Design
  - Accounting and Auditing
  - Architecture and Building
  - Automotive Engineering
  - Aviation
  - Electrical Engineering
  - Diesel Engineering
  - High School Course
  - Liberal Arts
  - Mechanical Engineering
  - Radio and Television
  - Plastics
  - Retail Merchandising

Name.....  
Address.....

**DEFENSE WORKERS EARN \$50-75 AS**

**MACHINISTS-ENGINE LATHE, TURRET LATHE, MILLING MACHINE, SHAPER, GRINDER & DRILL PRESS OPERATORS. NOW IS THE TIME TO LEARN TO RUN THESE MACHINES. SEND FOR FREE INFORMATION.**

**LURZ MACHINE SCHOOL—N. Y. STATE LICENSE. DEPT. P.M. 1043 SIXTH AVE., N.Y. CITY**

**Special Offer to INVENTORS!** Two valuable books for 25c—115 mechanical movements illustrated and explained—gives you \$1 credit against usual \$5 Patent Search charge. Victor J. Evans & Co., 671-K—Merlin Building, N.W., Washington, D. C.

**AIRCRAFT DRAFTING TOOL DESIGN**

Tool designers, aviation and mechanical draftsmen are the key men urgently needed for the Army and Navy armament aircraft program. This is your opportunity to help in the biggest production job America has ever faced. Learn quickly to qualify for good pay drafting positions. Former naval aviator instructor will teach you at home, through individual home study lessons. Want ads full of openings for aviation draftsmen and tool designers waiting to be filled. Great shortage of trained men. Industry crowding us for men. Salaries highest in history. Rush name and address for catalog. Please state age.

**THE OHIO INSTITUTE OF TECHNOLOGY BOX 73. GREENVILLE, OHIO**

**Short-Cut Mathematics COMBINED WITH Practical Mechanics Simplified**

NEW 2-in-1 reading course! Now you can learn the speedy, simplified system of calculation used by draftsmen, engineers, accountants, "master minds" on the stage. Learn easy way to multiply 4 figures by 4 figures without using old-fashioned multiplication; add long columns of figures this lightning short-cut method. Learn horsepower, slide rule, micrometer, logarithms, wood measure, puzzles, etc., etc. Large illustrated volume complete with answers, only \$1 postpaid. Satisfaction or refund.

**FREE** Amaze friends with your magic-like mental powers. Complete details... mail coupon TODAY!

NELSON CO., 500 Sherman St., Dept. J300, Chicago  
Please send free details about "Short-Cut Mathematics and Practical Mechanics Simplified." No obligation.  
Name.....  
Address.....

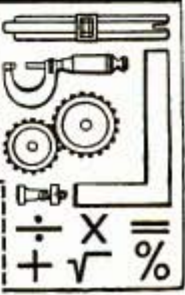



# ELECTRICIANS

Earn More Money. Know Your Job Better. Serve Your Country.  
Know the RIGHT ANSWER to Your Electrical Problems with This...

## Amazing 3 VOLUME ELECTRICAL ENCYCLOPEDIA!

**AUTHORITATIVE**—Prepared by experts who KNOW Electricity. **PRACTICAL**—Used regularly on the job by hundreds of Electricians, service men, Radio men, air cadets, students, maintenance men, etc. **EASY, COMPLETE.**

Covers everything Electrical from magnetism and signal systems to Armature winding, A.C. and D.C. motors, generators, electronics, automotive electricity, refrigeration, Diesel Electricity, telephones, etc.

Also includes Radio, Television. Answers your electrical questions quickly, clearly.

### MAIL COUPON

You don't have to risk a penny. To get your set promptly, just mail coupon. Examine them 7 days risk free! Mail coupon now. LIMITED OFFER!

H. C. LEWIS, President,  
COYNE ELECTRICAL SCHOOL  
500 S. Paulina St., Dept. 62-R1, Chicago, Ill.  
Send me the 3 big Coyne Electrical Reference and Instruction Encyclopedia. Within 7 days after receiving the books, I'll either return them or send you \$3, and \$3 a month until advertised price of \$12.00 is paid. We pay the shipping charges.

NAME \_\_\_\_\_  
ADDRESS \_\_\_\_\_  
CITY \_\_\_\_\_ STATE \_\_\_\_\_



3 big volumes, 1100 big pages, 8 1/2 x 11 inches. 2000 subject listings. Over 2000 easy-to-understand pictures and diagrams. Handsomely bound in Harvard Red and Gold Leatherette.

H. C. LEWIS, President  
**COYNE ELECTRICAL SCHOOL**  
500 South Paulina Street, Dept. 62-R1, Chicago, Illinois

### FREE WITH ENCYCLOPEDIA

One year of personal advice by mail. IF YOU ACT NOW, we'll include Certificate entitling you to 1 year of Technical Service: This means you can write us for advice on any Electrical subject for one year after you buy this encyclopedia.

ASK TO SEE THEM...RISK FREE

## WHY NOT BE AN EXPERT ACCOUNTANT? YOU CAN!

MORE and more opportunities—that is Accountancy's appeal to ambitious people like YOU! Government, industry, thousands of firms, are needing trained accountants. C. P. A.'s and executive accountants earn \$2,000 to \$10,000 yearly; new conditions are steadily increasing the demand! LaSalle trains you at home in your spare time; among our alumni are over 10 per cent of the C. P. A.'s in United States. Training prepares you for C. P. A. examinations or executive accounting positions. Staff of C. P. A.'s personally supervises every phase of your training. You do not need previous experience, for we start you from the beginning. Numerous new opportunities now waiting in Governmental and industrial lines warrant your considering this subject carefully! So act now—investigate LaSalle Accountancy training's possibilities without delay.

Write today for free 48-page booklet, "Accountancy, the Profession That Pays"

**LASALLE EXTENSION UNIVERSITY • A CORRESPONDENCE INSTITUTION**  
DEPT. 964-H CHICAGO, ILL.

Say you saw it in  
**POPULAR MECHANICS**

Learn  
**PHOTOGRAPHY**  
at Home

Splendid opportunities. Prepare in spare time. Easy plan. No previous experience needed, common school education sufficient. Send for free booklet "Opportunities in Photography", particulars and requirements.  
American School of Photography  
1315 Michigan Ave., Dept. 1356, Chicago, Ill.

## LEARN A BIG PAY TRADE

in 2 to 8 WEEKS!

We Pay Room and Board

To meet the great demand for men at high wages, we have inaugurated intensive training courses in the trades listed here. Learn in 2 to 8 weeks by actual shop work. One of America's leading schools. Established 1902. 7 floors of shops. Many employers send their young men here for intensive training. Free employment service.

### GREER SHOP TRAINING

Dept. 292, 2024 S. Wabash Ave., Chicago, Ill.  
Send "Shop Training Facts" describing trade checked below:

- |   |                                       |
|---|---------------------------------------|
| <input type="checkbox"/> Auto-Diesel                        | <input type="checkbox"/> Body-Fender  |
| <input type="checkbox"/> Welding                            | <input type="checkbox"/> Machine Shop |
| <input type="checkbox"/> Refrigeration and Air Conditioning | <input type="checkbox"/> Tool and Die |
|   | <input type="checkbox"/> Aviation     |

Name \_\_\_\_\_  
Address \_\_\_\_\_  
Age \_\_\_\_\_

MAIL COUPON!

# AUTO-LITE SPARK PLUGS

**IGNITION ENGINEERED**



"GOSH, WILLIE — SINCE WE GIVE THE OLD CAR THAT 'PLUG-CHEK' ONCLE RAFE AIN'T MISSED A ONE!"

## HOW "PLUG-CHEK" HELPS PEP-UP SLUGGISH, GAS-WASTING ENGINES

Yes, the Mountain Boys know what to do when cars are hard to start, sluggish on the road. It's time for "Plug-Chek" — the new inspection service offered exclusively by Auto-Lite Spark Plug Dealers. "Plug-Chek" helps spot gas and power-wasting plugs — and shows what to do about it. Simply cleaning and regapping your present plugs may cut dollars off your gas bills. Stop for a "Plug-Chek" today.

**THE ELECTRIC AUTO-LITE COMPANY**  
Toledo, Ohio • Merchandising Division • Sarnia, Ont.



Color and condition tell if plugs are operating properly. Matching your plugs with those illustrated on the "Plug-Chek" is the first step in getting new life for spark-wearied engines.



In its 26 Great Manufacturing Divisions, Auto-Lite is Producing for America's Armed Forces on Land, Sea and In the Air

# Popular Mechanics Magazine

REGISTERED IN U. S. PATENT OFFICE AND CANADA

WRITTEN SO YOU CAN UNDERSTAND IT



Vol. 78

SEPTEMBER, 1942

No. 3

## PLANES of TOMORROW



M 628

This is the plane of tomorrow, a 125-ton leviathan designed by Martin

By **Glenn L. Martin**

President, The Glenn L. Martin Company,

*Baltimore, Md.*

**WHAT'S** ahead for aircraft in peace and war?

I am not a military expert. But I have spent a lifetime in the design and production of military aircraft. In 1913 it was my privilege to help conduct the Army's first bombardment experiments at San Diego. So fascinated was I with the airplane's demolition possibilities that I made this statement, culled from newspapers of August 7,

1914, which were headlining the beginning of World War I:

"The aeroplane will practically decide the war in Europe. Veritable flying death will smash armies, wreck mammoth battleships and bring the whole world to a vivid realization of the awful possibilities of a few men and a few swift aerial demons. For the old-time war tactics are no more. The generals who realize this quickest and

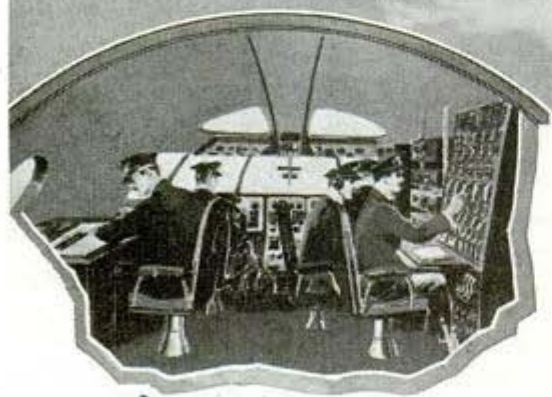
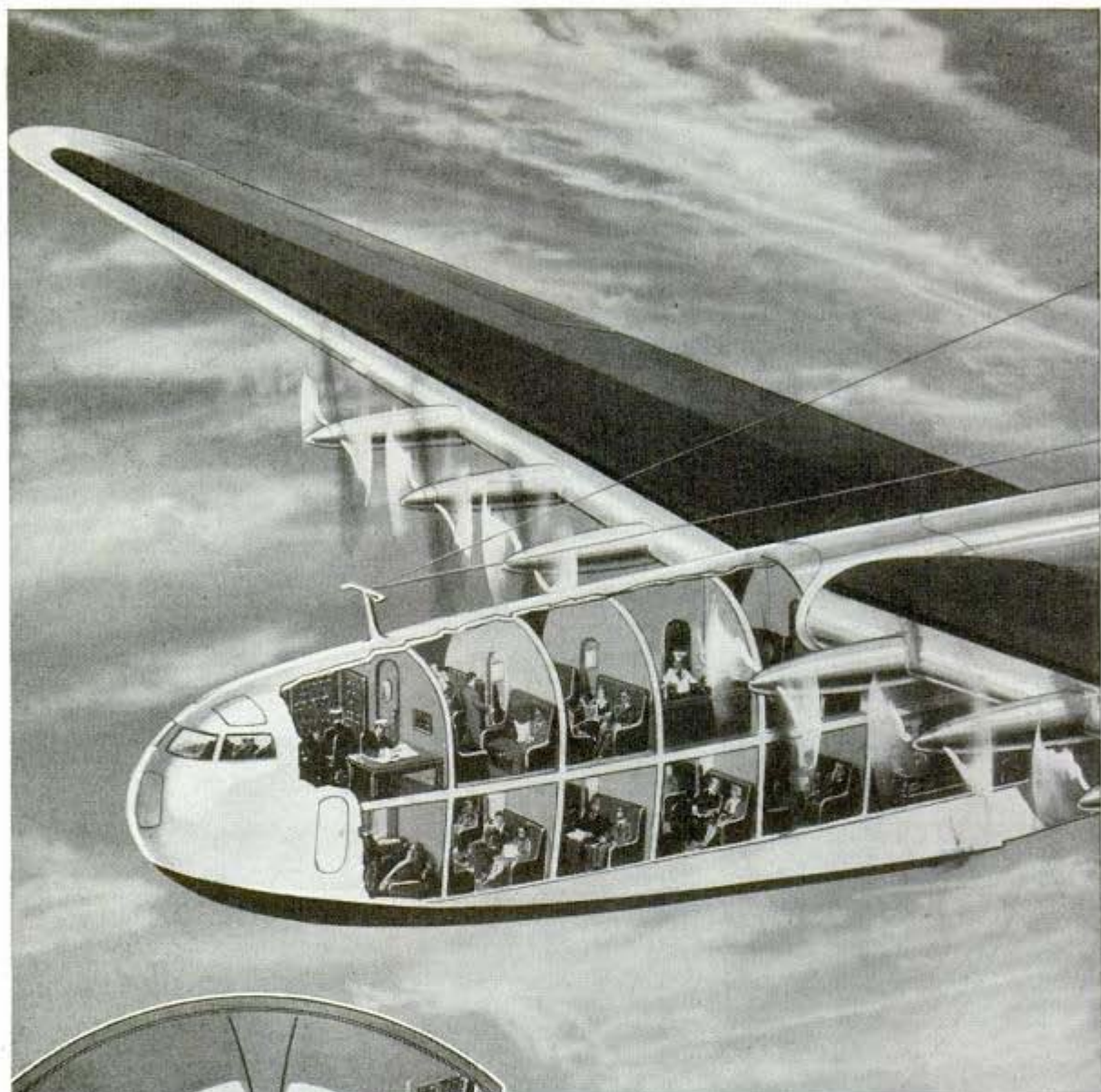

Drawings and photos from Glenn L. Martin Co.

Across the pages is a sectional drawing of the six-engine transoceanic hotel, which would fly from New York to London in less time than you ride a train from Chicago to New York. Left, the huge flight deck

fight first with the flying death, will win."

I was one war too early on that one. But today we find air forces the most powerful influence in victories; lack of them, the outstanding cause of defeats. No armed force can be successful in any major project without air supremacy in its theater of war.

Few stop to consider the versatility of

aircraft in this war. In addition to its more spectacular functions of bombardment and defense, the airplane is maid-of-all-work for the armed services. It performs long-range reconnaissance, patrol and scouting work for Army and Navy. It transports troops and heavy loads of supplies at high speed. It is a moving and elusive machine-gun nest. In some situations it is a basic supply source for soldiery.

Too few understand the power of the airplane—rather, the fleet of airplanes—as long range artillery. Let me excite your imagination with a hypothetical mission.



Word arrives at a battleship station that a hostile force has been sighted 1,000 miles away. The battleship is stocked with supplies and ready for battle. In 38 hours, if the target has not moved too far, the first salvo of nine tons of explosives will be fired at the target.

Now a fleet of 150 bombers, costing about the same as a battleship, gets word of the force 1,000 miles away. In six and a half hours these planes discharge 750 tons of explosives on the target; in 38 hours, 2,250 tons of bombs will have fallen on the objective. Even a continuous cannonade from the battleship could not ap-

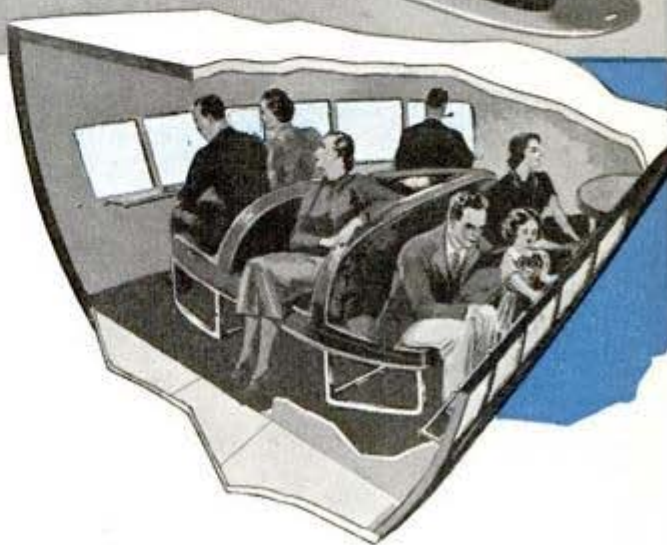

Observation rooms will offer a spectacular view during the ocean crossing. Except for swimming pool and open-air deck the plane will compete with the luxuries of a surface liner

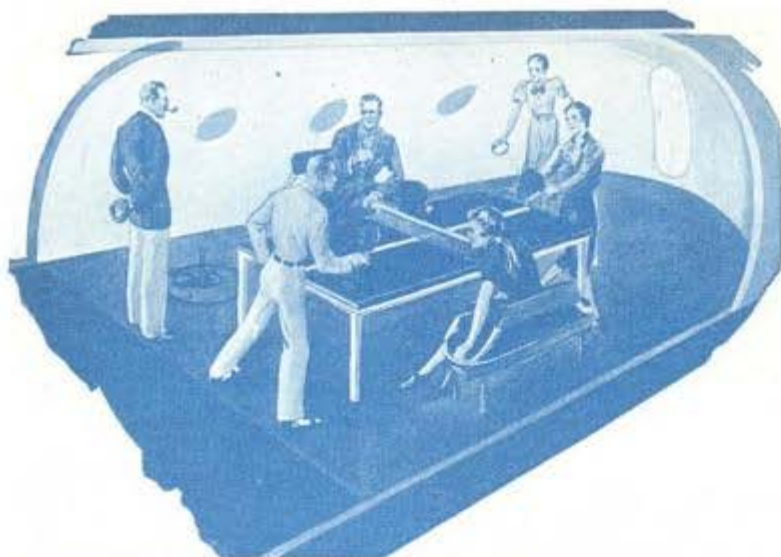

Lounge space will be ample to provide the hundred air travelers such games as table tennis. Showers and baths are planned

It takes 11,500 parts to build center fuselage section (left) and nose of a Martin medium bomber, a toy beside a 125-ton ship

Below is a glimpse inside the Glenn L. Martin plant where bombers are built on a gigantic scale for the United Nations

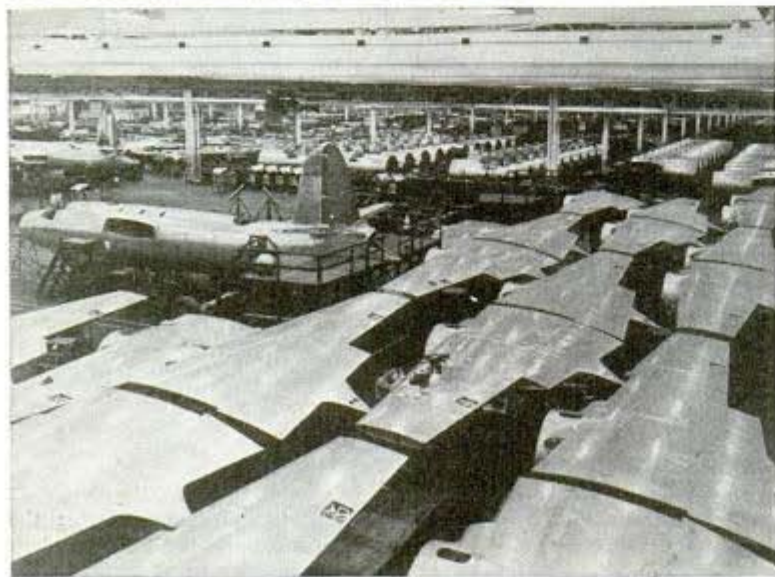

proach the destructive power unleashed by the air fleet.

Again, the extreme mobility of great naval air forces would answer in large part the desperate need for a two-ocean navy. A powerful air force can serve in either ocean in full strength on short notice, without worrying about the Panama Canal.

I have no hesitation in predicting that when peace comes, every nation that preserves its integrity will see that strong air forces will be an important part of its permanent military establishment. Never again will any country risk the swift thrust of the blitzkrieg.

Let us turn now to the very large airplane—a subject dear to me because my company made the first transoceanic Clippers, which are still going strong with service records unapproached by any other airplane. Just now we are testing the world's largest flying boat, the 140,000-pound Mars—three times the size of the China Clipper. Such ships have a definite place in naval and military plans; they carry extremely heavy bomb loads, they can patrol vast areas of ocean at high speed, they carry large numbers of men or large cargoes and have unbounded landing and takeoff areas that are unassailable. You can't bomb holes in water.

Commercially, the extremely large air vessels have a great future. Bad though war is, it is contributing to the great future of world air trans-

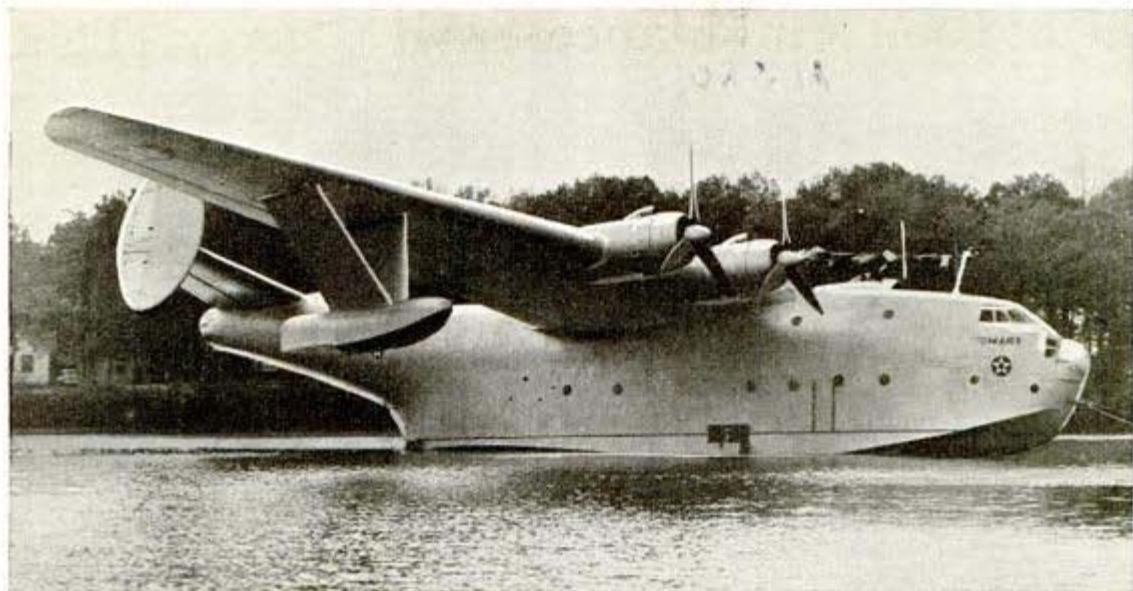

The bridge of the "Mars," flying battleship of the U. S. Navy, is larger than interior of a 21-seat air liner

port. Already this war has sold ocean air transport to the world. Today people—those who can get passage—step aboard the Clipper with a perfect feeling of security. They board surface ships with fear and trembling of skulking submarines. Organized airline travel not only has been the safest means of transport since the war began, but it was safer for several years before the war. In the future it will be safer yet, largely because of developments during the war.

We are heading for winged vessels larger than we have yet dreamt of. Transoceanic operations are presently based on aircraft having a gross weight between 82,000 and 84,000 pounds. These flying boats can carry a payload of about 4,000 pounds for 3,000 or 4,000 miles, depending on head winds and fuel reserve needed—a technical achievement considered impossible a very few years ago.

But these aircraft are inconsiderable indeed compared with the flying ships we are already planning. My company has plans for a 250,000-pound commercial air vessel—plans which recently won for us the American Design Award.

Tomorrow's air liners not only will offer such luxuries as this lounge, but safety developed by aircraft engineers for warplanes

As a matter of fact, there is no technical limit to the size of airplanes; the only limit is the amount of payload available. We should be able to build 500,000-pound airplanes in a few years.

Let's look at the economics of air travel in one of these flying ships between New York and London, a non-stop distance of around 3,500 miles. Prevailing winds are eastward, averaging around 20 miles an hour at low altitudes. It is sound commercial practice to provide sufficient fuel for the head winds forecast for a given flight, plus four hours of reserve fuel. On the London-New York span, against the wind, we would need fuel for 4,700 miles in still air to cover the 3,500 ground miles, with four hours of fuel remaining at the end.

Under the conditions assumed, the 250,-

(Continued to page 178)

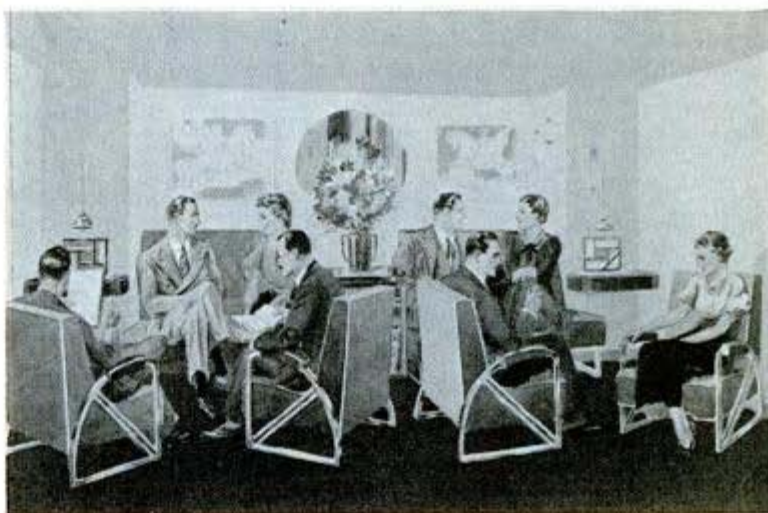

*Aeronca Aircraft Corp., Middletown, Ohio.*

## Lightplane Ambulance Stages Mercy Flights

M 580



Doors in side of fuselage swing wide open, above, for ease in transferring patient. Left, patient in ambulance ready to go

hour, the ship has a range of 350 miles, sufficient for darting quickly between its base and points remote from adequate hospital facilities. It is capable of landing in small fields or even on a highway, and in cooperation with the Civil Air Patrol the plane can perform emergency errands such as delivering medical supplies and first aid

Filling a gap in ambulance service existing between the short-haul automobile and long-haul air transport, a low-priced lightplane ambulance is being produced by Aeronca after months of designing and experimenting. Powered with a 65-horsepower engine and cruising at 100 miles an

equipment. The stretcher contains a rubber foam mattress and has special safety straps to hold the patient securely. A hatch opens at the left side of the craft to receive the stretcher, and the pilot, seated at the controls, is in position to administer simple aid to the patient while in the air.

## Forging Cuts Engine Weight to Pound Per Horsepower

M 531



Cooling fins, left, are cut into forged head at right

Cylinder heads made by forging—a revolutionary process in engine manufacture developed by the Wright Aeronautical Corporation—reduce the weight of airplane engines to less than one pound per horsepower. This will make U. S. combat planes superior to others in speed, operation at high altitudes, load and range, according to experts. The forging process will also increase production by eliminating nine drop-hammer operations in mak-



ing cylinder heads. After they are pressed into final shape by dies, cooling fins are cut into them by specially designed milling machines. Forged heads for big 2,000 horsepower engines for bombers can be made as well as those for smaller fighter craft.

*M 568*  
**'Party Line' Chutes Are Jerked Open In Mass Jump**

It's rapid-fire jumping when the U. S. Marines go overboard in mass parachute leaps, using their automatic "envelope opener." The paratroopers line up inside the transport plane awaiting the "go" signal from the "jump master" at the door. Each man has hooked his ripcord to a cable installed in the plane, and as the chutists leap out in quick succession the cable jerks the cord, opening the parachute. The line is arranged so the soldier is certain to clear the plane before the chute opens.



Marines ready for mass parachute jump snap their ripcords to long line stretched through the ship, so 'chutes open uniformly as each man leaps

SEPTEMBER, 1942

*The Tirestone Tire & Rubber Co.  
Akron, Ohio*  
**Animated "Sprinkling Sambo"**  
**Rotates and Wiggles Hose**  
*M 550*

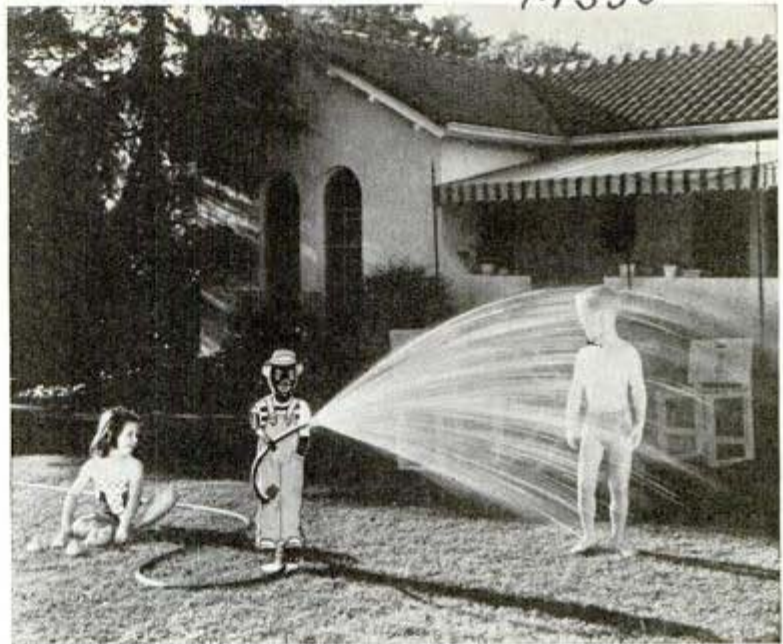

Although children may let "Sprinkling Sambo" give them a cooling shower on hot summer days, his primary purpose is to spread water over the lawn

Silent, black-faced comedy has been introduced into the serious business of lawn sprinkling with a wooden colored boy who holds the nozzle and distributes water evenly about the lawn and garden. The smiling midget, powered by the force of water, turns round and round, while his double-jointed right arm swishes the nozzle in rhythmic motions. Occasionally the animated comedian reverses the direction of his rotation as if to spray extra water on a spot he had

missed. The tempo of his gyrations can be stepped up or diminished by varying the water pressure. Standing 33 inches high and wearing a patched red, blue, yellow and black costume, the whirling figure can be anchored to the ground in any part of the lawn by two spikes inserted through a flat base.

Powered by six batteries driving a 1½ horsepower motor, an electric tricycle just introduced in Sweden travels up to 38 miles on one charge, at a top speed of 25 miles an hour.

*Dept. of Commerce  
No. info.*

# MODERN MIRACLE

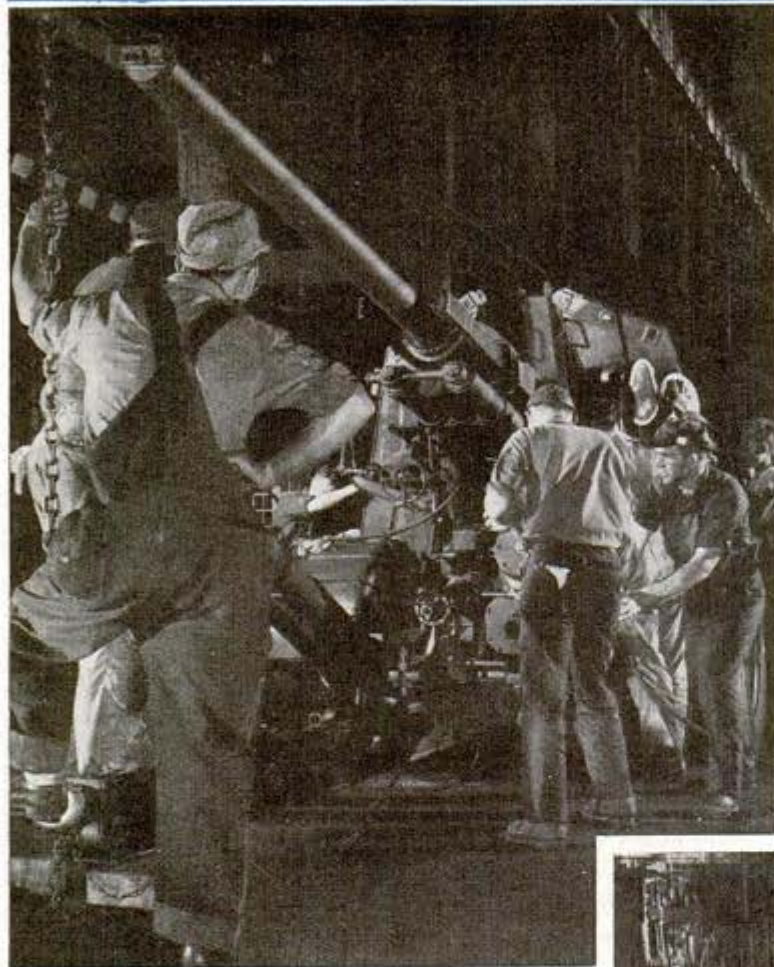

The workman came back, halted, and his jaw dropped. He looked like a man who has walked into the wrong house. When he could talk, he said: "Hey! Somebody stole my machine!"

Things like that happened all through the automobile industry. Lumbering tanks all but pushed the last Chryslers out of the way. One Friday evening the army inspectors in a Detroit plant left for their homes. The plant at that moment was still turning out cars as well as armament. When the officers came back Monday morning they couldn't find their desks.

"What hit this place? A cyclone?" one asked. The whole factory had

← A midwestern plant works 24 hours a day building 90-millimeter antiaircraft gun mounts

Multiple drill converted from automotive work combines 20 different operations in one  
↓

**W**HEN Buick builds Pratt & Whitney engines for Consolidated bombers from a Ford factory, that's miracle enough.

But the swiftness of the change was a greater miracle. It was like a reincarnation. The automobile industry died—or was put to sleep for the duration—and a vaster war industry was born.

Before the last glittering sedan rolled off the production line, acetylene torches were remorselessly burning away the conveyors that had carried an endless parade of new cars through an era. Pneumatic hammers were tearing complex and beautiful tools from concrete floors. Funny things happened. One workman left his machine for a few minutes. In those minutes the moving gang arrived, uprooted the machine, hoisted it into a truck and hauled it away.





Photo from Firestone

Scores of Swedish-designed Bofors anti-aircraft gun mounts roll from assembly lines of a five-acre plant built by Firestone in 50 working days

been transformed for war over the weekend.

At the outset, of course, the automotive industry took a licking. Besides the complete deflation of sales of automobiles and refrigerators and air conditioners and whatnot, besides the blow to sales and dealer organizations and the temporary unemployment of factory workers, millions of dollars worth of tools and dies went to the graveyard. They saved what they could. Engineers marched miles through the factories tagging the machines that could be converted for airplane and tank and gun manufacture, tagging others for the limbo of an open-air graveyard. Dies of the 1942 model cars were

A 50-ton crane hoists a 28-ton M-3 tank aboard flatcar in Chrysler plant



OEM photo

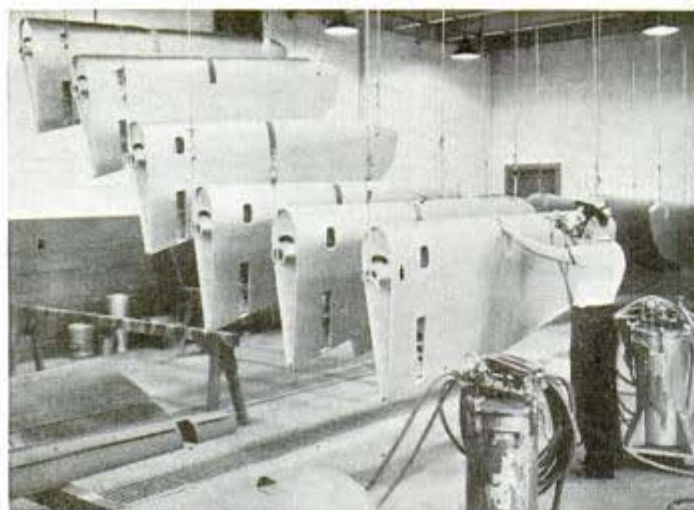

Control surfaces for the Army's B-26 Martin bomber are finished at a Goodyear plant that was once a great airship dock

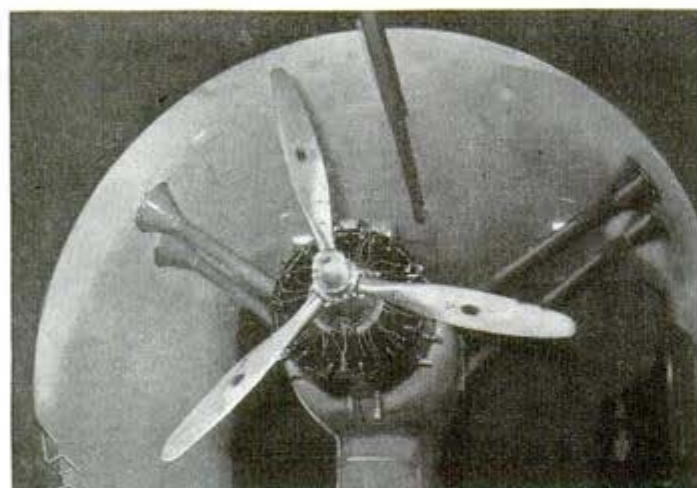

Propeller goes on test at Buick factory building Pratt & Whitney engines for bombers. Production is far ahead of schedule

Here tools that once built automobiles are on war duty; machining 4,000-pound turret casting for Chrysler M-3 medium tank

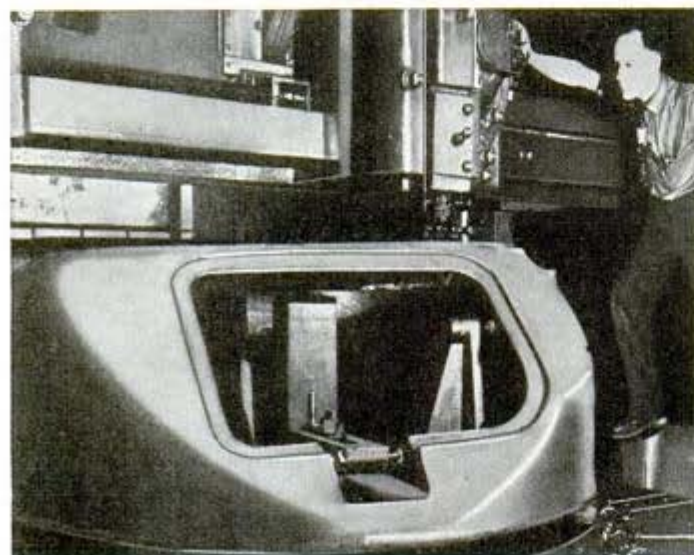

stored in hope they would be put to work again, but even these are threatened; they may be scrapped to recover the precious nickel-alloy steel. If they must, \$60,000,000 worth of dies will go into the melting pot and it would mean perhaps a year's delay in getting back into automobile production after the war.

Many automobile tools, through engineering magic, could be converted to new jobs. Huge rotary, multiple-spindle milling machines that once milled tops and bottoms of cylinder blocks were adapted to replace dozens of smaller machines turning out cannon parts. But some simply weren't adaptable. Conveyor lines that auto workers went lyrical about were sliced up into junk. Above them, in the rafters of one factory, you might notice clusters of big moistureproof paper bags; inside them is valuable but momentarily useless electrical apparatus, put away in bags to keep the sparrows from nesting in it. Among the saddest of men are those who worked around the big "merry-go-round" where tires and tubes were once assembled on wheels. It was a marvelous contraption, gathering rims and rubber from conveyors and putting them together with little assistance from the men. At the last stop on the circle, the tire was inflated and the wheel dispatched on the conveyor to the final assembly line. But the merry-go-round is worthless now.

To facilitate tooling up these factories, the industry formed the Automotive Council for War Production, and under it a Tooling Information Service was set up. If Packard had an idle tool and Hudson needed it, the tool was found and exchanged. One Michigan plant making 20-millimeter projectiles ordered 287 different jigs, fixtures and gauges through the Information Service. If a Chrysler engineer



Tanks stream in endless procession from automotive factories to flatcars and on to training camp and war front

U. S. Signal Corps photo

developed a new trick for adapting a machine or speeding production or saving material, it was passed on through the industry.

Tooling was an initial bottleneck, but it's not there any more. The American tool industry reported a jump from a normal output of \$150,000,000 worth of tools to \$800,000,000 in 1941 and an expected \$2,400,000,000 in 1942.

Bombers are driven by gasoline engines, they're made of metal and wear rubber tires. Other than that, they aren't much like automobiles. One cylinder of an aircraft engine delivers as much power as an automobile engine. Bomber engines are air-cooled, and made of light metal. A Consolidated B-24, the bomber they're building at Ford's 37-acre Willow Run plant, consists of 300,000 rivets and 188,193 other parts—without the engine.

It didn't take long for the brains of the automobile industry to turn up some new tricks the aircraft builders, with their hitherto small, hand-tailored production basis, hadn't thought of. Ford cut production time on a bomber wing section from 99 man hours to 64 by substituting a spot welding process for riveting. Fisher Body engineers had to design some special machinery of their own and draw their own blueprints for a welded tank hull, but they turned out a 30-ton tank on its own power in 47 days—from scratch. One of the giants they built for this job was a 30-ton fixture that grips the entire tank hull and revolves it in two directions for assembly. A Chrysler technician sug-

(Continued to page 168)

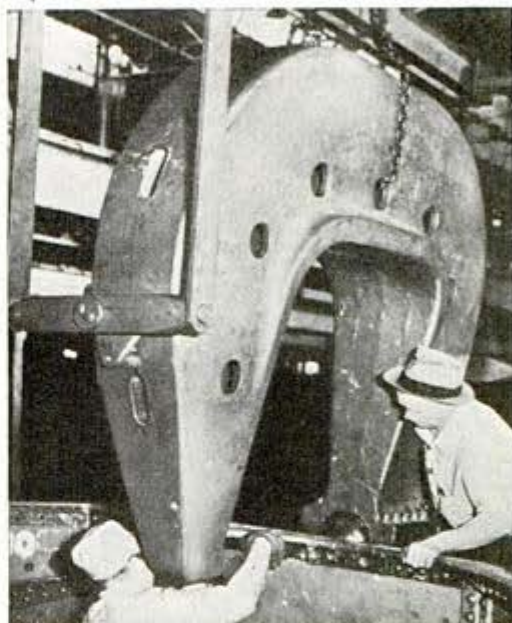

A giant 4-ton riveter with 200,000 pounds per square inch "squeeze" cold-rivets M-3 tank parts  
The last Plymouth rolled off the line January 31. Three weeks later guns and tanks were rolling



Evans Products Co., Tullerton at Greenfield  
Detroit, Mich.

## "Bomb" Train Operates on Rails or Highways

Two sets of wheels—rubber-tired and steel-flanged—enable a train built by the Evans Products Company of Detroit to operate with equal facility on rails or highways. The auto-train, which will be used in a U. S. ordnance plant to move bombs and other explosives, has retractable steel wheels. When operated on rails the

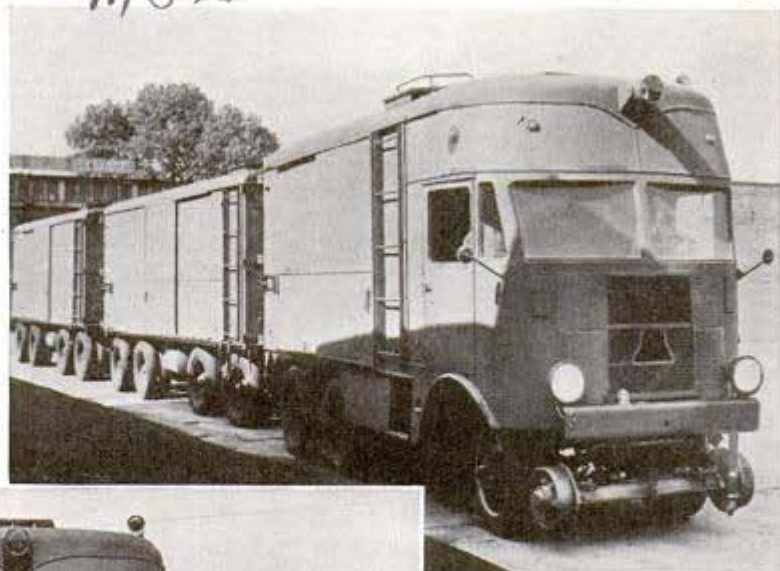

Leaving the rails, this train will roll along on 42 rubber-tired wheels

Small retractable steel wheels are lifted for travel on paving

wheels are let down to act as pilot wheels while 42 rubber-tired wheels carry 80 percent of the load. The train consists of a locomotive and two double-end express cars having a gross capacity of 90,000 pounds. The pilot wheels are raised and lowered by compressed air and the train can be converted from rail to highway use quickly.

## End of War to See Plastic Car With a Transparent Body

Looking into the future and a return to peace, industrial designer Raymond Loewy of New York City foresees the coming of plastic-bodied cars with transparent top section and opaque under part. But plastic windshields, he says, will depend on the development of materials resistant to abrasion. Such a body would be strong and

rigid enough to protect occupants in case of a roll-over collision. Light metal alloys, now in course of development for aircraft, will help improve the power-to-weight ratio, resulting in smoother performance and reduced maintenance costs. Streamlining will get a boost from non-projecting door handles, hinges and headlights, as well as flush-type windows and doors. Motors may be smaller and more efficient, probably using high-octane gasoline. Cars may even have pancake-type motors, which would permit their placement at the front,



Designer's conception of automobile built from plastics and lightweight metals now being developed for use in construction of airplanes and tanks

Ref: Bayshore Bus Lines  
 Goose Creek, Texas

# Auto Carriers Given a New Job Hauling War Workers

M 625

rear or center. Another new material, non-reflecting glass, may be available for the post-war auto, and air-conditioning may also become standard equipment.

Firestone '1 eye' & Rubber Co. Akron, Ohio  
 Reclaiming Plant

## Mountains of Tires Yielding Rubber For Defense

M 621

Great stacks of worn-out automobile tires, spread like mountain ranges over 20 acres of ground near the Firestone company's reclaiming plant in Akron, are dwindling rapidly because scrap rubber is being salvaged faster than motorists are throwing away their old tires. Millions of miles of carefree travel are represented in these casings, which rolled during an era when there was little thought of conserving treads or impending rationing. In contrast, the average driver of today treats his tires gently, as they may have to serve years without replacement.



Bus, bottom, was converted from an auto transport trailer like the one above, opening a useful life for trailer that had lost its regular job

Forced to retire from their former task of carrying new automobiles from factory to showrooms, the familiar transport trailers are being converted into busses for the more vital duty of hauling defense workers. This idea was originated by the sales manager of Jackson Brothers, of Beaumont and Orange, Tex., whose fleet of transports stood idle

while workers in nearby shipyards had difficulty getting to and from their jobs. The bus, operated by the Bayshore Bus Lines between Lake Charles, La., and Orange, seats 88 men and stands about 25 more. Only a few slight alterations were necessary in the conversion of a transport to a bus, as the trailers have a large amount of framing.



Eating into the great piles of cast-off auto tires is a crane used for loading cars that shuttle between the storage yard and reclaiming plant

SEPTEMBER, 1942

Four-fifths of the annual 4,000 grade crossing accidents occur at crossings specially protected by flashing lights, gates or watchmen.

*taken from*  
 Railway Age 13

3/7/42 - P.493

# THAT'S ALL THERE IS - -

M-511

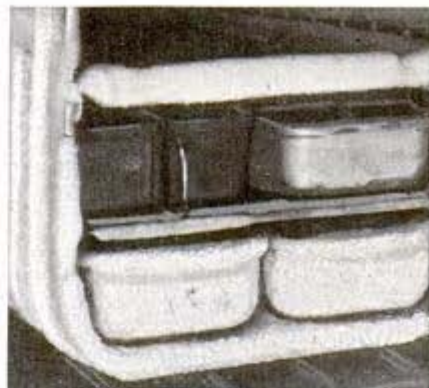

An overdose of Ol' Man Winter comes to this neglected refrigerator, coated with excess frost. Defrost often to keep the formation less than  $\frac{1}{4}$  inch thick

America's skies are heavy with the smoke of industries producing goods for the Army, the Navy, the Air Force and the Marines—but not for civilians. Factories that once manufactured washing machines, refrigerators, vacuum cleaners, radios, automobiles and scores of other consumer goods are now turning out planes, tanks, guns and shells to smash the Axis. Until the war is won the civilian consumer must take a back seat and do his part to help win battles by conserving present equipment—knowing that when it is worn out there will be no replacement. The pictures on these pages contain a few tips on conservation. Above is something to try on your refrigerator. Close the door on a slip of paper. If you can pull it out you are wasting valuable electricity and should have the door strip repaired at once



Above, cleaning the brush of a vacuum cleaner frequently will prolong its life. See that it is not forced to inhale pins, bits of wire and metal and make sure the rubber thong that keeps the brush in place is free of hair and strings. Empty the dust bag at least once every week and consult instructions that came with it for oiling. Left, this man's mood—bad news or indigestion?—is playing havoc with the electric cord. Don't jerk it from the wall socket, but dislodge the plug gently and firmly if you'd have it last





# THERE ISN'T ANY MORE



Keeping the stove clean is part of "home defense" because there will be a long wait between new stoves. Soap and water or steel wool will help. The young lady, at right, does her bit by saving tinfoil and empty tubes

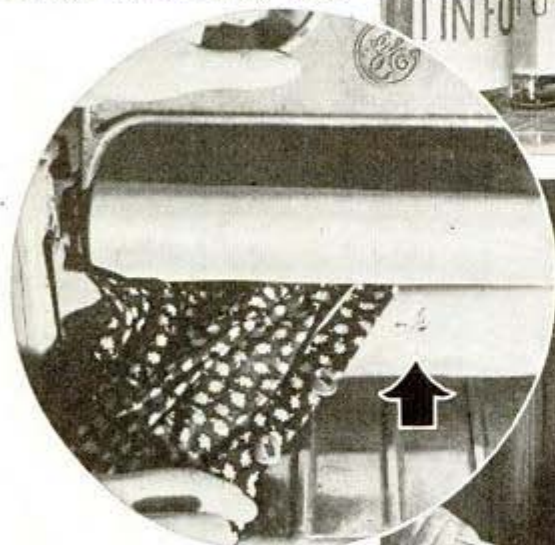

The clothes wringer, above, made of precious rubber, is scarred for life by a sharp button. If this and other accidents should happen to yours, you'll be out of luck—and wringers—for the duration. Ornaments and all buttons should be covered with cloth and turned slowly through the machine. At right, the small boy is proud of the bundle of old newspapers he collected to help his Uncle Sam win the war. When the pile is broomstick high there'll be 100 pounds of waste paper and he will sell it to the junkman or give it to the Red Cross, Boy Scouts or other agencies in the neighborhood. All members of the family can help save scrap and conserve goods



## Bantam Sub-Machine Gun Fires 510 Shots a Minute



Heavy firepower packed into light sub-machine gun

Rapid fire, light weight, small size and low cost of manufacture are claimed for a sub-machine gun invented by William D. Hammond, Los Angeles mechanical engineer. The gun weighs 6½ pounds (lighter than other guns of its type), is only 29 inches long, and can shoot 510 bullets a minute. It has only 31 parts and fires a 45-caliber standard bullet.

## Wheel Lock Clamps Over Hub To Guard Axle Shaft Nut

Double security against theft of wheels and tires is offered by a front wheel lock

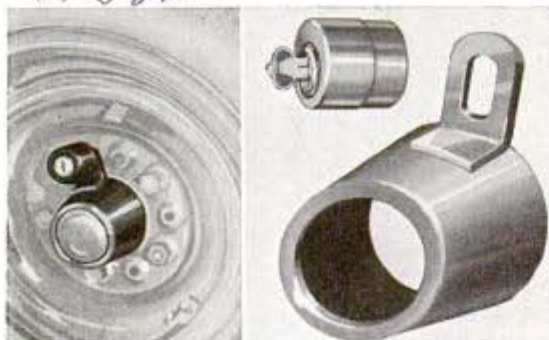

Note how lock covers hub so wheel can't be removed

*Winkenevelder & Ladd, Inc.*  
16  
14 21 S. Michigan, Chicago, Ill.

*Cressant Machine Works*  
39 Moss, Reading, Pa.

that guards both the axle shaft nut and wheel nut against removal by unauthorized persons. Covering the inner hub is a flanged and slightly tapered cylinder, equipped with a lip at the base having an opening that permits it to be secured to one of the wheel bolts. A cylinder lock, applied after the large cylinder is in place, prevents access to either the axle nut or wheel nut without a key.

## Threaded Anchor Holds Screw In Any Kind of Wall

Shelves, cabinets and fixtures of all kinds can be fastened securely to any wall material with a combination anchor and screw. The anchor, made in several sizes, is a slotted tube threaded at the inner end to receive the screw, or bolt. When the bolt is tightened, the strips between the slots bend outward forming fingers that grip the inner side of the hole in which the

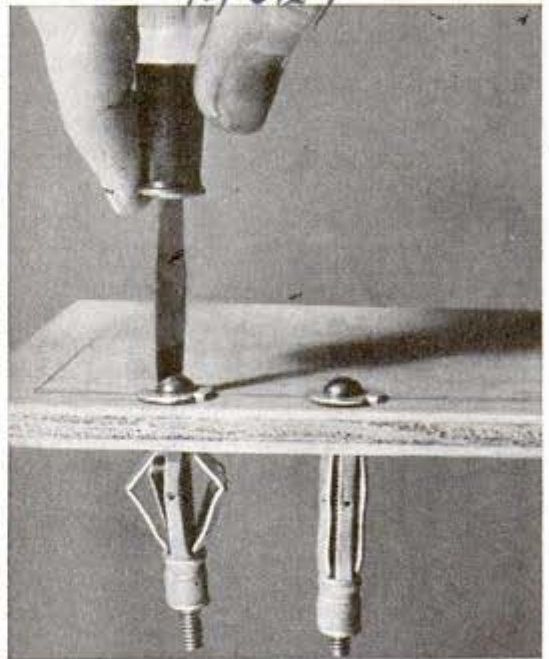

Anchor spreads within wall as screw is tightened

anchor is lodged. In concrete or thick blocks, the hole should be enlarged on the inside so the "fingers" may hold firmly by outward pressure. In thinner walls, such as tile, plaster on wood or metal lath, or any kind of composition board, the fingers may be expanded fully. Once it is in place, the threaded portion of the anchor behind the wall surface acts as a fixed nut so the screw may be removed and replaced as many times as desired.

POPULAR MECHANICS

# BIG MACHINES

*for the* **BIG TASK**

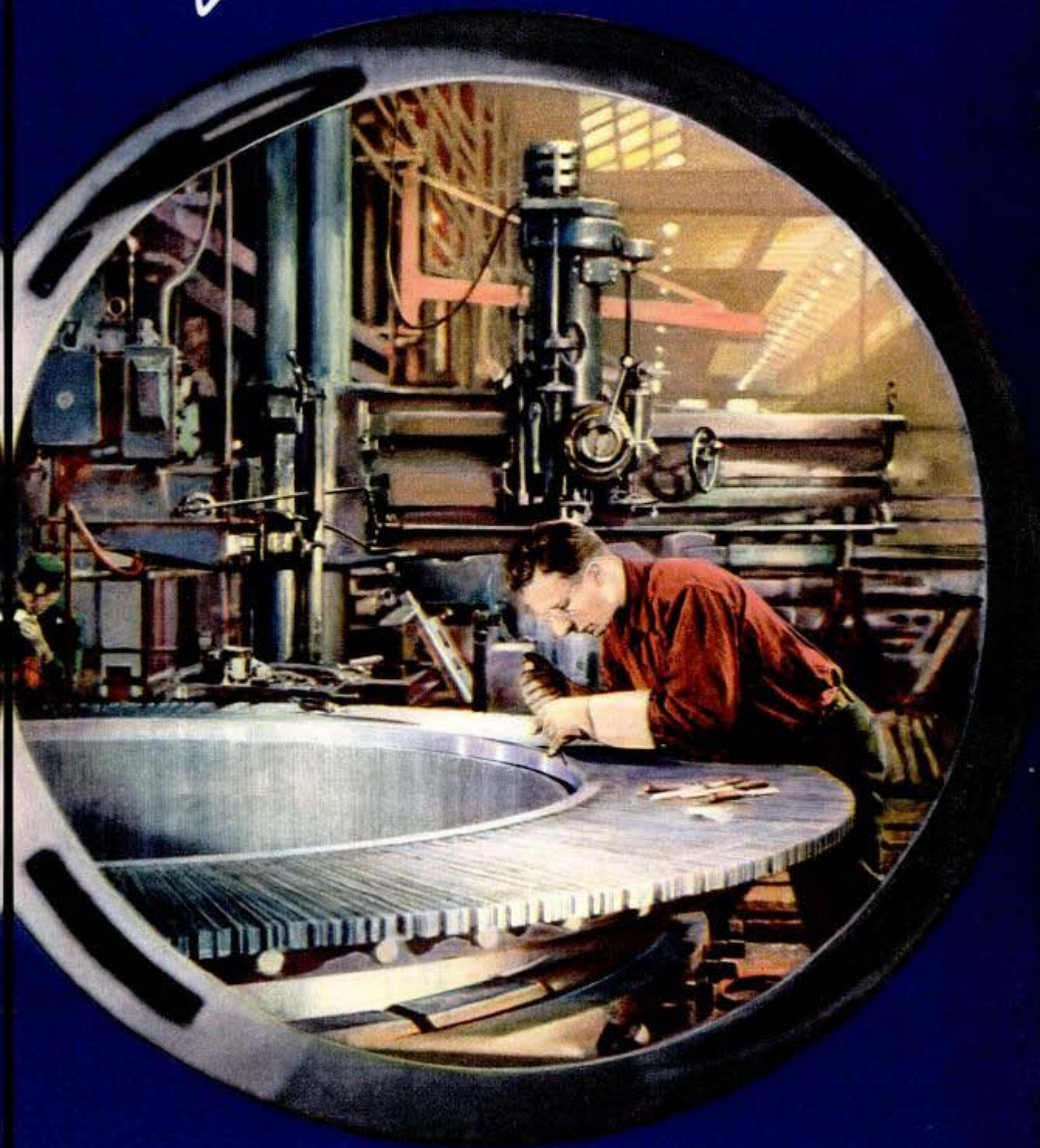

Assembled with a watchmaker's precision, this commutator and its twin will form a 10,000-horsepower unit to roll 48-inch steel slabs in an electrically powered mill



*M 348 - Mr. Leggett.*

Multiply this by unknown hundreds and you have a picture of industry gaining mastery of the air for America. This is one of the moving assembly lines for 4-engine Consolidated bombers

Once a machinist's helper at a Westinghouse plant, this man took a "learner" course and became a full-fledged engine lathe operator. Here he gauges the cut on a marine equipment part

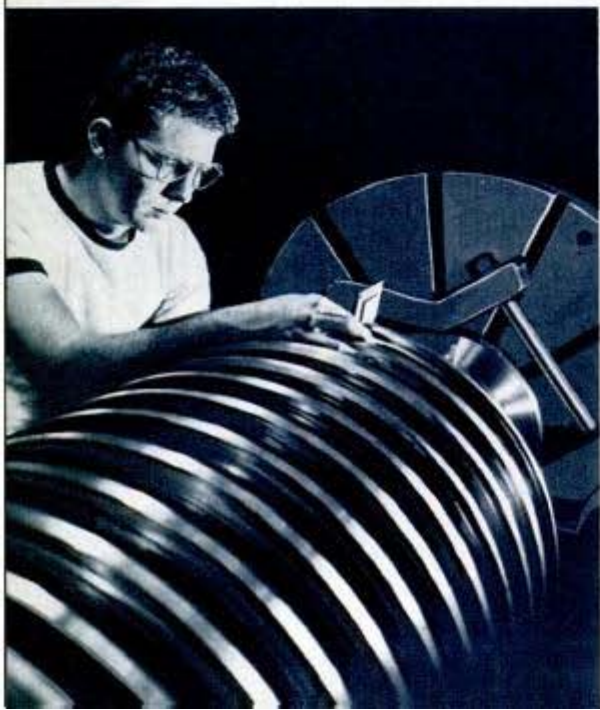

Ford Motor Company men, from engineers and designers down to the last plant worker, had to learn a new industry in a matter of days. This engineer is literally and figuratively "wrapped up" in a wing section of a bomber to examine structural details. Now Consolidated B24D's are rolling off the line

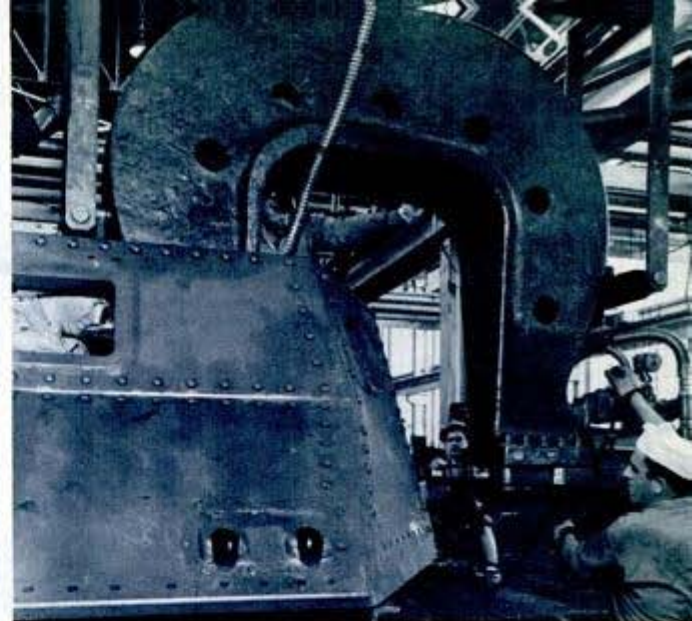
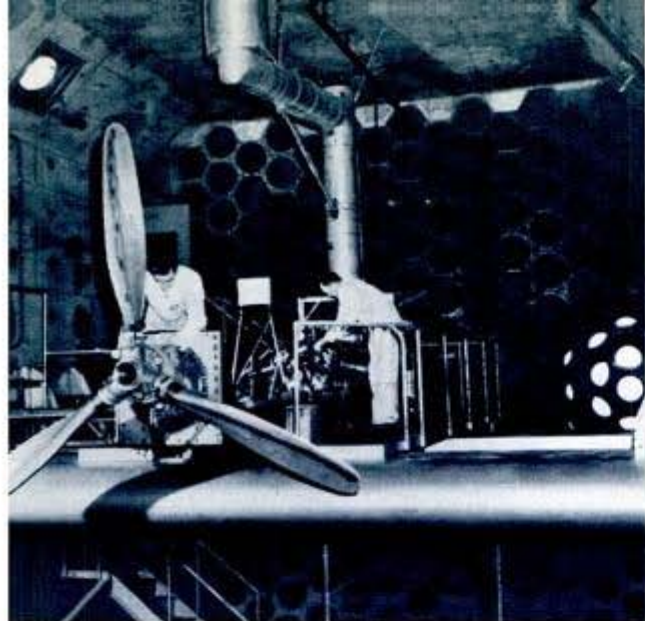

Advanced type hydraulic airplane propeller, above, is prepared for a vibration test with an Allison engine. Vibration stresses will be measured and eliminated at all speeds in the propeller's operating range

It takes big industrial machines to build big machines of war. Above, at the right, a gigantic riveter in a Chrysler factory pounds away on a tank for the Armored Forces. Welders can now do the job faster

Sheet steel that once rolled into automobiles and stoves rolls now into tanks and ships. Right, a steel ribbon comes from three-stand tandem continuous cold-reduction mill of Carnegie-Illinois Steel Company

Twenty-eight-ton monsters ready to crawl out of the Chrysler Tank Arsenal—America's largest—for 75-mile test run. They will be armed with 75-millimeter guns. This factory was a cornfield a few months ago





↑  
 Biggest of their kind are the two 5,000-horse-power electric motors built to power a plant producing aluminum for fighting planes. One of these powerful twins is shown here on test at a Westinghouse factory where it was completed months ahead of schedule as rush job for war program



←  
 This is another giant of the power industry—an Ignitron, the "traffic cop" that changes alternating into direct current required for the manufacture of aluminum and magnesium. The mechanic is lowering the anode assembly into the Ignitron casing, which is cooled by encircling copper coils

→  
 Another big machine for changing alternating current into one-directional flow is this rotary converter, used by a chemical company in producing an important element in the gasoline that powers American war planes, tanks and jeeps. The process is electrolytic, and this converter is capable of supplying 5,400 kilowatts of electric power—enough to drive an electric railway train



Inspecting coil windings for a hydro-cooled turbine generator to supply New York 50 million watts. Its 90-ton outer and inner frames surround rotor spinning 3,600 times a minute →

Below, final tests are given a 40,000-horsepower motor built to fan 400-mile-an-hour gales through a wind tunnel at Wright Field, where models of Uncle Sam's planes are tried

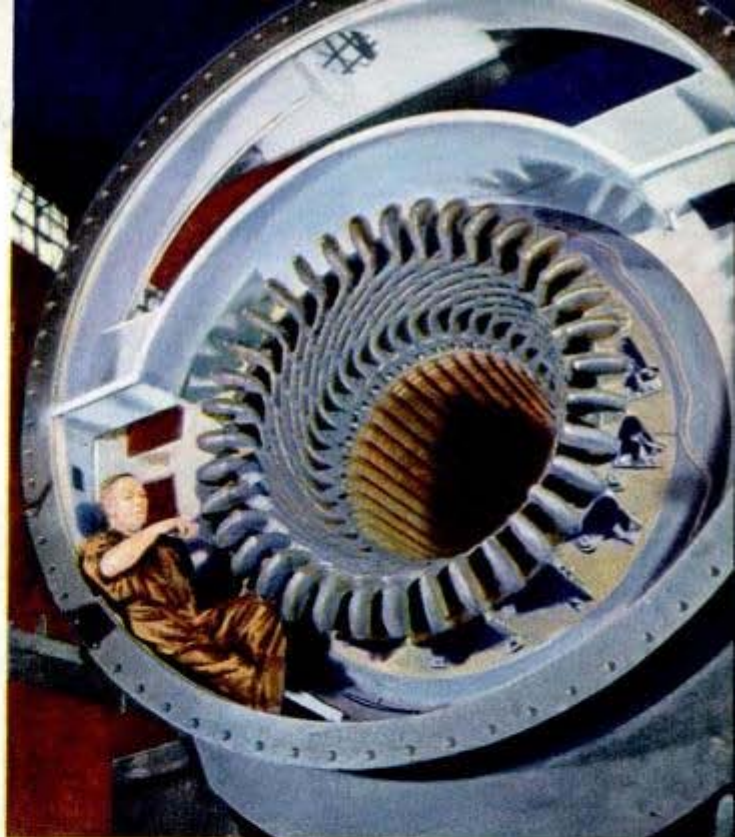
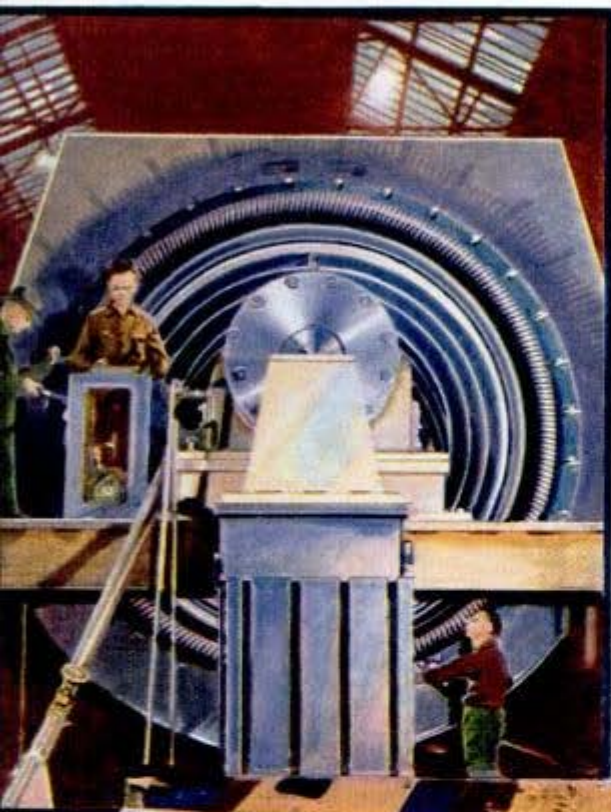

Under the guidance of a skilled craftsman, a machine bites its way into a solid steel shaft that weighs 60,000 pounds. It is cutting a keyway to hold in place the spider-shaped rotor of a waterwheel generator ↓

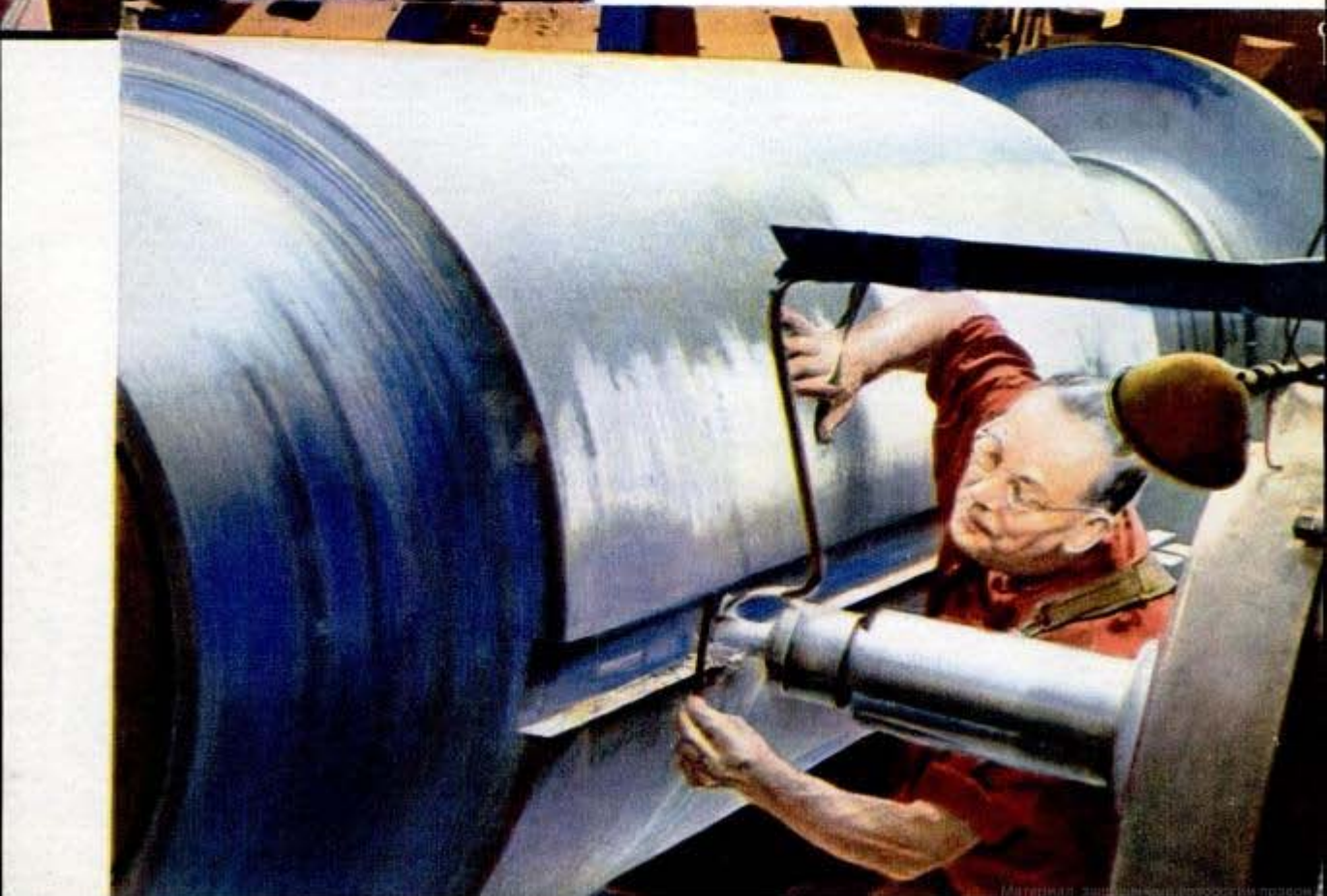

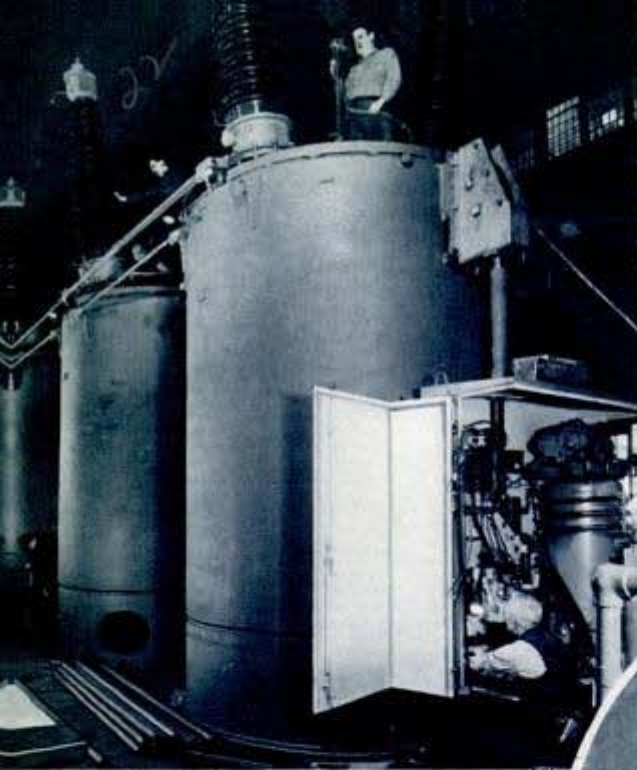

← These three tanks protect generating equipment at a large hydro-electric plant against short circuits by lightning, flood, earthquake or sabotage. Capable of interrupting 2,500,000 kilovolt amperes in 5/100 second, the automatic circuit breakers extinguish electric arcs in oil

This is another view of the metal-clad rotary converter with which a chemical factory translates its "a.c." electricity into direct current for producing a vital element of aviation gasoline. The metal trailer-shaped housing prevents chemical fumes from reaching the converter

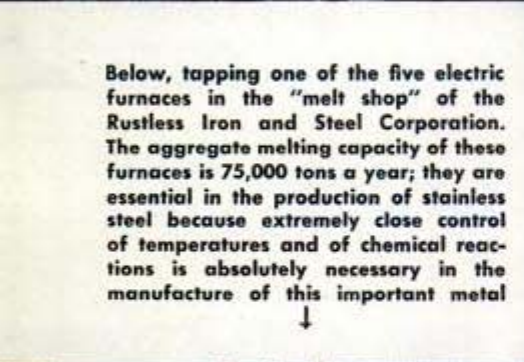

Below, tapping one of the five electric furnaces in the "melt shop" of the Rustless Iron and Steel Corporation. The aggregate melting capacity of these furnaces is 75,000 tons a year; they are essential in the production of stainless steel because extremely close control of temperatures and of chemical reactions is absolutely necessary in the manufacture of this important metal

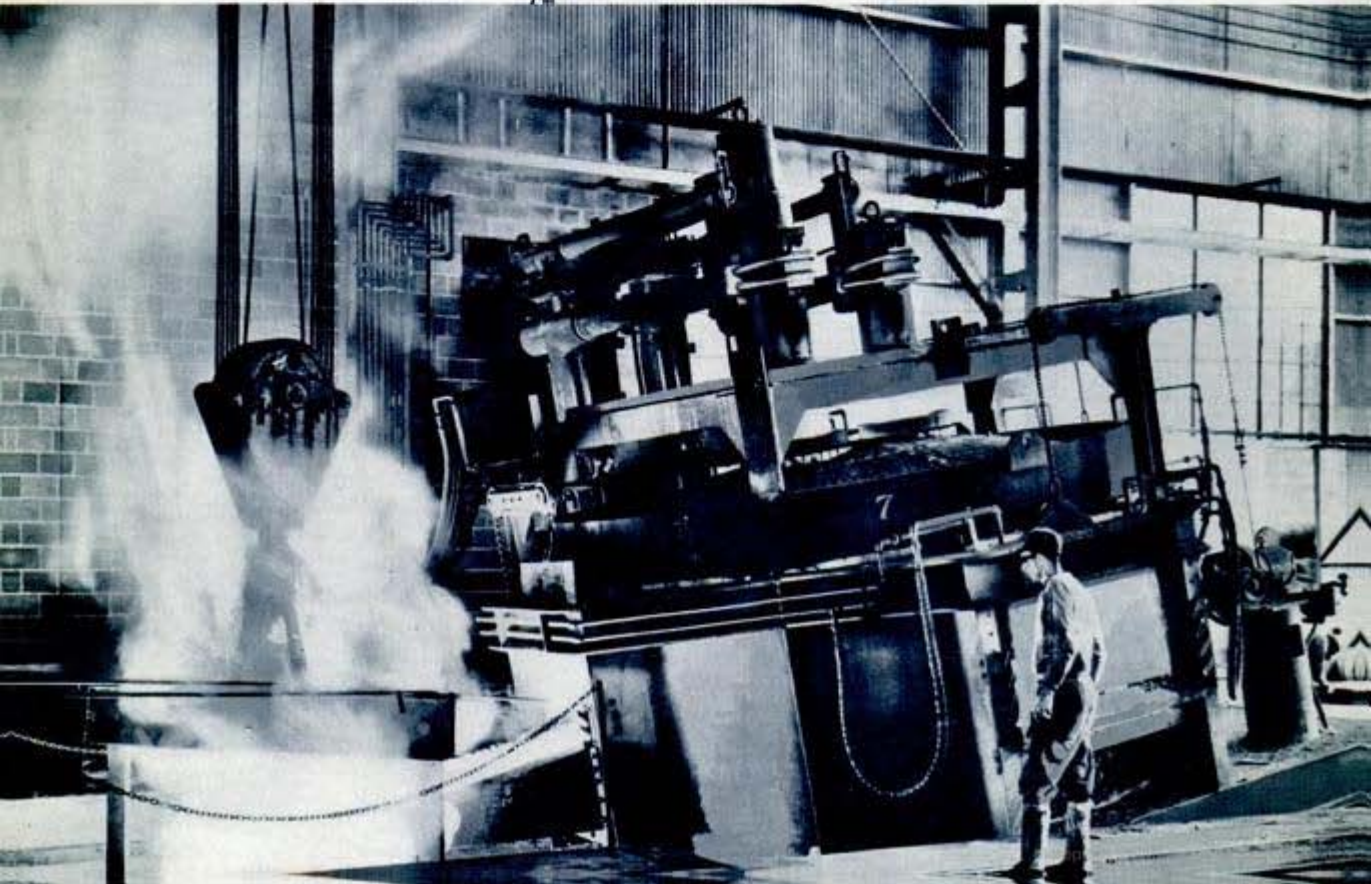
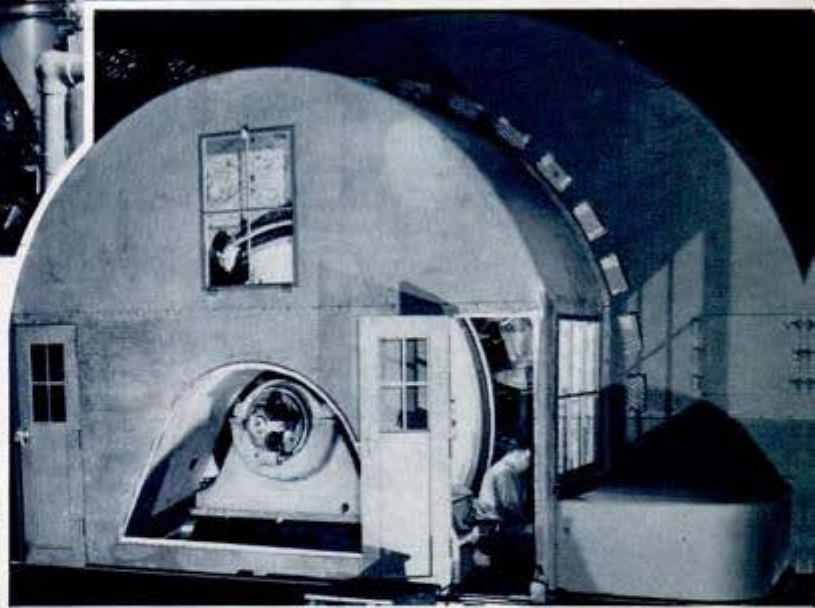



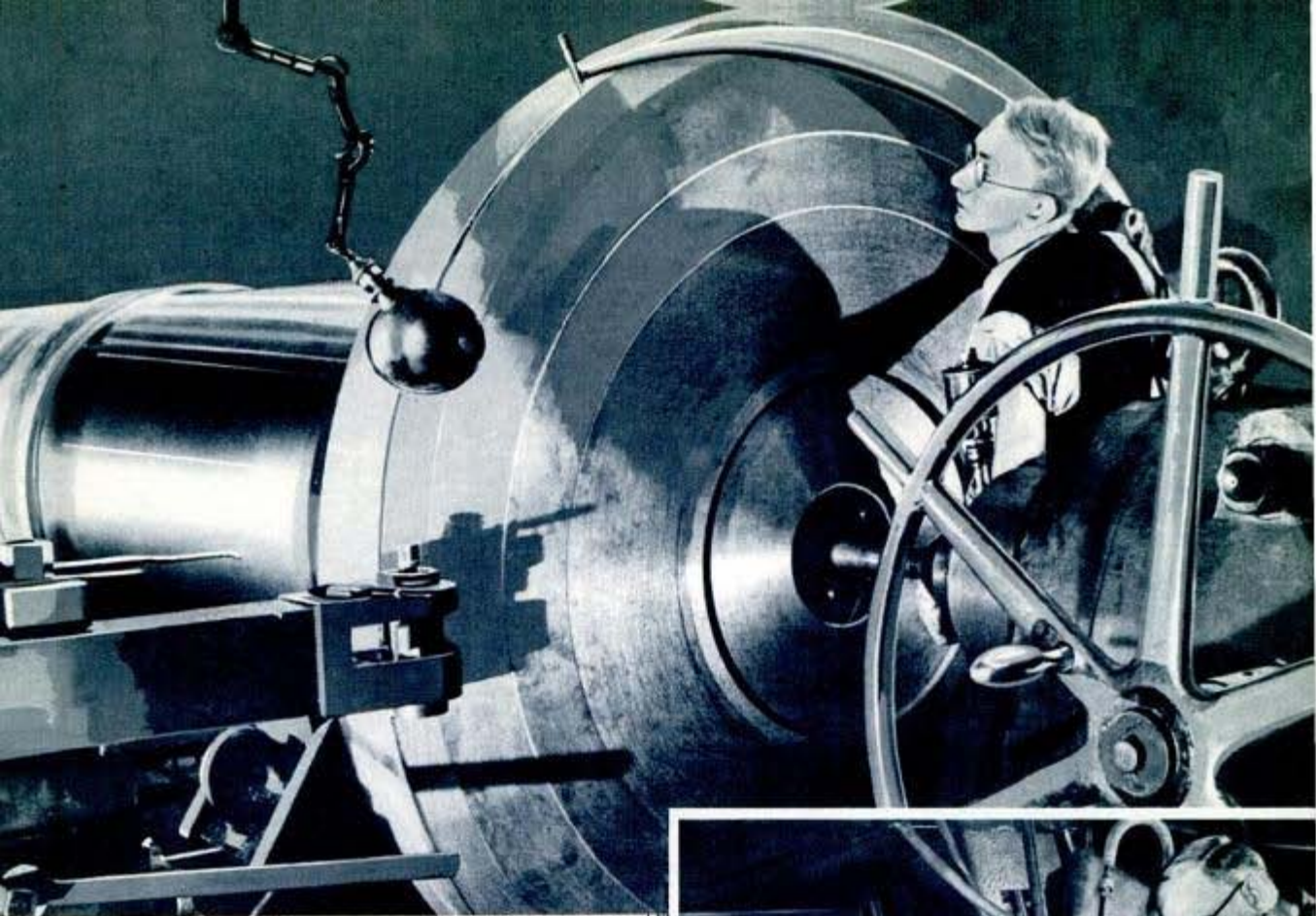

↑  
Three of the largest waterwheel generators ever constructed were shipped from the Westinghouse plant at Pittsburgh to the Grand Coulee power project in Washington. Here a machinist is checking the flange diameter of the shaft for the first of the generators

At control board the operator awaits a signal to start an Allison engine for a propeller test. Each type of propeller must pass three basic tests and meet rigid Army specifications. The tunnel and laboratory are equipped for both liquid- and air-cooled engines

↓

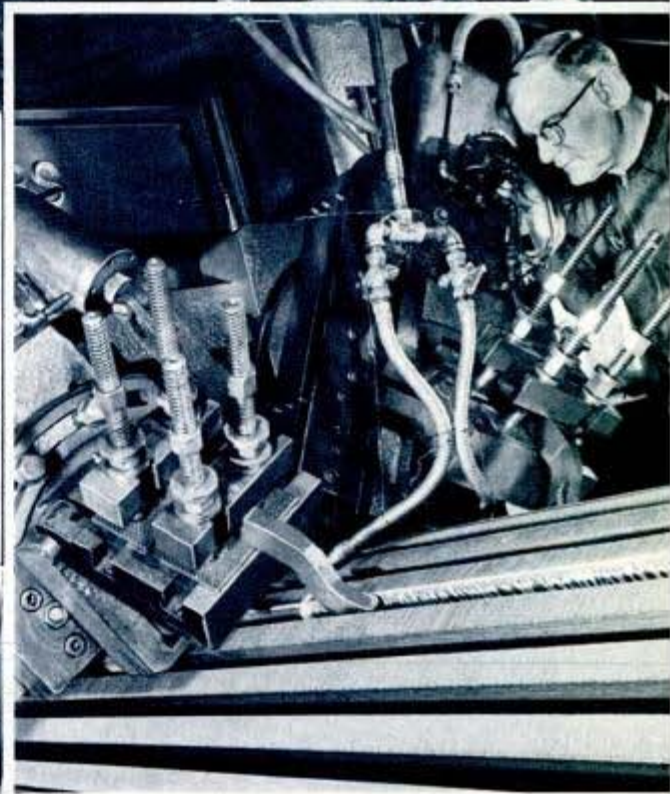

↑  
Steel cutting tool grooves slots in a rotor for large electric generator; slots in this steel cylinder are for insertion of coil windings. The operator, a veteran of 41 years service, speeded production 40 percent by suggesting a compressed air device that automatically lifts cutting tools while 14-ton rotor glides into place for next stroke



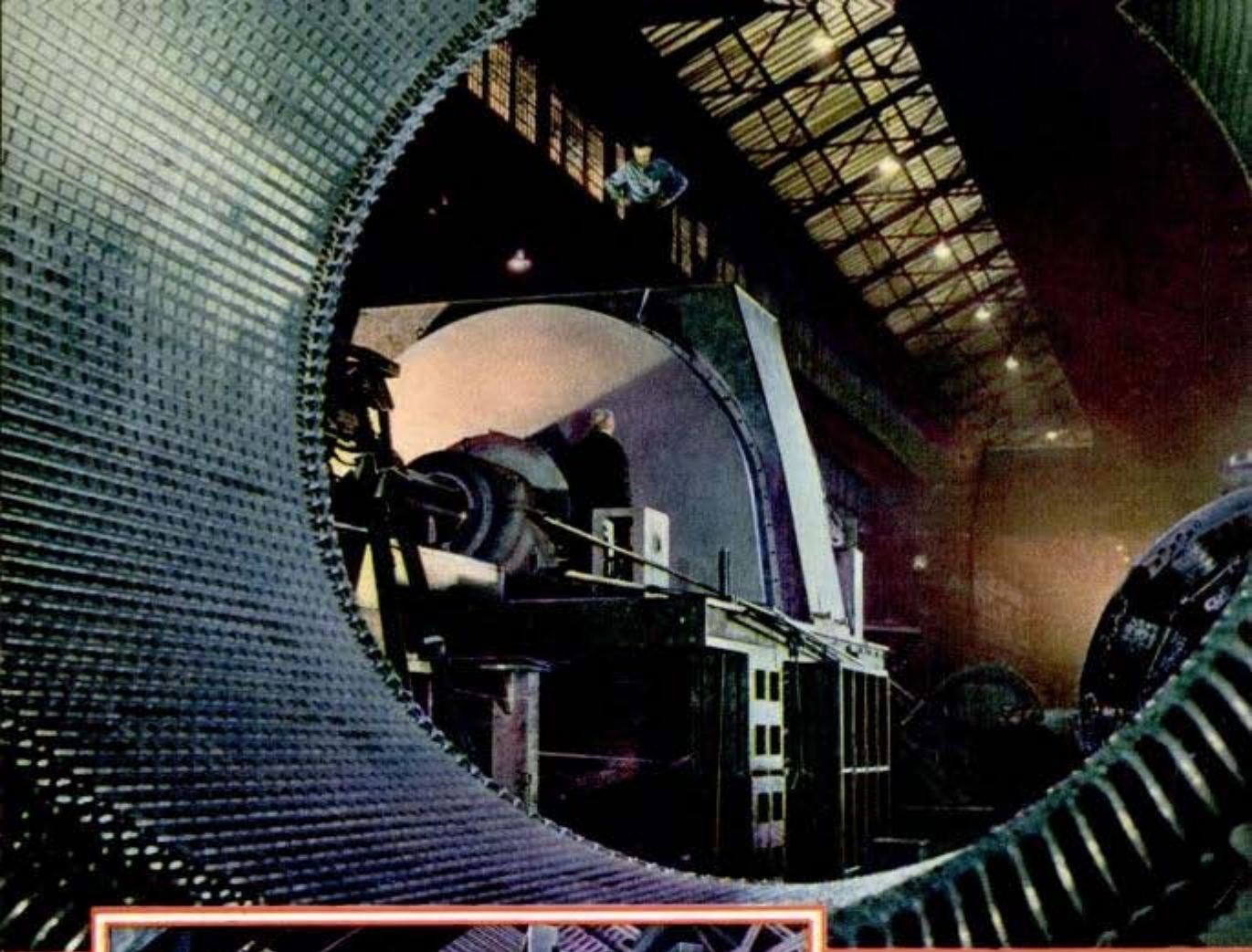

↑  
This is a wind-maker in the making. The fans powered by this 40,000-horsepower motor were designed to drive air at 400 miles an hour through the new wind tunnel for testing plane models at Wright Field

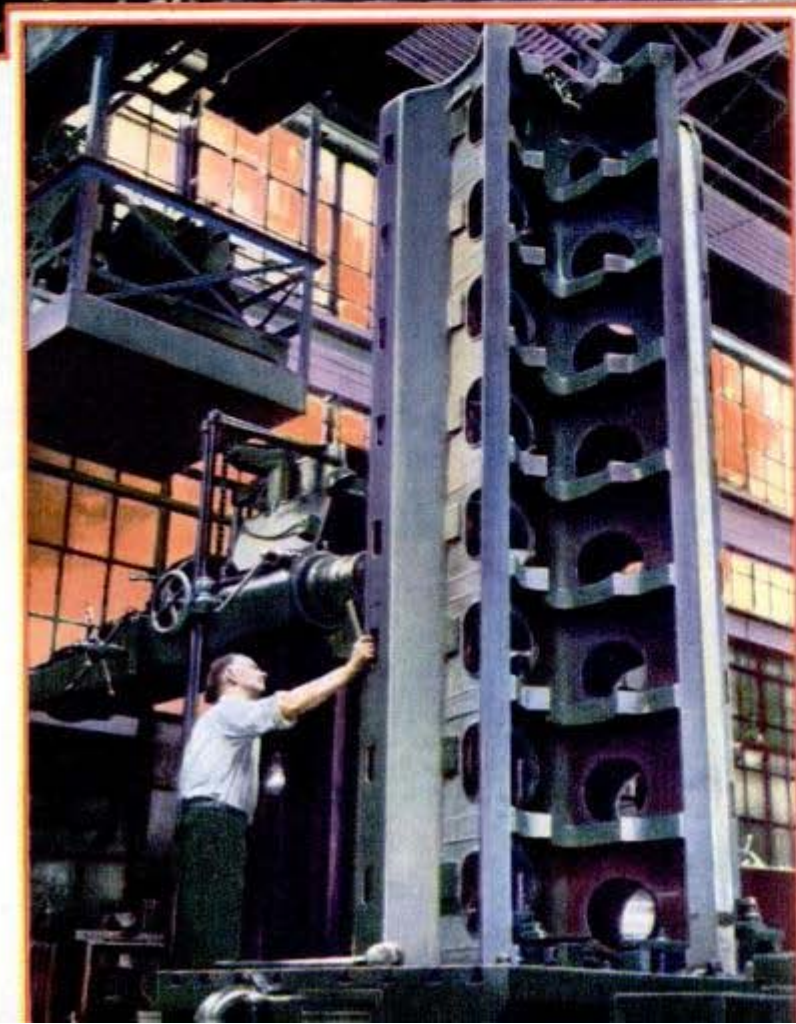

Dwarfing the men who build it, the enormous Diesel engine cylinder block at the left may already be at work in the engine room of some U. S. Navy vessel. Here it is being machined by a large horizontal boring mill in a General Motors plant where virtually the entire production is devoted to propulsion machinery for Uncle Sam's fleet. Diesel engines, too, are built in tremendous numbers to drive the Army's tanks, trucks, big guns and tractors

# Saving the Normandie Is a Tricky Balancing Act

Accustomed as they are to tackling the "world's biggest" jobs in building construction, electric power generation, factory production and dam building, American engineers have taken on a staggering task in salvaging the U.S.S. Lafayette, once the Normandie of blue-ribbon speed and fabulous luxury.

Her hull, about 54,000 tons deadweight, lies at an angle of 80 degrees in cramped quarters between two piers in the North river at New York, the keel at its stern

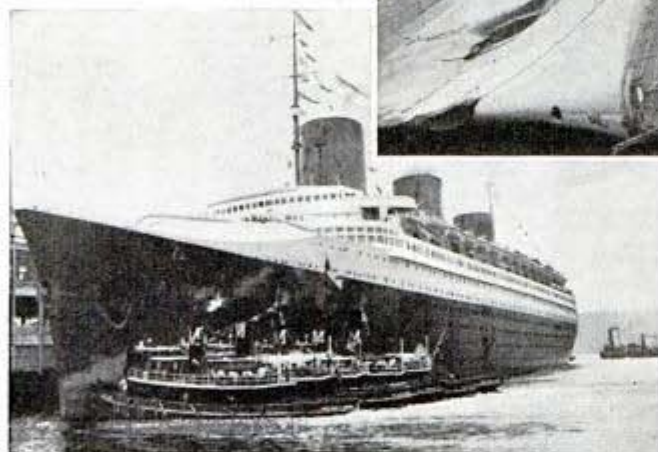
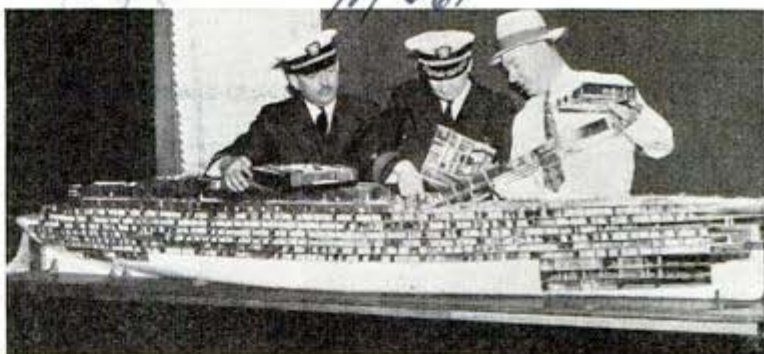

A model (top) of the flame-scarred Normandie, now on her side in New York harbor, aids engineers mapping salvage job. At left, the luxury liner in happier days

jammed under one pier where it has broken several supporting piles. Inside the ship lie 100,000 tons of water and silt so dense the most powerful submarine lamps cannot pierce it and divers must walk and work by sense of touch alone. The Navy board which appraised the job ahead said this of it: "The salvage of the U.S.S. Lafayette will undoubtedly exceed in both magnitude and complexity any salvage operation hitherto undertaken." It will require more than a year.

Ultimate objective of the salvagers is to pump air into the flooded sections until the ship rights itself by its own restored buoyancy. On paper it sounds simple. But first of all it entails the complete removal of all the superstructure above the promenade deck and cleaning out all inflammable ma-

terials above water. Ladders, staging and passageways must be provided for accessibility. Passages of ample height when the ship was on its keel are so confined in its present position that divers must crawl through them. About 375 portholes, 14 cargo ports and innumerable scupper and drain pipe openings on the submerged port side must be closed with concrete, timber or steel patches; hatches closed and watertight bulkheads built to prevent water shifting as the pumps begin their work. There are 10,000 cubic yards of mud to be expelled.

Extreme delicacy is essential in restoring buoyancy, for a sudden shifting of balance would probably have tragic consequences. The Lafayette rests partly on mud and sand, but toward the bow it is balanced on rock that acts as a fulcrum. Since the ship heeled over, it has been steadily settling by the stern with a corresponding rise of the bow, and one of the first tasks is to lighten the weight at the stern.

# "Aerial Octopus" Snares Enemy Sky Fighters

M 618

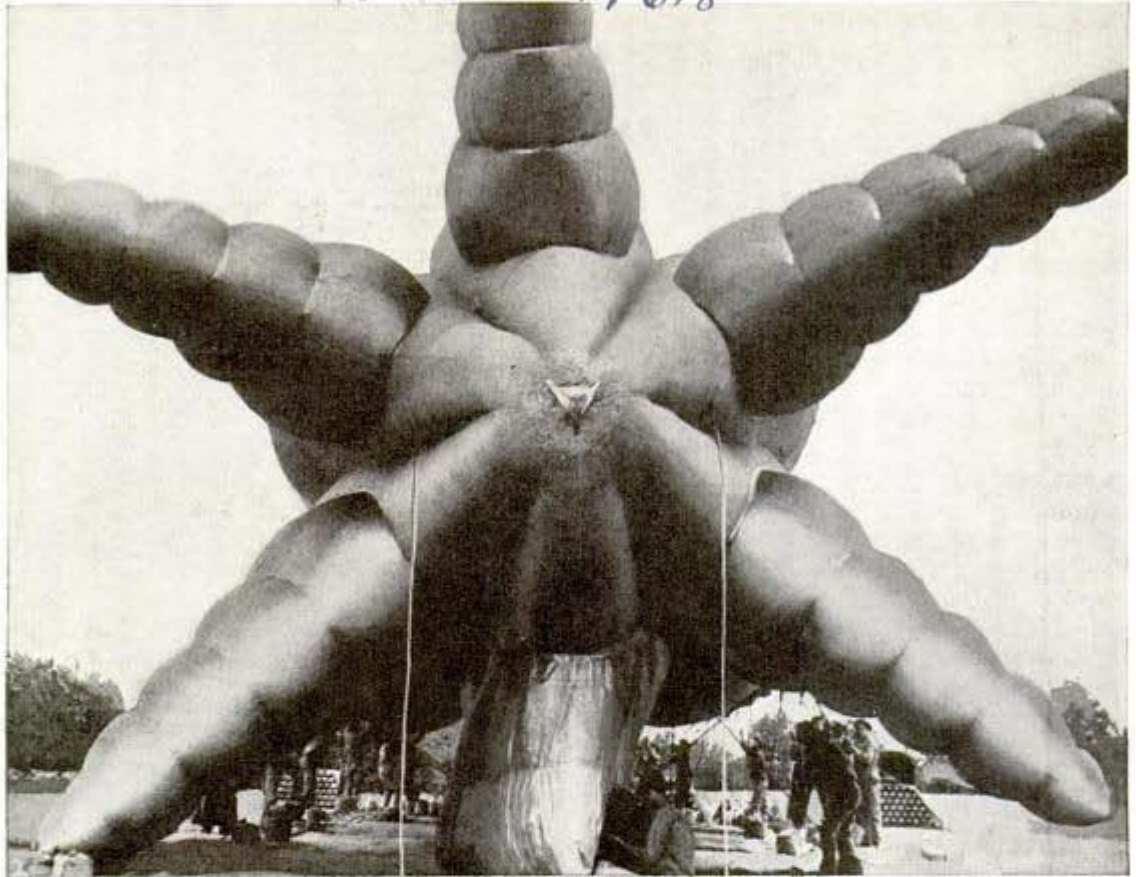

Barrage balloon swells to elephantine proportions as gas inflates the bag for its skyward journey

Six "hefty" arms outstretched at the tail end of a barrage balloon give it the appearance of some strange inhabitant of the sea, as an octopus or starfish. The lower fin, shown collapsed in the picture, is the

last one filled with gas as the balloon begins to rise slowly from the ground. Crews in training at Camp Tyson, Tenn., are learning how to send these gas-bags aloft as protection against raiding bombers.

## 30-Passenger Army Trailer Carts Men About Air Field

Large groups of cadets can be moved quickly around an air field in an open carry-all wagon drawn by a small "peep-like" tractor. Affectionately called "The

Drip" by the flyers, the trailer has room for thirty men and their equipment. Similar units are expected to be used widely on air fields and in military camps.

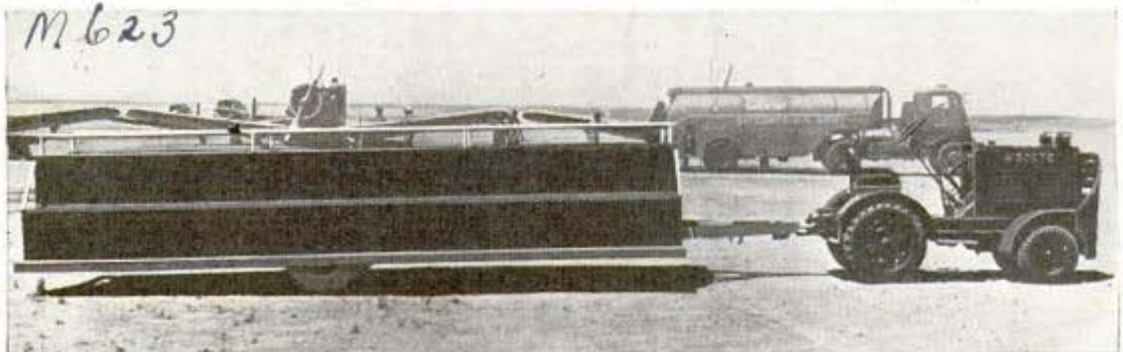

Trailer "bus," towed by tiny tractor, saves time of cadets when large groups are moved long distances

# 'Chutists Drill in Storm Kicked Up by Blower

M 692



Wind machine creates artificial storms for paratroops learning the tricks of handling their 'chutes

Parachute jumpers of the U. S. Army know how to keep themselves from being blown along the ground when storms whip viciously at their cavernous "envelopes,"

because of early training received at Fort Benning, Ga. When a windstorm is needed for training purposes, the army uses a wind machine that creates a powerful blast.

## Flame Thrower Attacks Pillbox Under Rifle-Fire Cover

M 639

"Fight fire with fire" is advice taken literally by United States Army forces. Having observed the successful use of flame-throwing technique against pillboxes during the fighting in Poland, France and Russia, our army is producing highly skilled flame throwers in order to keep pace with Axis methods. During recent chemical warfare maneuvers, soldiers set up a covering fire while one of them carrying a flame thrower on his back poured a lethal stream of fire into a concrete pillbox.



While one of their group approaches pillbox with flame thrower, infantrymen among logs in foreground cover him with protective rifle fire

# SHORTCUT *to* TOKYO



Caterpillar Tractor Co.

Big "Cats" like this are moving mountains of earth to pave a way to Alaska for caravans of army supplies

By Roderick-M. Grant M581

WHEN they started building America's "Burma Road," the army engineers dropped from their vocabulary the word "impossible." They say, with the infinite reserve of a war communique, that it's "difficult."

That's putting it mildly. Travel is at its

best along the route of the new highway to Alaska when it's 30 degrees below zero and the snow trains can lay their own tracks. Over the frozen rivers and through narrow forest lanes the Caterpillar tractors drag sled trains laden with supplies, some of them resembling a caboose on skids. At

a clearing in the woods one train turns off the trail to await the down-bound train like a freight on the railway siding.

In summer certain difficulties arise. Man-eating flies and mosquitoes swarm. Thaws send ice floes down the rivers, and floods spill into marshy pockets. Bulldozers and scrapers crash through thickets and saplings, skim the crust off the muskeg and are swal-

The Corps of Engineers built this trestle on the pioneer road that precedes the permanent highway





U. S. Army men lay planks across a frozen river in northwest Canada to help support the loads of road building material rushing north before the ice thaws

lowed up in ooze 15 feet deep. You might describe the country as impassable, but that word is also stricken from the vocabulary of the Corps of Engineers. The army wants a short cut to Alaska the worst way, and it's getting it with impossible speed. A short cut to Alaska is a short cut to Tokyo.

Exactly 75 years ago the United States bought Alaska from Russia for \$7,200,000. Critics called it "Seward's Folly," but it was a bargain at any price. Alaska is the base for any thrust across the north Pacific; it flanks any attack striking at the North American coast; enemy bases in Alaska could pour streams of bombers into our cities. Take a piece of string and stretch it across your globe from the Panama Canal to Tokyo. It shows that the shortest route from the canal to Japan and Vladivostok touches the Aleutian Islands.

In the last few years we have spent ten times its original cost to begin fortifying Alaska. Now we're spending 30 or 40 million dollars to build a road to the back door.

It will be a road like no other. Here, for the first time, highway follows airway.

It was only yesterday that caribou trails alone crossed this British Columbia wilderness. The Indians followed the caribou, fur traders and trappers followed the Indians. Only last year Canada completed a chain of air bases from Edmonton, Alta.—jumping-off place for the radium and gold

Double lines on map mark the new highway, which follows the chain of airports Canada built last year

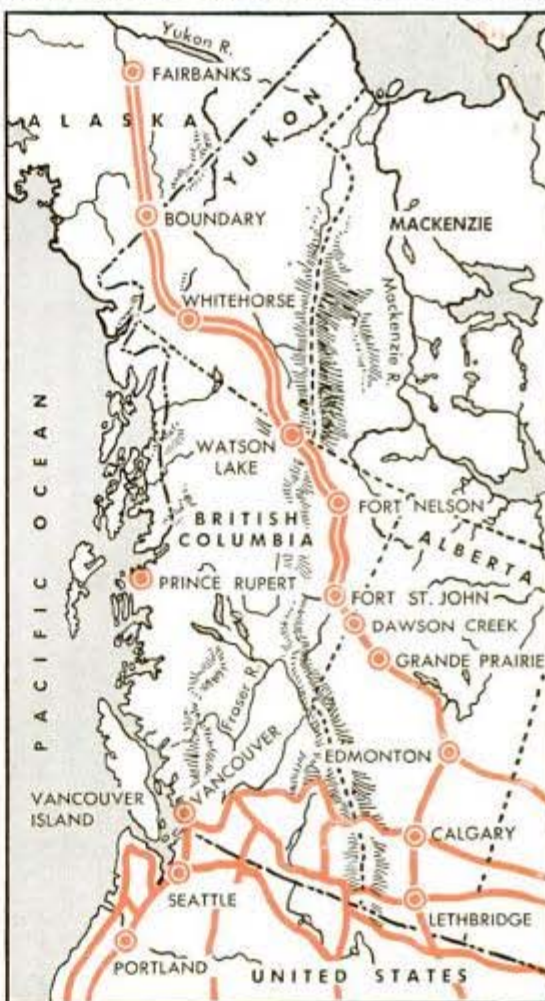



The ubiquitous peep pauses at "Broadway and 42nd street" in a winter camp of the Army Engineers on the short cut to Tokyo

Somewhere in the winterbound wilderness a big shovel gets a lift from a tractor. The pioneer road is to be finished in a year



mines, the oil fields and trap lines of the north country—to Fairbanks, Alaska. Those air fields are the anchors of the new highway.

A full week before Canada and the United States actually agreed formally to the terms of the project, a 26-car trainload of troops from the states with jeeps and trucks, road machinery released from CCC camps, field kitchens and tents reached rail end at Dawson Creek, B. C., and overnight the hamlet of

one hotel, two stores and a cluster of houses, became the booming base of the road to Fairbanks.

Thirty miles north of Dawson Creek is Fort St. John, starting point of a winter road to Fort Nelson. Once the spring thaw set in it would be a quagmire, and the hundreds of American soldiers began the struggle in early March to push a fleet of ten-wheel trucks and gasoline trailers and road machinery up to Fort Nelson while ice still paved the trail. From Fort Nelson, bush country guides with dog teams led army reconnaissance units on to survey the route to Watson Lake, site of another air field, and westward across the Continental Divide—north end of the Rockies—into Whitehorse in the Yukon. From there the road strikes northwestward to the Boundary airport and thence to its terminal at Fairbanks, Alaska. Along those bleak miles the engineers step now and again upon the trail of the prospectors who fought their way here in the Klondike Gold Rush. At Watson Lake a band of 50 luckless gold hunters reached the end of their trail in 1898 and died of starvation and disease.

It's 1,200 miles from Edmonton to Fairbanks, and there's a problem for every mile. After the political problem, settled by the agreement that the United States



would build and maintain the road during the war and turn it over to Canada when peace returns, there came the topographical problem. The surveyors are settling that. Next, the job of getting men and supplies in. A pioneer road had to be surveyed and built to keep the truckloads of material flowing north. Over the Peace River and other water barriers a "bridge" of planks was laid to help support the heavy loads of equipment crossing on the ice before the spring break-up. Sawdust spread on the ice under the planks helped delay the thaw. When the ice did break, there would be a pause of



Crawling Diesels haul the "snow trains" laden with supplies. Usually there is a "caboose" serving as cookshed and dormitory

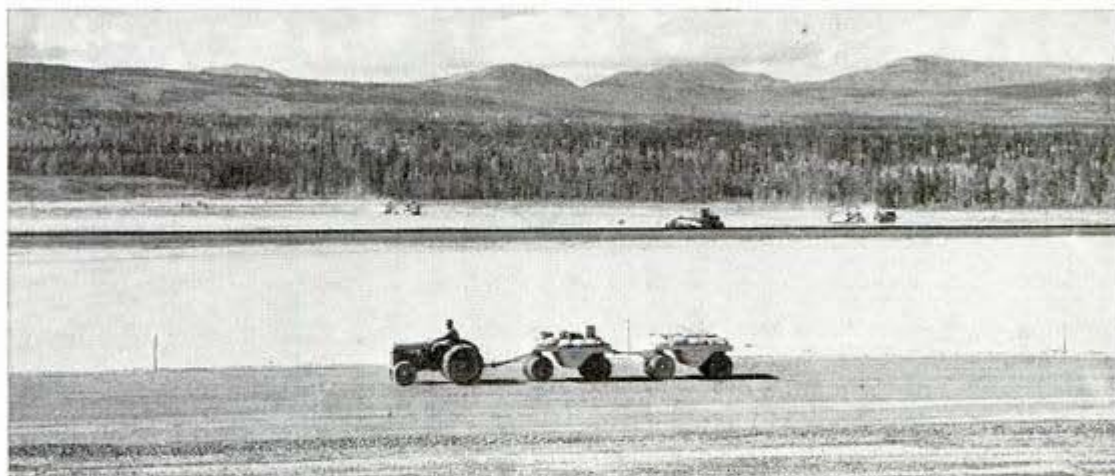

several weeks before the river cleared enough to reestablish the flow of transportation by ferries and ponton bridges. Until a surface is laid over the bottomless muskeg, the engineers at Fort Nelson will be isolated from the outside world for 150 days of the year, with airplanes the only means of bringing in food and equipment. At some work stations along the road cableways have been slung from lakes to hilltops to carry pipes for the camp water supply.

Even in the well-paved United States there are places where sinkholes continually undermine the highways. Bridging those hundreds of miles of quicksand and granite and muskeg in the

(Continued to page 170)

Not much more than a year ago this broad expanse of smooth air field was carved out of a wilderness of evergreen forest

Dog sleds, tractors, jeeps and airplanes all do their part in hauling men and supplies. Here a dog team skirts an airport



# Mesta Machine Co., Pittsburgh, Pa Giant Boring Lathe Hollows Out Huge Rifle

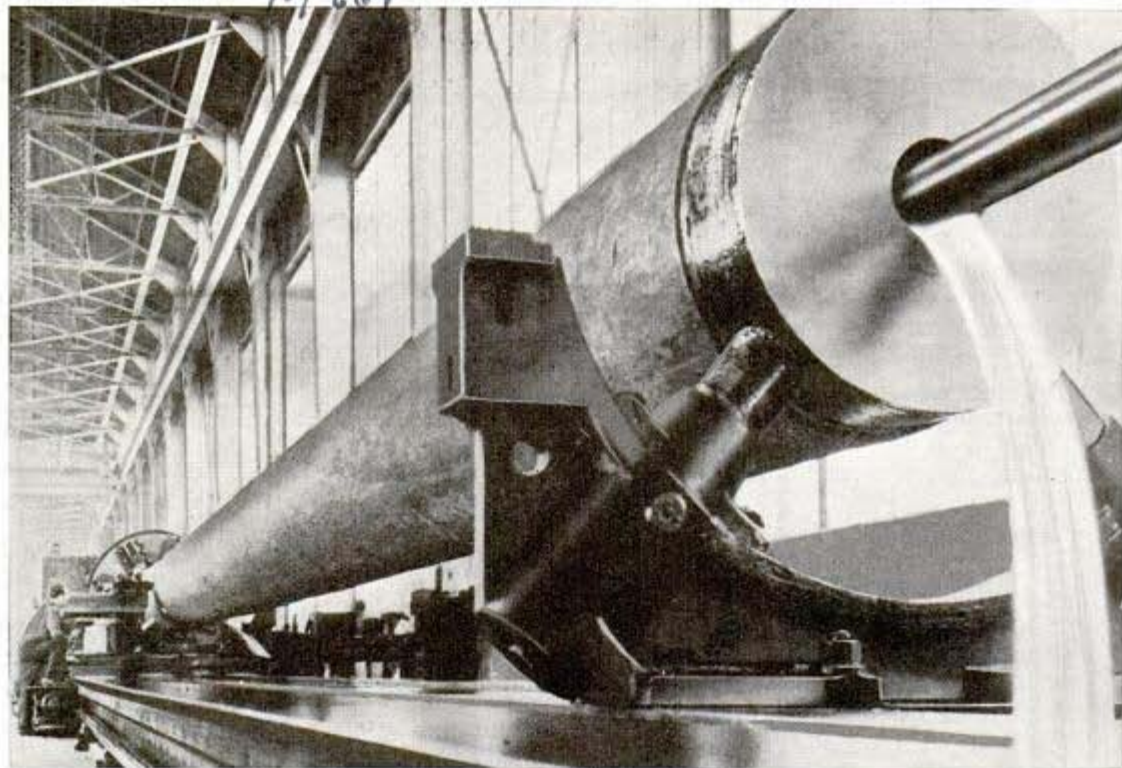

Workmen using an 84-inch boring lathe to hollow bore a forging for gun barrel nearly 70 feet long

Industry's largest tools have their part in creating gigantic engines of destruction needed to win the war. In one example of this, workmen may be seen hollow boring

a huge gun forging, nearly 70 feet long, in an 84-inch boring lathe, at a Mesta Machine company plant where big-scale production is in progress.

## Machine Gun With "False Nose" Screens Flash of Fire



Tubular extension at nose of machine gun hides the flashes that might otherwise aid hostile gunners in spotting the airplane's exact position

Flashes of fire emitted from a plane-mounted machine gun, as it spits death into enemy craft, can be hidden by a tubular piece fitted to the nose of the gun barrel. This .30-caliber Browning machine gun, a compact instrument of destruction, is fed cartridges by means of a belt, empty shells falling in a can under the barrel and used links flying into another container.

Look in the index to find where to buy articles described in this magazine. Say You Saw It in Popular Mechanics.

# Pigeons Carry Cameras to Spy for Nazi Army

Small cameras attached to the breasts of pigeons are being used by the Germans to get pictures behind the Russian lines. The cameras are equipped with automatic time releases that take photographs at intervals of about five minutes. Discovery of the use of birds as aerial spies was made by the Russians when the Germans abandoned six trucks equipped with pigeon coops. The booty included trained dogs that carry the birds in baskets to starting points.



Trained dogs carry birds in baskets tied to their sides to starting points where the roads are impassable

## Electric Dial on Riveting Gun Keeps Operation Uniform

War production may be speeded up with an electric control for rivet guns which permits only the number of taps required, makes the work uniform and reduces waste. The flow of compressed air to the gun is electrically controlled by a dial which may be regulated for any particular job. Hitherto, the riveter had to possess skill sufficient to apply just the right amount of pressure. If the invention proves successful in current tests it will reduce sharply the 200 hours of instruction required to prepare riveters for jobs.

## War Plants Hide Underground in Ancient Stone Quarries

British war factories and hundreds of skilled workmen are finding sanctuary from air raids in underground stone quarries begun in Roman times 2,000 years ago. Guided by quarrymen who alone knew their way about the dark caverns, surveyors mapped the quarries for the engineers who then laid plans for two factory sites. In the first site, a million cubic yards of space were added for the plant, but it was not necessary to widen or straighten the streets and avenues. Walls and roofs were painted yellow to bind the fine dust so it could not damage machinery. The second

underground factory is entirely air conditioned, the temperature being kept between 60 and 65 degrees. Elevators and moving stairways carry men and materials, and fluorescent lighting is used. The main restaurant is above ground, but a small room for making tea is underground, from which tea is delivered to the men and women at work. This factory is featured by a control room linked to all parts of the factory by telephone, loud speaker and microphone. A glance at the hourly production records tells the managing director how work is progressing at any section.

W 400 Cont. Thomas E. Stinson, Jr.  
3872 Franklin Av., S. A. Calif.

# NEW WEALTH from BLACK GOLD

the asphalt runways of air fields. Its white oils and petrolatums are necessities for the medical corps and its aromatic solvents are a basis of the lacquers used in camouflage. Submarines could be traced by oil spots on the surface if it were not for an unusual petroleum grease used to lubricate the fins of the underwater craft. Glycerin for nitroglycerin and 70 percent of the toluene used in TNT explosives are contributed by petroleum to munitions manufacture.

In fact, modern warfare is fought with petroleum. If it were not for the gasolines, fuel oils, and lubricating oils used by land, water, and air vehicles, the current war would be conducted at the tempo of the Civil

War. Our advantage here is that we possess more petroleum than our enemies and have super gasolines that give our airplanes more speed and punch. More than 60 percent of the world's output of crude oil is produced on this continent. This, ultimately, is going to give us superiority in the creation of synthetic rubber, another of the substances that is made from crude oil. One authority estimates that the Unit-

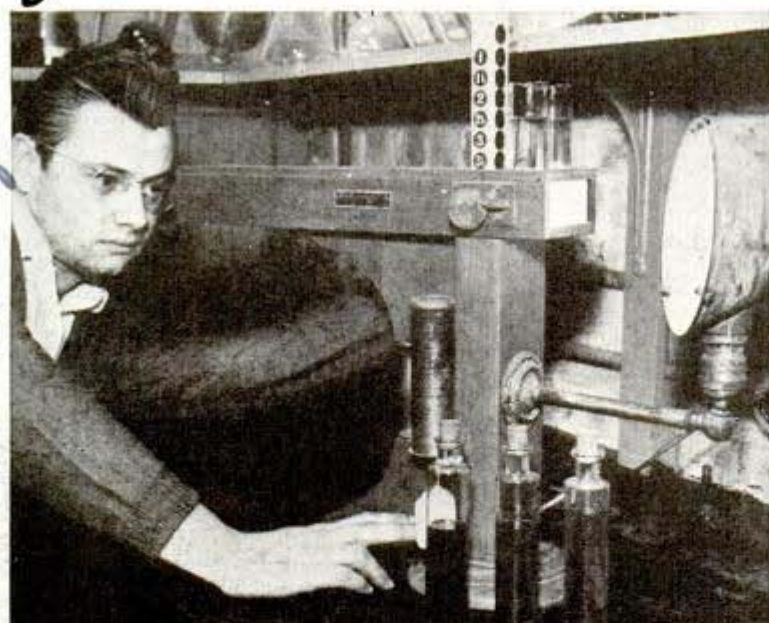

A petroleum engineer measures the opacity of samples of lubricating oils

**A** LADDIN'S wonderful lamp must have had a hydrocarbon flame, for no other substance has the magical qualities possessed by petroleum. Like the lamp in the story, this versatile oil can provide almost anything we wish.

Crude petroleum is a mixture of paraffinic, olefinic, naphthenic, and aromatic hydrocarbons. It ranges in quality from solid asphalt to almost pure gasoline. Its color may be cherry, green, yellow, brown, or dense black. Some crude oil is fluorescent and the oil from some fields is radio-active. Traces of platinum, gold, silver, and other metals are found in samples.

Today petroleum has joined the fighting forces and in a thousand and one ways is helping to win the war. It supplies wool oil for uniforms, furnishes the hard waxes that coat ammunition, and creates

Diagram shows how directional drilling from under one roof can tap oil sands over 1,000 acres

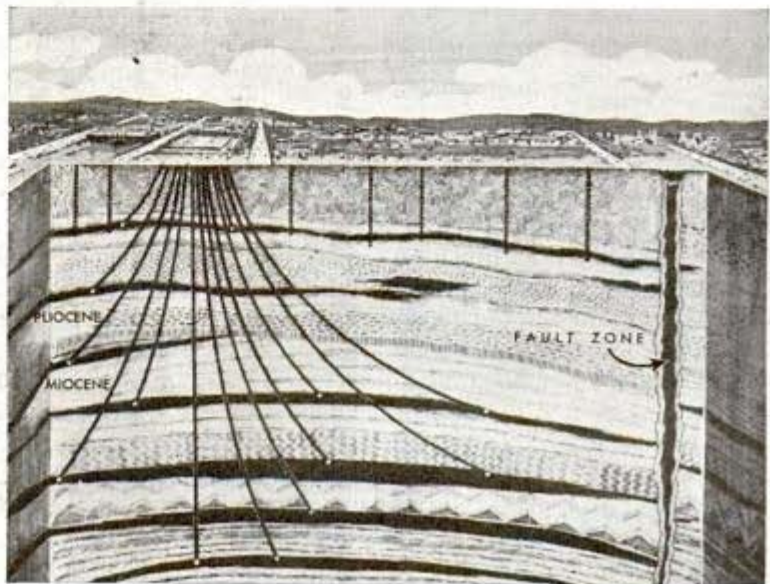

Ref. Lynn Talch, Public Relations Dept. Standard Oil Co. of Calif.  
Standard Oil Bldg., San Francisco, Calif.



Part of a big oil field is seen above through the spokes of drilling apparatus

ed States can more than make itself self-sustaining in rubber from its own vast hydrocarbon resources, some of this rubber being of a type that has 30 percent greater wear and strength as tire material than has natural rubber.

The contributions of petroleum to everyday life, even aside from transportation, are hard to total. It is the basis of a gas odor that makes gas leakages apparent, coal is treated with petroleum to make it dustless, an oil of petroleum keeps the leather plungers in bottling machines and other equipment soft and pliant, and an odorless and tasteless petroleum wax coats our paper milk cartons.

We use petroleum products in salad dressing, as movie fog, for airplane sky writing, for waterproofing vases, and for candling eggs. Fruit wrappers are insulated with a product of petroleum to avoid mildew, and petroleum paints keep the knots from drying out of knotty pine woods.

One of its oils is used as a float to prevent hot splashes from preserving kettles. A hydrocarbon chemical is used to roughen some of the surfaces in Diesel engines so that lubricating oils will cling to them, reducing scuffing and breaking-in wear by 90 percent.



Photo from Lane-Wells Co.

Lowering an electric gun into well to tap oil-producing zone. Each dimple on the barrel is a slug that will be fired into sands to drain off oil. Below is a night scene at the Richfield refinery





Expansion loops in hot oil lines at a big refinery

An asphaltic mastic painted on pipes prevents rust and corrosion underground. One sort of petroleum wax preserves our floors and another greases the ways for launching ships. An emulsified oil is used to waterproof adobe earth, which then becomes a satisfactory building material. Some of us heat our homes with fuel oil and keep them sanitary with germicides



Lane-Wells test apparatus being lowered into a well

and sprays compounded from petroleum.

At least one new plastic material has been created from crude oil, cosmetics and pharmaceuticals have been made from it for years, ethyl alcohol is another derivative, and an acid that attacks iron oxide is used for pickling steel plates.

All of these products are possible because chemists have found that they can take the hydrocarbons of petroleum apart and re-arrange them in different forms. Catalytic cracking, hydrogenation, polymerization, alkylation, and other processes developed in the last decade have been put to work on a giant scale. In the United States alone petroleum operations amount to a 14 billion dollars a year industry.

The refineries are busy increasing production, particularly of aviation gasoline, rubber, and raw materials for munitions. Emphasis is on production, but research has also been speeded up. Petroleum chemists are certain that there are many other raw materials in crude oil, not yet isolated, that can be put to use.

Now that we have become so dependent on petroleum it is important to know what our resources amount to. One pessimistic estimate is that the present known domestic reserves contain enough oil for no more than 15 years production, while a more optimistic point of view suggests that even without the discovery of new oil pools, the known oil shale and coal deposits will yield



Union Oil Co. photo

A research man tests the action of a new petroleum window-cleaning liquid under various conditions

enough oil for 20 centuries. Coal is petroleum's first cousin, and by hydrogenation can produce large quantities of gasoline and other oil products. Our known coal reserves amount to some three trillion tons. Converting coal into gasoline is expensive, but this might be offset by greater refining efficiency and more efficient engine carburetion, keeping miles per gallon cost low.

Oil drilling methods are being improved. The most interesting feature of this is the accuracy with which directional drilling can be controlled. Oil well holes can now be drilled in curves toward any desired direction and to within an accuracy, say, of 15 feet of a point 6,000 feet down and 4,000 feet to one side. This is done in part by placing steel wedges in the holes so that the drilling bits are forced to one side. The technique permits reaching far out under the ocean from beach locations and is also the basis of a proposal for "indoor" drilling to recover oil under residential areas.

In Los Angeles, for instance, a vast pool containing an estimated half billion barrels of crude exists under a fashionable residential district. No drilling is allowed. J. E. Elliott, petroleum engineer, proposes to recover the oil from inside a drill building that would avoid the ordinary noise, odor, and unsightliness of outdoor drilling. The plan calls for the construction of a building 75 feet tall covering up to 12 acres. Sixty-foot stands of drill pipe would be handled inside the building by roof hoists, eliminating the usual derrick structures. It is estimated that by directional drilling, some 1,000 acres of underground deposits could be tapped from the central building. The building would be soundproofed, include air conditioning equipment to wash objectionable odors from the air, and electric power instead of steam power would be used for drilling. There are several other potential fields in Los Angeles from which ordinary drilling is now barred and it is thought that oil deposits underlie residential portions of Oklahoma and Texas.

Some experts are coming to the conclusion that petroleum is being formed under the seas faster than we are consuming it. Attempts are being made to convert vegetable matter into alcohols which may then be changed into hydrocarbons, and chemists are also dreaming of the day when they will be able to combine simple hydrogen and carbon into the compounds upon which much of our civilization depends.

SEPTEMBER, 1942

*B. F. Goodrich Co.  
Akron, Ohio*  
"Guillotine" Tester for Tire  
Drops Plunger 92 Feet



Testing a truck tire for resistance to sharp blow

Truck tires are tested by the B. F. Goodrich company for their resistance to terrific blows with a special "guillotine" that drops a 37-pound plunger from a tower 92 feet high. The plunger travels downward at a speed of 52.4 miles per hour to strike a blow of 5,250 pounds on the tire. After this test the tire is examined for injury which would reveal flaws in construction.

Folding Pipe Locks Ashes In  
When Stored in Pocket

Tobacco ashes will not spill into your pocket when the swivel stem of a vest-pocket pipe is turned around to serve as a cover for the bowl. The folding pipe is useful for workmen who can take only a few puffs at one time, yet dislike to throw away the unsmoked tobacco.



The swivel stem turns around to cover the pipe bowl

*The National Briar*  
*Pipe Co.*  
*45 Morris, Jersey City, N.J.*

## Cushions Quiet Typewriter As Bars Hold It to Table

M452

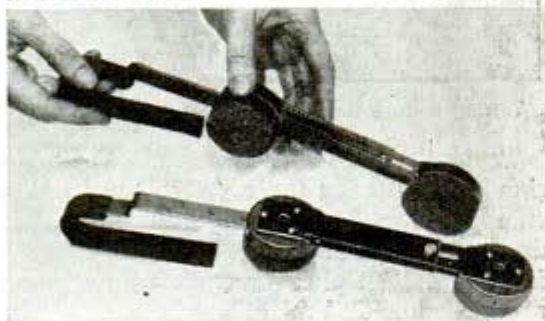

Legs of the machine are screwed to the pad holders

To reduce the pounding noise made by your typewriter, woolen cushions may be obtained for its legs. The pads are fastened to metal holders attached to brackets—one for each side of the typewriter. The legs of the machine are screwed to the pad holders and hooked bars covered with black felt hold the typewriter to the desk.

## Plastic Tips for Open-Toe Shoes Guard Hose From Soiling

M406



Plastic toe-tip inserts, available in various colors to match all hosiery shades as well as shoe colors, protect hose from rain, dirt and gravel without detracting from the smart appearance of the shoes. To produce spe-

*Dr. E. H. Evans, Jr.*  
*Univ. of Chi, Chicago, Ill.*  
cial style effects, contrasting colors may be worn. It is only necessary to push the toe tip into the toe of the shoe, to convert an open-toe shoe into a closed-toe shoe.

## Animals Use Carbon Dioxide For Growth Like Plants

M430

Animals as well as plants use carbon dioxide to build up cells and tissues, according to a discovery announced by Dr. E. A. Evans, Jr., of the University of Chicago. This finding was based on the tracing of radioactive carbon atoms in food fed to the animals studied. The "tagged" atoms were found later in muscle and liver tissues. Water solutions from dried liver were found to contain enzymes able to convert carbon dioxide into organic molecules. Hitherto it was thought that animals expelled all carbon dioxide as waste.

## Postal Scale Shows Mailing Cost Instead of the Weight

Weighing letters up to and including the three-ounce rate, a balance scale made of plastic shows the cost of mailing the letter instead of indicating its weight in ounces. In three small windows the figures two, three and six appear until a letter weighing more than one ounce is placed upon the platform. These figures represent the one-ounce rate for letters directed, respectively, within the local post office area, outside the area but within the United States, and for domestic air mail service. For heavier letters the figures tell two and three-ounce rates for each type of service.

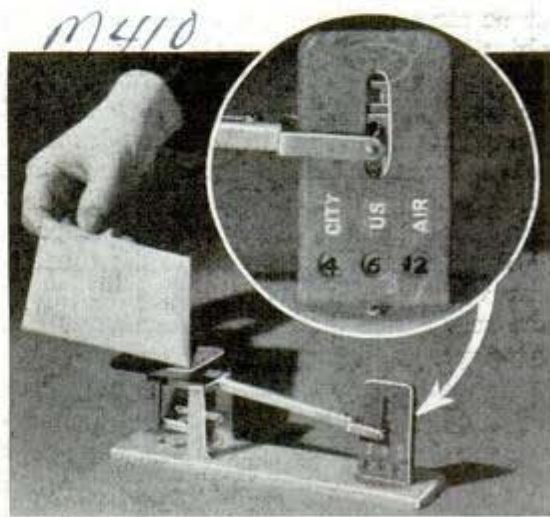

Scale indicates city, domestic and airmail postage

POPULAR MECHANICS

*Beverlycraft*  
*Beverly Hills, Calif.*

*Dist. Gardner's Inc., Indae Mart, Chicago, Ill.*  
*Dist. Sears Roebuck & Co State & Gen. Bureau, Ill.*



# Actor "Tailors" Features With Plastic Makeup

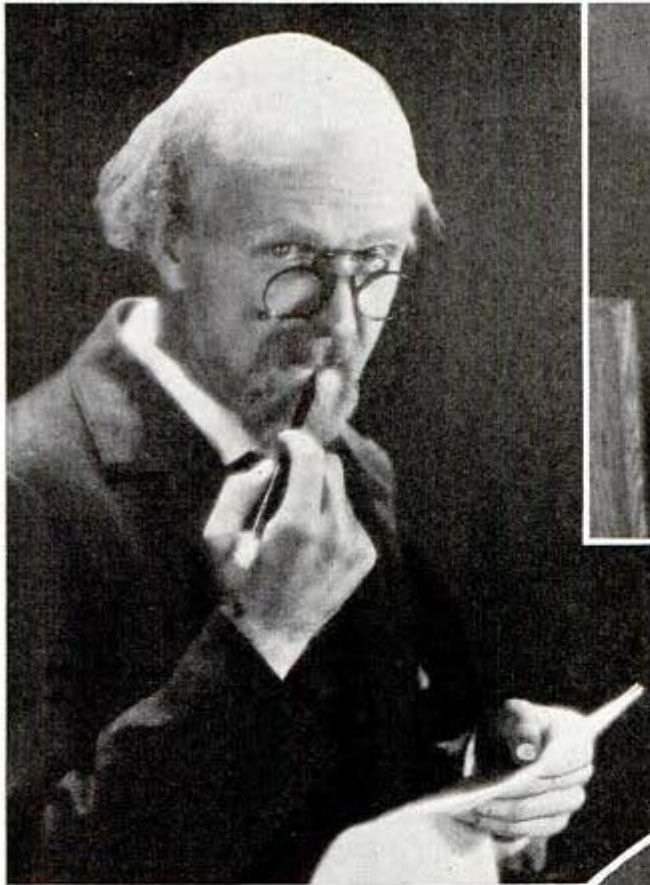

Plastic nose and brows fit perfectly, for they were made from a plaster model of the actor's head. The "rubber" features are smoothed out so no dividing lines show and they are tinted a flesh color. The plastic, flexible enough to permit a normal show of emotion, will not crack or lose shape under the hot studio lights

Handed a script for a new movie role, Lucien Littlefield, the character actor, studies it and decides he should have a new nose, a slight sag to his jowls and changed contour of his cheekbones. This is a simple matter for Mr. Littlefield, a student of makeup since the age of 10, who has developed a process for making artificial features with plastics to eliminate painful skin-stretching or padding



Molding clay is applied to the plaster model, changing the features. Above, the actor is enlarging the eyebrows for a sinister appearance. After the clay is molded he makes a plaster-of-Paris cast, lines it with a thin layer of absorbent cotton and pours the liquid plastic into the parts where the features have been altered. When set, the plastic nose, brows, cheeks or other features are carefully removed. At left, Mr. Littlefield is lifting the cast from the full-sized model. Clay is scraped off and the model is put away till a new script appears

Mr. Grant M 369

# GIRLS *in* OVERALLS



Two former drug-store cashiers torch-welding stainless steel at North American Aviation factory

for women's war work by sewing a flag. Women are still more skillful than men at that sort of work; modern Betsy Rosses are sewing barrage balloons and patrol blimps, rubber life rafts and silk parachutes and airplane wings, not to mention a few million uniforms.

But industry has so mechanized itself that there is scarcely a job too heavy for the ladies. Their dexterity, accuracy, and aptitude for repetitive tasks make them adept at handling assembly of small parts, using hand tools, and such erstwhile

**WANTED:** 6,000,000 women.

It's a sign of the times. If there was a faint echo left of that old refrain—"it's a man's world, and woman's place is in the home"—it has faded completely now. Manpower is not enough to win a war today.

At the start of 1942 a half million girls and women were in overalls, and by the year's end 6,000,000 may be at work in war industries and essential services. That would be 40 percent of the war labor army of 15,000,000 Uncle Sam wants on the job by December 31.

Several wars ago Betsy Ross set the style

masculine machines as drill presses, punch presses, lathes, and welders. And lately the introduction of automatic machinery and lifting and positioning devices has made it possible for women to handle really big stuff we used to think was "For Men Only." At the Glenn L. Martin aircraft plant, for example, the engineers have worked out new manufacturing methods and installed new devices so that women employees could operate unusually heavy machinery.

The girls seem to like building bombers and fighters, for there are more than 15,000

A small army of women at the Goodyear plant fabricate flotation bags for airplanes, life rafts, balloons, etc. (left). Right, a girl in overalls operates automatic riveter in the Glenn L. Martin bomber factory

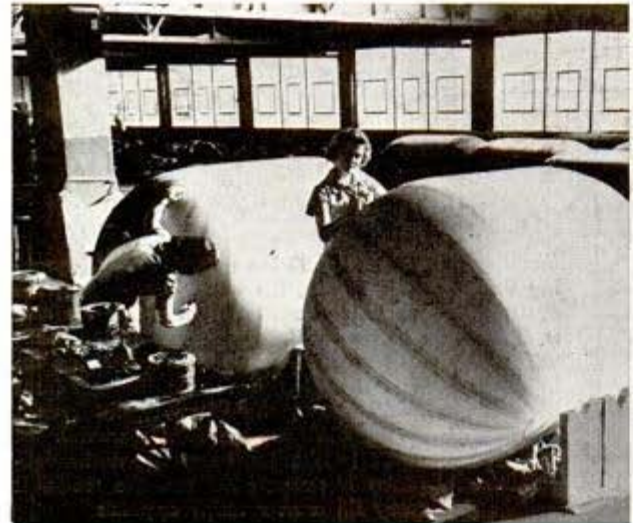



Douglas Aircraft Co. photo  
Thousands of girls work in the Douglas plant. They wear slacks-style uniforms for comfort and efficiency

of them in the airplane factories and they're doing every job imaginable. One girl applied for a place as stenographer in the Ryan Aeronautical works but they found out she'd studied drawing at the Kansas City Art Institute and now she's doing perspective drawings for the engineers. Another, a crack shot with a pistol, became the first of her sex on Ryan's plant protection force. Douglas Aircraft discovered that women have "what it takes to buck rivets—or any other wartime chore," and the delusion of feminine frailty went out the window. Girls who had built their own radio stations, raced and repaired automobiles, and one who welded fuel tanks in the first world war are doing anything from aluminum welding, turret lathe operations, handling rivet guns and assembly-line installations on Vultee planes down to electric wiring and radio assembly and sewing fabric on ailerons, rudders and elevators. A Kentucky school teacher supervises 50 girls using precision gauges and test apparatus at the N. A. Woodworth factory, producing a hundred different airplane engine parts. In the Texas plant of North American Aviation they call them "planes-women"; a one-time interior dec-



Girl at left bucks rivets driven by gun at right in assembling fuselage bulkhead for a Vultee plane



Masks protect girls from fumes in paint shop at Vultee Field

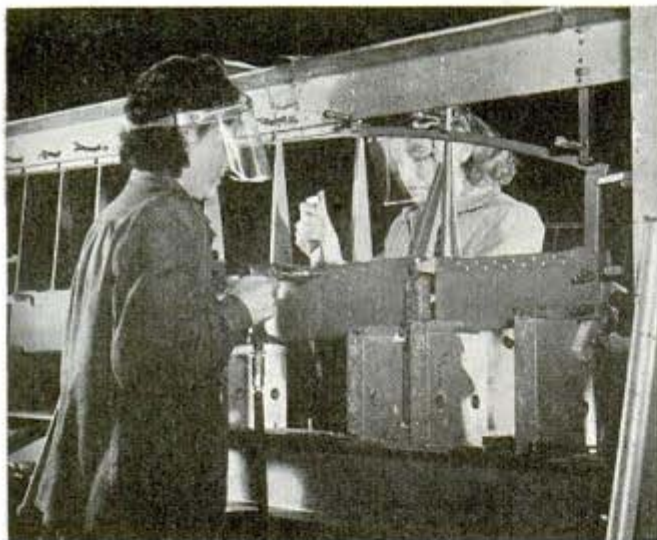

† Douglas girls team up at the rivet gun and bucking bar in a scene symbolic of an age of aluminum planes and girl mechanics

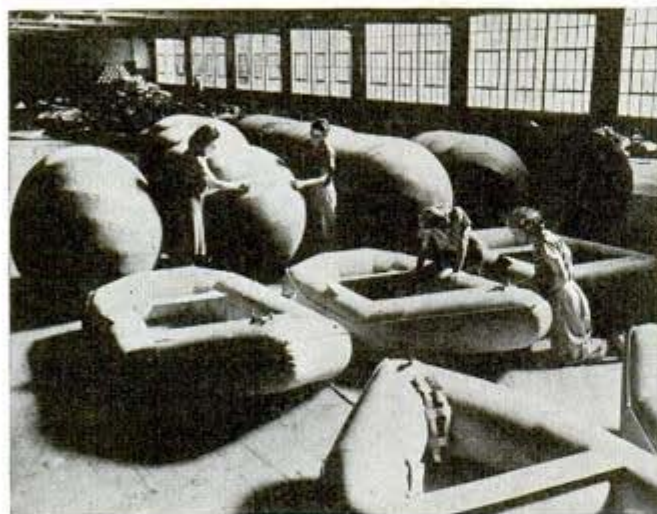

Thousands of pneumatic boats flow from Goodyear workrooms to the armed forces. Here modern Betsy Rosses are building them

This may resemble a permanent wave machine, but it's not even a distant relative. The woman is welding an aluminum fuel tank



Canadian Information Bureau

orator is an inspector on the final assembly line, a girl studying for grand opera by night helps on sub-assemblies of plane parts by day.

Once upon a time a girl in an engineering school was a rarity. She might even have been considered a little queer. But the girls are making up for lost training today. The University of California organized a three-months engineering training course for aircraft draftswomen. Goodyear Tire & Rubber company is training junior draftswomen and sheet metal workers in two special classes. Ford, breaking a 40-year rule against women in factory work, started 28 women in the enormous Willow Run bomber plant and is training hundreds; eventually 12,000 to 15,000 women may be put to work there. The Navy Yard is looking for women who hold degrees in mathematics and physics, and mechanical, electrical, metallurgical and chemical engineering. Women engineers, industrial chemists, smart mathematicians and photomicrographers are sought by Westinghouse and General Electric.

At first some of the factory managements were a little worried about bringing girls into the plants. They were afraid the men would pay more attention to the girls than to the machines. But that wore off. Men and women work side by side today; in most cases efficiency has stepped up rather than down; women employees are treated like the men, paid the same for equal work; but there is one thing they must give up. No more feminine frills and high heels, fluffy hairdos and jewelry. There are exceptions according to the job, of course, but generally slacks are essential and skirts are out, low heels and closed toes are required for comfort and safety, hair must be tight against the head or protected by net, snood or scarf lest it be caught in whirling machinery. Bracelets, rings, dangling necklaces and frilly garments are banned for the

same reason. There must be nothing to snag on a spinning drill or cog or rolling conveyor belt.

These girls in overalls are not crowding men out of jobs. There just aren't enough men to go around. At Douglas Aircraft the management gave assurance that no experienced man, young or old, would lose his job to a woman; instead, men who had gained experience are being promoted to key positions and women are helping fill the vacancies in the ranks.

Over in England, women 80 years old make airplane parts; women in a Midlands factory repair crashed planes; others are running transmitting stations of the British Broadcasting company, making money at the Mint, servicing locomotives, building ships and working in steel foundries. There are plenty of men in America who'd



↑  
**Women's dexterous fingers excel at a job like this, winding insulating tape on a huge Westinghouse turbine generator that develops 65 million watts**



←  
**In the Briggs factory many women are employed in sewing fabric on wing sections, working on final wing assemblies and various other tasks**

↓  
**Rows of delicate instruments which serve as eyes of our warplanes parade across the desk of a Westinghouse girl in final assembly operation**



envy the English girls who are operating steam shovels.

A survey by the U. S. Census Bureau showed there are 15,600,000 housewives between the ages of 18 and 44 who constitute the principal reserve from which war labor may be drawn. It indicated that the bulk of the women war workers must come from urban and rural, non-farm areas.

There may not be much glamor about cleaning spark plugs for the Pan-American Clipper, riveting a cockpit cabin on a fighter plane, shearing metal at a shipyard or running a tool shop. But women are finding opportunities never open to them before; they're discovering skills they never realized were theirs, and they're doing a job that's needed.

*Westinghouse Elec + Mfg. Co.*  
*East Pittsburgh, Pa.*  
**Transformers Given 'Voice Test'**  
**Before They Are Installed**

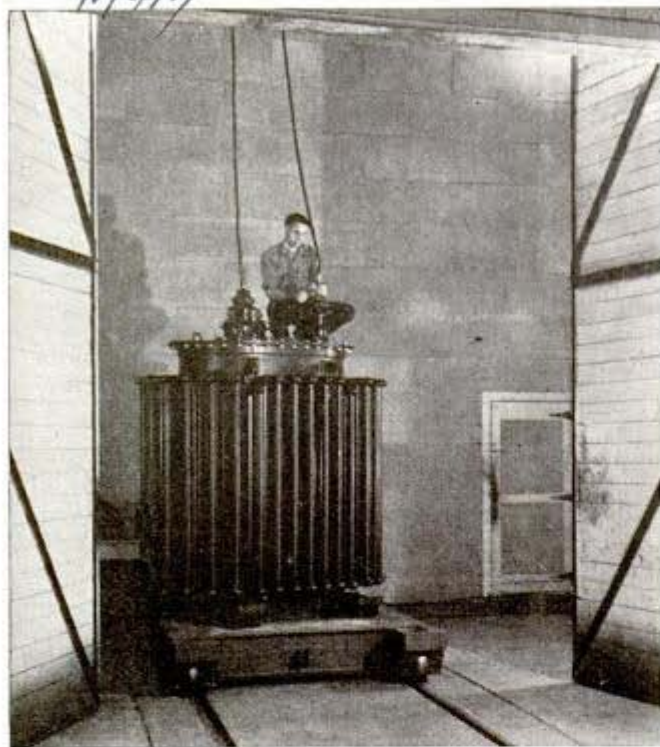

Large transformer carried into soundproof laboratory on rails receives a "voice test" before being assigned for installation

Electric transformers intended for outdoor use on power lines are wheeled into a soundproof laboratory for a "radio voice test" before being assigned to their post. The object is to make sure that a transformer will not produce louder sounds than the normal noises of the location in which it is to be installed. For instance, the noise level of a residential district at night is from 25 decibels, about equal to the purring of a cat, to 30 decibels, which is nearly twice as loud. In a business district a transformer may be louder, since the noise of a busy city street is about 90 decibels. An increase of six decibels represents approximately doubled noise level, so 90 decibels would be nearly 2,000 times as loud as 25 decibels. Regardless of their degree of loudness, transformers

always hum at a monotone of 120 cycles a second, which corresponds with the second B below middle C on a piano. The laboratory, located at the Westinghouse Transformer Division in Sharon, Pa., is a building within a building, the inner one enclosed in walls composed of sound-absorbing materials, and the outer building having eight-inch brick walls. Three soundproof doors help shut out noises from a nearby factory. Noise within the soundproof laboratory has been reduced to only 20 decibels. A microphone, held a foot from the humming transformer, is connected to a sensitive electric sound meter to record the intensity of the hum.

**Vibrator for Concrete**  
**Speeds Drying Floors**

M 455  
Concrete for floors or pavements may be smoothed speedily and the moisture brought to the top for quick drying with a motorized unit attached to the conventional screed used in tamping and smoothing. The unit reduces the concrete to a solid mass by vibration and may be operated on a pour of only one inch instead of the usual four to six inches.

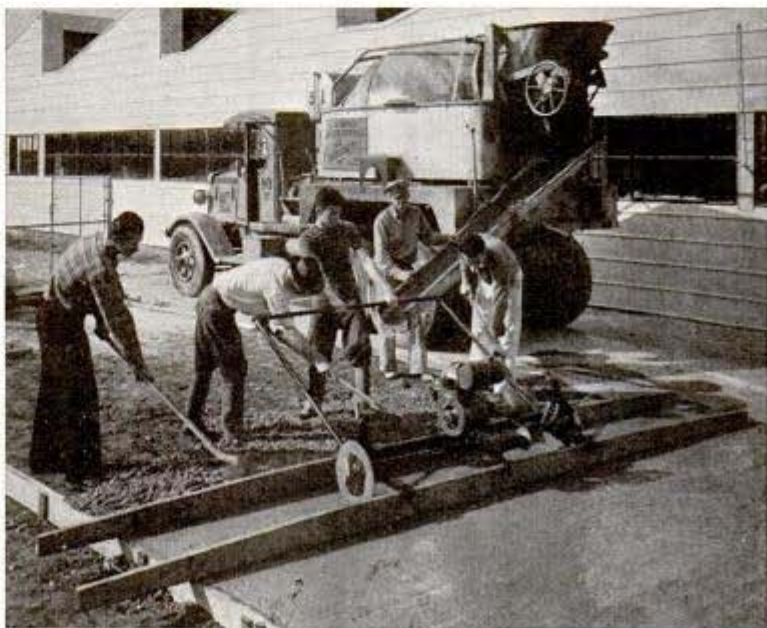

Motorized unit shakes concrete, bringing water to the top for drying

# Highway "Mounties" Train to Hunt Parachutists

M 478



California's highway patrolmen gird for defense duties that may include running down saboteurs and parachutists or keeping the roads clear for troops during maneuvers. Rookie patrolman (above) learns the hazardous trick of leaping from one moving automobile to another.



Firing machine gun while speeding along on motorcycle (above) requires great skill, for both hands are used in shooting gun. Below, one of 300 rookies recently added to regular force of 850, tries his hand—and feet—at scaling barrier left by "foe"



Left, patrolmen are instructed in use of balloon to raise an aerial for attachment to emergency radio which members of force must know how to set up and operate. The vast new training program also includes use of tear-gas grenades, gas masks, how to fight incendiary bombs, and the usual instruction pertaining to small arms and self-defense. Patrolmen, more familiar with California's highways than any other group, might be first to arrive at the scene of an enemy parachute landing along desolate areas of the west coast.

Cost: Mr. Leggett - U. S. Army Air Corps, Wright  
Field, Dayton, Ohio.

# SKY HIGH and a STATE WIDE

M394



In this official photographic plane of the Army Air Forces, new techniques in aerial mapping are tried out

**T**WENTY thousand feet above the green and yellow checkerboard of Ohio a Wright Field cameraman caught with his wide-angle lens the remarkable photograph on the opposite page. It embraces hundreds of square miles, spans a state. The army man pointed his camera toward Fort Wayne and South Bend, Ind. Nearly four miles beneath him the main highways and section lines ruled off Ohio like a printed map. In the middle distance a black

blot marked Lake St. Marys, with Celina, O., at its upper corner. Beyond was Indiana, and just over the horizon, about 250 miles away, was Chicago.

Infrared film and the new camera made possible this picture, with its amazing clarity of detail which the human eye itself could not discern through the haze. The Air Force cameramen have recently completed a series of tests with this metrogon wide-angle lens, which has a six-inch focal length and takes in everything within a 74-degree angle in one shot; and it is probable that it will soon supplant the five and nine-lens mapping camera.

Wright Field men map-photographed an area of 1,600 square miles from an altitude of 25,000 feet and were back on the ground in three hours and 35 minutes. They shot "strip" photographs each 50 miles long, overlapping each strip. With the technique and equipment in army use ten years ago this 1,600-mile mapping project would have required days of flying at 100 miles an hour and at 15,000 feet. The new camera is already in mass production.



Here one of the army's multi-lens cameras is installed in a plane to shoot through the floor, mapping the country by strips





You are 20,000 feet high over western Ohio, looking toward Ft. Wayne and South Bend, Ind. The ink blot is Lake St. Marys, Chicago is just over the horizon. This remarkable photograph was made on infra-red film with a new army wide-angle lens

*Spinks Scale Co.*  
*422 Hillside Dr., S.W.*  
**Filling Bag Is One-Man Job**  
**With U-Shaped Holder**  
*M 466*

*Atlanta, Ga.*



Adjustable holder has trough to guide sand into bag

One man can fill a sand bag with a U-shaped metal rack which holds the sack and also provides a trough into which the sand may be shoveled. Adjustable to all sizes of bags, the holder allows the bag to rest on the ground and saves unnecessary handling and lifting.

**Gauge Measures Butter Stick In Fractions of Cupfuls**

Swift and easy measuring of quarter-pound pieces of butter into portions varying from one teaspoonful to one-half cup

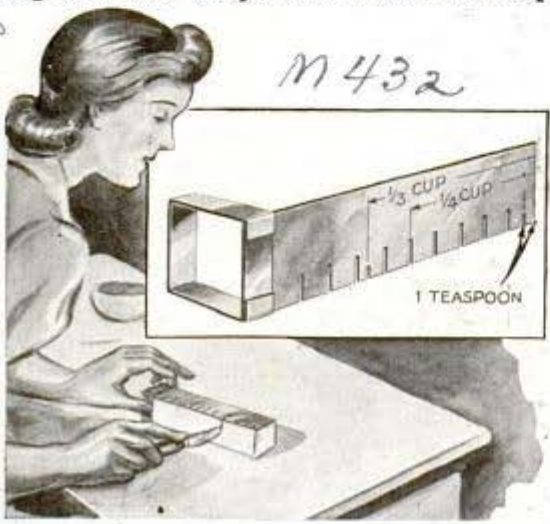

Slots on the back of gauge aid cook to follow recipe

*Distr: E.H. Vandy*  
*Midw. Mart. Chicago.*  
 is permitted by a gauge now on the market. The gauge consists of a flat metal scale with a square frame on one end. Slots on the back of the gauge bear notations telling where to cut for the desired portions. Using the scale as a handle, the square frame may be pressed into bulk butter to form quarter-pound sections.

**Waste-Paper Press for Home Use Binds Bundle With Cord**

Waste paper can be pressed and tied into neat bundles with a handy home press. Cord on a wooden needle is passed through grooves under the lid and on the bottom and between thick slats that form the sides.

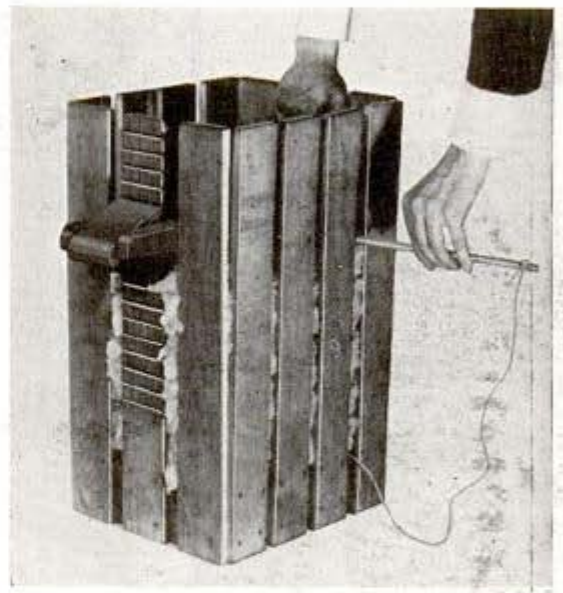

Wooden needle passes through grooves under the lid

After each dumping the lid is pressed down and held in place by handle blocks that engage slots on each side. The bundles can be stacked to await the collector.

**"Kick" Removed From Explosive Until Ready for Use**

Observing that sticks of dynamite hardened with age often fail to explode, Jacob Barab of Wilmington, Del., has developed a reversible explosive which is made harmless for shipping and then activated for use. The explosive, intended for blasting, is made by mixing ammonium nitrate with combustible particles of exceedingly small size and compressing the mixture into hard sticks. The explosive is made active again by grinding it into grains.

POPULAR MECHANICS  
*Mr. Jacob Barab*  
 Pat # 2,280,366

*Distr: Carson Lue Scott & Co.*  
*State & Monroe St., Chicago, Ill.*

# Chinese Divert Rivers to Hasten Rail Building

Railroad engineers in China are diverting rivers from their natural courses into tunnels to save building bridges. This method is speeding the construction of the Lunghai railroad through the mountains of Shensi province in northwest China. In some of the especially rocky sections of the area, the track is being laid in open tunnels which must be cut laboriously through solid rock.



Track is laid in open tunnel cut through rock. Upper right, changing river's course to save building bridge

## Metal "Ice Grips" in Tire Tread Keep Plane From Skidding

Skidding of an airplane on glare ice can be prevented by using a new "ice-grip" tire having sharp, cylindrical, crimped steel inserts in its tread. These inserts, distributed profusely over the surface of the tread, wear down with the tire so their exposed portion remains below the outer surface of the tread, and do not contact the road until after the initial engagement of the tread; hence they cause no sudden impact or objectionable noise. The metal inserts provide traction to insure good braking power on snow and ice.

M.S. Rubber Co., Rochester, N.Y.  
 M. 649

## Life Span in the United States Almost Doubled Over Sixty Years Ago

During the past 60 years the average length of life for a wage-earner's children in America has almost doubled, according to mortality figures computed by Metro-politan Life Insurance company. In 1941 the average life span for industrial policy holders was 63.42 years, while records for the 10-year period 1879 to 1889 show it was then 40 years. Other records of that day indicate that expectation of life at birth was

about 34 years, a little more than half of what it is now. The average policy holder 35 years old today still has as many years before him as was held out for a child in the wage-earning family sixty years ago at its birth.

Look in the index to find where to buy articles described in this magazine. Say You Saw It in Popular Mechanics.

Cont: H. J. Hamilton, 1177 1/2 S. Westmoreland Ave., Los Angeles, Calif.

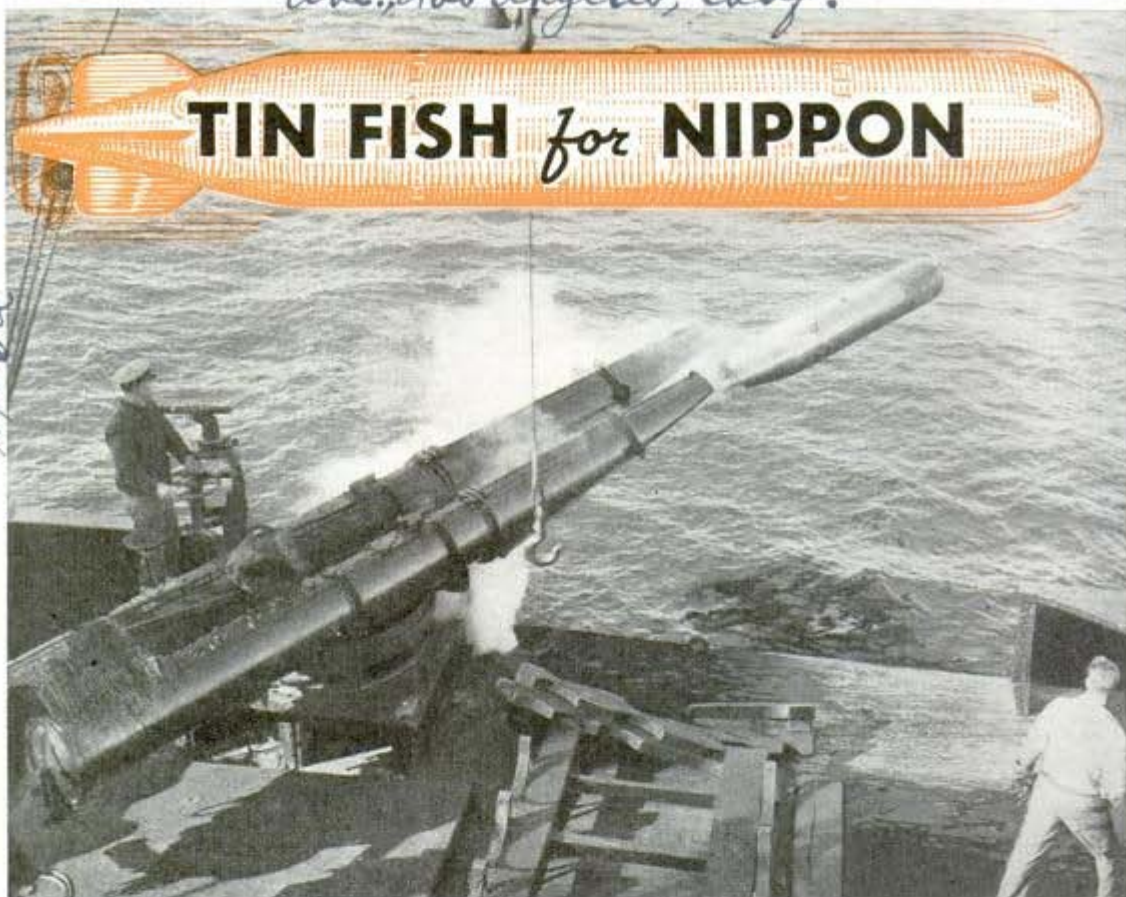

M362

"Fire one!" is the order and a deadly torpedo takes to the water where it will guide itself to the target

Checking the "test run" of a torpedo from the tower of a U. S. Navy torpedo station before it is approved for a load of TNT



THE American submarine skipper's face was grim as he sighted through the periscope. Within the circle of vision lay a Japanese cruiser, the flag of the Rising Sun fluttering from her stern. He moved the greasy crossbars of the periscope a fraction of an inch to center his target.

"Range, 1,200 yards," he said, "bearing one four seven."

The men within the steamy hull were tense. They knew they were moving in for the kill.

"Stand by all tubes!" came the order.

Another moment of silence and then . . .

"Fire one!"

The bow of the American sub lurched as deadly steel and TNT left the tube.

"Fire two!"

A second "tin fish" plowed from her oily bed.

"Fire three!"

Another tremendous roar . . .

"Fire four!"

And another . . .

The average newspaper reader, conditioned by headlines, often thinks that the torpedo is exclusively an Axis weapon. But the U. S. Navy is also using the torpedo—and getting results.

The torpedo, like the mine, is sometimes said to be the weapon of the inferior naval power. Properly used, it can be extremely effective no matter who uses it. Torpedoes are coming into their own in World War II as a powerful offensive weapon.

They can be shot out of the belly of a submarine, launched from the deck of a surface ship and dropped from planes.

Yankee ingenuity and scientific perfection have made American built torpedoes the finest in the world. And years of practice in peacetime have made the crews of our warships first-rate marksmen with the deadly "tin fish."

The Civil War saw the forerunner of the torpedo. A charge of powder was fastened to a long pole on the bow of a small patrol



Fish out of water—two early models of American torpedoes. At right is a depth charge

boat. In the blackness of the night daring Union naval officers piloted their suicide craft alongside Confederate ships and detonated the powder by an electric wire. The attacker had a chance to escape—if he could swim. His own boat was usually blown up as well as that of the enemy.

Credit for the modern, self-propelling torpedo which moves under its own power is given to Robert Whitehead, a Scotch engineer. The idea was suggested by a Capt. Luppis of the Austrian Navy while White-

At 60 miles an hour a squadron of "mosquito boats" closes in for the "kill." Each carries four torpedoes





Loading torpedoes with "dummy" heads filled with water on a testing barge where they will be fired to check propellers, rudders and gyroscopes

head was working at the naval base at Fiume.

Whitehead experimented for two years and in 1866 produced a cigar-shaped steel cylinder, 14 inches in diameter, 10 feet long and weighing 300 pounds. In its nose it carried a 14-pound charge of powder. It was propelled by a compressed-air rotary motor and could do about 6 knots for a short distance.

Torpedoes have been much improved since Whitehead's first crude model, but in spite of many changes his basic principles still remain.

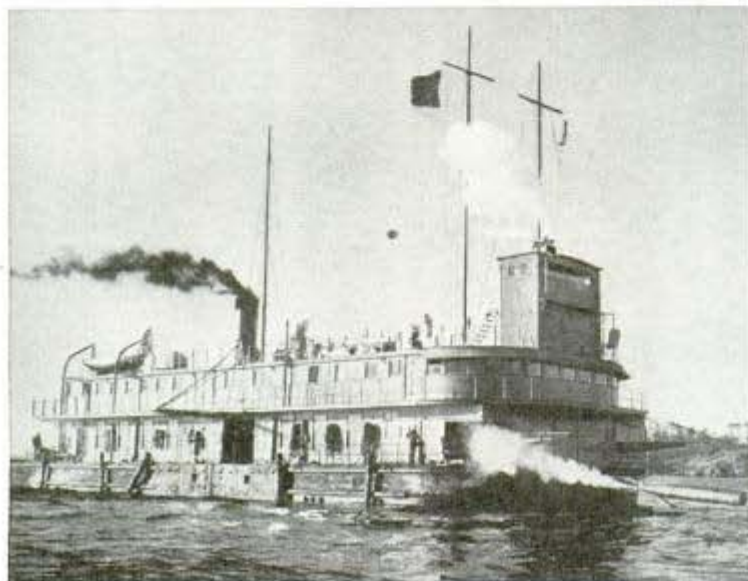

Before World War I most torpedoes averaged 14 inches in diameter. But during the years 1914-18, they went up to 18 inches and then 21 inches. The latter size is most widely used today.

Except in some of its early "mosquito boats," the U. S. Navy uses the standard 21-inch torpedo in submarines, destroyers, motor torpedo boats and planes. The British Navy also uses the 21-inch size, but it is said that the battleships Rodney and Nelson are equipped with 24-inch giants. Until recently Germany was content to use 19.7-inch torpedoes but its newest vessels are

using the 21-inch model. The French navy has five sizes—15.7, 18, 19.7, 21 and 21.7 inches, which makes mass production difficult. The Japanese navy, modeled on the British pattern, is believed to use 21-inch torpedoes.

The standard 21-inch torpedo used by the U. S. Navy is 24 feet long. In its head it carries a powerful charge of TNT. The cost of these instruments of death and destruction runs around \$12,000 apiece.

Internally, the torpedo is divided into six compartments and is so balanced that it will just float when placed gently in the water. The foremost section contains the TNT charge, followed by a thinly walled flask containing compressed air under pressure of 3,000 pounds per square inch, the rudder mechanism, the propelling mechanism, the buoyancy chamber, the gyroscope and propellers.

The modern, American-built torpedo contains a highly complicated set of mechanisms and its manufacture calls for accurate

Away for its final test run—a "tin fish" leaves the testing barge under the eyes of experts

Крестовый разрез торпеды

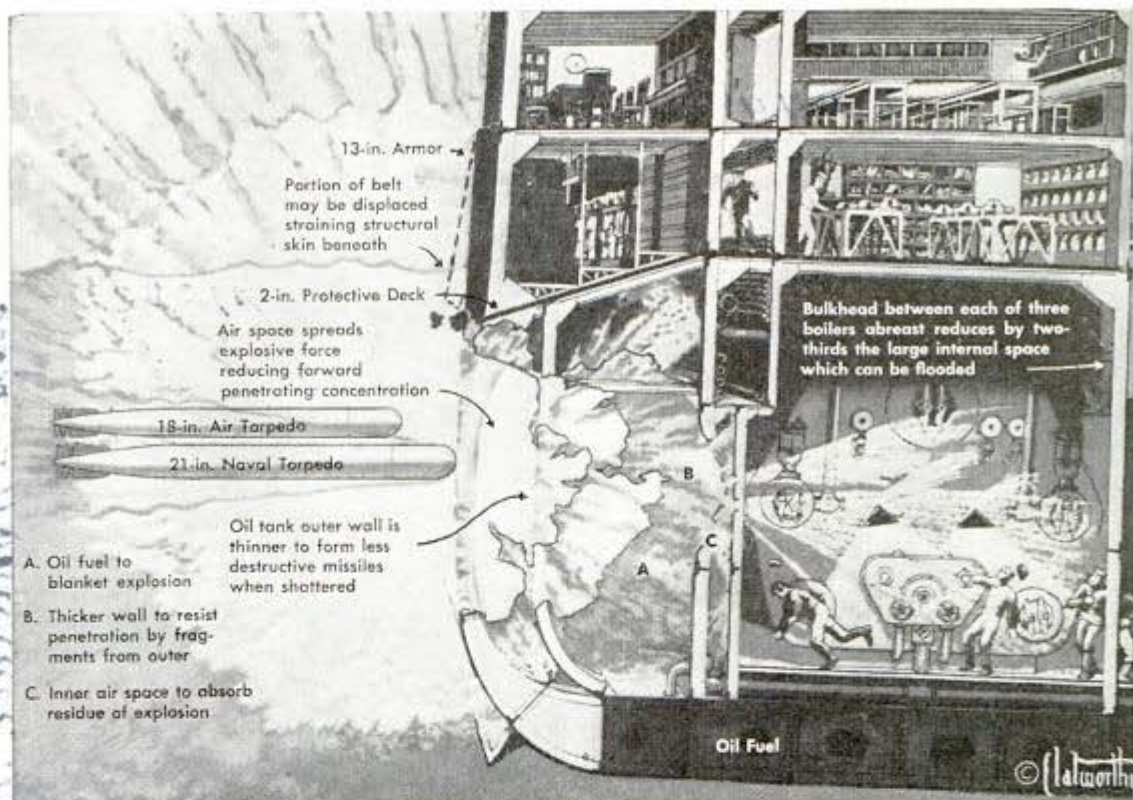

and precise machine tools. There are more than 1,325 parts, many of which work with watchlike precision. That's why the U.S. Navy's torpedo-manufacturing plants look strangely like modern machine shops.

At the U. S. Navy Gun Shop and the Torpedo Station, principal centers for making Uncle Sam's torpedoes, men are working night and day, seven days a week, to provide ammunition for the hundreds of torpedo tubes of the growing fleet.

After the gleaming steel cylinders are finished and their clock-like works installed, they are taken to a proving range for checking. One of these is located on the Potomac. An old barge, fitted with torpedo tubes, is anchored in the river. Torpedoes are shot from its tubes to make test runs down the river under the keen eyes of naval torpedo experts.

During these trial runs, the torpedoes are fitted with dummy heads—filled with water. At the end of the run the water is ejected

(Continued to page 176)

**Cross-section of a heavily armored capital ship showing how the hull construction partially checks the torpedo explosion**

**Taxiing across the deck of a carrier far at sea, this squadron of torpedo bombers carries a load of big 21-inch torpedoes**

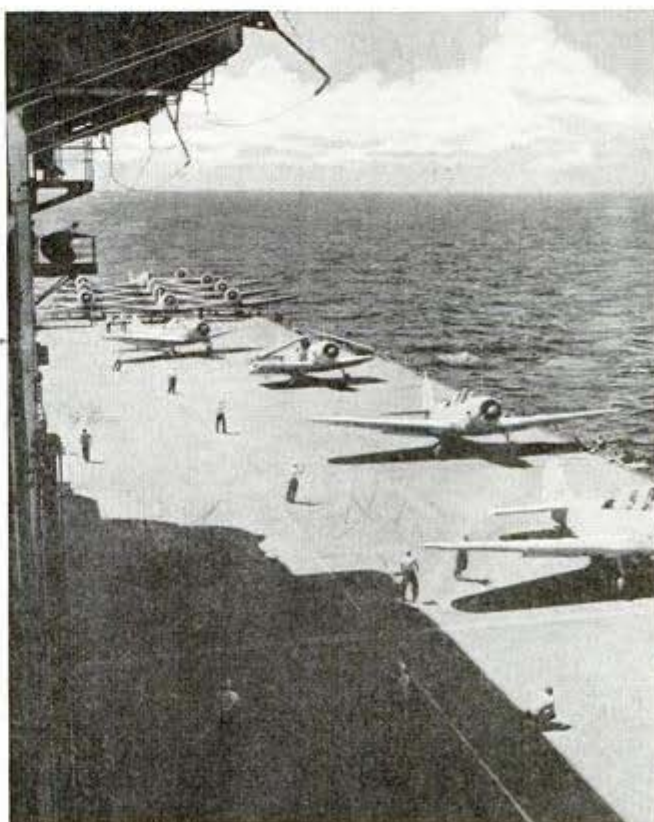

## Mower Motor on a Bicycle Gets Big Gas Mileage

M 449



Motorbike has top speed of about 18 miles per hour

Gas and automobile rationing hold no terrors for M. E. Morris of Richmond, Va., who has rigged up a bicycle with a lawnmower motor and can travel 140 miles on a gallon of gasoline. The one-cylinder motor transmits power to the rear wheel through a friction pulley driven by a V-belt. It is controlled by a hand lever.

## Holder Helps Assemble Papers In Proper Sequence

Papers may be assembled speedily in proper sequence by using a device which

M 1446



Twelve-section unit has a capacity of 6,000 sheets

fits the average-sized desk and holds the papers at a 45-degree angle. The standard unit of 12 sections, each with a capacity of 500 sheets of paper, permits operators to work from either side.

## Pencil Chained to Vacuum Cup Is Always Handy for Use

M 282

Handy for use in the automobile, home or office, a pencil that will stay put is chained to a reel fitted with a vacuum cup. It may be secured to any flat, smooth surface such as a windshield, kitchen cabinet, typewriter or drawer of a filing cabinet, and the fine chain holding the pencil may be unreeled for 14 inches.



## Fast Driver Could Save Money By Cutting His Speed

M 357

Observance of a 40-mile-an-hour speed limit would result in a financial saving for drivers who have made a practice of "burning up the road" on long trips. At 25 miles an hour on a 1,000-mile trip, for instance, the average auto expense would be \$14.38, including fuel and oil consumption, tire wear and maintenance costs, based on studies reported by the Illinois Automobile Club. Increase the speed to 35 miles an hour and the cost becomes \$17.88; at 45 miles it increases to \$22.03; rises to \$30.33 at 55 miles, and jumps to \$38.63 at 65 miles an hour. Fuel consumption for 1,000 miles at 25 miles an hour averages 50 gallons, 55 gallons at 35 miles, 60 gallons at 45 miles, 69 gallons at 55 miles, and about 80 gallons at 65 miles an hour. Tires deteriorate twice as fast when going at 60 as they do at 40 miles per hour, it is estimated, while maintenance costs are about double for a car habitually driven at 65, as compared with one driven at 45 miles an hour.

☛ To learn where to buy commercial products described in these pages, see the index.

2115 Halifax

The Co-Collector Co.  
16 1/2 No. 9th St. Richmond Va.

Retelham + Mc Orungal, Inc.  
Water-Mountain, N.Y.



# Bunk Is Not Far From Battle Station on a Sub

M 441



You really get to know your neighbor on a sub. The four-deck bunks might seem a bit tight-fitting to land-lubbers, but to sub men they're snug; and it's not a long walk to "battle stations" when a Jap ship looms up in the periscope



Surfacing to run on her Diesel engines during a long patrol, an American submarine plows along at top speed with her crew ready at the deck gun. More often than not the deck is under water in choppy seas, but submarines like it rough, for it's easier to escape detection

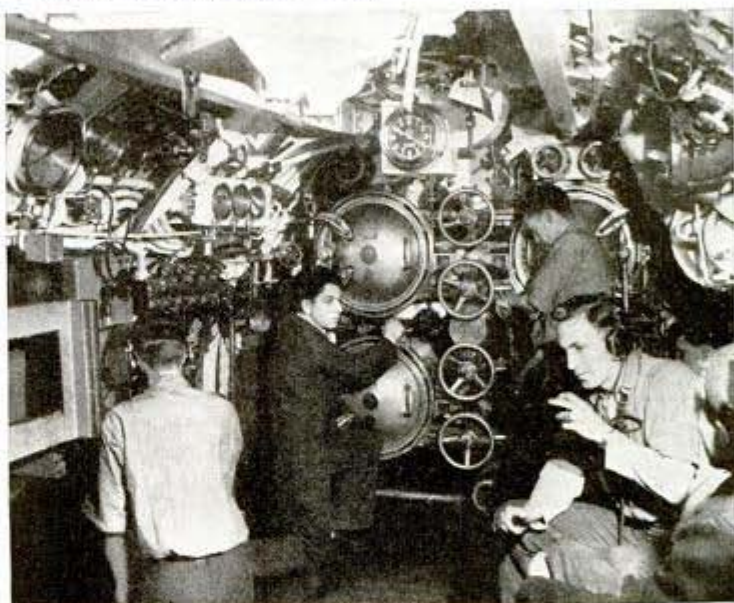

The "tin fish" get their kickoff in the tight little room above, its walls studded with vital gauges and valves. Two of the torpedo tubes are visible at the center, behind the kneeling man. At right, the man with earphones is receiving orders from the control room, and at the second the enemy ship appears in the periscope sight at proper range, the torpedo is away. Even the skipper sleeps close to his work. At left is the lieutenant who commands the undersea ship, examining the navigation chart brought in by his junior officer. As he awakens he glances above his bunk at three gauges which tell him the heading of the ship, its depth and the time. From left to right they are compass, depth gauge and chronometer

M395

# IT'S *the* SPARES *that* COUNT

By **Tony Monteverde**

Famous Bowling Star and Hollywood Coach

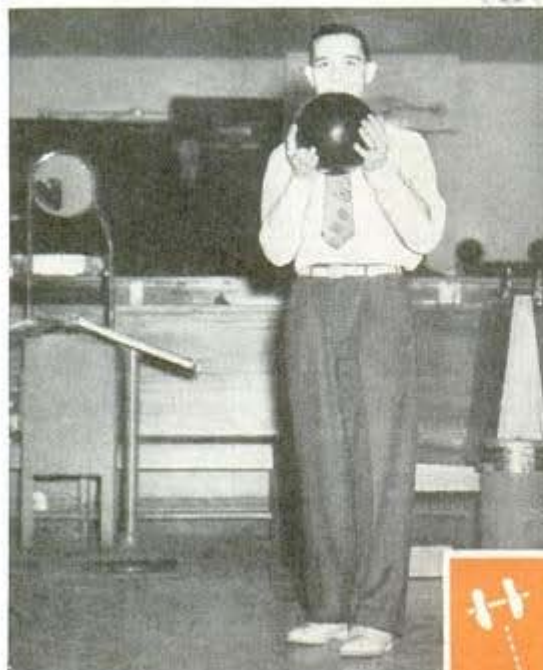

Preparing to throw cross alley at the 10 pin in the far right corner, Tony Monteverde faces directly at the pin. Diagram shows stance for spare leaves



Throwing for the 10 pin, Tony lays the ball down about 9 or 10 inches from left hand side of the alley—a hard shot

THE other day I saw a bowler lay down five consecutive strikes. After the last one, he beamed, snapped his suspenders, and sat down, certain that he had won the game. His opponent had been struggling along without doing anything spectacular, just picking up his spares. After the fifth frame, the mighty strike bowler got a little out of the groove, which wouldn't have done him any great harm—if he hadn't missed his spares.

The accurate spare bowler kept plugging along. In the end, he won the match by eight pins. The fellow who laid down the five strikes at the start of the game was so mad he threatened to shoot the pin boy.

That sort of thing happens daily in every bowling alley. Hundreds of bowlers have low averages—and short tempers—simply because they haven't learned to pick up spares. Just to show how important it is to pick up spares, take a look at the following statistics:

A man who makes five strikes in a game—and is lucky enough to bowl them in succession—but doesn't spare, would have a maximum possible score of 183. On the other hand, if a bowler spared every frame, and got nine pins on the first throw after each spare, his score would be 190. Therefore, he would easily beat the man who rolled five strikes in a row.

Even if a bowler rolled seven strikes in a game, including two doubles (a double is two strikes in succession), he would

Ready to be thrown, the ball is supported by the → left hand with elbow on hip bone to give balance

still have a maximum possible score of only 170—or 20 pins less than the man who simply picked up his spares. Picking up spares helped me maintain an average of 212 for 60 games in a match against Gene Gagliardi.

I don't think I have to give any more proof of the importance of sparing. Just try to beat a consistent spare bowler, and you'll see that figures don't lie.

In teaching bowlers how to become accurate in picking up spares, I always begin by saying a few things about "spare psychology."

There are two mental attitudes which cause bowlers to miss spares. The first attitude is: "This is just a simple little spare, and I don't need to pay much attention to it." Making a spare is just as hard, often harder, than making a strike. So, never think that any spare is simple. Concentrate on a spare even more than on a strike, concentrate so completely that you don't realize what's happening in the alleys beside you, or what other players are saying.

The second mental attitude that results in poor spare bowling is "spare jitters." This is usually caused by the bowler thinking how much space there is on each side of the pin he's trying to hit. The simple



Don't let a one-pin spare give you the jitters— → you have two feet of leeway to pick up the pin

A	X		X		X	X	X	X		XX	
	19	28	47	56	85	104	113	132	141	170	170
B	X	X	X	X	X						
	30	60	90	119	138	147	156	165	174	183	183
C	/	/	/	/	/	/	/	/	/	/	/
	19	38	57	76	95	114	133	152	171	190	190

These bowling scores show how the player who made a spare in each frame defeated opponents with strikes

antidote for this type of psychology is to remember the following facts:

A bowling pin is approximately 4.7 inches across at its widest point. The diameter of a standard bowling ball is a little over 8.6 inches. Pins are set so that their centers are 12 inches apart. Therefore, in throwing at a single pin, you actually have a mark 23 inches across to shoot at. In other words, you can be nearly two feet wide of

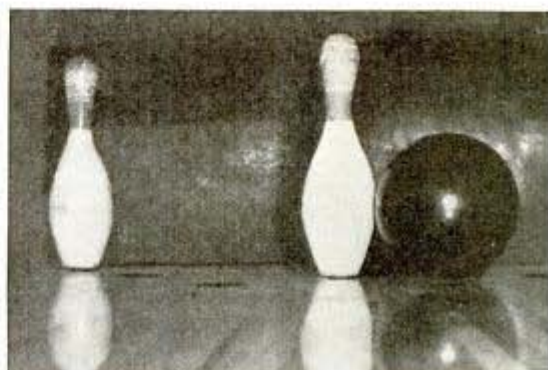

The average bowler has little chance of clipping a → pin thin enough to pick up a 5-7 split like this



study the actual mechanics of spare bowling.

First, let's take up the matter of how to hold the ball when you are standing perfectly still, ready to begin your run and throw. Many people think this is unimportant. Nothing can be farther from the truth. Bowling is a game of balance, and spare bowling takes even

Tony lets a ball fly toward a "sleeper" (a pin directly behind another in a spare leave). Diagram shows the path of the ball aimed at the 8 pin sleeper. Below, front pins will fall

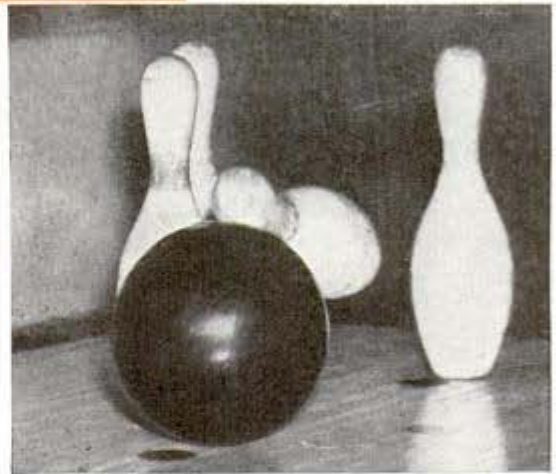

the spot where you intended to throw the ball, and still get the pin.

Of course, you don't have quite as much leeway when throwing for the 7 and 10 pins (the two pins at the extreme corners of the alley). However, you still have a 13½-inch target—which is pretty big.

Once you've mastered the psychology, so that you can concentrate on the throw without getting the jitters, you're ready to

more balance than strike bowling. Throughout your entire run and throw, you have to swing the weight of a 16-pound bowling ball. If that weight isn't placed in the proper position to begin with, you'll never get it in balance.

When you take your stance ready to begin your throw, hold the ball about shoulder high, support it with your left hand and brace the left elbow on the point of the hip bone. In

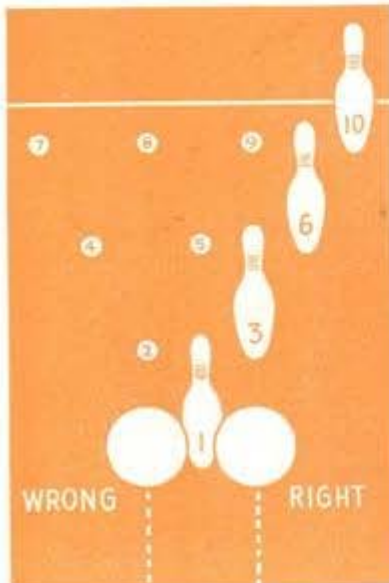

To take out a 1-3-6-10 spare leave, the ball should strike between the front pin and the next one to it as shown in diagram—not on the outside of the front pin



this position, the weight of the ball is properly placed, and at the same time supported by the left hip bone. This is a great help in easing the tiring effect on the arms and fingers of a long stretch of bowling.

When you have set yourself for your throw, make sure that you are facing your spare. In other words, stand so that your shoulders are at right angles to an imaginary line drawn from your feet to the point where you want to hit the pins. This system works as follows: If you are throwing at a pin in the center of the alley, say the 5 pin, stand with your shoulders at right angles to the alley. If you are throwing at a pin on either edge of the alley, say the 7 or 10, turn your body at enough of an angle so that you face the pin. Incidentally, always throw cross-alley at the 7 or 10 pin.

By facing directly at your spare, you are in a position to walk along the line you want to roll your ball, whereas if you always face straight at the center of the alley, you are forced to jerk your ball at an angle when throwing at such spares as the 7 or 10 pin.

Many bowlers, particularly those who use a hook ball, feel that they must throw exactly the

**This is what happens if you try to make a 2-7 "baby split" the wrong way—hitting the 2 pin on the far side from the 7**

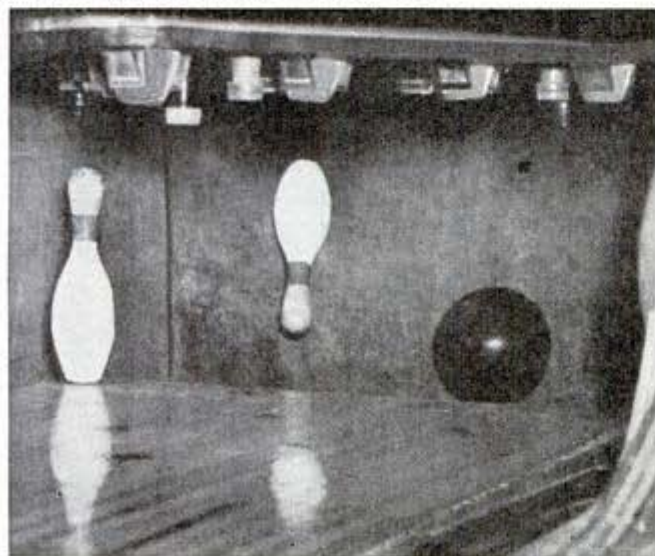

SEPTEMBER, 1942

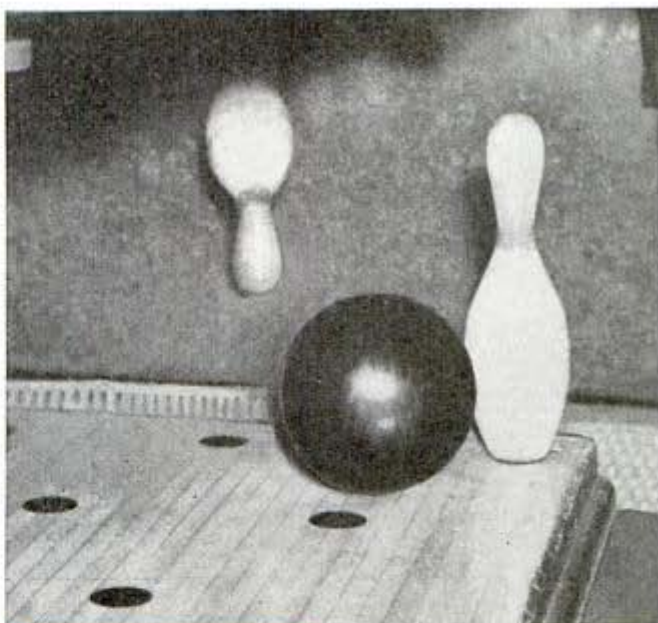

**How to make a 3-10 or 2-7 "baby split"—the ball is thrown to hit the front pin and is deflected to strike rear pin**

same type of ball at all spares. I don't agree with this. For instance, the 10 pin (which is at the extreme right hand corner of the alley), is very difficult for most right-hand bowlers. It is harder still for a right-hand bowler who throws a hook. Therefore, such a bowler often finds it is far easier to pick up a 10 pin by using a straight ball. I al-

ways tell him to go ahead and use a straight ball for all spares at the right of the alley.

So, if there is any one spare which you find it difficult to get with the ball you normally throw, use a different type of delivery for that particular spare. Under such circumstances throwing two types of balls doesn't hurt your game.

I consider it best for the average bowler to look at the pins when throwing for spares. In throwing for strikes, you can pick out a spot on the boards and attempt to roll your ball over it; but with spares it is generally better to keep your eyes focused directly on the pins.

59



The wrong way to throw for a spare—the bowler is tense and trying to control ball with his fingers

Most bowlers feel they gain accuracy on spares by throwing a slower ball. My own experience, and the experience of persons whom I have taught, has been just the opposite. I throw a slightly faster ball for a spare than for a strike. I have found that the additional speed tends to keep the ball more surely on its course and prevents it from drifting or wavering.

There are three types of spares which require special treatment:

1. When throwing at a spare containing a "sleeper" (a sleeper is a pin directly behind another pin), aim for the sleeper rather than for the front pins. Almost always if the ball hits the sleeper, it also hits the pin in front of it. Therefore, concentrate on getting the sleeper.

2. When throwing at the 1-2-4 or 1-3-6 pins, roll your ball at a spot between the front pin and the pin next to it. Not only is this the best method of making the spare,

Picking up a 6-9-10 spare, as pin boy sees it. Hit forward pin of triangle from an angle, never head-on



The right way to throw—the bowler is relaxed and controls the ball with a rhythmic swing of his arm

but if you do miss it, you will probably get at least two pins.

3. When you are throwing at any pin or combination of pins in the back line, that is, the 7, 8, 9, and 10 pins, remember that these pins are almost three feet farther away than the head pin. A failure to compensate for this fact is particularly noticeable with a hook ball, as the extra distance



permits the hook to pull the ball past the pins.

Now a word about splits. It is my firm opinion that the average bowler would do much better if he didn't try to be too accurate when throwing at a split. He should simply concentrate on hitting the front pin on the proper side to drive it toward the remaining pin or pins. If you try to clip the pin just thick enough, you'll probably tighten up and miss the spare entirely. Whereas, if you simply try to hit the pin on the right side, you always have a good chance that you'll pick up the split.

There are four types of splits that you should never attempt to make. They are the 4-6, the 7-9, 8-10, and the 7-10. These splits are virtually never picked up, and when they are made it is only by some freak of luck. Therefore, just throw to make one pin. This has two advantages: first, you get that much more practice in throwing at single pins; second, one pin, particularly if you are on a strike, will make an appreciable difference in your score. Remember if you are on a strike, one pin makes a difference of two pins in your final score—and a lot of games are lost by two pins.

There is one type of split which the average bowler has a good chance of making. That is the so-called "baby" split. A baby is either the 2 and 7 or the 3 and 10 pins. In picking up this split, always throw to make it from the "inside." In other words, your ball should hit the front pin and be deflected so as to hit the back pin. This method is much surer than trying to drive the front pin over so it will take out the back pin.

Finally, let me say that anyone may become a good spare bowler. Spare bowling comes easier to some people than to others. If you are one of those persons who finds it hard to become consistent on spares, then spend a few sessions at the bowling alley throwing at nothing but spares. Have your pin boy set only those spares which are most difficult for you to make.

Whether you have your sights set on being an excellent bowler or merely a good average bowler, the first thing to do is to learn to pick up your spares.

Write to the firms listed in the Where-to-Buy-It index, to learn more about products described in this magazine. Say You Saw It in Popular Mechanics.

## Homemade Motorized Bike Runs 78 Miles to Gallon

M 638



Gas-saving motorbike supplies cheap transportation

Seeking an answer to problems of gasoline rationing, Technical Sergeant A. Keuntz of Kelly Field, Tex., built a motor-cycle that will carry him far on meager rations. With an engine mounted over the rear wheel, the motorbike weighs only 90 pounds, developing one horsepower and giving 78 miles to the gallon of fuel.

## Long-Shank Cutter Used as Tong Retrieves Small Articles

Small objects can be lifted from inaccessible places with a cutter having a long, slender barrel. Pressure on the trigger actuates a rod within the barrel causing the cutter to close. The blades can snip off wires or act as a tong to pick up metal parts.

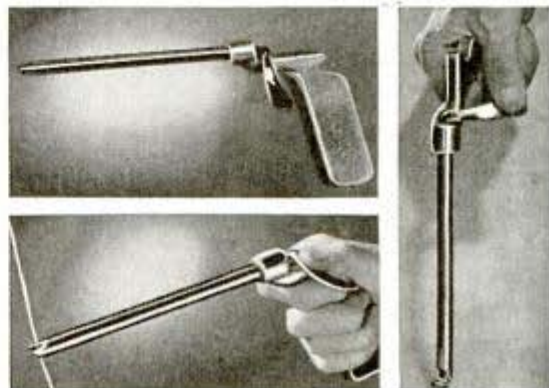

Cutter snips wires or grips articles hard to reach

Pack-Rite Machine Corp.  
828 No. Broadway, Milwaukee, Wis.

*Inv. Wm. J. Jones, Maintenance Foreman, Seattle  
Fire Dept., Seattle, Wash.*

## Family Car Is Fire Engine in Raid Emergency

*M 472*



Every family car in Seattle is a potential fire engine with the use of a pump invented by Fireman William J. Jones as his contribution to the city's air raid defense system. When the car is backed onto the mechanism the spinning rear wheels supply power to operate a pump that will project streams of water from small hose to considerable heights.

**Spinning rear wheels of car supply enough power to pump water through small hose to top of a three-story building**

## Portable Torch Speeds Rescue by Burning Away Girders

*M 393*

Rescue of victims that may be pinned under debris in the wake of falling bombs can be hastened with the aid of a portable acetylene-oxygen torch invented by J. C. Phillips of San Francisco. The 96-pound demolition torch, carried as a back-pack, can be used to cut away steel girders and heavy timbers in cleaning up the wreckage after air raids.



**Cutting away heavy steel girder to release victim pinned beneath wreckage. Rescuer, carrying tanks on back, can reach confined places**

## Flexible Hone for Brake Cylinder Saves Removing It From the Car

*445*

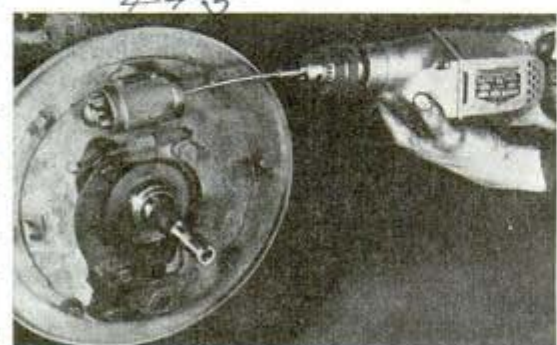

**Tool automatically adjusts itself to any cylinder size; flexible shaft is designed for work in cramped space**

Wheel cylinders may be honed to improve braking efficiency without removing them from a car with the aid of a tool on a flexible shaft, which attaches to an electric drill. The tool, equipped with three stones mounted to prevent out-of-round honing, automatically adjusts itself to any cylinder diameter and may be used in cramped space.

**Look in the index to find where to buy articles described in this magazine. Say You Saw It in Popular Mechanics.**

*62 Thermoid Co.,  
Whitehead Rd.,  
Trenton, N.J.*



Cont. Thomas E. Steinson, Jr. 3872 Franklin Av.  
 Los Angeles, Calif.

# Railroads Keep 'Em Rolling During Blackout

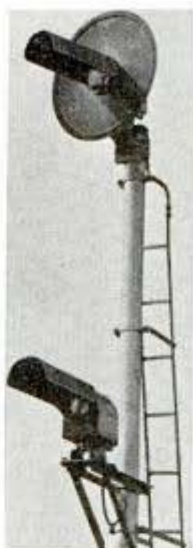

Signal lights are fitted with metal hoods (left) making them visible only from the ground. All blackout equipment was carefully tested by army officers who made observations from the air over a blacked out section of the Southern Pacific and reported horizontal rays are invisible from above. Below, hooded trackside signals can be seen easily by the engineers

Railroads on the west coast operate through blackouts with hooded lights hiding vertical beams from enemy bombers; fire boxes are screened; windows are painted black. Above, a brakeman attaches a hooded marker light at rear of Southern Pacific train

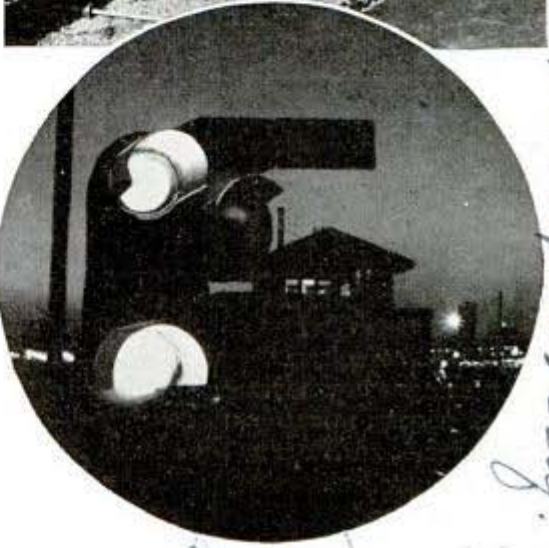
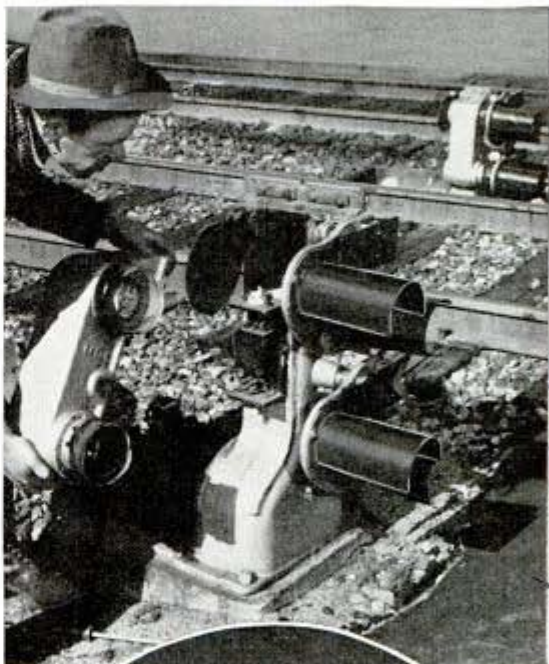
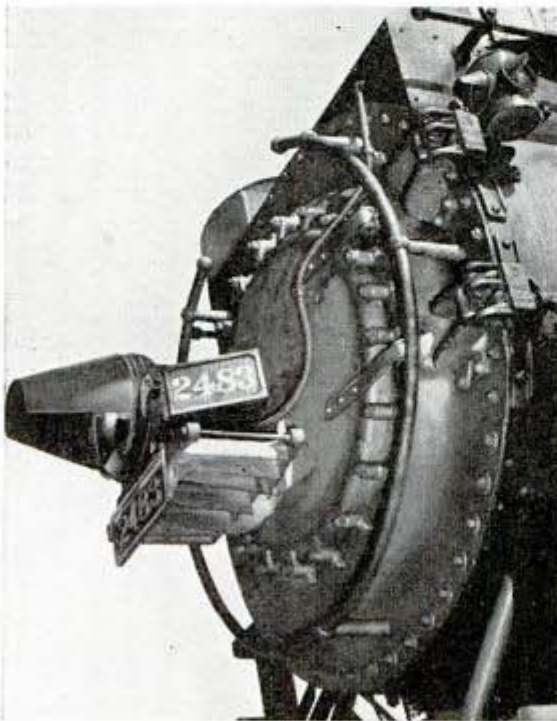

Locomotive headlights that would serve as a beacon for a flier miles away wear blackout hoods (above) that throw the powerful ray downward. At right are "dwarf" signals subdued at night with long protective coverings that give plenty of light for safe travel and the transportation of vital war materials without violating blackout regulations. All station and switch lights are also equipped with circular covers and the powerful floodlights in the yards have been replaced by smaller lamps for the "duration"

SEPTEMBER, 1942

Rep: Fred Woodward, News Bureau, Southern Pacific Co. 406 Pacific  
 Los Angeles, Calif.

*[Faint, illegible handwritten notes at the bottom left of the page.]*

# Army Optical Shop on Wheels Serves Men on Battlefield

American Optical Co. Southbridge, Mass.

M-508



Truck is equipped with optical machinery to care for 300,000 soldiers

Mobile optical shops, first of their kind to be attached to field armies of the United States, will repair or replace spectacles broken or lost by overseas soldiers in camp or on the battlefield. One unit, housed in a big army truck, contains optical machinery, 36,000 lenses, 8,400 frames, 600 pairs of extra temple pieces and 1,200 spectacle cases. Sixty pairs of lenses can be edged and mounted daily. This is estimated to be sufficient to care for the needs of 300,000 men. Soldiers who wear glasses (about 15 percent of the men in service) will have prescriptions attached to their service records to facilitate the work in the field.

## Lacquer Made From Milk Replaces Tin in Cans

M-514

Lacquer made from cow's milk to serve as a substitute for the tin coating in cans used for evaporated milk has been developed by the Bureau of Dairy Industry of the U. S. Department of Agriculture. It is made from lactic acid and a small proportion of vegetable oil. The acid is obtained by fermenting the sugar in whey, a by-product of cheese manufacture for which the industry has long sought a profitable outlet. The bureau found that evaporated

milk sealed in cans coated with the lacquer retains its normal flavor after a month of storage. Tests are also being made with the large five and 10-gallon steel cans which are used for shipping milk and cream.

## Plastic Pontoons Speed Takeoff

M-509 of Plane

Airplane pontoons made of plastic conserve aluminum and at the same time function better than those made of metal, according to a Cincinnati inventor who has developed a method of molding plastic without heat or pressure. Plastic pontoons are as light in weight as those made of aluminum, cost only half as much and permit faster takeoffs by eliminating the drag caused by rivets and seams on metal pontoons. They are also said to be as strong as those made of aluminum.

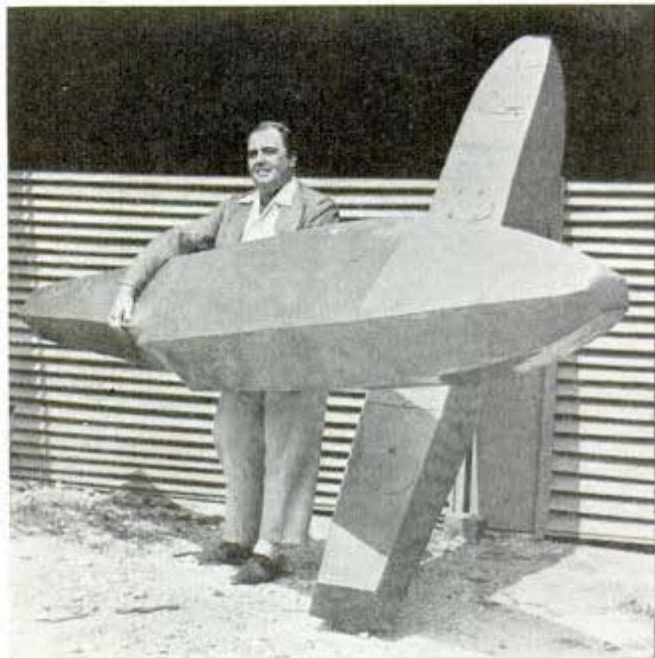

Light and strong as aluminum, pontoons of plastic save metal

64 Wash. D.C.

POPULAR MECHANICS  
Powell Crosby III, Crosby Corp.  
1329 Arlington, Cincinnati, O.

# Handrails on 100-Foot Ladders Help Firemen

Handrails on the sides of two 100-foot extension ladders recently acquired by the Chicago Fire Department provide portable fire escapes for persons trapped in a burning building. The ladders, mounted on trucks, are made of steel and hydraulically operated. Each unit costs \$20,000.

## Tiny Radio 'Bomb' Tossed by Pilot Tells Altitude

If a pilot is flying through clouds or darkness and his instruments fail, he won't have to wait until he hits a chimney or high wire to find out how far he is from the ground—thanks to a Chicago inventor. The altitude may be figured with a small automatic radio set in a bomb-shaped casing. As soon as the radio "bomb" is tossed overboard it starts to send a signal which ceases when it strikes the ground. The pilot measures the time of the fall and translates it into terms of height. This system of waiting for the falling body to become silent is like the old practice of measuring wells by dropping a stone and listening for the splash.

Mrs. Laurens Hammond  
 421 N. State, Chicago

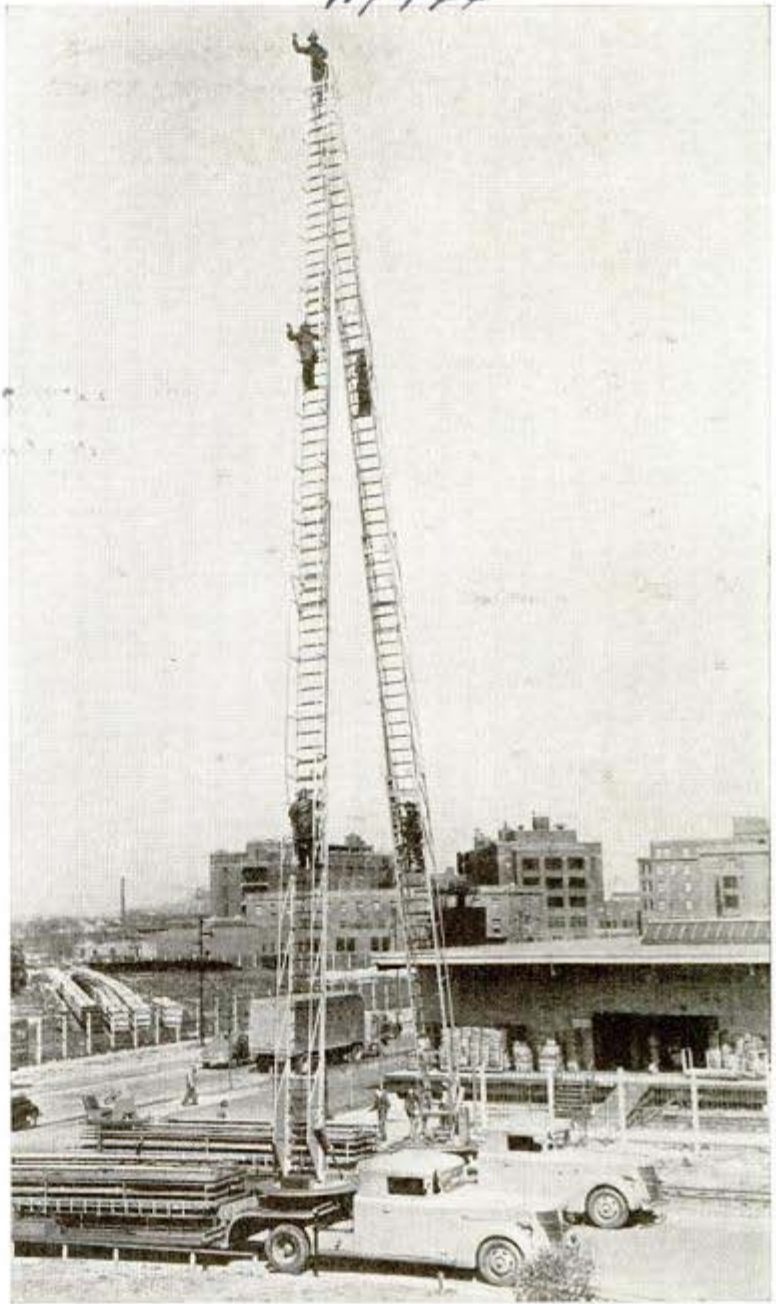

Huge steel ladders, hydraulically operated, make portable fire escapes

## Sliding Band on Wrench Handle Automatically Adjusts Jaws to Nut



Strength of the grip is increased with size of nut

Sliding a band in the handle of a new wrench automatically adjusts the jaws on a nut, holding it in a firm grip. The action on the handle is accomplished by a spiral shaft that meshes with a worm gear inside the wrench head which operates the sliding jaws. The hold on a nut is loosened by merely zipping the handle band downward. The wrench is made in four sizes.

SEPTEMBER, 1942

Pack-Rite Machine Corp. 828 No. Broadway, Milwaukee, Wis.

M 68



A 24-foot octopus stares back at Lieutenant Rieseberg as he peers from the window of his deep-sea robot during a dive

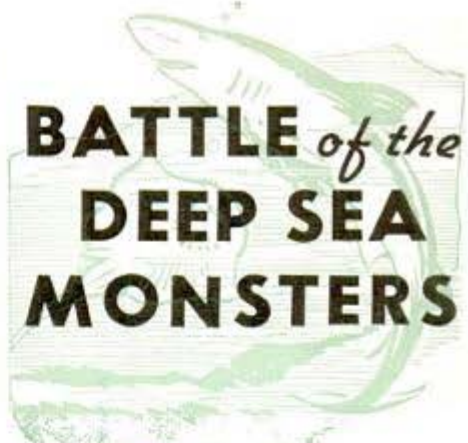

# BATTLE of the DEEP SEA MONSTERS

5127 Jountain Av.  
Los Angeles By Calif

**Lieut. Harry E. Rieseberg**

Deep Sea Explorer and Salvage Expert



The savage battle between the octopus and the tiger shark begins with a sudden thrust of the tentacles at the shark's neck

The battle made a bull fight tame by contrast. At the end the shark lay on the ocean floor, strangled by those powerful arms



IT WAS while I was exploring the seaways and depths of the Caribbean, 100 miles north of Port au Prince, Haiti, that I witnessed the death duel between two huge monsters on the floor of the ocean—a scene of savagery that fascinated me with its horror as never before in my underwater experiences.

During my travels as a deep-sea salvor of sunken treasure I have seen plenty of action, yet none like that struggle on the sea bed thirty fathoms down in the Silver Shoals Passage.

Our expedition was equipped with the latest deep-sea diving gear and robot; the latter had powerful underwater lights which illumined the bottom for many yards about. An observation bell and other scientific equipment also were a part of our expedition, and we had a movie camera, specially devised for subsea operations.

The cumbersome 3,900-pound diving robot was constructed of iron and steel. It was equipped with barometer, thermometer-humidity recorder, telephone and battery box, blower, trays and pan of chemical apparatus for absorption of carbon dioxide, and oxygen tank. Its vision plates were of half-inch fused quartz, the strongest and most transparent substance in the world.

It was through these windows

*[Handwritten notes and signatures at the bottom of the page, including 'M. Rieseberg' and other illegible text.]*

that I peered out into the world on the bottom of the sea—and photographed the dramatic battle between an octopus and a shark.

I dropped over the schooner's rail, encased within the huge diving sphere, and was slowly lowered to the bottom. There, where a shoal stretches a mile or more between coral atolls an enormous and squirming creature made its appearance from the jagged rock caves. Through the murky water came a quivering mass with long arms, sinister eyes—the largest octopus I had ever gazed upon.

Suddenly, from above, a shadow came over the scene.

It was a shark! A huge tiger shark about 18 feet long, and a glance at this ferocious creature was enough to send a shiver down anyone's backbone. The natives along these shores of the Caribbean call it the tiger of the sea—"El tigre!" And it is a man-eater, the most savage and tricky of all sharks.

This "tiger" stirred enormous



Before venturing into the sea with his movie equipment, Riesenberg inspects the pump that supplies air to his diving suit

Divers stage an underwater fight with a mechanical rubber octopus for Paramount film, "Reap the Wild Wind"

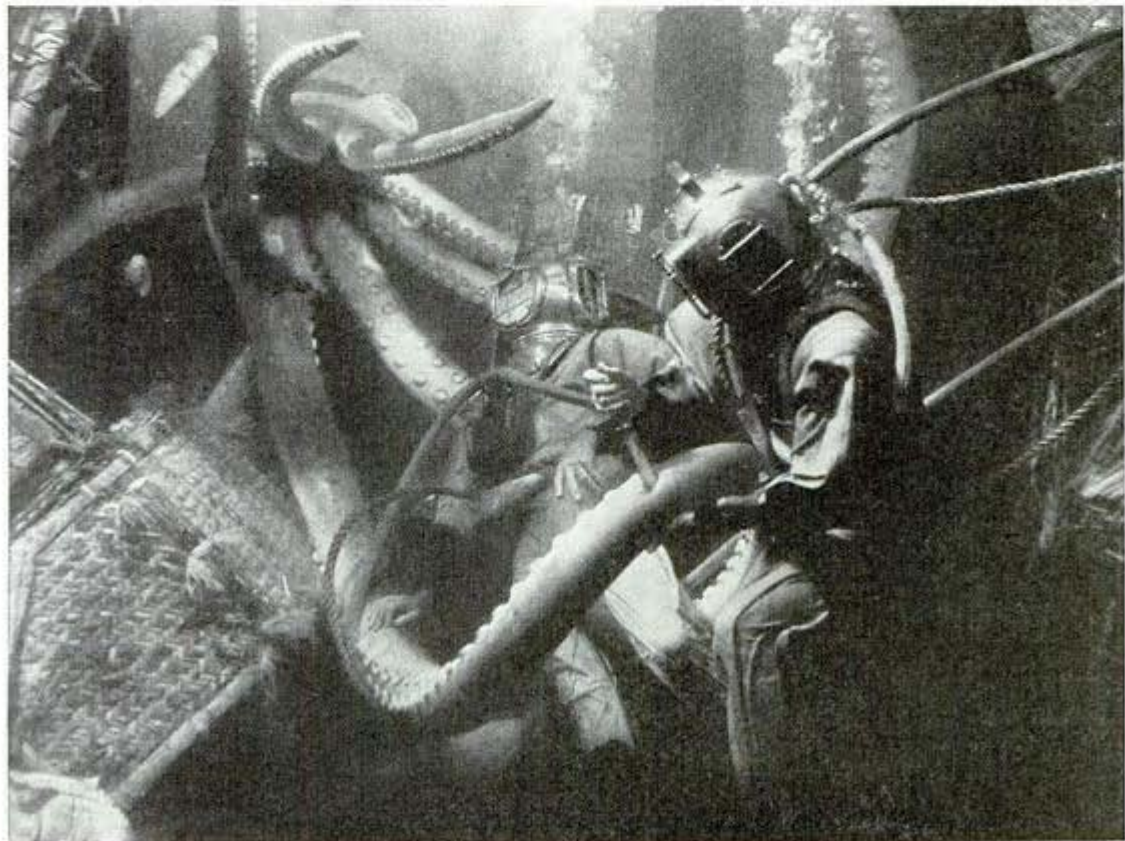

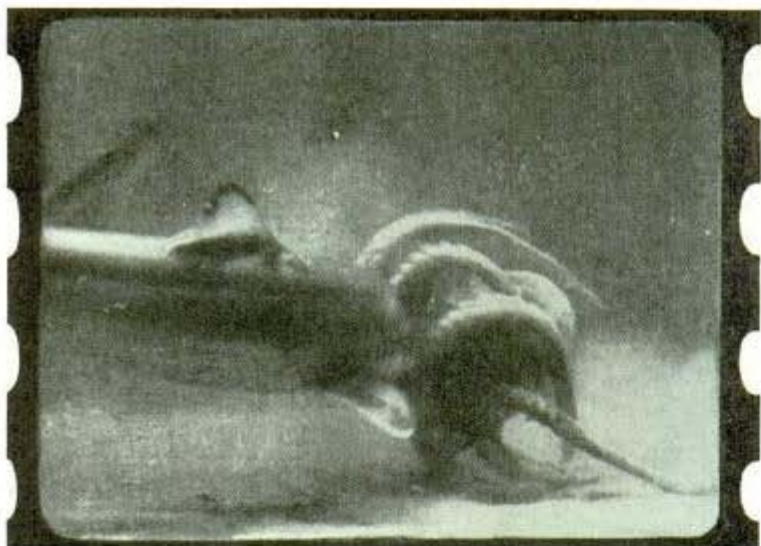

The tiger shark charges into the octopus in another real-life movie scene

swirls and eddies with his massive tail as he cruised about. Suddenly the shark made a swift downward plunge. He sighted the octopus!

The effect of the octopus upon the charging shark was most extraordinary, for the shark seemed to be driven insane, dashing up and down, back and forth in a frenzy, darting to the surface, hurling spray high into the air, then down again.

But the wily octopus moved with deadly purpose. Rearing up on his eight slimy tentacles, his little slanting eyes steadily watching the mad gyrations of its enemy, the strangler took his own good time. As I watched through the vision plates of the robot, I thought that it was no wonder the shark found such terror in this nightmare of a creature! I had my own fears, too, yet it was an opportunity that comes to an underwater explorer but once in a lifetime—to witness and photograph such dramatic action as was taking place before my eyes.

So for the moment I laid aside these fears, and reached for the camera. I placed it in position against the vision plate, and the camera started whirring.

What followed made a bull fight seem dull, slow business. The shark had become wildly nervous, for all his huge bulk and power. The octopus was playing for position. Like a boxer sparring, the tentacled creature feinted this way and

Sighting an enemy, the octopus throws out its protective "smoke screen" of inky fluid

that, crawled slowly forward and then darted sideways, dodged a rush from the maddened shark and shot backward, ever working, it seemed, with some definite plan in mind. It made little difference to him how long these preliminary moves took, he was always waiting, watching, alert for the moment of attack.

Thus, for some minutes, the two monster gladiators sparred in the arena of the underwater world. Then, suddenly and with supernatural speed it seemed, that hydraulic drive of the

octopus exploded with swift action as the creature shot himself at the shark so fast that my eyes could not follow his motions! He missed his aim, then tried again.

It was most thrilling to watch the address with which the octopus curved to one side, gathering himself together, then began all over again. Yet sooner or later one of these powerful catapultings must be too swift for the tiger.

There it was! A flash! A blur, and the slimy creature was locked fast to the shark's neck, its 12-foot tentacles wound about and clinging with their leech-like suckers to the shark's hide. Each sucker has a gripping capacity of approximately 19 pounds—and there are hundreds of them, it seems, lining the tentacles.

Now water began to fly! The great shark dashed madly about, endeavoring desperately to unseat its foe. The octopus merely took his ride, gripped like a vise

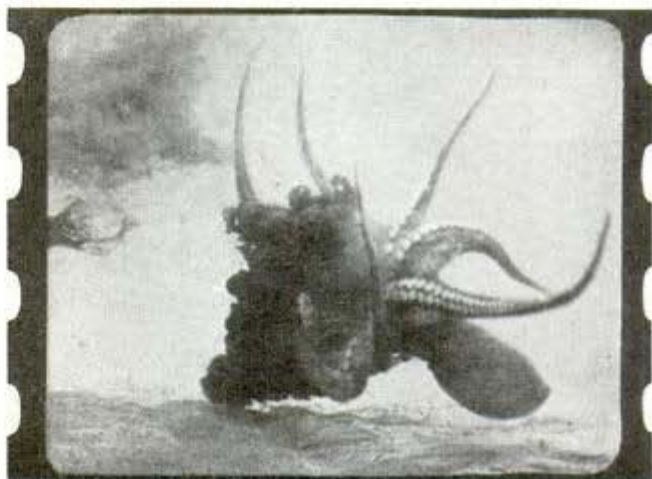

to the shark's neck. The powerful fish could not rub him off against the jagged coral without injuring himself. The shark tried to rid himself of his rider with the leaps and bounds, plunges and turns and speed of a bucking bronco. But it was in vain, for the octopus still clung to that huge neck.

Presently the shark began to speed back and forth with renewed energy. From behind the clear quartz plates of my robot I could see all his swift movements vividly while I kept the camera whirring, focused on the action. However, the beast soon slackened in his pace, then thrashed wildly again. This lasted but a few short minutes, when finally the shark slowed almost to a dead stop with the fleshy ball of octopus still clinging to his neck. Down to the sandy sea-bed they sank together at last.

That was the shark's finish! There were a few kicks, some feeble convulsions, but it was all over.

The octopus slowly secured its tentacles about the shark's gill-flaps and strangled him, the sucker-like arms shutting off the creature's wind and thus actually drowning the shark. Then the winner slid his tentacles fan-wise, like anchors, ready to haul the carcass away into some rocky crevice for a leisurely dinner.

All this time—possibly no more than 25 minutes—I was grinding away, one magazine load after another, each 100 feet in length, yet it seemed like hours down there on the bottom of the sea watching the greatest underwater adventure I had ever witnessed. I had seen it from a ringside seat, my nerves all on edge. Better still, I found later I had caught on film nearly every action of the fight!

Drawing shows how the deep-sea observation bell is operated with its long grappling arms



Rieseberg examines plaster cast of angel shark from Caribbean  
The big octopus that fought the shark comes in for a closeup

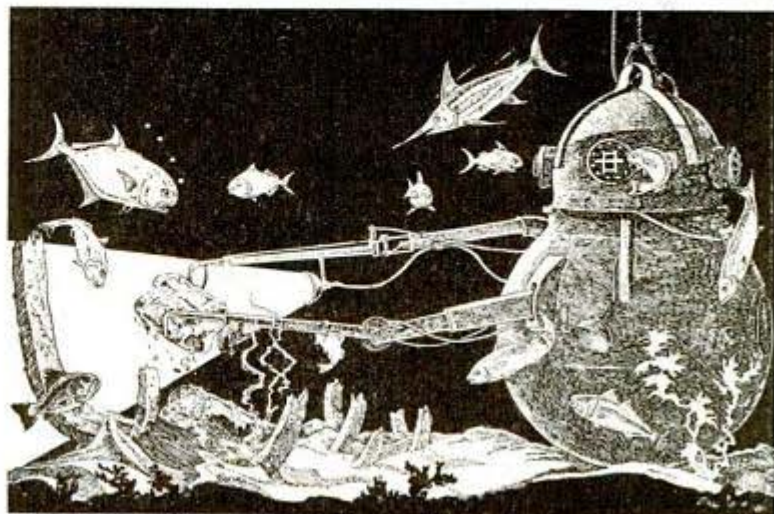
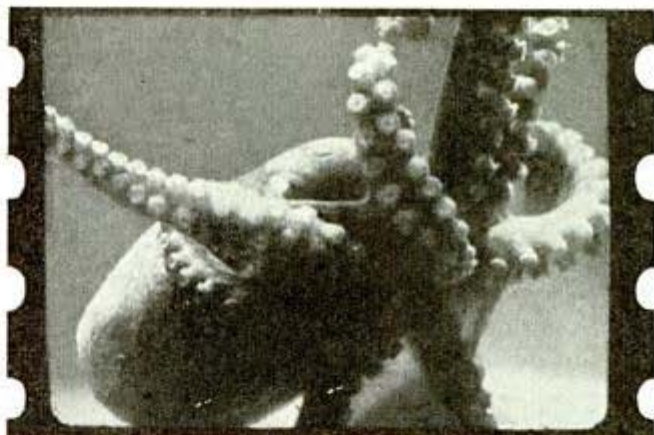

# Workman Dangles From a Rope To Beautify Face of Dam

M424



This beauty operator removes blemishes with hammer and chisel

Finishing touches to massive Friant Dam, near Sacramento, Calif., include a beauty treatment administered with hammer and chisel. Blobs of spilled concrete, water streaks and other blemishes that mar the downstream face of the structure are removed by workmen dangling from ropes suspended from the top. Although this stone "facial" does not add to the dam's utility, it leaves a smooth surface—at least from a distance—to be admired by the thousands who will visit this project.

## Diesel Locomotives Eclipse Steam By 3 1/2 to One in Building Rate

M1571

Seven years after the first Diesel entered railroad passenger service at the head of a Burlington "Zephyr," the Diesel locomotive has stepped far ahead of steam in units built during the year 1941. Out of a total of 1,436 locomotives of all kinds ordered last year, 1,096, or 76 percent, were Diesels;

70 Taken from  
"Diesel Power and  
Transportation" - May 1942

302, or 21 percent, were steam-powered, and 38 were electric. In 1934, out of a total of 185 locomotives purchased, 37, or only 20 percent, were Diesel-powered. In locomotives actually in service, however, the steam-powered variety still outnumbers the Diesels by many thousands. At the close of 1941, American railroads owned about 40,000 locomotives of all kinds, while there were only 2,600 Diesel-powered locomotives owned and operated by railroads and industrial companies. The Diesel started as a switching engine, then in 1934 entering the passenger field in a streamline dress, and recently emerged as a long-haul freight locomotive.

## Canvas for Rolling Dough Folds to Save Space

Designed to save space, a folding device on which dough may be rolled is made of cloth resembling canvas and held taut by a frame of two wooden pieces and metal bars that loop over the ends of the smaller stick. The larger wooden piece helps hold it in place by hanging over the table edge. It rolls up like a curtain for storage.

M476

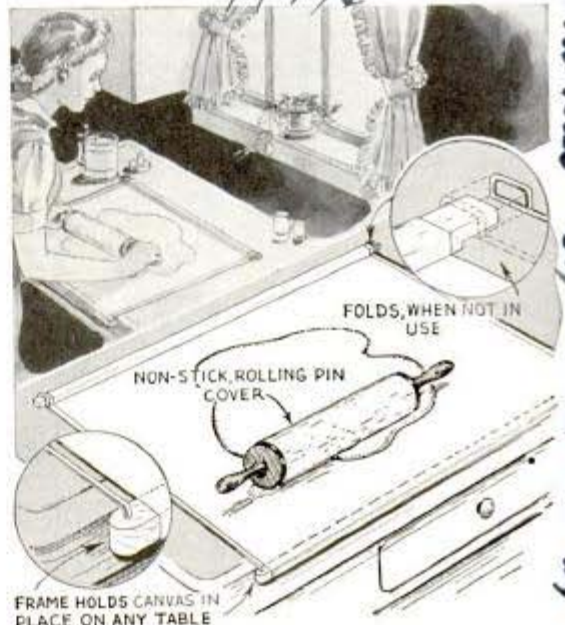

Cloth is dusted with flour to prevent dough from sticking; if soiled, it can be taken off frame and washed

POPULAR MECHANICS  
Distr. Sears Roebuck & Co.  
State & Van Buren, Chicago.

ref. E. S. Cardwell Co., Duotoma, Minn



John R. ... (1942) ...  
Kitchen Broom "Drafted" as Splint for First-Aid

M.573

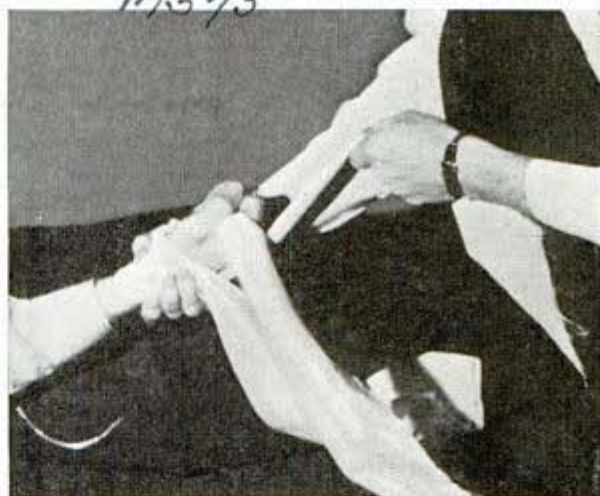

If you know how to use them, many ordinary household tools are helpful in administering first-aid. One example is the broom which may be used as a temporary splint for a broken arm. A few pieces of bandage and a cylindrical object about the size of a clothespin are required to apply the splint. The first step, shown above, is to wrap the cylinder in a triangular piece of cloth. The wrapped cylinder is placed in the victim's hand. Another triangular bandage is turned around the wrist (upper right) and then tied around the knuckles to hold the cylinder firmly in position

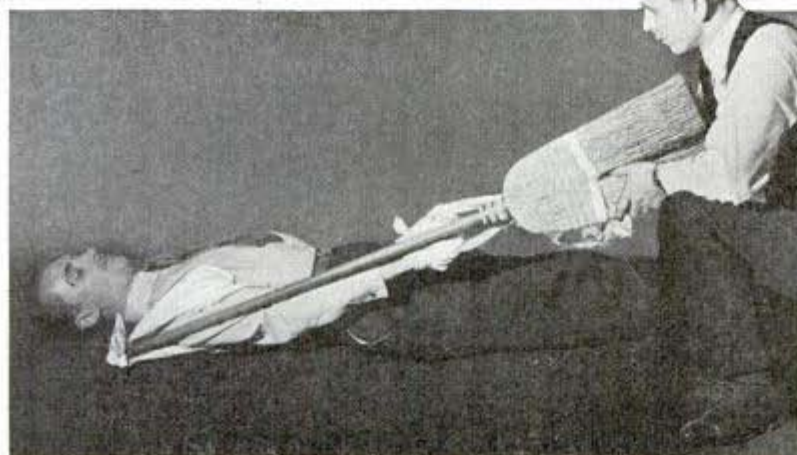

Ends of the bandage, which is fixed tightly in the victim's hand, are pulled (above) to apply traction preventing the broken bones from rubbing together. The end of the broom handle is thrust into a loop tied around the shoulder, as shown at left, and the bandage is drawn through the straw and tied securely. The straw provides a spring. After the splint is adjusted, as demonstrated at the new safety school of the New York Telephone Company, the victim may be moved to a hospital without agitating the injury

Cont: Mrs. Mary Elliott, 34 3 E. 33rd St  
N.Y., N.Y.

M361

## The LAST ROUND-UP

ONE of the most surprising possibilities in this changing world is that your children's children may never see a live bison, grizzly bear, mountain lion or scores of other varieties of American mammals that held the land before the predatory white man came.

Authentic background for this belief has just been provided in New York City where the American Museum of Natural History, the largest of its kind in the world, recently opened—even before it was half finished—the most modern exhibit of animals ever put together by artistic skill.

The fact that it is entirely devoted to North American mammals is proof that they are becoming so rare even in our day that they have a new curiosity value to the American public.

Up to now, Africa and Asia and faraway lands with strange-looking beasts in romantic settings have held the attention of natural history museums and the public. Elephants, wildebeests, pandas, zebras and others have been fashionable. All of a sudden elk, deer, moose—as American as the Indian or cowboy—are coming in for their share of attention because museum experts realize our own animals are vanishing at an alarming rate.

The fact that the new exhibition was

This bison calf wears a Cellophane overcoat to protect his fur during the preparation of an exhibit

A Hollywood touch is supplied by making a "studio" tree from real branches stuck on an artificial trunk



thrown open in an incomplete state in the hope that American interest in American animals might help push the \$250,000 project to an early completion has a sinister aspect, the learned museum experts admit.

While one group of scientists, employed by the government, is trying to keep the ever-disappearing animals alive, this group of experts is working with unusual haste for them, saving the vanishing species in museum settings—just in case worst comes to worst.

Dr. Harold E. Anthony, curator of mammals in the famous museum, points out that the war has provided a new threat to American wildlife, a threat that cannot be lightly disregarded.

Since the impact of the war in America thus far has followed the European pattern, it is quite possible that before the conflict is ended we may be forced to shoot our animals in zoos, national parks and reservations as they have in other countries to save food for our



The white-tail deer look realistic enough to nibble the grass held out to them

"Just like his pictures and the model," say the experts of brown bear, right

Sculpturing the body of a grizzly in clay—stuffing of skins is now outdated

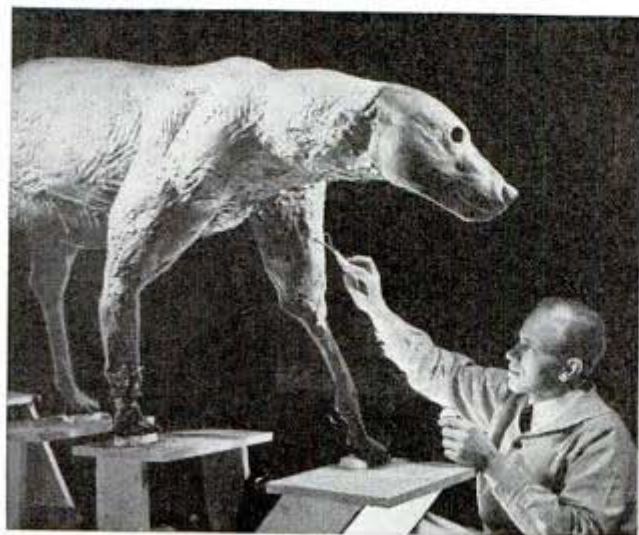



Painting the background for the Alaskan brown bear, the artist works from color photographs and sketches made at the scene by the museum's staff

soldiers, civilians and domestic animals.

It is also likely that the increased need for meat, hides and wool will greatly increase grazing throughout the West and more and more cattle and sheep will encroach on the already restricted areas in which the remaining wild American mammals roam. The danger here is not a lack of food for the undomesticated animals, but in the fact that sheep and cattle carry diseases into uncontaminated areas. Then, too, in the face of mounting demands for conservation of money spent on nonwar projects, it is quite likely that the government's expenditures for protection of wild animals will be cut or stopped entirely.

The final possibility is that if this nation becomes pinched for food, herds of protected buffalo, moose and deer will present themselves as a temptation for the hunter's gun.

Whatever the outcome may be, the museum is taking no chances.

Dozens of other museums have American mammals in cases, but because of the recent discoveries in plastics, adhesives, paints and other materials, some of these exhibits are outdated by the newly

**Miniature models serve as blueprints in making the life-size bison group exhibit**

opened hall in the New York institution. Earlier exhibits represent American mammals about as well as Model T Fords would portray the American automobile if scientists decided that autos would become extinct in a generation or two and wanted to place representative cars behind glass for preservation.

People who think museum artists merely stuff something into a bear skin, no matter how artistically, and produce a natural-looking bear would be surprised to learn that it has taken 18 years of planning by Dr. Anthony and six years of actual work by him and Dr. James L. Clark, head

of the department of arts and preparation, assisted by about 35 men, to complete 10 habitat groups which are now being shown to the public.

The result, however, is that the new hall presents a panorama of wildlife throughout the continent, extending from Ellesmere Land, near the North Pole, to Mexico and from New York to the west coast of Alaska. The American animals are mounted in realistic life settings of their native plains, forests, swamps, mountains and deserts—a vista of North America's natural wonders and tremendous space. The hall has none of the "stuffed animal" appearance



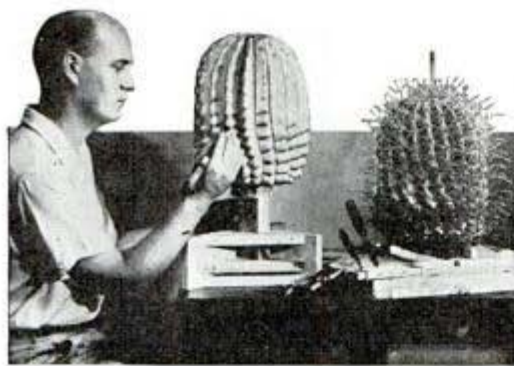

**New lacquers and plastics will help fool the experts when this cactus is finished**

of the average museum exhibition.

Particularly striking is the Alaskan brown bear group. The scene is of the Aghileen Pinnacles at the tip of the Alaskan Peninsula in late spring. In the foreground, seeming to dwarf the snow-topped mountains, are two immense Alaska brown bears. This species is the largest carnivorous land mammal in existence, and the giant relative of the grizzly and the European brown bear. The size of the Alaska bear is probably due to his abundant food supply, the hordes of salmon that run all summer and the vegetable food available in late spring and fall. These bears are most active in the daytime and they are usually solitary except when drawn to a common source of food. The cubs remain with the mother for almost two years and apparently take six or seven years to reach full size and weight.

In the museum group, the huge bear standing on his hind legs, seeming to sniff the air for danger scents, is more than 8 feet in height and weighed 1,400 pounds. The female, beside him, has stolen a salmon from an otter shown in the background. The painting of the volcanic Aghileen Pinnacles is authentic. Stones and pebbles in the foreground are water-rounded igneous rock brought down from the mountains.

Another striking ensemble is the bison group. It represents a buffalo trail on the North Platte River in Wyoming. Brilliant summer



**Applying finishing touches to the clay model of the huge Alaska brown bear from which molds are made for casting the body**

Elk shed their Cellophane wrappings before the "show" goes on





To make a tree trunk, wooden framework is covered with a wire mesh, burlap, plaster of Paris and bark



Painting in herds of bison, scattered by the thousands on the plains. Note buffalo grass in foreground

sunlight beats upon a flat plain and a herd of dust-covered buffalo feeding on the buffalo grass. Specimens of pronghorn antelope are also in this group. The expanse of the exhibit permits the delineation of a great herd of bison in the background painting; the animals seem to stretch off into the distance in countless thousands, a scene which has already vanished from this world.

Only years of work made a group like this possible. After an interval of negotiation with federal authorities, the museum obtained permission to collect—which means shoot—the required number of bi-

son from government herds which now number around 5,000 head. At one time the herds reached the critically low figure of 319 and bison were very nearly extinct.

This collection had to be timed so that the coats of the animals would be glossy, since the bison shed and become ragged in certain months. They also had to time the shooting so that the calves would be of the right age and the surroundings had to be seasonally in harmony with the coats and the age of the calves.

One of the most difficult problems in connection with this group was supplying the correct kind of buffalo grass, the grass on which the huge herds of bison once thrived and the loss of which brought about dust bowl conditions. The long and tenacious roots of this grass kept the soil together until farming and plant diseases destroyed it on much of the western plains.

To find the right kind of buffalo grass it was necessary to consult government authorities who directed the museum experts to a section of Kansas which would also serve as territorial background for the exhibit.

As is customary, the museum experts went after their animal and plant quarry in a group of three. One was the hunter who preserved the skins of the animals until they could be transported to the

(Continued to page 163)

The sky and clouds are copied from photographs taken at the scene reproduced in exhibit they will cover



# Planes Tow Squads of Troop-Moving Gliders

M 543

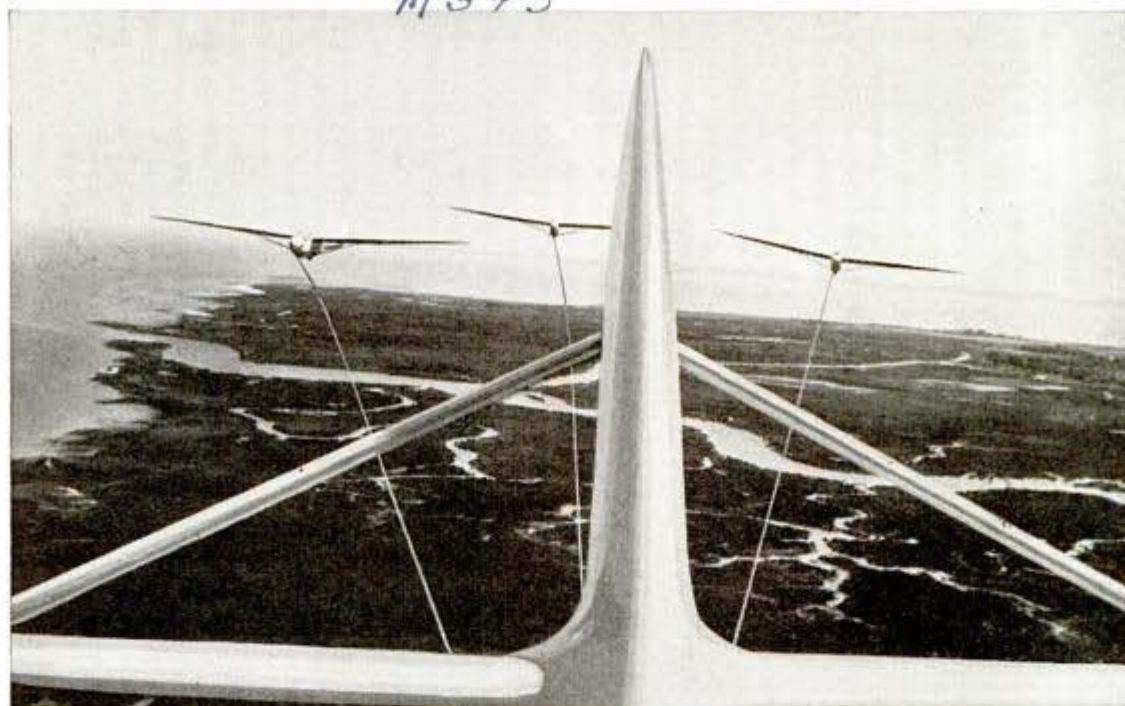

Multiple passenger gliders are on the way and this is how the "air infantry" will be towed in glider squadrons for a surprise attack. At right is a winch sometimes used to tow the gliders to a takeoff. Note headphone on man, right

Two passenger planes are used to tow "squadrons" of troop-carrying gliders at the U. S. Marine Corps Glider School on Parris Island, S. C. Glider pilots acquire skill in the manipulation of their craft as they are towed in groups of three or more at varying distances behind a plane. Winches are also used at the school to tow gliders to a takeoff. Multiple-passenger gliders now being built will be used to transport large units of air-borne infantry and paratroopers for surprise attacks on the enemy.



## "Shotgun" Rocket Projector Used by Russians Fires 30 Shells at Once

German tanks are finding it difficult to dodge shells fired by multiple rocket projectors used by the Russians, according to Prof. George B. Kistiakowsky, ordnance expert at Harvard University. The big projectors fire 20 or 30 shells at once, like a shotgun discharge. Two other rocket weapons are being used on airplanes. One is used against other planes or ground tar-

gets; the other, an "upside-down" rocket employed by the Germans in the bombardment of Malta and against armored ships, is used only for ground targets. The latter has the attraction of gravity added to the force of the rocket-stream push. Since rocket projectiles can be fired without recoil, a heavier shell can be fired from a plane than is possible with a light cannon.

SEPTEMBER, 1942

Reported by Prof. Geo. B. Kistiakowsky,  
Ordnance Expert, Harvard Univ., Cambridge, Mass.

Cont: Don Black, Publicity Dept., Douglas Aircraft Co., Santa Monica, Calif.

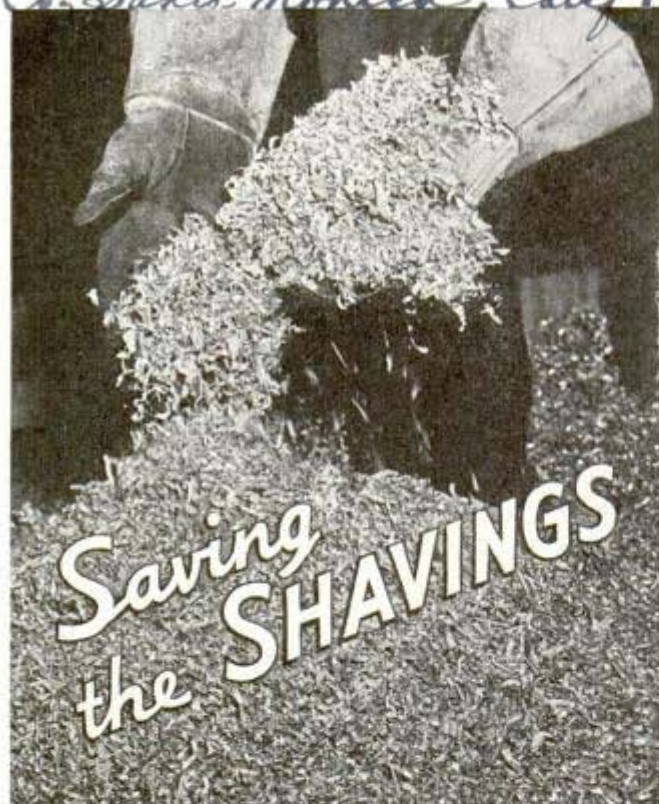

Photos from Douglas Aircraft Co.

M 364

**T**HEY used to say the meat packers used everything but the pig's squeal. That's nothing to what the war factories are doing. They sweep up millions of dollars' worth of metal dust from the floor and convert it into hundreds of planes and war machines. Westinghouse Electric reclaims scrap alu-

**P**lexiglas and Lucite scrap, being thermal plastics, are easily reworked or converted into novelty items

Metal shavings and dust like this are more precious than gold to the war industries

minum at a rate of 120,000 pounds a month—nearly 1,500,000 pounds a year; and that is less than half the aluminum salvaged in the Douglas Aircraft plant.

Last year Buick piled up a 244,-000,000-pound scrap heap, but it didn't go to waste. Buick even saves exhaust steam, uses it again and again, then converts it back to water. They say that Ford even salvages the echo from the plant whistle, catching it on a phonograph plate.

And speaking of phonographs, Douglas collects the shavings from Dictaphone records—for there are several precious chemicals in those wax cylinders. Most of the scrap at the Douglas plant is sheet metal, and this is carefully segregated into seven classifications according to alloy content, baled and shipped to the source factories as part payment on new sheet metal.

But there is also a vast pile of salvaged metal clips, electric furnace dross, culled pistons, forge flashings, short ends of rods, tubes, extrusions, stampings and other material. Some 23,000 pounds of rivets were picked up from the floor last year, re-sorted and re-inspected for use. After sheet metal and rivets, the principal

**B**oxes that brought airplane engines west to Douglas plant go back east with salvaged electric wire



Handwritten scribbles and signatures at the bottom of the page, including the name 'Don Black' and other illegible text.





scrap items at Douglas are Lucite and Plexiglas, the transparent phenol plastics used in bomber turrets and cockpits; being thermal plastics, these are easily reclaimed, and large pieces are in demand for making cigaret cases and similar decorative novelties. Sawdust is reclaimed to be turned into briquets, sweeping compounds and bonding material for adobe bricks. Odd items such as nuts, bolts, springs, and screws go to a store where Douglas employees can buy them at bargain prices—and these gleanings bring \$6,000 a month in cash.

General Electric is "panning" nickel dust by a new process, recovering 20 percent of requirements for one big plant.

There's pay dirt in the industrial ash cans these days, and it's getting no vacation. It's put right back to work.



Shoveling scrap into the baler press. The salvaged metal is turned in as part payment on new metal

Discarded as imperfect, these small castings have been segregated for return to the foundry furnaces

Baled scrap is trucked to the rails for shipment back east. It has first been sorted according to alloys



Virginia Lincoln, Room 1001  
Furniture Mart, Chicago.

## Dining Table Becomes Seat When Top Is Raised

M479



Table top swings back on hinges to form back rest

Home furnishings designed for multiple uses during wartime include a small dining table which is converted into a bench by raising the top, hinged to form the back rest. The seat is a flat wooden piece between the legs which are inset from the table's edge. When the top is raised the bench may be backed against the wall.

## Cork Jacket Shields Young Tree From Sun Scald and Rodents

Protection for young trees is offered by an insulating sheet which wraps about the



M413

Jacket is rolled about tree and held by wire loops

80 Serviced Products Corp  
6051 N. 65th St, Chicago, Ill.

Distr: Steffen's Rubber Co.  
15 N. Van Buren, Chicago.

tree trunk like a jacket. Consisting of an asphaltic-saturated felt back with cork granules distributed over one side, the jacket is placed with the cork side toward the tree, thus acting as a heat distributor during warm days in winter and spring when unprotected trees may be damaged by the sun heating one side and causing the sap to flow, while the other side remains dormant. The cork insulation permits even circulation of air and admits a sufficient amount of rain water at the top to keep the bark moistened. Trees wearing the jacket are guarded against sun scald, rodents, borers and certain diseases.

Account  
insert

## Abrasive Puts Edge on Mower While You Push It

Sharpening a lawn mower is reduced to the simple process of pushing the machine after hooking a sheet of metal coated with

M438

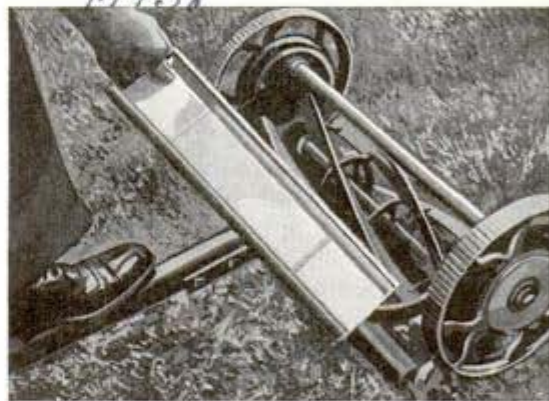

Handy sharpener hooks over the cross piece of mower

carborundum over the cross piece. The revolving blades scraping against the sharpener at the correct angle are sharpened with a few movements of the mower.

## Plane Gunner Rides a Turntable To Fire in Any Direction

M500

Rear gunners in airplanes will be able to fire at almost any angle with a mount for machine guns invented by Alexander P. de Seversky, noted aeronautical engineer. With this mount the gunner can swing himself and his weapon around and shift the gun from side to side. The gunner's seat is suspended from a carriage that runs on a track circling the cockpit. An arch-shaped girder mounted on the same wheeled frame carries the machine gun which may be locked in any position.

POPULAR MECHANICS

Inv. Alexander P. de Seversky, Northport, N.Y.

# Builders of Dam Risk Lives to Harness River

Dangerous jobs such as inspecting a highline (right) stretched across a canyon, or drilling on the side of a lofty cliff (below) are all in the day's work for builders of the great Shasta Dam that will harness the water of the Sacramento River and supply power for war plants. In circle, repairing a bucket

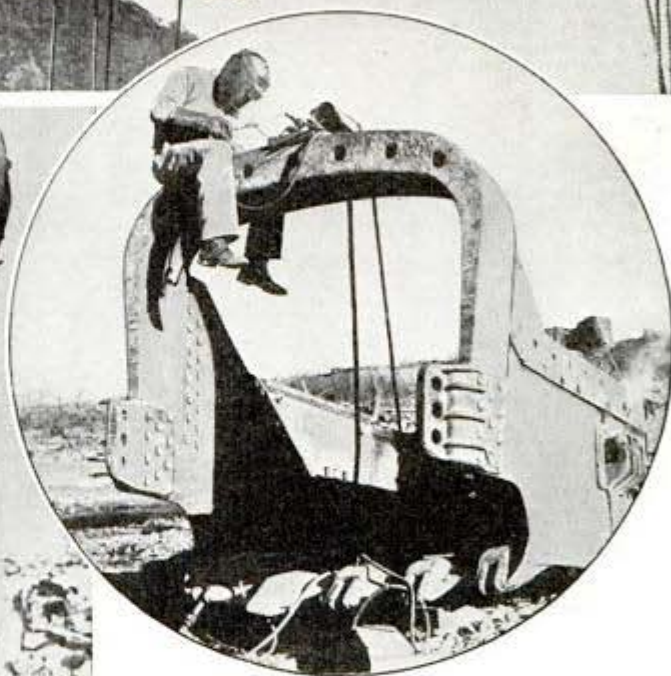
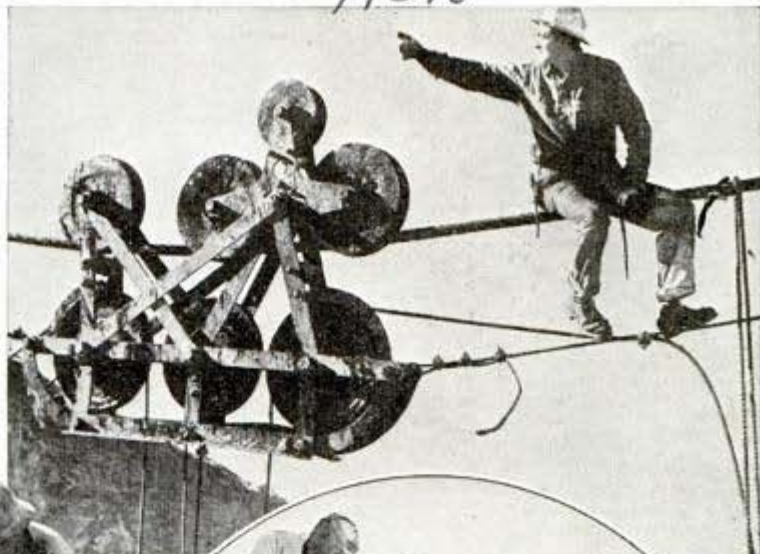

Drilling a hole for a dynamite blast high on a rocky abutment, inspecting a highline stretched across the Sacramento River Canyon, or repairing a giant bucket used to excavate gravel are only a few of the hazardous jobs performed by skilled

workmen in building the great Shasta Dam in California. These "men behind the lines" are wielding giant tools to speed the project that will increase America's supply of electric energy and turn new wheels for war production. The concrete and steel of Shasta Dam will check the ravages of the Sacramento River and harness its waters to supply power and irrigation.

## Cutting Impure 'Gum' From Sorghum May Add New Source of Sugar

Sorghum may yield as much sugar as Louisiana cane in the future due to an invention for removing impurities from the syrup. The process, developed by chemists of the U. S. Department of Agriculture, prevents the formation of "gums" when the

symp is boiled down, allows crystallization of sugar, and recovers starch, calcium and aconitic acid as valuable byproducts. Sorghum can be planted in the spring and harvested in the fall, while sugar cane requires two years to mature.

Mr. Leggett M.312

Ref: U. S. Public Health Service, Natl Institute of Health, Bethesda, Md.

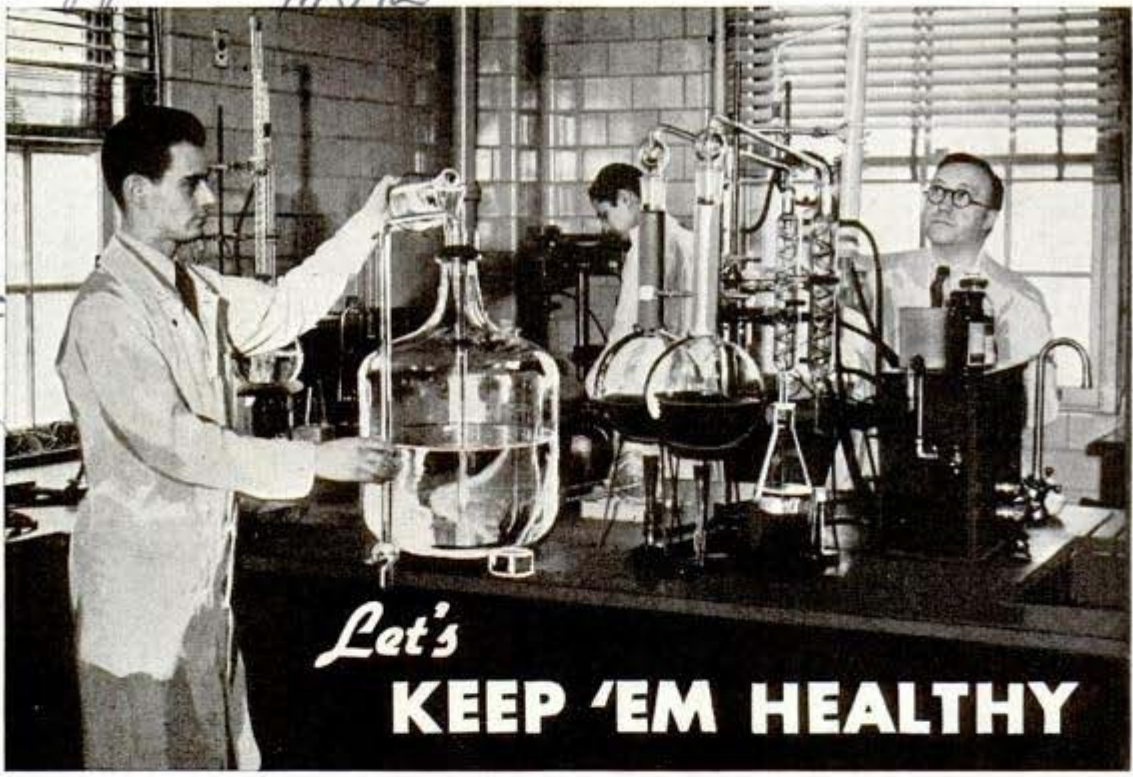

*Let's*  
**KEEP 'EM HEALTHY**

**Guardians of the health of millions of defense workers test the effects of new chemicals used in industry**

ONE of the war's greatest battles is raging just outside Washington—a battle to conserve the health and strength of America's rearguard army of some fifty million workers, the machinists, welders, riveters and others doing the jobs so vital to victory.

On one side in this struggle is a terrible enemy, sickness. When this nation's industrial legions go to the factories, shipyards and mines each day, a million men are missing because of this enemy. Thus

are lost some four hundred million days of work per year, a period in which 164,000 tanks could be built—a line of tanks that would present a solid front more than 200 miles long.

Ranged against the enemy are the National Institute of Health of the United States Public Health Service, numerous governmental agencies, state and municipal health departments and the medical and safety departments of hundreds of factories—all allied in the cause of keeping 'em healthy and keeping 'em working.

There are many reasons for this astounding loss of time. The old ones are that some jobs are dangerous and some workers are careless. But there are new reasons; new developments in industry, new machines and materials are creating hazards that challenge the old safety controls. And war production has brought the necessity for speed

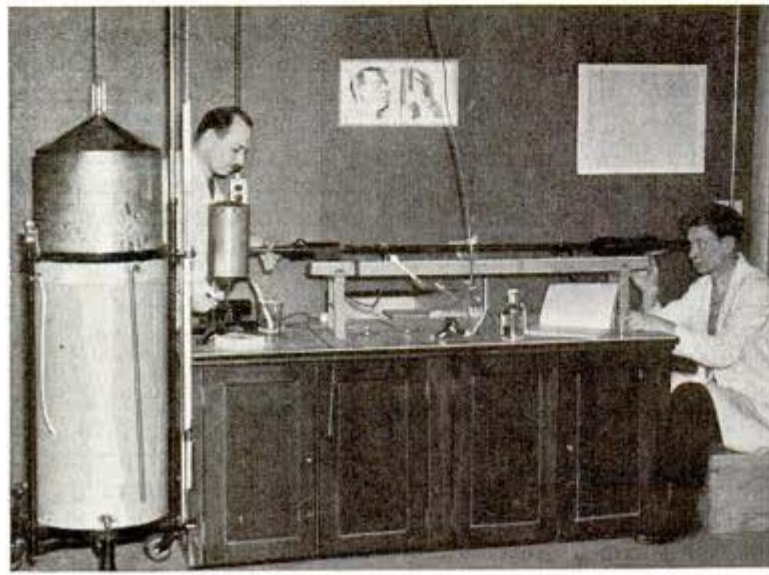

**Measuring gas in sealed chamber, while human guinea pig, in window, reads temperature**

Exhaling into a machine which charts the amount of poison a man retains in gas-filled room

and strain that spell danger. To keep the workers on the job, these hazards, both old and new, must be controlled. But how?

That's the question on which all these allied agencies are working frantically. Speedy solution of the problem is the key not only to victory over sickness on the home front, but also over our enemies on the battlefields of the world.

A few miles from the nation's capital, the division of industrial hygiene of the National Institute of Health is leading the search for answers to the many phases of the question, "How can these wasted days be saved?" Swiftly working scientists are hunting for the answers in the laboratories there, seeking for a better understanding of metal poisoning, for ways to fight dust hazards and fatigue, for more information on the effects of ventilation and lighting on workers' health.

The laboratories of the division of industrial hygiene are crammed with scien-



tific equipment for studying almost any problem that may arise in this struggle to keep the workers working. Bell jars and cages full of small animals, white mice and guinea pigs, make easy preliminary studies of gas fumes, dust and many other things that may affect man's efficiency at the machine. All sorts of analyses can be made. In the division's pressure chamber, the temperature and pressure of different altitudes can be reproduced so that here, on solid ground, the effects of flight and thinning air on the airplane pilot can be ob-

This laboratory on wheels—a Westinghouse X-ray bus—is brought to the gates of a war plant to save time





If the needle reveals eye strain, the worker will get vitamin A capsules

served and studied and perhaps the answers found to the dangers of sudden climbs to high levels and swift dives. Then there is the cold chamber in which clothing can be tested to determine which is best for protection of the ground worker in the Arctic and which for the bomber crew fighting at 30,000 feet.

Here is the way the fight goes on. A call comes from the War Department to Dr. J. G. Townsend, chief of the Division of Industrial Hygiene, for a certain type of investigation in a government-operated



arsenal. A quick discussion of the problem brings a decision to put a field unit on the job. Testing apparatus is checked carefully and loaded. The doctor and engineer, the field unit crew, leave for the arsenal ready to track down the cause of a high accident rate, or a strange skin rash, or dizziness and fatigue that suddenly have attacked a group of workers. In a majority of cases, the answer will be found by the field unit and safety precautions applied immediately.

There are more than 30 of these units working throughout the country, helping state and local health departments. Paid for by state and federal funds, these units stand ready to study any of the health problems of industry. Perhaps a call comes from a mine. Down the shaft go men and equipment to search out the hazard and to find a way of removing it. Dry drilling may be the means of extracting the mineral ore from this mine. Even the uninitiated can see at a glance the danger in the dust-filled air, but the engineer cannot guess. He takes a sample to find out exactly how dangerous it is. This is the dust that leaves scars on men's lungs, that gives them tuberculosis or silicosis and sometimes takes their lives. The engineer and his assistants make their tests, counting the dust particles in the air taken from the mine. They suggest a solution for the trouble—a stream of water to keep dust out of the air or an exhaust system to clear the air where workers may be bagging powdered mineral.

But there are conditions that cause illness in industry that are harder to find, harder to correct. Here, too, the mobile units do their work—analyzing gases, chemicals and metals; investigating the causes of sickness. And the simpler things, like recommending machine guards, shoes, gloves and goggles, also are part of the division's work.

Many state health commissions have

Transferring cancer cells from one test tube to another to study their growth under varying conditions

been expanding their work in industrial hygiene. Some are building trucks that make it possible to take the laboratory and the clinic right to the gates of the factory and to the mouth of the mine. In these trucks material can be tested, men X-rayed and examined and speedy answers found for problems that have caused lost time.

While the job of saving wasted days begins in the laboratory, it must end in the plant. Many industries, with the advice and assistance of the U. S. Public Health Service, are doing their part of the job with programs of their own. They are introducing pre-employment examinations which tell them if a man is physically fit for the job. And with a regular checkup, they make sure that the men who are healthy stay healthy and those who need treatment get it. Here the well-equipped infirmaries of industry are saving many days. They prevent a cut from developing into blood poisoning and other minor injuries from becoming serious. Their special equipment quickly performs work like aiding in the diagnosis of a twisted ligament or broken bone, thus pointing the way to treatment and early return to work.

Slips and falls are blamed for about one-fourth of all industrial accidents. One company devised a robot that "falls down" scientifically to measure the "skidability" of floor waxes—one phase in the campaign to reduce

(Continued to page 162)

SEPTEMBER, 1942

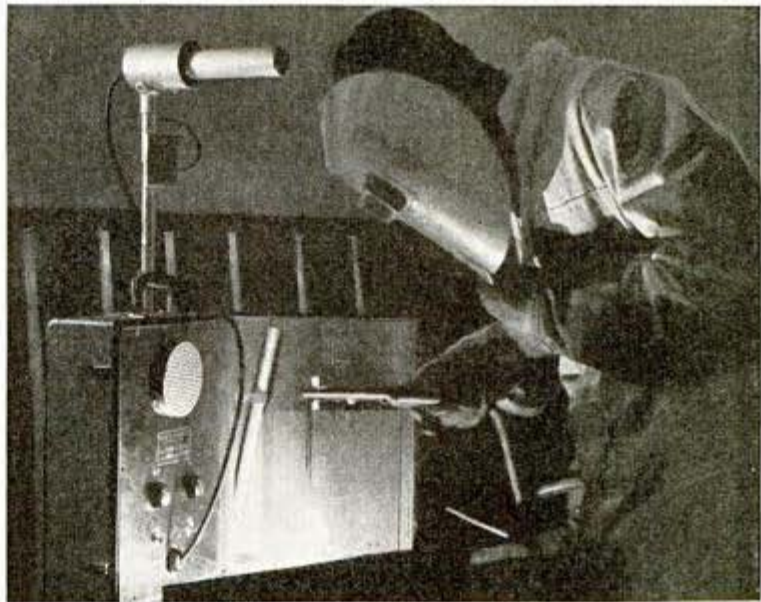

↑  
Samples of air about this welder are tested for purity by an electric machine that charges dust particles



←  
X-raying patient with a new fluoroscopic and radiographic instrument mounted in laboratory on wheels

↓  
The white rat is being de-fleaed with a vacuum tube to further the studies of endemic typhus fever



# Trick Movie Gun Fires "Bullet" Made of Earth

M 489



Out of camera range on the movie set a gun pumps "bullets" that smash against the target with a realistic splash of dust. The bullets are celluloid capsules filled with fuller's earth, fired by compressed air from a tank attached to the gun with a heavy rubber hose. Resembling a large rifle, the .38-caliber gun has a smooth-bore barrel, regular sights and a revolving cylinder at the breech which holds 12 capsules. The gun, invented by Roy Wade of Republic Pictures Studio, removes the hazard of ricocheting bullets.

Celluloid capsules are filled with fuller's earth and shot from this gun with compressed air from a tank that is attached to it with rubber hose. White earth is used for dark targets and brown for light ones to kick up dust that will send chills down the backs of movie audiences



# "Paul Bunyan" Model of Rifle Shows How Gun Operates

M 3 68

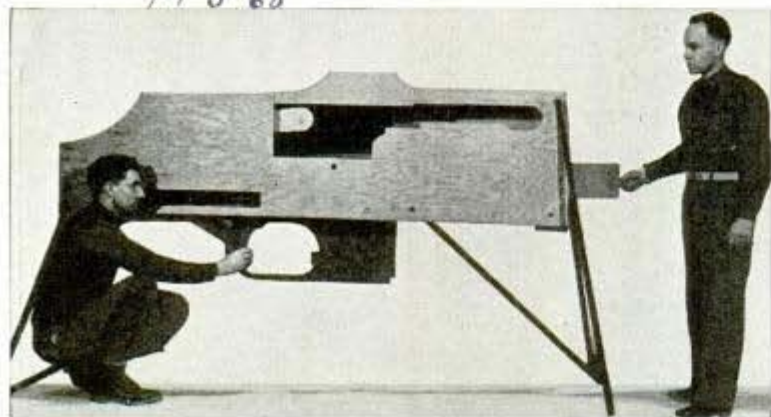

To make it easy for trainees to understand the mechanism of the Browning automatic rifle, Lieut. B. R. Porter of Camp Robinson, Ark., a former teacher of woodwork and industrial art, constructed a wooden model of the working parts eight times actual size. Although it does not include the stock and barrel, the model is more than eight feet long. It

Mechanism of rifle is easily demonstrated with aid of this big model

86 Blk. by: Lt. B. R. Porter of Camp Joseph T. Robinson, Ark.



has 31 parts, all of which function as in the regular rifle. In the complicated trigger mechanism alone there are 19 different parts. Various parts of the model have been painted in contrasting colors, enabling the men to distinguish and identify them from any place in the classroom.

### "Six-in-One" Table Changed in Jiffy By Shifting Top

One of the features of a coffee table with at least five other uses is a hinged square piece that may be lifted from the top and tipped to hold a book for reading. On the reverse side of the removable square is a checker board. The height of the wooden table is adjusted by slots along a single supporting piece that extends from the base through the top. This single support also makes it possible to place the table close to a bed for serving.

M 486



Hinged square piece is lifted from the table top and tipped to support a book; on reverse side is a checker board. Top adjusts to various levels

## Fire Cart Fitted for Air Raids Carries Own Water Tank

M 345



Completely equipped fire cart, handy for industrial plants and large buildings, can be wheeled in a hurry to any point endangered by bomb

Standard fire fighting equipment for air raid protection and incendiary bomb control is carried in a wheeled cabinet now available. The cart has its own storage and pressure tank that delivers a stream of water at 125 pounds pressure, throwing it three stories high or 100 feet horizontally. It can also produce a fog which is particularly effective in combating incendiary bombs and extinguishing fires in volatile

liquids. It carries chemicals, fire extinguishers, a large bin of sand, rope and chain, salvage cover and tarpaulin, as well as fire ax, fire pick, shovels, fire department fittings, lanterns, asbestos helmet, gloves, goggles and gas mask. Ample space is provided in the cabinet for storing additional equipment to meet special hazards.

You can obtain additional information about products described in this magazine by writing to the firms listed in the Where-to-Buy-It index. Say You Saw It in Popular Mechanics.

SEPTEMBER, 1942

distr. Steinmetz & Kelly, Mdse. Mart, Chicago

Chicago Fire Equipment Co., 546 N. Lake St., Chicago, Ill.

# DUST *the* DESTROYER

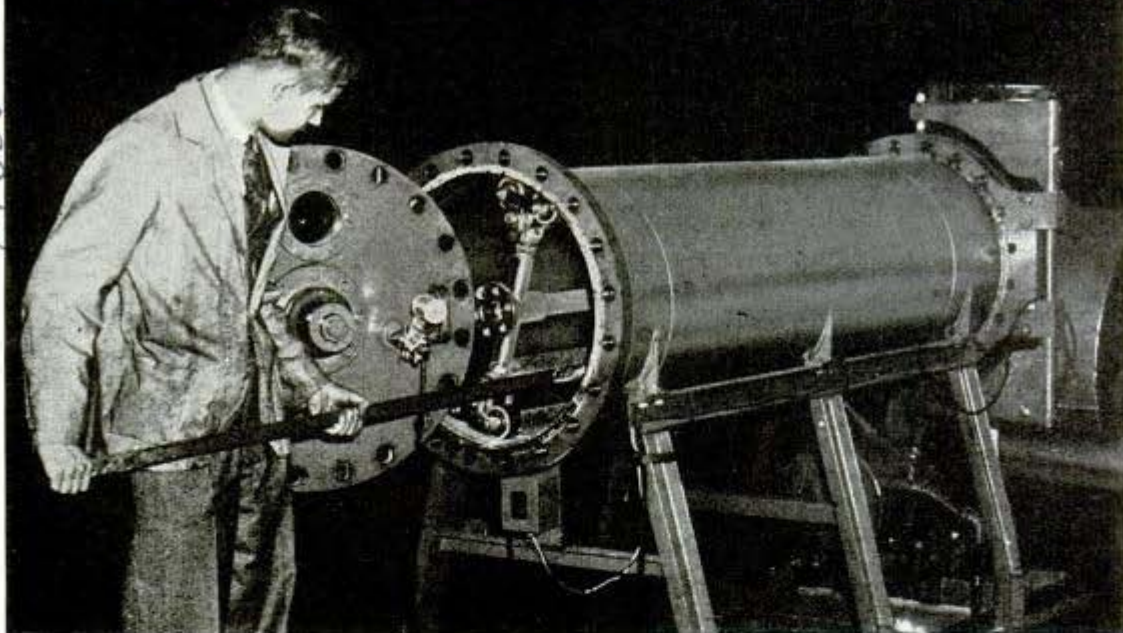

Dust and air are mixed in predetermined quantities and then exploded in this test "bomb" at the Underwriters' Laboratories

Finely divided wood, flour, carbon black, metallic and other dusts are sprayed on this dust-tight lamp to test its safety



**D**UST is dynamite. Any kind of dust, from the household variety to the dust in mines and metal-working factories and grain elevators.

In a Texas grain mill, workmen were cleaning white corn to prepare it for milling when dust set off a tremendous explosion that killed one man, injured four others and destroyed nearly \$200,000 in grain, building and equipment.

A woman about to bake a pie in her third-story apartment found the flour unfit for use and promptly dumped it into the incinerator. Flour particles filled the incinerator shaft and in the few seconds the fire at the bottom touched off a blast that blew off the cast iron incinerator doors on every floor of the apartment building. The damage was extensive, and the woman who unthinkingly caused the accident was struck by the iron door in her kitchen and painfully injured.

In Baltimore a huge grain elevator was destroyed by a dust explosion that cost seven lives, property damage estimated at \$1,500,000, and 22 men were injured.

Dust—in the right proportions and the wrong conditions—is as dangerous as gasoline. As a matter of fact, if there weren't better fuels, more easy to control, you could run an engine on the power packed in dust.

But dust must be controlled—particularly today, when disruption of a war industry by a needless explosion could cause serious curtailment of production. Dust particles, suspended in air, are easily ignited by a tiny spark which might even be caused by friction. It is estimated that some 28,000 industrial plants in the United States are confronted with a dust explosion hazard. Woodworking and cabinet making shops have serious dust risks.

Almost all common types of dust are combustible in air and therefore produce an explosion hazard. Among these, apart from metal, grain, flour, and ordinary house dust, are wood, starch, and coal and coke dust, to name only a few. Dust from black powder and TNT in war plants is an outstanding hazard. There are a few non-inflammable dusts, one of which is sodium bicarbonate.

Incomplete figures, covering only indus-

trial plants, show that in the last 20 years, dust explosions have caused a \$28,000,000 property loss, and killed or injured hundreds. Nearly 400 dust explosions have been recorded in industrial plants alone.

The growing menace of dust has brought about a vast amount of research and experimental work having as its objective both the elimination of the hazard and the effective control of the explosions themselves. An organization that is playing an important part in these activities is Underwriters' Laboratories, Inc., which has chemists, engineers and electrical experts

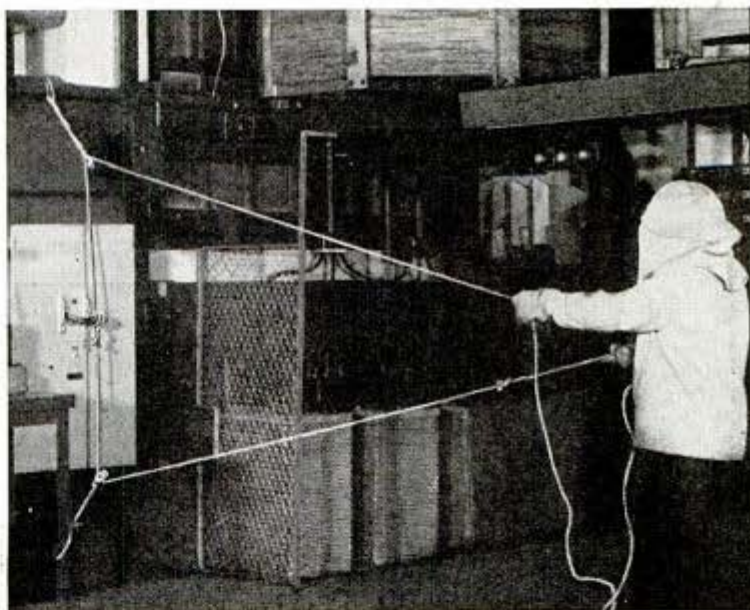

Asbestos-clad engineer tests a heavy-duty electric switch for fire, shock and explosion hazards after it has been put to "dust chamber" test

Electric motors destined for use amid dust hazards, as in grain elevators or starch plants, are given an overwork test in an atmosphere of dust and under a blanket of dust at Underwriters' Laboratories

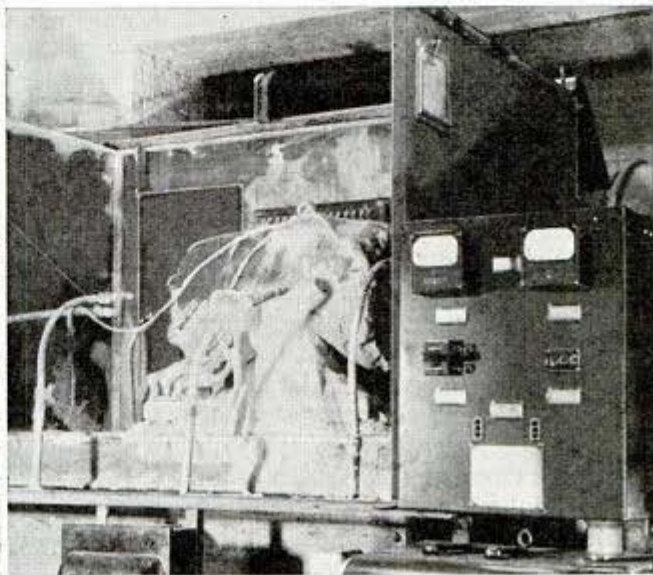

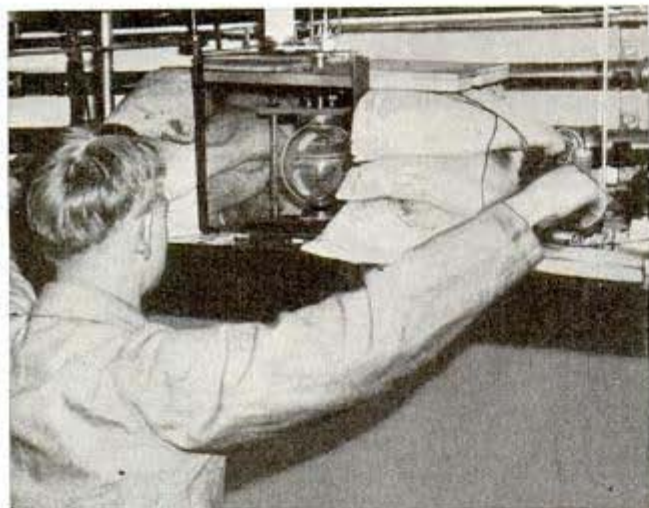

This small dust "bomb" has walls of thick glass which permit view of the dust explosion

at work on the problem in laboratories in Chicago, New York and San Francisco, as well as in actual plants with dust problems.

Since explosions are a danger only when dust concentrations in the atmosphere are between an "upper limit" and a "lower limit," depending on the type of dust present, much of the work involves methods of finding out how much or how little dust, of any specified kind, will cause an explosion. Just completed by Underwriters' Laboratories is the newest means of testing the explosive limits of dust concentrations. It is called a "bomb" but in reality is a reinforced steel cylindrical chamber with a capacity of 21 cubic feet into which given amounts of any type of dust can be introduced, mixed with the atmosphere, and then actually exploded.

Because of its size, this bomb gives a better and clearer picture of dust explosions, as well as explosive pressures developed, than any other artificial method yet devised. It is used principally to determine the "upper limits" of dust concentra-

tions. It is possible for air to become so saturated with dust that explosions no longer are a hazard. The bomb determines where the saturation point occurs with various types of dust. The "lower limit" of dust concentration, or the minimum amount that will cause an explosion, is less difficult to determine.

The value of the information disclosed by tests in the dust bomb is obvious. The owner of any factory or other establishment, knowing the kind of dust most likely to be present, can learn the degree of concentration of that dust which constitutes a definite explosion hazard. Then he can test the atmosphere in his plant to find out just what dust concentration exists, and take suitable steps to eliminate or control the hazard. Several instruments for testing dust concentrations are available. One operates on the principle of directing a stream of air, in given volume, through a cloth or paper "thimble" and determining, by weight, the amount of dust present. Another filters dust laden air through a water chamber.

Eliminating or controlling dust explosion hazards, however, is no simple matter. The first



Testing a fluorescent light fixture to be used in factory with a dust hazard

Electric switch may undergo as many as 10,000 tests to be certain of safety



and most important safeguard, according to Underwriters' Laboratories engineers, is to strike at the danger at its source which means minimizing the possibility of any initial spark or flame near the area of dusty atmosphere.

To achieve this safeguard, close attention must be paid to the type of electrical fittings, fixtures and equipment used. One of the activities of Underwriters' Laboratories consists of testing such equipment for dust tightness.

Among the items of equipment tested and approved are circuit breakers, conduit fittings, including outlet and wiring connection boxes, elevator interlocks and appliances (there is considerable danger of dust concentrations in elevator shafts), lighting fixtures and fittings including portable lighting equipment and fluorescent fixtures, industrial motor control equipment, motors and generators, panel boards for light and power, plug-in receptacles, portable tools, switches, signal appliances, relays, temperature indicating appliances, and a host of others.

Tests take into consideration that sparks may be caused by overheating, by friction, by static, by lightning, by improperly designed or protected electrical equipment. Grounding of all metal parts is, of course, recommended. Even electrical conducting floors (also grounded) are used to reduce static hazards. Special consideration has been given to efficient lightning protection systems, especially in cases of grain elevators and other rural buildings.

Good housekeeping measures in factories are strongly advocated. Maintenance, cleanliness and the elimination of natural or structural "dust collectors"—even cobwebs in grain elevators—are important in reducing the amount of dust likely to become concentrated in the atmosphere. In addition there are several systems of collecting or disseminating dust already gathered in the atmosphere. The most common systems are those of ventilation or air circulation. Another new way is to precipitate dust by electricity.

Some plants have a far greater dust explosion hazard than others. Such products as food starch, alkali starch, corn dextrin, corn sugar, grain and flour, all of which are dust producing in the extreme, are carried in enclosed conveyor systems from one part of a factory to another, or from

(Continued to page 166)

SEPTEMBER, 1942

*Distr: Anti-Rust Coop.*  
*340 Canal St., N. Y. C.*  
**Plastic Cup Feeds Solvent**  
**To Free "Frozen" Studs**  
*M 381*

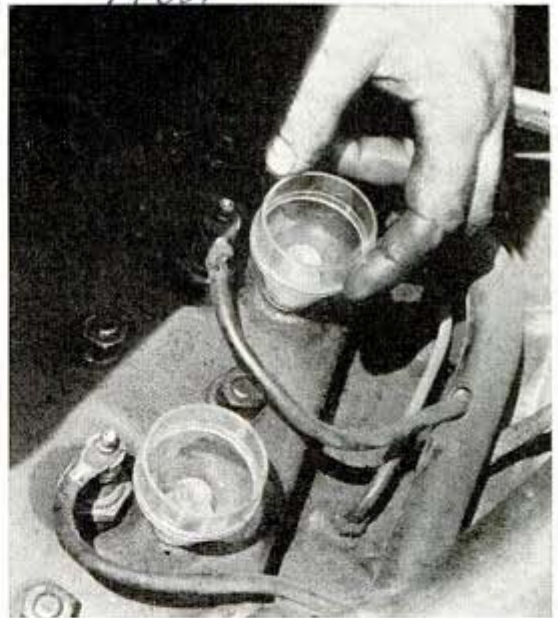

Cup dispenses solvent to free sticking auto stud

Penetrating solvent to loosen the heat-hardened formation around the studs on "frozen" automobile cylinder heads, may be fed into the right place through perforations of an injection-molded plastic cup. The cups are built for long service, being molded of sturdy cellulose acetate plastic.

### Frying Pan Made of Pottery Doubles as Serving Dish

Material that was formerly considered worthless by the ceramic industry is used to make a new type of pottery for both cooking and serving. It withstands a direct flame, is attractive enough for table use and is easy to clean. Various types of cooking utensils are made of the ware.



New type pottery used for cooking over open flame

*Joaquin Potteries*  
*P.O. Box 522, Stockton, Cal.* 91

# NEW CROPS for AMERICA

*Mr. Leggett*

*M 253*



Preparing sorghum flower for crossing to help relieve the sugar shortage  
Nature gets a hand with artificial pollination to boost yield of grass

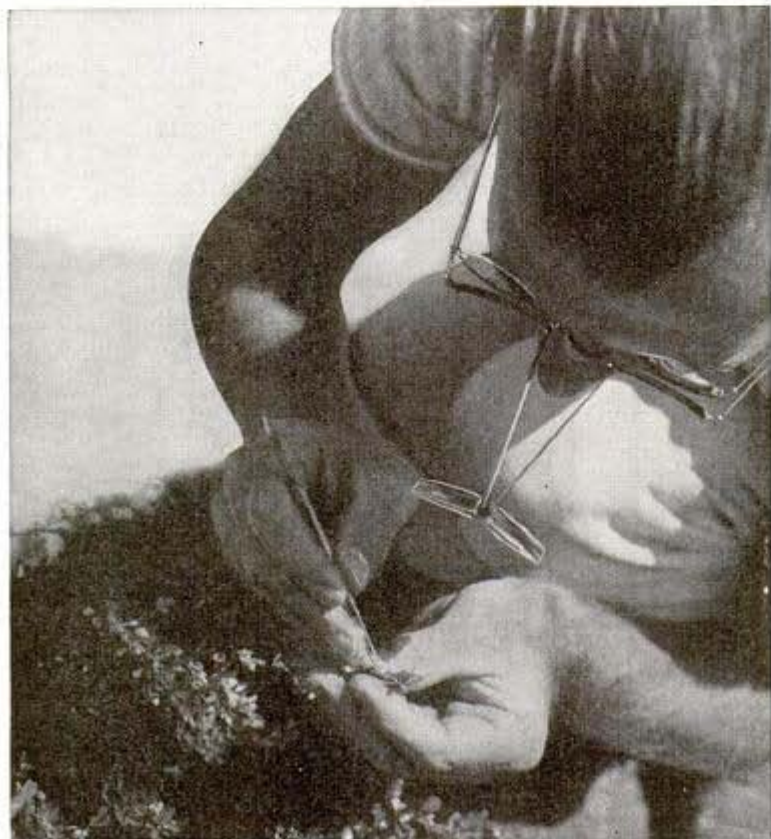

U. S. Department of Agriculture photos

AT AN annual cost of about \$130,000,000, the United States has been importing drugs, spices and oil-yielding materials, part of which could be grown successfully in this country—materials that have been cut off by the war.

The knowledge that the American farmer stands to share in the money formerly spent abroad and that the shortage in these materials assures a market as long as the war lasts, perhaps longer, gives him a double-barreled reason for investigating this situation. In addition to supplying the immediate demand for these products, he may wish to produce a small surplus with which to experiment. From experimentation may come more valuable information like the discovery that an odor identical to that of the costly oil of rose can be made from coriander oil.

These materials include aromatic plants and essential oils, drugs, spices, gardening and forage seeds, edible oils and quick-drying oils for the paint and varnish industry. Although most of them show unusual possibilities for cultivation in this country, no farmer should embark upon this venture blindly; it's no get-rich-quick scheme. Some could be grown in the subtropical regions, others in the northern states. The farmer should determine which can be produced in the climate and soil conditions of his section.

Marketing conditions likewise should be inves-

tigated. There is sufficient demand for some crops to warrant cultivation on a large scale, but others are marketable only in small quantities. Complete information, such as selection of a crop, planting, cultivation, harvesting and marketing, may be obtained from the U. S. Department of Agriculture and its agents throughout the country. However, the department cannot supply seed for planting stock.

Experimentation has proved that specialty crops such as these can be cultivated in this country. Scientific implements and agricultural knowledge enable American farmers to produce crops more cheaply by our machine methods than they can be grown and harvested in foreign countries where labor is available for a few cents a day. Thus, we can grow rice more economically than we can buy it from China. On some large specialty crops machinery built for other purposes might be used with minor changes. Small specialty crops do not lend themselves to mechanized harvesting.

In stressing the value of experimentation, the National Farm Chemurgic Council points to the soybean. Brought from Asia to this country nearly 150 years ago, only in the past 25 years has it come to be such an important crop that 10,000,000 acres are now cultivated not only for agricultural purposes of hay, pasture and silage, but for extensive



Feeding a tung tree planted in jar reveals its soil requirements



Soybeans, first grown in U. S. as forage, now developed for table use and source of cooking oil, flour, plastics

← Cutting leaves of digitalis, medicinal drug which has been successfully cultivated in many of the northern states





↑  
Planting golden seal roots for cultivation; this wild U. S. herb supplies drugs used in tonics

use of the extracted oil as an edible product and for wide industrial applications, including the making of plastics and a wool-like fabric.

Domestic mint oil had not been considered seriously as a source of natural menthol as long as Japanese mint oil was available at low prices. Also the two oils were different chemically and physically in so far as the menthol constituents were concerned. Our production of citrus oils is almost sufficient to supply our needs and production of domestic lemongrass oil is a still more recent enterprise.

Among 131 crops listed by the chemurgic council as having possibilities in this country is pyrethrum, the flowers of which are the source of a poison useful in insecticides. Imports have amounted to about \$3,000,000 per year, part of which came from Japan. The plant can be grown successfully in southern California, Colorado and in the northern United States, but much hand labor is required in harvesting unless a recently developed picking



machine is used. The U. S. Department of Agriculture has developed a mechanical harvester for operation by two men. Its capacity is three to five acres per day. In a similar field is red squill, of which some 500,000 pounds per year have been imported for making rat poison. Red squill, known in the wild state as the sea onion, might be grown in the sandy coastal regions of this country where the climate is mild, and particularly where bulbs are cultivated most successfully. There are two drawbacks. It takes five years to develop a marketable bulb, and the volume of business is not large enough to engage many growers. Right now, it probably would be difficult to get stock for planting because red squill has been gathered from wild

← Hardy alfalfa, left, resists disease which has withered standard variety at the right

↓  
Soybean seedlings are grown in quartz gravel to study effect of varied plant food





Lumelite Corp., 261-5th  
av. N.Y.C.

## Plastic Reflectors on Stairs Are Handy in Blackout

M 463

plants along the Mediterranean shores. Species and varieties of so-called drug and medicinal plants collected from all over the world and used in the United States number several hundred. The Department of Agriculture points out that possibly not more than 3,500 acres would be required to grow our essential drug plants and for this reason, only people in the most favored circumstances for cultivation will find their production a profitable enterprise. There are many cultural, soil, disease and harvesting problems which must be considered.



Disks that glow in dim light help prevent accidents

One of these drug plants is belladonna, of which the United States has been importing about \$18,000 worth per year. It can be grown in the northern states and California. Harvesting requires hand labor and there must be facilities for drying and curing. S. B. Penick & Co., one of the world's largest drug houses, has begun cultivation of several hundred acres of belladonna with the approval of governmental agencies. Another is digitalis, which has been collected from plants growing wild in the Pacific northwest. Only a small amount of digitalis is needed. Stramonium, which has uses like those of belladonna, grows almost anywhere in this country. Here it is known as Jamestown weed and Jimson weed. One drawback is that only 250 acres, cultivated efficiently, would be required to supply all demands.

Plastic disks that glow in dim light—such as cast by a "blackout" flashlight—and prevent stumbling on stairs or other objects, are now on the market. They are of penny-size with a hole in the center for tacking. Available in crystal, amber, red or green, the reflectors are virtually unbreakable and weather resistant.

Condiment plants comprise another group to which the American farmer has paid little attention. Coriander is a typical example. Some \$60,000 worth of the seed is imported annually. A short-season crop adapted to a wide range of conditions, it has possibilities as a winter or spring crop in irrigated valleys. The seeds, harvested by machine in Russia, are used for condiment purposes, in the medicinal field and in the making of oil useful in flavoring, condiment sauces, mayonnaise, canned foods, chili sauce and candies. Another in this class is caraway, the seed of which has been an annual import item of about \$400,000. Cultivation is considered possible in the northern Pacific coast states and perhaps as a winter crop in the northwest.

## Mitten Brush for Grooming Dog Is Worn on Either Hand

Its surface covered with bristles to form a brush, a mitten for scrubbing and grooming the dog protects the hand and saves

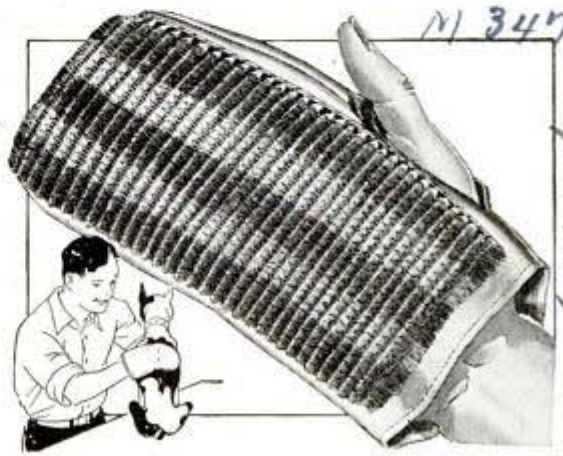

Brush is worn like a mitten when grooming the dog effort. Recommended specially for short haired dogs, the brush has slits in the sides permitting the thumb to protrude.

Licorice, another of the condiment plants, might be grown in the southwest and in California. About \$1,300,000 worth of licorice has been imported each year, making this a crop worth experimentation. The

(Continued to page 164)

1831 Randolph St., Chicago, Ill.  
Coughlans Seed Store

# Homemade "Ear" Spots Plane Eight Miles Off

M465

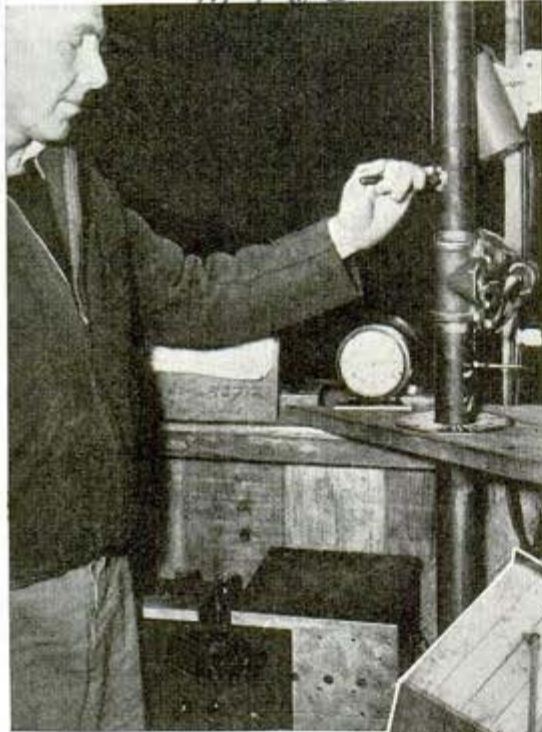

If an enemy plane gets within eight miles of Yuba City, Calif., the sound of its motors will be heard through a homemade listening device designed by air raid watchers. A boxlike receiving unit made from a loud speaker and powered by a radio extends above a glassed-in tower atop a small structure used as a "cook house." A 2½-inch pipe which may be turned around with a handle is used as the main mounting for the receiving unit. Another handle attached to a half-circle ratchet with a rod extending up through the pipe to the detector permits tipping the device up and down. The turning pipe and the ratchet enable the watchers to point the detector in any direction.

Air raid watcher adjusts listening device with a handle attached to pipe (above) which extends to boxlike unit mounted on top of "cook house" and watch tower built and used by civilian workers, at Yuba City, Calif. It turns in any direction

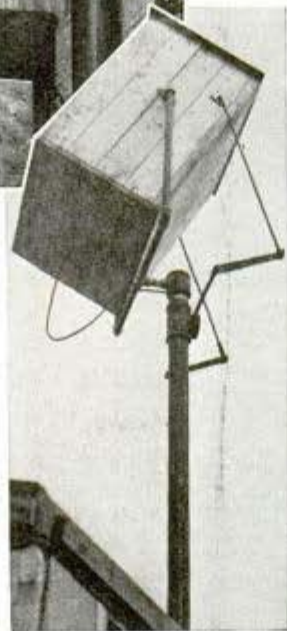

# Individual Ash Trays Hold Chips in Stacks on Card Table

M407



For use with games requiring counters, as in some card games, a set of four ash trays, each holding an assortment of chips, keeps the chips in tidy stacks instead of permitting them to scatter about the table top. When not in use, the trays are stacked as a unit and held together by a strong spring clamp.

**IF YOU WANT TO BUY IT—**

Write to the manufacturer or distributor listed in the Where-to-Buy-It index to learn more about commercially available products described in this magazine. Say You Saw It in Popular Mechanics.

Ash trays keep chips in order for card players

96 Distr: Mandel Bros., State & Madison, Chicago, Ill.

POPULAR MECHANICS



# The CRAFTSMAN

## TRACEOGRAPH *aids in sketching*

A "drawing camera" that enables you to trace people or scenes. It consists only of a ten-cent lens, a small mirror and some plywood

THE simple sketching box shown in Fig. 1 makes it easy for youngsters and others having some artistic ability to copy people and landscapes in true proportion, using regular tracing paper which is placed on a hooded window in the top and is held in place securely by the hood when the latter is locked in position. The objects to be drawn should be in bright sunlight. A ten-cent lens gives good definition at the center, but if sharp definition at the edges is desired, a lens of better quality, such as a good reading glass, will be required. The lens throws the image on a mirror set at a 45-degree angle, which in turn projects it on the tracing paper. While the picture sketched will be a reverse of the actual scene from left to right, the tracing paper can be turned over and the picture traced on the opposite side.

With a lens having a focal length of about 6 in., the box can be made according to the dimensions given, but in case one of greater focal length is used, it will be necessary to experiment with the exact location of the mirror and the tracing window. This can be done by using a temporary top board and adjusting it and the mirror unit back and forth until the point is found where the image will be sharp. With a lens of 6-in. focal length,

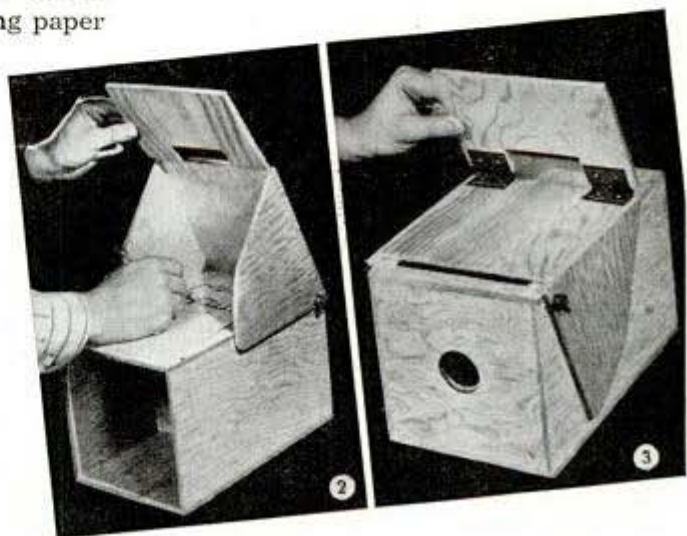

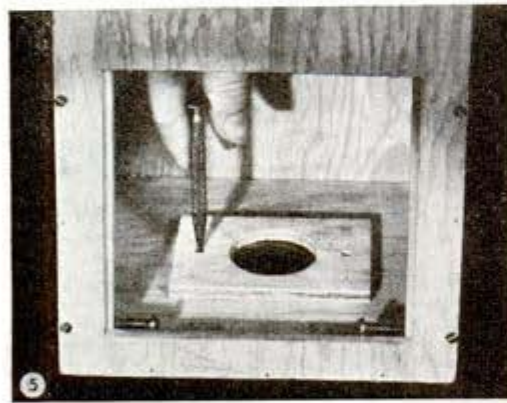

the center of the mirror should be 3 in. from both the lens and the tracing window.

The cutaway view in Fig. 6 shows the general construction of the camera. Practically all parts are of plywood. The mirror unit, which is assembled to slide snugly in the open end of the box as in Fig. 4, must be of a height to allow the unit to pass under the cleats that support the tracing-window glass. Figs. 5 and 7 show how the lens is held in place in the center of the end. The 1½-in. reading glass used in the original was the type having a one-piece plastic rim and handle, the latter being cut off close to the rim to make it fit flush in the lens hole. An expansive bit can be used to cut the rabbeted lens hole by first boring the largest diameter part way, and then reducing the cutting radius of the bit ¼ in. before continuing. The hood in which you look through an opening at the top, also serves to hold the paper in place as it bears against the top of the box when locked in a raised position. Figs. 2 and 3 show how the hood can be folded flat over the window when not in use. Note that the leather-hinged flap provides an opening for the hand. If you should want to shield the picture still more, a cloth bag having an elastic in the hem to fit the wrist could be attached around the hand opening.

3/8" x 5 3/4" MIRROR SET IN GROOVES AT 45° ANGLE

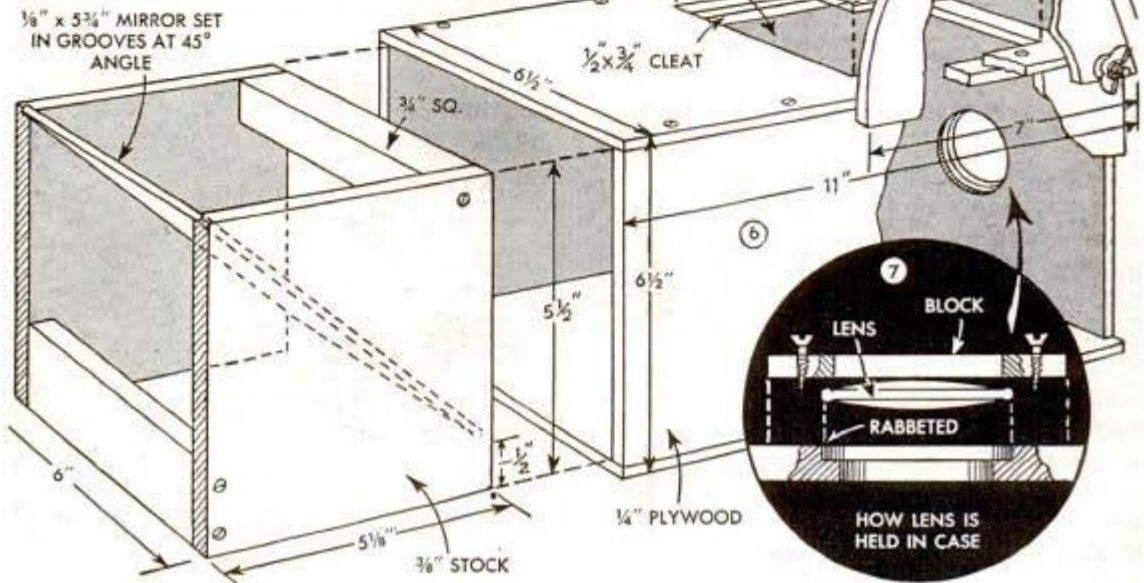

# Tricycle Wheels Give Added Support to Bicycle

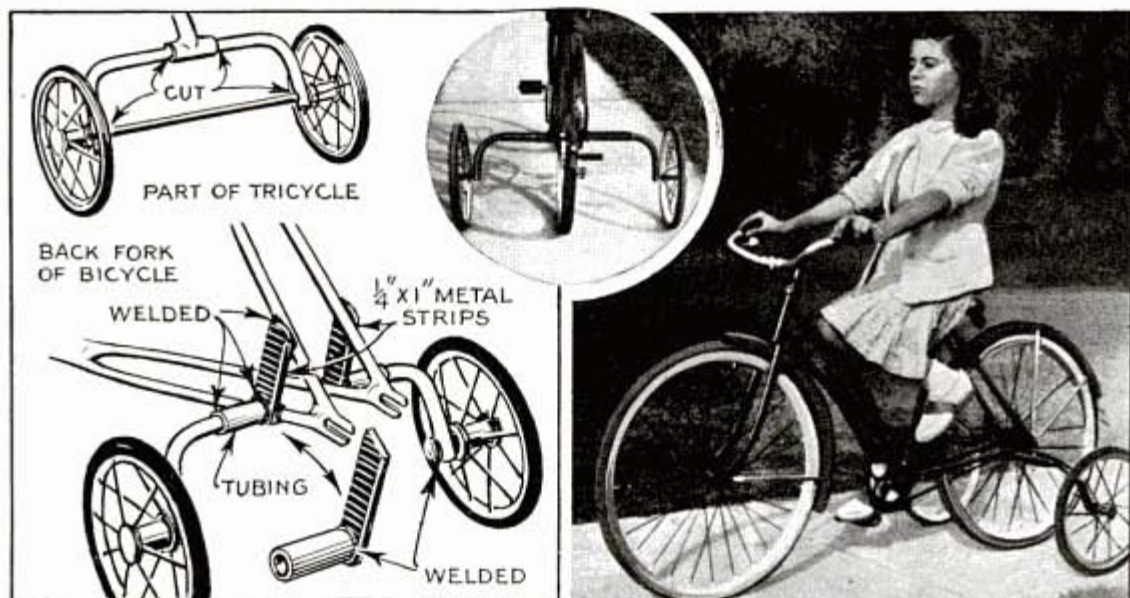

One father, discovering that his child could pedal a bicycle but could not balance it, due to a physical handicap, simply added a couple of tricycle wheels to the rear fork to provide extra support. The same idea can be applied in similar cases or where a child is too young to balance, it being possible to remove the added parts later. The frame and axle of the tricycle are cut off at the points indicated in the

upper left detail, and the short ends of the axle are welded to the lower ends of the curved frame members. The upper ends of the latter are set into short lengths of metal tubing or pipe attached to strips of flat iron on the bicycle fork, these parts being welded together securely as indicated. In assembling the parts they must be placed properly so that all three wheels will touch level ground.

## Portable Lawn Shower Is Fun for the Whole Family

Pushed into the ground, this shower not only provides fun for children as well as adults, but it also saves water, which goes on the grass instead of down the drain. The shower consists of a length of pipe bent as indicated, and fitted with a spray head at one end and a tee at the other. An adapter for connecting a garden hose, and a pipe plug drilled and tapped for an iron rod, are fitted to the tee openings as shown in the detail. If you are unable to obtain a shower-bath head, you can make a suitable one easily from an evaporated-milk can.



### Making Grips Stay on Handlebars

To prevent bicycle handlebar grips from slipping off, wrap friction tape around ends of the handlebars. Then dip the grips in turpentine, gasoline, or kerosene. This allows the grips to slide over the tape. When the turpentine or gasoline evaporates, the grips will shrink to their original size.

## Snap-On Skirt for the Sewing Box Keeps Accessories at Hand



To increase the capacity of her sewing box and to make it possible to keep the most-used accessories where they could be reached easily, one seamstress made a cloth skirt having many pockets, which she snaps around the sewing box while working. Large-size dress snaps are used for attaching the cloth, the snaps being fastened to the sewing box with small brads. When not in use the skirt is rolled up and stored in the box.

## Comb Used to Make Dotted Lines

When it is necessary to make a number of dotted lines on paper, and there is no typewriter available for the job, you can



do it with a comb and stamp pad. Press the end of the comb teeth on the pad and then on the paper just as you would an ordinary rubber stamp.

—William Swallow, Brooklyn, N. Y.

## Clamp to Hold Band-Saw Blade Made From Slotted Pipe

Slotted and bent as indicated, a short piece of  $\frac{1}{2}$ -in. pipe makes a handy vise clamp for holding band-saw blades while sharpening them. The projecting ears formed on the piece of pipe rest on the upper edges of the vise jaws and prevent the clamp from falling out of place when the jaws are released to remove the blade.



—G. E. Hendrickson, Argyle, Wis.

## Button Aids in Tying Fishing Flies

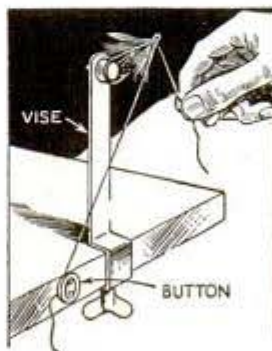

Nailed to the base of a fisherman's fly vise, a large button serves as a holder for the end of the thread to keep it taut when desired. The button is pulled up tightly, and in use the end of the thread is merely given a few turns around it. This makes it easy to attach or release the thread.—Duwaine Starck, Monett, Mo.

## Papering Calcimined Walls

Never attempt to hang wallpaper directly over calcimine. All calcimine should first be removed by thoroughly wetting and rewetting, applying water with a large brush, then scraping until the original surface has been exposed. For best results, size the wall with cold-water size, mixed according to manufacturer's directions. Paper, when hung may stick for a time to calcimined surfaces, but shortly the calcimine will pull away from the walls.

# Compact Kitchen Step-Stool Opens Into Ladder

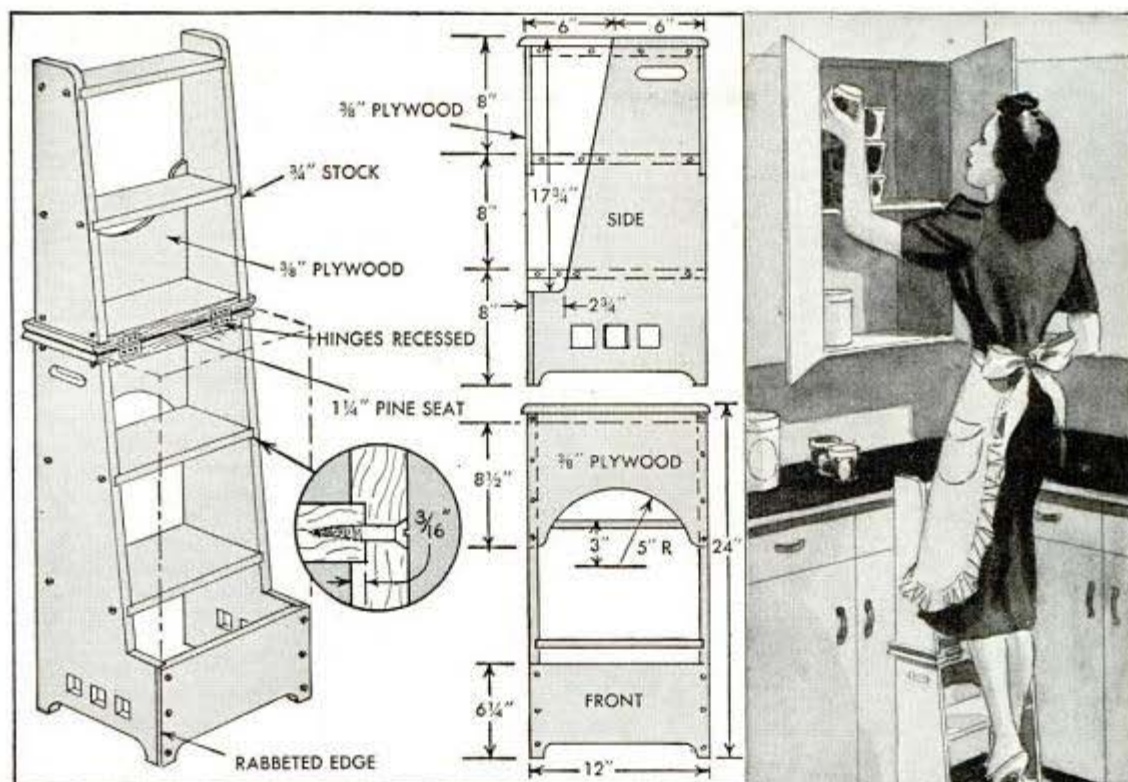

Kettles and other seldom-used utensils stored on high cupboard shelves are reached easily with this double-duty stool, which opens up into a sturdy 40-in. step-ladder. Except for the seat, plywood may be used entirely or combined with solid stock. Run the grooves for the treads in the side panels first, then tack both together and saw out the section that swings up on top of the seat. Glue and screw the treads in place and hinge the two-part seat to bring both sections flush when folded. Rubber-headed tacks will keep the stool from slipping on waxed floors

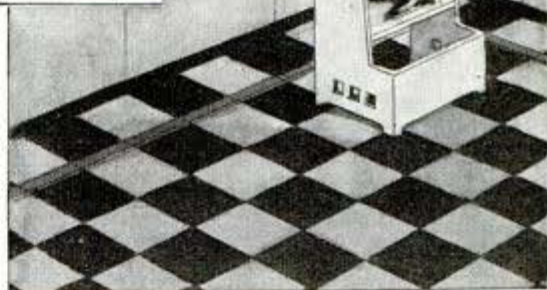

## Your Profile Traced on Mirror and Transferred to Paper

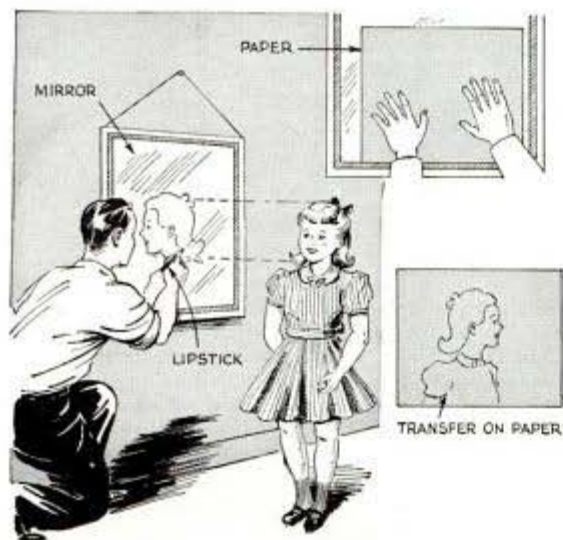

You can have a lot of fun at parties, or entertain the younger members of your family by tracing their profiles as seen in a mirror. To do this, have the subject stand in front of the mirror. Then trace around the image with lipstick or a grease pencil, and fill in the features as desired. You can even fill in the eyes, hair line and eyebrows with ease. If you desire, the profile can be transferred to a piece of paper by pressing the latter over the lipstick outline to take the impression. The lipstick can be removed from the mirror with soap and water or any other glass cleaner.

☛ If you wax floors before painting the walls and woodwork of a room, any paint dropped on the floor will not stick.

# Solving HOME



3. Besides keeping a sheet in place at the foot of the bed, increased sleeping comfort is claimed if a bed is made up with a fold in the sheet as indicated. The slack produced by the fold prevents one's feet from working out beneath the sheet

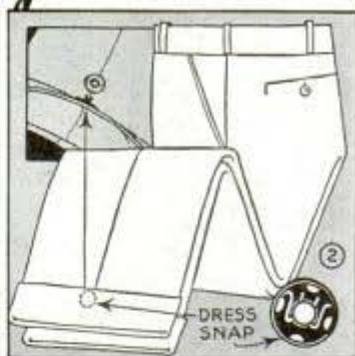
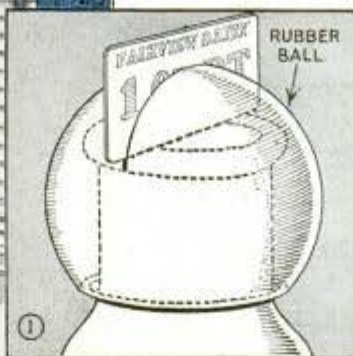

1. When milk bottles are left at the doorstep, part of a hollow rubber ball slipped over each one, will assure a greater degree of sanitation against prowling animals. A slit in the top provides a handy place to put a note or ticket. 2. Dress snaps used in place of stitching on the cuffs of wash trousers simplify the job of letting the cuffs down for laundering. Place the snaps, one at each seam, a little below the cuff edge so that they will be unnoticed

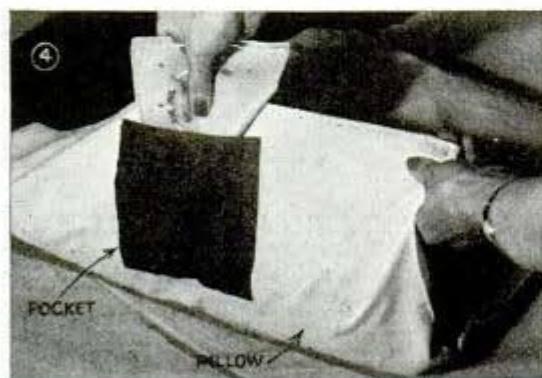

4. Loss of a handkerchief among bedclothes is unlikely if you provide a pocket for it on the underside of the pillow. 5. A hairnet of the type used for keeping a finger wave in place makes an excellent holder for crochet thread as it can be hung from the arm where the ball will be always close at hand. 6. Using a glass pie plate as a cover when cooking dumplings enables you to keep them from "falling" and becoming soggy as you can watch them rise without raising the lid and admitting air





# PROBLEMS

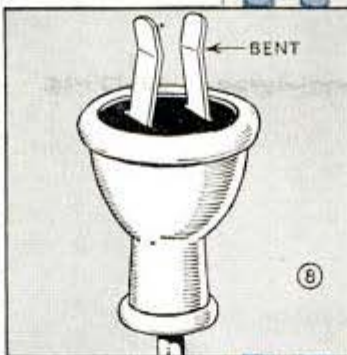
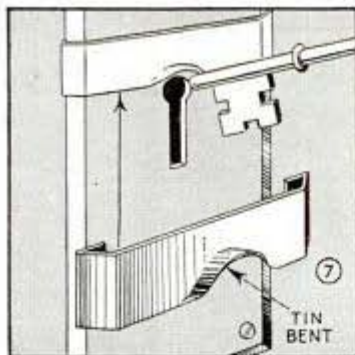

7. Less time will be spent in locating an outside key-hole in the dark if you provide the lock escutcheon with a key guide like the one shown, which is a piece of tin or wire to slip under the plate. 8. Spreading the prongs of an electric plug with the fingers to improve contact in a wall outlet often loosens them in the base. A better way to make the prongs fit snugly is to bend just the ends outward as shown, with a pair of pliers



9. Entry or departure from an open-end porch which is fitted with a full-width drop awning, will not require raising the entire curtain if you provide a "doorway" at one side. Simply cut a 3-ft. strip from one edge of the awning, tack it to a window-shade roller and mount it to overlap the drop curtain

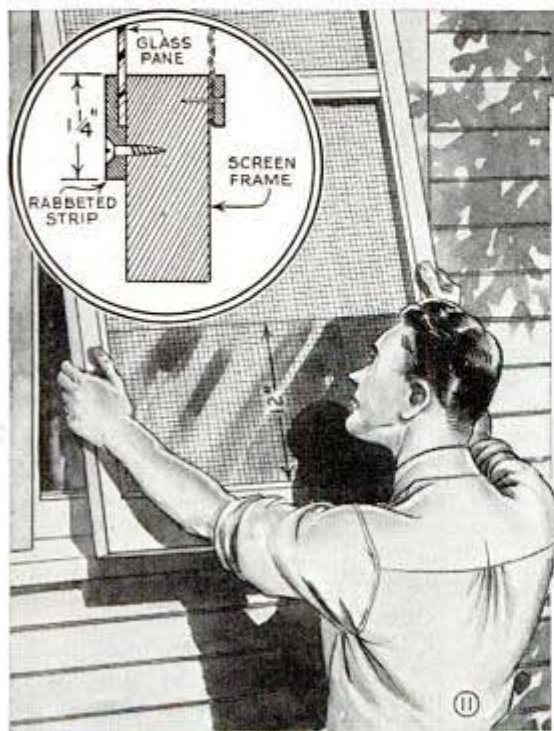

10. When washing fails to remove oven stains try using ammonia. Saturate a cloth pad placed over the stain and let stand. After 2 hrs. you can wipe away most or all of the stain with a cloth, after which the oven should be given a thorough washing with soap suds. 11. You can keep a bedroom partially ventilated during threatening weather and still be protected from entry of spasmodic rains by fitting a glass deflector to the inside of the screen frame. Thin rabbeted strips hold the glass on three sides. 12. Attractive arrangement of cut flowers in a wide-mouthed vase is made easy if a paper doily is used as a "frog" to hold them in the desired position

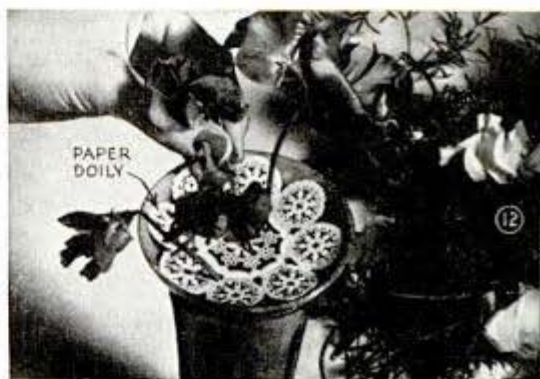

## Sliding Gauge on Tape Measure Helps Mark Duplicate Pieces



When marking a number of duplicate pieces before sawing, one craftsman uses an adjustable gauge on his steel tape measure to speed up the job. The gauge is nothing more than an ordinary paper clamp or clip, with a slot cut between the handles so it can be slipped over the tape. It is adjusted quickly by squeezing on the handles and moving it to the desired position, which in some cases, may be done more easily if the clamp is reversed so that the blades are toward the end of the tape.

—Opie Read, Jr., Chicago.

## “Joggle Wheel” Lime Duster Lines Tennis Court

You can mark off a tennis court quickly by using an octagonal-shaped container, or wheel, as shown. Pushed along the desired line, the bumping action of this duster shakes out the lime, thus making it unnecessary to go over the line more than once.

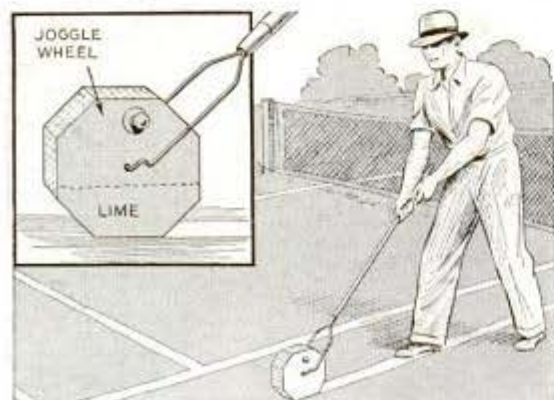

The container can be fitted with a handle by using a heavy piece of wire as a fork at the container, and a length of broomstick.

## Rivets Are Set With a C-Clamp

If a tool for setting hollow rivets is not at hand, you can do a neat job by using a C-clamp and ball-peen hammer as shown in the photo. By turning the clamp screw the peen end of the hammer is forced firmly against the rivet end, spreading and clinching it securely. If a ball-peen hammer is not available, you can use a ball bearing of the proper size.



## Notch Under End of a Pencil Clip Makes It Hold Firmly on Pocket



To make a pencil clip grip firmly on a pocket of thin material, such as a pocket of your shirt, cut a notch in the pencil where the end of the clip contacts it. If the clip is removed and the end bent downward and then replaced, it will press the fabric of the pocket into the notch and provide a good grip.

## Emergency Tips for Crutches From Pieces of Hose

Needing some rubber tips for his crutches and not being able to obtain them immediately, one man used short pieces of garden hose.

The ends of the crutches were whittled down to provide shoulders against which the pieces of hose rested when pushed over the reduced ends of the crutches. The hose should project beyond the end of the crutch at least  $\frac{1}{4}$  in. to provide a cushion effect.



# Taxi Scooter Has Seat for an Extra Passenger

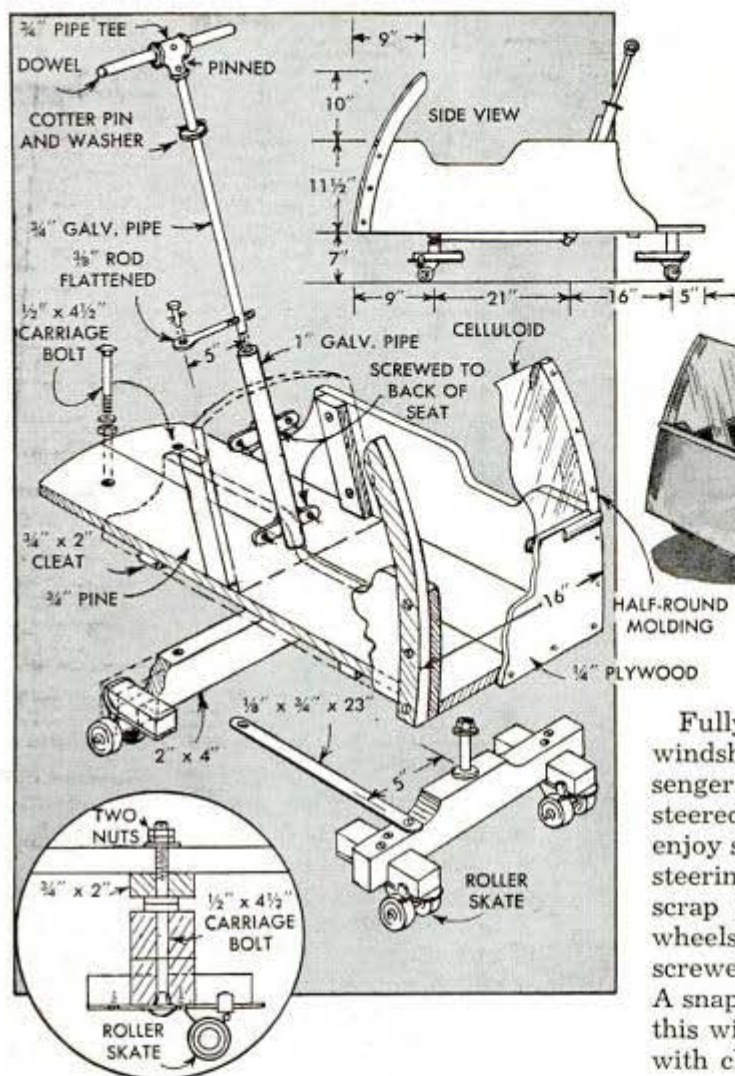

Fully equipped with a celluloid windshield and a seat for an extra passenger, this taxi scooter is pushed and steered by a "chauffeur" who can also enjoy swift rides on down grades. The steering unit is made from pieces of scrap pipe. Roller skates provide wheels, which are clamped and screwed in place on a sturdy chassis. A snappy paint job is recommended as this will make the scooter a sensation with children in any neighborhood.

# Simple Pull-Down Shelter on Newsstand Keeps Papers Dry

If you operate a street-corner newsstand that is unprotected, here's an easy way to keep your papers and magazines from becoming soaked during light showers. Just tack a piece of oilcloth on an ordinary window-shade roller of the required length and mount it over the stand as shown. Then look around for two forked sticks to support the lower end of the oilcloth when in use. In this way, the shelter is always conveniently at hand and requires only a few seconds to pull down or raise whenever desired.

☛ Before heating coffee over an open fire, rub both the bottom and sides of the coffee pot with soap. Then soot that collects on the pot can be removed more easily.

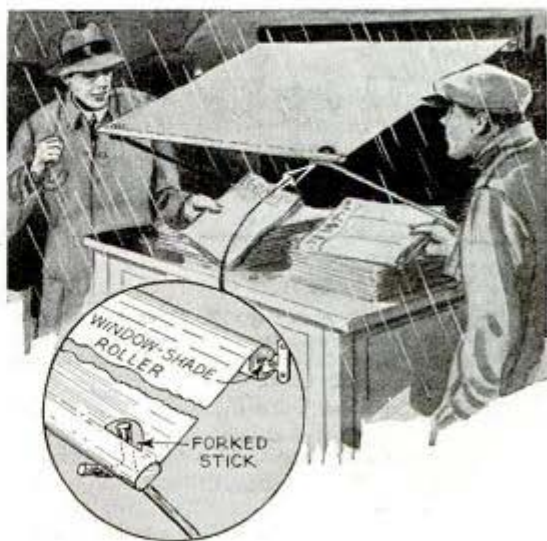

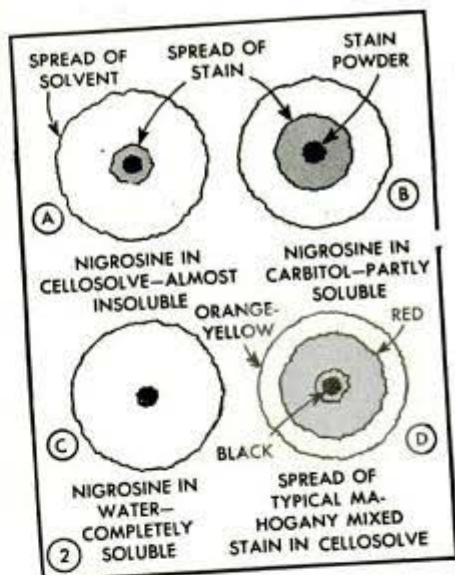

# STAINS

By Sam Brown

**PENETRATING OIL STAIN**  
Add to 1 oz. oil soluble stain powder, 1 qt. warmed, light oil (benzol, turpentine, naphtha, gasoline) or a blend. Half and half benzol and VMP naphtha is recommended. A small amount of asphaltum or 4-hour varnish (1/8 to 1/2 pt.) can be added for body if desired.

**POWDER STAIN (OIL SOLUBLE)**  

**WATER STAIN**  
Add to 1 oz. water soluble stain powder, 1 qt. of hot but not boiling water. Allow to cool and then strain. Keep in glass jar.

**NON-GRAIN-RAISING STAIN**  
Add to 1 oz. water soluble stain powder, 1 qt. Carbitol or Cellosolve (see text). Keep in glass. Dilute as used with denatured alcohol but not over 3 parts alcohol to 1 part stain.

**HOW TO MIX POWDER STAINS** 3

**4 OTHER TYPES OF STAIN**

**Pigment Oil Stain:** 4 oz. any color pigment ground in oil with 1 pt. of benzol, turpentine and boiled linseed oil in equal parts. Under lacquer, use colors ground in japan and mix with turpentine.

**Wiping Stain:** Same as above.

**Shading Stain:** 1 oz. oil soluble stain powder to 1 qt. lacquer thinner. Add to clear lacquer in any proportion.

**Staining Filler:** Color regular paste wood filler with penetrating oil stain.

**S**TAINING is the first and most important step in applying a clear finish on wood. It gives the wood color and enhances the beauty of the grain. No other step in finishing brings about so radical a change in the appearance of the wood.

**Types of stains:** Essential ingredients of any stain are a liquid or solvent, and coloring matter. The solvent usually is water, oil or alcohol, and the general description of the stain is the same as the solvent used, that is, water stain, oil stain, spirit stain. There are several branches of these main groups, including non-grain-raising stain, wiping stain, shading stain, etc. The coloring matter usually is an aniline dye, which is available as a dry powder in numerous colors, and comes in cans as small as 1 oz. All types of stains can be made by mixing the dry powder with the required solvent. Also, all types, except water stain, can be obtained in liquid form if a ready-to-use product is desired.

**Mixing powder stain:** Directions for mixing powder stains are shown in Figs. 3 and 4. As a general rule, 1 oz. of powder will make 1 qt. of stain. The powder dissolves better if the solvent is warmed to about 160 degrees F. Where inflammable oils or alcohol are being used, the bottle containing the solvent can be placed in a



## *in wood finishing*

pan of hot water as shown in Fig. 5. It is good practice to strain all stains through muslin or cheesecloth after they have cooled to room temperature. This removes impurities and filters undissolved pigment.

**Non-grain-raising stains (NGR):** These are made from water-stain powders dissolved in a synthetic chemical. The result is a stain with all the good features of water stain, but minus the grain-raising fault. The solvents Carbitol and Cellosolve mentioned in the lower right-hand corner of Fig. 3, are the commercial names for diethylene glycol and ethylene glycol respectively. Both are obtainable from finishing supply houses, and are of the alcohol family, miscible in all proportions with water and each other. They are solvents for practically all of the water-soluble powders. However, two important exceptions in solubilities should be remembered. Cellosolve is not a solvent for walnut crystals or nigrosine and Carbitol is not a solvent for walnut crystals, and only a partial solvent for nigrosine. If these solvents are used in mixing a powder containing any part of nigrosine, the resulting color will be lighter than the same powder mixed with water, as the black (nigrosine) will not dissolve. As manufacturers of stain powders generally favor the purer form of mixing colors from the primary colors (red, yellow,



### ⑥ TREATMENT OF VARIOUS WOODS

WALNUT and MAHOAGANY	Often finished natural, without stain. Stain used for wide variety of brown and red tones. Preferable stain, water or NGR; seldom oil or spirit. Excellent for bleaching, after which wood may be stained light amber, straw, etc., or sufficient color can often be obtained by filler alone.
OAK	Seldom finished natural or red. Attractive in any brown tone. Grain raising very bad with water stain, hence NGR preferable. Excellent for bleaching. Good for novelty effects.
PHILIPPINE MAHOAGANY	Same as mahogany, NGR stain preferable. Sometimes filled direct on bare wood with an orange-brown filler (pigment coloring, not dye) and further toned by adding shading stain to first finishing (sealer) coat.
FIR SPRUCE CYPRESS BASSWOOD POPLAR REDWOOD PINE	Usually stained mahogany or walnut color, using penetrating oil stain, which brings out grain. To kill grain, use wiping stain. Water stain not commonly used but if used will penetrate better on resinous wood if work is first washed with an alkali solution (4 oz. of sal soda, 1 oz. washing soda per gal. of water).
MAPLE	Use water or NGR stain. Add further color with shading or wiping stain between finishing coats. Often stained with wiping stain on bare wood.
POPLAR BIRCH GUM BEECH	Commonly used in combination with walnut or mahogany. A uniform color is obtained by spraying NGR stain overall; heavy on birch or gum; light on walnut or mahogany. After filling, birch or gum can be darkened to match by using shading or wiping stain.
CEDAR	Always finished natural. A red wiping stain can be used to blend or smooth any excessive contrast between the white and red wood.



PROTECT INLAYS WITH SHELLAC

blue), it is not likely that much trouble will be encountered in this respect. When mixing stains, a deep blue-violet will answer all color requirements for a black. Walnut crystals are mixed usually as a single color to produce a walnut brown for which there are many good browns as substitutes.

**Solubility rings:** A good check for solubility when making NGR stains is as follows: Take a blotter or a folded facial tissue and place a small pinch of the powder on the paper. If you are checking more than one solvent, put down a separate pinch of powder for each. Now, wet each

mound of powder with several drops of warm solvent, so that the wet ring of solvent makes a circle about 2 in. in diameter, as shown in Fig. 1. Observe the stain color obtained. If it spreads instantly in a uniform color to the fullest extent of the wet solvent ring, the powder is very soluble in the solvent being tested. A color spread of about two-thirds the diameter of the wet solvent ring can be considered satisfactory. Note the examples in Fig. 2. Data contained in the tables of Figs. 6 and 8 should enable the finisher to make a satisfactory selection as to the type

of stain he should use for any particular job.

**Application of stain:** One rule that applies to all types of stains is to start on less important parts. When using water stain, sponge the wood with warm water just enough to dampen it, Fig. 13, and sand smooth when dry as in Fig. 14. Apply the stain with brush or spray. Use a fairly large brush and apply the stain freely and rapidly, shaking out the brush after finishing each surface. Brush lightly with the grain to obtain a smooth color. End grain should be brushed with water immediately before staining to prevent darkening. Touch up sap streaks to same color as

		⑧ TYPE OF STAIN				
		WATER STAIN	NON-GRAIN-RAISING STAIN	PENETRATING OIL STAIN	PIGMENT OIL STAIN	SPIRIT STAIN
CHARACTERISTICS OF STAIN	COLORING MATTER	Water-soluble aniline powder	Water-soluble aniline powder	Oil-soluble aniline powder	Pigment colors in oil	Alcohol-soluble aniline powder
	SOLVENT	Water	Carbitol or Cellosolve plus alcohol	Benzol, turpentine, etc.	Benzol, turpentine, naphtha	Denatured alcohol
	COST	Low	High	Medium	Medium	High
	APPLICATION	Brush or spray	① Best sprayed but can be brushed	Brush and wipe with cloth	Brush and wipe	Spray only
	GRAIN RAISING	② Bad	③ Very little	None	None	③ Very little
	CLARITY	Excellent	Excellent	Good	Fair	Good
	BLEEDING	None	None or very little	⑤ Bad	None	④ Bad
	PERMANENCE OF COLOR	Excellent	Excellent	Fair	Excellent	Poor
	EFFECT ON TOP COATS	None	Possible slight bleeding	⑤ Bleeds. Must be sealed with shellac	⑥ None	④ Bleeds
	MIXES WITH LACQUER	No	Yes	Yes	No	Yes
	MIXES WITH VARNISH	No	Yes	Yes	Yes	Yes
	DRYING TIME	12-18 hrs.	1-4 hrs.	⑦ 2-18 hrs.	⑦ 6-18 hrs.	1 hr.
PRINCIPAL USE	Staining quality hardwoods	Same as water stain. Also for refinishing	Staining softwoods	Softwoods. Also as a glaze coat or wiping stain	⑧ Patching and quick work	

**Notes Applying to Table Above:**

1. Some types, factory mixed in liquid form, dry very quickly and are difficult to brush smoothly.
2. The only fault of water stain — water solvent causes wood fibers to lift. Work must be resanded smooth when dry. The addition of up to 25% Carbitol or Cellosolve will help correct this fault.
3. Alcohol solvent absorbs moisture from air causing slight grain raising in muggy weather.
4. Refers to own-mix stain. Some factory-mixed stains of the alcohol series are strictly non-bleeding.
5. Seal with shellac when used under varnish. Do not use under lacquer.
6. Refers to factory-mixed product, made with specially treated oils to work under lacquer.
7. Use benzol as solvent for fast-drying. Retard drying with turpentine or turpentine substitute.
8. Non-grain-raising stains answer all requirements for a spirit stain and the colors are more permanent.

**9 BASIC COLOR RULES**

- Blue and yellow make green
- Blue and red make purple
- Yellow and red make orange
- Black and red make dark brown
- Green and red make brown
- Black, red and yellow make light brown
- Brown and yellow make light brown

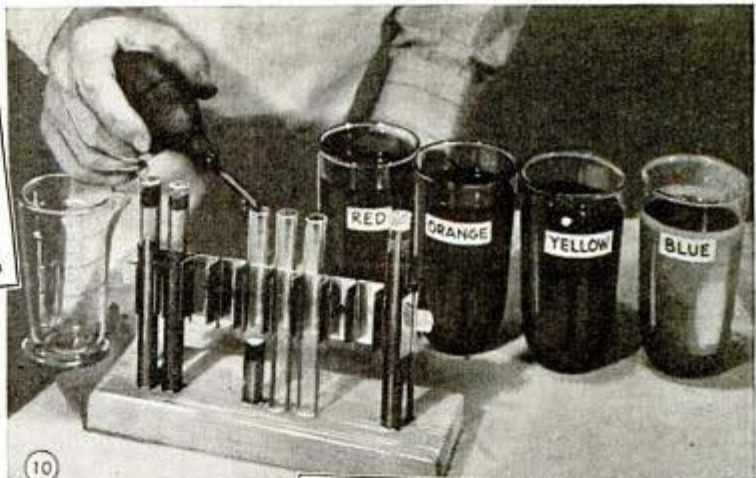
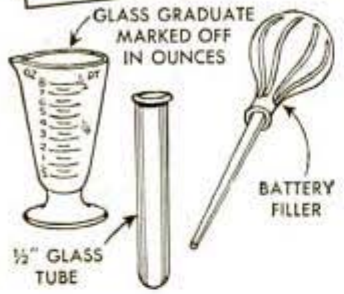

**10 COLOR MIXING**

**11 STAIN COLORS BY LIQUID PARTS**

Color **	Yellow	Orange	Red	Dark * Blue	Black *
Sheraton Mahogany (Lt. Red)	—	12	5	3	—
Medium Red Mahogany	2	6	6	—	3
Red Mahogany	—	9	7	4	—
Dark Red Mahogany	2	6	7	—	4
Brown Mahogany	1	18	—	4	—
Light Walnut	—	12	1	—	4
Medium Walnut	—	14	1	—	6
Oriental Walnut	—	3	—	—	2
Light Oak	1	10	—	2	—
Dark Oak	2	10	—	5	—
Golden Oak	—	22	1	3	—
Honey Maple	4	11	—	2	—

heartwood before staining the entire surface. Stain should dry 12 hours. Then a wash coat consisting of shellac, 1 part and alcohol, 6 parts is applied and sanded smooth, after which the work is ready for filling if the wood is open grain, or for finishing if it is close grain. Non-grain-raising stain is handled the same as water stain except that preliminary sponging with warm water is unnecessary. This stain usually is sprayed. Penetrating oil stain is sprayed or brushed on. No particular care is needed in application. The color is spread uniformly by wiping with a cloth 10 to 15 min. after application.

\*\* Lighter tints of same color can be obtained by diluting with solvent.  
\* Add dark colors last.

For Mahogany or Walnut—Van Dyke Brown  
WIPING For Red-Orange Maple—Half and half raw  
STAINS Sienna and Burnt Umber  
For Brown Maple—Burnt Umber

**Color palettes for mixing stains** 12

Color	Water Stain and NGR Stain	Penetrating Oil Stain	Spirit Stain	Pigment ** Oil Stain
Red	Brilliant Scarlet ZR Azo Rubine	Oil Red Oil Scarlet	Fuchine Safranine Y	Alizarin Scarlet Crimson Lake
Yellow	Tartrazine Metanil Yellow	Oil Yellow	Auramine O	Alizarin Yellow Cadmium Yellow Golden Ochre
Blue	Acid Green B Pontacyl Brilliant Blue	Oil Blue Victoria Blue	Methylene Blue	Prussian Blue Cobalt Blue
Black	Nigrosine * (Use any deep blue, buffalo black) for NGR stains	Oil Black	Nigrosine	Mixture of Raw Umber and Ultramarine Blue
Brown	Walnut Crystals * Lautre Brown Sap Brown	Oil Brown	Bismarck Brown	Brown Ochre Raw and Burnt Umber Raw and Burnt Sienna
Orange	Orange A Grocetin Orange	Oil Orange	Chrysoidine	Alizarin Orange
Green	Naphthal Green	Oil Green	Malachite	Alizarin Green Transparent Green

\* For water stain only

\*\* Colors in oil—All others are powder stains



Immediate wiping of end grain will prevent darkening. Allow the stain to dry overnight, and then seal with shellac but do not use this stain under lacquer. Spirit stain dries almost instantly and must be sprayed. If necessary to brush it, add Cellosolve and shellac. It is best to spray the wash coat of shellac over stain as it must be applied deftly to prevent lifting the stain. Pigment oil stain is handled the same as penetrating oil stain. Also, it is used as a glazing or shading stain over the filler or between finishing coats. In either case, it is applied and wiped with cloth.

**Mixing stain colors:** While all standard colors are obtainable ready-mixed in powder form, the finisher may wish to mix his own color or modify the color of a commercial mixture. The table in Fig. 9 gives a few rules on color mixing that generally are useful, while Fig. 12 gives complete color palettes for all types of stain. The apparatus shown in Fig. 10 simplifies the job. Where two or more colors are given,



any one will be satisfactory. Fig. 11 shows how various standard wood colors are mixed, using liquid parts. As the exact color will depend on the original selection of basic colors, these formulas will not be exactly correct but will serve as a rough guide.

Mixing is done easily if a stock solution of each of the required colors is on hand. The unit or part for mixing can be any convenient measure, a drop for very small test runs, the cubic centimeter (c.c.) for accurate tests, and the liquid ounce for final measuring. Liquid stain is drawn by using a small syringe or rubber bulb battery filler. Wet pour-tests can be used as a preliminary in judging color, but the final selection should be made on the basis of a completely finished panel.

**Special applications:** Where it is necessary to stain over inlays, the wood, if light colored, should be protected with a coat of white shellac as in Fig. 7. The stain is brushed or sprayed right over the shellac, but will not "take" and is wiped off easily. An equally good method is to mask off the inlay with masking tape previous to staining. Tape or stencils can be used also for a two-tone effect, spraying stain lightly or not at all on the protected areas. Various highlighted and antique effects are obtained easily with wiping stain. The initial staining is done as usual with any type of stain. The wiping stain is applied over the sealer coat and is wiped to produce highlights as required. Similar work is done with shading stain. This is sprayed and is a somewhat different technique in that the wood is darkened in certain areas as desired by the finisher.

## File Handle Holds Pins Safely for Reshaping on Grinder

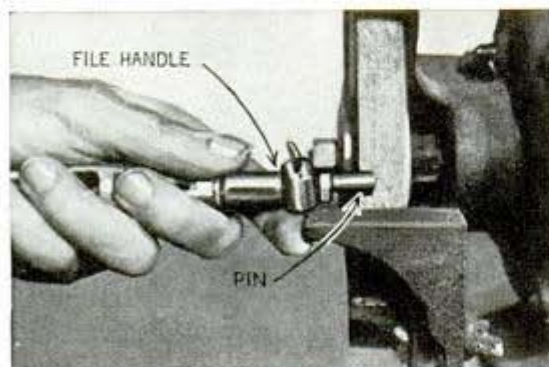

When it is necessary to dress down or reshape short pins, bolts, screws or other very short metal pieces on a grinding wheel, a cast-iron file handle having a thumbscrew attachment for holding the file tang is ideal for holding the work. A pin can be clamped in the holder in a second and is under perfect control at all times, while the fingers are safe.

☐ If spinach is planted late in the fall, it will produce the first spring crop.



# Inlaid Bread Tray Combines Walnut and Maple

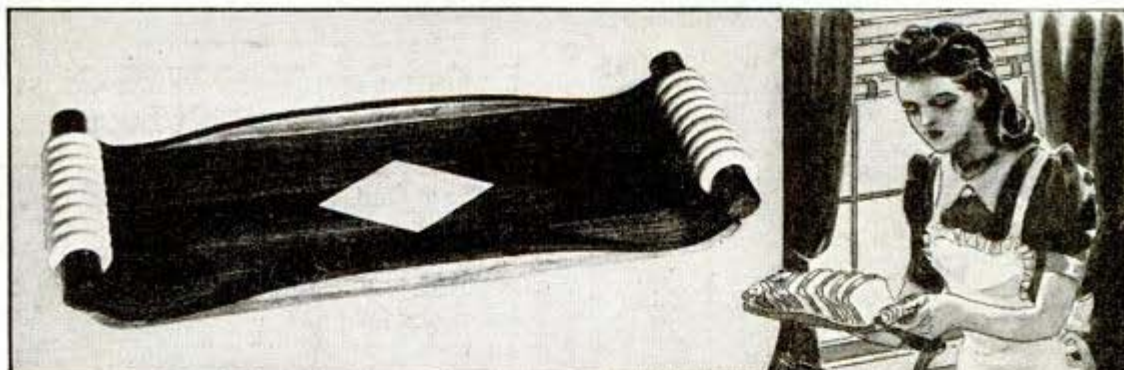

This smart tray is sure to bring pleasing comments from your guests. Five separate pieces, scroll-sawed from  $\frac{3}{4}$ -in. walnut to the shape shown and doweled together edge to edge, form the bottom of the tray. To make it, mark and saw carefully the inlay opening while the pieces are clamped together temporarily; then glue and clamp both inlay and strips together at one time. Before adding the tray sides, which curve from flush at the ends to  $\frac{3}{4}$  in. above at the center, sand the bottom smooth. The maple section of the handles in which the beads are formed is turned to  $1\frac{1}{4}$  in. in diameter, after which a  $\frac{5}{8}$ -in. hole is bored in each end to receive the tenons of the  $\frac{7}{8}$ -in. walnut plugs. By turning each pair of plugs from a  $4\frac{1}{2}$ -in. piece, after which the tenon is formed and cut apart, the lathe-center marks in the ends of the plugs can be used to remount the complete handle in the lathe for beading and trimming to length. The handles are attached to the tray with dowels after first grooving the maple section so it will fit over the curved end of the tray as shown in the side view. Note that the handles are not flush with the sides of the tray.

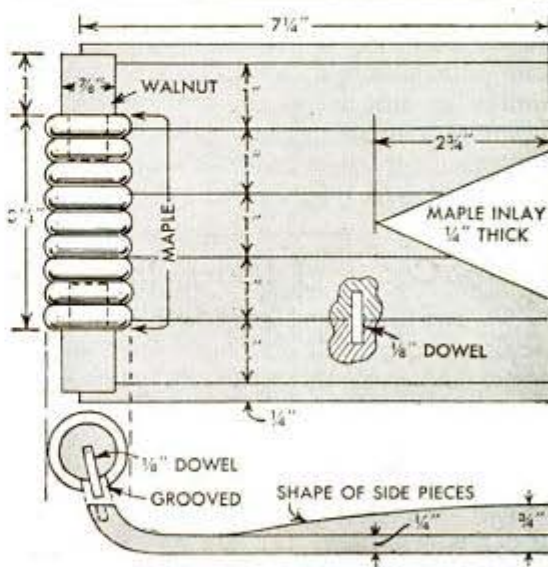

## Roll of Wall Paper Held on Paste Table by Pivoted Wire Hook

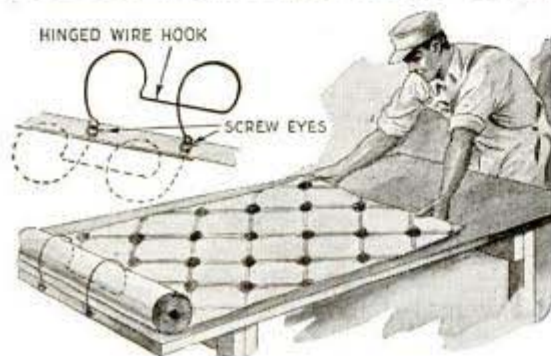

To keep a roll of wall paper in place on his paste table, one paper hanger uses a length of wire which is bent to form a double hook and pivoted to the end of the table with screw eyes. In use, the paper roll is placed under the hook and is unrolled by pulling on the end.

☛ A piece of crumpled Cellophane will make a cap hold its shape longer than tissue paper as it does not flatten easily.

## Small Bell on Blind Man's Cane Helps to Summon Aid



Living in a large city where it was difficult to attract attention of people nearby to aid him in crossing street intersections, one blind man attached a bicycle warning bell to his cane as indicated. When he came to an intersection a ring of the bell usually attracted someone to aid him in crossing the street.—Charles J. Maier, Racine, Wis.

## Nut Centers Dividers in Hole

The next time you have to mark a circle or do spacing with dividers from the center of a hole, try this little trick of using an acorn nut as the center for the leg of the dividers. Drill a small hole in the closed end of the nut in which the divider can be placed. Then, using this as a pivot point

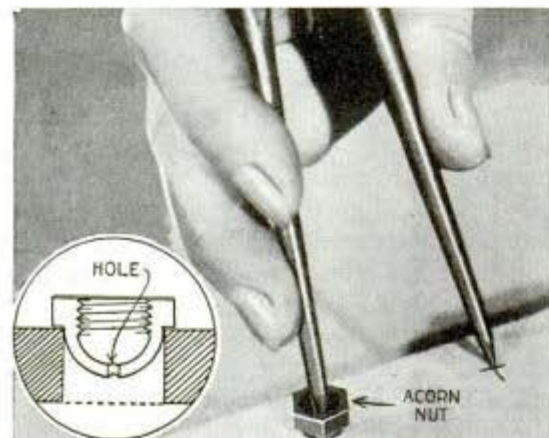

you can strike the desired arc easily. If much of this work-is done, it's a good idea to have acorn nuts of various sizes on hand.

## Burlap Bag Filled With Grass Locates Lost Fish Lures

To locate his expensive fishing lures that may be lost on the bottom of a lake or stream, one fisherman uses a small burlap bag filled with grass or leaves. This is pulled along the bottom of the stream at the ap-



proximate position of the lost lure, the hooks of which will stick into the sack. A stone is placed in the sack to make it sink.

## Emergency Pestle for Chemicals From Pencil and Thumbtack



If there isn't a pestle at hand for crushing small amounts of chemicals, a pencil and thumbtack can be used in an emergency. The thumbtack is merely forced into the eraser of the pencil to provide a

good end for crushing the chemicals when the pencil is pressed against them.

## Rubber-Sheathed Hammer Head Avoids Marring Work

One cabinet maker uses a piece of inner tube, which he stretches over his hammer head as shown to help prevent accidentally marring finished work. This idea is especially handy when working in close places where it is almost impossible to avoid the claw end of the hammer striking the work.

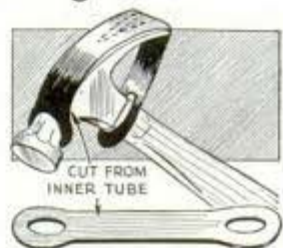

# Chopping-bowl COOKIE JAR

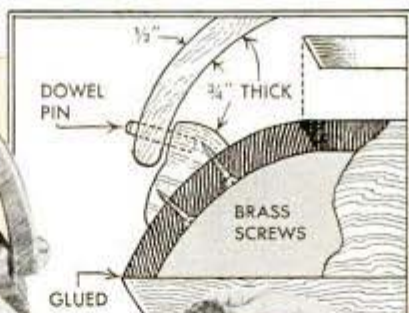
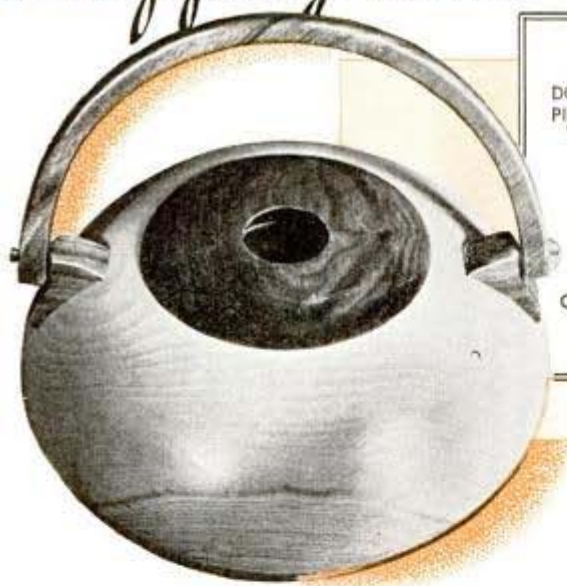

**T**WO maple chopping bowls are used to make this novel cookie jar. About all you have to do is to replace the bottom of one with a cover, and add a handle. Scroll-sawing out the bottom is done with the table tilted 10 degrees to seat a walnut disk which you bevel at the same angle. A good way to cut down the edges of the bowls evenly so that a tight-fitting joint will be had when both are placed together, is to fasten several sheets of sandpaper side by side, to a flat bench top upon which you can rub each bowl back and forth until perfectly flat. Try to sand down each one the same amount so that the two will match flush. In gluing the bowls together, warping can be checked if you place them with the grain at right angles to each other. Watch to see that they do not shift and then weight them with a heavy object until dry. The handle, which can be built up of three separate pieces of solid walnut stock or simply cut from a piece of  $\frac{3}{4}$ -in. plywood, is attached to ears of maple which you fasten with screws from the inside. Apply paste wood filler to the walnut parts, let flatten and wipe off across grain. After 24 hrs. give the complete jar two coats of shellac followed by two of wax or varnish. Leave the inside surface of the bowls bare.

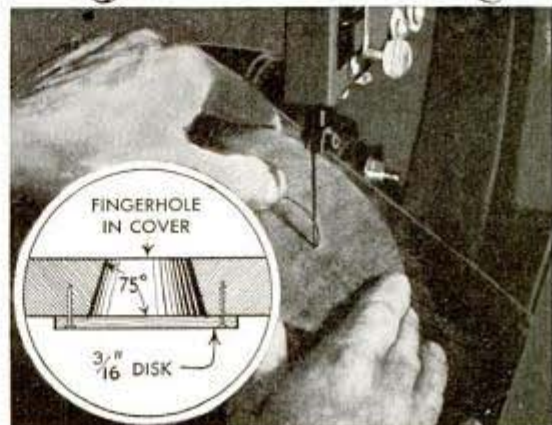
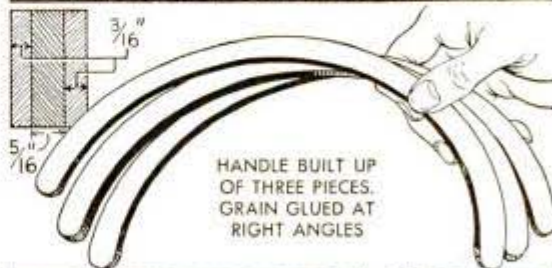

Large turnings made from solid stock will be more likely to retain their original shape if they are seasoned a few days after rough-turning to approximate shape.

## Damaged Tape Measure Repaired By Flowing Solder on Crack



Steel tape measures that have been cracked at the end can be repaired easily by flowing a little solder over the crack. This does not affect the operation of the flexible tape and will make it as serviceable as a new one. Tape cases that are made in two parts will also last much longer if the joint is soldered together.

—Vernon Peterson, Bremerton, Wash.

## Screwdriver Shielded to Avoid Electrical Shocks

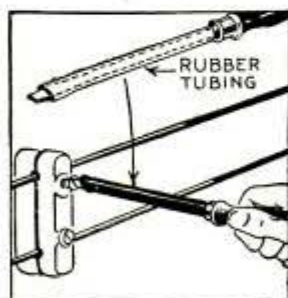

Slipped over the blade of a screwdriver, a length of small rubber tubing provides a shield that helps prevent accidental electric shocks when working around "hot" wires. Such a screwdriver is used by an electrician in Phoenix, Ariz., when he must work in places where there is a possibility of inadvertently touching the wires.

## Further Use for Worn Auger And Dowel Bits

When auger and dowel bits used in a brace become unsuited for use, the square tang on the end can be cut off with a hacksaw, leaving a straight shank that will fit

into a drill-press chuck. Under speed, the bit will cut clean holes in the wood. In a drill press, the spur center cannot be used to feed the bit into the wood. A pilot hole, about the size of the diameter of the spur is drilled first and the auger bit fed by hand pressure as in metal drilling.

## Improving Your Fish Stringer

Instead of using a piece of wire or wood on your fish stringer, get an old toothbrush handle and use it for the purpose. Just cut off the bristle portion of the brush and point one end of the handle. Usually the other end is already drilled so that the stringer can be tied to it. This makes a strong, serviceable point for the end of the stringer.

—Everett Hanson, Argyle, Wis.

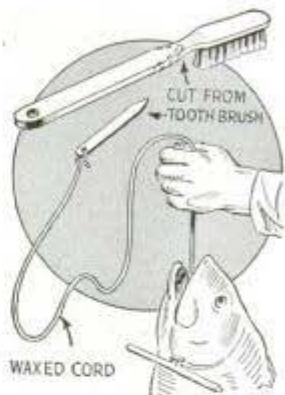

## Emery Paper From Match Book Smooths Fishing-Rod Tip

If your fishing rod has a metal tip or guides that have become roughened to such a point that they might wear the line, you can smooth them easily with a strip of emery paper torn from the end of a match box. Roll the strip into a cone and insert it in the tip or guide with a twisting motion, repeating this procedure until the metal is smooth. The strip will also serve to clean the ferrules of a jointed rod, if they become corroded.

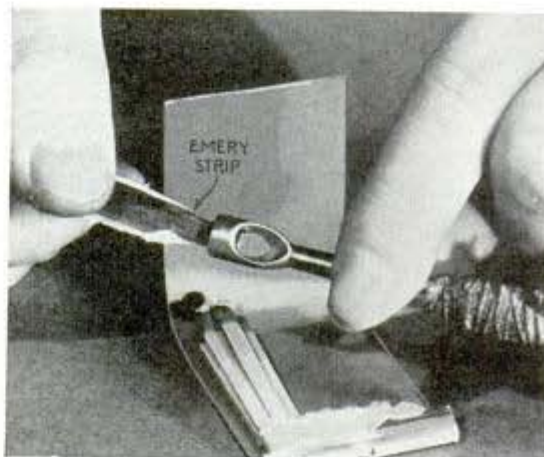

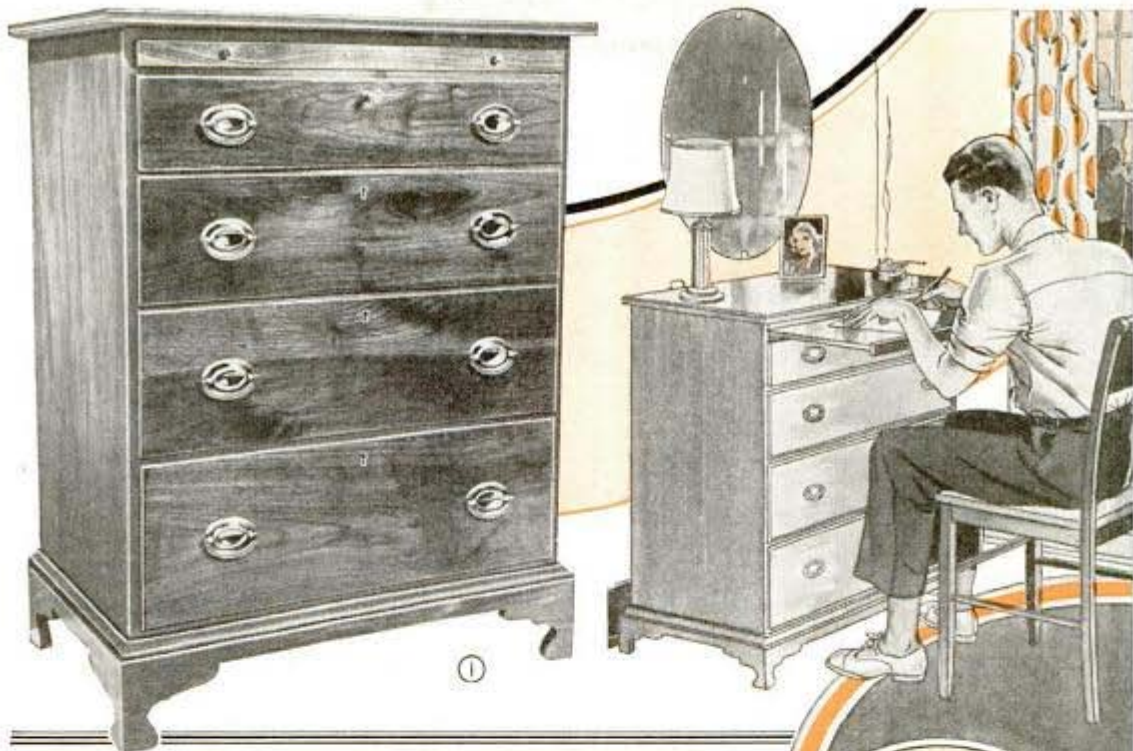

## BACHELOR CHEST

*built with hand tools*

Low, four-drawer chest of Colonial design has a pull-out leaf under the top to provide a handy place for writing

By W. W. Buffmire

**I**DEAL for the man who does occasional writing, but whose room will not accommodate both a chest and a desk, the attractive chest shown in Fig. 1 combines both. If the chest appeals without the desk feature, the pull-out shelf can be omitted and the overall height increased to a full-size chest.

For economy, rip the front rails of the six drawer frames of finished stock and the inner members of less expensive material such as birch or gum. From Fig. 3 you will see that the bottom frame differs from the others by being of thicker stock, wider and fitted with a dust panel. Dovetails formed on the ends of the top frame to engage similar cuts in the chest sides as in Fig. 2, lock the assembly together at the top. At the base, the sides are fastened even with the bottom edge of the lower frame, using screws and glue, the screw

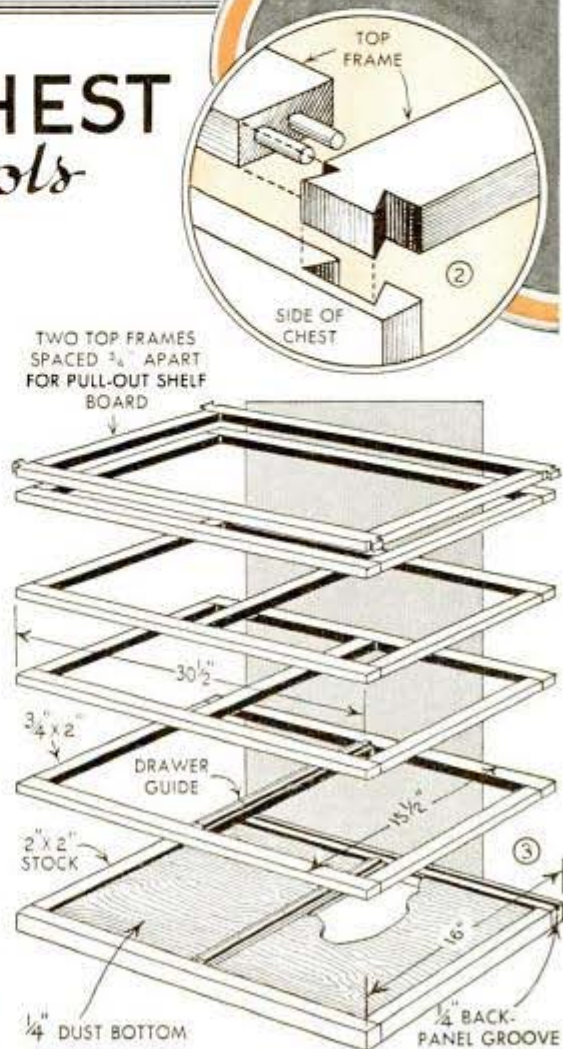



TOP OVERHANGS SIDES AND FRONT 1 IN.

heads being concealed later by the base and its molding. All the frames, with the exception of the two top ones, include a center crossrail to which a narrow strip is nailed to register with a grooved one fastened to the underside of the drawer bottom. If you prefer, a rabbet can be cut along the rear edge of the lower frame instead of a groove as indicated. Keep the dust panel close to the top of the frame so it will not interfere in attaching the base with screws, which are driven from the inside. The screw holes

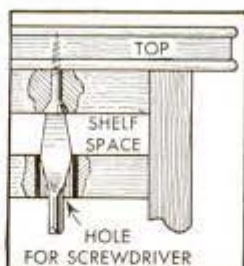

should be drilled before the frame is assembled. Use two  $\frac{1}{4}$ -in. dowels at each joint, glue and clamp flat.

As the sides of the chest are 16 in. wide, you will have to build these up in width from three or four separate pieces. Take care in planing the abutting edges straight and true and in locating the dowel holes in the edges to bring the surfaces flush. The use of dowels will assure sound construction, but a glued butt joint will be satisfactory provided the edges have been jointed properly. Fig. 6 gives the spacing of the frames. All the frames are fastened to one side of the chest first, and then to the other side. Notice from Fig. 8 that short dowels and screws are used in addition to glue to hold the frames, three screws being driven through each end from the inside as shown in Fig. 9. Before fastening the two top frames to the sides, be sure to provide holes in the top frame for the screws that hold the top in place; also bore holes in the second frame to permit insertion of a screwdriver to reach the screws. This is shown in the detail to the right of Fig. 4. Leave about a  $\frac{7}{8}$ -in. space between the top

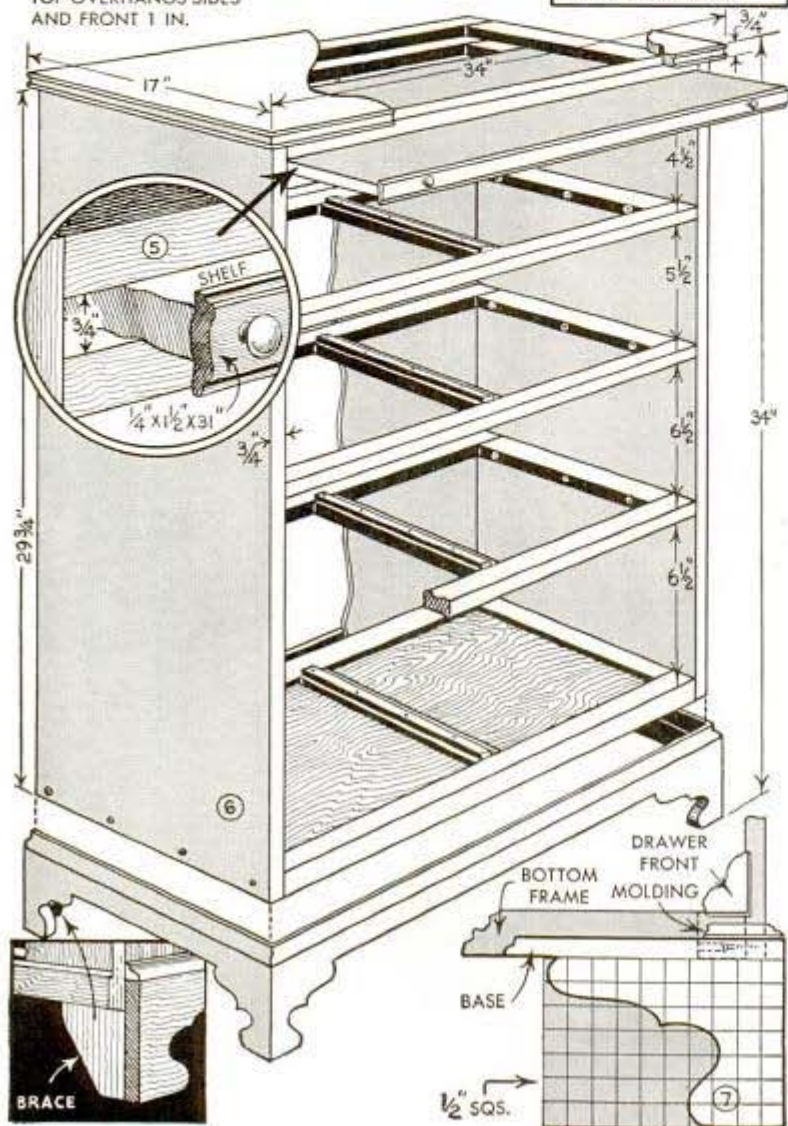

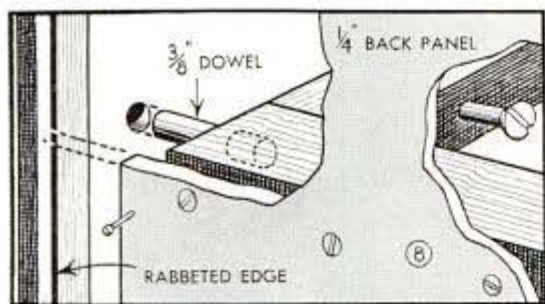

frames to allow ample clearance for the finish and for thumbtacks, which are pressed in place at each end to make the shelf slide easier. Cut the back plywood panel squarely so that when it is fitted snugly in the rabbets and screwed to each frame, it will automatically square up the assembly.

The base pieces, which are mitered to overlap the sides and front of the chest, are scrollsawed at the ends according to the pattern given in Fig. 7. The chest is set down inside the base  $\frac{3}{4}$  in., and is attached with screws from the inside through holes provided for them in the lower frame. At the back the cross grain of the leg is reinforced with a brace as indicated in the detail to the left of Fig. 7, while each front leg is fitted with a triangular corner block. Complete the base by attaching the molding to it with small finishing nails, setting the heads below the surface and filling with plastic wood.

Drawer fronts are rabbeted as shown in Fig. 10 to overlap the openings  $\frac{1}{4}$  in. If you feel capable of cutting a dovetail drawer joint, this may be used instead of rabbets as in Fig. 4. As in the case of the frames, only choice stock is used for the fronts. With this type of drawer, ample clearance can be allowed to prevent binding as the extra-loose fit of the drawer will not be seen. The bottom, which is set in grooves run in the front and sides, is left long enough to extend under the drawer back. The writing shelf is built up like a drawing

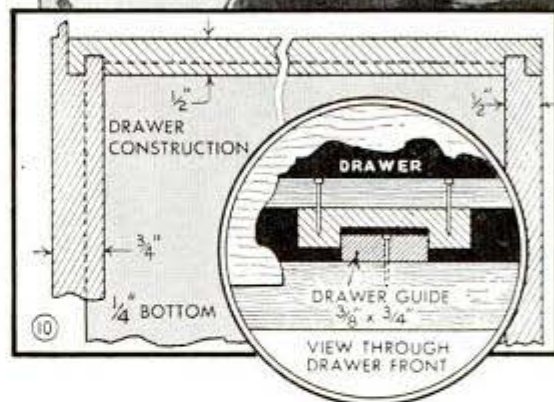

board, that is, with strips doweled across the ends to check warping. Saw kerfs cut lengthwise on the underside of the shelf about 1 in. apart and  $\frac{3}{8}$  in. deep, before the end strips are added, also will help keep it from warping. The facing strip along the front edge of the shelf is cut to overlap the opening about  $\frac{1}{4}$  in. all around as shown in Fig. 5, after which a small brass knob is fitted at each end. Metal drawer pulls of the type shown on the original chest are standard and can be obtained in either antique finish or polished brass.

## Reversing the Pen Point in Its Holder May Avoid a Serious Accident

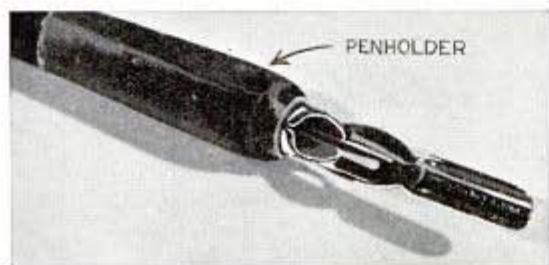

If you are in the habit of leaving a writing pen on a desk or table top where a small child is apt to get hold of it, a serious accident may be avoided by taking the time to reverse the point in the holder when you finish using it. When placed in the holder in this position, few small children are able to remove the point and yet it is always at hand when needed.

## Flowers Under a Sealed Window Watered From Inside Building

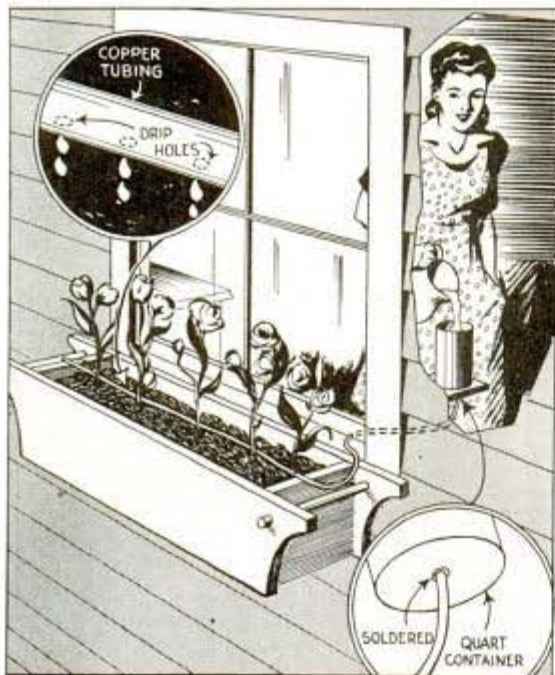

Desiring to put a window box in front of a sealed window on the second floor, one home owner overcame the problem of watering the flowers in the box by the method shown. A length of copper tubing was passed through a hole drilled in the window sash and then run across the top of the flower box, several small holes being drilled in this portion of the tubing. A quart container was soldered to the other end of the tubing inside the window. Water poured into the container inside the house passed through the tube and was distributed over the soil in the flower box.

—John E. Mason, Hamilton, Ont., Can.

## Long Fishline Waxed Quickly With Cork and Funnel

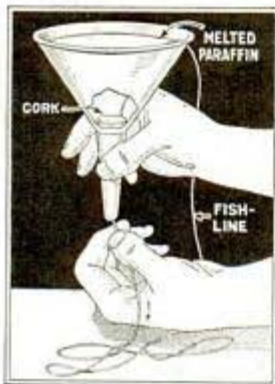

A small funnel with a cork in the neck as indicated will save you a lot of time when waxing and waterproofing a fishline. Start the line through the funnel, insert the cork and fill the funnel with melted wax or waterproofing

liquid. Then pull the line through the funnel. The cork retains the wax and also serves as a wringer to remove surplus wax from the line.

## Empty Shell Helps Scour Rust Off Shotgun Barrel

When removing rust from the outside surfaces of his shotgun and rifle barrels, one sportsman uses an empty shotgun shell to help speed up the job. The end of the shell is moistened with oil and then dipped into the abrasive and used as a scouring pad.



## Nail Polish Attracts Attention When Light Switch Is On

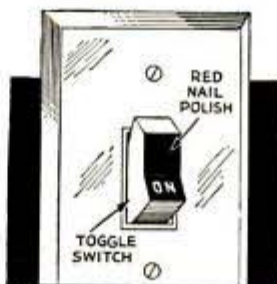

If you sometimes forget to turn off a light in your basement or other place where the light is not seen from the switch that controls it, paint the toggle of the

switch with red nail polish so that it shows only when the switch is in the "on" position.

## Water Colors Pulverized Easily In Onion Chopper

Hardened water colors can be pulverized quickly with the cutter of an ordinary onion chopper. All you need to do is remove it from the regular container and place it over any water-color jar, using the up-and-down spring motion to cut the hardened contents.



If water colors in small jars need such treatment, the chopper cutters can be either bent as indicated or ground down to suitable size.



# Body Shield Aids in the Control of Fire Bombs

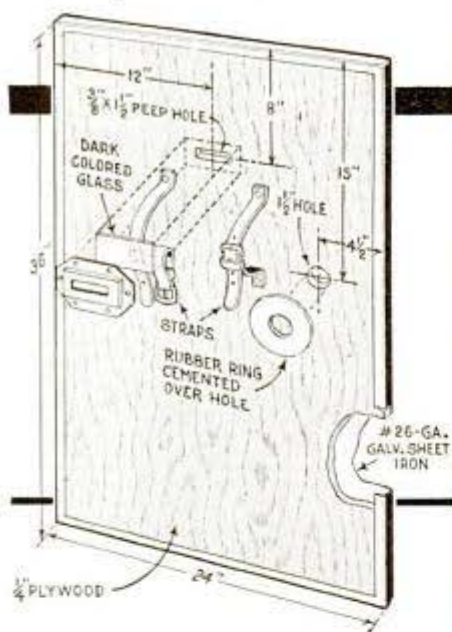

Developed by the fire department of a U. S. Marine Corps Base, this shield helps to provide safety in the control of incendiary bombs. Weighing less than 5 lbs., the shield is worn on the arm much like an ancient warrior's shield. A rubber-covered opening is provided near the right-hand side for the nozzle of a hose or fire extinguisher, and a peep hole is located near the top on the centerline of the shield, the hole being covered with dark-colored glass to permit looking at a burning bomb. Two leather or web straps attached to the shield beside the nozzle

opening are buckled over the left forearm to simplify handling it, and to leave both hands free for operating a suction pump if necessary. The shield is made from a piece of 1/4 or 3/8-in. plywood faced with 26-ga. galvanized sheet iron. The iron is bent around the edges of the plywood to extend about an inch on the back of the shield where it is tacked to hold it in place. A shield 24 in. wide and 36 in. long will afford protection for the entire body as close as 15 ft. to a burning bomb if the user crouches on one knee in the position shown in the photo.

## Razor Blades Kept From Rusting by Dipping in Paraffin

New razor blades can be prevented from rusting by tying them into small bundles and then dipping these into melted paraffin. When the paraffin has cooled, the string is cut and removed, as each bundle forms a solid pack from which one blade at a time may be peeled off as needed. Such treatment is especially handy for campers who keep blades for a long period of time or others who use them in a damp climate, or near salt water.—C. E. Packer, Chicago.

☞ You cannot grow delphiniums successfully in soggy soil. If the plants are in soil of this type, cover the crowns with wood ashes before the ground freezes. If you cannot obtain wood ashes, use coal ashes.

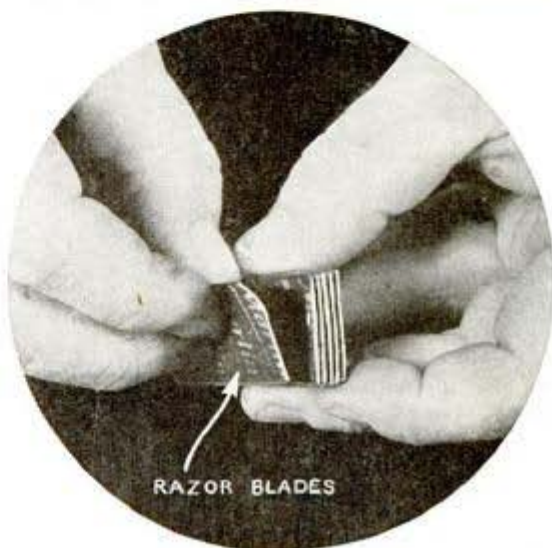

# Model of U.S. Frigate

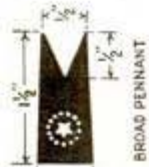
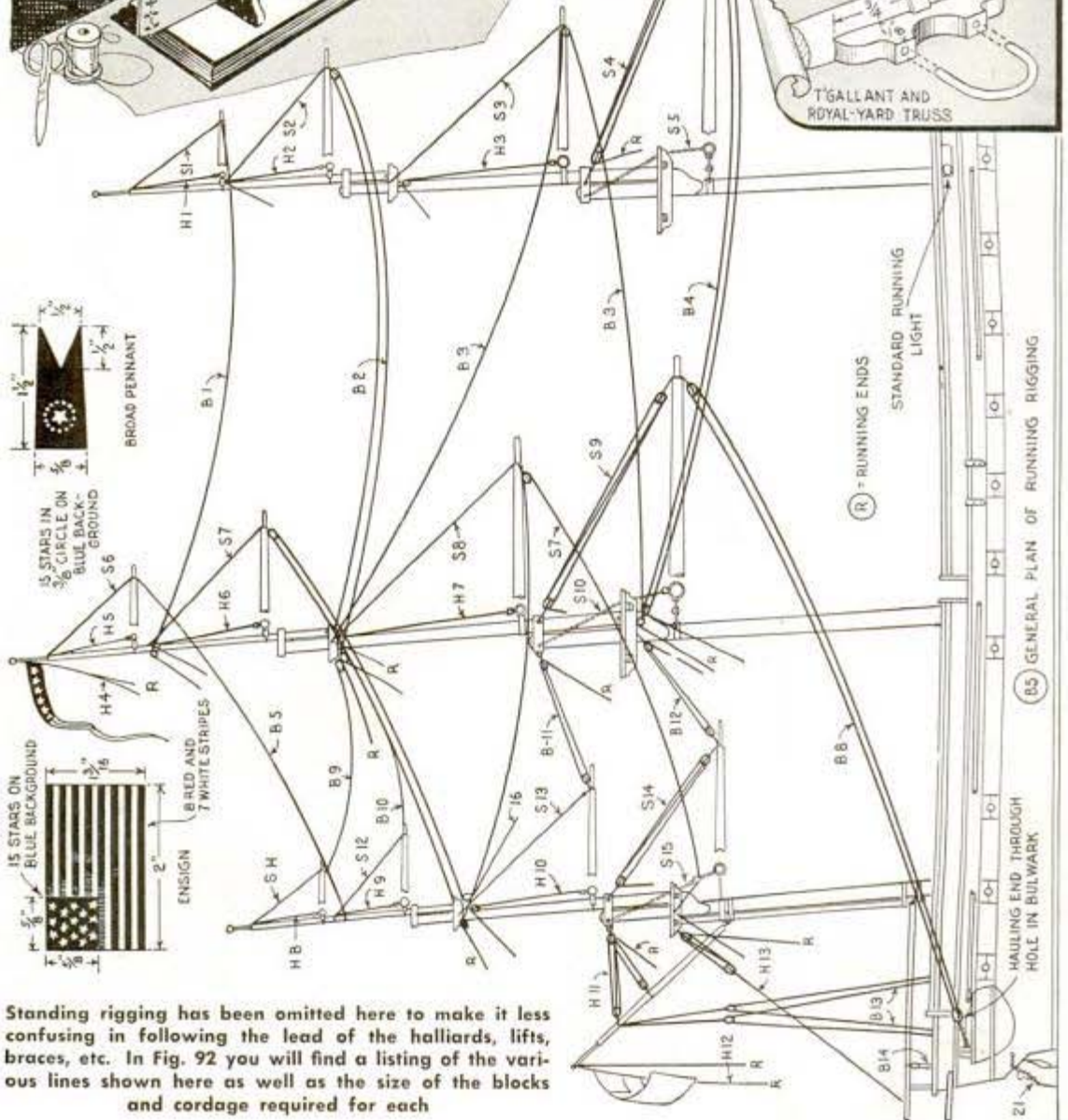
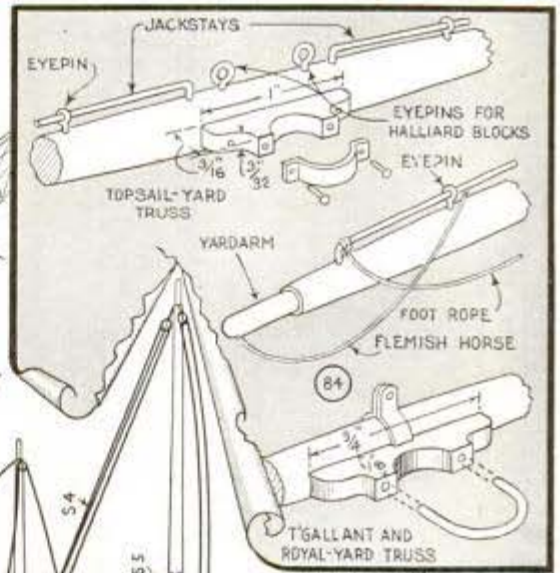
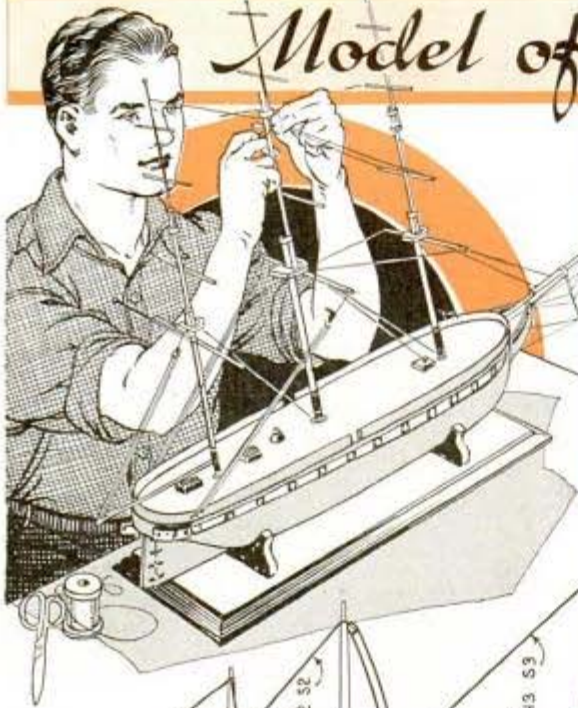

BROAD PENNANT

15 STARS IN  
BLUE CIRCLE ON  
BLUE BACK-  
GROUND



ENSIGN  
7 RED AND  
7 WHITE STRIPES

Standing rigging has been omitted here to make it less confusing in following the lead of the halliards, lifts, braces, etc. In Fig. 92 you will find a listing of the various lines shown here as well as the size of the blocks and cordage required for each

# "CONSTELLATION"

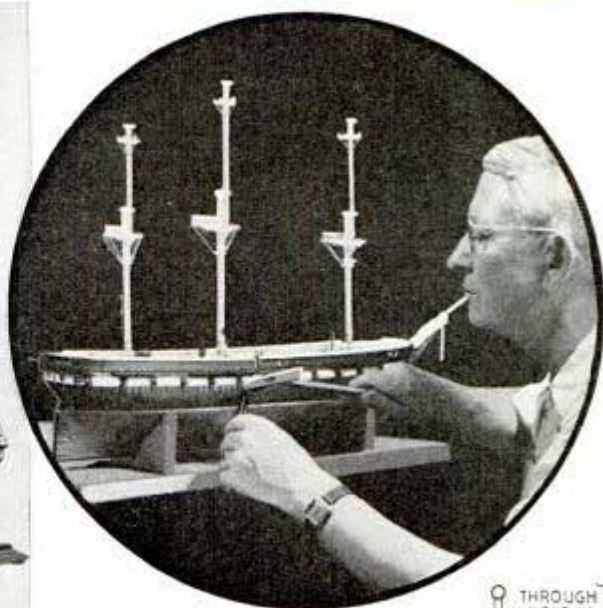
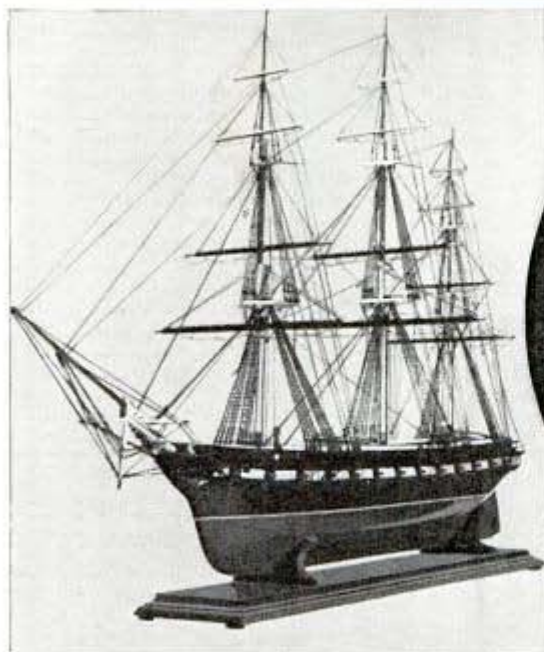

By H. W. Potter

## Part V—Running Rigging

WITH the standing rigging in place, all that remains to complete your model of "Constellation" is to set up the running rigging. Before the yards can be shipped to their respective masts, yard fittings such as trusses, jackstays, foot ropes, etc., must be added. The type of truss shown for supporting the lower yards in Part III, Fig. 57, can be purchased, but those used on the topsail, topgallant and royal yards must be made as detailed in Fig. 84. Jackstays on the top of the yards, to which the sails are attached, are of No. 24-gauge iron wire on the lower yards and decrease in size aloft in proportion to the size of the upper yards. The footropes on which the men stood to take in and stow the sail, are fitted on the aft side of all yards, and consist of fine enameled magnet wire with the stirrups twisted to them. A short rope, called a "Flemish horse," is provided at the outer ends of the lower and topsail yards for the sailor who had to sit astride the yardarm.

Now to begin the running rigging. Like the standing rigging, the size of cordage and the number of blocks required for each respective line can be found quickly by referring to the table given in Fig. 92. This

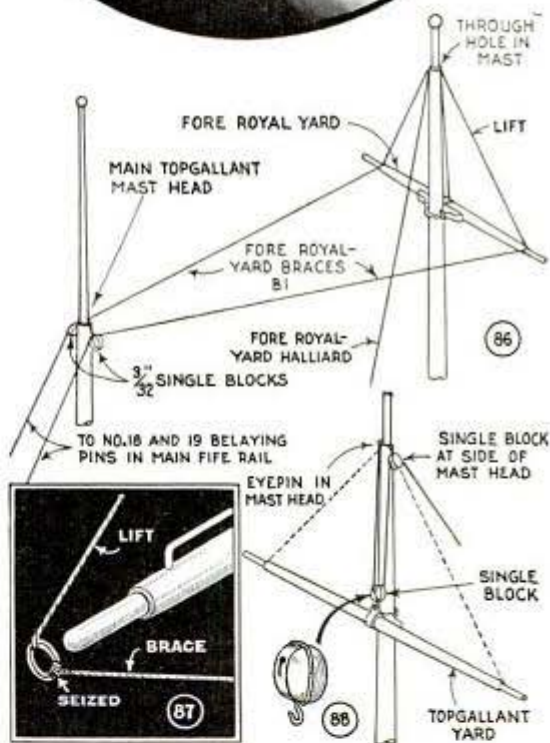
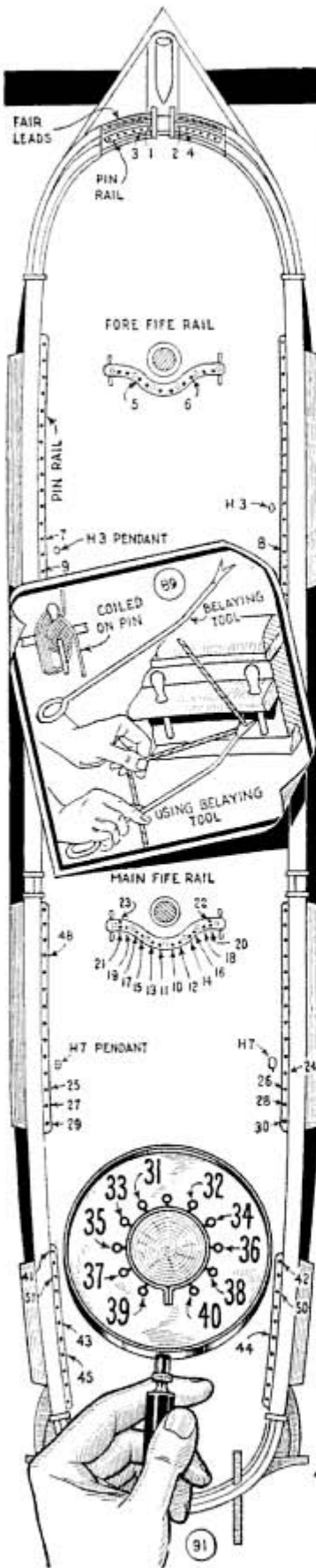

table is used in conjunction with Fig. 85, which shows each line correspondingly lettered and numbered; letters S, B and H standing for lifts, braces and halliards respectively. As the running rigging is tan, with the exception of the slings which are black, it will be necessary to dye the cord as near the color of rope as you can. Use an aniline dye dissolved in alcohol. Also, don't forget to draw each cord through a

### BELAYING-PIN KEY

1 Fore royal stay (Port).....	1	26 Mizzen topgallant-yard brace.....	B10
2 Fore flying jibstay (Starboard).....	2	27 Mizzen royal-yard brace.....	B9
3 Fore topgallant stay (Port).....	3	28 Mizzen royal-yard brace.....	B9
4 Fore outer jibstay (Starboard).....	4	29 Main topgallant-yard halliard.....	H6
5 Fore lower-yard lifts.....	S4	30 Main royal halliard.....	H5
6 Fore lower-yard lifts.....	S4	31 Mizzen lower-yard lifts.....	S14
7 Fore topsail-yard halliard.....	H3	32 Mizzen lower-yard lifts.....	S14
8 Fore topgallant-yard halliard.....	H2	33 Main topsail-yard brace.....	B7
9 Fore royal-yard halliard.....	H1	34 Main topsail-yard brace.....	B7
10 Main lower-yard lifts.....	S9	35 Main topgallant-yard brace.....	B6
11 Main lower-yard lifts.....	S9	36 Main topgallant-yard brace.....	B6
12 Fore lower-yard braces.....	B4	37 Main royal-yard brace.....	B5
13 Fore lower-yard braces.....	B4	38 Main royal-yard brace.....	B5
14 Fore topsail-yard braces.....	B3	39 Spanker-boom topping lift.....	H13
15 Fore topsail-yard braces.....	B3	40 Spanker-boom topping lift.....	H13
16 Fore topgallant-yard braces.....	B2	41 Spanker-gaff throat halliard.....	H14
17 Fore topgallant-yard braces.....	B2	42 Spanker-gaff peak halliard.....	H11
18 Fore royal brace.....	B1	43 Mizzen topsail halliard.....	H10
19 Fore royal brace.....	B1	44 Mizzen topgallant halliard.....	H9
20 Mizzen topsail-yard braces.....	B11	45 Mizzen royal halliard.....	H8
21 Mizzen topsail-yard braces.....	B11	46 Main lower-yard brace.....	B8
22 Mizzen lower-yard braces.....	B12	47 Main lower-yard brace.....	B8
23 Mizzen lower-yard braces.....	B12	48 Main pennant halliards.....	H4
24 Main topsail-yard halliard.....	H7	49 Spanker-gaff ensign halliards.....	H12
25 Mizzen topgallant-yard brace.....	B10	50 Spanker-gaff vang.....	B13



cake of paraffin or beeswax the same as you did for the standing rigging. As was true of the yard jackstays, the rigging cordage used aloft also should gradually decrease in size to keep it in proportion to the reduced size of the masts and yards.

Commencing aloft, sling the royal yards first, starting at the foremast and working aft. Referring to the table in Fig. 92, you'll find that the fore royal-yard halliard (H-1) is of .014 cordage which is the approximate diameter of No. 80 linen thread. The halliard is seized to the eye in the center of the yard, threaded through the hole in the masthead and left to hang free for the time being, after which the wire staple, or yard parrel, is inserted in the truss to hold the yard to the mast at a point approximately midway above the cap.

If the staple does not fit tightly enough to prevent the yard from being hauled aloft by the halliard when the latter is set up taut, a small pin can be pressed into the mast directly above the yard. Next, the yards are supported laterally by slings, which run from the port yardarm, up around the masthead and down to the starboard yardarm. Note from the table that No. 100 linen cordage is used for this. The slings on the topsail, topgallant and royal yards of all masts are formed from a single length of cord. Fig. 87 shows how the cord may be attached to the yardarms, the braces being seized as indicated, or simply fastened to the yard with a slip knot and coated with glue. The turns around the masthead should be adjusted to level the yard laterally with the deck and make the slings taut before finally applying a drop of glue to the turns. Royal halliards are rigged as shown in Fig. 90, the fore and mizzen ones being set up to deck eyes near the port pinrails and the main one to starboard. This is shown clearly in Fig. 94.

To determine the belaying point of the halliards as well

as all other running ends of the rigging, refer to the belaying-pin key shown above Fig. 90. For example, (H-1), which is the fore royal-yard halliard, is listed belayed to No. 9. Referring to Fig. 91, you'll see that position No. 9 is at the port pinrail. Thus it is a simple matter to determine exactly where the running or "hauling" end of each line is belayed. When belaying, coil the line on the belaying pin in a figure-of-eight as shown in Fig. 89. A tool such as the one shown, and used as indicated, will be found exceedingly handy for winding the line around the pin, especially in close quarters. A drop of glue applied to the pin will keep the cord in place. Belaying pins can be purchased from any ship-model supply house for a few cents a dozen. The lead of the royal braces is shown in Fig. 85, the fore royals running aft from the yardarms through blocks stropped to each side of the main topgallant masthead as in Fig. 86, and on to their proper belaying point in the main fife rail. When you have all royal braces in place, the topgallant yards may be slung to their respective masts in the manner given in Fig. 88. Notice in Fig. 85 that these yards are mounted slightly above the topmast cap, with the fore and mizzen halliards running to starboard and the main halliard to port. Alternating the halliard leads in this way distributes strain evenly on the hull. The halliard lead to the deck should follow closely the lead of the backstays. The manner of rigging the braces differs from that of the royals in that they are reeved through single blocks seized to the yardarms.

Fig. 94 shows how the fore topsail halliard looks from the aft side, the main and mizzen being rigged the same. Here chain and cord are combined. The sling, also of chain, is attached to the tye block, passed through a sheave hole in the mast and finally shackled to the yard truss. As indicated, one end of the halliard chain is fastened to a length of cord and seized to a port deck pendant; the other end is rigged with a luff tackle, which is set up to a starboard pendant and the hauling end belayed



SLINGS AND LIFTS					
NO.	NAME	GORGE	NO.	PARTS	
S 1	FORE ROYAL-YARD SLINGS	100 LINEN			
S 2	" T'GALLANT "	1018.15.10.14			
S 3	" TOPSAIL "	.017			
S 4	" LOWER " LIFTS	.014	2	5/32 DOUBLE BLOCKS	PENDANT .017
S 5	" " " SLING		6W.	22-LINK CHAIN, BLACK	
S 6	MAIN ROYAL " SLINGS	100 LINEN			
S 7	" T'GALLANT "	1018.15.10.14			
S 8	" TOPSAIL "	.017			
S 9	" LOWER " LIFTS	.014	2	5/32 DOUBLE BLOCKS	PENDANTS .017
S 10	" " " SLING		6W.	22-LINK CHAIN, BLACK	
S 11	MIZZEN ROYAL " SLINGS	100 LINEN			
S 12	" T'GALLANT "	1018.15.10.14			
S 13	" TOPSAIL "	.014			
S 14	" LOWER " LIFTS		2	1/2 DOUBLE BLOCKS	1/8 SINGLE "
S 15	" " " SLING		6IN.	22-LINK CHAIN, BLACK	
HALLIARDS					
H 1	FORE ROYAL-YARD HALLIARD	.014	2	3/32 SINGLE BLOCKS	
H 2	" T'GALLANT "	.017	2	1-1/8 SINGLE BLOCK	1-1/8 DOUBLE " TACKLE, .014 CORD
H 3	" TOPSAIL "			6" 22-LINK CHAIN, 2-1/2 DOUBLE BLOCKS	10" 30 " "(TYE) TACKLE, .014 PEN. .022
H 4	BROAD PENNANT "	100 LINEN			
H 5	MAIN ROYAL "	.014	2	3/32 SINGLE BLOCKS	
H 6	" T'GALLANT "	.017	1	1/8 SINGLE BLOCK	1/8 DOUBLE " TACKLE .014 CORD
H 7	" TOPSAIL "			6" 22-LINK CHAIN, 2-1/2 DOUBLE BLOCKS	10" 30 " "(TYE) TACKLE, .014 PEN. .022
H 8	MIZZEN ROYAL "	.014	2	3/32 SINGLE BLOCKS	
H 9	" TOPGALLANT "	.014	1	3/32 SINGLE BLOCK	3/32 DOUBLE " TACKLE .70 LINEN
H 10	" TOPSAIL YARD "			6" 22-LINK CHAIN, 2-1/2 DOUBLE BLOCKS	9" 30 " "(TYE) TACKLE, .014 PEN. .022
H 11	SPANKER-GAFF PEAK "	.017	2	1/8 SINGLE BLOCKS	1/8 TRIPLE BLOCK
H 12	" " ENSIGN "	100 LINEN	1	1/16 SINGLE BLOCK	
H 13	" BOOM TOPPING LIFTS	.014	2	1/8 SINGLE BLOCKS	1/8 DOUBLE " PENDANTS .022
H 14	" GAFF THROAT HALLIARD	.014	1	1/8 SINGLE BLOCK	1/8 DOUBLE "
H 15	BOAT FALLS	.014	2	3/32 DOUBLE BLOCKS	
H 16	CAT "	.022	2	3/16 TRIPLE "	
BRACES					
B 1	FORE ROYAL-YARD BRACES	100 LINEN	2	3/32 SINGLE BLOCKS	
B 2	" T'GALLANT "	80 LINEN	4	3/32 " "	
B 3	" TOPSAIL "	30 " "	4	1/8 " "	
B 4	" LOWER "	.014	4	5/32 " "	
B 5	MAIN ROYAL "	100 LINEN	2	3/32 " "	
B 6	" T'GALLANT "	.70 " "	4	3/32 " "	1-1/2 DOUBLE
B 7	" TOPSAIL "	.014	4	1/8 " "	1-1/2 " "
B 8	" LOWER "	.017	6	3/32 " "	
B 9	MIZZEN ROYAL "	100 LINEN	2	3/32 " "	
B 10	" T'GALLANT "	.100 " "	2	3/32 " "	
B 11	" TOPSAIL "	.70 " "	2	1/8 " "	1-1/2 DOUBLE
B 12	" LOWER "	.014	2-2	1/8 SINGLE 1/8 DOUBLE	
B 13	SPANKER-GAFF VANGS	.014	2	3/32 SINGLE BLOCKS	
B 14	" BOOM SHEETS	.014	2	1/8 DOUBLE "	1/8 SINGLE "

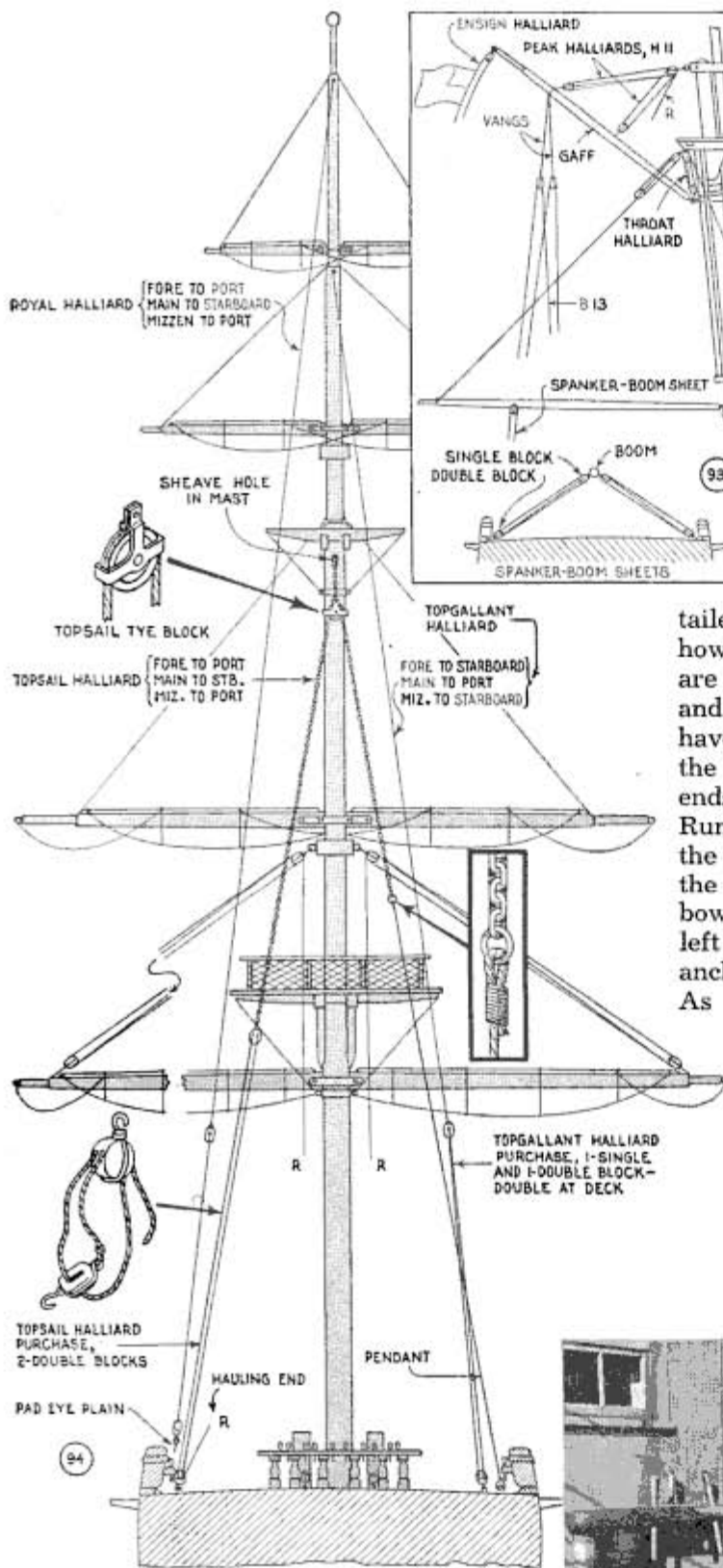

This aft view of the foremast, looking forward, is typical of how the halliards and lifts of all yards on each mast should be rigged. Note that the lower yard has no halliard, and that only the lower and topsail yards are fitted with a "Flemish horse" at the yardarms

to its pinrail. Braces are run the same as the top-gallant ones. The lower yards do not have halliards. Instead, chain slings are used between the yard truss and eyes provided in the mast-head. Lifts supporting the yard, are reeved in the manner shown in Figs. 90 and 94. The lead of all lower-yard braces can be followed easily by studying the general rigging plan which is given in Fig. 85.

This leaves the rigging of the spanker boom and gaff, which is detailed in Fig. 93. Note carefully how the peak and throat halliards are reeved. By consulting Fig. 92 and the belaying key you should have no difficulty in determining the lead of the various running ends, and the size blocks to use. Running ends of the cat falls at the cat heads are carried through the bulwark and belayed to the bow pinrail. The blocks may be left hanging free, or hooked to the anchors to indicate their purpose. As "Constellation" has been recommissioned for administrative purposes, the 48-star ensign can be used instead of the 15-star flag of her early history. Likewise, the long commission pennant can be flown from the main truck in place of the broad pennant. This completes construction of the model.

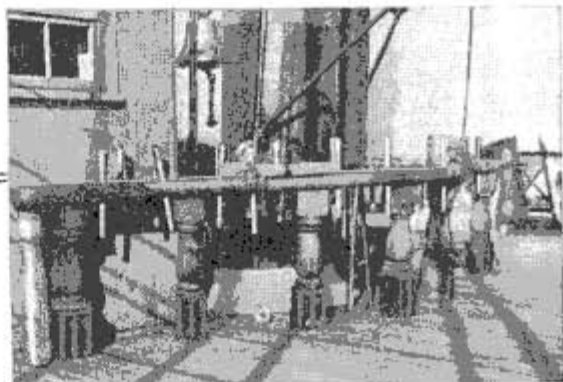

# Crocheting Yarn Held Conveniently on Stand

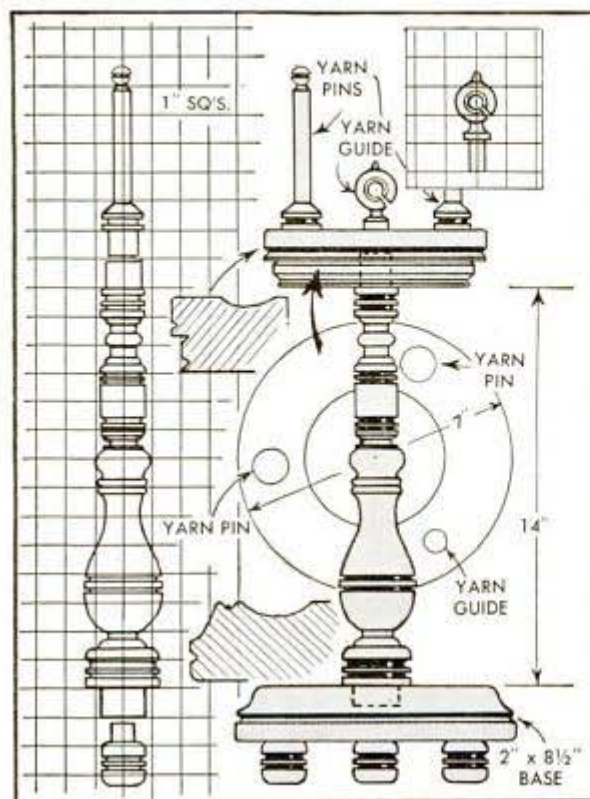

Women who crochet will find this handy stand a timesaver, especially when making rugs where two different colored warps are used, as it helps to prevent tangling and delivers the two strands side by side. The parts are turned from hardwood, and are finished right in the lathe. Dimensions of the feet, standard, yarn pins and guide

are determined by enlarging them on paper ruled in 1-in. squares. Profiles of the base and top are given in the sectional views in the drawing. All parts that are joined together have tenons turned on their ends, and are assembled with glue. The stand can be finished to match your furniture.—Harold Jackson, Kankakee, Ill.

*W.T.M. Concrete*

## Flagstone Steps Anchored on Hillside by Lengths of Pipe

Flagstone steps will not be undermined by water running down around them if they are anchored as shown. After cutting steps to shape in the soil, concrete building blocks are placed on them and anchored by driving 3-ft. lengths of pipe through the openings of the blocks into the ground. Then the flagstones are laid on the blocks and cemented into place.

—H. E. Meredith, Rocky River, Ohio.

When using varnish to make a label waterproof, which will discolor the paper, making it practically transparent and hard to read, first apply a thin coat of mucilage and over this apply the varnish. The paper will then keep its original color.



## Plywood Panels Marked Quickly With Weighted Chalkline

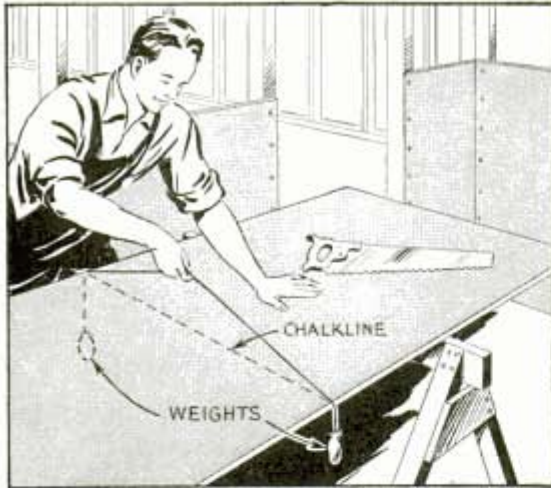

When working with large plywood panels, one carpenter uses a weighted chalkline to mark them in a jiffy before sawing. Weights which hold the line in place while snapping it consist of small tobacco sacks filled with sand and tied to each end of the cord. However, small lead fishing weights could also be used for the purpose if they are more readily available.

## Cleats on Plank Prevent Slipping When Pushing Wheelbarrow

Next time you have to haul concrete or other material up an inclined plank with a wheelbarrow, nail short cleats along the edges of the plank. In addition to preventing your feet from slipping when going up and down, these cleats also serve as stops for the wheelbarrow legs, making it possible to stop and rest while on the way up with a heavy load.



## Hand-Rubbed Silverware Chest Enhanced by Beauty of Grain

Rounded edges and corners are just enough to impart pleasing lines to this simple but beautiful silverware chest in polished walnut or other fine wood. The tight-fitting cover minimizes oxidation, which causes silver to tarnish. Solid stock is used for the ends and sides and walnut-faced plywood for the top and bottom. By ripping the pieces making up each side and end of the chest from one length of  $\frac{3}{4}$ -in. stock, the grain of the cover and bottom will match completely around the chest. From the sectional detail you can see the type of cut to be made at each joint. Run all the rabbets first, including the slot for the lining, then miter the pieces to length. It is not so important to obtain a perfect fit at the bottom rabbet, as this will not show, but at the top you should use extra care. The recess for the hinge can be cut neatly after assembly by clamping both cover and bottom together temporarily and passing it over a dado head set to bring the hinge flush, after which each end of the cut is cleaned up square with a chisel. The mitered corners of the chest are reinforced with short cross dowels. The novel handles are cut from logger's oak-tanned sole leather, drilled and polished to a hard glossy finish, after which a double row of corresponding holes are drilled in the chest in a curved line for attaching them. To make the lacing fit flush on the inside, the surface around the holes can be recessed slightly. The inside of the bottom can be lined with cloth specially treated to prevent tarnish. Along the sides and front it is tucked into the slotted edges, while at the back it is left long enough to glue inside the cover as a lid check strap. Cut the spoon-and-fork holder to a length which will permit it to be wedged in place at a curve, notch it and cover with cloth before inserting. The top half of the cover is lined with white satin, gluing it in folds, after which the knife-holder panel is cut to shape, slit as shown, covered and finally fitted with knife loops by lacing a ribbon of the same material in and out through the slits. A dab of glue on the back of the cardboard will keep the loops from shifting. If made of walnut, fill the grain, shellac and apply four coats of high-grade rubbing varnish, allowing 48 hrs. between coats.—Benj. Nielsen, Aurora, Nebr.



# You can make this SILVERWARE CHEST

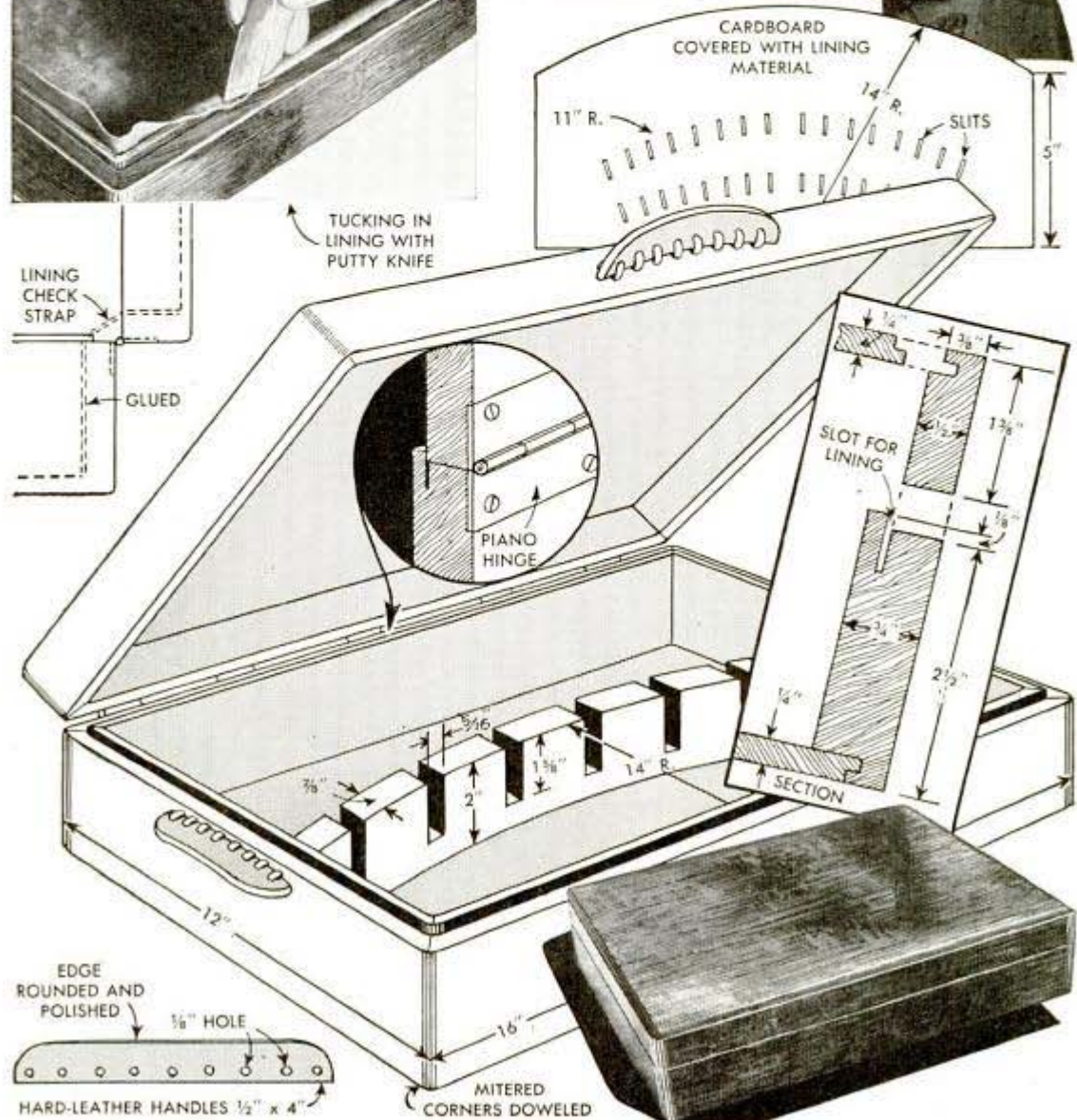
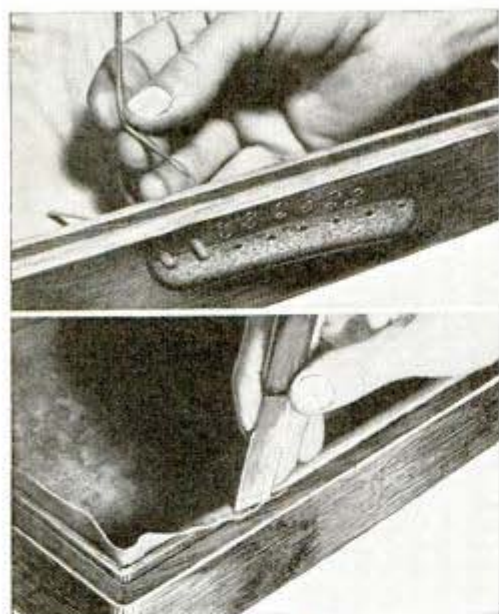

## Tennis Racket Helps Art Student Proportion Work to Be Copied



TENNIS RACKET SUPPORTED WITH BOOKS

In practice work, art students and others who are studying drawing will find that a tennis racket placed in front of the object that they are sketching will be of great help in proportioning the various parts to be drawn. If the measurement squares formed by the strings in the racket are known, the student will be able to draw the object accurately to any size desired.

—Axel E. Ogren, Chicago.

## Long-Handled Shrubbery Tool Prevents Scratched Arms

Scratches caused by thorns when thinning some kinds of shrubbery can be avoided if a long-handled tool of the type shown is used. It is made easily by filing a deep notch near the end of a discarded



spring leaf, after which both sides of the notch are ground sharp. In use, it's a simple matter to reach into a clump of bushes and cut out the undesirable growth. Such a tool has also been found handy for cutting small overhanging limbs from trees.

## Socket Wrench Speeds Up Work When Rethreading Nuts

On a job that required the rethreading of a number of nuts, the work was simplified by using a socket wrench to hold them. The

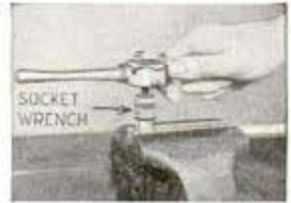

wrench was clamped in a bench vise as indicated so that a nut could be dropped into it and the tap run through the nut quickly. With this arrangement, it is unnecessary to loosen and tighten the vise each time a nut is threaded.

## Fish Can't Swallow This Hook

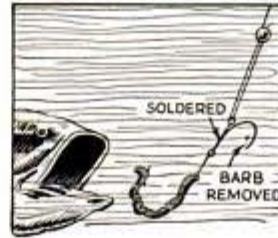

If you have experienced the annoyance of having a fish swallow a hook so that it was almost impossible to remove it, try using a hook made

like the one shown. This consists of a regular hook with a smaller one soldered onto it in a reversed position. This will serve as a stop regardless of how the bait is taken.

## Drill-Press Sander to Smooth Irregular Surfaces

Sanding inside of holes and other openings, or in concave surfaces can be done easily with this sander, which fits in the chuck of your drill press. It consists of a carriage bolt, which has the head padded with cotton taped in place as shown, and then covered with emery cloth also taped in place.

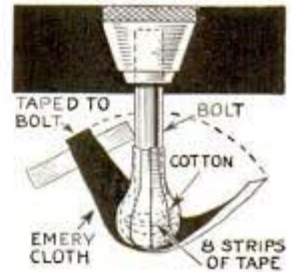

—C. R. Waddingham, Rosemead, Calif.

## Convenient Safelight Mounting

Added convenience can be given a safe-light of the type shown by fitting it with a pushbutton socket and a swivel mounting. The light is held by an angle bracket above



the sink, so the light is thrown directly on a print in the developing tray. The swivel permits the light to be adjusted as desired. If left on continuously, the light at this close range might fog the print, but by

using the switch to turn on the bulb only for short inspection periods, no harm will result.

## Plain Glass Rubbed With Soap Serves as Ground-Glass

Plain glass coated with a film of soap provides a good substitute for ground glass when you need a piece quickly and none



is at hand. Rub a cake of dry soap over the glass to leave a light deposit. Then, with a cloth or the finger tips, spread the deposited soap until the glass is completely covered with a thin, even coating.

☐ After placing prints on a ferrotype tin, cover them with several thicknesses of newspapers and squeegee off the excess water with a roller; this will absorb excess water, stick the prints firmly to the tin and help produce a high gloss.

## Audible Timer on Electric Clock Clicks Once Each Second



Especially handy when dodging prints or doing other darkroom jobs that make watching the clock difficult, this audible timer will not affect the normal operation of your electric clock. Find the shaft on the clock that turns once each second and drop a spot of solder on one side of it. Then mount a small piece of spring metal so that one end of it rests lightly on the shaft. As the shaft turns, the solder will raise the spring-metal piece once each second and it will snap against the shaft with an audible click.

—E. F. Whiteside, Wilmette, Ill.

## Rubber Crutch Tips Hold Bulbs Safely on Closet Shelf

There's less chance of photo bulbs falling off a shelf if the base of each one is pressed into a rubber crutch tip screwed to the shelf. A hole is drilled through each crutch tip and a single screw holds it in place. The ridges on the inside of the rubber tip grip the bulb base securely when it is pressed into it.

—Louis Hochman, Brooklyn, N. Y.





# How to Use Your

By Thomas P. Lake



It's not enough to point your meter at a scene, take the reading and then expose the film accordingly. For the best exposures, get the average illumination from several readings—except when certain portions of a picture are to be emphasized at a sacrifice of detail in other parts

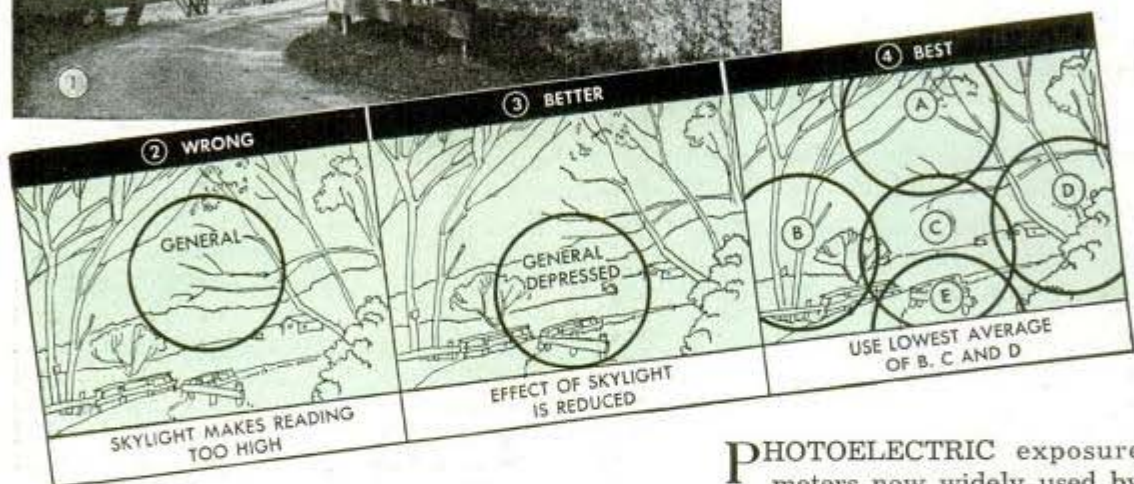

## 5 POSSIBLE RANGE IN ILLUMINATION

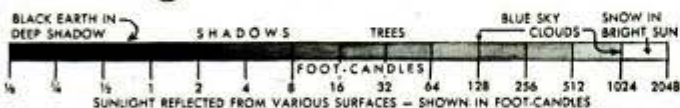

## 6 NEGATIVE EXPOSED TO EXTREME ILLUMINATION SHOWS:

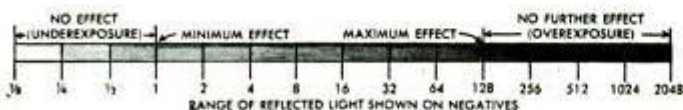

## 7 CHOOSING EXPOSURE OF EXTREME-RANGE SCENES

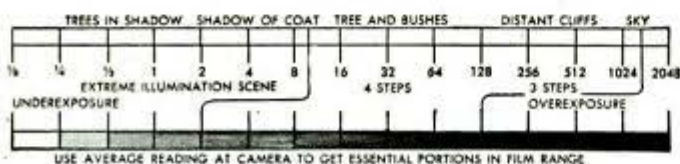

Average landscape, Fig. 1, has tone range well within that of film. For best exposure, take five meter readings as in Fig. 4, instead of one as in Figs. 2 or 3. Reading A measures sky illumination, E checks for extremes, B and D measure depth of shadows and check for extremes of range. Select average of B, C and D

PHOTOELECTRIC exposure meters now widely used by amateurs as well as professionals, have been responsible for a remarkable improvement in the average quality of negatives produced. For best results, a meter must be used accurately. Although the practice of pointing the meter at a scene, noting the reading, and then making the indicated exposure, may be occasionally correct, in the long run it leads to disappointing failures. The picture shown in Fig. 1 is typical of a normal photographic landscape scene. There are moderate shadows and highlights, and there is no extreme distance. The commonly used way of securing a light reading of such a scene is to remain at the camera position, sight across the top of the meter at the center of the scene, and note the reading shown on the light scale, as is

# PHOTO-ELECTRIC EXPOSURE METER

shown in Fig. 2. A second and better method, Fig. 3, is to direct the meter about 10 to 20 degrees below the horizon. This has the effect of reducing the amount of blue-sky light that enters the light-cell window. Since blue-sky light varies from about 200 to about 1,000 foot candles in power, and probably averages about 400, it is obvious that this high-intensity light probably would boost the meter reading far enough to underexpose the shadow portions of the ground. The best method of determining exposures is shown in Fig. 4. First, a reading of the sky alone is taken at A. This measures the illumination falling into shadows, since shadow illumination must come from the blue sky. Readings B, C and D are taken as the meter is swept slowly across the field of view, keeping the meter depressed sufficiently to exclude most of the sky. Then the average of these readings is used for exposure. A fifth reading in the foreground, E, is taken to make sure that it doesn't differ by more than two or three steps from the average reading obtained. If experience shows that the chosen reading is higher than might have been expected, the first, or sky reading will indicate the source of this unexpected light. If the sky reading is high, and shadow illumination is correspondingly high, the high figure chosen probably will be justified. If the sky reading is low, a further investigation usually will disclose a local area that is reflecting an unusual amount of light, such as a patch of sand, gravel or a stretch of dead grass. If this is the case, the chosen reading might be lowered about one-third, one-half or even one full step. If it is important that full detail be retained in the bright area no change need be made in the chosen reading. A little practice in this procedure will make it possible to obtain an exposure reading in about 30 seconds.

It often happens that a scene will have so great a range of tones

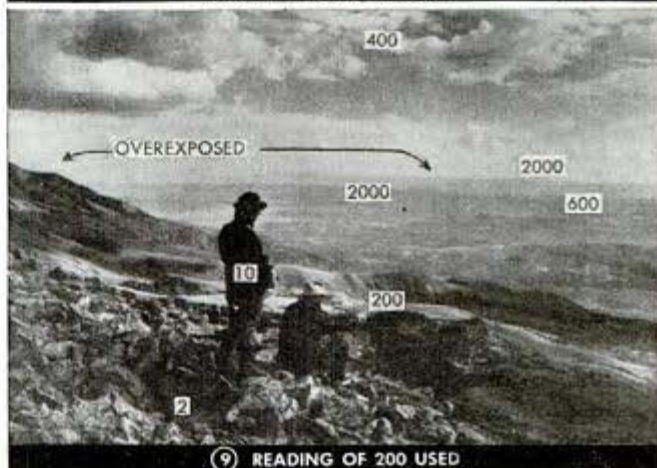

10 RANGE OF LIGHT VALUES IN FIGS. 8 AND 9

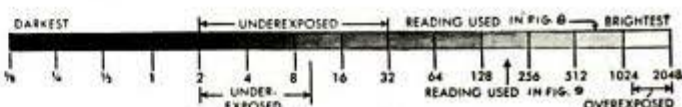



more than four steps below the indicated reading, and to show detail in highlights no more than three steps above the indication, a carefully taken average reading will lose least detail in both shadows and highlights, as indicated in Fig. 7.

However, it is not always possible to use the average light reading if certain types of views are to be photographed satisfactorily. Two such scenes are shown in Figs. 8 and 9. In Fig. 8 good detail of distance was desired, necessitating sacrifice of detail in the foreground as the range of tones far exceeded the recording range of the film. In Fig. 9 detail in both foreground and middle distance was desired. Although light readings were similar in both cases, Fig. 9 was



Circles at left representing area covered by the "eye" or light-cell window of the meter should not include the background, which is light in one case and dark in the other, resulting in under- and over-exposure of the face. Take the reading of the face only, holding the meter at a distance of about 8 or 10 in.

that the film is unable to reproduce all of them. This range may run from less than 1 foot candle to more than 2,000 foot candles, as indicated in Fig. 5. A film exposed to such a scene must necessarily overexpose a large portion, underexpose a large portion, or show smaller portions both underexposed and overexposed, as indicated in Fig. 6. Correct exposure for such a scene places the major portions of the scene in the normal range of the negative between the area of underexposure and the area of overexposure (underexposure, where no detail is shown in shadows; overexposure, where highlights are burned-in solid black and show no detail). As most exposure meters are designed to produce a negative showing detail in shadows down to no

exposed four times longer than Fig. 8 as indicated in Fig. 10. If a meter receives light from a wide angle, it may be unable to obtain the high readings shown for the distant horizon, as the weaker sky and middle distance will lower the reading obtained. In such a case, a 4-in. piece of mailing tube held tightly in front of the cell window will allow accurate relative measurements to be obtained. The tube lowers the readings obtained, and at the same time makes the cell highly directive. It is possible to determine the correcting factor, and to use such a tube in the field to determine accurate exposures.

In Figs. 11 and 12 are illustrated two extreme cases where a light reading taken from the camera position fails to determine

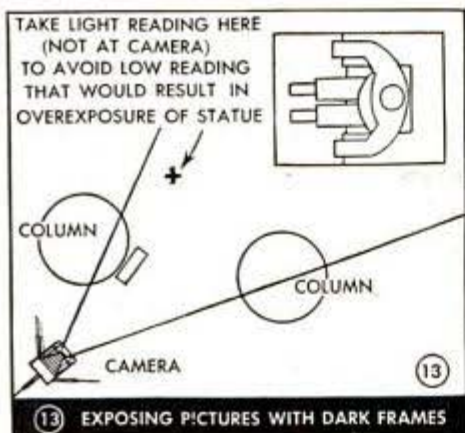

the correct exposure. Generally pictures of people are wasted effort unless faces are shown in good detail without harsh shadows. The photo shown in Fig. 11 was taken on a bright winter day when the general light reading was well over 1,000 foot candles, and would have shown the face in deep shadow if such a reading had been used, although snow texture would have been well rendered.

In Fig. 12 the absorption powers of the dark green shrubbery gave a very low general light reading, in spite of the fact that the summer sun was nearly overhead. An exposure based on such a reading would have overexposed the face (made it appear white and without detail), since under these circumstances the skin reflects much more light. In such cases, the photographer must take a light reading from within 8 or 10 in. from the face, taking care to avoid casting a shadow on it while the reading is being obtained.

Photographs showing the reflections of the sun on water are always interesting subjects, yet they require a peculiar technique to make them satisfactory pictures. If the light meter is directed at the scene to be photographed, the direct reflections of the sun will give a very high reading, possibly slightly beyond the scale. An exposure based on this reading will give a thin negative which will yield a night-effect picture. The sun's reflections will be sharp, however, since there will be little halation. However, a daylight effect may be more desirable. To secure this it would be well if a light reading could be taken of the scene without the sun's reflections. This is obviously impossible to obtain, so the next best thing must be done, which is



to take a reading on one side of the desired scene. The light reading obtained in this manner is used to determine the exposure. The somewhat longer exposure used in this method will allow reflections to lose some detail, and there may be some blurring on account of halation, yet the effect on the whole is pleasing.

Many types of subjects are more effective if they are "framed" as in a doorway, arch, a gracefully branching tree, or between a pair of columns, as in Fig. 14. As such foreground objects are often in deep shadow, a special method must be used to obtain good exposures. A light reading from the camera position, which averages the light reaching the cell window, is likely to badly overexpose the important object while obtaining a small amount of detail in the framing object. The correct method of obtaining a light reading is to approach near enough to the main object to exclude the frame from the light-receiving circle of the meter, and obtain a reading. See Fig. 13. If it is impossible to eliminate the frame from the meter reading, a substitute method is to give only one-half the indicated exposure.

Surprisingly good negatives may be obtained at first attempt from scenes that are



When a scene like the one above is too dark for taking general readings, measure the brightest spots, divide the highest meter reading by 8 and use the resulting figure to compute exposure

so dark that a general reading cannot be obtained, by a rather peculiar yet thoroughly sound use of the photoelectric meter. Such a scene is shown in Fig. 15. This picture was taken by obtaining a light reading from the brightest area to be found, in this case a patch of snow in bright

light. As the exposure meter is calculated to give a general reading four steps (equal to four lens stops) above the deepest shadow the film will record, and three steps below the brightest highlight the film will record, the light reading for the very dark scene may be assumed to be three steps lower than the reading obtained from the highlight. Usually such low figures are not shown on the calculating dials or tables of exposure meters, so the bright-area reading may be used and the lens opened three stops more than indicated, or the exposure may be given at the indicated stop but lengthened eight times (each full stop doubles or cuts in half the amount of light passed, so  $2 \times 2 \times 2 = 8$ ). After a little experience in this method of determining the correct exposure for very dark scenes, it is possible to take a well exposed picture every time.

## Dutch Windmill, Lawn Furniture, Trellises



Dutch Windmill Plan—1059

Two Cedar Chests—795, 25c  
 Gun Cabinet—991, 25c  
 Queen Anne Coffee Table—526, 25c  
 Dutch-Style Breakfast Set—822, 25c  
 Priscilla Sewing Cabinet—617, 25c  
 Corner Book Shelves—1029, 25c

### BUILD-IT-YOURSELF PLANS

Dutch Windmill—1059 (illustrated at left) 25c  
 Lawn Chair—1058, 25c  
 Jigsawed Ornaments—1051, 25c  
 Porch Chair and Table—1028, 25c  
 Two Barrow Chairs—924, 25c  
 Lawn and Garden Furniture—920 to 922, collection of seats, swings, arbor-and-seat combinations, 75c  
 Artistic Dog Houses—826, 25c  
 Dutch Windmill Tool House—890, 25c  
 Bird Houses—884 to 886, 20 designs, 75c  
 Five Wren Houses—1065, 25c  
 Trellis Suggestions—639, 25c  
 Lawn Arbor and Trellis—715, 25c  
 Sunbonnet Girl Cutout—35c  
 Keep Off Grass Policeman—35c  
 Humped Cat Cutout—30c  
 Tulip Girl—35c  
 Dutch School Boy—35c  
 Ornamental Wood Fences—798, 99, 50c  
 Circular Arbor and Gate—637, 25c  
 Flower Boxes—1061, 25c  
 Sand Box and Wading Pool—708, 25c  
 Outdoor Fireplaces—917, 25c  
 Log Cabin Construction—916, 25c  
 12-Ft. Utility Rowboat—707, 25c

Order plans by number and title. Send 3 cent stamp for catalog describing complete list of 364 easy-to-follow plans

**Popular Mechanics Plan Service, Dept. 411, 200 East Ontario Street, Chicago, Ill.**





# SHOP NOTES

## Simple, four-way TOOL TURRET *fits 9-in. lathe*

By Dana H. Bailey

**Clamps to base of compound rest in place of regular tool post. Operates easily and indexes accurately**

**B**UILT to withstand production use on a small bench lathe, this inexpensive, four-way tool turret, Fig. 1, can be machined on a lathe. Although the turret has no depth stops, marks on the various tools themselves will serve to check longitudinal travel. Cutaway views in Figs. 2 and 4 show you how its nine parts are fitted together. While the dimensions given are for a 9-in. lathe, the turret can be made for use on a larger machine by increasing its size proportionately.

Turn the pivot post first, as it will be needed to support the rotor for drilling the tool-holder sockets, and the holes for the bosses. The shoulder at the base of the post is turned to give a drive fit for the foot, which is the collar just above the dovetail. Next, you turn the space ring, rotor and headpiece, taking care to see that the rotor makes a snug sliding fit on the pivot post. In the absence of an indexing chuck or head, center lines for the four bosses in the rotor can be located 90 degrees apart in the following manner: First chuck the rotor on its side in a four-jaw chuck. Then, with a tool bit in the tool holder, advance it to bring the bit just under one of the chuck jaws. With the jaw resting on the bit, scribe a center line lightly on the work by moving the carriage.

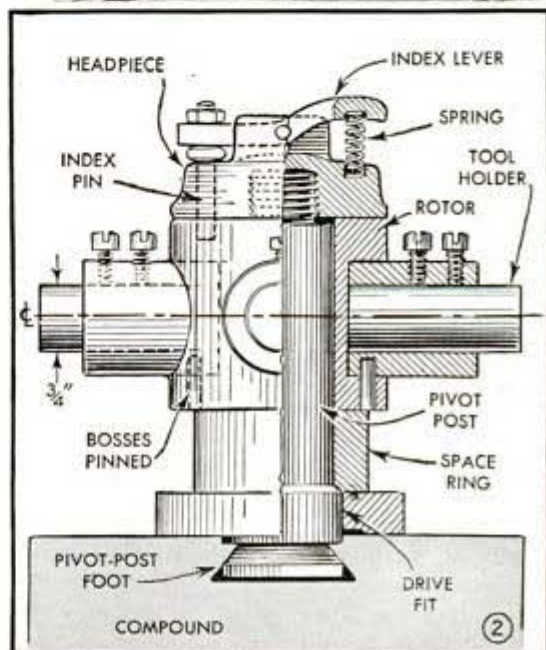

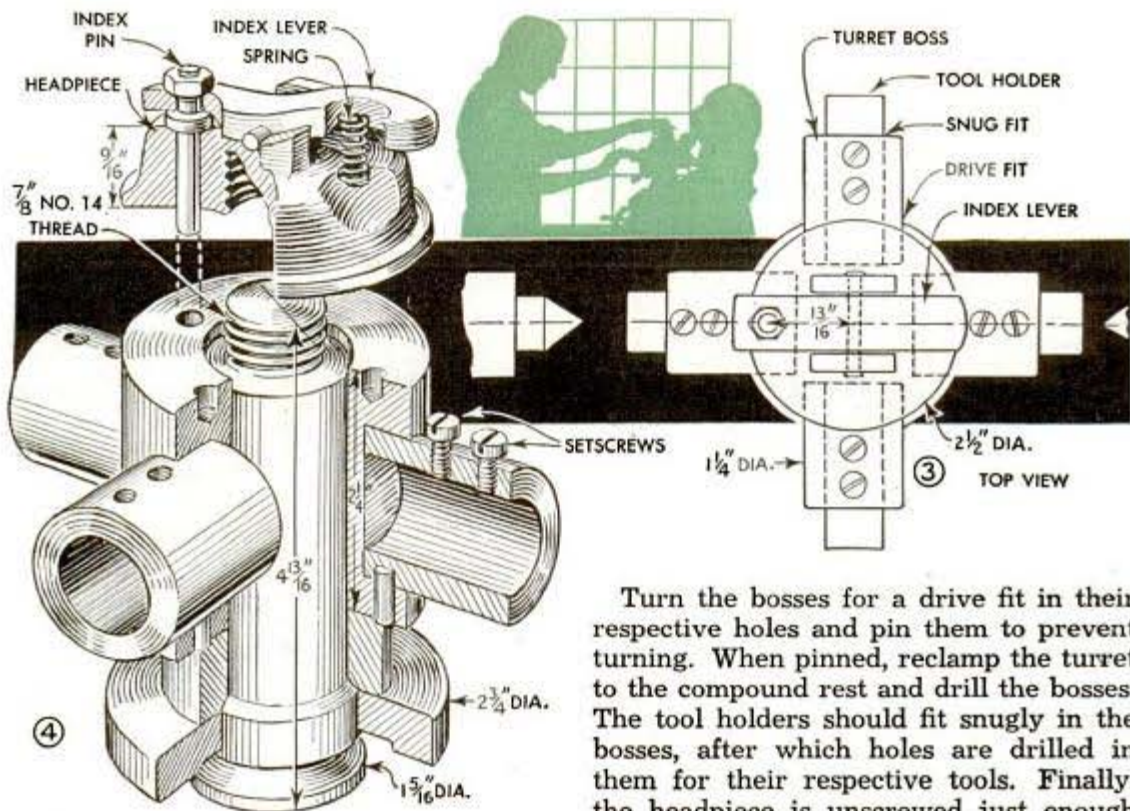

Return the bit in line with the second chuck jaw and repeat until all four are located. By aligning the four vertical center lines scribed on the rotor with the index-hole center line marked on the headpiece, and screwing the latter firmly onto the rotor, you can drill the index holes accurately, using the index hole in the headpiece as a drill guide.

With the index pin and release lever fitted in place, the complete turret assembly is clamped to the compound rest in place of the tool post for locating and center-drilling the rotor boss holes. This is done by advancing the cross-slide to bring opposite rotor center lines in alignment with the head and tailstock centers, after which the cross-slide gibs are tightened to hold the turret rigidly and the headpiece is screwed tightly against the rotor. Then, with a centering drill chucked in the headstock, advance the turret by means of the carriage long feed and center-drill, bore and finally end mill the boss holes to finish size. By engaging the index pin in the next hole, the rotor will automatically center itself 90 degrees. In case your lathe is not equipped with an end mill, the holes can be finish-bored to size by chucking the rotor in a four-jaw chuck and using the drilled holes as guides to center the work.

Turn the bosses for a drive fit in their respective holes and pin them to prevent turning. When pinned, reclamp the turret to the compound rest and drill the bosses. The tool holders should fit snugly in the bosses, after which holes are drilled in them for their respective tools. Finally, the headpiece is unscrewed just enough so that the rotor can be rotated easily, yet without play. Two headless setscrews, fitted in the top of the headpiece to enter the rotor, are provided to hold the two in position permanently. As shown in Fig. 3, each toolholder is held in the turret by two setscrews fitted in its boss. Then, in turn, each individual tool is clamped securely in its respective toolholder by similar setscrews.

## Counter Sign Shows Rope Sizes And Safe Working Loads

If you own a hardware store, here's a simple display that will be a big help to customers in deciding on the size rope best suited to their needs. It is made by attaching samples of the rope to a board supported by the counter as shown, after which the safe working load for each rope is painted on a wooden disk and slipped over the lower end. This makes it easy for the customer to examine the rope and tell at a glance its size and the load it is capable of handling.

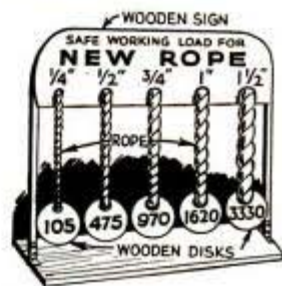

# A Few Tricks That Enable Anyone to Cut Glass

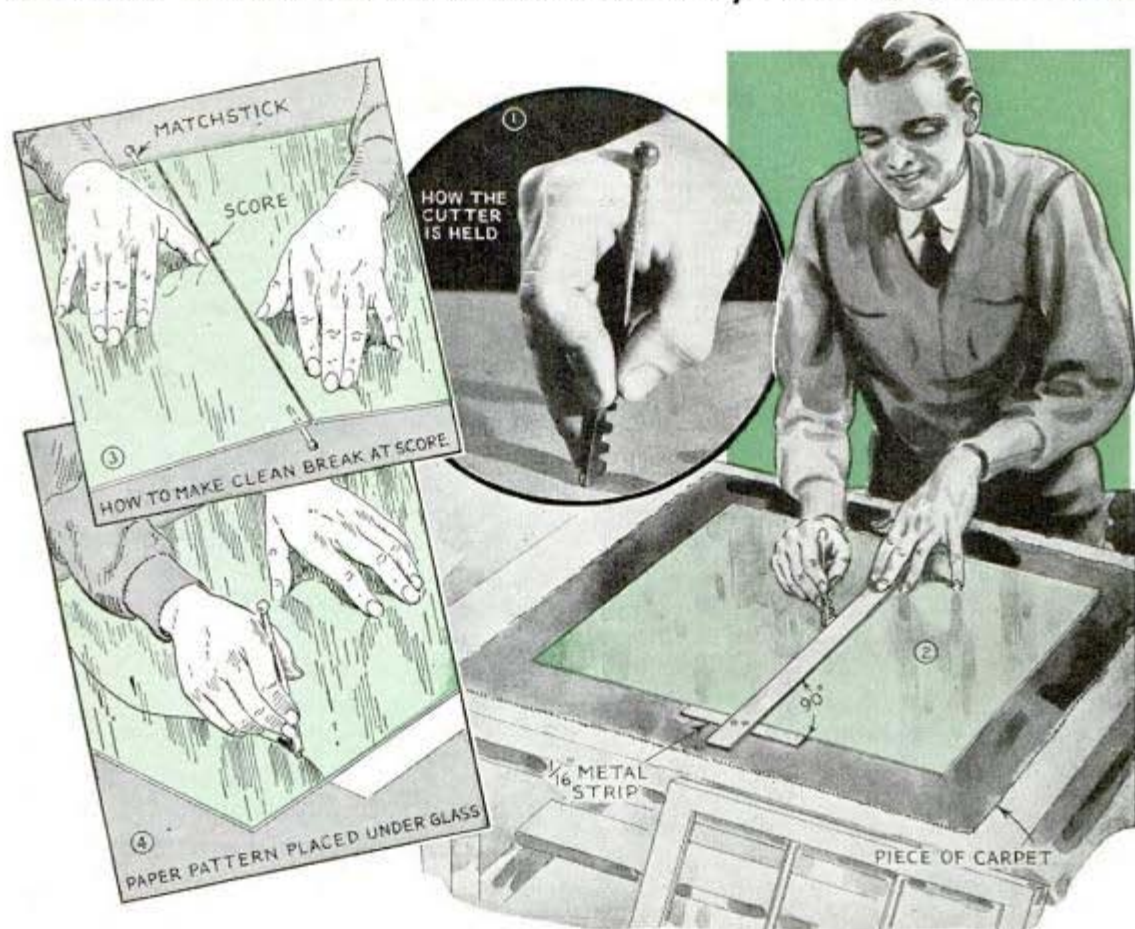

Glass cutting is not as difficult a job as it seems if a few tricks of the art are kept in mind. First, the method of holding the cutter is important. Fig. 1 shows the correct way. Keep the cutter between the middle and index fingers with the tip of the latter on the flat spot on the edge of the cutter. Notice that it is held almost vertically. When cutting glass, you will need a straightedge as a guide for the cutter. A yardstick can be used, but a T-square is better. Or, you can improvise a straight-edge like the one shown in Fig. 2. Place the glass on a smooth, flat surface. If it is laid on a piece of rug or carpet, there will be less tendency of it skidding under pressure of the cutter. Start at the edge farthest from you and make the score with one sweep, pressing the cutter firmly against both the glass and the straightedge. Never go over a score a second time. You will not improve it, and you will ruin the cutter. If you make a mistake, turn over the glass and score it from the opposite side. Don't worry about the first score

having any effect when breaking the glass as it will break only at the score on the upper side. A good way to assure a clean break is to place a couple of matches under the glass close to the score as in Fig. 3, and press down on both sides of the score with the fingers held in the positions indicated. When cutting freehand, the design should be drawn on paper, which is placed under the glass as in Fig. 4 to serve as a template.

—E. J. Davy, San Diego, Calif.

## How to Determine the Board Feet In Pile of Small Pieces

In many woodworking concerns where scrap wood is sold by the board foot, time can be saved by selling the scrap by weight. A board foot is made up, using average pieces from the pile of scrap material, after which it is weighed. Then, by weighing the rest of the pile, and dividing the sum by the weight of the sample board foot, you can tell how many board feet are on hand.

## Chicks Herded Into Colony House With Scoop-Shaped Board



Have you ever had trouble chasing a flock of baby chicks into a coop or colony house before a rainstorm? If so, here's a scoop-shaped board that will be helpful in cornering them at the entrance. It is made by assembling a wooden framework and attaching this to a handle, after which a piece of heavy cardboard is tacked to the curved frame member as shown. In cases where it is possible for two or more of these boards to be used, the job can be done quickly by keeping the ends together to form a pen outside the door.

—Fred W. Schneider, Towaco, N. J.

## Simple Leather Attaching Holder For Identification Badge

At the plant where I worked recently, it was necessary to display an identification badge at all times. When changing the badge from work clothes to street clothes, one workman soon found that the pin holes were becoming noticeable on his coat lapel. To overcome this, he cut a piece of scrap leather to the shape indicated and pinned

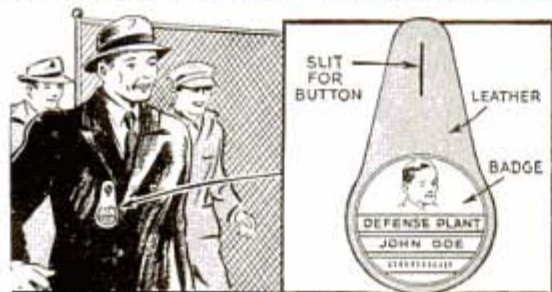

the badge to the circular bottom. A slit was then cut near the top, making it possible to slip the holder over a coat button. The holder can be changed quickly and there is no danger of the pin wearing the clothing.—H. R. Wallin, Falls Church, Va.

## Vegetable Crates Fitted With Feet Are Easy to Stack

Vegetable crates that are made with the corner members projecting about  $1\frac{1}{2}$  in. above the top edges can be stacked in tiers several crates high without any possibility of damaging the contents,



and the resulting space between the crates allows ample room for circulation of air. If filled crates are stacked in a building, they should be spaced at least 20 in. from the walls to allow proper air movement.

## Pigeonhole Shortened by Stop To Hold Small Envelopes

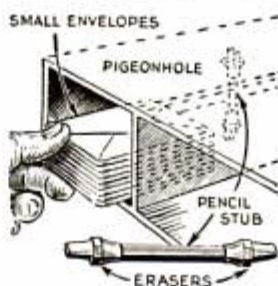

To provide a stop in a deep pigeonhole so that short envelopes could not slip back out of easy reach, one clerk provided a stop as shown. It consisted of a short piece of lead

pencil having slip-on erasers at the ends. The over-all length should be slightly more than the height of the pigeonhole so that the pencil can be wedged in place.

## Circle Stamp From Vacuum Cup

Shipping clerks and others who require a stamp to make circles calling attention to certain marks on shipping containers, will find a rubber vacuum cup handy for this purpose. The cup is used just like a regular rubber stamp.



## Adjustable Rest to Grind Bevel-Edged Tools

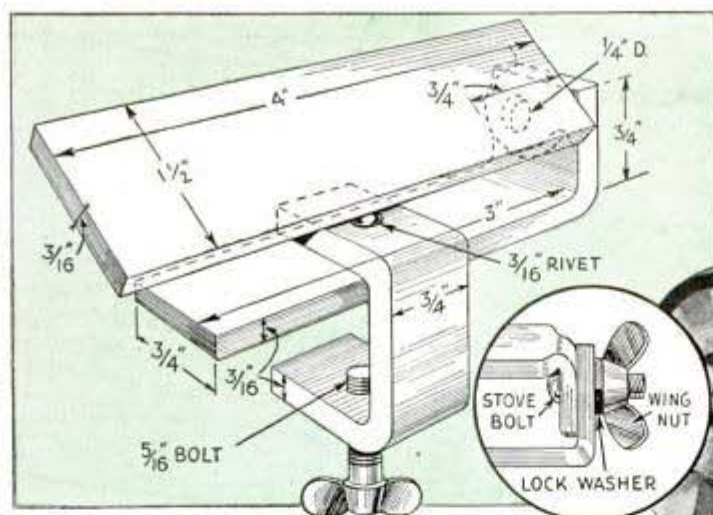

This tool rest for a grinder can be adjusted instantly to support work such as chisels, plane irons, spokeshaves and similar tools at the correct angles for sharpening them conveniently. The rest is made of iron or steel and the adjustable part is locked in the desired position by a stove bolt and wing nut as shown in the detail

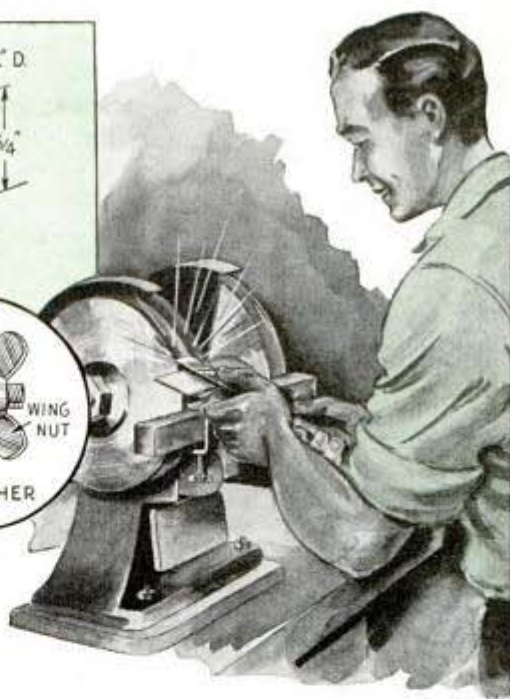

## Counter Turntable for Autographic Register Saves Time



Clerks of a California basket company appreciate this turntable which makes it easy to turn an autographic register for the customer's signature without lifting it from the counter. The top of the register and turntable are flush with the counter surface. Consisting of two large wooden disks spaced the thickness of the register, the turntable is supported on a wooden platform, which is suspended from the counter and is fitted with a pivot, the latter passing through the center of the lower disk. This disk rotates on three evenly spaced casters which are inverted with their shanks set in the platform.

## Diagonal Mounting of Electrical Outlet Boxes Eases Strain on Cables

When using armored cable in electrical wiring where octagon-shaped outlet boxes are mounted on hangers between ceiling joists, mount the boxes with their sides running diagonally to the joists instead of parallel with them which usually is done. With this method, there is less strain on the cables and it is easier to connect them to the boxes because it is unnecessary to bend them sharply, especially when the cables are run along the joists to the boxes.

—W. Dittman, West Bishop, Calif.

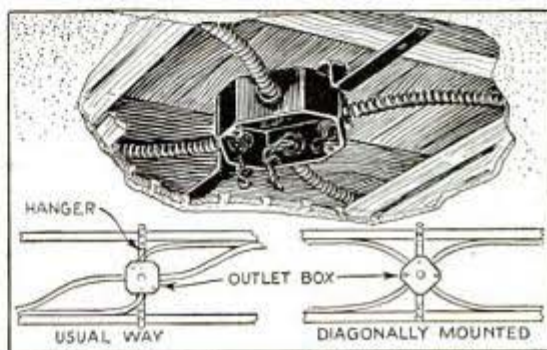

## When **STORING**



How to protect the paint finish, chrome, upholstery, tires and other rubber parts, when putting your car in dead storage for the duration; also, methods of safeguarding the motor and mechanical parts against corrosion, keeping up the battery and other important details

A good moth-proofing solution applied with a spray gun to assure uniform coverage helps preserve the upholstery, floor carpets and the seat padding

By James R. Ward

**STORING** your car for the duration is not just a matter of putting it in a garage and locking the doors—not if you expect it to be in a usable condition later. It should be put in a clean, dry building that is free from water leaks and lime from whitewash, and as dark as possible. Remember that a car is made up mainly of metal and rubber which deteriorate rapidly in storage unless steps are taken to protect the finish, motor, upholstery, battery and tires.

Prepare for storage by washing the car thoroughly, taking care to remove all dirt and grime under the fenders and from the chassis. Then clean and wax the body. Do a good job here, even better than you would normally, because the wax will seal any pores in the paint film and help prevent moisture from reaching the metal underneath. If the paint under the fenders and on the chassis is damaged, go over the parts lightly with fine steel wool to remove the flaked paint and rust, and then spray the parts with light oil. You must protect the chrome parts too. Clean them carefully and coat them with light oil, vaseline or cup grease. This is best done with a small paint brush, being careful not to get oil or grease on the rubber gaskets around the windshield, lamps and other parts, as oil left on rubber will soften it and cause it to deteriorate rapidly.

Now you are ready for the motor. Drain



Lard oil injected through the spark-plug holes prevents rusting of pistons, rings and cylinder walls. When draining the cooling system, don't forget to open the cock or plug in the cylinder block

# YOUR CAR



Spread over the entire car to reach the floor, a tarpaulin or paper cover helps exclude light and dust

and flush the crankcase. Use plenty of flushing oil, draining and refilling a couple of times if necessary, because it is important to have the interior of the motor free from old oil, which may contain acids that will be extremely harmful to the motor. Refill the crankcase with light, clean oil. This will do for the first 500 miles of driving when you again put the car into service. Drain the gasoline from the tank, and run the motor until the carburetor and



Wipe oil and grease from all insulated cables and wires to prevent rotting the rubber coverings. Waxing the car protects the finish as it seals the pores in the paint film and keeps moisture from penetrating to the metal under the paint



fuel pump are empty, working the throttle up and down to facilitate draining the parts. Remove all of the gasoline. If any remains in the carburetor, it will evaporate and leave a gum deposit that will clog the tiny openings.

Other parts of the motor that need attention are the rings, cylinder walls, valves, etc. Lard oil, because of its nonevaporating qualities and tendency to stick to



Vaseline, light oil or cup grease brushed on chromium trim provides a coating that will afford protection almost indefinitely. The clutch should be propped in the released position by depressing the pedal and placing a wood block between it and the lower part of the front seat



It's best to remove tires from the wheels, replace the tubes, inflate them slightly and then stack the tires horizontally in a dark, cool place

metal, is ideal for protecting these parts. Remove the valve cover and apply the oil plentifully to the valve stems. Have the oil warm so it will flow freely and penetrate into tight places. Then remove all spark plugs and inject the oil into the cylinders, turning the motor over several times to work the oil over the cylinder walls, pistons, rings, etc. If desired, you can purchase oils made especially for this

purpose. They are noncorrosive and have the necessary oiliness to maintain a film on the metal parts. When these are used, the lard oil and the cylinder oil in the crankcase are unnecessary. The oil is put into the drained crankcase and the motor is run for some time to circulate the oil throughout the system. It is a good idea to tie paper bags over the carburetor air cleaner, and the crankcase-ventilator inlet and outlet to keep out dust.

Next comes the cooling system, which should be drained thoroughly, opening the cocks at the bottom of the radiator and at the side of the motor block. Be sure that all liquid drains, to prevent rusting and freezing. To preserve the battery, it is best to remove it and put it in the hands of a reliable service station for proper care. If you keep it yourself, the specific gravity should be checked at regular intervals of six weeks, except during extremely hot weather when inspection should be made at three-week intervals. Recharge the battery slowly every six weeks to bring the gravity reading to 1.280 or above. In no case should the gravity be allowed to fall below 1.220. The specific gravities given here are correct at 60 degrees Fahr. Check and correct the water level in the cells at each inspection prior to recharging.

Differential and transmission can be left as they are, but the hand brake should be released fully, and the clutch should be





Dust cannot enter the carburetor air cleaner and the crankcase-ventilator inlet and outlet openings if paper bags are tied over them. Rubber gaskets should be protected by coating them with special paint



propped in the disengaged position. This can be done by placing a wood block between the pedal and the front seat. A piece of 2 by 4-in. stock is ideal for this purpose. All rubber weatherstrips, such as are used around doors, deck or trunk openings and window ventilators, as well as rubber gaskets with exposed edges around taillights, cowl ventilator, etc., should be covered with special paint for rubber parts. The floor mats should be left in their normal positions.

Care of the upholstery is important. It should be protected with a good moth-proofing solution, using a spray gun to get uniform coverage. The seat cushions should be lifted and sprayed, making sure that every part of cloth and padding is covered thoroughly. Before doing this, however, be sure that the upholstery is clean so that the solution will not set the dust

or cause discolored spots. The floor carpets should be treated in the same way.

After this, you are ready to put the car up on blocks. Any method of blocking desired can be used, but be sure that it is substantial so that the car will not fall. It is best to remove the tires from the wheels and store them in a cool, dark place. Light, particularly sunlight, heat and dry air are injurious to rubber. After removing the tires, replace the tubes and inflate them slightly, stacking the tires horizontally instead of vertically. If it is impractical to remove the tires, they should be kept inflated to a pressure of 4 or 5 lbs.

As a last precaution, cover the entire car with a tarpaulin, or even paper. If a tarpaulin or paper cover is unavailable, you can make one by pasting or taping old newspapers or sheets of kraft paper together to form one of suitable size.

## Rubber Disks Protect Air Hose on Concrete Driveways

Life of an air hose at filling stations and garages can be increased considerably by fitting small rubber disks over it. The disks are cut from an auto casing after which they are slipped on the hose and cemented in place at regular intervals. In this way, the hose is not damaged by continually dragging it across the concrete driveway.

Drills and other polished tools are less likely to rust, if several cakes of chalk are placed on the shelves near them.

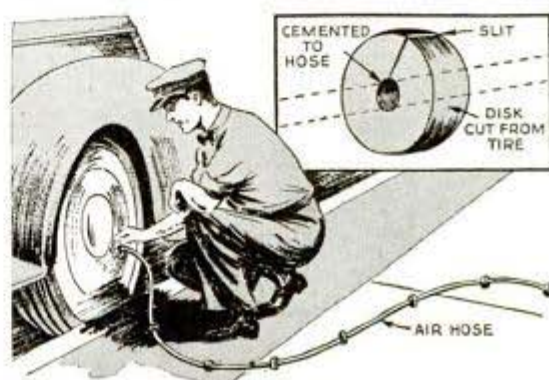

## Beef Hung With Model-T Axle While Butchering

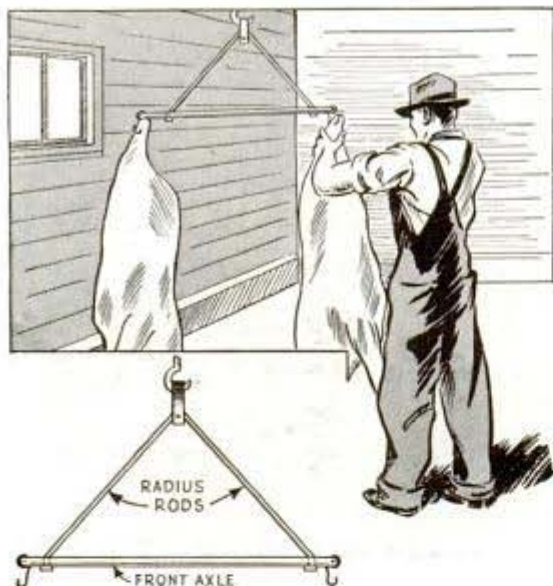

Hanging a beef while butchering is not a difficult job for one farmer who uses an old model-T front axle and radius rods for the purpose. Both steering knuckles and spindles are removed after which improvised hooks are fitted on the spindle bolts. A clevis placed at the ball-and-socket end of the radius rods makes it an easy matter to attach a block and tackle to the assembly and raise the beef.

## Drop Leaf on Circular Saw Holds Small Work

Metal stands for circular saws and jointers of the type shown can be equipped easily with a drop leaf to hold stock from which a number of pieces are to be cut to

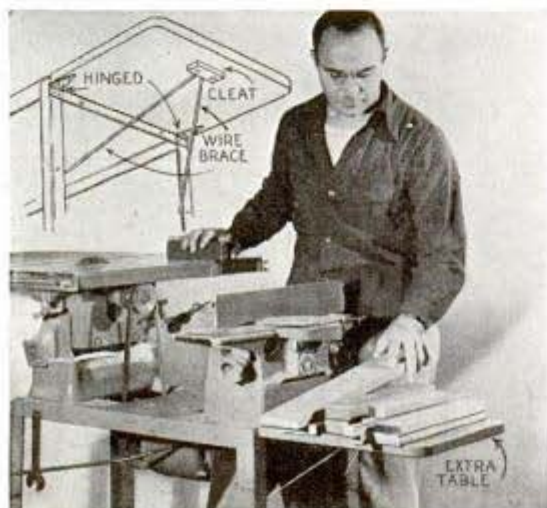

size. Using the saw table to hold work to be cut is inconvenient at times and is very dangerous. The leaf is cut from  $\frac{3}{4}$ -in. plywood of any suitable size and hinged to the stand. Three-sixteenths-inch wire rod is bent V shape for a brace and the two ends bent to fit into two metal straps. The straps act as hinges and are bolted to the stand legs. A metal bracket or stop is fastened underneath the leaf.

## Finger Rest for Showcard Writer From Sewing Thimble

To provide an easy gliding rest for his hand when lettering showcards, one artist uses a sewing thimble. It is worn on the third finger and does not interfere with the use of his hand.



## Comb Guard of Safety Razor Cleans Printing Rollers

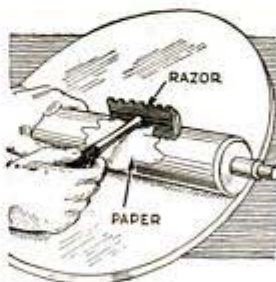

One printer employs a bladeless safety razor, as indicated, to remove torn bits of paper from the rollers of a printing press, without damaging the composition of the roller. The

comb of the razor scrapes off the paper but does not dig into the roller.

## Flapping of Roller-Chain Drives Avoided With Wood Raceways

Where long runs of roller or pintle chain drives carry the load on the top side, the lower or idling side can be prevented from vibrating or flapping by using a wooden raceway as indicated. This is fitted with sides and is slightly wider than the width of the chain. This type of raceway is particularly effec-

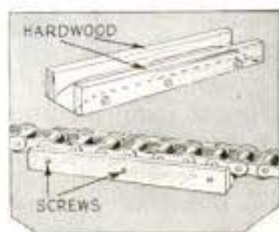

tive where the drive operates with the sprocket at an angle from the vertical, as it not only prevents vibration but keeps the loose side of the chain from sagging.

### Pinion Gear Prevents Slipping Of Wire Cable on Logs

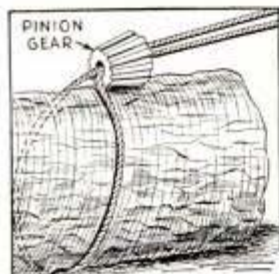

To permit quick attachment and removal of a wire cable on logs to be pulled and also avoid the possibility of it slipping off and causing an accident, slip a pinion gear over the looped end of the cable. With the loop tightened and the gear resting against the log, pulling causes it to bite into the wood.

### Tabs on File Dividers Reinforced With Ordinary Paper Clips

Alphabetical index tabs on file dividers will last much longer if they are reinforced with paper clips. These are held in place securely without covering the letters by applying strips of transparent cellulose tape over them. In cases where the tabs have been bent and cracked, this method will also serve as a quick repair.

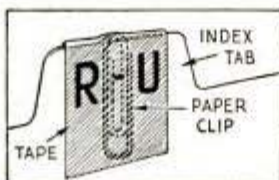

### Water Glass Spreads Uniformly If Wetting Agent Is Used



Sodium silicate (water glass), which is commonly used as a protective coating over labels, can be made to spread uniformly instead of forming into small droplets by using a minute quantity of a wetting agent such as used in photographic solutions. A smaller quantity of water glass is required and the appearance of the work is much better.

### Pipe Bender Is Made From Jack And I-Beam

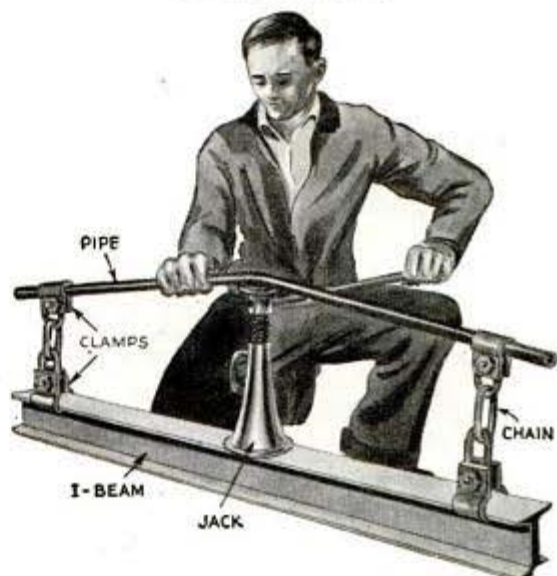

In fabricating pipe work where regular bending equipment is not available, a tool to do the job can be made quickly by using a strong jack and a short length of I-beam as indicated. The jack is set in the center of the beam and chain clamps slip over the pipe and the edges of the beam to hold it. Running the jack up will then bend the pipe at any desired angle.

—Geo. Holman, Marissa, Ill.

### Steel Fence Posts Held Safely While Driving With Maul

When driving steel fence posts with a maul or sledge, one farmer and his helper do the job safely by using a discarded auto connecting rod to steady each post. The connecting rod is slipped over the post and held with a downward pressure which causes it to grip the post and steady it for the workman swinging the maul.

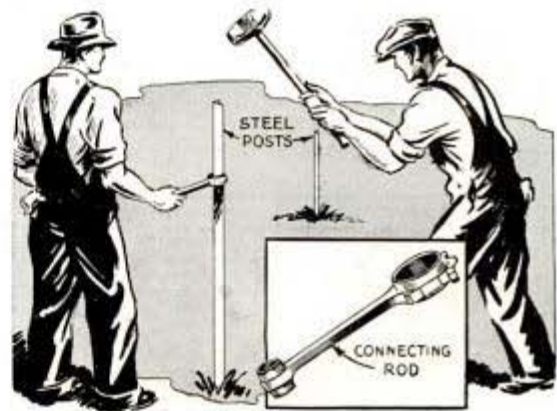

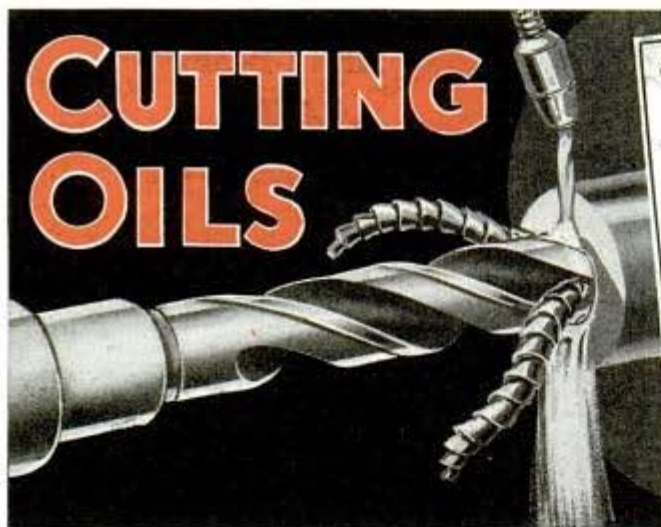

## War Speedup!

Faster and better work! Every metal-working machine must answer this demand now. Correct use of the right coolant on a cutting or chip-producing machine is just as important as proper grinding and correct set-up of the tools. Without the right cutting fluid, tools wear out quickly and rate of replacement is high; also, production of work is of inferior quality. Therefore, every machine operator who wants maximum results, should know about cutting oils and how to use them

By C. A. Crowley

**C**UTTING fluids are compounds applied to tool points to facilitate metal-cutting operations. There are two general classes: straight-oil cutting fluids and emulsion cutting fluids or the so-called water-soluble oils. The straight oils are usually viscous, dark-colored, chemically treated mineral oils containing sulphur or chlorine or both, and proportions of animal or vegetable oils. Water-soluble or emulsifying oils also consist of a mixture of mineral oil and animal or vegetable oil chemically treated with sulphur or chlorine. These chemically treated animal or vegetable oils are commonly sulphated, sulphated or chlorinated oils according to the process of chemical treatment which they have undergone. Soluble oils also contain an emulsifying agent, that is a substance which has the property of causing the oil to form a milky solution or emulsion when stirred into water. Many compounds such as certain soaps and alkaline compounds are used as emulsifying agents. For use, soluble oils are mixed with water in varying percentages from 5 to 95 percent, according to recommendations of the manufacturer.

**Purpose of cutting fluids:** Intense heat produced in a metal-cutting operation will

soon remove the temper from a tool point, resulting in short tool life and the production of improperly finished work. Therefore, the first requirement of a cutting fluid is cooling. Excessive friction, which is evidenced by increased heat and noticeable increase in power consumption, can be minimized by using a cutting fluid of good lubricating quality. A cutting fluid should aid also in producing a good finish, as well as inhibiting rust and corrosion. In deep borings, a washing action must be maintained to remove excess chips.

The best type of cutting fluid with respect to cooling is an emulsion or one that contains a large percentage of water. Water seldom is used alone because it is a poor lubricant and rusts the tool rapidly, but these effects can be minimized by adding a soluble oil to the water. By increasing the amount of oil added, the solution will increase proportionately in lubricating ability. It is obvious then, that a cutting fluid will have the greatest lubricating ability when it is 100 percent oil, which is termed a straight-oil cutting fluid. A light



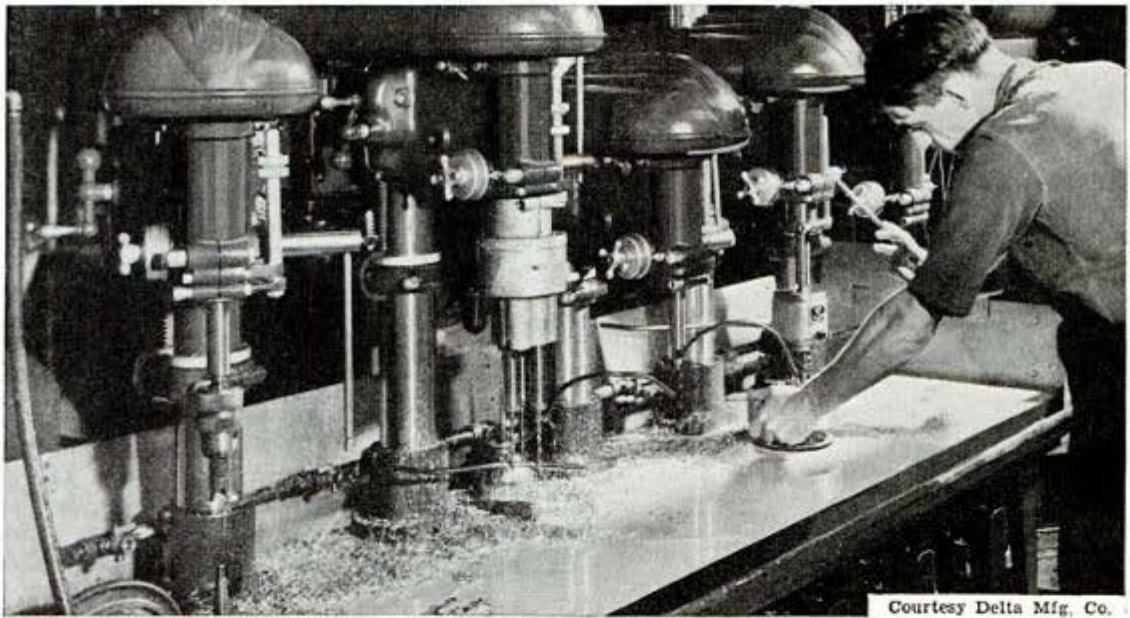

Courtesy Delta Mfg. Co.

mineral oil alone has little lubricating ability; so a pure or chemically treated fatty oil, (animal or vegetable oil) generally is added to increase its lubricating properties or "oiliness." When the requirements of cooling and lubricating are satisfied by a cutting fluid, the work being machined will receive a good finish.

**Selecting best cutting fluid for the job:**

When performing a cutting operation, such as threading, tapping, milling, etc., the following points should be kept in mind: First, the kind of metal being machined, that is, steel, copper, cast iron, etc., and secondly, the actual machine operating conditions, such as speed, and depth of cut. Metals such as brass, cast phosphor bronze, gunmetal, and gray cast iron, which break up easily to form short chips, and aluminum and magnesium alloys, which are of low tensile strength, usually are machined without any cooling or lubricating fluid unless the speed of the operation produces an excessive amount of heat requiring a coolant such as a soluble oil emulsion with a high percentage of water. Tough metals such as steel, monel metal, and certain copper alloys, which form a continuous chip that presses heavily upon the face of the

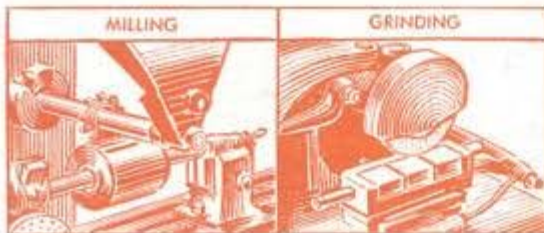
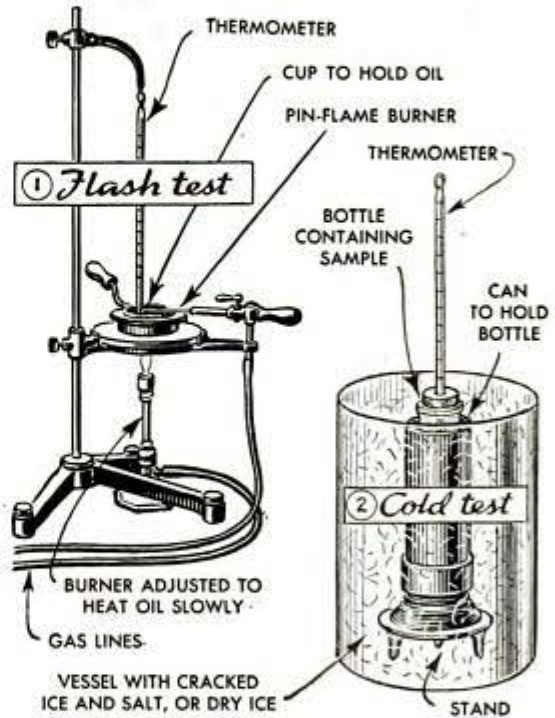



④ CUTTING FLUIDS FOR VARIOUS METALS

Metal	Cutting Fluid to Use
Aluminum	Kerosene, lard oil or Soluble cutting oils
Soft alloys	Soluble oil and water
Brass	Paraffin oil
Cast iron	None
Malleable iron	Soda water
Wrought iron	Soda water or lard oil
Hard steel	Soluble oil and water
Magnesium alloys	None

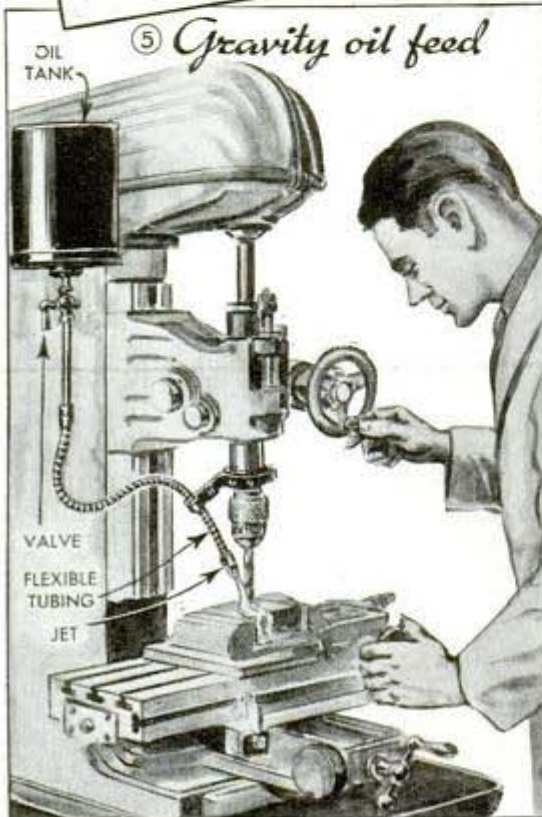

tool, require a lubricant as well as a coolant. A shallow cut at a low speed generally requires little coolant or lubricant; a low speed and heavy cut, particularly on a tough metal, demands a good lubricant; high speed and shallow cut demands a coolant; high speed and heavy cut requires a cutting fluid of great lubricating as well as cooling quality. When long tool life is desired, a cutting fluid of good lubricating ability is required to reduce wear. The table in Fig. 4 gives the types of fluids preferable for common metals.

**Judging quality of cutting fluids:** In selecting the proper cutting fluid, the composition and character of the oil is of utmost importance. Besides doing an efficient job of cooling and lubricating, the cutting fluid should not rust or corrode either the tool or the work. Corrosion is caused by plain water, excess acid or alkali, and chemical constituents that may react with the metal being worked. The cutting fluid must not decompose on standing or under operating conditions. If this does occur, impurities will form, which will cause gumming, clogging, and possibly offensive odors. Straight mineral oils are very stable, but to improve their oiliness, fatty oils, which are not as stable and soon become rancid, must be added. Other physical characteristics to be noted are flash-point and cold test. The flash-point, illustrated in Fig. 1, is the temperature at which oil first flashes but does not continue to burn. This should be well above any temperature at which the oil is to be used. The cold test, Fig. 2, indicates the temperature at which the fluid ceases to flow. Let the oil cool slowly, remove and invert the bottle at a drop of every few degrees in temperature. The pour-point temperature is reached when the oil will barely flow. The cutting fluid should be as clear as possible and free from cloudiness and suspended matter when held up to the light as in Fig. 3. The color is not important. Clearness of the oil enables the operator to watch the actual cutting operation at the tip of the tool.

**Application of oil:** The method of application of a cutting fluid depends on the type of operation. Where a profuse amount of cutting fluid is not necessary, it can be applied with a common oil can or a gravity drop-feed system as shown in Fig. 5, but where a large amount of fluid is to be used, an automatic system such as is built into

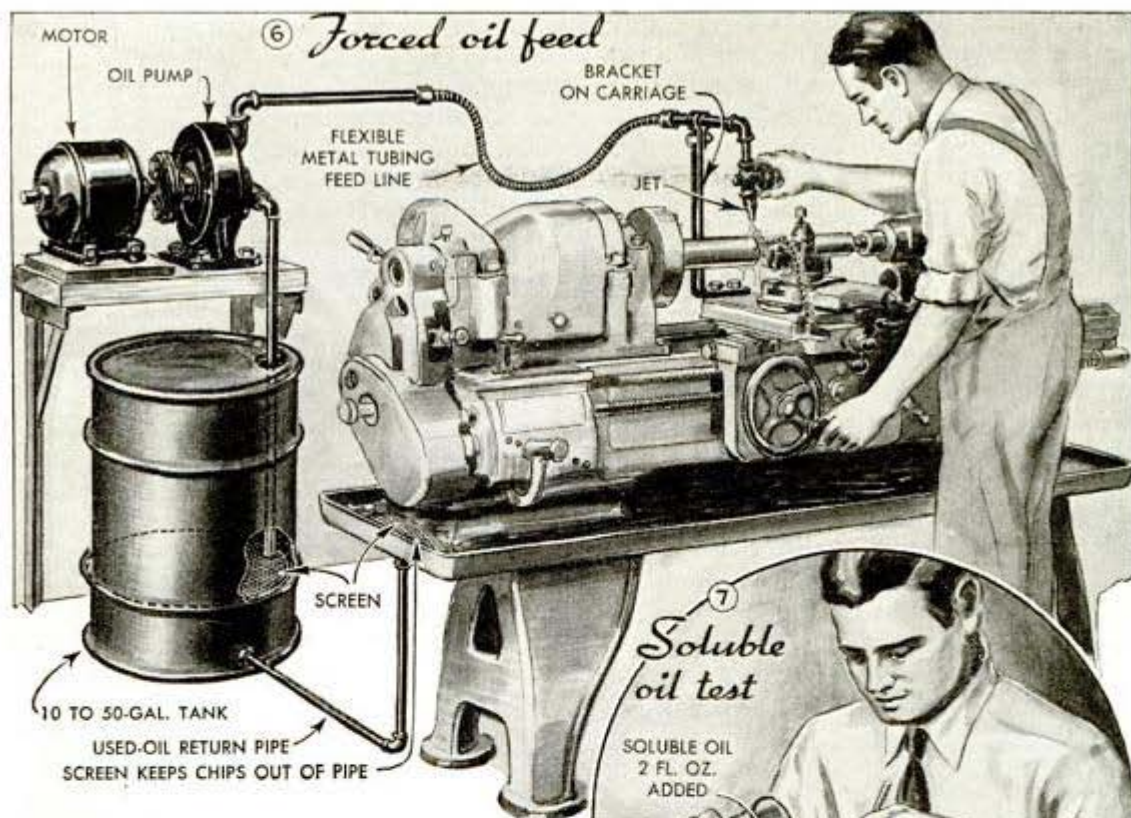

many machines or can be arranged as shown in Fig. 6, should be used.

**Problems in using cutting fluids:** If the balance between the oil and water in an emulsion cutting fluid is disturbed, cutting troubles usually follow because of the separation of the constituents. Careless mixing and the use of impure water are among the chief causes of failure. The manufacturer's directions for compounding should be followed explicitly. Soluble oil should mix well in water between temperatures ranging from 70 to 120 degrees Fahr. See Fig. 7. An inadequate flow of cutting fluid over a hot tool point will shorten the active life of the emulsion. For this reason a generous flow is advisable. Many soluble oils break down when machining cast iron or brass with high lead or zinc content. In such cases it is best to use a specially compounded soluble oil. The cutting fluid may become excessively acid when machining acid-pickled metals. The addition of a little soda (soda ash) to neutralize the acid, which is determined by using red litmus paper as in Fig. 9, will solve the problem. Discoloring of emulsions may be caused by the collection of rust or reaction products between the metal being worked and certain constituents of the cutting fluid. Rust may be caused by improper mixing or the

The emulsion of a soluble cutting oil in water should be uniform; no oil or grease should float on the surface of the solution after the oil has been stirred in

use of impure water. Gummy deposits may be the result of a large amount of rosin present in some cutting fluids. If a good soluble oil is used properly, little or no trouble should be encountered with bearing trouble or the sticking of slides or guides on machine tools.

Machining troubles with straight oils are usually made evident by smoking, which is the result of exceptional surface speeds, heavy cuts on tough materials, or inadequate flow of cutting fluid. Sulphurized oils tarnish copper-rich alloys, because of a reaction that takes place in the presence of moisture. For this reason the oil should not be stored in a damp place in an open container.

**Grinding:** Grinding operations produce heat resulting in an uneven temperature

in the work, which causes distortion and a consequent inaccuracy. The flow of a cutting fluid serves to prevent this and serves also to keep the wheel clean and free cutting which makes for greater production. Here again clear water will rust the machine and work. The addition of a water-soluble oil will inhibit the corrosive action, but it must be remembered that too small an addition will not afford the proper protection.

**Drawing, extruding and pressing:** Drawing, extruding, and pressing operations are accomplished generally by using relatively high pressure which results in high temperature and great friction. The proper cutting fluid should provide sufficient lubrication and cooling qualities and yet not break down, decompose, or char under the severe operating conditions. It should also be easy to remove and not interfere with subsequent operations, such as welding, plating, and painting. Dry drawing is usu-

ally done with a very dry sodium soap powder free from oil, fat and glycerin. Wet drawing baths are merely a water solution of the sodium soap called an emulsion. Sulphonated fatty acids, that is, the acids from natural fats which have been chemically reacted with acid under proper conditions, produce stable emulsions of fine particle size for this purpose. Graphite has been used in drawing and pressing operations, but as it causes excessive charring, which is almost impossible to remove, its use has been restricted.

**Using soluble cutting oils:** The chart given in Fig. 8 has been prepared to serve as a guide in the use of the most common cutting fluid or water-soluble cutting oils. This chart makes it possible to determine quickly and accurately the proper amount

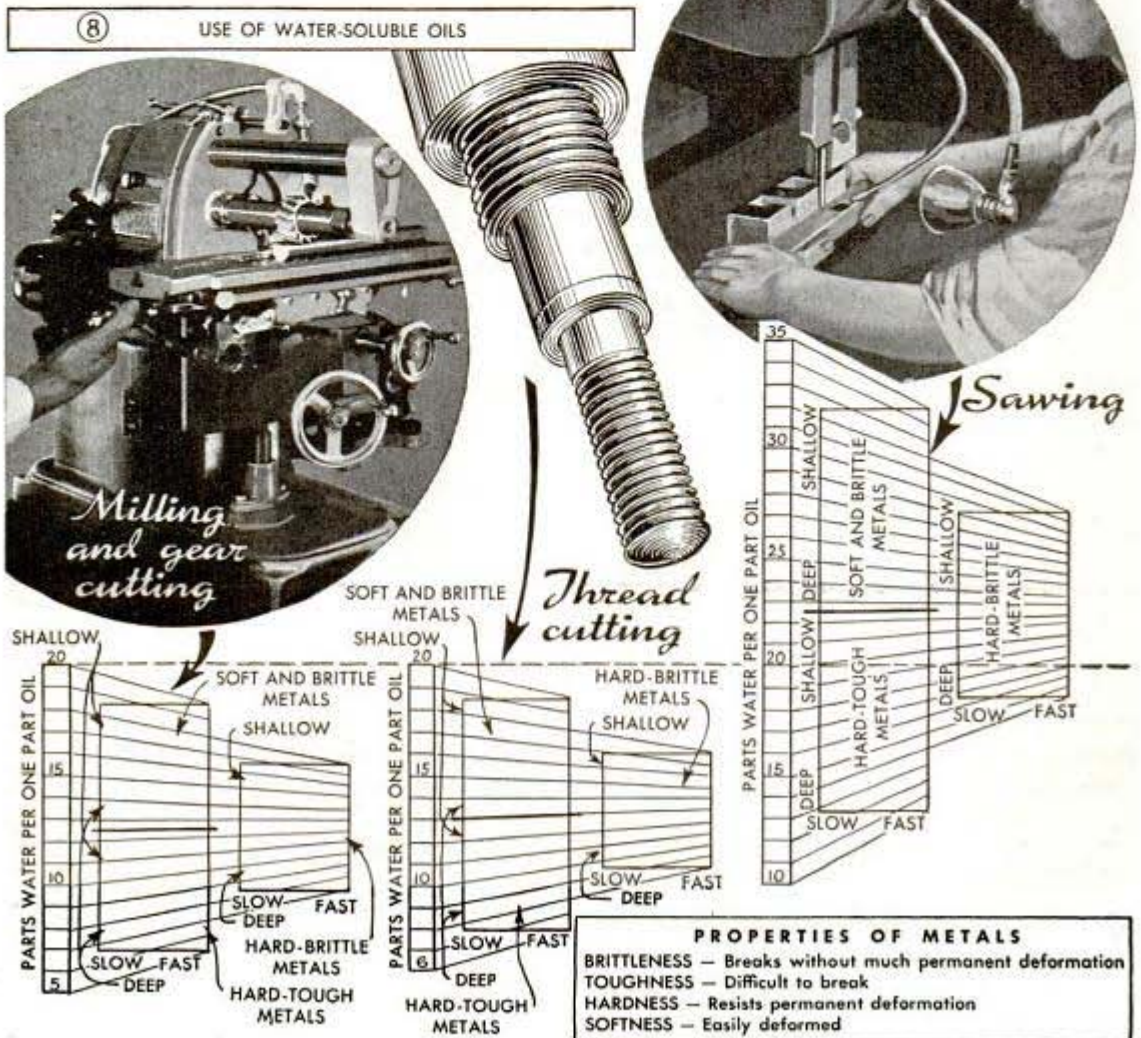



of water to add. To aid in using the chart, a shop operation will be followed through. We will assume that a certain metal rod is to be threaded, although we are not certain what type of metal it is. The chart gives two common methods for determining the type of metal, that is, whether it is hard, brittle, etc. After performing a test grinding, noting the sparks, a confirmatory test can be made with a cold chisel. In our example we will assume that these tests show that the metal is hard and tough, that is, the large white sparks are relatively few in number and continuous chips are formed with difficulty by a chisel. Next, we must determine the speed of the operation and the depth of cut. Here again we will make an assumption that a heavy thread is to be cut, which means a deep cut, and that the operation is to be carried out as fast as possible. In any case, before the selection of the amount of water to be added to the soluble oil can be made, four things must be known:

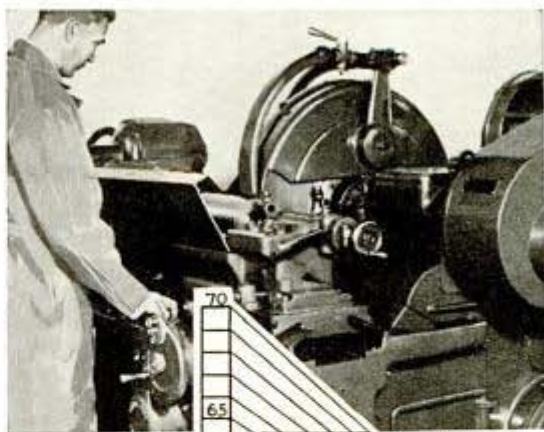

*Boring, turning and shaping*

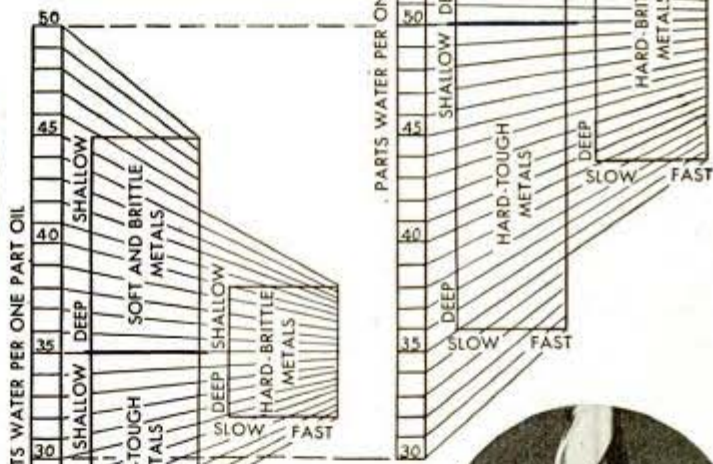
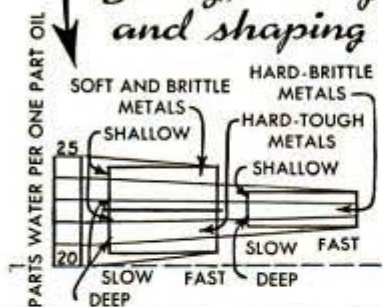

*Drilling*



**TESTS TO DETERMINE TYPE OF METAL**

METHOD OF DETERMINATION	TYPE OF METAL					
	SOFT	BRITTLE	HARD	TOUGH	HARD-BRITTLE	HARD-TOUGH
COLD CHISEL TEST	Easily cut	Chips break in-to small pieces and tend to powder	Difficult to chip	Chips long with little tendency to break under chisel	Hard cutting accompanied by chips that break into small pieces	Hard cutting accompanied by a long chip
GRINDING TEST	Few or no sparks with tendency of metal to adhere to stone	Small yellow sparks	Small white sparks	Large forked white sparks	Many very fine white sparks	Few large white sparks

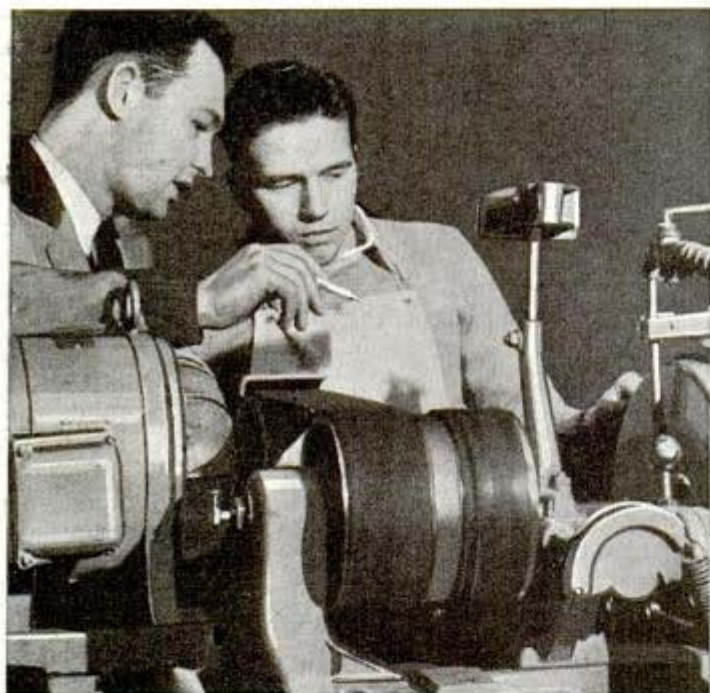

Red litmus paper immersed in soluble cutting oil should turn blue. If this does not happen, add soda ash to the oil, a little at a time, and stir in, testing with fresh red litmus paper between additions

(1) Type of metal to be worked, as a hard-tough metal, etc. (2) Operation to be performed, as threading, etc. (3) Speed of operation (4) Depth of cut. With this information, the next step is to determine the parts of water that are to be added to one part of oil. To do this, first select the portion of the chart treating with the desired operation, which in our case is thread cutting. This is found on the graph as the second scale from the left. This scale, as in the case of the other five, is divided into three main parts by rectangular areas labeled; (1) Hard-tough metals, (2) Hard-brittle metals, and (3) Soft and brittle metals. If the metal is a hard-tough metal, as in our example, the rectangular area treating hard-tough metals is referred to. If the metal is soft, or if it is brittle, the rectangular area treating soft or brittle metals is referred to. The same method is applied to hard-brittle metals. Following our example again, we see that we must refer to the rectangular section marked hard-tough metals under thread cutting. This rectangular section, is crossed by lines that lead to the scale at the left marked "parts water per one part oil." As one moves to the bottom of the rectangular area, this corresponds to an increase in the depth of cut. As one moves along the bottom from left to right, this corresponds to an increase in operational speed. In our example, the depth of cut is to be deep and the speed of operation fast. Therefore, this places us in

the lower right-hand corner of the rectangle marked hard-tough metals under thread cutting. All that is now necessary is to follow down the nearest line that leads to the scale marked "parts water per one part oil." In our case we find that six parts of water are to be used with one part of oil. The same procedure is followed through for all other types of shop operations. For the specific shop operations that are not actually listed on the graph, select the most similar operation listed and consult it for the selection of the proper cutting oil.

(Next month—How to Read Machine Shop Blueprints)

## Scratch Brush Reversed Weekly To Make It Last Longer

For several years, I have devoted an hour or so each Saturday night to cleaning up the shop preparatory to the next week's work, and one of the points of procedure during this clean-up is to remove the wire scratch brush from the motor shaft and turn it around. By this means the brush is rotated in the opposite direction and any tendency for the bristles to become bent backward from hard use one week is automatically corrected the following week. A brush periodically turned in this manner will give satisfactory service much longer than one which is installed and never moved until it wears out.

—W. C. Wilhite, Carlinville, Ill.

## Re-Inking Typewriter Ribbons

Regular stamping ink can be used to re-new a typewriter ribbon. Just remove one side from the ribbon reel and apply the ink to the edges of the rolled ribbon. Then



wind the ribbon onto another spool and re-wind it onto the first spool again, twisting the ribbon so that the edges of the ribbon not previously inked are exposed

to the side of the reel that has been removed. The re-winding is best done on a typewriter. Now ink this side and let the ribbon stand for a day or two so that the ink works evenly throughout the entire surface. Then re-assemble the spool.

## Split Hose on Delivery Basket Retains Order Slips

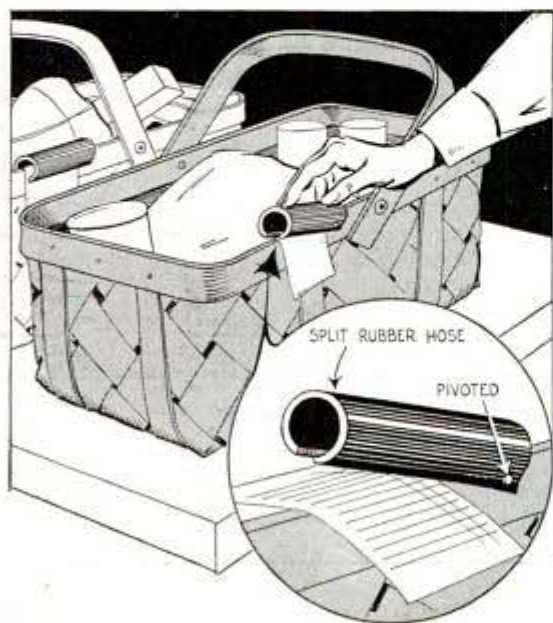

To keep delivery slips on baskets of groceries, one merchant fits each basket with a short piece of rubber hose, which is slit on one side to fit over the edge. A tack through one end prevents loss of the improvised clip, which is merely lifted to clamp down over the delivery slip.

When repairing V-belts by beveling the ends and gluing them together, additional strength can be provided by inserting two catgut strings through the joint.

## Quarter-Notched Hitching Post Holds Halter Rope Easily



A Wisconsin veterinarian who often treats or examines horses in the yard of his office, has a special hitching post for the purpose. The top is quarter-slotted as shown, the slots running to a depth of about 6 in. from the upper end. The halter rope or strap can be drawn through these slots quickly and pulled to hold the animal with a long or short hitch as required. No tying or knotting of the rope is necessary as the double looping through the slots holds it securely in place.

## Sloping Sides on Wooden Trough Prevent Hogs Rooting It

The nuisance of having hogs root their feed trough around the floor, sometimes spilling the contents, can be eliminated by adding sloping sides to the trough. These are additional boards the same length as the trough and they are set at an angle and fastened by nailing through the ends and sides of the trough. In this position the extra sloping sides make it impossible for the hogs to work their snouts under the trough or to gain leverage against the sides to push it on the feeding floor.

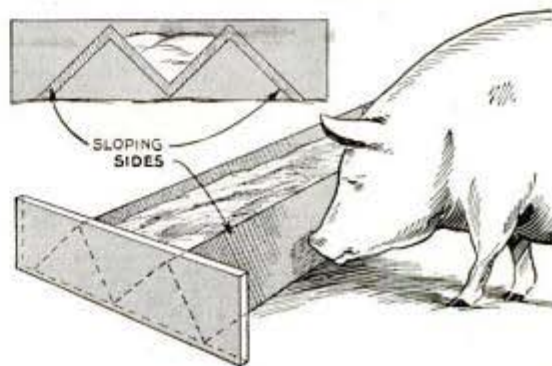

## Form on Which to Oil Harness Made From Barrel



Set on a sawbuck or other suitable support, a barrel provides a good form on

which to place a harness while oiling it. In this way, the job is not only simplified, but the various parts are more easily available for adjustments that may be necessary.

## Double Hooks Replace Tie Wires On Sidewalk Form Boards

To avoid wasting time handling tie wires on concrete forms for sidewalks, one contractor uses double-pointed hooks which are made from medium gauge wire. In use, one end of the hook is driven into the form which leaves the other hook at an angle to be swung and driven into the stake that supports the form.

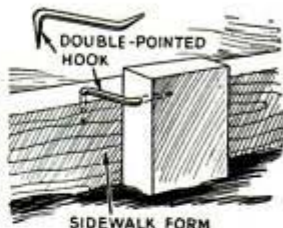

The rapidity with which the fasteners can be attached or removed makes the time necessary to construct them worthwhile.

# 564 Things You Can Make for Fun and Profit

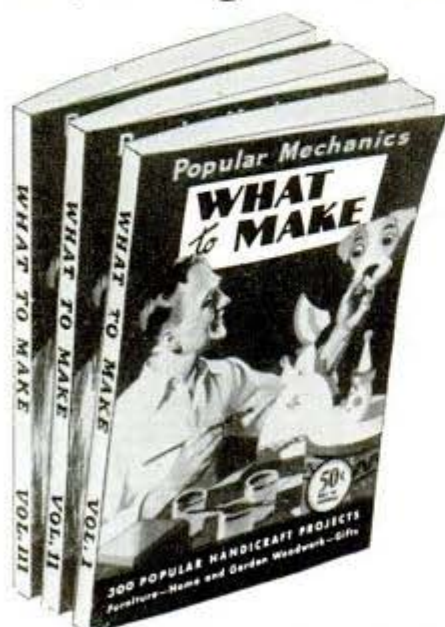

You will never be at a loss for something to make if you have these volumes. You will find hundreds of ideas you can use around home, and things that can be made in spare time for profit. Furniture, novelties, jig saw projects, gifts, toys, games, photographic equipment, etc. Set of 3 books. Volumes 1, 2, 3 (588 interesting pages) \$1.47. Single volumes 50c.

Order from this list. Ask for FREE book catalog. Money refunded if you're not satisfied

Popular Mechanics Press, Dept. 410, 200 East Ontario Street, Chicago, Illinois

## Other Helpful Books

**Forty Power Tools You Can Make**—Shows how to make forty different machines, such as lathes, drill press, jig, band and circular saws, sanders from pipe fittings, old auto parts, etc. \$1.25.

**Your Car**—Add thousands of miles of life to your car and operate it economically. 192 pages of money and labor-saving ideas, short cuts. For motorists, service men. \$1.25.

**1001 Ways to Use Concrete**—Do work for yourself, others. Save, make money. \$1.98.

**Money Making Formulas**—Start own business by transforming simple ingredients into wanted products. \$2.00.

**Garden Book**—Build your own trellises, fences, lawn furniture, outdoor fireplaces, attractive ornaments, etc. \$1.00.

**Welding, Brazing and Soldering**—How to construct welding equipment and use it efficiently. Soldering, brazing, heat treating. \$1.25.

**The Boy Mechanic**—For any boy. Tells how to build midget auto, boats, models, games, craftwork. \$2.00.

**Build a Boat for Pleasure or Profit**—How to build 17 low-cost boats at home—power, sail or row boat. No experience needed. \$1.25.

**Shop Notes**—The mechanic's guide. Lathe operation, drafting, shop practice, using tools, welding, autos, electricity, etc., time and money-saving shortcuts. Set of 4 books (Shop Notes for '42, '41, '40, '39) \$1.95. Single volumes 50c.



# Radio

## First Aid Suggestions for Your Radio Sets

### PART IV

**DO NOT** mistreat your radio set or any electrical appliance by yanking the cord out of the wall socket. Bad connections and broken power cords are the result of such treatment and it is easier to grasp the plug and remove it, as shown in the insert photo. Many midget and table model receivers employ a line cord that has a built-in voltage-dropping resistor that will withstand just a few such jerks, then the set will develop crackling noises or refuse to work. The only remedy in such cases is a major operation on the line cord or a new cord. Even where there is no resistor in the line cord, the plug is easily damaged and rubber-covered plugs are not plentiful.



Although there is no serious shortage in receiving tubes at the present time, production will be discontinued on many of the obsolete and seldom used old

types, as well as many others that are duplications in all but minor details. However it is claimed that there will be several years supply of these discontinued types on hand after production ceases.

The RCA interchangeable tube chart No. 1 shows tubes interchangeable with their preference types. The tubes listed are ordinarily interchangeable but occasional exceptions will be found. Such exceptions will generally be caused by size difference of tube types or unusual circuit conditions. In receivers designed for glass-octal tube types, the No. 1 terminal of sockets is often used as a tie-point support for circuit parts. In such sets, the interchange of a metal-type tube may not be advisable because the No. 1 socket terminal connection may put a high voltage on the shell of the metal tube. Tube chart No. 2 will list Raytheon types. Reference to these and charts issued by other tube manufacturers will solve tube renewal problems.

(To be continued)

### INTERCHANGEABLE TUBE CHART

RENEWAL TYPE	INTERCHANGEABLE TYPE(S)	RENEWAL TYPE	INTERCHANGEABLE TYPE(S)
OZ4	OZ4-G	12A8-GT	12A8-G
1A5-GT	1A5-G	12K7-GT	12K7-G
1A7-GT	1A7-G	12Q7-GT	12Q7-G
1C5-GT	1C5-G	12SA7-G, 12SA7-GT	12SA7-G, 12SA7-GT
1H5-GT	1H5-G	12SK7	12SK7-GT
1N5-GT	1N5-G	12SQ7	12SQ7-GT
2A3	2A3-H	24-A	
2A5		25L6-GT	25L6, 25L6-G
3Q5-GT		25Z5	
5Y3-G	5W4, 5Z4	25Z6-GT	25Z6, 25Z6-G
5Y4-G		26	
5Z3	83-V	27	
6A7		30	
6A8	6A8-G, 6A8-GT	35	
6C6	77	35L6-GT	35L6-G
6D6	78	35Z5-GT	35Z5-G
6F5	6F5-G, 6F5-GT	39/44	
6F6	6F6-G	41	
6H6	6H6-G, 6H6-GT	42	
6J5	6C5, 6C5-G, 6C5-GT, 6J5-G, 6J5-GT	43	
6J7	6J7-G, 6J7-GT	45	
6K6-GT	6K6-G	50L6-GT	
6K7	6K7-G, 6K7-GT	56	
6L6	6L6-G	57	
6Q7	6Q7-G, 6Q7-GT	58	
6SA7	6SA7-G, 6SA7-GT	75	
6SJ7	6SJ7-GT	76	37
6SK7	6SK7-G, 6SK7-GT	77	6C6
6SQ7	6SQ7-G, 6SQ7-GT	78	6D6
6U5/6G5		80	
6U7-G		83	
6V6-GT	6V6, 6V6-G	84/6Z4	
6X5-GT	6X5, 6X5-G		

CHART NO. 1

The short length of the "GT" type ordinarily permits it to be interchanged with either "G" or metal type

# EXPERIMENTERS' "SPECIAL" 5-BAND

By Stanley Johnson



THIS is No. 2 "Special" in the series of "V" sets for students and experimenters. No. 1 appeared in the July issue and, although this two-tube receiver utilizes all of the same parts that were used in the 1-tube, it is a complete and entirely different set. Like the previous set this one uses a 1Q5-GT as a detector, and a second 1Q5-GT serves as an audio-amplifier stage, boosting the output to loud-speaker volume on local broadcast stations and gives excellent headphone volume on weak distant short-wave stations.

If you have built the one-tube set, it will not be necessary to dismount the volume control, tube socket or the Fahnestock clips. Resistor (R<sub>1</sub>) and fixed condenser (C<sub>2</sub>) also can be left in position, however all other parts and wiring should be removed before starting construction on this two-tube receiver. Frame and shaft of variable condenser (C<sub>1</sub>) must not touch metal panel.

Five-band operation is obtained by the use of five hand-wound plug-in coils, and a simple switching arrangement, switch No. 2, which permits the use of all of the capacity in the .000365 mfd. variable condenser (C<sub>1</sub>) on the broadcast band, and to reduce

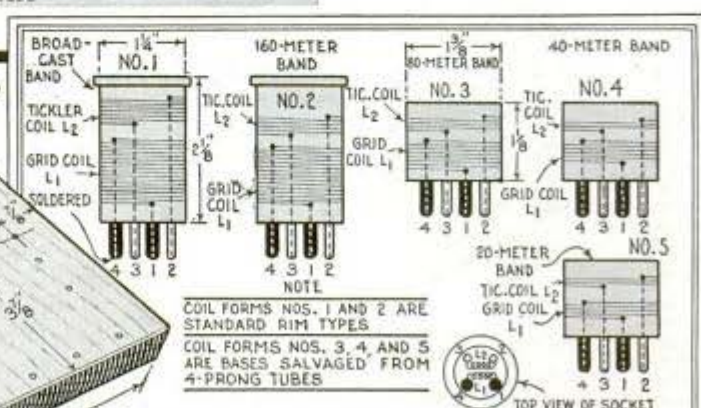
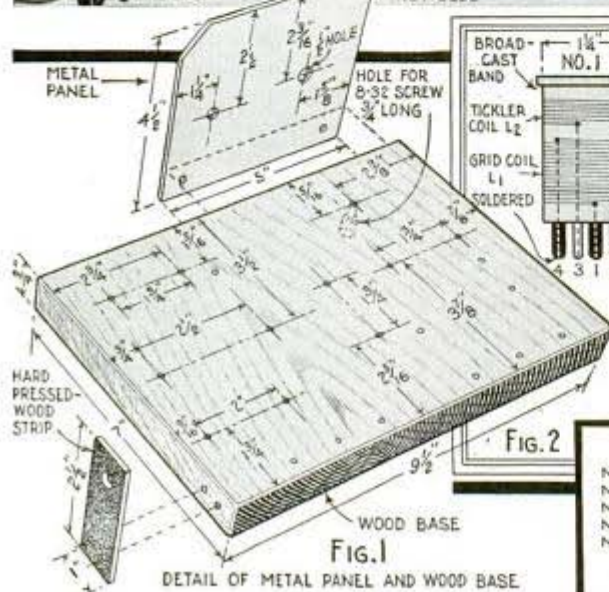
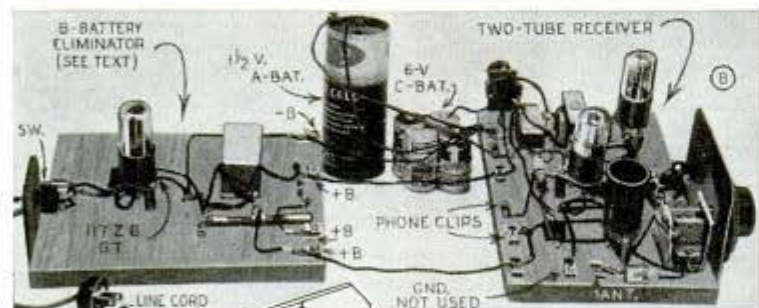
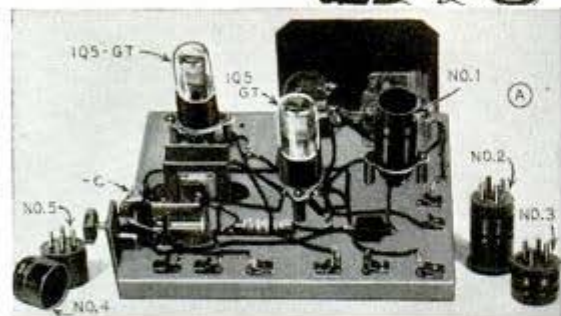

**COIL CHART**

No. 1—(BROADCAST BAND)—GRID 90 TURNS—TICKLER 25 TURNS
No. 2—(160 METERS)—GRID 43 TURNS—TICKLER 16 TURNS
No. 3—(80 METERS)—GRID 22 TURNS—TICKLER 9 TURNS
No. 4—(40 METERS)—GRID 12 TURNS—TICKLER 6 TURNS
No. 5—(20 METERS)—GRID 5 TURNS—TICKLER 5 TURNS

NOTE—ALL COILS ARE CLOSE WOUND IN THE SAME DIRECTION WITH No. 30 ENAMELED WIRE

# BEAM-POWER "TWIN" TWO-TUBER

JUNK-BOX PARTS ADDED TO THE JULY BEGINNER'S "SPECIAL" ONE TUBER

the capacity of condenser ( $C_1$ ) by switching in a .0002 mfd. fixed condenser ( $C_3$ ) in series with it, so that the short-wave bands may be tuned with the customary four plug-in coils.

Complete baseboard and panel details for this set are given in Fig. 1, and the coil-winding data appears in Fig. 2. All parts are clearly shown in the simplified wiring diagram Fig. 3, schematic circuit diagram Fig. 4 and photos A, B, C, D and E. It will be noted that both octal tube sockets and the 4-prong coil socket are mounted on 1-in. bushings cut from any kind of metal tubing available. The audio transformer and other parts, indicated in Fig. 2 are commonly found in any radio experi-

(Continued to page 172)

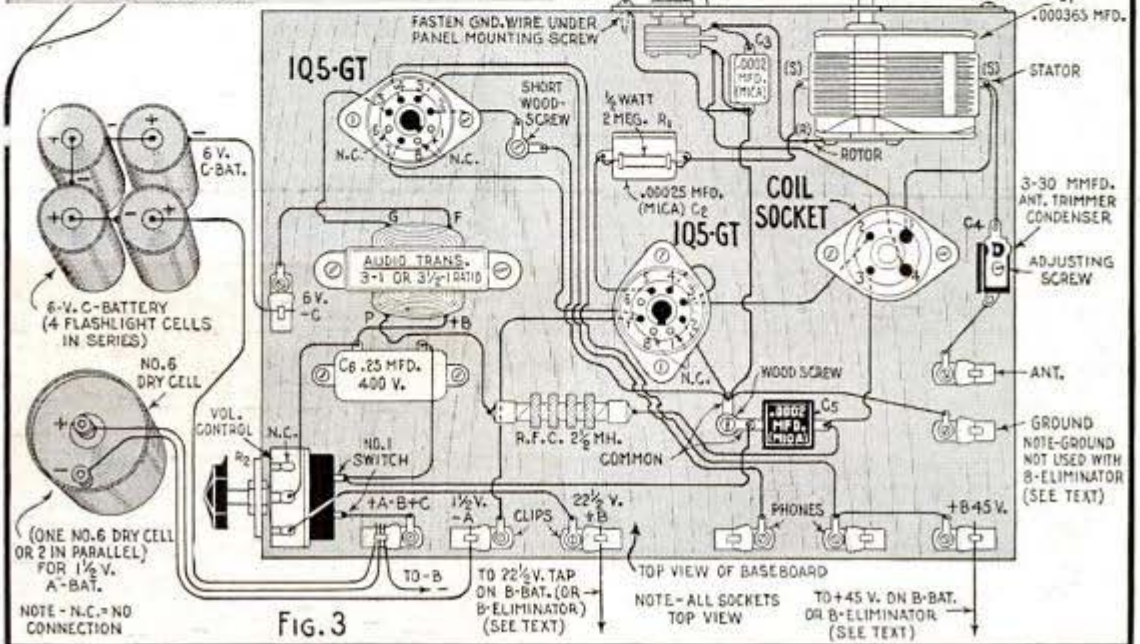
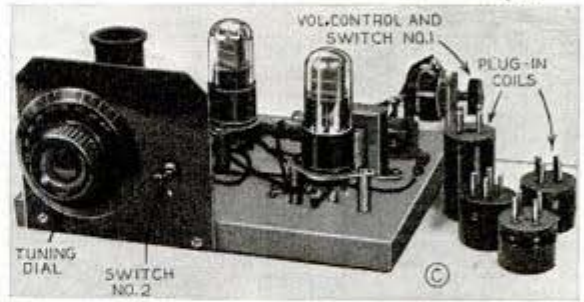
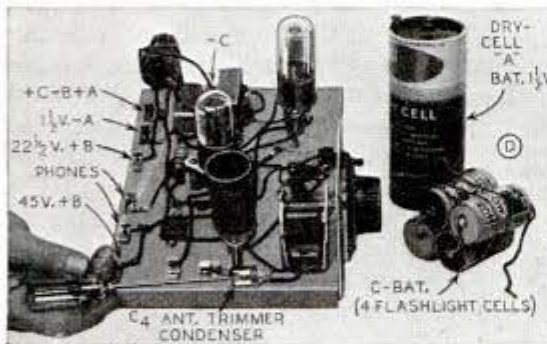

# Crystal-Tube Receiver From Junk-Box Parts

By L. B. Robbins

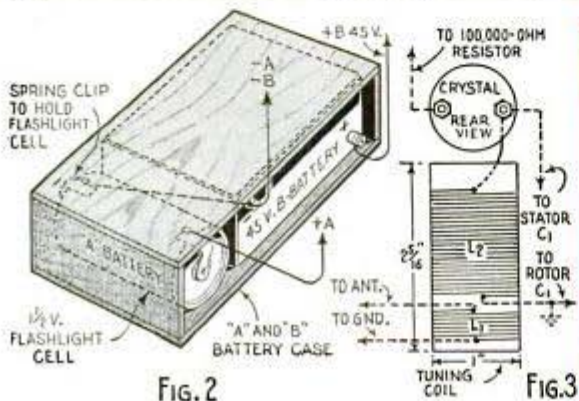
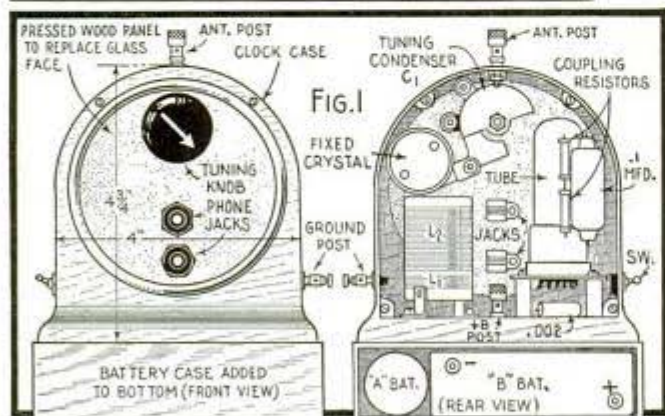
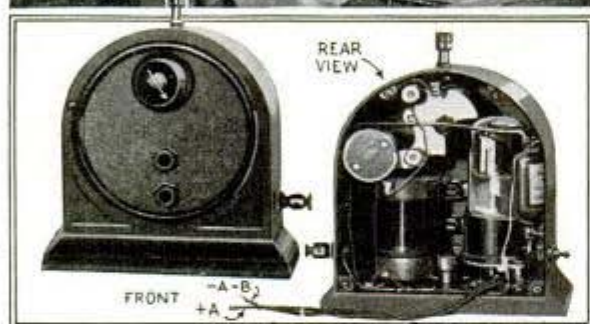

HERE is a crystal receiver that really "goes to town" because it combines a fixed crystal with one stage of resistance-coupled audio amplification. If a long, high antenna and a cold water pipe ground are used, local stations come in clear and quite loud, while many distant stations have been logged by the writer, especially at night when signals are best.

Any triode tube of the 1.4 volt filament type such as the 1G4-GT/G, HY-113 or similar variety may be employed. The entire receiver was assembled in the case of a small defunct electric clock and then mounted on a suitable cigar-box wood base to hold the batteries for the amplifier stage, as detailed in Figs. 1 and 2. The completed set is about 6 in. high, 2½ in. thick and 4½ in. wide. If an old clock case is not available, any wood box of similar dimensions may be used and extended to include the batteries.

The circuit diagram and coil winding details are given in Figs. 3 and 4. Coil L<sub>2</sub> is close-wound on the form; then wrap a piece of paper or Scotch tape over the lower end, and over that wind the 20-turn coil L<sub>1</sub> in the same direction. If you have an old r.f. coil from a broadcast receiver it may be adapted for use; the resistors are ¼ watt. In case the band is not completely covered, add to or remove turns from L<sub>2</sub> or use a larger capacity for condenser C<sub>1</sub>. Try reversing the crystal terminals for best sensitivity. A 150 mmfd. fixed condenser in parallel with C<sub>1</sub> aids in covering the lower half of the broadcast band.

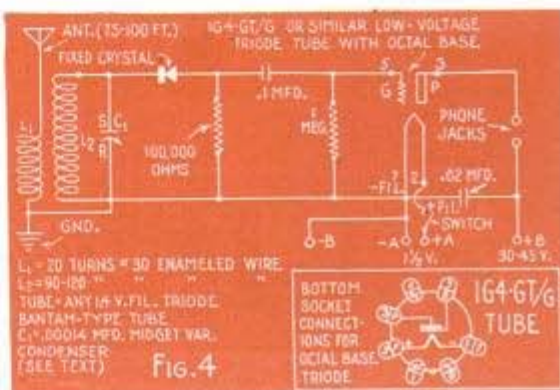



# Helpful RADIO HINTS

(A) When battery packs for portable receivers are difficult to obtain, you can operate such sets by means of a compact A and B power unit that works from the 115-volt 60-cycle house line. Plug-in sockets provide 1.4 volts "A" and 90 volts of hum-free "B"-power for any 4, 5 or 6-tube battery receiver. A simple cable harness is supplied to fit all standard sets as shown in Figs. 1 and 2



(B) Screwdriver designed to fit all Reed & Prince and similar recessed head cross slot screws from the smallest size to the largest, as indicated in the sketch. (C) Rough coat air-drying wrinkle-finish varnish brushed or sprayed on metal cabinets provides a durable, attractive finish; it is available in the silver-gray shown, also in black, brown, green, red and blue. (D) Condenser color code is based on standard RMA resistor color code

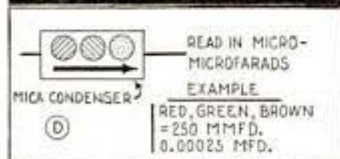
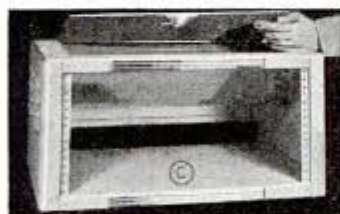
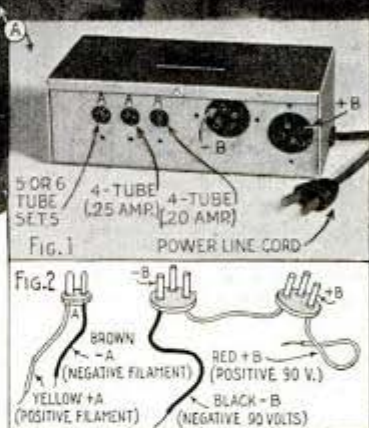

(E) Call letters drawn on scrap plastic and cut out with a fret-saw, for mounting on your car. The same idea can be used for house numbers, weather vanes and similar applications. The light shades may be illuminated. Draw the design on typewriter paper with pen and ink; each figure or letter is tied in as shown. Transfer the design with a hard pencil and provide a V-block on the bench for sawing and filing. (F) 5-megohm universal "Clarostat" or similar variable resistor, with switch and fixed condenser permits use of headphones with any receiver

(G) Polarized pilot-light assembly provides regulation of light intensity. (H) "Cardioid" type microphone is unidirectional, receiving front sounds and rejecting rear sounds yet has wide angle front pick-up. Diagram No. 1 shows how an ordinary microphone is subject to feedback, No. 2 is not. (I) Soldering unit for emergency connections; match applied to shell flows solder into splice. (J) Experimental short-wave adapter for a broadcast receiver; variable condenser permits flexible tuning over the police bands

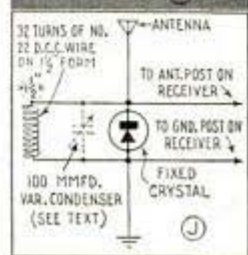
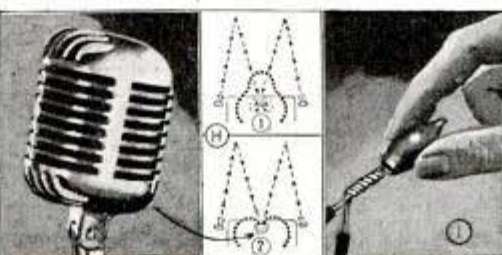
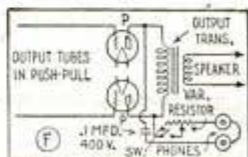

## Giant-Screen Oscillograph

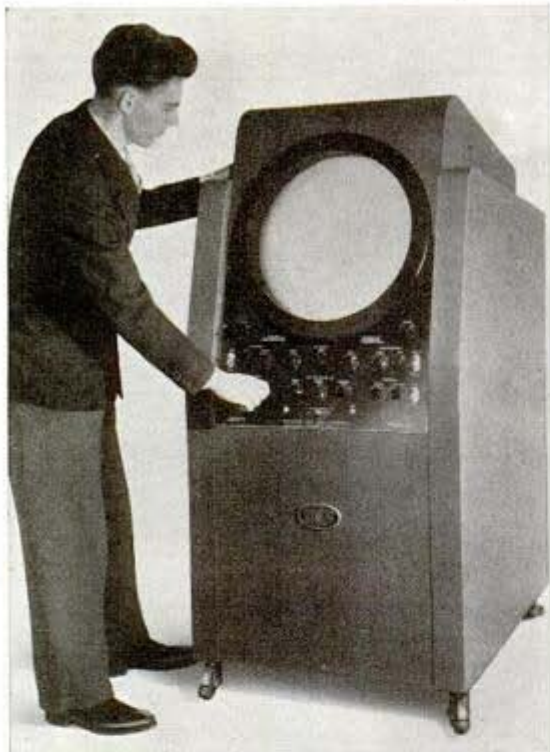

Designed for lecture-room demonstration and for more critical laboratory studies, this giant oscillograph employs a 20-inch intensifier-type cathode-ray tube with a medium-persistence green screen. The final accelerating potential of 6,000 volts provides a high-intensity spot so that a highly detailed trace may be observed even in lighted rooms by a large group.

## Illumination Blackout Control



This compact blackout control unit permits illuminated billboards, store-window displays and other time-switch-controlled illumination to remain in operation in districts where blackout regulations are in effect.

Its photo-electric optical system is focused on the nearest street lamp; when this street lamp is turned out, the blackout control unit immediately turns off the illumination which it is controlling. It is claimed to be relatively insensitive to light from any source other than the street lamp which it is observing. A special feature is a time delay circuit that makes it independent of momentary fluctuations and flickering of the street lamp.

## Ultra-Short-Wave Transceiver

This combination 2½ meter radiotelephone and receiver has been developed for authorized fixed station operation or as a mobile unit in an automobile, truck, boat or plane or anywhere a 6-volt battery or 110 volts 60 cycle a.c. is available. It incorporates a separate receiver using an HY-615 tube as a super-regenerative de-



tector and a separate transmitter utilizing an HY-75 as an ultra-high-frequency oscillator. The input is rated at 20 watts. A 5-inch speaker is self-contained and good volume was obtained from most stations during field tests.

Blueprints covering simplified radio construction articles in this and past issues are available for 25c each. Many popular tested circuits for beginners, students and experimenters may be built with used parts. Detailed material lists can be obtained from Popular Mechanics Radio Department upon receipt of postage.

**NEXT MONTH—Experimenter's All-Wave "Special" Three-Tube Junk-Box Super. No. 3 set in the Special "V" series; each unit in this series is a complete receiver of progressive type employing the same parts with minor additions. Also A Home-made Tungar Battery Charger and First Aid for Home Sets, Part 5.**

# New, Practical WORKSHOP LIBRARY

## 1400 Photographs and Drawings

A practical, up-to-the-minute, modern workshop library containing over 1400 photographs and line drawings—covering every phase of operation and maintenance of every major workshop motor-driven tool—with hundreds of special operations explained—valuable shop hints, short cuts, and scores of time-saving tables. Tells how to obtain unusual results, how to solve shop kinks and problems and how to keep your tools and accessories up to top efficiency. Every operation "shop-tested" by practical craftsmen.

### What you get in this Modern Workshop Library

**Circular Saw & Joiner**—Ripping; Saw Projection; Use of Moulding Fence; Crosscutting; Mitering; Cutting to Length; Resawing; Rabbeting; Tilt Table Operations; Taper Ripping; Spline Grooves; Cutting Curves; Production Work; Pattern Sawing; Cove Cutting; Long Work; Gang Saws; Simple Tenoning Jig. The Moulding Head and its use; the use of Abrasive Wheels, Dado Head, Tenoning Jig; Common Wood Joints; Jointer Operations; Jointing an Edge; Side Pressure Jointing an End; Surfacing; Rabbeting; Beveling; Taper Jointing; Tapering in the Round; Stop Chamfering.

**Lathe**—Wood turning, metal turning and metal spinning, including: Spindle Turning; Faceplate and Chuck Turning; Special Turning Operations; Post Blocking; Oval Turnings; Split Turnings; Turned Boxes; Duplicate Turning; Spiral Turnings; Hollow Spirals, Fluting and Reeding; Use of Lathe attachments; Jigs and Fixtures; Wood Finishing; Metal Turning Operations; Spinning Equipment; Methods of Working; Special Spinning Chucks and Appendix containing tap drill sizes; Polishing Materials; Decimal Equivalents; Table of Taper Cuts; Grinding Angles for Wood Turning.

**Band Saw & Scroll Saw**—Ripping and Resawing; Use of Standard Fence; The Ripping Blade; Ripping Curves; Tilt Table Operations; Cutting off with Fence and Gage; Use of Stop Rod; Cutoff Block; Using Clamp attachment; Crosscutting Wide Stock—Cutting Circles; Jig Construction; Cutting Glue Blocks; Round Corners; Circular Rails; Sanding; Compound Band Sawing; the Cabriole Leg; Compound-Sawed Turnings; Ornamental Work; Sawing in Multiple; Ripping Thick Stock; Split Dowels; Tapering Jigs;

### FREE...Extra Gift

With every order for the Delta Modern Workshop Library we include a Free copy of "How to Make Money with Delta Tools."



Marking Turning Squares; Pattern Sawing; Beveled Curves Metal Cutting; Scroll Saw Operations; Sanding and Filing.

**Drill Press**—Methods of Laying Out Drill Press Work; Use of Wood Bits; Sanding Drums and Grinding Wheels; Drill Practice in Wood; Use and Grinding of Twist Drills; Drilling and Tapping in Metal; Routing, Shaping and Mortising on the drill press; Miscellaneous drill press operations and special useful ideas.

**Abrasive Tools**—Buffer, Belt and Disk sander attachments—Explanation of Different Abrasives; How to Sharpen Tools; Grinding Shaper Cutters; Grinding Twist Drills; How to Use Sanding Drums, Cut-Off Wheels.

**Shaper**—Shaper Adjustments Cutters and Collars; Shaping with guides; with collars; with patterns; Use of Forms; Jigs and Fixtures; Application of Shaper Cutters; Grinding Shaper Cutters.

#### Practical Finishing Methods

Tells how to do every possible finishing operation—how to prepare the work, how to stain, fill varnish—lacquer. Proper use of spray gun and brush. How to finish metal, how to mix your own low cost materials. Silk screen process. Secret methods developed over many years.

Examine this Library at our risk!

Send Coupon Today



You can inspect the Delta Modern Workshop Library without risking a penny. Simply fill out and mail coupon today. When the complete library, plus the FREE extra gift book arrives, postpaid, inspect it thoroughly. If you aren't fully satisfied in every way—you can return the library—and every penny you have paid, including return postage, will be promptly refunded—without question.



ONLY  
\$2.00  
Complete

Modern Workshop Library Div.  
The Delta Manufacturing Company  
680-K E. Vienna Ave., Milwaukee, Wis.  
Gentlemen: I enclose \$2 for which please send me complete Modern Workshop Library, postpaid, plus FREE gift book. It is understood that if I am not fully satisfied, I can return the library and you will refund every penny I paid, including return postage.

Name.....  
Address.....  
City.....State.....

## Let's Keep 'Em Healthy

(Continued from page 85)

accidents of this type. The wax tester was built like a midget bobsled, with three little leather runners supporting an eight-inch wood base. When a 100-pound weight was placed on the sled the load was carried by the runners much as the weight of an average person is distributed over the soles of his shoes. When pulled by a spring balance across a waxed surface, the sled measured the amount of pressure required both to start it and to keep it moving, thus determining how easily a person might slip on the wax and how far the slip would carry him. Numerous tests with the robot uncovered one wax on which a pull of more than 100 pounds was necessary to start the sled and almost as much to keep it sliding.

Of all occupational diseases, skin irritations are dominant. Even if a worker has a mild skin disease, he may have to be transferred to another department to prevent aggravation of the ailment by dirt, dust or grease. This costs time. Unless safeguards are provided, skin irritations may be caused by a number of the countless new materials, such as solvents, resins, waxes and cleaners that are being used in industry today. One large company alone used some 4,200 different materials in its manufacturing processes and something about the toxicity of all must be known. Precautionary instructions may be necessary in handling a material. For example, a new paint-spraying operation may require the use of a special hood or ventilating system; the vapor from a new lacquer may be injurious to the hands or lungs and instructions must be given for wearing a respirator or gloves.

The importance of keeping the worker on the job was pointed out not long ago by Dr. Thomas Parran, Surgeon General of the U. S. Public Health Service. Here is the way he puts it: "Based on data from the Bureau of Labor Statistics showing the man-hours required to produce various kinds of war material, I have calculated that a 10 percent reduction in industrial manpower losses from disability would build twelve cantonments of average size, or five battleships or 16,407 tanks."

So the great battle goes on, for victory over industrial hazards means victory elsewhere.

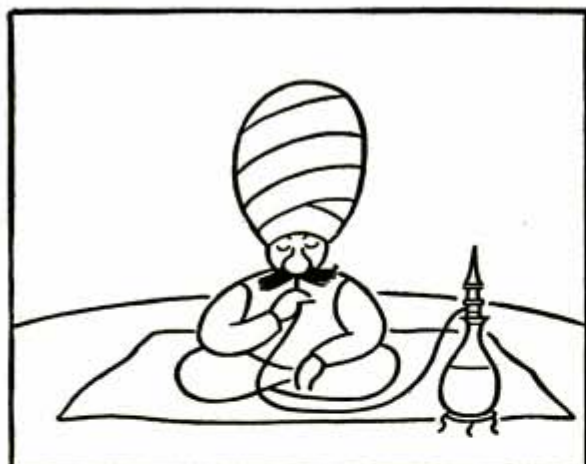

## The Last Round-Up

(Continued from page 76)

museum. Another was the artist who made the painting or field study for the background. The third man was the artist-technician who collected grass, sage, trees, soil, rocks, and also photographed in black and white and in color the grass, sage and trees as well as the sky, distant hills and the horizon.

For the most commonplace article of all, the buffalo grass, transportation was a tremendous problem because the thin stalks were so easily broken. As in the case of the small sage brush, the grass was shipped by express suspended inside of specially made boxes so that the stalks might wave without cracking. Speed was necessary so that the uprooted grass would not fade and wither.

As soon as the grass reached the museum it was treated with an arsenic solution to kill all bacterial life, given a soaking in alcohol and treated with glycerin. Similar preservative methods were applied to the sage and other bushes.

In the case of a tree, however, the trunk is not usually shipped, but is measured and photographed, after which the bark is removed, along with the branches which will be used. Back in the huge preparatory rooms of the museum, a tree is constructed to measure for the bark with a foundation of bolted wood, a covering of wire mesh, burlap, plaster of Paris and papier-mache. After an adhesive has been applied to this, the bark is cemented on and the branches are attached in the correct places. This is not just any tree, but a replica of a real tree which actually grew many miles away from the glass cage of the museum.

Meanwhile, in the case of the bison, the hides are tanned while artists prepare a body to receive them. From photographs and measurements, the sculptor produces a replica of the original animal's shape. This sculpture is used to make a mold from which the final body is cast. An adhesive is applied and the skin is put on.

New methods together with new products have made possible the lifelike character of the exhibits, never before achieved by a museum on such a scale. Paints with casein bases and light lacquers have made it possible to color flowers and large areas

(Continued to page 164)



**"Sani-Flush saved my car's life.  
Cleaned out the radiator,  
you know"**

A clogged radiator can cripple a car—cause overheating and expensive damage. Keep the delicate veins of the cooling system free and open with Sani-Flush. It's easy. It costs only a few cents.

Don't take chances on just flushing with water. Sani-Flush is thorough. Use it yourself, or ask your service station. *Sani-Flush is absolutely safe in auto cooling systems, when used according to directions on can.* It's in most bathrooms for cleaning toilets. Sold in grocery, drug, hardware and 10c stores. The Hygienic Products Co., Canton, O.

## Sani-Flush

**CLEANS OUT RADIATORS**

**ENJOY AN OUTDOOR  
VACATION THIS SUMMER!**

Send for "Outdoors With Ta-pat-co"—telling famous camp tricks and trail secrets to make your outdoor vacation more comfortable, pleasant, and safe. See styles of Ta-pat-co sleeping bags and other outdoor equipment in beautiful colors. Write today—it's FREE! Address . . .

The American Pad & Textile Co.  
Dept. 51, Greenfield, Ohio



of delicate grass which would soon bend and collapse under the weight of the lead in old-fashioned paint. Lakes and streams, for which glass never was practical because it continued to look like glass regardless of what was done to it, are now created by the use of Plexiglas or Lucite or some similar plastic which renders molding and shaping easy. Paint is sprayed on lightly, in contrast to the heavy brush in exhibits a generation or so ago. Fluorescent lights soften natural effects. Color photography brings the correct hues back

to the museum for duplication. New adhesives are more lasting. And Cellophane raincoats protect animals while exhibits are being built.

Thus science, which specializes in artificial reproduction of nature's wonders, is working to make more natural the reproduction of wildlife so that the future generations—if the time should come when any of our American mammals are extinct—may find in the museums what we can still see today in zoos and reservations, or in the woods.

## New Crops for America

(Continued from page 95)

first thing the American farmer would need do is to strive for a worthwhile yield per acre.

Other condiment crops include anise, which might be grown on the Pacific coast and in the north-central states; cayenne, suitable for cultivation in the cotton producing states; cumin, adapted to gulf coastal and Pacific coast states; dill (used in making dill pickles), which may be grown in the north-central states; fennel, adaptable to northern states; ginger, which has possibilities in subtropical parts of southern Florida; marjoram, requiring a mild climate; paprika, (\$740,000 worth imported each year), which might be produced in the southern states, east and Pacific coast states and in irrigated valleys; sesame (imports totaled \$3,120,000 in 1936), which can be grown in warmer parts of the country, chiefly where cotton grows best; sage, adaptable to the central and eastern states, and thyme, a small crop that can be produced in mild sections of northern states or local regions on the west coast. The farmer faces many difficulties in cultivating and harvesting these crops, however.

Few people can imagine that this country imports approximately \$700,000 worth of sunflower seed and oil from the seed each year. Surely, thinks the average farmer, nobody should be paying good money to "foreigners" when sunflowers can be grown so easily in this country. One drawback has been that the yield has not been sufficient for the crop to compete with others that could be grown in the same region at a greater profit. Too, cultivation has not been on a scientific scale, with the result that the oil yield from seed

is only 32 percent. Experimentation might raise this yield to 50 percent, making this crop more profitable. Factors influencing the yield of oil are soil, irrigation, fertilization, climatic conditions, planting methods, and quality and variety of seed. Oil from sunflower seed is used in making edible oil, soaps, illuminants, glues, paper, plastics and drying oils for paint.

Some other crops which the farmer might be wise to plant experimentally, with the idea of eventually adopting them as profitable sidelines, are listed by the chemurgic council, with the annual value of imports, as follows:

Arrowroot, \$189,000; bergamot oil, \$225,000; blueberries, \$558,000; canary seed, \$519,000; castor beans, \$2,794,000; garlic, \$208,000; hops, \$1,671,000; mushrooms, \$668,700; pepper, \$3,000,000; perilla (oil), \$2,000,000; psyllium (seed), \$310,000; rapeseed (oil and seed), \$1,600,000; sugar beet (seed), \$1,456,000; tea, \$16,669,000; tung trees (oil), \$10,999,000; vanilla (beans), \$1,661,500; flaxseed, \$20,156,000 and many others.

Already test plantings of castor beans, perilla, coriander, caraway, fennel, safflower, anise and sunflower have been made. The yield in castor beans has been as high as 1,000 pounds per acre at the Urbana station of the University of Illinois. Last year experimental plantings of castor beans were made in the region from Florida and Georgia to Texas, Oklahoma and Kansas. Some individual plots were grown in New Mexico, Arizona and California. In the region marginal to the cotton and corn belts the average yield was about 500

(Continued to page 166)

# NOW! YOU CAN OWN A GENUINE PROFESSIONAL TYPE REFLEX CAMERA AT A LOW PRICE THAT YOU NEVER DREAMED POSSIBLE!



"See What You Get—  
Get What You See!"



**This Is The Type Camera  
That News Photographers Use.  
Thousands Paid \$5.50 For It!**

Here is positively the most amazing camera bargain ever offered! Because the manufacturer, who is one of the world's largest makers of cameras, is engaged in the manufacture of war materials, we have purchased the last few thousand TWIN FLEX Reflex Cameras at a "close-out" price. A few months ago this camera was being sold by camera dealers at \$5.50. In the face of sky-rocketing prices, a few thousand lucky camera fans can own one of these genuine \$5.50 TWIN FLEX Cameras for the unbelievably low price of \$2.98! This marvelous camera, with its matched focusing lenses, shows you the actual picture on the ground glass range-finding screen *before* you take the picture. You can tell *exactly* the way each and every picture will look before you snap it. There is no squinting through small view finders! No out-of-focus pictures, whether the subject is close up or far away!

*Now Only*  
**\$2.98**  
**Film FREE**

## Amazing Matched Focusing Lens Prevents "Duds" or Blurry Shots

Even at the old price of \$5.50, the Univex TWIN FLEX was the sensation of the camera world. This marvelous camera, with its matched focusing lenses, shows you the pictures on the ground glass range-finding screen *before* you take the picture. In other words, you can tell *exactly* the way each and every picture will look before you snap it. You automatically focus every picture before you take it. There is no squinting through small view finders! No out-of-focus pictures, whether the subject is close up or far away! **YOU GET EXACTLY WHAT YOU SEE!**

**This TWIN FLEX  
Comes To You  
On A Money  
Back Guarantee  
Of Satisfaction!**

**The Only Popular-  
Priced Reflex that  
Focuses on Viewer.  
"Tunes In" Close-ups  
or Distant Shots!**

There's no "trial-and-error" with your TWINFLEX! No squinting through small view-finders! No complicated gadgets! Every shot's a "hokey" because you see every one before you take it!



## TWIN FLEX Has Many Features Found in \$35.00 Cameras

So confident are we that you won't be able to duplicate this camera "buy" anywhere else in the country, that we will gladly send it to you along with a FREE roll of film, on our no-risk money-back guarantee. If after getting and using the TWIN FLEX for ten days, you and your friends don't think that this is far and away the most amazing camera bargain you have ever seen, just return the camera (keep the film) and we will refund your money—every penny of it! The price is only \$2.98 for the camera! The film comes to you **ABSOLUTELY FREE!**

### ECONOMICAL!

**Takes 6 Pictures on Any  
No. 00 Film—Costs Only 15c**

The TWIN FLEX uses economical No. 00 film which can be purchased at any store in the country at the low price of 15c per roll. If you take advantage of our special offer, we will send you seven rolls of film for only \$1.00. Order film on the coupon below.

## SEND NO MONEY—RUSH THIS COUPON!

Illinois Merchandise Mart (Camera Div.)  
Dept. 321-A-54 W. Illinois St., Chicago, Ill.

**NO RISK OFFER**

- Enclosed find \$2.98 for Camera, Free Roll of Film and Free Photo Album. Ship postage paid.  
 Send Camera and Free Roll of Film. I'll pay postman \$2.98 plus postage.

Name .....

Address .....

Town or City.....State.....

Take advantage of this big film saving! Get seven (7) rolls of film (42 pictures) for only \$1.00.

- Enclosed find \$1.00 for 7 rolls of film. Ship postage paid.  
 Send 7 rolls of film C.O.D. for \$1.00 plus postage.

### Special Money-Saving Combination Offer

- Enclosed find \$3.98. Ship me, all postage paid, 1 Camera and roll of film, and 7 extra rolls of film (enough for 48 pictures). Include Photo Album FREE.

**FREE!**

If you send money in advance with your order, we include Absolutely FREE, this beautiful hard-bound HOME PHOTO ALBUM. This album will keep dozens of snapshots in perfect condition for years to come. We send it Free, if you send money with your order.



# Save your tools!



Get this FREE  
**DISSTON  
MANUAL**

from your  
**HARDWARE DEALER**



**48 Pages • 200 Illustrations**

Packed with useful workshop advice, instructive pictures, practical helps and hints. Contains this statement from George T. Weymouth, Bureau of Industrial Conservation, War Production Board: "TOOLS ARE WEAPONS. CONSERVE THEM. USE THEM PROPERLY TO AVOID BREAKAGE AND THE WASTE OF CRITICAL MATERIALS NEEDED TO WIN THIS WAR." . . . Make your tools last longer. Get your FREE copy of the Disston Saw, Tool and File Manual from your Hardware Dealer.

**HENRY DISSTON & SONS, INC., 911 Tacony, Phila., Pa., U.S.A.**

## PAINT STRIPING TOOL

Try it! See the Added Beauty

ONLY  
**\$1.00**  
POST  
PAID

With this NEW TOOL (not a brush) everyone can now draw lines with paint. Used on autos, models, toys, tiled walls, cabinets, furniture, linoleum floors and all home workshop projects.

As easy to use  
as a pencil



Send only \$1.00 for complete tool for painting a 1/16" wide stripe, including adjustable guide, operating instructions, etc. C.O. D. price \$1.25. Tool uses paint, enamel, lacquer, etc. Patented interchangeable tips are available for wider or narrower stripes.

**Every Painter and Craftsman Should Own One**  
Send for your tool today. Use it. If you are not satisfied that you have added character as well as beauty to your work, return the tool and we'll refund your money promptly.

Dealers: Write for literature, etc.  
**WENDELL MFG. CO.**

2531 N. Ashland Ave. Chicago, Ill.

New  
Only **\$6.95**

## REAL ENGINE VALUE



The G. H. Q. is a miniature gasoline engine that really operates. Over 15,000 sold in the last year. Now is your chance to buy the New Improved 1942 model kit for \$6.95. Absolutely complete with coil, condenser, plug, instructions, etc. Only a screwdriver needed. For boats, planes, midget cars, etc. All parts guaranteed. Send only \$1.— Shipped collect C. O. D. same day. Send for FREE circular or 6c for Jumbo catalog of hundreds of plane, boat and hobby items.

**GHQ MOTORS, Dept. B, 40 East 21 St., New York, N. Y.**



## AUTO ENGINE SPEED CONTROL GOVERNORS

Give constant speed to any make of auto or truck engine, regardless of load changes, when used for power. No better governor can be made. Fully guaranteed. Complete, simple instructions. Courtesies to garages and established agencies. Montreal branch, 7546 Wiseman St. Free circulars. **CANDEE, 129-8 Llewellyn St., Los Angeles.**

pounds per acre. In a few cases plots under irrigation yielded more than 2,000 pounds per acre.

Experts warn that in experimenting with any of these new crops, it would be highly advisable that the best varieties of seeds, roots or cuttings be used and that none be planted until a thorough investigation has been made of soil composition. Care in selecting the crop, equal care in planting, cultivating, harvesting, handling and marketing, plus a lot of hard work, may add up to a profit. But each of these crops is a specialty in itself and the farmer would make a mistake in attempting to grow and handle several at the same time. In this, like any other endeavor, success must be earned.

## Dust the Destroyer

(Continued from page 91)

one building to another, in the course of manufacturing processes. In these conveyors, often of the wood box type, there is a definite and forever present explosion hazard.

Notwithstanding every precautionary measure for preventing explosions in the enclosed conveyors, it has been found advisable, because of heavy dust concentrations in the enclosed areas, to devise "chokes," "seals," and flame arrestors in the conveyor systems themselves. These serve to confine explosions to comparatively small areas in the conveyor systems, thus preventing spreading throughout entire systems and to other buildings. Safety pressure vents likewise have been designed to help prevent structural damage to buildings in case of explosions.

Despite the continual educational efforts by industrial safety groups, the dust hazard persists. Factory owners say "It can't happen here." But it can. Any factory doing grinding has an explosion hazard. The dusts of lead, antimony, zinc, tin, aluminum and magnesium have high explosive power. There have been estimates that explosions have occurred in a third of all the magnesium plants in the world.

One laboratory built a special explosion chamber to test the explosibility of various dusts. The engineers found that, with a high enough concentration of oxygen, even diamond dust will explode.



## Nail Polish Prevents Fraying Of Ribbon Ends



You will never be bothered by having ribbons on your dresses and hats fray if you apply fingernail polish to the ends. Just run the polish applicator along the edge of the ribbon, using colorless polish or a shade to match the ribbon.

## Simple Brush to Sweep Chimneys

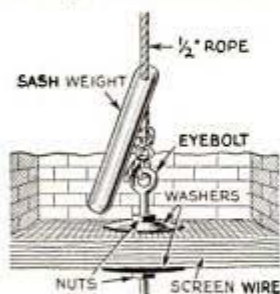

Cleaning a chimney is a simple matter with this inexpensive brush. It consists of six to twelve thicknesses of screen wire sandwiched between two large washers

and nuts on an eye bolt. The pieces of wire should be of a size to scrape firmly against the sides of the chimney. A long rope tied to the eye of the bolt is used to raise and lower the brush inside the chimney. Weight to push the brush downward is provided by a sash weight.

## Repairing Refrigerator Door

In one case what was thought to be weakened or defective door fasteners, causing the door on a refrigerator to remain slightly opened, proved to be worn hinges. In such cases the hinge pins can be withdrawn, permitting the insertion of a bronze washer to take the thrust and to raise the door position. In others it may be possible to place a piece of copper wire around the pin and bend it into the form of a washer in the worn space.

# Tough...but oh so gentle

**TOUGH ON OIL-PUMPING...  
GENTLE ON CYLINDER WALLS**



John Steiner

★ **Protect what you have. Save everything you possibly can. Install Hastings Steel-Vent Piston Rings to protect your motor, lengthen its life and restore its economical performance.**

*Note to Used Car Buyers: Ask the dealer if it's Steel-Vent Reconditioned. It's a better buy if it is.*

HASTINGS MFG. CO., HASTINGS, MICH.

Hastings Mfg. of Canada, Ltd., Toronto

# HASTINGS

STEEL-VENT PISTON RINGS

*Stop Oil-Pumping*  
IN CARS, TRUCKS AND TRACTORS

## IF YOU'RE IN THIS FIX..

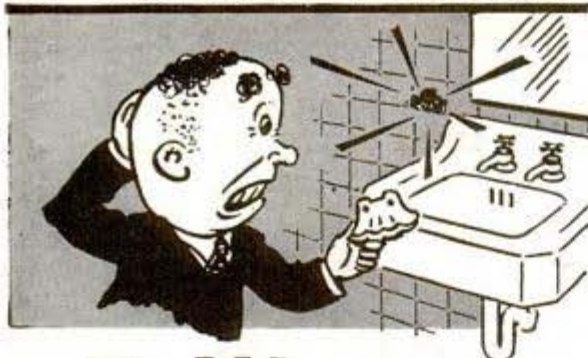

# P. W. WILL FIX IT

LOOSE BATHROOM FIXTURES, such as towel racks or soap dishes, can be quickly and easily reset in plaster, wood or tile, with **PLASTIC WOOD**. Get it today at Paint, Hardware and 10¢ Stores.



**HANDLES LIKE PUTTY—HARDENS LIKE WOOD**

**BE PREPARED! SHOOT NEW BENJAMIN TARGET PISTOL**



**NEW Streamlined Hand Pump—Longer Shot Barrel—Larger Grip—More Power—Accurate—Practical—Economical—Safe—Clean—Quiet. No smoke or fumes. Bolt Action—Hammer Fire—Hair Trigger—Safety Lock. Single Shot BB with 1 lb. shot \$9.00; Single Shot Cal. .177 or .22 rifled—with 500 pellets \$10.50; Holster \$2.50. Also a complete line of Benjamin Genuine Compressed Air Rifles for BB and Cal. .177 or .22 pellets. Write today for complete specifications and free targets. BENJAMIN AIR RIFLE CO., 890 Marion St., St. Louis, Mo., U. S. A.**



**OTTAWA  
TRACTOR  
SAW**

**Falls Tree—Cuts Log**

Fits rear power take-off shaft. Drive thru gear reduction. 18-in. stroke, 10-ga. blade. Economical, saws to profit.

**FREE Circular  
and Price List**

**OTTAWA MFG. CO., 1327 Forest Avenue, OTTAWA, KANSAS**



**only  
10c**

# Wood workers: Here it is!

Harold Hunt's big No. 14 wood catalog! Latest **UP-TO-DATE IDEAS** for experts and amateurs: **SPECIAL BARGAINS** in rare woods, veneers, and ALL kinds of supplies. 148 pages—20 of rare woods in color. Get posted! Send only 10c to **CRAFTSMAN WOOD SERVICE CO., 2729 S. Mary St., Dept. A-25, Chicago, Ill.**

## Modern Miracle

(Continued from page 11)

gested one change in making foreign-designed 40-millimeter antiaircraft guns which saves 30 pounds of material per gun and eliminates six machine tools.

The list of war implements that are pouring from automotive and allied plants is fabulous. Frigidaire refrigerators have given way to airplane parts, and machine guns; those machine guns consist of 292 parts, and 118 spare parts accompany each gun. A partial list of war products built in automobile factories totals 150 items, including airplanes and ambulances, armor plate, air pumps, ammunition hoists, guns, fuses, artillery ammunition and carriers, assault boat carriers, batteries, bombers and bomb loaders, buses, cantonment furnaces, cartridge cases and clips, jeeps and peeps, communication equipment, crash cars, earth borer and dump trucks, field kitchens, radio cars, fire engines, flood-lighting trucks, gas mask parts, instruments and gauges, generators, grinders, gun control apparatus, helmets, lathes and jigs, marine engines, oxygen cylinders, shells, radios and radio compasses, gun recoils, spark plugs, tanks, tools, torpedoes, tractors and trailers, gun turrets and troop carriers. That's merely suggestive of the job they're doing.

Most Americans have been blasé about mass production. Millions of new cars, millions of radios every year have come to be expected, and it's hard to get excited about the achievement.

But even the most sophisticated of us would get a kick in his amazement if he could look behind the curtains of what used to be the automobile industry. Four-motored bombers were flying from the end of a half-mile assembly line 13 months after they broke ground for the Ford Willow Run plant, which is so unimaginably colossal it could swallow Hollywood and all its adjectives without gagging. It's the largest aircraft plant in the world, and about the end of this year will be outproducing Boeing, Douglas, Consolidated, Lockheed and Vega combined. Now Chrysler is building an airplane engine factory big enough to swallow the Willow Run plant and 20 baseball diamonds besides. The famous River Rouge plant of Ford is already rolling out Pratt & Whit-

ney airplane engines, trucks, jeeps, tires, army automobiles and 30-ton tanks. The bomber program of Ford alone is as big as the whole motor car business used to be, and Ford war production will be twice as large as the company's entire peacetime production.

Chrysler was four months ahead of schedule in medium tank production on Jan. 1, and in the first four months of this year more than doubled its 1941 total output. In three consecutive months Chrysler tripled production of anti-aircraft guns and the accelerator was still down to the floor, with delivery 39 percent ahead of promises at this writing. Hudson has been turning out the 20-millimeter Oerlikon anti-aircraft gun at several times the contract rate. Willys is building 30,000 four-wheel-drive cars for the army. General Motors plants turned out 50 percent more war goods in the first quarter of 1942 than in the last quarter of '41. One entirely new plant built by Buick was turning out 1,200-horsepower airplane engines eight months after ground was broken. Packard, building engines for the "mosquito" boats, has doubled its plant capacity three times. Studebaker and Nash are both building planes and parts.

Mass production it is, but precision is as vital as bulk. An anti-aircraft gun built with the accuracy of a watch and hurling shells at 500 a minute is coming from one automobile factory at 30 times the rate specified in the Navy's orders.

In one month early this year, more American tanks were built than in all of the first World War. By the end of 1942 tank production will be more than four times the present rate.

What if you can't buy a new car? Your next car is an engineer's dream; today's reality is a mighty procession of war machines. You're sitting on the sidelines of a miracle.

### Printing Type Cast From Nylon Saves Use of Metals

Nylon may take the place of metals in printing type, according to a patent recently assigned to E. I. du Pont de Nemours & Co., Wilmington, Del. Type cast from nylon is declared to make sharp and clear impressions, and extremely thin-lined letters can be printed with it.

## The GREEKS Had A Word for It\*

\***PANOPTES**, the all seeing, was the word the Greeks had for the hundred-eyed Argus [ ἄργος. ] of ancient mythology.

**I**N COMPARISON with his modern namesake—the ancient Greek Argus could see but little.

Optical science has become one of the "fine arts" in manufacturing, and Argus, with greatly increased facilities is rapidly becoming one of the leaders in this industry.

Its research, quality and precise mass production methods are now applied to the manufacture of lenses and precision instruments for the Government services.

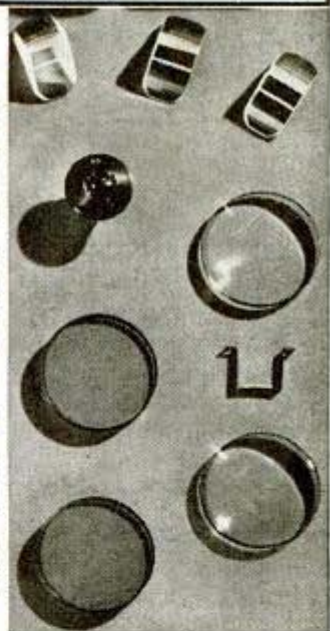

**argus**

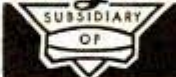

**INTERNATIONAL INDUSTRIES, INC.**  
ANN ARBOR • MICHIGAN

**SAVE MONEY**  
**BUILD YOUR OWN FAN**

Aluminum Propellers White They Last. Shipped Collect	THREE-BLADE for 1/4 H.P. Motor			TWO-BLADE for 1/8 H.P. Motor		
	Size	Shaft	Price	Size	Shaft	Price
20 1/2"	1/2"	\$4.50	12"	1/2"	\$2.75	
24"	3/4"	5.00	16"	3/4"	3.00	
26"	1"	5.50	20 1/2"	1"	3.50	

MICHAEL ELECTRIC COMPANY, Dept. P., Fort Worth, Texas

**BURN YOUR NAME ON TOOLS**  
**WITH THE ARKOGRAF**

**PROTECT YOUR TOOLS FROM THEFT**  
Write with electricity any name or design on the hardest and finest tools and instruments, or any metal, like writing on paper with pen or pencil.  
**Complete Outfit \$3.50 — Prepaid Anywhere**  
Interesting illustrated circular free. Write today.  
Agents wanted.  
ARKOGRAF PEN CO., 3927 S.E. Stark St., Portland, Ore.

**MAKE BIG MONEY at HOME!**  
**NEW INVENTION**  
**Electroplates by Brush**

Now Plates CHROMIUM Too!

New, patented invention makes possible big earnings AT HOME. Replate auto-parts—worn articles in homes, stores, hotels, restaurants, etc., with durable, sparkling, new coat of metal—with stroke of brush. Easy, simple, quick. Genuine Gold, Silver, Nickel, Cadmium, etc. Everything furnished. Outfit complete, ready for use. No shop required. Clear from \$2 to \$5 an hour in lifetime business. Small investment starts you in business. Steady repeat. Machine can pay for itself in week. Send TODAY for FREE SAMPLE and illustrated BOOKLET how you can have a life income from a business of YOUR OWN built upon satisfied customers. Act at once!

**WARNER ELECTRIC COMPANY**  
215 W. Ohio St., Chicago, Ill., Dept. 202

**FREE SAMPLE and BOOKLET EXPLAINS ALL**

Ref: E. I. du Pont de Nemours & Co.  
Wilmington, Del.

# CHAMPION SPARK PLUGS



Champion Spark Plugs are on active duty in every phase of wartime service on land, water and in the air, demonstrating day after day that they are more vital—more dependable than ever. The knowledge and experience gained in this highly diversified and rigorous service will be invaluable. Obviously this will add to the inherent dependability of Champions—the preferred spark plugs.



You wouldn't pay for gasoline pumped on the ground; but you are continually paying for gasoline wasted if you keep spark plugs too long in service, fail to keep them clean and spark gaps properly spaced. So have your spark plugs tested and cleaned at regular intervals. Replace old, worn-out or inferior quality spark plugs with new Champions.

*More Vital-  
More Dependable  
than ever!*

TO SAVE GASOLINE • KEEP YOUR SPARK PLUGS CLEAN

## Shortcut to Tokyo

(Continued from page 31)

wildest part of America is a Paul Bunyan task no one but the Corps of Engineers would undertake. Once the crust of that sponge-like muskeg is broken, it won't even support a man. For a beginning, they're laying mats or building trestles over the bog to keep the supply convoys above ground. One of the first photographs to come back from the scene of operations showed one truck hoisting back to the rocky road another that had gone over the shoulder—reminiscent of the Burma Road.

They picked a he-man to handle this job—Col. William Morris Hoge, U. S. Army Corps of Engineers. In the World War he was awarded the Distinguished Service Cross for bridging the Meuse under shell fire. They have given him a year and 30,000 men to do the job. The latest word is that a passable road will be ready by winter, the full length of the route. Others have attempted smaller trail-making projects in this desolation; back in 1905 the Northwest "Mounties" superintended the construction of a wagon road from Peace River Crossing to the mountains 400 miles away. The job was abandoned after three years of work. But if Col. Hoge's engineers annihilate time as American industry and armed forces are, there'll be troop and supply convoys rolling overland to Alaska on a permanent, 24-foot rock-topped highway in less than a year. Then reinforcements will reach our northwestern bastion in three to four days instead of the eight days by steamer up the Inside Passage.

Military considerations are paramount at the moment. But after the war, what vistas of commercial developments the highway opens! The lands northwest are

**Model Builders  
Attention!**



	V	V-2	V-3
Hex	1/2"	3/8"	5/16"
Thread	3/8"-24	1/4"-32	1/4"-32
Thread Length	7/32	7/32	5/32
Weight, Grams	8	3 1/2	2 1/2

Actual Size V-Plug

Champion spark plugs for model gas engines give the same dependable performance as regular Champions. Sillimanite insulator. Alloy needlepoint electrodes for easy starting. One piece construction.

## CHAMPION

SPARK PLUG COMPANY • TOLEDO, OHIO

unopened treasure chests of precious ores. Not far from Fort Nelson there are oil fields. The vast storehouse of mineral wealth lies waiting, and transportation has been the principal obstacle to its realization; freight planes have only begun to tap it. Alaska—still an almost unexplored wilderness twice the size of Texas and with a population under 80,000, half of it native—holds vast stores of timber and ore and game, yet its principal industry is—salmon.

Hardly had the road building begun when Canada and the United States agreed on a survey to determine the feasibility of a railway to Alaska. Army engineers took over that job, too.

And after the war—perhaps it will be a highway to Asia. A dream? Until now, yes. But the engineers pour dreams in concrete.

Years back, there was talk of tunneling under Bering Strait and driving a railroad across to Russia. The strait is only 55 miles across, only 30 to 60 feet deep. Motorists drive over the ocean to Key West, Fla. Why not a bridge to Russia?

That's looking ahead, but not too far. If Russia built roads from Khabarovsk or Vladivostok or some point on the Trans-Siberian railway to the peninsula opposite Nome, eventually a motorist might journey across a Bering Strait bridge on a highway reaching from New York—yes, from Buenos Aires to Gibraltar.

### Self-Sterilizing Silver Varnish Kills Germs on Tumblers

In the war against germs, it is now possible to make drinking glasses, bottle caps and similar items self-sterilizing by application of a silver-containing, varnishlike, viscous fluid developed by scientists at California Institute of Technology. Applied by brush, spray or impregnation to materials like plastics, glass, wood, paper and cloth, it quickly kills germs of the type found on drinking glasses, as well as molds in cider, and retains its sterilizing ability over relatively long periods. The compound has no odor or taste, and resists weak alkaline and acid action and boiling water.

Look in the index to find where to buy articles described in this magazine. Say You Saw It in Popular Mechanics.

SEPTEMBER, 1942

Ref: dr. A. Goetz, dr. R. Tracy & dr. S. Goetz  
of Calif. Inst. of Technology, Pasadena, Calif.

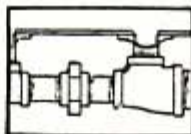

Pipe Leaks



Boiler Leaks

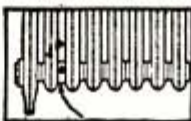

Radiator Leaks

By keeping old equipment in good repair with SMOOTH-ON, you will save metals and other materials which are so vitally needed by our armed forces. When heating or plumbing systems, auto engine blocks or radiators, household utensils, hardware, tools, etc., are worn, broken or leak, DON'T REPLACE THEM . . . REPAIR THEM WITH SMOOTH-ON. It's easy to fill cracks or holes and make loose parts lastingly tight with SMOOTH-ON No. 1. No heat or special tools are required. A few cents worth of SMOOTH-ON can save you many hard-earned dollars.

Buy Smooth-On in 1 3/4-oz., 7-oz., and larger cans from your dealer or if necessary from us. For your protection, insist on genuine SMOOTH-ON.



#### MAIL COUPON FOR free BOOK

Smooth-On Manufacturing Co., Dept. 37  
570 Communipaw Ave.,  
Jersey City, N. J.

Name .....

Address .....

9-42 .....

Do it with SMOOTH-ON



**NO Drip** **A SURE CURE . . . .**  
 Use this plastic cork coating to positively stop sweating and condensation drip. Easy to apply with whisk broom, brush or trowel to pipes, tanks, walls, ceilings, air ducts—any surface of metal, concrete, brick, wood, plaster, composition. Insulates and prolongs life of metal by preventing rust and corrosion. A gallon covers about 30 ft. of 1" O.D. pipe. The permanent, stucco-like finish can be painted any color. Comes in 1, 5 and 55 gal. drums. Get at Hardware, Plumbing, Mill Supply Dealers or send \$1.90 for 1 gal. prepaid. **CIRCULAR FREE.**  
**J. W. MORTELL CO., 522 Burch St., Kankakee, Ill.**

**FREE RADIO CATALOG!**

You'll want this Big FREE 1942 Book that shows Everything in Radio! Here's everything you need for radio servicing, for experiment, for instruction in the science of modern Radio! More than 15,000 quality radio items—replacement parts, books, tools, lab and experimental equipment—all at the lowest prices! Send for this FREE Catalog now—and don't miss the two big book values described below—They're a "must" for Everyone in Radio!

**Radio Builders' Handbook.** Everyone in radio needs it **10¢**

**Radio Dictionary.** Complete, valuable, defines all terms **10¢**

**FREE**  
 Send for it NOW

**ALLIED RADIO CORP.**  
 833 WEST JACKSON DEPT. 5-J-2 CHICAGO

**REED MICROMETERS**

**0-1" reading in 1/1000"**

One of America's finest precision micrometers made over 30 years. Quick delivery to men working in war plants. Price model No. 801 shown above \$8.25 less 10%, plus 12c postage. **ORDER TODAY.** Send money order or we ship C.O.D. Write for our shop agents' proposition.

**GEORGE SCHERR CO. 128A Lafayette St. New York, N. Y.**

Always write your name and full address clearly when answering advertisements.

**MIND POWER**

**A FREE BOOK**

Develop your personal, creative power! Awaken the silent, sleeping forces in your own consciousness. Become Master of your own life. Push aside all obstacles with a new energy you have overlooked. The Rosicrucians know how, and will help you apply the greatest of all powers in man's control. Create health and abundance for yourself. Write for Free book, "The Mastery of Life." It tells how you may receive these teachings for study and use. It means the dawn of a new day for you. . . Address: Scribe Q. F. A.

**The ROSICRUCIANS**  
 SAN JOSE (AMORC) CALIFORNIA

**Beam-Power "Twin" Two-Tuber**

(Continued from page 157)

menter's junk box or may be salvaged from old sets.

Either a tapped 45-volt B-battery or the "junk-box B-eliminator" described in the August issue, and shown in photo B, may be used for the "B" supply. If the B-battery eliminator is used, do not use a ground connection as no direct ground can be used with the B-eliminator. To keep line hum pickup at a minimum it may be necessary to place the B-eliminator several feet away from the receiver. If you are a beginner it is best to use the 45-volt B-battery, and

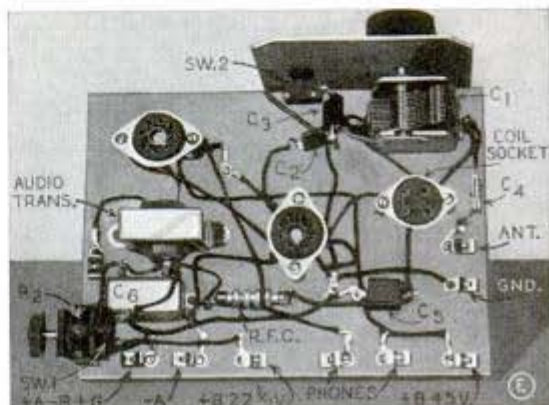

then replace it later with the B-eliminator. When using the B-eliminator, use the "low" tap to supply the non-critical 22½-volt lead to the set and either the "medium" or the "high" tap to supply the 45-volt lead. If the builder finds it necessary to use a ground on any set with which the B-eliminator is used, a .1 mfd. 400-volt tubular-type paper condenser must be connected in series with the set ground lead.

All of the coils are wound with No. 30 enameled wire on the forms shown in Fig. 2. Tube bases from old 4-prong tubes serve nicely for the three smaller coils and, should manufactured forms for the larger coils not be available, the experimenter can improvise by cementing two tube bases end to end with china cement, sawing off the spare set of prongs. The slight difference in the diameter of the forms will not matter. Solder all coil prong and circuit connections carefully with rosin-core wire solder.

The small metal panel may be cut from scrap sheet metal; it serves both as a shield to eliminate hand capacity, and as a mount

(Continued to page 174)

# A BLITZKRIEG for SALES and PROFITS

MILITARY STYLE OXFORD

Sensational, soft as glove leather, Military Style Oxford selling like wildfire. Making tremendous profits for our salesmen. This is one of over 250 specialty shoe styles for dress, sport, work, including new Zipper and Air Cushion Insole Shoes for men and women—Prices low as \$2.98. Biggest commissions. Write today for FREE Outfit of Actual Sample Shoes. Reserve your territory. ACT NOW.



FREE SALES KIT

MASON SHOE MFG. CO.  
Dept. M-77, Chippewa Falls, Wisc.

## BUILD YOUR OWN ARC-WELDER

For Light or Heavy Work

No rewinding necessary—use coils taken from old auto generators. Works on 110 or 220 A.C. Has 20 different heats. Complete plans and BIG Catalog 35c.

LEJAY MFG. CO., 3347 LeJay Bldg., Minneapolis, Minn.



## FREE LITERATURE FOR TRAILER BUILDERS

New up to date facts on world's most reliable parts, axles, hitches, draw bars. Used by U. S. Gov't. and largest trailer Mfrs. Easy to build in spare time. Complete working Blue Prints only \$1.00. Write for Free Literature.

HAMMER BLOW TOOL COMPANY Dept. 109 Wausau, Wis.



## GENUINE U.S. BARGAINS

O. D. WOOL BLANKETS (USED) . \$2.95  
MCCLELLAN SADDLES (USED) . 5.95  
U. S. ARMY PUP TENTS (USED) . 3.50  
ALUMINUM MESS PANS (USED) .35  
Thousands of Other Bargains in Military, Outdoor & Sport Goods for Hunter, Farmer, Scout Send 10¢ for 32-page catalog returned with first order.

A and N SUPPLY CO.  
4720 LESTER ST. RICHMOND, VA.

EST. 1868

Get Your Share of U. S. Defense BONDS ★ STAMPS

# New 7" SHAPER TAKES HEAVIER CUTS!

Now, take really heavy cuts on a small shaper, and forget all about punishing vibration, chatter marks and gear lash. With a reasonably machinable metal, this new PORTER-CABLE 7-inch SHAPER takes  $\frac{1}{8}$ " cuts with .004" feed at 80 strokes per min. . . . with close accuracy.

Here's the reason: It is made of steel and cast iron—no light diecast parts. The extra-heavy cast iron crank-pin-plate stores energy like a flywheel, insuring an easy, powerful, steady cut. And the roller-chain drive distributes strain and wear over five sprocket teeth at a time—there's no gear backlash.

Exclusive Micro-set ram saves set-up time. Ani-Speed control allows changes from 64 to 175 strokes per min. without stopping. Tapered locating pins on tool head and vise. 6 automatic cross feeds. Head turns 360°. Table traverse, 10 $\frac{1}{2}$ ", vertical travel, 5 $\frac{1}{2}$ ".

Phone your local Porter-Cable man (name in classified directory) or write for complete data.

## PORTER-CABLE

- ★ No chatter
- ★ No gear lash
- ★ Revolutionary new chain drive gives extra speed and smoothness



PORTER-CABLE MACHINE CO.  
2000-9 N. Salina St., SYRACUSE, N. Y.

# MORE VICTORY MILEAGE

WITH

## Harley-Davidsons

With today's gas, oil and tire shortages, Harley-Davidson Motorcycles assure faster, more convenient miles-per-dollar than any other kind of motorized transportation. Dependable Harley-Davidsons long have been famous for unmatched economy. That's why their owners are extra fortunate these days. Whether using their sturdy motorcycles to ride to and from work — or in volunteer civilian defense — they're always sure of top performance — just like the courageous riders of Harley-Davidsons with America's armed forces. While there are no new Harley-Davidson Motorcycles available now for civilian use, your dealer may have some good values in reconditioned models . . . See him today.

# HARLEY-DAVIDSON

ON AMERICA'S FRONT



## SEND COUPON NOW!

HARLEY-DAVIDSON MOTOR CO., Dept. P, Milwaukee, Wisconsin

Send FREE copy of big 24-page "Enthusiast" magazine filled with thrilling motorcycle pictures and stories. Also other literature. Stamp is enclosed for mailing cost.

Name

Address



... EASY TO READ

—easy to clean—unconditionally guaranteed for one year. The crack-proof white surface is bonded to the steel—protects it from rust. 25, 50, 75, 100 ft. lengths. Sold by hardware, building material, mill supply dealers everywhere. Write for folder.

KEUFFEL & ESSER CO., Hoboken, New Jersey



LOOK FOR THIS DISPLAY

**K&E WYTEFACE**  
STEEL MEASURING TAPES

**FREE TRAILER PARTS CATALOG**  
We'll save you money on—axles, springs, wheels, couplers, windows, sinks, water pumps, brakes, refrigerators, beds, lamps, inside and out, RV lamps, furniture, jacks—everything. Special discount to mfrs. **NATIONAL TRAILER EQUIPMENT CO.** Successors to K&E-Van Industries, Inc. Dept. P. 719 North Seventh St., Milwaukee, Wis.

Complete Plans and Building Instructions. 10c

Use your car LESS.  
your HULL COMPASS MORE

• Conserve rubber, gasoline, your car itself, by eliminating non-essential driving. But when you do drive, drive by compass. Your Hull Streamline Auto Compass, used wisely, can save miles of wasted travel.

HULL MFG. CO., P.O. Box 246-D9, WARREN, OHIO

**MOTORISTS Wanted!**

TO MAKE THIS UNIQUE  
**GAS SAVING TEST**



Will you permit us to send you at our risk the Vacu-matic, a device which auto owners everywhere are praising? Install it on your car. Test it at our risk. Unless it trims dollars off your gas bills by saving up to 30% on gasoline consumption, gives more power, quicker pickup and faster acceleration, the test will cost you nothing.

**Automatic Supercharge Principle**  
Vacu-matic is entirely different! It operates on the supercharge principle by automatically adding a charge of extra oxygen, drawn free from the outer air into the heat of the gas mixture. It is entirely automatic and allows the motor to "breathe" at the correct time, opening and closing as required. Saves up to 30% on gas costs, with better motor performance.

**AGENTS** Get Yours FREE

**FOR INTRODUCING.** Here's a splendid opportunity for unusual sales and profits. Every car, truck, tractor owner a prospect. Send name and address now for big money making offer and how you can get yours Free. The Vacu-matic Co., 7617-755 W. State Street, Wauwatosa, Wis.

for switch No. 2. The variable condenser is mounted on the baseboard by means of an 8-32 machine screw countersunk on the underside of the baseboard. Short wood screws mount all other parts. The volume control ( $R_2$ ) is used to control regeneration; switch No. 1 is combined with this control. A detailed list of materials is available to students and experimenters, from Popular Mechanics radio department without charge, if desired. The antenna should have a total length of at least 50 feet

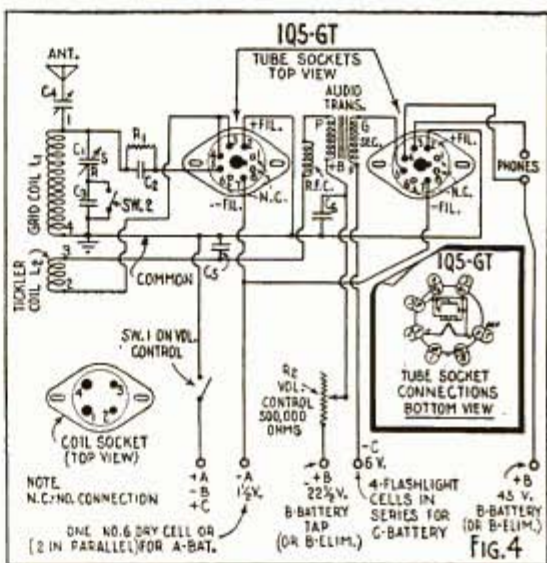

for best results. Use a good pair of 2,000-ohm headphones and do not expect too much on the short waves until you are familiar with short-wave tuning which is more critical than broadcast-band tuning.

Check all wiring carefully before inserting the tubes in the sockets. To tune the broadcast band, insert coil No. 1 in the coil socket and see that switch No. 2 is closed to short out condenser ( $C_3$ ). Turn the variable condenser until a whistle is heard, then back off the volume control  $R_2$  until the whistle stops and the station comes in clear. For short-wave reception, open switch No. 2 and insert the coil for the short-wave band desired. The set is most sensitive at the point just where the whistle stops and the station comes in. Adjust antenna trimmer ( $C_4$ ), photo D, for maximum results on each band. When the set is not in use be sure that switch No. 1 is turned off and if the B-eliminator is employed there will be another toggle switch to throw. The blueprint number for this two-tube set is R-307.





"I FIND  
STANLEY CHISELS  
LAST LONGER"

You'll find Stanley Chisels in most carpenters' kits because they need the extra toughness, the careful tempering to assure a keen edge, the long-lasting dependability.

Stanley Socket Chisels are forged in one piece—no welded socket—from special chisel steel. Handles are selected hickory, capped with leather washers. Made in Firmer, Pocket, and Butt styles, in a wide range of sizes.

Catalog No. 35 describes hundreds of popular Stanley Tools, and gives helpful data on their construction, care, and use. Write for a copy.



**STANLEY**  
Trade Mark

- No. 720 Firmer—12 sizes  
1/8" to 2"
- No. 740 Pocket—7 sizes  
1/4" to 1 1/2"
- No. 750 Butt—11 sizes  
1/8" to 2"

## STANLEY TOOLS

DIVISION OF THE STANLEY WORKS

NEW BRITAIN, CONN., U. S. A.

"The Tool Box Of The World"

### WHEN YOU BUY FLASHLIGHT BATTERIES DEMAND "EVEREADY" FRESH DATED BATTERIES

The word "Eveready" is the registered trade-mark of National Carbon Co., Inc.

### OTTAWA LOG SAW \$39 BIG BOOK FREE



PUTS THIS OTTAWA TO work for you. MAKE MONEY! Wood is valuable. Does more than 10 men. Easily operated. Falls trees—saws limbs. Use 5-hp. engine for other work. Write for FREE Book. OTTAWA MFG. CO. 5927 Wood St., Ottawa, Kans.

SAW 10 TO 20 CORDS A DAY



### GERSTNER TOOL CHESTS

for safe-guarding and protecting fine tools. Free Catalog to machinists and toolmakers. GERSTNER TOOL CHESTS 442 Columbia St. Dayton, Ohio

## HOW TO SAW METAL QUICKLY, EASILY!

20-page pocket-size hack saw handbook shows you how to saw metal more easily, more quickly—make blades last longer. Scores of helpful tips—clear illustrations—complete blade selection tables. Covers selection, use and care of hand and power blades, frames, band saws. 5c bargain at hardware stores or send dime with coupon to cover handling, mailing direct to you.

Published by makers of STAR Hack Saw Blades, Frames, Band Saws, Clemson D-17 Lawn Machine.



Clemson Bros., Inc., Dept. MD Middletown, N. Y.  
Enclosed is dime for "Metal Cutting Booklet", postpaid.

Name: \_\_\_\_\_  
Address: \_\_\_\_\_

New...Up-to-the-minute

## Arc Welding Manual

516 Pages  
512 Illustrations  
Helpful charts, diagrams, tables  
... it's easy to understand.

ORDER your copy at once. Do this ... Clip this ad, send it to us with name, address and check or money order.

Explaining fully all the latest techniques, materials, methods and procedures. It's a materials, methods and procedures. It's a complete handbook, reference manual and complete training course all in one. Not operator's training course all in one. Not a cheap booklet, but a full-sized, sturdily bound manual you'll use every day... and thank your stars you've got it. It will be worth hundreds of dollars in helping you get and hold the big pay jobs.

5 Days Approval. Your money refunded if you're not satisfied. Order now at only \$2.00 Postpaid  
HOBART BROS. CO., Box M-92, Troy, O.



The Hobart Portable Electric Arc Welder as shown in FREE catalog. Ask for it.

**HOBART**  
"Simplified" ARC WELDERS

"One of the World's Largest Builders of Welding Equipment"



Only Indian has Spring Frame's flight-smooth riding, easier handling, faster getaway, surer control. See your Indian dealer for some swell "buys" in reconditioned machines.

**ASK YOUR DEALER FOR FREE BOOKLET**

Jam-packed with ideas to help you get more out of any make of motorcycle. Ask your local Indian dealer for a free copy, and Indian literature.



**INDIAN MOTORCYCLE CO., SPRINGFIELD, MASS.**

**WEATHER FORECASTER**



This "Swiss" Weather House, made in the U.S.A. PREDICTS the WEATHER IN ADVANCE. Guaranteed to work. When the witch comes out watch for bad weather, girl and boy indicate nice weather. Acts with amazing accuracy. Has thermometer on front. Shipped complete ready to use.

**SEND NO MONEY** Just pay postman \$1.49 plus postage. Money back guarantee. Don't wait — Write today to WEATHER MAN, Dept. PM, 29 E. Madison, Chicago

**Powerful Vision—8 Mile Range  
BINOCULARS**

20 Days Free Trial \$4.75  
Postpaid or C.O.D.



Scientifically ground, powerful lens that give clear vision equal to 110 yds. at 1000 yds. distance! Adjustable for all distances and eye widths. Binoculars come with handsome case and straps. **GUARANTEED.**

If not satisfied after 20 days free trial money refunded. American Binocular Co., 7759 S. Halsted, Dept. F-662, Chicago.

**SAW-FILING**

**Pays up to \$2 or \$3 an Hour**

A FOLEY Automatic Saw Filer files hand, circular and hand saws better than the best hand filer. Cash business, no canvassing, no eyestrain. No experience needed. "Bought a Foley, one year later had all debts paid and \$400 on a new home. Many days I earn as much as \$16." —J. H. Kellogg. Send coupon for FREE PLAN, no obligation.



**FOLEY MFG. CO., 916-2 Foley Bldg., Minneapolis, Minn.**

Send Free Plan on Saw Filing business. Name ..... Address .....

Paste coupon on postcard

**Tin Fish for Nippon**

(Continued from page 53)

and the spent tube floats on the surface. Under war conditions, torpedoes are adjusted to sink if they miss their target. This removes them as a menace to navigation and prevents them from being captured by the enemy.

When the newly built torpedoes get the official O.K. of Navy inspectors, they are fitted with "war heads" of TNT. They are then ready to send Axis warships to Davy Jones's locker.

A modern American submarine carries from six to 12 torpedo tubes, some fore and some aft. A torpedo is loaded in each tube and spares are carried within the sub itself. The tubes can be fired when the submarine is on the surface, partially submerged or completely submerged.

Among our Navy's surface craft, torpedoes are used for the most part by destroyers and motor torpedo boats. Some of our older battleships and cruisers used to be equipped with torpedo tubes, but they have been abandoned in the newer ships. Destroyers, sometimes called the "cavalry of the sea," usually carry eight to 16 torpedo tubes, mounted in quadruple rows amidships. Each of the fast little motor torpedo boats, nicknamed "mosquito boats," mounts four torpedo tubes.

The torpedo-carrying plane has also proved its worth. Lugging a 21-inch torpedo in its belly, the plane swoops low over the water toward its objective and drops its cylinder of destruction near its target.

Torpedoes are sent thundering from their tubes aboard ship either by a charge of black powder or a puff of compressed air. Once a torpedo is free from its tube, it is on its own. Modern torpedoes are small, high-speed submarines — equipped with their own turbine-propelling engines and automatic depth-control mechanism.

When a torpedo hits the water, a lever is tripped which immediately starts the propeller's mechanism. Compressed air is mixed with alcohol and water to produce a hot steam. This steam is directed against the blades of turbines which drive the two propellers. Horizontal and vertical rudders control the direction of the torpedo and prevent it from turning over.

Against a deep-draft vessel such as a battleship, the torpedo is usually set to

travel from 20 to 25 feet below the surface of the water. Against a destroyer a depth of from five to 10 feet is sufficient.

Around 1900 the torpedo was equipped with a "brain." The gyroscope was added to the torpedo's internal mechanism for the purpose of increasing accuracy. It allows a torpedo, launched with its nose pointing anywhere within an arc of 120 degrees, to swing back on a pre-determined course. Therefore, a destroyer with torpedo tubes mounted at right angles to its keel, can fire straight ahead. The torpedoes shoot from their tubes at a 90-degree angle and, as if guided by a ghostly hand, turn and head straight for their target.

Torpedoes plow through the water at speeds varying from 30 to 50 knots. The range of the modern torpedo is up to 13,000 yards—about seven and one-half miles. The longest hit on record, however, is only about 3,000 yards, made by a German U-boat in 1917 on the American destroyer Jacob Jones.

World War I torpedoes often left a wake of bubbles which could be spotted and avoided. But these telltale signs have now been largely eliminated and usually the first sign of a torpedo attack is the explosion itself.

One of the newest developments in torpedoes is the "gun torpedo." When this type of torpedo pierces the side of a ship, it sets off a gun that fires an eight-inch projectile and causes further damage. It is thought that German U-boats are using this weapon.

As yet the world's best military brains have failed to perfect a device which will give adequate protection against the torpedo. The torpedo does its deadly work below the water line where armor protection is thin.

Many experiments have been made—double bottoms, intricate compartments, armor plates or shields carried at some distance from the ship's hull, blisters, nets, booms, negative electric fields, etc. But none has proved satisfactory. A smart skipper, however, can sometimes out-manuever a torpedo attack by zigzagging at top speed.

But as one veteran Navy officer said, the best protection against the torpedo is "a good, old-fashioned prayer—and that is none too good!"

**BETTER, QUICKER WORK  
WITH LESS EYESTRAIN**



MASTER BRITE-BLADE is the only 6' steel tape rule with black markings on a pure white surface. It's easier to read in any light. Special white surface is acid-proof, crack-proof, smooth and hard.

Flat-edge unbreakable metal case with push-button lock (optional) gets and holds inside and outside measurements quickly, accurately—a one-hand job. Case comes apart for cleaning or inserting spare blade, an exclusive MASTER feature that doubles service life!

Measuring is faster, more accurate and easier on the eyes with MASTER BRITE-BLADE. At hardware stores and mill supply houses or direct from factory.

**MASTER**  
WOOD AND TAPE RULES

Easy to see  
BRITE-BLADE's  
best!

LIST PRICE  
\$1.50 each  
with lock  
\$1.75 ea.

--- CLIP AND MAIL COUPON TODAY ---

Master Rule Mfg. Co., Inc., Dept. FD, 815 E. 136th St., N. Y. C.

Please send me  BRITE-BLADE RULE (\$1.50).  Spare blade (65c).  BRITE-BLADE RULE with lock (\$1.75). I enclose \_\_\_\_\_

Name \_\_\_\_\_

Address \_\_\_\_\_ City & State \_\_\_\_\_

(7) 2344

**DOOR-EASE**  
STAINLESS STICK LUBRICANT

**EASES STICKING DRAWERS**

Use Door-Ease — like a crayon — for things that stick or squeak . . . drawers, doors, windows, latches and friction catches, screws, zippers, etc. Clean, weather-proof, long lasting!—Door-Ease Mfrs., Muskegon, Mich.

**10¢** in metallic container at Hardware, Auto Accessory, Dept., and Dime Stores.



**How long since you made movies  
of your family?**

— Load up your CINÉ-KODAK today —

**CAN AN  
INVENTOR  
MAKE MONEY TODAY?**

In 1941 alone over 4,000 Assignments of Patents a month were made by inventors to manufacturers or individuals. This shows today's demand for new patented inventions. If you have ideas, write for our FREE BOOK, "Protect, Finance and Sell Your Invention" that gives you the complete facts. Special form "Invention Record" also mailed FREE. No obligation.

**McMORROW & BERMAN**  
Registered Patent Attorneys  
1355 Barrister Building Washington, D. C.



## DRILL PRESSES

In producing many of Uncle Sam's best weapons, someplace along the line you'll find Atlas Drill Presses. Sound engineering of the floating drive spindle plus smooth SKF ball bearings keep Atlas Drill Presses in continuous accurate service.



**ATLAS PRESS CO.**  
KALAMAZOO, MICHIGAN

**LATHES - DRILL PRESSES - SHAPERS**  
**ARBOR PRESSES - MILLING MACHINES**

## 110-VOLT AC GENERATORS

& AC light plants, 1800 & 1200 rpm. Available for all standard voltages such as 110, 220 or 440 three phase; three phase, three wire or three phase four wire & 25, 30 or 50 cycles, 350 through 15,000 watts. Also rotary converters, motor generators, frequency changers, etc.

KATOLIGHT, 24 Elm St., Mankato, Minn.



**10" ACCURATE SLIDE RULE only 50¢ COMPLETE**

Complete with 32-page illustrated instructions and black leather-like case. Easy to learn to make lightning calculations without pencil and paper. Multiply, divide, square, cube, extract square and cube roots exactly the same way as any professional engineer. Accurate white composition face. Plastic magnifying indicator makes numbers easy to read. Standard A, B, C, D, CI and K scales. 100% American made.

**RUSH ORDER TODAY**—Send 50¢ in coin (50¢ in Canada or elsewhere in the Americas) or stamps. Complete outfit mailed postpaid. Satisfaction guaranteed or money refunded. (Special quantity prices to schools and dealers.) Rush cash today for this great slide rule value.

**FRANKLIN PRODUCTS CO., 250 N. Maple Grove Ave., Ft. Wayne, Ind.**

**BOOK & CASE FREE of Extra Cost!**

**PHOTO ENLARGEMENTS**

Is Photography your hobby? Do you want a profitable easy business at home? Make **PHOTO ENLARGEMENTS** for yourself and others. Your cost 5¢ each and less. The Ideal Photo Enlarger is **AUTOMATIC**. No experience required. Also **COPIES** any picture **37.5¢ COMPLETE**. Interesting circular **FREE**.

**5¢ ANY SIZE**

Ideal-O, 148 West 23rd St., New York City

**NEW AMAZINGLY POPULAR COMMANDO Military Style Shoes**

Crash through to biggest shoe profits in years with sensational new soft-us-glove leather Military Shoes for Men of Action—also hundreds of other fast-selling styles for men and women, for dress, work, sport.

**FREE SALES KIT**

Victory name and address for **FREE SAMPLE OUTFIT**, and Tested Sales Plans.

**VICTOR THOMAS SHOE CO.**  
619 W. Van Buren St., Dept. V-49, Chicago, Ill.

## Planes of Tomorrow

(Continued from page 5)

000-pound airplane will carry a payload of 50,000 pounds—equivalent to 100 passengers with 80 pounds of baggage apiece, plus 25,000 pounds of mail, cargo and express. This flight would be at sea level to avoid the higher head winds at higher altitudes, at a cruising speed of 200 miles an hour. Eastbound, the flight would be at 10,000 feet, taking advantage of the tail wind of 30 to 40 miles an hour. The saving in fuel would enable the ship to cruise with 60,000 pounds of payload at 230 miles an hour. Elapsed time eastbound would be about 13 hours, westward around 19. We could ride from New York to London faster than by train from New York to Chicago. If the airplane carries 75 percent of the maximum permissible payload, an operating profit can be had if a passenger pays \$225 one way, \$400 round trip.

Passenger accommodations will be luxurious indeed. Lavatory facilities will include bath and shower. Lounge space will be ample for such amusements as table tennis. Observation rooms will afford a spectacular view. Except for swimming pools and air promenade decks, we shall compete very favorably with the comforts of a luxury surface liner.

Navigational aids and safeguards required for a 25,000-pound airplane can be doubled in our 250,000-pound ship. The old standard of four engines will be increased to six or more with standby equipment in case of mal-functioning without adding appreciably to gross weight.

Out of the perils of this war is coming, paradoxically, safety for postwar air travel. The very instruments by which we locate hostile aircraft and assail them will assure both air and surface craft safe passage in any weather. We all read of the soldier, on watch at Pearl Harbor the morning of December 7, who clamored into deaf ears that there were airplanes 150 miles from his post. Imagine such a power devoted, by airplanes and ships, to detecting navigational hazards many miles away without dependence on visual or audible warning signals.

Or consider another device by which we see through fog. Grim enough when we know it is used by fighting pilots fingering triggers in wait for the enemy planes thus

spotted. But what a blessing for the commercial pilot coming in for a landing with his precious freight of human lives.

What part the very large airplane will play in this war I am not prepared to say. Our big Martin Mars is designated a patrol bomber. She is heavily defended with guns. But I can easily see what a part a ship of the 140,000-pound size might play as a naval auxiliary, serving the surface forces and their bases.

Even as we contemplate the plans for our 250,000-pound ship, the size of the Mars—not much over half as big as the projected liner—still staggers us. The flight deck of this “flying battleship” of the U. S. Navy is actually larger than the interior of a 21-passenger air liner. It takes a crew of 11 men to operate the Mars. Up where the pilot and co-pilot sit, the cockpit is much like that of any ordinary air liner. But when they turn around, they face a vast “bridge” occupying 2,175 cubic feet, office of the captain, navigator and engineer officer. Yet this is but a small part of the great ship. Through the windows the pilot catches a glimpse of the wings and their enormous engines, so far back they seem to be on some other craft. A staircase leads from the bridge to the lower deck and its spacious wardroom. High above are passageways to rooms behind the engines, where mechanics service them in flight. In a room on the upper deck, auxiliary motors drive eight generators supplying electricity. There are 24 telephone stations on the Mars. The ship’s control surfaces are tremendous; each of the twin rudders is twice as tall as a tall man; between them are 30-foot elevators, and each aileron is longer than the entire wing span of an average pursuit plane.

Air freight, domestic and foreign, will be a very important part of our commerce when the war is over. The Army has done more to develop air freight than any other operator—and it is surprising to some people to discover that in the last several years the Army has carried more cargo by air than all the airliners of the United States together. That all first class mail will travel by air in the future is a foregone conclusion. That domestic air travel will boom after the war is another reasonable conclusion. The great safety record hung up by the air lines in the last several years

(Continued to page 180)

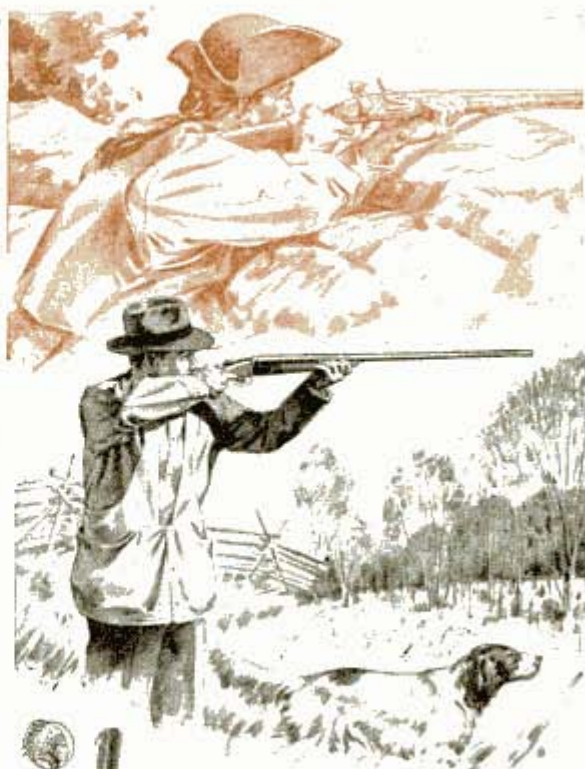

## Able Defenders of America

At Concord, at San Juan, at Chateau Thierry, time and time again American superior marksmanship proved the decisive factor in gaining victory. It will repeat the performance now, all over the world. Since the days of the flintlock America has been a nation of shooters. Today ten million hunters, skeet, trap and target shooters are thoroughly familiar with guns—and know how to shoot straight!

In this development Stevens long has played an important part. Ever seeking for betterment of product, Stevens has pioneered substantial improvements leading to greater accuracy and dependability in the realm of sporting arms.

Stevens rifles and shotguns have aided a vast army of today's young boys and men to become adept in the use of arms and thus to carry on the tradition of superior marksmanship that helps keep America strong.

J. Stevens Arms Company  
Division of Savage Arms Corporation  
Chicopee Falls, Mass.

# STEVENS

## PAINT BRUSHES SCARCE! Keep NEW brushes soft RENEW old brushes

Conserve valuable Paint Brushes! Save them by using DIC-A-DOO PAINT BRUSH BATH after every use. Amazingly efficient in loosening, washing away paint from bristles. Brush remains good as new for long time. . . Restores old hardened brushes to usefulness. Enough to clean several brushes. Costs only 5 cents. Get it at hardware or 5-&-10¢ stores. You'll want to keep several packages on hand. The Patent Cereals Co., Makers of Dic-A-Doo Paint Cleaner, Geneva, New York.

**DIC-A-DOO  
Brush Bath**



8 Mile Range-Wide Vision  
**BINOCULARS \$4.75**  
15 Days FREE TRIAL  
Postpaid or C. O. D.

Comes complete with case and straps. Well ground powerful lens. Easily focused for all distances and ideal all-weather binoculars. Guaranteed. If not satisfied after 15 days trial, money refunded. AGENTS WANT! Vogue Binocular Co., 7759 S. Halsted, Dept. 908, Chicago

## GOOD NEWS!

For Future  
**SYNCRU SAW Owners!**



**PLANS FOR NINE NEW JIM DANDY TRAILERS Ready**  
Build your own trailer! Send 10¢ for Jim Dandy's interesting new TRAILER PLAN CATALOG which illustrates and describes NINE new models including 6 modern house trailers, plus sport, camp, and utility trailers. Rush 10¢ (in U.S.) for Catalog today to JIM DANDY, BOX 125-A, WAUSAU, WIS.

## BUILD YOUR GRANDFATHER CLOCK

Send 35¢ for Simple SHOP TESTED COPYRIGHTED BLUEPRINT. The Simple Sensible Red-I-Kut way as thousands have. DIME brings PLANS and sixty pictures "HOW" Book pricing many fine brass weight Westminster, tube chime, electric and battery movements showing nine beautiful colonial grandfather cases. Build now and save half. KUMPEL CHIME CLOCK CO., Bldg. 68, Guttenberg, Iowa.



## WAR VOLUNTEERS

Materials to build famous WITTE Log Saws and Engines are now needed for war equipment. America's victory program has first call at the large WITTE factory. After victory these money-makers will again be available. They're worth waiting for. . . .

**WITTE ENGINE WORKS**  
Kansas City, Missouri



**WITTE LOG SAWS  
and ENGINES**

continues. Air travel is filling every available seat, and people are irked at being turned away from ticket windows. It is human nature to want what you are denied. Besides, hundreds of thousands of men, trained to the air by the war, will see no other means of transport when they return to peaceful pursuits.

But the spectacular development, I repeat, will be in the ocean field—the field of flying ships that will grow larger and larger. With them we shall rehabilitate a weary world, draw it closer together, reestablish the broken threads of commerce, cross the last frontiers of isolation.

## Wood Scraper for Model Parts From Safety Razor



Modelmakers and others who work with small wood parts will find an old safety razor just the thing for smoothing the wood. The razor is taken apart and the comb teeth are filed off after which the razor is reassembled. Removing the teeth permits the blade to project just the right amount to give a good scraping action.

Every square mile in the United States is struck by lightning an average of 10 times a year, two electrical engineers of Westinghouse learned while conducting a four-year study to find means for protecting power lines.



## KRW ARBOR PRESSES BENCH TYPE AND HYDRAULIC

NEEDED IN EVERY SHOP—SAVE TIME AND MONEY—DO BETTER WORK, QUICKER.

No shop is complete without a small arbor press. Pressing and squeezing operations can be done better and faster on a KRW Arbor Press. Stop using vise and sledge hammer methods—they generally deliver spoiled work in the end. KRW Factory-To-You Prices give you greater value for your money. Order today.

### KRW Bench Type Arbor Presses, 3 sizes

No. 37-P ½ Ton, \$13.25\*  
No. 37-O 1 Ton, \$25.00\*  
No. 37-N 3 Ton, \$33.00\*

\*Prices F.O.B. Arcade, N. Y. Slightly higher west of Rockies. Stand illustrated extra.



KRW Hydraulic Presses are built in 25, 50 and 75 ton sizes. Prices start at \$198.00\*



**K. R. WILSON 17 Lock St., BUFFALO, N. Y.**

Builders of Shop Equipment for Ford Dealers Since 1916

Say you saw  
it in . . .

# POPULAR MECHANICS

## Profit from Books

Popular Mechanics Press specializes in supplying helpful books. Look over this list. Check the books you want, and mail this advertisement as your order blank. Pay postman (U. S. A. only) on delivery plus few cents postage. Ask for FREE book catalog.

### □ FORTY POWER TOOLS YOU CAN MAKE

If you want an inexpensive motorized workshop that will speed up your work and do it accurately, get this amazing book. Shows how to make forty different machines, such as lathes, drill press, jigsaw, bandsaw, circular saw, sanders from pipe fittings, old auto parts, etc. \$1.25.

### □ YOUR CAR

Tells how to add thousands of miles to life of your car and operate car economically. 192 pages of money and labor-saving ideas, short cuts. For motorists, garage and service men. \$1.25.

### □ BUILD A BOAT FOR PLEASURE OR PROFIT

How to build 17 low-cost boats at home—power, sail or row boat. New book prepared especially for the home builder with limited tools, no experience and little money to spend. \$1.25.

### □ 1001 WAYS TO USE CONCRETE

How to use concrete around the home, garden, workshop and business. Do work for yourself. Save, make money. \$1.98.

### □ MONEY MAKING FORMULAS

Over 3,000 up-to-date formulas; supply directory; how to start your own manufacturing business by transforming simple ingredients into wanted products. Reduced to \$2.00.

### □ GARDEN BOOK

Build your own trellises, fences, lawn furniture, outdoor fireplaces, attractive ornaments, etc. \$1.00.

### □ WELDING, BRAZING AND SOLDERING

How to construct welding equipment and use it effectively. Small arc welder, spot welder, arc torch. Tricks of soldering, brazing, heat treating iron and steel. \$1.25.

### □ WHAT TO MAKE

Shows what to make and how to make hundreds of things in spare time for fun or profit. Furniture, craftwork novelties, jig saw projects, gifts, toys, games, photographic equipment. Set of three books. Volumes 1, 2 and 3 (588 interesting pages) \$1.47. Single volumes 50c each.

### □ SHOP NOTES

Popular Mechanics annual mechanic's guide. For every man who uses tools. Few of subjects covered are lathe operation, drafting, shop practice, using hand and power tools, welding, autos, electricity, time and money-saving photographic equipment. Set of three Notes for 1942, 1941, 1940, 1939) \$1.95. Single volumes 50c each.

### □ THE BOY MECHANIC

The book for your boy—for any boy. Tells how to build midget auto, boats, models, games, craftwork. Hundreds of pictures. \$2.00.

## POPULAR MECHANICS PRESS

Room 420 • 200 East Ontario St., Chicago

SEPTEMBER, 1942

## ONAN ELECTRIC PLANTS ALTERNATING AND DIRECT CURRENT



Produce Current, same as City Power Lines, for FARMS, SCHOOLS, THEATRES, PUBLIC BUILDINGS . . . Operate Lights, Radios, Motors, All Appliances.

Over 40 STOCK MODELS—150 to 50,000 Watts.

Any Voltage—Any Frequency.

Combinations A. C. - D. C. Types.

Manual, Full Automatic and Self-Starting. \$79 up.

Shipped—COMPLETE, READY FOR OPERATION.

THOUSANDS IN USE IN ALL PARTS

OF THE WORLD

Write for Complete Details.

D. W. ONAN & SONS

1073 Royalston Avenue • MINNEAPOLIS, MINN.

## BRUSH PLATING OUTFITS

for autoparts, reflectors, faucets, bicycles.  
No tanks necessary. Free particulars.

GUNMETAL CO., AVE. M, DECATUR, ILLINOIS

## HANDY MAIL LIST ORDER Little Library of USEFUL INFORMATION

5 for \$1.00 • 12 for \$2.00 • 25c Each

Rewinding & Servicing Electric Motors—75  
Fitting Home Game Room—55  
Homemade Power-Driven Saws—74  
Drill Presses, Plane, Grinders—79  
Sanders (8 types)—80  
How to Read Blueprints—71  
Built-In Fixtures—78  
Lawn and Garden Novelties—72  
Trellises, Pergolas, Fences—76  
Lawn & Garden Furniture—77  
Playground Equipment—73  
Magazine Backs—49  
Clock Cases—50  
Serving Trays for Every Occasion—53  
Children's Room Furniture—51  
Small Tables—54  
Smoking Stands—56  
Jigsawed Novelties—57  
Desks—58  
Book Cases—59  
Doll House & Doll Furniture—60  
25 Shelves You Can Make—64  
Novelties Turned on Lathe—62  
Inlay Pictures—Veneering—63  
Whittling and Wood & Soap Carving—65  
Action Toys—66  
High Flying Kites—67  
Windmills & Weathervanes—68  
Lamps in Wood, Metal, Plastics—69  
Photo Enlargers—1  
14-Ft. Outboard Runabout—2  
Secrets of Electroplating—3  
Colored Concrete Garden Furniture—6  
Building Arc & Spot Welders—5

Radio-Type Treasure Finder—13  
Bird Houses—7  
Farm & Garden Tractors—8  
Taxidermy—9  
Money Saving Auto Kinks—10  
Make Own Cleaning Preparations—11  
Cosmetic Formulas—12  
Log Cabin Construction—14  
Food Products Formulas—15  
Soldering and Brazing—17  
Home Work Opportunities—19  
Building 4-in. Telescope—20  
Metal Plating & Coloring—21  
Fast Ice Yacht—22  
Extra Rooms in Attic—23  
Basement Playrooms—24  
Photo Printer and Dryer—25  
14-FL. Sailing Dinghy—26  
Utility Trailers—27  
Metal Craft—28  
Magic for Everybody—29  
Canoe, Kayak, Surfboard—30  
Lower Your Fuel Cost—31  
Wood Turning—32  
Trapping Small Animals—33  
Motor-Driven Midget Car—31  
Training Your Dog—35  
Electric & Gas Furnaces—36  
Making Money with Hand Looms—37  
Hanging Wallpaper—38  
Backyard Gardening—39  
Wood Finishing—40  
Gem Cutting—42  
The Boy Electrician—43  
Curing Leaky Basements—45  
Workbenches & Tool Cabinets—47  
Building 21-Ft. Sloop—46

Check Titles Wanted, Write Name and Address in Margin and Mail to  
POPULAR MECHANICS PRESS, Dept. 418, 200 E. Ontario St., Chicago

# PAY-RAISING — EXTRA MONEY BOOKS

Use these books to prepare for a better job—bigger pay—to start a profitable spare time or full time business of your own. Popular Mechanics specializes in supplying outstanding books on many subjects. As new books of merit appear, we will revise this list.

- PHOTO GUIDE**  
Construct own equipment, gadgets. Make better photos... **\$1.50**
- MODERN WELDING PRACTICE**  
Very latest information on all kinds of welding... **\$3.50**
- HOW TO READ TECHNICAL BLUEPRINTS**  
New self-study book... **\$3.00**
- GARDEN BOOK**  
Build own trellises, lawn furniture, fireplaces, ornaments, etc... **\$1.00**
- FORTY POWER TOOLS**  
Build own saw, drill, lathe, sander, etc. from scraps—save money... **\$1.25**
- SHOP NOTES LIBRARY**  
Four big volumes including new 1943 edition (224 pages—28 in color); over 1900 articles on money-making & money-saving ideas... **\$1.95**
- WELDING, BRAZING AND SOLDERING**  
How to build and use arc, spot welders; tricks of soldering... **\$1.25**
- RUNNING A MILLING MACHINE (new)**... **\$1.50**
- HOW TO TRAIN SHOP WORKERS (new)**... **\$1.25**
- AUTOPOWER**  
Convert old auto generators into motors, welders, etc... **\$1.00**
- PRACTICAL SHIP PRODUCTION (new ed.)**... **\$3.00**
- TOOL DESIGN**  
New book on production tools... **\$4.50**
- TIN SMITH'S HELPER**  
Seams, piping, gutters, etc... **\$3.00**
- MODERN REFRIGERATION**  
Electric, gas. Be service expert... **\$5.00**
- AUTO BODY AND FENDER REPAIRS**  
Shows how to do professional job... **\$3.00**
- DYKE'S AUTO ELECTRIC PEDIA (includes Diesels, airplane engines)**  
World's greatest book for mechanics... **\$6.00**
- SHEET METAL WORK**  
Self instruction in all phases... **\$2.50**
- ARMATURE WINDING**  
Construction, winding, repairing AC & DC Motors, generators... **\$2.00**
- BUILD YOUR OWN BOAT**  
Describe 17 popular boats—rowboats, sailboats, plywood outboard, etc. 192 pages... **\$1.25**
- FORGING PRACTICE**... **\$1.50**
- HIGH SCHOOL SELF TAUGHT**  
4 yr. course in one vol... **\$1.89**
- CARPENTRY & JOINERY**  
Learn modern methods... **\$2.00**
- FOUNDRY WORK**... **\$2.00**
- WHAT TO MAKE**  
3 Big Books, 588 pages of popular handicraft projects... **\$1.47**
- PRACTICAL FURNITURE FINISHING**... **\$1.25**
- MACHINE SHOP WORK**  
Modern methods, construction, use of tools, machines... **\$2.75**
- BLUEPRINT READING**  
For machine trades... **\$1.50**
- BLUEPRINT READING**  
For building trades... **\$1.25**
- PAINTING & DECORATING**... **\$1.50**

- PATTERN MAKING**  
Wood, metal... **\$2.00**
- MILLING-MACHINE INDEXING (new)**... **\$1.50**
- TOOL MAKING**  
For beginners, advanced workers... **\$3.50**
- FIVE ACRES AND INDEPENDENCE**  
How to make money on small farm... **\$2.50**
- KNOTS, TIES, SPLICES**  
For everyone who uses rope... **\$1.00**
- LATHE TRAINING**  
New book... **\$1.35**
- ELECTRIC WIRING**  
Includes estimating and new code... **\$2.50**
- HOUSE CONSTRUCTION**  
Gives every step in House construction... **\$2.89**
- MACHINISTS' AND TOOL MAKERS' HAND BOOK**  
New 1600-page book... **\$4.00**
- FORD V8 CAR AND TRUCK**  
Repairing, operating... **\$3.00**
- 1001 WAYS TO USE CONCRETE**  
Do work for yourself, others, save, make money... **\$1.98**
- OIL BURNER HANDBOOK**  
New book takes guess work out of servicing... **\$2.50**
- STEEL SQUARE POCKET BOOK**  
Best methods of using... **\$1.00**
- DE LUXE SMALL HOMES**  
New plan book shows 210 popular designs... **\$1.00**
- MODERN HOMECRAFT**  
New 230 page book on modern furniture... **\$3.00**
- YOUR CAR**  
New 192-page auto-owners guide describes hundreds of simple car repairs, shortcuts, how to operate car economically... **\$1.25**
- ARCHITECTURAL DETAILS**  
For every type of building... **\$1.50**
- CHEVROLET CAR & TRUCK**  
How to repair all models... **\$3.00**
- EASY-TO-MAKE TOYS**... **\$1.85**
- PRACTICAL BRICK LAYING**... **\$1.75**
- WELDING, ELECTRIC**  
Forge, thermostat, resistance, arc... **\$1.25**
- WELDING, OXY-ACETYLENE**  
Welding, cutting... **\$1.25**
- METALWORK**... **\$1.50**
- FLOUORESCENT LIGHTING**  
New manual on construction, installation, repair... **\$3.00**
- SIGN PAINTING**... **\$3.00**
- AUDELS DIESEL ENGINE MANUAL**... **\$2.00**
- TECHNICAL BULLETINS**  
Simplified data for Practical Men
- SILVER SOLDERING AND BRAZING**... **\$1.00**
- REWINDING ELECTRIC MOTORS**... **\$1.00**
- FLEXIBLE MOLDS FOR CASTING NOVELTIES**... **\$1.00**
- WORKING WITH PLASTICS**... **\$1.00**
- MIRROR SILVERING**... **\$1.00**
- SMALL ELECTRIC LIGHT PLANTS, CONSTRUCTING**... **\$1.00**
- HEAT TREATMENT OF IRON AND STEEL**... **\$1.00**
- DESIGNING AND BUILDING TRANSFORMERS**... **\$1.00**

★ ★ ★

## MAKE YOUR OWN POWER TOOLS at Low Cost from old Auto Parts, etc.



**New Book Will Save Hundreds of Dollars Shows How to Make Forty Tools**

Now you can have a good lathe, drill press, circular and band saw and other power tools in your home workshop, at a cost of only a few dollars each. Make them yourself from old auto parts, discarded sewing machines and other odds and ends that cost little or nothing. Get this new book—"Forty Power Tools You Can Make." Costs only \$1.25 postpaid. This book gives every detail in plain language you can understand and follow. Hundreds of pictures and plans show every step to follow in making the power tools you want. Actual photographs of finished machines included. Send \$1.25 today. Money back if not satisfied.



**MAKE EVERY POWER TOOL NEEDED IN YOUR HOME WORKSHOP**

Some of the power tools you can make are:

2 Band Saws	2 Drill Presses
9 Sanding Machines	1 Scroll Saw
2 Circular Saws	2 Wood Turning Lathes
1 Metal Lathe	3 Grinders
1 Power Hack Saw	1 Shaper or Moulding Machine
1 Jig Shears	1 Vibrating Pencl
1 Cut-Off Wheel	and others

Information too, about pulleys, belts, motors and drive methods. Just published. No other book like it. Order today.

## POPULAR MECHANICS PRESS

Dept. 416 • 200 E. Ontario Street, Chicago

## Famous SHOP BOOKS

4 VOLUMES (While They Last) ONLY \$2

USEFUL IDEAS BOOK Given Free



**Sent for 5 DAYS EXAMINATION Money Refunded if not Satisfactory You Keep the FREE BOOK**

Here are hundreds of money-making, time and labor saving ideas you can use. The Shop Notes Library will help you on your job in hundreds of different ways. If you do machine shop work of any kind, sheet-metal work, painting, carpentry, auto repairing, concrete work, plumbing, electrical work, welding, building, glass work, general repairing, tool-making, masonry or home repair work, you need the Shop Notes Library. Order today while supply lasts. Four big books including the 1942 volume—500 pages. 1500 helpful articles—only \$2.00 postpaid.

**ACCEPT THIS GIFT**

Send two one-dollar bills with coupon below or pay postman anywhere in U.S.A., plus few cents charges on delivery. We will include "USEFUL IDEAS," a 100 page book, with hundreds of illustrations and 304 useful and helpful ideas FREE. Examine the Shop Notes Library for 5 days and if you don't like it return books and we will refund your entire payment, but you keep the Useful Ideas book as a gift from us. Hurry! We have only limited supply of some volumes. Mail coupon today.

Rush the Shop Notes Library, 4 volumes and Free Book, "Useful Ideas." If I return Library in 5 days and keep the free book you will refund full amount paid.  I enclose \$2.00.  I will pay postman on delivery.

Name .....

Address .....

City .....

State .....

Mail to POPULAR MECHANICS PRESS, Dept. 419, 200 E. Ontario St., Chicago

## MAIL THIS COUPON TODAY

Just check the books you want, write your name and address below, and mail this advertisement. It is your order blank. When postman hands you books, pay him the price and few cents postage. Outside U. S. A. enclose remittance and include 15% additional for shipping charges. Ask for big FREE catalog of helpful books.

Name .....

City .....

Address .....

Mail to Popular Mechanics Press  
Dept. 415—200 East Ontario St., Chicago, Ill.



# NOW a DYNAMIC HEAVY DUTY INDUSTRIAL WELDER



Works off 110 volt electric light circuit. For this unheard of price you can get the marvelous Dynamic Super-Charged Welder complete—ready to plug into light socket. The Dynamic does both metallic and carbon arc welding. You can also solder and braze on the lightest material.

**for Only \$195**

**EASY PAYMENTS**

Works on Iron, Steel, Tin, Brass, Copper and All Other Metals

With our free instructions you can in no time do finished repair jobs. **BIG PAY IN BOOMING WELDING INDUSTRY** Once you have the Dynamic outfit, you are all set in this profitable field. In a year a Dynamic Welder costs you Less Than 6c a Day. Write for FREE particulars TODAY.

**DYNAMIC WELDER CO., 2226-UF, Silverton Road, Chicago, Ill.**

## WELDS BUMPERS, FENDERS, CYLINDER BLOCKS, BODIES, FRAMES, ETC. Does Farm, Factory and Home Repairs

Every Farmer should have a Dynamic Welder for machinery and home repairs. The Dynamic is light and easily portable. **IT SAVES TIME AND MONEY.** You can make big money doing repair jobs for others.

**AGENTS WANTED!**  
Get our big profit plan and 10-day trial offer. Send for it TODAY.

### BUILD YOUR OWN SHAW Victory GARDEN TRACTOR

OUR COMPLETE PLANS tell you how to build a sturdy garden tractor with many features of the famous SHAW DU-ALL and PEPPY PAL. Built chiefly by welding and bolting up scrap steel. Powered by engine from washer, mower, etc. Will do light plowing, cultivating, other garden work. Plans tell how to build several types; give illustrated, step-by-step instructions; easy for mechanically minded person to follow. Mail \$1.00, name and address today for complete plans!

SHAW MFG. CO., 4709 Front St., Galesburg, Kans. 668-G No. 4th St., Columbus, Ohio; 5812-G Magnolia Ave., Chicago, Ill.



**Wonder-Tone NOISE ELIMINATOR**  
Just attach to your radio (long, short wave) and enjoy reception free from distracting noises. Send No-Money Pay Postman 60c plus postage or send 60c and we'll send postpaid. Return in 5 days for refund if not delighted.

WONDER-TONE COMPANY, Dept. 20, 7078 N. Clark St., Chicago, Ill.

### Aviation Type AUTO COMPASS

**only \$7.00**

**SAVES TIRES AND GAS**

With a critical gas and tire shortage, be sure you are driving the right direction. You won't go wrong with this professional Aviation Type Instrument. 100% Jewel Bearing. Direct reading. Guaranteed. Swank, molded plastic case. Installed permanently in few seconds. No tools needed. Fingertip compensators. An auto or small boat necessity, especially in these times. Sensational bargain. Only \$1 postpaid if you send cash with order. If C.O.D. \$1 plus postage. Order direct. Dealers write.

Dept. 942 **SHERRILL RESEARCH CORPORATION** Peru, Ind.



### MONUMENT

Genuine Granite or Marble, \$10.95 UP. Order Direct By Mail and save. Don't wait. **U. S. MARBLE & GRANITE CO., A-18, Oneco, Fla.**

**BIG FREE CATALOG**

Freight Paid anywhere in U.S.A. Lettered. Guaranteed. Free Catalog & samples of stone.

### WITTE DIESELECTRIC PLANTS

Your present power bill will buy a WITTE that produces power and light for 1c a K.W.H. Save up to 75%. A Size for Every Need. Write today for finance plan, literature and name of dealer.



**WITTE ENGINE WORKS, 1746 Oakland Ave., Kansas City, Mo.**

### MONEY IN RABBITS — CAVIES

**WE BUY** and put you in touch with other markets. Catalog and copy of magazine 10c. Or send 25c for Book Catalog and Price List and Year's Subscription to the **AMERICAN SMALL STOCK FARMER**.

**OUTDOOR ENTERPRISE CO., BV 919, PEARL RIVER, N. Y.**

### METAL AND WOOD WORKING MACHINE TOOLS

**walker-turner**

Send for new **FREE** catalog of complete line of Machines, Motors and Accessories

**WALKER-TURNER CO., INC. • 152 Berckman St., Plainfield, N. J.**

### Money Making Pay Raising BOOKS Catalog FREE

Send Name and Address Today

Selected books covering all trades, office helps, home workshop, spare time work, hobbies, etc. Learn how to earn more. Write today.

**Popular Mechanics Press**  
DEPT. 421  
200 E. Ontario St.  
CHICAGO



### 4000 BARGAINS IN FREE 260 Page CATALOG

Shows money makers for dealers, agents and salesmen. Articles desirable for the home, office, factory or store are displayed for your selection. Satisfaction guaranteed or your money back. Get your copy, now, as supply is limited.

**SPORS CO., 7-42 National, LE CENTER, MINN.**

### BUILD a BOAT



**FOR PLEASURE OR PROFIT NEW BOOK — 17 LOW COST BOATS**

Get this brand new book and build a boat at home for your own use or to sell at a profit. You can do it. Just the boat you've always wanted—power, sail or row boat—17 different kinds and sizes.

Order **BUILD A BOAT** on postal card and pay only \$1.25 plus postage on delivery. Return in 6 days if not pleased and get money back. Or send \$1.25 with order. (Outside U. S. \$1.45 with order.) Order today.

**POPULAR MECHANICS PRESS**  
Dept. 422, 200 E. Ontario St., Chicago

Row Boat—12 Foot  
Dinghy—8 Foot  
Dinghy—14 Foot Sailing  
Training Ship—6 Foot  
Sea Sled—5 Foot  
Outboard—12 Foot  
Cruiser—18 Foot  
Bicycle Boat—Kayak  
Row Boat—Sailing  
Canoe—15 Foot  
Sailing—12 Foot  
Outboard—Runabout  
Pontoons—Ice Yacht

### DO YOU

WANT a permanent business profession of your own? Then **BECOME A FOOT CORRECTIONIST.** Earnings in this greatly needed profession run as high as \$50-\$100 weekly after a few weeks home training—no medical or chiropody—no further capital needed, no goods to buy, 47th year. Write for free booklet.

**Stephenson System of Foot Correction**  
28 Back Bay, Boston, Mass.

### WORLD'S LOWEST PRICED ADDING MACHINE

**FREE TRIAL ONLY \$250**

**IDEAL FOR BUSINESS OR PERSONAL USE** GUARANTEED ACCURATE. Not a Toy. Operates with only a finger flick. Adds, subtracts, multiplies, divides. Counts up to ten million. Pays for itself over and over. **Ideal Gift—** for Business, Income Tax and School use, **MONEY BACK GUARANTEE.** Send name and address. Pay postman only \$2.50 plus postage. (Send full cash if outside U. S.) Money back in 10 days if not delighted. **AGENTS WRITE.**

**CALCULATOR MACHINE COMPANY (Mrs.)**  
DEPT. 133 P. O. BOX 1118 CHICAGO, ILLINOIS





Awarded to the South Bend Lathe Works for outstanding performance in the production of ordnance material for the United States Navy.

16" Toolroom Lathe

No. 2-H Turret Lathe

# PRECISION

## FROM START TO FINISH

War production demands precision from start to finish—from toolroom to production shop. Without precision, the vast quantities of war supplies so urgently needed could not be produced in time—for efficient mass production is based on a degree of precision which permits the perfect interchangeability of thousands of duplicate units.

Because of their dependable precision, South Bend Lathes have long been favorites in the toolroom. For this same reason, plus a fatigueless ease of operation, they have been equally popular for manufacturing operations. And now South Bend Turret Lathes are stepping up production in shops of hundreds of war industries—with no sacrifice in precision.

South Bend Toolroom Lathes and Quick Change Gear Lathes are made in five sizes: 9", 10", 13", 14½" and 16" swings. South Bend Turret Lathes are made in three sizes: 900 Series, 1000 Series, and No. 2-H. Write for a catalog and the name of our nearest distributor.

**SOUTH BEND LATHE WORKS**  
 LATHE BUILDERS FOR 35 YEARS      Dept. 621, South Bend, Ind.



PRINTED BY POPULAR MECHANICS COMPANY, CHICAGO, ILL., U. S. A.

**AUDELS NEW  
MACHINISTS  
HANDYBOOK  
NOW READY!**

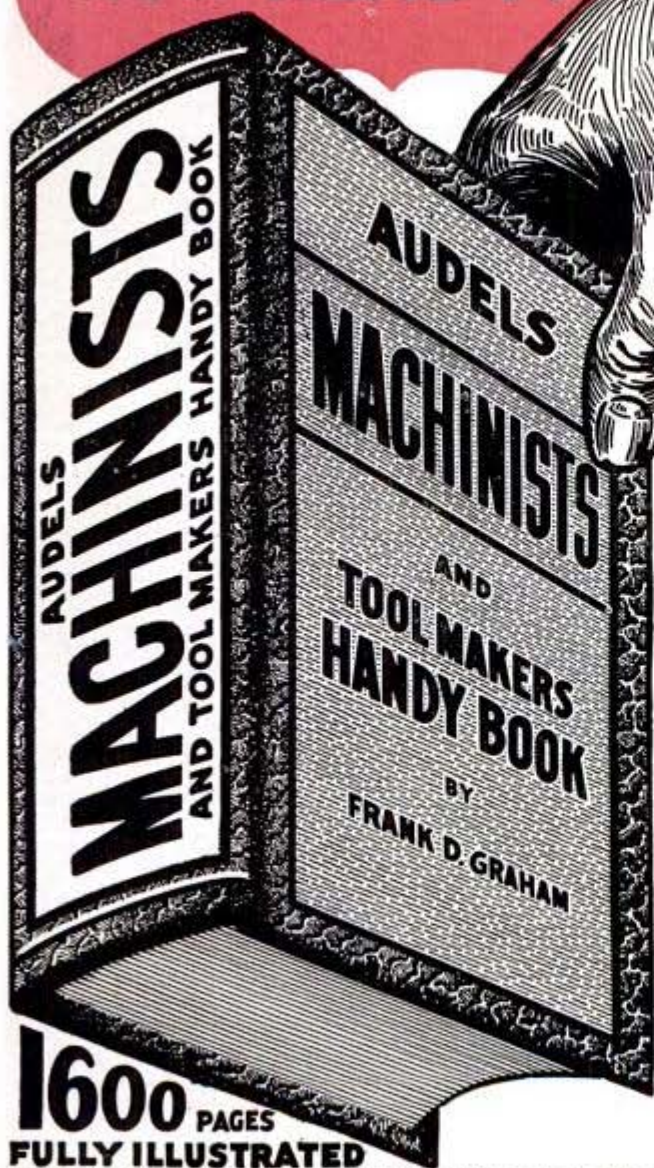

*Prepare!*

**A KEY TO  
MODERN SHOP PRACTICE**

**PRACTICAL INSIDE INFORMATION**

For Every Machinist, Toolmaker, Engineer, Machine Operator, Mechanical Draughtsman, Metal Worker, Mechanic or Student. This 1600 Page Handy Book Covers Modern Machine Shop Practice in All Its Branches.

**A COMPLETE INSTRUCTOR WITH  
READY REFERENCE INDEX**

New from Cover to Cover. Tells How to Operate and Set Up Lathes, Screw & Milling Machines, Shapers, Drill Presses & All Other Machine Tools.

**5 PRACTICAL BOOKS IN ONE!  
60 FULLY ILLUSTRATED CHAPTERS**

Covering: **1**—Modern Machine Shop Practice. **2**—Blue Print Reading and How to Draw. **3**—Calculations & Mathematics for Machinists. **4**—Shop Physics. **5**—How to Use the Slide Rule.

**ASK TO SEE IT!**

**THEO. AUDEL & CO., 49 West 23rd St., New York**  
Mail AUDELS MACHINISTS & TOOLMAKERS HANDY BOOK, Price \$4 on 7 Days Free Trial. If O. K. I will remit \$1 in 7 days and \$1 Monthly until \$4 is Paid. Otherwise I will return it.

Name \_\_\_\_\_  
Address \_\_\_\_\_  
Occupation \_\_\_\_\_  
Reference \_\_\_\_\_ P.M.

**1600 PAGES  
FULLY ILLUSTRATED**

**A SHOP COMPANION THAT ANSWERS YOUR QUESTIONS**  
Easy to read and understand—flexible covers—Handy size 5 x 6½ x 2—a ready reference that answers your questions accurately.

**TO GET THIS ASSISTANCE FOR YOURSELF SIMPLY FILL IN AND MAIL COUPON TODAY**

**\$4 COMPLETE  
PAY \$1 A  
ONLY 1 MO.**

**THEO. AUDEL & CO., 49 W. 23rd St., New York**

When Bombers are your Business — **YOU WANT STEADY NERVES**



**IMPORTANT TO STEADY SMOKERS:**

**GUN-RINGS FOR A BOMBER TURRET!** That's a job only for steady nerves. Consolidated riveter, Chilton Bass (right), smokes Camels. "They have the mildness that counts," she says. Yes, mildness means more than ever these days. Camel's slow burning means *extra mildness!*



The smoke of slow-burning

**CAMELS**

contains

**LESS NICOTINE**

than that of the 4 other largest-selling brands tested—less than any of them—according to independent scientific tests of *the smoke itself!*

R. J. Reynolds Tobacco Co.  
Winston-Salem, N. C.



**B-24 ASSEMBLY—** Marjorie Blackmore (with drill, at left) speaking: "It's always Camels with me. They're milder and more flavorful." *Wherever you hear it—that's what they mean when they say: "I'd walk a mile for a Camel!"*



**CAMELS ARE THE FAVORITE HERE, TOO. GRAND-TASTING AND EXTRA MILD**

★ **FIRST IN THE SERVICE...** ★

With men in the Army, Navy, Marines, Coast Guard, the favorite cigarette is Camel. (Based on actual sales records in Post Exchanges and Canteens.)

**...AND AT HOME**