

Alloys for the Allies

POPULAR MECHANICS

MAGAZINE

WRITTEN SO YOU CAN UNDERSTAND IT



U.S. TRADE MARK, GREAT BRITAIN, NO. 40426

REG. U.S. PAT. OFF.

AUG.
25 CENTS
30c IN CANADA

BUY UNITED STATES
WAR SAVINGS
BONDS AND STAMPS

"UNITED WE STAND"

YOU'RE "FOOLING YOURSELF" WHEN YOU NEGLECT REPAIRS



GET A PACKARD CERTIFIED RE-WIRING CHECK-UP TODAY



The electrical system in your car needs attention at regular intervals. You can avoid a lot of trouble by getting a Packard Certified Re-Wiring check-up today.

A Packard Certified Re-Wiring check-up is performed by a specially-trained mechanic using accurate instruments. He locates faulty wiring that can cause sluggish performance, hard starting, poor headlight illumination, gas wastage and fire hazard, and replaces it with new Packard cable of the correct gauge and type. He also checks for "bottle-necks" in the electrical units themselves, and makes necessary repairs or adjustments.

When your car has had a Packard Certified Re-Wiring check-up, it will be safer, run better. You can avoid more costly repairs later on, and protect your car from electrical breakdown, by stopping at a Packard Certified Re-Wiring station soon. Packard Electric Division, General Motors Corporation, Warren, Ohio.

Packard

REG. U.S. PAT. OFF.
TRADE MARK

"WORKING FOR VICTORY"

Packard manufactures electrical cable for military aircraft, tanks, trucks, tractors, scout cars, barrage balloons, gun turrets and bomb releases.

THE STANDARD WIRING EQUIPMENT OF THE AUTOMOTIVE INDUSTRY



Wanted: Future Faradays and Curies

ALL OVER AMERICA there are high school seniors . . . boys and girls . . . who have potential scientific ability and budding creative genius of a high order. These talents are latent . . . awaiting the opportunity for further development through higher education.

To provide this opportunity, Science Clubs of America, sponsored by Science Service, is now conducting an *Annual Science Talent Search* . . . made financially possible by Westinghouse. This Talent Search has three objectives:

- 1. To discover and foster the education of boys and girls of exceptional scientific skill and ability.**
- 2. To focus the attention of large numbers of gifted youth on the need for perfecting their creative and research skill.**
- 3. To help make the American public aware of the role of science in war and in the post-war reconstruction.**

High school seniors, who enter the Science Talent Search competition, must take special examinations in their local schools to determine their aptitude for science, and must submit essays and school records.

Each year, forty winning contestants are to be given all-expense trips to Washington, D. C. While at the Nation's Capital, these embryo scientists will take part in scientific programs and will be given additional tests.

Judges will then select the two most talented youngsters . . . a boy and a girl . . . who will be awarded Westinghouse Grand Science Scholarships of \$2400 each. Additional Westinghouse Science Scholarships . . . each valued at \$200 . . . will be given to eighteen contestants.

By aiding the education of these gifted boys and girls today, we hope to help develop the scientists of tomorrow who will lead the way in the advancement of research and engineering.



Westinghouse

WESTINGHOUSE ELECTRIC AND MANUFACTURING COMPANY, PITTSBURGH, PENNSYLVANIA

Be Calm Courteous Effective

Right now, when times are tense and everybody is under strain, "The Voice with a Smile" is more important than ever.

We've all got a big job to do and the friendly, effective use of the telephone helps every one do it faster and better.

The calm way is usually the competent way. Being courteous usually means saving time and tempers all along the line.

BELL TELEPHONE SYSTEM



"THE TELEPHONE HOUR"— presenting great artists every
Monday evening — N. B. C. Red Network.



Popular Mechanics Magazine

Registered in U. S. Patent Office and Canada

H. H. WINDSOR, Founder

H. H. WINDSOR, Jr., Editor and Publisher

August, 1942

Vol. 78, No. 2

IN THIS ISSUE

Production Line—the Road to Victory	1
Broadway Blackout	8
Alloys for the Allies	17
College for Police Horses	26
Uncle Sam Digs In	34
Decade of the Dam Builders	40
The Iron Horse Delivers the War Tools	50
Teamwork in a Tank	56
If You Can Drive You Can Fly (Part 3)	66
Keeping Our Sailors in Trim	72
There's Money in Honey	82
They Play Jackstraws With Trees	88
Fighting Fire With Magic	92

Where-to-Buy-It Index Starts on Next Page

Shortcut to Tokyo

A CROSS 1,200 miles of Canadian wilderness a terrific battle is being waged. Swarms of man-eating flies and mosquitoes attack by air; uncharted mountains and marshes impose obstacles that would throw back any invader less determined than U. S. Army Engineers. It was easier when the men, tenting in 40-below-zero weather, could drive snow trains over the ice. Now bulldozers skim the crust of the muskeg to wallow in bottomless ooze, and axes hew a path through miles of forest. America's "Burma road" to Alaska furnishes an important story in September.

It's the Spares That Count

WITHOUT a single miss or split, Tony Monteverde rolled nine games for a total of 1,856 pins in the 1941 American Bowling Congress tournament. His genius is based on deadly accuracy in making spares. Now this famous Hollywood coach has set down in story and pictures his best advice for improving your game. Read "It's the Spares That Count," next month.

Next Month

YOU think gasoline's pretty important when you drive up to a filling station. That's only a drop in the whole oil field. Petroleum furnishes wool oil for uniforms, asphalt for airports, lacquers for camouflage and ointments for the medical corps. It greases the fins of submarines and is the base of nitroglycerine and TNT. It waxes your paper milk carton, provides the smell that tells you the gas stove is leaking. In fact, it oils the harness of civilization. This is just a taste of a September feature, "New Wonders of Petroleum."

Girls in Overalls

SEVERAL wars ago Betsy Ross set the style for women's war work by sewing a flag. There is still room for seamstresses in a modern war; they're sewing barrage balloons and rubber rafts and a few million uniforms. But the girls do heavier duty today. You find them bucking rivets in a bomber, shearing metal in a shipyard and running a ten-ton press. Meet the girls in overalls next month—the first of 6,000,000.

Machines in Color

DON'T think big machines are drab. Next month we present in true colors some of the vast implements of war and equally vast tools that turn them out—a 40,000 horsepower fan, a submarine engine cylinder block thrice as tall as a man, a 30-ton steel shaft being grooved with a jeweler's precision. See "Big Machines for the Big Task," the next Coloroto feature.

Published monthly by POPULAR MECHANICS COMPANY, 200 East Ontario Street, Chicago, U. S. A. Single copy in the United States, 25 cents; subscription rates in United States and possessions, and countries of the Pan-American Postal Union including Spain, \$3.50 a year. Single copy in Canada, 30 cents; subscription rates, \$3.00 a year. To all other countries add \$1.00 a year over United States prices for overseas postage. Changes in address must be reported to us immediately to eliminate delay. Entered as Second Class Matter, Sept. 15, 1903, at the Post Office at Chicago, Illinois, under Act of March 3, 1879. Entered as Second Class Matter at Post Office Dept. Canada.

Copyright 1942, by Popular Mechanics Company, Copyright under International Copyright Union. All rights reserved under Pan American Copyright Union. Printed in the United States of America

YOUR CAR HAS A JOB TO DO



Increase Your Gasoline Mileage—Help Your Car "Ride Out" The Emergency

The car you own has become vital to America. It has a job to do for the duration, second to no other. It must outlast the emergency.

With proper care, your car can serve dependably. It can be made to give you increased mileage for every gallon of gasoline you use! The kind of care you give your car, will determine this.

Pyroil has been found to markedly increase gasoline mileage—because it is an engine conditioner and performance booster. Pyroil provides an unusual protection factor for all moving parts of the engine—pistons, cylinder walls, valves, bearings, shafts. It reduces wear; keeps parts operating smoothly and safely. It cleans your engine of power thieves, like carbon, sludge and gum. It prevents dangerous acid-corrosive attack that scuffs the metal.

So treat your car with Pyroil today, for the job it has to do. Only a few ounces in crankcase and gasoline tank are needed. But, use it every mile you drive!

Mail the coupon below if you would like further interesting and important facts. Manufactured and Guaranteed by Pyroil Company, W. V. Kidder, Founder, 58 Pyroil Bldg., LaCrosse, Wisconsin, U. S. A.



IN THE WAR PRODUCTION PLANT, AND ON THE FARM—Pyroil renders the same vitally important safety factor in the operation of all machinery, motors, engines and equipment.



ADD MERELY OUNCES TO GAS TANK & CRANK CASE

DISTRIBUTORS: CHECK AND MAIL COUPON FOR FRANCHISE FACTS.

PYROIL COMPANY
58 Pyroil Bldg., LaCrosse, Wisconsin

Please send me further interesting and important facts regarding Pyroil's effectiveness in the operation of car engines, machinery and equipment.

Send details of Plan for Distributors.

Name.....

Address.....

City..... State.....

"KEEP 'EM ROLLING!"

WHERE-TO-BUY-IT INDEX

Where no name and address appear directly under an item, the product is not believed by us to be commercially available

Life raft holds 30 persons.....	5
Sculler Safety Corp., 118 Broad St., New York City	
Shopping bag snuffs out bomb.....	5
Coal tar pitch: G. F. Pettinos, 1206 Locust St., Philadelphia, Pa.	
Spray quells bomb quickly.....	6
Battleship uses 75 tons of rubber.....	6
Cheesecloth makes windows shatterproof.....	6
The Arabol Mfg. Co., 110 E. 42nd St., New York City	
Fighter guns spray fireworks.....	7
U. S. Army uniforms for any weather.....	7
Double-deck trailer ambulance.....	14
Cargo plane built of wood.....	14
Air raid shelter made of timber.....	14
Solid Timber Products Co., 101 Park Ave., New York City	
Blackout aids.....	15
Mine-layer drops 300 per hour.....	16
Flying ambulance of future.....	16
Piper Aircraft Corp., Lock Haven, Penna.	
Hollow rivets that "pop".....	25
United-Carr Fastener Co., Ltd., Hamilton, Ont., Canada	
Model house has glass floor.....	25
A. M. Byers Co., Clark Bldg., Pittsburgh, Penna.	
Meat tenderized by pineapple juice.....	25
Linoleum map on ceiling.....	31
Armstrong Cork Co., Lancaster, Penna.	
Instrument training in monoplane on ground.....	31
Bomb shovel smothers bomb with sand.....	32
Industrial Maintenance Eng. Co., 724 S. Spring St., Los Angeles	
Electric-pulled trailers carry workers.....	32
Mercury Mfg. Co., 4044 S. Halsted St., Chicago	
Enlarged models of paint crystals.....	32
Krebs Pigment & Color Corp., 1007 Orange, Wilmington, Del.	
Zoo keepers drill for air raids.....	33
Zip for long-eared dogs.....	33
Vaughan's Seed Store, 10 W. Randolph St., Chicago	
"Whirlwind" fighter plane.....	38
Shells may fly by own power.....	38
Mechanical pencil with electric pointer.....	38
TEC Pencil Co., 9381 Olympic Blvd., Beverly Hills, Calif.	
Toys save cars in movie crackups.....	39
Plastic flashlight.....	39
Gits Molding Corp., 4600 W. Huron St., Chicago	
Gas driven "kiddie car".....	45
Six-foot rule built in flashlight.....	45
Giffords, Inc., 136 Roosevelt Ave., Flushing, N. Y.	
Puffed-up sand for insulation.....	45
Fishing for 10,000,000 dollars.....	46
Minnows kept alive in pail.....	48
V. L. & A., 9 N. Wabash Ave., Chicago	
Sponge mop and drainer.....	48
Minute Mop Co., 2227 S. Calumet Ave., Chicago	
Bicycle has wood frame.....	48
Electric test for cancer.....	48
Air raid equipment in small train.....	49
Chutist frees self as he hits water.....	49
Telephone holder leaves hands free.....	54
Horder's, 231 S. Jefferson St., Chicago	
Using flashlight safely in blackout.....	54
Hooded flashlight:	
F. W. Woolworth Co., 520 N. Michigan Ave., Chicago	
Shield for any flashlight: The Emeloid Co., Arlington, N. J.	
Piston-ring pressure found.....	54
Toledo Scale Co., Toledo, Ohio	
Fuel oil piped to homes.....	54
Fluid Meters, Inc., 60 Wall Tower, New York City	
Rubber ponton carries army over rivers.....	55
Snow roller for airport runway.....	55
Transparent electric cable.....	55
Irvington Varnish & Insulator Co., Irvington, N. J.	

(Continued to page 6A)

AUTO-LITE SPARK PLUGS

Presents the *MOUNTAIN BOYS* by P. W. E. B. D.



"SHECKS, ONCLE TIGE--IT'S STILL TOO DERN GOOD FER THE HAWGS --- WITH SOME WHEELS ON 'ER AN' A FEW NEW AUTO-LITE PLUGS SHE'D RUN LIKE A DAISY"

GET "LIKE-NEW" PERFORMANCE FOR SPARK WEARY ENGINES...

The Mountain Boys are right—these days cars must be kept in service. Car owners find new Auto-Lites give flashing pick-up and power, restored gas economy to spark-weary engines. To discover if your present plugs are the reason for hard starting, lack of power, ask for a "Plug-Chek." Simply cleaning and regapping your present plugs often makes your car run like new.

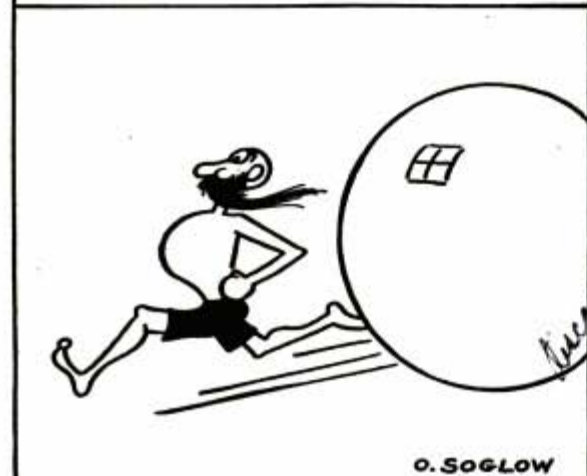
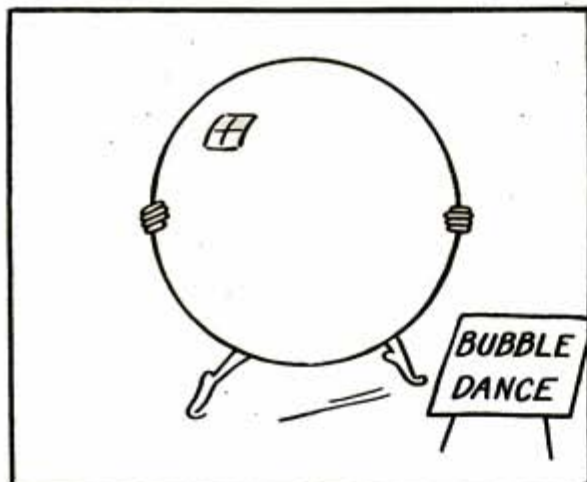
THE ELECTRIC AUTO-LITE COMPANY
Toledo, Ohio • Merchandising Division • Sarnia, Ontario

In its 26 Great Manufacturing Divisions, Auto-Lite is Producing for America's Armed Forces on Land, Sea and in the Air



Color and condition tell if plugs are operating properly. Matching your plugs with those illustrated on the "Plug-Chek" is the first step in getting new life for spark-weary engines.





Purity...
in the big big bottle
...that's **PEPSI-COLA**

(Continued from page 4A)

Film projector and shadow box.....	60
Spencer Lens Co., 19 Doat St., Buffalo, N. Y.	
Twin radio spots planes.....	60
Paper cut-outs of pilot's hands.....	60
Two trucks haul 37-ton girder.....	61
Molds for ice box cookies.....	61
Carson Pirie Scott & Co., State and Monroe Sts., Chicago	
Maize is tapioca substitute.....	61
Who says there's nothing new?.....	62
Plane carrier on Great Lakes.....	64
Pilots have two-way vision.....	64
Biscuit dough cutter.....	64
Marshall Field & Co., State and Randolph Sts., Chicago	
Air-borne infantry loads plane mockup.....	65
Plants need daily temperature change.....	65
Scoop smothers bomb with sand.....	70
Globe Machine & Stamping Co., 1250 W. 76th St., Cleveland, O.	
Locking wheel nut prevents tire theft.....	70
Auto Wheelox Co., 461 Eighth Ave., New York City	
Sulfa drug for whooping cough.....	70
Wall rack for garden hose.....	70
Stebbins Hardware Co., 15 W. Van Buren St., Chicago	
Oven inspector rides tricycle.....	71
Huge building camouflaged.....	71
Pipe cleaner kept in stem.....	71
Briarcraft, Inc., 347 Fifth Ave., New York City	
Army rescue plane drops rubber boat.....	76
Cellulose may aid in making explosives.....	76
Tiny lamp made from battery.....	76
Dry cell lamp: Marks Products, 80 N. Ninth St., Brooklyn N. Y.	
Flashlight battery lamp:	
Elkay Mfg. Corp., 200 Fifth Ave., New York City	
Girls tested for ambulance driving.....	77
Soilless seed germinator.....	77
Servicised Products, 6051 W. 65th St., Chicago	
Training Scouts for war work.....	78
Clay underlay slabs for lawns.....	80
Servicised Products, 6051 W. 65th St., Chicago	
Venetian blind brush fits vacuum cleaner.....	80
H. B. Dodge & Co., 332 S. Michigan Ave., Chicago	
Stencils for scientific drawings.....	80
Biological stencil:	
Fisher Scientific Co., 711 Forbes St., Pittsburgh, Pa.	
Chemical stencil: E. H. Sargent, 155 E. Superior St., Chicago	
Locomotive heats new factory.....	81
"Beep" joins army as courier.....	81
Emergency "minute wheel" saves flat tire.....	86
Drill attachment cuts sheet metal.....	86
E. W. Timper & Associates, Inc., Tyler, Texas	
Wire connector for auto ammeter.....	86
Cole-Hersee Co., 54 Old Colony Ave., South Boston, Mass.	
Moisture in glass refuses to evaporate.....	86
First-aid kit for home.....	87
Two-wheeled sickle bar mower.....	87
Moto-Mower Co., 1045 Washington St., Chicago	
Milk truck has wooden tires.....	90
Hose reel installed indoors.....	90
Zierden Machine & Mfg. Co., St. Francis, Wis.	
Twin vase made by hammering.....	90
Portable wheel-alignment gauge.....	91
Snap-On Tools Corp., Kenosha, Wis.	
Homemade motor scooter.....	91
Marine pack takes load off back.....	96
Alcohol from steam of baking bread.....	96
Home kit applies color to fabrics.....	96
The American Crayon Co., Sandusky, Ohio	
Replacement speaker for battery sets.....	159
Quam-Nichols Co., 33rd Pl. and Cottage Grove Ave., Chicago	
Speaker in wall installation.....	159
Jensen Radio Mfg. Co., 6601 S. Laramie Ave., Chicago	
Speaker field supply unit.....	159
Jensen Radio Mfg. Co., 6601 S. Laramie Ave., Chicago	
French varnish kit.....	159
General Cement Mfg. Co., Rockford, Ill.	

(Continued to page 8A)

WARTIME OPPORTUNITIES for You in ACCOUNTING



Accounting faces an unusual situation during this war period. The need and demand for accountants—both beginners and experts—is increasing while the

supply is diminishing. That spells opportunity for many—perhaps for you.

The reason is simple.

Government needs more accountants. Many new activities are enlarging old bureaus and creating new ones—military, supplies, taxes, priorities, social security, price regulation, more indeed than we can name here.

Industry needs more accountants. New plants, enlarged plants, conversion to war production, more government regulations and reports, taxes, priorities, etc.—all call for more and better records.

This need will persist and increase all during the war—it will open many, many fine jobs, fine both in responsibility and pay. Nor will it end sharply with peace—it will continue through the difficult post-war adjustment period.

Yet many present accountants are going into the armed services. Their places and the calls for more accountants can only be filled by new men and women coming into accounting and coming quickly.

Can You Grasp This Opportunity?

That depends largely on you.

The opportunity is open most directly to women and to men not called to service (although we know of our accounting students given specialized duty and ranking in the army and navy).

If you are ambitious, willing to work hard in preparation and are at least average in mentality and education,

this opportunity to serve a national need and profit personally is open to you. It will take real work but the rewards will be correspondingly good.

We Can Help You

Through our interesting, practical training—developed in 34 years of training accountants—you can learn accounting from the ground up or from any point where you now are in accounting. You need not lose an hour from your present work. The cost will be moderate and the payment terms easy. Free placement aid. And soon—surprisingly soon—you will be ready for the simpler positions and on your way up.

Your first step is to investigate. Ask for our free 48-page booklet, "Accountancy, the Profession That Pays." It tells of the opportunities and requirements in accounting and describes how you can prepare for them. It can be your starting point towards real success and income. Send the coupon—today.

LASALLE EXTENSION UNIVERSITY A Correspondence Institution

Dept. 864-HR

CHICAGO

If Accounting has special opportunity for me, I want to know about it. Please send me your free booklet and full details about how I can prepare for this field.

Name.....Age.....

Present Position

Address

"Gas . . . or No Gas . . . I Can't Afford to Neglect the Finish"



Why Simoniz is Necessary in Preserving Your Car's Value

You'll want to buy a new car when Victory comes. What will the one you have be worth then? The value of any car will depend a lot on how it looks . . . so, Simoniz now!

You may not be driving much, but the finish should be Simonized regularly. Even in your garage, dust, moisture, and ultra-violet rays are constantly attacking the paint. Simoniz protects and preserves the finish . . . keeping your car beautiful for years.

Is Your Car Dull Now? Then clean first with paste or liquid Simoniz Kleener. It makes the finish sparkle like new. So, get Simoniz and Simoniz Kleener for your car today!

THE SIMONIZ COMPANY, CHICAGO, U. S. A.



(Continued from page 6A)

Portable amplifier with lapel microphone.....	160
Philco Radio & Television Co., Philadelphia, Penna.	
Electronic air-raid siren.....	160
John Meck Industries, 1313 W. Randolph St., Chicago	
Automatic entertainment unit.....	160
Allied Radio Corp., 833 W. Jackson Blvd., Chicago	

Craftsman and Shop Notes Index

AUTOMOTIVE

Turntable holds motors for repairing.....	137
Warning reflectors on truck door.....	143
Extension for car trunk.....	143
Hub caps loosened without marring finish.....	144
Pass card attached to windshield.....	144
Removing broken starter bolt.....	144
Catwalk around garage wall.....	144
Small-parts holder from old tire.....	144

CAMPING, HUNTING, FISHING

Fishhook kept from snagging.....	102
Rudder for outboard motor.....	104
Trotline reel on side of boat.....	110
Depth line for fisherman.....	110
Live-bait container aerated.....	113
Car-top carrier for fishing poles.....	116
Fishhooks held on pole.....	116

FARM

Yard pen for chicks.....	110
Window shade protects young plants.....	136
Checking amount of honey in beehive.....	138
Divider on mower sickle bar.....	138
Shield keeps plow wheel clean.....	145
Weeds kept from clogging cultivator shanks.....	152
Wire protects edge of feed box.....	154

HAND TOOLS

Holder for jigsaw blades.....	102
Cutting hole in plastered wall.....	105
Shingling hatchet held on roof.....	109
Combination square improved.....	109
Errors in tempering tools.....	151

HOUSEHOLD

Towel rack has positive grip.....	99
Outside porch-light keeps bugs out.....	102
Bale your waste paper.....	103
Making cut flowers last.....	104
One sash weight used on double window.....	109
Shower cabinet for the basement.....	119
Shoes held while shining them.....	120
Early American stool.....	121
Tool to stretch webbing.....	145

LAWN AND GARDEN

Motor driven rotary mower.....	105
Plants protected from cutworms.....	110
"Flying ducks".....	111
Portable lath house.....	117
Protecting small fruit trees.....	117
Fence-wire trellis for vines.....	118
Better traction for mower.....	120

OFFICE

Desk ruler improved.....	102
Date stamp and ink pad holder.....	104
Emergency rubber stamp.....	121
Improving a pencil sharpener.....	128
Typing shipping tags.....	145
Truck drivers' time board.....	154

PAINT AND PAINTING

Bail and brush holder for paint can.....	112
Paint sprayed to give stipple effect.....	112
Paint cans resealed.....	153

(Continued to page 10A)

RADIO EXPERTS

NEEDED

★ *by owners of home sets for service and repair work!*

★ *by broadcasting stations, police departments, air lines, public address system operators, etc.!*

★ *by U.S. Armed Forces, which give higher rating and pay to trained radio experts!*

YOU can become a trained radio technician—NOW!

WHEN your Uncle Sam said, "No more new radio sets for civilians!", it meant *increased opportunity* for trained radio technicians to make *big money*—servicing and repairing radios that would normally be "junked."

When your Uncle Sam said, "We're going to blast the living daylights out of the Fascist rats!", it meant that both the Army and Navy needed (and *still need*) trained radio technicians—who get *higher ratings, higher rank*, and are paid as much as *five times base pay!*

In addition, radio stations, air lines, police departments and other civilian enterprises still employ many thousands of radio technicians at *good salaries*—and when the war is won, television will probably make radio a new "boom industry"!

So now's the time to mail this coupon, and learn how *quickly* a low-cost I. C. S. Radio Course can fit you for Success and Prosperity in this golden field of opportunities!

Thousands of I. C. S. Radio Course graduates are today earning real money—because their careers were founded on *sound, practical, up-to-date I. C. S. training*. IT IS NOT TOO LATE FOR YOU TO FOLLOW THEIR EXAMPLE!

• **EARNINGS INCREASED 50%! "Very largely as a result of I. C. S. training and your fine recommendation, I am now Engineer for the Pape Broadcasting Company operating Station WALA. I am earning more than 50% over what I made on the old job."**

Herman L. Kramm, Mobile, Alabama

• **HEAD OF SERVICE DEPT. "As a result of completing your course, I am employed as head of Service Department for M—— Bros., Inc. I strongly urge any one considering a radio career to enroll now for the I. C. S. Course."**

Thornton Hogley, Danville, Illinois

• **COMPLETE AND INFORMATIVE! "I cannot praise your fine Radio Course enough. It was even more complete and informative than I expected."**

W. H. Humphrey, Jr., Chief Engineer, Police Radio, Wilmington, N. C.

FREE information on low-cost I. C. S. Radio Courses if you mail this coupon at once!

MARK AND MAIL THIS COUPON RIGHT NOW!

INTERNATIONAL CORRESPONDENCE SCHOOLS

Box 5641-J, Scranton, Penna.

Explain fully about your course in the subject marked X:

- GENERAL RADIO PRACTICAL RADIO SERVICING
 RADIO OPERATING SOUND TECHNICIAN
 SOUND-PICTURE PROJECTIONIST

Name _____ Age _____

Address _____

City _____ State _____

HOW TO *Conserve* ON SPARK PLUGS and Gasoline Cost *What to do-*

Have your spark plugs cleaned and adjusted every 4,000 miles. (Costs only 5c a plug.)

Replace all badly worn plugs promptly.

Why-

Dirty or worn spark plugs waste as much gas as 1 gallon in 10. They also cause hard starting (bad for batteries!) and loss of power.

Where-

Go to your neighborhood Registered AC Spark Plug Cleaning Station. Look for this Sign.



BEST BY TEST
AC SPARK PLUGS
SAVE GAS

"Keep 'em Rolling"
Do Your Part
Buy Defense Bonds

AC SPARK PLUG DIVISION • General Motors Corporation

(Continued from page 8A)

PHOTOGRAPHY

Multiple safelight has three filters.....	129
Making photo medallions	130
Keeping prints from clogging drain.....	130
"Magazine" holds enlarging paper.....	130
Rubber feet for ferrotype tins.....	130
Photo exposure meter	131
Covers protect lens and reflector.....	132
Lettering on negative with eyebrow pencil.....	132

POWER TOOLS

Quick-change lathe arbors	137
Non-slip bottom for oilcan.....	138
Cord lagging for small pulleys.....	138
Precision grinding	146
Governor for old auto engine.....	152

RADIO AND ELECTRICITY

First aid for radio receivers (Part 3).....	155
Inter-room communicator saves time.....	156
B-battery eliminator for experimenters.....	158
Insulator used for antenna mast pulley.....	159
Emergency airplane detector	159
Soldering lug terminal connector.....	159
Condenser tester from junk-box parts.....	159
Improved indoor antenna system.....	159
Dowel rod coil form.....	159

SPORTS

Wire tennis net	99
Birds kept off seats on golf course.....	110
Painted clothespins mark croquet arches.....	116
Weighted croquet ball adds fun to game.....	120

STORE AND SHOP

Keeping tailor's thread untangled.....	104
Nail scoop made from trowel	112
Full-size patterns transferred	120
Pencil holds candy-display box.....	128
Clocks control burglar alarm.....	133
Traveling hoist from barn-door hanger.....	139
Magnet holds printer's gauge pins.....	139
Weights for platform scales.....	139
Tool tray protects glass counter.....	139
Grease sponge oils sign hanger.....	139
Ladder tool tray for fimsmith.....	152
Spring-roller unit as door stop.....	152

TOYS AND MODELS

Magnetic warship game	97
Control-line flying of model planes.....	106
Safe pegs for child's tent.....	112
Sidecar for Junior's bike.....	113
Toy balloons inflated with gas.....	118
Trailer hitch for a tricycle.....	118

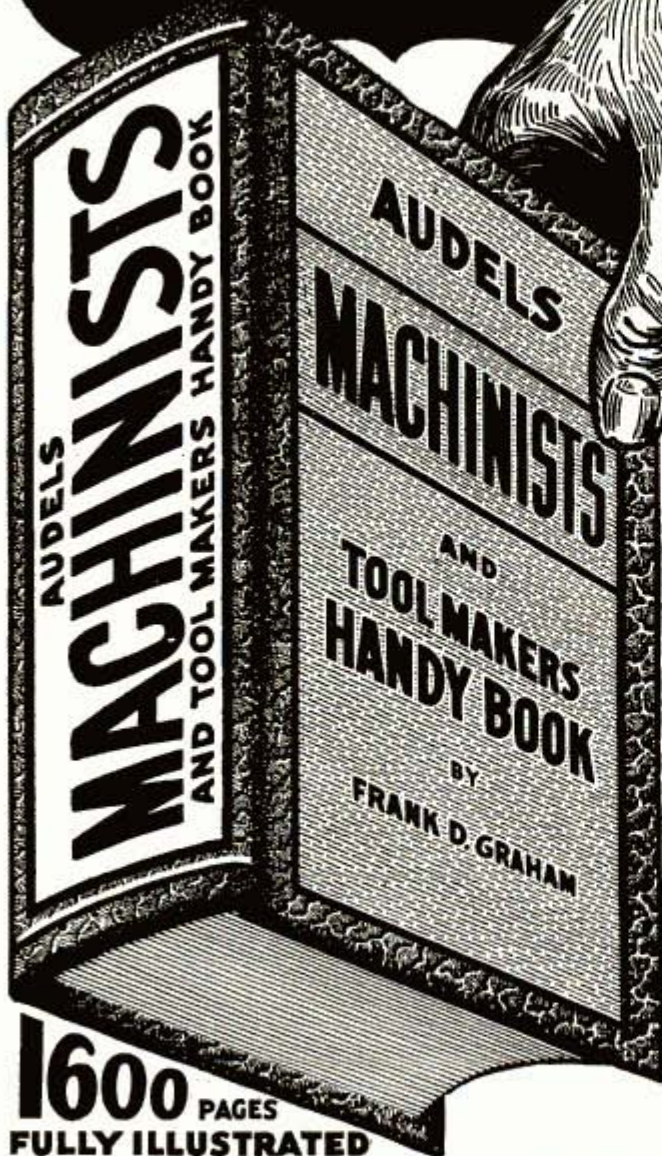
MISCELLANEOUS

Basket prevents soiling flag.....	102
Improving drafting triangle	104
Thumbtacks held-on T-square.....	112
Beach umbrella anchored	116
Buried wheel is flagpole base.....	116
Stabilizing weak extension ladders.....	128
Seesaw kept from slipping	128
Depth gauge measures liquid in glass.....	128
Hoist on ladder lifts tools.....	137
Sling to extend surveyor's level rod.....	153

IMPORTANT NOTICE

It is the intention of this magazine to provide its readers with information regarding the latest developments in the mechanical arts. We take no responsibility as to whether the disclosures contained in our articles are covered by patents and advise readers to investigate this subject before making, using, or selling any of the products, machines, or processes described in order to avoid possible liability for patent infringement.

**AUDELS NEW
MACHINISTS
HANDY BOOK
NOW READY!**



1600 PAGES
FULLY ILLUSTRATED

A SHOP COMPANION THAT ANSWERS YOUR QUESTIONS
Easy to read and understand—flexible covers—Handy
size 5 x 6½ x 2—a ready reference that answers your
questions accurately.

TO GET THIS ASSISTANCE FOR YOURSELF SIMPLY FILL IN AND MAIL COUPON TODAY

**\$4 COMPLETE
PAY \$1 A
ONLY 1 MO.**

THEO. AUDEL & CO., 49 W. 23rd St., New York

Prepare!

**A KEY TO
MODERN SHOP PRACTICE**

PRACTICAL INSIDE INFORMATION

For Every Machinist, Toolmaker, Engineer, Machine Operator, Mechanical Draughtsman, Metal Worker, Mechanic or Student. This 1600 Page Handy Book Covers Modern Machine Shop Practice in All Its Branches.

**A COMPLETE INSTRUCTOR WITH
READY REFERENCE INDEX**

New from Cover to Cover. Tells How to Operate and Set Up Lathes, Screw & Milling Machines, Shapers, Drill Presses & All Other Machine Tools.

**5 PRACTICAL BOOKS IN ONE!
60 FULLY ILLUSTRATED CHAPTERS**

Covering: **1**—Modern Machine Shop Practice. **2**—Blue Print Reading and How to Draw. **3**—Calculations & Mathematics for Machinists. **4**—Shop Physics. **5**—How to Use the Slide Rule.

...ASK TO SEE IT!...

THEO. AUDEL & CO., 49 West 23rd St., New York
Mail AUDELS MACHINISTS & TOOLMAKERS HANDY BOOK, Price \$4 on 7 Days Free Trial. If O. K. I will remit \$1 in 7 days and \$1 Monthly until \$4 is Paid. Otherwise I will return it.

Name _____

Address _____

Occupation _____

Reference _____ P.M.



MACHINE SHOP MEN

Learn to set up and run ANY kind of machine; MAKE MORE MONEY NOW by learning quickly HOW TO DO THINGS which usually take years of study and practice. The demand for SKILLED men is ALREADY ahead of the supply, then what WILL IT BE a month or two from now?

Needed NOW!

Bigger Pay Don't miss this chance to qualify for promotion, don't miss this Big Opportunity which is yours almost for the asking. Eight Big Books checkfull of important mechanical facts told simply and clearly. Over 3000 pages, nearly 3000 illustrations cover every subject fully, including Tool Making, Pattern Making, Foundry Work, Mechanical Drawing, Forging, Machine Shop Practice and Management, and hundreds of other subjects.

8 Big Books (Up-to-date Edition) Sent FREE to you for examination. With them we send a Big Binder of nearly 800 pages with 267 original shop tickets with 1200 illustrations. These show, step by step, how to set up and run almost any kind of job and are in addition to the 8 books. Decide in your own home or place of business whether or not you want to keep them, check up on any facts you want to. Note their great MONEY MAKING value, then, if you want them, pay on the easiest kind of payments. A year's consulting privileges with our engineers now given with these books without extra charge. American Technical Society, Vocational Publishers since 1898.

American Technical Society, Dept. SC19, Drexel at 58th St., Chicago
You may send me the 8 big books and binder of shop tickets for free examination. I will pay the delivery charges only, unless I decide to keep them in which case I will send \$2.00 in ten days and \$3.00 per month until the total price of only \$34.80 is paid. If I return them in 10 days I will owe you nothing. You also agree to send me a certificate entitling me to consulting privileges with your experts for one year without extra charge.

Name.....
Address.....
Please attach a letter stating age, occupation, employer's name and address and that of at least one business man as reference.



START \$1260 to \$2100 YEAR

Hundreds War positions

Prepare immediately for next examinations

32-Page Civil Service Book

Mail Coupon Today—SURE

Franklin Institute
Dept. M174
Rochester, N. Y.

Gentlemen: Rush to me FREE of charge, list of U. S. Government big pay jobs. Send me FREE 32-page book describing salaries, vacations, hours and work. Tell me how to qualify for one of these jobs.

Name.....

Address.....

ARREST HIM, OFFICER! I'LL HAVE COMPLETE FACTS ON THE OTHER FELLOW TONIGHT!



Secret Service Operator No. 38 is on the job... FOLLOW HIM through all the excitement of his chase after the counterfeit gang. Write NOW for

FREE Confidential Reports

No. 38 Made to His Chief!

It may open your eyes to the great opportunity for YOU as a well paid Finger Print Expert. The kind of work you'd like. Excitement! Travel! Thrills! A REGULAR MONTHLY salary. REWARD MONEY. Graduates of this school HEAD 43% of all Identification Bureaus in U. S. Write for Free Reports, Finger Print Book, low prices. Easy Terms Offer.

Literature will be sent only to persons stating their age.

INSTITUTE OF APPLIED SCIENCE
1920 Sunnyside Ave., Dept. 135-C Chicago, Illinois

ENGINEERING DEGREE IN 27 MONTHS

INDIANA TECHNICAL COLLEGE

Courses in Aeronautical, Chemical, Civil, Electrical, Mechanical, and Radio Engineering. One-year courses in Radio and Drafting. Approved by C.A.A. Prep courses without added cost. Low tuition. Large industrial center. Opportunity to earn part living expenses. Enter September 8, December, March, June. Catalog. 582 E. Washington Blvd., Ft. Wayne, Ind.



FREE BOOKLET answers the many questions bound to be in your mind about where you stand in relation to the war—about how you can serve your country well, and still plan for a secure, successful future. It tells why YOU—by entering the aircraft industry—can be NECESSARY to your country's victory. For your free copy of this helpful booklet, airmail your request NOW to

AERO INDUSTRIES TECHNICAL INSTITUTE
5253 W. SAN FERNANDO RD., LOS ANGELES, CALIF.

TRAIN Your VOICE!
Results GUARANTEED

We build, strengthen the vocal organs—not with singing lessons—but by sound, scientifically correct silent and vocal exercises and absolutely guarantee complete satisfaction with results. Write for Voice Book. FREE. Sent to no one under 17 years old unless signed by parent.

PERFECT VOICE INSTITUTE, Studio C-135, 64 E. Lake St, Chicago, Ill.

Learn PHOTO-ENGRAVING

We teach you quickly, at home in spare time. Earn while you learn. Establish your own profitable business with equipment we furnish, or work for others at good salary. Cuts in this magazine made by process we teach. Send for your copy of our big illustrated catalog. It's free!

THE AURORA SCHOOL OF PHOTO-ENGRAVING
Tasopar Bldg. (Dept. PM-43) Aurora, Mo.

EARN THE DEGREE Doctor of Psychology (Ph.D.), Doctor of Divinity (D.D.), many others. Courses in business, accounting, law, etc. Low fees. Send for large Bulletin and student picture-folder at ONCE. No obligation whatever.

TEMPLE BAR EXTENSION COLLEGE
1411 Fourth Avenue, Dept. 4-R, Seattle, Washington, U. S. A.

MONEY for MEN ALL FREE

THE PLASTEX Industry needs manufacturers on small scale and for big production of Lamp and Clock Stands, Art Goods and Novelties in Plastex and Marble imitation. Experience unnecessary. 1/2c material makes regular 10c store sellers. Rubber molds furnished for speed production. Small investment brings good returns. WE ARE NOW PLACING BIG CHAIN STORE ORDERS WITH MANUFACTURERS. Ambitious men have chance for real prosperity. Our FREE booklet will interest and benefit you.

PLASTEX INDUSTRIES, Dept.P, 1045 Washington Ave., New York, N.Y.

Be a RADIO Technician



J. E. SMITH, President
National Radio Institute, Established 27 Years

I Train Beginners at Home for Good Spare Time and Full Time Radio Jobs

More Now Make \$30 \$40 \$50 a Week than Ever Before

HERE is a quick way to more pay. Radio offers a way to make \$5, \$10 a week extra in spare time a few months from now, plus the opportunity for a permanent job in the growing Radio industry. There is an increasing demand for full time Radio Technicians and Radio Operators. Many make \$30, \$40, \$50 a week. Clip the Coupon below and mail it. Find out how I train you at home for these opportunities.

WOMEN HELP WIN THE WAR

Patriotic women can help themselves—help fight the war—by doing a man's job—at a man's pay. The Government, broadcasting stations and many branches of Radio will employ women who can qualify as Radio technicians and operators. I will teach you Radio at home in your spare time. Investigate. Mail the coupon.



Jobs Like These Go To Men Who Know Radio

The 882 broadcasting stations in the U. S. employ Radio Technicians and operators with average pay among the country's best paid industries. The Radio repair business is booming now because manufacturers have stopped making new home and auto Radios and the country's 57,400,000 sets are getting older, requiring more repairs, new tubes, parts. Many N. R. I. trained Radio Technicians take advantage of the opportunities to have their own full time or spare time Radio service businesses. The Government needs many Civilian Radio Operators, Technicians. Radio factories employ thousands of trained technicians as they rush to fill millions of dollars worth of Government orders. Think of the many good jobs in connection with Aviation, Commercial, Police Radio and Public Address Systems. N. R. I. gives you the required knowledge of Radio for these jobs. N. R. I. trains you to be ready when Television opens jobs in the future.

Yes, N. R. I. trained Radio Technicians make good money because they use their heads as well as their hands. They are THOROUGHLY TRAINED. Many N. R. I. trained men hold their regular jobs, and make extra money fixing Radio sets in spare time.

Beginners Soon Learn to Make \$5, \$10 a Week Extra in Spare Time

Nearly every neighborhood offers opportunities for a good part time Radio Technician to make extra money fixing Radio sets. I give you special training to show you how to start cashing in on these opportunities early. You get Radio parts and instructions for building test equipment, for conducting experiments which give you valuable practical experience. My 50-50 method—half working with Radio parts, half studying my lesson texts—makes learning Radio at home interesting, fascinating, practical.

Find Out How N. R. I. Teaches Radio and Television

Act today. Mail coupon now for 64-page Book. It's FREE. It points out Radio's spare time and full time opportunities and those coming in Television; tells about my Course in Radio and Television; shows more than 100 letters from men I trained, telling what they are doing and earning. Find out what Radio offers you. Mail coupon in envelope or paste on penny postcard—NOW.

J. E. SMITH, President
Dept. 2HP, National Radio Institute
Washington, D. C.




Broadcasting Stations employ N. R. I. trained Radio Technicians as operators, installation, maintenance men and in other capacities and pay well.


Set Servicing pays many N. R. I. trained Radio Technicians \$30, \$40, \$50 a week. Others hold their regular jobs and make \$5 to \$10 extra a week in spare time.



Loudspeaker System building, installing, servicing and operating is another growing field for N. R. I. trained Radio Technicians.



Extra Pay in Army, Navy, Too



Men likely to go into military service, soldiers, sailors, marines, should mail the coupon Now! Learning Radio helps men get extra rank, extra prestige, more interesting duty at pay up to several times a private's base pay. Also prepares for good Radio jobs after service ends. IT'S SMART TO TRAIN FOR RADIO NOW!

TRAINING MEN FOR VITAL RADIO JOBS

FREE BOOK HAS SHOWN HUNDREDS HOW TO MAKE GOOD MONEY

J. E. SMITH, President, Dept. 2HP
National Radio Institute, Washington, D. C.

Mail me FREE without obligation, your 64-page book "Rich Rewards in Radio." (No salesman will call. Write plainly.)

Mr. _____
Miss _____
Mrs. _____
ADDRESS _____

CITY _____ STATE _____



I Trained These Men



\$10 a Week in Spare Time
"I repaired some Radio sets when I was on my tenth lesson. I really don't see how you can give so much for such a small amount of money. I made \$600 in a year and a half, and I have made an average of \$10 a week—just spare time."—JOHN JERRY, 1729 Penn St., Denver, Colorado.



Had Own Business 6 Months After Enrolling
"I went into business for myself 6 months after enrolling. In my Radio repair shop I do about \$300 worth of business a month. I can't tell you how valuable your Course has been to me."—A. J. BATEN, Box 1168, Gladewater, Texas.



Sergeant in Signal Corps
"I am now a Sergeant in the U. S. Army, Signal Corps. My duties cover Radio operating, maintenance of Army Transmitters and Receivers, operating Teletypes, handling duties of the Chief Operator in his absence." SERGEANT RICHARD W. ANDERSON, U. S. Army (Address omitted for military reasons.)



ELECTRICAL BOOKS

shipped
FREE

**10
BIG BOOKS**

FOR EXAMINATION
**MODERN
ELECTRICITY
INCLUDING RADIO
AND TELEVISION**

Here's great news for anybody interested in Electricity. NEW 18th. edition of Applied Electricity brought right down to date with NEW Electrical subjects fully covered, including Electrical Blue Print Reading. 10 big Volumes and all shipped FREE for examination.

1942 Edition
For Beginners
and Experts

over 3000 pages—hundreds of illustrations—the most complete work of its kind we have ever published. Dynamos, motors, power stations, Radios, television, everything electrical explained so anyone can understand it.

BIG FIELD! Big Demand!

Big Pay! Men who understand electricity are urgently needed in thousands of War Production industries. Airplanes, ship building, arms plants, machine shops—practically every industry depends on electricity and men who know this subject make big money. Pleasant, fascinating work, easy to learn and do; learn with these books. Send coupon for a set for FREE examination and see for yourself.

SEND NOW

A year's consulting privileges with our engineers now given to all buyers of this famous Cyclopedia of Electricity.

AMERICAN TECHNICAL SOCIETY
Vocational Publishers since 1898

American Technical Society, Dept. EC19, Drexel at 58th St., Chicago
Send for 10 days' free use, 10 volume set of 1942 Edition, Applied Electricity, including a certificate entitling me to consulting privileges for one year. I will pay the delivery charges only on the books. If I wish I may return them in 10 days and owe you nothing, but if I keep them, I will send \$2.00 after 10 days, then \$3.00 a month until the total price of only \$29.80 is paid.

NAME.....
ADDRESS.....
CITY..... STATE.....
Please attach letter stating age, occupation and name and address of employer and give at least one business man as reference.

AVIATION CAREER

Offers You
A GREAT FUTURE!

Complete Aeronautical Engineering or Master Aviation Mechanics training in the heart of the Aircraft industry. Graduates obtaining immediate employment. No flying involved. Aviation's foremost school, established in 1929. Located on Grand Central Air Terminal. For full information, address Department PM-8.

**CURTISS WRIGHT
TECHNICAL INSTITUTE**

GRAND CENTRAL AIR TERMINAL
GLENDALE (LOS ANGELES) CALIF.

THIS TOWER OVERLOOKS AVIATION'S MOST DISTINGUISHED SCHOOL OF AERONAUTICS



DRAW for MONEY

Be An ARTIST!

Trained Artists Are Capable of Earning
\$30 - \$50 - \$75 A WEEK

This spare-time training leads to profitable Art careers!

NOW is the time to prepare for a pleasant, profitable future. **COMMERCIAL ART, ILLUSTRATING, CARTOONING**—all in ONE complete course. No previous Art experience necessary—hundreds have profited by our practical home study method since 1914. Write today for information in FREE BOOK, "Art for Pleasure & Profit"—tells all about our course, service—and commercial opportunities for you in Art. State age.

WASHINGTON SCHOOL OF ART
STUDIO 128A, 1115 15th St., N. W.,
Washington, D. C.

FREE TRIAL LESSON IN DRAFTING

More good jobs now in Drafting. Learn AT HOME in spare time (or at our Chicago School). Send postcard for FREE TRIAL LESSON and see how easy to learn and get a good job.

CHICAGO TECHNICAL COLLEGE
K-203 Tech Bldg., 2000 S. Mich. Ave., Chicago, Ill.

LEARN WATCH REPAIRING

AT HOME You can learn by our modern and original system of instruction every part of the Watch Repairing Trade at home. Prepare yourself for a well paying position or start in business after completing our course of instruction. Good watch repairers are in demand and generally earn very good salaries. For particulars apply to the Wisconsin School of Watch Repairing 524 E. Mason St., MILWAUKEE, WIS.

Regain Perfect Speech, If You STAMMER

Every stammerer should have the new 287 page book "Stammering, Its Cause and Correction." Sent free to stammerers. It describes the Bogue Unit Method for the scientific correction of stammering and stuttering. Method successfully used at Bogue Institute for 41 years—since 1901. Endorsed by physicians. Write for full information. No obligation. Benjamin N. Bogue, Dept. 1341 Circle Tower, Indianapolis, Indiana.

RADIO ENGINEERING.

broadcasting, aviation and police radio, servicing, marine and Morse telegraphy taught thoroughly. 48 weeks' engineering course equivalent to three years' college radio work. School established 1874. All expenses low. Catalog free.

The Dodge Institute, Dept. D, Valparaiso, Ind.

Learn Profitable Profession in 90 days at Home

Earnings of Men and Women in the fascinating profession of Swedish Massage run as high as \$40 to \$70 per week but many prefer to open their own offices. Large incomes from Doctors, hospitals, restaurants and private patients open to those who qualify through our training. The Army and Navy need hundreds trained in massage. Write for Anatomy Charts and booklet—They're FREE.

THE COLLEGE OF SWEDISH MASSAGE
30 E. Adams St., Dpt. C64, Chicago

America Needs Men Trained for TOOL & DIE MAKING, MACHINIST & SCREW MACHINE TRADES

HARRY LEBESON
PRESIDENT & FOUNDER

ALLIED School offers you short intensive, Practical training courses in Our fully equipped Shops. Learn on Actual Jobs! State Approved. Learn Days or Evenings. Enter anytime, FREE Employment Service and opportunity to earn while learning. Write for FREE Book "Practical Machine Shop Training."

ALLIED SCREW MACHINE CO., (School Division)
609 West Lake Street, Dept. PM-8, Chicago, Illinois

The 97 Pound Weakling

—Who became "The World's Most Perfectly Developed Man"

"I'll prove that YOU, too, can be a NEW MAN!"

Charles Atlas

I KNOW, myself, what it means to have the kind of body that people pity! Of course, you wouldn't know it to look at me now, but I was once a skinny weakling who weighed only 97 lbs.! I was ashamed to strip for sports or undress for a swim. I was such a poor specimen of physical development that I was constantly self-conscious and embarrassed. And I felt only HALF-ALIVE.

Then I discovered "Dynamic Tension." It gave me a body that won for me the title "World's Most Perfectly Developed Man."

When I say I can make you over into a man of giant power and energy, I know what I'm talking about. I've seen my new system, "Dynamic Tension," transform hundreds of weak, puny men into Atlas Champions.

Only 15 Minutes a Day

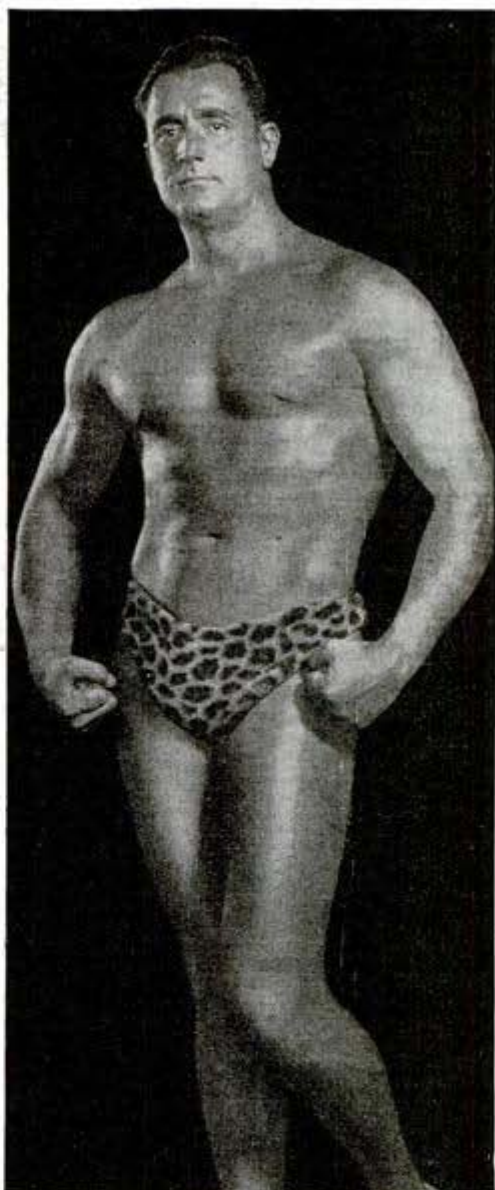
Do you want big, broad shoulders—a fine, powerful chest — biceps like steel — arms and legs rippling with muscular strength — a stomach ridged with bands of sinewy muscle—and a build that you can be proud of? Then just give me the opportunity to prove that "Dynamic Tension" is what you need.

No "ifs," "ands," or "maybes." Just tell me where you want handsome, powerful muscles. Are you fat and flabby? Or skinny and gawky? Are you short-winded, pepless? Do you hold back and let others walk off with the prettiest girls, best jobs, etc.? Then write for details about "Dynamic Tension" and learn how I can make you a healthy, confident, powerful HE-MAN.

"Dynamic Tension" is an entirely NATURAL method. Only 15 minutes of your spare time daily is enough to show amazing results — and it's actually fun! "Dynamic Tension" does the work.

Send for FREE BOOK

Mail the coupon right now for full details and I'll send you my illustrated book, "Everlasting Health and Strength." Tells all about my "Dynamic Tension" method. Shows actual photos of men I've made into Atlas Champions. It's a valuable book! And it's FREE. Send for your copy today. Mail the coupon to me personally. CHARLES ATLAS, Dept. 8-X, 115 East 23rd St., New York, N. Y.



CHARLES ATLAS
Holder of Title, "The World's Most Perfectly Developed Man."

**CHARLES ATLAS, Dept. 8-X,
115 East 23rd Street, New York, N. Y.**

I want the proof that your system of "Dynamic Tension" will help make a New Man of me—give me a healthy, husky body and big muscular development. Send me your free book, "Everlasting Health and Strength."

Name.....
(Please print or write plainly)

Address.....

City..... State.....

NEWS

Increased production means



More Jobs for MACHINISTS and bigger pay for men who know their work

This big home-study and reference course gives you the practical facts on machines and methods you need to advance in machine shop work. Take advantage of the other man's experience as found in books, to solve your problems, increase your efficiency, with

The AMERICAN MACHINISTS' LIBRARY

6 volumes—2368 pages—2516 illustrations

(A combined home-study course and reference library)

This library of machine shop practice was written for practical men. It gives you the best methods for every kind of machine shop work. It fully explains lathes, drills, and other machine tools and their operation, automatic screw machines, speeds and feeds, gear design and production, jigs and fixtures, punch and die work, metal surfacing, etc., etc. Plainly written—completely illustrated—the best kind of help to the machine shop man who wants to advance himself.

No money down—special price—easy payments.

EXAMINATION COUPON

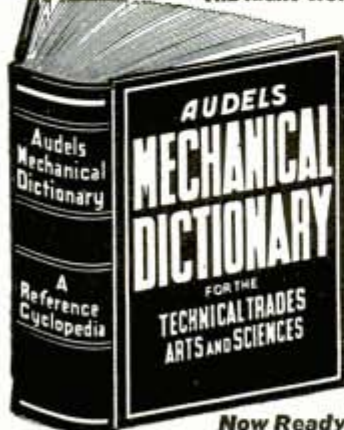
McGraw-Hill Book Co., 330 W. 42nd St., New York

Send me for ten days' examination the American Machinists' Library. If satisfactory I will send you \$1.50 in 10 days and \$3.00 monthly until the price of \$19.50 is paid. If not wanted, I will return the books postpaid. (To insure prompt shipment write plainly and fill in all lines.)

Name.....
 Home Address.....
 City and State.....
 Position.....
 Name of Company..... PM-8-42

DEFINING WORDS 17000 TERMS PHRASES

THE RIGHT WORD WHEN IT'S NEEDED MOST



The revolutionary progress being made today in the Mechanical Trades brings a new Trade language that every mechanic must know.

KNOW THE LANGUAGE OF YOUR TRADE

A WORD BOOK FOR MECHANICS, Technical Workers and Students
 Audels New Mechanical Dictionary gives you this new language. Its 950 pages contain over 17,000 new and standard mechanical terms, words, phrases, fully explained and defined for the Mechanic and Engineer of Today. This big book gives every word you need to know.

Now Ready!

Fully understand the work instructions you receive.

Alphabetically arranged—Durable bound, A Very Useful Book.
\$4 COMPLETE • PAY ONLY \$1 A MONTH ←
 To get this assistance for yourself simply fill in and mail coupon today for Free Examination.

AUDEL Publishers, 49 West 23rd St., New York
 Mail AUDELS MECHANICAL DICTIONARY. Price \$4 on 7 Days Free Trial. If O.K., I will remit \$1 in 7 days and \$1 monthly until \$4 is paid. Otherwise I will return it.

Name.....
 Address.....
 Occupation.....
 Employed by..... PM

Quick! Get into DRAFTING now



All working tools, including drawing table, sent to you at once—furnished free with course.

Learn At Home From An Engineer

With industry working feverishly—the field for DRAFTSMEN is bigger than ever! Get into a better job with more pay and fascinating, pleasant work. I will train you at your home in your spare time until you are holding a better paying position as Draftsman. My practical training in drafting also includes a working course in Industrial Designing valuable on new products, improving, restyling and modernizing—all extremely important and profitable to draftsmen. Write for full illustrated details and booklet. Give your age.

ENGINEER DOBE, Division C337 Libertyville, Illinois

LAW STUDY AT HOME

Legally trained men win higher positions and bigger success in business and public life. Greater opportunities now than ever before. Big corporations are headed by men with legal training.

More Ability: More Prestige: More Money
 We guide you step by step. You can train at home during spare time. Degree of LL. B. Successful graduates in every section of the U. S. We furnish all text material, including 14-volume Law Library. Low cost, easy terms. Get our valuable 48-page "Law Training for Leadership" and "Evidence" books FREE. Send for them NOW.
 LaSalle Extension University, Dept. 864-L, Chicago
 A Correspondence Institution

WELDING



Welding offers immediate opportunities for better pay. Day and evening classes. New short courses at low prices. Special Student Finance Plan. Modern, well-equipped shops. Free employment service. Write for free "Blue Book"

CHICAGO TECH. COLLEGE
 K-75 Tech. Bldg., 2000 S. Mich. Ave., Chicago, Ill.



Begin today. Write now for our Free Book, "How to Become a Good Penman." It contains specimens and tells how others learned to write in spare time. Enclose 10¢ for your name beautifully written and a pen point suitable for shaded writing. Write today.

THE TAMBLYN SCHOOL OF PENMANSHIP, X441 Ridge Building, Kansas City, Mo.

Correspondence Courses in RADIO and ELECTRICAL ENGINEERING LOW AS \$25

ELECTRICAL ENGINEERING. Get good grasp of wide electrical field. Modern. Very understandable. Theory made easy.
RADIO ENGINEERING. Extra five courses in radio, public address, photo-electric work. Trains you to be super-service man, real vacuum tube technician. Tuition ONLY \$25, either course. Deferred payment plan. Experiment kits furnished.
FREE Write for free copies of school catalogs, student magazines, etc.
FREE LINCOLN ENGINEERING SCHOOL, Box 531-P-44, Lincoln, Nebr.

700,000 people can't be wrong!

You, too, can learn Music this EASY way!

Over 700,000 people have studied music at home this quick, easy way. Many didn't know one note from another yet learned to play their favorite instrument. You can, too. It's great fun. You learn real tunes by note right from the start. Costs only few cents a day.



FREE Send for Free Book and Print and Picture Sample. Mention Instrument preferred.

U. S. School of Music, 78 Brunswick Bldg., N. Y. C.
 Please send me free illustrated Booklet and Free Print and Picture Sample. I would like to play the (name Instrument).....
 Name..... Have You Instr.?.....
 Address.....

WAR SAVINGS BONDS
SOLD AT THIS WINDOW

"I BUY ONE EVERY PAY-DAY!"

• "I figure there are two good ways for a married man with kids to help his Uncle Sam right now.

• "One way is to do his job better than ever before—help to outproduce the Axis, and 'keep 'em flying!' That's why I enrolled for an I. C. S. Course in my line of work a few months ago. Already, the training I've acquired is helping me to be a better soldier on the industrial front!

• "And with the extra money I'm earning as a result of modern I. C. S. training, I'm buying a War Bond every pay-day! The whole family's buying War Stamps. Why don't you mail this coupon, and find out how a low-cost I. C. S. Course can increase your job efficiency, and make you worth more to your country in this battle of production? *Do it today!*"



INTERNATIONAL CORRESPONDENCE SCHOOLS

HELPING TO TRAIN AMERICANS FOR VICTORY



BOX 5642-J, SCRANTON, PENNA.

Without cost or obligation, please send me a copy of your booklet, "Who Wins and Why," and full particulars about the course *before* which I have marked X:

TECHNICAL AND INDUSTRIAL COURSES

- | | | | |
|--|--|---|--|
| <input type="checkbox"/> Air Brake | <input type="checkbox"/> Contracting and Building | <input type="checkbox"/> Marine Engines | <input type="checkbox"/> Sanitary Engineering |
| <input type="checkbox"/> Air Conditioning | <input type="checkbox"/> Cotton Manufacturing | <input type="checkbox"/> Mechanical Drafting | <input type="checkbox"/> Sheet Metal Work |
| <input type="checkbox"/> Airplane Drafting | <input type="checkbox"/> Diesel Engines | <input type="checkbox"/> Mechanical Engineering | <input type="checkbox"/> Ship Drafting |
| <input type="checkbox"/> Architectural Drafting | <input type="checkbox"/> Electrical Drafting | <input type="checkbox"/> Mine Foreman | <input type="checkbox"/> Shipfitting <input type="checkbox"/> Shop Practice |
| <input type="checkbox"/> Architecture | <input type="checkbox"/> Electrical Engineering | <input type="checkbox"/> Navigation | <input type="checkbox"/> Steam Electric <input type="checkbox"/> Steam Engines |
| <input type="checkbox"/> Auto Engine Tune-up | <input type="checkbox"/> Electric Lighting | <input type="checkbox"/> Patternmaking <input type="checkbox"/> Plumbing | <input type="checkbox"/> Steam Fitting |
| <input type="checkbox"/> Auto Technician | <input type="checkbox"/> Foundryman <input type="checkbox"/> Heating | <input type="checkbox"/> Practical Telephony | <input type="checkbox"/> Structural Drafting |
| <input type="checkbox"/> Aviation <input type="checkbox"/> Aviation Mechanic | <input type="checkbox"/> Heat Treatment of Metals | <input type="checkbox"/> Public Works Engineering | <input type="checkbox"/> Structural Engineering |
| <input type="checkbox"/> Boilermaking | <input type="checkbox"/> Highway Engineering | <input type="checkbox"/> Pulp and Paper Making | <input type="checkbox"/> Surveying and Mapping |
| <input type="checkbox"/> Bridge Engineering | <input type="checkbox"/> House Planning | <input type="checkbox"/> Radio, General | <input type="checkbox"/> Telegraph Engineering |
| <input type="checkbox"/> Chemistry | <input type="checkbox"/> Industrial Metallurgy | <input type="checkbox"/> Radio Operating | <input type="checkbox"/> Telephone Work |
| <input type="checkbox"/> Civil Engineering | <input type="checkbox"/> Locomotive Engineer | <input type="checkbox"/> Radio Servicing | <input type="checkbox"/> Textile Designing |
| <input type="checkbox"/> Coal Mining | <input type="checkbox"/> Machinist | <input type="checkbox"/> R. R. Section Foreman | <input type="checkbox"/> Toolmaking |
| <input type="checkbox"/> Concrete Engineering | <input type="checkbox"/> Management of Inventions | <input type="checkbox"/> R. R. Signaller <input type="checkbox"/> Refrigeration | <input type="checkbox"/> Welding |
| <input type="checkbox"/> Concrete Engineering | | | <input type="checkbox"/> Woolen Manufacturing |

BUSINESS COURSES

- | | | | |
|--|--|--|---|
| <input type="checkbox"/> Accounting <input type="checkbox"/> Advertising | <input type="checkbox"/> College Preparatory | <input type="checkbox"/> First Year College | <input type="checkbox"/> Railway Postal Clerk |
| <input type="checkbox"/> Bookkeeping | <input type="checkbox"/> Commercial | <input type="checkbox"/> Foremanship <input type="checkbox"/> French | <input type="checkbox"/> Salesmanship |
| <input type="checkbox"/> Business Correspondence | <input type="checkbox"/> Commercial Illustrating | <input type="checkbox"/> Good English | <input type="checkbox"/> Secretarial <input type="checkbox"/> Spanish |
| <input type="checkbox"/> Business Management | <input type="checkbox"/> Cost Accounting | <input type="checkbox"/> High School | <input type="checkbox"/> Showcard and Sign Lettering |
| <input type="checkbox"/> Cartooning <input type="checkbox"/> Civil Service | <input type="checkbox"/> C. P. Accounting | <input type="checkbox"/> Managing Men at Work | <input type="checkbox"/> Traffic Management |

HOME ECONOMICS COURSES

- | | | |
|---|---|--|
| <input type="checkbox"/> Advanced Dressmaking | <input type="checkbox"/> Home Dressmaking | <input type="checkbox"/> Tea Room and Cafeteria Management, Catering |
| <input type="checkbox"/> Foods and Cookery | <input type="checkbox"/> Professional Dressmaking and Designing | |

Name..... Age..... Address.....
City..... State..... Present Position.....

Canadian residents send coupon to International Correspondence Schools Canadian, Limited, Montreal, Canada
British residents send coupon to I. C. S., 71 Kingsway, London, W. C. 2, England

DRAFTSMEN NEEDED Now



Industry is clamoring for more draftsmen for the job can't start until plans are drawn. Buildings, airplanes, machines, guns, tanks, bridges, all start on the drafting board, so it's no wonder that every good draftsman has a fine job. Yes, more draftsmen are needed NOW. The pay is good and the opportunities for advancement great.

Learn at Home in Spare Time

Begin now to turn spare hours into money. Be a draftsman, the connecting link between a mechanic and an engineer. Enjoy the wonderful opportunities for promotion that exist now. No experience or artistic talent is needed. You don't have to leave your present job while learning. Use spare time.

American School, Dept. DDC45, Drexel Ave. at 58th St., Chicago, Ill.

Gentlemen: Send me FREE information covering special training in subjects checked below. No obligation on my part.

<input type="checkbox"/> Drafting and Design	<input type="checkbox"/> Diesel Engineering
<input type="checkbox"/> Accounting and Auditing	<input type="checkbox"/> High School Course
<input type="checkbox"/> Architecture and Building	<input type="checkbox"/> Liberal Arts
<input type="checkbox"/> Automotive Engineering	<input type="checkbox"/> Mechanical Engineering
<input type="checkbox"/> Business Management	<input type="checkbox"/> Radio and Television
<input type="checkbox"/> Aviation	<input type="checkbox"/> Business Law
<input type="checkbox"/> Electrical Engineering	<input type="checkbox"/> Retail Merchandising

Name.....
Address.....

Say you saw it in Popular Mechanics!

Learn WELDING This Easy Way!

AUDELS NEW WELDERS GUIDE

Contains Important Facts and Essential Information!



WELDING METHODS
WELDERS
ELECTRIC
OXY-ACETYLENE
THERMIT
UNIONMELT
SHEET METAL
SPOT
PIPE
PRESSURE VESSELS
VARIOUS METALS
AIRPLANE
HARDENING-FACING
CUTTING
EYE PROTECTION

\$1


Just Out!

Every Welder Should Own This New, Useful Book containing clear, concise, practical information, pointers and facts relating to modern practice in all Branches. Easy to read and understand—over 400 pages Fully Illustrated—flexible cover—pocket size—a Ready Reference that Answers Your Questions accurately—Money Back if not O.K. To get this assistance for yourself, order copy today.



THEO. AUDEL, Publishers, 49 W. 23rd St., New York
Please mail AUDELS WELDERS GUIDE (Price \$1). If satisfactory, I will remit \$1 on its safe arrival, otherwise I will return the book.

Name.....
Address.....
Occupation.....
Employed by..... P.M.

World's Finest SAXOPHONE




ENDORSED BY
ORRIN TUCKER
AND CHARLIE
BARNET

Why not play a Conn Saxophone, when you can have all its exclusive, patented features without added cost? Choice of leading artists. Produced by exclusive method which gives perfect glass-like interior for clearer tone. Drawn, positive non-sink tone hole sockets. Patented locking pivot screw maintains perfect adjustment, assures positive, light action. Plays easier, finer, more true. See Conn dealer or write for book, C. G. CONN, LTD.
831 Conn Bldg., Elkhart, Ind.

Write FOR FREE BOOK



STUDY AT HOME

With A Chartered Educational Institution

Courses in **ENGINEERING**: Electrical, Civil, Mechanical, Drafting, Architectural, Steam, Aeronautical, Radio, Structural, Mining, Industrial, Highway, Petroleum, Marine, Chemical.

Courses in **ARTS AND SCIENCES**: Philosophy; Education; Letters; Public Health; Medical Jurisprudence; Psychology; Sociology; Physics; Chemistry; Geology; Pol. Science; Theology; Law; Business and Commerce; Accounting; Mathematics; Statistics; Agriculture.

McKinley-Roosevelt Incorporated, 4610-UTC, Sheridan Road, Chicago

BECOME AN EXPERT MEAT CUTTER



Greater opportunities! Thousands of firms are needing expert Meat Cutters. Train in 6 weeks at famous National School. It's quick, easy to learn Meat Cutting by ACTUAL PRACTICE in big National cutting rooms and retail department. No previous experience or advanced education necessary. BIG PAY JOBS. Union card guaranteed. Employment services FREE Train free. Pay later. Easy terms. Write TODAY for FREE catalog and plans to help you get ahead.

National School of Meat Cutting, Inc., Dept. U-33, Toledo, Ohio

AIRCRAFT Designing & Engineering



You can learn to design airplanes. A Ryan Home Study Course in Aeronautical Engineering will prepare you quicker for a job with good pay and a future. Easy to understand. No previous training necessary. Write today for free literature.

RYAN AERONAUTICAL INSTITUTE
428 Lindbergh Field • San Diego, California

RADIO REPAIR HINTS 5¢

"Introduction to Radio" explains circuit tracing and radio trouble-shooting. Gives many service hints. Tells how to find radio faults and make repairs quickly. New 32 page book. Price only

SUPREME PUBLICATIONS, 3727 W. 13th St., Chicago, Ill.

THERE'S MONEY IN CARTOONS!




RAYE BURNS will teach you HOW to CREATE ORIGINAL CARTOONS at home that you may SELL. Course contains 26 lessons and over 500 illustrations. All for Only.....

\$2.85

Send name and address for free details.

RAYE BURNS SCHOOL, Dept. M, Box 3583, CLEVELAND, OHIO

EARN MONEY PAINTING PORTRAITS



No previous training or talent necessary. Unique Stuart System teaches you, by mail, in 10 simple, easy-to-follow lessons, to make excellent charcoal and oil likenesses. Detailed guidance for your every step. Send for free book today.

STUART STUDIOS,
121 Monument Circle, Room 682, Indianapolis, Ind.

Please send me free book and outline of lessons.

Name.....
Street.....
City..... State.....

INVENTORS

Get Expert Advice on HOW to PROTECT and SELL Your Invention

Get
FREE COPY

"Why I thought of that years ago!" How many persons have said that, when they found later that somebody else had thought of the same thing, had it patented, sold it, and were profiting from it? Too many, sad to say. These unfortunates did not know what to do about their inventions, in order to protect and profit from them. Some thought elaborate working models were necessary to secure a patent—others felt their idea wasn't "worth much." They failed to realize that a good practical invention, plus prompt action in securing a Patent, and locating a buyer or a good market, have proved the secrets of success for thousands of inventors.

Patent Guide Shows What To Do

Our "Patent Guide for the Inventor" answers many important questions concerning Patents that inventors constantly ask. It tells what facts, details, drawings, sketches, etc. are necessary to apply for a Patent; how to protect your invention through dated and witnessed disclosure; how to do this AT ONCE to safeguard your rights; how Patent Office Records can be checked to determine whether the invention is probably patentable before filing fees need be paid; discusses costs involved and a practical way these can be paid as the application progresses. It tells how some inventors secured financial backing; how many simple inventions have proved large commercial successes; how Patents covering improvements also can be profitably utilized and marketed; tells countless other facts of interest.

Why You Need Expert Assistance

The Patent Laws were enacted for your benefit—to give you protection for the features of your invention which are Patentable. But these features must be legally and concisely set forth in the form of "claims." This phase of the procedure is so complex that the Patent Office advises the Inventor to engage a competent Registered Patent Attorney. We maintain a large staff—carefully trained registered patent attorneys—expert draftsmen—experienced searchers—to serve you. We have been serving inventors for more than 20 years.

Take First Step Now

With the Patent Guide you will receive also Free a "Record of Invention" form which will enable you at once to establish the date of your invention, before you file your Patent application. This step costs you nothing yet may be vital to your success. Remember—in Patent Matters, ACTION is IMPORTANT. Delay can be costly. Mail the coupon in an envelope, or paste it on a penny postcard NOW.

CLARENCE A. O'BRIEN
and
HARVEY B. JACOBSON
"Worthy of Your Trust"
Registered Patent Attorneys
21-H Adams Building
Washington, D. C.



48
PAGES
Over 100
Illustrations



CLARENCE A. O'BRIEN
and **HARVEY B. JACOBSON**

CLARENCE A. O'BRIEN AND HARVEY B. JACOBSON
Registered Patent Attorneys before the United States Patent Office
21-H Adams Building, Washington, D. C.

Please send me your 48-Page "Patent Guide for the Inventor" and your specially prepared "Record of Invention" form FREE. This request does not obligate me.

Name

Address

City..... State.....

(Please write or print plainly.)

Get This
FREE BOOK
IMMEDIATELY MAIL COUPON TODAY!

POPULAR INVENTIONS

For Your Home

Where-to-Buy-It index of commercially available Popular Inventions appears on page 24A

M 346

Dual Teapot With Two Spouts Pours Water and Tea



Actually two teapots in one, a server now on the market has two spouts, one of which pours tea and the other hot water. It provides tea to anyone's taste, permitting each guest to dilute the tea as desired.

M 405

Thermometer in a Stirring Rod Tells When Drink Is Cool



You can enjoy drinking your favorite beverage at any desired temperature with the aid of a glass stirring rod with built-in thermometer. Most drinks, particularly those that are carbonat-

ed, require a low drinking temperature to retain their life and sparkle, and should be served between 45 and 50 degrees, although some prefer them lower. At about the middle of the stirring rod is a green spot marked "Go." When the thermometer spirit reaches its center, the beverage is cold enough for the average taste.

L 1278

Fruit Knife With Four Blades Cuts Uniform Slices

With the same effort ordinarily taken to cut one slice, it is possible to cut four uniform slices of fruit with a four-bladed knife. The blades are parallel and spaced evenly, the forward half of each blade be-



ing sawtoothed and the other part having a knife edge. This makes it easier to cut through tough rinds and aids in producing better slices.

(Continued to page 24A)

POPULAR MECHANICS

Dist: Roy F. Ranger & Associates
 Mace Mch. Chicago, Ill.
 The Ohio Thermometer Co.
 Springfield, Ohio

Dist: Goldblatt Bros., State & Van Buren, Chicago.

AMAZINGLY EASY WAY TO GET INTO ELECTRICITY

Learn Without Books in 90 DAYS



Electricity is the mighty power behind our Victory Program. Trained Electrical men are needed. **PREPARE FOR YOUR PLACE** this amazingly easy way. "Learn By Doing" in 12 weeks. You don't need much money—I'll finance your training. **READ EVERY WORD OF MY MESSAGE ON THIS PAGE AND SEE HOW YOU CAN DO YOUR PART EITHER IN THE ARMED FORCES OR INDUSTRY.**



How Can You Best Serve Your Country Now? How Can You Best Serve Your Country After the War?

IF YOU'RE DRAFTED

If you enter the Army as a trained electrical man, you are eligible to apply for higher rating and bigger pay. In both the Army and the Navy, rated Electrical Workers hold mighty important jobs—just as skilled Electrical Workers hold vital jobs in civilian life. **AND THIS IS IMPORTANT:** There will be a **TREMENDOUS NEED** for trained Electrical men after the war. By getting your Electrical Training NOW, you will be ready for a **BIG PAY, BIG FUTURE JOB** after your service in the Army is over.

IF YOU'RE DEFERRED

Everyone cannot serve in our Armed Forces . . . Some may be too young . . . others too old . . . others with dependents . . . and others with some physical defect. If you cannot serve, don't be discouraged. **FROM 16 to 50, EVERYONE WITH PROPER TRAINING CAN SERVE IN WAR INDUSTRY . . .** turning out weapons and materials. **And remember:** Electricity in war time is essentially no different from Electricity in peace time. After the war you'll be an all-around **SKILLED ELECTRICIAN** ready for a good-pay Peace-time job.



**GET YOUR TRAINING
NOW . . . PAY FOR
IT LATER !**

Coyne Training is **EASY, PRACTICAL!** You **LEARN BY DOING.** No dull books. No baffling charts. No reciting. **Don't let lack of money stop you.** You can get training first—then pay for it in easy monthly payments after you graduate. If you need **part-time work** to help out with living expenses, I'll help you get it.

**EXTRA
4 WEEKS
COURSE IN
RADIO
INCLUDED**

Get the Facts

This school is 43 years old—Coyne training is tested and proven. Mail the coupon and let me send you the big, free Coyne book. This does not obligate you. So act at once. Just mail coupon.

H. C. LEWIS, President
COYNE ELECTRICAL SCHOOL
500 S. Paulina St. Dept. C2-72 CHICAGO, ILLINOIS

H. C. LEWIS, President
COYNE ELECTRICAL SCHOOL, Dept. C2-72
500 S. Paulina St., Chicago, Ill.

Send me your Free Book and tell me about your plans to help me.

NAME.....

ADDRESS.....

CITY STATE



Know Electricity as Experts Know It—and Get an Expert's Pay!

What about your future? Who is safe today? Surely not the man who is contented to stand still! Know your job thoroughly—prepare yourself for jobs ahead. To do just this thousands of men have used

The Croft Library of Practical Electricity

The Croft Library is a complete electrical educator. It is founded on practice—on 20 years of shirt-sleeve experience—on work as it is actually done. It is jammed from cover to cover with the kind of hard-headed facts you want. Written so that the beginner can easily understand it, yet so sound, so thorough, that it is the daily guide of 50,000 highly paid electrical workers and engineers. Croft tells you the things you need to know about motors, generators, armatures, commutators, transformers, circuits, switchboards, distribution systems—electrical machinery of every type—wiring for light and power—wiring of finished buildings—underwriters and municipal requirements—illumination in its every phase—the most improved methods of lighting—lamps and lamp effects, etc.—how to do a complete job, from estimating it, to completion.

No money down — easy payments

Fill in and mail the coupon attached and we will send you the entire set of seven volumes for ten days' examination on approval. We take all the risk—you assume no obligation. If you decide to keep the books, send \$3.00 in ten days and the balance at the rate of \$3.00 a month. Send the coupon NOW and see the books for yourself.

EXAMINATION COUPON

McGraw-Hill Book Co., 330 W. 42nd St., New York

Send me for ten days' examination on approval the Croft Library of Practical Electricity, 7 vols. If satisfactory, I will send you \$3.00 in 10 days and \$3.00 monthly until the price of \$18.00 is paid. If not wanted, I will return the books postpaid. (To insure prompt shipment write plainly and fill in all lines.)

Name.....

Home Address.....

City and State.....

Position.....

Name of Company..... PM-8-42

Prepare for JOBS
In AVIATION'S MOST VITAL BRANCH
AIRCRAFT INSTRUMENTS
HOME STUDY—Learn By Doing!

Practical—complete training on Actual Instruments furnished by the school, qualifies you for well-paying positions with manufacturers, airlines and instrument service and repair stations. Write for CATALOG today.

EASTERN AIRCRAFT INSTRUMENT SCHOOL
 "The Largest in the East"
 Dept. M-J, 116 Newark Ave., Jersey City, N. J.

Learn PLASTICS

Get into Plastics! Your big opportunity. Enter a NEW industry. Plastics, the miracle material! Revolutionizes design and construction. Plastics is thrilling, profitable, uncrowded. Learn Now! First Plastics School in the East with complete Study and Lab. courses. Write Dept. M. Today! State age.

THE SCHOOL OF PLASTICS
 DIVISION OF LEXTER TECHNICAL SERVICES
 452 COMMERCIAL AVE., BOSTON, MASS.

SUPER JU JITSU

NOW You Can Get Tough Quick!



For personal defense and counter-attack... no system is more powerful! Almost unbelievably efficient. You don't need big muscles. Lick brutes twice your size with your bare hands, even if they are armed. Get ready now for any emergency—protect your loved ones. This amazing new self-study course teaches you double-quick. Startling low price. Satisfaction guaranteed or your money back. FREE DETAILS. Write today sure... time is short!

NELSON CO., 500 SHERMAN, DEPT. H-502, CHICAGO, ILL.



Harvey Cocklin

Are You Eligible To Buy a LACO?



Restrictions have been eased somewhat! If you are now eligible and live in a zone where delivery of oil is feasible, order one of these modern Oil-Burning LACOs! Now in its 18th year! Has features you'll like. Heater (above) delivers more heat into the room, less up chimney, without a fan. Self-contained fuel tank. Easy finger-tip control. Gun-type model (below) equips your furnace for automatic oil-burning. Quiet. Economical. Uses low priced oil.



WRITE for Free Book, full details, low prices and facts about your eligibility to buy. **SEND TODAY!**

LACO OIL BURNER CO., 128 Union Ave., Griswold, Iowa

5¢ EACH LITTLE BLUE BOOKS

Send postcard for our free catalogue. Thousands of Bargains. Address: **HALDEMAN-JULIUS CO., Catalogue Dept., Desk M-888, GIRARD, KANSAS**

Learn PHOTOGRAPHY at Home

Splendid opportunities. Prepare in spare time. Easy plan. No previous experience needed, common school education sufficient. Send for free booklet "Opportunities in Photography", particulars and requirements.

American School of Photography
 1315 Michigan Ave., Dept. 135C, Chicago, Ill.

Learn CARTOONING

FREE TRIAL LESSON! Cash in on your sense of humor—**AT HOME—BY MAIL.** Have fun! Make money! No experience needed to start. Write today for **FREE LESSON**, mailed postpaid. No obligation.

MOON Gag-Cartoon School, Dept. 1, Fall Creek, Wis.

LAW

STUDY AT HOME FOR PERSONAL SUCCESS and LARGER EARNINGS. 31 years expert instruction—over 106,000 students enrolled. LL.B. Degree awarded. All texts furnished. Easy payments. Send for **FREE BOOK!**

AMERICAN EXTENSION SCHOOL OF LAW
 Dept. 20-M, 8 East Huron St., Chicago, Ill.

FIBRE ARMS AND LEGS!

Light, correctly fitted, strong and comfortable. Natural appearance. Braces for all deformities. Scientific design. Fair Terms.

BUCHSTEIN-MEDCALF
 610-3rd Av. S., Minneapolis, Minn.

Always write your name and full address clearly when answering advertisements.

BROOKLYN YMCA TRADE SCHOOL



Short Trade Courses, including War trades, offered day or evening. **5 to 10 week courses** qualify you for Essential Jobs. **Full Shop Equipment.** Unexcelled Instruction. Fireproof Dormitories. Special Privileges. **Check your interests** on coupon to receive free literature.

- Aircraft Construction
- Machinist
- Mechanical Pre-Engineering
- Diesel Engines
- Diesel Pre-Engineering
- Mechanical Drafting
- Auto Mechanic
- Refrigeration
- Television and Radio Mechanic
- Architectural Drafting
- Armature Winding
- Welding
- Tool and Die Making
- Talking Pictures
- Electrical

MAIL COUPON

1123 Bedford Ave., Dept. P. M. Brooklyn, New York City, N. Y.

Name.....

Address.....

TRI-STATE COLLEGE

Degree in 2 1/4 years

B. S. Degree in Civil, Electrical, Mechanical, Chemical, Radio, Aeronautical Engineering; Business Administration, Accounting, Secretarial Science. Short diploma courses (36 weeks) in Surveying, Drafting, Special Preparatory Department for those who lack required high school work. Cosmopolitan student body. Approved by Civil Aeronautics Administration for flight training. Distinguished for 2 1/4-year technical courses (Non-essentials eliminated). **59th year.** Tuition, living costs low. Defense needs call for engineers. Demand for graduates exceeds supply. Enter Sept., Jan., March, June. Catalog. **482 COLLEGE AVE., ANGOLA, IND.**



ENGINEERING

TIME & MOTION STUDY

The Vital War Profession

Fight on the Production Lines with Cost Reductions and Methods Improvement. Our 40 intensive, guaranteed sessions complete for \$15.00, prepare YOU! Big pay, plus await trained engineers in this profession. INDUSTRIAL TIME CLINIC, 4000 Washington Blvd., Chicago

Big Pay in AVIATION

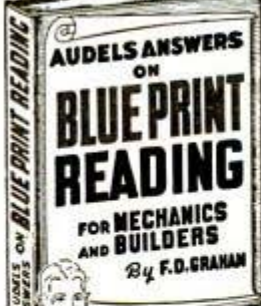


Earn \$50, \$75, \$100 a week! Prepare NOW at this Lincoln Government Approved School for high pay position ESSENTIAL to America's war effort. Be a Pilot Flight Instructor, an Aeronautical Engineer, a Government Licensed Airplane and Engine Mechanic, an Aircraft Inspector, an Aircraft Factory Mechanic. Exceptional opportunities in all these fields. We train you and assist graduates in locating positions. **WRITE TODAY for complete information**

stating which course best suits you.

LINCOLN AERONAUTICAL INSTITUTE
598 Aircraft Building Lincoln, Nebraska

AUDELS BLUEPRINT READING



JUST OUT—FOR THE MAN WHO WORKS FROM BLUE PRINTS

"The Blue Print of Today is the Machine of Tomorrow." AUDELS ANSWERS ON BLUE PRINT READING covers All Types of plan reading including AIRCRAFT & SHIP BUILDING—tells How to Easily Understand Working Drawings.

What to look for first. Tells what each Line and each Symbol Means. The relation of one part to another. How to Understand Scales & Specifications. How to Make a Sketch. How to Make Blue Prints. A Key Book for Every Mechanic, Builder & Draughtsman—352 pages—It's New, Comprehensive, Fully Illustrated. Gives Short Cuts, Helps, Hints, Suggestions, Questions and Answers.

Make Blue Prints. A Key Book for Every Mechanic, Builder & Draughtsman—352 pages—It's New, Comprehensive, Fully Illustrated. Gives Short Cuts, Helps, Hints, Suggestions, Questions and Answers.

ASK TO SEE IT!

To get this assistance for yourself, simply fill in and mail coupon today. **\$2**

AUDEL, Publishers, 49 West 23rd St., New York
Please mail AUDELS BLUE PRINT READING (Price \$2). If satisfactory, I will remit \$2 on its safe arrival, otherwise I will return the book.

Name _____
Address _____
Occupation _____
Company _____ PM

AUGUST, 1942

SPECIAL OFFER to INVENTORS

If you're an original thinker—a practical man with inventive ideas—NOW IS YOUR TIME TO ACT.



These two valuable works on patent procedure and commercializing an invention may be worth hundreds of dollars to you. They tell you the steps to take to safeguard your idea—advise you against costly mistakes—illustrate 115 mechanical movements among which you may find just what you need to complete your invention. If you have a worthwhile idea, by all means send for these books today.

SEND 25¢ IT'S GOOD FOR \$1.00

Send 25c in coin or stamps to cover handling expense. We'll immediately send you these two books and our regular "Evidence of Invention" form. Study "Patent Protection" carefully. You'll learn that the first step you should take is to have a search made of invention records in the United States Patent Office. Our search fee is ordinarily \$5.00. Your 25c earns you a credit of \$1.00 against this regular charge. Don't delay. Enclose 25c for these two books today.

USE THIS COUPON—Now!

VICTOR J. EVANS & Co.
Merlin M. Evans
REGISTERED PATENT ATTORNEYS
Main Office — 630-J, Victor Bldg., Washington, D. C.
Pittsburgh Office: 521-N Empire Building
Los Angeles Office: 738-N Security Building
I am enclosing 25c. Please send me your two advisory books. I understand this 25c earns me a credit of \$1.00 on your regular search fee.
Name _____
Address _____
City and State _____

Always write your name and full address clearly when answering advertisements.

23A



A pocket-size booklet of help for better pictures

NEW G-E PHOTO DATA BOOK

TELLS how to use your meter to get more out of every shot.

..how to make prints and enlargements easier.
..how to make metered-flash shots, and how to control photo backgrounds.

GIVES in handy, compact form, many other helpful facts: film speeds, developing formulas, flash exposure data. Fifty cents at your dealer's. Get a copy and get *more* out of your picture-taking. *General Electric, Schenectady, N. Y.*

If your dealer cannot now supply you with a G-E exposure meter, here's the reason: Materials and facilities are needed to produce equipment for our armed forces and vital war industries. Our efforts are being expended to speed VICTORY for the United Nations. We know you'll understand.

GENERAL  ELECTRIC
606-125-6336

Do you want

→ .. to go to College?

→ .. or to enter a Profession?

(Such as Accounting, Architecture, Nursing, Dentistry, Teaching, Social Work, Osteopathy, Beauty Culture, Optometry, Embalming, Chiropody, Law, Medicine, etc.)

→ .. or get an Office Position?

To get anywhere, you practically **MUST** finish High School **FIRST**. You can complete our simplified High School Course in **SPARE** time at home, as **FAST** as your time and abilities permit. Equivalent to resident school work—prepares you for college, pre-professional examinations, business, industry. Standard texts furnished. Diploma. Credit for H.S. subjects already completed. Single subjects if desired. Low tuition, easy terms. American School, Chicago, est. 1897—endorsed by educators. Finish your high school education **NOW**. Write **TODAY!**

High School Course at Home

Many Finish in 2 Years

American School, Dept. HC45, Drexel Ave. at 58th St., Chicago, Ill.

Gentlemen: Send me **FREE** information covering special training in subjects checked below. No obligation on my part.

- | | |
|--|---|
| <input type="checkbox"/> High School Course | <input type="checkbox"/> Diesel Engineering |
| <input type="checkbox"/> Accounting and Auditing | <input type="checkbox"/> Drafting and Design |
| <input type="checkbox"/> Architecture and Building | <input type="checkbox"/> Liberal Arts |
| <input type="checkbox"/> Automotive Engineering | <input type="checkbox"/> Private Secretary |
| <input type="checkbox"/> Business Management | <input type="checkbox"/> Mechanical Engineering |
| <input type="checkbox"/> Aviation | <input type="checkbox"/> Radio and Television |
| <input type="checkbox"/> Electrical Engineering | <input type="checkbox"/> Salesmanship |
| <input type="checkbox"/> Elec. and Gas Refrigeration | <input type="checkbox"/> Business Law |
| <input type="checkbox"/> Air Conditioning | <input type="checkbox"/> Retail Merchandising |

Name

Address

POPULAR INVENTIONS

For Your Home

L 958

(Continued from page 20A)

Cone in Scrub Pail Wrings Mop



Built into one corner of a triangular scrub pail, a cone-shaped grill saves getting hands wet while wringing out the mop. Most of the water can be squeezed out by simply forcing the mop into the cone.

M 261 Tea-Ball Plunger Squeezes Leaves



More strength can be extracted from tea leaves with a tea ball having a long handle and a plunger that squeezes out the liquid. Pressing the handle forces a small disk within the ball against the leaves.

WHERE-TO-BUY-IT INDEX OF POPULAR INVENTIONS

- Teapot holds both tea and water.....20A**
Roy P. Trauger & Associates, Merchandise Mart, Chicago
- Stirring rod with thermometer.....20A**
The Ohio Thermometer Co., Springfield, Ohio
- Four-blade fruit knife.....20A**
Goldblatt Bros., State and Van Buren Sts., Chicago
- Cone in pail wrings mop.....24A**
Marshall Field & Co., State and Washington Sts., Chicago
- Tea ball with plunger.....24A**
Carson Pirie Scott & Co., State and Monroe Sts., Chicago

Get into **RADIO** now!



SHOP METHOD HOME TRAINING
fully qualifies you for bigger pay jobs

More than 50,000,000 radios in use. They need servicing. Over 800 Broadcasting Studios employ trained radio technicians. The movie industry and thousands of theatres employ Sound Experts. Factories are adopting audible address systems. The Air Lines and Government need Trained Men. Here is your opportunity to get into a permanent, profitable field of enjoyable work.

BIG OPPORTUNITY FOR NATIONAL GRADUATES

Shortages in trained, skilled men run into the hundreds of thousands. One of the biggest fields is **Radio**, with its many fascinating branches. War-time demands for Radio men are tremendous and will continue unabated after the war. That's important to you. You want training in a field that will continue to advance. National Schools offers you a time-tested method of Home Training which has helped thousands of men to more pay, and unlimited opportunity in the growing **RADIO** Industry. You can actually start earning in Spare Time, even while you are training for a good permanent job as a **RADIO** Technician. You need training. National can definitely help you. Simply send the Coupon and we will mail you a **FREE Specimen Lesson** and **Big Opportunity Book** so you can judge for yourself just how you can be helped to bigger pay and a Life Career of Success.



COMMAND ANY OF THESE JOBS
Radio Expert
Radio Broadcasting
Sound
Industrial Electronics
Studio Technician
Television Technician

Step up in life!
Be independent!
Insure your success!

Keep your present job while learning. National brings to you the same proven instruction methods as used at the School. No dull text books.



YOU GET HOME TRAINING FROM A REAL, ESTABLISHED TECHNICAL TRADE SCHOOL

For 37 years National Schools has trained ambitious men for Top Pay trades. Squarely behind you are the modern, completely-equipped Training Shops of National where we **pre-test** and **prove** every instruction sent to you. Every phase of your training is **personally supervised** by an established Faculty of practical, experienced instructors and engineers. They have developed progressive methods of training you in your home comparable to actual shop practice. Unique training facilities give you Home Training based on Resident School Shop principles—**methods not available from any other source**, to our knowledge. You'll be amazed when you receive our Complimentary Lesson and full details. **Write today.**

MEN SUBJECT TO MILITARY SERVICE AIDED BY TRAINING



Radio Training helps men get extra rank, extra pay in war service. Every man eligible for service should mail coupon. Many Service Men now enrolled.



Regardless of your age, you can enroll.

DUPLICATE THE SUCCESS OF THESE GRADUATES WITH U. S. GOVT.

"I have been accepted by the U. S. Federal Communications Commission at a starting salary of \$1800.00 per year, thanks to National Training."

PRICE G. GARNER
San Diego, Calif.

\$3000.00 PER YEAR

"I am married now. Just going fine. My pay this year is over the \$3000.00 mark."

LEO BROMBEREK
Lomont, Ill.

WITH BIG CONCERN

"I got a job with International Telephone & Radio Co. It's a good, straight salary position. Delighted with your training."

DOUGLAS NIELSEN
Jamaica, N. Y.

THOUSANDS OF GRADUATES ATTRIBUTE THEIR SUCCESS TO NATIONAL TRAINING



NATIONAL SCHOOLS

Los Angeles, California

Established 1905



"I will train you in your spare time to qualify as a Radio Expert."

J. A. ROSENKRANZ
President

MAIL COUPON FOR LESSON & BOOK

National Schools, Dept. 8M.
4000 So. Figueroa, Los Angeles, Calif.

Mail me **FREE**, without obligation, one Lesson and Opportunity Book, with full details about Radio Training.

NAME _____ AGE _____
ADDRESS _____
CITY _____ STATE _____

REQUEST FULL DETAILS

Monastery Secrets

... THE FORBIDDEN KNOWLEDGE OF TIBET

What strange secrets of nature are locked within the mountain fastness of Tibet? What control over the forces of the Universe do these cloistered sages exercise? For centuries the world has sought to know the source of their power—to learn their mastery of life, and their faculty for overcoming problems with which the masses of mankind still struggle. Have they selfishly deprived humanity of these rare teachings?

WRITE FOR THIS FREE BOOK

Like the streams that trickle from the Himalayan heights to the plateaus below, the great truths of these brotherhoods have descended through the ages. One of the preservers of the wisdom of the Orient is the Rosicrucian Brotherhood (not a religious organization). They invite you to write today for their FREE Sealed Book, with its amazing revelations about these mysteries of life. Address: Scribe E. Y. R.

The ROSICRUCIANS
AMORC
San Jose, Calif.
U. S. A.



AMAZING NEW ELECTRIC ARC WELDER

FULLY GUARANTEED

RETAILS ONLY
\$2.95
COMPLETE

PLUGS INTO LIGHT SOCKET

Amazing new HANDWELD Electric Arc Welder—operates from 110 volt A.C. or D.C. same as other arc welders higher priced—generates tremendous heat to weld all kinds of metal. Not a toy welder that uses carbons, but actually uses standard coated rods—sizes 1/16" and 3/32". Generous supply furnished with welder. Guaranteed not to burn out. Repairs fenders, auto bodies, radiators, pre-heated small castings and machinery parts. Take HANDWELD anywhere to job, operate from light socket. Sturdily built of finest materials to last years. Fully guaranteed by Big Manufacturer.

SEND NO MONEY! You'll find a thousand uses for the HANDWELD around your home, garage, work shop. Also by garages, factories, repair shops, mechanics, farmers, inventors, tinshops, plumbers, etc. Order HANDWELD now. Send no money. We'll rush one to you complete with rods and goggles. Pay postman only \$2.95 plus few cents postage. If not delighted, return HANDWELD in 5 days from receipt and money paid for it will be refunded instantly. Rush your order now.

KUMFY PRODUCTS INC., Dept. J-202, Cincinnati, Ohio

Say you saw it in Popular Mechanics!

PAY-RAISING — EXTRA MONEY BOOKS

Use these books to prepare for a better job—bigger pay—to start a profitable spare time or full time business of your own. Popular Mechanics specializes in supplying outstanding books on many subjects. As new books of merit appear, we will revise this list.

- MODERN WELDING PRACTICE** Very interesting information on all kinds of welding \$3.50
- HOW TO READ ELECTRICAL BLUEPRINTS** New self-study book \$3.00
- GARDEN BOOK (Just Out)** Build own trellises, lawn furniture, fireplaces, ornaments, etc. \$1.00
- BUILDING INSULATION (new)** Covers heat and sound \$3.00
- FORTY POWER TOOLS** Build own saw, drill, lathe, sander, etc. from scraps—save money \$1.25
- SHOP NOTES LIBRARY** Five big volumes including new 1942 edition (224 pages—28 in color); over 1900 articles on money-making & money-saving ideas \$2.45
- WELDING, BRAZING AND SOLDERING** How to build and use arc, spot welders; tricks of soldering \$1.25
- RUNNING A MILLING MACHINE (new)** . . . \$1.50
- MOTOR'S FACTORY SHOP MANUAL (1942 ed.)** Covers 480 pas. cars, 390 trucks \$4.00
- HOW TO TRAIN SHOP WORKERS (new)** . . . \$1.25
- AUTOPOWER** Convert old auto generators into motors, welders, etc. \$1.00
- PRACTICAL SHIP PRODUCTION (new ed.)** . . \$3.00
- TOOL DESIGN** New book on production tools \$4.50
- TIN SMITH'S HELPER** Seams, piping, gutters, etc. \$3.00
- MODERN REFRIGERATION** Electric, gas. Be service expert welder \$5.00
- AUTO BODY AND FENDER REPAIRS** Shows how to do professional job . . . \$3.00
- DYKE'S AUTO ENCYCLOPEDIA (includes Diesels, airplane engines)** World's greatest book for mechanics . . . \$6.00
- SHEET METAL WORK** Self instruction in all phases \$2.50
- ARMATURE WINDING** Construction, winding, repairing AC & DC Motors, generators \$2.00
- BUILD YOUR OWN BOAT** Describes 17 popular boats—rowboats, sailboats, plywood outboard, etc. 192 pages . . . \$1.25
- FORGING PRACTICE** . . . \$1.50
- HIGH SCHOOL SELF TAUGHT** 4 yr. course in one vol. \$1.89
- CARPENTRY & JOINERY** Learn modern methods \$2.00
- FOUNDRY WORK** \$2.00
- WHAT TO MAKE** 3 Big Books, 588 pages of popular handicraft projects . . . \$1.47
- PRACTICAL FURNITURE FINISHING** \$1.25
- MACHINE SHOP WORK** Modern methods, construction, use of tools, machines . . \$2.75
- BLUEPRINT READING** For machine trades . . \$1.50
- BLUEPRINT READING** For building trades . \$1.25
- PAINTING & DECORATING** \$1.50
- PATTERN MAKING** Wood, metal \$2.00
- MILLING-MACHINE INDEXING (new)** . . . \$1.50
- TOOL MAKING** For beginners, advanced workers \$3.50
- FIVE ACRES AND INDEPENDENCE** How to make money on small farm . . . \$2.50
- KNOTS, TIES, SPLICES** For everyone who uses rope \$1.00
- LATHE TRAINING** New book \$1.35
- ELECTRIC WIRING** Includes estimating and new code \$2.50
- HOUSE CONSTRUCTION** Gives every step in house construction \$2.89
- MACHINISTS AND TOOL MAKERS HAND BOOK** New 1600-page book \$4.00
- FORD VS CAR AND TRUCK** Repairing, operating \$3.00
- 1001 WAYS TO USE CONCRETE** Do work for yourself, others, save, make money \$1.98
- OIL BURNER HANDBOOK** New book takes guess work out of servicing \$2.50
- STEEL SQUARE POCKET BOOK** Best methods of using \$1.00
- DE LUXE SMALL HOMES** New plan book shows 210 popular designs \$1.00
- MODERN HOMECRAFT** New 250 page book on modern furniture . \$3.00
- YOUR CAR** New 192-page auto-owners guide describes hundreds of simple car repairs, shortcuts, how to operate car economically \$1.25
- ARCHITECTURAL DETAILS** For every type of building \$1.50
- CHEVROLET CAR & TRUCK** How to repair all models \$3.00
- EASY-TO-MAKE TOYS** \$1.85
- PRACTICAL BRICK LAYING** \$1.75
- WELDING, ELECTRIC** Forge, thermit, resistance, arc \$1.25
- WELDING, OXY-ACETYLENE** Welding, cutting . . . \$1.25
- METALLURGY** \$1.50
- FLOUORESCENT LIGHTING** New manual on construction, installation, repair . . . \$3.00
- SIGN PAINTING** \$3.00
- AUDELS DIESEL ENGINE MANUAL** \$2.00
- TECHNICAL BULLETINS** Simplified data for Practical Men
- SILVER SOLDERING AND BRAZING** . . . \$1.00
- REWINDING ELECTRIC MOTORS** \$1.00
- FLEXIBLE MOLDS FOR CASTING NOVELTIES** \$1.00
- WORKING WITH PLASTIC** \$1.00
- MIRROR SILVERING** . . \$1.00
- SMALL ELECTRIC LIGHT PLANTS, CONSTRUCTION** \$1.00
- HET TRAINING IN IRON AND STEEL** . \$1.00
- DESIGNING AND BUILDING TRANSFORMERS** \$1.00

MAIL THIS COUPON TODAY

Just check the books you want, write your name and address below, and mail this advertisement. It is your order blank. When postman hands you books, pay him the price and few cents postage. Outside U. S. A. enclose remittance and include 15% additional for shipping charges. Ask for big FREE catalog of helpful books.

Name
City State
Address

Mail to Popular Mechanics Press
Dept. 409-200 East Ontario St., Chicago, Ill.

INVENT *for* VICTORY & PROFIT



GET THIS BOOK FREE

ALL Americans who have an invention or an idea which might be useful to their country are urged to patent it immediately. Our new **FREE BOOK** "How to Protect, Finance and Sell Your Invention" guides you from the first step in getting patent protection to the final step of marketing and profiting from your invention.

INVENTIONS ARE NEEDED NOW! All Americans—inventors and mechanical-minded individuals—who have an invention or an idea which might be useful to their country are urged to mail it in. Submit to us any new gadgets, weapons or improvements on existing ones. We can help you. Your disclosure maintained in secrecy. Take the **FIRST IMPORTANT STEP NOW.** Write today for **FREE Book.** It explains necessary steps leading toward patent protection.

McMORROW & BERMAN Registered Patent Attorneys Before U. S. Patent Office
1354 Barrister Building Washington, D. C.

NEW YORK Established 1902 ELECTRICAL SCHOOL

FOR MEN 16 to 60

The unique school—known the world over for its distinctive method of combining "Why & How"—theory with all electrical-trades practices.

Free descriptive booklet

NEW YORK ELECTRICAL SCHOOL
44 West 17th St. New York City

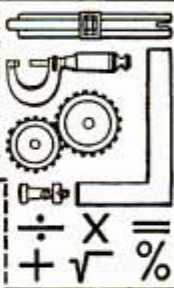
Short-Cut Mathematics COMBINED WITH Practical Mechanics Simplified

NEW 2-in-1 reading course! Now you can learn the speedy, simplified system of calculation used by draftsmen, engineers, accountants, "master minds" on the stage. Learn easy way to multiply 4 figures by 4 figures without using old-fashioned multiplication; add long columns of figures this lightning short-cut method. Learn horsepower, slide rule, micrometer, logarithms, wood measure, puzzles, etc., etc. Large illustrated volume complete with answers, only \$1 postpaid. Satisfaction or refund.

FREE Amaze friends with your magic-like mental powers. Complete details... mail coupon TODAY!

NELSON CO., 500 Sherman St., Dept. H300, Chicago
Please send free details about "Short-Cut Mathematics and Practical Mechanics Simplified." No obligation.

Name.....
Address.....



Learn GLIDING



The amazing sport that has swept America over night. Holds tremendous commercial possibilities for carrying freight. Offers the greatest opportunity in the well-paid field of aviation. Low-priced course prepared by nationally-known glider authority taught by mail. Covers fundamentals of design, construction and operation of gliders. Write for Booklet.

BOWLUS AVIATION CO., 12680 Greenfield, Detroit, Mich.

MAKE MONEY FROM POULTRY



with a business of your own. How to start small way, spare time, grow from profits, or prepare for good job in large poultry plant. Harry M. Lamon, nationally known Poultry Expert, shows latest scientific methods, money-making secrets in poultry raising. His system of home study training used by thousands. Endorsed by many colleges and leading Poultrymen. Established 20 years. Write Today for his big **FREE BOOK** "How To Raise Poultry For Profit." Shows way to real business opportunity.

NATIONAL POULTRY INSTITUTE
Dept. 50-12 Adams Center, N. Y.

Say you saw it in Popular Mechanics!

Learn Now To Read the Language of Defense BLUEPRINTS

A PRIMER OF BLUEPRINT READING

teaches you in double-quick time. Practical and simplified for the beginner. Prepare yourself now! Use these actual blueprints and easy drill method. By Thomas Diamond. Only 60 cents. Order NOW. Money back guaranteed.

THE BRUCE PUBLISHING COMPANY
1308 MONTGOMERY BLDG., MILWAUKEE, WIS.

Gentlemen: Please RUSH copy of A PRIMER OF BLUEPRINT READING. I am enclosing 60 cents. I understand you will refund my money if I am not satisfied and return the book in 5 days.

Name.....
Address.....
City and State..... PMS-43

Get into the BAKING BUSINESS

Bakers make good money! Now 7th Industry in wages! Nearly depression-proof. New home study Baking Course qualifies you. Common school education sufficient. If you're ambitious, write for **FREE BOOK**, "Opportunities in Baking." National Baking Institute, 3601 Michigan, Dept. 135-C, Chicago



LEARN A BIG PAY TRADE in 2 to 8 WEEKS!

**We Pay
Room and Board**

To meet the great demand for men at high wages, we have inaugurated intensive training courses in the trades listed here. Learn in 2 to 8 weeks by actual shop work. One of America's leading schools. Established 1902. 7 floors of shops. Many employers send their young men here for intensive training. Free employment service.

GREER SHOP TRAINING

Dept. 282, 2024 S. Wabash Ave., Chicago, Ill.

Send "Shop Training Facts" describing trade checked below:

- Auto-Diesel
 Welding
 Refrigeration and Air Conditioning
- Body-Fender Machine Shop
 Tool and Die
 Aviation

Name.....
Address.....
..... Age.....

**MAIL
COUPON!**

INVENTORS PATENT YOUR IDEAS SEND FOR FREE BOOK



HOW TO OBTAIN A PATENT

Written by a Former Member of the Examining Corps (1922-24) of the U. S. Patent Office. If you want to profit by your ideas, you should take steps to apply for a U. S. Patent at once. Your first step is to get this Free Book. This interesting illustrated book contains valuable information you should have. It tells you fully how to obtain a patent on your idea in the quickest way. With this Free Book you will also receive a "Record of Invention" form on which you can easily record your idea. Personal and Confidential Service: Your case will be personally handled only by a Registered Patent Attorney who is also a Former Member of the Examining Corps of the U. S. Patent Office. All communications confidential.

MAIL COUPON TODAY for FREE PATENT BOOK and RECORD OF INVENTION Form.

CARL MILLER

REGISTERED PATENT ATTORNEY
FORMER MEMBER EXAMINING CORPS U. S. PATENT OFFICE

Woolworth Bldg., 35th Floor, Dept. 82-A, New York City
MILLER BUILDING, Dept. 82-A, WASHINGTON, D. C.

Please send me your Free Book, "How to Obtain a Patent," and your "Record of Invention" form.

NAME.....

ADDRESS.....

PATENTS

Booklet Free • Highest References
Promptness Assured • Best Results
Send drawing or model

All Business Given Prompt
and Proper Attention

WATSON E. COLEMAN

Registered Patent Lawyer

724 Ninth Street, N. W. Washington, D. C.

PATENTS AND TRADE MARKS

C. A. SNOW & CO.

Registered Patent Attorneys Since 1875
Write for Free Book and "Certification of Invention" form
427 SNOW BUILDING, WASHINGTON, D. C.

PATENTS—TRADE MARKS

All cases submitted given personal attention
Form "Evidence of Conception" with instructions
for use and "Schedule of Government
and Attorneys' Fees"—FREE!

LANCASTER, ALLWINE & ROMMEL

Patent Law Offices

412 Bowen Bldg. Washington, D. C.

get the story of PLASTICS

See the important place of plastics in virtually every industry—in War as well as Peace. Learn what a knowledge of plastics can mean to your future career. Write today for interesting, illustrated literature.

PLASTICS INDUSTRIES TECHNICAL INSTITUTE

1221 Chas. Bldg. Room 626 E. LaSalle-Walker Bldg. 190 S. Alameda Street
NEW YORK CITY CHICAGO, ILLINOIS LOS ANGELES, CALIF.

Free Book

MOUNT BIRDS, ANIMALS, FISH

You FREE. Explain Taxidermy. Tells how to learn at home by mail to mount birds, animals, heads... to TAN skins and furs. Great for MEN and BOYS. Part I also earn money in spare time. WRITE TODAY—NOW for free book containing 100 game pictures. State AGE, H.W. School of Taxidermy, Dept. 337C, Omaha, Neb.



MAIL
Postal
Today

ARTISTS MAKE MONEY

Find out your ability. Send name, age, occupation and address for Free Vocational Art Test.

ART INSTRUCTION, INC. (Formerly Federal Schools)
8132 Art Instruction Building, Minneapolis, Minnesota

Learn PROFITABLE PHOTOGRAPHY

Modern, practical training. You "learn by doing." For pleasure or career. Unusual wartime opportunities. Black & White, Motion Picture, or Color photography. 32nd year. Free Booklet.

NEW YORK INSTITUTE OF PHOTOGRAPHY
10 West 33 St. (Dept. 49) New York City

ELECTRICAL TECHNICIANS—Urgently Needed!

BLISS

In industry—in Army and Navy—*electrical technicians* win better jobs and ratings. Bliss training combines theory and practice in classroom and laboratory. Students construct motors; install wiring, test generators, motors, transformers, electronic tubes; learn drafting.

REGULAR COURSE COMPLETE IN ONE SCHOOL YEAR

ELECTRICAL SCHOOL

118 Takoma Ave., Washington, D. C.



You'll PROFIT by using this VALUABLE NEW ARC WELDING MANUAL

Full of lessons, charts, diagrams, etc. 1942 edition, gives latest information all welders need. 5 day free inspection. Write.

Hobart Bros., Bz. M-821 Troy, O

HOBART

"Simplified"

ARC WELDERS

ORDER YOUR COPY NOW!

With the Absolute Remote Control



"One of the World's Largest Builders of Arc Welders"

To PROTECT YOUR INVENTION—Use this coupon, NOW

Delays are dangerous and may be very costly. My personal service assures prompt action, strict confidence, and a minimum of expense. I suggest that you send me a model or drawing, or sketch and description of your invention, and \$5.00. I will make a search and report

promptly as to its patentability and send you a copy of my 72-page booklet. Or, if you prefer to read my booklet first, mail the attached coupon at once. I will also send my "Record of Invention" form. (Over 40 years experience as a Registered Patent Attorney.)

L. F. Randolph, 302-D Columbian Bldg., Washington, D. C.

Please send me at once, free of charge, your 72 page booklet and "Record of Invention" form.

Name.....

Address.....

A PERSONAL CONFIDENTIAL PATENT SERVICE—

PARKS AIR COLLEGE

PARKS AIRPORT EAST ST. LOUIS, ILL.

Offers YOU COLLEGE and PROFESSIONAL TRAINING
Majoring in AVIATION

Accredited by the Illinois Superintendent of Public Instruction. "Included in the Accredited Higher Institutions 1938, issued by the U. S. Office of Education, Federal Security Agency." U. S. approved as a Commercial Ground and Flying School and Mechanics' School. Accredited by and cooperating with the United States Army Air Corps in giving flight and mechanical training. Open to high school graduates. FOUR courses lead to B.S. degrees in Professional Piloting, Aviation Operations, Maintenance Engineering, Aeronautical Engineering. TWENTY-TWO TRAINING PLANES are used in professional flight training which prepares graduates for airline flight operations. FACULTY of 104 specialists in various fields of aviation. Enrollment limited to a total of 300 commercial aviation students. Capacity enrollment of 870. Airport, 25 buildings devoted to school purposes exclusively. Dormitories and dining hall at the College. Fall term September 28. Send postcard for new 64-page catalog.

15th YEAR Registrar, Dept. PM-8
PARKS AIR COLLEGE, East St. Louis, Ill.

ELECTRICITY MEN NEEDED

Electricians are needed everywhere. Hollywood studios alone claim shortage 200 men. This is a live money making profession. Learn at home, spare time. Easy payments. Selective Employment service. Write for FREE Bulletin. No obligation.

AMERICAN SCHOOL

Dept. EEC45 Drexel at 58 St., Chicago

WELDERS WANTED!



ELECTRIC ARC-OXY-ACETYLENE
Skilled Welders earn \$8 to \$15 a day. The demand now greater than the supply. Learn this highly paid trade in 2 weeks by actual shop work. One of America's leading schools. Established 1902. 7 floors of shops. Endorsed by welding industry. Limited number of students. 2 week course in Electric Arc or Acetylene Welding, including room and board, only \$108. Write or wire for reservation. Ask for "Welding Facts." State age.
GREER COLLEGE, Dept. 182, 2024 S. Wabash Ave., Chicago

TRAIN FOR TECHNICAL RADIO WORK
I'll train you at home... or at camp for a good-paying Radio job, or a business of your own. I give you Radio Parts to study a complete 5-Tube Receiver. You learn quickly by doing many practice-giving experiments. You gain Radio repair experience right in your own home.
Write for complete details in new catalog "HOW TO MAKE FREE: MONEY IN RADIO." **SPRAYBERRY ACADEMY OF RADIO**, 510-H University Place, N. W., Washington, D. C.

AIRCRAFT DRAFTING TOOL DESIGN

Tool designers, aviation and mechanical draftsmen are the key men urgently needed for the Army and Navy armament aircraft program. This is your opportunity to help in the biggest production job America has ever faced. Learn quickly to qualify for good pay drafting position. Former naval aviation instructor will teach you at home, through individual home study lessons. Want ads full of openings for aviation draftsmen and tool designers waiting to be filled. Great shortage of trained men. Industry crowding us for men. Salaries highest in history. Rush name and address for catalog. Please state age.

THE OHIO INSTITUTE OF TECHNOLOGY
BOX 65, GREENVILLE, OHIO

INVENTIONS WANTED

Practical new ideas are urgently needed to meet the rapidly changing conditions of warfare and commerce. If you have a useful invention for sale your country needs it now—and it can be safely marketed without patenting expense! Write for complete details, today. Chartered Institute of American Inventors Dept. 4, Barrister Building, Washington, D. C.

Get Your Share of **U. S. Defense BONDS ★ STAMPS**

Free 7-Day Offer!

AUTO MECHANICS!

REPAIR ANY MAKE CAR— TODAY!



Helps EVERY Mechanic—even experts—do repair jobs easier, quicker
Explains every auto repair operation STEP-BY-STEP. Easy-to-use! Hundreds of photographs, diagrams, drawings, show exact "how to do it" of repairs, adjustments, replacements. All jobs on every model since 1935—plus 405 truck models! Engine; Electric, Fuel, Cooling, Lubrication Systems; Clutch, Transmission; Universals; Rear End; Wheels, Brakes; Knee Action, Shock Absorbers, Springs; Body; Free Wheel, Overdrive, Fluid Coupling!

Explains Every Repair Job on Every Model of All These Cars—1935 through 1942!

- | | |
|-----------|--------------|
| American | La Salle |
| -Bantam | Lincoln |
| Auburn | Lincoln |
| Austin | -Zephyr |
| Buick | Mercury |
| Cadillac | Nash |
| Chevrolet | Oldsmobile |
| Chrysler | Overland |
| Cord | Packard |
| De Soto | Pierce Arrow |
| Dodge | Plymouth |
| Ford | Pontiac |
| Graham | Reo |
| Hudson | Studebaker |
| Hupmobile | Terraplane |
| Lafayette | Willis |

And major data needed to service 405 models of trucks
Nearly 200,000 Vital Facts on Every Phase of Tune-Up and Repair • Over 450 Charts, Tables • More than 900 Photos, Drawings, Diagrams • Over 600 Big Pages—Size 8 1/4 x 11 inches.
Published by MoToR, the Leading Automotive Business Magazine, 572 Madison Ave., New York, N. Y.

150 FACTORY BOOKS IN ONE!
Imagine a COMPLETE COLLECTION of ALL official shop procedure manuals, prepared by each car manufacturer's own engineers! That's what you GET in this book! Open the manual to the car you want—you'll find everything to show the right way to do the job.

AUTO MECHANICS INSTRUCTORS AND STUDENTS:
This is the factory shop manual used by the U. S. Army, trade, technical, and vocational schools for training auto mechanics.

SEND NO MONEY
Simply fill out coupon below. Mail it today and a copy of MoToR's up-to-the-minute 1942 Factory Shop Manual will be sent to you at once for 7 days Free Examination.

7 DAY TRIAL

MoToR BOOK DEPT., Desk 18, 572 Madison Ave., New York, N. Y.
Rush me MoToR's 1942 Factory Shop Manual. If O.K. I will remit \$1 plus 20c shipping charge in 7 days, and \$1 monthly for 3 months. (\$4.20 in all.) Otherwise I will return book in 7 days. (Foreign \$6, cash with order.)

NAME _____ AGE _____
ADDRESS _____
CITY _____ STATE _____
OCCUPATION & EMPLOYER _____



CLASSIFIED Advertisements



Advertisements in this section, 35 cents per word, each insertion, minimum 10 words, payable in advance
To be inserted under proper classification in September issue, copy should be in our office July 8th

September issue on sale August 1st

Popular Mechanics Magazine, 200 East Ontario Street, Chicago, Illinois

YOU'LL PROFIT

By reading and answering the classified ads in this section. Hundreds of opportunities to make and save money.

Popular Mechanics Company,
Chicago, Illinois.

Gentlemen:

I have had an ad in Popular Mechanics for the past 11 years without missing an issue. The cost per inquiry is about 8c during the summer months, and about 6c each during the winter and early spring months.

The high percentage of orders and repeat business from these inquiries makes the ad a profitable investment.

Very sincerely yours,

JOSEPH H. BELFORT.

(Original letter on
file in our office)

AUTOMOBILES—MIDGET CARS

AUTOMOBILE Racing book, fifth edition, well illustrated. Instructions on building bodies, frames, engines. Ford A and B conversions. Plans, AAA rules, specifications. Roadster racing, Indianapolis cars. \$1.00 postpaid. \$1.15 C.O.D. Ray Kuns, Dept. 44, Madisonville, Cincinnati, Ohio.

SEAL-MATIC Substitutes new rings, re-bore. Details. Devereaux, Box 212-J, Battle Creek, Michigan.

MIDGET Motors, \$5.00 up. Used motors, midgets, motorscooters, parts. Latest lists, 20c. Shipp's Midgets, Box 543-H, Zanesville, Ohio.

WHIRLGAS Superchargers, \$3. Increase mileage 20%; power 10%. Refund guarantee. University test. Any car; give make, year. Wrench installs 15 minutes. John Hanley, Manufacturer, 5719 Loraine, Detroit, Mich.

AUTO SUPPLIES AND EQUIPMENT

TIRES Worn out? Storing your car for the duration? It won't run later-on without a costly overhaul job unless you use "Parfax" Auto Lay-Up Kit. Prevents disintegration, corrosion, rust. Provides full protection for all parts. Simple, inexpensive. For free details, write Parfax Sales, 266 Bryant Street, Buffalo, New York.

SAVE Gasoline, new invention uses gasoline engines waste, only \$7.50 for most cars and trucks. Self addressed stamped envelope for pamphlet. H. H. McDowell Co., 318 SE. Grand, Portland, Oregon.

NEW Spark plugs at 1/2 price. \$11 East 31st, Kansas City, Mo.

RENEW Used crankcase oil without cost. Free diagram, instructions. Box 1081, Bismarck, N. D.

1942 **IGNITION** Supercharger \$1.75. E. G. Sales Mfg. Co., New York.

CHEMICAL Discovery. Get 20 extra gallons of gasoline by placing "gas-lub" in gas tank. Send \$1.00 to R. Bensl, Box 134, Dearborn, Michigan.

RECLAIM Used oil without cost. Particulars. F. Gerwin, Alva, Okla.

ACT Now; protect your tires. Make your own auto sentinel. Toots horn when car is disturbed. Send 20c for detail drawings. 75c drawings and necessary materials. \$1.00 for assembled sentinel. Auto Sentinel Co., 19808 Kinsman Rd., Cleveland, Ohio.

PLATING Outfits for auto parts. Connect to a battery. No tanks used. Free particulars and proofs. Gunmetal Co., Ave. J. Decatur, Ill.

RECLAIM Scrap rubber, simple method, make plastic rubber cement, has many uses repairing tires, also 12 tire maintenance trade secrets, send \$1.00 for complete information, money back guarantee, free literature. The Harris Co., Boaz, Wis.

AUTO TRAILERS

READY Now—Plans for nine new Jim Dandy Trailers including six modern house trailers. Catalog 10c. Also new edition of Trailer Builders Manual and catalog of parts, supplies and equipment. Price 25c. Both 35c postpaid. Trailer Supply Co., 5120-A Fulton St., Wausau, Wis.

MOTORCYCLES, BICYCLES, MOTOR-SCOOTERS, SUPPLIES

LAST Call for duration! Nearly new and rebuilt motor scooters, motorcycles. Save gasoline, oil, tires. Hurry if you want one while available. Send dime for literature. Clymer, 307 W. Pico, Los Angeles, Calif.

MOTORCYCLISTS. We can save you money on parts and accessories. Bargain list and decal free. Illustrated Henderson list 10c. Triangle, 2157 Harrison, Chicago.

MOTORCYCLE Bags—\$3.90 and up. Allen Streamlined Bag Co., 216 Summit St., Elgin, Ill.

PARTS—New and used. Catalogue and wings pin 10c. Ballak, 811 N. 9th, St. Louis, Mo.

WANTED—Wheelbarrow tires 4.00x7, 4.00x8, Jumbo 12 ply bonus. Want used or new Lawson, Cushman, Briggs engines. Used scooters, motorcycles. Describe your merchandise, price asked. Clymer, 307 W. Pico, Los Angeles, Calif.

BUILD Electric power bicycle, low cost, easily built, operate cheaply, practical. Detailed plans 50 cents. Leland Hoke, 312 Market Street, Watertown, Wisconsin.

MOTORCYCLES. Reconditioned. New, used, parts and accessories. All makes. Large stock. Bargains. Illustrated catalogue, 15c. Indian Motorcycle Sales, Kansas City, Mo.

BATTERIES, GENERATORS, ETC.

GENUINE Edison batteries for light, power, Non-acid. Fifteen year life. Five year unconditionally guaranteed. Low prices. Complete lighting plants. Free literature. See-Jay Company, 82 Sterling Avenue, Yonkers, New York.

EDISON Lifetime storage batteries for light and power. Eliminate acid battery diseases. Long guarantee. All kinds rebuilt generating plants, motors, and miscellaneous articles at bargain prices. Free interesting literature. T. Hawley Smith Co., Croton Falls, N. Y.

AVIATION

A & E Mechanics Manual prepares for "multiple choice" examinations. \$3.00 postpaid or C.O.D. Aviation Publishers, Box 503, Studio City, California.

WAR-BARGAIN Airplanes located anywhere. Cubs \$125.00 up. Complete directory 25c. Aircraft Directory, Athens, Ohio.

QUALIFY For army pilot training. Thorough instruction by mail assures success in passing educational examination. \$25. Captain A. T. Bell, Merrick, N. Y.

ELECTRIC FENCING

1-WIRE Electric fence units \$2.95. Write, Wholesale Fence, Hales Corners, Wisconsin.

AIR CONDITIONING, PLUMBING, HEATING

BUILD Evaporated coolers, "Complete part kit \$7.95." Three speed a.c. motor and fan blade combination \$5.95. Evaporative cooler pumps 75c. CMCO, 514 Van Buren, Chicago.

ELECTRICAL SUPPLIES, EQUIPMENT

1/2 HORSE, 3450 Speed, repulsion induction alternating motors \$12.50; 500 watt, alternating generators \$20.50, other sizes. Butler Electric, 1885 Milwaukee, Chicago.

ELECTRIC Pencil: Writes-engraves all metals. \$1.00 postpaid. Beyer Mfg., 4515-H Cottage Grove, Chicago.

DEALERS Sell electric motors, exhaust fans, air circulators, air compressors, and paint spraying equipment. Wholesale catalog free. CMCO, 514 Van Buren, Chicago.

WELDING—SOLDERING—PLATING

ARC Welders wanted by the thousands. Learn with 516 page lessons manual. Over 500 how-to-do-it photos. \$2.00 copy. Money-back guarantee. Hobartweld, Box M-824, Troy, Ohio.

FOR Sale: Used d.c. vehicle motors, (automotive, originally battery driven). P. b. \$35.00 each up. Build your own heavy duty arcwelder. No rewinding. Plans \$1.00. Welders Club, AB-3432 M-Mart, Chicago.

WELDING Outfits, for heavy, medium, light metal welding \$37.33 up. Welding supplies, accessories, a.c. electric welders. Write today, Superior Oxy-Acetylene Co., Hamilton, Ohio.

GOVERNORS—Auto engine speed control. Candee, 129-W Llewellyn, Los Angeles.

MACHINERY, TOOLS, SUPPLIES

BUILD Your own machine tools. Lewis furnishes semi-finished castings for bench milling machine and shaper; rough castings for 23 metal and woodworking tools. Shop-tested materials and professional blueprints. Never a complaint on quality, design or price! Send 10c—New 1942, 32 page illustrated catalog. Lewis Machine Tool Co., Dept. M-20, Box 116, Station A, Los Angeles.

BROKEN Steel tapes spliced, 50c. Not shortened. Capps, 1008 Bertsch, Waterloo, Iowa.

13"x5" WILLARD Lathe with gap. No. 2 Pratt & Whitney hand milling machine, four step cone drive. Write for full particulars. Cincinnati Machinery & Supply Company, 217 E. Second St., Cincinnati, Ohio.

GRIND Drills like factory; attachment for bench grinder. Cheap. Factory, 811-B East 31, Kansas City, Mo.

"BRINKS" Bargain Bulletin. New-used machines, motors, tools for all shops. Brinkerhoff, 33 Walker St., New York City.

RECLAIM Dull and broken drills, with Nu-Way Drill Grinder. Circular free. Tractor-Lite Mfg. Co., Sidney, Iowa.

ENGINES, MOTORS, DYNAMOS

BIG Pay jobs in welding. Complete welding lessons and reference book, 516 pages, 41 lessons, \$2.00 copy. Money-back guarantee. Hobartweld, Box 825-M, Troy, Ohio.

\$100.00 SAVED Yearly, combination heating and electric plant; plans 75c. Efficient heating boiler from old radiators, enormous surface; plans 50c. Simple motor alteration, adds 25% to 50% mileage, particulars 50c. Bargains used electric plants. Hinton Electric Co., 81-A Alexander Ave., Montclair, N. J.

1/2 HORSE, 110 Volt, induction motors. Rebuilt, guaranteed \$9.75; other sizes, Wilmet Auto Supply, 2247 St. Paul Ave., Chicago.

GOVERNORS—Auto engine speed control. Candee, 129-X Llewellyn, Los Angeles.

WINDING Data, 225 motors, single and three phase, \$1.00. Motor Data Co., Box 7631, Kansas City, Mo.

AC And DC generators, motors, exhaust fans. State your needs. Queen City Electric, 519 South California, Chicago.

BOATS, OUTBOARD MOTORS, ETC.

FULL Size, cut to shape boat patterns, blueprints, 7 1/2 - 38 feet. Illustrated "Build a Boat" catalog, 10c (coin). "How to Build Boats" book, \$1.00. Cleveland Boat Blueprint Co., Station A-66, Cleveland, Ohio.

\$9.75 UP! America's biggest Kayak values. Safe! Sturdy! Dedham Kayaks, Dedham, Mass.

SAIL Your rowboat! Mast, boom, sail \$10. Trysail, Patterson, N. Y.

TEN Plywood boat plans 50c. Free catalog boat building plans. The Radder, 15 Murray Street, New York.

U-MAK-IT Boats—Easy-to-build. Kayaks, rowboats, dinghies, outboards, inboards, sailboats. Runabout for auto engines. Over 300 in stock. Complete kits. Simple to assemble. Send 10c (coin) for all catalogs with illustrated construction details. Largest selection offered. Kayak Boat Co., 154-P East 129th St., New York City.

REBUILT Outboard motors. Fully guaranteed. Over 300 to pick from. Send 10c for complete list. Boat design book 15c. Buy now before prices advance. Chicago's largest dealer, Masters & Son, 214 West Chicago Ave., Chicago.

BOAT Designers are highly paid professionals. Complete course by mail. Catalog. Westlawn, Montville, N. J.

OUTBOARDS—Save 1/2. Good used parts, all makes and models. Bargains rebuilt motors. Crandall Hicks Co., 959 Commonwealth, Boston, Mass.

FORD Mercury-Zephyr marine conversions. Catalog 10c. Lehman Engineering Company, Dept. D, Newark, N. J.

OUTBOARD Motors, used parts. Outboard Exchange, 9614 Flatlands Ave., Brooklyn, N. Y.

SPORTING GOODS, GUNS, FISHING TACKLE, ETC.

ARCHERY Equipment: Catalogue free. Mid-West Archery, 2209-A East 75th, Chicago.

ARCHERY Equipment manufacturers since 1924. Indianhead, Box 303A, Lima, Ohio.

BOWS—Arrows: Construction-instruction book 50c. Catalog free. Archery, 617 South State, Chicago.

USED Guns, bought, sold, exchanged. List stamp. Howe Fur Company, Coopers Mills, Maine.

WANTED: Used revolvers; automatics. State price; condition. Send stamp for bargain list sporting goods. Lee Sales, W-35 West 32nd Street, New York.

"RAISE Earthworms for Profit." Information free. Stamp appreciated. Bureau Zoological Research, 106 "P" Broadway, Peoria, Ill.

ATHLETIC EQUIPMENT—BODY BUILDING COURSES

SWIM! Teach yourself. Write for details. W. Power, 923 W. Vine, Kalamazoo, Michigan.

SUPER Ju-Jitsu—lightning defense and attack system. Sensational new home study course now ready! Learn to lick brutes twice your size with only your bare hands. Free details. Nelson Co., 500 Sherman, Dept. H-508, Chicago.

BAR-BELLS. Exercise equipment. Courses. Special offers! Free booklet. Good Barbell Co., 4676aPM, So. Grand, St. Louis, Mo.

ANTIQUES, RELICS, INDIAN GOODS, CURIOS

100 ANCIENT Bird arrowheads \$3.50. Catalog 5c. Sistershop, Northbranch, Kansas.

ANTIQUES By mail. Lists 10c. Antiques, 892 E. Market, York, Penna.

GUNS, Swords, armor, war relics catalog, 20c. Thomas Woroniecki, Roslyn, N. Y.

SWORDS, Pistols, daggers, armor list 20c. Roberts Abels, 860A Lexington Ave., New York.

INDIAN Relics, coins, bills, gems, crystals, curios, etc. Illustrated catalog 5c. 100 ancient arrowheads \$3.00. H. Daniel, Hot Springs, Ark.

INDIAN Relics, beadwork, coins, curios, minerals, old glass. Catalog 6c. Indian Museum, Osborne, Kansas.

FIELD GLASSES, TELESCOPES AND MICROSCOPES

LENSES—Build your own telescope, field glass, microscope, rifle scope, etc. Assortment of fifteen lenses—\$1.00 postpaid. Slightly chipped on edge. Satisfaction absolutely guaranteed. American Lens Company, 324 North Mayfield, Chicago.

DOGS, PETS, BIRDS, RABBITS

FARM Raised registered Irish Setter puppies. Write Earl Bond, Albert Lea, Minnesota.

MONEY Raising rabbits. Investigate. Folder 10c. Close Rabbitry, Tiffin, Ohio.

REPTILE Catalog free. Horned toad 25c. Sidewinder rattlesnake \$1.50. Quivira Specialties, Winfield, Kansas.

PUPPIES. Many breeds—particulars free! Book 108 colored pictures, descriptions recognized breeds, 35c. Royal Kennels, No. 91, Chazy, N. Y.

ST. BERNARD Puppies. Champion sired beauties. Franklin Young, R4, Riverhead, Long Island, New York.

ANIMALS, Birds, reptiles. All kinds. Send stamp for lists. Snake King, Brownsville, Texas.

TREES, SHRUBS, PLANTS, HERBS

CALIFORNIA Wildflowers—Three pack-etc 10c. List. E. Johnson, Jersey Ave., Eureka, California.

HERBS! Profitable hobby, business. Particulars 3c stamp. The Brandons, 2322 Commonwealth, Chicago.

FARMS, FARM LANDS, REAL ESTATE

FARMS And business; \$1000—In village, near river; 16 tillable acres; good 7-room dwelling, barn, store building 16x28; terms; page 47 big free catalog 1384 bargains many states. Strout Realty, 255-P 4th Ave., New York City.

GOOD Farm bargains. Washington, Minnesota, Montana, Idaho, Oregon, North Dakota. Dependable crops, favorable climate. Write for literature and lists describing farms for sale. Specify state. J. W. Haw, 119 Northern Pacific Ry., St. Paul, Minn.

40 ACRES. Near White River, unimproved; poultry land. \$190, \$5 down, \$5 monthly. Free list and literature. Hubbard, 216 Crossman Bldg., Kansas City, Kans.

GOVERNMENT Land \$1.00 acre up. Information all states 25 cents. National Tax Service, 1037A Majestic Bldg., Detroit.

SEE The Highlands of Louisiana. Choice cut-over land selling at low prices on liberal terms. Descriptive book sent upon request. Long-Bell Farm Land Corp., 878 R. A. Long Bldg., Kansas City, Mo.

FARM MACHINERY AND SUPPLIES

MANY Have built at small cost, their own garden tractor powered by engine from washing machine or lawn mower, etc., and handy farm tractor powered by old automobile engine. \$1.00 brings our plans postpaid for building either; state which is wanted, plans for garden tractor or farm tractor. Shaw Mfg. Co., Galensburg, Kansas.

POULTRY AND FARM SUPPLIES

MORE Profits from poultry—Learn how others get big daily income. Read America's leading poultry magazine. Three years 50c, one year 25c. Poultry Tribune, Department PB-3, Mount Morris, Ill.

PROFITABLE OCCUPATIONS

MAN You'll like silvering mirrors! Learn gilding, chipping, drilling. Outfit prices. Sprinkle Plater, 411, Marion, Ind.

WELDING Pays. Learn with 1942 trade school text manual. 516 pages. Over 500 photos. \$2.00 copy. Money-back guarantee. Hobartweld, Box M-823, Troy, Ohio.

MAKE Miniature novelties. Pleasurable, fascinating, money-making hobby. Unique. Details free. Welder Studios, 1171 Wilshire, Los Angeles, California.

STANDARD Rabbit Journal, Milton, Pa. 3 years, \$1.00, sample dime.

\$40.00 WEEKLY. Made growing mushrooms, fresh, dried. Dominion patent 331583. Free spawns. North American, 169Y Yonge, Toronto, Canada.

RAISE Chinchilla rabbits for us. We pay up to six dollars each. Catalog and contract 10c. Book catalog. Year subscription Rabbit Magazine 25c. Stahl's, Box 10, Holmes Park, Mo.

RAISE Angora rabbits—wool brings \$5.00 pound. Particulars free. Grinstead's, Edwardsville, Illinois.

BOOKS, PERIODICALS, PICTURES, POSTCARDS

BUSINESS, Trade, professional and diversion magazines. Current copies. Choice of 400 different publications—representing over 100 callings. Free price list. Commercial Engraving Publishing Company, 34C North Ritter, Indianapolis, Indiana.

EXCELLENT Sparetime profits taking subscriptions—2500 magazines. Complete starting supplies free! Pines, 583 Monroe, Brooklyn, N. Y.

SELF-EXPLAINING Bible: Illustrated circular free. Box 446-P, Minneapolis, Minn.

BOOK Assortments—10 books 50c. Folklore, fiction, poetry. Arcadian, Lonsdale, Arkansas.

RATIONAL View of Life—50c. Scientific. Benjamin Seibert, Urbana, Ohio.

PRETTY Girl pictures. List 3c. Scott's, Box 342, Covington, Ky.

BACK Dated magazines 5c. Used, new books. (Foreign, domestic). Catalog 10c. Ciceron's, 863 First Avenue, New York City, New York.

FREE—100 Page catalog. More than 50,000 titles, new and used text and reference books. Established 1902. College Book Co., Columbus, Ohio.

MAGAZINE Binding: We assemble and bind magazines. Have your old books, Bibles, and hymnals rebound. Durable! Attractive! Prices are reasonable. Heckman Bindery, Dept. D, North Manchester, Indiana.

MACHINIST'S Reference book \$1.00 postpaid. G. A. Knudsen, 523 - 48th St., Brooklyn, N. Y.

ANY Book (new, used, out-of-print, rare) promptly supplied! Lowest prices! Send for free bargain catalogues! Old Prof's Book Shop, M16 Arcadia Court, Pontiac, Mich.

FREE Books and magazines. Your name and address will bring you information how to get any national magazine for one year free. How you can get one book free with each book you buy. Book and Magazine Club, 315 Fifth Avenue, New York, N. Y.

GAMES—ENTERTAINMENT

WHICH Of these amazing joke, magic, astrology, game book bargains do you want for free 5-day examination? Order as many as you like! Read 5 days. Return those you don't want—pay only \$1 each (plus postage) for books you keep! Your choice: "How to Play Piano by Ear"—complete course; "400 Tricks You Can Do"—mammoth coin, dice magic book; "Ask Me Another"—quiz book, 4,100 questions; "Fun for the Family"—1,000 word puzzles, magic, stunts; "Astrology for the Millions"—Evangeline Adams advises on job, money, future; "Home Book of Quizzes, Games, Jokes"—900 brain-teasers, 100 games, plus latest jokes; astrology, palmistry, dreams; "Secrets of Reading Character at Sight"—amazing proved method (illustrated); "Blackstone's Card Tricks and Secrets of Magic"; "Great Ghost Stories"—25 masterpieces; 1,500 interpretations, what your dreams mean; "World's Best Jokes"—400 pages. Send free-examination order (without money) now! Garden City Publishing Co., Dept. 108, Garden City, N. Y.

PLAYS, Operettas, musical comedies, complete minstrel first-parts with song programs, blackface skits, vaudeville acts, monologs, dialogues, recitations, juvenile plays and songs, musical readings, entertainments, make-up goods. Catalog free. T. S. Denison & Co., 203 N. Wabash, Dept. 11, Chicago.

MAGIC TRICKS, PUZZLES, JOKER NOVELTIES

MAGIC Tricks. Deluxe catalogue 10c. Magcraft, Heights Station, Houston, Tex.

CLEVER Card trick. Battles experts. Details free. Harry H. Willis, Box 1704, Cleveland, Ohio.

NEWLY Invented! Modernistic card tricks! Surprisingly easy! Conaway, W-123, Champaign, Illinois.

"250 TRICKS Explained"; catalog, samples, 25c. Eastern Sales, 32 West Randolph, Chicago.

DOLLAR Magic set free with gigantic catalog 25c. Mysto, 4462-N Germantown, Philadelphia.

SENSATIONAL New trick, 10c. Trix, 2004 LaSalle, Niagara Falls, N. Y.

DOUGLAS' Famous 1942 catalog of 500 tricks you can do! Brand new effects for pocket, parlor or stage. Send 10c for year's biggest catalog value. Douglas Magic Shop, Box 274, Dallas, Texas.

LEARN Ventriiloquism, 3c stamp brings particulars. Smith, 801 Bigelow, Peoria, Illinois.

NEW Vanishing key and catalog 25c. Sterling Magic, 345 John R. Detroit, Mich.

BE A magician. Large professional magic catalogue of latest tricks 25c. Ireland, C-109 North Dearborn, Chicago.

HOLLYWOOD Special! Magicians button, catalogue, ghost illusion and free trick for 25c. Magic House of Charles, Box 888, Hollywood, California.

EARN Money in any crowd. Call names of strangers, tell unspoken questions. Professional course mind reading, spirit writing, etc., \$1. Henderson, Box 341, San Bernardino, Calif.

WORLD'S Largest professional magic shop keeps you in touch with latest tricks. To receive mailings send 25c for 1942 catalog. Holden, 220 W. 42nd St., New York.

MAGICIANS' Headquarters, 216-page catalog, pocket, parlor, professional tricks, 25c. Kanter's, M-1311 Walnut, Philadelphia.

STAMP COLLECTING

150 DIFFERENT Philippines, U. S., Canada and Mexico. Special packet containing large commemoratives, airmails, parcel post, specials, revenues and other scarce items only 25c with approvals. International Stamp Co., Hallettsville, Tex.

POSITIVELY Greatest free offer—Latest Scott's International \$3.50 Stamp Album—covering entire world, contains 30,000 illustrated, descriptive spaces; Scott's 1942 standard \$3.00 catalogue "Philately's Encyclopedia"—absolutely free to applicants for foreign approvals becoming customers. Plymouth, A-9, Bell, California.

UNITED States and foreign approvals at attractive prices. Hermes Stamp Company, Box 276, Hempstead, N. Y.

SUPERB Approvals, net prices. Stamps 1/3 to 1/8 catalogue. F. G. Beals, 170A Tremont St., Boston, Mass.

FREE! Complete "United States" stamp catalog with 1,000 illustrations! Send 3c for postage. Harris & Co., 137 Transit Building, Boston, Mass.

U. S. Commemoratives, 1,000, \$2.50, 100 different, Columbians to latest, including 10c denominations. Oroc, 696 Market, San Francisco.

66 DIFFERENT Foreign western hemisphere—including Argentine, Brazil, Cuba, Guatemala, Jamaica, Uruguay, 6c to approval applicants. Crowncity, 795 Elizabeth, Pasadena, California.

PINE Approvals, freshly mounted. Past, personal service. Tell me what countries you prefer and I'll send their stamps. Skinner, 345 East Ocean, Long Beach, Calif.

4 TRIANGLES, 3c Postage. Approvals. Super Stamp Shop, Route 1, Greencastle, Indiana.

SWAP Duplicates with collectors everywhere. Dime brings packet, Swappers Guide, registration card, and pledge. Stamp Swappers, R.1102, 480 Lexington, New York.

SENSATIONAL Combination offer! Big packet 105 different including Iceland, Manchukuo, Ecuador (American flag in full colors), Danzig; airmails, commemoratives, triangle stamp, \$4 United States; complete set United States telegraphs, cataloging 20c. Packet British Colonies, including Gwailor, Hyderabad, Burma (new country) jubilee and coronations. Scarce Far Eastern republic cataloging 50c. Big illustrated lists of other bargains. Total catalog price over \$3.00! All for only 5c to approval applicants! World-Wide Stamp Company, Department 600-N, Camden, New York.

DUPLICATE Exchange. Send 50 different duplicates and dime. Receive duplicates and letter of fellow-collector. Clark, 1650 Pearl, Denver, Colorado.

NEW! 28 U. S. Army division insignia poster stamps in full official colors, 25c per sheet. Hobby shops, write for discount. J. H. Kennedy, 5910 Wellington Ave., Chicago.

SEYCHELLES, Nejd Caymans, Manchukuo, Brunel, Turks Caicos, British Solomons (Cannibaland). Everything 3c with approvals. Viking, 130-Z Clinton St., Brooklyn, N. Y.

AIRMAILS! 25 Different, 25c; 50 different, 50c; 100 different, \$1.00. Ernie Phillips, Azusa, Calif.

U. S. Best buys. Big list free. Ewing-Stamps, 109 N. Dearborn, Chicago.

100 REAL Good mixed foreign 30c. Howard L. Grosser, 24 Birch Avenue, Methuen, Massachusetts.

AIRMAIL Packet 6c. Approvals. Jack Millhiser, 7724 Abbott, Pittsburgh, Penna.

PRINTING—Stock forms. Samples for stamp. Keelerprint, 3822-W Ogden, Chicago.

BARGAIN Approvals! Airmails, commemoratives, pictorials, triangles, Philip Stafford, Wurtland, Ky.

A WHOLE Year of Kawchief Stamp Journal—10c. Lawrence, Kansas.

TRY Our jumbo penny approval books. O. K. Stamps, Centralia, Ill.

ONE Hundred different United States stamps for seventy-five cents. Gail Boes, 38 Catharine St., Dayton, Ohio.

81c FOR Nothing! Scarce set of four Russian stamps cataloging 81c plus giant illustrated bargain lists. All absolutely free for the name and addresses of three friends who collect stamps. Frederick A. Pitts, Framingham, Massachusetts.

HITLER—Mussolini stamp, new issue, 5c. Approvals. Moore, Emsworth, Penna.

SCARCE \$5.00 Presidential No. 834, catalog 85c (port. initialed) only 10c to approval customers. Marco Stamp Company, Box 888, San Francisco, California.

COMMEMORATIVES And airs, 100 different 50c. 150 different \$1.00. Chas. Hurford, Ponca City, Okla.

FREE—Martinique, Niger, Senegal, etc., to approval applicants sending postage, we will include a army, navy or air corps insignia ring. Pacz, 232 North Olive, Los Angeles, California.

4,000 U. S. foreign \$1. Approvals 1c up. Free stamps. Grist, 409 Oak, Daventport, Iowa.

WORLD'S Smallest airmail—diamond and triangle stamps, free stamp magazine, also magnifier to study your stamps, with large collections of stamps from scarce countries. A bargain, 5c with approvals. Capital Stamps, Dept. 2, Little Rock, Arkansas.

50 HYDERABAD, Travancore, Charkhari, British Colonies. 3c. Approvals, Cymerman, 177 Huron, Brooklyn, N. Y.

LOWEST United States stamp prices. Free illustrated catalogue. Creevey's, Berwick, Penna.

VICTORY Packet free—Includes stamps from Tanganyika, British Cayman Islands, animal, scarce babyhead, coronation, early Victorian, airmail, map stamps, with big catalogue—all free. Send 5c for postage. Gray Stamp Company, Dept. PM, Toronto, Canada.

19th CENTURY U. S. commems. Civil War revenues, battleship, \$5 and \$10 stamps—1942 illustrated U. S. catalogue, free to U. S. approval applicants. Metropolitan Stamps, 198-P Broadway, New York.

POLISH "Anti-Hitler" stamp, smashed U. S. embassy, also Ecuador with U. S. Flag in natural colors, "Christ" triangle, diamond, Chinese "midget," red army soldier, R.A.F. pilot, ex-Nazi colony, etc.—all only 5c with approvals. Potomac Stampco, Dept. 1A, Washington, D. C.

APPROVAL Sheets. Frederick B. Driver, 401 Finance Bldg., Philadelphia, Penna.

25 DIFFERENT China, 3c with approvals. Knopp, Box 1381, Bristol, Conn.

WILL Rogers and U. S. Flag Panama showing "Old Glory" in natural colors, Nicaragua "Rogers," North Mongolia diamond (world's largest), "peace" stamp, Thailand, war countries, etc. All 5c with approvals. Belmont Stamp Co., Dept. 8, Washington, D. C.

MEXICO Census commemorative set free with approvals. Pladon Stamps, 1717-M Idaho, Toledo, Ohio.

WHOLESALE Supplements to dealers for 10c postage. Hundreds of bargains. Grossman Stamps, 102 West 42nd, New York.

15,000 VARIETIES 1c, 2c each! Davison, Box 31A, Wollaston, Mass.

60 DIFFERENT U. S., including commemoratives, airmail 10c. No approvals. Seidenberg, Cassopolis, Mich.

LOOK! 1000 Different only \$1.50; 2000, \$4; 3000, \$8. Fred Onken, 630 79th St., Brooklyn.

FREE! Austria war set. Postage 3c. Williams, 606 Archer, Bay City, Michigan.

FREE! Pony Express set (facsimiles). Postage 3c. Roberts, 406 Building, Bay City, Michigan.

FREE! Leeward Is., Cayman Is., Turks and Caicos plus 60 different mint Geo. VI coronation poster stamps, to approval service applicants sending 3c postage. Tatham Stampco, Springfield-30, Mass.

DEALERS—Wholesale list. Postage 3c. Frank's, 4900 Chalgrove, Baltimore, Md.

NEW 1942 Bargain packet—Over 100 different stamps; includes strange "mystery stamp" now prohibited in United States mail; stamps you'll treasure from Aserbaijan, Georgia, Transcaucasia, etc. Complete packet for only 5c to approval applicants. Cactus Jr. Approvals, Box 1870-M, Tucson, Arizona.

100 DIFFERENT British colonies—Stamps from the four corners of the world—Special 10c to approval applicants. Official Stamp Co., Fairlawn, N. J.

UNITED States approvals complete coverage, fine quality, attractive prices. Seminole Stamps, Box 436, Coconut Grove, Florida.

WEEKLY Stamp magazine, thirteen weeks, 10c. Stamp Journal, Kalamazoo, Mich.

A REAL Bargain. Specially prepared packet containing 150 different foreign and 65 different U. S. stamps; catalog value about \$5.00; pamphlet which tells you "How to Make Your Stamp Collection Properly" and large bargain lists, all for only 23c postpaid. Queen City Stamp Co., Room 38, 604 Race St., Cincinnati, Ohio.

WOW! \$10.00 Worth of fun for only 10c! 500 foreign stamps, unsorted and unpicked (mostly on bits of paper) just as received from the church missions and other sources. Africa, So. America, Australia, China, Philippines, Dutch Indies, and other countries are represented. Includes a few commemoratives, airmails, and stamps cataloging up to 25c or more each! The biggest package of fun in stampdom—and you might find something really valuable! Price only 10c to serious approval applicants! Money back if not delighted. Jamestown Stamp Co., Dept. No. 22, Jamestown, New York.

PENNY Approvals, that satisfy. Neil Gronberg, Box 5441-P, Philadelphia, Penna.

\$1.00 (CAT. Price) for 1c! Two mint U.S.A. cat 20c; "queer countries" packet (Djibouti, Manchuria, etc.); scarce set Russia, cat. 75c. Everything for only one cent to approval applicants! Garcelon Stamp Company, Box 490, Calais, Maine.

GIANT Packet 136 all different from Africa, South America, South Sea Islands, etc. Includes Nicaragua airmail, two scarce unused United States cataloging 20c, triangle and animal stamps; many others. Also includes fine collection 25 different British Colonies—Charkari, Jamaica, Johore, etc. and United States \$4 and \$5 high values. Total catalog price over \$4.00! Everything for only 5c to approval applicants! Mystic Stamp Company, Department 80-A, Camden, New York.

SEND Postage for free United States price list. Stanley Gibbons, 38-P Park Row, New York.

CANADA 100 Different 25c—approvals all countries. Lists. Victoria Stamp Co., London, 4, Canada.

STAMP Dealers, your ad here will bring wonderful returns. Ask me for proof. F. W. Johnson, Manager, Classified Advertising, Popular Mechanics Magazine, 200 E. Ontario St., Chicago.

COINS, TOKENS, CURRENCY

PRICE List of U. S. coins, bills and collectors' accessories 10c. 75 illustrations, 2500 quotations. James Randall, 341 South Dearborn, Chicago.

10 INDIAN Head cents, different dates, also pricelists 35c. Schultz, 1053 Richmond, Cincinnati, Ohio.

OLD Money wanted. Do you know that coin collectors pay up to \$100.00 for certain U. S. cents? And high premiums for all rare coins? We buy all kinds. Send 4c for large coin folder. May mean much profit to you. Numismatic Co., Dept. 20, Fort Worth, Texas.

RARE Commemorative half-dollar, and pricelist, \$1.00. Toivo Johnson, East Holden, Maine.

BARGAIN Coin list 10c. Ramsay, 882 East Market, York, Penna.

OLD Money wanted. Big premiums paid. 1,000 quotations. Catalogue 10c. Allan Appell, Sedalia-6B, Missouri.

SELLING—1500 Indian cents. Gohn, 250 E. Bdwy., Red Lion, Penna.

COMMEMORATIVE \$1.00, Columbia, Lincoln, Stone-Mountain, Long-Island, Cleveland; \$1.00 each. Large illustrated catalogue 25c. Norman Shultz, Salt Lake, Utah.

I MAY Have just the scarce U. S. coins you want. Send me list. "Meet me by mail." William H. Kenworthy, Waterville, Maine.

GET Profit and pleasure in collecting old coins. Send 10c for 56-page illustrated coin catalog. You'll be delighted with it. Send for it now. B. Max Mehl, 370 Mehl Building, Fort Worth, Texas. Largest rare coin establishment in U. S. Established 42 years.

FREE! Foreign coin, banknote and large 50 page illustrated coin catalogue to approval service applicants. Send 3c postage. Tatham Coinco, Springfield-125, Mass.

COINS, Domestic, foreign, bought, sold. Bargain catalogue free. Wittlin, 1681 Broadway, New York City.

HOBBIES AND COLLECTIONS

ALBUMS! For most hobbies. Write for new album booklet now! Matchless Album Co., Dept. P, Long Branch, N. J.

WANTED Old cigarette cards. Write Bray, 1127 Jackson, Easton, Penna.

20 DIFFERENT Cactus plants \$1.00 postpaid. Lida Delap, Azusa, Calif.

A GENUINE Arizona ruby (garnet) for dime and three cent stamp. Limited get-acquainted offer. Mineral Specimen Co., P.O. Box 2651, Phoenix, Arizona.

2,500 ADVERTISING Book matches, \$8.95. Ocho DeWitt, 54 Lafayette, Pontiac, Michigan.

PENCILS—Collectors assortment, regulars, bridge, carpenters, mechanicals. \$1.00 postpaid. Anderson Pencil Co., 362 Hillcrest, Louisville, Ky.

BEAUTIFUL Jewelry stones removed from rings, etc. 100 assorted \$2.00. Lowe's, Box 311, St. Louis, Missouri.

NEW—15 Different match covers 10c. Box 202, Rochester, N. Y.

EXCHANGE Your duplicate stamps, match covers, etc. with collectors everywhere. List, swappers, dime. (Mention hobby.) Secretary, Box 2166, Denver, Colo.

HOBBY Books—Latest titles—Bargain catalog free. Popular Mechanics, 633 St. Clair, Chicago.

CAMERAS AND PHOTO SUPPLIES

NO More wasted film or unnecessary expense. Take pictures you can be proud of. Sell to magazines and newspapers. Make good money wherever you live. Easy, low cost, home study course shows you how! Free catalog. Universal Photographers, Dept. 10, 10 West 33 St., New York City.

CAMERAS And supplies. Free illustrated catalog listing everything photographic—still and movie cameras, films, lenses, enlargers, meters, supplies—at tremendous savings. Hundreds of bargains. All guaranteed. We take your old camera or equipment in trade. Write now for your free copy of our newest money-saving bargain book—just out! Limited edition. Hurry! Central Camera Co., (Photographic Headquarters since 1899), 230 S. Wabash Ave., Dept. H-16Z, Chicago, Illinois.

BASS Offers DeVry Walkiesnap cameras, for sidewalk photos or identification, complete with card recording equipment and F-3.5 lens at \$99.50. Full information and photo on request. Bass Camera Company, Dept. PW, 179 W. Madison St., Chicago, Illinois.

SPEED-O-COPY Groundglass focusing attachment for Leica, Contax, Argus C-2 and C-3. Send for literature. D. Paul Shull, Dept. PM-8, 240 So. Union Ave., Los Angeles, California.

35MM. Camera users attention! Eastman Plus X, Super X; Dupont No. 1, No. 2; Agfa infra red. 25 feet \$1.00—100 feet \$3.00. Dept. PM, Box 2910, Hollywood, Calif.

BASS Says: Astounding buy, exclusive here, latest Argus C3 with coupled range finder, synchro flash, 50 mm. F-3.5 lens, also 75 mm. Bausch & Lomb telephoto F-5.6 also coupled to range finder. \$82.50 value; price \$60.50, unconditionally guaranteed. Cowhide Eveready case, \$4.75. V. P. Ihagee Deluxe, F-4.5 lens. Prontor shutter, big value at \$18.75. Send for yours quick while they are available. Write for quotations and advise what you have to trade. We pay cash for good cameras, lenses, binoculars. Don't trade until you write Bass Camera Company, Dept. AG, 179 W. Madison St., Chicago.

MAKE Money in photography. Learn quickly at home. Easy plan. Previous experience unnecessary. Common school education sufficient. Booklet and requirements free. American School of Photography, 1315 Michigan, Dept. 3432, Chicago.

CAMERA Repairing. Bellows made to order, shutters repaired. Bellows made to fit all standard cameras! United Camera Co., Inc., A-1515 Belmont, Chicago.

CASH! Spot cash for cameras, lenses, binoculars, movie or still, sound projectors. Send full description by mail, or wire for prompt cash offer. Over 30 years of dependability insures honorable dealings. Bass Camera Company, 179 West Madison Street, Chicago, Illinois.

HAVE You a camera? Send ten cents for recent number of our big magazine, showing how to make better pictures and earn money. American Photography, 116 Camera House, Boston, Mass.

EXPERT Camera repairs. Foreign, domestic, movie, still. Bellows made to order. Projectors. Camera Repair Shop, 30 E. Adams Street, Chicago, Ill.

PHOTO FINISHING

"YOUR Work sure is swell," writes customer. 35mm. films fine grain developed, 3 1/2"x5" enlargements 36 exposures \$1.25; 18 exposures 95c. No premiums—just honest, careful workmanship, best chemicals and papers insure sparkling negatives, brilliant glossy enlargements. Send us your roll today. Prime Photo Labs., Dept. A, Box 1283, Milwaukee, Wis.

FREE! Best snapshot on attractive photo button with 16 prints each roll 25c. Beautiful novelty premiums. Novel-Ad Co., B.M.-3327 North Ave., Chicago.

FREE Beautiful album with cellophane envelopes, plus roll developed, two sets prints, 30c. Same-day service. Photo-Pho, Box 24F3, Highland Park, Mich.

IMMEDIATE Service! Pictures returned same day order received. Sixteen guaranteed deckled-edge Velox prints from roll, 25c. One colored or two plain enlargements plus 8 deckled-edge Velox prints, 25c. Free! Coupon for 8x10 enlargement free with each 25c order. Any 36 exposure 35mm. film fine-grain developed, "Magic-Eye" timed, vapo-rated and each good negative enlarged to 3x4 on deckled-edge Velox paper, \$1.00. 18-exposure, 60c! Reloads: 36 exposure, 50c; 18 exposure, 35c. 3x4 deckled-edge reprints, 3c each! Write for free mailers, free premium offers. American Studios, Dept. 406, LaCrosse, Wis.

ROLL Developed—Three enlargements, 15 prints, 25c. Dick's Photo, Louisville, Ky.

ENLARGEMENT 4x6 In colors and film developed 8 Velox deckled-edge prints, 25c. Free film mailers 1-day service. Mail films to Joy-Photos, Dept. 12, GPO Box 606, New York, N. Y.

BIGGEST \$1.00 Value in 35mm. finishing today. 36 exposure fine grain 3 1/2"x4 1/2" enlargements; deckled, embossed margin and date. Eighteen exposures 75c; sixteen exposure splits 55c. Free mailers. 8 exposure rolls in beautiful, deckled contact finish with free handy album 25c. Mailbag Film Service, Box 5440A, Chicago.

35 MM., Argus, Leica, etc., (except "Mercury") 36 exposure rolls, fine grain developed (Eastman DK-20) and beautifully enlarged to 3"x4" glossy prints, 90c. Cartridge reloaded with Eastman Plus X, 35c. 18 exposure rolls, 55c, reload 20c. Films permanently protected by revolutionary Cryolite process. 24-hour service. Satisfaction guaranteed. Free mailing bags, sample print. Write Technifinish Laboratory, 607 Brown St., N.W., Rochester, N. Y.

FREE Mailing bags. Outstanding pictures, individual attention each negative. Roll developed and 8 prints 25c. 8 beautiful 4x6 enlargements 35c. Immediate service. Minicam Photo Labs., Dept. 58, LaCrosse, Wisconsin.

20c FILM Developed, 8 Velox Mirrotrone prints, guaranteed workmanship. Wilson's, GPO Box 202, New York.

"SUPERFINE" — 35mm. 36 exposure rolls developed, chemically hardened and enlarged semi-matte with exclusive "Exposurequalizer," to 3x4, \$1.00. Cartridges reloaded 35c. "Our laboratory head pioneered 35mm. photography." Send for free mailbag. Superfine Laboratories, 113 Court Street, Newark, N. J.

HAVING Trouble? Professional analysis negative and print, 25c; 3, 50c. Enclose stamped envelope. Crooker, Kenwood, Brockton, Mass.

ROLLS Developed 8 exposure, 16 prints or 8 prints 2 enlargement coupon 25c. 35 mm. developed, enlarged 3x4, 36 exposure 90c. Reloads. Kodak films 35c and 50c. Camera City Studio, 225 Shelter St., Rochester, N. Y.

NO Free offers! No automatic printers! Individual attention to each negative roll developed and eight sparkling prints 25c. Immediate service. Write for free mailing bags. Universal Photo Service, LaCrosse, Wisconsin.

FIRST Roll 35 mm. fine grain developed, 36 big 3 1/2"x5 enlargements \$1.36 exposure superior reload 35c. Nationwide Finishers, Linton, Ind.

NATIONAL Reputation for quality—exclusive but not expensive. 8 exposure rolls, deckle edge prints in handy pocket album 25c, reprints 3c. Miniature rolls enlarged 3 to 6 times, 8 exposures 30c, 16 exposures 60c. 35mm. 36 exposures, 3x4 enlargements, \$1.25, 16 exposures 75c. Paramount Photo Co., 1583 - 1st Ave., New York.

ROLLS Developed, two sets prints 25c. Reprints 20c dozen. Eshleman Studios, 120-08 Liberty, Richmond Hill, N. Y.

OIL-COLORED 5x7 Enlargement 25c; small size 20c. Ariet Studio, 41-31 47th St., Long Island City, N. Y.

16 SPARKLING Lifetone prints, 2 beautiful Hollywood enlargements, free Leatherette frame and photo wallet only 25c. Free photo album with first order. Lifetone Studios, Dept. A-839, Des Moines, Iowa.

1942 35MM. Hit! 36 exp. rolls, fine grain, developed, enlarged, 3 1/2"x4 1/2" glossy (except Univex), 85c; 18 exp. 55c. Include postage with remittance. "Studio 35." Box 677 Grand Central P.O., New York City.

ROLL Developed, printed, plus one 5x7 enlargement. 25c. Square Deal Studio, Dept. F, Huntington, Ind.

IDEAL Photos beautifully finished wide border—deckle-edge, 25c per roll of eight. Fade-proof, superior quality. Write for free mailers. Ideal Photos, Box 2255, Paterson, N. J.

ROLL Developed, eight snappy 4x6 enlargements, or sixteen sparkling prints 25c. Crystal Studios, Box 159-F, Rushford, Minnesota.

THE Photo Mill. Immediate service! No delay! Eight exposure roll developed, printed and coupon for your choice of two beautiful 5x7 professional enlargements, one tinted enlargement, eight reprints or other premiums, for 25c coin. Developing and eight Jumbo prints 30c coin. The Photo Mill, Box 629-12, Minneapolis, Minnesota.

ROLLS Developed; two prints each negative 25c. Reprints 2c each; 100 or more, 1 1/2c. Summers Studio, Unionville, Mo.

3 1/4x4 1/2 ENLARGEMENTS From 36 exposure roll \$1.00, 18 exposure roll 75c. Double size prints, 8 exposure 628-127-120 rolls 25c. 8 exposure 116-129-130 rolls 30c. Split rolls 45c. Write for complete price list. Village Film Laboratories, Box 4046, Dept. M, Village Station, Los Angeles, California.

SPECIAL Limited offer! If you enclose this advertisement, 4 enlargements from 4 negatives 10c coin. Enlarge Photo, Box 791D, Boston, Mass.

AMAZINGLY Beautiful hand colored prints 6-8 exposure roll developed, printed 25c trial. Reprints 4c each. National Photo Art, D118, Janesville, Wisconsin.

ROLL Developed, two prints each good negative, 25c. (Limit 16 prints). Portland Film Co., Box P-4213, Portland, Oregon.

SIXTEEN Beautiful Holly-tone prints with eight exposure roll developed—25c. Hollytints, P-1350, Hollywood, California.

BEAUTIFUL Enlargement from each picture on roll 25c. Cut Rate Photos, Dept. B-4, Janesville, Wis.

EVERY Picture an enlargement! 8 sparkling deckle-edge enlargements and roll developed 25c coin; 116 size or smaller; enlarge reprints 3c. Enlarge Photo, Box 791D, Boston, Mass.

EIGHT Beautiful enlarged prints (nearly postcard size) or 16 regular prints 25c. 35mm. rolls enlarged 3 1/4x4 1/2 \$1.00. Burton Studios, 443M, Roscoe, N. Y.

TWO Beautiful prints from each picture on roll 25c. Twenty-two years of satisfied customers. Quick service. Lens Photos, Dept. J-4, Janesville, Wis.

THREE Prints each good negative, 6 to 8 exposure rolls, 30c. 12, 16, 18 exposure rolls, 50c. Reprints, 3c. Fred D. Eastman, Bode, Iowa.

DOUBLESIZE Prints. Your roll developed and 8 doublesize prints 25c; from 116 or 120 size negatives you receive 4x6 inch prints. All other size negatives printed in proportion. 16 exposure rolls 50c; 12 exposure rolls 35c. Reprints 3c each. "Our guarantee." Everlasting hi-gloss finish. Overnight service. Pacific Photo Service, Box 666, San Francisco, Calif.

EIGHT Prints, two enlargements 25c. Quality Picture Co., Box P-3573, Portland, Oregon.

ROLL Developed and 16 prints, or 8 prints and 2 enlargements, 25c. Candid 35mm. film developed and 36-3x4 prints, \$1.00, 18 exposure roll, 60c. Mercury Studios, Dept. 21, 109 N. Dearborn, Chicago, Ill.

16 BEAUTIFUL Oversize deckledged prints and two enlargements with first order 25c. Owlphoto M1, Weatherford, Oklahoma.

PHOTOGRAPHY For pleasure and profit. Prepare at home. Common school education sufficient. Write for information and requirements. American School of Photography, 1315 Michigan, Dept. 3451, Chicago.

ROLL Developed and 8 lustrous distinct finish permanent Velox glossy prints 25c—reprints 3c each. Fotoprint Service, Box I, Roanoke, Virginia.

8x10 SILK Finish enlargement—25c. Send negative, Irving Studio, 4006A Irving Park, Chicago.

AMAZING 35mm. Value 36 exposures developed, Vapored, enlarged, 75c with this advertisement. Limited time. Send films. Write to Miniservice, PM82, GPO Box 318, New York.

MOTION PICTURES AND SOUND EQUIPMENT

BASS Says: War time means Bass as the logical supply center for hard to get cine equipment. We have it. Write for latest condensed Cine price list, 8 mm. and 16 mm., and sound. New Revere double 8 with F-3.5 lens, \$38.50. RCA 16 mm. S.O.P. newared camera, \$325.00. Spot cash for good used movie equipment and sound projectors. Bass Camera Company, Dept. A, 179 W. Madison St., Chicago, Ill.

CLEARANCE! 8-16-35mm. Cameras, movie films. Extension movie rental library; lowest rates; sent anywhere. 16-35mm. projectors, sound, silent. Time payments, trades accepted. Mogull's, 64 West 48th, New York.

DEVELOP Your own 8-16mm. movies. Save 60%. Bulk films—developers. Write Genera Company, Davenport, Iowa.

35MM. FILMS. Projectors. Silent. Sound. Demasey, 1223 Berkley, Youngstown, Ohio.

\$1 BRINGS "Surprise" assortment 8mm. colorful titles! LeMoine Films, Nevada, Missouri.

WANTED: Used equipment for cash. Films, cameras, projectors, etc. Peters, 41-C South Fourth, Allentown, Penna.

100 FT. 8mm. Subjects 98c. Spring Films, Hopkinton, Mass.

SEVEN Emulsions for all 8mm. movie cameras! Spooled ready for use, or bulk. Save 50%. Eso-S, 3945 Central, Kansas City, Missouri.

MOTION Picture films exchanged B-49 2209 Main Street, Bridgeport, Conn.

AUTHENTIC Child health and training films for schools, colleges, health workers, social workers, parent teacher groups. Silent and sound. Complete information. Health Film Service Producers, Salem, Oregon.

BULK Film, 16 or double 8 Panchromatic Weston 16, 100' \$2.75, 400' \$10.00, not including processing. Shooks Laboratory, 40 Fort, Fortyfort, Penna.

MOVIES, 1942 Catalog free; samples 10c. Goodwill Company, Jackson, Tenn.

16MM. Films exchanged, 400-ft. reel, silent—\$1.00, sound—\$2.00. Latest releases. Free 40-page catalogue. Better Films, 742 NewLots Avenue, Brooklyn, N. Y.

"THE World's Greatest Passion Play." Extensive 16mm. film rental library. Write Hemenway Film Co., 33-P Melrose St., Boston, Mass.

BARGAINS New-used movie cameras, projectors, accessories. Large film rental library. Send 10c for catalogues. Don Elder's, M-739 Boylston Street, Boston, Massachusetts.

8-16-35MM. Films. Bought, sold, exchanged. Complete subjects \$2 up. Catalogue, sample film 10c. International, 2120 Strauss, Brooklyn, New York.

8-MM.-16MM. Silent-sound; all latest subjects. Films rented everywhere. Free catalogue (sample film 10c). Garden Film, 317 West 50th, New York.

8MM.-16MM. Films. Free catalogue (sample film 10c). Parkway Exchange, 961 Eastern Parkway, Brooklyn, New York.

MUSIC AND MUSICAL INSTRUMENTS

LEARN Popular piano! Write Magic Key, 111-A Broadway, Glendale, Calif.

TRADE New Bacon banjo for 16 mm. projector. Other instruments easy terms. Aub Horton, Osyka, Miss.

SONGWRITERS! Amazing outstanding offer. Hibbeler, C5, 2157 No. Avers, Chicago.

NOVELTY Phonograph records. Free list. Records, Box 111, Roselle, N. J.

SONGWRITERS. Write for free booklet, profit sharing plan. Allied Music, 204 East Fourth, Cincinnati, Ohio.

SONGS. Song poems considered for publication. Write today. Radio Music Company, 6912 Hollywood Blvd., Hollywood.

YOUR Song completed and published \$20.00. Melvyn Dinger, Ironton, Missouri.

SONGS Composed, arranged. Excellent beginners proposition. Basil Alt, Ottoville, Ohio.

LYRIC Writers: If you can write the words to a song please contact us immediately. We already have royalty contracts on three melodies, but don't have the words. National Music Agency, Dept. A, Box 768, Hollywood, Calif.

SONGWRITERS: Send poems for offer and free rhyming dictionary. Phonograph records made. Vanderbilt Studios, Box 112-CY, Coney Island, N. Y.

SONGS—Song poems wanted. No charge for melodies. Free examination. Hollywood Recording Studios, 87G19 Preuss Sta., Los Angeles.

WANTED: Original song poems. Five Star Music Masters, 630 Beacon Building, Boston.

HIT-QUALITY Music composed to words. Square deal. Best offer. Helpful facts free. Ahlstrand, Lake Stevens, Washington.

SONGWRITERS—Write for free book. Send poems. Variety, Dept. 2, Sarasota, Fla.

SONGWRITERS: Write for free instructive booklet concerning song poems. United Music, Dept. 14, Salem, Ind.

SONGWRITERS—Send poem for immediate consideration and free rhyming dictionary. Richard Brothers, 24 Woods Building, Chicago.

GOOD Music composed to good words. Reginald Belcher, Chatham, New Jersey. Established 1910.

SONGS, Poems wanted. Newart Song Publications, 1207 Carbon, Syracuse, N. Y.

MUSIC Composed to words. Rhyming pamphlet on request. Phonograph recording of completed songs. Send poem for consideration. Keenan's Studios, Dept. PM, Box 2140, Bridgeport, Conn.

WANTED! Lyrics, melodies for songs. We arrange, publish, sell. Superior Song Studios, Passaic, N. J.

MUSIC Composed to words. Wonderful proposition. Bauer Bros., Oshkosh, Wis.

LEARN Swing piano! Postal brings free folder. Christensen, 451 Kimball Hall, Chicago.

WRITE Songs. Big money and reputation. Write for information. J. Gordon Pub. Co., 201 N. Hoyne, Ave., Chicago.

RADIOS AND SUPPLIES

10 LATEST Radio and electric 10c books for experimenters and beginners. Send postcard for list. Radio Publications, 29 West Broadway, New York City.

NEW RCA-Victor, Admiral, Crosley radios. Immediate delivery at discounts. Write or wire Gravlee & Son, Kennedy, Alabama.

MAKE Simple long distance crystal radios. 2 regular 25c supersensitive crystals and complete illustrated instructions 25c. Alva Allen, A427, Clinton, Mo.

RADIO Men. Special quick review. License preparation. Circular 5-P. Nilson Radio School, 51 East 42nd St., New York, N. Y.

RADIO Communications courses qualifying for all federal licenses. Home study and resident courses. American Radio Institute, 1123 Broadway, New York, N. Y.

RADIO Service men and experimenters send for our giant radio catalog. Save dollars. United Radio Co., (1000 M.) Newark, N. J.

MONEYMAKING OPPORTUNITIES

AMBITIOUS Men and women wanting spare time work. Send for free listings. A. M. Brockway Publisher, 19 High Street, Bristol, Connecticut.

SELL Advertising on your own. Get all profits. Send others to work for you and pile up more. Folio over 30 practical plans reveals secrets how to start. Free circular. Mail Order Money, 604b North Broad, Lansdale, Penna.

SPARKLING Glass sign outfit \$3.00 (few left), luminous paint included. Learn to make nameplates, numbers, wall-mottos, grave-markers. John Sprinkle, M20, Marion, Indiana.

300 TESTED Money makers, 68 page book, 40,000 words. 25c postpaid, business secrets, formulas, wholesale supply source. Homer Shell, Box 74, Palmetto, Ga.

INVESTIGATE The commercial report-plan. The most successful plan in mail order. Information 10c with 3 regular 25c plan included free. Leo Adams, 492 Barrett St., Elgin, Ill.

AMATEUR Cartoonists, earn up to \$220.00 per month, doing copy work for advertisers. Ad-Service, Argyle, Wis.

SWAP Anything at Paws, 1857 University Center Sta., Cleveland, Ohio.

SURE-FIRE Dime puller. No stock to carry. Complete plan 25c. Collar Mailing Service, 19 High St., Bristol, Connecticut.

MILLION Articles. Buy wholesale. Valuable directory 10c. Ideal Service, D-8, Park Ridge, Ill.

TIMELY Home business. Tremendous profits. Formula, instructions, sample, dime. Gansler, Box P125, Bridgeport, Ohio.

AMAZING Gourd novelties! Details, 10c. O'Brien, 310 West 73rd, Chicago.

CASH Daily! Let the postman deliver it. 68 page book (over 40,000 words) jam-packed with mail-order, homework money-makers, 25c. Two mail order opportunity publications included free. O'Kay, Box 773-G, Ft. Smith, Ark.

EASY—Quick money copyrighted plan, 25c. Shelton Specialty Service, 58 Glemby St., Hamden, Conn.

NEED Money? Operate sideline. Home—sparetime! Different! Box 102-PM, Austin, Texas.

MAKE Statuary, flooring, etc. Imitation marble formula 25c. Ideal Service, 8M, Park Ridge, Ill.

START Mail order business. Stamp brings information. Albert Ludwig, 532 Geary, San Francisco.

LUMINOUS Number plate — Entirely new. Free circular. "Steere," 349 W. 64, Chicago.

MONEY, Samples, mail galore, get them all in stacks by sending 25c to Robert Bensi, Box 134, Dearborn, Michigan.

"SCHEMER" Alliance, Ohio, prints tested 8-getters: Schemes, opportunities, formulas. Six magazines, 264pp., just 40c.

MONEY In names—details free. Mako, 5226P Tennessee, St. Louis, Mo.

MAKE—Sell made-to-measure arch supports. Ease aching feet. Particulars free. Jul Corssen, 3609 Texas, St. Louis, Mo.

FREE Literature explains how; make money through mail. Cutler Publishers, Reading, Pennsylvania.

WHOLESALE Sources, 500,000 articles. Free directory. Maywoods, 1133 Broadway, New York.

BE A metascientist. Remarkable drug-less healing system. No manipulation, no apparatus. Inexpensive correspondence course. Free information. Metascience, Deland, Florida.

BUSINESS OPPORTUNITIES

START Own money making business. Enormous profits. Steady demand. Write for free amazing particulars. Shineite, 1001-C Jefferson Ave., Brooklyn, N. Y.

ARCHERY Ranges earn \$100 weekly. Prices, plan, Stanley Johnson, Salamanca, N. Y.

MEN—Women, start own business, home, office; booklet describing over 100 moneymaking plans free. Mantoman, 1014M, Hollywood.

START Home business making statuary, plaques, art goods, novelties, souvenirs, concrete pottery, garden furniture, artificial marble flooring, liquid marble. Make your own flexible molds. Amazing profits. Valuable folder free. Creative Publishers, (PM8), Glencoe, Illinois.

FOR An extremely profitable lifetime business, operate a collection agency-credit bureau. Many make \$4,000 yearly, up. Write, Cole Associates, Syracuse, N. Y.

THE Knack of making money in any business, job or profession easily mastered if you know how. Send me a 3c stamp and I'll tell you. Collar Mailing Service, 19 High St., Bristol, Conn.

I CAN Start any man or woman of intelligence, in a successful lifetime business. Whitman, P.O. Box 893, Tampa, Florida.

START Own business home, office. No peddling, little or no investment. Free folder tells how. Wm. Buckett, 23128 Battelle St., Hazel Park, Mich.

MECHANICALLY Inclined men—Own and operate general appliance repair shop. Complete, illustrated course shows you how. Welding, refrigeration, motor repair, how to get business, etc., all phases covered. Free literature. Christy Supply, Dept. 419, 2835 N. Central Ave., Chicago.

DOZENS Slickest moneymaking propositions! Surprising. Particulars free! Box 102-PM, Austin, Texas.

TIN Cans make steel scrap, valuable tin. Forty formulas 25c. Harry D. Cater, 455 Washington St., Denver, Colorado.

MAKE Your own Flexible Molds. Statuary, Art Goods, Novelties, Artificial Marble Flooring, Liquid Marble. Literature free. Kemico, 108-M, Park Ridge, Ill.

GUARANTEED Income! Grind lawn mowers. \$2.00 capital! Mowers, Janesville, Wis.

FREE Booklet. How to manufacture many products. Western, 201 Climax Bldg., Cleveland, Ohio.

COLLECT Your own accounts. Money-back guarantee. Creditors Service, Moorcroft, Wyoming.

SELLING Established business of easily compounding items. 400% profit, will take \$75.00. Kay, 129 W. Third St., Los Angeles, Calif.

MEN—What about your future? With business booming this is a good time to get established in a Rawleigh business—a business of your own with no priorities or shortages to worry about. You need no experience and can use our capital. Write Rawleigh Co., Dept. H-152-PPM, Freeport, Ill.

SELL By mail—Suggestions free. Harry R. Dean, 1828 Ave. L, Galveston, Texas.

HERE'S A real opportunity. If you want a business of your own that is substantial money maker right now and has unlimited future with exclusive protection, and if you have \$600 cash to operate a business, write 163 Stockton Street, Dept. 18, Jacksonville, Florida, for complete details.

WHERE To buy anything: Names, addresses. 25c coin. Nelson, Dakota Bldg., St. Paul, Minn.

SILVERING Mirrors. Home-sparetime. Profitable! Instructions 25c. Box 102-pm, Austin, Texas.

MAKE A good living in the mail order business. 64 pages of money-making plans and simple, workable instructions—\$1.00 postpaid; \$1.15 C.O.D. Regan, 2720-D Broadway, New York City.

FREE—200 Clever mailorder, homework, local business offers—all snappy moneymakers. Lewis Co., 828-M Carpenter, Oak Park, Illinois.

MAILORDER Letters, literature, campaigns, written. Powerful! Guaranteed! Reasonable! Finkel Advertising, 1013P Los Angeles Street, Los Angeles, Calif.

SIGNS And showcards easily and expertly painted with letter patterns. Many sizes and styles. Write for descriptive folder. John Rahn, A1330 Central Ave., Chicago.

START Sideline mail order business. Small capital. Legitimate. Choose from several propositions. Details free. Gasser, 4908 West 21st, Los Angeles, California.

SHATTER-STOP Invisible window coating (painted on inside) stops flying glass splinters. Washable. Protects like safety glass for ten cents a window. Big profits, sample 35c stamps. Details free. Staminite Corporation, Dept. SS, New Haven, Conn.

BE Notary public, make money. School, M-30 West Washington, Chicago.

EXPERT Vacuum repairing taught by mail. Business booming. Associates, Box 708, Warrensville, Ohio.

3 MOST Read mail order magazines, 10c. Armand Cartier, 695 North, Pittsfield, Mass.

HOME Work business. Many propositions. Suggestions free. McPherson Stamp Works, Middletown, Connecticut.

\$1.00 MAKES Dead-beats pay up? Buy 12 persuasive collection letters. Copy on your own letterhead—then mail—collections will amaze you! \$1.00 postpaid; \$1.15 C.O.D. Regan, 2720-B Broadway, New York City.

BRUSH Plating outfits connect to a battery, no tanks necessary. Almost as simple as painting. Your opportunity to make good income plating autoparts, bathroom fixtures, reflectors, mirrors. Get free proof and particulars that put you in a paying business of your own. Gunmetal Co., Ave. H, Decatur, Illinois.

OPERATE Route used 1c, 5c candy bar, peanut, popcorn, gum vendors. Lowest prices. Northside Company, Indianola, Iowa.

COLOR Cement with chemicals. Make artistic cement garden ornaments Hollywood style. Sample 10c. Hollywood Cementcraft, 8527 Wonderland, Hollywood, Calif.

YOUR Own business. 66 page book, 40 plans; 64 page magazine 10c. De Selms, 250-P, North 9th, San Jose, Calif.

STATUARY: Make all kinds. Simple process. Make and install artificial stone flooring in color. Liquid marble. Other money-makers. Write promptly. Literature free. Compo-Tex, Box 786, St. Louis, Mo.

PLASTEX Industries offers industrious men an opportunity to start a business of their own, manufacturing art goods, novelties, souvenirs, etc., in Plastex and marble imitation. 5c material makes \$1 articles. Rubber moulds furnished for speed production. Small investment brings good returns. We are now placing big chain store orders with manufacturers. Write for interesting booklet mailed free. Plastex Industries, Dept. A, 1085 Washington Ave., New York.

WEBER Typewriter Mechanics School. Simplified homestudy-repairing increasing. Canton, Ohio.

\$50.00, \$100.00 WEEKLY Using sawdust. Stamp please. Clement, 943 Arthur St., Rochester, N. Y.

MAKE Money by mail, the way we do. Free information. Maywood, 1133 Broadway, New York.

HOW And where to obtain capital. Fully explained, particulars free. Star Service, Wapakoneta, Ohio.

POPCORN And potato chip machines. We help start men and women in business. Long-Eakins, 1960 High, Springfield, Ohio.

LIQUID Marble—Colorful, glazed! Mold, brush, spray! Composition floors, rubber-lastic molds. Particulars free. Marbleizing Service, Edwardsville, Illinois.

CHARTERS: Delaware; best, cheapest; free forms. Colonial Charter Co., Wilmington, Del.

127 WAYS To make money, in home or office, business of your own. Full particulars free. Elite Co., 214 Grand St., New York.

2c DAILY Pays for New York office under your own name. Co-Operative Offices, 126 Lexington Avenue, New York.

SELL Books by mail on commission. No stock to carry. Orders come to you. Maywood Publishers, 1133 Broadway, New York.

MOLDMAKING—Plaster Casting. Complete formulas—fully illustrated. 25c. Ideal Service, RM-8, Park Ridge, Ill.

FREE—Big list of helpful books. Popular Mechanics Press, 200 E. Ontario St., Chicago.

FORMULAS, PLANS, ETC.

FORMULAS, Money making books, list free. Scott's, Box 343, Covington, Ky.

TWELVE Unique formulas—Added surprise—one dollar. H. Porter, 30 West Washington, Chicago.

MAKE Fast selling products. No machinery. "Chemist Approved Formulas." Write Kemico, 15, Park Ridge, Illinois.

AUTHENTIC Formulary 924 pages (illustrated). 10,000 formulas, recipes, instructions, substitutes. \$1.50 postpaid or C.O.D. (Foreign \$1.85). Catalog 3c. Adams Brown Company, Chestnut Hill, Massachusetts.

"LUMINOUS Paint" shines in dark. Easily made. 100 other formulas, plans—all 25c. Ideal Service, 308, Park Ridge, Ill.

ICELESS Ice! Colder; cleaner; cheaper. Instructions 25c. Duffy, Covington, Ky.

REAL Manufacturing formulas. Lists free. Cummings, Chemist, Gordon Ave., Syracuse, N. Y.

CHEMISTRY

FREE Catalog: chemistry, mineralogy, biology. Special: 28 piece chemistry set, send \$1.00. Tracey Laboratories, Evanston, Illinois.

WINN'S New Idea chemical kits for students; apparatus and chemicals, retail. Free catalog, send 3c return postage. J. H. Winn, Dept. 508, 124 W. 23rd Street, New York.

50 "POISON" Gummed labels, 10c. Garda, 264 Ninth, Paterson, N. J.

CHEMISTRY Laboratory apparatus and chemicals for industrial, analytical, and private experimental laboratories. Complete chemical laboratory supply service for correspondence school students. Send 3c for free 48-page catalog of chemicals and apparatus. Dept. M-43. Biological Supply Co., 1176 Mt. Hope Ave., Rochester, New York.

CHEMICAL Experimenter's supply catalog 5c. Colonial Chemical Company, Brockton, Mass.

SPECTROSCOPE For quick chemical analysis \$2.50. Kutting Sons, Campbell, California.

CHEMICALS—Small quantities, apparatus. Catalog 5c. Fleischer's Laboratories, Medford, Mass.

HELP WANTED

SPECIAL Work for women. Demonstrate lovely dresses in your home. Earn to \$23.00 weekly, get own dresses free. No investment. Give age, dress size. Fashion Frocks, Desk 42140, Cincinnati, Ohio.

LOCAL Agents wanted to earn bonus suits and demonstrate to friends. Up to \$12 in a day easy. Experience unnecessary. Valuable demonstrating equipment, actual samples absolutely free. Progress Tailoring, 500 S. Throop, Dept. H-117, Chicago.

WRITE For free fabric samples amazing stainproof tablecloths. Clean with damp cloth. Require no ironing. Beautiful patterns. Look expensive, long wearing, low priced. Commissions big. Also complete dress line. Melville Company, Dept. 3308, Cincinnati, Ohio.

CALL On friends with sensational personal Christmas cards from 50 for \$1.00 up. Stationery. Also magnificent 21 card \$1.00 assortment. Profit 50c. Experience unnecessary. Samples on approval. Wallace Brown, 225 Fifth Ave., Dept. L-34, New York.

SELL Dresses at low prices. Hundreds sensational bargains. Actual samples free. Send dress size, age. Harford, Dept. K-354, Cincinnati, Ohio.

HUSTLERS Wanted! To introduce, supply demand for Rawleigh necessities. Good routes open nearby. Rawleigh methods get business. No selling experience needed to start. We supply sales, advertising literature—all you need. Profits should increase every month. Low prices; good values; complete service. Rawleigh Co., Dept. H-63-PPM, Freeport, Ill.

AGENTS WANTED

MONEY Making sensation! Sell friends 50 name imprinted personal Christmas cards only \$1.00—free samples. Outstanding line 30 assortments 30c up. Patriotic cards. Experience unnecessary. Famous 21 assortment on approval. Special offer. Hedenkamp, 343 Broadway, Dept. R-4, New York.

BIG Money taking orders; shirts, ties, hosiery, underwear, pants, jackets, sweaters, uniforms, etc. Sales equipment free. Experience unnecessary. Nimrod, 4922-AN Lincoln, Chicago.

MAKE—Sell your own products. Vanilla, Fly Spray, Hand Soap, Amazing Cleaner, hundreds other fast-sellers. Our formulas tell how. Write, Kemico, 128, Park Ridge, Ill.

BIG Profits selling Shelton Dust Absorbers. Sample 6—\$1.00 prepaid. Shelton Mfg. Company, Colorado Springs, Colorado.

WE Pay you \$5 for selling ten \$1 boxes. 50 beautiful assorted name imprinted Christmas cards. Sell \$1.00. You make 50c. Free samples. Cheerful Card Co., 48, White Plains, N. Y.

WONDERFUL Opportunity. Miracle stone gives 100 shaves to razor blade. Inquire. Orenstein, 6221 - 23 Ave., Brooklyn, N. Y.

MAKE Extra money easily. Sell 50 assorted personal Christmas cards for only \$1.00. Fourteen box assortments 33-1/3c up. Odd cards 2 1/2c each. Send for free samples exclusive \$1 line personal cards and imprinted stationery. Request \$1 assortment on approval. New England Art Publishers, North Abington, E-361, Mass.

EASY Money; customers come to you. 100% profit. No investment. First time offered to agents. Knight Kopygraph, 55 E. Wacker Dr., Chicago.

SELL New, different kind of Christmas cards. Embossed designs, name-imprinted, 50 for \$1. Quick cash profits. 21-card \$1 assortment pays you 50c. Other fast sellers. Samples on approval. Friendship Studios, 435 Adams, Elmira, New York.

AGENTS: Sell patented extension handle fly swatter. Every home a prospect. Big profits. Write Box 36, Bliss, N. Y.

MAKE Extra money easy! Sell famous "Dollar King" Christmas card assortment. Up to 100% profit. Fine selection 50 for \$1 name-imprinted; big money-making Christmas, everyday line. Samples on approval. Schwer, Dept. G-4, Westfield, Mass.

I WILL Give you \$5.00 worth full size packages foods, groceries, soap, etc., free if you agree to show friends and others. Amazing spare time money making opportunity. Write Zanol, 6304 Monmouth, Cincinnati, Ohio.

SELL Christmas cards—Make extra money. 50 gorgeous folders with name, \$1. Sensational selling 21-card box. 12 other big value assortments. Up to 100% profit. Experience unnecessary. Free samples. Southern Greetings, Dept. 757, Memphis, Tenn.

AMAZING Profits—Post war independence with route "Silver King" vendors. Free instructions. Automatic, 3225 Ravenswood, Chicago.

6 INCH Bust General MacArthur \$1.00 postage paid. Kittrell Co., Waterloo, Iowa.

CHRISTMAS Cards—Sell 50 for \$1 with sender's name imprinted. Amazing values get quick easy orders. 15 fast-selling box assortments. Generous cash profits. No experience needed. Samples on approval. Cardinal Craftsmen, Dept. 568, Cincinnati, Ohio.

FREE Water and our concentrates, makes flavors, lotions, shampoos, 72 products, labels, bottles furnished. Qualco, E-20030 Russell, Detroit.

DON'T Be a job hunter—Start your own business on our capital. No hard times; no layoffs; always your own boss. Hundreds average \$3,000 to \$5,000 annual sales year after year. We supply stocks, equipment on credit, 200 home necessities. Selling experience unnecessary to start. Wonderful opportunity to own pleasant, profitable business backed by world wide industry. Write Rawleigh Co., Dept. H-U-PPM, Freeport, Ill.

CHRISTMAS Cards. Earn \$2 an hour. Take orders galore from friends. 50 exquisite folders with name \$1. Free samples 20 designs. America's fastest selling 21 Christmas folder box. Costs 50c. Sells \$1. Request samples today. Sunshine Art, Dept. E, 115 Fulton St., New York City.

AGENTS—300% Profit selling gold leaf letters; stores and offices. Free samples. Metallic Letter Co., 438-B North Clark, Chicago.

CLEANING Supplies, mops, brushes, cone shaped mop strainer. Fulton Sales Corp., Lancaster, Penna.

QUICK Cash earnings easy. Show friends, others finest value Christmas cards with name, 50 for \$1. Also famous "HertelArt" 21-card \$1 Christmas assortment. Up to 100% profit. 11 assortments—Gift wraps, etchings. Samples on approval. HertelArt, 305 Adams, Dept. 219, Chicago.

AGENTS—Whirlwind profit opportunity. Finest silk Nylon, and Rayon hosiery. Big selection. Very latest styles and colors. Replacement guarantee. Your own hose free with large outfit. Rush hose size, name today. Wilkmit, Dept. CH-37, Greenfield, Ohio.

CHRISTMAS Card leaders bring you quick cash earnings. Name-imprinted Christmas cards, 50 for \$1. up. Sensational "Prize" 21-card assortment sells \$1.00. Up to 100% profit. 11 fast-selling assortments. Samples on approval. Chilton Greetings, 147 Essex, Dept. P-2, Boston, Mass.

MEXICAN Feather, straw, pictures; sandals, tablecloths, etc. Quick sellers! 100%-300% profit! Free particulars. Samples 10c stamps. Marquez PB Apartado 1176, Mexico City.

MAKE Extra money easy. Show smart personal Christmas cards with name, 50 for \$1 up. Outstanding values. Also 21-card assortment, \$1; others. Big profits. Samples free. Wetmore & Sugden, 749 Monroe, Dept. 74, Rochester, New York.

COMIC Clever everyday greeting cards. List 10c. Straley, 1015 Mulberry, Springfield, Ohio.

SELL Super Christmas card values! 50 for \$1 with sender's name inscribed. New silver printing. 8 fast-selling box assortments. Up to 100% profit. Samples on approval. Colonial Studios, 642 S. Sumner, Dept. 8-11, Holyoke, Mass.

AGENT—Build a business that repeats every week with our full line of repeat products. Part or full time. No age limit. Established over thirty years. Royal Palm Products, Tunkhannock, Penna.

BIG Profits selling famous Waltham Christmas cards. 21-card \$1 assortment pays you 50c. Christmas cards with name, 50 for \$1. Complete line. Samples on approval. Waltham Art Publishers, 160 N. Washington, Dept. 545, Boston, Mass.

NOMORGRAY—The guaranteed coloring for gray hair—repeats automatically. 200% profit. Write for exclusive territory. Miracle Products, 10 S. Clark, Chicago.

SCISSORS Sharpener—10c. Wholesale prices free. Janas, 160 Lyman, Holyoke, Mass.

AT Last! Something new and sensational in Christmas cards. Amazing "Oilette" cards. Like costly oil paintings. Never before offered. Gets orders fast. Beautiful 50 for \$1 cards, name imprinted. 10 other assortments. Big profits. Bonus. Samples on approval. Puro Co., 3043 Locust, Dept. 228, St. Louis, Mo.

LORD'S Prayer on a real penny. Sells on sight. Full particulars and samples 25c. Perkins, 4745 Broadway, M-8, Chicago.

DANDELION Death. Profit 1,000%. Simplified manufacturing processes. Thermosp, Peoria, Ill.

POPULAR 8"x10" Prizefighter photographs, Famous Knockouts. Tremendous field! Big profits! Price Sports Photos, 1210PM South Kolin, Chicago.

WANTED Medicine agents for the fastest selling and best repeating medicine. You may have sold them all, but we guarantee Healthtrus Tonic Laxative to be the best seller and fastest repeater you have ever sold. Large 12 ounce bottle meets government requirements, registered in Washington. A pocket size ingredient case containing 8 small bottles showing what Healthtrus is made from—creates confidence—helps make quick sales—Free with first order for 6 dozen \$21.60, net profit \$86.40, freight paid. Trial order of 3 dozen \$10.80, net profit \$43.20, freight paid. Send post office money order. Southern Distributors, 549 South Limestone, Lexington, Ky.

AGENTS. Big line including food products. Fast selling premium and bargain deals. Low prices. Send card for big outfit offer with gift. Ho-Ro-Co, 2715 Dodier, St. Louis, Mo.

AGENTS: Stamping names on pocket-key protectors. Sample check with your name, address, 25c. Stamping outfits. Emblem checks, check-fobs, name plates. Hart Mfg. Co., 303 Degrav St., Brooklyn, N. Y.

AGENTS—To mail our literature. Good profits. Home business. Maywood, 1133 Broadway, New York.

BIG Money applying initials on automobiles. Easiest thing today. Free samples. If you sell printing and advertising specialties we have an excellent sideline featuring Decalcomania name plates in small quantities. "Ralco," 727 Atlantic Ave., Boston, Mass.

DO You want agents for your proposition? Your ad in this space will place your message before hundreds of men seeking fast-selling products. My folder "How to Secure Agents" is filled with proof. I'll gladly send you a copy free. F. W. Johnson, Manager Classified Advertising, Popular Mechanics Magazine, 200 E. Ontario St., Chicago.

HIGH-GRADE SALESMEN

ADVERTISING Book matches. America's largest manufacturer of union label book matches. Fast selling line. Large sales producing kit. Sample matches. Complete cut catalog, 17 color combinations makes selling easy. Commission in advance. Superior Match Company, 7530 Greenwood, Dept. N-8, Chicago.

BIG Commissions—selling to stores celluloid pricing tickets, metal shelf moulding. To restaurants, menu covers, signs. P. Pricing Press, 124 White St., New York.

SALESMEN Sell retail stores new stamp deal. Steady income assured. No investment. Free samples. King, 10 Tremont Street, Boston, Mass.

ADVERTISING Book matches offer liberal earnings—full, spare time. Experience unnecessary. Factory direct. Low prices, high quality, quick deliveries, powerful patriotic display, repeats. All business firms prospects. Free kit, instructions. American Match & Printing Co., Dept. 68, 4822 South Trumbull Ave., Chicago.

SALESMEN: Write for details selling twin scrubbing brushes, self-wringing mops with changeable heads. Also floor wax applicators fitting our twin-brushes. A revolution in cleaning materials. The Twin-Brush Corporation, Clarksville, Tennessee.

SELL Everyday greeting cards! Liquidating 3,000,000 profitable sellers! Bulletin free! Sample box 25c. Eifco, 438 North Wells, Chicago.

EDUCATIONAL AND INSTRUCTION

"HOW To Break and Train Horses"—A book every farmer and horseman should have. It is free; no obligation. Simply address Berry School of Horsemanship, Dept. 1108, Pleasant Hill, Ohio.

DRAFTING, Trigonometry courses \$1 each! Inquire J. R. Giles, 1326 Myers, Burbank, Calif.

WELDING Opens the way to good pay and future in important industries. Growing need for trained welders. Prepare now. Practical, personal training spare time at home and Chicago. Write for free facts. Utilities Engineering Institute, 1314 Belden, Dept. 128, Chicago.

MACHINISTS, Layout, inspectors, apprentices. One hour course, angles, slides, chords, logarithms. Simplified essentials only. On handy photographic reference cards \$1.00. Hal Donnelly, Box 72, R. L. R. D. No. 1, Boonton, N. J.

WELDING—Electric arc. Learn profitable trade quickly through actual practice. Individual welder instruction at bare cost of materials. Full particulars free. Valuable welding lessons book 50c. Hobart Welding School, Box M-822, Troy, Ohio.

LEARN Drugless therapy at home. Wonderful openings. Diploma. Free literature. Institute of Drugless Therapy, Tama, Iowa.

WELDERS Wanted immediately for defense and other jobs. Learn by actual shop work. One of America's leading schools. Established 1922. 7 floors of shops. 2 weeks intensive course, including room and board, only \$108. Come to Chicago or write for "Welding Facts." Greer College, Dept. C-82, 2024 South Wabash Ave., Chicago.

WANT A government job? Commence \$105-\$175 monthly. Hundreds appointments. Men-women. Prepare now at home, for examinations. Full particulars—list positions, free. Write today. Franklin Institute, Dept. N2, Rochester, N. Y.

BLUEPRINT Reading. Learn quickly at home. Personal instruction. Complete 28-lesson course. Armament industry needs blueprint readers. Get better job. \$15.00 complete. Ohio Institute of Technology, Box 67, Greenville, Ohio.

BECOME Director of physical culture, physical training, body building methods. Correspondence course. Booklet. Physical Training Institute, 4753-P Broadway, Chicago.

LEARN While you learn typewriter repairing. Write for free details. Decatur Typewriter Shop, Decatur, Georgia.

RADIO Communication course for home study. Covers all phases of operator license and job requirements. Free circular No. 3M. Nilson Radio School, 51 East 42nd St., New York.

SECRET Investigation. Experience unnecessary. Detective particulars free. George Wagner, M-2640 Broadway, N. Y.

BECOME A Doctor of Psychology (Ps. D.) Teach secret of contentment, happiness. Solve mental worries. Free book. College of Universal Truth, 20-B East Jackson, Chicago.

LOCKSMITH Course. Lock picking, key fitting, etc. \$1.00 prepaid. Locksmith, Canadian, Texas.

CLINICAL Laboratory technic taught in your own home. Practice outfit supplied. Bulletin free. Imperial Technical Institute, Box 973-E, Austin, Texas.

LEARN Telegraphy! Splendid opportunities now prevail. All expenses low. Catalog free. Dodge Institute, Dept. M, Valparaiso, Indiana.

RADIO Engineering, broadcasting, aviation and police radio, servicing, marine and Morse telegraphy taught thoroughly. All expenses low. Catalog free. Dodge Institute, Dept. R, Valparaiso, Ind.

ARC And spot welders. Make them yourself. Very simple. Inexpensive. Complete details 25c. Popular Mechanics Press, Dept. 402, 200 E. Ontario, Chicago.

CARTOONING, COMMERCIAL ART, SHOWCARD WRITING, SIGN PAINTING

CARTOONING Lessons 25c each, including personal criticism. Details free. Templeton Studios, 146N Wellington, Elgin, Illinois.

CREATE Cartoons—here's how. Brand new book of instruction on comic drawing. Over 350 illustrations. \$1.00 postpaid. Roy Hetzler, Box 407, Rochester, N. Y.

ADVERTISING AGENCIES, LETTER WRITERS, FOR ADVERTISERS

MAIL-ORDER Or agent ad reaching 1,000,000 families throughout United States \$14.00 inch. Newspaper, magazine, mailing-list, rate-book, free. Chicago Advertising Agency, 20-PM West Jackson, Chicago.

ADVERTISE: 24 Words, 149 newspapers, \$6.50. Lists free. Advertising Bureau, 4515-C Cottage Grove, Chicago.

INCH Display advertisement fifty magazines, year \$15. Wood's Popular Services, Atlantic City, (N. J.)

FREE—New Advertisers Rate Guide, 44 pages. Includes everything. Lowest rates. E. H. Brown Advertising Agency, Merchandise Mart, Chicago.

ADVERTISING Placed all magazines, newspapers U.S.A., Canada. Lowest rates. Free service, 54-page catalog free. Baker Advertising Agency, A-189 W. Madison, Chicago. Established 29 years.

ADVERTISE Without money! Practical. Proven. Instructions 25c. Box 102-pm, Austin, Texas.

FREE—"Amazing New Book"—"Profits From Classified Advertising." Tells how and what to advertise. Be sure to read this book before you invest one cent in advertising. Remember—it's free! Write for your copy now. F. W. Johnson, Classified Advertising Manager, 200 East Ontario Street, Chicago, Illinois.

BUSINESS SERVICE

CHICAGO Mail address: \$1 monthly—Receiving, reforwarding your business, personal mail. General, 30 West Washington, (Established 1919).

NEW, Money making formulas book tells how to go into business for yourself. Send for free details. Popular Mechanics, 200 E. Ontario, Chicago.

RUBBER STAMPS, OFFICE SUPPLIES

CUSHIONED, Indexed, 3 lines 35c. Signatures \$1.50. Lentz, Box 402, Youngstown, Ohio.

3 LINES 35c. 2 Lines 25c. Cushion with handle. Illinois Rubber Stamp Works, 2913 No. Rockwell, Chicago.

ARMY, Navy, air service. Three lines 35c, four 50c, signatures \$1.50. Slocum, 814 Bradley, Peoria, Illinois.

3 LINES 30c; Cushioned, indexed, 35c. Signatures \$1.50. Stamprite, Wauwatosa, Wis.

KNOB Handle, cushioned, 2 lines 25c, 3—35c. Stamp Works, Centerport, N. Y.

2 LINES 25c, 3 Lines 35c. Stamp Works, Auburn, Nebr.

TYPEWRITERS, DUPLICATORS, OFFICE DEVICES

FILING Cabinets, bargains. Literature for stamp. Holger's Service, Canton, Kans.

TYPEWRITERS, Adder, mimeograph, multigraph, addressograph. Send for free lists of machines that will help you at half price. Pruitt, 28 Pruitt Bldg., Chicago.

PRINTING, MULTIGRAPHING, MIMEOGRAPHING, GUMMED LABELS

100 8½x11 LETTERHEADS And 100 envelopes \$1.00 postpaid. 100 business cards 50c. Sales books. Everything printed lowest prices. Yankee Printing Co., 4701 N. Sheridan Rd., Chicago, Ill.

5000 3x6 CIRCULARS \$3.75, 6x9 \$7.50. Salesbook manufacturers. Generalprint, Columbia Street, Newark, N. J.

COMPLETE Printing. Free cuts, estimates, proofs. Longstone, R. 4, Dayton, Ohio.

FREE Samples of reasonably priced printing. Quick deliveries. Address, Chelsea, Oklahoma.

PRINTING—8½x11 Letterheads, 250, \$1.00; envelopes, \$1.00, both \$1.75; 100 each \$1.00. Cards, circulars, Braendle, Freeport, Mich.

\$1.00 POSTPAID—75 8½x11 Hammermill letterheads and 75 Whitewave envelopes. Benneville, 907 West Roosevelt, Philadelphia.

250 LETTERHEADS; Envelopes; or cards \$1.25. Puzzle free. Globe, 5518 Norwood, Baltimore, Maryland.

100 ENVELOPES And 100 letterheads, \$1.00; 500 6x9 handbills, \$1.25. Crown Print, Adelphi, O.

YOUR Name, address, printed, 500 each—Stickers, ½"x2" and memorandums 4"x5" \$1.50 postpaid. Miniature label specialties—700 designs. 10c. Arrowprint, PM842, Waterbury, Connecticut.

GOOD Printing reasonably priced. 500 letterheads, statements, envelopes, cards \$1.50 box. Service stationery \$1.50 box. Ask for low estimates on your printing. Write for samples today! Birchwood Printers, E. Paterson, N. J.

MODERN Mimeographing. \$1.00 up. Free samples. Lowelly, 277 Foster, Lowell, Mass.

HAMMERMILL Letterheads, envelopes, all colors, 32 styles type. Free particulars. Woodruffs, 217-A4 Lewis, Duluth, Minn.

"NO Lineage Limit" Mimeographing—300 letters or 300 postcards \$1.00. Dollar Letter service, 180 West Washington, Chicago.

500 ¾x2¼ FOUR Line gummed stickers, 25c. Moritz Printery, Saginaw, Mich.

JOB Printing. Quick, reasonable. Samples. Atlantic, Box 653-H, Rock Hill, S. C.

WANTED Printing of all kinds by thousands of our readers. Your ad in this space will bring you some nice orders. Write for positive proof. F. W. Johnson, Classified Advertising Manager, Room 304, 200 East Ontario Street, Chicago.

PRINTING OUTFITS AND SUPPLIES

MAKE Ready knife 50c. Retractable blade. Refillable. Mark Specialty Co., Temple Building, Rochester, N. Y.

INEXPENSIVE 6x9 Printing press. Details free. Novelty Shop, Downsville, Louisiana.

PRINT Your own cards, stationery, circulars, advertising. Save money. Simple rules furnished. Print for others, nice profit. Junior outfit \$8.25, senior outfits \$17.38. Details free. Kelsey, Inc., T-11, Meriden, Conn.

PRINT At home. 10c will bring a complete catalog of presses, type and supplies. P. Feiffer & Company, 6 Columbia St., Newark, N. J.

BARGAINS—Presses, type, supplies. Send stamp. 159 Harvard, Cambridge, Mass.

USED Presses, type, supplies. Lists 3c. Turnbaugh Service, Loysville, Penna.

PATENT ATTORNEYS

INVENTORS: Take first step toward protecting your invention—without obligation. Write for free "Record of Invention" form for establishing date of invention and free "Patent Guide for the Inventor"—telling about confidential search service; how to sell and market inventions; details of convenient payment plan. Send today for free "Patent Guide" and "Record of Invention" form. Clarence A. O'Brien and Harvey Jacobson, Registered Patent Attorneys, 21B-H Adams Building, Washington, D. C.

68 PAGES Of facts for inventors. Two valuable advisory books specially prepared for men with ideas. "Patent Protection" tells you steps to take quickly without cost. "When and How to Sell an Invention" gives you six basic ways to commercialize your patent rights. Both books sent free. Write us today in confidence. Victor J. Evans & Co., Registered Patent Attorneys, 631-J Victor Building, Washington, D. C.

WESTERN Inventors, save time; employ C. L. Drew, Atty. Registered in U. S. Patent Office, Central Tower, San Francisco, Calif. 32 years practice.

"INVENTOR'S Guide", 100 mechanical movements, free; advises on patenting, selling inventions. Frank W. Ledermann, 154 Nassau Street, New York.

L. F. RANDOLPH, 302-B Victor Bldg., Washington, D. C. Low cost. Book and information free.

PATENTS, Booklet free. Highest references. Best results. Promptness assured. Watson E. Coleman, Patent Lawyer, 724 Ninth St., Washington, D. C.

INVENTORS—Before disclosing your invention to anyone send for form "Evidence of Concealment"; "Schedule of Government and Attorneys' Fees" and instructions. Sent free. Lancaster, Allwine & Rommel, 411 Bowen Building, Washington, D. C.

FOR INVENTORS

115 MECH. Movements—Just what you may need to complete your invention. 48-page illustrated book contains valuable information for inventors. Yours—free. Write today. Victor J. Evans & Co., 632-J Victor Building, Washington, D. C.

INVENTORS—Protect your idea with a patent. Secure "Patent Guide" and "Record of Invention" form—free. No charge for preliminary information. Write Clarence A. O'Brien and Harvey Jacobson, Registered Patent Attorneys, 21A-H Adams Building, Washington, D. C.

INVENTORS—Entirely new products are urgently needed for the drastic changes in our every-day needs. If you have a practical, useful non-military invention it can now be sold safely, without patenting expense. Write today for complete details. Chartered Institute of American Inventors, Dept. 4A, Washington, D. C.

CAN An inventor make money today? In 1941 alone over 4,000 assignments of patents a month were made by inventors to manufacturers or individuals. This shows today's demand for new patented inventions. Write for our free book, "Protect, Finance and Sell Your Invention." Special form "Invention Record" also mailed free. No obligation. McMorrow & Berman, 134-E Barrister Building, Washington, D. C.

CASH For practical ideas and inventions. Mr. Ball, AB-9441 Pleasant, Chicago.

SELL Your patent through a small classified ad in Popular Mechanics. Many inventors have found buyers in this way. Ask me for proof—I'll gladly send it to you. F. W. Johnson, Manager Classified Advertising, 200 E. Ontario St., Chicago.

INVENTIONS WANTED

INVENTORS—Manufacturers urgently need new ideas for drastically altered civilian markets. If you have a useful new invention, or a practical improvement on an already established product, you can now sell it safely without patenting expense. Complete details, free. Chartered Institute of American Inventors, Dept. 4-D, Washington, D. C.

MANUFACTURER Wants new invention or idea. Nelson, Dakota Bldg., St. Paul, Minn.

WANTED—Meritorious patented, unpatented inventions. Booklet, references, free. Invention Reporter, 5B-11236 So. Fairfield, Chicago.

CASH For inventions, patented, unpatented. Mr. Ball, A-9441 Pleasant, Chicago.

YOUR Ad in this space will bring amazing results. I'll prove it to you. Write at once for interesting information. F. W. Johnson, Room 300, 200 East Ontario St., Chicago.

PATENTS FOR SALE

PRIME Your post-war dollar now! Investigate. Plastics compound tool patent for sale. T. Pasanen, Franklin Mine, Mich.

SNOW Scraper fastens to car bumper. Sell U. S. and Canadian patent. 340 43rd, Des Moines, Iowa.

MANUFACTURING

MODELS—Small lot manufacturing. Metals, plastics, etc. Milburn, Burlington, Kentucky.

MODELS, MODEL SUPPLIES

MFG. Dies, stampings and model supplies. Send 3c for catalog. Pierce Model Works, Tinley Park, Ill.

RAILWAY Models, complete line informative catalogs O gauge, 112 pages. 25c; HO, 48 pages 15c. Walthers, 247 Erie, Milwaukee, Wisconsin.

"CONSTELLATION" Carved hull construction set, separate fittings, blueprints. 52 page illustrated catalog 25c, listing hundreds of ship and yacht model fittings. A. J. Fisher, 1002-7 Etowah Ave., Royal Oak, Mich.

SHIP Models and yacht supplies complete. Large 56 page catalogue 15c. Bill Wild's, 510 East 11 St., New York City.

MINIATURE Steam locomotives, new catalog listing all builders' needs 25c. Little Engines, Wilmington, California.

SHIP Model kits and fittings. Complete line Fisher model yacht equipment. All Boucher, Fisher, Marine Model and Ideal kits, fittings and blueprints at catalog prices. Most complete stock in New England. James Bliss & Co., Inc., 220 State Street, Boston, Massachusetts.

FREE—Big list of helpful books. Popular Mechanics Press, 200 E. Ontario St., Chicago.

HOME CRAFTSMEN

15 FULL Size what-not patterns 25c coin. Albright Service, M-6901 Railroad Ave., Omaha, Nebr.

MAKE Wood tires. Copyrighted instructions \$1.00. M. Schumacher, Westhampton Beach, N. Y.

BUILD—Sell Rollaround kitchen tables. Plans, selling pointers 25c. Murphy, 193 Savoy, Springfield, Mass.

KNOCKDOWN Cedar chest, lumber, veneers, illustrated catalog 10c. Giles Kendall Co., Decatur, Ala.

GET Free leathercraft instruction pamphlets, prices of leathers, tools, projects. Fascinating hobby. Make beautiful gifts. Leather samples 5c. Wilder & Company, 1938 Crosby, Dept. 8F, Chicago, Illinois.

LEATHERCRAFTSMEN: Send 10c for new handbook and catalogue of tools and supplies. E. A. Sweet Company, Inc., Leathercraft Division, A-60, 148 State Street, Binghamton, N. Y.

28 LAWN Ornament patterns 25c. Other patterns; 15"-20" high; Dutch girl, Dutch boy, pirate, bull terrier, Mexican girl, Mexican boy, dwarf, penguin, flower girl. 10c each; 3 for 25c. 25 novelty patterns 30c. All 62 full size patterns \$1.00 postpaid. Strother, Box 383-DS, Bellington, W. Va.

WOODWORKING Power tools—Make them yourself. Lathe, scroll saw, saw table, drill press, portable sander, bandsaw, motorized plane. Complete details only 25c. Popular Mechanics Press, Dept. 401, 200 E. Ontario Street, Chicago.

WATCHES, OLD GOLD, JEWELRY, ETC.

GENUINE Diamonds, out-of-pawn prices, unredeemed loans and distress merchandise; men's, ladies' rings, one carat \$95.00, 1/2 carat \$45.00. Shipped for free inspection, appraisal. Send for free list, hundreds of beautiful diamonds, very low prices. Lloyd Butler, President, Prudential Loan Association, 133-EH North Clark St., Chicago.

ZIRCONS—White diamond-cut, mounted or unmounted. Other gems. Wholesale, retail. Luthold, 2227 1/2 N. Alabama, Indianapolis, Ind.

CASH! Gold, jewelry, teeth, coins, diamonds, mercury, etc. Ship! Simon's, 353 Old Arcade, Cleveland, Ohio.

ELGIN, Waltham watches. Attractive buys. Make big money. Free watch and jewelry catalog. Plymouth Jewelry Co., 163F Canal St., New York.

AGATES, Fossil woods, three pounds \$1.50 postpaid. Jay Ransom, Aberdeen, Wash.

WATCHMAKERS' Materials, tools, jewelry—bought, sold. Best prices for old gold, diamonds. Free catalog. Ben Segal Company, Box 150, Chicago.

HIGHEST Prices for old gold—Mail your teeth, watches, jewelry. 100% full cash value mailed day shipment received. Satisfaction guaranteed or articles cheerfully returned. Information free. Chicago Gold Smelting Company, 300-P Champlain Building, Chicago.

GOLD \$35.00 Ounce. Mail old gold teeth, diamonds, jewelry, watches. Receive cash by return mail. Satisfaction guaranteed. Free information. Dr. Weisberg's Gold Refining Company, 1500-Q Hennepin, Minneapolis, Minn.

5000 REBUILT Watches! Free catalogue—Diamonds, jewelry, (3c postage). The New York Jobbers, 74 Bowery, Dept. M, New York, N. Y.

ELECTRIC SHAVERS, RAZORS, BLADES, SHARPENING

ELECTRIC Razors repaired. Guaranteed. Cooley-Van Howe, 746 Michigan Building, Detroit.

ELECTRIC Razors repaired like new by factory experts. Any make, any condition. All work guaranteed. Send or bring it in for an estimate. Pharmacal Products Co., Inc., 480 Lexington Ave., New York, N. Y.

SURVEYING INSTRUMENTS

GUARANTEED Factory rebuilt transits and levels for sale (cash or terms) or rent (with purchase option). Large selection. Low prices. We will repair, trade or buy old instruments. Ship prepaid for estimate and valuation. For complete information write for list M-78. Warren-Knight Co., (Manufacturers of Transits and Levels), 136 N. 12th St., Philadelphia, Penna.

FOR SALE—MISCELLANEOUS

RAZOR Blade shortage not for you. Get Gillett Dry Shaver with the money back guarantee. Only \$9.95 postpaid. R. Bensi, Box 134, Dearborn, Michigan.

WANTED—MISCELLANEOUS

WANTED: Mercury (quicksilver) \$1.50 per pound, any condition. Western Metal Co., Bloomington, Illinois.

MERCURY (Quicksilver), tungsten, molybdenum, cadmium, high speed tool steel, bismuth, purchased in any quantity. Write for quotations. Metallurgical Products Co., 35th and Moore Sts., Philadelphia, Penna. Established 1909.

HIGHEST Prices for used cameras, binoculars, microscopes, drawing sets, tools, any optical or scientific instrument. Satisfaction guaranteed. Gordon's, 162-M Madison, Chicago.

CASH For anything. Justice Jewelry Jobbers, 190 North Wells, Chicago.

PERSONAL

HANDWRITING Reveals much, let me read yours, helpful, 35 cts. coin. Lockett, 627 Gerald, Long Branch, N. J.

BIRTH Certificates, all ages, any state, ten (10) day service. Enclose postage. Herndon J. Thompson, Dept. (D324), Davis, Oklahoma.

NASAL Ailments; send name and address for free booklet on Bullock's discovery. National Laboratories, Benj. Franklin Station, Washington, D. C.

HELP Loved ones in service. 100 photo stamps \$1, initials free. Printed stationery. Victory Service, FM2, Emmaus, Penna.

SONGWRITERS. Write for free booklet, profit sharing plan. Allied Music, Dept. S5, 204 East Fourth, Cincinnati, Ohio.

LIKE To see your name in screaming newspaper headlines? Loads of fun. Send wording desired. Only 25c. Horne, Box 372N, Back Bay Annex, Boston, Mass.

MEXICAN Legal matters, Wm. Cocke, Reliable American Attorney, El Paso, Tex.

MISCELLANEOUS

AUTOMOBILE Flag holder with seven flags. American and British 60c. Bicycle holder with flags 40c. Harvie's Flag Store, 238 King East, Toronto, Canada.

NEW Gun swats flies. Amazes everyone. Nothing like it. Sport, fun, excitement. Cost nothing to use. Metal constructed. Order now. Stock limited. \$1.00 postpaid. Satisfaction guaranteed. Kahler Fly Gun, Kankakee, Illinois.

BIG Mail for you. Latest moneymaking offers, opportunities, catalogs, magazines. Name listed in directory 10c. Ideal Service, 129-M, Park Ridge, Ill.

CHRIST'S Coming! Get absolute proofs free. Scheall, 263-X, Duluth, Minn.

HEATING Six rooms \$20.00 yearly. Circars 10c. Rosenzweig, RR10A2, Cincinnati.

MEXICAN Jumping beans. Three 10c; dozen 25c; hundred \$1. Gardens, 126 N. Main, Tulsa, Oklahoma.

UNPAINTED Wall plaques 5c each. 24 different \$1.00. Oman, 642 Broadway, St. Paul, Minn.

GUARANTEED Protection against theft of tires, accessories, and gas from your car. If "Devil Dog" fails, return it and get your money. For one, send \$7.50 to R. Bensi, Distributor, Box 134, Dearborn, Michigan.

FREE: Printed information about searching for minerals, treasures and money. Henry Bergman, Box 70-P, Springfield, Missouri.

TATTOOING Outfits, supplies. 1942 lists free. Percy Waters, Anniston, Ala.

WE Train you to become medical laboratory technician at home in spare time. Free catalogue. Imperial Technical Institute, Box 973-J, Austin, Texas.



INSTRUCTS & ILLUSTRATES **Actual Factory Methods**
FOR SERVICING & MAINTAINING
AIRCRAFT POWER PLANTS
 WRITTEN BY THE NATIONAL AUTHORITY
G. BURNELL MANLY, WITH ALLISON MOTOR
DIVISION OF GENERAL MOTORS

Puts YOU in the BIG PAY CLASS!

Right now unlimited opportunities at Big Pay await men who know the "whys" and "hows" of aircraft power plants and their allied accessories. Superchargers, fuel injectors, valve and ignition timing, variable pitch propellers, and every single essential element that has bearing on the power plant is explained and illustrated in an authoritative, understandable way in this book. AIRCRAFT POWER PLANT MANUAL is used as a text book by commercial, military and defense schools, where accurate clear instructions are vital. Illustrated step-by-step procedures show you how to tear down, overhaul and reassemble any of the modern power plants using original factory methods. All data on modern "in use now" engines—nothing obsolete, experimental—no theoretical non-essentials.

760
Pages
300
Illustr.

Anyone interested in aviation, its present or future opportunities, needs this MANUAL. It is the equivalent to serving an apprenticeship to one of the nation's leading aircraft engine authorities. Go to your dealer today; examine this 760 page book with over 300 illustrations; Buy it! If your dealer cannot supply you, send the coupon and take advantage of our Free 5 day money-back examination offer. You can't lose a cent and you can gain a splendid future by acting right now!

FREDERICK J. DRAKE & CO.,
604 W. Van Buren St., Chicago, Ill.

IF YOUR BOOKSELLER CANNOT SUPPLY YOU

FREE 5-Day Examination!

FREDERICK J. DRAKE & CO., 604 W. Van Buren St., Chicago.
 () I am enclosing \$4.00. Please rush my copy of AIRCRAFT POWER PLANT MANUAL, Postpaid.
 () Please send C.O.D. I will pay postman \$4.00, plus a few cents postage.
 If I am not entirely satisfied and return this book within five days, you will refund my money in full.

NAME.....
 ADDRESS.....
 CITY..... STATE.....
 Please include catalog on complete line of technical books.

WAR-TIME INDUSTRIES NEED
More
ARC WELDERS

Now's the time to get set for a good paying job. Today's industries are calling for more trained men. You can get practical experience under actual production conditions—in our modern, completely equipped shops. Moderate training fee—assistance given in securing employment. A few "Service Scholarships" offered by Milwaukee Industries still available to qualified men who want to earn real money while learning.

AIRCRAFT WELDING

"We need more planes!" That's the demand on every side. No wonder there's a big shortage of aircraft welders. Other industries need trained welders, too. Milwaukee School of Engineering trained welders get top pay because they know the "how and why" of Welding, Metallurgy, Drawing, Blueprint Reading, Set-up Work and Metal Fabrication—and they enable manufacturers to cut production time and costs. Remember—industries everywhere need practical trained Aircraft Welders, Arc Welding Operators, Aircraft Technicians and Engineers. Don't be content to struggle along on ordinary hit-or-miss jobs with poor pay—when in a short time you can become a trained specialist—an essential worker in a vital industry—with an expert's pay, and a better rating if drafted. Send coupon today—classes begin within a month.

MILWAUKEE
SCHOOL OF ENGINEERING
Institute of Electrotechnics

PM-842 North Broadway and E. State, Milwaukee, Wis.
 Without obligation send Free Booklet, "Golden Opportunities in Defense Work." Also tell me How to Become an
 Arc Welding Operator (3 mo.)... Electrical Engineer B.S. Degree...
 Aircraft Welder (3 mo.)... Commercial Radio Engineer...
 Welding Technician (1 yr.)... Armature Winder...
 Aircraft Technician (1 yr.)... **STUDENT LOAN PLAN**...
 Electro Technician (1 yr.)... **EARN PART EXPENSE PLAN**...
 Aircraft Draftsman (1 yr.)... "Earn \$1040 while learning."
 Name..... Address.....
 City and State..... Age..... **PM-8-42**

FACTORY MEN

NEW QuickWAY
 to learn to set up and run
ANY MACHINE

New Chart-Diagram method shows you how to lay out, set up and run all kinds of jobs on the LATHE, MILLING MACHINE, SHAPER, BORING MILL (HORIZONTAL & VERTICAL), DRILL PRESS, PLANER, SLOTTER, and GRINDER, as well as how to do Bench and Floor work. Also covers fully use of all types of Measuring tools. There are over 850 loose leaf pages, in handsome binder, with over 1300 illustrations showing each detail of the job as well as nearly 300 complete job tickets.

Remember, everything is shown by actual examples, and all tools needed for each job are listed. Easy to understand and do. Invaluable to any man doing any kind of mechanical work as well as for those who want to enter these highly paid trades.

WAR WORK Needs Trained Men

Do your part by speeding up production, learn to do these jobs the best way, make yourself worth more on any job. Send in the coupon for your copy of Machine Operations. Your money cheerfully refunded if you don't call it the biggest help to better work and advancement you have ever seen.

AMERICAN TECHNICAL SOCIETY
 Dept. TC19, Drexel at 58th St., Chicago
 Vocational Publishers since 1898

American Technical Society, Dept. TC19, Drexel at 58th St., Chicago
 You may send me the complete set, "Machine Operations," with binder for examination, I enclose \$2.00 as a deposit until I see if I like this set. If satisfied I will send \$3.00 in 30 days and \$2.98 in 60 days to cover total cost. Otherwise, I will return the set and you will refund my money immediately. Note: If you send only \$6.00 now everything will be sent complete—same money-back agreement.

Name.....
 Address.....
 Please attach a letter stating age, occupation, employer's name and address and that of at least one business man as reference.

WONDERS OF AMERICA

Aerial Ears



ASTONISHING INSTRUMENT FOR DETECTING APPROACH OF ENEMY PLANES MANY MILES OFF. HORNS ARE ROTATED TO FIND PLANES' ELEVATION AND DIRECTION. THE HORN UPPER RIGHT ASSISTS THE OTHER TWO

THIS MECHANISM WITH THE MINIATURE PLANE CHECKS ON DETAILS OF THE ATTACKING SQUADRON SUCH AS ITS SPEED AND THE WIND-DRIFT OF THE SOUND



THIS INSTRUMENT CALCULATES THE RANGE — THAT IS, THE DISTANCE OF THE ENEMY PLANES. THIS AND THE OTHER DATA CONTROL THE FIRING OF THE GUNS



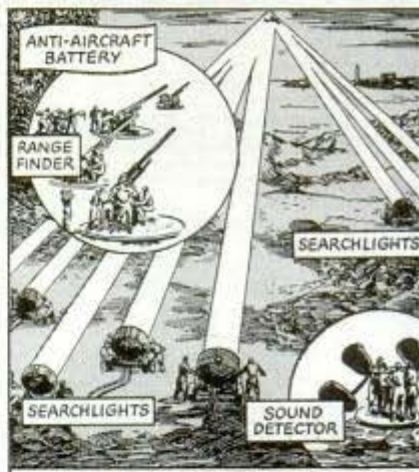
THE SEARCHLIGHT THROWS AN 800 MILLION CANDLE-POWER BEAM 3 TO 6 MILES. THE LIGHT SOURCE IS HOT ENOUGH TO BURN UP A DIAMOND



IN RECENT LABORATORY "SMOKING BOWL" TESTS, PRINCE ALBERT BURNED

86 DEGREES COOLER

THAN THE AVERAGE OF THE 30 OTHER OF THE LARGEST-SELLING BRANDS TESTED — COOLEST OF ALL!

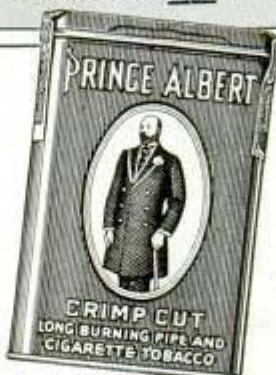


LIGHTS 'FLICK' THE PLANE — GUNS BEGIN

R. J. Reynolds Tobacco Company, Winston-Salem, North Carolina



50 PIPEFULS OF FRAGRANT TOBACCO IN EVERY HANDY POCKET CAN OF PRINCE ALBERT



PRINCE ALBERT

THE NATIONAL JOY SMOKE



70 FINE ROLL-YOUR-OWN CIGARETTES IN EVERY HANDY POCKET CAN OF PRINCE ALBERT

Popular Mechanics Magazine

REGISTERED IN U. S. PATENT OFFICE AND CANADA

WRITTEN SO YOU CAN UNDERSTAND IT

Vol. 78

AUGUST, 1942

No. 2

PRODUCTION LINE— *The Road to* VICTORY

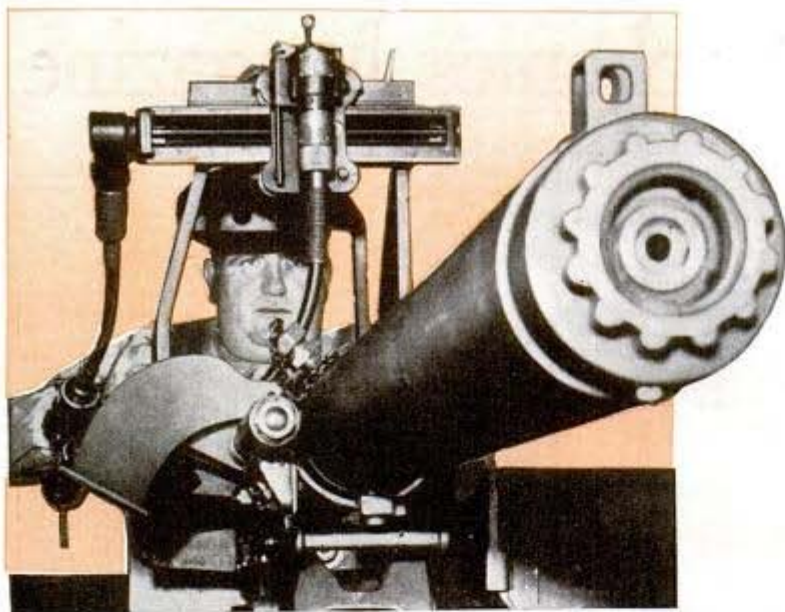


ONE plane every four minutes, one war tank every seven minutes and two ships a day—that, in a nutshell, is the All-Out-For-Victory goal set for America's manufacturers and workers.

To carry the war to the enemy's home ground and hit him again and again wherever we can reach him, the President has called for the production of 60,000 planes this year and 125,000 next year, 45,000 tanks this year and 75,000 next year, 20,000 antiaircraft guns this year and 35,000 next year, and 8,000,000 tons of merchant shipping this year and 10,000,000 tons in 1943. The word "if" cannot even be considered—we MUST turn out one plane every four minutes, one tank every seven minutes and fractionally more than two ships every day next year.

In the aircraft industry, this program

Swung by a crane, a giant gun barrel moves down an arsenal's production line



Trying out one of the rapid-fire antiaircraft guns, now streaming from U. S. government factories

means spectacular increases in employment and floor space. Back in 1940 we had about 190,000 men and women building planes, but for 1943 we must have approximately 1,390,000 on the job. Vastly greater floor space will be necessary, of course. This expansion may be estimated at about 100,000,000 square feet of floor space, with the ultimate area devoted to military plane production some three times the area in use at the beginning of 1942.

Some reliable sources recently estimated our plane production at 2,500 per month, or 30,000 per year. What the figures are now is a military secret, but we all know that the rate of production must be close to 7,500 planes every 30 days before the end of this year and must approach 12,500 planes per month before the end of 1943. In comparison, the monthly output a year ago was 1,000.



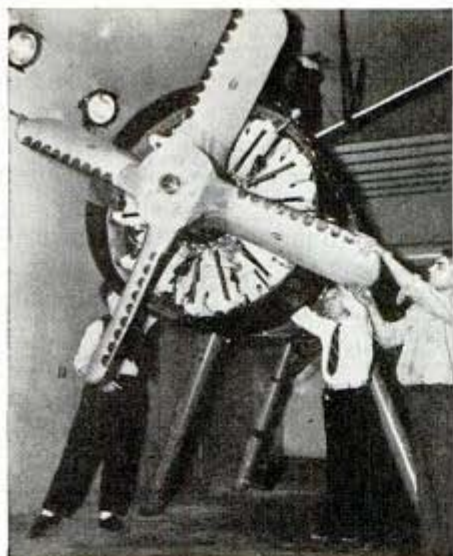
Girls who once tested home electric appliances in Westinghouse refrigerator plant now inspect munitions for the army

This is "Bomb Bay, U. S. A."—a U. S. Steel company factory where bombs for American forces are spun out by a new process



And, also in comparison, the Axis nations—Germany, Italy and Japan—will produce about 40,000 planes this year, perhaps a few more or a few less. Taking all of these figures for their face value, it seems reasonable to believe that the United States will equal or surpass Axis' production by the middle, or soon thereafter, of this year and increase rapidly to give the Allies that superiority so desirable in the air. Many authorities consider air supremacy as the key to victory, pointing to successful German and Japanese operations as evidence of the soundness of their opinion.

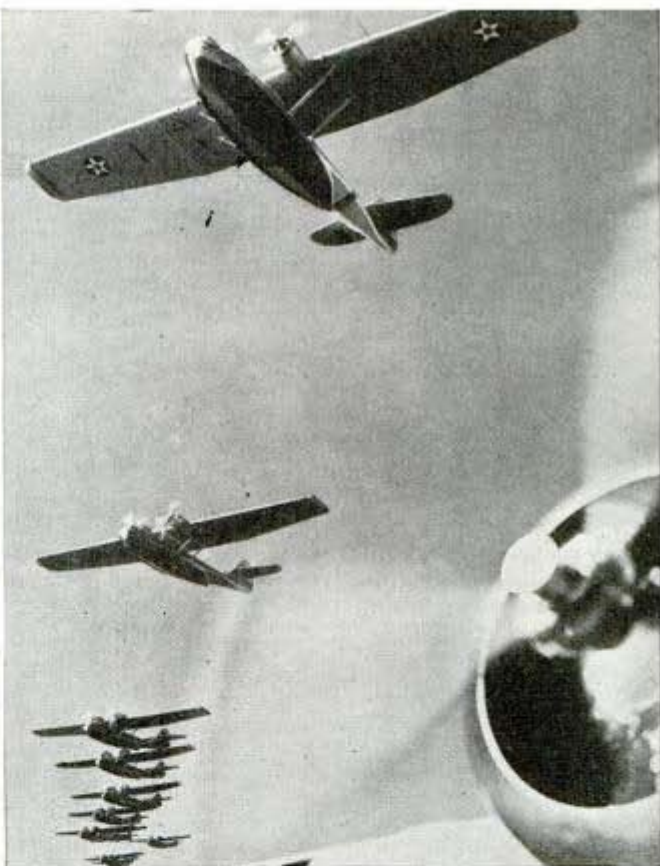
To a vast section of our population the problems surrounding the production of fighting planes are hard to comprehend. Many Americans think it should be as easy to build a million airplanes—and in as short a time—as to construct a million automobiles. They know, of course, that more than one Detroit manufacturer has been able to produce a million cars a year. What they don't realize is that



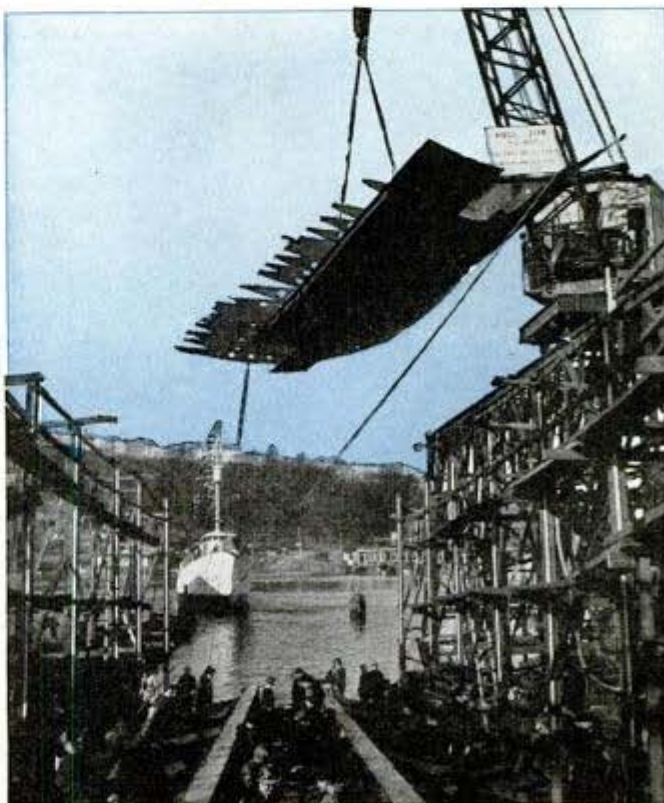
Test engineers prepare to give a new aircraft engine its arduous trial run in a 50-acre plant of Wright Aeronautical Corp.

an airplane, particularly one capable of fighting the best our enemies can build, is vastly more complicated in construction and requires special instruments and equipment not needed in the automobile. In addition, the factory space must be vastly greater than anyone ever dreamed of before the industry can turn out 185,000 planes in two years.

Another factor is the cost. A training plane means an expenditure of about \$25,000, a fighter costs approximately \$50,000 and bombing planes from \$100,000 to \$300,000. And the costs are still rising because power turrets for guns and other modifications are necessary in many military aircraft, as well as machine guns and cannon, central firing controls, bomb sights and automatic flight controls, while for high-flying planes there must be oxygen and pressure-cabin equipment. Everyone knows about the engine in his automobile. Well, an airplane engine has about ten times the power and costs 100 times as much as an automobile engine. That's because it must be constructed of the very best metals and other materials and must be built to very close working limits, or tolerances. Where the automobile engine operates nicely with its parts fitted

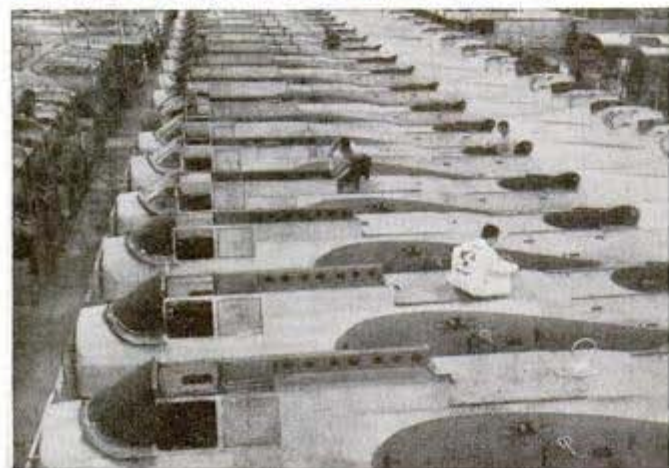
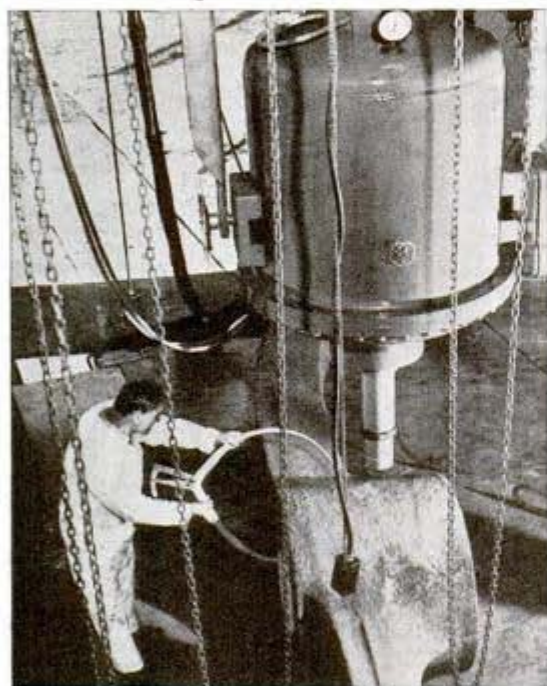


Patrol bombers (above), guardians of our long coast lines, exhibit their might in a mass flight. Below, a submarine chaser has no sooner splashed from the ways in an eastern shipyard than a crane lowers the keel for the next ship to be built





Through the breechblock seat of one big gun (above) you see a worker tailoring another major-caliber rifle barrel with a flexible-shaft grinder. Below, inspecting a huge naval casting



to 1/10,000 of an inch, the airplane engine calls for a closer fit, perhaps 1/100,000 of an inch. Again, the aircraft power plant's weight must be held down, for obvious reasons, but its horsepower must be high. When you consider that combat planes average from two to three engines apiece, ranging from one-engine craft to four-engine bombers, plus some 33 percent more for replacements, and that each engine costs from \$15,000 to \$25,000, you begin to get an idea of the problem.

No one would reveal production figures on any single classification of combat plane; that's information the enemy would be only too glad to get. So suppose we consider the

problem of turning out 500 four-engine bombing planes—of the type that would be valuable in long-range attacks. If the goal were 500 of these per month, not less than 400,000 workers would be needed to do the job and not less than ten tons of aluminum would be required for each plane.

If, at the end of 1942, the United States should have 50,000 fighting planes in service, two to three men per plane would be necessary, figuring that some types of planes are good for more hours in the air than one pilot can stand and that bombing planes carry five to nine men each. Thus, we would need a flying personnel of 150,000. A much larger personnel is required on the ground, perhaps bringing the total to 1,000,000 men. This looks like another problem, but our government already is taking steps to work out the solution before the problem presents itself. Under a recently announced program, the air

force is being expanded to 2,000,000 men, with about 50 percent of them in service before the end of the year.

Such a force is about twice as large as Germany's famous Luftwaffe, as well as double the size of Britain's Royal Air Force. Certainly it is far superior in numbers to Japan's air arm.

Uncle Sam's big hurdle at this point appears to be the training of

(Continued to page 173)

Attack bombers for British and American forces crowd the factories and the skies

M521

Seuller Safety Corp., 118 Broad St., N. Y. C.

Life Raft Supports 30 Persons on "Net" of Discs



Discs made of a new rubber filled with nitrogen gas are roped together to form a raft lighter than cork

Life rafts that hold 30 persons are being made of a network of rubber discs strung together with ropes. The discs are formed from a new rubber which has twice the buoyancy of cork and is composed of small cells filled with nitrogen gas. The extreme lightness of the raft makes it especially

valuable as a lifesaving aid in torpedo sinkings when there is no time to launch a lifeboat. Attached to the ropes are self-lighting electric lamps which float in the water and guide rescuers to the scene. The rubber, developed by United States Rubber Company, is resistant to oil, acid and fire.

M494

Shopping Bag Snuffs Out Fire Bomb With Salt and Pitch

If an incendiary bomb should fall on the Academy of Natural Sciences in Philadelphia it would be smothered quickly with a mixture concocted by the mineralogical staff. The ingredients—inexpensive and effective—are ten parts of ordinary salt and one part flaked coal-tar pitch, mixed dry. Containers for the mixture are paper shopping bags taped shut with gummed paper. About 25 pounds are placed in each bag. In approaching a bomb the bag is held as a shield for the face, then dropped on the bomb which burns the paper to speed its own destruction.



Mixture of ordinary salt and coal-tar pitch is placed in shopping bag and sealed to keep out moisture. At right, using bag as a shield for the face.

AUGUST, 1942

R. G. Samuel I. Gordon, Curator of Minerals
Academy of Natural Sciences, Phila. Pa.

Coal-tar Pitch can be purchased from H. F. Pettino
Inc., 1206 Locust St. Phila. Pa.

Mr. James L. Danks, Battalion Chief, Fire Dept., Los Angeles, Calif.

^{M 499}
**Sieve and Spray Quell Bomb
In Just Half a Minute**



Spray causes bomb to burn itself out under sieve

Magnesium fire bombs—the type that explode when you toss a bucket of water over them—are extinguished in half a minute with a perforated metal cone invented by James L. Danks, battalion chief of the Los Angeles Fire Department. The sieve-like apparatus helps smother the bomb, offers protection from exploding magnesium and at the same time allows a fine spray of water to play on the incendiary. The spray causes the bomb to burn out in a fraction of the normal time.

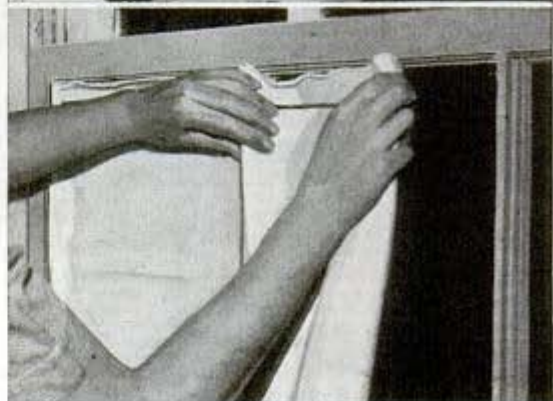
^{M 552}
**Rubber Enough for 10,341 Tires
Goes Into One Battleship**

Seventy-five tons of a 35,000-ton battleship consist of rubber, which, according to the Illinois Automobile Club, is enough to produce 10,341 automobile tires. Other reasons for the restrictions placed on rubber's nonmilitary use are apparent from the following: A 75-mm. gun carriage requires 175.3 pounds and a scout car 339

pounds of rubber; there are 33 to 96 pounds of rubber in an airplane tire, and up to 33 pounds in an inner tube; while 29 pounds of rubber go into each pneumatic raft of the type carried in airplanes.

^{M 390}
**Cheesecloth Pasted on Window
Makes Glass Shatterproof**

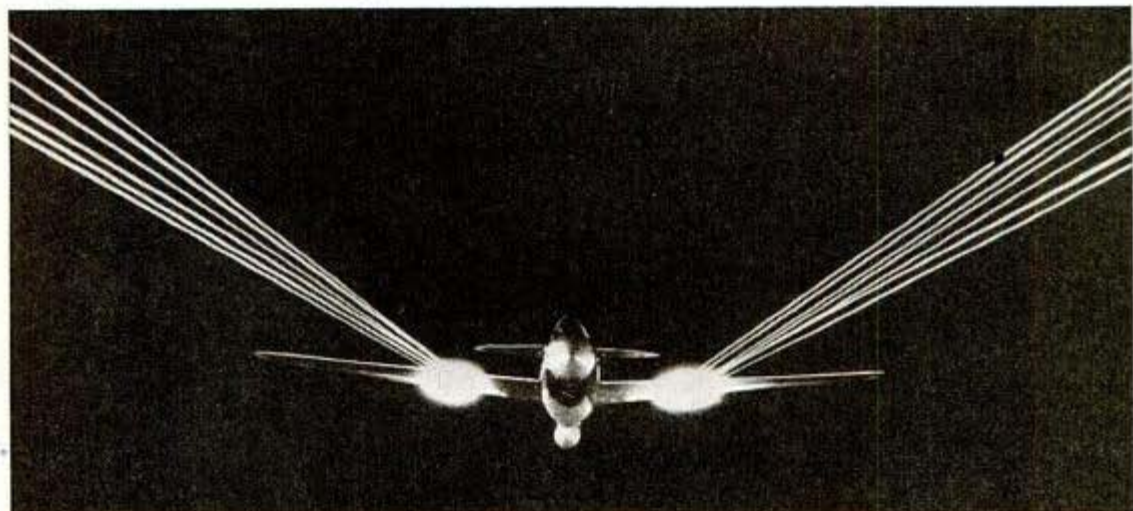
Because flying glass is responsible to a large degree for injuries and damage caused during bombing raids, it is advisable to protect the windows of homes and occupied buildings against shattering and splintering. Pasting cheesecloth or netting over the entire pane of glass is a simple and satisfactory way to prevent shattering provided the adhesive does not dry out, become brittle or lose its holding power due to the effects of moisture. A paste produced especially for this purpose is said to hold the backing securely, retain its elasticity and to be immune from weather changes. In explosion tests, the glass did not shatter, every piece adhering to the netting. To apply cheesecloth it should be cut to window-pane size; then the paste is spread on the glass and the cloth stretched over the pane. It can be stripped off easily when no longer needed.



Paste is spread on glass and the cheesecloth applied

Mr. Charles H. Ing. Co., 110 E. 42nd St. N.Y.C.

Fighter Guns Spray Fireworks in Night Attack



Tracer bullets used in night gunnery tests show how a Kittyhawk would look to the enemy in a head-on attack

Night gunnery tests for fighter planes conducted on the Curtiss-Wright firing range show how a Kittyhawk or one of the new Curtiss Warhawks might look to the enemy as it attacks head on with guns

blazing. Tracer bullets stab the darkness with fingers of fire. Camera shots of an attacking plane give the impression that the bullets are diverging when they are actually converging in front of the fighter.

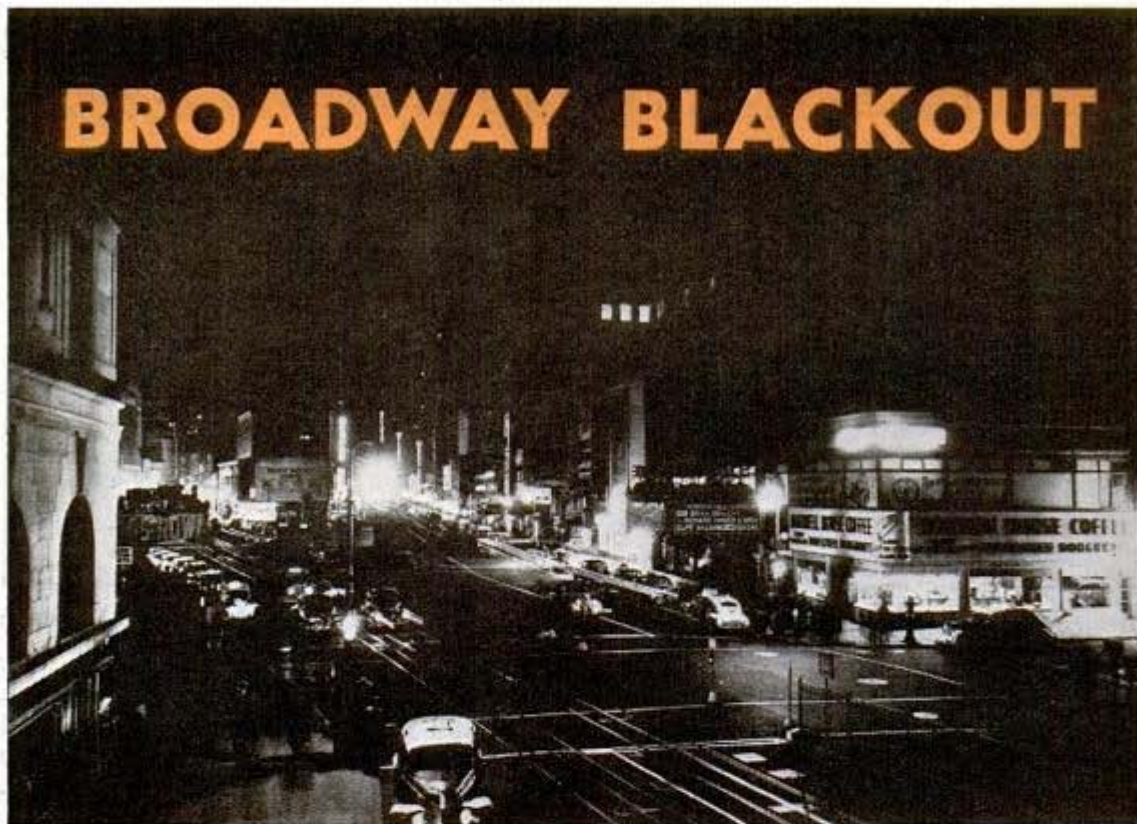
Uniforms for Poles and Tropics Made for U. S. Troops

Whether America's expeditionary forces will be fighting under a blazing tropic sun, through Arctic blizzards or parachuting from planes thousands of feet in the air, the Quartermaster's Corps has insured that their clothing will fit the weather. Sun helmet, shirt and short breeches of thin material will help the Yank in the tropics keep cool, while the ski and snow shoe troopers are provided with heavy clothing and thick-soled boots. The uniform of the paratrooper contains commodious pockets and is designed to accommodate the heavy bulk strapped to his back. A metal helmet, kept in place by a strap and cup arrangement which protects the chin, is also worn by the parachute jumper.



Army official inspects new uniforms designed, from left to right, for tropical wear, for the snowshoe and ski trooper, an arctic fighter and a paratrooper

BROADWAY BLACKOUT



Signs on the Gay White Way are blacked out to prevent cloud reflections that aid submarines off shore

This canyon of brilliance is dimmed for the duration



THE same scientific ingenuity that made the bright lights of Broadway one of the wonders of the world is being employed to save these spectacular signs—now that the “dim-out” order of the army has extinguished most of the 200,000 bulbs which made the Gay White Way glisten.

The result is that Broadway, already a canyon of unfamiliar, comparative blackness, may take on an eerie appearance like nothing ever before presented to the eyes of the estimated 1,100,000 nightly gazers who still visit the area.

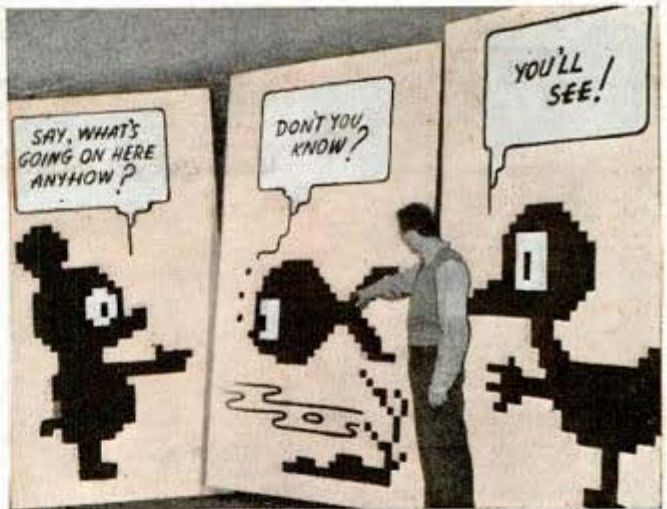
Some of the “spectaculars,” as the giant advertising signs are called, will soon blossom forth with gigantic fabric awnings and metal shields which permit the scintillating displays, but prevent the lights from striking clouds and setting up a glow which silhouettes United Nations’ ships, making them easy prey for Axis submarines lurking offshore.

More bizarre are the experiments now being conducted by the leading sign corporations in the use of ultra-violet or “black light” to illuminate paints. If they succeed, the Gay White Way will no longer be white, but will glow with a ghostly luminescence—just as colorful, but no longer as glaring.

Cont: Warren Elliott, 543 E. 53rd St., N.Y.C.



Douglas Leigh, sign wizard, turning dial that operates a sign by remote control



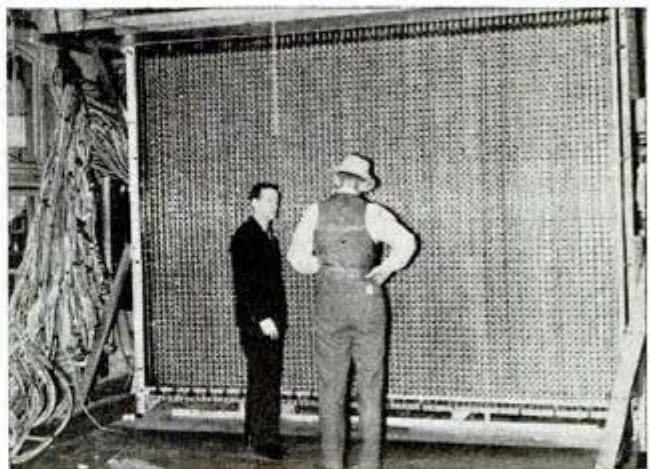
Enlarged drawings for animated cartoons that will be flashed on a "screen" to amuse Broadway's 1,100,000 nightly visitors

Another line of research deals with the possibility of substituting motion for light, making the district a maze of mechanical devices—whirling windmills, waving arms, winking eyes, beckoning fingers, dancing feet. This would give the wartime spectaculars a daytime attention value even greater than they formerly enjoyed, although it is the practice of the sign companies to flash on the lights the moment daylight falls below normal. At night moving objects would heighten the queer effect of black light on luminous or fluorescent pigments.

Another possibility under serious consideration is the strangest of all. Inquiry is being conducted on the value of taking the huge signs on tour of the United States just as Broadway shows go on tour to smaller cities.

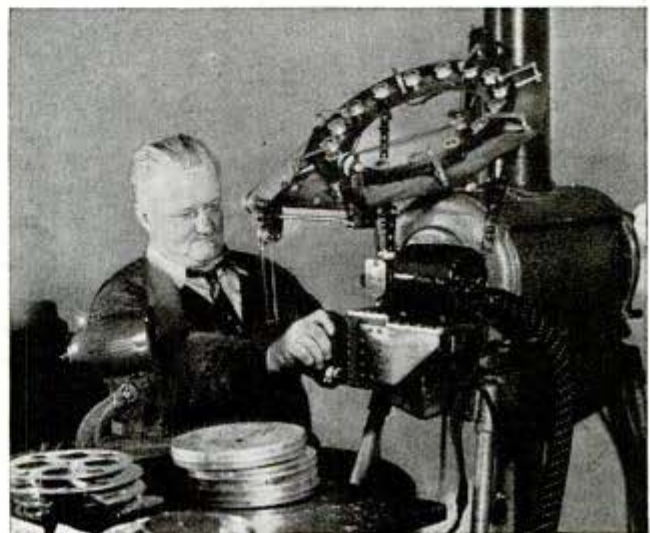
In this scheme, a giant sign would be routed to a city like Pittsburgh or Cleveland and erected there, remaining until most of the people in the vicinity had seen it. The high cost of Broadway spectaculars has been justified partly in the past by the fact that the street is a mecca for out-of-town visitors. It is possible that the lights which made New York City famous may go to the byways of the nation, instead of waiting for millions to come to Gotham to see them.

Proponent of the "traveling spec-



"Back stage" of an animated-cartoon sign is this great bank of 4,104 photo-electric cells that control bulbs "out front"

This machine projects 16mm. cartoon films onto the photocell bank. The picture on the screen is enlarged about 100,000 times





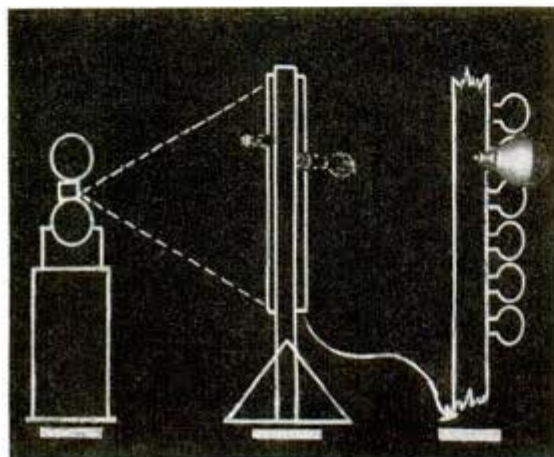
Real smoke rings are blown by the soldier in the sign, left, one every five seconds

Below, holding switch that will blackout instantly 16 of Broadway's largest signs



tacular" idea is Douglas Leigh, the sign wizard who owns most of the spectaculars on Broadway although he is only in his early thirties. His record for the unexpected makes the plan seem possible.

So many novel features have been added to the signs along Broadway, particularly those erected by Leigh, that on a single stroll from Times Square to Columbus Circle, if the day happens to be murky so the lights can be lit effectively, one can get the time, the temperature, the weather prediction, hear the quarter hours sounded by radio chimes, watch an animated cartoon show, see famous Broadway characters in pantomime on a bank of lights, watch drinks poured by the use of flowing light, observe a coffee percolator steam, see great smoke rings puff from a soldier's lips, and admire tall fountains of water shimmering and dancing behind the largest plastic screens ever constructed.



The controls for some of these signs are as fascinating as the signs themselves. An example is the towering neon weather bureau atop a building at Columbus Circle. It is 4,000 square feet in size, contains 12,000 square feet of metal, 2,000 feet of a fluorescent neon many times brighter than ordinary neon, 1,050 electric bulbs, and 10 miles of wire. Four times a day, on a permanent neon landscape with a neutral sky above, it forecasts tomorrow's weather. If the forecast is for rain, the word "rain" flashes on the sign while neon raindrops fall on the landscape. If the sun is going to shine, a big sun with sparkling rays appears. If it is going to be cloudy but warmer, clouds appear in addition to the sun. If it is going to be cold, neon icicles crystallize all over the sign. And if snow is predicted, beautiful giant snow crystals

Diagram shows how animated cartoons are projected from machine, left, via photocells to electric screen

appear in white-and-blue neon.

The whole mechanism of the sign is operated by remote control from the offices of Leigh where there is an instrument with a dial system, with 10 different weather conditions listed: warm, warmer, cold, colder, rain, fair, cloudy, snow, cool, cooler. Over a special telephone wire, Leigh, four times a day, telephones the New York Weather Bureau, to learn tomorrow's weather forecast. Immediately upon learning, he turns the dial to the corresponding weather forecast, whereupon the proper word flashes on the sign and the proper scene on the landscape. A red light then flashes back in the Leigh offices, as a double-check against error. That's just so Leigh will know that when he is dialing "cold" or "snow," the sign isn't dramatizing a heat wave.

Another sensational sign is a three-pan-



This sign not only gives the weather report, but dramatizes it with a neon landscape that has 10 variations including rain, snow and sunshine

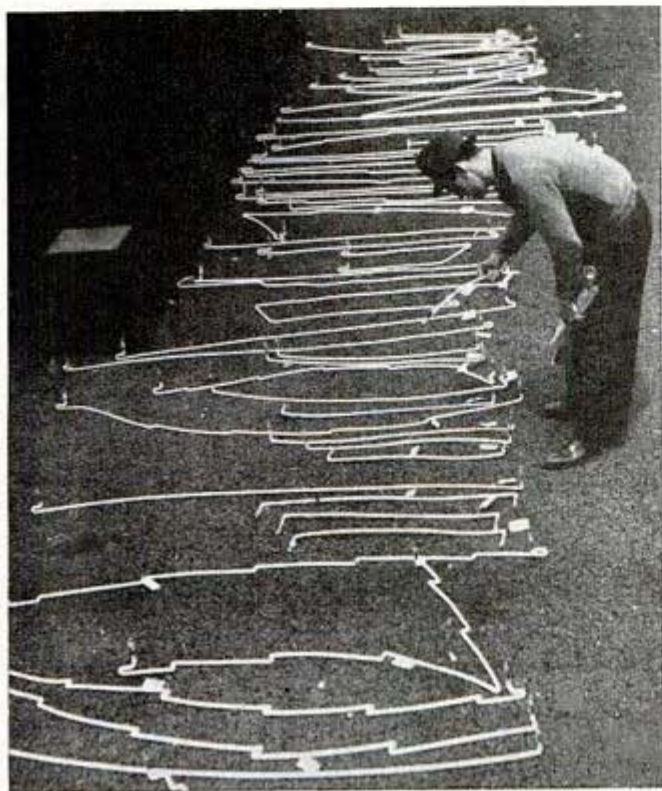
eled affair, with one panel on top and two underneath. On the top panel are eight plastic-enclosed fountains which spout water 20 feet high; centered between the fountains is a 35-foot, three-dimensional bottle. On one of the lower panels is a novel animated-cartoon mechanism. On the third panel is a bottle and glassy "pouring" effect in brilliant colored bulbs.

The entire sign is 4,000 square feet in size, and includes, among other things 14,000 square feet of porcelain, 100 miles of wiring, 10,000 lamps, 4,104 photocells, and a total wattage of 200,000.

This is the first time real fountains have ever been used in a sign on Broadway. They are enclosed in transparent tubes, so none of the watery spray falls on passers-by below. Colored lights play on the fountains which spout into a mushroom effect; when the watery mushrooms break up, myriads of multi-colored bubbles float in the transparent tubes. The tubes are made of plastic.

Little air holes keep the tubes from frosting inside, and a mixture of anti-freeze keeps the water from freezing in the cold weather.

When this jumble of neon tubing is assembled it will form the petals of a giant rose





Resembling a new type of air raid shelter, the lower part of the largest bottle ever made for a sign awaits the neck. It will be 35 feet high

There is an extra ring of water on top of each tube. This acts as a shower bath, rinsing the tubes inside and out, so they will always be clean. The pumps that spout the water are flexible, so that each one of the eight fountains rises to a different height, thereby making a variety of geometric patterns in the whole colorful spectacle. As the fountains spout the water, it drops into a metal container from which it is pumped up again.

The same water is used over and over for 24 hours and then changed. The total amount of water pumped per minute is 2,000 gallons. The lights playing on the fountains are at their base: 56 floodlights in all. A drum of color, operated by a motor, passes over them giving a kaleidoscopic color effect. The lights are hidden by a real boxwood hedge, also making its first appearance on a Broadway sign.

The animated-cartoon panel on this sign has a lamp bank of 4,104 lights on a screen 20 by 30 feet. The animated cartoons on this bank of lights, because of great improvements in the mechanism, are now more than ever like the Walt Disney cartoons, except that these, by the magic of photocells, are turned into electric lights.

The 4,104 lights on the screen outside are controlled by a bank

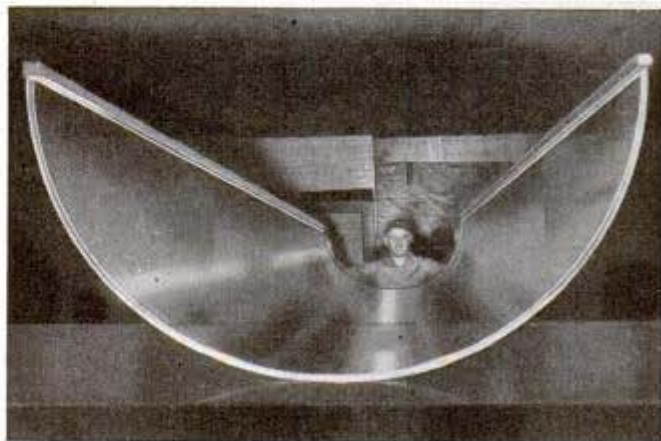
This curved sheet of transparent plastic shields a lofty fountain from the winds

of 4,104 photocells in the control room behind the sign. The animated-cartoon films are projected by an operator onto the bank of photocells. The projector's light beam can pass through only the transparent part of the film and not through the opaque part, so that if a negative film is used the picture appears in lights; and if a positive film is used, the background appears in lights and then the unlighted parts make the picture. The photocells that are touched by the light beam become activated, send the current to a bank of mercury

tubes, which in turn magnify the current and turn on the corresponding lights on the screen outside.

The animated-cartoon mechanism is much like television, but television operates by lines, while the Leigh cartoon signs operate by dots, or lights. To give you better figures, the picture on the electric screen outside on the sign is enlarged from a fraction of one square inch to a size totaling 93,744 square inches—in other words, more than 100,000 times.

The first type of cartoon is one in which the characters are made in squares. A different drawing is made for each progressive movement, and a special non-shrinking paper is used. The drawings are then photographed, the trigger of a 16-mm. camera clicking each time a progressive movement is made. Then when the film passes the projector at 20-24 frames per



second, the figures are in motion. These figures on the films are then projected onto the photocells.

The second type of cartoon is made by using models for the drawings, then photographing the various drawings making the progressive movements.

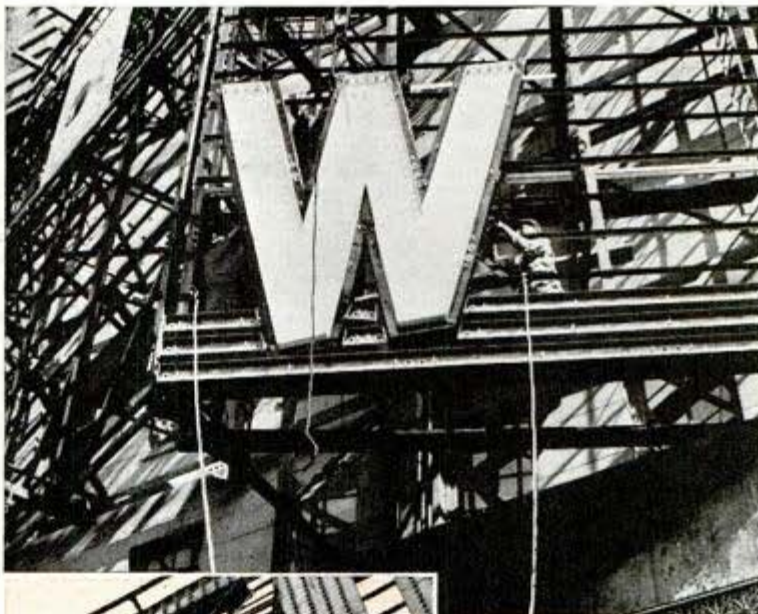
The third type of cartoon is the one in which 16-mm. movie shots are made of actual people. It is necessary, however, that the characters be photographed in front of a lighted screen. This gives sharp black and white definition.

The blackout arrangement includes a half-block-long electric sign advertising cigarettes. The giant head (23 feet high) is of an American soldier in an overseas cap smoking a cigarette. By means of a patented device based on the principle by which you blow smoke rings, the soldier blows huge real smoke rings every five seconds into Times Square—a total of 8,500 smoke rings each night.

The method of producing the right kind of smoke in the right quantity is a trade secret, but the method of causing steam to emit from a huge coffee percolator nearby is not. This steam is piped under the street from a plant many blocks away and it takes 50,000 pounds of steam a year to keep the sign operating.

Meanwhile, there is always the chance that the submarine menace will be conquered, leaving only the danger of air raids and the need for sudden blackouts. If the signs flash on again, not one enemy bombing pilot will be able to use the canyon of color

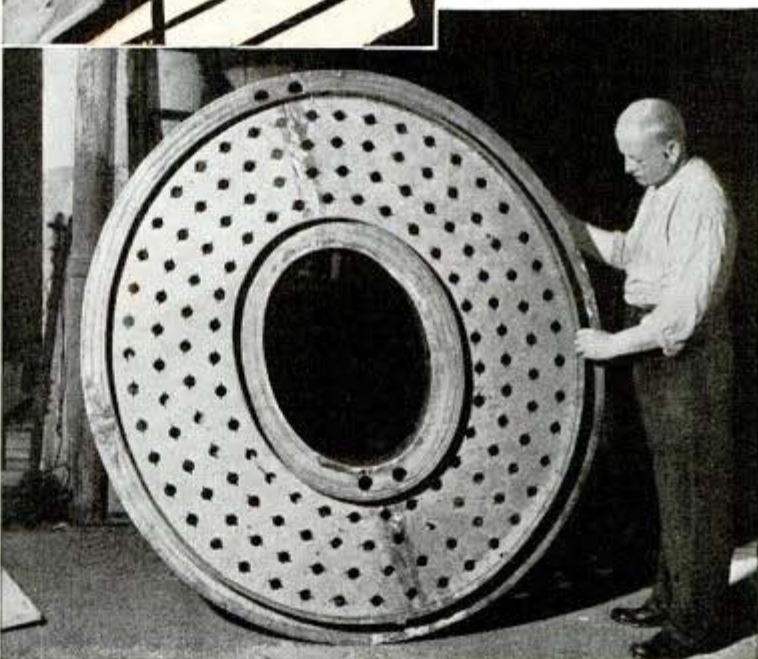
(Continued to page 176)



↑
Hoisting the big "W" into its high niche over Broadway is no job for an amateur. The letter weighs 750 pounds, has 450 bulbs

← The two dancers standing on the neon rose leaf on a rooftop sign are dwarfed by huge 30-foot letters that twinkle no more at night

Socket holes in the letter "O" are ready for the enameler. The letter weighs 300 pounds and uses light enough for 10 homes
↓



Edward H. Struebling, Tona-wanda, N.Y.

Trailer Ambulance Transports Four Patients



Stretchers may be placed in trailer ambulance from end or either side

Four patients can be carried in a two-wheeled double-deck trailer ambulance developed by E. H. Struebling of Tona-wanda, N. Y. Stretchers may be placed in the trailer from the end or either side. The roof of the ambulance is wood, sides and ends are enclosed in canvas and it is mounted on a steel chassis easily attached to the rear bumper of any passenger car. The trailer is eight feet long and weighs about 500 pounds.

Flying Freighter Built of Wood to Carry Military Cargo

Built of wood and other nonstrategic materials, giant planes to transport military cargo are being constructed by the Curtiss-Wright Corporation at a new plant "some-where in Kentucky." The plane, called the Curtiss C-76, has twin engines and is about the size of a large passenger plane.



Powered by twin engines, planes made of wood and large as metal ships will carry army freight

Air Raid "Igloo" Built of Heavy Timbers Saves Strategic Materials

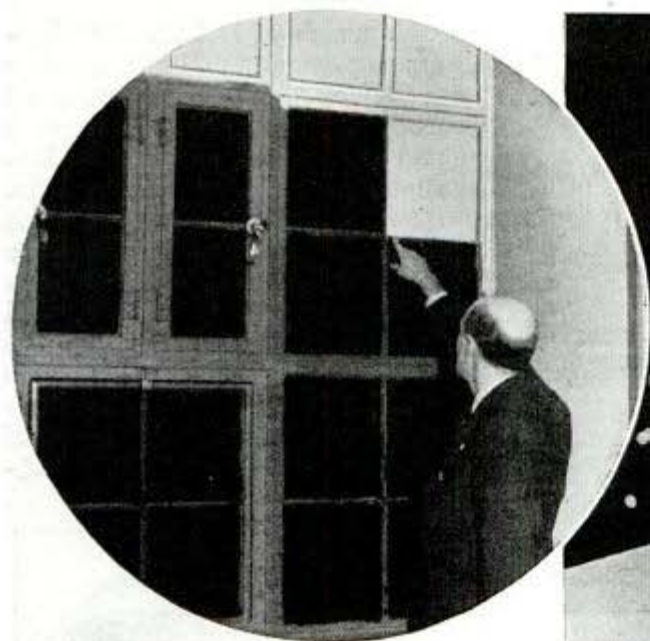


If you object to crawling under a table in the basement when the air raid siren blows, here is a shelter for home use made entirely of non-strategic materials. Looking somewhat like an igloo, the shelter is built of heavy timbers held together with pegs in place of nails. It is roomy enough for a double bed.

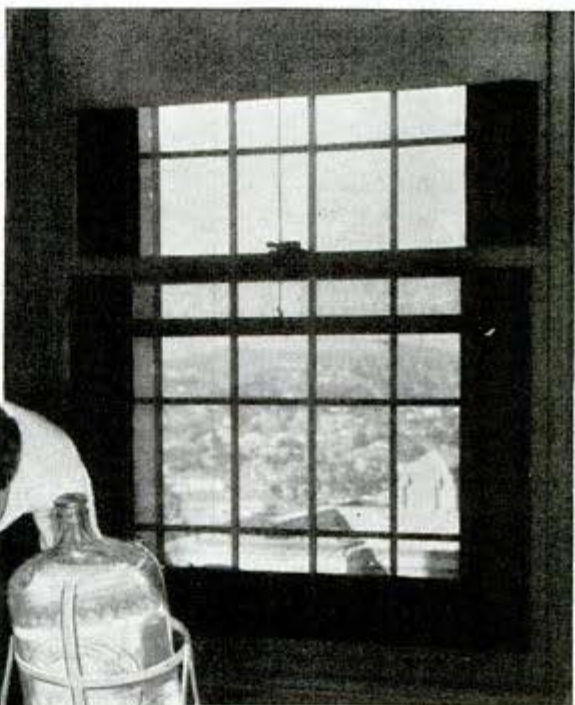
Wooden shelter for home use in air raids will hold double bed and paraphernalia to fight fire

30 Rockefeller Plaza
N. Y. C.

Civil Defenders Invent New Blackout Schemes



There are right and wrong ways to blackout. If you paint a window black it's likely to absorb so much heat it will expand and break; white paint inside a blackened exterior (top) will dispel the heat. Don't paint windows larger than 24 by 50 inches. Upper right, wardens spot lights in hospital windows during blackout, locating windows by 10-watt bulbs studding walls at known levels



By painting six-inch black strips around window edges (above) Los Angeles County General Hospital blacks out its 10,000 windows completely with dark window shades already in use. At extreme left, sheet-metal mobile shed to guard fire fighter putting out incendiary bomb. Left center, emergency supply of distilled water for air raid shelter has its special stand

Mine-Layer Drops 300 Death "Eggs" Per Hour

M 512



Hundreds of British mine-layers are planting their deadly "eggs" by the thousands to blast German submarines from the seas and tighten the blockade of Europe. Pushed along tracks on the stern of a vessel, 300 big mines can be laid in one hour. Half the space in the mine heads is filled with explosives and firing batteries and the rest of the space is an air chamber for buoyancy. In this war the Royal Navy has far surpassed its mine-laying activities of World War I when a total of 128,652 mines were laid.

British sailor (above) wearing life jacket passes a line through ring of a big mooring buoy to bring mine-layer to anchorage. At right, mine heads lined up on the stern of a ship



Flying Ambulance of Future to Land on Field by Hospital

M 480



Persons injured in isolated regions in the future may be rushed to hospitals in a lightplane ambulance now in an experimental stage. Planes of this type can land in a small field. The fuselage provides space for two stretchers, or a more elaborate single litter. This flying ambulance might be used to carry wounded soldiers to base hospitals.

Two patients can be carried on stretchers in fuselage of light plane

*Reper Aircraft Corp.,
Lack Haven, Pa.*

ALLOYS *for the* ALLIES



Because of its strength and resistance to heat and corrosion, stainless steel is even more valuable in war than in peace



M 184

Cylinder heads are fitted with barrels of alloy steel

United Aircraft Corp.

Barrels of rapid-fire antiaircraft guns must be of high quality alloy steels to stand heat and corrosion

By Walter S. Tower

President American Iron and Steel Institute

THE German bomber that had just crashed in flames near an English city appeared to be one of the conventional types, even though the force of the crash and the heat of the fire had made it a misshapen mass.

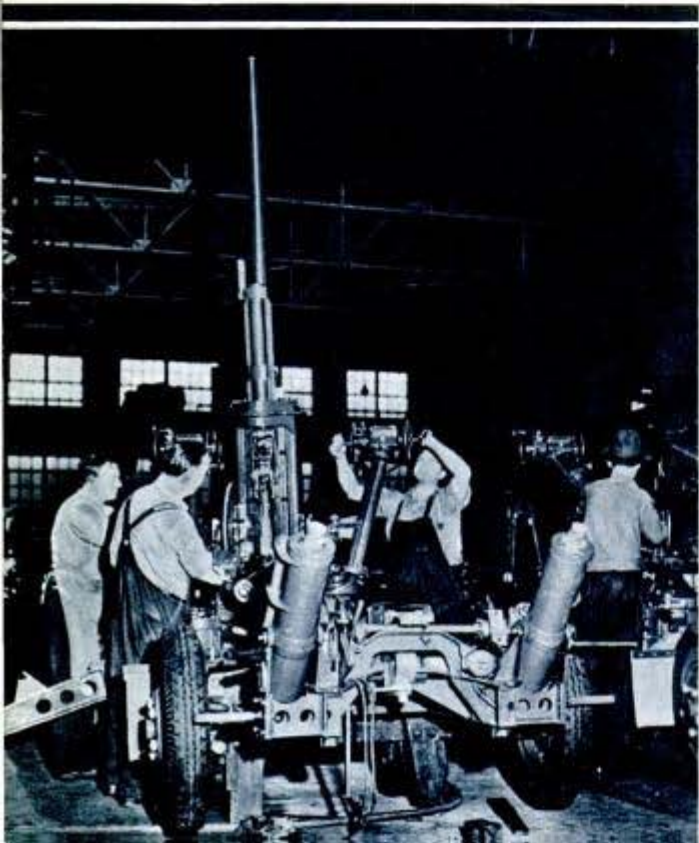
Hardly had the tangled wreckage cooled before technical experts were swarming over it to extract its secrets. Aviation engineers searched for new instruments and equipment; combustion engineers checked over what was left of its motors; mechanical engineers looked for evidences of new structural ideas.

There was also a metallurgist among the experts. As he combed over the wreckage, he picked up bits and chunks of metal, labeled their location and apparent use as best he could, and took them away for examination.

In his laboratory he carefully scrutinized the specimens, determined their composition by chemical analysis and by the spectrograph, examined them under a

Ref: The Amer Iron & Steel Inst.
356 - 5th av.

W. S. Tower



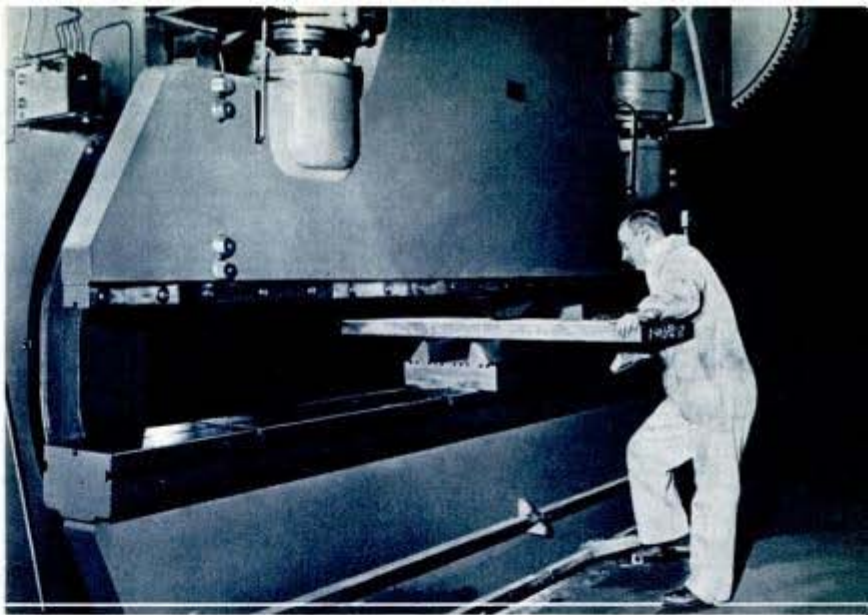
metallurgical microscope, tested them for hardness, strength and elasticity. Most of the specimens were familiar, either through previous examination of German planes or because they were standard metals and alloys used almost universally in airplane construction.

One specimen was puzzling, however. It was a small piece of steel which the tests showed contained a small percentage of a rare metal sometimes used as an alloying element with certain nonferrous metals, but not generally alloyed with steel.

The presence of the rare element in the steel was probably accidental, but it might have been purposeful. The Germans might have developed a new and useful alloy steel. To determine the facts, metallurgists in both England and the United States were set to work. What they learned cannot be disclosed for military reasons.

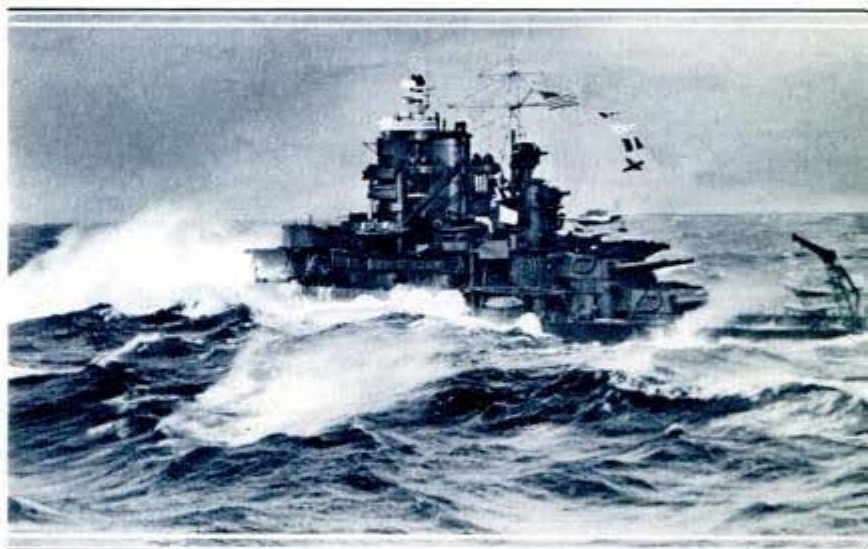
Analysis of the metals in captured war equipment is routine in modern warfare. The purpose is not only to discover whether new and better alloy steels are being used, but also to learn whether the enemy is running short of valuable alloying elements and having to rely on leaner alloys or even plain carbon steels. This war is primarily a war in which one side pits its steel in the form of planes, ships, tanks and guns against the steel produced by the other side. The outcome will depend partly upon the quality of the steel available to the victor, as well as the quantity.

The United States and our allies are fortunate in that they can make considerably more than twice as much steel as all the axis and axis-dominated countries of the world together. The United States



Steelweld Machinery Co.

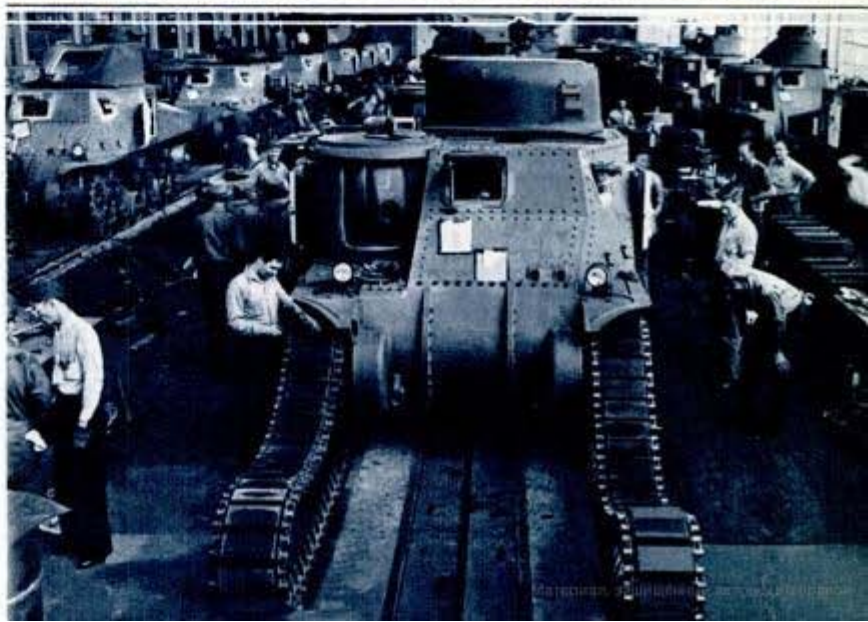
An armor-plate slab 2½ inches thick is straightened in a press while cold, for heating would affect the hardness of the armor



U. S. Navy Photo

Up to one-third of a battleship's weight may be its steel armor

Alloy steel transmission of medium tank weighs about 3½ tons





OEM Photo by Palmer

If a housewife were to mix the ingredients for her cake with the meticulous care and precision a metallurgist takes in making alloy steels, she would add flour and sugar by the grain

The army's 75-millimeter field gun must be extremely tough to endure the terrific heat and wear of battle, and the shield must really stop bullets. Both gun and shield are of alloy steel

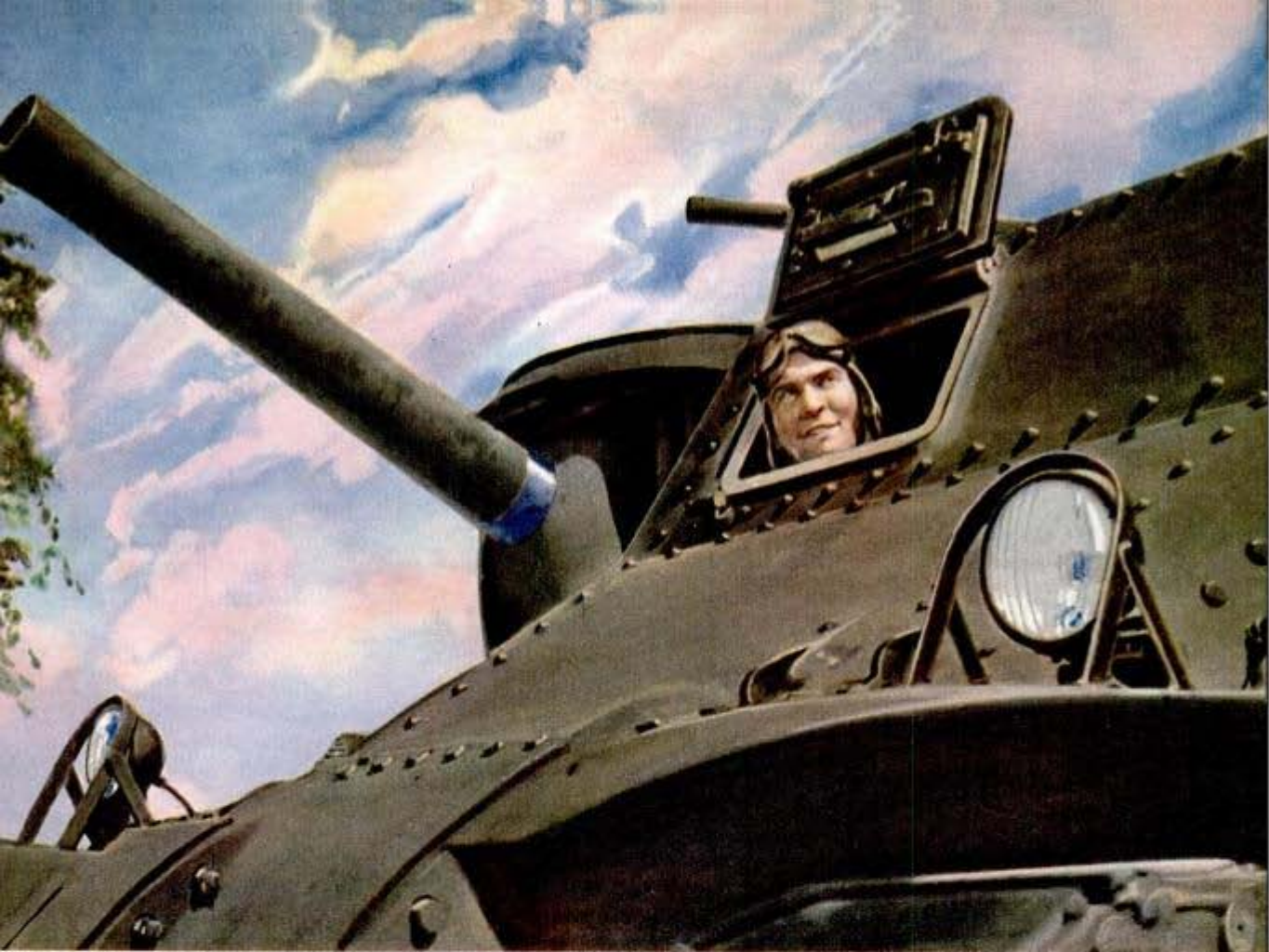
alone can produce three tons of steel for every two tons that can be made in Germany, Italy and Japan and all of conquered Europe. In quantity, we lead the world by a wide margin. In quality, too, we are supreme.

If there is any such thing as a "mystery weapon" in this war, it is the great family of alloy steels the American steel industry is producing in record-breaking tonnages for the specialized needs of war. Some are new; others were developed for peacetime purposes but have been adopted for military use.

Plain carbon steels will probably always remain the basic material of construction in both peace and war. When extra strength, hardness, or corrosion resistance is needed, however, elements such as nickel, chromium or molybdenum are added to carbon

U. S. Army Signal Corps Photo





Steel armor plate, hardened by alloys, can be riveted or welded

This tubular mount will hold a heavy airplane engine secure

Douglas Aircraft Co.

steel. The result is an alloy steel. By adding as little as one-half of one percent of molybdenum, for example, steel is made more resistant to heat. A little chromium makes steel harder; more chromium makes steel corrosion resistant. Nickel makes steel tough. Each of those alloy steels, and many others besides, have specific uses in modern war equipment.

Already the alloy steels in American-made fighting equipment have passed the severe test of combat service. The first test came with the torpedoing of the destroyer Kearny nearly two months before Pearl Harbor. The Kearny is a bigger ship than most older destroyers, but she is at least as fast and maneuverable as her predecessors. Unlike the destroyers of World War I, the Kearny has two sets of boilers and two





General Electric Co.

Impellers for turbosuperchargers are carefully cut out of solid block of steel forging. With them our Flying Fortress flies highest of all bombers

pects could employ in her power plant alloy steels not available in the last war.

The boiler tubes and turbines of the Kearny were made of alloy steels so much stronger than ordinary steels that her engines could be made proportionately lighter than those in older destroyers. Thus the Kearny could be powered with two engines rather than one, at no sacrifice of speed. The turbine shafts of the Kearny were forged from an alloy steel approximately twice as strong as those used in 1920. Boiler tubing has similarly been improved so that per pound of weight it is far stronger than formerly and can function at higher temperatures and pressures.

Originally the steels used in the Kearny's power plants were developed for the nation's power and light companies. The operating economies resulting from the utilities' use of these steels have been an important factor in cutting in two since 1920 the price the consumer pays for electricity. In wartime, these same alloy steels have helped increase the speed and operating range of our navy, reduced fuel consumption, and, in the case of the Kearny, helped keep a naval vessel afloat.

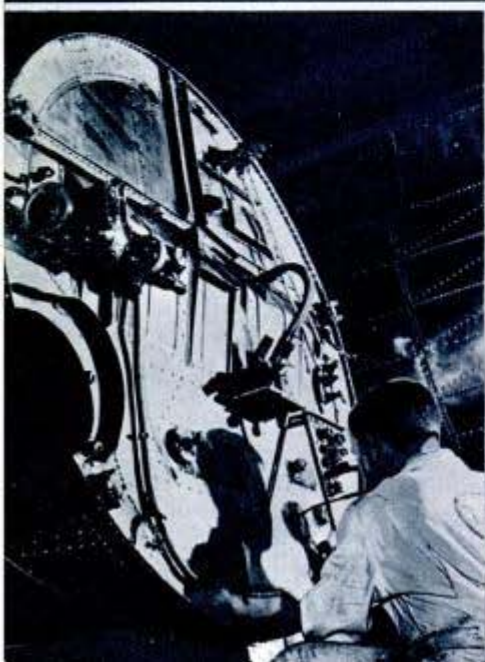
In the air, too, American alloy steels have been showing their ability to absorb punishment. Perhaps the outstanding per-

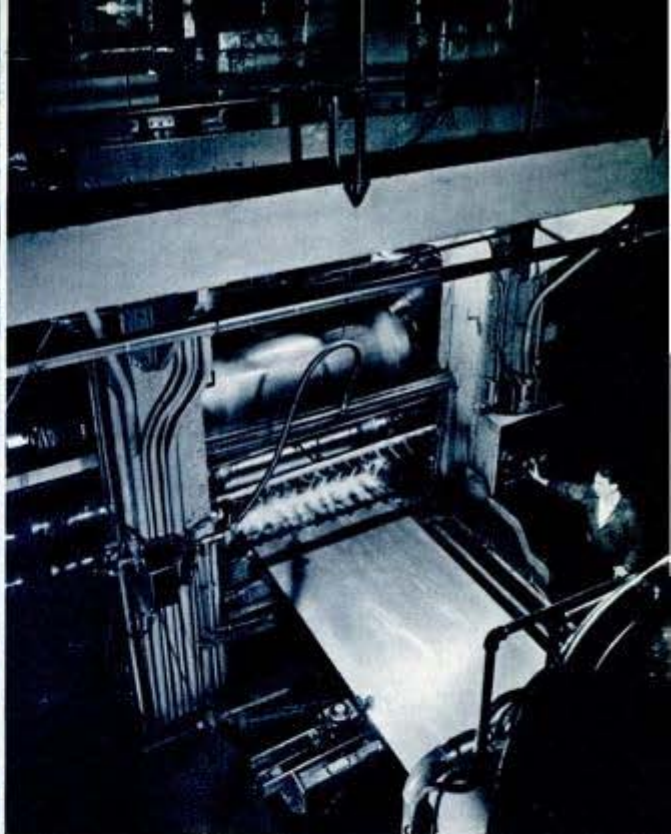
engines—one forward and one aft. Explosion of the torpedo crippled the forward boiler and engine, but she was able to make port with her aft engine. The fact that the Kearny is a big destroyer is only one reason why she could be equipped with the second engine and boiler. Of almost equal importance is the fact that the naval archi-

Stainless steel firewall (left) resisting 1,650-degree temperature will keep aircraft engine blaze from spreading into plane. Right, army trucks whose dependability rests on alloy steel axles, gears, engines

Transcontinental & Western Air

U. S. Army Signal Corps





Tennessee Valley Authority

American Rolling Mill Co.

Huge hydroelectric generators of a Tennessee Valley Authority power station rotate on hard steel shafts (left). Steel sheets for army truck bodies and field kitchens (right) are flattened by alloy steel rolls

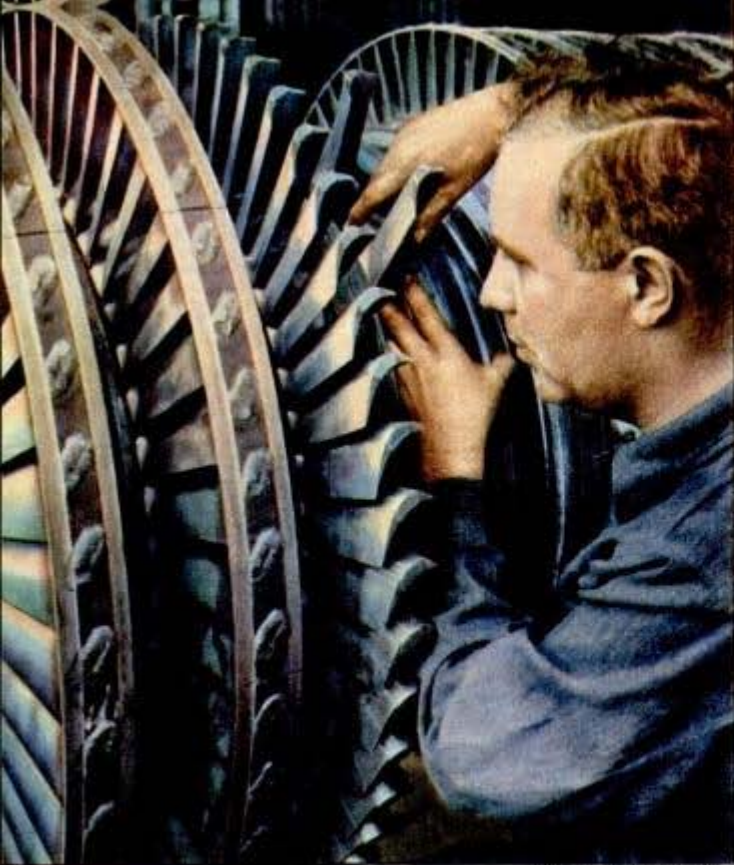
formance of American planes has been given by the huge Flying Fortress bombers. Used in the attack on Japanese ships in the western Pacific, those bombers have time and time again struck heavy blows without the protection of fighter planes. No bomber can fly higher than the Fortress planes, and few enemy planes can intercept them at their maximum height of over five miles. Such high-altitude flying would be impossible without a supercharger to increase the supply of air to the engine. Flying five miles high, a 1,000-horsepower motor not so equipped would deliver less than half its rated power. Superchargers are operated by the hot, corrosive gases exhausted from the plane's engines. Alloy steels make it possible to harness the blast.

Modern bombers use tons of other alloy steels in vital parts. One grade of

steel is extensively used in tubing, much like a bird's hollow bones. It forms, in effect, the feet, neck and strongest wing bones of the modern plane. This alloy steel has twice the strength of the best tubing available 20 years ago. Used in the landing gear or "feet," it is better able to withstand the shock of emergency landings. In the "neck" of the plane, alloy steel tubing securely anchors the heavy high-powered

This stainless-steel tubing is needed to carry off corrosive gases from 2,000-horsepower engine





Westinghouse Photo

Outside tips of stainless-steel turbine blades revolve as fast as 850 miles an hour. These turbines are used to generate electric power or propel a ship

There are still plenty of tons in these big mobile guns, but several tons weight were saved by fabricating the gun carriages of high-tensile alloy steels

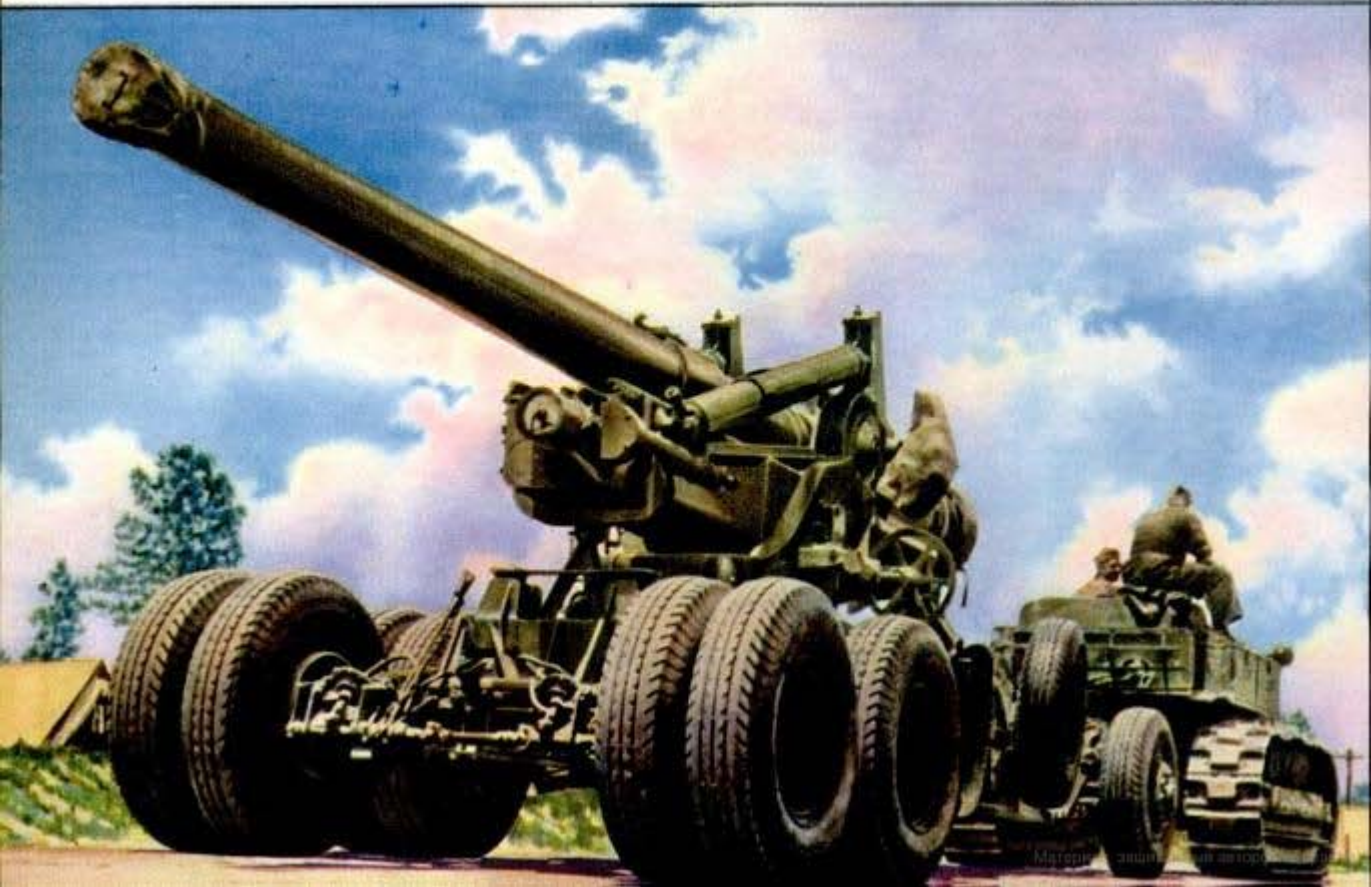
engine to the frame. Wings and fuselage are strengthened in key places by alloy steel tubing and forgings. Alloy steels comprise most of the engine's weight. The strength and durability of such steels have greatly increased the reliability of the engine. Exhaust valves, for example, stand up under temperatures of 1,600 degrees Fahrenheit and help make possible sustained speeds of over 400 miles an hour.

In fighting on land, the value of high-quality alloy steels has been enormous. Military observers report that American light tanks in Libya showed great speed and durability and on numerous occasions outfought heavier tanks. A tank is not designed to operate on smooth concrete highways, and the conditions under which it does operate impose terrific strains, particularly upon its track. If a single link in the track is broken, whether by antitank shell or by a metallurgical defect, the tank is immobilized. The tracks of American tanks have proved highly reliable. Alloy steels are used in key parts, one steel used being the same type that in peacetime was used for heavy truck axles.

In almost all kinds of mechanical military equipment, whether tanks, jeeps

(Continued to page 176)

U. S. Army Signal Corps Photo



United-Carr Foster Co. of Canada, Hamilton, Ont. Canada.

The International Nickel Co., Inc., 67 Wall St. N.Y.C.

Hollow Rivets That "Pop" End Blind Fastening

In answer to the cry for more speed in war production, a tubular rivet has been developed that can be fastened entirely from the outside of "blind" sections of an airplane wing or fuselage with a specially equipped pneumatic squeezer. A commercial nail of plain carbon steel is used in the operation. The rivet is slipped over the shank of the nail which is inserted head first into the rivet hole. Then the claw of the squeezer grips and pulls the nail while the chuck presses against the lip of the rivet holding it in place. This section expands the inside end of the rivet. The nail head falls off inside and the shank is removed. The nails are necked down so they will break when the expansion has



Tubular rivet slips over nail. Diagram shows double action of squeezer

reached maximum holding power. Tubular rivets, also called "pop" rivets, can be used in combat zones for repairing airplanes that formerly had to be dismantled when it was necessary to patch them.

Glass Floor of Model House Shows Heat Coils Beneath



Floor-type heating equipment is demonstrated by one manufacturer with a model house having a translucent glass floor. Tubes of glowing Lucite reproduce the complete coil system and may be viewed easily by raising the house, which is hinged at the back. One corner of the floor is cut away to show the construction of a typical unit.

Model house is raised to demonstrate floor-type heating unit with Lucite tubes under glass

Meat Tenderizer in Pineapple Is Produced From Juice at Low Cost

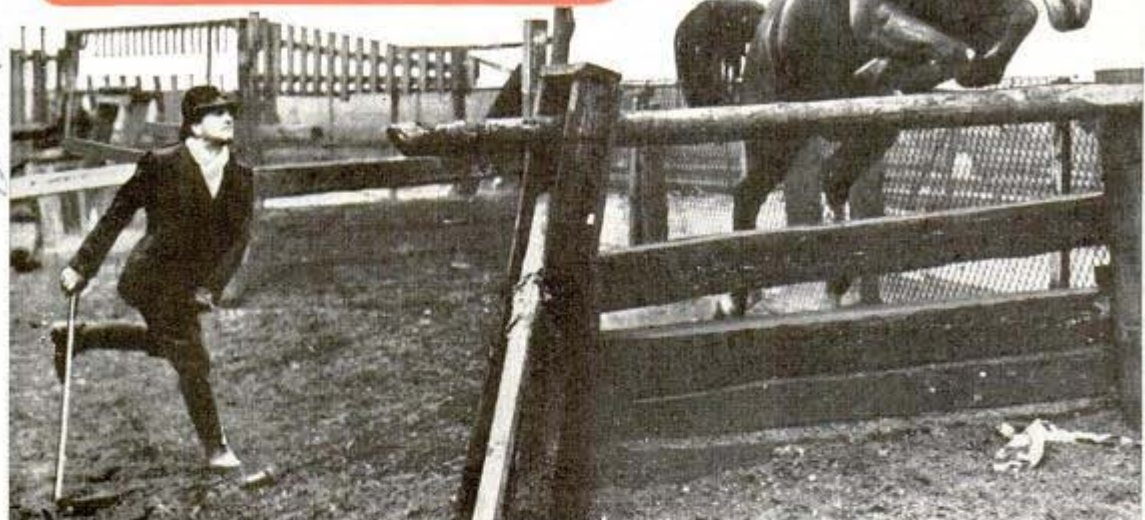
It has been known long that raw pineapple juice makes tough meat cuts tender. This is due to the presence of an enzyme called bromelin which breaks down the meat protein, but only recently has the method been found whereby the meat-tenderizing factor can be obtained cheaply.

The process, discovered by the U. S. Department of Agriculture and the Hawaiian Agricultural Experiment station, involves the precipitation of the bromelin, with alcohol, from juice pressed from the peels and cores of pineapples in a stage of manufacture where the juice is of little value.

A. M. Dugan Co. 1000 1/2 Adams St. Pittsburgh, Pa.

Материал, защищенный авторскими правами

COLLEGE *for* POLICE HORSES



A star "pupil" gracefully tops a high hurdle at New York City's training school for traffic horses

By Allen Warren Elliott, 343 E 33rd, M 388 NYC.

YOU might just call them police horses and let it go at that. On the department records they are "mounts." But members of the famed New York traffic squads speak of them affectionately as "pals"—these super-educated equines whose wise deportment on crowded streets

never ceases to appear marvelous in a metropolis full of marvels.

Faithful pals they have been in time of peace, thanks to their training in the unique police-training school. And faithful pals they will remain in time of war. The rigorous schooling they now undergo before facing the traffic maelstrom includes enough training in shrill and booming noise to withstand the scream of raid sirens and the crash of bombs.

The only concession the New York mounted police have made to Nazi air blitz tactics is a strong but slender cord attached to each saddle. This can be used to tie a horse to a pole on a bombed street should the horse be left alone during an air raid while the officer is afoot on an emergency errand. Or, the animal can be tied inside a building. But most of them won't need to be tied.

It is this trick of standing quietly in the midst of a veritable river of honking and tooting traffic, or remaining motionless in a busy



Horses are trained to become accustomed to autos. The horse in foreground is being retrained after an accident

Capt. James P. Neenan, Police Mounted District, 16 Ericsson Pl., N. Y. C.



This clumsy student is learning to become surefooted the hard way with a workout over an obstacle bank

street after the uniformed rider has nonchalantly dropped the reins and strolled off, which puzzles hundreds of thousands of people. Anyone can make a horse stop and go. But how do you make one stand still if alone for fifteen or twenty minutes? What makes him remain patient and practically motionless in a dizzy traffic jam? Why does he wait there without being tied until his rider returns?

The secret back of this phenomenon of horsemanship reveals the intricate modern day psychology put into practice in New York City's school for traffic horses. The horse is merely taught to relax.

Day after day in a course of education that lasts from 12 to 16 weeks, a police horse is given a strenuous workout which includes galloping or trotting, jumping, wheeling, pivoting and climbing obstacles. The instructor watches shrewdly until the animal shows signs of fatigue. When the horse has reached the point where a rest would be welcome, the instructor halts the animal in his tracks with

Standing calm in the midst of a noisy whirlpool of traffic, a trained police horse is alert only to the commands of his officer





Around the trainer's neck is the horse's "diploma"—the standard police-horse bit and bridle. In his hands are training bits

a sharp command, dismounts, drops the reins and walks off.

Being fatigued and no longer having an instructor around to annoy him with more exercise, the horse does what most all tired little boys do when teacher leaves the room. He merely relaxes. Pretty soon he catches the idea that when a man gets off his back and walks away, one of his pleasant periods of relaxation has arrived. He just unwinds his nerves and stays there thinking his equine thoughts. This moment belongs to him. Why work when there is no work to do? Anyway, he learns to stay put.

The analogy between the schoolboy and the police horse is closer than one might believe, and Sergeant Jame. Gannon, who is in charge of the school that has been turning out crack police horses for a quarter of a century, uses something like schoolboy psychology.

Take, for instance, the manner in which a police mount will stand in the middle of a teeming street

A "freshman" gets his first lesson with a breaking saddle to get the feel of the equipment; reins and straps are loose

with automobiles whizzing past in two directions at a dangerous rate, some missing him by inches. If he shied from one, he would jump into the path of another.

Now for a schoolboy parallel. Children are not taught to fight school fires, or avoid school fires, or jump out of school windows in time of fire. They are taught to drill—all about fire drill and nothing about school fires. They get so accustomed to thinking about the drill that the idea of fire never crosses their minds. The fire doesn't exist as anything of importance. Thus they have no fear and are docile in an emergency.

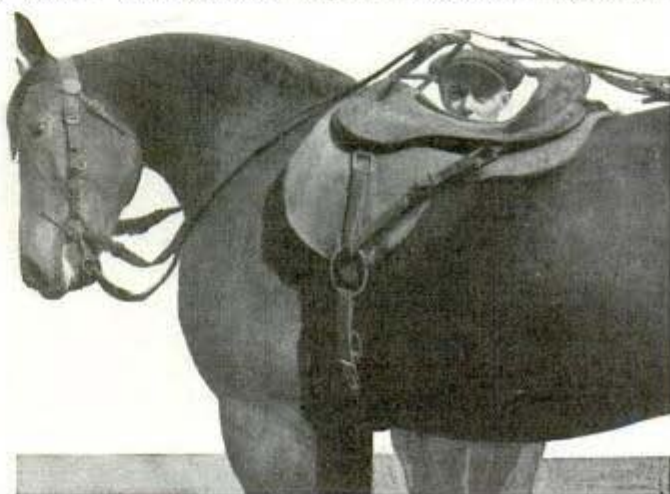
Likewise, for a well trained police horse, automobiles do not matter as far as he is concerned. From the beginning of his training he is permitted to nose around them. Usually there is an instructor near. The horse is brought to such a stage of alertness to the wishes of the men who work and coax and discipline and pet and feed him that it has no time for

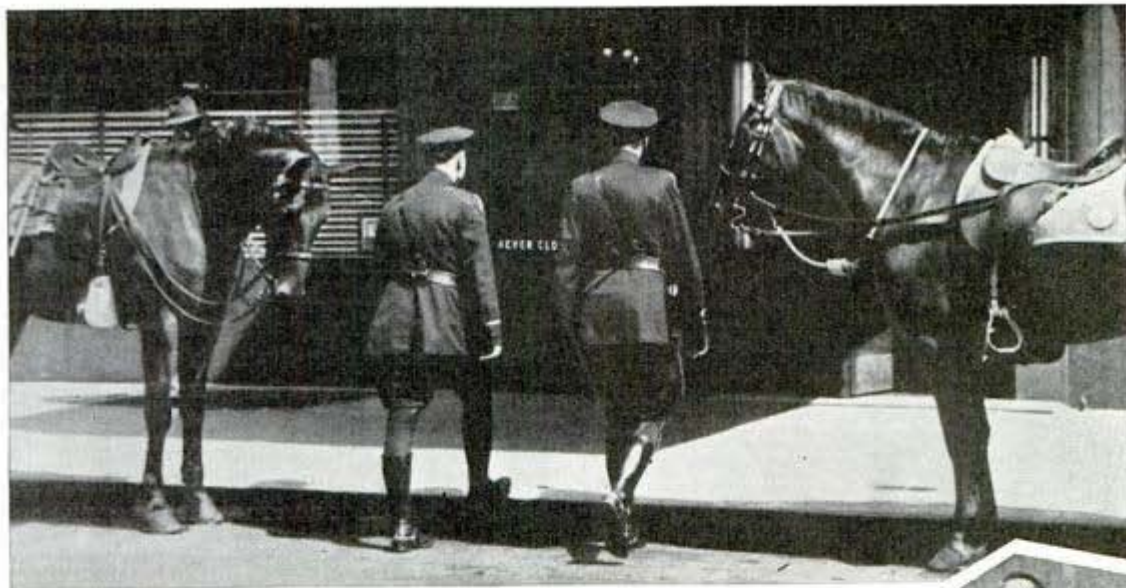
interest in an automobile, whether it is moving or standing still.

To complete the explanation of this traffic training, the instructors delve into the realm of telepathy or mental suggestion.

"It seems to be a fact," says horse-wise Sergeant Gannon, "that these animals communicate with each other through some unspoken language. We know that because we use a trained horse to teach a green one.

"But stranger still, it appears that a horse can to some degree read the mind, or the





A whole bag of sugar wouldn't lure these faithful horses away while the "mounties" are gone to lunch

emotions, or at least the intentions of his rider. How much of this is mental and how much physical reaction it is hard to tell, but the point is that when our instructors are breaking in a horse, they just never give a thought to an automobile when they are around one. Neither does the horse.

"On the other hand, a sudden start of the rider will bring a horse to immediate attention and he glances about to see what has disturbed his master. They seem even to respond to the moods of the policemen in time of excitement or peril, but it is hard to tell how much of this response is due to the tightening of a knee, or the slight motion of the hand holding the rein."

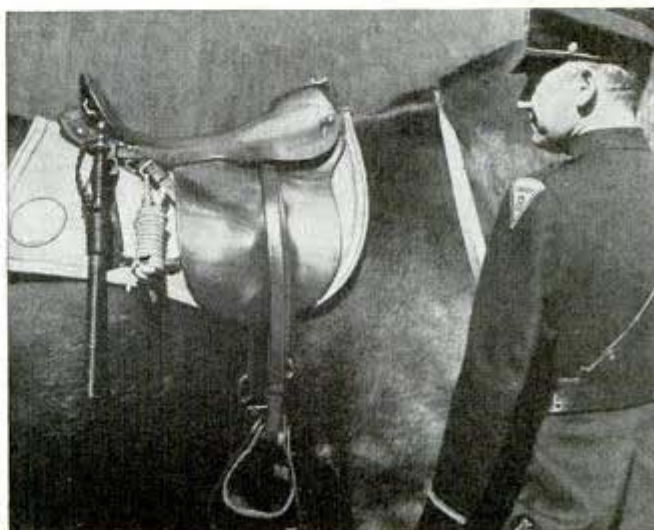
Whatever the reason, it is an axiom of the department that a cool policeman usually has a spirited, but tractable and dependable mount.

This relationship between horse and rider may explain another remarkable trick practiced by New York police horses—swinging their shoulders carefully into a crowd to break up an illegal gathering without trampling citizens.

When a mounted patrolman approaches a gathering of citizens, he does so calmly and without either fear or anger toward the crowd. He gives his horse the same slight nudge of the heel and



Dragging a sheet of tin duplicates noise of air raid



The rope fastened to the saddle for use as a tether during bomb raids is the mounty's only concession to blitz tactics



↑
 Learning to sidestep daintily over objects he cannot see will come in handy if a pedestrian falls under the horse

He flies through the air with the greatest of ease, this pupil with the white star. He is as good as a show horse →

Nearing "graduation day," these horses are carrying uniformed officers over the obstacle bank as the trainer looks on ↓



the same easy pressure on the reins which the instructors taught the animal to obey in school and the result is not a lunge or leap, but a series of dainty, five-inch sidesteps before which the crowd falls back. The danger of a horse lashing out into the crowd with his hoofs is unheard of.

After his friendly but firm schooling, a police horse will permit a friendly man to lean an elbow on his rump and smoke a cigarette. He learns to trust a man behind his back.

The pressure of the foot toward the direction in which the instructor wishes the animal to sidestep is more than a signal. As the rider presses one foot into the animal's ribs, it throws him slightly off balance in the intended direction. The rider's other foot is moved out and this further shifts the horse's

center of balance. A slight movement of the reins tells the horse it is time to move sideways to restore his balance. As the horse learns, the pressure becomes more and more slight.

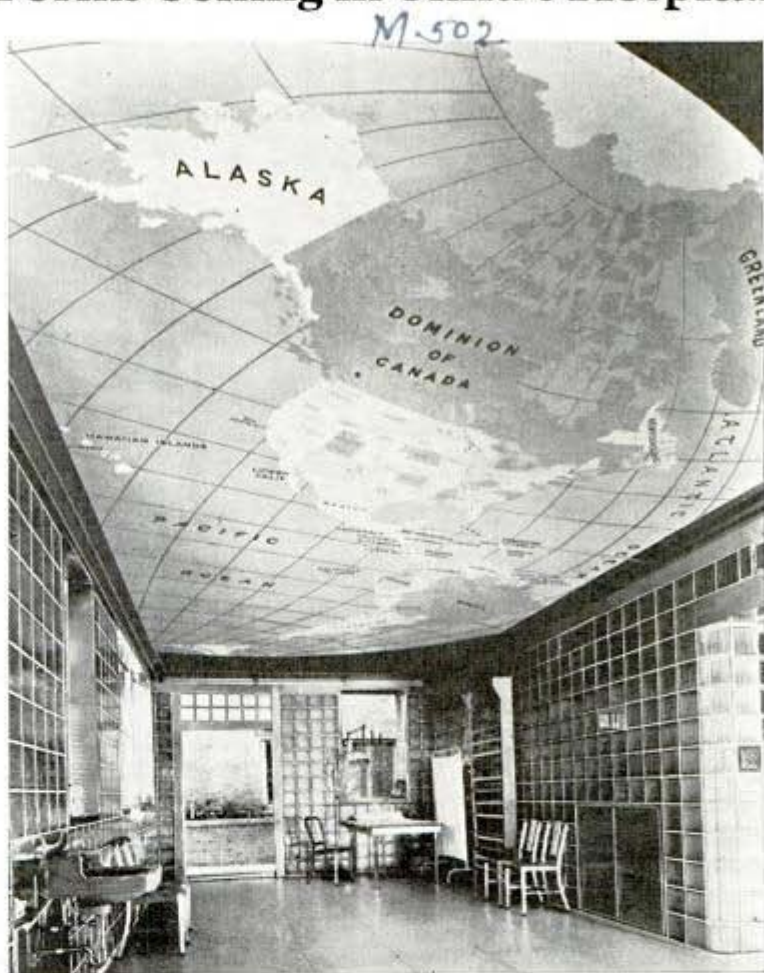
This is true of all motions of a mounted man. The horse gets acquainted with his master and soon learns that a mere hunching of the rider's body forward means that he is to move ahead. Pretty soon the horse responds almost as if he

(Continued to page 178)

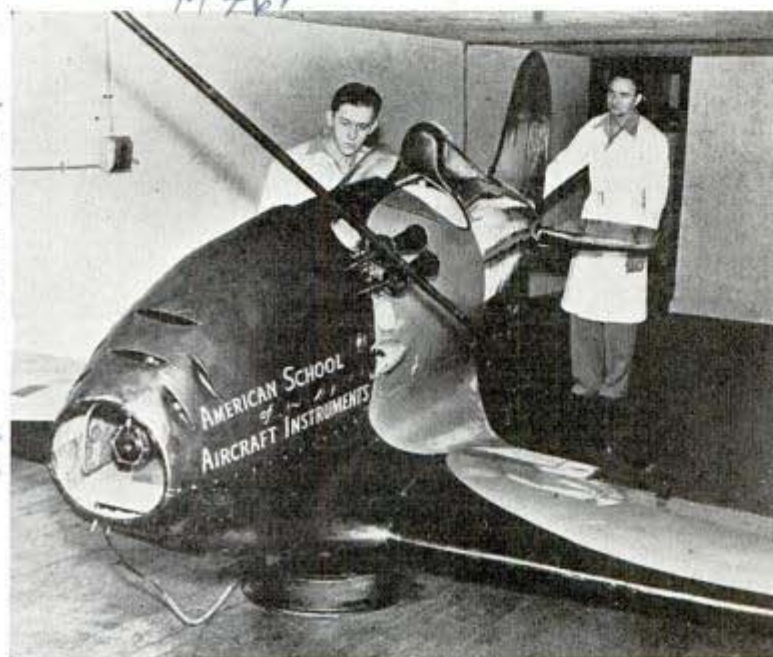
Linoleum Map Forms Ceiling in Child's Hospital

Geography lessons are made easy for crippled children in the Shrine Hospital at San Francisco with a huge linoleum map of the Western Hemisphere on the ceiling of the physical therapy room. There the children lie on a table undergoing corrective treatments and study the map which was made from 451 individual pieces. It measures 32 feet and seven inches by 12 feet and seven inches. Seventeen colors are used to indicate the various countries and the names of the larger nations and some cities are in black. Lines for longitude and latitude on the blue of the oceans give the map a globular effect.

Crippled children study map on ceiling while they lie on table taking treatments. The map was made from 451 pieces of colored linoleum; dark lines give globe effect



Monoplane 'Flies' on Ground to Give Instrument Training



Experience in instrument installation and maintenance is gained by students at the American School of Aircraft Instruments, Glendale, Calif., with a small monoplane that does everything but take off. With power supplied by an electric motor, the plane can be made to roll, pitch and yaw while the instruments respond to the movements exactly as they would under actual flight. The plane also serves as a testing device for the automatic pilot. Instruments in the machine are operated through vacuum and hydraulic systems.

This light plane rolls and pitches while instruments record movements

AUGUST, 1942

Ref: Amer. School of Aircraft Instruments, Glendale, Calif. 31

"Bomb Shovel" Drops Sand From Hollow Handle



Shovel weighs only 19 pounds when loaded with sand

Incendiary bombs can be smothered quickly with a shovel that carries a load of sand in the handle. The sand is automatically expelled when the shovel is turned hollow side down over a blazing bomb. Then it is turned over and used as a scoop. The bomb shovel is made of galvanized sheet metal, weighs 19 pounds when loaded and can be carried easily to attic or roof. It is also useful around a garage for putting out oil or gasoline fires.

Electric "Tug" Pulls Trailers To Carry Defense Workers

Defense workers can be speeded to their posts in buildings half a mile long on trailers pulled by electrically operated "tugs."

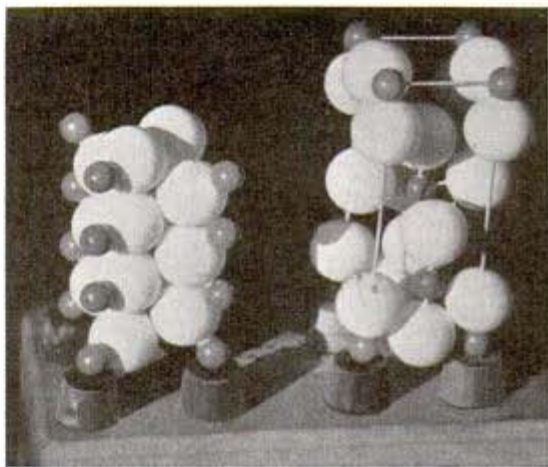


Trailer runs without rails through aisles in plant

The trailer consists of a platform on rubber-tired casters. Each trailer accommodates six persons on three seats and one tug can haul several trailers. It is especially useful in munitions factories, as the electric motor minimizes the danger of fire. The unit requires no rails and travels freely through narrow aisles.

Enlarged Model of Paint Crystal Reveals Covering Power

Models representing two forms of white paint crystals, magnified about 15,000,000 times, have been constructed to explain for the layman why a new white paint has a covering power 25 to 33 percent greater than its predecessor, although both use titanium dioxide in the pigment. When first made available, titanium pigment revolutionized white paints by more than doubling the hiding power of other paints of that day. This paint came in the form of anatase titanium dioxide, whereas the new paint contains a pigment available in



Models compare rutile crystal, left, with anatase

rutile form, the result of 10 years of research. In the rutile crystal the titanium and oxygen atoms cling closely together, while those in the anatase crystal are arranged in an open, loose fashion. It is this added compactness that permits a rutile enamel to cover an area one-third greater than an anatase enamel without increasing the "show-through" of the background; 75 pounds of rutile will do the work of 100 pounds of anatase pigment.

Look in the index to find where to buy articles described in this magazine. Say You Saw It in Popular Mechanics.

Distr.: Industrial Maintenance Engineering Co., Ltd.
 724 So. Spring St., Los Angeles Calif.

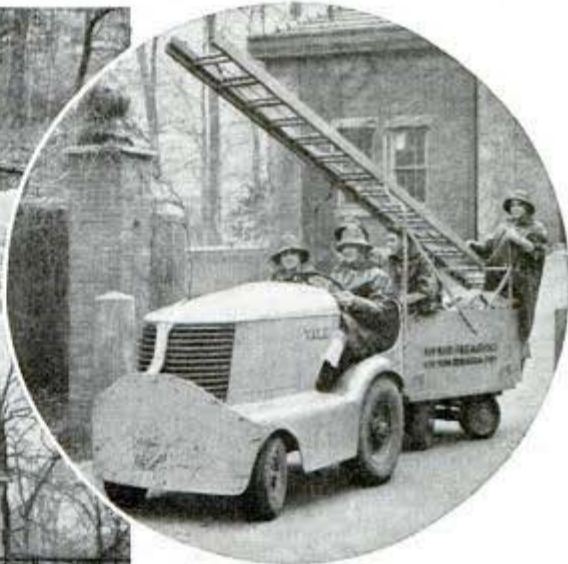
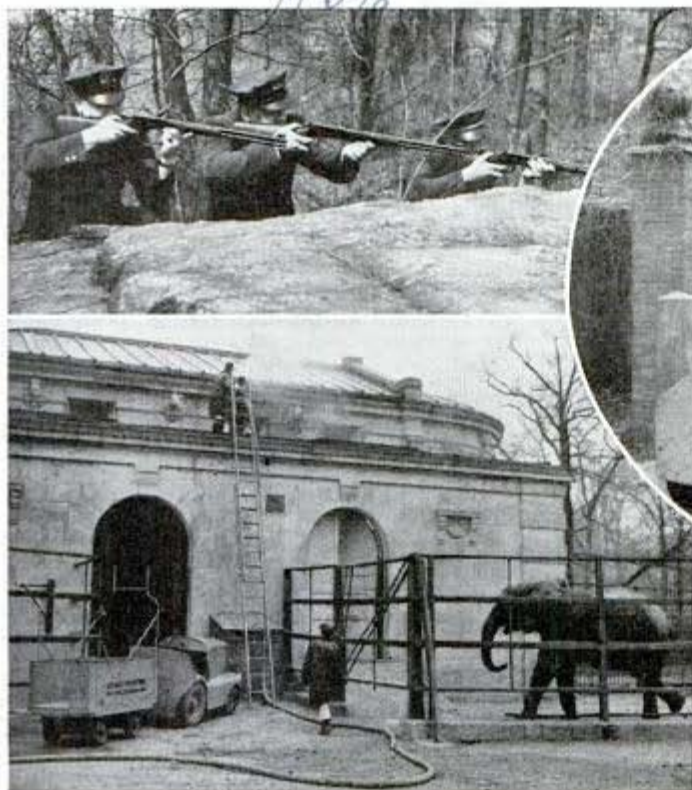
Mercury Mfg. Co.,
 4044 S. Hollywood
 Chicago, Ill.

E. I. du Pont de Nemours & Co., Wilmington, Del.

Bronx Zoo, Bronx, N.Y.

Zoo Keepers Turn Firemen to Fight Air Raid

M 378



Fire truck, in circle, dashing out for air raid rehearsal. Left, elephant looks on disdainfully as men clamber to roof. Top, how guards would kill wild beasts on a rampage

Because of the havoc that might result if an enemy bomb were to fall among buildings housing animals, the keepers and guards at the Bronx zoo occasionally rehearse the duties they will perform in the event of an air raid. Roundup of escaped animals can be accomplished by using a portable canvas wall, but panic may cause some to flee the zoo grounds. To prevent rampaging wild animals from getting away, keepers have been armed with rifles. In a

recent drill, the fire fighting squad, always on the alert, dashed to the scene of a theoretical fire on the roof of the elephant house, largely for the purpose of learning how the pachyderms would react. Neither the arrival of the apparatus, loaded with all necessary equipment for fighting fires and incendiary bombs, nor the activity of the firemen setting up a ladder and running a hose to the roof, drew more than a look of utter disinterest from the huge beasts.

Cup for Long-Eared Dogs Saves Ears From a Soaking

Long-eared dogs that can't avoid dipping their ears in the water each time they take a drink should try the specially designed cup that helps keep the ears dry. The opening is just large enough for the dog's mouth, so when he drinks, his ears hang outside the cup. It is made of both metal and crockery in several sizes, and the cup has a handle built into the side.

☐Sulfanilamide was first synthesized by a young Viennese chemist in 1908, who thereupon vanished into obscurity a quarter of a century before the medical properties of his invention became known.



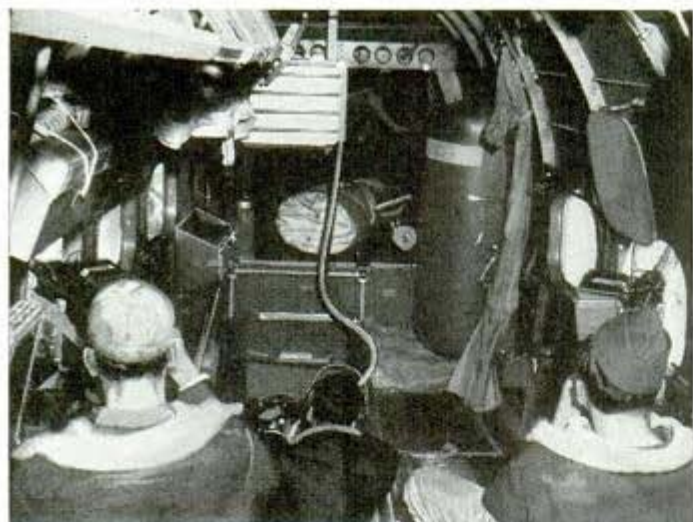
Cup permits dog to drink without immersing his ears

*Director: Vaughan's Lead Store
18 W. Randolph St.,
Chicago, Ill.*

AUGUST, 1942

*Journal-American Medical
Assoc.*

*Cont: Thomas G. Stinson, Jr. 3872 Franklin Av.
Los Angeles, Calif.*

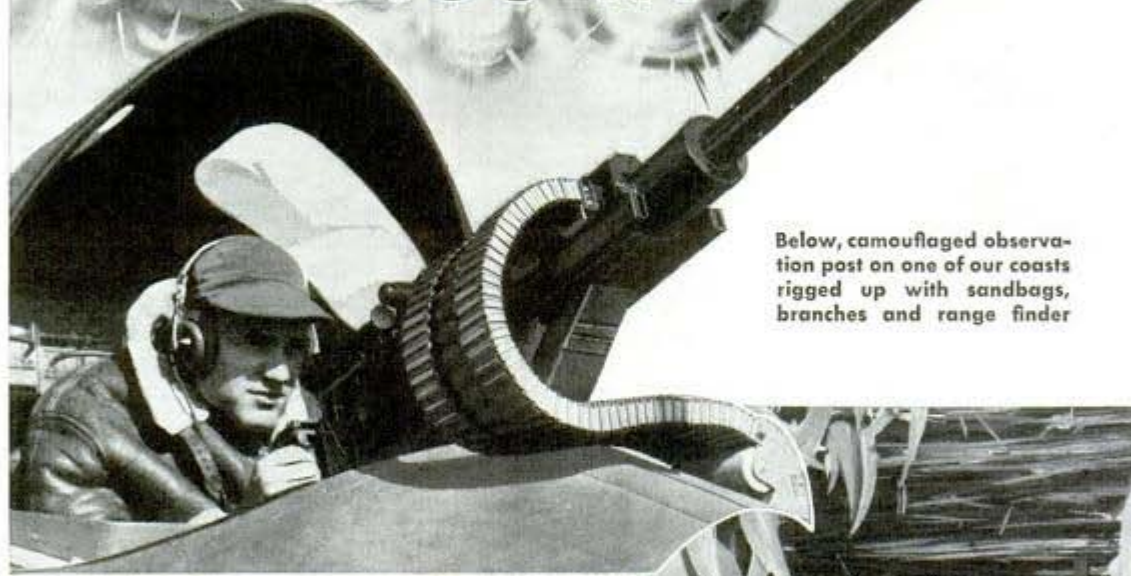


Three gunners go into action (left) in crowded fuselage as American patrol bomber guards approaches from sea

Rear gunner (below) ready to pump stream of fire on enemy diving from clouds or sneaking up behind bomber

M313

UNCLE SAM DIGS IN



Below, camouflaged observation post on one of our coasts rigged up with sandbags, branches and range finder

IT LOOKED like a sub, the little streak of white water with a dark shadow below it, and the gunner phoned its position to the cockpit. The heavily loaded plane swung around to have a closer look while the bombardier settled himself for the sighting run. Then everybody relaxed. It was another whale, after all.

The big bomber was on outer patrol, a good fraction of the distance to Honolulu, and it was making a sweep that might last all day. The plane was one unit of a vast aerial organization that is guarding our east and west coasts against surprise attack. Close inshore, other planes of the bomber command were ready to pounce on any enemy submarines that they might sight in





Infantry gunner stationed at beach outpost on the U. S. coast fires at floating target in rehearsal to repel an invasion force. Nearby are dugouts protected with sandbags and filled with reserve supplies of ammunition

the coastal traffic lanes. Blimps slowly patrolled their over-water beats. At advance airdromes back of the beaches, pursuit planes were standing by, fueled and armed for the alarm that might come tonight and that might never come.

The big bomber had left its base long before daybreak that morning. It had joined a procession of mammoth shapes that had lumbered and rumbled out to the runway, then waited its turn to roar across the field and lift its load into the air. The sun was just clearing the horizon when the bombers crossed a coastal mountain range, following a flight path that was secret for today and that would be changed for tomorrow. Approaching the coast, the planes scattered out to fulfill their assignments.

The men on this particular bomber are anxious for the time—it might come today—when they can help to pay back the Japs for Pearl Harbor. Their great, almost clumsy-looking four-engined plane is heavy with bombs that are as tall as a man and powerful enough to crush a submarine or pierce an armored deck. Crawl down from the cockpit, squeeze yourself past the mechanism of the bombs, wriggle past the retracted nose wheel, and you find yourself in the bombardier's plastic nose cage. He is on the alert. At his left is the panel by which he retracts the bomb bay

doors, selects the bombs and launches them. In front of him is the bombsight. Below him is a gun.

In fact, the bomber is studded with guns, all heavy enough to blast apart armored planes that could hardly be hurt by the aerial guns of 20 years ago. At open ports in the fuselage the side gunners stand by their gear. They are huskies who can manhandle the protruding gun barrels up or down or forward in the terrific wind. Overhead, the gunner in the power turret needs a different sort of skill, for he points his turret with delicate touches on a set of keys. In the tail of the plane, the rear gunner has pulled back the sides of his cage and is sitting in the open so that he can maneuver his gun easily if he gets a chance.

By the time the bomber turns back for shore, other bombers are leaving hidden bases to take up the patrol. Sometimes the gunners need to replenish their ammuni-



This antiaircraft crew is ready to blast enemy planes flying over our coasts. Big searchlights will help spot enemy thousands of feet up



Peep crew gets a workout with machine gun on anti-aircraft mount during maneuver on coast. Peeps make portable gun nests

tion cans after they have landed. They may have been testing their aim against clouds, or they may have had other targets. Sometimes the bomb bay is empty. Such a fact, backed up by the wide grins of the flight crew, remains a military secret for a while.

The bomber patrols and what they are accomplishing are only a chapter in the story of our continental defense system. The navy's inshore patrol, the aircraft-detection system, and our coast defenses are some of the other parts of the organization. Each of our coasts is an armed camp today. Many enemy aliens have been moved and others will go out of the defense areas. The army has moved in. Ordinary citizens go about their business as usual, unhampered by the precautions that are being taken to protect them. Posters warn them to avoid talking about what they see though the fact is that most people, busy with everyday life, see only a fraction of what is going on. Many patriotic citizens are serving as airplane spotters, air raid wardens, and are performing other duties in their spare time.

Air raid sirens are installed on top of traffic signal standards, placards on buildings point the way to the nearest shelters, and piles of sand are spotted here and there in case of need for quelling incendiaries. Barrage balloons sway in the sky in some areas. Flocks of interceptor planes that

look like dragonflies and that are so fast that the noise of their engines seems to drone from the sky miles behind them swoop and maneuver overhead.

Railroad engines wear hoods over their headlights to prevent their beams from escaping upward. Air line terminal buildings, along with defense factories and other vital buildings, are blacked out for the duration of the war. You enter such a building through a "light lock." Going through an entrance door, you find yourself in a black closet with another door in front of you. Close the entrance door behind you, then open the inner door. That way, no light leaks out.

Occasionally, a radio silence is ordered and all radio stations go off the air. Less frequently, a blackout occurs. These precautions are sometimes taken when unidentified aircraft or surface vessels are reported offshore or when enemy submarines are known to be on the prowl. Shore lights or radio broadcasts might give them the directions they need to do harm, providing perfect beacons to lead the enemy to its goal.

In some areas you are apt to notice anti-aircraft guns in vacant lots or fields. Searchlights may be mounted on tall buildings or hilltops. On some nights searchlight practice is held and you stand in the street and watch an airplane trying to

Loading live bombs into big planes is an everyday job for this ground crew. Here they are preparing to load the deadly "eggs" into ship's bomb bay



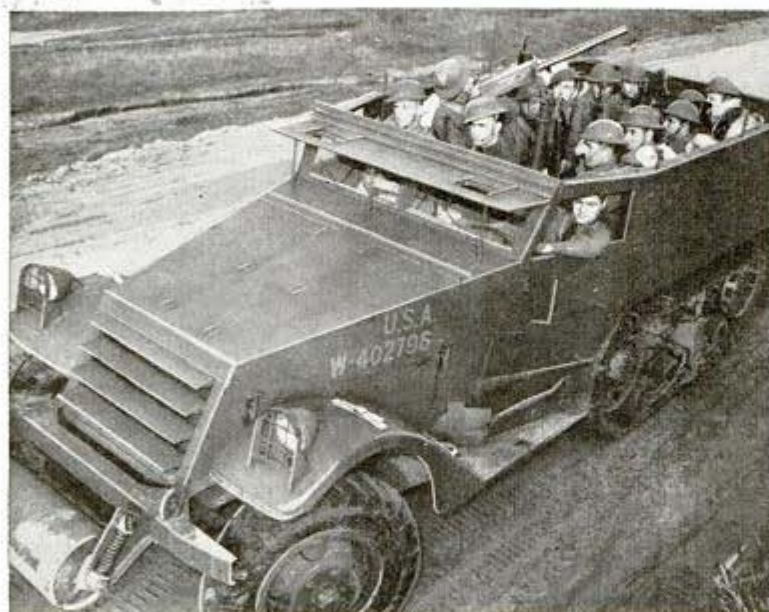
dodge away from the converging beams of the searchlights.

Fortified strong points have been established along beaches and headlands but there have been no restrictions for ordinary swimming and beach parties.

At some more exposed positions along the coasts the troops have gone underground, digging themselves living quarters below the surface, walled and roofed with empty



↑
Crash wagon and expert crew are on the alert at bomber field while planes are taking off and landing. Flameproof suits aid in rescue of victims on burning ship



← Scout car runs on half-track (note rear) and rubber-tired wheels to speed this combat crew along stretches of sand "somewhere on the coast" as they keep sharp watch for foe

↓
From the air this large-caliber coastal defense gun is just part of the scenery with its camouflage net, scattered branches and leaves and spotted paint job on barrel

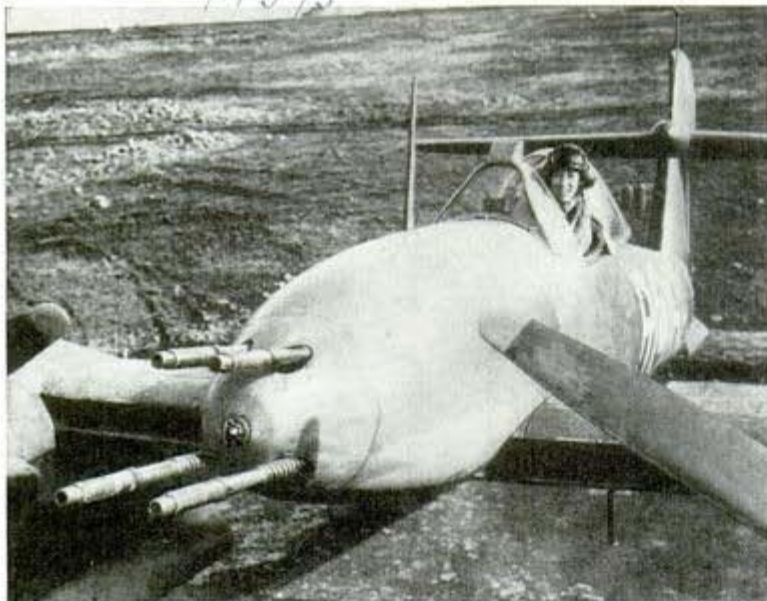
aircraft engine crates, and protected with sand bags. They have strung electric lines to their dugouts for illumination and they provide their own hot water for shower baths by turning a blow torch on a cold water line.

All in all, the United States today resembles a well armed and bristling porcupine, ready to repulse all invaders. And having completed his home defenses, Uncle Sam is now carrying the fight to the enemy.



Twin-Engine "Whirlwind" Plane Has Four Cannons in Nose

M 373



England's twin-engine fighting plane carries four-gun wallop in nose

Faster than the "Spitfire" is England's new fighter airplane, the "Whirlwind," a single seater powered by two 850 horsepower engines. Armed with four cannons set in its nose, it has shown remarkable ability in aerial combat, having destroyed many enemy planes in the air and on the ground. It is built for long-range flights, and can accompany bombers as far as Antwerp. One distinguishing feature is the plane's high tail.

Shells That Fly by Own Power Tested for Future War

M 351

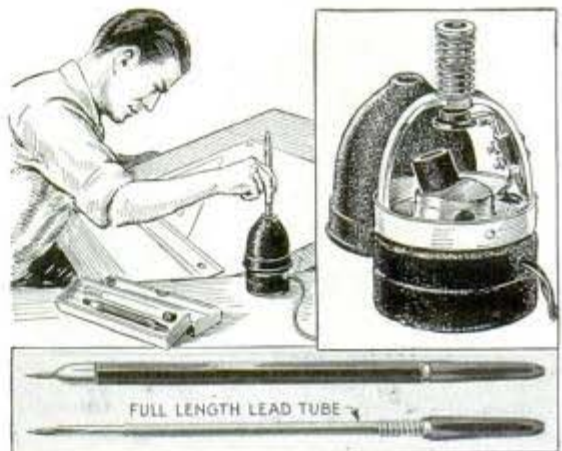
Cannon firing shells that will fly by their own power with jet propulsion may be the outgrowth of a gun designed by Edward F. Chandler, New York engineer. The first experimental weapon is a light metal tube four feet long and three inches in diameter, shooting a shell six inches long and a little

more than two inches thick. Jets have been used to drive non-military projectiles up to 18 feet long, which supplies the basis for the present gun. Power and distance already have been achieved, but the problems of accuracy in flight, cheapness of construction, and types of fuel have not been solved.

Fast Pencil Pointer Saves Time for Draftsmen

M 355

Draftsmen can keep a fine point on their mechanical pencils with an electric pointer that starts automatically when the pencil is inserted and stops when the point is completed. The pointer does not sharpen wooden pencils, however. Convenient also is a drafting set which includes a mechanical pencil and an eraser that feeds a 4½-inch-long rubber as a mechanical pencil feeds lead. The pencil has a special lead-grip at the tip which prevents the lead from wobbling, yet it does not cut rings into the lead which might cause the point to break.



Details of pointer shown at right; pencil, bottom

Chicago Daily News
Mar 25, 1942

POPULAR MECHANICS
The Pencil Co., Beverly Hills, Calif.
9381 Olympic Blvd.

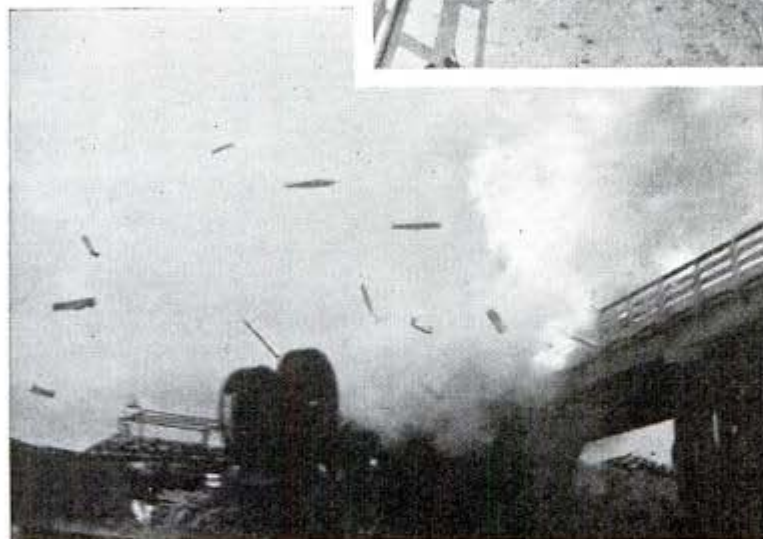
Cont: Powell Clarke, Box 5403
Metro Station, Los Angeles, Calif. M363

Toys Save Cars and Tires in Movie Thrillers

When automobiles are demolished before your eyes in movie-thriller crackups, sighing over the loss of the car and a set of good tires may be wasted emotion, since in most scenes of destruction only miniatures are involved. For instance, a thrilling auto chase in the serial "Spy Smashers," produced by Republic Pictures, ended in the



Special-effects workmen, above, trimming bridge tracks to make cars swerve; left, camera filming miniature explosion



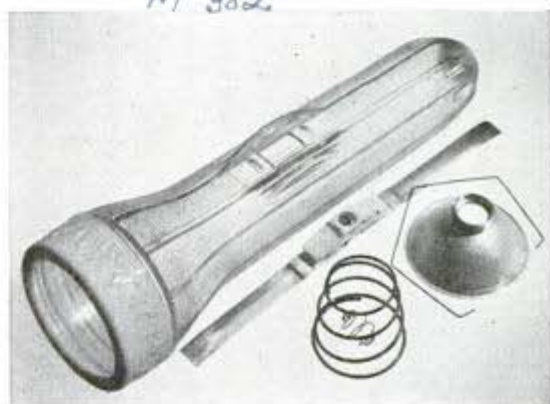
blasting of a wooden bridge which plunged the car into the depths beneath, all done without the loss of anything really valuable. Up to the point where the chase en-

tered upon the bridge, legitimate cars were used; but for the thrilling finale, special effects director Howard Lydecker substituted a duplicate of the bridge in miniature and a tiny sedan took the place of the real one. Under the bridge, small powder bombs were placed, and over these were set toy balloons filled with gasoline. The explosion shot balls of fire 10 feet upward and hurled broken bits of wood 20 feet.

Plastic Flashlight for Blackout Contains Few Metal Parts

To comply with restrictions imposed by war needs, a plastic flashlight has been designed with as little metal as possible and eliminating brass parts entirely. It is made of tough, lightweight cellulose acetate plastic which is sturdy and resists corrosion. Besides the usual clear lens, the flashlight is supplied with a reddish-purple lens for blackout needs.

☐ You can obtain additional information about products described in this magazine by writing to the firms listed in the Where-to-Buy-It index. Say You Saw It in Popular Mechanics.



Courtesy Hercules Powder Co.

Blackout flashlight cuts use of metal to minimum

77 337

DECADE of the DAM BUILDERS



From this control table, concrete ingredients are weighed for the mixers

Each cableway bucket carries a 16-ton load of concrete to Shasta dam



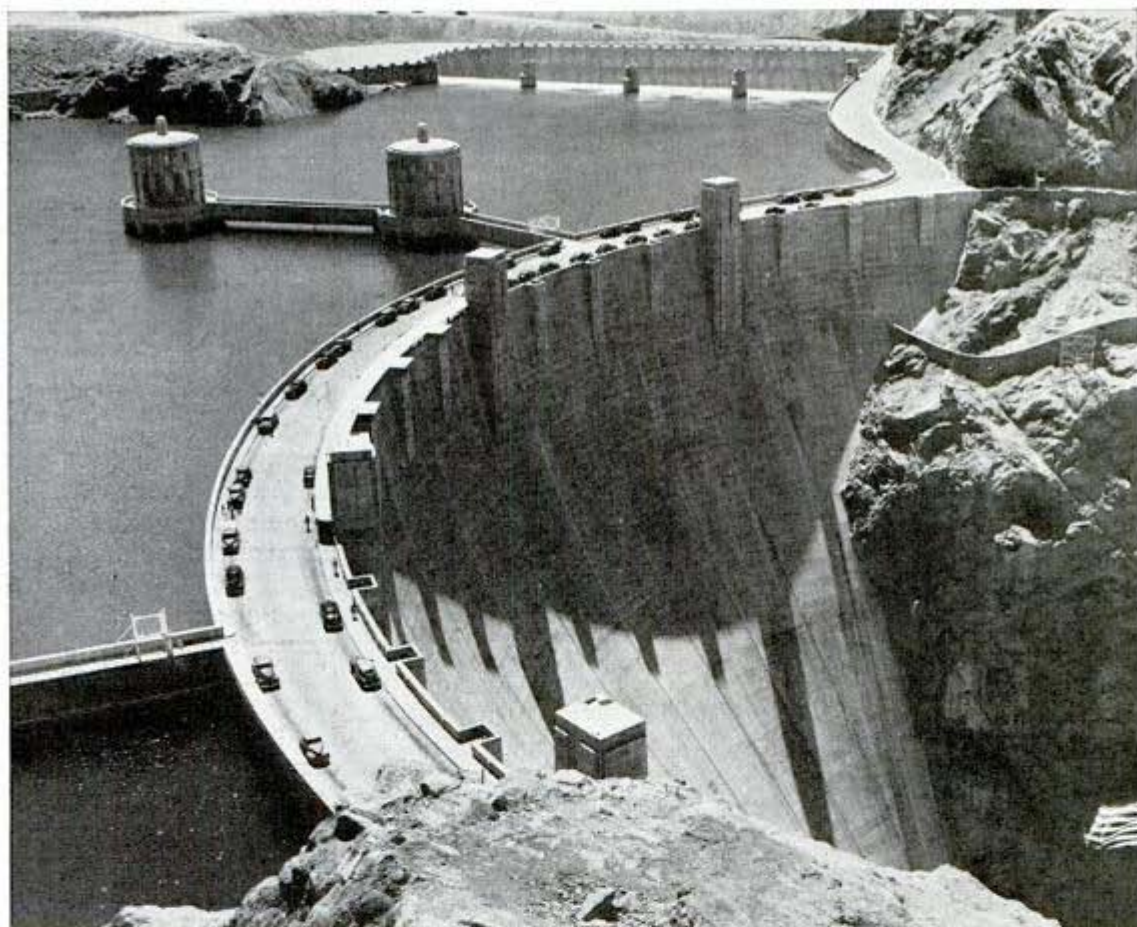
MORE than 70 huge dams, including the five largest concrete dams in the world, have been completed in the United States during the last 10 years or are now under construction. They have been built to last forever.

A dam is a device by which mankind gets something for nothing. Build a dam across a river and at once there are all sorts of benefits that didn't exist before. A source of electric power is created that will continue as long as rainfall occurs. A check is provided to hold back disastrous spring floods. Then the water can be released gradually during the rest of the year to maintain the navigable water level below the dam. Water can be drawn from the reservoir for irrigating dry farm lands. Long after they have earned their cost, possibly for thousands of years hence, we shall be enjoying the benefits of these dams.

The engineers who build dams have improved on nature. Earthen dams, sometimes with a concrete heart, are built to last longer than natural hills of the same size. Concrete dams should outlast natural mountains of stone.

Building a big dam is a Gargantuan task. It is also a delicate scientific undertaking. Ingredients for the artificial mountain must be prepared and mixed with all the skill and care with which a druggist compounds a prescription. Water, cement, and possibly two sizes of sand and four sizes of gravel and

Ref: Bureau of Reclamation, Dept. of Interior, Wash., D. C.



Boulder Dam with its 3,250,330 cubic yards of concrete is already exceeded by Grand Coulee and Shasta Dams

crushed rock from carefully selected sources are weighed out in automatic batching machines and then dumped into big mechanical mixers. A small amount of diatomaceous earth may be used to improve workability. Then an admixture of pumicite; this volcanic dust is finer than cement and serves as a filler.

Occasionally ice is an important ingredient. This is because temperatures have to be watched carefully. A hot dam takes longer to cool. It contracts too much.

Temperature control was a big problem at Friant dam in California. If it were not for three other Bureau of Reclamation dams that make it

Concrete cores taken from dam are stored in curing room under constant temperature and humidity conditions preparatory to testing their strength



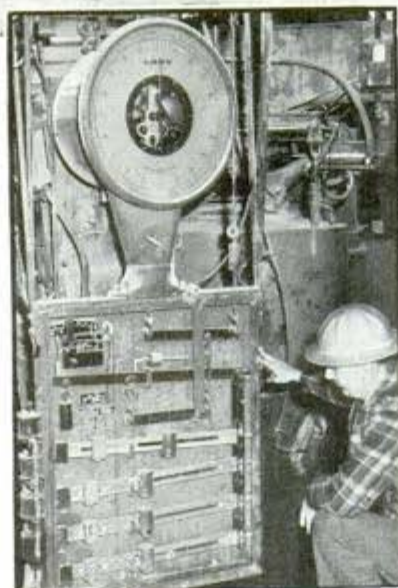


Floodwaters flow through Grand Coulee dam while work is progressing on the overflow spillway

Complex electric scales (right) at Friant dam weigh the construction materials automatically

seem a pygmy in comparison, Friant dam would be the largest concrete structure in the world. Summer temperatures in this part of the San Joaquin valley reach 110 degrees. Cement shipped to the site in box cars retained some of the heat of manufacture and averaged 169 degrees. The compressed air that was used to blow the cement through pipes from the railroad cars to the silos and then to the mixing plant had a temperature of up to 225 degrees.

Everything had to be cooled off. A water-type cooler reduced the heat of the compressed air. Sand and gravel were sprinkled with cold river water en route to the mixing machines. Slush ice, manufactured on the spot, was dumped into the mixers to help pull the temperature down. The result was that con-

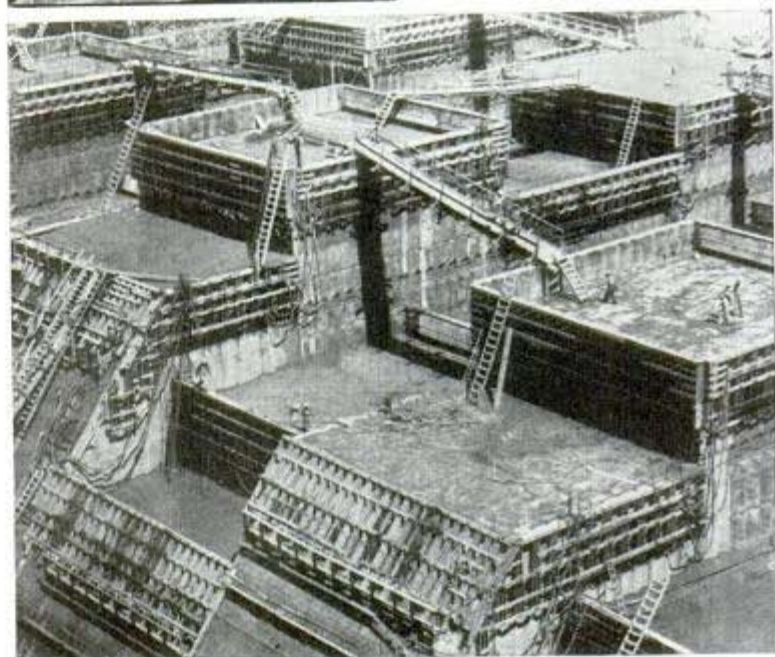


crete left the mixers at about 70 degrees instead of almost 100 degrees. Even so, chemical action raised the temperature of the concrete to 90 degrees while it was setting.

The concrete is poured in huge interlocking blocks, one block being allowed to cool for a time before neighboring blocks are poured. Cold river water is circulated through pipes that are buried in the mass. This helps shrink the block down closer to its final dimensions. Later these pipes are pumped full of cement and rich cement is also forced down into the expansion joints between the blocks, welding the dam into one immense monolithic structure.

Once it is completed, the artificial rock mountain will be subjected to all the strains and stresses that nature's heat and cold impose on the earth's surface. Temperature

Concrete is poured in blocks and allowed to cool, to reduce the size of the expansion joints



changes, frost, and running water slowly erode any mountain. To minimize such actions at Friant the exposed surfaces of the dam were "case hardened." Fiberboard forms were used for shaping the faces. The smooth boards provide an extremely smooth face to the dam. Being porous, they first absorbed water from the fresh concrete and then retained it, helping to cure the concrete properly. Ultimately, of course, some scaling off or spalling of the concrete surfaces can be expected. But instead of being allowed to continue unchecked such wear will be repaired.

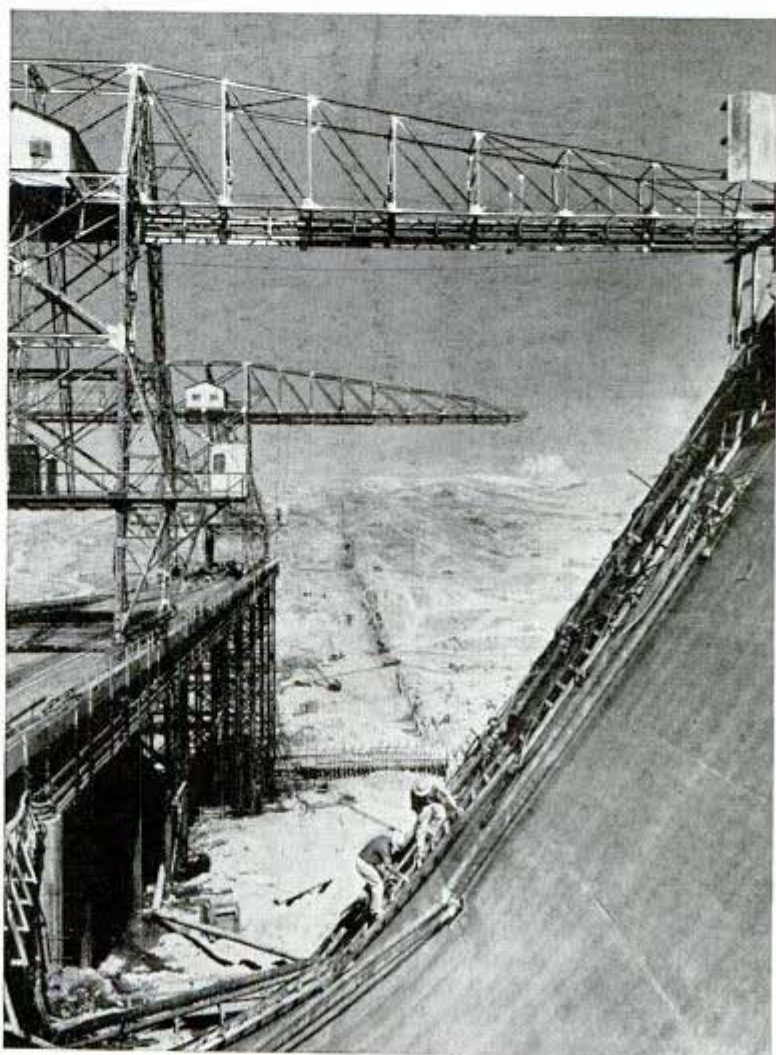
Some people wonder whether a dam ultimately becomes useless because of the silt that flows down the river and is trapped in the reservoir. In time the silt may fill up the reservoir, they think. But engineers don't regard this as a serious factor. The silt deposit simply reduces the amount of dead storage, and besides, as soon as the current in the river is slowed down by the dam, much of the silt begins dropping far upstream of the reservoir area.

Just as important as the actual construction of a dam is the tremendous amount of work that precedes it. Geological surveys of various locations, backed up by diamond drilling, determine the best site. It was because of such surveys that Boulder dam wasn't built in Boulder canyon. Studies showed that Black canyon would be a better site, so it was in Black



Measuring the crushing strength of a core of concrete taken from a dam

These huge traveling cranes are used to place concrete at Friant Dam

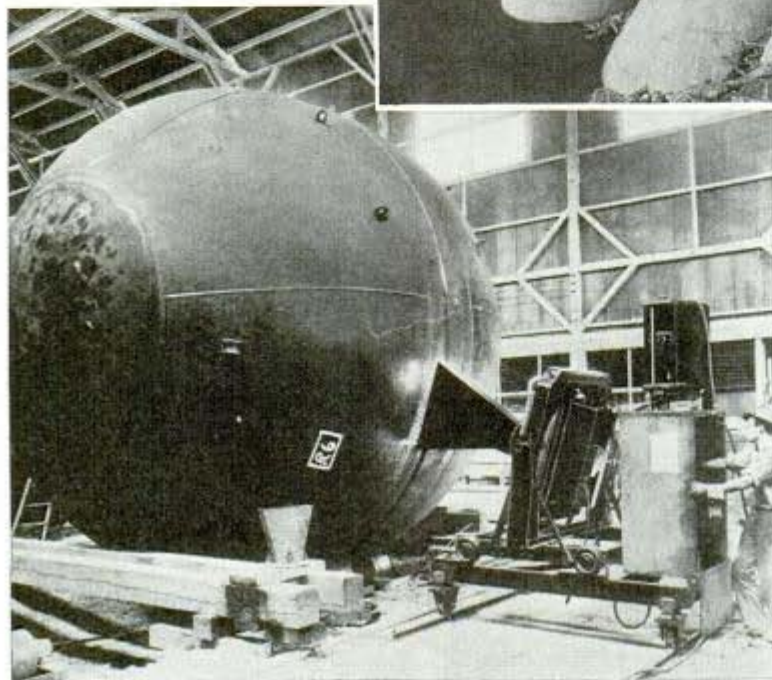
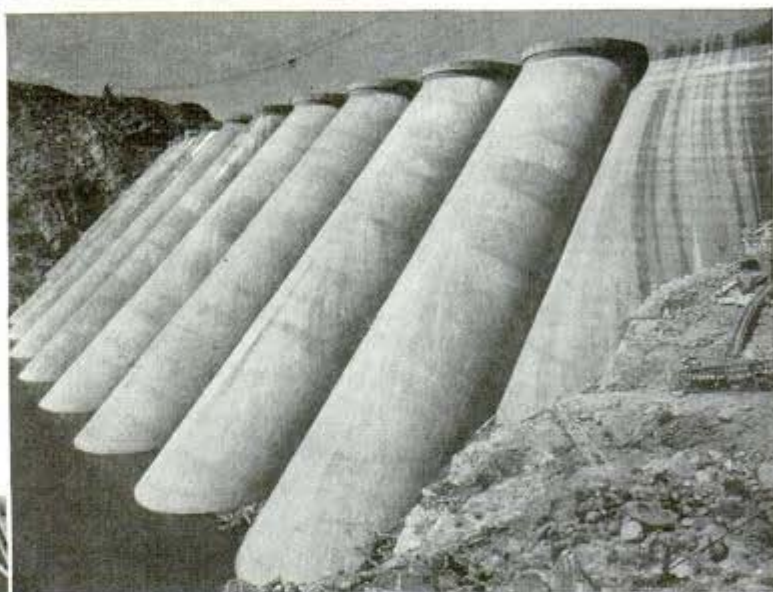




Odd-shaped auger (above) is at the end of an air suction line which is used for the transportation of bulk cement from box cars to silos

Not so well known is Bartlett Dam in Arizona, whose multiple-arch structure is seen at right. Over 70 huge dams have been built in a decade

200,000-volt X-ray inspects seams of 18-foot steel welded plug to be used for closing off penstocks and pipe line of Grand Coulee Dam



canyon that Boulder dam was finally built. Once the site is selected it must be prepared for the dam. Holes are drilled down into the foundation material and a rich concrete mixture known as grout is forced down into the holes under pressure. The grout will flow into and seal off any cracks in the subsurface rock. Later on, as the weight of the dam begins to grow, other holes are drilled from galleries inside the dam to depths as great as several hundred feet and

again grout is forced down the holes, at pressures up to 500 pounds per square inch. Even the finest fissures in the natural rock are sealed by this method.

Meanwhile, laboratory research on the design of the dam has been finished. Scale models of the structure, some of rubber and some of plaster, have been tested under varying conditions of load and temperature. Models of such features as spillways and control valves have

undergone experiments in a hydraulics laboratory, and samples of the sand, rock, and other ingredients that would go into the dam have been given exhaustive tests. Such experimental work will continue long after the new dam goes into service. From time to time cored samples from inside the mass will be subjected to breakdown tests, just to keep track of the dam's strength as it ages.

The world's first true dams appear to have been built in Spain upwards of 800 years ago. Earlier, irrigation dikes and levees for diverting river water had been used in Egypt and Ceylon. From these crude beginnings developed the science that has created gigantic Grand Coulee dam in Washington, a solid concrete mass four-fifths of a mile long and 550 feet high, and Boulder dam across the Colorado River, a monolithic structure 726 feet high. From point of mass, the world's largest concrete dams are Grand Coulee, containing 10,-200,000 cubic yards, Shasta dam in California, 5,400,000 cubic yards, Boulder dam with 3,250,330 yards, Friant dam with 1,900,000 cubic yards, and Marshall Ford dam in Texas, 1,864,000 cubic yards. Even these giants are not the largest of all dams. There are eight earthen fills in the United States and one in the Canal Zone that outrank them. Largest of all is the vast Fort Peck dam in Montana that controls the Missouri River, an earth fill 250 feet high and four miles long. Built by Army Engineers, Fort Peck dam has a volume of 109,000,000 yards.

M 539
**"Puffed" Sand Insulation
 To Reduce Ice-Box Size**

Puffed-up sand is being used as insulating material in laboratory furnaces and in low-temperature chambers by the Monsanto Chemical company. The nature of the material, which is called silica aerogel, may make it possible to reduce three-inch refrigerator walls to one and one-half inches.

AUGUST, 1942

*Monsanto Chemical Co.
 Boston, Mass.*

*Bull Haley F. E. Smith
 East Point, Ga.*
**Gasoline-Propelled "Kiddie-Car"
 Uses Paint-Sprayer Motor**

M 473



Homemade car travels 40 to 50 miles on gallon of gasoline

With a 1/2-horsepower motor taken from a paint sprayer, F. E. Smith of East Point, Ga., travels 40 to 50 miles on a gallon of gas on his homemade "kiddie-car." The car, which he call a "lolley," has a framework of bed railings and three wheels with 12-inch tires. The rear wheels are driven by fan belts and the maximum speed is about 20 miles per hour.

**Six-Foot Flexible Rule Built in Flashlight
 Handy for Measuring in Dark**

Taking measurements in dark places can be speeded with a flashlight that has a built-in flexible rule extensible to six feet. It is specially handy for fuel-oil deliverymen who measure the levels of oil tanks in dark cellars. The steel rule can be pulled out any desired length and the end slipped into a slot at the pointed end of the flashlight to form a suspension loop about a man's shoulder. In this way it may be used by meter readers, electricians, plumbers, mine workers and others who operate in unlighted quarters.



☛To preserve your rubbers keep them in a cool, dark place and avoid oily soap for cleaning.

The Rubber Infrs. Assn. Inc. 45

*444 of Madison Ave. N. Y. C.
 2144*

*Hyper Inc., Inc.
 136 Roosevelt Dr., Newburg, N.Y.*

FISHING for

M 298



MERIDA—
200 FEET

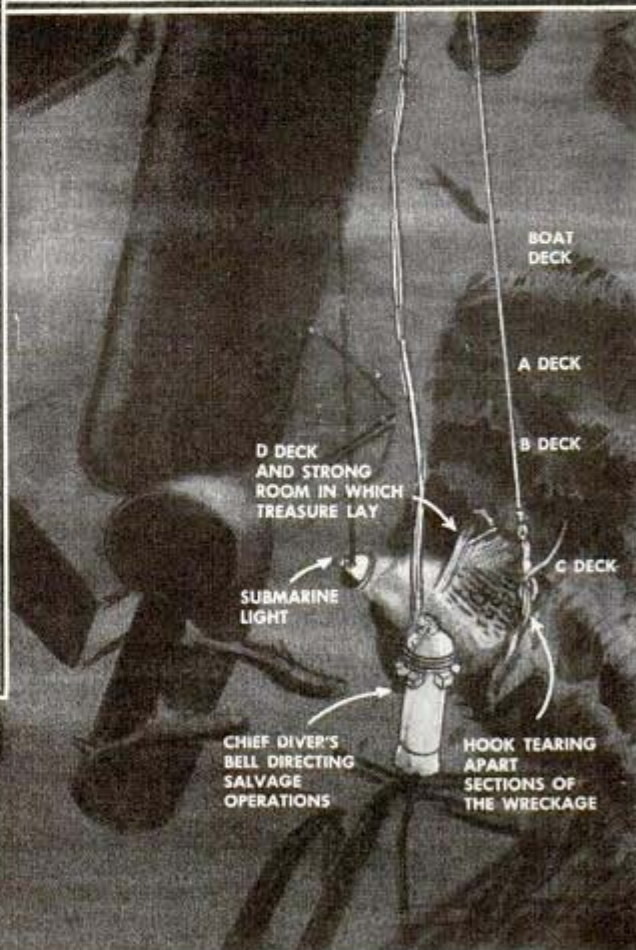
EGYPT—
396 FEET

NIAGARA—
470 FEET

DEEP WRECKS FROM WHICH SALVAGERS HAVE SOUGHT TREASURE RECENTLY

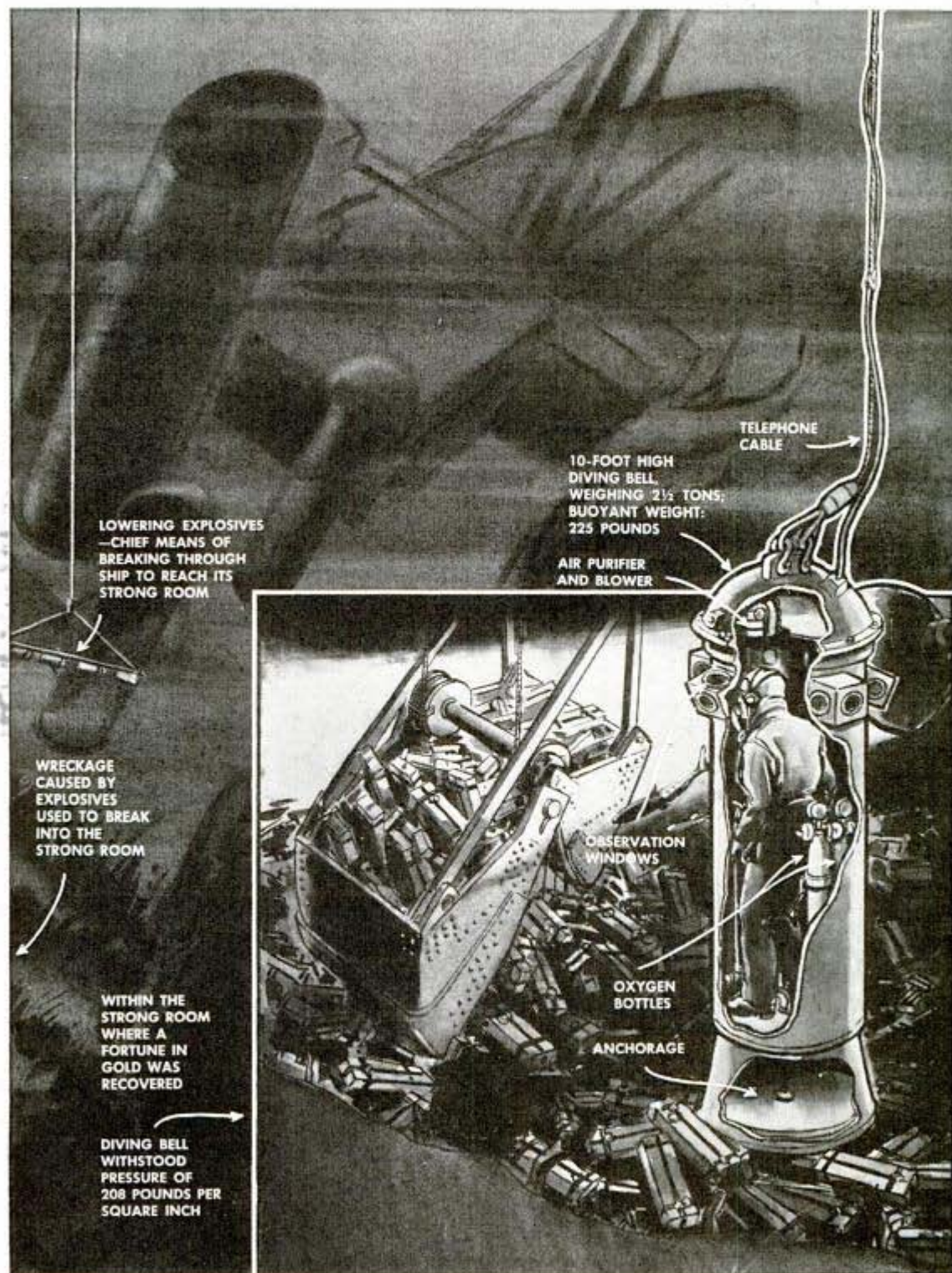


DIVER JOHNSTONE HEROICALLY DISENTANGLING HIS LINES FROM THE DANGEROUS HORNS OF A MINE WHICH THREATENED THE DESTRUCTION OF THE SALVAGE VESSEL



This was one time the "big one" didn't get away. Down on the bottom lay a \$10,000,000 fortune in gold ingots, sunk off the coast of New Zealand, June 19, 1940, when the Australian-Canadian liner "Niagara" ran into a floating mine while outward bound for Vancouver. Capt. J. P. Williams headed the expedition of Australians that went fishing for the treasure. In one adventure he does not care to reenact a diver had to free his snarled lines from the horns of a live mine floating perilously close to the salvage boat

10,000,000 DOLLARS



The divers worked at a depth of 470 feet, with perils of war added to the natural perils of the deep sea. By means of the specially designed cylindrical diving bell shown above, they succeeded in tearing through deck after deck with explosives and a powerful hook, finally reaching the strong room deep in the hull between the two stacks. Then the salvage crew at the surface, guided by the observer in his submerged bell, hauled up great buckets of gold. The job took 11 months and 21 days, without a man injured

*Advt: VonLengerke & Antoine, Inc
9 N. Wabash, Chicago, Ill.*

"Air Pills" Keep Minnows Alive in Pail for Hours

M 453



OXYGEN RELEASED FROM SMALL CAN KEEPS FISH ALIVE

Oxygen tablets keep minnows lively in bait pail

Small tins packed with a composition which releases thousands of oxygen bubbles when dropped in water may be placed in a minnow pail to keep shiners lively. One tin will keep four or five dozen minnows alive from six to eight hours without changing water. The tablets cannot be dried and used over again, but may be kept indefinitely when not exposed to air.

Sponge-Mop Squeezer on Bucket Saves Wringing by Hand

M 354

Used with a perforated drainer hooked inside the bucket, a sponge mop saves



Drainer on bucket, inset, squeezes water from sponge

stooping and wringing the mop by hand. The sponge is of synthetic material, mounted on a wooden mop head that may be used with or without a long handle. To wring out the mop, you simply thrust it into the drainer and press down lightly on the mop handle. Its cellular construction provides a vacuum action that picks up dirt and tiny particles. The metal drainer has four hooks for mounting it on the pail, and holes perforated throughout permit the water to run off quickly.

Bicycle Has an All-Wood Frame Assembled by Three Bolts

M 384



Bicycle frame made of wood saves metal for war uses

Only three metal bolts are needed to hold the parts of an all-wood bicycle together. Tires for the vehicle are made from reclaimed rubber, thus saving materials made scarce by the demands of war industries.

Electric Test for Stomach Cancer May Bring Early Diagnosis

M 451

Diagnosis of stomach cancer in an early stage in 85 percent of 150 cases by means of an electrical test was recently revealed by the National Advisory Cancer Council. The test measures electrical potential differences across stomach membranes when milk is in the stomach. Authorities hope that the tests will result in earlier diagnosis of the disease.

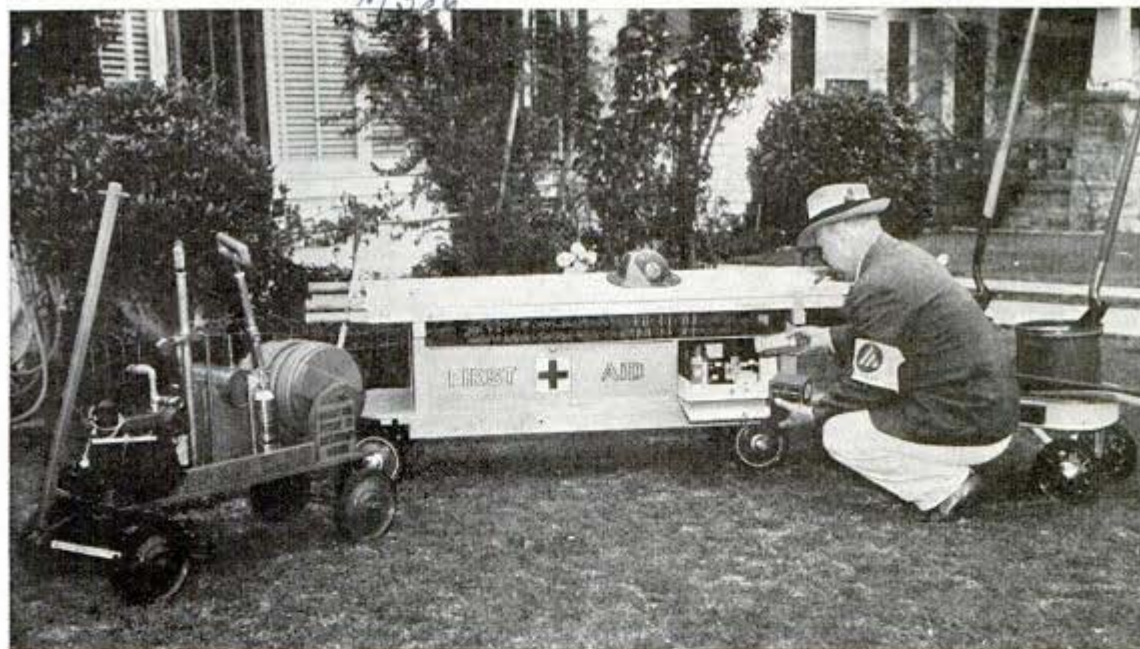
POPULAR MECHANICS

*Ref: Dr. Allen O. Whipple
Columbia, Mo. 64108*

*Minute Mop Co., 2227 Calumet Ave
Chicago, Ill.*

Information

Toylike Train Carries Air Raid Equipment



Air raid warden's train carries essential equipment for fighting fires and giving first aid to injured

What the well equipped air raid warden should possess has been assembled by M. M. Groven of Los Angeles and strung together into a toylike train which he can tow by hand. Included in the fire fighting

outfit are two stirrup pumps connected to an outboard motor which can pump water from swimming pools, bird baths or bath tubs. The train also contains an auxiliary sand wagon as well as first aid equipment.

Parachutist Sheds His Harness Just as He Hits the Water

Getting out of harness is as vital as getting into it when a parachutist is coming down over water. At the naval air station at Corpus Christi, Texas, the men are taught to free themselves from the chute just before they splash. On the way down, the chutist begins by unfastening the chest strap while balancing himself on the cushion. The tubes seen on the flier's chest are not part of the parachute harness but lead to the rubber life jacket. This he inflates by releasing carbon dioxide from metal containers in the jacket. He can use lung power to add more air when the supply in the gas flasks is exhausted.



Unfastening chest strap as he descends, chutist is free as he hits water

M226 Grant

The IRON HORSE *Delivers the* TOOLS of WAR



Acme Steel Co. photo

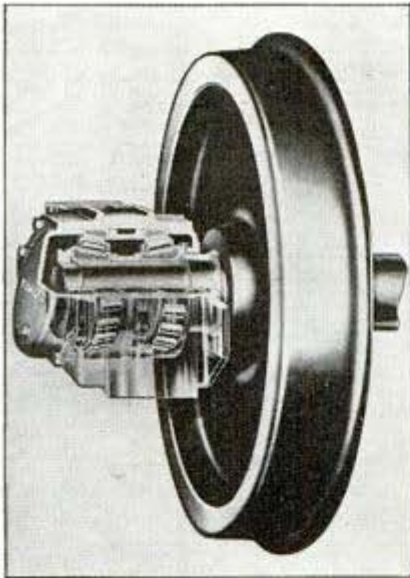
Steel strap for packaging is one of the methods making economical use of freight car space. Union Pacific's "Big Boy" shows its articulation in the odd view below



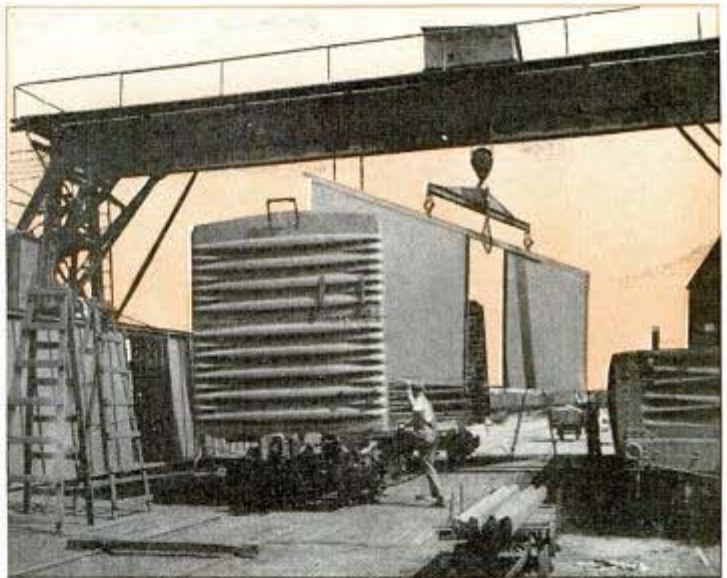
Part II

WAR BEGAN trying to break the back of the railroads three years ago, and it's still trying. The freight load on American rails rose 55 percent from May to October, 1939. For many months they have delivered every day more than 5,000 carloads of war materials to government camps and construction projects. That's 50 miles of freight cars a day.

Now that we're in it, the burden grows enormously. Tankers go down in the Atlantic, the east cries for oil, and the railroads step up tank car deliveries tenfold, from 1,827 cars in one January week to 19,926 cars in an April week—an all-time record of 640,478 barrels per day. The Panama Canal is virtually closed to intercoastal shipping and the rails take over the job, which may give full-time employment to as many as 35,000 freight cars. Tires are rationed and folks and goods that



Roller bearings seen in this "X-ray" view of a Timken journal application smooth the ride of locomotive and cars



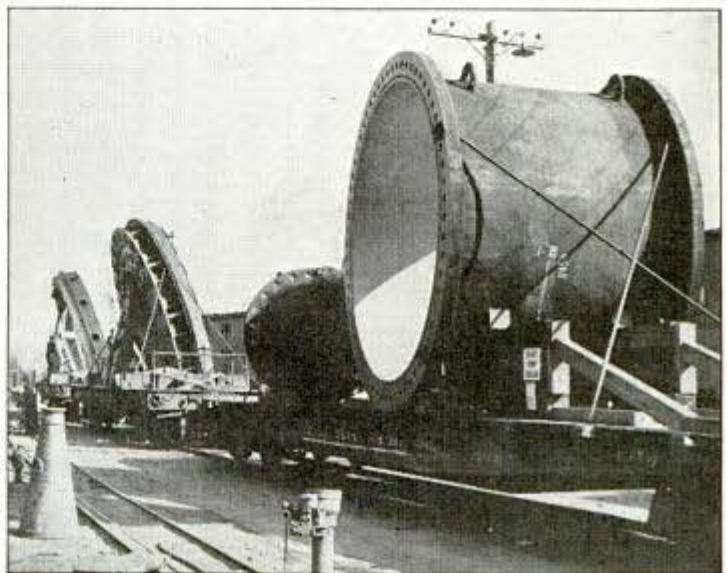
Erecting side panel of a light steel boxcar at Union Pacific shops
These little lift trucks speed up handling of freight tremendously

went by highway go by train.

The stuff they carry is as strange as it is stupendous. Special 24-wheel flatcars cradle a big coast-defense gun. Towering turbine parts ride from eastern factories to western dams. A Denver shipyard builds a vessel for the navy and sends it west by rail. Prefabricated sections of steamers' hulls are loaded at inland plants.

Last year the railroads did the biggest job in history. This year should be 10 percent bigger. Carloadings are expected to hit a million a week. Last October's peak was 922,000 cars. And yet the railroads are doing this—hauling nearly 25 percent more tons of freight per mile than in 1918—with 625,000 fewer freight cars and 21,000 fewer locomotives than they owned in that other world war.

How do they do it? There are a number of answers. "Big Boy" is a typical one. "Big Boy"—there are 20 of him on the Union Pacific line—is a



These gigantic turbine parts for a western dam had to be shipped on specially built freight cars



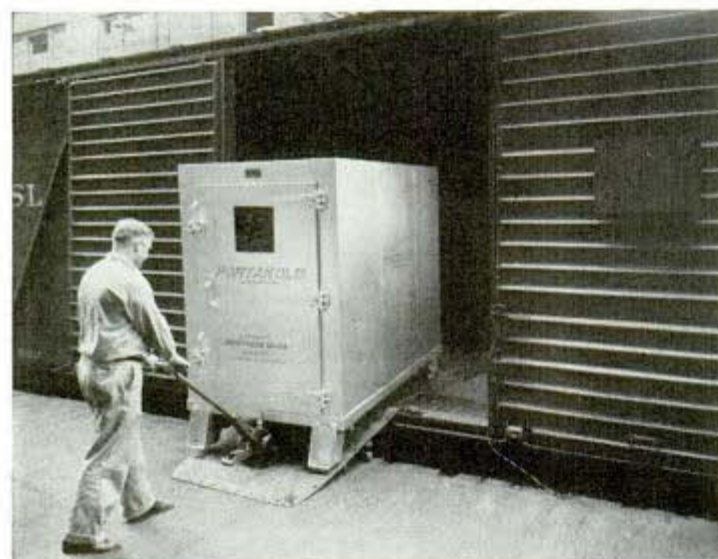
Chain conveyor in specially fitted boxcar facilitates loading of engines with minimum packing

Photo from Chrysler Corporation



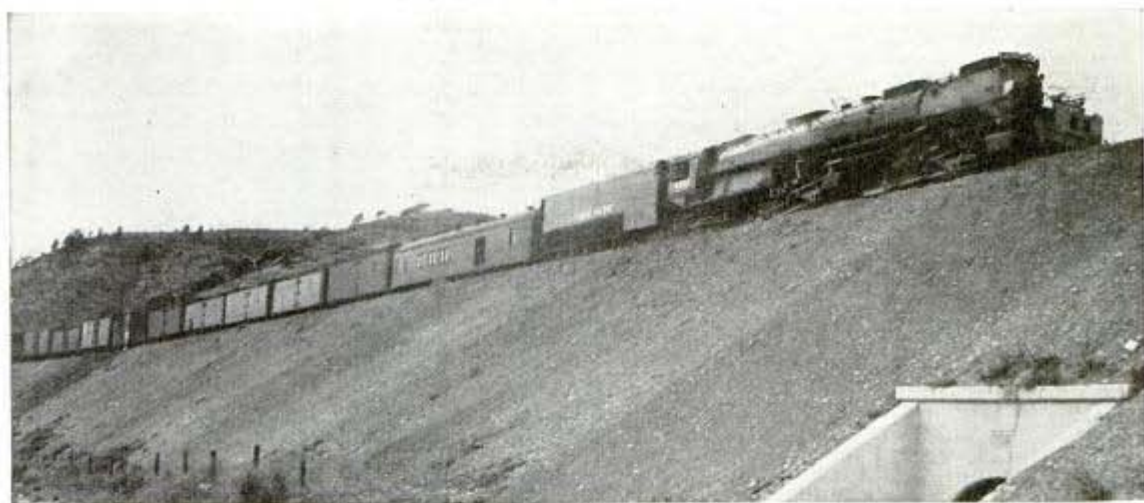
Differential Steel Car Co.

This car can be dumped to either side by air valve, and an entire train can be dumped by operating valve from engine. The "Portakold" refrigerator, below, carries perishables in ordinary boxcar



Hercules among locomotives, capable of hauling more than a mile-long freight train more than a mile a minute. Just under 133 feet long, it is the biggest steam freighter in the world, so long that it had to be hinged at the center to take the curves and grades over the Wasatch mountains between Ogden, Utah and Green River, Wyo., where it does the work of two ordinary engines. Of the 4-8-8-4 type, "Big Boy" has 16 drive wheels, weighs 1,197,800 pounds and pulls the biggest freight you ever saw at 80 miles an hour top speed, "cruising" at 70.

The railroads may have only two-thirds as many locomotives as they had in '18, but they do more work. The average steam engine of 1918 had a tractive effort of 34,995 pounds; today's average engine is rated at 51,915 pounds. "Big Boy's" rating is 135,375 pounds tractive effort, and it has an expected working life of 3,000,000 miles. Another new powerhouse on wheels is the Chesapeake & Ohio railway's "Allegheny" type, with a 2-6-6-6 wheel arrangement never before used. There are 10 of these \$250,000 locomotives, and more ordered, built to haul coal across the Allegheny mountains. Another big lift for the general power average of 1942 locomotives is provided by the growing fleet of main-line Diesel-electric freighters with their tremendous tractive effort of 220,000 pounds. All these modern giants are equipped with roller bearings that let them ride with the frictionless ease of a ship in water. A handful of men can push a million-pound locomotive with roller bearings.



"Big Boy" of the Union Pacific, with 16 drive wheels, pulls a mile of freight more than a mile a minute, "cruising" at 70

So—"more power to the railroads" is one answer to the question, "How do they do it?" Other answers are—better equipment, better track. Grades and curves have been ironed out, heavier rails installed so that streamliners and freights alike go faster. Twenty years ago less than 1.5 percent of the steel rails weighed 110 pounds or more per yard; today 22 percent. Freight car hot boxes then were five times as frequent as now, locomotives broke down seven times as often.

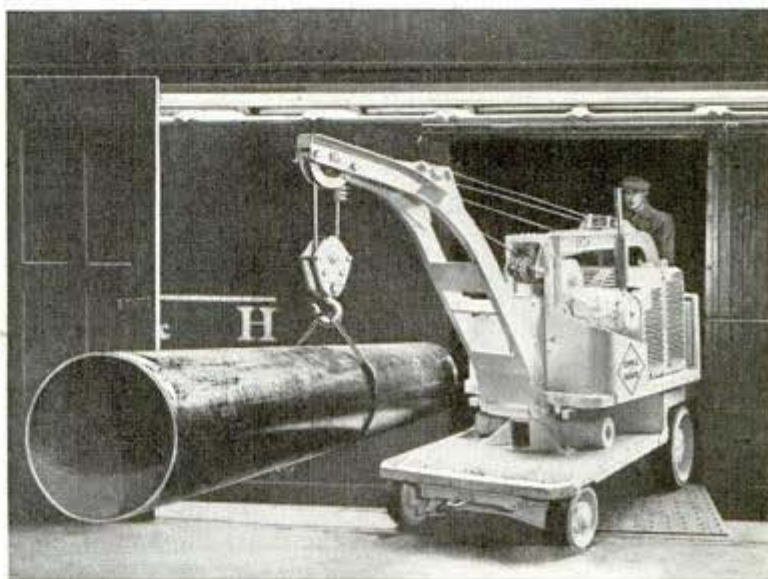
The creaking, groaning, swaying boxcar has been to the rejuvenation clinic. It's built now of lightweight steel, some with wrought steel wheels good for as many as 300,000 miles; and the average freight car carries nearly nine tons more than in 1918. The roads will add about 115,000 new freight cars and 1,000 locomotives in the year ending Oct. 1 if materials can be obtained. They're shooting at a fleet of 1,765,000 cars and over 42,000 engines on that date. Since 1923 they've junked 40,700 old locomotives as obsolete!

Fast? The average

(Continued to page 164)



Caterpillar Diesel uprooting and salvaging ties from a 60-mile abandoned railroad, loading ties into truck at rear. Below, an Elwell-Parker loading truck carries a pipe into a boxcar



Phone Holder Frees Hands For Work While Talking

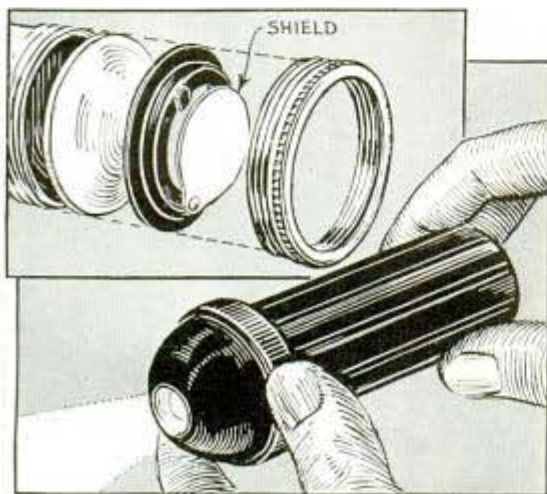


Telephone holder supports instrument on shoulder

With a simple device that fits over a cradle telephone, the user may hold the phone on his shoulder and have both hands free for writing, typing, or handling papers. The holder, made of a resilient material, is easily adjusted for the user's comfort.

Hooded Flashlight or Lens Shield Help Hide Light in Blackout

Two recent flashlight developments, intended to conceal the rays against visibility from above so the lamps may be used safely during a blackout, consist of a flashlight with built-in hood and a shield which may be trimmed to fit any flashlight. With the hooded flashlight, a strong beam may be aimed straight ahead, but the hood prevents side glow. The shield, attached to

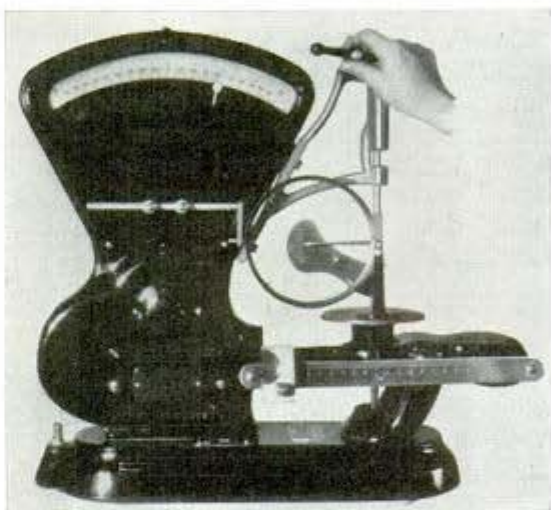


Lens-shield assembly, top; bottom, hooded flashlight

any ordinary flashlight, provides a window that opens or closes for a clear or subdued light. It is inserted inside the lens-holding ring, and if it does not fit exactly it may be trimmed easily with a pair of scissors to the right size.

Piston-Ring Pressure "Weighed" On Scale-Type Tester

Pressure that will be exerted on the cylinder wall of an automobile engine by a piston ring can be determined quickly with a scale-type testing apparatus. To "weigh" the force applied by a piston ring, the ring is placed inside a flexible band, and then by turning a handle this band is compressed until an indicator in the center



Scale "weighs" pressure exerted by auto piston ring

shows that it has been squeezed sufficiently. By releasing the handle and turning it clockwise until a zero appears on the center scale, a reading appears on the main or weighing scale. This reading is then divided by the cylinder radius in order to find the pressure the ring will exert on the cylinder wall when in actual use.

Fuel Oil Piped to War Homes Saves Individual Tanks

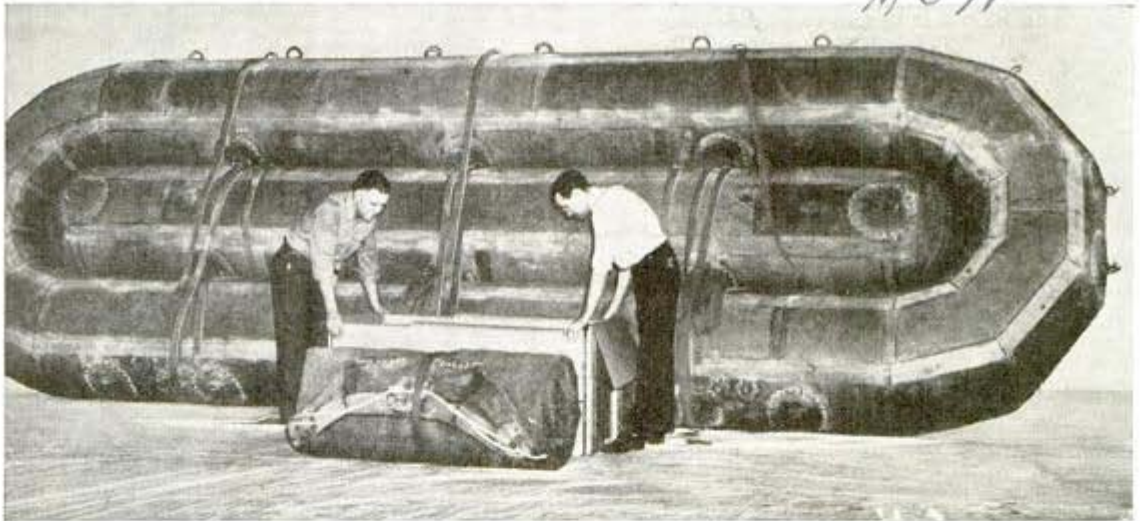
Fuel oil carried by pipe lines will be metered to tenants in a defense housing project at Alexandria, Va., like gas and electricity. Pipe lines are being laid from centrally located storage tanks direct to the dwelling units. Such a pipe-line system eliminates the installation of individual tanks and the cost of making deliveries.

dist. Holder's Inc., 231 S. Jefferson St., Chicago, Ill.
 Shield: Emeloid Co. Inc., Arivaton, N. J.
 Flashlight: F. H. H. or Lumbard Co., 520 N. Michigan, Chicago.

Goodyear Tire & Rubber Co., Akron, Ohio.

Rubber "Sausages" Carry Army Over Rivers

M 371



This gigantic rubber float can be deflated, rolled up and packed into small box as shown in foreground

United States Army engineers have recently added to the mobility of armored forces by adopting a massive rubber ponton constructed in a Goodyear factory. Inflated, the pontoons resemble huge sausages, which can be joined quickly to form

a bridge "paved" with heavy steel treadways capable of carrying heavier loads than any other portable military bridge. They may be used also to form rafts for ferrying. When deflated, the pontoons can be rolled into compact bundles.

Heavy Roller Packs Down Snow on Airport Runways

M 343

Because snow piled alongside airport runways by snowplows might imperil planes running too close to it, J. Twing Brooks, director of Allegheny (Pa.) County Airport, developed a snow roller that can crush a five-inch depth of snow to two inches on 5,800 feet of runway in five and one-half minutes. The rollers are drawn by a truck or tractor. Eight feet in diameter and weighing 1,750 pounds, they are painted with creosote to protect the wood.



Snow roller, instead of plowing snow from the airport runways, packs it down so plane may use them soon after heavy snowfall

Brooks, J. Twing, Director, Allegheny County Airport, Pa.

Transparent Electric "Cable" Reveals the Condition of Wires Inside

M 374



Tubing covers wires without hiding them from view

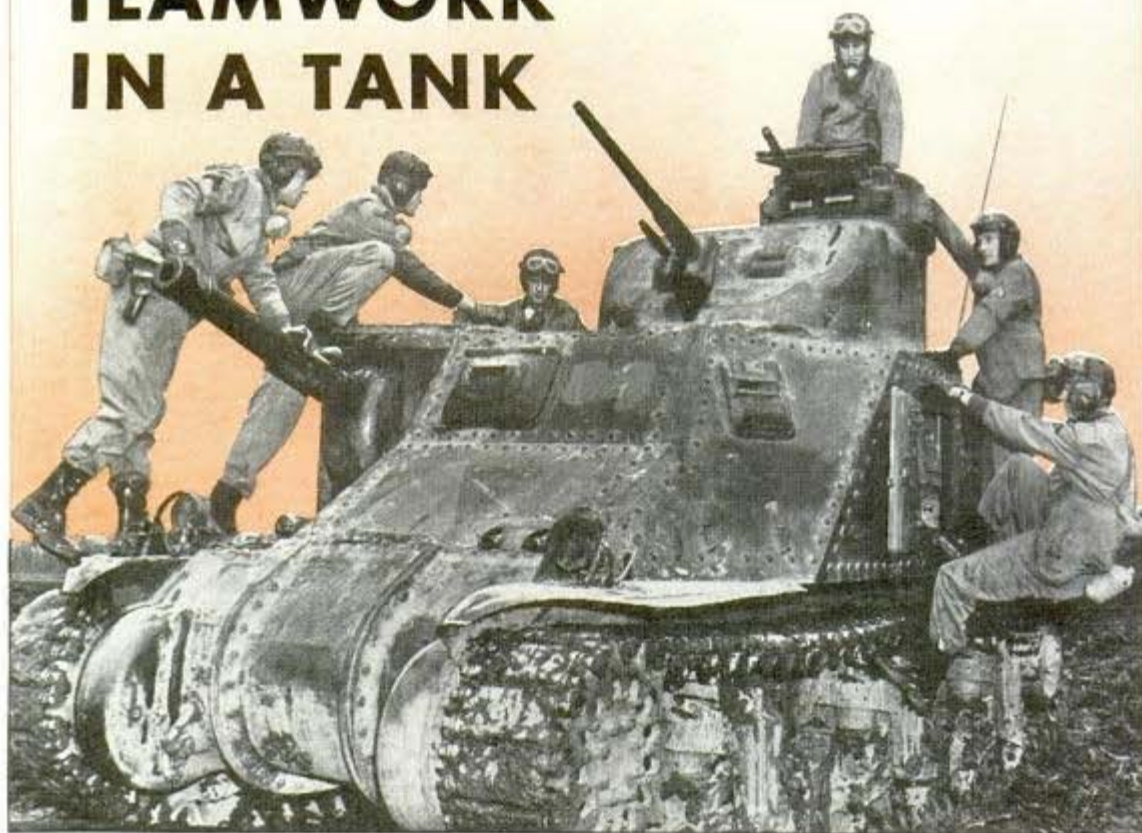
Suitable for use as wire insulation, a new flexible, transparent tubing having the tough qualities of rubber, permits instant location of breaks and identification of wires inside. In tests made by two aviation companies it was found to have high tensile strength and did not become brittle at low temperatures. The tubing, called Transflex, is serving effectively as insulation on high-altitude airplanes and has a wide variety of applications in industries.

AUGUST, 1942

Inverton Varnish & Insulator Co. 31 Argyle St., Inverton, N.J.

Cont. Robert D. Polatsek Edgs. Armored Force
Public Relations Bureau Ft. Knox, Ky.

TEAMWORK IN A TANK



It's "All aboard!" for the hard-hitting crew of one of America's new rolling fortresses at Fort Knox, Ky.

By Staff Sergeants Robert D. Polatsek and James Cowen

EVERY time an M-3 medium tank bounces its 28 tons off some assembly line the Armored Force is faced with the job of training six men to man this \$35,000 rolling fortress.

At Fort Knox, Ky., home and nerve center of the Armored Force, the army has

spent millions of dollars erecting and equipping a modern "blitz" college known as the Armored Force School. Here, in this unique training center, the six-man crews learn about tanks—and teamwork.

From the time they report as rookies to the Ft. Knox Replacement Training Center, the men who are

finally chosen as members of a tank crew are constantly exposed to the fundamentals on which the fast-moving, hard-hitting Armored Force is based.

Let's take a look at a typical crew, one of the crack tank teams in the 1st Armored Division (known as "Old Ironsides") which was the

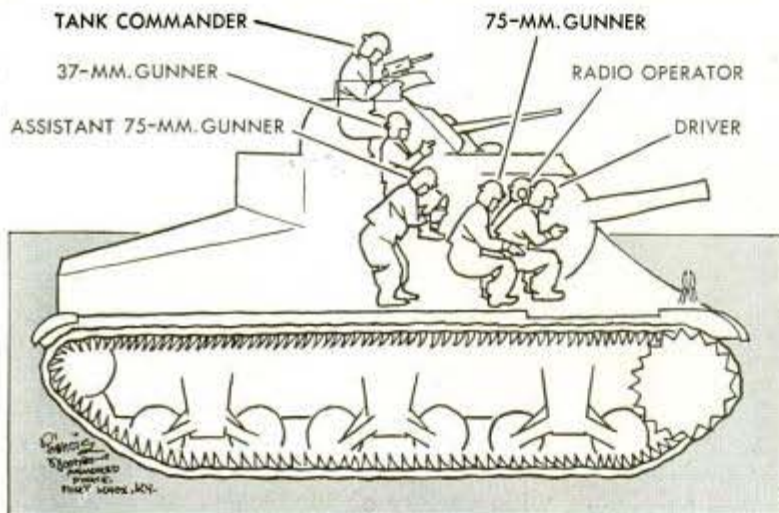


Diagram shows six-man crew at "battle stations" in a 28-ton blitz "buggy"—M-3 medium tank

first "panzer" unit organized by Uncle Sam.

Sergeant Glenn E. Hinzman, from Dailey, W. Va., is a strapping 6-foot 2-inch 180-pounder. Tank operation is no mystery to him. He used to run a Caterpillar Diesel on big construction jobs. He's the tank commander.

Technician 4th Class James H. Bowser (known to his buddies as "Bow Wow") is the regular driver. He weighs 189 pounds, hails from Jasper, Ala., and has been around tanks for four years.

The big 75-mm. cannon, which has a surprisingly small amount of recoil, is ably handled by Corporal Ellis Lott, who weighs 186 and comes from Rosedale, Miss. He was a tractor mechanic before his induction.

Technician 5th Class Arnold F. Mees is the 37-mm. gunner. This heavyweight—185 pounds—was formerly an automobile mechanic in Jansen, Nebr. Assisting him is Technician 5th Class Albert I. Hess, Plymouth, Utah, who tips the scales at 175. He ran a tractor on a farm before joining the army.

Sixth member of the crew is Private First Class William T. Daniels of Irvin, Ky., who handles the radio set. Smallest member of the crew, he weighs 176 pounds and is 5 feet 10 inches tall. Ages of the crew range from 22 to 25.

Tank crews must be big, tough and cool headed. The men are as hardened as any football team and work as smoothly in the cramped quarters of a tank as a Stanford backfield from a "T" formation. It's "teamwork" that counts!

No one man stars at any one job on this team. If

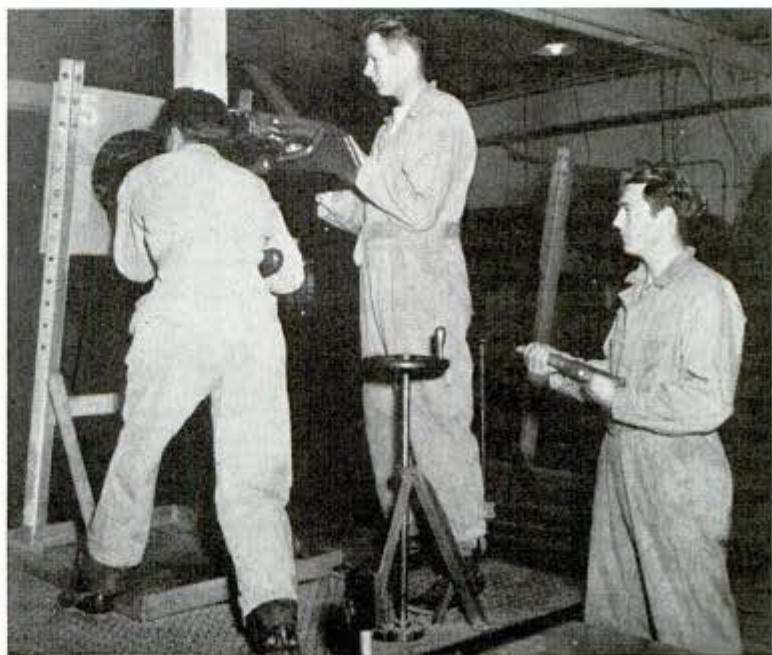
Firing a 37-mm. cannon mounted on "wobble plate" gives gunner feeling of tank charging enemy



Roaring over rough terrain in maneuvers, a light tank leaps off ground. The crew swaps seats to practice different operations and avoid fatigue

the radio operator is hit, any other man in the crew can take over. The same applies to the gunner and the driver. Every man knows the three main operations of a tank—driving, firing and radio operation in addition to maintenance.

This versatility and teamwork is not an accident. It is the result of thorough training in both the theory and practice of tank operation. In the Replacement Training Center at Ft. Knox, they drove tanks and received elementary pointers in tank construction and maintenance for approximately 13 weeks. Having worked with





Big brother of the M-3 is the Army's new land battleship, a 60-ton tank that can crush an ordinary house like a matchbox. Note long range cannon

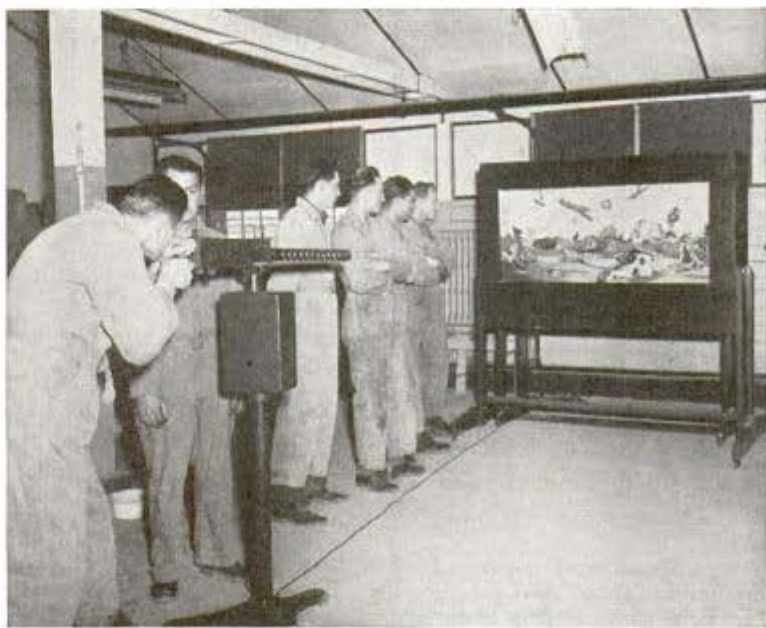
tractors, most of them were familiar with the operation of the tracks which give a tank its advantages on rough terrain.

Specialized courses began when they were transferred to the mammoth 314-building Armored Force School, headed by Brig. Gen. Stephen G. Henry, which turns out 22,000 technicians and 1,440 officers annually.

In the tank department they learn, step by step, through the use of ingenious charts, models, and actual parts, the advantages and limitations of a tank. Each man studies the Diesel or Wright Whirlwind gasoline motor, takes it apart in the "dead engine" division, puts it back together, and learns the theory on which it operates.

The transmission of power from the engine to the tracks and the electrical system are studied in separate divisions, each of which are 8-day courses. Finally, the crew members are taken into the "live engine" test building. The instructor sets up motor troubles and the student must diagnose them successfully. If he doesn't make the

Coach keeps his eye on gunner as tank crew learns machine-gun technique at "shooting gallery"



grade, he fails to graduate as a qualified mechanic and is permitted to take the course over again. Since the tank course is run in sections, a man may repeat any one part of the course without disrupting his schedule. This "assembly-line" method trains more men than would be possible under usual conditions in civilian schools.

The 14-week communications course encompasses the International Morse code and the various standard types of army radio sets. Every tank has a radio set and everyone in the crew is

expected to be able to operate it in case the regular operator is injured. The operator must be able to receive 16 words per minute and send 12. If he can do better than this he is termed a "hot shot."

In the field, he sends messages from moving vehicles, tunes up his set, contacts the other stations in his "net" and makes repairs when necessary. The operator has channels to the company and battalion commanders, and can both receive and send messages. Some tanks have only one-way communication, but the M-3 medium usually has a two-way set.

The six-week gunnery course includes

the study of small arms, machine guns, the 37-mm. and 75-mm. cannons, and the Thompson sub-machine gun. All of the crew carry .45 revolvers. The tank has a 75-mm. cannon, a 37-mm. cannon, four 30-caliber machine guns, and "Tommy Gun."

During the first part of the course, students learn the parts and nomenclature of the various guns, and test their marksmanship on the electric-eye guns. Next step is firing on the 1,000-inch range from a "wobble plate," an ingenious mechanism which simulates a moving tank in action. The final weeks are spent firing on the range from both stationary and moving tanks. At times sub-caliber shells are used (37-mm. bored to shoot a .22 short) to save money. On the range, the regular caliber shells are used.

After completing this thorough training, the men are ready to get the feel of their tank, learn what it will do under certain conditions, and adapt themselves to unforeseen situations.

Although each member of this crack six-man crew is a specialist in his own right, the beauty of the combination is the efficient manner in which they can shift positions and keep the tank operating effectively without lost motion. On road marches, maneuver problems and in com-

(Continued to page 166)

U. S. officials, right, inspect one of the new steel giants. Below, tanks roll into action at war games



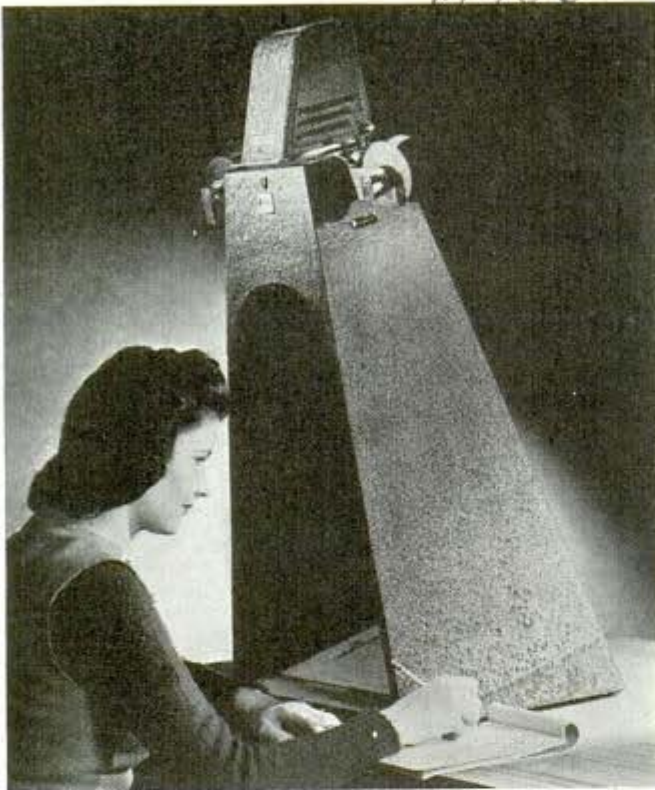
Sgt. Glenn Hinzman tests the controls of a cut-away tank model that shows inner mechanism, while Ellis Lott, left, and Jim Bowser, right, look on



Spencer Lense Co., 19 South St., Ruffalo, N.Y.

Shadow Box for Reading Films Permits Use in Light Room

M 456



Shadow box eliminates need for dark room to read microfilms

Tiny films used for the filing of records may be read easily in a lighted room with the aid of a combination shadow box and projector now on the market. The projector, mounted at the top of the unit, can be rotated to show either vertical or horizontal microfilms from a few inches in length to 100 feet.

Twin Radio Spots Plane By Bouncing Signals

M 385

Reflected radio beams from a dual transmitter not only detect the presence of planes but also tell which direction the instrument should be moved in order to point directly at the craft. According to a patent issued to the inventor, Laurens A. Taylor, which has been assigned to General Electric company, the apparatus sends out two high-frequency radio beams each of a certain power, phase and amplitude. These can be directed to any part of the sky. A receiver,

General Elec. Co.
Science Bldg., N.Y.

picking up any waves reflected by an airplane entering the radio beam, records the difference in volume between the received parts of each beam, thereby telling the operator how to move the instrument so it will point at the plane. This is accomplished with the aid of filters separating the two received frequencies and a meter with a pointer to simplify the reading. When an airplane is detected, the operator merely watches the pointer and moves the radiolocator so the needle stays at the center of the dial in order to follow the plane in its course.

"Glad Hands" of Flyers Symbolized in Paper

M 392

Airplane pilots of the U. S. Army Air Force Ferry Command, located on the west coast, have their own "glad hands of the great," in imitation of the custom of movie stars whose footprints are cast permanently in the concrete courtyard of Grauman's Chinese theater. Each pilot makes a paper pattern of his hand, autographs it, and tacks the cut-out to a large board where it joins hands with other pilots of the Command.

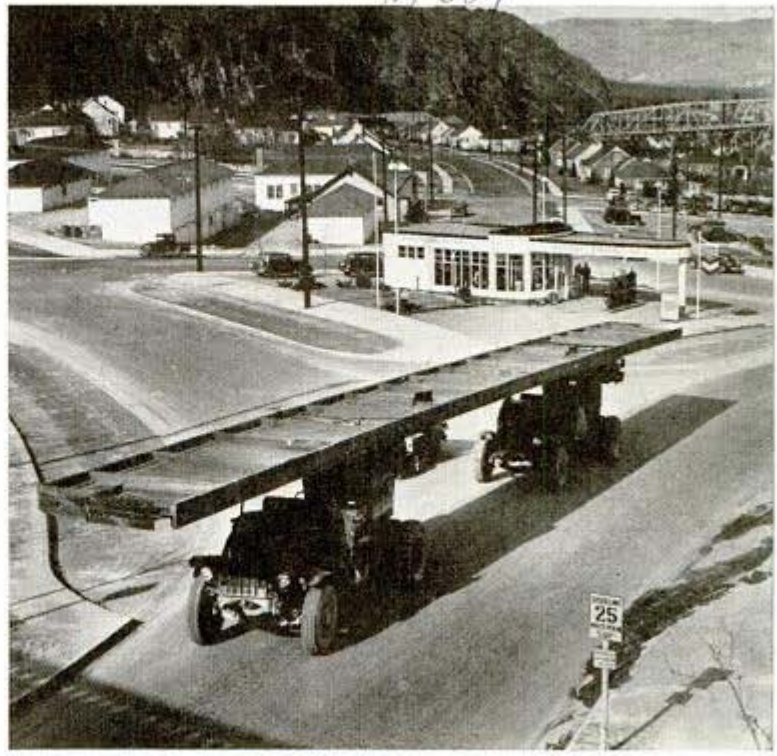


Army pilots autograph paper patterns of their hands on wall

Trucks Coupled Like Bobsled to Haul Girder

How to haul a girder weighing 37 tons and measuring 100 feet long and eight feet across, was a problem recently solved by movers. The girder, a part of the construction trestle on the downstream face of Grand Coulee Dam, had served its purpose and was to be moved to another site. Moving contractors rigged timber cribs on two large trucks and swung the huge girder onto them, forming a vehicle somewhat resembling a bobsled. The drivers had to use extreme care in synchronizing their speed and turns.

Trucks arranged in tandem are equipped with special crib-work to carry 100-foot girder



Molds Eliminate Rolling Pin in Making Ice Box Cookies



Metal molds in varied designs hold dough for ice box cookies which can be sliced into pan quickly after dough is "frozen"

Molds in which dough for ice box cookies may be formed and then removed for slicing into a pan will speed up cookie making by eliminating the use of rolling pin and cutter. The forms, about 9 inches long, are easily opened and closed with attached clips. They are available in several shapes, including playing card symbols.

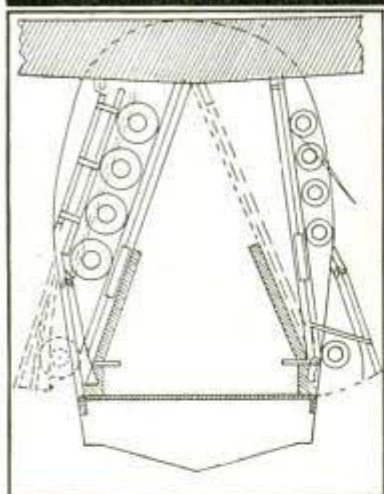
Tapioca Substitute Found In New Variety of Corn

Waxy maize, a new variety of corn hailed as a substitute for tapioca, has been developed by the Bureau of Plant Industry and the Iowa Agricultural Experiment Station. The importance of the new hybrid is highlighted by the choking off of commerce between the United States and the Netherlands Indies from whom we imported about 350,000,000 pounds of tapioca annually. A cornstarch with properties similar to tapioca is obtained from waxy maize.

Another: Can one find better to state + measure changes.

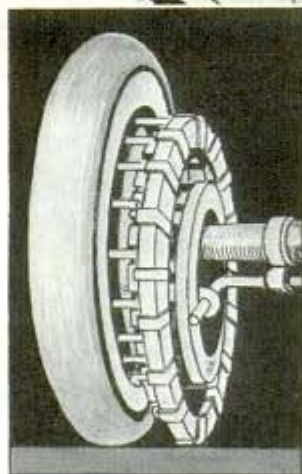
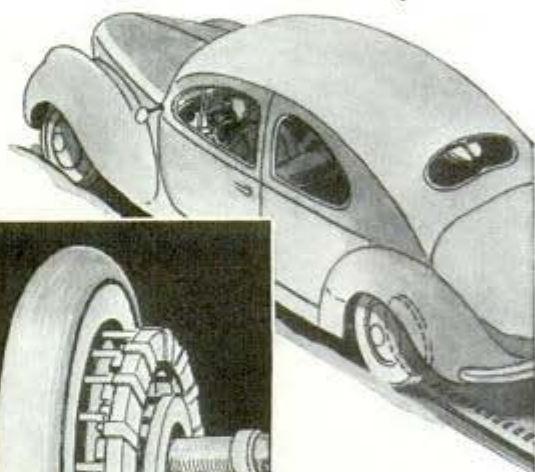
Ames, Iowa

WHO SAYS THERE'S NOTHING NEW ?



Among patents granted recently is one covering a bomb carrier for aircraft. Easy release of bombs, singly or in "strings," is a feature. It is understood to be in use

Skidding might be reduced by retractable wheel attached to driving wheel of auto. A crank control brings anti-skid wheel into contact with road



Airtight container would prevent evaporation of paint and drying out of brush. Sketch shows how brush is suspended



Fishermen would find use for a device which permits maneuvering a boat by means of a hand-operated propeller while fighting a fish

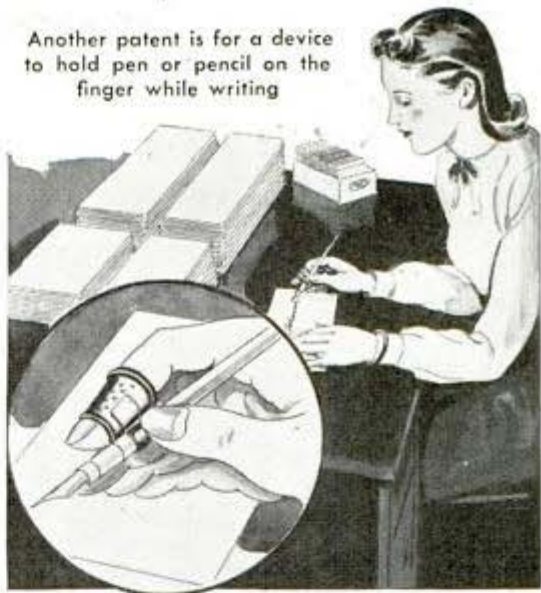




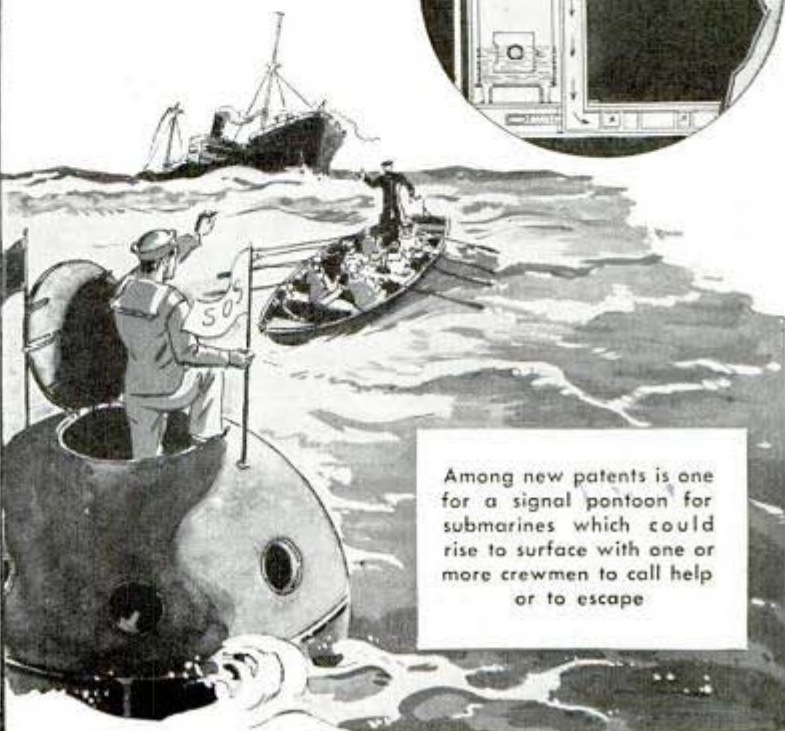
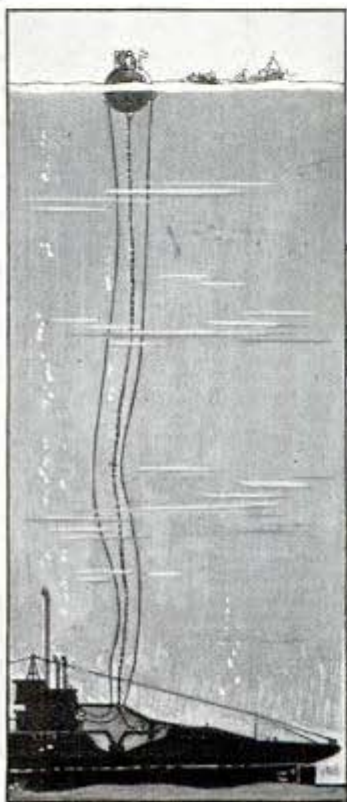
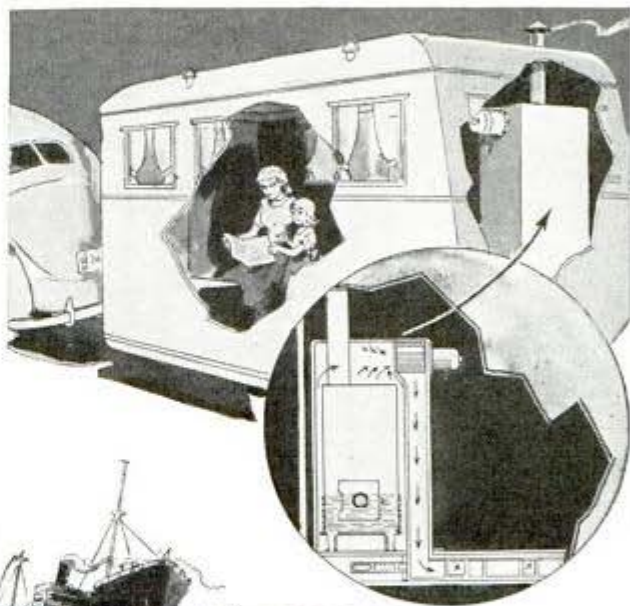
For warming up airplane engines, a traveling machine shop just patented has engines for generating heat and a flexible hood for conveying the heat to plane's motor

(Popular Mechanics Magazine can supply no information to prospective purchasers of items on these pages; granting of patent is no indication that any item is on the market)

Heating trailers would be made easy by a floor heater which has an under-the-floor system for carrying warm air currents to all parts of the trailer



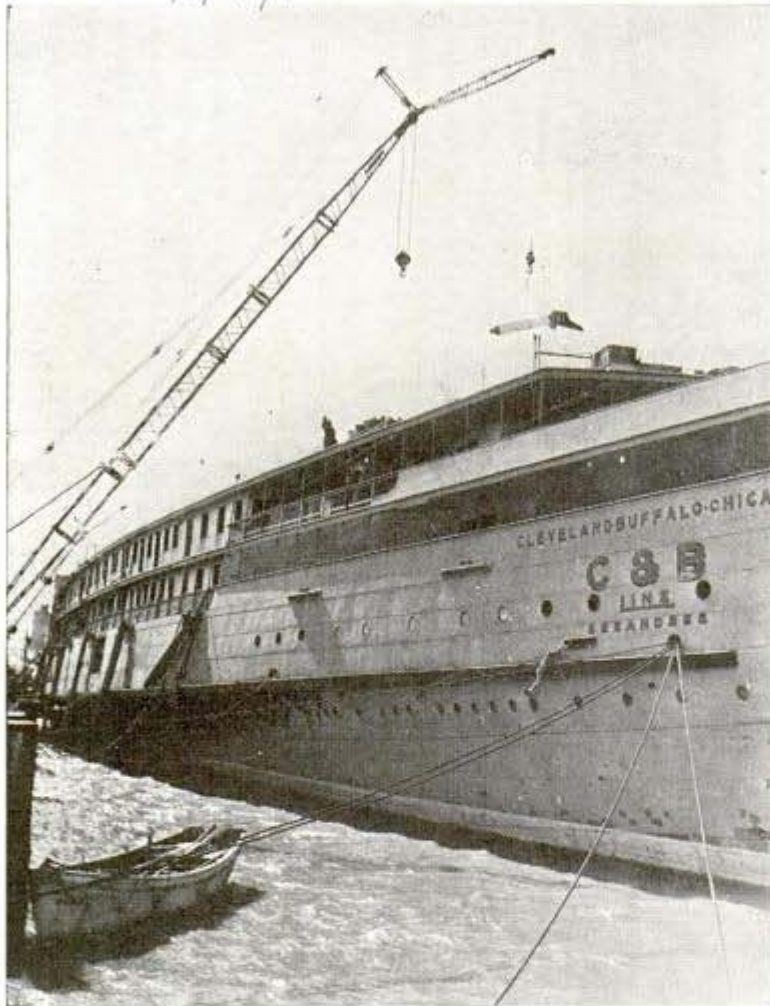
Another patent is for a device to hold pen or pencil on the finger while writing



Among new patents is one for a signal pontoon for submarines which could rise to surface with one or more crewmen to call help or to escape

Airplane Carrier for Great Lakes Built From Excursion Boat

M 471



Big excursion liner on Great Lakes is converted into aircraft carrier

Fighting Navy planes will take the place of carefree summer passengers on the decks of the Great Lakes steamer "Seeandbee" which is being converted into an aircraft carrier for training. Its great length provides adequate runway space.

"Day Eyes" and "Night Eyes" Give You Two-Way Vision

M 576

Night pilots who have been flying in the dark for an hour can see the light of a candle exposed for a thousandth of a second. They are using their "night eyes" which employ a separate set of senses from those used for daylight seeing. Though night eyes are colorblind and cannot see detail sharply, they are thousands of times more

sensitive than day eyes, according to Prof. Selig Hecht of Columbia University's laboratory of biophysics. Blue, green, red and orange lights are colorless to night vision, but their brightness varies. Blue and green—once widely used for blackout lighting—are easiest to see and red and orange—so conspicuous to day eyes—are hardest to see at night. Both day and night sense organs operate at the same time only when light is as bright as full moonlight.

Biscuit Cutter Lifts Dough and Ejects Disk Into Pan

Much of the baking time can be saved with a biscuit cutter that cuts the dough into shape, lifts the disk and deposits it into the pan when the center shaft is pressed. It is only necessary to roll the dough to the thickness desired and the cutter does the rest of the job. It may also be used for cutting bread for canapes and sandwiches.

M 376



Pressing plunger releases disk of dough from cutter

Ref: Prof. Selig Hecht, Laboratory of Biophysics, Columbia Univ., N.Y.C.

Air-Borne Troops Go "Aloft" in Plane Mockup

Loading a "peep" into an airplane "mockup" (right) trains America's mechanized infantry for speed on the battlefields. Below, troops carry bicycles and light artillery aboard for quick transport to the "front"



America's air-borne infantry is being trained in the loading of "peeps," bicycles and other equipment on airplanes for transport to danger spots in the line of battle. The men receive preliminary train-

ing in "mockup" fuselages, replicas of the army transport planes in which they later receive advanced training. Midget army cars, bikes and light artillery are rolled into the "mockups" on ramps.

Plants Need to Cool Off During Night to Produce Fruit

To produce fruit and seeds, plants require daily fluctuations in temperature between day and night, according to experiments conducted by Prof. Fritz Wendt of the California Institute of Technology. Working with tomatoes in air-conditioned greenhouse rooms where he could control light and heat, Prof. Wendt found that

plants in an unchanging temperature of 79 degrees Fahrenheit did grow and blossom, but failed to produce fruit. A parallel set of plants was kept in a room where the temperature was dropped every night and raised again in the morning. These plants not only produced fruit abundantly but also showed better general growth.

Ref: Prof. Fritz Wendt
Calif. Institute of Tech, Pasadena, Calif



IF YOU CAN DRIVE YOU CAN FLY

By Roderick M. Grant

PART III

THEY tell the story of an air-mail pilot in pre-radio-beam days who couldn't find Chicago. It ought to be right down below, but there was still no sign of the city lights.

It was a chill night upstairs, and he pulled the cork of his coffee bottle for a bracer. Hot coffee shot upward from the mouth of the flask. Startled, the pilot glanced up. There was Chicago, lying directly above! He was flying upside down.

Absurd? Not quite. Things like that happened when pilots flew "by the seat of their pants" and instruments were primitive or nonexistent. Things like that could happen today. You can't trust your senses in the air. A novice in the cockpit can lose himself ten minutes from the home hangar. To the flier just graduating from automobile to light plane, the flat world down below has a totally foreign look. Familiar landmarks vanish and there is momentary panic as he looks for the railroad or river or highway that orients his position.

Trail-finding in the sky is really simple and part of the fun of flying. You can, of course, do it the



Top, a metal-clad Luscombe lightplane makes a front-yard landing. Center, a Piper Cub tandem trainer. The canvas hanger below, with steel frame and roll-up door, can be erected in five hours



hard way, learning to shoot the sun or stars as the navigator of the Clipper or patrol plane must. It's too much trouble for the average private flier; still, the more you know about navigating, the better off you are when an emergency comes. Many light-plane pilots will not bother to navigate by dead reckoning, yet it is not too difficult, affords satisfaction, saves time and distance on a long trip and may prove a lifesaver when visibility is low and landmarks hide in haze. Dead reckoning requires first of all the checking of your compass, for each individual plane will affect its own compass reading. An expert will do it, or you can do it yourself, jotting down on a card the compass correction, as "For North, steer 18 degrees," etc. Many airports have a compass rose marked out on which the check can be made easily.

Before any long cross-country trip you obtain a government map of the region and lay out your course upon it. Then the compass heading for the



A private flier takes a holiday among the clouds, above, in his Luscombe "Silvaire." Beacons, lights and radio beams guide the pilot on the principal air thoroughfares on the map below. The four-seater at bottom was designed for the private plane boom that will come after the war



AUGUST, 1942

Des. by Fred N. Wise
Cleveland Ohio.

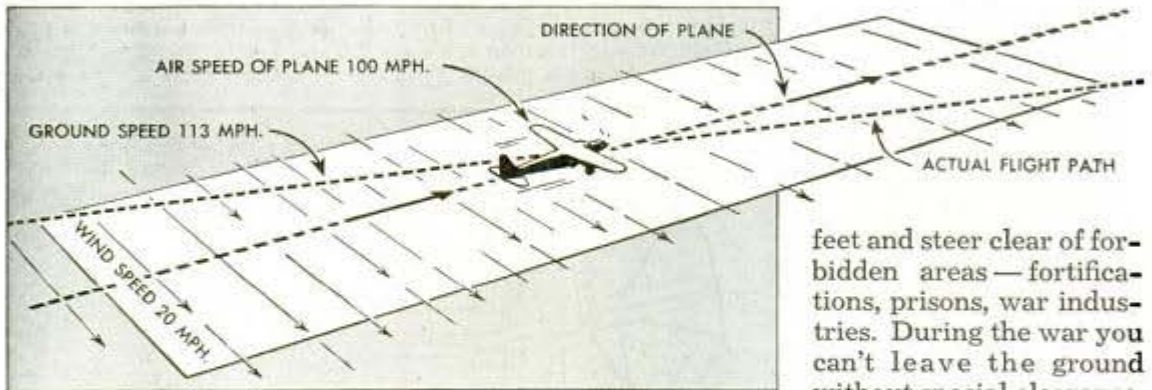
67

not mfgd.



Compensating compass of a plane on compass rose at Curtiss-Wright plant

Diagram shows effect of wind on a plane's heading and actual flight path



Luscombe photo

Given a tow for a few feet, a light seaplane easily takes off from land

flight is calculated, taking into account the deviation of your own compass, the local variation of magnetic north from true north—poles of the earth do not coincide with its magnetic poles, and the magnetic compass in Idaho, for example, will point about 20 degrees east of true north; and, finally, wind drift, to which the light plane is particularly sensitive.

Your paternal Uncle Sam is constantly in the picture as travel bureau, weather laboratory, inspector and traffic cop. He won't let you solo until you're 16, after 8 hours of instruction, a physical examination, flight test and written examination in aeronautics and Civil Aeronautics Administration regulations. You can't carry a passenger until after 35 hours of solo and more tests. After that you must follow rigid C.A.A. rules, fly above 500 feet and below 3,500

feet and steer clear of forbidden areas—fortifications, prisons, war industries. During the war you can't leave the ground without special clearance.

Today neither you nor the air lines can get weather forecasts outside your local area. In peacetime Uncle Sam is very helpful. You call the nearest C.A.A. headquarters for up-to-the-minute weather information including wind direction and velocity on your route; then, tuning to the radio beam or finding the time of the periodical weather broadcasts of

other stations in the radio guidebook, you pick up weather data along the route several times per hour.

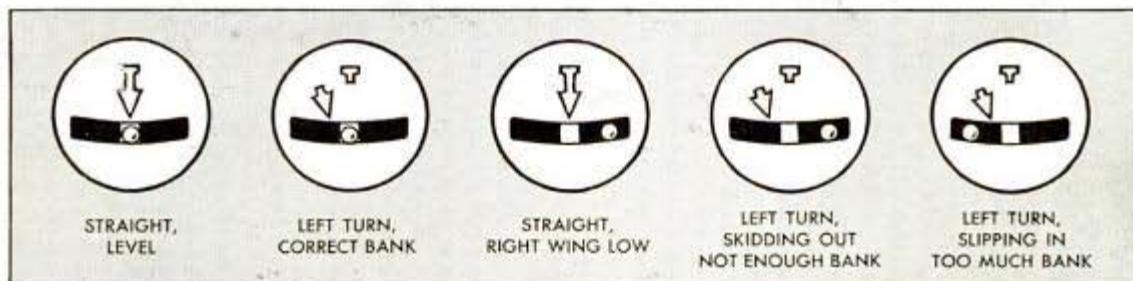
Although unavailable to civilians, weather information is still collected from thousands of points and distributed over an intricate gathering system to C.A.A. offices. In one such office there is a complex master switchboard comprising 1,600

wire circuits, governing a battery of 20 teletypes linked with a 56,000-mile nationwide wire system carrying data on a second-by-second schedule around the clock. Local winds are calculated by sending aloft balloons and plotting their direction and velocity at various heights with a theodolite. These four-foot balloons swell to diameters as great as 15 feet as they rise, and on one clear day a Chicago observer kept a balloon in view until it was 75 miles away, at an altitude of 9 miles.

There are simple wind-drift guides with which you can sight the ground. Many amateurs, however, dispense with dead reckoning and drift calculations and simply fly by landmark. Airway maps are sprinkled with symbols representing landing fields and beacons, railroads, highways, forest ranger stations, towers and similar easily recognized landmarks. Starting a "contact" flight you could head for a landmark, per-



Photo from Westinghouse
Radio controls lights in "doughnut" buoy marking seaplane base

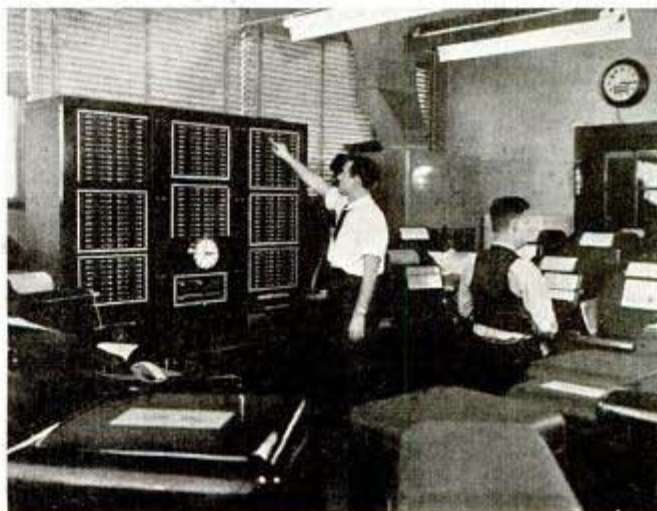


haps a golf course 10 miles away, judge your ground speed and drift when you reach it, and make corrections in your heading then and at intervals beyond. Or, with a radio that costs \$35 or \$40, you could use its loop to head for the broadcasting station nearest your destination; or if you are following a Civil Airway, tune to the airway beam. Navigating by radio loop, however, will not take wind drift into account.

Uncle Sam has set his goal at 4,000 airports, and you may be sure he'll have them for you by the war's end. Already there were 2,453 on Jan. 1, 1942. In addition,

(Continued to page 168)

Here's how a turn and bank indicator tells attitude of plane. Twenty teletypes in C.A.A. office are linked by 1,600-circuit switchboard with government's 56,000-mile "weather wire"



Scoop Smothers Fire Bomb And Picks It Up Safely



Views show bucket closed and opened to form scoop

For fighting incendiary bombs, a combination sand bucket and scoop shovel performs the double service of smothering the bomb with sand and carrying it away to be burned out in safety. Made of sheet metal, the bucket resembles a waste basket with a cover, and may be mounted on a long handle to guard against heat and flying sparks. From a safe distance the user can spread sand gradually on a sputtering bomb until it is ready for removal. Then a cover on the bucket is flipped back, converting it into a scoop, and the unquenchable part of the bomb is easily snared. A baffle at the bottom of the scoop keeps the bomb from burning through the metal.

Wheel Nut With Small Padlock Prevents Theft of Tire



Tire thieves can be foiled in their attempts to remove an auto wheel if one of the wheel nuts is replaced with a locking nut which prevents the nut and bolt from being turned. The

special locking nut can be placed on the wheel in three minutes, according to the manufacturer, being locked in place with a retaining steel plate and a rustproof padlock. One key fits all four padlocks used on any one car.

Sulfa Drug for Whooping Cough Is Promising Preventive

Experiments with sulfadiazine, one of the new sulfa drugs, indicate that it may be helpful in warding off whooping cough in children exposed to the disease. When the drug was given to mice one hour before whooping cough germs were administered the germs failed to grow in 19 out of 20 mice. Germs given to mice not treated with sulfadiazine grew in 10 out of 14 cases. However, the drug had no effect when administered after the germs were injected. No experiments with human patients have yet been tried.

Wall Rack Holds Garden Hose Ready for Any Emergency

Looking ahead to the role garden hose may be called to play in fighting fires caused by incendiary bombs, a wall holder has been designed to keep the hose easily available, eliminate kinks and also help preserve the rubber. It consists of a curved metal channel, less than a half circle, over which the hose is hung. A side ring secures the holder to the wall in a handy position.



Holder keeps hose off ground and eliminates kinks

POPULAR MECHANICS

Distr. Stebbins Hardware Co.
15 N. Van Buren, Chicago

Blake T. ...
 1250 N. 76th St., Cleveland, Ohio

U.S. Public Health Serv., Wash., D.C.

M.387

M.427

M.437

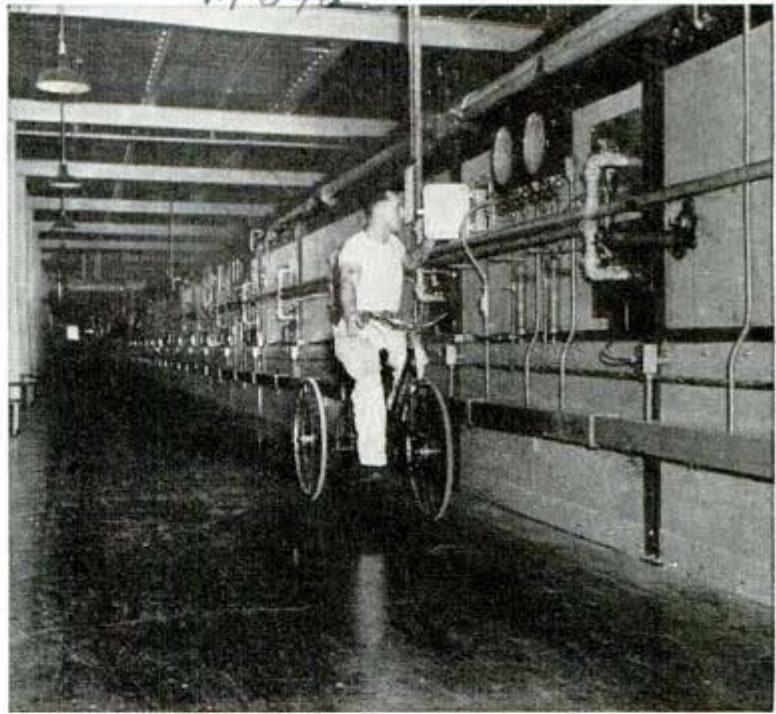
M.305

70 Auto Wheel Co
461 - S. Ch. Ave.
N. D. C.

29-10th Thomson Ave., Long Island City, N.Y.
M 342

Tricycle Rider Inspects Long Line of Ovens

Inspectors checking a line of baking ovens more than five city blocks long average 12 miles of travel daily. However, they don't have to walk, for the Loose-Wiles Biscuit company supplies transportation in the form of tricycles, on which the technicians pilot themselves in speed and comfort while making the rounds to check the precision instruments that control the temperature of the mammoth ovens.



Tricycle enables inspector to dart quickly from one oven to another while inspecting the instruments in five-block-long bakery.

Camouflage "Breaks Up" Building Into Small Shapes



Camouflage converts building into patches of highlights and shadows

What camouflage can do to change the appearance of things to the confusion of enemy flyers is illustrated by a view of the Chicago Merchandise Mart depicting the building in a shadowy disguise as visualized by a camouflage artist. By a judicious application of various shades of paint the camouflage artist created highlights and shadows that transformed the massive structure to resemble a large number of small objects instead of a single large unit.

Cleaner Kept in Stem of a Smoking Pipe Absorbs Unsavory Liquid

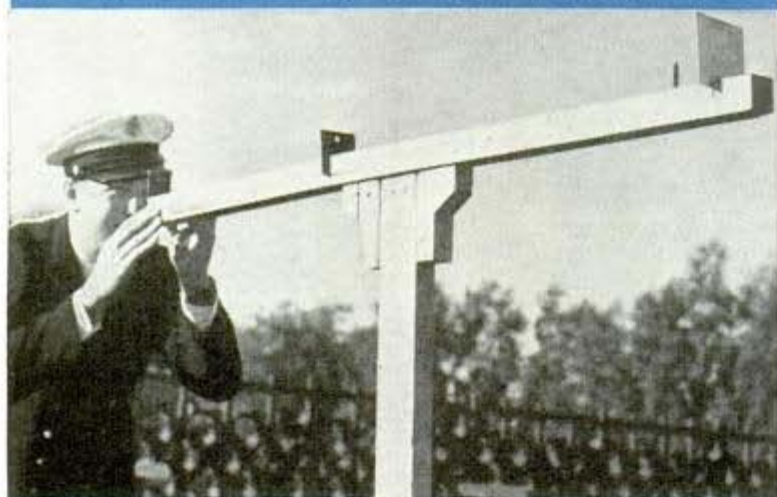
Inserted in a supplementary channel beneath the passage in the stem of a smoking pipe, an ordinary pipe cleaner collects and retains unsavory moisture passing from the bowl so it cannot reach the smoker's mouth. To renew the cleaner, the stem is removed, the old pipe cleaner discarded and a fresh one folded and installed.



Briarcraft Inc
347-5th Ave. N.Y.C.

Ref: Lt. Comdr. Pierre Wood, Public Relations Officer, Naval Training Station, San Diego, Calif.

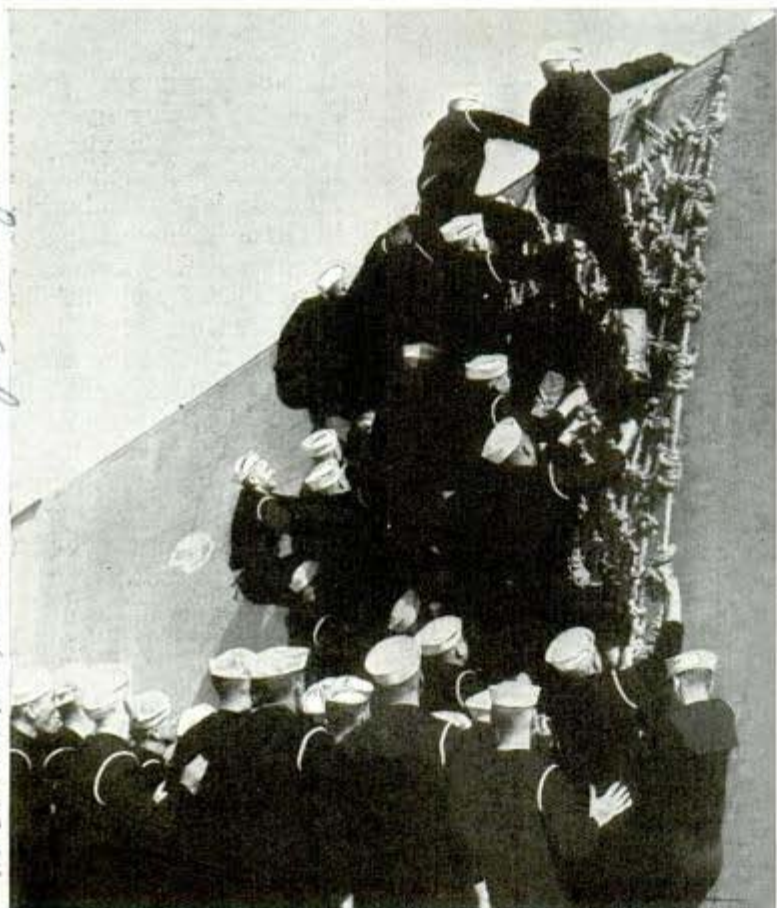
KEEPING *our* SAILORS in TRIM



"Steady on, sailor" is the admonition to the navy man at the sighting machine used to instruct recruits in aiming gun and sight at the target

M 159

Swarming up a cargo net suspended from the side of a dummy ship combines training and sport for gobs as company crews vie for speed records



IF YOU are pointing a big gun on one of America's fighting ships, you must be "on and steady on" when you turn the elevating wheel to match the needle of the fire control dial. Your turret gets a miss instead of a hit if you err by a fraction of an inch.

When you are depressing an anti-aircraft pom-pom to knock down an oncoming torpedo plane, the barest hesitation may give your enemy time to drop his "fish" and sink your ship.

Accuracy and speed are two things that win a battle and this applies to men as well as to battleships or airplanes. No matter what his job, every man in Uncle Sam's Navy is on his toes these days. To help keep him so the Navy has developed an athletic program of sports and exercises that keeps him in trim all the time he is afloat.

"Physical fitness is a prerequisite to mental alertness," says Lieut. Comdr. Gene Tunney, former world champion fighter and now director of the navy's physical training program.

"Through the physical education activities at the training stations, sound bodies are toughened like that of a boxer preparing for a fight. Our men are learning to live like professional warriors."

The toughening program starts on the day a young recruit enters a training station. Landlubbers need special instruction before they can be useful on board ship, so new sailors go to school before they go to sea. A

"One - two - up - down" shouts the instructor, as recruits exercise with rifles to keep fit

modern battleship is so large and complex below deck, for instance, that a green hand can easily become lost. He has to learn how to train a gun and how to handle himself in a small boat, how to sling his hammock and how to take care of marine machinery before he can call himself a sailor.

America is fighting on two oceans today and our double navy is being expanded as fast as more ships can be produced. Thousands of new sailors are needed to man these ships, hence training facilities are being expanded and naval instruction is being speeded up. From the time he hears the bosun's pipe at two bells in the morning watch until he falls into bed at night, the recruit's day is packed with classes and lectures. He has to absorb as much knowledge as he can.

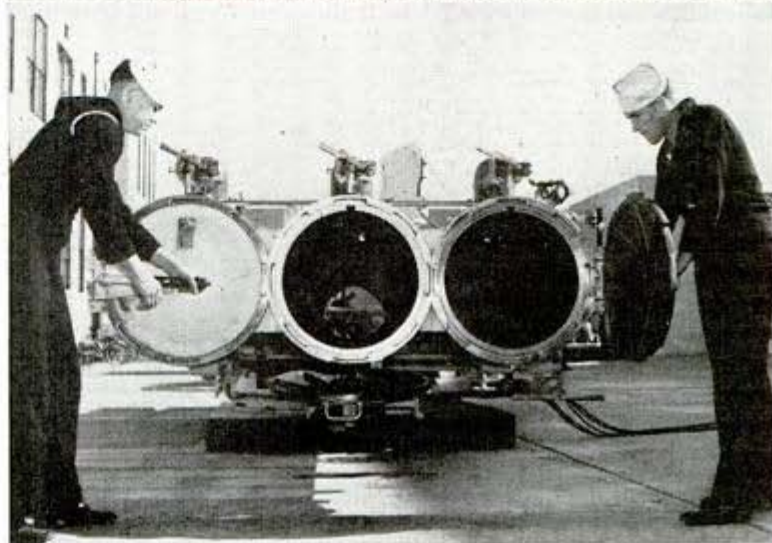
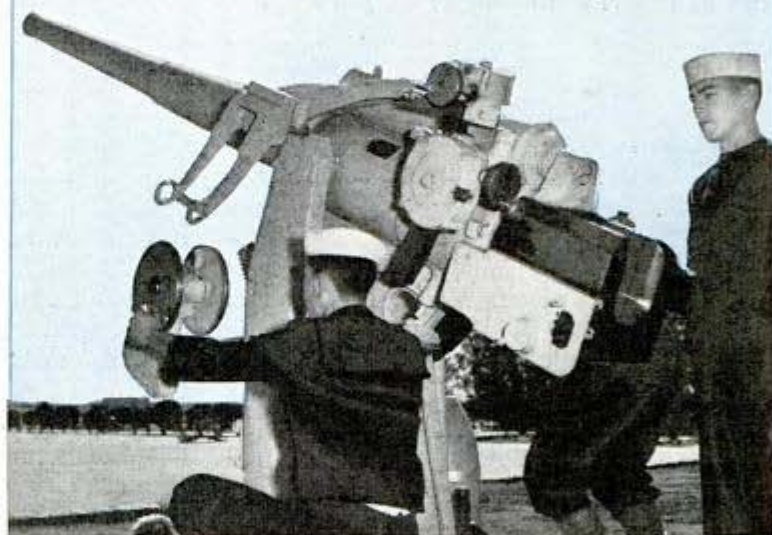
Yet time is still found for plenty of athletics. That, plus regular meals and regular hours, makes him gain an average of nine pounds in weight by the time he is ready for sea duty. Uniforms that were baggy when first issued to him now fit perfectly. Amateur boxers who had been lightweights before they entered the service discover that they have moved up to the welterweight class.

At the Naval Training Station in San Diego a typical day in the life of a

Skill in handling torpedo tubes is acquired by recruits long before they are ordered to sea



Cool heads and steady nerves are needed to operate the big gun (below) on anti-aircraft mount at training station





Learning how to handle themselves on masts and booms, husky recruits train on ladders and rigging at the San Diego Naval Training Station

young sailor begins with half an hour of setting-up exercises and double-time drill before the 6:15 breakfast call. After chow he falls in for infantry maneuvers and the manual of arms, gas lectures and first aid instruction, and talks on seamanship. There are more lectures and drills after the noon-day meal and the school day ordinarily ends at three o'clock. However, in times like these the recruit is likely to attend lectures on a few nights each week.

To become a good fighting sailor he must have plenty of competitive spirit and competition is fostered all through the course in practical seamanship. At the loading machine that represents a gun and at which he learns his duties as part of a gun crew he does more than simply go through the motions. Each crew competes against the other crews in the company for speed and accuracy. The physical drills become recreation and sport instead of drudgery.

Lining up to learn how to scale the side of a ship with the aid of a cargo net, each crew gets away with a rush at the instructor's cry of "Hit that net, sailors, and hit it hard!" The instructor's stopwatch decides which crew took the least time to get over the rail.

"Keep quiet" is the No. 1 rule on instruction board where recruits get tips before going out to shoot on practice range

Mooring an imaginary ship with the aid of heaving lines and 8-inch hawsers is a dry-land exercise that teaches the real thing and the crews go to work with a ready tug-of-war will. While still at the station the recruits learn how to handle themselves on masts and booms. They climb Jacob's ladders to an overhead boom, make their way across it, and descend by means of another ladder at the end.

Funny stories have been told for generations about men who spent their lives at sea yet never learned to swim a stroke. This doesn't apply to American sailors.

Swimming instruction for those who cannot swim starts during their first week.

Other parts of the physical program include bayonet drills and mass boxing instruction. During the training period the recruit is inoculated against lockjaw, yellow fever, and several other conditions. His food is the special concern of a staff of doctors and dieticians who prepare balanced menus, oversee the cooking, and who make daily inspections of the kitchens to insure the utmost cleanliness. Feeding the thousands of recruits at the station promptly and without delay requires good timing. The sailors line up cafeteria style for chow after their company name has been called on the loud speaker system.

The sport facilities at the San Diego Naval Training station include a 9-hole golf



This full-rigged ship model, displayed at post by movie studio, has electric cannon

course with a larger one projected, a large gymnasium and swimming pool, an outdoor boxing arena, and a boat landing. There are eight double and eight single handball courts, 16 tennis courts, eight basketball courts, five softball diamonds, one master baseball diamond and several batting cages, as well as volleyball, badminton, and table and paddle tennis equipment. In addition there is a track and field layout. Many of the courts are lighted for night playing. An average of 100 recruits a day find time for a game of golf and participation in the other sports is on a corresponding scale.

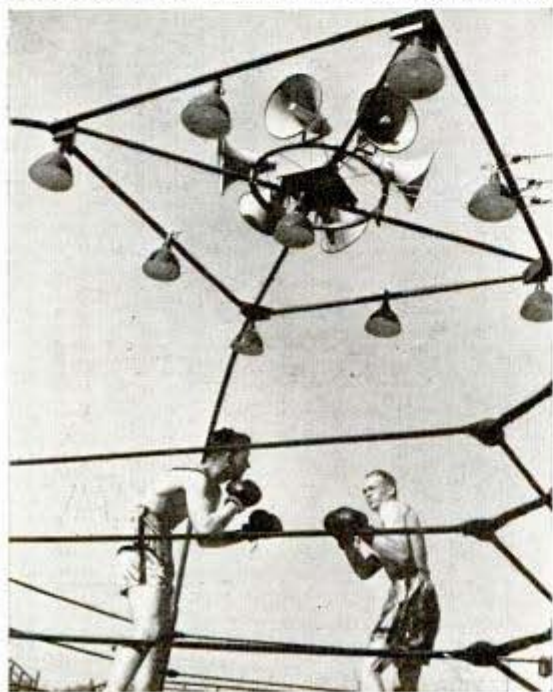
Lieut. George O'Brien, athletics officer, and his staff of instructors, including Lee Ramage, former well known boxer, have worked out a sports program in which every recruit may participate. Teams representing different companies compete in the major sports.

Athletics are still part of the recruit's life after he has finished training and joined the fleet. In

Sailors attending class in rope tying → learn that well-tied knots are lifesavers



Future champions of the sea spar in open air arena



AUGUST, 1942

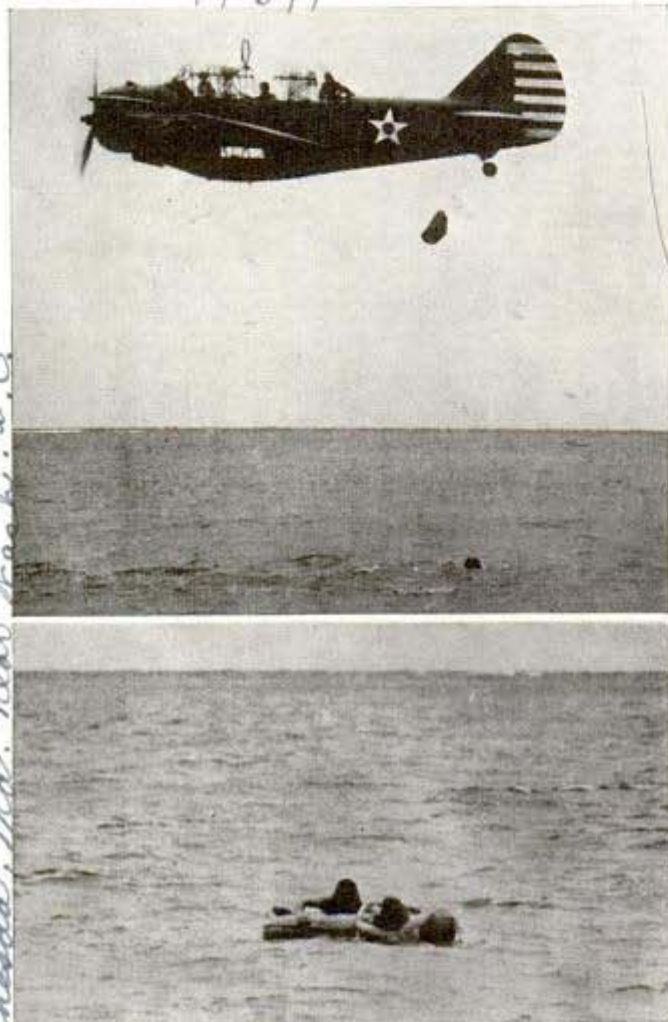
the cramped spaces of a ship, where ordinary facilities for sports are lacking, brisk exercises help maintain the high physical condition of the men. Special setting up exercises have been devised by Tunney and his staff of experts.

Ordinarily, one room below deck is used as a gymnasium and is stocked with equipment that the sailors use during their time off. Boxing, running, and other contests are held between teams chosen from each watch. Field sports are practiced ashore when ships are in port and each ship has football, basketball, baseball, and other teams that compete for fleet championships.

These days, of course, formal athletic competition is practically at a standstill, though athletics are still as much a part of daily life afloat as the exigencies of war will permit. Not every young sailor can become an athletic champion, but athletics is doing its part to help our navy win the championship of the world.

75

Army Plane Drops Rubber Boat To Fliers Down at Sea



At top, rescue plane drops a rubber raft to men in the water, who inflate it with a gas bottle (below) and then climb aboard

Practice at saving airmen down at sea is part of the regular training of every army flier in Hawaiian territory. Most of their operations are over the ocean, and each man must know how to save himself or the other fellow. A rescue plane flies low above the men in the water and a rubber boat is dropped, which can be inflated with a gas bottle. The men then climb aboard and float until rescued.

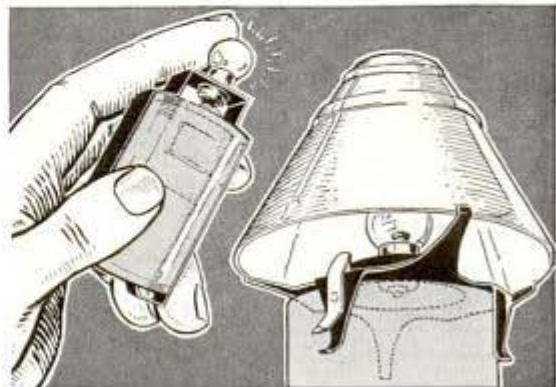
Man-Made Cellulose May Aid In Making of Explosives

For the first time in history, synthetic production of the fundamental "building block" of cellulose—the stuff that wood, cotton and other useful substances are made of—has been accomplished by re-

search workers of the U. S. Public Health Service. When cellulose was first analyzed years ago it broke down into molecules of common glucose which were later found to be united in pairs to make double-sized molecules of a more complex sugar named cellobiose, now made artificially for the first time. The discovery is expected to aid in the manufacture of explosives, rayon, plastics and transparent wrappings.

Battery Made Into Lamp With Snap-On Bulb

Tiny emergency lamps can be made quickly from a standard dry cell or a flashlight battery simply by fitting the batteries with special metal frames holding small bulbs. The dry cell lamp fits over the top and is held securely by the outside battery post and nut. The bulb rests on the center post and a switch makes contact with the other. A small shade gives it a neat appearance. For the flashlight battery the frame is still more simple. It passes beneath the battery to make contact at the bottom, and a bulb is screwed into the top of the frame. No switch is needed as it is only necessary to remove or loosen the bulb to turn out the light. This frame may be used as a tester for both flashlight bulbs and batteries. Both lamps are handy in blackouts and are economical for lighting dark shelves or cabinets in the home.



Lamps made from flashlight battery and a dry cell

Dr. H. H. Harkins, Dr. Raymond M. Hanson &
 Dr. C. S. Hudson, Natl. Institute of Health
 U.S. Public Health Service, Bethesda, Md., near Wash. D.C.

Mainly by battery frame: Elkay, Ind.
 200-5th Av., N.Y.C.
 Sof - the Emergency Lamp: Marks Prod. Co.

"Screen Test" Finds Best Ambulance Drivers

Machines which simulate actual driving conditions are being used to test thousands of girls for posts in the Southern California Women's Ambulance Corps. They are tested on steering ability and reaction time by means of a clocking device that records the time the driver stays on the road, and the operation of brake and clutch. The machine consists of a driver's seat and steering wheel, recording panel, the picture of a road which moves back and forth and a simu-



The driver faces a moving picture of road

lated hood of a car which the driver attempts to keep pointed directly at an arrow on the road. Whenever the driver swerves from the center of the road a light flashes. The candidates are also given tests for side vision, color perception, and for hearing. The examinations are being conducted by the Division of Drivers Licenses of the California Motor Vehicle Department.

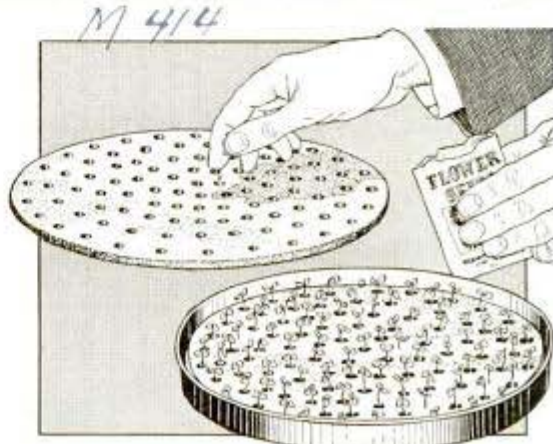


Pointer is slowly moved backward to test range of side vision

Soilless Germinating Disks Start Plant Growth in Water

Seeds can be germinated quickly without soil, by placing them in a 12-inch disk designed for use in a pan of water. The porous disk, one-quarter inch thick, is perforated with holes large enough to receive seeds. It saves time and disappointment for the home gardeners when seeding and transplanting, or testing seeds. Easy to move, the germinator is handy for use in the home, hothouse, and out-of-doors.

Fireproof paper made from clay, which takes printing or writing, may be subjected to white heat without being consumed, and resists acid, alkali and oil.



After sowing seeds, germinator is placed in water

AUGUST, 1942

Dr. Ernst Hauser, Mass. Inst. of Tech.
Dept. of Chemistry, Cambridge, Mass.

Commercial Products Corp.
605 1/2 N. 65th St., Chicago, Ill.

Cont: F. Leland Elam, 3822 Miller Way,
Sacramento, Calif.

TRAINING SCOUTS for WAR WORK

M 245



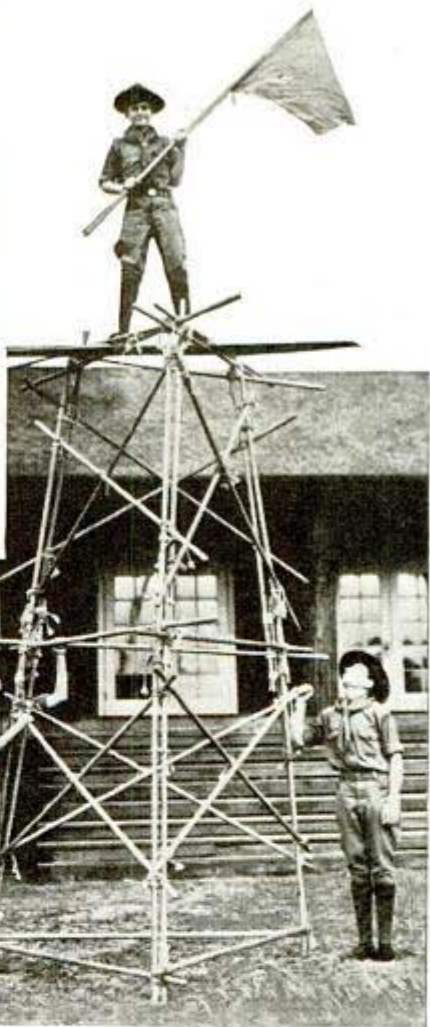
When Uncle Sam called on his vast army of Boy Scouts to help man the home front during wartime they pitched in and organized Emergency Service Corps composed of older boys who are being trained for special duty during air raids, invasion or other emergencies. The hard-working Scouts learn how to give first aid during blackouts (above) by wearing blindfolds. Stiff tests they must pass include climbing an 18-foot rope in 15 seconds (upper right) and crawling over barriers (lower right) such as might be caused by an enemy bomb. Below, two Scouts carry a "victim" on an emergency stretcher which is suspended between their bicycles





Any Scout knows how to tie a knot—but not with a large-sized rope. A fireman (above) shows how a knot can be tied to form a rope saddle for lowering a person from a building. At right, a "signal corps," that some day may relay messages along a beleaguered coast, goes into action with its homemade tower

Sea Scouts—the salty arm of America's Scout Army of 1,500,000—have been "called up" for war training. Below, a group rehearses a "rescue" in a flooded district by removing a member who has sought refuge in a tree. They are also drilled in lifesaving and navigation and every man is handy at the oars



The two Scouts above are practicing the rescue of a person who has been overcome with smoke. The hands of the "victim" are tied securely behind the rescuer's neck so that he can be dragged along the floor to avoid the smothering fumes which increase in density toward the ceiling

*Service Products Corp.
6057 N. 65th St., Chicago, Ill.*

Slabs Under Sloping Lawns Hold Soil and Moisture

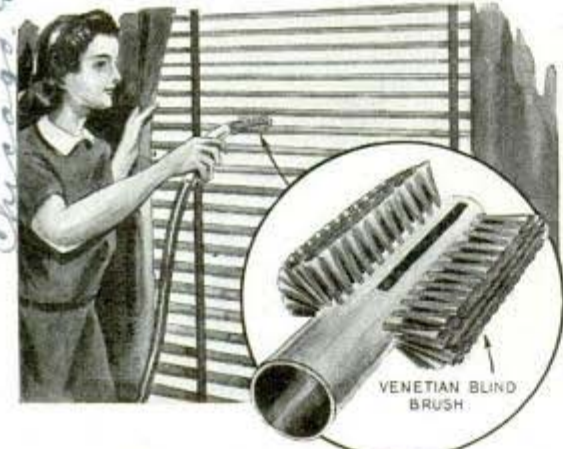


Clay slab (inset) beneath lawn keeps soil in place

Fine lawns can be grown on steep slopes and in sandy areas with the aid of clay underlay slabs which are laid beneath the topsoil to form a nonslip foundation and a water-retaining base. The slabs, a mixture of straw and clay pressed into a solid mass, are tongue-and-grooved so they will interlock when installed. Corrugations prevent the surface soil from sliding or bulging on sloping ground, and on level, sandy ground the slabs keep water from escaping too rapidly.

Venetian Blind Brush Attachment Fits Any Vacuum Sweeper

Made to fit the nozzle of any household vacuum sweeper, a special brush for re-

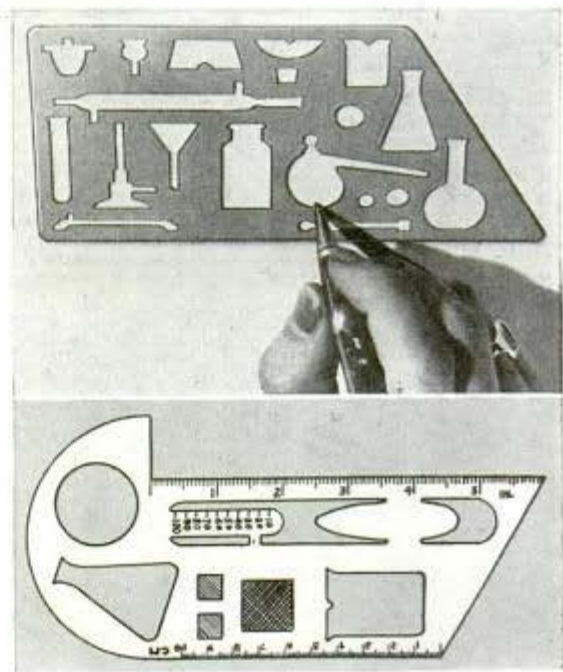


Venetian blind brush cleans two slats at one sweep

moving dust from venetian blinds is now available. Bristles jutting from two sides wipe the underside of one slat and the top-side of the other in one motion. Between the bristles, and opposite each other, are two long vents which draw in all the dust raised by the brush.

Stencils for Scientific Drawings Offer Patterns of Apparatus

Experimenters can make neat, accurate sketches to illustrate their biological, botanical, bacteriological and chemical writings by using two special stencils made of transparent celluloid. The combined biological stencil and guide, 7 3/4 inches long, contains outline patterns in exact size, of a three-by-one inch microscope slide; out-



Chemical stencil, top; bottom, biological stencil

line of microscope field, an inch scale, millimeter scale, various angles, culture tube, agar slant in culture tube, patterns for fermentation tube and gasometer scale, and semicircle of the same diameter as a Petri dish. On the other hand, the chemical stencil helps in drawing apparatus such as crucible and cover, thistle tube, evaporating dish, cork or rubber stopper, beaker, condenser, Bunsen burner, funnel, clamp, circles and support base.

To learn where to buy commercial products described in these pages, see the index.

*Chemical stencil: E. H. Sargenter, 155 E. Sargenter St., Chicago, Ill.
Biological stencil: J. H. Sargenter & Co., 711 Parker St., Pittsburgh, Pa.*

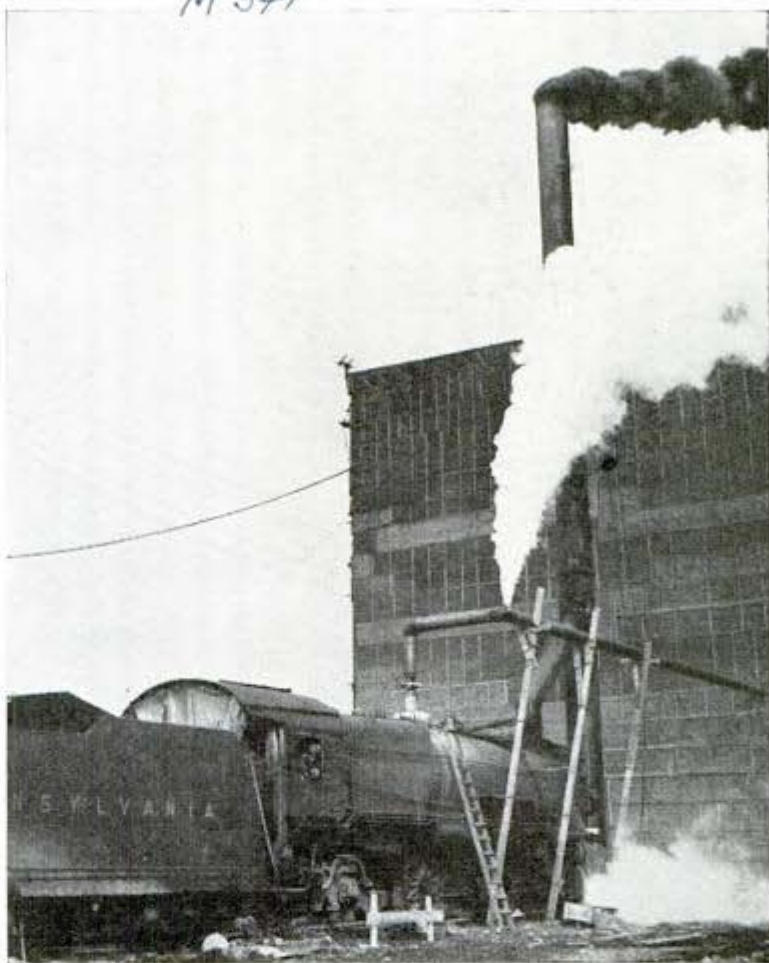
N. B. Dodge & Co., 332 S. Michigan Ave., Chicago, Ill.

East Kittsburg, Pa.

Locomotive Lends Steam to Start New Factory

M 341

Starting the production of marine turbines and gears would have lagged at Westinghouse Electric's new merchant marine works except for the help obtained from an old locomotive. A large section of the plant was ready for operation before the steam heating system had been installed. Recognizing speed of production as the keynote to victory, company officials rented the "iron horse" from a railroad company and ran it to the plant on specially laid tracks. Steam from the locomotive flowed through a line into the plant's system and soon made the building comfortably warm, enabling the men and machines to start a three-shift production program. A 60-foot stack added to the short "funnel" of the locomotive provided a strong draft and sent the smoke skyward.



Steam from locomotive parked outside building heats new defense factory

"Beep" Joins the Jeep and Peep as Courier for the Army

M 399

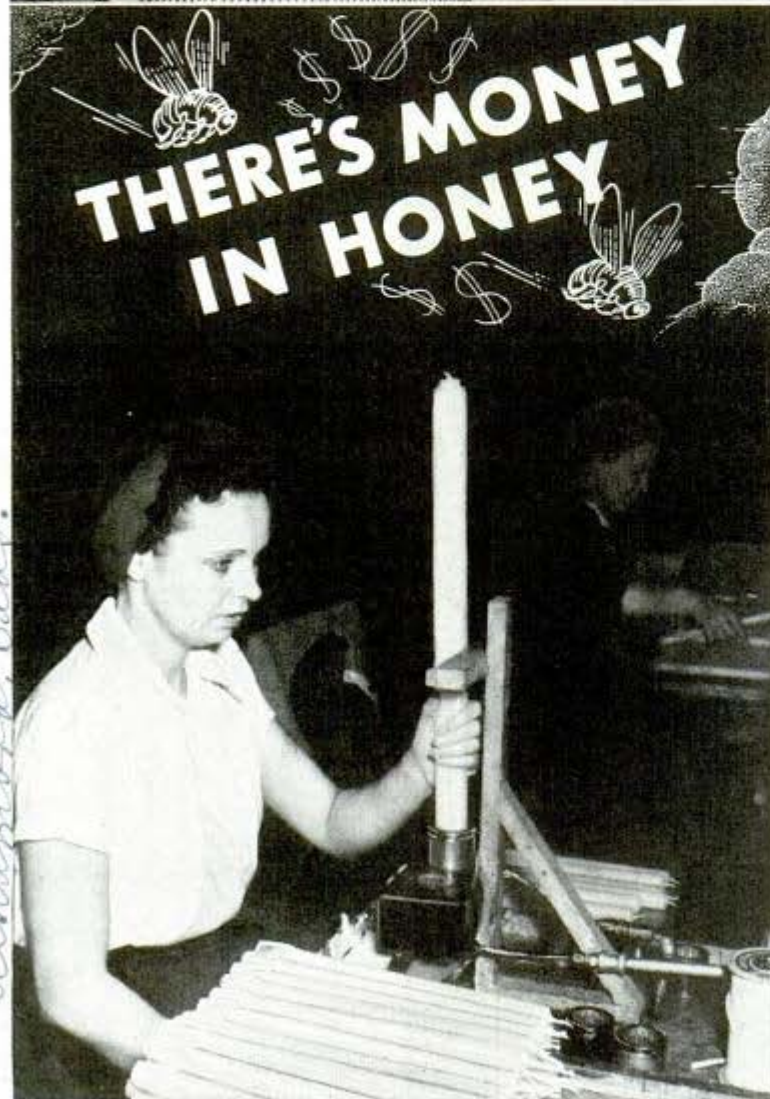


Newest member of the "Jeep" family is the "Beep," a fast little three-wheeled motor scooter that's joined the army as a courier. The jeep and peep, tough little command cars and infantry carriers that will go wherever they're sent, have already attained fame as the rough riders of '42. The beep is an economical carrier with plenty of storage space in front for packages. It has a top speed of 25 miles an hour, and requires little rubber.

This is the "beep," the three-wheeled courier car of the army, here being used for deliveries at an air corps base. It has ample capacity

Cont: Thomas G. Williams, Jr., 3872 Franklin Ave.,
M 205 Los Angeles, Calif.

1124 No. Riverside Ave.,
Alhambra, Calif.



IF YOU live in the country, you can save money by producing honey for your own use, or you can earn money by selling it.

Honey is twice as sweet as sugar and you use only half as much for ordinary purposes.

Fifteen dollars will outfit you with one hive, which will produce from 50 to 300 pounds of honey a year.

Last year beekeepers received an average of a nickel a pound for honey; early this year the price had risen to 12 cents and was still climbing.

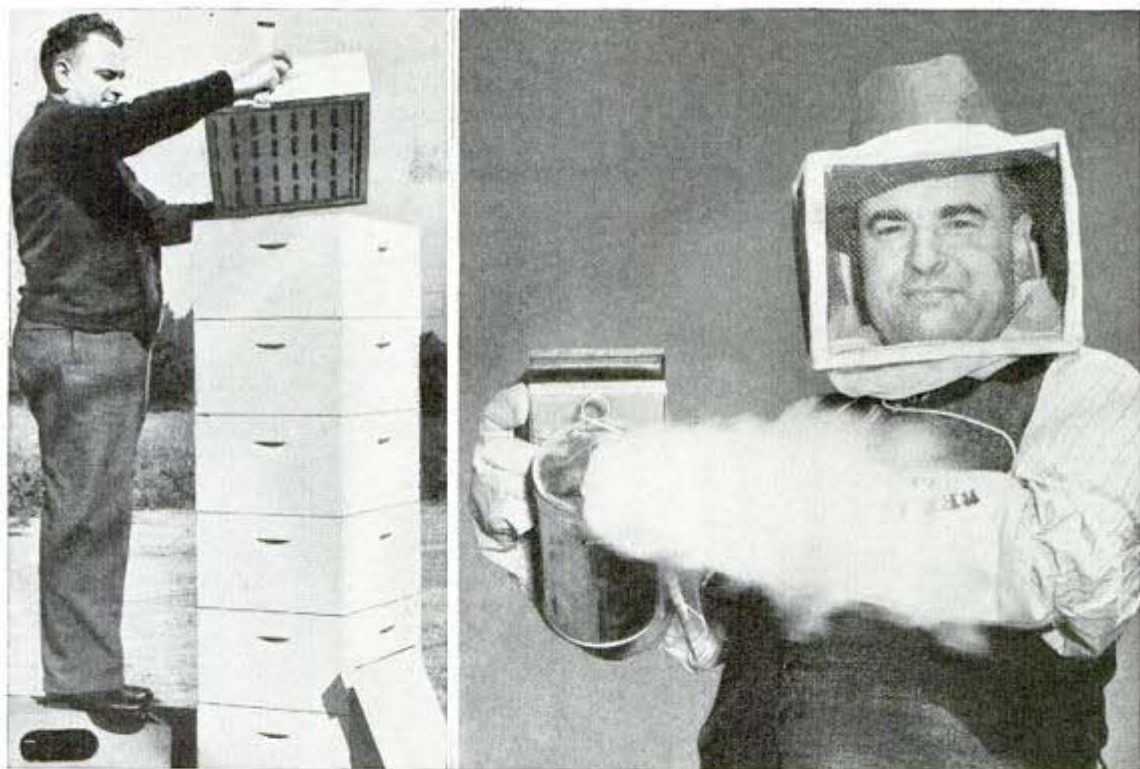
These are a few of the facts about honey that the sugar shortage has made important.

Honey is in demand today as a supplement of refined sugar. It may be used to sweeten tea and coffee, breakfast food, and for all cooking purposes. It is used by bakeries, soft drink manufacturers, and by candy and ice cream makers. Beeswax, a by-product of beekeeping, is also in big demand.

Bees flourish in almost all parts of the United States and if you would like them to go to work for you, consult your county farm advisor on the amount of food available where you live. He can also give you a few tips for starting your colony. Suburban flower gardens won't produce much honey and even in the country a difference of a few miles makes a big difference in

At top, a beekeeper—without benefit of gloves—examines a honeycomb from a hive of bees

Beeswax candles, profitable by-product, are manufactured by rolling a thin beeswax sheet



Left, a skyscraper of top supers that will be filled with honey by bees from bottom hive during a busy season. Right, a bee smoker that uses smoke from burning burlap to pacify bees while working around the hives

production. Clover is the biggest producer of nectar and yet bees have to visit 62,000 clover blossoms to create a pound of honey. In the middle west one hive of bees may be enough to satisfy the sugar requirements of a family while two hives will be needed in other areas.

From a bee supply house you can buy a wooden hive, knocked down and ready to be painted white and nailed together, for about \$3.50. The hive includes a bottom board, the empty hive box, the top cover, and ten frames and sheets of beeswax foundation. Two pounds of bees and a queen, enough to start the colony, cost \$2.75. You also need a honey storage box called a top super. This costs another \$2.50 and is placed on top of the hive, separated from it by an excluder grid that costs 65 cents. The top super may be emptied when partly filled with honey or more top supers may be placed above it.

Plenty of honey storage space must always be available to prevent the bees from swarming and starting a colony somewhere else. The type of top supers that you buy depends on whether you want comb honey or whether you plan to extract honey from the combs and keep it in liquid form.

Comb honey takes the least work but the advantage of extracted honey is that

Back of this upland apiary lives watchman to keep bears and thieves away





Pouring melted beeswax into molds. This wax is to be used by housewives for greasing their flatirons

the combs can be replaced in the top super after the honey has been removed. Relieved of the job of creating more wax, the bees can manufacture a greater amount of honey. To extract the honey you need a centrifugal extractor that costs upwards of \$20. For working around the hives you likewise need a \$1.00 bee smoker, a 75 cent veil, and a 55 cent hive tool.

The two pounds of bees with which you start the colony comprise about 10,000 bees. These should be placed in the hive at least six weeks before the honey season begins. The queen at once starts laying a couple of thousand eggs a day, which mature into bees in 21 days, and which then live and work an average of 45 days. At the peak of the honey season the hive will contain more than 50,000 individuals. Depending on their age, the bees perform various duties such as building honeycomb, gathering water, guarding the hive, collecting nectar, and feeding the queen. The nectar that a bee extracts from a flower consists of about one-third sugar and two-thirds water. The bee converts the sugar into honey and consumes about four-fifths of it, storing one-fifth in the combs. The beekeeper takes 60

percent of this stored honey, leaving 40 percent as food for the bees during the nonproductive winter season.

The first of May is about the right time to start a hive east of the Rockies, while in the west and in the extreme south the hives can be started a month earlier. The season lasts all summer and the bees wind up their work when the asters and golden-rod finish blooming in the fall.

When starting a new hive you should feed the bees with a thick cane sugar and water syrup in a bee feeder placed in the hive. Never feed honey from another colony to a new hive of bees.

Honey production will depend on the availability of food. The hives should be placed within a mile or so at most of some flowering crop, wild or cultivated. Some beekeepers place their hives down wind from the crop in areas where the prevailing wind is steady, so that the bees can "coast" home with their loads of nectar. Production runs from 150 to 300 pounds per hive per year in the middle west to as little as from 25 to 200 pounds in California. Low production in California is because the state has the largest bee population in the country, making for reduced produc-

Placing a filled honeycomb in extractor which will whirl honey out centrifugally without injuring comb



tion per colony, and because of the limited nectar-producing crops in that state. These factors have caused some western bee keepers to follow the crops with their hives. Albert C. Mayer, for instance, operator of the Honeyville apiaries at Monrovia, Calif., has 2,000 colonies that he transports to the local orange groves during the winter blooming season, moving them to the desert when the oranges finish blooming and the wild desert sage begins to bloom, and later taking the hives to still other locations when the wild buckwheat comes into flower.

Beekeepers and farmers form a co-operative team because if it were not for the bees there would be practically no crops. In gathering nectar the bees perform the important duty of pollenizing the flowers. Some insecticides will kill bees as well as injurious insects so farmers try to notify local beekeepers ahead of time when crops are to be dusted, so that the bees can be moved temporarily. Once, in California's Imperial Valley, the owner of a large acreage planted to peas forgot to tell the beekeepers that the crop was to be dusted against aphids and the result was that all the bees in the fields were killed. That was one result;



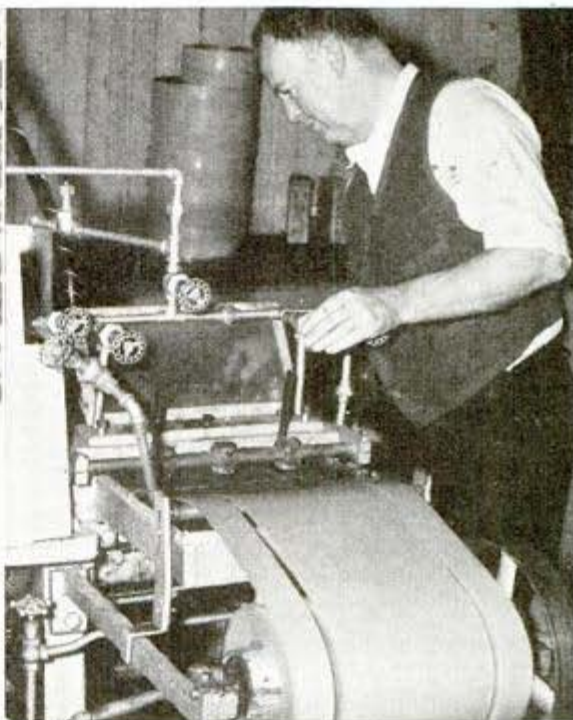
The beekeeper places a new queen in colony at start of season. Bees usually do not sting hands and arms where skin is tough

another was that there was no pea crop that year. The pea flowers weren't pollenized, hence when the pods matured they contained no peas. The impression that bees ruin such crops as apples and grapes by eating the fruit is wrong. The bees feed only at wounds caused by birds.

(Continued to page 162)



Bees have swarmed to the tree, above, because the honey storage capacity of their hive was too small. At the right, refined beeswax is seen coming out of a press in which it is being rolled up into coils



Cole-Herrell Co., 54 Old Colony Ave., So. Boston, Mass.

Emergency 'Minute Wheel' Saves Ruining Flat Tire

M 401



Emergency wheel fits on square extension of the hub

Precious rubber can be destroyed beyond repair by driving on a flat tire. A New York inventor has brought out a "minute wheel" that can serve as an emergency spare to get the car to a garage or to its destination without delay if the time is valuable, as in the case of an ambulance. The wheel fits on a permanent extension of the axle while the tire is still flat, and the car can be driven away immediately.

Drill Adapted to Cut Sheet Metal With Special Attachment

M 356

Any electric or pneumatic drill having a quarter-inch chuck can be made to cut sheet metal by fitting it with a special



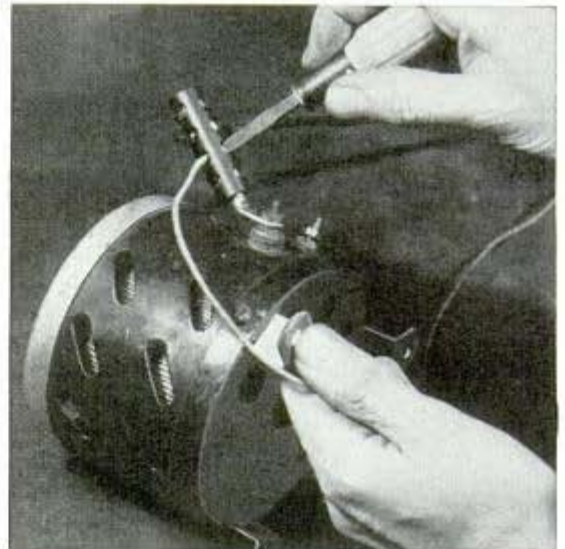
Drill attachment nibbles strip of metal as it cuts

shearing attachment. Operating at twice the drill speed, the blade removes a strip of metal less than one-eighth inch wide, leaving edges that are smooth and workable and need no grinding. In cutting out panels it is necessary to drill a quarter-inch hole in which to start the blade. It also cuts paper or cardboard. The cutting head can be attached to the drill and removed with ease.

Multiple Electric Wire Connector Bolts to Auto Ammeter

M 367

For simplicity in attaching many wires to one electrical contact point, as in hooking up a heater, radio, cigar lighter, fan and other devices to the automobile ammeter, a multiple connector may be used with many kinds of electrical equipment. Consisting of a heavy brass rod within an insulating sleeve, the connector is flat-



Connector bolted to binding post holds several wires

tened, drilled and bent at one end for convenience in fastening it with a bolt. Connecting wires can be inserted into holes in the rod and secured with setscrews.

M 440

Vitamin "A" Yield of Whale Oil Is Doubled by Heating

Hitherto discarded as an impurity when extracting vitamin A from whale liver oil, a chemical known as kitol is now being converted into the vitamin by heating to 500 degrees Fahrenheit. This will double the amount of the vitamin obtained from whale and probably other fish liver oils.

POPULAR MECHANICS

Ref: also? axis D. Embrose & Edgar M. Schantz, distillation Prods.

no address

*Bro: Nicholas J. Graves
Yonkers, N. Y.
E. H. Timper & Associates
Hudson, N. Y.*

War Emergencies Call for Home First-Aid Kit

Basic items that should be in every home medicine chest to care for wartime casualties have been listed for American citizens by a government department. The essentials include sterile gauze for bandages and adhesive tape, scissors, tweezers, clinical thermometer and a group of simple medicines. Topping this list is a tannic acid jelly for burns; greasy ointments are advised against. Five-grain tablets of aspirin are suggested for relief of pain, but these are to be used in small doses and not too frequently. For faintness, the medicine chest should have a bottle of aromatic spirits of ammonia. Bicarbonate of soda is indicated for indigestion, and in larger quantities as an emetic. For laxatives, mineral oil or milk of magnesia are suggested. An antiseptic such as iodine is also a valuable standby.



Courtesy Bauer & Black
Here's what home medicine chests should hold ready for wartime injuries

Two-Wheel Sickle Bar Mower Cuts Close to Obstacles

Cutting weeds along railroad track shoulders, ditches, banks and around bridge pilings, trees, and other obstruc-

tions, is simplified with a two-wheeled, heavy duty sickle bar mower, powered by a two-horsepower gasoline engine. When



Motor-driven mower permits cutters a close approach to obstructions

working in close quarters or around obstacles, the operator can release the traction clutch and maneuver the cutter by hand. For traveling from job to job, the sickle bar may be left idle. It will cut weeds of any height, a special deflector keeping the cut plants from jamming the bar. The mower cuts a swath 40 inches wide, the speed range being from one to four miles per hour.

AUGUST, 1942

distr: Moto-Mower Co. (Discontinued until after war)
1045 Washington Blvd. Chicago, Ill. 7/9/42 87

Source: Mfg Co. Bauer & Black, New York, N.Y. Photo: Mr. Chicago Mr. Kendall Co.

They **PLAY JACKSTRAWS** with **TREES**



The wanigan goes through at full speed with the men aboard putting full pressure on the steering arm to avoid a rocky point ahead

Whitewater men must step lively when the big timbers start rolling



Releasing log stuck on rock at edge of fast channel is dangerous job



WHEN hundreds of grinding, crunching logs pile up in a roaring river and it's up to you, as you balance yourself on a wet, rolling timber, to break the jam—then you have to have nerve. Lose your balance, miss a step and it's all over.

To be sure there are not as many log jams as there once were. Railroad trains and trucks, instead of rivers and spring floods, now transport logs in most lumbering centers, but out in the Pacific Northwest, in the Panhandle of Idaho on the North Fork of the Clearwater, the wanigan still comes down. Wanigan or wangan was the Indian name for boathouse or houseboat, and the wanigans, carrying the cook shacks and supplies, floated down the rivers when the pioneer log drives were underway. Occasionally, in some of the northeastern states, the wanigan traveled on a wagon trailing along shore as near the logging as possible.

The Clearwater river, down which Lewis and Clark pushed their dugouts and canoes in their hazardous effort to reach the Snake and Columbia and at last the Pacific, is one of the last on which wanigan-followed log drives are staged. And where the wanigan is, there also are the whitewater men. There's Pete,—one of the burliest, biggest handed of all and with a lusty roaring voice when he's really angry. But Pete's superstitious about the way he speaks to logs. He sort of coaxes them. When he's out



Into the flume goes a big timber as the crews prepare for the start of a drive down the river; the logs are carried in this manner to the deep, roaring water for the trip downstream to the sawmill

there playing jackstraws with a wet stick weighing in the neighborhood of a ton, balanced so it might roll over on him any minute, and he has only his peavey to help him push it the right way, Pete talks softly to the log, murmurs and whispers almost caressingly. Sounds absurd, but Pete has one of the best records on the river.

The work and the thrill and the danger start right at the beginning of the drive. Back in the forest, cutting and felling crews

have been piling up logs for months—thousands of them ready for floating downstream in the spring. When the snow begins to melt, picked crews hear the call “Roll out or roll up” and in the cold dark of the morning, they do roll out.

Chances are that logs loom high above their heads, for if possible the cutting crew

(Continued to page 162)

Breaking a log loose from the lower side of a jam, men must keep on the alert. Object is to free the key log in the mass →

On the quarter-deck of one of these logs, a man must watch his step. If he slips off a rolling timber, it may mean death



Wooden-Tired Milk Wagon Saves Use of Rubber



Milk truck equipped with wooden tires on iron rims

One of the first vehicles to discard its rubber tires due to the shortage of rubber was a milk wagon operated by a dairy in Waukegan, Ill. The new tires, made of wood, are mounted on iron wheels.

Indoor Reel Attached to Faucet Feeds Hose Through Wall

Permanent installation of the garden hose, with direct connection to the water pipe, has been made possible with a reel designed for mounting on the basement ceiling. The hose is passed outdoors



Hose reel on ceiling is connected direct to faucet

through a lead-in pipe, and is returned to the reel by pushing the hose back through the opening. It coils itself up automatically on the reel, which rotates as the hose is fed. Water is turned on and off from outside the house by means of a through-the-wall extension from the valve. A lock at the wall outlet protects the hose against theft while it is stored indoors safe from ill effects of the weather. The hose is ready for instant use either for sprinkling or any emergency. Since it can store air hose as well as water hose, the reel is being used in both industrial plants and homes.

Twin Vase Made by Hammering From Single Copper Disk

Starting with a copper disk 21 inches in diameter, William E. Hummel of Santa Barbara, Calif., hammered it until the metal was formed into a "Siamese twin" vase. There are no welds or any soldered joints.

21 W. Ortega St.



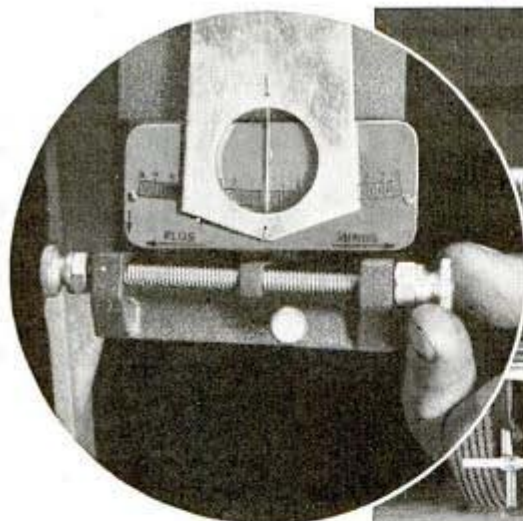
Twin vase hammered from disk like one in background

and the only tools used were hammers of different shapes, a stick of wood, a tapered railroad iron, and a gas plate for annealing. The copper, 21 gauge, was all hammered cold. Approximately 100 hours were required to complete the vase. The connecting link between the "twins" is hollow.

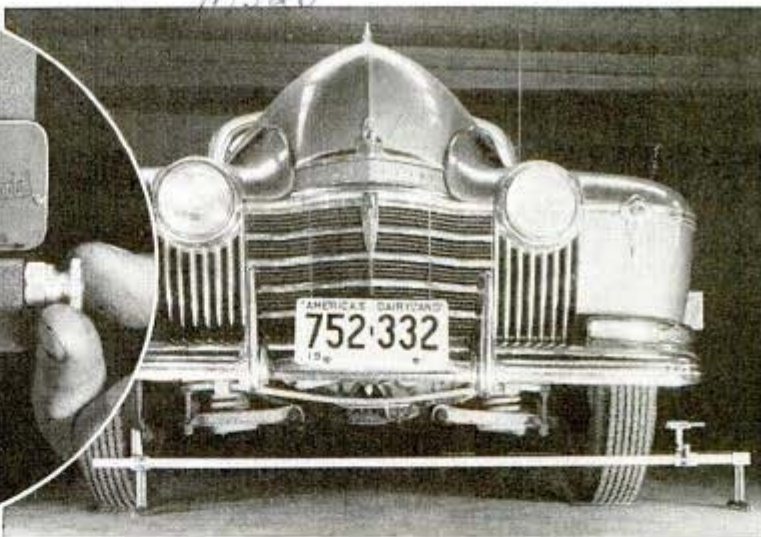
Names and addresses of makers or sellers of commercial products described in this magazine are listed in the Where-to-Buy-It index. Write to them for additional information and be sure to Say You Saw It in Popular Mechanics.

Everett Bauer making delivery.
 Garden Machine & Mfg. Co.
 St. Francis, Mo.

Portable Wheel Aligner Saves Garage Space



Dial, above, indicates both camber and caster. Right, top, toe-in trammel bar and gauge; bottom, angle gauge shows up bent radius rod. All parts are easy to handle



Permanent obstruction of floor space in the garage is avoided with a portable front-wheel alignment unit that takes the mystery out of the work. Consisting of two camber and caster protractors, a toe-in trammel bar with gauge, and an angle gauge, the device accurately checks wheel camber or caster, toe-in and toe-out, and indicates bent radius rod, all

by simplified methods. Plus and minus signs on a dial indicate the camber and caster. When the toe-in trammel bar is used, no chalk markings are required.

Homemade Motor Scooter Runs 120 Miles on a Gallon



M 365

Tubing found in a junkyard, discarded tires from tail wheels of airplanes and a 1½-horsepower gasoline engine from a lawnmower went into the assembly of a motor scooter constructed by Jack Edwards, airplane mechanic for Delta Air Lines in Atlanta, Ga., as the solution of his transportation problem. The pieces of tubing were bent into shape and welded to make the frame, and the tubular spring used over the front wheel is somewhat similar to the hydraulic springing arrangement on airliners. The scooter was built at a cost of \$27, including the engine. Its top speed is 40 miles an hour.

Delta Air Corp., Mechanics Airport, Atlanta, Ga.

Courtesy Delta Air Corp.
Motor scooter carries plane mechanic about airport

¶ To learn where to buy commercial products described in these pages, see the index.

Cont. Thomas E. Hineon, Jr., 355 Franklin Av.
Los Angeles, Calif.

FIGHTING FIRE with MAGIC

M 125



Firemen, here answering an alarm, are well trained; but are civilians?

TWO firemen were arranging a toy house on the school stage. "Want to see what's inside this magic house?" one of them asked. He lifted off the roof while his partner picked up the four walls and tilted them toward the audience. Everyone could see the small building had nothing inside.

A couple of minutes later the firemen who had turned magicians for the occasion

learned things about common fire hazards in a way they won't forget.

Today in some cities an inspector is apt to walk unannounced into a school, stopwatch in hand, and tell the principal: "This is an emergency fire drill. You are to pretend that the building is on fire and that rain has shorted out your electric alarm system. What are you going to do?"

Carbon dioxide extinguishes fires by cooling below the ignition point



were extracting a lighted cigaret, a small stove, an incinerator shooting off sparks, and armful of cloths and draperies from the "empty" house. The fascinated audience watched with amazement while a lighted electric lamp on the end of a short frayed cord, and other items that often cause fires, were likewise produced from the empty "house of hazards."

Teaching fire safety by pulling rabbits out of hats and cooking cakes in schoolboys' caps is a novel method that really works. When Captain H. H. Ross and Inspector Charles W. Bahme of the Los Angeles Fire Department pack up their bag of tricks after giving a demonstration they leave behind them an audience of students who have

Once a principal rushed to the hallway and yanked the cord of the manual gong that all schools should have. But the cord broke and the principal stood perplexed. The inspector examined his watch and announced: "The fire is gaining headway every second. You have 500 students in this building and had better get them out." At once messengers were sent to every room and the fire drill commenced. That afternoon, a sturdy metal chain was installed on the fire gong.

Ref. Inspector Chas. W. Bahme, Los Angeles Fire Dept. Hdqrs. Los Angeles, Calif.



Students learn things about fire hazards they won't forget, when Los Angeles firemen open their bag of tricks

In another city an inspector visited a large wood frame school. He was appalled by what he found. Some of the doors were nailed shut and couldn't be pushed open. The basement was littered with rubbish. The auditorium was a real fire trap. One exit, the light above it smashed, opened into a dark hallway with a locked door at its end. Another main exit led down a stairway under which paints and other combustibles were stored. If fire ever started during school hours it would take a miracle to get all the children out unharmed.

Conditions at this school were exceptionally dangerous, yet numerous fire hazards exist in thousands of schools. Fire prevention officials are trying to eliminate every hazard they can find. In Los Angeles, for instance, Fire Chief John H. Alderson has a special inspection detail that assists school authorities in their watchfulness against fire.

Five schools catch fire every day in the United States. One booklet alone, issued by the National Fire Protection Association, analyzes 1,000 school fires that occurred in the 10 years previous to 1939. Eight hundred eleven people died



Firemen carry a hose up the ladder and into a school window

Leaders halt a column of children in "blocked exit" fire drill





The firemen's "house of hazards" is taken apart to show it is empty. In the foreground are the articles afterward removed from it by magic

in 60 school fires since 1903 and this list is not complete. The death list would have been much greater, probably, except for the lucky circumstance that many fires started after school hours.

How do schools catch fire, anyway? Officials have spent millions of dollars for fireproof construction, safe heating apparatus, spark arresters, and other means of fire prevention. The trouble is that in the safest building built, poor maintenance or pure accident can convert the structure into a potential incinerator. Spontaneous combustion started 66 fires out of 1,000. One miscellaneous cause was a truck that crashed into a building and ignited it.

One estimate is that 60 percent of the nation's schools are of the old wooden fire-trap type. Many of these, however, are considered safer than some modern concrete buildings because the instructors and maintenance men, aware of the hazard, are most scrupulous in guarding against fire.

Fire officials point out that even if a building is fireproof, its contents and children aren't. They frown, for example, on the former common practice of storing sweeping compounds, dust mops, and oily rags under a staircase. Such materials may ignite by spontaneous combustion and although the fire can't burn the concrete steps, hot fumes and smoke rising up the natural flue a stair opening makes can cause panic and deaths on upper floors.

Fire inspectors recommend that ev-

ery classroom have two exit doors, but sometimes they find one door locked or blocked by a piano. Every door should be openable from the inside, a rule that would have made it impossible, as once happened, for a fire inspector to find a child locked in the closet of a vacant classroom. The door had swung shut when she entered. A one-story school is safer than a school of several stories, but an Oklahoma school in which 38 were burned to death was a one-story structure. Its doors opened inward.

It was a good thing that a fire inspector insisted on

checking every detail of one school that seemed perfectly safe. On the third floor he found a door leading to a fire escape was locked. The passageway behind the door was used as a storeroom. The window to the fire escape itself was locked and nailed down, to prevent entrance of thieves. Today the lock has been removed from the

Panic bar on exit won't work, and the door is nailed shut. An hour's work makes the door safe again



door, the passageway is clear, and the window is locked against outsiders but anyone inside can break out in case of need.

Inspectors see that fire hose is racked properly, that fire extinguishers are freshly filled and uncorroded, and that all doors swing outward easily and that their panic bars actually operate. Exit lights should always be burning. Spark arresters on incinerators should be replaced before they burn out. Fire drills should be held frequently.

Some schools have student fire brigades whose members open classroom doors when the alarm rings, check each closet, and shut the room doors after the rest of the students have left. Occasionally a blocked-exit drill is held to train students to keep their heads in case an exit is blocked by fire or barricade. Leaders of the column, reaching such a blocked exit, raise their arms overhead to signal those behind. The students are trained, in such a case, to do an about-face and march to another exit, instead of crushing forward. Fire drills should be conducted at a walk to prevent tripping, and handrails should be installed on all stairs.

Keeping children safe at school is one part of fire prevention work; another important part is teaching them safe habits they can use in their daily lives. Areas such as Kansas City and West Virginia have found that such education reduces the per capita fire loss as much as 75 percent.



↑
Fireman-magician uses an extinguisher on a student's hat that has "accidentally" caught fire in a demonstration

Testing the panic bar on every door every day is part of this school janitor's routine. It should be so in every school →

Passageways of proper width, guide fence separating opposing traffic and handrails on stairs make this school safe ↓



Combat Pack Lightens Load On U. S. Marine's Back

M. 366



Pack carried high on shoulders takes load off back

To take the heavy load off the back of the U. S. marine, a new method of pack suspension has been adopted, replacing the World War I "heavy marching order" and combat pack. The new pack rides high on the shoulders where it causes less fatigue to the back. Included in the pack are two canvas sacks, one replacing the haversack and the other having space for extra clothes and other articles.

Steam From Bread Harnessed To Make Alcohol for Fuel

Strange sources of substitute motor fuels for civilian use in blockaded Europe are revealed in recent studies made by Dr. Gustav Egloff and P. M. Van Arsdell of the Universal Oil Products Company, Chicago. A baker in Sweden is fueling 30 trucks with alcohol condensed from the steam of baking bread. In France and Spain grape alcohol is used as a substitute for gasoline. Gas from garbage disposal plants, peat

from the bogs of Holland and even wooden paving blocks ripped from Paris streets are helping to keep the cars of civilians rolling during the war. These substitutes release vital quantities of liquid fuels for military use. Dr. Egloff estimates that development of synthetic fuels has made some 122,700,000 barrels of fuel available to the Axis powers, while the Russian campaign has been costing Germany about 21,500,000 barrels of oil per month. Substitute fuels in the form of compressed gases, liquids (alcohol, turpentine, benzol and shale oil) and solids (peat, coal and wood) are used almost exclusively for civilian transport. The result has been the appearance of wood-burning and coal-burning automobiles, gas stations dealing in wood chips, tanks of compressed gas and other substitutes. At the end of 1941 it was estimated that civilians in Europe were operating 107,225 compressed gas vehicles and 373,143 producer gas cars.

Home Kit Prints Cloth Patterns In Sunfast, Washable Colors

Plain, inexpensive fabrics can be transformed at home into attractively decorated tea towels, curtains and bedspreads by applying color with a kit that requires no experience. The user prepares his own stencils with the cutter, stencil paper and assorted patterns contained in the kit, which also includes special liquid textile coloring and suitable brushes. Colors are washable and sunfast, and easy to apply.



Kit holds all material needed for printing on cloth

310 S. Michigan



The CRAFTSMAN

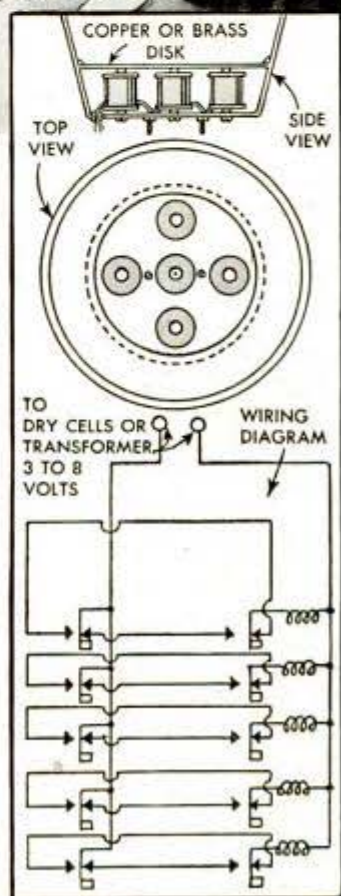
"Sink 'em"

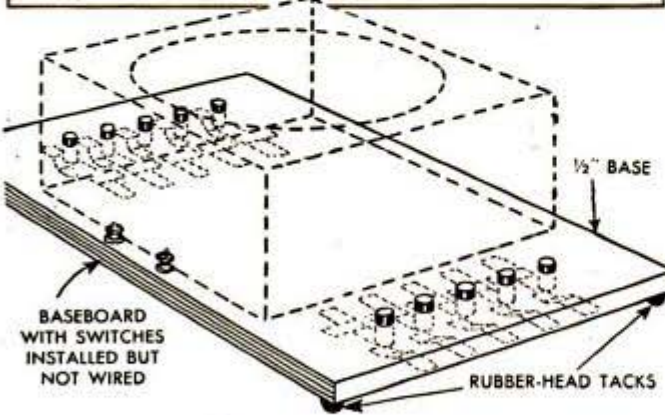
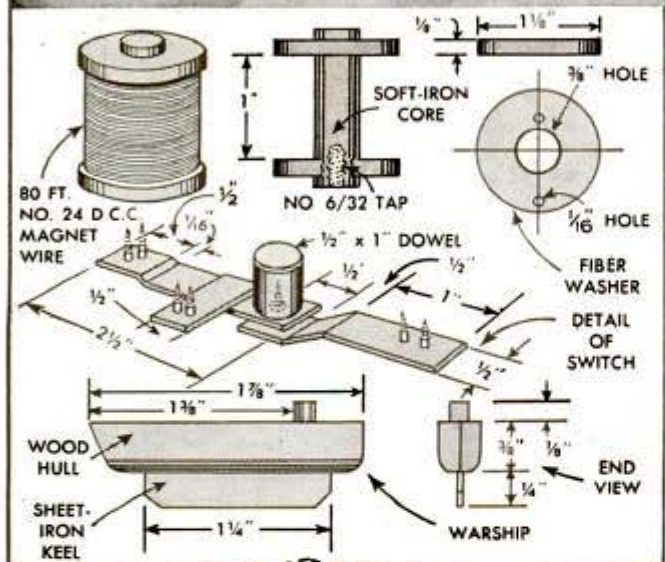
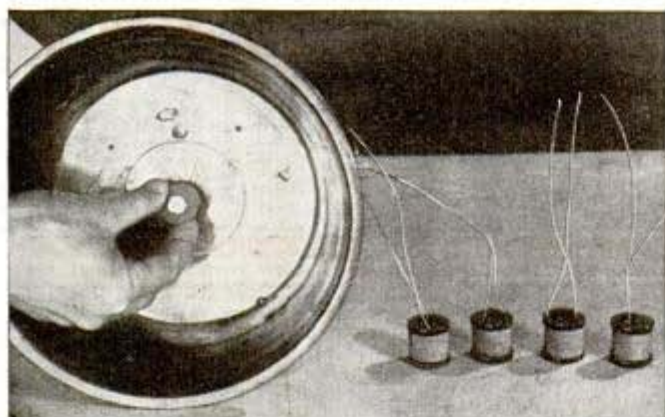


Table game in which toy warships are "sunk" with concealed electromagnets. The players must be alert and act quickly

By W. B. Ford

THIS game will provide many hours of fun and entertainment for adults as well as children. It consists of a tin pan having five electromagnets concealed under a false brass or other non-magnetic metal bottom, the upper part of the pan being filled with water on which miniature ships float. Pushbuttons control the magnets which, when energized, attract iron keels on the boats and pull them under the water. The winner of the game is the one who sinks the greatest number of his opponent's ships within a given time, or who first reaches a predetermined number of sinkings. As you will notice in the wiring diagram, each magnet is wired to two pushbuttons so that either player can control it, but a player can forestall a sinking if he anticipates what his opponent will do and is quick enough to press the pushbutton on his side. This action breaks the circuit so that the magnet cannot be energized. For example, if one player starts to sink a ship, the opponent can bring the ship back to the surface again. To score, a player must make the





ship actually touch the bottom of the pan.

Forms for the electromagnets consist of $\frac{3}{8}$ by $1\frac{3}{8}$ -in. iron rods, with $1\frac{1}{8}$ -in. fiber washers placed over the ends. One end of each iron core should be drilled and tapped to provide mounting threads. Each form is wound with 80 ft. of No. 24 d.c.c. magnet wire, passing the ends of the coil through $\frac{1}{16}$ -in. holes in the fiber washer nearest the threaded end of the core. All coils are wound in the same direction so that like poles are at the top. The magnets are

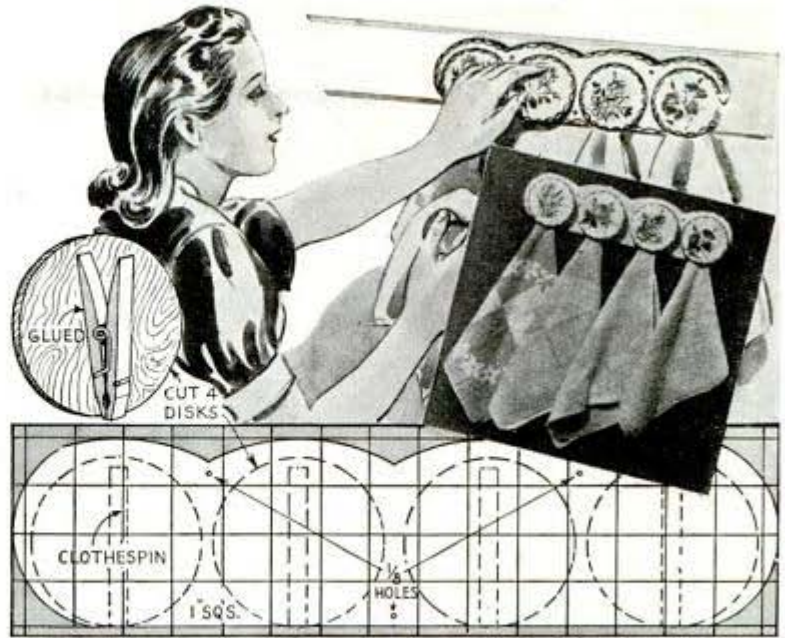
spaced evenly around the bottom of the pan, one being placed in the center. As all of the coils have a common lead, one wire from each coil may be soldered directly to the inside of the pan. The remaining five leads should be brought through a hole in the bottom of the pan, using a rubber grommet as an insulator. Two 1-in. machine screws soldered to the bottom of the pan secure it to a baseboard. The false bottom is soldered to the side of the pan, directly over the magnets. There are ten pushbuttons; each consists of a strip of spring brass fitted with a wooden knob at one end, the other end being screwed to the mounting board and wired to one side of the current source. Stationary contacts are placed above and below the spring strip, which remains against the upper one except when the button is depressed to touch the lower one. The contacts are connected to the magnets as indicated in the wiring diagram. A wood housing is made for the pan and is mounted on the baseboard. Terminal screws are mounted on the baseboard, and the unit is wired as shown.

The miniature warships are formed from pieces of $\frac{3}{8}$ -in. wood dowel, with pieces of smaller dowel, or matches, for the funnels. The keels are made from pieces of sheet iron, which are sharpened with a file and driven into the wood hulls. The ships should be just buoyant enough to keep afloat when the magnets are not energized. The keels should be made larger than necessary, then the ship should be placed in a vessel filled with water. By trimming the keel with tinsnips, the correct buoyancy can be determined easily. The game may be operated with dry cells, storage battery, or a low-voltage transformer.

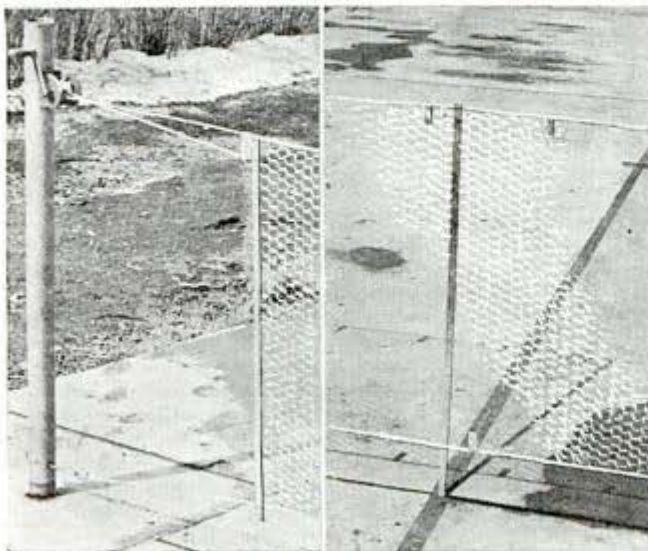
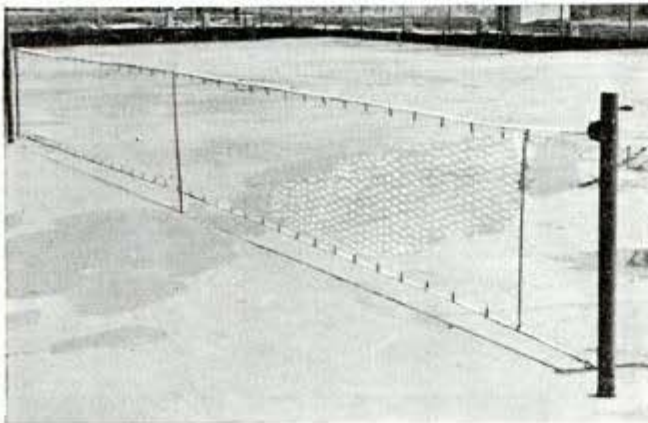
“Philippine mahogany” has about the same relation to genuine mahogany as Hudson seal (dyed muskrat) has to genuine sealskin. “Philippine mahogany” comes from trees that are as unrelated to genuine mahogany trees as oak or maple.

Towels Cannot Slip From This Bathroom Rack

Hung on a kitchen or bathroom wall, this decorative rack keeps towels and wash cloths separated when hung up to dry. Spring-type clothespins glued and bradded to a scrolled backboard and covered with wood disks grip the towels or cloths. After jigsawing the backboard to shape, take the pins apart and glue one leg of each to the board. Attach a disk to the other leg of each pin, countersinking the brad heads and putting the holes, then reassemble the pins and paint the rack.



All-Weather Tennis Net of Wire Need Not Be Removed



Used at the State Teachers College of Wayne, Nebr., in conjunction with their new concrete courts, these metal nets can remain up indefinitely. The nets are made of chicken wire, which is fastened to two horizontal supporting wires by means of riveted sheet-metal clips. Metal strips in the center and at each end of the net tend to keep the wire stretched vertically. Tightening of the net is accomplished in the conventional manner.

—John A. Moore, Wayne, Nebr.

Tracing Faint Blueprints

Where it is necessary to make rough drawings in the field or on the job that have to be traced over old blueprints that are often faint, I have found that sheets of clear Cellophane are highly suitable for the overlay. Draw on the Cellophane with a grease pencil of the type used for marking china and glassware. A sketch or drawing made this way may be water-proofed by spraying with an ether-collodion mixture.

—A. M. Chester, Seattle, Wash.

W.T.M. Concrete

Solving HOME



1. Dresses and slips with shoulder straps often slip off a curved wooden hanger, but you can overcome this trouble easily by attaching an extra hanger in an inverted position, using rubber bands around the ends to hold them together. 2. When doing light laundering or when washing photo prints in a lavatory, a slow drain of the water is provided quickly by snapping a rubber band around the stopper as shown. Attaching an ordinary vacuum cup to a sink or bathtub stopper also makes it possible to suspend the stopper at any convenient place on the porcelain surface, eliminating the nuisance of having it fall into the draining water or misplacing it



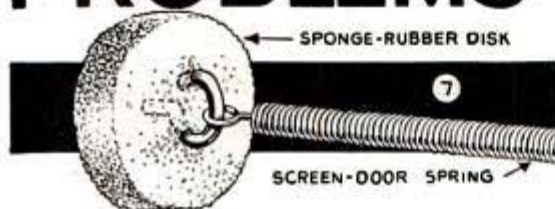
3. Next time you find it difficult to turn the wire opener on a can of sardines, try slipping a screwdriver or similar tool through the looped end of the opener so that it can be used as a lever, which makes it possible to turn the opener with little effort. 4. To avoid having a bar of laundry soap slip or fall off the washboard when lifting or moving it about, simply fasten the comb guard from a discarded safety razor onto the board in the position shown. A couple of screws will keep the guard in place, and by pressing the soap against it, the bar will be held securely, especially when it has been softened from being in warm water



5. When frying meat or other food on top of a stove and you don't want to put a tight-fitting cover over it, hot grease can be prevented from popping out by inverting an ordinary colander and placing this over the pan. The colander should be just large enough so that the top of it slips over the outside edge of the pan. 6. If you have a number of milk bottles to sterilize, the task can be accomplished quickly by placing a small teakettle full of boiling water in a baking pan and then setting these over the flame of a gas stove. As the bottles are slipped over the teakettle spout, steam will enter them and flow down into the pan after condensing

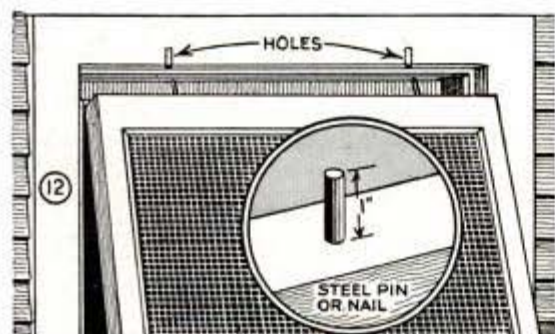


PROBLEMS



7. Driving the hook of a screen-door spring through a small sponge-rubber disk provides an effective means of covering the hook end so that it will not catch on clothes and tear them. Although the hook end extends into the rubber, the spring can be removed or replaced again easily by compressing the rubber at the point where the hook is embedded. 8. Time required to put up or take down a clothesline is reduced to a minimum when screw eyes are driven into the poles and harness snaps are tied on both ends of the line. A similar snap attached permanently to the top of the clothesline prop is also useful as it eliminates danger of the line slipping off

9. The rubber gasket around a refrigerator door will last much longer if it is coated with talcum powder at least two or three times a year. Such treatment has been found effective even after a gasket has become sticky. 10. Requiring only a few minutes to make, this safe and convenient kitchen-knife rack fits on a cupboard door. It consists of a $\frac{1}{4}$ -in. piece of wood onto which are fitted small cleats that serve as partitions between the knives. After staining or painting the rack to match the cupboard, it is attached to the door with a brass screw at each end. If desired, the outer panel can be made wide enough to cover the entire length of the knife blades



11. You won't have to worry about flower pots marring window sills if a discarded fruit-jar rubber is slipped under each pot. Protectors of this type also provide excellent nonslip bases that keep the pots from being pushed off the sill easily. 12. A good way to hold window screens in place is to drive two nails or steel pins in the top of the screen frame about 6 in. from each end. Then mark the positions of these pins on the window frame and drill two holes slightly larger than the pins at these points. To install the screen, all you need to do is slip the top of it in place and lock the bottom part of the frame with an ordinary hook and screw eye



Basket Prevents Soiling the Flag When Raising or Lowering It



One school janitor uses a market basket to keep the flag from becoming soiled by coming in contact with the ground. When the flag is lowered each evening it is folded into the basket, which makes it easy to store at night. When raising the flag in the morning, it is attached to the ropes and pulled out of the basket.

Light Outside of Screened Porch Helps Keep Bugs From Entering

If tiny bugs come through the screens of your porch, try mounting a light outside above the windows, as indicated. It is the light that attracts the bugs, of course, and



if it is outside they will have less tendency to try to reach the light inside the porch.
—Mae Foster Jay, Springfield, Ill.

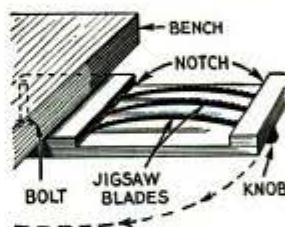
Ordinary Desk Ruler Improved With Stop Fitted on End

Measuring the length of articles quickly with an ordinary desk ruler, can be done with less trouble and greater accuracy if the ruler is provided with a stop in the form of



a small angle bracket. The bracket is attached to one end of the ruler with a small screw or it can be held in place by a liberal application of household cement.

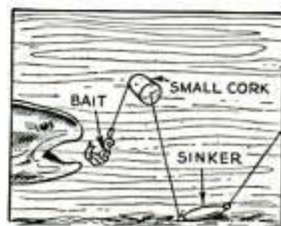
Jigsaw Blades Selected Quickly From Holder Under Bench



To keep jigsaw blades handy and exposed for instant selection, cut a notch in a narrow board and pivot this with a small bolt or screw under your workbench. The notch should be slightly less in width than the length of the saw blades so they will wedge in place and at the same time bow up slightly in the center, making them easy to grasp. If desired, a knob may be added on the underside of board to make it easier to pull out.

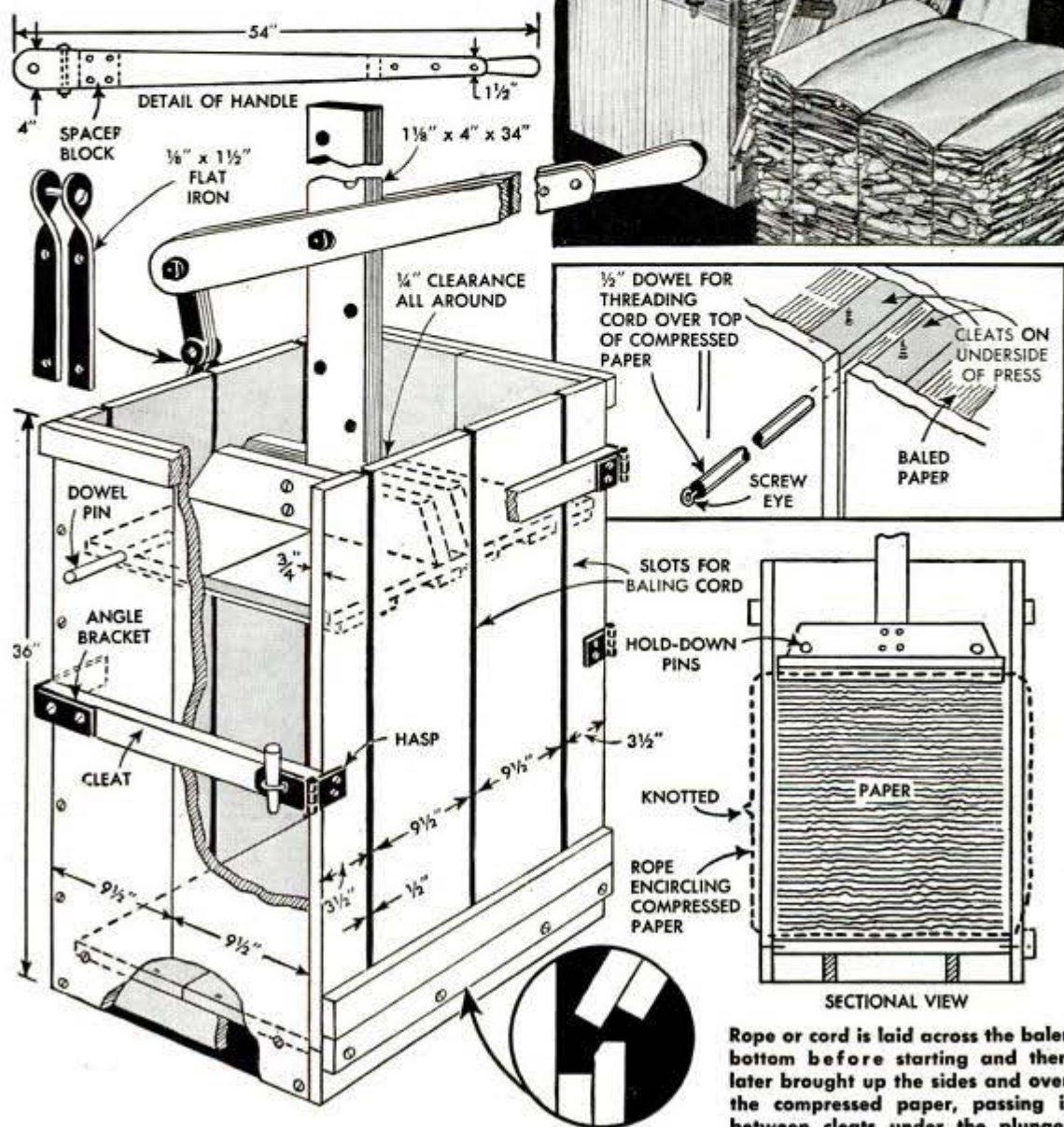
Fishhook Kept From Snagging By Use of Small Cork

Placed on a fishing line between the sinker and hook, a small cork will keep the bait off the bottom of a lake or river and prevent it from snagging. The cork should be large enough to float the baited hook, but too small to lift the sinker. A cork of the proper size used in this manner will not interfere greatly with ordinary casting.



Bale your WASTE PAPER!

If you are saving waste paper, this inexpensive baler will enable you to compress it for easy handling and to take little storage space while waiting for the collector. Made from stock lumber, all sides of the baler are reinforced, and one side is held by staples and hasps so that it is easily taken off for removal of the paper bale. The plunger should have at least a $\frac{1}{4}$ in. clearance all around. Holes are drilled through opposite sides of the baler for the insertion of dowels, which hold the plunger in the compressed position while tying the baling cord in place.



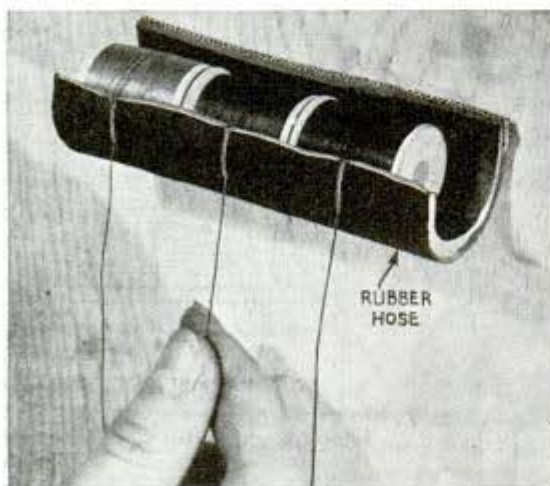
Combination Date-Stamp Holder And Ink Pad



If your work requires frequent use of an adjustable date stamp, you will find this combination holder and ink pad a time saver. It consists of a block of hardwood slotted in the center to take the stamp, the bottom of the slot being fitted with a piece of sponge rubber which serves as an ink pad. With this arrangement, the stamp is always ready for use when it is lifted from the holder.—Paul H. Smith, Norfolk, Mass.

Hose Trough for Tailor's Thread Keeps It From Tangling

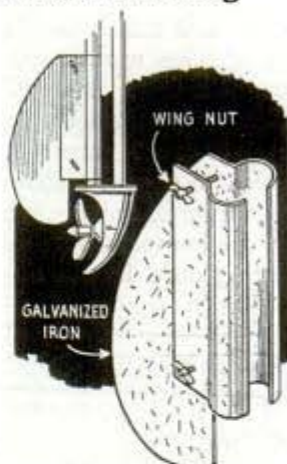
To keep his spools of thread handy and at the same time prevent them from rolling or tangling, one tailor made a trough from a half-section of rubber hose and tacked this on a wall. The hose was slit at inter-



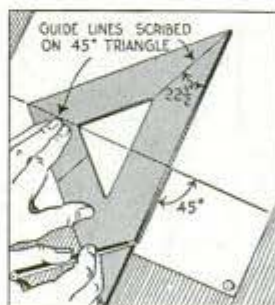
vals along the outer edge and the thread ends drawn through these so they would hang free for easy selection. Friction of the rubber permits the thread to be unwound without tangling.

Removable Rudder on Outboard Steers Boat When Trolling

The difficulty of steering an outboard motorboat at slow speeds for trolling was overcome by one fisherman who fitted the motor with a removable rudder. This was made of sheet metal and clamped to the motor as shown. The sheet metal should be heavy, and the exact method of clamping will be determined by your particular motor.



Improving Drafting Triangle



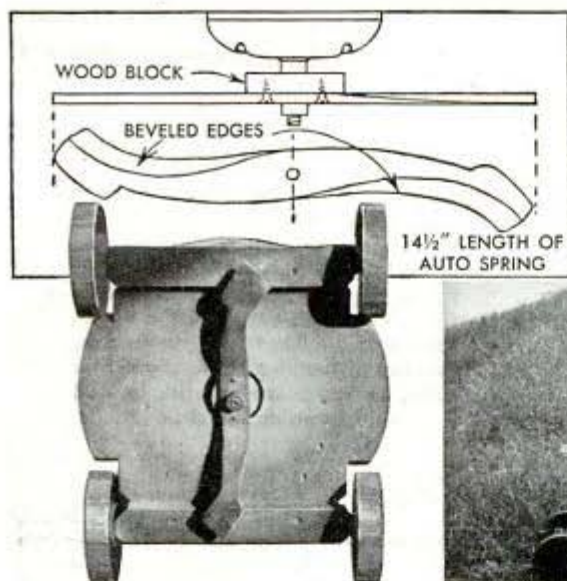
By scribing two or three lines at different angles on a transparent triangle, you can instantly place it in a position to draw lines at various angles. First, scribe a line at right angles to the

long side. Now, when you want to draw a line at an angle of 45 degrees from one already drawn, place the triangle on the work so that the scribed line is directly above the one on the work. Other lines can be scribed at different angles.

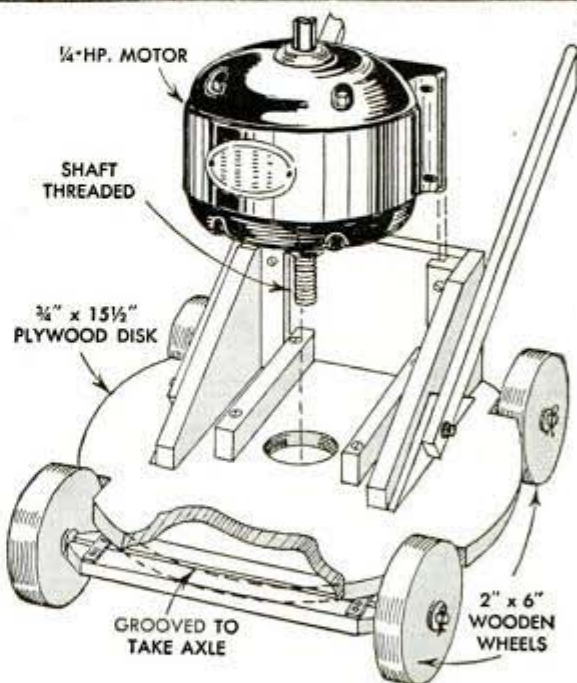
Making Cut Flowers Last

When cut flowers are brought into the house, an inch or more of the lower ends of their stalks should be cut off while holding them under the surface of the water in the bowl or vase. This removes the portions of the stalks into which air bubbles entered when the flowers were cut. With the removal of these air bubbles, the upward movement of water is resumed.

Rotary Lawn Mower Driven by Electric Motor

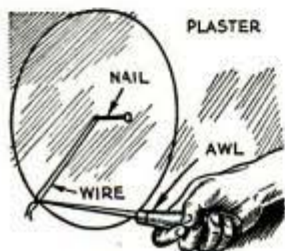


Long or short grass, tough weeds or short tree shoots—it makes no difference with this unusual lawn mower because it will cut all of these. A $\frac{1}{4}$ -hp. motor rotates a cutting blade horizontally directly underneath the circular base, which also serves as a guard for the blade. The motor can be removed in a minute or two and used for other work. A glance at the upper left-hand detail will show how the cutting blade is made from a straight length of old auto spring and how it is attached to the threaded end of the motor shaft, a nut being placed on each side. It is necessary that the blade be well balanced to avoid vibration. The base of the mower is sawed from waterproof plywood, and the wheels are cut from hardwood. The lower detail shows the framing on top of the base to support the handles and motor. Be sure that the latter is of the type that can be mounted in a vertical position. Some motors should not be operated in this position unless they are fitted with thrust bearings. Notice that the motor mounting consists merely of two



vertical cleats slotted to take the motor base, making the motor removable by lifting it up.—W. E. Burnell, Sarasota, Fla.

Looped Wire and Awl Cut Hole in Plastered Wall for Electric Outlet

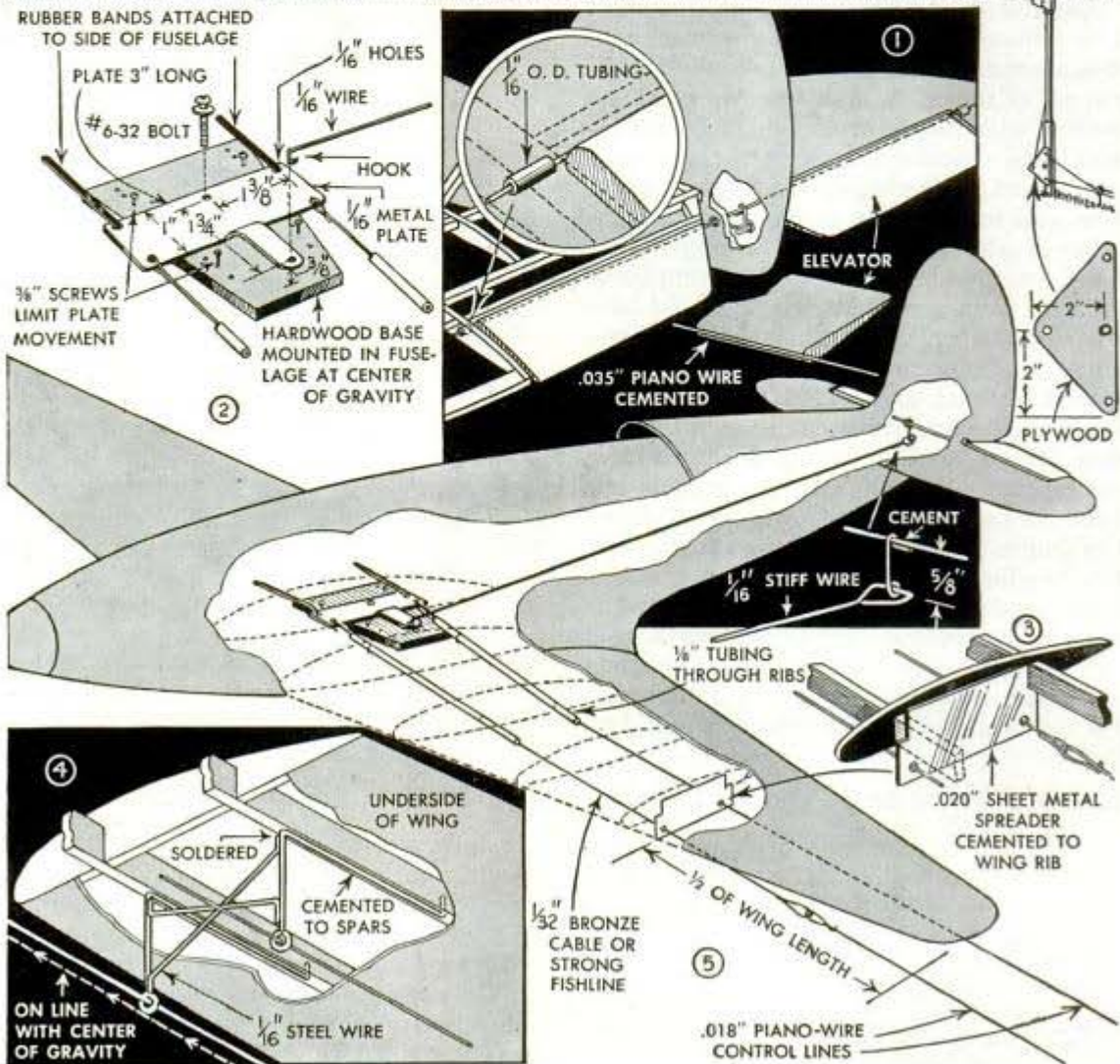


Finding it necessary to cut a round hole in a plastered wall for the installation of an electric outlet box and not having special tools at hand for the purpose, I accomplished the job with a nail, loop of wire and a sharp brad awl. After driving the nail into the center of the opening desired, I hooked the loop of wire over it and inserted the awl in the opposite end. By rotating the awl with the looped wire as a radius, the hole was cut in a short time.—G. E. Hendrickson, Argyle, Wis.

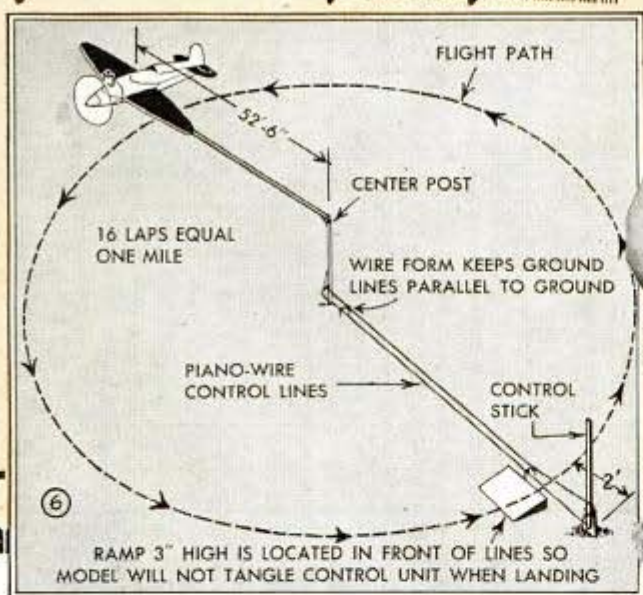
CONTROL-LINE FLYING



Advantage over free flying is that the plane can be maneuvered by the pilot, which makes possible many stunts such as "dogfighting," "dive bombing," speed dashes, endurance runs and balloon bursting. Control-line flying requires less space than free flying and does not have the drawback of long hikes to retrieve models. You can fly the plane around you in a circle, or use a control stick located just outside the circle



of model gas planes



By Ronnie Albert

"CONTACT" you cry, and you're off with a burst of speed! Easing back on the stick you begin to climb higher and higher. At 25 ft. you level off at a mile-a-minute clip. Although you're not actually in the cockpit, control-line flying gives you the thrill of piloting your own plane in much the same way as a real ship, except remotely. This comparatively new and realistic way of flying model gas planes consists of operating the elevators from the ground by means of wire cables as the plane flies overhead in a circle. Because the pilot has control over his model at all times, control-line flying offers more than free flying. "Dog-fighting," "dive bombing," speed dashes, endurance runs and balloon bursting are a few of the many exciting and practical stunts to tax the pilot's skill. Other advantages are

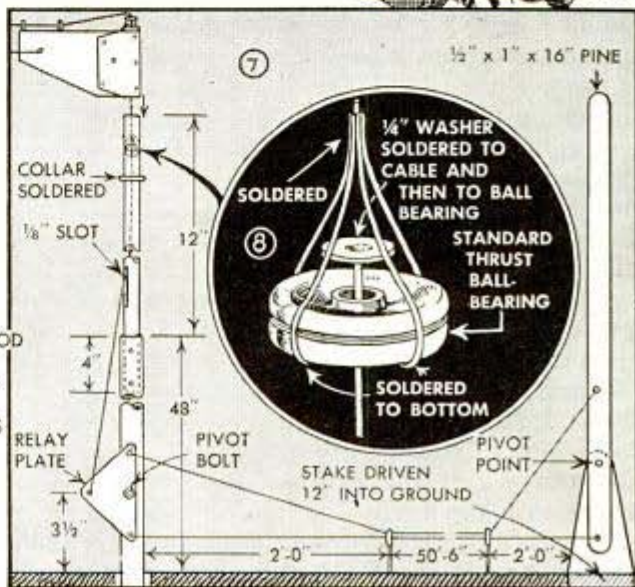
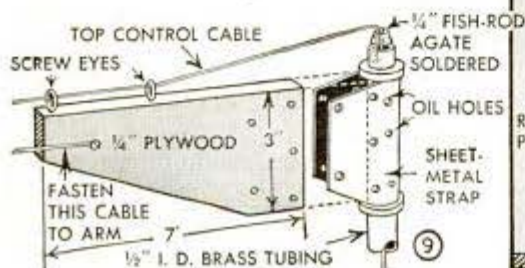
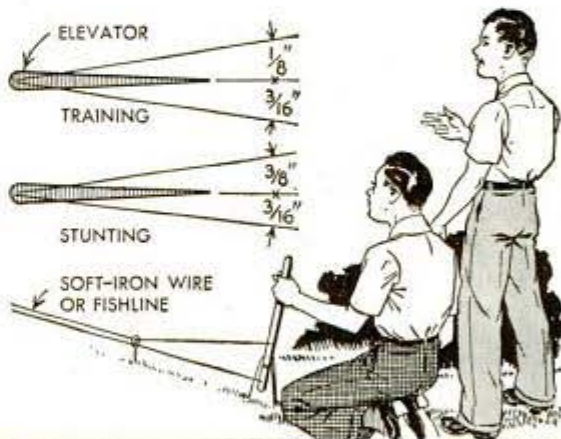
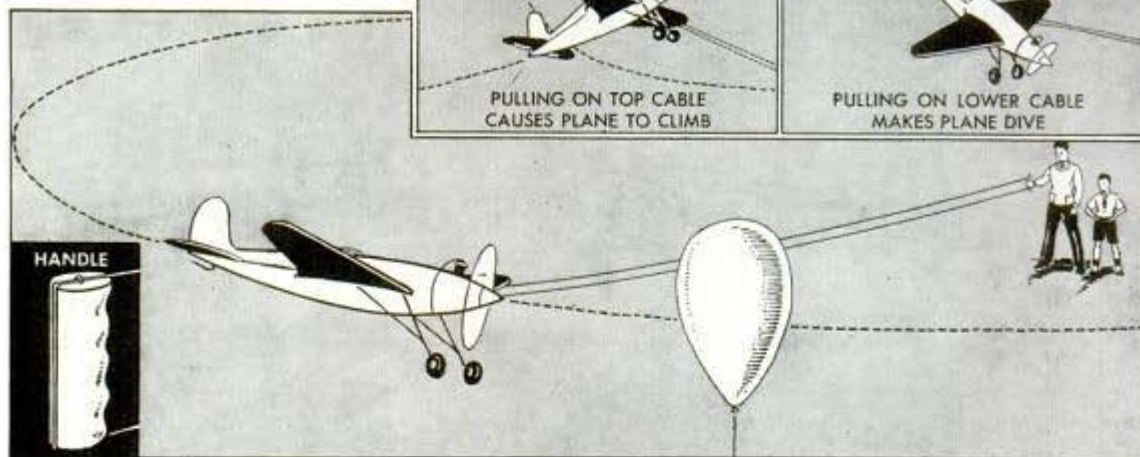


Fig. 10—Here is how you control the plane directly by hand. With the cables attached to a wooden handle, deft manipulation of the wrist will make the plane climb, dive, hedge hop and even loop. It is advisable to practice this method first



that less space is required to fly models, and long-distance chasing of models to retrieve them is avoided. There are two accepted methods of control-line flying; with one you control the flight of the plane by holding the guide wires in your hand as in Fig. 10, and regulating the elevators up or down by movement of the wrist. With the other method, the plane is maneuvered around a center post by a control stick which is located outside the flight circle as shown in Fig. 6. Although outside-the-circle flying is much more thrilling and realistic than the hand method, it is practical only when there is little or no wind because the wind tosses the plane and slackens the control lines. This trouble is avoided in flying by the hand method as the operator can take up such slack by moving his position. However, outside-the-circle flying eliminates the chance of becoming dizzy during prolonged flights.

Adapting a model for control-line flying in most cases requires simple alterations. Essentially, it requires installing a control plate in the fuselage at the plane's center of gravity through which connecting cables transmit movement to the elevators. Installation varies somewhat with the type of plane to be converted. In the case of a low-wing monoplane, it will be necessary to provide tubular guides in the wing spars through which the control cables can emerge on the underside of the wing, in line with a spreader which is mounted to the wing as in Fig. 5. Here a sheet-metal

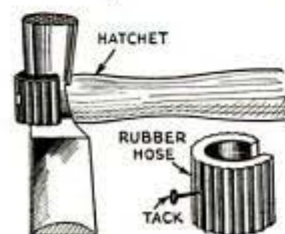
spreader like the one shown in Fig. 3 will do to keep the cables running parallel, but where a high-wing monoplane is to be used, the cables, which simply enter the side of the fuselage at its center of gravity, are kept parallel along the underside of the wing by the type of spreader shown in Fig. 4. The cable eyes of the spreader must be in line with the plane's center of gravity. To locate the center of gravity, first find the horizontal balancing point and make a mark on each side of the fuselage. Then, with a plumb bob or weight attached to a cord to extend past the nose of the ship, suspend the plane by the tail with the cord. The point where the cord intersects the balancing mark is the center of gravity.

With most models it will be necessary to alter the tail surface to make the elevators movable. Elevator area should be from 7 to 12 percent of the total horizontal area of the tail. As the elevators will be rather small, it is best to carve them to conform with the stabilizer airflow from stiff sheet balsa. Fig. 1 shows how they are hinged to the stabilizer. See that they move freely but not to the point where they flutter. The control plate, Fig. 2, diverts the side-ward pull of the cables to an up-and-down movement by a connecting link of tubing or stiff wire. This link must be fitted with care so that sensitive movement will be had without backlash. In coupling it to the plate, make sure that the elevators are in a neutral position, that is, perfectly horizontal when the control-plate arm is at exact

right angles to the centerline of the fuselage. Thus a pull on the front cable will cause the elevators to move upward, while a pull on the rear cable reverses the action. To limit the movement of the elevators, wood screws are used in the plate base as stops. Rubber bands, under slight tension, serve as an "automatic pilot" so to speak, in that they keep the plate in a neutral position and the plane on an even keel in case the pilot loses control momentarily. Fig. 7 details the center post and control stick, and how movement of the latter is relayed to the plane. The revolving head of the post to which the front control cable is attached, is detailed in Fig. 9. To keep the cable which enters the top of the post from twisting, the line is cut and coupled with a thrust ball bearing in the manner shown in Fig. 8.

Now to test-fly your model. It is best to set the stop screws in the plate base so that elevator movement will equal approximately the amount specified above Fig. 7. To make certain that the lines will be taut and elevator movement sensitive, adjust the rudder so that the engine tends to pull outward in a clockwise or counter-clockwise course. When the breeze begins to toss the plane about, causing the control lines to slacken, switch to the hand method. Care of the control cables is important. When they are not in use, keep them wound on an 8-in. spool, and when flying, make certain that spectators do not become too curious and tangle your lines. The size of piano wire specified for the control lines is sufficiently strong to fly planes which weigh not over 3 lbs. With 52½-ft. lines from plane to center post, sixteen laps will constitute one mile.

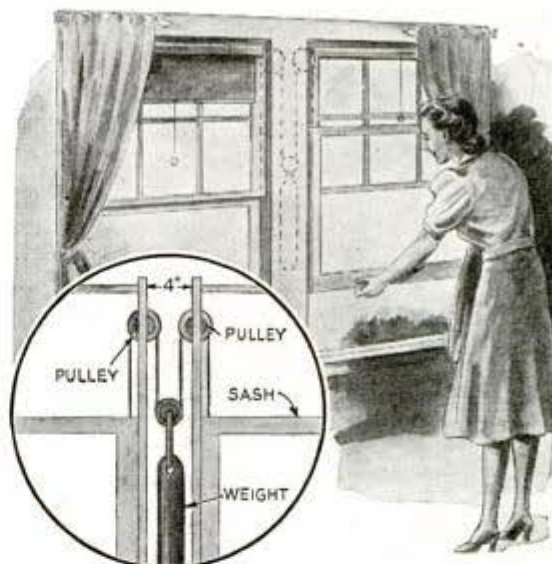
Shingling Hatchet Held on Roof By Piece of Garden Hose



After making several trips down a ladder to recover his hatchet while shingling a house, one carpenter prevented it from sliding off the roof by splitting a short

piece of garden hose and tacking this to the handle. A piece of fluted hose was used, as the sharp edges of this type tend to provide more friction on the shingles.

One Sash Weight Does the Work Of Two on Double Window



One sash weight will do the work of two in double windows where the sash are opposite one another. The weight is suspended between the two casing pulleys as shown. This permits narrower mullion casings than would be possible when a weight is used for each window. The weight, of course, should be just twice as heavy as the ordinary single one.

Hole Drilled Near End of Blade Improves Combination Square

To improve his combination square when used as a marking gauge, one craftsman drilled a 1/16-in. hole near the end of the blade to accommodate a pencil point or scratch awl, depending upon the work at hand. In this way, there is no chance of the point slipping while the tool is being moved along the edge of the work.

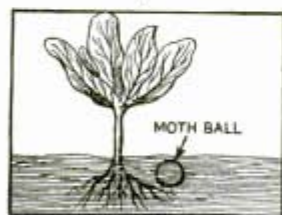


Trotline Reel Rotates in Socket On Side of Rowboat



To simplify the setting and taking up of long trotlines, one fisherman made a reel of the type shown for each one of them. Only a few minutes were required to assemble the reels as they are simply blocks of wood, notched at both ends and fitted with a bolt and knob. In use, the reel is slipped in a socket in the side of the boat where it can be operated easily with one hand while the other guides the line.

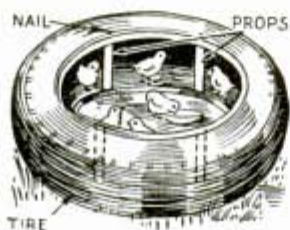
Plants Protected Against Worms By Use of Moth Balls



Destruction of newly transplanted seedlings by cutworms, is prevented by one gardener who buries a moth ball alongside each plant as he sets it out. The ball will not injure the plant, but keeps the worms away.

Auto Casing Serves as Yard Pen And Shelter for Baby Chicks

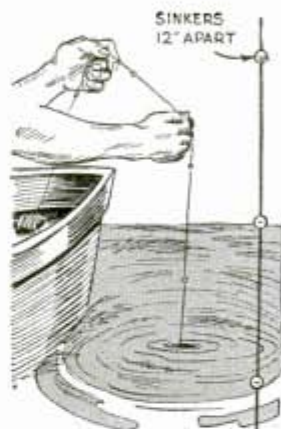
A large, discarded auto casing makes an ideal yard pen for baby chicks, also providing protection from hot sun, wind



and light showers. All you need to do is cut several props to spread the casing and then nail through the beading to hold them in place so that the pen can be moved to new feeding grounds merely by sliding it. If the chicks grow large enough to jump or fly out of the pen before another enclosure is prepared for them, the casing can be covered with a screen.

Line to Measure Depth of Lake Made From Cord and Sinkers

By attaching split-shot sinkers on a cord and spacing them every 12 in., one sportsman had a good line for measuring the depth of the water wherever he was fishing. If you have a set of metal stamps, each shot can be marked to show the depth at a glance.



Birds Kept Off Golf Course Seats With Wire Perches



Troubled by birds perching on the backs of seats on a golf course and soiling them, one workman fitted each seat with a wire perch, which projected 2 or 3 in. beyond and a little above the seat back. In this position, the birds

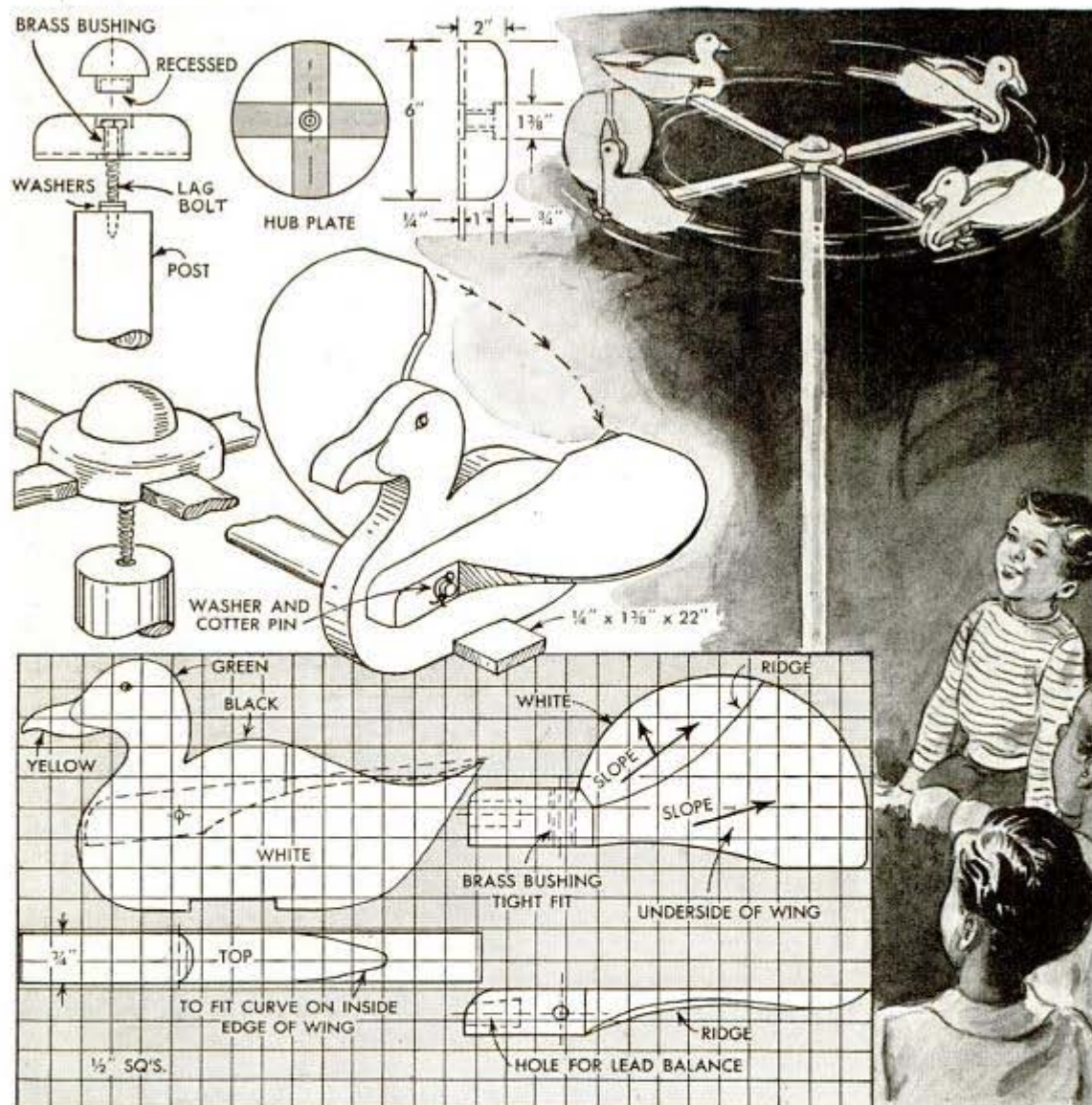
alighted on the wire in preference to the seat back with the result that the seats were kept clean.

—Albert Mayhew, Pasadena, Calif.

CASH FOR YOUR IDEAS

We pay cash for ideas showing simpler and better ways to do daily tasks, shortcuts in shop work, darkroom aids, household hints, auto kinks, etc. Send a good photo or sketch and a concise but full explanation of your idea to the Homecraft Editor, Popular Mechanics, 200 East Ontario St., Chicago.

Amusing Ducks "Fly" Around Pole in the Garden



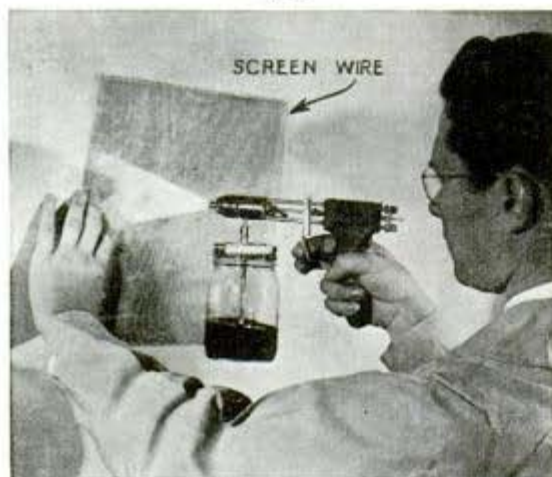
These flying ducks are sure to add an amusing touch to your garden or backyard as they are colorfully painted and rotate around a pole in the breeze, raising and lowering their wings in a realistic manner as they go around. After jigsawing the wings and bodies from waterproof plywood or other softwood, and shaping them as indicated, they are assembled and mounted on crossarms pivoted on a pole. Before attaching the ducks permanently, however, the wings should be fitted with brass bushings and balanced by hammering a piece of lead in a hole drilled in the front end of each wing. In this way, small portions of the lead can be removed with a drill until the wings are balanced so they will be

raised easily by a slight breeze. Note that each duck's back is shaped to permit the wings to drop down and rest on the tip of the tail when in a horizontal position.

Tulip Bed Does Double Duty

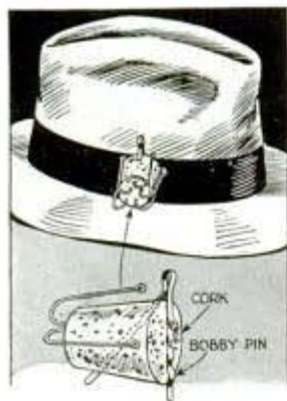
Instead of the usual practice of leaving tulip and other spring bulbs in the beds until the foliage has died, dig and heel them in at another place in the garden where they will be inconspicuous. After the leaves have become dry, which is essential for blooming the following season, the bulbs may be dug again and stored in a dry place until fall. In this way, you can use the bed for summer flowers.

Paint Sprayed Through a Screen Gives Stipple Effect



The next time you are spraying some work and want to produce an unusual effect try directing the spray through a piece of screen wire. You will find that the paint appears to be stippled, the fineness of which depends on the mesh of the wire.

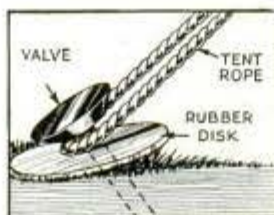
Fishhook Carried on Hat Band By Bobby-Pin Clip



Extra hooks are kept handy by one fisherman who sticks them in a cork and clips it to his hat band. The clip is a bobby pin with one prong bent and inserted through the cork, leaving the other one to serve as a clip over the band.

Old Auto Valves Used as Pegs For Child's Play Tent

Instead of using ordinary stakes to put up your child's play tent, why not substitute old auto valves which can be driven flush with the top of the ground? Besides reducing the possibility of accidents caused by small children stumbling over protruding stakes, these



pegs will last indefinitely. Tent ropes are prevented from coming in direct contact with the ground by slipping rubber disks over the valve stems as shown.

Small Cork Glued on T-Square Holds Extra Thumbtacks

One draftsman keeps extra thumbtacks in a small piece of cork glued on the heel of his T-square as shown in the photo. A suitable cork for this purpose can be sliced from the top of a large bottle stopper with a sharp knife or a razor blade.



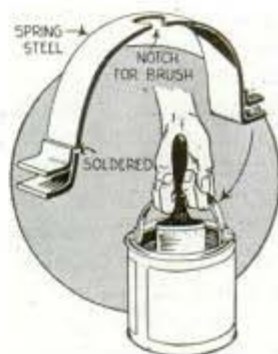
Trowel Converted to Nail Scoop



To prevent scratched fingers when filling orders for small quantities of nails, one hardware-store owner uses a scoop made by soldering sheet-metal sides on an ordinary trowel. The pointed end of this scoop can be pushed in the nails easily.

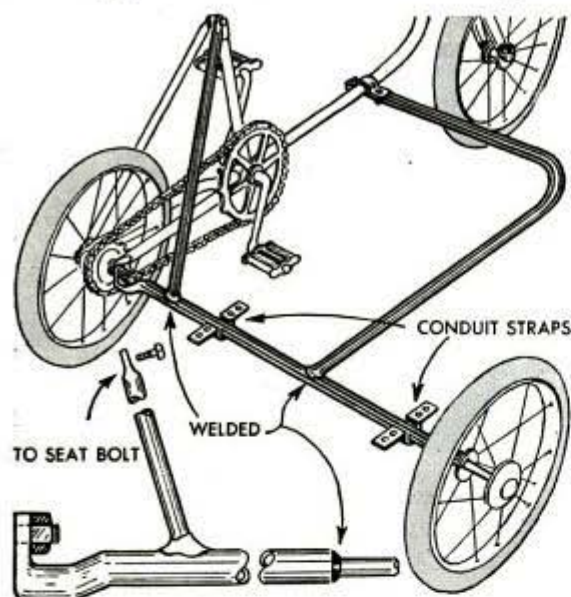
Handle for Bail-less Paint Can Also Holds the Brush

Bent to form a handle and slotted in the center to suspend a brush, this simple unit is ideal for carrying paint cans not fitted with bails. Extra pieces soldered to the ends slip over the edge of the can.



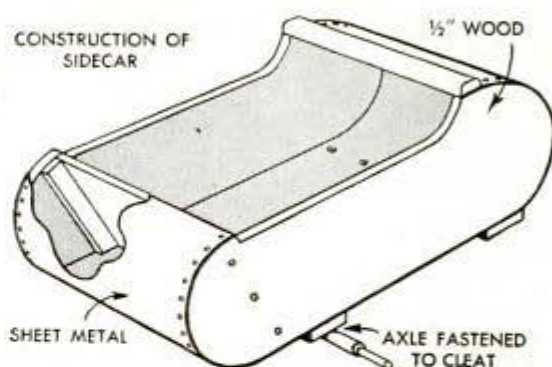
Ⓞ A lock washer around the shank of a key, and beneath the keyhole escutcheon will prevent removal of the key by children.

Midget Sidecar for Junior's Sidewalk Bicycle



Here's a simple bicycle sidecar that is bolted to the bicycle at three points and can be attached or detached in a few moments. Besides carrying a passenger, the sidecar is handy on a newspaper route or for delivery of packages. The simple frame is made of $\frac{3}{4}$ -in. conduit, bent and welded together, while the body is assembled by screwing a piece of sheet metal onto duplicate wood sides. Two wood cleats screwed to the underside of the bottom give rigidity

CONSTRUCTION OF SIDECAR

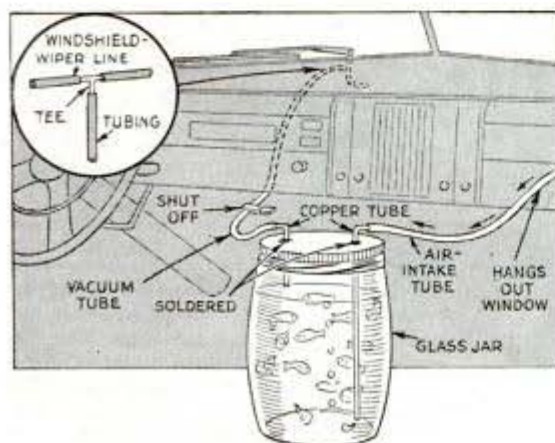


and at the same time provide good solid surfaces for attaching the body to the frame with conduit straps screwed in place.

Live-Bait Container Is Aerated by Vacuum of Car Motor

Fishermen who have to transport live bait over long distances will find this method of aerating the container highly satisfactory. The container consists of a glass jar with a sealed screw-top lid in which are soldered two copper tubes, one to reach

almost to the bottom of the container and the other just long enough to pass through the lid. A length of rubber tubing connects the short copper tube to the windshield-wiper line. This is done by means of a tee as shown in the circular detail. A second rubber tube is slipped over the long copper tube and hangs outside of one of the car windows. In use, the vacuum from the motor creates a vacuum inside the glass jar, which in turn pulls air in through the long tube, and the air escaping from the bottom of the tube bubbles up through the water and aerates it. Then it passes out through the short tube and into the car motor intake. A spring clothespin on the windshield-wiper line serves as a shut off.



☐ If you will cover the corners of your wire bed springs with adhesive tape, the sheets will not catch on the corners and tear.

Simple HOUSEHOLD REPAIRS



AS MANY ordinary household items and appliances are becoming more difficult to get and may possibly be off the market entirely, everybody should know how to make their present equipment last longer by proper care and repair. Simple repairs often double or triple the life of even such things as can openers and food graters. In the case of a can opener, a few strokes of a file across the cutting blade will restore its usefulness. On types having a toothed friction wheel as in Fig. 5, you may find that the wheel does not grip a can as well as formerly. A few hammer taps will tighten the rivet that holds the wheel. A dulled food grater can be sharpened with a file as in Fig. 2. For grater surfaces that consist of raised projections partially punched in the metal, merely in-

sert the point of an ice pick through each cutter from the back, Fig. 1.

Another repair problem frequently encountered is that of chipped porcelain enamel on parts of a stove, refrigerator or sink, Fig. 7. Usually the chipping affects only the appearance, which can be restored with a white lacquer made by mixing finely ground zinc white and clear fingernail polish. Apply to the chipped places carefully. Ordinary crack filler is



If some of your kitchen cutlery has plastic handles and one has become broken, you can cast one that will closely resemble the original by using colored crack filler. A hardened and shrunken bathtub drain stopper can be sanded down to expose live rubber and then used as a stopper for the lavatory drain, which is smaller

Aid Defense



highly satisfactory for repairing plastic articles. If you have a cutlery set with plastic handles, for instance, and one of the handles has been broken, you can mold a substitute one from colored crack filler. Mix the powder with water and add ordinary water color if that is required. Roll up a waxed paper tube for the mold, fill it with the material and insert the knife as in Fig. 3. When the mixture has hardened, polish it well and give it a coat of furniture wax. Also, crack



filler is excellent for filling small holes gouged in linoleum, Fig. 6, as it can be colored for an exact match. Articles made of rubber need to be considered too. Although rubber will deteriorate with age, proper care will slow this action. Keep rubber articles clean and out of the air as much as possible. Also, there are preparations that will help preserve rubber, such as cleaning fluids used on typewriter platens, Fig. 8. When a rubber bathtub stopper becomes shrunken from age, sand down the edges, which will expose a new, live surface, Fig. 4, after which the stopper can often be used in a lavatory drain, which is smaller. Use coarse sandpaper at first, finishing with a finer grade.



The unsightly appearance of a nicked porcelain-enameled surface can be improved by filling the nicks and chipped places with a mixture consisting of zinc white and clear fingernail polish. Use of type cleaner on typewriter platens and other articles of similar composition helps make them last



Sand Pocket on Large Umbrella Anchors It While at Beach

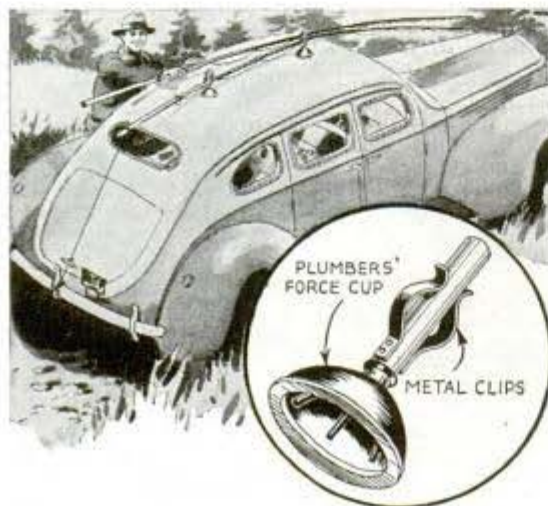


FILL POCKET WITH SAND

Large beach umbrellas can be prevented from being rolled away by the wind if a cloth pocket is stitched to one side between two of the metal ribs as shown. When at the beach, this is filled with sand to anchor the umbrella against light winds so that it will not roll away when left unattended. The end of the handle is rammed in the sand to keep the umbrella from tipping.

Fishing Poles Held on Car Top With Plumbers' Force Cups

Here's a simple way to carry your long fishing poles on top of a car safely without marring the finish. Just obtain a couple of plumbers' force cups, cut off part of the handles and fit metal clips on them as shown. These can be cut and bent from a discarded clock spring or piece of spring steel. In use, you merely press the cups on the car top, slip the poles in place and then tie the pole ends to the radiator ornament



and rear bumper, which prevents them from whipping or sliding in the clips.

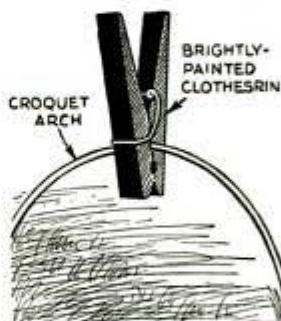
—A. H. Waychoff, Phoenix, Ariz.

Piece of Garden Hose on Pole Keeps Hooks From Tangling

You won't be troubled with fishhooks tangling when carrying several long cane poles on the car if a section of garden hose is slipped over each pole to hold the hooks. The sections of hose are cut so they can be opened and slipped over the poles, then adjusted to keep the lines taut when the hooks are stuck in them.



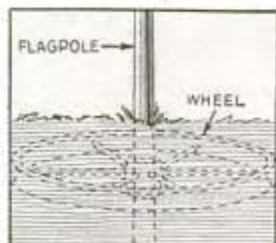
Croquet Arch Made Easy to See By Painted Clothespin



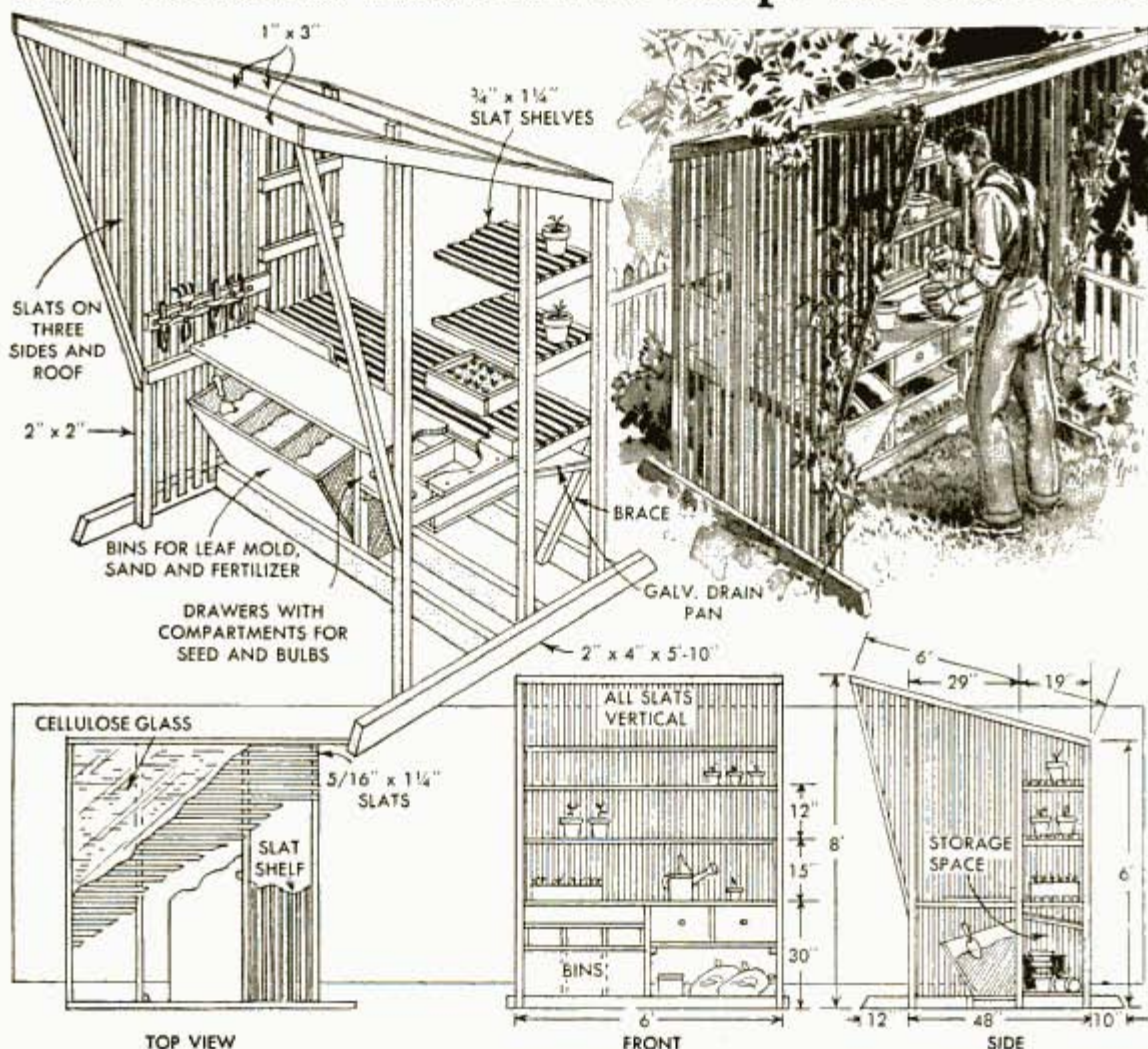
To mark the positions of croquet arches plainly for the convenience of players, and to help prevent anyone from falling over them when a game is not in progress, paint a number of spring-type clothespins a bright color and clip them to the top of the arches. An orange colored paint is most suitable as this color is more noticeable to the average person.

Buried Wheel Serves as Base For Small Flagpole

Instead of pouring a concrete base to anchor a small flagpole, just slip a discarded sulky-plow wheel over the end of it and bury this a few inches in the ground. Such a base will last indefinitely and does not detract from the appearance of the lawn or interfere with mowing it.



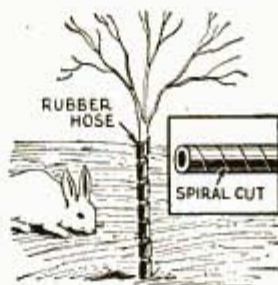
This Portable Lath House Helps the Gardener



Tender young plants that require partial shade until they are sturdy enough for transplanting can be grown successfully in this lath house. It has 27 sq. ft. of shelf space for plants, in addition to a roomy work bench, beneath which are bins for leaf mold, fertilizer, etc., and drawers with compartments for seeds and bulbs. A tool rack is handy at one side, and under the plant shelves is storage space accessible from the rear for flower pots. Construction is simple and cost of materials moderate. The slats should be spaced a distance equal to their own width. If available, cellulose glass can be tacked on the roof slats to prevent heavy raindrops from damaging tender young shoots. If the structure is left on one location for any length of time, excess water from sprinkling the plants will drain away quickly if you provide a 6-in. "floor" of cinders or

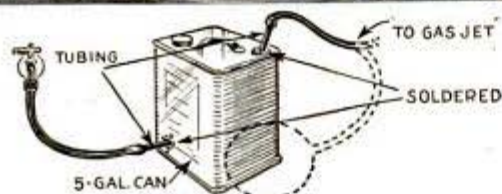
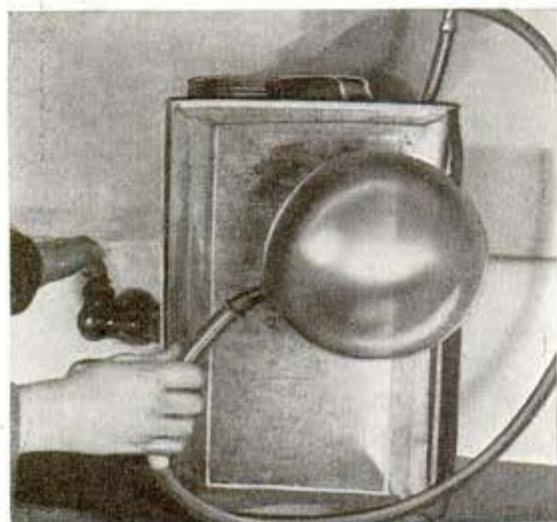
gravel. Note that under the lowest plant shelf, and just above the rear storage space, a sheet of galvanized iron is installed to drain off drip from the plants above. The open side of the house should face north.

Old Rubber Hose Cut Spirally Protects Small Fruit Trees



If rabbits and other rodents damage the trunks of small fruit trees during the winter, you can prevent this trouble by using pieces of standard hose that have been cut spirally as indicated. By cutting the hose in this way, it will be easy to put in place.

Easy Way to Inflate Toy Balloons With Illuminating Gas



Here is an easy way to inflate toy rubber balloons with illuminating gas. Get an empty 5-gal. oil can and solder a short piece of brass or copper tubing in the top and another short piece near the bottom. Connect the bottom tubing with a hose to a water faucet, and then fill the can with water. Next connect the top tube to a gas jet. Now open the jet and let the water drain out. This will fill the can with gas, which is then forced into the balloon by placing it over the upper tube and again filling the can with water. Repeat this as many times as is necessary to inflate the balloon completely.

—Wm. Swallow, Brooklyn, N. Y.

Fence-Wire Trellis for Vines



Instead of staking vegetables such as beans, gourds and the like, stretch a length of woven-wire fencing along the row. The wire not only provides a good surface for the climbing vines in half the space,

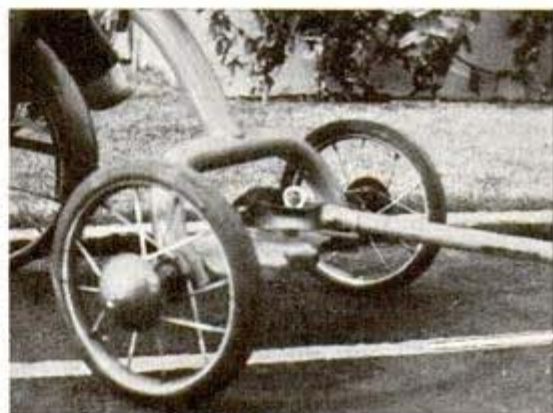
but if the rows are planted north and south, the fruit is exposed to sunlight during the entire day. If steel posts are used to support the wire, there will be no holes to dig and posts and wire are removed easily and stored in the fall.

Wooden Snakes Scare Pigeons

If pigeons are soiling your front porch, roof, or the statue in your garden, you can prevent this trouble by installing wooden snakes. At Saratoga Springs, N. Y., pigeons were soiling the World-War Memorial in the city's leading park. Department of public works employes whittled out three green painted wooden snakes and placed them atop the monument. Now the pigeons perch in the trees.

Trailer Hitch for a Tricycle

The urge of most small children to tow a wagon behind their tricycles can be satisfied with this hitch without the aid of father or mother to fasten and unfasten the vehicles. The hitch consists of a large eyebolt set vertically in the step plate of the tricycle, over which the loop in the end of the wagon tongue is dropped. If the eye of



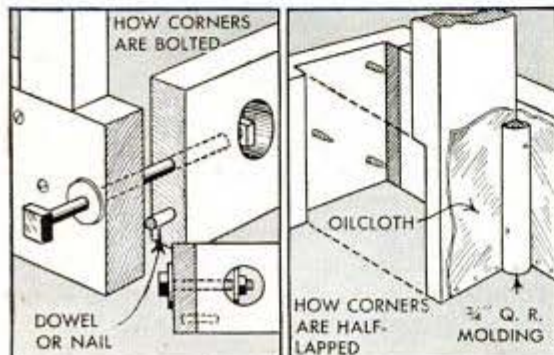
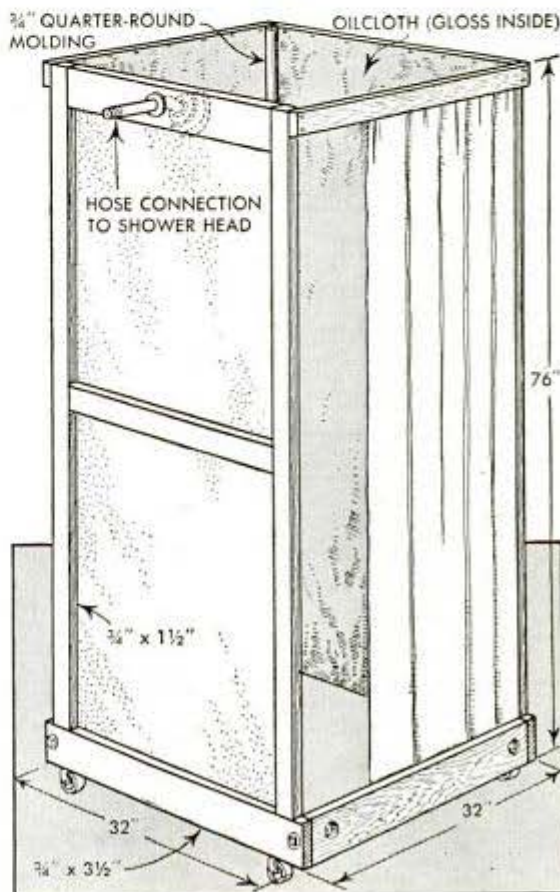
the bolt is placed parallel with the wheels, it will prevent accidental dislodgement of the wagon tongue when starting and stopping. Also, the hitch will automatically release the wagon when too short a turn is attempted as the wagon tongue will be lifted off the bolt by the forward motion of the rear tricycle wheel.

SHOWER CABINET

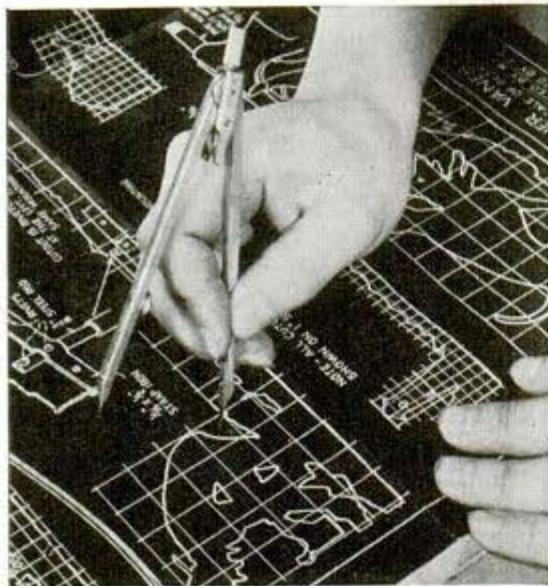
for the basement



This portable shower stall on casters is rolled over the basement drain when used. The hardwood base is bolted at the corners for rigidity, dowels being used to prevent twisting of the members. Side frames are half-lapped to the base and are connected by means of crosspieces at the top and center of the back. Apply white lead or paint to all contacting surfaces and joints as a precaution against rot. After assembling and painting, oilcloth is tacked to the inside so that it overlaps the base frame, which prevents water from wetting the wood. The door is fitted with a separate curtain. Quarter-round molding is nailed over the oilcloth where the sides join the back so the oilcloth will not tear away from the tacks. If a shower spray is not available, you can make one from odds and ends. It is fitted to the top crosspiece of one side and a length of garden hose connects it to the water supply at the laundry tub where the temperature of the water can be controlled



Full-Size Patterns Are Transferred With Pair of Dividers



If a sheet of carbon paper is not at hand the next time you want to transfer a full-size blueprint pattern onto a piece of wood for sawing, here's how you can do it with a pair of dividers. First, smooth out the print, tack it in place and punch around the outline with one of the divider points. Then remove the print, powder a small piece of carpenters' chalk and dust it over the punch marks on the wood. This brings out the marks clearly so they can be connected with a sharp pencil.

Croquet Ball Weighted With Lead Adds Fun to the Game

To inject a little more fun into their game, when a new player is invited to participate, one croquet club has a ball that is



weighted at one side with lead. This ball is given to the unsuspecting player and creates considerable merriment when he tries to score an arch with it. The ball is also used to pep up the regular games by making the loser of each game use it in the next one. Regardless of how it is struck, the ball takes a wavering path so the player scores mostly by accident.

Rubber-Headed Tacks in Tires Give Mower Better Traction

When rubber tires on a lawn mower wear smooth, traction can be gained by driving rubber-headed tacks in the tires as indicated. The tacks should be long enough to clinch when they penetrate the tire.



Old Skate Top Serves as Holder For Shoes While Shining

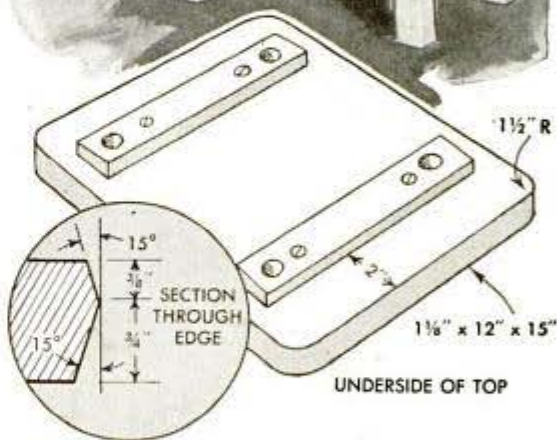
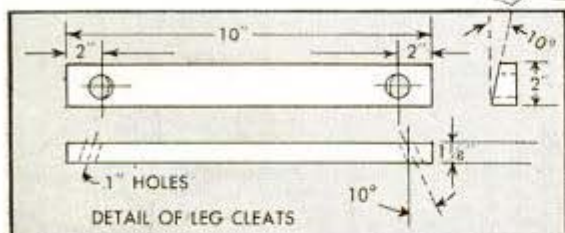
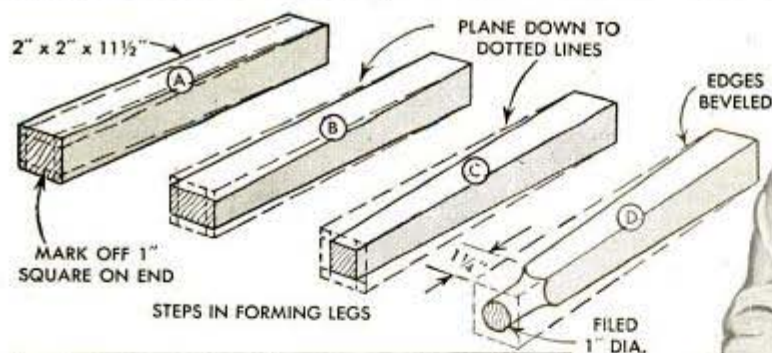


Shoes can be shined quickly without smearing polish on your socks if a holder of the type shown is used. It is made by bolting the top from an old roller skate onto an ordinary shelf bracket and then screwing the bracket to a wall or other support. After the skate clamp has been adjusted properly, a shoe can be slipped in the holder easily, leaving both hands free to apply polish and use the shining rag.

—Axel E. Ogren, Chicago.

While painting over old stained woodwork, home owners frequently find that the dyes from the stains persist in showing through, often coloring the new paint. Time and money can be saved by first applying a coat of aluminum house paint—not bronzing aluminum.

Attractive Early American Stool Easy to Make



Just like the real Early American stools, this one is made entirely of white pine. It will fit in well with other furniture of this type, or two of the stools are ideal for the play table of small children. After tapering the legs, bevel the corners slightly and form tenons on the upper ends. The bevel-edged seat can be made from one wide piece or you can glue and dowel two pieces together. The latter construction is less likely to result in a warped seat. Next come the cleats that join the legs to the seat. Be sure to bore the holes in the cleats for the legs at the correct angle. This gets the first angle. The second comes from the tilt of the cleats when they are glued and screwed to the underside of the seat.

—Harold T. Bodkin, Detroit, Mich.

Emergency Rubber Stamp Carved on Soft Rubber Eraser

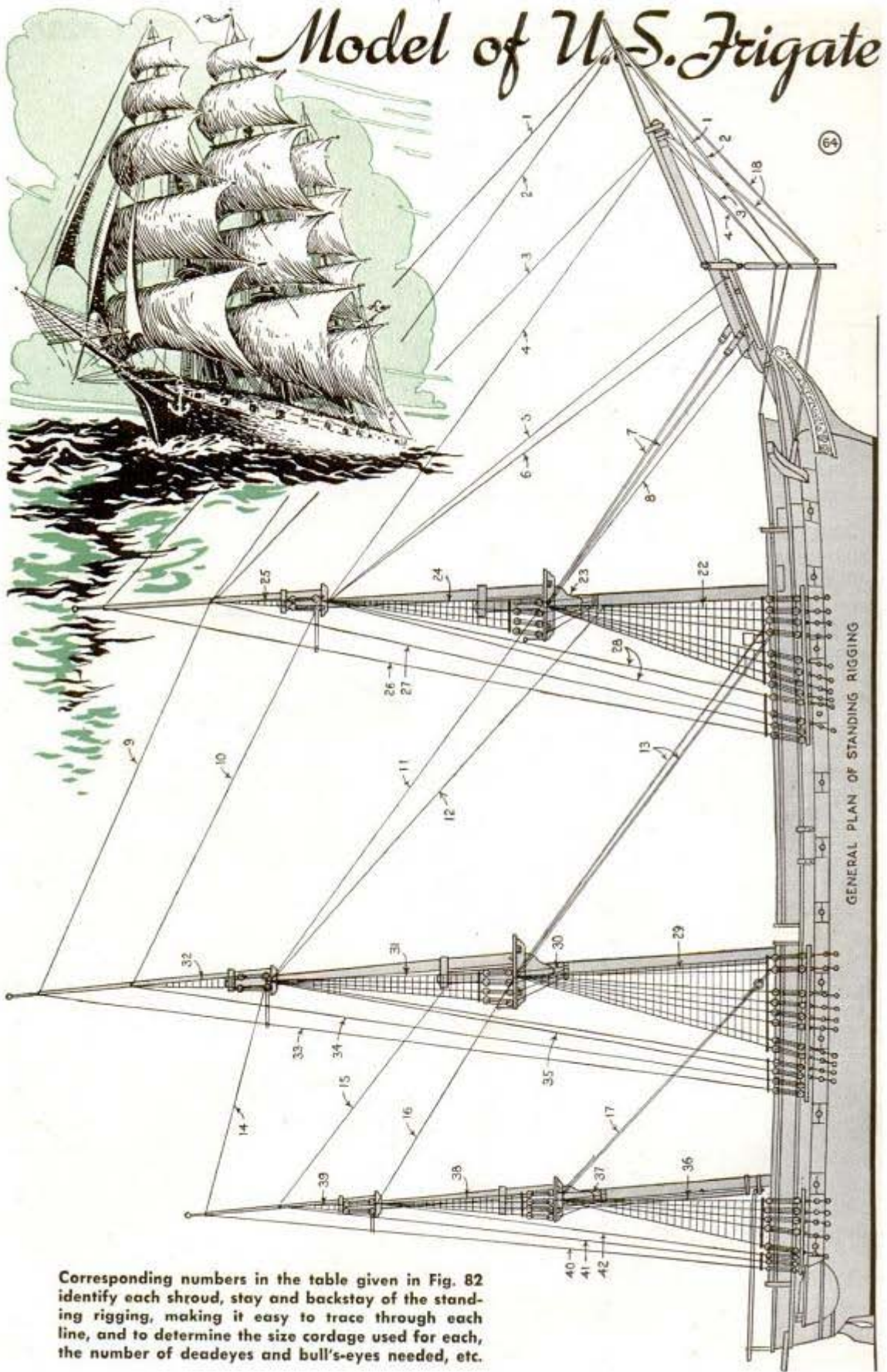


When you need a rubber stamp and the job does not warrant the purchase of a new one for the purpose, just outline the letters on a soft art eraser and carve them in relief. An old razor blade serves as a good tool for carving sharp letters that will print for a considerable length of time. When making such improvised stamps, remember that the letters must be in reverse to reproduce correctly when printed.

☐ A nail can be driven into a plastered wall without crumbling the plaster if the nail is first put in hot water for a few minutes, or dipped in melted paraffin.

Model of U.S. Frigate

64



Corresponding numbers in the table given in Fig. 82 identify each shroud, stay and backstay of the standing rigging, making it easy to trace through each line, and to determine the size cordage used for each, the number of deadeyes and bull's-eyes needed, etc.

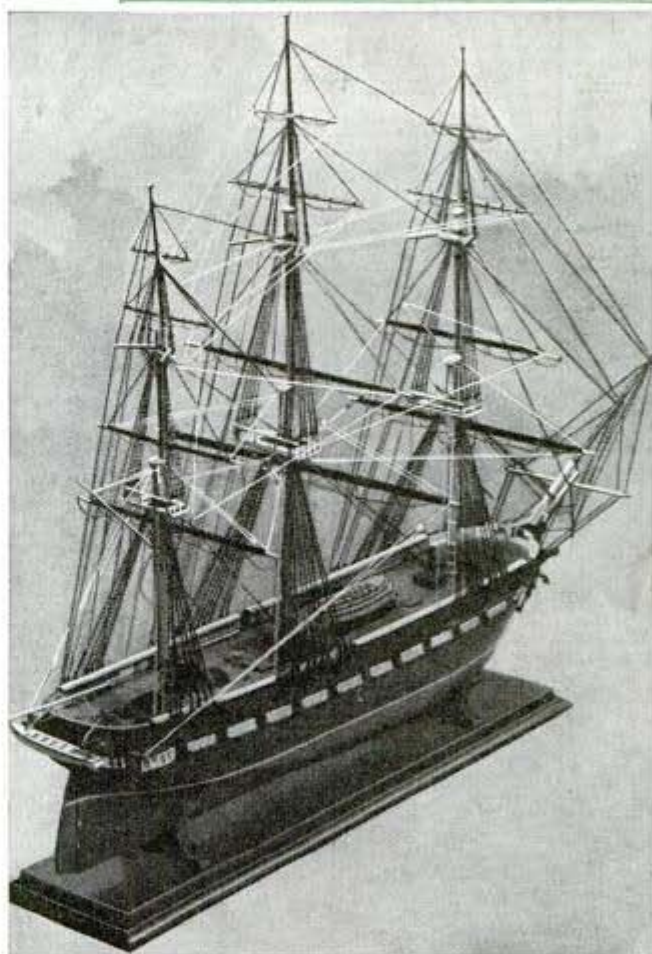
"CONSTELLATION"

By H. W. Potter

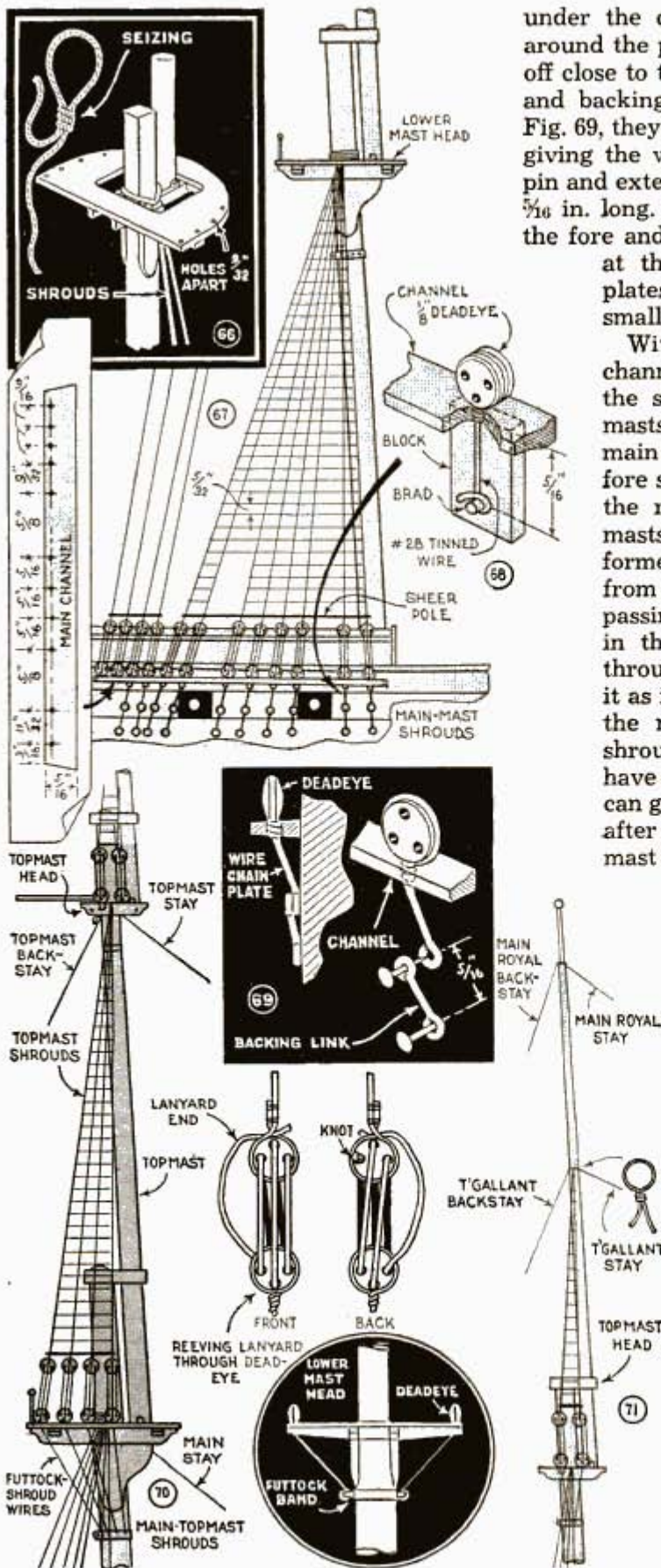
PART IV—Standing Rigging

TO SIMPLIFY the rigging of "Constellation," it has been divided into two parts—standing and running—each to be explained separately to avoid confusion. As the names imply, the standing, consisting of shrouds, stays and backstays, is the rigging supporting the masts, while the running rigging is for handling the yards and sails. It is well to study all drawings and explanations carefully beforehand, and be sure of each step in advance. The general view in Fig. 64 is to be used in conjunction with the table given in Fig. 82, which specifies the size of cordage to use for each respective line, as well as the size and number of deadeyes and bull's-eyes required. Where the cordage size is given as .017, .022, .027, and .032 in. it means the average diameter of 6, 9, 12, and 15-thread cuttyhunk fishline respectively. Since all standing rigging is black, (running is light tan) it will be necessary to dye the linen cord with aniline dye dissolved in alcohol. Also, before installing each line, the cord should be made moistureproof by drawing it through a cake of paraffin or beeswax.

Begin by fitting the deadeyes in the fore, main and mizzen channels. You will notice in Fig. 67 that the forward shroud coming from the lower mast head assumes the same rake as the mast. With this in mind you locate the forward hole in the channel and from it space the aft holes the distance given for each in the detail to the left of Fig. 67. Holes in the fore channels are grouped according to Fig. 73, while the holes in the mizzen channels are spaced as indicated in Fig. 74. Deadeyes $\frac{1}{8}$ in. in diameter are used at the channels, each one being fitted with a chain plate, except those which carry the royal and topgallant backstays of the fore and main masts, and the royal, topgallant and topmast backstays of the mizzen as in Fig. 75. These aft dead-



eyes are held in place by passing the strops through two holes and twisting together on the underside of the channel. An easy way to form the eyes in the chain-plate strops so that each will be alike and exactly the same distance below the channel, is to use a little jig, about 5 in. long, as in Fig. 68. You use it by holding the stick up



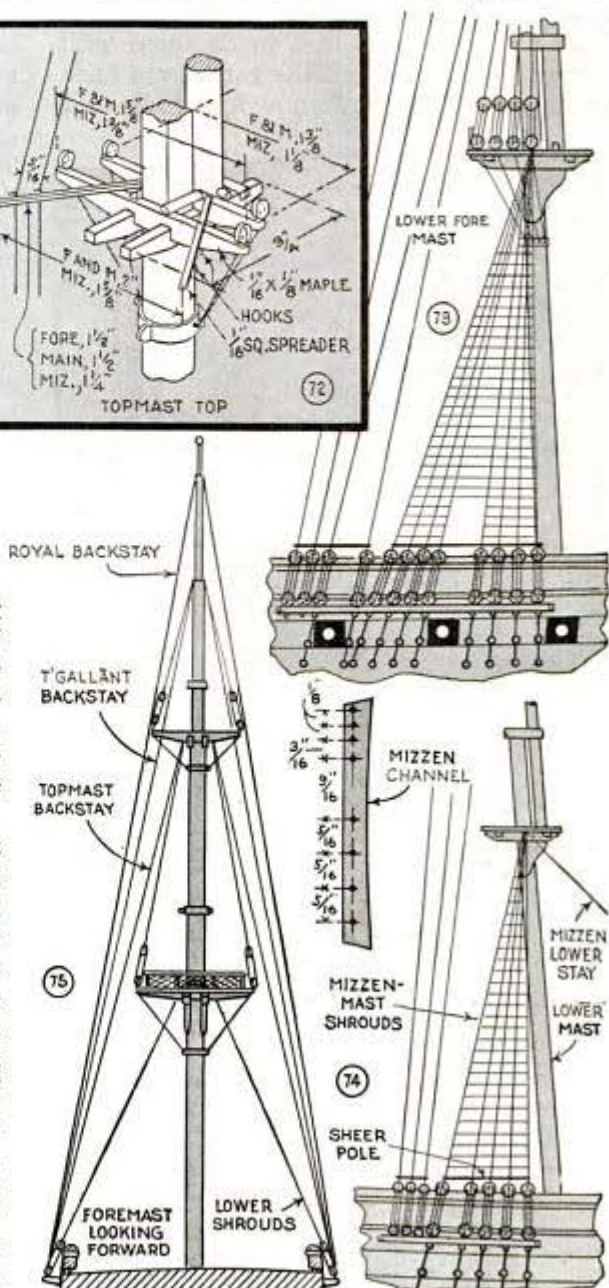
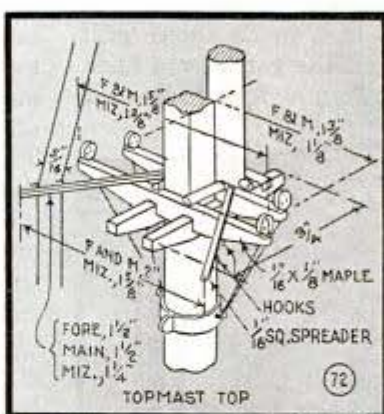
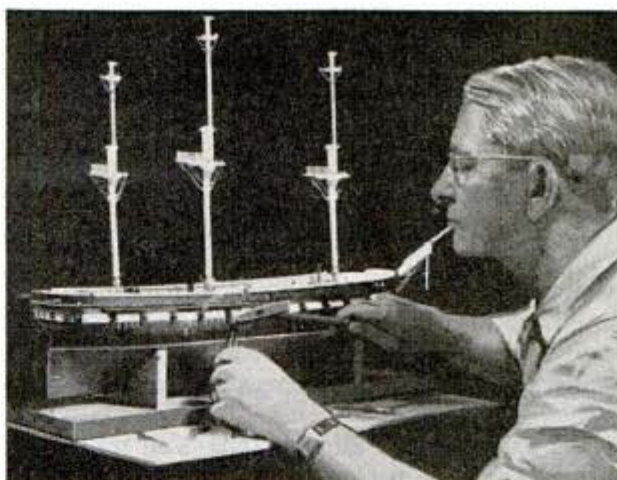
under the channel and coiling the wire around the pin, after which the end is cut off close to the eye. While the chain plate and backing link are shown separate in Fig. 69, they can be formed in one piece by giving the wire a single turn around the pin and extending it on into a backing link $\frac{5}{16}$ in. long. Ten chain plates are used at the fore and main channels, but only five at the mizzen. Fasten the chain plates and links to the hull with small pins known as "lills."

With the deadeyes in place in all channels, you can begin setting up the shrouds which support the masts thwartships. Start at the main and main topmast so that the fore shrouds will not interfere with the rigging of the stays of these masts later on. Two shrouds are formed on each side of the mast from a single length of cord by passing it through the lubber hole in the top and bringing it down through the same hole and seizing it as indicated in Fig. 66. Note that the mizzen mast has only five shrouds, while the main and fore have eight. The odd mizzen shroud can go straight over to the port side, after giving it a turn around the mast head. Now, the end of each

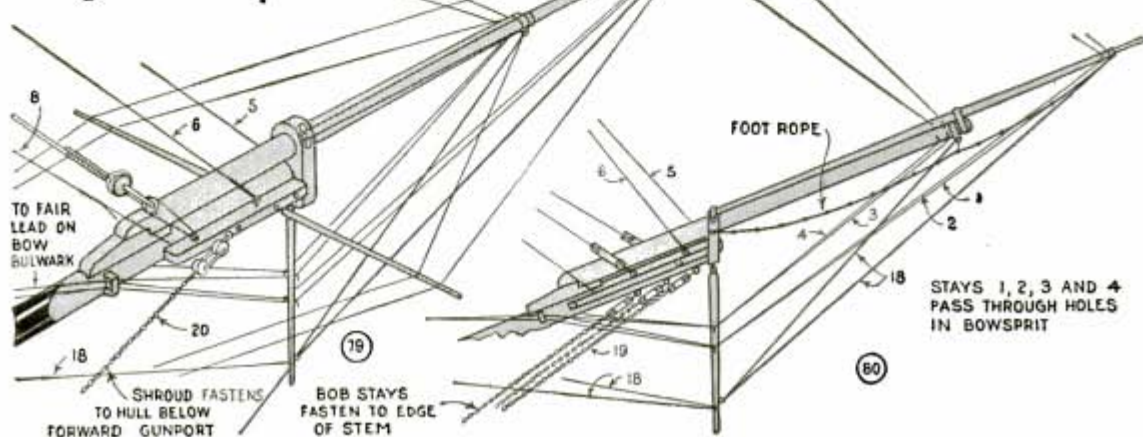
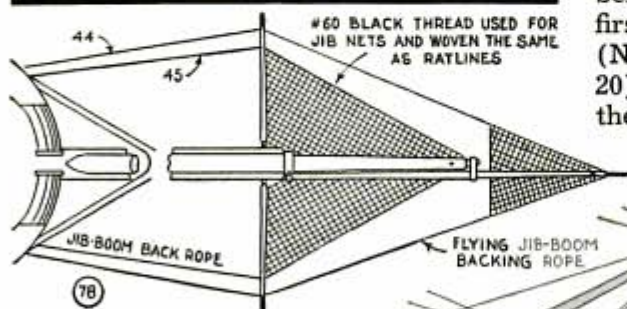
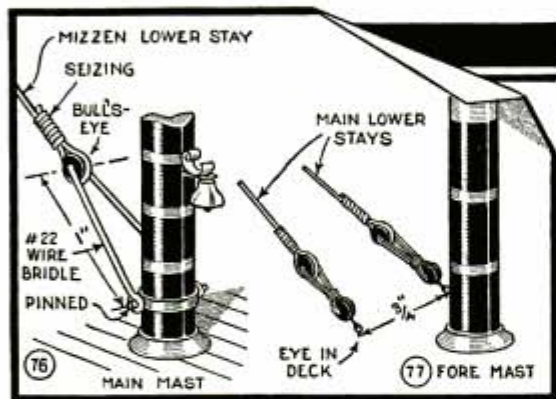
shroud is fitted with a $\frac{1}{8}$ -in. deadeye. Let the up-turned end of the shroud extend about $\frac{5}{8}$ in. above the deadeye and seize it with No. 50 black thread at three points; one at the deadeye and two above, equally spaced. Be sure to keep the enter hole in the deadeye at the top. It is important that all knots and lashings be coated with glue, thinned slightly with water, so that they will not open up when the ends are cut short. When you have the forward shrouds in place, add the forward port pair, then the next pair aft on the starboard side, and so on. Seize the deadeyes in the ends of the shrouds so that they will be in a straight row parallel with the bulwark.

The detail below Fig. 69 shows you how the lanyards are reeved through the deadeyes. When facing the hull, either starboard or port, the lanyard is always started through the right-hand hole. For the lanyards use No. 50 or 70 black linen thread, well waxed, and note the position of the holes in the deadeyes. Make the masts plumb by tightening or loosening the lanyards on each side and then tuck the end of the lanyard between the parts of the shroud, pull tightly and apply a touch of glue. Do not trim the ends close until the entire rigging is completed, as the cordage will stretch slightly in time and need to be taken up. A pair of tweezers will be found especially handy for drawing up the lanyards. Before proceeding further, install the fore, main and mizzen lower stays. At the fore and at the main there are two which can be formed from one length of cord by looping it around the mast head. The mizzen mast has just one lower stay. The fore lower stays are seized to $\frac{5}{32}$ -in. bull's-eyes which in turn are lashed to bull's-eyes attached to eyepins in the bowsprit. See Figs. 64 and 80. The ends of the main lower stays are anchored to eyes driven into the deck just aft of the fore mast. Fig. 77 shows how the ends are seized to bull's-eyes and lashed with lanyards of No. 50 black linen thread, while Fig. 76 shows you how the mizzen lower stay is set up to the main mast. The upper ends of the fore, main and mizzen stays go between the cross-trees, but the upper ends of the three topmast stays go on the outside of the cross-trees.

With all lower shrouds in place, start to tie the ratlines. These are the ropes that cross the shrouds to form ladders. "Rattling down," as it is called, is rather a tedious job and must be done carefully if it is to look right, but a little practice will soon develop a technique that makes it comparatively simple. First you must lash a sheer pole, made from a piece of No. 20-gauge tinned wire, across the tops of the deadeyes as indicated in Figs. 67, 73 and 74, above which the ratlines are spaced $\frac{5}{32}$ in. apart. To install the ratlines you tie a length of No. 60 black thread to the eye of a needle and clove



hitch it to the aft shroud of the group. Then work forward, hitching to each shroud and touching each knot with thin glue after several ratlines have been tied. Leave the ends about $\frac{1}{2}$ in. long for final trimming after the glue dries. Continue on up the shrouds in this same manner. Fig. 81 shows clearly how the clove hitch is made, and you'll find it a good stunt to cover the deadeyes with a piece of cardboard as in Fig. 65, so that the ratline thread will not be catching continually in the deadeyes. Where the shrouds converge at the top, a simple overhand knot may be used instead of the clove hitch. You will notice at the main and fore mast that the lower ratlines do not extend clear across. However, you'll do best to tie them as if they did and later cut the ratlines to form openings at the bottom where indicated.



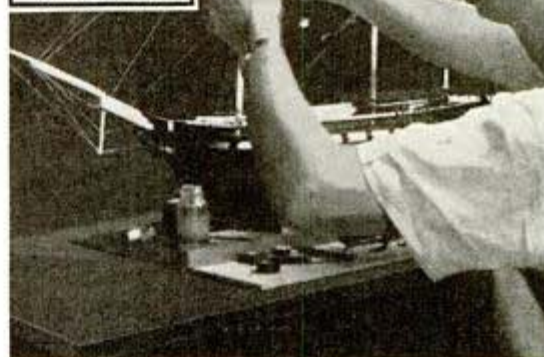
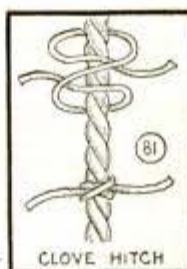
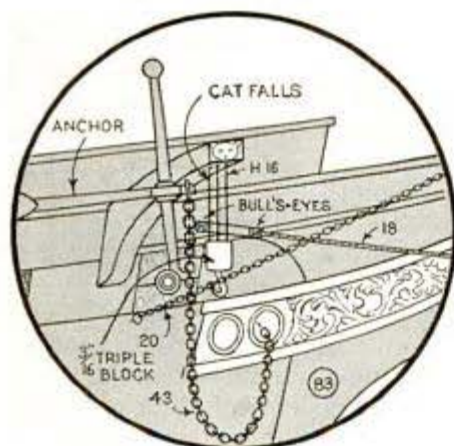
The fore and mizzen shrouds are "rattled down" in the same way, all ratlines on the mizzen being carried clear across.

Now proceed to set up the topmast shrouds. The fore and mizzen are rigged the same as given for the main in Fig. 70. Here four shrouds are used on each side from the topmast head to the lower mast head. The futtock shrouds are of No. 28-gauge tinned wire (painted black) and run from $\frac{1}{8}$ -in. deadeyes in the tops to the futtock mast band as shown in the circular detail at the right of Fig. 70. Complete by "rattling down" as before. Before adding the topgallant shrouds, Fig. 71, outriggers which spread the topgallant and royal backstays, should be fitted to each topmast head as shown in Fig. 72. Besides the fore topmast stay (No. 5) two other stays, the outer jib stay (No. 4) and the inner jib stay (No. 6), are seized at the topmast head. The outer jib stay passes through a hole in the jib boom, then under the upper hook on the starboard side of the dolphin striker, continuing on through the upper hole in the fair-lead block and finally belayed to the bow pinrail. This you can see quite clearly in Figs. 79 and 80. The inner jib stay is simply seized to the forward starboard eye on the bowsprit. Do not draw the stays up tightly until the topmast backstays are in place, otherwise you are apt to pull the topmasts out of line. However, before installing the fore stays, it is well first to set up the three bobstay chains (No. 19), and the bowsprit shrouds (No. 20). The bobstays run from eyes driven in the edge of the stem to bull's-eyes fitted to the underside of the bowsprit as shown in Fig. 80. Shroud chains fasten to an eye on each side just below

the forward gun port as in Fig. 83. The fore topgallant stay (No. 3) passes through a second hole in the jib-boom which is made slightly forward of the one carrying the outer jib stay and is rigged practically the same as the latter except that it runs along the port side of the dolphin striker. The main topmast stays (No. 11 and 12) run double; the mizzen single.

You will notice in Fig. 64 that all backstays, which are rigged in pairs, lead to deadeyes in the channels and carry a sheer pole the same as the shrouds. The royal stay and the flying jib stay lead to holes drilled in the end of the flying jib boom from where they continue on to the lower hooks on the dolphin striker, one on each side, up through the fair-lead blocks and belay to the bow pinrail. This leaves the martingales, the jib boom and the flying jib boom to install. As shown in Figs. 80 and 83, the martingales (No. 18) aft of the dolphin, are seized to the lower end of the striker and lashed to bull's-eyes attached to eyepins fitted below the cat heads. Forward of the dolphin, they run single from an eye in the end to bands at the tips of the jib and flying jib booms. Although not shown, wire braces from the lower end of the dolphin to the outer ends of the whisker booms will keep the former from swinging sideways. The back ropes (Nos. 44 and 45) pass through holes in the whisker booms and belay to eyes placed in the hull just forward of the cat heads. If you wish to add the optional jib nets, Fig. 78, they are woven on a frame, tied the same as the ratlines and lashed to the back ropes.

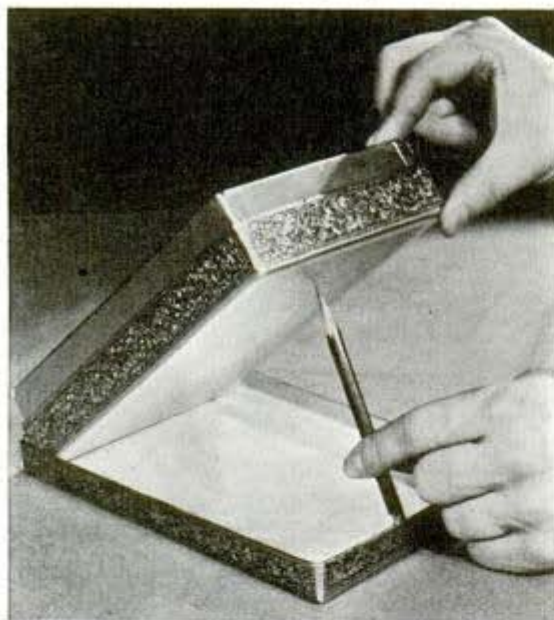
(To be concluded)



"Rattling down" (tying ratlines) will tax your patience at first, but after practice you'll develop a technique which will make the work go fairly fast

STAYS, BACKSTAYS AND SHROUDS				
No.	Name	Cordage	No.	Parts
				Description
1	Fore royal stay	10-lb. Nylon		
2	Fore flying jibstay	10-lb. Nylon		
3	Fore topgallant stay	15-lb. Nylon		
4	Fore outer jibstay	15-lb. Nylon		
5	Fore topmast stay	.022 in.		
6	Fore inner jibstay	.022 in.		
7	Fore lower stays	.032 in.	4	5/32-in. bull's-eyes, black
8	Fore stay sail stay	.022 in.		
9	Main royal stay	10-lb. Nylon		
10	Main topgallant stay	15-lb. Nylon		
11	Main topmast stay	.027 in.		
12	Main topmast stay sail stay	.022 in.		
13	Main lower stays	.032 in.	4	5/32-in. bull's-eyes, black
14	Mizzen royal stay	72-lb. Linen		
15	Mizzen topgallant stay	10-lb. Nylon		
16	Mizzen topmast stay	10-lb. Nylon		
17	Mizzen lower stay	.026 in.	1	1/8-in. bull's-eyes, black
18	Bowsprit martingales	.027 in.	4	5/32-in. bull's-eyes, black
19	Bowsprit bob-stays		6	5/32-in. bull's-eyes, 7-in. 18-link chain
20	Bowsprit shrouds		4	5/32-in. deadeyes, 9-in. 18 link chain
21	Rudder preventer chains			7-in. 22-link chain, black
22	Fore lower shrouds	.032 in.	32	1/8-in. deadeyes, black
23	Fore topmast futtock shrouds			No. 22-ga. tinned wire
24	Fore topmast shrouds	.017 in.	16	1/8-in. deadeyes, black
25	Fore topgallant shrouds	.017 in.	8	3/32-in. deadeyes, black
26	Fore royal backstays	10-lb. Nylon	4	3/32-in. deadeyes, black
27	Fore topgallant backstays	15-lb. Nylon	4	3/32-in. deadeyes, black
28	Fore topmast backstays	.022 in.	8	1/8-in. deadeyes, black
29	Main lower shrouds	.032 in.	32	1/8-in. deadeyes, black
30	Main topmast futtock shrouds			No. 28-ga. tinned wire
31	Main topmast shrouds	.017 in.	16	1/8-in. deadeyes, black
32	Main topgallant shrouds	.017 in.	8	3/32-in. deadeyes, black
33	Main royal backstays	10-lb. Nylon	4	3/32-in. deadeyes, black
34	Main topgallant backstays	15-lb. Nylon	4	3/32-in. deadeyes, black
35	Main topmast backstays	.022 in.	8	1/8-in. deadeyes, black
36	Mizzen lower shrouds	.027 in.	20	1/8-in. deadeyes, black
37	Mizzen topmast futtock shrouds			No. 28-ga. tinned wire
38	Mizzen topmast shrouds	.017 in.	16	3/32-in. deadeyes, black
39	Mizzen topgallant shrouds	.017 in.	8	3/32-in. deadeyes, black
40	Mizzen royal backstays	10-lb. Nylon	4	3/32-in. deadeyes, black
41	Mizzen topgallant backstays	10-lb. Nylon	4	3/32-in. deadeyes, black
42	Mizzen topmast backstays	15-lb. Nylon	4	3/32-in. deadeyes, black
43	Anchor chain			8-in. 11-link chain, black
44	Flying jib-boom back ropes	.022 in.	4	1/8-in. bull's-eyes, black
45	Jib-boom back ropes	.027 in.	4	1/8-in. bull's-eyes, black

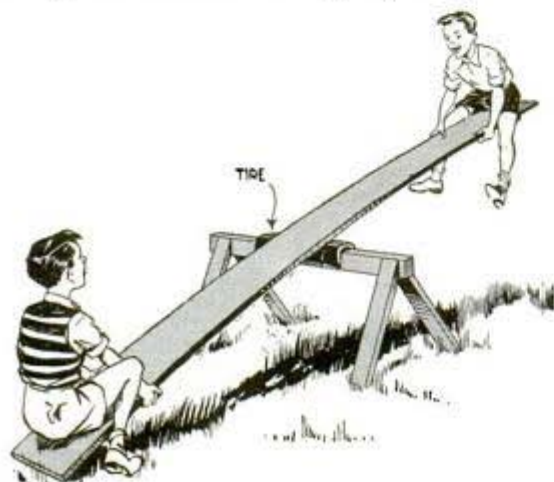
Lead Pencils Serve as Supports For Candy Display Boxes



Supporting candy boxes at an angle in store windows to display the contents properly is an easy matter if lead pencils or pointed sticks are used to raise one end of the boxes. All you need to do is remove the lid, turn it upside down under the box and then lift one end of the box so that a pencil can be inserted as shown.

Seesaw Board Kept From Slipping By Section of Auto Tire

Next time you set up a seesaw for the youngsters, using a loose plank and a sawhorse, cut a section out of an old auto tire and place it over the sawhorse as shown. The rubber provides enough friction to keep the board from slipping. A piece of



inner tube rubber on the underside surface of the board to contact the tire section will provide more friction to prevent slipping.

Rubber Slide on Stirring Rod Measures Liquid in Tumbler

When a glass graduate is not at hand and repeat measures of liquid must be made, you can save time and do the work rapidly by using this depth gauge to check the level of the liquid each time. It consists of a piece of small rubber hose slipped over the stirring rod, the hose being moved up or down to get the depth of liquid desired.



Extension-Ladder Sides Stiffened With Lengths of Angle Steel

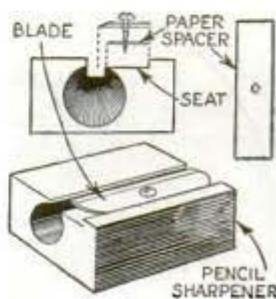


steel pieces do not interfere with handling the ladder or extending it, and they add very little to its weight.

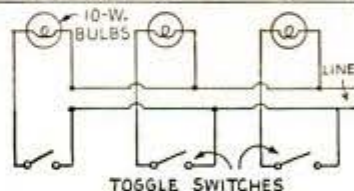
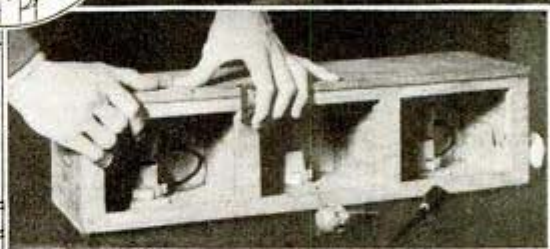
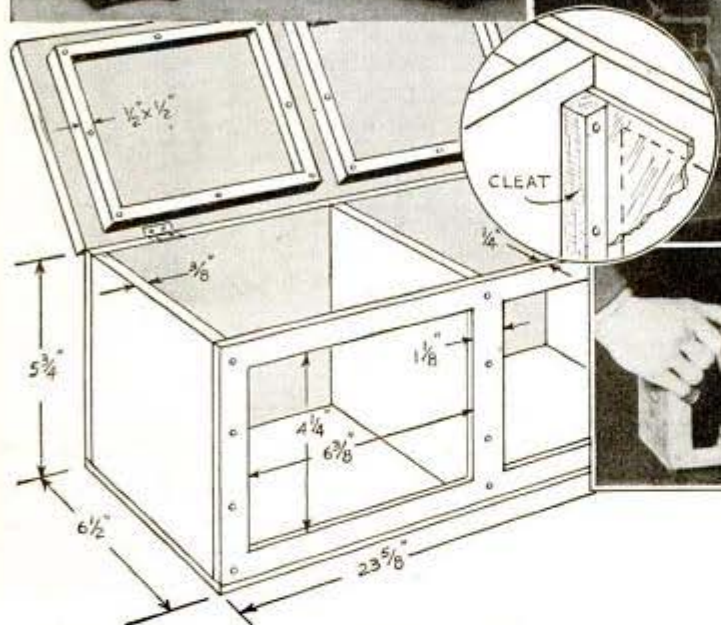
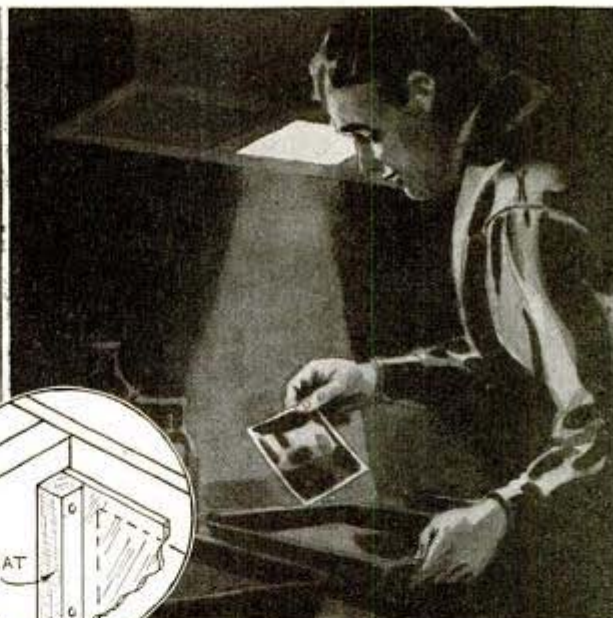
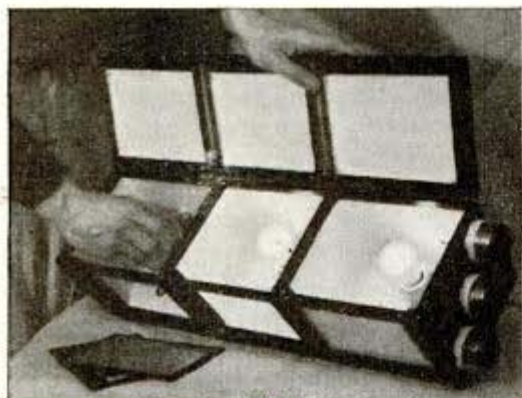
If, after long use, an extension ladder becomes springy and unsteady when fully raised, it can be stiffened by screwing lengths of light angle steel to the sides of the lower section. The

Improving a Pencil Sharpener

By merely making a simple adjustment on a pencil sharpener of the type shown, you can make it work correctly. If it takes too deep a bite, place a piece of thin paper between the cutting blade and its seat as shown in the upper detail. When the blade does not cut deep enough into a pencil, lower it slightly by filing down the seat.



Multiple Safelight Has Three Different Filters



With this inexpensive safelight no time is lost in changing filters for different kinds of work in a darkroom. You just turn on one of three conveniently located switches to bring into service instantly the filter desired, the safelight being fitted with the three types of filters you use most frequently. Assemble a box of convenient size as shown, and partition it to provide three compartments of equal size. Before screwing the front side into place, saw three openings in it for the filters. Dimensions of the openings are for standard 5 by 7 by $\frac{3}{16}$ -in. filters. These should slide snugly in grooves, which are formed by cleats placed inside the box as shown in the circular detail. Next, fit the box with a hinged lid, setting the hinges flush so that the lid will close tightly. As a further precaution against leakage of light, put strips of wood to serve as light traps on the underside of the lid above each compartment. Mounting 10-watt lamps and porcelain

sockets inside each compartment and wiring them as shown in the lower detail completes the job. Locate the sockets so that the lamps are at least 3 in. from the filters. Three switches to control the lamps individually can be located at one end of the box. Paint the inside white and the outside black.—Edwin L. Bond, Roland Park, Mo.

Spinning Titles for Home Movies

Movie titles that are first seen spinning around on the screen and then stop so the words can be read, are easy to produce if you have a phonograph. Make the lettering on a cardboard disk that will fit on the phonograph turntable. Focus the camera on the disk and start the turntable and the camera. The disk can be stopped with the lettering upright by using your finger as a brake on the side of the turntable.

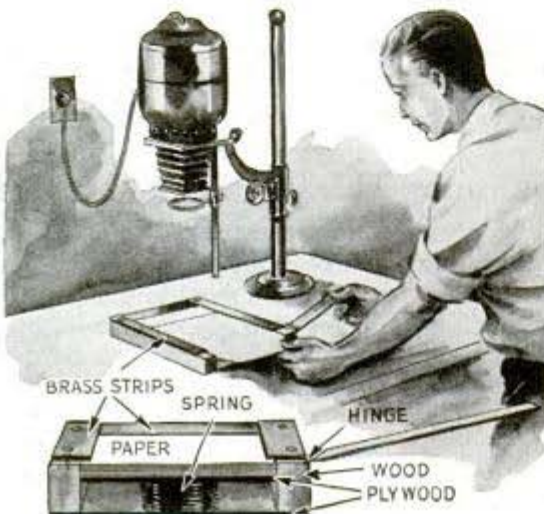
Rubber Feet on Ferrotypes Tins Help Prevent Slipping



A ferrotypes tin will not slip when leaned against a wall while prints are drying if two short sections of rubber hose are slipped over the bottom edge. The hose sections are slit so that they can be slipped on and off easily.

'Magazine' Holds Enlarging Paper For Making Duplicate Prints

Duplicate enlargements from a negative can be made rapidly by using this holder, which takes the place of an easel and holds a stack of sensitized paper. After an exposure has been made, the top sheet is withdrawn, leaving the next one ready to



be printed. A piece of plywood on which the stack of paper is placed, rests on a coil spring that forces the paper up against sheet-metal strips extending over the edges. The strips hold the paper flat and make neat borders on the prints. The strip at the front is hinged so that it can be raised to remove the top sheet after exposure. Dimensions are determined by the size of the paper to be used and the width of the borders desired.

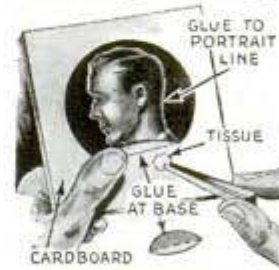
Ice Pick Keeps Prints Off Drain While Washing Them in Sink

Prints being washed in a kitchen sink will not be so apt to lie flat over the drain and stop the flow of water through it if an ice pick is stuck in one of the drain holes as shown. A



penholder, small artist's brush or a pointed stick can be used for the same purpose.

Making Photographic Medallions



Here's a simple way to give profile portraits a third dimension. Cut out the portrait in a circular shape and mount it on a piece of heavy cardboard,

using glue only between the edge and the lines of the face and head. As this leaves the center part of the picture unattached, soft tissue paper or cotton batting can be stuffed under the unattached part, using tweezers and varying the thickness of the stuffing to conform to the curvature and prominence of different parts of the features. By keeping the print moist where it is not glued, it will yield to slight stretching as may be necessary. After the tissue has been inserted, the small opening at the bottom can be closed with a piece of cardboard cut to fit it and glued in place.

When making scenic enlargements cover the enlarging paper with a woman's sheer silk stocking and project, thus giving you a canvas finish on the surface.

Jar Covers Protect Camera Lens And Flash-Gun Reflector



Protection for your camera lens and flash reflector while taking photographs in rain or snow can be provided with two oiled-

silk jar covers. These are slipped over the lens and reflector between shots, being removed only when exposures are made. Left in place when the equipment is put away, the covers keep dust off the lens and help prevent tarnish on the reflector.

Lettering on Photo Negatives Made With Eyebrow Pencil

Lettering on a negative, to show in reverse on the print, can be made with an eyebrow pencil. Use a dark colored pencil and make the lettering carefully on the glossy—not the emulsion side. The lettering can be removed with a wad of cotton dipped in benzene.



Scratches on a negative often will be invisible in an enlargement if the negative is coated with glycerin before it is placed in the enlarger negative carrier.

"Skipper"—Low-Cost, 14-Ft. Outboard Runabout



You can build this five-passenger runabout, which is powered by a 4 to 24-hp. outboard motor. Its speed ranges from 9 to 24 m.p.h. depending on the size motor used. The boat has a 54-in. beam, 15½-in. freeboard, 24-in. depth, a 5-in. draft at 725 lbs., and a weight of about 275 lbs. Six plans (Nos. 1018 to 1023 incl.) showing details of building besides sheets giving material list and outline of procedure will be sent postpaid on receipt of \$1.50

Other Boats You Can Build

16-Ft. Canoe—811 and 812: Canadian type. Cedar planking covered with canvas. 33-in. beam, weight 70 to 80 lbs. Two plans 50c.

Canvas-Covered Kayak—928 and 929: 17 ft. in length and weighs about 40 lbs. Two prints 50c.

"Sea Saucer"—893: Lightweight sailboat. Length 9½ ft. Beam 4 ft. Deck, bottom and sides are 3/16-in. plywood. 25c.

15-Ft. Rowboat—644: Flat bottom, all purpose. Covered forward deck. Has three seats. 25c.

12-Ft. Utility Rowboat—707: Flat bottom, four seats. Very sturdy design. 25c.

"Arrowhead" Sloop—944 to 951: A fast and able sailboat. Over all length 21 ft., beam 5 ft. 11 in. Accommodates up to 10 persons. Set of 8 prints \$2.00.



"Roamer"—765 to 770: Outboard cabin cruiser. 16 ft. long, 66 in. beam. Requires outboard motor of 20 to 36 hp. Set of six prints \$1.50.

"Hi-Ho," 14-Ft. Family Runabout—840 to 845: Powered by 11 to 22 hp. outboard or light inboard motor. Beam 58 in. Set of six prints \$1.50.

Address—Dept. 408, Popular Mechanics Press, 200 East Ontario Street, Chicago



SHOP NOTES

CLOCKS *control* BURGLAR-ALARM *system*

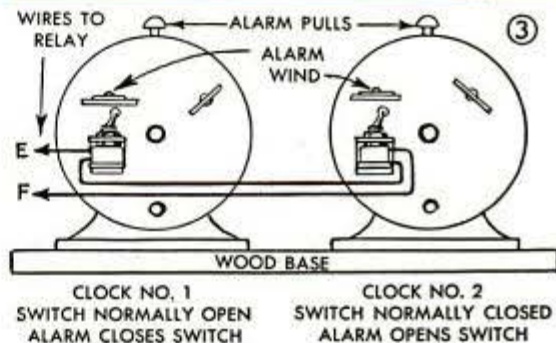
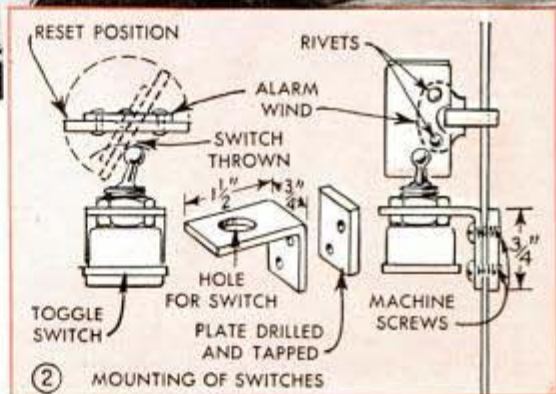
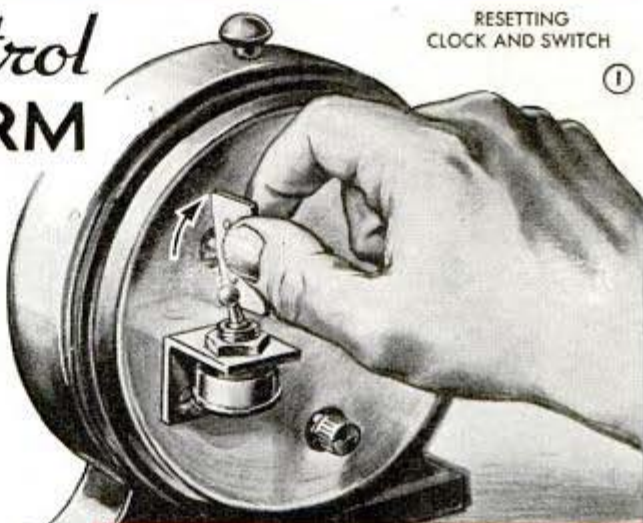
By C. A. Crowley

Winding keys on clocks flip toggle switches, which turn the alarm system on and off at predetermined times. Lights and motors can also be controlled the same way

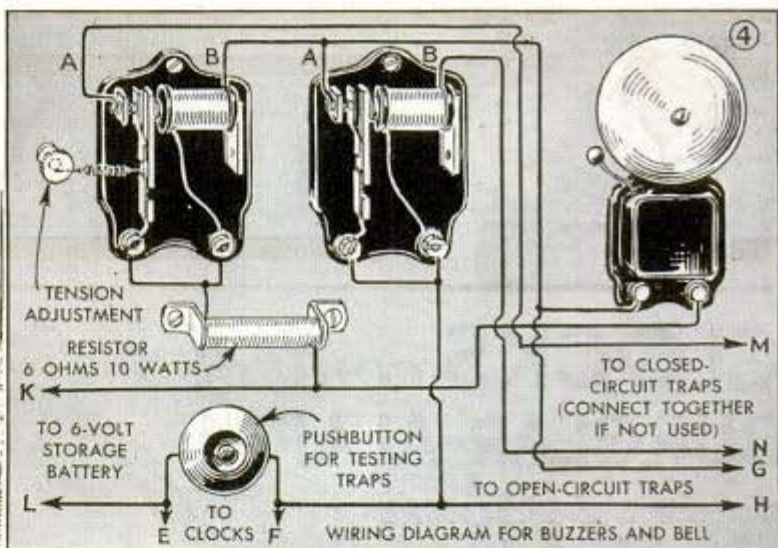
WITH this alarm system, it is possible for a store owner to set the alarm and depart through a door as usual without the alarm sounding. After a predetermined time following his departure, a clock will turn on the alarm system, thus initiating the period of protection. Early on the following morning, just before the arrival of the person who opens the store, a second clock will disconnect the alarm.

Mounting the clock switches: Two cheap alarm clocks, two toggle switches and three buzzers will be required. Both clocks are modified in exactly the same manner. An ordinary toggle switch is mounted on the clock by means of a bracket as shown in Fig. 2. Before doing this, the clock movement must be taken from the case carefully, after which the bracket is spotted in the position that will permit the alarm-wind key to throw it when the alarm sounds. With these positions marked, the back of the clock is drilled after which the bracket and a metal reinforcing strip are attached. Then the clock is reassembled and the alarm key is fitted with an extension to push the toggle switch from one position to the other. The key should turn about one-quarter of a revolution, and in so doing, throw the switch to the opposite posi-

RESETTING CLOCK AND SWITCH



tion. The edge of the key should remain against the ball of the toggle at this point so that the alarm will not run down. When properly adjusted, the switch is reset by turning the key to its original position, Fig. 1, and then throwing the switch back.



⑤ CHANGES IN BUZZERS

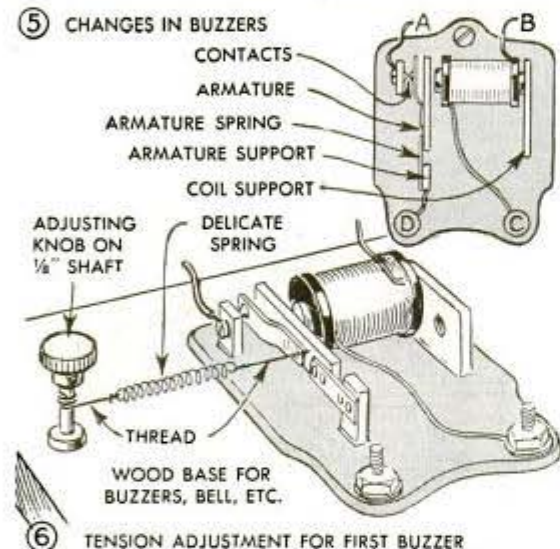


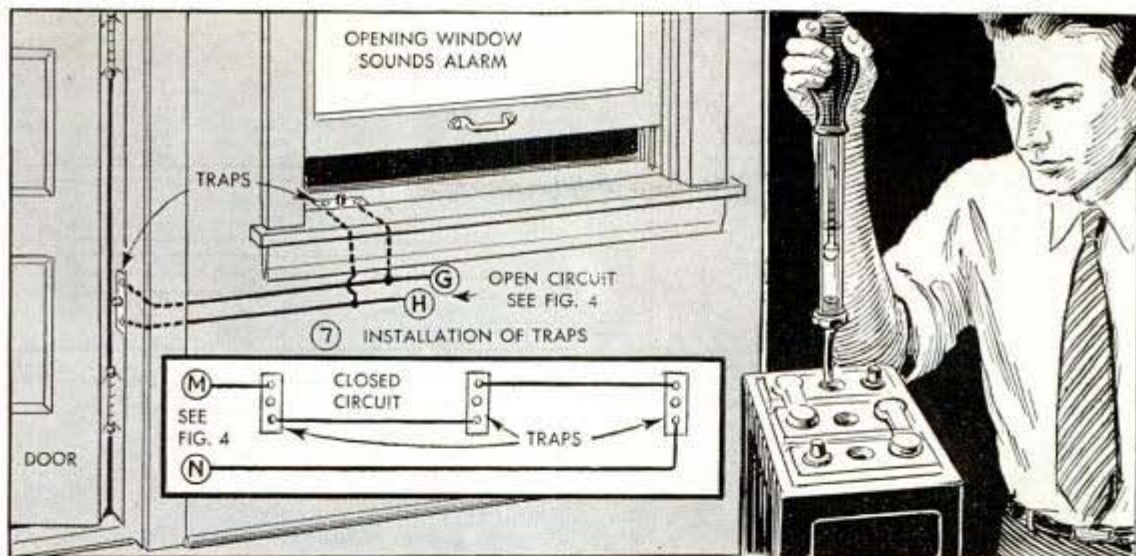
Fig. 3 shows two alarm clocks on a base with their switches properly connected for use with a simple alarm system. It should be noted that clock No. 1 is set in a position that the clock closes the circuit, while switch No. 2 is set so that the clock opens the circuit. The wires E and F are to be connected to the corresponding connections on a pushbutton shown in Fig. 4.

Buzzers converted into alarm releases: Two ordinary bell buzzers and a bell will be required to complete the remaining parts of the alarm system. Both buzzers should be reconnected as shown in Fig. 5, after which they are mounted on a board or panel approximately 1 by 6 by 10 in. The first one shown in Fig. 4 must be modified further as in Fig. 6. A long screw is driven into the hole in the board at the relative position indicated so that it can be rotated to apply additional tension to the

armature of the first buzzer. The buzzers and the bell are next connected as shown in Fig. 4.

The resistor used in the wiring may have to be altered to suit the particular buzzers, as the resistance should be such that when the current is applied to the coils, the armatures can close and the coils will not heat too much. The lead wires marked K and L are connected to a storage battery. The leads E and F are connected to the wires from the clock switch as previously explained.

Testing connections and adjusting tension screw: For testing the connections and adjusting the tension screw, a jumper wire should be connected temporarily between lead wires M and N. The lead wires G and H should be left open for test. After making these connections, the battery is connected temporarily to the leads K and L. When the tension adjustment on the first buzzer is correct, the armature of buzzer No. 2—the right-hand one in Fig. 4—should be pulled against the coils immediately, and the armature on the first buzzer should be unaffected. If the first buzzer should close, thus causing the bell to ring, the battery should be disconnected immediately and the tension increased by turning the adjustment screw. Increases in the tension should be made in small steps. Between each increase the battery should be reconnected until the armature of the second buzzer always closes and the armature of the first buzzer remains open. After the correct adjustment has been attained, the battery should be connected and disconnected repeatedly to make sure that in each

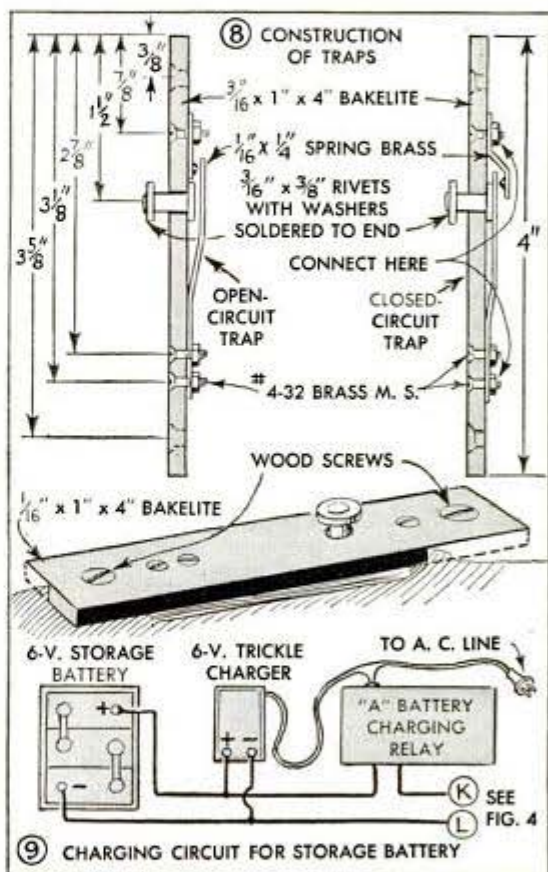


instance only the second buzzer is affected. When this condition prevails, the outfit is ready to be put into service.

In order to test the system further, the jumper wire between M and N leads may be removed while the battery is connected to the system. Removal of the wire will cause the bell to ring. Then the jumper should be replaced and the bell should continue to ring in spite of the fact that the jumper has been put back into its original position. With the system in this condition, the lead wires G and H should be touched together. This should cause the bell to ring again, and it should continue to ring when the leads are disconnected. From these experiments, you can see that we have a dual-purpose burglar-alarm system, which can be used either with open-circuit traps or with closed-circuit traps as will be explained later.

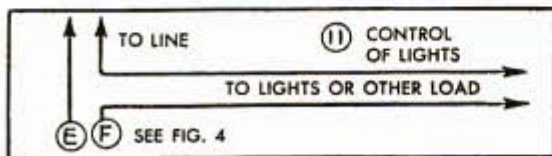
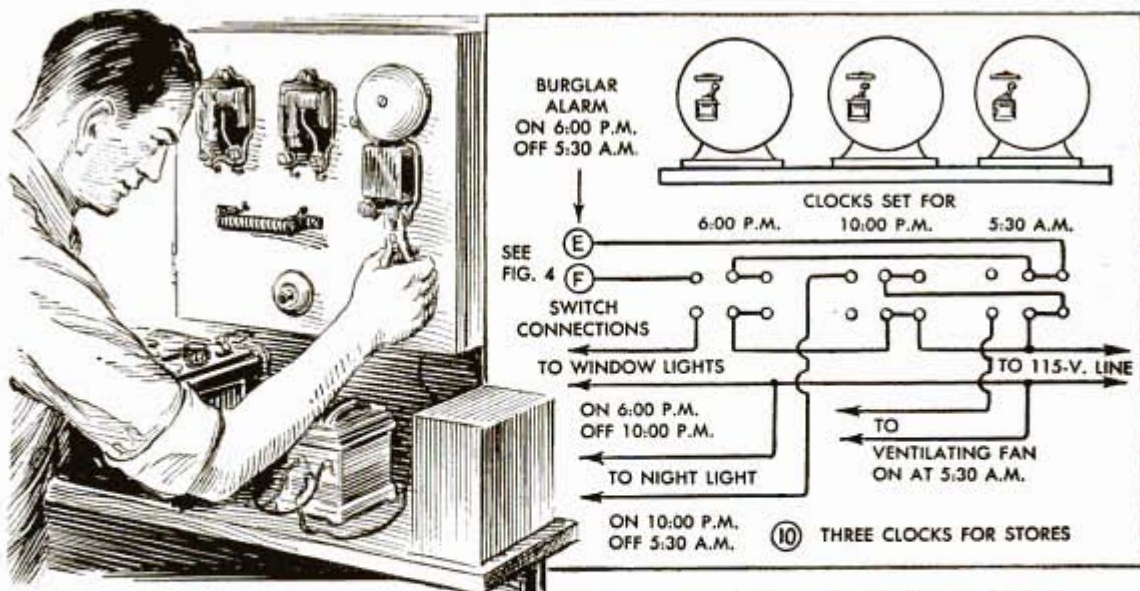
Construction and installation of traps:

Open and closed-circuit traps are shown as A and B in Fig. 8. When the rivet heads are depressed, the open-circuit traps are opened, and the closed-circuit traps are closed. These traps should be installed in such a manner that the rivet heads are depressed when the premises are left. They should also be so arranged that any disturbance in a door or window will allow the rivet head to come to its normal position, thus altering the circuit. Fig. 7 shows the method of connecting the two kinds of traps to windows and doors. Open-circuit traps are connected in parallel, while the closed-circuit traps are connected in series. When the traps have been installed and connect-



ed respectively to the proper lead wires from the buzzers, the system is ready to be put into operation.

Before departing from the premises, clock No. 1 should be set so that its alarm will go off about 5 or 10 min. after the last person expects to be out of the premises. The second alarm should be set so it will go off before the arrival of the first person who is expected to reenter the premises.



With the clocks thus set, and the alarm levers pulled up so that they will both go off, it is advisable to test the system to make sure that all of the traps are ready for operation. With all doors and windows in their respective positions, depress the pushbutton shown in Fig. 4. If everything is in order, the bell will not ring, but the armature of the second buzzer will be attracted by the coil. If the bell sounds, some of the open-circuit traps are short-circuited or some of the closed-circuit traps are open. An inspection of the traps will reveal which window or door has not been properly prepared for the night. If all of the doors and windows have been properly set the pushbutton can be depressed without ringing the bell. When everything is in order, you can leave the premises and lock the door. In the operation of such an arrangement as this, often it is advisable to equip the storage battery with a trickle charger such as is commonly used in battery-operated radios. By this means, the battery will be given a slow charge during the time the alarm is not in use. The relay will automatically cut off the charger at night. All of the connections for this arrangement are shown in Fig. 9.

Special use for the clock switches: Fig. 11 shows a simple scheme by which one clock may be used to turn lights on or off

at any predetermined time. This is convenient when you want to leave the lights on and turn them off at 9 or 10 o'clock in the evening. Fig. 10 shows just one example of the kind of elaborate arrangement which is possible with alarm clocks equipped with switches. In the example shown, three clocks are required. Each clock is equipped with double-pole, double-throw toggle switches. The heavy lines connecting the switch poles in the diagrams indicate the position of the switch before the alarms sound, and the blank spaces between the switch poles show the switch after the alarm has sounded. By this method, the burglar alarm is connected to E and F as shown in Fig. 4, and the first and last clock will give the same protection as was previously explained.

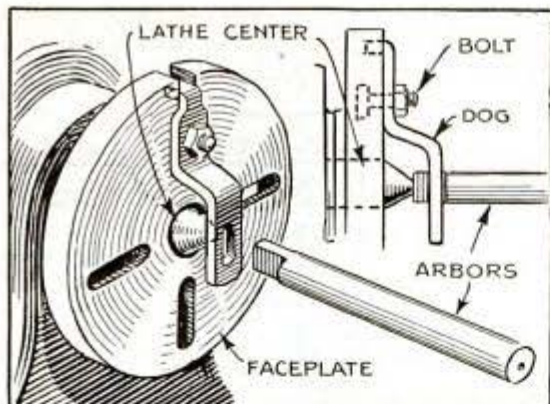
Plants Shielded by Window Shade

When seedlings require more protection than that afforded by the usual slat shade, mount an ordinary opaque window shade on the hot bed or cold frame as indicated.



When this is pulled down over the seedlings, it will protect them adequately from both the sun and moving currents of air which cause too rapid evaporation of moisture. On wide frames, it may be necessary to lay two or three strips across them to support the shade above the plants.

Quick-Change Lathe Arbors Speed Production



By equipping my lathe faceplate with this dog which permits arbors to be changed quickly, I have increased the production of small gear blanks, bushings and sleeves as much as 30 to 40 percent. The dog is made easily from a piece of $\frac{1}{4}$ by $1\frac{1}{2}$ -in. stock by bending it to the shape indicated and cutting a slot near the lower end, making it possible to drive arbors up to $1\frac{1}{4}$ in. in dia. It's a good idea to caseharden this end to prevent the slot from spreading or wearing rapidly when used for production work. After grinding



two flats on one end of each arbor to fit the slotted dog, it takes only a couple of seconds to change them, thus eliminating time spent in removing an ordinary lathe dog from one arbor and putting it on another.

—W. F. Kelley, Michigan City, Ind.

Turntable Simplifies Repairing of Small Electric Motors



Made from a piece of plywood or hard-pressed board, four casters and a pointed bolt, this simple turntable is ideal for holding electric motors on a bench or table while repairing them. After cutting a plywood disk of sufficient diameter to suit your needs, drill a hole in the center of it to accommodate a $\frac{3}{8}$ -in. bolt which has a sharpened end as shown. Then divide the disk into four equal sections and mount ordinary roller casters near the edge. When assembled, the pivot bolt should be locked in place with a nut and adjusted so that the point extends $\frac{1}{4}$ in. below the caster wheels to prevent the table from sliding when in use. If considerable painting is done, a similar table is handy for this work as it can be turned easily or lifted without touching the article being painted.

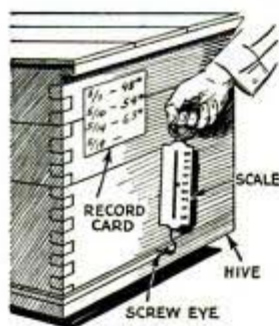
☞ To prevent a saw blade from creeping away from the work when cutting a narrow slice off the end of a board, always use a clamp on the miter gauge or feed the work very slowly.

Hoist Mounted on Side of Ladder For Raising Tools



Mounted on one side of a ladder with a heavy screw eye or eyebolt, a small hoist provides a handy means of raising boxes of tools and materials to a workman at the top of a ladder. In this way, two men working together can save themselves many steps going up and down the ladder to get the various articles needed.

Checking the Amount of Honey In Individual Beehive



During the season of heaviest production in a large apiary, a beekeeper keeps track of the amount of honey by using a small pair of scales as shown. A screw eye driven into the bottom edge of each hive provides a means of attaching the scales. Day to day changes are recorded on a card tacked at the side and when the weight indicates that the capacity of the hive is about reached, surplus stocks of honey are removed. Although not dependable for comparisons

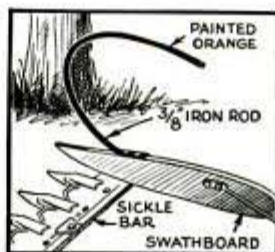
between several hives because of varying support points at the front ends, this method does give a good idea of honey accumulations of individual hives without disturbing the bees by opening the hive.

Serrated Rubber Band on Oilcan Provides Nonslip Bottom

Oilcans will have less tendency to move around on tables or machines that are vibrating if rubber bands are snapped around the bottom rims of the cans. It's a good idea to serrate one edge of each band and let it project about $\frac{1}{4}$ in., which provides more friction on the table as the small rubber points bend when the cans are set down.



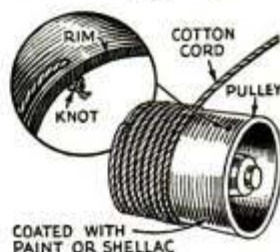
Divider on Sickle Bar of Mower Helps in Mowing Fence Rows



Screwed to the forward end of the swathboard of a mower sickle bar, a divider made from an iron rod as indicated will serve as a guide when mowing weeds along fence rows. The divider is painted an orange color, thus making it easy for the operator to judge the exact location of the outer end of the sickle bar.

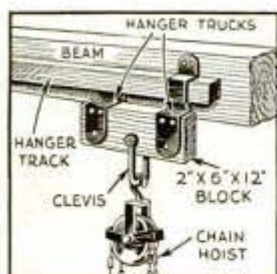
Slipping of Belt on Iron Pulley Avoided by Cord Lagging

If you have a small iron pulley on which the belt has a tendency to slip, try lagging it with cotton cord. First, clean the face of the pulley carefully to remove all grease and belt dressing and roughen the surface with coarse emery cloth. Coat it with paint or shellac and



while this is still tacky wind the cord on the pulley. Two small holes at the outer edges will provide a means of anchoring the ends of the cord. After the face has been completely covered, paint or shellac the lagged surface.

Lightweight Traveling Hoist From Barn-Door Hanger



Needing a light traveling hoist to move loads weighing up to 600 lbs. in the repair department of his implement shop, one dealer used an ordinary barn-door hanger. The

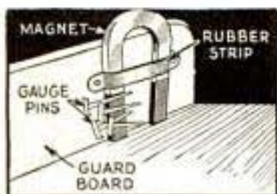
trucks of the hanger are bolted to a block of hardwood, and a clevis bolted to the block carries a light chain hoist. The hanger track is attached to a heavy beam.

Weights for Platform Scales Are Sand-Filled Bottles

Time wasted in setting a scale beam slide and selecting weights for a certain load, which was always the same, was saved by one manager of a warehouse who made up special weights by partly filling bottles with sand. Screw hooks driven into tightly fitting corks in the bottles permitted the weights to be hung on the scale.



Gauge Pins Held on Job Press By Small Magnet



To keep gauge pins conveniently at hand on his job press, one printer tacked a strip of rubber to the guard board near the end to hold a small magnet. Gauge pins pushed against the ends of the magnet will stay there until they are needed.

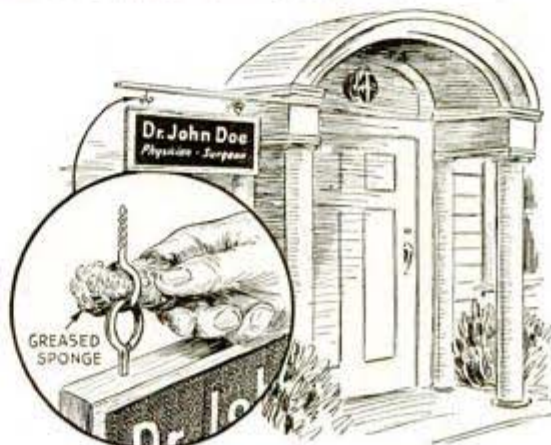
Counter Tray for Inspecting Tools Prevents Breaking Glass

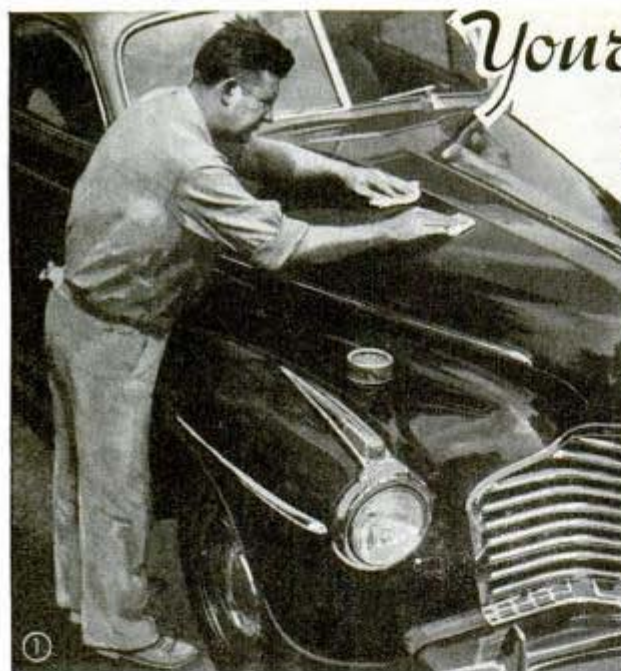


This simple tray is used in a large hardware store and is kept on the glass counter to hold tools while customers examine them. Used in this way, the tray prevents any possibility of a tool being laid down too hard and breaking the glass counter. Crutch tips slipped over the ends of the legs cushion the counter against the tray.

Sponge Impregnated With Grease Lubricates Sign Hanger

Annoyed by the squeaking of the screw-eye hangers of his office sign, one doctor remedied the trouble by forcing pieces of sponge through the eyes of the sign hangers. The sponges were impregnated with grease and kept the hangers well lubricated for several months at a time.

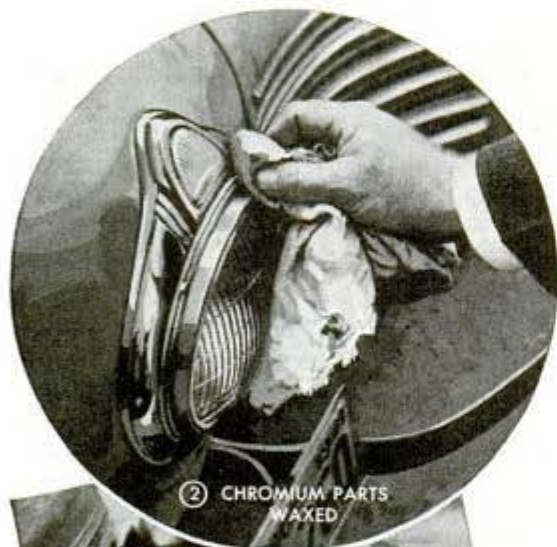




Your CAR BODY must last too!



How to avoid corrosion that weakens or destroys doors, sills and other body parts



TO MAKE your car last for the duration, don't overlook the body—the largest part of the car and the part most exposed to the weather. Although the body is covered with a protective coat of paint or lacquer, any steel surfaces where the paint film is broken will soon start to rust. This is often unnoticed, especially around joints, under fenders and body ledges, and similar places where moisture accumulates.

One of the best protective measures for a car body is to keep it washed and well waxed, Fig. 1. Be careful when using a cloth on the car in either washing or waxing that it does not contain sand or other hard particles that will scratch the finish and allow moisture to penetrate. If you drive over streets where salt has been used to melt ice, always have the car washed with a hose. See that the job is done thoroughly and that all parts of the car have been flushed with the water to remove all traces of salt that might have been splashed on them. Salt is hard on the finish and will cause unprotected parts to rust rapidly. Also, be careful about driving where calcium chloride is used on roads or streets to melt ice or lay dust as it is highly destructive to paint and should be washed off the car as soon as possible. It is especially harmful to chromium plating, which should be kept waxed, Fig. 2.

Besides keeping the car clean and waxed, inspect the body regularly for any spots where rust may be starting. If your spare



tire is kept in a fender well, it is likely that rust has started at the bottom of the well. Clean away all rust with a steel brush, Fig. 3, and then repaint it. Before touching-up a rusted spot, be sure all rust has been removed. After using the steel brush, go over the spot with fine steel wool, rubbing the metal until it is bright. It is a good idea to take off some of the paint that seems in good condition adjacent to the rusted spot. This is to make sure that rust has not worked back under the paint, which has not yet flaked off. If this is not done, the repair may have to be repeated in a short time. Usually, when doing a touch-up job, it is better to apply two thin coats of paint than one heavy one, allowing the first coat to dry thoroughly before applying the second one. Look for signs of rusting at the lower edges of the doors. Although most water that gets between the door panels during a rain runs out at the bottom, there's always some moisture that remains on the surface to evaporate and accelerate the process of rusting. Spots where water settles should receive extra attention; clean them thoroughly and touch up with paint as in Figs. 7 and 8. The drain trough around the cowl ventilator, Fig. 11, also requires this attention. And, don't forget

the joint around the rear-deck lid as rust often appears here as indicated in Fig. 9. All places on the body where parts are joined should be examined carefully, as moisture is retained in the narrow crevices for several hours, sometimes even days, and such places are likely to rust rapidly, especially if the car is over 2 yrs. old. Nicks in the paint on the edges of doors, Fig. 6 and fenders should be touched up immediately. Flashing compound applied as in Fig. 12 will protect the undersides of fenders. Sometimes the rubber covering on run-



⑩ ROOFING CEMENT



⑪ DRAIN TROUGH CLEANED



⑫ FLASHING COMPOUND PROTECTS UNDERSIDE OF FENDERS

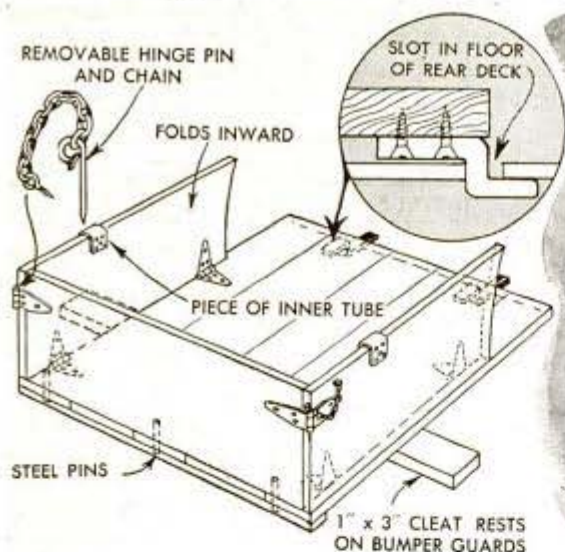


ning boards wears through to the metal, permitting rust so that the running board is severely damaged. Ordinary asbestos roofing cement is highly suitable for repairing these places as shown in Fig. 10. Probably one of the first places where rust forms is around the joint between the windshield and the rear-window glass and their frames. Usually a rust attack is not apparent here until considerable damage has been done. This can be avoided by making regular applications of a clear compound made especially for this purpose, Fig. 4. Another place where rust does considerable damage before it is noticed is on the floor, especially at the joints where the floor is joined to the body. Rusting in these places usually results in weakening the body. Regular inspection of these parts with careful cleaning and painting usually will avoid the trouble. For maximum protection some motorists apply roofing cement to such places, carefully sealing them against the entrance of moisture.

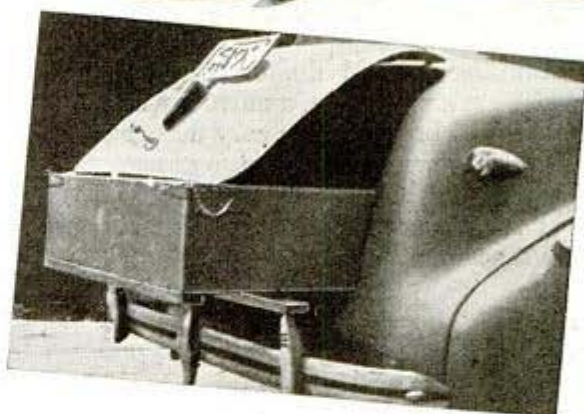
All bolts and rivets in a car body are put there for a purpose so keep them tight, but don't overdo it, especially on the bolts that attach the body to the frame. Usually there is an insulator on these bolts to help absorb vibration from the chassis. If they are pulled up too tightly, the insulators are ineffective. Lubricate regularly all parts requiring lubrication. Use a grease stick for hinges and latch bolts, and a tube of powdered graphite, Fig. 5, for locks and places where a grease stick cannot be used effectively.

❑ In a shop making small boat propellers out of cast aluminum, a cutting lubricant of paraffin oil, 20 percent, and kerosene, 80 percent, was found far superior to any other lubricant for machining the parts.

Folding Extension Increases Size of Car Trunk



As I often have to carry bulky or long articles in my car trunk, I made this extension box to accommodate them. It is attached in a minute without the use of bolts or screws, and lies flat inside the trunk when not in use. The sides are hinged at the lower edges and are held in the opened position by the tail gate, which is removable. It is held at the bottom by steel pins, which slip into holes in the bottom of the box, and at the top by two hinges, one half of each one being screwed to the box side and the other half to the tail gate. Inserting the hinge pins into the halves locks the tail gate in place. The extension is put into place by tilting it so that metal cleats screwed to the bottom at the front will slip



into slots cut in the bottom of the car trunk. The rear end is supported by a long cleat, which rests on the rear bumper guards.

—Carl Aufdermarsh, Cincinnati, Ohio.

Red Reflectors Warn Traffic When Truck Door Is Opened

Attached to the inside surface of the left-hand door of a truck or car, red reflectors may help avoid an accident by warning traffic approaching from the rear that the door has been opened. Another reflector soldered to the outside surface of the door will warn traffic approaching from the front. Thus protection is offered the driver should he be forced to stop on the highway and open the door without first looking up and down the road.

☐ Children can't turn on the dome light in your car if you connect the live wire of the light into the dead side of your parking-light circuit.



Catwalk Around Garage Wall To Walk Behind Cars

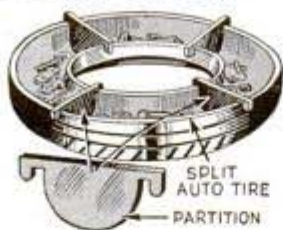


CATWALK GIVES EASY PASSAGE BEHIND CARS

Running around the outer walls of a public parking garage, a narrow walk constructed of boards gives easy access to the rear of any cars parked in the garage. The walk should be anchored to the walls so that it will not be dislodged by backing into it accidentally.

Half of Auto Tire Partitioned Is Good Small-Parts Holder

When dismantling a car or other machine, a good container for keeping the small parts stored and separated can be made from one half of an old tire by splitting it lengthwise through the center. The container can be partitioned with thin pieces of wood.



SPLIT AUTO TIRE PARTITION

Screwdriver Loosens Hub Caps Without Marring Finish



Scratches on auto wheels caused by a screwdriver when prying off hub caps can be prevented easily by slipping a 1-in. length of rubber

hose over the screwdriver blade. In use, just force the blade between the hub cap and wheel. Then slip the hose down as far as possible so that it will act as a cushion, making it possible to pry the cap off without scratching the finish on the wheel.

Pass Card Attached to Windshield With Twisted Cellophane Tape

Workmen who must show their pass cards before entering and leaving a company parking lot will find it convenient to attach them to their car windshields in such a manner that they can be displayed or removed easily. This can be done by merely twisting strips of Cellophane tape and sticking them on the glass as shown.

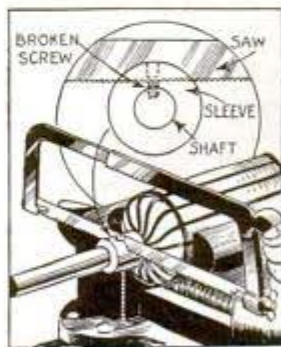


Easy Way to Detect Cracks

Cracks in auto parts are often difficult to detect with the naked eye. Axle shafts, castings, etc., may be checked easily by painting with a light, even coat of whiting and alcohol. The alcohol causes the coating to dry quickly. The part to be checked should be clean and free from grease. After the whiting has dried, a light tap with a hammer will usually vibrate the part sufficiently to show and outline any possible cracks. When the metal has been exposed to oil or grease, even a very fine crack will retain some of the lubricant and the vibration will cause it to ooze out and show up very plainly through the whiting.

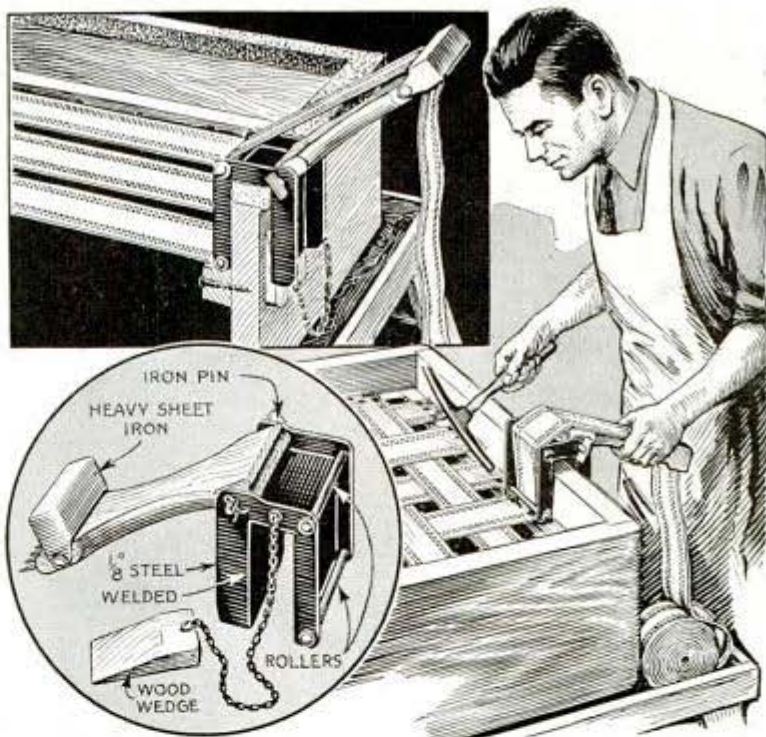
Removing a Broken Starter Bolt

Much of the difficulty of removing a starter bolt that has been sheared off flush with the sleeve on an armature shaft, can be avoided by slotting the bolt so that it can be removed with a screwdriver. This can be done with a hacksaw by sawing right into the bolt and sleeve as indicated.



Tool to Stretch Webbing on Deep Box Frames

Upholsterers who have many jobs that require webbing to be stretched and tacked to a cleat below the upper edge of a deep box frame in a manner similar to that shown, will find this stretching tool a timesaver. Designed by an upholsterer of the Pullman Company and brought to their attention through the company's employees' suggestion system, the tool is of steel, welded together. The jaws slip over the frame edge, the length of the jaws being determined by the depth of the cleat from the frame top. In use, the end of a webbing roll is fed under two steel rollers at the upper



and lower ends of one of the jaws, and then over the teeth of a regular wooden stretcher, which is pivoted to the jaws. A sheet-iron guard is pivoted to slip over the teeth of the stretcher to help avoid injuring a workman's hands. Various thicknesses of

frames on which the tool may be used are compensated for by a wooden wedge, which is attached to the assembly with a chain, and is slipped between one jaw and the frame when required to make the stretcher fit the frame snugly.

Metal Shield Prevents Furrow Wheel From Winding Trash

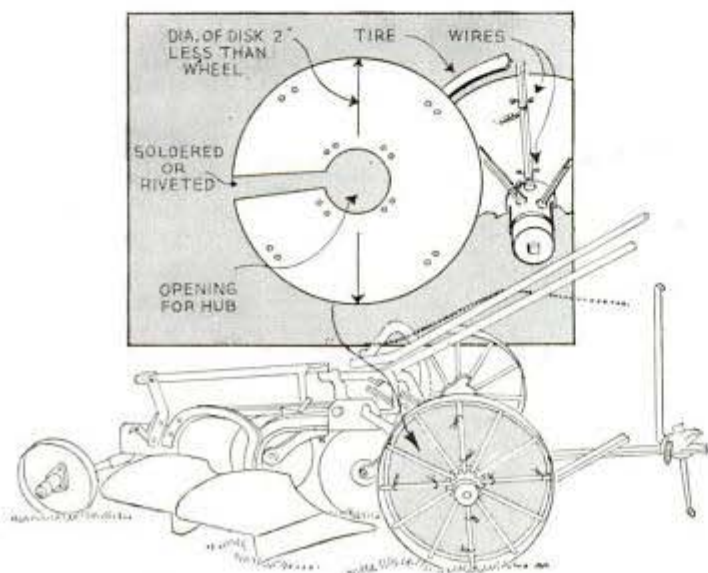
Under extremely trashy conditions the furrow wheels of tractor plows sometimes give trouble by winding trash about the

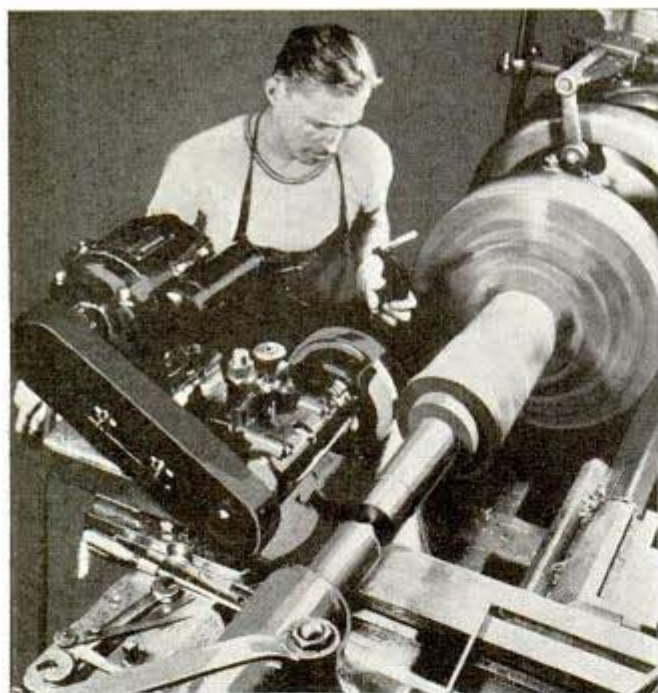
hub and spokes. One farmer prevented this by fitting a sheet-metal shield over the spokes on the land side of the wheel.

The shield is cut from galvanized iron, and its diameter is about 2 in. less than that of the wheel. An opening in the center allows the disk to fit over the hub, as indicated. It is wired to the spokes.

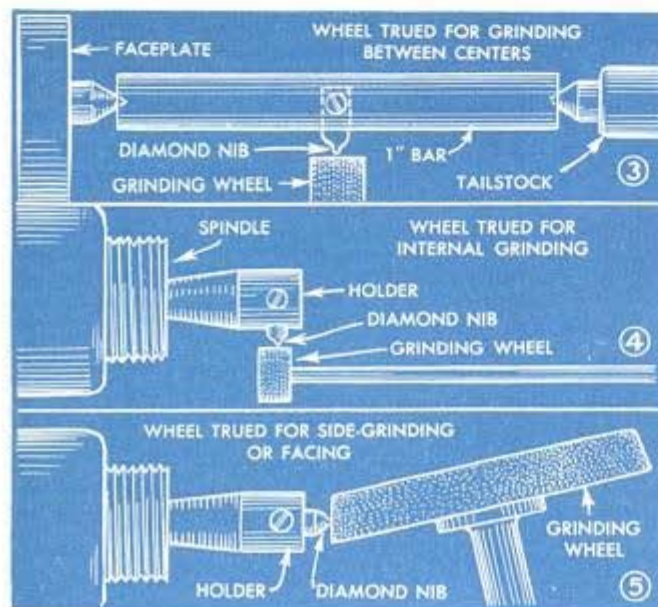
Typing Shipping Tags

One shipping clerk has his shipping tags printed in strips of six with a perforated edge between each one. This saves time in putting in and taking the tags out of his typewriter, as the tags can be typed in strips and then be torn apart for the various packages.





① *Tool-post grinder*



PRECISION

PART 6 OF BASIC SHOP

ACTION *behind the lines!*

One secret of fast, mass production of interchangeable parts for planes, tanks, guns and other war equipment lies in precision grinding — sometimes to within .0001 in. of perfect size. This article gives you the highlights on precision grinding, which every apprentice machinist should know

By H. J. Chamberland

LOW-COST mass production of interchangeable parts is largely the result of semi-mechanically controlled precision grinding with improved machines and grinding wheels.

Tool-post grinding: Cylindrical grinding originated in the lathe and is commonly known as tool-post grinding, the grinder being mounted on the lathe tool post as in Figs. 1 and 2, which show an external and an internal grinding operation. This particular grinder is of 1-hp. capacity and produces an excellent finish while holding close tolerances. It can be set up instantly for internal grinding by a quick change of the driving and driven pulleys. Precision ball-bearing construction of such units assures accuracy. Also, with the addition of an economical attachment to such a grinder, thread grinding can be done in any screw-cutting lathe, Fig. 6, which makes it possible to correct threading-tool errors and heat-treating distortion. A wheel-truing device is provided to shape the wheel face to the desired thread form. Figs. 3, 4 and 5 show three methods of dressing wheels for lathe grinding. Note that in each case the wheel face is

GRINDING

MACHINES & HOW TO USE THEM

dressed so its entire surface will cut in alignment with the surface being ground. Tool-post grinding is not restricted to use on the lathe only; in Fig. 7 a tool-post grinder is used on a milling machine to finish a die. While this is somewhat of a duplication of vertical milling work, it is much more precise as a pencil-type grinding wheel replaces the end mill.

Types of grinding machines: Besides tool-post grinders, which could be considered accessories, the major types of grinding machines used for parts production are the universal, the cylindrical, and surface grinders. In addition to these there are specialized floor and bench-type grinders. The universal grinder, indispensable in any machine shop, is of utmost interest to the apprentice. As vibration is the greatest problem of precision grinding, the machine must have considerable weight and rigidity so that vibration is eliminated.

Universal grinders: A universal grinder, Fig. 8, is a machine readily adaptable to either external or internal cylindrical work, besides side or face grinding. Usually this type of grinder is made in three sizes, has automatic transverse and cross-feeds, will grind straight or tapering longitudinally; also straight, concave, convex and at an angle transversely. With all grinders, a compound or coolant is used for maximum cutting efficiency. This not only avoids generating excessive heat but also serves to impart the desired finish. A mirrorlike finish is possible when grinding cylindrical work but this requires practice. To change from external to internal work on a universal grinder, it is only necessary to swivel the wheel-head platen 180 degrees to bring the internal spindle into working position. Fig. 10 shows a closeup view of an internal grinding operation. In this case the part is bolted to the faceplate.

When using a chuck to hold work for



Upper photo shows how thread grinding is done in a screw-cutting lathe by means of an attachment on a tool-post grinder, which corrects threading-tool errors and heat-treating distortion. Lower photo shows how a tool-post grinder is set up for use on a milling machine

grinding, the work is trued while in alignment with the tailstock. Then the center rest is adjusted to replace the tailstock which is removed from the table. When so using a chuck, the center rest or steadyrest should always be used even with short parts to avoid too much pressure on the

Universal grinder



stock is not in reality a finishing wheel, and quantity and quality cannot be had simultaneously.

For a shaft-grinding operation when the length of the part is comparatively long in relation to its diameter, one, two, three or more so-called back rests are used to compensate for wheel pressure. Fig. 12 illustrates the directions of wheel and work rotation for various grinding operations, A for lathe grinding and B for regular grinding machines. Note in C that a hole or bore may be ground from the back side in both cases and still maintain the desired opposite wheel-work direction of rotation.

The conventional method of dressing the face of a grinding wheel for external cylindrical grinding is shown in Fig. 14. The dressing fixture should be positioned about midway on the table. The diamond should never be forced to remove more than .002 in. at each pass, and use of the automatic transverse feed is advisable for best results. The improved diamond dressing fixture shown in Fig. 15 is of simple construction and permits obtaining a fresh cutting edge from the dia-

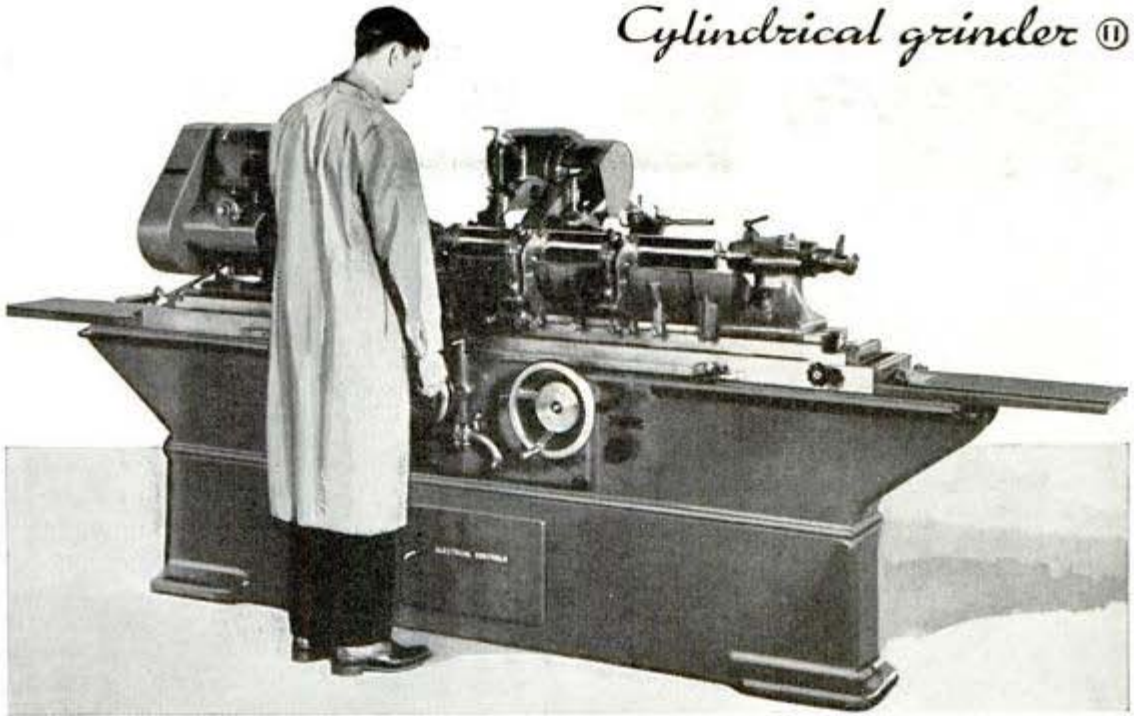
In Fig. 9 a permanent-magnet chuck is used to hold the work for side or face grinding. Below, closeup view of an internal grinding operation using small wheel. Work is bolted to faceplate

chuck jaws and to maintain concentricity. Fig. 9 shows how work for side or face grinding is held by means of a permanent-magnet chuck which requires no electrical connections.

Cylindrical grinders: An example of a plain external cylindrical grinding machine is shown in Fig. 11. It is not unusual for one of these machines to remove $\frac{3}{16}$ -in. stock from cast or malleable iron, brass, bronze and aluminum castings three to six times faster than can be done by turning. However, one must bear in mind that a grinding wheel intended to hog off



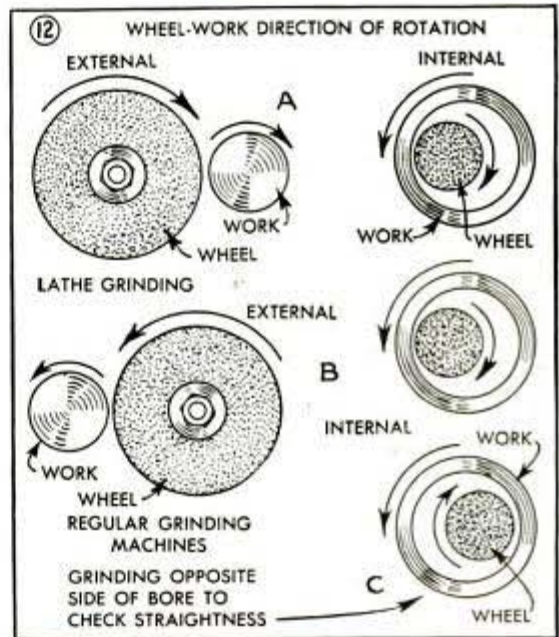
Cylindrical grinder ⑪



mond point for each dressing. By using the twelve divisions consecutively the diamond point will remain permanently sharp. It is advisable always to use a diamond about 50 percent larger than normally recommended, and to use plenty of coolant if available. Diamond costs are high when tools are victims of sudden temperature changes. Wheel-truing diamonds vary in several shades from white to black but the color has no bearing on the hardness or internal structure of the stones.

Chatter marks: The problem of chatter marks has been overcome to a great extent in grinders but there are still many antiquated cylindrical grinders in use. It is a simple matter for an apprentice to learn how to operate a grinder but it is a different story to be a trouble shooter. Chatter marks are very often invisible to the naked eye and only show up after a ground surface is polished or lapped. The chief causes of chatter marks are given in Fig. 13.

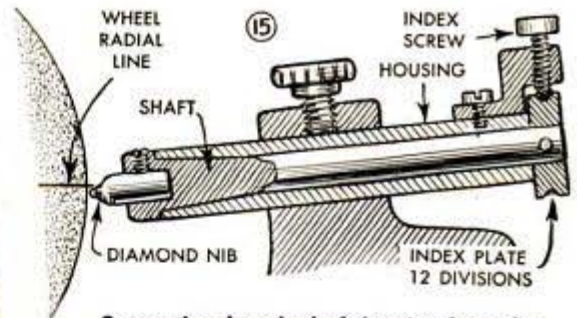
Surface grinders: Surface grinders are as indispensable to machine-shop practice and production as grinders already described. They grind machine parts singly or in multiples, and perform all surface-grinding operations related to tool work such as dies, fixtures, gauges and the like. Although the rotary-type grinder is productive, it is limited to plain surfacing. On the other hand, the transverse table grinder such as shown in Fig. 16 is used for the many diversified surface-grinding operations and is well suited for the trainee or apprentice to gain extended experience. In



⑬ CAUSE OF CHATTER MARKS IN CYLINDRICAL GRINDING

- 1—Loose belts and lacing bumps on belts
- 2—Worn centers or poorly fitted centers
- 3—Centers not ground to precise angle
- 4—Poorly lubricated centers
- 5—Wrong ratio between work speed and longitudinal feed
- 6—Uneven wear in the wheel slide or worn spindle bearings
- 7—Improperly dressed wheel face
- 8—When wheel is cutting out of round owing to insufficient coolant
- 9—When work is too heavy for grinder
- 10—Wheel, work, or both, out of balance
- 11—Poorly adjusted steadyrests or loose shoes in holders

Dressing the wheel



Conventional method of dressing face of a grinding wheel for external cylindrical grinding is shown in Fig. 14. The improved diamond dressing fixture above permits obtaining fresh cutting edges by slight rotation of the shaft on which the diamond is mounted



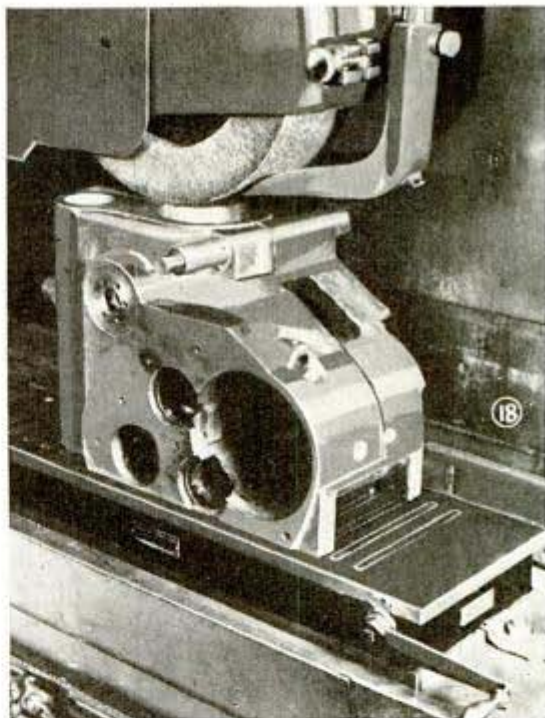
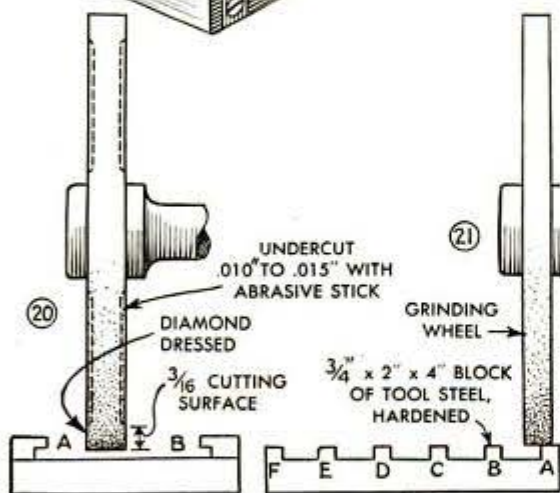
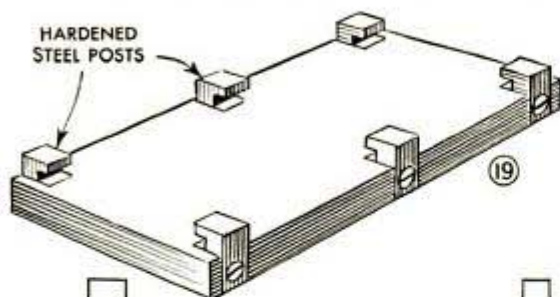
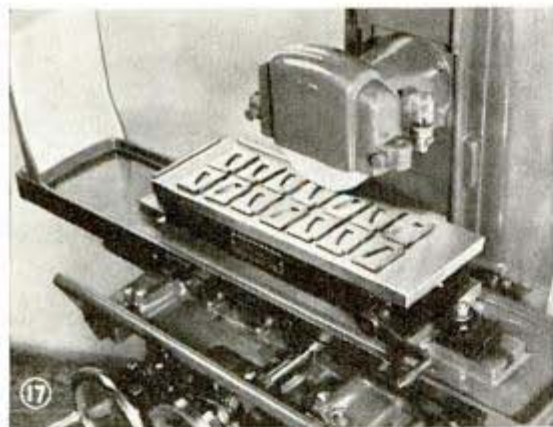
Fig. 17 a number of small parts are arranged on a permanent-magnet-type chuck to surface-grind them simultaneously, while Fig. 18 shows a large spindle head being surface-ground square with the bore. A coolant is imperative to remove more stock per pass on soft steel and to prevent injuring hardened steel parts.

Checking for error: Modern grinding machines are easy to operate and control, especially surface grinders whereby the operator can master not only a .001-in. but even a .0001-in. cut. On some types of surface grinders much of the work has to be surfaced with the sides of the wheel and

therefore it is important to check up for errors between vertical and transverse movements due to wear. This can be done by a fixture of the kind shown in Fig. 19. By dressing the sides of the grinding wheel as in Fig. 20 and taking very light alternate cuts transversely on surfaces A and B, a variation in width between both ends of the recess indicates wear. A test for utmost accuracy in the vertical feed is made with a part as shown in Fig. 21. After dressing the wheel face accurately, the wheel is fed down to barely contact surface A. Then surfaces B to F are spotted in their order by stepping down B .0002 in. C .0004 in. and so on. If, after doing this, F measures .001 in. lower than A, the vertical feed mechanism can be rated as perfect.

Hints to operators: The apprentice on a grinding wheel need not worry about such things as grade, grain, bond and structure of the wheels. They are selected with extreme care. Wheel manufacturers do the experimenting and pass on the results to users of grinding machines who see that recommendations are followed.

The operator should use extreme care when dressing grinding wheels, especially the harder grades. To make a wheel of fine and closely spaced grains cut faster, open the grain structure with rapid transverse movement of the diamond across the face. To make a wheel of coarse and widely spaced grains cut more smoothly, use a slow transverse feed of the diamond. The



This is the last installment of the series of articles on basic shop machines. However, similar articles relating to essential machine-shop practice will be continued. Next month's issue will contain information on cutting oils of practical value to every machine operator.

essary per pass of the wheel. In cylindrical grinding, watch the last .001 in.; the more transverse movements you get out of it, the better for accuracy and finish.

An Error That Is Likely to Occur In Tempering Steel

In some shops, small tools often are hardened by cooling the end back an inch or so and then tempered by allowing the remaining heat in the body of the tool to reheat the hardened part to a certain temperature, indicated by oxidation colors appearing on the polished surface. However, if the tool is not cooled back far enough the heat will run out to the end too rapidly and the first color, a straw, will be polished off before it is observed, and the colors following will not indicate the proper temperature. Instead, the tool should be cooled back far enough to polish the end before heat sufficient to produce oxidation colors travels toward the hardened end. Then, when the colors do appear they may be observed in their regular order and the tool cooled at the proper color and temperature.

sharper the diamond, the better it will work in both cases.

Grinding wheels operate at predetermined speeds, computed in surface feet per minute, (s.f.p.m.) It is important that the original surface speed be maintained for precision work, as the wheel wears down. Correct relation of work speed and transverse feed is easily determined with a little experience. It is best to favor an increase in work speed rather than in transverse feed, until the correct cylindrical cutting action has been determined.

In internal grinding, too large a wheel in relation to the size of a hole results in too wide an area of contact, which generates excessive heat. In surface grinding, the deeper the cut, the less cross-feed is nec-

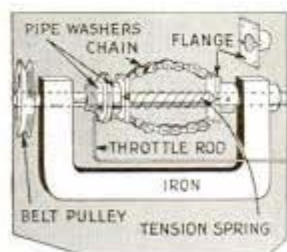
Tray Held Between Ladder Rails Keeps Tools Handy



Tinsmiths and others who often have to work on a ladder will find this simple tool tray a timesaver. It is made from a section of eave trough with ends soldered in place and fitted with a couple of metal-strap anchors. These are drilled to slip over screws driven part way into the ladder rails.

Governor for Old Auto Engine

Anyone having an old auto engine that is used as a stationary power plant will find this governor highly satisfactory. It consists of a U-shaped piece of iron which is



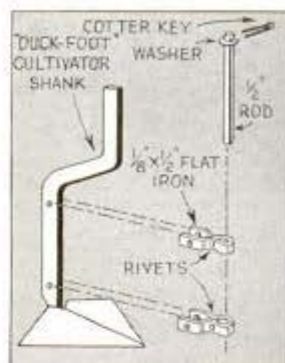
drilled near the ends to take the governor shaft. The weights are two short pieces of motorcycle or bicycle chain fastened to a couple of flanges, one of which is keyed to the shaft, the other floating on it. The flanges are made from a couple of short pieces of pipe which is split back half of its length and then bent outward at right angles. A large ring carrying a throttle rod rides between two pipe washers coupled to the floating flange. A coil spring placed over the shaft end between the two flanges provides tension on the floating flange. If an old generator housing is available, it can be cut down and used instead of the U-

shaped piece. This will be better as your governor shaft will then rotate on ball bearings.

—Chas. Guthrie, Smith Falls, Ont., Can.

Rolling Edge on Cultivator Shank Prevents Clogging by Vines

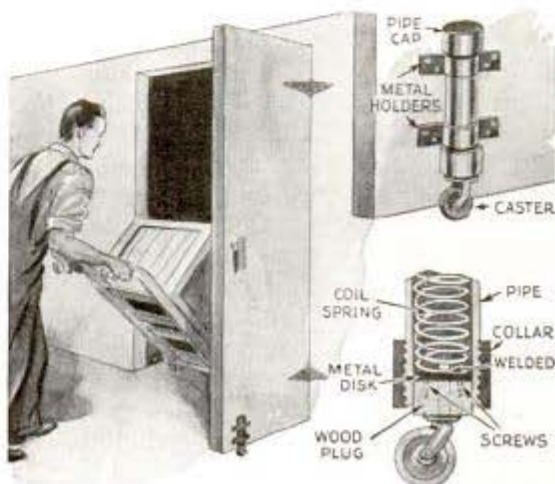
One farmer prevents his cultivator from clogging when working in fields containing a heavy growth of weeds and vines by providing rolling edges on the shanks of the cultivator beams. Each roller consists of a small rod



supported vertically in front of the shank by eyes or bearings formed from flat iron. These are bolted in place as indicated. A washer and cotter key at the top of the rod keep it in place and allow it to turn freely.

Spring-Roller Unit on Large Door Acts as a Stop and Support

Fastened to the inside of a large door that opens off a hallway or corridor, this spring-roller unit is ideal for factories and warehouses where a door must operate easily yet remain in any desired open position. The unit consists of a piece of 1-in. pipe with the top capped and a collar around the lower end. A coil spring with a metal disk welded to one end is placed inside the pipe to bear against a loosely fitted wood plug, which carries a caster. The



spring exerts a constant pressure on the roller and plug thus keeping the door at any position desired, and allowing the door to be opened or closed easily. By turning the caster wheel to a position parallel with the door, the latter may be held rigidly.

Kerosene Locates Leak In Tanks

One dealer who sells used hot-water tanks locates tiny leaks for repairing by using kerosene. About a quart of this is poured inside a tank, which is then rolled around to distribute the kerosene over the entire surfaces. Next the tank is set on end and painted on the outside with a weak lime whitewash and allowed to dry. At any spot where there is any indication of a leak, a yellowish spot will appear on the whitewashed surface. After all leaks have been repaired, the interior of the tank must be cleaned thoroughly to remove all traces of kerosene, especially if the tank is to be put back into home service.

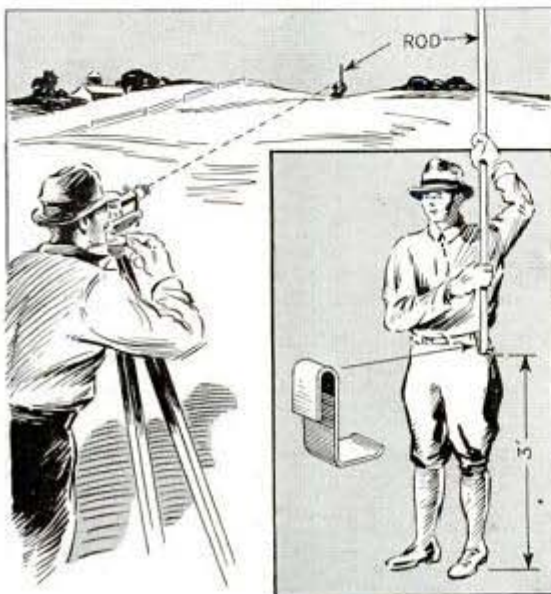
How to Reseat Lids on Paint Cans And Prevent "Skin" on Contents



Once a paint can is opened and only a part of the contents used, it is difficult to reseal it properly unless you use some form of straight-line press. One way is to cut several disks from hardwood to a slightly larger diameter than the lids on pint, quart, half-gallon and gallon cans. Next, remove all paint from the groove in the top of the can, add a small quantity of linseed oil and replace the lid, with a wood disk of proper size on top. The lid can then be reseated in an improvised press or the can may be set on a drill-press table where it is possible to apply pressure to the wood disk by lowering the chuck. Of course, you can't remove all the air as was done in the original sealing, but tipping the cans upside down occasionally will prevent the formation of a film or "skin" over the top of the contents.

—W. C. Lammey, Downers Grove, Ill.

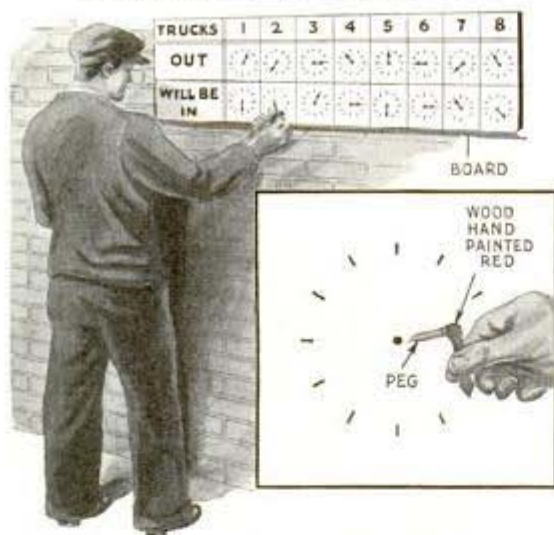
Metal Waist Sling Extends Level Rod for Surveyor on Hilly Ground



When surveying for ground elevations where the level rod is too short to be sighted when it is resting on the ground, this sling will elevate it to the line of sight. The sling is made from a piece of wide flat iron bent to the shape shown so that it can be hooked over the workman's trouser belt. The sling should be made so that the rod will be held a measured distance from the ground, usually about 3 ft. Such a sling is accurate enough for most ground elevations or for measuring for cuts and fills.

☛ If your band-saw blade has a tendency to track to one side, the trouble can be corrected easily by honing this side of the blade with a fine stone while the machine is running. Excessive set is cut down on the leading side, which corrects trackage.

Truck Drivers' 'Out and In' Time Shown by Dials on Board

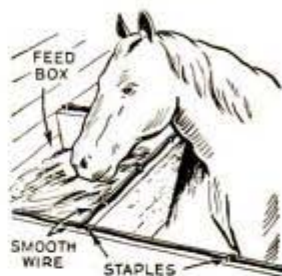


To keep track of his drivers at all times, one owner of a trucking company ruled off a piece of plywood and painted a series of dials on it as shown. Holes were then

drilled in the center of each dial to take tight-fitting pins which hold red hands or pointers. As the board is mounted on a wall in a convenient position for all drivers, it takes only a minute for them to set the hands under their number to indicate times of departure and expected return.

Smooth Wire Protects the Edges Of Feed Box and Manger

To prevent stabled horses damaging the edges of their feedboxes and mangers by gnawing away portions of the soft wood, one farmer stapled lengths of heavy smooth wire to the top edges as shown. If suitable wire is not readily available, strips of flat iron could be used.



THIS NEW BOOK DESCRIBES SEVENTEEN LOW-COST BOATS



What to Make

Shows what to make and how to make hundreds of things for fun or profit. Furniture, novelties, jig saw projects, gifts, toys, games, photographic equipment. Set of 3 books. Volumes 1, 2, 3 (588 interesting pages) \$1.47. Single volumes 50c.

Shop Notes

Popular Mechanics annual mechanic's guide. For every man who uses tools. Few subjects covered are lathe operation, drafting, shop practice, using tools, welding, autos, electricity, time and money-saving shortcuts. Set of 4 books (Shop Notes for '42, '41, '40, '39) \$1.95. Single volumes 50c.

Order from this list. Ask for FREE book catalog. Money refunded if you're not satisfied

Popular Mechanics Press, Dept. 407, 200 East Ontario Street, Chicago, Illinois

Get this new book and build a boat at home. You can do it. Just the boat you've always wanted—power, sail or rowboat. They're all here in this new 192-page book, prepared especially for the home craftsman with limited tools, no experience and little money to spend. Only \$1.25 postpaid.

Other Helpful Books

Forty Power Tools You Can Make

If you want an inexpensive motorized workshop that will speed up your work and do it accurately, get this amazing book. Shows how to make forty different machines, such as lathes, drill press, jigsaw, bandsaw, circular saw, sanders from pipe fittings, old auto parts, etc. \$1.25.

Your Car

Add thousands of miles of life to your car and operate car economically. 192 pages of money and labor-saving ideas, short cuts. For motorists, garage and service men. \$1.25.

1001 Ways to Use Concrete

How to use concrete around the home, garden, workshop and business. Do work for yourself. Save, make money. \$1.98.

Money Making Formulas

Over 3,000 up-to-date formulas; supply directory. Start your own manufacturing business by transforming simple ingredients into wanted products. \$2.00.

Garden Book

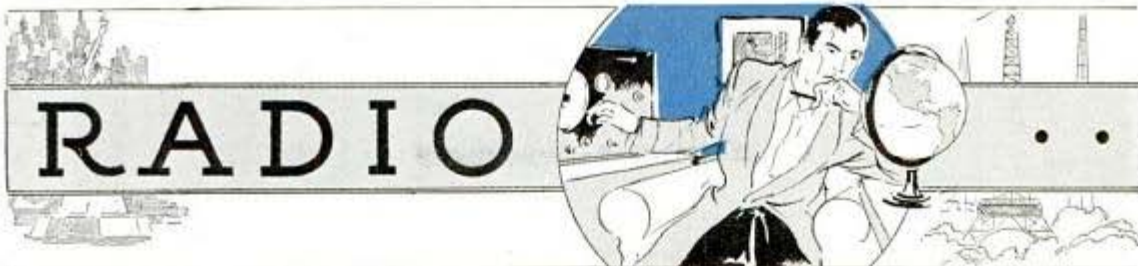
Build your own trellises, fences, lawn furniture, outdoor fireplaces, attractive ornaments, etc. \$1.00.

Welding, Brazing and Soldering

How to construct welding equipment and use it efficiently. Small arc welder, spot welder, arc torch. Tricks of soldering, brazing, heat treating iron and steel. \$1.25.

The Boy Mechanic

The book for your boy—for any boy. Tells how to build midget auto, boats, models, games, craftwork. Hundreds of pictures. \$2.00.

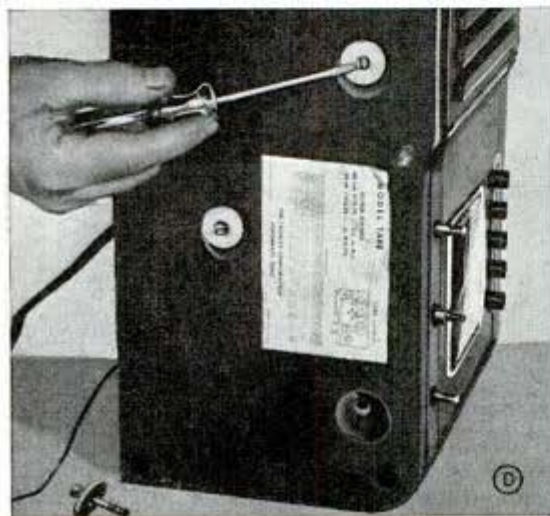
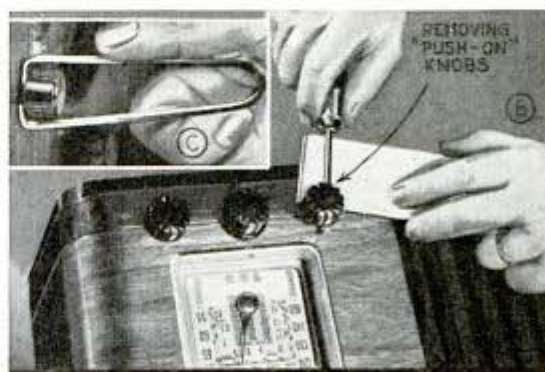


First Aid Suggestions for Your Table Sets

PART III

LADY, take that set out of the window, also keep it off radiators and out of bathrooms if you want it to last for the duration. Extremes in temperature and humidity can cause any receiver, especially table models, to develop bad hum and crackling noises very quickly; they even "pass out" entirely when electrolytic condensers freeze. If a set has been subjected to extreme cold, always give it a chance to thaw out completely before you turn it on. Excessive heat and dampness also should be avoided for just as good reasons. It is highly dangerous to operate radio receivers in bathrooms, and the moisture certainly does not do the set a bit of good.

Tube replacement procedure in table model receivers is not quite so easy as in the console sets previously considered in this series. Table models are necessarily compact; in most cases the designer utilizes every inch of available space and the tubes can be removed only by first taking the chassis out of the cabinet. However this is not difficult to do, as it is a more or less standardized operation. Beginning



with photo A, please note that the line cord is removed from the wall socket and the external antenna wire is disconnected, in case one is used. Now remove the back cover which is held in position by several small wood screws. Next, pull or pry off the push-on knobs as illustrated in photos B and C. Now stand the cabinet on end, as

(Continued to page 170)

INTER-ROOM COMMUNICATOR

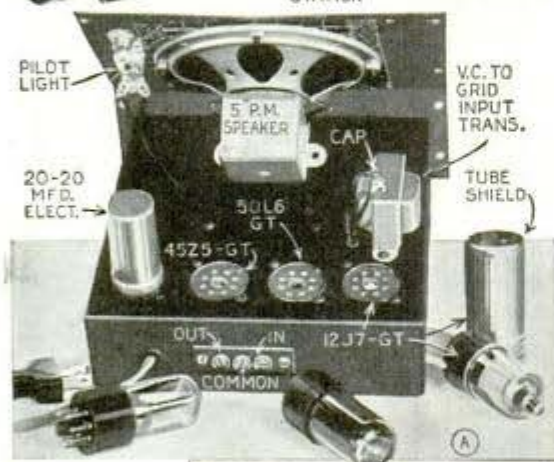
By L. M. Dezettel

RADIO servicemen, classroom instructors and experimenters will find this simple intercommunicator easy to assemble from odds and ends of standard parts, many of which can be salvaged from discarded apparatus. It consists of a master station and a sub-station as a basic system which is subject to many variations and uses in shops and schools.

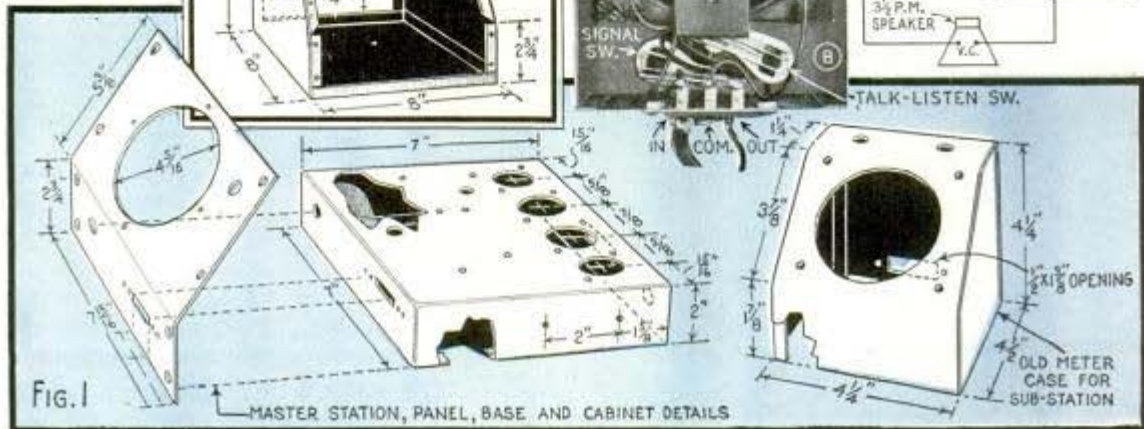
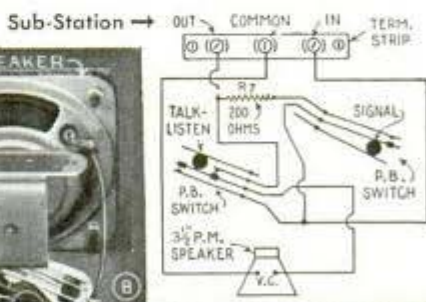
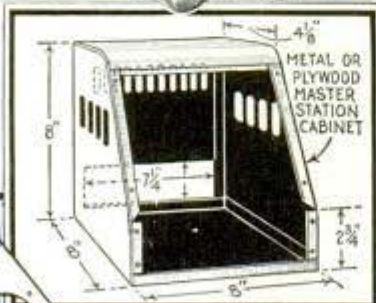
An old meter case was employed to house the sub-station, and the master station cabinet may be made of plywood instead of metal. The base can be formed from scrap sheet metal, or an old set chassis of similar size may be used.

The master station is a high-gain amplifier operating from any 115-volt a.c. or d.c. line. Simplified switching circuits at both stations switch the speakers from the output of the amplifier to the input in such a manner that they also serve as microphones. A special feature is the signal tone produced at either station at will for calling. This tone is produced by oscillations resulting from feed-back coupling.

Presented pictorially in Figs. 1 and 2, and photos A, B, C and D, all construction details are clearly shown; the schematic cir-



Right, master station cabinet should be well ventilated; rear opening is 2 in. high



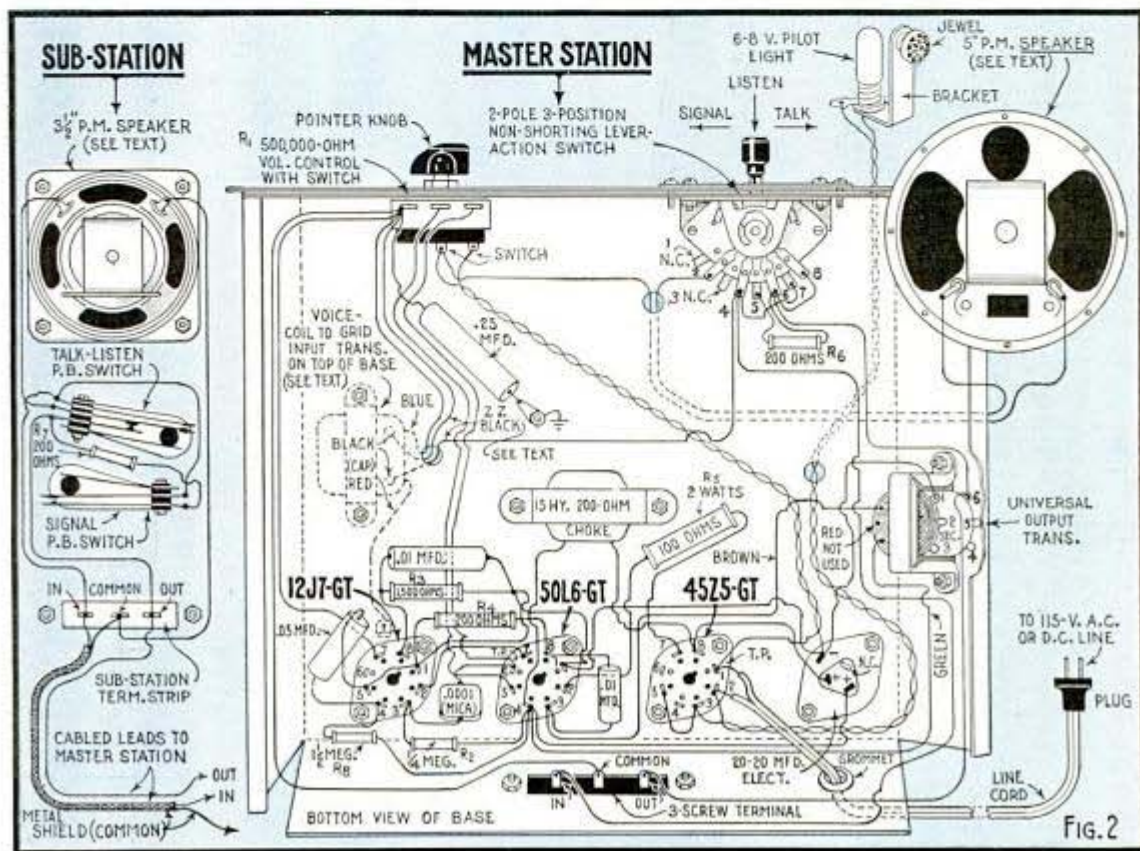
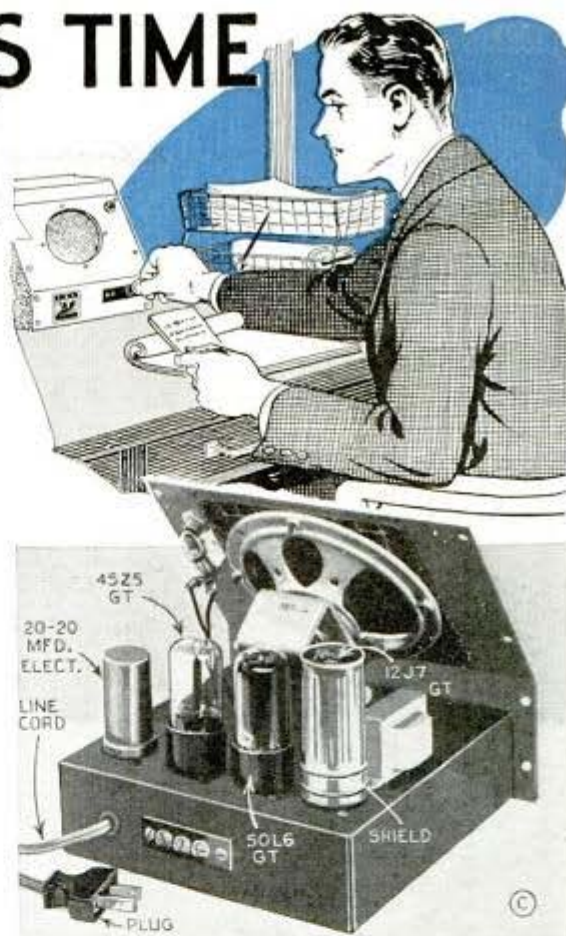
SYSTEM SAVES TIME

HAS SIGNAL TONE FOR CALLING
OPERATES UP TO 3 SUB-STATIONS

cuit diagram appears in Fig. 3. The 12J7-GT tube serves as a high-gain pentode and is resistance-coupled to the 50L6-GT beam power tube which has ample power to drive both speakers. Inverse feed-back is used in this stage to improve quality. A 45Z5-GT half-wave rectifier tube has a tapped filament for the pilot light.

A piece of heavy screen is mounted back of the master station speaker hole to back up the grille cloth. The switches are "Centralab" or similar types; the speakers and the input transformer are inexpensive "Cinaudagraph," or similar units. It is important that the wire from the center screw of the output terminal strip be connected to the same point as the grounded lead of the input transformer. Cabled leads may be up to 2,000 ft. long; shielded lead is cloth covered.

(Continued to page 172)



Junk-Box B-Eliminator for the Experimenter

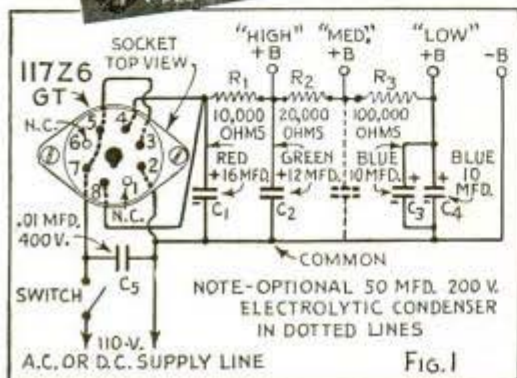
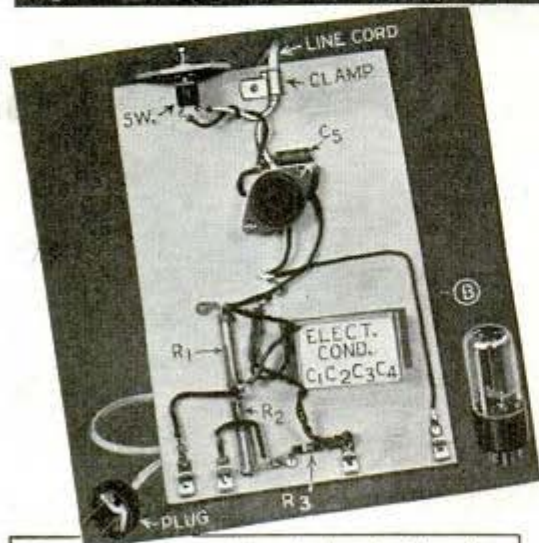


FIG. 1

ALTHOUGH designed primarily for the new Special "V" receiver that will appear in the September issue, this extremely simple B-eliminator is suitable for use with practically all of the small battery-operated sets that have been described in previous issues. The B-eliminator simply replaces the usual B-battery.

The 117Z6-GT, or 117Z6-GT/G tube, either of which may be used, has a heater which can be operated directly off the power line without a dropping resistor. Three fixed resistors and a standard a.c.-d.c. type filter and by-pass filter condenser block provide all the filtering necessary. However if it is desired to reduce the low hum level to a still lower value, the optional 50 mfd. 200-volt electrolytic condenser may be used as indicated in Fig. 1. All parts are clearly specified in photos A and B, and the simplified wiring diagram Fig. 2. Like all a.c.-d.c. circuits, this one must not be grounded. This means that the receiver with which the B-eliminator is used should be connected to ground through a .1 mfd. 400-volt paper-type condenser if a ground connection is required, as no direct ground can be used. The B positive voltages supplied at the Fahnestock clips are as follows: "high" 80 volts; "medium" 45 volts and a "low" of 6-8 volts which is suitable for the flashlight-battery type receivers. Keep the B-eliminator several feet away from the receiver to prevent stray hum pickup.

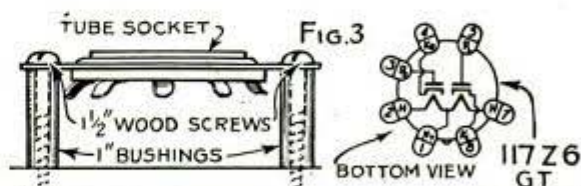


FIG. 3

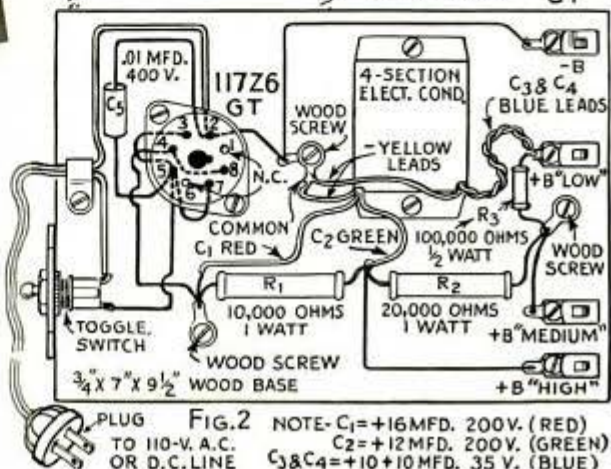
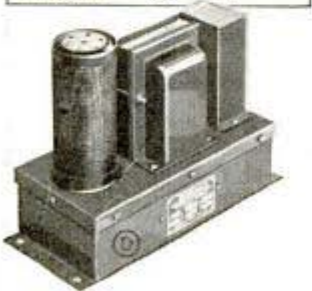
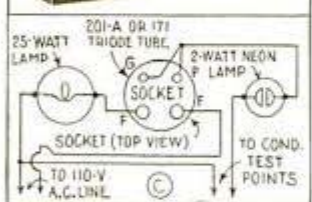
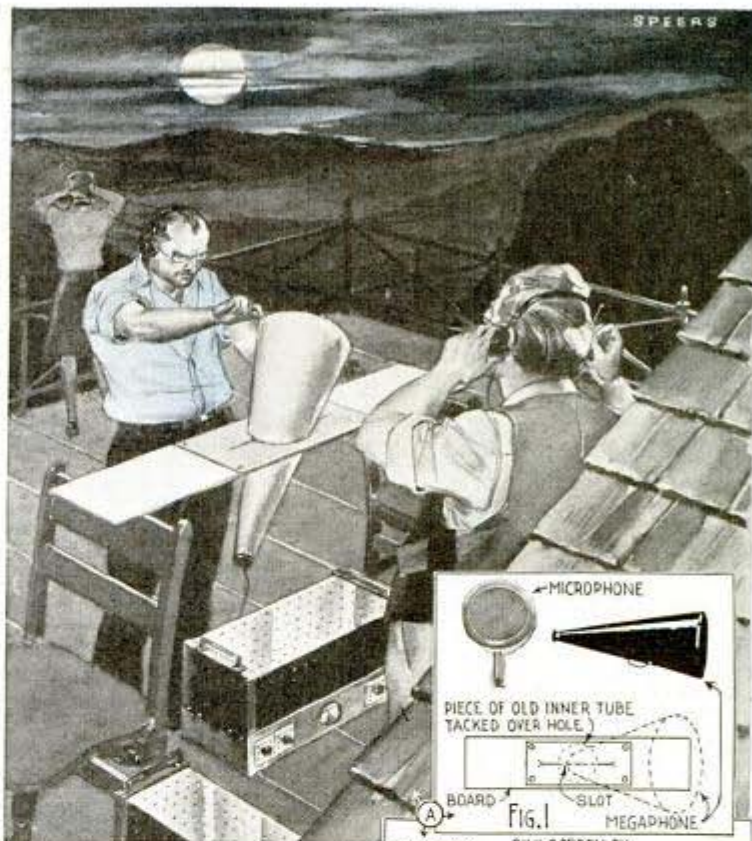


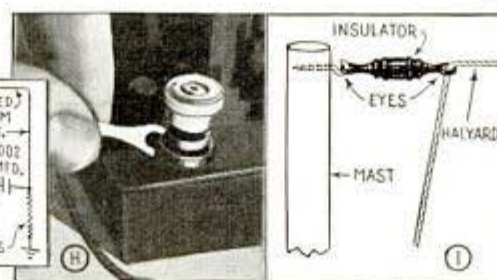
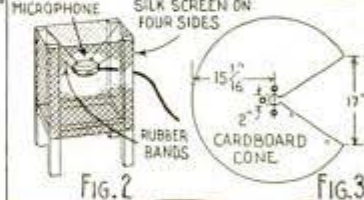
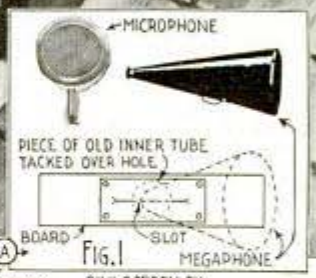
FIG. 2

Practical RADIO SUGGESTIONS

(A) Emergency aircraft detection range may be extended in quiet localities by using an ordinary high-gain hum-free audio amplifier, with headphones plugged in ahead of the final power output stage. Fig. 1 and sketch illustrate a lapel-type microphone and megaphone pick-up arrangement; this is fairly directional but some noise is caused by horn wall vibrations. Fig. 2 is a practical method of using a nondirectional microphone in a frame screened with silk to prevent wind noises. Fig. 3 shows construction details for making a large experimental cone. (B) Flush-type tilting wall speaker assembly for classrooms houses an 8-in. peridynamic speaker



(C) Condenser tester from junk-box parts. Any fixed blocking or by-pass condenser can be checked across the test prods. If good the neon bulb will flicker; a brilliant steady light indicates a shorted condenser; no light shows blown condenser. (D) Field coil power supply unit for any separately excited dynamic speaker. (E) Fixed condenser and resistor connected as shown, improve efficiency of indoor antenna. Condenser passes r.f. signals to set without possible surge; resistor by-passes some static to ground. (F) Inexpensive replacement-speaker for battery sets. (G) Wood dowel slotted for metal terminal strips provides a form for experimental inductances and chokes. (H) Large round hole soldering lug cut for quick connection to binding post. (I) Insulator substitutes for antenna halyard pulley. (J) French varnish kit blends cabinet repairs with finish



Lapel 'Mike' and Sound Amplifier In Compact Portable Form



Weighing only 35 pounds, this really portable 15-watt amplifier can be carried anywhere and set up ready for immediate use simply by plugging it into any 110-volt, 60-cycle outlet. The tiny microphone clips to the speaker's lapel and prevents the user from "walking away from the microphone"—a feature appreciated by vocalists and other entertainers and listeners.

Electronic Air Raid Siren

Designed to give both great volume for alarms as well as a simple method of crowd control, this unit makes use of a vacuum-



tube tone generator which can either duplicate the rising and falling tone of a mechanical siren, or can be set to any pitch for best audibility over traffic or manufacturing noises. A microphone can be used for voice announcements over the same system, an important feature in avoiding confusion and panic in crowded places. A reassuring voice following an air raid signal may save countless lives. It operates normally from any 110-volt source, but in case of current failure can be switched to 6-volt storage battery operation.

Automatic Entertainment Unit

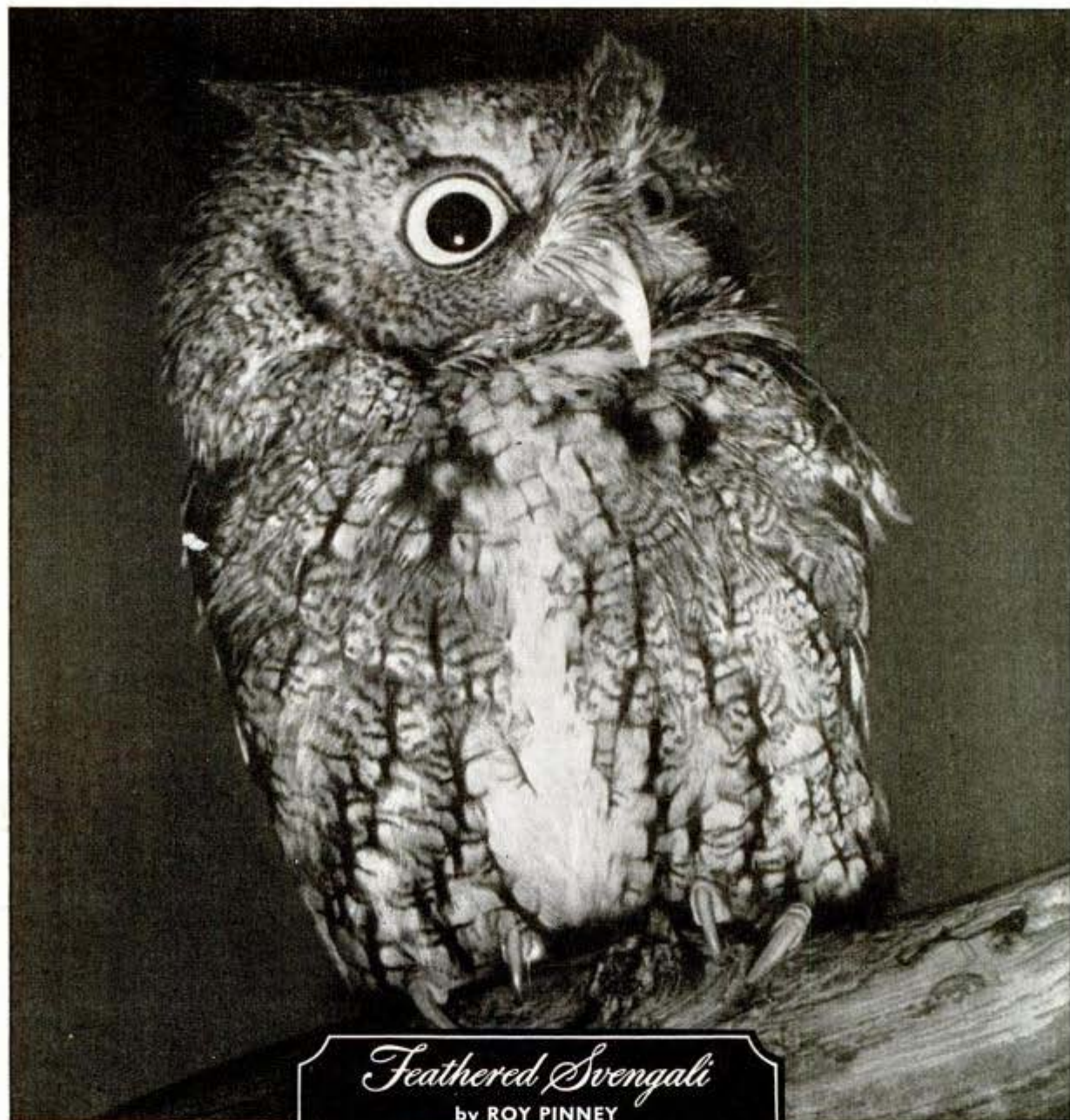
Providing entertainment for recreation centers, canteens and homes or wherever a compact counter or table-model unit is required, this 110-volt a.c. 6-tube phono-radio combines 3-band radio reception with automatic record reproduction. The automatic record changer plays up to



twelve 10-in. or ten 12-in. records at one loading. Automatic volume control, tone control, built-in loop antenna and a 5½-in. dynamic speaker are some of the outstanding features. The superheterodyne circuit includes a noise-reducing r.f. stage incorporating the following tubes: two 6SK7, one 6SA7, one 6SQ7, one 25L6, one 25Z6.

Blueprints covering simplified radio construction articles in this and past issues are available for 25c each. Many popular tested circuits for beginners, students and experimenters may be built with used parts. Detailed material lists can be obtained from Popular Mechanics Radio Department upon receipt of postage.

NEXT MONTH—Experimenter's "Special" 5-Band "Twin" Two-Tube. No. 2 set in the Special "V" series; each unit is a complete receiver and employs similar parts, with minor junk-box additions. Set No. 1 appeared in July. Also—**Cystal-Tube Set Built Into an Old Clock Case**, and, **First Aid for Home Receivers, Part 4.**



Feathered Svengali

by ROY PINNEY

Philadelphia Natural History Salon

Film: Kodak Plus-X

KODAK PLUS-X FILM, with which Mr. Pinney made his flash shot, is fully panchromatic. Combines extra speed with unusual fineness of grain. Negatives made under adverse light conditions yield generous enlargements free from disturbing graininess. Has a special antihalation base. Available in rolls and packs.

There is a Kodak Film especially designed for every picture-taking purpose . . . Meet the complete Kodak Film Family at your Kodak dealer's. . . . Eastman Kodak Company, Rochester, N. Y.

The Great Pictures are made on KODAK FILM

There's Money in Honey

(Continued from page 85)

Some of the bees will sting you now and then, of course, but how often depends on several things. Of the three races of bees most used in the United States, the Caucasian bee is one of the gentlest, the Italian bee is fairly gentle, and the Cyprian bee is the "hottest." But the Cyprian holds the world record for honey production. Colonies of stingless bees have been developed but such bees generally are pretty poor honey producers.

The best defense against stings, of course, is proper dress. Most beekeepers protect their heads with a veil or wire screen but few of them bother to wear gloves. Hives should be kept in lonely spots where the bees are not apt to be disturbed. The bees should be approached during the hottest part of the day, when they are inclined to be lethargic. Taking a bath just before approaching the hives is said to decrease the chances of getting stung. Never stand directly in front of the opening of a hive.

A few puffs of smoke from a bee smoker pacifies the insects when top supers are being changed or combs are being removed.

You must beware of two bee diseases, neither of which will affect the quality of honey as far as humans are concerned. The so-called American foul brood is highly contagious and to combat it the bees and honey must be completely destroyed, the interior of the hives burned out, and an entirely fresh start must be made. European foul brood may be combatted by killing the queen bee and obtaining a new queen of healthy stock.

Right now beekeepers are receiving returns that amount to one or two hundred percent per year on their investment, although they estimate that after the cost of their own time is deducted their profit amounts to about 33 percent per season. Anyway, there's money in honey these days. But be careful! Even if your beekeeping is a success you may get stung!

They Play Jackstraws With Trees

(Continued from page 89)

has stacked the felled trees in a stream which falls from a considerable grade into the river down which the logs must float. In this way the drive will have the advantage of the fall to give it its first impetus.

The loggers carry dynamite. With practiced eye they look for the "key" timbers. They set the charge, light the fuse and dash for shore. With a roar, thousands of giant logs go up in the air like toothpicks and crash down to fill the river from bank to bank. The battle of men against frantic waters and boulders and huge timbers is on. If you don't think it is a battle, you've never spent sixteen hours a day on a log tossing in a surging torrent.

Although few of them can swim, the white-water boys of the upper Clearwater scorn to use life belts. Each, however, wears the best caulked shoes, for caulks are to a lumberman what a tail is to a monkey. He couldn't go anywhere without them. On them depends his life when he digs into slippery wood and "birls" to keep his balance.

Each man also has a peavey as his most useful tool. With the peavies, logs are

grasped and turned and the men pull themselves up out of the water, steady themselves when they must drop flat, and sometimes test the depth of the river.

As the drive gets underway and passes on ahead, behind it float the wanigans. One is the cook shack, the second houses the men's sleeping quarters.

The shanty boys get plenty of good "grub" and they need it, for about eight weeks each spring they work in wet clothes and frigid water all day and try to dry their duds by a bonfire on the bank every night.

Behind the great body of logs, but in front of the wanigan, "sackers" travel in light boats having flat bottoms and tapering ends. These sackers are the men who loosen the logs that have caught along the shore and stayed there as the rest rushed downstream. The boats are built to run up close on the banks and rocks. Wading in water and mud, with their peavies and cant hooks, this part of the crew frees the heavy timbers that have lodged fast.

Meanwhile, all has been going well ahead. The acres of logs have kept in mo-

(Continued to page 164)

CHAMPION SPARK PLUGS



"Harnessing" over a thousand horses—by hooking up the ignition harness of a giant aircraft engine to a set of Champion Ceramic Aircraft Spark Plugs. Dependable Champions are on active duty on every war front on land, water and in the air.



*More Vital-
More Dependable
than ever!*



The Saturday afternoon ritual of the early car owner was a spark plug cleaning session. The old-timer spent a lot of time tinkering with engines and spark plugs. Now, all you have to do, for the best spark plug performance and economy, is to have your Champion dealer test and clean them regularly with his scientifically designed equipment.



All of us are using our cars less—doubling up—making a special event of what used to be a commonplace trip. Makes you appreciate your car, doesn't it? Give your car an extra lease on life by replacing old, worn-out, or inferior quality spark plugs with new Champions.

TO SAVE GASOLINE • KEEP YOUR SPARK PLUGS CLEAN

tion. Then without warning one strikes a rock around which the stream is swirling, or a hidden snag catches it. It swings across channel. Blocked, the log behind it rears on end. Another presses against the second and keeps it upright. On come the others. They, too, are caught in the jam.

The rivermen spring out on the mass.

The "king-log," the one that caught first, has to be freed to break the jam even though the weight of hundreds is upon it and behind it. Perhaps by a miracle they can turn the trick with peavies and a quick jump to safety. Perhaps they can get a rope around the key timber and with the whole crew tugging from shore, pull it free. But it may take dynamite. It's a dangerous

battle. The roar of the water kills the sound of orders. Each has to know what to do and how to do it. Each has to look out for himself, and no man can be heard if he calls a warning to another. Every sense alert—the men work. Then comes an ominous cracking, sharp as gunfire.

"She's a-pullin', she's a-pullin'!" the cry warns that the jam is going to fall apart.

Churning spray—a great dirty-brown funnel of water shoots skyward. Bark flies, logs whirl in spirals higher than the banks.

Fleeing before the fury, rivermen leap from timber to timber toward shore, or if they can't make it,—catlike they crouch, and with luck, they ride it out ahead.

The Iron Horse Delivers the Tools of War

(Continued from page 53)

speed of all freights between terminals—including stops—in 1921 was 11.5 miles an hour; now it's 16.7 miles an hour, 45 percent faster. Furthermore, they burn less fuel doing it. Twenty years back it took 162 pounds of coal to pull 1,000 tons of freight one mile; today it takes but 111 pounds of coal.

The railroads measure transportation in tons carried per mile. Here's where the contrast between 1918 and 1941 shows up in black and white. In the first half of '41 the ton-miles per freight car were 57 percent greater than in '18. In other words, today's car is delivering three-fifths more transportation.

Diesel-electric switchers shunt carloads of TNT and high-explosive shells up and down 100 miles of track at one of the government's big new ordnance plants, and these isn't a semaphore in sight. Inside the cab of one of these locomotives the engineer is listening to his radio. "Pick up 5 carloads of TNT at track 7, deliver to magazine 47, track 4," comes an order; and a minute later, "Ten carloads of shells half a mile ahead. Proceed slowly."

A dispatcher controls all the deadly traffic in this vast yard by two-way FM radio. This is a private, "intra-mural" railway, of course, but it's typical of the new techniques the roads are adopting. Short-wave radio signals, for example, direct traffic in one big freight classification "hump" yard.

Another system now in operation on many railroads, doubling the capacity of

their tracks, is the two-way, reverse traffic signal. It enables the operation of trains in either direction on both tracks. To cite one example, one midwestern railroad is installing two-way signals on a section of its double-track main line, thus converting several miles into the equivalent of a four-track line. The westbound freight that used to pull over into a siding and wait while the streamliner streaked by westward can now roll right along while the fast passenger train highballs past on what normally would be the eastbound track. All the trains on the division will operate without written orders, governed by the wayside signals controlled by dispatchers watching their movements on illuminated "Centralized Traffic Control" boards. Signals on the section of two-way operation read in both directions.

Waybills sent by teletype, messages sent by facsimile and carrier currents step up the pace of both freight and communications. Electric "mules" snake around loading yards hurrying the freight aboard. Tough little electric high-lift trucks pick up huge loads and trundle 'em into box-cars. One of these baby giants can lift a 10,000-pound loaded steel container and set it in its proper place on a compartment freight car.

It takes all kinds of freight cars to move the load. There are more than 100 types of tank cars specially designed for milk or molasses, oil or acid, water, ice cream.

(Continued to page 166)



...but here is one worry you can avoid

GOLF BALLS, or automobiles—today they've got to *last longer*. That's why king pins, tie rods, drag links, bearings and other vital friction points require the *extra care*, the *superior protection* of stem-to-stern Marfak chassis lubrication every 1,000 miles.

Marfak helps add miles to your car's life because it's super-tough. Applied by chart—not by chance—it resists wear-out, wash-out and squeeze-out.

For your peace of mind, don't say "grease job." Insist on genuine Marfak 40-point Lubrication Service. At Texaco and other good dealers everywhere.



Tune in the **TEXACO STAR THEATRE** every Sunday night—CBS

You're Welcome at **TEXACO DEALERS**

Hopper cars with watertight hatches protect cement and similar perishables from rain. End-loading boxcars accommodate army tanks, trucks, bomber wings. Portable refrigerators on wheels, loaded into ordinary boxcars, obviate the use of a full-size refrigerator car for small lots of frozen foods and flowers and fish. Underslung flatcars take on half-million-pound ingots and ingot molds for armor plate. Pneumatic dump cars automatically tilt to either side to dump 50-yard loads of earth.

In peace time the 235,000 miles of Amer-

ican railways carry about two-thirds of the nation's freight. In war the burden is heavier; more than any other war in history, this is a war of movement. The army has told the railroads they must be ready this year to assign 2,000 cars a day for ordnance shipments.

Every five seconds a freight train starts its run. Every five seconds a passenger train slides out of its terminal.

The railway system, says the War Department, is "the backbone" of national defense. The main line is the front line today.

Teamwork in a Tank

(Continued from page 59)

bat, the job of driving is generally rotated so as not to decrease the efficiency rating through fatigue of any one member. During the intensive maneuver problems in the war games of the Carolinas and Louisiana, this sextet was constantly swapping seats in order to remain fresh and learn everything possible about all the tank operations.

When it is revealed that tank crews in some cases were kept moving almost constantly for 60 hours on maneuvers, catching only occasional cat-naps, the value of rotating positions is readily apparent.

You'd think "Bow Wow" Bowser would have his hands full just knowing how to drive the medium monster and keeping the enemy on the run firing the dual set of 30-caliber machine guns sputtering in front of him. But he's also an accomplished handler of both the 75 and 37-mm. cannon and adept at taking over the radio position.

Likewise, Sergeant Hinzman can come down from his turret position where he mans the 30-caliber antiaircraft machine gun in addition to directing the operation of his rolling fortress and take over the controls of the driver or the radio operator. In addition, he knows the intricacies of both cannon. A speaking tube connected to the helmets of the tank commander and the driver is used for communication.

Handy man of the outfit is Radio Operator Bill Daniels. As the radio operator generally isn't constantly tied up with telegraphy, he's in a position to shift his attention in other directions when necessary. Daniels is a deft hand at slithering around in the cramped quarters helping both the 75 and 37-mm. gunners, or driving, or manning the machine guns.

Corporal Lott's assignment is the care and feeding of the devastating 75-mm. cannon and woe be to the vehicle and crew that get a taste of it. Mees' chief duty is firing the 37-mm. cannon and Hess is his assistant when he isn't needed elsewhere.

In addition to operation, the tank crew is responsible for first-echelon maintenance, that is, maintenance equivalent to what a motorist gets from the corner filling station attendant. The tank jockeys must see that their vehicle is properly lubricated, filled with gas, oil and water, their guns cleaned, the tread free of rocks and other missiles, and perform other duties that become immensely important in combat.

Seven days a week the "team" is out on daily problems—ironing out faults, learning better formation coordination, firing the guns at moving targets while rumbling swiftly cross-country, or refreshing the mind and hand with the intricate mechanism that makes the American medium M-3 one of our most formidable weapons.

Frozen Lard Lines Ship's Hold To Keep Other Foods Cool

Losses of refrigerator ships will not stop the flow of perishable foods to England and Russia due to an ingenious American plan of making frozen foodstuffs act as the cooling agent for other foods on ordinary ships. Insulated holds are lined with large containers of lard chilled to zero temperature to form floor and walls around perishable foods. A layer of lard containers is placed over the top and covered with insulation. This method also saves space which refrigerating machinery would occupy.

New! SPECIAL EVEREADY FLASHLIGHT FOR CIVILIAN WARTIME USE!



Made of special 5-ply fibre, new laboratory-tested design saves copper, brass, nickel, chromium and other metals vital to war use!



STRONG! . . . Made of special fibre sheets, tightly laminated in 5 layers, the tube is tough and hard. It will give long years of service!



WATER-REPELLENT! This new "Eveready" flashlight is protected by a special water-proof coating which seals out moisture.



LONG LASTING! . . . Drop it on concrete floor—this flashlight case can "take" ordinary abuse. It's actually more durable than millions of flashlights now in use.

METALS HAVE GONE TO WAR!

But metals or no metals, America needs flashlights . . . at home, in business, on the farm, in the factory . . . needs them for a thousand vital civilian uses.

And America shall have them!

This national need — made more pressing than ever by wartime emergency conditions—has

been answered by the world's largest flashlight-and-battery laboratory.

Here it is—the new "Eveready" flashlight made of tough, 5-ply fibre—tested and proven under severest laboratory conditions.

Yet it is made virtually *without* the use of metal. Soon available at all dealers!



NATIONAL CARBON COMPANY, INC.

30 East 42nd Street, New York, N. Y.

Unit of Union Carbide and Carbon Corporation



The word "Eveready" is a registered trade-mark of National Carbon Company, Inc.



Keep flashlights loaded with dependable fresh DATED "Eveready" batteries—and have an extra set on hand for your light in case of long-continued use.

**FRESH BATTERIES LAST LONGER . . .
Look for the DATE-LINE**

If You Can Drive You Can Fly

(Continued from page 69)

the air map is freckled with 400 seaplane bases, and nautical light planes are fast gaining popularity. You can change a landplane to a seaplane in two hours. Any small lake or wide river is home to these sporty pontoon craft and a transcontinental flight from pond to pond is quite feasible. The light seaplane can land or take off on turf with unexpected ease. The pontoons skid smoothly to a quick stop in front of your country home. Taking off, an automobile tows it just far enough to break the inertia and the seaplane quickly casts off on its own. One airman trying it for the first time towed his partner in a Taylorcraft seaplane a little over 10 yards and then, surprised at the slack rope, hardly had time to turn his car aside before the pontoons were winging over him. The C.A.A. is experimenting with lighted rubber doughnuts that mark landing areas, the lights controlled by radio shortwaves.

Many of the technical marvels that have contributed to safe commercial and fast military flying are available to the private flier, but at a price. And most of them are unnecessary on the light plane. Self-starter, two-way radio, variable-pitch propeller and other extras can be had; but buy all the instruments and de luxe equipment and you'd double the price of the plane. A sensitive altimeter may cost \$205, two-way radios \$100 to \$255, rate of climb indicator \$45 to \$125, navigation lights and battery \$55. What the government requires in your private plane for contact daytime flight is an airspeed indicator, altimeter, tachometer; oil-pressure, temperature and fuel gauges; fire extinguisher, log book for engine and plane, safety belts, first-aid kit and if you're flying more than 100 miles from home, a magnetic compass.

The actual cost of flying is astonishingly low. Light planes average a half cent a mile per person for gas and oil. An engine check every 25 to 30 hours will probably cost less than ordinary maintenance of an automobile. Hangar rent varies around \$10 or \$15 a month, but low-cost private hangars are appearing. A Detroit company has introduced an inexpensive canvas hangar with a steel frame. The Stinson Aircraft company computed all costs of flying a Stinson "Voyager" at 105 miles an hour for 1,000 hours per year at 3.234 cents a

mile, and up to 6.591 cents a mile for a plane flown only 300 hours a year. This included allowance for engine overhaul, insurance, and depreciation at 25 percent per year. Actually a plane can be depreciated over 10 years, for its normal life is far longer than that of an automobile. Its engine is a simple one of low horsepower, with direct drive, no complex transmission and gears, no cooling system, no water pump nor pipes nor fan, simple controls, less starting and stopping and road jolts than your automobile endures. Original cost runs from around \$1,000 up, and includes a primary course in flying. But the average light plane enthusiast either rents, or forms a club in which 5 to 20 members share costs and take turns flying. The club vastly reduces individual costs, and rare is the man who can get his money's worth of flying his own plane after office hours. There is also a large market in used planes, and the second-hand plane buyer has the advantage over the buyer of a used automobile in that the log of both plane and engine tells you what you're getting.

Busy as they are winning the war, the aeronautical designers are preparing for a post-war world that will be at home in the sky. Northrop's flying wing may revolutionize the light plane as well as the transport. Cessna Aircraft is planning a "family car of the air" priced like today's automobile, radical in appearance and safety features. Molded plastic airplanes may roll from assembly lines by hundreds. Charles Kettering, General Motors' research genius, has designed a simple four-cylinder liquid-cooled engine developing 400 horsepower and weighing 200 pounds. A California inventor has an opposed-barrel engine delivering over one horsepower per pound. William B. Stout has been developing a four-wheel sky car that will fold its wings and roll down the street to your garage.

Man's ancient dream of flying came true at Kitty Hawk 38 years ago. Today it has come true to more than 200,000 Americans. Military and commercial craft aside, civilians rode the skies more than 200,000,000 miles last year. Nothing is surer than that when war clouds clear, the blue sky will be the road to work and play for millions of Americans, and you'll be among them.

HOME WORKSHOPS Aid War Program in 2 ways



Tucked away in basements and garages from Maine to California are tens of thousands of vitally important machine tools. Operated in home workshops, these tools are bringing happiness and "release" from the speed and strain of modern life to a growing army of home craftsmen.

Today, Uncle Sam is mobilizing this reservoir of tools and this reserve army of hobbyists for the desperate battle of war production. For, vast though America's manufacturing resources are, they must be reinforced by every available bit of man and machine power to speed the arming of our fighting forces.

Already hundreds of lathes and saws and drill presses, which once turned out furniture, model planes, ships and novelties are

producing parts for guns and planes and shells on war-order sub-contracts.

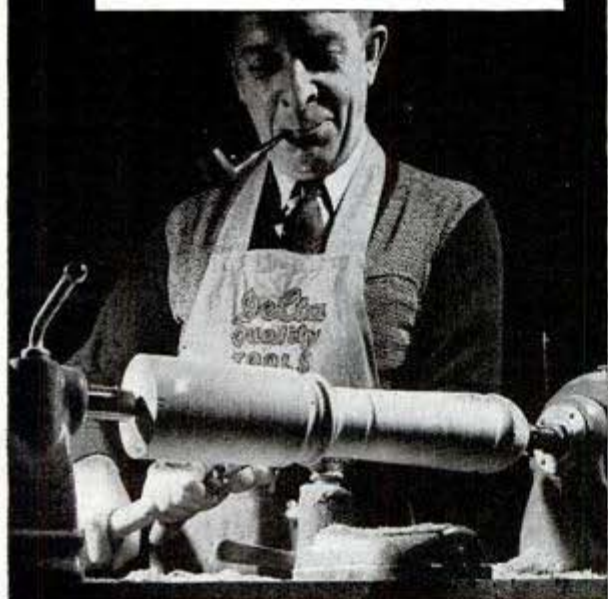
Now, through the pooling unit of the Division of Contract Distribution of the War Production Board, every machine and every home craftsman in the country is asked to enlist in America's victory production army!

Send for FREE Booklet

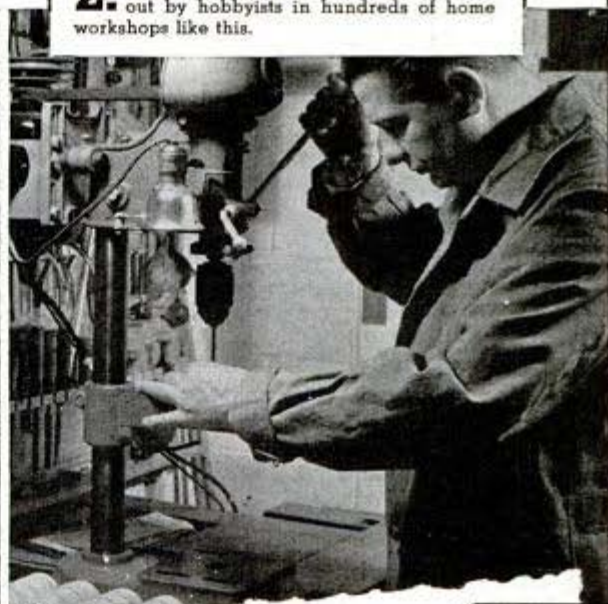
If you own a home workshop or are interested in machine handicraft . . . for business or as a hobby . . . find how you can enlist your skill and your machine tools in behalf of your country! Send for "Happiness is in Your Hands." It gives full details of how happiness can be obtained through creative handwork—and contains practical suggestions for building up your own home workshop.



1. Hundreds of thousands of men are gaining greater efficiency for war work by spare time craftsmanship.



2. Small parts for guns are being turned out by hobbyists in hundreds of home workshops like this.



DELTA MILWAUKEE

THE DELTA MFG. COMPANY
680-H E. Vienna Ave., Milwaukee, Wis.

Gentlemen: Please send me FREE copy of your booklet "Happiness is in Your Hands" telling how to build up a home workshop.

Name.....

Address.....

City..... State.....



**"He says it's his patriotic duty
to clean out the radiator
with Sani-Flush"**

Don't risk damage due to car overheating. Sludge and rust clog the radiator—may lead to expensive trouble. Sani-Flush cleans out impurities. Does it quickly, easily. Costs only a few cents.

Don't take chances on just flushing with water. Sani-Flush is thorough. Use it yourself, or ask your service station. *Sani-Flush is absolutely safe in auto cooling systems, when used according to directions on can.* It's in most bathrooms for cleaning toilets. Sold in grocery, drug, hardware and 10c stores. The Hygienic Products Co., Canton, O.

Sani-Flush

CLEANS OUT RADIATORS

BE COMFORTABLE— SLEEP OUTDOORS!

Send for "Outdoors With Ta-pat-co"—telling famous camp tricks and trail secrets to make your outdoor vacation more comfortable, pleasant, and safe. See styles of Ta-pat-co sleeping bags and other outdoor equipment in beautiful colors. Write today—it's FREE! Address . . .

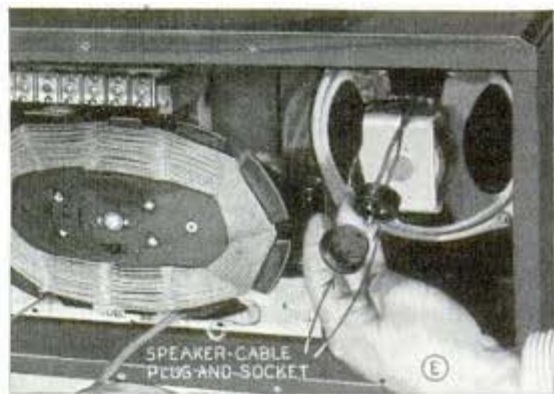
The American Pad & Textile Co.
Dept. 51, Greenfield, Ohio



First Aid Suggestions For Your Table Sets

(Continued from page 155)

shown in photo D, and remove the countersunk screws that hold the set chassis to the base of the cabinet, and disconnect the speaker cable as indicated in photo E. Lift out the chassis carefully and do not disturb any of the parts or wiring above or



below the base. From now on, follow the instructions given in the July issue and mark each socket to identify the tube as you remove it. If they fit very tight, use a small screwdriver to pry them up as illustrated in photo F. After having the



tubes tested, replace them firmly in their respective sockets and don't forget the grid caps or shields.

Now re-assemble the set in the cabinet, lining up the chassis carefully so that the control shafts clear the holes in the front, and the dial is correctly centered. Support the chassis in position and replace the mounting screws, then screw on the back cover and push on the knobs.

(To be continued)

Now Only \$6.95

REAL ENGINE VALUE

The G. H. Q. is a miniature gasoline engine that really operates. Over 15,000 sold in the last year. Now is your chance to buy the *New Improved 1942 model kit* for \$6.95. Absolutely complete with coil, condenser, plug, instructions, etc. Only a screwdriver needed. For boats, planes, midget cars, etc. All parts guaranteed. Send only \$1.—*Shipped Collect C. O. D. same day.* Send for *FREE circular or 6c for Jumbo catalog* of hundreds of plane, boat and hobby items.



GHQ MOTORS, Dept. B, 40 East 21 St., New York, N. Y.

NEW Grinding Attachment

For 8" to 16" Metal Lathes. Build it Yourself.

At last, a precision grinder within your means. You save 2/3 by finishing our semi-machined castings, on your own lathe. HURON handles both internal and external grinding. Accuracies to .00125". Mirror finish easily obtained. Grinds valves, pistons, bushings, shafts, hard or soft steels, lathe centers. Sharpens reamers, milling cutters. Does eccentric drilling; taps; polishes; scores of other uses, for home workshops, garages, machine shops. Write for *FREE* illustrated folder and price list of supplementary items. Mention your lathe.

Huron Machine & Tool Co., Dept. B, Yale, Mich.



Semi-Machined Castings
Only \$6.45



SAVE MONEY

BUILD YOUR OWN FAN

Aluminum Propellers
White
They Last
Shipped
Collect

THREE-BLADE

for 1/4 H.P. Motor

Size	Shaft	Price
20 1/2"	1/2"	\$4.50
24"	3/8"	5.00
26"	1/2"	5.50

TWO-BLADE

for 1/8 H.P. Motor

Size	Shaft	Price
12"	1/4"	\$2.75
16"	3/8"	3.00
20 1/2"	1/2"	3.50

MICHAEL ELECTRIC COMPANY, Dept. P., Fort Worth, Texas



OTTAWA TRACTOR SAW

Falls Tree—Cuts Log

Fits rear power take-off shaft.

Drive thru gear reduction. 18-in. stroke, 10-ga. blade. Economical, saws to profit.

FREE Circular and Price List

OTTAWA MFG. CO., 1227 Forest Avenue, OTTAWA, KANSAS

FREE LITERATURE FOR TRAILER BUILDERS

New up to date facts on world's most reliable parts, axles, hitches, draw bars. Used by U. S. Gov't. and largest trailer Mfrs. Easy to build in spare time. Complete working Blue Prints only \$1.00. Write for Free Literature.

HAMMER BLOW TOOL COMPANY

Dept. 108 Wausau, Wis.



GERSTNER TOOL CHESTS

are for men who take pride in their tools and in their work. Free Catalog.

GERSTNER TOOL CHESTS
442 Columbia St. Dayton, Ohio

BRUSH PLATING OUTFITS

for autoparts, reflectors, faucets, bicycles.

No tanks necessary. Free particulars.

GUNMETAL CO., AVE. M, DECATUR, ILLINOIS

Say you saw it in *Popular Mechanics!*



You'll PROFIT by using this

Valuable ARC WELDING Manual

You'll refer to this ready reference manual daily. It will answer all kinds of questions on techniques, methods, procedures, materials and equipment. Hundreds of diagrams, tables and charts makes it so valuable you can't afford to be without it.

5 days FREE inspection

\$2.00 Send name, address and this ad with check or money order. If not satisfied money will be refunded.

Postpaid **HOBART BROS., Box M-82 Troy, O.**

HOBART HELPS SPEED UP WAR PRODUCTION.
with amazing "10 Years Ahead" Electric Arc Welder.
Send for FREE Catalog



Hobart

"Simplified" ARC WELDING

"One of the World's Largest Builders of Arc Welding Equipment"



ONE STEP IN THE RIGHT DIRECTION and you're in HOTEL CLEVELAND

It's as easy as that to be in Cleveland's most convenient, most friendly hotel. Hotel Cleveland is directly connected with the Union Passenger Terminal and a modern garage. Located on Public Square Park, at the heart of the city, all through motor routes come right to our door. Convenient, too, for theatres, stores, boat docks, Stadium, Auditorium, and every part of the city. May we welcome you to Cleveland on your next trip here?

HOTEL CLEVELAND

SAVE WORK, MONEY ON METAL SAWING

Only 3c in hardware stores for 20-page bargain booklet of tips on metal cutting with hand and power hack saws, hand saws. How to save money, speed work, make blades last longer. Many illustrations. Or send dime with coupon to cover handling, mailing direct to you.

Published by makers of STAR Hack Saw Blades, Frames, Band Saws, Clemson D-17 Lawn Machine.



STAR HACK SAW BLADES

CLEMSON BROS. INC., Dept. M-8, Middletown, N. Y.

Enclosed find dime for bargain hack saw booklet, "Metal Cutting".

Name _____

Address _____



NO Drip **A SURE CURE**
 Use this plastic cork coating to positively stop sweating and condensation drip. Easy to apply with whisk broom, brush or trowel to pipes, tanks, walls, ceilings, air ducts—any surface of metal, concrete, brick, wood, plaster, composition. Insulates and prolongs life of metal by preventing rust and corrosion. A gallon covers about 30 ft. of 1" O.D. pipe. The permanent, stucco-like finish can be painted any color. Comes in 1, 5 and 55 gal. drums. Get at Hardware, Plumbing, Mill Supply Dealers or send \$1.90 for 1 gal. prepaid. **CIRCULAR FREE.**
J. W. MORTELL CO., 522 Burch St., Kankakee, Ill.

FREE RADIO CATALOG!

You'll want this Big FREE 1942 Book that shows Everything in Radio! Here's everything you need for radio servicing, for experiment, for instruction in the science of modern Radio! More than 15,000 quality radio items—replacement parts, books, tools, lab and experimental equipment—all at the lowest prices! Send for this FREE Catalog now—and don't miss the two big book values described below—They're a "must" for Everyone in Radio!

FREE
 Send for it NOW

ALLIED RADIO CORP.
 Radio Builders' Handbook. Everyone in radio needs it 10¢
 Radio Dictionary, Complete, valuable, defines all terms 10¢

833 WEST JACKSON DEPT. 5-H-2 CHICAGO

BE PREPARED! LEARN TO SHOOT WITH BENJAMIN

MADE IN U. S. A.

HARD ACCURATE SHOOTING WITH CHAMBERED AIR

You can use new model BENJAMIN AIR RIFLES WITH LEVER HAND PUMP anywhere, for practice firing or just plinking, around the house or camping, fishing, hunting, etc., at lowest cost. Shooting force is adjustable with amazing maximum power and accuracy—no recoil or forward lunge to disturb your aim. Bolt Action—Hammer Fire—Hair Trigger—Safety Lock—Hand Pump. Single Shot BB with 1 lb. shot \$9.00; Single Shot Cal. .177 or .22 rifle—with 500 pellets \$10.50. Also a complete line of Improved BENJAMIN GENUINE COMPRESSED AIR TARGET PISTOLS. "No License Required." Write for details and FREE TARGETS. **BENJAMIN AIR RIFLE CO., 895 Marion St., St. Louis, Mo., U. S. A.**

DO YOU

high as \$50-\$100 weekly after a few weeks home training—not medical or chiropody—no further capital needed, no goods to buy, 47th year. Write for free booklet.

Stephenson System of Foot Correction

28 Back Bay, Boston, Mass.

ONAN ELECTRIC PLANTS
 ALTERNATING AND DIRECT CURRENT

Produce Current, same as City Power Lines, for FARMS, SCHOOLS, THEATRES, PUBLIC BUILDINGS . . . Operate Lights, Radios, Motors, All Appliances.

Over 40 STOCK MODELS—150 to 50,000 Watts. Any Voltage—Any Frequency. Combination A. C. - D. C. Types. Manual, Full Automatic and Self-Starting. \$99 up. Shipped—COMPLETE, READY FOR OPERATION. THOUSANDS IN USE IN ALL PARTS OF THE WORLD

Write for Complete Details.

D. W. ONAN & SONS
 1072 Royalton Avenue - MINNEAPOLIS, MINN.

Inter-Room Communicator

(Continued from page 157)

input transformer. A detailed list of materials is available from Popular Mechanics radio department. Up to three sub-stations may be connected to the master station. All are built alike and radiate from the master station or may be tapped

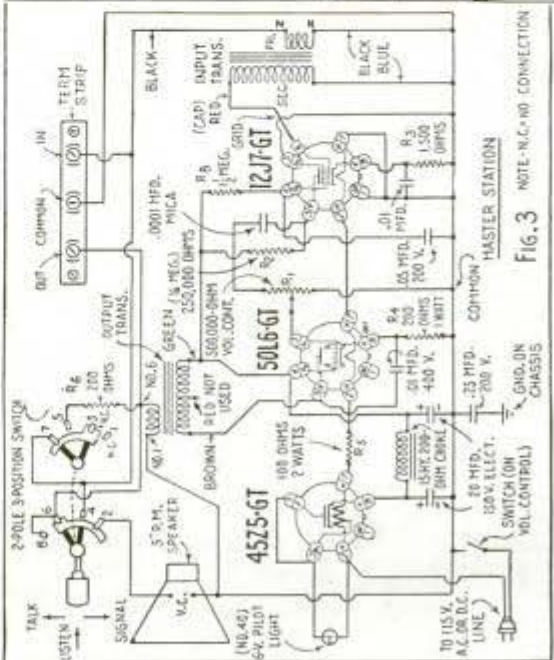
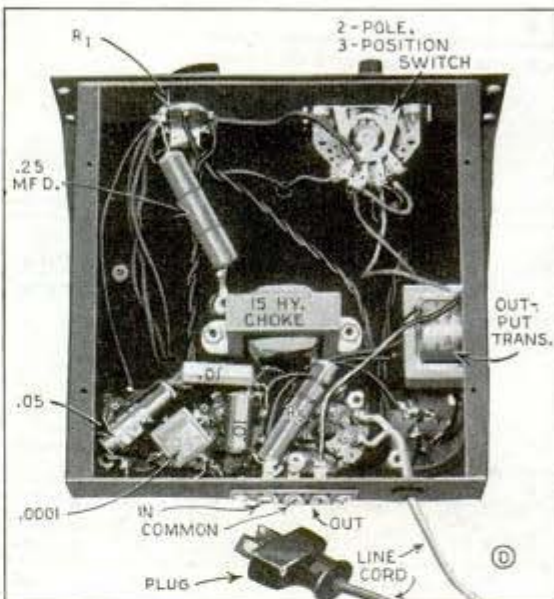


Fig. 3

along the one cable; each may be assigned a number and signaled accordingly. A sub-station may call the master station or a sub-station, however, all stations will hear the conversation. The blueprint number for this article is R-306.

Production Line

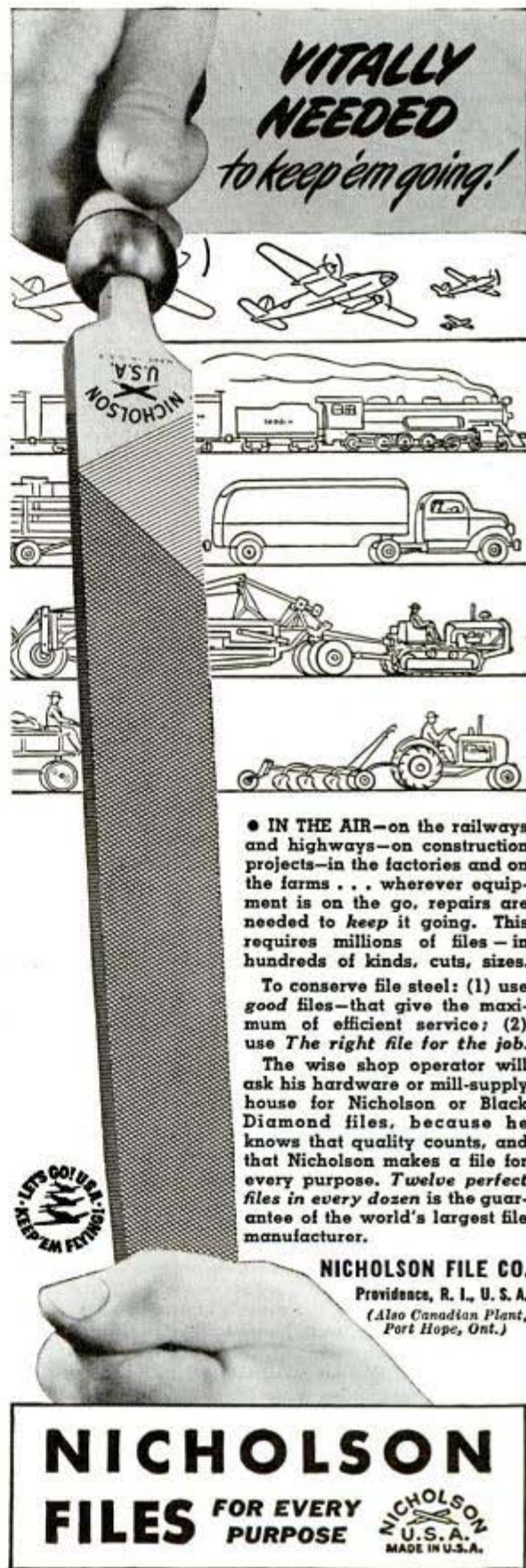
(Continued from page 4)

2,000,000 pilots and ground men. They must all be specialists—expert mechanics, navigators, bombardiers, pilots, weather men, radio operators and supply men. To become specialists, they must be trained for several months, as in the case of the aviation mechanic whose required course under present conditions runs about five months. This means a very considerable expansion of every type of school doing this kind of work, as well as the establishment of new training centers.

What our armed services could accomplish with just half the number of combat planes contemplated—92,000—is only a matter of conjecture. Anyone knows that 1,000 planes, with full personnel and equipment, can mean the difference between victory and defeat—if the planes are in the right place at the right time. In the largest continuous blitz on London, some 500 planes were employed, some military experts estimate. Of course this does not mean that 500 planes were over the British capital at any one time; possibly this raid was prosecuted with as few as 100 planes working in relays. And there are few indications that Japan has used more than 100 planes in any single attack. The Royal Air Force bombed Cologne with a reported 1,250 planes. In contrast, what would be the result of an attack by 5,000 Yankee bombing and fighting planes on an objective—perhaps a gigantic raid on Tokyo some moonlight night? The reader will have to use his imagination here because nothing like it has ever been attempted. But it's worth thinking about because we—the manufacturers, the airplane workers and the air force personnel—are going to make it a possibility.

From the National Association of Manufacturers comes the information that to meet the President's goal of 8,000,000 tons of merchant shipping in 1942, it would be necessary to sustain a rate of approximately two ships a day. In comparison, this country produced 13,627,311 tons of shipping during the World War when we were preparing to transfer 4,000,000 troops overseas. At the end of 1941 shipyards in the United States had under construction 833 seagoing merchant vessels, of which more

(Continued to page 174)



VITALLY NEEDED
to keep 'em going!

● **IN THE AIR**—on the railways and highways—on construction projects—in the factories and on the farms . . . wherever equipment is on the go, repairs are needed to *keep it going*. This requires millions of files—in hundreds of kinds, cuts, sizes.

To conserve file steel: (1) use good files—that give the maximum of efficient service; (2) use *The right file for the job*.

The wise shop operator will ask his hardware or mill-supply house for Nicholson or Black Diamond files, because he knows that quality counts, and that Nicholson makes a file for every purpose. *Twelve perfect files in every dozen* is the guarantee of the world's largest file manufacturer.

NICHOLSON FILE CO.
Providence, R. I., U. S. A.
(Also Canadian Plant,
Port Hope, Ont.)

NICHOLSON
FILES FOR EVERY PURPOSE
NICHOLSON
U.S.A.
MADE IN U.S.A.

Save your tools!



Get this **FREE**
DISSTON
MANUAL

from your
HARDWARE DEALER



48 Pages • 200 Illustrations

Packed with useful workshop advice, instructive pictures, practical helps and hints. Contains this statement from George T. Weymouth,

Bureau of Industrial Conservation, War

Production Board: "TOOLS ARE WEAPONS. CONSERVE THEM. USE THEM PROPERLY TO AVOID BREAKAGE AND THE WASTE OF CRITICAL MATERIALS NEEDED TO WIN THIS WAR." . . . Make your tools last longer. Get your **FREE** copy of the Disston Saw, Tool and File Manual from your Hardware Dealer.

HENRY DISSTON & SONS, INC., 811 Tacony, Phila., Pa., U.S.A.



IN YOUR COUNTRY'S SERVICE

Government and Industry moves to jobs where needed. Thousands of men have been quickly mobilized and housed in key centers in Schult Trailers, the nation's top trailer value. . . Larger, roomier, more luxurious than ever. Interiors include private bedrooms, dinettes or davenport—super insulation for maximum year round comfort. Rugged construction assures long life. Cut costs and live comfortably. Write Schult for complete information. Schult Trailers, Inc., Dept. 3208, Elkhart, Ind.



Schult Trailers

than 700 would have to be completed this year.

Two years ago there were only 83 ways in this country capable of accommodating vessels more than 300 feet in length, according to the American Bureau of Shipping. This meant a capacity of about 160 ships per year. Early in 1941, there were 170 building ways and today there are more than 400 that can be used for constructing steel seagoing vessels. To some extent, these facilities are taken up by Naval construction. When Japan struck we had 17 battleships and 15 more building, seven aircraft carriers and 11 building, 37 cruisers and 54 building, 171 destroyers and 183 building, and 113 submarines and 73 being built—under our program of a "two-ocean" navy.

Along with the increase in building ways has been a comparable growth of drydocks, machine shops, fitting-out piers and the other buildings needed in a shipyard. This rapid growth has required large-scale expansion in allied industries—for instance, steel shapes, boilers, turbines, pumps and machinery. The employment increase in the shipbuilding industry is on the order of 500,000—from an estimated 240,700 at work at the beginning of 1941 to an estimated 740,000 necessary to attain the goal set by our government.

Production of tanks and combat vehicles is more than three times that of a year ago, according to the Office of Facts and Figures, giving our army the mobility needed for offensive action. The rate of tank production has been pyramiding and, at present, far exceeds estimates of a year ago. The 1942 goal of 45,000 tanks is great enough to equip and maintain with replacements more than 60 armored divisions—in action.

From where we stand it seems that the United States is on its way toward outbuilding the world in planes and tanks—the two most important weapons in this war. But it's a herculean task—one in which every man, woman and child can, and must play a part.

☐ To protect the cotton crop against insects and fungi requires 40,000,000 pounds of calcium arsenate, 20,000,000 pounds of sulphur dusts, 600,000 pounds of organic-mercury seed disinfectants, 500,000 pounds of Paris green, and other poisons.

Reported by Dr. R.C. Roark of the
POPULAR MECHANICS
Bureau of Entomology & Plant Quarantine, U. S. Dept. of Agriculture, Wash.

Use Air Pressure to BEAUTIFY & REMODEL

Renew old buildings. Make new construction more permanent and attractive. Plastic COLORCRETE is water-proofed. It fuses with any masonry surface. It fills cracks and checks. It can be applied in any thickness and in 30 colors and shades.

Fully proven by over 14 years actual use. Offers big earnings. With this machine you can supply big waiting market at amazingly low cost. Some present operators report earnings that have paid for their equipment from first few jobs. Machine capacity up to 1,000 sq. ft. per hour.

Get the facts. Send for Free Book "Proven Business Opportunity." Write today.

COLORCRETE INDUSTRIES, INC.

570 Ottawa Ave. Holland, Michigan



110-VOLT AC GENERATORS

& AC light plants. 1800 & 1200 rpm. Available for all standard voltages such as 110, 220 or 440 three phase; three phase, three wire or three phase four wire & 25, 30 or 50 cycles. 350 through 15,000 watts. Also rotary converters, motor generators, frequency changers, etc.

KATOLIGHT, 23 Elm St., Mankato, Minn.



OTTAWA LOG SAW \$39 USE BOOK FREE

PUTS THIS OTTAWA to work for you. **MAKE MONEY!** Wood is valuable. Does more than 10 men. Easily operated. Falls trees—saws limbs. Use 5-hp. engine for other work. Use for FREE BOOK. **OTTAWA MFG. CO.** Wood St., Ottawa, Kans.



Build a **STURDY WORK BENCH** from complete working plan in Stanley Set No. 11. Includes 4 other good plans. Now 14 Sets to choose from. **EACH SET OF 5 PLANS ONLY 10c**

STANLEY TOOLS Division of The Stanley Works 178 Elm St., New Britain, Conn.

RE-STRING RACKETS AT HOME—EARN MONEY

EASY—PLEASANT—PROFITABLE WRITE FOR 1943 CATALOG AND FREE INSTRUCTION SHEET NOW

W. A. Bickel & Co., 137 N. Marion, Dept. A-82, Oak Park, Ill.

Wonder-Tone NOISE ELIMINATOR

Just attach to your radio (long, short wave) and enjoy reception free from distracting noises. Send-No-Money Pay Postman 60c plus postage or send 60c and we'll send postpaid. Return in 5 days for refund if not delighted.

WONDER-TONE COMPANY, Dept. 19, 7078 N. Clark St., Chicago, Ill.

Print Your Own

Cards, stationery, circulars, tags, labels, photo and movie titles, advertising, etc. Save money. **Print for Others. Good Profit!** easy rules sent. Raised Printing with any Kelsey press. Junior outfit \$5. Senior outfit from \$17.35. Send for free catalog and all details. **KELSEY INC., 5-37, Meriden, Conn.**

BUILD THESE PROJECTS

For garden or lawn. Easy to build. Easy to sell. Detailed Blueprints Model B-25 Dutch Windmill 50c; Model OM-60 Old Mill, 85c. Lawn Figure Patterns—Sunbonnet Girl, Dutch Boy, Tulip Girl, Holland Fair, 35c each, all 4—\$1.50. Catalog illustrating many models, send 15c, today.

CRAFTSMAN'S MODEL CO., Dept. P-65, 2030 N. 41st St., Milwaukee, Wis.

BUILD YOUR GRANDFATHER CLOCK

Send 35c for Simple SHOP TESTED COPYRIGHTED BLUEPRINT. The Simple Sensible Red-i-Kut way as thousands have. DIME brings PLANS and sixty picture "HOW" Book peicing many fine brass weight Westminster, tube chime, electric and battery movements showing nine beautiful colonial grandfather cases. Build now and save half. **KUENPEL CHIME CLOCK CO., Bldg. 67, Guttenberg, Iowa.**

See you saw it in Popular Mechanics!

WARTIME REPAIRS

WITH
SMOOTH-ON



By using SMOOTH-ON to stop leaks, fill cracks and tighten loose parts on plumbing and heating systems, on your car, and on utensils, tools, etc., you can save many hard-earned dollars. But even more important, by repairing with SMOOTH-ON you will be helping to win the war.

It's easy to use SMOOTH-ON. No heat or special tools are required. All you do is mix SMOOTH-ON with a little water, and tamp it into the hole or crack or between loose parts. Our FREE HANDBOOK shows you how a few cents worth of SMOOTH-ON can save both money and materials.



Buy Smooth-On in 1 3/4-oz., 7-oz., and larger cans from your dealer or if necessary from us. For your protection, insist on genuine SMOOTH-ON.

FREE

Latest 40 page SMOOTH-ON HANDBOOK packed with useful information on making economical, lasting repairs. 170 illustrations show how. Comes to you FREE if you send us the coupon below.

SMOOTH-ON CEMENTS

STOPS LEAKS

SMOOTH-ON No. 1 CEMENTS IRON

For the Motor Car and Boat. Home, Factory and Power Plants

MAIL COUPON FOR free BOOK

Smooth-On Manufacturing Co., Dept. 37
570 Communipaw Ave.,
Jersey City, N. J.

Name

Address

8-42

Do it with **SMOOTH-ON**

Alloys for the Allies

(Continued from Coloroto Section)

or gun carriers, dead weight is reduced to a minimum so that higher speeds may be reached or heavier guns and armor carried. Here again, alloy steels have a big role. Alloy steels make possible such reductions in weight because, being stronger, they permit the use of thinner and lighter sections in structural and moving parts. The armed forces are finding the high-tensile, low-alloy steels especially useful for this purpose. Those steels contain only small quantities of alloys, but they have substantially better physical properties than ordinary steel. One grade used in mechanized military equipment was originally developed for railroad cars and trucks.

America's capacity to produce steels of all kinds has already been a factor in certain theaters of the war. The full weight of its superiority over the enemy countries, however, has not yet made itself felt. During 1941 and even in the early months of this year, a large proportion of our steel capacity was still needed for uses "behind

the lines." New factories had to be built and tooled up; shipways, training camps and defense housing projects had to be erected. In the enemy countries, this phase of preparing for actual fighting was completed years ago. As 1942 progresses, however, the proportion of our steel output that can be used against the enemy in combat equipment will steadily increase. Rigid conservation will be necessary in the use of alloying elements, many of which must be imported, to assure maximum production of military and naval equipment.

So urgent is the demand for alloy steels in war, and so necessary is it to conserve our supplies of the alloying elements, that many alloy steels are for the moment unavailable for civilian needs. When victory is won, however, there will be available for civilian use not only those steels which have already contributed so much to our material progress, but new steels besides. They will all be used to raise still further the American standard of living.

Broadway Blackout

(Continued from page 13)

as a guide to strike at the heart of the nation's largest city. The pressure of a finger on a single tiny switch, hidden in a towering bombproof skyscraper many blocks away from the twinkling river of illumination, will plunge into blackness most of the midtown spectaculars. The switch is smaller than the one which turns on the parlor light in most American homes.

To make safety doubly certain, the blackout control set-up is duplicated right on Broadway in a small space near one of the most intriguing of the Gay White Way's many signs. The sign, however, is so distracting that not one of the nightly gazers dreams that within a few feet of the spectacular an air raid watcher sits ready to click out most of the 200,000 incandescent bulbs and miles of vari-hued neon.

Also concealed from the eyes of the million or more who nightly pack the glowing sidewalks of the theatrical district are a few more switches within an arm's reach. These control the remainder of the greatest collection of advertising signs in the world. Soon the twisting of a radio dial is

expected to be enough to eliminate the switches.

In these days of clear skies, the magnificent show is seldom seen in its full glory and New York misses the spectacle. Still, while "Keep Them Burning on Broadway" is the slogan of the famous district, they don't want them lit a second that would bring peril to the city or the ships at sea.

Wood Pipe "Pinch Hits" for Steel In Oil Drilling Experiment

Pipe made of molded wood fiber as a substitute for steel is being used in oil drilling experiments conducted by the Illinois Geological Survey. Wood pipe was used successfully at a shallow well where a 460-foot drill hole was completed in 12 hours. The use of wood fiber in oil well casings may permit an increase in drilling operations now curtailed by the steel shortage, according to Dr. H. M. Leighton, chief of the survey. Material to manufacture the fiber pipe is available in unlimited quantities at a fraction of the cost of steel.



KRW ARBOR PRESSES BENCH TYPE AND HYDRAULIC

NEEDED IN EVERY SHOP—SAVE TIME AND MONEY—DO BETTER WORK, QUICKER.

No shop is complete without a small arbor press. Pressing and squeezing operations can be done better and faster on a KRW Arbor Press. Stop using vise and sledge hammer methods—they generally deliver spoiled work in the end. KRW Factory-To-You Prices give you greater value for your money. Order today.

KRW Bench Type Arbor Presses, 3 sizes
 No. 37-P 1/2 Ton, \$13.25*
 No. 37-O 1 Ton, \$23.00*
 No. 37-N 3 Ton, \$33.00*
 *Prices F.O.B. Arcade, N. Y. Slightly higher west of Rockies. Stand illustrated extra.



KRW Hydraulic Presses are built in 25, 50 and 75 ton sizes. Prices start at \$198.00*



K. R. WILSON 17 Lock St., BUFFALO, N. Y.
 Builders of Shop Equipment for Ford Dealers Since 1916

TEST-O-LITE

Tests Everything Electrical From 100 to 550 Volts

A real necessity for electricians and home because it has 1001 uses. Equipped with a Neon light which tells instantly where trouble lies in electric circuits, fuses, cut-outs, motors, radios, all kinds of electric appliances, etc. Tells A. C. from D. C. Far superior to ordinary clumsy test bulb. Fountain pen size with clip for carrying in vest pocket. Lifetime guarantee.

PATENTED

L. S. BRACH MFG. CORP.
 55 Dickerson St., Newark, N. J.



APPLIANCES



MOTORS



FUSES

THE KNIFE THAT MAKES THOSE

NAVY PLANE MODELS

QUICKER, EASIER, really ACCURATE!

AT YOUR CRAFTSMAN'S DISCRETION

X-ACTO CRESCENT PROD. CO., INC. Dept. PW 440 45 Ave. NEW YORK CITY

X-acto

Refill-blade KNIFE

Send 10c for booklet "HOW TO MAKE SCALE MODELS FOR DEFENSE"

HARLEY-DAVIDSONS SAVE Gas, Oil and Rubber

Today's shortages find the lucky owners of Harley-Davidson Motorcycles cooperating patriotically in the conservation of gas, oil and rubber. They get back and forth to work in a jiffy and at a small fraction of the cost of other motorized transportation. Harley-Davidsons are regular gas and oil misers, and with only two tires they save rubber. While there are no new Harley-Davidsons available now for civilian use, your dealer may have some good values in reconditioned models.



HARLEY-DAVIDSON

ON AMERICA'S FRONT



SEND COUPON NOW!

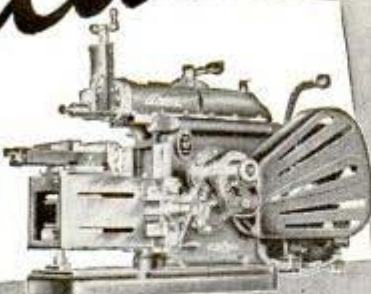
HARLEY-DAVIDSON MOTOR CO., Dept. P, Milwaukee, Wis.

Send FREE copy of big 24-page "Enthusiast" magazine filled with thrilling motorcycle pictures and stories. Also other literature. Stamp is enclosed for mailing cost.

Name


Address

Atlas



7-INCH SHAPER

Everywhere the nation's war production engineers are acclaiming the dependable accuracy and ruggedness of the Atlas Shaper.



ATLAS PRESS CO.
KALAMAZOO, MICHIGAN

LATHES • DRILL PRESSES • SHAPERS
ARBOR PRESSES • MILLING MACHINES



PHOTO ENLARGEMENTS

Is Photography your hobby? Do you want a profitable ear business at home? Make **PHOTO ENLARGEMENTS** for yourself and others. Your cost 5¢ each and less. The Ideal Photo Enlarger is **AUTOMATIC**. No experience required. Also **COPIES** any picture \$7.94 **COMPLETE**. Interesting circular **FREE**. No deliveries guaranteed after July 30th.

5¢ ANY SIZE

Ideal-O, 148 West 23rd St., New York City



CHESSMEN Here's A Bargain!

• Chess players are raving over these beautiful Staunton Design, Tenite Plastic Chessmen. They are sweeping the country! 2-3/4" King size, Black and Ivory or Red and Ivory colors. Make wonderful presents. Sturdy, attractive. Boxed, with beginners chess rules. Also in larger 2-3/4" King size for \$3.50. Send check or money order for size wanted. Designate color. Satisfaction guaranteed.

\$2.00
32 Pieces Set Postpaid

CHESSMEN CO., 401 N. Franklin, Chicago, Ill.



8 Mile Range-Wide Vision BINOCULARS \$4.75

15 Days FREE TRIAL
Postpaid or C. O. D.

Comes complete with case and straps. Well ground powerful lens. Easily focused for all distances and eye widths. Latest features. Ideal all-weather binoculars. **Guaranteed**. If not satisfied after 15 days trial, money refunded. **AGENTS WANTED.**

Vogue Binocular Co., 7759 S. Halsted, Dept. 808, Chicago

MAKE BIG MONEY at HOME!

NEW INVENTION

Electroplates by Brush

Now Plates CHROMIUM Too!



New, patented invention makes possible big earnings AT HOME. Replate auto-parts—worn articles in homes, stores, hotels, restaurants, etc.—with durable, sparkling, new coat of metal—with stroke of brush. Easy, simple, quick. Genuine Gold, Silver, Nickel, Cadmium, etc. Everything furnished. **Output complete, ready for use. No shop required.** Clear from \$2 to \$5 an hour in lifetime business. Small investment starts you in business. Steady repeat. Machine can pay for itself in week. Send **TODAY** for **FREE SAMPLE** and illustrated **BOOKLET** how you can have a life income from a business of **YOUR OWN** built upon satisfied customers. Act at once!

FREE SAMPLE and BOOKLET EXPLAINS ALL

WARNER ELECTRIC COMPANY
215 W. Ohio St., Chicago, Ill., Dept. 201

College for Police Horses

(Continued from page 30)

were a part of the man's body—moving in the proper direction almost as soon as his master has made up his mind and telegraphed his wishes by some imperceptible movement. Or perhaps by telepathy, as some horse-lovers think.

Each of the 400-odd mounted police horses now active in the city was a problem in himself when he went to "college" in the big town corral in the Long Island City section. Some are docile; some are too spirited; some are a bit clumsy or dull; others are sly, and it is the job of the instructors to mold them into a common pattern of dependability.

Occasionally, a fine police horse will develop a case of nerves and "go haywire"—a sort of a shell-shock victim in the battle for traffic safety. The cure is a curious one.

He is taken to the training stables and merely left alone for a while—left alone in the sense that the men have as little to do with him as possible for a period of weeks. His food is changed and enriched. He is permitted to fatten up. Once a day, perhaps, he is turned out to exercise at random. He is allowed to mingle with other horses occasionally, perhaps to exchange horse gossip. The rest of the time he is left in his stall to meditate on his troubles or worries, whatever they were, that caused him to shy at autos, jump around in the street, or disobey orders. At any rate, a period of fattening and relaxed discipline usually gets him ready for re-entering and soon he is learning his lessons all over again.

About half of the horses ridden by the men commanded by Captain James Meehan of the Mounted Division are bought in New York and half in Chicago. The eastern horses are more docile and more alert than the westerners, which are rugged, suspicious and doubtful about mankind, his intentions and his teachings. The easterners are neater in appearance and the westerners are a bit shaggy of coat and heftier in build. All are geldings.

The horses must be either a true bay, or in the family of bays which is a mixture of red and brown. They must weigh around 1,100 to 1,200 pounds and stand about 16 hands high. They must be not more than

(Continued to page 180)



Protect the Families of Navy Men!

To care for Navy men and their families—(this includes the Marine Corps and the Coast Guard Welfare)—the Citizens' Committee of the Navy Relief Society is asking for your help. Give generously to your local Navy Relief Committee. Give today!

Check should be made payable to Navy Relief Society and sent to Citizens' Committee, 730 Fifth Ave., New York.



NEW POPULAR MECHANICS BOOK CATALOG

Give yourself the lift you need with pay-raising, extra money books. Every man who reads Popular Mechanics will want this new, big illustrated catalog of the world's BEST practical books on trades, professions, opportunities, crafts and hobbies. You must see it to appreciate its value. Send your name and address on penny post card. Do it today.

SEND YOUR NAME TODAY

POPULAR MECHANICS PRESS
Dept. 404, 200 E. Ontario St., Chicago

PLANS FOR NINE NEW JIM DANDY TRAILERS Ready

Build your own trailer! Send 10c for Jim Dandy's interesting new TRAILER PLAN CATALOG which illustrates and describes NINE new models including 6 modern house trailers, plus sport, camp, and utility trailers. Rush 10c (in U.S.) for Catalog today to JIM DANDY, BOX 125-A, WAUSAU, WIS.

MONEY IN RABBITS — CAVIES

WE BUY and put you in touch with other markets. Catalog and copy of magazine 10c. Or send 25c for Book Catalog and Price List and Year's Subscription to the AMERICAN SMALL STOCK FARMER. OUTDOOR ENTERPRISE CO., BV 919, PEARL RIVER, N. Y.

TOMBSTONES \$10.95 UP FREIGHT PAID

High Quality Granite and Marble. Lettered. Guaranteed. Write for Free Catalog and samples of stone. Without Delay. Order By Mail. U. S. MARBLE & GRANITE CO., A-18, ONECO, FLA.

Get Your Share of U. S. Defense BONDS ★ STAMPS

OUTDOOR FUN!

Indian

SPRING FRAME MOTORCYCLE

Exclusive "Spring Frame" smooths out roughest country roads. New comfort, safety. Brilliant streamlined beauty. See your Indian dealer.

INDIAN MOTORCYCLE CO., SPRINGFIELD, MASS.



RATION YOUR DRIVING BY COMPASS

● Tire and gasoline restrictions require a self-enforced rationing of your driving—to eliminate unnecessary miles so that your car will be ready to run when needed. Your Hull Streamline Auto Compass is an important aid to efficient driving. Use it wisely.



HULL MANUFACTURING CO., P. O. Box 246-D8, WARREN, OHIO

BURN YOUR NAME ON TOOLS WITH THE ARKOGRAF

PROTECT YOUR TOOLS FROM THEFT Write with electricity any name or design on the hardest and finest tools and instruments, or any metal, like writing on paper with pen or pencil. Complete Outfit \$3.50—Prepaid Anywhere. Interesting illustrated circular free. Write today. Agents wanted. ARKOGRAF PEN CO., 3927 S.E. Stark St., Portland, Ore.



BUILD YOUR OWN AIRPLANE FAN ALL EQUIPMENT FURNISHED



Let us show you how to make a cooling Airplane Fan equal to \$25.00 fan, at fraction of cost! We can furnish all or as many parts as needed, at unbelievably low prices. Blades, guards, motors, etc. Our Ace Aerophone Blade has about 24-inch spread, graceful lines, well-seasoned wood, lightweight, sturdy; warp-proof treated, beautiful mahogany finish. Special introductory price, \$1.50. Order from ad. Send money, or if you wish, we'll send blade C.O.D. plus handling charges. DEALERS: Chance for big money. FREE information. Postcard will do. ACE CO., 1601-N Market, ST. LOUIS, MO.

24 INCH BLADE \$1.50

WILL YOU WEAR THIS SUIT and Make up to \$12 in a Day!



Let me send you a fine union tailored-to-measure tailored suit FREE OF ONE PENNY COST. Just follow my easy plan and show the suit to your friends. Make up to \$12 in a day easily. No experience—no house-to-house canvassing necessary.

Send for Samples—FREE OF COSTS Write today for FREE details. ACTUAL SAMPLES and "sure-fire" money-getting plans. Send no money. H. J. Collin, PROGRESS TAILORING CO., Dept. H-116, 500 South Throop Street, Chicago, Illinois.

SAW-FILING

Pays up to \$2 or \$3 an Hour

A FOLEY Automatic Saw Filer files hand, circular and band saws better than the best hand filer. Cash business, no canvassing, no eyestrain. No experience needed. "Last year I sharpened 2300 hand saws, for which I got \$1154.40. The Foley Saw Filer has made a good living for me."—John Joseph. Send coupon for FREE PLAN, no obligation.



FOLEY MFG. CO., 816-2 Foley Bldg., Minneapolis, Minn. Paste coupon on postcard. Send Free Plan on Saw Filing Business.

Name
Address

Up to
 $\frac{3}{16}$ " CUT
with .004" feed
at 80 strokes
per minute

With this NEW
PORTER-CABLE
7" Metal SHAPER

Given reasonable operator skill and a machineable metal, this shaper will make a $\frac{3}{16}$ " cut with a .004" feed at 80 strokes per minute. Not its full capacity, but faster than most.

The roller-chain drive distributes the strain and wear over five sprocket teeth at a time. There's no backlash. No chatter. The extra-heavy cast iron crank-pin-plate acts as a flywheel, giving an easy, powerful cut.

Exclusive Micro-set ram is quickly and accurately adjusted. "Any-speed" control gives speed changes from 64 to 175 strokes per minute, without stopping. Six automatic cross feeds. The head turns 360°. Table traverse is 10 $\frac{1}{2}$ ". Vertical travel, 5 $\frac{1}{2}$ ".

Ask your local Porter-Cable man (name in phone book) or write for complete data.

PORTER-CABLE MACHINE CO.
2050-8 North Salina Street
SYRACUSE, N. Y.



Revolutionary
New Chain
Drive Gives
Extra Speed
and
Smoothness

Something New! MECHANICS' TELESCOPE GAUGE

A REAL 20th CENTURY TOOL. These small instruments measure by the thousandths the exact size of holes and slots using an outside caliper or micrometer to determine measurement and making either shrink or loose fit. Four measuring rods with lock adjustment measuring from $\frac{3}{8}$ " to 2 $\frac{1}{4}$ ". Guaranteed accurate and durable. ACT NOW! One set packed in box. Postage prepaid. Delivery C.O.D. Direct from factory to you. Send for booklet.

SEABOARD TOOL CO.
Baltimore, Md.

Pat. Applied For — Price \$5.25 P. O. Box No. 1214



NEW! SMART! DURABLE!

This all plastic collar bar is non-tarnishable. Holds smoothly, neatly, see collar design right through bar.

Only 50¢ Postpaid.
"Stago" Plastic Products Co.,
617 Drummond Pl.,
Dept. PM, Chicago, Illinois

NEW PRODUCTS WANTED

- COMPLETE MANUFACTURING FACILITIES
- COMPETENT SALES ORGANIZATION
- POST WAR HOUSEHOLD APPLIANCES PREFERRED

QUALITY HARDWARE AND MACHINE CORPORATION
RESEARCH LABORATORY
5849 NORTH RAVENSWOOD AVENUE, CHICAGO, ILLINOIS

LEARN BLUE PRINT READING

We teach you at home. Simple 28-lesson course covers dozens of industries. Personal instruction. Learn quickly. Enormous demand in armament plants for men who understand blueprints. Get a better job at bigger pay. \$15 complete. Or write for terms. OHIO INSTITUTE OF TECHNOLOGY, Box 71, Greenville, Ohio



AUTO ENGINE SPEED CONTROL GOVERNORS

Give constant speed to any make of auto or truck engine, regardless of load changes, when used for power. No better governor can be made. Fully guaranteed. Complete, simple instructions. Courtesies to garages and established agencies. Montreal branch, 7546 Wiseman St. Free circulars. CANDEE, 129-7 Llewellyn St., Los Angeles.

eight years old and not less than four and be of the saddle type. Most of them have thoroughbred blood somewhere in their veins and some are former race horses, particularly jumpers. They cost an average of \$300 and put in an average of 15 or 16 years in service.

No matter where they hail from, whether farm, ranch or race track, they seem to know that man is their master and they recognize the whip as his badge of authority, along with the rein, the voice and the gentle pressure of a foot or leg.

Police department horse experts claim they can pick an intelligent and eventually docile type by actions and appearance. Their results seem to prove them right and the whip as a weapon is not part of the equipment in New York City's school any more than it's standard equipment in police tack.

The whip wielded by the instructors is a thin leather thong six to eight feet long on a five-foot handle and by its very unwieldy proportions is of little value for punishment. It is a symbol of authority, however, and the horses respect it.

As soon as they get wise to the ways of their teachers the animals perform their tricks as a proud privilege. They build a new and responsible world of duty around themselves and are eager to do their share of police work—as might be expected of policemen's pals.

Brazil Rivers Now Run Uphill To Provide Electricity

American engineers are making three Brazilian rivers run uphill to provide power for the nation's major industrial center. The Serra hydroelectric development near Sao Paulo consists of a series of reservoirs, dams and pumping stations which reverse the flow of the rivers, pump the water up 100 feet over a divide and down a 2,400-foot drop to the main generating station. Aside from producing electricity, the development has helped in preventing floods. The power system, largest in South America, is being built by the Westinghouse Electric International Company.

Write to the firms listed in the Where-to-Buy-It index, to learn more about products described in this magazine. Say You Saw It in Popular Mechanics.

40 Hall St.
N. Y. C.



GENUINE U. S. BARGAINS

O. D. WOOL BLANKETS (USED) . \$2.95
 MCCLELLAN SADDLES (USED) . 5.95
 U. S. ARMY PUP TENTS (USED) . 3.50
 ALUMINUM MESS PANS (USED) . .35
 Thousands of Other Bargains in Military, Outdoor
 & Sport Goods for Hunter, Farmer, Scout Send 10¢
 for 32-page catalog returned with first order.

A and N SUPPLY CO.
 4720 LESTER ST. RICHMOND, VA.

4000 BARGAINS IN FREE 260 Page CATALOG

Shows money makers for dealers, agents and salesmen. Articles desirable for the home, office, factory or store are displayed for your selection. Satisfaction guaranteed or your money back. Get your copy, now, as supply is limited.

SPORS CO., 6-42 National, LE CENTER, MINN.



Powerful Vision—8 Mile Range BINOCULARS

20 Days Free Trial \$475
 Postpaid or C.O.D.

Scientifically ground, powerful lens that give clear vision equal to 110 yds. at 1000 yds. distance! Adjustable for all distances and eye widths. Binoculars come with handsome case and straps. **GUARANTEED.**

If not satisfied after 20 days free trial money refunded. American Binocular Co., 7759 S. Halsted, Dept. F-562, Chicago.

BUILD YOUR OWN ARC WELDER
 For Light or Heavy Work
 No rewinding necessary—use coils taken from old auto generators. Works on 110 or 220 A.C. Has 20 different heats. Complete plans and BIG Catalog 35¢.
LEJAY MFG. CO., 3347 LeJay Bldg., Minneapolis, Minn.

WALKER TURNER METAL AND WOOD WORKING MACHINE TOOLS
 Send for new FREE catalog of complete line of Machines, Motors and Accessories
WALKER-TURNER CO., INC. 102 Berkman St., Plainfield, N. J.

Machinist's Tool Chest 20" x 12 1/4" x 8 1/2"
 Popular top till chest. High grade material used throughout. Tough long wearing Fabrikoid Black seal grain leather with white metal trimmings. Drawers felt lined. Price \$18.00. Non open top with 3 1/4" drawers \$12.00.
JOHN WILLIAM MFG. CO., 710 W. Jackson Blvd. Chicago, Ill.

CRESCENT TOOLS
 Give Wings to Work
 ASK YOUR HARDWARE DEALER

FREE TRAILER PARTS CATALOG
 We'll save you money on—axles, springs, wheels, couplers, windows, sinks, water pumps, brakes, refrigerators, beds, lamps, inside and out. 6V lamps, furniture, jacks—everything. Special discount to mfrs. **NATIONAL TRAILER EQUIPMENT CO.** Successors to Kar-A-Van Industries, Inc. Dept. P. 719 North Seventh St., Milwaukee, Wis.

KNOW WHY YOUR FEET HURT. Torturous foot pains are quickly relieved with comforting
CUSTOM MADE ARCH SUPPORTS, \$3.95 PAIR—
 work bench direct to you! Scientifically moulded to your own individual foot condition from simple, home foot impression chart. Mail only 10¢ for Foot Fact booklet and home foot impression material.
NATIONAL FOOT HEALTH CENTER, (Dept. P. 1), 1474 Broadway, N.Y.C.

Say you saw it in
POPULAR MECHANICS

MOTORISTS Wanted!

TO MAKE THIS UNIQUE GAS SAVING TEST



Will you permit us to send you at our risk the Vacu-matic, a device which autoowners everywhere are praising? Install it on your car. Test it at our risk. Unless it trims dollars off your gas bills by saving up to 30% on gasoline consumption, gives more power, quicker pickup and faster acceleration, the test will cost you nothing.

Automatic Supercharge Principle
 Vacu-matic is entirely different! It operates on the supercharge principle by automatically adding a charge of extra oxygen, drawn free from the cooler air into the heart of the gas mixture. It is entirely automatic and allows the motor to "breathe" at the correct time, opening and closing as required. Saves up to 30% on gas costs, with better motor performance.

FITS ALL CARS
 Constructed of separate fused into a single unit, adjusted and sealed at the factory. Easily and quickly installed by anyone in a few minutes.

AGENTS Yours FREE

FOR INTRODUCING. Here's a splendid opportunity for unusual sales and profits. Every car, truck, tractor owner a prospect. Send name and address now for big money making offer and how you can get yours Free.
The Vacu-matic Co., 7617-753 W. State Street, Wauwatosa, Wis.

BUILD YOUR OWN SHAW Victory GARDEN TRACTOR

OUR COMPLETE PLANS tell you how to build a sturdy garden tractor with many features of the famous SHAW PEPPY PAL. Built chiefly by welding and bolting up scrap steel. Powered by engine from washer, mower, etc. Will do light plowing, cultivating, other garden work. Plans tell how to build several types; give illustrated, step-by-step instructions; easy for mechanically minded person to follow. Mail \$1.00, name and address today!
SHAW MFG. CO., 4708 Front St., Galesburg, Kans. 668-G No. 4th St., Columbus, Ohio; 5812-G Magnolia Ave., Chicago, Ill.



Wood workers: Here it is! Harold Hunt's big No. 14 wood catalog! Latest UP-TO-DATE IDEAS for experts and amateurs; **SPECIAL BARGAINS** in rare woods, veneers and ALL kinds of supplies. 148 pages—20 of rare woods in color. Get posted! Send only 10¢ to **CRAFTSMAN WOOD SERVICE CO., 2729 S. Mary St., Dept. A-24, Chicago, Ill.**

only 10¢

PUSH BUTTON CONTROLLED GAS TANK LOCK
 NO KEYS—Electrically operated from dashboard. One model fits all cars including fender door type. Greatest thing out! Sells on sight! Fully guaranteed. Distributors, dealers, here is your money making opportunity. Rush name for free literature.
SNAP-UP GAS CAP CO. Dept. k, ASHLAND, KY.

Man Wanted in Each Territory
 You, too, can help the war effort. Other established producers are helping builders replace critical materials. Exclusive process converts local unrestricted raw materials into low cost building products.

THE PRODUCT
 Used in all types of construction. Lower in cost — permanent — attractive. Factory-to-job delivery speeds construction. Line production cuts costs. Small inexperienced crew required.

QUICKLY UNDER PRODUCTION
 We can still equip a few men. Installation simple — requires small floor space. Learn how many manufacturers are working full capacity on private and government construction. Write today for full particulars.
W. E. DUNN MFG. CO.
 600 W. 24TH ST. HOLLAND, MICH.

TIRE THIEVES ARE AT WORK



Guard Yours Before It's Too Late!

YOU can't replace tires, car, rationed gas or accessories . . . protect them **NOW** with the original "VICTORY" Auto Burglar Alarm! Easily connected to the regular horn system — when thief tampers with car, horn blows; horn stops when thief runs! Assures dependable protection both on the street and in your garage.

FREE! Write for Booklet.

THE AUTOMATIC ELECTRICAL DEVICES CO.
321 East Third Street, Cincinnati, O.

REED MICROMETERS



0-1" reading in 1/1000"

One of America's finest precision micrometers made over 30 years. Quick delivery to men working in war plants. Price model No. 801 shown above \$6.25 less 10%, plus 12¢ postage. **ORDER TODAY.** Send money order or we ship C.O.D. Write for our shop agents' proposition.

GEORGE SCHERR CO. 128A Lafayette St. New York, N. Y.



it's FREE! it's NEW! LAFAYETTE RADIO CATALOG

Choose from hundreds of money saving values in famous Lafayette Radio Sets—Combinations—new Intercommunication and P. A. Systems—Standard Radio Parts, Tools, Books, Experimenters Equipment, etc. Save money at Lafayette's low prices. **CAMERA FANS**—Ask for Bargain Camera Catalog. Post Card will do.

LAFAYETTE RADIO, Dept. G2M 901 W. Jackson Blvd., Chicago, Ill.
265 Peachtree St., Atlanta, Ga.

WITTE DIESELECTRIC PLANTS

Your present power bill will buy a **WITTE** that produces power and light for 1c a K.W.H. Save up to 75%. **A Size for Every Need.** Write today for finance plan, literature and name of dealer.



WITTE ENGINE WORKS, 174-C Oakland Ave., Kansas City, Mo.

EMPIRE LEVELS

Preferred by **MASTER CRAFTSMEN . . .**

EMPIRE TORPEDO LEVEL . . . Smallest and Handiest Accurate Level made. "Cigar-shaped" no sharp corners to tear pocket. Walnut stock. Has Level, Plumb and 45° vials. 9" long, only \$1.10. Order from local dealer. Write for literature.

EMPIRE LEVEL MFG. CO., Dept. P-219, 717 S. Sixth St., Milwaukee, Wis.

IT'S EASY TO INSTALL YOUR OWN VENETIAN BLINDS

All You Need Is A Screw Driver
FREE! INSTRUCTIONS & COLOR SAMPLES
GARFIELD MFG., 14 N. MAY, CHICAGO Dept. P7

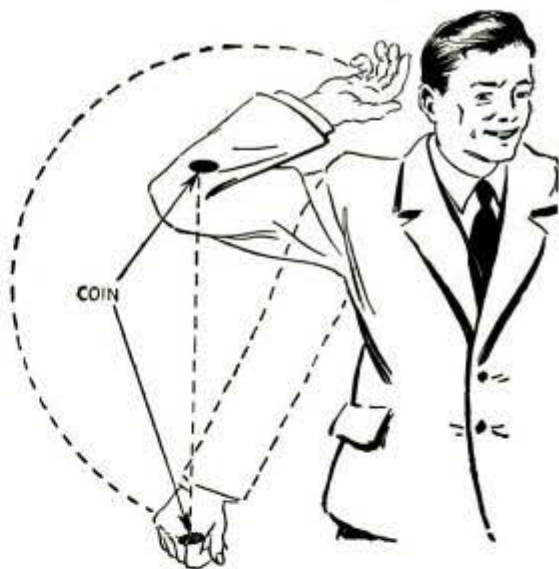


WORLD'S LOWEST PRICED ADDING MACHINE

IDEAL FOR BUSINESS GUARANTEED ACCURATE. Not a TOY. Operates with only a finger flick. Adds, subtracts, multiplies, divides. Counts up to ten million. Pays for itself over and over. Ideal Gift— for Business, Income Tax and School use. **MONEY BACK GUARANTEE.** Send name and address. Pay postman only \$2.50 plus postage. (Send full cash if outside U. S.) Money back in 10 days if not delighted. **AGENTS WRITE.**

CALCULATOR MACHINE COMPANY (Mfrs.)
DEPT. 132 P. O. BOX 1118 CHICAGO, ILLINOIS

Amusing Catch-the-Coin Trick Can Be Mastered Quickly



Here's an amusing coin-catching trick which appears difficult, but is really very simple. Just place a 50-cent piece upon the elbow of your arm and cup the fingers slightly. Then lower the arm quickly and the coin will drop accurately in your hand. A few experiments may be necessary to gain confidence in the operation, as the trick is not to try too hard to catch the coin.

—G. E. Hendrickson, Argyle, Wis.

Pipe Used as Coin Bank

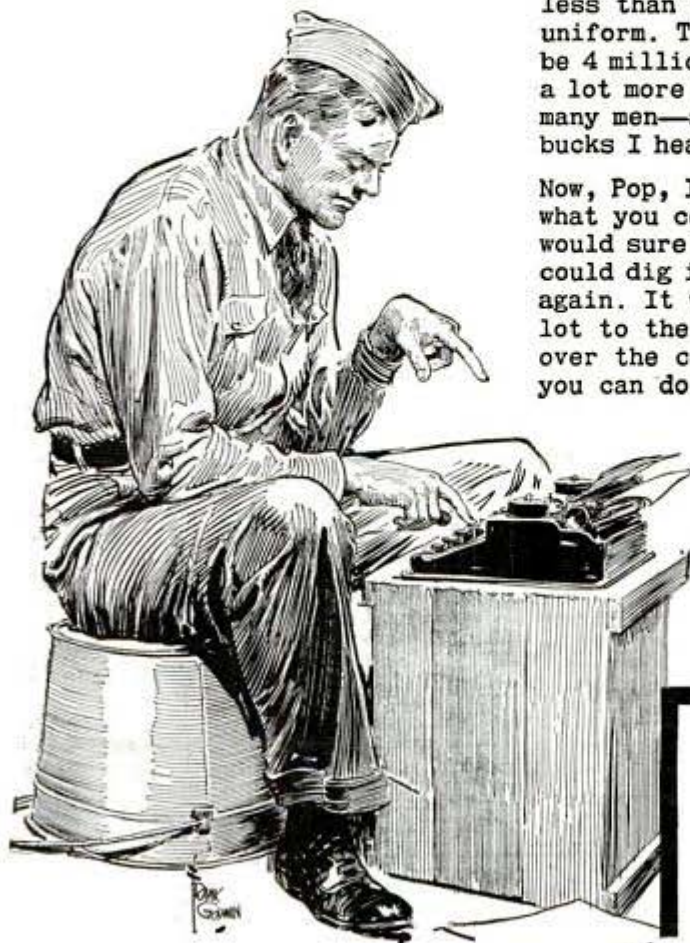
Capped at both ends and slotted halfway through, a pipe nipple provides a handy coin bank. If desired, pipe of different in-



side diameters can be used for each type of coin. If the caps are turned on tightly with a wrench, small children will be unable to remove them to get at the coins.

Dear Pop:

Even an old Rainbow Divisioner like you would pop your eyes at the army we're putting together this time. Let me tell you, they're doing everything to make us just about the best bunch of fighting galoots you ever saw.



And that goes for what they do for us off duty, too! Take this new clubhouse we got just outside of camp. It's got radios, dance floors, nice soft chairs and everything. And, Pop, you can get something to eat that won't cost you a month's pay!

Now, the army isn't running this. The USO is. And most of the other camps got USO clubs too, because you and a lot of other folks dug down and gave the money to the USO last year.

But, Pop, last year there was less than 2 million of us in uniform. This year there'll be 4 million. And the USO needs a lot more dough to serve that many men—around 32,000,000 bucks I hear.

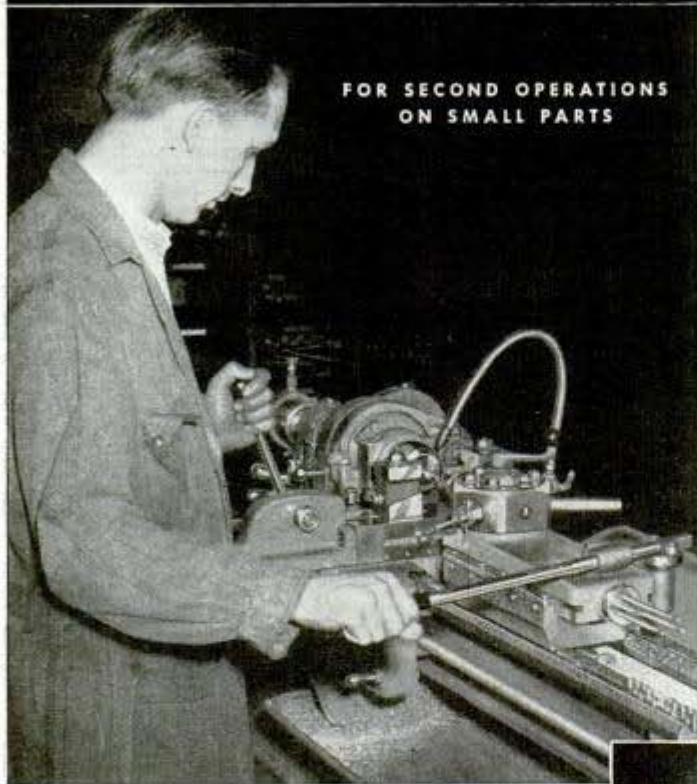
Now, Pop, I know you upped with what you could last time. But it would sure be swell if you could dig into the old sock again. It will mean an awful lot to the fellows in camp all over the country. See what you can do, huh, Pop?

Bill

Send your contribution to your local USO Committee or to National Headquarters, USO, Empire State Building, New York, N. Y.

**GIVE TO THE
USO**

New SOUTH BEND TURRET LATHES



FOR SECOND OPERATIONS
ON SMALL PARTS

Designed for the rapid machining of small duplicate parts, the new Series 1000 South Bend Turret Lathes are especially adaptable to second operation work. Their speed, accuracy, power and versatility make possible rapid production without sacrificing either efficiency or precision.

Features that contribute to the versatility and efficiency of these lathes are: the smoothly operating handlever bed turret, the handlever cross slide with double tool blocks, the compound cross slide with power longitudinal feeds and power cross feeds for the universal carriage, forty-eight thread cutting feeds driven by a precision lead screw, and a wide range of spindle speeds.

Standard extras simplify tooling this lathe for war production and make it easily convertible to other work when peace comes.

Series 1000 Turret Lathes

The Series 1000 Turret Lathes have a $1\frac{3}{8}$ " spindle hole, $10\frac{1}{2}$ " swing over bed, and 1" maximum collet capacity. They are made in bench and floor types — with or without coolant equipment. Standard equipment includes quick change gear box, power feed universal carriage, handlever cross slide, compound rest cross slide, and handlever bed turret. Standard extras (not included in prices of lathes) include 4-way turret tool block, tailstock, collet attachment, taper attachment, thread dial indicator, and micrometer carriage stop. Write for Bulletins 1002 and 1004 which contain complete information and specifications.



Awarded to the South Bend Lathe Works for outstanding performance in the production of precision metal.

SOUTH BEND LATHE WORKS

DEPT. 620, SOUTH BEND, IND. LATHE BUILDERS FOR 35 YEARS



NOW a DYNAMIC HEAVY DUTY INDUSTRIAL WELDER

THE BOOM IS ON IN WELDING—
EARNINGS ARE SKYROCKETING

WORKS OFF
110 VOLT
ELECTRIC
LIGHT
CIRCUIT



Thousands of welders have already left their jobs and shops to get "war-time" pay in plants devoted to defense production, such as ship building, tanks, airplanes, munitions, etc. Also, in the erection of industrial plants, bridge construction work, etc. This creates an unusual opportunity for men everywhere to get in the welding business right in their own communities, and take over the work these men have left behind. Now with the new DYNAMIC Super-Charged Transformer-Type Welder that works off a 110 volt electric light circuit, men by following the simple, concise home instructions can quickly fit themselves to do finished repair jobs. In this way you may qualify for a big pay job in the defense industry.

WELDS BUMPERS, FENDERS, CYLINDER BLOCKS, BODIES, FRAMES, ETC. Does Farm, Factory and Home Repairs

Many welders make big money. Any number of jobs can be done more efficiently with welding. The DYNAMIC Super-Charged Welder Saves Time and Money. Despite its serviceability, is so easily portable it can be carried around by hand and taken right to the job. This is an added feature whose value you will appreciate once you are in welding.

WORKS ON IRON STEEL, TIN, BRASS, COPPER, AND ALL OTHER METALS

With this Welder you can work on all kinds of metal—nothing will stump you—you can tackle anything and in no time at all you will be able to do finished repair jobs that will do credit to an expert.

DOES METALLIC AND CARBON ARC WELDING

Can be used efficiently on both types of welding. The cost of using the DYNAMIC Super-Charged Welder is amazingly low—costs only a few cents an hour to operate. It is built so strongly that repairs are practically unknown—you'll never have to worry about them. It cools so efficiently that you can use it continuously without ever having to stop in the midst of a job to let it cool down. **COSTS LESS THAN 6¢ A DAY.** You can buy the DYNAMIC Super-Charged Welder on easy payments. Over a year's time, it would cost you less than 6¢ a day. Once you have your welding business of your own—you boss it yourself. Send coupon for free particulars today.

for Only
\$19.75

EASY PAYMENTS



These pictures show how easy it is to operate the Dynamic Super-Charged Welder.



READ WHAT USERS SAY

Electrician says: "It is the best welding outfit." I wish to tell you that I demonstrated your welding outfit to a great many people, and they all agreed with me that it did the best welding job they ever saw. A. L., Bristol, Conn.

Mechanic Praises Welder. I have received my welder and like it very much. I am a mechanic and electrician by trade, so I can appreciate its usefulness to others. P. C., Perry, N. Y.

Repair Shop Owner Tells About Dynamic. I want to say I operate a repair garage and I am more than satisfied with the welder. It will do more than you say. C. P., Butler, Ohio.

Greatest Portable Outfit. I must say it's the greatest portable outfit any man could wish to own. You may put me on file as a booster. W. J. B., St. John, N. B., Canada.

MAKE BIG PROFITS FOR INTRODUCING: You can make big profits introducing to garages, factories, mechanics, janitors and maintenance men the new DYNAMIC Super-Charged Welder—we'll let you try it for ten days at our risk so you can be convinced of the immense sales possibilities. Get our big profit plan and ten day trial offer. Just send attached coupon for free particulars today!

DYNAMIC WELDER CO.

2226-UA SILVERTON ROAD

CHICAGO, ILL.

Dynamic Welder Co., 2226-UA Silverton Rd., Chicago, Ill. Gentlemen: I want to go into the welding business. Send me free particulars on how I can learn welding at home and full details on your Dynamic Welder.

AGENTS: Just mark an "X" here and you will receive full particulars of our big profit plan and 10 day trial offer.

Name.....

Address.....

Town..... State.....

KEEP 'EM SMOKIN'

**Our fighting men
rate the best . . .**

See that they get plenty
of milder cooler-smok-
ing Chesterfields.

Everybody who smokes
'em likes 'em.

It's CHESTERFIELD

THEY TREAT YOU RIGHT . . . They keep you happy because they're *Milder* . . . they let you know how good a cigarette can be because they *Taste Better*. You'll like them these hot days because Chesterfields smoke *Cooler*.

TODAY'S MILDER BETTER-TASTING CIGARETTE

