

# "Bomb Voyage" to Tokyo

By Rear-Admiral C. H. Woodward

# POPULAR MECHANICS

## MAGAZINE

IN SO YOU CAN UNDERSTAND IT



REG. U.S. PAT. OFF.

JULY  
25 CENTS  
30c IN CANADA

SEE PAGE 46



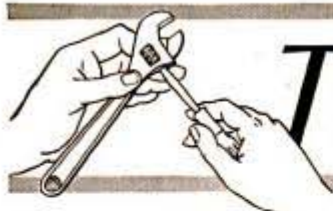

# TOOL NOTES

Maintenance  
and Repair  
Suggestions to  
Prolong Tool Life

## No. 1 HOW TO KEEP CRESCENT WRENCHES IN GOOD WORKING ORDER

● Regardless of war or shortages, a good mechanic always keeps his tools in excellent shape. Today, however, difficulty of replacement is perhaps the strongest argument for tool conservation. This is the first in a series of informative advertisements intended to help you make your "Crescent" and "Crestology" Tools last longer. Look for "TOOL NOTES" regularly.

With adjustable wrenches, as with most tools, abuse and neglect are the commonest cause of failure. Keep your wrenches clean . . . and oiled. Dirt or rust accumulations on the knurl or other moving part will make adjustment difficult. Don't use your wrench as a hammer . . . and don't hammer on the handle to start or "set" a nut. Never "overload" any tool. The handle length of your wrench is carefully computed to provide safe leverage at maximum opening. If you extend the handle length with a piece of pipe or tubing you are taking chances with most wrenches. The 15", 18" and 24" sizes of "Crestology" Wrenches (with tapered handles) have sufficient strength, however, to permit this practice.

Generally speaking, the CRESCENT Wrench should be turned in the direction indicated by the arrow in the drawing. However, when nuts are being tightened or loosened in close quarters, it is permissible to use the wrench either way. That is why the jaws are at an angle to the handle. Main point to remember is to have the jaws TIGHT upon the nut being turned. If this precaution is observed, the wrench will not slip and a good, hard pull can be exerted without fear of bruised knuckles or skinned fingers.

### Use Your Wrench Correctly

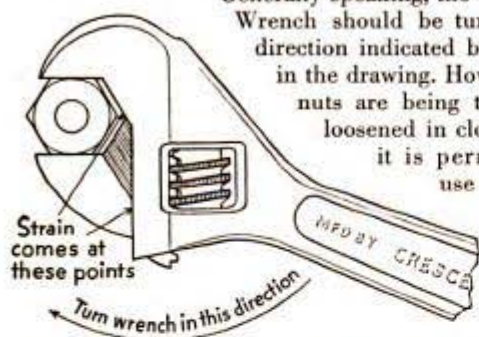

Generally speaking, the CRESCENT Wrench should be turned in the direction indicated by the arrow in the drawing. However, when nuts are being tightened or loosened in close quarters, it is permissible to use the wrench either way.

That is why the jaws are at an angle to the handle. Main

point to remember is to have the jaws TIGHT upon the nut being turned. If this precaution is observed, the wrench will not slip and a good, hard pull can be exerted without fear of bruised knuckles or skinned fingers.

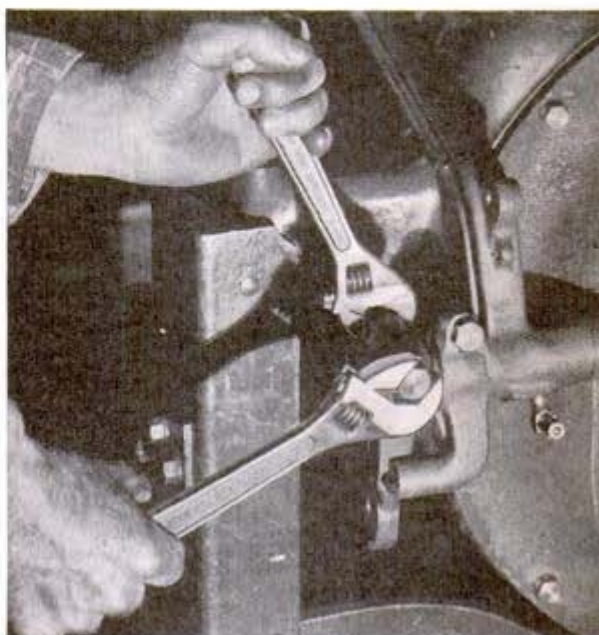

### Repair Parts Available



Broken wrenches can be repaired with these Crescent Parts, sold by hardware dealers. Ask for part by name, stating the size of your wrench and whether "Crescent" or "Crestology" as marked on handle. Be sure to replace knurl same end to as removed, or teeth will not line up.

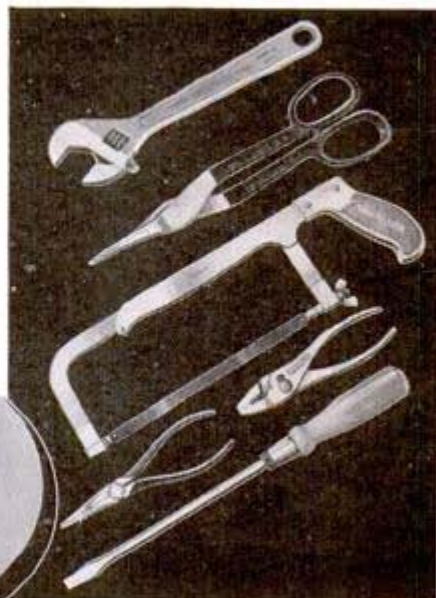

**CRESCENT TOOLS**  
*Give Wings to Work*

CRESCENT TOOL COMPANY, JAMESTOWN, N. Y.

# Popular Mechanics Magazine

Registered in U. S. Patent Office and Canada

H. H. WINDSOR, Founder

H. H. WINDSOR, Jr., Editor and Publisher

July, 1942

Vol. 78, No. 1

## IN THIS ISSUE

"Bomb Voyage" to Tokyo	1
The Iron Horse Delivers the War Tools	8
Black Light at Your Service	17
Television Trains the Home Guard	28
The Army Policeman—1942 Style	34
Flying Battleships Will Win the War	42
You Can't Catch 'Em Where They Ain't	50
Thrills in Davy Jones's Locker	56
The Eyes and Ears of the Navy	66
If You Can Drive You Can Fly (Part 2)	72
Is There Life Among the Stars?	82
The Heat Lamp Makes Good	92

Where-to-Buy-It Index Starts on Next Page

## Teamwork in a Tank

THOSE six Yanks inside the 28-ton tank are the equivalent of 36 men, for each of the six-man crew can take over the duties of any man disabled. The regular driver of this particular tank at Fort Knox is Technician 4th Class James H. "Bow-Wow" Bowser; he has his hands full driving the big M-3 and firing the two 30-caliber machine guns, but he's also quite capable of handling the 37- and 75-millimeter cannon on occasion or taking over the radio post. Two soldiers of the Armored Force have written an article, featured next month, on the teamwork inside a tank.

## There's Money in Honey

BEES haven't found out about the price of honey or they'd be asking for a raise. Honey is worth double the price paid to beekeepers a year ago, so take a tip from our August issue and—if there's bee food in your neighborhood—hire a hive to make money for you. For \$15 you can outfit a hive that will produce 50 to 300 pounds of honey a year.

## Next Month

SCARCELY had the wreckage of the German bomber cooled when technical experts climbed over it to extract its secrets. One, a metallurgist, found a puzzling bit of steel containing a rare metal. Had the Germans developed a new alloy? Metal specialists in England and America set to work to find out. For, as Walter S. Tower, president of the American Iron & Steel Institute, says in "Alloys for the Allies," this is a war of steel against steel. The story is illustrated by eight Coloroto pages.

## College for Horses

YOU would probably go mildly berserk, at the very least, if you had to take what a policeman's horse takes. But you haven't been trained right. The traffic cop's mount has been to school. In a course of applied psychology it has learned to relax amid the tooting, grinding, clashing melee of metropolitan traffic. It's ready, even, for the bombs. Read how they're trained in "College for Police Horses," an August feature.

## A Decade of Dams

THE last ten years have been world-shaking, but when historians begin to write they'll discover this was the "Decade of the Dam Builders." For in this brief time America has constructed more than 70 huge dams—concrete dams built to last forever, earthen dams that will outlast natural hills. An August story tells of the gigantic problems our engineers had to meet.

Published monthly by POPULAR MECHANICS COMPANY, 200 East Ontario Street, Chicago, U. S. A. Single copy in the United States, 25 cents; subscription rates in United States and possessions, and countries of the Pan-American Postal Union including Spain, \$2.50 a year. Single copy in Canada, 30 cents; subscription rates, \$3.00 a year. To all other countries add \$1.00 a year over United States prices for overseas postage. Changes in address must be reported to us immediately to eliminate delay. Entered as Second Class Matter, Sept. 15, 1903, at the Post Office at Chicago, Illinois, under Act of March 3, 1879. Entered as Second Class Matter at Post Office Dept. Canada.

Copyright 1942, by Popular Mechanics Company. Copyright under International Copyright Union. All rights reserved under Pan American Copyright Union. Printed in the United States of America



## Machines, Automobiles and Men

Men reporting for the most essential work in America, know that machines must operate safely and dependably, today. Tools, lathes, presses, equipment, are now doing three times normal duty. They must not break down. These men know, too, the urgency of keeping the automobiles which transport them to work, in better condition than ever before. These, and the machines, are the vitals of America.

The extra factor of safety and efficiency which Pyroil supplies in the operation of automobiles and machines, is unusual—and greatly needed now. The more severe the condition of operation, the greater is the need for Pyroil.

Protect all machinery, all equipment and every automobile, truck and bus with Pyroil. You can depend on the aid of this famous super lubrication process in efficient, safe operation. Manufactured and guaranteed by Pyroil Company, W. V. Kidder, Founder, 57 Pyroil Bldg., LaCrosse, Wisconsin, U.S.A.



Machinery, equipment, engines and motors run better and last longer when treated with Pyroil, because Pyroil inhibits dangerous corrosive attack on metal; reduces friction, heating and wear; disperses gummy substances, sludge and carbon—all of which hinder safe operation. Only a few ounces of Pyroil added to regular lubrication and fuel channels are needed. For sale at supply stores, service stations and garages, everywhere. Mail coupon for further information, Free.

ADD  
MERELY  
OUNCES TO  
GAS TANK &  
CRANK CASE

**DISTRIBUTORS:**  
CHECK AND MAIL  
COUPON FOR FRANCHISE FACTS.

**PYROIL COMPANY**  
57 Pyroil Bldg., LaCrosse, Wisconsin

Please send complete information about Pyroil; how it induces safe operation for machinery, engines and motors.

Send details of Plan for Distributors.

Name.....

Address.....

City..... State.....

"KEEP 'EM ROLLING!"

## WHERE-TO-BUY-IT INDEX

Where no name and address appear directly under an item, the product is not believed by us to be commercially available

Cabinet holds air-raid tools.....	6
Chicago Fire Equipment Co., 546 W. Lake St., Chicago	
Vibrating rod tests fruit ripeness.....	6
Battery-operated scoop truck.....	6
Yale & Towne, 4531 Tacony St., Philadelphia, Penna.	
Army decontamination squad.....	7
Furnace stores ashes in pit.....	7
Iron Fireman Mfg. Co., 3170 W. 106th St., Cleveland, Ohio	
Ship's nose prefabricated in shop.....	12
Painters rustproof dam gates.....	12
Plane engine "lab" on turntable.....	13
Transparent cover for hat.....	13
Carson, Pirlie, Scott & Co., State and Monroe, Chicago	
Keeping nature in balance.....	14
Navy boats built upside down.....	16
Fresh paint identifies target bullets.....	16
"Germ syrup" may make grass digestible.....	16
Thousands learn new trades.....	25
Acoustic alarm fence.....	26
Automatic Alarms Co., Youngstown, Ohio	
Huge bus carries 141 men.....	26
Armored fortress guards Chinese train.....	27
Liners converted into plane carriers.....	27
Army tests "Sea Jeep".....	32
Rotary bomb thrower for plane.....	32
Million-pound test machine.....	33
Locking cap for auto wheel nut.....	33
Rex Manufacturing Co., Racine, Wis.	
Secret of artificial wool structure found.....	39
Dog trained as stable hand.....	40
Salt inlaid in tire treads.....	40
Soldiers' clothes resist poison gas.....	40
Toys on canvas map depict battle.....	41
Measuring oil flowing in pipes.....	41
Streamline ammunition carrier.....	46
Tiny cars on chart depict accidents.....	46
Demonstrator Co., Box 127, Herkimer, N. Y.	
Airflow over plane shown.....	46
Ghost writing is camera trick.....	47
Lapel torch saves life at sea.....	48
Homemade walking-type mower.....	48
Three-in-one clothes hanger.....	48
The England Co., 508 N. 46th St., Seattle, Wash.	
Bullet-resistant cement blocks.....	49
Chicago Insulcrete Co., 10376 Franklin, Franklin Park, Ill.	
Aluminum replaced in planes.....	49
Model helps teach milking.....	54
Insecticide shortage due to war.....	54
Safety gate for auto entrance.....	54
Western R. R. Supply Co., 2330 S. Ashland Ave., Chicago	
Recording behavior of Golden Gate bridge.....	55
Blackout caps for transformers.....	61
Three-in-one screwdriver set.....	61
Evall White, Merchandise Mart, Chicago	
Plaster—Hollywood's greatest imitator.....	62
First aid bandage covers face.....	64
Use of germ-killing light to increase.....	64
Glass cover for auto tax stamp.....	64
Henry Mfg. Co., 421 Fifth Ave. So., Minneapolis, Minn.	

(Continued to page 5A)

(Continued from page 4A)

Adjustable jar lid remover.....	64
Carson, Pirie, Scott & Co., State and Monroe, Chicago	
Comic model aids "safety first".....	65
Golfer's silent motor scooter.....	65
Delivery bike carries 150 pounds.....	70
Schwinn Co., 1718 N. Kildare Ave., Chicago	
Substitute for morphine.....	70
Electrical memory machine.....	70
Rubber rollers on ladder protect walls.....	71
Safe-T-Grip Device Co., Covington, Ky.	
Rubber assault boats for army.....	71
Safety lamp on elastic belt.....	76
Hugh D. Kenney, Merchandise Mart, Chicago	
Overflow pipe inside bath tub.....	76
The Bloch Brass Co., 1900 Euclid Ave., Cleveland, Ohio	
Portland cement as fire extinguisher.....	76
Yarn holder on bracelet.....	76
Mrs. Sigrid Miller, Porter, Minn.	
Tent guards bridge workmen from rain.....	77
Ball and chain holds gloves on handbag.....	77
Mandel Bros., State and Madison, Chicago	
Passenger travel center of the future.....	78
Portable charcoal grill.....	80
Beverly Portable Units Co., 114 State St., Boston, Mass.	
Offset ratchet screwdriver.....	80
North Mfg. Co., Lehigh Ave. & American St., Philadelphia, Pa.	
Thread cutter on thimble.....	80
Mandel Bros., State and Madison, Chicago	
Folding tray.....	80
Haskelite Co., 208 W. Washington St., Chicago	
Two-wheel fire engine.....	81
Chrysler Corp., Sales Div., Detroit, Mich.	
"Peep" hops ravine on cable.....	81
Utility loaders pack freight compactly.....	86
Evans Products Co., 15310 Fullerton, Detroit, Mich.	
Army favors complete blackout.....	86
American flag made of tatting.....	87
Snow conveyor loads tin cans in car.....	87
Training dogs for defense.....	88
Bridge spans floated on barges.....	90
Dresser for convex or concave wheel.....	90
George Scherr Co., 128 Lafayette St., New York City	
"Jigger" travels under ice.....	91
Blackout tie glows in dark.....	91
Cutter-Crossette Co., 529 S. Franklin St., Chicago	
Hose painted white to use in blackout.....	95
Folding desk attaches to arm chair.....	95
X-ray inspects rubber heels.....	96
Poison gas used by retreating armies.....	96
"Mammy" houses sandwich shop.....	96
Centralized sound system for schools.....	155
The Rauland Corp., 4245 N. Knox Ave., Chicago	
Coaxial speaker for FM and AM receivers.....	159
Jensen Radio Mfg. Co., 6601 S. Laramie Ave., Chicago	
Cabinet touch-up kit for service men.....	159
General Cement Mfg. Co., Rockford, Ill.	
Home recording kit.....	159
Stromberg-Carlson Telephone Mfg. Co., Rochester, N. Y.	
Hand-set two-way radio phone.....	160
Weltronic Corp., E. Outer Drive, Detroit, Mich.	
Bi-directional speaker baffle.....	160
Atlas Sound Corp., 1443 Thirty-Ninth St., Brooklyn, N. Y.	
Portable dual-speed recorder.....	160
Speak-O-Phone Company, 23 W. 60th St., New York City	
All-purpose chairside unit.....	160
Zenith Radio Corp., 6001 Dickens Ave., Chicago	
New sources of alcohol found.....	172

(Continued to page 6A)

# "Save with SIMONIZ!"

U. S. Government Urges Motorists  
to Protect Finish 4 Times a Year



## Preserves Finish and Your Car's Beauty!

Simoniz your car! It's more important now than ever. If the finish is dull, first clean it with the wonderful Simoniz Kleener (Paste or Liquid). You'll be surprised how easily Simoniz Kleener brings back all the sparkle and beauty your car had when new. Then, to keep the finish shining through to Victory, apply Simoniz. It protects and makes the lacquer or enamel last longer. So, the sooner you Simoniz, the better!

THE SIMONIZ COMPANY, Chicago, U. S. A.



(Continued from page 5A)

## Craftsman and Shop Notes Index

### AUTOMOTIVE

Farm tractor used as truck.....	135
Go easy on your tires.....	138
Wheel shoes hold implements on trailer.....	144

### CAMPING, HUNTING, FISHING

Changing spark plugs while trolling.....	98
Stake holds bait can.....	104
Non-slip surface for boat seat.....	104
Fish hooks held in tackle box.....	118
Pine cone helps train hunting dog.....	118

### FARM

Puller removes fence posts.....	135
Support for plumbing wooden posts.....	136
Tar coating on cornpicker.....	137
Corners of brooder house rounded.....	137
Hog oiler set at angle.....	145

### HAND TOOLS

Cleaning steel tape measure.....	99
Pads for jaws of C-clamps.....	104
Ferrules for small tool handles.....	128
Roofer's non-slip tool box.....	144
Demagnetizer for hand tools.....	144
Scraper cleans rust from pipe.....	153

### HOME IMPROVEMENTS

Keeping flood water from basement.....	99
Insulating hot-water tank.....	102
Extra storage space provided in basement.....	105

### HOUSEHOLD

Solving home problems.....	100
Ornament for fireplace mantel.....	104
Five-point star pattern.....	112
Starting fire in oil heater.....	118
Putting curtains on stretcher.....	118

### LAWN AND GARDEN

Streamlining a picket fence.....	99
Holes bored for tree fertilizer.....	102
Lawn care.....	106
Snow fence as slat shade for plants.....	118
A lamp at your gate.....	119
Rack for storing garden tools.....	121

### OFFICE

Rubber bands hold papers on board.....	104
Worn typewriter platen renewed.....	113
Alphabetical tabs mark pages.....	128
Cutting circles around numbers on stencil.....	136
Holder for pins and clips.....	136

### PHOTOGRAPHY

Photo-mat cutter.....	129
Cellulose tape marks tray.....	130
Novel movie effects with venetian blind.....	131
Hose and valve over darkroom sink.....	131

(Continued to page 8A)

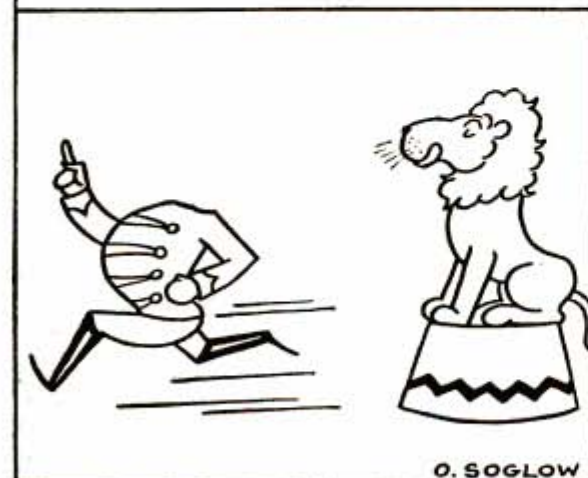



# THOUSANDS OF MEN ARE NOW PUSHING YOU UP TO PROMOTION AND HIGHER PAY

**N**EVER before have you faced the opportunity you have today.

Millions of men are going to work in expanded plants and offices, in new industries. They must have supervision; there will be thousands of new supervisory and executive jobs. Authorities agree that there is a shortage of men for these advanced jobs.

The industries haven't time to train all these executives—they must locate many men already prepared and capable. That means you—if you are ready or will get ready quickly.

These supervisory jobs will be of every kind—office, plant, accounting, traffic, legal, secretarial—they will occur everywhere. They will be in new defense plants, in plants expanded to handle defense orders, and in ordinary product plants (because many men will go from these to the defense plants or into military service).

Obviously, too, this demand will continue and grow for some time to come.

The men who act most quickly will get the most advantage from this unparalleled opportunity. They will be shoved up most quickly and farthest.

LaSalle training fits this situation exactly. It is supervisory, executive training. It is condensed, practical; you study methods and apply them to typical business problems. It is spare-time training—take it as fast as your time permits. You need not wait until you have finished it—what you study tonight, you can use on the job tomorrow. Employers know of LaSalle training—welcome the LaSalle trained men.

You must act quickly. Ask for our 48-page, free booklet on the field in which you are interested. It describes the field, its opportunities and its demands and tells how our training fits you for the field. Send the coupon today.

## LASALLE EXTENSION UNIVERSITY A CORRESPONDENCE INSTITUTION Dept. 764-R CHICAGO

I want to prepare for one of those advanced jobs created by the present situation. As a first step, I must get full information. Please send me your free 48-page booklet on the field I have checked below.

- |  |                                       |  |
|--|---------------------------------------|--|
| <input type="checkbox"/> Industrial Management   | <input type="checkbox"/> Foremanship  | <input type="checkbox"/> Accounting        |
| <input type="checkbox"/> Executive Management    | <input type="checkbox"/> Salesmanship | <input type="checkbox"/> Bookkeeping       |
| <input type="checkbox"/> Traffic Management      | <input type="checkbox"/> Business Law | <input type="checkbox"/> C. P. A. Coaching |
| <input type="checkbox"/> Business Correspondence | <input type="checkbox"/> Law          | <input type="checkbox"/> Business English  |

Name.....Age.....

Address.....

Present Position.....



# SECRETS ENTRUSTED TO A FEW



## The Unpublished Facts of Life

THERE are some things that can not be generally told—*things you ought to know*. Great truths are dangerous to some—but factors for *personal power and accomplishment* in the hands of those who understand them. Behind the tales of the miracles and mysteries of the ancients, lie centuries of their secret probing into nature's laws—their amazing discoveries of *the hidden processes of man's mind, and the mastery of life's problems*. Once shrouded in mystery to avoid their destruction by mass fear and ignorance, these facts remain a useful heritage for the thousands of men and women who privately use them in their homes today.

### THIS FREE BOOK

The Rosicrucians (not a religious organization), an age-old brotherhood of learning, have preserved this secret wisdom in their archives for centuries. *They now invite you to share the practical helpfulness of their teachings.* Write today for a free copy of the book, "The Mastery of Life." Within its pages may lie a new life of opportunity for you. Address Scribe O.X.D.

**The ROSICRUCIANS**  
(AMORC), SAN JOSE, CALIFORNIA, U. S. A.

## Learn PHOTO-ENGRAVING



We teach you quickly, at home in spare time. Earn while you learn. Establish your own profitable business with equipment we furnish, or work for others at good salary. Cuts in this magazine made by process we teach. Send for your copy of our big illustrated catalog. It's free!

**THE AURORA SCHOOL OF PHOTO-ENGRAVING**  
Tasape' Bldg. (Dept. PM-42) Aurora, Mo.

(Continued from page 6A)

Thread removes filter cotton from funnel.....	131
Periscope lets darkroom worker look out.....	132
Holding ferrotype tins upright.....	132

### POWER TOOLS

Floating power unit drives lathes.....	133
Springs wound in lathe.....	137
Make your own molding cutters.....	143
Milling machine.....	146
Lathe follower rest for slender work.....	153
Straightening bristles of scratch wheel.....	153

### RADIO AND ELECTRICITY

"Beginner's special" one tuber.....	156
First aid suggestions for your radio (Part 2).....	158
Bamboo mast for short-wave receiving antenna.....	159
Thumb protector for wire stripping.....	159
Bobby pins used for terminal plugs.....	159
Corks replace rubber feet on "mike" stand.....	159
Remote control switch in old headphone cap.....	159
Tags for cords in multiple outlet plug.....	159

### SPORTS

Water skis.....	97
Non-slip diving board.....	128
Rack for golf bags.....	154

### STORE AND SHOP

Several cabinet drawers locked at once.....	102
Page marker for catalog.....	102
Lamp pull chain kept untangled.....	112
Fastening metal band around large box.....	144
Holding glass for cutting.....	154

### TOYS AND NOVELTIES

Increasing power of tiny motors.....	102
Figurine candle holders.....	105
Ship model "Constellation".....	122

### WOODWORKING

Chairside table with lamp.....	103
Slotted bench stop as miter gauge.....	112
Cabinet doors hung without hinges.....	113
Napkin holder.....	121
Quick-acting bench vise.....	145
Tool cabinet has sliding racks.....	145

### MISCELLANEOUS

Pump suction line adjusted properly.....	112
Combating bomb fires.....	114
Magnifier for examining the eyes.....	118
Giving glass a frosted effect.....	120
Drain holes in terrace wall.....	128
Lacing for leather craft.....	128
How to color concrete.....	135
Pipette bent to prevent rolling.....	136
Building kink for contractors.....	154

### IMPORTANT NOTICE

It is the intention of this magazine to provide its readers with information regarding the latest developments in the mechanical arts. We take no responsibility as to whether the disclosures contained in our articles are covered by patents and advise readers to investigate this subject before making, using, or selling any of the products, machines, or processes described in order to avoid possible liability for patent infringement.



# What are YOU doing to defeat America's enemies?



Not all of us can serve our country in uniform.

But every man in America can serve Uncle Sam by doing his job more efficiently than ever before — and thus help to outproduce the gangster nations, and smash "totalityranny" on the industrial front, as on the military and naval fronts!

It is your duty to secure the sound, practical training that will help you to perform your job better! There are several ways you can secure this training — and one which has proved its worth during the past

50 years is the International Correspondence Schools.

Right now, more than 100,000 Americans are studying I. C. S. Courses in 400 different subjects. For a few dollars monthly, and a few hours of their spare time each week, they are getting the *modern training* that will help them do their present job better, and fit them for a more responsible position in their line of work.

Join the army of trained men that is helping to outproduce the Axis! Mail this coupon for information — right now!

## INTERNATIONAL CORRESPONDENCE SCHOOLS

HELPING TO TRAIN AMERICANS FOR VICTORY



BOX 5638-J, SCRANTON, PENNA.

Without cost or obligation, please send me a copy of your booklet, "Who Wins and Why," and full particulars about the course *before* which I have marked X:

### TECHNICAL AND INDUSTRIAL COURSES

- |  |  |   |  |
|--|--|---|--|
| <input type="checkbox"/> Air Brake   | <input type="checkbox"/> Contracting and Building                    | <input type="checkbox"/> Marine Engines   | <input type="checkbox"/> Sanitary Engineering                                  |
| <input type="checkbox"/> Air Conditioning                                    | <input type="checkbox"/> Cotton Manufacturing                        | <input type="checkbox"/> Mechanical Drafting                                    | <input type="checkbox"/> Sheet Metal Work                                      |
| <input type="checkbox"/> Airplane Drafting                                   | <input type="checkbox"/> Diesel Engines                              | <input type="checkbox"/> Mechanical Engineering                                 | <input type="checkbox"/> Ship Drafting   |
| <input type="checkbox"/> Architectural Drafting                              | <input type="checkbox"/> Electrical Drafting                         | <input type="checkbox"/> Mine Foreman   | <input type="checkbox"/> Shipfitting <input type="checkbox"/> Shop Practice    |
| <input type="checkbox"/> Architecture  | <input type="checkbox"/> Electrical Engineering                      | <input type="checkbox"/> Navigation   | <input type="checkbox"/> Steam Electric <input type="checkbox"/> Steam Engines |
| <input type="checkbox"/> Auto Engine Tune-up                                 | <input type="checkbox"/> Electric Lighting                           | <input type="checkbox"/> Patternmaking <input type="checkbox"/> Plumbing        | <input type="checkbox"/> Steam Fitting   |
| <input type="checkbox"/> Auto Technician                                     | <input type="checkbox"/> Foundryman <input type="checkbox"/> Heating | <input type="checkbox"/> Practical Telephony                                    | <input type="checkbox"/> Structural Drafting                                   |
| <input type="checkbox"/> Aviation <input type="checkbox"/> Aviation Mechanic | <input type="checkbox"/> Heat Treatment of Metals                    | <input type="checkbox"/> Public Works Engineering                               | <input type="checkbox"/> Structural Engineering                                |
| <input type="checkbox"/> Boilermaking  | <input type="checkbox"/> Highway Engineering                         | <input type="checkbox"/> Pulp and Paper Making                                  | <input type="checkbox"/> Surveying and Mapping                                 |
| <input type="checkbox"/> Bridge Engineering                                  | <input type="checkbox"/> House Planning                              | <input type="checkbox"/> Radio, General   | <input type="checkbox"/> Telegraph Engineering                                 |
| <input type="checkbox"/> Chemistry   | <input type="checkbox"/> Industrial Metallurgy                       | <input type="checkbox"/> Radio Operating  | <input type="checkbox"/> Telephone Work  |
| <input type="checkbox"/> Civil Engineering                                   | <input type="checkbox"/> Locomotive Engineer                         | <input type="checkbox"/> Radio Servicing  | <input type="checkbox"/> Textile Designing                                     |
| <input type="checkbox"/> Coal Mining   | <input type="checkbox"/> Machinist                                   | <input type="checkbox"/> R. R. Section Foreman                                  | <input type="checkbox"/> Toolmaking  |
| <input type="checkbox"/> Concrete Engineering                                | <input type="checkbox"/> Management of Inventions                    | <input type="checkbox"/> R. R. Signalman <input type="checkbox"/> Refrigeration | <input type="checkbox"/> Toolmaking <input type="checkbox"/> Welding           |
|  |  |   | <input type="checkbox"/> Woolen Manufacturing                                  |

### BUSINESS COURSES

- |  |  |  |   |
|--|--|--|---|
| <input type="checkbox"/> Accounting <input type="checkbox"/> Advertising   | <input type="checkbox"/> College Preparatory     | <input type="checkbox"/> First Year College                          | <input type="checkbox"/> Railway Postal Clerk                         |
| <input type="checkbox"/> Bookkeeping                                       | <input type="checkbox"/> Commercial              | <input type="checkbox"/> Foremanship <input type="checkbox"/> French | <input type="checkbox"/> Salesmanship                                 |
| <input type="checkbox"/> Business Correspondence                           | <input type="checkbox"/> Commercial Illustrating | <input type="checkbox"/> Good English                                | <input type="checkbox"/> Secretarial <input type="checkbox"/> Spanish |
| <input type="checkbox"/> Business Management                               | <input type="checkbox"/> Cost Accounting         | <input type="checkbox"/> High School                                 | <input type="checkbox"/> Showcard and Sign Lettering                  |
| <input type="checkbox"/> Cartooning <input type="checkbox"/> Civil Service | <input type="checkbox"/> C. P. Accounting        | <input type="checkbox"/> Managing Men at Work                        | <input type="checkbox"/> Traffic Management                           |

### HOME ECONOMICS COURSES

- |   |   |  |
|---|---|--|
| <input type="checkbox"/> Advanced Dressmaking | <input type="checkbox"/> Home Dressmaking                       | <input type="checkbox"/> Ten Room and Cafeteria Management, Catering |
| <input type="checkbox"/> Foods and Cookery    | <input type="checkbox"/> Professional Dressmaking and Designing |  |

Name.....Age.....Address.....  
City.....State.....Present Position.....

Canadian residents send coupon to International Correspondence Schools Canadian, Limited, Montreal, Canada  
British residents send coupon to I. C. S., 71 Kingsway, London, W. C. 2, England



## Know Electricity as Experts Know It—and Get an Expert's Pay!

What about your future? Who is safe today? Surely not the man who is contented to stand still! Know your job thoroughly—prepare yourself for jobs ahead. To do just this thousands of men have used

### The Croft Library of Practical Electricity

The Croft Library is a complete electrical educator. It is founded on practice—on 20 years of shirt-sleeve experience—on work as it is actually done. It is jammed from cover to cover with the kind of hard-headed facts you want. Written so that the beginner can easily understand it, yet so sound, so thorough, that it is the daily guide of 22,000 highly paid electrical workers and engineers. Croft tells you the things you need to know about motors, generators, structures, commutators, transformers, circuits, switchboards, distribution systems—electrical machinery of every type—wiring for light and power—wiring of finished buildings—underwriters and municipal requirements—illumination in its every phase—the most improved methods of lighting—lamps and lamp effects, etc.—how to do a complete job, from estimating it to completion.

### No money down—easy payments

Fill in and mail the coupon attached and we will send you the entire set of seven volumes for ten days' examination on approval. We take all the risk—you assume no obligation. If you decide to keep the books, send \$3.00 in ten days and the balance at the rate of \$1.00 a month. Send the coupon NOW and see the books for yourself.

#### EXAMINATION COUPON

McGraw-Hill Book Co., 330 W. 42nd St., New York

Send me for ten days' examination on approval the Croft Library of Practical Electricity, 7 vols. If satisfactory I will send you \$3.00 in 10 days and \$1.00 monthly until the price of \$18.00 is paid. If not wanted, I will return the books postpaid. (To insure prompt shipment write plainly and fill in all lines.)

Name.....

Home Address.....

City and State.....

Position.....

Name of Company..... PM-7 42

# AVIATION CAREER



## Offers You A GREAT FUTURE!

Complete Aeronautical Engineering or Master Aviation Mechanics training in the heart of the Aircraft industry. Graduates obtaining immediate employment. No lying involved. Aviation's foremost school, established in 1929. Located on Grand Central Air Terminal. For full information, address Department PM-7.

**CURTISS TECHNICAL WRIGHT INSTITUTE**

GRAND CENTRAL AIR TERMINAL  
GLENDALE (LOS ANGELES) CALIF.



THIS TOWER OVERLOOKS AVIATION'S MOST DISTINGUISHED SCHOOL OF AERONAUTICS

## TRI-STATE COLLEGE

*Degree in 2 1/4 years*

B. S. Degree in Civil, Electrical, Mechanical, Chemical, Radio, Aeronautical Engineering; Business Administration, Accounting, Secretarial Science. Short diploma courses (36 weeks) in Surveying, Drafting. Special Preparatory Department for those who lack required high school work. Cosmopolitan student body. Approved by Civil Aeronautics Administration for flight training. Distinguished for 2 1/4-year technical courses (Non-essentials eliminated). 59th year. Tuition, living costs low. Defense needs call for engineers. Demand for graduates exceeds supply. Enter Sept., Jan., March, June. Catalog.

472 COLLEGE AVE., ANGOLA, IND.



ENGINEERING

### Regain Perfect Speech, If You

# STAMMER

Every stammerer should have the new 287 page book "Stammering, Its Cause and Correction." Sent free to stammerers. It describes the Bogue Unit Method for the scientific correction of stammering and stuttering. Method successfully used at Bogue Institute for 41 years—since 1901. Endorsed by physicians. Write for full information. No obligation. Benjamin N. Bogue, Dept. 1340 Circle Tower, Indianapolis, Indiana.

### BECOME AN EXPERT MEAT CUTTER



Greater opportunities! Thousands of firms are needing expert Meat Cutters. Train in 6 weeks at famous National School. It's quick, easy to learn Meat Cutting by ACTUAL PRACTICE in big National cutting rooms and retail department. No previous experience or advanced education necessary. BIG PAY JOBS. Union card guaranteed. Employment service FREE. Train first. Pay later. Easy terms. Write TODAY for FREE catalog and plans to help you get ahead.

National School of Meat Cutting, Inc., Dept. U-32, Toledo, Ohio

### LEARN WATCH REPAIRING



AT HOME You can learn by our modern and original system of instruction every part of the Watch Repairing Trade at home. Prepare yourself for a well paying position or start in business after completing our course of instruction. Good watch repairers are in demand and generally earn very good salaries. For particulars apply to the Wisconsin School of Watch Repairing 524 E. Mason St., MILWAUKEE, WIS.

### AMAZING NEW ELECTRIC

# ARC WELDER

RETAILS ONLY  
**\$2.95**  
COMPLETE



#### PLUGS INTO LIGHT SOCKET

Amazing new HANDIWELD Electric Arc Welder—operates from 110 volt A.C. or D.C. same as other arc welders higher priced—generates tremendous heat to weld all kinds of metal. Not a hot welder that uses carbons, but actually uses standard coated rods—sizes 1/16" and 3/32". Generous supply furnished with welder. Guaranteed not to burn out. Repairs fenders, auto bodies, radiators, pre-heated small castings and machinery parts. Take HANDIWELD anywhere to job, operate from light socket. Sturdily built of finest materials to last years. Fully guaranteed by Big Manufacturer.

SEND NO MONEY! You'll find a thousand uses for the HANDIWELD around your home, garage, work shop. Also by garages, factories, repair shops, mechanics, farmers, inventors, tin shops, plumbers, etc. Order HANDIWELD now. Send us money. We'll rush one to you complete with rods and gauges. Pay postman only \$2.95 plus few cents postage. If not delighted, return HANDIWELD in 3 days from receipt and money paid for it will be refunded instantly. Rush your order now.

KUMFY PRODUCTS INC., Dept. H-202, Cincinnati, Ohio

# AUDELS NEW MACHINISTS HANDY BOOK NOW READY!

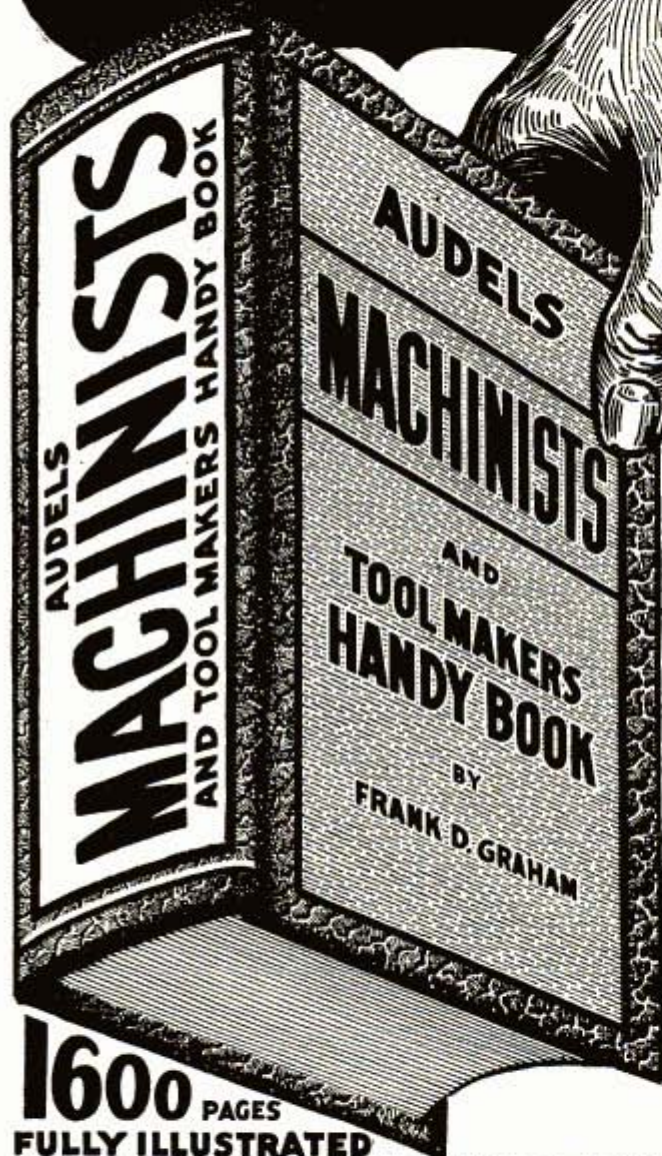

*Prepare!*

A KEY TO  
MODERN SHOP PRACTICE

## PRACTICAL INSIDE INFORMATION

For Every Machinist, Toolmaker, Engineer, Machine Operator, Mechanical Draughtsman, Metal Worker, Mechanic or Student. This 1600 Page Handy Book Covers Modern Machine Shop Practice in All Its Branches.

## A COMPLETE INSTRUCTOR WITH READY REFERENCE INDEX

New from Cover to Cover. Tells How to Operate and Set Up Lathes, Screw & Milling Machines, Shapers, Drill Presses & All Other Machine Tools.

## 5 PRACTICAL BOOKS IN ONE! 60 FULLY ILLUSTRATED CHAPTERS

Covering: 1—Modern Machine Shop Practice. 2—Blue Print Reading and How to Draw. 3—Calculations & Mathematics for Machinists. 4—Shop Physics. 5—How to Use the Slide Rule.

## ...ASK TO SEE IT!...

THEO. AUDEL & CO., 49 West 23rd St., New York  
Mail AUDELS MACHINISTS & TOOLMAKERS HANDY BOOK, Price \$4 on 7 Days Free Trial. If O. K. I will remit \$1 in 7 days and \$1 Monthly until \$4 is Paid. Otherwise I will return it.

Name \_\_\_\_\_  
Address \_\_\_\_\_  
Occupation \_\_\_\_\_  
Reference \_\_\_\_\_ P.M.

**1600** PAGES  
FULLY ILLUSTRATED

A SHOP COMPANION THAT ANSWERS YOUR QUESTIONS  
Easy to read and understand—flexible covers—Handy size 5 x 6½ x 2—a ready reference that answers your questions accurately.

TO GET THIS ASSISTANCE FOR YOURSELF SIMPLY FILL IN AND MAIL COUPON TODAY

**\$4** COMPLETE  
PAY \$1 A  
ONLY 1 MO.

THEO. AUDEL & CO., 49 W. 23rd St., New York

# DEFINING WORDS 17000 TERMS PHRASES

THE RIGHT WORD WHEN IT'S NEEDED MOST

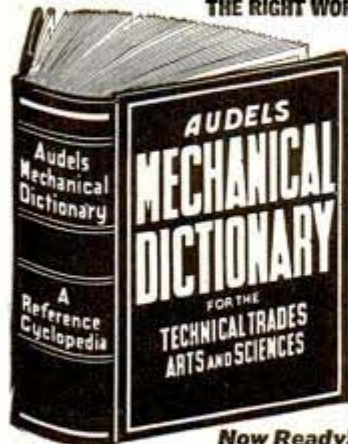

The revolutionary progress being made today in the Mechanical Trades brings a new Trade language that every mechanic must know.

## KNOW THE LANGUAGE OF YOUR TRADE

### A WORD BOOK FOR MECHANICS, Technical Workers and Students

Audel's New Mechanical Dictionary gives you this new language. Its 650 pages contain over 17,000 new and standard mechanical terms, words, phrases, fully explained and defined for the Mechanic and Engineer of Today. This big book gives every word you need to know.

Now Ready!

Fully understand the work instructions you receive.

Alphabetically arranged—Durably bound. A Very Useful Book.

**\$4 COMPLETE • PAY ONLY \$1 A MONTH** ←

To get this assistance for yourself simply fill in and mail coupon today for Free Examination.

**AUDEL PUBLISHERS, 49 West 23rd St., New York**  
Mail AUDEL'S MECHANICAL DICTIONARY, Price \$4, on 7 days Free Trial. If O.K., I will remit \$1 in 7 days and \$1 monthly until \$4 is paid. Otherwise I will return it.

Name.....

Address.....

Occupation.....

Employed by..... PM

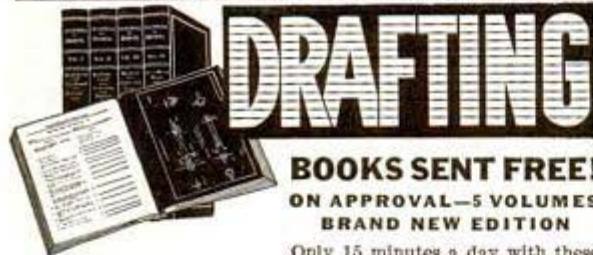

# DRAFTING

## BOOKS SENT FREE!

ON APPROVAL—5 VOLUMES  
BRAND NEW EDITION

Only 15 minutes a day with these WONDER BOOKS can prepare you for a good drafting job. Drafting from simple straight lines to important complex plans. A step at a time! Built especially for beginners, for men with only grammar schooling. Drafting room practice, PLUS ENGINEERING, made easy and clear. 400 pages on tool design, over 300 pages on machine design. Includes special volume on blueprint reading with full size actual production blueprints, some 20"x30", as well as question and answer sheets.

### For Beginners or Experts

Written so you can understand every word, by well known engineers. De Luxe modernistic, washable cloth binding, over 1600 pages, hundreds of blueprints, charts and diagrams; prepares you for a good drafting job in mechanical lines. Sent for 10 days' free use if you mail coupon immediately.

### Big Field • Big Demand • Big Pay

Competent draftsmen are urgently needed in all manufacturing lines at \$30.00 to \$75.00 a week. That's just the beginning—FOR DRAFTSMEN HAVE GOOD CHANCES FOR ADVANCEMENT. Pleasant, fascinating work, easy to learn and do. Learn quickly with these books—send coupon for a set and see for yourself.

[ A year's consulting service now given to all buyers of this famous cyclopedia of drafting. ]

### AMERICAN TECHNICAL SOCIETY Vocational Publishers since 1898

American Technical Society, Dept. DB19, Drexel at 58th St., Chicago, Ill. Send for 10 days' trial, Brand New 5 volume set of "Drafting for Machine Trades." I will pay the delivery charges only. If I wish, I may return books in 10 days and owe you nothing, but if I decide to keep them, I will send \$2.00 after 10 days, then only \$3.00 a month until \$19.50, the total price, is paid. Send Brand New edition and include Consulting Service Certificate.

Name.....

Address.....  
Please attach letter stating age, occupation, employer's name and address and that of at least one business man as a reference.

# FREE PROOF you can learn music without a teacher! Easy as A-B-C!

● Just read the letter at the right from one of the 700,000 students who have studied music this quick, easy way. Some are on the stage, others on the radio, thousands more enjoy new popularity by being able to play... convincing proof that you, too, can learn to play the Piano, Violin, Guitar or any other instrument without a teacher.



"PEOPLE WHO hear me play don't understand how I do it. They ask if I haven't had lessons from a teacher. To their surprise they find I haven't. I'm glad to be a student of your School. M.H., Athol, Kans.

Right from the start you learn real tunes by note—no confusing theories. And it costs only a few cents a day. For further proof send for FREE Book and Print and Picture Sample today! Mention instrument preferred. (44th year)

U. S. SCHOOL OF MUSIC, 77 Brunswick Bldg., New York City



## SPARTAN SCHOOL OF AERONAUTICS

Train at SPARTAN for a place in America's war program, and for a lifetime aviation career. \$2,000,000 worth of new buildings, new equipment. Government Approved. Personalized instruction—Sheet Metal, Aircraft or Engine Mechanics, Flight, Engineering, Radio, Instruments, Meteorology. Qualified SPARTAN graduates quickly employed. Spartan factory, contractor to U. S. Army and Navy, directly connected. Next semester starts Aug. 3. Write for new 64-page free catalog. Give age and education.

Captain Maxwell W. Balfour, Director—Dept. PM 72, Tulsa, Okla.

# WELDING



Welding offers immediate opportunities for better pay. Day and evening classes. New short courses at new low prices. Special Student Finance Plan. Modern, well-equipped shops. Free employment service. Write for free "Blue Book"

CHICAGO TECH. COLLEGE  
H-79 Tech. Bldg., 2000 S. Mich. Ave., Chicago, Ill.

# LAW...

**STUDY AT HOME** Legally trained men win higher positions and bigger success in business and public life. Greater opportunities now than ever before. **More Ability: More Prestige: More Money** We guide you step by step. You can train at home during spare time. Degree of LL.B. We furnish all text material, including 14-volume Law Library. Low cost, easy terms. Get our valuable 48-page "Law Training for Leadership and Evidence" books FREE. Send for them NOW. LaSalle Extension University, Dept. 784-L, Chicago  
A Correspondence Institution

**5¢ EACH LITTLE BLUE BOOKS**  
Send postcard for our free catalogue. Thousands of bargains. Address: MALDEMAN-JULIUS CO., Catalogue Dept., Desk M-867, GIRARD, KANSAS

## Learn PHOTOGRAPHY at Home

Splendid opportunities. Prepare in spare time. Easy plan. No previous experience needed, common school education sufficient. Send for free booklet "Opportunities in Photography", particulars and requirements.

American School of Photography  
1315 Michigan Ave., Dept. 1358, Chicago, Ill.

## MONEY FOR MEN ALL DATA FREE

THE PLASTEX Industry needs manufacturers on small scale and for big production of Lamp and Clock Stands, Art Goods and Novelties in Plaster and Marble imitation. Experience unnecessary. 1/2c material makes regular 10c store sellers. Rubber moulds furnished for speed production. Small investment brings good returns. WE ARE NOW PLACING BIG CHAIN STORE ORDERS WITH MANUFACTURERS. Ambitious men have chance for real prosperity. Our FREE booklet will interest and benefit you.

PLASTEX INDUSTRIES, Dept. P, 1095 Washington Ave., New York, N.Y.



**J. E. SMITH**  
President  
National Radio Institute  
Established 27 Years

# I WILL SEND A SAMPLE LESSON FREE to PROVE I can Train You at Home in Spare Time to BE A RADIO TECHNICIAN

## I Trained These Men



### \$200 a Month in Own Business

"For several years I have been in business for myself making around \$200 a month. Business has steadily increased. I have N. R. I. to thank for my start in this field."—ARLIE J. FROEHLER, 300 W. Texas Ave., Goose Creek, Tex.

### \$5 to \$10 Week in Spare Time

"I am engaged in spare time Radio work. I average from \$5 to \$10 a week. I often wished that I had enrolled sooner because all this extra money sure does come in handy."—THEODORE K. DUBREE, Horsham, Pa.



### Sergeant in Signal Corps

"I am now a Sergeant in the U. S. Army, Signal Corps. My duties cover Radio operating, maintenance of Army Transmitters and Receivers, handling duties of the Chief Operator in his absence."—SERGEANT RICHARD W. ANDERSON, U. S. Army. (Address omitted for military reasons.)



### Extra Pay in Army, Navy, Too

Men likely to go into military service, soldiers, sailors, marines, should mail the Coupon Now! Learning Radio helps men get extra rank, extra prestige, more interesting duty at pay several times a private's base pay. Also prepares for good Radio jobs after service ends. It's Smart to Train for Radio NOW!

### Now More Make \$30, \$40, \$50 a Week Than Ever Before

Here is a quick way to better pay. MAIL THE COUPON. Get my Sample Lesson and Free 64-page Book. See how complete and practical my Lesson Texts really are, how the information they contain is designed to help you make more money quickly. Read about the SIX Big Kits of Standard Radio Parts I send you with my Course. See for yourself how you LEARN the fundamentals of Radio from my Lesson Texts—PRACTICE what you learn by actually building some typical Radio circuits you study—PROVE what you learn by making tests and measurements while you adjust the circuits you have built.

### How You Get Practical Experience Studying Radio at Home Nights

I send you, in all, more than 100 standard Radio parts, including tubes, condensers, a meter, punched chassis bases, even a soldering iron, solder and wire. With these you perform more than 60 sets of experiments; make hundreds of practical tests and measurements. I give you special training to show you how to start making money fixing Radios a few months after you enroll. Many make \$5, \$10 a week extra fixing Radios in spare time, and gain extra valuable practical experience as well.

### Big Demand Now for Trained Radio Technicians, Operators

The Radio repair business is booming and will boom more as more and more old sets need repairs, new tubes, parts. The Government is spending MILLIONS for wartime Radio Equipment; Civilian Radio Technicians and Operators are needed in large numbers by the Government. Broadcasting, Police, Aviation, Commercial Radio Stations and Loud Speaker Systems give good jobs to many. The N. R. I. Course has led to good jobs in all these branches of Radio.

### Find Out How I Train You at Home for a Good Job in Radio

MAIL THE COUPON. I'll send you a Sample Lesson and my 64-page Book Free. Read them. Learn about my Course; how I train you; the types of jobs in the many different branches of Radio. Read letters from more than 100 men I trained, so you can see what they are doing, earning. MAIL THE COUPON NOW, in an envelope, or pasted on a penny postcard.

**J. E. SMITH, President,  
Dept. 2GP,  
National Radio Institute  
Washington, D. C.**

## You Build These and Other Radio Circuits with Parts My Course Includes

You Conduct 60 sets of Experiments,  
Make Hundreds of Interesting Measurements  
and Adjustments to Give you  
Valuable Practical Experience.



**SUPERHETERO-DYNE RECEIVER**, with preselector, oscillator-mixer-first detector, i. f. stage, diode-detector-a. v. c. stage and audio stage. Receives local and distant stations.

**MEASURING INSTRUMENT** you build early in the Course, and use in your training and practical Radio work. It is a vacuum tube voltmeter and multimeter, measures A. C. and D. C. volts; D. C. currents; resistance; receiver output.



**A. M. SIGNAL GENERATOR**, provides amplitude-modulated signal for test and experimental purposes.



## GOOD FOR BOTH 64 PAGE BOOK SAMPLE LESSON FREE

Mr. J. E. Smith, President, Dept. 2GP  
NATIONAL RADIO INSTITUTE, Washington, D. C.

Mail me FREE, without obligation, your Sample Lesson and 64-page book, "Rich Rewards in Radio." (No Salesman will call. Please write plainly.)

Name..... Age.....

Address.....

City..... State..... 2FR



# AUELS BLUEPRINT READING

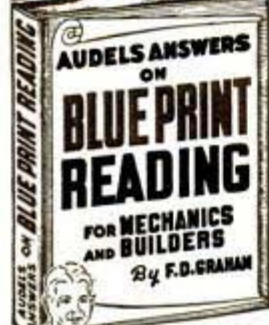

**JUST OUT—FOR THE MAN WHO WORKS FROM BLUE PRINTS**

"The Blue Print of Today is the Machine of Tomorrow." AUDELS ANSWERS ON BLUE PRINT READING covers All Types of plan reading including AIRCRAFT & SHIP BUILDING—tells How to Easily Understand Working Drawings.

What to look for first. Tells what each Line and each Symbol Means. The relation of one part to another. How to Understand Scales & Specifications. How to Make a Sketch. How to Make Blue Prints. A Key Book for Every Mechanic, Builder & Draughtsman—352 pages—It's New, Comprehensive, Fully Illustrated. Gives Short Cuts, Helps, Hints, Suggestions. Questions and Answers.



Make Blue Prints. A Key Book for Every Mechanic, Builder & Draughtsman—352 pages—It's New, Comprehensive, Fully Illustrated. Gives Short Cuts, Helps, Hints, Suggestions. Questions and Answers.

**ASK TO SEE IT!**  
To get this assistance for yourself, simply fill in and mail coupon today. **\$2**

**AUDEL Publishers, 49 West 23rd St., New York**  
Please mail AUDELS BLUE PRINT READING (Price \$2). If satisfactory, I will remit \$2 on its safe arrival, otherwise I will return the book.

Name \_\_\_\_\_  
Address \_\_\_\_\_  
Occupation \_\_\_\_\_  
Company \_\_\_\_\_ PM

# DRAFTSMEN NEEDED NOW



Industry is clamoring for more draftsmen for the job can't start until plans are drawn. Buildings, airplanes, machines, guns, tanks, bridges, all start on the drafting board, so it's no wonder that every good draftsman has a fine job. Yes, more draftsmen are needed NOW. The pay is good and the opportunities for advancement great.

## Learn at Home in Spare Time

Begin now to turn spare hours into money. Be a draftsman, the connecting link between a mechanic and an engineer. Enjoy the wonderful opportunities for promotion that exist now. No experience or artistic talent is needed. You don't have to leave your present job while learning. Use spare time.

## Employment Service Included

Students who take our home study drafting course are entitled to our employment service without extra charge. We are in constant touch with many great firms needing men, and in times like these Industry welcomes applications from American School advanced students and graduates. The total tuition cost is low and the monthly payments are easy. Write today for free bulletin outlining our instruction and giving you the details of our selective employment service. No obligation of any kind. Write today.

**AMERICAN SCHOOL**  
Drexel Avenue at 58th St. Dept. DDB45 Chicago

Say you saw it in Popular Mechanics!

# LET LACO Oil Heat Save You Time & Money For Greater War Effort!



My Free Book shows how to heat your home with oil for less. —Harvey Cocklin

It's your patriotic duty these days to save steps and hours . . . eliminate all unnecessary cost . . . build utmost home health—to give you more time, money and strength to do a better job for Uncle Sam! Install a modern Oil-Burning LACO if you live in zones where delivery of oil is feasible—prepare for years of heating comfort, pleasure, economy! LACOs, now in 18th year, are designed for More Heat! "Battle-Flued" firebox in LACO Heater (above) delivers more heat into room, less up chimney—without a fan! Self-contained fuel tank. Easy fingertip control. To equip your furnace for automatic oil-burning, install Gun-Type model (right). Only 1 moving assembly, very quiet, economical. Low priced heavy oil transformed into finest mist for extra rich mixture, extra hot flame, no waste. All LACOs Fully Guaranteed!



**WRITE**  
Rush card for free book with full details of Low-Priced LACO Heaters, Burners, Furnaces. Send NOW!  
**LACO OIL BURNER CO., 127 Union Ave., Griswold, Iowa**

# LEARN WELDING



Both Electric Arc and Acetylene by practical Shop-Plan method in a few short weeks. No text-books. You learn by doing. Finest equipment. Low tuition. Pay-After-Graduation-Plan. Also, courses in Auto Mechanics, Collision Work, Metal Finishing, etc. Illustrated literature free. Write today.

**MICHIGAN TRADE SCHOOL**  
3738 Woodward, Detroit, Mich. **FREE 32 PAGE CATALOG**



**FREE BOOKLET** answers the many questions bound to be in your mind about where you stand in relation to the war—about how you can serve your country well, and still plan for a secure, successful future. It tells why YOU—by entering the aircraft industry—can be NECESSARY to your country's victory. For your free copy of this helpful booklet, airmail your request NOW to

**AERO INDUSTRIES TECHNICAL INSTITUTE**  
5253 W. SAN FERNANDO RD., LOS ANGELES, CALIF.

## Correspondence Courses in RADIO and ELECTRICAL ENGINEERING LOW AS \$25

**ELECTRICAL ENGINEERING.** Get good grasp of wide electrical field. Modern, very understandable. Theory made easy. **RADIO ENGINEERING.** Extra fine courses in radio, public address, photo-electric work. Trains you to be super-service man, real vacuum tube technician. Tuition ONLY \$25, either course. Deferred payment plan. Experiment kits furnished. **FREE** Write for free copies of school catalogs, student magazines, etc. **FREE LINCOLN ENGINEERING SCHOOL.** Box 931-P-43, Lincoln, Nebr.

## EARN THE DEGREE

Doctor of Psychology (Ps.D.), Doctor of Divinity (D.D.), many others. Courses in business, accounting, law, etc. Low fees. Send for large Bulletin and student picture-folder AT ONCE. No obligation whatever.  
**TEMPLE BAR EXTENSION COLLEGE**  
1411 Fourth Avenue, Dept. 4-R, Seattle, Washington, U. S. A.

## Learn CARTOONING

**FREE TRIAL LESSON.** Cash in on your sense of humor—AT HOME—BY MAIL. Have fun! Make money! No experience needed to start. Write today for **FREE LESSON**, mailed postpaid. No obligation.  
**MOON Gag-Cartoon School, Dept. H, Fall Creek, Wis.**

## MONEY IN RABBITS—CAVIES

**WE BUY** and put you in touch with other markets. Catalog and copy of magazine 10c. Or send 25c for Book Catalog and Price List and Year's Subscription to the **AMERICAN SMALL STOCK FARMER.**  
**OUTDOOR ENTERPRISE CO., BV 919, PEARL RIVER, N. Y.**

## Burn Your Name On Tools Electro Name Etcher

Protect valuable tools from thieves and tool borrower! **Electro Name Etcher** BURNS your name, any design, permanently on tools, instruments, any metal. Easy! SIMPLE as writing with pen or pencil. SEND NO MONEY! Rush order today. Pay postman only \$1.00 plus few cents postage on delivery. Use 5 days—money back if not delighted. **Electro Name Etcher, Dept. F-600, Strader Ave., Cincinnati, O.**



# Let me make you a **SUPERMAN!**

"Give me just 15 minutes a day—and I'll PROVE I can Work Wonders with

**YOUR BODY"** Charles Atlas

Holder of Title, "World's Most Perfectly Developed Man"

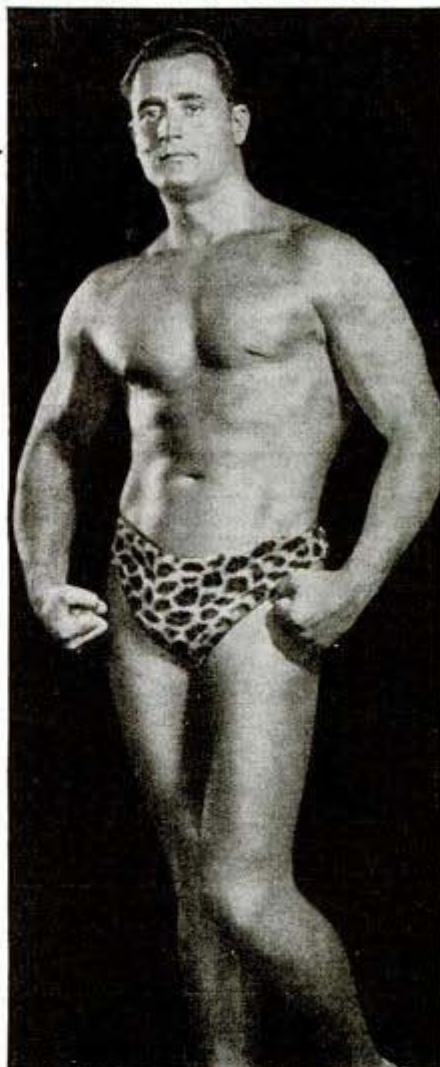
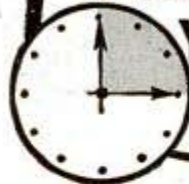

**WHEN** you stand before your mirror, stripped to the skin, what do you see? A body you can be really proud of? A build that others admire and talk about? OR—are you fat and flabby? Or skinny and gawky? Are your arms and legs like rails—when they should and CAN be driving pistons of power?

If you're honest enough with yourself to admit that physically you're only half a man now—then I want to prove I can make you a SUPERMAN in double-quick time!

Friend, I KNOW what it means to be on the "no-muscle" side of the fence. I was there myself at one time! Weighed exactly 97 pounds. A skinny, string-bean body that was so comical others laughed at me. But to me it was no joke. I was ashamed to strip for sports or undress for a swim.

## My Discovery

Then I discovered "Dynamic Tension". In record time it built my body to such ideal proportions that when I faced all comers in open competition the judges awarded me the title "The World's Most Perfectly Developed Man."

"Dynamic Tension" is the NATURAL method for building your body into the physical perfection every man wants. I've seen it work wonders for other men. I'll show you photographs of them so you can see for yourself!

## Only 15 Minutes a Day

Muscles grow fast the "Dynamic Tension" way! You don't slave away at monotonous, tiresome, "squirrel-in-a-cage" motions that get nowhere. Instead, this method is actually fun! You feel yourself developing!

That's why I say—"Give me the chance to prove it and I'll OPEN YOUR EYES!" No two ways about it. Tell me where you want the muscles and I'll make it my job to put them there.

Right in that body of yours is all the makings of an Atlas Champion. I'll show you exactly how to get a handsome, husky pair of shoulders—a deep, he-man chest—arm and leg muscles hard as rocks yet limber as a whip—rippled guards of solid muscle across your stomach (the surest protection against rupture)—every inch of you all man, he-man, SUPERMAN!

CHARLES ATLAS

This is an actual, natural photograph of the holder of the title "The World's Most Perfectly Developed Man."

### U. S. Navy Tests Show Better Build Can Lead to Better Job, More Money!

The N. Y. Herald Tribune reports astonishing results achieved through tests with U. S. Navy recruits. A former world's heavyweight boxing champion, now Lieut. Commander in charge of Navy's physical development, states after only 6 weeks' physical training, bodily strength of recruits increases one-third, while their ratings in intelligence tests rise 17%!

Uncle Sam proves that better physical condition brings higher mental ability, too. Let me put you into real he-man shape—and give yourself better brain power, a better job, better pay!

## Send for FREE BOOK

I don't ask a penny to tell you the story of "Dynamic Tension" and show you actual photographs of the amazing results it has given other men, young and old. And I don't know why it shouldn't do just as much for YOU!

So mail this coupon right now for full details. I'll send you at once—FREE—my illustrated book, "Everlasting Health and Strength."

Packed with photos it will tell you how to start putting "Dynamic Tension" to work for YOUR body. And remember, it's FREE. Get it now! Mail the coupon to me personally. CHARLES ATLAS, Dept. 8-W, 115 East 23rd Street, New York, N. Y.



### CHARLES ATLAS, Dept. 8-W 115 East 23rd St., New York, N. Y.

I want the proof that your system of "Dynamic Tension" will help make a New Man of me—give me a healthy, husky body and big muscular development. Send me your free book "Everlasting Health and Strength."

Name.....  
(Please print or write plainly)

Address.....

City.....State.....



Increased production  
means



## More Jobs for MACHINISTS and bigger pay for men who know their work

This home-study course gives you the practical facts on modern machines, up-to-date methods, you need to advance in machine shop work. Take advantage of the other man's experience as found in books, to solve your problems, increase your efficiency, with

### The AMERICAN MACHINISTS' LIBRARY

6 volumes—2368 pages—2516 illustrations  
(A combined home-study course and reference library)

This library of machine shop practice was written for practical men. It gives you the best methods for every kind of machine shop work. It fully explains lathes, drills, and other machine tools and their operation, automatic screw machines, speeds and feeds, gear design and production, jigs and fixtures, punch and die work, metal surfacing, etc., etc. Plainly written—completely illustrated—the best kind of help to the machine shop man who wants to advance himself.

No money down—special price—easy payments.

#### EXAMINATION COUPON

McGRAW-HILL BOOK CO., 330 W. 42nd St., New York

Send me for ten days' examination the American Machinists' Library. If satisfactory I will send you \$1.50 in 10 days and \$3.00 monthly until the price of \$18.50 is paid. If not wanted, I will return the books postpaid. (To insure prompt shipment write plainly and fill in all lines.)

Name .....  
Home Address .....  
City and State .....  
Position .....  
Name of Company ..... PM-7-42

## Learn WELDING This Easy Way!

### AUDELS NEW WELDERS GUIDE

Contains Important Facts and Essential Information!

- WELDING METHODS
- WELDERS
- ELECTRIC
- OXY-ACETYLENE
- THERMIT
- UNIONMELT
- SHEET METAL
- SPOT
- PIPE
- PRESSURE VESSELS
- VARIOUS METALS
- AIRPLANE
- HARDENING-FACING
- CUTTING
- EYE PROTECTION

Just Out! \$1

Every Welder Should Own This New, Useful Book containing clear, concise, practical information, pointers and facts relating to modern practice in all Branches. Easy to read and understand—over 400 pages Fully Illustrated—flexible cover—pocket size—a Ready Reference that Answers Your Questions accurately—Money Back if not O.K. To get this assistance for yourself, order copy today.

**THEO. AUDEL, Publishers, 49 W. 23rd St., New York**  
Please mail AUDELS WELDERS GUIDE (Price \$1). If satisfactory, I will remit \$1 on its safe arrival, otherwise I will return the book.

Name .....  
Address .....  
Occupation .....  
Employed by ..... P.M.

# Now is the Time for you to get into DRAFTING



All working tools, including drawing table, sent to you at once—furnished free with course.

### Learn At Home From An Engineer

With industry working feverishly—the field for DRAFTSMEN is bigger than ever! Get into a better job with more pay and fascinating, pleasant work. I will train you at your home in your spare time until you are holding a better paying position as Draftsman. My practical training in drafting also includes a working course in Industrial Designing valuable on new products, improving, restyling and modernizing—all extremely important and profitable to draftsmen. Write for full illustrated details and booklet. Give your age.  
Engineer Dobe, Div. B337, Libertyville, Ill.

## ELECTRICAL TECHNICIANS URGENTLY NEEDED!

In industry—in Army and Navy—electrical technicians win better jobs and ratings. Learn fundamentals of electrical theory and practice—testing, drafting, machine shop, wiring, control. Course complete in one school year. Dormitory; dining hall; campus. Send for catalog and Vocational Chart. 117 Takoma Ave., Washington, D. C.

## BLISS ELECTRICAL SCHOOL

# ACCOUNTANT

BECOME AN EXPERT

Executive Accountants and C. P. A.'s earn \$2,000 to \$10,000 a year. Thousands of firms need them. We train you thoroughly at home in spare time for C. P. A. examinations or executive accounting positions. Previous experience unnecessary. Personal training under supervision of staff of C. P. A.'s. Placement counsel and help. Write for free book, "Accountancy, the Profession That Pays."

LaSalle Extension University, Dept. 764-H, Chicago  
A Correspondence Institution

## ENGINEERING DEGREE IN 27 MONTHS

INDIANA  
TECHNICAL  
COLLEGE

Courses in Aeronautical, Chemical, Civil, Electrical, Mechanical, and Radio Engineering. One-year courses in Radio and Drafting. Approved by C.A.A. Prep courses without added cost. Low tuition. Large industrial center. Opportunity to earn part living expenses. Enter September 8, December, March, June. Catalog.  
572 E. Washington Blvd., Ft. Wayne, Ind.

## AIRCRAFT Designing & Engineering



HOME STUDY  
AFFILIATE OF  
RYAN SCHOOL  
OF AERONAUTICS

You can learn to design airplanes. A Ryan Home Study Course in Aeronautical Engineering will prepare you quicker for a job with good pay and a future. Easy to understand. No previous training necessary. Write today for free literature.

RYAN AERONAUTICAL INSTITUTE  
427 Lindbergh Field • San Diego, California



Begin today. Write now for our Free Book, "How to Become a Good Penman." It contains specimens and tells how others learned to write in spare time. Enclose 10c for your name beautifully written and a pen point suitable for shaded writing. Write today.

THE TAMBLYN SCHOOL OF PENMANSHIP  
X411 Ridge Building, Kansas City, Mo.



## Learn Profitable Profession in 90 days at Home

Earnings of Men and Women in the fascinating profession of Swedish Massage run as high as \$40 to \$70 per week but many prefer to open their own offices. Large income from Doctors, hospitals, sanitariums and private patients come to those who qualify through our training. The Army and Navy need hundreds trained in massage. Write for Anatomy Charts and booklet—They're FREE.

THE COLLEGE OF SWEDISH MASSAGE  
30 E. Adams St., Dpt. 864, Chicago



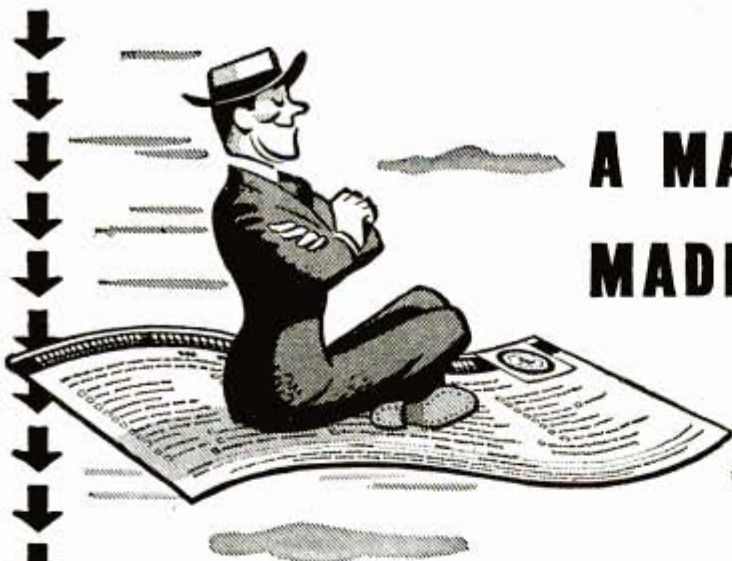

# A MAGIC CARPET— MADE OF PAPER!

YES, thousands of ambitious men transformed I. C. S. coupons into "magic carpets," on which they rode to success and prosperity. The coupons they mailed brought them information, and when they learned how little it costs to enroll for I. C. S. training, and how clearly and understandably I. C. S. presents the most involved subjects, they jumped at the chance to get a solid foundation for success—*modern training!*

Today, when your country needs trained men to man the vital industrial front, I. C. S. offers you a way to acquire sound, practical training in a few months' time. Act now! Mail this coupon for information.

## INTERNATIONAL CORRESPONDENCE SCHOOLS

HELPING TO TRAIN AMERICANS FOR VICTORY



BOX 5639-J, SCRANTON, PENNA.

Without cost or obligation, please send me a copy of your booklet, "Who Wins and Why," and full particulars about the course *before* which I have marked X:

### TECHNICAL AND INDUSTRIAL COURSES

- |  |  |   |  |
|--|--|---|--|
| <input type="checkbox"/> Air Brake   | <input type="checkbox"/> Contracting and Building                    | <input type="checkbox"/> Marine Engines   | <input type="checkbox"/> Sanitary Engineering                                  |
| <input type="checkbox"/> Air Conditioning                                    | <input type="checkbox"/> Cotton Manufacturing                        | <input type="checkbox"/> Mechanical Drafting                                    | <input type="checkbox"/> Sheet Metal Work                                      |
| <input type="checkbox"/> Airplane Drafting                                   | <input type="checkbox"/> Diesel Engines                              | <input type="checkbox"/> Mechanical Engineering                                 | <input type="checkbox"/> Ship Drafting   |
| <input type="checkbox"/> Architectural Drafting                              | <input type="checkbox"/> Electrical Drafting                         | <input type="checkbox"/> Mine Foreman   | <input type="checkbox"/> Shipfitting <input type="checkbox"/> Shop Practice    |
| <input type="checkbox"/> Architecture  | <input type="checkbox"/> Electrical Engineering                      | <input type="checkbox"/> Navigation   | <input type="checkbox"/> Steam Electric <input type="checkbox"/> Steam Engines |
| <input type="checkbox"/> Auto Engine Tune-up                                 | <input type="checkbox"/> Electric Lighting                           | <input type="checkbox"/> Patternmaking <input type="checkbox"/> Plumbing        | <input type="checkbox"/> Steam Fitting   |
| <input type="checkbox"/> Auto Technician                                     | <input type="checkbox"/> Foundryman <input type="checkbox"/> Heating | <input type="checkbox"/> Practical Telephony                                    | <input type="checkbox"/> Structural Drafting                                   |
| <input type="checkbox"/> Aviation <input type="checkbox"/> Aviation Mechanic | <input type="checkbox"/> Heat Treatment of Metals                    | <input type="checkbox"/> Public Works Engineering                               | <input type="checkbox"/> Structural Engineering                                |
| <input type="checkbox"/> Boilermaking  | <input type="checkbox"/> Highway Engineering                         | <input type="checkbox"/> Pulp and Paper Making                                  | <input type="checkbox"/> Surveying and Mapping                                 |
| <input type="checkbox"/> Bridge Engineering                                  | <input type="checkbox"/> House Planning                              | <input type="checkbox"/> Radio, General   | <input type="checkbox"/> Telegraph Engineering                                 |
| <input type="checkbox"/> Chemistry   | <input type="checkbox"/> Industrial Metallurgy                       | <input type="checkbox"/> Radio Operating  | <input type="checkbox"/> Telephone Work  |
| <input type="checkbox"/> Civil Engineering                                   | <input type="checkbox"/> Locomotive Engineer                         | <input type="checkbox"/> Radio Servicing  | <input type="checkbox"/> Textile Designing                                     |
| <input type="checkbox"/> Coal Mining   | <input type="checkbox"/> Machinist                                   | <input type="checkbox"/> R. R. Section Foreman                                  | <input type="checkbox"/> Toolmaking  |
| <input type="checkbox"/> Concrete Engineering                                | <input type="checkbox"/> Management of Inventions                    | <input type="checkbox"/> R. R. Signaller <input type="checkbox"/> Refrigeration | <input type="checkbox"/> Toolmaking <input type="checkbox"/> Welding           |
|  |  |   | <input type="checkbox"/> Wooden Manufacturing                                  |

### BUSINESS COURSES

- |  |  |  |  |   |
|--|--|--|--|---|
| <input type="checkbox"/> Accounting  | <input type="checkbox"/> Advertising             | <input type="checkbox"/> College Preparatory     | <input type="checkbox"/> First Year College                          | <input type="checkbox"/> Railway Postal Clerk                         |
| <input type="checkbox"/> Bookkeeping                                       | <input type="checkbox"/> Business Correspondence | <input type="checkbox"/> Commercial              | <input type="checkbox"/> Foremanship <input type="checkbox"/> French | <input type="checkbox"/> Salesmanship                                 |
| <input type="checkbox"/> Business Management                               | <input type="checkbox"/> Business Correspondence | <input type="checkbox"/> Commercial Illustrating | <input type="checkbox"/> Good English                                | <input type="checkbox"/> Secretarial <input type="checkbox"/> Spanish |
| <input type="checkbox"/> Cartooning <input type="checkbox"/> Civil Service | <input type="checkbox"/> Cost Accounting         | <input type="checkbox"/> C. P. Accounting        | <input type="checkbox"/> High School                                 | <input type="checkbox"/> Showcard and Sign Lettering                  |
|  |  |  | <input type="checkbox"/> Managing Men at Work                        | <input type="checkbox"/> Traffic Management                           |

### HOME ECONOMICS COURSES

- |   |   |  |
|---|---|--|
| <input type="checkbox"/> Advanced Dressmaking | <input type="checkbox"/> Home Dressmaking                       | <input type="checkbox"/> Tea Room and Cafeteria Management, Catering |
| <input type="checkbox"/> Foods and Cookery    | <input type="checkbox"/> Professional Dressmaking and Designing |  |

Name.....Age.....Address.....  
City.....State.....Present Position.....

Canadian residents send coupon to International Correspondence Schools Canadian, Limited, Montreal, Canada  
British residents send coupon to I. C. S., 71 Kingsway, London, W. C. 2, England

# Do you want

- .. to go to College?
- .. or to enter a Profession?
- .. or get an Office Position?

To get anywhere, you practically MUST finish High School FIRST. You can complete our simplified High School Course in SPARE time at home, as FAST as your time and abilities permit. Equivalent to resident school work—prepares you for college, pre-professional examinations, business, industry. Standard texts furnished. Diploma. Credit for H.S. subjects already completed. Single subjects if desired. Low tuition, easy terms. American School, Chicago, est. 1897—endorsed by educators. Finish your high school education NOW. Write TODAY!

## High School Course at Home

Many Finish in 2 Years

American School, Dept. HB45, Drexel Ave. at 58th St., Chicago, Ill.

Gentlemen: Send me FREE information covering special training in subjects checked below. No obligation on my part.

- |  |   |
|--|---|
| <input type="checkbox"/> High School Course          | <input type="checkbox"/> Diesel Engineering     |
| <input type="checkbox"/> Accounting and Auditing     | <input type="checkbox"/> Drafting and Design    |
| <input type="checkbox"/> Architecture and Building   | <input type="checkbox"/> Liberal Arts           |
| <input type="checkbox"/> Automotive Engineering      | <input type="checkbox"/> Private Secretary      |
| <input type="checkbox"/> Business Management         | <input type="checkbox"/> Mechanical Engineering |
| <input type="checkbox"/> Aviation                    | <input type="checkbox"/> Radio and Television   |
| <input type="checkbox"/> Electrical Engineering      | <input type="checkbox"/> Salesmanship           |
| <input type="checkbox"/> Elec. and Gas Refrigeration | <input type="checkbox"/> Business Law           |
| <input type="checkbox"/> Air Conditioning            | <input type="checkbox"/> Retail Merchandising   |

Name \_\_\_\_\_

Address \_\_\_\_\_

## Short-Cut Mathematics

COMBINED WITH

### Practical Mechanics Simplified

NEW 2-in-1 reading course! Now you can learn the speedy, simplified system of calculation used by draftsmen, engineers, accountants, "master minds" on the stage. Learn easy way to multiply 4 figures by 4 figures without using old-fashioned multiplication; add long columns of figures this lightning short-cut method. Learn horsepower, slide rule, micrometer, logarithms, wood measure, puzzles, etc., etc. Large illustrated volume complete with answers, only \$1 postpaid. Satisfaction or refund. Amaze friends with your magic-like mental powers.

**FREE** Complete details... mail coupon TODAY!

NELSON CO., 500 Sherman St., Dept. G300, Chicago  
Please send free details about "Short-Cut Mathematics and Practical Mechanics Simplified." No obligation.

Name \_\_\_\_\_

Address \_\_\_\_\_

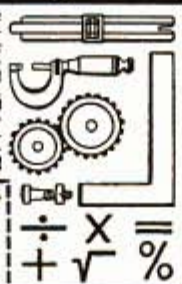

## PARKS AIR COLLEGE

PARKS AIRPORT EAST ST. LOUIS, ILL.

Offers YOU COLLEGE and PROFESSIONAL TRAINING  
Majoring in AVIATION

Accredited by the Illinois Superintendent of Public Instruction. "Included in the Accredited Higher Institutions 1938, issued by the U. S. Office of Education, Federal Security Agency." U. S. approved as a Commercial Ground and Flying School and Mechanics' School. Accredited by and cooperating with the United States Army Air Corps in giving flight and mechanical training. Open to high school graduates. FOUR courses lead to B.S. degrees in Professional Piloting, Aviation Operations, Maintenance Engineering, Aeronautical Engineering. TWENTY-TWO TRAINING PLANES are used in professional flight training which prepares graduates for airline flight operations. FACULTY of 82 specialists in various fields of aviation. 1509 graduates. Enrollment limited to a total of 300 commercial aviation students. Capacity enrollment of 650. 100-acre airport, 25 buildings devoted to school purposes exclusively. Dormitories and dining hall at the College. Summer term July 6. Send postcard for new 64-page catalog.

15th YEAR Registrar, Dept. PM-7  
PARKS AIR COLLEGE, East St. Louis, Ill.

## You Can Learn To Be an ARTIST



Trained Artists Are Capable of Earning \$30, \$50, \$75 Weekly. Many of our graduates are now enjoying successful Art careers. By our practical method, famous since 1914, we teach you COMMERCIAL ART, CARTOONING AND ILLUSTRATING in ONE complete home study course. Two art outfits included with training. Write for details in FREE BOOK—"Art for Pleasure and Profit," explains course and opportunities in Art. No obligation. State age.

WASHINGTON SCHOOL OF ART  
Studio 127A 1115-15th Street, N. W. Washington, D. C.

## TRAIN Your VOICE!

Results GUARANTEED

We build, strengthen the vocal organs—not with singing lessons—but by sound, scientifically correct silent and vocal exercises and absolutely guarantee complete satisfaction with results. Write for Voice Book, FREE. Sent to no one under 17 years old unless signed by parent.

PERFECT VOICE INSTITUTE, Studio B-135, 64 E. Lake St, Chicago, Ill.

## TRIAL LESSON IN Free DRAFTING

More good jobs now in Drafting. Learn AT HOME in spare time (or at our Chicago School). Send postcard for FREE TRIAL LESSON and see how easy to learn and get a good job.

CHICAGO TECHNICAL COLLEGE  
H-203 Tech Bldg., 2000 S. Mich. Ave., Chicago, Ill.

## RADIO REPAIR HINTS 5¢

"Introduction to Radio" explains circuit tracing and radio trouble-shooting. Gives many service hints. Tells how to find radio faults and make repairs quickly. New 32 page book. Price only

SUPREME PUBLICATIONS, 3727 W. 13th St., Chicago, Ill.

Get Your Share of U. S. Defense BONDS ★ STAMPS

# ★ GET ON "UNCLE SAM'S" PAYROLL ★

Victory Program Means Many Appointments

## \$1260 TO \$2100 FIRST YEAR

Railway Postal Clerks—Mail Carriers—  
Mail Clerks—Border Patrolmen—Positions  
at Washington, D. C.—Etc.  
Mail Coupon immediately—

FRANKLIN INST., Dept. L-174, Rochester, N. Y.  
Gentlemen: Rush to me, without charge, 32 page book with list of U. S. Government big paid positions. Advise me also regarding salaries, hours, work, vacations, etc. Tell me how to qualify for a position.

32-Page Civil Service Book — FREE

Name \_\_\_\_\_  
Address \_\_\_\_\_

# INVENTORS

Get Expert Advice on HOW to PROTECT and SELL Your Invention

Get FREE COPY

"Why I thought of that years ago!" How many persons have said that, when they found later that somebody else had thought of the same thing, had it patented, sold it, and were profiting from it? Too many, sad to say. These unfortunates did not know what to do about their inventions, in order to protect and profit from them. Some thought elaborate working models were necessary to secure a patent—others felt their idea wasn't "worth much." They failed to realize that a good practical invention, plus prompt action in securing a Patent, and locating a buyer or a good market, have proved the secrets of success for thousands of inventors.

## Patent Guide Shows What To Do

Our "Patent Guide for the Inventor" answers many important questions concerning Patents that inventors constantly ask. It tells what facts, details, drawings, sketches, etc. are necessary to apply for a Patent; how to protect your invention through dated and witnessed disclosure; how to do this AT ONCE to safeguard your rights; how Patent Office Records can be checked to determine whether the invention is probably patentable before filing fees need be paid; discusses costs involved and a practical way these can be paid as the application progresses. It tells how some inventors secured financial backing; how many simple inventions have proved large commercial successes; how Patents covering improvements also can be profitably utilized and marketed; tells countless other facts of interest.

## Why You Need Expert Assistance

The Patent Laws were enacted for your benefit—to give you protection for the features of your invention which are Patentable. But these features must be legally and concisely set forth in the form of "claims." This phase of the procedure is so complex that the Patent Office advises the Inventor to engage a competent Registered Patent Attorney. We maintain a large staff—carefully trained registered patent attorneys—expert draftsmen—experienced searchers—to serve you. We have been serving inventors for more than 20 years.

## Take First Step Now

With the Patent Guide you will receive also Free a "Record of Invention" form which will enable you at once to establish the date of your invention, before you file your Patent application. This step costs you nothing yet may be vital to your success. Remember—in Patent Matters, ACTION IS IMPORTANT. Delay can be costly. Mail the coupon in an envelope, or paste it on a penny postcard NOW.

**CLARENCE A. O'BRIEN**  
and  
**HARVEY B. JACOBSON**  
"Worthy of Your Trust"  
Registered Patent Attorneys  
21-G Adams Building  
Washington, D. C.



**48**  
**PAGES**  
Over 100  
Illustrations



**CLARENCE A. O'BRIEN**  
and **HARVEY B. JACOBSON**

CLARENCE A. O'BRIEN AND HARVEY B. JACOBSON  
Registered Patent Attorneys before the United States Patent Office  
21-G Adams Building, Washington, D. C.

Please send me your 48-Page "Patent Guide for the Inventor" and your specially prepared "Record of Invention" form FREE. This request does not obligate me.

Name .....  
Address .....  
City ..... State.....  
(Please write or print plainly.)

Get This  
**FREE BOOK**  
IMMEDIATELY MAIL COUPON TODAY!

# POPULAR INVENTIONS

For Your Home

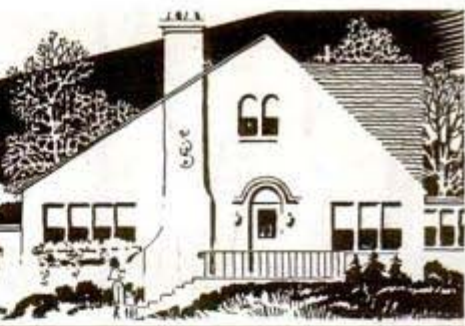

21134

## Ironing Board With Sleeve Insert Takes Large and Small Pieces

*Sleeve Board*



Sleeves, children's garments and other small pieces are easily pressed on a versatile ironing board that has a narrow insert at one end. Ironing sheets is speeded on the larger surface measuring 15 by 41 inches. Trousers may be laid out full length on the board.

m 163

## Scales Check Weight of Canary



In line with the physical fitness campaign, there's even a scales to keep watch on the weight of your canary. Attached to the swing in the bird cage, the indicator is set to show the bird's weight at the start,

and any gain or loss thereafter is easily observed as the canary hops on its swing. Changes in weight may indicate illness or overfeeding, and rapid fluctuations warn that a visit to the doctor may be in order.

m-9

## Pressed-On Jar Caps Removed Without Bending Them

Covers applied to jars and jelly glasses by pressure, usually entailing considerable struggle with a knife or other kitchen cutlery in opening them, can be removed easily with a lever top-lifter that does not bend the caps out of shape. With a hook at one end to engage the lip of the lid, it operates on a movable fulcrum which may be placed near the edge for thin caps, and toward the center of the heavy ones.

*pend 25 cent.*



### WHERE-TO-BUY-IT INDEX OF POPULAR INVENTIONS

- Ironing board has sleeve insert  
The Brewer-Titchener Corp., Cortland, N. Y.
- Scales check canary's weight  
The Fair, State and Adams, Chicago
- Pressed-on jar caps removed  
Edmund B. White, 5 Ashton St., Worcester, Mass.

# How Can You Best Serve Your Country Now? How Can You Best Serve Your Country When the War Is Over?

*Here's Your  
Answer*

## *If You're Drafted*

If you enter the Army as a trained electrical man, you are eligible to apply for higher rating and bigger pay. In both the Army and the Navy, rated Electrical Workers hold mighty important jobs—just as skilled Electrical Workers hold vital jobs in civilian life. **AND THIS IS IMPORTANT: Hundreds of new inventions are being made these days, ready to be brought out after the war. Electricity in Industry is increasing by leaps and bounds. Both of these facts mean there will be a TREMENDOUS NEED for trained Electrical Men after the war.** By getting your Electrical Training NOW, you will be ready for a BIG PAY, BIG FUTURE JOB after your service in the Army is over. When Peace comes, don't have to compete with thousands of untrained men. **THE BEST JOBS WILL GO TO TRAINED MEN!**

## TRAIN THIS QUICK, EASIER WAY FOR

# ELECTRICITY

**90 DAYS . . . BY ACTUAL SHOP WORK . . . NOT BOOKS**

Coyne Training is EASY, PRACTICAL! You LEARN BY DOING. No dull books. No baffling charts. No reciting. You get individual training. First the instructor TELLS you how to do a job. Then he SHOWS you how. Then YOU DO THE JOB YOURSELF on real, full-sized electrical equipment. You work on one of the greatest outlays of electrical machinery ever assembled.

## *I'll Finance Your Training*

Don't let lack of money stop you. Pay after graduation. You can get training first—then pay for it in easy monthly payments after you graduate. If you need part-time work to help out with living expenses, I'll help you get it. My Employment Manager will give you LIFETIME EMPLOYMENT HELP whenever you're looking for a better job. Right now we can't begin to supply all the men who are needed.

**H. C. Lewis, President**

## COYNE Electrical School

500 S. Paulina St., Dept. B2-72, Chicago, Ill.

## **ELECTRICITY IS THE POWER BEHIND OUR PROGRAM**

**If you are a trained electrical man,  
you are needed now—and you'll be  
needed when the War is over.**

You can PREPARE FOR YOUR PLACE in this field by an amazingly easy way. "LEARN BY DOING" IN 12 WEEKS. Be ready for your place in this important program.

**Read every word of my message on this page**

## *If You're Deferred*

Everyone cannot serve in our Armed Forces—some may be too young—others too old—others with dependents—and others with some physical defect. If you cannot serve, you should not be discouraged or feel you cannot do your patriotic duty. FROM 16 to 50, EVERYONE WITH PROPER TRAINING CAN SERVE IN WAR INDUSTRY . . . turning out the weapons our country needs to insure COMPLETE VICTORY. **And remember—Electricity in war time is essentially no different than Electricity in peace time. The same machinery that keeps industry running in war time will probably keep industry running when peace comes again. Learn to run that machinery.** Be an all-around SKILLED ELECTRICIAN. That's the way to prepare yourself for a steady, good-pay job when Peace comes again.

## PREPARE FOR JOBS IN THESE INDUSTRIES

**AIRCRAFT MANUFACTURING  
AIRCRAFT MAINTENANCE  
POWER COMPANIES  
MOTOR SHIP BUILDING  
ELECTRIC MANUFACTURING**

**STEEL INDUSTRY  
RAILROADS  
AIRLINES  
MOTOR INDUSTRY  
OIL INDUSTRY**

And many others. In fact, nearly every industry needs trained Electrical Men.



## GET THE FACTS!

I have prepared a BIG, FREE BOOK that gives all the facts about jobs . . . salaries . . . opportunities. Shows pictures of students at work in my big shops. Send for this FREE BOOK today. No obligation. Act at once. Just mail the coupon.

H. C. LEWIS, President  
COYNE ELECTRICAL SCHOOL, Dept. B2-72  
500 S. Paulina St., Chicago, Ill.

Send me your Free Book and tell me about your plans to help me.

NAME .....

ADDRESS .....

CITY..... STATE.....



## MACHINE SHOP MEN

Learn to set up and run ANY kind of machine; MAKE MORE MONEY NOW by learning quickly HOW TO DO THINGS which usually take years of study and practice. The demand for SKILLED men is ALREADY ahead of the supply, then what WILL IT BE a month or two from now?

# Needed NOW!

**Bigger Pay** Don't miss this chance to qualify for promotion, don't miss this Big Opportunity which is yours almost for the asking. Eight Big Books checkfull of important mechanical facts told simply and clearly. Over 3000 pages, nearly 3000 illustrations cover every subject fully, including Tool Making, Pattern Making, Foundry Work, Mechanical Drawing, Forging, Machine Shop Practice and Management, and hundreds of other subjects.

**8 Big Books (Up-to-date Edition) Sent FREE** to you for examination. With them we send a Big Binder of nearly 800 pages with 217 original shop tickets with 1200 illustrations. These show, step by step, how to set up and run almost any kind of job and are in addition to the 8 books. Decide in your own home or place of business whether or not you want to keep them, check up on any facts you want to. Note their great MONEY MAKING value, then, if you want them, pay on the easiest kind of payments. A year's consulting privileges with our engineers now given with these books without extra charge.

American Technical Society, Vocational Publishers since 1898.

American Technical Society, Dept. 5819, Drexel at 58th St., Chicago  
You may send me the 8 big books and binder of shop tickets for free examination. I will pay delivery charge only, unless I decide to keep them in which case I will send \$2.00 in ten days and \$3.00 per month until the total price of only \$34.80 is paid. If I return them in 10 days I will owe you nothing. You also agree to send me a certificate entitling me to consulting privileges with your experts for one year without extra charge.

Name .....

Address .....

Please attach a letter stating age, occupation, employer's name and address and that of at least one business man as reference.

## MOTORISTS Wanted!



### TO MAKE THIS UNIQUE GAS SAVING TEST

Will you permit us to send you at our risk the Vacu-matic, a device which auto owners everywhere are praising? Install it on your car. Test it at our risk. Unless it trims a dollars off your gas bills by saving up to 30% on gasoline consumption, gives more power, quicker pickup and faster acceleration, the test will cost you nothing. **Automatic Supercharge Principle** Vacu-matic is entirely different! It operates on the supercharge principle by automatically adding a charge of extra oxygen, drawn free from the outer air into the heart of the gas mixture. It is entirely automatic and allows the motor to "breathe" at the correct time, opening and closing as required. Saves up to 30% on gas costs, with better motor performance.

**FITS ALL CARS**  
Constructed of six parts, fused into a single unit, adjusted and sealed at the factory. Easily and quickly installed by anyone in a few minutes.

### AGENTS Your FREE

**FOR INTRODUCING.** Here's a splendid opportunity for unusual sales and profits. Every car, truck, tractor owner a prospect. Send name and address now for big money making offer and how you can get yours Free. The Vacu-matic Co., 7617-1779 W. State Street, Wauwatosa, Wis.

## MAKE MONEY FROM POULTRY



with a business of your own. How to start small way, spare time, grow from profits, or prepare for good job in large poultry plant. Harry M. Lamon, nationally known Poultry Expert, shows latest scientific methods, money-making secrets in poultry raising. His system of home study training used by thousands. Endorsed by many colleges and leading Poultrymen. Established 20 years. Write Today for his big FREE BOOK "How To Raise Poultry For Profit." Shows way to real business opportunity.

**NATIONAL POULTRY INSTITUTE**  
Dept. 50-11 Adams Center, N. Y.

## SUPER Ju Jitsu



For personal defense and counter-attack... no system is more powerful! Almost unbelievably efficient. You don't need big muscles. Lick brutes twice your size with your bare hands. Get ready now for any emergency - protect your loved ones. New self-study course teaches you double-quick. Startling low price. Satisfaction or refund. FREE DETAILS. Write today sure... time is short!

**NELSON CO., 509 Sherman, Dept. G-502, Chicago**

**New York** Established 1902  
**Electrical School**  
Ask for free illustrated booklet  
44 West 17th St., N. Y. C.

## THERE'S MONEY IN CARTOONS!

RAYE BURNS will teach you HOW to CREATE ORIGINAL CARTOONS at home that you may SELL! Course contains 26 lessons and over 600 illustrations. All for Only... **\$2.85**

Send name and address for free details.  
**RAYE BURNS SCHOOL, Dept. M, Box 3583, CLEVELAND, OHIO**

**ICELESS ICE!!**  
COLDER! CLEANER! CHEAPER!  
Formula and Instruction 25c. Postpaid.  
**DUFFY CO., COVINGTON, KY.**

**WILL YOU WEAR THIS SUIT**  
and Make up to \$12 in a Day!  
Let me send you a fine union tailored-to-measure tailored suit FREE OF ONE PENNY COST. Just follow my easy plan and show the suit to your friends. Make up to \$12 in a day easily. No experience—no house-to-house canvassing necessary.  
Send for Samples—FREE OF COST  
Write today for FREE details. ACTUAL SAMPLES and "sure-fire" money-getting plans. Send no money.  
**H. J. Collin, PROGRESS TAILORING CO., Dept. G-116, 500 South Throon Street, Chicago, Illinois.**

Always write your name and full address clearly when answering advertisements.

## LEARN A BIG PAY TRADE MAIL COUPON!

**in 2 to 8 WEEKS!**  
**We Pay Room and Board**

To meet the great demand for men at high wages, we have inaugurated intensive training courses in the trades listed here. Learn in 2 to 8 weeks by actual shop work. One of America's leading schools. Established 1902. 7 floors of shops. Many employers send their young men here for intensive training. Free employment service.

**GREER SHOP TRAINING**  
Dept. 272, 2024 S. Wabash Ave., Chicago, Ill.  
Send "Shop Training Facts" describing trade checked below:

<input type="checkbox"/> Auto-Diesel	<input type="checkbox"/> Body-Fender
<input type="checkbox"/> Welding	<input type="checkbox"/> Machine Shop
<input type="checkbox"/> Refrigeration	<input type="checkbox"/> Tool and Die
<input type="checkbox"/> and Air Conditioning	<input type="checkbox"/> Aviation

Name .....

Address .....

Age .....



### Learn to use the Slide Rule— SOLVE PROBLEMS QUICKLY

Every mechanic, engineer, draftsman, electrician, and student needs this book. Explains fully the use of slide rule—how to solve complicated problems quickly—accurately. Complete—easy to understand. Includes 10-place tables. Third edition, cloth bound, over 200 pages, illustrated.

**ORDER** • Pay postman **ONLY TODAY** • \$1.50 plus COD and postage charges. If cash in advance we pay postage. **\$1.50**

**FRED'K J. DRAKE & CO.**  
632 W. Van Buren St., Chicago, Ill.  
*Drake's books are sold at leading bookstores*

## Learn GLIDING



The amazing sport that has swept America over night. Holds tremendous commercial possibilities for carrying freight. Offers the greatest opportunity in the well-paid field of aviation. Low-priced course prepared by nationally-known glider authority taught by mail. Covers fundamentals of design, construction and operation of gliders. Write for Booklet.

**BOWLUS AVIATION CO., 12680 Greenfield, Detroit, Mich.**

## AIRCRAFT WELDING ENGINEERING

Defense Industries offer Outstanding Opportunities to properly trained Welding Technicians (1 year), Aircraft Draftsmen (1 year), Aircraft Welders and Arc Welding Operators (3 months). Learn By Doing. "Ask how to earn \$1040 while learning." Write for free 64-page Illustrated Book—" Dawn of A Giant Industry." Mention course desired.

**MILWAUKEE SCHOOL OF ENGINEERING**  
PM-742-N, Broadway & E. State, Milwaukee, Wis.



## Free Book

**MOUNT BIRDS, ANIMALS, FISH**

See FREE. Explains Taxidermy. Tells how to learn at home by mail to mount birds, animals, heads... to TAN skins and furs. Great for MEN and BOYS. Fun! Also earn money in spare time. **WRITE TODAY—NOW—** for free book containing 100 game pictures. State AGE. N.W. School of Taxidermy, Dept. 337B, Omaha, Neb.



MAIL  
Postal  
Today

## BRUSH PLATING OUTFITS

for autoparts, reflectors, faucets, bicycles.  
No tanks necessary. Free particulars.

**GUNMETAL CO., AVE. M, DECATUR, ILLINOIS**

## METAL AND WOOD WORKING MACHINE TOOLS



Send for new **FREE** catalog of complete line of Machines, Motors and Accessories

**WALKER-TURNER CO., INC.** • 172 Berckman St., Plainfield, N.J.

## WHEN YOU BUY FLASHLIGHT BATTERIES DEMAND "EVEREADY" FRESH DATED BATTERIES

The word "Eveready" is the registered trade-mark of National Carbon Co., Inc.

## WINDOW SIGN LETTERS

For Store Fronts and Office Windows. Anyone can put them on. Free Samples. Liberal Offer to general agents.  
**METALLIC LETTER CO., 430 N. Clark St., Chicago**

## FREE LITERATURE FOR TRAILER BUILDERS

New up to date facts on world's most reliable parts, axles, hitches, draw bars. Used by U. S. Gov't. and largest trailer Mfrs. Easy to build in spare time. Complete working Blue Prints only \$1.00. Write for Free Literature.

**HAMMER BLOW TOOL COMPANY** Dept. 107 Wausau, Wis.



**MONUMENT**  
Genuine Granite or Marble. \$10.95 UP. Order Direct By Mail and save. Don't wait. **U. S. MARBLE & GRANITE CO., A-18, Oneco, Fla.**

**BIG FREE CATALOG**  
Freight Paid anywhere in U.S.A. Lettered. Guaranteed. Free Catalog & samples of stone.

# FREE Personal File for Valuable Papers TO INVENTORS!



## HOW TO GET THIS HANDSOME PERSONAL FILE

Take these steps—(procedure which you would follow anyway to protect your invention with a U. S. Patent)—and this big, handsome, expanding personal notes file of genuine leather is yours at no extra cost.

(1) Send today for advisory books illustrated below and "Evidence of Invention" form. (2) Describe and sketch your invention in the "Evidence of Invention" form and return it to us with \$5.00 which is our usual fee for making a search of Patent Office Records. (3) We prepare our Search Report and recommendations and send them to you in your new leather personal wallet.



## SUPPLY LIMITED—ACT NOW

A limited number of these rich, leather notes files now available. Send coupon below for prompt action.

## VICTOR J. EVANS & Co.

Registered Patent Attorneys  
630-H Victor Building, Washington, D. C.

Please rush books and "Evidence of Invention" form. I want to get the leather Personal File you offer.

NAME .....

ADDRESS .....

CITY AND STATE .....

## WHOLESALE CATALOG FREE!



## 4000 TESTED SELLERS

For salesmen, dealers and agents. 260 pages of thrilling bargains. Over 4000 Opportunities to Make Money.

Household goods, display card items, wearing apparel, cosmetics, foods, jewelry and toys are a few of the thousands of articles shown in this exciting book for salesmen, agents and dealers. Address a postal card to address below and request a copy of this Book of Opportunity, NOW. No charge for it. Spors Co., 542 National, Le Center, Minn.

# NEW INVENTIONS *Urgently Needed*

The need for practical new inventions to meet changed conditions of warfare and commerce is greater today than ever before. Your ideas, regardless of their nature, may fill urgent present needs. For analysis of current requirements, ask by number for the following FREE bulletins:

- No. 1—WHAT TO DO NOW, WITH MILITARY INVENTIONS.
- No. 2—TODAY'S MARKET FOR COMMERCIAL INVENTIONS.

**CHARTERED INSTITUTE OF AMERICAN INVENTORS**  
DEPARTMENT 4, BARRISTER BUILDING WASHINGTON, D. C.

## ELECTRICAL BOOKS

*shipped FREE*

**10 BIG BOOKS**

**FOR EXAMINATION MODERN ELECTRICITY INCLUDING RADIO AND TELEVISION**

Here's great news for anybody interested in Electricity. NEW 18th. edition of Applied Electricity brought right down to date with NEW Electrical subjects fully covered, including Electrical Blue Print Reading. 10 big Volumes and all shipped FREE for examination.

**1942 Edition For Beginners and Experts**

over 3000 pages—hundreds of illustrations—the most complete work of its kind we have ever published. Dynamot, motors, power stations, Radios, television, everything electrical explained so anyone can understand it.

**BIG FIELD! Big Demand! Big Pay!** Men who understand electricity are urgently needed in thousands of War Production industries. Airplanes, ship building, arms plants, machine shops—practically every industry depends on electricity and men who know this subject make big money. Pleasant, fascinating work, easy to learn and do; learn with these books. Send coupon for a set for FREE examination and see for yourself.

**SEND NOW** [ A year's consulting privileges with our engineers now given to all buyers of this famous Cyclopedia of Electricity. ]

AMERICAN TECHNICAL SOCIETY  
Vocational Publishers since 1898

American Technical Society, Dept. EB19, Drexel at 58th St., Chicago  
Send for 10 days' free use. 10 volume set of 1942 Edition, Applied Electricity, including a certificate entitling me to consulting privileges for one year. I will pay the delivery charges only on the books. If I wish I may return them in 10 days and owe you nothing, but if I keep them, I will send \$2.00 after 10 days, then \$3.00 a month until the total price of only \$29.80 is paid.

NAME.....  
ADDRESS.....  
CITY..... STATE.....  
Please attach letter stating age, occupation and name and address of employer and give at least one business man as reference.

## New Accurate 10" Slide Rule

Enables you to do difficult calculations instantly without paper or pencil—multiplying, proportions, division, extracting roots, etc. Accurate, white composition face. Has Standard A, B, C, D, CI, and K Scales.

Equipped with magnifying indicator. For complete outfit, including slide rule, 32-page illustrated instruction book, carrying case, send 50c in coins (60c in Canada). U. S. Defense Stamps accepted. Mailed postpaid. Satisfaction guaranteed or money refunded. (Schools and dealers: write for quantity price.) Send today for this great slide rule value.

ENGINEERING SERVICE, Box 408-C, Plymouth, Indiana

Made in U. S. A. **50¢**

**PRACTICAL ARC WELDING**  
A TEXT BOOK  
HOBART

You'll PROFIT by using this VALUABLE NEW ARC WELDING MANUAL

Full of lessons, charts, diagrams, tables. Worth hundreds to you. \$2.00

1942 edition, gives latest information all welders need. 5 day free inspection. Write.

Hobart Bros., Box M-721 Troy, O

## HOBART

"Simplified" ARC WELDERS

ORDER YOUR COPY NOW!

with the Absolute Remote Control

"One of the World's Largest Builders of Arc Welders"

## Learn TOOL DESIGN

DEFENSE JOBS CALLING

Quickly qualify as Machine or Tool Designer by home study in spare time. Entire defense program depends largely upon the machine and tool designer. After atomic bomb, machine and tool designers will be equally necessary for reconstruction. Many now making \$100 to \$125 a WEEK. Rapidly expanding industry calling for more machine and tool designers than now available. Learn quickly with our step-by-step lessons supervised by a recognized professor of machine tool design. Rush name and address today for complete facts on Machine or Tool Design. Learn what these fields offer you and how quickly you can qualify for a big pay position. No obligation. State age. A penny postal will do—but hurry.

Ohio Institute of Technology, Box 64, Greenville, Ohio

## ANYONE CAN DO THIS IF THEY HAVE OUR CHART

Blue Print 27"x36" shows how to find length of any member, find any angle in degrees, frame 16 sides, round lozenge foot and brace tables, octagon scale, rafter tables and much other information. Can be scaled down for model work as well as full scale framing. Also Chart changing pitches to degrees for use with Radial Saws. Send 50c coin. No stamps. MASON AND PARRISH, ENGINEERS, PM-2105 North Burdick St., Kalamazoo, Mich.

## FOLLOW THIS MAN

Secret Service Operator No. 38 is on the job! Keeping down dangerous Counterfeit Gang. Falsely finger prints in murdered girl's room.

**Free** The Confidential Report Operator No. 38 made to his chief. Write for it.

Earn a Regular Monthly Salary

YOU can become a Finger Print Expert at home, in your spare time, at small cost. Write for confidential full report and details. Literature will be sent only to persons stating their age.

INSTITUTE OF APPLIED SCIENCE  
1920 Sunnyside Avenue  
Dept. B-135 Chicago, Ill.

## TAKE THIS PROVEN SHORTCUT TO SUCCESSFUL PHOTOGRAPHY

Enroll now at country's largest school. Men—women—profit by our 32 years experience in training students for photographic success. Big opportunities NOW in military and industrial photography. Individual coaching by experts for Commercial, News, Portrait, Motion Picture, Color Photography. Resident or home study. Free booklet.

N. Y. INSTITUTE OF PHOTOGRAPHY  
DEPT. 49, 10 WEST 33 ST., NEW YORK, N. Y.

## TRAIN FOR TECHNICAL RADIO WORK

I'll train you at home... or at camp for a good-paying Radio job, or a business of your own. I give you full Radio Equipment including a Tester, and complete Radio Set. You do practice-giving experiments. You gain Radio repair experience right in your own home.

**FREE** Write for complete details in new catalog "HOW TO MAKE MONEY IN RADIO." SPRAYBERRY ACADEMY OF RADIO, 512-G University Place, N. W., Washington, D. C.

## THINK

The Thinking Alphabet is a tested short-cut to a keener mind, better speech, stronger personality, quicker advancement, higher earnings. FREE Mind Power test and Particulars.

Self Advancement Institute, 99B Fern St., Philadelphia

Always write your name and full address clearly when answering advertisements.





**U. S. Merchant Marine Offers Wartime Jobs With a Peacetime Future**

## BE AN OFFICER

Are you between 18 and 23? High-school educated? A U. S. citizen? Anxious to get in and pitch for America?

Train now to be an **Officer** in the fast-growing U. S. Merchant Marine. Ship Officer's license and Naval Reserve commission after graduation. **\$65 per Month—All Expenses** Good pay, good quarters, during 16-month shore-ship

course. Status of Cadet in U. S. Naval Reserve during training. And opportunity for a *lifetime career*.

Send coupon today

## U. S. MERCHANT MARINE

—Fill out and mail—TODAY—

Supervisor of Merchant Marine Cadet Training  
U. S. Coast Guard, Box 7P  
Washington, D. C.  
Please send me, FREE, and without obligation, Information Booklet of the U. S. Merchant Marine Cadet Corps.  
Name.....  
Street.....  
City..... State.....

**Learn PLASTICS**

Get into Plastics! Your big opportunity. Enter a NEW industry. Plastics, the miracle material! Revolutionizes design and construction. Plastics is thrilling, profitable, uncrowded. Learn Now! First Plastics School in the East with complete Study and Lab. courses. Write Dept. M. Today! State age.

**THE SCHOOL OF PLASTICS**

420 COMMONWEALTH AVE., BOSTON, MASS.

**STUDY ENGINEERING AT HOME**

With A Chartered Educational Institution

Courses in ENGINEERING: Electrical, Civil, Mechanical, Drafting, Architectural, Steam, Aeronautical, Radio, Structural, Mining, Industrial, Highway, Petroleum, Marine, Chemical, Arts; Sciences; Philosophy; Education; Public Health; Medical Jurisprudence; Psychology; Sociology; Physics; Chemistry; Geology; Pol. Science; Theology; Law; Agriculture; Business Training; Accounting; Mathematics; Statistics.

McKinley-Roosevelt Incorporated, 4610-TD, Sheridan Road, Chicago

**WELDERS WANTED!**

**ELECTRIC ARC—OXY-ACETYLENE**

Skilled Welders earn \$8 to \$15 a day. The demand now greater than the supply. Learn this highly paid trade in 2 weeks by actual shop work. One of America's leading schools. Established 1902. 7 floors of shops. Endorsed by welding industry. Limited number of students. 2 weeks course in Electric Arc or Acetylene Welding. Including room and board, only \$104. Write or wire for reservation. Ask for "Welding Facts." State age.

GREER COLLEGE, Dept. 172, 2024 S. Wabash Ave., Chicago

**TIME & MOTION STUDY**

**The Vital War Profession**

Prepare to help your nation through cost reduction and methods improvement. 40 interesting weekly home study sessions. Big pay jobs await trained engineers. Write at once for descriptive folder.

INDUSTRIAL TI-MO CLINIC, 4000 W. Washington Blvd., Chicago

**HANDY RADIO** Watch Size Complete Only \$1.99

No TUBES—No BATTERIES BUILT-IN SPEAKER

At last! Amazing Handy Radio with built-in speaker! No bigger than a dollar watch! Weighs only 2 ozs. Fits vest pocket or purse. All standard broadcasts. Sensitive-super-audio crystal—no tubes, no batteries. Easy, accurate tuning. GUARANTEED. SEND ONE AS A GIFT TO YOUR FAVORITE "BUCK PRIVATE!" (Son, Brother, Sweetheart) He'll enjoy it.

Send No Money

Handy Radio comes complete, ready to listen to, with instructions and miniature built-in phone for enjoying programs in private without disturbing others. Complete, 100-foot aerial included FREE for extra loud volume. Operates anywhere—no electric connections! Just snap wires to best spring or any metal connection. SEND NO MONEY! Mail order and pay postman only \$1.99 plus few cents postage on delivery. Use 5 days. Your money back immediately if not delighted! Rush your order today!

Kumfy Products, Inc., Dept. F-911, Cincinnati, O.

Get Your Share of **U. S. Defense BONDS ★ STAMPS**

**HIGH SCHOOL GRADUATES EARN Big Pay in AVIATION**

**TRAIN AT LINCOLN**

This Lincoln Government Approved School of Aviation wants to immediately get in touch with men who will finish high school this spring. Exceptional opportunities and Big Pay in war industries open to men trained at this Lincoln School for positions as Aeronautical Engineers, Government Licensed Airplane and Engine Mechanics, Aircraft Inspectors, Airplane Assemblymen, Government Licensed Pilot Flight Instructors. WRITE TODAY . . . tell us which course interests YOU. Complete information will be mailed you.

**LINCOLN AERONAUTICAL INSTITUTE**  
597 Aircraft Building Lincoln, Nebraska

**INVENT for VICTORY & PROFIT**

Get This Book **FREE**

All Americans who have an invention or an idea which might be useful to their country are urged to patent it immediately. Our new FREE BOOK "How To Protect, Finance and Sell Your Invention" guides you from the first step in getting patent protection to the final step of marketing and profiting from your invention.

**INVENTIONS ARE NEEDED NOW**

All Americans—inventors & mechanical-minded individuals—who have an invention or an idea which might be useful to their country are urged to mail it in. Submit to us any new gadgets, weapons or improvements on existing ones. We can help you. Your disclosure maintained in secrecy. Take the FIRST IMPORTANT STEP NOW. Write today for FREE Book. It explains necessary steps leading toward patent protection.

**McMORROW & BERMAN**

Registered Patent Attorneys Before U. S. Patent Office  
1322 Barrister Building Washington, D. C.

Send me your NEW FREE Book "How To Protect, Finance and Sell Your Invention" and specially prepared "Invention Record" form at once. I understand that this request does not obligate me.

NAME.....  
ADDRESS.....  
CITY..... STATE.....

Write or Print Name Clearly

# INVENTORS PATENT YOUR IDEAS SEND FOR FREE BOOK



## HOW TO OBTAIN A PATENT

Written by a Former Member of the Examining Corps (1922-24) of the U. S. Patent Office. If you want to profit by your ideas, you should take steps to apply for a U. S. Patent at once. Your first step is to get this Free Book. This interesting illustrated book contains valuable information you should have. It tells you fully how to obtain a patent on your idea in the quickest way. With this Free Book you will also receive a "Record of Invention" form on which you can easily record your idea. Personal and Confidential Service: Your case will be personally handled only by a Registered Patent Attorney who is also a Former Member of the Examining Corps of the U. S. Patent Office. All communications confidential.

MAIL COUPON TODAY for FREE PATENT BOOK and RECORD OF INVENTION FORM.

## CARL MILLER

REGISTERED PATENT ATTORNEY  
FORMER MEMBER EXAMINING CORPS U. S. PATENT OFFICE

Woolworth Bldg., 35th Floor, Dept. 72-A, New York City  
MILLER BUILDING, Dept. 72-A, WASHINGTON, D. C.

Please send me your Free Book, "How to Obtain a Patent," and your "Record of Invention" form.

NAME.....

ADDRESS.....

# PATENTS

Booklet Free • Highest References  
Promptness Assured • Best Results  
Send drawing or model

All Business Given Prompt  
and Proper Attention

## WATSON E. COLEMAN

Registered Patent Lawyer

724 Ninth Street, N. W. Washington, D. C.

# PATENTS

## AND TRADE MARKS

### C. A. SNOW & CO.

Registered Patent Attorneys Since 1875

Write for Free Book and "Certification of Invention" form

427 SNOW BUILDING, WASHINGTON, D. C.

## PATENTS—TRADE MARKS

All cases submitted given personal attention  
Form "Evidence of Conception" with instructions  
for use and "Schedule of Government  
and Attorneys' Fees"—FREE!

LANCASTER, ALLWINE & ROMMEL

Patent Law Offices

412 Bowen Bldg. Washington, D. C.

# ELECTRICITY MEN NEEDED

Electricians are needed everywhere. Hollywood studios alone claim shortage 200 men. This is a live money making profession. Learn at home, spare time. Easy payments. Selective Employment service. Write for FREE Bulletin. No obligation.

## AMERICAN SCHOOL

Dept. EEB45 Drexel at 58 St., Chicago

# MAKE MONEY

Learn Portrait Painting at Home by the NEW, Easy Stuart System

• Previous art training or talent NOT necessary. This Stuart System is radically new and simple. It will REALLY TEACH PORTRAIT PAINTING. Cost is unusually low. Write today for free booklet how YOU can start your career NOW! Address:

STUART STUDIOS, Dept. F

121 Monument Circle Indianapolis, Indiana

# PATENTS Trade Marks, Copyrights, SALES ASSISTANCE

Expert, Confidential, Prompt Service. Moderate Fees. Information and Interesting Literature FREE. Registered Patent  
Agt., H. J. METZLER, Dept. 4-R., 11 West 42nd St., New York

# LEARN WELDING

Train in Industrial New England. Big opportunities. Tremendous Defense Program in Greater Boston area. Quick, expert instruction. Active FREE placement bureau. Low cost housing and living facilities. Also courses in Drafting, Sheet Metal, and Plastics (The School of Flexitex Division). Write today for full information about your opportunities in New England. State your age, education, and courses interesting you.

**BOSTON TECHNICAL INSTITUTE**  
120 COMMONWEALTH AVE., BOSTON, MASS.

# RADIO

ENGINEERING, broadcasting, aviation and police radio, servicing, marine and Morse telegraphy taught thoroughly. 48 weeks' engineering course equivalent to three years' college radio work. School established 1874. All expenses low. Catalog free.

The Dodge Institute, Dept. D, Valparaiso, Ind.

## Man Wanted in Each Territory

You, too, can help the war effort. Other established producers are helping builders replace critical materials. Exclusive process converts local unrestricted raw materials into low cost building products.

### THE PRODUCT

Used in all types of construction. Lower in cost—permanent—attractive. Factory-to-job delivery speeds construction. Line production cuts costs. Small inexperienced crew required.

### QUICKLY UNDER PRODUCTION

We can still equip a few men. Installation simple—requires small floor space. Learn how many manufacturers are working full capacity on private and government construction. Write today for full particulars.

W. E. DUNN MFG. CO.

600 W. 24TH ST. HOLLAND, MICH.

Always write your name and full address clearly when answering advertisements.

# To PROTECT Your INVENTION - Use this coupon, NOW

Delays are dangerous and may be very costly. My personal service assures prompt action, strict confidence, and a minimum of expense. I suggest that you send me a model or drawing, or sketch and description of your invention, and \$5.00. I will make a search and report

promptly as to its patentability and send you a copy of my 72-page booklet. Or, if you prefer to read my booklet first, mail the attached coupon at once. I will also send my "Record of Invention" form. (Over 38 years experience as a Registered Patent Attorney.)

L. F. Randolph, 302-D Victor Bldg., Washington, D.C.  
Please send me at once, free of charge, your 72 page booklet and "Record of Invention" form.

Name.....

Address.....

## A PERSONAL CONFIDENTIAL PATENT SERVICE

## get the story of **PLASTICS**

See the important place of plastics in virtually every industry—in War as well as Peace. Learn what a knowledge of plastics can mean to your future career. Write today for interesting, illustrated literature.

### PLASTICS INDUSTRIES TECHNICAL INSTITUTE

1221 Chevis Bldg. Room 426 E. LaSalle-Wacker Bldg. 190 S. Alvarado Street  
NEW YORK CITY CHICAGO, ILLINOIS LOS ANGELES, CALIF.



## 8 Mile Range-Wide Vision **BINOCULARS \$475**

15 Days **FREE TRIAL**  
Postpaid or C. O. D.

Comes complete with case and straps. Well ground powerful lens. Easily focused for all distances and ideal all-weather binoculars. Guaranteed. If not eye width. Latest features. **AGENTS WANTED.** **Vogue Binocular Co., 7759 S. Halsted, Dept. 708, Chicago**

## 2 Enlargements **GIVEN!**



**ROLLS developed and printed.** Two beautiful professional "Life-time" enlargements given with 8 prints. Or 16 sharp, clear prints. Or 8 large over-size prints, (deckle-edge if desired). 25c postpaid. Credit for unprintable negatives. Reprints 3c each. Fast 1 day service. Satisfaction guaranteed.

**35MM Prices:** Ultra-fine grain developed and vaporated—3x4 inch prints—36 exposures \$1; 18 exposures 60c.

**FREE MAILERS MAY'S PHOTO WORK GUARANTEED**  
Dept. P-7, LaCrosse, Wis.

## STUDY AT HOME

With A Chartered Educational Institution

Courses in Arts; Sciences; Philosophy; Education; Public Health; Medical Jurisprudence; Psychology; Sociology; Physics; Chemistry; Geology; Pol. Science; Theology; Law; Business Training; Accounting; Mathematics; Statistics; Agriculture. **ENGINEERING.** Electrical, Civil, Mechanical, Drafting, Architectural, Steam, Aeronautical, Radio, Structural, Industrial, Highway, Petroleum, Mining, Marine, Chemical. **McKinley-Roosevelt Incorporated, 4610-UD, Sheridan Road, Chicago**



## RE-STRING RACKETS AT HOME—EARN MONEY

**EASY—PLEASANT—PROFITABLE**  
**FREE** WRITE FOR 1942 CATALOG AND **FREE** NEWS LETTER. **W. A. Bickel & Co., 137 N. Marion, Dept. A-72, Oak Park, Ill.**

## LAW

**STUDY AT HOME FOR PERSONAL SUCCESS AND LARGER EARNINGS.** 31 years expert instruction—over 100,000 students enrolled. LL.B. Degree awarded. All texts furnished. Easy payments. Send for **FREE BOOK!**

**AMERICAN EXTENSION SCHOOL OF LAW**  
Dept. 19-M, 8 East Huron St., Chicago, Ill.

## ARTISTS MAKE MONEY

Find out your ability. Send name, age, occupation and address for Free Vocational Art Test.

**ART INSTRUCTION, INC. (Formerly Federal Schools)**  
7132 Art Instruction Building, Minneapolis, Minnesota



## OWN A Printing Business

Cards, Tickets, Stationery, etc. Good profit in spare time. **PRINT YOUR OWN** greeting cards, movie titles, church work, etc. Save money. Easy rules supplied. Junior Press \$8. Senior Outfits from \$17.35. Have home shop. Raised printing like engraving too. Sold direct from factory only. Write for free catalog and all details. **KELSEY, INC. X-37, MERIDEN, CONN.**



## FIBRE ARMS AND LEGS!

Light, correctly fitted, strong and comfortable. Natural appearance. Braces for all deformities. Scientific design. Fair Terms.

**BUCHSTEIN-MEDCALF** 610-3rd Av. S., Minneapolis, Minn.



## America Needs Men Trained for **TOOL & DIE MAKING, MACHINIST & SCREW MACHINE TRADES**

**HARRY LEBESON** PRESIDENT & FOUNDER  
**ALLIED School** offers you short intensive, Practical training courses in Our fully equipped Shops. Learn on Actual Jobs! State Approved. Learn Days or Evenings. Enter anytime. **FREE** Employment Service and opportunity to earn while learning. Write for **FREE** Book "Practical Machine Shop Training." **ALLIED SCREW MACHINE CO., (School Division)** 609 West Lake Street, Dept. PM-7, Chicago, Illinois

## Free 7-Day Offer!

# AUTO MECHANICS!

# REPAIR ANY MAKE CAR— TODAY!



Helps **EVERY** Mechanic—even experts—do repair jobs easier, quicker

Explains every auto repair operation **STEP-BY-STEP**. Easy-to-use! Hundreds of photographs, diagrams, drawings, show exact "how to do it" of repairs, adjustments, replacements. All jobs on every model since 1935—plus 405 truck models! Engine; Electric, Fuel, Cooling, Lubrication Systems; Clutch, Transmission; Universals; Rear End; Wheels, Brakes; Knee Action, Shock Absorbers, Springs; Body; Free Wheel, Overdrive, Fluid Coupling!

Explains Every Repair Job on Every Model of All These Cars—1935 through 1942!

American	La Salle
Bantam	Lincoln
Auburn	Lincoln
Austin	—Zephyr
Buick	Mercury
Cadillac	Nash
Chevrolet	Oldsmobile
Chrysler	Overland
Card	Packard
De Soto	Pierce Arrow
Dodge	Plymouth
Ford	Pontiac
Graham	Reo
Hudson	Studebaker
Hupmobile	Terraplane
Lafayette	Willys

And major data needed to service 405 models of trucks Nearly 200,000 Vital Facts on Every Phase of Tune-Up and Repair • Over 450 Charts, Tables • More than 900 Photos, Drawings, Diagrams • Over 600 Big Pages—Size 8 1/4 x 11 inches.

Published by **MoToR**, the Leading Automotive Business Magazine, 572 Madison Ave., New York, N. Y.

### 150 FACTORY BOOKS IN ONE!

Imagine a **COMPLETE COLLECTION** of ALL official shop procedure manuals, prepared by each car manufacturer's own engineers! That's what you **GET** in this book! Open the manual to the car you want—you'll find everything to show the right way to do the job.

### AUTO MECHANICS INSTRUCTORS AND STUDENTS:

This is the factory shop manual used by the U. S. Army, trade, technical, and vocational schools for training auto mechanics.

### SEND NO MONEY

Simply fill out coupon below. Mail it today and a copy of **MoToR's** up-to-the-minute 1942 Factory Shop Manual will be sent to you at once for 7 days Free Examination.

## 7 DAY TRIAL

**MoToR BOOK DEPT., Dept. 17, 572 Madison Ave., New York, N. Y.**

Rush me **MoToR's** 1942 Factory Shop Manual. If O. K. I will remit \$1 plus 20c shipping charge in 7 days, and \$1 monthly for 3 months. (\$4.20 in all.) Otherwise I will return book in 7 days. (Foreign \$6, cash with order.)

NAME \_\_\_\_\_ AGE \_\_\_\_\_  
ADDRESS \_\_\_\_\_  
CITY \_\_\_\_\_ STATE \_\_\_\_\_  
OCCUPATION \_\_\_\_\_

**WORLD'S  
BEST  
WANT AD  
MEDIUM**

# CLASSIFIED Advertisements



Advertisements in this section, 35 cents per word, each insertion, minimum 10 words, payable in advance  
To be inserted under proper classification in August issue, copy should be in our office June 8th

August issue on sale July 1st

Popular Mechanics Magazine, 200 East Ontario Street, Chicago, Illinois

## YOU'LL PROFIT

By reading and answering the classified ads in this section. Hundreds of opportunities to make and save money.

### AUTOMOBILES—MIDGET CARS

R & R Mfg. Co., Box 546, Anderson, Indiana. Speed equipment for racing cars, boats, and midgets. Catalogue 25c. Fuel data 75c. Instructions \$1.00.

**AUTOMOBILE** Racing book, fifth edition, well illustrated. Instructions on building bodies, frames, engines. Ford A and B conversions. Plans, AAA rules, specifications. Roadster racing, Indianapolis cars. \$1.00 postpaid, \$1.15 C.O.D. Ray Kuns, Dept. 43, Madisonville, Cincinnati, Ohio.

**FORD** Owners and mechanics—learn how to make your old brakes work like hydraulics. Stop chatter, groans. Costs less than \$5 bill. Free details. Super Brake Floater Company, 4022-P Lake St., Chicago.

**MIDGET** Motors, \$5.00 up. Used motors, midgets, motorscooters, parts. Lists, 20c. Shipp's Midgets, Box 543-H, Zanesville, Ohio.

**PROFESSIONAL** Midget racers, two-passenger roadsters. Midget motorcycles, motorscooters. Parts, plans, wheels. Handbook catalog—125 illustrations, plans—20c. Midwest, Box 1959-C, Chicago.

**WHIRLGAS** Superchargers, \$3, increase mileage 20%; power 10%. Refund guarantee. University test. Any car; give make, year. Wrench installs 15 minutes. John Hanley, Manufacturer, 5719 Loraine, Detroit, Mich.

**INCREASE** The horsepower of your Ford V8 from 85 to 128 hp, without supercharging. Send \$1.00 for detailed, simple instructions. Power Associates, P.O. Box 501-A, Wilmington, Delaware.

### AUTO SUPPLIES AND EQUIPMENT

**ELIMINATES** Battery recharging. New discovery—"Nu-Life" a chemical marvel often doubles life of battery. Only one treatment required. Noted chemist certifies this cannot harm any battery. Money-back guarantee. Protected territory available for agents. Trial price \$1.00 prepaid. Write today. Nu-Life Battery Co., 3629 Germantown Ave., Philadelphia, Penna.

**RECLAIM** Used motor oil. Inexpensive process. Instructions 50c. Charles, 12-AD, Norwood, Ohio.

1942 **IGNITION** Supercharger \$1.75. Pep gas 50c. E. O. Sales Mfg. Co., New York.

**HOW** to strengthen tire casings. Low cost. Stamp please. Box 1081, Bismarck, N. Dakota.

**NEON V** for victory installed on car. No transformers. Takes no current from the battery. \$5.00 complete. Pontiac Neon Mfg. Co., 51 North Parke Street, Pontiac, Mich.

**NEW** Spark plugs 30c. Specifications chart free. 811 East 31, Kansas City, Mo.

**RECLEAN** Used oil without cost. Oil never wears out. Write: Gerwin, R. 8, Oklahoma City.

Popular Mechanics Magazine, Chicago, Ill.

Dear Mr. Johnson: I am glad to tell you of the results of my advertising in Popular Mechanics. Have used the classified columns of this magazine almost continuously for the past twenty years or more years. My records show that the small copy I use in your magazine, not only brings practically as many inquiries as all the other mediums I use together, but that a far higher percentage of these inquiries results in orders than those received from any other source. May I also thank you for the very courteous attention you have given me?

Yours very truly,

(Original letter on file in our office)

W. L. CUMMINGS.

**ACT** Now, protect your tires. Make your own Auto Sentinel. Toots horn when car is disturbed. Send 50c for detail drawings. \$1.50 for drawings and necessary materials. Auto Sentinel Co., 19808 Kinsman Rd., Cleveland, Ohio.

**PLATING** Outfits for auto parts. Connect to a battery. No tanks used. Free particulars and proofs. Gunmetal Co., Ave. J, Decatur, Ill.

### AUTO TRAILERS

**READY** Now—Plans for nine new Jim Dandy Trailers including six modern house trailers. Catalog 10c. Also new edition of Trailer Builders Manual and catalog of parts, supplies and equipment. Price 25c. Both 35c postpaid. Trailer Supply Co., 5120-A Fulton St., Wausau, Wis.

### MOTORCYCLES, BICYCLES, MOTOR-SCOOTERS AND SUPPLIES

**BICYCLE** Scoop! Solve your wartime transportation problem! Ride a Gildacycle—the first rational bicycle ever designed specifically for adults. Modern as Nylon. Unique. Has more exclusive features than all others combined. Improved drive, less fatigue. More comfortable. Safer, speedier, marvelous coaster. Easier for beginners. Will not over-develop legs and hips. A smart, low-slung, streamlined beauty. Limited number. Send dime (stamps or coin) for illustrated brochure. Hurry! Gildacycle Sales Company, Dept. C, Box 362, New Orleans, La.

**MOTORCYCLISTS.** We can save you money on parts and accessories. Bargain list and decal free. Illustrated Henderson list 10c. Triangle, 2157 Harrison, Chicago.

**PARTS**—New and used. Catalogue and wings pin 10c. Ballak, 811 N. 9th, St. Louis, Mo.

**MOTORCYCLE** Bags—All sizes, all prices. Allen Streamlined Bag Co., 216 Summit St., Elgin, Ill.

**CASH** For motorcycles and scooters. Describe, price. Clymer, 397 W. Pico, Los Angeles, Calif.

**SEND** 10c For 1942 Handbook of Information. Lists new and used parts for Indian, Harley, Booter, 622 East Grand, Des Moines, Iowa.

**BUILD** Electric power bicycle, low cost, easily built, operate cheaply, practical. Detailed plans 50 cents. Leland Hoke, 312 Market Street, Watertown, Wisconsin.

**MOTORCYCLES.** Reconditioned. New, used, parts and accessories. All makes. Large stock. Bargains. Illustrated catalog, 15c. Indian Motorcycle Sales, Kansas City, Mo.

### ELECTRIC FENCING

**1-WIRE** Electric fence units \$2.95. Write. Wholesale Fence, Hales Corners, Wisconsin.

### AVIATION

**PROPELLERS**—Three blade, all types, sizes, lists free. Ford aircooled conversion diagrams, 25c. Lightplane literature, supplies. Standard Aircraft, Ft. Worth, Texas.

**A & E** Mechanics Manual prepares for "multiple choice" examinations. \$3.00 postpaid or C.O.D. Aviation Publishers, Box 503, Studio City, California.

**QUALIFY** For army pilot training. Thorough instruction by mail assures success in passing examination. \$25. Captain A. T. Bell, 119 Franklin Blvd., Merrick, New York.

**AVIATION** Cadet examination preparation by home study course. Rutherford Preparatory School, Long Beach, Calif.

### BATTERIES, GENERATORS, ETC.

**EDISON** Lifetime storage batteries for light and power. Eliminate acid battery diseases. Long guarantee. All kinds rebuilt generating plants, motors, and miscellaneous articles at bargain prices. Free interesting literature. T. Hawley Smith Co., Croton Falls, N. Y.

### AIR CONDITIONING, PLUMBING, HEATING

**BUILD** Evaporated coolers, "Complete part kit \$7.95." Three speed a.c. motor and fan blade combination \$5.95. Evaporative cooler pumps 75c. CMCO, 514 Van Buren, Chicago.

### ELECTRICAL SUPPLIES—EQUIPMENT

**OSCILLATING** Fans, 115 volt d.c., late models. Standard makes, 12" \$8.00, sixteen inch \$10.00. Check with order. Act. quick, Solon, 636 E. 3rd, Duluth, Minn.

**1/2 HORSE**, 3450 Speed, repulsion induction alternating motors \$12.50; 500 watt, alternating generators \$26.50, other sizes. Butler Electric, 1885 Milwaukee, Chicago.

**ELECTRIC** Pencil: Writes-engraves all metals. \$1.00 postpaid. Beyer Mfg., 4515-H Cottage Grove, Chicago.

**DEALERS** Sell electric motors, exhaust fans, air circulators, air compressors, and paint spraying equipment. Wholesale catalog free. CMCO, 514 Van Buren, Chicago.

### WELDING—SOLDERING—PLATING

**WELDING** Outfits, for heavy, medium, light metal welding \$37.33 up. Welding supplies, accessories, a.c. electric welders. Write today. Superior Oxy-Acetylene Co., Hamilton, Ohio.

**ARC** Welders wanted by the thousands. Learn with 516 page lessons manual. Over 500 how-to-do-it photos. \$2.00 copy. Money-back guarantee. Hobartweld, Box M-724, Troy, Ohio.

**BUILD D.C. arc-welder.** without re-winding armature: light plant generators; D.C. motors; automobile generators. Plans \$1.00 each. Welders Club, AB-3432 M-Mart, Chicago.

**GOVERNORS—Auto engine speed control.** Candee, 129-W Llewellyn, Los Angeles.

### MACHINERY, TOOLS AND SUPPLIES

**MICROMETERS.** All sizes, \$5.95 up. Dial indicators \$6.75. Mike depth gauges \$5.75 up. Special 1" range micrometer heads only, heavy duty precision, few left \$3.75. Stamp for list. Newkirk, 2709 Ivy Drive, Oakland, Calif.

**ONE Inch micrometer \$5.00 C.O.D.** Costes, 1220 - 9th Ave. South, Birmingham, Ala.

**BUILD Your own lathe grinder, castings, building instruction \$2.50.** Particulars 10c. Star Machine Shop, Kingfisher, Oklahoma.

**USED Rubber covered conveyor and elevator belting, 20", 24".** 121 Fairview, Saginaw, Mich.

**BUILD Your own machine tools.** Lewis furnishes semi-finished castings for bench milling machine and shaper; rough castings for 23 metal and woodworking tools. Shop-tested materials and professional blueprints. Never a complaint on quality, design or price! Send 10c—New 1942, 32 page illustrated catalog. Lewis Machine Tool Co., Dept. M-19, Box 116, Station A, Los Angeles.

**DIVING Helmets, pumps reasonable.** James, Monroe, Box 333, Middletown, O.

**MACHINISTS Tool chests at bargain prices.** Circular free. Cepuder, 3602 Wesley, Berwyn, Ill.

**CONCRETE Building block machines and molds.** Easy payments. Catalog free. Concrete Machine Co., 5129 South Compton Ave., St. Louis, Mo.

**"BRINKS' Bargain Bulletin."** New-used machines, motors, tools for all shops. Brinkerhoff, 33 Walker St., New York City.

**RECLAIM Dull and broken drills, with Nu-Way Drill Grinder.** Circular free. Tractor-Lite Mfg. Co., Sidney, Iowa.

**13"x5" WILLARD Lathe with gap.** No 2 Pratt & Whitney hand milling machine, four step cone drive. Write for full particulars. Cincinnati Machinery & Supply Company, 217 E. Second St., Cincinnati, Ohio.

**GRIND Drills like factory: attachment for bench grinder.** Cheap. Factory, 811-B East 31, Kansas City, Mo.

### ENGINES, MOTORS, DYNAMOS

**BIG Pay jobs in welding.** Complete welding lessons and reference book. 516 pages. 41 lessons. \$2.00 copy. Money-back guarantee. Hobartweld, Box 728-M, Troy, Ohio.

**1/2 HORSE, 110 Volt, induction motors.** Rebuilt, guaranteed \$9.75; other sizes. Wilnot Auto Supply, 2247 St. Paul Ave., Chicago.

**GOVERNORS—Auto engine speed control.** Candee, 129-X Llewellyn, Los Angeles.

**WINDING Data, 225 motors, single and three phase, \$1.00.** Motor Data Co., Box 7631, Kansas City, Mo.

**AC And DC generators, motors, exhaust fans.** State your needs. Queen City Electric, 519 South California, Chicago.

### BOATS, OUTBOARD MOTORS, ETC.

**ROWBOATS For home assembly.** Kits as low as \$19.85. 10, 12, 14 foot sizes available. Waterproof marine plywood construction. All parts ready-cut for quick easy assembly. Write for free folder. C. R. Dillabaugh, 7926 N. E. Mallory, Portland, Oregon.

**SAIL Your rowboat! Mast, boom, sail \$10.** Trysail, Patterson, N. Y.

**TEN Plywood boat plans 50c.** Free catalog boat building plans. The Rudder, 15 Murray Street, New York.

**FULL Size cut to shape patterns, blueprints, \$3.75 up.** Pleasure boats, to 38 feet. Knock-down frames. Illustrated "Build a Boat" catalog, 10c. "How to Build Boats" book, \$1.00. Cleveland Boat Blueprint Co., Station A-66, Cleveland, Ohio.

**KAYAK Blueprints, deluxe models—catalogue 10c.** Viking Kanoes, Merrick, N. Y.

**WELCH Boats—America's finest.** Two thirds saving. Build your favorite boat by the Welch System. 10c brings you a complete catalog showing 32 designs. Welch Boat Company, Station K-1, Milwaukee, Wisconsin.

**U-MAK-IT Boats—Easy-to-build.** Kayaks, rowboats, dinghies, outboards, inboards, sailboats. Runabout for auto engines. Over 300 in stock. Complete kits. Simple to assemble. Send 10c (coin) for all catalogs with illustrated construction details. Largest selection offered. Kayak Boat Co., 154-P East 129th St., New York City.

**REBUILT Outboard motors.** Fully guaranteed. Over 300 to pick from. Send 10c for complete list. Boat design book 15c. Buy now before prices advance. Chicago's largest dealer, Masters & Son, 214 West Chicago Ave., Chicago.

**BOAT Designers are highly paid professionals.** Complete course by mail. Catalog. Westlawn, Montville, N. J.

**OUTBOARDS — Save 1/2.** Good used parts, all makes and models. Bargains rebuilt motors. Crandall Hicks Co., 959 Commonwealth, Boston, Mass.

**PORD-Mercury-Zephyr marine conversions.** Catalog 10c. Lehman Engineering Company, Dept. D, Newark, N. J.

**OUTBOARD Motors, used parts.** Outboard Exchange, 9614 Flatlands Ave., Brooklyn, N. Y.

**MARINE Power—Easily convert any Ford motor (domestic and foreign) with Osco parts and kits.** Complete catalogue 25c (coin). Osmithson, 3644 Lawrence St., Philadelphia, Penna.

### SPORTING GOODS, GUNS, FISHING TACKLE, ARCHERY, TRAPPING

**ARCHERY Equipment manufacturers since 1924.** Indianhead, Box 303A, Lima, Ohio.

**BOWS—Arrows: Construction-instruction book 50c.** Catalog free. Archery, 617 South State, Chicago.

**WANTED—Guns, equipment.** Buy, sell, trade. Gordon Joslyn, Greenfield, Mass.

**USED Guns, bought, sold, exchanged.** List stamp. Howe Fur Company, Coopers Mills, Maine.

**"RAISE Earthworms for Profit."** Information free. Stamp appreciated. Bureau Zoological Research, 106 "P" Broadway, Peoria, Ill.

**ARCHERY Equipment: Catalogue free.** Mid-West Archery, 2209-A East 75th, Chicago.

### ATHLETIC EQUIPMENT—BODY BUILDING COURSES

**SUPER Ju-Jitsu—lightning defense and attack system.** Sensational new home study course now ready! Learn to lick brutes twice your size with only your bare hands. Free details. Nelson Co., 500 Sherman, Dept. G-508, Chicago.

**BAR-BELLS, Exercise equipment.** Courses, Special offers! Free booklet. Good Barbell Co., 4676APM, So. Grand, St. Louis, Mo.

**BE Strong, muscular, full of pep.** Amazing new body-building course. Write Olympic System, Dept. M, Waterville, Maine.

### ANTIQUES, RELICS, INDIAN GOODS, CURIOS

**JEFFERSON Davis presidential ballots cast 1861.** Genuine originals autographed by voter, \$2.50. A. W. Dunning, Box 574, Wilmington, N. C.

**GUNS, Swords, armor, war relics catalog, 20c.** Thomas Woroniecki, Roslyn, N. Y.

**GLASS, Books, minerals, curios, catalog 5c.** Junes Antiques, Northbranch, Kansas.

**FIVE Prehistoric Indian tools 50c.** Catalog 5c. Sistershop, Northbranch, Kansas.

**SWORDS, Pistols, daggers, armor list 20c.** Roberts Abels, 860A Lexington Ave., New York.

**10 TINY Perfect ancient bird arrowheads \$1.00.** List free. Lear Howell, Glenwood, Arkansas.

**INDIAN Relics, coins, bills, gems, crystals, curios, etc.** Illustrated catalog 5c. 100 ancient arrowheads \$3.00. H. Daniel, Hot Springs, Ark.

**25 GENUINE Indian arrowheads, \$1.00.** Catalog. Geo. Holder, Glenwood, Ark.

**INDIAN Relics, beadwork, coins, curios, minerals, old glass.** Catalog 5c. Indian Museum, Osborne, Kansas.

### FIELD GLASSES, TELESCOPES AND MICROSCOPES

**LENSES—Build your own telescope, field glass, microscope, rifle scope, etc.** Assortment of fifteen lenses—\$1.00 postpaid. Slightly chipped on edge. Satisfaction absolutely guaranteed. American Lens Company, 324 North Mayfield, Chicago.

### DOGS, PETS, BIRDS, RABBITS

**GREAT Dane pups on approval.** Time payments. Kaimar Dania, Stone-Mountain, Georgia.

**HORNED Toads 25c, five kinds turtles \$1.00.** Free catalog. Quivira Specialties, Winfield, Kansas.

**REGISTERED Newfoundland, cockers, spitz.** Best breeding, reasonable. Stamp appreciated. Dorothy Birkey, St. Johns, Michigan.

**ST. BERNARD Puppies.** Champion sired beauties. Franklin Young, R4, Riverhead, Long Island, New York.

**ANIMALS, Birds, reptiles.** All kinds. Send stamp for lists. Snake King, Brownsville, Texas.

**BEAUTIFUL Pure white police dogs.** Ansonia Kennels, Mose, N. Dak.

**ST. BERNARDS—All breeds—Details free!** Book 108 colored pictures, descriptions recognized breeds, 35c. Royal Kennels, No. 91, Chazy, N. Y.

### TREES, SHRUBS, PLANTS, HERBS

**HERBS! Grow for profit.** Particulars 3c stamp. The Brandons, 2322 Commonwealth, Chicago.

### FARMS—FARM LANDS—REAL ESTATE

**77-ACRE Farm; \$800—40 acres for crops, balance creek-watered pasture and wood; good 6-room dwelling, 30x64 barn, silo, poultry house; on state highway, handy village; worth much more; page 22 big free catalog 1384 bargains many states.** Strout Realty, 255-P 4th Ave., New York City.

**10 ACRES Good land \$50.00, \$5.00 down, \$5.00 monthly.** R. W. Stewart, Inverness, Florida.

**GOOD Farm bargains.** Washington, Minnesota, Montana, Idaho, Oregon, North Dakota. Dependable crops, favorable climate. Write for literature and lists describing typical farms for sale. Specify state. J. W. Haw, 119 Northern Pacific Ry., St. Paul, Minn.

**40 ACRES.** Near White River, unimproved; poultry land, \$190, \$3 down, \$5 monthly. Free list and literature. Hubbard, 216 Grossman Bldg., Kansas City, Kans.

**SEE The Highlands of Louisiana.** Choice cut-over land selling at low prices on liberal terms. Descriptive book sent upon request. Long-Bell Farm Land Corp., 874 R. A. Long Bldg., Kansas City, Mo.

### POULTRY AND FARM SUPPLIES

**100 CHICKS \$2.75; 200, \$5.00 postpaid.** Empire Hatchery, Seward, N. Y.

**MORE Profits from poultry—Learn how others get big daily income.** Read America's leading poultry magazine. Three years 50c, one year 25c. Poultry Tribune, Department PB-2, Mount Morris, Ill.

### PROFITABLE OCCUPATIONS

**WELDING Pays.** Learn with 1942 trade school text manual. 516 pages. Over 500 photos. \$2.00 copy. Money-back guarantee. Hobartweld, Box M-723, Troy, Ohio.

**YOU'LL Like resilvering mirrors, tableware, making chipped glass nameplates, signs.** Outfit prices. Sprinkle, Plater, 309, Marion, Indiana.

**MAKE Statuary, flooring, etc.** Imitation marble formula 25c. Ideal Service, 7M, Park Ridge, Ill.

**BOY Mechanics earn cash in spare time.** Instructive bulletin 10c. None free. Instructo Plans, Box 452, Newport, Tenn.

**MECHANICALLY Inclined men — Own and operate general appliance repair shop.** Complete, illustrated course shows you how. Welding, refrigeration, motor repair, how to get business, etc., all phases covered. Free literature. Christy Supply, Dept. 418, 2835 N. Central Ave., Chicago.

**BIG** Paying mailorder business, home-sparetime! Write! Box 102, PM, Austin, Tex.

**STANDARD** Rabbit Journal, Milton, Pa. 3 years. \$1.00, sample dime.

**\$40.00 WEEKLY**, Made growing mushrooms, fresh, dried. Dominion patent 331583. Free spawn. North American, 169Y Yonge, Toronto, Canada.

**RAISE** Chinchilla rabbits for us. We pay up to six dollars each. Catalog and contract 10c. Book catalog. Year subscription Rabbit Magazine 25c. Stahl's, Box 10, Holmes Park, Mo.

**RAISE** Angora rabbits—wool brings \$5.00 pound. Particulars free. Grinstead's, Edwardsville, Illinois.

### BOOKS, PERIODICALS, PICTURES, POSTCARDS

**KEEP** Informed on the progress of your business, trade or profession, through current copies of magazines devoted to your field. Choice of 400 different publications, representing 100 trades—professions—hobbies. Free price list. Commercial Engraving Publishing Company, 34C North Ritter, Indianapolis, Indiana.

**MAGAZINE** Binding: We assemble and bind magazines. Have your old books, Bibles, and hymnals rebound. Durable! Attractive! Prices are reasonable. Heckman Bindery, Dept. D, North Manchester, Indiana.

**OUR** Flag picture—natural colors (11x22). Pedigree free. \$1.00. Crews Art, Box 663, Peoria, Ill.

**5c BUYS** Back dated magazines, (foreign, domestic). Art studies, 100,000 stock used, new books. Engineering, architecture, metallurgy, surveying, electrical, nautical, machinist, aircraft, drafting, medical, chemistry, law, etc. Catalog 10c (refunded). (Magazines, books—bought, rented, exchanged.) Cicero's Exchange, Desk 11, 863 First Avenue, New York, N. Y.

**SAMPLE** Free! "For Better America." Beal, 402 Grand, Oakland, California.

**BOOKS**, Cards, magic, occult novelties, catalog, samples 10c. Eastern Sales, 32 West Randolph, (No. 816), Chicago.

**ART** Photos pretty girls, 50 pictures \$1.00. Sample assortment 35c. Scott's, Box 342, Covington, Ky.

**MACHINIST'S** Reference book \$1.00 postpaid. G. A. Knudsen, 523 - 48th St., Brooklyn, N. Y.

**EXCELLENT** Sparetime profits taking subscriptions—2500 magazines. Complete starting supplies free! Pines, 583 Monroe, Brooklyn, N. Y.

**ANY** Book (new, used, out-of-print, rare) promptly supplied! Lowest prices! Send for free bargain catalogues! Old Prof's Book Shop, M16 Arcadia Court, Pontiac, Mich.

**RENT** Money-making, health, authors' books for 10c a month. Lists free. Coates, 77C Millet, Dorchester, Mass.

### GAMES—ENTERTAINMENT

**NEWSPAPER** With your headline, 25c. Send six words. Krimm, 1609 Broad, Philadelphia.

**PIN** Ball, bagatelle games for homes, clubs and playrooms. Samuel Horrocks, 425 Alden St., Orange, New Jersey.

**PLAYS**, Operettas, musical comedies, complete minstrel first-parts with song programs, blackface skits, vaudeville acts, monologs, dialogs, recitations, juvenile plays and songs, musical readings, entertainments, make-up goods. Catalog free. T. S. Denison & Co., 203 N. Wabash, Dept. 11, Chicago.

### MAGIC TRICKS, PUZZLES, JOKER NOVELTIES

**NEW!** Simplified card tricks! Amazing, self-working bafflers! 25c (coin). Extra! Surprise "mystifier" included! Particulars free. Conaway, V-123, Champaign, Illinois.

**VENTRILOQUISM**. Secrets revealed. Home study course. Free particulars. State age. Fred Maher School of Ventriloquism, 1700 Casgrain Avenue, Detroit, Michigan.

**DOUGLAS'** Famous 1942 catalog of 500 tricks you can do! Brand new effects for pocket, parlor or stage. Send 10c for year's biggest catalog value. Douglas Magic Shop, Box 274, Dallas, Texas.

**"FIFTY** Card Tricks," and catalog. Quarter. Donnelly, 90 Barkley, Clifton, New Jersey.

**MAGIC**, Joker's novelties. Beautiful catalogue ten cents. Magicraft, Heights Station, Houston, Texas.

**SAMPLES** 40 Different tricks, jokes, novelties, with mammoth catalog \$1.00. Ariane, 4462-P Germantown, Philadelphia.

**LEARN** Ventriloquism, 3c stamp brings particulars. Smith, 801 Bigelow, Peoria, Illinois.

**NEW** Vanishing key and catalog 25c. Sterling Magic, 345 John R, Detroit, Mich.

**BE** A magician. Large professional magic catalogue of latest tricks 25c. Ireland, C-109 North Dearborn, Chicago.

**HOLLYWOOD** Special! Magicians button, catalogue, ghost illusion and free trick for 25c. Magic House of Charles, Box 888, Hollywood, California.

**EARN** Money in any crowd. Call names of strangers, tell unspoken questions. Professional course mind reading, spirit writing, etc., \$1. Henderson, Box 341, San Bernardino, Calif.

**WORLD'S** Largest professional magic shop keeps you in touch with latest tricks. To receive mailings send 25c for 1942 catalog. Holden, 220 W. 42nd St., New York.

**MAGICIANS'** Headquarters, 216-page catalog, pocket, parlor, professional tricks, 25c. Kanter's, M-1311 Walnut, Philadelphia.

### STAMP COLLECTING

**500** UNITED States for 10c! 500 U.S.A.—absolutely unpledged and unsorted—just as received from church missions. Many varieties, including commemoratives, airmails, high values up to \$5.00 denomination! Price only 10c to approval applicants! Money back if not delighted. Swan Stamp Co., Dept. 69B, Dunkirk, N. Y.

**16** PAN American sets 10c. To attract approval applicants of the better type we are making the following amazing offer: From our good neighbors in the Western Hemisphere 16 sets from 16 countries: Mexico 729-33 complete, Canadian Royal Visit complete, Puerto Rico 85-86, Jamaica George 2 values, Ecuador map, Guatemala birds 3 val., Venezuela 80, British Guiana new waterfalls, Old Newfoundland, Bolivia postal tax complete, Peru map and pictorials, Colombia 2 RA pictorials, Chile transportation pictorials 3 val., Paraguay commemoratives 2 val., Brazil 5 val. We will send all these for only 10c to sincere approval applicants. Kindly state whether you wish "on approval" United States, foreign or both. Approval Headquarters, Globus Stamp Company, 268 Fourth Avenue, New York City, Dept. 217.

**LOWEST** United States stamp prices. Free illustrated catalogue. Creevey's, Berwick, Penna.

**ABSOLUTELY** Free—Scott's latest deluxe loose-leaf \$3.50 album, covering entire Western Hemisphere—or—standard \$3.00 stamp catalogue, to approval applicants becoming customers. Our approvals feature only the finest and latest South and Central America. "America's Stamp Service," Palm Springs, California.

**15** DIFFERENT Airmails 5c. Approvals. Berkenstock, 217 Edgehill Road, Glenside, Penna.

**POSITIVELY** Greatest free offer. Latest Scott's International \$4.00 stamp album—covering entire world, contains 36,000 illustrated descriptive spaces; Scott's 1942 standard \$3.50 catalogue "Philately's Encyclopedia"—absolutely free to applicants for foreign approvals becoming customers. Stamp Service, Vista, California.

**LITTLE** America Byrd stamp is included in our famous 25 different selected airmail and commemorative packet for only 5c with approvals. Marco Stamp Company, Box 888, San Francisco, Calif.

**EXCEPTIONAL** Oriental packet, Dominican mourning stamp, set Ceylon commemoratives, Bhopal triangle, 10c with 1-3 cent approvals. Superior Stamps, 1019 Greyton, Cleveland Heights, Ohio.

**NEW** Way to exchange duplicates! Become a participant of our Exchange Circle and you can select leisurely at home without money from stamps sent to you by fellow participants. No dues. Write now for free information XIV! Liberty Stamp Exchange Circle, 30 East 92nd St., New York.

**FINE** Approvals, freshly mounted. Fast, personal service. Tell me what countries you prefer and I'll send their stamps. Skinner, 345 East Ocean, Long Beach, Calif.

**FREE!** Three obsolete foreign sets. Approvals. Loids, 5400 24th Street, Cicero, Illinois.

**21** DIFFERENT Guatemala including Quetzal bird airport 10c. Approvals. E. P. Johnson, Box 267, Morgan Hill, Calif.

**175** STAMPS From 175 countries \$1.00. Admiral Stamp Co., 125-21 Hillside Ave., Richmond Hill, L. I., N. Y.

**AIRMAILS** 27 Different 10c. Approvals. Hermes Stamp Company, Box 278, Hempstead, N. Y.

**SENSATIONAL** Combination offer! Big packet 105 different including Iceland, Manchukuo, Ecuador (American flag in full colors), Danzig; airmails, commemoratives, triangle stamp, \$4 United States; complete set United States telegraphs, cataloging 20c. Packet British Colonies, including Gwalior, Hyderabad, Burma (new country) jubilee and coronations. Scarce Far Eastern republic cataloging 50c. Big illustrated lists of other bargains. Total catalog price over \$3.00! All for only 5c to approval applicants! World-Wide Stamp Company, Department 600-N, Camden, New York.

**1,000** GRABBAGS 15c Each. 8 different \$1. Zandy, 630 Binghamman, Reading, Pa.

**555** U. S. Commemoratives. Tipex, S.P.A. sheets. Excellent variety—\$1.00. Alexander's, Box 713, Washington, D. C.

**U. S.** And foreign penny approvals. Lenatt Stamp Company, Oxford, Maryland.

**75% DISCOUNT** Approvals. Fine stamps. No junk. Riedell, Greensburg, Penna.

**50** HYDERABAD, Travancore, Charkhari, British Colonies 3c. Approvals. Cyerman, 177 Huron, Brooklyn, N. Y.

**VICTORY** Packet free—Includes stamps from Tanganyika, British Cayman Islands, animal, scarce babyhead, coronation, early Victorian, airmail, map stamps, with big catalogue—all free. Send 5c for postage. Gray Stamp Company, Dept. PM, Toronto, Canada.

**APPROVALS** That satisfy. All countries. Joe Sansone, 4169 Milwaukee, Chicago.

**SEYCHELLES**, Nejd, Caymans, Manchukuo, Brunel, Turks Caicos, British Solomons (Cannibalard). Everything 3c with approvals, Viking, 130-Z Clinton St., Brooklyn, N. Y.

**15** PERSIA Pictorials 10c. Free oriental bargain list. Light, 2161 Tiebout, Bronx, N. Y.

**4000** MIXTURE \$1. Approvals. Stamp list. 25c. Grist, 409 Oak, Davenport, Iowa.

**19th** CENTURY U. S. commems, Civil War revenues, battleship, \$5 and \$10 stamps—1942 illustrated U. S. catalogue, free to U. S. approval applicants. Metropolitan Stamps, 198-P Broadway, New York.

**20** DIFFERENT Nicaragua 5c. approvals. Pinehurst Stamp Co., 90 Pinehurst Ave., New York.

**POLISH** "Anti-Hitler" stamp, smashed U. S. embassy, also Ecuador with U. S. Flag in natural colors, "Christ" triangle, diamond, Chinese "midget," red army soldier, R.A.F. pilot, ex-Nazi colony, etc.—all only 5c with approvals. Potomac Stampco, Dept. 1A, Washington, D. C.

**U. S.** Approvals—Big discounts—Parks complete 12c. Box 488, Minneapolis.

**1000** U. S. Mixed, dime and 4c postage. Jem Stamps, Port Jefferson, N. Y.

**APPROVAL** Sheets, Frederick B. Driver, 401 Finance Bldg., Philadelphia, Penna.

**U. S.** Best buys. Big list free. Ewing-Stamps, 109 N. Dearborn, Chicago.

**25** DIFFERENT China, 3c with approvals. Knopp, Box 1381, Bristol, Conn.

**QUALITY** Approvals of the "Latin Americas." State interests. Write—Box 93-P, Hayward, California.

**50** CANADA 25c. Approvals. Rips, 100 Herriman Street, Syracuse, N. Y.

**WILL** Rogers and U. S. Flag Panama showing "Old Glory" in natural colors, Nicaragua "Rogers," North Mongolia diamond (world's largest), "peace" stamp, Thailand, war countries, etc. All 5c with approvals. Belmont Stamp Co., Dept. 8, Washington, D. C.

**MEXICO** Census commemorative set free with approvals. Pladon Stamps, 1717-M Idaho, Toledo, Ohio.

**WHOLESALE** Supplements to dealers for 10c postage. Hundreds of bargains. Grossman Stamps, 102 West 42nd, New York.

15,000 VARIETIES 1c, 2c each! Davison, Box 31A, Wollaston, Mass.

90 DIFFERENT Stamps, 3c with approvals. Neumann & Co., 6728 W. Finger Place, Milwaukee, Wis.

FIFTY Different U. S. 5c. Approvals. Fort Stamp Company, Defiance, Ohio.

50 DIFFERENT Ships, railroads, etc. 10c. Approvals. Buchanan, 307 East 23rd, New York.

AUSTRALIA, Argentine, Chile, Sweden, 100 mixed 10c. Steever, Elizabethtown, Penna.

50 FREE Kwangchow, etc. Album 3c. Bullard, 13 Winter Hill, Mass.

AIRMAILS: 25 Different 10c. Approvals. William Dillenback, Fort Plain, N. Y., R. D. No. 2.

SCOTT'S International Junior Album, or catalog—Free to approval customers! Send 3c for jumbo packet and information. Christy, 865 Caldwell Avenue, New York City.

15 BETTER Maps, hinges, quarter. Brown (P), "Floraces," Brecksville, O.

60 DIFFERENT U. S., including commemoratives, airmail 10c. No approvals. Seidenberg, Cassopolis, Mich.

DIME Brings sample America's best hobby monthly. Collector-Dealer-Trader Magazine, La Porte, Ind.

SOUTH American—105 different 20c—with approvals. Davis, Silver Lake, Ind.

LOOK! 1000 Different only \$1.50; 2000, \$4; 3000, \$8. Fred Onken, 630 79th St., Brooklyn.

FREE! Austria war set. Postage 3c. Williams, 606 Archer, Bay City, Michigan.

FREE! Pony Express set (facsimiles). Postage 3c. Roberts, 406 Building, Bay City, Michigan.

FREE! Leeward Is., Cayman Is., Turks and Caicos plus 60 different mint Geo. VI coronation poster stamps, to approval service applicants sending 3c postage. Tatham Stampco, Springfield-30, Mass.

DEALERS—Wholesale list. Postage 3c. Frank's, 4900 Calgrove, Baltimore, Md.

UNITED States stamps on approval. We offer a select stock at reasonable prices. Over 1500 varieties on hand, including scarce 19th century issues, commemoratives, airmails, parcel post, revenues, telegrams and confederates. Write today. Southern Stamp Co., Box 70, Miami, Fla.

NEW 1942 Bargain packet—Over 100 different stamps; includes strange "mystery stamp" now prohibited in United States mail; stamps you'll treasure from Aserbaïjan, Georgia, Transcaucasia, etc. Complete packet for only 5c to approval applicants. Cactus Jr. Approvals, Box 1870-M, Tucson, Arizona.

100 DIFFERENT British colonies—Stamps from the four corners of the world—Special 10c to approval applicants. Official Stamp Co., Fairlawn, N. J.

UNITED States approvals complete coverage, fine quality, attractive prices. Seminole Stamps, Box 436, Coconut Grove, Florida.

WEEKLY Stamp magazine, thirteen weeks, 10c. Stamp Journal, Kalamazoo, Mich.

A REAL Bargain. Specially prepared packet containing 150 different foreign and 65 different U. S. stamps; catalog value about \$5.00; pamphlet which tells you "How to Make Your Stamp Collection Properly" and large bargain lists, all for only 23c postpaid. Queen City Stamp Co., Room 36, 604 Race St., Cincinnati, Ohio.

WOW! \$10.00 Worth of fun for only 10c! 500 foreign stamps, unsorted and unpicked (mostly on bits of paper) just as received from the church missions and other sources. Africa, So. America, Australia, China, Philippines, Dutch Indies, and other countries are represented. Includes a few commemoratives, airmails, and stamps cataloging up to 25c or more each! The biggest package of fun in stampdom—and you might find something really valuable! Price only 10c to serious approval applicants! Money back if not delighted. Jamestown Stamp Co., Dept. No. 22, Jamestown, New York.

\$1.00 (CAT. Price) for 1c! Two mint U.S.A. cat 20c; "queer countries" packet (Djibouti, Manchuria, etc.); scarce set Russia, cat. 75c. Everything for only one cent to approval applicants! Garcelon Stamp Company, Box 400, Calais, Maine.

PENNY Approvals, that satisfy. Nell Gronberg, Box 5441-P, Philadelphia, Penna.

GIANT Packet 136 all different from Africa, South America, South Sea Islands, etc. Includes Nicaragua airmail, two scarce unused United States cataloging 20c, triangle and animal stamps; many others. Also includes fine collection 25 different British Colonies—Charkari, Jamaica, Johore, etc. and United States \$4 and \$5 high values. Total catalog price over \$4.00! Everything for only 5c to approval applicants! Mystic Stamp Company, Department 80-A, Camden, New York.

SEND Postage for free United States price list. Stanley Gibbons, 38-P Park Row, New York.

CANADA 100 Different 25c—approvals all countries. Lists. Victoria Stamp Co., London, 4, Canada.

STAMP Dealers, your ad here will bring wonderful returns. Ask me for proof. F. W. Johnson, Manager, Classified Advertising, Popular Mechanics Magazine, 200 E. Ontario St., Chicago.

### COINS, TOKENS, CURRENCY

OLD Money wanted. Will pay fifty dollars for nickel of 1913 with Liberty head (no buffalo). We pay cash premiums for all rare coins. Send 4c for large coin folder. May mean much profit to you. Numismatic Co., Dept. 20, Fort Worth, Texas.

WE Buy Indian cents, Lincoln cents. Old and rare coins. Send 10c for 1942 catalogue of prices we pay for all U. S. coins. American Rare Coin Co., Dept. 1, Transportation Bldg., Chicago.

SEND 3c Stamp for obsolete coin worth 15c. Rabin, 905 Filbert, Philadelphia, Penna.

OLD Money wanted. Big premiums paid. 1000 quotations. Catalogue 10c. Allan Appell, Sedalia, Missouri.

COMMEMORATIVE \$1.50. Bought-sold. Pricelist free. Toivo Johnson, Ea. Holden, Maine.

COMMEMORATIVE \$1.50. Columbia, Lincoln, Stone-Mountain, Long-Island, Cleveland; \$1.00 each. Large illustrated catalogue 25c. Norman Shultz, Salt Lake, Utah.

I MAY Have just the scarce U. S. coins you want. Send me list. "Meet me by mail." William H. Kenworthy, Waterville, Maine.

GET Profit and pleasure in collecting old coins. Send 10c for 56-page illustrated coin catalog. You'll be delighted with it. Send for it now. B. Max Mehl, 370 Mehl Building, Fort Worth, Texas. Largest rare coin establishment in U. S. Established 42 years.

FREE! Foreign coin, banknote and large 50 page illustrated coin catalogue to approval service applicants. Send 3c postage. Tatham Coinco, Springfield-125, Mass.

COINS, Domestic, foreign, bought, sold. Bargain catalogue free. Wittlin, 1681 Broadway, New York City.

### HOBBIES AND COLLECTIONS

20 DIFFERENT Cactus plants postpaid \$1.00, mixed seed 25c. Lida Delap, Azusa, Calif.

SPECIAL Albums—for autographs, match books, philatelic covers, phonograph records, photographs, scrap books. Write for brand new booklet now! Matchless Album Co., Dept. P, Long Branch, N. J.

50 DIFFERENT, Beautiful foreign hotel baggage labels, 60c. 20 different ocean liner baggage labels, 65c. 200 different poster stamps, 50c. 30 different jumbo match covers, complete, \$1.00. Marcus, 74 Bergen, Jersey City, New Jersey.

PEBBLES From Pacific Ocean, curious, natural polished, varicolored, unusual specimens. 25c. Rayco, Moss Beach, Calif.

200 UNUSED Match-book covers \$1.15. Hohnhaus, 921 1/2 Pape Avenue, Fort Wayne, Indiana.

BEAUTIFUL Jewelry stones removed from rings, etc. 100 assorted \$2.00. Lowe's, Box 311, St. Louis, Missouri.

NEW—15 Different match covers 10c. Box 202, Rochester, N. Y.

EXCHANGE Your duplicate stamps, match covers, etc. with collectors everywhere. List swappers, dime. (Mention hobby.) Secretary, Box 2166, Denver, Colo.

HOBBY Books—Latest titles—Bargain catalog free. Popular Mechanics, 633 St. Clair, Chicago.

### CAMERAS—PHOTO SUPPLIES

EXPERT Camera repairs. Foreign, domestic, movie, still. Bellows made to order. Projectors. Camera Repair Shop, 30 E. Adams Street, Chicago, Ill.

REALLY Earn money at home! Commercial photo-finishing course using minimum equipment. \$1.00 postpaid. Miller Studio, Canadian, Texas.

CAMERAS And supplies. Free illustrated catalog listing everything photographic—still and movie cameras, films, lenses, enlargers, meters, supplies—at tremendous savings. Hundreds of bargains. All guaranteed. We take your old camera or equipment in trade. Write now for your free copy of our newest money-saving bargain book—just out! Limited edition. Hurry! Central Camera Co. (Photographic Headquarters since 1899), 230 S. Wabash Ave., Dept. G-16Z, Chicago, Illinois.

WANTED To buy: Your pictures. Write for details. Free market letter. Freelance Photographers Guild, Inc., 219 East 44th Street, Dept. P-7, New York, N. Y.

CASH! Spot cash for cameras, lenses, binoculars, movie or still, sound projectors. Send full description by mail, or wire for prompt cash offer. Over 30 years of dependability insures honorable dealings. Bass Camera Company, 179 West Madison Street, Chicago, Illinois.

HAVE You a camera? Send ten cents for recent number of our big magazine, showing how to make better pictures and earn money. American Photography, 116 Camera House, Boston, Mass.

35MM. Film! 25 ft. Eastman Plus X \$1.00! Reloaded cartridges—3 for \$1.00 postpaid. Order now. Pacific Coast Film Co., 1508 N. Sierra Bonita, Hollywood, Calif.

SAVE Money on films, rolls, packs, etc. Lundman, 724 - 49th Street, Brooklyn, N. Y.

BASS Says: Astounding buy, exclusive here, latest Argus G3 with coupled range finder, synchro flash, 50 mm. F:3.5 lens, also 75 mm. Bausch & Lomb telephoto F:5.6 also coupled to range finder. \$82.50 value; price \$60.50, unconditionally guaranteed. Cowhide Eveready case, \$4.75. V. P. Ihagee Deluxe, F:4.5 lens. Prontor shutter, big value at \$18.75. Send for yours quick while they are available. Write for quotations and advise what you have to trade. We pay cash for good cameras, lenses, binoculars. Don't trade until you write Bass Camera Company, Dept. AG, 179 W. Madison St., Chicago.

MAKE Money in photography. Learn quickly at home. Easy plan. Previous experience unnecessary. Common school education sufficient. Booklet and requirements free. American School of Photography, 1315 Michigan, Dept. 3432, Chicago.

CAMERA Repairing. Bellows made to order. shutters repaired. Bellows made to fit all standard cameras! United Camera Co., Inc., A-1515 Belmont, Chicago.

### PHOTO FINISHING

FREE! Best snapshot on attractive photo button with 16 prints each roll 25c. Beautiful novelty premiums. Novel-Ad Co., BM-3327 North Ave., Chicago.

ROLLS Developed double prints in snap-folio 25c. Reprints 20c. Dozen enlargements 8 exposure 25c, 16 exposure 40c, 36 exposure 75c. Eshleman's Studios, 120-08B Liberty, Richmond Hill, N. Y.

FREE—8 Snapshots! With each kodak roll we develop and print for 25c; we include 8 extra prints free—16 in all! Or roll developed and 8 mammoth double size prints, 30c! 35mm rolls developed and enlarged to 3x4, 36 exp. \$1.00, 18 exp. 60c. Reprints, 3c each. Send rolls or write for free mailers. Fast-X-Foto, Dent, G, Jersey City, N. J.

ENLARGEMENT 4x6 In colors and film developed 8 Velox deckled-edge prints, 25c. Free film mailers 1-day service. Mail films to Joy-Photos, Dept. 8, GPO Box 606, New York, N. Y.

35 MM., Argus, Leica, etc. (except "Mercury") 36 exposure rolls, fine grain developed (Eastman DK-20) and beautifully enlarged to 3"x4" glossy prints, 90c. Cartridge reloaded with Eastman Plus X 35c. 18 exposure rolls, 55c, reload 20c. Films permanently protected by revolutionary Saturation Cryolyte process. 24-hour service. Satisfaction guaranteed. Free mailing bags, sample print. Write Technifinish Laboratory, 608 Brown St., N. W., Rochester, N. Y.

1942 35MM. Hit! 36 exp. rolls, fine grain, developed, enlarged,  $3\frac{1}{4} \times 4\frac{1}{2}$  glossy (except Univex), 85c; 18 exp. "Studio 35," postage with remittance. "Studio 35," Box 877 Grand Central P.O., New York City.

ROLL Developed, printed, plus one 5x7 enlargement. 25c. Square Deal Studio, Dept. P, Huntington, Ind.

THE Photo Mill. Immediate service! No delay! Eight exposure roll developed, printed and coupon for your choice of two beautiful 5x7 professional enlargements, one tinted enlargement, eight reprints or other premiums, for 25c coin. Developing and eight Jumbo prints 30c coin. The Photo Mill, Box 629-12, Minneapolis, Minnesota.

ROLL Developed, eight snappy 4x6 enlargements, or sixteen sparkling prints 25c. Crystal Studios, Box 159-F, Rushford, Minnesota.

IDEAL Photos beautifully finished wide border—deckle-edge, 25c per roll of eight. Fade-proof, superior quality. Write for free mailers. Ideal Photos, Box 2255, Paterson, N. J.

FREE Beautiful album with cellophane envelopes, plus roll developed, two sets prints, 30c. Same-day service. Pho-T-Pho, Box 242F, Highland Park, Mich.

FILM Developed, 16 non-fade Velvotone prints and two enlargement coupons, 25 cents. Work guaranteed. Laurent, Box 116, Eastwood Sta., Syracuse, N. Y.

FILMS, Fine grain developed free. You'll never regret getting acquainted with our fine printing by professional workmen. There's a difference. Trial, roll developed, enlarged 3x4 chromium gloss prints, 5x7 sepia enlargement, all 25c. 36 exposure roll enlarged \$1.00. Or send 12 favorite negatives, 25c, for chromium reprints. American Film Processors, Box 547, St. Louis, Mo.

BIG 5x7 Enlargement only 10c. In set up frame 25c. Colored 30c. In frame 49c. Special quantity prices. Wineholt Photo, Box 5, Woodbine, Penna.

EIGHT Roll films developed, enlarged, 25c. Selco Products, Danvers, Mass.

ROLLS Developed 16 prints or 8 prints 2 enlargement coupons 25c. 35mm. developed, enlarged 3x4, 36 exposure \$1.00. 18 exposure 70c. Reloads kodak film 50c. Camera City Studio, 225 Shelter St., Rochester, N. Y.

ROLLS Developed: two prints each negative 25c. Reprints 2c each; 100 or more, 15c. Summers Studio, Unionville, Mo.

BIGGEST \$1.00 Value in 35mm. finishing today. 36 exposure fine grain  $3\frac{1}{4} \times 4\frac{1}{2}$  enlargements; deckled, embossed margin and date. Eighteen exposures 75c; sixteen exposure splits 55c. Free mailers. 8 exposure rolls in beautiful, deckled contact finish with free handy album 25c. Mail-bag Film Service, Box 5440A, Chicago.

$3\frac{1}{4} \times 4\frac{1}{2}$  ENLARGEMENTS From 36 exposure roll \$1.00, 18 exposure roll 75c. Double size prints, 8 exposure 828-127-120 rolls 25c. 8 exposure 116-129-130 rolls 30c. Split rolls 45c. Write for complete price list. Village Film Laboratories, Box 4046, Dept. M, Village Station, Los Angeles, California.

35MM. Enlarged  $3\frac{1}{4} \times 4\frac{1}{2}$ —36 exposures \$1.00—18, 60c. E. Morton Co., 1515 Howard St., Chicago, Ill.

OIL-COLORED 5x7 Enlargement 25c; small size 20c. Send negatives. Arlett Studio, 41-31 47th St., Long Island City, N. Y.

SPECIAL Limited offer! If you enclose this advertisement, 4 enlargements from 4 negatives 10c coin. Enlarge Photo, Box 791D, Boston, Mass.

AMAZINGLY Beautiful hand colored prints 6-8 exposure roll developed, printed 25c trial. Reprints 4c each. National Photo Art, D118, Janesville, Wisconsin.

ROLL Developed, two prints each good negative, 25c. (Limit 16 prints). Portland Film Co., Box P-4213, Portland, Oregon.

SIXTEEN Beautiful Holly-tone prints with eight exposure roll developed—25c. Hollytints, P-1350, Hollywood, California.

QUALITY Developing—Prompt service. 6-8 exposure rolls, two each, 25c. Free enlargement coupon. Postcard brings mailer. Petyt Studios, 3310 W. 63th Street, Chicago.

35MM. Rolls fine grain developed 36 big  $3\frac{1}{2} \times 5$  enlargements, guaranteed better, \$1.25. Reload 35c. Nationwide Finishers, Linton, Ind.

BEAUTIFUL Enlargement from each picture on roll 25c. Cut Rate Photos, Dept. B-4, Janesville, Wis.

EVERY Picture an enlargement! 8 sparkling deckle-edge enlargements and roll developed 25c coin; 116 size or smaller; enlarge reprints 3c. Enlarge Photo, Box 791D, Boston, Mass.

EIGHT Beautiful enlarged prints (nearly postcard size) or 16 regular prints 25c. 35mm. rolls enlarged  $3\frac{1}{4} \times 4\frac{1}{2}$  \$1.00. Burton Studios, 443M, Roscoe, N. Y.

BETA-WORK For only 25c more: Extra quality, extra care—finest developing, outstanding enlargements ( $3\frac{1}{4} \times 4\frac{1}{2}$ ). 35mm. 36 exposures \$1.25—18 exposures \$1.00—12 and 16 exposure splits 75c—bantams 50c—Folder free. Beta Photo Laboratories, Box (B)745, Grand Central Annex, New York, N. Y.

TWO Beautiful prints from each picture on roll 25c. Twenty-two years of satisfied customers. Quick service. Lens Photos, Dept. J-4, Janesville, Wis.

THREE Prints each good negative. 6 to 8 exposure rolls, 30c. 12, 16, 18 exposure rolls, 50c. Reprints, 3c. Fred D. Eastman, Bode, Iowa.

IMMEDIATE Service—Pictures returned same day order is received! Professional ready-to-frame enlargements, 5c; hand colored, only 20c—Kodak roll developed with 16 guaranteed deckle-edge Velox prints, 25c. 16 reprints from your negatives, 25c. 36-exposure 35mm. roll developed, vaped, enlarged to 3x4, \$1.00! 3x4 reprints, 3c each. Write for free mailers, free premium offers, etc. American Studios, Dept. 334, La Crosse, Wis.

ENLARGEMENTS Only. 8x10, 25c. Kingsley Photo, 18 Day Street, Somerville, Mass.

DOUBLESIZE Prints. Your roll developed and 8 doublesize prints 25c; from 116 or 120 size negatives you receive 4x6 inch prints. All other size negatives printed in proportion. 16 exposure rolls 50c; 12 exposure rolls 35c. Reprints 3c each. "Our guarantee." Everlasting hi-gloss finish. Overnight service. Pacific Photo Service, Box 668, San Francisco, Calif.

EIGHT Prints, two enlargements 25c. Quality Picture Co., Box P-3573, Portland, Oregon.

ROLL Developed, 8 brilliant Fadeproof Velox prints and two professional enlargements 25c. Overnight service. Young Photo Service, 405-C, Albany, N. Y.

ROLL Developed and 16 prints, or 8 prints and 2 enlargements, 25c. Candid 35mm. film developed and 36-3x4 prints, \$1.00. 18 exposure roll, 60c. Mercury Studios, Dept. 21, 109 N. Dearborn, Chicago, Ill.

ROLL Developed and 4x6 oversize glossy Velox prints. 8 exposure 30c; 12 exposure 45c; 16 exposure 60c. Overnight service. Clemet Photo Service, 1318 W. Columbia Ave., Philadelphia, Penna.

16 BEAUTIFUL Oversize deckled prints and two enlargements with first order 25c. Owlphoto M1, Weatherford, Oklahoma.

PHOTOGRAPHY For pleasure and profit. Prepare at home. Common school education sufficient. Write for information and requirements. American School of Photography, 1315 Michigan, Dept. 3451, Chicago.

FOR The discriminating amateur—8 exposure rolls, 2 prints each 25c. Miniature rolls enlarged 3 to 6 times, 8 exposures 25c, 16 exposures 50c. 35mm. 36 exposures, 3x4 enlargements \$1.00. Unexcelled quality, prompt service. Paramount Photo, 1583 First Ave., New York.

ROLL Developed and 8 lustrous distinct finish permanent Velox glossy prints 25c—reprints 3c each. Fotoprint Service, Box 1, Roanoke, Virginia.

16 SPARKLING Lifetone prints, 2 beautiful Hollywood enlargements, free Leather-tone frame and photo wallet only 25c. Free photo album with first order. Lifetone Studios, Dept. A-739, Des Moines, Iowa.

8x10 SILK Finish enlargement—25c. Send negative. Irving Studio, 4006A Irving Park, Chicago.

#### MOTION PICTURES AND SOUND EQUIPMENT

FOR Sale—Good used 16mm. sound features, shorts. Bargain list free. Blackhawk Film, Davenport, Iowa.

BULK Movie film—8-16mm. Big savings. Fine grain, non-halation. Plans for building movie processing outfit with all formulae, 25c. Also bargains in accessories. Write for free circulars and film sample. Superior, Dept. D-7, 188 W. Randolph, Chicago.

BASS Says: Shrewd buyers send for the new Bass Cine Bargainaram No. 245, an 84-page catalog exclusively cine. The new Revere Double 8 with F:3.5 lens at \$38.50 is the buy. The RCA 16mm. SOF news reel camera at \$325.00. Write Cine Headquarters for your copy of this great free book. We pay cash for good used movie equipment. Bass Camera Company, Dept. A, 179 W. Madison St., Chicago, Ill.

SAVE 50% On movies, Bargain circulars. Genera Company, Davenport, Iowa.

SELECT Productions (catalogue-sample 10c). Midwest Cine Shop, Hannibal, Mo.

SOUND Features \$10.00 up, programs rented, silent features \$5.00. Projectors \$25.00. Free lists, Simpson Films, Miamisburg, Ohio.

BARGAINS: 8-16-35mm. Projectors; sound, silent. Cameras, screens, accessories. Feature films, shorts: sacrifice prices. Rental library sent anywhere. Trades accepted; monthly payments. Mogull's, 64 West 48th, New York.

16MM. Exchanges—Silent films—\$1.00 reel, sound—\$2.00. Also bought, sold Castle, Official, latest releases. Better Films, 742 New Lots Avenue, Brooklyn, N. Y.

FREE. 1942 Movie list; samples 10c Goodwill Company, Jackson, Tennessee

12 FILMS, Round robin, \$1.00. Summer film, Kodachromes, accessories. Movie Amateurs, 2521 Upham, Madison, Wis.

BARGAINS New-used movie cameras, projectors, accessories. Large film rental library. Send 10c for catalogues. Don Elder's, M-739 Boylston Street, Boston, Massachusetts.

ESO-S 8mm. Movie films 50% less! Spooled ready for use; bulk. Ask for D-2 catalogue. Eso-S, 3945 Central, Kansas City, Missouri.

8-16-35MM. Films. Bought, sold, exchanged. Complete subjects \$3 up. Catalogue, sample film 10c. International, 2120 Strauss, Brooklyn, New York.

8-MM.-16MM. Silent-sound; all latest subjects. Films rented everywhere. Free catalogue (sample film 10c). Garden Film, 317 West 50th, New York.

8MM.-16MM. Films. Free catalogue (sample film 10c). Parkway Exchange, 961 Eastern Parkway, Brooklyn, New York.

35MM. Odd reels 75c. Projectors. Features. Savarese, Woodcliff Lake, N. J.

SEND Stamp for 16mm. 8mm. catalogue. Sterling's, 679 Northampton, Easton, Pennsylvania.

LEARN Movie projection, management. Free catalog. Give age. Theatre Institute, Elmira, N. Y.

#### MUSIC AND MUSICAL INSTRUMENTS

WANTED — Musical instruments. All kinds. Zifferblatt, 55 Cooper, New York City.

LEARN Popular piano! Write Magic Key, 111-A Broadway, Glendale, Calif.

SONGS, Poems wanted for radio distribution. Publication on royalty basis. Free information. Dept. A, Words & Music, Ltd., 5956 Hollywood Blvd., Hollywood.

HARMONICA Craftsman — Wanted to rejuvenate, repair professional mouth organist's harmonicas. Reed replacement essential. Write 17 East 49th Street, New York. Room 604.

SONGS—Song poems wanted. No charge for melodies. Free examination. Hollywood Recording Studios, 87G18 Preuss Sta., Los Angeles.

SONGWRITERS: Send poems for offer and free rhyming dictionary. Phonograph records made. Vanderbilt Studios, Box 112-CP, Coney Island, N. Y.

POEMS Wanted. Immediate consideration for book of poetry. Pacific Press, Dept. D, 816 S. Robertson Blvd., Los Angeles.

SONGWRITERS! Amazing, convincing offer. Hibbler, C-5, 2157 No. Avers, Chicago.

SONGWRITERS—Write for free book. Send poems. Variety, Dept. 2, Sarasota, Fla.

SONGWRITERS: Write for free instructive booklet concerning song poems. United Music, Dept. 14, Salem, Ind.

WANTED: Original song poems. Five Star Music Masters, 630 Beacon Building, Boston.

LYRICS Wanted, songs composed, free offer. Basil Alt, Ottoville, Ohio.



**SONG Hits!** Send poems for free examination. Write for free de luxe rhymers, DeLuxe Music Service, Box 3163-P, Bridgeport, Conn.

**SONGWRITERS**—Send poem for immediate consideration and free rhyming dictionary. Richard Brothers, 24 Woods Building, Chicago.

**GOOD Music** composed to good words. Reginald Belcher, Chatham, New Jersey. Established 1910.

**SONGS, Poems** wanted. Newart Song Publications, 1207 Carbon, Syracuse, N. Y.

**SONGWRITERS** Write for free booklet. Profit sharing plan. Allied Music, 7608 Reading, Cincinnati, Ohio.

**MUSIC** Composed to words. Rhyming pamphlet on request. Phonograph recording of completed songs. Send poem for consideration. Keenan's Studios, Dept. PM, Box 2140, Bridgeport, Conn.

**WANTED!** Lyrics, melodies for songs. We arrange, publish, sell Superior Song Studios, Passaic, N. J.

**MUSIC** Composed to words. Wonderful proposition. Bauer Bros., Oshkosh, Wis.

**LEARN** Swing piano! Postal brings free folder. Christensen, 451 Kimball Hall, Chicago.

**WRITE** Songs Big money and reputation. Write for information. J. Gordon Pub. Co., 201 N. Hoyne Ave., Chicago.

**FREE**—Big list of helpful books. Popular Mechanics Press, 200 E. Ontario St., Chicago.

#### RADIOS, SUPPLIES, INSTRUCTION

**RADIO** Men. Special quick review. License preparation. Circular 5-P. Nilson Radio School, 51 East 42nd St., New York, N. Y.

**10 LATEST** Radio and electric 10c books for experimenters and beginners. Send postcard for list. Radio Publications, 27 West Broadway, New York City.

**MAKE** Your own simple long distance crystal radio. Amazingly simple radio requires no tubes or batteries yet reception over hundreds of miles reported. Special offer:—2 regular 25c supersensitive crystals and complete illustrated instructions only 25c, postpaid. Allen, Dept. A, Clinton, Mo.

**BROADCASTING** Station operator course, \$6.00. Institute, 524 Fairbanks, Oakland, Calif.

**RADIO** Communications courses qualifying for all federal licenses. Home study and resident courses. American Radio Institute, 1123 Broadway, New York, N. Y.

**RADIO** Service men and experimenters send for our giant radio catalog. Save dollars. United Radio Co., (1000 M.) Newark, N. J.

#### MONEYMAKING OPPORTUNITIES

**MACHINISTS** And students, free handbooks, big money introducing Derek's Gauge Dials. Thirteen complete shop tables at fingers end. Sample, two 25c defense stamps. Post Office Box 924, Department 26, Indianapolis, Ind.

**MAKE** Extra money while learning dignified, fascinating mail merchandising technique! Send 50c for 6 valuable booklets containing professional methods, practical plans, ideas, formulas for your profit! Adeptus Service, G.P.O. Box 301, 301-E, New York, N. Y.

**MAKE**—Sell made-to-measure arch supports. Ease aching feet. Particulars free. Jul. Corssen, 3609 Texas, St. Louis, Missouri.

**YOU'LL** Like resilvering mirrors, tableware, making chipped glass nameplates, signs. Outfit prices. Sprinkle, Plater, 311, Marion, Indiana.

**MILLION** Articles. Buy wholesale. Valuable directory 10c. Ideal Service, D-7, Park Ridge, Ill.

**EARN** Money, copying and duplicating comic cartoons for advertisers. Ad-Service, Argyle, Wisconsin.

**SENSATIONAL** Mail order money making opportunities. Write Bailey's, Bethel, Ohio.

**INCREASE** Your income. Several profitable propositions to select from. Send for free details. Geo. D. Talbot, Norwood, Mass.

**MAKE** Money by mail. Stamp brings facts. Graham, Real Estate Trust, Philadelphia.

**BIG Mail**—Magazine, opportunity ofers, name listed numerous mailing lists, 10c. Golliday Company, J1514 Long, Columbus, Ohio.

**NEED Money?** Operate sideline. Home—sparetime! Different! Box 102-PM, Austin, Texas.

**SWAPPING** Anything of value is our business! Stamp appreciated. Paws, 1857 University Center Sta., Cleveland, Ohio.

**FREE** Literature explains how; make money through mail. Cutler Publishers, Reading, Pennsylvania.

**EASY** To start your own business! Information free. Ludwig, 532 Geary, San Francisco.

**TIMELY** Home business. Profits tremendous. Formula, instructions, sample, dime. Gansler, Box P125, Bridgeport, O.

**WILL** You give us 5% first \$600 you make? Afternoons free! Work home, \$1,000 month reported (exceptional—full-time). Expect surprise! National, Box 1240, San Bernardino, Calif.

**WHOLESALE** Sources, 500,000 articles. Free directory. Maywoode, 1133 Broadway, New York.

**BE A** metascientist. Remarkable drugless healing system. No manipulation, no apparatus. Inexpensive correspondence course. Free information. Metascience, Deland, Florida.

**"MY-PLAN"** Brought me in \$17,730.52. Started with \$1.25. Information free. Taylor, Box 363-P, Hapeville, Georgia.

#### BUSINESS OPPORTUNITIES

**BLACKOUT** Luminous safety items. New unlimited field. Huge profits will be made from this new industry. 25c (coin) for pedestrian identification button and prices. Tobers, 45 Osgood, Springfield, Mass.

**BRUSH** Plating outfits connect to a battery, no tanks necessary. Almost as simple as painting. Your opportunity to make good income plating autoparts, bathroom fixtures, reflectors, mirrors. Get free proof and particulars that put you in a paying business of your own. Gunmetal Co., Ave. H, Decatur, Illinois.

**HERE'S** A real opportunity. If you want a business of your own that is substantial money maker right now and has unlimited future with exclusive protection, and if you have \$600 cash to operate a business, write 163 Stockton Street, Dept. 17, Jacksonville, Florida, for complete details.

**START** Home business making statuary, plaques, art goods, novelties, souvenirs, concrete pottery, garden furniture, artificial marble flooring, liquid marble. Make your own flexible molds. Amazing profits. Valuable folder free. Creative Publishers, (PM7), Glencoe, Illinois.

**START** Own business home, office. No peddling, little or no investment. Free folder tells how. Wm. Buckett, 2312 Battelle, Hazel Park, Mich.

**"RUBBER** Molds." Make them yourself. Formulas, instructions 25c. Ideal Service, RM-7, Park Ridge, Ill.

**OPERATE** Route used 1c. 5c candy bar, peanut, popcorn, gum vendors. Lowest prices. Northside Company, Indianapolis, Iowa.

**"MAIL** Order Bee" can bring you money—over 400 tested opportunities—Guaranteed methods earning money; home-work; spare-full time. 25c year. 5309C Forest, Kansas City, Missouri.

**GRIND** Lawn mowers. Guaranteed income! \$2.00 capital! Mowers, Janesville, Wis.

**TOO** Old for Job? Your own business makes future secure. Drop postal for over 100 money-making ideas. Mantoman, Box 1014, Hollywood, Calif.

**CONVERT** Tin cans into steel scrap, valuable tin, by chemistry. Process and sample \$1.00. Forty formulas 50c. Harry D. Cater, 455 Washington St., Denver, Colo.

**MILLER** Made fortune in perfume. Plans, local mailorder, formulas, source, 27c. Illustrated description 37 red hot-guaranteed money-makers, free. "Churchill," 319 So. Marengo, Pasadena, Calif.

**EASY** Money. Something new. E. G. Hagadorn, 164 W. Church St., Fairport, N. Y.

**INVEST** \$4.00. Profit \$75.00. Superman "Motor Overhaul." \$1.00 package. Amazing proof. 28c. Sekayo, 1407-W Cherry, Milwaukee, Wis.

**MAKE** Your own Flexible Molds. Statuary, Art Goods, Novelties, Artificial Marble Flooring, Liquid Marble. Literature free. Kemico, 107-M, Park Ridge, Ill.

**QUICK** Money—Luminous paint black-out necessity. Sample bottle 25c with details. Fabiano Chemical, Elberon, N. J.

**FREE**—200 Clever mail order, homework, local business offers—all snappy money-makers. Lewis Co., 828M Carpenter, Oak Park, Illinois.

**COLOR** Cement with chemicals. Make artistic cement garden ornaments Hollywood style. Sample 10c. Hollywood Cementcraft, 8527 Wonderland, Hollywood, Calif.

**INVESTIGATE** The commercial reporter plan. The most successful plan in mail order. Information 10c with a regular 25c plan included free. Leo Adams, 492 Barrett St., Elgin, Ill.

**PROSPERITY** Gold bag, circular free. Wayne Products, Pleasantville, New Jersey.

**COLLECT** Your outstanding accounts. Money-back guarantee. Creditor's Service, Moorcroft, Wyoming.

**DOZENS** Slickest moneymaking propositions! Surprising. Particulars free! Box 102-PM, Austin, Texas.

**MONEY** Making plans, formulas. Catalogue and 24 valuable plans 10c. Crittenden, 125 Lincoln, Lombard, Ill.

**START** Own money making business. Enormous profits. Steady demand. Write for free amazing particulars. Shinette, 1001-B Jefferson Ave., Brooklyn, N. Y.

**3 MOST** Read mail order magazines 10c. Armand Cartier, 695 North, Pittsfield, Mass.

**BECOME** Mail order business man at home. Details and supplies 25c. Foster Hays, Waynesburg, Ky.

**AMAZINGLY** Novel, fascinating, profitable business or hobby. New field will create demand, especially friends and sweethearts of boys in service. Women can handle. Business concerns will want your contract. Little or no investment. Be first in your locality. Complete details \$1.00 or defense stamps. Skill Craft, Box 2401, Kansas City, Mo.

**START** Your own mail order business on small capital. Be a successful mail order operator. Enormous profit possibilities, fascinating, interesting. Literature free. Century Mail Enterprises, 152 W. 43 Street, New York City.

**MANUFACTURER'S** Valuable formulas from analysis for today's greatest selling specialties. Our free Formula Messenger explains! Miller's Chemists, Tampa, Fla.

**POR** An extremely profitable lifetime business, operate a collection agency-credit bureau. Many make \$4,000 yearly, up. Write, Cole Associates, Syracuse, N. Y.

**YOUR** Own business. 66 page book. 40 plans; 64 page magazine 10c. De Selms, 250-P, North 9th, San Jose, Calif.

**WEBER** Typewriter Mechanics School. Simplified homestudy-repairing increasing. Canton, Ohio.

**STATUARY:** Make all kinds. Simple process. Make and install artificial stone flooring in color. Liquid marble. Other money-makers. Write promptly. Literature free. Compo-Tex, Box 786, St. Louis, Mo.

**WARTIME** Plan. Will you give us 5% first \$600 you make? Afternoons free! Work home, \$1,000 month reported (exceptional—full-time). Expect surprise. National, Box 1240, San Bernardino, Calif.

**\$50.00, \$100.00 WEEKLY** Using sawdust. Stamp please. Clement, 943 Arthur St., Rochester, N. Y.

**MAKE** Money by mail, the way we do. Free information. Maywood, 1133 Broadway, New York.

**INVENTORS:** Foresighted manufacturers already planning post-war sale of new non-military products. If you have a useful invention, patented or unpatented, write Chartered Institute of American Inventors, Dept. 4-C, Washington, D. C.

**PLASTEX** Industries offers industrious men an opportunity to start a business of their own, manufacturing art goods, novelties, souvenirs, etc., in Plastex and marble imitation. 5c material makes \$1 articles. Rubber moulds furnished for speed production. Small investment brings good returns. We are now placing big chain store orders with manufacturers. Write for interesting booklet mailed free. Plastex Industries, Dept. A, 1085 Washington Ave., New York.

**HOW** And where to obtain capital. Fully explained, particulars free. Star Service, Wapakoneta, Ohio.

**POPCORN** And potato chip machines. We help start men and women in business. Long-Eakins, 1960 High, Springfield, Ohio.

**LIQUID Marble**—Colorful, glazed! Mold, brush, spray! Composition floors, rubber-lastic molds. Particulars free. Marbleizing Service, Edwardsville, Illinois.

**CHARTERS:** Delaware; best, cheapest; free forms. Colonial Charter Co., Wilmington, Del.

**127 WAYS** To make money, in home or office, business of your own. Full particulars free. Elite Co., 214 Grand St., New York.

**2c DAILY** Pays for New York office under your own name. Co-Operative Offices, 126 Lexington Avenue, New York.

**SELL** Books by mail on commission. No stock to carry. Orders come to you. Maywood Publishers, 1133 Broadway, New York.

**FREE**—Big list of helpful books. Popular Mechanics Press, 200 E. Ontario St., Chicago.

#### FORMULAS, PLANS, ETC.

**MAKE** Fast selling products. No machinery. "Chemist Approved Formulas." Catalog free. Kemico, 12-P, Park Ridge, Illinois.

**"LUMINOUS Paint"** shines in dark. Easily made. 150 other formulas, plans—all 25c. Ideal Service, 307, Park Ridge, Ill.

**FORMULAS**—Latest, best. Analysis. Literature free. Belfort, Engineering Building, Chicago.

**NEW** "Athlete's foot" treatment formula, \$1.00. Sterling Products Co., Springfield, Ill.

**WHOLESALE** Catalog: Chemicals; 200 formulas, 47 single ingredient; 450 opportunity offers—10c. Linn Moore, Mosier, Oregon.

**RECLAIM** Used crankcase oil. Instructions dollar bill. Satisfaction guaranteed. Prairie Distributors, Wimmer, Saskatchewan, Canada.

**INDIVIDUAL** Formulas, prices, information free. Warren White, 1300 Commerce, Dallas, Texas.

**ICELESS** Ice! Colder; cleaner; cheaper. Instructions 25c. Duffy, Covington, Ky.

**10,000 MONEY-MAKERS!** Authentic formulas, recipes, secrets. Simple compounding instructions. Supply sources. Make most anything! 924 page illustrated book. \$1.50 postpaid or C.O.D. (Foreign \$1.85). Adams Brown Company, Chestnut Hill, Massachusetts.

**REAL** Manufacturing formulas. Lists free. Cummings, Chemist, Gordon Ave., Syracuse, N. Y.

#### CHEMISTRY

**WINN'S** New idea chemical kits and apparatus outfits for students, big value. Free literature and catalog of chemicals and laboratory supplies. Send 3c return postage. JE-7 Winn, 124 W. 23rd, New York.

**FREE** Chemical booklet, formulas, bargains. Rankin, Glover Bldg., Kansas City, Mo.

**CHEMISTRY** Laboratory apparatus and chemicals for industrial, analytical, and private experimental laboratories. Complete chemical laboratory supply service for correspondence school students. Send 3c for free 48-page catalog of chemicals and apparatus. Dept. M-43, Biological Supply Co., 1176 Mt. Hope Ave., Rochester, New York.

**CHEMICAL** Experimenter's supply catalog 5c. Colonial Chemical Company, Brockton, Mass.

**FREE** Catalog: chemistry, mineralogy, biology, microscopes. Tracey Laboratories, Evanston, Illinois.

**SPECTROSCOPE** For quick chemical analysis \$2.50. Kutting Sons, Campbell, California.

**CHEMICALS**—Small quantities, apparatus. Catalog 5c. Fleischer's Laboratories, Medford, Mass.

#### HELP WANTED

**BIG** Money taking orders; shirts, ties, hosiery, underwear, pants, jackets, sweaters, uniforms, etc. Sales equipment free. Experience unnecessary. Nimrod, 4922-BG Lincoln, Chicago.

#### AGENTS WANTED

**NEW** Air raid shoe sweeps country. Zips on—zips off. No fumbling or breaking of laces in blackouts or when alarm sounds. Huge profits for direct salesmen and women. Hundreds of other fast-selling shoe styles. Write for free sample shoe outfit. Mason Factory, Dept. M-59, Chippewa Falls, Wisconsin.

**PATRIOTIC** Signs—Big profits. Everybody buys. Samples 50c (no stamps). Reliable Screen Process Co., (Manufacturers) Washington Bank Bldg., Pittsburgh, Pa.

**JUST** Pull out and all items filed become visible. Agents 100% profit. Visible Filing Co., 615 Linn, Yankton, So. Dak.

**I WILL** Give you \$5.00 worth full size packages foods, groceries, soap, etc., free if you agree to show friends and others. Amazing spare time money making opportunity. Write Zanol, 6283 Monmouth, Cincinnati, Ohio.

**SELL** Welder's gloves and mittens, sample pair \$2.20 postpaid. Big agents discount. Kriewaldt Mfg. Co., Oconto, Wis.

**WONDERFUL** Opportunity. Miracle stone gives 100 shaves to razor blade. Inquire. Orenstein, 6221 - 23 Ave., Brooklyn, N. Y.

**FREE** Water and our concentrates, makes flavors, lotions, shampoos, 72 products, labels, bottles furnished. Qualco, E-20030 Russell, Detroit.

**MEN** Wanted for old Rawleigh routes which have paid our dealers big for years. Over 200 farm-home necessities. Old established demand. Specials every trip help make larger sales. Low wholesale prices. Good cash profits. No age limits. No layoffs. If you will work steady for good pay, write. Give age, references. Rawleigh Co., Dept. G-159-PPM, Freeport, Ill.

**COMIC** Clever everyday greeting cards. Straley, 1015 Mulberry, Springfield, Ohio.

**TIRES**, Autocop stops thieves cold, protects whole car, sample \$1.75. Autocop, B-20030 Russell, Detroit.

**MEXICAN** Feather, straw, pictures; sandals, tablecloths, etc. Quick sellers! 100%-300% profit! Free particulars. Samples 10c stamps. Marquez PA Apartado 1176, Mexico City.

**DOLLARS** Daily! Manufacturing, mail-order businesses. Surprising literature! Box 102-PM, Austin, Texas.

**SELL** Tire tools. Five exclusive features. Servwell Products, Cleveland, Ohio.

**NEWEST** Products. 200% profit repeaters. Peterschmidt, 139 Locust, Quincy, Ill.

**BE** Your own boss. \$1.00—\$1.50—\$2.00 advance commission every sale. Safelytco, sport, oilproof garage shoes. Special offers. Free equipment. Moench Shoe Co., FM-1, Boston, Mass.

**WE** Pay you \$5 for selling ten \$1 boxes. 50 beautiful assorted name imprinted Christmas cards. Sell \$1.00. You make 50c. Free samples. Cheerful Card Co., 47 White Plains, N. Y.

**AUTOLARM**—Protects car; tires. Sample offer. McGee Radio, S-2033, Kansas City, Mo.

**WAR** Maps! (Advertising or without.) Samples 10c. Yale Sales, 100 Yale, San Antonio, Texas.

**LORD'S** Prayer on a real penny. Sells on sight. Full particulars and samples 25c. Perkins, 4745 Broadway, M-7, Chicago.

**START** Simplified manufacturing. Hire agents. Extremely profitable. Thermowks, Peoria, Ill.

**FREE!** Mexican curios, novelties! Big profits! Gallo Apartado 9318, Mexico City.

**BIG** Money taking orders; shirts, ties, hosiery, underwear, pants, jackets, sweaters, uniforms, etc. Sales equipment free. Experience unnecessary. Nimrod, 4922-AN Lincoln, Chicago.

**BIG** Profits selling Shelton Dust Absorbers. Samples 6—\$1.00 prepaid. Shelton Mfg. Company, Colorado Springs, Colorado.

**AGENTS**. Big line including food products. Fast selling premium and bargain deals. Low prices. Send card for big outfit offer with gift. Ho-Ro-Co, 2715 Dodder, St. Louis, Mo.

**AGENTS:** Stamping names on pocket-key protectors. Sample check with your name, address, 25c. Stamping outfits. Emblem checks, check-jobs, name plates. Hart Mfg. Co., 303 Degraw St., Brooklyn, N. Y.

**AGENTS**—To mail our literature. Good profits. Home business. Maywood, 1133 Broadway, New York.

**AGENTS**—300% Profit selling gold leaf letters; stores and offices. Free samples. Metallic Letter Co., 438-B North Clark, Chicago.

**AMBITIOUS** School seniors—Sell classmates the "tops" in graduation name cards. Best commissions. Free cards. Agencies going like wildfire. Hurry! Craftcards, Box 235-L, Pittsburgh, Penna.

**GAS** Stations want this new patented necessity. Knipp, Long Beach, California.

**BIG** Money applying initials on automobiles. Easiest thing today. Free samples. If you sell printing and advertising specialties we have an excellent sideline featuring Decalomania name plates in small quantities. "Ralco," 727 Atlantic Ave., Boston, Mass.

**DO** You want agents for your proposition? Your ad in this space will place your message before hundreds of men seeking fast-selling products. My folder "How to Secure Agents" is filled with proof. I'll gladly send you a copy free. F. W. Johnson, Manager Classified Advertising, Popular Mechanics Magazine, 200 E. Ontario St., Chicago.

#### HIGH-GRADE SALESMEN

**ATTENTION** Calendar men! Make big money daily with Esquire's famous 1943 Varga Girl Calendar now. Can be specially imprinted with your customer's advertisement—sells instantly to prospects everywhere. Liberal daily cash earnings. Excellent exclusive sideline. Be first in field. Write today. Esquire Magazine, Varga Girl Calendar Division, 415 Palmolive Bldg., Chicago.

**SALESMEN:** Write for details selling twin scrubbing brushes, self-wringing mops with changeable heads. Also floor wax applicators fitting our twin-brushes. A revolution in cleaning materials. The Twin-Brush Corporation, Clarksville, Tennessee.

**CALENDARS**, Fans, novelties—Beautiful complete lines all sizes, including jumbos, samples free. Start now, be first in field. Fleming Calendar Company, 6539 Cottage Grove, Chicago.

**PATRIOTIC** Give-away. Your opportunity! Sell America's most timely business card. Merchant's advertisement printed free. Sells on sight to everyone in business. Free samples. No car, experience, or cash necessary. Reply air mail today. Box 51, Dept. P, Norwood Branch, Cincinnati, Ohio.

**SALESMEN:** Add a genuine \$12.00 leather jacket to your line. Sample \$7.95 postpaid. Kriewaldt Mfg. Co., Oconto, Wis.

**MAC ARTHUR'S** 280 Page history from grandfather down to Douglas MacArthur, the man of the hour. Sample \$1.50 prepaid, with agents selling proposition. John E. Elgin, Publisher's Distributor, Cochise, Arizona.

**WRITE** Your own income—There's no limit! 40% commission daily. No experience necessary. Sell 1000 everyday business necessities and advertising specialties. No investment. Free sales portfolio. Willens, 2130 Gladys, Dept. 47, Chicago.

**ADVERTISING** Book matches. America's largest manufacturer of union label book matches. Fast selling line. Large sales producing kit. Sample matches. Complete cut catalog, 17 color combinations makes selling easy. Commission in advance. Superior Match Company, 7530 Greenwood, Dept. N-7, Chicago.

**SALESBOARDS**—Lowest prices. Diverso, 617 No. Second Street, Milwaukee, Wis.

**MAN** With car to establish retail store route. Openings almost every locality. Handle orders for nationally known manufacturer-jobber. Average 50% commission. Steady big pay opportunity. Sales experience unnecessary. World's Products Co., Dept. 107, Spencer, Ind.

**ADVERTISING** Book matches—World's largest "direct selling" book match factory offers advance cash earnings calling on every type of business. Experience unnecessary; full, part time; low prices; high quality; quick deliveries; powerful patriotic display repeats. Free kit, instructions. Match Corp. of America, 3433 West 48th Pl., Dept. E-7, Chicago.

**SELL** Everyday greeting cards! Liquidating 3,000,000 profitable sellers! Bulletin free! Sample box 25c. Elico, 438 North Wells, Chicago.

**BIG Commissions**—selling to stores celulooid pricing tickets, metal shelf moulding. To restaurants, menu covers, signs. P. Pricing Press, 124 White St., New York.

**NEW Specialty**—Sells every business and professional man. Four \$15 sales daily pay \$270 weekly. Farrell cleared over \$1,000.00 monthly. Write, F. E. Armstrong, President, Dept. PM, Mobile, Ala.

**EARN Money** in your spare time taking subscriptions to Popular Mechanics. Unlimited possibilities, every family a prospect. Easy to sell. Bonus paid in addition to liberal commission. Send postcard for further details today. Circulation Dept., Popular Mechanics Magazine, 200 E. Ontario St., Chicago.

#### EDUCATIONAL AND INSTRUCTION

**LEARN To read Blueprints** for a better job in war production. This practice set in Blueprint Reading for beginners includes 39 machine blueprints for reading, all taken from actual machine operations, also instructions and answers. Send \$2.00 for set. McKnight & McKnight, Bloomington, Illinois.

**"BLUEPRINT Reading Made Easy."** Just published—\$2.98. "Diesel Handbook." (\$5.00 edition) now \$2.98. Alexander's, Box 713, Washington, D. C.

**BE Happy—earn more—win friends—**increase your enjoyment—with these great bargains in self-teaching books! Business—Music—complete textbook courses! Which do you want for free 5-day examination? How to get things done; Spanish self-taught; how to play piano by ear; art of conversation; new book of etiquette; writing and selling—Jack Woodford's system of writing for money; how to worry successfully—turn your natural tendency into money; Sherwin Cody's new art of speaking and writing English language; strategy in handling people; new ways in photography; great symphonies—how to recognize, enjoy, remember them; book-keeping made easy; how to write letters. Order as many as you like! Read 5 days. Return those you don't want—pay only \$1 each (plus postage) for books you keep! Send free-examination order (without money) now! Garden City Publishing Co., Dept. 107, Garden City, N. Y.

**WELDING**—Electric arc. Learn profitable trade quickly through actual practice. Individual welder instruction at bare cost of materials. Full particulars free. Valuable welding lessons book 50c. Hobart Welding School, Box M-722, Troy, Ohio.

**NEW Writers** wanted to re-write ideas in papers, magazines, books. Splendid opportunity to "break into" profitable writing field. Rush postcard for free details. Comfort Writer's Service, Dept. P-149, St. Louis, Mo.

**WELDING** Opens the way to good pay and future in important industries. Growing need for trained welders. Prepare now. Practical, personal training spare time at home and Chicago. Write for free facts. Utilities Engineering Institute, 1314 Belden, Dept. 127, Chicago.

**"SHORT-CUT Mathematics Combined With Practical Mechanics Simplified."** This new self-study course is now ready. Large illustrated volume with questions and answers. Only \$1 postpaid. Satisfaction guaranteed. Free details. Write Nelson Co., 500 Sherman, Dept. G-306, Chicago.

**LEARN Drugless therapeutics.** Practice Naturopathy and Metaphysical healing. Write Dr. Manks, DeLand, Florida.

**RADIO Communication** course for home study. Covers all phases of operator license and job requirements. Free circular No. 3M. Nilson Radio School, 51 East 42nd St., New York.

**DRAFTING, Trigonometry** courses \$1 each! Inquire J. R. Giles, 1326 Myers, Burbank, Calif.

**U. S. Government jobs.** War causing hundreds appointments. \$1260-\$1620 first year. Men-women. Prepare immediately for examinations. Full particulars and list positions, free. Write today. Franklin Institute, Dept. M2, Rochester, N. Y.

**MAIL** Only \$2.00 for \$5.00 diagrammed home ballroom dance course. Ludwig's, 532 Geary, San Francisco.

**GET Square,** now, with Biblical wealth lore and achieve real independence. Send only one dollar, today, for 8,500-word private typescript copy. Emetaz-2, Montville, New Jersey.

**SECRET Investigation.** Experience unnecessary. Detective particulars free. George Warner, M-2640 Broadway, N. Y.

**BECOME A Doctor of Psychology** (Ps. D.) Teach secret of contentment, happiness. Solve mental worries. Free book. College of Universal Truth, 20-B East Jackson, Chicago.

**LOCKSMITH Course.** Lock picking, key fitting, etc. \$1.00 prepaid. Locksmith, Canadian, Texas.

**CLINICAL Laboratory technic** taught in your own home. Practice outfit supplied. Bulletin free. Imperial Technical Institute, Box 973-E, Austin, Texas.

**LEARN Telegraphy!** Splendid opportunities now prevail. All expenses low. Catalog free. Dodge Institute, Dept. M, Valparaiso, Indiana.

**RADIO Engineering,** broadcasting, aviation and police radio servicing, marine and Morse telegraphy taught thoroughly. All expenses low. Catalog free. Dodge Institute, Dept. R, Valparaiso, Ind.

**ARC And spot welders.** Make them yourself. Very simple. Inexpensive. Complete details 25c. Popular Mechanics Press, Dept. 402, 200 E. Ontario, Chicago.

#### CARTOONING, COMMERCIAL ART, SHOWCARD WRITING, SIGN PAINTING

**CREATE Cartoons—here's how.** Brand new book of instruction on comic drawing. Over 350 illustrations. \$1.00 postpaid. Roy Hetzler, Box 407, Rochester, N. Y.

**CARTOONS** And commercial illustrations. Expert service. Ned Woodman, Monroe, Wisconsin.

**EARN Money,** copying and duplicating comic cartoons for advertisers. Ad-Service, Argyle, Wisconsin.

**CARTOON!** Guaranteed course, drawing pencil, paper, \$2. Warren, Cartoonist, N7509 Smith, Spokane, Wash.

**"HOW To Be a Gagster"**—25c. Illustrated booklet by professional gagman gives gag-writing methods, markets! Crash this big money-making field! R. Usher, Dept. M, 2716 Hampden, Chicago (enclose postage.)

**CARTOONING Course—36 lessons,** 6 booklets, 816 illustrations, 100 markets, personal criticism \$2.45. Templeton, 146 Wellington, Elgin, Illinois.

**CARTOONING Course—30 illustrated lessons,** over 500 sketches. \$1.00 postpaid. Montes Studio, Box 985, Pasadena, Calif.

#### ADVERTISING AGENCIES, LETTER WRITERS, FOR ADVERTISERS

**ADVERTISE Profitably:** \$15 reaches 5,000,000 Sunday newspaper readers with 24-word ad. Newspaper, magazine, mailing-list ratebook, free. Chicago Advertising Agency, 20-PA West Jackson, Chicago.

**MAILORDER Letters,** literature, campaigns, written. Powerful! Guaranteed! Reasonable! Finkel Advertising, 1013P Los Angeles Street, Los Angeles, Calif.

**ADVERTISE:** 24 Words, 149 newspapers, \$8.50. Lists free. Advertising Bureau, 4515-C Cottage Grove, Chicago.

**FREE—New Advertisers Rate Guide,** 44 pages. Includes everything. Lowest rates. E. H. Brown Advertising Agency, Merchandise Mart, Chicago.

**ADVERTISING** Placed all magazines, newspapers U.S.A., Canada. Lowest rates. Free service. 54-page catalog free. Baker Advertising Agency, A-189 W. Madison, Chicago. Established 29 years.

#### BUSINESS SERVICE

**CHICAGO Mail address:** \$1 monthly—Receiving, reforwarding your business, personal mail. General, 30 West Washington. (Established 1919).

#### RUBBER STAMPS AND OFFICE SUPPLIES

**UNION-MADE,** Superior quality—reasonable. Reinhardt's, 2295 Concourse, Bronx, N. Y.

**ILLINOIS Rubber Stamp Works,** 2913 P.M. N. Rockwell, Chicago. Catalog free.

**BUDDY,** Your name, address three lines 35c. Slocum, 814 Bradley, Peoria, Illinois.

**3 LINES 30c;** Cushioned, indexed, 35c. Signatures \$1.50. Stamprite, Wauwatosa, Wis.

**SIGNATURES,** Cushioned indexed \$1.50. Lentz, Box 402, Youngstown, Ohio.

**2 LINE 25c, 3 Line 35c.** M. Struble, Cupertino, California.

**KNOB Handle,** cushioned. 2 Lines 30c, 3-40c. Stamp Works, Centerport, N. Y.

**2 LINES 25c, 3 Lines 35c.** Stamp Works, Auburn, Nebr.

#### TYPEWRITERS, DUPLICATORS, OFFICE DEVICES

**TYPEWRITERS.** Adder, mimeograph, multigraph, addressograph. Send for free lists of machines that will help you at half price. Pruitt, 28 Pruitt Bldg., Chicago.

#### PRINTING OUTFITS AND SUPPLIES

**3-COLOR Printer—One operation.** Typing, drawing or writing. Free particulars. Color-Stamp Company, 143 N. Battin, Wichita, Kansas.

**WE Defy duplicators** to beat Screen-O-Print. Reproduces typewritten letters, halftones, printing. All colors. Letter size \$4.89 including ink stencils. Write Anthony Unis, Peoria, Ill.

**INEXPENSIVE 6x9 Printing press.** Details free. Novelty Shop, Downsville, Louisiana.

**PRINT Your own cards,** stationery, circulars, advertising. Save money. Simple rules furnished. Print for others, nice profit. Junior outfit \$8.25, senior outfits \$17.38. Details free. Kelsey, Inc., T-11, Meriden, Conn.

**PRINT At home,** 10c will bring a complete catalog of presses, type and supplies. P. Peiffer & Company, 6 Columbia St., Newark, N. J.

**BARGAINS—Presses,** type, supplies. Send stamp. 159 Harvard, Cambridge, Mass.

**USED Presses,** type, supplies. Lists 3c. Turnbaugh Service, Loysville, Penna.

#### PRINTING, MULTIGRAPHING, MIMEOGRAPHING, GUMMED LABELS

**AIR Mail envelopes,** large No. 10 size, red, white and blue border, your printed corner card, 100 postpaid \$1.00, 300-\$2.00. Free pricelist other printing. Transamerica Envelopes, 512 Shelby, Detroit, Mich.

**POSTPAID—All colors,** 200 sheets, 100 envelopes, \$1.00, 1000 lots, \$1.98 up. Thousands pleased! Vinnar Paper Supply Co., Thompsonsown, Penna.

**\$1.00 POSTPAID,** 100 Bond 8 $\frac{1}{2}$ x11 letterheads and 100 6 $\frac{1}{2}$  envelopes. Benneville, 907 West Roosevelt, Philadelphia.

**MODERN Mimeographing,** \$1.00 up. Free samples. Lowelty, 277 Foster, Lowell, Mass.

**SPECIAL Bargain month.** Also \$1.00 item. Samples stamp. Hart Printers, Fredonia, N. Y.

**FREE Estimates** printing of all kinds. Samples. Address, Chelsea, Oklahoma.

**WE Print anything:** State requirements. No obligations. Jack's Printing Service, Box 5450-Metropolitan Station, Los Angeles, California.

**HAMMERMILL Letterheads,** envelopes, all colors, 32 styles type. Free particulars. Woodruffs', 217-A4 Lewis, Duluth, Minn.

**75 ENVELOPES,** 75 Letterheads, together \$1 postpaid. Jaehler, 223 Woodworth, Yonkers, N. Y.

**YOUR Name,** address, printed, 500 each—Stickers 1 $\frac{1}{2}$ "x2" and memorandums 4" x5" \$1.50 postpaid. Miniature label specialties—700 designs, 10c. Arrowprint, PM742, Waterbury, Connecticut.

**"NO Lineage Limit"** Mimeographing—300 letters or 300 postcards \$1.00. Dollar Letter service, 180 West Washington, Chicago.

**150 EACH—8 $\frac{1}{2}$ x11 Letterheads,** 6 $\frac{1}{2}$  envelopes. \$1.50. John Ferreira, 220 Army St., New Bedford, Mass.

**5000 6x9 CIRCULARS \$8.00.** All printing reasonable. Samples, Specialty Sales, 3064 Fifth, Chicago.

**500 2 $\frac{1}{2}$ x2 $\frac{1}{4}$  FOUR Line gummed stickers,** 25c. Moritz Printery, Saginaw, Mich.

**JOB Printing,** Quick, reasonable. Samples. Atlantic, Box 653-H, Rock Hill, S. C.

**WANTED** Printing of all kinds by thousands of our readers. Your ad in this space will bring you some nice orders. Write for positive proof. F. W. Johnson, Classified Advertising Manager, Room 304, 200 East Ontario Street, Chicago.

**PATENT ATTORNEYS**

**INVENTORS:** Take first step toward protecting your invention—without obligation. Write for free "Record of Invention" form for establishing date of invention and free "Patent Guide for the Inventor"—telling about confidential search service; how to sell and market inventions; details of convenient payment plan. Send today for free "Patent Guide" and "Record of Invention" form. Clarence A. O'Brien and Harvey Jacobson, Registered Patent Attorneys, 21B-G Adams Building, Washington, D. C.

"INVENTOR'S Guide." 100 mechanical movements, free; advice on patenting, selling inventions. Frank W. Ledermann, 154 Nassau Street, New York.

115 MECH. Movements—Just what you may need to complete your invention. 48-page illustrated book contains valuable information for inventors. Yours—free. Write today. Victor J. Evans & Co., 631-H Victor Building, Washington, D. C.

L. F. RANDOLPH, 302-B Victor Bldg., Washington, D. C. Low cost. Book and information free.

**PATENTS.** Booklet free. Highest references. Best results. Promptness assured. Watson E. Coleman, Patent Lawyer, 724 Ninth St., Washington, D. C.

**INVENTORS—**Before disclosing your invention to anyone send for form "Evidence of Conception"; "Schedule of Government and Attorneys' Fees" and instructions. Sent free. Lancaster, Allwine & Rommel, 411 Bowen Building, Washington, D. C.

**FOR INVENTORS**

**WAR Inventions—**"National Inventors Council" now active! Recommending government's adoption of civilians' inventions considered valuable for nation's war effort. Act now for Council's prompt disposition of your invention. Get our free advisory books on patent procedure. Victor J. Evans & Co., Registered Patent Attorneys, 632-H Victor Building, Washington, D. C.

**INVENTORS—**Protect your idea with a patent. Secure "Patent Guide" and "Record of Invention" form—free. No charge for preliminary information. Write Clarence A. O'Brien and Harvey Jacobson, Registered Patent Attorneys, 21A-G Adams Building, Washington, D. C.

**INVENTORS—**Patent your invention. Secure book, "Protect, Finance and Sell Your Invention." No obligation. McMorro and Berman, Registered Patent Attorneys, 134-E Barrister Building, Washington, D. C.

**SELL** Your invention; direct, modern method. Crompton, 99-M Owen, Detroit, Michigan.

**INVENTORS—**Have you a useful, non-military invention for sale? Practical new ideas, patented or unpatented, urgently needed by manufacturers and consumers. Write for details. Chartered Institute of American Inventors, Dept. 4-A, Washington, D. C.

**I SELL** Patents. Established in 1900. Charles A. Scott, 773PM Garson Ave., Rochester, N. Y.

**CASH** For practical ideas and inventions. Mr. Ball, AB-9441 Pleasant, Chicago.

**SELL** Your patent through a small classified ad in Popular Mechanics. Many inventors have found buyers in this way. Ask me for proof—I'll gladly send it to you. F. W. Johnson, Manager Classified Advertising, 200 E. Ontario St., Chicago.

**INVENTIONS WANTED**

**LARGE** Manufacturer of metal and plastic products needs products for after war. Write Hordreg Company, Huntington, Indiana.

**WANTED—**Meritorious patented, unpatented inventions. Booklet, references, free. Invention Reporter, 5B-11236 So. Fairfield, Chicago.

**INVENTORS—**Small manufacturers need new inventions for altered civilian markets. If you have a practical, useful idea for sale, write Chartered Institute of American Inventors, Dept. 4-D, Washington, D. C.

**CASH** For inventions, patented, unpatented. Mr. Ball, A-9441 Pleasant, Chicago.

**YOUR** Ad in this space will bring amazing results. I'll prove it to you. Write at once for interesting information. F. W. Johnson, Room 300, 200 East Ontario St., Chicago.

**PATENTS FOR SALE**

**FOR Sale—**Patents on non chip bottle opener, also 3 models of 6 bottle metal carrier and one 6 bottle wooden carrier for beverages. If interested write G. H. Hutaff, Jr., Box 716, Wilmington, North Carolina.

**INVENTION.** Sheet metal, materials obtainable, useable in armies, cities, farms. Chas. Gardner, Pleasant Grove, Calif.

**NEW** Departure fluid coupling. Manufacturers act promptly. Hoehn, Alder-grove, B. C.

**MANUFACTURING**

**MODELMAKERS.** Diemakers, brass-workers, machinists, turnstiles, circulars. Baum's Specialties, Kansas City, Mo.

**MODELS—**Small lot manufacturing. Metals, plastics, etc. Milburn, Burlington, Kentucky.

**MODELS AND MODEL SUPPLIES**

**TREES—**Natural-ones for your displays. Circular and sample ten cents. Robert Morris, 2728 West Montgomery Ave., Philadelphia, Penna.

"**CONSTELLATION**" Carved hull construction set, separate fittings, blueprints. 52 page illustrated catalog 20c, listing hundreds of ship and yacht model fittings. A. J. Fisher, 1002-7 Etowah Ave., Royal Oak, Mich.

**SHIP** Models and yacht supplies complete. Large 96 page catalogue 15c. Bill Wild's, 510 East 11 St., New York City.

**SHIP** Model kits and fittings. Complete line Fisher model yacht equipment. All Boucher, Fisher, Marine Model and Ideal kits, fittings and blueprints at catalog prices. Most complete stock in New England. James Bliss & Co., Inc., 220 State Street, Boston, Massachusetts.

**LATEST** Engine catalog 25c. Refunded. Howardco, A-2417 North Ashland, Chicago.

**MINIATURE** Steam locomotives, new catalog listing all builders' needs 25c. Little Engines, Wilmington, California.

**FREE—**Big list of helpful books. Popular Mechanics Press, 200 E. Ontario St., Chicago.

**HOME CRAFTSMEN**

**SIMPLIFIED** Plans. For making camera tripod, printing press, rowing machine. Dime each! All three, 25c! Special tools unnecessary! Prohaska Publications, Johnstown, N. Y.

**28 LAWN** Ornament patterns 25c. Other patterns; 15" -20" high; Dutch girl, Dutch boy, pirate, bull terrier, Mexican girl, Mexican boy, dwarf, penguin, flower girl, 10c each; 3 for 25c. 25 novelty patterns 30c. All 62 full size patterns \$1.00 postpaid. Strother, Box 383-DQ, Belington, W. Va.

**GET** Free leathercraft instruction pamphlets, prices of leathers, tools, projects. Fascinating hobby. Make beautiful gifts. Leather samples 5c. Wilder & Company, 1938 Crosby, Dept. 7F, Chicago, Illinois.

**PUNCTURE** Proof retreadable wood tires \$20.00 each. Copyrighted instructions for making \$1.00. Michael Schumacher, Westhampton Beach, N. Y.

**SQUAREKNOTTERS!** Make belts, handbags, etc. Quality cord samples with catalog, free. Beginners book, catalog and samples 10c. Special! Regular \$1 book with 90c beginners outfit, all for \$1. P. C. Herwig Co., Dept. J-34, 121 Sands St., Brooklyn, N. Y.

**LEATHERCRAFTSMEN:** Send 10c for new handbook and catalogue of tools and supplies. E. A. Sweet Company, Inc., Leathercraft Division, A-59, 148 State Street, Binghamton, N. Y.

**15 FULL** Size what-not patterns 25c. 25 lawn ornament patterns 25c. Albright Service, M-6901 Railroad Ave., Omaha, Nebr.

**WOODWORKING** Power tools—Make them yourself. Lathe, scroll saw, saw table, drill press, portable sander, bandsaw, motorized plane. Complete details only 25c. Popular Mechanics Press, Dept. 401, 200 E. Ontario Street, Chicago.

**SURVEYING INSTRUMENTS**

**DRAFTING** Instruments or supplies. Free bargain catalog. Gordon's 162-PM Madison, Chicago.

**WATCHES, OLD GOLD, JEWELRY, ETC.**

**GENUINE** Diamonds, out-of-pawn prices, unredeemed loans and distress merchandise; men's, ladies' rings, one carat \$95.00, 1/2 carat \$45.00. Shipped for free inspection, appraisal. Send for free list, hundreds of beautiful diamonds, very low prices. Lloyd Butler, President, Prudential Loan Association, 133-EG North Clark St., Chicago.

**GOLD Wanted!** Old jewelry, bridge-work, watches, diamonds, etc. Honest appraisal, immediate cash. Leuthold, 2227 1/2 N. Alabama, Indianapolis, Ind.

**CASH!** Gold, jewelry, teeth, coins, diamonds, mercury, etc. Ship! Simon's, 353 Old Arcade, Cleveland, Ohio.

**ZIRCON—**White diamond-cut, also other gems. Wholesale, retail. List. Leuthold, 2227 1/2 N. Alabama, Indianapolis, Ind.

**GUARANTEED** Highest prices; pen and pencil set free. Mail any jewelry, teeth, watches, rings, eyeglass frames, diamonds, reliable company. Free information. Consolidated-Ward, Box 810, Dept. H-2, Chicago.

**ELGIN.** Waltham watches \$3.50. Make big money. Free watch and jewelry catalog. Plymouth Jewelry Co., 163-F Canal St., New York.

**AGATES.** Fossil woods, three pounds \$1.50 postpaid. Jay Ransom, Aberdeen, Wash.

**WATCHMAKERS'** Materials, tools, jewelry—bought, sold. Best prices for old gold, diamonds. Free catalog. Ben Segal Company, Box 150, Chicago.

**HIGHEST** Prices for old gold—Mail your teeth, watches, jewelry. 100% full cash value mailed day shipment received. Satisfaction guaranteed or articles cheerfully returned. Information free. Chicago Gold Smelting Company, 300-P Champlain Building, Chicago.

**GOLD** \$35.00 Ounce. Mail old gold teeth, diamonds, jewelry, watches. Receive cash by return mail. Satisfaction guaranteed. Free information, Dr. Weisberg's Gold Refining Company, 1500-Q Hennepin, Minneapolis, Minn.

**5000 REBUILT** Watches! Free catalogue—Diamonds, jewelry, (3c postage). The New York Jobbers, 74 Bowery, Dept. M, New York, N. Y.

**RAZORS, BLADES, SHARPENING**

**FRANZ'S** Wonder Never Pull Razor Stop. Guaranteed for safety or straight edge razor. Saves blades. Price \$1.50. Agents, 318 So. A St., Santa Rosa, Calif.

**WANTED—MISCELLANEOUS**

**WANTED:** Mercury (quicksilver) \$1.50 per pound, any condition. Western Metal Co., Bloomington, Illinois.

**WILL** Buy your unused United States stamps. Small discount. What have you? Mint Sheet Brokerage Co., 618 Caxton Building, Cleveland, Ohio.

**MERCURY** (Quicksilver), tungsten, molybdenum, cadmium, high speed tool steel, bismuth, purchased in any quantity. Write for quotations. Metallurgical Products Co., 35th and Moore Sts., Philadelphia, Penna. Established 1909.

**HIGHEST** Prices for used cameras, binoculars, microscopes, drawing sets, tools, any optical or scientific instrument. Satisfaction guaranteed. Gordon's, 162-M Madison, Chicago.

**CASH** For anything. Justice Jewelry Jobbers, 190 North Wells, Chicago.

**PERSONAL**

**100 BRILLIANT** Photostamps \$1.00. Any print. Schlyliander, Station C, Toledo, Ohio.

**MEXICAN** Legal matters, Wm. Cocke, Reliable American Attorney, El Paso, Tex.

**BIRTH** Certificates, all ages, any state. Enclose postage. Herndon J. Thompson, Dept. 324, Davis, Oklahoma.

**ARCH** Supports custom made \$2.50 pair, impression material free. Nufect Co., 1472 Broadway, New York.

**WIN** Prize money—Booklet, "Successful Contesting," shows how, 10c postpaid. Bulletin listing \$100,000.00 prizes included. World Publishers, 4515-B, Cottage Grove, Chicago.

**SONGWRITERS**, Write for free booklet, profit sharing plan. Allied Music, Dept. 55, 7608 Reading, Cincinnati, Ohio.

**ARCH Supports** custom made \$2.50 pair, impression material free. Nufect Co., 1472 Broadway, New York.

**HUMAN Analysis**, find right job, etc., illustrated, 25c. NuAge Books, 3915 - 24th St., San Francisco, California.

**TATTOOING Outfits**, Write today. Zeis Studio, 728 Lesley, Rockford, Illinois.

**MISCELLANEOUS**

**FREE Winchester** pen and pencil set with your name in 22-karat gold. Distribute coupons. Write The John Woodard Co., Box 4515, Atlanta, Ga.

**DEFENSE Workers**, mechanics use Emul-soap the new odorless liquid soap that dissolves grease, removing it instantly from hands. Also antiseptic preventing infection, healing cuts. Be modern, use Emul-Soap. Rush 35c (coin only). Box 1946, Boston, Mass.

**TREASURE Hunters**. If you have any kind of treasure finder, old or new, I am ready to pay you cash money. I have nothing to sell. Write me immediately giving make or short description of your finder. Tom Smith, 1046 South Olive St., Los Angeles, Calif.

**BIG Mail** for you. Latest moneymaking offers, opportunities, catalogs, magazines. Name listed in directory 10c. Ideal Service, 128-M, Park Ridge, Ill.

**PAINT**-Famous nationally advertised brand—3½ gal. pail—\$2.69. Send stamp for catalogue. United, Box 1000, Newark, N. J.

**SURPRISE Yourself!** Eat your way to robust health—with Kretschmer's Wheat Germ, a storehouse of powerful vitamins. Four weeks supply \$1.20 postpaid, west of Mississippi \$1.45. Kretschmer Corp., Saginaw, Michigan.

**EARN Money**, copying and duplicating comic cartoons for advertisers. Ad-Service, Argyle, Wisconsin.

**LUMINOUS Paint**—New, brilliant, ¾ oz. bottle 25c. Fabiano Chemical, Elberon, N. J.

**IDENTIFY** Your camp, 6" x 24" board sign, any copy, \$1.00. Ramsden Sign Service, Fitchburg, Mass.

**RECEIVE** Advertising samples valued \$20. Write advertisers direct. List 15c. Carly Service, P.O. Box 143, Olneyville Station, Providence, R. I.

**NOW**, Anyone can sharpen lawn mowers quickly and easily with Keenedge. This amazing device fits mower-blade perfectly. You simply slide it along entire length of blade a few times, and presto! mower is sharp and keen cutting! Dandy for scissors, too. Try it for 30 days free. Send no money unless you wish to. Just name and address on postal. When sharpener arrives deposit \$1 with postman, plus few pennies postage. Or send \$1 now and we pay postage. Either way, we guarantee you'll be pleased, or anytime within 30 days return sharpener and get your money back! Because of war supply is limited. Send today to Keenedge, 3027 Main Street, Merrill, Iowa.

**RECEIVE** Gigantic mails, magazines, samples. Your name in numerous mailing lists 10c. Howard, 396 Broadway, New York.

**TATTOOING Outfits**, supplies, 1942 lists free. Percy Waters, Anniston, Ala.

**WE Train** you to become medical laboratory technician at home in spare time. Free catalogue. Imperial Technical Institute, Box 973-J, Austin, Texas.

**GET A better job**. Our books will help you advance. Barkain catalog free. Popular Mechanics, 633 St. Clair, Chicago.

**STEREOSCOPIC** (Three dimensional) art photos, Particulars for stamp, Oddity House, St. Petersburg, Fla.

**LUMINOUS Paint**—Makes any object luminous. Few minutes exposure—Shines all night. Guaranteed brightest paint made. Amazing kit consists of 3 bottles luminous paint (various colors), luminous blackout button—6 luminous markers and complete working instructions \$1.00. We can also supply complete line of blackout equipment. Write now. Scientific Research Products, 1902 Patterson Avenue, Chicago.

**SILVERING Mirrors**. Eight page folio on making mirrors 25c. Weston, 85 Bell, Seattle, Washington.

**UNIVERSAL** Transparent angle and ratio ataglance protractors, 100% engineering mechanics doal \$1.50 postpaid. Refund guaranteed. Trigoscope Instrument Co., 614 5th Ave., Corapolis, Penna.

**HEATING** Six rooms \$20.00 yearly. Circulars 10c. Rosenzweig, RR10A1, Cincinnati.

**SEND 10c** For illustrated catalog "Hard-to-find merchandise." Goldshield Products, Dept. M, 350 Greenwich St., New York.

**KILL** Dandelions instantly. Details 10c. Robinson, 606 Wade, Muncie, Indiana.

**INVENTORS - PATENT YOUR INVENTION**

Secure book, "Protect, Finance and Sell Your Invention." No obligation. **McMORROW AND BERMAN**, Registered Patent Attorneys, 1353 Barrister Building, Washington, D. C.

**110-VOLT AC GENERATORS**

& AC light plants. 1800 & 1200 rpm. Available for all standard voltages such as 110, 220 or 440 three phase; three phase, three wire or three phase four wire & 25, 30 or 50 cycles. 350 through 15,000 watts. Also rotary converters, motor generators, frequency changers, etc.

**KATOLIGHT**, 22 Elm St., Mankato, Minn.



**WORLD'S SAFEST SAW!**

**SYNCR** cuts ¾" soft, 1½" hard wood, thin metal, plastics—smoothly, quickly, safely. 14,400 Strokes Per Minute—7200 down-cutting, 7200 upward, non-cutting, REPELLING SAFETY strokes. Needs no motor, no oil. Lasts lifetime. Portable. Plug in—saw! If Dealer hasn't it, send \$12.75 check, M.O., we'll ship postpaid in U.S.A. only. Satisfaction Guaranteed. Write for FREE CATALOG!

**SYNCR WORLD'S SAFEST SAWS**  
SYNCR DEVICES INC.  
3265 Bermuda, Dept. PH-72, Ferndale-Detroit, Mich.

**PUSH BUTTON CONTROLLED GAS TANK LOCK**

**NO KEYS**—Electrically operated from dashboard. One model fits all cars including fender door type. Greatest thing out! Sells on sight! Fully guaranteed. Distributors, dealers, here is your money making opportunity. Rush name for free literature.

**SNAP-UP GAS CAP CO.** Dept. k, **ASHLAND, KY.**

**OTTAWA Log Saw \$39** **BIG BOOK FREE**

**PUTS THIS OTTAWA MAKE MONEY!** Wood is valuable. Does more than 10 men. Easily operated. Falls trees—saves limbs. Use 5-hp. engine for other work. Write for FREE Book.  
**OTTAWA MFG. CO.**  
5727 Wood St., Ottawa, Kans.

Always write your name and full address clearly when answering advertisements.



**Make sure of your pictures—use the G-E EXPOSURE METER to guide your camera**

Why take two shots to be sure of one? Get the G-E exposure meter and get more out of your camera by knowing the correct exposure every time. Amazing G-E accuracy makes every shot count. Sharply directional hood guards shadow detail and rich color. For either movies or stills, one-hand operation gives you the answer fast. See the G-E at your photo dealer's. **General Electric Company, Schenectady, N. Y.**



**GENERAL ELECTRIC**

**BE PREPARED! SHOOT NEW BENJAMIN TARGET PISTOL**

**NEW Streamlined Hand Pump—Longer Shot Barrel—Larger Grip—More Power—Accurate—Practical—Economical—Safe—Clean—Quiet. No smoke or fumes. Bolt Action—Hammer Fire—Hair Trigger—Safety Lock. Single Shot BB with 1 lb. shot \$9.00; Single Shot Cal. .177 or .22 rifled—with 500 pellets \$10.50; Hoister \$2.50. Also a complete line of Benjamin Genuine Compressed Air Rifles for BB and Cal. .177 or .22 pellets. Write today for complete specifications and free targets. **BENJAMIN AIR RIFLE CO., 890 Marion St., St. Louis, Mo., U. S. A.****



★

# America is building two great armies — YOU BELONG IN ONE OF THEM!



★ Even if you are not a member of Uncle Sam's armed forces, you can do an important job in defending your country! America needs *trained workers* as much as she needs trained soldiers and sailors! The man who neglects his *training*—neglects his *patriotism*!

★ If you can read and write, and are employed in business or industry, I. C. S. offers you a personalized, proved training program at low cost. Hundreds of thousands of successful men got their start through I. C. S. training. Mail coupon for further information on courses and low costs—**TODAY!** There's no time to waste!



## INTERNATIONAL CORRESPONDENCE SCHOOLS

HELPING TO TRAIN AMERICANS FOR VICTORY



BOX 5640-J, SCRANTON, PENNA.

Without cost or obligation, please send me a copy of your booklet, "Who Wins and Why," and full particulars about the course *before* which I have marked X:

### TECHNICAL AND INDUSTRIAL COURSES

- |  |   |  |
|--|---|--|
| <input type="checkbox"/> Air Brake<br><input type="checkbox"/> Air Conditioning<br><input type="checkbox"/> Airplane Drafting<br><input type="checkbox"/> Architectural Drafting<br><input type="checkbox"/> Architecture<br><input type="checkbox"/> Auto Engine Tune-up<br><input type="checkbox"/> Auto Technician<br><input type="checkbox"/> Aviation <input type="checkbox"/> Aviation Mechanic<br><input type="checkbox"/> Boilermaking<br><input type="checkbox"/> Bridge Engineering<br><input type="checkbox"/> Chemistry<br><input type="checkbox"/> Civil Engineering<br><input type="checkbox"/> Coal Mining<br><input type="checkbox"/> Concrete Engineering | <input type="checkbox"/> Contracting and Building<br><input type="checkbox"/> Cotton Manufacturing<br><input type="checkbox"/> Diesel Engines<br><input type="checkbox"/> Electrical Drafting<br><input type="checkbox"/> Electrical Engineering<br><input type="checkbox"/> Electric Lighting<br><input type="checkbox"/> Foundryman <input type="checkbox"/> Heating<br><input type="checkbox"/> Heat Treatment of Metals<br><input type="checkbox"/> Highway Engineering<br><input type="checkbox"/> House Planning<br><input type="checkbox"/> Industrial Metallurgy<br><input type="checkbox"/> Locomotive Engineer<br><input type="checkbox"/> Machinist<br><input type="checkbox"/> Management of Inventions | <input type="checkbox"/> Marine Engines<br><input type="checkbox"/> Mechanical Drafting<br><input type="checkbox"/> Mechanical Engineering<br><input type="checkbox"/> Mine Foreman<br><input type="checkbox"/> Navigation<br><input type="checkbox"/> Patternmaking <input type="checkbox"/> Plumbing<br><input type="checkbox"/> Practical Telephony<br><input type="checkbox"/> Public Works Engineering<br><input type="checkbox"/> Pulp and Paper Making<br><input type="checkbox"/> Radio, General<br><input type="checkbox"/> Radio Operating<br><input type="checkbox"/> Radio Servicing<br><input type="checkbox"/> R. R. Section Foreman<br><input type="checkbox"/> R. R. Signalman <input type="checkbox"/> Refrigeration                                    |
| <input type="checkbox"/> Accounting <input type="checkbox"/> Advertising<br><input type="checkbox"/> Bookkeeping<br><input type="checkbox"/> Business Correspondence<br><input type="checkbox"/> Business Management<br><input type="checkbox"/> Cartooning <input type="checkbox"/> Civil Service   | <input type="checkbox"/> College Preparatory<br><input type="checkbox"/> Commercial<br><input type="checkbox"/> Commercial Illustrating<br><input type="checkbox"/> Cost Accounting<br><input type="checkbox"/> C. P. Accounting  | <input type="checkbox"/> First Year College<br><input type="checkbox"/> Foremanship <input type="checkbox"/> French<br><input type="checkbox"/> Good English<br><input type="checkbox"/> High School<br><input type="checkbox"/> Managing Men at Work  |
| <input type="checkbox"/> Advanced Dressmaking<br><input type="checkbox"/> Foods and Cookery  | <input type="checkbox"/> Home Dressmaking<br><input type="checkbox"/> Professional Dressmaking and Designing  | <input type="checkbox"/> Sanitary Engineering<br><input type="checkbox"/> Sheet Metal Work<br><input type="checkbox"/> Ship Drafting<br><input type="checkbox"/> Shipfitting <input type="checkbox"/> Shop Practice<br><input type="checkbox"/> Steam Electric <input type="checkbox"/> Steam Engines<br><input type="checkbox"/> Steam Fitting<br><input type="checkbox"/> Structural Drafting<br><input type="checkbox"/> Structural Engineering<br><input type="checkbox"/> Surveying and Mapping<br><input type="checkbox"/> Telegraph Engineering<br><input type="checkbox"/> Telephone Work<br><input type="checkbox"/> Textile Designing<br><input type="checkbox"/> Toolmaking <input type="checkbox"/> Welding<br><input type="checkbox"/> Woolen Manufacturing |

### BUSINESS COURSES

### HOME ECONOMICS COURSES

Name..... Age..... Address.....  
 City..... State..... Present Position.....

Canadian residents send coupon to International Correspondence Schools Canadian, Limited, Montreal, Canada  
 British residents send coupon to I. C. S., 71 Kingsway, London, W. C. 2, England

# Popular Mechanics Magazine

REGISTERED IN U. S. PATENT OFFICE AND CANADA

WRITTEN SO YOU CAN UNDERSTAND IT

Vol. 78

JULY, 1942

No. 1

## "BOMB VOYAGE" TO TOKYO

*M 332*

By

Rear-Admiral C.H. Woodward,  
U. S. Navy

LIEUT. GEN. KOBAYASHI, commander of Japan's home defenses, wasn't just being an alarmist when he warned his people that they could expect American bombing raids from China or from the American-owned Aleutian Islands at any moment.

The U. S. Naval bombers that hit Marcus Island in March had hit close to Nippon. Tokyo began to have jittery nights and black-outs, and the worried General Kobayashi instituted air defense

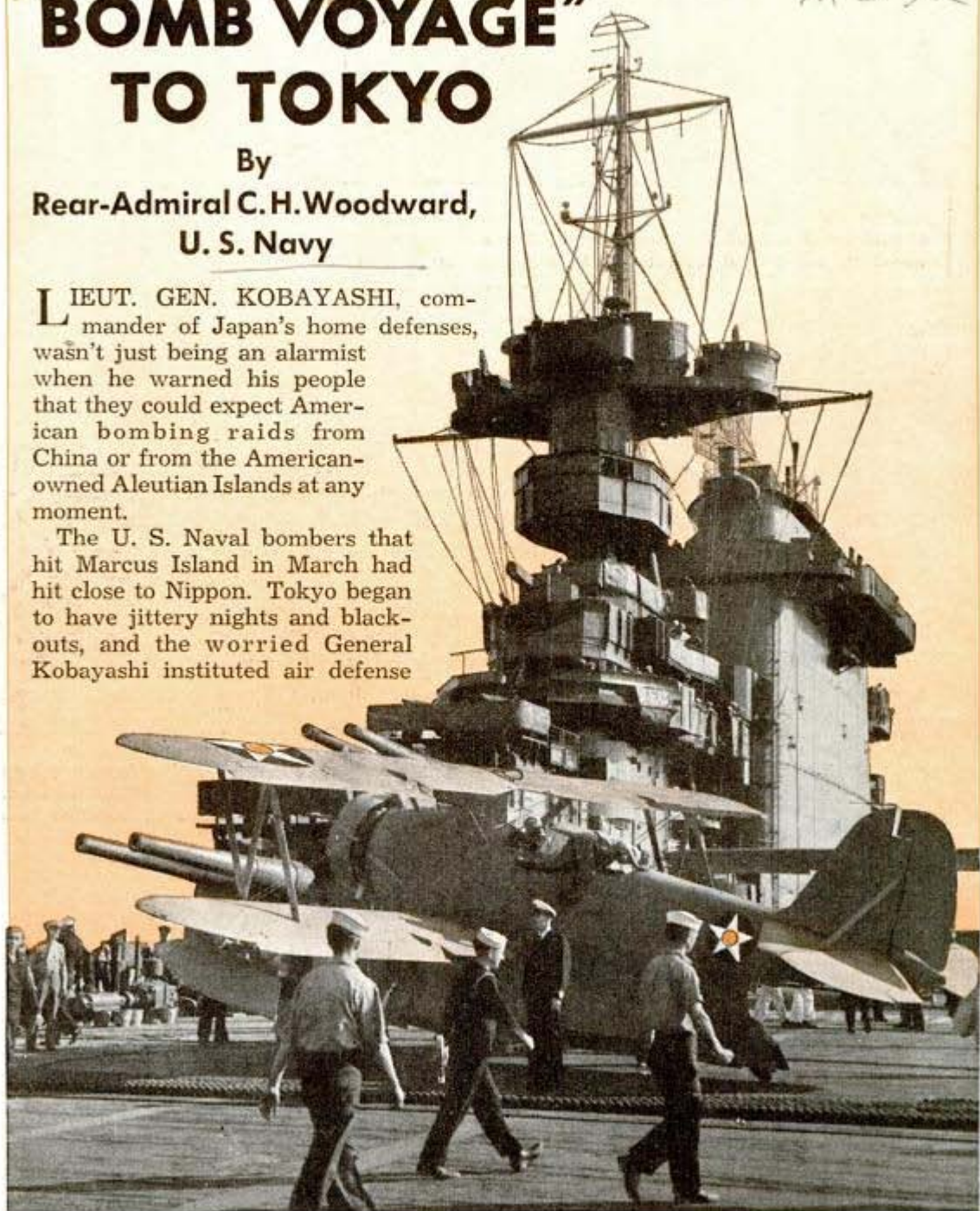

Somewhere on the Pacific a Grumman amphibian rests on the deck of the carrier Lexington, to which it has been lifted from the water by derrick on its return from an observation flight

JULY, 1942

*U.S. Navy - Grumman Amphibian  
1942 observation flight  
Washington, D.C.*

1



Hauling the observation plane aboard the Lexington; in the foreground is one of the carrier's guns. These planes scout ahead and alongside a "task force" on watch for enemy vessels

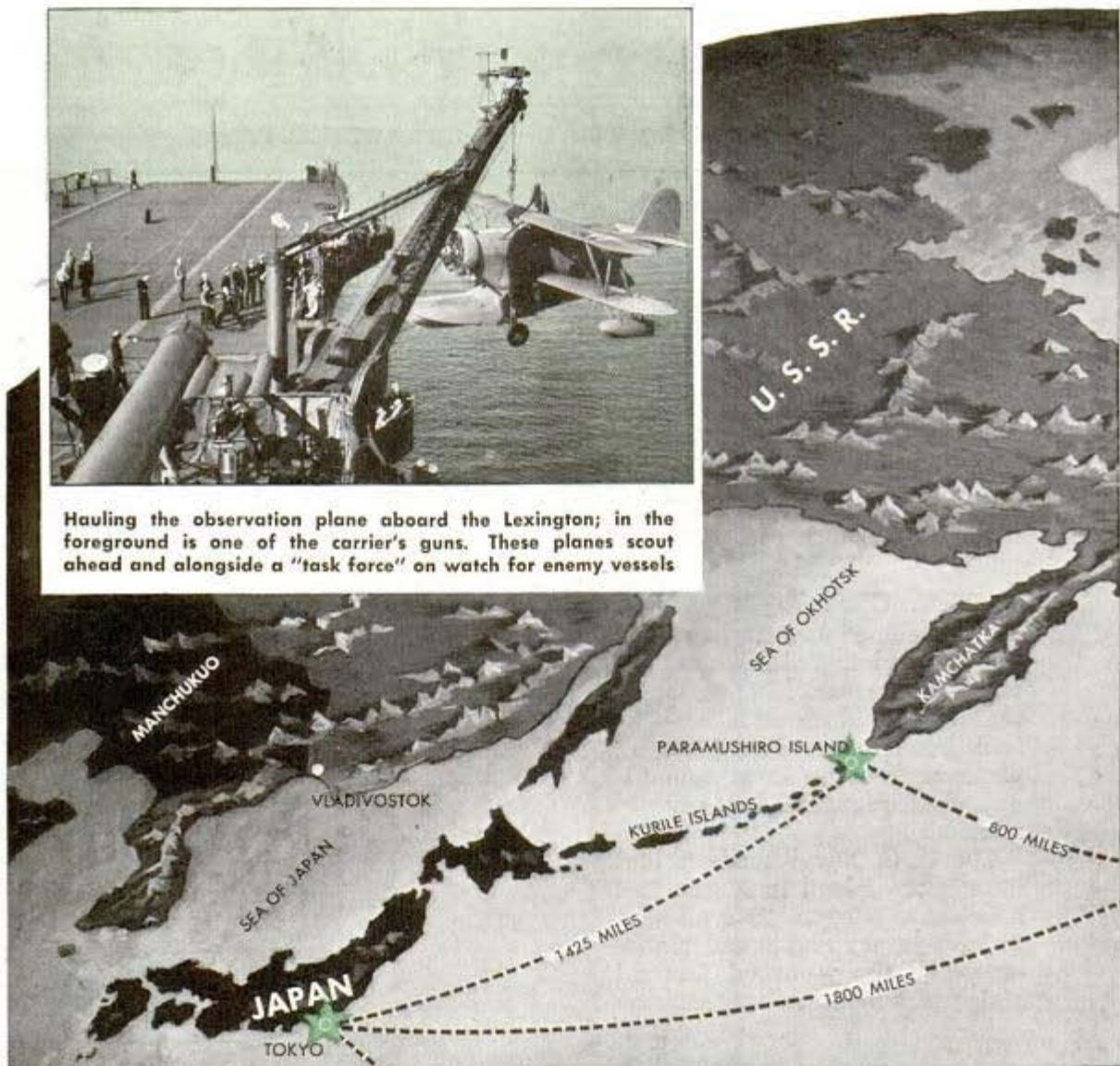

drills in every important community.

Then the bombs fell. Tokyo, Kobe, Yokohama, Nagoya felt the first blows of America's gathering might, and America was electrified by the news. At least a beginning had been made toward the fulfillment of General McArthur's official report to the War Department, wherein he said: "At the proper time I bespeak due retaliatory measures" for the "repeated, senseless and savage" bombing of the open city of Manila.

When he made that report, the immediate reprisal attacks on Tokyo for which Americans clamored were not considered sound military strategy. Unquestionably, though, "at the proper time," Tokyo and other important Japanese cities will be

The map shows the distances involved in an attack on Japan by way of the Aleutian island chain. Note that it is 800 miles from Attu to nearest Japanese base

blasted, bombed and burned — and ultimately exterminated.

A beginning has been made. And presumably further preliminary raids on Nipponese territory will be carried out to force Japan to recall some ships and planes to defend her own coasts, reducing the forces available for offensive operations.

The successive brilliant assaults on wide-



72 332

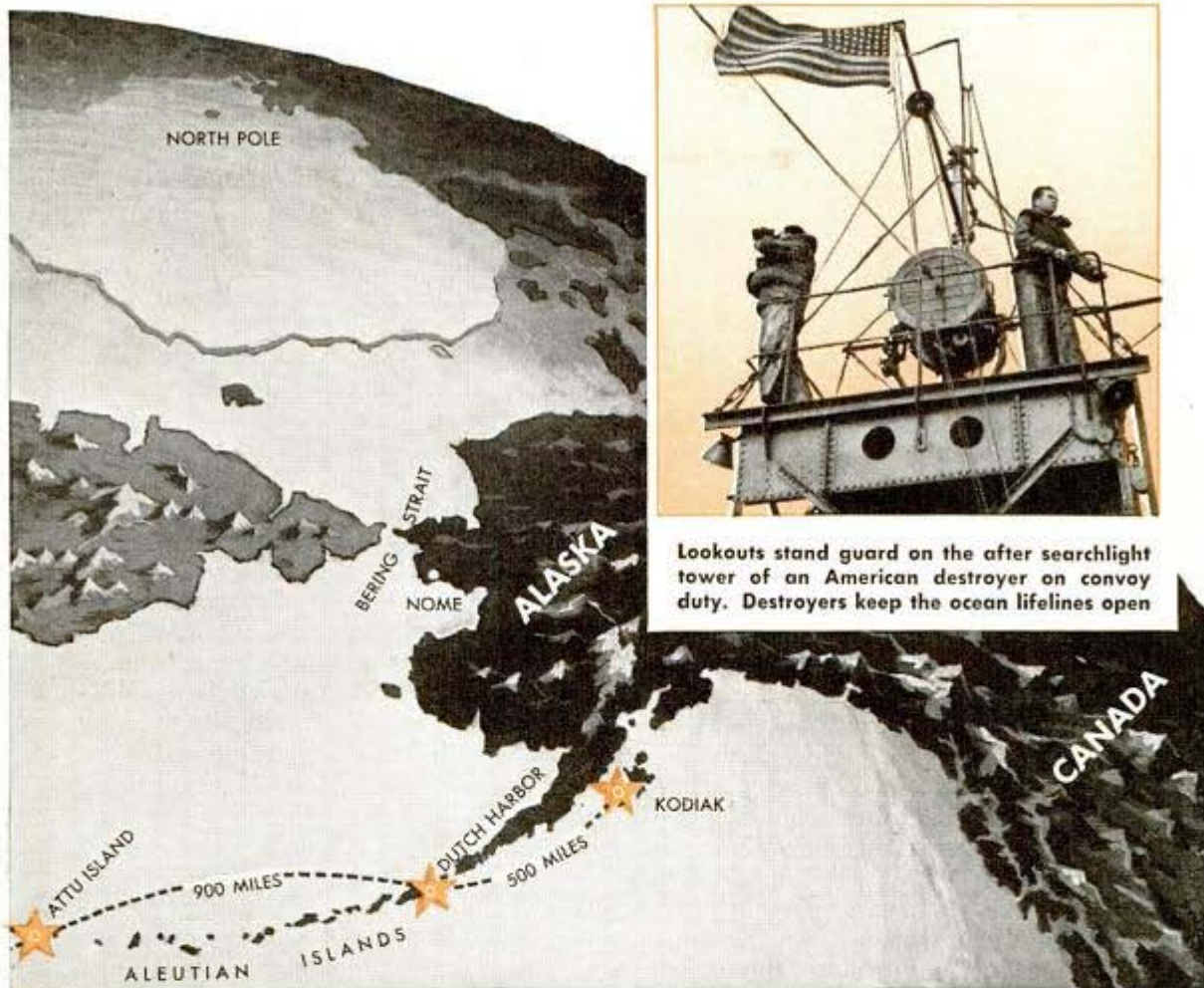

Lookouts stand guard on the after searchlight tower of an American destroyer on convoy duty. Destroyers keep the ocean lifelines open

ly separated Japanese-occupied islands by U. S. Navy striking forces under command of Vice Admiral William F. Halsey were thrilling and heartening news to America. Following hard after the smashing naval and air raids on the powerfully armed bases in the Marshall and Gilbert groups came the destruction of 16 out of 18 enemy planes "west of the Gilberts," a spectacular attack on the previously American-owned Wake Island, and then a raid on Marcus Island—a major stepping stone between Japan and her mandated territory (Nanyo, to the Nipponese), and only 970 miles from Tokyo and 700 miles from her two island bases at Chicha Jima and Saipan. The "task forces" employed consisted of one or more

aircraft carriers, each carrying several squadrons of planes, supported by heavy cruisers and destroyers.

As Japan still has superiority in the air, particularly over her own islands, it is extremely difficult—though by no means impossible—to dispatch planes (either shore-based or carrier-based) against her vulnerable cardboard cities. Sustained attacks would be out of the question. As carrier-based bombers are limited in both range and bomb-load, the greatest effect of "hit-and-run" raids would be psychological—terrorization of the populace.

There are a number of Allied air bases in Central China and near the coasts from which Japan can be bombed, and doubtless will be in good time. However, the other approach to Japan, via the Aleutian Islands, envisages a rapid movement from Alaska down the 900-mile bowspring of the Aleutians to Japan.

Without consideration of either the adequacy of base facilities (a vital military secret), the strategic value of the move-





Warplanes line up on carrier's deck as task force prowls in enemy waters

ment or the chance of success—which are the concern of expert war planners—and only as a matter of pure speculation, let us examine the physical possibilities of a combined sea-and-air attack by this route, keeping in mind the fact that this plan is not based on any official knowledge or inside information of what our navy planners are thinking.

A glance at a large map, or globe, shows us that the western islands of the Aleutian group are 1,800 miles from Tokyo or 1,600 miles nearer to the Japanese capital than are the Hawaiian Islands (3,400 miles distant); that the distance from Kodiak (site of a naval and submarine base, and keystone of the American North Pacific defense chain) to Dutch Harbor is approximately 500 miles, thence to Attu (the western extremity of the Aleutian group) another 900 miles; that Attu is only 800 miles from the Japanese air base of Paramushiro (northernmost point of the Kurile Islands and near the southern tip of the Kamchatka Peninsula), 1,425 miles from Tokyo.

The composition of the attacking force, considering that the intended blow is to be struck with

airplanes, undoubtedly would consist of five to seven aircraft carriers bearing some 350 - 400 bombers together with about 75 fighting planes, and a few torpedo planes for protection against any Japanese capital warships which might be encountered enroute.

With such a number of carriers, the protecting force would have to be a large and powerful one, and all units capable of making as much speed as the carriers:—say two of the new 35,000-ton battleships, six heavy cruisers, six light cruisers, and some 30-40 destroyers, with perhaps a number of submarines stationed along the route as additional precaution against patrolling enemy ships. Big patrol bombers ranging far out over the route from the Alaskan bases would add to the security of the task group, both on its outward and return passages.

Secretly assembled at Kodiak and Dutch Harbor, where fueling and other preparations would be completed, this formidable force should move out from its bases and at such speed as to pass Attu about midnight, thence at 25 to 27 knots on a southwesterly course approximately parallel to the Kurile Islands and at a distance of no less than 750 miles. Meanwhile an umbrel-



Silhouetted against the sinking sun, warships of the U. S. Pacific fleet carry out their patrol

7m 332

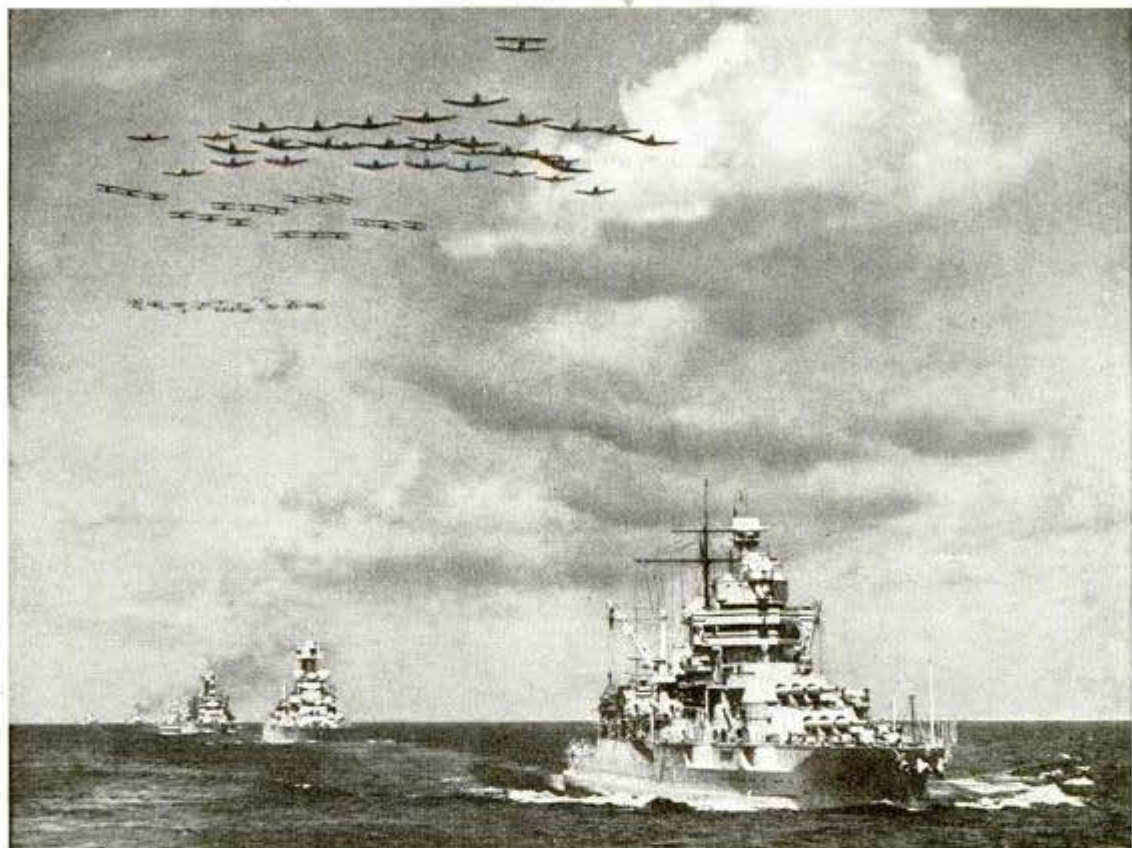

la of fighting planes should be maintained throughout the daylight hours, with scouting planes well advanced and on the flanks in order thoroughly to investigate the waters through which the attacking force will pass during the night.

If undiscovered, the force should continue on the second day as before and until within about 800 miles of Honshu, the main Japanese island, then head directly for Tokyo arriving, if possible, at a point 500 miles distant about dusk. With the added protection of darkness, all speed should be used in pressing forward for the kill, so as to arrive at a point some 350 miles off the coast about midnight, at which time the furies of hell would be loosed to wing their destructive way, squadron by squadron, toward the enemy's homeland,—two hours distant by air,—where a devastating and continuous blitz would be maintained for at least two hours.

Their mission accomplished, the bombers would wheel away and fly toward their rendezvous with the carriers and escorting vessels (already steaming toward home bases), timing the arrival just at daybreak so as to be able to make safe landings on

(Continued to page 178)

**Our mighty battleships, augmented by an air fleet rapidly gaining power, will carry the fight to Japan**

**Aboard the carrier Saratoga is a swarm of scout and fighter planes, light bombers and patrol craft**

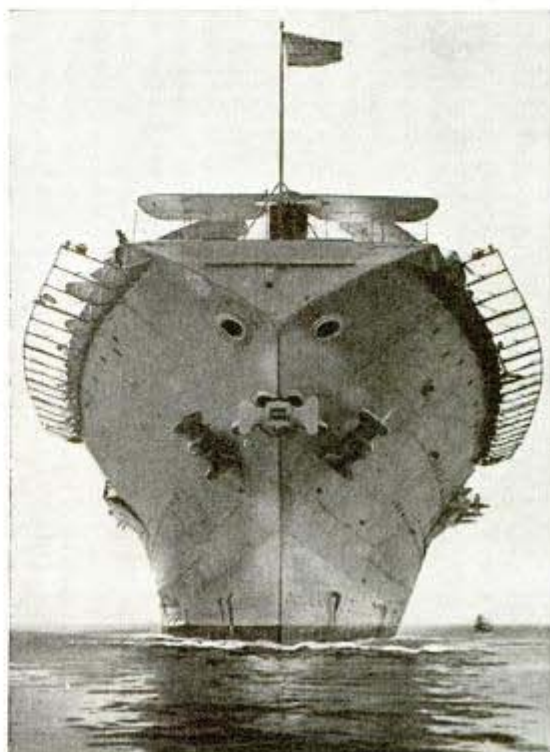

*m 344 Chicago Fire Equipment Co. 546 W. Lake Chicago Schenectady*

## Wall Cabinet for Air-Raid Tools Is Ready for Emergency



Wall cabinet holds complete equipment for fighting bomb fires

Produced especially for factories, office buildings and hotels, a steel cabinet housing equipment for combating fires started during air raids or by sabotage may be fastened to the wall within convenient reach. Painted a brilliant red, the case contains fire extinguishers including a five-gallon pump type with fire department hose connection, a quart of vaporizing liquid extinguisher for electrical and machinery fires, tarpaulin, fog nozzles, fire ax, shovels, asbestos helmet, gloves, goggles, gas mask, lanterns, pails and sand. In case of fire, a glass window in the front of the cabinet is broken to gain access to the apparatus.

## Vibrating Rods Test Fruit For Degree of Ripeness

Based on the old "plank" and "plunk" method of judging the ripeness of watermelons, but in a more scientific fashion, a fruit-testing device has been patented by Howard L. Clark of Ballston Lake, N. Y., and Walter Mikelson of Schenectady, who have as-

signed the rights to General Electric company. A blunt rod, vibrated by electromagnetic means, is thrust against the fruit to be tested, while a similar rod, pressed against its opposite side, picks up the vibrations as modified by the fruit. If its tissues are soft and ripe, they "damp" the vibrations more than they do if the fruit is hard and green. Converted again into electrical oscillations, the vibrations picked up by the second rod are registered by a pointer on a dial marked "green," "ripe," and "over-ripe."

## Electric-Drive Scoop-Truck Loads and Unloads Cars

Driven by three storage batteries, a scoop truck can ride inside box cars to pick up or unload loose materials of all kinds. It carries up to 1,800-pound loads and travels at a speed of seven miles an hour between the car and stock pile. A chain fitted with metal lugs lifts the scoop and holds it at convenient heights for dumping or filling. Holes in the bottom of the scoop permit drainage of water from wet materials. The three storage batteries, which are recharged every eight hours, supply ample power for the hard work performed by the truck.



Scoop truck runs in and out of freight car to load or unload

*Bennie L. Lucas 3 25 42*

*m 324*

*Pat. 112,247, 23, 24*

*m 316*

*Phyladelphie Tacoma*

72 40?

# Army Decontamination Squad Fights War Gas



Students in army's chemical warfare division clear a Hawaiian field and equipment of simulated poison gas

Preparing against every threat, the army has formed decontamination squads in Hawaii fully trained to counter any poison gas attack in the military area. In dress rehearsals the men wear gas masks and

special clothing to protect the skin. Smoke bombs simulate gas sprayed from enemy planes over an airport, and the chemical warfare students learn to decontaminate planes, trucks and ground with chemicals.

M 328

## Coal-Burning Air Conditioner Has Pit for Storing Ashes

Labor of firing a coal-burning winter air-conditioner is reduced to a minimum by a new stoker-fed heating unit that requires no shoveling and eliminates periodical ash disposal. Ashes are deposited into a large-capacity pit beneath the unit, from which they may be removed once a year by the dealer delivering coal. Coal flows through the stoker into the furnace from a dustless bin. Forced circulation carries air through spun-glass filters, and into the heating chamber where a large evaporating tank supplies humidity. The entire operation is controlled by a thermostat in the living room.

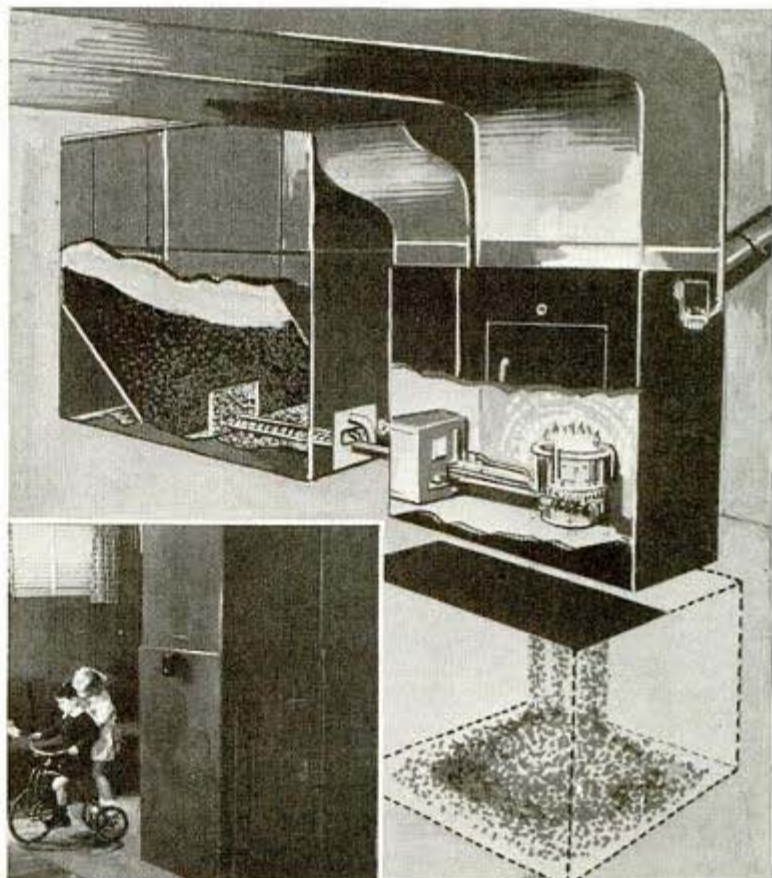

Cutaway sketch shows stoker, and ash pit under fire chamber. Inset, exterior view of cabinet



JULY, 1942

*Iron Kereiman Infy Co*  
3190 W. 106th St Cleveland  
Ohio

m225 Israil.

# The IRON HORSE Delivers the TOOLS of WAR

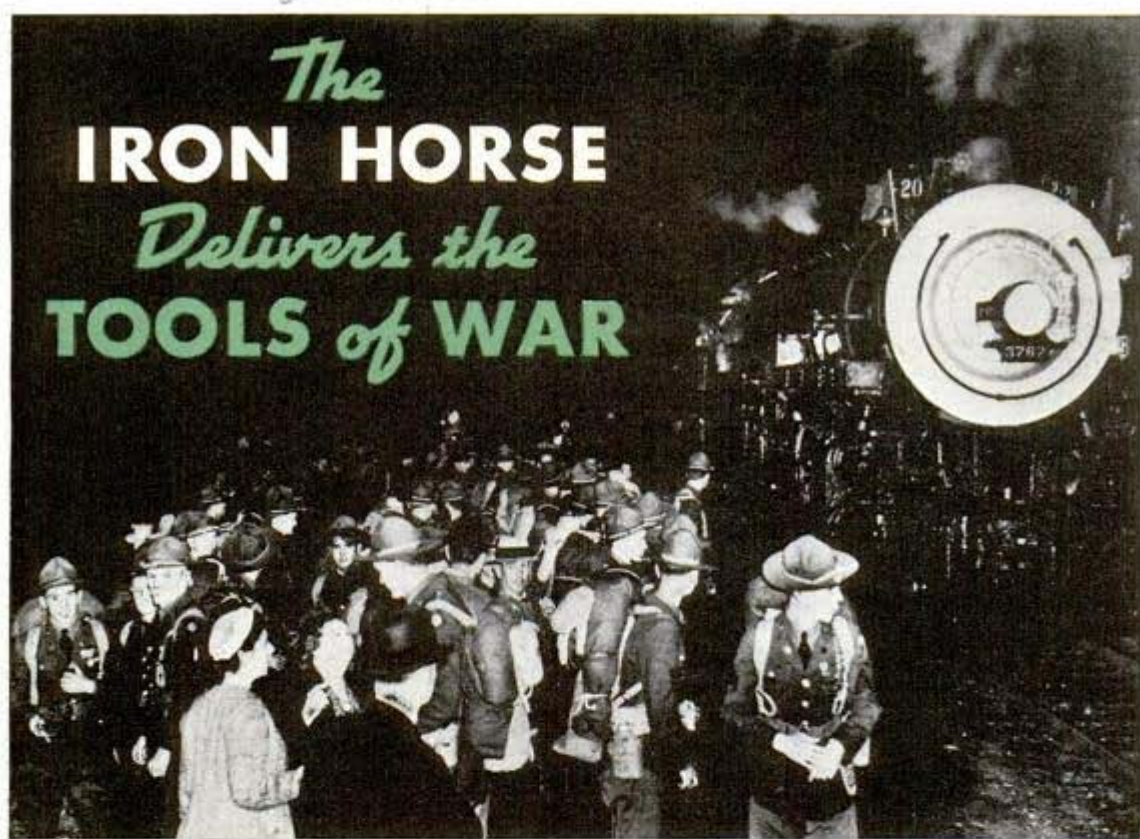

Troops boarding a special train. They travel in sleepers; "impedimenta" and field kitchens in baggage cars

## Part I

**S**UREST sign of an impending blitz in Europe is the public notice that passenger traffic on German or Italian railways is suspended or curtailed for the next few days. You can read between the lines—troops and supplies are on the move!

There's no such barometer to read in the United States. Unless you were halted at a grade crossing and saw the long strings

of flatcars laden with tanks and big guns pass by, or unless you caught a glimpse of the khaki uniforms at every window of the special train flashing westward, you could only guess that America was starting its own big blitz in the days after Dec. 7.

But it is no longer a secret that the greatest mass movement of troops and impedimenta and machines of war began within hours after the bombing of Pearl Harbor; that 600,000 soldiers and sailors and marines and airmen traveled across the states by railway in the first seven weeks of war with no more interference than an occasional sidetracking of your Midnight Express to let an army special race through. In round numbers that means that for 49 days, 30 trainloads a day of fighting Yanks moved from camps to bases; and the massing of forces still goes on. Nor does this include the vast number of military freight trains rolling across the land. Full trainloads of bomber and fighter

Its crew peering from portholes, a tank crawls from car to car



70225

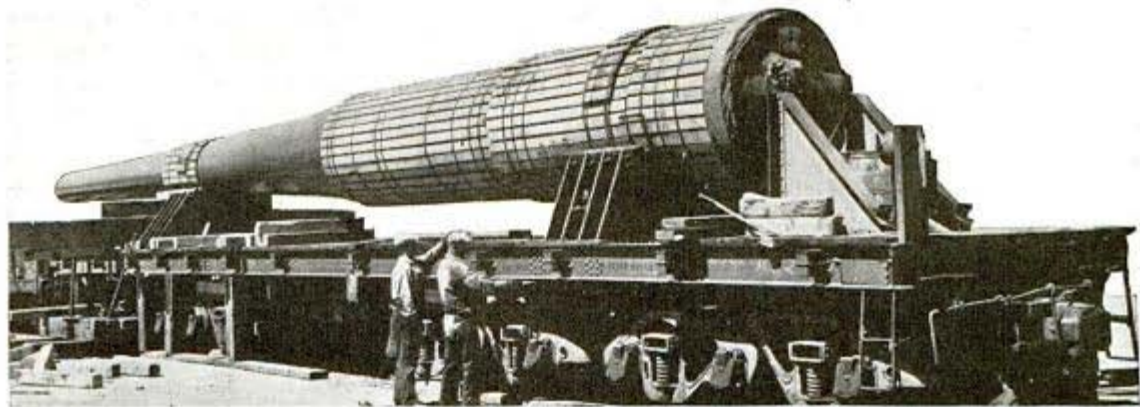

U. S. Army Signal Corps photo

An army big gun, weighing many tons, is cradled on an oversized flatcar

planes, knocked down for shipment but ready for quick assembly, steamed westward from aircraft plants and warehouses of the middle west a day after war broke. As one example of the swiftness of mobilization, within 24 hours of Pearl Harbor a 38-car train laden with prefabricated, portable airport runways passed through Chicago on its way to an untold front.

Some of these war freights string out more than a mile from cow-catcher to caboose. When they start rolling, everything else steps out of the way. A regular train arriving in a big classification yard at such a shipping center as Chicago or St. Louis



"Allegheny" type engine of the Chesapeake & Ohio, with unique 2-6-6-6 wheel arrangement, hauls heavy coal trains over eastern mountains. Below, armored division puts aboard a trainload of track-laying trucks



m 225



The railroads supply end-loading box cars to accommodate army trucks

Inspecting a wrought steel wheel. Some of these car wheels have averaged 300,000 miles of road service

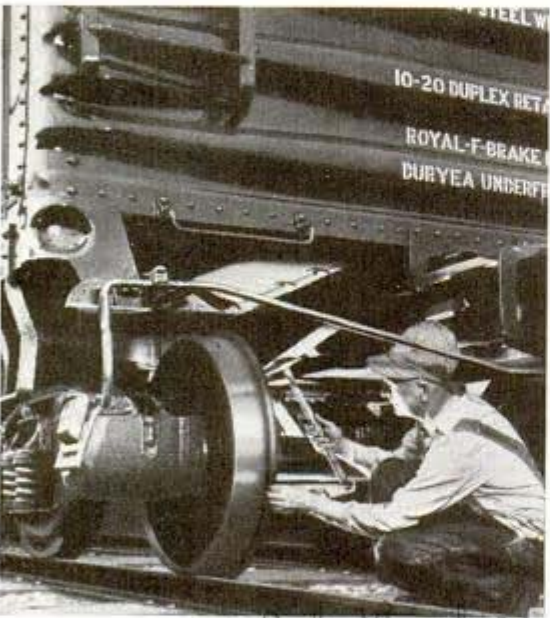

U. S. Steel Corp. 208 & La Salle Chicago

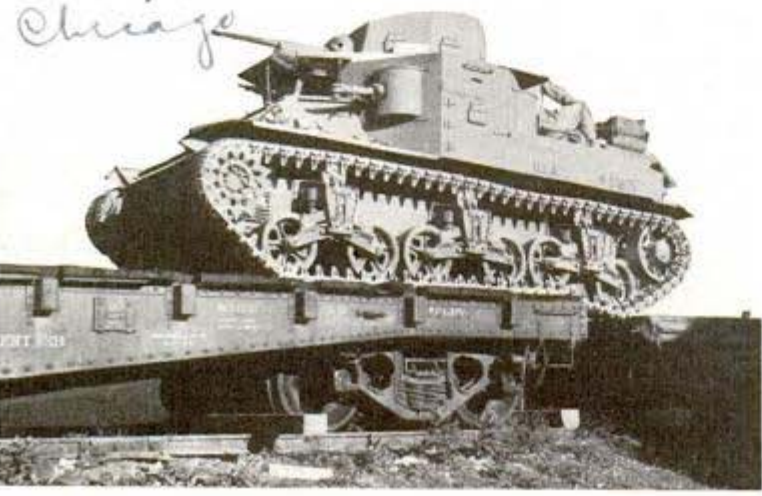

may spend two to eight hours being broken up and remade into new trains; the military freight will skirt the city, pause only long enough to pick up a fresh engine and crew, and be on its way. At the end of its journey the cars are unloaded as rapidly as men and machines and warehouse space permit and put to work again. Idle cars are a luxury neither the railroads nor the nation can afford these days.

Are the railroads moving the load? At a time

when civilians were taking the train to save their own tires, the biggest troop movement in history took place without serious inconvenience to anyone. Of the entire Pullman fleet of 7,000 sleeping cars, 1,500 have been set aside for troop transport and as many as 2,900 have been assigned to the army on peak days of military travel. As for freight, the railroads last year handled the greatest volume in their history, including virtually a two-year grain crop, without a car shortage. The situation looked rather critical last summer, for the grain elevators were still bulging with a record carryover of 400,000,000 bushels of 1940 wheat when the 1941 harvest came along. Old grain had to be moved out to distant storage points and the new grain moved in. But the railroads assembled a vast fleet of cars and moved the crop in orderly fashion. In one outstanding instance, 500 cars of wheat were hauled from

Chicago to elevators in Philadelphia, unloaded and the empties were back in Chicago in less than six days.

It isn't like the days of '17 and '18, when rail transportation bogged down on the eastern seaboard for want of some place to unload the cars and thousands of loaded freight cars lay idle for weeks and months. Ac-

Trainloads of tanks are loaded from one end, the heavy "forts" crawling from flatcar to flatcar





Delivering tools of war, a mighty locomotive on the Great Northern pulls a long freight in the mountains

tually, at one time 200,000 loaded cars stood on tracks in the northeastern states, not turning a wheel. Without sufficient ships or warehouse space to take over the cargo, without an efficient system of controlling the government's "priority" freight, cars that should have been hauling goods became warehouses on wheels. One example was the rush order for piling needed at the Hog Island shipyard. Priority tags got the piling there in a hurry, and before anyone was ready to unload them there were 5,000 flatcars loaded with piling sitting in the nearby railroad yards. They sat there, some of them for months, clogging the terminal tracks and unable to get back into useful service.

That's all changed now. Two important agencies born since the first world war—the railroads' Interterritorial Military Committee and their Car Service Division—are seeing to it that no traffic paralysis can occur again. In general the former cooperates with the Army Quartermaster General in handling troop movements; the Car Service Division is responsible for efficient management of the nation's supply of freight cars.

From Pearl Harbor forward these railway organizations have been on duty 24 hours a day. The Quartermaster General notifies the Committee's Washington office that a division is to start mov-

ing in 48 hours, say from a midwestern camp to Seattle. Immediately wires go out to the regional Committee offices over their interconnecting teletype directing the assembling of 750 to 1,000 cars from the nearest railway centers—in this case perhaps from Nashville, Chattanooga, Memphis, even as far as Chicago, Atlanta and St. Louis. A pool of 50 to 60 locomotives is concentrated at the camp and as many more must be ready to relieve them at a half dozen points on the chosen route to the coast. The mammoth task of diverting all this equipment, manning it, routing it over 2,000 miles of busy rails with scarcely perceptible effect on normal schedules, moving 20,000 men and their personal impedimenta and divisional equipment is an achievement the rails can be proud of.

(Continued to page 176)

Field and antiaircraft guns are usually guarded by their crews en route



m 340. Cont. U. S. Steel Corp. 202 of  
Le Ball, Chicago

## Ship's Nose "Tailored" Indoors Is Joined to Hull

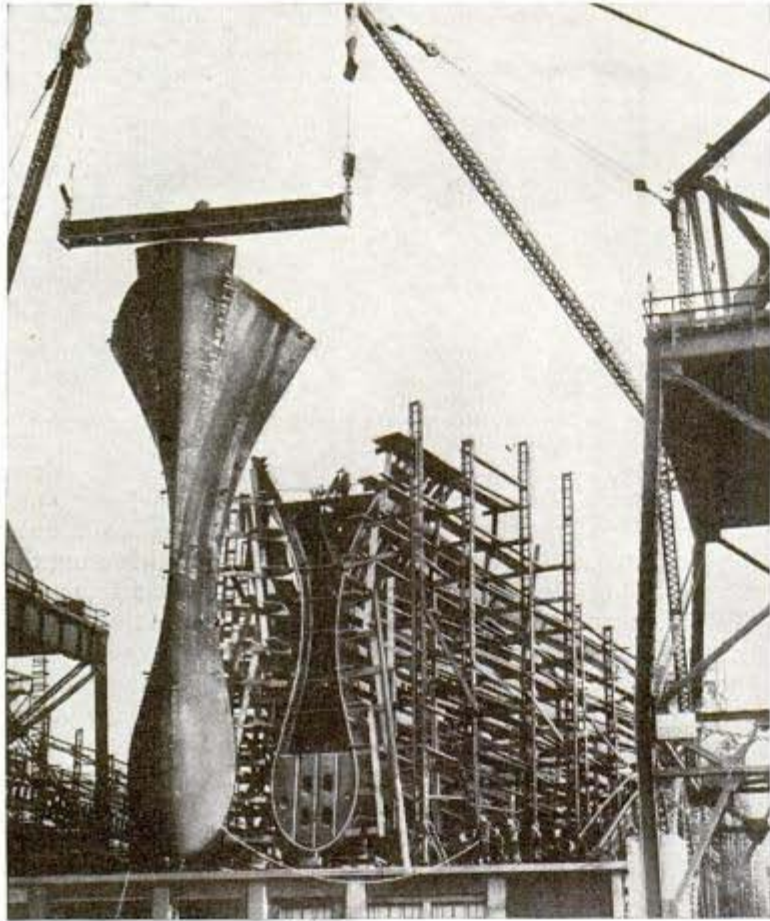

To speed the shipbuilding program, large sections of ships are now being prefabricated in the shop before they are joined to the vessel on the shipway. At the Kearny, N. J., shipyard of Federal Shipbuilding and Dry Dock company, the bulbous bow of a 17,000-ton oil tanker was formed at the factory into a single streamlined piece weighing 62,883 pounds, while the rest of the hull was taking shape outdoors. Two powerful cranes swung the completed bow gently into place for a tight fit, saving time formerly lost by the practice of welding plates one at a time from scaffolding.

Nose of ship, completed in the shop while the rest of the hull was "growing up" on the shipway, is attached to the vessel as a single unit

m 398

## Painters Rustproof a Waterfall Against the Coming Flood

As one of the last steps before the great man-made waterfall of Grand Coulee dam starts flowing over the spillway, painters have been swarming over the eleven huge drum gates. Several coats of paint were applied to protect the structure against rust. These gates will provide the crest for one of the mightiest waterfalls in the world.

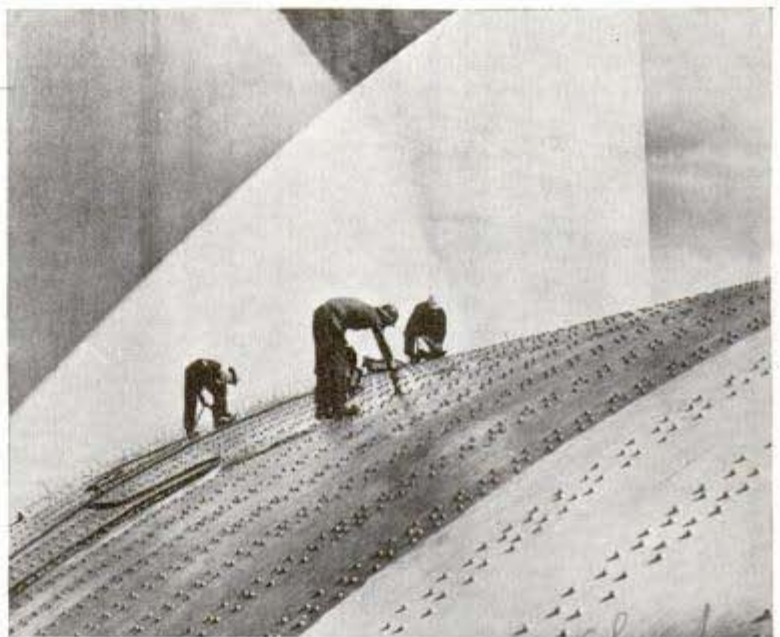

Curare, used by South American Indians to poison arrows, is being developed for medical uses, among them the relaxing of rigid muscles in certain paralytic cases.

More like a stage set than reality, this is a big dam gate being painted

m338

# Merry-Go-Round "Lab" Tests Airplane Engines

Like a horse operating a treadmill, an airplane engine mounted on a special turntable does a hard day's work but goes nowhere. The turntable in reality is a testing laboratory, and the engine does more to increase engineering knowledge than any on flying duty. Since it is on the takeoff that engines are speeded to full horsepower and undergo the greatest strains, tests that simulate takeoff conditions are among



Rotating stand for testing engine, above, rolls on a circular track. Left, the "flight crew" is watching result of a test



round laboratory at the Boeing Aircraft plant in Seattle, Wash., permits the engine to be turned as desired in order to check oil cooling, fuel flow, exhaust back pressures, vibration of engine and propeller, propeller clearances and dispersion of the heat generated in the cylinders. The tests can be run at cruising speeds to learn what may be expected in the air. The "test pilot" and crew are housed in a soundproof cabin on the turntable, equipped with instruments to measure pressures at many points and cameras for recording all instrument readings at one time.

the most important. Although normal takeoffs occur into the wind, airplanes frequently must take off in a cross wind. In the latter case a difference in pressure is created between the two sides of a radial engine, with the result that some cylinders get hotter than others. The merry-go-

m309

## Transparent Cover for Any Size Hat Guards It From Rain or Snow

Protection in rain and snow for the lady's expensive hat is provided by a transparent hat cover, compact enough to be carried in a purse. Ready for any emergency, it fits over any size or shape hat. After it has served its purpose, it may be dried, folded in accordion fashion and replaced in the envelope for another rainy day.



Hat cover, left, may be dried, folded and used again

☞ To learn where to buy commercial products described in these pages, see the index.

Mr. Thomas & Stewart Dr. 3872  
Franklin Ave Los Angeles  
Mrs. Casson L. Rice  
2201 1/2 Ca. Ave. N. W.

Mrs. C. Marshall Perham  
1128 Stearns Blinn  
Los Angeles

## KEEPING NATURE IN BALANCE



↑ Tagging a ground squirrel that will be released on one of the government's experimental ranges in the west. This is a part of the census of life on the range, which includes also a detailed study of native animal habits and their effect on general conditions on the range



Our livestock ranges depend upon a delicate balance of life, which, if upset, might seriously disturb our supply of meats, leather, wool and related products. The government is studying the necessary forms of life, both animal and vegetable, and how to maintain the vital balance. Cattle and sheep live essentially on wild grasses. The rain gauge, above, records the amount of precipitation on the experimental tract. Below, sample bags of various food grasses are hung up to dry, after which scientists at the experiment station will measure their exact food content



← Soil conditions are, of course, an important part of the picture. Here a government man takes a sample of soil to analyze its moisture and mineral and organic content. Later food grasses will be cultivated, and by comparing with other soils, best conditions for fodder will be found

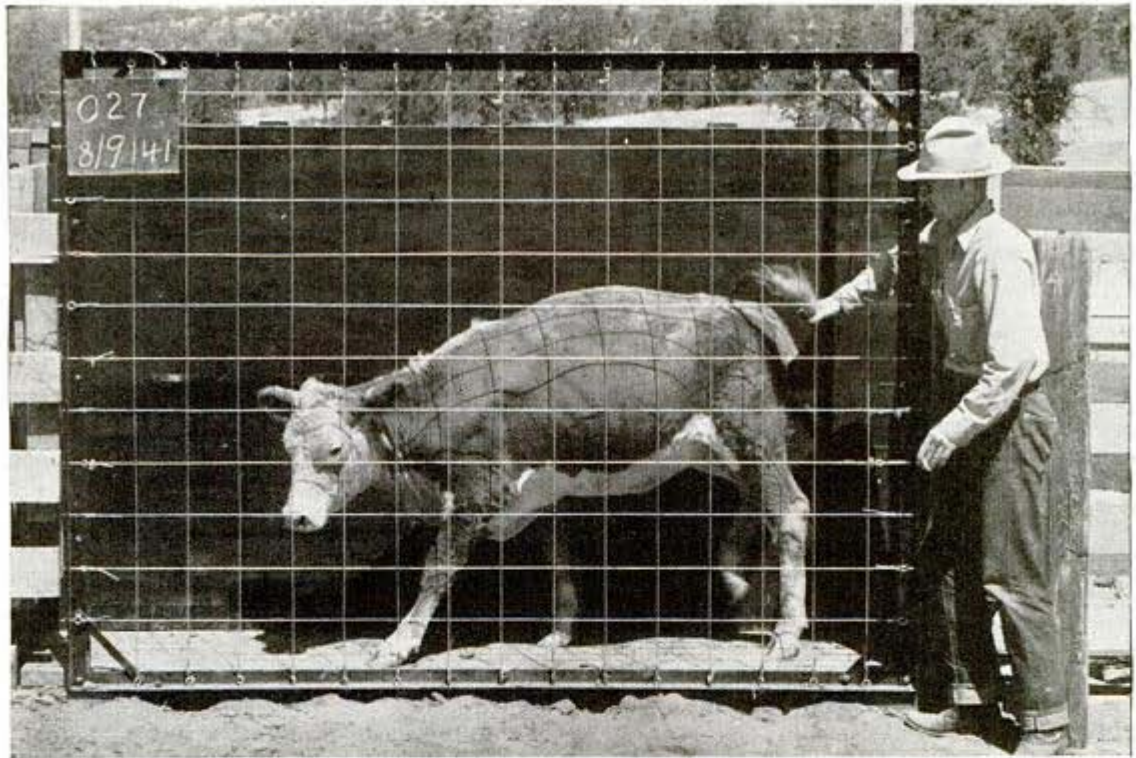

Burrowing animals are essential to keep the soil loose, but they also eat grass and too many would destroy the range; their natural enemies, mammals and birds of prey, are necessary to keep them in proportion. Insects and game birds, too, play vital parts. At the top is a pen devised for measuring growth of cattle; animals are driven in at regular intervals and photographed to keep a record of their exact size. By noting variations in rate of growth under controlled conditions it is possible to determine the best methods of raising cattle to maximum size and weight



The function of this tree-sitter is to study the habits of wild life. In large pens nearby a number of animals common to the region are kept, and the inspector makes notes on their modes of living. The ultimate purpose of these experiments is to determine what areas hold the best conditions of climate, soil and native life suited to livestock growing, and how that combination can be maintained. The drinking fountain at left is one of several installed for wild birds, encouraging them to frequent the range so that their habits and effects on range can be studied



m 331

4801 Reville Island

# Boats Built Upside Down to Speed Assembly

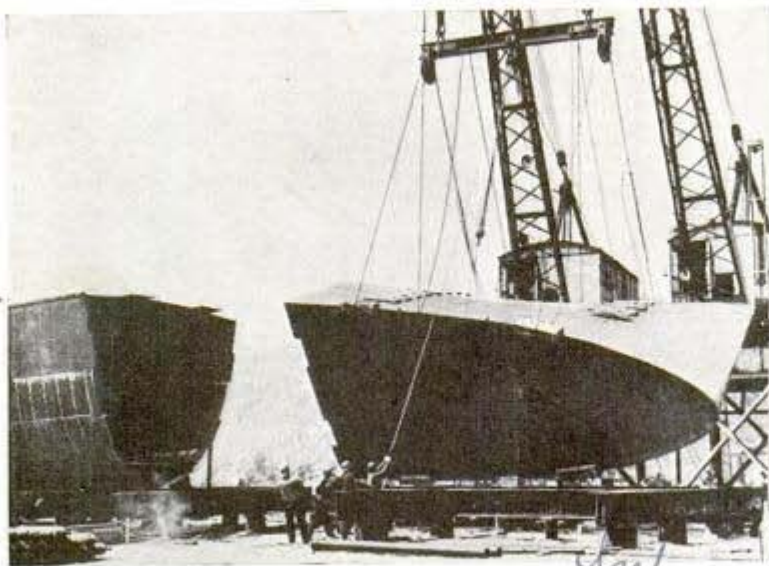

Section of ship's hull built bottomside up being set upright by cranes

Greater speed in production of submarine chasers has been achieved by adding a "bottoms up" technique to assembly line methods at the yards of Dravo Corporation of Pittsburgh, Pa. The 173-foot craft are built in an upside-down position, which facilitates the welding of the hull sections. Specially rigged gantry cranes turn the hull sections right-side up, and powerful hydraulic jack-operated transfer carriages are used to move them along to the final assembly line.

at Harlingen m 274

# Bullets Coated With Fresh Paint Show Who Hit Target

Dr. Henry Lacombe Sgt. Bill Cramer

With several gunners firing at the same target it's not easy to tell which have scored the hits, since ordinary bullets do not leave telltale marks. This has been solved at the United States Army Air Corps flexible gunnery school in Texas by dipping machine-gun bullets into colored paint just before they go into the training planes from which student gunners fire them at a towed target. The paint-coated bullets leave prints in the 14-foot sleeve of white canvas which help identify the gun from which each bullet was fired. That the students attain excel-



Dipping bullets into paint, left, and examining target after practice

lent marksmanship is indicated by one of the canvas targets which bore 287 holes from 300 shots that were fired at it.

1130 W. 18th

m 428

# "Germ Syrup" May Help Hungry Troops Digest Grass and Leaves

Soldiers who are cut off from their food supply may be able to eat grass, leaves and wood with the aid of a chocolate-flavored syrup of germs, according to preliminary tests conducted by Dr. Gustav J. Martin of the Warner Institute for Therapeutic Research in New York City. The syrup, containing germs of a type that do not

cause disease, is said to manufacture various B vitamins in the digestive tract and permits humans to live on hitherto inedible material. If the experiments prove successful, civilians as well as soldiers may be able to obtain a lifetime supply of vitamins from the germ syrup at a cost of only about \$2 per person.

Science Service 4/13/40

21393

# BLACK LIGHT *at Your* SERVICE



Natural-color photo  
of artificial Aurora  
Borealis (above)  
which is made with  
fluorescent paints.  
Right, black-light  
lamp with which  
illusion is created





Examining rocks with mineral light, while at right are two black-light lamps suitable for use in window displays of silk and plastic designs

store. With it you are ready for some real thrills.

Try dipping your shirt and necktie in a solution of fluorescein or quinine. When you turn out all other lights and switch on the black-light lamp, the shirt and tie glow in the ultraviolet rays as though they were afire. From this you can go on and create a real ghost. Apply vaseline around your eyes and mouth, then down the

bridge of your nose. Do it carefully, there's no need to smear it on. Now turn off the electric lights and turn on the ultraviolet lamp so its invisible rays will strike your face, shirt and necktie. Place a mirror so that you may see what you have created and grin as you look. To your amazement, it will appear that you are now a full-fledged Yogi of white magic with black light. Your face, in the ultraviolet radiation, is black, but the vaseline around eyes, mouth and nose glows strangely white and grotesque. And your grin reveals teeth that seem illuminated

*to W. Martin  
Route 2, La Grange  
Ill.*

### By Luther Gable

FOR a lot of fun, some new thrills and perhaps a cash return, "black light" offers real possibilities at rather low cost. Anyone with as much as fifty cents can take up this entertaining hobby and anyone willing to spend up to \$50.00 may go into it on an almost professional basis.

From some amateur experimenter may come new ideas for applying black light, perhaps a way to illuminate and decorate a theater or a restaurant without visible light sources. Ideas like this will mean money to their originators.

All you need to get started is a black-light lamp—one in which all visible rays have been screened out. You may launch your hobby by buying an argon globe for fifty cents. Certain things like vaseline, engine oils and some chemical paints respond to its rays, enabling you to create unusual effects. But if you wish to ride the hobby further, a better black-light lamp may be obtained for about two dollars. This is an ultraviolet globe and it may be purchased from any scientific equipment

You may start your fun with 50-cent argon lamp, making cheese, butter and molasses assume strange colors under the black-light rays





L139 3

19

Small objects may be painted with fluorescent solutions and plastics cut out, then exposed to black light from lamp in hanging flowers

from within—that is if they're your own teeth and not dentures. Too, if there is considerable calcium in your body, even your eyeballs will glow, adding to the ghostlike appearance.

Such an experiment illustrates the phenomenon of fluorescence, which means that a substance glows only while it is being exposed to some activating energy. It is not a reflection. If the substance continues to glow after the energy source is turned off, that is known as phosphorescence. If a mineral glows when rubbed or struck with a hammer, it is said to be triboluminescent. If it glows when heated, it is thermoluminescent.

One thoroughly practical use of black light is found in the field of prospecting. If you would like to search for gold, or better still, for radium and tungsten, you can take your hobby to the hills. With a battery-operated, portable black-light lamp, you may work at night, in the dark of the moon. Rocks containing minerals glow as though lighted from the inside when you expose them to ultraviolet radiations. This is par-

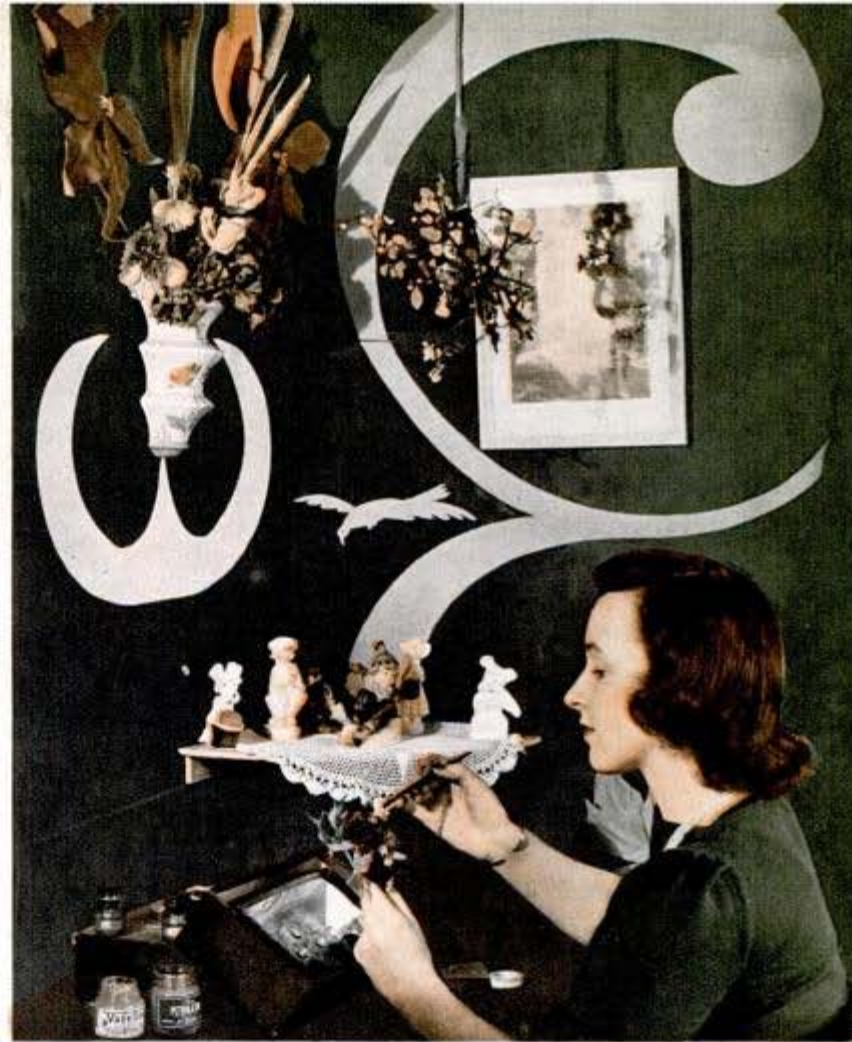

ticularly true of rock containing radium and tungsten. Known deposits of tungsten have increased ten-fold in the United States since prospectors began using a mineralight—a portable black-light lamp designed by Thomas S. Warren of California. Scheelite, or tungsten ore, appears golden yellow under the rays, thrilling its finder not only with its beauty, but also with the possibilities for cashing in on the find. One word of caution is necessary right here, for scorpions, horned toads, lizards and snakes have almost the same color under the black-light lamp. What appears to be a shining nugget of scheelite may come to life and squirm out of your hand. So it is wise to step on the "nugget" before picking it up.

The best black-light generators, like the Warren mineralight, op-



This is a \$2 ultraviolet lamp made in special black glass which can be placed in any suitable reflector and used by the amateur experimenter



L1393

↑  
This star, shown in natural colors, is composed of small pieces of several kinds of fluorescent rock attached to the board with sodium silicate. Under right kind of black light, it is a thing of beauty

↑  
Top, left, another view of the star, with black-light lamp held as it might be placed to bring out the beauties of the fluorescent pieces

← When you make up your own star, you have a wide choice of fluorescent pieces of rock—there are more than 300 known varieties. Different value lamps bring out different colors. This is a natural color photograph

↓  
This photo, in natural colors, demonstrates what can be done with fluorescent paints and black light. It also shows how successful may be photographers' efforts to record colors created with black light—a thing once regarded as impossible. Even now it takes a lot of patience and skill, plus determination, because you are apt to fail on the first few attempts. You might try it with your own camera

520  
As the painted disk is revolved and the black-light lamp turned on it, each band of color seems to turn in a different direction and at different speeds





21 ↑ 21393

Fluorescent paints and a little ingenuity can result in some amazing new ceramic beauty, as the natural color picture shows. Even the cheapest ware can be made to glow under the rays of an ultraviolet lamp

Top, right, vases and dishes may be painted to simulate jewels or gorgeous art ware. Photo shows fluorescent paint being applied

Another natural color photo which demonstrates how fluorescent paint and black light can turn the simplest pottery into a thing of matchless beauty. You'll have a lot of fun painting up a few discarded dishes →

Paste any type of design made up of different colored plastics on a circular disk, then revolve the disk rapidly—by attaching it to the wheel of a knife sharpener—while exposed to rays of black-light lamp. You'll be amazed by the strange, but beautiful patterns created, and you will have still more fun trying to catch the colors on Kodachrome film. But don't give up too easily, the result will be worth the effort ↓



Designs may be cut from any fluorescent plastic or paper sprayed with fluorescent solutions. The varieties are limited only by your imagination. They have many uses at a "blackout" dance or other party ↓





21393

Carpet treated with fluorescent solution glows with eerie brilliance under ultra-violet radiations. Black-light lamps are concealed on each side

But for the beginner, the cheaper lamp will serve many purposes. You may get excellent effects by using a few sheets of fluorescent plastics, or lumarith, in several colors—red, blue, green and yellow. Cut, fold and bend the pieces into designs to suit your fancy and decorate the corner of your study, library, den or office; possibly your Christmas tree. Black-light lamps may be concealed at one side. When all other lights are extinguished and the hobby lamp switched on, each piece glows with

operate through transformers, producing a very short, invisible wave length of radiation. You will find a great difference in results with different intensities of ultra-violet generators. Willemite, for instance, is not responsive to low grade radiations. But under a mineralight, the rock, which contains zinc, becomes brilliant green and under radium radiations it appears white hot. Smelters, refineries and assay offices no longer risk overlooking values of ore. They employ mineralight and thus cover a wide range of metal ores.

marvelous effect. Of course, what you see is not a reflection. The glow is induced by the bombardment of the short-wave impulses which accelerate molecular surface tension, creating fluorescence.

The hobbyist can have a lot of fun by using his lamp or lamps at a party. Try concealing a black-light lamp in the mistletoe or other overhead decoration, then turn it on when other lights are low. Couples dancing beneath the lamp will be surprised, even amazed, at the weird appearance of each other's faces, teeth, eyes, spectacles, rouge, lipstick, face powder, nail polish and even buttons and jewels. If some of the guests are willing to be guinea pigs, you can prepare them before hand by applying vaseline to their faces.

A vivid halo may be created over the pictured head of a saint by brushing the picture with invisible fluorescent solutions, then switching on your hobby lamp. In the same way, an entire landscape picture can be made to appear in all the beauty of its original colors, in a dark room. These transparent, fluorescent solutions, sometimes called invisible paint, cause any surface to which they are applied, to glow in the dark under black light. You will have a lot of fun experimenting with this paint, thinking up unusual ways to use it.

And here is something else you may want to do: start a corner bracket collection of fluorescent rock, porcelain orna-



Known tungsten deposits in U. S. have been increased ten-fold since prospectors use mineralight that reveals minerals in rock at night

It's a new indoor sport to watch your own cut-out and painted designs turn into flaming beauty when all ordinary lights are turned off

23 ments and vases. You might simply use the mantel shelf for the collection. Under ordinary lights, the different pieces will appear drab and uninteresting. But when you turn on the black-light lamp concealed just over the corner bracket or shelf, the collection springs into life—soft, deep crimson bespeckled with brilliant spots of green, azure blues, firelike yellows, purple facets ringed in red and pink streaked with blue.

More than 300 varieties of fluorescent rock have been found and collected from almost every quarter of the globe. You will be certain to find some of these varieties for your collection, but you really can start in your own pantry; cheese, butter and molasses fluoresce beautifully. Their exact color, and that of many other common things, like the buttons on your shirt, depends on the output of ultraviolet rays in the particular type of light you use.

If you are interested in a beautiful and unique display—that will cost very little you can have a lot of fun with fluorescent paints. Try painting a pint of beach pebbles and a few cheap pottery ornaments, then arrange them in a "shadow box" with a small argon lamp concealed just behind the top front edge. Switching on the lamp creates a little house of magic that will be a constant source of entertainment for you and your friends. An experimental kit of fluorescent paints, including the argon lamp, can be obtained for five or six dollars. Some of the paints are made for use on pottery, wood or glass, while another set is made for application to fabrics. Ordinary pottery pieces may be decorated in this manner, then subjected to black light with amazing results. Thus may exclusive caterers be expected to serve their patrons, in the near future, on fluorescent tableware—glowing with strange and exciting colors—on black tablecloths, amid the soft, colorful light of fluorescence gleaming from exotic designs of palms, peacocks and poinsettias in



all their vivid colors on the black walls of the lounge.

And in this connection, it might be fun at your next dinner party to use invisible place cards. Under ordinary light, they appear to be blank, but ultraviolet radiations reveal the name of the guest. Of course, the name is written in a fluorescent solution. In the same way, napkins may be decorated or some thought appropriate to the season or occasion expressed.

Something else you can do is create your own Aurora Borealis which will appear to flare over Arctic peaks. It is accomplished by painting designs on a pressed board, then attaching the board to a knife-sharpening stone. This permits turning the board rapidly while you expose its designs to black light. At times the aurora will seem to flare slowly from side to side, then it changes to show streaks of flame emanating from a central source.

Also in the invisible-light classification is the infrared. Lamps employing these



Turning the black-light lamp on fluorescent stones and beholding the beautiful colors will result in the first real enthusiasm for your new hobby. The lamp shown here is inexpensive

21393



A fluorescent silk gown maintains its charm under the brilliance of ordinary lights, but when black light alone illuminates it (see at right)—



Now the gown appears in fiery beauty, but its wearer virtually fades out. If she smiled, her teeth would glow under the black-light rays



Chart (above) can be opened in three sections to explain black light when ordinary lights have been extinguished. Below, color photo of chart showing visible rainbow octave in center arc and black-light wavelengths on either side



rays — with visible light screened out—are used by photographers in taking secret pictures in the dark and in recording enemy positions on film.

The pioneers of black light experimentation are already using it in criminology, identification of gems, medicine, biology, chemical analysis, prospecting, examination of antiques, glassware, detection of forgeries, theatrical work, mining and the selection of ores.

As you progress with your hobby, scores of new ideas will present themselves. It would seem that not far away may be dazzling window displays, created with the aid of a powerful ultraviolet generator. Designers of evening gowns soon may be turning out creations that will glow gorgeously under black-light radiations. Imagine the intriguing beauty of a fluorescent gown, a necklace of stones of fire more gorgeous than diamonds and a gleaming flower in the hair. That picture might be brought into reality. Already restaurants and night clubs are trying out black light; the next step is to design gowns that will be at their best when exposed to it.

# Thousands Learn New Trades in War Plants



Newcomers to the N. A. Woodworth Company factory are trained for new jobs similar to their previous work. Erstwhile building supervisor for a contractor (at upper left) interprets blueprints as supervisor of a production department. Kentucky school teacher (left) now instructs girls in use of precision gauges and test equipment. A one-time cafe cook (above) hardens tools in heat-treating oven

Tooling up American factories with new machines is only half of the problem that production for war entailed. The other half is equally important—"tooling up" with new workers at strange jobs. Salesmen and automobile dealers, lawyers and teachers, jewelers, tradesmen and students are being converted by the thousands into skilled mechanics and craftsmen in the tank and gun and plane factories. Industry is doing what it can to fit the unskilled workman into a job for which he is best adapted. For example, N. A. Woodworth, manufacturer of a hundred different precision parts for aircraft engines, spots new employes at his Ferndale, Mich., plants in jobs of a nature corresponding to previous work: a jeweler is now an inspector of precision parts, a school teacher from Kentucky was made supervisor of 50 girls whom she teaches to use gauges and test-

ing equipment. A Detroit restaurant cook moved from one oven to a bigger one. He knew heat control, he was accustomed to working in warm atmosphere, so he was assigned to tool hardening in the heat-treating ovens. A former building supervisor for a real estate contractor was familiar with blueprints, and found familiar work as a supervisor in a production division where he must interpret blueprints and specifications. The sales manager of a used car agency became an expert on engine parts through long experience appraising automobiles and supervising repair work. Now he's using that knowledge making various tests on airplane parts as they come from the production line.

☞ Look in the index to find where to buy articles described in this magazine. Say You Saw It in Popular Mechanics.

m. 35<sup>8</sup> Automatic Alarm Company, Chicago

# "Listening" Fence Rings Alarm to Halt Saboteur



Master control board for acoustic fence, left. Dog crawling under fence, right, would sound alarm

Efficient protection for war industries against sabotage is given by a tamper-proof wire fence that sends a signal to patrol stations or towers as soon as anyone approaches near enough to cause the slightest variations. It is virtually a fence with ears, thwarting all efforts to climb or jump over, dig under, or saw or cut through it. Even a dog or rabbit coming in contact with the fence sets off the alarm. Specially developed magnetic pickups using sensitive phonograph needles, are attached to the fence at intervals of 1,000 feet. These detect any vibrations which pass into the fence from the ground, and relay them to amplifiers located at remote points. A loud

speaker enables the guard to hear and usually identify the nature of the disturbance; a relay closes, ringing a bell in the guard tower, and a pilot light also indicates that the system has been disturbed. If desired, a signal may be transmitted to a central station over the telephone system. Developed by the Du Pont company, and manufactured by Automatic Alarms company, the acoustic alarm fence can be installed over ground that is flat or rolling, rough or smooth. It remains in constant operation regardless of weather conditions, and cannot be outwitted even by experts acquainted with its construction. Fences around ordnance plants may be up to 20 miles long.

m 403

## Super-Trailer Carries 141 Men to Jobs in War Industry



This 45-foot trailer for war workers is built of noncritical materials

One answer to the problem of getting the thousands of workers to their jobs in war industries is an oversized trailer recently demonstrated for government officials. This huge bus accommodates 141 persons. Simply constructed of noncritical materials, its superstructure is chiefly of plywood and Masonite. An ordinary 1½-ton tractor pulls the trailer.



m 386

# "Rolling Fortresses" Protect Chinese Trains

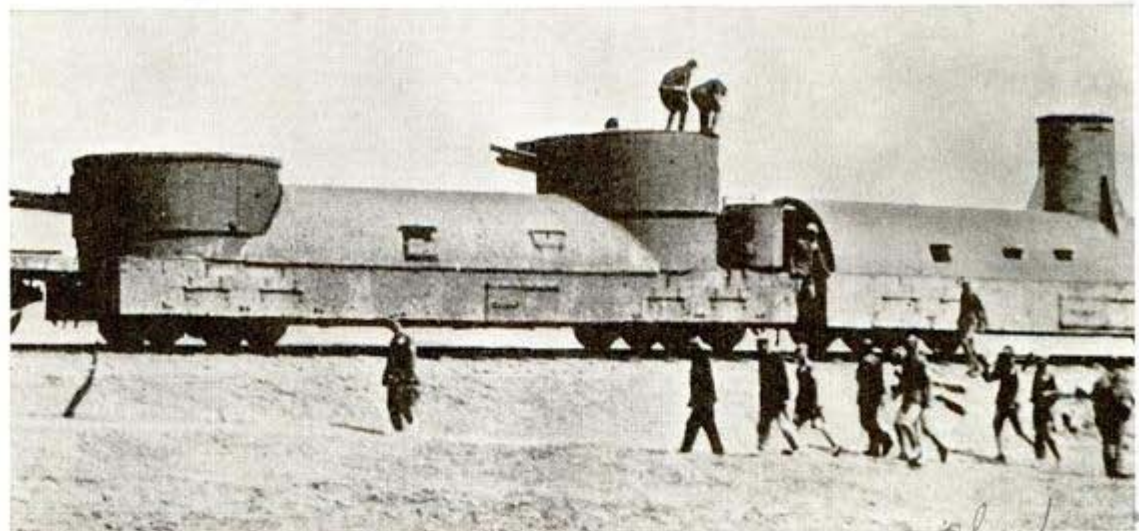

Armored cars like this one roll along with Chinese trains to fight off Japanese attacks from air

Heavily armored cars are now helping the Chinese Army to guard troop and supply trains from Japanese bomber attacks.

Revolving turrets bristling with guns, and thick walls of steel, make veritable rolling fortresses of these fighting railroad cars.

747 Grayly (?)  
Los Angeles

## Liner Made Into Plane Carrier by Adding "Lattice Deck"

Merchant ships may be converted quickly and cheaply into aircraft carriers if the invention of John B. Quinn receives Navy approval. He proposes to crown the ships with a "lattice deck" built of parallel tubes on which airplanes could land and take off. The planes would be fitted with wide-tread wheel-and-roller landing gears to prevent them from settling between the tubes, and it is said that the "grip" of the wheels upon the tubes would keep planes from slipping sideways. The inventor estimates the entire deck, made of eight-inch pipes and supported by steel girders, installed on a 400-foot freighter, would weigh only 300 tons.

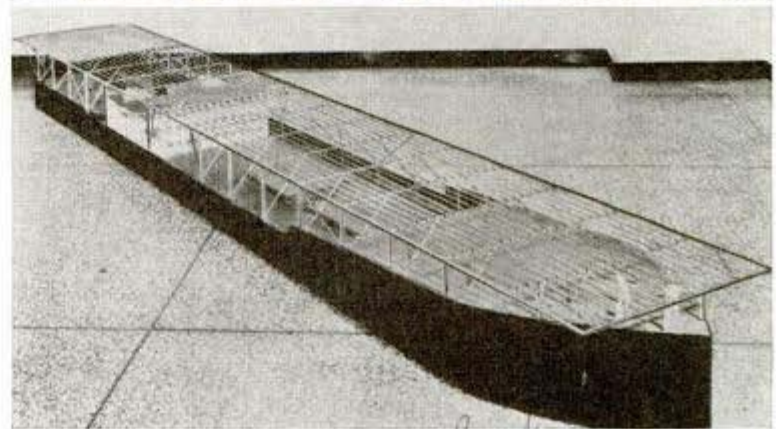
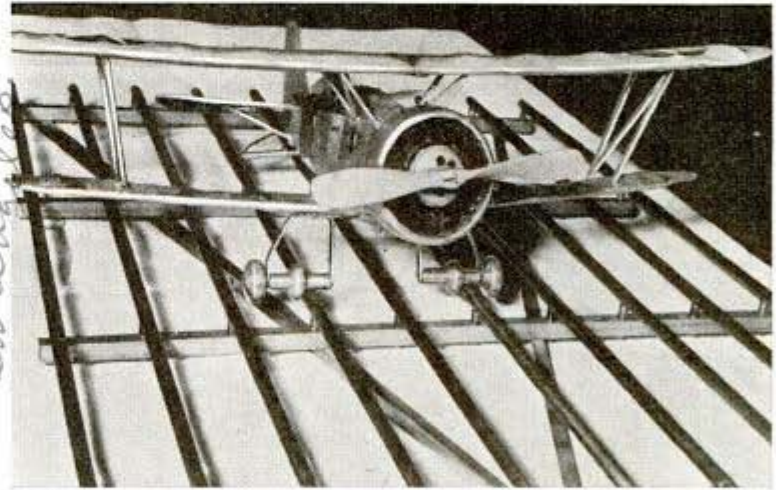

Models show (top) special wheels to grip deck; (bottom) "lattice deck" on ship

Mar 20, 4

Warrey Elliott, 3438 33rd



**TELEVISION  
TRAINS  
the HOME GUARD**

Red Cross workers demonstrate first aid before the television camera in a series begun after Pearl Harbor

From this panel, CBS program director and staff guide action on studio floor and control the transmitted image

Cont. Allen



**Y**ANKEE mass production, which is pouring billions of dollars worth of American guns, tanks and ships into the world conflict has another accomplishment to its credit—the mass production of expert defense workers through the medium of television.

Thousands of civilian defense volunteers, firemen and policemen within a radius of 50 to 75 miles of New York City, Philadelphia, Schenectady, N. Y., and Los Angeles are literally snatching from the air the training necessary to their roles as soldiers of the home front.

The nation's sudden entry into the conflict found its cities with plenty of volunteer workers, but few instructors capable of training them. At the rate they were being taught, months and perhaps years would have been necessary to train enough experts in the science of fighting a war which has no front lines and no impregnable defense points. The small group method of teaching was proving interminably slow in cities along the coasts faced with the threat of bombing almost any day.

An experiment in the form of a unique war school, a school with classrooms

№ 294



Replica of air-raid information center is set up for television demonstration of operation in bomb raid

scattered around New York City in police stations, fire houses, school auditoriums, private homes and radio dealers' shops, gave an answer to the problem of civilian preparedness.

The first broadcast was in the nature of a test by the National Broadcasting Company with only 130 of the city's 5,100 television receivers in use. So successful was the television method in this test that hundreds more sets were pressed into use and the classrooms were extended into New Jersey, Connecticut and Pennsylvania.

The Columbia Broadcasting System, which had been devoting a portion of its television programs to helpful war subjects, took over the task of educating the public to its defense duties.

Vastly expanded, these two television military training schools are filling the air not only with in-



An air-raid warden clears the streets in a televised lesson for defense volunteers gathered at receivers

Decontamination squad shows how it's done during a television interview



Madison Ave

New York Police

Bat Edge

485 Madison Ave New York

m  
294

Program develop  
Washington Times



Preparing a television set under banks of fluorescent lights

structions intended to make America war-wise, but with actual demonstrations of what is expected both of volunteers and the public.

The lessons deal with such subjects as the extinguishing of incendiary bombs and the treatment of poison gas victims. The teaching instruments are lectures, the demonstration laboratory and televised motion pictures, many of which are made for the express purpose.

A typical National Broadcasting course for volunteer defense soldiers would include a first lesson on the general duties of an air-raid warden, a second on the fire bomb, a third on what to do in blackouts, a fourth on gas warfare and two sessions in which the important points are reviewed.

Television's illustrations for the lessons have all the graphic and moving appeal of a Hollywood production. The first on NBC had Maurice Wells, as Post Warden "Arthur Smith," directing pedestrians to shelter and halting traffic on a street scene during an imaginary raid. The second lesson depicted a "bomb-

ing" of Times Square with the assistance of actors, stage sets, sound effects and motion pictures. The "Browns," television's typical New York family, also fought a fire bomb that fell into their apartment during the "raid."

In each of the NBC lessons, which are repeated eighteen times a week, a uniformed member of the staff of the Coordinator for Police Department Civilian Defense faces the electric cameras in the National Broadcasting Company's sight-sound studios at Radio City. He tells the points to be covered in the lesson. At intervals other cameras bring the words of the defense expert to life with dramatized demonstrations of rules laid down by the Office of Civilian Defense. For 30 minutes wardens follow the theatrical presentation on their sets. Then,

after the telecast is over, they discuss the lesson under the leadership of the precinct defense officer.

Nothing like this had ever been attempted before anywhere in the world. It is something new, not only in radio, but in education. And its success in practice pretty much parallels its daring in conception.

Typical of the CBS program was a replica of the heavily guarded information center "somewhere in New York," set up in front of the television cameras. This is the permanent nerve center of the air defense of the northeast quarter of the United

Fighting a "fire bomb" in an apartment as a screen lesson for wardens



m 294

Anne Francis

States. How it operates under bombing conditions was demonstrated from the first warning telephone flash of approaching raiders, through the order for anti-aircraft searchlights and barrage-balloon defense, to the dispatching, navigation, and control of the interceptor planes that do battle with the enemy before it gets a chance to bomb the city.

As information of approaching aircraft was phoned to the "center" by observers from Maine to Carolina, the television audience saw some of the 3,000 civilian volunteers go into action. The course of the attacking planes was carefully mapped by the volunteers, who directed the interceptor planes until the squadron leader reported "enemy sighted." The squadron leader was then on his own.

The system is patterned after that developed by the British. But the United States is not only adapting British methods to its own use, but is passing on to the British air-raid protection techniques developed here.

Some of the lessons are dramatized to show what should be done in the event of an attack on an American city. In other cases, an instructor goes before the televi-

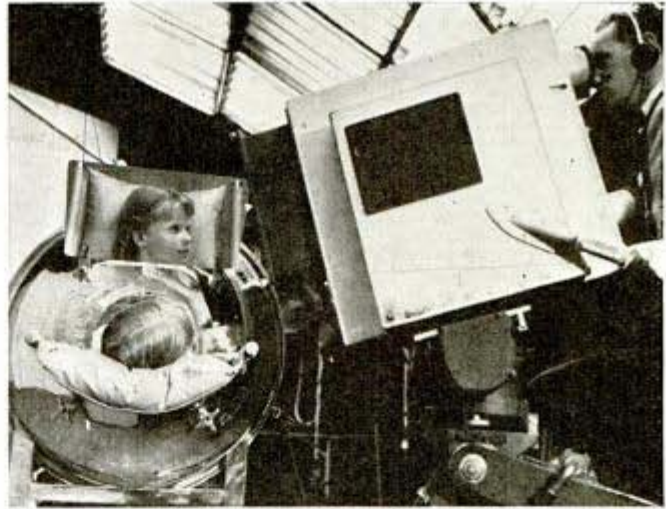

A young actress demonstrates the use of iron lung respirator

CBS television news program is visualized by maps and cutouts



Stirrup pump attacks fire bomb on NBC television set



sion camera to address the householder something like this:

"Go around the house to see that no lights, visible from the outside, are left burning. All gas lamps and, if possible, the gas at the meter, should be turned off to reduce danger of explosion. Do not use more open-flame lights in the 'refuge room' than necessary, but any amount of shielded electric lights is permissible.

"Do whatever else your own common sense indicates is necessary, and then, after making certain that every one and everything needed is at hand, close the door and seal it if there is any possibility that gas might be used."

Or, regarding traffic regulations during a raid:

"During raids, all except essential vehicles should stop, leaving two lanes in the

(Continued to page 169)

m 379

# Amphibian "Sea Jeep" Rides Land or Water



*Aene*

"Sea jeep" plowing along in 40 feet of water as army officers put the amphibian car through its paces

Something new has been added to the army "jeep" family—a new vehicle that can navigate water as well as land. Designed as a personnel carrier, the amphib-

ian has been undergoing tests by the Armored Force Board at Fort Knox. While its manufacturer calls it the "aqua cheetah," army men prefer the name "sea jeep."

m 354

# Rotary 'Bomb Gun' for Airplane Can Toss 5,000 a Minute



*See Patent*

*Andrew's man. See Patent*

As many as 5,000 small round incendiary bombs per minute can be tossed from an airplane, it is said, with a bomb thrower invented by Dr. L. S. Adams of Irwin, Pa. Of a rotary type attached to the underside of the plane, the "gun" throws bombs in a complete circle. The bomb thrower was demonstrated recently for members of the House and Senate Military Affairs Committee.

From a tungsten rod 5½ feet long and slightly thicker than a pencil, Westinghouse spins out filaments for three-watt lamps in a strand of wire that would reach a distance of 469 miles.

Spinning beneath an airplane, this bomb thrower could hurl 5,000 bombs a minute. Inventor, right, shows thrower to House and Senate members

*Elec. & Machinery Co.*

*M 285 Baldwin Southwark Corp  
 940 Lombard St  
 Eddystone, Philadelphia*

# Million-Pound Test Machine Crushes Column

Rated at the greatest transverse testing capacity in the world, the new pressure machine at Northwestern University, Evanston, Ill., can exert a pressure of 1,000,000 pounds on a beam 55 feet long. In addition, objects may be tested for tension and distributed or twisting loads, and the recording device draws stress-strain graphs charting the various stages of each test. Despite its enormous power, the measurements are accurate up to one-tenth of one percent for ordinary loads, and up to one-twentieth of one percent for the higher loads. The \$90,000 machine, 2½ stories high, crushes an 18-inch concrete column as readily as it cracks an egg. Objects up to 18 feet long and 7½ feet wide may be accommodated for compression tests, and a beam this size may be placed between two ends of the machine and pulled until it snaps. Only a little more than half the available power was used in

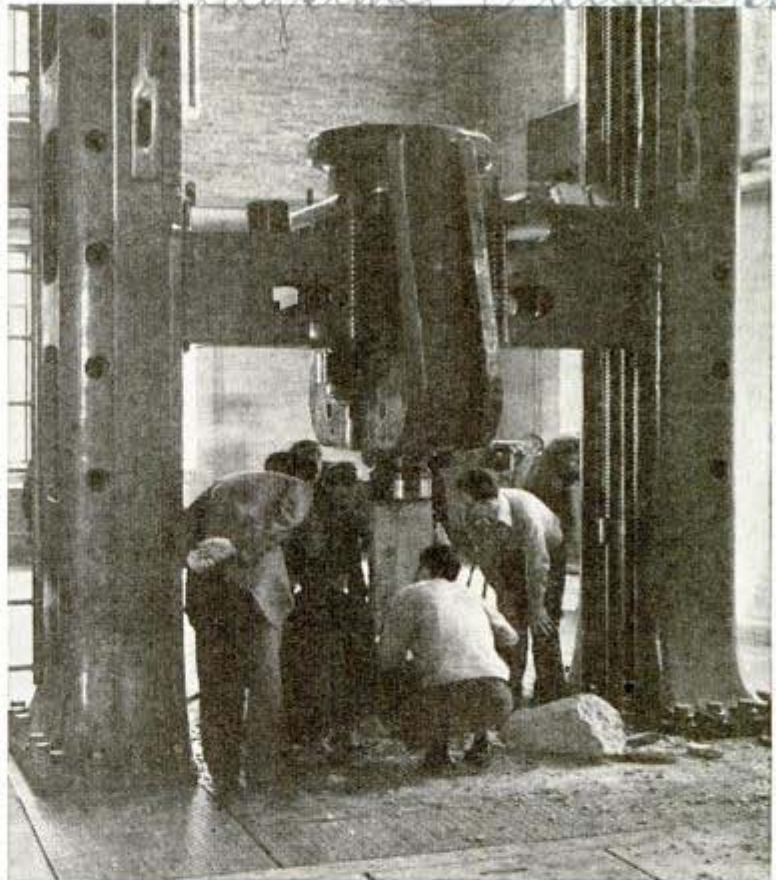

Concrete column shattered like a match under 505,000 pounds of pressure

testing a concrete column six feet high and one foot thick, which disintegrated under a pressure of 505,000 pounds.

# Locking Cap for Auto Wheel Nut Cannot Be Pried Off

*M 290  
 ap. \$3.00*



Removal of the automobile wheel can be prevented by a cap that covers one of the wheel nuts and thus protects tires against theft. One lock, consisting of two parts, is used on each wheel. The cuplike part slides over the bolt before the nut is applied. After the nut has been tightened a cap is snapped into the cup, concealing the nut completely and leaving no protruding portions by which the lock can be pried off. To remove the cap a threaded key is turned into it until the key strikes the end of the bolt, and further turning exerts pull upon the cap, lifting it out of the cup.

Bottom, how lock (top) is put on (left) and removed

Look in the index to find where to buy articles described in this magazine. Say You Saw It in Popular Mechanics.

*Res. Infg. Co.  
 Ravine, Ill. is*

# The ARMY POLICEMAN • 1942 STYLE

Capt. Allen Warren Elliott  
 343 E 33, New York City



Lanyard for preventing loss of automatic even when dropped is special equipment for the 1942 military policeman

Military police on ground demonstrates how he can toss opponent over his head by using feet to meet the rush



ONE of the developments in the art of war that has been almost overlooked in the excitement of conflict is the evolution of the military police in Uncle Sam's Army. Today they differ from the gruff and club-wielding "M. P.'s" of the last war as the modern parachute trooper differs from the mule skinner of World War I.

On Governor's Island in New York harbor and at a new school across the Potomac from Washington, thousands of picked men are being educated for special duties and by special methods developed by two officers who started from scratch. The officers, Lieut. Col. Glen T. Strock, Provost Marshal, First Army and Lieut. Col. Harry D. Scheibla, commanding the 518th Battalion, First Army, decided that a military policeman cannot club respect for his authority into a man, but he can impress him with superior intelligence.

So, "brains—not brawn" became the requirement. Lawyers have been brought in to teach the men civil and military law and court procedure. Educators have been





And here the M. P. shows how he breaks "mugging" hold around the neck and throws antagonist over shoulder

borrowed for intelligence tests and New York City policemen for instruction in the psychology of handling people. Expert drillmasters are putting snap and pep into their carriage and step. Crack marksmen teach them to handle their army automatics. Boxers train them to use their fists. Wrestlers instruct them in the art of rough-and-tumble.

But, perhaps most important of all is their initiation into the mysteries of body leverage, muscular skill and balance which makes the average unarmed, 1942-style military policeman superior to the average soldier or civilian with pistol, knife, club or fists.

Because of these clever tricks of leverage, skill and balance, which were developed from the ancient Japanese art of judo, or jujitsu, one of these super-soldiers can be caught with a gun pointed at his spine or stomach, and by a few quick movements of his body knock the gun aside, close in, wrest it from the ag-

gressor's hand, and render him helpless.

A man with a knife is practically helpless against this new training. By blocking the swing or thrust with a wrist and stepping forward, the military policeman can not only escape being cut, but with a few unexpected maneuvers of the arms and legs, force the knife wielder to drop the weapon or sustain a broken arm. The same is true if the weapon is a club, bottle, or

"Button up, Soldier," is M. P.'s order to the untidy man in the army





A gun in his back, the M. P. swings and knocks gun aside, clearing way for action shown on page opposite

similar object. If the attacker uses an object like a chair, as he might in a restaurant or barroom, which prevents the military policeman from getting in close, he is taught to pick up a salt or pepper container, shake a quantity into a hand and toss it into the assailant's eyes. This invariably stops him.

Even should the military policeman find himself flat on his back, he is down but not out. For he has been drilled hours in another trick. As the aggressor leaps on him, he doubles up his knees, meets the assailant with a sudden kick of both feet to the stomach and this sends the surprised aggressor sailing over the M. P.'s head with most of the fight knocked out of him.

If the man jumps on a military policeman

who has been knocked down, instead of trying to fight from this position, he is taught to grab the man's shirt front and cradle his knees or feet in the man's stomach. By pushing with his feet or knees and pulling on the shirt, the M. P. tosses him lightly over his head, follows him over and then is on top.

And when caught unaware from behind by an assailant who pins his arms at his side, the military policeman has a special set of tricks, too. First he takes a deep breath. This loosens the arms that circle his body. Exhaling quickly, the M. P. slips down and reaches up for the man's arm, or head, and, bending lower and forward, he tosses him neatly over his head. The resulting crash usually shakes the fight out of an untrained assailant.

He is taught how to use his knees instead of his fists to knock a man out if this last resort procedure is necessary. By one method he twists a man's wrists until his head is lowered. A quick blow with a knee does the rest. When he is in a desperate plight, the military policeman is permitted to use these trained knees to knock out an assailant's wind with a quick thrust into the groin or stomach.

Other last-ditch methods of stopping a fight are pressure on the phrenic nerves just under the ears and painful manipulation of the muscles of the forearm.

Useful as they are, however, these methods are used only when

Proper use of the knee can persuade an opponent to drop a club





With gun at one side, M. P. grabs opponent's wrist and gives a twist while wrenching gun out of his hand

intelligent handling of an emergency has not resulted in peaceful settlement of a difficulty. The men are taught to speak quietly and authoritatively, to avoid argument as much as possible and, above all, to set an example of cool decisiveness in a hot emergency.

Subduing recalcitrants, however, is only a small part of the duties of the new military police. They are also used in evacuation of civilians, in handling of communications, reconnoitering and protecting railroad yards and public utility structures used for water, lights, power and communications in war zones, coordination of army and civilian defense forces in battle areas, hunting saboteurs, caring for enemy

prisoners as well as keeping order among the soldiers, coding and decoding messages, taking and identifying fingerprints and directing traffic.

The last item of duty illustrates how thoroughly the First Army military police are educated, for scores of them have been assigned to the busiest traffic intersections of New York City, where, alongside the seasoned traffic officer of the police department, they learn the tricks of this trade the hard way—under fire.

Also, partly as a matter of duty and partly for training, the First Army military police direct traffic on the Governor's Island ferry and groups of them are stationed at Times Square, Pennsylvania Station and

Parrying knife thrust by throwing left arm under blade, grabbing wrist and hand holding knife and twisting the wrist; this throws opponent backward and can be counted on to make him drop the knife





**Bringing up knee against opponent's chin is quick way to end the argument**



**Thrusting armed man against building causes him to throw up hands to save face; pressure on back keeps hands up**

Grand Central Terminal in the big city. In the railroad stations they check soldiers' papers and tickets, handle the loading of troop trains, keep order among soldiers and sailors, supply information and make themselves generally helpful, both to uniformed men and civilians.

Although it is not generally known, a military policeman can arrest a soldier for such apparently minor things as leaving his coat unbuttoned, or his shoes untied or his hat slouchy, or his blouse torn. They seldom do arrest anyone for these infractions, since a warning is usually enough, but a sloppy soldier here and there would have a bad effect on the morale of the army and if the careless habits were permitted in public, the people of the nation would form a bad opinion of discipline in the army. So they are more careful about a

soldier's appearance in a railroad terminal than they would be in camp.

And, once more, the new-style military policeman sets an example to the average soldier. As soon as he is selected for this special service, he is issued an extra uniform so that one can always be clean and trim. In addition to standard equipment, he gets the blue and white M. P. brassard which he wears on his arm, his traffic whistle, and white web equipment which sets his uniform apart from the standard army clothing.

In seeking men for this branch of the service, preference is given to college men or others who display unusual intelligence, policemen, detectives, firemen, bank guards, armored car guards, state troopers, boxers, wrestlers, athletes or physical trainers.

**M. P. grabs hand thrust against his chest, twists it and applies pressure with right hand to overcome opponent**



As soon as they are in the service, they undergo a series of mental and physical tests. Passing these, they are put to work on an eight-hour-a-day routine to learn the policing business and get into good physical shape.

Heavy emphasis at first is placed upon physical condition and the first half hour of the training day is taken up with calisthenics. An hour or so of close order drill follows, with flying-wedge exercises and formations used to break up rioting crowds. On top of this there is likely to be a period of judo, or leverage and balance training.

A typical day's physical work also includes bayonet practice, education in the use of gas bombs and gas masks and pistol and rifle practice, and any spare time is usually used to play baseball, basketball or some other muscle-building activity.

The result is that while many of the new military policemen are small compared to the World War I variety, which tended toward giants and bruisers, they are hard as nails and more than a match for the average man, even without the "brain tricks" which enable them to toss the average man like a bag of potatoes.



M. P.'s job includes checking on train schedules at large railroad stations

Military policeman blowing whistle to signal traffic as a ferry approaches



## Artificial Wool Fiber May Be the Result of Baring Molecule's Secret

Production of synthetic wool has been brought closer to realization by finding the secret of its molecular structure, says Dr. Milton Harris, research director for the Textile Foundation, Washington, D. C. It was discovered that wool molecules are flexible and derive their elasticity and strength from the way some of them form ties or bridges across others. When it is

laundered, however, wool tends to lose the special cross-linkage properties. This latter discovery gave a clew which enabled research workers to develop a process for stabilizing wool which promises to double, or triple its durability. Dr. Harris said the Foundation has made no attempt to produce artificial wool, but added that the manufacture of synthetic wool is feasible.

*Blaney, Wernick, Sadler*

*Isenmors deland slip*

*Chicago Tribune 5/21/42*

*m 297*

*4th and 6th*

M 226

# Dog Trained to Care for Horses Performs Many Chores



Dog stable-hand, top, leading horse; bottom, fetching equipment

Dog lovers get a thrill watching "Flash," a white German shepherd dog, as he does his daily chores faithfully and unerringly about the stable of his owner, R. J. Rossi, a horse trainer at Tropical Park, Fla. The first thing each morning Flash silences an alarm clock that rings shortly after five o'clock. That starts him on a round of activity as stable hand and assistant in training four horses. He carries water in a pail, filling it himself by turning the spigot on and off with a powerful forepaw. He even knows just how much water he can carry. Going about his work with an unmistakable look of seriousness and determination in his eyes, Flash delivers horses' equipment to their stalls and never makes the mistake of carrying equipment belonging to one horse to another's

Jerome Bruce  
3/3 '42

stall. He leads horses about as ordered, and if the horse attempts to halt or change his course, the dog discourages such efforts by a persuasive tug on the shank. In addition to performing regular duties, Flash instantly obeys spoken or gestured commands.

M 240

## Salt Inlaid in Tire Treads Lengthens Nonskid Life

Economy of rubber and a longer nonskid life are advantages claimed for a method of embedding crystals of common salt or similar chemical in tire treads. A Detroit inventor patented the system and assigned it to the United States Rubber Company. As the "salted" tire wears down, the cavities containing small bits of salt are opened and the substance dissolves and keeps the tread rough.

M 296

## Soldiers in Gasproof Suits Train to Fight Poisons

Dressed in protective clothing, soldiers of the chemical warfare service have no fear of poisonous, skin-burning gases as they decontaminate areas sprayed by the enemy. The clothes worn by the gas-fighters are treated in a secret solution that makes them resist and neutralize any dangerous vapor that may touch them.



Soldiers spray chemical to decontaminate gas-spattered jeep

m 292

# Toys on Canvas Map Depict Tanks in Battle



Above, the toys of war; right, section of the canvas map; bottom, men move metal toys with magnets to simulate war



Brought to the United States from England, a miniature of a stretch of English countryside, reproduced on canvas, is being used by army officers studying tank tactics at the armored force school at Fort Knox, Ky. It represents an 8-by-13-mile section of Salisbury, Wiltshire, with woods of sponge rubber, Lilliputian farm houses, and plowed fields depicted in water colors. Rolling knolls of England's pastureland are reproduced by the upright sticks that support the 24-by-38-foot canvas at a height that will permit men to walk beneath it. Distributed at strategic points on the canvas are tiny models of tanks, artillery, motorcycles and troops; and five men stand under the canvas holding magnets. As an officer describes a problem for



the class, the men contact designated spots with their magnets, moving the various army units about the canvas as the fight progresses. Bursts of artillery fire are simulated by ejecting cigarette smoke through openings in the canvas. Student officers sit on a narrow balcony above the map.

Science Service 2/00

## Flow Meters Installed in Oil Pipes Would Save Oil, Labor and Steel

General use of recording or ticket-printing meters to measure oil as it flows through pipes, instead of pouring it into tanks, would result in saving steel, oil and labor, says L. R. Van Arsdale of the Pittsburgh Equitable Meter company, Pittsburgh, Pa. Although in the army and navy, trucks and warship tenders are equipped with these meters, and some of the new oil fields, trunk pipelines and delivery trucks

have them, their use is still very limited. When measured by meters within the pipe, the oil is never exposed to the atmosphere as when poured into tanks, thus protecting it against the loss of gasoline vapors which are valuable in the manufacture of 100-octane gasoline for airplanes. Pipe metering also would save a vast amount of steel that is required for the measuring tanks, extra pipes and pumps.

398 4i Lexington Ave

7/156

Hamilton 1177 1/2 d  
Westward Lo Ancher

Andrew

Barrie, with

# FLYING BATTLESHIPS



# WILL WIN THE WAR

Mass-production "Flying Fortress" which may be America's key to victory is described as "deadlier" than its predecessors

Specially built helmets and oxygen masks are standard equipment for pilots who ascend to altitudes greater than 15,000 feet

**By Wellwood E. Beall**

Chief Engineer, Boeing Aircraft Company



WINSTON CHURCHILL appeared before Congress last December and declared that the Allies would be ready "to take the initiative on an ample scale" by 1943 and in the end would give the Axis powers a lesson the "world will never forget."

There is no doubt that he was thinking largely in terms of air power. By 1943 American factories will be producing hundreds of four-motored bombers each month, and these mighty "air battleships" may well be the deciding factor of the war. Two and one-half years of aerial warfare in Europe and several months fighting in the Pacific have indicated that the nations which first acquire a fleet of long-range, hard-hitting planes will win final victory.

Boeing's first Flying Fortress was produced in 1935. Even though it cracked up in a takeoff, the Army immediately ordered thirteen more. In 1941, the United States sent a few big bombers to





Another "battleship of the air" is the huge Martin flying boat, above, used by the Navy. In cubic content, it approximates a 16-room house

England. They were promptly dubbed "flying targets." Too big, too slow and too costly to build was the snap judgment on them at first. But when R.A.F. pilots took the American-built air battleships over the European continent and dropped bombs on Germany, they came home singing their praises. Last July the British Air Ministry revealed that Boeing Flying Fortresses had staged daring daylight raids on docks where German pocket battleships were berthed at Brest. Flying at 30,000 feet, the big planes could be neither seen nor heard. Antiaircraft fire couldn't reach them and fighter planes were ineffective at that height. Instead of carrying 250-pound bombs, the Flying For-

Looking aft in fuselage of a heavy bombing plane gives you some idea of what it takes to build a large all-metal ship like this one



7/15/6

281



Marines boarding one of the Navy's transport planes to be rushed wherever they may be needed for action

tresses carried what Lord Beaverbrook described as "big, beautiful bombs" of 1,000 to 2,000 pounds.

Right then the character of World War II underwent a drastic change. Germany frantically began to convert its Kurier, a large transport, into a long-range bomber. The British stepped up production on their big Stirling and Halifax bombers.

But it remained for the United States, whose engineers had been building big bombers for six years, to undertake the most gigantic task of all. Plans were adopted to hit a production schedule of several hundred air battleships a month by 1943.

Such a job calls for the brains and brawn of 500,000 men.

Almost overnight Boeing, Douglas and Vega—a subsidiary of Lockheed—pooled resources and facilities for building Flying Fortresses, each to turn out completely assembled four-motored bombers, with complete exchangeability of parts. In addition, Consolidated Aircraft Company arranged to speed production on its four-motored bombers and the Ford Motor Company's Willow Run plant moved rapidly toward the day when mass production might be achieved.

Both the new Boeing and the Consolidated ships have more fire power, carry a heavier bomb load and provide more armor and self-sealing gas tanks than did earlier models. Radio locators help to spot enemy fighters. Several machine guns bristle from powered turrets. The bombers are able to lug several tons of bombs on a 2,500-mile trip at exceptionally high speed.

Planes such as these are the first to combine the three necessities of modern military power—great striking range, great speed and great carrying capacity. Up until now, modern air fleets have resembled navies consisting only of destroyers and cruisers. There have been few "air battleships" to deliver the decisive blows.

Left, below, one of the Navy's paratroopers; right, some of the big bombs which four-motored planes carry





Above, test crew boarding plane for high-altitude flight. Right, exercising during "denitrogenization" process



Almost daily dispatches from the war fronts indicate that aerial battlefronts are on the move—up. Combat at 25,000 feet and above in Europe has already taken place. Greater heights will become common as the four-motored bombers get into action. Germany is said to have a Messerschmidt fighter plane capable of reaching 39,000 feet. At 35,000 feet, the air is so thin that a man becomes unconscious in less than a minute without artificial air supply. Conditions such as these require not only precision engineering but careful training of flight crews.

At the Boeing plant much attention has been devoted to this phase of stratosphere warfare. Using its "strato-chamber," the first extensive stratosphere-conditioning tests to be carried out on a large group of men were undertaken several months ago. Whole test crews have made experiments both in the laboratory and in the skies to gather data on flying conditions in the "purple twilight" of the upper atmosphere.

America's four-motored bombers will outperform those of any other nation because of the famous Norden bombsight whose accuracy is uncanny from great heights, and the turbosupercharger

(Continued to page 164)



Test crew checking oxygen equipment in strato-chamber. Right, sketch of present-day fighting levels and those of tomorrow

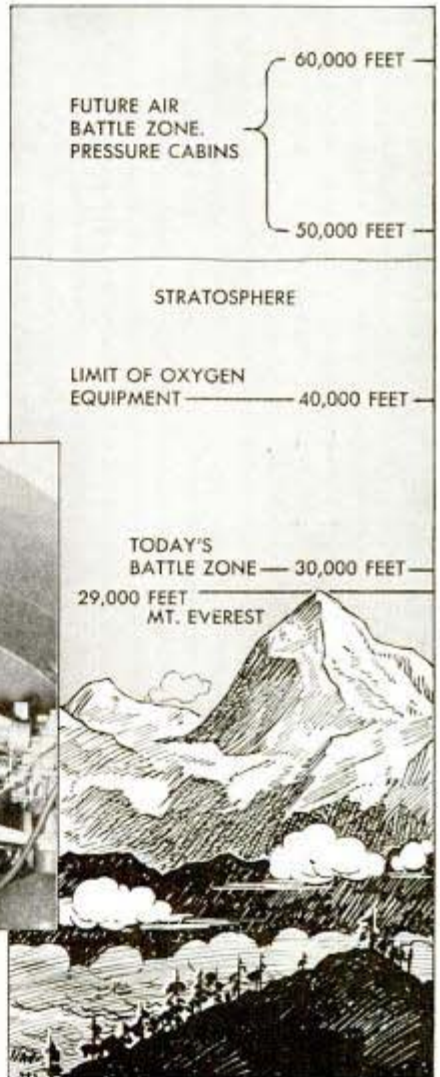

M 25

New World Bldg

# Ammunition Carrier Towed by Armed Truck

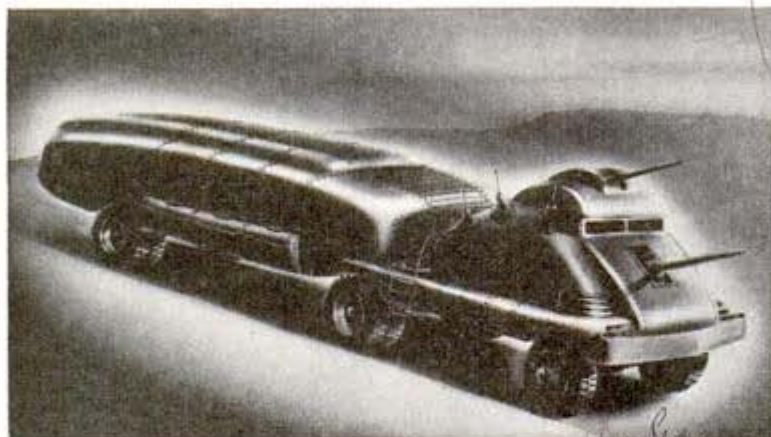

Streamline ammunition carrier is well armed to fight its own battles

Streamline warfare will add another streamline vehicle to help outblitz our enemies if the ammunition carrier designed by George Walker of Detroit, Mich., is accepted by the United States Army. Looking like some large-headed insect of gigantic proportions, the squatty truck and motor-driven tractor would be armored and well armed against attackers.

Walker

Army day

M 227

# Strands of String on Pursuit Ship Aid Wind Tunnel Tests

Action of air currents passing over an airplane in a wind tunnel can be studied better, it has been found, by "growing hair" on the fuselage and wings. Short strands of string fastened to the ship at regular intervals fly in all directions with the air-flow over different parts of the plane, indicating streamline and eddy patterns which can be recorded permanently by movie cameras.

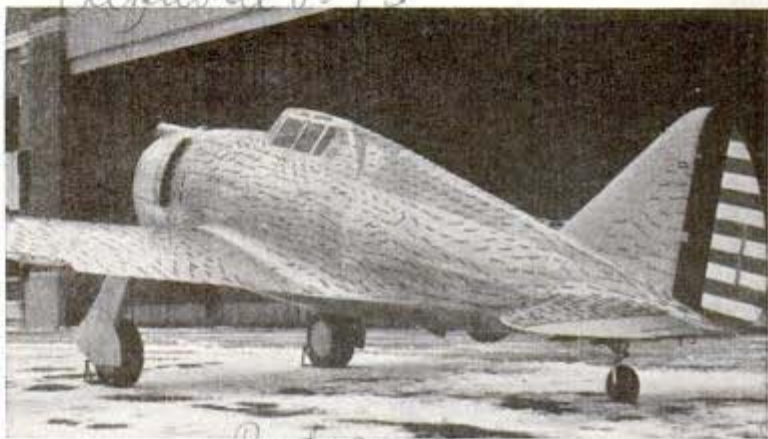

Little tufts of string "planted" on plane indicate flow of air currents

Republic P-43

Pursuit arrow

Republic Aviation Corp. New York

# Tiny Magnetized Autos on Chart Depict Traffic Accidents in Court

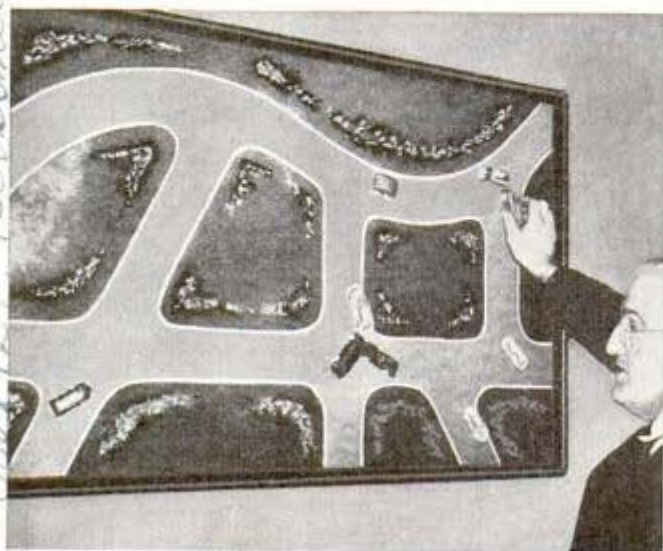

Traffic conditions at the time of an automobile accident can be reproduced on a novel board intended for use of court and jury when a traffic case is being considered. Toy trucks and cars may be placed in any position and moved about on the board which contains designs of all manner of crossings, curves and road junctions. Magnets in the tiny vehicles hold them to the board, so virtually any traffic situation may be simulated while the board stands upright.

Witnesses at traffic trials can arrange cars on this board in presenting their version of how an accident occurred

Illustrator G. Box 127 Berkeley, Calif.

*in 1900. Ref: Early 26 U.S. Pat. No. 1,100,000*

# Ghost Writing Is a New Trick for Your Camera

*Paul Thore Lewis, 557-5, 8th Ave. New York*



*Robert Hill*

↑  
Try lighting your cigarette with the magic match that leaps right up from your hand. It's easy—with a camera. No magic camera, either; the magic is in the old, familiar double exposure trick. It's done with lights

They call it "ghost writing," this latest fad of camera fans, and here the lady is pictured dancing with the ghost itself. The camera, loaded with a slow film, is placed on a tripod in a darkened room, the shutter at time, the lens at f:2. A small light bulb or match flame traces the desired outline, then a flash-light exposes the subjects

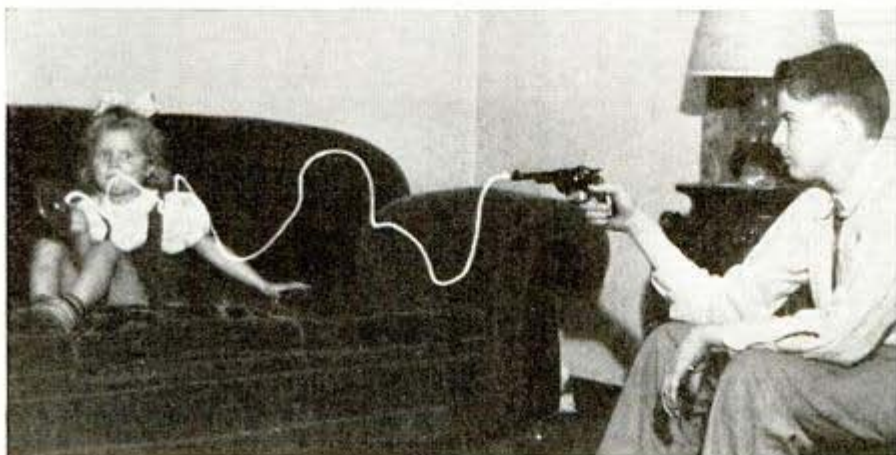

The "ghost writing" camera even makes sound visible, and here's the evidence—the telephoned "hello" captured in black and white on film. At the left, a "tracer bullet" meanders around until it finds its mark. In making these trick pictures you must plan carefully so that the tracer light fits the scene exactly. It needs a dark background

*m 25 4*

## Light on Life-Jacket Lapel Helps Save Men at Sea



Life jacket carries lamp to help spot it in the sea

More than 400 men, it is said, have been saved from a watery grave by a new lapel torch that is worn on the life jacket. Its glowing red bulb leads rescue vessels to men who otherwise might not be found in a dark sea. Every British seaman will wear the torch.

*m 30 1*

## Fence-Line Weed Cutter Built From Old Farm Machines

Swinging a scythe to cut weeds along farm fence rows is a thing of the past for

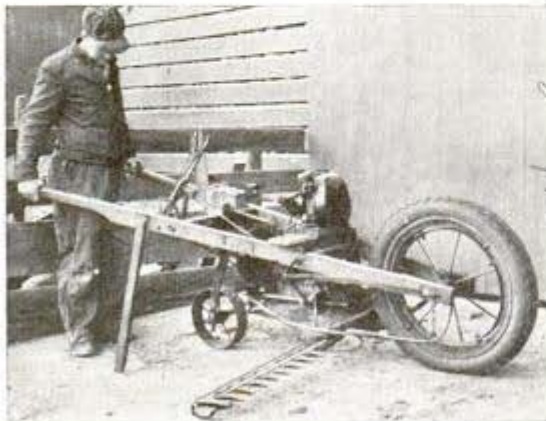

Homemade weed cutter is walked like a wheelbarrow

Charles Gibson of Gilbert, Ia., who built a wheelbarrow-type mower from parts of junked farm machinery. The only parts purchased were the engine to run the sickle, two V-belts and the pulleys. From an old grain binder came the 27-inch sickle and pitman; the sickle-bar is a piece of scrap iron in which holes were drilled to give the proper interval to the small guards; and the frame, on the style of a wheelbarrow, is made from scrap pieces. A hand lever adjusts the height of the sickle bar. In front is an old cart wheel bolted inside a steel tire rim, and a small wheel behind helps carry part of the load.

*m 23 7*

## Three-in-One Garment Hanger Holds Two-Pants Suit

Two pair of pants besides a coat and vest can be hung on a clothes hanger now available. The crosspiece below the arched sec-

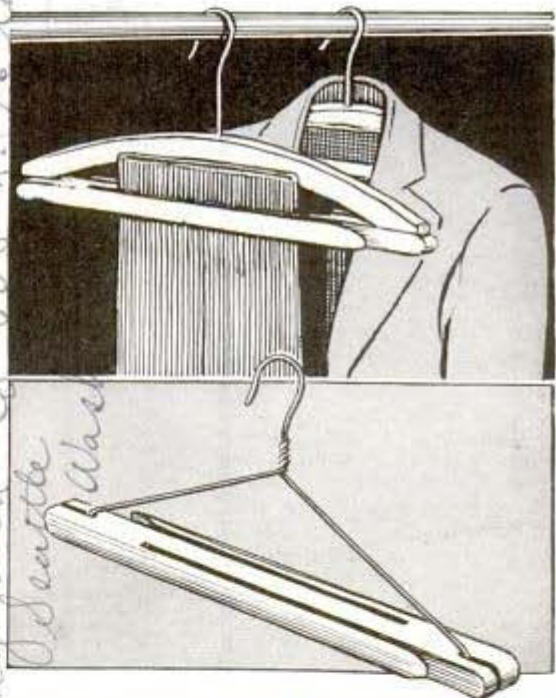

Two-pants hanger, top, and adapter for wire hanger

tion has two slots, one on each side and cut from opposite ends. Each slot holds either a pair of trousers or a skirt without interfering with the coat. Wire hangers can be used the same way by inserting a double-slot adapter designed to fit them.

Write to the firms listed in the Where-to-Buy-It index to learn more about products described in this magazine. Say You Saw It in Popular Mechanics.

m 293

Chief H.A. Oak  
of Chicago

# Bullet-Resistant Block Made From Waste Slag

Concrete blocks made from a mixture of cement and slag, a by-product of blast furnaces, have been found to stop bullets that would shatter ordinary cement. As it comes from the furnace, the slag is whipped up with cold water, making a bubbly cellular mass which, after being crushed, is combined with cement, making a block less than three-fourths the weight of ordinary concrete. In tests of the blocks, a standard army rifle, using the new armor-piercing bullets, penetrated only five inches. A Krag rifle, firing ammunition loaded with 180 grains of powder, pierced to three or four inches, while a sub-machine gun kicked up a lot of dust but did no damage. It is said that for civil defense the material could be used instead of sand bags, as the blocks are cheaper and would not rot from exposure.



Policemen, top, lined up to fire into concrete blocks made by mixing slag with cement. Bottom, examining the bullet-resisting blocks after the test

similar names (Harvard, Bristol, ...)  
 m 304

# Wood and Steel Trainers Save Aluminum for Warplanes



Surface of training plane is marked to indicate parts that will be covered with wood and steel instead of aluminum, to save the metal for fighters

To save aluminum for bombers and other fighting aircraft, wood and steel are being used instead of the light metal in training planes. To show how much of this metal could be spared, a North American AT-6A advanced trainer was marked off to show parts which will be replaced by wood and low alloy steel.

Scientific research has reduced the list of imported materials strategic for defense from 42 in 1921 to 14 today.

10 12 39  
Cmt. March 11 1938  
Perkins  
Stearns Clinic  
Washington



"You Can't Catch 'Em  
Where They Ain't"



The fisherman below is too clearly outlined close to the bank. The preferred method is shown above; natural surroundings shield him from view



ALMOST every living angler can remember the first steps to check depletion of fish in our lakes and streams. Conservation was regarded with much hope by sportsmen. Millions of fish were to be planted, and the day seemed near when the fisherman would have to hide to bait his hook.

But the plan did not work as expected. Planted fish often did not thrive, were not spirited, or did not get very large. Veteran anglers were soon sneering at planted streams, and shouldering

Below, at left, lowering a sampler for test of water near bottom, where food sources often are best. Fisherman at right is too exposed for luck





21089

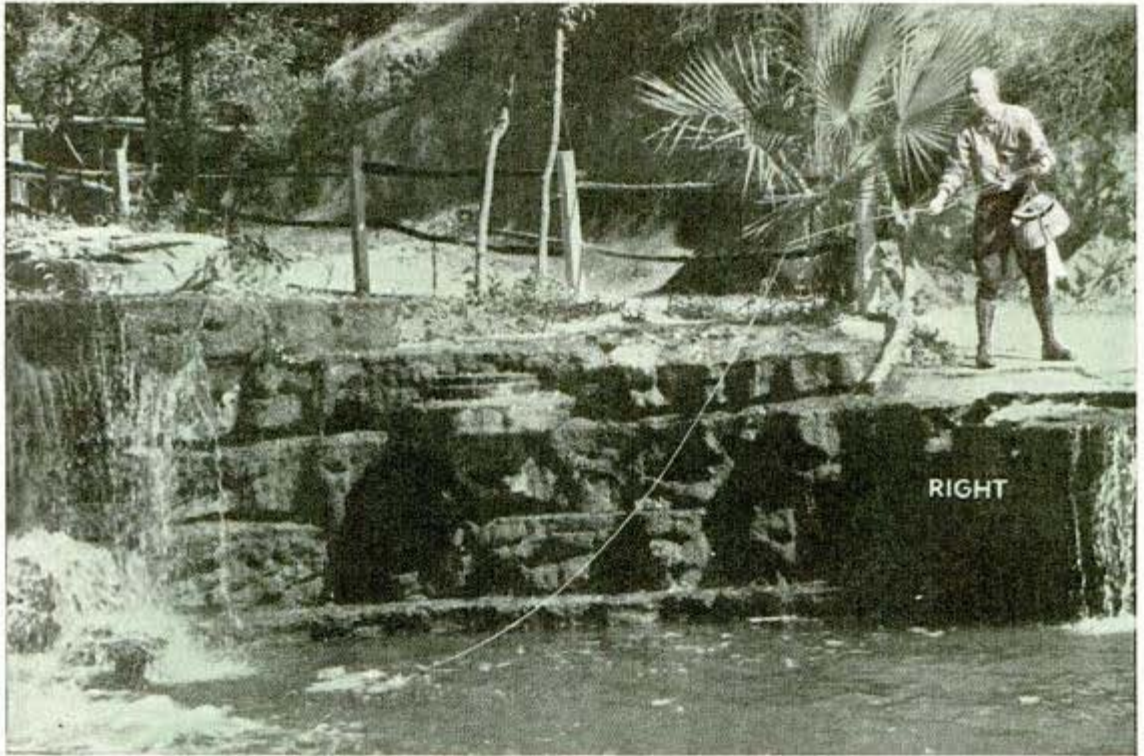

Choicest fishing spot of all is a waterfall where the water is oxygenated and white foam hides the fisherman from the fish. Notice that the angler is standing well back on the rocky bank

their packs for distant and virgin country.

However, behind the scenes were small groups of scientific men to whom the failures of fish culture simply did not make sense. They set out to learn what was wrong, and slowly but surely came information that was to make the stocking of streams successful; and of even more immediate interest, they learned facts that can be applied for increased catches.

Why, these investigators asked, did planted fish often not grow? Why sometimes did they lose their gameness? Why, in some waters, did they turn up their bellies and die? Why did they frequently fail to reproduce? When they knew the answers, fish culture was on the road to success—and when you know them, you will be a better fisherman.

First, planted fish sometimes failed to grow for the same reason that a certain species in one lake or stream will be smaller than the same species in another lake or stream. Fishermen are often heard to say, "There were sure a lot of fish in that lake last year, but they were awfully little. Maybe this year they will be bigger."

Maybe—but probably not. The fish were not necessarily small because they were young. Probably there were too many of them for the food supply. When the orig-

inal fish planters put out millions of young, they bumped into this dilemma, and their little fingerlings failed to grow. One could not expect a thousand head of cattle to become fat on a dozen acres of pasturage, but not until scientific stream surveys began did anybody think of that.

Surveys proved that there is an iron bound relationship between the number of fish and the amount of available food and the size to which the fish will grow. A certain body of water may support a thousand fish of two pounds each. Reduce the fish to five hundred, and they will grow to four pounds each, providing the species will get that large. Increase the number to two thousand, and they will shrink to a pound apiece. Now when fish are planted, careful studies are made, and the number planted is confined to the number the area can bring to full size. If subsequent tests fail to show growth, no more are planted for a while. If growth is rapid, more are planted, until the correct balance is struck.

Knowledge of this fact will help fishermen to keep their fishing grounds productive. It is lots of fun to fish in a spot where they are big, fat, and fighting, but if they are, beware; don't spoil a good thing by overdoing it; you may fish the spot barren. On the other hand, if they are compara-

21270



Don't tramp along the shore (above). Vibrations from the earth will frighten the fish some distance away. Below, fishery truck with cans of fish to be planted; air is fed into cans by tube



tively small and bite like mad dogs, they are undoubtedly hungry, the water is probably overpopulated, and you will actually improve fishing conditions by catching a lot of them. Don't wait for them to grow. Take some out, and the rest of them will grow better.

Food is not the only factor governing growth. Temperature is highly important, not only to size but to living conditions. Every fisherman should invest a dollar in a thermometer, and learn to use it. A good angler can take as big a fish on a cheap pole as he can on a fine one, but he can't catch a big fish in water too cold for growth—

He caught one this time—but generally it's not a good practice to wade, for it may disturb the fish

big fish simply don't live there.

In regions where summer temperatures are less than 80 degrees, it is futile to expect good sized large-mouth bass. That is the minimum temperature required for good growth, and they can tolerate temperatures of 90 degrees, and higher. But in hot lakes or streams such as this, don't expect to catch trout. They like cooler temperatures, indeed, can live in water almost at the freezing point, although growth is retarded without warmer summer conditions.

The common brook trout will do best in temperature from 65 down to 45 degrees. It can stand warmer water if there is plenty of shade, and can live in far colder water, but growth is poor. The famous fighting beauty of the west, the rainbow trout, can tolerate from 70 down to 38 degrees, and, of course, needs the warmer summer water to bring him to maturity. It is generally at its best around 60 degrees. The Loch Leven and brown trout are the best in warmer waters, being able to take temperatures up to 85 if there is plenty of shade.

If you are going to fish in grounds that you know are good, and the water is quite warm, test with your thermometer for the coolest spots, and try fishing there. On the other hand, if it is generally cold for the species you expect to take, look for them in the warmest spots.



Why are some fish sluggish in a certain body of water, and full of life in others? Too high or too low temperatures may cause this condition; the planting of species not adapted to prevailing temperatures was responsible in some of the early fish culture. But sluggishness generally is due to lack of dissolved oxygen in the water. All game fish like rather high oxygen content.

There is no test for oxygenation as simple as taking the temperature, but by using your eyes you get some indications. If you see a slow moving stream, or a deep, placid lake, there is less chance of getting fighters than in more turbulent areas. If wind has a good sweep across the water, and creates a lot of little ripples, this situation may be reversed, but unless the water is stirred and aerated, the best you can hope for is a bullhead or a half dead trout or bass.

The best spots for the fighters are always where water comes cascading down heavy slopes, thunders over the rocks, rolls and boils and bubbles.

One of the great mistakes made by the early artificial planters was trying to cul-

**A novice would call this a good spot, well out with plenty of room for casts, but he is far too exposed**



JULY, 1942



**This is a section of tank in which fish are raised for planting later in streams; tank is being refilled after having been drained and scrubbed**

tivate areas that had inadequate spawning grounds. For good reproduction, fresh water game fish must have clean rocky or shale bottoms, where eggs may be afforded protection. Streams without areas quite free from sediment do not provide such conditions. The rocks have probably been long since covered over, and if they have not, the first freshet will cover up and smother the unhatched eggs. So it is well when selecting fishing grounds to bear in mind that catches will be relatively better where the best spawning grounds are.

You may as well save yourself the time and disappointment in fishing a stream that has much industry at the headwaters. Waste products, draining into the water, often kill fish for miles. Salts of zinc and copper, fine sawdust, wastes from wineries and milk processing plants are among the worst pollutants. Construction work in the river is bad, too. Sediment thus generated smothers eggs, sometimes clogs gills.

Some states have gone so far as to experiment with various types of fishing, and issue scientific reports on correct techniques. It has been found that those who consistently get prize catches are not just lucky. Fish are clever, especially the big ones who grew to that size by refusing to take the first carelessly offered bait to come near.

He who would take the wily fighting beauty must remember that while a fish cannot hear, he can both see and feel. You

(Continued to page 172)

## Milking Is Taught With a Model In City Boys' Classes

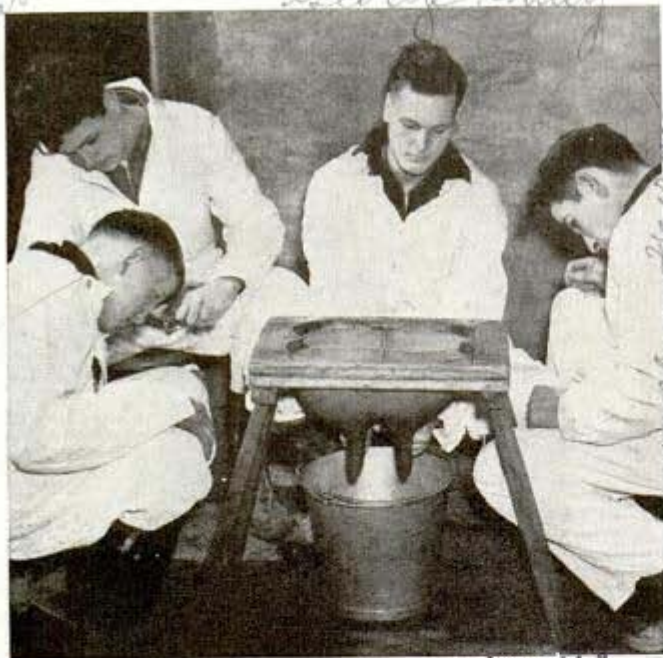

It's always milking time at the school where this model is in daily use by students learning work they will do on the farm

One of the first lessons for city youths learning how to farm at the Bowdoin farm training school, of New Hamburg, N. Y., is the correct procedure in getting milk out of a cow. However, as there was no cow available for this kind of classwork, a "stand in" was prepared consisting of a rubber udder which may be operated in the accepted fashion. In six months a class of boys who have never seen a farm are made proficient in many chores about the farm, such as planting, harvesting, storing crops, caring for poultry and livestock, chopping wood and milking.

## Scarcity in Insect Poisons Is Precipitated by War

Chemicals for making insecticides used in the fight against crop pests and diseases have been made scarce by the war, both because of demands for them by war industries and the cutting off of foreign sources, says James R. Hile of the Acme White Lead and Color Works, Detroit, Mich. Arsenic, for instance, is hit both ways. About half of our arsenic in normal times came from Sweden, Belgium and Japan, all now shut off by the war,

and great quantities are needed in the manufacture of khaki cloth, blankets, etc., and in glassmaking. It is also used in production of weed killers to replace chlorates now absorbed by the powder mills. Rotenone, an important organic insecticide, came largely from the East Indies, with about 40 percent coming from South America. Although the South American supply can be stepped up to perhaps 60 percent, it still leaves a severe lack. The principal source of pyrethrum was Japan, but the British African colony of Kenya can replace this loss if enough shipping space can be made available.

## Push-Button Safety Gate Guards Defense Plants

Useful for barring unauthorized entry of automobiles at vital defense plants, an electrically-operated safety gate has simple push-button controls. Mounted on the striped top crosspiece, electric lights flash on and off when the gate is lowered and turn off automatically as it rises. The sturdy gate may be used at private switch tracks or as a barrier to stop cars for identification, collection of tolls or inspection.

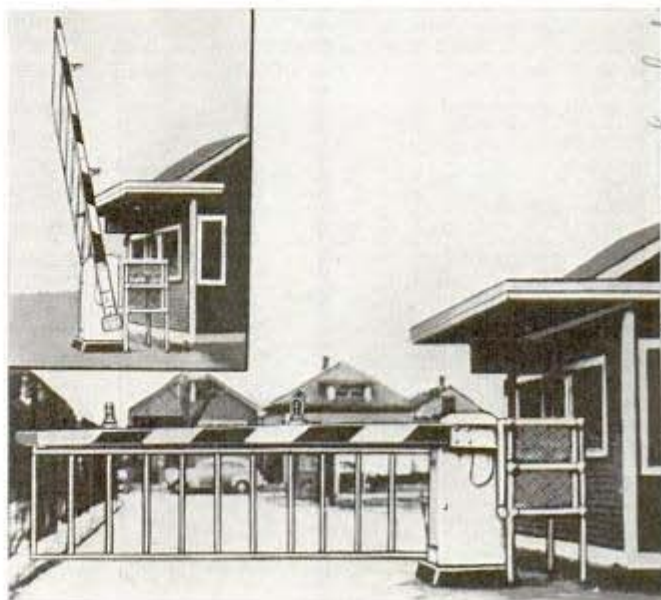

Safety gate easy to operate can be used to halt cars at entrances to defense plants. Inset shows it in the raised position

7m 249

# "Diary" Records Behavior of Golden Gate Span

*Wm. H. Keirelson, Jr.,  
San Francisco  
By Dickson, maintenance super.  
of Post San Francisco*

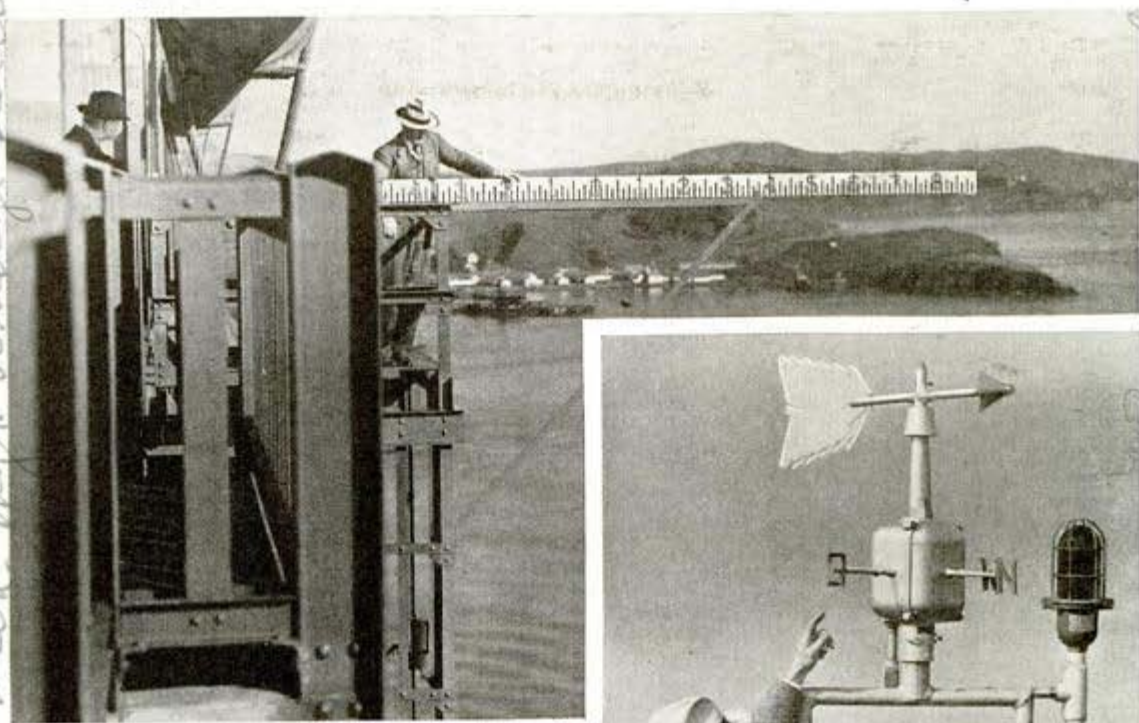

Photos, courtesy Redwood Empire Association  
Horizontal measuring rod, above, is 17 feet long; right, instruments chart wind speed and direction

For the first time, the "antics" of a great suspension bridge in all kinds of weather conditions are being recorded regularly by scientific instruments installed on the Golden Gate Bridge at San Francisco. The record includes temperature, wind direction and speed, and horizontal and vertical structural deflection of the 4,200-foot span. Two automatic electric wind instruments are mounted atop a supporting tower high enough to clear any obstructions that might interfere with their proper functioning. The topmost portion is a four-foot all-metal vane mounted above an electrical wind generator, operating in series with the wind velocity transmitter. Beneath the wind directional transmitter is a multi-cup rotor connected with a wind velocity transmitter calibrated for determining speeds from zero to 100 miles per hour. Impulses are transmitted electrically to recording devices in the south tower some 2,100 feet distant. In order that the transit may be set up in uniform position for determining horizontal and vertical deflections, metal cups are embedded in the sidewalk near the south tower, whence the transit is sighted on targets placed on the north tower 4,200 feet away. Midway of the span,

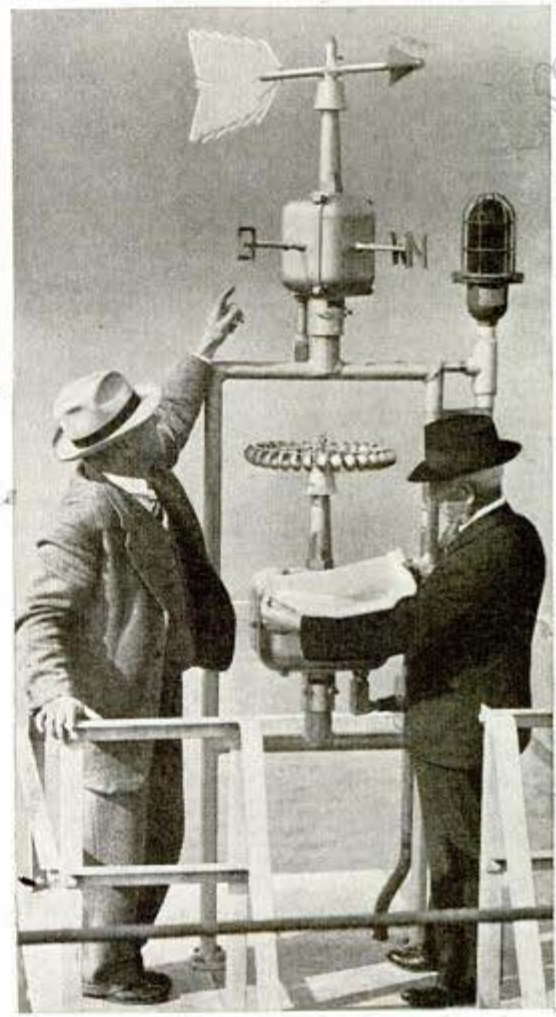

horizontal and vertical measuring rods have been installed, and at a known atmospheric temperature the transit sighted on the targets registers zero on both the measuring rods. Temperatures are recorded at both the south tower and mid-span. Thus authentic information concerning the actions, or behavior, can be recorded over a 24-hour period on special charts, which will be invaluable to engineers working out problems to meet atmospheric or storm conditions to be faced by other structures.

*Michigan Golden Gate Bridge and Light House Engineer*

# Thrills in DAVY JONES'S LOCKER



South sea turtle above was over seven feet long. Upper right, helmeted diver in shallow water without usual rubber suit. Below, Spanish sword, cannon balls and pistol found on sea floor



Paramount Pictures

By  
**Lieut. Harry E. Rieseberg**

Noted deep sea explorer and salvage expert, and author of "I Hunt Treasure," (Robert H. McBride Co., publishers) from which this story has been condensed

5127 Hamilton Ave. - Channahon, Ill.

**C**RUSTED bars of gold, glittering jewels from Incan temples, silver plate, doubloons, ducats, and ancient Spanish pieces of eight have lain in rotting treasure chests on the floor of the seas waiting for some inventive genius to devise ways of raising them.

And now there are ways. The author of this article, veteran of many treasure salvage expeditions, has proved that depths of the ocean never reached before can be explored safely with a new all-metal device, the most scientific deep-sea diving gear produced so far.

Because the resting places of the wrecks sought are in waters beyond the depth range of ordinary diving dress, the latter has been seldom used. The standard rubber suit carries air and life lines, which in treacherous and reef-strewn waters are too easily fouled and broken. Too often there are mishaps with the air pumps aboard the salvage craft, and the greatest handicap is compression.

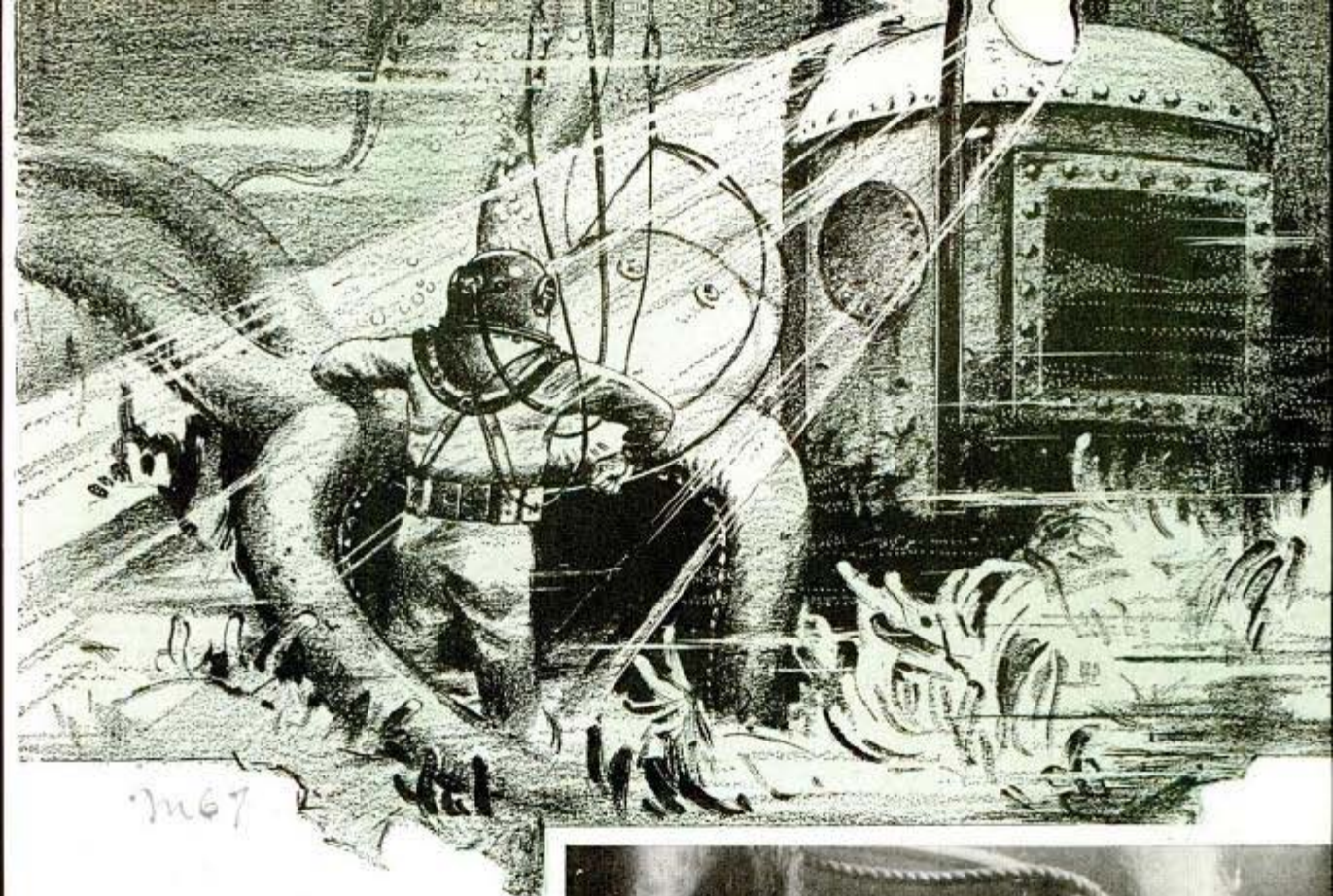

↑  
Lt. Rieseberg examining huge octopus after chopping its tentacles from the observation bell in which his partner had been trapped

The period of decompression required with the traditional type of diving dress is often longer than the time the diver is able to work on the sea bed. Under these circumstances such equipment is useless in deep sea operations.

With the new robot such obstacles are entirely eliminated, for the device may be hoisted from the greatest depth without decompression stops, as fast as the winches on the salvage vessel can lift it, for it is self-contained. This robot is of the sphere type, in appearance somewhat pear-shaped, cumbersome and bizarre, and much like the fabled "man from Mars." It is the only sphere equipped with workable arms of toggle-jointed hydro-pneumatic operation.

At the end of these nine-foot arms are mechanical hands, claws and fingers, consisting of steel grips, so sensitively adjusted that a coin may be picked up from the floor of the ocean, or a section of heavy planking torn from its fastenings. They have such strength they can lift 500 pounds



Two divers in the Paramount motion picture, "Reap the Wild Wind," communicate with each other by means of hand signals

each; and with astonishing flexibility they can tie rope or steel cable under water!

These metal hands may be removed from the arms and replaced by a dozen different special instruments screwed into the hand sockets for various types of undersea work. With them objects may be raised, knots tied, three-inch holes drilled through ships' steel plates, and at the same time they are so delicately adjusted in their movement that the diver within the gear may



A diver in a movie thriller works on a treasure chest aboard a sunken ship

"make a fourth" at bridge, picking up and laying down his cards as needed.

Oxygen for breathing is supplied to the operator from a tank inside the sphere, and there is an absorbing cell for carbon dioxide. Thus, unlike the standard suit, there is no danger of a leak releasing the precious air and leaving the diver to suffocate before he can be drawn to the surface. With this equipment the diver may remain on the bottom of the sea for ten or more hours at a time. He can move about freely, watch the dials and indicators, use the telephone, even read a newspaper at great depths. In northern seas, the water is murky and visibility poor, even in shoals, while at great depths the water is a dark, greenish-black void. So powerful illuminating devices have been provided which light the ocean floor for 100 feet or more.

The robot is constructed of steel and iron, and weighs 3,900 pounds. It has been tested and proved at the terrific pressure 5,000 feet—nearly a mile—beneath the surface. United States Naval inspectors pronounced it the "greatest stride in deep-sea salvage operations, and as revolutionary in its element as the airplane was in the air!"

But let us climb aboard the treasure expedition's salvage schooner and sail out into the Caribbean for an actual descent into the sea. The first thing we notice is this gigantic iron sphere, lashed against the bulwarks on the lee side of the schooner's deck. Behind it are motor winches and drums that control the cables by which the robot is lowered or raised. From a powerful derrick or boom hangs the three-quarter inch steel cable affixed to the head of the metal "Frankenstein."

After reconnoitering for a suitable base from which to start operations, the craft lowers anchors, fore and aft, together with a weighted cable-anchor from amidship. With these preliminaries completed, we are ready for the first descent.

The electrician is standing by to aid the diver, myself, in preparation; his assistants are fussing with the various "gadgets" that stud the robot's inner walls; the navigator of the schooner, Captain Alvin Loesche—that old seamaster of forty-odd years at

His air lines menaced, a diver fights off an attacking octopus





7167

sail—is at the wheel, and several seamen are un-lashing the robot from its brackets; the engineer, who is to handle the winches and drums, awaits the signal to start the engines. I have donned a sweater, cap, heavy woolen socks and moccasins, and over all a white work-suit. I give the signal. The winch groans, the drums turn, and the huge robot is lifted a few inches from the deck. I climb through its eighteen-inch aperture. The watertight opening is closed, locked and bolted down with a huge wrench after hammers have placed the pin bolt-nut. A moment more and the



Two-way microphone and speaker at upper end of the communication system between ship and diver  
 Lt. Rieseberg inspects a huge anchor that has been encased in shells during years on the sea bottom



derrick lifts, the sphere swings up, over the side—and down into the sea!

There is momentary quiet on the schooner's deck. Presently the electrician begins to talk into the phone, the other end of which is beside my head, attached to the robot's dome; the ear-phones are snapped to my head. Over this telephone, every movement below is described. A robot-diver's voice is always calm, quiet, for danger is a part of his life. Whether he be down 300 feet, or 1,000

← Diving helmets of a salvage venture



This short, stubby brass cannon is a relic of some Caribbean shipwreck

feet, in tides or currents or the unknown perils of unexplored depths, he does not get excited, for he is trained for it, and it is his calling.

There is only one thing of which the robot-diver is even slightly apprehensive, and this is that he may some day be caught or twisted so that the cable that supports the robot may be snapped in two. True, he could live in the iron vault on the bottom for ten or twelve hours, but how would they find him? They couldn't! You think of those dangers, as you listen to the crisp

Closeup of octopus tentacles wrapped around top of the observation bell



voice of the electrician from up above.

Down on the bottom I stare through the vision plates, watching everything that swings into sight; rotting hulks of ships; walls of rock that rise before me sheer as a mountain cliff; walls of mud, soft and oozy and dangerously enveloping; banks of quicksand; weird denizens of the deep that few have ever gazed upon. Here are dazzling blue parrot-fish, gaudy, graceful angel fish, butterfly and four-eyed fish, marbled groupers, scarlet snappers, vermilion squirrel fish, cruel-jowled sharks.

Here too, deep in these crystalline waters of the Caribbean, I am lugged along past marvelous living corals—orange, yellow, crimson, mauve, green, brown, scarlet, black and fawn; endless in their variety of fantastic forms. Some are in the shape of domes, others like giant mushrooms, some with branches that form veritable jungles; still others like gnarled forest trees, and everywhere the waving purple and black sea-plumes, orange and golden sea-fans.

As my huge shell is tugged slowly, rolling sickeningly if it be one's first experience, I adjust the claws of the nine-foot arms to an old hulk and haul away, tearing off a plank and peering at it in the light beam.

Now, I am resting beside the wreckage of a once stately Spanish galleon with a mound of gold and silver coins marking the spot that once had been her strong room—treasure of ancient plate and works of art, possibly a part of the loot of the Incas and the Aztecs, gold and silver pieces of eight, and jewelry, filched perhaps by some pirate centuries ago.

On the deck above me,

away from the telephone mouthpiece, someone called out: "Twenty-five fathoms!"—and at that moment I could feel the robot touch the sea bed. I turned on the searchlights, and gazed about in all directions. The brilliance knifed into the gloom and revealed the strange beauty of the sea depths with a clearness I had never experienced before.

As I gazed out into the fairyland, I was startled by a huge, undulating monster approaching me. It was a great octopus! Creeping out of a cave in the coral, the ugly creature launched itself toward me along a natural trough that led from out its rocky lair. It hesitated a few seconds between my robot and our observation bell, which had been dropped to the bottom to take still pictures of the coral gardens. Then, suddenly, with a sideways surge, the creature eased over toward the bell. An arm as thick around as a man's body flicked out and touched the metal cage. When nothing struck back, the octopus flung more arms around the observation bell, and shook it angrily as though trying to break the steel shell. When nothing happened, the monster worked itself into a frenzy, banging and tugging at the bell so that it swung and bobbed in crazy pendulous sweeps.

I realized now that my assistant within the shell was in misery, so I barked an order into the telephone, and my robot dragged into the fray. Quickly I swung the arms into position and opened wide the jaws that served as hands. The steel nippers jabbed into the soft mass of the monster and with 500 pounds of pressure in each, bit through one of the clinging tentacles.

Instinctively the monster released a jet of inky defense fluid, and the water about me grew dark.

Again I adjusted the mighty claws, and again a writhing tentacle was sheered from the body. Still the monster refused to leave the observation bell. The great arms thrashed about in the now murky waters, and steadily I bore in, watching each opportunity. One after another the arms of the octopus fell away, until there were only three left, and the creature's strength was so reduced that it could hardly cling to the observation bell. Weakened and mutilated, it dropped away helpless, writhing, spewing the last of its inky barrage in a

(Continued to page 176)

## Blackout Caps to Be Worn By Transformer Signals



Thousands of these little metal caps are being made for concealing signal lamps on outdoor transformers

Tiny signal lamps on outdoor transformers atop power-line poles, barely noticeable when street lights are turned on, were found glowing brightly in a blackout and had to be concealed from possible enemy planes. In answer to a rush call from the Pacific coast, engineers of the Westinghouse company designed a helmetlike cap which, when placed over the lamp, permits a narrow beam to shine downward but cannot be seen from above. In normal conditions the lamp is turned off, coming on only as a warning for the service man if the transformer is becoming overheated.

## Three-in-One Screwdriver Set Fits Vest Pocket

Shaped like a fountain pen for convenience in carrying it in the vest pocket, a shockproof screwdriver set includes three different size blades. Each blade it attached to its own handle.



Carl Thomas & Syncope Jr. - Los Angeles  
3872 Franklin Ave.



Even the old anchor (above), encrusted from years of use, is made of plaster rather than being cast from concrete. The huge "granite" blocks on which the anchor rests in the movie are plaster-covered wooden boxes painted to resemble stone. The deception is perfect

The army can't spare burlap sacks for sandbags to be used in war films, so the plaster shop at 20th Century-Fox cast section after section of sandbag-barricaded wall—far easier to handle than the real thing. At right the plasterers are stacking them ready to use on the set



# PLASTER-

When something on the movie screen moves and talks, you can assume with some degree of assurance that it's real. About the rest of the scene you may be skeptical, for the chances are a good bit of it is plaster. What appears to be a Capitol building or a Grecian temple, for example, may have come from the plaster shop, left



Lightweight bricks that weigh "only a few pounds to the ton" are cast of a special plaster mixed with air bubbles almost to the consistency of whipped cream. They can be dropped on an actor's head quite harmlessly. Similarly a "concrete" wall in bombed London is actually a plaster shell

# HOLLYWOOD'S GREAT IMITATOR

Strategic materials can no longer be used in making motion pictures and Hollywood is depending more than ever on the genius and versatility of the property man. And plaster is the most versatile substitute. At the right, Jeffrey Lynn, screen actor, undergoes a plastering in the Warner Brothers shop; artists are making a mold of his head to be used by makeup and wardrobe departments in planning makeup and apparel for a picture. Below, Monte Bonome, staff and plaster superintendent at 20th Century-Fox studio, puts the finishing touches on a plaster medallion. Huge sets sometimes consist chiefly of wooden frames on which plaster and pebbles have been sprayed and smeared



Plaster boulders, plaster anchor chains, plaster cannon—these are only three of the hundred-and-one uses for Hollywood's greatest imitation material. The workmen above are hanging up some plaster icicles to receive their finishing touches. After the paint department gets through you can't tell the false from the real on the screen. At the left, plasterers are pouring a section of brick wall, while behind them two finished sections are being removed. This lightweight plaster brick will appear in a movie as part of a factory wall or the exterior of a brick residence. "Breakaway" plaster vases that smash harmlessly on your head were a welcome invention for the actors

m 321.

## One-Piece Face Bandage Developed for First Aid



Bandage made from single piece covers entire face

Red Cross workers are learning how to make full-face bandages for first aid treatment. Made in a single piece, the bandage is brought about the face and fastened loosely about the neck. Openings are cut for the eyes and mouth.

## Wider Use of Germ-Killing Light Predicted for Future Homes

Sterilizing air by means of ultraviolet light produced artificially is destined for a rapid increase in places such as apartments, offices, private homes, military mess halls, barracks and hospitals, Dr. Theodore S. Wilder of Philadelphia, Pa., has predicted. Ultraviolet light, the invisible part of the sun's rays which causes sunburn, is fatal to bacteria and apparently to the viruses which are so small they cannot be seen under a microscope. In apartments with air conditioning the ultraviolet light would help prevent contagion which may be carried by recirculated air. Private homes can apply the rays to sterilize air in the nursery, and ultraviolet light might also take the place of the sheet, soaked in antiseptic, which used to be hung across the door of a sickroom. However, Dr. Wilder warned that the need for ultraviolet

Henry M. Co. South  
4218. 5th Ave. South

## Glass Cover Seals Tax Stamp On Auto Windshield

Protection for the federal tax stamp affixed to the automobile windshield can be provided by covering it with a rectangular piece of glass made specially for that purpose. Around its edge is a quarter-inch band of adhesive material protected by a white tape until used. When the tape is removed the adhesive portion is pressed firmly to the windshield, thus enclosing the tax stamp and keeping it dry and clean as well as preventing easy theft of the stamp.



## Adjustable Opener for Fruit Jars Fits Caps of Many Sizes

Small and large caps of bottles or jars can be unscrewed or tightened quickly with an adjustable remover now available. One side closes to a small opening to grip narrow-neck bottles, while the other side opens wide for jar lids.

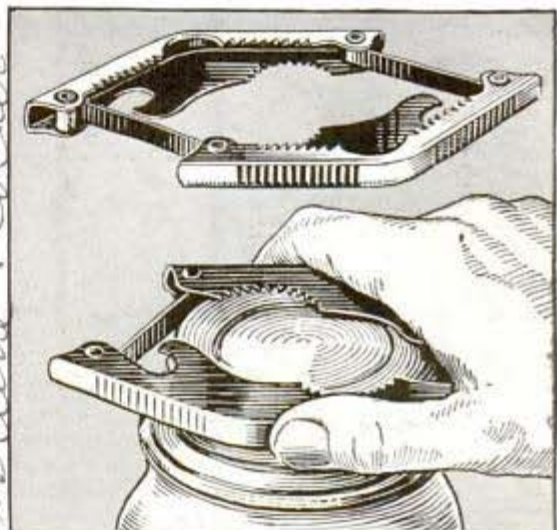

Teeth in opener grip cap for twisting left or right

Re'worked to American  
Standard & Pediatrics

Science service  
4/1/42

cut. corner. pure copoly. Co.  
state; mirror, Chicago

m 241

main and 13 ch  
Speedway  
Engineering

# Comic Model Depicts the Perils of Carelessness

Bitter results from carelessness in industrial plants are illustrated for workmen with the aid of comic models at the plant of the Allison Division of General Motors. The hero of the plastic cartoons, "Otto Nobetter," suffers the penalties of violating the rules of safety first, and frequently he causes pain to others. In one instance, letting his mind wander while using a welding torch, Otto applies the flame to a fellow worker's pants. The flowing tie, which is tabooed in factories where there is whirling machinery, gets him in difficulty when it winds around a spinning shaft. Another model has Otto showing the wrong way to descend a flight of stairs.



Stevens

These accidents can happen: Top, burning fellow workman; right, stumbling on stairs; below, catching tie in shaft



William

# Golfer's Silent Motor Scooter Operates on Six Batteries

Determined to save his energy for playing the game of golf, instead of consuming

it walking about the fairway, Dr. R. A. Richardson designed and built an electric tricycle after discarding a gasoline-driven vehicle which proved too noisy on the course. Riding this silent scooter, the golfer can play 36 holes daily without fatigue. The three-wheeler is steered by a curved stick, purrs instead of exploding, and does not tear up the grass. Six storage batteries supply power for three speeds of one, three and one-half, and six miles an hour.



Golfer climbing hill in his electric motor scooter

Shubert Alday  
Kansas City

You can obtain additional information about products described in this magazine by writing to the firms listed in the Where-to-Buy-It index. Say You Saw It in Popular Mechanics.



## The EYES and EARS of the NAVY



The blinker is the recognition light at night and is used for transmitting messages whenever it can be employed without detection by the enemy

SOMEWHERE off the Maryland coast the American freighter *San Gil* wallows in the sea, paralyzed by a torpedo that has just crashed into her port side. Two men in the engine room are dead. It is midnight, and 40 men are groping through the black intestines of the doomed ship and feeling their way across the deck to the lifeboats. Out there in the ink, the submarine is taking its time, maneuvering for the kill.

The radio has been wrecked by the explosion, but the operator is frantically rigging up an emergency antenna. He has only a few minutes to work, but in those minutes he manages to put a spark of life back in the transmitter and pour a stream of distress signals into the air. Then he climbs into a boat and it pulls away, to watch 11

Official U. S. Navy photos

In the radio room an operator translates dots and dashes into a message for the bridge—perhaps battle orders from the admiral on his flagship

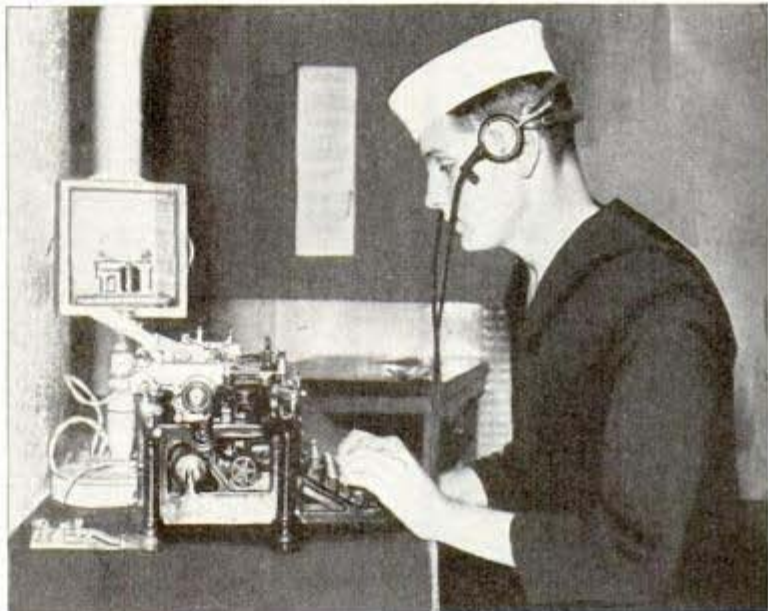

shells and a final torpedo blast their ship to the bottom.

Ashore, a radio monitoring station has picked up the call for help, and instantly the swift communications system of the Navy is in action. By radio and land lines, messages flow to the nearest Coast Guard station and to the Navy Building at Washington, nerve center of the entire Navy. The office of the Chief of Naval Operations is informed of the sinking and another section is consulted as to the position of naval units in the area of the attack.

Quickly the Naval Operations office gives orders for the rescue and the submarine hunt. The orders go to the code room, then Naval Communications dispatch them by radio or wire to the units involved; perhaps to a destroyer or other craft patrolling the coast, to a "mosquito" boat headquarters or a Coast Guard station from which a rescue cutter or flying boat can be dispatched to the scene, or to a lighter-than-air base, where blimps are ready to move out on a sub hunt.

Seven hours after they took to the life-





Hollow pipes were once the chief avenue of communication aboard ship. Now telephones link all sections

boats the survivors are picked up by Coast Guardsmen—thanks to the ingenuity of the radio man and the vigilance of the communications watch on shore.

Communications are the vital nerves of the Navy, and nothing is more secret. Even an admiral can't enter the code room at Washington unless some important mission specifically requires it. Long before Pearl Harbor the pace of preparations for defense could be measured by the flood of messages handled in the Communications Office. From 1,534 messages a day in the early part of 1939 the average stepped up to 4,518 messages—156,864 words a day—in July, 1941. Unquestionably the pace is even faster today. To relieve the load carried by radio, telephone and telegraph service has been expanded and telegraph printers brought into wider use. Before we entered the war the Navy operated 37 radio traffic stations, 28 aviation radio stations and numerous smaller radio stations assigned to particular activities. Establishment of the new hemi-

Photo from U. S. Navy Recruiting Bureau

Seamen on the battleship California run up the signal flags, picking them from the rack at the left much as a printer sets type from his case



Semaphore flags talk from ship to ship. This is one of the first lessons a recruit learns at a navy school

sphere bases, new shore patrol stations and the world-wide operation of the Atlantic, Pacific and Asiatic fleets have made it essential to expand the communications facilities, and close cooperation with the Signal Corps of the U. S. Army has been effected through the Defense Communications Board, to which representatives of



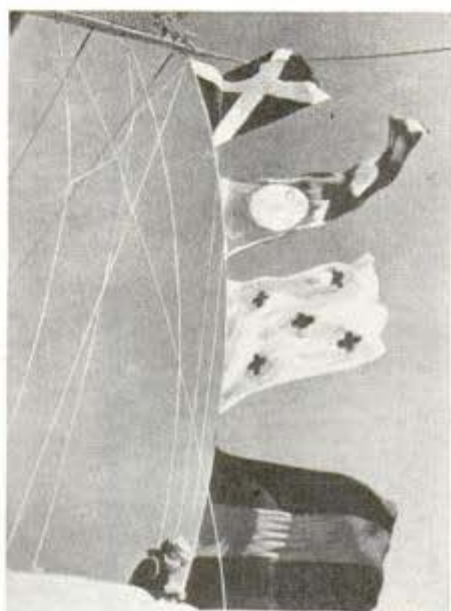
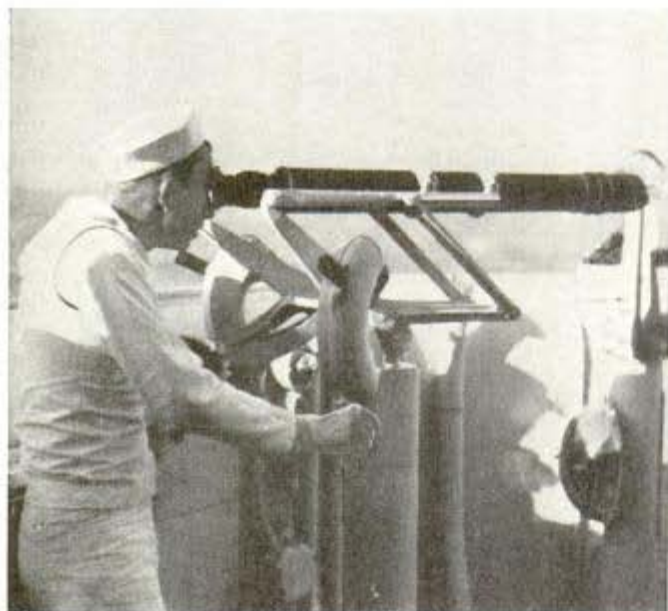

Left, navy signalman at 40-power telescope. Right, looking aloft aboard U.S.S. North Carolina toward multi-colored battle flags. When Prime Minister Churchill's battleship bound for England passed a convoy, his ship ran up flags spelling "Good voyage—Churchill," and every ship in the convoy answered with the "V" flag

both branches of the service are appointed.

Through the Communications center, the Operations Office must keep accurate check on the movements of Navy vessels—and presumably, too, of Allied merchant ships at sea. There may be hours or days of radio silence while warships convoy transports or supply ships across the ocean. Without a word to Washington that might betray its position to the enemy, a destroyer may swerve suddenly to blast with depth charges a U-boat lurking near the convoy's path. Not until the ships are safe in port will the report on the submarine's finish go over the air to some radio operator sitting at his typewriter in the Communications center. Or a long-range flying boat, which can talk more freely than a ship, may flash home the cheerfully laconic report, as did one recently: "Sighted Sub. Sank Same."

Communications between Washington and the ships at sea and the outlying bases are only a part of the picture. There is a vast amount of aerial traffic control handled by short waves, there is the detection of enemy radio messages and the monitoring of illegal transmitters—and there

**At the phone watch. Timing is a most important element in battle, and the bridge, fire control tower, turrets, range-finding stations and magazines all must keep in constant touch by telephone**

is the exchange of messages between ships by visual signals.

Talking with flags is an ancient art, still practiced daily by warships, either with code flags flown from the mast or by wig-wag signals. When Prime Minister Churchill, returning to England on the battleship Prince of Wales after his visit at sea with President Roosevelt, passed a British convoy, his flagship ran up the three-flag signal "PYU," International



Code for "Good Voyage," and, on the port side, spelled out "Churchill" in nine flags. Every ship in the convoy answered by flying the "V" flag.

By night the blinker lamp replaces the flag—and woe to him that's slow on the draw. When blacked-out ships meet at sea there must be quick recognition or quick work at the turrets. Uncle Sam's signalmen had better be quick, and they'd better be right the first time. The Navy would not like to blunder into a battle among its own ships, as the Italian fleet is believed to have done by mistaking signals after the Battle of Cape Matapan. The Communications personnel for the Navy was doubled from 1939 to 1941; in the latter year 1,350 officers, 9,200 radiomen and 3,150 signalmen were in service, and training has been increased at a rapid rate at the dozen or more special schools under the impulse of the war, which has expand-

The boatswain's mate pipes into a ship's public address system and the signal is carried to all hands

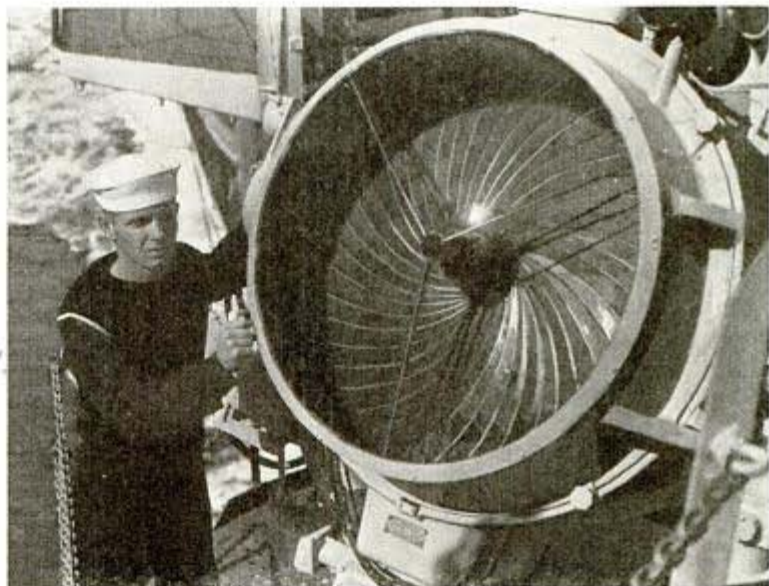

Searchlights not only pick out enemy ships and planes at night but can also serve for signaling. It was quick work with the lights on the dark Mediterranean that enabled British warships to wipe out an Italian flotilla

ed every branch of the service at an unprecedented rate.

How much use if any is now being made of Frequency Modulation is a military secret, but it has certain definite advantages over the conventional Amplitude Modulation system. "FM" can operate on lower power, travels in a rather straight line with a known range, is static-free and is less likely to be picked up by enemy receivers. There have been published reports that German use of "FM" for messages on the eastern front gave them one advantage over the Russians, who had only conventional radios.

Another communications method with which the U. S. Army is experimenting is writing "dot-dashes" on clouds with signal lamps.

Every ship in the Fleet has its own intricate nerve system. From bridge to engine room runs one vital nerve, the electric bell signal to which the engineers must be alert at every instant. Telephones interconnect bridge and fire-control tower and turrets. And the old hollow tube that used to pipe the captain's voice throughout the ship has been supplanted by the loudspeaker system that carries the "Call to Battle Stations" from bridge to lookout, turrets, magazine and galley. And it sounds pretty good, after a hot battle with a fleet of enemy bombers, to hear the booming voice of the "old man" come over the loudspeaker with a "Well done, men."

315

## Delivery Bike for Small Shop Carries 150-Pound Load



cycle truck.

Large basket attached to frame carries 150 pounds

Constructed of sturdy parts so it can carry loads of 150 pounds with ease and safety, a bicycle now available is designed to take care of delivery problems for the grocer and small shop at low first cost and virtually no upkeep expense. An under-size front wheel allows space for an extra large basket which hangs on the frame and does not interfere with the balance or steering. Baskets are supplied in two sizes, or the purchaser may mount his own container. A wide parking stand pivoted on the front axle locks the front fork, making a rigid unit of the entire bicycle when parked. The bicycle has a low gear ratio for easy pedaling and has heavy-duty tires, rims, spokes, fork and front wheel hub.

M 327

## Substitute for Morphine Is Seen In New Pain-Killing Drug

As a pain killer, the synthetic drug, Demerol, seems to come closest of any to being the long-sought safe substitute for the highly habit-forming morphine, according to reports by several doctors, among them Dr. David R. Climenko of the research laboratory of the Winthrop Chemical company. Although large doses are required when Demerol is used, this is not harmful since it does not cause craving

for the drug to the extent that morphine does. The pain-relieving effect starts within 15 or 20 minutes after treatment and lasts as long as six hours. In the tests reported, laboratory animals could not be addicted to Demerol, while humans who had been morphine addicts became addicted to Demerol only when given daily doses 35 times the size prescribed for relieving pain. At present the drug is available only to research institutions.

M 295

## Electric Robot With a Memory Forgets When You Please

Its electric brain consisting of selector relays and about 1,000 separate connections to various switches, a memory machine built by J. E. Hancock, a General Electric engineer, can be adjusted for a short or long memory, as desired. On the front panel of the metal cabinet, which is about the size and shape of a large table model radio receiver, are four numbered push-buttons and four lights, in addition to several switches. Press the four buttons once in any order you choose, and each time the corresponding lamp flashes. Then press a fifth button off to one side, and the lamps flash again in the same order as when last pushed. If a certain switch is set, the flashing continues automatically. When the four buttons are pressed in another sequence, the new order is substituted for the old and is repeated thereafter. The machine remembers only the last order of impulses given it. One setting causes it to



Maze of wires is nerve center of the memory machine

Schwendler Co. 1777 N. Midway Cicero

Schwendler Co.

at Chicago  
at New York City

remember them indefinitely, or it can be set for a short memory, in which case it forgets one item at a time at intervals of a few seconds each, finally flashing a sign reading, "I forgot." Another switch setting makes it forget all four at once. In the machine are five selector relays each consisting of a group of little arms which sweep around in a circle, step by step, making a different contact at each point. Four of these take up positions as the buttons are pressed, while the fifth remains blank. A sixth relay serves as a selector, telling each of the other relays which position it should take up for each push of the button. Two relays and an electron tube circuit control the forgetting action.

7-306

### Rollers at Top of Ladder Protect the Walls

Easily attached to extension ladders, a safety bracket may be fitted with rubber rollers to avoid scratching or marring when the ladder is supported against painted walls. For other uses of the ladder, the rubber rollers are interchangeable with three other types of tips: vacuum cups, pointed spikes and U-shaped extension arms. The vacuum cups and pointed spikes keep the ladder from slipping or falling from certain kinds of surfaces, while the U-shaped arm is handy when the ladder is leaned against rods.

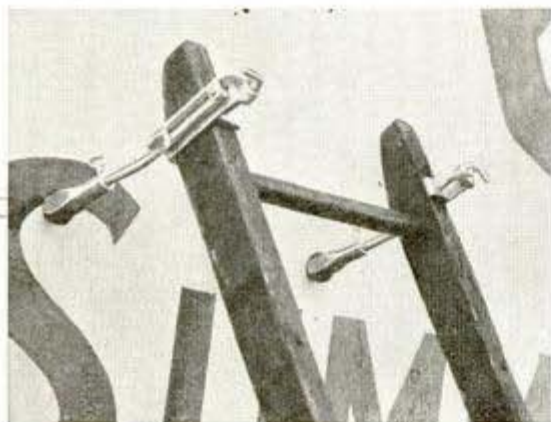

Attachments holding the rubber rollers clamp to the upper ends of ladder and protect walls from injury

## Collapsible Rubber Assault Boat Withstands Rough Usage



Two views of rubber assault boats being completed for United States forces. Deflated, the boats can be rolled into bundles

Constructed largely of rubber, collapsible assault boats being made at the Good-year factory, Akron, O., for the United States military forces can be deflated and folded into bundles for storage or transportation. Yet they are rugged enough for hard service when inflated for amphibious action by the army or marines. Extremely light for the loads they can carry, the rubber craft can hold 10 men comfortably, may be used for ferrying supplies or may serve as pontoons.

Look in the index to find where to buy articles described in this magazine. Say You Saw It in Popular Mechanics.

# IF YOU CAN DRIVE YOU CAN FLY



Four Charleston, W. Va., pilots built this inclined railway on which a one-half horsepower electric motor lifts and lowers the Cub seaplane between the river and hangar

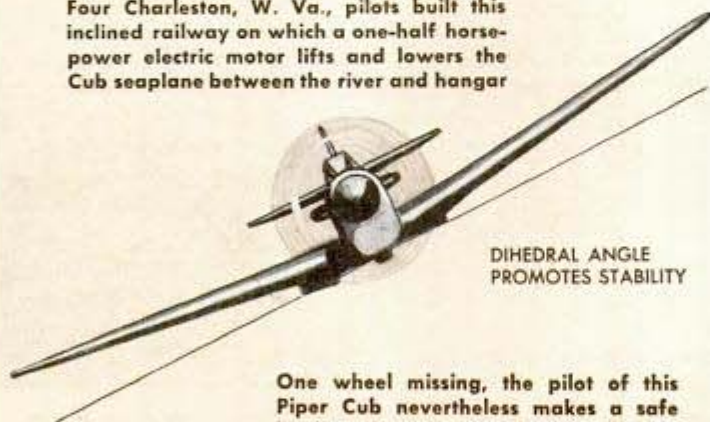

DIHEDRAL ANGLE  
PROMOTES STABILITY

One wheel missing, the pilot of this Piper Cub nevertheless makes a safe landing. Here's where the slow landing speed of the light plane is appreciated



By  
**Roderick M. Grant**

PART II

**C**ALL them sky flivvers if you will. They'll be the "Model T's" of the post-war world. And you'll be driving one.

Why not? If you can drive, you can fly. A light plane will take you up to 25 miles on a gallon of gasoline. It will land and take off at 30 to 40 miles an hour, and any level stretch not much longer than a football field is an "airport." You can learn the fundamentals of control in 20 minutes, the rest comes with experience.

Light planes were just growing out of the fledgling stage when the war came along and let down the flaps on backyard flying. Even now you can fly your own plane, if you've obtained the certificate of identification and loyalty from the Civil Aeronautics Administration. But you can only fly from designated airports, and even to circle the farm and land again you must obtain proper authority from the C.A.A. "clearance officer."

Nevertheless, this war that has trimmed the feathers of civilian aviation is surely preparing America for a many-winged peace. The vast factories gearing up to build 125,000 warplanes a year will be able to throw their capacity into efficient, low-cost production of sport planes and family-size sky cars at a price in both dollars and safety that the average man is willing to pay. And the air war is pre-

Im 37

see also Easy & Fly Your Own Plane

Feb  
1940  
168



Just to show how tough these little planes are, more than a score of flying fans pile on a Luscombe "Trainer"

paring a peacetime market, too. On Jan. 1, 1941, there were about 63,000 private pilots in the land. On Jan. 1 this year the number had passed 100,000, and more than 104,000 others hold student pilot certificates. The C.A.A. aimed its pilot training program at 100,000 a year, and tens of thousands more are earning their wings in army, navy and marine air schools. Here is the backlog of a tremendous roster of flying Americans who will make the sky their home after the next armistice.

The bogeys that have kept you from flying your own plane no longer exist. There was the bogey of danger, or fear of it; the bogey of expense; of inconvenience—distance to the airport, lack of time for week-day flying. The real bogey today is ignorance of the ease and safety and low cost of modern flight in a light plane.

Flying isn't for you? Why, your grandmother could pilot a light plane. Plenty of grandmothers do. There's nothing short of a serious mental or physical disability to stop you. Douglas Bader, who had lost both legs, was a wing commander of the Royal Air Force. A California boy lacking one hand earned his license recently. Wiley Post, with but one eye, soloed around the world. A woman flew her 65-horsepower Taylorcraft 1,700 miles non-stop from Vancouver, B. C., to Tia Juana, Mexico, in 16½ hours the other day. An 8-year-old Arizona boy and a 12-year-old Connecticut girl pilot Piper "Cubs," although too young

to be licensed for solo flight. What's wrong with you?

Let's knock the chocks from under those bogeys. In the first place, it's natural to be afraid of something unfamiliar. You're afraid of water until you learn to swim. Step into the cockpit and get the feel of the controls as an experienced airman takes you up. With familiarity comes confidence. In the excitement of a first flight you forget until afterward that the anticipated dizziness and the fight to hold the plane level in rocky air—those bugaboos just weren't there. Last month I told of flying one of the new rudderless, spinproof planes; never in a cockpit before, I had piloted it up and back to earth with far more ease and comfort and skill than I first rode a bicycle. But still I doubted my ability to handle a conventional plane with rudder pedals. I

A Taylorcraft's wheel feels natural to a motorist





The rudderless "Skyfarer," top, rides level on the ground with its tricycle wheel arrangement

remembered one mournful attempt to play the bass pedals of a pipe organ with my feet. If they couldn't think fast enough for an organ, what would happen if they had to steer a 100-mile-an-hour airplane?

So I thumbed a ride in a Taylorcraft, typical conventional light plane, to find out. We got away so fast I never knew the tail had lifted level. In less than 10 seconds, in less than the length of a football field, we were up. The lightness, the quick response is always amazing; you feel that you could set this plane down in a school yard and get away again.

I was resting my feet very gingerly on the rudder pedals when Ernie Spiller, the

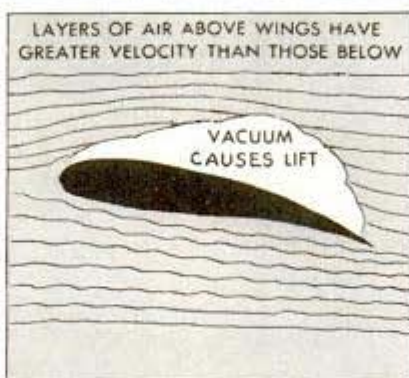

Vacuum above wing, indicated at left, provides 65 percent of lift; pressure below, 35 percent

pilot, said "You take it."

What I had learned in that one previous session in the rudderless Skyfarer I applied again. I eased back on the wheel and we climbed. I shoved it forward and we were in a glide. Then, leveling off, I tried thinking with

hands and feet. Strangely enough it seemed natural; nothing like the pipe organ. Wheel to the right, pressure on the right pedal, and we banked and turned right. Maybe it was too shallow, for which you can blame lack of confidence. But we turned and straightened out again and we didn't spin or break off a wing. Don't thank me, thank the designers. What about a spin, by the way? A slip and a spin had always been

words of terror to me, preludes to a crash. Ernie Spiller showed me how a sideslip is a useful maneuver to lose altitude when overshooting a field; he tilted the wings, and we slipped—so he said; I'd never have known we were dropping. As for the spin, once a leading cause of fatalities, Spiller said: "Just neutralize the controls and

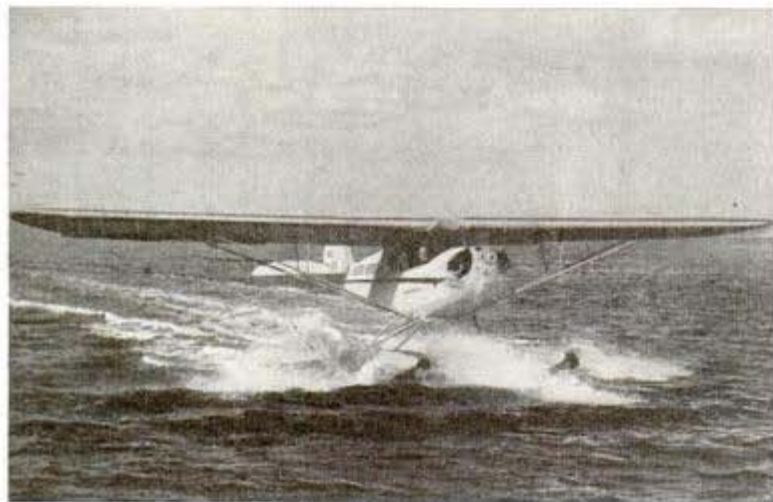

A Piper Cub seaplane churns the water white. Pontoons and wheels are interchangeable



the plane will right itself." Wing designs have been improved so that most planes will recover from a spin automatically.

With the engine idling, we floated down, light as a postage stamp, to a slow and gentle landing. I was not by many hours an aviator, but a large hurdle of doubt was behind.

Reading in the magazines these days of interceptors that climb more than a mile a minute and bombers that dive ten miles a minute, one forgets factories have been building a different breed of planes for you and me —planes as different from military craft as old Dobbin is from a Derby winner. You shouldn't, but you could crack up a light plane and not get bruised.

Exactly what is this light plane we're talking about? Well, it was born about ten years ago. Until then, aviation was for millionaires and sportsmen, most of whom hired a "chauffeur" to fly them. It was a popular notion that two engines were safer than one, three engines were safer than two. As a consequence, airplanes were getting bigger, faster, costlier, farther from the skill and purse of the average man.



Lycoming engines, standard on several lightplanes, are given their first "run-in" electrically

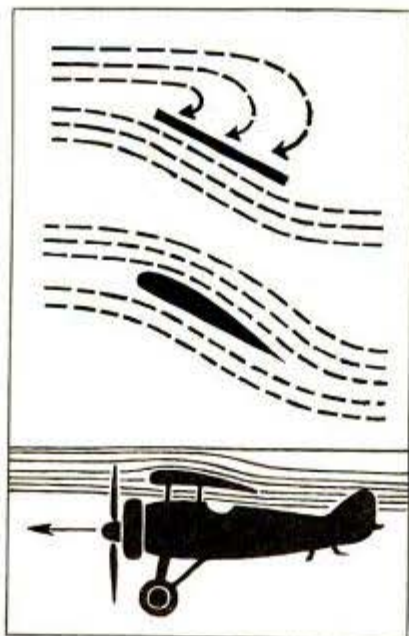

Turbulence over the flat wings of the early planes led to development of the airfoil, over which air flows smoothly

Skeleton of a "Plexweve" plane of geodesic construction, formed by wrapping spruce spirally over laminated bulkhead

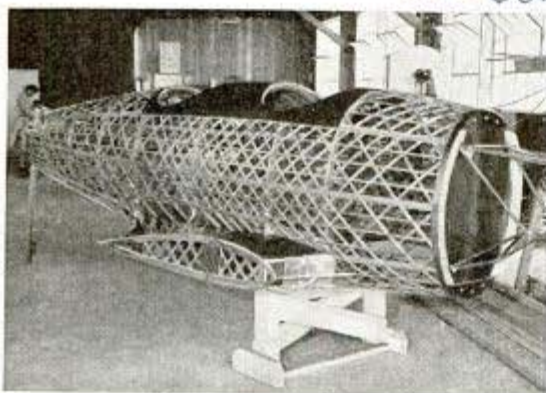

see Aug 1940  
time you've driven out to your airport, flown 500 miles over to Cincinnati with a pause midway to tank up, then taxied into town at your destination, you're little if any ahead of train schedules or your own motoring time on the highway. You can't compete with an overnight train. And, humming along a thousand feet above farm and village and railroad you don't even get a sensation of speed. So if it's racing you crave, the light plane is not the answer. The faster it is, the more it costs, the hard-

(Continued to page 171)

*m 23 Jeff W. Way Protect Co. 2443 Virginia Ave. S*

## Safety Lamp on Elastic Belt Worn as Tail Light



Top shows how to wear belt, sketches illustrate uses

Accidents at night can be avoided by wearing a safety belt fitted with an electric lamp illuminated by flashlight batteries. The lamp may be worn at the front, side or rear, and used as a tail light its red glow gives protection when boating, hiking, hunting and riding horseback or bicycle.

*m 333*

## Overflow Pipe Inside Bath Tub Needs No Outside Connection



Overflow from the bath tub is taken care of and drainage is controlled by a plastic drain installed within the tub without any of the usual back-of-the-tub pipe connections. Resting in the drainage outlet, the overflow drain may slide up and down through a supporting ring fastened to the tub. In the "down" position the drain, which is held

by spring tension at all times, acts as a plug to stop any flow of water except through the overflow outlet if the water reaches that height. The "toothed" bottom part of the drain serves as a strainer. It is only 3/4-inch thick and does not interfere with cleaning of the tub.

*m 292*

## Cement Is Efficient Extinguisher For Oil or Bomb Fires

Fires from oil and incendiary bombs can be extinguished with ordinary Portland cement, says Dr. Roy Cross, president of the Kansas City testing laboratory, who considers it superior to pitch, recently suggested as an extinguisher for incendiary bombs. It has put out fires successfully where water, carbon tetrachloride, foam and similar substances failed. Furthermore, it gives off no injurious gases and is in itself not combustible. Portland cement is readily available and can be stored in kegs wherever there may be danger of fires.

*m 244*

## Yarn Holder Clamped on Wrist Keeps Ball Handy

A hook and chain attached to a bracelet, now on the market, keep the ball of yarn dangling conveniently from the wrist while knitting. It helps speed the work and prevents the annoyance of having the ball roll away accidentally.



Ball of yarn anchored to bracelet cannot get away

# "Big Top" Shields Bridge Workmen From Rain

Work on the Pit River bridge roadway, in California, continued in rain or shine under protection of a huge tent that could be moved as the workmen progressed. The tent was made of 20 sections of canvas 65 feet long and 20 feet wide, each section being placed with its 65-foot length across the bridge deck with a one-foot overlap between sections. They were hung over a ridge rope anchored to an A-frame at each end of the tent and supported at intervals by 4-by-4-inch posts. Iron pipe railings provided 5½-foot sidewalls, and block-and-tackle stretchers were attached to the ends of the canvas and fastened to outriggers on the bottom of the bridge stringers. The tent was 380 feet long, 51 feet wide and 13 feet high, and could be moved forward one section at a time as required by the progress of the work.

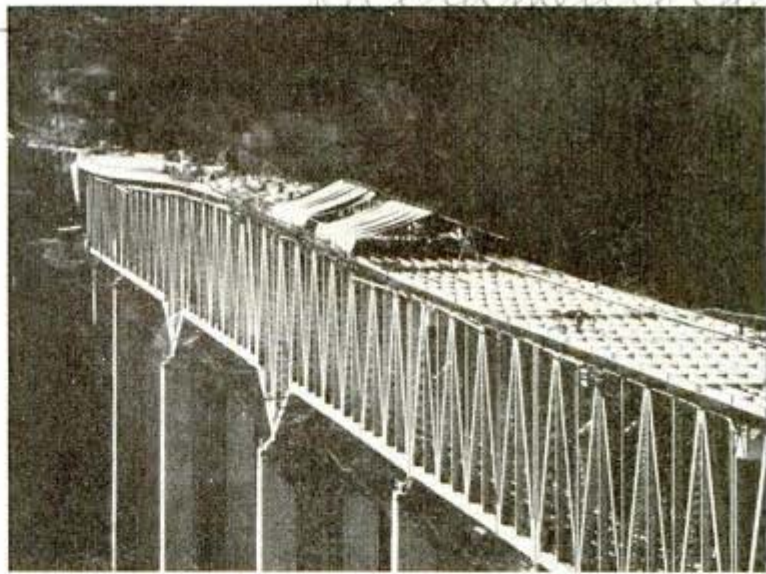

Tent on bridge (top) covered men (bottom) so they could work in all kinds of weather

## Gloves Are Held by Ball and Chain Attached to Handbag



Glove holder opens like key chain for attachment to purse. Note how ornament is hooked to grip gloves

Instead of stuffing gloves into the handbag, they now may be hung on the outside by means of a ball and chain attachment which fastens to the handbag handle. Made in different colors, the holder grips the gloves when the ball, or ornament, is moved to the top of the chain and the chain encircles the gloves, looping the end over the ball. Pulling the ball downward locks the gloves tightly, and slipping the chain off the ball permits them to be removed.

☐ To learn where to buy commercial products described in these pages, see the index.

mt 77

# PASSENGER TRAVEL CENTER *of the* FUTURE

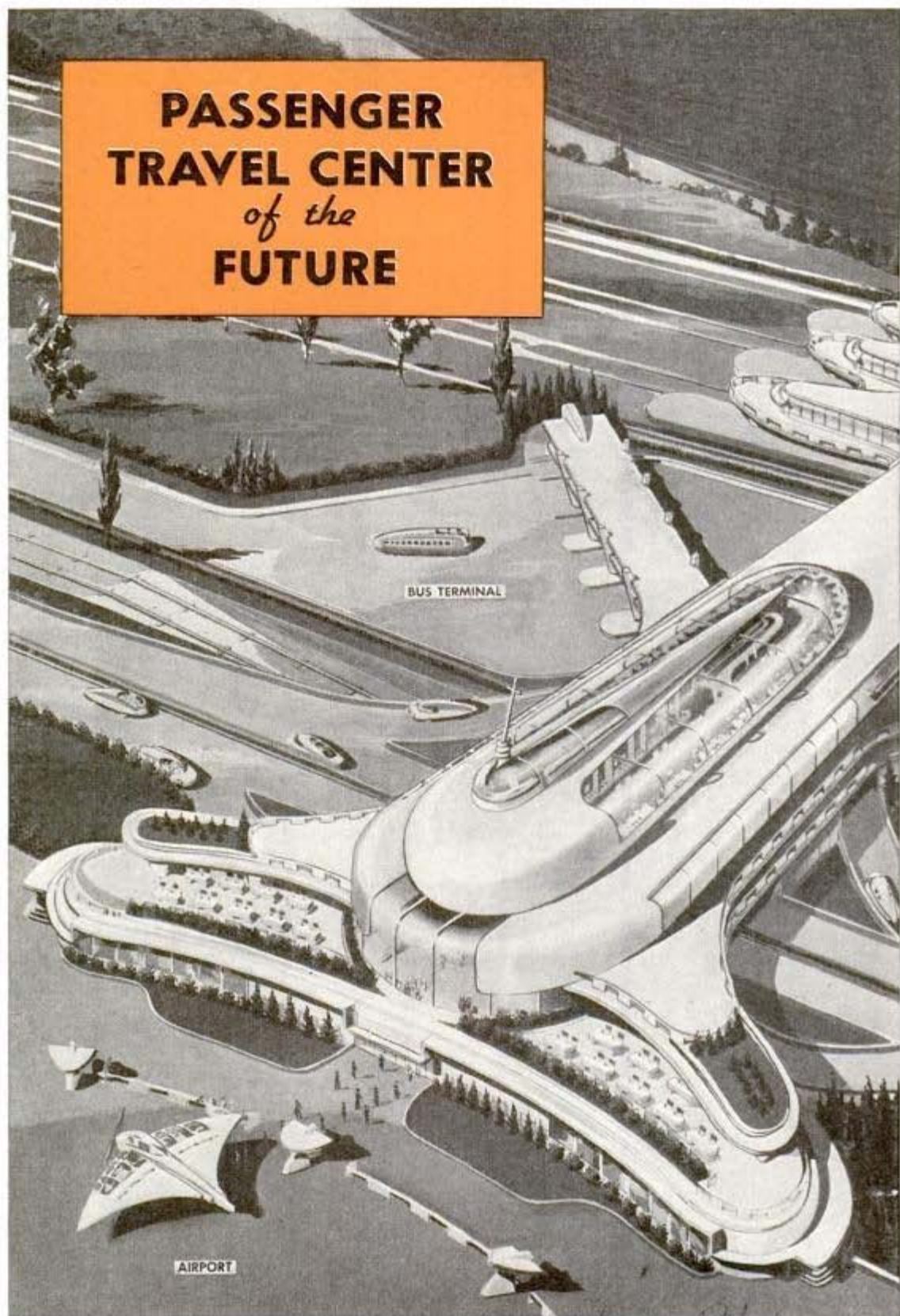

Courtesy "Steel Horizons," published by Allegheny Ludlum Steel Corp.

What's ahead in transportation? Peter Muller-Munk, head of the School of Industrial Design at Carnegie Institute of Technology, suggests in this drawing that great travel centers will appear in the post-war reconstruction, served by railway, bus, plane, ship, subway, interurban and automobile



Instead of competing air, water, road and rail companies, there may be companies selling any form of travel. Such a travel center as this, a universal interchange point located on slum-cleared land or away from the "downtown" area, would relieve the city of much of its cross-traffic congestion

*M 323*

## Portable Charcoal Cooker Rolled Like Wheelbarrow



*Cooking wagon (C.F.)*

Outdoor grill is rolled on wheel by lifting handles

Picnic dinners can be prepared in your own backyard with a portable outdoor grill handled like a wheelbarrow. Steaks, chops or hamburgers can be broiled over charcoal on a cooking grill 16 by 24 inches, or larger roasts may be barbecued on a spit rotated by hand. Weighing 80 pounds and standing 27 inches high, the grill can be moved easily on a wheel having a four-inch rim to protect lawns. A clean-out ash door permits easy removal of ashes.

*M 288*

## Offset Screwdriver With Ratchet Operates in Tight Places

Permitting more leverage than an ordinary eight-inch screwdriver, a small-size offset tool drives or draws screws in places where there is little space to work. Once



Offset ratchet screwdriver reaches into close places

*Good! Made by Del Bros. State & Made in Chicago*

the blade is in the slot, the handle is simply moved back and forth to turn the screw either to right or left according to the setting of the ratchet.

*M 310*

## Handy Thread Cutter on Thimble Saves Sewing Time

Utting slightly from the upper rim of a thimble, a metal cutter is a convenience when sewing. The cutter does not protrude enough to interfere with use of the thimble.



*M 223*

## Hinged Tray for Home or Picnic Folds to Half Its Size

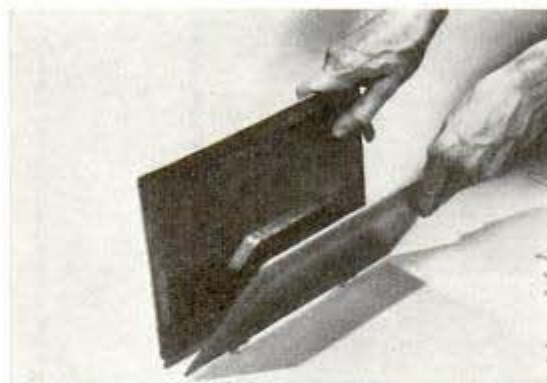

Two views show how the tray folds (top) and opens

For convenience in packing in a grip or picnic basket, a folding, lightweight tray may be collapsed to one-half its size. The body of the tray consists of two leaves which may be folded inward toward the metal handle. Finished in walnut, the tray is useful for parties in the home, on the lawn or at picnics.

*North Bros. Mfg. Co. Lehigh Ave. and American St. Beverly Portable Units Co. George P. Carver Engineering Co.*

*W. Washington Chicago*

*Chrysler Karcher Body Plant*

*M29/*

*Alex Thompson, Chief Fire Dept. Detroit*  
*Harry H. White, Chief*

# Two-Wheel Fire Engine Towed by Any Car

Profiting from England's experience with small-size fire-fighting apparatus, the U. S. Government is acquiring complete mobile units at a Chrysler Corporation plant for protection of federal property. The engine and pump unit is mounted on skids so it may be placed on a special trailer and towed by an ordinary passenger car, or hauled on a light truck. The fire pump, powered by an engine rated at 95 horsepower, has a capacity of 500 gallons per minute at 120 pounds pressure, or can deliver 250 gallons a minute at 200 pounds for fires requiring a more powerful stream. Two sections of suction hose are carried, and 500 feet of 2½-inch standard fire hose. The latter may be rolled on two double reels or folded into a box-type body. Several of these small fire engines may be spotted about strategic plants that might be ex-

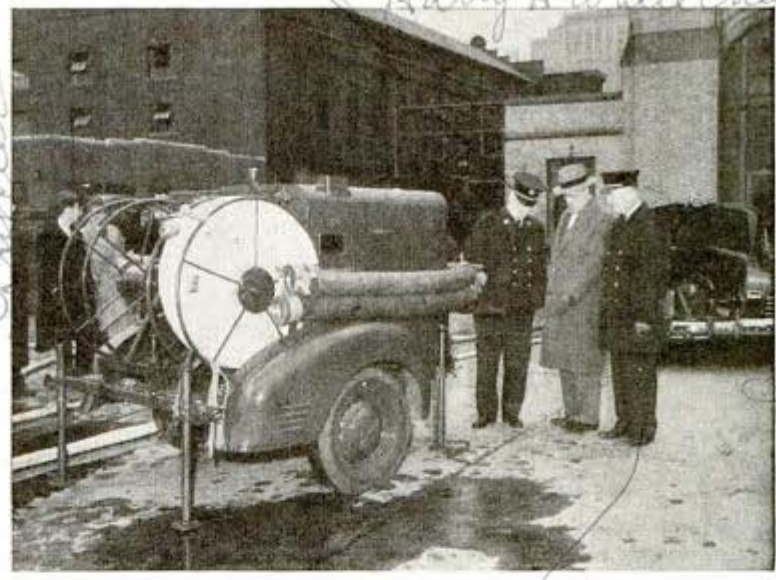

Fire fighting unit mounted on trailer can be hitched to bumper of any car

posed to incendiary fires caused by air raids or sabotage. If fires break out at more than one place, they can all be reached before the fires have much chance to spread. Two or three men can handle one of the pieces, and it can be taken into cramped quarters that would not be accessible to a large fire engine.

*Edward C. Cursey, Chief*

## Quarter-Ton "Peep" Leaps Ravine on Cable "Sky Ride"

When members of Battery C, 103rd Coast Artillery, under Capt. Steve J. Meade at

Fort Sheridan, Ill., come face to face with a ravine that is impassable for quarter-ton "peeps," their last thought would be to turn back or look for a way to run around it. Instead, they rig up a "sky ride" by anchoring a cable to two trees and suspending it over the big ditch. Then the peeps are slung on the cableway by means of a pulley arrangement, and a rope, powered by a winch on a truck, tows them across one at a time.



Army "peep" and crew ride cableway across ravine too steep for the car

ⓄAll the timber cut in American forests since 1909 would build a two-foot plank walk 93,000,000 miles long—the distance from earth to sun.

*Georgia Sch*  
*Engineer*  
*69*  
81

# IS THERE LIFE AMONG THE STARS?



Plant life on some other planet may have a carpetlike appearance, or it may have stony skeletons like these forms of coral

By Dr. R. M. Langer

California Institute of Technology

AND THOMAS E. STIMSON, JR.

*Pasadena Calif*  
**WE ARE** not as positive as we used to be that the earth is the only planet that supports life.

Life on earth seems a miracle indeed when we study the delicate balance that sustains it. An increase of 100 degrees in temperature such as might occur if the earth's color were darkened would allow our atmosphere to escape and the earth would become as dead as the moon.

Or consider the importance of the small amount of carbon dioxide in the atmosphere—only one-twentieth of one percent; yet if it were doubled or cut in half the average temperature might change 20 degrees. An increase of 20 degrees could evaporate enough water to form a perpetual cloud that would screen out the life-giving sun. No plants could grow. A decrease of 20 degrees would bring the glaciers and cover us with ice.

People have believed that life can exist only under the exact circumstances found on our planet. Today it is easier to think that life has modified itself to terrestrial conditions instead of being a consequence of them. Research in chemistry and biology allows us to visualize life systems far different from ours, developing in radically different environments.

Elsewhere in the universe there may be people who breathe an atmosphere of laughing gas and whose bloodstreams circulate a

At the left are conceptions of the bird, fish and animal forms that Dr. Langer suggests may have evolved on other worlds

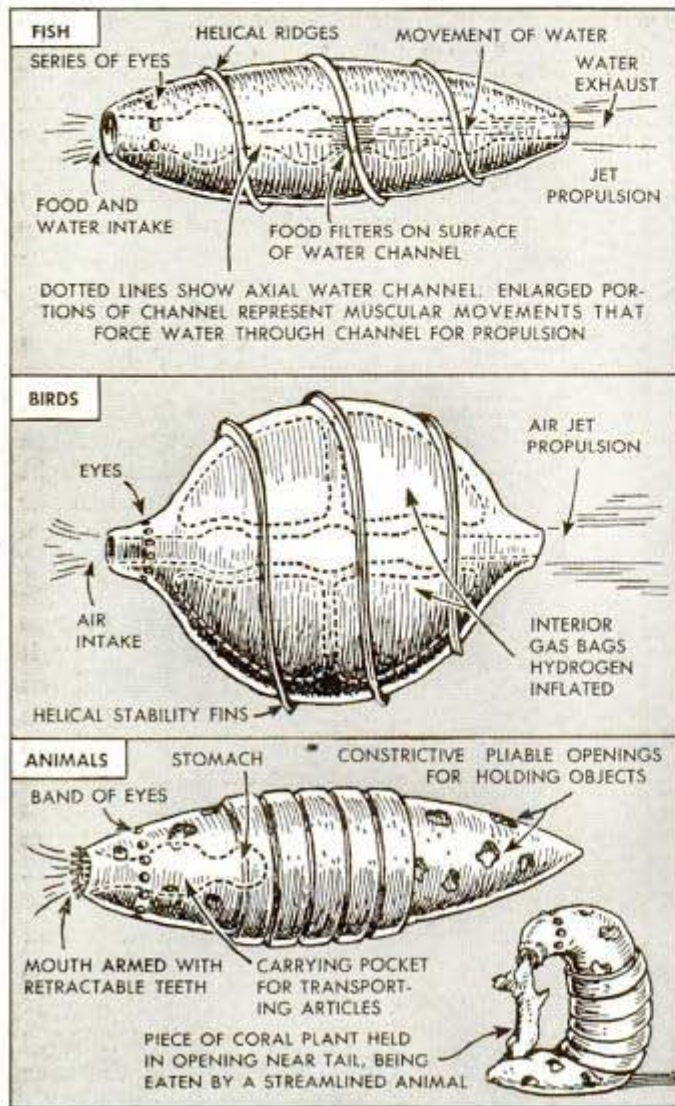



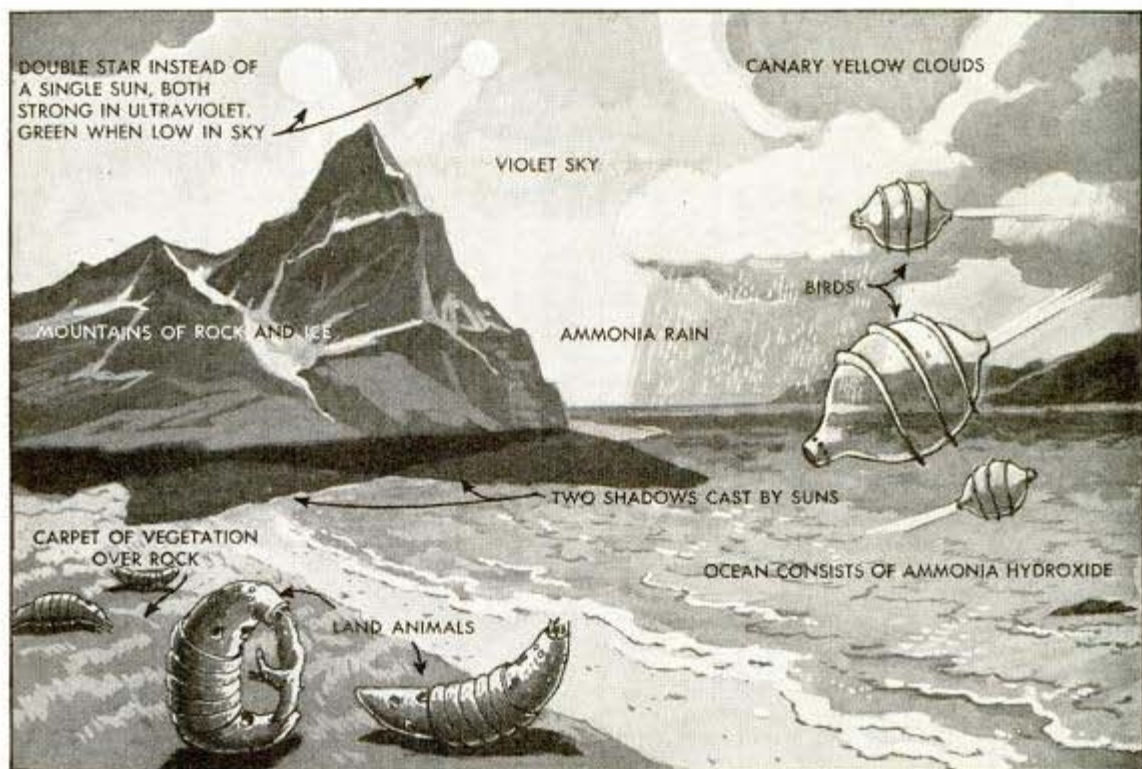

↑  
Such a scene as this is possible on a planet where life is based on nitrogen chemistry instead of carbon, like ours

This is a film conception of "rock men" on an imaginary planet, as depicted in → a movie produced by Universal Pictures

Freonlike refrigerator fluid. The possibility that other civilizations exist somewhere cannot be ruled out.

We should remember that our sun is just an ordinary star. There are billions of stars in our galaxy and there seem to be billions of galaxies in the universe. Solar systems such as ours, in which the star provides the energy necessary for life, and its planets provide possible locations for life in some form, must be quite common.

Another of the physical bases necessary for life is a chemical system in which an unlimited variety of combinations is possible. Ours is a carbon chemistry that seems unique. On earth, nature uses hundreds of thousands of carbon compounds. But in other environments other elements might

Models of Saturn and Jupiter, two of our solar system's planets. Saturn is readily recognized by its rings





Above, skeleton of the prehistoric bison of our western plains

Below, a huge scale model representing the surface of the moon



serve as well as carbon. We know that the 92 basic elements found on earth are distributed all through the universe. Nitrogen is one element that might be as satisfactory as carbon. Its compounds would make up an ammonia chemistry.

We can imagine in some detail the conditions that would regulate life in an ammonia chemistry. The conclusions are intrinsically no more fantastic nor improbable than the wonder of our own life.

For the purpose we can take a cold planet in the gravitational field of a blue star, perhaps a double one. Assuming there is no ozone in the atmosphere, daylight on the planet includes much of the ultraviolet. Its noonday sun is a dazzling blue against a violet sky, with a green sun and canary yellow clouds at dawn and sunset.

The planet may require 100 of our years for one revolution around its stars and one of its days may be as long as our month. Possibly the temperature is in the neighborhood of minus 40 degrees Centigrade. Most of the earth's liquids are solid there, and many of our gases are liquids.

The planet must have an ocean and an atmosphere. These appear necessary for the beginning of life. A liquid ocean permits free movement and mixing of atoms, and the atmosphere furnishes winds that stir the land and ocean, bringing on chance chemical unions. The ocean could be of ammonia hydroxide and the atmosphere a nitrogen oxide such as laughing gas.

Mountains are of ordinary rocks and contain many of the metals we know. At this temperature mercury is solid and is a good soldering material. What we know as water is a brittle rocklike material there. Such ice becomes a handy building material. All an inhabitant needs to do is to heat it up to make it flow and then pour it into forms.

Three odd water creatures, a porcupine fish, "mailed" catfish and a flying fish, suggest the variety of life on this earth

77. 10. 11

Just as our earth has plants and animals that provide a nice balance by living off each other, so on the ammonia planet there would have to be two balanced main forms of life. Earth vegetation grows mainly in the form of columns; on this other planet it might be carpetlike, the main growth taking place on the upper surface so that the plant thickens with age. The sheetlike material might make a desirable covering and could be cut up into robes and tents. Or it might be that vegetation would have rocklike skeletons like south sea coral. The predominating color of the vegetation would be blue instead of green to absorb sunlight most effectively.

We couldn't exist on this planet, of course, because our chemistry is different. Its atmosphere would poison us. And inhabitants of the ammonia planet would die after a few breaths of our air. Their nat-

(Continued to page 166)



Above, skeleton of a ground sloth that lived 40,000 years ago

Mechanical model of part of solar system, not built to scale

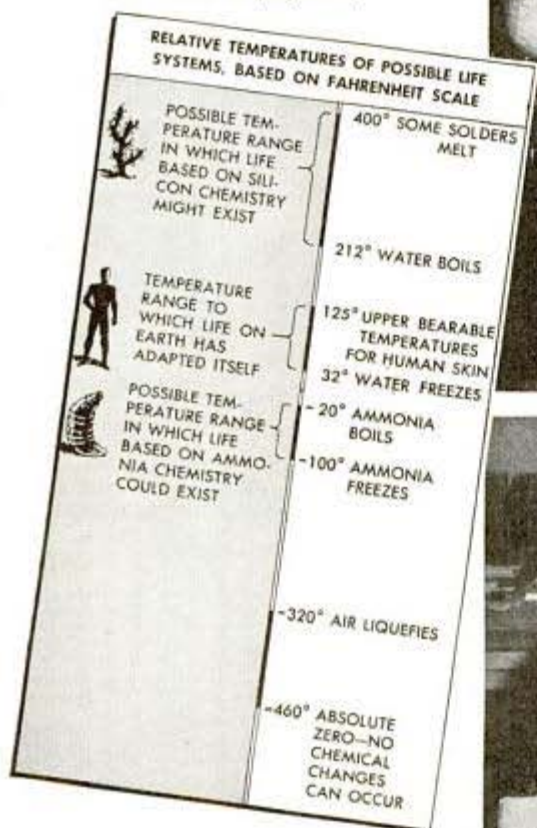
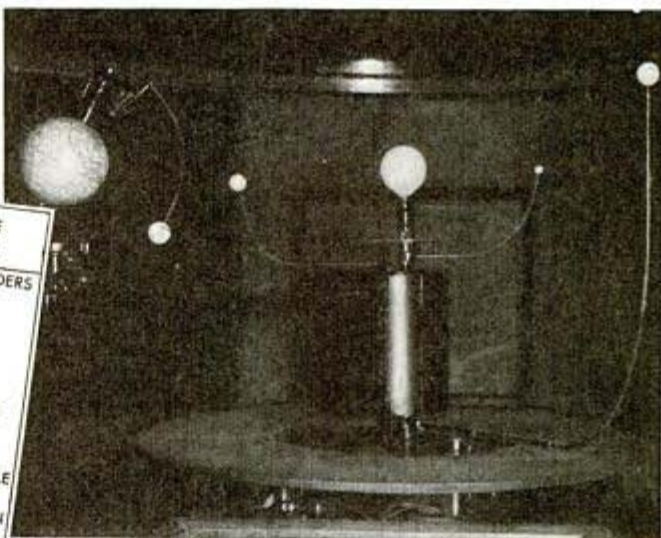

Chart shows the narrow range of temperatures in which man exists. Other ranges may suit other life forms. Right, the Amazon mata-mata, another odd earth creature



# 212 Loading Racks Pack More Freight in Box Car

Railway box cars can be packed within inches of their full capacity and damage to freight reduced to a negligible quantity by means of a "utility loader"—grooved walls and cross members that form adjustable racks for packing cargo. These utility loaders increase the capacity of the average

car by five tons, or from 20 to 200 percent, according to the product shipped, and in 50 test loads they eliminated 98 percent of all damage to cargo. Engines, airplane parts, agricultural implements, storage batteries for the navy, stoves—these are some of the products being shipped in this manner. Shells were loaded at an army arsenal into fitted cars at half the cost and with a saving of one-fourth of the usual loading time. Batteries weighing 90,000 pounds were packed in one car with a normal load of 40,000 pounds. Because these racks furnish a sturdy anchorage and prevent any shifting of cargo, the time and expense of bracing and bulkheading the freight car are eliminated and in many cases it is unnecessary to crate and wrap the shipments. The cross members are adjustable at 1/2-inch spacings up and down, thus accommodating units of any size.

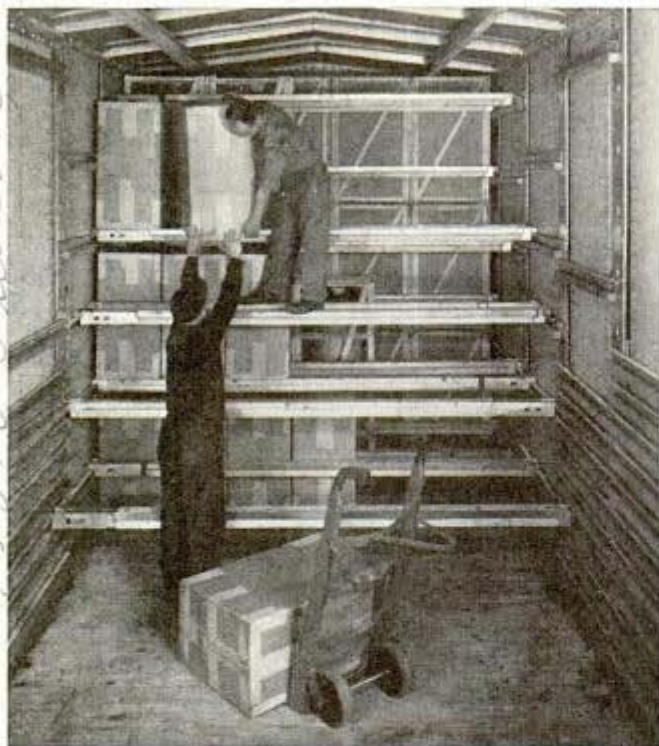

↑  
Workmen using cross members of utility loader as platform while stowing cargo on top

Tightening a load of 155-milimeter shells in a utility loader box car at U. S. arsenal →



## m 311 Army Officers Favor Complete Blackout Instead of Lighting Pattern

High officials of the Army Engineer Corps who have studied various ways of confusing enemy bombers at night say that blackout of all illumination visible from the air will continue to be favored for protection of cities and industries. They express doubt concerning the effectiveness of fixed lighting patterns or dim-outs. The United States, with its long coastline and vast interior, presents defense problems

exactly opposite to those of Great Britain. An enemy flyer can reach any city by instruments, and at comparatively low altitude can pick up features of the terrain, rivers, hills, etc., to guide him to the target spotted on his map. If a pattern of lights confronts him on the ground, he would not attempt to find his chosen target by these lights, but once he spots it by features of the terrain shown on his map, he could use

War no Products Co. 15310 Fullerton Blvd. Inver

Science 12/25/47

7/2/47

the lights as reference points to guide him while maneuvering to get over the target. In other words, lights supposed to confuse any attacker may actually aid him, and therefore dim-outs as well as light patterns are looked upon as less effective than total blackouts. If a blackout is complete, the pilot may be able to find his target by noting the terrain, but the instant he begins to circle or maneuver he probably would lose it again if there were no lights to serve as reference points.

## Snow Conveyor Loads Tin Cans Into Freight Cars



Snow loader fills freight car quickly. Tin cans pushed onto the scoop are hoisted in a steady stream over side of the car by means of conveyor

7/2/47

## U. S. Flag in Tatting Took Five Years To Complete

Devoting a large part of his spare time over a period of five years to the task, Walter Mueller, a furrier of Des Moines, Ia., has completed a lacy American flag of unusual beauty. The red and white stripes and the blue field with its white stars are made up entirely of tatting.



Five years of shuttle-welding were needed to tat this flag

JULY, 1942

Miss Katherine Esammon

Considerable time and labor were saved recently by loading salvaged tin cans into a freight car with a snow loader. The cans were gathered by the department of sanitation in New York City and transported to a plant which reclaims the tin for making war products. Employees of the department shoveled the cans onto the scoop of the loader where they were caught by an endless conveyor and elevated into the car. For loading snow, the machine would be driven into the snow bank with a truck following close by under the conveyor, both vehicles moving along together until the truck is filled.

The railroads of the United States moved an average of 904,000 tons of revenue freight one mile every minute in 1941, and in October, period of peak traffic, the average was over a million tons.

Railway Age 87

7/21/47

Gay Mt. Co. 301 Danbury Ct. Danbury, Ct.

# TRAINING DOGS



Dog finds "wounded" man, takes the bringsel in its mouth and returns to its master, who presumably is leading a party of rescuers



Here the animal leads stretcher-bearers to wounded individual; below, wounded man being carried on stretcher



MANY military and civilian defense duties can be performed by dogs, especially those dogs which have been trained for the obedience tests that have been a feature of dog shows for several years. Harland W. Meistrell, an air raid warden in one of the eastern states, points out that trained dogs of this type can be adapted readily to war-time uses.

And Mr. Meistrell proves the point with his own dogs. There are six of them, an Irish setter, a German shepherd and four Dalmatians. Two of them have an obedience rating of "utility dogs" and the others are rated as "companion dogs" and "companion dogs, excellent."

Without great difficulty, these animals have been taught to carry messages from one point to another — equally useful to armed forces or civilian defense units, to locate persons wounded in air raids or on the battlefield and to lay telephone wire across areas in which the danger to soldiers or civilians might be too great for their use. For locating wounded men, a highly ingenious piece of training equipment is employed. It is what Mr. Meistrell calls a "bringsel," a short batonlike stick with knobs at each end. The bringsel hangs loosely from the dog's collar in a position where the animal can reach it with its jaws. Upon finding a wounded man in the field, the dog simply takes

# for DEFENSE

the bringsel into its mouth and returns to its master. The fact that the stick no longer dangles from the collar but is held between the dog's teeth signals rescue workers that a wounded person has been discovered. Then the dog leads a party to the man requiring attention.

Formerly it was the custom to train dogs for this mission with an article of the victim's clothing, but the animals became so eager in their work that they tore off bandages or injured the patient when a piece of clothing was difficult for the dog to retrieve.

For carrying messages, the dogs are equipped with a leather carrier fastened to the collar and the animals are trained simply to run from one fixed point to another, then return. Recently during an air raid alarm on the east coast, Mr. Meistrell sent one of his dogs to the home of a neighbor in a demonstration of message-carrying in an emergency.

The dogs can lay telephone wire with minimum training. One end of the wire is fastened to the dog's collar and the animal is directed to the spot where the wire is to be carried. As the dog drags the line, its master unwinds it from a reel until the length desired has been strung across the dangerous area. Someone at the other end takes the wire from the dog's collar and a telephone instrument from the dog's back, then makes the connection.

Dogs are being trained also to help guard factories, airports and other places that are vital to the war program. In this work, the



One of the Meistrel dogs leaping through fence as on a message-carrying trip; below, closeup of bringsel dangling from the animal's collar



animals are taught to accompany watchmen on their rounds and to stand guard alone at some posts. The Army finds dogs useful for sentry duty.

Owners of dogs not trained for obedience tests probably would find training their animals for such duties difficult, but there are many dogs which could be taught simple duties that might be of value on the home front. The key to such training is patience.

# Old Bridge Ferried on Barges To Salvage Its Steel

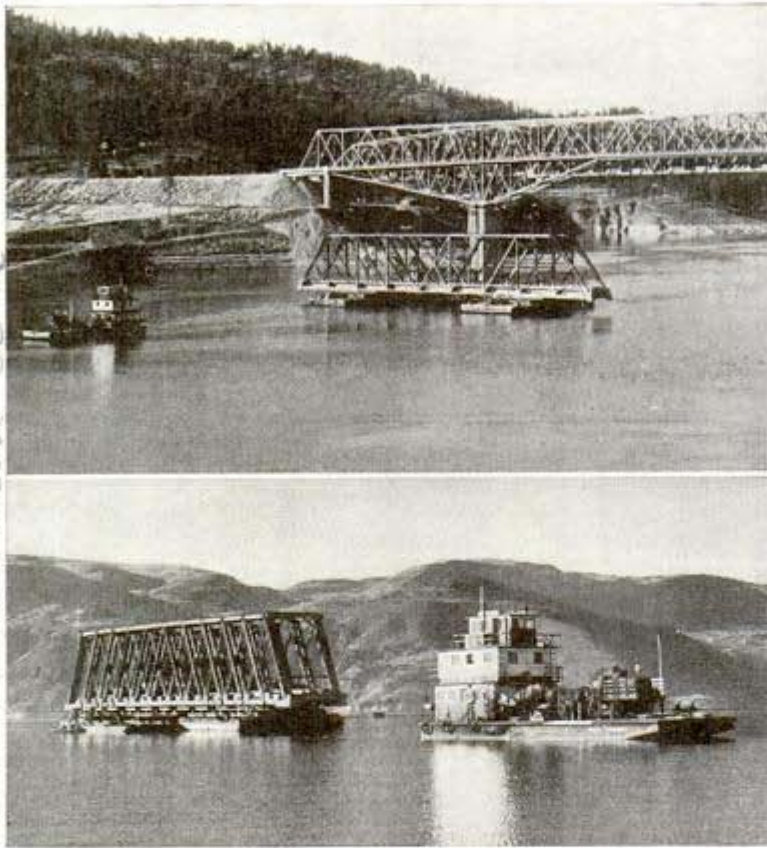

Old span, top, passing under new railroad and highway bridges five miles downstream. Bottom, one of the wooden spans towed by a motor barge

Its usefulness ended by the rising waters of the new lake above Grand Coulee Dam which would soon overflow it, the 1,340-foot-long railroad bridge at Marcus, Wash., contained steel and other material which could be used to good advantage in a large storage and fabricating plant to be erected at Grand Coulee Dam, 113 miles away. Engineers of the Bureau of Reclamation, working out details of transporting this vast tonnage, decided to mount sections of the bridge on barges and float them down the reservoir to Grand Coulee. Because of the high water level, it was necessary to pump water into the barge hull in order to slip it under the bridge span. When it was in place, pumps removed the water until its buoyancy caused the vessel to bear the full weight of the span. The barges were towed by the Bureau's motor barge "Paul Bunyan." The largest span, made of steel, was 253 feet long and 36 feet high, weighing 295 tons, and required two

barges to float it, but a single barge was sufficient to carry the small sections. Seven spans were moved by this method, comprising 965 tons of structural steel, 306,000 board feet of timber, and 150 tons of miscellaneous metals. About five miles downstream, the spans of the dismantled bridge passed under the new railroad crossing.

## Adjustable Dresser Set for Convex or Concave Wheel

For dressing the radius on grinding wheels, an adjustable tool is available. Simple to operate, set quickly and accurately by means of a depth gauge or micrometer, the tool can be used to dress either a convex or concave radius from zero to one inch. The dresser uses a one-half carat diamond; it is free of chatter and does not become charged with emery.

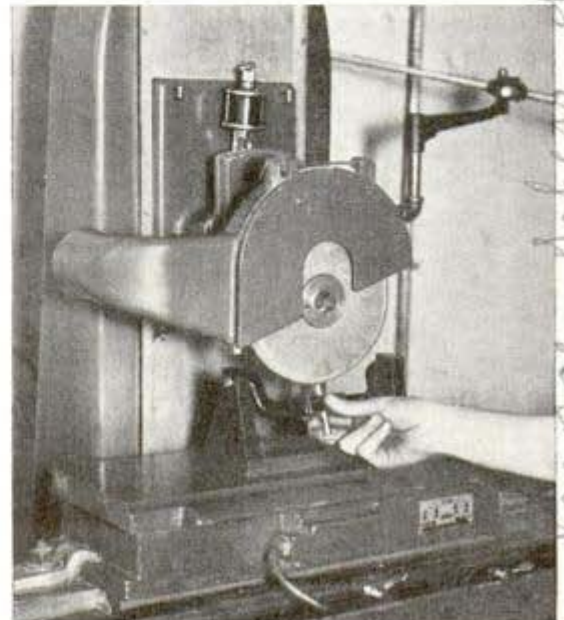

Dresser mounted beneath grinding wheel can be set to smooth concave or convex surfaces to desired radius



# "Jigger" Travels Under Ice to Help Fishermen

During winter months fishermen on Lake Winnipeg, in Canada, use what they call a jigger that "walks" under the ice dragging with it a line which is used for pulling the net through. Its "chassis" is a buoyant two-inch board, 10 feet long and 10 inches wide, fitted with skates or runners which slide along against the ceiling of the ice. The "walking stick" is a wooden shaft, four feet long and weighted downward by a five-foot iron bar hinged to a slot in the board. A rope extending from the surface passes through a ring bolt at one end of the board and is attached to the lower end of the bar. Pulling this rope drives the spiked end of the

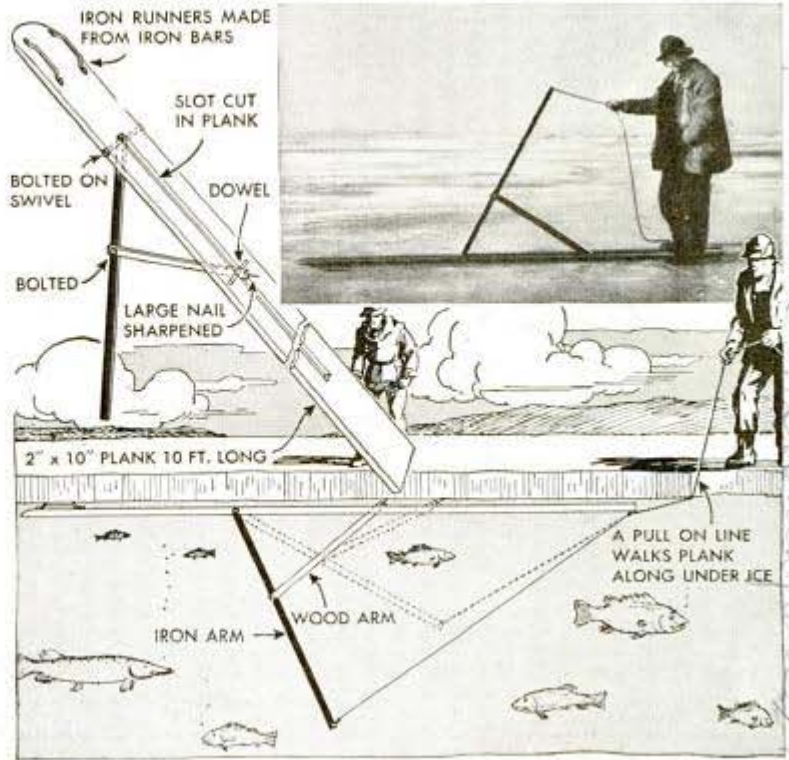

Sketches show how "walking jigger" travels under ice by remote control.

wooden shaft into the ice and exerts a push that moves the jigger forward. Relaxing the line drops the iron bar, and the pull may be repeated. Step by step the jigger travels until it is about 80 yards from the starting point, when fishermen cut a new hole and recover the jigger. To one end of

the rope a net is then attached which can be drawn under the ice and the end anchored to stakes. Floats fixed along the top edge of the net and weights along the bottom keep it upright in the water. After remaining in place for a day or two the nets are lifted out and the fish removed.

## Blackout Tie With Luminous Design Glows in the Dark



Tie and lapel button, left, glow brightly when lights go out

Printed with a fluorescent chemical, a luminous necktie glows brilliantly in the blackout. After exposure to light, the treated pattern will glow about 20 minutes. In daylight the tie has no unusual markings, but in total darkness an entirely different pattern appears. The same fluorescent chemical has been applied to a new buttonhole decoration.

On the basis of normal automobile mileage, motorists would save about \$62,000,000 per year on gasoline by reducing speeds to a maximum of 40 miles an hour, or \$97,000,000 at 35 miles an hour.

7m 32  
1940 593

# The HEAT LAMP makes GOOD

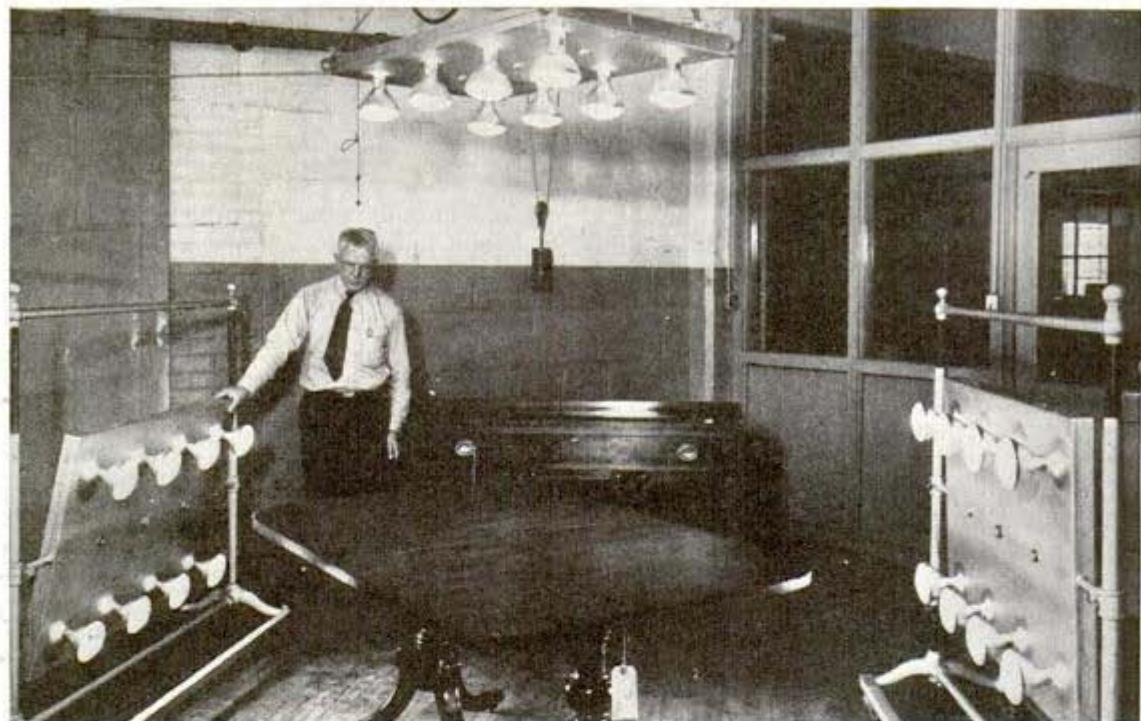

Portable banks of 250-watt lamps dry the finish on a table. Furniture finishes can be dried in 20 minutes



Heat lamps toasted bread in less than ten minutes  
1,000 and 65-watt lamps with gold-plated reflectors

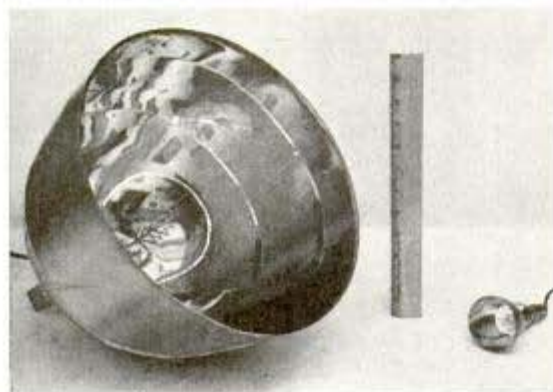

NOTHING irritates the proud automobile owner so much as to have his car come back from the paint retouching shop with an apple-green spot on a blue-green body. So there were purple words in a paint shop one day. They were having trouble matching colors on a touch-up job.

If only the original baked enamel could be patched on—but that would mean putting the whole car into an oven. Then someone who probably had suffered at one time or another from a wrenched shoulder or infected sinus suggested the oven be brought to the car. If you can use a heat lamp to broil a stiff neck, why can't you use it to bake a scuffed fender? So the foreman arranged some lamps in a reflector and turned them on the painted area.

Results were amazing. So beautifully did the enamel bake under the lamps that the stunt became standard practice. Before long, automobile plants were installing row after row of heat lamps arranged to form a hollow tunnel in which entire automobile bodies could be baked.

Today, specially engineered heat lamps are working wonders in industrial painting and drying of all kinds, and are on duty in bathrooms and workshops of American homes. In scores of factories they are help-



General Electric photos

Held at focal point of reflector, a cigarette is lighted almost instantly by the heat from a 65-watt lamp

ing eliminate bottlenecks in the production of guns, airplanes, and other military equipment.

These drying lamps produce an abundance of infrared energy—long-wave radiation just beyond the visible red light in the spectrum. There is little new or startling about the lamps generating this invisible “light.” Essentially they are ordinary lamps burned at reduced voltage. Some of the 110-volt drying lamps have filaments practically identical with ordinary 220-volt lamps; and by using a 220-volt lamp at reduced wattage on a 110-volt line, or two 110-volt lamps in series, about the same drying action would result. Theoretically the filaments of the infrared lamps should last 200,000 hours; but breakage and other practical limitations reduce the actual life to about 10,000 hours. A bank of 114 lamps in a Cleveland factory is still going strong, without a single lamp burned out, after 20,000 hours.

Infrared energy has become one of industry’s most useful genies because of a single trait: When it strikes an object and is absorbed, it raises the temperature of that object. Some substances such as air are not heated by the rays. Thus infrared loses none of its power by traveling through air. It bores into many solid materials to considerable depth, and liberates heat all the way. In paint drying, the rays heat both the paint and the metal, so that the paint dries uniformly and not on the sur-



A battery of infrared lamps bakes enamel on an auto in repair shop

Infrared rays popping corn inside a Cellophane bag





These are reflector-type 250-watt therapeutic lamps giving heat treatment



Drying photographic films with 250-watt lamp. The fan speeds drying and prevents damage to emulsion

These are lamps of the type used extensively in industrial paint drying



face first, as in conventional drying. Infrared energy can be focused by lenses and reflectors. Gold-coated reflectors are more efficient, aluminum less costly.

Howard Haynes, an engineer at General Electric's research center at Nela Park, Cleveland, has been specializing in drying lamps ever since they went to work. He has used drying lamps for such lecture-platform stunts as popping corn in transparent cellulose-film bags, broiling a steak with two 250-watt reflector lamps, and lighting

his pipe with a 65-watt heat lamp. One day, as a stunt, he even toasted bread by infrared. He suspended the slice midway between two 250-watt drying lamps placed about 10 inches apart. In a half minute the bread began to steam. For a time nothing more seemed to happen, until a slight browning of the surface appeared. When this was a tempting golden tone, Haynes removed the slice and broke it in two. It was almost black inside! The infrared rays had penetrated the bread and toasted it from the inside out.

Steak broiling as a stunt has been successful because infrared rays penetrate the meat deeply and cook it thoroughly. He has broiled a small cube steak in 3½ minutes with two 250-watt reflector lamps.

Visitors are always stopping in to light their pipes and cigarettes with a novel 65-watt heat lamp he keeps in his desk drawer. A gold-plated reflector encircling the tubular bulb brings the infrared rays to a focus a couple of inches in front of the bulb end. Hold a piece of paper at this focus, and it bursts into flame in two seconds. A cigarette, cigar, or the tobacco in a pipe smoulders almost instantly. The lamp will melt solder at its focal point. This lamp

24 32  
originally was designed to replace expensive resistance units on a shoe-making machine whose leather-piercing tools had to be kept heated.

Infrared lamps have virtually revolutionized painting operations in scores of factories by speeding up the drying. A stoker manufacturer used to allow 12 hours to air-dry the finish on his stokers. Today, 144 drying lamps in gold-plated reflectors take just nine minutes for the job; and the cost per stoker is three cents. Drying synthetic lacquer on flat sheets of pressed wood is a 90-second operation for a battery of lamps. One manufacturer of electrical equipment bakes parts made of steel, cast aluminum, cast iron, and plastics in a tunnel of 200 250-watt reflector-type lamps wired so that 125 different heats can be applied, saving 85 percent in time. Heat lamps are speeding the manufacture of dynamite.

A Tennessee power station was put out of commission by a flood. Before operations could be resumed, the generator and exciter windings and other parts had to be dried thoroughly. Precedent pointed to expensive removal of the parts to drying ovens; but with batteries of 250-watt drying lamps, the job was done in record time without disturbing a single machine.

Infrared drying technique works with any finishing material that can be dried or baked by heat. Drying lamps usually produce superior finishes, in addition to being easier to use, faster, and space-saving.

In one print shop, an infrared unit is mounted beside the proof press and used to dry ink on proofs. This eliminates smudging and other troubles traceable to wet ink. Experiments are being made in applying the lamps to drying print while the paper moves at high speed through a press. An envelope-making company uses a battery of lamps to dry the adhesive.

A foundry making heavy iron castings had trouble with its molds because of improperly dried sand. Letters used to spell the manufacturer's name on the castings came out fuzzy and had to be hand-worked to final shape. A hot-air oven was built and the molds shoved into it; but this made the sand shrink and threw dimensions off. A battery of drying lamps suspended over a mold did the trick by drying the sand to a depth of one-half to one inch in 45 minutes. The remainder of the sand stays moist enough to eliminate shrinking. Not

(Continued to page 162)

## Hose Visible in a Blackout Has Ends Painted White

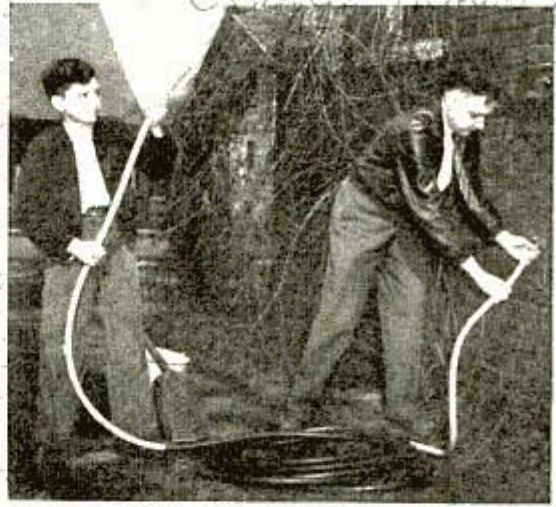

White-painted ends of hose are easy to find in dark

Getting ready to fight fires that may be started by incendiary bomb or sabotage, one home owner has applied white sidewall tire paint to both ends of his garden hose. In case of fire during a blackout, the whitened hose would enable him to locate the coupling and nozzle ends quickly.

## Folding Desk Handy for Artist Attaches to Arm Chair

A Seattle inventor has patented a folding desk for use with an arm chair, its pitched top offering a convenient surface for drawing. Hinged supports attached to its rear edge adapt it to the chair.



Arms of chair help support this hinged drawing desk

m 243

## X-Ray Examines Rubber Heels For Hidden Defects

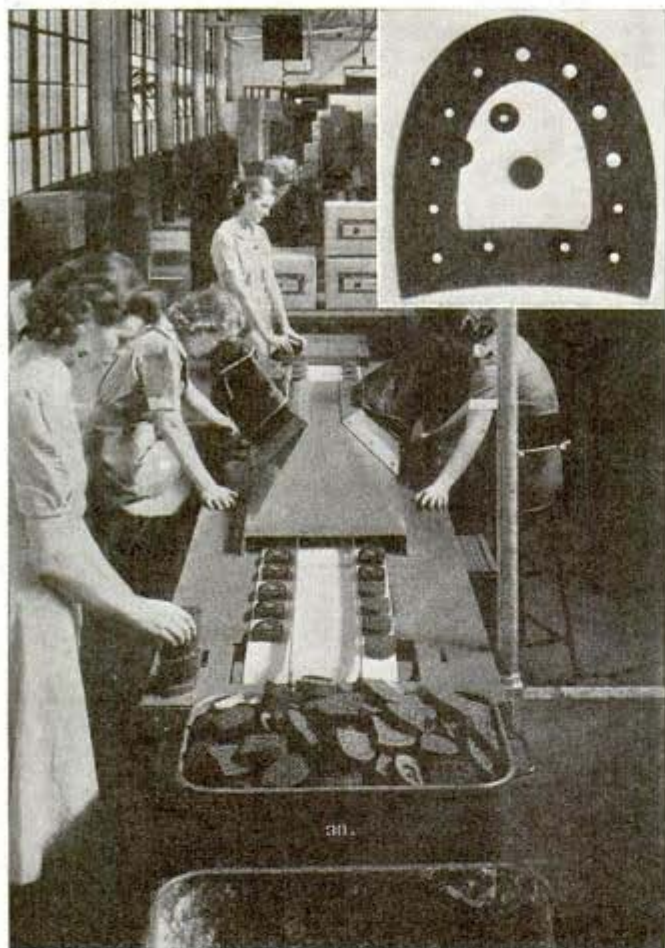

Inspectors watch rubber heels moving along fluoroscopic table. The inset is an "X-ray" of a heel with misplaced steel washers

Rubber heels participate in their first parade past an X-ray reviewing stand where inspectors peer through them in search of internal defects. Occasionally some of the steel washers embedded in the heel are misplaced. These washers hold the nails attaching the heel to the shoe, and if a washer is misplaced it fails to anchor the nail and the heel may loosen, wear out prematurely or be lost. Under the X-ray a misplaced washer is spotted quickly.

m 280

## Retreating Armies May Use Gas To Slow Pursuing Enemy

Although poison gases have had little use in the present war, they may make an appearance later as a means to hamper an advancing enemy, Lieut. Col. Alden W. Waite of the Chemical Warfare Service be-

lieves. In this role gases may be added to fire and dynamite in "scorched earth" tactics. Of course, such areas could be decontaminated by the enemy before occupation, but the process would be slow, hampering swift pursuit. Some so-called war gases are really liquids distributed in fine sprays or mists to cling to foliage, soil and other objects. Bodily contact with some of them, such as mustard gas, lewisite and other vesicants or blister-raisers, is almost certain to result in more or less severe poisoning. One effective method of spreading the chemicals probably would be by means of a land mine which would explode when its firing mechanism is tripped by an incautious enemy.

m 243

## "Mammy" in a Hoop Skirt Houses Sandwich Shop

Near Natchez, Miss., tourists' eyes are caught by a roadside building that looks like a large, smiling negro "mammy." The structure, made of brick and cement, houses a sandwich shop within its wide "skirt."



Standing at the roadside ready to serve customers is this lunchroom constructed to resemble a "mammy"

The



# CRAFTSMAN

## Thrills with WATER SKIS

By Pete Peterson

ANYONE who wants to enjoy the thrills of water skiing can make skis for this sport at small cost, with ordinary hand tools. No elaborate steaming equipment for bending them is necessary as the wood is bent cold. Each ski is made from a 7-ft. length of  $\frac{7}{8}$  by 7-in. clear spruce, pine or fir.

To begin, make a slot  $\frac{3}{16}$  in. wide and 18 in. long in the toe or forward end of each ski blank and a similar slot 3 in. long in the heel end. Next, coat pieces of  $\frac{3}{16}$ -in. mahogany or other suitable hardwood liberally with a good waterproof glue, such as the new resin glue, and insert them into the slots with the grain running at right angles to that of the ski, Fig. 6. Then immediately place the toe ends of the skis between bending blocks, Fig. 4, and clamp them as in Fig. 5. The blocks are built up from several pieces of wood which are bolted together

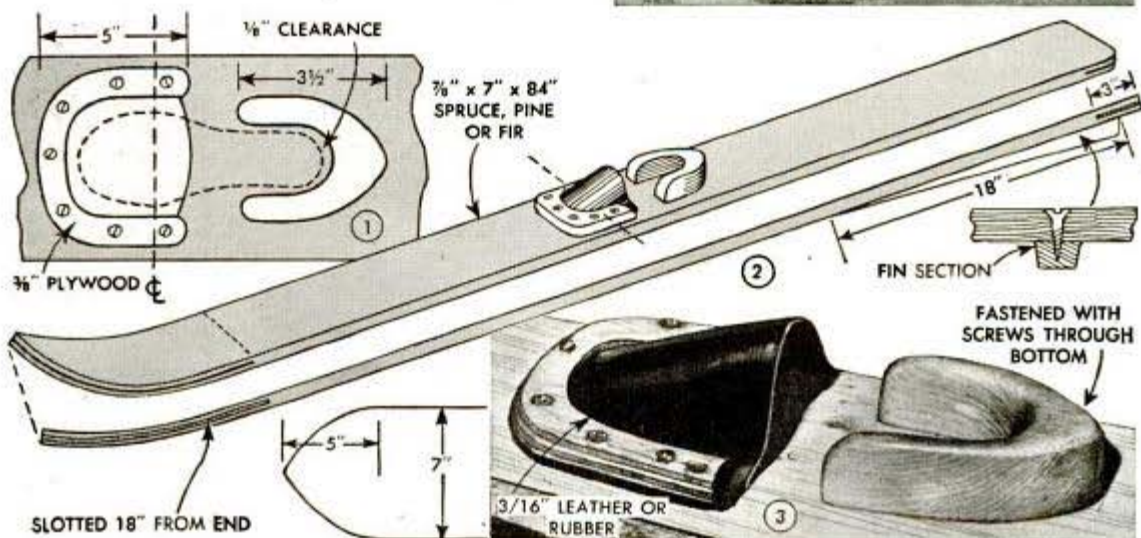

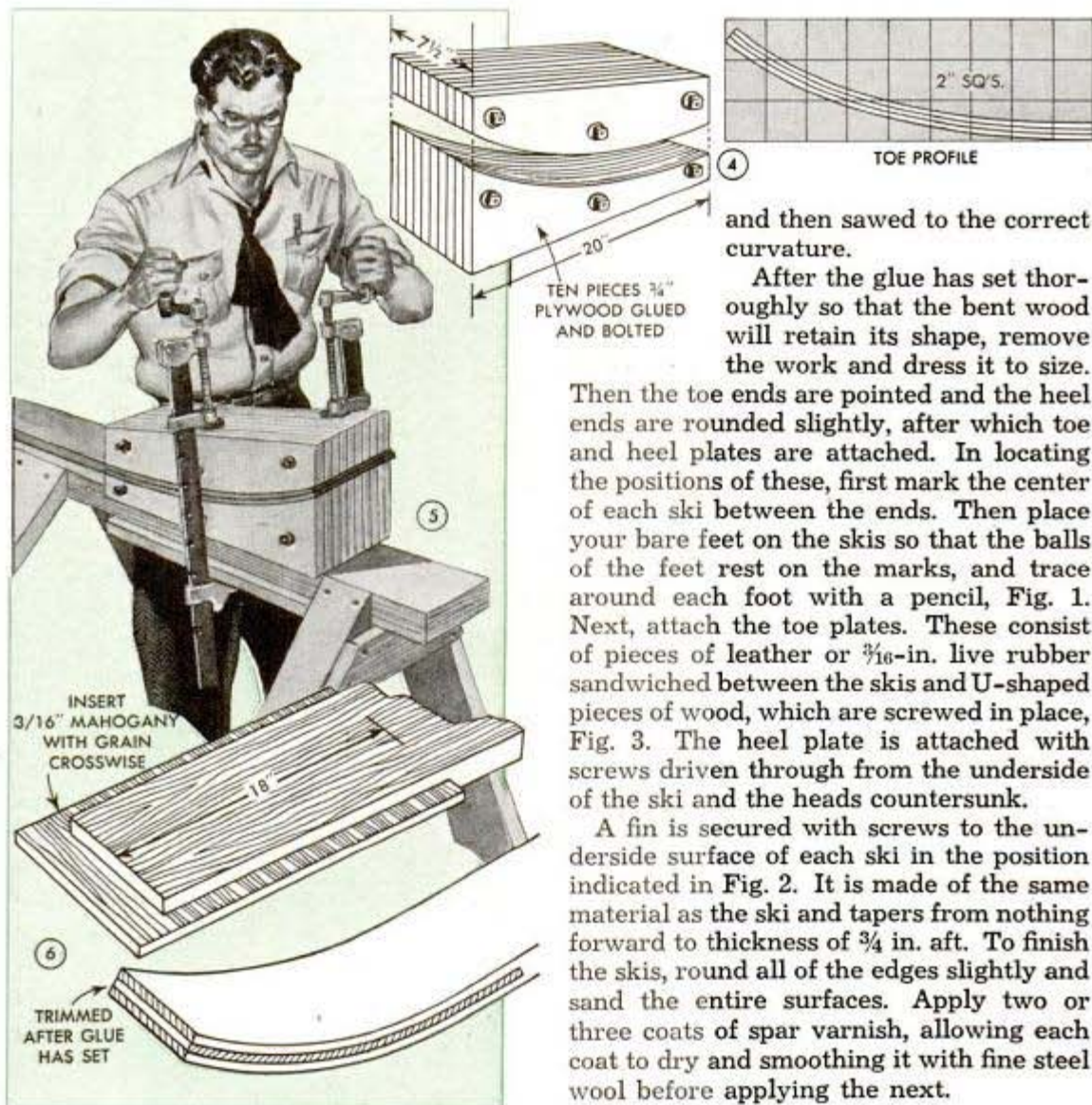

and then sawed to the correct curvature.

After the glue has set thoroughly so that the bent wood will retain its shape, remove the work and dress it to size.

Then the toe ends are pointed and the heel ends are rounded slightly, after which toe and heel plates are attached. In locating the positions of these, first mark the center of each ski between the ends. Then place your bare feet on the skis so that the balls of the feet rest on the marks, and trace around each foot with a pencil, Fig. 1. Next, attach the toe plates. These consist of pieces of leather or  $\frac{3}{16}$ -in. live rubber sandwiched between the skis and U-shaped pieces of wood, which are screwed in place, Fig. 3. The heel plate is attached with screws driven through from the underside of the ski and the heads countersunk.

A fin is secured with screws to the underside surface of each ski in the position indicated in Fig. 2. It is made of the same material as the ski and tapers from nothing forward to thickness of  $\frac{3}{4}$  in. aft. To finish the skis, round all of the edges slightly and sand the entire surfaces. Apply two or three coats of spar varnish, allowing each coat to dry and smoothing it with fine steel wool before applying the next.

## Spark Plugs Changed Without the Motor Being Stopped

When trolling for lake trout, the slow speed and cold operation of an outboard motor frequently causes the spark plugs to foul. And if several metal lines that may be as much as 500 ft. in length, are used, stopping the motor to change the plugs may result in the lines becoming badly tangled. To prevent this, you can change a plug without stopping the motor by grounding it, thus letting the other cylinder keep the boat in motion. Grounding is done by fastening a short length of wire to a bolt on the motor and clipping the other end over the spark-plug cable as indicated in the photograph. When this is done you can remove the cable from the plug without getting a shock.

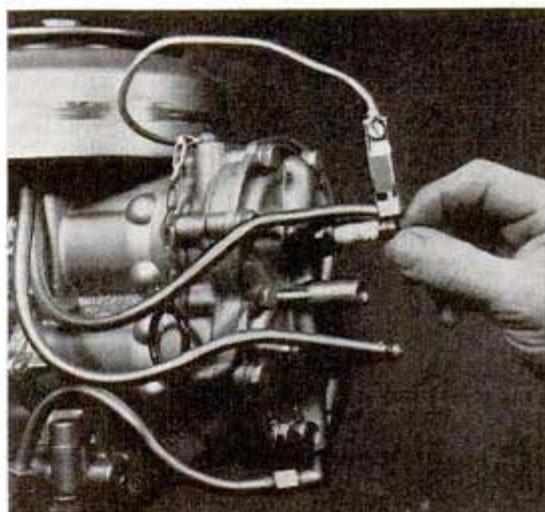



# Using T-Iron Posts Streamlines Picket Fence

In order to avoid the usual bulky appearance of a picket fence, especially from the side not covered by the pickets, I substituted T-irons for the 4 by 4-in. wood posts ordinarily used, and placed the 2 by 4-in. horizontal pieces edgewise instead of the usual way. These are attached to the T-irons with screws in the manner indicated in the circular detail. Besides giving the fence a better appearance, this method of construction permits one of the panels to be removed easily if at any time it is necessary to enter the enclosed grounds with a large vehicle. And as there is no wood in contact with the ground, the fence will last a long time.

—Carl C. Buebke, Portland, Ore.



## Pressure Drain Seal in Basement Keeps Out Flood Waters

One home owner who lived in a district where water backed up the sewer into his basement during a heavy rain, seals the drain by means of the pressure unit illustrated. It consists of a wood disk attached to a pipe assembly, which is pivoted to the joist directly above the drain. The disk is attached to a  $\frac{3}{4}$ -in. pipe by a floor flange and a smaller  $\frac{3}{8}$ -in. pipe telescopes inside of it and is pivoted at the upper end to the

ceiling by means of a tee and a U-shaped bracket. The smaller pipe is threaded at the lower end to take a handle, which consists of a 4-way fitting and two short pieces of pipe. The wood disk is lined on the underside with thick sponge rubber. To seal the drain the unit is placed on top of it and forced down tightly by screwing the handle down on the end of the larger pipe. When not in use the entire assembly swings up out of the way and rests on two hooks screwed to one of the floor joists.

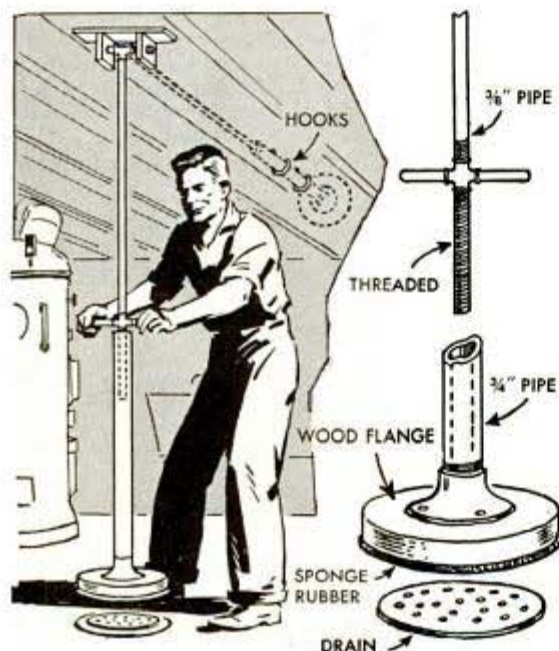

## Pipe Cleaners Remove Grease From Steel Tape Measure

To increase the life of your tape measure, make a practice of cleaning it thoroughly after each job. Ordinary pipe cleaners provide handy brushes for this purpose as they can be wrapped around the tape to remove dirt and grease as it is being rolled up. It's a good idea to keep a package of these cleaners in your toolbox so they will always be at hand when needed.



# Solving HOME

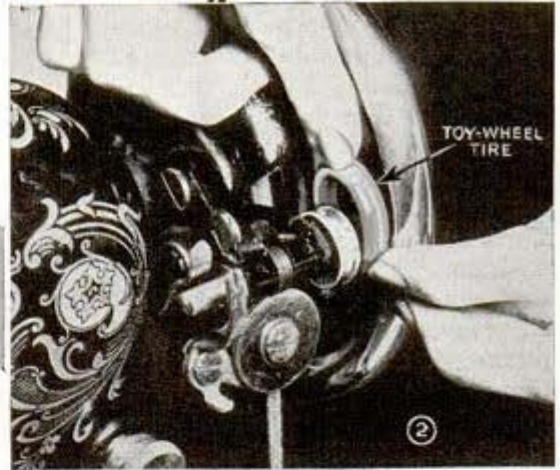

1—Pulling out the drawer of your kitchen table to expose an oilstone makes the whetting of knives convenient. Simply notch the drawer side to bring the stone flush and then cement it to a wood block

2—When the friction-drive band on your bobbin winder needs replacing, a rubber tire taken from a child's discarded toy will make a good substitute



3—Steel knitting needles carried loosely in a knitted sewing bag are apt to work through unless the ends are shielded. Ideal for this purpose are the little rubber caps provided on medicine droppers

4—Your straining cloth will stay stretched across a pail or pan without the use of clothespins if you weight it with a chain run through a hem at the edge. Use galvanized chain so it will not rust easily

5—Save those empty safety-match boxes and when you have six or more bind them together with a strip of gummed-paper tape, label the "drawers" and you'll have a handy little pin-and-button chest

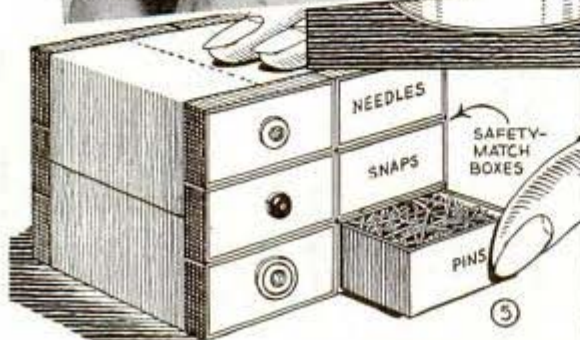

6—A tea ball can be made to serve a double purpose by using it to hold onion or other seasoning when flavoring stews, soups, etc. The ball makes it handy to remove the condiment, when the flavor is just right

# PROBLEMS

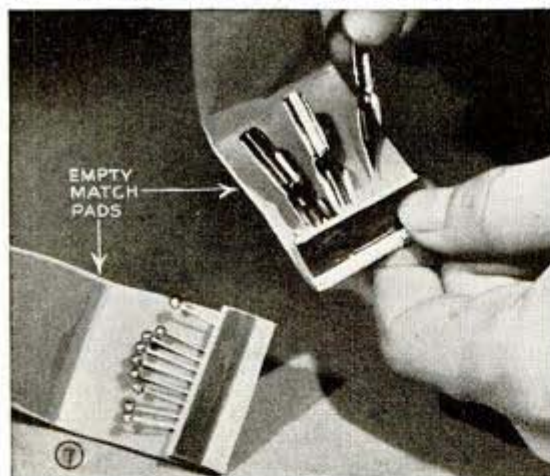

7—Empty match pads provide a safe way to carry pins or pen points in a purse or pocket. The torn stubs serve as a cushion in which to stick the sharp points

8—Cloth weatherstrip makes an effective seal on the doors of wooden iceboxes when they become worn and no longer fit tightly. It may be necessary to shim the hinges with pieces of cardboard

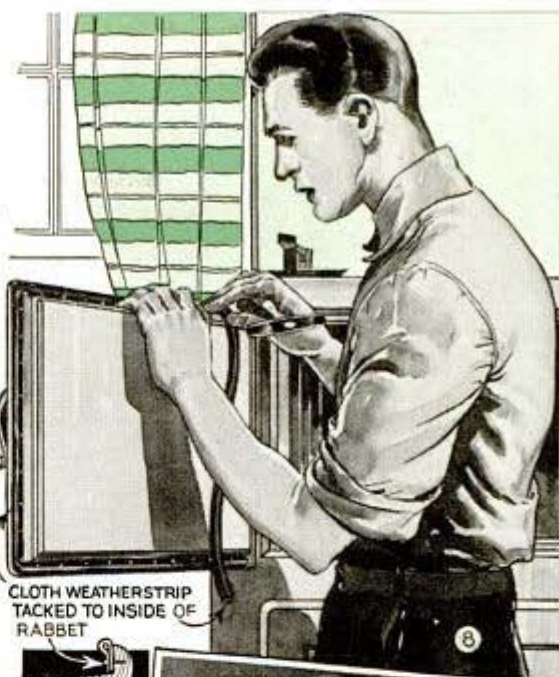

CLOTH WEATHERSTRIP TACKED TO INSIDE OF RABBIT



9—About the simplest way to keep a garbage can from being upset by strong winds or stray dogs is to drive a pipe solidly in the ground so that the handle can be slipped over the projecting end of the pipe

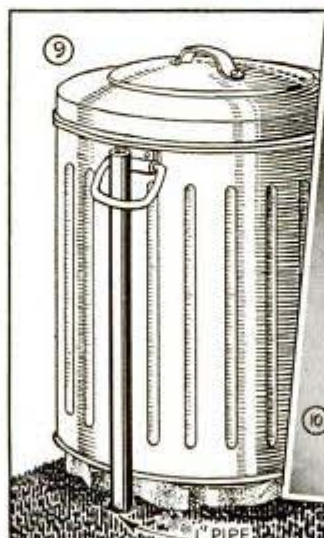

10—When the cork is left in an empty insulated bottle, stale odors within cannot escape. A good way to air the interior and still keep it clean is to lay the cork on its side and set the cap over it



11—In humid weather when varnished surfaces become sticky, a newspaper laid on a table may adhere to it. If this happens, don't mar the finish by applying water; rub the stuck pieces with olive oil

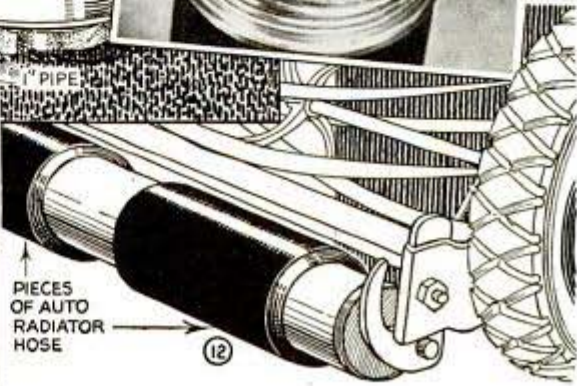

PIECES OF AUTO RADIATOR HOSE

12—Cushioning the wooden roller on your lawnmower with old radiator hose of the proper size saves it from wear and will reduce noise when cutting along walks. Force a piece of hose tightly over each end

## Holes in Soil to Fertilize Tree Made With Electric Drill



Fertilization of trees by applying fertilizer in a number of holes in the ground at varying distances from the base is simplified by use of a 2-in. wood auger used in an electric drill. It will be necessary to weld an extension to the auger so the holes can be drilled deep enough. For trees with shallow roots like a soft maple, the holes should be about 18 in. deep and spaced about 2 ft. apart.

## Envelope Is Handy Page Marker In a Small Catalogue

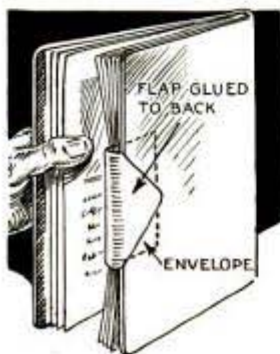

In a garage where a number of small catalogues were kept at hand for ordering parts and accessories, a marker was provided for each one by gluing an envelope by its flap to the back cover. This per-

mitted the body of the envelope to be folded over to mark any desired page. When not needed, the marker could be folded between the last page and the cover.

## Auxiliary Magnet Increases Life Of Miniature Electric Motors

No motor can deliver power beyond the ability of its field winding to build up a magnetic force. Therefore, it is a simple matter to increase the power of miniature d.c. motors by means of small separate magnets applied as indicated. The magnet



should be placed so that the north pole of the extra magnet corresponds with the south pole of the motor magnet.

## Several Cabinet Drawers Secured By One Padlock

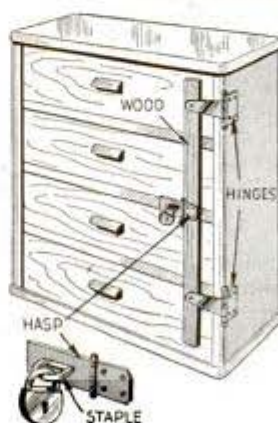

Having a cabinet in his shop with four drawers and no locks, one workman made a serviceable locking device from a wood strip. It was hinged to the side of the cabinet to fold over the drawers as indicated in the drawing. A hasp and padlock then secured the drawers in one operation.—John F. Quinn, Camden, N. J.

## Insulating a Hot-Water Tank With Corrugated Cardboard

By covering a hot water storage tank with one or more layers of flexible corrugated cardboard, it will be found to maintain the heat within the tank and lower the temperature of the cellar. The tank, of course, must not be close enough to the heating plant or smokepipe to ignite the cardboard.—I. Salzer, Baldwin, L. I., N. Y.

# Chairside TABLE has Swinging Lamp

This table not only keeps your favorite reading material handy beside your easy chair, but it also has a book trough, shelves to accommodate the largest magazines, and a reading lamp that can be swung around 90 degrees for good illumination. Also, a spacious compartment for smoking accessories is provided behind the shelves

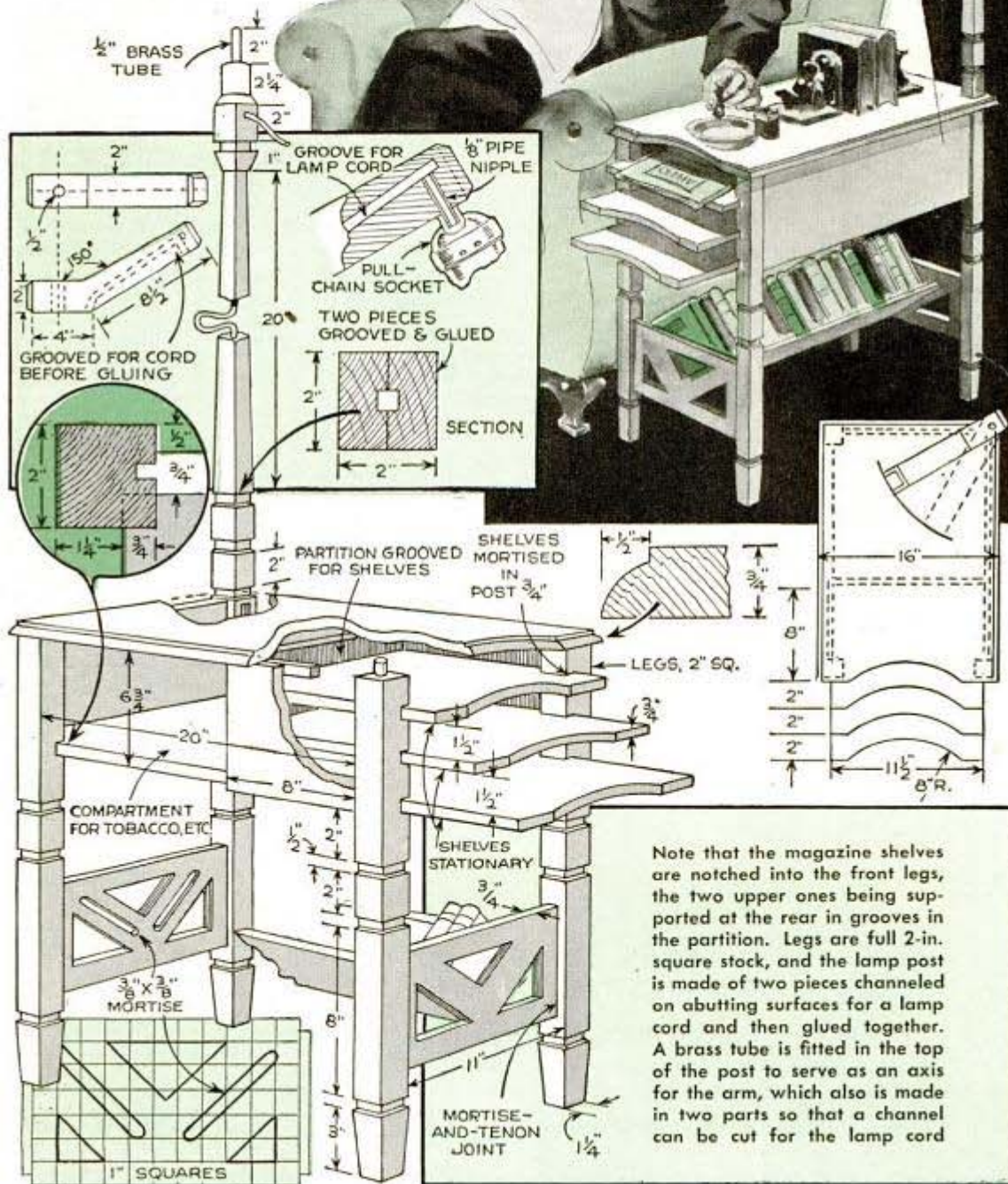

Note that the magazine shelves are notched into the front legs, the two upper ones being supported at the rear in grooves in the partition. Legs are full 2-in. square stock, and the lamp post is made of two pieces channeled on abutting surfaces for a lamp cord and then glued together. A brass tube is fitted in the top of the post to serve as an axis for the arm, which also is made in two parts so that a channel can be cut for the lamp cord

## Stake Prevents Loss of Bait Can On Grassy Bank of Stream



Have you ever had trouble losing your bait can in the grass or weeds when still fishing along the banks of a stream? If so, just cut a stake from a tree branch, sharpen one end and attach the can to this with string or a couple of rubber bands. When forced into the bank, the stake will keep the can elevated so that it can be seen from a considerable distance.

## Neat Mantel Ornament to Match Your Fireplace Screen

This ornament, made to match or harmonize with your fireplace screen, is an ideal decoration for the mantel. It consists of a metal frame having copper screen wire stretched tautly over it and soldered in place. The frame can be of any desired



shape, and the figure, which is cut from copper or brass, can represent anything desired. The figure can be plain or it can be hammered, or even made to appear in relief by hammering it over a hardwood form. The figure is spot-soldered in place, after which the ornament is gone over thoroughly with fine steel wool to remove all grease and acid. Then a couple of coats of clear lacquer are applied.

## Two Rubber Bands on Clip Board Hold Papers Flat

To hold the corners of bills, invoices, etc., flat on his clip board, one checker slips rubber bands across the lower corners as shown. Small notches cut in the board about 2 or 3 in. from each corner keep the bands in place so they can be lifted easily to insert new sheets or remove old ones.

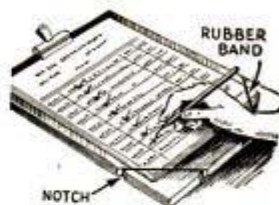

## C-Clamp Padded With Hose

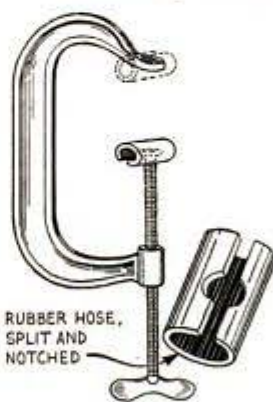

Next time you want to pad the jaws of a C-clamp to protect the work, try using two pieces of rubber hose. Split the pieces and notch the edges to fit the jaw shafts. These pads will not fall off when the clamp is removed.

## Nonslip Surface for Boat Seat

One sportsman made the surface of his rowboat seat slip-proof by coating it with ground cork. This was done by first painting the seat and then applying the cork while the paint was still tacky. This is better than using a piece of corrugated rubber as it does not require any attention when the boat is left unprotected.



# Novel Figurine Candle Holders in Bright Colors



These novel wooden candle holders will add a gay touch to your table for the children's birthday and party dinners. The bases are cut from  $\frac{1}{2}$ -in. pine and the candle sockets are made from strips of tin curled at the ends and assembled in the form of crosses. The figurines are scrollsawed from 1-in. stock, and painted in appropriate colors. They are held to the bases with glue and brads.—R. L. Fairall, Los Angeles, Calif.

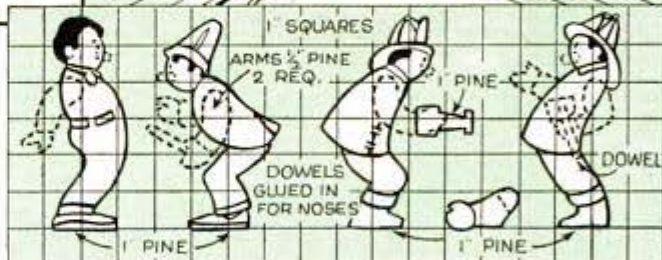

# Wire Mesh Nailed Under Joists Provides Storage Space

Instead of nailing a wide board to the basement joists to provide extra storage space, use wire mesh. You can see through it and pick out the article you want without fumbling around. Use wood strips over the wire to keep the nails from pulling through it.—John Krill, Youngstown, O.

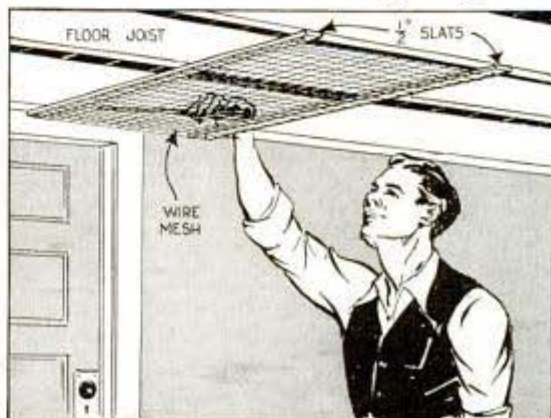

Applying liquid wax to clothespins and rope clotheslines not only makes them last longer, but it also simplifies cleaning with a damp cloth as the wax film tends to keep moisture from penetrating the surfaces.

# LAWN

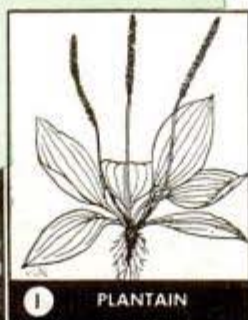
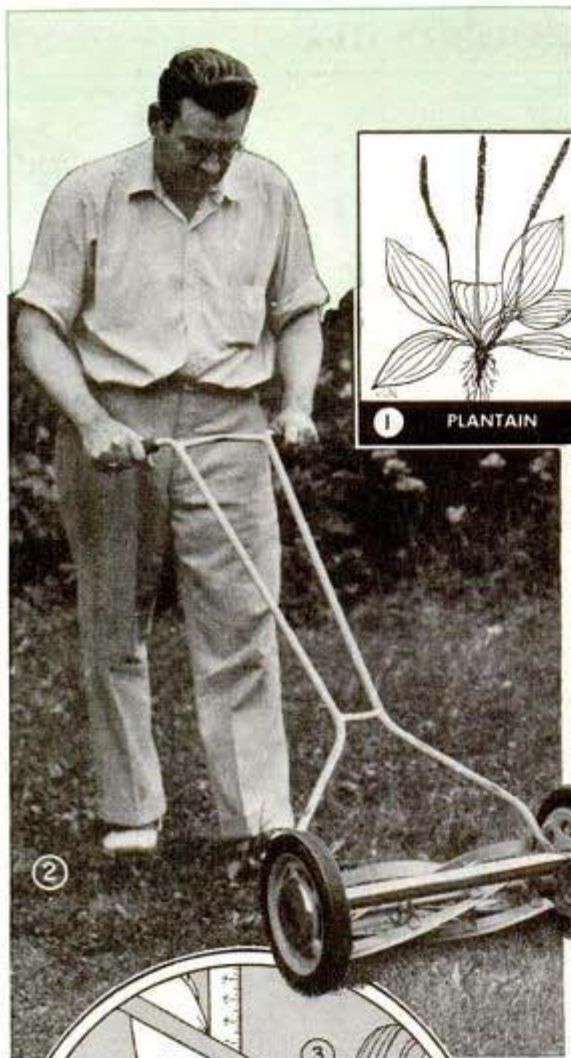

**W**HY do all kinds of noxious weeds and unwanted grasses apparently thrive in my lawn while the good grass steadily grows more thinly sodded, spindly and sickly in color? That is the question many home owners ask themselves each year. Other pertinent associated problems are what to do with bare spots, creeping moss, washed terraces and places where grass doesn't seem to grow at all. Solutions are often found upon investigating the characteristics of the soil, condition of the grass and the method of mowing it.

Starved, close-clipped lawns provide just the right conditions for a flourishing crop of weeds. The sod, when thin, offers a place for the weed seeds to lodge, and also provides protection for the tiny but vigorous weeds during their starting period while the repeated close clippings only help to stimulate weed growth. A thinning lawn with a steadily thickening weed crop simply means that the tame grass is slowly starving. Weeds never crowd out a healthy, vigorous sod as they cannot root and survive in a heavy turf. If you give lawn grass the growing conditions it requires—ample plant food in a deep soil well supplied with organic matter and plenty of moisture, set the lawnmower so high that the mowing job looks just a bit "shaggy," the grass will win every time in the battle against weeds.

Fig. 1 shows five of the most troublesome weeds and grasses that are quick to strike root and spread in any poor sod. They can safely be called the most troublesome for several reasons. Quack grass and dandelions are familiar and unwanted aliens in any lawn but even more to be dreaded are crab grass, spurge and creeping buttercup. After these get a solid foothold, they are

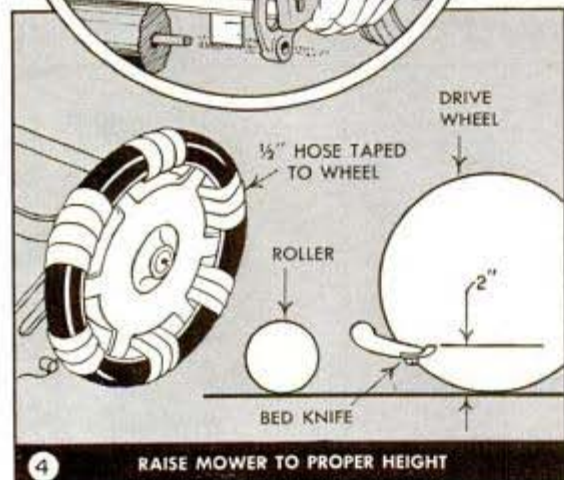
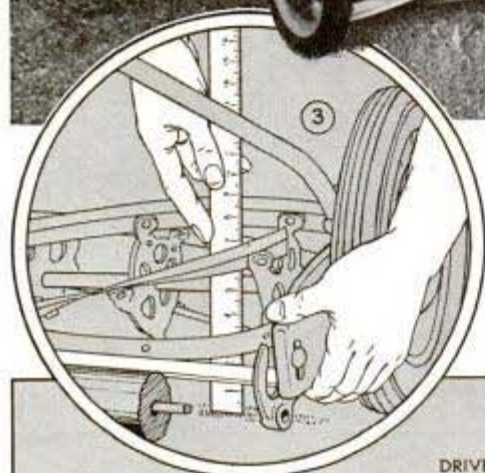



# CARE



KNOTWEED



SPURGE

tenacious and difficult to get rid of. Although new chemical-control methods are effective in eradicating the stands of most of them, crab grass for example, the growing and spreading habits of these weeds make it necessary to decide whether control by chemicals or uprooting and complete rebuilding of parts of the lawn are advisable. Either way, the existing grass is certain to be damaged to some extent. If single weeds are scattered here and there over the lawn, they can usually be eliminated by digging them out with a small hand trowel.

But where they are growing in clusters surrounded by a fairly vigorous sod, it is usually best to dig them out with a shovel, making sure that you get all the roots, add new soil and reseed to grass, as in Figs. 5, 6 and 7. This method is very effective where the growth is so concentrated that if weeds were killed out by chemicals a resulting bare spot would necessitate patching in the end anyway. As a rule chemical control is most effective where there is only a moderate weed infestation of a fairly vigorous sod. Then you can use an over-all application of the chemical or a "spotting" procedure for individual plants or clusters. Which method is best is determined by the number of weeds and their distribution over the lawn. The common lawn blue-grasses are unusually resistant to injury by the chemical weed killers if administered as recommended by the manufacturers. It should be remembered that injury to the grass is not likely to be permanent unless unduly heavy and frequent appli-



6

WEED CLUSTERS LIFTED WITH SHOVEL

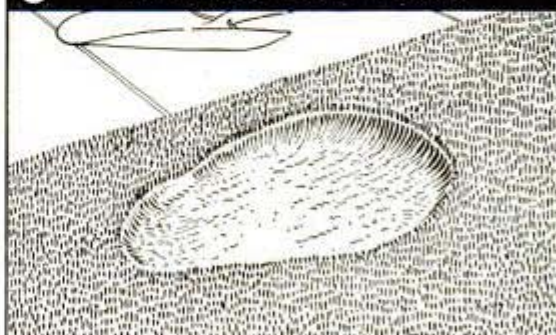

7

BE SURE TO GET ALL THE ROOTS

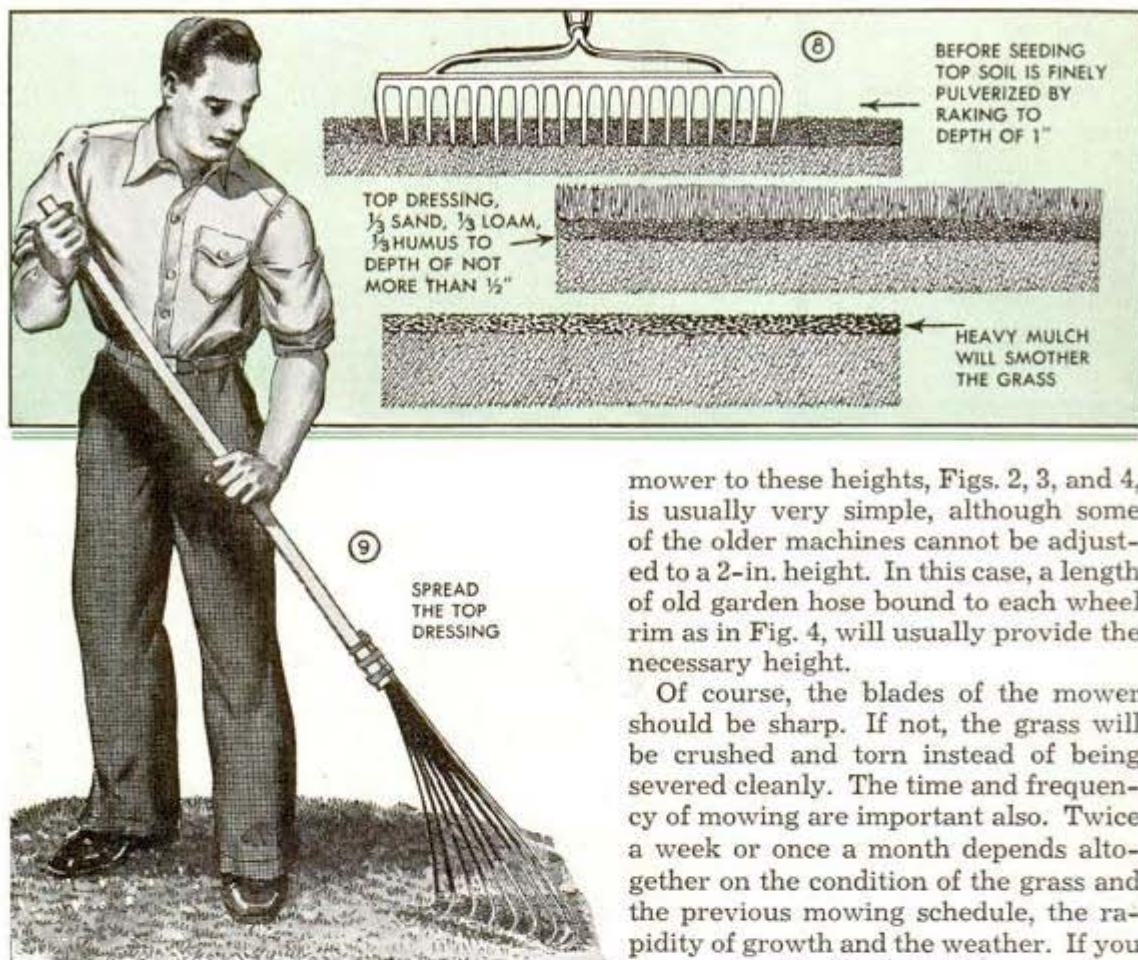

cations are used. The toxic effect is in more or less direct proportion to the strength of the chemical solution. Several light over-all applications at intervals of three weeks or so are generally better than one heavy dose. Some chemicals are applied dry and the lawn is immediately sprinkled so that there will be slight discoloration of the grass.

On either new or old lawns, the way the grass is mowed has much to do with the maintenance of a vigorous sod. Every time you mow the lawn you perform what amounts to a critical operation on the grass. Medium-close clipping may remove more than half the blades from each plant. As the blade or leaf aids the plant in converting to growth the food taken up by the roots, the result is a greatly weakened plant. Although the bent grasses can be clipped as close as  $\frac{1}{2}$  in. and in some instances even shorter, bluegrass and the various fescues should never be cut closer than  $1\frac{1}{2}$  in. Bent grasses will do better if clipped not less than 1 in., and the bluegrass not less than 2 in. Setting a lawn-

mower to these heights, Figs. 2, 3, and 4, is usually very simple, although some of the older machines cannot be adjusted to a 2-in. height. In this case, a length of old garden hose bound to each wheel rim as in Fig. 4, will usually provide the necessary height.

Of course, the blades of the mower should be sharp. If not, the grass will be crushed and torn instead of being severed cleanly. The time and frequency of mowing are important also. Twice a week or once a month depends altogether on the condition of the grass and the previous mowing schedule, the rapidity of growth and the weather. If you have mowed to  $1\frac{1}{2}$  in., let the grass grow to at least 3 in. before you mow again. Or, if you have formerly cut it to  $\frac{3}{4}$  or 1 in. high, it is better to raise the mower by stages, that is, raise it to  $1\frac{1}{2}$  in. and clip the grass a couple of times when it is 2 in. high, then raise to 2 in. and clip when the grass is 3 in. high. The longer the period for recovery of growth between mowings the better. Coming into the hot, dry summer months, the frequency of mowings should be determined by the height and condition of the grass and not by intervals of time. In some localities it is advisable to use a grass catcher behind the mower, as an accumulation of clippings may cause fermentation which may injure the grass. However, in most sections the clippings which dry soon provide excellent mulch.

Avoid raking a lawn too vigorously during early spring. Usually a bamboo rake is best as it gets leaves and trash without tearing the sod. After a winter of alternate freezing and thawing, an early spring rolling is helpful as it tends to firm the soil around the grass roots. However, it is best to avoid rolling when the soil is wet. A top

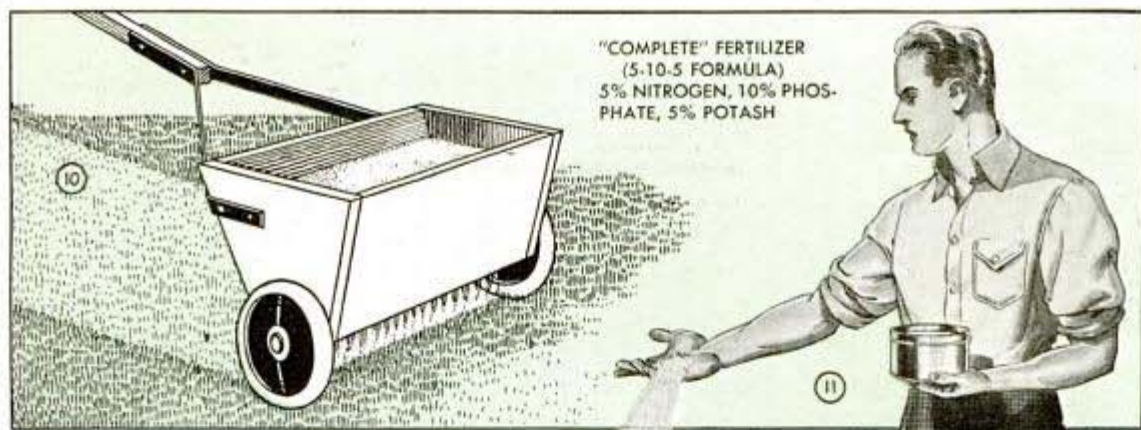

dressing, Fig. 8, on a well-established lawn always helps to stimulate early spring growth. Plant food can be added to the dressing in the form of a "balanced" or complete fertilizer of the usual 5-10-5 formula, Fig. 11. Although there are several ways of applying the fertilizer, scattering it by hand or with a distributor as in Figs. 10 and 11, another way is to mix it with the top dressing. Then spread the whole thing by hand, at the rate of about one cu. yd. of top dressing and 15 lbs. fertilizer to each 1,000 sq. ft. of lawn. Spread it as evenly as possible and then rake to a uniform thickness of about  $\frac{1}{2}$  in., Figs. 8 and 9. This should not be done until new growth is up to a height of about 2 in. and even then care should be taken to avoid getting the mulch too heavy, or it will smother the grass, Fig. 8.

Two effective ways of seeding on a steep terrace or slope are shown in Figs. 12 and 13. Mesh fabric, Fig. 12, is laid after the soil has been prepared and seeded and is left in place to prevent erosion of the topsoil. Sodding a slope in strips with natural sod as in Fig. 13, is a permanent protection against soil loss. Sod is cut into blocks about 1 ft. square and reset immediately after cutting. Soil should be moist but not muddy, and the sod squares

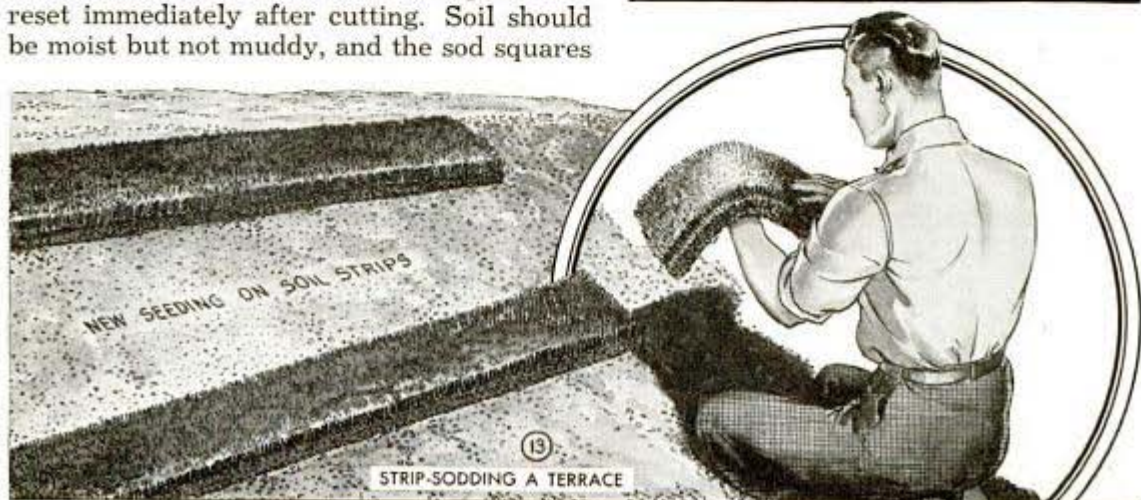



should be tamped into firm contact with the earth. If the slope is curved and of considerable extent make sure that the strips follow the contour on the level. On a medium slope, the strips should be about 6 ft. apart; on a steep slope not more than 3 or 4 ft. apart.

Lawn clippings, weed stalks, refuse from the vegetable and flower gardens, wheat straw, and well-rotted manure can be made into a valuable humus and plant-food compost by piling it in layers, as in Fig. 14. The important detail is to keep the edges of each layer higher than it is at the center. Then each time you add more material, tramp the center and soak the pile thoroughly with water. The size of the pile should not be less than 4 by 8 ft., but a size of 6 by 10 ft. is preferable. Add 20 percent acid phosphate, bone meal, ammonium sulphate, or complete fertilizer, about a pound or two, to each layer. To hasten the fermentation or breaking-down processes of the organic matter shovel earth against the sides of the pile.

Patches of moss, Fig. 15, indicate low

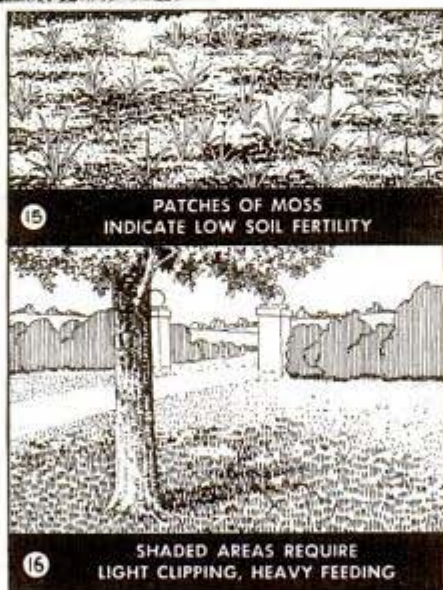

soil fertility. Where moss grows there is little use of reseeding unless the soil is built up either by adding new soil, or compost and plant food in readily available form. If there are scattering patches of moss in your lawn, take a dozen or more samples of soil from points uniformly spaced over the whole area and have them tested at your state experiment station or by your county advisor. The data thus obtained will enable you to rebuild the soil to the humus and plant-food requirements of a healthy and vigorous sod. In rebuilding any old lawn it is always a good idea to test the soil.

Shaded areas, Fig. 16, usually require special treatment and seeding with grasses that will make a satisfactory growth under this condition. Heavy feeding is generally the primary requirement as the grass must compete with the feeding roots of the tree. Borders around flower beds and edgings

along walks are perfect lodging places for blown weed seeds. Also these edges are difficult to mow so it is best to keep them clipped with shears made for the pur-

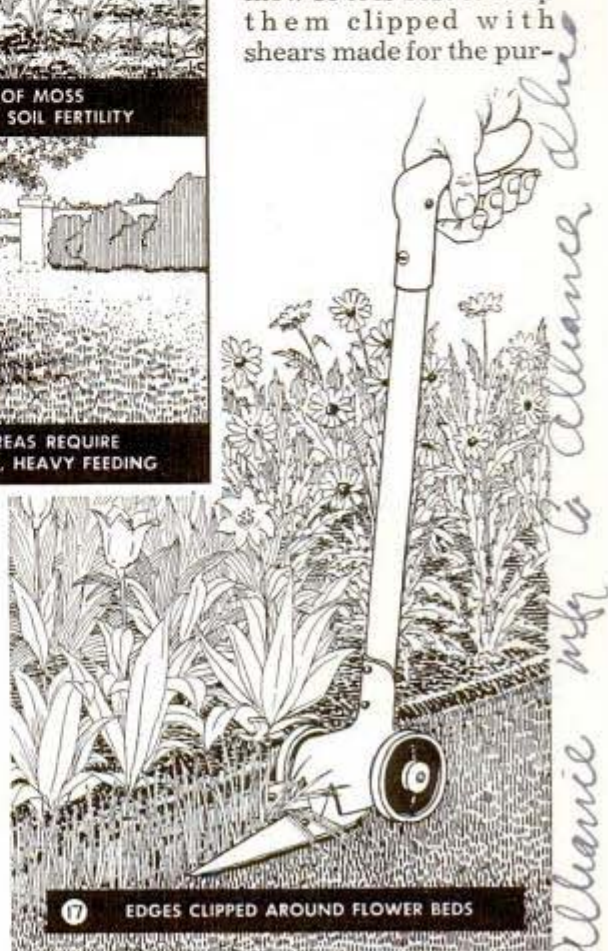

pose as in Fig. 17. Whenever you patch bare spots with new soil add enough soil to bring the level up to that of the surrounding turf, rake it to break up any lumps, then roll as in Fig. 18. After rolling, rake the surface lightly and scatter the seed. If the soil is fairly dry so that it does not stick to the roller, roll again to press the seed into firm contact with the earth. Then sprinkle gently, but long enough to soak the spot thoroughly. Be careful that the water does not "puddle." Keep the soil from drying out on top until the grass starts. If the patch is on a slope or the crown of a steep terrace and is more than 1 ft. square, it will be necessary to protect it from washing away with a mesh fabric or with coarse burlap.

In feeding old, established lawns on clayey soils, "spiking" the sod with the implement shown in Fig. 19 is a valuable practice. The openings made by the spiker allow air to enter the soil and also conduct water and fertilizer to the root level more rapidly. As a rule, spiking should be done in the spring; once a season is best. It should be done uniformly over the whole lawn, forcing the tool into the sod at a slight angle, and at intervals of about 6 or 8 in. Move the handle of the spiker back and forth slightly each time to enlarge the openings somewhat, but be careful not to lift or tear the sod.

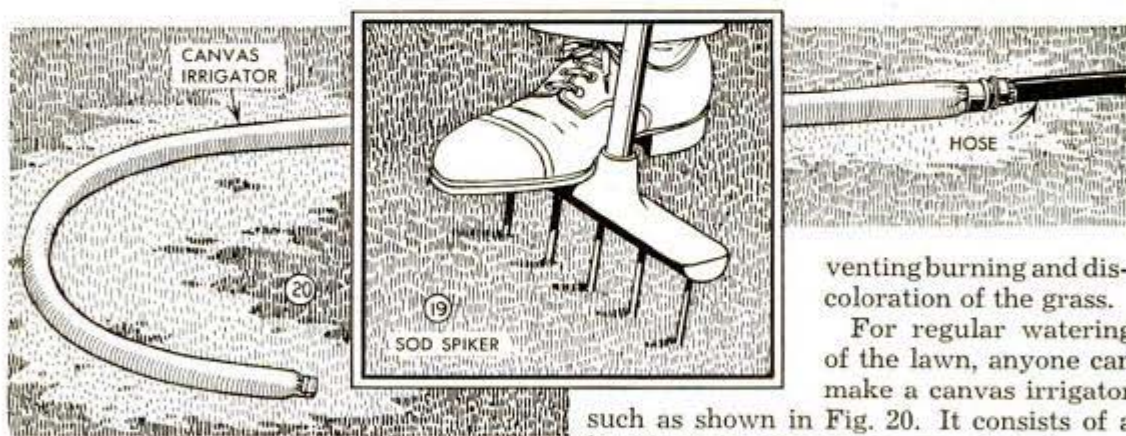
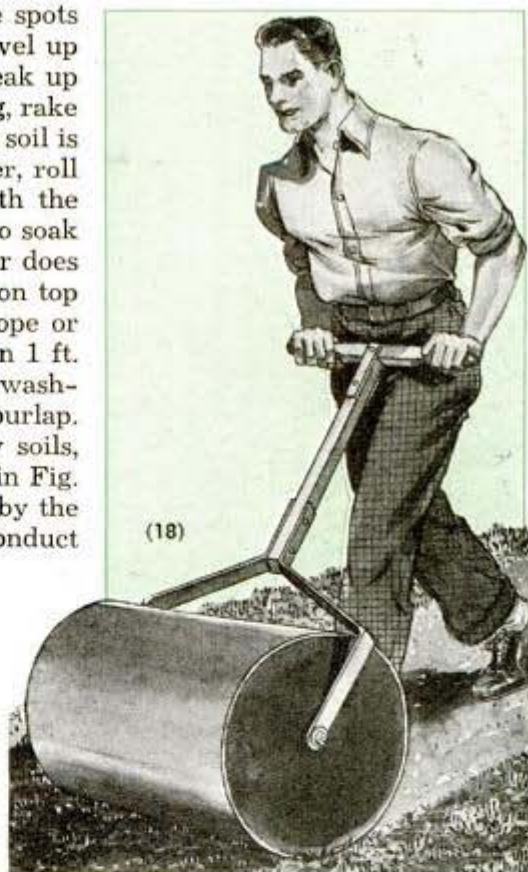

Dry chemical fertilizers of higher concentrations should be scattered over the lawn on a still day. If there is any wind, it will make it impossible to distribute the chemical uniformly over the ground. Those who have a large lawn to care for will find a wheeled distributor of the kind shown in Fig. 10 very convenient. It speeds the work of spreading the fertilizer over large areas uniformly. Immediately after spreading the fertilizer, the lawn should be sprinkled. Adjust the hose nozzle to give a gentle spray, as this will wash the chemical from the blades of grass and into the soil, pre-

venting burning and discoloration of the grass.

For regular watering of the lawn, anyone can make a canvas irrigator such as shown in Fig. 20. It consists of a length of heavy canvas, sewed to form a tube, with one end sewed shut. A standard coupling is fitted to the other end for attaching the tube to the garden hose. Water oozing out through the cloth will soak the ground thoroughly and gently. As soon as one area is soaked, the irrigator is moved to a new location, until the entire yard has been covered.

The one prime requirement in watering is to give the ground a thorough soaking. Frequent scanty watering will cause the feeding roots to seek the surface moisture, while prolonged drought or neglect of watering will also cause serious damage.

## Right-Angle Slots in Bench Stop Serve as Handy Miter Gauge

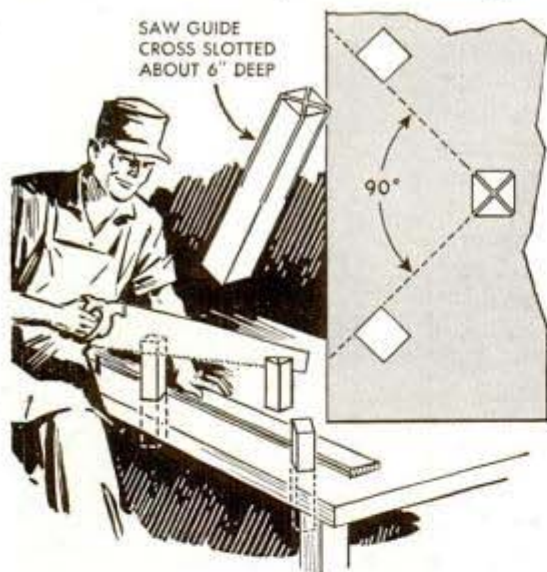

If your workbench is fitted with square hardwood stops that may be driven up or down to suit the need, you can convert one into a handy gauge for cutting miters. Just remove one of the stops and cut two slots in it at right angles as indicated. This stop can then be driven up and used as a handy miter gauge for all ordinary work.

## How to Overcome Pump Troubles Due to Air in Suction Line

Incorrect installation may be causing the trouble if you have a pump that is not operating properly. Usually, a small amount of air is present in all water, and if any point in the suction line is higher than the level of the pump, air will automatically separate from the water and form a pocket at the high point. The air will gradually collect until it reaches such a volume that it compresses and expands with the piston strokes. In the drawing, note that the suction line should be laid with a grad-

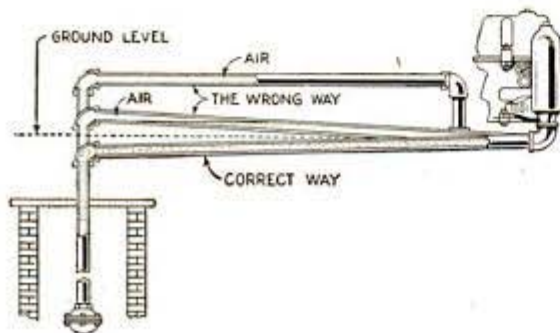

ual slope of 1 in. in 15 ft. from pump to water supply. If conditions make it necessary to install a suction line with a high point between water supply and pump, a tee and plug should be used instead of the first elbow, which will provide a means of releasing accumulated air when necessary. Special care should also be taken to lead or paint all joints as leaks will prevent a pump from operating properly.

## Wire Solder Prevents Tangling Of Shop-Light Pull Chain

By wrapping several turns of wire solder around the pull chain or cord of a bench light as shown, you can prevent it from becoming tangled in the shade holder when released.



If wire solder is not readily available, a nut or heavy washer will also serve the purpose by providing weight on the cord end.

## Five-Point Pattern for a Star

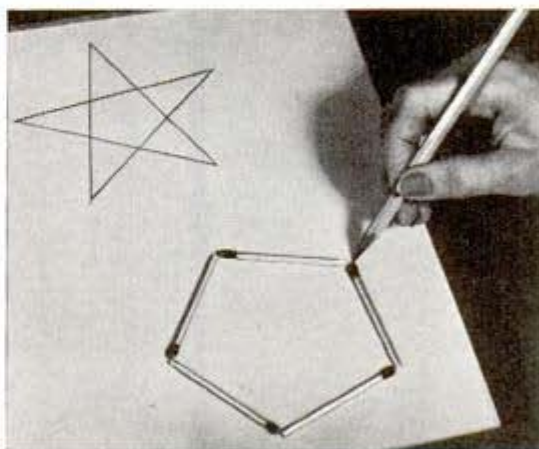

Here is a simple way to make a five-point star for quilt designs and other patterns. Take five matches and lay them end to end, forming a hexagon shape. Then, with a pencil make a dot at each point where the matches join. To complete the star, draw lines with a pencil connecting these points. If you want the star to be larger than is possible by this method, just measure out any desired length from the points and draw the lines.

# Cabinet Doors Hung in Place Without Hinges

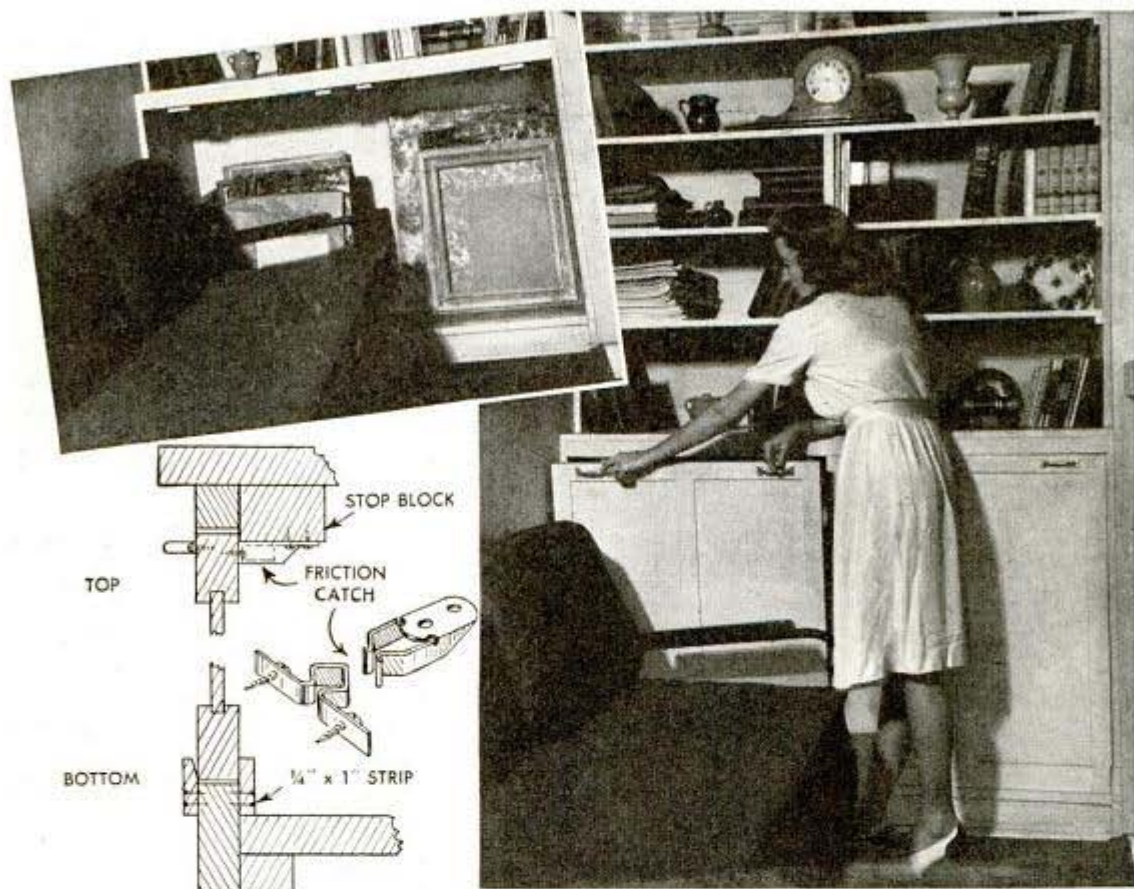

On a built-in cabinet where space did not permit swinging the doors on hinges, they were held by means of friction catches. To do this, grooves were formed on the bottom of the door frames by screwing wood strips to the inner and outer faces of the frame. The lower ends of the doors rest in these grooves, while the top ends

are held by the friction catches which are screwed to stop blocks. Notice that the inner surface of one of the strips forming the groove is chamfered slightly. This is necessary to prevent the strip from being loosened when the top of the door is pulled forward for opening.

—H. O. Bumann, Savannah, Ga.

## Old Typewriter Platen Renewed by Motor and Sandpaper

Pitted surfaces of a worn typewriter platen can be restored to practically new condition by rotating it while holding a piece of sandpaper against it. The platen is belted to a small electric motor by winding tape around the axle just inside the right-hand turning knob. This provides a friction surface for the belt. Of course, the ratchet lever is released to allow the platen to turn freely.—Pio Panieri, Roslyn, Wash.



☞The "bloom" or bluish haze occasionally seen on mahogany furniture is the result of the use of poor finishing materials and can be removed only by refinishing.

# Combating INCENDIARY-

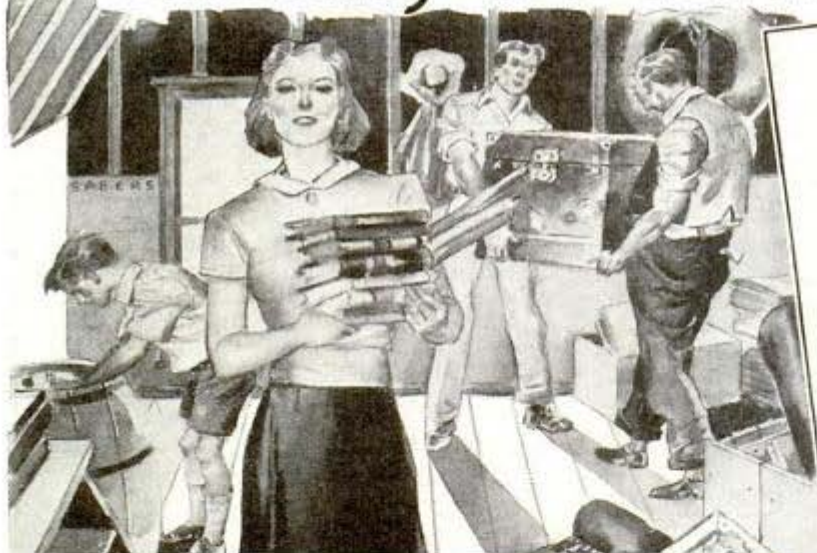

**1 CLEAR ALL INFLAMMABLE MATERIAL OUT OF ATTIC**

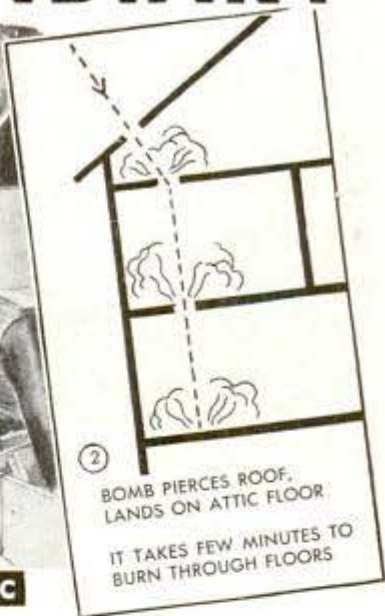

**3 FIRE RESISTANT COATING**

CHINA CLAY, 6 LBS., AND WATER GLASS (SODIUM SILICATE), 6 LBS., MIXED TOGETHER THOROUGHLY AND THEN MIXED IN WATER, 2 QTS.

GYPSUM BLOCKS

ASBESTOS BOARD

2 1/2" LAYER OF SAND, SIFTED DIRT OR ASHES

**4 COVERINGS ON ATTIC FLOORS**

ONE thousand 2-lb. incendiary bombs carried by a single plane and dropped on a closely built city will start 166 fires, as it has been found that one out of every six will penetrate a building. When you multiply this by a large number of planes, it is obvious that a city fire department plus auxiliary fire-fighting squads cannot always deal effectively with all fires started, and therefore every householder must be ready and equipped to combat fires in his own or his neighbor's home in localities where bombing is possible.

Dropped from a height of 20,000 ft., small incendiary bombs such as shown in Fig. 7 will pierce any ordinary roof, but as most of the force is spent on such impact, they fall on the top or attic floor. Then the priming charge is ignited, the magnesium casing catches fire with a sputtering action and some white-hot metal is thrown about which ignites inflammable material. If not smothered at once, the intense heat of the molten metal will burn through the second and then the first floors quickly, starting fires at all points, Fig. 2. (The thermit filling of iron oxide and finely divided aluminum develops a tremendous heat of 4,500 degrees.) However, if proper precautions have been taken in advance, and prompt action is taken the moment an ominous thud is heard, a bomb can be smothered.

Clearing the attic of inflammable objects and material as in Fig. 1, so that the whole space is instantly accessible, is the first



# BOMB FIRES



5 COVER MOLTEN MAGNESIUM BOMB WITH SAND

precaution. Next, the roof boards and rafters can be rendered less inflammable if you apply a fire-resistant coating consisting of China clay, 6 lbs., and water glass (sodium silicate), 6 lbs., mixed together thoroughly, and then mixed with water, 2 qts., Fig. 3. Apply this mixture liberally to all exposed wood, making up more as you need it. A heavy coating of whitewash will help somewhat, but ordinary paint is of no value.

A fire-resistant floor covering is needed to delay burning through of the molten metal. All joists should be boarded over, and the floor should be covered with a 2½-in. layer of sand, finely sifted earth or ashes, Fig. 4. Other good coverings, which may be used but are relatively expensive, are gypsum blocks and asbestos board, if available. You can also apply a 1-in. layer of asbestos cement topped with a 1-in. layer of sand. Metal is not recommended as a floor covering as it will melt under the intense heat and then help to ignite wood underneath. Sand bags laid on the floor may be too heavy for the floor to support and molten metal can run in between them.

After the foregoing precautions have been taken, you should provide the fire-fighting equipment shown in Fig. 6, near the attic stairs to be available for instant use. Dry sand may be kept in bags, buckets or boxes, small enough to be carried. You can also have a garden hose connected to a hydrant, with the nozzle set to a spray, the hose being coiled up in a convenient location. Also, be sure to keep one or more windows of the attic open at all times.

Dry sand is used to smother a magnesium bomb that has not started a fire, but if

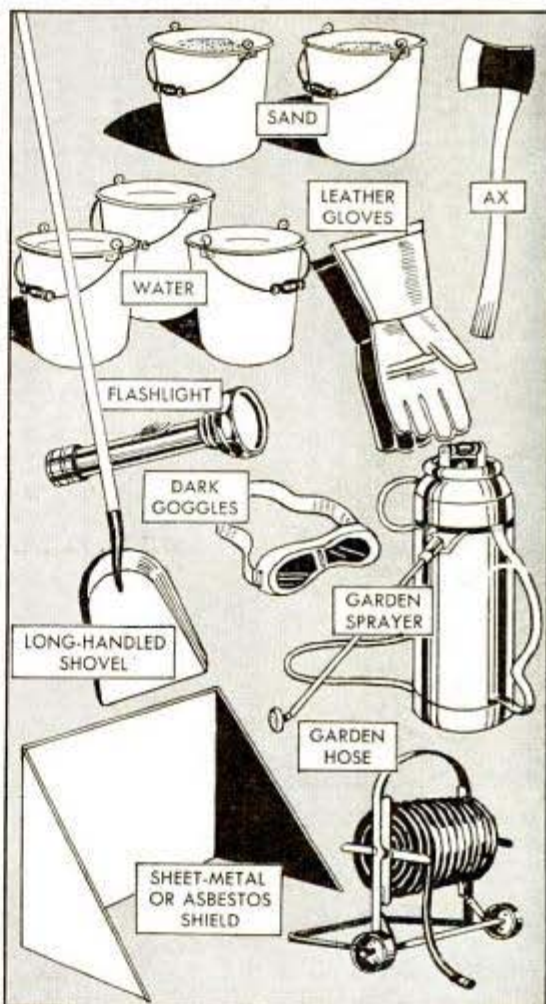

6 EQUIPMENT KEPT NEAR ATTIC

it has already ignited the wood around it or the roof above it, a spray of water is best. Close approach to a burning magnesium bomb for the first minute or so is dangerous as it may contain a delayed explosive

# Magnesium bombs smothered



8) SCOOP UP "SNUFFED" BOMB



9) DROP IT OUT OF WINDOW



10) OR, IN A BUCKET OF SAND



11) AND CARRY IT OUTDOORS

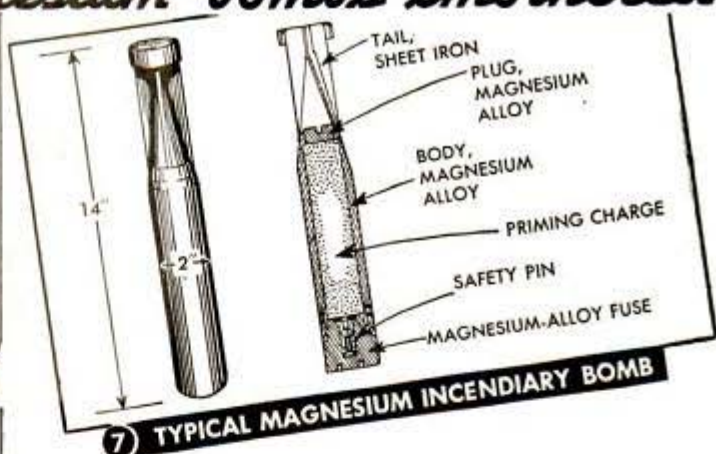

7) TYPICAL MAGNESIUM INCENDIARY BOMB

charge designed to spread the fire and keep fire fighters away. Also, the normal starting mixture sputters, throwing about a shower of sparks for some distance. Although the intense heat will make close approach impossible, sand or dirt can be thrown on the molten metal with the long-handled, straight-edged shovel as in Fig. 5. Wear dark goggles and leather gloves, and if there is considerable smoke crouch down to keep your head as low as possible. Try to breathe slowly and do not over-exert. Covering the molten metal with sand cuts off the oxygen supply needed for violent burning, and also reduces the heat and the dazzling glare. However, snuffing the bomb with sand does not extinguish it, and it will burn through the floor in a short time. So, immediately after snuffing, scoop it up with the shovel, Fig. 8, (the shovel being covered with sand to protect the metal from melting), and then drop it to the ground through an open window, Fig. 9. If there is no window, drop the bomb into a bucket having at least a 4-in. layer of sand on the bottom, Fig. 10, cover it with more sand, and then carry the bucket outdoors, holding it on the end of the shovel, Fig. 11.

Water applied to a magnesium bomb should be sprayed—never directed in a solid stream or by the pailful as this causes an explosion which endangers persons and helps to spread the fire by dispersing the molten metal. Water does not extinguish a magnesium bomb but causes it to burn faster and more intensely so that it will burn itself out in a fraction of the time that it does naturally. Water does extinguish fire started by the bomb and by soaking wood around it, will make it less likely to ignite. When using a hose to spray the bomb and adjacent wood, shield yourself behind a sheet of metal, asbestos board or other flame-resisting material, from a position about 10 or 15 ft. distant. As the regular water supply cannot be depended upon during an air raid, have plenty of water available in the bathtub and in extra vessels. A garden spray can be relied upon when regular water supply fails. One per-

*with sand or sprayed with water*

son directs the spray on the bomb, another pumps and replenishes the tank while a third provides extra water, Fig. 12. It takes from 5 to 6 gal. of water to deal with a small magnesium bomb so at least twice this amount should be available. Fire extinguishers having a water base, such as the soda-acid or foam type, are effective but the contents of one (average 2½ gal.) is not enough to deal with a bomb. Those having carbon dioxide and carbon tetrachloride are not effective on magnesium bombs, but can be used to put out fire resulting from the bombs. If fire started by a bomb has gained considerable headway, it may be necessary to ignore the bomb itself and start fighting the fire. A small magnesium bomb burns itself out in 15 to 20 min. Where a bomb burns through floors, they should be opened with an ax to be able to apply extinguishing agents around the place where the bomb burned through.

Other types of incendiary bombs that the householder should know about are burning thermit bombs, which consist of powdered aluminum and iron oxide. These cannot be extinguished as they do not depend on oxygen to burn. A 10-lb. thermit bomb burns intensely for about a minute. All that can be done is to try to cool the molten metal with a spray of water, and soak inflammable material nearby. The most commonly used scatter-type incendiary material is white phosphorus, which bursts into flame when exposed to air and produces intense white smoke. "Incendiary leaves" are moist pieces of cardboard or nitrocellulose coated with phosphorus, which ignite when they become dry. Phosphorus does not readily ignite heavy boards but will set fire to shingles, dry grass and other easily combustible materials. Phosphorus bombs are likely to cause more panic than damage, owing to the intense



smoke, which is irritating but harmless. The best way to fight phosphorus is to spray it with a concentrated solution of copper sulphate. This forms a thin copper shell around each particle shutting off exposure to air. Water will extinguish it but as soon as the water evaporates, exposure to air again causes it to burn. Phosphorus should be removed outdoors and disposed of by burning, although sometimes small particles can be allowed to burn themselves out if the surrounding inflammable materials are soaked. Great care should be taken as phosphorus causes severe burns on the skin, and it is also poisonous.

If an incendiary bomb and the resulting fire cannot be put under control immediately, don't fail to turn in an alarm at once, but keep fighting the fire until help arrives or fire-fighting supplies are exhausted.

## Foreign Object in Eye Located With Magnifier and Mirror

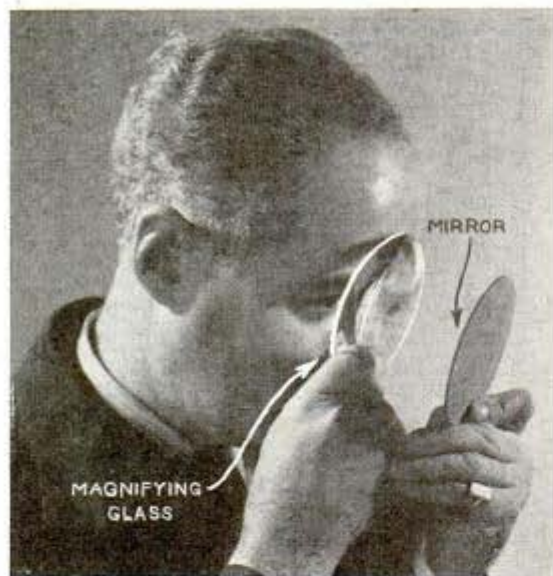

If a foreign particle lodges in one of your eyes, you can locate it by using a magnifying glass in conjunction with a small concave make-up mirror. Hold the magnifying glass to the eye and through it look into the mirror. The reflected image will be magnified three times instead of once, making the examination easy.

## Modeling Clay Holds Fishhooks On Lid of Tackle Box

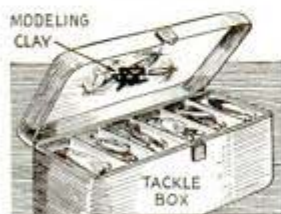

To keep his favorite flies and hooks conveniently at hand in a tackle box, one fisherman inserts them in a piece of modeling clay stuck to the underside of the lid. In this way, the hooks do not tangle and are much easier to remove than when stuck in a cork or a piece of rubber.

## Starting a Fire in Oil Heater

Trouble experienced in starting a fire in a pot-type oil heater, by having a strong draft extinguish the flame before the oil becomes thor-



oughly ignited, can be avoided by propping open the draft valve in the smoke pipe. A piece of cardboard, a block of wood or any other small object at hand can be used as shown in the photograph. When the valve is held open, strong drafts over the flame will be prevented. As soon as the oil ignites properly, the valve is released.

## Pine Cone Teaches Retriever Dog To Carry Game Carefully

Annoyed by the habit of a retriever puppy to bite and tear game birds that he shot, one hunter cured the dog of the habit by using dry pine cones for practice training.

Biting into one of the sharp cones a few times soon taught the animal to be cautious.



## Curtains Are Put on Stretcher Without Pricking Fingers

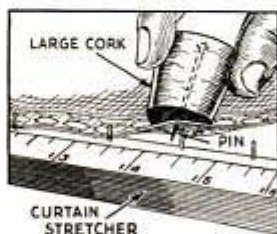

Forced into one end of a large cork, a stout pin makes an excellent tool with which to place curtains on a stretcher. The pin projecting through the cork engages the fabric of the curtain so that it may be pulled over the pins in the stretcher. The cork permits the fabric to be forced over the sharp points without danger of pricking your fingers.

## Snow Fence Makes Slat Shade For Hot or Cold Frames

A roll of snow fencing makes a cheap and effective slat shade for either hot or cold frames where it is necessary to provide a "traveling" shade over tender plants on warm, sunny days. The fencing can be cut into convenient lengths and is easy to roll up into a small space when not in use.

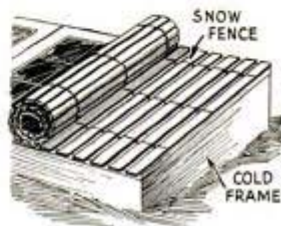

# A LAMP . . . . . . at your gate

ANYONE with a period type home will appreciate one of these reproductions of old-style lamps. Mounted on a post at your entrance gate, the one in Figs. 1 and 2 is an electrified replica of an old gas street lamp, and can be made of brass or galvanized sheet iron. Brass angle stock is recommended for the frames around the glass, which should be especially sturdy. The top can be cut from a single sheet. Note that the wood post is made up of two pieces, which are first channeled for an electric armored

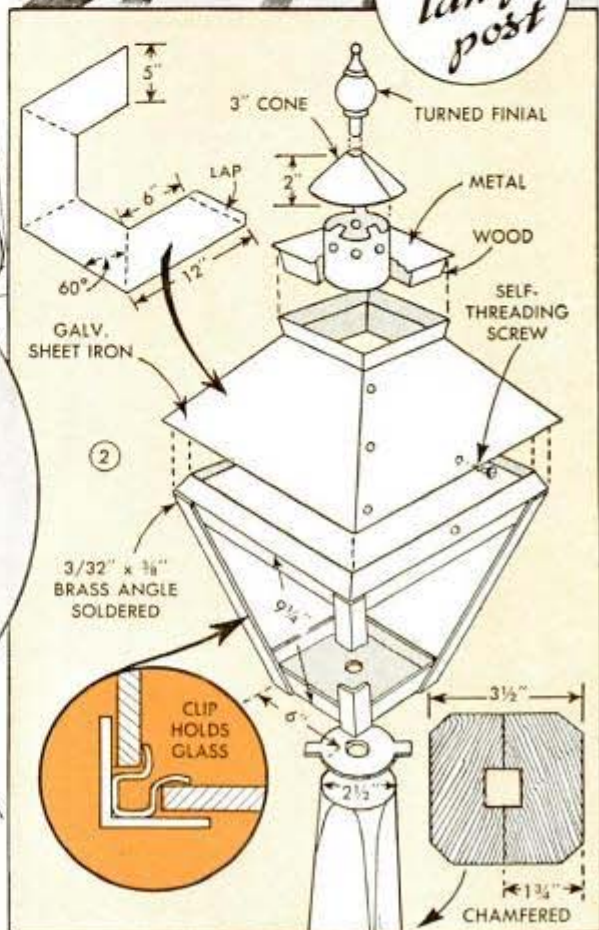
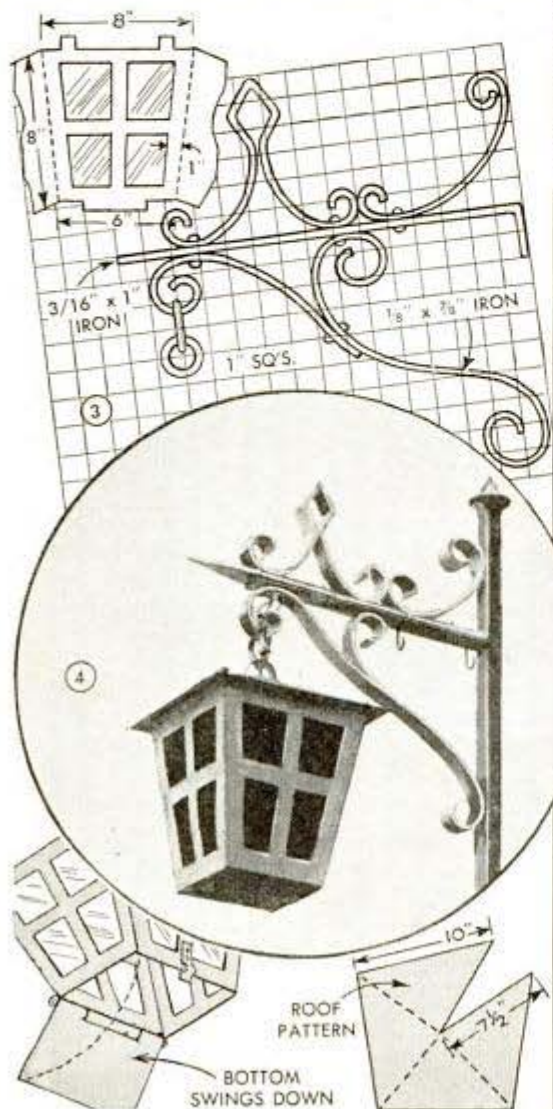

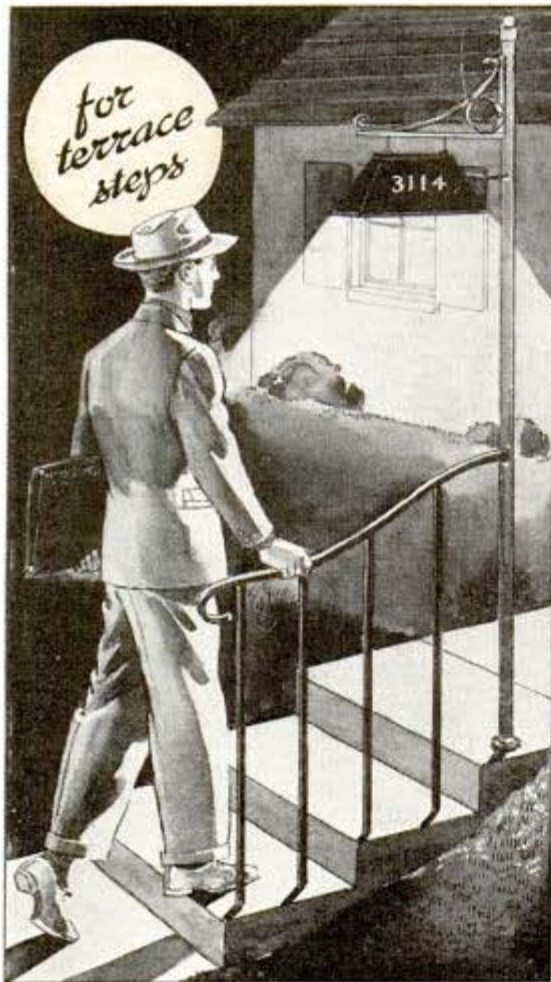

cable, and then fastened together. The lamp can be mounted on the post by using a disk of heavy sheet metal having tabs on opposite sides. Then the disk is soldered to the lamp bottom and the tabs are bent down over the sides of the post and screwed to it. It may be necessary to have four equally-spaced tabs on the disk in localities subjected to high winds. The top of the lamp can be lifted off for replacing the bulb by removing two screws.

The graceful lamp pictured in Figs. 3 and 4 can be made of galvanized sheet iron soldered together and supported by an iron-pipe standard with wrought-iron bracket. The latter may be riveted or welded. The top of the lamp is made in one piece, as is the frame supporting the glass. The latter is attractive in soft green tint, and is secured with galvanized tabs soldered inside the frame. The bottom swings downward for replacing bulbs. The standard should be set in concrete to a depth of at least 18 inches.

If your lawn is terraced and steps lead-

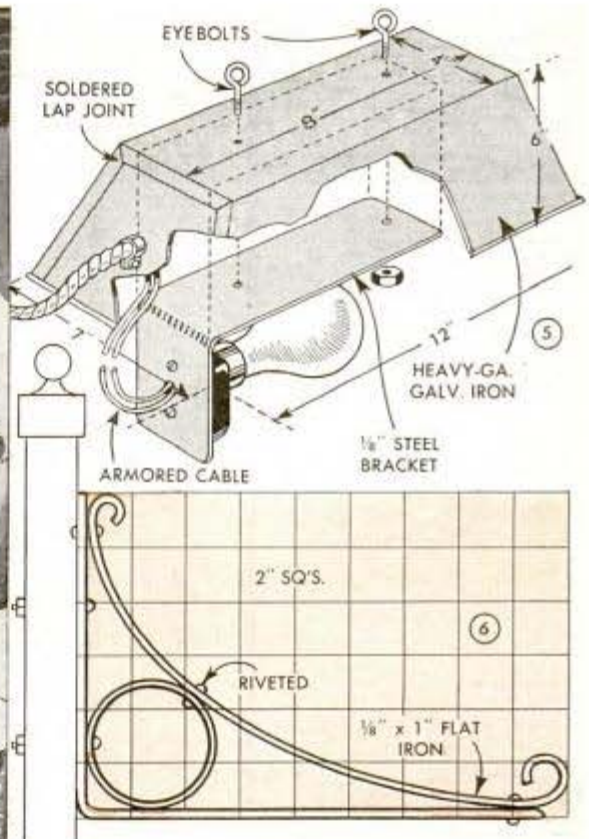

ing off the sidewalk are required, the lamp shown in Figs. 5 and 6 is highly pleasing. The post is a 2-in. galvanized pipe, which supports a wrought-iron bracket carrying the lamp. The latter has a reflector made of galvanized sheet iron. Inside, a steel bracket is secured with eyebolts, also used to hang the fixture, and a porcelain socket is fastened to the bracket. An armored cable is brought up inside the standard.

### Giving Glass a Frosted Effect

When you want to give a window or a piece of glass a frosted effect so that plenty of light will pass through yet no object will show from either side, the following mixture will do the trick: Boiled linseed oil, 1 part, turpentine,  $\frac{1}{2}$  part, clear varnish,  $\frac{1}{3}$  part, mix well. Add powdered whiting to this mixture until the mixture turns very white. Apply to the glass with a brush. Then make a pad of cheese cloth and press or tap all the glass lightly while the mixture is still wet, and when the glass becomes dry it will look exactly like frost had formed on it. If a finer grain is desired, put a piece of silk stocking over pad and tap the glass. Twisting the pad as you tap will make a number of different designs.

## Handy Rack Stores Garden Tools in Small Space

Assembled from scrap lumber, this handy rack is just the thing for gardeners who have limited space in which to store their tools. While dimensions can be varied to accommodate more tools, distance from the sloping base to the large nails on which the handles rest should not be greater than the length of the shortest tool handle. Also, space should be provided between the base and lower crosspieces to insert picks and similar tools. Long-handled tools, such as rakes, hoes, cultivators, etc., stand upright between the upper and lower crosspieces. A shelf is provided at one of the upper corners in which trowels and other small tools can be stored. Even the lawnmower can be accommodated by driving two large nails or L-hooks

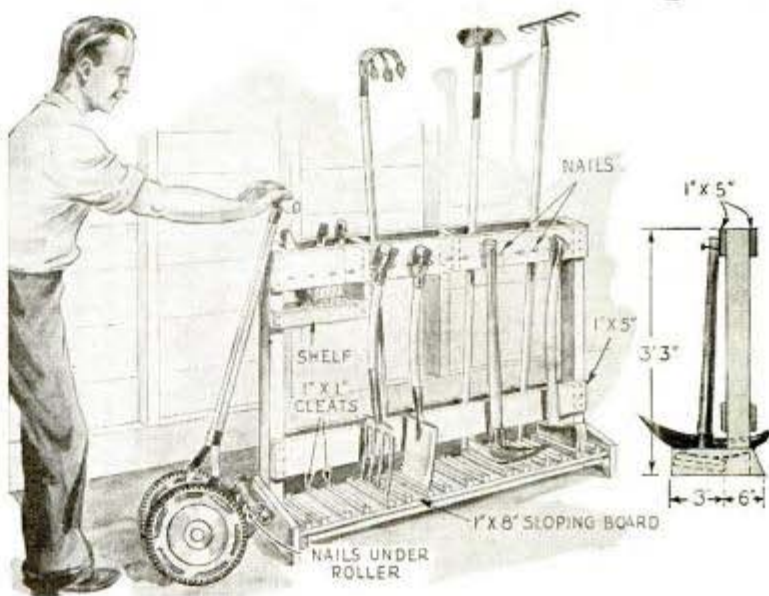

into the end of the rack near the bottom. These are spaced so that when the wooden roller of the mower is hooked over them the handle will be in upright position. The rack requires only a small space in the garage or tool shed.

## Jigsawed Napkin Holder of Wood Simulates Spring Clip

At a glance, the arms of this novel napkin holder appear to be literally "coiled," but it's all done by carving.

enlarge the paper pattern of the arm and trace it on 1-in. walnut. Then bore a  $\frac{15}{16}$ -in. hole through the rounded end before

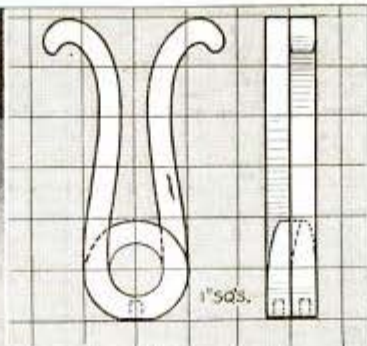
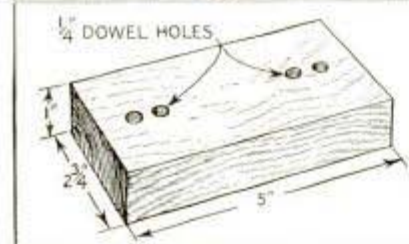

sawing out the design. To obtain the coil effect, you split each arm down the center with a hand-saw to a point 2 in. from the bottom, after which the waste pieces from alternate sides are cut off and the rounded end carved to make the arm look as if it were coiled from a single strip. Small dowels are used to hold each arm to the base, which may be of matching or contrasting wood. It may be easier to finish the holder if you fill, shellac and varnish each part separately before it is assembled. — Benjamin Nielsen, Aurora, Nebr.

# Model of U.S. Frigate

By H. W. Potter

## Part III—Painting, deck fittings, masts and yards

AT THIS stage, your model of "Constellation" should look like Fig. 48, minus deck fittings, and ready for painting. It is imperative that the hull be perfectly smooth and free of tool marks, as any surface flaws will only be emphasized by the paint. So give the parts a careful sanding, using progressively finer grades of paper until all uneven spots are removed. Follow the sanding with a coat of natural paste wood filler to seal the end grain at the bow and stern and produce a smooth surface. Allow the filler to flatten and then wipe it off across the grain with a cloth. When dry, apply a coat of thin shellac. Start actual painting inside the bulwarks. Three coats of flat-white enamel are applied here, and to the cap rails along the port and starboard bulwarks to represent canvas. After this the half-round molding at the bottom of the cap, on the inside, is trimmed black. The seven dummy posts which line the inside of the stern bulwark (see Fig. 32, Part II) are finished natural with varnish and cemented in place after you have the bulwark painted. Except for the spaces between the gun ports, the windows at the

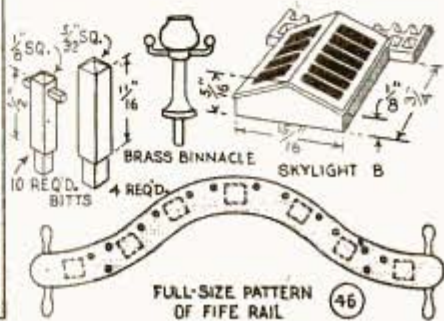
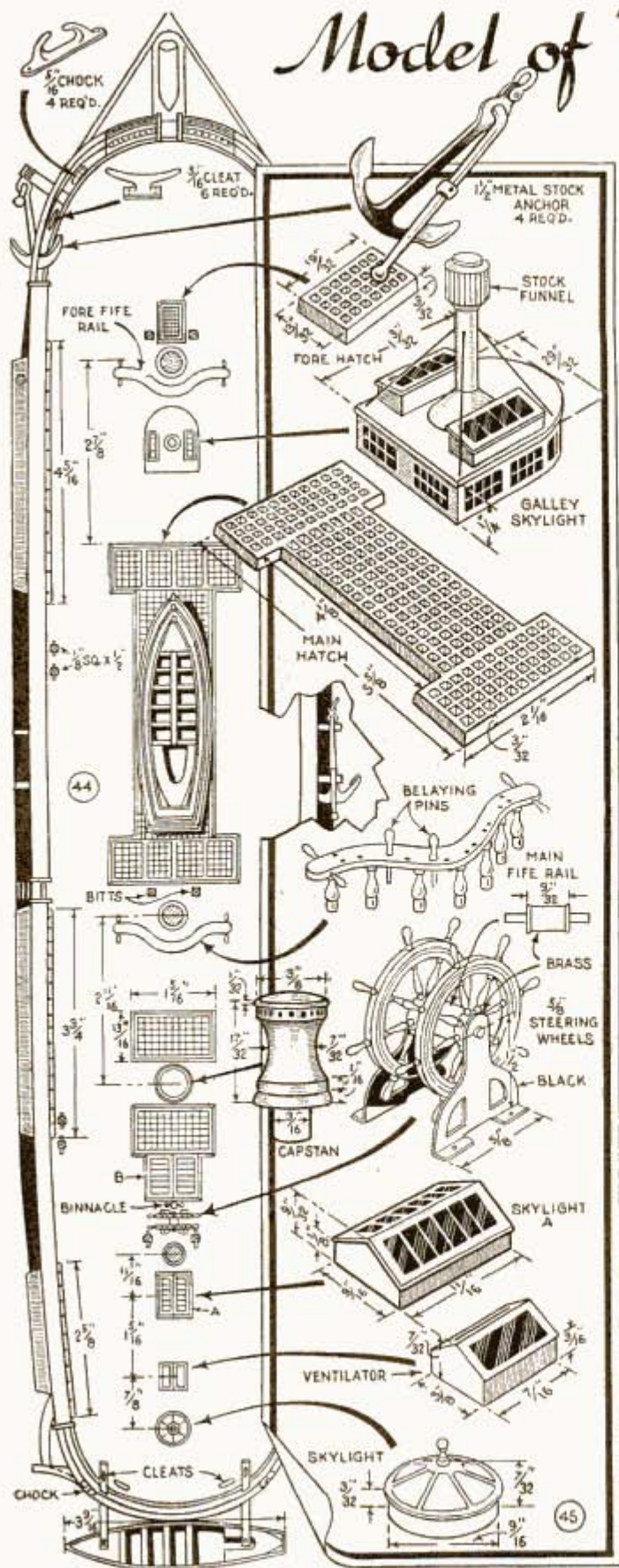



# "CONSTELLATION"

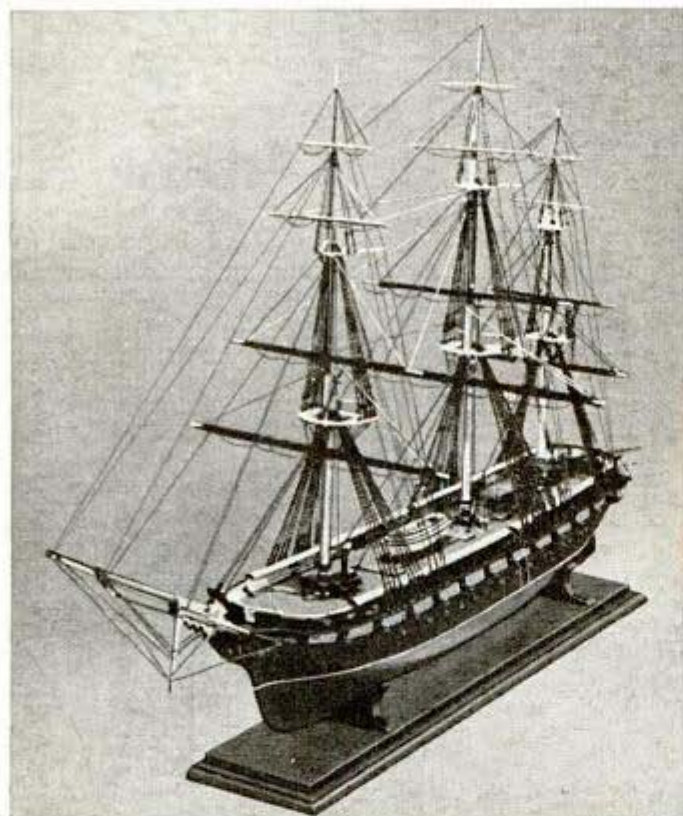

gold stars in place and adding the sun rays. All end boards are finished natural mahogany with the exception of the two at the bow, which are white. Now turn the hull upside down and apply three coats of high-grade bronze paint below the waterline. Then finish by adding the  $\frac{1}{8}$ -in. white stripe

stern and the quarter galleries, which are white, the outside of the hull from the cap rail down to the waterline is painted flat black. This includes all surfaces inside the head, but leave the cap rail around the stern and the bow bulwark natural mahogany. Don't on any account use a gloss enamel. Plan to use paints ground in japan. Such paint can be purchased in four-ounce tubes and is cut with turpentine to the right brushing consistency. Fig. 47 gives successive steps to follow in building up a smooth surface for the final coats. The aft end of the quarter galleries is painted black up to the edge of the windows before cementing the

## 47 FINISHING STEPS

- 1st coat—Paste wood filler after sanding
- 2nd " —Thin shellac: alcohol, 1 part, shellac, 1 part
- 3rd " —Enamel undercoater
- 4th " —Enamel undercoater tinted black
- 5th, 6th and 7th coats—Flat black paint

Add small amount of varnish to tinted undercoat. Rub work between coats with 00 steel wool or No. 60 garnet paper. Below water line, apply three coats high-grade bronzing paint. Give inside of bulwarks three coats white enamel. The decorative knee scrolls, cat faces, stars and ship's name are done in gold

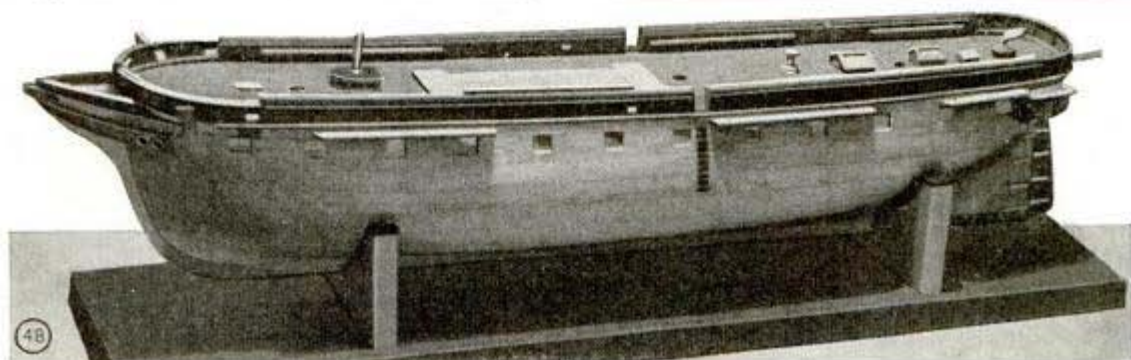

DETAIL OF TOP BOAT  
OF NESTED GROUP

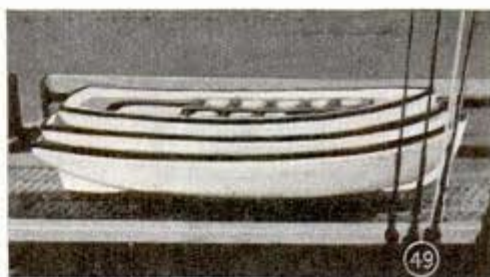
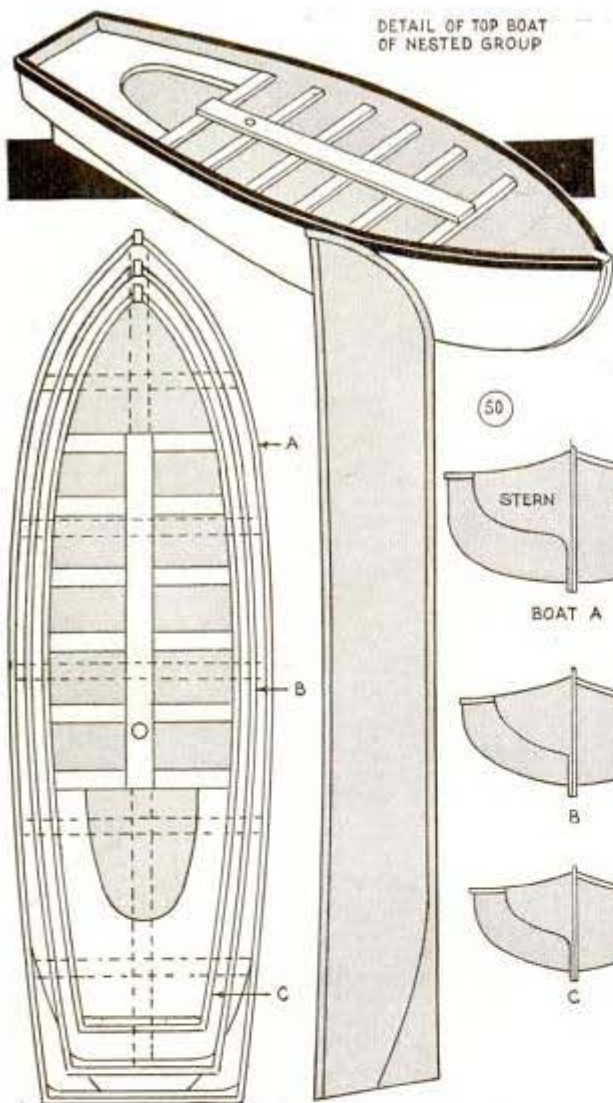

50

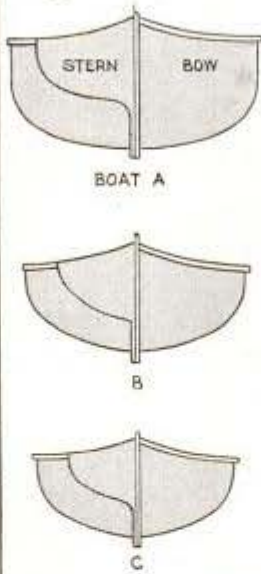

at the waterline, being careful to keep it running straight within the guide lines previously scored.

While the paint is drying thoroughly, you can be making the deck fittings shown in Figs. 45 and 46. Many of the parts are standard items which you will do best to purchase rather than try to make them. These include the following: anchors, galley skylight funnel, hatch grating, binnacle, steering wheels, belaying pins, chocks, cleats and stanchions for the fife rails. The deck plan in Fig. 44 shows you where each fitting is placed. A pattern for the fife rails is given full size in Fig. 46 for tracing to  $\frac{1}{16}$ -in. wood. The fore fife rail requires

To simplify carving, the general contour of each boat can be roughed out by tracing respective plan and profile patterns on adjacent sides of pine blocks and sawing as you did when cutting the stem knees

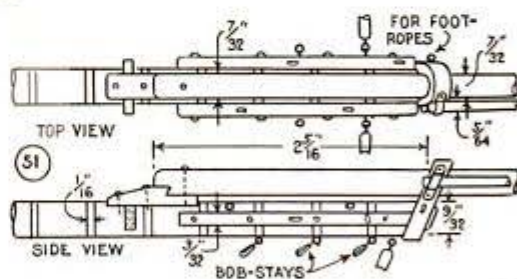

51

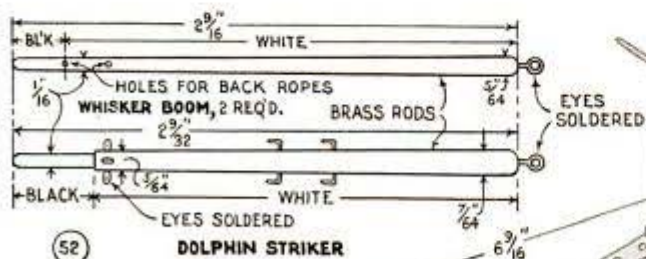

52

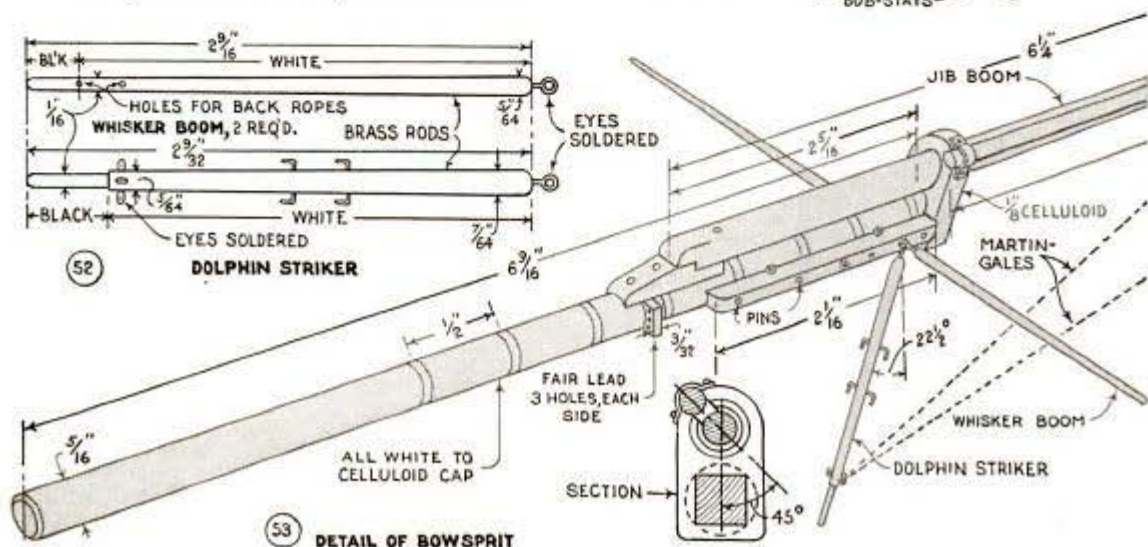

53  
DETAIL OF BOWSPRIT

six stanchions and the main seven. Make the pin rails, bits and capstan of maple, and shape the various skylights from mahogany, finishing them all natural with varnish. Fig. 50 shows the lifeboats full size. Four are required; a nest of three being attached to the main hatch, Fig. 49, and one slung from the davits at the stern. Note that the latter one and the top one of the nested group are fitted with tiny seats. About the easiest way to rough out each boat is to follow the method described in Part II for sawing the knees and filler block. This will give you the general contour of each one, which you then carve to conform with the full-size half-breadth patterns given for each respective boat. When painted white and trimmed black along the gunwales, the group of three is supported atop the main hatch by a tiny cradle which is glued to the grating and in turn to the bottom of the outside boat. The

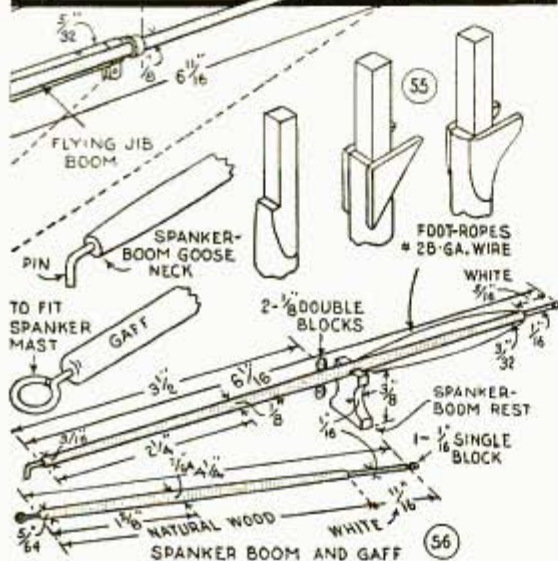
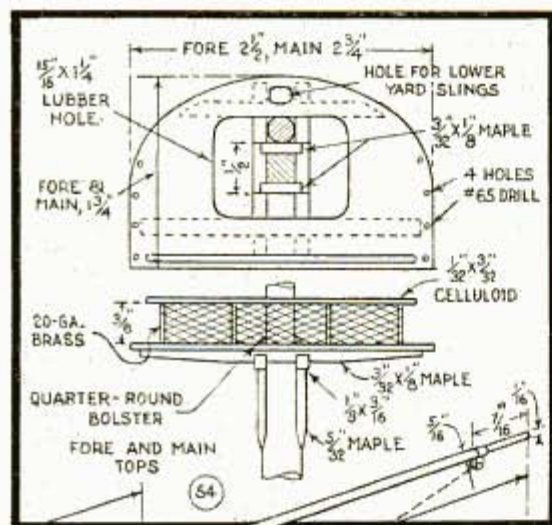

stern boat is shaped like the others and hung by falls which are threaded through slots representing sheaves in the end of the davits.

With the hull completed, you can turn to making the mast and yards. Figs. 51 and 53 detail the combined bowsprit, jib boom and flying jib boom. This is rather a delicate job but not a hard one with a little patience. Two turns of black gummed paper, applied at the points indicated and then varnished, represent metal bands on the bowsprit, fore, main and mizzen masts. The bowsprit is painted white, including the cap, and the rest varnished, after which the tip is painted white. The whisker booms and the dolphin striker are shaped from brass rod according to Fig. 52 and fitted with eyes at the points indicated. Attach the booms to eyes fitted directly opposite each other as in Fig. 51, and the striker to an eye located on the underside a little aft of the celluloid cap. The bowsprit should set about 2 in. in the hull.

Although some of the masts will be found a little difficult to shape so small, it is advisable to keep to the diameters given so that the appearance of the finished model will be as fine as possible. Each of the three masts, the fore, main and mizzen, consists of a lower, top and topgallant mast. Fig. 59 details and dimensions the lower masts. The best way to round and taper the masts straight is to plane them square

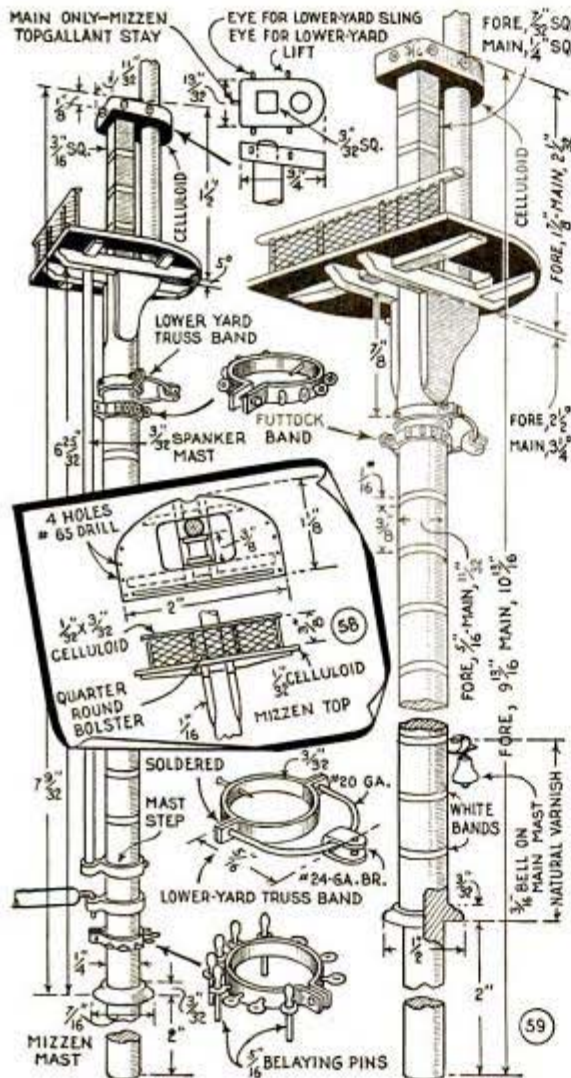
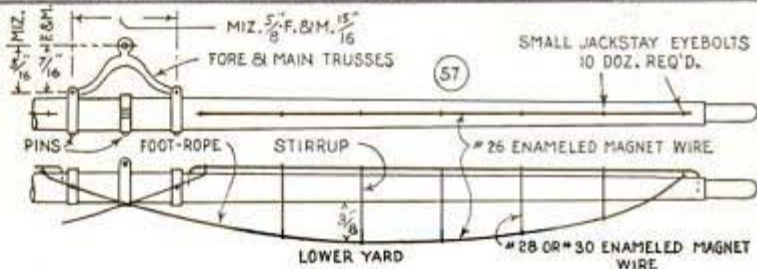
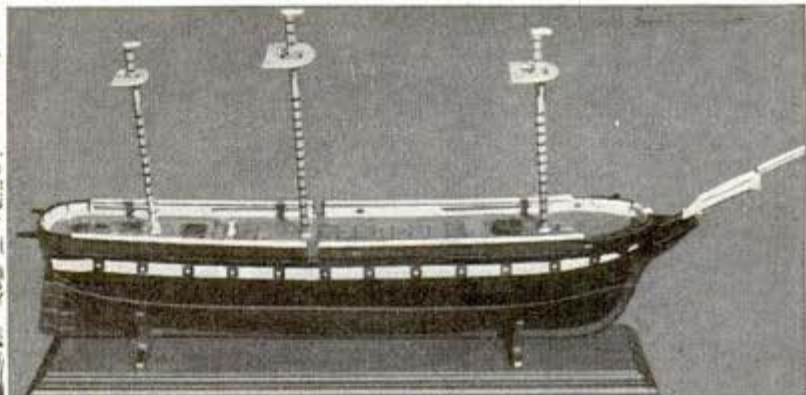
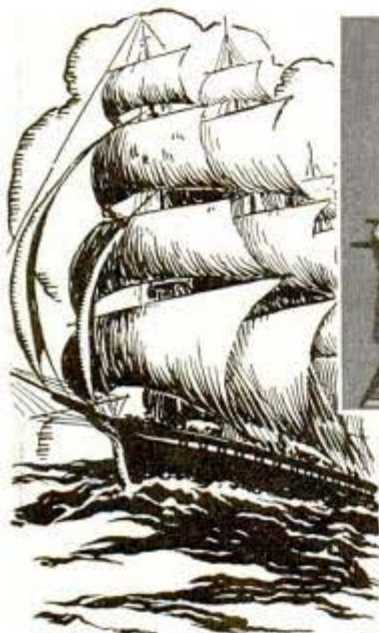

first, then plane off the corners to make them octagonal, and finally form them round with a file or sandpaper. Where the mast is tapered, plane the taper while the mast is still square; don't attempt to round and taper it at the same time. The lower masts have no taper, and the upper ones very little. At the "doublings," the point where the upper mast overlaps the lower, the masts are filed square the distance given for each. The method for fitting the  $\frac{3}{32}$ -in. maple "cheeks" upon which the tops rest, is shown in Fig. 55. To do this, you file down the sides of the mast, below the squared head, for a distance of  $\frac{3}{4}$  in. and glue on two triangular pieces of  $\frac{1}{16}$ -in. wood. Then you shape them to look like the final step. No cheeks are used on the top masts. On the mizzen the cheeks are  $\frac{5}{8}$  in. long.

Next, trestletrees are fitted to the top of the cheeks as shown in Figs. 54 and 58. Note that the top of the cheeks are slanted equal to the mast rake to allow the trees to set parallel with the waterline. Crosstrees are fitted to the trestletrees in notches filed at the points indicated. These form a square hole forward for the heel of the topmast, and another directly aft of this for the main-mast head. Cut the top platforms from  $\frac{1}{16}$ -in. wood or celluloid to correspond with the pattern, saw the lubber hole and glue to the top of the crosstree assembly. The netting for the rails at the aft edge of the tops may be cut from 40-mesh, brass

strainer gauze, available at most hardware stores. Topmast heads are made in practically the same manner, except that they have no platform. The heels of the upper masts are supported on the trestletrees by fids which are simply pins inserted through the heel of the masts about  $\frac{1}{8}$  in. from the lower end as in Fig. 62. The upper masts are held to the lower by caps which you shape from either wood, metal or celluloid. Finish each mast natural up to the third band and white from there to the tip.

The futtock bands hold the futtock shrouds coming from the tops. Each of the eight eyepins in the bands is fastened with a spot of solder. On the fore and main masts, the bands are fastened  $\frac{1}{16}$  in. down from the underside of the trestletrees, and  $\frac{7}{8}$  in. down on the mizzen. Then about  $\frac{3}{16}$  in. above the futtocks, yard trusses are attached. When tapering the combined topgallant and royal masts, don't forget to make a decided shoulder at the point indicated to carry the stays and backstays that will be rigged here. The mizzen mast carries a  $\frac{3}{32}$ -in. wood or brass spanker mast, painted black if metal and varnished if wood. Set the upper end in a hole in the top and the lower end in a black, shim-brass step attached to the mast  $\frac{1}{8}$  in. above the deck. Two more bands are added to the mizzen, the gooseneck for the spanker boom, Fig. 56, and the belaying-pin band. The latter is fitted

with eyes to take eleven belaying pins, each pin being fastened to its eye with a spot of solder. The outer end of the spanker boom rests in a block glued to the rail of the stern bulwark, while the gaff is fitted with an eye to slide over the spanker mast.

The length and diameter of each yard is given in Fig. 60. Make them the same as you did the masts. You'll notice that they do not taper straight from the center to the ends, but are proportioned as in Fig. 63.

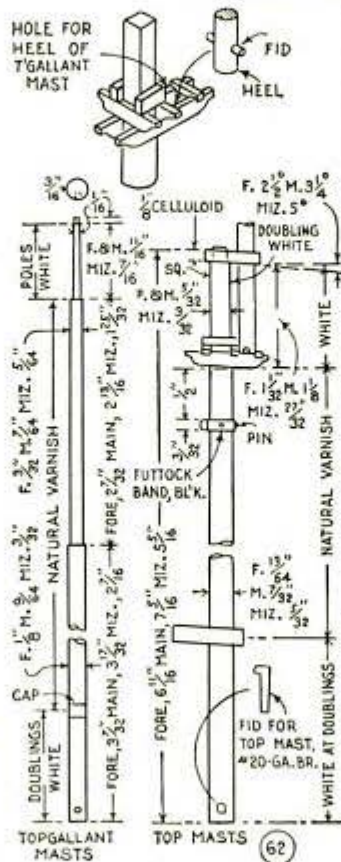
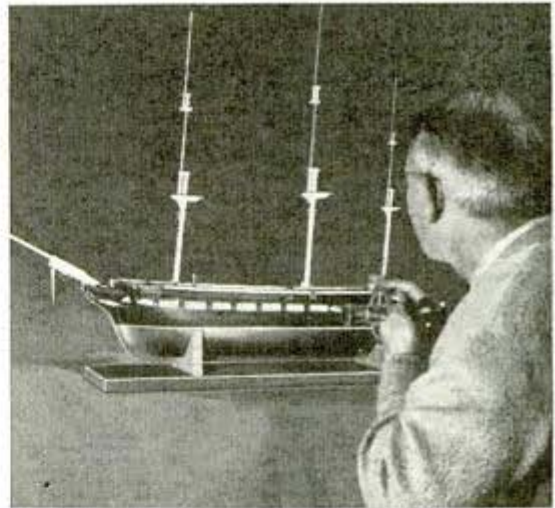

60 YARD DIMENSIONS, INCHES				
NAME	OVERALL LENGTH	DIA.	YARD ARMS	
			LENGTH	DIA.
FOREYARD.....	10 $\frac{1}{32}$	$\frac{1}{32}$	$\frac{1}{16}$	$\frac{3}{64}$
FORE TOPSAIL YARD.....	7 $\frac{1}{16}$	$\frac{3}{32}$	$\frac{3}{32}$	$\frac{3}{64}$
FORE TOPGALLANT YARD.....	4 $\frac{23}{32}$	$\frac{3}{64}$	$\frac{3}{32}$	$\frac{1}{16}$
FORE ROYAL YARD.....	3 $\frac{1}{16}$	$\frac{5}{64}$	$\frac{1}{8}$	$\frac{3}{64}$
MAIN YARD.....	11 $\frac{1}{2}$	$\frac{1}{4}$	$\frac{1}{16}$	$\frac{1}{8}$
" TOPSAIL YARD.....	8 $\frac{19}{32}$	$\frac{3}{16}$	$\frac{3}{32}$	$\frac{3}{64}$
" TOPGALLANT YARD.....	5 $\frac{1}{4}$	$\frac{1}{8}$	$\frac{5}{16}$	$\frac{1}{16}$
" ROYAL YARD.....	3 $\frac{15}{32}$	$\frac{3}{64}$	$\frac{3}{32}$	$\frac{3}{64}$
MIZZEN YARD.....	7 $\frac{19}{32}$	$\frac{3}{32}$	$\frac{15}{32}$	$\frac{3}{64}$
" TOPSAIL YARD.....	5 $\frac{19}{32}$	$\frac{3}{32}$	$\frac{15}{32}$	$\frac{3}{64}$
" TOPGALLANT.....	3 $\frac{15}{32}$	$\frac{3}{64}$	$\frac{1}{16}$	$\frac{3}{64}$
" ROYAL YARD.....	2 $\frac{5}{16}$	$\frac{1}{16}$	$\frac{7}{64}$	$\frac{3}{64}$
SPANKER MAST.....		$\frac{3}{32}$		
" BOOM.....	6 $\frac{1}{16}$	$\frac{1}{8}$		
" GAFF.....	4 $\frac{1}{4}$	$\frac{7}{64}$		

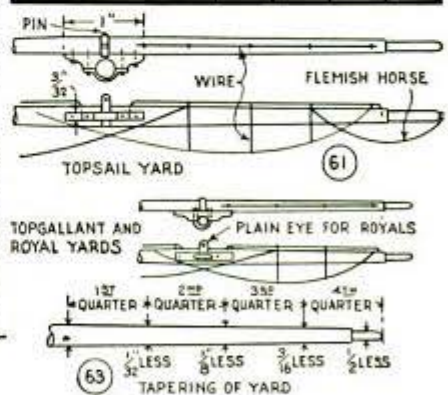

From a centerline, the yard is divided into quarters at which points the diameter decreases the amount specified from full diameter at the center. From Fig. 57 you can see what the standard trusses look like that hold the lower yards to the mast, while Fig. 61 shows the type of truss used on the topsail, topgallant and royal yards. Except for the yard arms, which are varnished, the lower and topsail yards are painted black. The topgallant and royal are varnished.

(To be continued)

## Tabs Mark Pages of Catalogue For Ready Reference



Time-saving alphabetical tabs that can be attached easily to pages of a large catalogue or ledger are simple to make from cardboard and paper clips. All you need to do is print the letters on small cardboard squares, make a tiny hole in each square and then slip them on the clips. In this way, the letters are held securely and can be moved from one page to another.

## Nonslip Diving Board

To overcome the danger occasioned by a wet, slippery diving board, one swimming-pool owner tacked a strip of composition roofing on the board. The kind having a crushed-slate coating is the most satisfactory and will last several years.

## 'Weeping' Holes in Terrace Wall Relieve Water Pressure

When you build a masonry retaining wall at the base of a terrace or at the foot of a slope, it is a good idea to provide for the escape of water that drains down

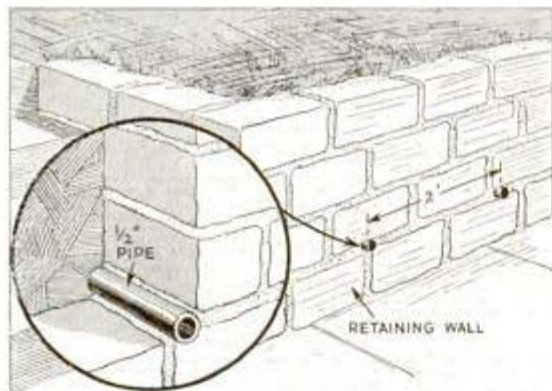

against the wall. This may be done by placing short lengths of  $\frac{1}{2}$ -in. pipe in the first mortar joint, spacing them at intervals of about 2 ft. The end of each piece of pipe should be flush with the wall at the back. In old walls, you can use a star drill to make openings through the mortar joints.

## Cord Impregnated With Lacquer Used as Lacing for Leather

Colorful lacing for your leather-craft can be made by impregnating cotton string or cord with lacquer, which is available in a number of different colors. First dip the cord in the lacquer and then stretch it tautly between two supports. After it has dried, apply another coat of lacquer with a small brush. When this coat has dried, the lacing is ready for use.



## Ferrules for Small Tool Handles Made From Gun Shells

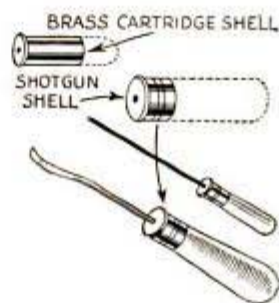

Anyone who occasionally makes a small hand tool for a special purpose and fits it with a wood handle, will find that the brass end of an empty shotgun shell provides a good ferrule for the handle. Just remove the paper part of the shell and then ream out the cap hole to take the tang of the tool. For very small tools, empty brass cartridges provide good ferrules. Empty shells can be picked up at a local gun club, or you can have a friend who hunts save them for you.

☛ To renew cane chair seats that have sagged, sponge them with a hot solution of equal parts of vinegar and water. Then place the chairs in the sun to dry and the cane splints will shrink back to shape.

# PHOTO-MAT CUTTER

*bevels the edges*

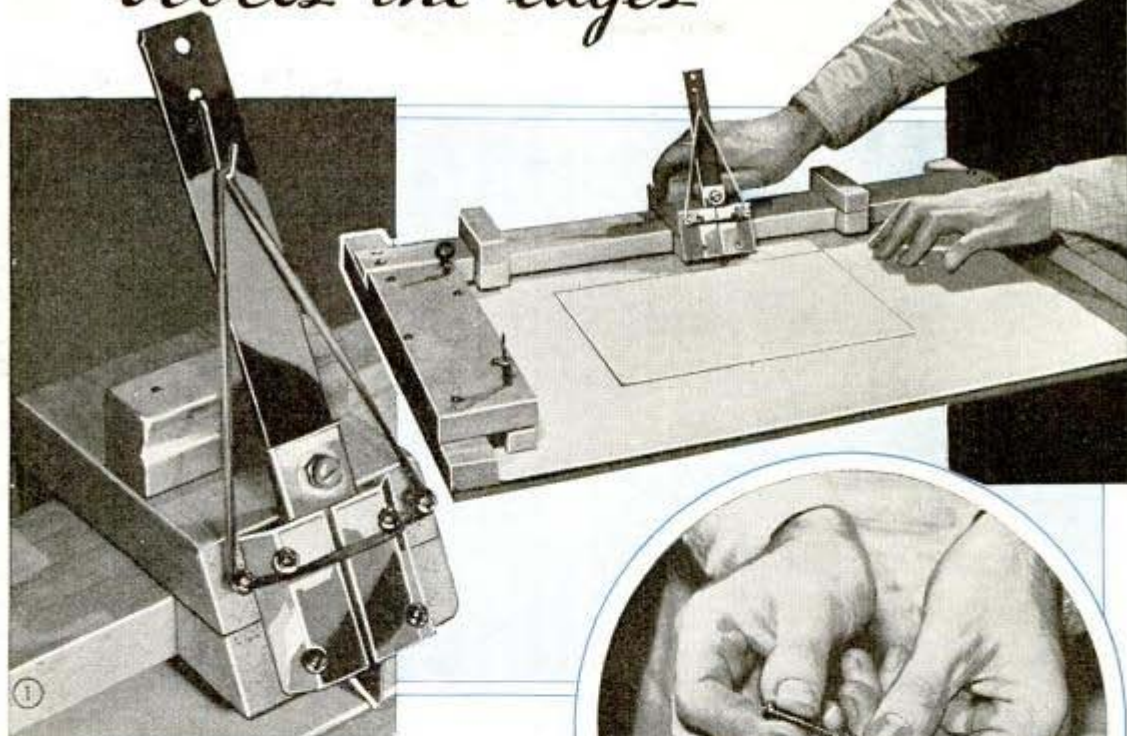

WITH this cutter you can turn out mounts for photographs and mats for all kinds of framed pictures, as well as bevel the outer edges of picture mounts, or trim cardboard and heavy paper to size. The secret of making the cuts is the operation of the sliding knife, Fig. 1. The blade is fed into the work by pressure of a spring or rubber band so that only a shallow cut is made at each passage instead of trying to cut through the mount

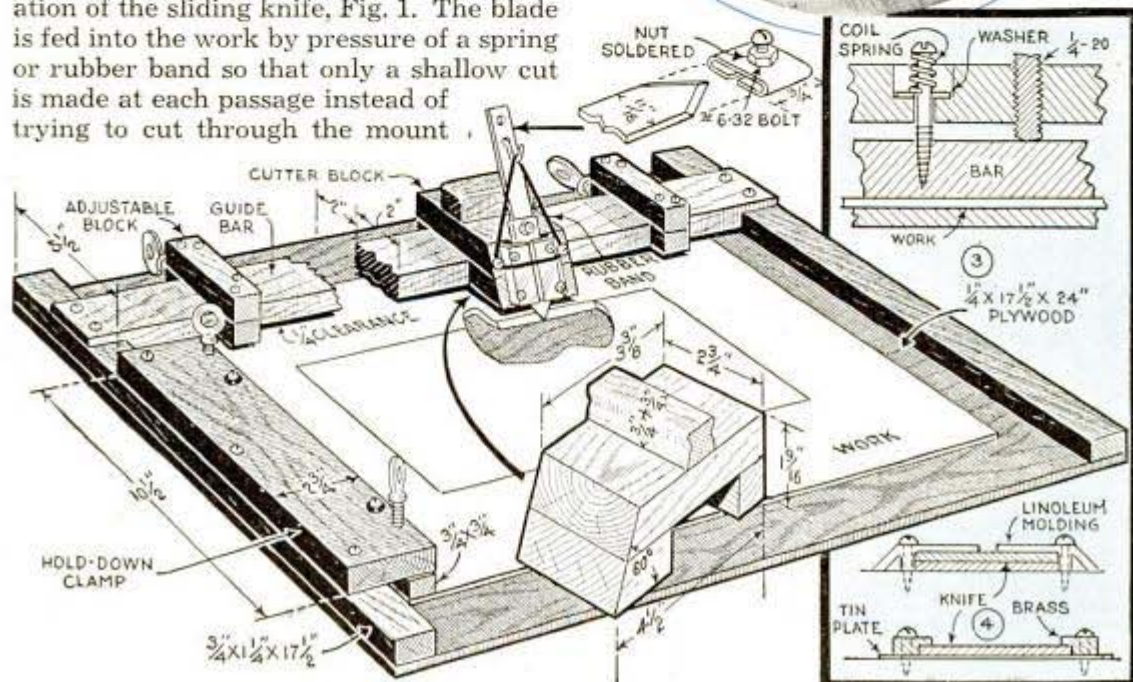

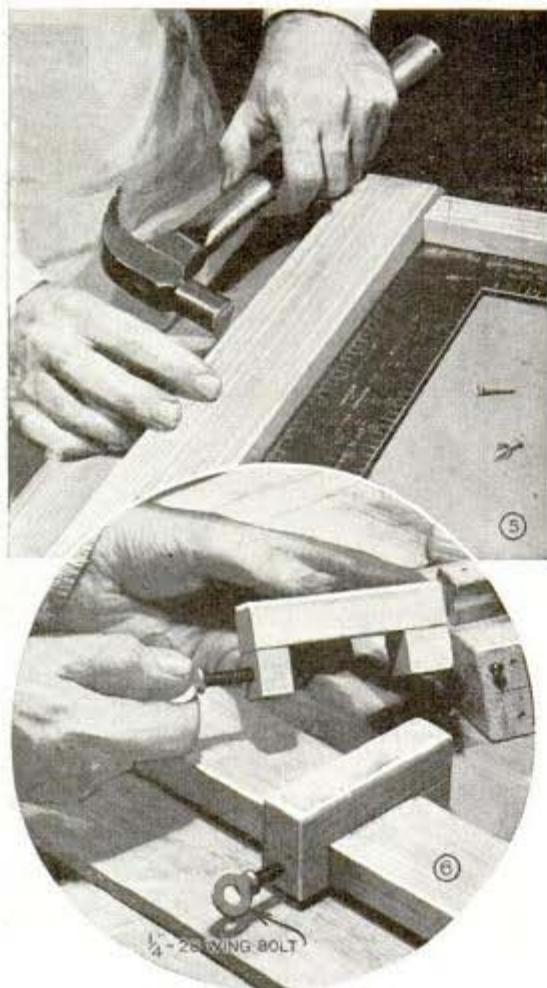

at one sweep. The blade cuts in both directions of movement.

General construction is shown at the left of Figs. 3 and 4. Dimensions are for a cutter that will handle work up to 16 by 20 in. Plywood or similar material is used for the base. All exposed edges and corners are rounded to protect knuckles and fingers. It may be desirable to place a strip of zinc on the base where the knife travels to assure smooth cuts. A hold-down clamp at the right-hand end of the base keeps the work securely in place while it is being cut. The clamp consists of two pieces of wood, one of which acts as a pressure bar that is forced against the work by two thumb-screws. If desired, these can be made by soldering washers to the heads of screws, Fig. 2. The pressure bar is held in position by two wood screws that slide in counter-bored holes and are provided with coil springs to lift the bar, Fig. 3.

The sliding knife and its holder are the most critical part of the cutter as success depends on the smoothness of operation

and freedom from play in both the knife blade and the sliding block. The knife blade is a sliding fit between two guide strips of metal rabbeted to provide recesses in which the blade slides, Fig. 4. If available, strips of metal molding of the type used around linoleum will save the work of making the guides. It may be necessary to use a strip of sheet brass or tin plate to reduce the space to the thickness of the knife and to provide a smooth bearing surface. You can make an adjustable stop from a strip of sheet metal and a bolt for limiting the downward movement of the knife in its guides. The guide bar on which the cutting block slides is a strip of wood measuring  $\frac{3}{4}$  by 2 by 24 in. Ends are rabbeted so the lower surface of the bar is  $\frac{1}{4}$  in. above the surface of the base. Be sure the bar is absolutely straight and with both edges parallel. Use an accurate try-square to align it at right angles with the crosspiece that carries the hold-down clamp, Fig. 5. Two adjustable stops that limit the movement of the knife are cut from hardwood or each can be made by joining a strip and two small blocks as shown in Fig. 6. Each stop is tapped for a thumbscrew, which is used to lock the adjustment of the stop.

### Cellulose Tape Marks Trays

Trays for certain photographic solutions can be marked with cellulose tape for quick and easy identification. Just cut strips of colored tape to form the various letters such as "H" for hypo, "D" for developer, "S" for short stop, etc., and stick them on the end of each tray. Cellulose tape is waterproof and will not wash off.

—William Swallow, Brooklyn, N. Y.

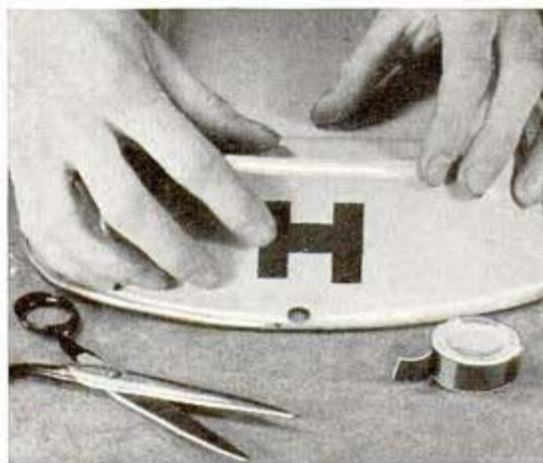



# Venetian Blind Provides Novel Movie Effects

Interesting transitions from one title to another and novel opening and closing scenes for home movies can be filmed easily with the aid of a venetian blind. Letters are cut from black paper or cellulose tape and stuck to opposite sides of the slats of the blind. Start filming the first title and, when sufficient footage is run off, pull the cord to turn the slats over slowly, revealing the second title. After filming the titles, the blind can be drawn up slowly to reveal the opening scene of the movie. At the end of the final scene, the blind is lowered and the slats turned to reveal the words, "The End." The blind must be mounted on a portable frame which can be placed between the camera and the action at the proper time.



# Valve and Hose Above Sink Have Several Darkroom Uses

Connected to a valve at the end of a water pipe above the darkroom sink, a short length of garden hose proves a valuable addition to the regular faucets. Water

from the hose can be directed to almost any part of the sink, and bottles too tall to go under a faucet can be filled easily. Ferrotyping tins can be washed quickly and without splashing by laying them in the sink and running water from the hose on them as they are rubbed with a sponge. In washing films, the hose is placed in the tank and the stream adjusted to run into the tank at the same speed it runs out.



## Thread Placed Under Cotton Lifts It From Funnel Easily

A small wad of cotton that is used as a filter in a funnel will not have to be dug or pushed out after use if a strong thread is placed under it before the liquid is poured through. Lay the thread in the funnel, allowing the ends to hang over the sides, then place the cotton on top of it.

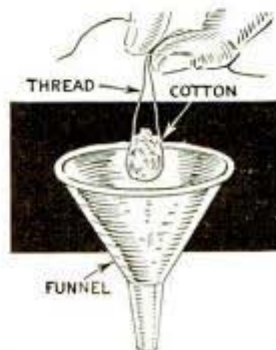

## Darkroom Worker Sees Callers Through Periscope in Wall

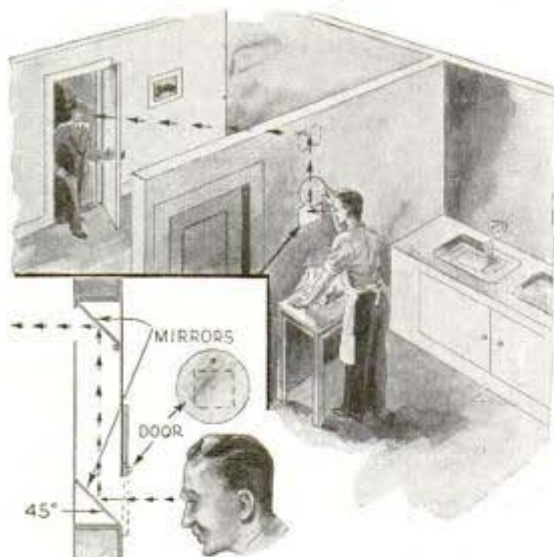

Mounted in the wall between his darkroom and reception room, one photographer installed a periscope to see anyone

entering his studio without opening the darkroom door. Two holes are cut in the wall, and mirrors are mounted at 45° angles as shown. A swinging cover over the lower hole opening into the darkroom can be raised to look through the periscope. Each opening should be covered with a piece of amber Cellophane to subdue the small amount of light that might be reflected into the darkroom.

## Holding Ferrotypes Tins Upright

Holding ferrotypes tins upright while prints are drying is no problem if you have several pieces of small channel iron bent as shown.



One side of the channel is cut and the piece is bent at a right angle. Tins up to 14 by 16 in. will stand upright without buckling.

## This Sturdy Lawn Chair Is Designed for Comfort



**JIGSAWED LAWN ORNAMENTS—1051:** Ten colorful figures. Color scheme of each given. You can increase your income by selling such ornaments at roadside stands. 25c.

**LOG-CABIN CONSTRUCTION—916:** Two floor plans. Shows how to make corner joints. 25c.

**OUTDOOR FIREPLACES—917:** Several simple, but practical types, to match other items in rock garden. 25c.

**Lawn Chair—1058:** This chair can be built with a few hand tools. Plan calls for stock sizes of lumber. Curved, slatted seat assures comfort. Complete construction details and list of material will be sent postpaid for only 25c.

### OTHER GOOD SUMMER PROJECTS

**DUTCH WINDMILL—1059:** Stands about 5 ft. high. Simplified design. 25c.

**FLOWER BOXES—1061:** Three attractive patterns, designed for durability. 25c.

**LAWN CHAIR ON WHEELS—978:** Light in weight and easy to wheel to any desired location. Cushion extends over both seat and back. 25c.

**ORNAMENTAL WOOD FENCES—640:** Five artistic designs for standard wood stock. 25c.

**CIRCULAR ARBOR AND GATE—637:** Popular style anyone can build. 25c.

**LAWN AND GARDEN FURNITURE—920 to 922 incl.:** Collection of designs for arbor-and-seat combination and swings. 3 prints 75c.

**TRELLIS SUGGESTIONS—639:** Six types that will help beautify your home. 25c.

**BARROW CHAIRS—924:** Two styles. Built for comfort. Simple construction. 25c.

**12-FT. UTILITY ROWBOAT—707:** Flat bottom, four seats. Very sturdy design. Fine for boat livery rental purposes on small lakes. 25c.

Order plans by number and title. Send 3c for latest catalogue of popular handicraft plans

Dept. 399 — Popular Mechanics Press, 200 East Ontario Street, Chicago, Illinois



# SHOP NOTES

## *Floating* **POWER UNIT** *drives* **LATHE**

By Walter E. Burton

How countershaft-type lathe is modernized with a swinging unit that rests on floor

WITH this power unit any old-style lathe, which operates from an overhead lineshaft and depends upon shifting of the belt to stop it, can be changed over to one having a compact, clutch-controlled drive at very little cost. The unit consists of a countershaft-and-motor assembly which is pivoted at the lower end to lean against the belt as shown in Fig. 1. This floating action keeps the belt at the proper tension, and as the unit is mounted independent of the lathe, spindle vibration

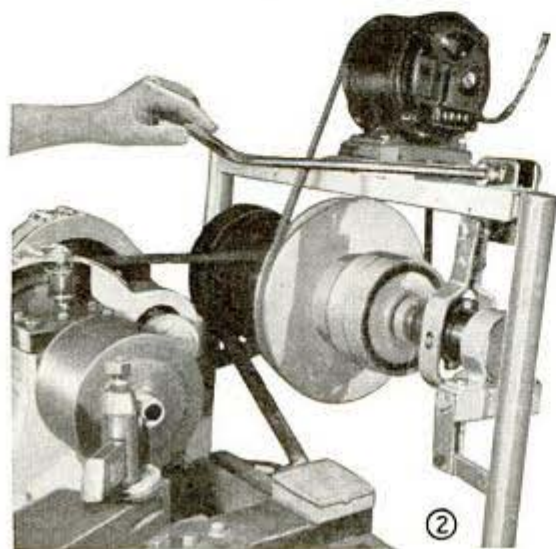
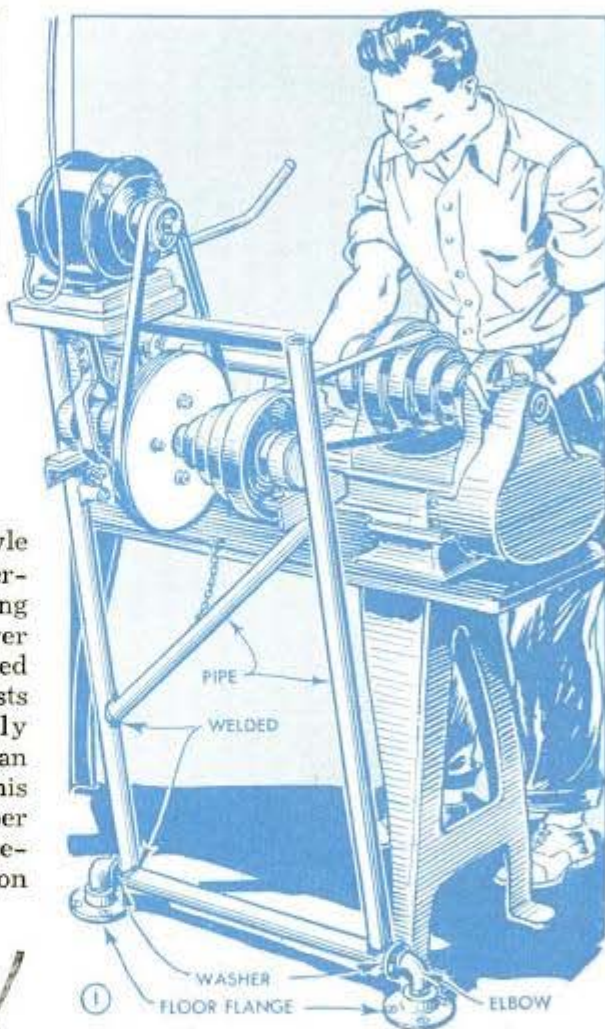

transmitted through the belt is negligible. With a suitable clutch fitted to the drive pulley, the motor can be made to idle by simply moving a hand lever as in Fig. 2.

Your step pulley and the clutch used will determine the length and size of the countershafting. The original measured  $1\frac{7}{16}$  in. in diameter. Each end of the shaft is turned down to fit standard automobile ball bearings which you encase in housings machined from 3-in. cast-iron pipe. The bearings are of the type shown in Fig. 3 and can be obtained from a second-hand

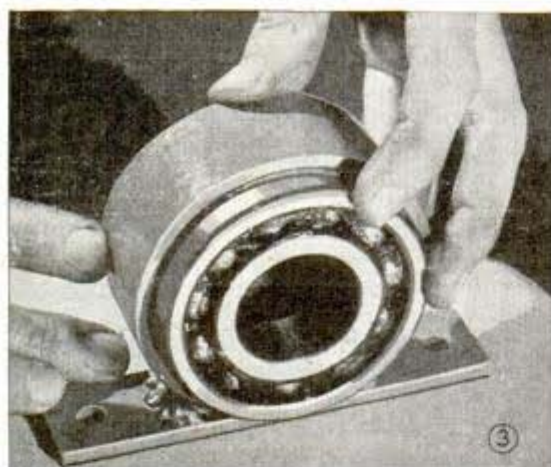

of the clutch is not fixed to the shaft. A true running pulley will be had if the V-belt groove is turned after it is on the shaft. Fig. 4 shows clearly how the yoke is bent of flat iron and linked to a control rod for sliding the clutch sleeve back and forth on the shaft. To use a standard-length V-belt on the drive pulley, you may have to add a block or two to the motor platform to make the belt fit.

Odd pieces of pipe and angle iron are used to make up the supporting framework as detailed in Figs. 1 and 4. It is pivoted to the floor by running a smaller pipe through the base piece and fitting each end

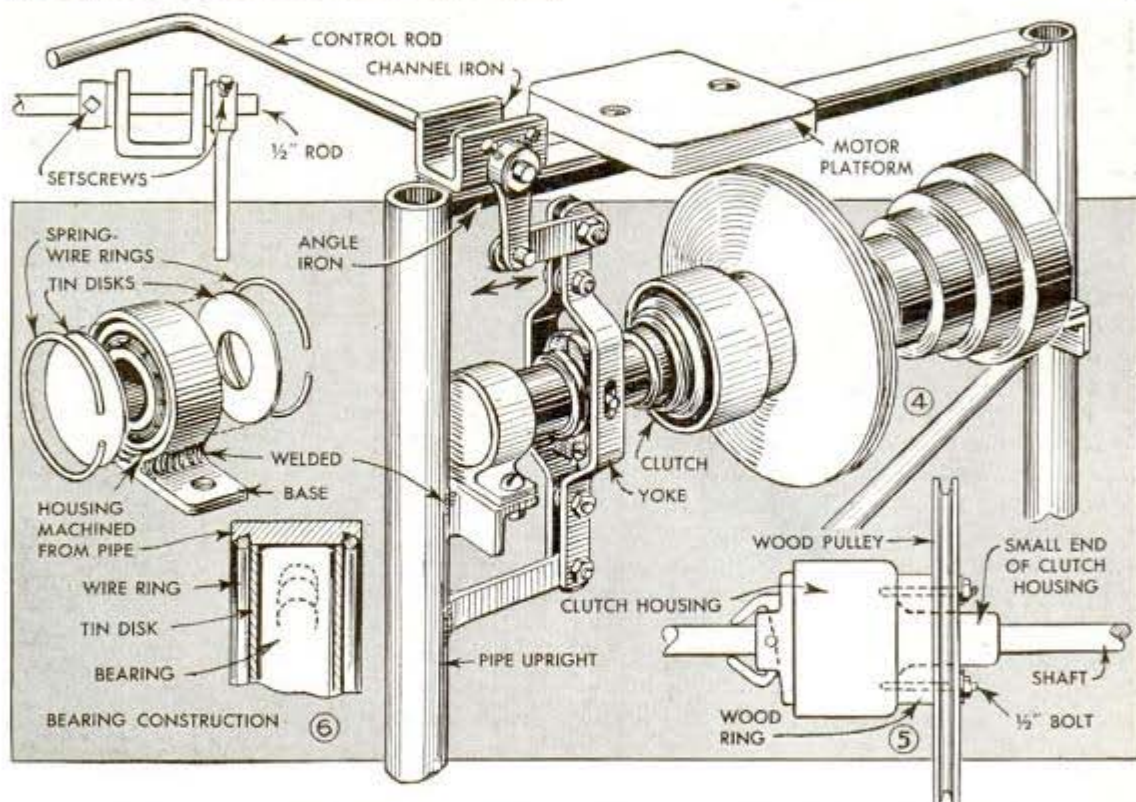

auto-parts dealer at small cost. In boring the pipe, leave an internal shoulder in one end of the housing to seat the bearing. This will permit end play to be taken up without forcing the bearings out through the end. Finally, rabbets are undercut in each edge of the pipe for the spring-wire rings which lock the grease-retainer disks in place, see Fig. 6.

Motor speed and pulley ratios necessary to give the desired lathe speed determine the size of the wooden drive pulley. Fig. 5 shows how it is fitted over the small end of the clutch and bolted securely to the face of the housing. Thus the drive pulley is free to idle when disengaged as this half

with an elbow and floor flange. The unit should assume a backward rake of about 10 degrees when belted to the lathe, although if you find that the weight of the unit is insufficient to prevent slippage at this angle, the slant can be increased. If your shop floor is of concrete, the unit can be anchored solidly to it by setting short bolts, head down, in oversize holes made with a small star drill and then pouring lead around them. This will produce a rigid mounting when the flanges are set over the projecting bolts and drawn up tightly. Be sure to provide a check chain from the frame to the lathe to prevent the unit from dropping to the floor in case the belt breaks.

## Platform on Farm Tractor to Use It Like Truck



By fitting his tractor with a strong platform, a rancher of Malaga, Wash., uses it to take the place of a truck. The platform consists of two 4 by 6-in. timbers fastened to the tractor chassis and covered with boards to provide supporting surfaces for the load, which is carried in front and behind the tractor. Where necessary, stake sides and ends can be provided to retain the load, or grain-tight boxes can be built on the platform. If this is done, the boxes should be constructed in panels for easy removal.

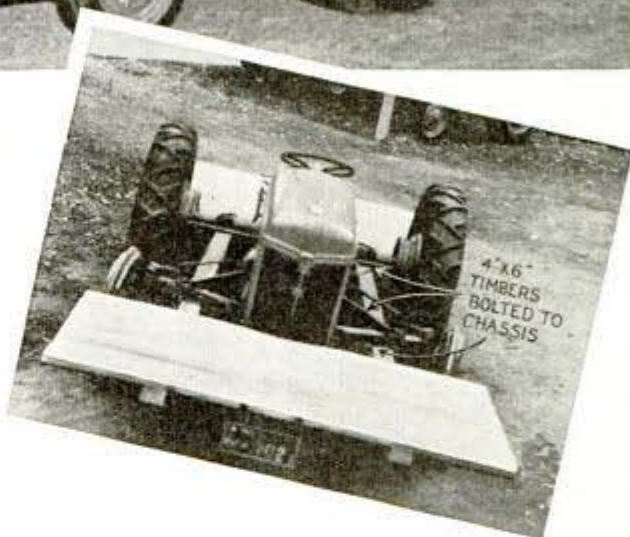

## Steel Fence Posts Removed Easily With This Simple Puller

Having a number of steel fence posts to remove, one farmer used this simple puller for the job. In this case, it consisted of an old sled runner having a steel link fitted at the upturned end. In use, the link is

dropped down over the post under the anchor plate, after which pressing down the end of the runner raises the post. If a sled runner is not available, the tool can be cut from a strong piece of hardwood.



## How to Color Concrete

When making a concrete terrace or colored concrete slab, mix and pour in the usual way. Float the wet concrete and then apply your coloring dry by sprinkling it lightly all over the surface, and then re-float. This will save time and material and will be deeper in color than when using 1 in. of colored dressing on top.

❏ Instead of oiling machines the first thing in the morning, wait until within 15 minutes before quitting time. The machines are still warm then and the oil will be more effective when applied to warm metal parts.

## Wire Hoop on Wood Fence Posts Is Support for Plumb Bob



To plumb wooden fence posts quickly when setting them in concrete, try this self-anchoring support for the bob. It consists of a length of wire bent into a loop, which is larger than the post. One end of the wire is bent inward so that it rests against the post to serve as a support, and the other end has a hook formed on it for the attachment of the plumb cord. In this way the hoop is easily turned so that the posts may be plumbed from any side instantly.

## Pencil Ferrule Encircles Numbers On Mimeograph Stencil

Office workers who cut mimeograph stencils will find an ordinary lead-pencil ferrule ideal for encircling paragraph numbers, letters, etc., on the stencils. The



eraser is first removed, after which the pencil is inverted and placed directly over the number to be circled. Slight pressure on the pencil cuts a neat circle much faster and easier than drawing one with a stylus.

## Pipette Bent at Slight Angle To Prevent Rolling

By heating and bending his glass pipettes at the point indicated, one laboratory operator prevents them from rolling off the table. The bending does not interfere with their regular use, and can be done over any flame such as an alcohol lamp, Bunsen burner or gas stove.



## Convenient Pin-and-Clip Holder Glued on Desk Tray



This simple holder provides a convenient place for clips, pins and pen points. It is nothing more than a piece of softwood shaped as shown, with a well on each side and a shallow trough in the center. When finished to match surrounding office furniture, the holder is hardly noticeable.

Keep non-grain-raising dye stains in glass jars only, as they usually corrode tin.

# Springs Wound in Lathe Easily With This Tool

This simple tool automatically avoids the spaces between the coils when winding closed springs. It has been found that the spring soon breaks if such spaces are left. As shown, the tool is locked in the toolpost and consists of a steel shank carrying a specially turned bolt at the outer end. The bolt head is drilled to take a spacing finger, which is held in place by a set screw. The finger rests on the mandrel, forcing the spring coils together tightly as each one is formed. Wire from which the spring is wound passes between the shank and bolt head, thus making it possible to maintain the correct tension at all times. The lathe is run at its slowest speed in back geared speed. It will be found that the tension of the wire combined with the pressure of the spring on the finger will be sufficient to move the carriage along. The drawing shows the

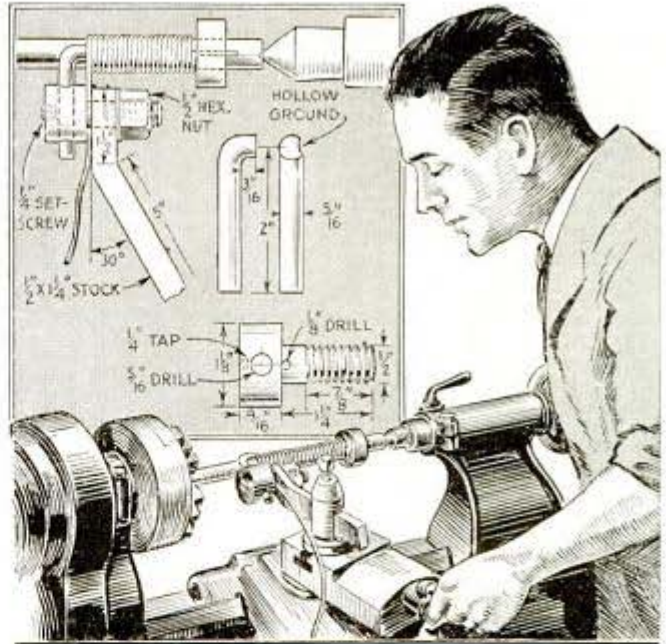

tool set up for left-hand springs. Those who prefer to work from left to right can do so by turning the bolt in the shank end for end.—Robert E. Paquin, Lowell, Mass.

# Tar Coating on Cornpicker Rolls Aids in Gripping Stalks

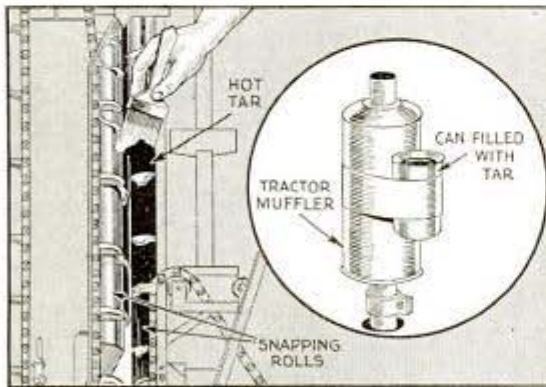

When harvesting dry corn with a picker, the snapping rolls sometimes acquire a glass-smooth polish, which causes them to lose the normal grip on the stalks. This interferes with the snapping action and tends to break the dry stalks into short lengths which often clog the machine. To avoid this trouble, one farmer coats the rollers at regular intervals with a thin film of hot tar. The tar is kept warm enough to remain in a liquid state by placing it in a can, which is wired to the side of the tractor muffler as indicated in the circular detail.

# Corners of Brooder House Rounded to Prevent Crowding of Chicks

To prevent small chicks from crowding into the corners of his brooder house where they might smother, a poultryman tacked strips of light sheet metal around the corners. The strips should be about 20 in. wide and long enough to reach at least 3 ft. each way from the corner.



☐ An excellent device to hold thin plastics for turning can be made by fitting four or five suction cups to a wooden faceplate.

# GO EASY

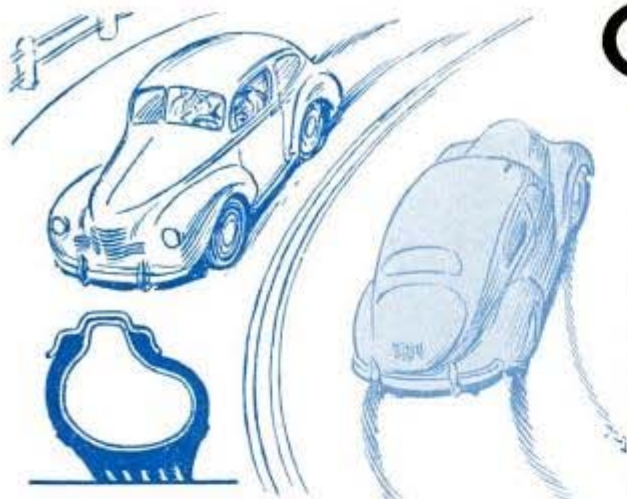

SCREECHING TIRES ARE COSTLY "MUSIC"

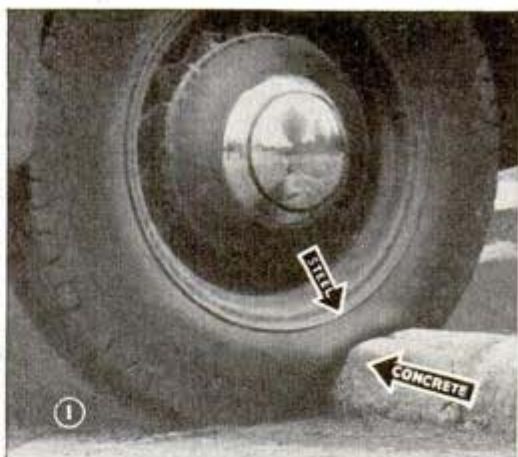

By C. E. Packer

**M**OST of us can prolong the life of our tires as much as 50 percent simply by being careful in our driving habits and by giving the tires the attention they should have. Yielding to the temptation of driving fast to reach a destination in a period of time that requires the speed of a streamliner literally tears mileage off your tires. Actually, tires wear 60 percent faster at 70 m.p.h. than they do at 50 m.p.h. because brakes must be applied more severely, slippage between tires and road is increased, and heat generated at high speeds softens the rubber and tends to separate the cords from it. Fig. 2 shows the percentage of tire wear at different speeds.

You wouldn't deliberately run a grinding wheel over your tires, but they are subjected to similar abrasive action when you take a curve too fast or when the rear wheels slip when making fast starts. Coasting up to known stops and trying to anticipate the unknown ones in plenty of time to avoid set-

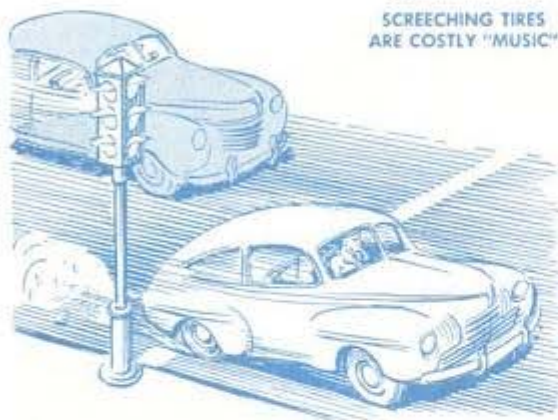

STARTING LIKE A RABBIT WILL MAKE WALKING A HABIT

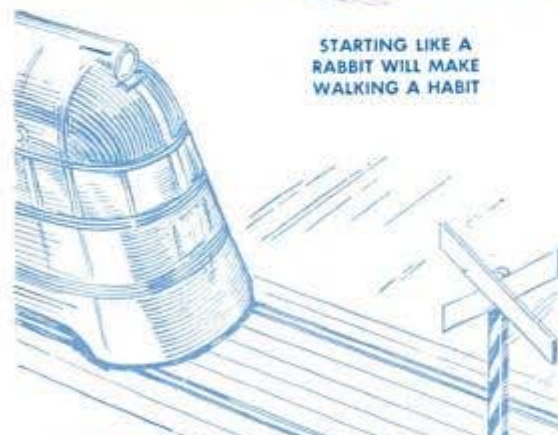

USE YOUR EYES INSTEAD OF YOUR FOOT



PIGEON-TOED WHEELS GRIND OFF RUBBER

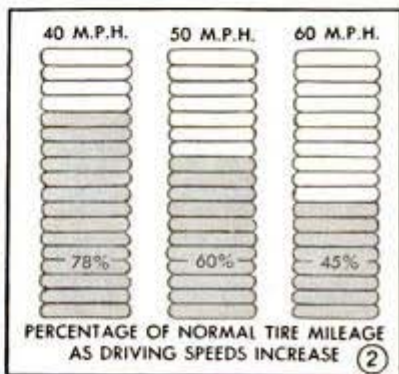



# on your TIRES

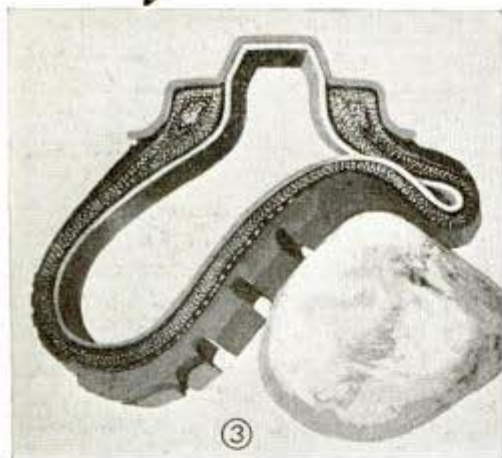

ting the brakes hard will add many miles to your tires. Also, avoid holes in the pavement and small objects lying on it, and be careful when you park to avoid hitting a curb, Fig. 1. Striking such obstacles pinches a tire, creasing it sharply and pressing it against the steel rim of the wheel, which is likely to break the fabric and cords, Fig. 3.

Probably the greatest enemy of long tire life is incorrect inflation, which can be avoided by making weekly or semi-weekly checks. Both the air and service for this are free and it takes only a few minutes of your time. Keep the pressure in your tires as recommended by the tire manufacturer. If you put in a pound or so too much, let it out, Fig. 4, because overinflation is just as bad as underinflation. While it's true that underinflated tires give a soft ride, they are very expensive cushions as the tread wears rapidly and the cords inside the tire tend to separate from the rubber as in Fig. 12. A glance at Figs. 5, 6 and 7 will show more results of underinflation. One tire manufacturer

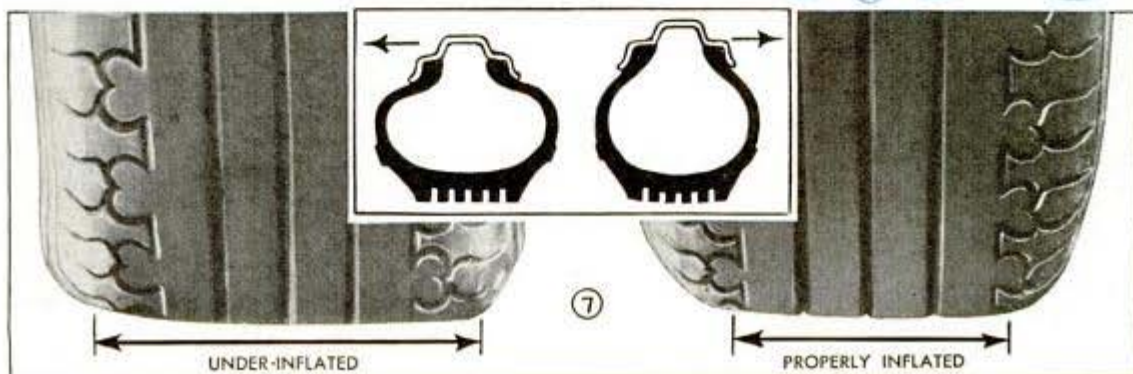
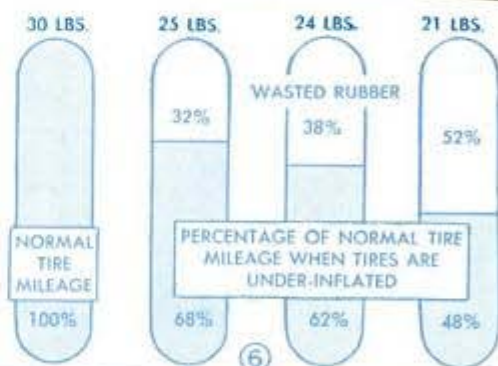

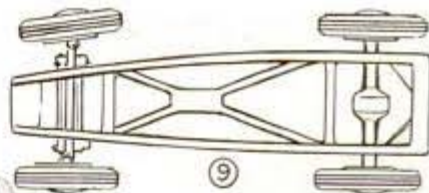

claims that under average driving conditions a popular-size tire loses 2 lbs. of air a week. Such a tire, under-inflated 6 lbs., loses as much as 25 percent of its normal mileage. Aside from increased mileage resulting from regular attention to the tires, there is another ad-



**RESULTS OF NEGLECTED TREAD CUTS, UNDER-INFLATION AND**



vantage in the fact that a slow leak can be detected when checking air pressure. With a 2-lb. pressure loss per week, a tire that has lost 6 to 8 lbs. is sure to have a leak. If a piece of glass or a nail is found and removed, Fig. 8, the cut should be cleaned and sealed with rubber putty or cement to prevent moisture from working into the cords. Cords act like wicks and hold moisture, causing them to rot and eventually break as in Fig. 11.

Blow-outs don't just happen, but the contributing causes often occur sometime previously. The cause may be a small tread cut, Fig. 10, that was neglected or was enlarged by over- or underinflation. Contacting a sharp object

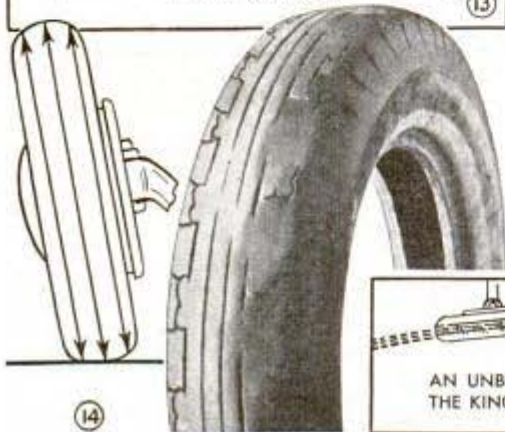

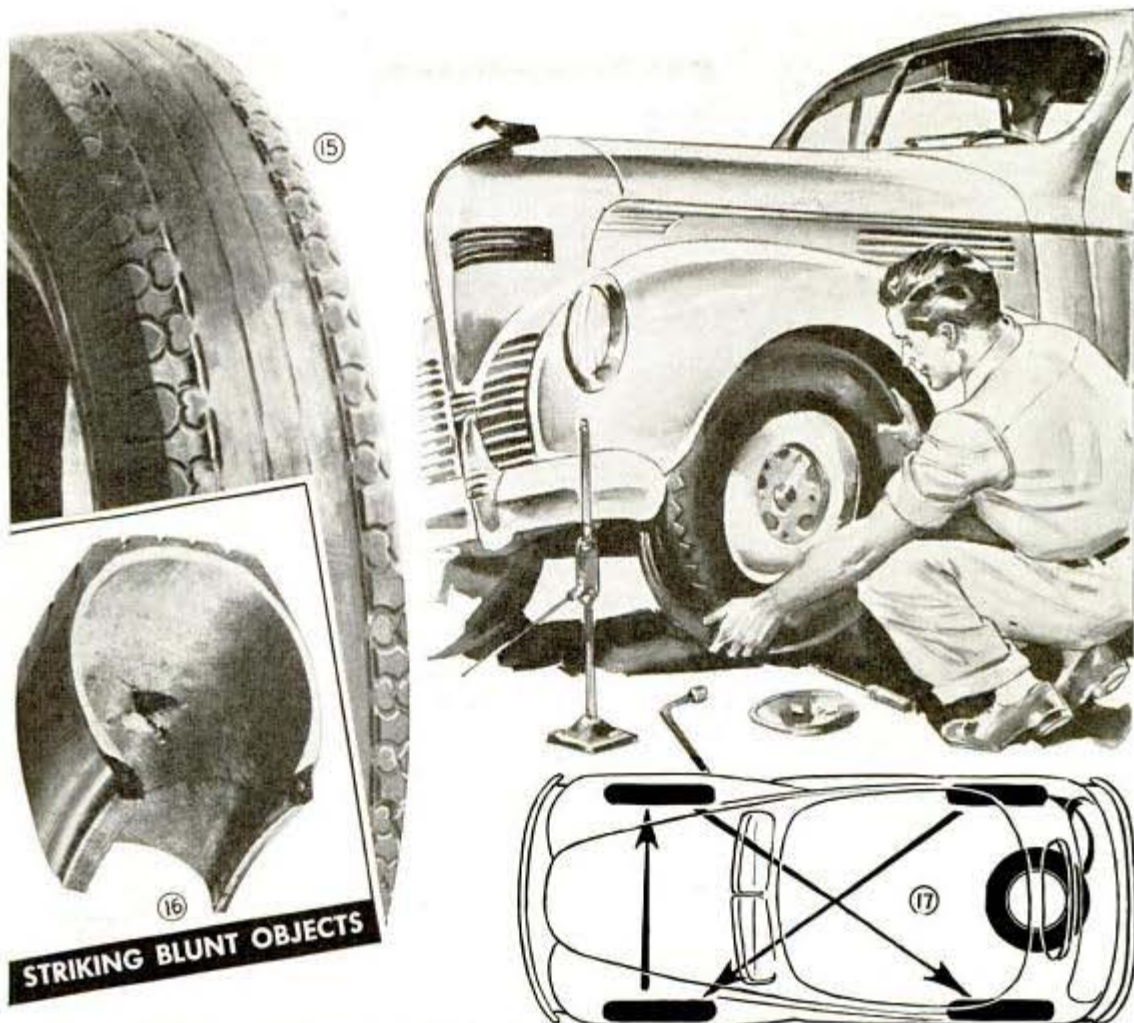

on the road does not always result in immediately visible damage but may break the cords as seen in Fig. 16, and this in turn may lead to a blowout. When your car is on a hoist being lubricated, it is a good idea to run the fingers over the tires. If the tire has been damaged in this way, there may be a slight bulge which may not be enough to see, but can be felt.

Misaligned wheels or improperly adjusted brakes take a high toll in tire life. A wheel that is  $\frac{1}{2}$  in. out of alignment, drags sideways 87 ft. per mile. Fig. 15 shows what happens to the tire tread when this condition exists. Where front wheels do not track true, Fig. 9, one of them does the steering and the other one drags, which scuffs away the tread just like rubbing the tire with a file. If the edges on one side of the tread design are sharp or feathered, Fig. 13, when rubbing the hand across the tread, this condition indicates that the wheels are not in perfect alignment.

Does your car pull to one side when the brakes are applied? If so, you may be sure

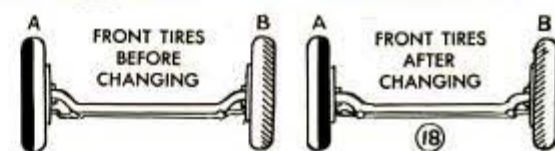

that brake adjustment is unequal, that most of the braking action is on one tire. On a test made by one manufacturer, the brakes were adjusted so that one wheel only would lock. At a speed of 80 m.p.h. the brakes were applied and held until the car stopped. When the tires were exam-



ined, the tread of the tire on the locked wheel was worn down to the breaker strip by this single operation alone. Even stepping hard on the brakes at 35 m.p.h. will scuff off enough tread to carry a car a full road mile.

"Heel-and-toe" wear may occur on any type of tread design, and to some extent is normal, though high-speed driving and excessive use of the brakes will accelerate the rate of wear. The remedy for this condition is to change the position of the tires on the car. Two ways of doing this are shown in Figs. 17 and 18.

The subject of wheel alignment includes far more than mere toe-in, one of the other important factors being that of camber, or the outward inclination of the wheel at the top. This is necessary for easy steering and maximum strength of the front system, but if present in excessive or unequal amounts, it creates tire trouble. In effect, due to the roundness of the tread, camber gives a tire several diameters, as indicated by the three arrows in Fig. 14. As the tire revolves as a unit, something must slip, and where the camber is excessive there will be tread wear. To minimize this, tires should be changed about as indicated by A and B in Fig. 18. To do this it is necessary to remove the tire from the wheel and turn it around. Rounding turns at excessive speed, especially with tires that are soft, creates a screeching sound. It is expensive "music," resulting in tread wear as indicated by the heavy arrows in Fig. 19. This can be offset to some extent, by changing the tires about as indicated in Fig. 17.

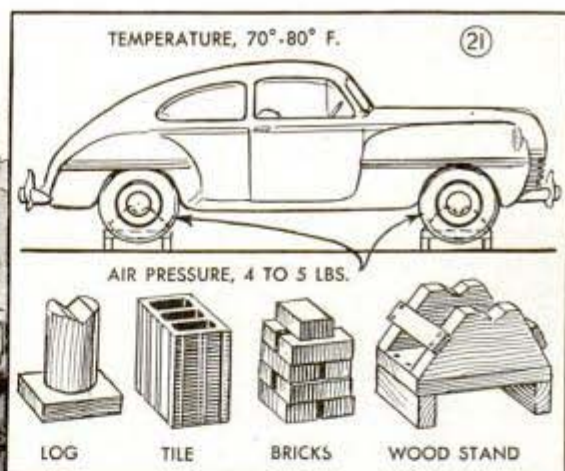

An unbalanced wheel may develop a spotty or cupped tread condition such as that shown in the photo of Fig. 14. Consequently, balancing of wheels should be considered as a regular maintenance item, for an unbalanced wheel, besides increasing tire wear, also causes considerable wear in the steering spindles, spring shackles and other chassis parts, thus contributing to a looseness which is conducive to further troubles. The disturbing forces produced by an unbalanced wheel increase tremendously with increase of speed. An assembly 1 oz. out of balance at the tread, will develop a 12-lb. vibrating force at 60 m.p.h. And, it is not uncommon to find wheels that are 6 or 12 oz. out of balance. While it is most important to keep the front wheels balanced, it is highly desirable to balance all wheels if the smoothest, most economical car operation is to be had. Alignment of wheels also should include an inspection of the rims, for a rim that is badly bent or rusted will injure the tube as well as the tire.

If it becomes necessary eventually to store your car until tire replacements can be made, careful attention must be given the tires to preserve them. Place the car on blocks, Fig. 21, thus relieving the tires, and reduce the air pressure to a few pounds. It's best to remove the wheels and tires and store them in a cool, dark place, packing them horizontally instead of vertically. If the tires must remain on the car, and they are in the light, coat them with synthetic rubber paint for protection, Fig. 20. Also they may be covered with heavy canvas or similar material. As heat and air tend to destroy rubber, 79 or 80 degrees Fahrenheit should be the maximum storage temperature.

# Make your own MOLDING CUTTERS

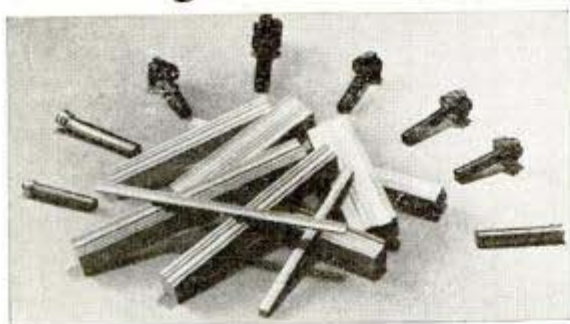

**I**NTRICATE moldings used in dioramas and models built by Carl W. Bertsch of the Atwater-Kent Museum at Philadelphia, are produced easily and quickly by using small homemade routers in a drill press. They are turned from drill rod to correspond to a profile drawing made first as in Fig. 1, using a tool bit ground as shown in Fig. 4. A right and left-hand tool of this kind will take care of all contours. After the cutting head has been turned, it is finished with die-sinkers' files and polished with fine emery cloth. Then the shaft is turned; it should not be less than  $\frac{1}{4}$  in. in diameter for speeds of 5,000 r.p.m. or over. Next, four equidistant cuts, Fig. 2, are made slightly deeper than the smallest diameter of the cutting head and the metal behind each cut is filed away as shown in Fig. 3 to provide the necessary clearance—but not entirely to the next cut as the high spot left will serve to polish the molding. After sharpening the cutting edges, the heads are hardened by heating to a cherry red and plunging in water. In use, a fence is clamped to the drill-press table and light cuts taken.

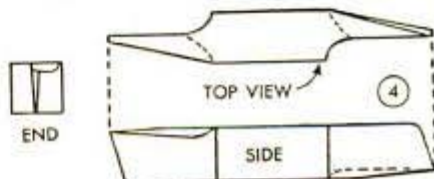
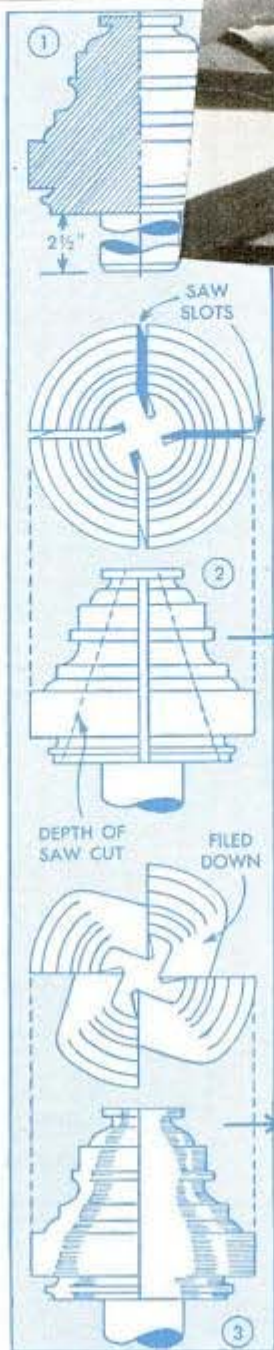

## Slipping of Roofer's Tool Box Avoided by Hack-Saw Blades



HACKSAW BLADES ATTACHED TO EACH END OF TOOL KIT

To keep his tool box from sliding while repairing a sloping roof, one workman fitted it with nonslip feet. These consist merely of a couple of hack-saw blades tacked to the ends so that the teeth project slightly below the bottom. When not needed, the blades can be removed by pulling out the nails.

## Wheel "Shoes" Hold Implements Stationary in Trailer

Instead of tying a wheeled farm implement to keep it stationary while hauling it in a trailer, one farmer uses these wheel shoes or chocks, which are attached or removed quickly. The shoes are cut from

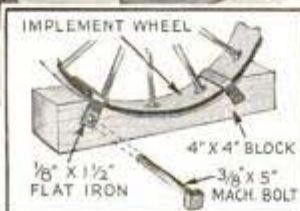
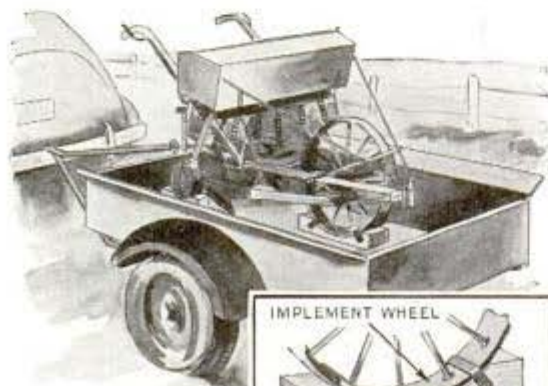

4 by 4-in. stock (or heavier, if necessary) and are fitted with U-shaped clips of flat iron which slip over the wheel rims and are bolted to the shoes as indicated.

## Demagnetizer for Hand Tools

Machinists and others who work with magnetic chucks and find that their tools become magnetized and pick up metal filings and dirt, will find this demagnetizer handy.

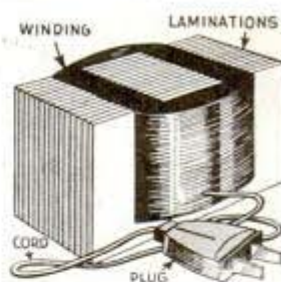

It is nothing more than a choke coil from an old radio B-battery eliminator. The legs of the coil are removed so that the top laminations will slip off. The original windings are used, and an extension cord is connected to them for plugging into an outlet for 110-volt current. The tool to be demagnetized is placed on the coil and the current turned on for a few minutes.

## Simple Tool Fastens Metal Bands Around Large Boxes

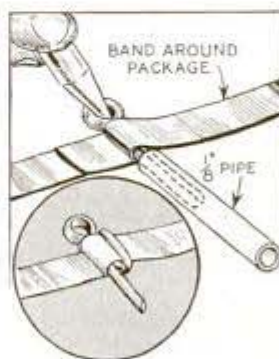

The next time you have some banding metal on hand and want to use it on a large, heavy box, you can pull it up tightly and fasten it by using a cotter key and a short piece of small pipe or tubing. After overlapping the

ends of the metal, slip the key astraddle of the metal at the joint and roll it, using a nail or small rod through the eye of the key for leverage. The pipe or tubing is slipped over the legs of the key to keep them from spreading. When the band is tight, remove the pipe and bend one of the key legs over the band.

☐ If you wish to avoid weakening the flavor of your beverage as the ice cubes melt, pour a bottle of the flavor desired in an ice-cube tray and freeze it. Then use these cubes to cool drinks of the same flavor.

# Quick-Acting Vise Holds Flat Work on Bench

Consisting mainly of an eccentric disk bolted to an adjustable bar, this quick-acting vise is especially handy for holding flat work on a bench while planing and sanding it. The 8-in. disk is cut from a piece of hardwood after which a hole is drilled in it off center for attaching to the slotted steel bar. Two bolts hold the bar in place while a strip of hardwood near the bench edge provides a stop for the work. In use, one edge of the work is placed against the stop, the sliding bar is adjusted and the disk is turned until it bears against the edge of the work.

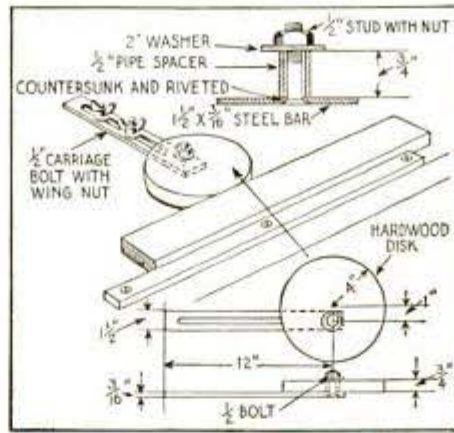

# Tool Cabinet Has Sliding Racks and Occupies Small Space

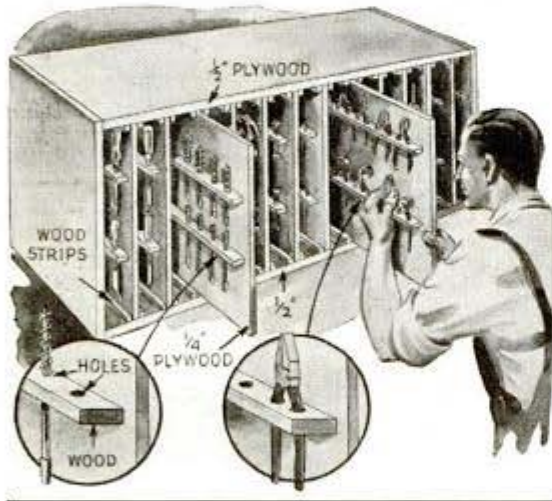

In shops where only a small amount of space is available, this handy cabinet will be just the thing for storing tools within easy reach of the bench. While almost any wood can be used to make the ends, top and bottom of the cabinet, plywood or hard-pressed board is recommended for the tool racks which are cut slightly undersize and slide between small cleats screwed or nailed in place. As each rack is fitted with holders to accommodate specific tools, it's a simple matter to locate any tool desired when needed.

## Band-Saw Kinks That Help

If the blade of a band saw drags in the cut or pulls sidewise so that the line cannot be followed, check the set and sharpness of the teeth and the adjustment of the guides. When changing from one blade width to another, or when putting on a new blade for the first time, always retract the upper wheel and readjust the upper and lower guides to suit. To line up your saw properly, make sure that the table rests on a leveling screw and, by setting a combination square on the table with its edge against the blade, the saw can be lined up by adjusting the guide pins.

## Hog Oiler Is More Practical When Set at an Angle

This simple hog oiler is made by wrapping several thicknesses of burlap around a post set in the ground at an angle of about 45 degrees. In this way, the animal can scratch its back as well as its sides.

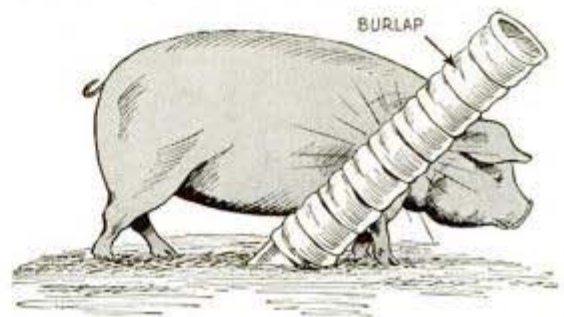

## PART 5

BASIC  
METAL-WORKING  
MACHINES AND  
HOW TO USE THEM



The large vertical miller above uses a 12-in. cutter with inserted teeth, which mills a flat surface and faces a projection on the work simultaneously. Right, a small but efficient horizontal bench miller with a V-belt drive and quick-change countershaft. It has a hand-operated screw feed, rapid lever feed and reversible automatic longitudinal table feeds

## MACHINE GUNS! *of Production!*

Unified and concentrated action, harnessed to American resources and manpower, means national production at machine-gun tempo. Such action depends on individual effort, efficiency, ability and knowledge in using tools. If you can serve in this capacity, don't fail to read these articles on basic machine tools and then apply yourself to studies in the particular work for which you are best suited. For your further studies, a list of outstanding books pertaining to this field will be sent to you upon request. Write to Shop Notes Editor, Popular Mechanics Magazine

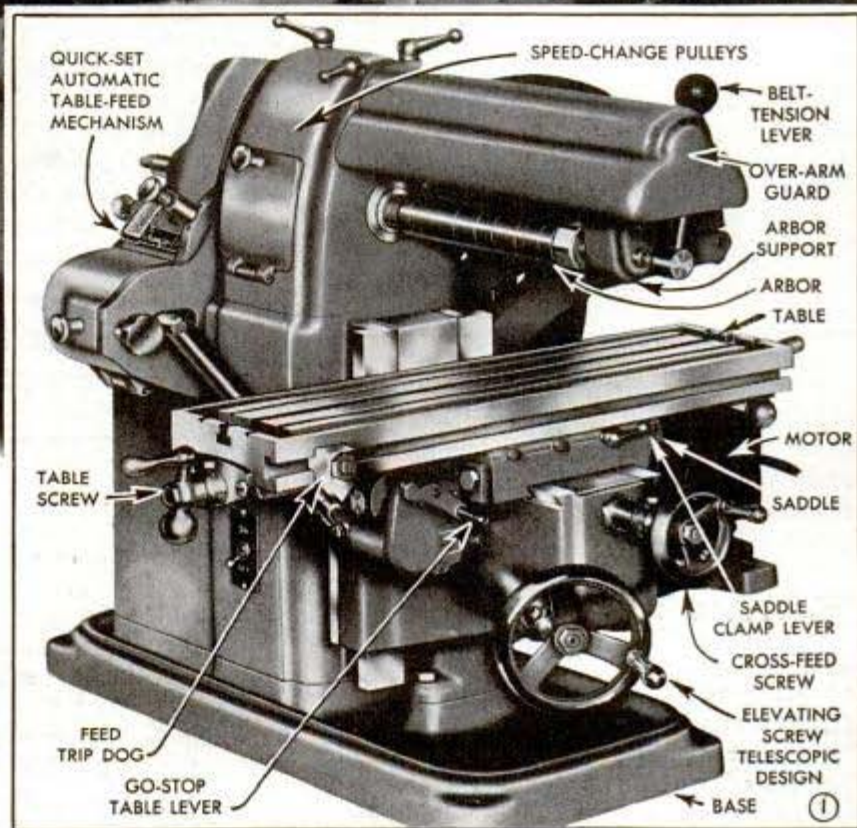



# The mechanics of a MILLING MACHINE

By H. J. Chamberland

REGARDLESS of its size, no machine shop is complete without a milling machine, although milling on a minor scale can be done in a lathe provided with a milling attachment, which is common practice in amateur and small experimental workshops. However, production milling requires the use of specially designed machines, of which there are many types ranging from the monster heavy-duty machines to small bench millers such as the one shown in Figs. 1 and 2. Although the conventional milling machine is the horizontal-spindle type, there are vertical-spindle milling machines, and vertical heads for horizontal type millers are available. Vertical milling machines are especially designed for cutting irregular contours, edges and curves without the use of form cutters. Other machines are designed to cut in both planes and intermediate angles.

**How millers work:** In milling machines the basic idea is to duplicate regular and irregular shapes in pieces of metal. The work is clamped to a table, in a vise or indexing head attached to the table, and is fed against one or more rotating cutters which remove metal from the work until the cut corresponds in shape to that of the cutting teeth. Cutters are made in a variety of shapes so that the range of cuts possible is almost unlimited. The machine is driven either from a countershaft or by a train of gears in order to obtain various cutting speeds. The table can be fed longitudinally against and past the cutters either by hand or automatically.

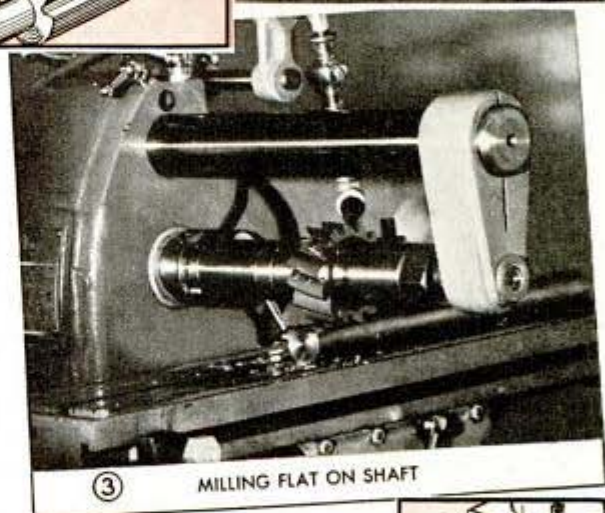
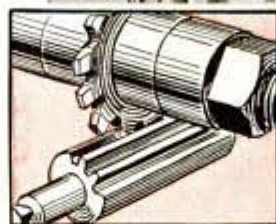
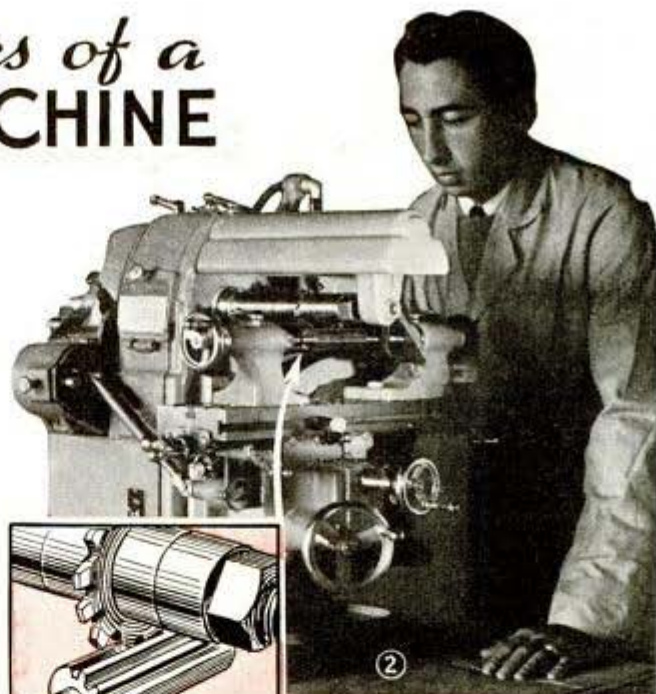

MILLING FLAT ON SHAFT



MOST COMMONLY USED PLAIN CUTTERS

⑥ SHANK-END MILL FOR INTERNAL CUT

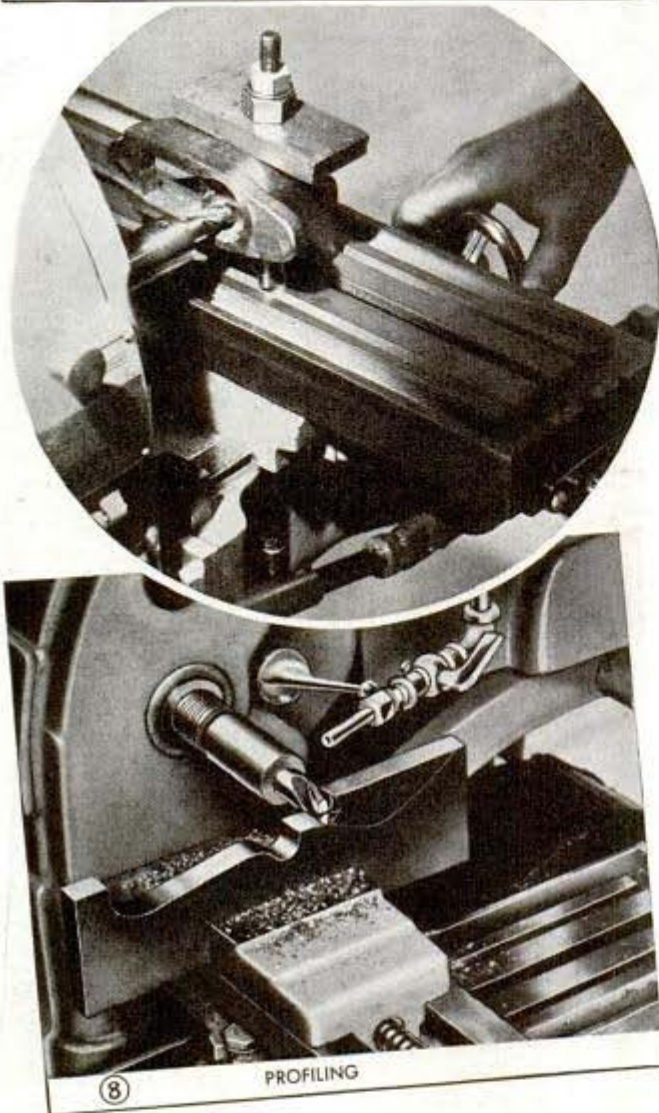

Also, it can be moved transversely and vertically. The feed is variable and is sometimes independent of the spindle speeds. As the nature of the work varies, there are no fixed rules governing speeds and feeds, but the table in Fig. 7 gives the general recommendations for peripheral speeds. The diameter of the cutter multiplied by 3.1416, multiplied by the arbor r.p.m. gives peripheral speed in inches per minute. This divided by 12 gives the feet per minute, (f.p.m.). Feeds on a milling machine are determined by the nature of the material, type of the cutter used, the rigidity of the machine and the work on the table, as well as the finish desired. Cutters are held in the desired position relative to the work either on a shank that fits the spindle or on an arbor, one end of which fits the spindle and the other a supporting arm. There are different styles of arbors for light and heavy work. The cutters are spaced on the arbor by means of collars, and a nut at one end of the arbor tightens the whole

⑦ Peripheral Speeds for Milling Cutters

Material	Ft. Per Min.
Extra-tough steel	50-60
Regular tool steel	60-80
Machinery steel	80-100
Cast iron	70-100
Brass, bronze and aluminum	150-200

assembly uniformly. However, for heavy work, a cutter may be keyed to the arbor. Most small cutters are single units but on large ones the blades are often separate, fitting into slots cut in the body and locked securely in position by means of tapered bushings, then fastened with screws. For certain jobs such as milling spirals, an indexing head which rotates, and to which work is attached, is fastened to the table and is geared to the table-elevating screw so that the work can be rotated at uniform speed while being fed against the cutter.

**Plain milling cutters:** Fig. 3 shows a cutter mounted on the arbor and used in milling a flat on a shaft. This is a plain milling cutter. A similar one is shown in

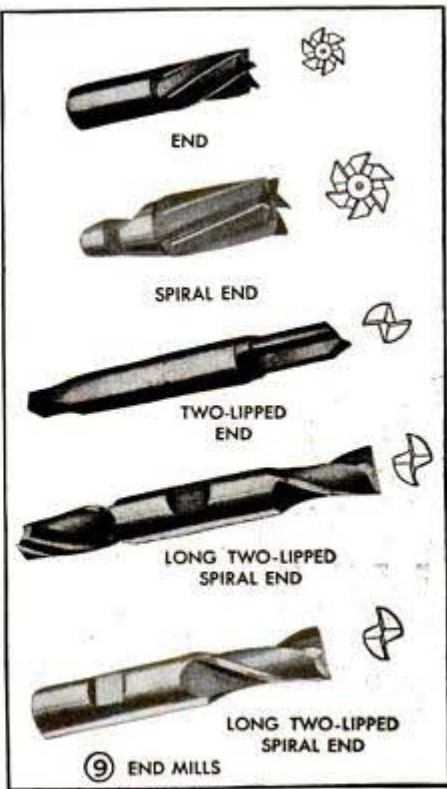



Left, work is held in an indexing head, which can be rotated, for milling evenly spaced radial slots. Below, two identical side mills used together to cut two slots in one operation

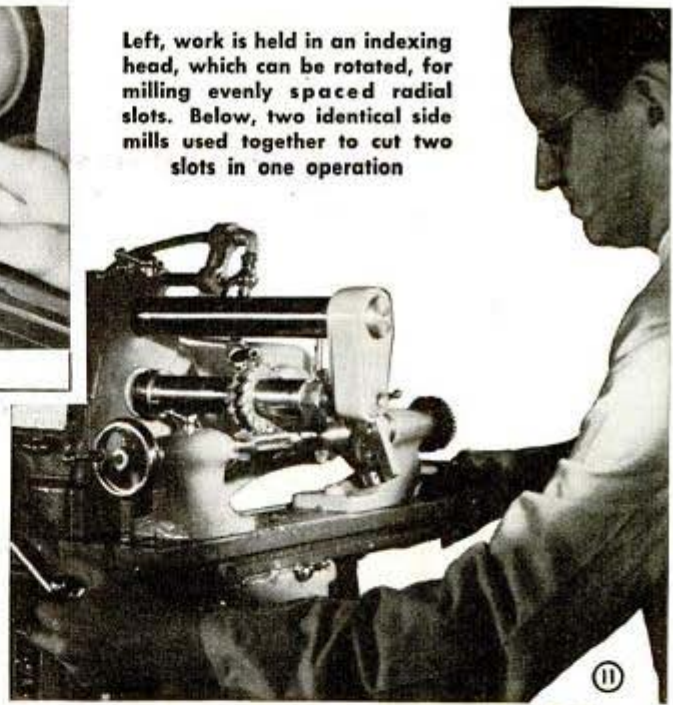
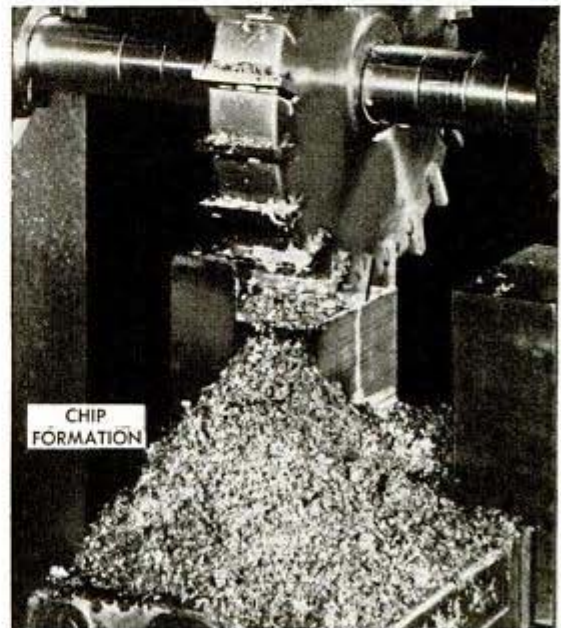
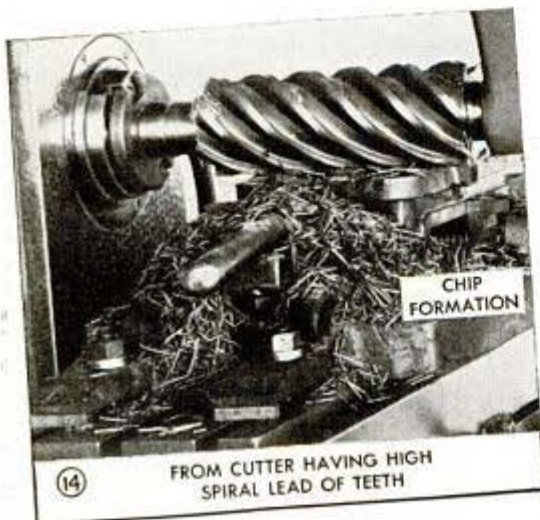

Fig. 5A. Cutters of this type are intended for taking light and medium-depth cuts at normal feed. Fig. 5B shows a high-power, coarse-tooth, plain milling cutter that will stand a much greater depth of cut and rate of feed, requiring less power due to fewer teeth contacting the work, sharper tooth spiral and more room for chips. It operates horizontally only and is intended to take a straight cut. Another type of plain milling cutter that cuts with its sides as well as its periphery, is shown in Fig. 5C.

**End mills:** The use of a shell end mill in a facing operation is shown in Fig. 4. Notice that this cutter is not fastened on the regular arbor but is held on an arbor especially designed for it, which fits the spindle. Also it cuts with its end as well as its periphery. Another cutter having the same purpose is a shank end mill, Fig. 5D. This one can be used also for internal milling as in Fig. 6. Although shank end mills are able to cut two surfaces simultaneously,



13 FROM CUTTER HAVING STRAIGHT TEETH



(16)

MILLING TEETH IN BEVEL GEARS

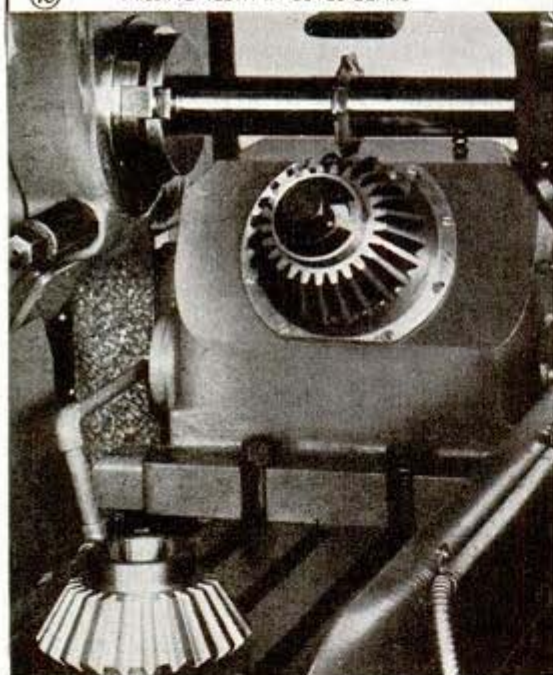
(18)  
GEAR  
CUTTERS

(19)

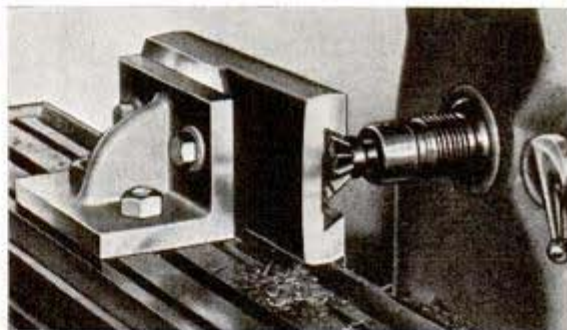

(17)

MILLING DOVETAIL WITH ANGULAR CUTTER

those of small diameter are intended for cutting at the end only. Another frequent use for end mills is the operation shown in Fig. 8, which is known as profiling, and necessitates progressive milling adjustments. Various types of end mills are also shown in Fig. 9.

**Side mills:** Side mills are the next most commonly used tools on milling machines. Cutting with these mills is done mostly with the sides of the teeth. In Fig. 10 such a cutter is used for milling evenly spaced radial slots in a part bolted to an indexing plate. Many side mills must retain their exact width for quantity production and are therefore made of two interlocking parts so that thin collars can be inserted between the parts to compensate for side wear and repeated sharpenings. As shown in Fig. 12, side mills are of different types. Those having spirally cut teeth are generally more productive than those having straight cut teeth; those having the spiral or angle of the teeth alternately right and left will stand maximum depth of cutting and feeding, and are considered most productive. Two identical side mills are used together frequently as shown in Fig. 11 so that two slots can be milled in the same time it takes to do one.

**Chip formation:** Figs. 13 and 14 give a fair idea of chips formed by straight and spiral-edge cutters. The one used in Fig. 13 is a large side mill having removable straight teeth. Chips produced by a straight-tooth cutter or one having only a



FORM CUTTERS

(20)





21 TEETH GENERATING HOBS

slight spiral, are more or less broken up. When the mill has a pronounced spiral and particularly when it has a lead (angle of the spiral edge to axis of tool) such as shown in Fig. 14, the tool performs with a shearing action, requires less power with increased feed, the surface milled is precisely flat, and the chips are more or less rolled. The cutter in Fig. 14 is a helical mill; sometimes a pair of them are used end to end, one having a right-hand spiral and the other a left-hand spiral. When a very wide surface has to be milled in a single pass, an assembly such as shown in Fig. 15, called a slabbing mill, is used, its size being limited only by the size and rigidity of the milling machine itself.

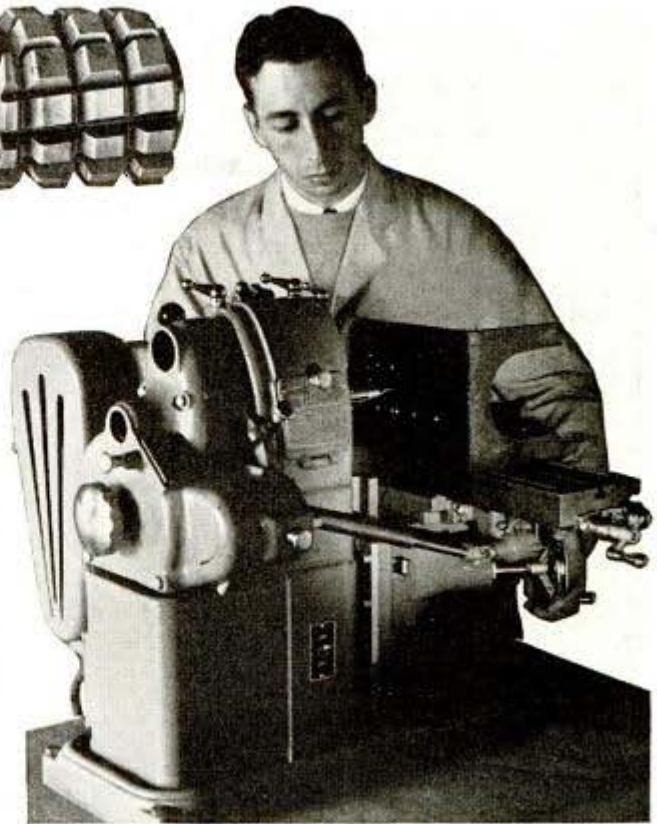

22 DRILLING EVENLY SPACED HOLES

**Angular cutters:** Angular cutters play an important part in milling technique and save considerable time over producing angles in a shaper. These cutters are made for right and left-hand milling, (arbor turning counter clockwise and clockwise respectively) and cut either single or compound angles with peripheral teeth only, or with peripheral and side teeth. With compound-angle cutters, both angles may be the same or different. An angular cutter such as shown in Fig. 20E is used on a regular arbor but angular cutters used for dovetailing as in Fig. 17, have threaded holes and are fitted to special arbors fitting the spindle.

**Form cutters:** In form cutters the teeth are ground to the desired form, which never changes because only the face of the

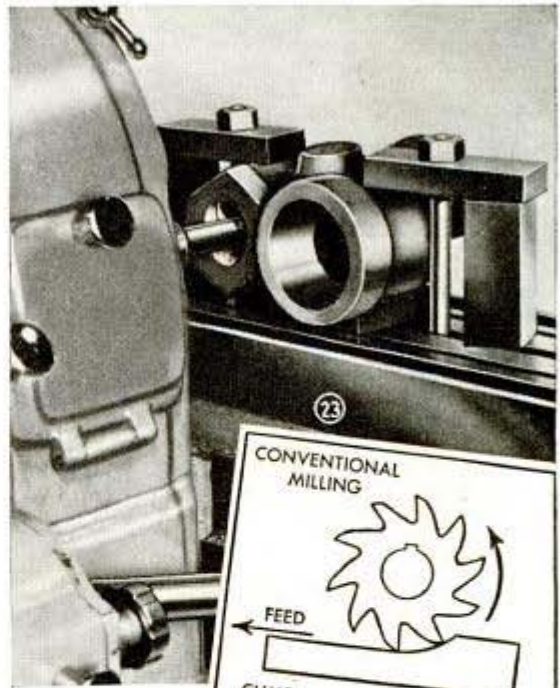

23

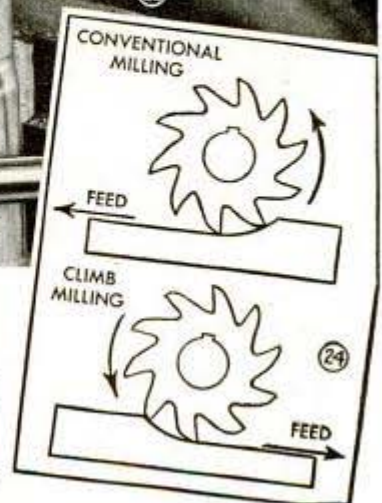

24



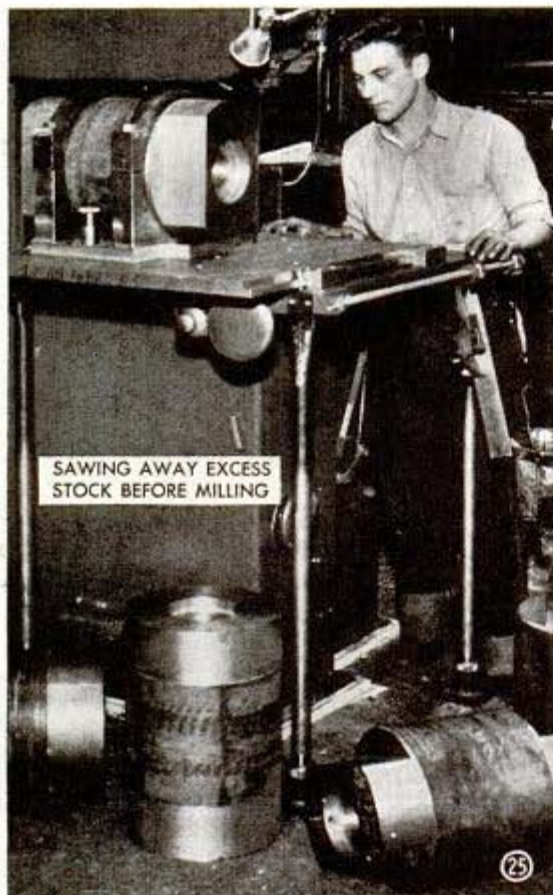

SAWING AWAY EXCESS STOCK BEFORE MILLING

25

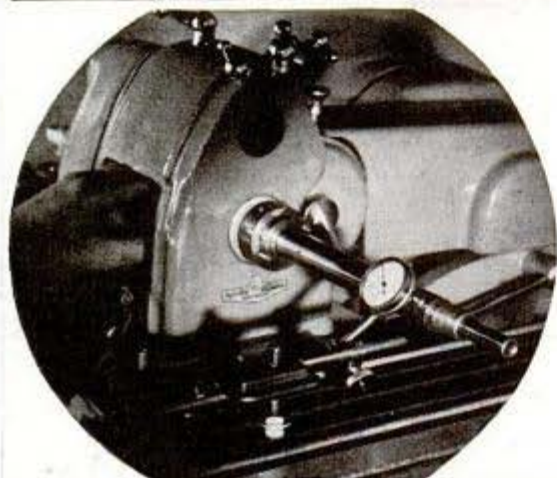

27 CHECKING ARBOR FOR RUN-OUT ERRORS

teeth are ground when sharpening. Form cutters are strictly quantity-production tools designed and made for certain jobs and are not used for odd milling jobs. Fig. 20 shows a few regularly used form cutters. A is a convex cutter and will make a concave cut, reproducing the half circle or segment thereof. B is a concave cutter and mills a convex shape. C shows the appearance of a cutter similar to B after repeated sharpenings; note that the form never



26

TWELVE SURFACES MILLED AT ONE TIME

changes. D is a form style angular cutter used to mill spiral teeth. A milling machine equipped to cut spirals is called a fully universal milling machine. Cutters E and F of Fig. 20 are for rounding corners, being available in various radii. They eliminate extensive and costly filing. Gear cutters, Fig. 18 are also form cutters. Gears being cut are mounted on an indexing head, Fig. 19, so that the teeth will be spaced equidistantly. Fig. 16 shows a special fixture for indexing teeth of bevel gears. Generally a roughing or stocking gear cutter is used first and then a finishing cutter is used to produce teeth of maximum accuracy. The three formed cutters shown in Fig. 21 are teeth generating hobs. Unlike the conventional gear cutting method, the hobbing method produces teeth by the hob advancing continuously as the blank rotates. It is used to produce teeth on spur, spiral, herring-bone and worm gears, worm and spline shafts and ratchets.

**Laying out holes and boring:** Owing to its universal adjustment facilities, a milling machine can be used for laying out holes as shown in Fig. 22, although of course, special layout equipment is given preference for such work. Holes can be spaced with precision if the milling machine is in good shape and backlash has been eliminated. Fig. 23 shows how a milling machine is used for boring operations in jig and fixture work.

**Climb milling:** During recent years a new technique known as climb milling has been introduced, Fig. 24. In conventional milling, the work moves in a direction opposite to that of the cutter, but in climb milling, both cutter and work travel in the same direction. This technique helps to keep the work down, whereas in conventional practice the work has a tendency to rise. Another advantage of climb milling

is that a roughing cut can be taken on the forward stroke of the table and a light finishing cut can be taken on the return stroke. However, climb milling should not be attempted on a worn milling machine. In equipment intended for using this technique, provisions have been made for the purpose.

**Economy of time and material:** Sometimes waste of material from milling can be kept at a minimum by using a metal-cutting band saw to cut away excess stock that would otherwise have to be removed by milling. Often the stock thus removed in single pieces can be used for other purposes and the time saved over milling away the excess stock is considerable on many production jobs. For example, milling four sides on each 350-lb. Diesel engine wrist-pin required 7 hrs. By bandsawing away excess stock as in Fig. 25, the work was done in 2 hrs., and four pieces of steel totaling 50 lbs., were saved from each part. The waste of rejected parts can also be minimized by checking regularly to determine whether the spindle is running perfectly true, which can be done with a dial indicator as in Fig. 27. Waste of time also results from dull cutters and therefore it is necessary to keep them sharp. Another saving in time can be made by grouping a number of cutters in a gang as shown in Fig. 26 where twelve surfaces are milled simultaneously instead of separately.

Next month: Precision Grinding

## Keeping Bristles of Scratch Brush In Good Condition

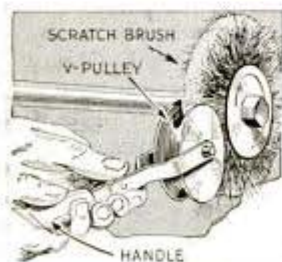

Continued use of a scratch wheel or brush on flat or straight surfaces tends to cause the steel bristles to flare outward, thinning the number of points in the center and lowering the efficiency of the wheel. To avoid this, I straighten the bristles by holding a V-pulley against them while the wheel is rotated. Any tendency of the bristles to bend backward from the direction they rotate can be eliminated by changing the wheel on the mandrel so that it rotates in the opposite direction.

—W. C. Wilhite, Carlinville, Ill.

JULY, 1942

## Easily Made Lathe Follower Rest To Handle Long Slender Stock

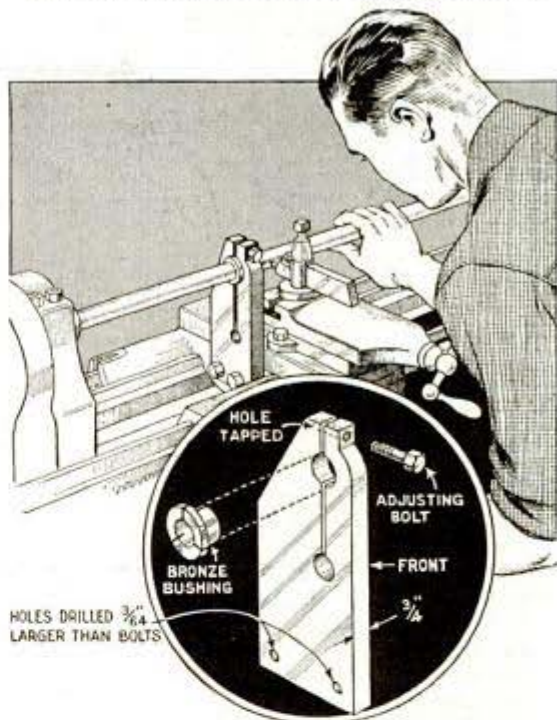

Often my job requires turning down and threading slender shafts, most of which are used as cross feed screws for lathes, which require square threads. To provide a firm support for this type of work, I made and used this simple follower rest, which is attached to the lathe carriage. It consists of a  $\frac{3}{4}$ -in. piece of flat steel shaped, slotted and drilled as indicated. A bronze bushing is provided in which the work rotates. In use, the rest is slipped over the work to hang freely and then the carriage is lined up with the free end of the rest and bolted into position, assuring perfect alignment.

—B. F. Bowman, North Weymouth, Mass.

## Scraper Removes Rust From Pipe

Having several hundred feet of used pipe to clean of rust and corrosion, one contractor found that a scraper made like the one shown was superior to a steel brush.

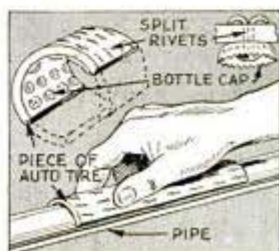

The scraper is made by riveting several rows of bottle caps to the inside surface of a piece of old automobile tire. Each cap is held by a single split rivet.

153

## Weatherstrip on Edge of Counter Holds Glass for Cutting



To keep a pane of glass from slipping while cutting it, a hardware man tacked a length of weatherstrip along the edge of the counter so that the rubber portion projected about  $\frac{1}{4}$  in. above the top. By placing the glass so that the end rested on the rubber, it was held securely while using the glass cutter.

## Building Kink for Contractors

On alteration jobs where a large floor is divided into many smaller rooms, half-rooms or offices it soon becomes quite a problem to move long scaffold planks from room to room without damage to walls,

corners or edges. Under such circumstances it will be found a good idea to leave a large enough opening suitably located in the dividing wall between rooms so that planks may be passed directly through these openings. The openings are closed easily at the conclusion of the job.

## Inexpensive Rack for Golf Bags Made of Flat Iron

Golfers will appreciate this rack, as sturdy partitions are provided to keep each bag of clubs in an upright position. It is simple to make from short lengths of flat iron by bending them in the shape of half circles to form partitions, after which they are screwed to the side of a building or heavy framework.

—Albert Mayhew, Pasadena, Calif.

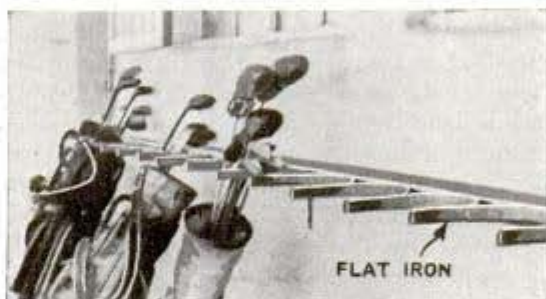

## Forty Motor-Driven Tools You Can Make

Do you want a motorized workshop that is inexpensive, will speed up your work and do it accurately? Then don't fail to get this amazing book! It shows every detail and explains in non-technical style just how to go about making forty different machines. The material used to build them is available almost anywhere—standard iron and brass stock, wood, pipe, old auto parts, etc., which can be picked up for almost nothing. If you want to earn extra money by making things in your spare time to sell, you'll need to employ fast production methods only possible with motorized equipment. Building just one of the tools described in this book will pay for it many times. Send for your copy now and start making the machine you want.

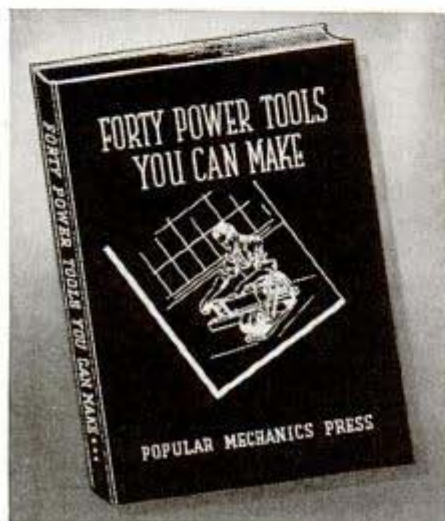

**Only \$1.25 postpaid**

(money refunded if you are not satisfied)

### SOME OF THE MACHINES DESCRIBED

- |                     |                        |
|---------------------|------------------------|
| 10-In. Circular Saw | Stroker Belt Sander    |
| Midget Circular Saw | Hand Belt Sander       |
| Sliding Cut-off Saw | Small Shaper           |
| Scroll Saw          | Heavy Duty Grinder     |
| Band Saw            | Small Portable Grinder |
| Drill Press         | Metal-turning Lathe    |
| Wood-turning Lathe  | Hack Saw               |
| Disk Sander         | Filing Machine         |
| Belt Sander         | Milling Unit           |
| Drum Sander         | Abrasive Cut-off Wheel |

### POPULAR MECHANICS PRESS

Dept. 400 200 E. Ontario St. Chicago





# Radio

## Centralized Sound System Serves Eighty Rooms

**D**ESIGNED for large modern schools, this table model centralized sound system has a capacity for handling up to 80 room speakers and the system will distribute a microphone, radio, or recorded program to any group, or all room speakers. An independent intercommunicating system allows two-way conversation between the main office or any room of a school without interfering with the program in progress. It will also pick up a program, or special recitations, in any room and distribute them to any other rooms simultaneously.

A phonograph unit is housed in a drawer in the main cabinet as will be noted in photo A; this plays 10-in. and 12-in. records and the recorded programs can be distributed to any of the room loud-



speakers desired. A single-button emergency call switch permits immediate call over the entire system irrespective of any switch settings or programs in progress; this feature is important in case of fire or air-raid alarms. Additional features include monitoring loudspeaker, push-button tuning radio

with reception of domestic and foreign broadcasts, and provision for remote control of volume.

Microphones of all types may be used; photo B shows a lightweight, close-talking variety used with a "third hand" mike holder that is supported with a neck band. A flexible gooseneck holding the microphone is adjustable, does not obstruct the view, and leaves both hands free.



# "BEGINNER'S SPECIAL" ONE TUBER

By Stanley Johnson

THIS is No. 1 of a series of "V" sets for students and experimenters. Each set will be a complete and thoroughly tested unit built from junk box parts, and many of the same parts will be used in progressive sets to follow. Simple hand-wound coils, breadboard construction and parts of non-critical values give the builder an opportunity to use odds and ends.

Now is the time for the student and experimenter to save old wire, coil forms, condensers and resistors to build up a junk box that will provide a means for assembling useful units for study and practical radio experimenting. Advancing students and experimenters will find interesting possibilities in several of the Special "V" units to be described.

Made-to-order for the beginner, this one-tuber employs a type-1Q5-GT tube commonly used in battery portables; the circuit and layout has been planned to allow adding another tube and hand-wound plug-in coils at a later date. The same baseboard, and all parts will be used except the coil. Sufficient time will elapse between the first two sets to permit the builder to complete and become familiar with the operation of the first receiver before starting the second. In the meantime an extremely simple B-eliminator will be described next month, and this will constitute Part 2 in the "V" series.

The coil is wound on the cardboard tube case removed from a standard size "D" flashlight battery; see Fig. 1 for complete details. The first step is to punch two holes in the tube with a needle, about  $\frac{1}{16}$  of an inch from the end of the tubing and about

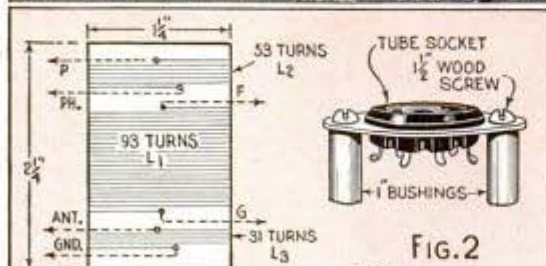
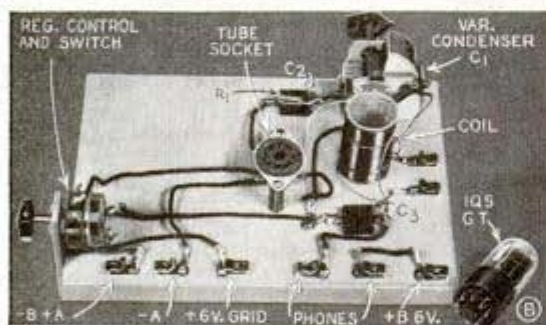

NO. 30 ENAMEL WIRE FOR L<sub>1</sub>, L<sub>2</sub>, L<sub>3</sub> (ALL COILS CLOSE-WOUND IN SAME DIRECTION AND SPACED  $\frac{1}{8}$  APART) FIG. 1

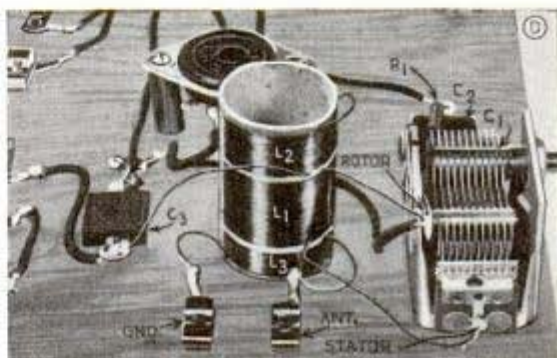
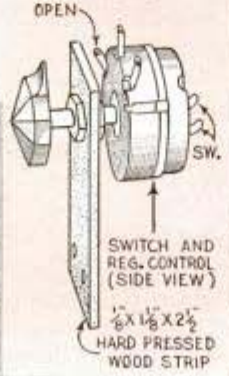

# WORKS on 6 FLASHLIGHT BATTERIES

$\frac{1}{4}$  in. apart. Thread No. 30 enameled wire through the holes, leaving a lead about 5 in. long for connecting as indicated in photo C; now that the wire is anchored, start the 31-turn antenna winding ( $L_3$ ), rotating the form with one hand and guiding the wire with the other. Punch two more holes at the end of the 31st turn and clip the wire, leaving a 5-in. lead and anchoring the wire as at the start. Now in exactly the same fashion, start the 93-turn tuning coil ( $L_1$ )  $\frac{1}{8}$  of an inch from the antenna coil. The 53-turn "tickler" coil ( $L_2$ ) completes the coil-winding job.

Mounting details for the tube socket, regeneration control and switch appear in Fig. 2. The 1-in. bushings may be cut from any kind of metal tubing available. Select a piece of  $\frac{3}{4}$ -in. clear pine wood, cut to size indicated in Fig. 3, and then sand it smooth. Now mount the various parts in the positions indicated in this simplified wiring diagram. Make sure that the key slot in the center of the tube socket is in the position shown so that the terminal markings given will be correct. Drill and countersink a hole for an 8-32 machine

(Continued to page 170)

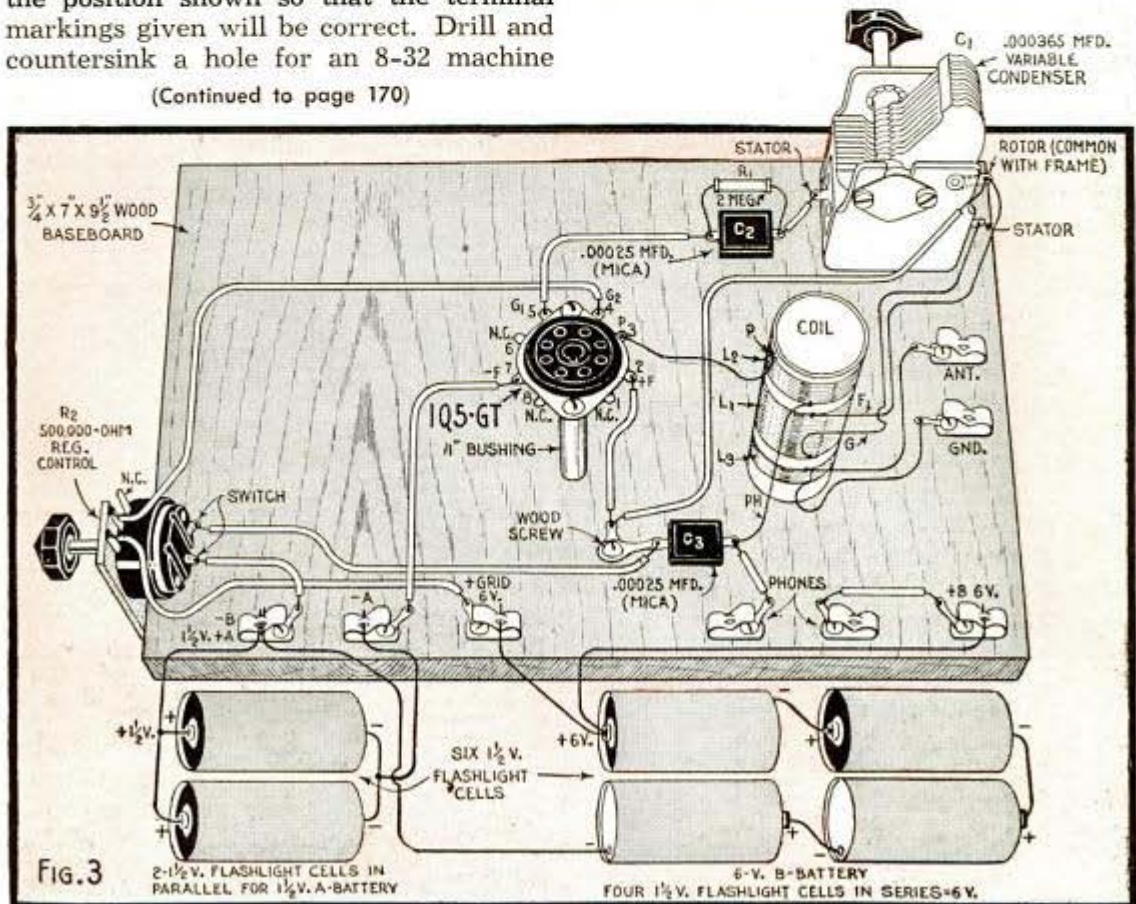
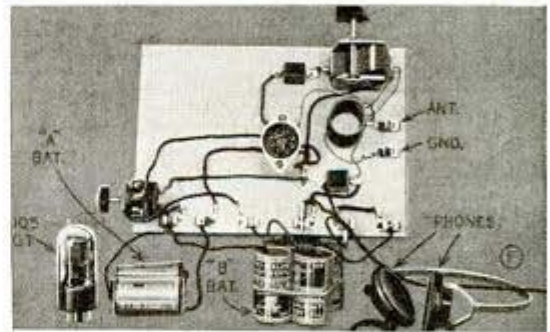

# First Aid Suggestions for Your Radio Sets



## PART II

**C**ONTINUING the first-aid steps outlined in Part I of this series of self-help articles for set owners, you, as "Mr. Average Set Owner," are removing the tubes from your receiver that suddenly "went dead" during an important broadcast, preparatory to taking them to the store for testing. In ordinary

times you probably would have called a radio serviceman, but now you realize that many of them are in the armed forces therefore fewer are available for routine service calls, and you are doing what you can to help yourself.

As tubes are the heart of any radio set, they immediately come under suspicion when the set lacks volume, develops poor tone or goes dead. It is not always necessary to remove the set chassis from the cabinet in order to take out the tubes, especially in console receivers where there is plenty of room above the tubes, and we are now dealing with that type.

The first important thing to do in all cases, is to remove the power cord plug from the wall socket before you touch the set chassis. Now move the console cabinet out from the wall for examination. Have a

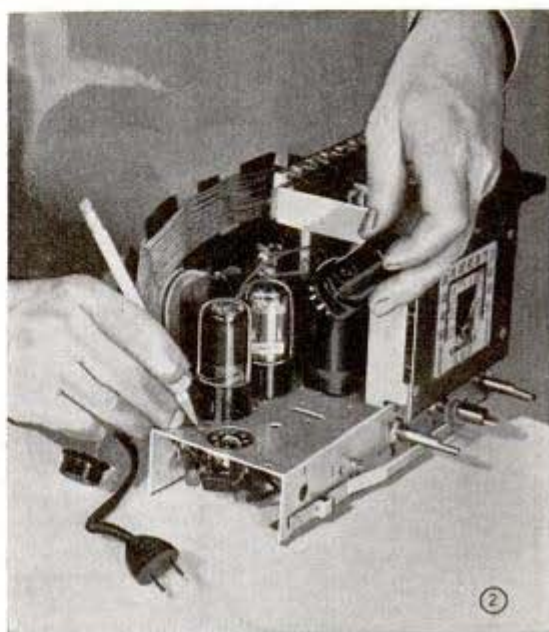
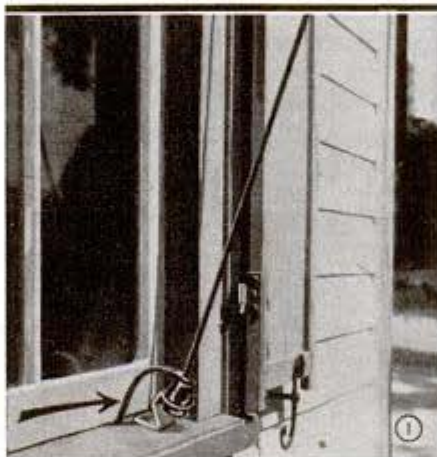

floor lamp or flashlight handy so that you can light up the interior of the cabinet. Disconnect the antenna and ground wires if they are in the way, but be sure to tag them first so that you can replace them correctly.

Now resist the temptation to dust off the tubes and chassis. A little dust will do no harm but a dust cloth flirited around inside a radio receiver will break delicate leads and interfere with critically adjusted parts. You will note that the tubes are of various shapes, and some of them probably will be shielded in metal cans, or shells. In many cases there will be a flexible lead terminating in a cap that fits on top of the tube.

terminating in a cap that fits on top of the tube.

Please remember that each type of tube belongs in a certain socket which should be clearly identified for that tube. This important point was mentioned in Part I of this series and is repeated here in case you did not have a copy of the June issue. If there is no tube layout chart

(Continued to page 174)

# Practical RADIO HINTS

(A) Easily erected lightweight bamboo mast to elevate ultra-high frequency antenna well above the house. It provides a handy means for experimenting with FM, AM and television antenna systems as the mast can be erected and taken down quickly by one person. The mast proper consists of three fairly heavy 10-ft. lengths of bamboo; these pieces should be of three diameters to provide for 1-ft. telescoping joints made as shown in the sketch. Fill joint spaces with casein glue or other waterproofing compound, wrap with cord as shown and seal joints with paint or spar varnish. Mast support is a 2-ft. length of iron pipe closed at the lower end with a deck flange and supported with strap-iron brackets

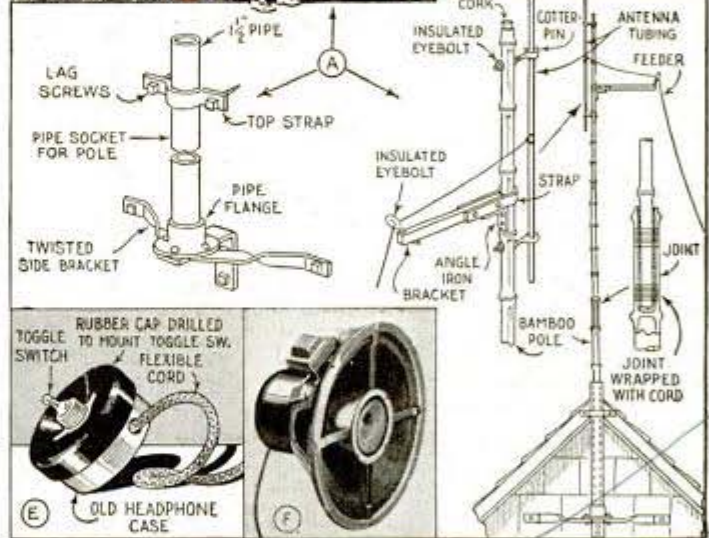

(B) Thumb protector for wire stripping; (C) Corks replace rubber feet on microphone stand; (D) Touch-up kit for repairing scratches and dents in wood or plastic radio cabinets; (E) Case from old headphone provides handy portable mounting for remote control switch; center hole is enlarged for toggle switch and a hole is drilled in side of case for cord; (F) Coaxially mounted speakers for both low and high frequencies; designed for FM, television sound, AM and phonograph records; (G) Emergency cord tips made from bobby pins, scrape bright and solder leads as shown; (H) Home recording kit designed for use with sets using "Webster-Chicago" record changers; (I) Tags identify cords in multiple outlet plug

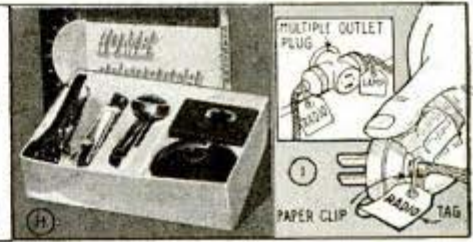
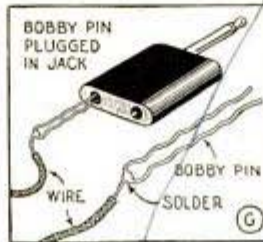

*Abrahamson Carbon  
Telephone Mfg Co. Rochester, N.Y.*

*Welltronic Corp*

### Two-Way 'Handset' Radiophone



Completely self-contained, this combination transmitter and receiver weighs only 4 pounds and is not much larger than the handset of a "French" telephone. It is being made available to governmental agencies and services, including municipal divisions, public utilities, fire and police departments. Power is supplied with batteries, and the range is upwards of a mile over land. The change-over switch is finger operated, and an adjustable "fish-pole" antenna is employed.

### Portable Dual-Speed Recorder



Complete with amplifier, microphone and 8-in. built-in speaker, this recording and playback assembly is designed for schools and other applications where it is desired to provide recordings of up to 24 minutes on a 10-

*Atlas Sound Corp*

in. record. It plays all records up to 12 in. and may also be used as a public address amplifier; audio power output is 5 watts.

### 1443-39th Brooklyn Speaker Baffle Is Bi-Directional

Designed for paging and inter-communication systems, in national defense factories, army barracks, airports and other locations requiring extensive sound coverage, this two-directional sound projector consists of a pair of individual sections, between which a single 8-in. cone unit is mounted; bells are 21½ in. in diameter.



### All-Purpose Chairside Unit

Practically nothing but television reception has been omitted from this chairside radio which provides frequency modula-



tion, standard and short wave reception, plus the automatic playing and changing of phonograph records. All controls are within easy reach for station finding and band selection.

Blueprints covering simplified radio construction articles in this and past issues are available for 25c each. Many popular tested circuits for beginners, students and experimenters may be built with used parts. Detailed material lists can be obtained from Popular Mechanics Radio Department upon receipt of postage.

**NEXT MONTH—A.C.-D.C. Inter-Room Communicator System.** A simple two-way time-saving hookup that includes a signal tone for calling, and operates up to 3 sub-stations. Non-critical specifications permit experimenters to use many old parts. Also—**B Eliminator for "Beginner's" Sets and Home Set Service, Part 3.**

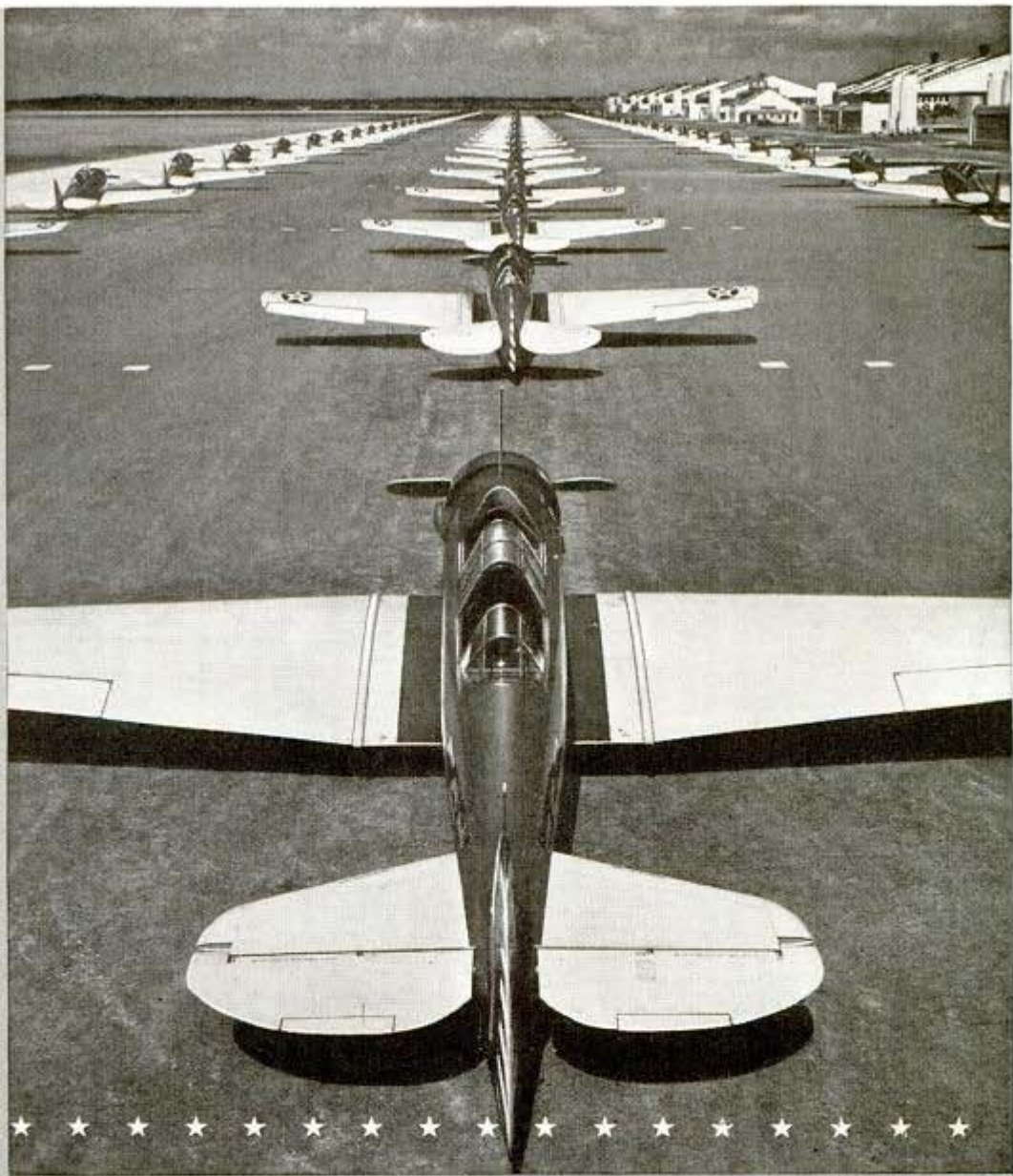

### **PATTERN PICTURE—1942**

Photograph of low-wing BT's (basic trainers), made at Randolph Field, Texas, by Master Sergeant Albert L. Barr. 1/50-second; K-2 filter; *f*/16; Kodak Super-XX Film. Kodak Super-XX is a high-speed panchromatic film widely used both for indoor photography and for outdoor

work under adverse light conditions or at high shutter speeds. Rolls, packs, sheets.

**There is a Kodak Film especially designed for every picture-taking purpose . . . Meet the complete Kodak Film Family at your Kodak dealer's . . . Eastman Kodak Company, Rochester, N. Y.**

**THE GREAT PICTURES ARE MADE ON KODAK FILM**



## ... EASY TO READ

—easy to clean—unconditionally guaranteed for one year. The crack-proof white surface is bonded to the steel—protects it from rust. 25, 50, 75, 100 ft. lengths. Sold by hardware, building material, mill supply dealers everywhere. Write for folder. KEUFFEL & ESSER CO., Hoboken, New Jersey



T. M. Reg. U. S. Pat. Off

LOOK FOR THIS DISPLAY



## K&E WYTEFACE STEEL MEASURING TAPES



HANDBOOK—How to Make and Use Bows and Arrows—90 Pages well illustrated (with catalog) 35c.  
CATALOG—100 pictures—color spread—Instruction Folder, 10c.  
CATALOG alone 5c. Stamps or Coin.

L·E·STEMMLER · QUEENS VILLAGE · N·Y·

## The New DA-SCOPE Kodachrome VIEWER... \$1.95



A compact folding slide viewer handsomely made of durable red and white plastic, that practically makes Kodachrome stills "breathe."

The magnification of the viewing lens is such that the smallest detail is brought into sharp and clear focus. The lens springs into position when the Da-Scope is opened. The translucency of the white plastic top permits both sufficient illumination and diffusion for viewing the slide. The small size (2 3/8 x 2 3/4 x 5/8") and light weight of the Da-Scope make it truly a "vest-pocket" instrument.

Price \$1.95 postpaid. Mail orders promptly filled.

**WILLOUGHBY'S**  
32nd Street near 6th Avenue, N.Y.C.  
ESTABLISHED 1898

## The Heat Lamp Makes Good

(Continued from page 95)

only were mold-drying costs lowered, but the lettering now needs no touching up.

Such applications of drying lamps in industry are saving millions of dollars and thousands of precious hours in America's war effort; but Haynes has made a less spectacular discovery that, in the long run, may prove a more appreciated gift. If you ever have shaved in a chilly bathroom you will appreciate a little convenience he rigged up. He mounted 250-watt, reflector-type drying lamps on the wall and aimed them so that, when he stands before the shaving mirror, the lamps bathe his back and shoulders with infrared warmth, along with some incidental visible light, even when the air temperature is well below the comfort point.

Haynes uses reflector drying lamps in clamp-on sockets for a great many around-the-house purposes such as thawing frozen water pipes, drying paint in his workshop, and drying photographic film.

Drying lamps currently are made in sizes ranging from 100 to 1,000 watts, and in a number of bulb types. They are designed for use on 105 to 120 volts. When higher voltages are used, lamps are connected in series. Prices range from 50 cents for the 100-watt lamp, which is the same size as a standard 100-watt clear-bulb lighting lamp, and requires an auxiliary reflector, to \$7.75 for a 1,000-watt lamp also requiring a reflector. Most versatile of all is the 250-watt, \$1.75 lamp that has its own reflector consisting of an aluminum coating applied to the glass.

Another reflector-type heat lamp, also of 250-watt rating, is designed specially for therapeutic use. Visible light emitted by it is of low brightness. The therapeutic lamp can be used for treating various physical pains such as those arising from sprained muscles. Although the therapeutic lamp can be screwed into any convenient socket, two stands developed for it make it easy to use. One is a floor-type stand, the other a table-type; both have metal hoods to protect the glass bulb from accidental breakage.

The human body is a pretty fair radiator of heat rays. You may have noticed this when a partly-filled theater that was comfortable when you came in became uncom-



fortably hot by the time you left. Haynes asserts that a man doing hard work gives off as much radiant energy as a 1,000-watt incandescent lamp.

Here is a table of specifications for human heat lamps, compiled by Haynes:

Task	Incandescent lamp equivalent
Person completely at rest.....	110 watts
Person standing, at rest.....	126 watts
Office worker, active.....	144 watts
Walking at 2 m.p.h. and light dancing.....	223 watts
Restaurant serving (waitress).....	293 watts
Walking at 3 m.p.h.....	310 watts
Walking at 4 m.p.h.....	406 watts
Bowling.....	440 watts
Sawing wood by hand.....	530 watts
Slow running.....	670 watts
Walking at 5 m.p.h.....	680 watts
Very severe exercise.....	750 watts
Maximum exertion.....	900 to 1400 watts

Drying lamps still are in their infancy. Future homes may be heated by radiant energy from lamps mounted in or on walls and ceilings. The room air temperature might be far below the point we regard as comfortable, yet the occupants would feel perfectly cozy. Infrared radiation heats the body or other solid object, not the air. Furthermore, it can be snapped on to full power in an instant, and off just as quickly. The current boom in drying lamps comes about through a deliberate reversal of engineering practice. Millions have been spent to produce a lamp that generates a lot of light and little or no heat. And here we have lamps being made deliberately inefficient as light-producers — lamps in which light is only a by-product, although some of it is converted into heat by absorption. In the future, incandescent lamps may be designed to produce only heat, while the job of making light is given to fluorescent lamps or other efficient light sources.

**Model Builders Attention!**



	V	V-2	V-3
Hex	1/2"	3/8"	5/16"
Thread	3/8"-24	1/4"-32	1/4"-32
Thread Length	7/32	7/32	5/32
Weight, Grams	8	3 1/2	2 1/2

Actual Size V-Plug  
Champion spark plugs for model gas engines give the same dependable performance as regular Champions. Sillment sealed. Sillimanite insulator. Alloy needlepoint electrodes for easy starting. One piece construction.

**CHAMPION**

SPARK PLUG COMPANY • TOLEDO, OHIO

# CHAMPION SPARK PLUGS



*"Dirty old plugs  
Corroded and worn  
Make your car act  
Weak and forlorn  
They waste its gas  
and steal its oil—  
They're highway  
robbers  
New plugs will foil."*



*"Clean shiny plugs  
With electrodes  
bright  
Make any engine  
Run just right,  
They pay their way  
By saving gas  
What about your  
plugs,  
—think they'll pass?"*

*More Vital-  
More Dependable  
than ever!*



A Champion sign denotes dependable service—a place where you can have your spark plugs tested and cleaned and, if need be, new Champions installed. Wartime economy dictates periodic checking of spark plugs—replacement of old, worn-out, wasteful spark plugs.



Big tanks, little tanks, half-tracks, and jeeps—these are the sinews of war. Thousands of the engines in these and all kinds and sizes of trucks, cars and motorcycles in mechanized warfare are equipped with dependable Champion Spark Plugs for that vital spark that makes them alive. They depend on Champions for that same championship performance that has made them the preferred spark plugs of the motoring public.

**TO SAVE GASOLINE • KEEP YOUR SPARK PLUGS CLEAN**

# Flying Battleships Will Win the War

(Continued from page 45)

which makes plane motors perform as efficiently at 35,000 feet as they do at much lower altitudes.

Equipped with the turbosupercharger, the Boeing Flying Fortress was the first large ship to take a passenger load of aeronautical engineers to make detailed performance observation at high altitudes. The turbosupercharger enables the four-engine planes to fly regularly at high altitudes, including trips to above 35,000 feet.

The problem in training flight crews for high-altitude work is two-fold. Proper equipment must be assembled from many sources. Procedures must also be developed to guide crews in preparing for flight, in handling equipment during a hop, and for meeting any emergency.

The well dressed, high-altitude pilot must wear—in addition to his flying suit, parachute, helmet, goggles and radio equipment—complete oxygen equipment. This includes an emergency mask and a separate oxygen supply. While oxygen is often used as low as 12,000 feet as an aid against tiring, the average man can maintain consciousness up to about 18,000 feet. The atmospheric pressure there is about one-half what it is at sea level. A man's efficiency, however, is much reduced.

If a man's oxygen supply is cut off at 20,000 feet, he will pass out in ten minutes. At 25,000 feet, unconsciousness comes in three minutes. Above 35,000 feet an oxygen mask may furnish enough pure oxygen, but the rarefied atmosphere doesn't supply enough lung pressure. At the 40,000-foot level a man equipped with oxygen equipment breathes with as much difficulty as he would without a mask at 18,000 feet. He's getting only about half enough oxygen at the pressure required.

Most important consideration in preparing for high-altitude flights, of course, is physical condition, especially digestion. Food that will cause gas will bring extreme discomfort at high altitudes. Yet the person who chooses not to eat will require more oxygen on the flight. Carbohydrates such as sugar and plain chocolate bars require the least oxygen in digestion.

In the past, aero-embolism has been the dread of high-altitude pilots—an effect similar to a diver's "bends." To guard against this condition, high-altitude flyers

"denitrogenize" themselves. Breathing pure oxygen, they exercise mildly for thirty minutes before a flight to wash all atmospheric nitrogen from their blood. Otherwise this gas expands into tiny bubbles in the blood vessels at high altitudes, bringing the discomfort of aero-embolism.

The strato-chamber can reproduce flight conditions at altitudes up to 40,000 feet and can accommodate three trainees and their equipment at one time. Vacuum pumps reduce the inside pressure to the equivalent of the atmospheric pressure at any altitude. Observers outside the tank can watch the progress of the flight through the thick windows and communicate with those inside by telephone.

Once denitrogenized and wearing complete flying equipment to become used to the cumbersome paraphernalia, the trainees enter the tank. The tank door is sealed tight, pumps are started and the fliers begin their journey to 35,000 or 40,000 feet. At various altitudes they practice handling their equipment under simulated emergency conditions. There's little margin for error in an atmosphere that won't support life and a practice "flight" in the stratosphere chamber develops confidence in the men who later on will make an actual journey into the stratosphere.

Thus, with present-day oxygen equipment, 40,000 feet seems to be the ceiling of human endurance—dangerous even for sustained flights. When the atmosphere's upper frontiers are pushed farther it will undoubtedly be done by pressure-cabin planes, or by suits and helmets which will maintain an inside pressure. The pressure cabin is a specially designed fuselage which is strengthened to withstand an even pressure inside for all members of the crew. Air from the outside is pumped into the cabin under pressure and stale air is forced out. In the pressure cabin the crew is able to move about at normal duties without feeling fatigue or loss of mental powers.

With land armies locked in static combat and with the world's navies checkmating one another on the high seas, the big bomber appears the best weapon in the arsenal of democracy with which to get at the Germans, Italians and Japanese. It will carry the war right up to their ports, their factories, their railroads and their cities.



You may worry  
about the  
sugar shortage

## but here is one worry you can avoid

**E**VERYTHING has to "go further" today —automobiles as well as sugar. That's why it pays to take *extra* care to avoid *extra* wear on your car's king pins, tie rods, steering crank bearings and other vital friction points that mean costly repair bills when neglected! Play safe—with Marfak stem-to-stern chassis lubrication every 1,000 miles!

Marfak is scientifically applied by *chart*, not by chance. It is *super-tough* . . . contains heavy-bodied oils . . . and resists wear-out, wash-out and squeeze-out!

Do you want your car to "ride like new"? Do you want extra miles of quieter, smoother performance? Then never say "grease-job". Insist on Marfak 40-point lubrication! At Texaco and other good dealers everywhere.



**TUNE IN: FRED ALLEN** every Sunday night. See your local newspaper for time and station.

*You're Welcome at* **TEXACO DEALERS**

72104  
Is There Life Among the Stars?

(Continued from page 85)

ural thermostatic controls couldn't adjust their bodies to our heat. We can guess that animals would be warm blooded compared to the temperature of their surroundings. They would have sight, hearing, senses of touch, taste and smell.

In some ways they would have advantages over us. The low temperature of their environment might make them sluggish but their long days and years might free them from urgency and give them opportunity to advance beyond us in civilization.

There is no way of telling what forms life might assume; there is no reason why life should duplicate the forms found on earth. One type that might work well could be a group we might call the streamlines. The fish of this family would have a true streamlined shape, with a central tube or channel from one end to the other through which water might be pumped by muscular contraction to provide jet propulsion. The fish might have a helical ridge around the body to give it stability through rotation while in motion. A band of eyes runs around the head, images being transferred from eye to eye as he rotates so that he has constant "gyroscopic" vision.

If the fish had an electrical apparatus such as the electric eel has, this apparatus might be employed in a few species for converting ammonia hydroxide into hydrogen. That would provide a form of bird life that could float in the air because of its hydrogen buoyancy and that needs no wings, since its jet propulsion apparatus could suck in and expel a stream of atmosphere. The land type might move by rolling itself like a barrel, having interior muscles that constantly change its center of gravity and tip it to one side. The streamlined land animal could be a quite dexterous mass of muscles without bony structure, and could take on almost any shape it pleased. Suction cups and pliable depressions in the skin would allow the animal to hold and work objects.

Some planets much hotter than our earth might have life systems based on the chemistry of silicon. Silicon is related to carbon and, like carbon and nitrogen, is an abundant element that forms a multitude of compounds. The silicates form most of our rocks and soils. Combined with sodium

*Smooth as Flying*

**Indian** SPRING FRAME MOTORCYCLES

Only Indian has Spring Frame's flight-smooth riding, easier handling, faster getaway, surer control. See your Indian dealer for some well "buys" in reconditioned machines.

**ASK YOUR DEALER FOR FREE BOOKLET**

Jam-packed with ideas to help you get more out of any make of motorcycle. Ask your local Indian dealer for a free copy, and Indian literature.



**INDIAN MOTORCYCLE CO., SPRINGFIELD, MASS.**

**Thompson**  
BEATS  
the World  
on BOATS



**Better Built  
Lower Prices**

- Canoes \$75 and up
- Rowboats \$48 and up
- Outboards \$48 and up

**Safe Boats With Full Length Spray Rails**  
Keep passengers perfectly dry—even at high speeds. Catalog also shows today's seven most popular models of sailboats. Two big factories. Prompt shipment.

**CATALOG FREE**  
Write for your copy. State kind of boat in which you are interested.  
**THOMPSON BROS. BOAT MFG. CO.** (114)  
213 Ann St. (Write to either place)  
PESHIGO, WIS. 113 Elm St. CORTLAND, N.Y.

Light "Car-Top" Boat  
**THOMPSON BROS. BOAT MFG. CO.** (114)  
113 Elm St. CORTLAND, N.Y.

**New IMPROVED Electric MOTO-SAW**

**SPEED-UP DEFENSE PROJECTS**  
More like nails than any tool you ever saw. Imagine an electric saw only slightly heavier than a hand coping saw... a tool that takes no effort to run, no pressure to feed. Works at any angle—on big assembly jobs or on the tiniest piece you can hold in your fingers. Runs 7999 strokes a minute... so fast the blade seems to stand still. Sturdily built... only two moving parts... never needs oiling. Easily cuts intricate designs—so smooth it eliminates sanding. **Safe as a Hand Saw JUST GUIDE IT!**

**U. S. Patent 2233862**  
Other Patents Pending  
**DREMEL MFG. CO.**  
Dept. 5112-C  
RACINE, WISCONSIN

**New Blade Holder Faces Blade 4 Ways**  
.. Multiplies Capacity

No Limit to Length of Stock It Will Cut. Saves to Center of 1 1/2 Widths. It's fast... cuts on an average of 1 ft. per minute up to 3/4" medium hard wood. Operates on 110-120 V. 50 or 60 cycle alternating current. If your dealer does not yet have MOTO-SAW, send \$4.85... we'll pay postage. Or send \$1. plus postman balance plus postage. **MONEY BACK** if not delighted after 9 days trial.

and oxygen, silicon forms a family of liquids called water glass. These are good solvents and might be the sea water and life blood of hotter life systems.

At high temperatures new problems arise to complicate the evolution of life. The atmosphere is likely to be dense and opaque. Living creatures would have to be floating or flying things that could rise toward the surface of the atmosphere for sunlight. Their sight would be feeble but the rich smells that prevail at elevated temperatures would give them a sensory keenness we cannot begin to imagine.

This is all as difficult for us to visualize as we would seem difficult for creatures of an ammonia planet to imagine. Even our own tropic races couldn't understand at first that there were inhabited lands of ice near the poles. Even the queer creatures of millions of years ago, our revolutionary ancestors, were unbelievable until we learned something about them.

Of course, among the billions of stars there may be many with planets just like the earth as to temperature and chemical conditions. Would life similar to ours develop on them? Why not? But even if our own evolution is in progress elsewhere it might go at a different pace or in a different way with humans not the lords of creation. It was just an accident that at the strategic moment in geological time our brains were good enough to make up for our physical imperfections. Elsewhere it might be that the insects, birds, or even trees are the dominating form of life.

It is amusing to consider what might have happened here if the giant birds of past ages had continued their evolution. If they had used their claws to put things together as well as to tear things apart, adaptation might slowly have given them skill in doing so. The result today might have been a bird civilization not essentially different from our own except that streets and most methods of transportation wouldn't exist. Humans would be an inferior race obedient to the shrill commands and threatening talons of the lordly birds.

Science doesn't expect ever to learn of other beings in the universe. Even the other planets of our solar system are too far away for us to observe whether life exists on them. But what we have discussed gives us a better understanding of our own life and our place in the universe.

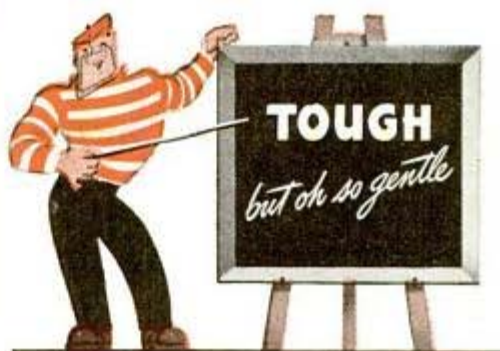

**YOU DON'T NEED TO BE A MECHANIC  
TO UNDERSTAND THIS SLOGAN.**



**- AS MILLIONS KNOW**



**- MORE VITAL TODAY THAN EVER.**

Even if your cylinder walls are badly worn, it's probably not too late to save them—by the installation of Hastings Steel-Vent Piston Rings. Any good mechanic can install them—quickly and economically.

HASTINGS MANUFACTURING CO., HASTINGS, MICH.  
Hastings Mfg of Canada, Ltd., Toronto

**HASTINGS**  
STEEL-VENT PISTON RINGS  
Stop Oil-Pumping  
IN CARS, TRUCKS AND TRACTORS



## KRW ARBOR PRESSES BENCH TYPE AND HYDRAULIC

NEEDED IN EVERY SHOP—SAVE TIME AND MONEY—DO BETTER WORK, QUICKER.

No shop is complete without a small arbor press. Pressing and squeezing operations can be done better and faster on a KRW Arbor Press. Stop using vise and sledge hammer methods—they generally deliver spoiled work in the end. KRW Factory-To-You Prices give you greater value for your money. Order today.

### KRW Bench Type Arbor Presses, 3 sizes

- No. 37-P ½ Ton, \$13.25\*
- No. 37-O 1 Ton, \$23.00\*
- No. 37-N 3 Ton, \$33.00\*

\*Prices F.O.B. Arcade, N. Y. Slightly higher west of Rockies. Stand illustrated extra.



KRW Hydraulic Presses are built in 25, 50 and 75 ton sizes. Prices start at \$198.00\*



**K. R. WILSON 17 Lock St., BUFFALO, N. Y.**

*Builders of Shop Equipment for Ford Dealers Since 1916*



## ONE STEP IN THE RIGHT DIRECTION and you're in HOTEL CLEVELAND

It's as easy as that to be in Cleveland's most convenient, most friendly hotel. Hotel Cleveland is directly connected with the Union Passenger Terminal and a modern garage. Located on Public Square Park, at the heart of the city, all through motor routes come right to our door. Convenient, too, for theatres, stores, boat docks, Stadium, Auditorium, and every part of the city. May we welcome you to Cleveland on your next trip here?

## HOTEL CLEVELAND

## NEW Grinding Attachment

For 8" to 16" Metal Lathes. Build it Yourself.

At last, a precision grinder within your means. You save 2/3 by finishing our semi-machined castings on your own lathe. HURON handles both internal and external grinding. Accuracies to .00025". Mirror finish easily obtained. Grinds valves, pistons, bushings, shafts, hard or soft. Ales, lathes, cutters. Sharpens rasps, welding cutters. Does recentral drilling; taps; polishes; scores of other uses for home workshops, garages, machine shops. Write for FREE illustrated folder and pricelist of supplementary items. Mention your lathe.

Huron Machine & Tool Co., Dept. B, Yale, Mich.



Semi-Machined Castings Only \$6.45

## TRAILER BUILDERS · BUYERS · OWNERS

TRAILER Send 25c for this Big Book Today

Over 80 pages! Beautifully Printed and Illustrated! Trailer Suggestions and Ideas galore! Catalog shows America's greatest line of Trailer Parts and Equipment at lowest prices. Everything from wheels to top. Rush 25c (in U.S.) today. Satisfaction guaranteed!

TRAILER SUPPLY CO.

Box 360-A

WAUSAU, WIS.

## PLANS FOR NINE NEW JIM DANDY TRAILERS Ready

Build your own trailer! Send 10c for Jim Dandy's interesting new TRAILER PLAN CATALOG which illustrates and describes NINE new models including 6 modern house trailers, plus sport, camp, and utility trailers. Rush 10c (in U.S.) for Catalog today to JIM DANDY, BOX 125-A, WAUSAU, WIS.



**U. S. TWO LOCK TOOL CHESTS**  
FOR GREATER CONVENIENCE AND PROTECTION

GEO. SCHERR CO., INC., 128A LAFAYETTE STREET, N. Y.

### REED MICROMETERS

Highest precision used by mechanics everywhere. Write for FREE literature.



SHOP AGENTS WANTED

## GENUINE U.S. BARGAINS

- O. D. WOOL BLANKETS (USED) . \$2.95
  - MCCLELLAN SADDLES (USED) . 5.95
  - U. S. ARMY PUP TENTS (USED) . 3.50
  - U. S. MARINE PONCHOS (USED) . 1.29
- Thousands of Other Bargains in Military, Outdoor & Sport Goods for Hunter, Farmer, Scout Send 10c for 32-page catalog returned with first order.

**A and N SUPPLY CO.**  
EST. 1868 4720 LESTER ST. RICHMOND, VA.

New...Up-to-the-minute

## Arc Welding Manual

516 Pages  
512 Illustrations  
Helpful charts, diagrams, tables  
... it's easy to understand.

ORDER your copy at once. Do this ... Clip this ad, send it to us with name, address and check or money order.

Explaining fully all the latest techniques, materials, methods and procedures. It's a complete handbook, reference manual and operator's training course all in one. Not a cheap booklet, but a full-sized, sturdily bound manual you'll use every day. . . . and thank your stars you've got it. It will be worth hundreds of dollars in helping you get and hold the big pay jobs. \$2.00

5 Days Approval. Your money refunded if you're not satisfied. Order now at only Postpaid

HOBART BROS. CO., Box M-72, Troy, O.



The Hobart Portable Electric Arc Welder as shown in FREE catalog. Ask for it.

**HOBART**  
"Simplified" ARC WELDERS

"One of the World's Largest Builders of Welding Equipment"

## Television Trains Home Guard

(Continued from page 31)

center of streets clear. They should not park closer than 25 feet to intersections and should leave at least 25 feet of curb clear on both sides of any fire hydrant.

Specialized training is also televised for fire watchers, rescue squads, messengers and drivers.

In the case of the special lessons, a list of questions is sent to all civilian defense "schoolrooms" and the person in charge, usually a policeman or fireman, asks questions from the list to ascertain how well the lesson was learned.

Since "live" demonstrations, motion pictures, slides, maps, lectures and round table discussions may be included in a single hour's session on the television stage, a staff of more than 50 experts is often needed to put on one show.

An example is this program: Beginning with a vivid motion picture of incendiary bombs raining down on London, the program switched to New York for sequences dealing with the insignia of air raid wardens, the warning flashed to interceptor command headquarters upon the appearance of enemy planes, siren alarms, the duties of senior and post wardens, and the system by which the city is divided into precincts, zones and sectors.

Gathered in the NBC television studios in Radio City more than twenty wardens, men and women, asked and answered questions concerning civilian behavior during a raid. A police lieutenant answered questions the wardens missed. Observers of the show were advised to keep out of subways in case of a raid, to seek shelter in the nearest building or to lie down on the ground if no shelter is near, to lock up pets, and not to gape at aerial combats.

Demonstrations also show how to handle injured persons with fractured bones, how to control bleeding, how to apply artificial respiration, how the "iron lung" is used, and even dramatize the proper way of caring for hot water bottles, gloves, boots, swimming suits, hoses and other precious rubber products.

The result is that Americans in the television zones are rapidly becoming wise in the ways of the war ridden world. They want to be shown, and television is showing them.

**More Miles**

**SAVE WEAR**

**AC OIL FILTERS**

**SAVE OIL**

**PER QUART OF OIL**

If you drive with dirty engine oil, you buy *more* oil than you should—and, *more often*. Dirt clogs the oil control piston rings, and they cease to perform their function as oil economizers.

A new AC Oil Filter Renewal Element keeps oil clean, and removes *discoloration*. You can safely continue to drive as long as the AC Oil Test Pad (used by your AC dealer) shows that your oil is clear. Thus, you protect your engine and get more miles per quart of oil.

### SEE THAT YOUR OIL IS CLEAN

Have your oil checked for dirt  
with an AC Oil Test Pad



Whenever you have your oil checked, ask the attendant to wipe your gauge stick with an AC Oil Test Pad. Then, look at the Test Pad. The spot will tell you whether there's dirt in your oil.

### AC OIL FILTERS Get the Dirt

For engines not already equipped, there's a complete AC Oil Filter which your dealer can install in a short time.



LOOK FOR THIS SIGN—There's one near you

NOTE: Follow the recommendation of your service man as to when oil should be changed.

AC SPARK PLUG DIVISION • General Motors Corporation

## DRILL PRESS OWNERS!

HERE'S 1 TOOL WITH 5 DISTINCT USES  
THE BARRON MULTI-PURPOSE  
ROTARY WOOD PLANER



PLANES & SURFACES • PANELS & BEADS  
ROUTS & GROOVES • RABBETS • TENONS **\$7.50** COMPLETE

Converts ANY drill press into a time saving, low cost planer, paneler, toner, etc. Surface finishes all types of tough grained and knotty surfaces to agate smoothness. Safe! Guaranteed harmless to drill press. Thousands now in use. **SOLD ON MONEY BACK GUARANTEE.** Full refund on 5 day trial. Shipped prepaid on receipt of \$7.50—or C.O.D. **YOU RISK NOTHING.** Free literature.

STEEL TOP AUXILIARY  
DRILL PRESS TABLE

Has 300 sq. in. smooth working surface. Equipped for shaper and many other important workshop uses—a real buy at **\$5.95**



Barron Tool Co., 369 Architects Bldg., Detroit, Mich.

## FREE RADIO CATALOG!

You'll want this Big FREE 1942 Book that shows Everything in Radio! Here's everything you need for radio servicing, for experiment, for instruction in the science of modern Radio! More than 15,000 quality radio items—replacement parts, books, tools, lab and experimental equipment—all at the lowest prices! Send for this FREE Catalog now—and don't miss the two big book values described below—They're a "must" for Everyone in Radio!

Radio Builders' Handbook. Everyone in radio needs it **10¢**

Radio Dictionary. Complete, valuable, defines all terms **10¢**



FREE  
Send for  
it NOW

ALLIED  
RADIO  
CORP.

833 WEST JACKSON DEPT. 5-G-2 CHICAGO

## SLEEP OUTDOORS ON YOUR VACATION!

Send for "Outdoors With Ta-pat-co"—telling famous camp tricks and trail secrets to make your outdoor vacation more comfortable, pleasant, and safe. See styles of Ta-pat-co sleeping bags and other outdoor equipment in beautiful colors. Write today—it's FREE! Address . . .

The American Pad & Textile Co.  
Dept. 51, Greenfield, Ohio



FREE!

THE  
OUTDOOR  
BED



FOR THE  
OUTDOOR  
MAN

## Cushman with FLOATING DRIVE

Save Your Auto—speed anywhere comfortably—100 miles per gallon! Powerful engine climbs hills easily. "Floating Drive"—no gear shift or clutch. Electric lights for safe night use. Long wheel base. Balloon tires. Coil springs front and rear wheels.

Unable fill new orders until July 1, except those with defense priority. Write!  
**CUSHMAN MOTOR WORKS**  
Dept. 17 Lincoln, Nebr.



## DOOR-EASE STAINLESS STICK LUBRICANT

EASES STICKING DOORS

Use Door-Ease—like a crayon—for things that stick or squeak . . . doors, drawers, windows, latches and friction catches, screws, zippers, etc. Clean, weather-proof, long lasting!—Door-Ease Mfrs., Muskegon, Michigan.

**10¢** In metallic container at Hdw., Auto Accessory, Dept., and Dime Stores.



## "Beginner's Special" One Tuber

(Continued from page 157)

screw on the underside of the base for mounting the .000365 mfd. (365 mmfd.) variable condenser. Check the correct position for the mounting screw so that the condenser will be mounted flush with the front edge of the baseboard. The 2-megohm resistor ( $R_1$ ) is a  $\frac{1}{2}$ -watt carbon type. Mount the coil on the baseboard with china cement, see photo D. Use ordinary hook-up wire with push-back insulation for the circuit connections and solder every con-

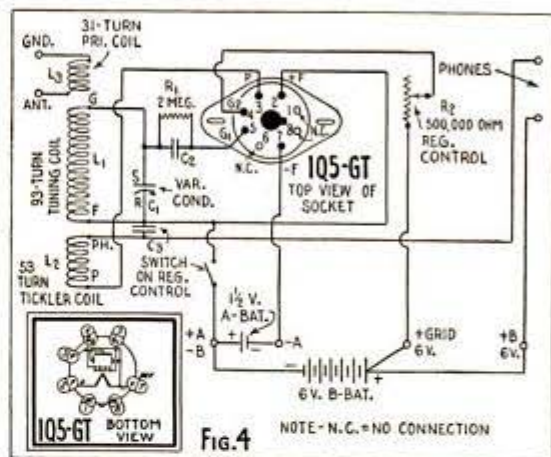

Fig. 4

NOTE—N.C. = NO CONNECTION

nection carefully with rosin-core wire solder. A detailed list of the materials is available from Popular Mechanics radio department without charge, if desired. Scrape the enamel insulation carefully from the ends of the various coil leads before soldering, and keep all coil leads short.

Connect the flashlight batteries as shown by soldering leads directly to the positive and negative ends as indicated in photo E. Check all wiring carefully before inserting the tube in the socket. All battery connections are clearly shown in both Fig. 3 and the schematic circuit diagram Fig. 4. Using this type of circuit, the 6-volt B-battery supplies plenty of plate voltage for any good pair of 2,000 ohm phones, 1,000 ohms or less in each phone unit. The antenna should have a total length of at least 50 feet. A ground on a cold-water pipe is recommended. To tune the set, turn the variable condenser until a whistle is heard. When you pick up a whistle, back off the variable resistor until the whistle stops and the station comes in clear. The blueprint number for this one-tube set is R-305.



## If You Can Drive You Can Fly

(Continued from page 75)

er it is to land. The baby of the species won't even carry your family; to seat more than two it needs more power, speed and room on the field. To get that you sacrifice safety. The light plane, so called because it weighs five to ten pounds per square foot of wing area compared with the 25-pound wing loading of a transport plane, is as light and slow as engineers can build it. To this it owes its low stalling speed and ease of control, its ability to slip into the nearest cabbage patch when the unexpected happens. It will glide 10 feet for every foot of altitude; from a half mile up you can choose a landing spot anywhere in 20,000 acres. You may fly 500 hours, 40 to 50 thousand miles, without engine service. Piper Aircraft says you can fly at 90 miles an hour with half the concentration you need to motor at 30; that you don't have to know any more about an airplane engine to fly than you need know about an automobile engine to drive.

Aeronautical design has traveled a long road since Kitty Hawk. When men first experimented with wings it was supposed that pressure of air under the wings provided the lift. Today it is known that 65 percent of the lift is suction created on the upper surface as the wing rushes through air; only 35 percent comes from pressure beneath the wing. The first wings were flat surfaces, and they proved unstable. The airfoil was developed, its thick leading edge and curved surfaces scientifically calculated to provide a smooth flow of air and thus the greatest lift and control. All that has been learned over the years in the air and in wind tunnels is being utilized by the designers today to produce a safe, dependable craft for the average man.

Flying a light plane is fun. Two men crossed the continent in three days in their "flivver" plane, spending \$30 for fuel. It is the plane for the business man flying of a summer's evening to join the family at seashore or mountain resort 300 miles away, for the rancher remote from centers of supply, for factory machinist or stenographer who can take to the sky any evening or weekend and shake the world away. Even the army is taking to the "grasshopper" plane, buying fleets of Piper and Tay-

(Continued to page 172)



**I**N EVERY branch of warfare—in every field of industry—in nearly every kind of repair business—there are production and maintenance jobs on which *nothing can take the place of FILES.*

And this is no time for files which, through poor quality, waste time or lead to inefficient workmanship. Whether you're in training for a war-industry job, or as a repairman are engaged in making cars, trucks, tractors, implements and appliances last longer—it's worth looking for the file brands that carry the sweeping guarantee of *Twelve perfect files in every dozen: NICHOLSON and BLACK DIAMOND.* At good hardware and mill-supply houses.

**NICHOLSON FILE CO., Providence, R. I., U. S. A.**  
(Also Canadian Plant, Port Hope, Ont.)

**NICHOLSON**  
**FILES** FOR EVERY  
PURPOSE

**NICHOLSON**  
U.S.A.  
MADE IN U. S. A.

FREE TECHNICAL BULLETINS on Special Purpose files for Stainless Steel, Aluminum, Brass, Foundry and Die Castings, Plastics; Shear Tooth and Lathe filing. Name ones wanted.

# Atlas

## BENCH MILLING MACHINE



Key precision unit for the production of many a small but vital armament part is the compact Atlas Milling Machine. It handles the full range of milling work from slabbing and facing cuts to end milling, finishing, and layout work.

**ATLAS PRESS CO.**  
KALAMAZOO, MICHIGAN

**LATHES - DRILL PRESSES - SHAPERS**  
**ARBOR PRESSES - MILLING MACHINES**

## Use Your COMPASS wisely



Thousands of motorists today are conserving rubber and gasoline through wise use of their Hull Streamline Auto Compasses. Driving by compass saves the needless wear and tear of wasted miles.

**HULL MFG. CO., P. O. Box 246-D7, WARREN, OHIO**

New Only \$6.95

## REAL ENGINE VALUE



The G. H. Q. is a miniature gasoline engine that really operates. Over 15,000 sold in the last year. Now is your chance to buy the New Improved 1942 model kit for \$6.95. Absolutely complete with coil, condenser, plug, instructions, etc. Only a screwdriver needed. For boats, planes, midget cars, etc. All parts guaranteed. Send only \$1.— Shipped Collect C. O. D. same day. Send for FREE circular or 6c for Jumbo catalog of hundreds of plane, boat and hobby items.

**GHQ MOTORS, Dept. B, 40 East 21 St., New York, N. Y.**

## "LET'S TRADE CAMERAS!"



Generous allowance on your camera toward a new or used model of your choice. Write giving description of present camera and tell us what you want. Write for free MOVIE or STILL Bargaingram. Dept. P

## Bass CAMERA CO.

179 W. MADISON ST., CHICAGO, ILL.

## FREE TRAILER PARTS CATALOG



We'll save you money on—axles, springs, wheels, couplers, windows, sinks, water pumps, brakes, refrigerators, beds, lamps, inside and out, 6V lamps, furniture, jacks—everything. Special discount to mfrs. NATIONAL TRAILER EQUIPMENT CO. Successors to Kar-A-Van Industries, Inc. Dept. P. 714 W. Wisconsin Ave., Milwaukee, Wis.

Complete Plans and Building Instructions, 10c

## AUTO ENGINE SPEED CONTROL GOVERNORS



Give constant speed to any make of auto or truck engine, regardless of load changes, when used for power. No better governor can be made. Fully guaranteed. Complete, simple instructions. Courtesies to garages and established agencies. Montreal branch, 7546 Wiseman St. Free circulars. **CANDEE, 129-6 Llewellyn St., Los Angeles.**

2037

lorcraft and Aeronca courier planes that will land on a handkerchief with a message for the colonel.

When pioneer automobile makers were trying to overcome the resistance of horse-and-buggy days they fashioned motor buggies in the likeness of the carriage, even to the dashboard whipsocket. Now, to ease the motorist into the cockpit, aircraft builders are styling the pilot's compartment like the highway coupe. The stick has become the familiar wheel, which in recent models steers not only the ailerons but turns the front wheel of the tri-cycle landing gear. Side-by-side seats are taking preference over tandem arrangements. Cockpits are soundproofed, upholstered, heated. Dashboards ape the family sedan and the glove compartment and radio are in the same niches. You're at home when you climb behind the wheel.

The skyway map even begins to resemble the illustrated road map, and next month we'll tell a bit about the way you find your trail in the air, and what it costs to fly your own.

## "You Can't Catch 'Em Where They Ain't"

(Continued from page 53)

may shout at the top of your lungs when fishing, but don't tramp around, and don't expose yourself carelessly near the pool. Approach a stream carefully, sneaking along with as little vibration as possible, find a spot where you will be sheltered, and toss in your bait as gently as possible.

Wading should be held to a minimum. Some streams require it, and when they do, enter the water as quietly as possible, at a turbulent spot if you can find one, and then walk without splashing.

The less you use sinkers, the better. Weight keeps the bait from drifting naturally, and wise and big fish will get suspicious and let it alone. However, some weight is often necessary in swift streams, or where large snags exist.

Much of our natural game has been disappearing rapidly before the approaches of civilization, but this fate is unlikely to overtake our game fish. Almost all states that face depletion have created commissions for re-stocking and scientific study.

Fish are artificially raised in centralized locations, millions at a time. From there,

they are transported to fishing grounds predetermined to be suitable. Transportation alone is quite a problem. Milk cans are used for containers, and frequently they have to be kept cool while passing through hot regions. Trucks are equipped with oxygenators which keep air bubbling through the water. When pack animals are used, sloshing keeps the water aerated.

Little fish receive fastidious care. Their tanks are carefully drained, cleaned, and scrubbed at regular intervals. In some modern plants, the water is cooled or heated to just the right temperature for maximum growth. Food is usually a mixture of raw beef liver and clabbered milk, put through a meat grinder to insure no lumps or strings to choke the fish.

All this adds up to a steady growth and improvement in fishing conditions for the American angler. Scientific management will keep the sport alive when otherwise it would surely die.

### New Sources of Alcohol Found To Meet U. S War Needs

To make a single 16-inch naval shell requires 140 gallons of alcohol. That is one of the reasons the demand for industrial alcohol, essential in the manufacture of smokeless powder and other munitions, is now running 300 percent above normal. Efforts to tap new sources of supply and to speed up present processes have resulted in three recent major developments. Scientists at Fordham University report that they have discovered how to break down nonfermentable sugars in corn, wood and paper mill waste liquors which exist side by side with the fermentable sugars. This may result in a new industry producing alcohol from materials that have been ignored in the past. Experiments at Iowa State College reveal that common bread molds can be used in converting grain into alcohol with greater speed and efficiency than the customary malt. Use of the molds would increase the alcoholic yield of 100,000,000 bushels of corn or wheat by 25,000,000 gallons. A continuous fermentation process for molasses that speeds the cycle from 50 to five hours has been developed at the Seagram Laboratories in Louisville.

¶ To learn where to buy commercial products described in these pages, see the index.

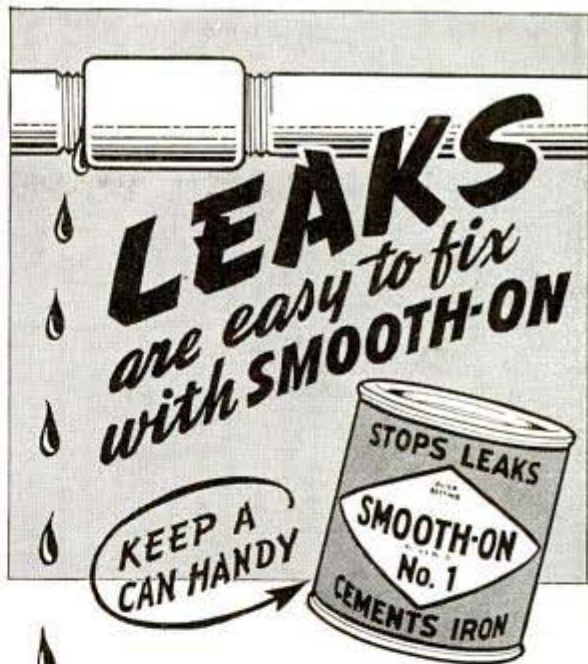

### SMOOTH-ON SEALS CRACKS, STOPS LEAKS, TIGHTENS LOOSE PARTS . . . QUICKLY

Anyone can easily make lasting repairs with SMOOTH-ON. Leaks in pipes, furnaces, radiators and boilers cost only a few cents to fix the SMOOTH-ON way. Loose screws, handles, casters and knobs can be made tight and permanently serviceable in a jiffy with SMOOTH-ON. You can use SMOOTH-ON for many repairs on your car too. The war makes replacement of worn, leaky or broken parts difficult if not impossible. Do as experienced repair men and mechanics have done since 1895 . . . keep a can of SMOOTH-ON handy. Buy SMOOTH-ON in 1 1/4-oz., 7-oz., 1-lb. or 5-lb. cans at your hardware store or if necessary, from us.

### MAIL THIS COUPON . . . GET THIS FREE BOOK

40 page Handbook with 170 illustrations shows how to save money by using SMOOTH-ON to make quick, lasting repairs. Your copy mailed FREE if you send this coupon.

Smooth-On Manufacturing Co., Dept. 37  
570 Communipaw Ave., Jersey City, N. J.

NAME \_\_\_\_\_

ADDRESS \_\_\_\_\_

7-42



Free

Do it with SMOOTH-ON

Science Service 4/8/42

*Science Service*  
*4/8/42*  
*Smithsonian Institution*

# Make BIG MONEY AT HOME!

## NEW Invention Electroplates by BRUSH



**Now Plates CHROMIUM!**  
ALSO GOLD, SILVER, NICKEL, COPPER, ETC.

**War Increases Demand—You Profit!**

New, patented invention makes possible big earnings AT HOME. Replate auto-parts—worn articles in homes, stores, hotels, restaurants, etc., with durable, sparkling, new coat of metal—with stroke of brush. Easy, simple, quick. Genuine Gold, Silver, Nickel, Cadmium, etc. Everything furnished. Outfit complete, ready for use. No shop required. Clear from \$2 to \$5 an hour in lifetime business. Small investment starts you in business. Steady repeat. Machine can pay for itself in week. Send TODAY for FREE SAMPLE and illustrated BOOKLET how you can have a life income from a business of YOUR OWN built upon satisfied customers. Act at once!

**WARNER ELECTRIC COMPANY**  
215 W. Ohio St., Chicago, Ill., Dept. 110

### FREE BOOK & SAMPLE

WARNER ELECTRIC CO., 215 W. Ohio St., Chicago, Ill., Dept. 110  
Gentlemen: Send me Free Sample and Illustrated Booklet.

Name \_\_\_\_\_

Address \_\_\_\_\_

City \_\_\_\_\_

State \_\_\_\_\_

## How to make your workshop pay dividends

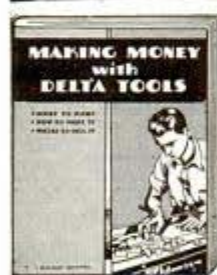

● Learn how you can build up a profitable spare or full-time business in your own home. This new book "How to Make Money in Woodworking" is crammed with practical tested ideas, plans, and suggestions. Tells you exactly what to make, how to make it and how to sell it. Describes plans that have worked for others. Woodworking, the new way, is light, pleasant, and profitable. Send only 10c and complete book will be mailed postpaid. Satisfaction guaranteed or money refunded. Write to

The Delta Mfg. Co. (Dept. 681-G)  
600 E. Vienna Ave., Milwaukee

## BUILD YOUR OWN AIRPLANE FAN

ALL EQUIPMENT FURNISHED



Let us show you how to make a cooling Airplane Fan equal to \$25.00 fan, at fraction of cost! We can furnish all or as many parts as needed, at unbelievably low prices. Blades, guards, motors, etc. Our Ace Aeroplane Blade has giant 24-inch spread, graceful lines, well-seasoned wood; lightweight, sturdy; warp-proof treated; beautiful mahogany finish. Special introductory price, \$1.50. Order from all. Send money, or if you wish, we'll send blade C.O.D. plus handling charges. AGENTS, DEALERS: Chance for big money. FREE information. Postcard will do. ACE CO., 1501-M Market, ST. LOUIS, MO.

24 INCH  
BLADE  
\$1.50



only  
10c

# Wood

**workers: Here it is!** Harold Hunt's big No. 14 wood catalog! Latest UP-TO-DATE IDEAS for experts and amateurs; SPECIAL BARGAINS in rare woods, veneers, and ALL kinds of supplies. 148 pages—20 of rare woods in color. Get posted! Send only 10c to CRAFTSMAN WOOD SERVICE CO. 2729 S. Mary St., Dept. A-23, Chicago, Ill.

## First Aid Suggestions for Your Radio Sets

(Continued from page 158)

inside the cabinet, or the tube sockets are not marked for the types of tubes used, simply mark the tube numbers and letters plainly on the metal base as near as possible to each tube socket when you remove the tubes, as illustrated in photo 2. Remove the tubes one at a time; if there is a grid cap lead take it off first, then remove the shield, if any, by pulling it up over the tube, unless it is the "glove" fitting type. Take out the tube by grasping it as near the socket as possible and pull it straight up. Sometimes it may be necessary to rock the tube slightly and give it a strong pull as they fit tightly. Place each flexible grid cap lead near the tube socket of the tube that it serves. Wrap each tube in a piece of paper and place them carefully in a box and take them to your local dealer for testing. He will quickly show you the defective ones, if any, and tell you the condition of the others. If the tubes have been in the set for several years it is always a good safe plan to replace them with new ones, saving others that are in fairly good condition for temporary replacements. Returning home, replace all of the tubes in the set, first making sure that the power cord is still disconnected from the wall socket. Push each tube down firmly in its designated socket, and carefully replace the shields and insulated grid cap leads; connect the antenna and ground wires and push the set back in place before you plug it in. Check your antenna and ground leads, especially the antenna lead-in, and replace the window strap lead strip, see photo 1, if the insulation is frayed or worn. This is a window sill variety commonly used in urban localities. If you are using a roof or yard antenna installation now is the time for an inspection to be sure that everything is in order so that those new tubes will not be handicapped with poor signal pick-up. See that the antenna and lead-in wires are tight, well insulated from the building and free from tree branches and other obstructions. Insulators should be inspected and cleaned. A complete antenna check-up will be outlined later. Tube replacements in table model receivers will be considered next.

(To be continued)

POPULAR MECHANICS

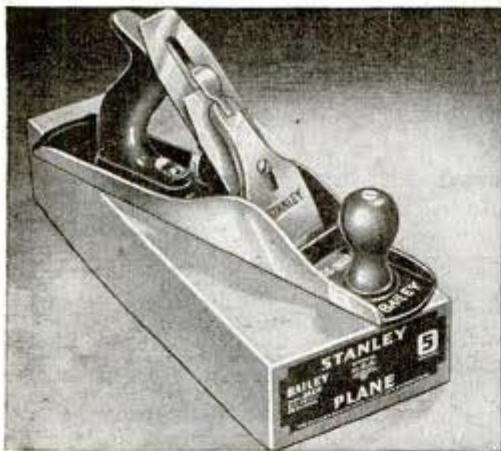

# STANLEY PLANES

## For All Common And Unusual Cuts

Builder of the first iron plane, Stanley has constantly improved planes and extended their usefulness until today the Stanley line is the widest and most dependable in the world. Get them at your dealer's, or write for Catalog No. 35, your complete guide to good tools.

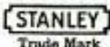

STANLEY RABBIT Plane, No. 78 has two cutter seats for regular and bullnose work. Fitted with Spur, removable Depth Gauge and Fence.



STANLEY "BAILEY" Plane—famous throughout the world for over fifty years, for its quality construction, balance and "feel."

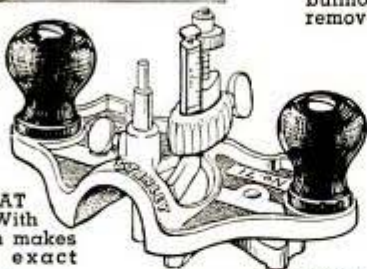

STANLEY OPEN THROAT Router Plane No. 71. With adjustable fence which makes it easy to rout the exact distance from an edge.

STANLEY SIDE RABBIT Plane No. 79. Both right and left hand, for side rabbeting in trimming dados, mouldings and grooves.

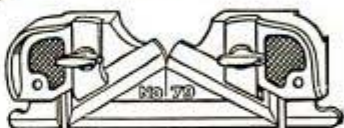

## STANLEY TOOLS

DIVISION OF THE STANLEY WORKS

NEW BRITAIN, CONN., U. S. A.

THE TOOL BOX OF THE WORLD



## OTTAWA TRACTOR SAW

Falls Tree—Cuts Log

Fits rear power take-off shaft.

Drive thru gear reduction. 18-in. stroke, 10-ga. blade. Economical, saws to profit.

FREE Circular and Price List

OTTAWA MFG. CO., 1127 Forest Avenue, OTTAWA, KANSAS

## BURN YOUR NAME ON TOOLS

WITH THE

## ARKOGRAF

PROTECT YOUR TOOLS FROM THEFT

Write with electricity any name or design on the hardest and finest tools and instruments, or any metal, like writing on paper with pen or pencil.

Complete Outfit \$3.50—Frigid Apparatus

Agents wanted. ARKOGRAF PEN CO., 3927 S.E. Stark St., Portland, Ore.

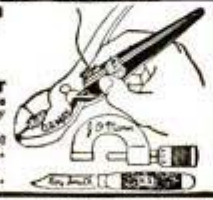

## BUILD YOUR OWN ARC-WELDER

For Light or Heavy Work

No rewinding necessary—use coils taken from old auto generators.

Works on 110 or 220 A.C. Has 26 different heats. Complete plans and BIG Catalog 35c.

LEJAY MFG. CO., 3347 LeJay Bldg., Minneapolis, Minn.



## DO YOU

WANT a permanent business profession of your own? Then BECOME A FOOT CORRECTIONIST. Earnings in this greatly needed profession run as high as \$50-\$100 weekly after a few weeks home training—not medical or chiropody—no further capital needed, no goods to buy. 47th year. Write for free booklet.

Stephenson System of Foot Correction

28 Back Bay, Boston, Mass.

## BUILD YOUR GRANDFATHER CLOCK

Send 35c for Simple SHOP TESTED COPYRIGHTED BLUEPRINT. The Simple Sensible Red-Kut way as thousands have. DINE brings PLANS and sixty picture "HOW" Book peeing many fine brass weight Westminster, tube chime, electric and battery movements showing nice beautiful colonial grandfather cases. Build now and save half. KUEMPEL CHIME CLOCK CO., Bldg. 66, Guttenberg, Iowa.



## FILING SAWS FOR VICTORY



The Foley Filer is in use by U. S. Navy for shipyards, air bases, battleships, navy tenders — by U. S. Army posts and airports — by U. S. Engineers, Light House Dept., N.Y.A., W.P.A., —also hundreds of Defense and Mfg. plants.

"Bought a Foley, one year later had all debts paid and \$400 on a new home. Many days I earn as much as \$16." —J. H. Kellogg, Louis P. Wadwick says: "I have filed 764 saws in spare time."

## MAKE A GOOD LIVING WITH FOLEY AUTO SAW FILER

The Foley files hand, band and circular saws better than the best hand filer. You can do expert work easily, quickly, without eyestrain. Patented jointing principle brings uneven teeth back to uniform size. FREE PLAN shows you how to start your own cash business in spare time—no canvassing. Send coupon now,—no salesman will call.

Paste coupon on postcard

## Mail Coupon for FREE PLAN

FOLEY MFG. CO. 716-2 Foley Bldg., Minneapolis, Minn.

Send Free Plan on Saw Filing business—no obligation.

NAME.....

ADDRESS.....



# Save your tools!



Get this **FREE**  
**DISSTON**  
**MANUAL**  
from your  
**HARDWARE DEALER**



**48 Pages • 200 Illustrations**

Packed with useful workshop advice, instructive pictures, practical helps and hints. Contains this statement from George T. Weymouth,

Bureau of Industrial Conservation, War

Production Board: "TOOLS ARE WEAPONS. CONSERVE THEM. USE THEM PROPERLY TO AVOID BREAKAGE AND THE WASTE OF CRITICAL MATERIALS NEEDED TO WIN THIS WAR." . . . Make your tools last longer. Get your **FREE** copy of the Disston Saw, Tool and File Manual from your Hardware Dealer.

**HENRY DISSTON & SONS, INC., 711 Tacony, Phila., Pa., U.S.A.**

## PAINT STRIPING TOOL

Try it! See the Added Beauty

**ONLY \$1.00 POST PAID**

With this **NEW TOOL** (not a brush) everyone can now draw lines with paint. Used on autos, models, toys, tiled walls, cabinets, furniture, linoleum floors and all home workshop projects.

As easy to use as a pencil



Send only \$1.00 for complete tool for painting a 1/16" wide stripe, including adjustable guide, operating instructions, etc. C. O. D. price \$1.25. Tool uses paint, enamel, lacquer, etc. Patented interchangeable tips are available for wider or narrower stripes.

**Every Painter and Craftsman Should Own One.** Send for your tool today. Use it. If you are not satisfied that you have added character as well as beauty to your work, return the tool and we'll refund your money promptly.

Dealers: Write for literature, etc.

**WENDELL MFG. CO.**

2531 N. Ashland Ave. Chicago, Ill.

## BRONZE FOUNDRY Schools and Home Workshops

Make your own castings of aluminum, copper, bronze, silver. Foundry sets are available in three sizes including 2400 Deg. F. blast Furnaces. \$17.50, \$24.00, \$34.50, f.o.b. Kansas City. Free Circular.

**KANSAS CITY SPECIALTIES CO.**

P. O. Box 6022, Dept. P-22 Kansas City, Mo.

## ONAN ELECTRIC PLANTS ALTERNATING AND DIRECT CURRENT



Produce Current, same as City Power Lines, for **FARMS, SCHOOLS, THEATRES, PUBLIC BUILDINGS** . . . Operate Lights, Radios, Motors, All Appliances.

Over 40 STOCK MODELS — 250 to 50,000 Watts. Any Voltage — Any Frequency.

Combination A. C. - D. C. Types. Manual, Full Automatic and Self-Starting. \$99 up.

Shipped — COMPLETE, READY FOR OPERATION. THOUSANDS IN USE IN ALL PARTS OF THE WORLD.

Write for Complete Details.

**D. W. ONAN & SONS**

1071 Royalton Avenue - MINNEAPOLIS, MINN.

## Thrills in Davy Jones's Locker

(Continued from page 61)

final burst of rage. Even with the lights it was difficult to see now because the bottom had been churned up and mixed with the creature's "smoke screen."

I now gave the signal to raise the observation bell and my robot to the surface. I would later return to examine and photograph the octopus and to recover the treasure from the ancient Spanish vessel. The winches and the drums began to turn in reverse, reeling in the bell and sphere as you might reel in your fishing-line. The derrick at last lifts the huge steel robot from the water. Swiftly and efficiently the crew swing it into its bracket against the bulwarks and brace it, unlock and open the trap and speak to me. I crawl out with the aid of one of the men no more excited than a man who has just stepped from a modern elevator. "Sure, I'm all right!" I answer my electrician.

It's a weird picture to those who have never been down. Yet it is not a page from Jules Verne and his "Twenty Thousand Leagues Under the Sea." It is an ordinary business trip on one of my salvage expeditions with the deep-sea diving robot, in search of sunken treasure!

m 2 2 5

## The Iron Horse Delivers The Tools of War

(Continued from page 11)

The average troop train consists of 14 to 20 cars; 10 sleepers carrying 39 men each, another for officers, two baggage cars, one for the army kitchen equipment—all military units serve their own meals except the Air Force, which enjoys dining car luxury—and additional cars for heavy equipment. Artillery units move on freight trains of 10 to 25 cars, with their men constantly guarding their guns and trucks. Smaller groups of men, of course, travel on regularly scheduled trains.

One railroad alone moved 200,000 soldiers and equipment. Another was called on to furnish 1,500 flatcars, 286 automobile cars, 200 tourist sleepers and 89 baggage cars to transport one unit. A motorized unit traveled 3,000 miles in four trains assembled on short notice. One division required 64 trains.

Early this year the government issued

7/12/25

an order which meant that 28,000,000 bushels of corn must be moved by rail. That called for more than 15,500 freight cars. The cars were there at the proper time and place. This was no military movement, but it's one example of the gigantic tasks the railroads can take in their stride through the "pooled management" of the Car Service Division of the Association of American Railroads.

From its 22 offices this Division supervises the movement of loaded and empty freight cars between railroads, anticipates the needs, prevents congestion of loaded cars at the ports or shortages of empties where there's a load to carry. Before the tremendous grain crop of 1941 matured the Car Service Division ordered eastern and southern railroads to send a huge fleet of empty box cars to the wheat belt, and there was no shortage. In October alone 175,000 cars of grain moved. If unloading facilities at a seaboard terminal are overtaxed—the bogey in World War I—Car Service issues an embargo halting further shipments to that port until congestion is relieved. If a big manufacturer "hogs" idle freight cars on his siding, Car Service embargoes the plant and it will get no more supplies hauled in or products hauled out until it cooperates in keeping the cars moving.

Shippers, however, are now cooperating to eliminate the waste of idle cars by rapid loading and unloading. And they have cooperated for nearly 20 years in regional Shippers Advisory Boards which are the "crutch" on which the Car Service Division leans in anticipating freight volume. Every three months these boards gather from their 20,000 member shippers, who load or receive four-fifths of the nation's freight, information on their expected freight volume in the ensuing quarter. From these reports the Shippers Advisory Boards issue their forecasts of freight movement. Their judgment guides the Car Service Division in providing cars when and where they're needed; and in the last six years they have been right, on the average, within 3½ percent. The biggest error in estimate was 6 percent, in one period when an expected strike did not materialize.

Even the war, which has given the Car Service Division a 24-hour problem assembling the rolling stock for trainloads of

(Continued to page 178)



# Super-X SPEED makes a monkey of him!

OLD Long Ears can sure cover the ground but he might as well be dozing in the shade as to attempt a get-away from the s-t-r-e-a-k-i-n-g bullet of a Super-X .22! There's no monkey business about this 1400\* feet-per-second power slug! When it hits there's one less pest on the prairie.

When you want speed and power say "SUPER-X" to your dealer—and when extreme accuracy is paramount ask for the Western XPERT .22.

## Western Super-X LONG RANGE .22's

\*Muzzle speed of the Super-X .22 L. R. Hollow Point. At 100 yards it hits with practically 100 foot pounds of energy.



WESTERN CARTRIDGE COMPANY  
 Dept. G-46, East Alton, Illinois  
 Please mail FREE, your folder on Super-X and Xpert .22's, and the helpful 76-page Western Ammunition Handbook.

Name \_\_\_\_\_  
 Address \_\_\_\_\_ State \_\_\_\_\_  
 Post Office \_\_\_\_\_

**METAL SAWING  
MADE EASY NOW!**

You'll saw all kinds of metal more quickly, easily with this 20-page illustrated booklet of time and money-saving hints on selection, use, care of hand and power hack saw blades, frames and band saws. 5-cent bargain at hardware stores or send dime with coupon to cover handling, mailing direct.

Clemson Bros. Inc., Dept. M7 Middletown, N. Y.  
Enclosed is dime for "Metal Cutting" booklet, postpaid.

Name \_\_\_\_\_  
Address \_\_\_\_\_

Published by makers of STAR Hack Saw Blades, Frames, Band Saws, Clemson D-17 Lawn Machine.

## LUMINOUS BLACKOUT SAFETY ITEMS GLOW IN THE DARK

**BLACKOUT SAFETY KIT . . . \$1.00.** Contains: Victory Button 10c, Gardenia 25c, Arm Band 35c, Hat Band 20c, Plastic Ring 20c, Plastic V-Pin 20c. Special prices on quantity purchases.

**FLUORESCENT OUTFIT No. 4 . . . \$5.00.** Complete equipment for experiments with Fluorescent Colors and Ultra-Violet Blacklight.

**STROBLITE CO., Dept. P, 35 W. 52 St., New York**

## YOU'VE ALWAYS WANTED THIS • Glock Finishing Kit •



New soft felt-like surface quickly and easily applied on photo-grammables, cabinets, radio panels, tackle box compartments, lamp bases and dozens of other uses. Colors—Brown, Blue, Taupe. Complete Deluxe Kit \$2.00. Regular Kit \$1.65. Specify Color. Order Today. See Editorial P.M., Page 54, Sept. 1941.

**FREE: WRITE FOR OUR COMPLETE CATALOG: A LOG OF MANY OTHER ITEMS**  
General Cement Mfg. Co., Dept. PM, Rockford, Ill.



## PHOTO ENLARGEMENTS 5¢ ANY SIZE

Is Photography your hobby? Do you want a profitable new business at home? Make **PHOTO ENLARGEMENTS** for yourself and others. Your cost 5¢ each and less. The Ideal Photo Enlarger is **AUTOMATIC**. No experience required. Also **COPIES** any picture \$7.94 **COMPLETE**. Interesting circular **FREE**. No delivery charges *ordered after June 30th.*

**Ideal-O, 148 West 23rd St., New York City**

## WITTE DIESELECTRIC PLANTS

Your present power bill will buy a WITTE that produces power and light for 1c a K.W.H. Save up to 75%. A Size for Every Need. Write today for finance plan, literature and name of dealer.



**WITTE ENGINE WORKS, 174-B Oakland Ave., Kansas City, Mo.**



**Machinist's Tool Chest 20" x 12 1/4" x 8 1/2"**  
Popular top till chest. High grade material used throughout. Tough long wearing Fabritoid Black seal grain leather with white metal trimmings. Drawers felt lined with metal bottoms. Price \$18.00.

**JOHN WILLIAM MFG. CO.**  
710 W. Jackson Blvd. Chicago, Ill.



## WORLD'S LOWEST PRICED ADDING MACHINE

**FREE TRIAL ONLY \$250**

**IDEAL FOR BUSINESS OR PERSONAL USE** GUARANTEED ACCURATE. Not a toy. Operates with only a finger flick. Adds, subtracts, multiplies, divides. Counts up to ten million. Pays for itself over and over. **IDEAL Gift—** for Business, Income Tax and School use. **MONEY BACK GUARANTEE.** Send name and address. Pay postman only \$2.50 plus postage. (Send full cash if outside U. S.) Money back in 10 days if not delighted. **AGENTS WRITE.**

**CALCULATOR MACHINE COMPANY (Mrs.)**  
DEPT. 131 P. O. BOX 1118 CHICAGO, ILLINOIS

tanks and airplane parts and trucks and petroleum and munitions, did not upset the calculations greatly, for the volume of consumers' goods is shrinking as the freight of war increases.

(Concluded next month)

## "Bomb Voyage" to Tokyo

(Continued from page 5)

board. This job completed, the task force would continue on its way at top speed, the protecting umbrella of fighting planes once more raised to keep off enemy bombers which unquestionably would follow.

Japanese surface ships could not hope to catch the speedy American task force. Should any be in position to intercept, however, the supporting craft would be able to stand off the attack. The first day of the return trip would be the most hazardous, naturally, then would come the welcome relief of darkness. Beginning with the next dawn the attacking group would be safe from all attack except, perhaps, from lurking submarines enroute. The scouting planes ranging far ahead and on the flanks should be able to spot these and give ample warning of their presence.

Thus ends our speculative air raid against Tokyo. Would an actual assault of this nature be worth the risk to men, ships and planes? That is a question which only the Navy High Command can decide. Undoubtedly the losses sustained by the American attackers would depend upon the promptness and efficiency of the anti-aircraft fire and of the effectiveness of the opposition from Japanese fighting planes, which latter might not be so formidable because of the large offensive operations being conducted in other theaters of war thousands of miles distant.

On the other hand, one can easily picture the destruction that 300-odd bombing planes might wreak upon Japan, to say nothing of the state of mind created in the average Japanese by such a raid. This form of attack has been most feared by them, particularly because of their over-populated cities and their flimsily constructed houses, so vulnerable to incendiary bombs.

Japan knows that so long as the Hawaiian and Aleutian Islands are held by the United States as potential springboards,

(Continued to page 181)



# Bean's Saddle Sport Oxford



Men's  
**\$5.65**  
Postpaid

Made of white elk with brown calf saddle. Full leather lined counter with white drill vamp lining. Dark red rubber gristle sole that will outwear leather. Men's: \$5.65, ladies': \$4.65 postpaid. Send for new spring catalog.

**L. L. Bean, Inc.**  
269 Main Street  
Freeport, Maine  
*Mfrs. Fishing and  
Camping Specialties*



**"Rust killed it! I forgot to clean out my radiator with Sani-Flush"**

A clogged radiator can lay up an automobile—cause dangerous overheating and expensive damage. Don't take chances when it's so easy to keep the cooling system clean and free with Sani-Flush. Costs only a few cents.

Don't take chances on just flushing with water. Sani-Flush is thorough. Use it yourself, or ask your service station. *Sani-Flush is absolutely safe in auto cooling systems, when used according to directions on can.* It's in most bathrooms for cleaning toilets. Sold in grocery, drug, hardware and 10c stores. The Hygienic Products Co., Canton, O.

## Sani-Flush

**CLEANS OUT RADIATORS**

## IDEAL Lawnmower Sharpeners

Go into business for yourself. Earn up to \$25 per week sharpening lawnmowers. BIG CATALOG FREE. Send post card to The Fate-Root-Heath Co., 1742 Bell St., Plymouth, Ohio

**SAVE MONEY**  
**BUILD YOUR OWN FAN**

Aluminum Propellers	THREE-BLADE for 1/4 H.P. Motor			TWO-BLADE for 1/8 H.P. Motor		
	Size	Shaft	Price	Size	Shaft	Price
White	20 1/2"	3/8"	\$4.50	12"	1/2"	\$2.75
They Last.	24"	1/2"	5.00	16"	3/8"	3.00
Shipped	26"	1/2"	5.50	20 1/2"	3/8"	3.50
Collect						

MICHAEL ELECTRIC COMPANY, Dept. P., Fort Worth, Texas

## Lower Cost BUILDING MATERIALS



MEN OF FORESIGHT realize the big possibilities today in the building industry. Big opportunity supplying locally made, low-cost, permanent, fire-safe building materials. GET READY TO SUPPLY this demand in your locality. You can build up a complete modern plant from a single machine at \$190.00. INVESTIGATE—Now is the time to get ready. Write today for our big new catalog No. 72 and easy payment plan.

**CONCRETE EQUIPMENT CO.**  
512 Ottawa Ave. Holland, Mich.

## Build Models the Men in the Air Force Build CLEVELAND 3/4" SCALE WAR MODELS BRAND NEW!

• 48 1/2" Lockheed Hudson Bomber, Kit SF-95.....\$7.50  
• 30" Hawker "Hurricane," Kit SF-78.....\$3.00  
25 1/2" Airacobra (shown at right), "Cannon-Plane" Kit SF-76.....\$3.00  
28" P-40 Tomahawk, Kit SF-77.....\$3.00  
31 1/2" Skyrocket, Kit SF-75.....\$3.50  
Biggest \$1. Plane in U.S. 7ft. Condor Glider Kit. \$1.00  
38 1/2" Lockheed P-38 "Lightning," Kit SF-85.....\$4.90  
All Kits complete. At dealers, or order direct. Send 5c for latest catalog.  
**CLEVELAND MODEL & SUPPLY CO. INC., 4508B65 Lorain Ave., Cleveland, Ohio**



## it's FREE! it's NEW! LAFAYETTE RADIO CATALOG

Send for FREE catalog of values in radio—beautiful new Lafayette radio models—America's greatest line of nationally advertised parts, equipment, tools, instruction books—all stand-out values at Lafayette's rock-bottom money-saving prices. Send for your Lafayette catalog TODAY! Penny post card will do.

**LAFAYETTE RADIO, Dept. G2M** 901 W. Jackson Blvd., Chicago, Ill.  
265 Peachtree St., Atlanta, Ga.

## Powerful Vision—8 Mile Range BINOCULARS 20 Days Free Trial \$475 Postpaid or C.O.D.

Scientifically ground, powerful lens that give clear vision equal to 110 yds. at 1000 yds. distance! Adjustable for all distances and eye widths. Binoculars come with handsome case and straps. GUARANTEED. If not satisfied after 20 days free trial money refunded. American Binocular Co., 7759 S. Halsted, Dept. F-462, Chicago.

## SHAW and "Peppy-Pal" GARDEN TRACTORS

• 1 to 9 H. P. Circulars on request. War limits production—YOU CAN BUILD YOUR OWN GARDEN TRACTOR

at small cost, powered by engine from washing machine, power mower, etc. \$1.00 brings our plans, postpaid, telling how to build a garden tractor, for cultivating, light plowing, etc., chiefly by welding and bolting up scrap steel.

**SHAW MFG. CO., 4507 Front St., Galesburg, Kansas**  
658-G No. 4th St., Columbus, O.; 5812-G Magnolia Ave., Chicago, Ill.



# NEW! CHAIN DRIVE 7" METAL SHAPER!

**FASTER  
SMOOTHER  
CHATTER-  
FREE**

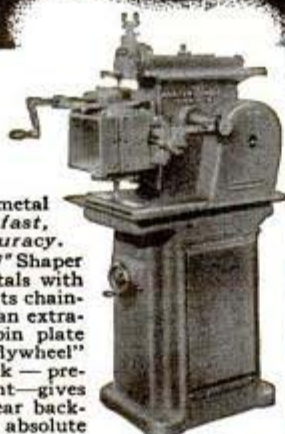

● At last—a small-size metal shaper with the "beef" for fast, heavy cuts, with accuracy.

This new Porter-Cable 7" Shaper handles the toughest metals with amazing effortless ease. Its chain-and-sprocket drive plus an extra-heavy cast iron crank pin plate give a smooth, powerful "flywheel" action that reduces shock—preserves true work alignment—gives faster cutting—avoids gear backlash—keeps chatter to an absolute minimum!

Micro-set ram, driven through Porter-Cable's exclusive "Anyspeed" control, operates at any speed from 64 to 175 strokes per min. Six automatic cross feeds. Tapered locating pins in both tool head and vise. Equipped with 1/2 h.p. motor. Complete, self-contained, a machine that's "all ready to go" on war work. Write today for full details and prices.

Table traverse, 10 1/4"  
Vertical travel, 5 1/4"

BE SURE IT'S

**PC**

**PORTER-CABLE  
MACHINE CO.**

2050-7 N. Salina St., Syracuse, N. Y.

REPRESENTATIVES IN ALL PRINCIPAL CITIES

# Use Air Pressure to BEAUTIFY & REMODEL

Renew old buildings. Make new construction more permanent and attractive. Plastic COLORCRETE is water-proofed. It fuses with any masonry surface. It fills cracks and checks. It can be applied in any thickness and in 30 colors and shades.

Fully proven by over 14 years actual use. Offers big earnings. With this machine you can supply big waiting market at amazingly low cost. Some present operators report earnings that have paid for their equipment from first few jobs. Machine capacity up to 1,000 sq. ft. per hour.

Get the facts. Send for Free Book "Proven Business Opportunity." Write today.



**COLORCRETE INDUSTRIES, INC.**

570 Ottawa Ave. Holland, Michigan

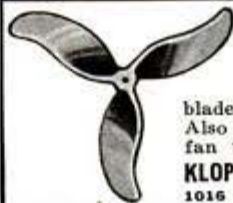

## LIMITED STOCK

● We have on hand a limited stock of quality aluminum fan blades—2 blade, 3 blade—in six sizes. Also frames, wire guards, shutters and fan trust motors. Write for prices.

**KLOPPENBORG ALUMINUM FOUNDRY**

1016 East River St., Davenport, Iowa

## Wonder-Tone NOISE ELIMINATOR

Just attach to your radio (long, short wave) and enjoy reception free from distracting noises. Send-No-Money Pay Postman 80c plus postage or send 60c and we'll send postpaid. Return in 5 days for refund if not delighted.



WONDER-TONE COMPANY, Dept. 18, 7078 N. Clark St., Chicago, Ill.



**HARLEY-DAVIDSONS are**

*Out in front*

**in War as in Peace!**

Now, as always, sturdy construction, zooming power, and rugged dependability are the in-built qualities which enable Harley-Davidson Motorcycles to stand up under toughest service. For just as Harley-Davidsons set the pace in civilian use, they serve with distinction on the front line of action with America's armed forces. While there are no new Harley-Davidsons available now, your dealer may have some good values in reconditioned models. See him today.

## MAIL COUPON NOW

HARLEY-DAVIDSON MOTOR CO., Dept. P, Milwaukee, Wisconsin

Send FREE copy of 24-page "Enthusiast" magazine filled with thrilling motorcycle pictures and stories. Also other literature. Stamp is enclosed for mailing cost.

Name.....

Address.....

**HARLEY-  
DAVIDSON**



ON AMERICA'S FRONT

LINE OF ACTION

7. 332

punishing raids by carrier striking groups are possible and probable, as basically the problem is similar to that which she faced in her attacks against Pearl Harbor, and subsequent successive Allied outposts in the Southwest Pacific. Moreover, weather conditions are propitious now for such attacks, due to the fact that the northern Pacific, tempered by the Japan current, is generally free from fog at this season.

Should Russia enter the war against Japan the Allies would have the great advantage of using immediately the air bases of Vladivostok and the Maritime Provinces. This would change the complexion of the problem considerably. American planes could then hop from the Aleutian Islands to Petropavlovsk (Kamchatka), refuel and circle down to Tokyo, 1,700 miles, or use Vladivostok as a stepping stone enroute. These Siberian bases are excellently located, both geographically and strategically, for direct blows on all important Japanese cities—a menace hard to overcome.

Meanwhile, periodic harassment of Japan's widely scattered island outposts probably will be continued and intensified by American hit-and-run task groups, for the purpose of preventing their development into useful bases for Japanese naval and air forces until a full-dress American offensive—land, sea and air—is initiated. As to the route to be taken, every avenue of attack is being given deep thought and study by the American High Command. There is little doubt that before the vast Pacific war is finished the Land of the Rising Sun will have seen plenty of American war planes and fighting ships.

**Note:** The opinions and assertions expressed herein are the author's and are not to be construed as official or reflecting in any way the views of the Navy Department or the Naval Service at large.

7. 48

### Raincoats Made of Limestone Wear Better Than Rubber

Limestone powder is being used to make raincoats for Canada's armed forces. These coats resist heat, cold, light, acids and grease better than rubber, the Department of Munitions and Supply reports. The inexpensive white powder is transformed into a resin as the first step in producing synthetic rubber. After the resin is dissolved, it is colored, treated for flexibility and applied to cotton fabric.

JULY, 1942

*Arthur*



**STOP that... DRIP!**

**NO Drip** **A SURE CURE . . . .**

Use this plastic cork coating to positively stop sweating and condensation drip. Easy to apply with whisk broom, brush or trowel to pipes, tanks, walls, ceilings, air ducts—any surface of metal, concrete, brick, wood, plaster, composition. Insulates and prolongs life of metal by preventing rust and corrosion. A gallon covers about 30 ft. of 1" O.D. pipe. The permanent, stucco-like finish can be painted any color. Comes in 1, 5 and 55 gal. drums. Get at Hardware, Plumbing, Mill Supply Dealers or send \$1.90 for 1 gal. prepaid. **CIRCULAR FREE.**

**J. W. MORTELL CO., 522 Burch St., Kankakee, Ill.**

**SAVE TOBACCO!**

**New Funnel-shape Pouch fills pipes easily & quickly WITHOUT SPILLING!**



**REAL Leather . . . only \$1.00 Prepaid**

• Press sides and small end opens . . . spring release closes it tightly. Oil silk lined. Genuine Black or Brown Morocco grain leather. Zipper opening for filling. Send \$1, or will ship C. O. D. charges extra.

**IWAN RIES - 71 WEST MONROE - CHICAGO**



**35 YEARS**  
of service to toolmakers and machinists.  
Free Catalog.

**GERSTNER TOOL CHESTS**  
442 Columbia St. Dayton, Ohio

**BLACK-OUT—LUMINOUS PAINT—APPROVED FOR BLACKOUT**

New—Amazing luminous paint. Makes any object shine in darkest night. Few minutes exposure—shines all night. Users simply started. Coat any object you want. Sold on money-back guarantee. Complete kit of 3 bottles luminous paint (various colors). Luminous blackout button—6 luminous markers and complete working instructions all prepaid for only \$1.00. We can also supply complete line of blackout equipment. Write immediately. **SCIENTIFIC RESEARCH PRODUCTS, 1904-PM PATTERSON AVE., CHICAGO.**



**SEND TODAY FOR YOUR FREE COPY**

**argus**  
ann arbor michigan

**IT'S FREE!**

**CHOOSING YOUR CAMERA for Good Pictures**

## Long Fishing Poles Carried Easily On One Side of a Car

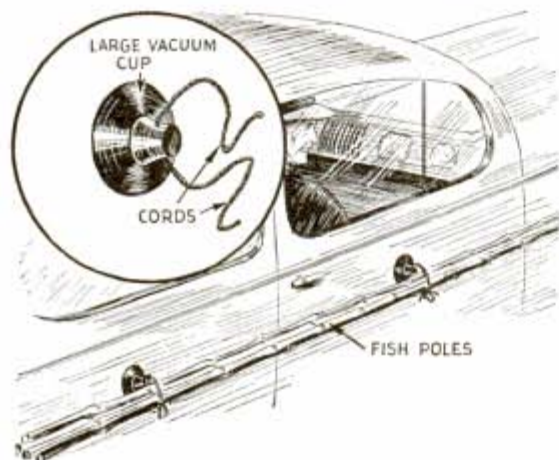

Long fishing poles can be carried on the side of a car without marring the finish by tying them to a couple of large vacuum cups attached as shown. It is not necessary to remove the cups while on a fishing trip as they do not interfere in any way with opening and closing the doors. Where exceptionally long poles are to be carried, it may be advisable to attach an extra vacuum cup on the front fender so that the pole ends can be tied.

## Barbed Wire Is Unrolled Safely With Team and Wagon

Unrolling spools of barbed wire safely when putting in a fence is no job for one farmer who uses his team and wagon for the purpose. A plank is first fitted in front of the rear endgate cleats after which a hole is bored in the center of this to take a length of 1-in. pipe. In use, it's a simple matter to fasten the wire end to a corner post, slip the spool on the pipe spindle and

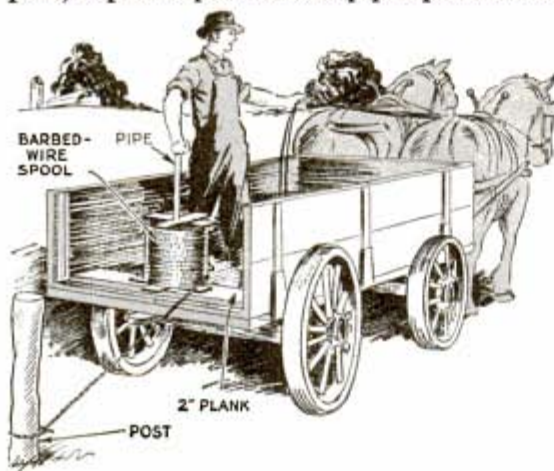

drive down the fence row. Friction between the plank and spool serves as a brake which prevents the wire from unrolling too fast and becoming tangled. If desired, an additional hole can be bored in the plank, making it possible to unroll two spools of wire at the same time.

## Sign Made of Metal Lath

An ideal sign for localities subject to high winds is one used by a business man in a southern city where frequent tropical storms and hurricanes occur. It is made from metal lath which is set in a suitable frame, and sprayed with aluminum paint to form the background for the letters. These are cut from galvanized iron, each being bolted to the metal lath with three to five machine bolts and washers. Not only is this sign safe in gales and high winds, but it is inexpensive to maintain. Wording may be changed easily. When painting is necessary, it is a simple matter to remove the letters, coat and replace them. Furthermore, it will not warp nor rot due to dampness.

## Coil Spring Used as Flexible Tie For Boat in Berth

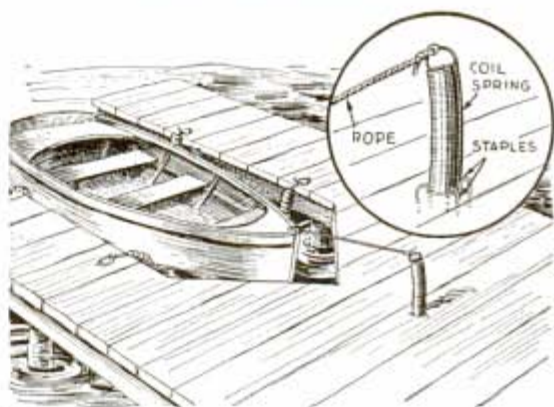

One boat owner uses a stiff coil spring as indicated to keep the boat snug in a dock berth yet allow it to move with tides or waves. The spring is 1½ in. in diameter and is fastened to the wharf with three large staples through the lower turn. A rope at the top of the spring is used to tie up the boat.

—Dale Van Horn, Lincoln, Nebr.

Chinese and Indian matting rugs as well as bamboo curtains and furniture will not become yellow if cleaned with salt water.

# NOW.. a DYNAMIC HEAVY DUTY INDUSTRIAL WELDER

THE BOOM IS ON IN WELDING—EARNINGS ARE SKYROCKETING

WORKS OFF  
110 VOLT  
ELECTRIC  
LIGHT  
CIRCUIT



Thousands of welders have already left their jobs and shops to get "war-time" pay in plants devoted to defense production, such as ship building, tanks, airplanes, munitions, etc. Also, in the erection of industrial plants, bridge construction work, etc. This creates an unusual opportunity for men everywhere to get in the welding business right in their own communities, and take over the work these men have left behind. Now with the new DYNAMIC Super-Charged Transformer-Type Welder that works off a 110 volt electric light circuit, men by following the simple, concise home instructions can quickly fit themselves to do finished repair jobs. In this way you may qualify for a big pay job in the defense industry.

**WELDS BUMPERS, FENDERS, CYLINDER BLOCKS, BODIES, FRAMES, ETC. Does Farm, Factory and Home Repairs**

Many welders make big money. Any number of jobs can be done more efficiently with welding. The **DYNAMIC Super-Charged Welder Saves Time and Money.** Despite its serviceability, is so easily portable it can be carried around by hand and taken right to the job. This is an added feature whose value you will appreciate once you are in welding.

**WORKS ON IRON STEEL, TIN, BRASS, COPPER, AND ALL OTHER METALS**

With this Welder you can work on all kinds of metal—nothing will stump you—you can tackle anything and in no time at all you will be able to do finished repair jobs that will do credit to an expert.

**DOES METALLIC AND CARBON ARC WELDING**

Can be used efficiently on both types of welding. The cost of using the DYNAMIC Super-Charged Welder is amazingly low—costs only a few cents an hour to operate. It is built so strongly that repairs are practically unknown—you'll never have to worry about them. It cools so efficiently that you can use it continuously without ever having to stop in the midst of a job to let it cool down. **COSTS LESS THAN 6c A DAY.** You can buy the DYNAMIC Super-Charged Welder on easy payments. Over a year's time, it would cost you less than 6c a day. Once you have your DYNAMIC outfit, you are all set in a profitable welding business of your own—you boss it yourself. Send coupon for free particulars today.



These pictures show how easy it is to operate the Dynamic Super-Charged Welder.



### READ WHAT USERS SAY

**Electrician says:** "It is the best welding outfit." I wish to tell you that I demonstrated your welding outfit to a great many people, and they all agreed with me that it did the best welding job they ever saw. A. L. Bristol, Conn.

**Mechanic Praises Welder.** I have received my welder and like it very much. I am a mechanic and electrician by trade, so I can appreciate its usefulness to others. P. C. Perry, N. Y.

**Repair Shop Owner Tells About Dynamic** I want to say I operate a repair garage and I am more than satisfied with the welder. It will do more than you say. C. P. Butler, Ohio.

**Greatest Portable Outfit** I must say it's the greatest portable outfit any man could wish to own. You may put me on file as a booster. W. J. B., St. John, N. B., Canada.

**AGENTS WANTED:** Do you want something easy to sell? You can make big profits introducing to garages, factories, mechanics, janitors and maintenance men the new DYNAMIC Super-Charged Welder—we'll let you try it for ten days at our risk so you can be convinced of the immense sales possibilities. Get our big profit plan and ten day trial offer. Just send attached coupon for free particulars today!

**DYNAMIC WELDER CO.**

2226-TY SILVERTON ROAD

CHICAGO, ILL.

**Dynamic Welder Co., 2226-TY Silverton Rd., Chicago, Ill.**

Gentlemen: I want to go into the welding business. Send me free particulars on how I can learn welding at home and full details on your Dynamic Welder.

AGENTS: Just mark an "X" here  and you will receive full particulars of our big profit plan and 10 day trial offer.

Name .....

Address .....

Town .....

State .....

# SOUTH BEND TURRET LATHES

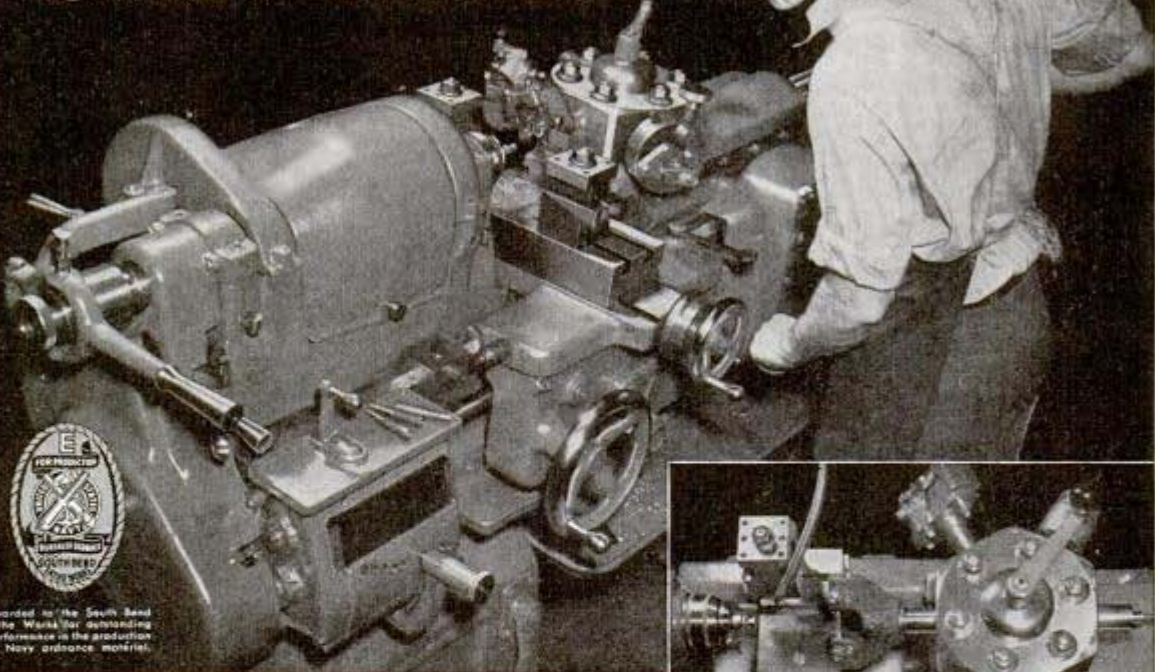

Awarded to the South Bend lathe Works for demanding performance in the production of Navy ordnance material.

## Productive Versatility

South Bend Turret Lathes have the kind of versatility that speeds production on many classes of work. A wide range of spindle speeds permits maximum cutting tool efficiency. Rapid change from high speeds to low speeds saves time on thread cutting and reaming operations. A quick change gear box provides 48 changes of power feeds for the universal carriage and the turret. The universal carriage has 48 precision thread cutting feeds driven through a lead screw and half-nuts.

Standard extras include compound cross slide, four-way turret tool block, micrometer carriage stop, thread indicator dial and taper attachment. These attachments simplify tooling the lathe for many classes of work, and make it especially adaptable to second operation jobs.

The South Bend No. 2-H Turret Lathe has a chucking capacity of  $16\frac{1}{4}$ " swing over the bed and saddle wings, a spindle bore of  $1\frac{3}{8}$ " and a collet capacity of 1" for round stock. Twelve spindle speeds (16 to 880 r. p. m.) are provided. The effective feed of the turret slide is  $6\frac{1}{8}$ " and the distance from spindle nose to turret is  $30\frac{1}{2}$ ". Complete specifications are contained in Bulletin 67-T, which will be sent upon request.

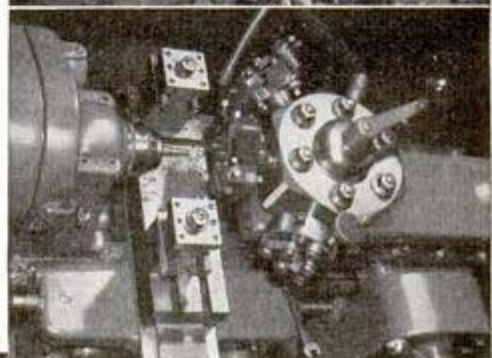
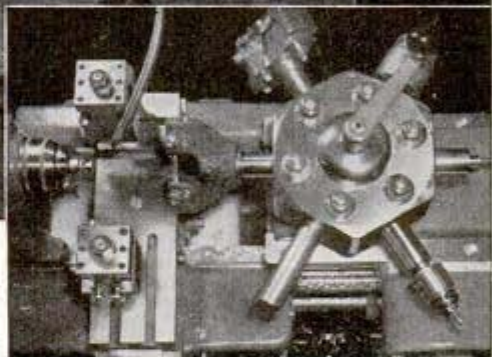

## SOUTH BEND LATHE WORKS

619 E. Madison Street, South Bend, Indiana, U. S. A.

LATHE BUILDERS FOR 35 YEARS

# NOW! YOU CAN OWN A GENUINE PROFESSIONAL TYPE REFLEX CAMERA AT A LOW PRICE THAT YOU NEVER DREAMED POSSIBLE!



"See What You Get—  
Get What You See!"



**This Is The Type Camera  
That News Photographers Use.  
Thousands Paid \$5.50 For It!**

Here is positively the most amazing camera bargain ever offered! Because the manufacturer, who is one of the world's largest makers of cameras, is engaged

in the manufacture of war materials, we have purchased the last few thousand TWIN FLEX Reflex Cameras at a "close-out" price. A few months ago this camera was being sold by camera dealers at \$5.50. In the face of sky-rocketing prices, a few thousand lucky camera fans can own one of these genuine \$5.50 TWIN FLEX Cameras for the unbelievably low price of \$2.98! This marvelous camera, with its matched focusing lenses, shows you the actual picture on the ground glass range-finding screen *before* you take the picture. You can tell *exactly* the way each and every picture will look before you snap it. There is no squinting through small view finders! No out-of-focus pictures, whether the subject is close up or far away!

*Now Only*  
**\$2.98**  
**Film FREE**

## Amazing Matched Focusing Lens Prevents "Duds" or Blurry Shots

Even at the old price of \$5.50, the Univex TWIN FLEX was the sensation of the camera world. This marvelous camera, with its matched focusing lenses, shows you the pictures on the ground glass range-finding screen *before* you take the picture. In other words, you can tell *exactly* the way each and every picture will look before you snap it. You automatically focus every picture before you take it. There is no squinting through small view finders! No out-of-focus pictures, whether the subject is close up or far away! **YOU GET EXACTLY WHAT YOU SEE!**

**This TWIN FLEX  
Comes To You  
On A Money  
Back Guarantee  
Of Satisfaction!**

**The Only Popular-  
Priced Reflex that  
Focuses on Upper,  
"Tunes In" Close-ups  
or Distant Shots!**

*There's no "trial-and-error" with your TWINFLEX! No squinting through small view-finders! No complicated gadgets! Every shot's a "honey" because you see every one before you take it!*



## CAMERA FANS! HERE'S WHAT THE TWIN FLEX OFFERS YOU

Words and pictures can't do justice to the precision-built TWIN FLEX. It's made of handsome black Textolite with a satin-finish and chrome-plate trim. The matched, focusing lens gives you needle-sharp pictures—as sharp as any pictures you have ever taken with any camera irrespective of the price. The new, improved shutter design has both "instantaneous" and "time" exposure settings. The TWIN FLEX makes beautiful close-ups without any special "portrait" or "close-up" attachments. If you're anxious to get a camera that will give you years of unsurpassed performance and magnificent service, mail the coupon today and get a TWIN FLEX before the limited supply is gone.

## TWIN FLEX Has Many Features Found in \$35.00 Cameras

So confident are we that you won't be able to duplicate this camera "buy" anywhere else in the country, that we will gladly send it to you along with a FREE roll of film, on our no-risk money-back guarantee. If after getting and using the TWIN FLEX for ten days, you and your friends don't think that this is far and away the most amazing camera bargain you have ever seen, just return the camera (keep the film) and we will refund your money—every penny of it! The price is only \$2.98 for the camera! The film comes to you **ABSOLUTELY FREE!**

### ECONOMICAL!

**Takes 6 Pictures on Any No. 00 Film—Costs Only 15c**  
The TWIN FLEX uses economical No. 00 film which can be purchased at any store in the country at the low price of 15c per roll. If you take advantage of our special offer, we will send you seven rolls of film for only \$1.00. Order film on the coupon below.

## SEND NO MONEY—RUSH THIS COUPON!

Illinois Merchandise Mart (Camera Div.)  
Dept. 321, 54 W. Illinois St., Chicago, Ill.

### NO RISK OFFER

- Send Camera and Free Roll of Film. I'll pay postman \$2.98 plus postage.
- Enclosed find \$2.98 for Camera and Free Roll of Film. Ship postage paid.

Name .....

Address .....

Town or City.....State.....

Take advantage of this big film saving! Get seven (7) rolls of film (42 pictures) for only \$1.00.

- Enclosed find \$1.00 for 7 rolls of film. Ship postage paid.
- Send 7 rolls of film C.O.D. for \$1.00 plus postage.

### Special Money-Saving Combination Offer

- Enclosed find \$3.98. Ship me, all postage paid, 1 Camera and roll of film, and 7 extra rolls of film (enough for 48 pictures).

# YOU WANT STEADY NERVES

when you're  
flying Uncle Sam's  
bombers across  
the ocean



WITH THESE MEN WHO FLY BOMBERS, it's Camels all the time. The co-pilot of this crew (name censored), (*second from left, above*) says: "I've found Camels a milder, better smoke for me in every way. And that grand flavor never wears out its welcome." Yes, in times like these when there's added tension and strain for everyone, steady smokers stick to Camels.



### FIRST IN THE SERVICE—

The favorite cigarette with men in the Army, the Navy, the Marines, and the Coast Guard is Camel. (Based on actual sales records in Post Exchanges, Sales Commissaries, Ship's Service Stores, Ship's Stores, and Canteens.)

### —AND THE FAVORITE AT HOME!



R. J. Reynolds Tobacco Company, Winston-Salem, N. C.

GERMANS OR JAPS, storms or ice... you've got to be ready for anything when you're flying the big bombers across the ocean. You bet you want steady nerves. These two veterans above are Camel smokers. (Names censored by Bomber Ferry Command.) The captain (*nearest camera*), a Tennessean, says: "I stick to Camels."

## STEADY SMOKERS STICK TO CAMELS

*There's LESS NICOTINE  
in the smoke*

The *smoke* of slower-burning Camels contains 28% less nicotine than the average of the 4 other largest-selling brands tested—less than any of them—according to independent scientific tests of *the smoke itself!*

IN MY NEW  
DEFENSE JOB, LESS  
NICOTINE IN THE  
SMOKE IS IMPORTANT  
TO ME. I STICK  
TO CAMELS

