

Dogs of War

★
**POPULAR
MECHANICS**

MAGAZINE

WRITTEN SO YOU CAN

REGD. TRADE MARK, GREAT BRITAIN, NO. 4043E

JUNE
25 CENTS
30c IN CANADA



SEE PAGE 45



You may worry
about the age
of your car

but here is one worry you can avoid

WHEN Uncle Sam said, "No new cars this year," he also meant "The car you own has got to last a long time—every precious part of it!"

That's why king pins, tie rods, drag links, bearings and other vital friction points require the *extra* care, the *superior protection* of stem-to-stern Marfak chassis lubrication.

Marfak helps add miles to your car's life because it's super-tough. Applied by chart—not by chance—it resists wear-out, wash-out and squeeze-out.

For your peace of mind, don't say "grease-job." Insist on genuine Marfak 40-point Lubrication Service. At Texaco and other good dealers everywhere.



TUNE IN: FRED ALLEN every Sunday night.
See your local newspaper for time and station.

You're Welcome at **TEXACO DEALERS**

"TO PROVIDE FOR THE COMMON DEFENSE, TO PROMOTE THE GENERAL WELFARE"



Bad medicine for big bombers

ONE WAY to spoil a bomber's aim is to hang a curtain of steel over your ship and dare him to come down through it. To get that curtain of steel up there requires quick-firing, flexible guns.

To the plant of the Westinghouse Electric Elevator Company the Navy, a few months ago, brought its plans for such a gun. And to Westinghouse was given the important job of building the mounts that would control the aiming of these batteries of quick-firing guns.

Today, over that Westinghouse plant, there floats the Navy's "E" pennant—for excellence—testimony to the manner in which this Westinghouse plant did the job. How was this plant able to get into growing production of these mounts so quickly? The answer lies in a Westinghouse characteristic called "know how"—the ability to get things done in the best possible way.

This Westinghouse "know how" makes itself felt wherever Westinghouse craftsmen build things. Whether for the common defense or the general welfare, this "know how" is doing a job. The same skill and ingenuity that made so many splendid things for peacetime living are now being applied to many important war weapons.

"Know how" will work for you again

We look forward to the day when we can give your home, your farm, or your factory the full benefit of Westinghouse "know how" again. To speed that day means just one thing to us: to produce, in ever increasing quantities, the tools with which to get the victory job done.

Westinghouse

For the Common Defense

Sterilamps
Bomb Fuses
Tank Equipment
Military Radio
Equipment

Plastic Plane Parts
Seadrome Lighting
Equipment
Blackout Plant Lighting
Equipment

For the General Welfare

Air Conditioning
Electric Refrigerators
Electric Irons

Switchboards
Lamps
Motors and Controls

These lists mention only some of the many thousands of Westinghouse products.

Westinghouse Electric & Manufacturing Co., Pittsburgh, Pa.

Cop. 1942. Westinghouse Electric & Manufacturing Co.

JUNE, 1942

This One



F4JR-A7J-2W43

Microfilm, microfiche and microfilm editions available.

1A

“Carrying
lots of pressure
these days...”

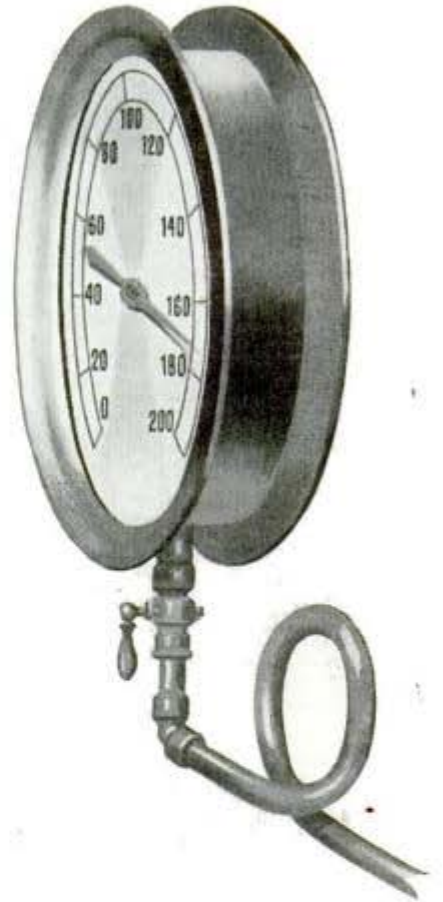

“THERE is more steam up in the Bell System than I ever remember. The wires hum with war and wartime production. There's more telephoning than ever before.

“The pressure of war and war's work is on — especially on our toll lines. If you are going to use Long Distance you can help by —

**Knowing the number you want to call.
Calling in the less busy hours — before 10 A. M. and after 8 P. M., for example.**

“Let's give vital war calls the right of way and make equipment go as far as possible, saving copper and other materials for the war.”

BELL TELEPHONE SYSTEM



“The Telephone Hour”—presenting great artists every Monday evening — N. B. C. Red Network

Popular Mechanics Magazine

Registered in U. S. Patent Office and Canada

H. H. WINDSOR, Founder

H. H. WINDSOR, Jr., Editor and Publisher

June, 1942

Vol. 77, No. 6

IN THIS ISSUE

Fishing for Vitamins	1
Dogs of War	8
Shoot Them in Color	17
Stars' Secrets Revealed by Midget Eye	28
The Coast Guard Girds for Battle . . .	34
Flying Mules of the Army	40
New Disguises of the Demon Fire . . .	50
Hit or Miss	56
Piloting the Tom Thumb Water Bugs	66
If You Can Drive You Can Fly (Part 1)	72
Keeping Our Warbirds Flying	82
Torture Chamber Guards Power Lines	88
The Revolution in Farming	92

Where-to-Buy-It Index Starts on Next Page

'Black Light at Your Service

NEXT month's Coloroto section is a blueprint for black magic. It tells how to make a ghost of yourself and your party guests with a bit of vaseline and an ultraviolet lamp, how to hang a weird fluorescent halo over a portrait on the wall, how to dress up the bric-a-brac cabinet with dull rocks and cheap vases that bloom into lovely luminous colors and vivid patterns under a hidden "black light" bulb. You can play with black light for 50 cents or \$50, and its bag of tricks is bottomless. With the story there will be eight pages of color photographs.

The Main Line Goes to the Front

BEFORE the blitz in Europe, passenger traffic on the railroads is suspended. It's not like that here. The Quartermaster General tells the railroads an Army division, 15,000 men and equipment, is to move in 48 hours. The railroads assemble a fleet of locomotives and cars and do the job. Read "The Iron Horse Delivers the Tools of War" in the July issue.

Next Month

MEET the 1942 M. P. He's not just a gruff, club-wielding army cop; something new has been added—brains! The new style army policeman is learning law from lawyers, marksmanship from the army's crack shots; intelligence tests and the psychology of handling people are part of the training. But they also learn tricks of body leverage: how to wrest away a gun pointed at your stomach, or send your assailant flying when he has you on your back. Read in the July issue how our M. P. has improved on juditsu.

Life on the Stars?

MAYBE there is life on other worlds. Fish with gyroscopic stabilizers swimming in an ammonia ocean. Animals that roll like a barrel. Lighter-than-air birds made buoyant by hydrogen, flying by jet propulsion. People living in an atmosphere of laughing gas, their blood streams circulating refrigerating fluid. Next month a noted scientist offers intriguing answers to the question: "Is There Life Among the Stars?"

War Study on the Air

TIMES SQUARE is "bombed" for the television screen, and thousands in the New York area listen and look as the scene moves across their home sets. They are "rookies" of the civilian defense army—fire wardens and rescue workers, learning the job in this new way. "Television Trains the Home Guard," in July, tells of this home-study school for war.

Published monthly by POPULAR MECHANICS COMPANY, 200 East Ontario Street, Chicago, U. S. A. Single copy in the United States, 25 cents; subscription rates in United States and possessions, and countries of the Pan-American Postal Union including Spain, \$2.50 a year. Single copy in Canada, 30 cents; subscription rates, \$3.00 a year. To all other countries add \$1.00 a year over United States prices for overseas postage. Changes in address must be reported to us immediately to eliminate delay. Entered as Second Class Matter, Sept. 15, 1903, at the Post Office at Chicago, Illinois, under Act of March 3, 1879. Entered as Second Class Matter at Post Office Dept. Canada.

Copyright 1942, by Popular Mechanics Company, Copyright under International Copyright Union. All rights reserved under Pan American Copyright Union. Printed in the United States of America



Vital Machinery Must Not Break Down Under the Excessive Strain of its All Out War Production Job

A machine at home is a gun on the battle front. A machine failure is a supply failure. Failure of supply means lives sacrificed, and battles lost.

Pyroil, the super lubrication process, helps save machinery from breaking down, just as it has aided thousands of automobile engines in escaping many operation troubles and early wear-out. Pyroil is not a substitute lubricant. It is different from the regular lubricant you use. You merely add it, by ounces, to lubrication boxes and channels; to crank-cases and fuel tanks. Pyroil overcomes excessive heating, excessive friction. It safeguards during periods of strain.

Machines now must do three times their normal duty. Pyroil will help keep them running faster, running better, operating longer for a job that must not fail. See Coupon Below. Manufactured and Guaranteed by Pyroil Company, 56 Pyroil Bldg., La-Crosse, Wisconsin, U. S. A.



Fight for your country. Keep your car running longer. Keep Machinery running better. Pyroil will help you do it.

DISTRIBUTORS:
CHECK AND MAIL COUPON FOR FRANCHISE FACTS.

PYROIL COMPANY
56 Pyroil Bldg., La-Crosse, Wisconsin
Please send me literature, bulletins, reports showing Pyroil's essential contribution to efficient machine and auto operation.

Send details of Plan for Distributors.

Name.....

Address.....

City..... State.....

"KEEP 'EM ROLLING!"

WHERE-TO-BUY-IT INDEX

Where no name and address appear directly under an item, the product is not believed by us to be commercially available

Scoop picks up incendiary bomb.....	5
Western Fire Protection, Inc., 661 E. 3rd St., Los Angeles, Cal.	
Self-propelled combine.....	5
The Massey-Harris Co., Racine, Wis.	
Five senses duplicated by science.....	6
Leather kit holds six tools.....	6
Heinrich, Herrmann & Weiss, 29 E. Madison St., Chicago	
Bird and plane collisions.....	6
Blackout window shade.....	7
Sherman Paper Products Corp., Newton Upper Falls, Mass.	
Guayule seeds gathered by vacuum.....	7
Ready-made steel home trucked to site.....	12
R. G. LeTourneau, Inc., Peoria, Ill.	
Exposure to 63,000-foot altitude fatal.....	12
Bracket holds motor to canoe.....	13
Evinrude Motors, 4143 N. 27th, Milwaukee, Wis.	
Four-place defense ambulance.....	13
Henny Motor Co., Freeport, Ill.	
Blacking out Hollywood.....	14
Plastic utensils for the home.....	16
(Available in most variety stores)	
Prefabricated house.....	25
Allied Housing Corp., Langhorne, Pa.	
Phosphorescent blackout paint.....	25
Lightweight lifesaving suit.....	26
Reciprocating electric file.....	26
Chicago Pneumatic Tool Co., 6 E. 44th St., New York City	
Carbon dioxide would smother hangar fires.....	26
Cardox Corp., 307 N. Michigan Ave., Chicago	
Luminous disk visible in dark.....	26
Luma, Inc., 305 E. 46th St., New York City	
Lifesaving apparatus for British seamen.....	27
Sedan rebuilt into ten-seat bus.....	27
Siren operated by compressed air.....	32
Helium helps weld magnesium.....	32
Cart for unexploded bombs.....	32
Plane to carry 57 passengers.....	33
Spider webs for precision instruments.....	33
"Plug-in" electric belt conveyor.....	39
The Rapids-Standard Co., 535 Bond Ave., Grand Rapids, Mich.	
Thumber for casting reel.....	39
Pachner & Kolier, 2310 W. 69th St., Chicago	
Machine gun sheds barrel.....	43
Slippers fold into case.....	43
Heinrich, Herrmann & Weiss, 29 E. Madison St., Chicago	
Indoor parachute jump.....	44
Silver useful in war industry.....	44
Japs launch fake periscope.....	44
Portable airplane detector.....	45
The Zadis Patents, 1 Bouton St., South Norwalk, Conn.	
Lock nuts prevent tire theft.....	45
Pontiac Motor Div., G. M. Corp., Pontiac, Mich.	
Message spans globe.....	45
Landing tactics of Japanese.....	46
Bomb-fighting equipment on hand cart.....	48
Masters Planter Co., Benton Harbor, Mich.	
Russia gets rubber from "dandelion" plant.....	48
Scoop for farm tractor.....	48
Stockland Road Mach. Co., 2653 34th Ave., Minneapolis, Minn.	
Steel fort guards Britain's sea approaches.....	49
Housetop equipped to fight bomb fires.....	49
Huge, speedy oil circuit breaker.....	55
Wheel shows accident risk.....	55
Transparent Mystery Clock.....	61
Etalage Reclame Corp., 48 E. 28th St., New York City	

(Continued to page 6A)

Wake up Sleepy Motors



with
**CHAMPION
SPARK PLUGS**

Wake up your sleepy motor—step-up gasoline mileage to the maximum by having your spark plugs tested, cleaned, and re-gapped at regular intervals.

When should spark plugs be changed? That varies, as most any spark plug will continue to function in a hit or miss, wasteful and inefficient manner almost indefinitely. But why continue wasting gas with old, worn-out, carbon encrusted spark plugs, and why put up with sluggish, inefficient performance when new Champions will rectify these troubles—which usually occur after 10,000 miles of service?

Have your spark plugs checked today. If you need new ones insist on dependable Champions the only spark plugs with the Sillment seal which prevents harmful gas leakage *common to ordinary spark plugs*. Since leakage in spark plugs causes over-heating, pre-ignition and rough, wasteful engine operation, it's decidedly to your advantage to insist on Champion Spark Plugs for champion performance.



TO SAVE GASOLINE • KEEP YOUR SPARK PLUGS CLEAN

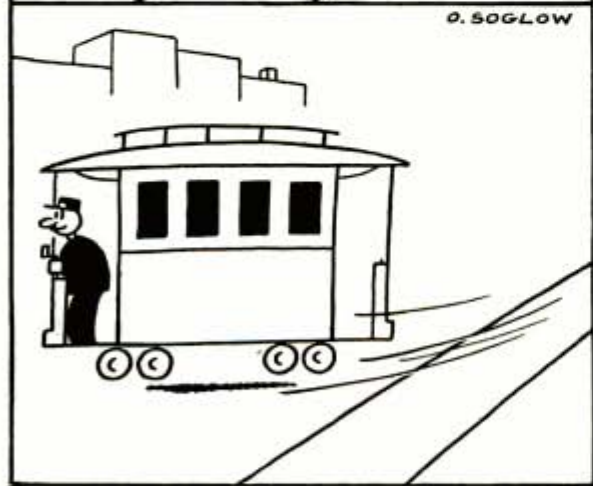
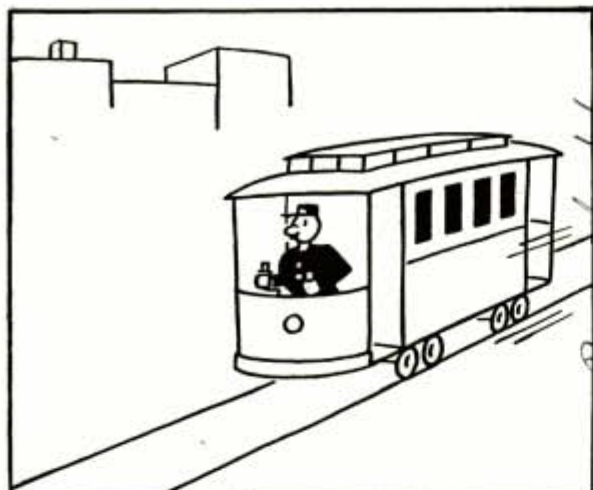

O. SOGLOW

Purity...
in the big big bottle
...that's **PEPSI-COLA**

(Continued from page 4A)

Heater has removable casing.....	61
<i>Cole Hot Blast Mfg. Co., 3108 W. 51st St., Chicago</i>	
Liquid massage for arm or leg.....	61
Why didn't you think of these?.....	62
Salvaging tin cans.....	64
Weather sayings based on science.....	64
Household brush has side bristles.....	64
<i>Lovall White, Merchandise Mart, Chicago</i>	
Plug for broken gas mains.....	65
Canadian coast guns camouflaged.....	65
Ready-made metal parts for skull.....	65
Auto wheels chained to bumpers.....	70
Ice cubes frozen in plastic cups.....	70
<i>Swift Mfg. Co., 247 McDougall Ave., Detroit, Mich.</i>	
Bath tub shower fits any spout.....	70
<i>Lovall White, Merchandise Mart, Chicago</i>	
Two-story telescoping trailer.....	71
<i>Liberty Coach Co., Inc., Bremen, Ind.</i>	
Plastic cork stops condensation drip.....	71
<i>J. W. Mortell Co., Kankakee, Ill.</i>	
Pocket-size bridge table.....	71
<i>C. F. Rump & Sons, Merchandise Mart, Chicago</i>	
Screen hangers snap in place.....	76
<i>National Lock Co., Inc., Rockford, Ill.</i>	
Delayed jump of steel to magnet.....	76
Tiny flower pot holds ant poison.....	76
<i>D. O. Eakin Co., 3964 Hopedale Dr., Sherman Oaks, Calif.</i>	
Women's fire brigade.....	77
Latest streamline trains.....	78
Luminous shoe soles for blackout.....	80
<i>Adler Shoe Store, 249 W. 42nd St., New York City</i>	
Sun is huge atom smasher.....	80
Adjustable book cover.....	80
<i>The Reis Co., 114 W. 27th St., New York City</i>	
Three gliders towed by army plane.....	81
Scale weighs tarnish film.....	81
"Walking" pistol range.....	86
Foolproof hearing tester.....	86
<i>Maico Co., 2632 Nicollet Ave., Minneapolis, Minn.</i>	
Name embossed on match books.....	87
<i>Universal Match Corp., 840 Boatmen's Bk. Bldg., St. Louis, Mo.</i>	
"Chinese puzzle" shell carrier.....	87
<i>Kellems Co., 1911 Park Ave., New York City</i>	
Huge bomb-carrying seaplane planned.....	87
Precision-built tile mural.....	90
Adjustable sweater-drying stretcher.....	91
<i>Chicago Curtain Stretcher Co., 3727 S. May St., Chicago</i>	
Blackout shields for auto lights.....	91
<i>Ray Bauer, 401 S. 17th Ave., Maywood, Ill.</i>	
Crocheted sling for injured arm.....	96
Air velocity meter.....	96
<i>Illinois Testing Lab., Inc., 420 N. LaSalle St., Chicago</i>	
One-man truck wheel remover.....	96
<i>Bear Mfg. Co., Rock Island, Ill.</i>	
Universal replacement power cord resistor.....	159
<i>Clarostat Mfg. Co., 285 N. 6th St., Brooklyn, N. Y.</i>	
Swivel auto antenna mounts on fender.....	159
<i>Camburn Electric Prod., Inc., 490 Broome St., New York City</i>	
Five-range dial for experimenters.....	159
<i>National Company, Inc., 61 Sherman St., Malden, Mass.</i>	
Record changer has needle guide.....	159
<i>The General Industries Co., Elyria, Ohio.</i>	
Automatic feed attachment for soldering iron.....	159
<i>Electric Supply Corp., 705 W. Jackson Blvd., Chicago</i>	
Hearing aid amplifier.....	158
<i>Microtube Laboratories, 2414 Lawrence Ave., Chicago</i>	
Robot raid warden.....	160
<i>Industrial Timer Corp., Newark, N. J.</i>	
Multi-Purpose set tester.....	160
<i>Radio City Products Co., 88 Park Place, New York City</i>	
Pre-tuned antenna for 2-way radio.....	160
<i>Jefferson-Travis Radio Mfg. Co., 380 2nd Ave., New York City</i>	

(Continued to page 8A)



Business Demands Accountants



... because Accountants Command Business

Accountants are usually in demand—at better than average earnings.

But today—more than ever before—the competent accountant finds his services at a premium.

Business in war has tightened up the reins and is watching costs—prices—every move—striving to operate on that basis of close control so essential to service and profits.

Then, too, business is working under tighter government regulations, with many more records and reports—war production, priorities, more and larger taxes, wage and hour laws, payroll deductions for Defense Bonds, etc., etc.

The Home Study Way to Accountancy Success

Thousands upon thousands of men have trained for Accountancy with LaSalle—at night—at home.

Their success—their progress—is a matter of record.

Whether their goal was a C. P. A. certificate or advancement in business, our files are full of letters reporting income increases far out of line with the time and cost investment.

Note for instance, these six cases out of many we might cite. (Names on request.)

A cost clerk, J. S. H. became, after completing 30 training assignments, cost accountant. Within nine months, only half through the course, he became chief cost accountant with a salary nearly four times what it was when he enrolled. C. K. was an immigrant day laborer. Within a few months he secured a bookkeeping job. Within a year, he secured three raises. In two years, he was in charge of his company's accounting department, although not yet through the training. W. J. F. moved up from store clerk to assistant bookkeeper after the first ten lessons. Now he is office man-

ager. S. W. N. knew nothing about bookkeeping. With 19 months of training he passed the C. P. A. examination on first attempt and opened his own public accounting office. Although a university graduate, P. M. was a grocery clerk at small wages. Today he is Secretary and Credit Manager with an income 300 per cent higher. Already in cost work, G. N. P. within nine months was earning 40% more; within two years, 100% more. The third year his income went up still more. Now he is manager.

These Men Won Success in Ordinary Times —You Have War Opportunities

Remarkable as is the success of these men—you will have an advantage over them—you will be entering accountancy when unusual national conditions work with you for success.

Conditions not only call for more accountants—but offer unusual opportunities for both quick and permanent success. The need for accountants will increase during war and will continue for years afterwards during the difficult post-war adjustment period.

—If You Can Qualify

Ask yourself three questions:

1. Are you ambitious?
2. Have you determination?
3. Can you see and grasp an opportunity?

If you have determination; if you are ambitious; if you can take advantage of circumstances—prove it by investigating. A three-cent stamp, sixty seconds time, and the coupon below will bring you full information regarding Accountancy training and the opportunities to which such training leads. Then you can judge intelligently.

LASALLE EXTENSION UNIVERSITY

A Correspondence Institution Dept. 664-HR CHICAGO

Opportunities in Accountancy—Check below and we will send you a free copy of "Accountancy, the Profession That Pays," also, information about our training in Higher Accountancy, all without obligation.

Higher Accountancy

Other LaSalle Opportunities: If more interested in one of the other fields of business indicated below, check that:

- | | | |
|--|--|--|
| <input type="checkbox"/> Business Management | <input type="checkbox"/> Effective Speaking | <input type="checkbox"/> Modern Foremanship |
| <input type="checkbox"/> Expert Bookkeeping | <input type="checkbox"/> Law: LL.B. Degree | <input type="checkbox"/> Business Correspondence |
| <input type="checkbox"/> C. P. A. Coaching | <input type="checkbox"/> Commercial Law | <input type="checkbox"/> Stenotypy |
| <input type="checkbox"/> Traffic Management | <input type="checkbox"/> Industrial Management | <input type="checkbox"/> Modern Salesmanship |

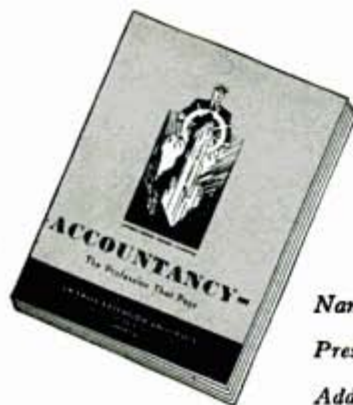

Name Age

Present Position

Address City and State

**U. S. Government
Urges Motorists
to Protect Finish
4 Times a Year!**



**SIMONIZ
Saves Your
Car's Beauty!**

How your car "looks" determines its worth when Victory comes. So, preserve the finish with Simoniz! It keeps weather, dirt, and ultra-violet rays from dulling and destroying the lacquer or enamel . . . makes these finishes last longer . . . and keeps any car beautiful for years.

**THE SIMONIZ CO.
Chicago, U. S. A.**

If your car is dull, first restore the lustre with Simoniz Kleener . . . now a liquid as well as a paste.



Your car deserves the best. Insist on the genuine. Sold anywhere by dealers having auto accessories.

(Continued from page 6A)

Craftsman and Shop Notes Index

ART AND ARTISTS

Pica gauge used for scale drawings.....118
 Rubber sponge cleans triangle.....128
 Scale improves French curve.....128

AUTOMOTIVE

Making car motors last longer.....138
 Skid chains attached easily.....141
 Reflectors under trunk lid.....141
 Sawhorses fit into auto trunk.....142
 Car-light blackout.....143
 Removing tire from safety rim.....145
 Ball shield for trailer hitch.....145
 Garage doors oiled to prevent freezing.....145
 Installing new oil seals.....145
 Hiding spare key on car.....154
 Tool to repair motorcycle chain.....154

BOATS AND BOATING

Holding oars steady when rowing.....102
 Adjustable boat footrest.....104
 Neat boat fenders.....118
 Small sailboats make good seamen.....120

FARM

Portable shade for field workers.....126
 Colter guards on tractor plow.....137
 Sprayer on wheelbarrow.....137
 Protecting grain fields from ducks.....142
 Keeping hay carrier oiled.....142
 Making shovel handle easy to grip.....142
 Portable fence.....153

HAND TOOLS

New handle burned in hammer.....102
 Soft face for wrench or vise.....104
 Toothpick used as screwdriver.....106
 Holding file in wood handle.....128

HOME IMPROVEMENTS

Effective way to lock windows.....104
 Part of window screen hinged.....118
 Hinged partitions in cottage.....119
 Draft control for hot-water heater.....119

HOUSEHOLD

Filter in kerosene stove.....99
 Solving home problems.....100
 Tumblers used as place cards.....102
 Mending glove fingers.....102
 Preventing tots from opening drawer.....112
 Freeing clogged drain pipes.....118
 Repairing refrigerator gasket.....126
 Clothespin holder slides on line.....126

LAWN AND GARDEN

Shelter provides shade on lawn.....99
 Wren houses.....114
 Sturdy hinge for gate post.....128
 Ridding garden of moles.....168
 Light solves blackbird problem.....170

(Continued to page 10A)



It's the trained man who does most to "keep 'em flying"! Would modern training make you a better soldier on the industrial front? Mail this coupon for free booklet.

INTERNATIONAL CORRESPONDENCE SCHOOLS

BOX 5636-J, SCRANTON, PENNA.

★ Without cost or obligation, please send me a copy of your booklet, "Who Wins and Why," and full particulars about the course *before* which I have marked X: ★

TECHNICAL AND INDUSTRIAL COURSES

- | | | | |
|--|--|---|--|
| <input type="checkbox"/> Air Brake | <input type="checkbox"/> Contracting and Building | <input type="checkbox"/> Marine Engines | <input type="checkbox"/> Sanitary Engineering |
| <input type="checkbox"/> Air Conditioning | <input type="checkbox"/> Cotton Manufacturing | <input type="checkbox"/> Mechanical Drafting | <input type="checkbox"/> Sheet Metal Work |
| <input type="checkbox"/> Airplane Drafting | <input type="checkbox"/> Diesel Engines | <input type="checkbox"/> Mechanical Engineering | <input type="checkbox"/> Ship Drafting |
| <input type="checkbox"/> Architectural Drafting | <input type="checkbox"/> Electrical Drafting | <input type="checkbox"/> Mine Foreman | <input type="checkbox"/> Shipfitting <input type="checkbox"/> Shop Practice |
| <input type="checkbox"/> Architecture | <input type="checkbox"/> Electrical Engineering | <input type="checkbox"/> Navigation | <input type="checkbox"/> Steam Electric <input type="checkbox"/> Steam Engines |
| <input type="checkbox"/> Auto Engine Tune-up | <input type="checkbox"/> Electric Lighting | <input type="checkbox"/> Patternmaking <input type="checkbox"/> Plumbing | <input type="checkbox"/> Steam Fitting |
| <input type="checkbox"/> Auto Technician | <input type="checkbox"/> Foundryman <input type="checkbox"/> Heating | <input type="checkbox"/> Practical Telephony | <input type="checkbox"/> Structural Drafting |
| <input type="checkbox"/> Aviation <input type="checkbox"/> Aviation Mechanic | <input type="checkbox"/> Heat Treatment of Metals | <input type="checkbox"/> Public Works Engineering | <input type="checkbox"/> Structural Engineering |
| <input type="checkbox"/> Boilermaking | <input type="checkbox"/> Highway Engineering | <input type="checkbox"/> Pulp and Paper Making | <input type="checkbox"/> Surveying and Mapping |
| <input type="checkbox"/> Bridge Engineering | <input type="checkbox"/> House Planning | <input type="checkbox"/> Radio, General | <input type="checkbox"/> Telegraph Engineering |
| <input type="checkbox"/> Chemistry | <input type="checkbox"/> Industrial Metallurgy | <input type="checkbox"/> Radio Operating | <input type="checkbox"/> Telephone Work |
| <input type="checkbox"/> Civil Engineering | <input type="checkbox"/> Locomotive Engineer | <input type="checkbox"/> Radio Servicing | <input type="checkbox"/> Textile Designing |
| <input type="checkbox"/> Coal Mining | <input type="checkbox"/> Machinist | <input type="checkbox"/> R. R. Section Foreman | <input type="checkbox"/> Toolmaking <input type="checkbox"/> Welding |
| <input type="checkbox"/> Concrete Engineering | <input type="checkbox"/> Management of Inventions | <input type="checkbox"/> R. R. Signalman <input type="checkbox"/> Refrigeration | <input type="checkbox"/> Woolen Manufacturing |

BUSINESS COURSES

- | | | | |
|---|--|--|---|
| <input type="checkbox"/> Accounting <input type="checkbox"/> Advertising | <input type="checkbox"/> College Preparatory | <input type="checkbox"/> First Year College | <input type="checkbox"/> Railway Postal Clerk |
| <input type="checkbox"/> Bookkeeping | <input type="checkbox"/> Commercial | <input type="checkbox"/> Foremanship <input type="checkbox"/> French | <input type="checkbox"/> Salesmanship |
| <input type="checkbox"/> Business Correspondence | <input type="checkbox"/> Commercial Illustrating | <input type="checkbox"/> Good English | <input type="checkbox"/> Secretarial <input type="checkbox"/> Spanish |
| <input type="checkbox"/> Business Management | <input type="checkbox"/> Cost Accounting | <input type="checkbox"/> High School | <input type="checkbox"/> Showcard and Sign Lettering |
| <input type="checkbox"/> Cartography <input type="checkbox"/> Civil Service | <input type="checkbox"/> C. P. Accounting | <input type="checkbox"/> Managing Men at Work | <input type="checkbox"/> Traffic Management |

HOME ECONOMICS COURSES

- | | | |
|---|---|--|
| <input type="checkbox"/> Advanced Dressmaking | <input type="checkbox"/> Home Dressmaking | <input type="checkbox"/> Tea Room and Cafeteria Management, Catering |
| <input type="checkbox"/> Foods and Cookery | <input type="checkbox"/> Professional Dressmaking and Designing | |

Name..... Age..... Address.....

City..... State..... Present Position.....

Canadian residents send coupon to International Correspondence Schools Canadian, Limited, Montreal, Canada
British residents send coupon to I. C. S., 71 Kingsway, London, W. C. 2, England

STOP DRIPPING



No Drip

No More Damage from Condensation or Sweating Pipes, Tanks, Walls, Ceilings and Air Ducts

Insulates and adds years of life to pipes and other metal surfaces by preventing rust and corrosion. Easy to apply with a brush, trowel or spray. Stucco-like finish. Can be painted any color.

A gallon covers about 30 feet of 1" O. D. pipe. Get at Hardware, Plumbing, Mill Supply Dealers or direct. **Circular free.** Write today.

J. W. MORTELL CO.
522 Burch St. Kankakee, Ill.



No Drip—A sensational new plastic cork coating prevents condensation drip from metal, concrete, brick, wood, composition, plaster.

LIVE DANGEROUSLY

---said Nietzsche, Philosopher

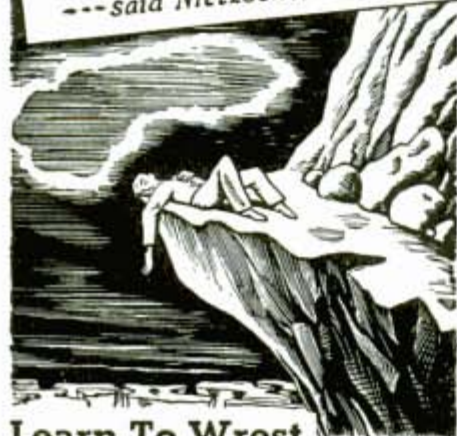

Learn To Wrest

The Utmost From Life!

DON'T HOLD BACK—life is yours to live and enjoy each conscious moment. Not in a sheltered, routine living, but only in a tempest of life's forces—which challenges every element of your nature—will you receive that inspiration, those ideas, which will bring you personal supremacy and happiness. *Live boldly but knowingly*—learn to utilize nature's laws to the fullest extent.

A FREE Book of Facts

Let the Rosicrucians (not a religious organization) show you how to direct *little-known* laws of life and mind—used by the sages for centuries. Write for the free book, "The Mastery of Life" today. Address Scribe: W. X. L.

The ROSICRUCIANS (A M O R C)

San Jose, California, U. S. A.

(Continued from page 8A)

PAINT AND PAINTING

Blackout paint on windows.....	104
Paint brushes suspended in liquid.....	126
Inexpensive crack filler.....	137

PHOTOGRAPHY

Tubular lamps heat negative dryer.....	129
Folding legs for camera case.....	129
Delayed-action shutter release.....	129
Photos with people.....	130
Keeping a darkroom dry.....	133
Photos held in spiral notebook.....	134
Wire rack for light bulbs.....	134

POWER TOOLS

Work held on drill-press table.....	106
Using steel wool in a hand grinder.....	116
Boring-bar holder.....	135
Lathe dog notched for square stock.....	142
How to use a bench shaper.....	146
Removing oil from leather belts.....	152
Using threading die in a lathe.....	152

RADIO AND ELECTRICITY

First aid for home receivers.....	155
Two-tube economy set.....	156
Homemade speaker case has cable compartment.....	159
Set holder for lawn table.....	159
Adding broadcast antenna to FM dipole.....	159
Visual check of heaters in metal tubes.....	159
Counter-balance keeps antenna wire tight.....	159

STORE AND SHOP

Wiping excess water from bottles.....	102
Thin paper cut easily.....	113
Non-slip surface on gangplank.....	137
Nails selected from display.....	153
Pressman's apron protects hips.....	153

TOYS AND MODELS

Ship model "Constellation".....	107
Lacquer preserves soap carvings.....	118
Toy auto seat upholstered.....	128

WOODWORKING

Choice book ends.....	97
Boudoir chair.....	103
Closest-door magazine rack.....	105
Sewing box with drawer.....	117

MISCELLANEOUS

Twin spectacle case.....	99
Postage stamps kept from sticking together.....	106
Locking lapel button on.....	106
Ink bottle kept from upsetting.....	112
Flashlight shield used in movie.....	112
Tube spout on oil can.....	112
Dog's leash carried on collar.....	117
Nut slotted to lock on bolt.....	119
Choosing the correct nail.....	126
"Fish sled" for surf fishing.....	127
Strengthening a weak magneto.....	153

IMPORTANT NOTICE

It is the intention of this magazine to provide its readers with information regarding the latest developments in the mechanical arts. We take no responsibility as to whether the disclosures contained in our articles are covered by patents and advise readers to investigate this subject before making, using, or selling any of the products, machines, or processes described in order to avoid possible liability for patent infringement.

**AUDELS NEW
MACHINISTS
HANDY BOOK
NOW READY!**

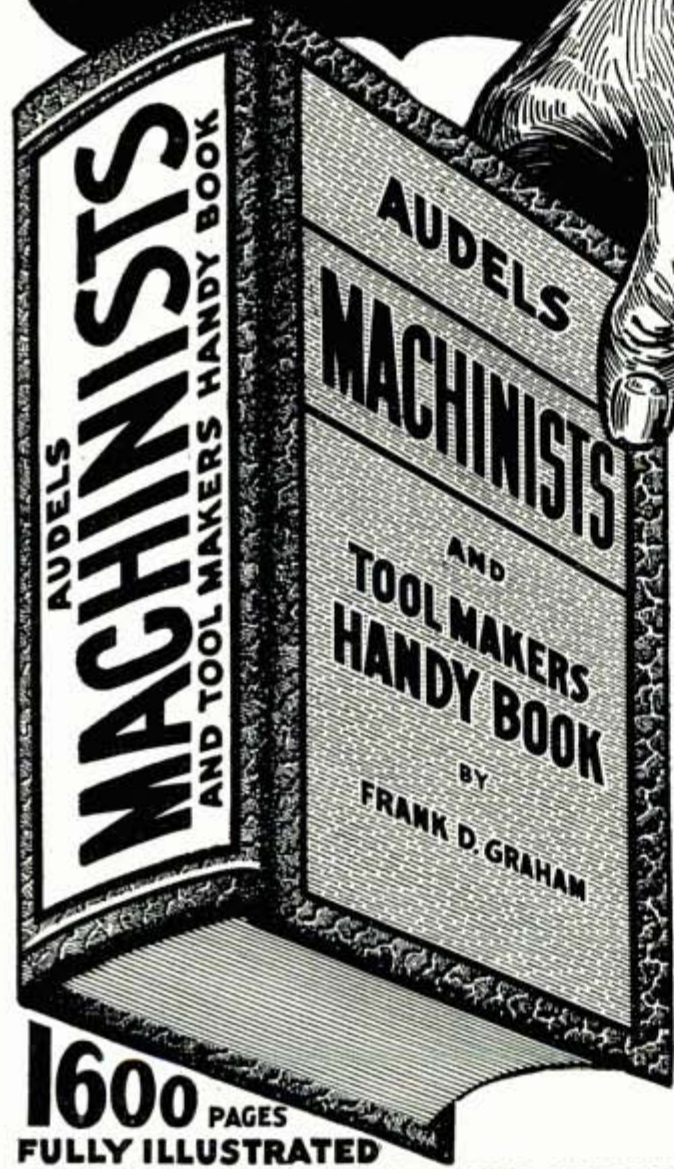

Prepare!

**A KEY TO
MODERN SHOP PRACTICE**

PRACTICAL INSIDE INFORMATION

For Every Machinist, Toolmaker, Engineer, Machine Operator, Mechanical Draughtsman, Metal Worker, Mechanic or Student. This 1600 Page Handy Book Covers Modern Machine Shop Practice in All Its Branches.

**A COMPLETE INSTRUCTOR WITH
READY REFERENCE INDEX**

New from Cover to Cover. Tells How to Operate and Set Up Lathes, Screw & Milling Machines, Shapers, Drill Presses & All Other Machine Tools.

**5 PRACTICAL BOOKS IN ONE!
60 FULLY ILLUSTRATED CHAPTERS**

Covering: **1**—Modern Machine Shop Practice. **2**—Blue Print Reading and How to Draw. **3**—Calculations & Mathematics for Machinists. **4**—Shop Physics. **5**—How to Use the Slide Rule.

...ASK TO SEE IT!...

THEO. AUDEL & CO., 49 West 23rd St., New York
Mail AUDELS MACHINISTS & TOOLMAKERS HANDY BOOK, Price \$4 on 7 Days Free Trial. If O. K. I will remit \$1 in 7 days and \$1 Monthly until \$4 is Paid. Otherwise I will return it.

Name _____
Address _____
Occupation _____
Reference _____ P.M.

**1600 PAGES
FULLY ILLUSTRATED**

A SHOP COMPANION THAT ANSWERS YOUR QUESTIONS
Easy to read and understand—flexible covers—Handy size 5 x 6½ x 2—a ready reference that answers your questions accurately.

TO GET THIS ASSISTANCE FOR YOURSELF SIMPLY FILL IN AND MAIL COUPON TODAY **\$4 COMPLETE PAY \$1 A MONTH ONLY**

THEO. AUDEL & CO., 49 W. 23rd St., New York



MACHINE SHOP MEN

Learn to set up and run ANY kind of machine; MAKE MORE MONEY NOW by learning quickly HOW TO DO THINGS which usually take years of study and practice. The demand for SKILLED men is ALREADY ahead of the supply, then what WILL IT BE a month or two from now?

Needed NOW!

Bigger Pay Don't miss this chance to qualify for promotion, don't miss this Big Opportunity which is yours almost for the asking. Eight Big Books chockful of important mechanical facts told simply and clearly. Over 3000 pages, nearly 3000 illustrations cover every subject fully, including Tool Making, Pattern Making, Foundry Work, Mechanical Drawing, Forging, Machine Shop Practice and Management, and hundreds of other subjects.

8 Big Books (Up-to-date Edition) Sent FREE to you for examination. With them we send a Big Binder of nearly 800 pages with 267 original shop tickets with 1200 illustrations. These show, step by step, how to set up and run almost any kind of job and are in addition to the 8 books. Decide in your own home or place of business whether or not you want to keep them, check up on any facts you want to. Note their great MONEY MAKING value, then, if you want them, pay on the easiest kind of payments. A year's consulting privileges with our engineers now given with these books without extra charge. American Technical Society, Publishers—Home Study Courses.

American Technical Society, Dept. SA19, Drexel at 58th St., Chicago
You may send me the 8 big books and binder of shop tickets for free examination. I will pay the delivery charges only, unless I decide to keep them in which case I will send \$2.00 in ten days and \$3.00 per month until the total price of only \$34.80 is paid. If I return them in 10 days I will owe you nothing. You also agree to send me a certificate entitling me to consulting privileges with your experts for one year without extra charge.

Name.....

Address.....
Please attach a letter stating age, occupation, employer's name and address and that of at least one business man as reference.



START

\$1260 to \$2100 A YEAR

Victory Program.
Increasing Appointments.

Prepare immediately
for Examinations

MEN—WOMEN

32-Page Civil
Service Book
—FREE

Mail Coupon
Today—
SURE



Name.....

Address.....

FRANKLIN INSTITUTE

Dept. K174

Rochester, N. Y.

Gentlemen: Rush to me, FREE of charge, list of U. S. Government big pay jobs. Send me FREE 32-page book describing salaries, vacations, hours, work, and full particulars telling how to qualify for one of these jobs.

PARKS AIR COLLEGE

PARKS AIRPORT EAST ST. LOUIS, ILL.

Offers YOU COLLEGE and PROFESSIONAL TRAINING
Majoring in AVIATION

Accredited by the Illinois Superintendent of Public Instruction, "Included in the Accredited Higher Institutions 1938, issued by the U. S. Office of Education, Federal Security Agency." U. S. approved as a Commercial Ground and Flying School and Mechanics' School. Accredited by and cooperating with the United States Army Air Corps in giving flight and mechanical training. Open to high school graduates. FOUR courses lead to B.S. degrees in Professional Piloting, Aviation Operations, Maintenance Engineering, Aeronautical Engineering. TWENTY-TWO TRAINING PLANES are used in professional flight training which prepares graduates for airline flight operations. FACULTY of 82 specialists in various fields of aviation. 1569 graduates. Enrollment limited to a total of 300 commercial aviation students. Capacity enrollment of 500. 100-acre airport, 25 buildings devoted to school purposes exclusively. Dormitories and dining hall at the College. Summer term July 6. Send postcard for new 64-page catalog.

15th YEAR Registrar, Dept. PM-6
PARKS AIR COLLEGE, East St. Louis, Ill.



Auto-Diesel

Master a real trade. Auto Mechanics, Diesel Mechanics, Arc Welding, Acetylene Welding, etc. Let us train you to be an expert Auto-Diesel Mechanic and help you get a good job. The cost to you is reasonable. Learn on modern equipment with tools under experienced instructors. Real shop work. Steam heated buildings. Room and board in our steam heated dormitory. We pay your fare to Nashville. For free catalog write.

Nashville Auto-Diesel School, Dept. 75 Nashville, Tenn.



Learn PHOTO-ENGRAVING

We teach you quickly, at home in spare time. Earn while you learn. Establish your own profitable business with equipment we furnish, or work for others at good salary. Cuts in this magazine made by process we teach. Send for your copy of our big illustrated catalog. It's free!

THE AURORA SCHOOL OF PHOTO-ENGRAVING
Tasopel Bldg. (Dept. PM-41) Aurora, Mo.

Regain Perfect Speech, If You

STAMMER

Every stammerer should have the new 287 page book "Stammering, Its Cause and Correction." Sent free to stammerers. It describes the Bogue Unit Method for the scientific correction of stammering and stuttering. Method successfully used at Bogue Institute for 41 years—since 1901. Endorsed by physicians. Write for full information. No obligation. Benjamin N. Bogue, Dept. 1339 Circle Tower, Indianapolis, Indiana.



Learn Profitable Profession in 90 days at Home

Earnings of Men and Women in the fascinating profession of Swedish Massage run as high as \$40 to \$70 per week but many prefer to open their own offices. Large incomes from Doctors, hospitals, sanitariums and private patients come to those who qualify through our training. The Army and Navy need hundreds trained in massage. Write for Anatomy Charts and booklet—They're FREE.

THE COLLEGE OF SWEDISH MASSAGE
30 E. Adams St., Dept. A64, Chicago



BECOME AN EXPERT MEAT CUTTER

Greater opportunities! Thousands of firms are needing expert Meat Cutters. Train in 6 weeks at famous National School. It's quick, easy to learn Meat Cutting by ACTUAL PRACTICE in big National cutting rooms and retail department. No previous experience or advanced education necessary. BIG PAY JOBS. Union card guaranteed. Employment service FREE. Train Fast. Pay later. Easy terms. Write TODAY for FREE catalog and plans to help you get ahead.

National School of Meat Cutting, Inc., Dept. U-31, Toledo, Ohio

LEARN WATCH REPAIRING



AT HOME You can learn by our modern and original system of instruction every part of the Watch Repairing Trade at home. Prepare yourself for a well paying position or start in business after completing our course of instruction. Good watch repairers are in demand and generally earn very good salaries. For particulars apply to the Wisconsin School of Watch Repairing 524 E. Mason St., MILWAUKEE, WIS.

LEARN RADIO

I Will Train You At Home

In Spare Time-Mail Coupon



J. E. SMITH, President
National Radio Institute
Established 27 years

nesses. It describes the good-pay jobs for Radio Technicians and Operators in the country's 882 Broadcasting Stations and in Aviation, Police, Commercial, Marine and Government Radio, and how Loud Speaker Systems give good jobs to many. It shows how the Government is calling for Civilian Radio Technicians and Operators; how men with Radio Training can get extra rank, pay in the Army and Navy; and how Government orders are increasing jobs in Radio Equipment factories. Also it tells about many Radio developments, held back by the war, which will make Radio a live-wire field for the future.

How Many Make \$5, \$10 a Week Extra in Spare Time While Learning

My book describes my course which equips you to get and handle Radio Repair jobs in your neighborhood while learning. It tells of my 50-50 methods of training—half with Radio parts I send you, half with lesson texts—how these methods make learning Radio at home interesting, fascinating and give you valuable practical experience. My book shows you letters from more than 100 men I trained, so you can see what they are doing—earning. You owe it to yourself to GET MY BOOK NOW.

**I TRAINED
THESE MEN
AT HOME**

MAIL THE COUPON—in an envelope, or pasted on a penny postal—NOW.

J. E. SMITH, President
Dept. 2FP, National Radio Institute
Washington, D. C.

Chief Operator Broadcasting Station



—Before I completed your lessons, I obtained my Radio Broadcast Operator's license and immediately joined Station WMPG where I am now Chief Operator.—**HOLLIS W. HAYES**, 327 Madison St., Lapeer, Michigan.

\$40 a Month Extra in Spare Time



—I do Radio service work in my spare time only, operating from my home, and I net about \$40 a month. I was able to start servicing Radios 3 months after enrolling with N. R. I.—**WM. J. CHERMAK**, R. No. 1, Box 287, Hopkins, Minn.

Sergeant in Signal Corps



—I am now a Sergeant in the U. S. Army, Signal Corps. My duties cover Radio operating, maintenance of Army Transmitters and Receivers, operating Teletypes, handling duties of the Chief Operator in his absence.—**SERGEANT RICHARD W. ANDERSON**, U. S. Army (Address omitted for military reasons).

Had Own Business 6 Months After Enrolling



—I went into business for myself 6 months after enrolling. In my Radio repair shop I do about \$300.00 worth of business a month. I can't tell you how valuable your Course has been to me.—**A. J. BATTEN**, Box 1168, Gladewater, Texas.

RADIO SERVICE BUSINESS BOOMING

57,400,000 Radios To Keep In Repair, New Tubes, Parts,

SPARE TIME RADIO REPAIRING PAYS MANY \$5, \$10 A WEEK EXTRA

GOVERNMENT SPENDING MILLIONS FOR RADIO EQUIPMENT, EMPLOYING MANY CIVILIAN OPERATORS AND TECHNICIANS

882 U. S. BROADCASTING STATIONS EMPLOY THOUSANDS, PAY WELL Police and Aviation Radios... Commercial Stations, Loud-Speaker Systems, Other Active Fields

RADIO TECHNICIANS CAN WIN EXTRA RANK, PAY IN ARMY, NAVY



MAIL COUPON NOW!

J. E. SMITH, President, Dept. 2FP
National Radio Institute, Washington, D. C.
Please rush me, without obligation, your Book "Rich Rewards in Radio." (No salesman will call. Please write plainly.)

Age.....

Name.....

Address.....

City..... State.....



Do you want

- .. to go to College?
- .. or to enter a Profession?
- .. or get an Office Position?

(Such as Accounting, Architecture, Nursing, Dentistry, Teaching, Social Work, Osteopathy, Beauty Culture, Optometry, Embalming, Chiropractic, Law, Medicine, etc.)

To get anywhere, you practically MUST finish High School FIRST. You can complete our simplified High School Course in SPARE time at home, as FAST as your time and abilities permit. Equivalent to resident school work—prepares you for college, pre-professional examinations, business, industry. Standard texts furnished. Diploma. Credit for H.S. subjects already completed. Single subjects if desired. Low tuition, easy terms. American School, Chicago, est. 1897—endorsed by educators. Finish your high school education NOW. Write TODAY!

High School Course at Home

Many Finish in 2 Years

American School, Dept. HA45, Drexel Ave. at 58th St., Chicago, Ill.

Gentlemen: Send me FREE information covering special training in subjects checked below. No obligation on my part.

- | | |
|--|---|
| <input type="checkbox"/> High School Course | <input type="checkbox"/> Diesel Engineering |
| <input type="checkbox"/> Accounting and Auditing | <input type="checkbox"/> Drafting and Design |
| <input type="checkbox"/> Architecture and Building | <input type="checkbox"/> Liberal Arts |
| <input type="checkbox"/> Automotive Engineering | <input type="checkbox"/> Private Secretary |
| <input type="checkbox"/> Business Management | <input type="checkbox"/> Mechanical Engineering |
| <input type="checkbox"/> Aviation | <input type="checkbox"/> Radio and Television |
| <input type="checkbox"/> Electrical Engineering | <input type="checkbox"/> Salesmanship |
| <input type="checkbox"/> Elec. and Gas Refrigeration | <input type="checkbox"/> Business Law |
| <input type="checkbox"/> Air Conditioning | <input type="checkbox"/> Retail Merchandising |

Name

Address

AVIATION CAREER

Offers You
A GREAT FUTURE!

Complete Aeronautical Engineering or Master Aviation Mechanics training in the heart of the Aircraft industry. Graduates obtaining immediate employment. No flying involved. Aviation's foremost school, established in 1929. Located on Grand Central Air Terminal. For full information, address Department PM-5.

CURTISS WRIGHT TECHNICAL INSTITUTE

GRAND CENTRAL AIR TERMINAL
GLENDALE (LOS ANGELES) CALIF.

THIS TOWER OVERLOOKS AVIATION'S MOST DISTINGUISHED SCHOOL OF AERONAUTICS



Operator No. 38

Follow This Man!

Secret Service Operator No. 38 is On The Job!

Follow him through all the excitement of his chase after the counterfeit gang. See how a crafty operator solves a murder with tell-tale finger prints! Thrills! Mystery!

FREE! The Confidential Reports
No. 38 Made to His Chief
Earn a Regular Monthly Salary

Write for reports and free "Blue Book of Crime." Learn how YOU can become a Finger Print Expert, at home, in spare time, at small cost. Our graduates run 43% of all

the Identification Bureaus in America! Send for list of over 840 bureaus employing our graduates. Write today! Literature sent only to persons stating their age.

INSTITUTE OF APPLIED SCIENCE
1920 Sunnyside Avenue, Dept. A-135, Chicago, Ill.

Learn AUTO-DIESEL or RADIO-TELEVISION

Oldest, largest Trade School in West trains you for top pay jobs. Flexible, proven plan to meet your individual needs. Transportation allowed to L.A. Earn room, board while learning. Request Catalog. Dept. PMA-6.

NATIONAL SCHOOLS - Los Angeles



LACO OIL BURNERS

18th Year!

Send for free folder and low prices on LACO's Nu-Comfort Room Oil Heater, Gravity and Forced-Air Furnaces, Gun-Type Burner for furnaces. Newly improved. Clean, quiet, automatic. Thousands of users, everywhere.



WRITE!

LACO OIL BURNER CO., 126 Union Ave., Griswold, Iowa

ENGINEERING DEGREE IN 27 MONTHS

INDIANA TECHNICAL COLLEGE

Courses in Aeronautical, Chemical, Civil, Electrical, Mechanical, and Radio Engineering. One-year courses in Radio and Drafting. Approved by C.A.A. Prep courses without added cost. Low tuition. Large industrial center. Opportunity to earn part living expenses. Enter June, September, December, March. Catalog. 562 E. Washington Blvd., Ft. Wayne, Ind.

AMAZING NEW ELECTRIC ARC WELDER

RETAILS ONLY \$2.95 COMPLETE

FULLY GUARANTEED



PLUGS INTO LIGHT SOCKET

Amazing new HANDIWELD Electric Arc Welder—operates from 110 volt A.C. or D.C. same as other arc welders higher priced—generates tremendous heat to weld all kinds of metal. Not a toy welder that uses carbons, but actually uses standard coated rods—size 1/16" and 3/32". Generous supply furnished with welder. Guaranteed not to burn out. Repairs fenders, auto bodies, radiators, pre-heated small castings and machinery parts. Take HANDIWELD anywhere to job, operate from light socket. Sturdily built of finest materials to last years. Fully guaranteed by Big Manufacturer.

SEND NO MONEY! You'll find a thousand uses for the HANDIWELD around your home, garage, work shop. Also by garages, factories, repair shops, mechanics, farmers, inventors, tin shops, plumbers, etc. Order HANDIWELD now. Send no money. We'll rush one to you complete with rods and goggles. Pay postman only \$2.95 plus few cents postage. If not delighted, return HANDIWELD in 5 days from receipt and money paid for it will be refunded instantly. Rush your order now. KUMFY PRODUCTS INC., Dept. G-202, Cincinnati, Ohio

15 Minutes a Day!

**Give me
and I'll prove I can
A NEW MAN!**

**just this
make you**

*Charles
Atlas*



Actual photo
of the man
who holds the
title, "The
World's Most
Perfectly De-
veloped Man."

I'M "trading-in" old bodies for new! I'm taking men who know that the condition of their arms, shoulders, chests and legs—their strength, "wind," and endurance—is not 100%. And I'm making NEW MEN of them.

Today, a wave of FITNESS is surging over America! Suppose YOU are called to the colors! Will your body be the laughing-stock of the company or will it command the envy of your buddies! Why RIGHT NOW many soldiers and sailors in active service are using my methods. They know that a MAN'S body means "easier going," more fun and quicker promotion!

**Now as Never Before You Need a
Body That's Ready for ANY Job
the War May Bring**

"GOD BLESS AMERICA"—yes, we all pray that. But it's the BODIES of America's MAN-POWER that must make that blessing safe. Where do YOU fit in? Are you ALL MAN—tough-muscled, on your toes every minute, with all the up-and-at-'em that can lick your weight in wild-cats? Or do you want the help I can give you—the help that has already worked such wonders for other fellows, everywhere?

All the world knows I was ONCE a skinny, scrawny 97-lb. weakling. And NOW it knows that I won the title, "The World's Most Perfectly Developed Man." Against all comers! How did I do it? How do I work miracles in the bodies of other men in such quick time? The answer is **Dynamic Tension**, the amazing method I discovered and which changed me from a 97-pound weakling into the champion you see here!

In just 15 minutes a day, right in the privacy of your own home, I'm ready to prove that **Dynamic Tension** can lay a new outfit of solid muscle over every inch of your body. Let me put new, smashing power into your arms and shoulders—give you an armor-shield of stomach muscle that laughs at punches—strengthen your legs into real columns of surging stamina. If lack of exercise or wrong living has weakened you inside, I'll get after that condition, too, and show you how it feels to LIVE!

**Charles Atlas — America's
Greatest "Builder of Men"**

Among all the physical instructors and "conditioners of men" ONLY ONE NAME STANDS OUT—only one name instantly comes to the mind of any man who wants to develop his body to its full physical proportions and muscular power. That name is Charles Atlas!

THAT is the name immediately thought of by men who WANT to attain a physique that will withstand hardship and strain, ready for any task, in Uncle Sam's Services or on the home front!

In every part of the country, Charles Atlas is recognized as "America's Greatest Builder of Men." Thousands upon thousands have put their physical development into his capable hands!

And now that the call is for men capable of helping America win the war, many thousands of others (even those already in their country's Army and Navy) are asking Charles Atlas to give them the kind of bodies America vitally needs!

**MAIL THE
COUPON NOW!**



FREE This Famous Book That Tells You How to Get a Body That Men Respect and Women Admire

Almost two million men have sent for and read my book, "Everlasting Health and Strength." It tells you exactly what **Dynamic Tension** can do. And it's packed with pictures that SHOW you what it does. RESULTS it has produced for other men. RESULTS I want to prove it can get for YOU! If you are satisfied to take a back seat and be pushed around by other fellows week-in, week-out, you don't want this book. But if you want to learn how you can actually become a NEW MAN, right in the privacy of your own home and in only 15 minutes a day, then man!—get this coupon into the mail to me as fast as your legs can get to the letterbox! CHARLES ATLAS, Dept. 8-V, 115 East 23rd St., New York, N. Y.

CHARLES ATLAS, Dept. 8-V
115 East 23rd St., New York, N. Y.

I want the proof that your system of "Dynamic Tension" will help make a New Man of me—give me a healthy, husky body and big muscular development. Send me your free book, "Everlasting Health and Strength."

Name

(Please print or write plainly)

Address

City State

NEWS

Increased production means



More Jobs for MACHINISTS and bigger pay for men who know their work

This home-study course gives you the practical facts on modern machines, up-to-date methods, you need to advance in machine shop work. Take advantage of the other man's experience as found in books, to solve your problems, increase your efficiency, with

The AMERICAN MACHINISTS' LIBRARY

6 volumes—2368 pages—2516 illustrations
(A combined home-study course and reference library)

This library of machine shop practice was written for practical men. It gives you the best methods for every kind of machine shop work. It fully explains lathes, drills, and other machine tools and their operation, automatic screw machines, speeds and feeds, gear design and production, jigs and fixtures, punch and die work, metal surfacing, etc., etc. Plainly written—completely illustrated—the best kind of help to the machine shop man who wants to advance himself.

No money down—special price—easy payments.

EXAMINATION COUPON

McGraw-Hill Book Co., 330 W. 42nd St., New York

Send me for ten days' examination the American Machinists' Library. If satisfactory I will send you \$1.50 in 10 days and \$3.00 monthly until the price of \$19.50 is paid. If not wanted, I will return the books postpaid. (To insure prompt shipment write plainly and fill in all lines.)

Name.....
Home Address.....
City and State.....
Position.....
Name of Company..... PM-6-42

AUDELS BLUEPRINT READING

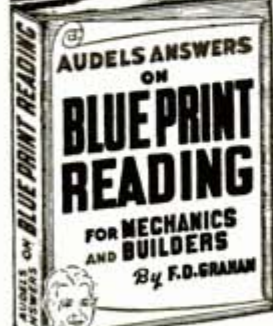

JUST OUT—FOR THE MAN WHO WORKS FROM BLUE PRINTS

"The Blue Print of Today is the Machine of Tomorrow." AUDELS ANSWERS ON BLUE PRINT READING covers All Types of plan reading including AIRCRAFT & SHIP BUILDING—tells How to Easily Understand Working Drawings.

What to look for first. Tells what each Line and each Symbol Means. The relation of one part to another. How to Understand Scales & Specifications. How to Make a Sketch. How to

Make Blue Prints. A Key Book for Every Mechanic, Builder & Draughtsman—352 pages—It's New, Comprehensive, Fully Illustrated. Gives Short Cuts, Helps, Hints, Suggestions, Questions and Answers.

ASK TO SEE IT!

To get this assistance for yourself, simply fill in and mail coupon today. **\$2**

AUDEL Publishers, 49 West 23rd St., New York
Please mail AUDELS BLUE PRINT READING (Price \$2). If satisfactory, I will remit \$2 on its safe arrival, otherwise I will return the book.

Name.....
Address.....
Occupation.....
Company..... PM

TRI-STATE COLLEGE

Degree in 2 1/4 years

B. S. Degree in Civil, Electrical, Mechanical, Chemical, Radio, Aeronautical Engineering; Business Administration, Accounting, Secretarial Science. Short diploma courses (36 weeks) in Surveying, Drafting. Special Preparatory Department for those who lack required high school work. Cosmopolitan student body. Approved by Civil Aeronautics Administration for flight training. Distinguished for 2 1/4-year technical courses (Non-essentials eliminated). 59th year. Tuition, living costs low. Defense needs call for engineers. Demand for graduates exceeds supply. Enter June, Sept., Jan., March. Catalog. 462 COLLEGE AVE., ANGOLA, IND.



ENGINEERING

LEARN WELDING



Both Electric Arc and Acetylene by practical Shop-Plan method in a few short weeks. No text-books. You learn by doing. Finest equipment. Low tuition. Pay-After-Graduation-Plan. Also, courses in Auto Mechanics, Collision Work, Metal Finishing, etc. Illustrated literature free. Write today.

MICHIGAN TRADE SCHOOL
3738 Woodward. Detroit, Mich.

FREE 32 PAGE CATALOG

ELECTRICAL TECHNICIANS—URGENTLY NEEDED!

In industry—in Army and Navy—electrical technicians win better jobs and ratings. Learn fundamentals of electrical theory and practice—testing, drafting, machine shop, wiring, control. Course complete in one school year. Dormitory; dining hall; campus. Send for catalog and Vocational Chart. 116 Takoma Ave., Washington, D. C.

BLISS ELECTRICAL SCHOOL



Your VOICE!

Results GUARANTEED

We build, strengthen the vocal organs—not with singing lessons—but by sound, scientifically correct silent and vocal exercises and absolutely guarantee complete satisfaction with results. Write for Voice Book, FREE. Sent to no one under 17 years old unless signed by parent.

PERFECT VOICE INSTITUTE, Studio 1356, 64 E. Lake St, Chicago, Ill.

Learn PHOTOGRAPHY at Home

Splendid opportunities. Prepare in spare time. Easy plan. No previous experience needed, common school education sufficient. Send for free booklet "Opportunities in Photography", particulars and requirements.

American School of Photography
1315 Michigan Ave., Dept. 135A, Chicago, Ill.

5¢ LITTLE BLUE BOOKS

Send postcard for our free catalogue. Thousands of bargains. Address: HALDEMAN-JULIUS CO., Catalogue Dept., Desk M-866, GIRARD, KANSAS

LAW

STUDY AT HOME for PERSONAL SUCCESS and LARGER EARNINGS. 31 years expert instruction—over 106,000 students enrolled. LL.B. Degree awarded. All texts furnished. Easy payments. Send for FREE BOOK!

AMERICAN EXTENSION SCHOOL OF LAW
Dept. 18-M, 8 East Huron St., Chicago, Ill.

Learn CARTOONING

FREE TRIAL LESSON! Cash in on your sense of humor—AT HOME—BY MAIL. Have fun! Make money! No experience needed to start. Write today for FREE LESSON, mailed postpaid. No obligation.

MOON Gag-Cartoon School, Dept. G, Fall Creek, Wis.



Begin today. Write now for our Free Book, "How to Become a Good Penman." It contains specimens and tells how others learned to write in spare time. Enclose 10c for your name beautifully written and a pen point suitable for shaded writing. Write today.

THE TAMBLYN SCHOOL OF PENMANSHIP
X441 Ridge Building, Kansas City, Mo.

"IT WAS LIGHT IN A WILDERNESS OF DARKNESS TO ME"

"I was stuck. A wife and three kids — and the same old pay envelope. I couldn't see a thing ahead except the same old grind. Then one day I read an I. C. S. ad. The coupon fascinated me. A new idea struck home — it was light in a wilderness of darkness to me! Today, because I mailed that coupon two years ago, I am a trained man — making a trained man's pay, playing a more important part in the industrial war-program!"

Fifty years ago, the International Correspondence Schools were established to provide sound educational facilities to men unable to attend resident schools. Millions of dollars have been spent in

preparing I. C. S. textbooks and keeping them up-to-date. Today, you'll find I. C. S. graduates holding leading positions in every field of American business and industry.

INTERNATIONAL CORRESPONDENCE SCHOOLS

HELPING TO TRAIN AMERICANS FOR VICTORY



BOX 5637-J, SCRANTON, PENNA.

Without cost or obligation, please send me a copy of your booklet, "Who Wins and Why," and full particulars about the course *before* which I have marked X:

TECHNICAL AND INDUSTRIAL COURSES

- | | | | |
|--|--|---|--|
| <input type="checkbox"/> Air Brake | <input type="checkbox"/> Contracting and Building | <input type="checkbox"/> Marine Engines | <input type="checkbox"/> Sanitary Engineering |
| <input type="checkbox"/> Air Conditioning | <input type="checkbox"/> Cotton Manufacturing | <input type="checkbox"/> Mechanical Drafting | <input type="checkbox"/> Sheet Metal Work |
| <input type="checkbox"/> Airplane Drafting | <input type="checkbox"/> Diesel Engines | <input type="checkbox"/> Mechanical Engineering | <input type="checkbox"/> Ship Drafting |
| <input type="checkbox"/> Architectural Drafting | <input type="checkbox"/> Electrical Drafting | <input type="checkbox"/> Mine Foreman | <input type="checkbox"/> Shipfitting <input type="checkbox"/> Shop Practice |
| <input type="checkbox"/> Architecture | <input type="checkbox"/> Electrical Engineering | <input type="checkbox"/> Navigation | <input type="checkbox"/> Steam Electric <input type="checkbox"/> Steam Engines |
| <input type="checkbox"/> Auto Engine Tune-up | <input type="checkbox"/> Electric Lighting | <input type="checkbox"/> Patternmaking <input type="checkbox"/> Plumbing | <input type="checkbox"/> Steam Fitting |
| <input type="checkbox"/> Auto Technician | <input type="checkbox"/> Foundryman <input type="checkbox"/> Heating | <input type="checkbox"/> Practical Telephony | <input type="checkbox"/> Structural Drafting |
| <input type="checkbox"/> Aviation <input type="checkbox"/> Aviation Mechanic | <input type="checkbox"/> Heat Treatment of Metals | <input type="checkbox"/> Public Works Engineering | <input type="checkbox"/> Structural Engineering |
| <input type="checkbox"/> Boilermaking | <input type="checkbox"/> Highway Engineering | <input type="checkbox"/> Pulp and Paper Making | <input type="checkbox"/> Surveying and Mapping |
| <input type="checkbox"/> Bridge Engineering | <input type="checkbox"/> House Planning | <input type="checkbox"/> Radio, General | <input type="checkbox"/> Telegraph Engineering |
| <input type="checkbox"/> Chemistry | <input type="checkbox"/> Industrial Metallurgy | <input type="checkbox"/> Radio Operating | <input type="checkbox"/> Telephone Work |
| <input type="checkbox"/> Civil Engineering | <input type="checkbox"/> Locomotive Engineer | <input type="checkbox"/> Radio Servicing | <input type="checkbox"/> Textile Designing |
| <input type="checkbox"/> Coal Mining | <input type="checkbox"/> Machinist | <input type="checkbox"/> R. R. Section Foreman | <input type="checkbox"/> Toolmaking <input type="checkbox"/> Welding |
| <input type="checkbox"/> Concrete Engineering | <input type="checkbox"/> Management of Inventions | <input type="checkbox"/> R. R. Signalman <input type="checkbox"/> Refrigeration | <input type="checkbox"/> Woolen Manufacturing |

BUSINESS COURSES

- | | | | |
|--|--|--|---|
| <input type="checkbox"/> Accounting <input type="checkbox"/> Advertising | <input type="checkbox"/> College Preparatory | <input type="checkbox"/> First Year College | <input type="checkbox"/> Railway Postal Clerk |
| <input type="checkbox"/> Bookkeeping | <input type="checkbox"/> Commercial | <input type="checkbox"/> Foremanship <input type="checkbox"/> French | <input type="checkbox"/> Salesmanship |
| <input type="checkbox"/> Business Correspondence | <input type="checkbox"/> Commercial Illustrating | <input type="checkbox"/> Good English | <input type="checkbox"/> Secretarial <input type="checkbox"/> Spanish |
| <input type="checkbox"/> Business Management | <input type="checkbox"/> Cost Accounting | <input type="checkbox"/> High School | <input type="checkbox"/> Showcard and Sign Lettering |
| <input type="checkbox"/> Cartooning <input type="checkbox"/> Civil Service | <input type="checkbox"/> C. P. Accounting | <input type="checkbox"/> Managing Men at Work | <input type="checkbox"/> Traffic Management |

HOME ECONOMICS COURSES

- | | | |
|---|---|---|
| <input type="checkbox"/> Advanced Dressmaking | <input type="checkbox"/> Home Dressmaking | <input type="checkbox"/> Tea Room and Cafeteria |
| <input type="checkbox"/> Foods and Cookery | <input type="checkbox"/> Professional Dressmaking and Designing | <input type="checkbox"/> Management, Catering |

Name..... Age..... Address.....
 City..... State..... Present Position.....

Canadian residents send coupon to International Correspondence Schools Canadian, Limited, Montreal, Canada
 British residents send coupon to I. C. S., 71 Kingsway, London, W. C. 2, England

Be an Officer

U. S. MERCHANT MARINE

OFFERS WARTIME JOBS WITH A PEACETIME FUTURE



This Cadet is typical of the high type of American youth seeking a lifetime career as an Officer in the U. S. Merchant Marine.

America's new ships have the finest Officers afloat. Those who start Officer training now at a U.S.M.M. Academy can find a lifetime career which combines good pay with opportunity.

READ EVERY WORD THAT FOLLOWS

Are you between 18 and 23? High-school educated? A U. S. citizen? Anxious to get in and pitch for America? Here's a way to serve your country now . . . and have opportunity for a fine future in peacetime. Train to be an *Officer* in the fast-growing U. S. Merchant Marine.

\$65 a month while you learn . . . high calibre associates, good quarters. Cadets of the Merchant Marine are enrolled in the U. S. Naval Reserve.

The 16-month course includes both shore and ship training under outstanding Naval and Merchant Marine Officers. After graduation, a **WELL-PAID, LIFETIME CAREER**, rank and prestige lie ahead.

GET FREE DETAILS. Clip and mail this coupon today. Don't wait. Write now!

U. S. MERCHANT MARINE

Fill out and mail - TODAY

Supervisor of Merchant
Marine Cadet Training
U. S. Coast Guard, Box 6P
Washington, D. C.

Please send me, **FREE**, and without obligation,
Information Booklet of the U. S. Merchant Marine
Cadet Corps.

Name

Street

City State

Get Your Share of **U. S. Defense BONDS ★ STAMPS**
18A

LAW

LEARN AT HOME

Are you adult, alert, ambitious, willing to study? Investigate **LAW!** We guide you step by step—furnish all texts, including 14-volume Law Library. Training prepared by leading law professors and given by members of bar. Degree of **L.L.B.** conferred. Low cost, easy terms. Send **NOW** for Free, 48-page "Law Training for Leadership."

LASALLE EXTENSION UNIVERSITY
A CORRESPONDENCE INSTITUTION
DEPT. 654-L CHICAGO

ELECTRICITY MEN NEEDED

Electricians are needed everywhere. Hollywood studios alone claim shortage 200 men. This is a live money making profession. Learn at home, spare time. Easy payments. Selective Employment service. Write for **FREE** Bulletin. No obligation.

AMERICAN SCHOOL

Dept. EEA45

Drexel at 58 St., Chicago

Learn TOOL DESIGN

Qualify quickly as a Machine or Tool Designer by home study in spare time. Entire defense program depends largely upon the machine and tool designer. After defense boom, machine and tool designers will be equally necessary for reconstruction. Many now making \$100 to \$125 a WEEK. Rapidly expanding industry calling for more machine and tool designers than now available. Learn quickly with our step-by-step lessons supervised by a recognized professor of machine tool design. Rush name and address today for complete facts on Machine or Tool Design. Learn what these fields offer you and how quickly you can qualify for a big pay position. No obligation. State age. A penny postal will do—but hurry.



Ohio Institute of Technology, Box 58, Greenville, Ohio

Learn WELDING This Easy Way!

AUDEL'S NEW WELDERS GUIDE

Contains Important Facts and Essential Information!

- WELDING METHODS
- WELDERS
- ELECTRIC
- OXY-ACETYLENE
- THERMIT
- UNIONMELT
- SHEET METAL
- SPOT
- PIPE
- PRESSURE VESSELS
- VARIOUS METALS
- AIRPLANE
- HARDENING-FACING
- CUTTING
- EYE PROTECTION

Just Out!

\$1

Every Welder Should Own This New, Useful Book containing clear, concise, practical information, pointers and facts relating to modern practice in all Branches. Easy to read and understand—over 400 pages Fully Illustrated—flexible cover—pocket size—a Ready Reference that Answers Your Questions accurately—Money Back if not O.K. To get this assistance for yourself, order copy today.

THEO. AUDEL, Publishers, 49 W. 23rd St., New York

Please mail **AUDEL'S WELDERS GUIDE** (Price \$1). If satisfactory, I will remit \$1 on its safe arrival, otherwise I will return the book.

Name

Address

Occupation

Employed by

P.M.

POPULAR MECHANICS



DRAW for MONEY

Be An ARTIST!

Trained Artists Are Capable of Earning
\$30 - \$50 - \$75 A WEEK

*This spare-time training leads
to profitable Art careers!*

NOW is the time to prepare for a pleasant, profitable future. **COMMERCIAL ART, ILLUSTRATING, CARTOONING**—all in ONE complete course. No previous Art experience necessary—hundreds have profited by our practical home study method since 1914. Write today for information in FREE BOOK, "Art for Pleasure & Profit"—tells all about our course, service—and commercial opportunities for you in Art.

WASHINGTON SCHOOL OF ART
STUDIO 126A, 1115-15th St., N. W., Wash., D. C.

Learn PLASTICS

Get into Plastics! Your big opportunity. Enter a NEW Industry. Plastics, the miracle material! Revolutionizes design and construction. Plastics is thrilling, profitable, uncrowded. Learn Now! First Plastics School in the East with complete Study and Lab. courses. Write Dept. M. Today! State age.

THE SCHOOL OF PLASTICS

DIVISION OF SOUTH TECHNICAL INSTITUTE
470 COMMONWEALTH AVI, BOSTON, MASS.



Come to this 2 MILLION DOLLAR School

SPARTAN SCHOOL OF AERONAUTICS

SPARTAN'S new buildings, new equipment, new training planes, new technical courses representing an investment of \$2,000,000 offer you superior training—tremendous advantages for a successful career. Government program making SPARTAN even greater. Skilled personalized instruction for Sheet Metal, Aircraft or Engine Mechanics, Flight, Engineering, Radio, Instrument Mechanics, Meteorology. All recommended graduates receiving immediate employment. Spartan factory, contractor to U. S. Navy, directly connected. Next Semester Starts August 3. WRITE for New 64-page Catalog—It's Free!
Captain Maxwell W. Balfour, Director—Dept. PM-62, Tulsa, Okla.

WELDERS WANTED!



ELECTRIC ARC—OXY-ACETYLENE
Skilled Welders earn \$9 to \$15 a day. The demand now greater than the supply. Learn this highly paid trade in 2 weeks by actual shop work. One of America's leading schools. Established 1902. 7 floors of shops. Endorsed by welding industry. Limited number of students. 2 weeks course in Electric Arc or Acetylene Welding, including room and board, only \$104. Write or wire for reservation. Ask for "Welding Facts." State age.
GREER COLLEGE, Dept 162, 2024 S. Wabash Ave., Chicago

EARN THE DEGREE Doctor of Psychology (Ph.D.), Doctor of Divinity (D.D.), many others. Courses in business, accounting, law, etc. Low fees. Send for large Bulletin and student picture-folder AT ONCE. No obligation whatever.

TEMPLE BAR EXTENSION COLLEGE
1411 Fourth Avenue, Dept. 4-R, Seattle, Washington, U. S. A.

FIBRE ARMS AND LEGS!

Light, correctly fitted, strong and comfortable. Natural appearance. Braces for all deformities. Scientific design. Fair Terms.
BUCHSTEIN-MEDCALF
610-3rd Av. S., Minneapolis, Minn.

RADIO REPAIR HINTS

"Introduction to Radio" explains circuit tracing and radio trouble-shooting. Gives many service hints. Tells how to find radio faults and make repairs quickly. New 32 page book. Price only **5¢**
SUPREME PUBLICATIONS, 3727 W. 13th St., Chicago, Ill.

America Needs Men Trained for TOOL & DIE MAKING, MACHINIST & SCREW MACHINE TRADES

HARRY LEBESON
PRESIDENT & FOUNDER
ALLIED School offers you short intensive, Practical training courses in Our fully equipped Shops. Learn on Actual JOBS! State Approved. Learn Days or Evenings. Enter anytime. FREE Employment Service and opportunity to earn while learning. Write for FREE Book "Practical Machine Shop Training."
ALLIED SCREW MACHINE CO., (School Division)
609 West Lake Street, Dept. PM-6, Chicago, Illinois

INVENTORS

Get this
FREE →
Expert Advice



ON HOW TO
PATENT and SELL
YOUR INVENTION

ACT QUICK—DELAY CAN BE DANGEROUS

If you have an invention—if you feel that it is commercially valuable and want to protect your rights to profit from it—send for our Free "PATENT GUIDE FOR THE INVENTOR"—NOW! For a good practical invention, plus prompt action in securing a Patent and locating a buyer or a good market, have proved the secrets of success for thousands of inventors.

"PATENT GUIDE" SHOWS WHAT TO DO

Our "Patent Guide" answers many important questions concerning Patents. It tells what facts, details, drawings, sketches, etc. are necessary to apply for a Patent; how to establish proof of your invention through dated and witnessed disclosure. We also send you our FREE "Record of Invention" Form and show you how to USE IT AT ONCE, without cost, before you file Patent Application. Our Guide also shows you how Patent Office Records can be checked to determine whether an invention is probably patentable before filing fees need be paid; discusses costs involved and a practical way these can be paid in installments

as the application progresses through our office. It tells how some inventors secured financial backing; how many simple inventions proved large commercial successes; how patents covering improvements can be profitably protected and marketed; tells countless other facts of vital interest to ALL inventors.

Remember—in Patent matters DELAY CAN BE COSTLY—ACTION IS IMPORTANT. Mail the Coupon NOW—in an envelope or pasted on a penny postcard to: CLARENCE A. O'BRIEN and HARVEY B. JACOBSON, Registered Patent Attorneys, 21-F Adams Building, Washington, D. C.

CLARENCE A. O'BRIEN and HARVEY B. JACOBSON

CLARENCE A. O'BRIEN and HARVEY B. JACOBSON
Registered Patent Attorneys before the United States Patent Office
21-F Adams Building, Washington, D. C.

Please send me your 48-Page "Patent Guide for the Inventor" and your specially prepared "Record of Invention" form FREE. This request does not obligate me.

Name

Address

City..... State.....

(Please write or print plainly.)

GOOD NEWS for AUTO MECHANICS!

You Don't Have to be an Expert to Do ANY Job on ANY Car! This Amazing New Shop Manual Solves Every Repair Problem!



RIGHT NOW hundreds of service stations are looking for able mechanics. Fleet owners need repair men to replace draftees. Mechanics are getting "Specialist" ratings at high pay in the Army itself. MoToR's 1942 FACTORY SHOP MANUAL will help you cash in! This is famous Auto Repair Manual used by U. S. Army, trade schools. Complete step-by-step instructions for ANY repair job on every model auto built since 1935, including 1942s, with data for 405 trucks! Actually ALL auto manufacturer's own official repair manuals! Open manual to car you want—there's everything you need to do any job!

SEND NO MONEY Fill out and mail coupon, MoToR's Giant 603-Page Factory Shop Manual will be sent at once. Deposit only \$4 with postman on delivery (plus few cents postage). If not completely satisfied within 7 days, return for refund. No obligation.

Published by MoToR, The Leading Automotive Business Magazine, 572 Madison Ave., N. Y.

MoToR BOOK DEPT., Room 512, 572 Madison Ave., New York, N.Y.

Rush me MoToR's 1942 Factory Shop Manual. I will pay postman \$4, plus few cents postage. If not satisfied, I may return book for full refund. (Foreign Price \$6, cash with order.)

NAME _____ JOB _____

ADDRESS _____

Put X here if enclosing \$4 with coupon. We then pay postage.

ELECTRICAL BOOKS

shipped FREE

10 BIG BOOKS

FOR EXAMINATION MODERN ELECTRICITY INCLUDING RADIO AND TELEVISION

Here's great news for anybody interested in Electricity. NEW 17th. edition of Applied Electricity brought right down to date with NEW Electrical subjects fully covered. 10 big Volumes and all shipped FREE for examination.

For Beginners and Experts
over 3000 pages—hundreds of illustrations—the most complete work of its kind we have ever published. Dynamom, motors, power stations, Radios, television, everything electrical explained so anyone can understand it.

BIG FIELD! Big Demand!

Big Pay! Men who understand electricity are urgently needed in thousands of industries. Autos, airplanes, machine shops—practically every industry depends on electricity and men who know this subject make big money. Pleasant, fascinating work, easy to learn and do! Learn with these books. Send coupon for a set for FREE examination and see for yourself.

SEND NOW [A year's consulting privileges with our engineers now given to all buyers of this famous Cyclopaedia of Electricity.]

AMERICAN TECHNICAL SOCIETY (Publishers—Home Study Courses)

American Technical Society, Dept. EA19, Drexel at 58th St., Chicago
Send for 10 days' free use, 10 volume set of Applied Electricity. You also agree to send me a certificate entitling me to consulting privileges for one year. I will pay the delivery charges only on the books. If I wish I may return them in 10 days and owe you nothing, but if I keep them, I will send \$2.00 after 10 days, then \$3.00 a month until the total price of only \$29.80 is paid.

NAME _____

ADDRESS _____

CITY _____ STATE _____

Please attach letter stating age, occupation and name and address of employer and give at least one business man as reference.

Quick! Get into DRAFTING now



All working tools, including drawing table, sent to you at once—furnished free with course.

Learn At Home From An Engineer

With industry working feverishly—the field for DRAFTSMEN is bigger than ever! Get into a better job with more pay and fascinating, pleasant work. I will train you at your home in your spare time until you are holding a better paying position as Draftsman. My practical training in drafting also includes a working course in Industrial Designing valuable on new products, improving, restyling and modernizing—all extremely important and profitable to draftsmen. Write for full illustrated details and booklet. Give your age.

ENGINEER DOBE, Division A337 Libertyville, Illinois



TRAIN FOR TECHNICAL RADIO WORK

I'll train you at home... or at camp for a good-paying Radio job, or a business of your own. I give you full Radio Equipment including a Tester, and complete Radio Set. You do practice-giving experiments. You gain Radio repair experience right in your own home.

FREE: Write for complete details in new catalog "HOW TO MAKE MONEY IN RADIO" SPRAYBERRY ACADEMY OF RADIO, 518-F University Place, N. W., Washington, D. C.

\$5 FOR YOUR PICTURE!

Universal-trained men and women everywhere selling their photographs for \$5 and more each—earn \$15 to \$50 EXTRA every month! Home Study photo-journalism course teaches you what to take, how, and where to sell photographs. FREE Book gives details. UNIVERSAL PHOTOGRAPHERS, Inc., Dept. 7, 10 W. 33 St., New York City

AIRCRAFT Designing & Engineering



HOME STUDY AFFILIATE OF RYAN SCHOOL OF AERONAUTICS

You can learn to design airplanes. A Ryan Home Study Course in Aeronautical Engineering will prepare you quicker for a job with good pay and a future. Easy to understand. No previous training necessary. Write today for free literature.

RYAN AERONAUTICAL INSTITUTE
426 Lindbergh Field • San Diego, California

STUDY AT HOME

With A Chartered Educational Institution

Courses in Arts; Sciences; Philosophy; Education; Public Health; Medical Jurisprudence; Psychology; Sociology; Physics; Chemistry; Geology; Pol. Science; Theology; Law; Business Training; Accounting; Mathematics; Statistics; Agriculture. ENGINEERING, Electrical, Civil, Mechanical, Drafting, Architectural, Steam, Aeronautical, Radio, Structural, Industrial, Highway, Petroleum, Mining, Marine, Chemical. McKinley-Roosevelt Incorporated, 4610-UD, Sheridan Road, Chicago

LEARN SUPER JU JITSU

Most powerful personal defense and counter-attack system ever developed. Unbelievably efficient. You don't need big muscles. Lick brutes twice your size with your bare hands. Get ready now for any emergency—protect your loved ones. New self-study course at startling low price. Satisfaction or refund. Free details, write today. Nelson Co., 500 Sherman, Dept. F-502, Chicago.

700,000 people can't be wrong!

You, too, can learn Music this EASY way!

Over 700,000 people have studied music at home this quick, easy way. Many didn't know one note from another yet they learned to play their favorite instrument. You can, too. It's great fun. You learn real tunes by note right from the start. Costs only few cents a day.

FREE Send for Free Book and Print and Picture Sample. Mention Instrument preferred.

U. S. School of Music, 76 Brunswick Bldg., N. Y. C.

Please send me free illustrated Booklet and Free Print and Picture Sample. I would like to play the (name Instrument) _____

Name _____ Have You Instr. 7 _____

Address _____

MAKE MONEY IN A CHICKEN BUSINESS of YOUR OWN

50 billion eggs in 1942! That's what the Federal Government is asking for. Think of it! Here's your opportunity to enjoy a real income from Poultry with a successful business of your own. Prepare now to have that little chicken farm you have always wanted and guarantee yourself a permanent income when the war is over. Harry M. Lamm, nationally known Poultry Expert, teaches you money-making secrets. Learn at home quickly, easily, at low cost. Start small way, spare time, grow from profits. Method endorsed by many colleges—leading Poultrymen. Write TODAY for free catalog "How to Raise Poultry for Profit." Tells how to get started in this fascinating work. No obligation.

National Poultry Institute, Inc.
Dept. 50-10 Adams Center, N. Y.



"Valuable Investment" says Herbert L. Whalley, New Paltz, N. Y., who recently finished the course. He wrote: "The N.P.I. course was a very valuable investment for my poultry business. I've cut feed costs, managed my flock more economically and have learned to market my products to greater advantage. The N.P.I. course is simple . . . practical . . . complete. Of equal value for the beginner and the more experienced poultry farmer."

AIRCRAFT WELDING ENGINEERING

Defense Industries offer Outstanding Opportunities to properly trained Welding Technicians (1 year), Aircraft Draftsmen (1 year), Aircraft Welders and Arc Welding Operators (3 months). Learn By Doing. "Ask how to earn \$1040 while learning." Write for free 64-page illustrated Book—"Dawn of A Giant Industry." Mention course desired.

MILWAUKEE SCHOOL OF ENGINEERING
PM-642-N, Broadway & E. State, Milwaukee, Wis.



Factory-to-You 1942 MIDWEST RADIOS

At Bargain Prices!

16 Tubes
9 Bands

SAVE your present cabinet, by putting in one of our powerful, new radio chassis. Also, a complete line of radio and radio-phonograph console models to select from. Supply limited—don't delay—send for FREE full-color catalog NOW!

30
DAYS'
TRIAL

Dept. 15-P, The Midwest Radio Corp., Cincinnati, Ohio

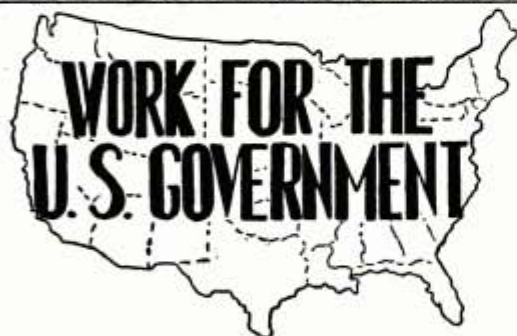

START \$1260 to \$2100 YEAR

MEN—WOMEN

Postoffice Clerks-Carriers
Railway Postal Clerks
Stenographers
Accountants
Statistical Clerks
Typists
Printer's Assistant
Many Other Jobs

Victory program
increasing
appointments

MAIL
COUPON
TODAY
SURE

Franklin Institute

Dept. K195

ROCHESTER, N. Y.

Gentlemen: Rush to me, FREE of charge, list of U.S. Government big pay jobs. Send FREE 32-page book describing salaries, vacations, hours, work, etc. Tell me how to qualify for one of these jobs.

Name.....

Address.....

JUNE, 1942

FREE 68 Pages of Facts About PATENTS and SELLING INVENTIONS

Many pictures and examples from inventive history make these excellent guide books for inventors.

OTHER MEN HAVE READ AND PROFITED BY THESE FREE BOOKS

If you have an invention—or an idea for one—you should have these free books. They tell real facts like these: How the patent laws protect you. Why you need the protection of a U. S. Patent. What a competent, registered patent attorney can do for you. They tell what kind of sketch or model is needed and how to make proper disclosure of your idea to help establish your claims. They tell how some successful inventors have secured financial assistance. They show 115 different mechanical principles.

HOW WE SERVE YOU

For nearly half of a century—we have represented thousands of inventors. We answer questions. We study each device to bring out its best patentable possibilities. Often, also, we advise inventors against going ahead with inventions which could not possibly be protected. By carefully developed methods, we try to keep expense at a minimum and we can arrange a deferred payment plan.

With the books, we will also send you a copy of our "Evidence of Invention" form on which you can sketch and describe your invention and establish a date of disclosure. Such a date of disclosure may later prove important to you. You can deal with us in strictest secrecy. Learn the facts. Simply sign and mail the coupon below. Take that first step today.



VICTOR J. EVANS & Co.

Merlin M. Evans

REGISTERED PATENT ATTORNEYS

Main Office—630-G, Victor Bldg., Washington, D. C.

Pittsburgh Office—521-N Empire Bldg.

Los Angeles Office—738-N Security Bldg.

Send me free copies of your books "Patent Protection" and "When and How to Sell an Invention"—also important "Evidence of Invention" form.

Name.....

Address.....

City or Town.....

Say you saw it in Popular Mechanics!

NEW INVENTIONS *Urgently Needed*

The need for practical new inventions to meet changed conditions of warfare and commerce is greater today than ever before. Your ideas, regardless of their nature, may fill urgent present needs. For analysis of current requirements, ask by number for the following FREE bulletins:

- No. 1—WHAT TO DO NOW, WITH MILITARY INVENTIONS.
No. 2—TODAY'S MARKET FOR COMMERCIAL INVENTIONS.

CHARTERED INSTITUTE OF AMERICAN INVENTORS
DEPARTMENT 4, BARRISTER BUILDING WASHINGTON, D. C.

DRAFTSMEN NEEDED Now



Industry is clamoring for more draftsmen for the job can't start until plans are drawn. Buildings, airplanes, machines, guns, tanks, bridges, all start on the drafting board, so it's no wonder that every good draftsman has a fine job. Yes, more draftsmen are needed NOW. The pay is good and the opportunities for advancement great.

Learn at Home in Spare Time

Begin now to turn spare hours into money. Be a draftsman, the connecting link between a mechanic and an engineer. Enjoy the wonderful opportunities for promotion that exist now. No experience or artistic talent is needed. You don't have to leave your present job while learning. Use spare time.

American School, Dept. DDA45, Drexel Ave. at 58th St., Chicago, Ill.

Gentlemen: Send me FREE information covering special training in subjects checked below. No obligation on my part.

- | | |
|--|---|
| <input type="checkbox"/> Drafting and Design | <input type="checkbox"/> Diesel Engineering |
| <input type="checkbox"/> Accounting and Auditing | <input type="checkbox"/> High School Course |
| <input type="checkbox"/> Architecture and Building | <input type="checkbox"/> Liberal Arts |
| <input type="checkbox"/> Automotive Engineering | <input type="checkbox"/> Mechanical Engineering |
| <input type="checkbox"/> Business Management | <input type="checkbox"/> Radio and Television |
| <input type="checkbox"/> Aviation | <input type="checkbox"/> Business Law |
| <input type="checkbox"/> Electrical Engineering | <input type="checkbox"/> Retail Merchandising |

Name.....

Address.....



FREE BOOKLET answers the many questions bound to be in your mind about where you stand in relation to the war—about how you can serve your country well, and still plan for a secure, successful future. It tells why YOU—by entering the aircraft industry—can be NECESSARY to your country's victory. For your free copy of this helpful booklet, airmail your request NOW to

AERO INDUSTRIES TECHNICAL INSTITUTE
5253 W. SAN FERNANDO RD., LOS ANGELES, CALIF.

get the story of PLASTICS

See the important place of plastics in virtually every industry—in War as well as Peace. Learn what a knowledge of plastics can mean to your future career. Write today for interesting, illustrated literature.

PLASTICS INDUSTRIES TECHNICAL INSTITUTE
1279 Chanin Bldg. Room 626 LaSalle-Wacker Bldg. 190 S. Alvarado Street
NEW YORK CITY CHICAGO, ILLINOIS LOS ANGELES, CALIF.

Free Book



MOUNT BIRDS, ANIMALS, FISH
You FREE. Explains Taxidermy. Tells how to learn at home by mail to mount birds, animals, heads... to TAN skins and furs. Great for MEN and BOYS. Fun! Also earn money in spare time. WRITE TODAY -- NOW -- for free book containing 100 game pictures, State AGE, N.W. School of Taxidermy, Dept. 337A, Omaha, Neb.

Correspondence Courses In RADIO and ELECTRICAL ENGINEERING

LOW AS \$25



ELECTRICAL ENGINEERING. Get good grasp of wide electrical field. Modern. Very understandable. Theory made easy.
RADIO ENGINEERING. Extra fine course in radio, public address, photo-electric work. Trains you to be super-service man, real vacuum tube technician. Tuition ONLY \$25, either course. Deferred payment plan. Experiment kits furnished.
FREE LINCOLN ENGINEERING SCHOOL. Box 933-P-42, Lincoln, Neb.

TIME & MOTION STUDY

The Vital War Profession

Prepare to help your nation through cost reduction and methods improvement. 40 intensive weekly home-study sessions. Big pay jobs await trained engineers. Write at once for descriptive folder.
INDUSTRIAL TI-MO CLINIC, 4000 W. Washington Blvd., Chicago

FOR VICTORY



BUY UNITED STATES DEFENSE BONDS AND STAMPS

TOMBSTONES \$10.95 UP FREIGHT PAID

High Quality Granite and Marble. Lettered. Guaranteed. Write for Free Catalog and samples of stone. Without Delay. Order By Mail.
U. S. MARBLE & GRANITE CO., A-18, ONECO, FLA.

Always write your name and full address clearly when answering advertisements.

LEARN A BIG PAY TRADE in 2 to 8 WEEKS!

We Pay Room and Board

To meet the great demand for men at high wages, we have inaugurated intensive training courses in the trades listed here. Learn in 2 to 8 weeks by actual shop work. One of America's leading schools. Established 1902. 7 floors of shops. Many employers send their young men here for intensive training. Free employment service.

GREER SHOP TRAINING

Dept. 262, 2024 S. Wabash Ave., Chicago, Ill.
Send "Shop Training Facts" describing trade checked below:

- | | |
|---|---------------------------------------|
| <input type="checkbox"/> Auto-Diesel | <input type="checkbox"/> Body-Fender |
| <input type="checkbox"/> Welding | <input type="checkbox"/> Machine Shop |
| <input type="checkbox"/> Refrigeration and Air Conditioning | <input type="checkbox"/> Tool and Die |
| | <input type="checkbox"/> Aviation |

Name.....

Address.....

Age.....

MAIL COUPON!

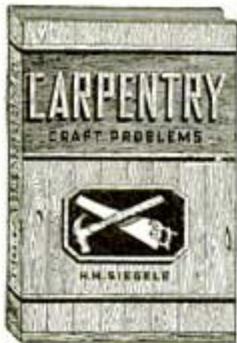

CARPENTERS NEEDED

Many Big Pay Jobs Open

This brand new book explains and illustrates hundreds of solutions to carpentry problems—makes it easy for you to handle difficult jobs. Authoritative—concise—easy to understand. Practical for both amateur and professional. Cloth bound. Over 300 pages—700 illust.

ORDER TODAY Pay postman \$2.00 plus C. O. D. charges. Postage prepaid if cash in advance. **ONLY \$2.00**

FRED'K J. DRAKE & CO.

626 W. Van Buren St., Chicago, Ill.
Drake books sold by all leading booksellers.

WELDING

Welding offers immediate opportunities for better pay. Day and evening classes. New short courses at new low prices. Special Student Finance Plan. Modern, well-equipped shops. Free employment service. Write for free "Blue Book"



CHICAGO TECH. COLLEGE

G-79 Tech. Bldg., 2000 S. Mich. Ave., Chicago, Ill.

THERE'S MONEY IN CARTOONS!

RAYE BURNS will teach you HOW to CREATE ORIGINAL CARTOONS at home that you may SELL. Course contains 26 lessons and over 600 illustrations. All for only **\$2.85**

Send name and address for free details.
RAYE BURNS SCHOOL, Dept. M, Box 3583, CLEVELAND, OHIO

Burn Your Name On Tools Electro Name Etcher

Protect valuable tools from thieves and tool borrower! Electro Etcher BURNS your name, any design, permanently on tools, instruments, any metal. Easy! Sample as writing with pen or pencil. SEND NO MONEY! Rush order today. Pay postman only \$1.00 plus few cents postage on delivery. Use 5 days—money back if not delighted. Electro Name Etcher, Dept. E-600, Strader Ave., Cincinnati, O.

STUDY ENGINEERING AT HOME

With A Chartered Educational Institution

Courses in ENGINEERING: Electrical, Civil, Mechanical, Drafting, Architectural, Steam, Aeronautical, Radio, Structural, Mining, Industrial, Highway, Petroleum, Marine, Chemical, Arts; Sciences; Philosophy; Education; Public Health; Medical Jurisprudence; Psychology; Sociology; Physics; Chemistry; Geology; Pol. Science; Theology; Law; Agriculture; Business Training; Accounting; Mathematics; Statistics.

McKinley-Roosevelt Incorporated, 4610-TD, Sheridan Road, Chicago

Learn PROFITABLE PHOTOGRAPHY

Modern, practical training. You "learn by doing." For pleasure or career. Unusual wartime opportunities. Black & White, Motion Picture, or Color photography. 32nd year. Free Booklet.

NEW YORK INSTITUTE OF PHOTOGRAPHY
10 West 33 St. (Dept. 49) New York City

Short-Cut Mathematics COMBINED WITH Practical Mechanics Simplified

NEW 2-in-1 reading course! Now you can learn the speedy, simplified system of calculation used by draftsmen, engineers, accountants, "master minds" on the stage. Learn easy way to multiply 4 figures by 4 figures without using old-fashioned multiplication; add long columns of figures this lightning short-cut method. Learn horsepower, slide rule, micrometer, logarithms, wood measure, puzzles, etc., etc. Large illustrated volume complete with answers, only \$1 postpaid. Satisfaction or refund.

Amaze friends with your magic-like mental powers.
FREE Complete details... mail coupon TODAY!

NELSON CO., 500 Sherman St., Dept. F 300, Chicago
Please send free details about "Short-Cut Mathematics and Practical Mechanics Simplified." No obligation.

Name _____
Address _____

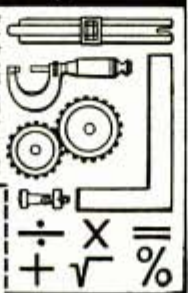

INVENT for VICTORY & PROFIT

GET THIS BOOK FREE

All Americans who have an invention or an idea which might be useful to their country are urged to patent it immediately.

Our new FREE BOOK "How To Protect, Finance and Sell Your Invention" guides you from the first step in getting patent protection to the final step of marketing and profiting from your invention.

INVENTIONS ARE NEEDED NOW

All Americans—inventors & mechanical-minded individuals—who have an invention or an idea which might be useful to their country are urged to mail it in. Submit to us any new gadgets, weapons or improvements on existing ones. We can help you. Your disclosure maintained in secrecy.

Take the FIRST IMPORTANT STEP NOW. Write today for FREE Book. It explains necessary steps leading toward patent protection.



McMORROW & BERMAN

Registered Patent Attorneys Before U. S. Patent Office
1351 Barrister Building Washington, D. C.

Send me your NEW FREE Book "How To Protect, Finance and Sell Your Invention" and specially prepared "Invention Record" form at once. I understand that this request does not obligate me.

NAME _____
ADDRESS _____
CITY _____ STATE _____
Write or Print Name Clearly



Know Electricity as Experts Know It—and Get an Expert's Pay!

What about your future? Who is safe today? Surely not the man who is contented to stand still! Know your job thoroughly—prepare yourself for jobs ahead. To do just this thousands of men have used

The Croft Library of Practical Electricity

The Croft Library is a complete electrical educator. It is founded on practice—on 20 years of short-sleeve experience—on work as it is actually done. It is jammed from cover to cover with the kind of hard-headed facts you want. Written so that the beginner can easily understand it, yet so sound, so thorough, that it is the daily guide of 29,000 highly paid electrical workers and engineers. Croft tells you the things you need to know about motors, generators, armatures, commutators, transformers, circuits, switchboards, distribution systems—electrical machinery of every type—wiring for light and power—wiring of finished buildings—underwriters and municipal requirements—illumination in its every phase—the most improved methods of lighting—lamps and lamp effects, etc.—how to do a complete job, from estimating it, to completion.

No money down — easy payments

Fill in and mail the coupon attached and we will send you the entire set of seven volumes for ten days' examination on approval. We take all the risk—you assume no obligation. If you decide to keep the books, send \$3.00 in ten days and the balance at the rate of \$3.00 a month. Send the coupon NOW and see the books for yourself.

EXAMINATION COUPON

McGRAW-HILL BOOK CO., 330 W. 42nd St., New York

Send me for ten days' examination on approval the Croft Library of Practical Electricity, 7 vols. If satisfactory I will send you \$3.00 in 10 days and \$3.00 monthly until the price of \$18.00 is paid. If not wanted, I will return the books postpaid. (To insure prompt shipment write plainly and fill in all lines.)

Name _____
Home Address _____
City and State _____
Position _____
Name of Company _____ PM-6-42

PATENTS

Booklet Free Highest References
 Promptness Assured Best Results

Send drawing or model.

ALL BUSINESS GIVEN PROMPT AND PROPER ATTENTION

Listed Patent Lawyer in the latest editions of the Rand-McNally Directory of Bankers and Bank-Recommended Attorneys, published by Rand-McNally & Co., Chicago, Ill.; American Lawyers Annual, Cleveland, Ohio; Bankers Service Legal Directory, published by Bankers Service Co., Boston, Mass.; and the Snow-Church Directory Co. Lawyers List, published in New York City.

WATSON E. COLEMAN, Victor Building, 724 Ninth Street, N. W.
REGISTERED PATENT LAWYER **WASHINGTON, D. C.**

INVENTORS PATENT YOUR IDEAS SEND FOR FREE BOOK



HOW TO OBTAIN A PATENT

Written by a Former Member of the Examining Corps (1922-24) of the U. S. Patent Office. If you want to profit by your idea, you should take steps to apply for a U. S. Patent at once. Your first step is to get this Free Book. This interesting illustrated book contains valuable information you should have. It tells you fully how to obtain a patent on your idea in the quickest way. With this Free Book you will also receive a "Record of Invention" form on which you can easily record your idea. Personal and Confidential Service: Your case will be personally handled only by a Registered Patent Attorney who is also a Former Member of the Examining Corps of the U. S. Patent Office. All communications confidential.

MAIL COUPON TODAY for FREE PATENT BOOK and RECORD OF INVENTION form.

CARL MILLER
 REGISTERED PATENT ATTORNEY
 FORMER MEMBER EXAMINING CORPS U. S. PATENT OFFICE

Woolworth Bldg., 35th Floor, Dept. 62-A, New York City
 MILLER BUILDING, Dept. 62-A, WASHINGTON, D. C.

Please send me your Free Book, "How to Obtain a Patent," and your "Record of Invention" form.

NAME.....

ADDRESS.....

PATENTS—TRADE MARKS

All cases submitted given personal attention
 Form "Evidence of Conception" with instructions
 for use and "Schedule of Government
 and Attorneys' Fees"—FREE!

LANCASTER, ALLWINE & ROMMEL
 Patent Law Offices

412 Bowen Bldg. Washington, D. C.

PATENTS AND TRADE MARKS

C. A. SNOW & CO.

Registered Patent Attorneys Since 1875
 Write for Free Book and "Certification of Invention" form
 427 SNOW BUILDING, WASHINGTON, D. C.

Established
1902

New York Electrical School

Ask for free illustrated
 booklet

44 West 17th St., N. Y. C.

YOU'LL PROFIT BY USING THIS

VALUABLE New



ARC WELDING MANUAL

\$2.00

1942 edition explains newest techniques, methods. Contains lessons, charts, diagrams. All data sons, charts, diagrams. All data any welder needs. Order now. Hobart Bros., Box M-821 Troy, Ohio

Hobart Welders are helping win production battle—learn to weld.



ORDER YOUR BOOKS TODAY!

Clip this Ad. Attach Your Name, Address, Money Order and MAIL!

Hobart

One of the World's
 Largest Builders of
 Arc Welders

BE PREPARED! SHOOT NEW BENJAMIN TARGET PISTOL



NEW Streamlined Hand Pump—Longer Shot Barrel—Larger Grip—More Power—Accurate—Practical—Economic—Safe—Clean—Quiet. No smoke or fumes. Bolt Action—Hammer Fire—Hair Trigger—Safety Lock. Single Shot BB with 1 lb. shot \$9.00; Single Shot Cal. .177 or .22 rifled—with 500 pellets \$10.50; Holster \$2.00. Also a complete line of Benjamin Genuine Compressed Air Rifles for BB and Cal. .177 or .22 pellets. Write today for complete specifications and free targets. BENJAMIN AIR RIFLE CO., 890 Marion St., St. Louis, Mo., U. S. A.

Say you saw it in Popular Mechanics!

A Career in AIRCRAFT INSTRUMENTS

BIG PAY JOBS PRACTICAL COMPLETE HOME STUDY SHORT COURSE

training on actual instruments furnished by the school. Short resident period completes the course and qualifies you for jobs with manufacturers, air lines, and instrument service stations. This is the largest Aircraft Instrument School in the East. For Full Details Send For Booklet.

EASTERN AIRCRAFT INSTRUMENT SCHOOL
 Dept. M, 116 Newark Ave., Jersey City, New Jersey

To PROTECT YOUR INVENTION—Use this coupon, NOW

Delays are dangerous and may be very costly. My personal service assures prompt action, strict confidence, and a minimum of expense. I suggest that you send me a model or drawing, or sketch and description of your invention, and \$5.00. I will make a search and report

promptly as to its patentability and send you a copy of my 72-page booklet. Or, if you prefer to read my booklet first, mail the attached coupon at once. I will also send my "Record of Invention" form. (Over 38 years experience as a Registered Patent Attorney.)

L. F. Randolph, 302-D Victor Bldg., Washington, D. C.

Please send me at once, free of charge, your 72 page booklet and "Record of Invention" form.

Name.....

Address.....

A PERSONAL CONFIDENTIAL PATENT SERVICE

Be an AIRCRAFT INSPECTOR



TRAIN NOW AT LINCOLN

Here is REAL opportunity for you. Prepare now at this nationally known Lincoln School for good-pay position as Aircraft Inspector. Big demand. Quick promotion to earnings as high as \$3600 a year. Lincoln's new Inspector Training developed in cooperation with Aircraft Factory executives, takes only 14 weeks to complete. Men 18 to 48, not immediately subject to draft, with high school or equivalent education, accepted. Married men with children especially desired. **WRITE TODAY** for information.

LINCOLN AERONAUTICAL INSTITUTE
596 Aircraft Bldg., Lincoln, Nebraska

Big Pay

LEARN WELDING



Train in Industrial New England. Big opportunities. Tremendous Defense Program in Greater Boston area. Quick, expert instruction. Active FREE placement bureau. Low cost housing and living facilities. Also courses in Drafting, Sheet Metal, and Plastics (The School of Plastics Division). Write today for full information about your opportunities in New England. State your age, education, and courses interesting you.

BOSTON TECHNICAL INSTITUTE
472 COMMONWEALTH AVE., BOSTON, MASS.

TRAIN FOR ELECTRICITY



LEARN BY DOING 12 WEEKS TRAINING

I'LL FINANCE YOUR TRAINING
All practical work on real electrical machinery and equipment. No advanced education or experience needed. Lifetime employment help after graduation. Get training first, then pay tuition later. Write for all details of my "Pay-Tuition-After-Graduation" plan and how many can earn while learning. H. C. Lewis, Pres., Coyne Electrical School, Dept. A2-72, 500 S. Paulina St., Chicago.

FREE TRIAL LESSON IN DRAFTING



More good jobs now in Drafting. Learn AT HOME in spare time (or at our Chicago School). Send postcard for **FREE TRIAL LESSON** and see how easy to learn and get a good job.

CHICAGO TECHNICAL COLLEGE
6-203 Tech Bldg., 2000 S. Mich. Ave., Chicago, Ill.

ARTISTS MAKE MONEY

Find out your ability. Send name, age, occupation and address for Free Vocational Art Test.

ART INSTRUCTION, INC. (Formerly Federal Schools)
6132 Art Instruction Building, Minneapolis, Minnesota

RADIO ENGINEERING

broadcasting, aviation and police radio, servicing, marine and Morse telegraphy taught thoroughly. 48 weeks' engineering course equivalent to three years' college radio work. School established 1874. All expenses low. Catalog free.

The Dodge Institute, Dept. D, Valparaiso, Ind.

MONEY for MEN ALL FREE

THE PLASTEX Industry needs manufacturers on small scale and for big production of Lamp and Clock Stands, Art Goods and Novelties in Plastex and Marble imitation. Experience unnecessary. 1/2c material makes regular 10c store sellers. Rubber moulds furnished for speed production. Small investment brings good returns. **WE ARE NOW PLACING BIG CHAIN STORE ORDERS WITH MANUFACTURERS.** Ambitious men have chance for real prosperity. Our FREE booklet will interest and benefit you.

PLASTEX INDUSTRIES, Dept. P, 1095 Washington Ave., New York, N. Y.

Get Your Share of **U. S. Defense BONDS ★ STAMPS**

SPARE TIME TRAINING for YOUR Part in NATIONAL DEFENSE and... the AFTER YEARS!

OUR first job is to aid our nation in this world crisis—to serve her most effectively. Our second task is to prepare for the adjustment years that will follow.

For most of us, fortunately, both tasks call for the same preparation; quick, thorough training that we may know more and do more. The trained man will help more in this crisis, and he will be better equipped for the adjustment years. He will be more valuable to the nation now and to himself all the rest of his days.

Right now one of our bottlenecks is the shortage of leaders—supervisors, managers, and executives—in defense industries. The millions of workers need thousands of trained supervisors. When the adjustment years arrive, these leaders will still be the needed and preferred men. So immediately and in the long run, training for the leadership jobs is both a patriotic and selfish investment.

If you are interested in knowing the possibilities of such an investment, simply check on the coupon below the field of business in which you are most interested. We will send you—without obligation—a free 48-page booklet about the opportunities and requirements in that field, and full details about our low cost, home study training. It will cost you only a 3 cent stamp to inquire—the returns may mean larger success and service for years to come.



LASALLE EXTENSION UNIVERSITY A Correspondence Institution Dept. 664-R, CHICAGO

I want to prepare myself for greater service now and for larger success. So I'd like to have your 48-page free booklet about the field I have checked below and information about your spare-time training.

- | | |
|--|---|
| <input type="checkbox"/> Industrial Management | <input type="checkbox"/> Foremanship |
| <input type="checkbox"/> Business Management | <input type="checkbox"/> Salesmanship |
| <input type="checkbox"/> Accounting | <input type="checkbox"/> Expert Bookkeeping |
| <input type="checkbox"/> Traffic Management | <input type="checkbox"/> Law |
| <input type="checkbox"/> Business Correspondence | <input type="checkbox"/> Business Law |
| <input type="checkbox"/> Stenotypy | <input type="checkbox"/> Business English |

Name..... Age.....

Position.....

Address.....



CLASSIFIED Advertisements



Advertisements in this section, 35 cents per word, each insertion, minimum 10 words, payable in advance
To be inserted under proper classification in July issue, copy should be in our office May 8th
July issue on sale June 1st

Popular Mechanics Magazine, 200 East Ontario Street, Chicago, Illinois

YOU'LL PROFIT

By reading and answering the classified ads in this section. Hundreds of opportunities to make and save money.

AUTOMOBILES—MIDGET CARS

AUTOMOBILE Racing book, fifth edition, well illustrated. Instructions on building bodies, frames, engines, Ford A and B conversions. Plans, AAA rules, specifications. Roadster racing, Indianapolis cars. \$1.00 postpaid, \$1.15 C.O.D. Ray Kuns, Dept. 42, Madisonville, Cincinnati, Ohio.

INCREASE The horsepower of your Ford V8 from 85 to 128 hp. without supercharging. Send \$1.00 for detailed, simple instructions. Power Associates, P.O. Box 501-A, Wilmington, Delaware.

CHANGE Automobile motor into air compressor. Instructions \$1.00. Tuck, 73 Shirley, Pontiac, Mich.

STOP Tire thieves—Instructions \$1.00. Materials cheap. Tirelox, 502 W. Concordia, Milwaukee, Wisconsin.

MIDGET, Motorscooter parts, kits. Closing out! Stamp brings circulars. List 50 used motors (\$5.00 up). 20c. Shipps Midgets, Box 543-H, Zanesville, Ohio.

CONQUER Priority fear! New rims, rebore needless! Details. Devereaux, Box 212-J, Battle Creek, Michigan.

PROFESSIONAL Midget racers, two-passenger roadsters. Midget motorcycles, motorscooters. Parts, plans, wheels. Handbook catalog—125 illustrations, plans—20c. Midwest, Box 1959-C, Chicago.

WHIRLGAS Superchargers, \$3. Increase mileage 20%; power 10%. Refund guarantee. University test. Any car; give make, year. Wrench installs 15 minutes. John Hanley, Manufacturer, 5719 Loraine, Detroit, Mich.

AUTO SUPPLIES AND EQUIPMENT

"CAR Watchman" prevents thieves from stealing tires, gas, equipment. Amazing invention. Whirlwind seller. Big profits. Write quick. Northwest Electric Co., G-12, Pukwana, So. Dak.

SAVE Gasoline—More speed and power for automobiles. Vacuum supercharger uses the gasoline engines waste, only \$7.50. Self-addressed, stamped envelope for pamphlet. H. H. McDowell Co., 318 S. E. Grand, Portland, Ore.

ACT Now, protect your tires. Make your own Auto Sentinel. Toots horn when car is disturbed. Send 50c for detail drawings. \$1.50 for drawings and necessary materials. Auto Sentinel Co., 19808 Kinsman Rd., Cleveland, Ohio.

VALUABLE Information on how to repair and save your auto tires and tubes. Post card brings full particulars. The Harris Co., Boaz, Wis.

RECLEAN Used oil without cost. Oil never wears out. Write: Gerwin, R. 8, Oklahoma City.

MINERAL Mined here in Rocky Mountains saves rebore and rings. Sample free. Manufacturers wanted. Xralite, 12 Pine Street, Kalispell, Montana.

Popular Mechanics Magazine, Chicago, Illinois.

Gentlemen:—Our business is that of selling watchmakers' tools and supplies and in addition to advertising in Popular Mechanics we also advertise in the various jewelers' publications.

Our records show that through Popular Mechanics, we reach more watchmakers than we do through all the jewelers' trade papers combined.

Very truly yours,

DEAN COMPANY.

(Original letter on file in our office)

KEEP Her rolling! Gasless gas, puncture preventative, vulcanizing cement, 9 other wartime maintenance secrets. Rush \$1.00. (Money back guarantee). Auto-saver, Dept. F-120, Cincinnati.

GAS Saver. Made and installed in five minutes. Your cost one cent. Sell for dollar. Saves up to 25% gasoline. Plans, instructions and samples for dollar bill. Mechanic, Box 741, Worland, Wyo.

AUTOMOBILE Owners protect your tires. Install Liberty Lock Rings. Guaranteed not to throw wheels off balance. Only \$1.25 per set postpaid anywhere in the U.S.A. Deal direct with factory and save. Money back guarantee if not satisfied. State year, make and model. Liberty Lock Ring Co., 346 No. Snelling Ave., St. Paul, Minnesota.

1942 IGNITION Supercharger \$1.75. E. G. Sales & Mfg. Co., New York.

PLATING Outfits for auto parts. Connect to a battery. No tanks used. Free particulars and proofs. Gunmetal Co., Ave. J, Decatur, Ill.

AUTO TRAILERS

ALL About trailers, construction, parts, supplies, etc. 64 pages vital information for anyone interested in home trailers. Send 25c. Stepes Co., 2801PM 14th, Kansas City, Mo.

READY Now—Plans for nine new Jim Dandy Trailers including six modern house trailers. Catalog 10c. Also new edition of Trailer Builders Manual and catalog of parts, supplies and equipment. Price 25c. Both 35c postpaid. Trailer Supply Co., 5120-A Fulton St., Wauau, Wis.

MOTORCYCLES, BICYCLES, MOTOR-SCOOTERS AND SUPPLIES

MOTORCYCLISTS. We can save you money on parts and accessories. Bargain list and decal free. Illustrated Henderson list 10c. Triangle, 2157 Harrison, Chicago.

SEND 10c For 1942 Handbook of Information. Lists new and used parts for Indian, Harley, Booter, 622 East Grand, Des Moines, Iowa.

MOTO Scoots: Slightly used. Bargains. Write or wire Gem Vending Co., 803 Penn Ave., Wilkensburg, Penna.

BUILD 6 Inch dia. friction clutch for shop, inboards, scooters, power mowers. Castings and parts. Send 75c for plans. Build Craft Engineering Co., Linden, New Jersey.

MOTORCYCLE Bags—\$3.90 pair and up. Allen Streamlined Bag Co., 216 Summit St., Elgin, Ill.

BUILD Electric power bicycle, low cost, easily built, operate cheaply, practical. Detailed plans 50 cents. Leland Hoke, 312 Market Street, Watertown, Wisconsin.

PISTONS And parts, new and used, all models. Catalogue and wings pin 10c. Ballak, 811 N. 9th, St. Louis, Mo.

MOTORCYCLES. Reconditioned. New, used, parts and accessories. All makes. Large stock. Bargains. Illustrated catalogue, 15c. Indian Motorcycle Sales, Kansas City, Mo.

AVIATION

PROPELLERS For aircraft, sleds, boats, dehydrators, fans. Catalog 10c. Banks Propellers, R.F.D. 7, Ft. Worth, Texas.

MODEL Aircraft Magazine. New monthly publication for beginner students of aviation. Nothing else like it. Sample only 10c. Model Aircraft, Dept. PM1, 110 West 42nd St., New York, N. Y.

BUILD And fly your own motorcycle powered monoplane, home. Easy, cheap. Tested plans, guaranteed, \$1.00. Aerotech, Dearborn, Mich.

AVIATION Cadet examination preparation by home study course. Rutherford Preparatory School, Long Beach, Calif.

BATTERIES, GENERATORS, ETC.

EDISON Lifetime storage batteries for light and power. Eliminate acid battery diseases. Long guarantee. All kinds rebuilt generating plants, motors, and miscellaneous articles at bargain prices. Free interesting literature. T. Hawley Smith Co., Croton Falls, N. Y.

GENUINE Edison batteries for light, power. Non-acid. Fifteen year life. Five year unconditionally guaranteed. Low prices. Complete lighting plants. Free literature. See-Jay Company, 82 Sterling Avenue, Yonkers, New York.

ELECTRICAL SUPPLIES—EQUIPMENT

$\frac{1}{2}$ HORSE, 3450 Speed, repulsion induction alternating motors \$12.50; 500 watt, alternating generators \$26.50, other sizes. Butler Electric, 1885 Milwaukee, Chicago.

ELECTRIC Pencil: Writes-engraves all metals. \$1.00 postpaid. Beyer Mfg., 4515-H Cottage Grove, Chicago.

WELDING, SOLDERING, PLATING

BUILD D.C. arc-welder, without re-winding armature: light plant generators; D.C. motors; automobile generators. Plans \$1.00 each. Welders Club, AB-3432 M-Mart, Chicago.

WELDING Outfits, for heavy, medium, light metal welding \$37.33 up. Welding supplies, accessories, a.c. electric welders. Write today. Superior Oxy-Acetylene Co., Hamilton, Ohio.

GOVERNORS—Auto engine speed control. Candee, 129-W Llewellyn, Los Angeles.

ARC Welders wanted by the thousands. Learn with 516 page lessons manual. Over 500 how-to-do-it photos. \$2.00 copy. Money-back guarantee. Hobartweld, Box M-624, Troy, Ohio.

POPULAR MECHANICS

LAST Chance—200 amp. a.c. welder. \$75.00. Holgeron's Service, Canton, Kas.

BUILD Arc-welder using toaster. Directions 25c. Essay Mfg., H. N., Quincy, Mass.

MACHINERY, TOOLS, SUPPLIES

BUILD Your own machine tools. Lewis furnishes semi-finished castings for bench milling machine and shaper; rough castings for 23 metal and woodworking tools. Shop-tested materials and professional blueprints. Never a complaint on quality, design or price! Send 10c—New 1943, 32 page illustrated catalog. Lewis Machine Tool Co., Dept. M-18, Box 116, Station A, Los Angeles.

PORTABLE Electric tools bought and sold. Saws, drills, routers, sanders, mortisers, hammers, grinders. Ed. Brown, 2029 Colonial Ave., New York City.

RECLAIM Dull and broken drills, with Nu-Way Drill Grinder. Circular free. Tractor-Lite Mfg. Co., Sidney, Iowa.

13"x5" WILLARD Lathe with gap. No 2 Pratt & Whitney hand milling machine, four step cone drive. Write for full particulars. Cincinnati Machinery & Supply Company, 217 E. Second St., Cincinnati, Ohio.

GRIND Drills like factory; attachment for bench grinder. Cheap. Factory, 811-B East 31, Kansas City, Mo.

ENGINES, MOTORS, DYNAMOS

BIG Pay jobs in welding. Complete welding lessons and reference book. 516 pages. 41 lessons. \$2.00 copy. Money-back guarantee. Hobartweld, Box 625-M, Troy, Ohio.

1/2 HORSE 110 Volt. induction motors. Rebuilt, guaranteed \$8.75; other sizes. Wilmet Auto Supply, 2247 St. Paul Ave., Chicago.

SMALL High speed universal motors, 1/10 h.p. Supply limited. \$2.75 postpaid. McConnell, 701 Wolff, Racine, Wis.

ELECTRICAL Maintenance men and war workers are preparing for better paying positions by using our practical electrical books. Literature upon request. Educational Advancement Co., Lakewood, New York.

GOVERNORS—Auto engine speed control. Candee, 129-X Llewellyn, Los Angeles.

WINDING Data. 225 motors, single and three phase. \$1.00. Motor Data Co., Box 7631, Kansas City, Mo.

AC AND DC generators, motors, exhaust fans. State your needs. Queen City Electric, 519 South California, Chicago.

BOATS, OUTBOARD, MOTORS, ETC.

U-MAK-IT Boats—Easy-to-build. Kayaks, rowboats, dinghies, outboards, inboards, sailboats. Runabout for auto engines. Over 300 in stock. Complete kits. Simple to assemble. Send 10c (coin) for all catalogs with illustrated construction details. Largest selection offered. Kayak Boat Co., 154-P East 129th St., New York City.

REBUILT Outboard motors. Fully guaranteed. Over 300 to pick from. Send 10c for complete list. Boat design book 15c. Buy now before prices advance. Chicago's largest dealer, Masters & Son, 214 West Chicago Ave., Chicago.

BOAT Designers are highly paid professionals. Complete course by mail. Catalog. Westlawn, Montville, N. J.

OUTBOARDS — Save 1/2. Good used parts, all makes and models. Bargains rebuilt motors. Crandall Hicks Co., 959 Commonwealth, Boston, Mass.

BUILD Your own boat with knock-down frames. Easy to put together. Save 2/3 builder's cost. Big boat catalog—25c. Brooks Boat Co., Dept., PP, Saginaw, Mich.

FORD-Mercury-Zephyr marine conversions. Catalog 10c. Lehman Engineering Company, Dept. D, Newark, N. J.

KAYAKS. Outboards, row boats, duck boats, construction kits. 10c for catalogs. Cre-Craft Boats, Millburn, New Jersey.

\$9.75 UP! America's biggest Kayak values. Safe! Sturdy! Dedham Kayaks, Dedham, Mass.

WELCH Boats—America's finest. Two thirds saving. Build your favorite boat by the Welch System. 10c brings you a complete catalog showing 32 designs. Welch Boat Company, Station K-1, Milwaukee, Wisconsin.

OUTBOARD Motors, used parts. Outboard Exchange, 9614 Flatlands Ave., Brooklyn, N. Y.

MARINE Power—Easily convert any Ford motor (domestic and foreign) with Osco parts and kits. Complete catalogue 25c (coin). Osmithson, 3644 Lawrence St., Philadelphia, Penna.

SAIL Your rowboat! Bast, boom, sail \$10. Trysail, Patterson, N. Y.

SPORTING GOODS, GUNS, FISHING TACKLE, ARCHERY, TRAPPING

"STAYS ON" Bait. Catfish, carp, perch. Sample 10c. 24 baits \$1.00. Duck decoy eyes \$1.00 doz. Prs. postpaid. "A-B-C" Bait Co., Dept. 14, 433 Bates, Detroit.

FLYTYERS—Illustrated chart teaches how step by step, quickly. Two dimes, or complete kit, \$1.00 postpaid. Satisfaction. Fishcrafters, Box 804, Worcester, Mass.

EVERYTHING In sporting goods, guns, rifles, motors. Mahowald Co., Mankato, Minn.

BOWS, Arrows, accessories, materials. Write for 1942 catalog. Hatfield's, 1762-A N. Vermont, Hollywood, Calif.

USED Guns, bought, sold, exchanged. List stamp. Howe Fur Company, Coopers Mills, Maine.

WANTED—Guns, equipment. Buy, sell, trade. Gordon Joslyn, Greenfield, Mass.

"RAISE Earthworms for Profit." Information free. Stamp appreciated. Bureau Zoological Research, 106 "P" Broadway, Peoria, Ill.

INTRODUCTORY Offer. Your tennis racket restrung with Permatex for \$2.00. Other prices on request. Ace Stringers, 253 Fetter Avenue, Trenton, New Jersey.

CASH Paid for used Lugers, revolvers, rifles and shotguns. Stoecker Arms Corp., 507 5th Avenue, New York.

ARCHERY Equipment: Catalogue free. Mid-West Archery, 2209-A East 75th, Chicago.

ATHLETIC EQUIPMENT—BODY BUILDING COURSES

ACROBATICS, Handbalancing and tumbling: Spectacular tricks. Fast-learning method. Natural body builder. Contains 141 illustrations. Complete course only \$2.98. Money back guarantee. Ken Cooper, Acrobat, Box 877, Dept. 6421, Milwaukee, Wis.

ACROBATICS—Flips, air somersaults, handstands, handbalancing. Circus method instruction. \$2.00. Wallace Power, 923, W. Vine, Kalamazoo, Michigan.

BAR-BELLS, Exercise equipment. Courses. Special offers! Free booklet. Good Barbell Co., 4676aPM, So. Grand, St. Louis, Mo.

BE Strong, muscular, full of pep. Amazing new body-building course. Write Olympic System, Dept. M, Waterville, Maine.

ANTIQUES, RELICS, INDIAN GOODS, CURIOS

SPINNING Wheel \$10.00. Hanging lamp \$10.00. Guy Saubury, Spicer, Minn.

PREHISTORIC And modern, old arms, minerals, coins. Carter, Elkhorn, Wis.

FIVE Different Indian tools 50c. Relic catalog 5c. Sistershop, Northbranch, Kas.

INDIAN Relics, coins, bills, gems, crystals, curios, etc. Illustrated catalog 5c. 100 ancient arrowheads \$3.00. H. Daniel, Hot Springs, Ark.

25 GENUINE Indian arrowheads, \$1.00. Catalog. Geo. Holder, Glenwood, Ark.

SWORDS, Pistols, daggers, armor list 10c. Robert Abels, 860A Lexington Ave., New York.

INDIAN Relics, beadwork, coins, curios, minerals, old glass. Catalog 6c. Indian Museum, Osborne, Kansas.

12 BEAUTIFUL Select arrowheads \$1.00. List free. Lear Howell, Glenwood, Arkansas.

FIELD GLASSES, TELESCOPES AND MICROSCOPES

LENSES—Build your own telescope, field glass, microscope, riflescope, etc. Assortment of fifteen lenses—\$1.00 postpaid. Slightly chipped on edge. Satisfaction absolutely guaranteed. American Lens Company, 324 North Mayfield, Chicago.

ASTRONOMICAL Telescopes, binoculars, cameras, microscopes: bought, sold, repaired. Send 10c for list of instruments desired. Rasmussen, Box 294, Amsterdam, N. Y.

REFLECTING Telescopes, 3 1/2" diameter, equatorially mounted. View planets, stars. \$16.50. Write Skyscope Co., 475 - 5th Avenue, New York.

DOGS, PETS, BIRDS, RABBITS

ST. BERNARDS! Registered puppies. Three beautifully illustrated folders free. Manitou Kennels, Watrous, Sask., Canada.

ANGORA Wool rabbits. Finest pedigree breeding stock. Kovalevsky, Madison, New Hampshire.

MONEY Raising rabbits. "Investigate." Folder 10c. Close Rabbitry, Tiffin, Ohio.

ST. BERNARDS—All breeds—Details free! Book 108 colored pictures, descriptions recognized breeds, 35c. Royal Kennels, No. 91, Chazy, N. Y.

TREES, SHRUBS, ROOTS, HERBS

HERBS! Grow for profit. Particulars 3c stamp. Brandons, 500 Fullerton, Chicago.

FARMS, FARM LANDS, REAL ESTATE

OSARK Land \$3 acre. Terms. Williams Realty, Mt. Vernon, Ill.

ON Lovely Choptank river—Delightful vacation or year round residence overlooking river; 4 rooms, Delco lights, garage, workshop, poultry house; 4 acres, 3 tillable, family orchard; mile to county seat; bargain at \$2250, terms; pg. 48 big free catalog 1384 bargains many states. Strout Realty, 255-P 4th Ave., New York, N. Y.

TWENTY Acres good land \$75.00. \$5.00 down. \$5.00 monthly. R. W. Stewart, Inverness, Florida.

GOOD Farm bargains. Washington, Minnesota, Montana, Idaho, Oregon, North Dakota. Dependable crops, favorable climate. Write for literature and lists describing typical farms for sale. Specify state. J. W. Haw, 119 Northern Pacific Ry., St. Paul, Minn.

GOVERNMENT Land \$1.00 acre up. Information all states 25c. National Tax Service, 1037A Majestic Bldg., Detroit.

40 ACRES. Near White River, unimproved; poultry land. \$190. \$5 down. \$5 monthly. Free list and literature. Hubbard, 216 Grossman Bldg., Kansas City, Kans.

SEE The Highlands of Louisiana. Choice cut-over land selling at low prices on liberal terms. Descriptive book sent upon request. Long-Bell Farm Land Corp., 878 R. A. Long Bldg., Kansas City, Mo.

POULTRY AND FARM SUPPLIES

PROMPT Shipment on Salem Chameleon chicks. Prices low. 18 varieties. Sexed or unsexed. Catalog free. Salem Hatchery, Box 81, Salem, Indiana.

MORE Profits from poultry—Learn how others get big daily income. Read America's leading poultry magazine. Three years 50c, six months 10c. Poultry Tribune, Department PB-1, Mount Morris, Ill.

DAVIS Chicks, amazingly low prices this year. 21 varieties. Catalog free. Davis Poultry Farm, Route 34, Ramsey, Indiana.

PROFITABLE OCCUPATIONS

WELDING Pays. Learn with 1942 trade school text manual. 516 pages. Over 500 photos. \$2.00 copy. Money-back guarantee. Hobartweld, Box M-623, Troy, Ohio.

LEARN Industrial camouflage methods. Postpaid 65c. Suite 24, Putney Block, Waukesha, Wis.

MECHANICALLY Inclined men—Own and operate general appliance repair shop. Complete, illustrated course shows you how. Welding, refrigeration, motor repair, how to get business, etc., all phases covered. Free literature. Christy Supply, Dept. 417, 2835 N. Central Ave., Chicago.

STANDARD Rabbit Journal, Milton, Pa. 3 years, \$1.00, sample dime.

ANNOUNCING New home study course in commercial baking. Good field. Nearly depression proof. Common school education sufficient. Send for booklet "Opportunities in the Baking Industry" and requirements. National Baking Institute, 1315 Michigan, Dept. 3433, Chicago.

\$40.00 WEEKLY. Made growing mushrooms, fresh, dried. Dominion patent 331583. Free spawn. North American, 1697 Yonge, Toronto, Canada.

RAISE Chinchilla rabbits for us. We pay up to six dollars each. Catalog and contract 10c. Book catalog. Year subscription Rabbit Magazine 25c. Stahl's, Box 10, Holmes Park, Mo.

RAISE Angora rabbits—wool brings \$5.00 pound. Particulars free. Grinstead's, Edwardsville, Illinois.

YOU'LL Like resilvering mirrors, tableware, making chipped glass nameplates, signs. Outfit prices. Sprinkle, Plater, 288, Marion, Indiana.

ANGORA Wool rabbits pay. America's fastest growing industry. Start now. Dakota Rabbitry, Oakes, North Dakota.

STUDY And become a licensed practitioner of the New Psychological Religious Conception called "Oneness" for Health, Happiness and Prosperity for self and others. Home study course. Exclusive territory. Either sex. Young or old. Be first. 7,000 word booklet free. Write "Oneness Society," Box 171-B, Stoneham, Mass.

BOOKS, PERIODICALS, PICTURES, POSTCARDS

CURRENT Copies business, vocational, diversion magazines. Choice 400 different publications. Free price list. Commercial Engraving Publishing Company, 34C North Ritter, Indianapolis, Indiana.

MACHINIST'S Reference book \$1.00 postpaid. G. A. Knudsen, 523 - 48th St., Brooklyn, N. Y.

EXCELLENT Sparetime profits taking subscriptions—2500 magazines. Complete starting supplies free! Pines, 583 Monroe, Brooklyn, N. Y.

5c BUYS Back dated magazines. Largest assortment. Foreign, art, mechanics, photography, technical, radio, snappy, etc. 30 page catalog 10c (refunded). Cicerone's Magazine Service, 863 First Ave., New York City.

SELF-EXPLAINING Bible: Descriptive circular free. Box 446-M, Minneapolis, Minn.

ANY Book (new, used, out-of-print, rare) promptly supplied! Lowest prices! Send for free bargain catalogue! Old Prof's Book Shop, M16 Arcadia Court, Pontiac, Mich.

NEW Popular text book scientific piano tuning and servicing. \$3.00. Howe, 116 Pinehurst Ave., New York.

RENT Moneymaking, health, authors' books for 10c a month. Lists free. Coates, 71C Millet, Dorchester, Mass.

LEARN More, earn more. Get "Aircraft Processes" by Sidney H. Phillips, Process Engineer America's great Douglas plant. Only \$2.50 postpaid. Free folder. Warren F. Lewis, Publisher, 707 So. Broadway, Los Angeles, California.

ARTISTIC Girl pictures. Real models. 8 postcards 25c, 20—50c, 50—\$1.00. Scott's, Box 342, Covington, Ky.

SAVE Money, time, material—763 methods. Amazing new book. Details free. Alsop, Highland Park, Illinois.

BACK Number magazines, also book bargains, list 10c. Magazine Mart, Roslyn, N. Y.

GAMES—ENTERTAINMENT

PLAYS, Operettas, musical comedies, complete minstrel first-parts with song programs, blackface skits, vaudeville acts, monologs, dialogs, recitations, juvenile plays and songs, musical readings, entertainments, make-up goods. Catalog free. T. S. Denison & Co., 203 N. Wabash, Dept. 11, Chicago.

MAGIC TRICKS, PUZZLES, JOKER NOVELTIES

NEW! Simplified card tricks! Amazing, self-working bafflers! 25c (coin). Particulars free. Conaway, H-123, Champaign, Illinois.

LEARN Ventriloquism. 3c stamp brings particulars. Smith, 801 Bigelow, Peoria, Illinois.

SIX Mechanical tricks, one dollar. Donnelly, 90 Barkley, Clifton, New Jersey.

POCKET Magic. Deluxe catalogue twenty-five cents. Magicraft, Harrisburg Station, Houston, Texas.

DOLLAR Magic set free with gigantic catalog 25c. Mysto, 4462 Germantown, Philadelphia.

DOUGLAS' Famous 1942 catalog of 500 tricks just out! Tricks you can do! Brand new effects for pocket, parlor, stage. With coins, cards, cigarettes, ropes, balls, thimbles, apparatus. Magic books, illusions. Send only 10c for year's biggest catalog value. Douglas Magic Shop, Box 274, Dallas, Texas.

NEW Vanishing key and catalog 25c. Sterling Magic, 345 John R, Detroit, Mich.

BE A magician. Large professional magic catalogue of latest tricks 25c. Ireland, C-109 North Dearborn, Chicago.

HOLLYWOOD Special! Magicians button, catalogue, ghost illusion and free trick for 25c. Magic House of Charles, Box 888, Hollywood, California.

EARN Money in any crowd. Call names of strangers, tell unspoken questions. Professional course mind reading, spirit writing, etc., \$1. Henderson, Box 341, San Bernardino, Calif.

WORLD'S Largest professional magic shop keeps you in touch with latest tricks. To receive mailings send 25c for 1942 catalog. Holden, 220 W. 42nd St., New York.

BAFFEL, World's greatest puzzle; will keep you entranced for hours, 25c. Brock, Box 1451K, Hollywood, Calif.

MYSTIFY Friends! Make tricks fascinating hobby! Become a magician. Earn good money. Dollar trick, two catalogs, circulars, all for dime. Neigar, N-2851 Milwaukee, Chicago.

JOIN Magicians' Fraternity! Free tricks. Monthly magazine, sample 10c. International Magicians, Mt. Morris, Illinois.

PROFESSIONAL Magic for amateurs! Pocket tricks! Joker's novelties! Hundreds of items! Complete line! Two big catalogs combined into one giant edition! 600 illustrations! Only 25c. Vick Lawson, Dept. J24, Queens Village, N. Y.

VENTRILLOQUISM. Secrets revealed. Home study course. Free particulars. State age. Fred Maher School of Ventriloquism, 1701 Casgrain Avenue, Detroit, Michigan.

MAGICIANS' Headquarters. 216-page catalog, pocket, parlor, professional tricks, 25c. Kanter's, M-1311 Walnut, Philadelphia.

STAMP COLLECTING

POSITIVELY Greatest free offer—Latest Scott's International \$4.00 stamp album—covering entire world, contains 36,000 illustrated, descriptive spaces; Scott's 1942 standard \$3.50 catalogue "Philately's Encyclopedia"—absolutely free to applicants for foreign approvals becoming customers. Plymouth, Dept. A-9, Bell, California.

UNITED States bargain. Here's an offer so stupendous that it is almost unbelievable; 52 different U. S. stamps ranging in age as far back as over 60 years and in face value as high as the dollar Wilson, composed entirely of face different postage, airmail and commemorative stamps, nothing else. In addition 2 U. S. possession pictorials. We will send all these for only 10c but only to sincere approval applicants. In asking for approvals, please state whether you are interested in United States or foreign stamps or both. Approval Headquarters, Globus Stamp Co., 268 - 4th Ave., New York City, Dept. 201.

ABSOLUTELY Free—Scott's latest deluxe loose-leaf \$3.50 album, covering entire western hemisphere—or standard \$3.00 stamp catalogue, to approval applicants becoming customers. Our approvals feature only the finest and latest South and Central America. "America's Stamp Service," Palm Springs, California.

PINE Approvals, freshly mounted. Fast, personal service. Tell me what countries you prefer and I'll send their stamps. Skinner, 345 East Ocean, Long Beach, Calif.

1000 MIXED U. S. old and new 25c. Weatherby, Amherst, Ohio.

ECUADOR, 25 Different 3c. Approvals. Southwest Stamps, Box 650, Denison, Tex.

SENSATIONAL Combination offer! Big packet 105 different including Iceland, Manchukuo, Ecuador (American flag in full colors), Danzig; airmails, commemoratives, triangle stamp, \$4 United States; complete set United States telegraphs, cataloging 20c. Packet British Colonies, including Gwallor, Hyderabad, Burma (new country) jubilee and coronations. Scarce Far Eastern republic cataloging 50c. Big illustrated lists of other bargains. Total catalog price over \$3.00! All for only 5c to approval applicants! World-Wide Stamp Company, Department 600-N, Camden, New York.

WELL Mixed. 1100 U. S. 28c. Henderson, 962 72nd Street, Brooklyn, N. Y.

50 HYDERABAD, Travancore, Charkhari, British Colonies 3c. Approvals. Cymerman, 177 Huron, Brooklyn, N. Y.

AIRMAILS. Special selections on approval. Ireman, Box 204M, Blue Island, Ill.

UNPICKED! 100 U. S. revenues on documents—10c! (700—50c). "Vanvoorhis, Hyndman, Penna."

TEN Cent packets; 5 United States airmails. 5 triangles. Free illustrated lists. Creevey's, Berwick, Penna.

ASTONISHING! 100 Different 5c! Attractive approvals. United Stamp Service, Box 491-S, Lexington, Kentucky.

START Stamp company? Fifty approvals imprinted 50c. Felber, W2GFW, Hillside, N. J.

\$1.00 WILSON, U. S. illustrated catalogue. Send 3c. Mozian, 505 - 5 Ave., New York.

MIXTURE—4000, \$1. Free stamps with \$1 purchase. Approvals. Griest, 409 Oak, Davenport, Iowa.

SEYCHELLES, Nejd, Caymans, Manchukuo, Brunel, Turks Caicos, British Solomons (Cannibaland). Everything 3c with approvals. Viking, 130-Z Clinton St., Brooklyn, N. Y.

80 MIXED U. S. commemoratives 48 cents. Jungkind, Box 806PM, Little Rock, Ark.

60 DIFFERENT U. S., including commemoratives, airmail 10c. No approvals. Seidenberg, Cassopolis, Mich.

CANADA, 500 Mixed, 50 different 25c. Approvals. M. Hughes, Shaunavon, Sask., Canada.

SPECIAL—All different: 100 China, 100 Portugal and 100 Romania \$1.00. Approvals. Hermes Stamp Company, Box 276, Hempstead, N. Y.

NEW Wholesale catalogue. Fifty-eight page list free to dealers. Empire Stamp, Dept. 5, Toronto, Canada.

1000 MIXED Foreign. 25c. Well worth sorting for values. Plaza Stamp Co., Santa Fe, N. Mex.

OPERATE Your own stamp business. Details free. Hansen, 1825 N. Washtenaw, Chicago.

BETTER Value 1c approvals. 10 stamps free—your choice. Excel, Box 1315, Chicago.

DIME Brings sample America's best hobby monthly. Collector-Dealer-Trader Magazine, La Porte, Ind.

300 DIFFERENT Stamps 10c with approvals. B. McKinney, Elsie, Michigan.

FREE! Western Hemisphere packet. Postage 3c. Owens, 806 Welsh, Bay City, Michigan.

KNOW Your stamps! Read "Postage" monthly, 25c year. Alhambra, Calif.

LADIES, Five different Austrian stamps showing women's hats, only 5c with approvals. Ledue, Saint Petersburg, Florida.

REAL Value—Ten different South American airm. 3 Chili big pictorials—Britain George VI 2/6, 5 and 10 shillings. Sent upon receipt of 50 cents with approvals. Philatelic Sales, Box 11, Station G, New York.

FREE 15 Different beautiful foreign commemoratives, pictorials with approvals, against sending 3c postage. Monosson, 505-M Fifth Avenue, New York.

SOUTH American—105 different 20c—with approvals. Davis, Silver Lake, Ind.

SMOKY Mountain sheet with 10 beautiful commemoratives. Approvals 5c. Stamp Shop, 809 Holland Bldg., St. Louis, Mo.

500 MIXED U. S. postage dues \$1.00. Kaye, Beaumont, Springfield, Mass.

STAMP Swappers Fellowship, 480 Lexington, New York. Send two dimes and your best 100 duplicates all different for exchange 100 best duplicates of Fellow Swapper. No dealers. One dime brings Stamp Swappers' Guide.

FREE Premium with approvals. Vargo Stamps, 1423 Cleveland, Racine, Wis.

25 WORLD Famous scenics, 10c. Smithy, Box 162, Mt. Pleasant, Utah.

19th CENTURY, United States commemoratives, Civil War revenues, battle-ships including \$5-\$10 stamps plus 1942 illustrated catalogue. Free to U. S. approval applicants. Metropolitan Stamps, 198-P Broadway, New York City.

APPROVALS Containing 400 diff. U. S. at 1c each. Potter, 1314-P McGee, Kansas City, Mo.

TRY Our jumbo penny approval books. O. K. Stamps, Centralia, Ill.

20 MAPS, Quarter; reference, approvals. Brown, (P), "Floracres," Brecksville, O.

U. S. \$5.00 Presidential No. 834 (perf. initialed) 15c to applicants for U. S. approvals. M. Haycock, 61A Obrien Place, Brooklyn, N. Y.

25 DIFFERENT Asiatic stamps free. Quality penny approvals included. Harding Stamp Co., 5031 No. Harding, Chicago, Ill.

SUPERB Approvals, net prices. Stamps 1/3 to 1/8 catalogue. P. G. Beals, 170A Tremont St., Boston, Mass.

CONFEDERATE Stamps catalog \$325.00. But 25c buys exact facsimiles (will baffle experts). Send no money; your request brings them for free examination. George Wentz, Dept. P. San Marcos, Texas.

40,000 VARIETIES Foreign approvals 1/4c up. First class service, honest prices, fair treatment. Representative selection on request. P. Keigwin Stamp Company, Vineland, N. J.

UNUSED Foreign sets at bargain prices. On approval against reference. Paul Rogers, Tuscarawas, Ohio.

CORONATIONS, Ten different 5c with junior approvals. Lange, East Freetown, Mass.

LOWEST United States stamp prices. Free illustrated catalogue. Creevey's, Berwick, Penna.

LOOK! 1000 Different only \$1.50; 2000, \$4; 3000, \$8. Fred Onken, 630 79th St., Brooklyn.

9 ALL Different Fiume 5c to approval applicants. Wonder Lake Stamp Co., Route No. 1, Ringwood, Ill.

WORLD'S Smallest airmail—diamond and triangle stamps, free stamp magazine, also magnifier to study your stamps, with large collections of stamps from scarce countries. A bargain, 5c with approvals. Capital Stamps, Dept. 2, Little Rock, Arkansas.

TEN Crazy-shaped stamps. 3c with approvals. Knopp, Box 1381, Bristol, Conn.

FREE! Austria war set. Postage 3c. Williams, 606 Archer, Bay City, Michigan.

FREE! Pony Express set (facsimiles). Postage 3c. Roberts, 406 Building, Bay City, Michigan.

FREE! Leeward Is., Cayman Is., Turks and Caicos plus 60 different int. Geo. VI coronation poster stamps, to approval service applicants sending 3c postage. Tatham Stampeo, Springfield-30, Mass.

DEALERS—Wholesale list. Postage 3c. Frank's, 4900 Chalmers, Baltimore, Md.

UNITED States stamps on approval. We offer a select stock at reasonable prices. Over 1500 varieties on hand, including scarce 19th century issues, commemoratives, airmails, parcel post, revenues, telegraphs and confederates. Write today. Southern Stamp Co., Box 70, Miami, Fla.

NEW 1942 Bargain packet—Over 100 different stamps; includes strange "mystery stamp" now prohibited in United States mail; stamps you'll treasure from Aserbajan, Georgia, Transcaucasia, etc. Complete packet for only 5c to approval applicants. Cactus Jr. Approvals, Box 1870-M, Tucson, Arizona.

BRITISH Empire collection! Burma, Cyprus, Gwalior, Sarawak, Tasmania; also 50 other British only 5c with pictorial and commemorative approvals. Lyman, 95 Nassau, New York City.

100 DIFFERENT British colonies—Stamps from the four corners of the world—Special 10c to approval applicants. Official Stamp Co., Fairlawn, N. J.

500 UNITED States for 10c! 500 U.S.A.—absolutely unpicked and unsorted—just as received from church missions. Many varieties, including commemoratives, airmails, high values up to \$5.00 denomination! Price only 10c to approval applicants! Money back if not delighted. Swan Stamp Co., Dept. 69B, Dunkirk, N. Y.

UNITED States approvals complete coverage, fine quality, attractive prices. Seminole Stamps, Box 436, Coconut Grove, Florida.

WEEKLY Stamp magazine, thirteen weeks, 10c. Stamp Journal, Kalamazoo, Mich.

A REAL Bargain. Specially prepared packet containing 150 different foreign and 65 different U. S. stamps; catalog value about \$5.00; pamphlet which tells you "How to Make Your Stamp Collection Properly" and large bargain lists, all for only 23c postpaid. Queen City Stamp Co., Room 36, 604 Race St., Cincinnati, Ohio.

WOW! \$10.00 Worth of fun for only 10c! 500 foreign stamps, unsorted and unpicked (mostly on bits of paper) just as received from the church missions and other sources. Africa, So. America, Australia, China, Philippines, Dutch Indies, and other countries are represented. Includes a few commemoratives, airmails, and stamps cataloging up to 25c or more each! The biggest package of fun in stampdom—and you might find something really valuable! Price only 10c to serious approval applicants! Money back if not delighted. Jamestown Stamp Co., Dept. No. 22, Jamestown, New York.

\$1.00 (CAT. Price) for 1c! Two mint U.S.A., cat 20c; "queer countries" packet (Djibouti, Manchuria, etc.); scarce set Russia, cat. 75c. Everything for only one cent to approval applicants! Garcelon Stamp Company, Box 400, Calais, Maine.

WILL Rogers and U. S. flag—Panama showing "Old Glory" in natural colors, and Nicaragua Rogers; diamond and triangle stamp, North Mongolia diamond (world's largest), Pope Pius "peace" stamp, slave colony, genuine Far Eastern Republic, Thailand, Antipodes, "puppet" country, animals, airmails, etc., all 5c with approvals. Belmont Stamp Co., Dept. 8, Washington, D. C.

CANAL Zone—Panama Canal commemorative and Ecuador with U. S. flag in natural colors, also "bullfight" stamp, Chinese "midjet," giant diamond, "Christ" triangle, "earthquake" airmail, Mozambique, Morocco, Ex-Nazi colony, stamps showing giraffe, Royal Air Force pilot, etc.—all 5c with approvals. Potomac Stamp Co., Dept. 1, Washington, D. C.

GIANT Packet 136 all different from Africa, South America, South Sea Islands, etc. Includes Nicaragua airmail, two scarce unused United States cataloging 20c, triangle and animal stamps; many others. Also includes fine collection 25 different British Colonies—Charkari, Jamaica, Johore, etc. and United States \$4 and \$5 high values. Total catalog price over \$4.00! Everything for only 5c to approval applicants! Mystic Stamp Company, Department 80-A, Camden, New York.

SEND Postage for free United States price list. Stanley Gibbons, 38-P Park Row, New York.

CANADA 100 Different 25c—approvals all countries. Lists, Victoria Stamp Co., London 4 Canada.

PENNY Approvals, that satisfy. Neil Gronberg, Box 5441-P, Philadelphia, Penna.

COINS, TOKENS, CURRENCY

COMMEMORATIVE 1/2c. Bought-sold. Pricelist free. Toivo Johnson, Ea. Holden, Maine.

HIGHEST Cash prices paid for Indian cents, Lincoln cents, old rare coins. Know coin values. It pays. Send 10c for 1942 catalogue of prices paid for all U. S. coins. American Rare Coin Co., Dept. 1, Transportation Bldg., Chicago.

30 DIFFERENT Indian cents \$1.50, catalogue free. Wittlin, 1681 Broadway, New York City.

INDIAN Head penny with list 10c. Charles Banker, Salina, Kansas.

Old Money wanted. Will pay \$100.00 for 1894 dime, S. mint, \$50.00 for 1913 Liberty head nickel (not buffalo). Big premiums paid for all rare coins. Send 4c for large coin folder. May mean much profit to you. Numismatic Co., Dept. 20, Fort Worth, Texas.

SWEDISH Copperplate coins. Greatest curiosity known, first minted 1624, twelve larger seventeen cents, both quarter. Hobby Club, 214 Masonic Temple, Minneapolis, Minn.

HIGHEST Prices paid for all rare coins. Illustrated buying list 10c. Chester Brooks, 1109 Garner, Austin, Texas.

ELEVEN Different coins 25c. Oddehon, Box 44, Overland, St. Louis, Mo.

OLD Money wanted. Big premiums paid. Catalogue 10c. Allan Appell, Sedalia, Missouri.

COIN Card collector's our price list is free. Write Hanson's, 1326 Main, Kansas City, Missouri.

COMMEMORATIVE 1/2c. Columbia, Lincoln, Stone-Mountain, Long-Island, Cleveland; \$1.00 each. Large illustrated catalogue 25c. Norman Shultz, Salt Lake, Utah.

I MAY Have just the scarce U. S. coins you want. Send me list. "Meet me by mail." William H. Kenworthy, Waterville, Maine.

GET Profit and pleasure in collecting old coins. Send 10c for 56-page illustrated coin catalog. You'll be delighted with it. Send for it now. B. Max Mehl, 370 Mehl Building, Fort Worth, Texas. Largest rare coin establishment in U. S. Established 42 years.

FREE! Foreign coin, banknote and large 50 page illustrated coin catalogue to approval service applicants. Send 3c postage. Tatham Coinco, Springfield-125, Mass.

PRICE List of U. S. coins, bills and collectors' accessories 10c. 75 illustrations, 2500 quotations. James Randall, 341 South Dearborn, Chicago.

HOBBIES AND COLLECTIONS

PEBBLES From Pacific Ocean beach, curious, natural polished, varicolored specimens. 25c. Rayco, Moss Beach, Calif.

NEW—15 Different match covers 10c. Box 202, Rochester, N. Y.

TWENTY Cactus plants postpaid \$1. Art Glover, San Dimas, Calif.

WANTED Old cigarette cards. Write Bray, 1127 Jackson, Easton, Penna.

ART Pretty girl pictures. Nifty new series. Complete set 18 pictures \$1.00. Sample package 25c. Each picture full postcard size 5 1/4 x 3 1/4. Harlem, Box 10, Station J, New York, Dept. A-21-H.

20 DIFFERENT Cactus plants postpaid \$1; mixed seed, 25c. Lida Delap, Azusa, Calif.

BEAUTIFUL Jewelry stones removed from rings, etc. 200 assorted \$2.00. Lowe's, Box 311, St. Louis, Missouri.

EXCHANGE Your duplicate stamps, match covers, etc. with collectors everywhere. List, swappers, dime. (Mention hobby.) Secretary, Box 2166, Denver, Colo.

CAMERAS AND PHOTO SUPPLIES

CASH! Spot cash for cameras, lenses, binoculars, movie or still, sound projectors. Send full description by mail, or wire for prompt cash offer. Over 30 years of dependability insures honorable dealings. Bass Camera Company, 179 West Madison Street, Chicago, Illinois.

35MM. Bulk film. Eastman Plus X; Dupont Superior No. 1 and No. 2; Infrared—27 1/2 feet \$1.25; 50 feet \$2.25; 100 feet \$3.50. Reload cartridges, two for 85c, four for \$1.45. Nitrol Laboratories, 1014 Marquette, Minneapolis.

CAMERAS And supplies. Free illustrated catalog listing everything photographic—still and movie cameras, films, lenses, enlargers, meters, supplies—at tremendous savings. Hundreds of bargains. All guaranteed. We take your old camera or equipment in trade. Write now for your free copy of our newest money-saving bargain book—just out! Limited edition. Hurry! Central Camera Co. (Photographic Headquarters since 1899), 230 S. Wash Ave., Dept. F-16Z, Chicago, Illinois.

ENLARGER \$1.79. Enlarges eight times size of small negatives. Fully guaranteed. Paramount Sales Company, 89 Dudley Street, Boston, Mass.

MAGIC Fluid sensitizes cloth, paper, etc., for printing photos. Easy to use. No darkroom. Many novel uses. Liberal sample 25c. Magic Picture Co., Box 1451-D, Hollywood, Calif.

SPEED-O-COPY Groundglass focusing attachment for Leica, Contax, Argus C-2 and C-3. Send for literature. D. Paul Shull, Dept. PM-6, 240 So. Union Ave., Los Angeles, California.

SAVE Money on films, rolls, packs, etc. Lundman, 724 - 49th Street, Brooklyn, N. Y.

TRIPODS With tilt pan heads. For 8-16, still cameras. Unheard of value. Write 11745 Hortense St., No. Hollywood, Calif.

35MM. Film! 25 ft. Eastman Plus X \$1.00! Reloaded cartridges—3 for \$1.00 postpaid. Order now. Pacific Coast Film Co., 1508 N. Sierra Bonita, Hollywood, Calif.

OIL Coloring photographs a fascinating hobby or profitable business. Learn at home. Easy simplified method. Previous experience unnecessary. Send for free information and requirements. National Art School, 1315 Michigan, Dept. 3441, Chicago.

HAVE You a camera? Send ten cents for recent number of our big magazine, showing how to make better pictures and earn money. American Photography, 116 Camera House, Boston, Mass.

BASS Says: Astounding buy, exclusive here, latest Argus C3 with coupled range finder, synchro flash, 50 mm. F.3.5 lens, also 75 mm. Baush & Lomb telephoto F.5.6 also coupled to range finder. \$82.50 value; price \$60.50 unconditionally guaranteed. Cowhide Eveready case, \$4.75. V. P. Inagee Deluxe, F.4.5 lens, Prontor shutter, big value at \$18.75. Send for yours quick while they are available. Write for quotations and advise what you have to trade. We pay cash for good cameras, lenses, binoculars. Don't trade until you write Bass Camera Company, Dept. AG, 179 W. Madison St., Chicago.

MAKE Money in photography. Learn quickly at home. Easy plan. Previous experience unnecessary. Common school education sufficient. Booklet and requirements free. American School of Photography, 1315 Michigan, Dept. 3432, Chicago.

CAMERA Repairing. Bellows made to order. Shutters repaired. Bellows made to fit all standard cameras! United Camera Co., Inc., A-1515 Belmont, Chicago.

PHOTO FINISHING

35MM. Argus, Leica, etc., (except "Mercury") 36 exposure rolls, fine grain developed (Eastman DK-20) and beautifully enlarged to 3"x4" glossy prints, 90c. Cartridge reloaded with Eastman Plus X, 35c. 18 exposure rolls, 55c. reload 20c. Films permanently protected by revolutionary Cryolite process, 24-hour service. Satisfaction guaranteed. Free mailing bags, sample print. Photo contest! Valuable prizes. Request entry blank. Write Technifinish Laboratory, 609 Brown St., Rochester, N. Y.

ENLARGED 4x6 in colors and film developed 8 Velox deckled-edge prints, 25c. Free film mailers 1-day service. Mail films to Joy-Photos, GPO Box 606, New York, N. Y.

FREE Beautiful album with cellophane envelopes, plus roll developed, two sets prints, 30c. Same-day service. Pho-T-Pho, Box 24Fl, Highland Park, Mich.

CUSTOM Finishing—3 1/4 x 4 1/2 enlargements from 35 exposure roll \$1.00. 18 exposure roll 75c. Double size prints—8 exposure roll 25c. 16 exposure roll 35c. Write for complete price list. Village Film Laboratories, Dept. M, Box 4046, Village Station, Los Angeles, Calif.

SPECIAL Limited offer! If you enclose this advertisement, 4 enlargements from 4 negatives 10c coin. Enlarge Photo, Box 791D, Boston, Mass.

AMAZINGLY Beautiful hand colored prints 6-8 exposure roll developed, printed 25c trial. Reprints 4c each. National Photo Art, D118, Janesville, Wisconsin.

BIGGEST \$1.00 Value in 35 mm. finishing today. 36 exposure fine grain 3 1/4 x 4 1/2 enlargements; deckled, embossed margin and date. Eighteen exposures 75c; sixteen exposure splits 55c. Free mailers. 8 exposure rolls in beautiful, deckled contact finish with free handy album 25c. Mailbag Film Service, Box 5440A, Chicago.

EIGHT Exposure rolls developed—printed 25c. Reprints 3c. Simpson's Studio, Winston-Salem, N. C.

ROLL Developed, two prints each good negative, 25c. (Limit 16 prints). Portland Film Co., Box P-4213, Portland, Oregon.

SIXTEEN Beautiful Holly-tone prints with eight exposure roll developed—25c. Hollytints, P-1350, Hollywood, California.

QUALITY Developing—Prompt service. 6-8 exposure rolls, two each, 25c. Free enlargement coupon. Postcard brings mailer. Petyt Studios, 3310 W. 65th Street, Chicago.

ROLLS Developed two sets prints 23c. Reprints 20c dozen. 35mm. enlarged 75c. 120-08LD Liberty, Richmond Hill, N. Y.

YOUR Initials free on 100 photo stamps, \$1. Victory Service, Emmaus, Penna.

DELUXE, Double weight velour or glossy prints with 8 exposure roll 35c. Superb quality! Free sample! Mailing bag. National Photos, 509 Fifth Avenue, New York.

ESTABLISHED 1914. Roll developed, 8 prints, 5x7 enlargement 25c. Gaither Photos, Moulton, Iowa.

ROLL Developed and printed 10c with 25c minimum order. Many specials. Free mailers. Film-Foto, Box 357, Passaic, N. J.

EVERY Picture an enlargement! 8 sparkling deckled-edge enlargements and roll developed 25c coin; 116 size or smaller; enlarge reprints 3c. Enlarge Photo, Box 791D, Boston, Mass.

IMMEDIATE Service—Pictures returned same day order is received! Professional ready-to-frame enlargements, 8c; hand colored, only 20c—Kodak roll developed with 16 guaranteed deckled-edge Velox prints, 25c. 16 reprints from your negatives, 25c. 36-exposure 35mm. roll developed, vapo-rated, enlarged to 3x4, \$1.00! 3x4 reprints, 3c each. Write for free mailers, free premium offers, etc. American Studios, Dept. 334, La Crosse, Wis.

ENLARGEMENTS Only. 8x10, 25c. Kingsley Photo, 18 Day Street, Somerville, Mass.

1942 35MM. Hit! 36 exp. rolls, fine grain, developed, enlarged, 3 1/4 x 4 1/2 glossy (except Univex), 85c; 18 exp. 55c. Include postage with remittance. "Studio 55," Box 677 Grand Central P.O., New York City.

35MM. Rolls fine grain developed 36 big 3 1/2 x 5 enlargements, guaranteed better, \$1.25. Reload 35c. Nationwide Finishers, Linton, Ind.

EIGHT Beautiful enlarged prints (nearly postcard size) or 16 regular prints 25c. 35mm. rolls enlarged 3 1/4 x 4 1/2 \$1.00. Burton Studios, 443M, Roscoe, N. Y.

BETA-WORK For only 25c more: Extra quality, extra care—finest developing, outstanding enlargements (3 1/4 x 4 1/2). 35mm. 36 exposures \$1.25—18 exposures \$1.00—12 and 16 exposure splits 75c—bantams 50c—Folder free. Beta Photo Laboratories, Box (B)745, Grand Central Annex, New York, N. Y.

TWO Beautiful prints from each picture on roll 25c. Twenty-two years of satisfied customers. Quick service. Lens Photos, Dept. J-4, Janesville, Wis.

THREE Prints each good negative, 6 to 8 exposure rolls, 30c. 12, 16, 18 exposure rolls, 50c. Reprints, 3c. Fred D. Eastman, Bode, Iowa.

BEAUTIFUL Enlargement from each picture on roll 25c. Cut Rate Photos, Dept. B-4, Janesville, Wis.

ROLL Developed, photo album, 2 enlargements, 8 prints, 25c. Wards Studio, 386, Des Moines, Iowa.

DOUBLESIZE Prints. Your roll developed and 2 doublesize prints 25c; from 116 or 120 size negatives you receive 4x6 inch prints. All other size negatives printed in proportion. 16 exposure rolls 50c; 12 exposure rolls 35c. Reprints 3c each. "Our guarantee," Everlasting hi-gloss finish. Overnight service. Pacific Photo Service, Box 666, San Francisco, Calif.

EIGHT Prints, two enlargements 25c. Quality Picture Co., Box P-3573, Portland, Oregon.

ROLL Developed, 8 brilliant Fadeproof Velox prints and two professional enlargements 25c. Overnight service. Young Photo Service, 405-C, Albany, N. Y.

YOUR Choice: 8 enlarged prints (nearly post card size) or 16 regular size prints from 8 exposure roll or negatives 25c. Willard Studios, Box 3536D, Cleveland, Ohio.

THE Photo Mill. Immediate service! No delay! Eight exposure roll developed, printed and coupon for your choice of two beautiful 5x7 professional enlargements, one tinted enlargement, eight reprints or other premiums, for 25c coin. Developing and eight Jumbo prints 25c coin. The Photo Mill, Box 629-13, Minneapolis, Minnesota.

ROLL Developed and 16 prints, or 8 prints and 2 enlargements, 25c. Candid 35mm. film developed and 36—3x4 prints, \$1.00. 18 exposure roll, 60c. Mercury Studios, Dept. 21, 109 N. Dearborn, Chicago, Ill.

ROLLS Developed two prints each and two free enlargement coupons, 25c; reprints 2c each; 100 or more 1 1/2c. Summers' Studio, Unionville, Mo.

ROLL Developed and 4x6 oversize glossy Velox prints, 8 exposure 30c; 12 exposure 45c; 16 exposure 60c. Overnight service. Clemet Photo Service, 1318 W. Columbia Ave., Philadelphia, Penna.

16 BEAUTIFUL Oversize deckled prints and two enlargements with first order 25c. Owlphoto M1, Weatherford, Oklahoma.

PHOTOGRAPHY For pleasure and profit. Prepare at home. Common school education sufficient. Write for information and requirements. American School of Photography, 1315 Michigan, Dept. 3451, Chicago.

IDEAL Photos beautifully finished wide border deckled edge, 25c roll of 8 and free enlargement. Ideal Photos, Box 2255, Paterson, N. J.

OIL Coloring photographs a fascinating hobby or profitable business. Learn at home. Easy simplified method. Previous experience unnecessary. Send for free information and requirements. National Art School, 1315 Michigan, Dept. 3431, Chicago.

FOR The discriminating amateur—8 exposure rolls, 2 prints each 25c. Miniature rolls enlarged 3 to 6 times, 8 exposures 25c. 16 exposures 50c. 35mm. 36 exposures, 3x4 enlargements \$1.00. Unexcelled quality. Prompt service. Paramount Photo, 1583 First Ave., New York.

ROLL Developed and 8 lustrous distinct fish permanent Velox glossy prints 25c—reprints 3c each. Fotoprint Service, Box I, Roanoke, Virginia.

16 SPARKLING Lifetone prints, 2 beautiful Hollywood enlargements, free Leathertone frame and photo wallet only 25c. Free photo album with first order. Lifetone Studios, Dept. A-339, Des Moines, Iowa.

8x10 SILK Finish enlargement—25c. Send negative. Irving Studio, 4006A Irving Park, Chicago.

MOTION PICTURES AND SOUND EQUIPMENT

BULK Movie film—8-16mm. Big savings. Fine grain, non-halation. Plans for building movie processing outfit with all formulae, 25c. Also bargains in accessories. Write for free circulars and film sample. Superior, Dept. D-6, 188 W. Randolph, Chicago.

BARGAINS New-used movie cameras, projectors, accessories. Large film rental library. Send 10c for catalogues. Don Elder's, M-739 Boylston Street, Boston, Massachusetts.

DEVELOP Your own movies. Save 60%. Bulk films—Prepared developers. Write Genera Company, Davenport, Iowa.

PRACTICAL Police Jiu-Jitsu—16mm. 1 reel in sound. Gun and knife tricks and weaponless defenses—For sale or lease except to rental libraries. L. J. Frankel, P.O. Box 1195, Charleston, W. Va.

8MM. Oldtime slapstick comedies 2c per foot new, direct from 35mm. Copc, 3729 South Figueroa, Los Angeles.

16MM. Sound subjects exchanged 50c, silent 25c. Also buy, sell, trade. Apt. B-49, 2309 Main Street, Bridgeport, Conn.

FILMS Exchanged 50c; bargain lists 3c. Hoffman Cut Rate Films, 57 Broad, Albany, N. Y.

USED Library subjects. Reasonable. Films Exchanged, large list. Gary, 369 E. 55, Brooklyn, N. Y.

ESO-S 8mm. Movie films 50% less! Spooled ready for use; bulk. Ask for D-2 catalogue. Eso-S, 3945 Central, Kansas City, Missouri.

TWO 35mm. Royal Zenith sound projectors with arc lamps \$600.00. Washington Jr. High School, Duluth, Minn.

16MM. Exchanges, trade-ins. Silent films, \$1.00 reel; sound, \$2.00. Bought, Sold, Castle, official latest releases in stock. Better Films, 742 Newlots Avenue, Brooklyn, N. Y.

8-16-35MM. Films, Bought, sold, ex-changed. Complete subjects \$2 up. Catalogue, sample film 10c. International, 2120 Straus, Brooklyn, New York.

8-MM.-16MM. Silent-sound; all latest subjects. Films rented everywhere. Free catalogue (sample film 10c). Garden Film, 317 West 50th, New York.

8MM.-16MM. Films. Free catalogue (sample film 10c). Parkway Exchange, 961 Eastern Parkway, Brooklyn, New York.

DEFENSE Films; 16mm. sound; Star Spangled Banner \$4.95. Hitler Does Lambeth Walk \$6.00. Others. Home talkie projectors; 1/3 down (\$50 down; \$50 on delivery) balance \$3.50 weekly. Largest film library. Mogull's, 64 West 48th, New York.

MONEYMAKER! "The World's Greatest Passion Play" 16mm. and 35mm. Specify sound or silent. Rent or purchase. Superior than Oberammergau play. Hemenway Film Co., 33-F Melrose Street, Boston, Mass.

WANTED: Used equipment for cash. Films, cameras, projectors, etc. Peters, 41-C South Fourth, Allentown, Penna.

35MM. Odd reels 75c. Projectors. Fea-tures. Savarese, Woodcliff Lake, N. J.

SEND Stamp for 16mm., 8mm. catalogue. Sterling's, 679 Northampton, Easton, Pennsylvania.

USED 16MM. sound film—100 feet, \$1.00, postpaid. Blackhawk Film, Davenport, Iowa.

BASS Says: Shrewd buyers send for the new Bass Cine Barogram No. 245, an 84-page catalog exclusively cine. The new Revere Double 8 with F.3.5 lens at \$38.50, is the buy. The RCA 16mm. SOF news reel camera at \$275.00. Write Cine Headquarters for your copy of this great free book. We pay cash for good used movie equipment. Bass Camera Company, Dept. A, 179 W. Madison St., Chicago, Ill.

LEARN Movie projection, management. Free catalog. Give age. Theatre Institute, Elmira, N. Y.

MUSIC AND MUSICAL INSTRUMENTS

WANTED—Piano accordions—120 bass. Best prices. Send complete description. Chaton, 600 Blue Island, Chicago.

HAWAIIAN Guitar players send dime for easy snappy diagram song. National Guitar Club, Commercial Block, Benton Harbor, Michigan.

LEARN Popular piano! Write Magic Key, 111-A Broadway, Glendale, Calif.

SONG Poems wanted for musical setting. Free booklet explains everything. Write today. Song Service, 331-C West 46th, New York.

MELODY Writers: Fine piano arrangement \$5.00. Lon Healy, Colorado Springs, Colo.

SONGWRITERS! Amazing, convincing offer. Hibbler, C-5, 2157 No. Avers, Chicago.

SONGWRITERS—Write for free book. Send poems. Variety, Dept. 2, Sarasota, Fla.

SONGWRITERS: Write for free instructive booklet concerning song poems. United Music, Dept. 14, Salem, Ind.

WANTED: Original song poems. Five Star Music Masters, 630 Beacon Building, Boston.

LYRICS Wanted, songs composed, free offer. Basil Alt, Ottoville, Ohio.

PHONOGRAPH Records 10c. Free list. Recording blanks 15c up. Hoodwin Company, 4419 Broadway, Chicago.

SONGS—Song poems wanted. No charge for melodies. Free examination. Hollywood Recording Studios, 87G17 Preuss Sta., Los Angeles.

SONGS: Composed, arranged. Complete Song Service, Box 113, Kalida, Ohio.

SONG Hits! Send poems for free examination. Write for free de luxe rhymier. DeLuxe Music Service, Box 3163-P, Bridgeport, Conn.

SONGWRITERS—Send poem for immediate consideration and free rhyming dictionary. Richard Brothers, 24 Woods Building, Chicago.

GOOD Music composed to good words. Reginald Belcher, Chatham, New Jersey. Established 1910.

NEW And used accordions and wind instruments bought and sold. Complete factory repairs on all instruments. Ace Music Co., 307 So. Wabash Ave., Chicago, Ill.

SONGS, Poems wanted. Newark Song Publications, 1207 Carbon, Syracuse, N. Y.

SONGWRITERS. Write for free booklet. Profit sharing plan. Allied Music, 7608 Reading, Cincinnati, Ohio.

MUSIC Composed to words. Rhyming pamphlet on request. Phonograph recording of completed songs. Send poem for consideration. Keenan's Studios, Dept. PM, Box 2140, Bridgeport, Conn.

WANTED! Lyrics, melodies for songs. We arrange, publish, sell. Superior Song Studios, Passaic, N. J.

SONGWRITERS: Send poems for offer and free rhyming dictionary. Phonograph records made. Vanderbilt Studios, Box 112-CA, Coney Island, N. Y.

MUSIC Composed to words. Wonderful proposition. Bauer Bros., Oshkosh, Wis.

LEARN Swing piano! Postal brings free folder. Christensen, 451 Kimball Hall, Chicago.

SONG Poems wanted. Free examination. McNeil, Master of Music, 510-PM South Alexandria, Los Angeles, Calif.

WRITE Songs. Big money and reputation. Write for information. J. Gordon Pub. Co., 201 N. Hoyne Ave., Chicago.

FREE—Big list of helpful books. Popular Mechanics Press, 200 E. Ontario St., Chicago.

RADIOS, SUPPLIES, INSTRUCTION

MAKE Your own simple long distance crystal radio. Amazingly simple radio requires no tubes or batteries yet reception over hundreds of miles reported. Special offer:—2 regular 25c supersensitive crystals and complete illustrated instructions only 25c, postpaid. Allen, Dept. A, Clinton, Mo.

"PROFESSIONAL Recording Equipment." New Presto dualspeed 16" turntable, 12 watt class A amplifier. Radio tuner, 2 mikes with stands. J. Bauer, 29 E. Ohio, Chicago.

BROADCASTING Station operator course, \$8.00. Institute, 524 Fairbanks, Oakland, Calif.

RADIO Communications courses qualifying for all federal licenses. Home study and resident courses. American Radio Institute, 1123 Broadway, New York, N. Y.

RADIO Communication course for home study. Covers all phases of operator license and job requirements. Free circular No. 3M. Nilson Radio School, 51 East 42nd St., New York.

RADIO Service men and experimenters send for our giant radio catalog. Save dollars. United Radio Co., (1000 M.) Newark, N. J.

MONEYMAKING OPPORTUNITIES

DOLLARS, Quarters, dimes by mail! "Reliable Homework Tips" shows how. Dime brings sample; details. Colemans, Smithboro, N. Y.

MAKE Statuary, flooring, etc. Imitation marble formula 25c. Ideal Service, 6M, Park Ridge, Ill.

MAKE Hand press pay! Plenty suggestions! 25c. Sanford, 29-A Parker, San Francisco.

EARN Money, copying and duplicating comic cartoons for advertisers. Ad-Service, Argyle, Wisconsin.

EARN Money with your typewriter addressing envelopes, circulars, typing. Information 10c; none free. Ace-PMO, Box 1123, Birmingham, Ala.

MILLION Articles. Buy wholesale. Valuable directory 10c. Ideal Service, D-6, Park Ridge, Ill.

1001 MONEYMAKING Opportunities, etc. 10c. Hansen, 1825 N. Washenaw, Chicago.

MAKE—Sell amazingly spectacular new cleaner. Belfort, Engineering Building, Chicago.

MACHINIST'S—Students free handbook and big money introducing Derck's Gauge Dials. Thirteen complete shop tables at fingers end. Sample two 25c defense stamps. Post Office Box 924, Department 26, Indianapolis, Ind.

MAKE Money drawing and copying cartoons. Hamilton, Box 4, Woolsey Sta., Astoria, N. Y.

MAKE Up to \$50 weekly at home. Information free. Universal Service, Box 736-P, San Antonio, Texas.

MONEY In names—details free. Mako, 5226P Tennessee, St. Louis, Mo.

TIRE-LOCK Protects tires, wheels. Easy, make, sell, \$75 week. Instructions 50c. Charles, 12-AB, Norwood, Ohio.

HOW To sell by mail! Big profits! 48-page magazine and "110 Money-Making Formulas." All for 25c. National Publishers, 526 Washington Building, Los Angeles, Calif.

MAILORDER Opportunities—Free money-making literature. Stuart, Box 93-P, Hayward, Calif.

PUBLISH A magazine. Sample copy, details, 10c. Raymond Thomas, 84PM Van Zandt, Providence, R. I.

BECOME A demonstrator. Work fairs; factories, stores, etc. Spell, formula, instructions, only 25c this month! Best season now. Green, Buchanan, Mich.

EARN Money at home! Thousands do! "Home Worker Magazine" tells how. Sample, 25c. Sizemore, Box 7, 4917 North Kostner, Chicago.

WILL You give us 5% first \$600 you make? Afternoons free! Work home, \$1,000 month reported (exceptional—full-time). Expect surprise! National, Box 1240, San Bernardino, Calif.

EARN \$5.00, \$50.00 Evenings. Editors begging personal-experiences. Education unnecessary. Complete instructions 50c. Western Publishers, 409 Malaga, Wenatchee, Washington.

WHOLESALE Sources, 500,000 articles. Free directory. Maywoode, 1133 Broadway, New York.

BE A metascientist. Remarkable drugless healing system. No manipulation, no apparatus. Inexpensive correspondence course. Free information. Metascience, Deland, Florida.

YOU'LL Like resilvering mirrors, tableware, making chipped glass nameplates, signs. Outfit prices. Sprinkle, Plater, 287, Marion, Indiana.

BUSINESS OPPORTUNITIES

WOODEN Purses. Knockdown. Every woman would love to own one. Finish yourself and sell for greater profits. Illustrated details free. Woodcraft, Dept. H, Kokomo, Ind.

FOR An extremely profitable lifetime business, operate a collection agency-credit bureau. Many make \$4,000 yearly. Up. Write, Cole Associates, Syracuse, N. Y.

PROFITABLE Home business. Small capital required. Clark System, Ellwood City, Penna.

START Home business making statuary, plaques, art goods, novelties, souvenirs, concrete pottery, garden furniture, artificial marble flooring, liquid marble. Make your own flexible molds. Amazing profits. Valuable folder free. Creative Publishers, (PM6), Glencoe, Illinois.

MANY Ways to make more money. Stamp brings details. D. Dykes, 918 Alabama, St. Joseph, Mo.

YOUR Own business. 66 page book, 40 plans; 64 page magazine 10c. De Seims, 250-P, North 9th, San Jose, Calif.

GET Into legitimate sideline mail order business. Several opportunities for profit. Small capital. Wide market. Write, Central Industries, 601, Simpson, Kansas.

WEBER Typewriter Mechanics School. Simplified homestudy-repairing increasing. Canton, Ohio.

TEN War-time plans. Make \$10.00 a day. Booklet 36 pages 10c. Home Industries, 1318 S30, Omaha, Nebr.

STATUARY: Make all kinds. Simple process. Make and install artificial stone flooring in color. Liquid marble. Other money-makers. Write promptly. Literature free. Compo-Tex, Box 786, St. Louis, Mo.

MAKE Photo rings, 6 onyxlike rings and materials, illustrated instructions \$1.16 prepaid. Norris, Bath Beach Sta. 83, Brooklyn, N. Y.

MAKE Your own Flexible Molds. Statuary, Art Goods, Novelties, Artificial Marble Flooring, Liquid Marble. Literature free. Kemico, 106-M, Park Ridge, Ill.

MAKE Artificial marble, glazed tiles, pottery without molds, permanently stained cement, plaques, sanitary floors, figurines, whetstones. Fireproof, hard, inexpensive. Uncanny interesting unusual. Brilliant samples 3c. Pavn, 945 Grande Vista (Room 101), Los Angeles, Calif.

MAIL Order beginners and oldtimers should read "Mail Order Iconoclast." Send 10c for copy. Peerless Enterprises, Box 177-PM, Jacksonville, Illinois.

EXTRA Income—Plenty mail selling opportunities. Write Katz, 4254 N. Kimball, Chicago.

3 MOST-READ Mail order magazines. 3 months 25c. Armand Cartier, 695 North, Pittsfield, Mass.

WARTIME Plan. Will you give us 5% first \$600 you make? Afternoons free! Work home, \$1,000 month reported (exceptional—full-time). Expect surprise. National, Box 1240, San Bernardino, Calif.

EXTRA Cash. No selling. Operate ball games, nut vendors. Also snappy girl film machines. Special hand viewer—28 girl pictures \$2.00 postpaid. Catalog free. Automatic, 2422A Fullerton, Chicago.

MANUFACTURE—Wood plastic, gifts, plaques, novelties, 90% profit. We furnish material, molds, instructions for big production. Sample mold model large scottie, with illustrated molding circular, catalogue new flexible molds, 25c postpaid. Plastic Wood, 4816 Bell, Chicago.

FREE—200 Clever mailorder, homework, local business offers—all snappy money-makers. Lewis Co., 828-M Carpenter, Oak Park, Illinois.

LIFETIME Business. Steady income. Repairing sewing machines. Book instructions \$1.00. Connan, 114 S.E. 74, Portland, Ore.

GRIND Lawn mowers! Factory process, \$2.00 capital. Mowers, Janesville, Wis.

START Own business—home, office. No peddling, little or no investment. Free folder tells how. Wm. Buckett, 23128 Battelle, Hazel Park, Mich.

KEEP Every cent you take in. Your orders filled free. For details write Loftis Service, 1135 4th St., N.E., Washington, D. C.

HOME Craftsmen: Steady monthly rental income, build highway displays, plans and instructions only \$1 postpaid. Highway Displays, Waukesha, Wis.

START Own money making business. Enormous profits. Steady demand. Write for free amazing particulars. Shinette, 1001A Jefferson Ave., Brooklyn, N. Y.

MECHANICALLY Inclined men—Own and operate general appliance repair shop. Complete, illustrated course shows you how. Welding, refrigeration, motor repair, how to get business, etc., all phases covered. Free literature. Christy Supply, Dept. 117, 2885 N. Central Ave., Chicago.

HERE'S A real opportunity. If you want a business of your own that is substantial money maker right now and has unlimited future with exclusive protection, and if you have \$600 cash to operate a business, write 163 Stockton Street, Dept. 16, Jacksonville, Florida, for complete details.

\$50.00, \$100.00 WEEKLY Using sawdust. Stamp please. Clement, 943 Arthur St., Rochester, N. Y.

BE A skilled vacuum cleaner mechanic. Complete training by mail. Associates, Box 708, Warrensville, Ohio.

10,000 WORD \$2.00 Mail-order course, 50c. Agents samples. Limited quantity. Record Press, Box 914, Division 22P, Rochester, N. Y.

VALUABLE Spare or full time proposition; collection latest moneymaking plans, ideas, formulas—plus expert's "tips"—will help build your business successfully! Only 50c! Adeptus Service, G.P.O. Box 301-E, New York City.

OPERATE Mail order business at home. Details dime. Hirz, Ryerson Ave., Paterson, N. J.

RUBBERFORM—Plastic, flexible, elastic waterproof mold making liquid. Pint \$1.00, gallon \$7.00. Plastic Products, 4810 Bell, Chicago.

"HOW To Think and Grow Rich." Copyrighted, 4 dimes. Columbian Institute. (Established 1935) P.O. Box 4, Desk 12F, Rochester, N. Y.

"VARIOUS Opportunity Catalog." copy 10c. P.O. Box 1735, San Diego, California.

CAPITAL! Finance "idea" business. Cheaply! Quickly! System, Station 19128, Los Angeles.

MAKE Money by mail. Stamp brings facts. Graham, Real Estate Trust, Philadelphia.

"RUBBER Molds." Make them yourself. Formulas, instructions 25c. Ideal Service, RM-6, Park Ridge, Ill.

AMBITIOUS Men, women, start your own business, home or office, spare or full time. Low cost! Information gladly sent free. Albert Ludwig, 532 Geary, San Francisco.

PROFITABLE Manufacturing! Few dollars starts you in this extremely profitable business; manufacturing today's largest-selling necessities. Formula Messenger explains fully. Stamp, Miller's Chemicals, Tampa, Florida.

SEVERAL Legitimate money making mail order propositions. Small capital. Write for details. L & L Specialty Co., 407 East Fifth St., Royal Oak, Michigan.

START Your own mailorder business on small capital; learn "successful mail merchandising" in 15 fascinating lessons; interesting literature free. Century Mail Enterprises, 152 W. 42 St., New York City.

MAKE Money by mail, the way we do. Free information. Maywood, 1133 Broadway, New York.

COLOR Concrete with chemicals. Washing wells. Stucco-rock. Benches. Spin concrete pottery. Cement artistry. Garden ornaments. Cold glaze. Concrete paints. Marbling. Sample 10c. Hollywood Cement Craft, 8527 Wonderland, Hollywood, Calif.

MAKE Good money compiling names. Cash in advance for lists. Inexperience, location no handicap. Stamp, Darnell Service, Dept.-A, Jackson, Tennessee.

SIGNS And showcards easily and expertly painted with letter patterns. Many sizes and styles. Write for descriptive folder. John Rahn, A1330 Central Ave., Chicago.

OPERATE Mail order business at home. Details dime. Maples, 3418 South Marshfield, Chicago, Illinois.

OWN And control your own business. A masterpiece of 300 ways to succeed. New and guaranteed. 25c postpaid. Dept. PM13, Lytle Supply Co., 525 East Main St., Columbus, Ohio.

GOOD Paying business silvering mirrors, plating autopaarts, reflectors, bicycles, bathroom fixtures by late method. Free particulars and proofs. Gunmetal Co., Ave. H, Decatur, Ill.

INVENTORS: Foresighted manufacturers already planning post-war sale of new non-military products. If you have a useful invention, patented or unpatented, write Chartered Institute of American Inventors, Dept. 4-C, Washington, D. C.

MAKE Money metalizing baby-shoes, plaster, plastics, flowers, wood! New non-priorities methods! Simple, profitable, fascinating! Free particulars. Novelty Metallizers, Box 933-M, Church St. Annex, New York.

ELITE Collection of business plans, contains 127 tested plans and scores of formulas. Start own business; home, office. Particulars free. Elite Co., 214 Grand St., New York.

NO Rebore, no rings. Stop oil pumping. Raise compression. Write for sample. Manufacturers wanted. Xralite, 10 Pine Street, Kalspell, Montana.

PLASTEX Industries offers industrious men an opportunity to start a business of their own, manufacturing art goods, novelties, souvenirs, etc., in Plastex and marble imitation. 5c material makes \$1 articles. Rubber moulds furnished for speed production. Small investment brings good returns. We are now placing big chain store orders with manufacturers. Write for interesting booklet mailed free. Plastex Industries, Dept. A, 1085 Washington Ave., New York.

HOW And where to obtain capital. Fully explained, particulars free. Star Service, Wapakoneta, Ohio.

POPCORN And potato chip machines. We help start men and women in business. Long-Eakins, 1960 High, Springfield, Ohio.

LIQUID Marble—Colorful, glazed! Mold, brush, spray! Composition floors, rubber-lastic molds. Particulars free. Marbleizing Service, Edwardsville, Illinois.

CHARTERS: Delaware; best, cheapest; free forms. Colonial Charter Co., Wilmington, Del.

127 WAYS To make money, in home or office, business of your own. Full particulars free. Elite Co., 214 Grand St., New York.

YOU'LL Like resilvering mirrors, tableware, making chipped glass nameplates, signs, outfit prices. Sprinkle, Piater, 127, Marion, Indiana.

2c DAILY Pays for New York office under your own name. Co-Operative Offices, 126 Lexington Avenue, New York.

SELL Books by mail on commission. No stock to carry. Orders come to you. Maywood Publishers, 1133 Broadway, New York.

FORMULAS, PLANS, ETC.

DRUG And specialty formulas \$6.00, practical formulas for cosmetics, food products, medicinal preparations, etc. Emil Belanger, 2623 West 3rd Street, Duluth, Minn.

MAKE Fast selling products. No machinery. "Chemist Approved Formulas." Catalog free. Kemico, 12-P, Park Ridge, Illinois.

BOOK Of money making plans, formulas, etc. Send \$1. Success Sales, 258 N. 20th St., Columbus, Ohio.

"LUMINOUS Paint" shines in dark. Easily made, 150 other formulas, plans—all 25c. ("Soap-Making") 30 formulas \$1.00.) Ideal Service, 306, Park Ridge, Ill.

INDIVIDUAL Formulas, prices, information free. Warren White, 1300 Commerce, Dallas, Texas.

MIGHT Consider financing chemist able to perfect tarnish-proof container for silverware. Address P.O. Box 1275, Milwaukee, Wisconsin.

ICELESS Ice! Colder; cleaner; cheaper. Instructions 25c. Duffy, Covington, Ky.

FORMULAS, Analysis, free literature. Hertstein, 330 Charles, Grand Rapids, Mich.

ELITE Formulas and plans; make and sell your own products. Descriptive booklet free. Elite Co., 214 Grand St., New York.

10,000 MONEY-MAKERS! Authentic formulas, recipes, secrets. Simple compounding instructions. Supply sources. Make most anything! 924 page illustrated book. \$1.50 postpaid or C.O.D. (Foreign \$1.85.) Adams Brown Company, Chestnut Hill, Massachusetts.

REAL Manufacturing formulas. Lists free. Cummings, Chemist, Gordon Ave., Syracuse, N. Y.

CHEMISTRY

CHEMISTRY Laboratory apparatus and chemicals for industrial, analytical, and private experimental laboratories. Complete chemical laboratory supply service for correspondence school students. Send 3c for free 48-page catalog of chemicals and apparatus. Dept. M-43, Biological Supply Co., 1176 Mt. Hope Ave., Rochester, New York.

WINN'S New Idea chemical kits and apparatus outfits for students, big value. Free literature and catalog of chemicals and laboratory supplies, scientific books at big discount. Send 3c return postage. JE-6 Winn, 124 W. 23rd, New York.

CHEMICAL Experimenter's supply catalog 5c. Colonial Chemical Company, Brockton, Mass.

ANALYTICAL Chemist, formulas, chemical questions answered 25 cents. Abram Laboratories, Chowchilla, California.

COLCHICINE—Chemical which creates freak new mutant plants. Folder—copy 24 page illustrated booklet—copy Plant Experiments 25c. Questok, Wellesley, Mass.

CHEMICAL Drying desiccating agent, U. S. Navy user, 49c. Scientific Exchange, Brooklyn, N. Y.

FREE Catalog; chemistry, mineralogy, biology, microscopes. Tracey Laboratories, Evanston, Illinois.

SPECTROSCOPE For quick chemical analysis \$2.50. Kutting Sons, Campbell, California.

CHEMICALS—Small quantities, apparatus. Catalog 5c. Fleischer's Laboratories, Medford, Mass.

HELP WANTED

BIG Money taking orders; shirts, ties, hosiery, underwear, pants, jackets, sweaters, uniforms, etc. Sales equipment free. Experience unnecessary. Nimrod, 4922-BG Lincoln, Chicago.

AGENTS WANTED

BIG Money quick. Sensational book. General Douglas MacArthur—authentic life story. Over 300 pages. Elaborately illustrated. Only \$1.35. Enormous demand. Agents selling over 20 copies a day. Send for sample. Universal House, Dept. M, 1012 Arch Street, Philadelphia, Penna.

"CAR Watchman" prevents thieves from stealing tires, gas, equipment. Amazing invention. Whirlwind seller. Big profits. Write quick, Northwest Electric Co., G-10 Fukuwana, So. Dak.

HAND-WOVEN Mexican goods. Authentic masterpiece. Casa C. O. D., Saltillo, Coah., Mexico.

MAGIC Ant killer sells like wildfire. Ohio man sold 235,584 packages in 3½ months. Amazing profits. Write quick for territory. Barton Chemical Company, 3909 So. Langley Ave., Chicago, Illinois.

GEN. Douglas MacArthur—"America's Hero"—8x10 picture 50c. Jack Lofthouse, 1208 Madison, Peoria, Illinois.

DON'T Be a job hunter—Start your own business on our capital. No hard times; no layoffs; always your own boss. Hundreds average \$3,000 to \$5,000 annual sales year after year. We supply stocks, equipment on credit, 200 home necessities. Selling experience unnecessary to start. Wonderful opportunity to own pleasant, profitable business backed by world wide industry. Write Rawleigh Co., Dept. F-U-PPM, Freeport, Ill.

FREE Water and our concentrates, makes flavors, lotions, shampoos, 72 products, labels, bottles furnished. Qualco, P-20030 Russell, Detroit.

I WILL Give you \$5.00 worth full size packages foods, groceries, soap, etc., free if you agree to show friends and others. Amazing spare time money making opportunity. Write Zanol, 6282 Monmouth, Cincinnati, O.

TIRES, Autocop stops thieves cold, protects whole car. Sample \$1.75. Autocop, B 20030 Russell, Detroit.

VITAMINS — High potency capsules. Write for sales plan or send 50c for full size box and agent's offer. George Belido, 30 Church St., New York.

BIG Daily profits selling Fifth Avenue ties, hose, belts, etc. Big free catalogue. Danforth, Dept. P-105, 545 Fifth Avenue, New York City.

SELL Tire locks. No wheels to balance. Servwell Products, Cleveland, Ohio.

BIG Money taking orders: shirts, ties, hosiery, underwear, pants, jackets, sweaters, uniforms, etc. Sales equipment free. Experience unnecessary. Nimrod, 4922-AN Lincoln, Chicago.

SPECIAL Shoe offers bring quick sales, easy money. To \$2.50 per sale plus bonus. Sell full-part time. Free sample shoes to producers. Exclusive opportunity. No investment. Free outfit starts you. Merritt Shoes, A-11, Brockton, Mass.

LORD'S Prayer on a real penny. Sells on sight. Full particulars and samples 25c. Perkins, 4745 Broadway, M-6, Chicago.

LEARN "How to Sell by Mail." 25c (None free). Rochester Publications, Box 54, Dept. 1B6, Rochester, N. Y.

HOUSEHOLD And wagon salesmen! Shortage of standard drinks this summer means big profits in household beverage trade. Sell first really new home beverage drink in ten years. Delicious, sensational, different, new taste thrill, highly concentrated. Steady repeat profits. Send 25c for full size sample and complete details. General Fruit Products, Desk P. Point Pleasant, New Jersey.

ENGRAVED Name plates, etc., a brand new line, large profits. Brett Bros., Winthrop, Mass.

BIG Profits selling Shelton Dust Absorbers. Samples 6—\$1.00 prepaid. Shelton Mfg. Company, Colorado Springs, Colorado.

GREETING Cards, specialties, Hildebrand's 4554 North Uber Street, Philadelphia, Pennsylvania.

AGENTS. Big line including food products. Fast selling premium and bargain deals. Low prices. Send card for big outfit offer with gift. Ho-Ro-Co, 2715 Dodier, St. Louis, Mo.

AGENTS—To mail our literature. Good profits. Home business. Maywood, 1133 Broadway, New York.

AGENTS: Stamping names on pocket-key protectors. Sample check with your name, address, 25c. Stamping outfits. Emblem checks, check-fobs, name plates. Hart Mfg. Co., 303 Degraw St., Brooklyn, N. Y.

AGENTS—300% Profit selling gold leaf letters: stores and offices. Free samples. Metallic Letter Co., 438-B North Clark, Chicago.

AMBITIOUS School seniors—Sell classmates the "tops" in graduation name cards. Best commissions. Free cards. Agencies going like wildfire. Hurry! Craftcards, Box 235-L, Pittsburgh, Penna.

WINDOW Sign letters. New "Roman" style. Large sizes, penny each. Absolutely beautiful. Free samples. New catalogue. Atlas, 7941 Halsted, Chicago.

THIS Man's idea is a God-send to folks who need money. Laugh at "War-Pig." 25c complete. You make 1000% profit. Money back without question if not entirely satisfied. Send quarter to Ontario Enterprises, U. S. Post Office Box 575, Desk A25, Rochester, New York.

DIETHYL Super! Sensationally new: Make 500%! Saves millions! Needed everywhere! Free offer—information—write. Thermodex, Peoria, Ill.

GAS Stations want this new patented necessity. Knipp, Long Beach, California.

GOOD Paying business silvering mirrors, plating autoparts, reflectors, bicycles, bathroom fixtures by late method. Free particulars and proofs. Gunmetal Co., Ave. N. Decatur, Ill.

BIG Money applying initials on automobiles. Easiest thing today. Free samples. If you sell printing and advertising specialties we have an excellent sideline featuring Decalcomania name plates in small quantities. "Ralco," 727 Atlantic Ave., Boston, Mass.

DO You want agents for your proposition? Your ad in this space will place your message before hundreds of men seeking fast-selling products. My folder "How to Secure Agents," is filled with proof. I'll gladly send you a copy free. P. W. Johnson, Manager Classified Advertising, Popular Mechanics Magazine, 200 E. Ontario St., Chicago.

HIGH-GRADE SALESMEN

SELL Everyday greeting cards! Liquidating 3,000,000 profitable sellers! Bulletin free! Sample box 25c. Elfco, 438 North Wells, Chicago.

EVERY Merchant prospect simplified business records. Matz Products, Reading, Pennsylvania.

SALESMEN: America's finest sideline. 40% commission daily. 1000 fast selling repeat items. Every business uses and must buy. No investment. Sales portfolio free. David Lionel Press, 312 So. Hamilton, Dept. 76, Chicago.

SALESMEN—200% Profit. Sell stores, new 10c collar support every man needs. Free merchandise offer. Hawkins, 537 S. Dearborn, Chicago.

WARTIME Makes our essential business necessities sell fast. Not affected by priorities. Large commissions advanced daily. Experience unnecessary. Samples free. Northwestern, 621-O Jackson, Chicago.

ADVERTISING Book matches. America's largest manufacturer of union label book matches. Fast selling line. Large sales producing kit. Sample matches. Complete cut catalog, 13 color combinations makes selling easy. Commission in advance. Superior Match Company, 7530 Greenwood, Dept. N-6, Chicago.

MAKE—Sell made-to-measure arch supports. Particulars free. Corssen, 3609P Texas, St. Louis, Missouri.

MAN With car to establish retail store route. Openings almost every locality. Handle orders for nationally known manufacturer-jobber. Average 50% commission. Steady big pay opportunity. Sales experience unnecessary. World's Products Co., Dept. 106, Spencer, Ind.

BIG Commissions—selling to stores celluloid pricing tickets, metal shelf moulding. To restaurants, menu covers, signs. P. Pricing Press, 124 White St., New York.

ADVERTISING Book matches offer liberal earnings—full, spare time. Experience unnecessary. Factory direct. Low prices, high quality, quick deliveries, powerful patriotic display, repeats. All business firms prospects. Free kit, instructions. American Match & Printing Co., Dept. 66, 4822 South Trumbull Ave., Chicago.

FAST Sideline. 7 items top our sales this spring. No priorities! Real money makers for experienced advertising specialty salesmen with following among business men. Give experience and territory covered. Newton Mfg. Co., Bin DA, Newton, Iowa.

HOT Sideline for active salesmen. Midwest Finance Corp., Dubuque, Iowa.

NEW Specialty—Sells every business and professional man. Four \$15 sales daily pay \$270 weekly. Farrell cleared over \$1,000.00 monthly. Write, P. E. Armstrong, President, Dept. PM, Mobile, Ala.

EDUCATIONAL AND INSTRUCTION

WELDING Opens the way to good pay and future in important industries. Growing need for trained welders. Prepare now. Practical, personal training spare time at home and Chicago. Write for free facts. Utilities Engineering Institute, 1314 Belden, Dept. 126, Chicago.

"SHORT-CUT Mathematics Combined with Practical Mechanics Simplified." This new self-study course is now ready. Large illustrated volume with questions and answers. Only \$1 postpaid. Satisfaction guaranteed. Free details. Write Nelson Co., 500 Sherman, Dept. F-306, Chicago.

WELDING—Electric arc. Learn profitable trade quickly through actual practice. Individual welder instruction at bare cost of materials. Full particulars free. Valuable welding lessons book 50c. Hobart Welding School, Box M-622, Troy, Ohio.

NEW Writers needed! Free test shows your ability. It's fun. No obligation. Rush postcard to Comfort Writer's Service, Dept. 786-Q, St. Louis, Mo.

RESORT Hotel positions. Instructions. Lee Institute, 505A Bristol Building, Boston.

HOME Study course, drugless therapy. Free literature. Inst. of Drugless Therapy, Tama, Iowa.

SHORTHAND Typewriting course. Sensational. 25c. Jones, 1210P Dudley, Utica, N. Y.

ELECTRICIANS Urgently needed! Free book tells how to qualify. Write today. Electric Institute, Dept. B, Hinsdale, Ill.

STREAMLINED Accounting course. Inexpensive. Cantrell's Institute, 1002 Berkeley, Pueblo, Colorado.

DANCING Made easy! Diagrammed home course. Sample lesson 25c. Ludwig's, 532 Geary, San Francisco.

HOW To get a job! Information free. Guidance Service, Box 175, Crosby, North Dakota.

CLINICAL Laboratory technic taught in your own home. Practice outfit supplied. Bulletin free. Imperial Technical Institute, Box 973-E, Austin, Texas.

LEARN Telegraphy! Splendid opportunities now prevail. All expenses low. Catalog free. Dodge Institute, Dept. M, Valparaiso, Indiana.

RADIO Engineering, broadcasting, aviation and police radio, servicing, marine and Morse telegraphy taught thoroughly. All expenses low. Catalog free. Dodge Institute, Dept. R, Valparaiso, Ind.

SECRET Investigation. Experience unnecessary. Detective particulars free. George Wagner, M-2640 Broadway, N. Y.

LOCKSMITH Course. Lock picking, key fitting, etc. \$1.00 prepaid. Locksmith, Canadian, Texas.

BECOME A Doctor of Psychology (Ps. D.) Teach secret of contentment, happiness. Solve mental worries. Free book. College of Universal Truth, 20-B East Jackson, Chicago.

6,000 WRITERS Wanted. New, undeveloped field. Overton, 712 Diversey, Chicago.

ARC And spot welders. Make them yourself. Very simple. Inexpensive. Complete details 25c. Popular Mechanics Press, Dept. 402, 200 E. Ontario, Chicago.

CARTOONING, COMMERCIAL, ART, SHOWCARD WRITING, SIGN PAINTING

CARTOONING Course—36 lessons, 6 booklets, 816 illustrations, 100 markets, personal criticism \$2.45. Templeton, 146 Wellington, Elgin, Illinois.

LEARN Cartooning from newspaper cartoonist. Many drawings with explanation. \$1.00. "Batch," 2119 W. Bdwy., Enid, Okla.

EARN Money, copying and duplicating comic cartoons for advertisers. Ad-Service, Argyle, Wisconsin.

CARTOONING Course—30 illustrated lessons, over 500 sketches, \$1.00 postpaid. Montes Studio, Box 985, Pasadena, Calif.

"PAINT Expert Signs Without Experience." Send 50c for our new library indorsed, complete, simplified lettering course. It's mechanical. Get it today. Use it tomorrow. Satisfaction guaranteed. Haines Sign Service, Sabina, Ohio.

PEN And ink drawings. Let us draw your advertising and catalogue illustrations, from photos, copies or objects. Best work and fair prices. Heraldic Studios, 1914P Oakdale Avenue, Chicago, Ill.

GONE Is color guesswork. Let an expert select the right colors for you. Send 50c for the Color Helm, Model No. 102. Free folder about color. Fiatelle, Inc., Ridgewood, New Jersey.

ADVERTISING AGENCIES, LETTER WRITERS, FOR ADVERTISERS

24 WORDS, 40 Newspapers \$2.00. Good-all, 37 Gardner, Vallejo, California.

MAIL-ORDER Or agent ad reaching 1,000,000 families throughout United States \$14.00 inch. Newspaper, magazine, mailing-list, rate-book, free. Chicago Advertising Agency, 20-PM West Jackson, Chicago.

ADVERTISE: 24 Words, 149 newspapers, \$6.50. Lists free. Advertising Bureau, 4515-C Cottage Grove, Chicago.

IDEA Cut service, inexpensive, for advertisers, printers, publishers. Proofs free. Harper, 209 South High, Columbus, Ohio.

FREE—New Advertisers Rate Guide. 44 pages. Includes everything. Lowest rates. E. H. Brown Advertising Agency. Merchandise Mart, Chicago.

ADVERTISING Placed all magazines, newspapers U.S.A., Canada. Lowest rates. Free service. 54-page catalog free. Baker Advertising Agency, A-189 W. Madison, Chicago. Established 29 years.

BUSINESS SERVICE

CHICAGO Mail address: \$1 monthly—Receiving, reforwarding your business, personal mail. General, 30 West Washington, (Established 1919).

RUBBER STAMPS, OFFICE SUPPLIES

2 LINE 25c, 3 Line 35c. M. Struble, Cupertino, California.

ILLINOIS Rubber Stamp Works, 2913 PM No. Rockwell, Chicago. Catalog free.

SUPERIOR Natural rubber. Two lines 30c, three 40c, four 50c. Slocum, 814 Bradley, Peoria, Ill.

QUALITY, 4 Lines 45c. Federich Company, Box 412-S, East-Pittsburgh, Penna.

KNOB Handle, cushioned, 2 lines 30c, 3-40c. Stamp Works, Centerport, N. Y.

3 LINES 27c; Cushioned, indexed, 35c. Signatures \$1.50. Stamprite, Wauwatosa, Wis.

2 LINES 25c, 3 Lines 35c. Stamp Works, Auburn, Nebr.

TYPEWRITERS, DUPLICATORS, OFFICE DEVICES

TYPEWRITERS, Adder, mimeograph, multigraph, addressograph. Send for free lists of machines that will help you at half price. Pruitt, 28 Pruitt Bldg., Chicago.

PRINTING OUTFITS AND SUPPLIES

PRESSES, Type, cabinets, supplies. List for stamp. Lincoln Press, 220-J Hartwell, Fall River, Mass.

PRINT Your own cards, stationery, circulars, advertising. Save money. Simple rules furnished. Print for others, nice profit. Junior outfit \$8.25, senior outfits \$17.38. Details free. Kelsey, Inc., T-11, Meriden, Conn.

INEXPENSIVE 6x9 Printing press. Details free. Novelty Shop, Downsview, La.

PRINT At home. 10c will bring a complete catalog of presses, type and supplies. P. Pfeiffer & Company, 6 Columbia St., Newark, N. J.

BARGAINS—PresSES, type, supplies. Send stamp. 159 Harvard, Cambridge, Mass.

USED Presses, type, supplies. Lists 3c. Turnbaugh Service, Loyalsville, Penna.

PRINTING, MULTIGRAPHING, MIMEOGRAPHING, GUMMED LABELS

WEDDING Invitations 100—\$3.50 up. Samples. 4154 N. 5th, Philadelphia.

150 EACH—8½x11 Letterheads, 6¾ envelopes. \$1.50. John Ferreira, 220 Army St., New Bedford, Mass.

MIMEOGRAPHING, Letter size, thousand \$3.00 prepaid. Richmond, 2733 North Richmond, Chicago.

5000 LOTS Elegant envelope slips, \$3.75; 6x9 circulars, \$8.25; postcards, \$9.00; folders, \$10.00. All printing low prices. Samples. Goodprint, Harrisonburg, Va.

250 CARDS (Name, address, telephone), and attractive wallet card case \$1.00. Zinnsmith Press, 161 Grand St., New York, N. Y.

ENVELOPES, 6¾ Printed, \$3.00 thousand. Also job printing. Clipper Printing, 4114 Brooklyn, Kansas City, Mo.

PERSONAL Stationery, 100 sheets, 100 envelopes \$1.25. C.O.D. orders accepted. Victory Service, Emmaus, Penna.

WHOLESALE—Colored statements, letterheads, matching envelopes. Example: 200 letterheads, 100 envelopes, 79c. Thousands pleased! Write—Printing Dept., Vinmar Paper Co., Thompsonstown, Penna.

1000 ENVELOPE Slips \$1.50; 5000—\$3.75. Everything printed—lowest prices. Samples? Thriftprint, Box 318, Chicago.

100 8½x11 LETTERHEADS And 100 envelopes \$1.00 postpaid, 100 business cards 50c. Crowe, Box 1365, Baltimore, Md.

1000 DISTINCTIVE Letterheads, envelopes \$5.50. Pricelist. Davis Press, Webster, Mass.

"NO Lineage Limit" Mimeographing—300 letters or 300 postcards \$1.00. Dollar Letter service, 180 West Washington, Chicago.

1000 FINEST Business cards, \$1.49. 5000 6x9 circulars \$7.89. Globe Printing, Youngstown, Ohio.

5000 6x9 HANDBILLS, \$5.00. Liberty Press, Box 493, Indianapolis, Ind.

\$1.00 POSTPAID Each, 200 letterheads, envelopes, statements or cards. Benneville, 907 West Roosevelt, Philadelphia.

1000 6x9 CIRCULARS, \$2.95. 5000 3x5 Circulars \$3.75. Postpaid. Stationery, booklets, publications. Samples. Low prices. Address, Chelsea, Oklahoma.

1000 BUSINESS Cards attractively printed with modern type faces \$1.21 postpaid! Highspire Press, RR-1B, High Spire, Penna.

GET Prices, samples for next envelope or printing job from Transamerican, 514 Shelby, Detroit, Michigan.

ENVELOPES: All sizes. Jack's Printing Service, Box 5450—Metropolitan Station, Los Angeles, California.

5000 6x9 CIRCULARS \$8.00. All printing reasonable. Samples, Specialty Sales, 3084 Fifth, Chicago.

PERSONAL Stationery, 100—6x8½ single white sheets and matching envelopes, with name and address in rich blue—Only \$1.00. Order now, or write for samples. L & L Specialty Co., 407 East Fifth St., Royal Oak, Michigan.

EVERYTHING Printed, wholesale prices. Free list. Midwestern Printing Co., Springfield, Missouri.

500 4x2¼ FOUR Line gummed stickers, 25c. Moritz Printery, Saginaw, Mich.

JOB Printing, Quick, reasonable. Samples. Atlantic, Box 653-H, Rock Hill, S. C.

WANTED Printing of all kinds by thousands of our readers. Your ad in this space will bring you some nice orders. Write for positive proof. F. W. Johnson, Classified Advertising Manager, Room 304, 200 East Ontario Street, Chicago.

PATENT ATTORNEYS

INVENTORS: Take first step toward protecting your invention—without obligation. Write for free "Record of Invention" form for establishing date of invention and free "Patent Guide for the Inventor"—telling about confidential search details; how to sell and market inventions; details of convenient payment plan. Send today for free "Patent Guide" and "Record of Invention" form. Clarence A. O'Brien and Harvey Jacobson, Registered Patent Attorneys, 21B-F, Adams Building, Washington, D. C.

PATENT Your idea. Write immediately for two free books, "Patent Protection" and "When and How to Sell an Invention." Fully explain many interesting points to inventors and illustrate important mechanical principles. With books we also send "Evidence of Invention" form. Prompt service, reasonable fees, 43 years' experience. Avoid risk of delay. Address: Victor J. Evans & Co., Registered Patent Attorneys, 631-G Victor Building, Washington, D. C.

INVENTORS—Patent your invention. Secure book, "Protect, Finance and Sell Your Invention." No obligation. McMorro and Berman, Registered Patent Attorneys, 134-D Barrister Building, Washington, D. C.

"INVENTOR'S Guide," 100 mechanical movements, free; advises on patenting, selling inventions. Frank W. Ledermann, 154 Nassau Street, New York.

PATENTS, Protect your idea by securing free "Proof of Invention" folder. Exceptional personal service. Established 1908. E. E. Vrooman, 871 Woodard Bldg., Washington, D. C.

L. F. RANDOLPH, 302-B Victor Bldg., Washington, D. C. Low cost. Book and information free.

PATENTS, Booklet free. Highest references. Best results. Promptness assured. Watson E. Coleman, Patent Lawyer, 724 Ninth St., Washington, D. C.

INVENTORS—Before disclosing your invention to anyone send for form "Evidence of Conception"; "Schedule of Government and Attorneys' Fees" and instructions. Sent free. Lancaster, Allwine & Rommel, 411 Bowen Building, Washington, D. C.

PATENTS Procured; easy terms; helpful service. Sanders, 6430 Evans, Chicago.

FOR INVENTORS

PATENTS Secured. Two valuable booklets sent free. Write immediately. Victor J. Evans & Co., 632-G Victor Building, Washington, D. C.

INVENTORS: 94c is all you need spend for full protection, this quick, unique way. All particulars sent—\$1.00. Ebert's Inventors Guide, 189 West Bigelow Street, Newark, N. J.

INVENTORS:—Have you a useful, non-military invention for sale? Practical new ideas, patented or unpatented, urgently needed by manufacturers and consumers. Write for details. Chartered Institute of American Inventors, Dept. 4-A, Washington, D. C.

I SELL Patents. Established in 1900. Charles A. Scott, 737PM Garson Ave., Rochester, N. Y.

CASH For practical ideas and inventions. Mr. Ball, AB-9441 Pleasant, Chicago.

INVENTORS! Sell your invention yourself! Write: Crompton, 99-M Owen, Detroit, Michigan.

SELL Your patent through a small classified ad in Popular Mechanics. Many inventors have found buyers in this way. Ask me for proof—I'll gladly send it to you. F. W. Johnson, Manager Classified Advertising, 200 E. Ontario St., Chicago.

INVENTIONS WANTED

MANUFACTURER Wants new invention or idea. Nelson, Dakota Bldg., St. Paul, Minn.

SELL Your patented, applied for, pending, invention quickly. Write: Universal Guaranty Company, Box 772, Lancaster, Penna.

WANTED—Meritorious patented, unpatented inventions. Booklet, references, free. Invention Reporter, 5B-11236 So. Fairfield, Chicago.

INVENTORS! Have you good, patentable idea? Write Metzler, Dep't 72-O, 11 West 42nd, New York.

INVENTORS:—Small manufacturers need new inventions for altered civilian markets. If you have a practical, useful idea for sale, write Chartered Institute of American Inventors, Dept. 4-D, Washington, D. C.

CASH For inventions, patented, unpatented. Mr. Ball, A-9441 Pleasant, Chicago.

MANUFACTURING

MODELS—Small lot manufacturing. Metals, plastics, etc. Milburn, Burlington, Kentucky.

MODELS AND MODEL SUPPLIES

RAILWAY Models, complete line informative catalogs O gauge, 112 pages, 25c; HO 48 pages 15c. Walthera, 247 Erie, Milwaukee, Wisconsin.

STEAM Locomotives O gauge, engines, boilers, Circulars 10c stamp. Anton Bohaboy, 2297 Price St., Rahway, New Jersey.

SHIP Models and yacht supplies complete. Large 56 page catalogue 15c. Bill Wild's, 510 East 11 St., New York City.

SHIP Model kits and fittings. Complete line Fisher model yacht equipment. All Boucher, Fisher, Marine Model and Ideal kits, fittings and blueprints at catalog prices. Most complete stock in New England. James Bliss & Co., Inc., 220 State Street, Boston, Massachusetts.

NEW Model airplane motors \$3.35 each. Particulars stamp. Ace, 1017-PM North McBride, Syracuse, New York.

LATEST Engine catalog 25c. Refunded. Howardo, A-2417 North Ashland, Chicago.

MINIATURE Steam locomotives, new catalog listing all builders' needs 25c. Little Engines, Wilmington, California.

CARVED Hull ship model kits. Ship and yacht model fittings; model yacht sails. Illustrated catalog 20c. A. J. Fisher, 1002-M Etowah Ave., Royal Oak, Mich.

HOME CRAFTSMEN

LATEST 1942 Plans and full easy instructions for 17-family Martin house (75c), goose and goslings lawn figures (25c), wall and corner shelves (25c), two wren houses (25c)—based on standard lumber sizes, with minimum waste, fewest operations, attractive new designs, unlike anything available. Special introductory offer. Send \$1 for all four. Money back if not satisfied. Jackson Studio, Dept. M6, Shorewood, Wis.

MAKE \$17.00 For 14 hours of spare time work. Assemble and sell Dillabaugh rowboats. I furnish material, parts, instructions. Write today for big money making proposition. C. R. Dillabaugh, 7932 Malory, Portland, Oregon.

VENETIAN Blinds, supplies, machinery, wholesale. Catalog 10c. "Manufacturing Booklet" \$1.00. "Roberta," Gloversville, New York.

GET Free leathercraft instruction pamphlets, prices of leathers, tools, projects. Fascinating hobby. Make beautiful gifts. Leather samples 5c. Wilder & Company, 1938 Crosby, Dept. 6F, Chicago, Illinois.

CATALOG:—Decal transfers, handy hand tools, new power sander, patterns plywood novelties, lawn ornaments, silhouettes, letters and numerals. Other lines. 500 articles finely illustrated. Write today. Wo-Met Shop, Ashburn, Georgia.

MAKE Your own smoking pipe. Briar pipe blocks 25c each plus postage. Michelson & Sternberg, 116 Broad St., New York City.

MAKE Money building bird houses. Great demand. Illustrated instruction book 25c. Popular Mechanics, 200 East Ontario, Chicago.

LEATHERCRAFTSMEN: Send 10c for new handbook and catalogue of tools and supplies. E. A. Sweet Company, Inc., Leathercraft Division, A-58, 148 State Street, Binghamton, N. Y.

28 LAWN Ornament patterns 25c. Other patterns: 15"-20" high; Dutch girl, Dutch boy, pirate, bull terrier, Mexican girl, Mexican boy, dwarf, penguin, flower girl, 10c each; 3 for 25c. 25 novelty patterns 30c. All 62 full size patterns \$1.00 postpaid. Strother, Box 383-DP, Belington West Virginia.

15 PULL Size what-not patterns 25c. 25 lawn ornament patterns 25c. Albright Service, M-6901 Railroad Ave., Omaha, Nebr.

BLACK-OUT Home for few cents quickly. Instructions 20c. Charles, 12-AC, Norwood, Ohio.

49 LAWN Ornament patterns, Dutch boy, Dutch girl, some 21" high 60c, 20 novelty patterns 30c, 20 silhouette patterns 30c, 89 patterns \$1.00. Modern Woodcraft, Saginaw, Michigan.

WOODWORKING Power tools—Make them yourself. Lathe, scroll saw, saw table, drill press, portable sander, bandsaw, motorized plane. Complete details only 25c. Popular Mechanics Press, Dept. 401, 200 E. Ontario Street, Chicago.

WATCHES, OLD GOLD, JEWELRY, ETC.

ZIRCONS—White diamond cut, 3 for \$3.50 (2 carats). List. Leuthold, 2227½ N. Alabama, Indianapolis, Ind.

GENUINE Diamonds, out-of-pawn prices, unredeemed loans and distress merchandise; men's, ladies' rings, one carat \$95.00, ½ carat \$45.00. Shipped for free inspection, appraisal. Send for free list, hundreds of beautiful diamonds, very low prices. Lloyd Butler, President, Prudential Loan Association, 133-EP North Clark St., Chicago.

GOLD Wanted! Old jewelry, bridge-work, watches, diamonds, etc. Honest appraisal, immediate cash. Leuthold, 2227½ N. Alabama, Indianapolis, Ind.

CASH! Gold, jewelry, teeth, coins, diamonds, mercury, etc. Ship! Simon's, 353 Old Arcade, Cleveland, Ohio.

ELGIN, Waltham watches \$3.50. Make big money. Free watch and jewelry catalog. Plymouth Jewelry Co., 163-F Canal St., New York.

AGATES, Fossil woods, three pounds \$1.50 postpaid. Jay Ransom, Aberdeen, Wash.

WATCHMAKERS' Materials, tools, jewelry—bought, sold. Best prices for old gold, diamonds. Free catalog. Ben Segal Company, Box 150, Chicago.

HIGHEST Prices for old gold—Mail your teeth, watches, jewelry. 100% full cash value mailed day shipment received. Satisfaction guaranteed or articles cheerfully returned. Information free. Chicago Gold Smelting Company, 300-P Champlain Building, Chicago.

GOLD \$35.00 Ounce. Mail old solid teeth, diamonds, jewelry, watches. Receive cash by return mail. Satisfaction guaranteed. Free information. Dr. Weisberg's Gold Refining Company, 1500-Q Hennepin, Minneapolis, Minn.

5000 REBUILT Watches! Free catalogue—Diamonds, jewelry, (3c postage). The New York Jobbers, 74 Bowery, Dept. M, New York, N. Y.

GEMS, Agates, minerals, jewelry. Six rough gemstones—emerald, sapphire, garnet, topaz, fireopal, agate, \$1.00 postpaid. Catalog. Hill Co., Route 7, Salem, Oregon.

RAZORS, BLADES, SHARPENING

SAFETY Razor blades sharpened free. Send three as a trial—any make. Perfect shaving edge guaranteed—send only three cents postage. Independent Sales Company, Box 2912, San Diego, Calif.

SURVEYING INSTRUMENTS

GUARANTEED Factory rebuilt transits and levels for sale (cash or terms) or rent (with purchase option). Large selection. Low prices. We will repair, trade or buy old instruments. Ship prepaid for estimate and valuation. For complete information write for list M-76. Warren-Knight Co., (Manufacturers of Transits and Levels), 136 N. 12th St., Philadelphia, Penna.

FOR SALE—MISCELLANEOUS

TWENTY Repossessed peanut, confection vendors. \$125.00. Box 1591, Rockford, Illinois.

YORK 4x4 Ammonia compressor and coils. Harold Mitchell, Leslie, Mich.

WANTED—MISCELLANEOUS

SUPERHEATED Steam engine, self starting, size—about 2" bore, 2.5" stroke, length 15.5", weight 35 pounds, variable expansion gear. Trippe, West Point Pleasant, New Jersey.

WANTED: Mercury (quicksilver.) We pay \$1.50 per pound. Send express insured. Western Metal Co., Bloomington, Illinois.

NEW Products wanted. Will consider developing now for postwar production—can be mechanical or consumer goods. Confidential, responsible, progressive machinery building and sales organization. Address P.O. Box 1034, Short Hills, New Jersey.

WANTED To buy: Your pictures. Write for details. Free market letter. Freelance Photographers Guild, Inc., 219 East 44th Street, Dept. P-6, New York, N. Y.

WILL Buy your unused United States stamps. Small discount. What have you? Mint Sheet Brokerage Co., 618 Caxton Building, Cleveland, Ohio.

MERCURY (Quicksilver), tungsten, molybdenum, cadmium, high speed tool steel, bismuth, purchased in any quantity. Write for quotations. Metallurgical Products Co., 35th and Moore Sts., Philadelphia, Penna. Established 1909.

NEW Products wanted. Will consider developing now for postwar production—can be mechanical or consumer goods. Confidential, responsible, progressive machinery building and sales organization. Address P.O. Box No. 1086, Short Hills, New Jersey.

HIGHEST Prices for used cameras, binoculars, microscopes, drawing sets, tools, any optical or scientific instrument. Satisfaction guaranteed. Gordon's, 162-M Madison, Chicago.

CASH For anything. Justice Jewelry Jobbers, 190 North Wells, Chicago.

PERSONAL

ARCH Supports custom made \$2.50 pair, impression material free. Nufect Co., 1472 Broadway, New York.

PARTY Fun galore! Novelty shipping tags to tie on coat lapels of party guests. 10c dozen. Martin Co., 7431 Tulane, St. Louis, Mo.

WIN Prize money—Booklet, "Successful Contesting," shows how. 10c postpaid. Bulletin listing \$100,000.00 prizes included. World Publishers, 4515-B, Cottage Grove, Chicago.

ART Pretty girl pictures. Nifty new series. Complete set 18 pictures \$1.00. Sample package 25c. Each picture full postcard size 5¼x3¼. Harlem, Box 10, Station J, New York, Dept. A-21-P.

AMAZE Your friends! "Mystery Book" of magic tricks shows how. Also new system character readings, plus ten startling actual tricks. \$1.00 postpaid. If ordered now, 10c defense stamp free! Ellis Antkes, Publisher, 131 West 42nd, New York City.

REVITALIZE Your scalp! Stimulate normal hair growth! Complete instructions \$3.00 (formerly \$15.00). Money returned if not delighted after five-day trial. L. Webb, Lithonia, Georgia.

HUMAN Analysis, find right job, etc., illustrated, 25c. NuAge Books, 3915 - 24th St., San Francisco, California.

Z-O-M "B" Complex vitamin capsules for vim, vigor and victory. Lowest cost—100 capsules \$2.00 postpaid. Send money order or currency. Zom Research Laboratories, 7309 Paxton, Chicago, Illinois.

TATTOOING Outfits. Write today. Zeis Studio, 728 Lesley, Rockford, Illinois.

MEXICAN Legal matters, William Cocke, Reliable American Attorney, El Paso, Tex.

MISCELLANEOUS

NOW, Anyone can sharpen lawn mowers quickly and easily with Keeneed. This amazing device fits mower-blade perfectly. Simply slide it along complete length of blade two or three times, and presto! mower is sharp as when new. Dandy for scissors, too. More than 100,000 in use. 30 days free trial. Send no money. Just name, address on postal. When Keeneed arrives, deposit \$1 with postman plus few pennies postage. Or send \$1 now and we pay postage. If not entirely satisfied, return in 30 days and we'll refund money in full. Send today to Keeneed, 3026 Main Street, Merrill, Iowa.

KNITTING! Fascinating, profitable hobby for men and women both. Have beautiful knitted clothes. Folio shows how, and tells about modern invention. Only 50c prepaid. Weston, 85 Bell Street, Seattle, Washington.

BEAUTIFUL Hand-woven Mexican sarapes, blankets, babies' wear. Sample. Casa C. O. D., Saltillo, Coah., Mexico.

TWO 5" Beautiful living silk cocoons 25c. Johnson, 912 Benton, Nashville, Tenn.

MILK Goats—free literature—sample magazine, Goat World, Vincennes, Ind.

BIG Mail for you. Latest moneymaking offers, opportunities, catalogs, magazines. Name listed in directory 10c. Ideal Service, 127-M, Park Ridge, Ill.

FASTOFF Keeps steam off glasses. Sample free. Frost Laboratories, Tampa, Florida.

START Profitable tattooing business, free instructions write Tatucco, 651 South State, Chicago.

LOCATING Underground oil deposits for oil wells and structures. Price \$3. Chas. Bohm, Du Bois, Nebr.

PAINT—Famous nationally advertised brand, 3½ gal. pail \$2.49. Send stamp for catalogue. United, Box 1000, Newark, N. J.

SEND 10c For illustrated catalog "Hard-to-find merchandise." Goldshield Products, Dept. M, 350 Greenwich St., New York.

IDENTIFY Your camp. 6"x24" board sign, any copy. Ramsden Sign Service, Fitchburg, Mass.

FINE Abrasive stones and hones 25 cts. each. Wm. Campbell, 3623 South Ave., Youngstown, Ohio.

THE Old Hoss Trader—a lively magazine for swappers. Copy 25c. Box 57, El Paso, Texas.

"BLACKOUT" Button glows throughout the night (new process). Recharges when exposed to light. For air raid wardens, civilians, household use, etc. 25c (coin). Tober, 45 Osgood, Springfield, Mass.

RECEIVE Gigantic mails, magazines, samples. Your name in numerous mailing lists 10c. Howard, 396-J Broadway, New York.

FIREWORKS Wholesale. Boys buy direct at wholesale, write for circular. C. C. Groff, Box 84, Lancaster, Penna.

TATTOOING Outfits, supplies. 1942 lists free. Percy Waters, Anniston, Ala.

WE Train you to become medical laboratory technician at home in spare time. Free catalogue. Imperial Technical Institute, Box 973-J, Austin, Texas.

GET A better job. Our books will help you advance. Barrain catalog free. Popular Mechanics, 633 St. Clair, Chicago.

STEREOSCOPIC (Three dimensional) art photos. Particulars for stamp. Oddity House, St. Petersburg, Fla.

COATS Of arms and crests, correctly painted in colors or black and white. From heraldic description or furnished copy. \$10.00 and up. Highest grade work. Heraldic Studios, 1914P Oakdale Avenue, Chicago, Ill.

COLOR Guide. Let an expert help you select the right colors. The Spectrum Color Helm eliminates guesswork. Send 50c for Model No. 101, postpaid. Free folder about color. Flatelle, Inc., Ridge-wood, New Jersey.

WONDERS OF AMERICA

Silent Warbirds



IN RECENT LABORATORY "SMOKING BOWL" TESTS, **PRINCE ALBERT** BURNED

86 DEGREES COOLER

THAN THE AVERAGE OF THE 30 OTHER OF THE LARGEST-SELLING BRANDS TESTED—**COOLEST OF ALL!**



50 PIPEFULS OF FRAGRANT TOBACCO IN EVERY HANDY POCKET CAN OF PRINCE ALBERT

R. J. Reynolds Tobacco Co., Winston-Salem, N. C.



PRINCE ALBERT THE NATIONAL JOY SMOKE

Popular Mechanics Magazine

REGISTERED IN U. S. PATENT OFFICE AND CANADA

WRITTEN SO YOU CAN UNDERSTAND IT

Vol. 77

JUNE, 1942

No. 6

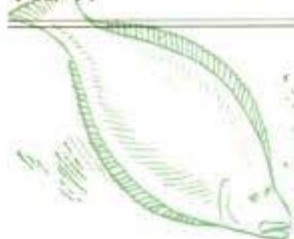

M 268

POSSIBLY you have heard about the army convoy that was moving, bumper to bumper and without lights, through a blacked-out town. Someone on the sidewalk called out, "How in the world can you fellows see to drive in the dark?" From the direction of a jeep came a one-word reply: "Meow."

The jeep driver really did have cat eyes, even if he was joking. His diet included vitamin A that helps him see in the dark. In one sense, vitamins are as important in this war as are bullets or gasoline. Vitamin A, for example, is being used by night fighter pilots to help them spot enemy planes in the dark. It is given to pilots of dive bombers to check nosebleed. It helps prevent colds and other infectious diseases among defense workers.

The war has trebled our need for vitamin A, and at the same time the war has cut us off from Norway, formerly our chief source of vitamin-rich cod liver oil. When imports ceased, a frantic search was started for a new source of the vitamin. To everyone's sur-

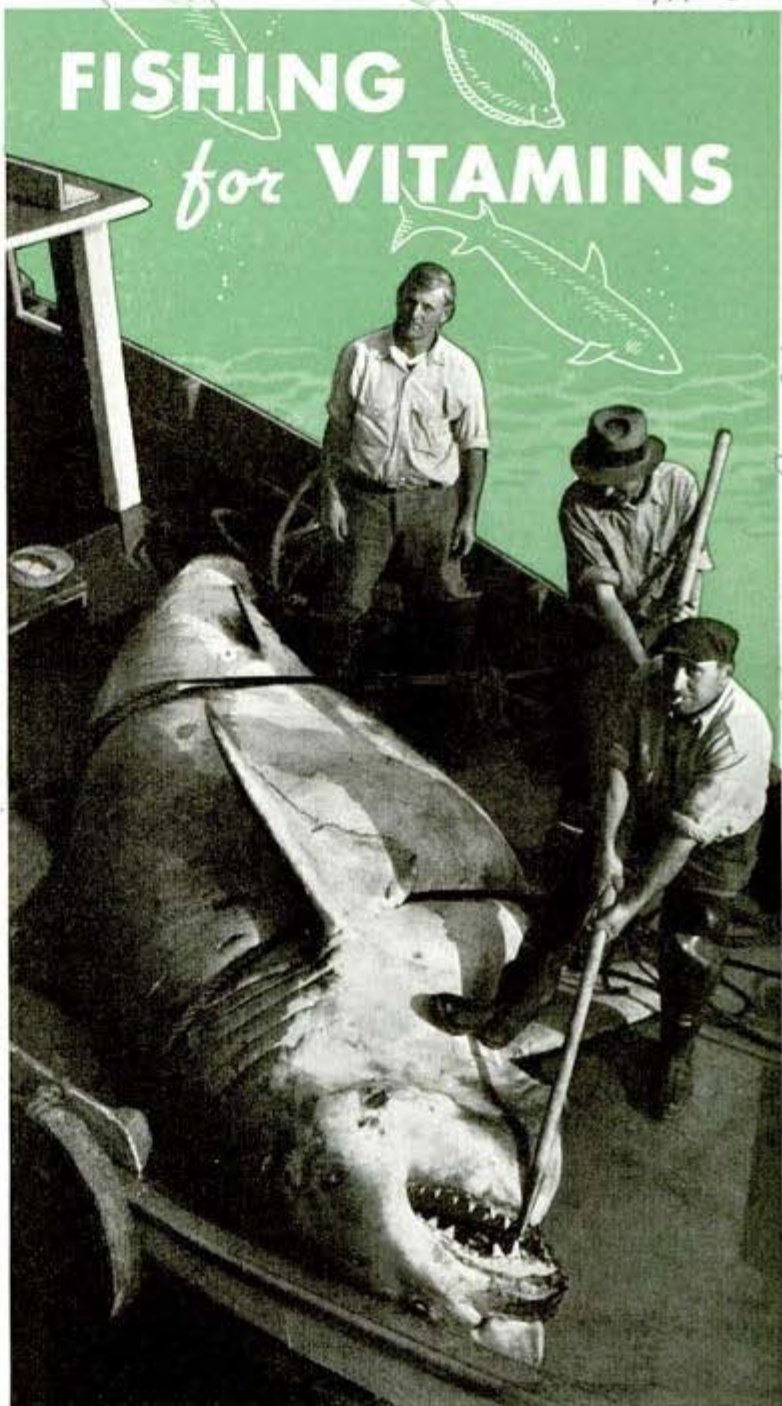

This great basking shark weighed several tons, with a 700-pound liver that—while low in vitamin content—helped pay for its damage to nets

*Emb. Thomas C. Stinson, Jr. Los Angeles
3872 Franklin Ave.*



Harpoon gun and line for capturing sharks basking on surface Centrifuge to extract Vitamin A from oil

prise, investigators on the west coast discovered that we had been overlooking a source of vitamin A that is even richer than the cod. Soupfin sharks, they learned, have livers that are extremely rich in the substance. Livers of other species of sharks also contain vitamin A. A shark's liver amounts to one tenth or more of the creature's weight.

The result is that sharks, until now nothing but a nuisance to commercial fishermen, have become their most prized catch.

Prices shot upward and for a while fishermen who were lucky enough to make big hauls earned movie-star incomes. Fifteen hundred dollars a ton were paid for soupfin carcasses in San Francisco and a boatload of sharks sometimes netted \$20,000. Even a 10-year old youngster who hooked a soupfin from a wharf received \$45 for its liver.

The high prices were the result of speculation and today shark liver prices are being stabilized. The actual price paid for sharks now depends on the vitamin A content of the liver and this varies with the species, sex, season of the year, and locality in which the shark is caught. In Los Angeles, Truesdail Laboratories, Inc., is busy determining such variations in vitamin content and is testing shark-liver oils



Rich in Vitamin A, liver of this soupfin shark accounts for ten percent or more of its weight

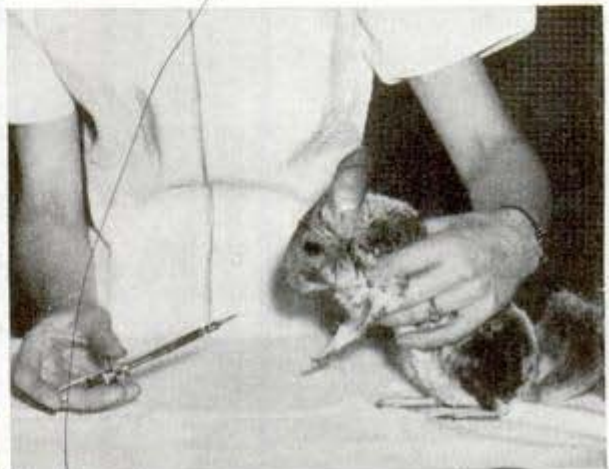

Feeding Vitamin A to \$1,200 chinchilla in a program to determine the best vitamin rations for valuable animals

m 268

from as far away as the west coast of South America.

The importance of vitamins has been understood only in the last decade or so. Vitamins are substances that in small amounts are necessary for health, along with other foods such as proteins and carbohydrates. It is now realized that the sufferings of some of the early polar explorers were due entirely to lack of vitamins in their foods. To a certain extent the American population has been starving itself of the vitamins it needs.

This is because, explains Dr. Roger W. Truesdail, Americans who live in cities have come to insist on convenient packaged and refined foods in which much of the vitamin content has been lost. Likewise, most of us do little heavy manual work these days, hence we don't eat as much as we otherwise would and as a result our vitamin intake is low. It is estimated that less than a quarter of the population consumes the well balanced diets that contain all the vitamins a person needs. One out of every ten men who have been examined for selective service was found to be suffering from disabilities connected directly or indirectly with nutrition.

"A start has already been

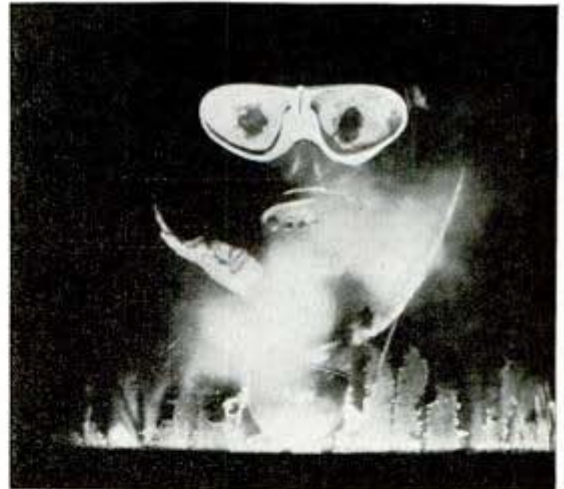

↑
Medical men are improving the night vision of fliers by adding Vitamin A to diet. Here an engineer peers out of the test "cold chamber"



← At the left is a halibut, at the right a large rock cod. These are among the varieties of fish whose livers rank high in yield of Vitamin A

Keep this chart showing the sources of vitamins in common foods. It is an excellent guide for planning health-building meals in a wartime economy

Nutrichart

VITAMINS IN COMMON FOODS					
(Compiled from the Nutrichart by Roger W. Truesdail, Ph. D.)					
FOOD	VITAMINS				
	A	B ₁	C	D	G (B ₂)
ORANGE OR LEMON JUICE	X	XX	XXX	...	XX
TOMATO JUICE	XX	XX	XX	...	XX
BREAD, WHITE	X	X
BREAD, WHOLE WHEAT	X	XXX	X
MILK, WHOLE	XXX	XX	X	X	XXX
MILK, BUTTER OR SKIMMED	X	XX	X	...	XXX
BUTTER	XXX	X	...
EGGS	XX	X	...	XX	XX
LIVER, BEEF, PIG	XXX	XX	X	X	XXX
MEAT (Average)	X	XX	XX
NUTS	X	XXX	XX
FRUITS, FRESH (Average)	X to XX	X to XX	XX to XXX	...	X to XX
GREEN VEGETABLES, FRESH (Average)	XX to XXX	X to XX	X to XX	...	X to XX

XXX = Excellent Source; XX = Good to Fair Source;
 X = Present but Poor Source; . . . = No Appreciable Amount or Evidence Lacking

m 2 68



Thresher shark, now being sought for its vitamin-rich liver, is characterized by an offset tail that is as long as its body

made to educate everyone on the importance of well rounded diets, and what these diets are," says Dr. Truesdail. "Such education will take years, yet today America must develop its full efficiency at once. Because of this, many of the aircraft plants and other defense factories are providing vitamin pills for employes to supplement their average diet. But don't take this as a recommendation that you should dose yourself with vitamin pills promiscuously. The best balance is obtained by eating the right foods, including fresh foods, properly prepared. And remember, even at best a dose of concentrated vitamins won't endow a person with superhuman qualities; such supplements merely make up for the vitamin deficiency in ordinary diets."

Vitamin A, the substance that is necessary for normal growth, tooth and bone formation, proper seeing, and resistance to infections, is found in liver, dairy products, green leafy vegetables, and in bright yellow fruits and vegetables. Vitamin B, the absence of which causes beriberi, occurs in meats, whole grains, milk, and in some vegetables. Vitamin C, the lack of which

Lockheed Aircraft worker is kept at peak of efficiency by doses of vitamins supplementing normal diet



From quartz emanate ultraviolet rays creating Vitamin D in body; the disk at center of the lamp generates infrared waves

causes scurvy as well as dental and gum troubles, is contained in rich amounts in citrus fruits and juices. Vitamin D helps the body utilize calcium and phosphorus and is contained in such commodities as butter, eggs, and canned salmon. It is the scarcest of all the known vitamins in natural foods.

It is also the sunshine vitamin, being formed in the body by exposure to sunshine or to ultraviolet radiations. Vitamin E and a number of other vitamins are contained in milk and other usual foods to a degree adequate for most people.

Certain kitchen practices should be fol-

(Continued to page 162)



m 228

Pacific Redue Bld

Pickup "Jaw" Handles Incendiary Bomb Safely

Inv. H. L. Mc Donald, Los Angeles

Incendiary bombs, sputtering viciously, can be handled in safety with a jawlike scoop combining a shovel, hoe and shield. It consists of two movable metal plates, opened and closed by manipulating a sliding rod to which one plate is attached. The operator crouches at the end of the long handle, where the other plate shields him from the intense heat. To pick up a bomb, the scoop is set down with the two curved plates on either side of the missile, and then it is closed like two jaws. It can be used also for scooping up sand and spreading it over the burning bomb.



Demonstrating with fuses, left, how jaws of pickup device, operated from distance, can grab incendiary bomb and, right, drop it into pail of sand

Western Jaw Protection, Inc.

m 206

Self-Propelled Combine Can Be Operated by One Man

Savings in fuel as well as the labor of one man are possible with a self-propelled combine which operates on only one engine, instead of using two as in the case of a tractor-drawn implement. One man can run the new combine. With hand levers in easy reach he can adapt the machine quickly to meet all crop conditions. One lever operates the threshing and cutting

mechanism, a wheel raises or lowers the platform and another lever engages or disengages the entire platform conveyor, cross conveyor canvases and reel drive. Operating on a separate drive, the threshing speed remains constant regardless of the ground speed. A 12-foot swath of grain is cut in front of the unit, and since no tractor leads the way the standing grain on

Walter A. Easterly, Sidney Neb.



five time tires

an opening cut is not tramped down. Both a bagger and tank model are offered, the bagger accommodating either one or two men besides the driver. The tank model is equipped with a 45-bushel tank. A larger size model, which takes a 16-foot cut, is available for big acreage operators.

Combine driven by its own engine can be operated by one man as all controls are placed within easy reach of anyone in the driver's seat

JUNE, 1942 The Massey-Harris Co., Inc. Racine Wis

(Starting with only 1,000 Frequency Modulation radio sets in use in October, 1940, a year later there were 100,000 sets in American homes.

U.S. Naval Institute Proceedings, Feb 1942

Human Senses Duplicated by Man-Made Tools



Girls standing back of table indicate by various gestures the function of the respective instruments

All five physical senses can be reproduced by various types of man-made apparatus which are even more sensitive than the senses bestowed naturally. Five such instruments were demonstrated publicly by engineers of the General Electric company. The electric eye, for instance, can see in the dark, where human eyes are blind. To an electric sound detector, or noise meter, a fly walking over the face of a microphone sounds like soldiers tramp-

ing over the drill grounds. It also picks up the sound of a dollar bill falling on the floor and a cat walking over a rug. Surfaces that feel smooth to the fingers, when tested by a smoothness gauge, become as rough as the rocky mountains. Then there is a mercury detector able to smell the poisonous mercury vapor missed by the nose. Another instrument can taste the smallest drop of lemon juice in a glass of water, a sourness which human taste cannot detect.

Leather Kit Holds Six Tools Handy for Air Raid Warden

Enclosed in a handy pocket kit made of leather, with a snap fastener, are six small tools—sufficient to do many minor repair

jobs. A one-blade knife serves as a handle for the hammer, chisel, awl, screwdriver and a three-inch saw. It is intended particularly for air raid wardens.

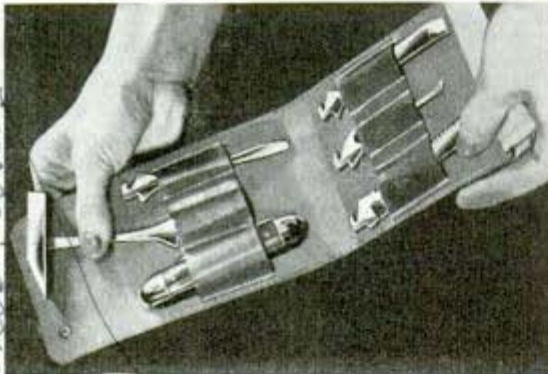

Leather folder holds the warden's tools conveniently

Collision of Birds With Airplanes Is Major Flying Hazard

Research to find materials that will protect airplanes against damage by collisions with birds is being advocated by Allen L. Morse, chief of the aircraft development section of Civil Aeronautics Administration. He points out that such accidents have totaled 61 since 1939, two-thirds occurring at night and more than one-third

Science Factory, 1966

M 165

Hinges by Herman
Wesco Inc

296 Madison Chicago

Washington, D.C.

Science Service
3/10/42

Sherman Paper Product Corp., Victor Upper Falls, Maine

shattering or penetrating the windshield. In one incident a flock of five swans hit a plane at night. One penetrated the leading edge of the left wing, the second almost tore off the left vertical stabilizer, jamming the rudders; the third struck and dented the engine cowl, and two swans went through the propeller. Wild swans weigh as much as 20 pounds. Even small birds have penetrated windshields, and in one instance a bird continued through the bulkhead, traveled the length of the cabin and penetrated the rear wall.

M 226

Blackout Window Shade Has Light Face Inside

Opaque window shades of semi-rigid material, developed for blackout, have an outward surface of black, while a cheerful ivory finish faces the interior. By a corrugating process the shade is given a one-way rigidity that permits rolling and unrolling and keeps the edges snug against the window frame to prevent light leaks. In its simplest form the shade may be fastened to the window frame by means of adhesive tape. A more convenient installation may be made by fastening one end to the top of the window by means of slats, and rolling the shade upward from the bottom where it is fastened to another slat. When not in use the shade remains tied at the top with a cord.

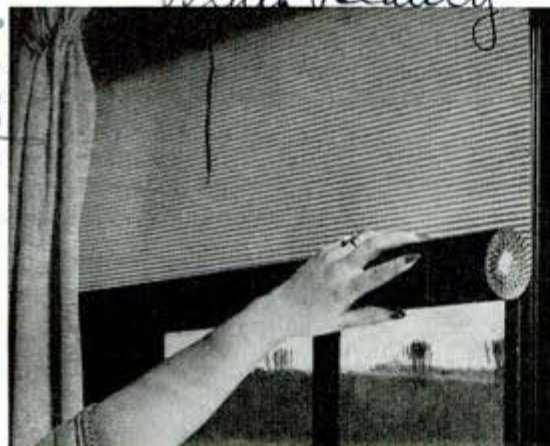

Blackout shade is rolled up on slat at the bottom

JUNE, 1942

Crop of Rubber Plants Speeded By Labor-Saving Methods

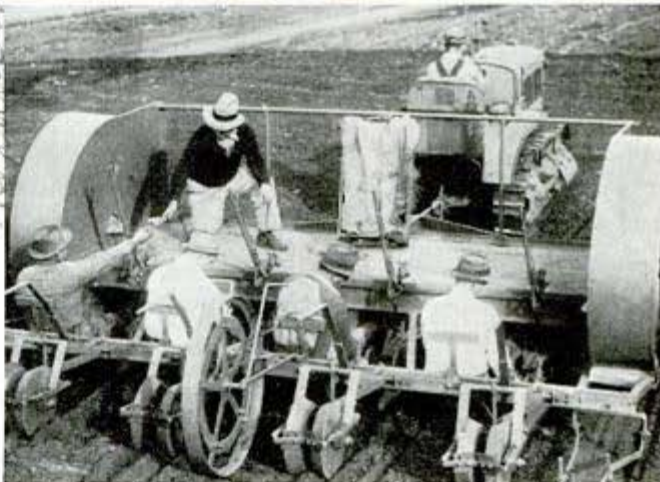

Top, machine travels up and down rows gathering seeds by vacuum. Four men, bottom, set seedlings in holes made by planter

Machines for planting and harvesting the seeds of guayule, a plant which yields rubber, are aiding in the fight to relieve the threatened rubber shortage. One machine gathers by vacuum enough seed from the rows of guayule plants in one acre to plant 10 acres. As seeds are vacuumed, they are stored in a bin at the rear of the machine. Another machine operated by four men prepares holes for transplanting seedlings and covers the plants after they are dropped into the field by the men. Each man can plant 60 seedlings a minute by this process. Once it is started, guayule grows without much help, needing relatively little moisture. In harvesting, the whole plant is taken, finely ground and dumped into tanks of water, where the crude rubber floats and is skimmed off. The pulp can be handled by the same machines that process rubber.

Salinas Valley
Calif

DOGS of WAR



A dog sentry leaps over hood of a "jeep." In the same way, the dogs go over fences and other barriers

WAR dogs of the United States Army are distinguishing themselves for bravery in the line of duty.

Recently a soldier and his dog companion were walking beat on night patrol against spies and saboteurs. All was well, as far as the sentry knew, but the dog's keen nose detected someone lurking in the brush. At the first growl the soldier challenged the unseen prowler. There was no answer. At once the sentry gave the sharp command

"Get him!" The dog leaped forward with a snarl and an instant later there was the sound of an impact and a cry of pain. The man was captured.

One soldier and a dog are better than two men for guard duty and for extended sentry duty in the field. The four-legged sentry smells and senses danger that the human can't see or hear. There is no chance now for the soldier on night patrol to be attacked by surprise or ambush. His

dog is a "one shot" weapon far better than a rifle in the dark.

At Fort MacArthur near Los Angeles the Army is using dog sentries in an operation that started as an experiment and that has turned out to be a success. Several dozen dogs go out on military duty each night. Some of them guard enclosures by themselves and give the alarm if anyone approaches, while

Training a dog to tow big reel of telephone wire makes him useful in communications work



Sak Pearce

7/24

others march with regular sentries.

Ordinarily a dog obeys one master best, but at Fort MacArthur the desire has been to produce trained dogs that will work equally well with any soldier. Under the direction of Lieut. Col. Glen Miller, a training course was worked out by Sergeant Robert H. Pearce that teaches the dogs to operate anywhere at any time and under the command of any soldier who is in charge of them. Savage fighters when the need arises, they are easy to control. They are trained to attack anyone who approaches a sentry and yet each permits himself to be handed over quietly to the sentry's relief when the guard is changed. Dogs work with different men each night.

High intelligence and a combative spirit are two of the canine enlistment requirements. And an Army dog must be able to knock a man down. Even a 200-pound man can be knocked sprawling by a dog that weighs only a quarter as much but that has learned to make a tremendous lunge and to hit high.

Most of the canine recruits were household pets in civil life and are friendly with each other at the start. But each becomes extremely jealous of the other dogs as training proceeds. The Army has a waiting list of nearly 1,000 dogs whose owners have volunteered them for the service.

You can teach an old dog new tricks, fortunately, and Sergeant Pearce picks dogs that



Trainer encourages dog to fight "proowler" and to go after the right arm, the one which usually wields a club or other weapon

Carl Spitz adjusting earphones and small radio on dog. The radio enables trainer to give commands when dog is some distance away

see June 1941 72



By having dog jump over the extended arm, the trainer gradually teaches the animal how to leap over high fences and walls

*Major Miller
Lt. Col. Islen*



7/24



Dog in training for army work is shown seeking trainer who lurks in bushes with a weapon

have outgrown the playful puppy stage. The training methods that he has developed are simpler than most and result in rapid and thorough training even for dogs that are five or six years old. First on the program are several weeks of standard obedience instruction. Pearce and several other trainers all work with each dog. This helps the dog to understand that he is to obey anyone who takes charge of him.

Next the dogs work out on a stuffed dummy hung several feet off the ground.

such an attack, the dog fights back savagely. This puts him constantly on the alert against surprise.

When a dog graduates from training school Sergeant Pearce stamps his name on a regular identification tag that reads "U. S. Army Dog Sentry" and attaches it to the dog's collar. The dogs work 12 hours a night with one night a week off. They get a meal of raw meat in the morning, sleep most of the day and sun themselves in the afternoons.

Here trainer, clad in old overcoats and protected by hand and arm padding, teaches dog to attack

Held by chain, dog is poised to spring at trainer who is encouraging him to fight



in 12 9-

Hollywood Dog Training School, 12356 Revere Ave

Similar to the work of the dog sentries at Fort MacArthur but not connected with it are the duties of a group of dogs that are guarding some of the depots of the quartermaster corps on the west coast. These dogs were trained and donated to the corps by Carl Spitz, Hollywood dog trainer. Spitz picks dogs that are about 25 inches in height and that weigh 80 or 90 pounds. He finds that purebreds are easier to train than most crossbreeds. German shepherds, collies, doberman pinschers, malamutes, and other working dogs take the work seriously and make dependable guard dogs. The dogs that he is training for military service are taught to regard with suspicion anyone who doesn't wear a uniform.

The first part of the schooling that Spitz gives his animals, of course, is the regular obedience training by which a dog learns to sit, drop, heel, stay, and come. Jumping over high and wide obstacles, carrying and retrieving objects, and barking on command are other parts of the course. The dogs learn how to search for a suspect who may have concealed himself, how to give an alarm, and how to attack. Part of his system is to teach the dogs to realize their own strength so that they will have the advantage of perfect confidence in a fight.

Most dogs abhor smoke and noise and yet dogs in military service should carry on their duties in spite of such conditions. Accordingly the dogs are walked and rehearsed through clouds of chemical smoke and they are taught to work unperturbed while firecrackers, torpedoes and guns are discharged close by. To be able to control the actions of a dog far in the field, out of sight or hearing, Spitz has experimented with a short-wave radio, the receiving set of which is carried by the dog. Earphones may be used but the best results have been had with a small speaker built into the

(Continued to page 164)



Dog sentry descending from high platform after climbing to the top; this training teaches way to surmount obstacles

Patrolling boundary fence of military post with dog sentry



M. Hollywood School

M 235

Nine-Ton Welded Steel Home Is Trucked to Site

Journapulle - Apart. Home

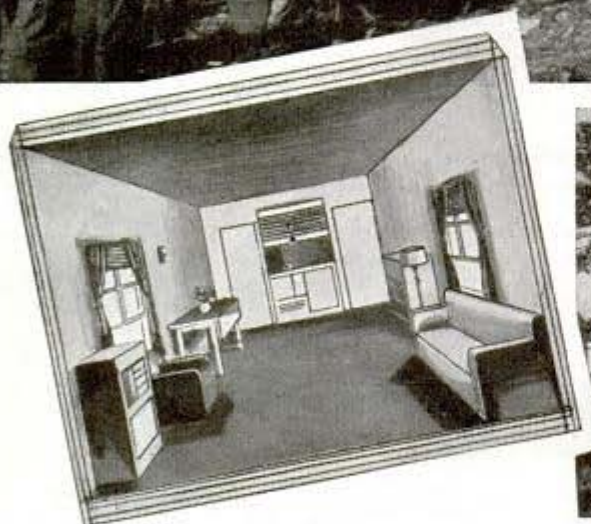
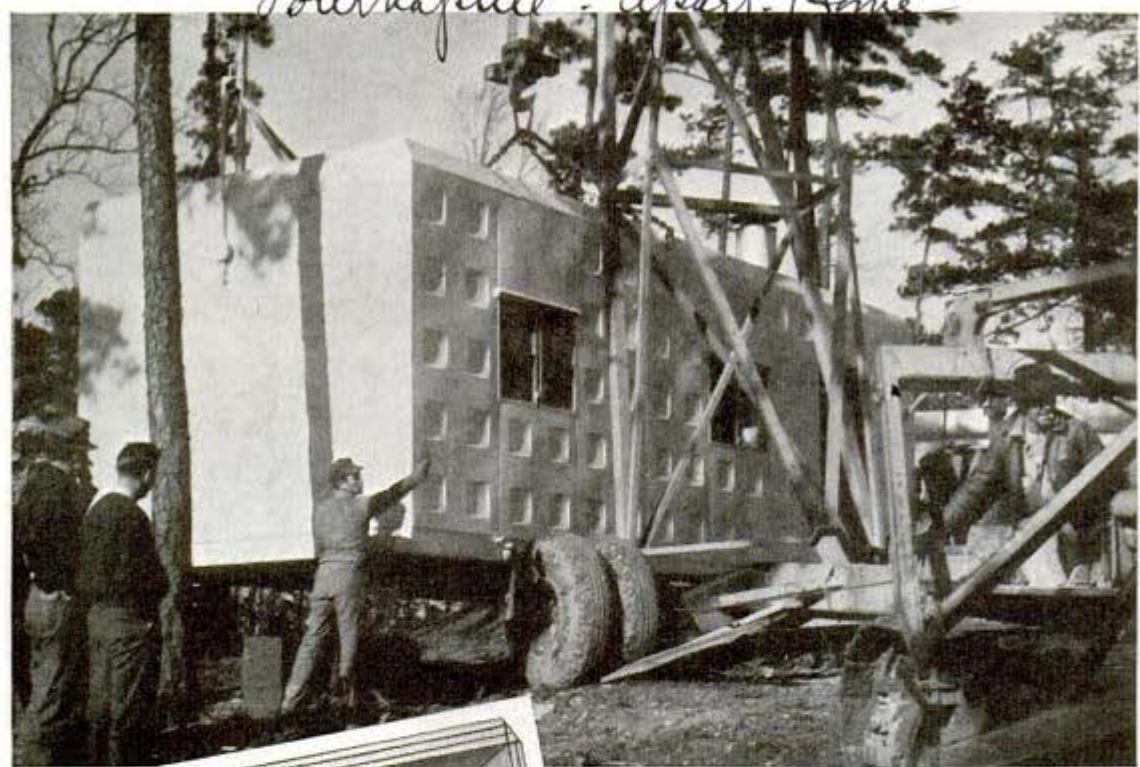

At lower right a truck hauls the ready-built house to its site, where a crane lifts it to concrete foundation piers (top). At far end of living room (lower left) is kitchen unit and doors to bedroom and bathroom

Ready-made insulated houses built of welded steel panels, weighing only nine tons equipped, are being trucked from factory to homesites and laid on prepared foundation piers by tractor crane. The 12-gauge sheet steel used in making the houses is too light for most war purposes. The basic "apartment-house" is 11 feet wide and 27 feet, 2 inches long. Inside is a 10½ by 18½ foot living room; at one end of it is a kitchen unit comprising sink, electric refrigerator, electric stove and storage cabinet. On one side of this kitchen unit is a door leading to the bathroom, on the other

side the bedroom, with a built-in roll-away bed. A hot water heater is also included. The kitchen unit, when not in use, is concealed by a venetian blind that can be pulled down to the floor.

M 269

Exposure to 63,000-Foot Altitude Would Kill by Boiling

If pressure-cabin airplanes of the future should ever fly as high as 63,000 feet, any failure of the pressure system would cause instant death of its occupants, says Major Harry G. Armstrong, director of the re-

R. S. Le Jorneye chm. Peoria, Ill.

200000 Journal m 15 2

search section, School of Aviation Medicine, at Randolph field, Texas. He explains that boiling point depends on atmospheric pressure as well as on temperature, and at the normal temperature of the body its fluids will boil in the presence of reduced pressures at 63,000 feet. However, this fact does not worry the Air Forces, since oxygen alone will sustain consciousness at 47,000 feet.

m 2/5

Adjustable Bracket Attaches Outboard Motor to Canoe

Without drilling or piercing the hull with screws or bolts, an outboard motor can be attached to a canoe with an adjustable bracket just brought out. The bar straddles the canoe and is fastened rigidly by two wing nuts that bolt through the gunwale openings. Then the motor is attached in the conventional manner. Both motor and bracket can be removed easily.

Winnipeg motors, 414 3 m. 27 M Milwaukee Wis

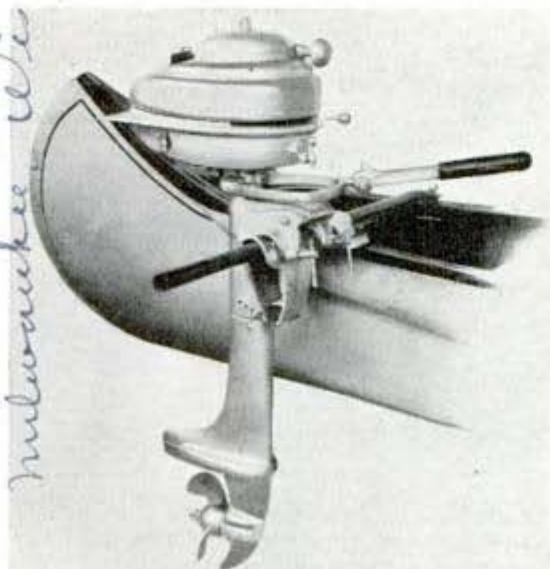

Wing nuts attach cross bar through gunwale openings

JUNE, 1942

Four-Place 'Defense Ambulance' Loads and Unloads Easily

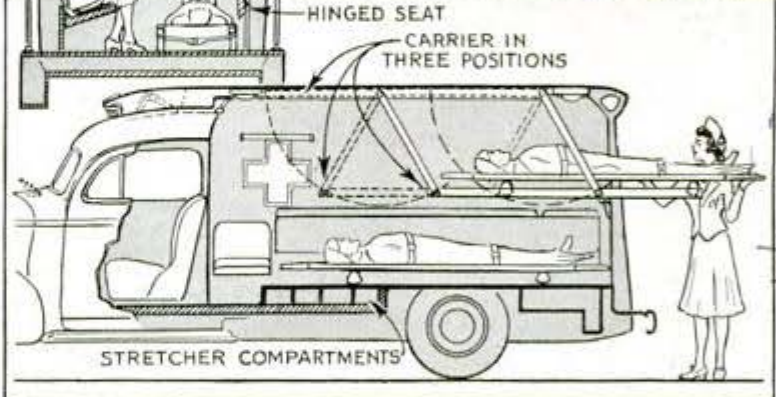

Top, removing patient from ambulance; sketches show interior arrangement

Swift evacuation of injured and helpless persons from bombed areas is made possible with a four-stretcher ambulance designed for use in civilian defense work. Besides carrying four patients on standard type stretchers, the ambulance has space for four attendants who can get in and out without crowding the patients. Any of the stretcher patients may be removed or new ones loaded without disturbing the others. Folding bench-type seats at the sides, when erected for use, will carry 12 adults or 20 children comfortably. Interior lighting is provided for runs during blackouts, and a circulating system supplies fresh or heated air. First aid and fire fighting equipment are carried in special compartments.

Seventy-five tons of rubber go into a battleship, and a ton into a medium tank.

S. A. E. Journal

Denney motor Co. Greepark. cl. 16

3/4/2

M 173 Col. Thomas G. Stinson, Jr.

BLACKING OUT HOLLYWOOD

3872 Franklin Ave. Los Angeles

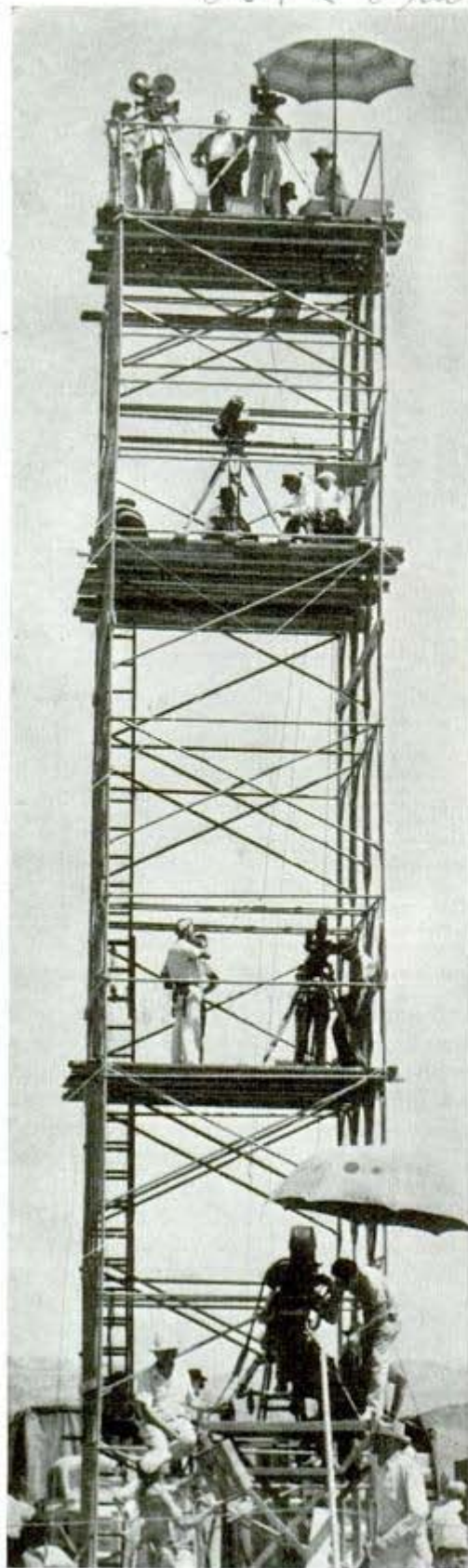

Hollywood's motion picture studios are a "bright spot" visible from the air for many miles, but they've been organized for quick action if air raids come. Above, electricians are cutting off the power at the Warner Brothers studio during a practice blackout. Air raid shelters have also been prepared in the film colony, and (below) an air raid rehearsal finds actors and technicians filing into the reinforced concrete basement on the Warner lot. A steel-helmeted warden directs them into the sand-bagged entrance. The shelter is stocked with food, water and medical supplies



It might be a good spot for air raid watchers, but the tower at left is an extensible mount for cameras. On some outdoor scenes cameras shoot various angles from the four platforms



The big studios in the movie capital have their own hospitals, which are equipped to take care of casualties in any bombing. First aid corps have also been formed, and (above) a squad of rescuers rushes a "victim" on a stretcher to the first aid headquarters in practice for air-raid work.



You'd scarcely consider the film producing studios a military target, but the clustered buildings make an easy target for enemy bombers to find; so Hollywood is not waiting for a raid to prepare. As part of their schooling for war rescue work, a first aid crew (above and at left) straps an "injured" man to a special stretcher and lowers him safely from the roof of a building that was part of a motion picture set.



M 252 Distributed thru Chain stores.

Bright Plastics Go to Bat for Metal in the Home



Attractive in their own right as well as useful substitutes for metal, plastic utensils of cellulose acetate are bringing a dash of bright color into the home. Or it may be colorless brightness, as in the crystal-clear fruit corer, above, which is unbreakable

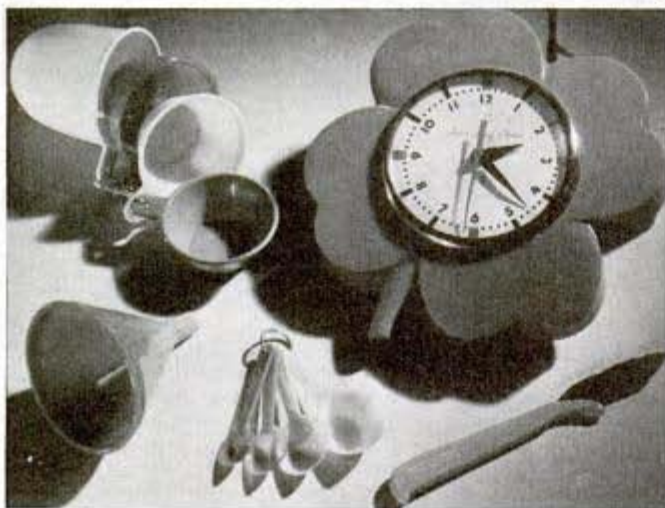

Photos from Hercules Powder Co.

Wilmington Del
 Dynamite and photographic film and egg cups bear no particular family resemblance yet they're first cousins. The film in your camera is made of cellulose acetate, and that fruit or cheese knife at the top of this column—cleverly designed to prevent loss of juice in cutting—was molded from powder based on cellulose acetate flake made by Hercules Powder Co., makers also of dynamite and gunpowder. An inexpensive replacement for the stainless-steel knife, the fruit cutter can be had in crystal, pink or blue. Below it is a salad set of "crystal" cellulose acetate; it's nonchipping, and imparts no foreign taste to the food. At the left center are a cluster of "color accents" for the breakfast table—an egg cup in red, or combination of red and white; plastic salt and pepper shakers that are moisture-proof and available in various bright colors. At the bottom are more plastics for the kitchen—measuring cups, funnel, "four-leaf" frame for the clock, knife and measuring spoons, all bright-hued and molded from plastic powder into modern shapes

L 1116 Leggett 19

SHOOT THEM IN COLOR



*Eastman Kodak Co
Rochester*

Beautiful Kodachromes can be made indoors by using the film designated for that purpose and by experimenting with lighting

Here's how the above Kodachrome → was made; any amateur can do the same sort of work if his camera is fitted with a proper lens



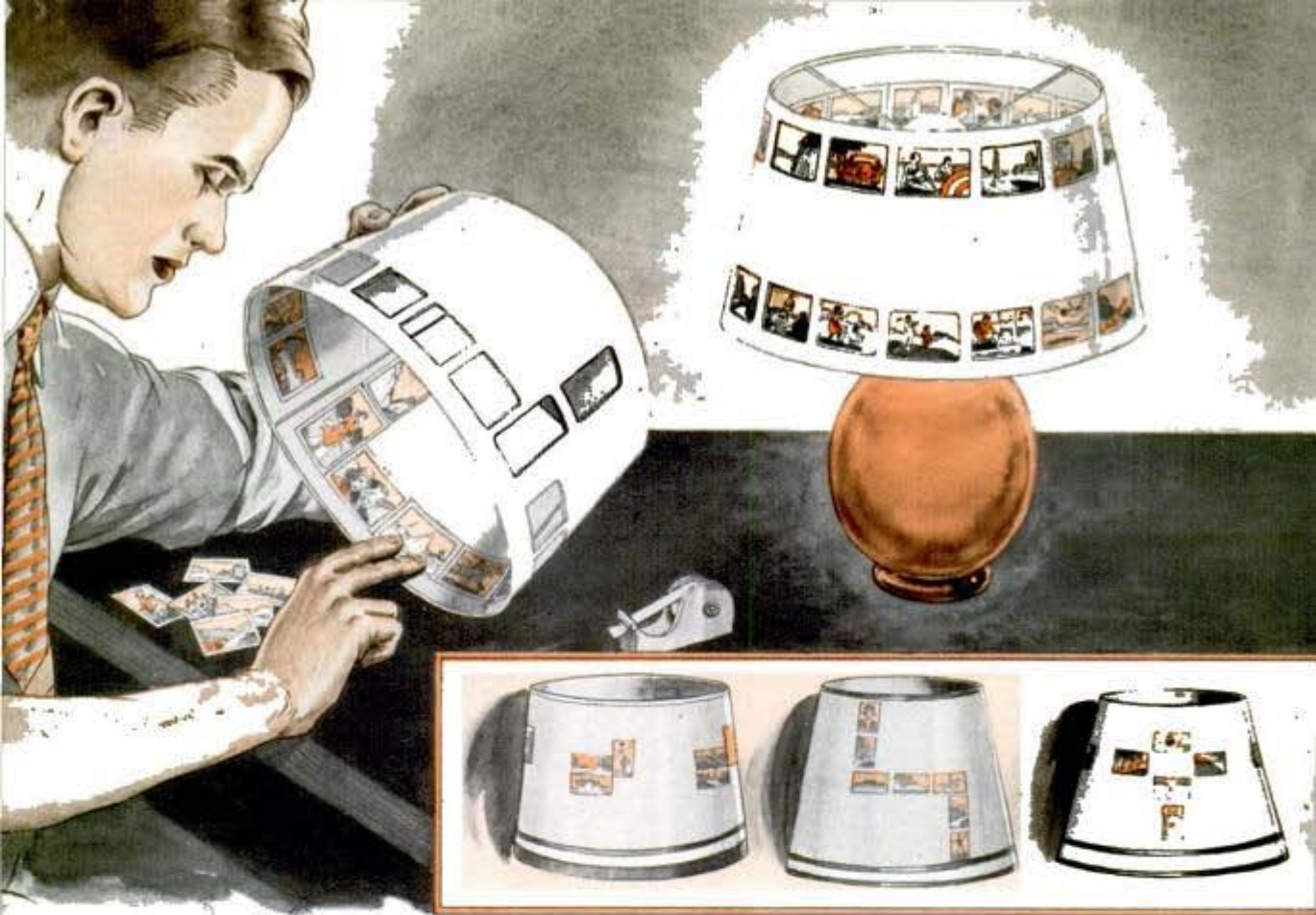

Among the things that you can do with Kodachromes is decorate lamp shades, particularly the more translucent ones. Note various ways in which the Kodachromes can be applied to shades

TODAY any amateur photographer can take beautiful, full-color shots if he is careful and stays within the limitations of his camera. And he can do it with a camera costing from \$15 to \$35.

Natural hues of outdoor and indoor subjects may be captured on Kodachrome film, which opens up the field of color to the amateur. Upon exposure the film is sent to processing laboratories for conversion into transparencies that may be enjoyed by holding them between the eye and a light source, by projecting them on a screen like the "magic lantern" slides of forty years ago or by looking at them in an inexpensive viewer containing an electric lamp behind translucent glass.

After satisfactory Kodachromes have been made, they may be turned into color prints at reasonable cost. From either 35-millimeter or Bantam size transparencies, in 2 x 2-inch mounts with standard central openings, enlargements may be obtained in two sizes. The smaller enlargement is about 2¼ x 3¼ inches, which comes with rounded corners and minus margins, at a cost of less than one dollar. The larger

is a print 5¾ x 7¾ inches, and is more expensive. Prints may be obtained through any camera supply shop.

To obtain entirely satisfactory results from Kodachrome film, the amateur must be sure his camera is equipped with an anastigmat lens, which has the ability to produce pictures that will be sharp not only at the central part but from edge to edge. Such lenses are free from aberrations, or errors in performance which cause defects in the pictures or distortions of the light rays passing through the lens.

Among the \$15-to-\$35 cameras especially designed for Kodachrome work is one that takes K828 size film, eight exposures to the roll, and is fitted with an f:4.5 anastigmat special lens. Three others, taking K135 size film, are equipped with f:5.6, f:4.5 and f:3.5 anastigmat lenses, respectively, yielding excellent color shots.

No filters or accessories are required for average conditions, because Kodachrome film is made in two types, "Regular" for daylight work and "Type A" for photo-flood lamp exposures. It is necessary that each type be used with the kind of lighting

for which it is intended. Filters are available which enable the amateur to shoot with either type of film and the alternate light source. These filters should be considered, however, as an expedient rather than a regular practice. A colorless haze filter (Wratten No. 1), which absorbs ultraviolet rays, is used with Kodachrome Regular for distant scenes which show bluish haze, for cloudy days and for some snow and water scenes. It prevents excessive bluishness in the color picture.

Good Kodachromes are relatively simple to make, provided care is exercised in several important details. The general precautions necessary in black-and-white photography, such as sharp focus and steady camera, are equally important in color photography. In addition, the amateur should consider accuracy of exposure, proper lighting contrast, variations in the color of sunlight and tungsten light, and color harmony.

For best renditions of col-

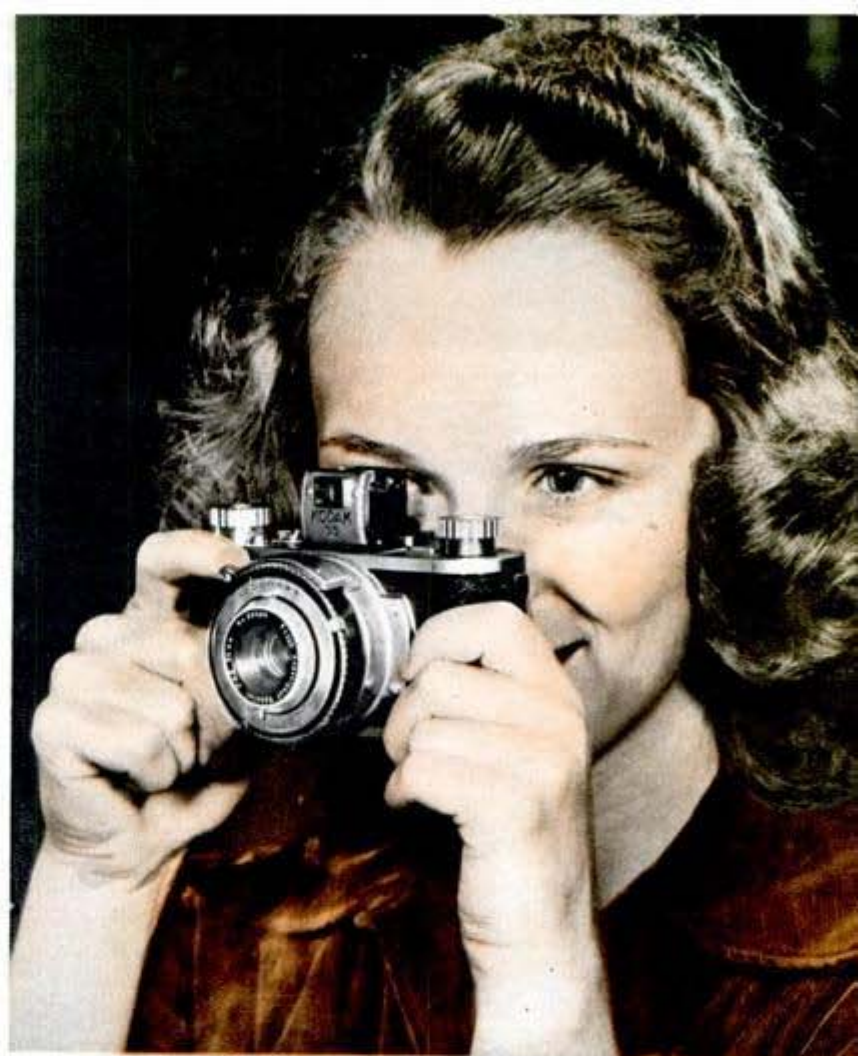

This is a miniature camera of the popular 35-mm. type; it has an anastigmat f:3.5 lens and shutter speeds up to 1/200 second

Stereopticon effects can be obtained by using two projectors and viewing picture with Polaroid-lens glasses; without glasses you see double image





20
 This beautiful color shot shows quality obtained by proper handling of the camera

ors on Kodachrome film, exposure must be correct within one-half stop or lens opening. And the type and condition of light, as well as the direction at which it strikes the subject, are important.

In bright, direct sunlight, with the subject facing the light, a basic exposure for an average subject combining both light and dark objects in approximately the

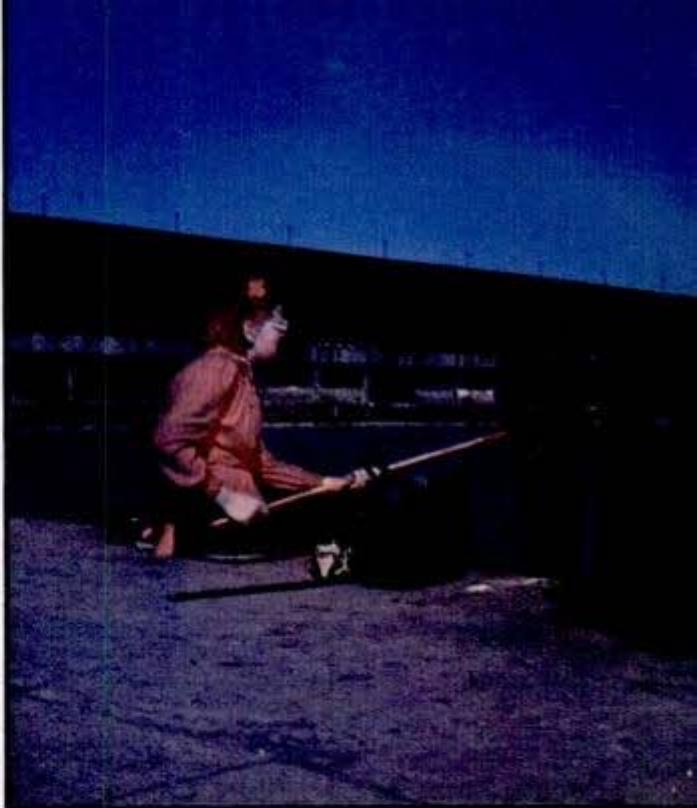

But incorrect exposure time will give you either too light or too dark Kodachromes

same proportions would be 1/50 of a second with the lens opening between f:5.6 and f:8. With light-colored subjects—snow and beach scenes, light-hued flowers, subjects with blond complexions and others—move the lens opening to f:8. For dark-colored subjects—dark foliage, deep-colored flowers, dark animals, buildings, etc.—f:5.6 should be used.

Special consideration must be given to subjects lighted from the side or from the back. For example, an average sidelighted subject, when the sun is bright and direct, requires an exposure of 1/50 of a second at f:4.5, or 1/25 of a second at f:6.3. The same subject backlit—the light coming from behind the subject—would need twice as much exposure, 1/50 at f:3.5, or 1/25 at f:4.5.

Many desirable effects can be obtained when the sun is slightly obscured by a hazy atmosphere. Under these conditions, the basic exposure for an average subject would be 1/50 at f:4.5, or 1/25 at f:6.3. For light-colored subjects, use 1/50 at f:5.6 and for those that are dark, 1/50 at f:3.5 or 1/25 at f:5.6. In open shade on a bright day, the photographer should use 1/50 at f:3.5 or 1/25 at f:4.5 for an average subject, 1/50 at



← Simple exposure guide is a valuable aid in making good Kodachromes out of doors

21 L1116

f:4.5 or 1/25 at f:6.3 for light-colored subjects, and 1/25 at f:4.5 for dark-colored subjects. The same exposures stand for shooting when the sky is overcast, cloudy but bright.

In the shade on a bright day, the basic exposure for an average subject should be 1/25 at f:3.5 and with light-colored subjects, a lens opening of f:4.5 should be used. Dark-colored subjects would require 1/10 second at f:4.5, but the camera must be placed on a firm support to prevent movement.

A correctly exposed Kodachrome has all the colors fully represented, and the properly projected picture is neither too light nor too dark, assuming, of course, that the subject was not too contrasty to record properly. An overexposed transparency appears diluted, or too light. A blue sky will be very pale or even white, a red sweater will appear pink and flesh tones will be very pale. An underexposed transparency appears just the reverse, or much too dark.



You can get black-and-white pictures from Kodachromes; note Kodachrome at top and the corresponding black-and-white, bottom, right

This is the exact size of color prints the amateur can get from his Kodachromes at reasonable cost; just consult your camera dealer



22 21116

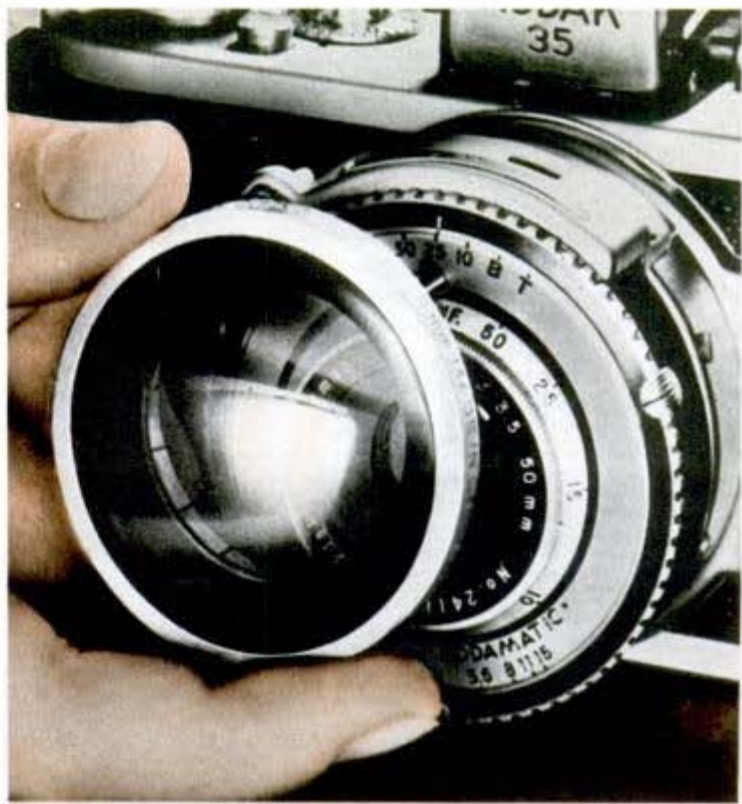
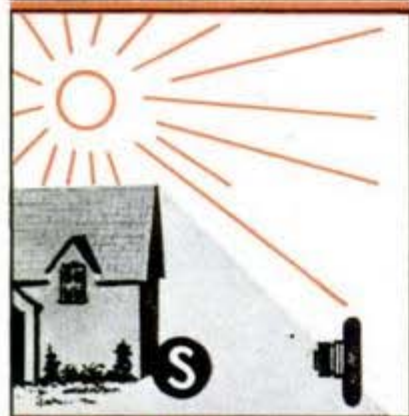

Adapter ring, into which has been inserted a Series V filter, being slipped onto anastigmat special f:3.5 lens on a Kodak 35

Exposure tables supplied with Kodachrome film and the Kodachrome outdoor exposure guide for 35-millimeter and Bantam film deal with pictures in different types of light and offer numerous suggestions for unusual conditions. Occasionally there are unusual subjects to which exposure guides cannot be applied readily. If the picture is important or impossible to retake, it is suggested that several exposures be made: one at the stop representing the best possible estimate, one at the stop below and a third at one stop above.

A Kodachrome transparency having dark areas which are much too dark or light areas which are too light indicates the subject brightness range was too great. It is important, therefore, to photograph the subject in such a manner that an excessive brightness range be reduced or avoided. Outdoors, this generally means care in choosing the camera position. Having the sun behind the photographer's back results in satisfactory lighting, or other positions which give sidelighting or backlighting are also satisfactory if the shadow side of the subject is well illuminated. For closeups of flowers, people and small subjects, a white sheet or large white blotter, placed just outside the view of the lens, will serve as a reflector, illuminating the shadow portions and giving a more even

← Top to bottom, various lighting conditions, with S denoting the subject: bright direct sunlight, bright indirect sunlight, in shade on bright day, cloudy but bright, and weak hazy sun with soft shadows. Camera setting should be watched carefully

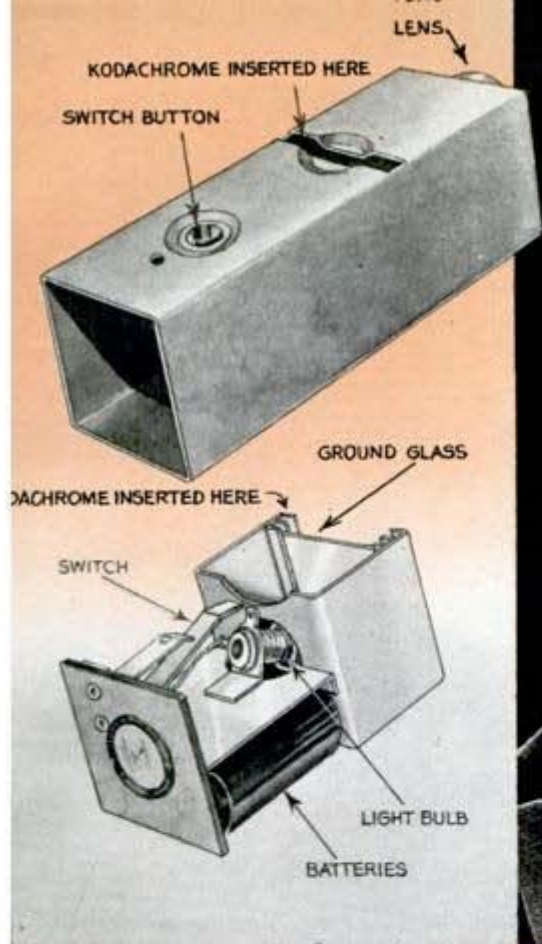

23 Right, using the Vuescope, an instrument for viewing Kodachromes. Drawings at left show that this is accomplished by employing a small light bulb drawing current from dry batteries

range of brightness over the entire picture.

Kodachrome Regular film is balanced for average daylight sunlight, yet it will render satisfactory results from an hour or two after sunrise until an hour or two before sunset. Near sundown, the direct rays of the sun are much redder than earlier in the day, and much less bright. However, the results are not necessarily displeasing, for sunset pictures, usually showing prominence in the reds, are a fascinating field for the amateur. Considerable variation in color may be noticed in a series of pictures made when the sun is alternately clear and obscured by clouds. Subjects under a gray sky, or misty white sky, are somewhat more bluish than those lighted by direct sunlight, and subjects in the shade, illuminated only by the blue sky, appear very

bluish. For pictures taken on dull days—the sun obscured by clouds—a haze filter slipped over the lens will produce a warmer color rendering.

Kodachrome Type A film can be used without filters with any of the photoflood lamps. Probably the best for general use is the No. 2, which has twice the candle-power and three times the life of the No. 1

Another use that can be made of Kodachromes is in decorating a translucent glass jewel box

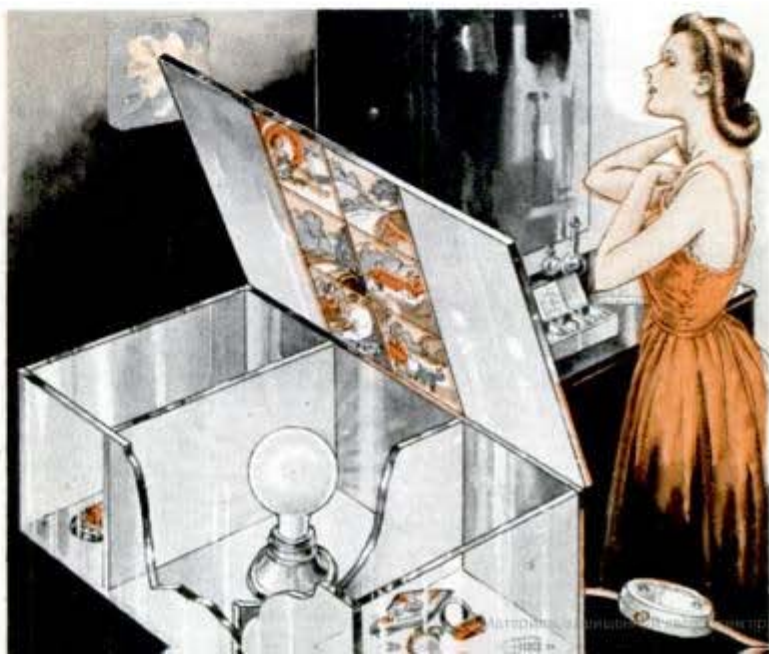



24 This is an example of Kodachrome's effectiveness in taking night shots of such objects as Christmas decorations and illuminated fountains

The possibilities for making good Kodachromes, like this, are virtually unlimited



lamp. Ordinary home lighting lamps should not be used, as their light is more yellowish than that from photofloods and will result in too-yellow transparencies. Any sunlight entering the room, when Kodachrome Type A is being used with floodlights, will result in pictures which are too blue. The remedy is to use Kodachrome Regular film with daylight type photoflood lamps. These lamps also may prove beneficial when a subject illuminated by daylight requires supplementary illumination.

Care must be exercised in the arrangement of color for indoor photographs. Most indoor subjects are people and the lightness and darkness of the background should be close enough to the face so that it will photograph properly, but it should also afford some contrast to the subject. Dark subjects are usually best presented against a lighter background, and light subjects against a darker one; in general, the background color should be of a subdued nature.

Black-and-white pictures must rely to a great extent on contrast and lighting for effectiveness. Kodachrome differs in that very acceptable results may be secured with flat lighting, because a color picture depends upon color contrast for its quality. Informal close-

(Continued to page 176)

Allied Housing Corp., Langhorne, Pa.
Knockdown House Can Be Moved and Rebuilt



Presson

Four trucks, above, moving dismantled house from one site to another. Right, group of men removing one of the gable ends of the house; bottom, house rebuilt at new site and needing only a few finishing touches



Prefabricated houses which can be set up quickly, and later disassembled, trucked to another site and rebuilt within a single day, are the latest solution offered for defense housing at army camps and in rural areas where munitions plants and other war industries are springing into being. Already the Federal Works Agency has approved purchase of about 10,600 of the portable houses, and plans are made for acquiring more units in the future. The houses are prefabricated of synthetic boards manufactured from old newspapers which are processed chemically and pressed into sturdy boards. In one demonstration a single family dwelling containing two bedrooms was taken apart, hauled 30 miles by truck over country roads and reassembled at the new site, all in less than eight hours.



20 189
Phosphorescent Paint Stores Its Own Light and Glows in Blackout

Research men are making an intensive study of phosphorescent materials for blackout lighting. Phosphorescent paint will store up energy while lights are shining, and then glow softly when lights are extinguished, helping workers to find their

way around in a sudden blackout. This stored light will fade out over periods of a few minutes to an hour, but is very helpful at the start of a blackout. Zinc sulfide, calcium sulfide and strontium sulfide are effective phosphorescent materials.

General Electric Co. Schenectady
N.Y.

7:30 5

Lightweight Lifesaving Suit Carries Food for Weeks



Easy to slip into, suit floats wearer comfortably

Convenience in handling and better protection are claimed for a rubberized lifesaving suit invented by a veteran of World War I, Capt. S. Kronhaus of Los Angeles, Calif. It costs less than the old-style cork preserver, weighs only ten pounds, can be folded into a space smaller than a lady's overnight bag, and can be put on in less than two minutes. It is said to permit ease in maneuvering and keeps the occupant warm and comfortable. A special pocket can carry enough concentrated food tablets to sustain a person for weeks if necessary.

M 2 59

Reciprocating Electric File Saves Time on Jobs



Time required for filing can be reduced to one-half with an electric file now in production. Having a reciprocating

motion excellent for filing, the file is suitable for speed cleaning of small die cast-

Chicago Pneumatic Tool Co. 6 E 44th St. Chicago, Ill.

Cardor Corp.
307 N Michigan, Chicago
ings and for general operations in tool and pattern shops. The motor, operating on either 110 or 220 volts, has a load speed of 1,500 revolutions. With file attached, the tool weighs four pounds.

M 2 39

Carbon Dioxide by the Carload Would Smother Hangar Fire

Gasoline and oil fires in aircraft hangars would be smothered by a veritable flood of carbon dioxide gas under a plan patented by an Illinois inventor. Liquid carbon dioxide, which becomes gas upon release from pressure cylinders, is effective against oil fires by cutting off the oxygen supply and reducing the temperature below ignition point. However, it has not been available in quantities sufficient to fight a large hangar fire. The inventor proposes storing the liquid under pressure in containers as big as railway tank cars, situated outside the hangar, with pipes leading to strategic points inside the hangar.

M 2 22

Stick-On Luminous Disks Help Locate Objects in Dark

Small luminous disks, plainly visible in the dark, aid in locating objects such as flashlights and door knobs during blackouts. Barely a quarter of an inch in diameter, they are gummed at the back so they

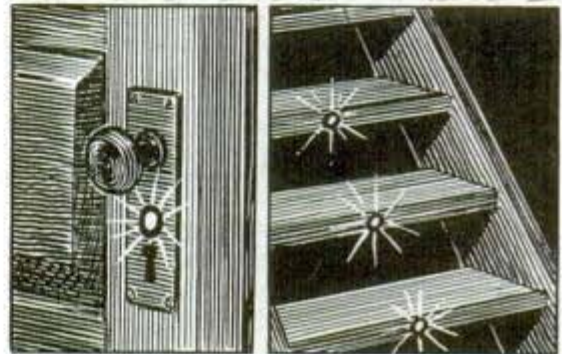
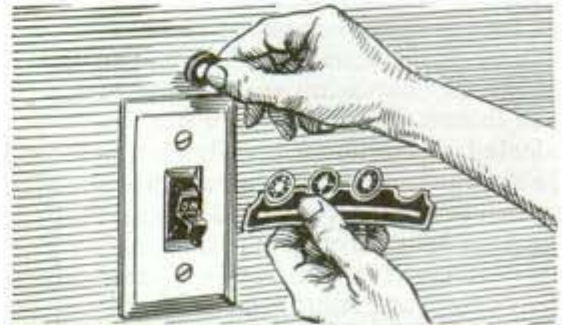

Sketches show methods of using the luminous disks

Luma Discs
305 E 46th St. New York

and see party file will be d.d.

value derive 3/5/42

will adhere to almost anything. The disks serve as guides in the dark when placed along cellar stair edges, walls or in doorways, and they can save fumbling for fuse boxes, light switches and auto ignition switches. They are said to glow permanently in the dark without exposure to light sources.

m 270
Special Equipment to Save Submarine Victims

Merchant seamen are given a better chance for their lives with new lifesaving apparatus and improvements. Every week the British ministry of war transport tests the latest devices to be offered. At present there are fire-proof hoods for crews of tankers and special suits for protection against exposure that are fitted with electric lights so the wearer can be spotted at night. A completely equipped motor lifeboat includes such things as automatic radio, fire fighting apparatus, signal torch, repair kit and smoke flares. For human needs the boats contain fresh water tanks, vitamin rations, a triple food tank with separated milk tablets, chocolate and pemmican; massage oil, first aid kit and drinking cups.



Some of the lifeboat's equipment is fastened by heavy cords

m 249
Sedan Rebuilt Into Ten-Seat Bus To Carry War Workers

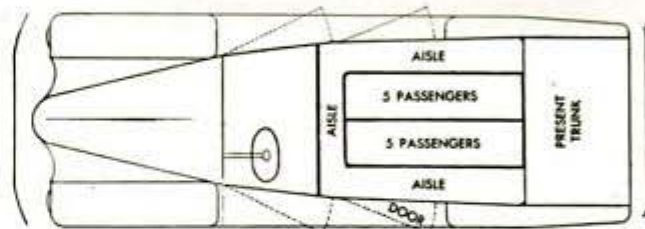
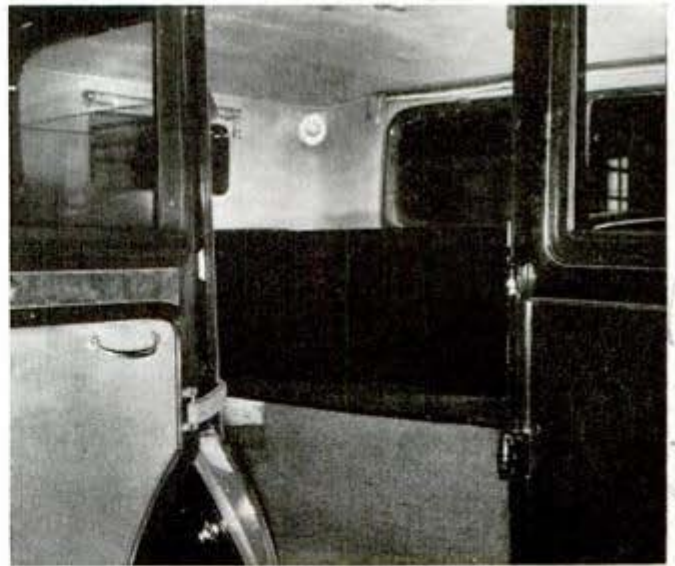

Seats facing the sides have been installed in this old seven-passenger sedan, nearly doubling its capacity, as floor plan shows

Conversion of old seven-passenger sedans into ten-seat buses for the transportation of workers to war factories is recommended by the Chicago Motor Club, whose plans for the rebuilding have been endorsed by rationing administrators of Illinois and Indiana. To demonstrate its idea, the club has bought a 1930 seven-passenger sedan for \$200 and raised its seating capacity by installing lengthwise seats in the rear section at a cost of \$47.16, broken down as follows: wood labor, five hours at \$1.00—\$5.00; trim labor, 17 hours, \$17.00; trim material, \$15.25; wood material, \$9.91. Officials estimated that in Illinois and Indiana alone there are 70,000 old seven-passenger family automobiles available for conversion, and the state rationing administrators said they would be eligible for new tires if rebuilt and used for transporting defense workers.

668 North Water

Los Angeles Astronomical Society of Los Angeles
2606 W. 8th St. L.A. 58

Center Thomas G. Stinson Jr
3872 Franklin Ave
Los Angeles



Inspecting the barrel of a small Schmidt telescope camera mounted on larger telescope at Griffith Observatory, Los Angeles

Secrets of the STARS Revealed by MIDGET "EYE"

LOCKED up in a simple picture of some stars is a tool that promises to answer many of the questions that civilization has been asking about the universe.

The extraordinary photograph gives astronomers the hope that they will be able to do as much research in the next twenty years as they had expected to accomplish in the next several centuries.

What is this remarkable picture? A collision of two stars? A comet headed for the earth? Nothing so spectacular. It is merely a sharp, clear picture of a large patch of sky.

There is nothing in it to excite the average person, yet no one has been able to take such a photograph before. It was made with a new kind of telescope camera invented hardly ten years ago.

What gives the new telescope and the pictures it takes such importance is the fact that a good deal of astronomical study is concerned with the relationship of one star with its apparent neighbors. Wide angle pictures that show lots of background permit comparisons and studies of relative star intensities.

Ideal as they are for some important

This Planetarium instrument is used to study star motions

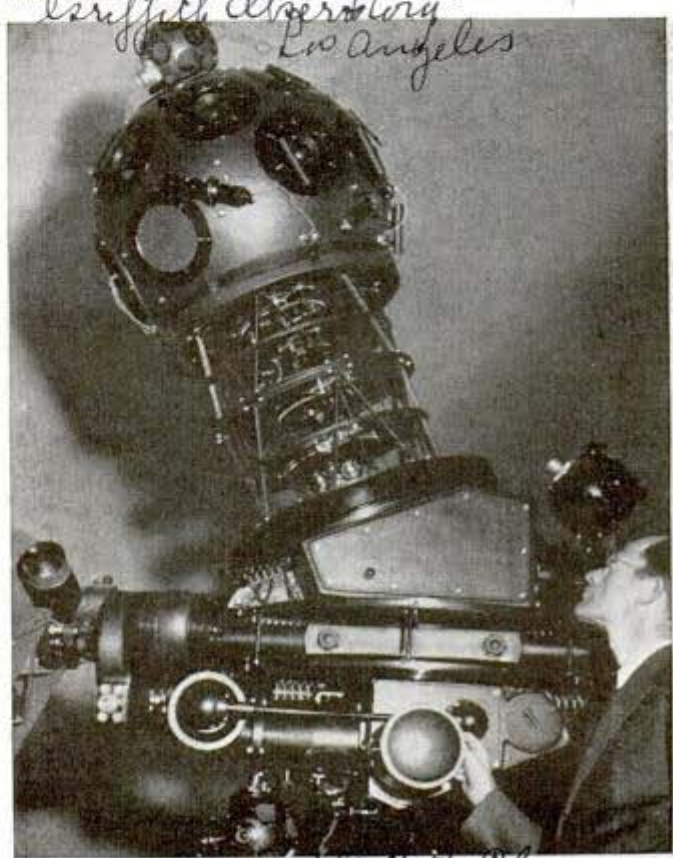

Griffith Observatory
Los Angeles

Herbert Clemenshaw
POPULAR MECHANICS

Various eyepieces for large refracting telescope are used for different types of observations

The fact is, all large reflecting telescopes that use a big concave mirror to concentrate the light of distant objects are an optical compromise. The simplest mirror shape is a spherical hollow but such a shape has spherical aberration that gives fuzzy reflections. Astronomers have had to deepen the spherical cut into a parabola that gives good definition although only in the center of the field. To make up for this handicap, the large telescopes are so powerful

that they can almost, as far as the average person is concerned, reach out to infinity.

The new kind of telescope, invented by Bernard Schmidt in Germany before the Nazi regime, uses a simple spherical reflecting surface and eliminates all spherical aberration with a correcting lens that disperses the incoming light equally over the curved mirror surface. The light reflected



from the mirror is then absorbed by a photographic film that is curved to the same radius as the mirror surface, producing a negative that is sharp and clear at all points.

Pictures made with an 18-inch Schmidt at Palomar cover an area in the sky 6,000 times as large as will be possible with the 200-inch telescope. A larger Schmidt with a spherical mirror four feet across is under construction at the same observatory and will bring out much fainter stars than does the present 18-inch instrument.

Originally it was planned at Palomar to use the Schmidts as reconnaissance telescopes for sweeping the sky for interesting objects at which the 200-inch "big eye" could then be pointed. But their wide fields of view make them ideal for other kinds of work as well. They are relatively simple and inexpensive and are comparatively insensitive to temperature changes. They focus all wavelengths of light on the same film surface. Even small Schmidts, because they take such clear pictures, can perform work that previously had required telescopes of far more power.

As cameras they are of the high speed type. Exposures require up to a maximum of 20 minutes, so it is possible to take upwards of a dozen photographs per night against an average of two exposures per night with the 100-inch telescope at Mount Wilson.

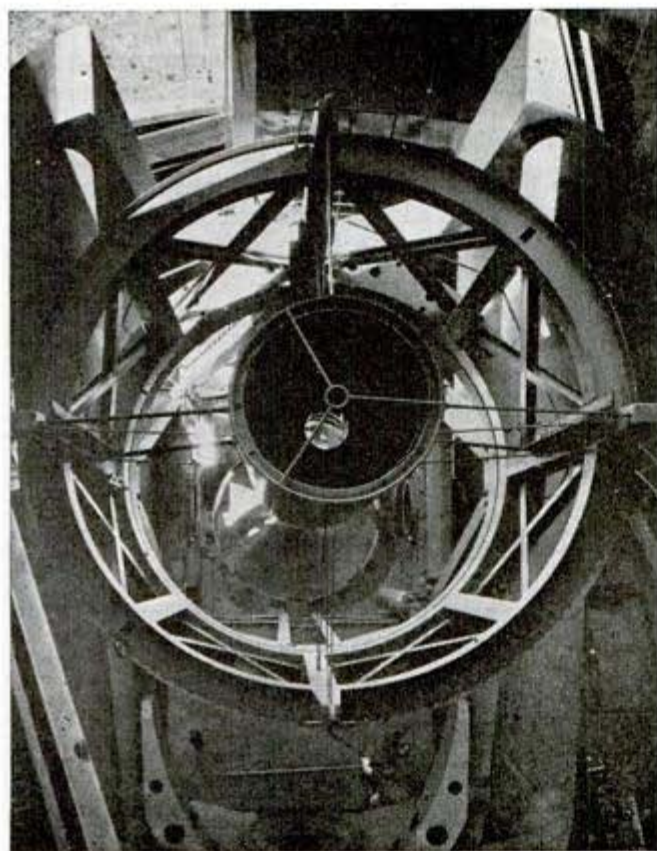

Looking down into open tube of 200-inch telescope; black chamber at center is room where astronomer will work while photographing star light reflected up through central hole from mirror far below

72.50

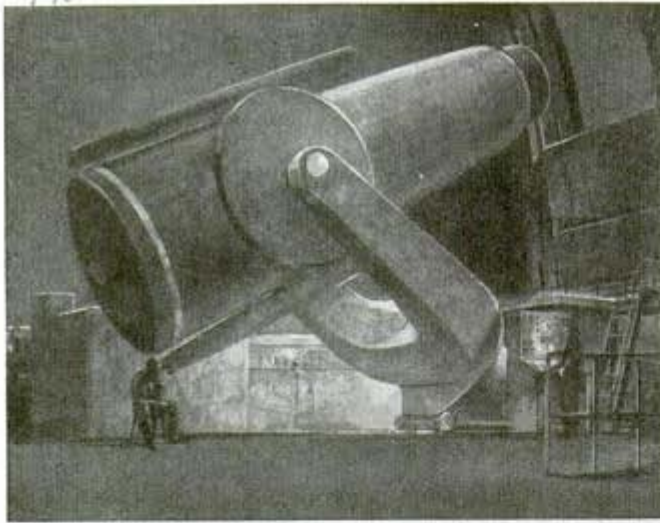

Drawing shows 48-inch Schmidt telescope being built at Palomar

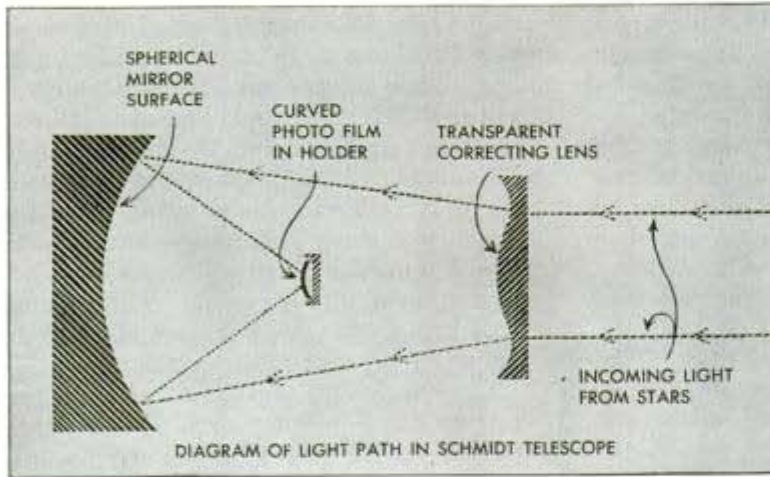

The diagram above indicates light path in a Schmidt telescope

Below, 18-inch Schmidt "reconnaissance" telescope at Palomar

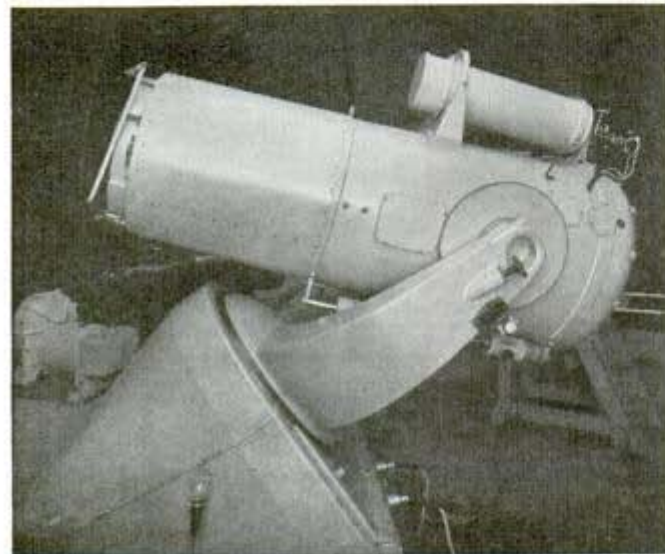

These characteristics mean several things. The Schmidt is ideal for studying regular and irregular variable stars, novae, and comets. Its speed plus its wide angle gives astronomers a patrol instrument that can map the whole visible sky in a few nights. Now they will be able to keep track of 100 times the possibly 100,000,000 stars that they systematically observe. More information on the distribution of stars in the Milky Way, the galaxy of which our sun is a member, will be gathered by the large Schmidts. Such study may clear up the puzzle as to whether the Milky Way has a spiral structure like some of the great nebulae.

Until now, progress in astronomy has been limited by the small number of telescopes available for supplying astronomers with information. Development of the Schmidt reverses the bottleneck and from now on the speed of research or accomplishments will depend more on the number of astronomers who are available for interpreting the data that the Schmidts provide.

To date the stars visible in the southern hemisphere have received little attention. Most of the world's large telescopes are north of the equator. But since small Schmidts cost only a fraction of the price of a large telescope and can do hundreds of times more general work, it now will be easy to map thoroughly the southern stars. Some astronomers believe that aside from one more giant telescope of conventional design that is needed for the southern hemisphere, all the important astronomical telescopes of the future will be of the Schmidt type.

The inventor of the Schmidt was an amateur rather than a professional astronomer, and development of the new telescope in the United States has been carried on

72.50

at Luffth Observatory

largely by amateurs. Amateurs probably have built and are using more Schmidts than the professionals, though many professional instruments are now under construction. A Chicago amateur group built a Schmidt for a Yerkes eclipse expedition several years ago, and the Los Angeles Astronomical Society is finishing a 12-inch Schmidt at present.

Amateur telescope-making groups are now planning to make terrestrial instruments for the armed forces. Many young men who took up star gazing as a hobby have learned that their understanding of celestial bodies has especially fitted them for training to become navigation officers on large bombers. The Schmidt telescope itself is contributing to our war effort, since an adaptation of the principle has produced a keen-eyed aerial camera now in mass production.

At the same time that the Schmidt has been in development, our bigger telescopes in effect have been growing in size. Recent advances in optics and photography have increased the efficiency of the 100-inch telescope to the "speed" expected of the 200-inch telescope when the latter was planned in 1928. When the Palomar instrument is put to work it will have the light-gathering capacity of at least a 400-inch instrument of earlier design.

One of the most important improvements has been in the speeding up of red-sensitive photo films, permitting shorter exposures. Red light is least affected by the clouds of cosmic dust that exist in space, hence films sensitive to red light can pick up stars not recorded on ordinary or blue-sensitive film. Another factor that has speeded up the telescope is the elimination of stray reflections by treating lens surfaces with nonreflecting films of lithium and calcium fluorides.



Installing camera box at focus of large refracting telescope



View of unfinished 200-inch telescope at Palomar observatory

Some of the special grinding tools used in shaping a 12-inch Schmidt reflecting mirror; mirror glass rests on white slab



M 215

Air-Operated Siren Gives Air Raid Warnings

Mr E C Wentel (Bell)
during V.A. Fair, Commencement
of Public Parks



463 West St. New York

Compressed air is used in a siren developed at the Bell Telephone laboratories to give it a powerful wail. Placed on the Manhattan bridge in New York City to test its ability as an air raid siren, it sent out a shriek that was heard as far away as the Battery.

New York Times March 24

Air raid siren tested on Manhattan bridge, pierced the din of busy New York City with a powerful shriek that was heard as far away as the Battery

M 276

Helium Cloud Saves Magnesium From Catching Fire While Welding

M 250 Hawthorne, Calif.

Welding of inflammable metals such as magnesium can be accomplished under a patent granted Russell Meredith of Los Angeles, Calif. The invention involves the application of helium, a noninflammable gas, to the welding area, and is used in a new welding torch developed by Northrop Aircraft, Inc. Due to its extreme lightness, magnesium is being used widely in the

construction of airplanes, and when applied in thin sheets it was necessary to fasten it by the slower riveting process, because the welding arc or flame would ignite the metal. To produce the protective blanket of helium the electric arc welder has a hollow handle and nozzle from which the gas is emitted to surround the point at which the magnesium is being welded.

Unexploded Bombs Hauled in Cart Made of Heavy Cable

Bombs that fall in a city and fail to explode present a constant danger until they have been removed and destroyed. The latest carrier for their removal is a trailer developed by the New York Department of Public Works. Its body is a heavy cable affair housing a smaller cage of similar construction in which the bombs may be conveyed to isolated areas.



Trailer with structure resembling an inverted basket will haul unexploded bombs from the city to remote places where they may be destroyed

m 200 Cont. Thomas E. Simpson, Jr.

Giant Air Transport to Carry 57 Passengers

Ready for test-flights this summer, a 57-passenger commercial plane designed for peacetime use will be capable of spanning the United States from Los Angeles to New York in 8½ hours. It is under construction for Transcontinental and Western Air lines at the Lockheed Aircraft Corporation's plant in Burbank, Calif. Powered by four 2,500-horsepower engines, the Constellation, as it is known, will have a range of 4,000 miles and will fly above altitudes of 25,000 feet at a cruising speed of 285 miles an hour and a top speed of 350. The \$500,000 transport will be handled by a crew of seven.

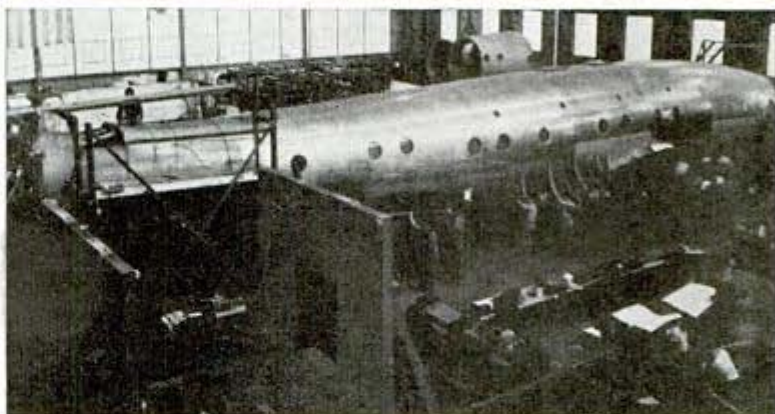

Top, wind tunnel model of coast-to-coast airplane. Fuselage, bottom, gives an idea of its enormous proportions

Special Tools Install Spider Webs in Optical Instruments

Mounting spider webs as cross-hairs in precision optical instruments is the delicate task performed by Henri Hoffman at Ohio State University's engineering ex-

perimental station. To attain the high degree of accuracy needed, he devised a mounting machine. The web is handled with a small fork. Hoffman gathers and

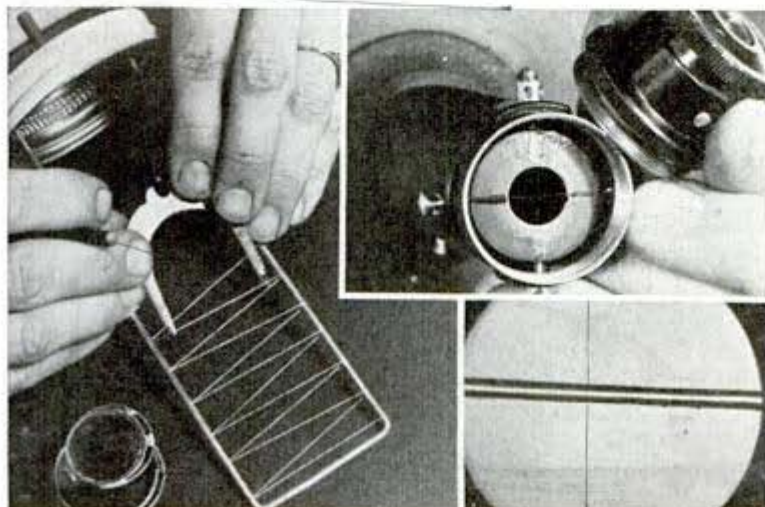

Left, using fork to pick up spider web from frame. Right, top, eyepiece with web in place; bottom, human hair (horizontal) compared with a web

preserves the webs for later use, and often a web must be untwisted carefully in order to obtain uniform thickness of the cross-hair. Webs are so thin it would require about 10 to equal the thickness of the page on which this is printed. Although in the latest instruments the mounted web is replaced by fine lines etched in a glass disk, there are thousands of older type instruments in use which require occasional replacement of broken cross-hairs.

21245
Andrew Hamilton
1177 1/2 S. Westmoreland
Los Angeles

The COAST

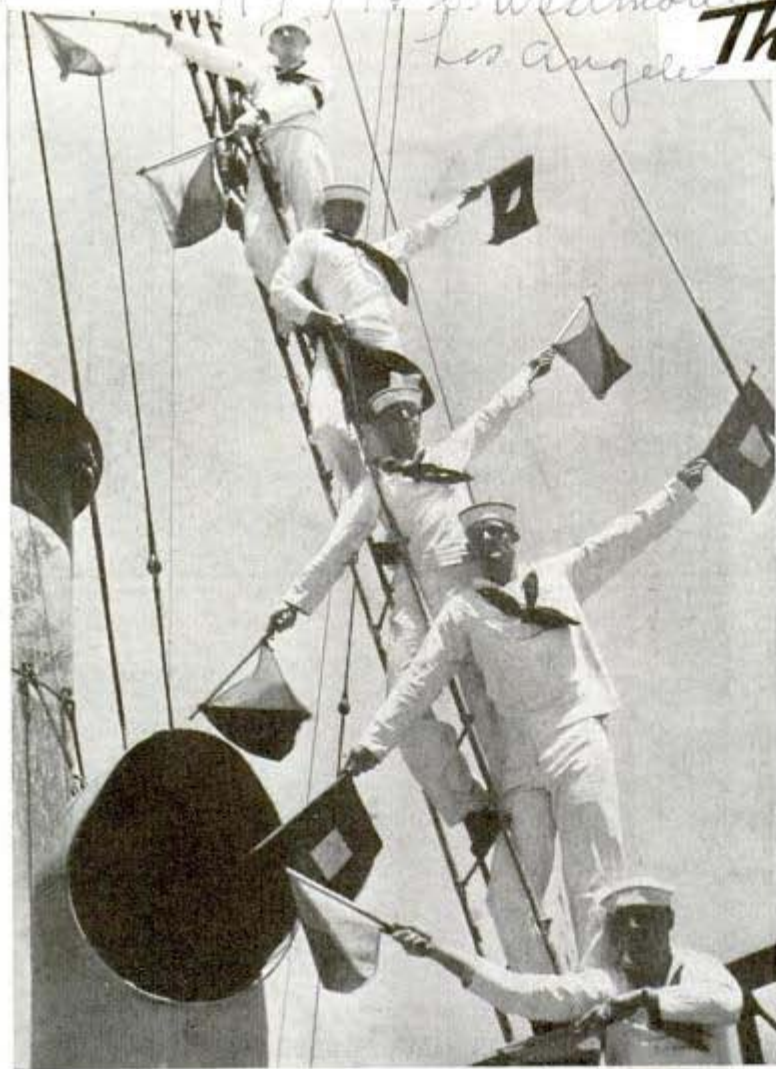

November 2, a month before actual war, President Roosevelt put the entire Coast Guard under Navy jurisdiction; but even before that Coast Guard ships and planes had been on "active" service. It was the Coast Guard Cutter "Bear," that reconditioned veteran that had served Admiral Byrd in the Antarctic, that apprehended off Greenland a Norwegian vessel that was acting as offshore base for a German radio station.

Although smaller than the Army or Navy in man power and equipment, the Coast Guard is the sentinel of the American coast-

← Coast Guard Academy graduates will quadruple by '45. At left, signal practice on training ship

Manning America's 500 lighthouses is one responsibility of the Guardsmen in peace and war ↓

THEY'RE lifesavers in peace, but the Coast Guard has never missed a fight. They're in the Navy now, as they were in other wars.

Back in 1812 they stood with the young American Navy against the British. They wrote exciting chapters in the Seminole uprisings of 1836, the Mexican War of '48 and the Spanish-American war in '98. In the first world war they performed valiant and dangerous service, maintaining the shore defenses of the United States, helping track and destroy submarines, conveying ships between Gibraltar and England. The percentage of men lost was the highest of any branch of Uncle Sam's forces, including even the army.

The Coast Guard began polishing up its famous motto, "Semper Paratus"—always ready—as long ago as 1934, when Hitler made his first open aggressive move by marching troops into the Rhineland. Last



21245

GUARD GIRDS *for* BATTLE

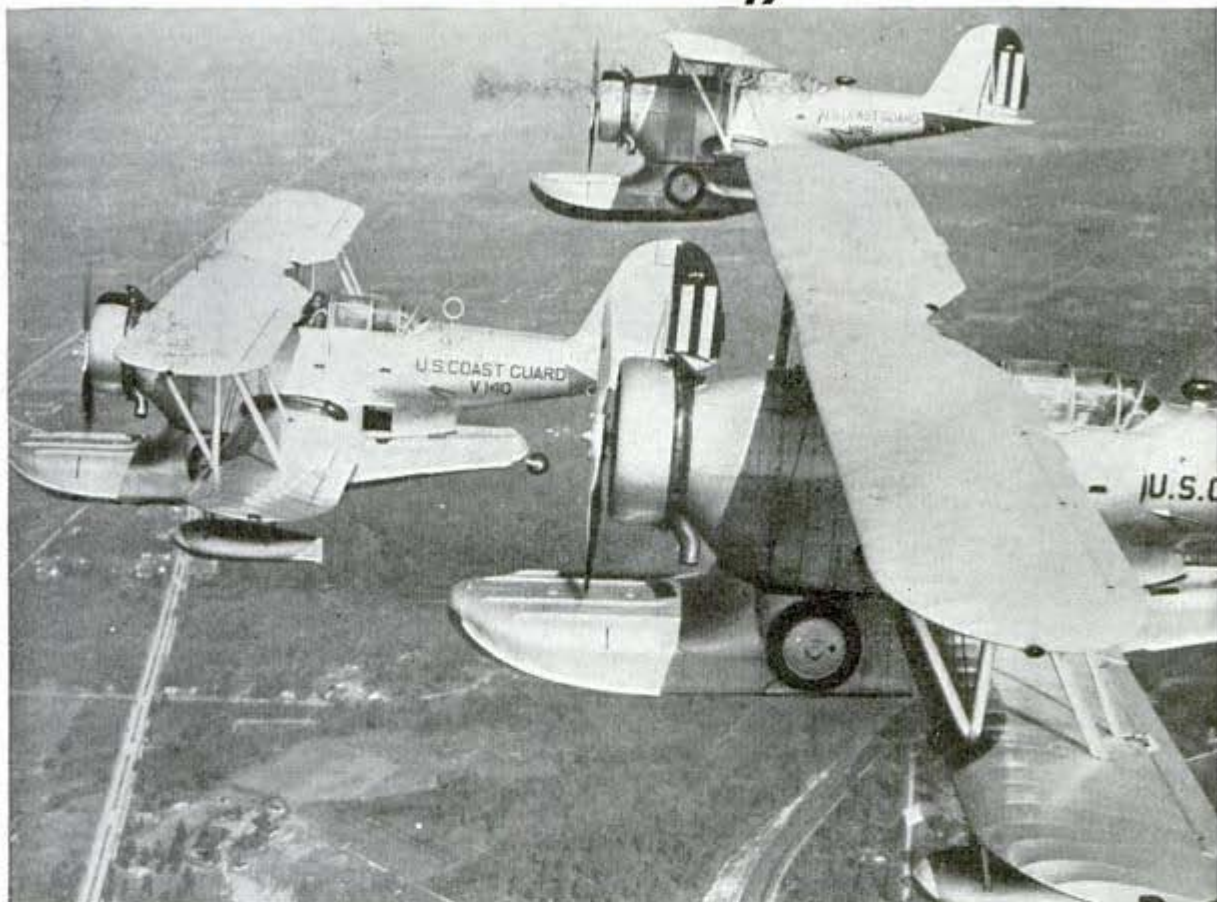

These Grumman amphibians are part of the Coast Guard's fleet spotting submarines and rescuing their victims

line, the United States' seagoing police. Since its founding in 1790 under George Washington, the Coast Guard has performed a wide variety of duties. These have included the prevention of smuggling of liquor, narcotics and other contraband; patrol of the waters of the North Atlantic and the North Pacific; enforcement of navigation laws; protection of fur-bearing animals, birds and fishing grounds; supervision of the anchorage and movement of vessels handling dangerous cargoes; winter patrol of the ocean to help people or vessels in distress; removal of derelicts and other obstructions to navigation; maintenance of a system of marine aids to navigation including lighthouses, lightships, radio beacons and buoys.

So essential to the welfare of the nation has the Coast Guard be-

Repairing the lens of one of 20,000 buoys guarding our coasts



U. S. Coast Guard photos



Wreckers from a cutter prepare to destroy a derelict menacing shipping

come that it is now more than five times as large as it was in 1917. Before Pearl Harbor it comprised 800 commissioned officers, 450 warrant officers, 19,000 men and 5,000 civilian personnel.

War has brought many new duties to the Coast Guard which it must carry on in addition to its peace-time chores.

The Coast Guard's hundreds of sea-going cutters have been converted for war duties under specifications provided by the Navy Department. The conversion work includes the installation of additional guns, enlargement of magazines, fitting of depth-charge racks and the installation of ordnance and underwater sound detection apparatus.

In addition to readying-up its present equipment, the Coast Guard has been authorized to obtain new ships—just how many is a military secret. Shipbuilding ways and a \$500,000 dry dock are being built to provide new cutters for the Coast Guard.

Since aviation has come to be an essential part of the Coast Guard, it was only natural that "the Service" should be called to help the Navy in patrolling the blue waters, spotting from the air and reporting the presence of enemy submarines and raiders.

The Coast Guard is especially proud of its record in the air. In addition to many dramatic and spectacular flights to deliver se-

rum or remove sick persons from ships at sea, it was patrolling the ocean long before the Neutrality Patrol came into being. The Coast Guard likes to remember that one of its own officers, Commander E. F. Stone was co-pilot of the first flying boat to cross the Atlantic, the NC-4.

With America's shipbuilding yards humming night and day, and dozens of military and merchant craft sliding down the ways each month, the Coast Guard's duties of keeping harbors, coastlines and rivers safe for shipping take on a vast military importance.

In 1939 the control of 30,000 navigational aids in America's rivers and harbors was transferred from the department of Commerce to the Coast Guard. In the last twelve months these have been increased by more than 1,000.

Navigational aids include some 500 fully attended lighthouses on the Atlantic and Pacific coasts, Puerto Rico, Alaska and Hawaii; several thousands of other helps to safe shipping; 31 lightships on both coasts; 20,000 buoys in navigable waters. All this has meant additional work for

Coast Guard ice breakers keep harbors, lakes and rivers open



1245



Coast Guard cadets are trained as thoroughly as midshipmen at Annapolis. Here they learn marine surveying

the stout-hearted men of the Coast Guard.

President Roosevelt's proclamation of June 27, 1940, gave the Coast Guard the job of supervising the unloading of explosives and other dangerous cargoes in American ports—as well as the anchorage and movement of all such vessels.

The Coast Guard's long experience in maintaining the International Ice Patrol in the Atlantic and the Bering Sea Patrol in the North Pacific waters around Alaska is now increasingly important with both these areas essential to the sea defenses of the United States.

Coast Guard Cutters have acted as stations in the mid-Atlantic serving as weather observation posts. Weather observations in mid-Atlantic are particularly important at the present time—if Clipper plane crossings of the Atlantic are to be continued. The war has halted nearly all of the voluntary meteorological reporting which used to be performed by commercial vessels and upon which the U. S. Weather Bureau relied. Information from Europe, too, has been seriously curtailed.

Weather reports ordinarily are flashed to the U. S. Weather Bureau from the mid-Atlantic

Coast Guard cutters at 6-hour intervals, day and night. This information is based upon observations made every three hours, upon pilot balloon observations of the upper air made every six hours and upon other observations taken hourly. In peace time, radiosonde observations were taken each morning at 3 a.m. in the upper air at heights of 50,000 feet. The radiosonde, a miniature radio broadcasting station weighing less than 2 pounds, is sent aloft attached to a carrier balloon. Observations of the temperature, air pressure and humidity are broadcast continuously by the radiosonde device and received aboard the cutter by a special radio receiver.

Nine-lens camera for flying boat will cover 300 square miles at 20,000 feet



76 1245

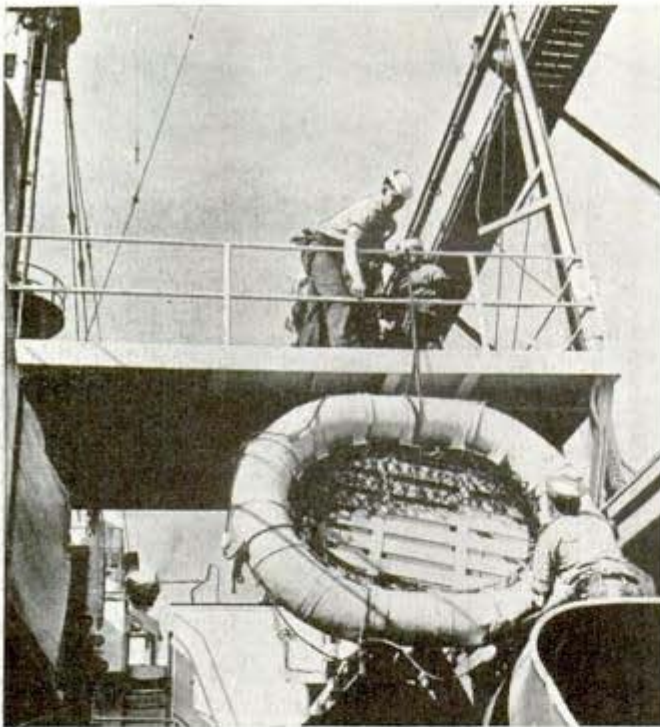

Extra life rafts are being stored aboard all Coast Guard ships

The Coast Guard's long experience in ice-breaking activities has already proved to be valuable in the national defense program. Last spring the Coast Guard opened the Sault Ste. Marie locks on the Great Lakes on April 13—the earliest navigation through the locks in 40 years. This record-breaking opening of ice-choked channels after a severe winter made possible the passage of ships from ore ports on Lake Superior to lower lake ports such as Chicago, Detroit and Cleveland.

An injured man brought ashore by rescue plane is removed to a hospital



Last year, for the first time, the Coast Guard sent one of its Grumman JRF-3 planes and a communications truck to the Great Lakes area. Each day reconnaissance flights were made to obtain information on the position, movement and thickness of the ice. This information, co-ordinated with reports from shore stations, proved valuable in sending ice-breaking ships to the proper places at the proper time.

The Coast Guard played an important role in putting into practical use the marine radio beacon—said to be the most important development in lighthouse engineering in recent years.

Radio beacon signals were broadcast from 144 lightships and lighthouses along the Pacific, the Atlantic and the Great Lakes. They are especially valuable to navigation because they are audible night or day, in clear weather

or in fog. They have a maximum range of up to 200 miles.

A simple dot and dash signal, broadcast on a definite time schedule, serves to identify the sending station. Then by means of a radio direction finder the listening ship determines the direction from which the signal comes. As radio beacons are audible far beyond the visibility of the most powerful lights, a comparatively small number of stations can effectively mark the navigable waters of the United States.

To carry on its wartime duties, in addition to its many regular jobs of peace time, the Coast Guard is increasing its personnel.

The Coast Guard Reserve, set up by Congress on February 19, 1941, created a reserve force of several hundred officers and enlisted men—all of whom are now on active duty. This organization is comparable to the United States Naval Reserve whose officers and men are called to active duty during a national emergency and who return to

21245

m 216

civilian life when hostilities are at an end.

Taking a page from the experience of the British at Dunkirk who found that amateur yachtsmen, fishermen and other small craft operators performed gallantly, the Coast Guard has organized the Coast Guard Auxiliary. This is a volunteer organization which operates its privately owned boats to patrol the harbor and coastline. Already there are thousands of volunteers and small boats in this organization.

The Coast Guard's role in America's defense was foreseen some time ago and steps were taken to provide a larger number of trained officers.

At its own Academy, the "Annapolis" of the Coast Guard, a new library, barracks, infirmary, ordnance building, boathouse and wharves are being built. The Coast Guard cadets undergo a four-year course of mathematics, seamanship, navigation, communications, history, foreign languages, etc. Upon graduation the young officers are commissioned as ensigns with the same pay and opportunities of promotion as in the U. S. Navy. *see ad. 18a.*

The Coast Guard has cheerfully shouldered another job in taking over the training of merchant seamen for the U. S. Maritime Commission. At training stations on both the Pacific and the Atlantic coasts, men without previous sea experience are whipped into shape to serve with America's fast-growing merchant marine. It is planned to train 1,000 licensed officers and 6,000 men under this program.

on messenger

Pulp to Paper at 13 M.P.H.

Forty million tons of wood per year are used for paper making in North America, yet this is but five percent of the timber cut. The rest goes into lumber, fuel and other uses. Some mills are turning pulp into paper 270 inches wide at more than 1,200 feet per minute.

JUNE, 1942

"Plug-in" Electric Belt Conveyor Saves Factory Elevator



This belt conveyor is ready for immediate use, needing only a convenient floor opening and connection to an electric outlet

Built ready for immediate installation, an endless belt conveyor prevents congestion on factory elevators in moving bags and other packaged material from one floor to the next. It is only necessary to cut an opening in the floor, hoist the unit in place and anchor it, then connect it to the nearest electric outlet. The ridged rubber surface prevents material from slipping.

m 194

Rolling Thumber for Casting Reel Saves Wear on Thumb

Novice casters are offered a reel thumbing attachment to aid them in handling the rod and reel. The attachment is said to prevent back lashes and "birds' nests." Spinning of the reel is controlled by pressing a rubber roller against it, thus avoiding direct contact with the line which might result in a raw thumb. Made in two sizes, the "thumb reel" works equally well on reels with or without level winders, and is attached easily by snapping its metal plate over one of the reel pillars and a wire spring under the next pillar so the roller may ride between them. Tension may be adjusted to suit the fisherman.



The Rapids Standard & Rapids News 535 B and Coast Guard Street

11111111

Pachner + Koller & Co. 2310 W. 69th

21314

"FLYING MULES" of the ARMY

Const. by Hamilton, Calif.
Westwood Ave. West Los Angeles
Calif.



Men and equipment being loaded into an army transport—one of the "flying mules"

ONE of the biggest, busiest and most rapidly expanding airlines in the country is the 50th Transport Wing, which is a freight and passenger-carrying section of the U. S. Army Air Forces.

Daily its big two-motored Douglas planes shuttle back and forth across the country or fly over mountains, jungle and blue water to reach such outlying bases as Newfoundland, Puerto Rico, the Panama Canal and Alaska. The line flies as much freight as 19 other major airlines and it stands fifth in the number of passengers carried. Its

planes have taken off on schedule for the past six years in storm, snow and fog, but it has never lost the life of a passenger or pilot through accident.

In other wars the U. S. Army has been content to rely on plodding mules, slow freight trains or lumbering trucks. But in this age of mechanized speed it has turned to air transportation—which is about four times as swift as rail transportation.

One of the 50th Transport Wing's major jobs in the past three years has been to fly airplane parts and supplies from manufacturers to assembly factories working on government contracts. The Army wants planes in a hurry, and it's willing to do its share to help "get 'em into the blue."

Likewise, the 50th Transport Wing carries propellers, motors, gas tanks, wing sections, landing gear and other necessary spare parts to outlying Army bases. As war needs demand, its

1177 '14
Westmoreland

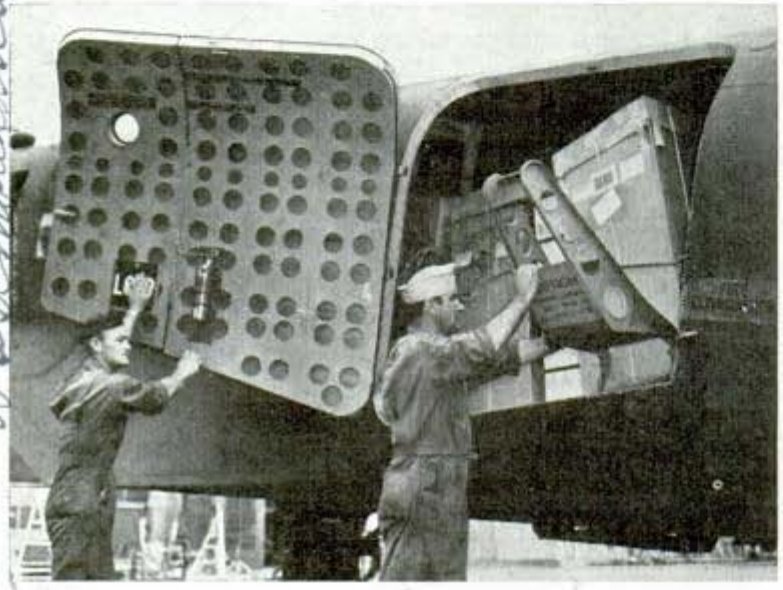

Freight loaded into army transport; 50th Transport Wing carries as much freight as 19 other major airlines in U. S.



Model planes are used in teaching Air Corps students certain flight maneuvers

cargo may be machine guns, light artillery, ammunition, blitz buggies or motorcycles. Army officers, engineers and civilian advisors ride the Army air line from coast to coast. Many precious days spent in transit are thus saved. Another of its jobs is to carry parachute troops.

Organized in 1935, the U. S. Army transport organization consisted then of four squadrons—each equipped with two C-27 Bellanca Airbuses. In 1936 the squadrons were augmented by two Douglas DC-2's per squadron. In 1938 speeds and payloads

were again boosted with the addition of 24 Douglas DC-3's. In that year, too, the service was extended to include regular interdepot flights and subsequent coast to coast flights.

At present the 50th Transport Wing has a large number of transport planes basically similar to the Douglas DC-3's which fly commercial airlines throughout America. The number is increasing and when a new Douglas plant gets into full operation hundreds of new C-47's will be added.

Commercial planes are like huge, silvery

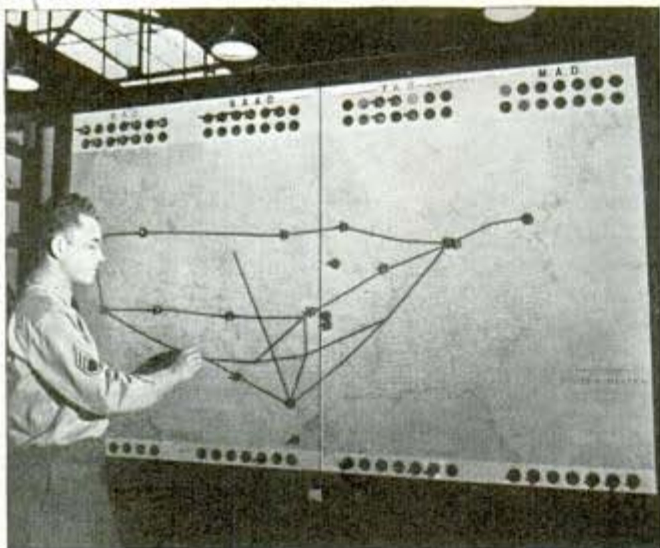

Routing board shows position of all planes at all times to officers in charge of 50th Transport Wing's operations



Rolled in felt pads, some kinds of supplies, including guns and ammunition can be parachuted safely to the ground

Special armed units—the parachute troopers and air-borne infantry—are moved rapidly by means of army transports



birds, but the Army's "flying mules" are drab and colorless with camouflage. Inside, though structurally similar to the passenger planes, the Army transports lack soundproofing, deep upholstering, and interior decorations which have made American commercial planes the last word in luxury. The transports, bare and utilitarian, are built for work. The floors and sides of the cabins are sturdily reinforced with heavy sheet metal to support the heaviest of loads. Special fittings make it possible to bolt and lash down cargo. More than 7,000 pounds of freight can be carried in a single plane. Each plane is equipped with its own portable crane and hoist so that loading and unloading can be done by the crew's members, if necessary, without ground equipment. Doors are extra large so that cargo can be loaded and unloaded quickly. When propellers are carried, they are lashed to the underside of the wings instead of being stored inside the plane.

Wright Field, Dayton, Ohio, is headquarters and "nerve center" for the 50th Transport Wing. Here, flight schedules are made up and teletype communication is maintained with the other Army depots throughout the continental United States. When a plane sets out on a flight, it is spotted on the routing board and its movements are followed through the entire flight. This enables headquarters to keep a close check on all planes at all times.

A regular schedule of flights is maintained from Wright Field to Fairfield Air Depot, Fairfield, Ohio; Middletown Air Depot at Middletown, Penn.; Sacramento Air Depot at Sacramento, Calif.; San Antonio Air Depot at San Antonio, Tex.; Ogden Air Depot at Ogden, Utah; and Mobile Air Depot, Mobile, Ala.

Under construction are several more large supply and regular depots, each of which will be served by regular freight schedules of the 50th Transport Wing.

L1314

M 20 9

For some time there have been regular, 2,116-mile flights from San Antonio to air depots in the Canal Zone. Flights from Sacramento to Alaska and trips to Newfoundland and Puerto Rico also are made.

The 50th Transport Wing takes its pilots from the young men who have won their wings at Kelly Field, the Army's advanced flying school in Texas. It picks men whom it thinks will make the best "big ship" pilots—steady, cool-nerved men instead of the impulsive, daring chaps who will make better fighter pilots.

Precise information on the activities of the 50th Transport Wing is a military secret, but figures for 1940 indicate the bustling growth of this airline. Some 13,311,000 pounds of cargo were moved, some 5,800 passengers carried, a total of 2,615,573 miles flown, 5,019,691 ton-miles flown and 2,377,933 passenger-miles flown—representing 100 to 200 percent increase over 1939. And 1941's figures probably would show a similar increase over 1940.

Let's picture a typical flight.

A drab-colored two-motored transport has just been overhauled at the Middletown, Penn., depot. The teletype chatters out this message from Wright Field:

"Proceed to Fairfield depot. Pick up motors, propellers and gas tanks for San Antonio."

The Army-trained pilots get into their flying gear and the transport trundles down the field and slips into the air. After about two hours of flying the big ship reaches the Fairfield depot.

As soon as it lands trained crews start loading. Engines on mobile shipping cradles are whisked out of the hangars and hoisted into the plane, propellers are mounted on special underwing carriers, and smaller articles are stowed away where space can be found. The businesslike manner in which the plane is loaded is a lesson in military efficiency and co-ordination.

As the plane nears St. Louis, however, another message comes by radio:

"Proceed to Kansas City. Leave cargo there and pick up aluminum castings for Santa Monica."

This change in orders is nothing novel to the pilots who fly the Army transports. Frequently load changes are made to rush material of a higher priority to places where it is sorely needed. The motors, propellers and gas tanks will be shipped to San Antonio on the next plane.

Machine-Gun Sheds Barrel By Pushbutton Release



Pressure on button releases machine-gun barrel

Quick removal of the barrel is a feature of a sub-machine gun, the invention of an Australian soldier, which has become an important weapon in arming men of the British Empire. After firing 300 rounds, the hot barrel of the 10½-pound gun must be replaced, and its simple mechanism makes it possible to complete the change in a few seconds at the touch of a button. The gun is said to be extremely deadly, too, having a greater velocity and deeper penetration, with lighter recoil.

Folding Slippers in Leather Kit Fit in a Coat Pocket

Slippers that fold into a small space are offered in a leather case for travelers and men in the armed forces. The kit, which has a slide fastener, is so compact that it can be carried easily in a coat pocket.



The case is handy for travelers or for service men

m 140

Ninety-Foot Jump in 'Chute Makes Indoor Record

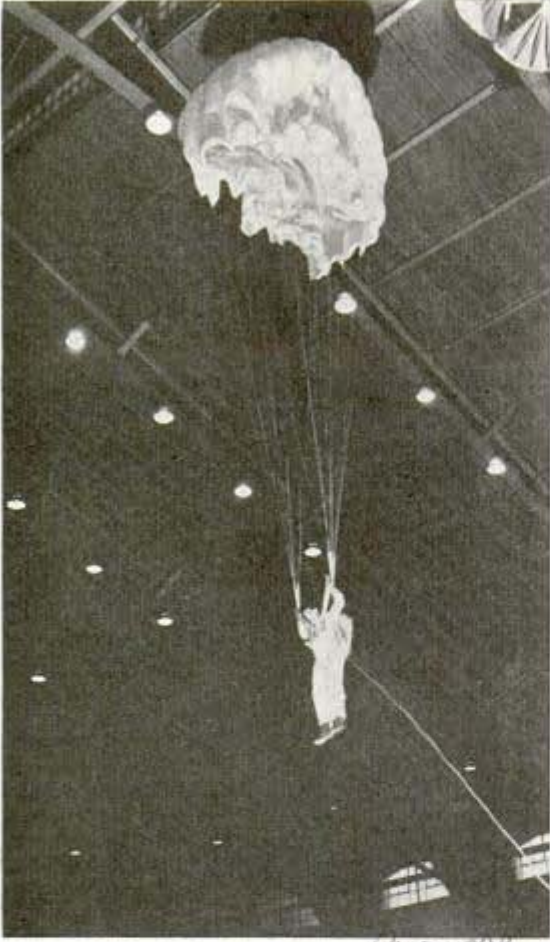

Jumper starting his fall from ceiling 90 feet up

What probably is a record for indoor parachute jumping was achieved by Carl Rupert, expert jumper, when he made his first indoor free fall from a 90-foot height in the International Amphitheater at Chicago. The stunt was performed as a public demonstration of the speed and control attained with a descending parachute.

m 266

War Puts Silver to Useful Work In Industry Instead of Coin

Silver as a useful metal has always been overshadowed in the public eye by silver as a precious metal—the metal of coins and jewelry and tableware. In the wartime economy, however, the industrial uses of silver are coming to the front. The heaviest industrial consumers of silver even in peace were the photographic film makers. Now silver is being substituted for copper,

brass, stainless steel and other "scarce" metals. It is easily fabricated into rods, wire, tubes, strips and sheets and will alloy with most common metals. Sterling silver, which is 925 parts silver and 75 parts copper, is the best thermal and electrical conductor and fine silver wire is replacing copper wire in coils. Silver brazing alloys are used for joints between metals, saving tungsten. Because of its germicidal quality, silver is proposed to replace tin as a lining for food cans, and lead-silver solder is proposed for sealing containers. Silver is relatively plentiful in America, and its consumption in industries and arts in the United States and Canada last year reached a record high of 80,000,000 ounces, nearly double the 1940 consumption.

m-197

Japs Set Fake Periscope Adrift In Attempt to Fool Allies

Japanese seamen have devised a new stunt in an effort to lure United States Army and Navy forces into wasting bombs and shells. Found floating off Pearl Harbor by our naval patrols was a dummy periscope made of wood, bamboo, glass, tin cans and a bit of coral for ballast, apparently set adrift as a "fooler." Authorities say trained observers could spot it as a fake in a few seconds.



One of the dummy periscopes found by navy patrol

44 *Condensed Air Magazine March 1942*

m 202 The Lady Patents

Portable Airplane Detector Worn by "Spotter"

Civilian and military airplane "spotters" can convert themselves into mobile listening stations with the aid of a portable plane detector designed for use where more elaborate units are not available. Sound of an approaching plane is picked up by a microphone centered in a parabolic concentrator worn as a headpiece. When a low-pitched sound is heard in the earphones, the listener turns his body until the sound is at its loudest, in which position he will be facing its source and can focus his binoculars swiftly and accurately on the aircraft for identification. The amplifier, batteries and accessories are housed in a carrying case slung over the watcher's shoulder. Three miniature tubes are used in the amplifier. Filters eliminate noises other than those created by airplanes. Volume can be controlled to suit the operator.



One Bouton St. South Norway Conn

Walking airplane "spotter" locates approaching craft by turning until sound picked up by directional microphone and heard in earphones is at loudest point

Lock Nuts on Auto Wheels Help Prevent Theft of Tires

Tire thieves would find it almost impossible to remove automobile wheels equipped with the new Pontiac wheel lock. It consists of two lock nuts holding a steel strap over the wheel hub. Replacing the

regular wheel nuts, the lock nuts can be removed only with a special wrench fitting only that particular set.

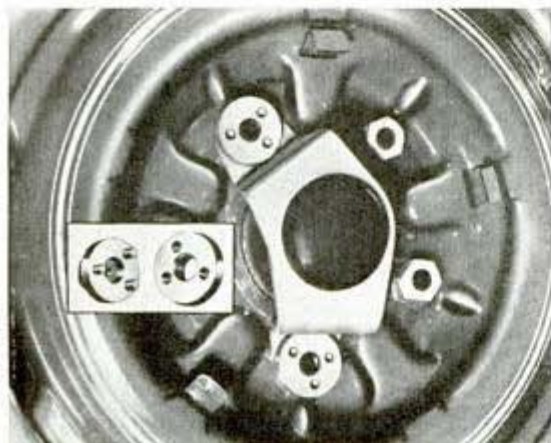

Locked wheel. Inset, special wrench head fits nut

Message Travels 27,000 Miles To City 700 Miles Away

Strange things happen to communications in war. When the Japanese cut the undersea cable between India and Sumatra, there was no direct line over which a bank in Madras, India, could communicate with its branch in Medan, only 700 miles across the Bay of Bengal. Radio service was not available. So the Madras bank sent its message to Bombay, India, by wire. From there it traveled by radio to London, and RCA radiograms leaped successively from London to New York, on to San Francisco and thence to Medan. To span 700 miles, the message traveled 27,000 miles.

JUNE, 1942

sold here Louisa

Radio Corp of America 45
30 Rockefeller Plaza

in 19.6. newspaper clip.

Hatches in Hull of Steamer Launch Jap Barges

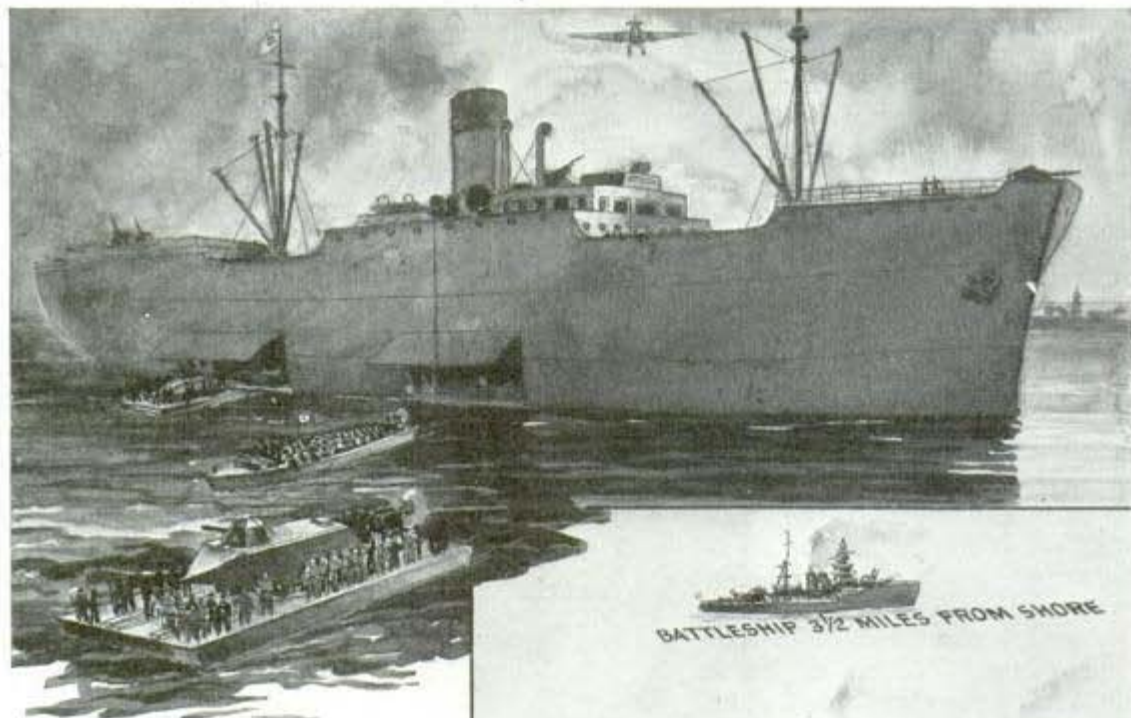

Landing tactics of the Japanese, as disclosed by the U. S. War Department, are illustrated on these pages. Guarded by a line of destroyers close in and a battleship or cruiser $3\frac{1}{2}$ miles off shore, the transports at dawn launch barges from side hatches (above). One type of landing barge is driven by an air propeller

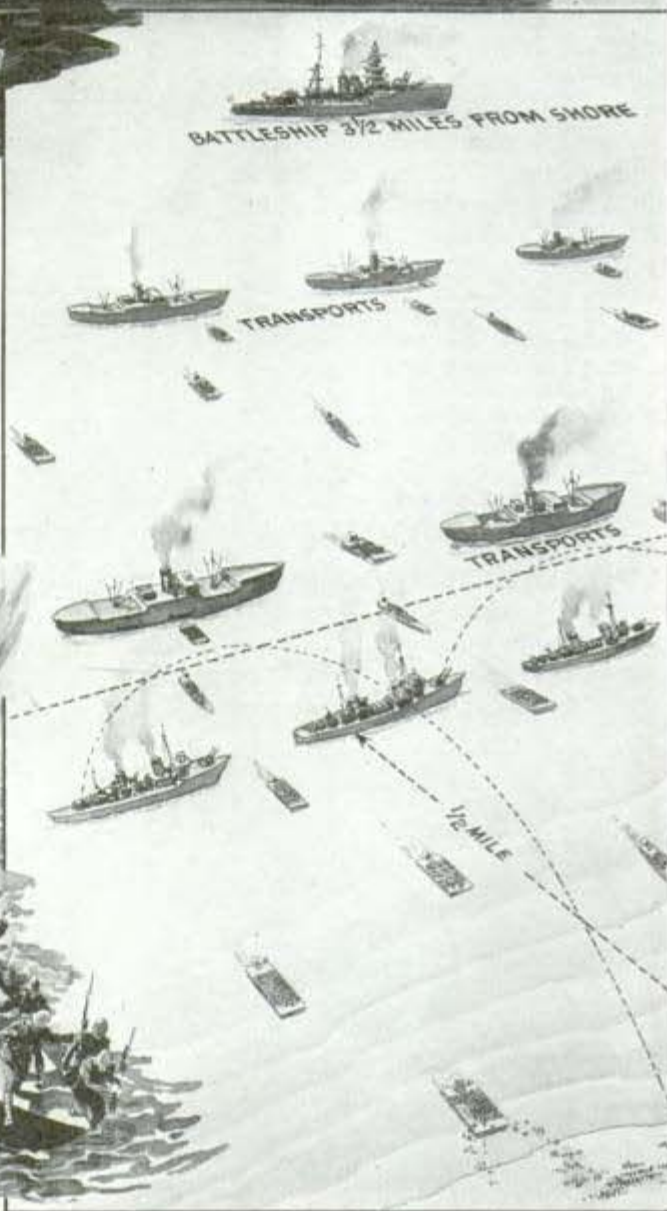
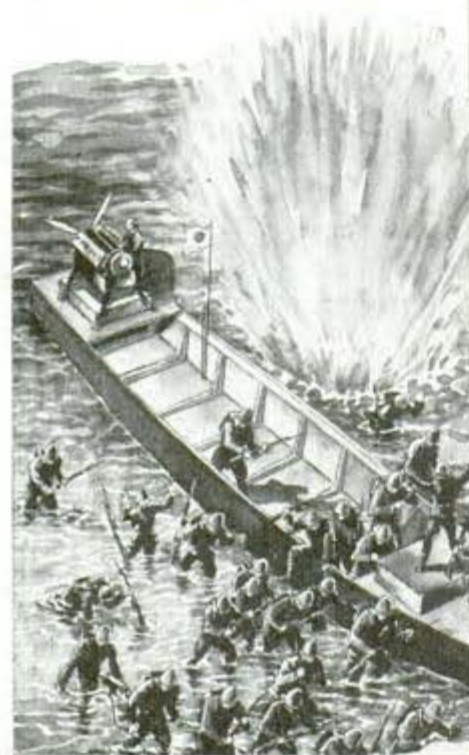

m 196

Warships Cover Landing of V-Shaped Tanks

Choosing a time when high tide occurs in the darkness of dawn, the barges move ashore while howitzers on the destroyers lob shells on the beaches. The Japanese land tanks from whose sharp-pointed prows anti-tank shells usually glance off harmlessly (right); their .50-caliber machine guns fire armor-piercing shells. Observation and pursuit planes cooperate closely; in some cases orders are transmitted by radio from planes to company commanders (bottom) wearing receivers on their chests. Infantry attack forces usually carry only light automatic weapons and grenades



M 224

Hand Cart for Incendiary Squad Carries Water, Sand, Tools



While sand is dumped on blazing bomb, the lid acts as shield

Among the new fire-fighting tools is a small hand cart that carries all the equipment necessary to tackle an incendiary bomb. Its bin contains 200 pounds of sand. You push the cart close to the flaming bomb, tilt it forward to dump a little sand, then pull the bomb into the sand with the long-handled hoe. While you are doing this, the lid of the cart acts as a shield protecting you from the heat. Once the bomb is resting on the sand, more sand is dumped to cover it completely. Then the water tank on the handle of the cart, holding two gallons, is turned over and becomes a sprinkler for extinguishing wood fires started by the bomb. There is also an ax on the side of the cart.

Russia Gets Rubber From Plant Like American Dandelion

After a decade of search for a native plant that would yield natural rubber, Russian scientists have begun large scale cultivation of the Kok-sagyz, a cousin of

the American dandelion. Harvested at the end of the first year, these plants have yielded 4,500 to 5,500 pounds of cleaned roots per acre; and from the roots 150 to 200 pounds of crude rubber were obtained. The Kok-sagyz grows best in black soil rich in organic material, especially nitrogen and superphosphates, and needs over 20 inches of rainfall per year, much of it in the spring. As long ago as 1938, Russia had 170,000 acres of Kok-sagyz under cultivation and expansion to 2,500,000 acres was planned. American agriculturists believe the plant could be raised profitably in this country. After extraction of the latex from the root, the non-rubber constituents might be used for other purposes and the green portion turned into cattle feed.

Scoop for Farm Tractor Lifts and Carries Load

Built for easy attachment to the rear of most farm tractors, a one-man earth scoop and carrier makes for fast, efficient and economical work. Under constant control by means of a hydraulic lift, the scoop excavates earth from one to twelve inches below the tractor wheels, and when full the shovel is lifted clear of the ground and carried away without dragging. The load may be dumped or spread while the tractor is in motion, thus permitting a continuous routine.



Scoop can raise load above ground and cart it away

Masters Planter Co. Benton Harbor Mich

M 182
2653
Cement
Stockland Road
34th Ave S.

M 267

48 National Farm

Chemurgic Council
507118 St. Louis
Columbus

m 238.

Steel Fort in Sea Guards Approaches to Britain

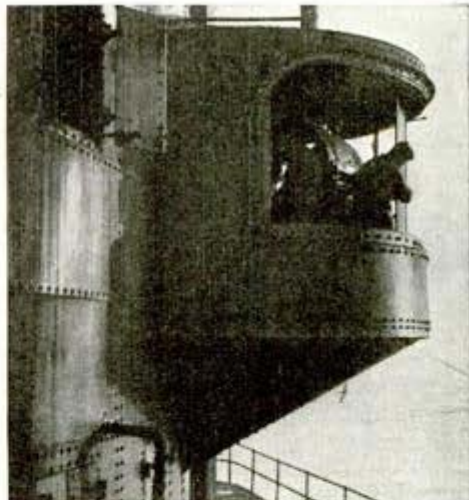
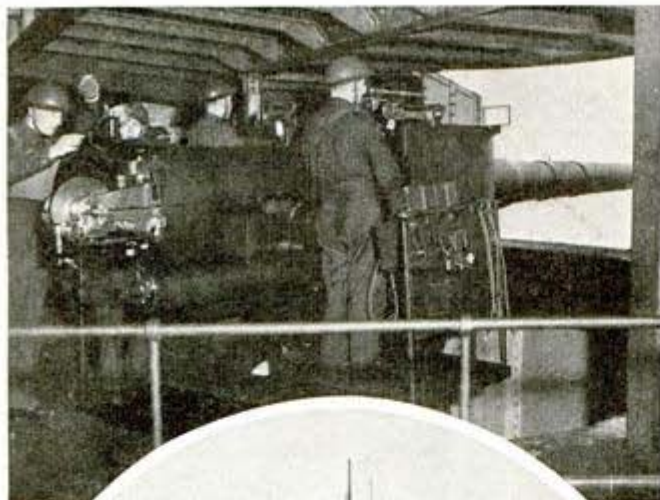

Above, at left, Royal Artillery men at one of the big guns; right, a searchlight bay. Below, the steel island fort

In a steel island fort built up from the sea floor several miles off the coast, a Royal Artillery regiment stands constant guard over the sea approaches to Britain. Big gun turrets fan out in every direction, and searchlights are ready to point the finger at enemy ships or aircraft. The walls are of heavy armor steel. High seas often cut the fort off from contact with the mainland, but despite the limited accommodations and monotonous existence, morale is high.

British Combustion Photos

m 234

Catwalks on Roof of House Give Access to Bomb Fire

If an incendiary bomb ever drops in on Frank Terramorse at his Menlo Park, Calif., home, he's ready for it. He has built catwalks along the top of the house and ladders and steps providing easy access to the rooftop. Barrels filled with water and sand have been placed at the junctions of the catwalks and there are buckets ready for dousing the bomb.

Ladders to the roof, catwalks along the top, barrels of sand and pails of water are ready for incendiary bombs



Presson

M-1

Crut: Thomas E. D'Amico, Jr.
 2872 Franklin Ave. Los Angeles

Ref: Paul Wells
 California State Fire Marshall's Office

Chamber of Commerce
 Los Angeles



Fireman adjusting self-contained oxygen apparatus as protection from dangerous fumes at industrial fire

NEW DISGUISES of the DEMON FIRE



A HELPER at an aircraft factory picked up an empty bucket, opened the faucet below a big tank of thinner, and —WHAM! The bucket blew up in his face.

A machinist idly turned his back on the lathe he was tending and a few seconds later the solid bar of metal being cut turned incandescent with heat. Liquefied metal dripped down on the lathe bed and warped the \$30,000 machine out of shape.

Neither of these happenings is part of a mystery story. Each really happened. In each case, fire or explosion resulted from handling materials so new to industry that their special hazards are not widely understood.

Many of the materials that science has developed for our everyday use have their chemical or physical dangers and we have had to build up elaborate safety rules to protect ourselves. Most people, for instance, know that it is foolhardy to hunt for a gas main leak with a lighted match. They know better than to try to revive a dying fire by pouring gasoline on it.

But the aircraft worker who was badly burned when his bucket blew up in his face wasn't violating any safety rule he had ever heard about. No one could imagine what had happened until an expert discovered that the buck-

Painter at Douglas plant working on wing insignia. Big fan behind him carries spray vapors to exhaust system of paint room



Extinguishing gasoline fire with fine water spray that cools gasoline below ignition temperature

et previously had contained chromic acid and that a small amount of dried residue remained in the bottom. That explained everything because he knew that dry chromic acid and the acetone that is an ingredient in most thinners form an explosive mixture that is as certain to "take off" as T.N.T.

Today in that plant, as in most others where chromic acid is used to prepare metal surfaces before painting them, such acid is handled only in brightly colored containers that may be used for no other purpose. Properly used, it is entirely safe.

Studying various types of nozzles used in fighting different kinds of fire





Demonstrating how sand is thrown out of tube to blanket fire like that of burning magnesium

The metal bar that caught fire seems mysterious but it was only another case of a new material that must be handled properly. The bar was composed of magnesium, the light metal that ignites at temperatures comparable to most woods. Ordinarily, when magnesium is being worked in a lathe, it is kept cool by a stream of cutting



"Dope room" worker at Douglas plant depositing matches as he enters working quarters

oil or other coolant that constantly pours over the metal. In the case above, scraps and chips had clogged the cooling system and stopped the flow just as the machinist turned his head. Within a few seconds the bar had built up enough heat from friction with the cutting tool to ignite. Repetition of the accident was prevented by installing a filter screen in the cooling system to avoid such clogging.

Thousands of tons of magnesium are being used every year in aircraft manufacture alone and its properties of lightness and strength suggest that it will be even more widely used in the future than it is today. Magnesium is perfectly safe as long as it is used with proper caution and as long as good housekeeping is observed in the shop while it is being worked. Scraps and filings must not be allowed to accumulate around lathes and saws. In many plants such cuttings are removed with a whisk-

Rookie firemen learning to use nozzle that throws a heavy stream of water



m-1

broom almost as soon as they fall. Magnesium scrap goes into special containers and shouldn't be mixed with other scrap. Especially it should not be mixed with iron scrap because the combination of these two metals forms one of the hottest fires known, once ignition has taken place. Fire prevention agencies and fire fighters long have been looking for a satisfactory extinguisher for magnesium fires. The trouble with magnesium is that the metal is a great thief of oxygen and steals oxygen from water or any other material containing it, thus increasing its own combustion.

Apparently the best extinguisher so far devised is a mixture of several viscous liquids and carbon dioxide, a combination perfected by Michael Farris of Vega Aircraft Corporation. This extinguishing agent, used in the Vega machine shop, has put out minor magnesium fires in lathes and milling machines in a matter of seconds.

There are only two ways in which a fire of any sort can be extinguished before it consumes all the flammable material it can



Fireman standing by with extinguisher as motors are tested

reach. One way is to blanket it away from the oxygen it needs, and the other is to cool it down below its ignition point. Magnesium, however, contains enough oxygen to keep going even when smothered with dry sand, and its fire is so hot that it can't be cooled below its ignition point by ordinary methods.

An instance of the odd way in which a material that apparently is safe can cause a bad fire happened at sea a short time ago. Fire started in a ship's hold that contained cases of photographer's flash bulbs and a quantity of industrial alcohol. These items are considered safe cargo and there seemed no way in which the fire could have started.

It was a real mystery until one of the inspectors, exasperated by the puzzle, threw down a flash-bulb he had been holding. The bulb broke, of course, and shortly



Cleaning up magnesium scrap in airplane company's machine shop reduces the hazard of fire



Portable fire-fighting equipment of type used in airplane factory

afterward a newspaper it was lying on broke into flames. Now there were two mysteries instead of one. Investigation showed that this type of bulb, manufactured under foreign patents and perfectly harmless in its intended use, contained a chemical mixture that was apt to self-ignite when exposed to air, as when an unused bulb was smashed. A few bulbs broken in a rough sea—that was the answer to the fire at sea. Sale or transportation of this brand of bulb is now forbidden, so don't worry about this hazard the next time you buy flash bulbs for your camera.

A good example of how proper precautions will safeguard a hazardous material is the way liquid petroleum gases including butane and propane are now handled. These hydrocarbon gases are used in some parts of the country as a truck fuel and for heating. They are stored under pressure in big metal cylinders.

Butane is as safe as gasoline when it is treated properly but its hazard wasn't fully understood five years ago when it first came into general use. Disastrous fires and explosions occurred, mostly from leaking containers. In one case a truck fueled with butane and parked at the curb was struck

a sharp blow by another car being parked behind. The blow damaged the pressure fuel tank and leaking gas flowed across the sidewalk and into a restaurant. Finally it reached the fire of a cooking stove in the rear. The resulting explosion did as much damage as if a bomb had been dropped.

Butane is a heavier-than-air gas and tends to flow down hill. It is apt to accumulate in pockets and remain there until a match or cigarette touches it off. Today butane installations in trucks are armored against the hazards of road shocks and collisions. When used for heating, present precautions are to install butane tanks out in the open, isolated from buildings, and protected from mechanical injury. Butane is as dangerous as gasoline when handled carelessly, and is as safe when handled properly.

Practically all the modern fast-drying paints and lacquers are dangerous under certain circumstances. Such paints in drying throw off a flammable vapor that in proper concentrations will ignite from any open flame, and sometimes over surprisingly long distances.

In industrial paint rooms, such as the department at the Douglas Aircraft Company where aircraft assemblies receive their camouflage paint and identification markings, this hazard is minimized by fans

(Continued to page 168)

Testing water curtain that picks up pigment in air of paint room

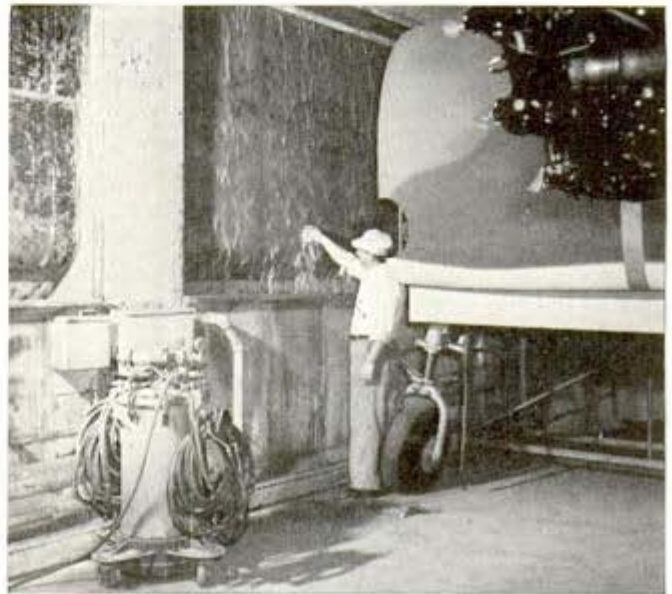

m/s.s General Electric Co. Schenectady N.Y.

"Big Gun" Cuts 230,000-Volt Line in 1/20 Second

Standing guard over the transmission line carrying power from the Bonneville hydroelectric plant to the war industries of the northwest is the fastest oil circuit breaker in the United States. It takes this huge electric robot just 1/20 second to interrupt the flow of 2,500,000 kilovolt amperes at 230,000 volts if a fault occurs in the transmission system.



Fastest-working oil circuit breaker in the land is this one, looking like a futuristic big gun as it guards the 230,000-volt power line of the Bonneville electric plant

m209

Wheel Reveals Accident Risk When Two Drivers Meet

Automobile drivers can be enlightened quickly concerning the degree of peril involved when various kinds of unfit drivers pass on the highway, with the aid of a "wheel of chance" constructed in modified form. It is used at the California Division of Drivers' Licenses, where persons wishing to learn rules of safe driving attend classes tutored by state driver's license examiners. The periphery of the wheel is

divided into sections indicating various good and bad driving habits, and each is assigned a number from 0 to 9, the numbers getting higher as the probability of accident increases. For instance, alert and keeping good distance are assigned 0, speeding 3, drowsy 8 and drunk 9. Spin the wheel and two arrows point out two types of drivers, designated as A and B. Adding the numbers indicates their chance of becoming involved in an accident. If the number totals five or more, it is believed an accident would result. In one example, driver A disregarded a boulevard stop sign and had a rating of 4, while driver B failed to signal for a turn, numbered 2. The total being 6, an accident would result. However, if either driver had been alert, with 0 for his number, the total would be less than 5 and there would have been no chance of accident.

Florence Sherman



Spin of wheel shows chance of accident when two cars meet

JUNE, 1942

*Dept of Motor Vehicles
25th and 1st Sts.*

all angles

□ All the light bulbs in the United States, burning simultaneously, would produce the equivalent of noon sunshine over a little more than a square mile.

*Georgia Tech Engr.
Jan. 42*

21337
Coul. Thomas E. Skinnon Jr.
3872 Franklin Av. Los Angeles

HIT OR MISS

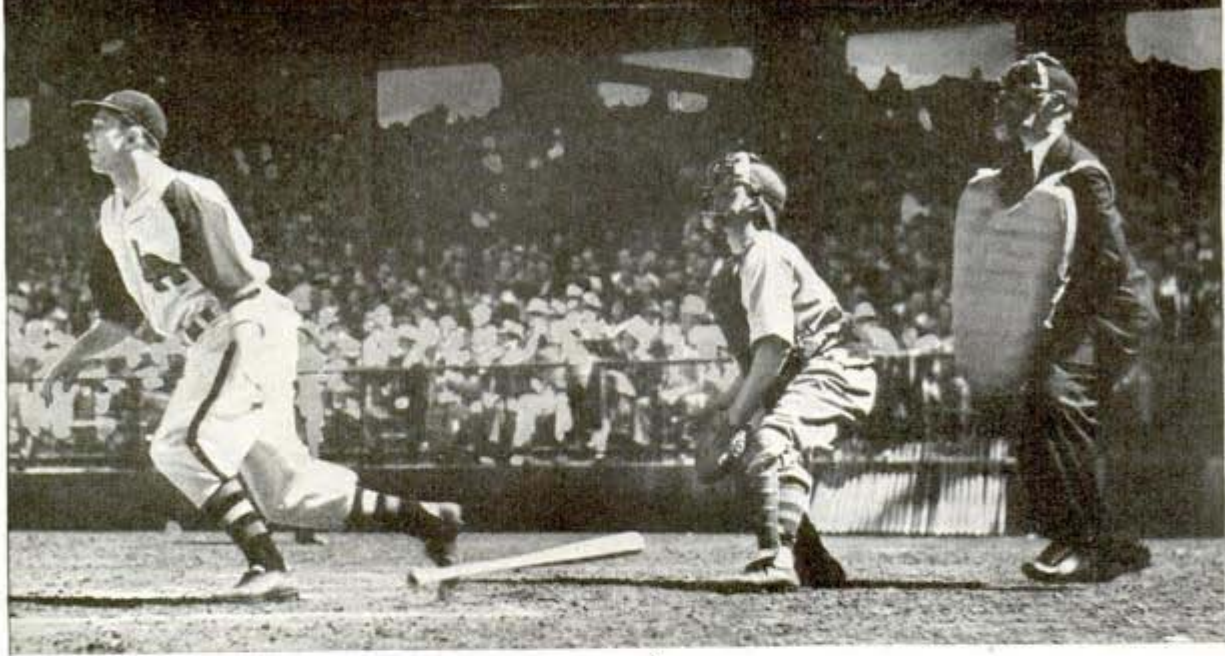

Right-handed hitter crossing plate on way to first base after making a hit

Catcher snatches off his mask as he prepares to try for a high foul ball near home plate

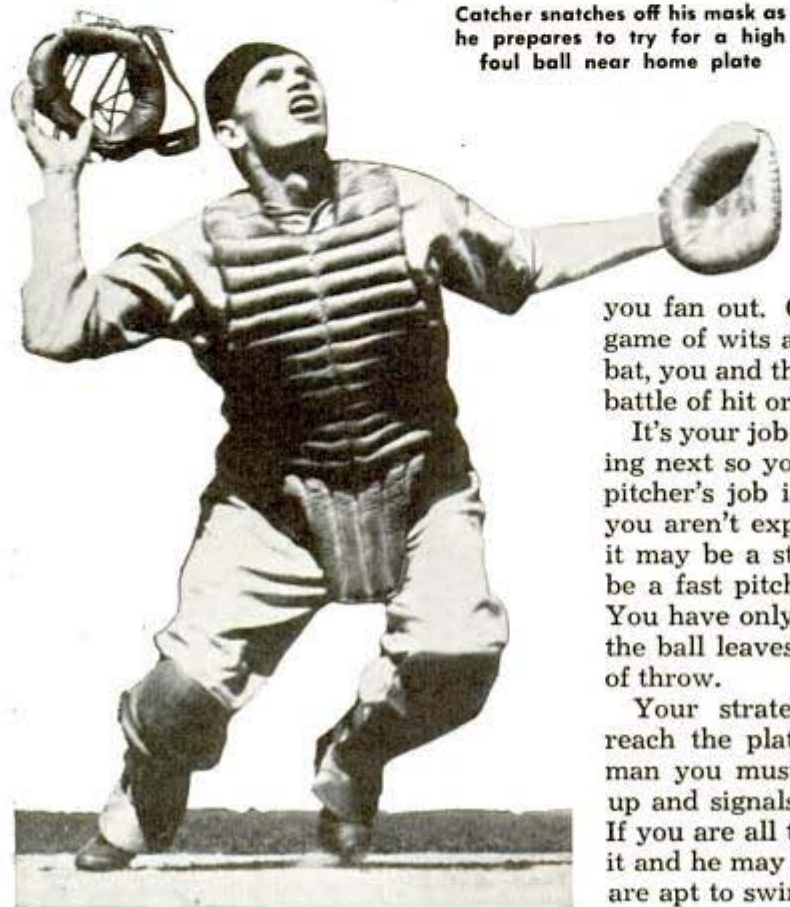

HAVE you ever hit a dozen balls in a row in batting practice and then struck out your first time at bat in a game? That often happens.

The reason is that the man who pitches to you in practice isn't trying to fool you, while an opposing pitcher uses every trick he knows to make you fan out. Good baseball is as much a game of wits as of skill. When you are at bat, you and the pitcher are opponents in a battle of hit or miss. And he has the edge.

It's your job to try to decide what's coming next so you can get ready for it. The pitcher's job is to throw almost anything you aren't expecting. It may be a ball or it may be a strike. If it's a strike it may be a fast pitch or a slow one or a curve. You have only a fraction of a second after the ball leaves his hand to judge the type of throw.

Your strategy starts the minute you reach the plate. The catcher is the first man you must fool because he sizes you up and signals the pitcher what to throw. If you are all tensed up the catcher senses it and he may call for a wide ball that you are apt to swing at even if you can't reach

21339

it. To relax your muscles at the plate, bend your knees and crouch down a couple of times.

Another thing the catcher watches is where and how you stand. If your position is awkward he may call for a strike right down the middle, knowing that it will find you off balance. Sometimes a batter is smart enough to stand in an awkward position purposely and then, just at the pitch, change to an easy stance that gives him full control.

If you are poor at reaching a high pitch, practice a high swing at the plate. The catcher may decide that you are all set for a high one and he will signal for a low throw, right where you want it. If you hold the bat all choked up you won't be able to reach an outside pitch and the catcher probably will be smart enough to call for one. If you think you know what sort of throw the pitcher is going to make next, don't advertise the fact by getting all set for it. The man behind you will signal for a different one.

How can you tell what the pitcher is going to throw next? You can't, always, but here are some tips from Lou Novikoff, leading hitter in the American Association in 1941, that may help:

"If he pitches a ball, the next one quite likely will be a strike, because pitchers like to keep trying something different. If a pitcher gets two strikes on a batter he feels pretty safe and is apt to throw a couple of balls. But if two balls have been called and no strikes the chances are a strike is coming up next.

"A pitcher tries not to signal what he is going to throw but many of them have mannerisms that give them away. One may betray the fact that he is about to throw a curve by the special way he steps, taking a shorter stride or planting his foot more to one side than usual. Some of them can't help making a face as they get ready for a curve. Another may

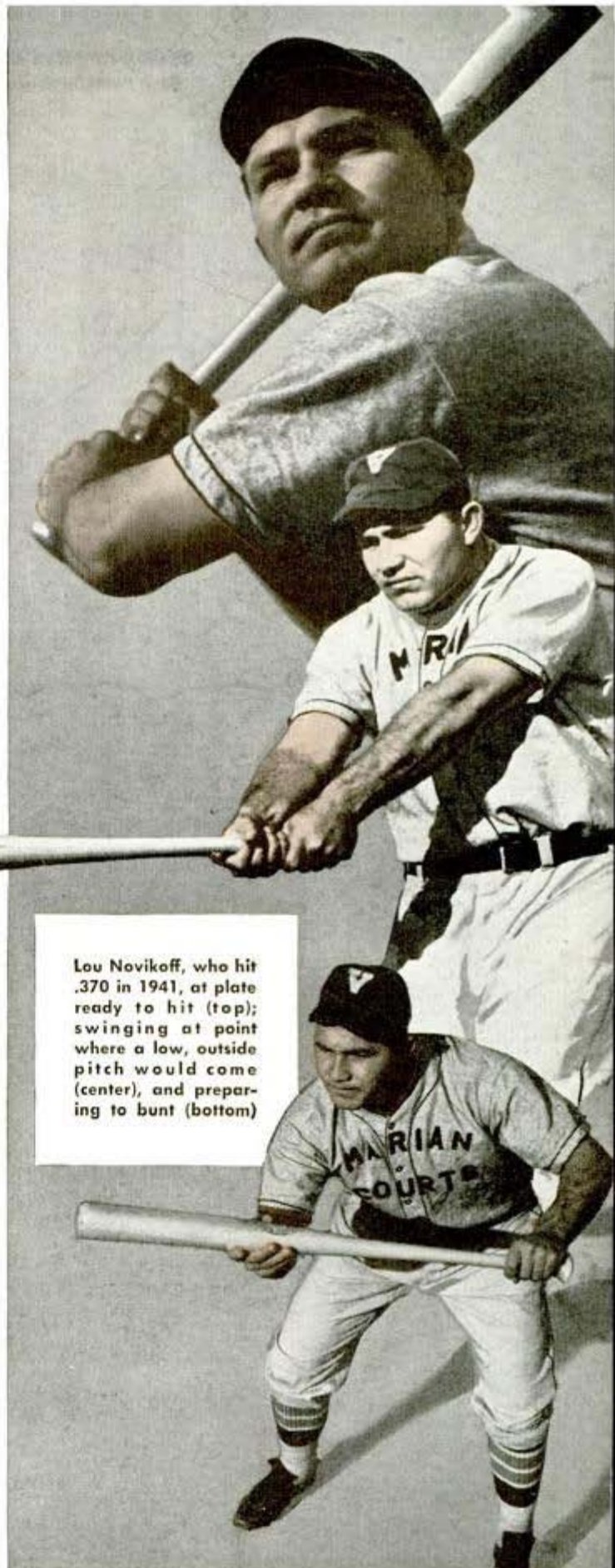

Lou Novikoff, who hit .370 in 1941, at plate ready to hit (top); swinging at point where a low, outside pitch would come (center), and preparing to bunt (bottom)

10324. Washington Aero. South Gate Calif

21337

Pitcher demonstrating two mistakes, one in holding ball with typical curve grip and the other in failing to conceal ball with his glove

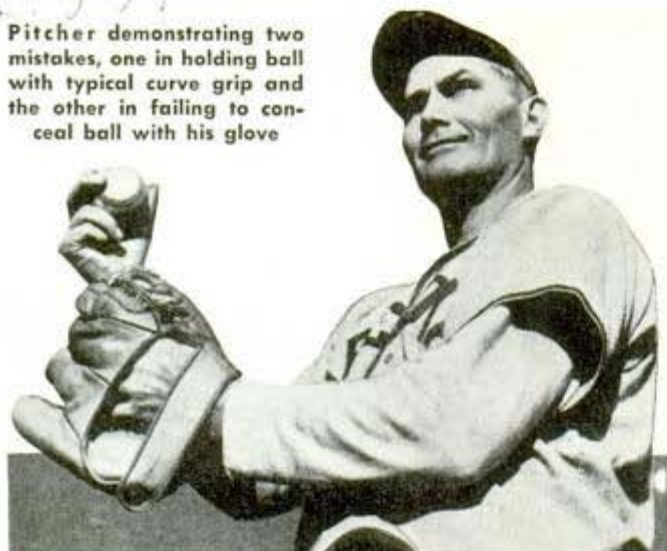

Some pitchers telegraph their intention of making a certain kind of pitch by mannerisms such as wiping hand across shirt before throwing curve

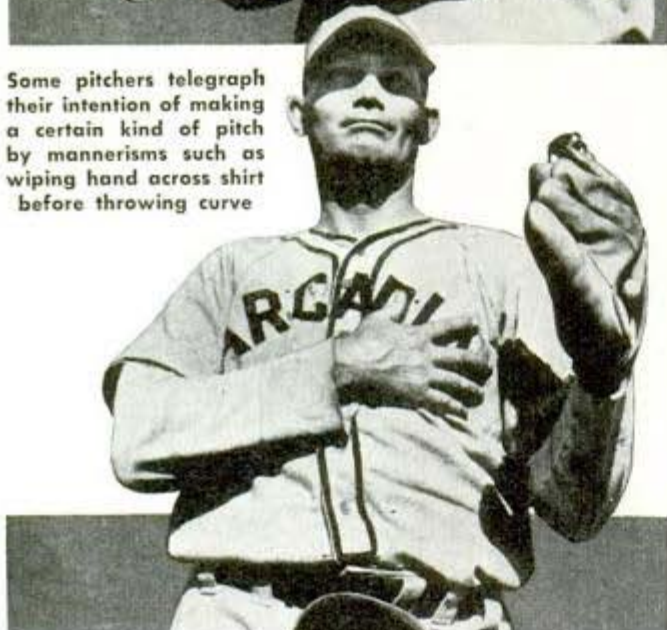

Unconscious habit of wetting his fingers before throwing a fast ball soon betrays the pitcher's intention; opponents study a pitcher's actions

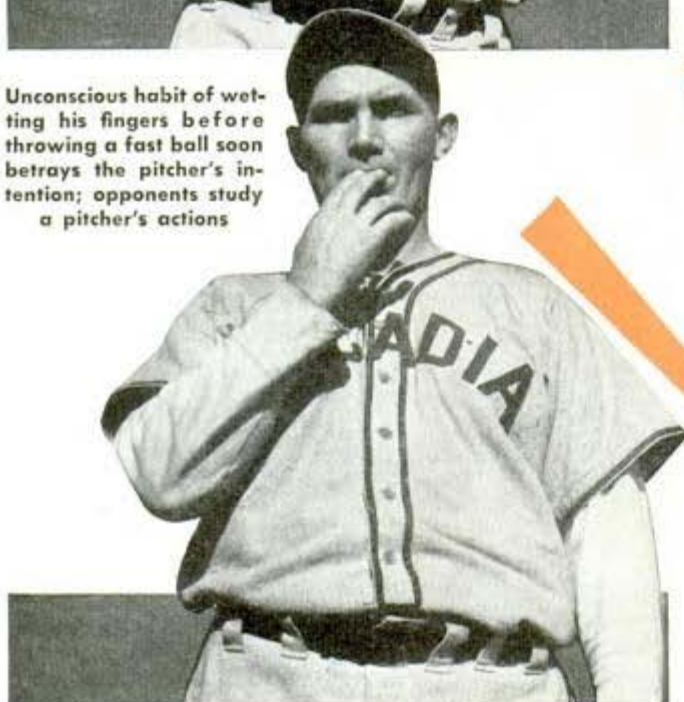

wipe his throwing hand across his shirt to dry his palm. Many of them throw curves with an overhand motion and the batter knows what is coming the minute he sees the arm go back.

"Some pitchers make a habit of leading off with a fast pitch. But don't be too sure that he will keep it up, even if he has done so for three innings. Just then the pitcher may start drifting them to one side, knowing that the batters are all set for fast ones.

"A tired pitcher loses his stuff and is easier to hit. When a manager can see that the opposing pitcher is getting tired he usually tells his batters to start swinging, especially if the score is close."

Stealing bases is almost a lost art now compared to the emphasis that used to be placed on this part of the game. A runner who has reached first is a long way from home, but if he can steal second he is apt to score the next time a long drive is hit. So, a fast runner can afford to take a chance stealing second unless he has been told to play it safe. He leads off as much as he dares, watching the

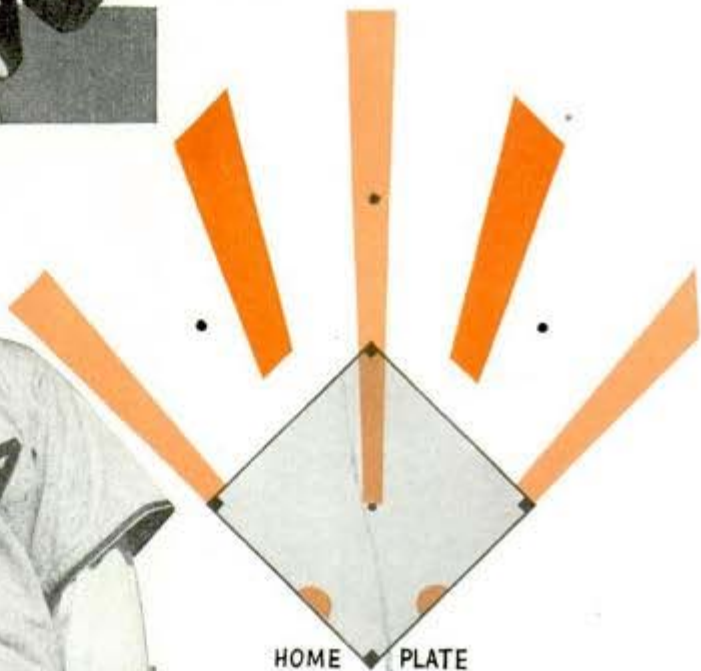

Shaded areas indicate parts of playing field in which the most safe hits are made; note bunting areas near plate



Runner caught in trap between bases; running the bases is almost a lost art

pitcher alertly because he must beat the ball back to first base if the pitcher tries to throw him out.

There is nothing hit-or-miss in the way the batting line-up is arranged. The first man at bat has only one duty and that is to try to get to first base. He must be able to hit safely and he must also be calm enough to wait it out and take a base on balls if the pitcher seems wild.

The second man in the line-up has the job of advancing the runner to second base no matter if he sacrifices himself in doing it. He must be a fast player who can bunt perfectly and he is preferably a left hander. A left-handed batter is two steps closer to first base and has a better chance to beat out a bunt. If the second man up has a chance for a long hit he should try to pull the ball over to right field behind the runner advancing to second, to reduce the chances of a double play.

The next three men up are the heavy hitters of the team. Their job is to bring home the men on bases. This is the spot for a home-run hitter, who sometimes drives two or three men ahead of him across the plate. Next come the weak hitters with the pitcher last. The pitcher is usually the weak-

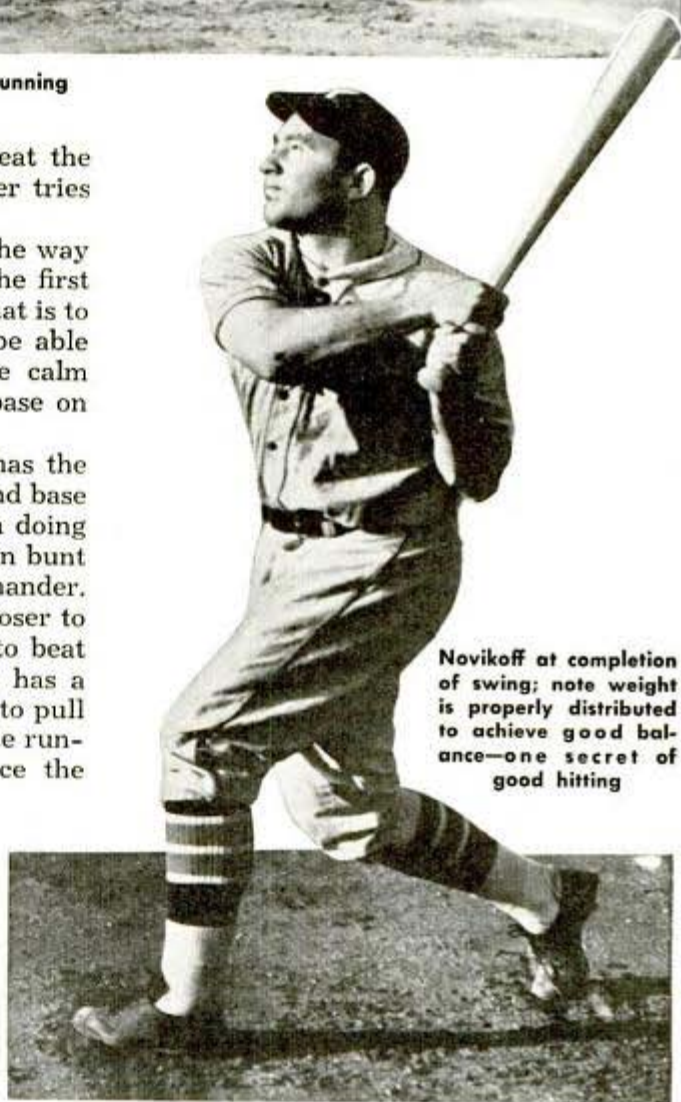

Novikoff at completion of swing; note weight is properly distributed to achieve good balance—one secret of good hitting

21337



Catcher signaling for pitch as batter stands at plate

est hitter and, in last place, he is apt to bat less often, conserving his strength.

The pitchers who are hardest to hit are the relatively few who "pitch out of their uniforms." Such a pitcher releases the ball toward the end of the throwing motion, when his body is behind the ball. It's easy to see the ball when the pitcher lets it go from above his shoulder but it's hard to see a ball against a light-colored uniform.

In the old days of baseball, managers tried to take advantage of this fact by playing tricks with the backfield fence. One such fence had a dark green panel behind the pitcher, an ideal background when the home team was at bat. But this panel was turned around to reveal a glaring yellow green surface when the visitors were up.

Another team placed a green advertising sign in the shape of a big disk on its backfield fence. It formed a perfect background when the home team was batting, yet the visitors could hardly ever hit the ball. Someone finally noticed that at the instant the home pitcher was throwing, the sign spun around, creating a moving background against which the ball was almost invisible. A boy behind the sign was spinning it with a crank.

Early in the century baseball teams tried all sorts of tricks to help them win. The grounds were "doped" in half a dozen different ways. Sometimes the area toward first base was hardened so that balls bunted to the spot bounced high in the air. The home team knew just where to bunt. Base lines were banked up to help prevent bunted balls from rolling foul. Often the pitcher's slab was elevated or depressed to suit the style of the home club's pitching staff. The grounds would be softened by soaking with water overnight before a game with a fast team, to help slow the visitors down. One stunt was to "soap" the dirt around the pitcher's box so that a visiting pitcher, reaching for dirt to dry his hand, got a greasy hand that made the ball slippery in his grasp.

All such tricks as these that give one team an advantage over another are obviously unfair. Modern baseball is played by teams that depend on their skill and wits alone to win. And often enough, a team that uses its brains will beat a team of better players who just aren't thinking as fast.



Ball delivered from over shoulder is easy to see

In 212 Etage - Reclayne Corp
Hands "Float" on Face of Transparent Clock

You could puzzle your friends with a transparent Mystery Clock now on the market. Its hands seem to float on air, since their means of support is not apparent except on close examination. However, manipulating the setting knob reveals the secret. The hands are each mounted on a separate glass disk framed in a metal ring. On the outside edge of the metal rings are teeth which engage rotating gears hidden within the base of the clock, where the tiny electric motor also is located.



Hands of Mystery Clock moving about the transparent dial have no apparent connection with the mechanism

In 208
Heater With Removable Casing Gives Access for Cleaning

Easy access for dusting the inner surfaces of a console-type oil or gas heater has been provided by equipping it with a detachable outer casing. Unscrewing four



Outer shell of heater lifts off for cleaning inside

wing bolts and lifting slotted metal pieces releases the covering, which can be accomplished while the heater is in operation, thus permitting the periodical removal of dirt before it escapes upward to lodge on walls and ceiling. In the salesroom the removable jacket allows the customer to examine the interior of the unit. Repairs and servicing are also simplified.

(To learn where to buy commercial products described in these pages, see the index.

In 187
Liquid Massage for Arm or Leg Is Given in Sealed Tube

Two Ohioans have patented a machine for administering a local treatment or massage by circulating liquid in a sealed tube into which the part to be treated, such as an arm or leg, is thrust. A seal at the open end of the tube prevents leakage. As the liquid is forced through the tube, ribs inside the tube impart a helical motion to the circulating fluid.

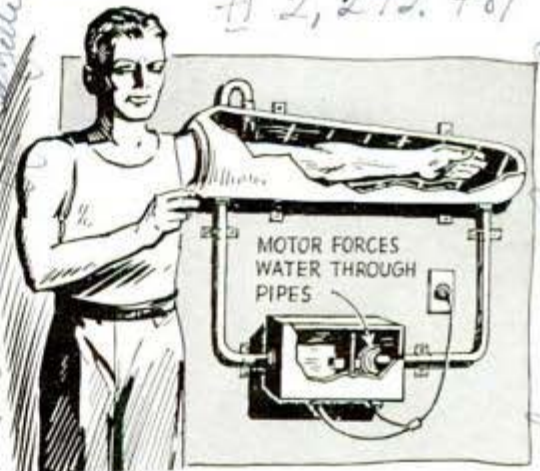

Forced circulation of water through sealed tube has the effect of a massage on arm or other part of body

WHY DIDN'T YOU

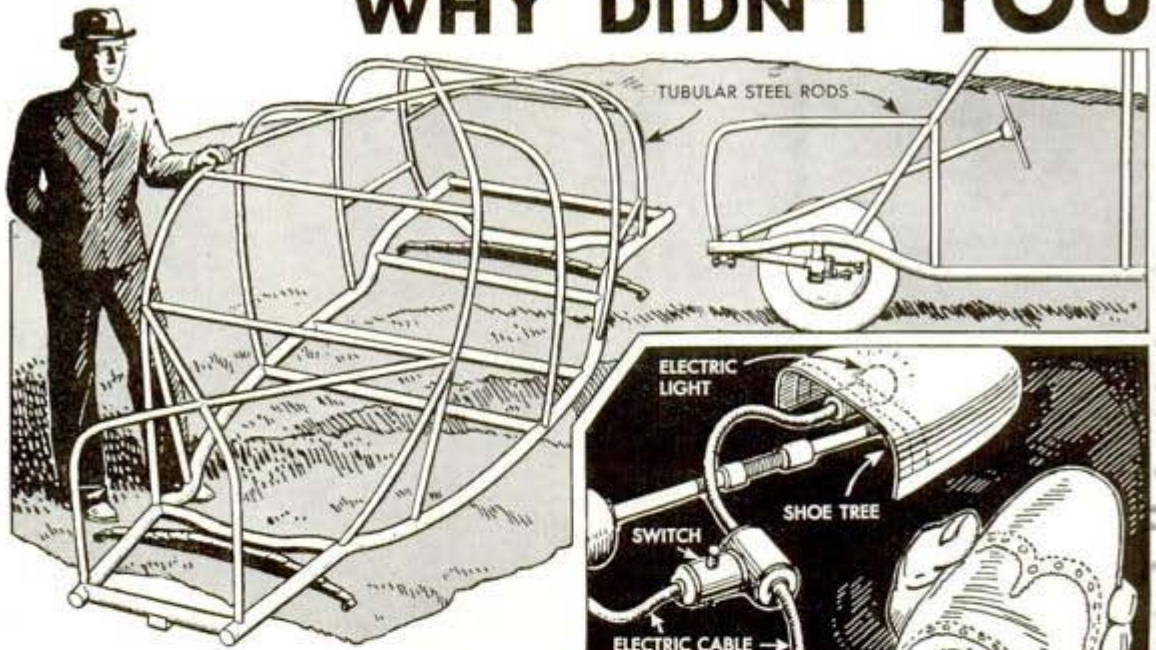

A hint of how the automobile of tomorrow will be constructed is found in two patents granted to the Ford Motor Company. They deal with a vehicle body composed of tubular-shaped members, a form of construction akin to methods employed in light airplane factories

Dragging extra lengths of cord around on ironing day may be eliminated by a U-clamp attachment which permits plugging in the iron just beneath the board instead of a distant wall socket. The attachment clips on the edge of the board

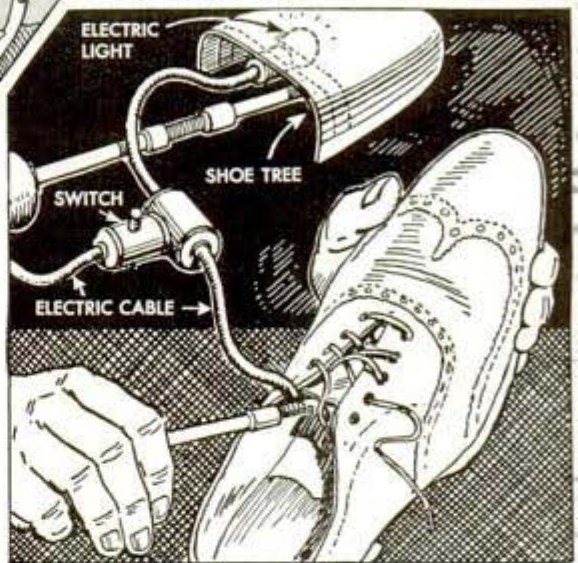

Shoes not only may be held in shape by a patented shoe tree, but may be dried out by the same means. Electric bulbs within each tree provide heat

(Since we have not been advised that items on these two pages are available commercially, Popular Mechanics Magazine cannot supply information to prospective purchasers; granting of a patent is no indication that an item is ready for the market)

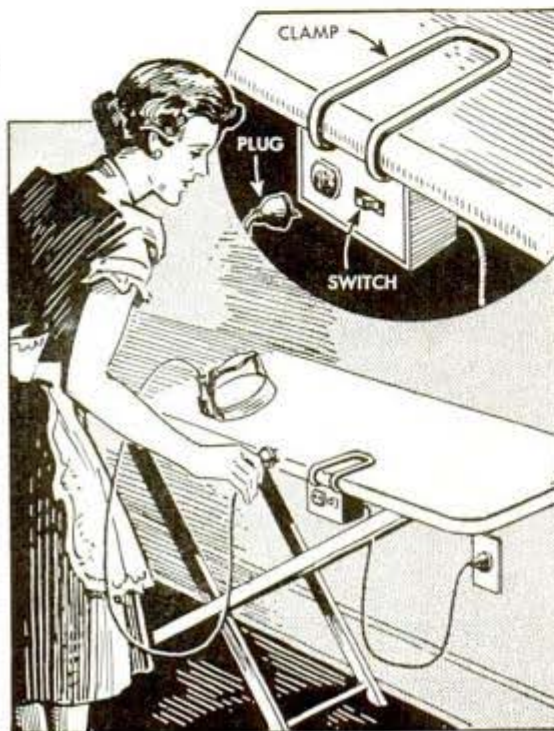

THINK OF THESE ?

2m 142

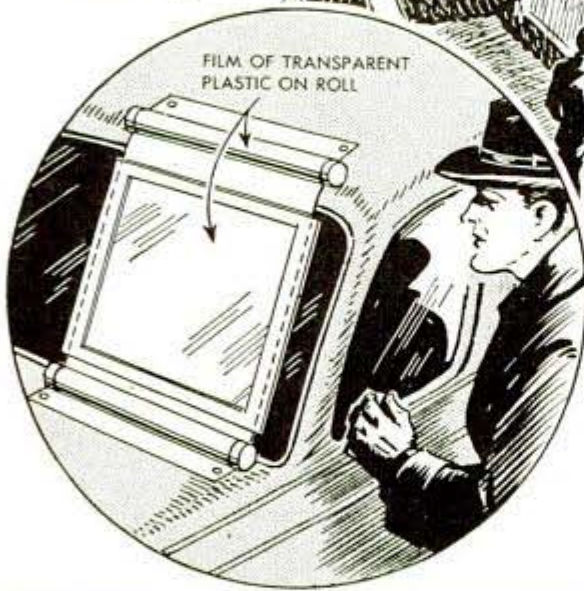
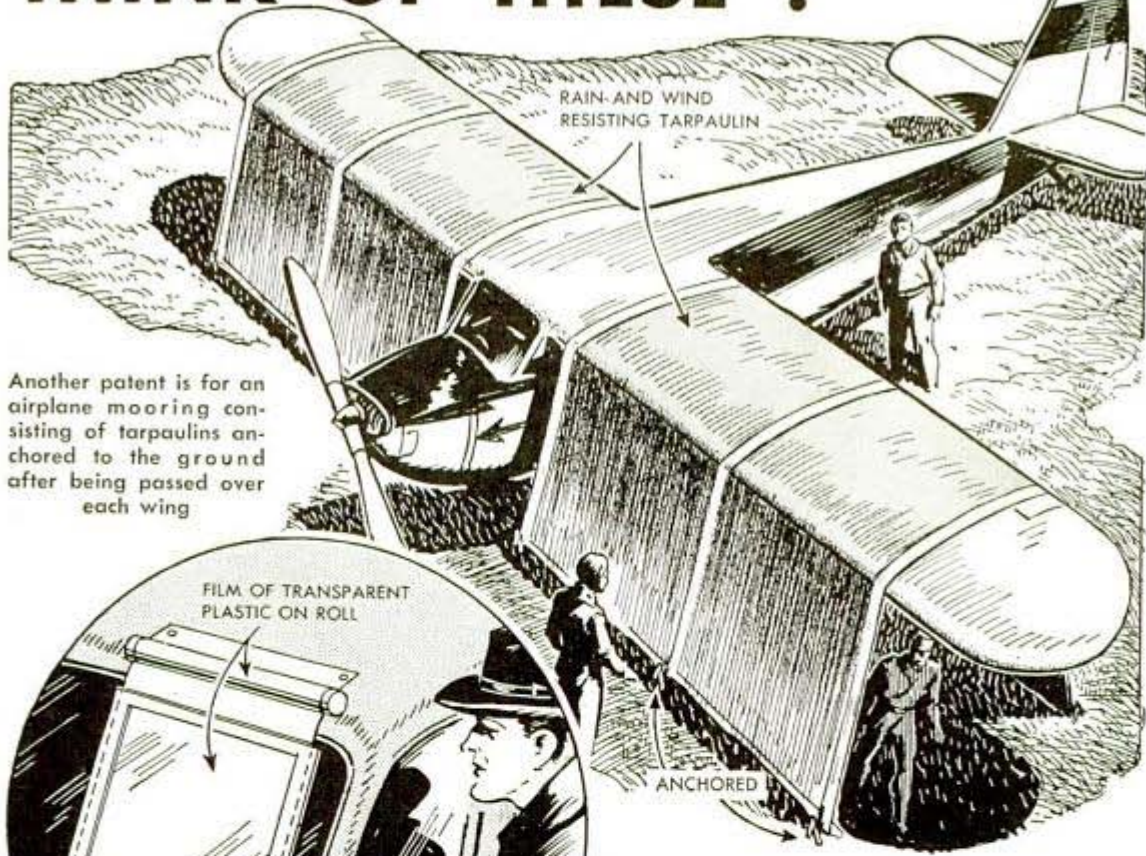

Auto windshields could be kept clean by means of transparent film. When film becomes dirty, it is replaced by rolling a clean section off a spool beneath windshield. At the same time the dirty film is rolled onto spool above windshield

A "woodpecker" doorbell would be a novel touch for the suburban or country home. When chain is pulled by visitors, woodpecker's figure set on pivot rocks forward and the beak strikes sound-producing bar

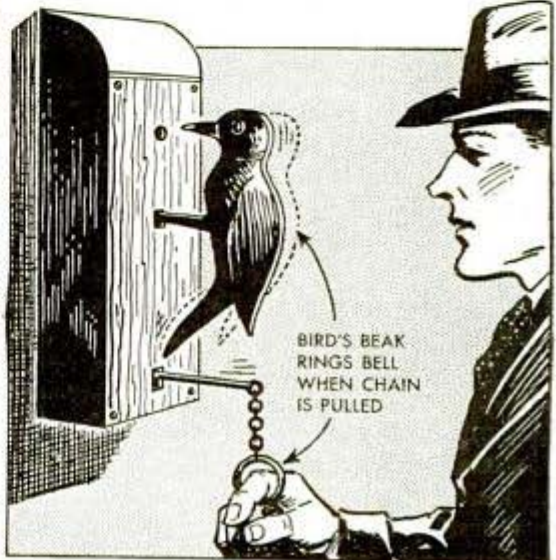

7/214

Tin Cans Easily Salvaged By Cutting Off Ends

Jewel Lindsell



Tin can flattens easily after both ends have been cut off, in which shape it takes less storage space

Tin cans may be salvaged with little difficulty and they do not take up much space if the correct procedure is followed. After removing the top of the can and rinsing it thoroughly, the can is easy to flatten side-wise if the bottom is also removed. It is best to leave a quarter-inch space inside for inserting the cut-off ends. This space also permits chemicals to circulate through the metal in the recovery process.

Dependable Weather Sayings Have Scientific Background

Amateur weather forecasters basing their predictions on folklore would have better luck using only the sayings which have a scientific background. Professors Ralph Clauser and Louis C. Jones, of the New York State College for Teachers at Albany, have outlined a few which may be depended upon. They agree, for instance, that dew on the grass in the morning may forecast a fair day. Dew, they explain, forms more readily when the sky is clear

than when overcast, since the clouds act like a blanket and hold the heat around the earth so little or no dew is precipitated out of the atmosphere. "Rain before seven, clear before 11," is true of certain kinds of showers. As a high-pressure area moves in to replace a low one, there may be a short, hard shower, preceded or accompanied by a shift in wind from southerly to northwesterly. If one of these showers starts before seven o'clock in the morning, it will probably stop before 11. "Mackerel sky, not 24 hours dry," also is based on fact. Cirrus clouds, coming from the west with a low pressure area, may soon spread out to become the characteristic mackerel sky, and, if the low pressure continues for the next 24 hours, rain is quite likely. When the underside of tree leaves can be seen, it is said to portend rain, because during a cyclone, or low pressure area, the air tends to rise, turning the leaves over. The professors advise farmers and gardeners against planting only under certain phases of the moon, because this can hardly have any telling effect on the plants, especially when their growth continues while the moon makes two or three trips around the earth. A good crop, they assert, depends rather on careful preparation of soil, planting the seed on time and correct cultivation.

Brush With Bristles at the Side Cleans Crevices and Edges

Crevices and grooves hard to clean are easy to reach with a household brush having side bristles. Efficient as a hand and nail brush, it also gets into deep-cut designs in woodwork and furniture and scrubs the inner edges of kitchen utensils.



Side bristles broaden usefulness of brush which is handy for many jobs in the kitchen, bathroom, etc.

POPULAR MECHANICS

Best: Sewall White Merchandise Mfg.

From Electrical Review & we need a lot

Cherry

m 232. 2950 Atlantic Ave

Plug Is Rammed Into Gas Main Set Afire in Raid

Brooklyn NY

Flames spouting from a gas main severed by an enemy bomb may be quickly extinguished by ramming into the broken main a special plug fitted on the end of a long pole. More than 2,000 volunteers are being trained by the Brooklyn, N. Y., Union Gas company for this sort of emergency work. The men wear asbestos hoods and gloves and are provided with ramrods and plugs, which have a rubber washer that fits tightly in the pipe.



Plugging a broken gas main in a "dress rehearsal" for air raid

Coast Gun Is Clad in Bark to Hide It From Enemy Eyes

m 233

acme

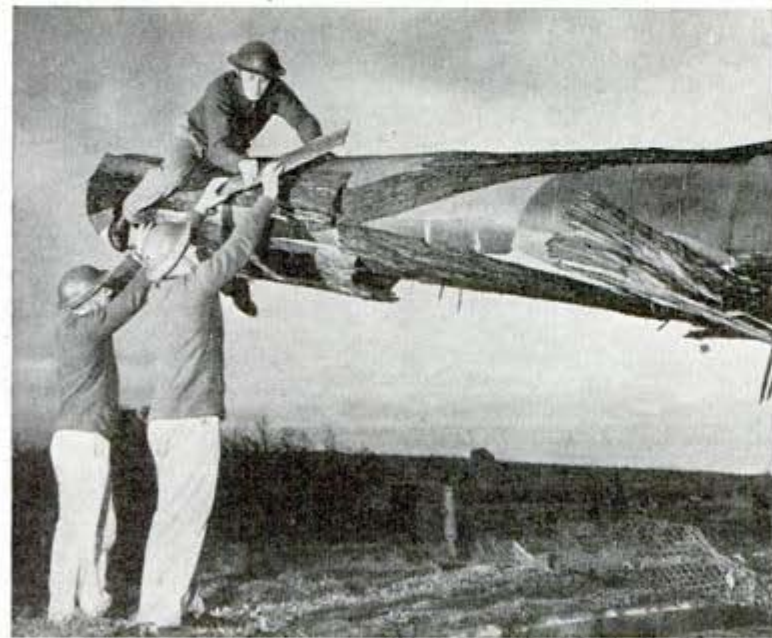

Perhaps barking dogs don't bite, but the bark on the big Canadian coast guns is just camouflage. They have plenty of bite. These long-barreled guns, pointing out into the Pacific, are being covered with strips of bark instead of the usual mottled camouflage paint, on the theory that they will resemble fallen logs to enemy aerial observers.

Pacific

Canadian artillerymen on the British Columbia coast dress their big guns in strips of bark, borrowing from nature for effective concealment

Metal Parts for Repairing Skull Are Now Ready-Made for Surgeons

m 230.

dress case

Ready-made metal plates now available for repairing defects in human skulls may be useful in the care of war wounds, according to Dr. Claude S. Beck of Western Reserve University school of medicine. The plates are made of the alloy, vitallium, which has been used successfully in repairing skull and other bone defects. Heretofore the plates have been cast specially

from a pattern of the skull defect, but it was Dr. Beck's idea to have plates made up in various sizes and kept in stock by surgeons who could use them as needed. The plates have a gentle curvature which may be altered by means of pliers to fit almost any case. If the wound is not infected, the plates, attached by vitallium screws, might be put in at the first operation.

Science Service Mar 7. 1942

Cleveland Ohio

2 1082

Cook, Thomas & Steinson, Jr.
3872 Franklin Ave.

Los Angeles

PILOTING the TOM THUMB WATER BUGS



Since weight is important in water bugs, a small driver has the edge over a heavier one. Here one of these marine jockeys is carrying his hull and engine down to the water for a run

IF YOU like to race an outboard and the high cost of competition has you stumped, try racing a midget.

These baby boats are inexpensive, use 7½-horsepower motors, and were developed for novices.

Seems too tame for you? Not unless hitting 40 miles per hour with a hull that is only seven feet long seems tame. Not if it's tame to ride a boat so touchy that it is apt to stand on its stern and spin over if it hits even a floating cardboard sparkplug box.

The midgets are the current sensation in outboard racing. Professional drivers are entering the class because racing the tiny hulls is so exciting.

The driver of a midget can pick up his boat in one hand and the motor in the other. The hull weighs 50 pounds and hull and driver together must weigh at least 200 pounds. A heavy driver is handicapped. During a race, the driver crouches on his knees in a boxlike cockpit so tiny that he has to cut down the back of his life jacket to prevent it from stuffing the carburetor intake of the motor behind him and shutting off the flow of air.

A midget is so sensitive that if the driver shifts his weight a couple of inches forward, he kills his speed. He uses his body instead of the throttle for changing speed in the turns. The throttle, incidentally, is automatic and kills the motor the instant the driver releases his grip, to cut down the chances of trouble in a spill. Being so light, the midgets are rough boats to ride, yet their lightness helps them speed over choppy water that would trip heavier hydroplanes.

Ref: Kent Hitchcock
Box 686, Ballou's Club L1082



Two midget outboards race for the finish line. Notice how small the hulls seem in relation to drivers

The speed record for the class is 41.65 miles per hour and the chances are that even faster speeds will be made this season or next. Even the present record seems phenomenal in view of the fact that outboards of many times the midget horsepower can hardly go twice as fast.

A midget racing motor costs \$131 and a factory-built hull costs \$150. You can build a hull cheaper and it may be better or poorer than factory construction. From

\$200 to \$400 will put you in midget competition as against several times that amount that is necessary before you have much chance of winning in the larger classifications. The costs of racing outboards have been going up in proportion to their increasing speeds because of the extra motor work and hull refinements that are necessary for speed. In spite of high speeds and the chances of spills, outboard racing remains one of the safest sports as long as

As racer rolls over at 40 miles an hour in rough water, driver is thrown out—his arm visible below boat



2 1082



Drivers drop steering wheels to pass batons at a tense moment in relay race. The other hand keeps grip on automatic throttle



motor exactly as it comes from the factory. Each owner spends long hours working over his power plant, principally to insure perfect alignment of parts, to reduce friction, and to improve the piston seal. Mufflers are replaced with exhaust stacks to provide better cooling. A cool methanol-base fuel at a dollar a gallon is used because with it pistons may be fitted tighter. Generally speaking, no material may be added to a motor except for reinforcing.

Mechanical ingenuity has devised scores of slight modifications to improve outboard motor efficiency and the hunt for more ways to extract additional power from the motors is still going on. Even

Below, buffing surfaces of cylinder head with a tool mounted on a dentist's drill

Left hand of driver is at the automatic throttle he must grip throughout race to keep motor going

proper equipment is worn and the safety rules are observed. Crash helmets and life jackets are obligatory.

Winning a championship in any outboard class is a matter of perfection in innumerable details. The motor, the propeller, the hull, and driving skill must all be tip-top. The slightest carelessness, even strapping the hull down improperly when towing it behind a car and thus warping its shape, may be enough to lose a race. Some of the smartest drivers spend as much time eliminating things that tend to slow them down as they spend in trying out ideas to increase their speed.

Drivers win few races when they use a



L 1082

such a detail as equalizing the tension on the cylinder head nuts is important. Some drivers chrome-plate their cylinders to insure smooth surfaces and to help increase piston seal. As much as six miles per hour may exist between two sets of pistons and the way they fit with the cylinders. Occasionally a driver discovers or perfects a pair of "record" cylinders that just happen to be perfect and with which race after race can be won. Cylinder walls in the small motors are thin, and unevenness in the metal may be disastrous, because if the heat dissipates unevenly the motor may heat up and freeze on a straight-away run, corkscrewing the boat over in a flip if the propeller blades happen to stop in a horizontal position. In perfect shape, a midget motor may turn 6,500 revolutions per minute and develop up to 10 horsepower.

Stainless-steel propellers are thinner than bronze blades and hence are best for some conditions. The fastest design of propeller for a speed dash is not the one to use in a closed course race, for which a propeller with slightly less pitch delivers the fastest get-away in coming out of the

Propellers to suit all conditions are carried in case



JUNE, 1942

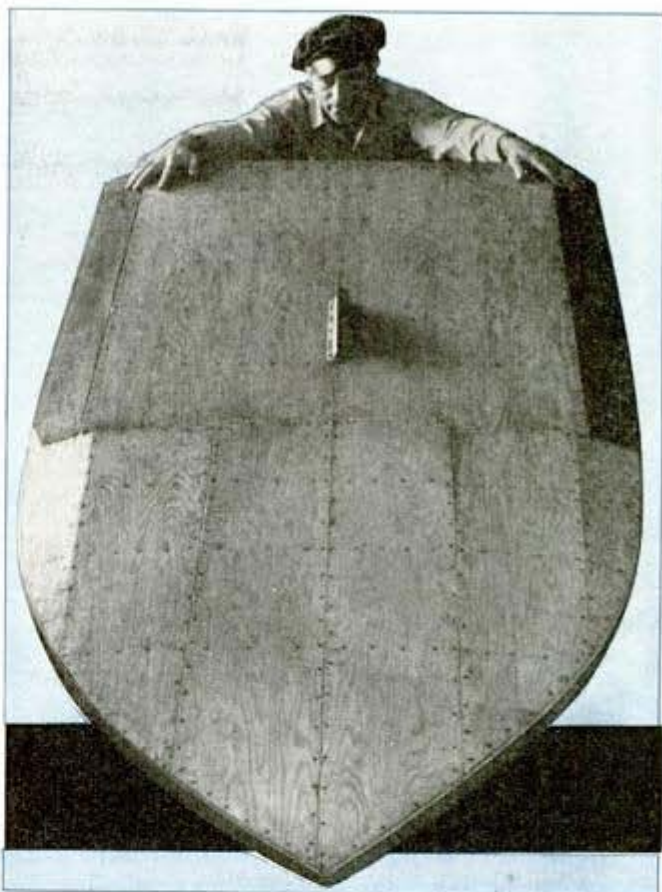

Rubbed-down coats of varnish give bottom a glasslike surface

turns. All propellers have slight variations and a driver who is out to win may test half a dozen before selecting the best. Recently a device was perfected that takes the measurement of propeller surfaces and aids in building up or reducing the metal to provide the right curve at all points. Five miles per hour or more are sometimes added to a boat's speed simply by this "true pitch" operation.

Most hulls are built up of spruce frames with a plywood bottom and linen deck. Average dimensions are 84 inches long and 43 inches wide. A flat bottom with one step that keeps all but part of the rear planing surface out of water is one of the fastest designs although a trend is growing toward a type that the drivers call three-point suspension, in which at high-speed the hull floats on its stern and on two pontoonlike attachments fastened to the hull forward of amidships. Difficult to balance, a three-point boat is very fast when it is working smoothly.

One driver has put nine different bottoms on his midget, each one a little faster

(Continued to page 170)

155

Chaining Tires and Wheels Helps to Foil Thieves



Chains lock tires and wheels to the nearest bumper

It required only the application of a simple idea by one automobile owner to protect all four tires and wheels from thieves while the car remains parked on the street overnight. A stout chain, strung through each wheel, secures it to the nearest bumper, and each chain is fastened by a padlock.

M 207

Ice Cubes Frozen in Plastic Cups Lifted Out One at a Time

Frozen in individual flexible cups, ice cubes may be removed from the refrigerator tray one at a time without touching the ice with the hands. Twelve cups are racked in a steel tray, and it is not necessary to remove the tray from the refrigerator when lifting out one of the cups, since cups come out easily without the use of levers or dousing the tray in water. Made of



Ice cubes in individual cups removed one at a time

Best: Lowell White
merchandise man.
transparent plastic, the cups are strong enough to withstand long use, and the ice tumbles out readily when the sides are pressed lightly with the fingers. Frozen cups may be stored in the refrigerator cold compartment or chill tray without fear that they will stick together.

M 221

Bath Tub Shower Fits Any Spout And Requires No Curtain

Usable without a curtain because it does not splash, a bath tub shower now available may be attached to any faucet by means of special adapter clamps. The fixture is an upright tube with three perforated cross pieces giving nearly horizontal

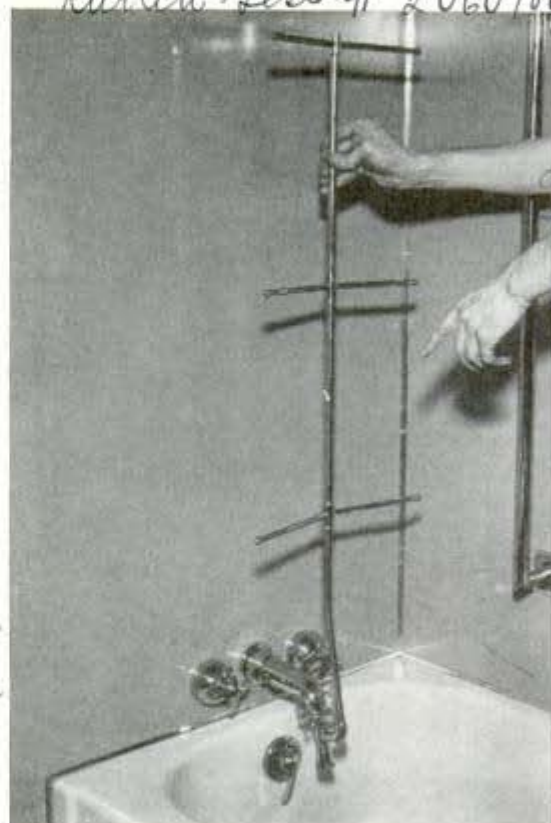

Shower for your bath tub sends spray from cross arms

streams that can be regulated from a gentle to a powerful spray. A standing shower can be taken without getting the face or hair wet. Installation of the unit does not interfere with other uses of the tub or faucet, since water may be run directly into the tub instead of through the shower by turning a collar at the base.

To learn where to buy commercial products described in these pages, see the index.

m 195

Liberty Coach Co. Greener, Ind.

Telescoping Trailer Adds Three Bedrooms

Twice the usual sleeping accommodations are offered in a telescoping house on wheels which has an upper story that may be raised when the trailer is parked. The walls of the top floor telescope over the bottom portion, and the operation of raising or lowering, accomplished with a hand crank, takes only 10 minutes. In raised position the upper section rests on wooden blocks, which are removed when it is to be let down. The top floor contains three rooms partitioned by venetian blinds, and all of the space may be used as sleeping quarters. An inside stairway connects the two floors.

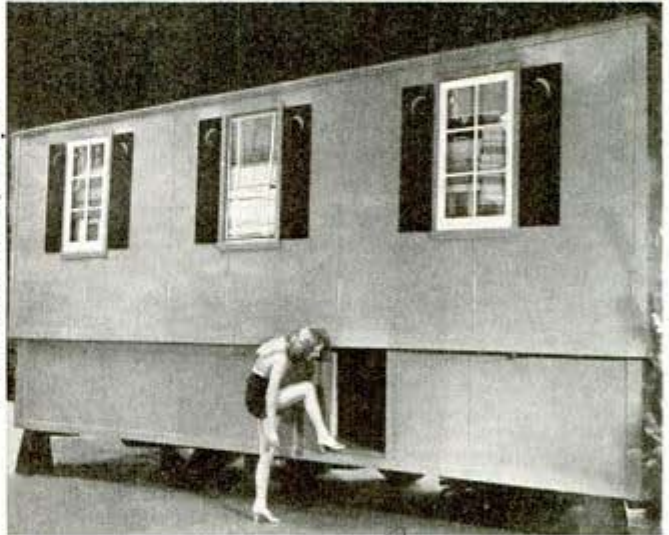

Trailer, top, in full height; bottom, top story being lowered

W. Marshall Co. Greener, Ind. m210

Plastic Cork on Pipes

Stops Dripping

Cold pipes, tanks or walls can be prevented from sweating and dripping by the application of plastic cork now available in gallon-size or larger cans. Spread on with a paint brush, whisk broom or sprayer, it can be used for covering surfaces such as metal, wood, concrete, brick, tile, cement and plaster, and it may be painted any color. Plastic cork makes a rough surface resembling stucco; it will not propagate fire, and is odorless and verminproof.

aa. may 1942 189

Pocket-Size Bridge "Table" Holds Dummy Hand in Slots

Offering the facilities of a bridge table, a folding leather bridge set which can be carried in the coat pocket is handy for playing cards on a train, the lawn and other recreational spots where a table is not available. North, South, East and West players are designated in gold lettering on four sections which may rest on the players' knees. Each section is provided with slots marked in the four suits to hold the dummy hand, where the cards are clearly visible to all players.

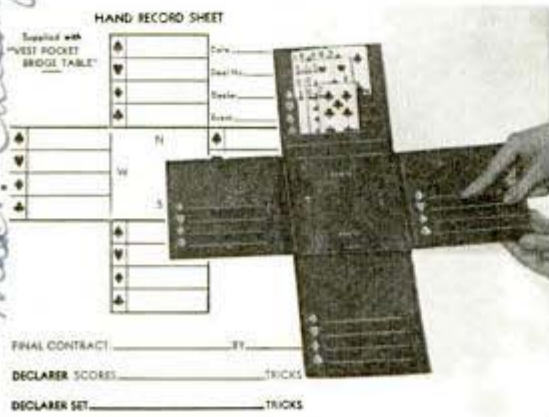

Folding bridge set, small enough to be carried in the coat pocket, forms tiny table top for players

Some fish which can change their color to resemble their background are unable to do this if they are blindfolded.

C. J. Rumpfs Sons 1523 Merchandise Mart Chicago

Better Version in style 205

2929
Lycium, Ltd. Aviation
Wm. Carl Williams, 112



IF YOU CAN DRIVE

It's steered like an automobile, and you pull the wheel back to climb, push it in for a glide. Notice the pilot's crossed legs. There are no rudder bars for the feet—only a brake pedal

By
Roderick M. Grant

PART I

THERE is no use being nonchalant about this. My stomach was tied up in a couple of granny knots and my spine was stiff as a new collar.

As casually as he'd have told me to come up to the blackboard and do an algebra problem, Bud Eddy, the Skyfarer's pilot, had said "All right, you take her up now."

We had been off the field, around the half-mile square and down the home stretch once, and now it was my turn at the control—I who had never sat in a cockpit before, never flown except as passenger in a transport plane. Air line travel, at least, had made me fearless of the third dimension, accustomed me to seeing cornfields and woodlots lying at a 45-degree slant under my left elbow. But then I had always depended on a veteran pilot who,

I was confident, was as anxious to come home unbroken as I.

"Cross your legs and forget you have any."

This plane was rudderless, and there was no work for feet until time to step on the brake pedal after landing. So I crossed them, but I was pushing them through the floor just as I "put on the brakes" when someone else is driving my automobile.

"Flaps down."

I fumbled around for the lever between us and pulled it into intermediate position.

"Throttle all the way in, now, and steer straight ahead."

Gripping the wheel like a life preserver, I did what I was told. We rolled down the

Pressing down on the tail of this light plane, you can lift the front wheel of the "tricycle" off the ground to turn the craft





Flaps half down, the "Skyfarer" climbs past the hangar. If you can drive an auto, you can fly this plane

see Oct. 1941-16

cinder lane, my eyes glued to the spot where the Skyfarer's nose bisected the runway.

"Back on the wheel, easy."

Very gingerly I pulled it toward me. The nose blotted out the cinders. We were climbing. This had happened to a lot of fellows before me, but now it was happening to me. We didn't seem to be traveling very fast, but it didn't occur to me to take my eyes off the nose and its up-tilt for a look at the air speed dial. We began drifting to the left.

"Keep her straight," said Eddy. "Make her do what you want her to do. Handle her as roughly as you like."

I gave the wheel a turn to the right, and incidentally pulled it toward me. We bit into the air at a steeper angle.

"Not so steep," Eddy cautioned, and I let the nose down, trying to

There's good visibility downward and on three sides. Here the author is watching for a clear runway before taxiing to the line



2929



B. Wayne
Wright

100 feet in the air, sensitive to cross winds at the slow speed of the climb after takeoff, is a critical point in conventional aircraft but the Skyfarer took my ill-coordinated manipulations of the control without a whimper and climbed away.

Eddy told me to retract flaps and keep the nose up as the angle of attack changed and the leveling of flaps gave us an extra 10 miles an hour. At 600 feet I made the first turn.

"Keep the nose up," Eddy said, and I pulled the wheel back slightly,

Seaplanes are gaining popularity for sport. This is a pontooned Stinson

remember that this one little wheel, which was all I had to worry about at the moment, has two functions—steering and elevating. That was the first problem in three-dimensional coordination. I don't know what sort of acrobatics I'd have embarked on if both feet had been working, too.

Now if this were simply the story of some fellow's first flight, it wouldn't be a story at this advanced stage of aviation. It's more than that. It's the story of a dub who considers himself a good automobile driver, who has never been to ground school, who knows about ailerons what he reads in the papers, taking up and flying and bringing down a new sort of airplane that the government has certified is incapable of spinning. It has no rudders and it can't side slip. If I do the wrong thing, the Skyfarer, like a wise old horse, is likely to correct my mistake. If I flirt with stalling speed the plane will dip its nose, fall forward instead of backward or sideways, recover flying speed and level itself off. Right here,

watching the angle of nose and horizon instead of the golf course below. I remembered with a flash the first time I looked down from a steeply banked Ford Trimotor. This time there were no qualms at all; I felt as stable as in my favorite lounge chair. My mentor reminded me to anticipate the flight path, returning the wheel for level flight before the turn was completed. The next turn was a bit steep, but almost before Eddy warned me I was correcting it.

On the third leg I followed directions to level off at around 800 feet, cruising about 80 miles an hour. I still wanted to fight with the control, but I began to find it wasn't necessary. I took my hands off the wheel a moment and nothing happened. The plane knew more about flying than I. There was time now to look across at the airport from the big window of the comfortably heated cabin and feel sorry for the folks standing down there in the chill, damp wind and for the motorists fighting

Here is the "Skyfarer's" clean profile. Dotted lines show position of ailerons and front wheel in right turn



1929

beginning of Aviation
Carp Williamsport Pa

each other at the highway crossing. I wanted to go right on flying, but Bud Eddy pulled me together. We turned the third corner. Then he said: "Pull out the carburetor heat control. . . Now pull out the throttle."

I knew better than that. We were more than a thousand feet from the runway, and it looked like a mile. I pulled the throttle about two-thirds shut, knowing I would need some power to reach the field. But I couldn't fool the doctor.

"Close the throttle all the way,"

Checking oil before taking off. Notice the accessibility of the 75-horsepower engine



This is the low-winged Ercoupe, another spinproof plane

Eddy ordered. I gave it a quick shove—the wrong way. The engine revved up. Eddy pulled it for me.

"Forgot which way was off," I apologized.

"Just like your automobile accelerator," he said, "push it in for speed." I remembered that next time.

We idled around the last corner, then I pointed the nose for the runway. Not steep enough. Too steep. Wobbling to the left. To the right. The flaps were down, the nose shoved forward to compensate for them. "Keep the air speed at 70

(Continued to page 166)



The drawing illustrates how the plane with flaps lowered can glide at a steeper angle and thus land safely in a smaller field

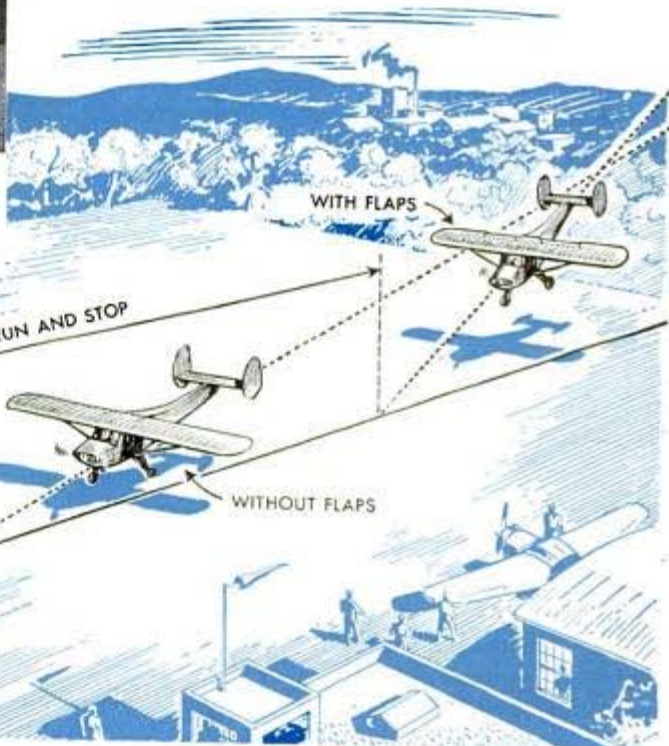

m 145.

Schneelady, NY

Snap-On Screen Hangers Easy to Attach

Simple Place

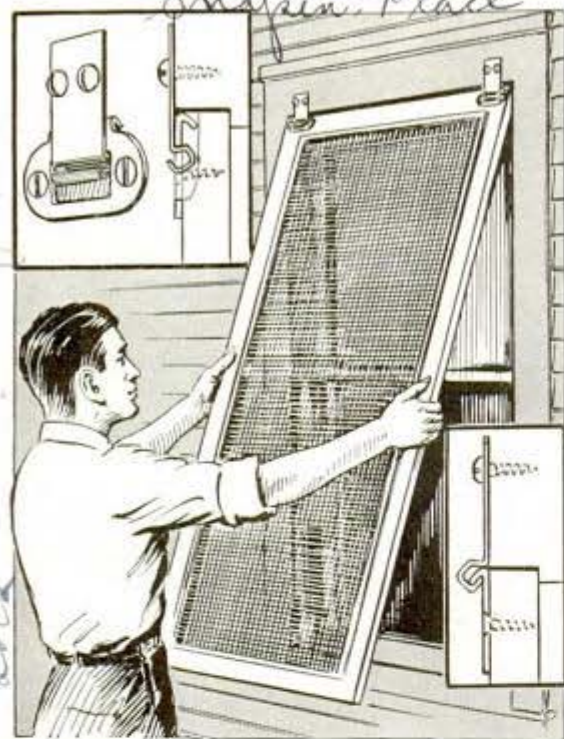

Hanger snaps screen in place. Inset, left, hanger is flush with frame; right, hook protrudes slightly

Simple in construction and easy for anyone to install, a set of metal window-screen holders permits the screen to be hung from the inside without the old method of "fishing and hooking." There are two parts to the holder, one to fasten on the screen and the other at the top of the window frame, each taking two screws. To put it up, the screen is pressed at a slight angle against the top of the frame and then given a hard push, thus snapping it into place. The screen may be opened at any time by swinging it outward. The holder may be installed in two ways: first, as a double hook, and second, it may be inverted and the woodwork routed so the holder will not interfere with stacking the screens.

National Book Co. Rochester, N.Y.

contains a little nitrogen. However, if a piece of nitrogen-free metal is heated to 1,100° Fahrenheit, and then cooled, the magnet phase returns when it is down to boiling point of water. In recent experiments, Dr. Herbert H. Uhlig of General Electric research laboratory, found that if the heated strip is cooled suddenly by quenching in water, it is not immediately attracted to the magnet, but after about a minute and a half it suddenly jumps toward it. To explain this it is pointed out that, although the atoms start rearranging themselves as soon as the strip is cooled, it takes about 90 seconds for a majority to shift, and at least a day passes before all reach a state of equilibrium. Research into this change in the crystalline structure of the metal is expected to reveal more about heat treatment of steels and lead to the production of alloys with better mechanical properties and resistance to corrosion.

m 166

Flower Pot Holds Ant Poison Concealed in Its Base

Everlasting artificial flowers bloom in a small decorative pot whose real function is to kill ants. Hidden in the bottom is a special ant paste, sealed off so children and animals cannot touch it. Four tiny notches in the base permit ants to reach the poison.



Slots permit ants to reach poison concealed in base

m 246

Delayed Jump of Steel to Magnet Shows Change in Structure

In delaying its jump to a magnet, a strip of steel reveals a delayed change in its atomic arrangement. The metal, known as 18-8, is stainless steel containing 18 percent chromium, 8 percent nickel and the rest iron. This metal is not ordinarily attracted by a magnet because it usually

Sherman Clark Co.

D.A. Baker, Dept. Co. 3964 Wakefield, N.Y.

70. * *Comp. J. Leland Clark*
3822 - Miller Way
Sacramento
Calif

Women's Fire Brigade Trains for War Duties



near Sacramento

Even before the war brought its new dangers to California, the women of Citrus Heights, an urban area near Sacramento, joined up to form a volunteer fire brigade. Already they've fought flaming gasoline truck and automobile fires, prairie and home fires. They'll take on anything—bombs included. Above, at left, they practice carrying hose into a building; at right, they learn how to handle a fire ladder

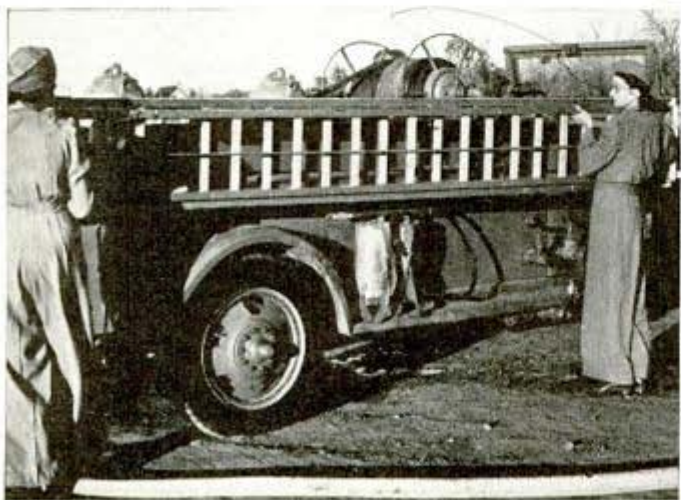

Citrus Heights has three fire trucks, and the women "man" them. They're trained to handle all the equipment (above) just as the men of the volunteer brigade do; most of the men work in nearby cities. At right, the ladies put in some practice with the hoses. For nearly two years they have engaged in weekly drills and monthly reviews of fire fighting technique, which means everything from starting the trucks to rescuing persons from buildings and giving first aid

m 134

Streamliner

The LATEST in STREAMLINERS

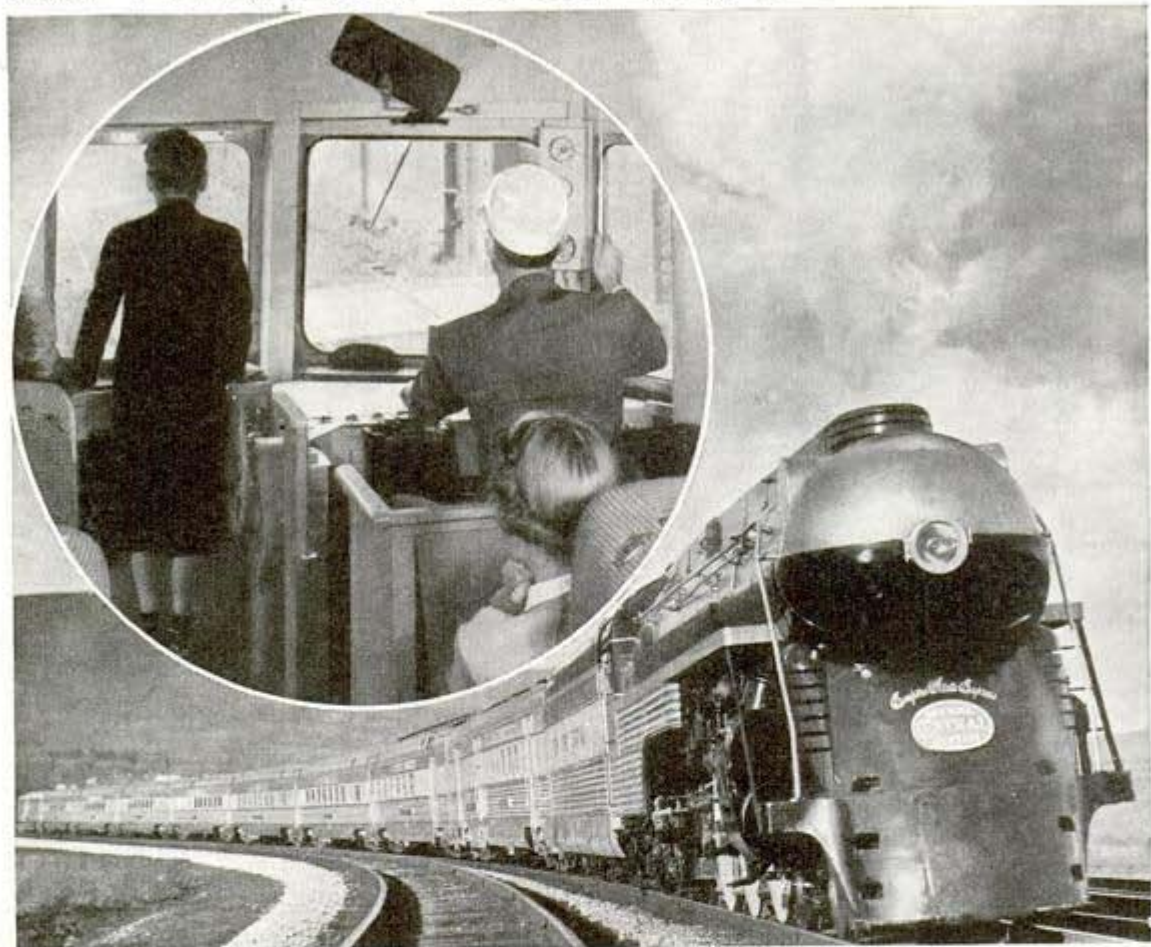

The era of streamline trains is not ten years old, yet today more than 130 streamliners are plying across all but a half dozen states and a score of new trains are being built. American railroads operate 75,000 miles daily of mile-a-minute passenger trains. Travelers take to them in swarms; last year the total of passenger-miles was 22 percent over 1940. This year war business and tire saving are adding to railway travel. One of the newest streamliners is the steam-driven, stainless steel "Empire State Express" of the New York Central, shown above. It offers coach passengers the luxuries of adjustable, sponge-rubber cushions and lounge-observation cars decorated with historic murals. In the circle, above, the operator and passengers look out the forward windows of the "Land o' Corn," a two-car streamliner on the Illinois Central railroad. It is driven by a 225-horsepower Hestelman engine, oil-burning like the Diesel but with spark ignition. It starts with hydraulic drive, then shifts automatically to mechanical drive, reaching top speed of about 83 miles an hour. At left, a traveler in dining car of the Pennsylvania's "Broadway Limited" chats by phone with a friend in the observation car

see Sept 1941

2134.



Wood veneer walls and fluorescent lighting add to the attractiveness of the "Empire State Express." The two new trains, which cost \$2,500,000, have disk-type brakes, and the trucks are insulated from the car bodies by composition molded parts to prevent transmission of the track noise.



Left, the "South Wind" roars around a curve on the Louisville & Nashville, bound from Chicago for Florida. Three roads cooperated in starting streamline high-speed coach service daily between Chicago and Miami, and it proved so popular that seats were sold out a week or more in advance.

The "Columbian," coach streamliner on the Baltimore & Ohio between Chicago and Washington, is wired for sound. From transmitters in diner and observation cars the stewardess describes historic and scenic spots, and here the dining car steward is calling a passenger who has reserved a table.



↑

Something really new under the railway sun is the pendulum car. There are three of them, built for The Santa Fe, Great Northern and Burlington. Riding on huge coil and leaf springs (above) the body is suspended from above its center of gravity and banks itself like an airplane when it rounds a curve.



JUNE, 1942 see Jan. 1941 P. 2.

m 176

Luminous Strip on Shoe Sole Glowes Visibly in Blackout



Luminous soles and heels make shoes glow in the dark

adler 44-45 - 8 5-8 5

Shoes given a luminiscent treatment around the edges of the soles are now offered for use of air-raid wardens, policemen and others whose work or civilian defense activities keep them out at night when there may be a blackout. Five different coatings, starting with a white base, are applied to the soles and heels to make them luminous.

m 27

Sun's Technique of Keeping Hot Is Copied in Atom Smashers

cl. Chana. N.Y.

For a billion and a half years the sun has been burning up energy and restoring itself, and—cheer up!—it probably will stay in business for another 10 billion years. It really is a big atom smasher, feeding on atomic energy by transmuting hydrogen into helium, with carbon acting as a go-between. Dr. H. A. Bethe, physicist at Cornell University, reports that scientists have worked out in their own atom smashers the six-step process by which the sun maintains its enormous output of energy. The process takes 5,000,000 years on the sun. A carbon nucleus picks up a hydro-

gen nucleus and is transformed into nitrogen, which disintegrates into another form of carbon. This picks up an additional hydrogen nucleus, and they turn into another form of nitrogen, which thereupon picks up a hydrogen nucleus and becomes oxygen. The oxygen disintegrates into a third variety of nitrogen, which is completely smashed by a hard-hitting hydrogen nucleus. From the fragments, two new elements are formed—helium and the original carbon. Thus, after 5,000,000 years, four hydrogen nuclei—the fuel of the solar fires—have been consumed but the original carbon, and the helium ash, remain.

m 220

Book Cover Fitting Many Sizes Applied Without Cutting

Adjustable to fit books up to 15 inches, a ready-made covering easy to apply is folded over like the ordinary paper cover and held in place with elastic tapes and hooks. No cutting or pasting is required. The flexible cover is folded evenly to book size, one book cover inserted into the fold and the elastic tapes drawn across each other, hooking at top and bottom. Then after wrapping the folded cover around the book and repeating the original performance for the second book cover, a few minor adjustments will give it the correct proportions. Made in various colors, the covers are interchangeable and provide long-lasting protection.

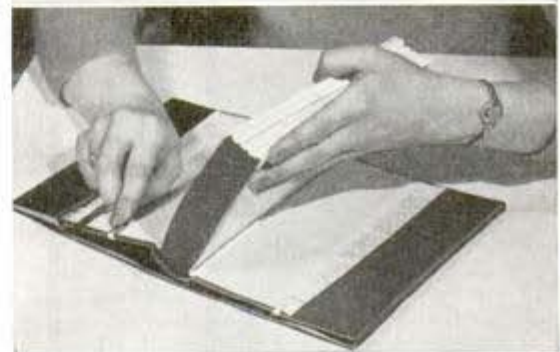

Cover folds about books and hooks on by elastic tape

*Science Service
mar. 13*

*The Reis Co.
114 W. 27th St. New York*

m 198.

Three Gliders Towed at Once by Army Plane

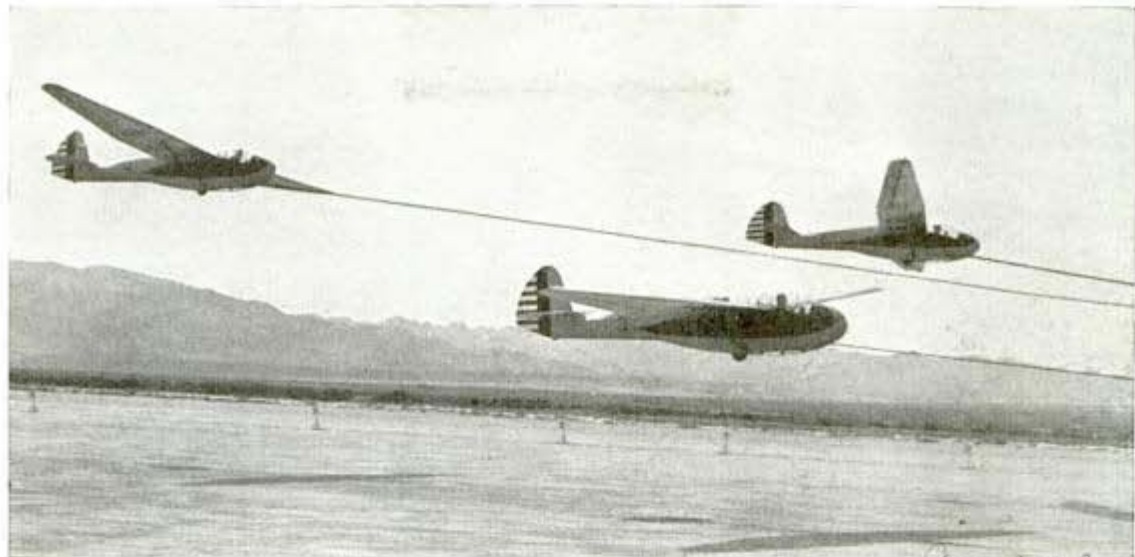

Three gliders attached by ropes to one army plane; two fly abreast and third one follows far behind

Pilots at the ^{California} West Coast Air Corps Gliding School can launch and tow as many as three gliders at a time, using one airplane equipped with a 295-horsepower engine. At an altitude of about 3,000 feet, the gliders may be cut loose from the tow lines to soar on their own, the length of soaring time depending on the thermal conditions

of the air. Gliders can be towed in units of one, two or three. A single tow is made with a rope about 400 feet long. Double tow requires two ropes forming a "Y," one glider flying slightly back of the other. In towing three gliders at the same time, a longer line is used for the craft in the middle and two shorter ones on either side.

Scale Weighs a Film of Tarnish 10 Billionths-Inch Thick

On the trail of an invisible saboteur—oxygen—which attacks metals with rust and corrosion, scientists at Westinghouse research laboratories have built a scale that weighs unseen tarnish films about 10 billionths of an inch thick weighing 15 billionths of an ounce. The scale is so sensitive it indicates loads in weight units of 10 billionths of an ounce, and movements of the pointer are so minute they can be seen only through a microscope. The balance is housed within a glass tube in the shape of a cross. A tiny piece of steel is used in the test, and after all tarnish has been removed from the sample, small amounts of oxygen are admitted into the sealed tube. As the oxygen combines with the surface layers of the steel, the sample becomes heavier and its gain in weight is recorded every few minutes. The experiments are expected to reveal such things as what makes stainless steel stainless, which it is hoped may lead to some simple way of giving other metals the same protection against oxygen in the air.



Reading the weight, top, and size of sample tested

2
137
8
reggeti

KEEPING OUR WARBIRDS

Randolph Fella

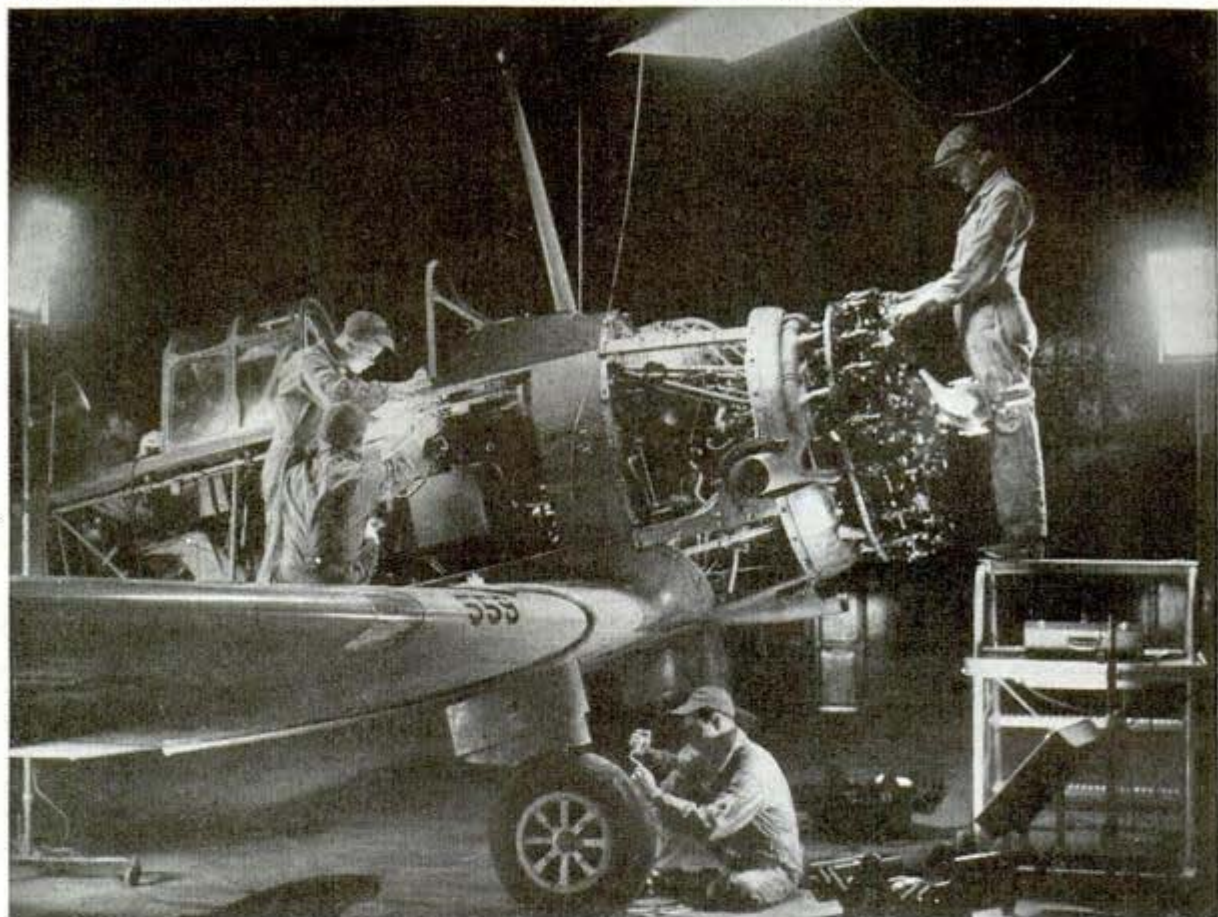

Night and day, under artificial light and sunlight, mechanics keep busy taking down and reassembling engines of fighting and training planes

And here two of the specialists test the landing gear of a big plane. Pilots' lives are precious and nothing can be permitted to go wrong

Curless A-18



BACK of America's fighting men of the air, and largely responsible for their success or failure in combat, are thousands upon thousands of specialists—the maintenance men of the Army and Navy air units. Their job is to keep our military planes in flying and fighting condition.

Beside the expert mechanics, to whom falls the task of repairing, overhauling and tuning the engines to the rhythm of victory, there are men who specialize in radio work, bomb loading, machine gun and cannon maintenance, landing gear, propellers, patching of wings and fuselage damaged by enemy fire, refueling and numerous other jobs essen-

FLYING

tial to effective operation of a mighty air force. Then, too, there are other thousands of men who keep a constant stream of supplies—gasoline and oil, ammunition and bombs, spare engines, replacement parts and many other items—moving to each unit. Their number is legion, of course, for it takes from eight to ten on the ground to every man in the air. When the United States Army Air Forces reach the projected strength of 2,000,000 men, there will be some 500,000 mechanics among the more than 1,500,000 members of the ground personnel.

In order to provide efficiency in operations of this kind, the Air Service Command was created a few months ago, with its headquarters at Wright Field, Dayton, Ohio. Its duties are to supply, maintain and store materiel and equipment and to provide essential services for the Army Air



↑
This is a typical ground operation, with the specialists grooming a line of airplanes

↓
A sign that our pilots mean business—loading machine guns and cannon in a Bell Airacobra



1397

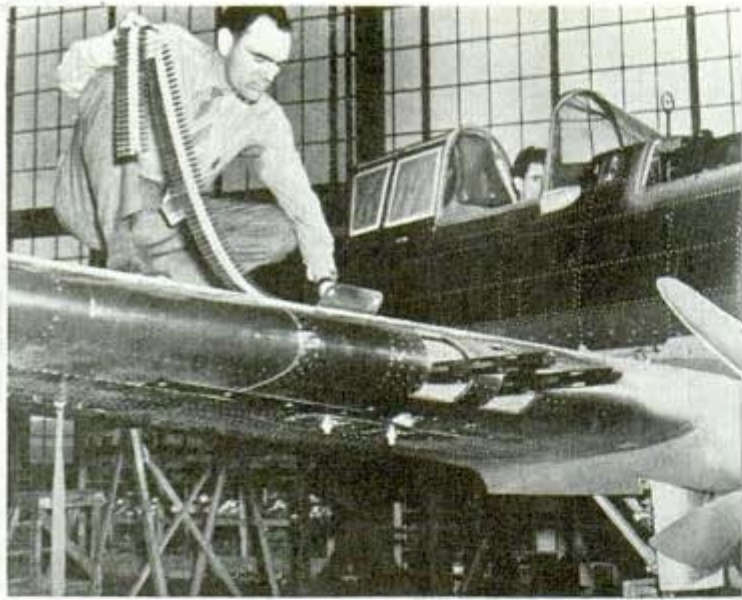

↑
Loading ammunition into the machine guns with which the Curtiss P-40 is armed

Brown

→
Preparing to install a machine gun in a Curtiss; soon the plane will be ready



Ladd Field, Fairbanks, Alaska

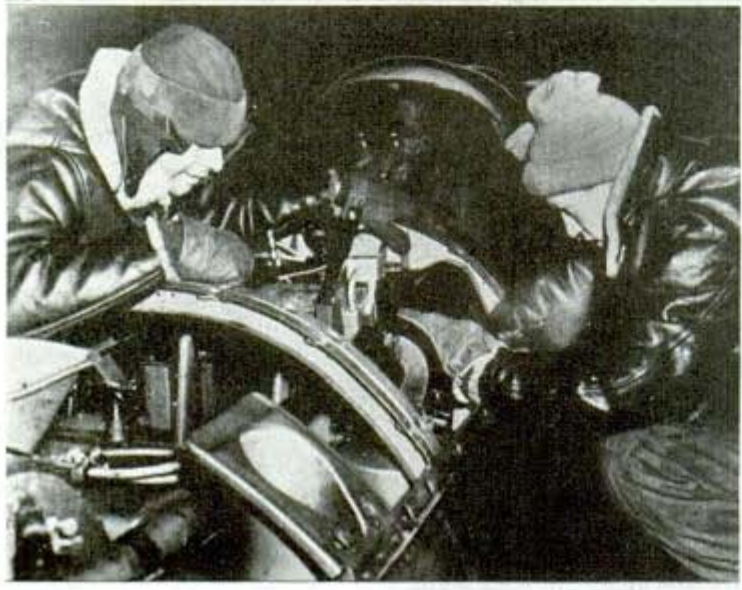

Forces, the Air Force Combat Command and the Air Corps. This means keeping every bombing plane, pursuit ship, observation plane and trainer—in fact, every plane in the Army Air Forces—ready to fly and ready to fight.

Major General Henry J. F. Miller is in command of this important organization, which re-

places the Maintenance Command, a former unit of the Air Corps Materiel Division. Since the Materiel Division has been concerned primarily with experimental work and procurement of new aircraft, it became apparent, with the continuing expansion of the Air Forces, that a separate supply and maintenance organization was required.

The Air Service Command

In every kind of weather—even the Arctic—our mechanics are grooming our warplanes

L1397

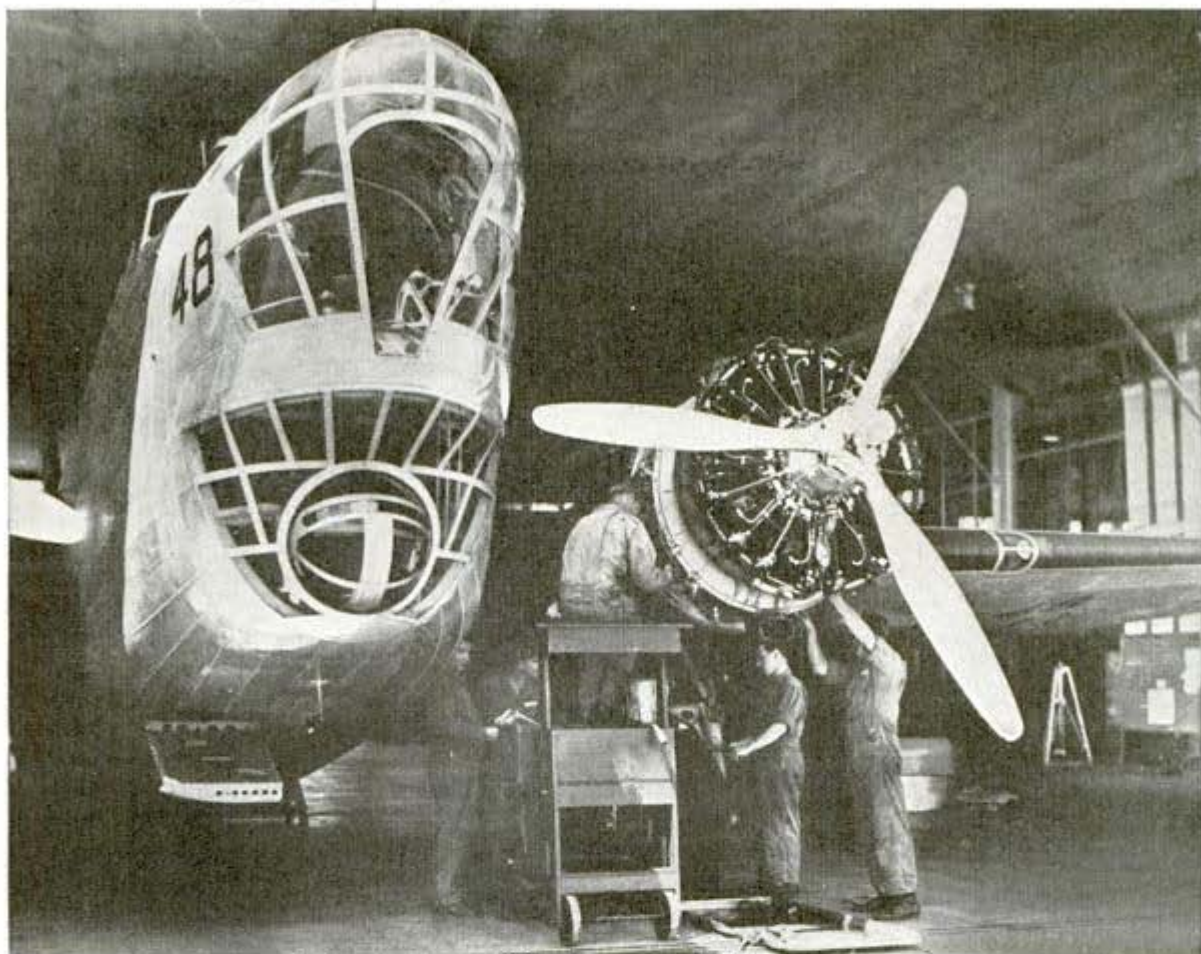

Douglas B-18 (9)

is charged specifically with supply, maintenance, warehousing and air transport between stations and is responsible for the adequate stocking, proper cataloging and rapid distribution of equipment and supplies. To facilitate this tremendous job, and daily growing greater because of the new program providing for the world's greatest air force, the country was divided into four areas, with headquarters established at Hempstead, N. Y., Spokane, Wash., Tampa, Fla., and San Francisco, Calif., each under the Command headquarters at Wright Field. Further expansion may come later.

To make U. S. bombing planes more effective, ground men, above, go over them carefully

It takes well-trained men for the job shown below, too; loading bombs into the plane's rack

Curtiss A-18



"Walking" Range Improves Marksmen's Aim

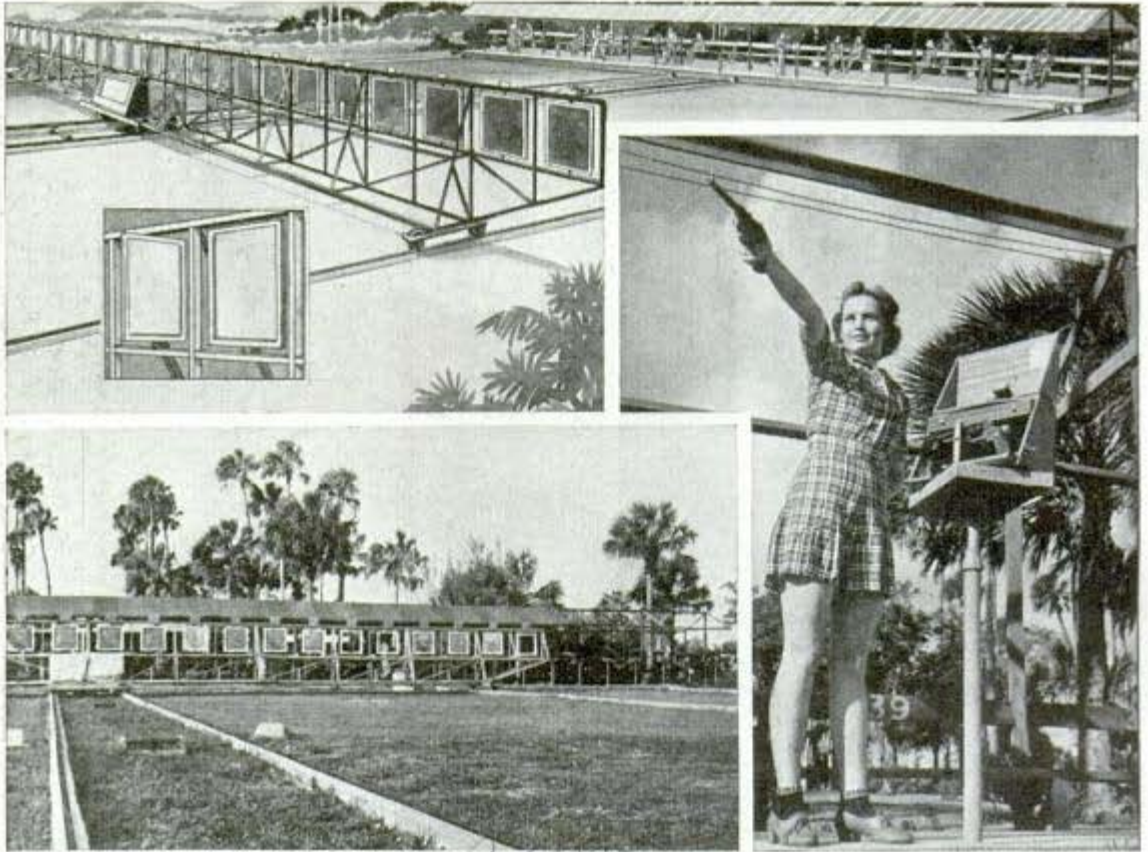

Drawing and photo show pistol range on wheels and swivel targets; right, one of the club's experts takes aim

So effective has a "walking" pistol range at a Miami, Fla., club proved, that the U. S. Marine Corps plans to build similar ranges to train its sharpshooters. Forty targets are mounted on a 2½ ton traveling crane 160 feet long. The targets advance from the rear of the range, 50 yards away, right to the firing line. A five-horsepower electric motor operates the crane. Another novel

feature is an "edging" arrangement operated by a compressed air cylinder. Only the edge of the target faces the firing line before a match begins; then at the touch of a pushbutton all 40 targets swing synchronously in a split second to face the marksmen. This acts as a foolproof signal in rapid-firing contests and trains the marksman to be steady and quick on the trigger.

Hearing Tester Cuts Off Sound to Detect Attempt to Cheat



Sound cut-off switch assures honest test of hearing

Former methods of testing hearing with the tuning fork, the dropped coin and the voice are being replaced by an audiometer now used by airlines. It is more accurate and speedier, and leaves little chance for outwitting the operator. Operating electrically as a calibrated audio-oscillator, the instrument produces sustained tones of precise frequencies and in measured decibels of intensity. Tones range from a low pitch of 64 cycles, to a high of 11,584 cycles. In a test the volume is adjusted to a point barely audible to the listener, and, starting with the lowest tone, the operator raises

Via Imetto Pistol Club
 Mexico Co. Inc. 2632
 m. 175
 Yucatan

the pitch through each successive frequency. If the listener fails to hear a tone, he presses the signal button. The operator then increases the volume to a point where the tone may be heard. A silent interrupter switch can cut off the tone at any time, thus exposing any attempt to claim better hearing than actually exists. A complete record is kept of every test showing the listener's ability to hear in each frequency.

m 119

Match Books Embossed With Ink and Powder

Anyone can emboss his own name on specially treated match packs by using a certain kind of powder, ink and pen. With the pen and ink, the name is first written on the match pack. Then the powder is dusted onto the ink, which become fused onto the flap when held over a 60-watt electric light bulb. The result is a signature in unique raised letters. To prevent burning the fingers or igniting the matches, an asbestos holder is supplied to slip over the matches when they are held over the light bulb.

Emboss O. Match

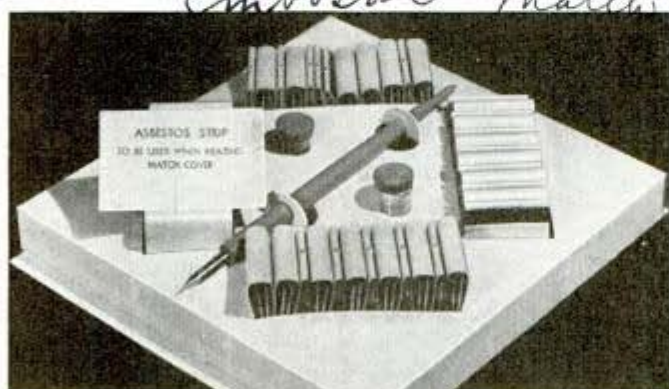

Kit for embossing match books, top, and steps in the process

JUNE, 1942

m 192

"Chinese Puzzle" Shell Carrier Guards Against Explosions

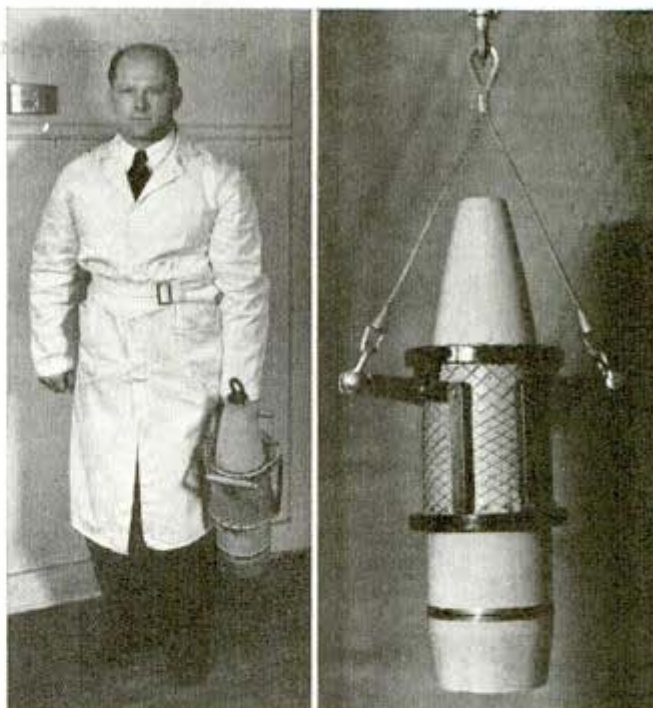

Safe shell carrier designed for use by hand (left) or hoist

Built like a Chinese puzzle—the tubular mesh that binds when you insert your fingers and then try to pull them free—a carrier for explosive shells distributes leverage evenly to grip the shells securely for safety in handling them. When the carrier is slipped over the shell and lifted, the weight of the shell extends the mesh and increases the leverage on the bars that extend along the side.

m 24

125-Ton Seaplane Planned To Fly 80 Tons of Bombs

Nearly twice the gigantic dimensions of the largest flying boat ever built, a 250,000-pound flying boat is on the drawing boards at the Glenn L. Martin aircraft plant. Probably the precursor of the huge Clippers that will fly freight across the oceans in peace time, this projected monster is planned to carry 80 tons of bombs. Details of the giant are secret. Mr. Martin, disclosing only that it would be able to span the Atlantic at well over 300 miles an hour, added: "And that's only the beginning."

Universal Match Co. Baltimore, Md. 87
840, Boatmen's Bank Bldg.

Kellems Co., 1911 Park Ave. New York

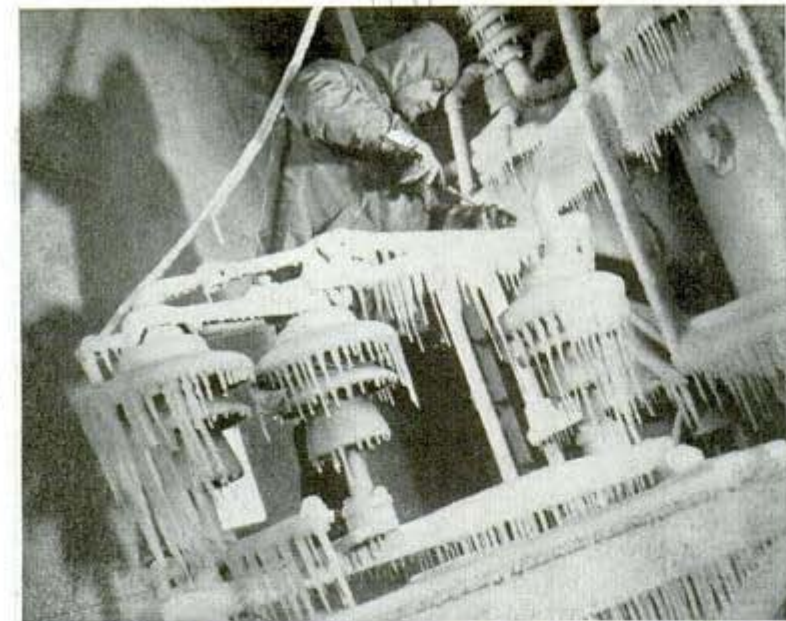

Power-line switch being prepared for test in 20-degree below-zero laboratory

station by a saboteur, the severance of a power line so it would fall to the ground, explosives planted on the ground or an aerial bomb might be the means of creating such short circuits.

These hard-hitting test charges, amounting to 2,000,000 kilowatts, carry twice as much power as is produced at any instant at Niagara Falls. They are created by twin, 500-ton generators in the laboratory, located at the Westinghouse East Pittsburgh works. Each generator is driven by a 6,000-horsepower motor. If the generators could deliver continuously their com-

TORTURE CHAMBER *Guards* POWER LINES

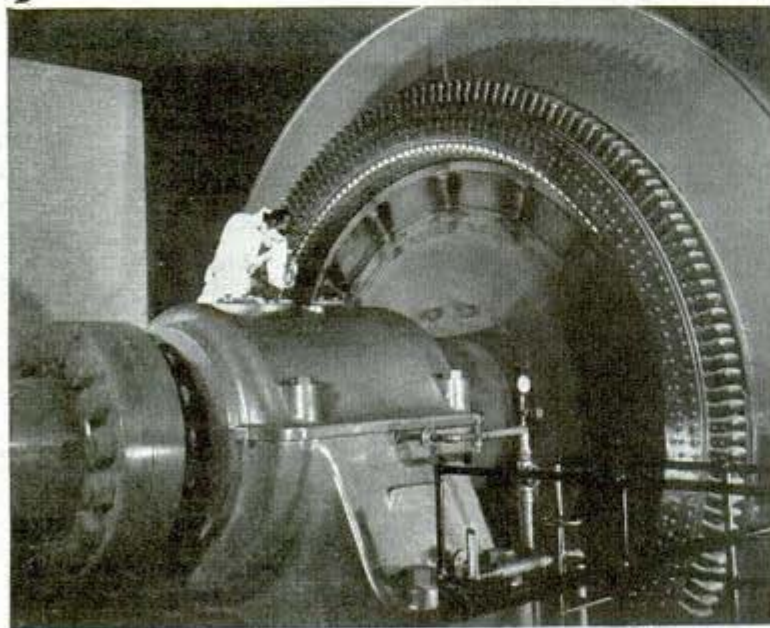

Checking oil in bearing of a 500-ton generator in test laboratory

Bank of 15-foot transformers in Westinghouse high-voltage yard



ELECTRICAL knockout punches—equal in destructive force to 75,000 lightning bolts—are being hurled in a new high-power laboratory that will play an important role in the protection of America's power lines against bomb and sabotage damage.

Safety fuses and circuit breakers, the guardians of power lines, are tested in this laboratory to determine their resistance to tremendous surges of electricity caused by short circuits. A bar of steel thrown across the electric circuits in a power

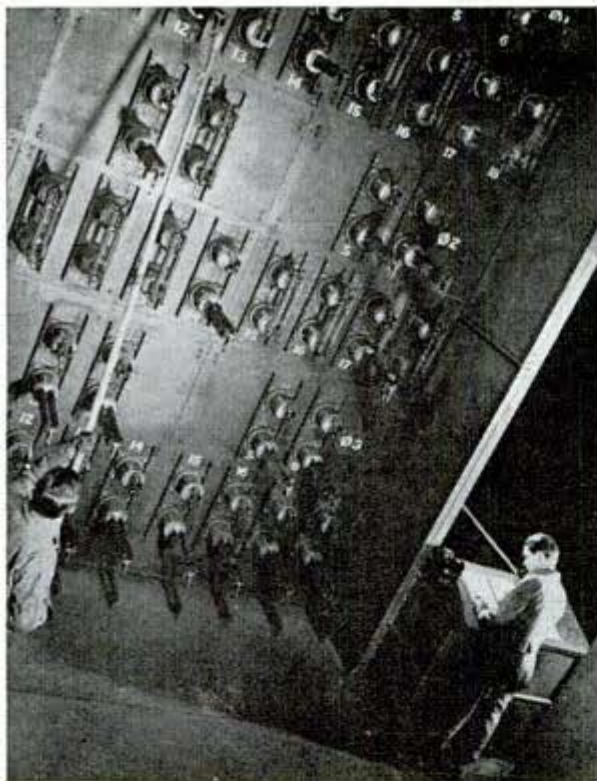

Electrician (at left) using wooden pole to close knife switch while man at right receives instructions for setting the switches



Engineer in control room of laboratory has at his fingertips 150 knobs, buttons and dials to regulate power creation and flow

bined output, the 2,000,000 kilowatts would light enough tube-shaped fluorescent lamps to girdle the earth twice at the equator. The mechanical equivalent of that much electricity is 2,680,000 horsepower—enough to drive 20 modern battleships.

Spinning at their top speed of 514 revolutions per minute, the generators' two 300-ton rotating members, called rotors, when short-circuited set up vibrations that shake the gymnasium-sized brick and steel laboratory building. Release of a short circuit surge from the machines drains electricity so suddenly from their copper windings that the entire mass of the two generators recoils like a gun and only special steel spring mountings

(Continued to page 174)

Explosive force of 1,500,000 kilowatts of power pulls apart three copper cables sandwiched between six-inch timbers bound with heavy rope

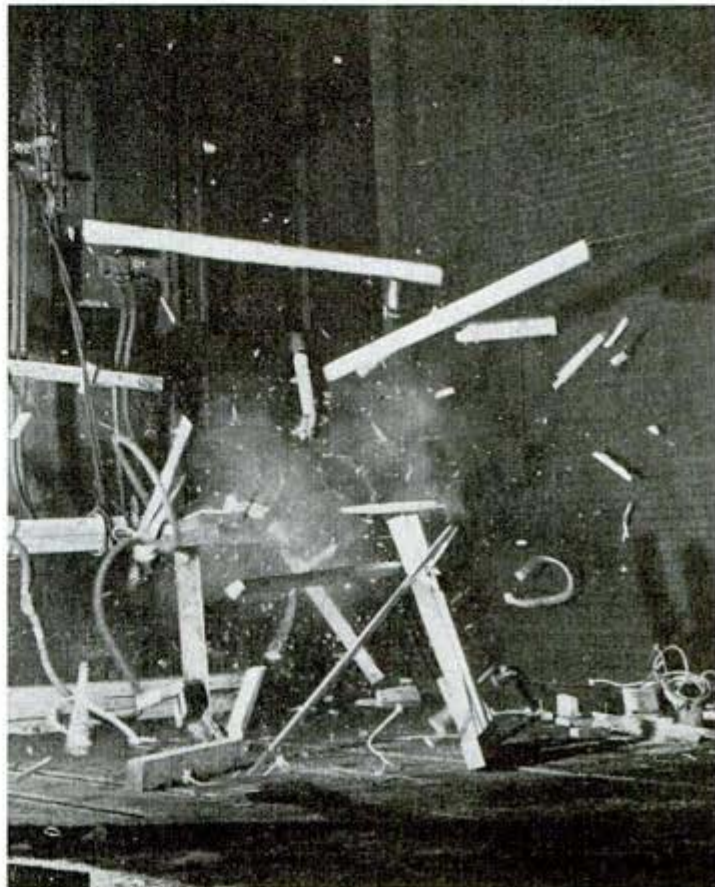

Emb. Joan White, 418-19th Ave San Francisco Calif

m 90.

Tile Mural Built With Watchmaking Precision

Arline Lodge

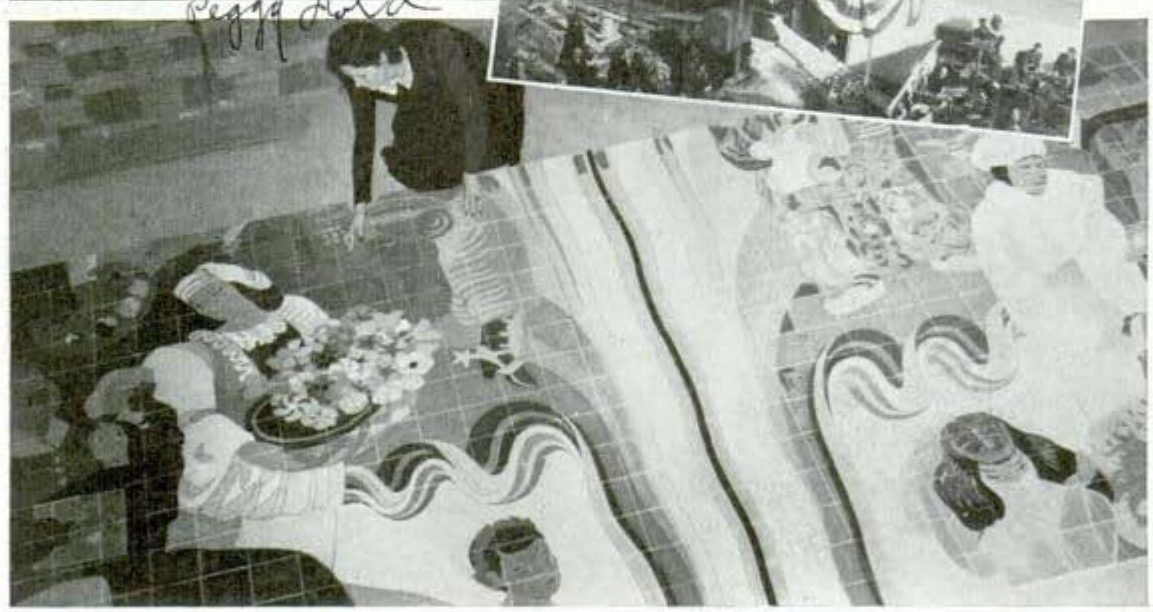
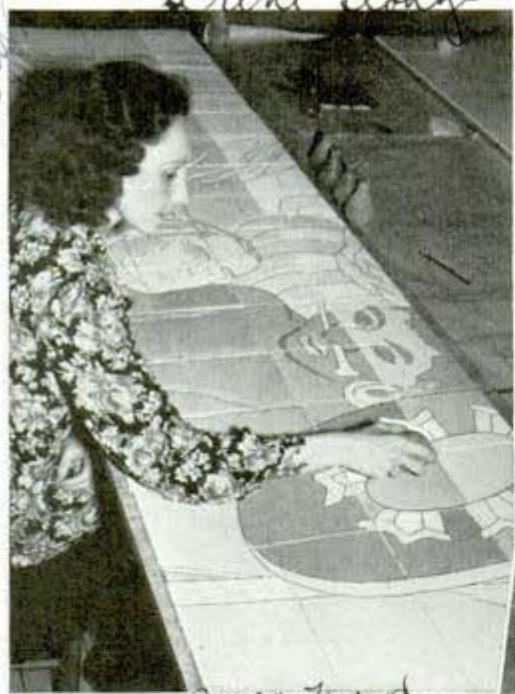

Peggy Ford

Top, right, finished mural on building; left, glazing head-hunter's shield; bottom, laying a tile

Hairline precision in forming the tiles for a mural erected over the entrance to the National Broadcasting Company's new building in San Francisco required new manufacturing methods and extreme care in selection of colors. Made up of 2,560 tiles, each six inches square and formed to an accuracy of 1/13,000 inch, this mural stands 40 feet high and 16 feet wide. The tiles consist of a mixture of flour-fine talc, silica and clay treated and molded in heavy

presses under a pressure of 1,000 pounds per square inch. They were then baked at a temperature of 2,150 degrees, Fahrenheit, thermostats being used to maintain a uniform kiln temperature throughout. After baking, the white tiles, or "bisques," were tested for warps or cracks that might occur in burning, and were checked for size with micrometer precision. To prepare them for coloring, several rows of the white bisques were laid out, constituting one section of

the mural, and the working drawing for that section was placed over it. Then lines were traced onto the tiles through carbon paper to form divisions between adjoining colors, or "glazes." Each color zone bore a number corresponding to one of the 114 colors in the original oil painting. The glazes, contained in small rubber syringes, were "flowed in" and the sections were returned to the kiln for baking up to 2,000 degrees. After the tiles were pieced together in the mural, it was discovered that the rich, high-fired colored glazes were more brilliant than the colors in the original, and they are said to be capable of holding true under all kinds of weather.

21388
**Sweater Drying Stretcher
 Adjusts for Many Sizes**

Fully adjustable in both length and width, a sweater stretcher holds garments in shape while drying. Made of wood with sliding metal strips that provide the extension feature, the blocking frame may be enlarged from size 32 to 44. The top and bottom pieces are split in the center and joined by the metal pieces for sidewise adjustment. The sides are similarly joined at the shoulder to permit adjustment in length. Wire sleeve holders, supplied in two sizes, fit into the frame.

Mueller

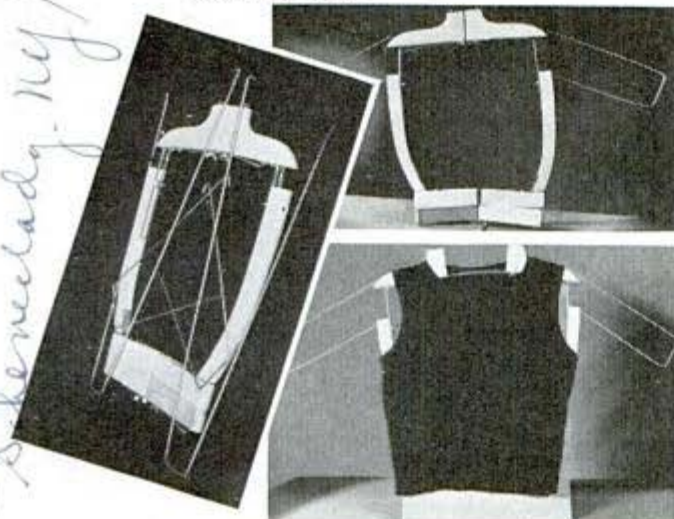

Frame is adjustable in all directions to fit size of garment

M190

**Slotted Hoods for Auto Lights
 Slip Over Lenses in Blackout**



Top, fitting blackout hoods over the headlamps. These slip on easily without special attachments. Below, the taillight mask

Metal shields that are easily installed over the automobile lights during a blackout are offered by a Chicago inventor in shapes and sizes to fit most recent car models. The hoods are slotted to throw a beam of light visible 100 yards ahead, but visors and baffles prevent any light from shining upward or against the ground, where it would be reflected and become visible to an airplane observer. In a test made with the blackout shields on a city street, no light was visible from the 19th floor of a building. The set of hoods, available in a protective metal box, includes coverings for headlamps, tail lamp and the rear license light.

*Mueller's garment frame Co.
 123 Broadway, N.Y.*

Clay Sawyer #01 of 17 the one

*Chicago Curtain Stretcher Co
 3727 N. May St. Chicago*

Cont. Thomas & Stinson
3892 Franklin

The REVOLUTION Los Angeles in FARMING



New Science

↑
Comparing plants, the smaller ones of which were fed nutrient solution deficient in a vital element

FEWER people than live in New York City some day may be able to raise enough food to feed the whole United States.

This startling conclusion is based on the rapid strides that agriculture is taking. In Revolutionary times more than 75 percent of the population worked on farms. By 1910 only a third of the people were farmers and today less than 25 percent of the population cultivates the soil. Of these, 50 percent account for about 90 percent of production. The trend toward greater production is still accelerating and some economists figure that within three years the average farm will be able to produce 30 to 40 percent more than it could back in 1930.

This is coming to pass



Gen. Schaub, University of California Berkeley Calif

↑
Water curtain on glass roof admits sunlight to growing plants but excludes heat

→
Tanks and covers, interiors painted black, used in water culture

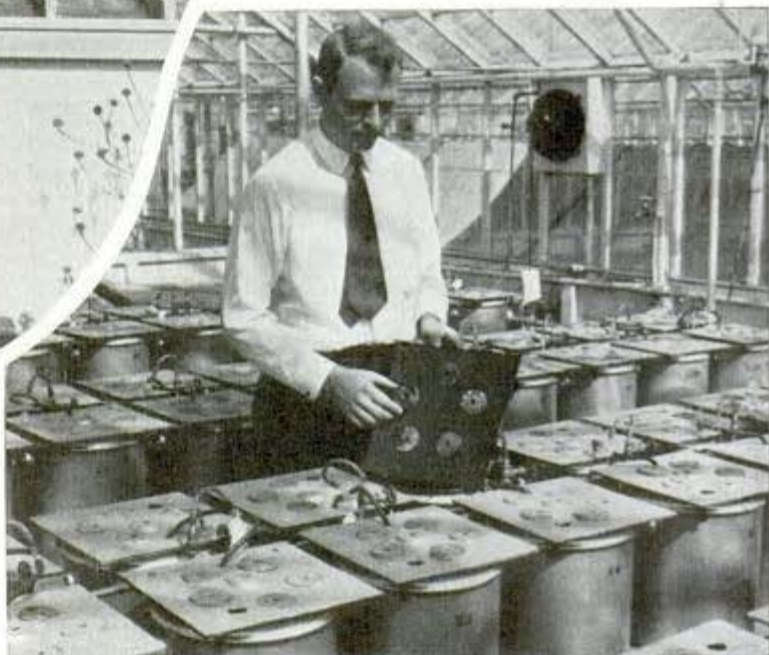

21390

because of improvements in the quantities and qualities of farm products, more accurate anticipation of weather conditions, better pest control, better plant feeding, and more complete mechanization of farm operations. The result is that farmers are raising more food of better quality with less effort than was ever imagined. The United States, with only two percent of the world's farm population, is the world's greatest agricultural nation.

Hybrid corn is an outstanding example of what is happening in plant breeding but it is not the only example. Hybrid corn yields 20 percent more per acre and is also more resistant to diseases, drought and wind, with the result that production per acre is really doubled. A new strain of oats developed in Wisconsin is just as remarkable, yielding 80 bushels per acre instead of 40, and having other desirable qualities. Other grains, fruits, and vegetables are being improved similarly.

Now that science is learning to foretell general weather conditions four and six months in advance, farmers are going to be able to advance or hold back their plantings to take advantage of the weather. One way to help get a crop no matter what the early weather is like is provided by a new variable depth cotton planter. Some of the seeds are planted shallow, some are planted deep. If the seeds from both depths grow the poorest can be hoed out. But if frost kills the upper sprouts, the deeply plant-



Apparatus which makes possible the determination of effect of various light spectra on plants; note the fluorescent light tubes

Measuring amounts of gas given off by fruit in storage; this is part of the program to reduce spoilage in large storehouses

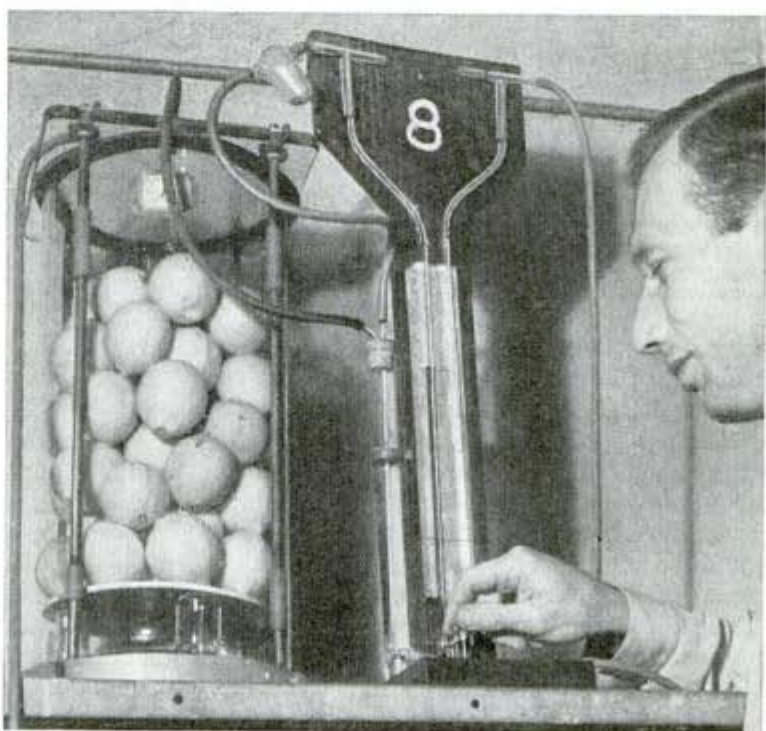



Sealed chamber inside of which elements required by cow will be studied

seems to be for the raising of a few such specialty crops as out of season tomatoes and hot house flowers.

Water culture may never revolutionize farming directly but it is more than doing its part in helping change agriculture into an exact science. It is the best tool research men have for studying the food that plants require. When soil deficiencies can be satisfied, crops will be of a more uniform high quality, of higher vitamin and mineral content, and more resistant to deficiency diseases. In some cases selective feeding controls and even alters some plant characteristics. Water culture is the favored method for such investigations. The complex minerals in soil used in experimental



Machine that gathers and chops guayule plants preparatory to rubber extraction process

Copyright 1941 Automobile Club of Southern California

ed seeds will still grow. If wet weather rots the deeper seeds the same weather makes the shallow seeds flourish.

Some people have hoped that the labor of growing food could be cut to a minimum by "factory farming," using the hydroponics or water culture method of raising plants in solutions that contain all the minerals needed. Great things were promised for hydroponics four or five years ago but now water culture has settled back into its old role of being an important research tool. Commercially, its only practical value

plots can't be controlled or even measured, while with water culture the exact amount of minerals fed to the plants is known.

Even so, the research men have their problems. Some of the zinc contained in rubber tubing, for example, is apt to contaminate the mineral solution as it flows through the tube, completely changing the proportions in the solution.

For healthy growth, plants must be pro-

21395

vided with such elements as nitrogen, potassium, phosphorus, and calcium. In addition they need tiny quantities of copper, boron, zinc, molybdenum, and manganese. Usually soils contain greater quantities of these micro-nutrients than the plants can use but sometimes the plants show signs of illness in spite of the plentiful mineral supply. Apparently some of the chemicals are in a state that can't be absorbed by the plants.

Many obscure plant diseases are now known to be caused by such lacks. Such deficiencies limit production. Little-leaf in fruit trees, it has been found, is caused by a lack of zinc and today trees are sprayed with a zinc solution to combat the condition. Corky tissue in apples results when the trees grow in soil lacking boron. Spreading a few pounds of borax in the soil around the trees improves the crop. Manganese salts are injected into walnut, orange, and lemon trees when lack of manganese in the soil retards them.

Today plant scientists are trying to learn how the minerals in a soil move into a

Examining two-year-old pear tree raised by water culture at Berkeley



Using Geiger counter to locate radio-active food fed to tomato plant

plant and through it from one part to another. From this they hope to be able to increase soil fertility when needed, either by adding needed chemicals or by adding material to the soil that will release some of the chemicals already present.

To trace the movement of food into and through a plant they are using elements that have been made radio-active in a cyclotron. On the Berkeley campus of the University of California, for instance, eight or ten elements including bromin, rubidium, zinc, and phosphorus, are being used in the radio-active studies. One of these radio-active elements is added to the nutrient solution and a Geiger counter that indicates radio-activity is used to determine how long it takes the plant to absorb the tracer material. In some cases the plant is dissected and each part is measured for radio-activity. In other cases "radio autographs" that show the distribution of the material through the plant structure are made with X-ray film.

The absorption of nitrogen, carbon and hydrogen by plants and the movement of these elements through the plant is achieved by adding heavy isotopes of such elements to the nutrient solution. These tagged atoms are later detected in the plant by using a mass spectrometer that sorts the heavy isotopes from the normal ones. Complicated as such studies are, these are only a few of the investigations that are being conducted to improve agriculture.

(Continued to page 175)

M 141

Crocheted 'Hammock' Sling Supports Arm in Comfort



"Hammock" sling gives arm a comfortable support

Made of cotton yarn crocheted in a wide mesh, a new arm sling shaped like a hammock has been developed for the British armed forces by Miss Marjorie Bate, a member of St. John's Ambulance. Said to give better and more evenly distributed support to an injured arm, the sling also does away with knots and pins.

M 120

Meter Reveals Velocity of Air Flowing Through Ducts

Better control of air velocity in heating systems and air-conditioning units is ob-

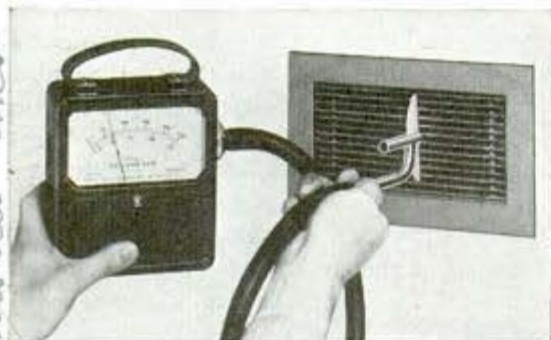

Meter shows speed of air leaving or entering duct

tainable with the aid of a direct-reading meter that indicates the speed of air in feet per minute without the use of a separate timing device or the need of calculations. Fitted with a special attachment for taking readings at intake and exhaust grilles, the instrument enables the operator to balance the incoming heated air with the outgoing stale air. By changing the jets, it is also possible to take readings of velocity and pressure in air conditioning ducts, paint spraying booths and wind tunnels.

M 106

One-Man Truck Wheel Remover Saves Labor of Lifting

One mechanic can remove or replace quickly the heaviest single or dual wheels with the aid of a truck wheel remover that bears the entire weight. With the truck jacked up, the remover is slid under the wheel to be taken off. Then the truck is lowered enough to allow only the weight of the wheel to rest on the platform of the remover. A few easy strokes of the handle

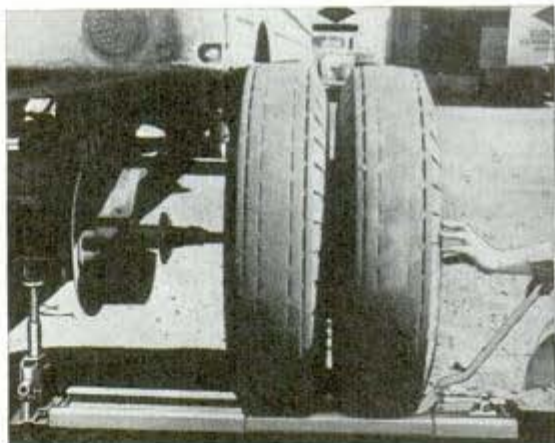

Heavy single or dual truck wheels can be removed or replaced by one man with this sliding platform

move the platform outward until it has carried the wheel completely clear of the truck axle. To replace a wheel, the operator reverses the ratchet, pumps the handle and slips the wheel onto the axle without manual lifting.

TRY THE WHERE-TO-BUY-IT INDEX

Names and addresses of manufacturers or distributors of commercially available products described in Popular Mechanics are listed in the Where-to-Buy-It index. Write to them to get additional information about any article in which you are interested. Say You Saw It in Popular Mechanics

420 N La Salle
Chicago



The CRAFTSMAN

Your choice in BOOK ENDS

AMONG the four designs given here, you'll find a pair of book ends to harmonize with your furniture regardless of whether the room is furnished in period or modern style.

For a den or recreation room depicting frontier days, the old west book end, Fig. 1, is just the thing. The popular cowboy motif in metal or thin plastic is fastened to a wood backing, the motif being encircled with a length of cotton string laid in a shallow groove to simulate a lariat. The base is a half circle of $\frac{3}{8}$ -in. plywood $5\frac{1}{2}$ in. in diameter, recessed on the underside for a piece of lead to add weight. The lead can be shaped to fit the recess and then screwed in place.

For a more conservative setting, the mission type of book end in Fig. 2 is suitable. It is made of maple and is finished in a warm brown. The small bell can be purchased at a dime store, or it can be spun. The bell is attached to a small maple turning, which is drilled so that it can be swung on a brass rod that projects from the

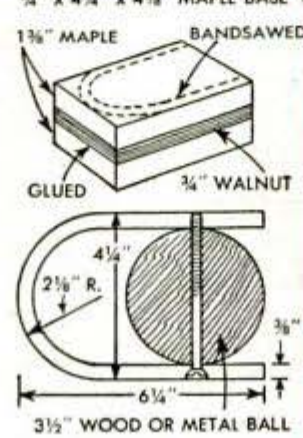
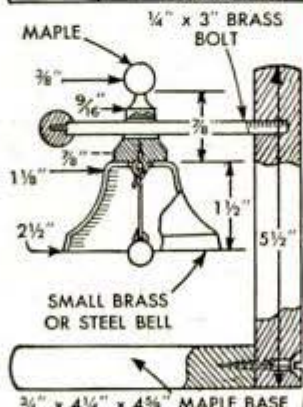

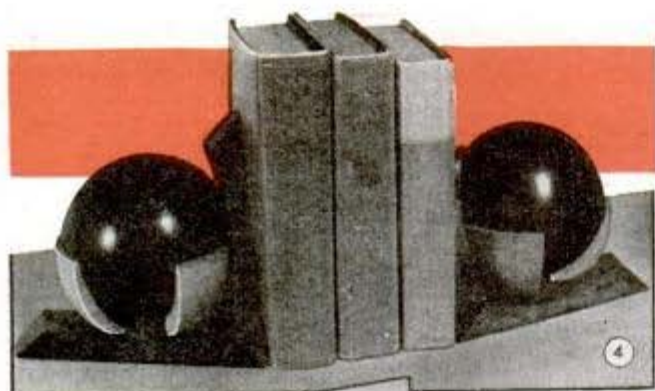

side of the book end. The modern book end in Fig. 3 features a 3½-in. wood or metal ball; this is mounted in a U-shaped wood frame cut from laminated maple and walnut. Finish for the wood parts should be natural to retain the color separation of the contrasting woods.

If you are looking for a book end of ultramodern design, the two-toned one in Fig. 4 will be suitable. First, the wedge-shaped base and

vertical piece are sawed to size. Then each one is glued to waste stock and the front surfaces turned to a concave shape, a socket being formed on the base piece to take a tenon on the ball as shown in Fig. 7, after which the two pieces are doweled together as in Fig. 9. When gluing the waste stock to the base and vertical piece, place paper between them to make separation easy. Next, the balls, which furnish substantial weight, are turned, leaving a tenon on each one to fit into the socket in the base. The decorative maple pieces in which the balls set are

segments of a bowl-shaped turning, the turning being cut into six segments, three for each ball, Figs. 6 and 8. These are glued to the balls at equidistant points, Fig. 10. To simplify the work, the balls and maple bowl are sanded and shellacked while in the lathe, the bases and vertical members being finished by hand. Pieces of thin felt are glued to the bases of the book ends to prevent marring any surface on which they may be placed.

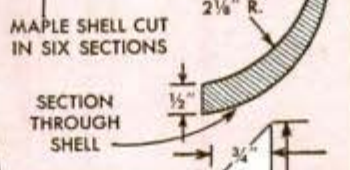
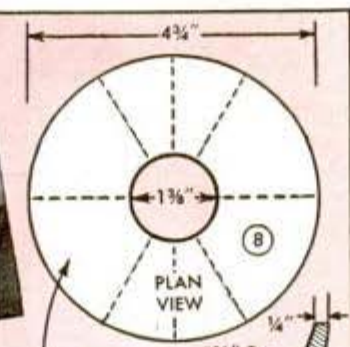
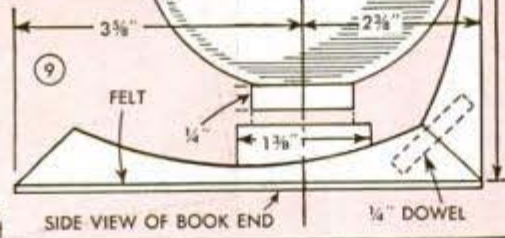
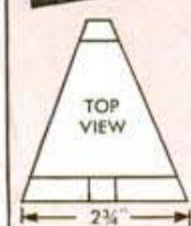

This Shelter Provides Shade for Lawn Furniture

If the trees in your yard are not large enough to provide a shady spot for lawn furniture on hot summer days, here's an inexpensive shelter that will serve the purpose. It consists of a simple framework of pipe fitted with a top made of bright-colored awning material. Secondhand pipe is entirely satisfactory for the framework as this can be painted after assembling to harmonize with other lawn furnishings. When enough strips of awning material have been sewed together to cover the top, all edges are scalloped and bound with tape. Loops are then provided for attaching the top and these are made by using a double thickness of awning material stitched through heavy woven tape. To attach the top, you thread a rope through the loops and around the pipe frame.

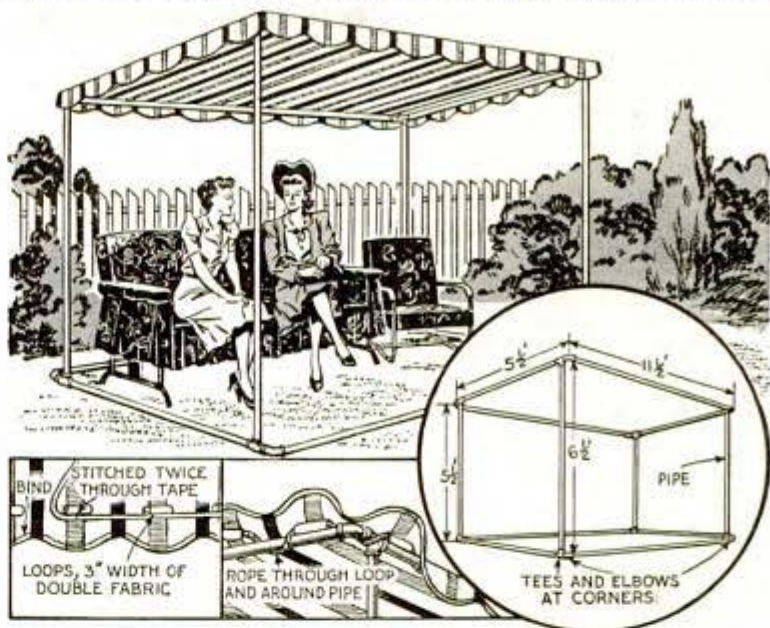

Filter Bowl on Kerosene Stove Prevents Clogged Fuel Line



Clogging of the fuel line on a kerosene stove was avoided by one householder who fitted a gasoline filter or sediment bowl in the line between the supply tank and the burners. The bowl was taken from an old car fuel line and was installed by cutting out a

section of the stove fuel line and threading the ends to screw into the bowl. Removing and cleaning out the bowl at regular periods is all that is necessary.

There is no need for your kitchen linoleum to become scratched from the furniture if you will glue pieces of felt to the bottom of the legs of tables, chairs, etc.

Twin Spectacle Case in One Unit

Anyone who has to carry two pairs of spectacles will find this twin case a time and pocket-space saver. It is made from two aluminum cases cemented together back to back with plastic wood. First sand the backs of the cases with very fine sandpaper, and then coat them with cellulose cement. Let this dry and apply plastic wood. Stick the cases together immediately, filling in around the edges with the plastic. Smooth the wet plastic with the fingertip dipped in alcohol. When dry apply a coat of cement and sprinkle aluminum powder on the tacky surface.



Solving HOME

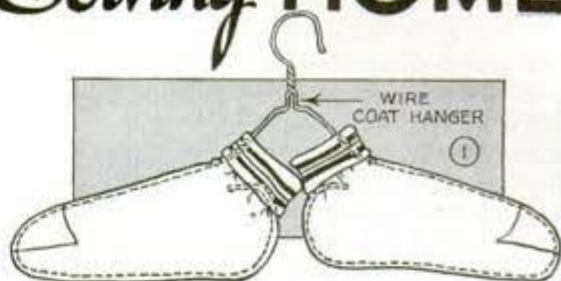

1, Laundered stockings of the ankle type will keep their shape if dried on a wire coat hanger which has been cut in the center and bent to the shape shown. 2, Made of colorful oilcloth and sewed to a strip of the same material, pockets provide handy receptacles for your toilet articles when hung on the mirror posts of a dresser or vanity. 3, The tedious job of removing pinfeathers from a fowl can be simplified by using a strawberry huller with which you can grip the feathers close to the skin of the bird. 4, You can avoid water marks on furniture caused by moisture on a flower vase if a piece of waxed paper is slipped under the vase. If the paper is cut to the same pattern as that of the doily used under the vase, the paper will be unnoticeable



5, Clean bottle caps with the cork inserts removed will serve as candy molds. If they are greased, the candy will come out easily after it has hardened. 6, A pin pushed into the side of the cork in a salt or pepper shaker will prevent it being pressed in too far

PROBLEMS

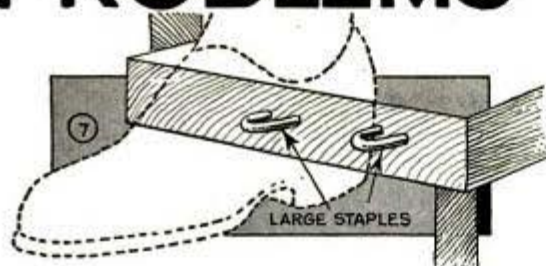

7, Driven into the edge of a porch step, two large staples provide a good bootjack for removing heavy rubbers easily. 8, Cotter keys bent as shown in the circle and slipped under the siding boards provide good fasteners for strings on which flower vines climb. 9, You'll find an empty adhesive-tape container just the thing on which to wind your tape measure and keep it clean. 10, Small holes in a window or door screen can be repaired neatly with cellulose cement, which is not noticeable when dry. First, bring the broken ends of the wires together with small tweezers and tie them, or use a patch if the hole is a large one. Coat both sides of the patch with the cement and then press it in place

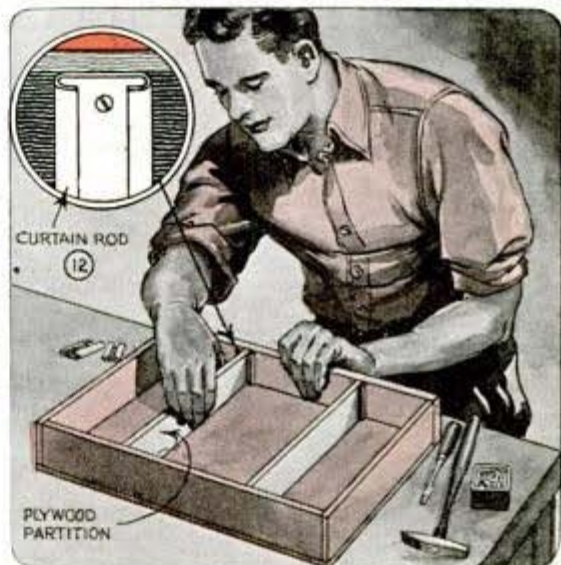
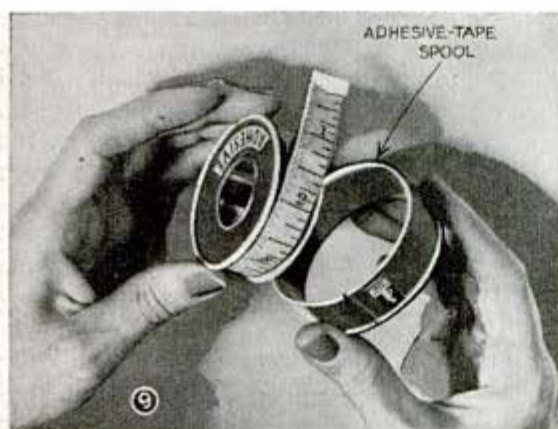
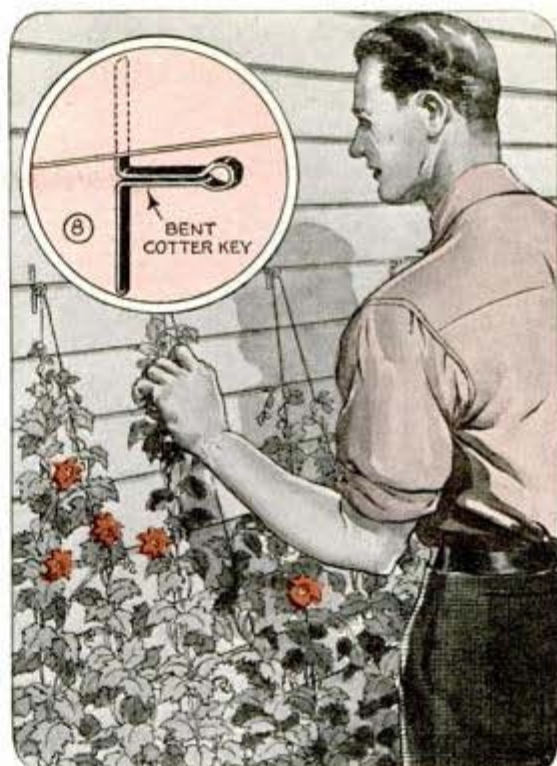

11, "Moleskin" adhesive, which can be obtained at most drug stores, is ideal to prevent bric-a-brac from scratching finished surfaces of furniture. 12, The grooved section of a flat curtain rod is just the thing to screw on inner sides of a drawer to hold partitions

Duster Brush Wipes Excess Water From Beverage Bottles

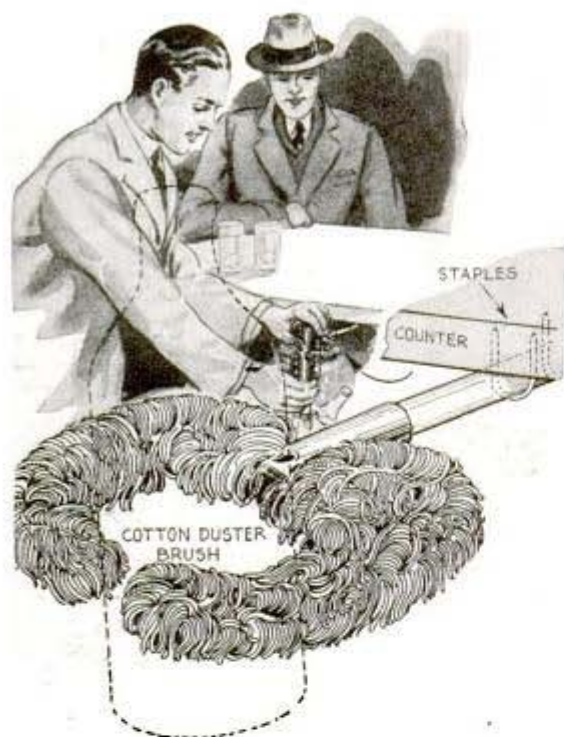

If you own a refreshment stand and cool beverages by keeping the bottles in ice water, here's a quick way to wipe excess water from the bottles before serving them to customers. Just attach a cotton duster brush in a convenient position under the counter with a couple of large staples. Only a second is required to push a bottle through the brush, which can be removed easily for washing whenever desired.

New Handle 'Burned' in Hammer

To fit a new handle in a hammer easily, first shape it so that it is slightly oversize and bevel the end a little. Then apply a mixture of grease and fuel oil to the end

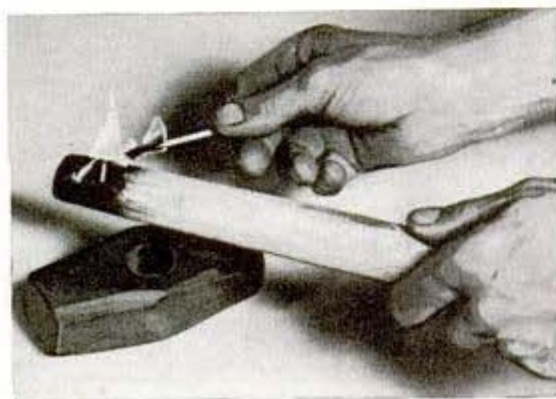

102

and ignite it, letting the oil flame until the wood is almost at the burning point. Now drive the handle quickly into the head and wedge it as usual.

—Benj. Nielsen, Aurora, Nebr.

Twisting of Oars When Rowing Avoided by Pins in Oarlocks

You can hold the blades of loose oars at the correct rowing angle without strain on the hands and wrists, by using short steel pins in the bottoms of the oarlocks. The pins are driven tightly into shallow holes drilled in the oarlocks and project into corresponding holes bored in the oars.

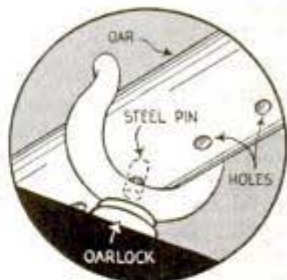

Tumblers Serve as Place Cards



A novel and unusual method of seating guests at a table is to write their first names or initials on the water glasses at the plates. This is done with heavy cord, either white

or colored. As the cord is formed into letters, it is held in place with small pieces of cellulose tape, using small dabs of cellulose cement to affix them more permanently. The letters or writing can be stripped off easily after it has served the purpose.

—Kenneth Murray, Colon, Mich.

Handle of Darning Egg to Mend Fingers of Ladies' Gloves

With a little trimming the handle of a darning egg is just the thing to insert into the finger of a glove while mending it. The handle can be trimmed to the proper shape easily with a knife and sandpapered to the desired diameter.



POPULAR MECHANICS

BOUDOIR CHAIR

has storage space

UNUSUAL in design, this chair has doors at the back with shelves on which can be stored small articles, such as lotions and make-up. Also, there's space under the seat for larger articles. After band-sawing the bottom, seat and frame members to shape, the chair is assembled as indicated, and then covered with $\frac{3}{16}$ -in. plywood, including the seat compartment. The entire chair is upholstered, the seat compartment being padded on the sides. A cushion is used on the seat, and is shaped to fit.

—W. K. Vining, Daytona Beach, Fla.

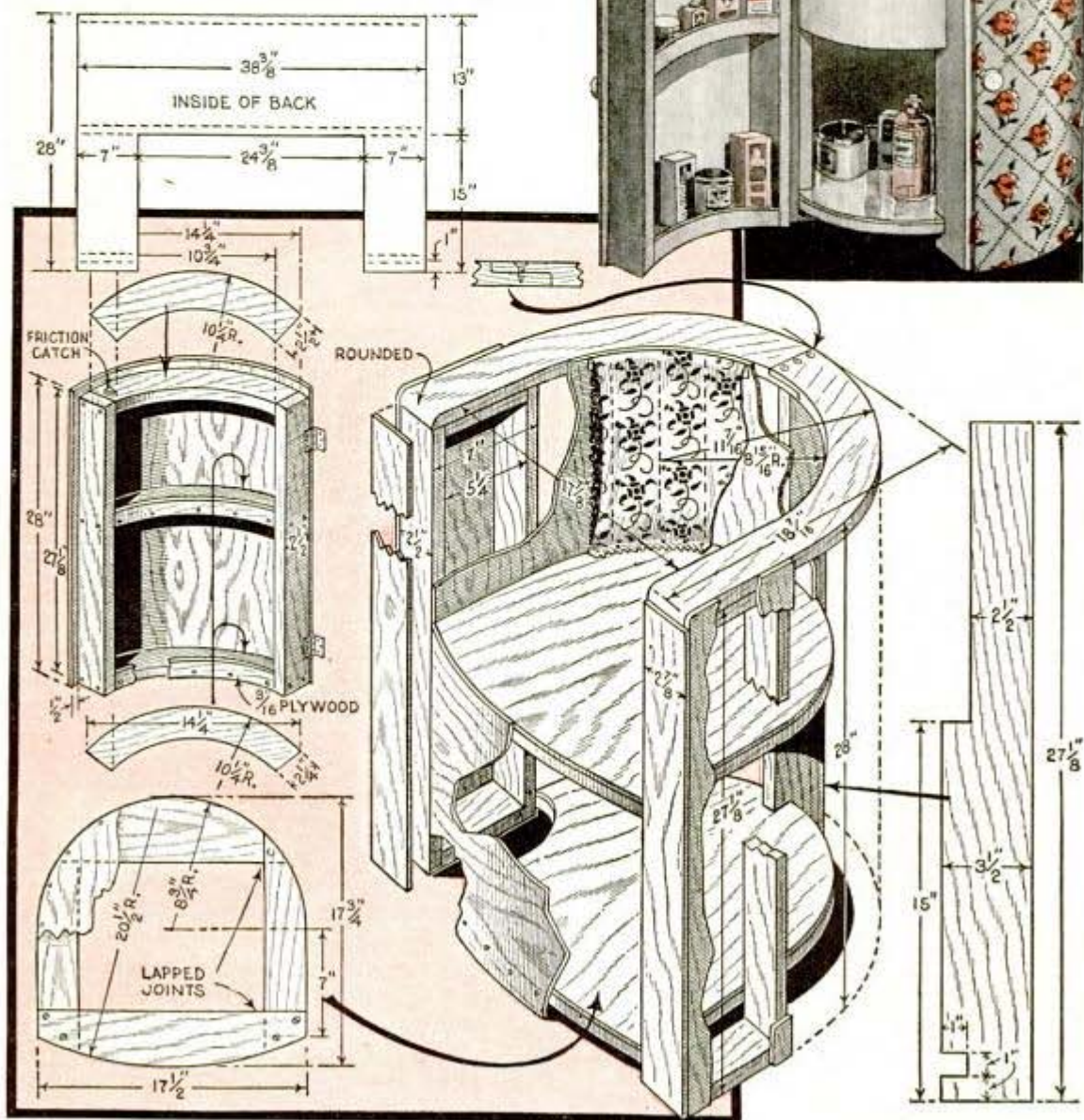

Adjustable Footrest in Rowboat Made of Bamboo Pole



Finding the permanent footrest of a rowboat not adapted to his height, one sportsman cut a length of bamboo from a fishing pole and bent it to fit across the bottom of the boat. The pointed ends of the bamboo engaged the sides of the boat sufficiently to prevent slipping.

Soft Face for Jaws of Wrench Or Vise From Bearings

Protection for the finest finish, yet ample strength to withstand the hardest service is provided by soft wrench or vise jaws made from steel-backed, babbitt-faced motor bearings. The bearings are cut to a suitable size to form the jaws. Then by hammering them to form, the stiffness of the steel back will prevent their coming off

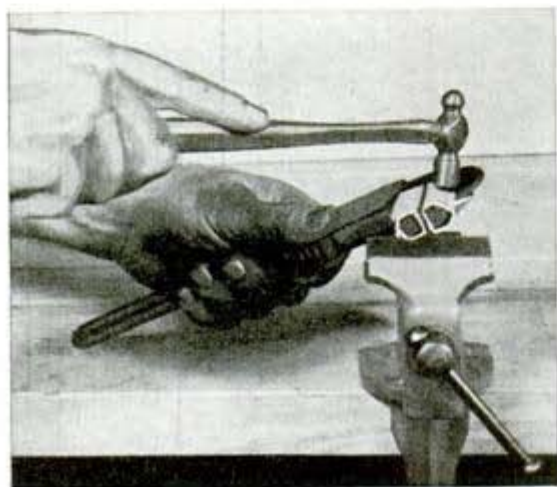

while in use. The babbitt gives the same protection that is obtained by using copper or lead with the advantage that it does not break down as quickly as these materials when in hard service.

Method of Locking Window Sash At Any Desired Height

With this method you can lock window sashes in the closed position, or at any predetermined opened position. To install the lock, close the sashes tightly and

close the sashes tightly and drill a small hole through the check rails for a small bolt. Next counterbore the check rail of the upper sash and fit in a tapped washer, fastening it in place with a couple of brads. Then plug the hole and counterbore the hole in the lower-sash check rail to take a smaller washer, which is soldered to the bolt to keep it from being pulled completely out of the hole. At one or more locations on the upper sash, provide holes and tapped washers to take the bolt as before. These lock the sash in the raised position.

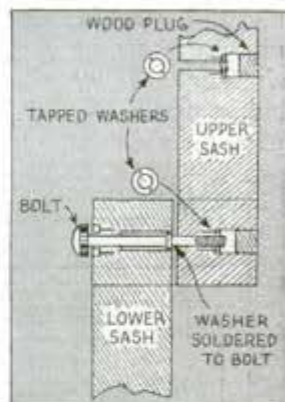

lock the sash in the raised position.

Blackout Paint on Windows

Black, dark brown and dark olive drab paints of a spar-varnish type applied on the outside surface of ordinary window glass are recommended for blackouts, where it is necessary to paint windows such as skylights. The paint should be flat—not glossy—in order to avoid reflections. Application of blackout paint to the inside of glass causes a mirrorlike effect so that moonlight and flares are reflected more than by uncoated glass. An inside painting job on windows therefore, is not fully effective as a blackout. Light can be shut off and reflected glare eliminated by painting the outside of windows. To counteract the depressing effect of darkened windows, a white undercoat can be applied before the blackout paint. On plate glass, it is advisable to use lighter colored paint because dark colored paints absorb so much heat from the sun that the glass is likely to crack.

Closet-Door MAGAZINE RACK

THOSE who live in single rooms or small apartments will find this rack a space saver for keeping favorite magazines filed neatly and hidden from view. Although the rack is light in weight, it may be necessary to add another hinge and reinforce the door at the corners, especially if the rack is loaded heavily. Screws driven through long cleats on the inner surfaces of the side members are used for attaching the rack to the inside of the door.

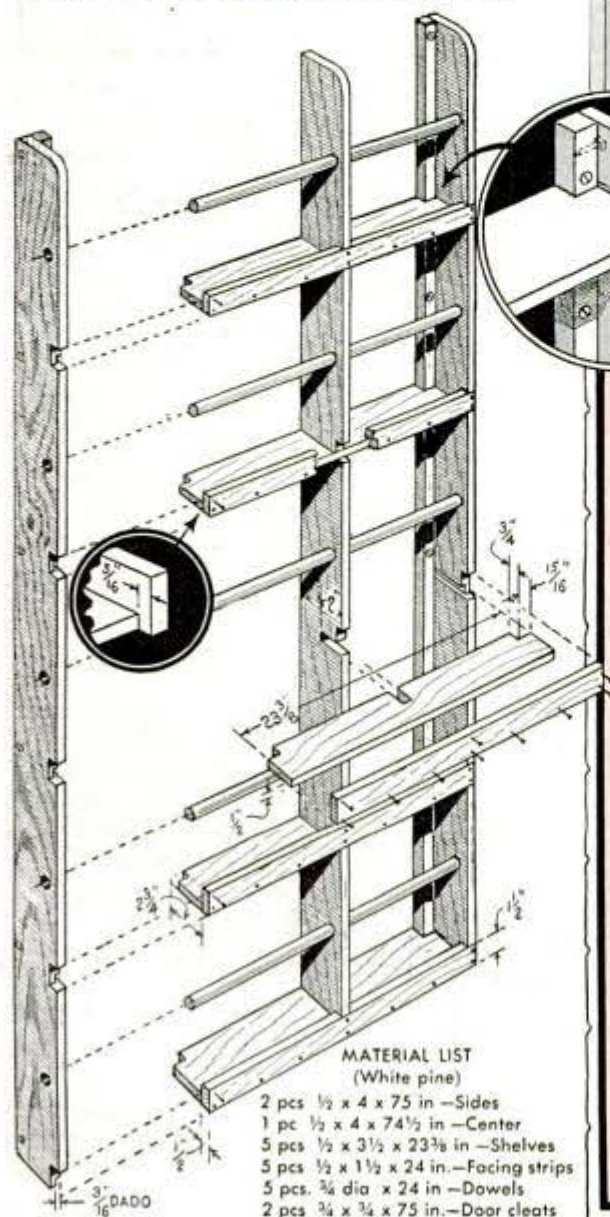

MATERIAL LIST (White pine)

- 2 pcs $\frac{1}{2}$ x 4 x 75 in.—Sides
- 1 pc $\frac{1}{2}$ x 4 x 74 $\frac{1}{2}$ in.—Center
- 5 pcs $\frac{1}{2}$ x 3 $\frac{1}{2}$ x 23 $\frac{3}{4}$ in.—Shelves
- 5 pcs $\frac{1}{2}$ x 1 $\frac{1}{2}$ x 24 in.—Facing strips
- 5 pcs $\frac{3}{4}$ dia x 24 in.—Dowels
- 2 pcs $\frac{3}{4}$ x $\frac{3}{4}$ x 75 in.—Door cleats

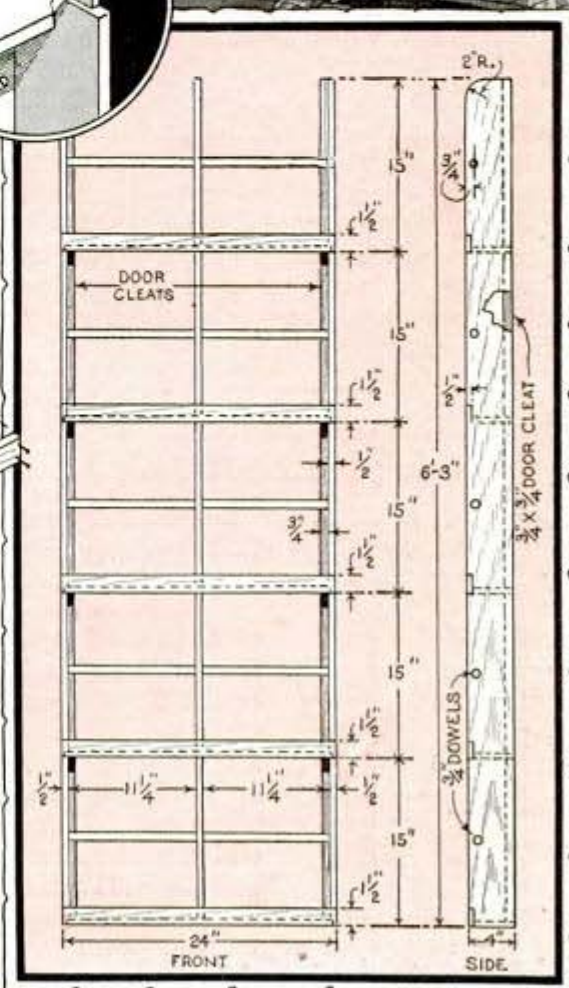

Sheet-Metal Work Held Safely On Drill-Press Table



Small pieces of thin sheet metal can be held safely on a drill-press table with this simple clamp, which consists of a handle cut from $\frac{3}{4}$ -in. stock and a bolt with washer and wing nut to fit. The underside of the handle is covered partially with a strip of fabric belting tacked or cemented in place while a hook is bent on the head end of the bolt so that it will slip over the table edge. In use, the work is placed under the wood strip and pressure is exerted on the handle to prevent the work from turning when operating the drill.

Lapel Button Altered to Avoid Losing It Accidentally



Lapel buttons that are made like the one shown can be altered to prevent them from being dislodged easily. First file a small notch in the rim on the underside of the pin. Then cut off the end of the latter so that it will just

clear the notch, and re-point it. When you put the button on a garment, press the point into the notch and turn the upper

part. This will move the notch to one side so that the point of the pin rests firmly under the rim, thus locking the button securely in place.

Toothpick Used as Screw Driver For Tiny Mechanisms

When assembling a watch, clock, camera shutter or other small mechanism, starting of tiny screws can be simplified by using a toothpick. Wet the wedge-shaped end and break it off so that it fits tightly in the



screw slot. This makes it possible to hold the screw in position for easy starting.

Powder Sprinkled Over Stamps Prevents Sticking Together

I often enclose several postage stamps when corresponding with a soldier friend as it is sometimes difficult for him to secure stamps, especially while on maneuvers. On one occasion, I learned that the stamps had stuck together and were impossible to separate. However, I found that by spreading a little talcum powder on the gummed side of the stamps, similar trouble was avoided. This idea has also proved effective in preventing stamps from sticking while carrying them in a billfold.

—William Swallow, Brooklyn, N. Y.



Model of U.S. Frigate "CONSTELLATION"

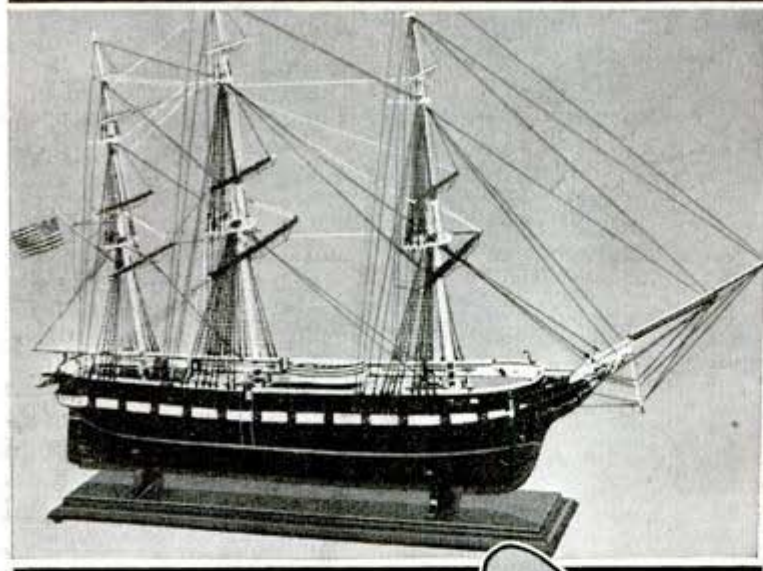

By H. W. Potter

PART II

Bow head, bulwarks and gun ports

NOW that you have the hull carved and the stem, rudder and keel fitted, start building up the head at the bow. If you haven't already made a cradle to hold the hull upright, make a temporary one of pine and later replace it with a nicely finished one of walnut as detailed in Fig. 28. The stem knees are rather tricky to fit, especially where they butt

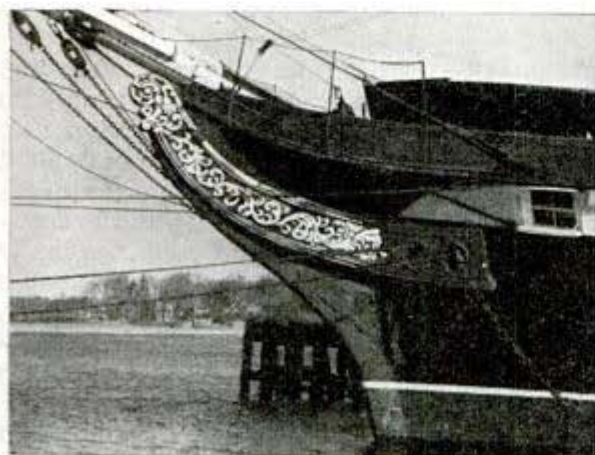
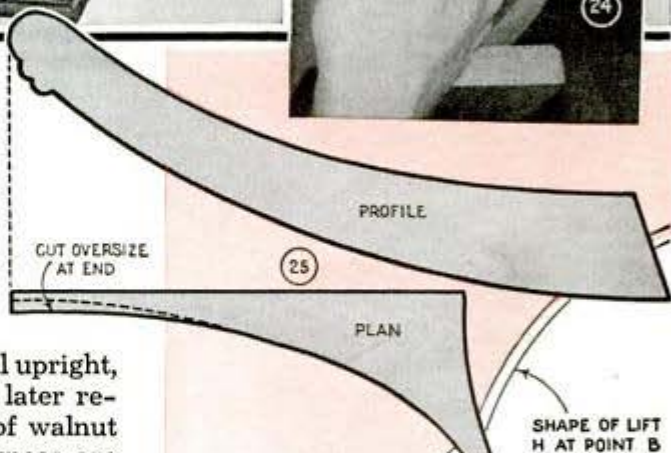

Compared with the scroll design at the right, this bow view of "Constellation" shows how faithfully the knee ornamentation has been reproduced in the model

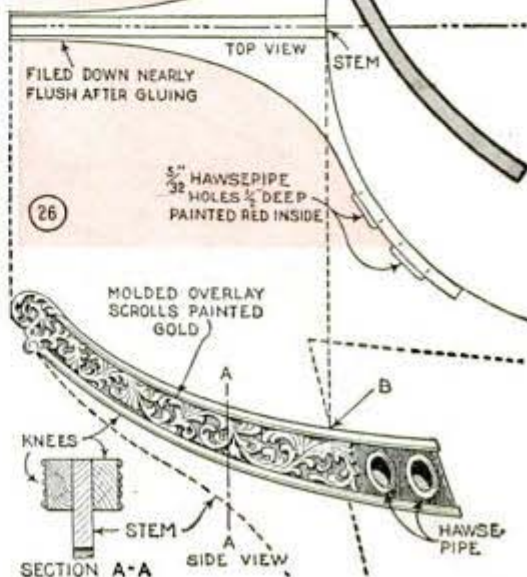

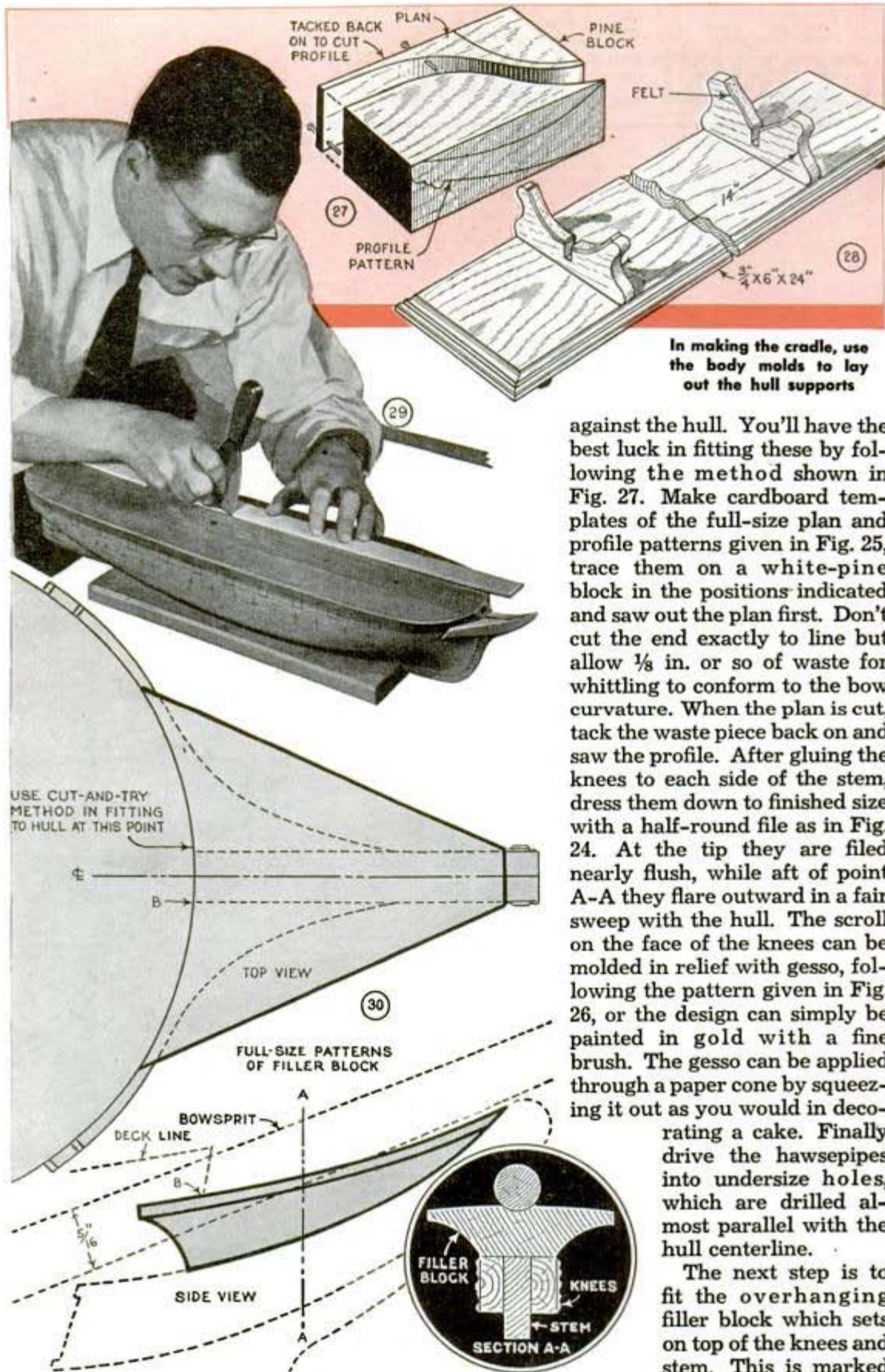

In making the cradle, use the body molds to lay out the hull supports

against the hull. You'll have the best luck in fitting these by following the method shown in Fig. 27. Make cardboard templates of the full-size plan and profile patterns given in Fig. 25, trace them on a white-pine block in the positions indicated and saw out the plan first. Don't cut the end exactly to line but allow $\frac{1}{8}$ in. or so of waste for whittling to conform to the bow curvature. When the plan is cut, tack the waste piece back on and saw the profile. After gluing the knees to each side of the stem, dress them down to finished size with a half-round file as in Fig. 24. At the tip they are filed nearly flush, while aft of point A-A they flare outward in a fair sweep with the hull. The scroll on the face of the knees can be molded in relief with gesso, following the pattern given in Fig. 26, or the design can simply be painted in gold with a fine brush. The gesso can be applied through a paper cone by squeezing it out as you would in decorating a cake. Finally

drive the hawsepipes into undersize holes, which are drilled almost parallel with the hull centerline.

The next step is to fit the overhanging filler block which sets on top of the knees and stem. This is marked

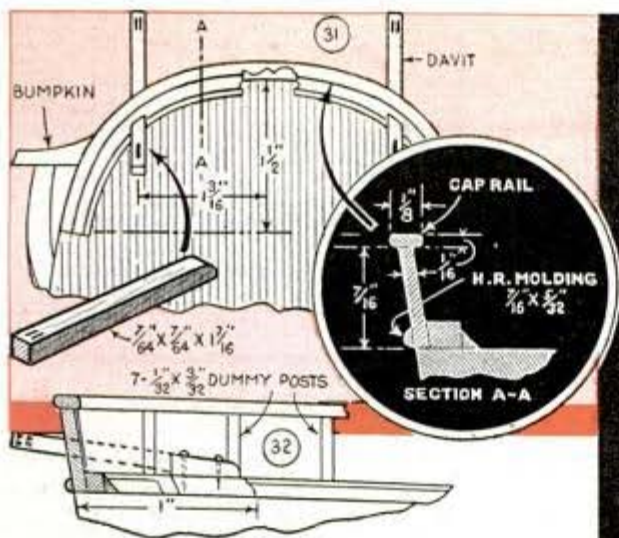

from the full-size plan and profile patterns given in Fig. 30 and cut and fitted to the hull the same way you did for the knees. You will notice in the circular detail below Fig. 30 that the block is flared on the underside. This cove follows the knee line at the bottom, while at the top it runs parallel with the edge as marked. Before going any further, it is well to score the deck to represent planking. This is done by stepping off $\frac{3}{32}$ -in. spaces each way from the centerline with dividers, and then drawing a putty knife along a flexible straightedge which you hold firmly in line with the marks as in Fig. 29. Bear lightly at first to keep the blade from running out of line with the grain and producing crooked "planks." About three passes of the knife will make the right score. Sand the wood lightly, dust and gauge a line completely around the deck $\frac{1}{4}$ in. in from the edge. Then apply a thin coat of shellac,

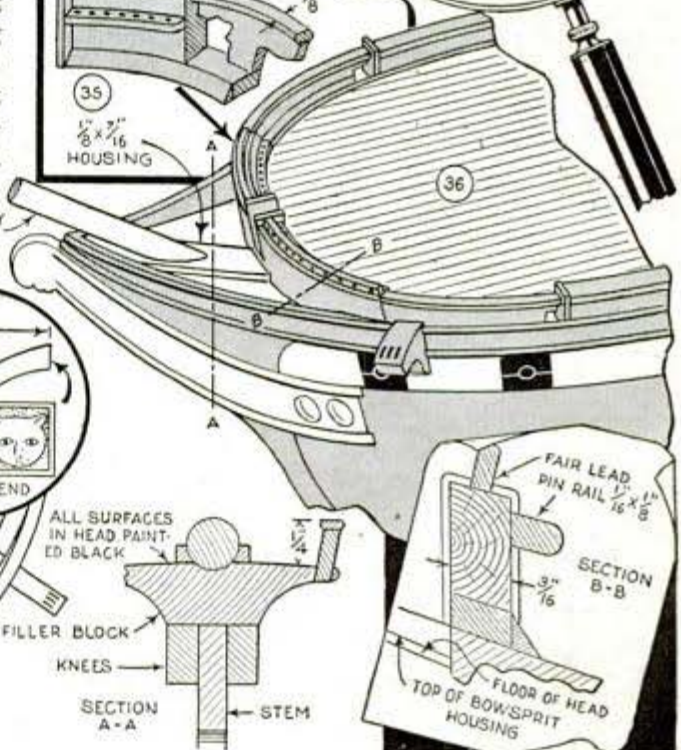
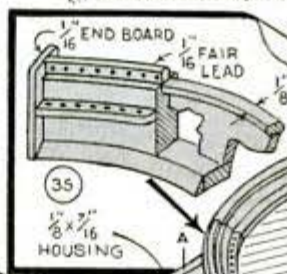
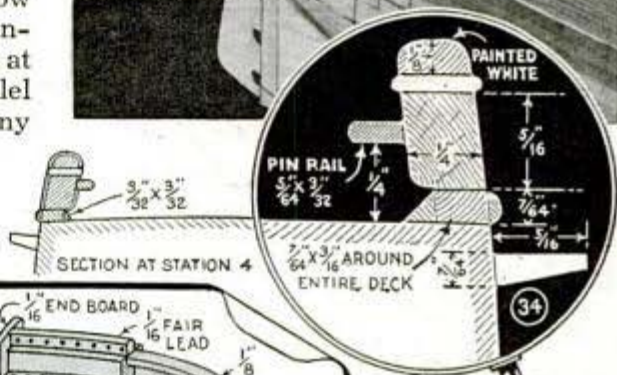

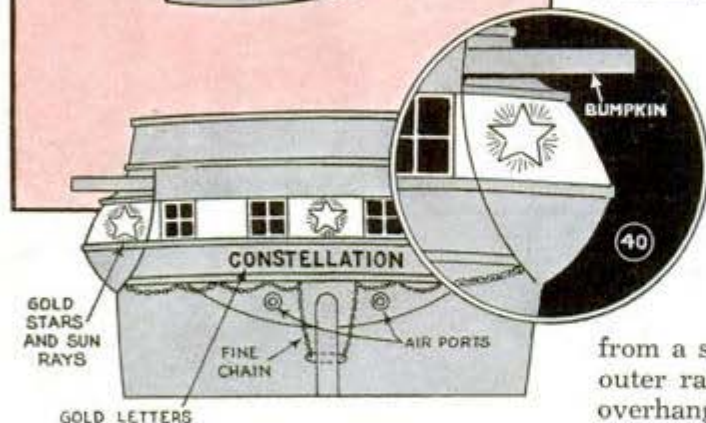
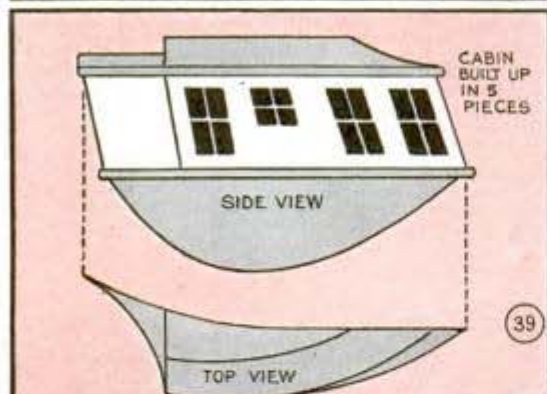
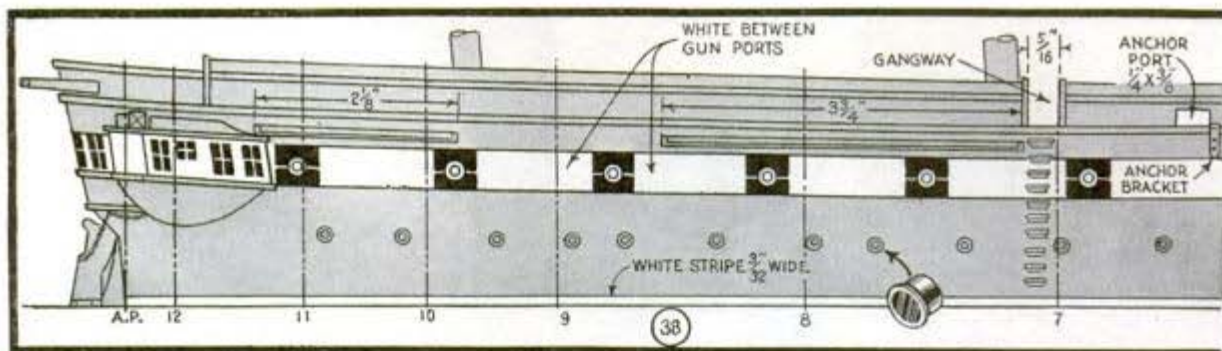

The odd shape of the quarter galleries makes them difficult to duplicate unless assembled in five layers. Thin pieces applied to overhang the top and bottom of the center section form the molded edges shown



leaving the outer edge bare for gluing the bulwarks.

Next, mark the centerline of the air ports, and locate the gun ports. Both run parallel with the deck, the gun ports being located within a $\frac{3}{8}$ -in. band drawn $\frac{5}{16}$ in. down from the top and the air ports $1\frac{1}{8}$ in. Individual spacing of each port is made in relation to the station lines. (See Fig. 38.) In recessing the gun ports, Figs. 41 and 42, take pains to make each mortise clean cut and slightly undersize so that the shutters, after being coated with cement, can be tapped snugly in place flush with the hull.

Begin the deck bulwark at the stern as detailed in Figs. 31 and 32. You can form the main part of this by steaming a thin strip and bending and clamping it around a wood block that is shaped to coincide with the stern, or it can be cut U-shape

from a solid piece. In the latter case, the outer radius is cut oversize and glued to overhang the stern, after which it is filed flush. Regardless of which method you use, glue in place the inner molding at the base first so that a rabbet will be had in which to glue and clamp the bulwark as shown in Fig. 33. The davits pass through square holes in the bulwark which are made by first drilling a hole and then filing it square. The magnified detail in Fig. 34 shows how the starboard and port bulwarks are built up. These follow the edge of the deck from the aft end boards at the stern bulwark to a point $2\frac{5}{8}$ in. in from the end of the bow and assume the same tumble home or inward rake of the hull. (See Fig. 37.) Below each side gangway which is cut through at station No. 7, a row of steps is added to the side of the hull. The bow bulwark is practically the same as at the stern except that it is thicker 1 in. each side of the centerline. Fig. 35 and the sectional detail below Fig.

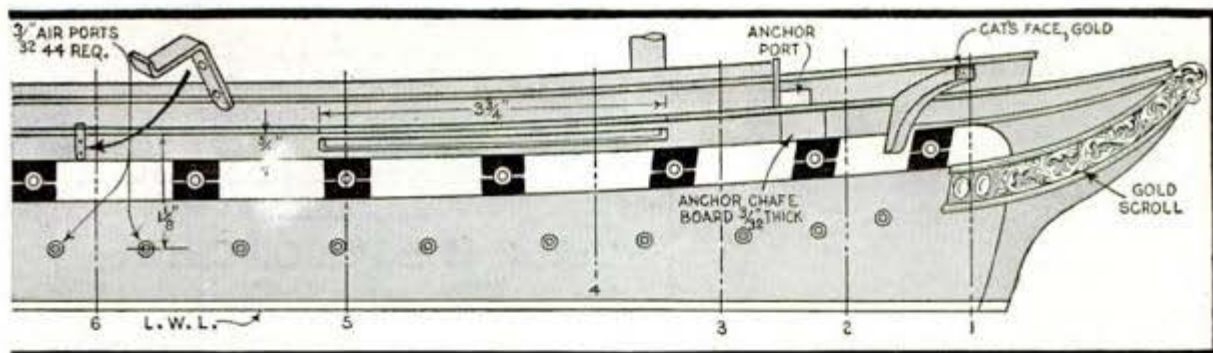

36 show this in detail. Complete the bow head by fitting bulwarks to the edge of the filler block, butting the ends against the hull in a sweeping line with the deck. Study Figs. 36 and 38.

You'll do best to build up the quarter galleries from five separate layers rather than try to cut them from a solid block. Figs. 39 and 40 give full-size patterns of the top, side and end. The windows at the stern are recessed $\frac{1}{8}$ in. and fitted with green celluloid to represent glass. Finish up by adding the channels, catheads, bumpkins, anchor brackets and the ornamentation at the stern. The name "Constellation" is made up of $\frac{1}{8}$ -in. white-metal pattern letters of the kind sold at hardware stores handling mill supplies.

As a last step before painting the hull, the waterline is scribed. With the hull in its cradle or turned upside down as shown in Fig. 43, level it both lengthwise and laterally. Cut the block supporting the scriber to bring the point in line with the joint between lifts D and E. After scoring the hull from stem to stern, remove the lift on the bottom of the block and scribe a second line parallel to the first. Hold the block at an angle to keep the scriber from digging into the end grain. Score the lines heavily enough to make them visible under paint so that they can be used as a guide in applying the white waterline stripe.

(To be continued)

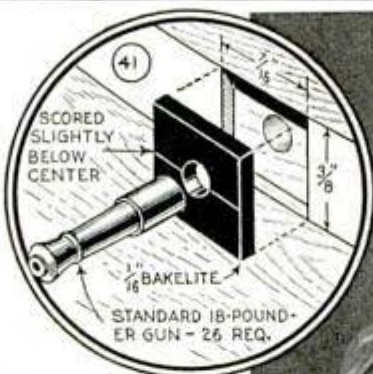

The gun ports are cut slightly undersize so that the Bakelite shutters can be tapped snugly in place, after which the holes in the shutters are used as a guide in drilling on through into the hull. The brass guns, which you purchase, project approximately $\frac{1}{2}$ in.

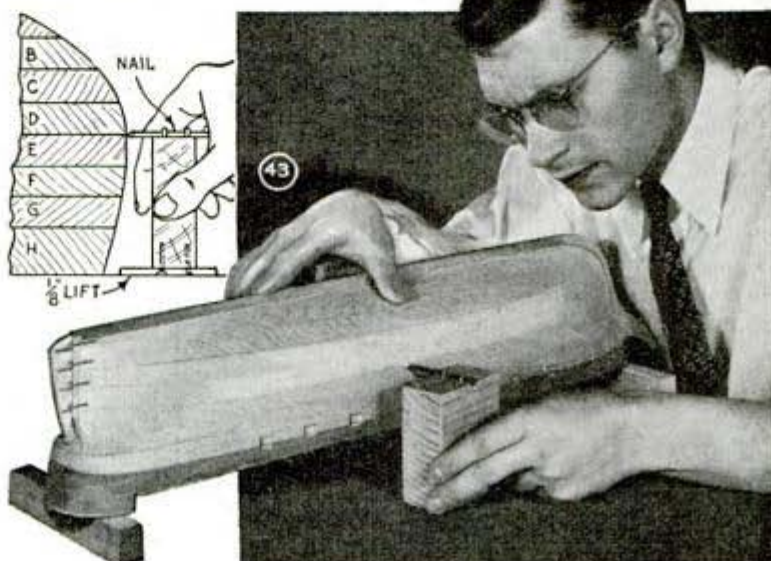
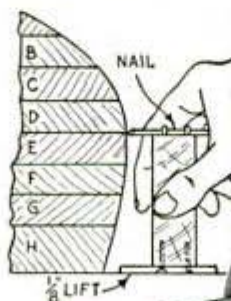

Flashlight Shield to Take Notes From Educational Movies



With this simple shield on a flashlight, a student can illuminate his paper to take notes while viewing an educational movie without disturbing others around him. The shield consists of a disk of opaque paper clamped under the lens rim of the flashlight, one side being turned up to permit light to shine on the note paper.

Hidden Catch on Table Drawer Prevents Child Opening It

It will take some time for small children to learn how to open the drawers in your kitchen worktable if they are fitted with

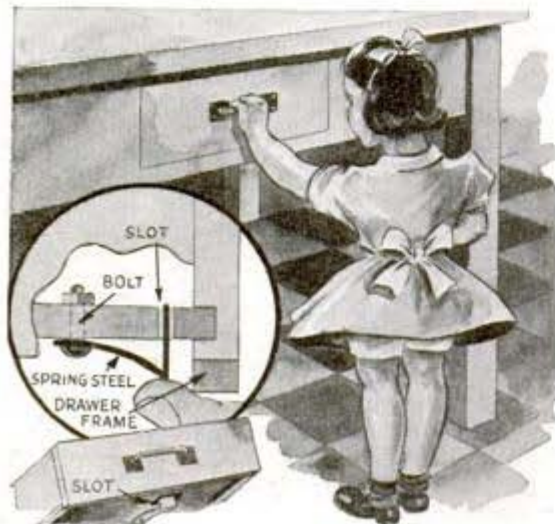

these hidden spring catches. To make them, just bend strips of spring steel to the shape indicated and bolt one on the underside of each drawer bottom. A slot for each catch permits it to be sprung up for opening the drawer by reaching under the table.

Tube Soldered on Oil-Can Top Eliminates Spilling

To overcome the difficulty of pouring oil from a container fitted with an ordinary screw cap, I punched a hole in the cap and soldered a copper tube on it. This spout makes it easy to pour oil into small openings without spilling and, as many containers of this type have interchangeable caps, I have also found the cap handy when screwed on cans containing other liquids.

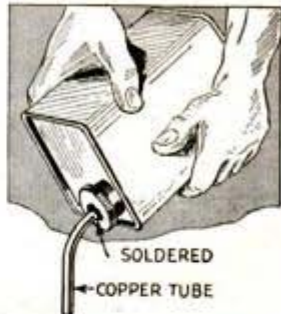

—W. F. Schaphorst, Newark, N. J.

Air-Rifle Shot Weights Ink Bottle To Avoid Upsetting It



After ruining several blueprint tracings by spilling ink on them, one draftsman poured some air-rifle shot in his ink bottle to prevent it from being upset easily. This provides added weight on the bottom of the bottle, making it have a tendency to slide on the table instead of upsetting when accidentally hit with a T-square or other drawing instrument.

EVERYBODY IS AN INVENTOR

Everybody has devised some shortcut or gadget to save time, labor, or money. If your idea would be applied by many other readers, why not pass it along to them and get a check for doing so? Just make a simple sketch or take a photo and explain the idea in 50 to 100 words. We pay promptly for accepted articles. Address Homecraft Editor, Popular Mechanics Magazine, 200 East Ontario Street, Chicago, Illinois.

Illuminated Mirror for Your Make-Up Table

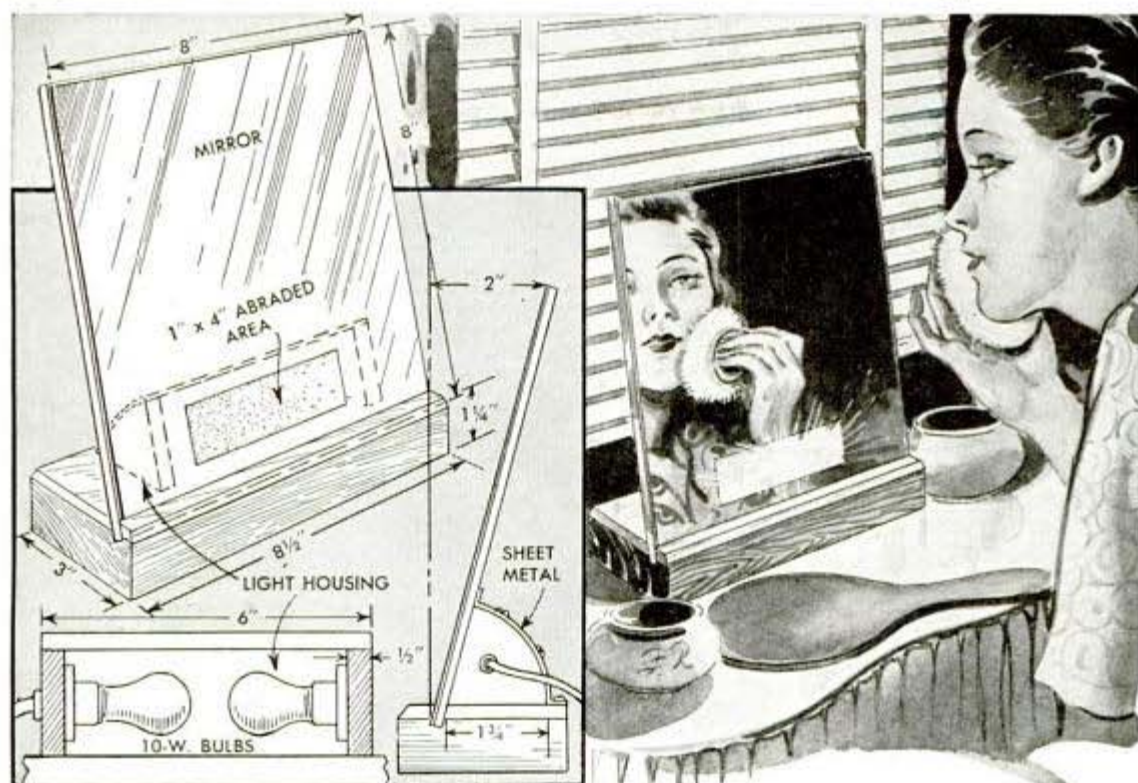

Two lamps in the base of this neat vanity mirror provide light through an abraded portion of it to illuminate your face. The base proper is a solid wood piece grooved near the front edge to take the lower end of the mirror so that it will stand at an angle as indicated. The lamp housing is located on the base just behind the groove so that the edges of the open end are flush with the back of the mirror. The ends of the lamp housing are two segments cut from a wood disk, while the top consists of sheet metal formed over them and screwed in place. A porcelain socket is mounted on each end of the housing. After the base

and lamp housing have been completed, a portion of the mirror in front of the housing is abraded to diffuse the light. This is done by removing the silver and rubbing the glass with emery cloth until it resembles a ground glass. A mask to form neat edges and prevent the abrasive from damaging the silvered portion of the mirror, should be cut from sheet metal and held firmly over the portion to be abraded while using the abrasive. Before final assembly, a thin coat of rubber cement should be applied to the sides and bottom of the groove in which the mirror is set.

—Dale Van Horn, Lincoln, Neb.

Thin Paper Is Cut Easily When Backed With Cardboard

Trouble experienced in cutting tissue or other very thin paper with an ordinary paper cutter can be overcome by slipping a scrap piece of cardboard under the paper as shown. The cardboard backing prevents the tissue from bending over the cutter edge as the knife is brought down.

☞ Ends of window shades will be less likely to tear if they are attached to rollers with rubber cement in addition to tacks.

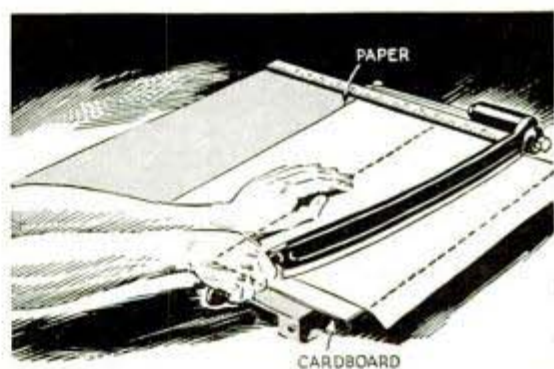

Insulated WREN

By A. L. Mills



USING empty tin cans, scrap wood and corrugated cardboard, you can make attractive wren houses that will be cool and comfortable inside. Those pictured in Figs. 1 and 4 are examples of what can be done with round 1-gal. cans. In the first one, the can is used in a vertical position, and a wooden base is substituted for the can bottom, which is removed. In the circular detail, note the novel locking feature used to hold the base for easy removal when cleaning the house. Top and sides are insulated with three layers of corrugated cardboard, and the sides are vented for air circulation. One long bolt attaches the roof, which is also insulated. A linoleum overlay around the entrance adds a decorative touch.

In Fig. 4, a can is used in a horizontal position, both ends being removed and replaced with jig-sawed wooden ends. Circular cleats or rings are screwed to the wooden ends and slip into the can, which is nailed to the cleats. A clean-out opening, covered with a compression-type can lid, is screwed into place. Three layers of cardboard inside the can insulate the house, which is

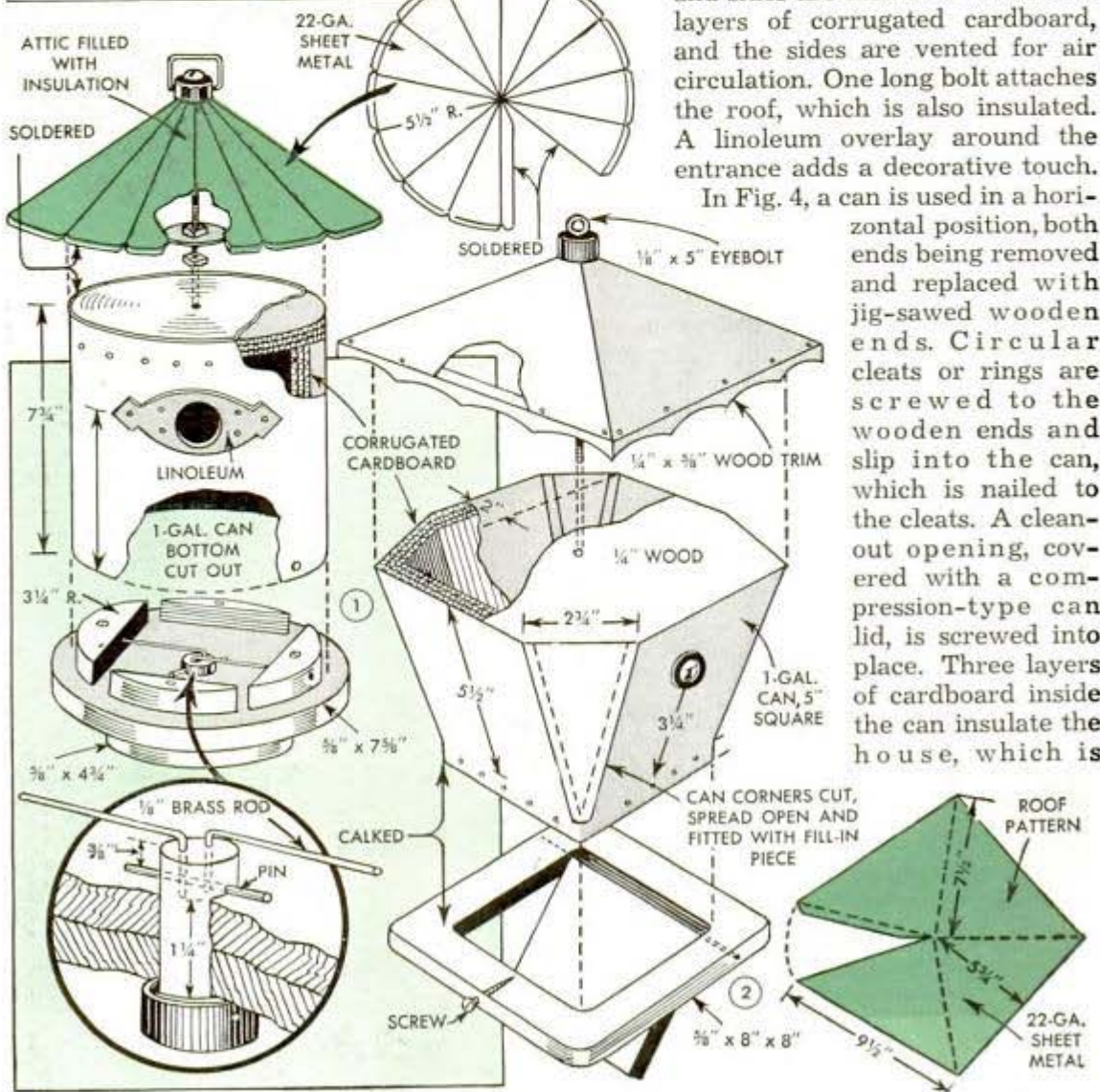

HOUSES of Metal

How old tin cans and scrap wood can be utilized in building durable wren houses that stay cool inside. Each design has a handy arrangement for cleaning out old nests



roofed with $\frac{1}{4}$ -in. wood. A decorative touch is added by nailing strips of perforated metal screen to the roof edges. When assembling the ends to the can, be sure that they are located to allow at least $\frac{1}{8}$ in. clearance between the can and the roof. This is to permit air to pass under the eaves and out of vent holes in the gable ends to cool the attic.

The houses in Figs. 2 and 3 are assembled from square cans. In Fig. 2, both ends of the can are removed and

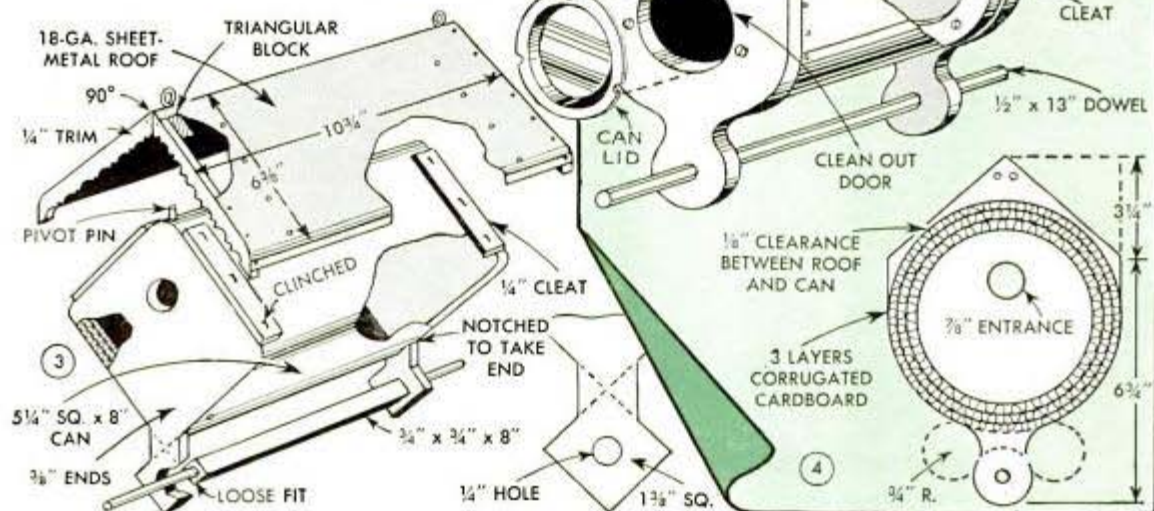

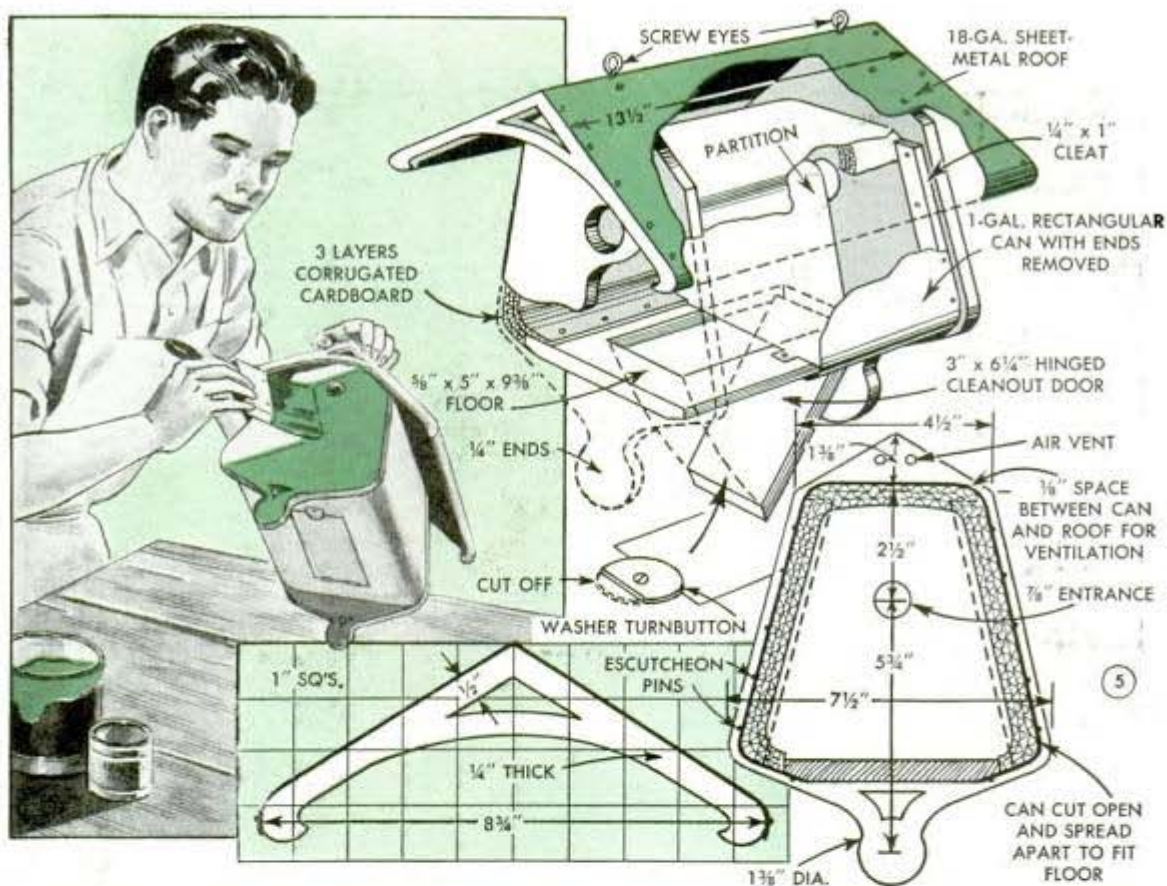

a wooden top and base are used. Notice that the center portion of the base is pivoted for easy cleaning. A long screw through one edge of the base locks the pivoted portion in the closed position. The unusual shape of the can is obtained by slitting the corners and soldering triangular fill-in pieces in them after spreading the top of the can. Scrolled wood decorates the edges of the metal roof, which is attached by a long eyebolt. Further decoration is added by a plastic or linoleum ring around the entrance hole.

The end containing the entrance opening of the house in Fig. 3 swings outward for cleaning. It is held by a pivot pin at the

top and by two screws at the bottom. Cleats are nailed to the can near the ends for attaching the roof, the latter being reinforced at the ridge by triangular corner blocks to take screw eyes. These are for suspending the house.

The neat shape of the house in Fig. 5 is obtained by using a rectangular can opened at one side, which is spread and nailed to the wooden floor of the house. A clean-out door is provided in the floor and is closed by a turnbutton fashioned from a washer. The roof is metal with a jig-sawed trim at the ends. Cardboard insulation is used inside the can, and holes are provided in the wooden ends to ventilate the attic.

Steel Wool in Hand Grinder Cleans and Polishes Small Surfaces



For polishing and cleaning small surfaces, steel wool used with a hand grinder will do the work rapidly. The wool is held in a grinding wheel accessory and is taped in place. A pad of cotton covered with a circular piece of flannel and held on the wheel in the same manner makes a good buffing tool for jewelry and similar work.

Because a large sponge drips less than a cloth, it is excellent for washing woodwork.

Sewing Box Has Accessory Drawer in One End

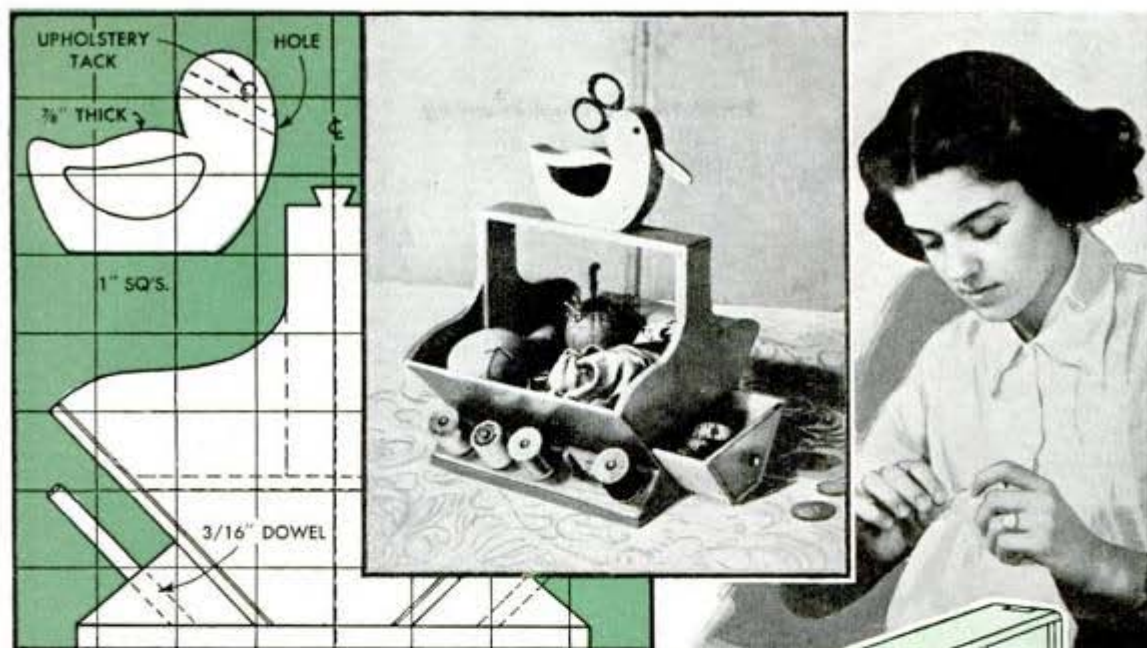

This sewing box has a compartment for unfinished sewing, pegs to hold spools of thread, a drawer for accessories and a jaunty duck cutout atop the handle to hold a pair of scissors. Made of either solid or plywood, the box is trough shaped and rests on a flat base, triangular filler blocks being used at the sides for rigidity. The blocks carry the spool pegs, and the box ends extend upward for attachment of the handle, which is dovetailed in place. The drawer, which is also shaped like a trough, slides in an opening formed by the bottom of the sewing compartment.

—Bertram Brownold, Woodmere, N. Y.

REINFORCING
CLEATS ADDED
IF SOLID STOCK
IS USED

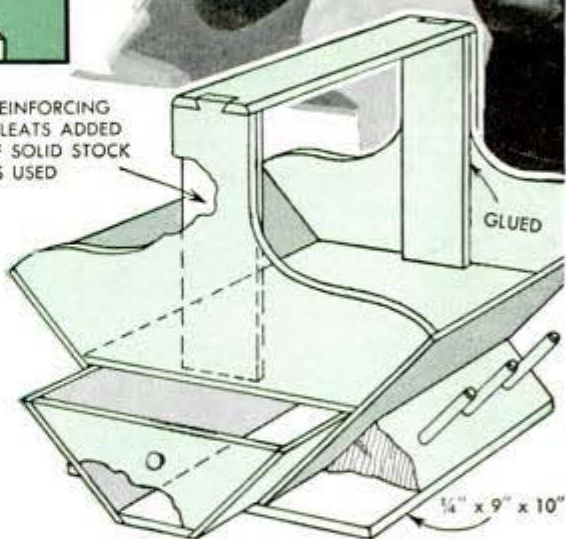

Dog's Leash Kept in Neat Case Riveted or Sewed on Collar



Fasten a neat case on your dog's collar and you can roll up the leash and leave it attached permanently. In this way, the leash is always at hand when needed and there is no danger of losing it. The case shown in the photograph is an old coin purse fitted with a slide fastener. It is attached to the collar with two rivets although it could also be sewed on with heavy thread if desired.

☞ To prevent leather upholstery from sticking to your clothing wash it with gasoline and allow to dry. Then mix lacquer and lacquer thinner in equal parts and apply over the leather.

Lacquer Preserves Soap Carvings And Gives "China" Finish



To prevent my soap carvings from drying out and crumbling, I put two coats of high-luster lacquer on them. The lacquer not only preserves the carvings but gives them a high luster similar to that of fine chinaware.—S. Kramerich, Detroit, Mich.

Lower Portion of Screen Hinged So It Can Be Opened Easily

If the screens on your upstairs windows are held in place tightly with turn buttons, here is an easy way to hinge a portion of one so that it can be opened for shaking dust mops, etc. First cut the frame about 15 in. above the lower edge and attach



strap hinges as shown. A crossrail is then fitted between the two side members to provide rigidity and this is held in place securely with corrugated fasteners. Bradding a piece of molding to the crossrail keeps the screen from bulging.

Neat Boat Fenders From Hose

Unusually neat fenders for a small boat can be made from lengths of large hose, preferably old fire hose. This is filled with tightly rolled sponge rubber, after which the ends are copper-riveted together.

A canvas cover for each fender improves its appearance and provides a good base for painting if desired.

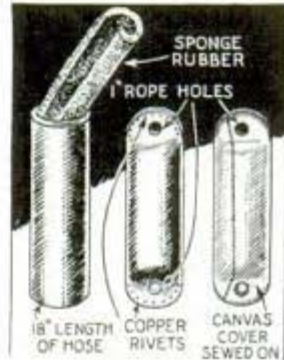

Printer's Pica Gauge Is Handy When Making Scale Drawings

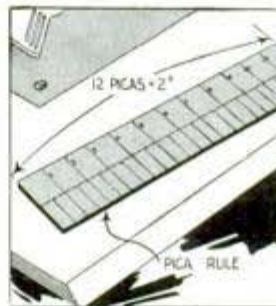

Craftsmen who have frequent occasions to make scale drawings before starting work on projects, will find a pica gauge (printers' rule) useful in drawing to a scale of 2 in. equals 1 ft. As

there are six picas to an inch on these gauges, each pica mark represents 1 in. or twelve of them represent 1 ft. Division marks between picas make it possible to use scales of 1 in. and 4 in. equal to 1 ft.

Clogged Sewer Cleaned Easily

After experiencing trouble by clogging of the main drain leading to the city sewer, I used a hose to clean it regularly. The clogging was caused by hair roots from trees growing into the joints of the drain pipe. By making a nozzle for the hose from a short piece of pipe, in which several small holes were drilled after plugging the end, the hose was inserted into the drain and the water turned on to flush it out.

—H. K. Carruthers, Ottawa, Ont., Can.

Thermostat Controls Draft in Hot-Water Heater

Costing less than one dollar to make, this automatic draft control for hot-water heaters of the coal-burning type not only keeps water at the proper temperature but it also eliminates the possibility of creating a dangerous pressure in the tank. To make it, first obtain a wafer-type thermostat and mount this on a lever pivoted to a flat-iron clamp that can be attached near the center of the tank. Then provide the stovepipe with a check draft having a pivoted flap and connect the two as shown. When a fire is started in the heater, the drafts remain open until the water in the tank is heated to the level of the thermostat. As the thermostat expands, the lever is raised, opening the check draft automatically. Being free to move inward, the flap will operate vigorously on windy days, adjusting itself to various conditions of draft in the chimney.—Leo A. Chartier, Danielson, Conn.

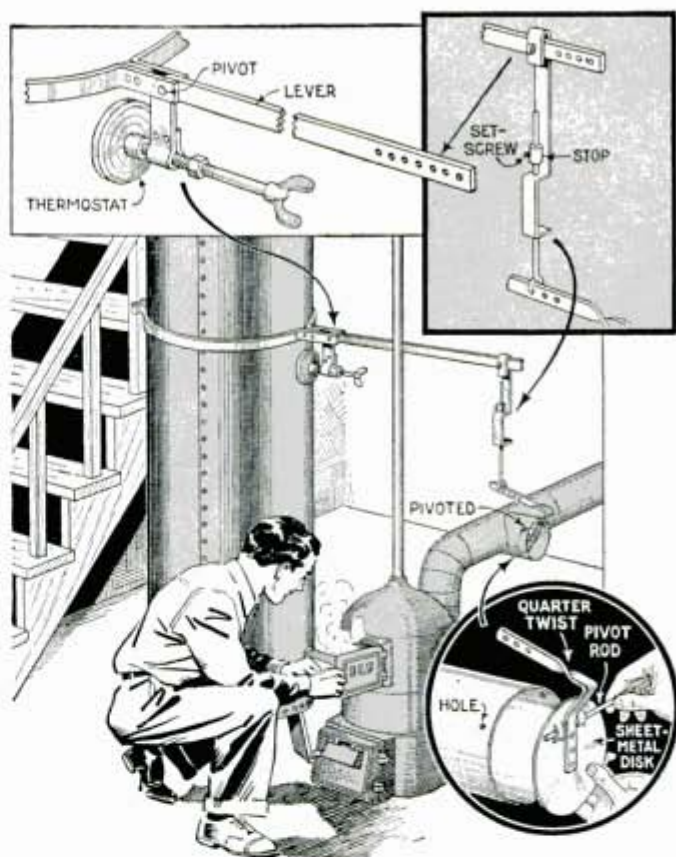

Cottage Partitions Extended by Panels Hinged to Rafters

If sleeping rooms on the upper floor of your summer cottage are separated by low partitions which have proved annoying to occupants on account of lights and disturbing conversations from adjoining rooms,

here is an easy way to correct the trouble. Just-extend the partitions to the roof, using plywood or hard-pressed-board panels, hinged to the rafters. Being light, they can be opened with a rope-and-pulley arrangement for ventilation whenever necessary.—Paul Roth, Battle Creek, Mich.

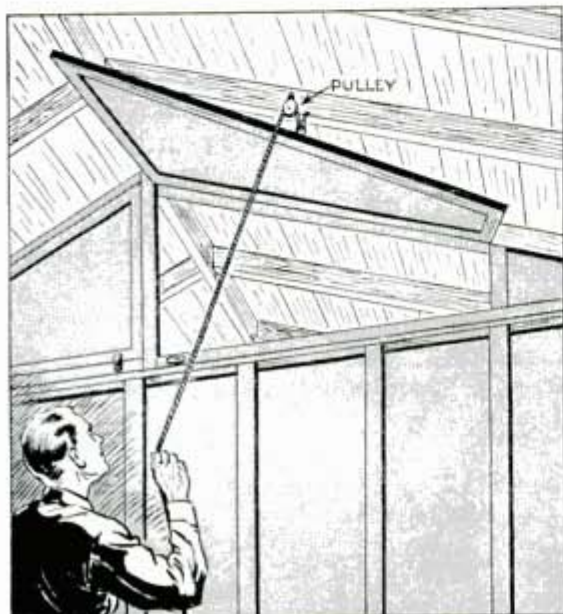

Nut Slotted to Lock It on Bolt

By slotting a nut as shown and then driving it on a bolt, it can be locked securely in place. To do this, simply close the slot with a punch. If the nut has to be removed later, open the slot with a chisel, holding a weight against the opposite side of the nut to avoid bending the bolt.—N. Bogoch, Winnipeg, Man., Can.

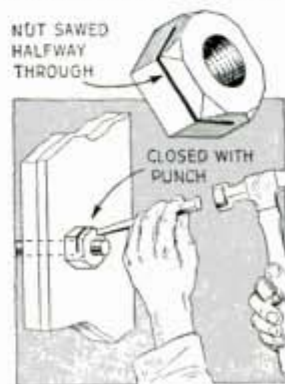

SMALL SAILBOATS

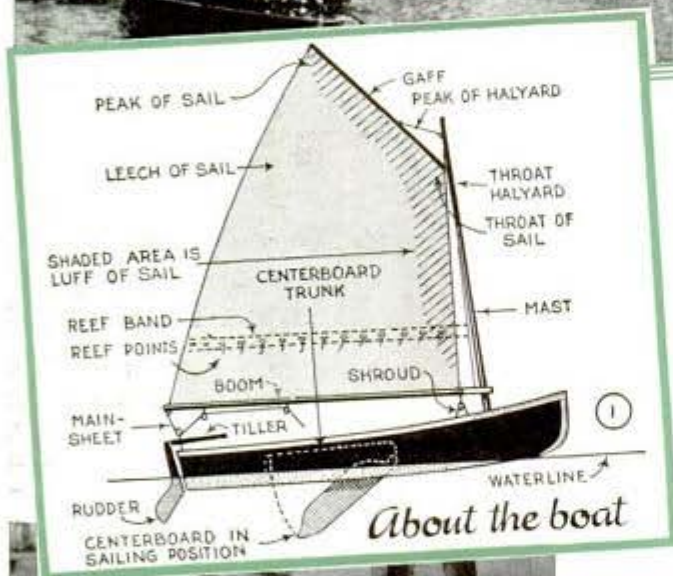

The three main points of sailing a small boat explained, as well as how to leave a mooring and return, meeting emergencies, etc.

SEAMANSHIP is doing the right thing quickly at the right time. Usually there is little time for careful thought and reasoning, thus making a seaman's actions more or less instinctive, based on repetition and thoroughly ingrained principles. Therefore, to handle a sailboat, one should understand how the action of the wind on the sail causes it to move forward. For this purpose, the sail can be compared to an airplane wing. The force of the air striking the windward side of a sail is but a small fraction of the total force; like a wing, most of the force is developed by the leeward (away from the wind) side—upper side in the case of a wing. This force may be considered to be exerted at right angles to the plane of the sail, in the direction a pin would project if thrust through a sheet of paper cut like a sail, Fig. 4. The centerboard of a dinghy, and the keel of keel-type boats, tend to resist the side pressure, with the result that the boat moves ahead, Fig. 3. Just as an airplane wing loses its lifting action when the angle of the wing with the wind becomes too great, so does a boat sail lose its driv-

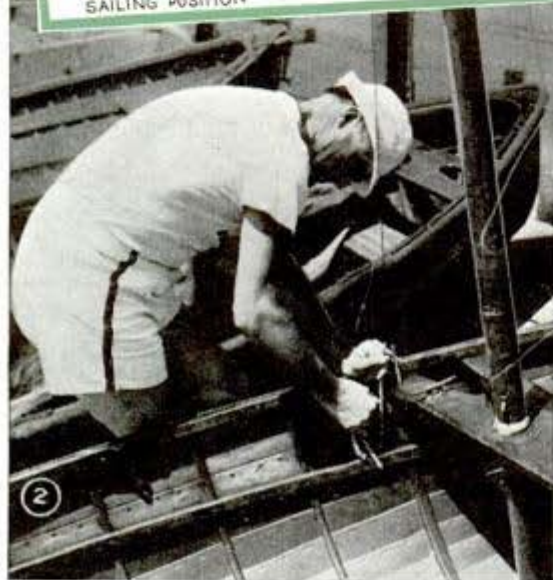

MAKE GOOD SEAMEN

MODEL OF BOAT
APPARENT WIND
PIN SHOWS WIND FORCE
CARDBOARD CUT TO SHAPE OF SAIL
CLOSE-HAULED

FORCE DRIVING BOAT AHEAD IS VERY SMALL
FORCE OF WIND
LEEWAY AND HEELING FORCE

3

APPARENT WIND
PIN
REACHING

FORCE DRIVING BOAT AHEAD IS GREATER THAN WHEN CLOSE-HAULED
FORCE OF WIND
LEEWAY AND HEELING FORCE

PIN
FORCE DRIVING BOAT AHEAD
WIND
LEEWAY & HEELING FORCE

4

Why boat moves ahead

5

5

ing force when its angle becomes too great. A sail is then said to be trimmed too hard.

Getting the boat ready: As the cat-rigged dinghy is one of the most popular and rapidly growing classes of boats, we will use it in our sailing test. First, the mast must be stepped; that is, dropped through the hole in the forward thwart and into its step. Then the shrouds, one to a side, are set up as Fig. 2, with the lanyard running through an eye in the shroud to give added purchase. The shrouds should be equally taut so that the mast is not pulled in either direction. Then the rudder is stepped, Fig. 5, and a cotter pin is inserted to keep the rudder from jumping off in a seaway (motion of the waves). Next, the sail is hoisted, setting the luff just hand taut so that when the breeze fills it there will be no wrinkles. You can learn the various parts of a sail and boat by referring to Fig. 1. Now, the boat is launched and the centerboard is lowered.

3 rd. MOORING DROPPED AS BOW IS SWUNG OFF
2 nd. MAINSHEET SLACK
1 st. WIND

TRIMMED
BROUGHT AMIDSHIPS

SLACK
TILLER PULLED SHARPLY TO WEATHER

TILLER AMIDSHIPS

6

Leaving mooring in a cat-rigged boat

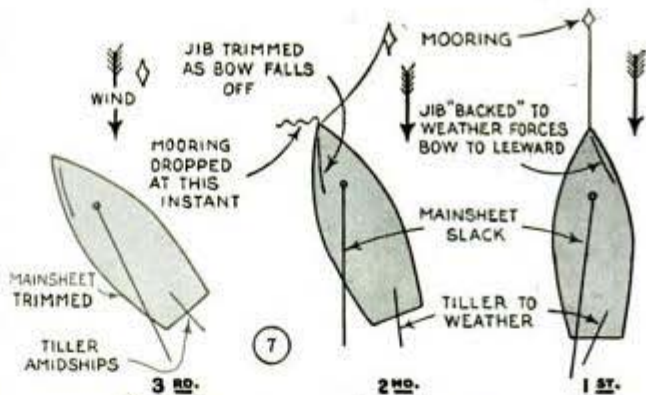

Leaving mooring in a jib-and-mainsail boat

from the wind). Hoist the sails with the mainsheet slack. Then unfasten the painter and trim the sail. If the boat is on the windward side of the dock, a smart shove will carry it clear as the sail is trimmed.

The "points" of sailing: There are three "points" of sailing: close-hauled, reaching and running, each referring to the direction of the wind in relation to that of the boat, Fig. 9. Close-hauled is difficult since

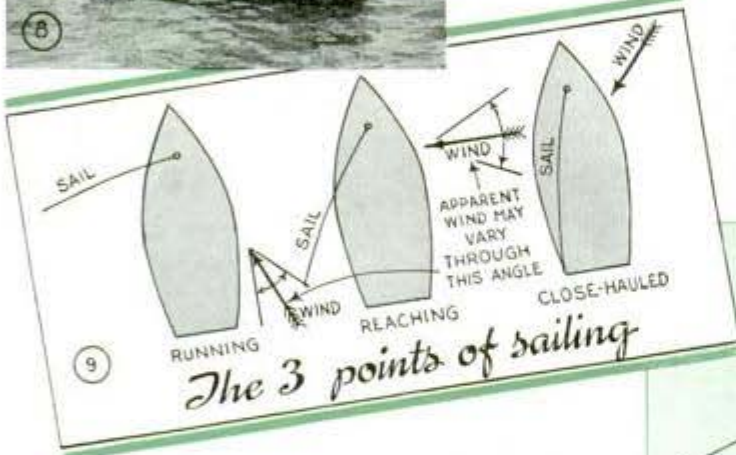

Leaving the mooring: As it is easier to take a boat away from a mooring than from a dock, this will be done first. When moored the boat lies head to the wind as in Fig. 6. A sharp pull on the tiller will swing the bow off in the desired direction, after which the sheet (a rope used to control a sail) is trimmed (taken in) until the sail is at the proper angle and the boat moves ahead. When it is on the desired course the tiller is brought amidships (to the center). With a boat having mainsail and jib, the procedure is different in that the pull of the jib can be used to turn the boat from head to wind, Fig. 7. The mainsheet must remain slack during this maneuver, otherwise the force of the mainsail will counteract that of the jib.

Leaving the dock: Leaving a dock is easy if the boat is to leeward (on the side away

A good seaman must decide whether to sail a shorter course A at slower speed or a longer course B at higher speed

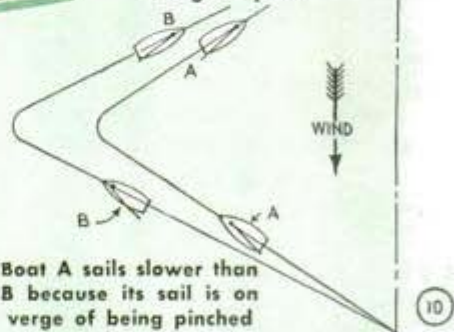



you must decide whether to point higher (closer to the wind) and travel a shorter course at a slower speed, or to sail a bit fuller (slightly farther from the wind) and travel a longer course at a faster speed, Fig. 10. This is important as it is by tacking, Fig. 14, that a boat sails to a point directly to windward. To sail a boat close-hauled, trim the mainsheet until the boom is over the leeward corner of the transom, Fig. 11, and ease the boat into the wind by moving the tiller slightly to leeward.

Use a telltale (wind direction indicator), so placed that it can be watched constantly. Several strips of colored silk ribbon, $\frac{1}{4}$ in. wide,

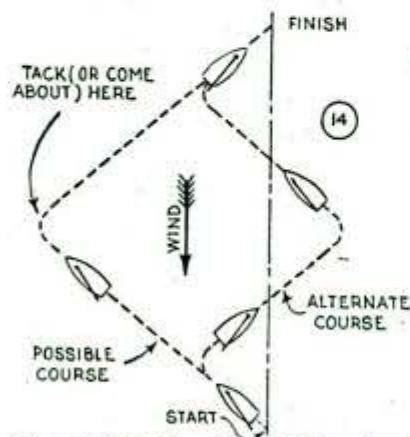

To work into the wind, sail close-hauled until finish point can be reached on next tack, or tack several times

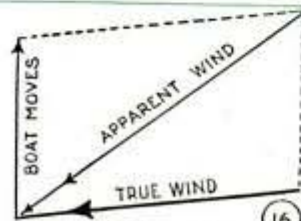
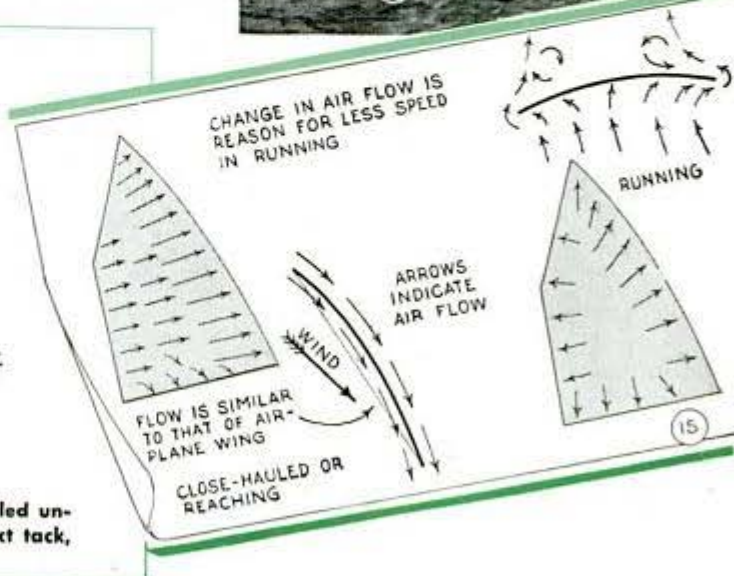

To estimate
apparent wind

on a 2 or 3-ft. length of bamboo that can be fastened to the end of the gaff is excellent, Fig. 8. The telltale shows the apparent wind, which is the true wind as it is changed to the sailor by the boat's motion. A boat sails on the apparent wind—never on the true wind. In sailing close-hauled, keep the upper portion of the sail almost parallel with the telltale ribbons. The twisting of the sail is normal and helps drive the boat in light air when the wind close to the water's surface is retarded.

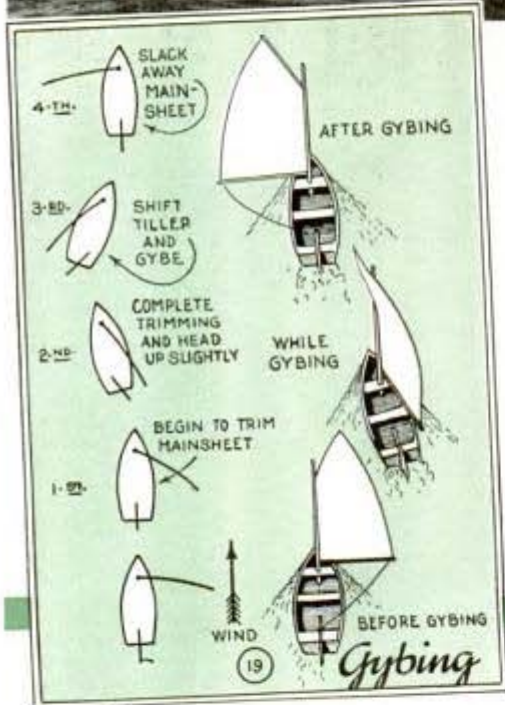
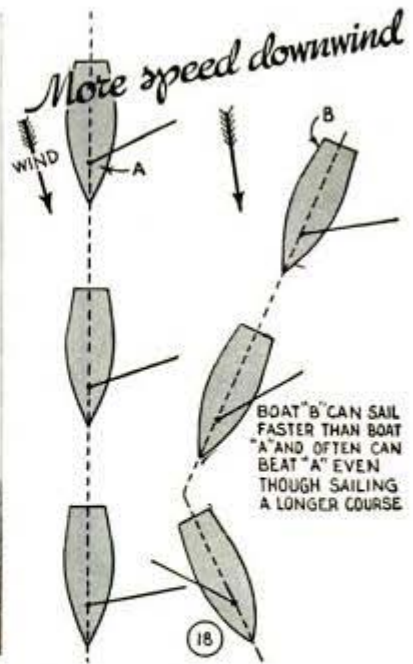

Reaching: In reaching, the boat sails more or less across the wind, Fig. 9. To change from sailing close-hauled to reaching, move the tiller up (toward the wind). Then as the boat's head falls off to leeward, slack the mainsheet. Fig. 12 shows how your dinghy looks now. Fig. 13 shows a Snipe class boat sailing on a reach.

Running: This is least exciting as the boat's speed is usually reduced and the apparent wind is much lighter. Fig. 16 shows how to estimate the apparent wind when the direction and the speed of the other is known, and the boat's speed can be estimated. To change from reaching to running, bring the tiller up slightly and pay out (slack away) the sheet. As you do this, the angle of heel is reduced, and the wind flows outward over all edges of the sail, Fig. 15. If the wind is very light, even small boats find it advantageous to tack downwind, Fig. 18.

While the maneuver called gybing (turning with the wind) is much used and is essential to sailing, an unexpected gybe can cause a lot of trouble. Guard against a sudden gybe by keeping close watch on the telltale; when the ribbons show that the wind is dead astern, bring the boat a few degrees into the wind. Gybing, Fig. 19, is more difficult than tacking as the mainsheet must be taken in very quickly, especially in stronger breezes, as the helm is put up. Fig. 17 shows two Star class boats; the left boat is about to gybe around a mark, while the right boat has just completed a gybe.

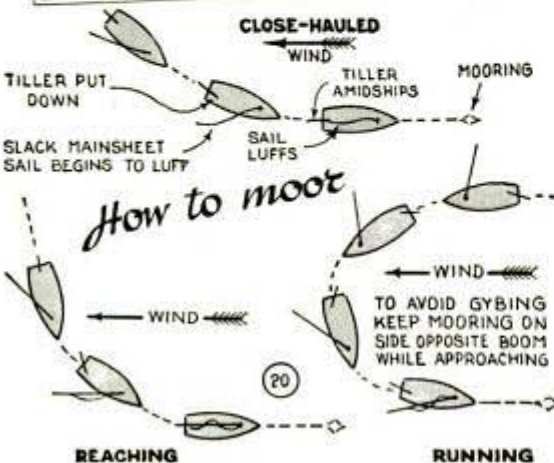

Mooring or docking: The methods of picking up a mooring from the three points

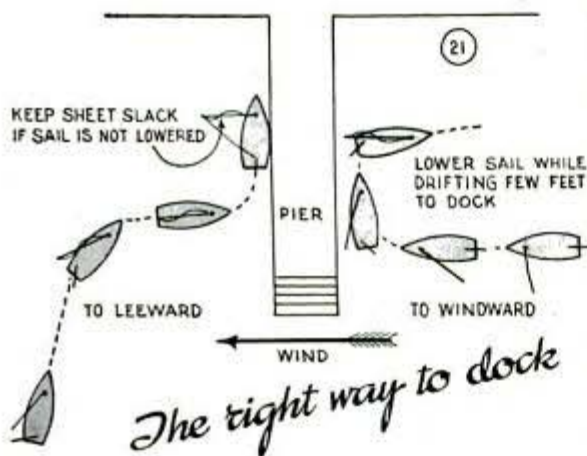

of sailing are shown in Fig. 20. Remember that the distance a boat will headreach (be carried forward into the wind) will vary with different conditions of speed and sea. When approaching a dock from leeward the task is simple. Merely headreach up to the dock, moor, and drop the sails. To land at the windward side of a dock, a small boat can be sailed directly downwind, Fig. 21, and then swung into the wind with a hard-over tiller. The hard-over rudder acts as a brake and the boat is almost dead in the water about a boat length away from the dock. By the time the sail has been lowered, the boat has drifted within reach.

Meeting emergencies: Three types of emergencies may be met in sailing a small boat. These are strong winds, hard squalls, and man overboard. Strong winds require a reefed (reduced in size) mainsail. On a small lake or bay where there is no possibility of being blown far from land, it is often wise to lower canvas on the approach of a squall that promises to be severe. In a jib-and-main-sail rig, the jib can be left standing. A small-keel boat or a centerboard boat with excellent stability can be luffed through a squall. This means that the mainsail is allowed to luff very markedly, as in Fig. 22. Practice picking up a man from the water by dropping overboard any object that will float, and then rounding back to it just as if you were coming up to a mooring, as in Fig. 23. Try to bring the object alongside



at the moment when speed is much reduced when it would be easy to assist a person. Nearly everyone that sails a boat sooner or later has occasion to assist a tired swimmer, and practice in all possible maneuvers is the only way to guarantee that it can be done quickly and correctly. When assisting a swimmer, it is a good idea to pass a line under his arms and support him in the water for a few minutes until he has rested sufficiently to assist himself before attempting to bring him aboard.

Clothespin Holder Hangs on Line And Eliminates Stooping

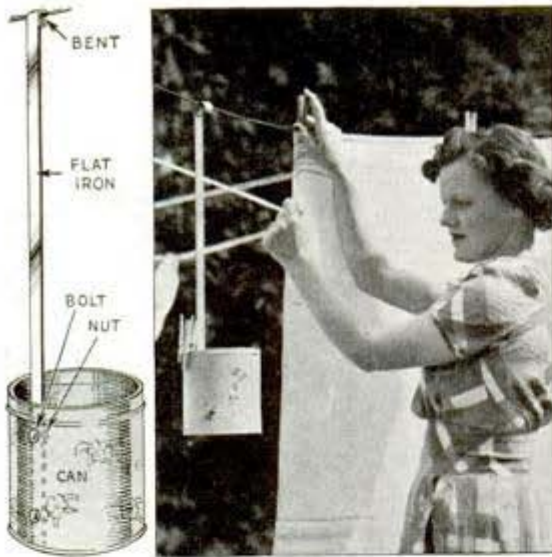

You won't have to stoop for clothespins on wash day, if they are kept in this holder. It consists of a tin can bolted to a length of flat iron having the top end bent to hook over the clothesline. Decalcomania transfers are used to decorate the holder after it has been given two coats of enamel.

—Robert M. Hughes, Long Beach, Calif.

Portable Shade for Field Workers

Where tedious work such as trimming small plants, slips and seedlings makes it necessary that the work progress at a slow pace, or that considerable time must be spent in a limited space, one nurseryman provides his workers with a portable shade. This not only protects the workmen against the sun but also prevents the immediate drying out of the plants. Two high cultivator wheels, supported by stub axles, provide one pair of supports for the light framework, over which is stretched thin



cloth. The supports at the other end of the shade consist of two rigidly braced legs, which are raised slightly when it is necessary for the shade to be moved.

—Elton Sterrett, Houston, Texas.

Simple Container to Suspend Paint Brushes in Liquid

One painter keeps his brushes from drying out overnight by suspending the bristles in a can of liquid. An empty motor-oil can is used, and one side is slotted and notches cut in the edges to take the brush handles as shown. Such a container costs nothing and takes only a few minutes to make with a pair of tin snips.

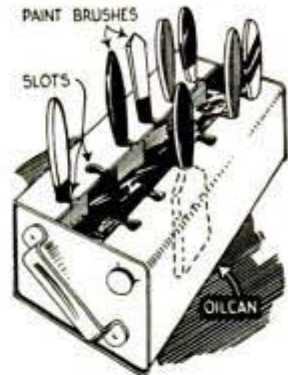

Choosing the Correct Nail To Suit the Job

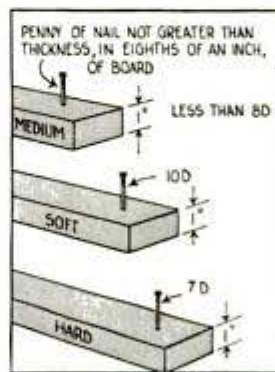

In assembling work with nails, the importance of selecting those of the right size for the job should not be overlooked. When using box nails in wood of medium hardness, the penny of the nail should not be greater than the thickness of the wood in eighths of an inch. In hardwood, the nail should be one penny smaller, while in very soft wood, the nail may be one or two penny larger.

Repairing Refrigerator Gasket

When the rubber gasket surrounding the door of a refrigerator seemed to lose its life and to half collapse, permitting outside air to seep into the box, a slight incision was made at the right-hand corner into the collapsed air cell. Then a length of single-strand drop cord wire was worked around the whole face, thus filling out the insulation and preventing the entry of warm air.

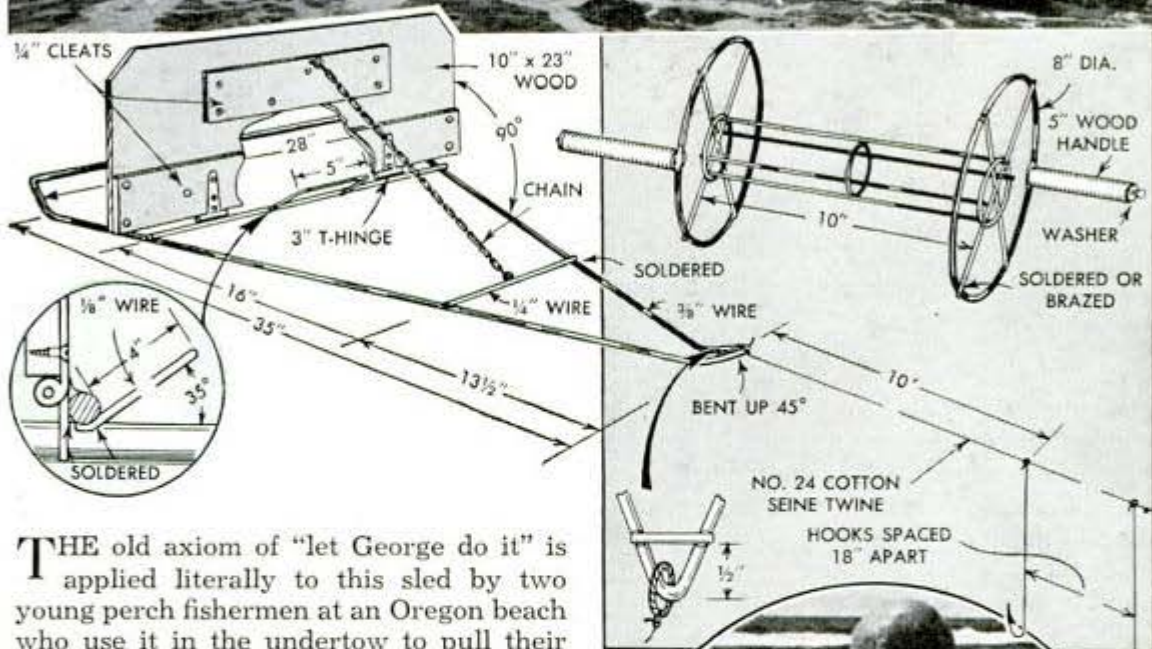
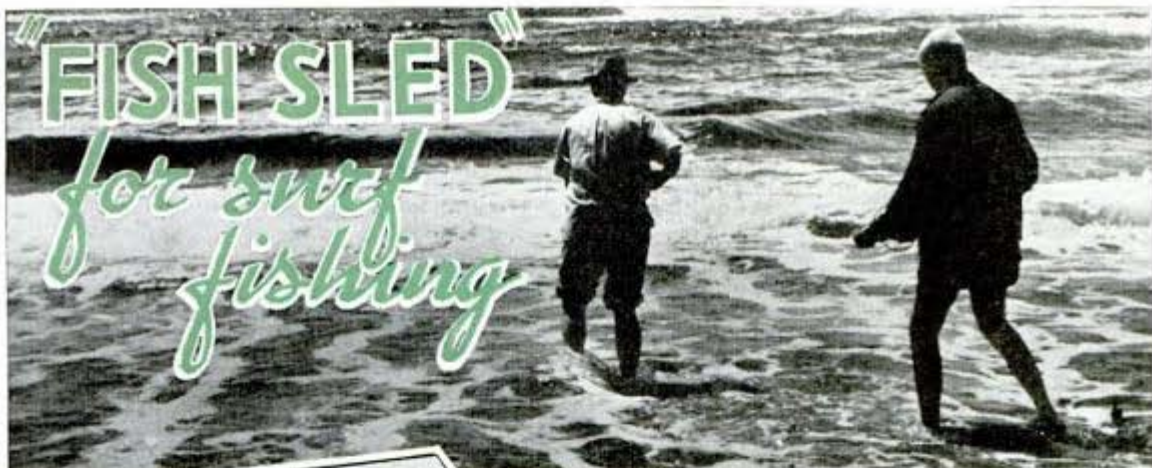

THE old axiom of "let George do it" is applied literally to this sled by two young perch fishermen at an Oregon beach who use it in the undertow to pull their line from the shore into deep water. The fishing line is tied to one end of the sled, which is placed in the water near the shore where it is 1 or 2 ft. deep. The undertow catches the pivoted flap and slowly moves the sled into deep water. The flap is pivoted with two hinges which are soldered to one of the cross braces. To prevent the sled from moving shoreward should it be caught by an incoming wave, the flap is hinged so that it will fold forward to an angle of 35 degrees where it is held by a wire support until the undertow again raises it to a vertical position, a light chain holding it in this position.

The sled is made from a length of heavy galvanized wire bent to a triangular shape and braced with three cross wires soldered in place. Bending up the ends of the sled at an angle of 45 degrees prevents it from catching on the bottom of the sea.

A reel for pulling in the line and sled at regular intervals is made of heavy wire

as indicated in the upper right-hand detail. The reel is fitted with two handles located at opposite sides of the reel ends for easy cranking action. However, any reel of suitable size and strength can be used instead if desired.

—R. Tarshis, Portland, Ore.

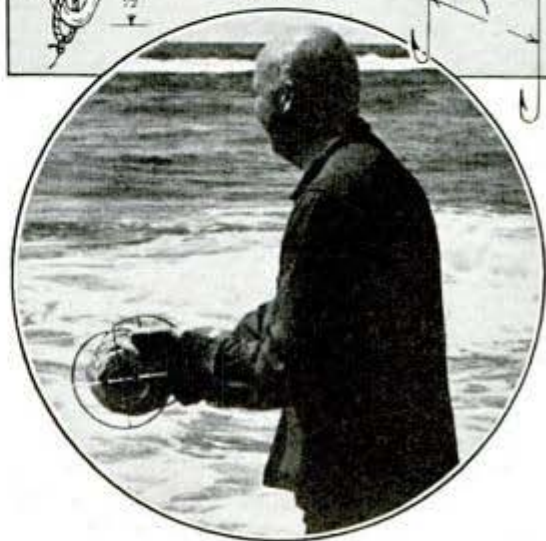

Car Axle Reinforces Gate Post And Provides Sturdy Hinge



Embedded in a concrete gate post as indicated, the front axle of an old car strengthens the post and provides a rigid support on which to pivot the gate. Before using the axle, it is bent at right angles at the ends, which project beyond the post. Bolts through the kingpin holes in the axle and the sockets in the gate pivot the latter.

Kneeling Pads Upholster Seat Of Junior's Sidewalk Auto

Upholstering the bucket-type seat of a sidewalk auto for comfort and safety of the young driver is an easy matter if you use sponge-rubber kneeling pads for the pur-

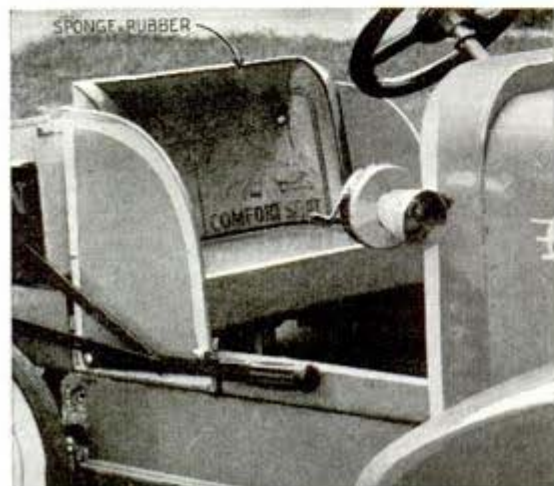

pose. As the corners are slightly rounded, a neat fit is obtained simply by fastening one on the back with a couple of round-headed stove bolts. Another pad could be used on the bottom of the seat to absorb shocks although two of them would be still better in simulating the comforts of modern cars.—Richard Kern, Belleville, Ill.

Sponge Rubber Cleans Triangle While Inking Drawings

Edges of triangles and other drawing instruments may be cleaned quickly merely by pulling them across a small piece of sponge rubber attached near the upper right-hand



corner of the drawing board. When a job is finished, the sponge should be removed and washed in warm water to remove ink.

Holding File in Wood Handle

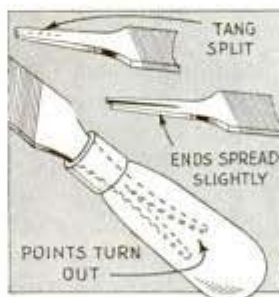

The next time you put a wood handle on a file, split the tang as indicated, and then drive the handle onto the file. The tang will spread slightly as it is driven on so

that it cannot loosen in use. The handle can be driven off with a hammer when file is worn out.—A. Waychoff, Phoenix, Ariz.

Scale on Edge of French Curve Aids in Duplicating Work

When you have a drawing that requires the making of duplicating curves, a scale on the edge of your French curve will aid greatly in this work. Equally spaced lines are scored on the curve, then every tenth one is numbered. Ink applied to the scored lines makes them easy to see.

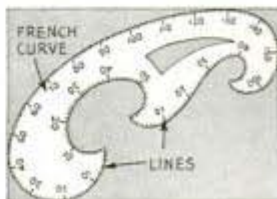

Equally spaced lines are scored on the curve, then every tenth one is numbered. Ink applied to the scored lines makes them easy to see.

Photographic Dryer Heated by Tubular Lamps

This low-heat negative dryer costs little to operate, is portable, and it can be placed in any room free of dust and drafts. If the two tubular lamps are controlled by a series-parallel switch, they can be operated in either a series or parallel circuit to produce a low or high heat. An electric-range switch will be found convenient for this purpose. Wiring connections for three varieties of this type of switch are given in details A, B and C. Plenty of vent holes should be provided in the lamp trough to get good air circulation. Coarse wire mesh to cover the trough will prevent negatives from dropping on the lamps.

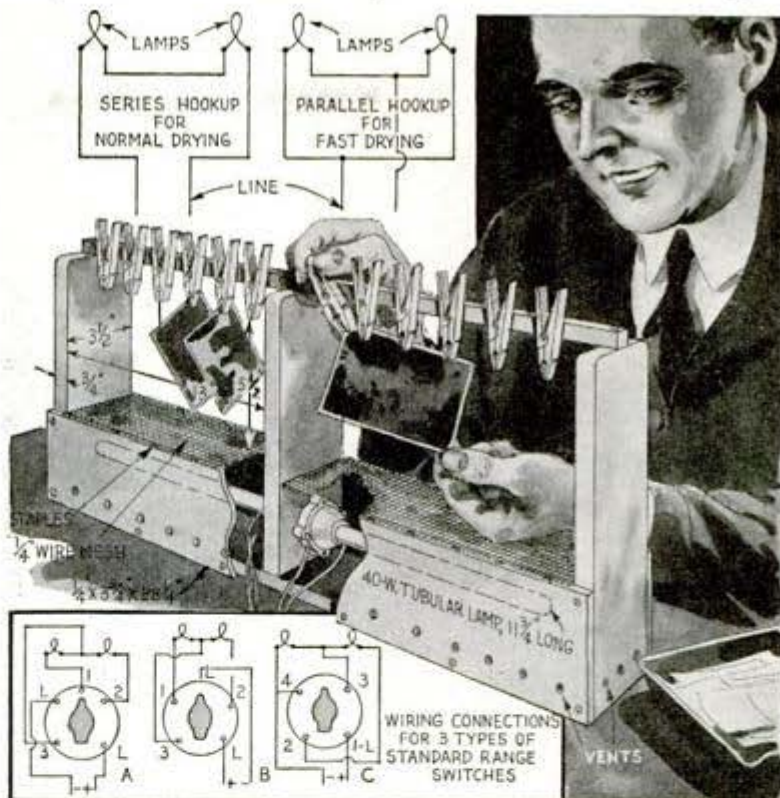

Folding Legs Raise Camera Case to Convenient Height

Folding legs on your camera-equipment case will serve a double purpose; they raise the case so that the contents may be reached easily without stooping and the case will be plainly visible so it will not be stepped on. The legs are obtained from an old card table, the four corners being sawed off, complete with the legs and folding mechanism, and riveted to the case.

The legs are sawed off to bring the case to a convenient height and the rails of the card table should be left long enough so that they butt together at the ends, for the sake of appearance.

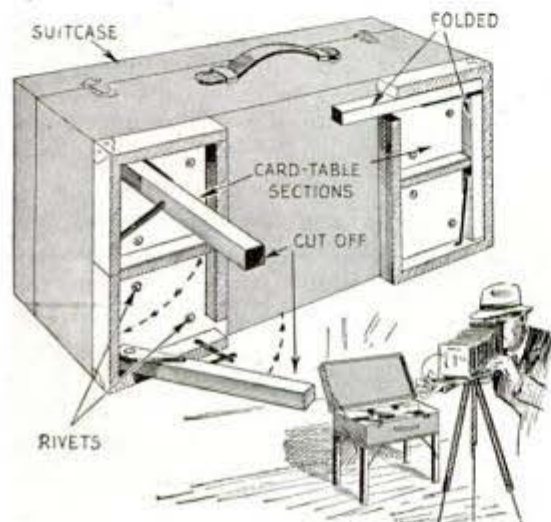

Delayed-Action Shutter Release

Tripping the camera shutter when its string fuse burns down and releases a spring clothespin, this delayed-action release can be used on any camera equipped with a cable release. Two U-shaped pieces of sheet metal are screwed to the jaws of the clothespin, one being slotted to take the shank of the cable release. The opposite ends of the clothespin are tied together with a string, leaving one end long enough to serve as a fuse, its length determining the interval between the time it is lighted and the time the shutter is tripped.

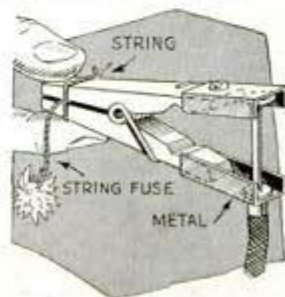



PHOTOS *with* PEOPLE

By Thomas P. Lake



USING people in scenic pictures such as Fig. 1 not only suggests mood and gives scale, but also adds human interest. In doing this the photographer must use imagination, must be prepared for doing additional painstaking work, and he must be resourceful. For instance, in getting the photo of a child with a fawn, Fig. 2, it was found that the fawn was in the habit of feeding from a bottle. So, after getting a bottle, it was an easy matter to take the picture. If there are no persons available to serve as models, the photographer himself can get into the picture by using a delayed-action shutter or a long push-button cord with an electric synchronizer release.



A subject such as Seattle's wishing well, Fig. 4, can be made interesting and its purpose emphasized by the way people are grouped about it as in Fig. 3. In this way the photographer can avoid stiff, obviously posed attitudes of models. When models are used, the first of five general rules is to pose them so that they seem to be unaware of the camera. The scene in Fig. 5 illustrates how the in-



terior view of an Indian canoe, uninteresting in itself, was obtained by tilting it and posing some of the people as though they were turning the canoe over to display it to a party of tourists.

Another example of simulated action—that of boarding a bus—is given in Fig. 6. The faces of the parents and child are outlined against contrasting darker tones. The stewardess was placed partly behind the woman to remove any suggestion of a “line-up” of the models. In such pictures as these, even spacing of the models should be avoided, which is the second rule in using people in photos.

Fig. 7 shows the headquarters of the Mount Rainier rangers. Such a picture can be taken by putting the camera on a tripod, setting the focus, shutter and diaphragm, and waiting patiently for action to occur. An exposure of 1/100 sec. will stop motion, especially if the exposure is made at a moment of suspended action. When photographing a distant view, you can call attention to the great range and distance by appropriate action as in Fig. 8, where one person is viewing the landscape through binoculars and another is pointing to the distant hills. The location of the camera was altered so that the sun struck diagonally

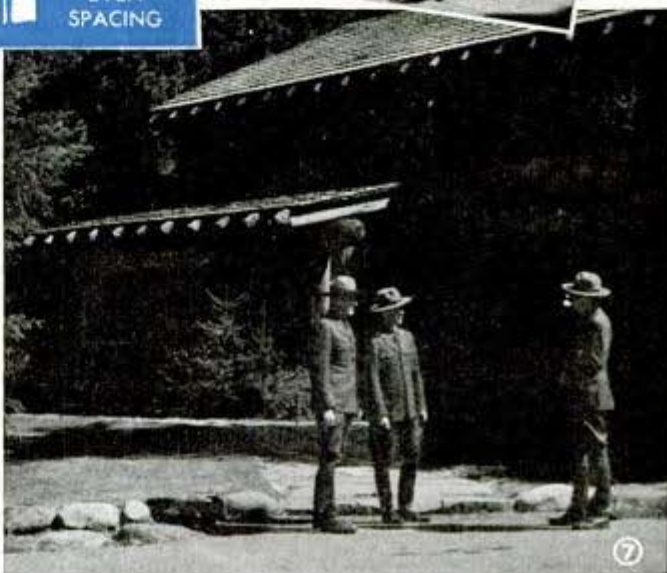



across the faces of the models, and in this way lively highlights and shadows were provided. One of the signs of good modeling of women in pictures is the way in which the feet are placed, good and poor poses being

shown at the right of Fig. 8.



In Fig. 10, the dummy compass card and the sighting vanes used in obtaining cross bearings of forest fires seemed to warrant a picture. An obliging ranger posed as if he were using the instrument, while the camera was again placed to show his face in sharp contrast with a dark portion of the window frame. A flashbulb to the right of the camera as shown in Fig. 11,

provided diagonal light, and was synchronized at 1/25 sec. at a lens stop of f:20.



Pictures of homes are important in every photographer's collection. Too often, however, such pictures lack human interest. Even though the house is to be the important subject, put some figures in the foreground, as in Fig. 9. It is easy to avoid the impression of deliberate posing by giving the people something to do such as playing with the dog, picking flowers or raking leaves. This illustrates the third rule when using models, which is that they should be subordinated to the subject of the picture. In this case the house was the main subject and the figures were placed far enough away from the camera so that their images would be small when compared to the house.



The picture in Fig. 13, showing climbers on Mount Rainier's Paradise Glacier, illustrates the

fourth important rule to remember when using figures in pictures, namely; when figures in a scene are moving or give the semblance of moving, they should move toward the center of the picture, not away from it. Also, this picture shows the use of people to give scale (relative size) to objects in the picture, in this case the fallen boulders and the crevasses. Avoid, if possible, having figures assume poses for which they are untrained. For example, it takes a good diver to look like a diver in the picture, although any normally graceful person in a bathing suit can take a relaxed pose like that shown in Fig. 12. When several figures are included in a scene, the majority should show a unity of interest by looking in the same direction or toward some single object within the picture. This is the fifth rule when using models. In Fig. 14 they are looking toward each other as if in conversation, which is the unity of interest.

Observing these five rules will help you to make interesting pictures out of many subjects that might otherwise be somewhat dull and lifeless. Make a brief list of the five points and paste it in your notebook. Refer to the list frequently and soon you will find that you are following the rules automatically.



Keeping a Darkroom Dry

If your darkroom is located in the basement, where it becomes quite damp at certain times of the year, try setting two or three shallow pans of calcium chloride in different locations about the room. The chemical will absorb large quantities of moisture and in most cases will keep the room quite dry. When the calcium chloride becomes saturated with moisture, it is only necessary to place it in the oven for a few minutes. This will expel the moisture from it, after which it can be used again.

Snapshots in Spiral-Bound Book Are Easy to Carry in Pocket

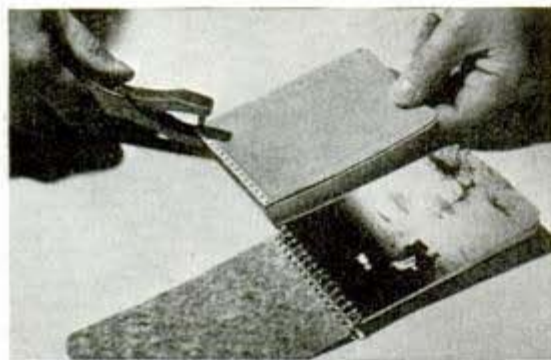

Small photos can be bound in book form for convenience in carrying in the pocket or purse by making use of a five-cent spiral-bound notebook. To remove the wire binding from the notebook, release each end and turn it. Trim the prints to the correct size, then use one of the notebook sheets as a guide to punch the holes in them. Place the prints between the covers,

interleaving them with note-book pages if desired, and then you replace the wire spiral in its original position.

Wire Rack on the Darkroom Wall Holds Photographer's Bulbs

One or two of these handy racks on your darkroom wall will keep your photoflood and other bulbs out of the way and protect them from breakage. Make each rack from a length of heavy wire—that from a coat hanger is just right. Bend a small eye at each end for the fastening screws and bend the wire as indicated to form loops to hold the bulbs.



How to Build a Farm Tractor in Your Spare Time

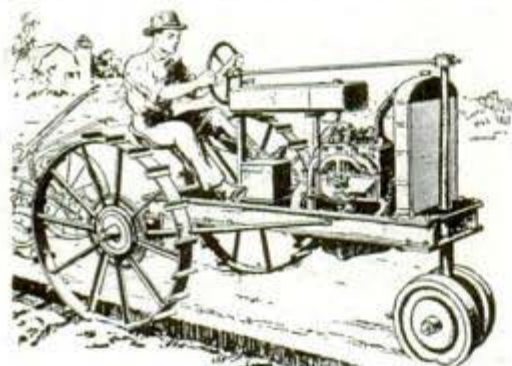

Having plenty of power to pull a two-bottom plow and other implements, this farm tractor, built from old car parts, includes a Ford model-A motor and twin transmissions giving six speeds forward. Wrenches, hacksaw and drill are about the only tools needed—welding can be done at your local machine shop. Set of three 17 by 22-in. plans, Nos. 1024 to 1026 incl., containing construction details and material list will be sent postpaid upon receipt of 75c.

OTHER BUILD-IT-YOURSELF PLANS

STREAMLINE FAMILY TRAILER—937 to 942: Includes all the conveniences of home with sleeping accommodations for four. Trailer is 15 ft. long, weighs about 1,400 lbs. Six prints \$1.50.

UTILITY TRAILERS—986 and 987: Built of old auto parts and lumber. Adaptations of body to suit various purposes. Two prints 50c.

ELECTRIC ARC TORCH—106: Carbon electrodes $\frac{1}{8}$ in. dia. produce arc for soldering, brazing, light welding. For 110-v. 60-cycle a.c. 25c.

OUTDOOR FIREPLACES—917: Fine for preparing meals outdoors during hot weather. Several simple, but practical types, to match other items of a rock-garden setup. 25c.

LAWN CHAIR—1058: Can be built with hand tools from stock material. Curved, slatted seat assures comfort. 25c.

TRELLIS SUGGESTIONS—639: Shows construction of six different types that will help to beautify your home. One includes corner seat. 25c.

ARTISTIC DOG HOUSES—826: Shows four attractive designs. Also tells how to determine right size house for any dog. 25c.

LAWN CHAIR ON WHEELS—978: Light in weight and easy to wheel to any location. 25c.

DUTCH WINDMILL—1059: Simplified design. Stands about 5 ft. high and is built of standard stock. 25c.

Order plans by number and title. Send 3c stamp for new catalog of popular handicraft plans

Address Plan Service, Popular Mechanics Magazine, 200 E. Ontario St., Chicago, Ill.



SHOP NOTES

"Little Giant" BORING-BAR HOLDER

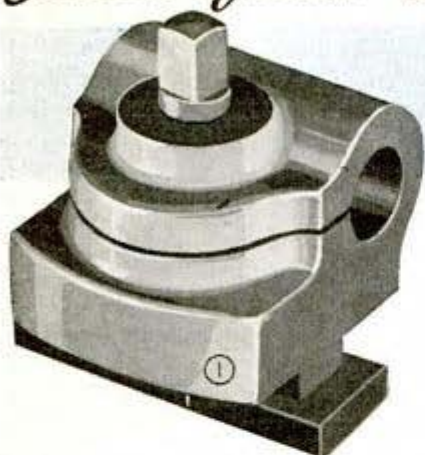

AFFORDING chatter-free rigidity to the overhanging cutting bit by extending the full width of the compound rest, this sturdy boring-bar holder will be found highly practical for all lathe boring, especially in making internal cuts where the tool must be advanced deep into the work. It consists mainly of a rough grey-iron



Make the pattern of white pine and seal the wood with several coats of shellac before having a grey-iron casting made from it like the one shown at the right

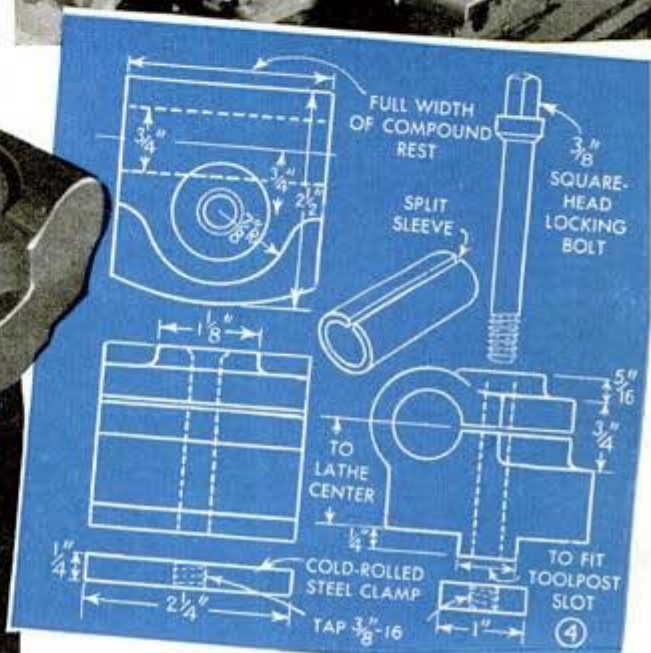
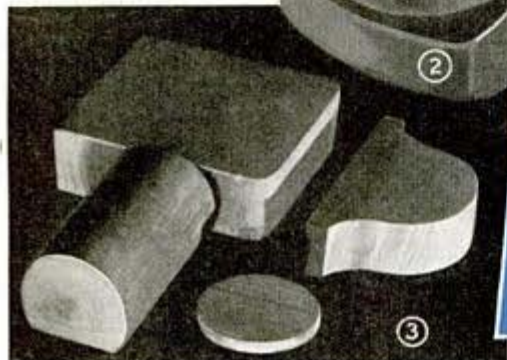



casting like the one shown in Fig. 2 which you have cast at a foundry and then machine in a lathe to look like Fig. 1. By furnishing the wood pattern, one or more castings usually can be had cast at little cost. Fig. 3 shows the shape of the four pieces which make up the wood pattern. These are cut to the sizes given in Fig 4, sanded and glued together, after which the corners are made concave by molding a beeswax fillet along the joint with a hot rod as in Fig. 6. No thickness dimension is given for the base piece of the pattern as this is determined by the distance between the compound rest and the headstock center of the lathe at hand. After a coat or two of shellac is applied to seal the wood, the pattern is ready for the foundry.

Here's how you machine the casting. To obtain a true working surface from which other measurements can be marked, surface the base first by centering the work in a four-jaw chuck in the position shown in Fig. 5.

Then locate and center-drill the hole for the boring bar and face the ends square with the base as in Fig. 7. Note that the tailstock center is advanced to engage the centering hole for support. While the work is chucked in this position, the hole for the boring bar can be drilled as in Fig. 8, or it can be done later when the holder is clamped in the compound rest. In the latter case the drill is chucked in the headstock and the work is fed to it by the carriage. Next, with the work held in a milling attachment as in Fig. 9, the base is rabbeted with an end mill to fit the tool-post slot, and then the hole for the locking bolt is drilled as in Fig. 10. Chamfer the top edge of the hole to seat the bolt head, which is turned to the shape indicated and then filed square to fit the tool-post wrench. Slitting the casting through to the boring-bar hole with a hack saw as in Fig. 11 completes the holder. Although it is dimensioned to take a $\frac{3}{4}$ -in. tool, smaller-size boring bars can be clamped in the holder by providing split sleeves to bush the hole.

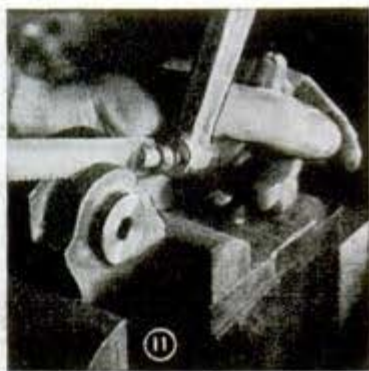
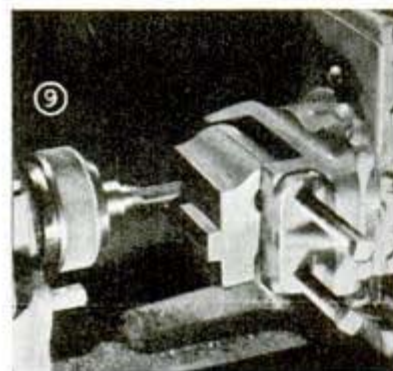

Wheelbarrow Orchard Sprayer Uses Auto Wheel

In order to provide spraying equipment that could be used easily in restricted or congested places as well as on exceptionally rough ground, one farmer made this sprayer of the wheelbarrow type. The frame is of light steel tubing welded together and braced by small rods as indicated. The wheel is one from an old car, and the barrel is a 30-gal. oil drum on which is installed a hand-operated sprayer. Four angle brackets welded to the sides of the drum bolt to the frame to keep drum in place and make it easy to remove when necessary.—Edwin Kilburn, Spring Valley, Minn.

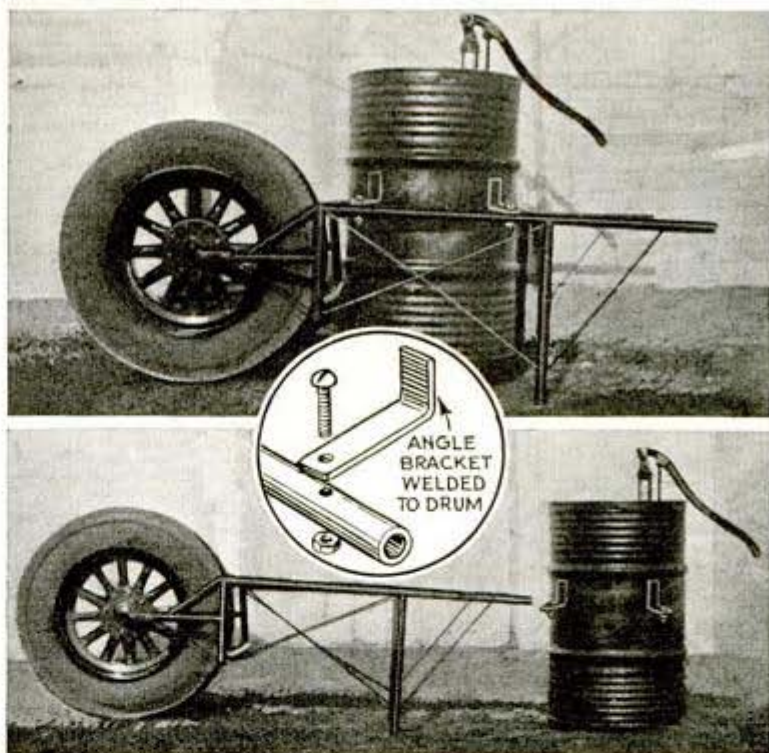

Metal Lath on Gangplank Provides Safe Place to Walk



Any possibility of workmen slipping on a gangplank when pushing heavy loads up it, was avoided by one foreman who nailed strips of metal lath to it as shown. The strips were nailed in the center of the plank, leaving the sides unobstructed for the wheels of the trucks.

—G. E. Hendrickson, Argyle, Wis.

Inexpensive Crack Filler

To fill and make small cracks cover well on a surface to be painted with white enamel, I mix enough white enamel with 1 or 2 teaspoons of white flour to make it the consistency of face cream. When this is rubbed well into a crack and allowed to set, the crack will cover easily and completely. Also it will not let loose and fall out.—Fred L. Stocker, Ottumwa, Iowa.

Colter Guards on Tractor Plow Ride Down Heavy Trash

Wishing to prevent his tractor gang plow from clogging in trashy fields, one farmer fitted curved guards ahead of the rolling colters. Each guard is made from two lengths of $\frac{1}{2}$ -in.

rod welded together so that they form a fork or "wishbone" with one prong on each side of the colter blade. Accumulations of trash ahead of the plow are pressed down by the prongs so that the colter shears through them easily.

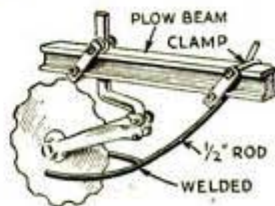

—W. C. Lamme, Downers Grove, Ill.

Making CAR MOTORS



PLUGS LIKE THIS
ALLOW UNBURNED FUEL
TO WASH OIL OFF
CYLINDER WALLS

①



YOU can lengthen the life of your car motor considerably by simply giving it the care that any precision machine should have. Keeping it carefully adjusted at peak efficiency is highly important because if one part is not functioning at its best, other parts may be subjected to extra strain, causing them to break down much sooner than normally. Also, handling the motor properly while driving is important. Avoid racing a cold motor, let it warm up at a moderate speed for a few minutes to give the oil a chance to circulate, or drive slowly for the first half mile or so. And don't "give it the gun" when starting. Gaining two or three seconds time this way wears the motor as much as many miles of driving under normal speeds and conditions.

However, correct lubrication is the most important. A motor that is properly lubricated at all times will last almost indefinitely. This means more than merely keeping the crankcase filled. For long motor life, use only the best oil of the correct viscosity and change it at regular intervals, even though you may have an oil filter which strains out much of the foreign matter that collects in the oil. The reason is that corrosive acids, which result from combustion vapors, and sludge caused by the combining of various foreign matters, collect in the oil. These can be removed only by draining and flushing the crankcase.

The worst enemy of a motor is oil dilu-

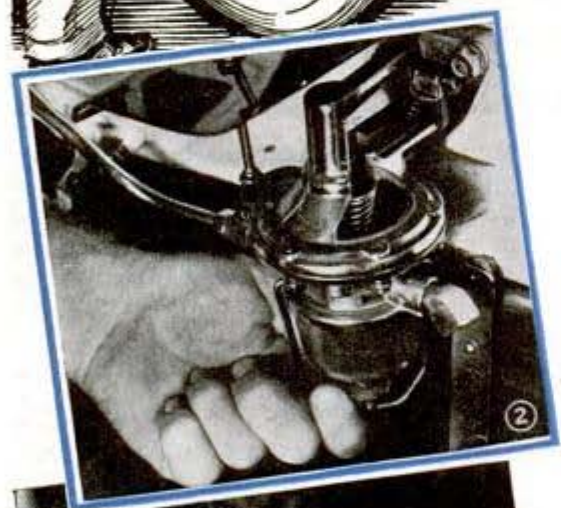

②



③

RESTRICTED FUEL LINES CAUSE
HARD STARTING, WHICH RESULTS IN
OVER-CHOKING AND OIL DILUTION



LAST LONGER

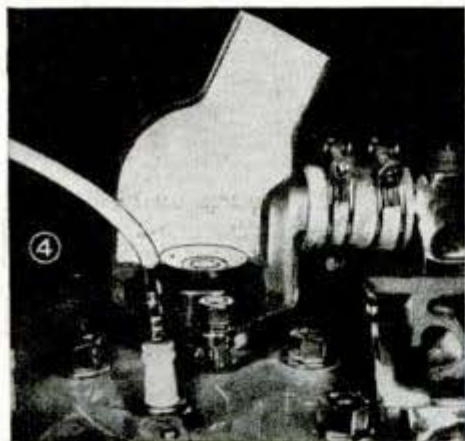

tion, which is the result of unburned fuel getting into the crankcase. Its causes are many, but the motorist who drives carefully and keeps the motor in good condition so that it will start easily and warm up quickly, can eliminate most of them. Oil dilution resulting from faulty motor operation may lead directly to the condition of parts shown in Fig. 12. These are not worn out, but each has been ruined by lack of lubrication. Carbon washed down by gasoline has caused the piston rings to stick, lack of oil of sufficient body has permitted the pistons to become scored, and acid in the oil has caused piston and wrist-pin corrosion. Burnt valves were the result of sticky, gummy sludge being thrown onto the valve stems.

When a motor is hard to start, you are likely to over-choke it, with the result that unburned fuel passes by the pistons, washing lubricant from the cylinder walls and diluting the oil. Likewise, a motor that warms up slowly means that an excessive amount of gasoline must be used to keep the motor running, and some of it, when striking the cold cylinder walls, condenses and results in still more dilution.

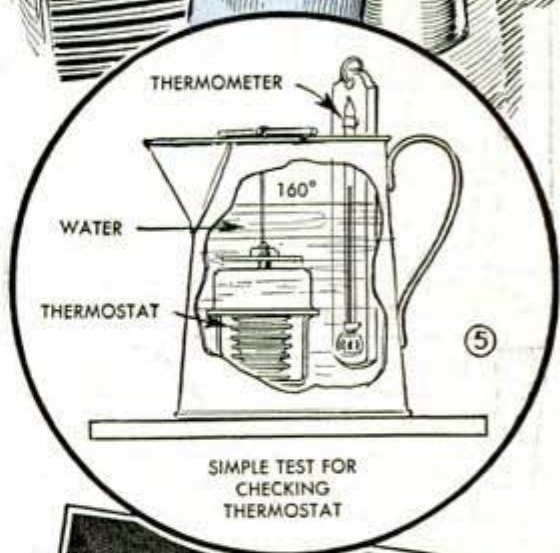
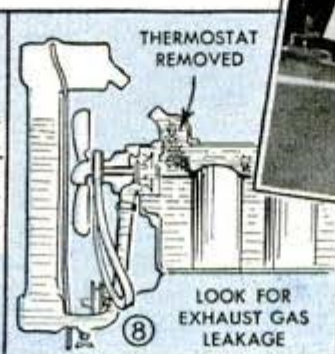
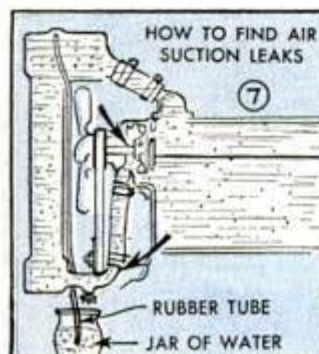



In most cases, hard starting is caused by faulty ignition. For example, look at the spark plugs in Fig. 1. The one on the left is clean, has the electrodes correctly spaced and delivers a hot spark. But the one on the right is so dirty and choked that, while it may fire, the spark will be weak and the fuel charge will be partly burned, the unburned fuel helping to dilute the oil. After cleaning and adjusting the plugs, remove one of the wires and hold it about $\frac{3}{8}$ in. from a cylinder-head bolt while the motor is running, Fig. 6. A good spark will jump to the bolt. If it is weak, check further. Look at the distributor points to see if they are bright, free of pits, and are adjusted correctly. Then go over the wiring. Clean and tighten all the connections and replace

wires having broken or frayed insulation. Don't forget the battery and its cables. If the source of the spark is weak, naturally you can't expect a strong one. Clean the battery posts, and be sure that the ground cable is making good contact at the grounded end.

If the ignition check has failed to improve starting, go over the fuel system. Look for a filter bowl near the fuel pump or carburetor, Fig. 2, and clean it thoroughly. In addition to this, there may be an unseen screen filter that needs cleaning. The one in Fig. 3, which is located at the carburetor, should be washed or blown out at regular intervals. Sometimes the carburetor float level, Fig. 9, is set too low and this may result in hard starting and excessive use of the choke. A level that is too high causes a wastefully rich mixture, with its resultant oil dilution, while a level that is too low reduces power and causes difficult starting.

Sometimes automatic chokes, Figs. 10 and 11, slip out of adjustment and cause starting troubles. They should be checked occasionally to see if they are in the fully-choked position when the motor is cold, and in the fully-opened position when the motor is hot. Usually these chokes are controlled thermostatically, and direct the exhaust gases against the intake manifold to assist in the vaporization of the incoming fuel. On some cars, the controls are eliminated and the gases are by-passed around the intake manifold near the carburetor. On this type, check to see if the by-passes are partly or completely clogged with carbon, which would interfere with proper fuel heating.

To further avoid oil dilution, be sure that the motor warms up quickly. If it doesn't,

check over the cooling system. Remove the thermostat, Fig. 4, and clean it, being sure that it is not stuck. Then check it in hot water as in Fig. 5. Those designed for high-temperature operation with permanent anti-freeze solutions should begin to open at 150 to 160 degrees. Others should open between 140 and 150 degrees.

Remember too, that overheating will shorten the life of a motor just as quickly as hard starting or slow warming up. It causes the oil to thin out, expands the metal of moving parts and reduces their recommended clearances, which results in rapid wear. In some severe cases of overheating, the motor block may even crack as shown in Fig. 13. Mild overheating may result from too rich a fuel mixture, or incorrectly timed valves and ignition. But generally it is caused by loosened particles of corrosion accumulating in either the radiator or the motor block. Use of an inhibitor in the radiator will help prevent rust, and using either pure rain water or distilled water will aid in reducing lime accumulations.

Looseness of hose connections, or water-pump bearings may permit air to be drawn into the cooling system at the point indicated in Fig. 7. This trapped air accelerates rusting and increases the bulk of the coolant, resulting in loss through the overflow. A check for air leaks is made by connecting a rubber tube to the lower end of the radiator overflow pipe, and immersing the tube in a jar of water. Then, with the radiator filler cap on tight and the motor running at a fairly high speed, a check is made to see if air bubbles are forced down into the jar of water. Bubbles indicate air leaks in the cooling system.

An equally bad condition is seen in Fig. 8 where a leaky cylinder-head gasket is allowing gases to escape from the combustion chamber into the coolant. Such gases contain sulphur, which unites with the coolant and produces sulphuric acid. In time, this may accumulate to a point where the coolant becomes highly corrosive. If such a condition is suspected, the thermostat should be removed and the cooling liquid adjusted to the level shown, with the upper hose removed. Then, if there is any leakage, sudden "gunning" of the motor will force combustion gas into the coolant. This test should be made quickly before boiling begins, or the resulting steam will cause confusion in the test.

Red Reflectors Under Trunk Lid Are Safety Measure at Night



Several red reflectors mounted on the underside of a trunk lid will flash a warning to a motorist approaching you while unloading your trunk at night. This idea is especially handy if you frequently have to open the trunk on congested streets or heavily traveled highways where there is a possibility that a driver will not see you.

Easy Way to Attach Skid Chains Without Jacking Up Car

A piece of heavy wire bent as shown with hooks formed on the ends provides a handy tool for attaching skid chains without jacking up the wheels. Just insert the wire in one of the chain-strap openings of the wheel and hook the end of the chain to it. Then stretch the chain out behind the wheel and back the car onto it until the two ends of the chain meet. Now hook them together and the job is finished.



Accidents caused by passengers stepping out of a cab into the path of moving traffic are avoided by one large cab company which removes all left rear door handles.

Portable Sawhorses Fold Flat When Not in Use

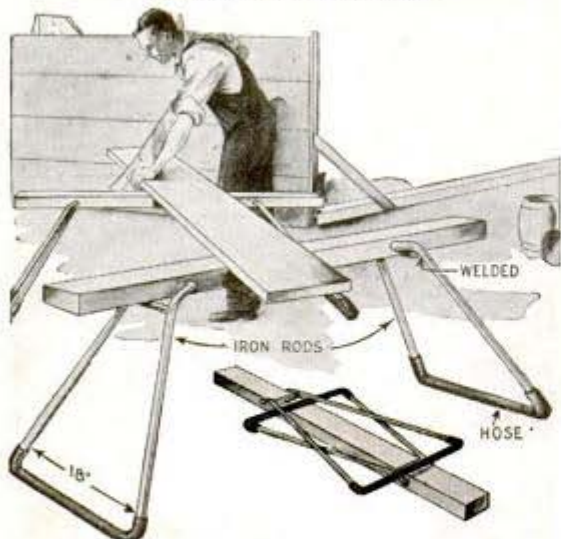

Carpenters who find it necessary to transport their tools from one job to another in a regular auto trunk will find these sawhorses just the thing as they fold flat when not in use and occupy little space. The tops are cut from 2 by 4-in. stock, after which holes are bored in the sides to accommodate folding legs, the latter being made of pipe or iron rods, bent to the shape indicated. Short lengths of garden hose slipped over each pair of legs prevent slipping on smooth surfaces, while cross braces welded in place near the top keep them from opening too far.

Beacons Protect Grain Fields From Migrating Ducks

According to the Bureau of Biological Survey, grain fields can be effectively protected against migrating ducks by operating simple frightening devices of the type shown for about an hour after sunset and an hour before sunrise. These are made easily by bolting six curved sheet-metal reflectors on a bicycle wheel. Two electric lanterns are then fastened, back to back,

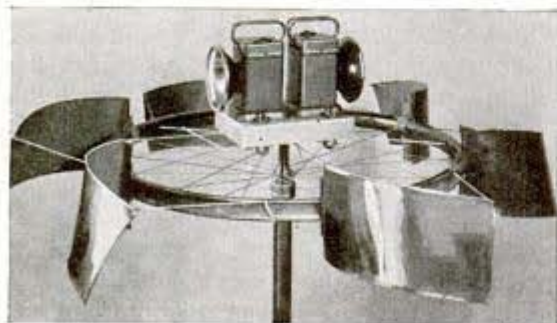

on a hardwood block in the center of the wheel which is mounted on a 6½-ft. length of pipe driven in the ground. When well lubricated, the beacons will rotate in the slightest breeze, resulting in flashes which frighten the ducks at night. In daytime, the reflectors alone were found to offer complete protection. To protect fields that are more than 1,200 ft. wide, several beacons will be required.

Notches Cut in Eye of Lathe Dog Adapt It for Square Stock

Sometimes it is handier to drive square stock in a metal-turning lathe by using a dog instead of a chuck. Any dog suited for round work can be made to hold square stock by filing two small notches in the position shown. In most small dogs, several sizes of squares can be held in one pair of notches.

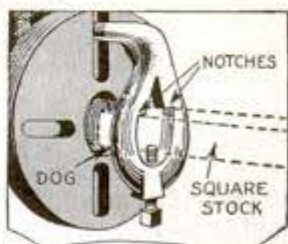

Hay Carrier Lubricated Easily With Felt Disks

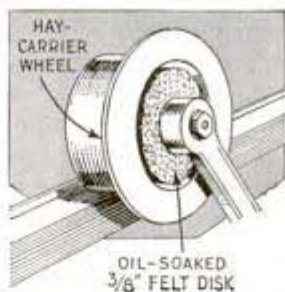

To keep the wheels of the hay carrier in his barn well lubricated, one farmer fitted felt disks to the wheels as shown. Soaking the disks with oil once each year is sufficient to keep the wheels well lubricated for an entire season's use.

Shovel Handle Flattened at End To Prevent Twisting in Hands

The tendency of a long-handled shovel, hoe or pitchfork to twist in the hands, thus tiring the finger muscles because of the necessary tight grip, can be avoided by flattening one side of the handle near the end. The flattened portion enables you to maintain a firm grip without undue strain.

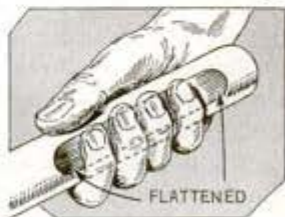

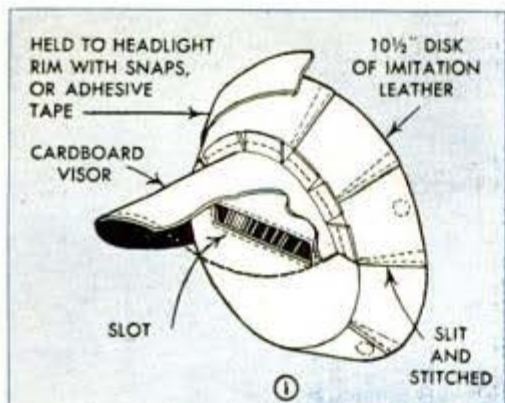

CAR-LIGHT BLACKOUT

AS DRIVING during a blackout is highly hazardous, all vehicles except essential ones should be parked at once at the side of the road not less than 25 ft. from a fire hydrant or from a street intersection, and the lights should be turned off at once for the duration of the blackout. If, however, your duties are such that they fully justify continuing to your destination, the lights of your car should be fitted with quickly attached blackout hoods, after which you can proceed slowly and with special caution. The hoods eliminate almost all road illumination and therefore they are of very little benefit to the drivers; their chief purpose is to warn pedestrians of approaching cars.

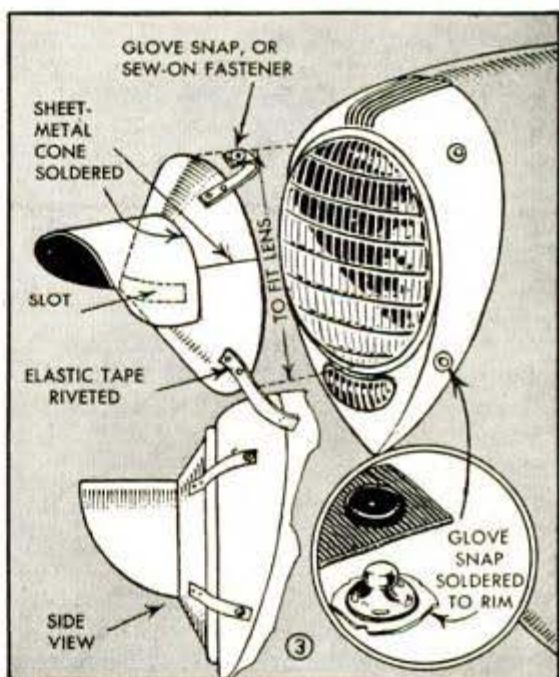
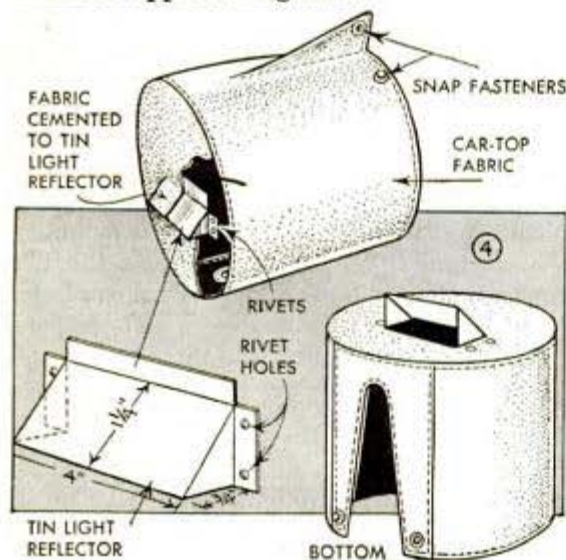
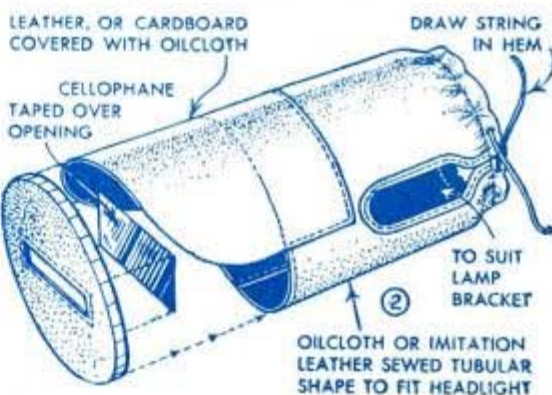

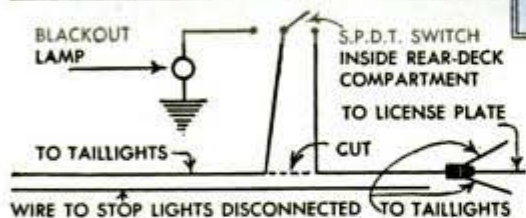
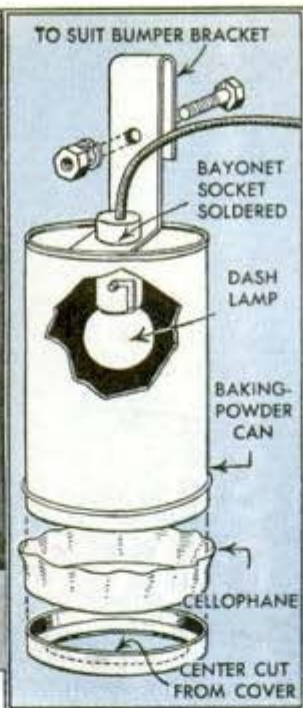
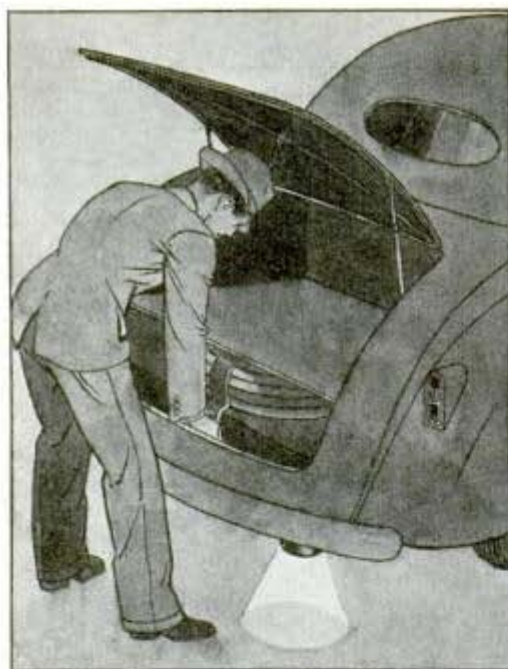

(5) Taillights can be blacked out from above yet continue to serve their usual purpose, or the taillights can be turned off entirely if a blackout lamp that throws light on the ground, is provided

Anyone can make either the slip-over hoods for the older type of headlights, or the snap-on hoods for fender-type lights. You can vary the construction and method of attachment as long as the lenses of the lamps are fully covered with an opaque material to shut off all light except that which is permitted to pass through horizontal slots about $\frac{1}{2}$ by 3 in. in size. These slots are shielded from above with visors so that the direct light cannot be seen at any angle greater than 12 degrees above the horizontal axis of the lamps. Thus only light reflected from the pavement will be visible to an observer above, and ordinarily this reflected light is not visible at an altitude over 400 feet.

The intensity of illumination from the headlights should be reduced with a few thicknesses of colored Cellophane, waxed paper or even translucent cloth, which is attached to the inside of the blackout hood to cover the slot. Blue Cellophane has been recommended for covering slots of headlight blackout hoods, on the erroneous assumption that blue light itself is less visible than other colored or white light of equal intensity. The purpose of covering

the slot with a translucent material is simply to cut down the intensity of illumination and therefore any colored Cellophane, waxed paper or similar material is satisfactory. However, general use of one color such as blue for blackout hoods on auto headlights has a value as a means of identification for pedestrians just as red is the customary color for taillights.

Fig. 1 shows an imitation leather or oilcloth hood for a fender-type headlight, the hood being attached with snap fasteners or simply with adhesive tape. A similar one of sheet metal is detailed in Fig. 3. Other hoods for headlights are shown in Figs. 2 and 4. Horizontal visors, curving downward at the sides, can be made of cardboard covered with oilcloth, imitation leather or other suitable waterproof material. They should extend far enough in front and the sides should be low enough to conceal light coming through the slot from any point over 12 degrees above horizontal. The hood in Fig. 4 has a small sheet-metal visor extending at an angle just over the slot.

Taillights can be masked by taping a piece of sheet metal or other waterproof material snugly over the lenses as shown in Fig. 5. A narrow portion at the bottom of the shield is cut away to permit passage

of light, and a small visor is provided above it. Any openings in the taillights for illuminating license plates, as well as any separate license-plate lights should be blacked out entirely with adhesive tape. As an alternative to using hoods on taillights, you can substitute a blackout lamp that throws light on the ground. A switch is provided to enable the driver to turn the taillights off and the blackout lamp on. The lamp itself consists of a small can fitted with a light of low intensity, and provided with a suitable hanger for attaching it to the car bumper.

Removing Tires From Safety Rims

It is not such a difficult job to remove a tire from a safety rim if you go at it in the right way. Just stand with the heels on the tire at about the edge of the tread or



white side walls and roll the bead out of the safety groove. This cannot be done when the heel is placed too close to the edge of the wheel. By using this method of breaking the bead from the safety groove, you can remove the tire in just a few minutes.

—Chuck Phillips, Visalia, Calif.

Ball Shield for Trailer Hitch



If you have a ball-type trailer hitch on your car, it can be protected when not in use by using a hollow rubber ball. A hole is cut in the

ball so that it can be slipped over the hitch, making the hole of a size to be a tight fit so that the ball will not slip off easily.

Oil on Frame of Garage Doors Prevents Them From Freezing

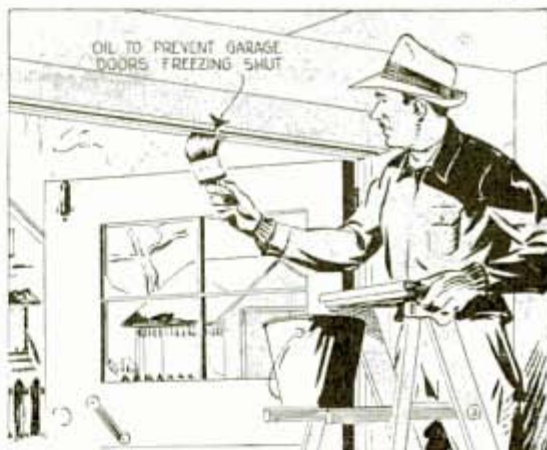

Have you ever had trouble with garage doors freezing shut after snow has melted and run down between the door and frame? If so, the trouble can be avoided by keeping the door edges and frame well oiled during freezing temperatures. Old crankcase oil is ideal for the purpose and may be applied with a paint brush.

Installing New Oil Seals

Here is a simple way of installing oil seals that will save considerable time as the differential-carrier assembly does not have to be removed. To do this, the rear axle shafts are removed, the grease drained and the cover plate taken from the differential housing. The old oil seals can now be removed easily with a heavy screw driver or pinch bar, which is hooked in back of them and bumped on the outside. Now, the new seal is pushed up in the axle-shaft tubing correctly, and a 1/4-in. steel plate a little larger than the seal is held in front of it by means of a long slim screw driver through a wire loop attached to the plate. Then, a long bar is pushed slowly up against the plate and struck a blow with the sledge hammer, forcing the seal into place.—Thomas L. Mino, Cincinnati, Ohio.

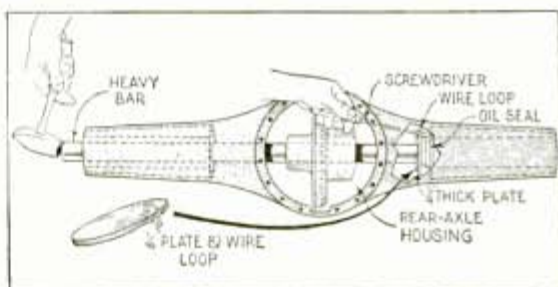

MACHINISTS for VICTORY!

Our men at the front are staking their all on the planes, tanks, guns and other mechanical equipment that the machinists and others at home must give their all to produce in this greatest, fastest and most important surge of industrial production in history! Not thousands, but millions of mechanics and machinists will meet this demand.

To make yourself an expert machinist, start now to get the knowledge it takes. First read these helpful articles on basic shop machines, of which this is the fourth, and then apply "full force" to studies in the work for which you are best qualified.

For your further studies, the Shop Notes Editor of Popular Mechanics Magazine will be glad to send you promptly a list of outstanding books on various machine-shop and allied subjects.

How to Use a

Part 4—By H. J. Chamberland

OF THE basic metal-working machines, the shaper is of importance as a means of chip-cutting metal, largely to produce flat surfaces. The manner in which metal is removed from the work, is much the same as it is in a lathe, but in a lathe the work rotates against the cutting tool, while in a shaper the tool travels back and forth, cutting the work on its forward stroke, the work being held securely on a stationary table. While a shaper resembles a planer in many respects, the fundamental difference between the two is that the table of a planer reciprocates instead of the tool as it does in a shaper. The

shaper is intended for small work whereas large work beyond the capacity of a shaper is handled on a planer. Belonging to the shaper family also are such tools as the nibbler, slotter, broaching machine and vertical shaper, Fig. 10, as they all produce chips by the stroke method. The broaching machine differs from the others in that it produces a shape or outline by a single stroke rather than by a series of strokes.

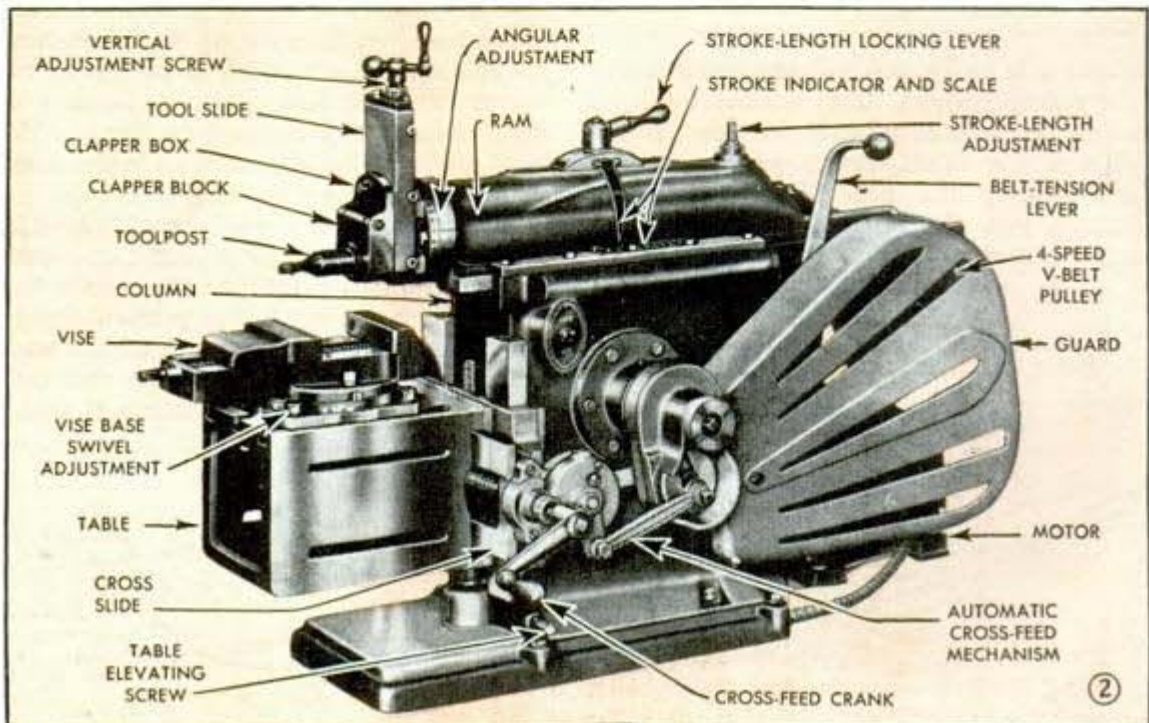
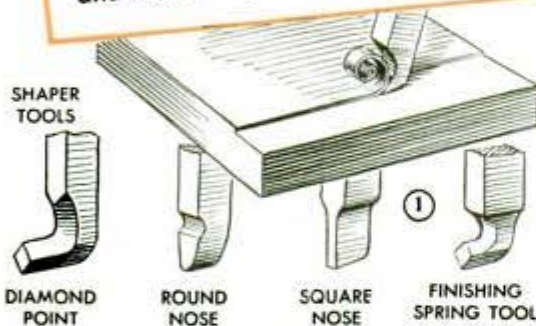

Atlas Press Co.
Kalamazoo

BENCH SHAPER

Mich
about
\$250.00

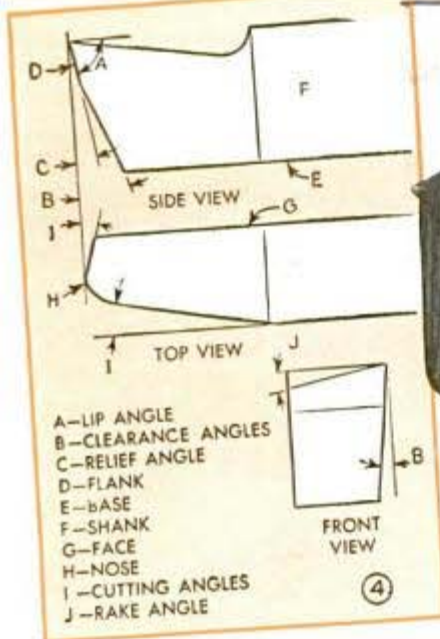

How shaper works: Fig. 2 shows a modern bench shaper and gives the terminology of its parts. The work is clamped securely in a swivel vise on the table, or directly to the top or side of the table, which can be elevated and moved crosswise so that the work can be positioned in correct relation to the tool stroke. Traverse movement of the table can be controlled either manually with a cross-feed crank, or automatically with the cross-feed mechanism. A pivoted toolslide is attached to the end of the movable ram permitting it to be swung around to any angular adjustment; it can be fed slowly against the work with the crank at the upper end of the toolslide. The tool engages the work on its forward stroke but clears it on the return stroke due to the action of the clapper box. This action of clearing the work prevents rapid dulling of the tool point. With the bench shaper shown in Fig. 2, different speeds are obtained by using 4-step cone pulleys on the motor and on the drive shaft of the shaper mechanism. The rotating movement of the drive shaft is converted into reciprocating movement of the ram. The length of stroke can be varied by a simple adjustment, which can be locked. The capacity of a shaper is designated by its maximum amount of stroke, one having 7 in. being known as a 7-in. shaper. Indus-



In shaping the male part of a dovetail, a long, sharply pointed tool bit is needed for clearing the metal in the angular cut

trially used shapers are made in sizes up to 36-in. stroke capacity.

Few tools needed: As is the case with a lathe, the tools required for the average run of work on a shaper are few, and the beginner can start with the assortment shown in Fig. 1. Owing to increasing cost of high-speed steel and regulations to reduce the tungsten content of this steel from 18 to about 2 percent, tool bits are used in holders for the sake of maximum economy. Regarding relief, clearance and rake angles of the tools, Fig. 4, they are identical to lathe tool bits, except in certain cases where steeper and longer angles are necessary on shaper tools as in Fig. 5. Therefore the operator who knows how to grind lathe tool bits, can apply this knowledge to his work on a shaper. When the

Saving both time and material, a metal-cutting band saw cuts out innumerable forms preparatory to machining in the shaper



the work and the vise jaws as this assures a uniform gripping surface when the vise is tightened properly. In case the work is of uniform thickness, but less than the depth of the vise, it should be placed on parallel bars set on the vise bed. Work that is too large to be held in the vise can be clamped directly on the table after removing the vise and its swivel base. When doing so one should always bear in mind that the positioning of the work should be such, if possible, that it will not have to be altered between successive operations. Various



tool-bit holder is clamped in the tool post, the distance from the tool post to the tip of the tool should be as short as possible, in order to assure the greatest possible rigidity and to prevent any tendency of the tool chattering on its forward stroke.

Mounting the work: Work that is mounted on a shaper table can be gripped in the vise, this being attached to the table and provided with a swivel so that the work can be swung around to any convenient angle for cutting. When cutting grooves or otherwise recessing in a line parallel to a flat surface of the work, this surface should be parallel to the top of the vise, which is ascertained easily by making a surface-gauge test for this purpose. It is good practice to insert pieces of cardboard between

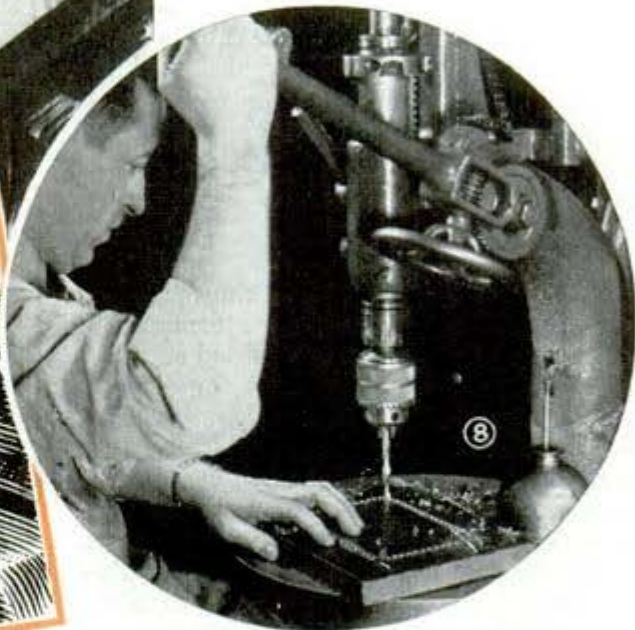

Fig. 8 shows time-wasting method of drilling numerous holes to remove internal portions; this can be done on band saw in a fraction of the time

ways to clamp the work on the table are possible, making use of bolts to engage the slots of the table. In some cases counter-bored holes through the work enable the operator to bolt it down; sometimes step blocks and hold-downs are permissible. To prevent the work from sliding forward on the table from the pressure of the tool on its cutting stroke, a couple of short bolts with washers under the nuts are adjusted to contact the forward edge of the work and are then drawn tight on the table as is shown in Fig. 3. In this example the job included surfacing, squaring and V-cutting operations on a small cast-iron surface plate, which was drilled and counterbored in the center for bolting to the table. The

GENERAL SHAPER-SPEED
RECOMMENDATIONS
(In Ft. Per Min.)

Stock	Roughing	Finishing
Cast Iron	40 - 50	20 - 25
Tool Steel	30 - 35	15 - 20
Machinery Steel	40 - 50	25 - 30
Bronze or Brass	50 - 60	40 - 50

As number of strokes per minute are known, multiply this figure by length per stroke to find ft. per min.

V-shaped piece in Fig. 9, band-sawed out of large plate of rough stock, is set up on shaper for finishing cuts. Fig. 10 shows "business end" of a vertical shaper

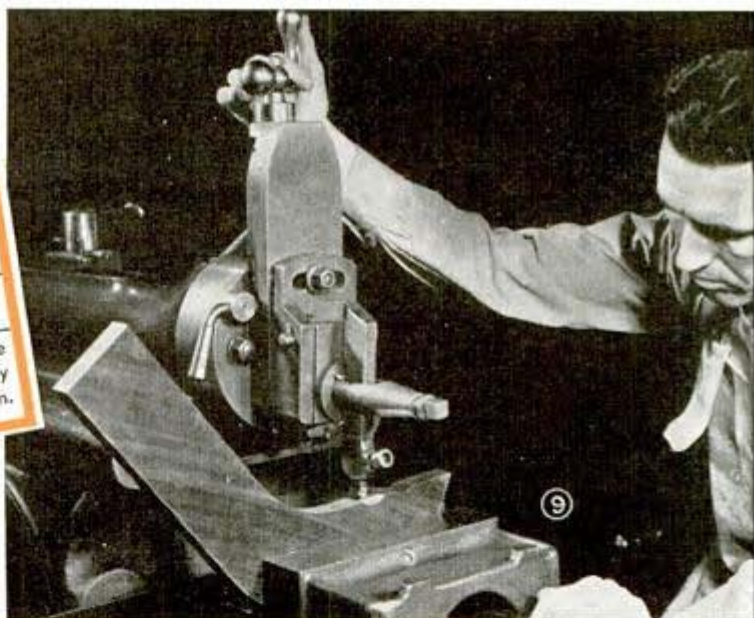

surface plate was 6 by 6 in. in size, the V-grooves $\frac{3}{32}$ in. wide and were spaced $\frac{1}{2}$ in. apart. After cutting the V-grooves in one direction, the bolt holding the plate down at its center was loosened, and, as the plate was perfectly square, it was merely given a quarter turn and pushed up against the washers on the stop bolts, after which the center bolt was retightened for cutting the second row of grooves at right angles to the first.

Shaper speeds and feeds: Similar to speeds and feeds when cutting with other chip-producing tools, the influencing factors in the case of the shaper are the kind of metal to be cut, the type of cut, whether a rough or a finishing cut, and also the rigidity of the entire outfit. The average bench shaper usually has four speeds, which give a range of 50 to 200 strokes per minute. As a general rule slow speeds are best on long cuts and vice versa. The table at the left of Fig. 9 gives recommendations for different materials when making rough or finishing cuts. The cutting speed is given in feet per minute but it is an easy matter to translate this into the number of strokes per minute simply by multiplying the figure in feet per minute by 12 to get inches per minute, after which you divide by the length of stroke to get number of strokes per minute. For instance, where 35 ft. per min. is recommended, and the strokes must be 6 in. long, you first multiply 35 by 12, which gives 420, and then divide this by 6, which gives you a speed of 70 strokes per minute. Accordingly, you adjust the shaper to 70 6-in. strokes per



minute. The amount of metal removed per stroke is also variable and must be judged by experiment on the part of the operator. Apprentices should start with light cuts in order to become accustomed to the performance of the shaper.

Saving time and material: As the shaper and planer, like other stroke-cutting machines, remove metal in practically worthless chips, it becomes a matter of great importance to pre-cut metal as closely to the approximate finish size by more economical means than wholesale removal of metal by chip production. Take for instance the work mounted in a shaper as shown in Fig. 9: This V-shaped piece was 2 in. thick, 15 in. long one way and 12 in. long the other way. Minimum waste of material and time in shaping was possible

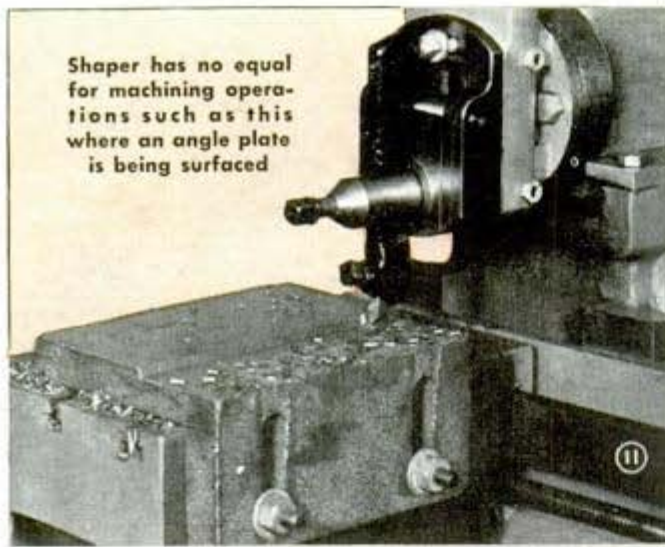

Shaper has no equal for machining operations such as this where an angle plate is being surfaced



Here full advantage is taken of vertical and cross-feed features of the shaper



To cut a T-slot, the center section is grooved first; then the wider bottom portion is cut with a specially formed T-shaped bit

by first sawing out the V-shaped piece from a large plate of rough stock with a metal-cutting band saw as in Fig. 6. Even for cutting out internal pieces, the band saw is an ideal tool to use as the blade can be cut, inserted through a hole in the work, and spot-welded together again in a

few minutes, after which the internal cut can be made. Compare this method with the older, time-consuming practice of drilling a series of holes, preparatory to removing the internal piece, as shown in Fig. 8. Although the material waste is not great in this case, much valuable time is lost. Another method of cutting metal is to use an oxy-acetylene cutting torch as is shown in Fig. 7. While there is a considerable saving in time by this method, hard spots are likely to develop on the metal along the edges of the cut and unless these are annealed, the tool bit will be subject to a terrific "beating," when the metal is being cut on the shaper.

Work particularly suited to shaper: From the angle of economy, the shaper has no substitute for machining operations such as shown in Figs. 11 and 12. Note from Fig. 11 how convenient the table is to handle angle plates for surfacing operations. Fig. 12 shows how a piece is squared by taking advantage of the vertical and cross-feed features of the machine in one setting. Making dovetails in a variety of sizes to meet machine-tool requirements are familiar jobs on the shaper. When

producing a rather limited quantity of dovetails, they are made in solid blocks or slabs of machinery or semi-steel, but where dovetails are produced constantly and in large volume, castings are used. Note in Fig. 5, which shows the male section of a dovetail being cut, that a long and sharply pointed tool bit is necessary in order to assure free-cutting action and to obtain square intersection of the horizontal and angular cuts. Another specialized shaper operation is shown in Fig. 13. This is a set-up for cutting a T-slot in a toolslide. In this case, the center section is cut first with a plain tool bit, after which the bottom of the slot is widened with a specially formed T-shaped bit as shown. On such current operations as dovetails and T-slots, full advantage should be taken of the micrometer adjustments for vertical and cross-feeds.

Making tools in the shaper: Bench-type and medium floor-type shapers play a

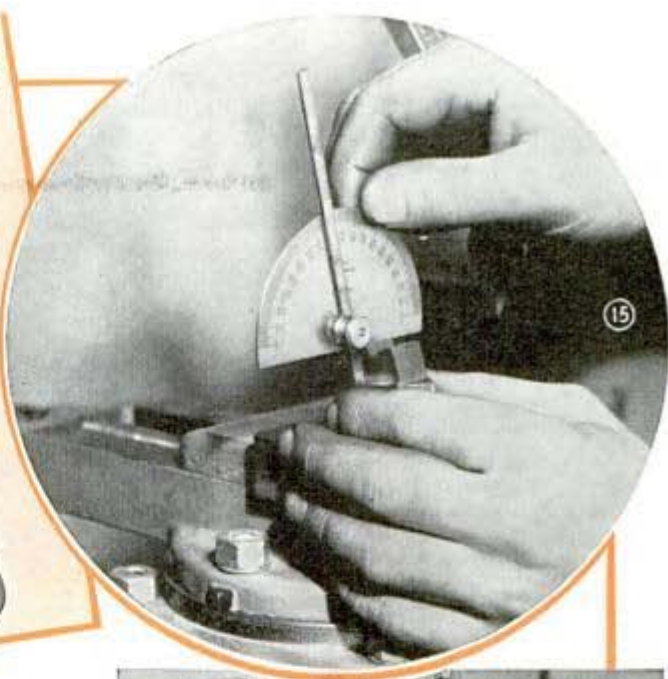
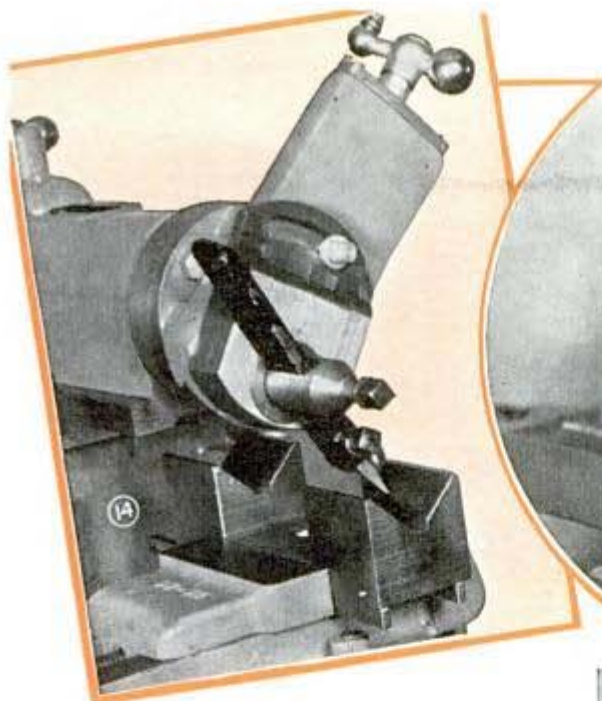

Cutting a pair of identical V-blocks in one operation is shown in Fig. 14. Fig. 15 shows checking clearance of grooving tool cut on shaper

prominent part in machine-shop practice of making a variety of tools. Such cutting tools as are used in lathes, boring mills, radial drills and automatic screw machines are made economically by a 95 percent roughing operation with small shapers. All one has to do is to work to within .010 or .015 in. of a template outline. Usually such tools are finished by hand filing, or if the surfaces must be extremely accurate, they may be finish-ground. Fig. 15 shows how a forming tool, which was cut on a shaper, is being checked for clearance with a protractor. In Fig. 16 a gauge that bears a great resemblance to a rack is being shaped. Although this demands strict accuracy it is not a complicated or difficult job to do on a small shaper. The tool bit must have its cutting section finished for the required toothlike shape. Each spacing is finished completely by a number of successively light cuts. Correct spacing of the grooves is easy to control by making proper use of the micrometer adjustment on the cross slide, and the depth of the cut is measured similarly with the micrometer adjustment on the toolslide. As V-blocks are generally used in pairs, cutting them on the shaper should be done in the same way as is shown in Fig. 14. This kind of work demonstrates the versatility of a shaper in its capacity to cut at compound

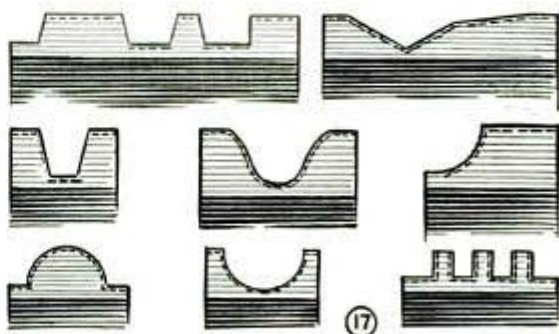
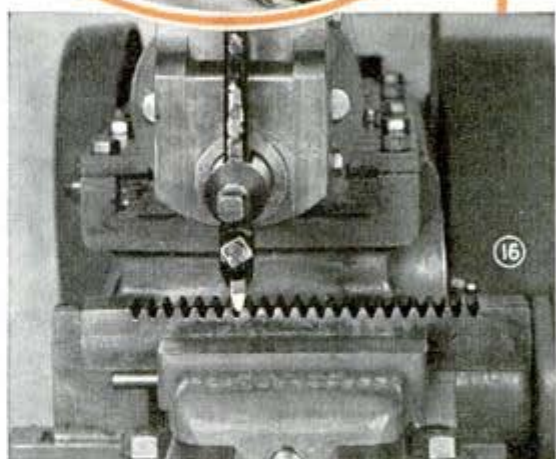

Strict accuracy is required for cutting racks or similar work as in Fig. 16. In Fig. 17 are some examples of forming tools cut on a shaper

angles without any disturbance in the mounting of the work. Fig. 17 shows cross-sectional views of a number of forming tools that can be produced with a bench shaper. Ordinarily these tools are made about 1 in. thick and are kept sharp by grinding the top only. Clearance

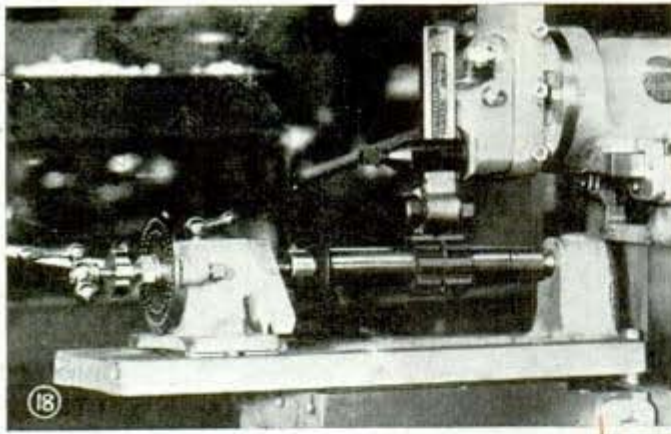

Fig. 18, a set of dividing centers on base plate bolted to shaper table for gear cutting and peripheral grooving

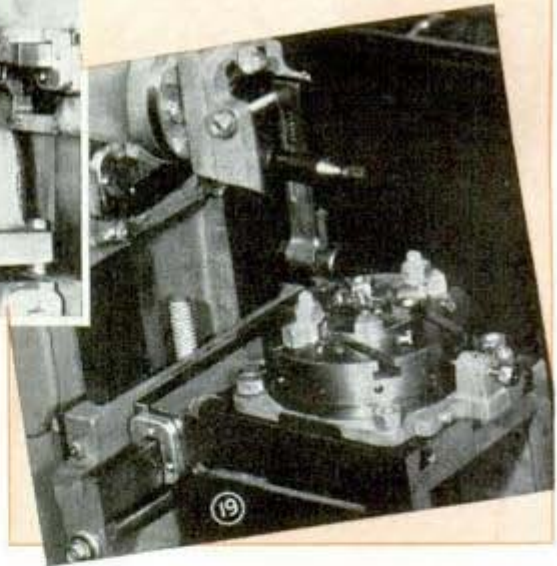

Fig. 19 shows indexing plate to cut on side of a turning

pend on the nature of the material to be formed. In Fig. 18, a set of dividing centers are fitted to a base plate, the whole assembly being bolted securely to the table of the shaper. This provides an accurate set-up to index the periphery of blanks when making gears, ratchet wheels, cutters and any other parts requiring evenly spaced divisions. Another similar attachment is shown in Fig. 19; a rotary indexing plate which is used to index on the side of a part instead of on its periphery.

Sometimes shaper operations seem to overlap those of a milling machine, and it is frequently a question which of these machines should be used to execute certain

jobs. After reading this article and the one in the next issue, which will deal with milling machines, the basic advantages of both machines should be clear to the average shop worker.

Next month—Milling Machine

Small Work Threaded Quickly by Using Die in a Lathe

On a job of threading four hundred $\frac{1}{4}$ -in. rods the slow, tiresome work of doing it by hand was avoided by using the die and stock in a lathe. One handle of the stock was mounted in the tool post so that the center of the die was exactly in line with the lathe centers and the body of the die stock at right angles to the lathe bed.

The carriage does not need to be engaged to the lead screw as once the thread is started, the thread itself will feed the carriage along. The lathe should be run at the slowest speed in back gear. When running off the die, time can be saved by switching over to the highest speed in back gear. Use plenty of cutting oil.

—C. C. Cooley, Wadesboro, N. C.



Removing Oil From Leather Belts

To clean oily leather belts, first scrape off the hardened grease that is visible. Then lay the belt on the floor and cover with a thick layer of fine, dry sawdust. After leaving the belt in this position overnight, remove the sawdust which will contain much of the oil, having soaked it up. Place the belt in a fairly warm room and cover with powdered chalk. Leave for several days. The capillary attraction will thus take up more oil and the belt will come out greatly improved.

This Portable Fence Requires No Holes for Posts

You won't have to dig post holes when putting in a temporary fence if supports of the type shown are used. These are assembled from native-sawed timbers and provide a portable fence that can be moved easily without loosening the wire. Such fences are especially handy when pasturing part of a meadow and it is desired to move the fence back occasionally to include more of the field. Chicken pens made by attaching the wire to supports of this type also may be moved quickly to new feeding grounds without driving or resetting posts.



Display on Store Counter Helps the Customers Select Nails

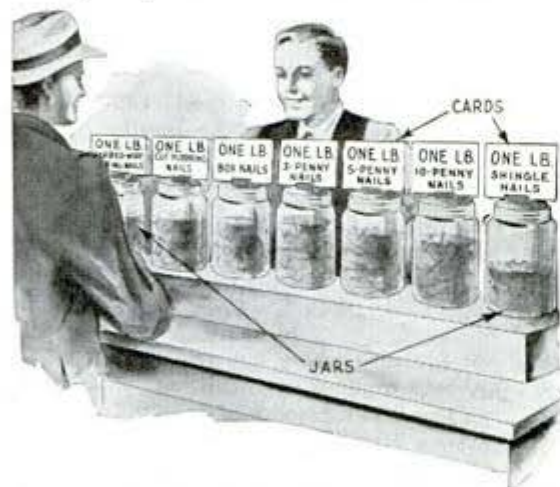

To help customers in their selection of proper size nails and quantities needed, one hardware store owner weighed a pound of each size and put them in fruit jars. The jar lids were then fitted with small cards to indicate sizes, so that customers can tell at a glance what size nail will be suitable for their purpose and about how many are in a pound.—Opie Read, Jr., Chicago.

Pressman Uses Apron as Pad

If your hips become sore from leaning against a job press on long printing runs, just roll your work apron as shown and secure it with a clothespin at each end. This provides a pad that will make the work much more comfortable.

Strengthening a Weak Magneto

After experiencing difficulty in starting a small gasoline engine, one farmer found that the trouble was caused by a weak magneto, which he repaired by using magnets from an old one. These magnets were large enough to slip over those on the engine magneto. In setting the larger magnets over the others, be sure the poles are placed to correspond with those on the regular magneto, otherwise they will tend to neutralize each other. Also measure the magnets to be sure they will slip over the others, as heating them will destroy the magnetism. In removing the magnets, loosen them without removing the armature and slip a piece of iron across the ends, as breaking the magnetic circuit even for a minute decreases their magnetism.

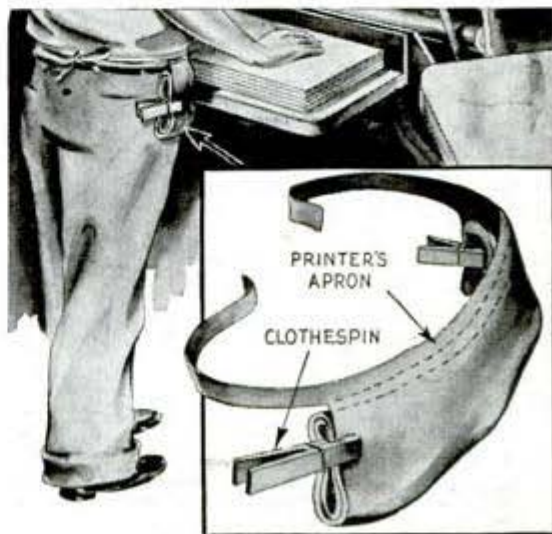

Possible Places to Conceal Key On Late Model Cars



Have you ever lost your car key and had to have a mechanic either break or remove the door lock? If so, the photo shows a number of places where an extra key can be concealed on most cars. On some cars the bumper guards are so shaped as to provide a good place for a key, while on others it may be possible to store them inside of the tail lamp or the license-plate lamp. One of the lamps is preferable as it

offers good concealment and if no wrenches of any kind are at hand the key can be obtained by breaking out the lamp lens. Replacement of the lens, of course, will cost a few cents but it saves you a lot of inconvenience and is cheaper than having a mechanic break into the car for you.

—R. Boettinger, Englewood, N. J.

Tool to Repair Motorcycle Chain Made From Pair of Pliers

When a broken motorcycle drive chain has to be repaired, the difficulty of pulling the ends of the chain together for insertion of a connector link can be overcome by using a pair of pliers that have been altered as indicated. The jaws of the pliers are drilled to take a couple of steel pins, which are inserted into the end links of the chain after the latter has been put over the sprocket wheels.

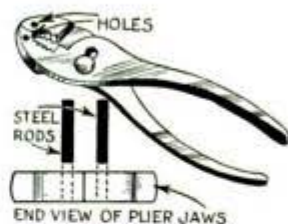

—James Vick, Church Road, Va.

HOW TO MAKE YOUR CAR LAST LONGER

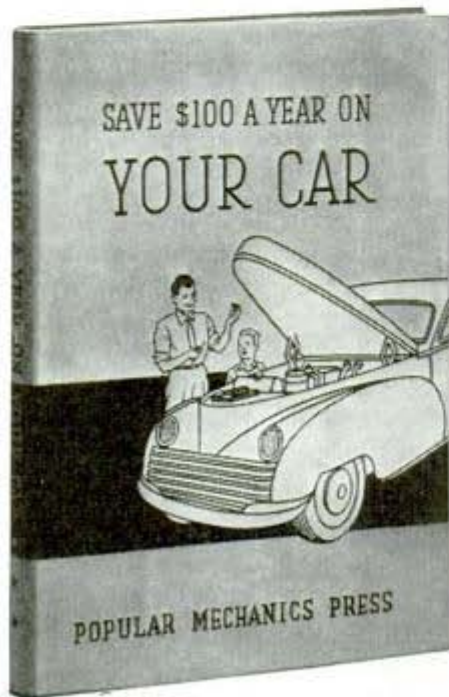

Tells how you can save money and still do your bit toward Victory, help conserve essential war materials and at the same time add thousands of miles to the life of your car. Popular Mechanics new automobile guide, "YOUR CAR," gives you hundreds of easy, practical kinks. Besides, it is filled with pictures and contains hundreds of time, money and labor-saving short cuts.

Would You Like to Know:

- How to double the life of your tires, as explained by experts?
- How to save money on your gas and oil?
- The secrets of picking a used car?
- How crankcase drainings can be put to practical use?
- How to cure electrical troubles?
- How to build and equip your own midget trailer?

All of these questions are simply and clearly answered in this thoroughly practical book, together with hundreds of others which you cannot possibly afford to miss. It has something for every driver, mechanic or garage man.

Order your copy today. Postpaid in U. S., \$1.25, or pay postman on delivery. Outside U. S. remit with order \$1.40. Your money refunded if you are not satisfied.

POPULAR MECHANICS PRESS, 200 E. Ontario Street, Dept. 391, Chicago, Ill.

RADIO



What to Do Before You Call the Radio Doctor

Part I

FIRST aid for home receivers is rapidly becoming a "must" for many set owners. All available radio servicemen are busy, and their ranks are being thinned by Army, Navy and production requirements. This means that there is a possibility that your receiver may "go dead" during an important broadcast and remain silent for some time, the length of time depending upon your ability to obtain service in your location, or your willingness to do a few simple things to help yourself.

This is the first of a series of practical "self help" articles de-



Each type of tube belongs in a certain socket, which must be clearly identified for that tube

signed to assist the readers of Popular Mechanics Magazine to keep their radio receivers in working order. Beginning with the average set owner who knows absolutely nothing about the internal "works" of his various home receivers, the series will gradually catch up with the more experienced amateur servicemen and radio experimenters who, with simple homemade test sets can go into some of the more serious problems of trouble shooting that can be solved without expensive equipment and advanced technical knowledge.

The upper photo shows Mr. and Mrs. Average Set Owner a few minutes after the family console receiver passed out. Unless there happened to be a radio station blackout at the time, it is quite possible that a tube finally reached the end of its useful life. At any rate that is a very common reason, and of course there are many others. Now if this happens to you, and it

(Continued to page 181)

TWO TUBES EQUAL FOUR

By L. M. Dezettel

ECONOMY is carried to a high point in this efficient 2-tube tuned-radio-frequency a.c.-d.c. broadcast receiver which employs two double-purpose tubes in a simple layout on a nonmetallic panel and base. Performance equal in every way to that obtained with four ordinary tubes in a t.r.f. circuit is possible because of these standard double-purpose tubes, which were developed for use in midget sets of unusually compact design.

Good selectivity, tone and volume are features that will please every radio experimenter. The 12B8-GT is an r.f. tube having a 12-volt filament and a separate pentode and triode section. The pentode portion of this tube is used as an r.f. amplifier and the triode portion as a grid-leak detector. It will be noted that the 32L7-GT is a combination half-wave rectifier and beam-power audio output tube which operates on 32 volts; the output section delivers power sufficient to drive a small speaker to full room volume. The circuit is designed for easy wiring, with no frills or tricks. All parts are standard inexpensive items, many of which will be found in any radio experimenter's assortment of used parts.

Hard pressed wood is used for both base and front panel. This $\frac{1}{8}$ -in. material is easily worked, and can be obtained from your local dealer in building materials; all construction details are given in Fig. 1. Photos A, B, C and D show front, top and

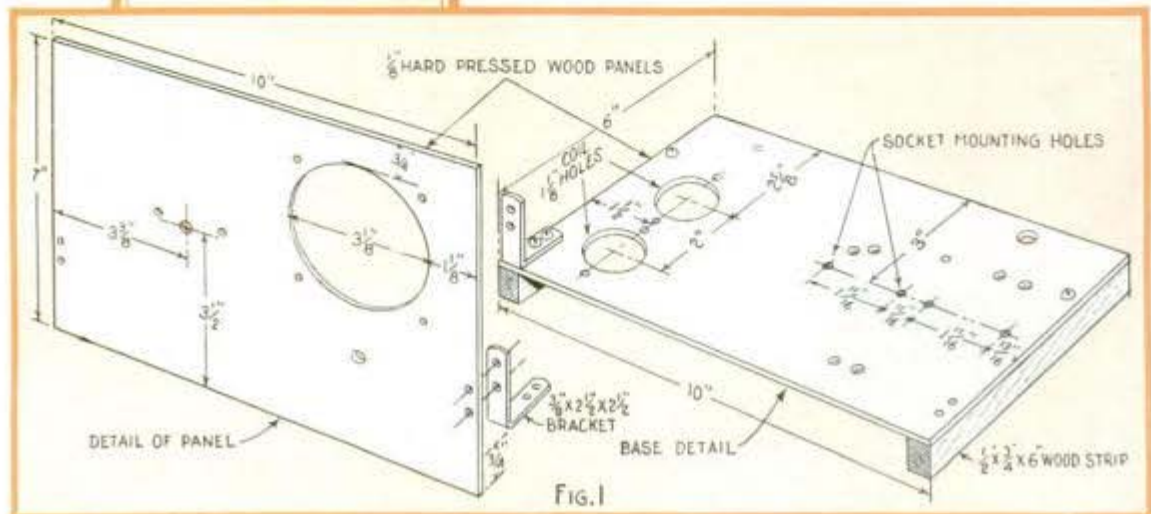
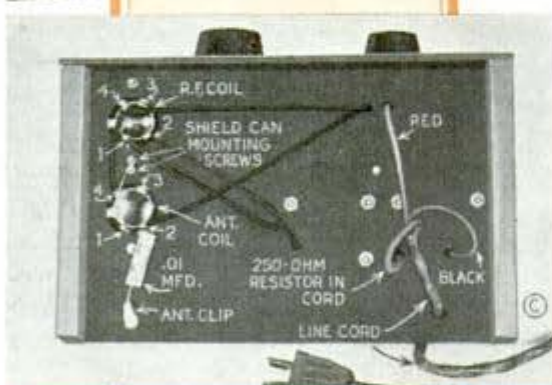
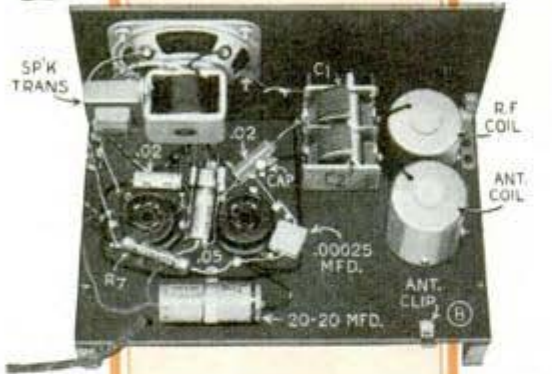

IN THIS ECONOMY T.R.F. SET

underside views. These photos, together with the simplified wiring diagram, Fig. 2, show all leads and connections with one exception; this is the voice coil lead which goes to the No. 6 lug on the universal-type speaker transformer and this terminal is hidden from view on the opposite side of the transformer. The schematic circuit diagram appears in Fig. 3.

The electro-dynamic speaker is fastened directly over a large hole in the front panel and backed with a piece of grille cloth. A 2-gang variable condenser with trimmers, is mounted by means of two 1/2-in. bushings and two 3/4-in. machine screws. Although the base panel is raised, most of the small parts are mounted on top as the tube sockets are of the base mounting type.

Assemble all of the parts carefully and wire slowly. Short leads and well soldered connections make a world of difference. Because a metal chassis base is not used, the antenna and r.f. coils must be of the shielded type. These coils may be either "Carron" S-523 and S-519, or "Knight" 60-555 and 60-556, or any similar shielded



(Continued to page 183)

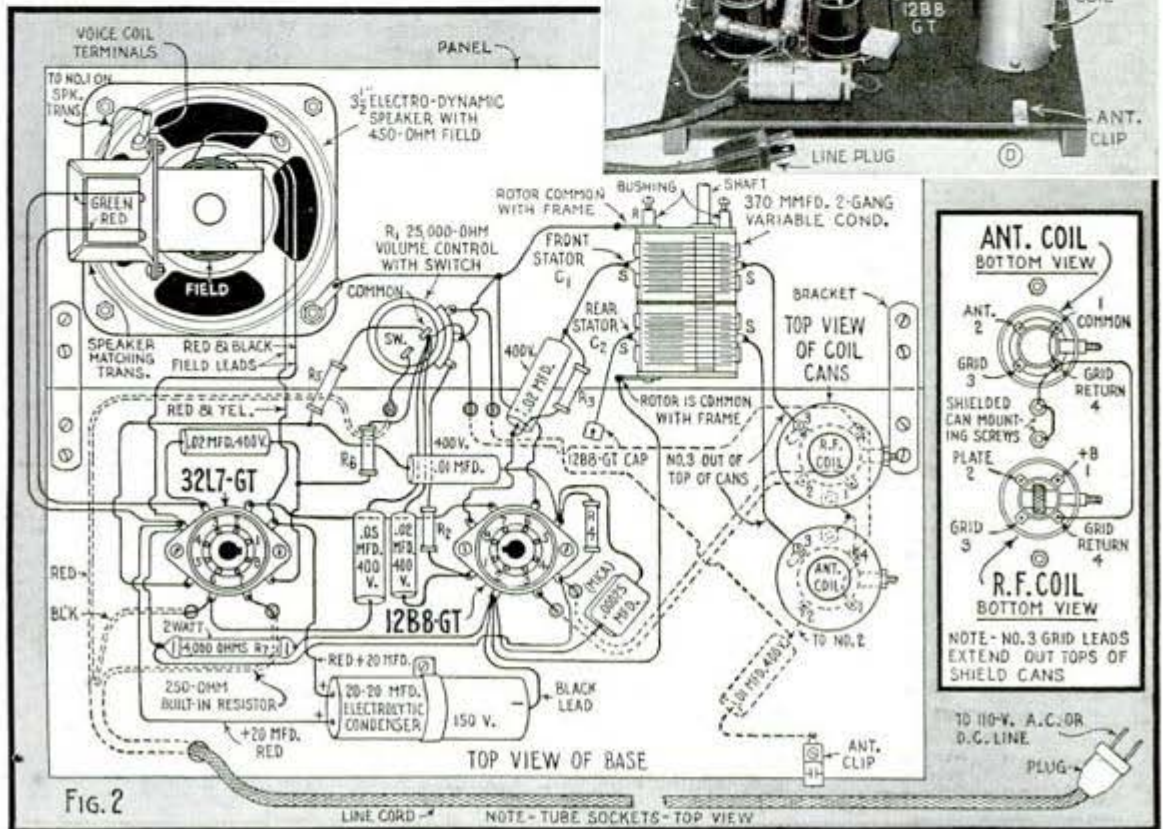

Microtube Laboratories
 2414 Lawrence Ave
 Chicago

Three "Microtubes" in Wearable Hearing Aid

By Edwin C. Ewing



THIS inexpensive 3-tube audio amplifier is housed in a metal case no larger than a typewriter-ribbon box. It fits easily in the vest pocket, or it may be clipped to the clothing as shown in the photo at the left. The battery container is quite small.

An excellent performer, it is helpful in any case where the degree of hearing deficiency has not progressed to a point where similar vacuum-tube hearing aids are not useful. Photo A shows the assembled units, and photos B and C the component parts that are available in complete kit form. The low-drain "microtubes" are familiar to the readers of Popular Mechanics Magazine as they were employed in the tiny 3-tube receiver R-297 which appeared in the December, 1941, issue.

Although this hearing aid amplifier is easy for radio craftsmen to build, it is not recommended for beginners. The chassis comes formed and fitted with the necessary eyelets, ready for installing and adjusting in the housing. Soldering should be done with a pencil-type iron and care taken in following the assembly details which are supplied with the kit. The schematic circuit diagram, parts values and tube chart are given in Figs. 1 and 1-A. Fixed resistor R_1 is included in the microphone unit.

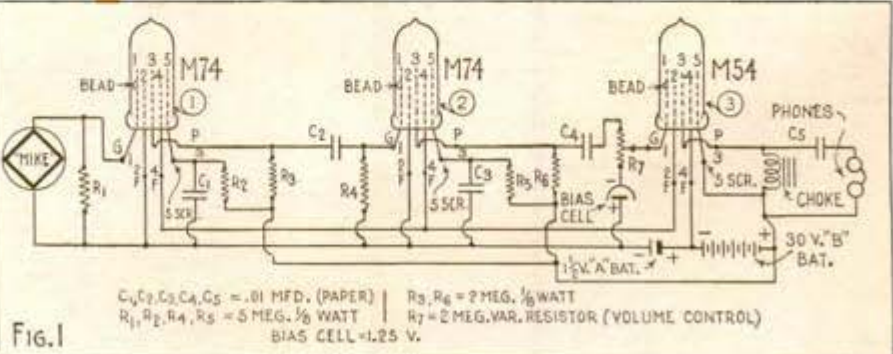
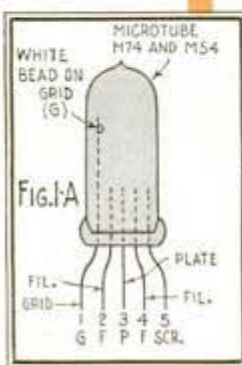
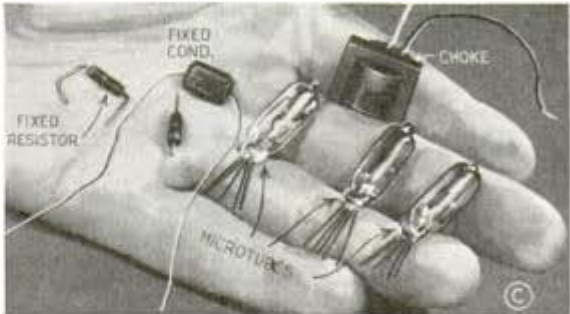
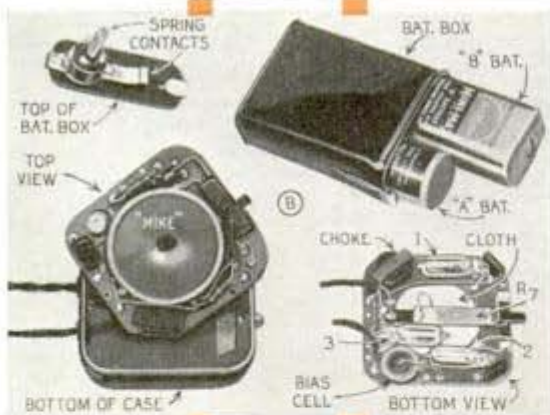
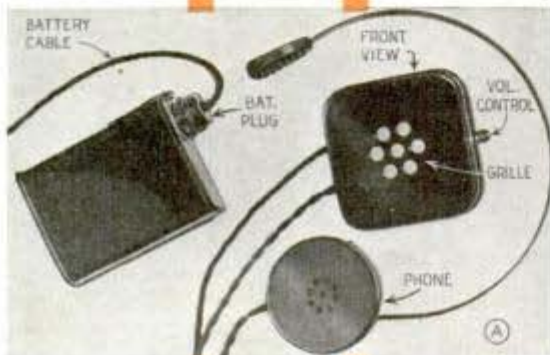

Electric Supply Corp

Practical RADIO SUGGESTIONS

705 W Jackson
Chicago

(A) This protective and space-saving set holder, mounted under the lawn table, may be arranged for any small portable or table-model receiver. A.C.-D.C. sets can be powered by means of an extension cord out a nearby window, for temporary use. The sliding open-frame holder provides a means for installing or removing the set quickly and holds it in a convenient position for tuning

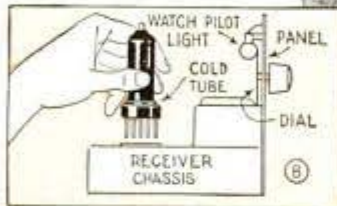

(B) Emergency check for locating a burned-out metal-type tube; remove suspected tube, later insert quickly; if pilot light does not momentarily dim slightly, tube is burned out

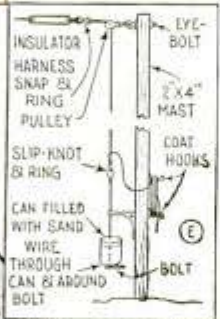

(E) Counter-balance keeps antenna wire tight. (F) Universal replacement type power cord resistor for repairing a wide variety of a.c.-d.c. sets

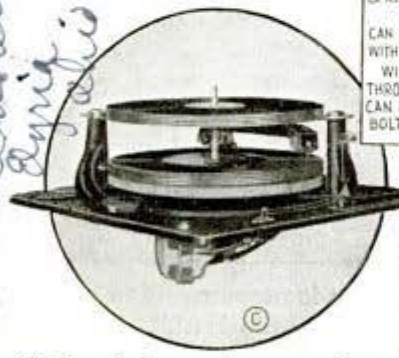
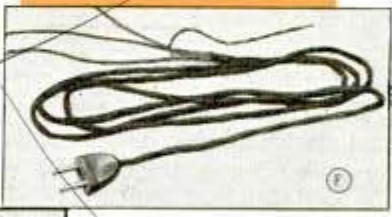
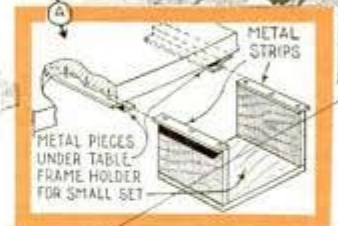

(C) Record changer has means for guiding needle into playing groove on records without lead-in groove. (D) Figs. 1 and 2, swivel auto antenna adjusts to vertical

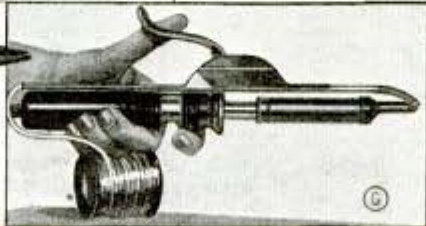

(G) Automatic wire solder feed attachment permits one-hand soldering. (H) To increase AM pickup on an FM-AM dipole antenna, add long wire at right angles as shown. (I) Dial has 5-range scale for hand-calibrating ultra short-wave receiver. (J) Homemade P.M. speaker case has rear compartment for long cable

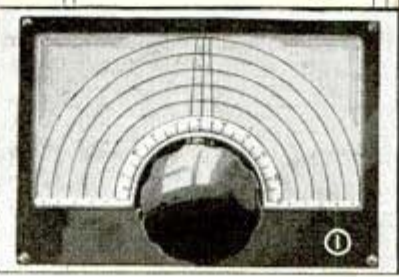
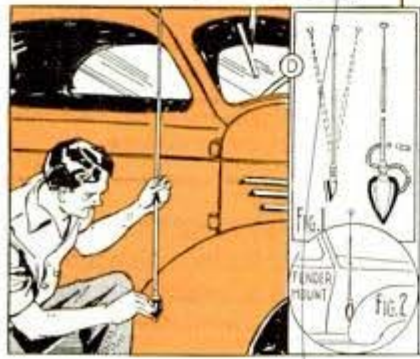
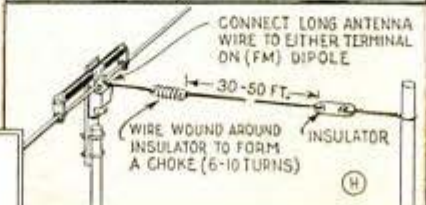

Cambridge Elec. Prod. Co. 490
Material: various electrical products
Bismarck

General Industries Co.
Radio

Charles H. Sherman
285 76th St.
Brooklyn

Industrial James Corp
Newark N.J.

Versatile Robot Raid Warden Controls Alarms and Lights



Tuned to any key radio station, this compact instrument automatically switches off unattended lighted signs, show windows, etc., and also sounds an alarm for employes or residents. It may also be employed to turn on safety blackout lights.

Multi-Purpose Test Meter

Designed for wide application in radio and electrical measurement work, this meter provides a total of 27 measurement

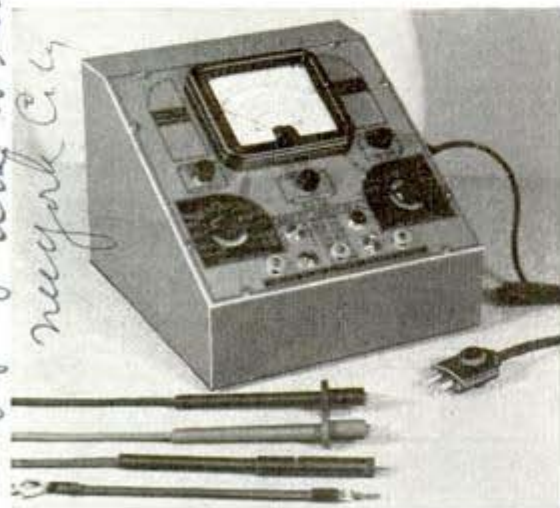

Jefferson-Case

ranges to take care of voltages, both a.c. and d.c., up to 6,000 volts; resistance to 1,000 megohms; capacities to 2,000 microfarads. The low ranges for each of these types of measurement are such that values as low as 0.1 volt, d.c.; 1.0 volt a.c.; 0.2 ohms and 30 micro-microfarads can be read directly from the meter scale without estimating fractional scale divisions.

Two-Way Antenna Is Pre-Tuned

Supplied with universal mounting for auto or marine use, this pre-tuned antenna provides increased signal strength for two-way radio communication. An adjustable coil may be tuned to the frequency used, thus overcoming power loss due to lack of

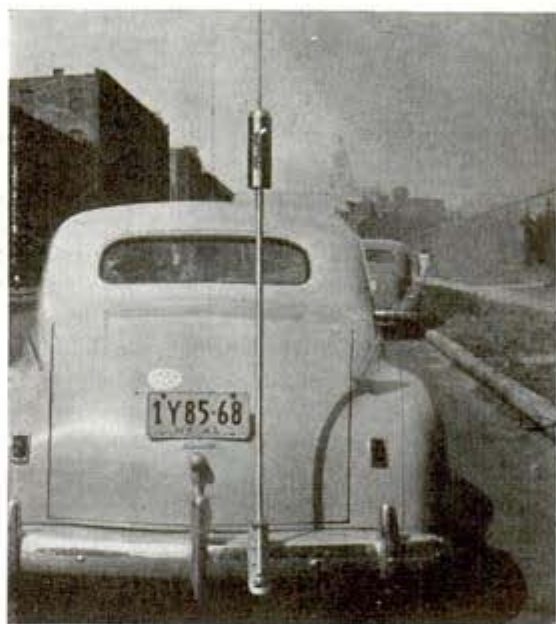

antenna length. It is recommended for use in ambulances, fire equipment, boats, military vehicles, police and patrol cars. Dead spots are eliminated, and coverage over terrain normally unfavorable to radio transmission is greatly improved.

Blueprints covering simplified radio construction articles in this and past issues are available for 25c each. Many popular tested circuits to choose from. Original detailed parts lists with names of supply sources, can be obtained from Popular Mechanics Radio Department upon receipt of postage.

NEXT MONTH—"Beginner's Special" One Tuber Works on 6 Flashlight Batteries. This extremely low-cost broadcast receiver is the first unit of a series in which most of the same parts are used. It employs a type-1Q5-GT tube and a homemade coil wound on the cardboard case of a flashlight cell. Also—**Home Set Service—Part 2.**



Grand-Prize Winner
(a \$1500 award)

Newspaper National Snapshot Awards

Photographer: LUCIEN GAGNON

Film: Kodak Panatomic-X

KODAK PANATOMIC-X FILM, with which Mr. Gagnon made his picture, is an extremely fine-grained, high-quality panchromatic film of moderate speed and contrast. Particularly valuable when great enlargement is intended or when very fine detail or texture is desired. Rolls, packs, sheets.

There is a Kodak Film especially designed for every picture-taking purpose . . . Meet the complete Kodak Film Family at your Kodak dealer's . . . Eastman Kodak Company, Rochester, N. Y.

The Great Pictures are made on KODAK FILM

Fishing for Vitamins

(Continued from page 4)

lowed to retain the vitamins in food. Since vitamins B and C dissolve easily in water, as little water as possible should be used in cooking. This water should then be used for soups and vegetables instead of being thrown away. If vegetables are to be boiled, the water should be raised to the boiling point rapidly. Vegetables that are cooked in their skins retain large amounts of their vitamins.

Don't stir air into foods while cooking, don't use soda in cooking vegetables, and don't sieve foods while they are still hot. Foods that are high in A, B, or C should not be fried. Storage destroys vitamins, hence fresh foods should be eaten before they become wilted or stale. Cooked foods should be eaten at once instead of standing for hours, and leftovers have small vitamin value. Modern pressure cookers are extremely good.

Orange juice should be squeezed just before serving, and salads likewise should be prepared just before the meal. Most canned foods retain a good proportion of their vitamins and quick freezing is another storage method that helps preserve these substances.

Today some foods are being fortified with vitamins. Some brands of milk are enriched with vitamin D, oleomargarine is enriched with vitamin A, and some brands of white bread now contain vitamin B as well as other needed substances.

Science has learned how to manufacture most kinds of vitamins artificially hence they can be had in relatively unlimited amounts, but vitamin A must still be obtained from natural sources. That explains the recent rush to find a substitute for cod liver oil. The fact is that the livers of many fish, including halibut, rock cod, mackerel, and tuna, are rich in the vitamin. Even sardine oil contains A and is used as such to fortify the feeds of domestic animals.

Not long ago investigators thought they had discovered an additional source of vitamin A that was as good as soupfin shark liver. They were making tests on the liver oil of giant sea bass and in the spectrometer the oil looked to be rich in the substance. As a check they then fed the material to rats, but the animals failed to respond in the expected manner. Now it appears that the giant sea bass contains a fake vitamin

and that its quantity of the true vitamin is fairly low.

Fishermen have been getting rich at shark fishing but the gold rush is over now, so forget about heading for the nearest coast to make a fortune. It will cost you several thousand dollars at the very least for a boat and gear, after which you will be just another fisherman who is wondering where the fish and sharks are today. So far, shark fishing has been spotty because, not being desirable in the past, they have been given very little study. When a shark got tangled up in a net the fishermen usually killed it and threw it overboard. The soupfin has been the exception because its fins, valued by Orientals, are worth saving, and fillets of meat are taken from its sides for the fresh fish market. The balance of the carcass goes to a reduction plant to be ground up as fish meal.

Today sharks are being sought for their own sake on both coasts. They are fished for with gill nets that are drifted below the surface or set on the bottom, or else trawl lines baited with sardines are used. To the public the shark has been notorious as the ruthless killer of the sea but the commercial fisherman has always known him as a worthless pest. Today both the public and the fishing industry are profiting by the vitamins that sharks store up.

What to Do About Scratches In Mahogany

Very light scratches in mahogany furniture often can be made less conspicuous by painting with iodine or mercurochrome, depending on which is the best color match. Apply with a fine paint brush, let dry and then wax. For deeper scratches, buy a shellac stick to match as closely as possible. Begin by dampening a cloth pad in alcohol and rubbing it crosswise over the scratch. The alcohol will soften the finish, smoothing the sharp, broken edges. Soften the shellac stick over a match or spirit lamp and work it into the scratch with a warmed flexible knife blade or spatula until the opening is filled. Then smooth the surface with very fine sandpaper and apply a coat of wax. Should your first attempt be unsatisfactory, you can remove the shellac with alcohol and start again.

AUTO-LITE SPARK PLUGS

Presents the *MOUNTAIN BOYS* by F. W. E. B. D. -



"MIGHT BE A SMART IDEA TO MOVE PAW'S HEAD OVER A LEETLE, LUKE...MEMBER SHE STARTS OUT LIKE A JACK-RABBIT SINCE MAW GAVE 'ER A PLUG-CHEK"

"SPARK-WEARY" ENGINES GET NEW LIFE

Take a tip from the Mountain Boys! See with your own eyes why your car is sluggish, hard on gas. Auto-Lite's new "Plug-Chek" inspection service helps spot gas and power-wasting plugs. Cleaning and regapping your present plugs often restores "like-new" economy. Replace faulty plugs with ignition engineered Auto-Lites.

THE ELECTRIC AUTO-LITE COMPANY

Toledo, Ohio • Merchandising Division • Sarnia, Ontario



Color and condition tell if plugs are operating properly. Matching your plugs with those illustrated on the "Plug-Chek" is first step in restoring new life to spark-weary engines.

In its 26 Great Manufacturing Divisions, Auto-Lite is Producing for America's Armed Forces on Land, Sea and in the Air

IF YOU'RE IN THIS FIX..



P. W. WILL FIX IT

HOLES AND CRACKS in floors, base-board, or woodwork can be easily and quickly repaired with PLASTIC WOOD! Takes a finish like the original wood. Get it at Paint, Hdwe., and 10¢ Stores.



HANDLES LIKE PUTTY—HARDENS LIKE WOOD

Mows and Trims Lawns

in One Simple,
Easy Operation



Save Time
and Labor with a
MONTAMOWER

Tired backs and aching arms just don't happen to users of Montamower. All the drudgery and noise of lawn mowing is done away with. No dead weight to push and pull. Instead, just 7 pounds of live mechanism that first gathers then cuts the grass closely, smoothly, and to the correct height; no matting; no streaking; no clatter; no rattles. Cuts a 16" swath through long grass, dandelions, spike grass and weeds. Cuts right up to walls, fences, trees or posts; leaves no fringes to be trimmed by hand. Cutters are self-sharpening. Built to last many years. Guaranteed. Thousands in use. Sold direct from factory. Costs little. Write at once for guarantee information and literature.

MONTAMOWER DISTRIBUTING CO.
329 Houseman Bldg. GRAND RAPIDS, MICHIGAN

Dogs of War

(Continued from page 11)

receiver. Responding to the radio commands, the dog obeys just as rapidly and accurately as if his trainer were beside him.

Armies in Europe have trained dogs to do many valuable duties. Finland, for instance, has a dog reserve in which the members are trained for service under battle conditions. Some of them are taught to operate while wearing gas masks. Dogs are reported to be used in England for guarding the invasion coasts, where their keen senses are especially useful during heavy fogs. It is said that Russia has a dog corps that is dropped by parachute along with regular paratroops for messenger work in the field.

Being smaller and faster than a man, a dog makes a useful messenger that can cross open country with less danger of being hit. During the first world war one dog is said to have covered the three kilometers between posts 30 times in one day, traveling back and forth with messages in a container strapped to his back. Some of Spitz' dogs have learned similar duties and are able to make their way from one point to another as far as three miles distant and even across strange country.

A dog is twice as strong as a horse, relatively, and many of them have long and honorable military records for carrying cartridges and food to isolated outposts. Occasionally they have packed a cage of carrier pigeons that were later used for dispatching messages back. Carrying reels of light telephone wire, dogs have laid long stretches of communication networks. When the reel is attached to a light cart behind the dog he can pull a load that weighs upwards of 150 pounds at the start of the trip.

Another chapter in the story of dog's usefulness during war concerns his Red Cross work. A dog that is trained for this service abroad can seek out the wounded on a battlefield, stand by while an injured man helps himself to the supplies carried on the dog's back, then return to headquarters and lead a stretcher party back to the man he has found.

☞ To learn where to buy commercial products described in these pages, see the index.

Clothespin as Mending Mark



Keep a few spring-type clothespins at hand when you are ironing. They are handy to clip over a garment to serve as a reminder that it needs mending. The marker will show at a glance where the repair is to be made.

Solutions to Clean Concrete

I used the following method with excellent results for removing rust stains, automobile oil and grease spots from my concrete driveway. To remove the rust stains, I dissolved sodium citrate, 1 part, in water, 6 parts and added commercial glycerin, 6 parts. Mix this (a portion) with enough powdered whiting or chalk to form a paste, and spread it in a thick coat. When dry, replace with fresh paste or moisten with the remaining liquid. A week or more may be required to remove the stains. To remove fresh oil stains cover them with an inch or two of dry portland cement. For old stains wash with a solution of trisodium phosphate, 2 lbs. to the gallon of hot water. After cleaning remove all traces of the solution by rinsing with clear water.

—Paul Astrella, Dorchester, Mass.

Lubricate Rubber-Band Motor For Long-Range Flights

Your model airplane will fly about twice as far if you lubricate the rubber band motor with a solution of liquid green soap, 3 parts, and glycerin, 1 part. This solution will make the elastic stretch about twice as far as normal.

—Herb Arrall, Newburyport, Mass.



AIDING BY SAVING



Any tools which help to *make things last longer* contribute valuable savings toward winning the war . . . by making more guns, ships, planes, tanks and supplies available for our Armed Forces.

If you are a repairman—auto, tractor, household appliance, farm or shop machinery—you are serving valiantly in this great conservation effort. . . . And finding yourself gainfully busy besides!

Among your most essential tools are *files*. And your best buys today are Nicholson or Black Diamond brands. They're quality files that give you the maximum number of efficient work strokes per file or per dollar. They're used in thousands of industrial plants; preferred by most experienced mechanics. They carry the guarantee of *Twelve perfect files in every dozen*. Obtainable through hardware and mill-supply houses.

NICHOLSON FILE CO., 23 ACORN ST.
Providence, R. I., U. S. A.

(Also Canadian Plant, Port Hope, Ont.)

NICHOLSON
FILES FOR EVERY
PURPOSE

NICHOLSON
U.S.A.
MADE IN U. S. A.



FREE TECHNICAL BULLETINS on Special-purpose Files for Stainless Steel, Aluminum, Brass, Plastics, Die Castings; Die Making; Foundry, Shear Tooth and Lathe filing. Name ones wanted.

OUTDOOR FUN!



Indian

SPRING FRAME MOTORCYCLE

Exclusive "Spring Frame" smooths out roughest country roads. New comfort, safety. Brilliant streamlined beauty. See your Indian dealer.

INDIAN MOTORCYCLE CO., SPRINGFIELD, MASS.

ATTENTION! DEFENSE WORKERS

FOR 27,000 R. P. M. INSIST ON A GENUINE

MOTO TOOL

100 Tools in One

- *Has shock-proof bakelite case.
- *Fan-cooled motor can't overheat
- *Has oil-less bearings
- *Dynamically balanced armature



Here's guaranteed quality! The handiest tool in the shop or home. Use it daily for model making, repairing, carving wood or plastics, etching glass or metal, touching up dices, sharpening, routing, sanding, drilling, and on a hundred other jobs. Higher speed does better work and saves ruts. **Model One**, wt. 6 oz., with chuck and 1/4" collet, only \$2.95. **Model Two**, wt. 12 oz., \$10.50. **10 DAY TRIAL—Money-Back Guarantee.** If your dealer does not have Moto-Tool, order direct . . . we pay postage if you send cash. Or, send only \$1, pay postman balance plus postage. New catalog of tools and accessories **FREE**

KIT NO. 1 with 23 high grade accessories and Model 1 Moto-Tool in hardwood case \$17.50
 KIT NO. 2 same as above with Master Model 2 Moto-Tool... \$23.50

DREMEL MFG. CO.
 Dept. T-112-F
 Racine, Wis.

PUSH BUTTON CONTROLLED GAS TANK LOCK

NO KEYS—Electrically operated from dashboard. One model fits all cars including fender door type. Greatest thing out! Sells on sight! Fully guaranteed. Distributors, dealers, here is your money-making opportunity. Rush name for free literature.

SNAP-UP GAS CAP CO. Dept. k. **ASHLAND, KY.**

BE PREPARED! LEARN TO SHOOT WITH BENJAMIN

MADE IN U. S. A.



LEVER HAND PUMP anywhere, for practice firing or just plink-ing, around the house or camping, fishing, hunting, etc., at lowest cost. Shooting force is adjustable with amazing maximum power and accuracy—no recoil or forward lunge to disturb your aim. **Bolt Action—Hammer Fire—Hair Trigger—Safety Lock—Hand Pump.** Single Shot BB with 1 lb. shot \$9.00; Single Shot Cal. .177 or .22 rifled—with 500 pellets \$10.50. Also a complete line of improved **BENJAMIN GENUINE COMPRESSED AIR TARGET PISTOLS.** "No License Required." Write for details and **FREE TARGETS.** **BENJAMIN AIR RIFLE CO., 895 Marion St., St. Louis, Mo., U. S. A.**

TEST-O-LITE

Tests Everything Electrical From 100 to 550 Volts

A real necessity for electricians and home because it has 1001 uses. Equipped with a Neon light which tells instantly where trouble lies in electric circuits, fuses, cut-outs, motors, radios, all kinds of electric appliances, etc. Tells A. C. from D. C. Far superior to ordinary clumsy test bulb. Fountain pen size with clip for carrying in vest pocket. Lifetime guarantee.

PATENTED
L. S. BRACH MFG. CORP.
 55 Dickerson St., Newark, N. J.



\$1.50 At Electrical Stores or Post-paid

If You Can Drive You Can Fly

(Continued from page 75)

miles an hour," Eddy said, but I was too absorbed in watching the ground come at me to give the dial more than a swift glance. The angle looked steep to me. The Skyfarer liked it better than I; its flaps permit a steep climb and steep descent, although the actual angle of the plane is not steep.

My stomach tied a fresh knot in itself, my legs were pushing the floor away from my face, and the little steering wheel winced in my grasp.

Just above the cinders Eddy gave the command: "Now pull her up level."

I did, and we were down, three wheels rolling swiftly down the field, no bump, no skid, no careening. No one was more surprised than I. Gentle pressure on the foot brake slowed us down, and with a turn of the steering wheel the front wheel led us off the runway. Stomach, untie yourself.

Now I am not going to claim that I'm a "natural" airman. The truth seems to be that Prof. Otto C. Koppen of Massachusetts Institute of Technology, vice president of General Aircraft Corporation and designer of the Skyfarer, has developed a "missing link" between motoring on the ground and in the air; a plane that any driver with ordinary coordinative ability and good sense can step into and learn to fly in a couple of hours. Its control wheel puts the motorist at home; on the ground it steers the front wheel of the tricycle landing gear; in the air it steers the plane by its ailerons, also operates the elevator. The twin tail assembly is rudderless, its fixed fins of patented design preventing any side slip. I rather expected to make a poor landing and feel the plane skid around or ground loop as youngsters do on a poorly balanced tricycle. In six or eight landings—I lost track—the craft never failed to set itself down on three wheels and roll straight ahead, the center of gravity (just forward of the pilot's body) pulling the rear wheels evenly. Once, paying too much attention to a plane nearing the runway on the ground, I leveled off six feet up and dropped her with a bump. Still, there was no bounce and Bud Eddy comfortingly said the Skyfarer had been dropped in from 20 feet up without damage.

Back to earth, I had time to revise my notions of flying. Having expected to be

1920

busy constantly jiggling the stick to keep the ship level in bumpy air, I was pleasantly surprised that it hadn't been necessary. Agreed, the air was not especially turbulent; but stability was built in, and the less control by the pilot, the better.

After an hour of ups and downs I told Bud Eddy I'd like to make one more flight, and this entirely without help from him.

"Why," he said, "you've made at least four good landings without my touching the wheel. But go right ahead."

So we did, and I did. Qualms about the takeoff had disappeared after the first trip; turns had become pure fun and Eddy was kind enough to call them perfect; I knew what to do with the flaps, and when, and was automatically compensating with the elevators while adjusting the flap position; I could even watch the air speed indicator and keep it at 55 on the way up, 70 on the way down. I could relax and lean back when Eddy reminded me to unstarch. But as a matter of fact my stomach has a way of tying itself in knots whenever I drive my automobile above 60 miles an hour, and it was taut all the way home from the airport in that Sunday afternoon's traffic.

Well, when they build a plane so safe and stable that an average motorist like myself feels confident he could solo in less than two hours, they've got something that should put folks in the air as flivvers put them on the road.

At this writing, General Aircraft's Skyfarer and the Ercoupe, a low-wing craft, are the only two planes approved by the Civil Aeronautics Authority as incapable of spinning. The Ercoupe has better visibility above and behind, the Skyfarer better visibility below. They differ somewhat in flight characteristics; the Ercoupe has no rudder pedals, but has rudders coordinated with the ailerons.

Its four-cylinder, horizontally-opposed, geared Lycoming engine of 75 horsepower will drive the Skyfarer at top speed of 100 miles an hour, cruising at 92. It takes off in 350 feet at 45 to 55 miles an hour, lands at less than 60 and stops in 150 feet. Its range is around 400 miles on 20 gallons of gasoline. You fly for a cent a mile.

The exciting thing about it is that if I can fly it, you can. Next month we'll thumb a ride in a conventional lightplane and learn what makes it tick.

STOP LEAKS

the way professional repair men do . . .



Boiler and Furnace Leaks



Pipe Leaks

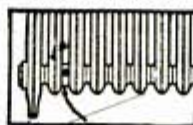

Radiator Leaks

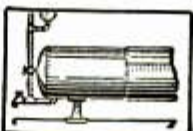

Tank and Heater Leaks

When a leak occurs in a pipe or pipe connection, or in a tank, radiator, heater or boiler, experienced plumbing and heating repair men use SMOOTH-ON No. 1, the time-proven iron repair cement. Auto repair mechanics, too, use SMOOTH-ON to stop leaks in radiators, gasoline and water lines and to seal cracks in gear cases and crank cases.

You can make repairs like these yourself, quickly, effectively, and economically; because SMOOTH-ON is applied like putty, requires no heat, special tools, dismantling of parts or previous experience. SMOOTH-ON repairs are lasting, too, and frequently save expensive replacements which are so hard to obtain these days.

Buy a can of SMOOTH-ON without delay, so you will be prepared for the next repair emergency which may occur at any time.

Buy Smooth-On in 1 1/2-oz., 7-oz., 1 lb., and larger cans from your dealer or if necessary from us. For your protection, insist on Smooth-On, proved by 47 years on the market.



Free

FREE 40 PAGE REPAIR HANDBOOK

Check full of simple, practical directions with 170 diagrams showing repairs that any handy man can make. A copy should be in every household. Send the coupon TODAY for your FREE copy.

SEND THIS COUPON

Smooth-On Manufacturing Co., Dept. 37
570 Communipaw Ave.,
Jersey City, N. J.

Name _____

Address _____

G-42 _____

Do it with SMOOTH-ON

*Lycoming fliv. Aviation help
Capt Williams part 1 a*

PRESENTING
the New **DAISY**

DEFENDER

1000-SHOT MILITARY MODEL

Get the new Daisy Defender featuring Military Gun Sling, Bolt-Action Safety, Elevation-Windage Rear Sight. Looks like real Army gun. \$5 at Dealers or from us postpaid. Free Daisy Catalog, Boy's Arms Manual FREE. Write! (Duty added in Canada).

DAISY AIR RIFLES

DAISY MANUFACTURING COMPANY, 546 UNION ST., DEPT. 2, PLYMOUTH, MICH., U.S.A.

"LET'S TRADE CAMERAS!"

Generous allowance on your camera toward a new or used model of your choice. Write giving description of present camera and tell us what you want. Write for free MOVIE or STILL Bargainingram. Dept. P

Bass CAMERA CO.

179 W. MADISON ST., CHICAGO, ILL.

WHEN YOU BUY FLASHLIGHT BATTERIES DEMAND
"EVEREADY" FRESH DATED BATTERIES

The word "Eveready" is the registered trade-mark of National Carbon Co., Inc.

ONAN ELECTRIC PLANTS
ALTERNATING AND DIRECT CURRENT

Produce Current, same as City Power Lines, for FARMS, SCHOOLS, THEATRES, PUBLIC BUILDINGS . . . Operate Lights, Radios, Motors, All Appliances.

Over 40 STOCK MODELS—150 to 50,000 Watts. Any Voltage—Any Frequency. Combination A. C. - D. C. Types. Manual, Full Automatic and Self-Starting. \$99 up. Shipped—COMPLETE, READY for OPERATION. THOUSANDS IN USE IN ALL PARTS OF THE WORLD.

Write for Complete Details.

D. W. ONAN & SONS
1070 Royalton Avenue - MINNEAPOLIS, MINN.

S WINDOW SIGN LETTERS

For Store Fronts and Office Windows. Anyone can put them on. Free Samples. Liberal Offer to general agents.

METALLIC LETTER CO., 430 N. Clark St., Chicago

Thompson
BEATS
the World
on **BOATS**



Better Built
Lower Prices



Safe Boats With Full Length Spray Rails
Keep passengers perfectly dry—even at high speeds. Catalog also shows today's seven most popular models of sailboats. Two big factories. Prompt shipment.

CATALOG FREE
Write for your copy. State kind of boat in which you are interested.

THOMPSON BROS. BOAT MFG. CO. (114)
213 Ann St. PESHIGO, WIS. Write to (either place)

Light "Car-Top" Boat
THOMPSON BROS. BOAT MFG. CO. (114)
113 Elm St. CORTLAND, N.Y.

New Disguises of the Demon Fire

(Continued from page 54)

driven by vaporproof motors that help exhaust the vapors from the painting rooms. In addition there are curtains of flowing water along the walls that pick up and carry away the particles of pigment blown into the air. Douglas dopers and painters work in rubber-soled shoes and, on entering a paint room deposit all matches they may be carrying in a special receptacle.

Painting is always safest when it is done in the open and if a job must be done indoors, doors and windows should be left open for good ventilation until after the work has dried. Even the pilot light of a water heater was enough to explode the gases rising from fresh paint in another room in one case in which two women were seriously burned.

Fortunately there are no special fire hazards in the new plastics that are coming on the market although many of the common semi-plastics are regarded as dangerous. These semi-plastics include some of the imitation ivories, celluloids, and similar compositions such as are used for cheap fountain pens and some toilet articles. To test what you are buying, use a knife to scrape a thin shaving of material from the bottom of the object and then touch a match to the shaving. If it flashes, the material is hazardous. Never lay a hot electrical appliance on semi-plastic material. A fire may even occur if you lay a celluloid comb on a hot steam radiator. Even the rays of the sun, concentrated by an air bubble in a window pane, have caused imitation ivory articles to ignite.

Ridding Garden of Moles

Home gardeners who are troubled with moles have cleared them out completely by putting up some kind of a wind-driven garden ornament, or better still, several such devices about their premises. Anything from the toy windmill whittled by a small boy to a more elaborate flying duck or whirling daisy sold by seed stores proves effective. Rattle and vibration from wind-driven ornaments transmitted to the earth through supporting stakes provides enough unusual commotion to drive moles considerable distances away from the locations of such ornaments.

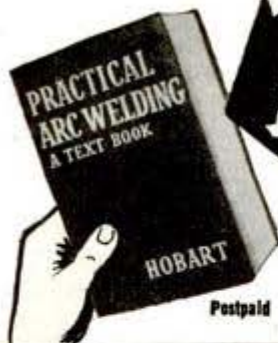

You Need this NEW and "UP-TO-THE-MINUTE" ARC WELDING MANUAL

of all the latest TECHNIQUES, MATERIALS and PROCEDURES

Get this New and Complete Catalog FREE!

New 1942 edition, 516 pages. 512 pictures—all that's new in arc welding. No welder or student can afford to be without it—answers all welding questions. Worth hundreds—5 day Free Inspection. Order now. **\$200**

Learn why Hobart is the outstanding welder.—Why you should know more about its advantages. Write for your catalog today.



HOBART

"Simplified" ARC WELDERS

ORDER Your Books at ONCE! Just clip this ad with your name and address together with your check or money order. **MAIL NOW!**

HOBART

"One of the World's Largest Builders of Arc Welders and Equipment"

Postpaid

HOBART BROS., Box M-62, Troy, Ohio



GERSTNER TOOL CHESTS

The choice of every machinist and toolmaker. Free Catalog.

GERSTNER TOOL CHESTS

442 Columbia St. Dayton, Ohio



GENUINE U.S. BARGAINS

- O. D. WOOL BLANKETS (USED) . \$2.95
 - MCCLELLAN SADDLES (USED) . 5.95
 - U. S. ARMY PUP TENTS (USED) . 3.50
 - U. S. MARINE PONCHOS (USED) 1.29
- Thousands of Other Bargains in Military, Outdoor & Sport Goods for Hunter, Farmer, Scout Send 10¢ for 32-page catalog returned with first order.

A and N SUPPLY CO.
EST. 1868 4720 LESTER ST. RICHMOND, VA.

10¢

Birdhouse plans, also plans for Feeding Box, Nesting Shelter, Garden Furniture. Complete Directions. All for 10¢.

STANLEY TOOLS,

Division of The Stanley Works,
156 Elm St. New Britain, Conn.



BUILD THESE PROJECTS

For garden or lawn. Easy to build. Easy to sell. Detailed Blueprints Model B-25 Dutch Windmill 50¢; Model OM-60 Old Mill, 85¢. Lawn Figure Fountains—Sunbonnet Girl, Dutch Boy, Tulip Girl, Holland Fair, 35¢ each, all 4—\$1.00. Catalog illustrating many models, send 10¢, today.

CRAFTSMAN'S MODEL CO., Dept. P-64, 2830 N. 41st St., Milwaukee, Wis.

TRAILER BUILDERS · BUYERS · OWNERS

Over 80 pages! Beautifully Printed and Illustrated! Trailer Suggestions and Ideas galore! Catalog shows America's greatest line of Trailer Parts and Equipment at lowest prices. Everything from wheels to top. Rush 25¢ (in U.S.) today. Satisfaction guaranteed!

TRAILER SUPPLY CO. Box 369-A WAUSAU, WIS.



PLANS FOR NINE NEW JIM DANDY TRAILERS Ready

Build your own trailer! Send 10¢ for Jim Dandy's interesting new TRAILER PLAN CATALOG which illustrates and describes NINE new models including 6 modern house trailers, plus sport, camp, and utility trailers. Rush 10¢ (in U.S.) for Catalog today to **JIM DANDY, BOX 125-A, WAUSAU, WIS.**



Spoonful of Gas per Mile!

Amazingly low-cost transportation! 100 miles on a gallon of gas! Super-powered, almost 3 H.P. engine climbs steep hills easily. Built ruggedly for long hard wear—has traveled up to 13,000 miles in one year—no repairs. "Floating Drive" eliminates gear shift, applies power smooth as oil! Swift, safe, comfortable.

Unable fill new orders until July 1, except those with defense priority. Write!

CUSHMAN MOTOR WORKS,
Dept. 16 Lincoln, Nebr.

DO YOU

WANT a permanent business profession of your own? Then BECOME A FOOT CORRECTIONIST. Earnings in this greatly needed profession run as high as \$50-\$100 weekly after a few weeks home training—not medical or chiroprody—no further capital needed, no goods to buy. 47th year. Write for free booklet.

Stephenson System of Foot Correction
28 Back Bay, Boston, Mass.

PAINT BRUSHES SCARCE!

Keep NEW brushes soft
RENEW old brushes

Conserve valuable paint brushes. *Save them* by using DIC-A-DOO PAINT BRUSH BATH after every use. Amazingly efficient in loosening, washing away paint from bristles. Brush remains good as new for long time. Restores old hardened brushes to usefulness. Costs only 5 cents—enough to clean several brushes. Get it at hardware or 5-&-10¢ stores. You'll want to keep several packages on hand.

THE PATENT CEREALS CO.
makers of Die-A-Doo Paint Cleaner
GENEVA, N. Y.



GREAT NEW

FLASHLIGHT IDEA

GIVES FREE USE OF BOTH HANDS!



Rex Ristlite snaps on like a wristwatch! Throws 500 ft. beam. A boon to mechanics, car owners, sportsmen, housewives, Army, Navy men! G-E pre-focused

bulb. Light, colorful plastic. 98¢—wherever flashlights are sold.

FLASHLIGHT COMPANY OF AMERICA
Dept. M, Jersey City, N. J.

98¢
with Batteries

REX **Ristlite**



HAWAIIAN WIGGLER

**Gets Bass,
Not Weeds!**



Henry and James Quimby, El Dorado, Ark., landed in their local newspaper with this picture of bass caught on No. 2 Hawaiian Wiggler. Mr. Quimby writes: "I have used Hawaiian Wigglers for 5 years. They are one of the best baits a man can use."

Take Hawaiian Wigglers on your next trip. You'll be surprised the way they wiggle through weeds and get bass without snagging.

Shallow Running
No. 2 Hawaiian \$1.00



1/2 Size

Write for New Free Catalog

FRED ARBOGAST, 1606 North St., Akron, Ohio

IDEAL Lawnmower Sharpeners

Go into business for yourself. Earn up to \$25 per week sharpening lawnmowers. BIG CATALOG FREE. Send post card to The Fate-Root-Heath Co., 1642 Bell St., Plymouth, Ohio

ENJOY AN OUTDOOR VACATION THIS SUMMER!

Send for "Outdoors With Ta-pat-co"—telling famous camp tricks and trail secrets to make your outdoor vacation more comfortable, pleasant, and safe. See styles of Ta-pat-co sleeping bags and other outdoor equipment in beautiful colors. Write today—it's FREE! Address.

The American Pad & Textile Co.
Dept. 51, Greenfield, Ohio



How to make your workshop pay dividends

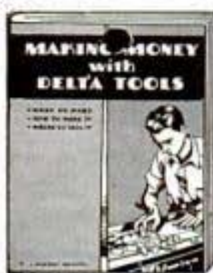

Learn how you can build up a profitable spare or full-time business in your own home. This new book "How to Make Money in Woodworking" is crammed with practical tested ideas, plans, and suggestions. Tells you exactly what to make, how to make it and how to sell it. Describes plans that have worked for others. Woodworking, the new way, is light, pleasant, and profitable. Send only 10c and complete book will be mailed postpaid. Satisfaction guaranteed or money refunded. Write to The Delta Mfg. Co. (Dept. 681-F) 600 E. Vienna Ave., Milwaukee

Piloting Tom Thumb Water Bugs

(Continued from page 69)

than the one before. All changes in hulls and motors are tested by means of a water pressure speedometer.

Half a dozen coats of varnish, rubbed down, seem to be the fastest surface for the bottom of the hull. Most of the varnish will be worn away after a day of racing and must be renewed.

Even when a driver has his outfit tuned to the peak of perfection a slower boat may beat him if his opponent is a more experienced driver. A good driver can beat a faster boat by running in the speed groove on the turns instead of turning too widely or too sharply. Another place where experience counts is in the clock start. If a driver can hit the starting line at full speed just as the 6-foot starting clock registers zero and the starting gun is fired, he has a long lead over drivers who had to slow down behind the line to avoid crossing it too soon. A boat that crosses the line ahead of the starting signal is disqualified.

Smooth water is slower than water with a slight chop on it, as drivers can tell from the feeling that brakes are being applied when they happen to hit a patch of slick, calm water on the course. Raising the motor a couple of inches on the transom helps keep the speed up when a race is being run in still water.

There is no money in racing the midgets. The larger classes of outboards, ranging up to big 225-pound runabouts that carry a two-man crew and are powered with 55-horsepower motors, provide trophies to amateur winners and cash prizes to professional winners. The midgets are strictly an amateur class so trophies alone go to the winners. But professional drivers like them enough to forsake cash prizes and race for cups.

Light Solves Blackbird Problem

After several other methods had failed to frighten away thousands of blackbirds roosting in a tree adjacent to a private home, the owner used a 200-watt electric lamp. This was fastened in the topmost branches of the tree and connected to the home current supply by means of a long, waterproof extension cord. The blackbirds have not returned to roost in the tree of perpetual daylight.

Bent Paper Clip Pulls String Through Notebook Sheets

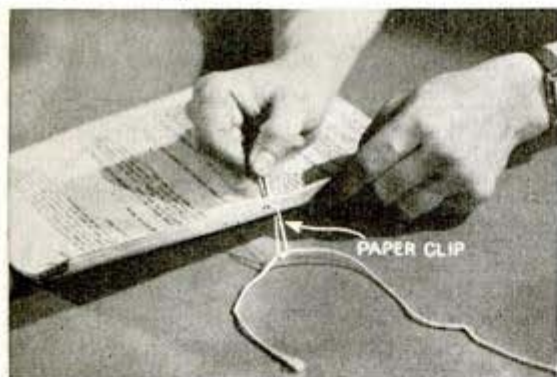

It's an easy matter to thread string through a stack of punched notebook sheets if you use an ordinary paper clip bent as shown. All you need to do is insert half the clip through the stack, hook the string in the lower loop and pull it through.

Bed Springs Reinforce Concrete

When the amateur mason contemplates a slab, pool, or base of concrete he logically thinks of reinforcing it with poultry netting or odd pieces of scrap iron. Neither is satisfactory, the netting because it lacks strength, and the iron because it does not tie together the whole mass of concrete. Old flat bedsprings of the individual coil, woven, or metal-strip type are one of the best substitutes for the regular bars or grids. If not found on a dump the spring can be picked up cheaply at second-hand shops. For thin slabs the frame should be removed. In making a tank the spring or springs should be arranged so that part will be in the bottom and the remainder bent up into the sidewall forms. This effectively ties the bottom to the sides. If the area of concrete is large enough to require more than one spring they should be overlapped slightly.

—R. C. Roetger, New York City.

Steaming Planks With Blowtorch

After completing the framing of a small sailboat, I was confronted with the problem of bending planks of $\frac{5}{8}$ -in. redwood. Not having the facilities for regular steam-box technique, I soaked the planks with water, sprung them in an arc against the garage and used a blowtorch for the steaming-in operation.

—James W. Milnor, Oyster Bay, N. Y.



"Speed shooting" with a Savage Automatic .22, is not the only pleasure it will give you. In target practice, for example, you can operate the loading mechanism by hand. The rifle then functions like a bolt-action repeater, with the bolt locked solidly behind the cartridge throughout discharge. When used by young folks, or in teaching beginners, the rifle can be loaded and fired one cartridge at a time. The accuracy of its barrel is outstanding in the inexpensive .22 rifle field. Its walnut stock is man's-size, well-shaped, beautifully checkered on full pistol grip. Its action is simple, positive, and dependable in functioning.



PATENTED TRIGGER RELEASE

makes certain that the rifle, when used as automatic, will not fire unless the trigger is released and pulled separately for each shot. The speed of rapid fire is as fast as the finger of the shooter can move back and forth. Savage Model 6 (illus.) Savage Model 7 Tubular Mag., capacity 15 .22 L. R. Cartridges Clip Mag., capacity 5 or 10 shot

SEND FOR FREE CATALOG

SAVAGE ARMS CORPORATION
Dept. 2805, Utica, N. Y.

SAVAGE
Automatic
.22 Rifles

Make BIG MONEY AT HOME! NEW Invention Electroplates by BRUSH



Now Plates CHROMIUM!
ALSO GOLD, SILVER, NICKEL, COPPER, ETC.

War Increases Demand—You Profit!

New, patented invention makes possible big earnings AT HOME. Replate auto-parts—worn articles in homes, stores, hotels, restaurants, etc., with durable, sparkling, new coat of metal—with stroke of brush. Easy, simple, quick. Genuine Gold, Silver, Nickel, Cadmium, etc. Everything furnished. Outfit complete, ready for use. No shop required. Clear from \$2 to \$5 an hour in lifetime business. Small investment starts you in business. Steady repeat. Machine can pay for itself in week. Send TODAY for FREE SAMPLE and illustrated BOOKLET how you can have a life income from a business of YOUR OWN built upon satisfied customers. Act at once!

WARNER ELECTRIC COMPANY
215 W. Ohio St., Chicago, Ill., Dept. 109

FREE BOOK & SAMPLE

WARNER ELECTRIC CO., 215 W. Ohio St., Chicago, Ill., Dept. 109
Gentlemen: Send me Free Sample and Illustrated Booklet.

Name _____

Address _____

City _____

State _____



White Hands

Keep them smooth, free from grime, with SKAT, original and best Paste Soap. Cleans almost everything, works fast. If not at dealer's, send 10c for large can. SKAT CO., Dept. M, Hartford, Conn.



OTTAWA TRACTOR SAW

Falls Tree—Cuts Log

Fits rear power take-off shaft. Drive thru gear reduction. 18-in. stroke, 10-ga. blade. Economical, saws to profit.

**FREE Circular
and Price List**

OTTAWA MFG. CO., 1027 Forest Avenue, OTTAWA, KANSAS

**THE ONLY KNIFE
THAT'S SHARP FOREVER—**

Because new blades can be inserted quick as a wink . . . only 10c each. Choose type you prefer . . . or use several. Also in kits of three knives with extra blades for any type cutting. Sets \$1.00 to \$3.50.

X-ACTO CRESCENT PRODUCTS COMPANY
Dept. PM, 440-4th Avenue, New York, New York

8 BLADE
TYPES

X-ACTO 50¢



**THE ONLY KNIFE
WITH RENEWABLE BLADES**

Cleaning Silverware Easily

Tarnished silverware can be cleaned easily by the electrolytic method, which consists of boiling it in an aluminum pan. Use a level teaspoonful of salt and a like amount of baking soda (or simpler, 2 teaspoonfuls of salt alone) in a quart of hot, but not quite boiling, water. Use a bright pan, and immerse the silver. Do not use on French gray or oxidized finish common in ornate patterns or on such objects as silver candlesticks or pearl-handled table knives, which are made of parts that are either held together or weighted by cement. More rapid results are obtained with the electrolytic method if a piece of bright copper or tin is placed in the solution below the silverware. An enamelware instead of an aluminum pan may be used, but in this case, put pieces of bright zinc and tin together in the pan, being sure that each piece of silverware is in actual metallic contact with the metals, either directly or through other pieces. After the silver is clean, wash and polish with a soft cloth or, if necessary, with a mild abrasive such as whiting. To avoid development of a dull or matt finish and the necessity of polishing with whiting after the electrolytic treatment, silverware should be cleaned before it becomes too tarnished. If an aluminum pan is used, the pan should be clean and bright; it soon becomes dull from the chemical reaction and must then be cleaned. The zinc or tin, when used, should likewise be bright; either may be cleaned by using scouring powder or by rubbing with sandpaper or emery cloth.

Repairing Finger Marks in Paint

How often have you finished a job of painting only to have someone put a deep fingerprint on the finish when the paint or enamel is just firm enough to prevent neat touching over? The print, in nearly every case, may be removed in the following manner: Being sure that your fingers are clean, wet your index finger in clean water and dampen the marred surface of the paint. Using rapid and smooth movements, massage the surface of the paint with the damp finger. The water prevents cohesion of fingers and paint, and allows you to remove all traces of the original mark by merely reflattening the surface to its former condition.



KRW ARBOR PRESSES BENCH TYPE AND HYDRAULIC

NEEDED IN EVERY SHOP—SAVE TIME AND MONEY—DO BETTER WORK, QUICKER.

No shop is complete without a small arbor press. Pressing and squeezing operations can be done better and faster on a KRW Arbor Press. Stop using vise and sledge hammer methods—they generally deliver spoiled work in the end. KRW Factory-To-You Prices give you greater value for your money. Order today.

KRW Bench Type Arbor Presses, 3 sizes

No. 37-P ½ Ton, \$13.25*
 No. 37-O 1 Ton, \$23.00*
 No. 37-N 3 Ton, \$33.00*

*Prices F.O.B. Arcade, N. Y. Slightly higher west of Rockies. Stand illustrated extra.



KRW Hydraulic Presses are built in 25, 50 and 75 ton sizes. Prices start at \$198.00*



K. R. WILSON 17 Lock St., BUFFALO, N. Y.
 Builders of Shop Equipment for Ford Dealers Since 1916

BIG MONEY Assembling NEW MEAD KI-YAK



MEAD'S complete cut-to-fit KI-YAK Kit easily assembled for pleasure

WRITE for big illustrated **FREE** Circulars!

or profit! Portable, Seaworthy... Light... Fast. Highest quality. Low cost. 3 models 20 lbs. to 45 open a new world of sport for you both in sailing, paddling. Also 2 portable Outboard Models. Finished double-blade paddle or Oars now INCLUDED with your KI-YAK. Write now for illustrated circulars, low Factory-to-You prices!

MEAD GLIDERS, 15 S. Market, Dept. B-62, Chicago

BURN YOUR NAME ON TOOLS WITH THE ARKOGRAF

PROTECT YOUR TOOLS FROM THEFT
 Write with electricity any name or design on the hardest and finest tools and instruments, or any metal, like writing on paper with pen or pencil.
Complete Outfit \$3.50—Prepaid Anywhere
 Interesting illustrated circular free. Write today. Agents wanted.
 ARKOGRAF PEN CO., 3927 S.E. Stark St., Portland, Ore.



METAL CUTTING MADE EASY!

You'll cut all kinds of metal with surprising ease and speed once you get this 20-page, fact-packed, liberally illustrated hack saw manual. Covers selection, use, care of hand, power blades, frames, band saws. Send 10¢ to cover handling, postage or at your hardware dealer's for only 5¢.



CLEMON BROS., Inc.
 Middletown, N. Y., Dept. CM
 Enclosed find 10¢ for which mail post-paid copy "Metal Cutting" booklet to:
 Name _____
 Address _____
 City _____ State _____

Makers of STAR hand, power Hack Saw Blades, Frames, metal cutting Band Saws, Clemson D-17 Precision Lawn Machine.

BRUSH PLATING OUTFITS

for autoparts, reflectors, faucets, bicycles. No tanks necessary. Free particulars.

GUNMETAL CO., AVE. M, DECATUR, ILLINOIS



FREE TRAILER PARTS CATALOG
 We'll save you money on—axles, springs, wheels, couplers, windows, sinks, water pumps, brakes, refrigerators, beds, lamps, inside and out, 6V lamps, furniture, jacks—everything. Special discount to mfrs. **NATIONAL TRAILER EQUIPMENT CO.** Successors to **Kar-A-Van Industries, Inc.** Dept. P. 714 W. Wisconsin Ave., Milwaukee, Wis.

BUILD YOUR GRANDFATHER CLOCK

Send 35¢ for Simple SHOP TESTED COPYRIGHTED BLUEPRINT. The Simple Sensible Red-I-Kut way as thousands have. DIME brings PLANS and sixty picture "HOW" Book pricing many fine brass weight Westminster, tube chime, electric and battery movements showing fine beautiful colonial grandfather cases. Build now and save half.
KUEMPEL CHIME CLOCK CO., Bldg. 65, Guttenberg, Iowa.



BIG OPPORTUNITY Stucco Spraying



Present day construction needs better and faster finishing methods. Plastic COLORCRETE is waterproofed. It can be used on new or old buildings or to repair walks, walls, roofs, etc. It fuses with any masonry surface. Fills cracks and checks. Can be applied in any thickness and in 30 beautiful colors and shades. Fully proven by over 14 years actual use under all climatic conditions. Offers big earnings. With this machine you can supply the big waiting market at amazingly low cost. Present operators report costs of 2¢ and up per sq. ft. and sell up to 7¢. Some have paid for their equipment from first few jobs. Machine capacity up to 1,000 sq. ft. per hour.



Get the facts. Send for free book "Proven Business Opportunity." Write today.
COLORCRETE INDUSTRIES, INC.
 500 Ottawa Ave., Holland, Mich.

NOW a DYNAMIC HEAVY DUTY INDUSTRIAL WELDER



Works off 110 volt electric light circuit. For this unheard of price you can get the marvelous Dynamic Super-Charged Welder complete—ready to plug into light socket. The Dynamic does both metallic and carbon arc welding. You can also solder and braze on the lightest material.

for Only **\$195**
EASY PAYMENTS

Works on Iron, Steel, Tin, Brass, Copper and All Other Metals
 With our free instructions you can in no time do finished repair jobs. **BIG PAY IN BOOMING WELDING INDUSTRY** Once you have the Dynamic outfit, you are all set in this profitable field. In a year a Dynamic welder costs you Less Than 6¢ a Day. Write for **FREE** particulars **TODAY.**
DYNAMIC WELDER CO., 2226-TT, Silverton Road, Chicago, Ill.

WELDS BUMPERS, FENDERS, CYLINDER BLOCKS, BODIES, FRAMES, ETC. Does Farm, Factory and Home Repairs

Without previous welding experience you can make for yourself as much as \$5.00 on a repair job that can be done in less than one hour. Many welders make as much as \$15.00 to \$20.00 a day. The Dynamic Welder is light and easily portable.

AGENTS WANTED!
 Get our big profit plan and 10-day trial offer. Send for it **TODAY.**

m 108

"Get Back you Fielders I Got My LOUISVILLE SLUGGER"



Louisville Slugger Softball bats, like their big brothers Louisville Slugger Baseball bats, are the finest that can be made. There are 29 models to choose from in the 1942 line. You will be sure to find one that exactly suits your style of hitting. Every Louisville Slugger carries a number on the barrel end of the bat for easy identification. Ask your dealer to show them to you.

GET YOUR 1942 SOFTBALL RULE BOOK

Your Louisville Slugger Dealer has a copy for you. In addition to all the latest information on the game it also contains complete information on the Louisville Slugger bat line for '42.



Ask your dealer for the LOUISVILLE SLUGGER OFFICIAL RULES FOR 1942"

or send 10c in stamps direct to Dept. P-31

HILLERICH & BRADSBY COMPANY, Inc.
LOUISVILLE, KENTUCKY

New Only \$6.95

REAL ENGINE VALUE



The G. H. Q. is a miniature gasoline engine that really operates. Over 15,000 sold in the last year. Now is your chance to buy the New Improved 1942 model kit for \$6.95. Absolutely complete with coil, condenser, plug, instructions, etc. Only a screwdriver needed. For boats, planes, midget cars, etc. All parts guaranteed. Send only \$1.— Shipped Collect C. O. D. same day. Send for FREE circular or 6c for Jumbo catalog of hundreds of plane, boat and hobby items.

GHQ MOTORS, Dept. B, 48 East 21 St., New York, N. Y.

STANDARD GARDEN AND SMALL FARM TRACTORS

Plow
Seed
Cultivate
Mow Hay
and Lawns

Powerful Gas Tractors for Small Farms, Gardeners, Florists, Nurseries, Fruit Growers, Poultrymen.

1 & 2 Cylinders

High Wheels, Rubber or Steel Tires. Walk or Ride.

Do Belt Work—Free Catalog

STANDARD ENGINE CO.

Minneapolis, Minn. 3221 Como Av. New York, N. Y. 617 West 26 St. Philadelphia, Pa. 1914-15 Fairmount



Get Your Share of U. S. Defense BONDS ★ STAMPS



AUTO ENGINE SPEED CONTROL GOVERNORS

Give constant speed to any make of auto or truck engine, regardless of load changes, when used as a stationary or portable power plant. No better governor can be made. Fully guaranteed. \$5.00 up. No cash down. Complete, simple instructions. Courtesies to garages and established agencies. Free circulars. 129-5 LLEWELLYN ST., LOS ANGELES.

Torture Chamber

(Continued from page 89)

under the machines prevent the shock from wrecking the concrete foundations.

These power producers, each 12 feet long and 18 feet high, can deliver the 2,000,000 kilowatts only five seconds at a time without danger of burning out. This surge or punch is like that which a power system receives when it is short-circuited. In one spectacular test, the generators are connected to two thick, curved pieces of wire called a horn gap. When the 2,000,000-kilowatt punch is released, it leaps the gap in a 20-foot waving, flaming, thundering arc as bright as mid-day sun and hot enough to melt instantly the hardest steel. When the same amount of power is shot into a 12-foot oil circuit breaker, only one-twentieth of a second elapses before the circuit breaker emits a mechanical grunt and blots out the flood of power quicker than you can wink your eye. In operation on a power line, this action disconnects the short circuited section, but permits normal operation of the remainder of the system. In another test, engineers combine ice and electricity to torture a four-foot outdoor power switch built for use in the sub-zero weather of Alaskan winters. This test is made in a room-sized refrigerator where temperatures of 20 degrees below zero are produced summer and winter.

Rotors of the two generators gain momentum for half an hour, until their surface speed is four miles a minute, before delivering the electrical knockout. When the short circuit switch is snapped shut, the generators instantly convert their stored mechanical energy into electricity. In addition to the generators, the power laboratory—"torture chamber"—also contains two switching boards, each 20 feet tall and studded with knife-type switches which are operated with long wooden poles. At strategic points in the power house are 10 photo-electric cells, or "electric eyes," guarding the machines and switches. Two men in a control room operate the generators and supervise tests through a system of communications much as a sea captain controls his ship from the bridge.

☞ Look in the index to find where to buy articles described in this magazine. Say You Saw It in Popular Mechanics.

L1390

The Revolution in Farming

(Continued from page 95)

Paralleling plant food studies is a research program to learn more about the mineral requirements of domestic animals. More knowledge about the iron and copper requirements of pigs, for instance, may lead to producing greater amounts of pork, once the right proportions of minerals can be supplied in the natural forage. Similar investigation may find a way of increasing the butterfat content of cow's milk.

What is going to happen to the surplus farm population now that fewer and fewer people are needed in the food industry?

Economists find the question a perplexing one although they have a number of answers that should help reduce such unemployment. One valuable suggestion is to increase the amount of food being raised and by a price adjustment arrangement make it available to low income families who now suffer from unbalanced diets. A good start has been made along this line.

Another partial answer is to stimulate the raising of fur animals as a profitable farming side line.

The greatest possibilities for farmers, now that our food demands are satisfied, lie in the raising of oils, motor fuels, rubber, raw materials for plastics, and other materials for which industrial uses can be found. Corn and soy beans have been exploited to some extent for this purpose although aside from cotton and wool, farming for industry is really a brand new subject.

Right now domestic rubber is of national importance and our small rubber industry is beginning to expand. A million pounds a year are being raised in California from a small desert shrub called guayule—pronounced Y-You-Lay. In its wild state this shrub has a rubber content of six percent but by careful selection and breeding this content has been increased to as much as 30 percent in the domesticated plant. Guayule can be raised in many parts of the semi-arid southwest. Exponents of this new industry think that some day the United States will raise all of its rubber at home.

Look in the index to find where to buy articles described in this magazine. Say You Saw It in Popular Mechanics.

Quicker, easier measuring!

All kinds of shop jobs are easier, quicker when you have MASTER "Streamline", the 6' steel tape rule that makes all measuring a one-hand job.



You'll use this rule for inside and outside measurement—as inside callipers—as outside callipers—just like three tools in one. Leverlock holds tape while you read both inside and outside measurements direct at marks on case—no adding or subtracting.

You'll save money too—because exclusive blade replacement feature makes this finer rule last twice as long as others. Treat yourself to this precision tool now and enjoy its extra convenience and accuracy while you save.

complete with spare blade

\$2⁶⁵

MASTER
WOOD AND TAPE RULES

Master Rule Mfg. Co., Inc., Dept. F-6, 815 East 126th St., New York City.
 Send me MASTER "Streamline" with spare blade. I enclose \$
 Send more information on this superior rule.
 Name _____
 Address _____
 City _____ State _____



MAKES A GOOD LIVING

With a Foley Automatic Saw Filer you don't need to have experience to do expert work easily, quickly, without eyestrain. "Last year I sharpened 2309 hand saws, for which I got \$1154.40. The Foley Saw Filer has made a good living for me!"—John Joseph, Calif. Louis P. Wadowick says: "I have filed 764 saws in spare time." The Foley files hand, hand and circular saws better than the best hand filer. Patented jointing principle makes uneven teeth perfect in size, shape, spacing. **FREE PLAN** shows you how to start your own cash business in spare time with small investment—no canvassing. No obligation, no salesman will call. (Paste coupon on postcard)

FILING SAWS FOR VICTORY
The Foley Filer is in use by U. S. Army, Navy, other Gov't Dep'ts., hundreds of Defense and mfg. plants.

Mail Coupon for FREE PLAN

FOLEY MFG. CO. 616-2 Foley Bldg., Minneapolis, Minn.
 Send Free Plan on Saw Filing business—no obligation.
 NAME _____
 ADDRESS _____



DRILL PRESS OWNERS!

HERE'S 1 TOOL WITH 5 DISTINCT USES



THE BARRON MULTI-PURPOSE ROTARY WOOD PLANER

PLANES & SURFACES • PANELS & BEADS \$7.50
ROUFS & GROOVES • RABBETS • TENONS COMPLETE

Converts ANY drill press into a time saving, low cost planer, paneler, tenoner, etc. Surface finishes all types of tough grained and knotty surfaces to agate smoothness. Safe! Guaranteed harmless to drill press. Thousands now in use. **SOLD ON MONEY BACK GUARANTEE.** Full refund on 5 day trial. Shipped prepaid on receipt of \$7.50—or C.O.D. **YOU RISK NOTHING.** Free literature.

Barron Tool Co., 369 Architects Bldg., Detroit, Mich.

STEEL TOP AUXILIARY DRILL PRESS TABLE

Has 300 sq. in. smooth working surface. Equipped for shaper and many other important workshop uses—a real buy at \$5.95



MAKE Every MILE COUNT!



Your Hull Streamline Auto Compass saves wasted travel. Choose the shortest route and drive by compass.



HULL MFG. CO., P. O. Box 246-D6, Warren, Ohio

110-VOLT AC GENERATORS

& AC light plants, 1800 & 1200 rpm. Available for all standard voltages such as 110, 220 or 440 three phase; three phase, three wire or three phase four wire & 25, 30 or 50 cycles. 350 through 15,000 watts. Also rotary converters, motor generators, frequency changers, etc.

KATOLIGHT, 22 Elm St., Mankato, Minn.



SAVE YOUR TIRES! \$1.00

GUARANTEED

AUTOMATIC TIRE COP! Yells for help when thieves go at your car. Screwdriver installs in 15 minutes on any car. Protects all tires, accessories, gas, car itself. Send no money. Pay postman \$1.00 (Special Sample Price) plus few cents postage on delivery. Use 5 days. Money back if not satisfied.

TIRE COP CO., Dept. C-10, Madeira, Ohio

JARI POWER SCYTHE

Cuts noxious weeds, brush and grass in less time with power—in orchards—in fields. Cuts in tight places. Trims 1 1/2" from ground, close to buildings, under fences. 36" sickle bar, self-propelled, light weight—easy to handle.



JARI PRODUCTS CO.
Dept. 20-E, 2938 Pillsbury Ave., Minneapolis, Minn.

WRITE FOR DETAILS AND PRICES

RE-STRING RACKETS AT HOME—EARN MONEY

EASY—PLEASANT—PROFITABLE

FREE INSTRUCTION SHEET NOW

W. A. Bickel & Co., 137 N. Marion, Dept. A-62, Oak Park, Ill.



only 10c

Woodworkers:

Here it is! Harold Hunt's big No. 14 wood catalog! Latest UP-TO-DATE IDEAS for experts and amateurs! SPECIAL BARGAINS in rare woods, veneers, and ALL kinds of supplies. 148 pages—20 of rare woods in color. Get posted! Send only 10c to CRAFTSMAN WOOD SERVICE CO. 2729 S. Mary St., Dept. A-22, Chicago, Ill.

Shoot Them in Color

(Continued from Coloroto Section)

ups can be lighted with two No. 2 photo-flood lamps, in handy cardboard reflectors replacing the shades in bridge type lamps, and the unit should be placed directly beside the camera and a little to the rear. The lamps should be about four feet from the subject's face, and a little higher than his head, but trained directly on him. If the subject is more than twelve inches from the wall, the background should be independently lighted, or the background color in the transparency will be too dark. More formal lighting requires several light sources; the amateur will find that various arrangements will lead to a number of attractive Kodachrome shots.

Most outdoor natural scenes have good color harmony, probably because the mind has grown to accept the color combinations of nature as harmonious and pleasing. In other scenes, color harmony—the effect on the eye to differences in color and the placing and relative size of colored objects—is left up to the imagination of the photographer.

The rule of loading and unloading your camera in subdued light—never in direct sunlight or exceptionally strong artificial light—is just as important with Kodachrome as with black-and-white negative materials. The small cylinder, in which the film is packed, should be retained for use as a container when sending the film to one of the Eastman Kodak Company's processing laboratories for conversion into transparencies. It is recommended that the film be processed as soon after exposure as possible. Keeping it for more than a few weeks in hot and humid climates results in faulty color because the image in one of the emulsion layers on the film may change more rapidly than in one of the others. Transparencies should be stored where they may be relatively cool and dry. They should never be kept near radiators, steam pipes or locations where they may be subjected to high temperatures.

There is no greater camera thrill than in taking pictures in full color. Careful attention to exposure and light, in addition to self training in color appreciation, will enable you to get excellent Kodachromes any time, anywhere.

PAY-RAISING BOOKS — EXTRA MONEY

Use these books to prepare for a better job—bigger pay—to start a profitable spare time or full time business of your own. Popular Mechanics specializes in supplying outstanding books on many subjects. As new books of merit appear, we will revise this list.

- GARDEN BOOK (Just Out)**
Build own trellises, lawn furniture, fireplaces, ornaments, etc. \$1.00
- BUILDING INSULATION (new)**
Covers heat and sound \$3.00
- FORTY POWER TOOLS**
Build own saw, drill, lathe, sander, etc. from scraps—save money \$1.25
- SHOP NOTES LIBRARY**
Five big volumes including new 1942 edition (224 pages—28 in color); over 1900 articles on money-making & money-saving ideas \$2.45
- WELDING, BRAZING AND SOLDERING**
How to build and use arc, spot welders; tricks of soldering \$1.25
- RUNNING A MILLING MACHINE (new)** . . . \$1.50
- MOTOR'S FACTORY SHOP MANUAL (1942 ed.)**
Covers 480 cars, 390 trucks \$4.00
- HOW TO TRAIN SHOP WORKERS (new)** . . . \$1.25
- FINANCING DEFENSE ORDERS** \$2.50
- GOOD MECHANIC SELDOM GETS HURT**
Shop safety 50c
- PRACTICAL SHOP PRODUCTION (new ed.)** . . \$3.00
- A THOUSAND WAYS TO MAKE \$1,000**
Tested methods that work \$2.50
- TOOL DESIGN**
New book on production tools \$4.50
- TIN SMITH'S HELPER**
Seams, piping, gutters, etc. \$3.00
- MODERN REFRIGERATION**
Electric, gas. Be service expert \$5.00
- AUTO BODY AND FENDER REPAIRS**
Shows how to do professional job . . \$3.00
- DYING AUTO ENCYCLOPEDIA (includes Diesels, airplane engines)**
World's greatest book for mechanics . . \$6.00
- SHEET METAL WORK**
Self instruction in all phases \$2.50
- ARMATURE WINDING**
Construction, winding, repairing AC & DC Motors, generators \$2.00
- BUILD YOUR OWN BOAT**
Describes 17 popular boats—rowboats, sailboats, plywood outboard, etc. 192 pages \$1.25
- FORGING PRACTICE** . . \$1.50
- HIGH SCHOOL SELF TAUGHT**
4 yr. course in one vol. \$1.89
- CARPENTRY & JOINERY**
Learn modern methods \$2.00
- FOUNDRY WORK** \$2.00
- WHAT TO MAKE**
3 Big Books, 588 pages of popular handicraft projects . . . \$1.47
- PRACTICAL WOOD FINISHING**
Shows woods in full color, describes new finishes \$1.25
- MACHINE SHOP WORK**
Excellent book on approved methods . . \$2.75
- BLUEPRINT READING**
For machine trades . . \$1.50
- BLUEPRINT READING**
For building trades . . \$1.25
- PAINTING & DECORATING** \$1.50
- PATTERN MAKING**
Wood, metal \$2.00
- MILLING-MACHINE INDEXING (new)** . . . \$1.50

- TOOL MAKING**
For beginners, advanced workers \$3.50
- FIVE ACRES AND INDEPENDENCE**
How to make money on small farm . . . \$2.50
- KNOTS, TIES, SPLICES**
For everyone who uses rope \$1.00
- PLUMBING**
Designing and installing \$3.00
- ELECTRIC WIRING**
Includes estimating and new code \$2.50
- HOUSE CONSTRUCTION**
Gives every step in house construction \$2.89
- MACHINISTS' AND TOOL MAKERS HAND BOOK**
New 1600-page book, machine shop practice in all branches \$4.00
- FORD VS CAR AND TRUCK**
Repairing, operating \$3.00
- 1001 WAYS TO USE CONCRETE**
Do work for yourself, others, save, make money \$1.98
- STEEL SQUARE POCKET BOOK**
Best methods of using \$1.00
- DE LUXE SMALL HOMES**
New plan book shows 210 popular designs \$1.00
- MODERN HOMECRAFT**
New 250 page book on modern furniture . . \$3.00
- BLACKSMITHING** . . . \$1.25
- YOUR CAR**
New 192-page auto-owners guide describes hundreds of simple car repairs, shortcuts, how to operate car economically \$1.25
- ARCHITECTURAL DETAILS**
For every type of building \$1.50
- BIRD HOUSES**
Simple, attractive, permanent \$1.50
- EASY-TO-MAKE TOYS**
Sixty-seven projects. \$1.85
- PRACTICAL BRICK LAYING** \$1.75
- WELDING, ELECTRIC**
Forge, thermal, resistance, arc \$1.25
- WELDING, OXY-ACETYLENE**
Welding, cutting . . . \$1.25
- METALLURGY** \$1.50
- RADIO PHYSICS COURSE**
Fundamentals made plain \$5.00
- AMERICAN MACHINISTS' HANDBOOK**
Standard data, methods \$4.00
- SIGN PAINTING** \$3.00
- AUDOLS DIESEL ENGINE MANUAL** \$2.00
- TECHNICAL BULLETINS**
Simplified data for Practical Man
- SILVER SOLDERING AND BRAZING** . . . \$1.00
- REWINDING ELECTRIC MOTORS** \$1.00
- FLEXIBLE Molds FOR CASTING NOVELTIES** \$1.00
- WORKING WITH PLASTICS** \$1.00
- MIRROR SILVERING** . . \$1.00
- SMALL ELECTRIC LIGHT PLANTS, CONSTRUCTION** \$1.00
- HEAT TREATMENT OF IRON AND STEEL** . \$1.00
- DESIGNING AND BUILDING TRANSFORMERS** . \$1.00

Atlas

10" F-SERIES LATHE



Enlisted for the duration! Atlas Lathes are important "soldiers" in the war of the production lines.

ATLAS PRESS CO.
KALAMAZOO, MICHIGAN

LATHES · DRILL PRESSES · SHAPERS
ARBOR PRESSES · MILLING MACHINES

THE HANDIEST COMPACT STOVE ON THE MARKET



IDEAL FOR BEACH PARTIES AND PICNICS

Open: 9" high, 14" long, 9 1/2" wide. Depth of pan 1".
The unit folds quickly into package 2" x 12" x 16".

STOVE: Upside down for Direct Heat! Boil water, warm milk, make coffee. No danger of causing disastrous fires. The burner has a variety of uses wherever fire is needed. Price, \$3

Instant-Fire Camp Kit Co.
Patented PEORIA, ILLINOIS

WARDS Big Free 1942 CAMERA AND COLOR CATALOG

Everything you need plus 12 Hints to Better Color Photos. Bargains in Still or Movie Cameras, Projectors, Supplies. Dozens of new items . . . more than you ever thought available this year. Many items are shipped POSTPAID. At LOW PRICES CASH or TERMS. Satisfaction guaranteed or money back. Act now. Write today!

MONTGOMERY WARD
Photographic Dept. PM-642 Chicago, Ill.

Modelbuilders Everywhere Are Raving About These CLEVELAND 3/4" SCALE WAR MODELS

<ul style="list-style-type: none"> 25 1/2" Airacobra, (shown as right) Kit SF-76 \$3.00 28" P-40 Tomahawk, Kit SF-77 . . . \$3.00 31 1/2" Skyrocket, Kit SF-75 . . . \$2.50 27 1/2" Spitfire, Kit SF-73 . . . \$3.00 24 1/2" Messer, ME-109, Kit SF-74 \$3.00 38 1/2" Lockheed P-38 "Lightning" All Kits absolutely complete. At dealers, or order direct. Send 5c for latest catalog. 	 <p style="text-align: right;">"Deadly Cannon-Plane"</p>
--	--

CLEVELAND MODEL & SUPPLY CO. INC., 4508B55 Lorain Ave., Cleveland, Ohio

AMAZING CHEAP OIL BURNER

Sweeping the Country!!

COOK and HEAT Without Coal or Wood

In Your Present Stove or Furnace — No Drudgery, Dirt or Ashes — Clean Heat at SMALL COST.

OVER 40,000 SOLD

Beats any cheap burner ever gotten out for low cost, efficient performance. Burns ordinary low priced free flowing oil without pre-generating or clogging up. Heat regulated by Turn of Valve.

30 DAYS TRIAL

Prove its efficiency, convenience and economical operation without risk. A Guarantee with each burner. Write immediately for SPECIAL OFFER to AGENTS who will demonstrate and take orders. Write quick, be first to learn how to make REAL MONEY right now, spare or full time—mail to postpaid today.

United Factors, F-751, Factory Bldg., Kansas City, Mo.

AGENTS Salesmen BIG MONEY

F. Silver says: "I can dispose of 250 HEAT KINGS before this year ends." Write us now for agents' offer.

MAIL THIS COUPON TODAY

Just check the books you want, write your name and address below, and mail this advertisement. It is your order blank. When postman hands you books, pay him the price and few cents postage. Outside U. S. A. enclose remittance and include 15% additional for shipping charges. Ask for big FREE catalog of helpful books.

Name _____

City _____ State _____

Address _____

Mail to Popular Mechanics Press
Dept. 392—200 East Ontario St., Chicago, Ill.

NEW IMPROVED CONQUEROR



Easy TO PLAY

• World's largest manufacturer announces sensational improvement in Band Instruments. New patented VOCABELL revolutionizes tone effects. Easier to play. You'll develop talent fast with these new Conns. Choice of world's greatest artists. See your dealer or write today for FREE BOOK and home trial, easy payment offer. Please mention instrument.

C. G. CONN, Ltd., 631 CONN BLDG.
Elkhart, Indiana

CONN
BAND INSTRUMENTS

Write FOR NEW FREE BOOK

FOR VICTORY



BUY UNITED STATES DEFENSE BONDS AND STAMPS

Always write your name and full address clearly when answering advertisements.

NEW Grinding Attachment

For 8" to 16" Metal Lathes. Build it Yourself.

At last, a precision grinder within your means. You save 2/3 by finishing out semi-machined castings, on your own lathe. HURON handles both internal and external grinding. Accuracies to .00025". Mirror finish easily obtained. Grinds valves, pistons, bushings, shafts, hard or soft, holes, locks, centers. Sharpens reamers, milling cutters. Does eccentric drilling; taps, polishes; scores of other uses, for home workshops, garages, machine shops. Write for FREE illustrated folder and price list of supplementary items. Mention your lathe.

Huron Machine & Tool Co., Dept. B, Yale, Mich.



Semi-Machined Castings Only \$6.45



G. S. TWO LOCK TOOL CHESTS
FOR GREATER CONVENIENCE AND PROTECTION

GEO. SCHERR CO. INC., 1224 LAFAYETTE STREET, N. Y.

REED MICROMETERS
Highest precision used by mechanics everywhere. Write for FREE literature.



SHOP AGENTS WANTED

They're Riding HARLEY-DAVIDSONS!

YOU bet, Uncle Sam has to have motorcycles that are dependable — that are built to stand the gaff of roughest going. That's why Harley-Davidsons have been chosen for action in the nation's hard-hitting motorized divisions. The fellows who ride 'em are getting real action as they handle toughest assignments with Harley-Davidson's power, stamina and rugged dependability to bring them through to victory! See your Harley-Davidson dealer — and learn all about the superior performance of these world champion motorcycles — also look over his special values in reconditioned models.



Top photo by U. S. Army Signal Corps.

SEND COUPON NOW

HARLEY-DAVIDSON MOTOR CO., Dept. P, Milwaukee, Wis. Send FREE copy of big 24-page "Enthusiast" magazine filled with thrilling motorcycle pictures and stories. Also literature on the latest Harley-Davidsons. Stamp is enclosed for mailing cost.

Name _____

Address _____

HARLEY-DAVIDSON

ON AMERICA'S FRONT



POPULAR MECHANICS

Install a New Refrigerator Gasket

If your mechanical refrigerator seems more expensive to operate than when it was new, perhaps only a worn-out door gasket is responsible. A poor gasket, letting warmth leak in and cold leak out, may cost several times the price of a new one each year. Here's a simple test: Take a slip of paper and close it in the door; if the gasket does not grip the paper firmly, it is not making a proper seal. Try this at various points around the edge of the door. You can replace the gasket yourself. Your refrigerator dealer will sell you a length of gasket material needed and the old gasket will give you a pattern for cutting the corners. The ends must be brought together snugly, with no gap where they meet.

Line Drawing Made From Photo

Magazine contributors and others who wish to make line drawings, yet feel they do not have sufficient artistic ability, can make clear, accurate drawings from photographs. I make an enlargement of the article to be drawn on matte paper, giving it just enough exposure to show the outlines clearly. Then the lines are drawn in with India ink. Next the photographic image is bleached out with a potassium ferricyanide solution, leaving only the white paper with the inked lines visible. This method works well for making drawings marked off in squares to show dimensions, as the enlargement can be made a convenient size and the lines of the squares marked in with a colored pencil after the photo has been bleached and the paper dried.—E. F. Whiteside, Wilmette, Ill.

Saving on Typewriter Ribbons

Ribbons for portable typewriters cost just as much as the ribbons for the larger desk typewriters, but there is a difference in the amount of ribbon which is on the spool. The portable ribbon has about one half as much on a spool. My portable typewriter uses a standard ribbon $\frac{1}{2}$ in. wide, so I purchase any $\frac{1}{2}$ -in. ribbon and simply wind the proper amount onto my small portable spool. This will leave almost half of the new ribbon left on its spool; I wrap it up again and save it. My ribbon costs are now just one half what they used to be.

—R. Boettinger, Englewood, N. J.



• THIS YEAR, of all years, don't risk the dangers of car overheating. Clean dangerous rust and sediment out of your radiator. Use Sani-Flush. Costs only a few cents.

Don't take chances on just flushing with water. Sani-Flush is thorough. Use it yourself, or ask your service station. *Sani-Flush is absolutely safe in auto cooling systems when used according to the directions on the can.* It's in most bathrooms for cleaning toilets. Sold in grocery, drug, hardware and 10c stores. The Hygienic Products Co., Canton, Ohio.

Sani-Flush

CLEANS OUT RADIATORS

FREE LITERATURE FOR TRAILER BUILDERS

New up to date facts on world's most reliable parts, axles, hitches, draw bars. Used by U. S. Gov't. and largest trailer Mfrs. Easy to build in spare time. Complete working Blue Prints only \$1.00. Write for Free Literature.

HAMMER BLOW TOOL COMPANY,

Dept. 106

Wausau, Wis.



Powerful Vision—8 Mile Range
BINOCULARS
20 Days Free Trial \$4.75
Postpaid or C.O.D.

Scientifically ground, powerful lens that give clear vision equal to 110 yds. at 1000 yds. distance! Adjustable for all distances and eye widths. Binoculars come with handsome case and straps. GUARANTEED.

If not satisfied after 20 days free trial money refunded. American Binocular Co., 7759 S. Halsted, Dept. F-362, Chicago.

New Accurate 10" Slide Rule

Enables you to do difficult calculations instantly without paper or pencil—multiplying, proportions, division, extracting roots, etc. Accurate, white composition face. Has standard A, B, C, D, CI, and K scales. Special magnifying indicator.

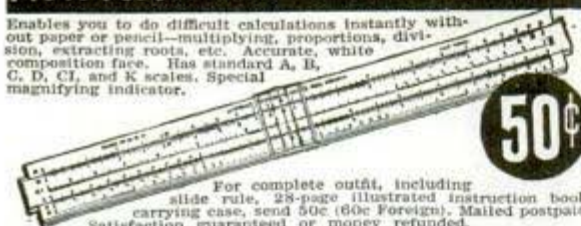

50¢

For complete outfit, including slide rule, 28-page illustrated instruction book, carrying case, send 50¢ (60¢ Foreign). Mailed postpaid. Satisfaction guaranteed or money refunded.

SPECIAL COMBINATION OFFER—Slide Rule and Instruction Book; 32-page slide rule practice book (300 practical examples showing many uses); Pocket Calculator for adding and subtracting up to 999,999—ALL 3 for \$1.00 cash (\$1.10 Foreign). Order NOW **HEWIG CO., Box 143-A, Grand Central Annex, New York City**

Lower Cost BUILDING MATERIALS



MEN OF FORESIGHT realize the big possibilities today in the building industry. Big opportunity supplying locally made, low-cost, permanent, fire-safe building materials.

GET READY TO SUPPLY this demand in your locality. You can build up a complete modern plant from a single machine at \$190.00. **INVESTIGATE**—Now is the time to get ready. Write today for our big new catalog No. 72 and easy payment plan.

CONCRETE EQUIPMENT CO.
512 Ottawa Ave. Holland, Mich.

Wonder-Tone NOISE ELIMINATOR

Just attach to your radio (long, short wave) and enjoy reception free from distracting noises. Send-No-Money Pay Postman 60¢ plus postage or send 60¢ and we'll send postpaid. Return in 5 days for refund if not satisfied.



WONDER-TONE COMPANY, Dept. 17, 7078 N. Clark St., Chicago, Ill.

CRESCENT TOOLS

Give Wings to Work

ASK YOUR
HARDWARE
DEALER

OTTAWA LOG SAW

\$39 BIG BOOK FREE

PUTS THIS OTTAWA to work for you. **MAKE MONEY!** Wood is valuable. Does more than 10 men. Easily operated. Falls trees—saws limbs. Use 5-hp. engine for other work. Write for FREE BOOK.

OTTAWA MFG. CO.
5627 Wood St., Ottawa, Kans.

SAW 10 TO 20 CORDS A DAY

Get Your Share of **U. S. Defense BONDS ★ STAMPS**

MOTORISTS Wanted!

TO MAKE THIS UNIQUE GAS SAVING TEST

FITS ALL CARS
Constructed of six parts fused into a single unit, adjusted and sealed at the factory. Easily and quickly installed by anyone in a few minutes.

Will you permit us to send you at our risk the Vacu-matic, a device which auto owners everywhere are praising? Install it on your car. Test it at our risk. Unless it trims dollars off your gas bills by saving up to 80% on gasoline consumption, gives more power, quicker pickup and faster acceleration, the test will cost you nothing.

Automatic Supercharge Principle
Vacu-matic is entirely different! It operates on the supercharge principle by automatically adding a charge of extra oxygen, drawn free from the outer air into the heart of the gas mixture. It is entirely automatic and allows the motor to "breathe" at the correct time, opening and closing as required. Saves up to 80% on gas costs, with better motor performance.

AGENTS *Get Yours FREE*

FOR INTRODUCING. Here's a splendid opportunity for unusual sales and profits. Every car, truck, tractor owner a prospect. Send name and address now for big money making offer and how you can get yours Free. **The Vacu-matic Co., 7617-1110 W. State Street, Wauwatosa, Wis.**

BUILD YOUR OWN

ARC-WELDER

For Light or Heavy Work

No rewinding necessary—use coils taken from old auto generators. Works on 110 or 220 A.C. Has 20 different heats. Complete plans and BIG Catalog 35c.

LEJAY MFG. CO., 3347 LeJay Bldg., Minneapolis, Minn.

Send for FREE CATALOG

\$9.50 UP

MONUMENTS

Enduring, strikingly beautiful GRANUDUR Memorials direct, at prices you can afford. **GUARANTEED.** Investigate our memorials before you buy.

ECONOMY MONUMENT CO. (Dept. 7) 537 So. Dearborn St. Chicago, Illinois

MONEY IN RABBITS — CAVIES

WE BUY and put you in touch with other markets. Catalog and copy of magazine 10c. Or send 25c for Book Catalog and Price List and Year's Subscription to the **AMERICAN SMALL STOCK FARMER.**

OUTDOOR ENTERPRISE CO., BV 919, PEARL RIVER, N. Y.

★ ★ ★

FORTY POWER TOOLS

You Can Build at Low Cost

USE OLD AUTO PARTS
SAVE HUNDREDS OF DOLLARS

Power tools for your home workshop—at a cost anyone can afford. Make them yourself—lathes, drill presses, sanding machines, shaper, circular, band, and scroll saws and other power tools—from old auto, sewing machine, and other discarded parts that cost very little. Get the new book, "Forty Power Tools You Can Make", and follow simple instructions, diagrams and photographs. Make yourself up to date, efficient machines that will do a good job for you and save you time, hard work, and many dollars. Send \$1.25 for "Forty Power Tools You Can Make" today or order on postal card and pay postman on delivery anywhere in U. S. A. Your money back if not satisfied.

POPULAR MECHANICS PRESS, Dept. 405, 200 E. Ontario St., Chicago

413 Pages
Profusely Illustrated

FIVE ACRES and Independence

A PRACTICAL GUIDE TO THE SELECTION AND MANAGEMENT OF A SMALL FARM

By **M. G. Kains**
U. S. M. S., formerly Special Crop Culturist of U. S. Dept. of Agriculture.

ALL OF US long some day to own a small farm, whether it be for permanent residence or as a weekend haven where we may enjoy the relaxation of rural life. With war upon us, inflation, depression, strikes, high rents, high cost of food and shortages threatening, we may find the solution in a properly operated small farm where we can eat regularly and abundantly, sleep soundly, have no money worries and live a healthy outdoor life. You don't have to own a large farm, but it is important to have practical advice from one who knows all about how to farm. There are many pitfalls which may easily be avoided. And there are many tried and proved methods which can lead to success.

We have found a practical book that starts at the beginning and takes you step by step into successful farming. This book takes nothing for granted. It tells what kind of farm to buy; how to choose it; how to finance it; what and how to plant, choice and care of livestock, poultry, bees, etc.; especially essentials of fruit and vegetable growing, fertilizers, irrigation, spraying, cultivation, harvesting, storage, sale of products and by-products. Every page is packed with proved ways to make the small farm self-supporting and profitable. Whether you have a farm now or are planning to purchase one, get this book by Mr. Kains and prepare yourself. Don't miss "Five Acres and Independence"; it might change your whole life, it may bring you the independence and security you are now striving so hard to obtain.

Only \$2.50, Postpaid in U. S. A. (Outside U. S. \$2.75). Order Today

POPULAR MECHANICS PRESS Room 406 • 200 East Ontario St., Chicago

What to Do Before Calling the Radio Doctor

(Continued from page 155)

probably has, your first thought is to call your local radio serviceman. Normally that is the proper thing to do. However, in the present situation this radio "doctor" may not be immediately available, therefore you can do a few things to solve the problem, which may not be as difficult as it looks. The very first thing to do is to remove the line-cord plug from the wall socket, even though you do nothing further.

As you have had this set for several years, you are familiar with the front panel controls, and probably know how to connect the antenna and ground. Now, with the receiver disconnected from the power line, have someone hold a flashlight so that you can see the various tubes on the chassis base, from the back of the set. Make sure that each tube is pushed down firmly in its socket, and that any leads running to caps on the tops of the tubes are in their proper positions, and that no bare wire, connected to these caps, comes in contact with the metal tube shields. Now examine the antenna and ground connections carefully, and, if everything appears to be right, push the receiver back in place and plug in the line cord. You may be surprised to hear the set again working properly which would be the case if a tube had been loose in its socket, or a grid-cap lead was shorting. On the other hand, if the set still refuses to work, immediately disconnect the line-cord plug from the wall socket, and leave it out. The next step, of course, is to remove all of the tubes so that you can take them to the radio store to have them tested. Now, unless you have a friend or neighbor handy who knows something about this procedure do not attempt to remove the tubes yourself, as right at this point many expensive receivers have been damaged although it is a very simple matter to remove them safely when you have once seen it done. Most modern receivers have a tube layout chart inside or under the cabinet, or the individual tube sockets are marked for the type of tube that must be used in them. If their positions are not identified in either way, it is necessary to remove one tube at a time, and mark each socket plainly.

(To be continued)



FREE RADIO CATALOG!

KEEP 'EM LISTENING!

Send for this FREE Spring and Summer Catalog that shows Everything in Radio vital for our home front, our war production and our armed forces. More than 40 new Radio models; Sound Systems; Builders' Kits; radio instruction equipment; 15,000 parts for every radio need—all at lowest prices!





EVERYTHING IN RADIO AT LOWEST PRICES!

See the new 1942 table model sets, portables, phono-radios, etc.; new Communication sets; 7-60 watt Sound Systems; Builders' Kits; supplies for radio training; tubes, tools, books—everything in Radio to keep 'em listening, keep 'em learning, keep 'em producing!

Radio Builders' Handbook. Radio fundamentals for beginners. Invaluable. Only **10c**

Radio Dictionary. Complete, authoritative. Everyone in radio needs it. Only **10c**

LEARN RADIO!



ALLIED RADIO

833 W. Jackson Blvd., Dept. 5-F-2
Chicago, Illinois

Rush me your FREE New Catalog.
 Enclosed is 10c for Builders' Handbook.
 Enclosed is 10c for Radio Dictionary.

Name

Address

Free

SEND FOR IT NOW!

BUILD THE U.S.S. "CONSTELLATION"

The oldest warship afloat, of the U.S. Navy.
Recommissioned August 21, 1910 by direct orders of President Roosevelt.

Construction set with carved hull. Detailed blueprints and fittings may be purchased separately.
Send 20c (coin) for 1942 catalog—52 illustrated pages.

A. J. FISHER
1002-1 Etowah Ave., Royal Oak, Mich.



PHOTO ENLARGEMENTS

Is Photography your hobby? Do you want a profitable easy business at home? Make PHOTO ENLARGEMENTS for yourself and others. Your cost 5c each and less. The Ideal Photo Enlarger is AUTOMATIC. No experience required. Also COPIES any picture 5¢-34¢ COMPLETE. Interesting circular FREE.

5¢

Ideal-O, 148 West 23rd St., New York City

Print Your Own

Cards, stationery, circulars, tags, labels, photo and movie titles, advertising, etc. Save money. Print for Others. Good Profit; easy rules sent. Raised Printing like Engraving, too. Junior outfit \$8, Senior outfits from \$17.35. Send for free catalog and all details. KELSEY INC., 5-37, Meriden, Conn.



FRY CALCULATOR
CHICAGO'S & PATENT APPLIED FOR



ADDITION
SUBTRACTION
MULTIPLICATION
DIVISION

WORLD'S LOWEST PRICED ADDING MACHINE

Vest Pocket Size
FREE TRIAL
ONLY \$250

IDEAL FOR BUSINESS GUARANTEED ACCURATE. Not a toy. Operates with only a finger flick. Adds, subtracts, multiplies, divides. Counts up to ten million. Pays for itself over and over. Ideal Gift—for Business, Income Tax and School use. MONEY BACK GUARANTEE. Send name and address. Pay postman only \$2.50 plus postage. (Send full cash if outside U. S.) Money back in 10 days if not delighted. AGENTS WRITE.

CALCULATOR MACHINE COMPANY (Mrs.)
DEPT. 130 P. O. BOX 1118 CHICAGO, ILLINOIS

TOTAL COST SEND NO MONEY

5 Power HANDY, POCKET SPY GLASS WITH CASE

This beautiful, durable, black plastic Spy Glass with optically ground polished lenses gives a clear "5 TIMES CLOSER" view of distant objects. Weighs no more than a jack knife.



ONLY
\$1.89

A BIG VALUE

8" when extended. Collapses to go into 4" carrying case with button fastener and belt loops. Convenient to carry where ever you go. Lots of Fun! Many educational and practical uses. Immediate delivery assured. Sent C.O.D. or we will pay postage if you remit with order. Money back guarantee.
LAKESIDE OPTICAL COMPANY
Dept. PG 1708 Winnebago St. Chicago, Ill.

WITTE DIESELECTRIC PLANTS

Your present power bill will buy a WITTE that produces power and light for 1c a K.W.H. Save up to 75%. A Size for Every Need. Write today for finance plan, literature and name of dealer.



WITTE ENGINE WORKS, 174-A Oakland Ave., Kansas City, Mo.



METAL AND WOOD WORKING MACHINE TOOLS

Send for new **FREE** catalog of complete line of Machines, Motors and Accessories
WALKER-TURNER CO., INC. 162 Berkman St., Plainfield, N.J.

SHAW and Peppy-Pal "DU-ALL" GARDEN TRACTORS

1 to 9 H. P. Circulars on request. War limits production—YOU CAN BUILD YOUR OWN GARDEN TRACTOR

at small cost, powered by engine from washing machine, power mower, etc. \$1.00 brings our plans, postpaid, telling how to build a garden tractor, for cultivating, light plowing, etc., chiefly by welding and bolting up scrap steel.

SHAW MFG. CO., 4506 Front St., Galesburg, Kansas
668-G No. 4th St., Columbus, O.; 5812-G Magnolia Ave., Chicago, Ill.



TENNIS
SAVE on our NEW LOW PRICES

- Gut Tennis and Badminton Strings direct from factory to you.
- Silk Tennis Strings • Vises & Frames • Tennis Equipment.

H.E. WILLS CO. Catalog FREE
1047 W. 47 St. Dept. PM-62 Chicago

SAVES TIRES
JUST PAINT ON
So-Lo's KOTE-A-TIRE

PROTECT YOUR TIRES against checking, cracking and corrosion due to dirt, air and harmful rays of the sun... EASY TO PAINT! OLD AND NEW TIRES with So-Lo's KOTE-A-TIRE. Makes tires look like new.

SEND NO MONEY! Send your name and address today. We'll ship large can containing enough for 5 tires. Pay postman only \$1.00 plus few cents postage. Or send dollar now and save postage. **YOUR MONEY BACK** in 5 days IF NOT DELIGHTED. Write to So-Lo Works—Department H-206, 3317 Madison Road—Cincinnati, Ohio.

Large Can
Enough for 5 Tires. Only **\$1**

A Fast Seller—An Ideal Gift



No. R300 Drexel brand pen set. You get a 3 year service guarantee with it. Built for everyday, long-time use. Pen fitted with a tarnish-resisting point; easy-filling pump filler; transparent window for showing ink supply. Mechanical pencil to match. Beautiful jet black color. A simulation of an expensive set. Your money back if not the smoothest writer you ever used.

Sample set 35c; Dozen \$3.25

FREE WHOLESALE CATALOG Illustrates about 4000 fast sellers. 260 pages of unusual numbers, for agents, dealers and salesmen. Stock of catalogs limited. Send for your copy today.
SPORS CO., 442 National, Le Center, Minn.

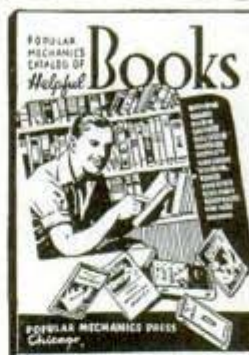

NEW POPULAR MECHANICS BOOK CATALOG

Give yourself the lift you need with pay-raising, extra money books. Every man who reads Popular Mechanics will want this new, big illustrated catalog of the world's BEST practical books on trades, professions, opportunities, crafts and hobbies. You must see it to appreciate its value. Send your name and address on penny post card. Do it today.

SEND YOUR NAME TODAY

POPULAR MECHANICS PRESS
Dept. 404, 200 E. Ontario St., Chicago

Get Your Share of U.S. Defense BONDS ★ STAMPS



MAKE AND SAVE MONEY WITH THE HELPFUL

LITTLE LIBRARY OF Useful INFORMATION

ONLY 25c EACH FIVE FOR \$1.00

The low cost and practical help you need. Illustrated with photos and diagrams. Order today.

1. Photo Enlargers
2. 14 Ft. Outboard Runabout
3. Electroplating
4. Woodworking Power Tools
5. Homemade Welders
6. Colored Concrete Garden Furniture
7. Bird Houses
8. Farm and Garden Tractors
9. Taxidermy
10. Automobile Kinks
11. Cleaning Formulas
12. Cosmetic Formulas
13. Treasure Finders
14. Log Cabins and Tourist Cottages
15. Food Product Formulas
16. Garden Woodwork and Furniture
17. Soldering and Brazing
18. Growing Miracle Plants
19. Home Work Opportunities
20. Telescopes
21. Metal Plating and Coloring
22. Fast Ice Yacht
23. Extra Rooms in Attic
24. Basement Playrooms
25. Photo Printer and Dryer
26. 14 Ft. Sailing Dinghy
27. Midget House and Utility Trailers
28. Metal Craft
29. Magic for Everybody
30. Building 16 Ft. Canoe
31. Lower Your Fuel Cost
32. Wood Turning
33. Trapping Small Animals
34. Motor-Driven Midget Car
35. Training Your Dog
36. Small Castings
37. Making Money With Hand Loom
38. Hanging Wallpaper
39. Backyard Gardening
40. Plain and Novelty Wood Finishing

POPULAR MECHANICS PRESS

200 E. ONTARIO STREET • Room 403 • CHICAGO

Two Tubes Equal Four in This Economy T.R.F. Set

(Continued from page 157)

coils with high impedance primaries. Use rosin-core wire solder for all connections and check your wiring carefully against both diagrams. A detailed list of the materials is available from Popular Mechanics radio department.

The set operates from any 105 to 125 volt a.c. or d.c. line. It will be noted that the

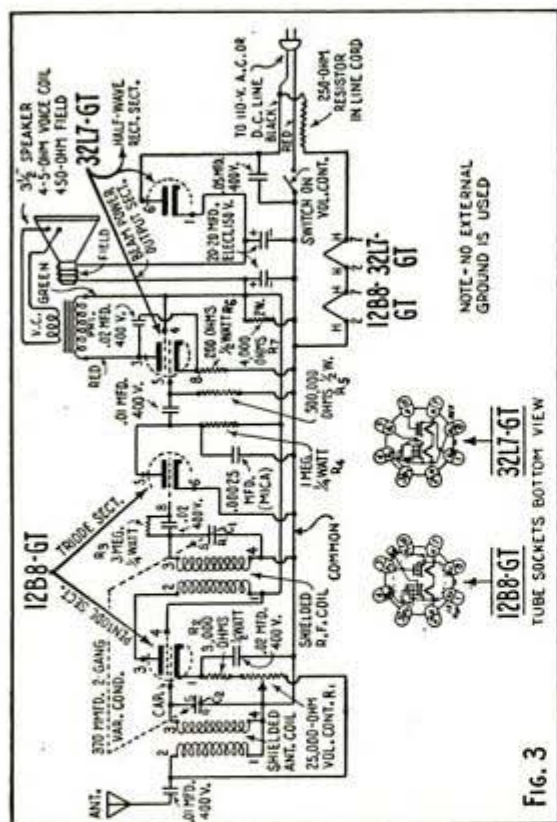

tubes are connected in series, and a 250-ohm linecord resistor is used to drop the line voltage to the proper filament voltage. To test the set, turn it on and allow about 30 seconds for warming up. A short antenna is all that is necessary for powerful local stations; no external ground is used. For DX reception a 50 or 75-ft. outside antenna will give excellent results. Tune to a station at the high frequency end of the broadcast band (lowest wavelength) and adjust each of the trimmer condensers on the side of the 2-gang variable condenser until the station comes in with maximum volume. The set is now properly balanced for the broadcast band. Blueprint number for this article is R-304.

DEFENSE BONDS and VALUABLES

Safe and Handy

IN ANY EMERGENCY

This Master Safety Box is strongly made of heavy gauge steel, beautifully finished in green wrinkle enamel. Just the thing for jewelry, cash, Defense Bonds and securities. No keys to lose!



CAT. NO. C-151

Select Your Own PERSONAL COMBINATION

Box No. C-151, 12 1/2" x 8 1/2" x 5 3/4", has removable eight-compartment tray. East \$5.50; West and South \$5.65; Gulf and Pacific States \$5.75. At your dealer or send check or money order to Master Metal Products, Inc., 329 Chicago St. Buffalo, N. Y.

Circular illustrating other types of boxes on request

A 2 OZ. HEARING AID BRINGS BACK A WORLD OF SOUND

Small as a pocket watch—yet enables a hard of hearing person to carry on normal conversation at twenty feet. Product of the Maico Company, Inc., which provides 90% of America's precision hearing test instruments, choice of America's armies and navies, ear physicians, airlines, etc.

FREE OFFER—You may give some hard of hearing friend, relative or acquaintance a happy day of good hearing—without cost or obligation. Send name and address of hard of hearing person to: THE MAICO COMPANY, INC., Dept. 10B, 2632 Nicollet Avenue, Minneapolis, Minnesota.

MAICO "ACE"
Transmitter Only
Weights 2 Ozs.

EMPIRE LEVELS

Preferred by MASTER CRAFTSMEN . . .

EMPIRE TORPEDO LEVEL . . . Finest and Handiest Accurate Level made. "Clear-shaped, no sharp corners to tear pocket. Walnut stock. Has Level, Plumb and 45° vials. 9" long, only 3 oz. No. 44 . . . \$1.10. Order from local dealer. Write for literature.

EMPIRE LEVEL MFG. CO., Dept. P-218, 717 S. Sixth St., Milwaukee, Wis.

MAKE Products REPLACING CRITICAL MATERIALS

Used daily in tremendous volume by the building industry.

We equip you with special line production machinery—using local low-cost raw materials—only modest investment required—balance easy monthly payments.

Scores of established manufacturers have proven the quality and salability of product, as well as the earning power and stability of this business. (Names on request.)

This opportunity offered only one man in each community to make this proven low-cost material. (Samples furnished.)

Act now while your territory is still open. Write or wire for Free Books and learn how you too can own one of these profitable businesses.

W. E. DUNN MFG. CO.
600 W. 24th St. Holland, Mich.



**TOOLING FOR
WAR PRODUCTION**
 Back of the planes and tanks and guns—back of our entire war program—stands the man behind the machine. In the toolroom of a large aeronautical plant, this craftsman at a South Bend Lathe is doing his part in defending America.



The Man Behind— the Man Behind the Gun!

"HOW TO RUN A LATHE"

A practical reference book for machinists, apprentices and shop students. Contains complete information on the operation and care of metal working lathes. 128 pages, 5½" x 8", 360 illustrations. Sent postpaid for 25c in stamps.

IN TIME OF WAR, the man behind the machine is just as important as the man behind the gun. Back of the production lines of every war industry is our first line of defense—the toolroom. Here, where precision is of the utmost importance—where tolerances are reckoned in split thousandths—you will find South Bend Lathes. Modern in design, built with extreme precision, South Bend Lathes are fast and accurate on the most exacting classes of toolroom work. Their wide range of spindle speeds permits machining with maximum cutting tool efficiency. Their versatility facilitates quick change-over through a minimum of set-up time.

South Bend Lathes are made in five sizes—9", 10", 13", 14½" and 16" swings, with toolroom or manufacturing equipment. We also manufacture turret lathes for production operations. Write for catalog and our dealer's name.

SOUTH BEND LATHE WORKS

618 E. MADISON STREET, SOUTH BEND, INDIANA, U. S. A.

LATHE BUILDERS FOR 35 YEARS



PRINTED BY POPULAR MECHANICS COMPANY, CHICAGO, ILL., U. S. A.

YOU'RE "ASKING FOR TROUBLE" WHEN YOU NEGLECT REPAIRS



GET A PACKARD CERTIFIED RE-WIRING CHECK-UP TODAY



Don't let the "blitz" of neglect put your car on the "fritz." The electrical system needs attention at regular intervals.

Go to a Packard Certified Re-Wiring station, where a trained Certified Re-Wiring mechanic will catch minor electrical troubles *before* they develop into major troubles. He will check the wiring with accurate instruments, replace defective cables with new Packard cables, and make necessary adjustments and repairs on electrical units.

Neglect this, and you may wind up with a big repair bill; do it now, and the cost will probably be small. Your car will use less gas, run better and run longer if you keep the electrical system in good repair. Packard Electric Division, General Motors Corporation, Warren, Ohio.

Packard

REG. U.S. PAT. OFF.
TRADE MARK

"WORKING FOR VICTORY"

Packard manufactures electrical cable for military aircraft, tanks, trucks, tractors, scout cars, barrage balloons, gun turrets and bomb releases.

THE STANDARD WIRING EQUIPMENT OF THE AUTOMOTIVE INDUSTRY



Where I work *It's*
CHESTERFIELD



Here's the answer to that . . . Chesterfields are *Milder, Cooler-Smoking and definitely Better-Tasting* in just the way you want a good cigarette to be. And no question about it, there's a lot more smoking pleasure in Chesterfield's Right Combination of the world's best cigarette tobaccos.

For steady enjoyment, make your next pack Chesterfields . . . regardless of price, there is no better cigarette made today.

Chesterfields are on the job
with Smokers everywhere *They Satisfy*

Copyright 1942.
LIGGETT & MYERS
TOBACCO CO.