

Battling War's Fire Bugs

POPULAR MECHANICS

MACHINE

UNDERSTAND IT

FEB.

25 CENTS

30c IN CANADA



SEE PAGE 1

YOU'RE "RIDING FOR A FALL" WHEN YOU NEGLECT REPAIRS



GET A PACKARD CERTIFIED RE-WIRING CHECK-UP TODAY



Don't let neglect of the electrical system "scuttle" your car and leave you stranded.

A Packard Certified Re-Wiring check-up will disclose minor defects in the wiring and electrical units *before* they lead to serious trouble. It will protect you from starting failure, poor gas mileage and sluggish performance; equally important, it will save you replacements of costly electrical units that can be ruined by neglect.

Your Packard Certified Re-Wiring mechanic has the specialized training and instruments to do the job right. All necessary cable replacements are made with Packard cable—the kind used in more than half of all new cars sold. Packard Electric Division, General Motors Corporation, Warren, Ohio.

PACKARD AND NATIONAL DEFENSE

Packard's extensive production facilities are turning out large quantities of Packard cable for military aircraft, tanks, trucks, tractors, scout cars, barrage balloons, gun turrets and bomb releases.

Packard
REG. U.S. PAT. OFF.
TRADE MARK

THE STANDARD WIRING EQUIPMENT OF THE AUTOMOTIVE INDUSTRY

NOW—THE WORLD-FAMOUS HARVARD CLASSICS at 1/3 the cost of current fiction!

Low price makes it easy for everyone to own THESE FAMOUS BOOKS that afford success and happiness!

HERE it is! The chance of a lifetime to own DR. ELIOT'S FIVE-FOOT SHELF OF BOOKS (The Harvard Classics) at a cost per volume 1/3 the price of popular fiction! Actually, for as little as 7¢ a day, you can have this marvelous library that makes a university of your home—a price so low that no one now needs to be without these world-famous writings.

Educational Background Necessary

To the modern man or woman, the broad background of general education is an absolute necessity for business or social success. Perhaps you didn't go to college. Perhaps you did—but missed the liberal courses that give cultural background. In either case, The Harvard Classics can make it up to you.

Liberal Education At Your Fingertips

It was the purpose of Dr. Charles W. Eliot, president of Harvard University for 40 years, to give the equivalent of a liberal education in this famous fifty-volume library. That he succeeded masterfully is borne out by the fact that more than half a million sets of 50 volumes each—or 25,000,000 actual volumes—have gone into American homes!

Nowhere else in the world will you find such riches for so little money! Brentano's, one of the largest firms of retail booksellers in the world, recently stated that for only the partial contents of The Harvard Classics, in ordinary cloth-bound editions, the cost would be \$402.00. Yet here, in a magnificent new Library Edition, exquisitely printed, beautifully illustrated, handsomely and uniformly bound, you can have these precious writings at a fraction of that cost! Truly, this is a marvelous opportunity!

Contents Complete, Inclusive

This handsome new edition contains the complete contents of DR. ELIOT'S FIVE-FOOT SHELF OF BOOKS! Every word, every line, every paragraph is here! Fifty volumes, 22,407 pages of superb reading, 418 of the world's masterpieces,

the famous Lecture Volume, the Daily Reading Guide—and the unique Index of 76,000 entries that gives you the key to this vast storehouse of knowledge! All at a cost per volume 1/3 the price of a current popular novel!

Unusually Liberal Terms

Not only is the new price of these famous books amazingly low! You are given the advantage of extremely liberal terms. Think of it! For an initial payment as low as \$2.00 you may have this luxurious edition placed in your home with all shipping charges prepaid by us! No man or woman in America needs to wait longer to profit from the stimulation, inspiration and entertainment of these precious volumes!

Send For This Famous Free Book

The famous little book, "Fifteen Minutes a Day," furnishes you with full information about The Harvard Classics. It gives Dr. Eliot's own plan of reading—is packed with helpful, practical information! It also contains "Men Behind the Classics," dramatic biographies of men whose immortal writings appear in the Harvard Classics. This book is beautifully illustrated and is a gem of literature. It is a welcome addition to any library. It will be sent you free, postpaid and without obligation. Simply fill out and mail the coupon below.

DR. ELIOT'S FIVE-FOOT SHELF OF BOOKS (THE HARVARD CLASSICS)



THIS COUPON ENTITLES YOU TO FREE BOOKLET (For Adults Only)

P. F. COLLIER & SON CORPORATION
The World's Largest Subscription Booksellers
250 Park Avenue, New York City

Yes! I am interested in receiving by mail, free and without obligation, your valuable booklet, "Fifteen Minutes a Day," describing the famous library, Dr. Eliot's Five-Foot Shelf of Books (The Harvard Classics) and containing Dr. Eliot's own plan of constructive reading.

BCN 693

Mr. _____
Name Mrs. _____
Miss _____
Address _____



THE HARVARD CLASSICS
50 VOLUMES
delivered for initial payment as low
as \$2.00

Busy

with a great big

capital

Telephone lines are humming as they never have hummed before.

About 1,300,000 new telephones have been installed in the past year. An average of 85,000,000 calls are completed every day. Both are all-time records.

The job is big and getting bigger but we're working at top speed to keep pace with every need. And increasing our facilities as fast as possible.

The Bell System put about 400 million dollars into new construction in 1941 and will spend millions more this year.

B



BELL TELEPHONE SYSTEM



"THE TELEPHONE HOUR" is broadcast every Monday evening over the N. B. C. Red Network

Popular Mechanics Magazine

Registered in U. S. Patent Office and Canada

H. H. WINDSOR, Founder

H. H. WINDSOR, Jr., Editor and Publisher

February, 1942

Vol. 77, No. 2

IN THIS ISSUE

Fighting at 50,000 Feet	1
Flying "Spiders" on Guard	8
On the Anti-Tank Firing Range	14
Solving Mysteries of the Deep	17
Subway for Black Gold	28
Every Ounce Counts on a Clipper	34
Battling War's Fire Bugs	40
Cave Men Up-to-Date	46
This Modern Age of Mud	50
Speed Demons of the Air Forces	56
The Ship That Never Sails	66
Hitch-Hiking on the Big Waves	72
Smokeless Town	78
Human Ant Hill	82
Wanted: 200,000 Men	92

Where-to-Buy-It Index Starts on Next Page

Tomorrow's Plane Takes Shape

ALREADY riding American skies are the largest and probably the fastest airplanes in the world. On the drawing boards are planes that will dive as fast as sound, interceptors that will better seven miles a minute. By spring, Lockheed hopes to test-fly transports for U. S. air lines that will carry 64 passengers at 300 miles an hour, the thin air 30,000 feet up their element. No fanciful tale, this, but facts up-to-the-minute. You'll read it in March: a story of new wings, new engines, new planes of '42.

Building the "Liberty" Fleet

THEY thought the pace of ship construction in world war days would never be equaled. Vessels were launched six months after keels were laid; but those records are too slow for us. The new "Liberty" ships will slide into water three or four months after they begin to take shape! An article next month pictures for you our gigantic shipbuilding program.

Next Month

YOU are a victim of color. Or a beneficiary. Tea rooms use it to whet your appetite, slow your departure. Blue-green walls, green sawdust floors of packing houses accentuate the redness of meat in the showcases and increase sales. By suitable use of red, the boss can get more muscular activity out of you. In the hospital, yellow walls cheer on your recovery. For a good look at what they're doing to you with color, see the March Coloroto story: "Color at Work," with its eight pages of pictures in color.

Submarine Sailors

IF YOU like the reek of hot Diesel oil and the acrid fumes of batteries, if you can "take" the smothering sensation of artificial lungs in a deep-sea escape and the stabbing pain of 50 pounds compression, if you've a stomach of steel and a shatterproof temper and the clear brain and courageous heart you'll need in emergencies, you may qualify for the submarine service. Read "Super Sailors for the Subs" next month.

The Battle for Safety

GENERAL Carelessness is leading a blitzkrieg exacting close to 20,000 lives a year in our factories. Industrial safety has become an industry itself. A March story tells of new developments on this front: electric eyes and wire "handcuffs" to shut off dangerous machines, waterfalls that curtain dust, weird "Martian" uniforms. Here's a war being won.

Published monthly by POPULAR MECHANICS COMPANY, 200 East Ontario Street, Chicago, U. S. A. Single copy in the United States, 25 cents; subscription rates in United States and possessions, and countries of the Pan-American Postal Union including Spain, \$2.50 a year. Single copy in Canada, 30 cents; subscription rates, \$3.00 a year. To all other countries add \$1.00 a year over United States prices for overseas postage. Changes in address must be reported to us immediately to eliminate delay. Entered as Second Class Matter, Sept. 15, 1903, at the Post Office at Chicago, Illinois, under Act of March 3, 1879. Entered as Second Class Matter at Post Office, Dept. Canada.

Copyright 1942, by Popular Mechanics Company, Copyright under International Copyright Union. All rights reserved under Pan American Copyright Union. Printed in the United States of America



Prepared...

As a winter-time motorist, you too can be soundly prepared against severe emergencies almost sure to come. Sudden blizzards. Bitter cold. Simply put Pyroil in your engine. Then throughout winter's fiercest you can drive care-free!

You need Pyroil's protection every mile you drive. Because Pyroil stands guard constantly against power-stealing contaminations that build up quickly in the average car. Hard carbon weakens valve and ring action. Moisture brings corrosion into your engine. Then look out for early wear! Gum and sludge hamper performance. These faults show up when tough winter driving calls for full power.

Pyroil puts an end to this. First, it cleans out these harmful by-products of every-day operation. Second, it keeps them out. Third, it keeps your engine always fit and ready for safe, efficient driving. Fourth, it makes your engine start easier, saves wear and battery drain, in coldest weather!

Be prepared with Pyroil! Ask your service man—today—to add a mere three ounces of Pyroil to the gasoline tank; twelve ounces to the crankcase. Then you'll know why so many all-weather motorists all over the world say, *I wouldn't drive a mile without Pyroil!* Manufactured and guaranteed by Pyroil Company, W. V. Kidder, Founder, 52 Pyroil Bldg., LaCrosse, Wisconsin, U. S. A.



FREE: Two brief but important-to-you message folders, "CONSERVING TRANSPORTATION," and "CLEAN OUT THAT ENGINE NOW!" Send coupon below and receive these Free.

DISTRIBUTORS:
CHECK AND MAIL COUPON FOR FRANCHISE FACTS.

PYROIL COMPANY
52 Pyroil Bldg., LaCrosse, Wisconsin

Please send me a copy of each of the two new message folders, "Conserving Transportation," and "Clean Out that Engine Now."

Send details of your plan for Distributors.

Name.....
Address.....
City or town.....State.....

WHERE-TO-BUY-IT INDEX

Where no name and address appear directly under an item, the product is not believed by us to be commercially available

Dog wears radio set.....	5
Dispenser for sauce bottle.....	5
Goldblatt Bros. State and Van Buren, Chicago	
Plastic coil for fluorescent tube.....	6
Schwab and Frank, Inc., Detroit, Mich.	
Rubber flashlight resists water and shock.....	6
Wm. M. Lennan, Inc., Pasadena, Calif.	
Oval bike-sprocket takes less energy.....	6
Stanley J. Blenke, 4437 E. Marshfield Ave., Chicago	
Grim faces painted on American-made planes.....	7
Frozen food delivered by trucks.....	7
Henney Motor Co., Freeport, Ill.	
Welded steel "igloo".....	7
Control for anti-aircraft weapon.....	12
Powder quells magnesium fires.....	12
Roy G. Davis Co., 617 E. 3rd St., Los Angeles, Calif.	
Largest flying boat.....	13
Shoe sole has nonskid tread.....	13
Sperry Top-Sider Footwear, 15 Main St., Beacon Falls, Conn.	
Heat-resistant "vanishing oil".....	13
Nonstop transatlantic plane.....	16
Mt. Rushmore memorial completed.....	25
Air-conditioned operating room.....	25
Carrier Corporation, Syracuse, N. Y.	
Chemical device melts ice in drain.....	26
Eastern States Supply Co., 127 Troutman St., Brooklyn, N. Y.	
Short, lightweight infantry rifle.....	26
Snowplow hooked to car.....	26
W. M. Coon Co. 72 Middlesex Rd., Buffalo, N. Y.	
Trainer planes await call to service.....	27
Grand piano has transparent base.....	27
Rudolph Wurlitzer Co., DeKalb, Ill.	
"Straddle chair" has tea tray.....	32
Geiler Co., Merchandise Mart, Chicago	
Sand blaster for small articles.....	32
Strang Mfg. Co., West Unity, Ohio	
Adjustable winter front for auto.....	32
Sears Roebuck & Co., Chicago	
Electronic revolving door.....	32
International Steel Co., Evansville, Ind.	
Acoustic mine.....	33
Portable runway for army airport.....	33
Suspension test for wheel balance.....	38
Sutton Mfg. Co., 2952 College Ave., Berkeley, Calif.	
Gauge measures gun bore.....	38
The Sheffield Gauge Corp., Dayton, Ohio	
Nonreflecting glass surface.....	38
Dry adhesive labels.....	39
Avery Adhesives, 451 E. 3rd., Los Angeles, Calif.	
Illuminated beverage fountain.....	39
National Silver Deposit Ware Co., Merchandise Mart, Chicago	
Special fixtures for heat lamp.....	44
General Electric Co., 570 Lexington Ave., New York City	
Lack of vitamin A increases night blindness.....	44
Metal chimney for gas furnace.....	44
Skuttle Sales Co., 999 Franklin St., Detroit, Mich.	
Fabric woven from cow's milk.....	45
Soldering stand has magnifier and lights.....	48
Photobell Corp., 116 Nassau St., New York City	
Patches vulcanized on stockings.....	48
No-Darn, 219 W. Chicago Ave., Chicago	
Tabulator keeps auto record.....	48
Automatic Gas-Lok Mfg. Co., 21 E. Van Buren, Chicago	
British bomber has three bomb racks.....	49
Powerful steam boiler.....	49
Portable bridge span for army.....	54
Self-locking link for skid chain.....	54
Leviton Specialty Co., 2328 S. Michigan Ave., Chicago	
Plane model teaches use of controls.....	55
Bomb sight aimed through plane floor.....	55

(Continued to page 6A)

DEATH WAILED THROUGH THE HIDEOUS NIGHT!



A true experience of HENRY STERGER, Fisher, Minn.



"MY WIFE AND I KNEW WHAT those signs meant—the jarring wind, the powdery snow streaking across our headlights, the quick cold. And then our lights went dim, trees and road disappeared, and the blizzard struck.

"SOON WAIST-HIGH drifts forced us to abandon the car a half a mile from home. As our feet touched the ground the wind kited us into a ditch 100 feet away. Dazed, bruised and nearly frozen, we struggled to our feet. I reached for my flashlight and with the aid of its steady beam, now stumbling, now falling, now rising, we inched along through the awful night.



"NUMB WITH COLD, more dead than alive, we at last fought our way to a farm building—our granary. Inside the granary, by means of the flashlight, I found an old hay knife, with which I cut enough wood to build a fire. Huddled close to its life-giving warmth, we weathered the blizzard. Beyond question of a doubt we are alive today because of our 'Eveready' flashlight and its dependable *fresh* DATED batteries. (Signed) *Henry Sterger*"

The word "Eveready" is a registered trade-mark of National Carbon Company, Inc.



FRESH BATTERIES LAST LONGER... Look for the DATE-LINE

NATIONAL CARBON COMPANY, INC., 30 EAST 42nd STREET, NEW YORK, N. Y.
Unit of Union Carbide and Carbon Corporation

UCC

This One



UC2W-P76-6RWX

READ WHAT YOU CAN DO

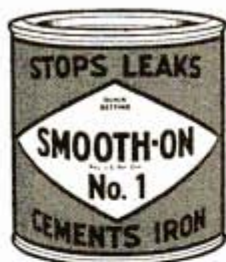

with
SMOOTH-ON
and
a little water



SEAL CRACKS
Don't assume that a crack in your heating boiler, radiator or tank means an expensive repair or replacement. Just force some Smooth-On into the crack, and you will have a *tight, lasting seal* . . . at the cost of a few cents.



STOP LEAKS

When water, steam, gas, or oil leaks from pipe joints, you need not take apart the connection for a dirty, lengthy repair job. Just tamp a little Smooth-On into the leaky joint, and you'll have a *permanently tight* connection.

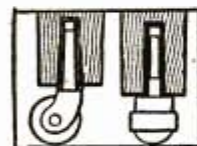

TIGHTEN LOOSE PARTS

Don't throw away utensils, tools, or fixtures just because handles or other parts become loose. A little Smooth-On, and they are fully useful again.

These are some of the many uses around the home, car and shop that make Smooth-On a real household necessity. Smooth-On is easy to apply, requires no special tools or heat, and makes repairs that *last*.

Buy Smooth-On in 1 1/2 oz., 7-oz., 1 lb., and larger cans from your dealer or if necessary from us. For your protection, insist on Smooth-On, proved by 47 years on the market.

FREE SEND THIS COUPON

and we will mail you, ABSOLUTELY FREE, a copy of our latest Smooth-On Handbook, 40 Pages packed with useful information on how to make lasting repairs. Contains 170 helpful diagrams. Mail it today!

Smooth-On Manufacturing Co., Dept. 37
570 Communipaw Ave.,
Jersey City, N. J.

Name.....
Address.....
2-42.....

Free

Do it with **SMOOTH-ON**

(Continued from page 4A)

Indoor barbecue table	59
Chas. A. Robinson, 8290 Santa Monica Blvd., Hollywood, Calif.	
Instrument warns pilot of lightning peril.....	59
General Electric Co., Schenectady, N. Y.	
Tiny explosionproof pump.....	60
Eastern Engineering Co., 45 Fox St., New Haven, Conn.	
Self-inflating duck decoy.....	60
Deeks, Inc., Kearns Bldg., Salt Lake City, Utah	
View finder for television camera.....	60
Allen B. Du Mont Laboratories, Inc., Passaic, N. J.	
Scale model of "sub cheater".....	61
Models show how street lamp spreads light.....	61
Metal hand sander.....	61
T. B. McGinnis, 400 W. 4th St., Big Spring, Texas	
Cutting 'em up to show 'em.....	62
Mobile water tank and cup supply.....	64
Universal Paper Products Co., 823 S. Wabash, Chicago	
Hand-saw cover stops rust.....	64
E. C. Atkins & Co., 402 S. Illinois St., Indianapolis, Ind.	
Triangle provides six angles.....	64
Elmer Coffey, LaGrange, Ill.	
Amphibian tank hauls 40 men.....	65
Motorcycle ambulance runs 90 m.p.h.....	65
Auto vacuum sucks poison from snake bite.....	69
Bumper extension prevents hooking cars.....	69
Von Gunten Enterprises, 999 Copley Rd., Akron, Ohio	
Automatic telephone dial.....	70
Automatic Electric Co., 1033 W. Van Buren, Chicago	
Adjustable platform on ladder.....	70
R. W. Fieroh, 3401 S. Hayne Ave., Chicago	
Animated tree model.....	71
Table clock has two faces.....	71
The Hobar Co., 220 5th Ave., New York City	
Auto scoop on tow truck.....	75
Bear Mfg. Co., Rock Island, Ill.	
Mobile engineering laboratory.....	76
Submarine cargo vessel towed by warship.....	77
Xylophone made with rock bars.....	77
Crane on trailer lifts airplane engines.....	80
Plastic tape for sealing windows.....	80
Metropolitan Mfg. Co., 1851 Flushing Ave., Brooklyn, N. Y.	
Balloon or kite lifts antenna.....	81
Hot-dog steamer for home.....	81
Luxhorn Corp., 20 E. Jackson Blvd., Chicago	
Skylight window washers.....	86
Drag bucket digger loads trucks quickly.....	86
Sauerman Bros., Inc., 438 So. Clinton St., Chicago	
"Direct printer" speeds defense plans.....	87
Auto heater in cowl ventilator.....	87
Liberty Foundries Co., Rockford, Ill.	
Gun torpedo shatters warship.....	88
Telescopic truck loads railway car.....	90
Movable guide helps trim photos.....	90
Photo Materials Co., 1323 S. Michigan Ave., Chicago	
Model of Soap Box Derby course.....	91
Light-reflecting letters for signs.....	91
Minnesota Mining & Mfg. Co., St. Paul, Minn.	
Fluorescent light tube can be bent.....	95
Everbright Electric Signs, Inc., 1440 N. 4th St., Milwaukee, Wis.	
Rubber pneumatic door silencer.....	95
Glynn-Johnson Corp., 1821 Berteau Ave., Chicago	
Meter tests vibration of machines.....	96
Westinghouse Research Laboratories, E. Pittsburgh, Pa.	
Adjustable pan insert for steaming food.....	96
Goldblatt Bros., State and Van Buren, Chicago	
Self-inflating life saving belt.....	96
Stark's Sport Store, 33 S. Wabash Ave., Chicago	
Television for the home.....	155
Allen B. Du Mont Laboratories, Inc., Passaic, N. J.	
Plastic handle radio tools and service kit.....	159
Park Metalware Company, Inc., Orchard Park, N. Y.	
Rechargeable flashlight battery.....	159
Allied Radio Corp., 833 W. Jackson Blvd., Chicago	
No-tool outlet plug.....	159
Allied Radio Corp., 833 W. Jackson Blvd., Chicago	

(Continued to page 8A)

This Bottle Neck is Your Opportunity



A very real bottle neck has occurred in industry.

The millions of men going to work in the defense industry and business boom need thousands—hundreds of thousands—of supervisors and executives. Expanding Government agencies are calling for many specialists. Regular business needs experts to take care of expansion and to replace men called to military service.

The need is for all sorts of executives and specialists—foremen, supervisors, superintendents, accountants, traffic men, tax experts, time keepers, department managers, auditors, cost experts, production men, etc. The need will grow and continue for years to come.

There just are not enough men ready for these places nor can industry take the time to train them. Thousands—scores of thousands—must get their own training.

That is your opportunity—if you are ready or will get ready quickly. Never again will you have such an opportunity to command the success you want. But you must act decisively—immediately. The more quickly you get ready,

the sooner these millions of new workers will be pushing you up the ladder.

And LaSalle Offers You Just the Help You Need

Our courses are practically built to order for this opportunity. Condensed, practical—the minimum of theory and the maximum of practice. Prepared for spare time study—you can go as fast or slowly as you wish. You need not wait until you finish—what you study tonight, you can use on the job tomorrow. All are specialized, executive training courses. They are moderate in cost and easy terms are available.

Some of our training programs may cover just the field in which you see opportunity. Read them in the coupon below. Then check the one about which you wish full information—and mail the coupon today. Remember—the sooner you start, the sooner you will be ready for the opportunity.

LASALLE Extension University A Correspondence Institution

Dept. 264-R
CHICAGO

I'd like to get ready for one of these supervisory jobs. So please send me your free 48-page booklet on the field I have checked below—and full information about your training in that field.

- | | | |
|--|---|---|
| <input type="checkbox"/> Industrial Management | <input type="checkbox"/> Traffic Management | <input type="checkbox"/> Executive Management |
| <input type="checkbox"/> Modern Foremanship | <input type="checkbox"/> Salesmanship | <input type="checkbox"/> Business English |
| <input type="checkbox"/> Accounting | <input type="checkbox"/> Law | <input type="checkbox"/> Stenotypy |

Name.....Age.....

Address.....

Present Position.....



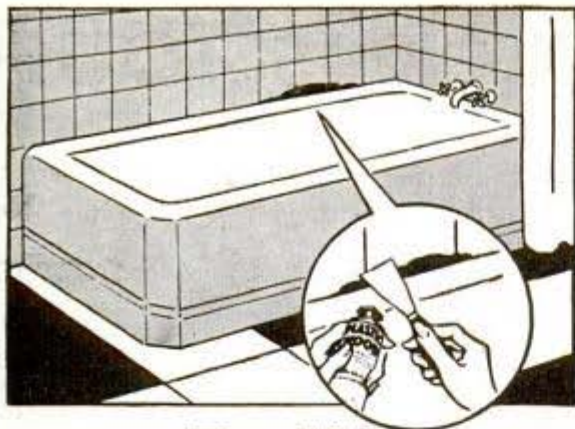

P. W. RESEALS BATH TUBS

You can quickly and easily seal unsightly cracks around bathtubs and sinks, and reset loose bathroom fixtures and tiles with water-resisting PLASTIC WOOD.



PLASTIC WOOD

BANG

Does Your Washer Drive You Wild?

QUIET IT WITH 3-IN-ONE

Washing Machines and Electric Refrigerators operate quieter, smoother when lubricated periodically with Heavy Body 3-IN-ONE Oil! Guards against rust—cuts down repair bills. At Hdwe., Drug, Grocery, 10¢ Stores.

HEAVY BODY 3-IN-ONE OIL

(Continued from page 6A)

Seven-tube automatic chairside combination.....	160
Farnsworth Television and Radio Corp., Fort Wayne, Ind.	
FM speaker has tone diffuser.....	160
Zenith Radio Corp., Chicago	
Super band-spread foreign tuning.....	160
Midwest Radio Corp., Cincinnati, Ohio	
One-hundred watt amplifier.....	160
Montgomery Ward & Co., Chicago	

Craftsman and Shop Notes Index

ART AND ARTISTS

Attachment for vanishing points.....	99
T-square kept from slipping.....	114
Tracing easel from picture frame.....	123
Utility drawing table.....	127
Thimble clip on brush aids sign writer.....	144
Inverted tumbler used as tray.....	144

AUTOMOTIVE

Lengthening small armature shafts.....	148
Shooting auto-starter troubles.....	149
Instrument-panel lights softened.....	152
Changing dealers' license plates quickly.....	152
Protecting cylinder when fitting bearing.....	152
Mechanic's apron held by sponge-rubber buttons.....	152
Electrical leaks located by compass.....	152
Grease fitting used to flare copper tubing.....	153
Car-side ski rack.....	153
Anti-spread chain for truck.....	153
Reclaiming used motor oil.....	153
Removable clearance lights for truck.....	154
Motor armatures clamped in vise.....	154

FARM

Horseshoe is handle on oil can.....	102
Sled runners from horseshoes.....	136
Three-speed pump jack.....	138
Gasket under pump excludes surface water.....	138
Weighted grain-drill openers.....	138
Staking down feed basket.....	144
Mice kept out of binder canvas.....	145
Rubber ball is stopper for acid carboy.....	146
Fastening wire on temporary fence.....	146
Pail elevates poultry feed pan.....	148

FURNITURE

Grille-door bookcase.....	97
Wood chest and bellows.....	110
Music cabinet.....	125
Replacing worn seats with upholstery.....	128

HAND TOOLS

Nail aids in driving cotter key.....	99
Emergency nail set.....	102
Broken nail set repaired.....	103
Centering gauge from tin box.....	112
V-blocks from pieces of pipe.....	112
Tool for locking stove-pipe seams.....	114
Jaws hold oval work in vise.....	118
Auto valve as tack hammer.....	118
Rubber mallet on hammer handle.....	151
Welding rod holder.....	151

HOUSEHOLD

Solving home problems.....	100
Brush fastened on paste jar.....	102
Repair for porcelain tanks.....	104
How to repair slide fasteners.....	105
Pictures hung straight with plumb bob.....	107
Keeping firing tools out of sight.....	112
Keeping pests from garbage can.....	114
Plants grown from cuttings.....	115
Fastening handles on twisted wire brushes.....	118
Scroll party invitations.....	128

(Continued to page 10A)

Where will you be ~~11 months~~ ~~ONE YEAR~~ FROM TODAY?



● This is the year you were going to get out of that rut — remember? The year you were going to *do* something about making progress in your work, and increasing your income. Yet here's one whole month gone by, and you're still marking time.

Take the first step toward Personal Success this very minute, sir: Look over the coupon below, and mark the course closest related to your line of work. Then mail it — *today!* Without obligation, we will send you complete information on International Correspondence Schools, and how they can give you the sound, practical knowledge and training you need in order to get ahead faster. Including information on the surprisingly low cost, the easy-to-understand texts, the *personal* service every I. C. S. student gets.

The time to "take steps" is **RIGHT NOW!**

INTERNATIONAL CORRESPONDENCE SCHOOLS

BOX 5626-J, SCRANTON, PENNA.

★ Without cost or obligation, please send me a copy of your booklet, "Who Wins and Why," and full particulars about the course *before* which I have marked X: ★

TECHNICAL AND INDUSTRIAL COURSES

- | | | | |
|--|--|---|--|
| <input type="checkbox"/> Air Brake | <input type="checkbox"/> Contracting and Building | <input type="checkbox"/> Marine Engines | <input type="checkbox"/> Sanitary Engineering |
| <input type="checkbox"/> Air Conditioning | <input type="checkbox"/> Cotton Manufacturing | <input type="checkbox"/> Mechanical Drafting | <input type="checkbox"/> Sheet Metal Work |
| <input type="checkbox"/> Airplane Drafting | <input type="checkbox"/> Diesel Engines | <input type="checkbox"/> Mechanical Engineering | <input type="checkbox"/> Ship Drafting |
| <input type="checkbox"/> Architectural Drafting | <input type="checkbox"/> Electrical Drafting | <input type="checkbox"/> Mine Foreman | <input type="checkbox"/> Shipfitting <input type="checkbox"/> Shop Practice |
| <input type="checkbox"/> Architecture | <input type="checkbox"/> Electrical Engineering | <input type="checkbox"/> Navigation | <input type="checkbox"/> Steam Electric <input type="checkbox"/> Steam Engine |
| <input type="checkbox"/> Auto Engine Tune-up | <input type="checkbox"/> Electric Lighting | <input type="checkbox"/> Patternmaking <input type="checkbox"/> Plumbing | <input type="checkbox"/> Steam Fitting |
| <input type="checkbox"/> Auto Technician | <input type="checkbox"/> Foundryman <input type="checkbox"/> Heating | <input type="checkbox"/> Practical Telephony | <input type="checkbox"/> Structural Drafting |
| <input type="checkbox"/> Aviation <input type="checkbox"/> Aviation Mechanic | <input type="checkbox"/> Heat Treatment of Metals | <input type="checkbox"/> Public Works Engineering | <input type="checkbox"/> Structural Engineering |
| <input type="checkbox"/> Boilermaking | <input type="checkbox"/> Highway Engineering | <input type="checkbox"/> Pulp and Paper Making | <input type="checkbox"/> Surveying and Mapping |
| <input type="checkbox"/> Bridge Engineering | <input type="checkbox"/> House Planning | <input type="checkbox"/> Radio, General | <input type="checkbox"/> Telegraph Engineering |
| <input type="checkbox"/> Chemistry | <input type="checkbox"/> Industrial Metallurgy | <input type="checkbox"/> Radio Operating | <input type="checkbox"/> Telephone Work |
| <input type="checkbox"/> Civil Engineering | <input type="checkbox"/> Locomotive Engineer | <input type="checkbox"/> Radio Servicing | <input type="checkbox"/> Textile Designing |
| <input type="checkbox"/> Coal Mining | <input type="checkbox"/> Machinist | <input type="checkbox"/> R. H. Section Foreman | <input type="checkbox"/> Toolmaking |
| <input type="checkbox"/> Concrete Engineering | <input type="checkbox"/> Management of Inventions | <input type="checkbox"/> R. R. Signalman <input type="checkbox"/> Refrigeration | <input type="checkbox"/> Woolen Manufacturing <input type="checkbox"/> Welding |

BUSINESS COURSES

- | | | | |
|--|--|--|---|
| <input type="checkbox"/> Accounting <input type="checkbox"/> Advertising | <input type="checkbox"/> College Preparatory | <input type="checkbox"/> First Year College | <input type="checkbox"/> Railway Postal Clerk |
| <input type="checkbox"/> Bookkeeping | <input type="checkbox"/> Commercial | <input type="checkbox"/> Foremanship <input type="checkbox"/> French | <input type="checkbox"/> Salesmanship |
| <input type="checkbox"/> Business Correspondence | <input type="checkbox"/> Commercial Illustrating | <input type="checkbox"/> Good English | <input type="checkbox"/> Secretarial <input type="checkbox"/> Spanish |
| <input type="checkbox"/> Business Management | <input type="checkbox"/> Cost Accounting | <input type="checkbox"/> High School | <input type="checkbox"/> Showcard and Sign Lettering |
| <input type="checkbox"/> Cartooning <input type="checkbox"/> Civil Service | <input type="checkbox"/> C. P. Accounting | <input type="checkbox"/> Managing Men at Work | <input type="checkbox"/> Traffic Management |

HOME ECONOMICS COURSES

- | | | |
|---|---|---|
| <input type="checkbox"/> Advanced Dressmaking | <input type="checkbox"/> Home Dressmaking | <input type="checkbox"/> Tea Room and Cafeteria |
| <input type="checkbox"/> Foods and Cookery | <input type="checkbox"/> Professional Dressmaking and Designing | <input type="checkbox"/> Management, Catering |

Name.....Age.....Address.....

City.....State.....Present Position.....

Canadian residents send coupon to International Correspondence Schools Canadian, Limited, Montreal, Canada
British residents send coupon to I. C. S., 71 Kingsway, London, W. C. 2, England

Establish
SELF
CONFIDENCE

KNOW WHAT TO DO
- AND WHEN TO DO IT!

IS your faith in yourself shaken? Can you adjust yourself to the changing times? Have you found your plans and enterprises suddenly thwarted by the unexpected—robbing you of confidence? You do not have to be a prophet to know what is coming—or a miracle worker to make the most of an opportunity. Just as straws in the wind show its directions, so you can learn from the things people do what their moods and fancies are—and use them to your good advantage. If you once know human nature—its traits and psychological tendencies—you will have a confidence, born of knowledge, and equal to every situation.

ACCEPT THIS *Free* BOOK

For several centuries the Rosicrucians—a world-wide Fraternity—have made a study of these *functions of mind* and their relationship to human conduct in the world in which we live. To thousands of men and women they have made life less mysterious—and success and happiness more assured. Write today for a free copy of the book, *The Secret Heritage*. It contains no strange formulas, but tells how you may have these beneficial teachings for study in the privacy of your home. Address Scribe J.Q.G.



The ROSICRUCIANS (AMORC)
ROSICRUCIAN PARK SAN JOSE, CALIF.
NOT A RELIGIOUS ORGANIZATION

YOU CAN HELP

SHOES, TIRES, RUBBER GOODS Last Longer.
Fix them with new plastanoid 'putty.'

MENDS holes and worn spots in leather, cloth, rubber. Spreads on like butter. Dries tough overnight. Flexible, non-skid, water-proof. Won't come off—guaranteed, 25 repairs—25 cents.

MENDS THE HOLE

So-Lo THE HOLE

AT HARDWARE AND 10c STORES

(Continued from page 8A)

LAWN AND GARDEN

Holding garden hose in pail.....	102
Bird feeder from mixing bowls.....	108
Air space under ice in fish pool.....	118
Lawnmower held against wall.....	128

METALWORKING

Turning thin metal washers.....	108
High-temperature furnace.....	137
You can spin it.....	140

PAINT AND PAINTING

Skin removed from top of paint.....	124
Bucket ladder hooks easily made.....	128
How to avoid drying of paint.....	146

PHOTOGRAPHY

Combination feet for tripod.....	129
Ferrotypes-in rack of wood.....	129
Extension hood for reflex camera.....	130
Self-closing box for photo-paper.....	130
Tilting enlarging easel.....	130
Rubber bands hold tripod legs.....	130
Checking camera shutter speeds.....	131
Inexpensive film slitter.....	133
Black spots removed from prints.....	133

POWER TOOLS

Centering fixtures for drill press.....	135
Keeping sawdust out of motor.....	138

RADIO AND ELECTRICITY

Time switch from alarm clock.....	151
FM adapter for your radio.....	156
"Black light" radio burglar alarm.....	158
Mounting octal socket on breadboard.....	159
Spark plug used as "thru-panel" insulator.....	159
Salvaging short lengths of copper tubing.....	159
Increasing bass response from phono pickup.....	159

STORE AND SHOP

Holding rule while cutting glass.....	108
Cards held vertical in file.....	108
Adjustable light for workbench.....	109
Shipping tags carried on wire hoop.....	139
Coil spring in dustpan cleans broom.....	139
Colored line aids press feeder.....	139
Plumber's candle holder from floor flange.....	139
Sandpaper paddle aids garment presser.....	144
Keys marked by linotype slugs.....	144
Weighing chlorine gas in drum.....	148
Pin tags as tabs to remove box lids.....	148
Screen wire kept from unrolling.....	148

TOYS AND NOVELTIES

Cigar lighter fires toy steam engine.....	104
Coin bank from rubber ball.....	104
Dutch-girl tray for glasses.....	107
Nursery yacht.....	113
Lamp merry-go-round.....	119
Ship plaques in metal and wood.....	120
Block dolls.....	123

WOODWORKING

Bar clamps from auto tie rods.....	99
Telescoping candy bowl.....	103
Decorative turned lamps.....	109
Sawhorse lifts work.....	112
An aid in mortising hinges.....	118
Rosin-coated nails hold firmly.....	127
Thickness sander on lathe.....	147

IMPORTANT NOTICE

It is the intention of this magazine to provide its readers with information regarding the latest developments in the mechanical arts. We take no responsibility as to whether the disclosures contained in our articles are covered by patents and advise readers to investigate this subject before making, using, or selling any of the products, machines, or processes described in order to avoid possible liability for patent infringement.

AUDELS NEW MACHINISTS HANDY BOOK NOW READY!

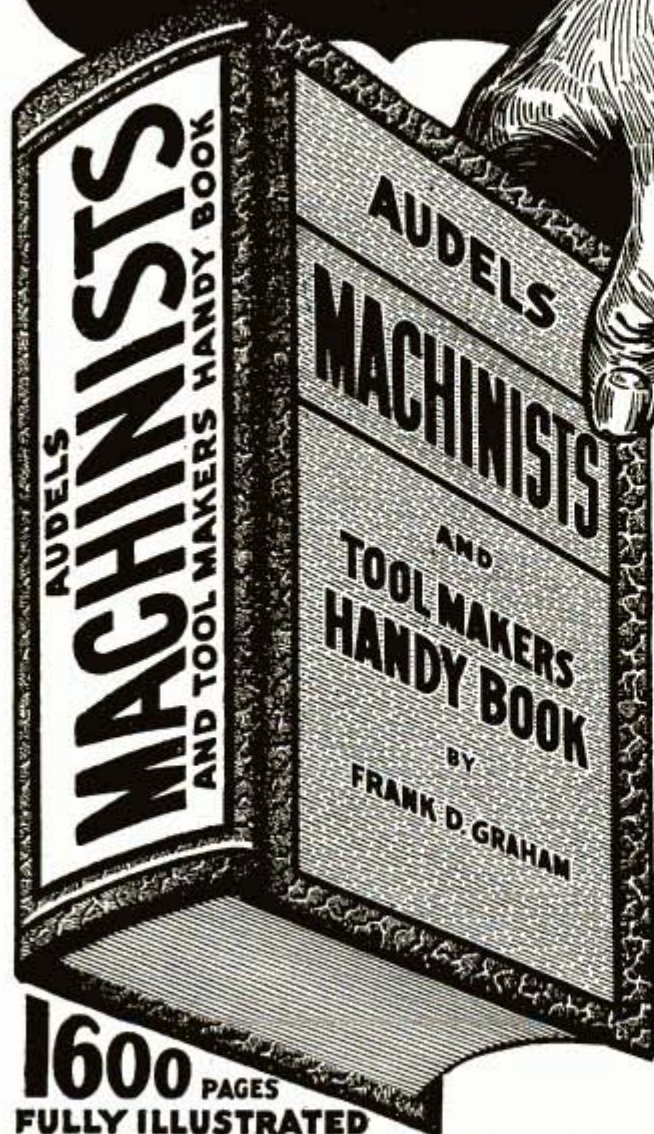

Prepare!

**A KEY TO
MODERN SHOP PRACTICE**

PRACTICAL INSIDE INFORMATION

For Every Machinist, Toolmaker, Engineer, Machine Operator, Mechanical Draughtsman, Metal Worker, Mechanic or Student. This 1600 Page Handy Book Covers Modern Machine Shop Practice in All Its Branches.

A COMPLETE INSTRUCTOR WITH READY REFERENCE INDEX

New from Cover to Cover. Tells How to Operate and Set Up Lathes, Screw & Milling Machines, Shapers, Drill Presses & All Other Machine Tools.

5 PRACTICAL BOOKS IN ONE! 60 FULLY ILLUSTRATED CHAPTERS

Covering: 1—Modern Machine Shop Practice. 2—Blue Print Reading and How to Draw. 3—Calculations & Mathematics for Machinists. 4—Shop Physics. 5—How to Use the Slide Rule.

ASK TO SEE IT!

THEO. AUDEL & CO., 49 West 23rd St., New York
Mail AUDELS MACHINISTS & TOOLMAKERS HANDY BOOK, Price \$4 on 7 Days Free Trial. If O. K. I will remit \$1 in 7 days and \$1 Monthly until \$4 is Paid. Otherwise I will return it.

Name _____
Address _____
Occupation _____
Reference _____ P.M.

1600 PAGES
FULLY ILLUSTRATED

A SHOP COMPANION THAT ANSWERS YOUR QUESTIONS
Easy to read and understand—flexible covers—Handy size 5 x 6½ x 2—a ready reference that answers your questions accurately.

TO GET THIS ASSISTANCE FOR YOURSELF SIMPLY FILL IN AND MAIL COUPON TODAY **\$4 COMPLETE PAY \$1 A MONTH ONLY!**

THEO. AUDEL & CO., 49 W. 23rd St., New York



Be a Radio

MANY MAKE \$30,

J. E. SMITH,
President
National Radio
Institute
Est. 27 years

I Train BEGINNERS at Home for Good Spare Time and Full Time Radio Jobs

MEN I TRAIN WIN SUCCESS LIKE THIS



\$10 a Week in Spare Time

I repaired some Radio sets when I was on my tenth lesson. I really don't see how you can give so much for such a small amount of money. I have made an average of \$10 a week—just fixing Radios in spare time.—JOHN JERRY, 1729 Penn St., Denver, Colorado.

Salary Increased \$1,800 Year in Radio

I have been regularly employed in Radio since my graduation and am now Chief Engineer of WDDO. My salary has increased \$1,800 per year since entering Radio and credit is given you for your excellent training.—JULIUS C. VESSELS, Station WDDO, Chattanooga, Tenn.



Makes \$50 a Week

I am making around \$50 a week after all expenses are paid, and I am getting all the Radio work I can take care of, thanks to N. R. I.—H. W. SPANGLER, 126 1/2 S. Gay St., Knoxville, Tenn.

Here is a quick way to more pay. Radio offers a way to make \$5, \$10 a week extra in spare time a few months from now, plus the opportunity for a permanent job in the growing Radio industry. There is an increasing demand for full time Radio Technicians and Radio Operators. Many make \$30, \$40, \$50 a week. On top of increasing civilian interest in Radio, the Radio Industry is rushing to fill hundreds of millions of dollars worth of Defense Orders. Clip the coupon below and mail it. Find out how I train you for these opportunities.

Jobs Like These Go to Men Who Know Radio

The 882 broadcasting stations in the U. S. employ thousands of Radio Technicians with average pay among the country's best paid industries. Repairing, selling, servicing, installing home and auto Radio receivers (there are more than 50,000,000 in use) gives good jobs to thousands. Many N. R. I. trained Radio Technicians take advantage of the opportunities to have their own full time or spare time service or retail Radio businesses. Think of the many good jobs in connection with Aviation, Commercial, Police Radio and Public Address Systems. N. R. I. gives you the required knowledge of Radio for these jobs. N. R. I. trains you to be ready when Television opens jobs in the future. Yes, N. R. I. trained Radio Technicians make good money because they use their heads as well as their hands. They are THOROUGHLY TRAINED. Many N. R. I. trained men hold their regular jobs, and make extra money fixing Radio sets in spare time.

Extra Pay in Army, Navy, too



Every man likely to go into military service, every soldier, sailor, marine should mail the Coupon Now! Learning Radio helps men get extra rank, extra prestige, more interesting duty at pay up to 6 times a private's base pay. Also prepares for good Radio jobs after the service ends. IT'S SMART TO TRAIN FOR RADIO NOW!



Set Servicing pays many N. R. I. trained Radio Technicians \$30, \$40, \$50 a week. Others hold their regular jobs and make \$5 to \$10 extra a week in spare time.



Loudspeaker System building, installing, servicing and operating is another growing field for N. R. I. trained Radio Technicians.

FIND OUT ABOUT THIS TESTED WAY

Technician

\$40, \$50 A WEEK

Why Many Radio Technicians Make \$30, \$40, \$50 a Week

Radio is already one of the country's large industries even though it is still young and growing. The arrival of Television, the use of Radio principles in industry, Frequency Modulation are but a few of many recent Radio developments. More than 28,000,000 homes have one or more Radios. There are more Radios than telephones. Every year millions of Radios go out of date and are replaced. Millions more need new tubes, repairs, etc. Over 5,000,000 auto Radios are in use and thousands more are being sold every day. In every branch, Radio is offering opportunities for which I give you the required knowledge of Radio at home in your spare time. Yes, the few hundred \$30, \$40, \$50 a week jobs of 20 years ago have grown to thousands.

Beginners Quickly Learn to Earn \$5, \$10 a Week Extra in Spare Time

Nearly every neighborhood offers opportunities for a good part time Radio Technician to make extra money fixing Radio sets. I give you special training to show you how to start cashing in on these opportunities early. You get Radio parts and instructions for building test equipment, for conducting experiments which give you valuable practical experience.



You Also Get This Professional Servicing Instrument

This instrument makes practically any test you will be called upon to make in Radio service work on both spare time and full time jobs. It can be used on the test bench, or carried along when out on calls. It measures A.C. and D.C. voltages and currents; tests resistances; has a multiband oscillator for aligning any set, old or new. You get this instrument to keep as part of your N. R. I. Course.

Find Out How N. R. I. Teaches Radio and Television

Act today. Mail coupon now for 64-page book. It's FREE. It points out Radio's spare time and full time opportunities and those coming in Television; tells about my course in Radio and Television; shows more than 100 letters from men I trained, telling what they are doing and earning. Find out what Radio offers you. Mail coupon in envelope or paste on penny postcard—NOW!

J. E. SMITH, President,
Dept. 2BP., National Radio Institute, Washington, D. C.



Radio Operators find good jobs with Government Departments, Shipping Companies and in Commercial Aviation; opportunities are increasing in these fields.



Broadcasting Stations employ N. R. I. trained Radio Technicians as operators, installation, maintenance men and in other capacities and pay well.

**THIS
Free Book
HAS HELPED
HUNDREDS OF MEN
MAKE MORE
MONEY**



Mail this to get 64 page book FREE

**J. E. SMITH, President, Dept. 2BP,
National Radio Institute, Washington, D. C.**

Dear Mr. Smith: Mail me FREE, without obligation, your 64-page book, "Rich Rewards in Radio," which points out Radio's opportunities and tells how you train men at home to be Radio Technicians. (No salesman will call. Please write or print plainly.)

Age.....

Name.....

Address.....

City..... State.....

TO BETTER PAY

NOT ALL DO IT
But **\$400**
PAST 2 WEEKS
GROSS IN MY OWN BUSINESS



IS REPORTED BY E. C. TRABOR. He uses newly invented machine which washes walls 6 times faster, and better than by hand. Here are more high earnings reported by men in their busy seasons. Of course they do not reflect earnings every day or every week, and a small amount must be deducted for materials, but they show what can be done by good men during their busy seasons.

Have \$1,570 worth of work lined up for next two months—Harry Tyler Machine arrived today. Have \$40 job tomorrow—H. Fredericks Got \$905 school building job. This is a repeat order—C. Irons First two jobs netted me \$26. Good beginning—L. Bach Just getting started. Did \$50 job in 2 1/2 days—N. Heath Paid for machine with work I did the past week—J. Hews \$25 for 1/2 day's work. Start on hotel tomorrow—J. A. Grinder

Customers everywhere. Homes, schools, offices, stores, churches, lodge halls, hotels —all have walls that need washing.

EASY PAYMENTS

It takes only a few dollars to get started in this money-making profession. No experience necessary. The total price is so small and the payments so easy that anyone with ambition should get started now.

Send for Free Information—There is No Obligation.
VON SCHRADER MFG. CO.
772 Pl., Racine, Wis.



AVIATION CAREER



Offers You

A GREAT FUTURE!

Complete Aeronautical Engineering or Master Aviation Mechanics training in the heart of the Aircraft industry. Graduates obtaining immediate employment. No flying involved.

Aviation's foremost school; established in 1929. Located on Grand Central Air Terminal. For full information, address Dept. PM-2.



CURTISS WRIGHT TECHNICAL INSTITUTE

GRAND CENTRAL AIR TERMINAL
GLENDALE (LOS ANGELES) CALIF.

THIS TOWER OVERLOOKS AVIATION'S MOST DISTINGUISHED SCHOOL OF AERONAUTICS

LAW
LEARN AT HOME
Are you adult, alert, ambitious, willing to study? Investigate LAW! We guide you step by step—furnish all texts, including 14-volume Law Library. Training prepared by leading law professors and given by members of bar. Degree of LL.B. conferred. Low cost, easy terms. Send NOW for Free, 48-page "Law Training for Leadership."
LASALLE EXTENSION UNIVERSITY
A CORRESPONDENCE INSTITUTION
DEPT. 264-L CHICAGO

LEARN WATCH REPAIRING
AT HOME You can learn by our modern and original system of instruction every part of the **Watch Repairing Trade** at home. Prepare yourself for a well paying position or start in business after completing our course of instruction. Good watch repairers are in demand and generally earn very good salaries. For particulars apply to the Wisconsin School of Watch Repairing 524 E. Mason St., MILWAUKEE, WIS.



Regain Perfect Speech, If You
STAMMER
Every stammerer should have the new 287 page book "Stammering, Its Cause and Correction." Sent free to stammerers. It describes the Bogue Unit Method for the scientific correction of stammering and stuttering. Method successfully used at Bogue Institute for 41 years—since 1901. Endorsed by physicians. Write for full information. No obligation. Benjamin N. Bogue, Dept. 1335 Circle Tower, Indianapolis, Indiana.

Learn AUTO-DIESELS
Practical, tested training. Backed by 36 years experience. Course includes Auto Mechanics, Diesel Service and Operation, Diesel Power Generation, Machine Shop Practice, Auto Electric, etc. Flexible plan to meet specific needs of those with or without jobs. Oldest, largest trade school in West qualifies you and helps you get a good pay job. Transportation allowed to L. A. Earn room and board while learning. Request Free Catalog.
NATIONAL SCHOOLS Dept. PMA-2
Los Angeles

5¢ LITTLE BLUE BOOKS
Send postcard for our free catalogue. Thousands of bargains. Address: HALDEMAN-JULIUS CO., Catalogue Dept., Desk M-811, GIRARD, KANSAS

LEARN WELDING
Both Electric Arc and Acetylene by practical Shop-Plan method in a few short weeks. No text-books. You learn by doing. Finest equipment. Low tuition. Pay-After-Graduation-Plan. Also, courses in Auto Mechanics, Collision Work, Metal Finishing, etc. Illustrated literature free. Write today.
MICHIGAN TRADE SCHOOL FREE 32 PAGE CATALOG
3738 Woodward, Detroit, Mich.



MONEY for MEN ALL FREE
THE PLASTEX Industry needs manufacturers on small scale and for big production of Lamp and Clock Stands, Art Goods and Novelties in Plastex and Marble imitation. Experience unnecessary. 1/2c material makes regular 10c store sellers. Rubber moulds furnished for speed production. Small investment brings good returns. WE ARE NOW PLACING BIG XMAS CHAIN STORE ORDERS WITH MANUFACTURERS. Ambitious men have chance for real prosperity. Our FREE booklet will interest and benefit you.
PLASTEX INDUSTRIES, Dept.P, 1085 Washington Ave., New York, N.Y.



America Can't Wait Industry needs you NOW

Defense Program Needs Trained Men

There is a tremendous shortage of skilled men in almost all branches of industry. Draftsmen, electricians, machine designers, machinists, are wanted for good jobs at fine pay. Executives too; foremen, superintendents, managers, are needed **right now** to handle the enormous demand for finished products of all kinds. If you are already in one of these fields, you owe it to your country, to your family, and to yourself to make yourself even more valuable, to climb and climb fast and help put through the most important program we have ever had to face.

Opportunities Everywhere

Home building, ship building, manufacturing plants, great utility projects, road building—everywhere you look you find a demand for men—not just ordinary workers, but men who know more than their fellows, who are better at their jobs, who know both theory and practice and can therefore train other men, thus rising to more and more important stations and being of greater and greater help. Practically every industry is included in those needing MEN, trained men, skilled men, men with ambition and punch.

Rich Rewards

In bidding for skilled men now, industry of all kinds, everywhere in the United States is offering top pay. They want the best men and they are willing to pay for their services. But remember this, you not only have opportunities for bigger pay than you probably ever hoped for, but the chances for advancement are even greater. Foremen, superintendents, factory managers, must be drawn from the ranks, and surely you know that the man who studies, who tries to know everything there is to know about his job will be picked first. Best of all, under the present training program, with the tremendous need for skilled men you don't have to look too far in the future for:

Learn at Home

Over 40 years ago we developed a system of home study which has helped thousands of men to important positions in the mechanical and business world. Those of you who have missed college training, who haven't the time to go away to school, who must LEARN AS THEY EARN, can get education in your particular field—yes, education of college grade right in your own home. Best of all, you can study when you have the time, and above everything else you will have the commendation and the respect of your employers in doing so. Rest assured that every superintendent, every factory manager, every general manager will have his eye on the man who pushes forward, who recognizes the great need of the day, and who has made up his mind to be one of the first to make good.

Get the Facts

(No Cost) All you have to do to find out about this type of training, to get the details and the outline of study, with histories of the successes of other men, is to write us or send the coupon. There is no cost and no obligation of any kind. Let this great school, one of the pioneers in the home study field, explain the methods which can do so much for you. Get this information now so that you can make up your mind quickly to get started on the road to the fulfillment of a real ambition, and so that you may be of the greatest possible help in this present emergency.

Results
Come
Quickly

Business Welcomes Applications from American School Advanced Students and Graduates

Whenever trained men have been badly needed, business has been quick to say, "We welcome applications from American School advanced students and graduates." We maintain an employment placement service to help put you in touch with the best openings, and we make no extra charge of any kind for this service. Write now for an outline of home study training courses; check the coupon indicating your preference and mail it promptly.

Mark, Clip and Mail This Coupon NOW!

AMERICAN SCHOOL, Dept. G245, Drexel at 58th, Chicago

Without obligation, Please send FREE and postpaid, bulletin and details of the Subjects checked.

- | | | |
|--|---|---|
| <input type="checkbox"/> Air Conditioning | <input type="checkbox"/> Retail Merchandising | <input type="checkbox"/> Drafting and Design |
| <input type="checkbox"/> Elec. & Gas | <input type="checkbox"/> Cost Accounting | <input type="checkbox"/> Radio and Television |
| <input type="checkbox"/> Refrigeration | <input type="checkbox"/> Practical | <input type="checkbox"/> High School |
| <input type="checkbox"/> Architecture | <input type="checkbox"/> Bookkeeping | <input type="checkbox"/> Home Economics |
| <input type="checkbox"/> and Building | <input type="checkbox"/> Economics of | <input type="checkbox"/> Courses |
| <input type="checkbox"/> Plumbing and | <input type="checkbox"/> Direct Selling | <input type="checkbox"/> Business Law |
| <input type="checkbox"/> Steam Fitting | <input type="checkbox"/> Private Secretary | <input type="checkbox"/> Liberal Arts |
| <input type="checkbox"/> Automotive | <input type="checkbox"/> Diesel Engineering | <input type="checkbox"/> Mechanical |
| <input type="checkbox"/> Engineering | <input type="checkbox"/> Surveying & Topo- | <input type="checkbox"/> Engineering |
| <input type="checkbox"/> Aviation Drafting | <input type="checkbox"/> graphical Drafting | <input type="checkbox"/> Shop Management |
| <input type="checkbox"/> Aviation Engineering | <input type="checkbox"/> Sheet Metal | <input type="checkbox"/> Tool Making |
| <input type="checkbox"/> Business Management | <input type="checkbox"/> Pattern Drafting | <input type="checkbox"/> Better Foremanship |
| <input type="checkbox"/> Accounting and C.P.A. | <input type="checkbox"/> Electrical | <input type="checkbox"/> Engine and Boiler |
| <input type="checkbox"/> Salesmanship | <input type="checkbox"/> Engineering | <input type="checkbox"/> Work |

Name Occupation

Address Age

City State

AMERICAN SCHOOL

Dept. G245, Drexel at 58th, Chicago



WOULDN'T TAKE \$1,000 FOR COURSE
 "The lessons are so simple. I have learned to play by note in a little more than a month. I wouldn't take a thousand dollars for my course."
 *S. E. A., Kansas City, Mo.



PLAYS ON RADIO
 "I am happy to tell you that for four weeks I have been on the air over our local radio station. So thanks to your institution for such a wonderful course."
 *W. H. S., Alabama.



FOUND ACCORDION EASY
 "I've always wanted to play the piano accordion," writes *H. E. from Canada. "But thought I'd never learn it. Then I read about your lessons. I don't know how to express my satisfaction."

Music Lessons for less than 7¢ a day

Here's your chance to learn to play your favorite musical instrument—quickly and easily—in your own home

YOU thought it was expensive to learn music? That it took lots of money to pay for a private teacher, sheet music and all the other essentials? That it required years of study?

Then here's grand news for you! You can learn to play your favorite musical instrument, any instrument, for less than SEVEN CENTS a day! That's ALL it costs. Not a penny extra for sheet music or anything else. And it doesn't take years, either.

Play a Tune in One Lesson

Actually, you start playing a familiar melody in your very FIRST lesson. Then you go on from one tune to another, until your friends are surprised to hear you play.

Easy as A-B-C

Look at the notes above—they are F-A-C-E. Could anything be simpler? You are already learning to read music. And it's easy to play, too, for a remarkable invention, the "Note-Finder," tells you just where each note is located on the keyboard.

*Actual pupils' names on request. Pictures by Professional Models.

You learn to play by playing—just as you learned the English language by speaking it. There is no lost time, no waste motion.

You learn by a remarkably short-cut method! A modern, simplified method that skips all the tedious, old-fashioned study and practice. A method that has literally swept the world, enrolling over 700,000 pupils. It's actually FUN to learn music this easy way.

Here's the Secret

"A picture is worth a thousand words," says the



ancient Chinese proverb. And that is the secret of this easy and fascinating way to learn music at home in spare time. Your lessons come to you in print and picture form. Large, clear illustrations show you every position, every move. And the accompanying text is like the voice of your teacher at your shoulder, explaining, coaching and encouraging you. You can't go wrong.

Send for Illustrated Booklet

See for yourself how easy it is to learn your favorite musical instrument this modern, short-cut way. And how inexpensive. Mail the coupon below, checking the instrument in which you are interested. Do it now. Instruments supplied when needed, cash or credit. U. S. School of Music, 72 Brunswick Bldg., New York City. Forty-fourth year. (Est. 1898).

U. S. School of Music, 72 Brunswick Bldg., New York City.

I am interested in learning the musical instrument checked. Please send me your illustrated booklet explaining how I can learn quickly at home, for less than 7¢ a day.

<input type="checkbox"/> Piano	<input type="checkbox"/> Mandolin	<input type="checkbox"/> Tenor Banjo	<input type="checkbox"/> Plain Accordion
<input type="checkbox"/> Violin	<input type="checkbox"/> Saxophone	<input type="checkbox"/> Ukulele	<input type="checkbox"/> Hawaiian Guitar
<input type="checkbox"/> Guitar	<input type="checkbox"/> Trumpet	<input type="checkbox"/> Cornet	<input type="checkbox"/> Other Instrument
<input type="checkbox"/> Cello	<input type="checkbox"/> Trombone	<input type="checkbox"/> Piano Accordion	

Have you instrument?.....

Name.....

Address.....

City..... State.....

Check here if under 16 years of age.

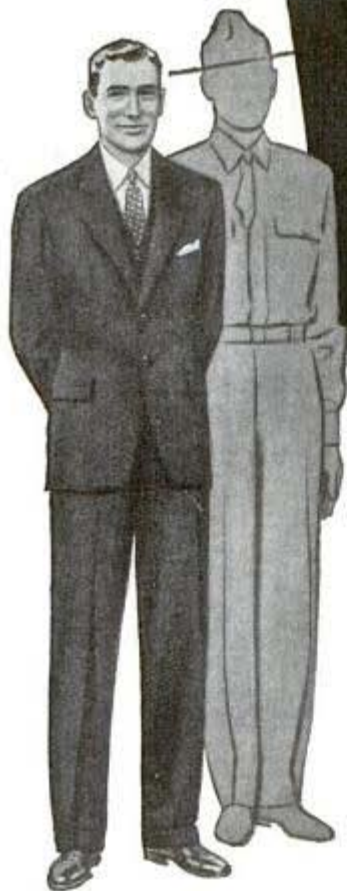

What about I.C.S. students who are drafted?

MAYBE you've learned that only with *proper training* can you hope to get ahead on your job — maybe you've often said, "Some day I'll take an I. C. S. Course, and really amount to something!" — but because of the draft, you've decided to put it off. *Don't do it!*

If you're drafted, you'll be encouraged to continue your I. C. S. studies — for the U. S. Army, like business and industry, needs trained men — *and pays them well!* Furthermore, you will have real training by the time your term of enlistment is over, and you'll be ready to step into a bigger, better-paying job than you have now.

Figure it out for yourself — training pays in peacetime or war-time, in army or civilian life. Mail this coupon *right now* for information on low-cost I. C. S. Courses in your line of work. *The I. C. S. Limited is headed for Success — climb on!*

INTERNATIONAL CORRESPONDENCE SCHOOLS

BOX 5627-J. SCRANTON, PENNA.

★ Without cost or obligation, please send me a copy of your booklet, "Who Wins and Why," and full particulars about the course *before* which I have marked X: ★

TECHNICAL AND INDUSTRIAL COURSES

- | | | | |
|--|--|---|--|
| <input type="checkbox"/> Air Brake | <input type="checkbox"/> Contracting and Building | <input type="checkbox"/> Marine Engines | <input type="checkbox"/> Sanitary Engineering |
| <input type="checkbox"/> Air Conditioning | <input type="checkbox"/> Cotton Manufacturing | <input type="checkbox"/> Mechanical Drafting | <input type="checkbox"/> Sheet Metal Work |
| <input type="checkbox"/> Airplane Drafting | <input type="checkbox"/> Diesel Engines | <input type="checkbox"/> Mechanical Engineering | <input type="checkbox"/> Ship Drafting |
| <input type="checkbox"/> Architectural Drafting | <input type="checkbox"/> Electrical Drafting | <input type="checkbox"/> Mine Foreman | <input type="checkbox"/> Shipfitting <input type="checkbox"/> Shop Practice |
| <input type="checkbox"/> Architecture | <input type="checkbox"/> Electrical Engineering | <input type="checkbox"/> Navigation | <input type="checkbox"/> Steam Electric <input type="checkbox"/> Steam Engines |
| <input type="checkbox"/> Auto Engine Tune-up | <input type="checkbox"/> Electric Lighting | <input type="checkbox"/> Patternmaking <input type="checkbox"/> Plumbing | <input type="checkbox"/> Steam Fitting |
| <input type="checkbox"/> Auto Technician | <input type="checkbox"/> Foundryman <input type="checkbox"/> Heating | <input type="checkbox"/> Practical Telephony | <input type="checkbox"/> Structural Drafting |
| <input type="checkbox"/> Aviation <input type="checkbox"/> Aviation Mechanic | <input type="checkbox"/> Heat Treatment of Metals | <input type="checkbox"/> Public Works Engineering | <input type="checkbox"/> Structural Engineering |
| <input type="checkbox"/> Boilermaking | <input type="checkbox"/> Highway Engineering | <input type="checkbox"/> Pulp and Paper Making | <input type="checkbox"/> Surveying and Mapping |
| <input type="checkbox"/> Bridge Engineering | <input type="checkbox"/> House Planning | <input type="checkbox"/> Radio, General | <input type="checkbox"/> Telegraph Engineering |
| <input type="checkbox"/> Chemistry | <input type="checkbox"/> Industrial Metallurgy | <input type="checkbox"/> Radio Operating | <input type="checkbox"/> Telephone Work |
| <input type="checkbox"/> Civil Engineering | <input type="checkbox"/> Locomotive Engineer | <input type="checkbox"/> Radio Servicing | <input type="checkbox"/> Textile Designing |
| <input type="checkbox"/> Coal Mining | <input type="checkbox"/> Machinist | <input type="checkbox"/> R. H. Section Foreman | <input type="checkbox"/> Toolmaking <input type="checkbox"/> Welding |
| <input type="checkbox"/> Concrete Engineering | <input type="checkbox"/> Management of Inventions | <input type="checkbox"/> R. H. Sign-in-man <input type="checkbox"/> Refrigeration | <input type="checkbox"/> Woolen Manufacturing |

BUSINESS COURSES

- | | | | |
|--|--|--|---|
| <input type="checkbox"/> Accounting <input type="checkbox"/> Advertising | <input type="checkbox"/> College Preparatory | <input type="checkbox"/> First Year College | <input type="checkbox"/> Railway Postal Clerk |
| <input type="checkbox"/> Bookkeeping | <input type="checkbox"/> Commercial | <input type="checkbox"/> Foremanship <input type="checkbox"/> French | <input type="checkbox"/> Salesmanship |
| <input type="checkbox"/> Business Correspondence | <input type="checkbox"/> Commercial Illustrating | <input type="checkbox"/> Good English | <input type="checkbox"/> Secretarial <input type="checkbox"/> Spanish |
| <input type="checkbox"/> Business Management | <input type="checkbox"/> Cost Accounting | <input type="checkbox"/> High School | <input type="checkbox"/> Showcard and Sign Lettering |
| <input type="checkbox"/> Cartooning <input type="checkbox"/> Civil Service | <input type="checkbox"/> C. F. Accounting | <input type="checkbox"/> Managing Men at Work | <input type="checkbox"/> Traffic Management |

HOME ECONOMICS COURSES

- | | | |
|---|---|--|
| <input type="checkbox"/> Advanced Dressmaking | <input type="checkbox"/> Home Dressmaking | <input type="checkbox"/> Tea Room and Cafeteria Management, Catering |
| <input type="checkbox"/> Foods and Cookery | <input type="checkbox"/> Professional Dressmaking and Designing | |

Name..... Age..... Address.....

City..... State..... Present Position.....

Canadian residents send coupon to International Correspondence Schools Canadian, Limited, Montreal, Canada
British residents send coupon to I. C. S., 71 Kingsway, London, W. C. 2, England

SPRAYBERRY RADIO TRAINING INCLUDES FULL EQUIPMENT

Experience Easily Acquired
At Home!



You Do Practice-Giving Experiments... Many Special Features... ALL Designed To Help You Make Fast Progress

SPRAYBERRY Training starts right at the beginning of Radio... unfolds each subject in a simplified, logical, understandable style. You easily

learn Television, Frequency Modulation, Signal Tracing, Mobile Radio (Auto-Tank), Aviation Radio, Electronics, Facsimile Radio, Radio Set Repair and Installation work.

Training Prepares You For A Business Of Your Own... Or Good Radio Jobs At Excellent Pay

The great fascinating and progressive field of Radio offers many opportunities to the man who wants to get ahead. My Training is designed to give you quick access to these opportunities. SPRAYBERRY Methods are thorough and practical. Your Training will not interfere with your present work.

No Previous Experience Needed
It makes no difference what your education has been. I can fit you quickly for a good-paying Radio job. I make it easy for you to grasp Radio principles and remember them. Your success is my full responsibility.



You Get Professional Test Equipment Plus Complete Radio Set

With the Radio Parts given (everything needed to build a Complete Receiver)... you conduct interesting informative experiments with your own hands. Also you are supplied a modern TESTER-ANALYZER.

Earn While You Learn

My BUSINESS BUILDERS show you how to put your equipment to actual use in handling money-making Radio Service Jobs shortly after you begin Training.

THE SPRAYBERRY COURSE IS SOLD UNDER MONEY-BACK AGREEMENT

RUSH COUPON for BIG FREE BOOK

SPRAYBERRY ACADEMY OF RADIO
F. L. Sprayberry, President
510-B University Place, N. W.
Washington, D. C.

Please rush my FREE copy of "HOW TO MAKE MONEY IN RADIO".

Name..... Age.....

Address.....

City..... State.....
(Mail in envelope or paste on penny postcard)

FULL RADIO SET

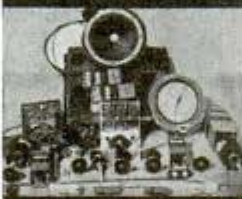

TESTER-ANALYZER



BE AN AIRCRAFT INSPECTOR



TRAIN AT LINCOLN

This Lincoln Government Approved School wants to immediately get in touch with men ready NOW to start 16 weeks training preparing for vitally essential employment as Aircraft Inspectors. Big Pay for men who qualify. 10,000 Aircraft Inspectors needed for East Coast, West Coast and Mid-West Airplane Factories. Men 18 to 40 with high school or equivalent education accepted. Course prepares for employment vitally essential to National Defense. WRITE QUICK for complete information.

LINCOLN AERONAUTICAL INSTITUTE
592 Aircraft Bldg., Lincoln, Nebraska

STRENGTHEN YOUR VOICE!

Give It Commanding Power!

Build up your speaking or singing voice. End faults due to weakness. Not with ordinary lessons but by scientifically correct silent and special vocal exercises perfected by famous teacher of many great speakers and singers. Gain faith in your own voice; know its full volume; how to control it.

FREE! Write today... now... for our interesting, inspiring Voice Book. Learn WHY one may actually possess a powerful, convincing voice. If you are under 17 have parent sign request for literature. PERFECT VOICE INSTITUTE, Studio 1352, 64 E. Lake St., CHICAGO



THERE'S MONEY IN CARTOONS!

RAYE BURNS will teach you HOW to CREATE ORIGINAL CARTOONS at home that you may SELL! Course contains 26 lessons and over 600 Illustrations. All for Only... \$2.85

Send name and address for free details.

RAYE BURNS SCHOOL, Dept. M, Box 3583, CLEVELAND, OHIO

Always write your name and full address clearly when answering advertisements.



Know Electricity as Experts Know It—and Get an Expert's Pay!

What about your future? Who is safe today? Surely not the man who is contented to stand still! Know your job thoroughly—prepare yourself for jobs ahead. To do just this thousands of men have used

The Croft Library of Practical Electricity

The Croft Library is a complete electrical educator. It is founded on practice—on 20 years of shirt-sleeve experience—on work as it is actually done. It is jammed from cover to cover with the kind of hard-headed facts you want. Written so that the beginner can easily understand it, yet so sound, so thorough, that it is the daily guide of 50,000 highly paid electrical workers and engineers. Croft tells you the things you need to know about motors, generators, armatures, commutators, transformers, circuits, switchboards, distribution systems—electrical machinery of every type—wiring for light and power—wiring of finished buildings—underwriters and municipal requirements—illumination in its every phase—the most improved methods of lighting—lamps and lamp effects, etc.—how to do a complete job, from estimating it, to completion.

No money down — easy payments

Fill in and mail the coupon attached and we will send you the entire set of seven volumes for ten days' examination on approval. We take all the risk—you assume no obligation. If you decide to keep the books, send \$3.00 in ten days and the balance at the rate of \$3.00 a month. Send the coupon NOW and see the books for yourself.

EXAMINATION COUPON

McGraw-Hill Book Co., 330 W. 42nd St., New York

Send me for ten days' examination on approval the Croft Library of Practical Electricity, 7 vols. If satisfactory I will send you \$3.00 in 10 days and \$3.00 monthly until the price of \$18.00 is paid. If not wanted, I will return the books postpaid. (To insure prompt shipment write plainly and fill in all lines.)

Name.....

Home Address.....

City and State.....

Position.....

Name of Company..... PM-2-42

Not Expensive to Learn SCIENTIFIC CRIME DETECTION

*The Steady Pay Profession
Good Times—or Bad*

FINGER PRINTING
*
FIREARMS
IDENTIFICATION
*
POLICE
PHOTOGRAPHY
*
SECRET SERVICE
METHODS



I TRAINED
THE MEN
WHO THEN
GOT THESE
BIG JOBS



"I will teach you Finger Print Identification—Firearms Identification—Police Photography—and Secret Service!" That's what I told the men who now handle the good jobs listed in the column at the right.

And now I repeat, but THIS time it's to YOU . . . "I will teach you Finger Print Identification—Firearms Identification—Police Photography—Secret Service." Just give me a chance and I'll train you to fill an important position in the fascinating field of scientific crime detection.

GET IN NOW!

But don't be misled. Scientific crime detection is not as simple as it might appear. It's not an occupation at which anyone without training might succeed. It's a science—a real science, which when mastered THROUGH TRAINING gives you something no one can EVER take from you. As long as you live—you should be a trained expert—able to make good in scientific crime detection. I teach you the real science so that you should be competent to do the work of a thoroughly trained employee in a bureau of identification.

LOOK AT THE RECORD!

Right now 43% of ALL Identification Bureaus in the United States are headed by our students and graduates. They have regular jobs—regular salaries—often collect reward money besides—and many of these men knew absolutely nothing about this work before they began their training with me.

INSTITUTE OF APPLIED SCIENCE
1920 Sunnyside Ave., Dept. 1352 Chicago, Ill.

Students or graduates of mine have complete charge of the Bureaus of Identification in the following states and cities—and, they are only a few of many!

State Bureau of Delaware
State Bureau of Florida
State Bureau of Maine
State Bureau of Michigan
State Bureau of New Mexico
State Bureau of Rhode Island
Charleston, S. C.
State Bureau of Texas
State Bureau of Utah
Lincoln, Nebraska
Portsmouth, N. H.
Albany, N. Y.
Trenton, N. J.
Canton, Ohio
Tulsa, Okla.
Mobile, Ala.
Phoenix, Ariz.
Los Angeles, Calif.
Seattle, Wash.
Madison, Wis.
Miami, Florida
Leavenworth, Kas.
Annapolis, Md.
Duluth, Minn.
Vicksburg, Miss.
Hartford, Conn.
San Juan, Porto Rico
Ketchikan, Alaska
Honolulu, Hawaii

Remember!—these are only a few of many! 43% of ALL Identification Bureaus in America are run by my students or graduates. Furthermore, I'll gladly send you a list of over 750 city and state institutions in which one or more of my graduates were placed as finger print experts!

MAN IN UNCERTAIN LOW PAY JOB



BECOMES HEAD OF BUREAU OF IDENTIFICATION



FREE! Blue Book of CRIME

This book takes you right behind the scenes where crime and science come to grips. It's full of exciting information on scientific crime-detection, including fascinating real case histories! It will show YOU how YOU, at a cost so low you shouldn't even think of it, can get started in this big important work without delay. Don't wait. Clip the coupon... send it NOW!

INSTITUTE OF APPLIED SCIENCE
1920 Sunnyside Ave., Dept. 1352, Chicago

Gentlemen: Without any obligation on my part, send me the "Blue Book of Crime," and complete list of bureaus employing your graduates, together with your low prices and Easy Terms Offer. (Literature will be sent ONLY to persons stating their age.)

Name:

Address:

Age:

INVENTORS *for*

Act Now TO PROTECT YOUR INVENTION WITH U.S. PATENT

SMALL IDEAS MAY HAVE Large Commercial Possibilities

Inventions do not have to be complicated to be profitable. The 10c stores flourish on simple Patented products which are commercially successful. The zipper, safety pin, thumb tack, paper clip, collar button—all are simple yet familiar inventions—brought their inventors rich rewards. If you have an invention—act now to protect it. Send for our FREE "PATENT GUIDE".

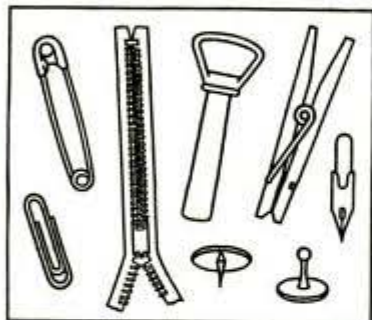

CLARENCE A. O'BRIEN
21-B Adams Building, Washington, D. C.
Registered Patent Attorney before U. S. Pat. Office

Free Patent Guide

TELLS HOW TO OBTAIN PATENT AND MARKET INVENTION

If you have invented something, if you are interested in inventing something, you need our new 48-page "PATENT GUIDE" that gives the entire Story of Patents. It tells you about new phases of invention, how others succeeded, how the patent laws protect you, how to market your invention, where to obtain finances, and how to arrange for royalties from the sale of your invention.

PRACTICAL BENEFITS OF THIS "PATENT GUIDE"

You will find 6 complete pages illustrated with simple inventions that have succeeded in six different fields of industry. Over 100 illustrations are in this book. You will read the stories of ten (illustrated) of America's most famous inventors. You will find an experienced and thorough survey of market conditions affecting the inventor—showing the possibilities for commercial invention today.

If you expect to realize profits from your invention you must protect it with a U. S. patent. Otherwise you may find that all your time and labor have been lost, because it often happens that other inventors are working on the same invention. If you have an invention, or an ambition to invent—get the information on obtaining patent AT ONCE!

FREE "RECORD OF INVENTION" FORM

When you send for your FREE "PATENT GUIDE", we include, also Free, our specially prepared "RECORD OF INVENTION" form, on which you can quickly make and date a sketch and description of your invention. This "disclosure" as it is called, may be absolutely invaluable as evidence for you, should your rights ever be contested. Be sure to get it and use it.

CLARENCE A

REGISTERED PATENT ATTORNEY • BEFORE U. S. PATENT

NEW EASY WAY TO LEARN IF YOU ARE FIT TO FLY

Do you want to FLY? Now you can take the basic Army, Navy tests for pilots—right in your own home! A thrilling new book, ARE YOU FIT TO BE A PILOT! by Dr. E. L. Ray, Army Flight Surgeon, and S. Washburn, Jr., actually RATES your flying fitness—with more than 20 ingenious charts, drawings, 50 photographs, cellophane disk, removable measuring scales, 4-color plates, self-scoring system! Tests depth perception, equilibrium, eyes, hearing, basic body factors that make an Army or Navy pilot! Fascinating party game—but more important, it gives genuine rating. All diagrams and charts duplicate Official Tests. "You get everything short of an actual plane to try your hand on!" says Air Facts Magazine. And you may examine this big, fascinating book on a 5-Day No-Risk Guarantee. SEND NO MONEY. Your name and address on penny postcard brings book for examination. Deposit only \$1.75 (plus C.O.D.) with postman. EXAMINE 5 DAYS. Unless delighted, return book for full refund. ACT NOW—mail postcard at once to: WILFRED FUNK, INC., Dept. P. 354 Fourth Ave., New York, N.Y.

Say you saw it in Popular Mechanics!

MEN WANTED!

EARN MONEY EASY WITH GREAT NEW TAILORING LINE SENSATIONAL PAYMENT PLAN

Unbeatable values! Order-getting features galore—make it easy to earn big money and get your own suits FREE as extra bonus, showing friends sensational new line made-to-measure suits and taking orders on partial payment plan. No experience. No money needed to cash in big! Write at once for complete actual sample line of rich new wools, newest styles and sure-fire-order-getting plans. Send Free! GIBSON, 500 South Throop Street, Dept. B-516, Chicago, Illinois

GET INTO THE BAKING BUSINESS!

National Baking Institute announces a new home study course in commercial baking. Baking now America's fifth industry in wages. Nearly a depression-proof business. Good field for ambitious men. Common school education sufficient. Send for free booklet "Opportunities in Commercial Baking" and requirements.

National Baking Institute
1315 Michigan Ave., Dept. 1352, Chicago, U. S. A.



Quick Action!

SEND TODAY

You Can Patent Improvements

GET FREE 48-PAGE PATENT GUIDE and Record of Invention Form

MAIL COUPON NOW TO CLARENCE A. O'BRIEN

Registered Patent Attorney
BEFORE U.S. PATENT OFFICE

Clarence A. O'Brien, 21-B Adams Building, Washington, D. C.
Please send me your Big, Free 48-Page "Patent Guide for the Inventor" and your Specially Prepared "Record of Invention" form. This request does not obligate me.

NAME.....
ADDRESS.....
CITY..... STATE.....
(Please write or Print Plainly)

In Machinery, Articles, Designs, Formulas, Etc. If New

Every year thousands of patents are granted. Very few, however, represent the discovery of entirely new principles. Most of them provide new methods of doing some every-day thing in a better way—changes for greater efficiency, usefulness, adaptability, or beauty in some previously Patented thing. These IMPROVEMENTS are patentable if new, and actually represent new inventions. These improvement Patents offer large chances for profit if commercially useful. The business world wants improved products and services.

OUR SERVICES TO YOU

We are Registered Patent and Trade-Mark Attorneys, serving Inventors all over the United States and abroad. Our Organization is complete. We have experienced Patent Attorneys, Draftsmen and Searchers to serve your interests. We can act as your adviser in all Patent Matters. Our fees are very reasonable—we can arrange convenient terms of payment. It is our custom to permit clients to pay for our services in installments as the application progresses in our office. Our complete service is described in Our "Patent Guide". Mail Coupon for it NOW.

GET FREE "PATENT GUIDE"—MAIL COUPON NOW

If you have an invention in the making—if you simply have the crude elements of an invention in mind—you should get our "PATENT GUIDE" without delay. It will guide you every step of the way—from the preliminary search stage to the issuance of the final patent grant. This book contains twenty-five chapters describing in plain man-to-man language the story of obtaining a patent and selling an invention. This book is absolutely FREE—just tear off the above coupon or write us a letter or postcard TODAY!

Get These FREE



MAIL COUPON NOW

O'BRIEN

Worthy of Your Trust

OFFICE • 21-B ADAMS BUILDING • WASHINGTON, D. C.

MAKE MONEY

Learn Portrait Painting at Home by the NEW, Easy Stuart System

● Previous art training or talent NOT necessary. This Stuart System is radically new and simple. It will REALLY TEACH PORTRAIT PAINTING. Cost is unusually low.

Write today for free booklet how YOU can start your career NOW! Address:

STUART STUDIOS, Dept. F
121 Monument Circle • Indianapolis, Indiana

RADIO LESSON FREE

"INTRODUCTION TO RADIO"
SUPREME PUBLICATIONS, 328 S. JEFFERSON ST., CHICAGO, ILL.

Do You Make Mistakes in English?

EVERY time you speak or write you show just what you are. Mistakes in English reveal you as a person who lacks education and refinement. Lack of language power prevents you from presenting your thoughts in the strongest possible way. No matter what you do, real command of English will help you to your goal. Stop making mistakes in spelling, punctuation, pronunciation. Increase your vocabulary.

WONDERFUL INVENTION

Only 15 minutes a day with Sherwin Cody's new invention—and you can actually SEE your English improve. It teaches by HABIT—makes it easier to do the RIGHT way. Wonderful self-correcting lessons include spelling, punctuation, grammar and expression.

FREE BOOK ON ENGLISH Lack of language power may easily be costing you thousands of dollars every year. See what Mr. Cody can do for you; it costs nothing to find out. Mail a postal card or letter this very minute for free book, "How You Can Master Good English in 15 Minutes a Day". It will prove a revelation to you. WRITE NOW. Address: Sherwin Cody School of English, 52 Searle Bldg., Rochester, N. Y.

Say you saw it in Popular Mechanics!



POPULAR INVENTIONS

For Your Home



Snap-On Seat Covers Permit Changes of Color

*County mfg Co
1358 merchandise
mart, Chicago
2874 ✓*



Quick change in the color of dining-room chairs is provided by covers that snap on the seats and are furnished in a wide variety of shades and fabrics. To apply it, the covering is pulled on the seat, smoothed out and fastened with snaps. It will not sag or slip off, and fits all types of upholstered dining room chairs.

merchandise mart

Hand-Cranked Beverage Shaker Has Handy Pouring Top

Turned end over end by a handle, a glass tumbler mounted on a metal stand mixes drinks or salad dressings with little effort.



To fill the tumbler, a ring at the side is moved, raising the lid. Contents are poured out by removing a cap and tilting the shaker. The unit includes a small tray to hold the glass while pouring. All metal parts are finished in chrome.

(More Popular Inventions on page 52A)

*Handy Sundry 5.00
National Silver Ware Dept
Chicago*

Ironing Board Turned Over For Ironing Sleeves

*Hy. Lee Co
98 Grand St
Chicago
7880*

Folding flat when not in use, a reversible ironing board has one side for ironing sleeves. Both sides are padded and covered, and a spring locks them apart when mounted for ironing.



Here I Am At WORK

Making
GOOD MONEY
thanks to this



DRAFTING

Yes, this free lesson **proved** that drafting is easy, mighty interesting work . . . convinced me I didn't need special talent to get into this well-paid profession . . . **proved** beyond a doubt that Drafting by the fascinating C. T. C. method can be mastered easily **AT HOME IN SPARE TIME**.

So I enrolled. Today I feel secure in my job. The **National Defense program** and rising business have increased the demand for Machine Draftsmen, Architectural Draftsmen, Electrical Draftsmen, Structural

Draftsmen and Aircraft Draftsmen. For draftsmen always come first on any new project in manufacturing and industry . . . and in those new Aircraft plants and Shipbuilding yards. Draftsmen can't be replaced with machines! What's more, I'm slated for promotion—but if I wish, I can be independent . . . go into business.

Here's a tip: Mail the coupon or drop a card for the free trial lesson. Do this today—and drafting will take care of you tomorrow.



YOU GET THIS COMPLETE DRAWING OUTFIT

without a penny extra. These are quality instruments—the kind that professional draftsmen use. With them you can put your ideas on paper quickly and with accuracy. With training, you're all set to master draftsmanship in months—not years—at home, and you can use these very same instruments some day as draftsman.

CHICAGO TECHNICAL COLLEGE

B-203 Tech Bldg., 2000 So. Michigan Avenue, Chicago, Illinois

LEARN AT HOME IN SPARE TIME

A few hours of pleasant home study every week—that's all! No interference with your present job! With Chicago Tech's help, you train yourself step by step. This tested method—developed over 37 years of C. T. C. progress—will fit you for a job in months—just the kind of job you've wanted.

Get this: Terms are low. You can't honestly say "I can't afford it." There isn't a reason why you shouldn't mail us the coupon today. When you get your **FREE TRIAL LESSON**, you'll say, "I never knew learning could be so easy and enjoyable." If you are 17 years or older, send for our trial lesson.

MAIL THIS COUPON

CHICAGO TECHNICAL COLLEGE

B-203 Tech Bldg., 2000 So. Michigan Avenue, Chicago

Please send me **FREE Trial Lesson** in **DRAFTING** and show me how I can prepare for a good position **in spare time AT HOME**. No cost or obligation for this Trial Lesson either now or later.

Name _____ Age _____

Address _____

City _____ State _____

Hold one of Aviation's BEST JOBS....



...Airline Mechanic

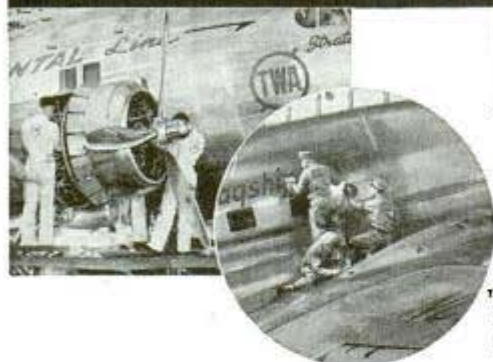

Photographs
Courtesy
Transcontinental
and Western
Air, Inc. and
American
Airlines, Inc.

To help keep great airliners in "flying trim" is one of the most fascinating jobs in all Aviation—and one of the BEST. The airline mechanic makes good pay from the start, has security ahead for life. Opportunities for advancement and success are unlimited—with air travel only in its infancy... and air freight coming with a rush. The man who gets into this work NOW can move up fast...with airlines growing bigger and bigger—pushing into every corner of the nation.

Your opportunities for a fine start on this great career are plentiful...waiting for you! One major airline alone called for 65 Aero ITI trained mechanics in only three months time. ALL leading airlines—and ALL leading aircraft manufacturers as well—employ Aero ITI graduates...and it has never been possible to meet the demand for men trained by this outstanding school. There are jobs and jobs in Aviation, but many of them are routine...so train the Aero ITI way for the sure-future, big-future field of airline maintenance.

In Aviation you can "write your own ticket" for success...IF you get into the right field and go to the right school for your training. Before you decide on ANY career...on ANY training...write to Aero ITI and find out how so many men have already found the way to the security and success that YOU want. Send the coupon NOW.

Executive Management Board

ROBERT E. GROSS President, Lockheed Aircraft Corporation
JOHN K. NORTHROP President, Northrop Aircraft, Inc.
C. A. VAN DUSEN Vice Pres., Consolidated Aircraft Corporation

AERO INDUSTRIES TECHNICAL INSTITUTE

5253 WEST SAN FERNANDO ROAD, LOS ANGELES, CALIFORNIA
Five Courses in AIRCRAFT MECHANICS and AERONAUTICAL ENGINEERING—Including 12 Month Aircraft Mechanics Course
Approved by U. S. Civil Aeronautics Administration

AERO INDUSTRIES TECHNICAL INSTITUTE
5253 West San Fernando Road, Los Angeles, California

Please send information on Aero ITI training for Aviation careers. I am interested in the following branch of Aviation: Aircraft Mechanics; Aeronautical Engineering; Undecided, please send more information. Years High School: 1, 2, 3, 4. Years College (Liberal Arts): 1, 2, 3, 4. Years Engineering College: 1, 2, 3, 4.

Name _____ Age _____
Address _____
City _____ State _____ a-38-P

FIX ANY RADIO

Amazing New Invention

Simplified
Radio
Servicing
by
Comparison
Method

Learn quickly to repair all radio sets. New, revolutionary different Comparison method permits you to do expert work almost immediately. No previous radio knowledge required. Introductory training included. Find any fault quickly. Use a screw driver, pliers, and a piece of wire—no testers needed. Simple, point-to-point, picture suggestions tell you where to look for faults and how to make the repair. Plan U. S. Copyrighted. Covers every radio set—new and old. You may try the plan for 10 days without any risk.

Easy to
Apply

Price only \$1.50, postpaid
In Manual form, 8 1/2 x 11 in., 112 pages.
Data on 210 radio tubes. 16 large
trouble-shooting blueprints. Over 1,500
time-saving service hints. Developed by
W. N. Beitman, noted engineer. Order
without risk for 10 days use.

SATISFACTION GUARANTEED

Read the introductory job sheets, follow the step-by-step picture blueprints, and fix any radio in 30 minutes instead of hours. The complete simplified training is yours for only \$1.50, postpaid, 10 days trial. Money back guarantee.

SUPREME PUBLICATIONS
328 S. Jefferson St., Chicago, Ill.

STUDY AT HOME

With A Chartered Educational Institution

Conducted by Correspondence
Courses in Arts; Sciences; Philosophy; Education; Public Health; Medical Jurisprudence; Psychology; Sociology; Physics; Chemistry; Geology; Pol. Science; Theology; Law; Business Training; Accounting; Statistics; Agriculture. ENGINEERING, Electrical, Civil, Mechanical, Drafting, Architectural, Steam, Aeronautical, Radio, Structural, Industrial, Highway, Petroleum, Mining, Marine, Chemical Engineering, McKinley-Roosevelt Incorporated, 4610-UD, Sheridan Road, Chicago

ELECTRICITY MEN NEEDED

Electricians are needed everywhere. Hollywood studios alone claim shortage 200 men. This is a live money making profession. Learn at home, spare time. Easy payments. Selective Employment service. Write for FREE Bulletin. No obligation.

AMERICAN SCHOOL

Dept. EE245 Drexel at 58 St., Chicago

Auto-Diesel

Master a real trade. Auto Mechanics, Diesel Mechanics, Arc Welding, Acetylene Welding, etc. Let us train you to be an expert Auto-Diesel Mechanic and help you get a good job. The cost to you is reasonable. Learn on modern equipment with tools under experienced instructors. Road shop work. Steam heated buildings. Room and board in our steam heated dormitory. We pay your fare to Nashville. For free catalog write.

Nashville Auto-Diesel School, Dept. 75 Nashville, Tenn.



Minstrels

Comedy
Stunts
Plays
Songs

Unique First Parts for complete show with special songs and choruses. Make-up. Catalog Free.

T. S. Denison & Co., 203 N. Wabash, Dept. 19, Chicago

NEW WAY TO CHOOSE A CAREER

LET SCIENCE
PICK A JOB
FOR YOU!

TODAY, getting a job or choosing a career is no longer a hit-or-miss task. Science can now accurately determine for you, in advance, just what type of work or profession you're best suited for.

FREE Send your name on a penny postcard for FREE booklet explaining this new proven way to greater success.

Vocational Guidance Assoc., Dept. 12, 25 N. Menlo Ave., Pasadena, Calif.

ANY BOOK IN PRINT!

Delivered at your door. We pay postage. Standard authors, new books, popular editions, fiction, reference, medical, mechanical, children's books, etc.—all at guaranteed savings. Send card now for Clarkson's 1942 Catalog.

FREE Write for our great illustrated book catalog. A short course in literature. The buying guide of 300,000 book lovers. The selection of a metropolitan book store brought to your home. FREE if you write NOW—TODAY!

CLARKSON PUBLISHING COMPANY
Dept. PM42 1253 So. Wabash Ave. Chicago, Illinois

CASH IN ON SENSATIONAL NEW TAILORING LINE

Sensational news! Show friends complete line men's made-to-measure suits—at low prices—and pocket big CASH PROFITS on easy payment-plan orders. Scores of rich quality woolsens, tailored-to-measure. Newest styles. Guaranteed: YOUR OWN SUITS FREE as a Bonus! No money, no experience needed! We send complete money-making sample outfit FREE and amazing FREE BONUS SUIT offer. PIONEER TAILORING CO., Dept. a-1116 Chicago

EARN BIG MONEY EASY!

INVENTORS



MERLIN M. EVANS—executive head of one of the world's largest firms of Registered Patent Attorneys, which for almost half a century has helped countless individual inventors to protect and commercialize their ideas.

"I have a word for you...only!"

WHEN you place in the hands of an attorney the responsibility of preparing your application for patent, you rightly expect to get the strongest, most comprehensive patent which your invention warrants.

This old established firm of Registered Patent Attorneys offers you those "EXTRA" services and facilities which contribute so richly toward obtaining this desired result. We are able to draw priceless information from our years of practice at the United States Patent Office. Very often we are able to give our clients money-and-time-saving advice based upon our extensive experience in patent matters. We assign to your case a Registered Patent Attorney who is thoroughly experienced in the particular art to which your invention appertains. Adequate financial resources enable us to offer you the convenience of deferred payments if you need it. But with all the "EXTRA" services we provide for our clients in our attempt to obtain strong patents, our fees are quite moderate.

Your inquiry about our services will bring you promptly, the two big plainly written books and Evidence of Invention form illustrated below.

PATENT and SELL your INVENTION

Opportunities for men with inventive ideas have never been greater. For 44 years this firm has been helping such men. We've prepared two books that plainly tell you how U. S. Patent Laws protect you; how to obtain a good strong patent and how to find a buyer for your invention. Use the coupon below; it brings you both books FREE—also our all-important useful "Evidence of Invention" form.

Delay may be costly...

MAIL COUPON NOW



68 pages of facts for INVENTORS

...and the important Evidence of Invention Form!

COUPON BRINGS YOU THESE 2 BOOKS FREE!

VICTOR J. **EVANS & Co.**

Merlin M. Evans

REGISTERED PATENT ATTORNEYS

MAIN OFFICE: 630-B VICTOR BUILDING WASHINGTON, D. C.

Pittsburgh Office: 521-N Empire Building Los Angeles Office: 738-N Security Building

Rush by return mail. Free copies of your books, "Patent Protection" and "When and How to Sell an Invention"—also important—"Evidence of Invention" Form.

Name.....

Address.....

City and State.....



It's Easy To Be A Contractor

Learn to estimate, to plan buildings, to take contracting jobs, and make money on them. Here are 9 up-to-the-minute books on building, estimating, and contracting which cover in an interesting way, the subjects that carpenters, builders, and contractors should know to make the most out of their jobs. Roof Framing, The Steel Square, Architectural Drawing and Design, Estimating, Painting and Decorating, Heating, Air Conditioning, Building, Contracting, Concrete Forms and other subjects are all well covered.

"Boss" Carpenters in Demand Up-to-Date EDITION

Vast public works jobs, immense projects, and the rapid growth of home building, are making jobs for MEN WHO KNOW HOW. These books give you quick training. With them you shouldn't be afraid to tackle any job, for needed facts can be found in a hurry.

These books are the most up-to-date, complete we have ever published on these subjects.

Coupon Brings Nine Books FREE For Examination

AMERICAN TECHNICAL SOCIETY (Publishers—Home Study Courses)
Dept. G219, Drexel at 58th Street, Chicago, Illinois

You may skip me the Up-to-Date edition of your nine big books, "Building, Estimating, and Contracting" without any obligation to buy. I will pay the delivery charge only, and if fully satisfied in ten days, I will send you \$2.00, and after that only \$3.00 a month, until the total price of only \$29.80 is paid. I am not obligated in any way unless I keep the books.

Name.....

Address.....

City..... State.....

Please attach a letter stating your age, occupation, employer's name and address, and that of at least one business man as a reference.

PARKS AIR COLLEGE

PARKS AIRPORT EAST ST. LOUIS, ILL.

Offers YOU COLLEGE and PROFESSIONAL TRAINING Majoring in AVIATION

Accredited by the Illinois Superintendent of Public Instruction. "Included in the Accredited Higher Institutions 1938, issued by the U. S. Office of Education, Federal Security Agency." U. S. approved as a Commercial Ground and Flying School and Mechanics' School. Accredited by and cooperating with the United States Army Air Corps in giving flight and mechanical training. Open to high school graduates. FOUR courses lead to B.S. degrees in Professional Piloting, Aviation Operations, Maintenance Engineering, Aeronautical Engineering. TWENTY-TWO TRAINING PLANES are used in professional flight training which prepares graduates for airline flight operations. FACULTY of 82 specialists in various fields of aviation. 1569 graduates. Enrollment limited to a total of 300 commercial aviation students. Capacity enrollment of 560. 100-acre airport, 25 buildings devoted to school purposes exclusively. Dormitories and dining hall at the College. Spring term March 30. Send postcard for new 64-page catalog.

15th YEAR Registrar, Dept. PM-2
PARKS AIR COLLEGE, East St. Louis, Ill.

TRI-STATE COLLEGE

Degree in 2 1/4 years

B. S. Degree in Civil, Electrical, mechanical, Chemical, Radio, Aeronautical Engineering; Business Administration and Accounting. World-famous for technical 2 1/4 year courses. Also short diploma courses (36 weeks) in Surveying, Drafting. Non-essentials eliminated. Tuition, living costs low. For ambitious earnest students. Special Preparatory Department for those who lack required high school work. Students from all parts of the world. 59th year. Graduates successful. Enter Mar., June, Sept., Jan. Write for catalog.

422 COLLEGE AVE., ANGOLA, IND.



ENGINEERING

Learn Arc Welding...

in one of
country's
finest trade
schools

With this five weeks course under the supervision of veteran operators you can become eligible for the big pay arc welding jobs. Shop methods taught. Individual instruction. Modern welding equipment. Tell about yourself in first letter.

HOBART Trade School Box M-221
Troy, Ohio



CARTOONING PAYS WELL

Exclusive instruction by an internationally known cartoonist makes it easy to learn at home. Write for Free Booklet describing details of the course. State age.

NATIONAL SCHOOL OF CARTOONING
437 Penton Bldg. Cleveland, Ohio

Learn Profitable Profession in 90 days at Home



Earnings of Men and Women in the fascinating profession of Swedish Massage run as high as \$40 to \$70 per week but many prefer to open their own offices. Large incomes from Doctors, hospitals, sanitariums and private patients come to those who qualify through our training. Reducing those offers rich rewards for specialists. Write for Anatomy Charts and booklet—They're FREE.

THE COLLEGE OF SWEDISH MASSAGE
30 E. Adams St., Dpt. 264, Chicago

MAKE MONEY

AT HOME!

Learn to color photos and miniatures in oil. No previous experience needed. Good demand. Send for free booklet, "Make Money at Home" and requirements.

NATIONAL ART SCHOOL
1315 Michigan Ave., Dept. 1352, Chicago

PLAYS

EASILY STAGED

For clubs, men, women, boys and girls, schools, colleges, churches. For entertainment, for money-raising, and just for fun! Send for FREE CATALOG containing full descriptions.

The Dramatic Publishing Co., Room 302
59 E. Van Buren, Chicago, Ill.

★ GET ON "UNCLE SAM'S" PAYROLL ★

Prepare Now for 1942 Examinations

\$1260 TO \$2100 FIRST YEAR

Railway Postal Clerks—Mail Carriers—

Mail Clerks—Customs Inspectors—

Stenographers—Typists—Etc.

Mail Coupon immediately—

32 Page Civil Service Book—FREE

FRANKLIN INST., Dept. F.195, Rochester, N. Y.

Gentlemen: Rush to me, without charge, 32 page book with list of U. S. Government big paid positions. Advise me also regarding salaries, hours, work, vacations, etc. Tell me how to qualify for a position.

Name.....

Address.....

Don't Look Now!

but if you want to see a real

HE-MAN BODY...



WHAT do people say when they see you on the beach? Then you show what you REALLY are—a HE-MAN or a weakling! Do girls' eyes give you the silent "ha-ha"? Or can you FEEL their admiring glances?

And don't think *clothes* can cover a flat chest, skinny arms, pipestem legs EITHER! People KNOW when a man's got a puny build like Caspar Milquetoast—or when his personality glows with smashing strength, rippling muscles, tireless energy! A fellow like that is BOUND to be the life of the party! Do YOU want to be that kind of a man? Then listen to THIS—

In Just 15 Minutes a Day I'll Prove I Can Make YOU a New Man Too!—Charles Atlas

That's what I said—15 minutes a day! That's all I need to PROVE—regardless of how old or young you are, or how ashamed you may be of your present physique—that I can give you a body men envy and women admire. Biceps that can dish it out, and a muscle-ridged stomach that can take it. A full, deep barrel-chest. Legs that never tire. A tough, sinewy back. An all-around physique that can laugh at ANY kind of rough going.

Today, a wave of FITNESS is surging over America! Suppose YOU are called to the colors! Will *your* body be the laughing-stock of the company or will it command the envy of your buddies? Why RIGHT NOW many soldiers and sailors in active service are using my methods. They know that a MAN'S body means "easier going," more fun and quicker promotion!

Would You Believe I Was Once a 97-lb. Weakling?

Yes, I was—a miserable 97-pound bag of skin and bones! But you'd never believe it to look at me now, would you? Through my discovery of "Dynamic Tension" I changed myself into "The World's Most Perfectly-Developed Man." I'm LIVING PROOF of the miracles "Dynamic Tension" can perform—right in the privacy of your own home! NOW—will you give my method 15 minutes a day to get the kind of HE-MAN build you have always longed to have?

My FREE BOOK "Everlasting Health and Strength" Tells How!

Just a postage stamp will bring you your copy of my famous book, "Everlasting Health and Strength," absolutely free. No wonder nearly 2,000,000 men have sent for this big 48-page story of "Dynamic Tension"—illustrated with action photos of myself and some of my pupils. You'll not only read about my secret of "Dynamic Tension"—but you SEE PROOF of it! **CHARLES ATLAS, Dept. 8P, 115 E. 23rd St., New York, N. Y.**



Charles Atlas

An actual, un-touched photo of "The World's Most Perfectly-Developed Man"

Here's PROOF Right Here!

"Feel like million dollars; have a 44" normal chest—a 2" GAIN IN 4 DAYS!"
—L.A.S., Illinois

"My doctor thinks your course is fine. In 15 days have put 2" on my chest and 1/2" on my neck."
—B.L., Oregon

"My muscles are bulging. I feel like a new man. Chest measures 38", an increase of 5", my neck increased 2",
—G.M., Ohio

"1 1/4" gain on biceps and 1" more on chest in two weeks!"
—J.F., Penna.

CHARLES ATLAS, Dept. 8P, 115 East 23rd Street, New York, N. Y.

I want the proof that your system of "Dynamic Tension" will help make a New Man of me—give me a healthy, husky body and big muscular development. Send me your free book, "Everlasting Health and Strength".

Name
 Address
 City
 State

Test the NEW MERRIAM-WEBSTER Dictionary
in the Field You Know Best

if you Know LATHES..

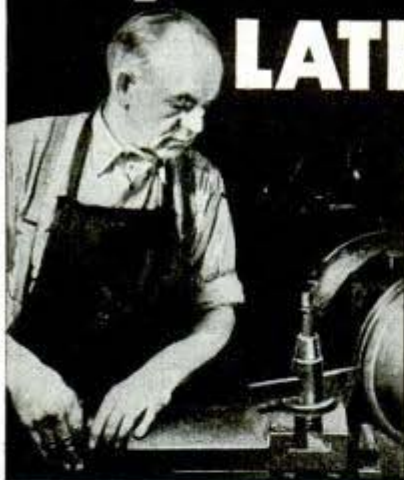

check these
42 kinds
described
in the New
Merriam-
Webster

- Cone
- Single, Double
- and Triple
- Back-Geared
- Geared head
- Speed
- Slide-rest
- Screw-cutting
- Threading
- Engine
- Manufacturing
- Turret
- Combination
- Automatic
- Bar-stock
- Chucking
- Backing off
- Fex
- Gap
- Extension gap
- Wheel
- Toolroom
- Precision
- Gun
- Ingot
- Projectile
- Shafting
- Pulley
- Roll-turning
- Mandrel
- Pit
- Gauge
- Bed
- Blanchard
- Column
- Face
- Flat-turret
- Geometric
- Pele
- Rose
- Slide
- Woodworking

An Amazing Coverage of Mechanics!

JUST start looking through the 12,000 pictures in the New Merriam-Webster. You'll find 23 kinds of KNIVES, 26 PLANES, 15 CHISELS, 59 KNOTS, 77 kinds of SAW TEETH, etc., and hundreds of MACHINES and Machine Parts! Then you'll find encyclopedic articles on Carpentry, Engineering, Chemistry, Architecture, Manufacturing, and Technical Processes of all kinds! And this great book covers hundreds of other useful subjects, all treated by the highest authorities. The New Second Edition of Webster's New International Dictionary (unabridged) is twenty years newer than any similar volume. In its 3,350 pages, its 600,000 entries, it embraces every science, every art, every field of thought and activity. Mail coupon for FREE Booklet, "The New Merriam-Webster: What It Will Do For You"—and see this great volume at your bookdealer's, G. & C. Merriam Company, Springfield, Mass.

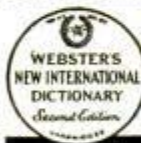

WEBSTER'S
NEW INTERNATIONAL
DICTIONARY
Second Edition

WEBSTER'S NEW INTERNATIONAL DICTIONARY Second Edition



MAIL THIS COUPON AT ONCE

G. & C. Merriam Co., Dept. 846, Springfield, Mass.
Please send me free illustrated booklet describing Webster's New International Dictionary, Second Edition—"The New Merriam-Webster: What It Will Do For You."

Name

Address

Advertisement Copyright, 1942, by G. & C. Merriam Co.

Say you saw it in Popular Mechanics!

A LITTLE LIBRARY of Useful Information



A Few Sample Pages

These booklets have been carefully designed to fill a long felt demand for instructions for making things and doing the everyday jobs around the home.

Only 25c Each, or 5 for \$1, 12 for \$2

- PHOTO ENLARGERS**—Shows you how to make four different enlargers.
- OUTBOARD RUNABOUT**—Fast, V-bottom boat, 14 ft. long.
- ELECTROPLATING**—Copper, nickel, chromium, gold, silver.
- POWER TOOLS**—Build your own workshop machines; saws, lathes, drill press, etc.
- WELDERS**—Details on arc and spot welders for 110 volt A.C.
- COLORLED CONCRETE GARDEN FURNITURE**—Pottery, benches, bird baths, sundials, misc.
- BIRD HOUSES**—Colony houses, miniature log cabins, single apartment houses of rustic design.
- FARM & GARDEN TRACTORS**—Two tractors you can build from old auto parts.
- TAXIDERMY**—Fun and profit in mounting fish, small animals. Expert tells how.
- AUTOMOBILE KINKS**—Money-saving shortcuts based on actual experience.
- CLEANING FORMULAS**—Preparations for woodwork, autos, brushes, paper, rugs, marble, etc. Also, soaps and bluing.
- COSMETIC FORMULAS**—Make Creams, lotions, other products for yourself and to sell.
- TREASURE FINDERS**—Build your own treasure finders and metal locator.
- LOG CABINS & TOURIST COTTAGES**—Two cabins; several inexpensive tourist cottages.
- FOOD PRODUCTS FORMULAS**—100 formulas for everyday necessities.
- GARDEN WOODWORK & FURNITURE**—Outdoor furniture, trellises, fences.
- SOLDERING & BRAZING**—Full of practical information.
- MIRACLE PLANTS**—Grow plants without soil; mix your own B-1 solution.
- HOME WORK OPPORTUNITIES**—Handicraft projects with sales possibilities.
- TELESCOPES**—How to grind lens and make mirror for 4 in. reflecting type.
- METAL PLATING & COLORING**—Essential formulas for decorating, coloring, plating metal.
- FAST ICE YACHT**—Complete details on building and sailing Class-F ice yacht.
- EXTRA ROOMS IN ATTIC**—Add value to your home by building extra room in attic.
- BASEMENT PLAYROOMS**—Build attractive playroom in your basement.
- PHOTO PRINTERS**—For both professional and amateur photographers. Negative dryer, split second timer.
- SAILING BINGHY**—This 14-ft. boat carries 140 sq. ft. of canvas.
- TRAILERS**—Midget "tear drop" house trailer; several utility trailers.
- METAL CRAFT**—Simple instructions for making novelties, useful articles.
- MAGIC FOR EVERYBODY**—Simple tricks to puzzle your friends.
- CANOES**—How-to-build-it details on 16-ft. Canadian type.
- LOWER YOUR FUEL COST**—Practical kinks on firing furnace, handling drafts, weather stripping.
- WOOD TURNING**—How to use lathe and chisels correctly.
- TRAPPING SMALL ANIMALS**—Luring fur bearers, preparing bait, traps; dressing skins.
- MOTOR-DRIVEN MIDGET CAR**—Complete details on boy's gas-powered car; also motor scooter.
- TRAINING YOUR DOG**—Teach your dog obedience, tricks, hunting.
- SMALL CASTINGS**—Build small gas or electric furnace to melt brass, copper, alloys.
- MAKING WOOLY WITH HAND LOOM**—Constructing hand loom for weaving rugs, spreads; leather novelties.
- HANGING WALLPAPER**—Tricks of hanging paper; also how to refinish floors, paint your home.
- BACKYARD GARDENING**—Selecting and planning.
- PLAIN & NOVELTY WOOD FINISHING**
- GEM CUTTING**—How to cut and polish semi-precious stones.
- BOY ELECTRICIAN**—Midget motors, telephone, vest pocket lab.
- CURING LEAKY BASEMENTS**—Ways to block out water.
- 21-FT. SLOOP**—Complete constructional details.
- WORKBENCHES AND TOOL CABINETS**—Four workbenches, kits for home repairs, tool chest.
- JIGSAW FUN AND PROFIT**—Make lawn ornaments, things for child's room, doorstops, toys.

CHECK TITLES WANTED—CLIP AND MAIL

POPULAR MECHANICS PRESS, Room 359, 200 E. Ontario Street, Chicago
Send me the "Little Library" booklets checked above. I enclose remittance for \$..... Send C.O.D. (U.S.A. only) (minimum C.O.D. order \$1.00)

Name

Address

City..... State.....

Note: On orders to Canada, Mexico and all foreign, enclose remittance and add 15% for postage.



They are ALL waiting for YOU

Before mechanics, carpenters, tool makers and other skilled men can go to work on new projects they must have plans made by the draftsman. Yes, drafting is tremendously important and skilled draftsmen are needed now in all lines.—Aviation, Architecture, Automotive, Diesel, Electrical, Structural, Mechanical, and many others. For any man who would like to be a draftsman there is good news, for it is a wonderful profession to learn at home. Yes, home training can make you a good draftsman, and only spare time is needed for study and practice. The price is low and the terms are easy.

Get into DRAFTING NOW!

Practically every good draftsman has a job. More and more men will be needed as Industry expands. As new factories are built, as a greater demand is made upon productive capacity, draftsmen should find more and more opportunities for jobs at good pay, and for promotion and advancement. Don't put off inquiring about our home study plan and our selective employment service which helps put you in touch with good openings as soon as qualified. In times like these Industry welcomes applications from American School advanced students and graduates. Write now for bulletin and complete information. There is no obligation of any kind.

AMERICAN SCHOOL

Drexel Avenue at 58th St. Dept. DD245 Chicago



AUELS BLUEPRINT READING

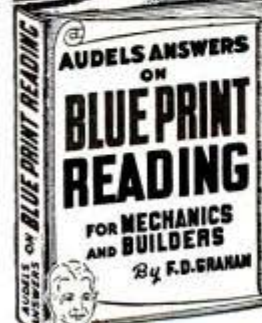

JUST OUT—FOR THE MAN WHO WORKS FROM BLUE PRINTS

"The Blue Print of Today is the Machine of Tomorrow." AUDELS ANSWERS ON BLUE PRINT READING covers All Types of plan reading including AIRCRAFT & SHIP BUILDING—tells How to Easily Understand Working Drawings.

What to look for first. Tells what each Line and each Symbol Means. The relation of one part to another. How to Understand Scales & Specifications. How to Make a Sketch. How to Make Blue Prints. A Key Book for Every Mechanic, Builder & Draughtsman—352 pages—It's New, Comprehensive, Fully Illustrated. Gives Short Cuts, Helps, Hints, Suggestions. Questions and Answers.

ASK TO SEE IT!
To get this assistance for yourself, simply fill in and mail coupon today. **\$2**

AUDEL, Publishers, 49 West 23rd St., New York
Please mail AUDELS BLUE PRINT READING (Price \$2). If satisfactory, I will remit \$2 on its safe arrival, otherwise I will return the book.

Name.....
Address.....
Occupation.....
Company..... PM

IMPORTANT Message To INVENTORS

We Will Send You Our **FREE BOOK**

"HOW TO PROTECT YOUR INVENTION" and Invention Record Form



Our laws favor the inventor who makes a dated record of his invention, and who is diligent in filing his patent application. You owe it to yourself, if you value your invention, to make an accurate, dated, and witnessed record of your invention, and then take steps to apply for a patent just as quickly as possible.

PERSONAL SERVICE

Hence, our service can be important to you: As soon as you write us, we send, by return mail, an "Invention Record" form for you to fill out. And then, when you return it to us, our prompt and personal service begins: We personally direct the search of the Patent Office Records. Personally report to you. Personally supervise the preparation and filing of your application and the handling of your case. There is no lost motion, no lost time.

PATENT AND SELL YOUR INVENTION

We handle your case skillfully and thoroughly with a view to securing the best possible patent for you—giving you the full benefit of our training as patent attorneys and our years of experience serving hundreds of inventors. We make personal calls at the Patent Office when required. And beyond this, we will endeavor to give you useful hints and suggestions on selling your invention.

WRITE US TODAY...

When your invention comes to us it is strictly confidential. All correspondence is handled personally by us. We take a personal interest in your success, so you can write us fully.

IMPORTANT TO GET STARTED RIGHT

Know how the laws protect you, and what steps to take. We will send you Complete FREE Booklet "How To Protect Your Invention", and FREE "Invention Record" Form. Write us, or mail this coupon today—McMorrow and Berman, Registered Patent Attorneys, 135-W Barrister Building, Washington, D. C.

MAIL COUPON NOW

McMORROW & BERMAN

REGISTERED PATENT ATTORNEYS BEFORE U. S. PATENT OFFICE
135-W Barrister Building Washington, D. C.

Send me your NEW FREE Book "How to Protect Your Invention" and specially prepared "Invention Record" form at once. I understand that this request does not obligate me.

Name.....

Address.....

City.....State.....

Write or Print Name Clearly

Say you saw it in Popular Mechanics!



Increased production
means



More Jobs for MACHINISTS and bigger pay for men who know their work

This home-study course gives you the practical facts on modern machines, up-to-date methods, you need to advance in machine shop work. Take advantage of the other man's experience as found in books, to solve your problems, increase your efficiency, with

The AMERICAN MACHINISTS' LIBRARY

6 volumes—2368 pages—2516 illustrations
(A combined home-study course and reference library)

This library of machine shop practice was written for practical men. It gives you the best methods for every kind of machine shop work. It fully explains lathes, drills, and other machine tools and their operation, automatic screw machines, speeds and feeds, gear design and production, jigs and fixtures, punch and die work, metal surfacing, etc., etc. Plainly written—completely illustrated—the best kind of help to the machine shop man who wants to advance himself.

No money down—special price—easy payments.

EXAMINATION COUPON

McGraw-Hill Book Co., 330 W. 42nd St., New York

Send me for ten days' examination the American Machinists' Library. If satisfactory I will send you \$1.50 in 10 days and \$3.00 monthly until the price of \$19.50 is paid. If not wanted, I will return the books postpaid. (To insure prompt shipment write plainly and fill in all lines.)

Name.....
Home Address.....
City and State.....
Position.....
Name of Company..... PM-2-42

Enter in February or September

ELECTRICAL TECHNICIANS

... Urgently Needed

Prepare now at Bliss for a better place in vital industries and national defense. Learn fundamentals of electrical theory and practice. Apply them in testing, drafting, machine shop, wiring, control. Modern shops and laboratories.

Course Complete in One School Year

Graduates are in demand. Bliss men hold excellent positions as technicians, engineers. Similar opportunities await you. Dormitories. Enter Feb. 10 or Sept. 30.

BLISS ELECTRICAL SCHOOL

132 Takoma Ave., Washington, D. C.

Please send me the free chart that will help me answer these important questions:
1. How can I qualify for the electrical field?
2. What jobs are open to me after Bliss electrical training?

Name.....

Address.....

City.....

Say you saw it in Popular Mechanics!

LEARN AT HOME TO MOUNT BIRDS



Animals, Heads, Fishes, Pets; to TAN. Be a Taxidermist. Profit and FUN.

Hunters, save your valuable TROPHIES. Mount ducks, squirrels, everything. Learn to TAN for leather and furs. Wonderful HOBBY. Have a HOME MUSEUM. BIG PROFITS mounting for others. INVESTIGATE NOW.

FREE BOOK With 100 fine game pictures. NOW absolutely FREE. Write TODAY.

Send Postal TODAY for FREE BOOK. State AGE. N. W. SCHOOL OF TAXIDERMY, Dept. 3372, Omaha, Neb.



STUDY ENGINEERING AT HOME

With A Chartered Educational Institution
Conducted by Correspondence

Courses in ENGINEERING: Electrical, Civil, Mechanical, Drafting, Architectural, Steam, Aeronautical, Radio, Structural, Mining, Industrial, Highway, Petroleum, Marine, Chemical Engineering, Arts; Sciences; Philosophy; Education; Public Health; Medical Jurisprudence; Psychology; Sociology; Physics; Chemistry; Geology; Pol. Science; Theology; Law; Agriculture; Business Training; Accounting; Statistics, McKinley-Roosevelt Incorporated, 4610-TD, Sheridan Road, Chicago

AUTO-MECHANICS & WELDERS

Auto Mechanics and Welders are in big demand. Complete courses in arc and acetylene welding, body and fender bumping, spray painting and metal finishing. Pay after graduation plan. Special low rates. Write today.

MICHIGAN TRADE SCHOOL
3748 Woodward Ave., Detroit, Mich.

FREE 32 PAGE CATALOG

Be a DRAFTSMAN-Designer

Prepare for Essential work—get into Big Pay Industry through Drafting and Design. There is need for well trained Draftsmen to meet Industrial and Defense demand. Get Practical Work Training from an Engineer at your home—until competent, and holding a good pay position. Tools furnished with training at reasonable cost. Write today for full details. State your age.

ENGINEER DOBE, DIV. 3372, LIBERTYVILLE, ILLINOIS

FOR SUCCESS IN PHOTOGRAPHY

Profit by 32 Years of Experience

Learn quickly at world's largest, best equipped photo school. Full-time experts coach you INDIVIDUALLY through "Learn by Doing" method in Commercial, News, Portrait, Motion Picture, Color Photography. Resident or home study. Free booklet.

N. Y. INSTITUTE OF PHOTOGRAPHY, Dept. 49, 10 West 33 St., New York, N. Y.

Learn PHOTO-ENGRAVING

We teach you quickly, at home in spare time. Earn while you learn. Establish your own profitable business with equipment we furnish, or work for others at good salary. Cuts in this magazine made by process we teach. Send for your copy of our big illustrated catalog. It's free!

THE AURORA SCHOOL OF PHOTO-ENGRAVING
Tasape' Bldg. (Dept. PM-37) Aurora, Mo.

Learn Public Speaking

At home—in spare time. Many overcome "stage-fright," gain self-confidence and increase earning power, this easy way. Write for free booklet, *How to Work Wonders With Words* and requirements.

North American Institute Dept. 1352
1215 Michigan Ave. Chicago, Illinois

Sell LOW PRICED DRESSES

Show friends sensational bargain new Spring and Summer styles and take orders. Easy to earn cash and your own dresses FREE as bonus. Beautiful Style Presentation and Actual Fabrics FREE! Write HARFORD FROCKS, Dept. G-262, Cincinnati, Ohio

Learn to Write

Begin today. Write for our New Free Book, "How to Become a Good Penman," it contains specimens and tells how others learned to write in spare time. Enclose 10c for a Professional Pen Point and your name beautifully written. Write today.

THE TAMBLYN SCHOOL OF PENMANSHIP
441 Ridge Building Kansas City, Mo.

POPULAR MECHANICS



The I. C. S. student STANDS OUT!

• Does your employer "know you from Adam"? Does he consider you "just another employee"? Or does he keep an eye on you, waiting for a chance to advance your position and pay, because he knows you are training yourself for a bigger future?

Read this letter recently received by the International Correspondence Schools:

"It affords me a great deal of pleasure to be in a position whereby I can recommend your courses to any one who wants to advance above the common level.

"In our organization it is easy to pick out the men who have been trained by International Correspondence Schools. In fact, our Manager and Vice-President, our Steel Shop Foreman, our Chief Engineer, our Foundry Foreman, and our Machine Shop Foreman are all products of your Schools, and they all rank high in their respective fields.

"I unhesitatingly commend your training to any one who has in mind advancing in his work and assuming responsibility.

JAMES H. MILLER, Pres.

Inter-State Foundry and Machine Co., Johnson City, Tenn."

The time to start preparing yourself for the future is RIGHT NOW!
And the WAY to start is to clip this coupon—and mail it—TODAY!



INTERNATIONAL CORRESPONDENCE SCHOOLS

BOX 5628-J, SCRANTON, PENNA.

★ Without cost or obligation, please send me a copy of your booklet, "Who Wins and Why," and full particulars about the course *before* which I have marked X: ★

TECHNICAL AND INDUSTRIAL COURSES

- | | | | |
|--|--|---|--|
| <input type="checkbox"/> Air Brake | <input type="checkbox"/> Contracting and Building | <input type="checkbox"/> Marine Engines | <input type="checkbox"/> Sanitary Engineering |
| <input type="checkbox"/> Air Conditioning | <input type="checkbox"/> Cotton Manufacturing | <input type="checkbox"/> Mechanical Drafting | <input type="checkbox"/> Sheet Metal Work |
| <input type="checkbox"/> Airplane Drafting | <input type="checkbox"/> Diesel Engines | <input type="checkbox"/> Mechanical Engineering | <input type="checkbox"/> Ship Drafting |
| <input type="checkbox"/> Architectural Drafting | <input type="checkbox"/> Electrical Drafting | <input type="checkbox"/> Mine Foreman | <input type="checkbox"/> Shipfitting <input type="checkbox"/> Shop Practice |
| <input type="checkbox"/> Architecture | <input type="checkbox"/> Electrical Engineering | <input type="checkbox"/> Navigation | <input type="checkbox"/> Steam Electric <input type="checkbox"/> Steam Engines |
| <input type="checkbox"/> Auto Engine Tune-up | <input type="checkbox"/> Electric Lighting | <input type="checkbox"/> Patternmaking <input type="checkbox"/> Plumbing | <input type="checkbox"/> Steam Fitting |
| <input type="checkbox"/> Auto Technician | <input type="checkbox"/> Foundryman <input type="checkbox"/> Heating | <input type="checkbox"/> Practical Telephony | <input type="checkbox"/> Structural Drafting |
| <input type="checkbox"/> Aviation <input type="checkbox"/> Aviation Mechanic | <input type="checkbox"/> Heat Treatment of Metals | <input type="checkbox"/> Public Works Engineering | <input type="checkbox"/> Structural Engineering |
| <input type="checkbox"/> Boilermaking | <input type="checkbox"/> Highway Engineering | <input type="checkbox"/> Pulp and Paper Making | <input type="checkbox"/> Surveying and Mapping |
| <input type="checkbox"/> Bridge Engineering | <input type="checkbox"/> House Planning | <input type="checkbox"/> Radio, General | <input type="checkbox"/> Telegraph Engineering |
| <input type="checkbox"/> Chemistry | <input type="checkbox"/> Industrial Metallurgy | <input type="checkbox"/> Radio Operating | <input type="checkbox"/> Telephone Work |
| <input type="checkbox"/> Civil Engineering | <input type="checkbox"/> Locomotive Engineer | <input type="checkbox"/> Radio Servicing | <input type="checkbox"/> Textile Designing |
| <input type="checkbox"/> Coal Mining | <input type="checkbox"/> Machinist | <input type="checkbox"/> R. R. Section Foreman | <input type="checkbox"/> Toolmaking |
| <input type="checkbox"/> Concrete Engineering | <input type="checkbox"/> Management of Inventions | <input type="checkbox"/> R. R. Signalman <input type="checkbox"/> Refrigeration | <input type="checkbox"/> Woolen Manufacturing <input type="checkbox"/> Welding |

BUSINESS COURSES

- | | | | | |
|--|--|--|--|---|
| <input type="checkbox"/> Accounting | <input type="checkbox"/> Advertising | <input type="checkbox"/> College Preparatory | <input type="checkbox"/> First Year College | <input type="checkbox"/> Railway Postal Clerk |
| <input type="checkbox"/> Bookkeeping | <input type="checkbox"/> Business Correspondence | <input type="checkbox"/> Commercial | <input type="checkbox"/> Foremanship <input type="checkbox"/> French | <input type="checkbox"/> Salesmanship |
| <input type="checkbox"/> Business Management | <input type="checkbox"/> Business Illustrating | <input type="checkbox"/> Commercial Illustrating | <input type="checkbox"/> Good English | <input type="checkbox"/> Secretarial <input type="checkbox"/> Spanish |
| <input type="checkbox"/> Cartooning <input type="checkbox"/> Civil Service | <input type="checkbox"/> Cost Accounting | <input type="checkbox"/> C. P. Accounting | <input type="checkbox"/> High School | <input type="checkbox"/> Showcard and Sign Lettering |
| | | | <input type="checkbox"/> Managing Men at Work | <input type="checkbox"/> Traffic Management |

HOME ECONOMICS COURSES

- | | | |
|---|---|--|
| <input type="checkbox"/> Advanced Dressmaking | <input type="checkbox"/> Home Dressmaking | <input type="checkbox"/> Tea Room and Cafeteria Management, Catering |
| <input type="checkbox"/> Foods and Cookery | <input type="checkbox"/> Professional Dressmaking and Designing | |

Name.....Age.....Address.....

City.....State.....Present Position.....

Canadian residents send coupon to International Correspondence Schools Canadian, Limited, Montreal, Canada
British residents send coupon to I. C. S., 71 Kingsway, London, W. C. 2, England

ELECTRICAL BOOKS

shipped
FREE

10 BIG BOOKS

Here's great news for anybody interested in Electricity. NEW 17th. edition of Applied Electricity brought right down to date with NEW Electrical subjects fully covered. 10 big Volumes and all shipped FREE for examination.

For Beginners and Experts
over 3000 pages—hundreds of illustrations—the most complete work of its kind we have ever published. Dynamos, motors, power stations. Radios, television, everything electrical explained to anyone can understand it.

BIG FIELD! Big Demand! Big Pay! Men who understand electricity are urgently needed in thousands of industries. Autos, airplanes, machine shops—practically every industry depends on electricity and men who know this subject make big money. Pleasant, fascinating work, easy to learn and do; learn with these books. Send coupon for a set for FREE examination and see for yourself.

SEND NOW [A year's consulting privileges with our engineers now given to all buyers of this famous Cyclopedia of Electricity.]
AMERICAN TECHNICAL SOCIETY
(Publishers—Home Study Courses)

American Technical Society, Dept. E219, Drexel at 58th St., Chicago
Send for 10 days' free use, 10 volume set of Applied Electricity. You also agree to send me a certificate entitling me to consulting privileges for one year. I will pay the delivery charges only on the books. If I wish I may return them in 10 days and owe you nothing, but if I keep them, I will send \$2.00 after 10 days, then \$3.00 a month until the total price of only \$29.80 is paid.

NAME.....
ADDRESS.....
CITY..... STATE.....
Please attach letter stating age, occupation and name and address of employer and give at least one business man as reference.

MECHANICS

KNOW YOUR CAR

You Need this Book



JUST OUT!

NEW FLUID DRIVE FULLY EXPLAINED

Ask to See it!

Every operator and mechanic needs AUDELS NEW AUTO GUIDE. This book saves time, money and worry. Highly endorsed. It presents the whole subject of auto mechanics: 1—Basic principles, 2—Construction, 3—Operation, 4—Service, 5—Repair. Easily understood. Over 1500 pages—1540 illustrations showing inside views of modern cars, trucks and buses with instructions for all service jobs. Diesel Engines fully treated, \$4 fully illustrated. To Get This Assistance for Yourself Simply Fill in and Mail Coupon Today.

COMPLETE • PAY ONLY \$1. A MONTH
THEO. AUDEL & CO., 49 WEST 23rd STREET, NEW YORK
Please send me postpaid AUDELS NEW AUTOMOBILE GUIDE (\$4) for free examination. If I decide to keep it, I will send you \$1 within 7 days; then remit \$1 monthly until purchase price of \$4 is paid. Otherwise, I will return it to you promptly.

Name.....
Address.....
Occupation.....
Reference..... P.M.

THIS VALUABLE BOOK

FREE

HOW TO MAKE MONEY WITH SIMPLE CARTOONS

LEARN CARTOONING AT HOME IN SPARE TIME

Send for this FREE book containing money-making tips, cartooning charts, idea creating methods, list of cartoon buyers, and other valuable information. Read about the money-making opportunities in one of the most fascinating of all professions—CARTOONING. With this booklet we will include a complete portfolio describing our easy Course in Cartooning and explaining our new Marionette Method of Instruction. We will also tell you how to get the Cartoonists' Exchange Laugh Finder FREE of extra cost. This amazing device actually helps create and originate humorous ideas. Send name at once and mention your age.

CARTOONISTS' EXCHANGE
Dept. 92, Pleasant Hill, Ohio

ENGINEERING DEGREE IN 27 MONTHS

INDIANA TECHNICAL COLLEGE

Courses in Aeronautical, Chemical, Civil, Electrical, Mechanical, and Radio Engineering. One-year courses in Radio and Drafting. Approved by C.A.A. Prep courses without added cost. Low tuition. Large industrial center. Opportunity to earn part living expenses. Enter March, June, September, or December. Catalog. 522 E. Washington Blvd., Ft. Wayne, Ind.

BECOME AN EXPERT MEAT CUTTER

Greater opportunities! Thousands of firms are seeking expert Meat Cutters. Train in 6 weeks at famous National School. It's quick, easy to learn Meat Cutting by ACTUAL PRACTICE in big National cutting rooms and retail departments. No previous experience or advanced education necessary. **BIG PAY JOBS** (Union card guaranteed). Employment service FREE. Train first. Pay later. Easy terms. Write TODAY for FREE catalog and plans to help you get ahead.

National School of Meat Cutting, Inc., Dept. U-27, Toledo, Ohio

PLAY Guitar

like famous stars of Radio, Records and Movies GIBSON tells you how.

FREE 60 PAGE BOOK

Send this ad for your copy and learn to play.

GEORGE BARNES NAC STAR

GIBSON, INC. 335 Parsons St., Kalamazoo, Mich.

WILL YOU WEAR THIS SUIT

and Make up to \$12 in a Day!

Let me send you a fine all-wool union tailored suit FREE OF ONE PENNY COST. Just follow my easy plan and show the suit to your friends. Make up to \$12 in a day easily. Partial Payment Plan. No experience—no house-to-house canvassing necessary. **SEND FOR SAMPLES—FREE OF COST**

Write today for FREE details. ACTUAL SAMPLES and "sure-fire" money-getting plans. Send no money. **H. J. COLLIN, PROGRESS TAILORING COMPANY** 500 So. Throop Street, Dept. B-216, Chicago, Illinois

MAKE MONEY AT HOME

RUBBER MOLDS

Low as 6¢ EA.

Amazing rubber mold-making outfit makes perfect flexible molds of plaques, ash trays, book-ends, etc. Molds cost from 6¢ to 25¢ each. Each mold makes hundreds of novelties and gifts to sell up to \$1.00 apiece! No experience necessary. Quick and easy. Start profitable business in your home; sell to stores, gift shops, friends, resorts, road stands, by mail. Full or spare time. "Molders Handy Book" and list of buyers FREE. Write

SO-LO WORKS
Dept. F-827 Cincinnati, Ohio

MAKE POULTRY PAY YOU A GOOD LIVING FOR LIFE



POULTRY RAISING PAYS GOOD PROFITS FOR THOSE WHO KNOW ITS SECRETS

Healthful, interesting occupation for whole or part time in country, village or city suburbs. Open to young and old. Win independence of low wages, uncertain employment, un congenial labor, with a Poultry Business of your own.

PROVED METHODS BRING SUCCESS FROM START

Harry M. Lamson, nationally known Poultry Expert, former Senior Poultryman U. S. Dept. of Agriculture, quickly trains ambitious men and women for Poultry Success from start. His famous Home Study System, endorsed by thirty leading Agricultural schools. Fascinating study, easy to learn, complete in every detail, shows valuable success secrets used by leaders, how they avoid losses. How to start in small way. Make business grow from sale of Poultry, Eggs and Baby Chicks. Big, ever increasing demand. Or prepare for a good job in large poultry plant. Established nearly twenty years—a multitude of graduates attest the success of his time-tested methods.

Mr. Harry Lamson has prepared a big 32 page illustrated book "How To Raise Poultry for Profit", telling how you can attain success in the poultry business. He offers to send it free to anyone interested in learning the splendid money-making opportunities in Poultry Raising. If you are "at sea" on your future, send for this Free Book today.

Address: Harry M. Lamson, President, NATIONAL POULTRY INSTITUTE, Dept. 50-6 Adams Center, N. Y.

FREE BOOK TELLS HOW

A multitude of poultry-raisers large and small are making money in this most interesting and profitable occupation.

Whether you have ever kept chickens or not—whether you have ten hens or ten hundred, you should read this FREE BOOK. It's yours for the asking.



LACO Oil Burners 18th Year!

Send postcard or letter for free folder and very low prices on LACO's No-Comfort Room Oil Heater, Gravity and Forced-Air Furnaces, Gun-Type Burner for furnaces. Newly improved. Clean, quiet, automatic. Thousands of users, everywhere. WRITE!

LACO OIL BURNER CO., 122 Union Ave., Griswold, Iowa

AMAZING NEW ELECTRIC ARC WELDER

RETAILS ONLY \$2.95 COMPLETE

PLUGS INTO LIGHT SOCKET

Amazing new HANDIWELD Electric Arc Welder—operates from 110 volt A.C. or D.C. same as other arc welders higher priced—guarantees tremendous heat to weld all kinds of metal. Not a toy welder that uses carbons, but actually uses standard copper rods—size 1/16" and 3/32". Generous supply furnished with welder. Guaranteed not to burn out. Repairs fenders, auto bodies, radiators, pre-heated small castings and machinery parts. Take HANDIWELD anywhere to job, operates from light socket. Sturdily built of finest materials to last years. Fully guaranteed by Big Manufacturer.

SEND NO MONEY! You'll find a thousand uses for the HANDIWELD around your home, garage, work shop. Also by garages, factories, repair shops, mechanics, farmers, inventors, tin shops, plumbers, etc. Order HANDIWELD now. Send no money. We'll rush one to you complete with rods and goggles. Pay postman only \$2.95 plus 15c. postage. If not delighted, return HANDIWELD in 6 days from receipt and money paid for it will be refunded instantly. Rush your order now.

KUMFY PRODUCTS INC., Dept. C-202 Cincinnati, Ohio

GET A Government JOB!

Start \$1260 to \$2100 a Year (\$105.00 TO \$175.00 MONTH)

Prepare Now for 1942 Examinations

Railway Postal Clerks

Railway Postal Clerks get \$1,900 the first year of regular employment, being paid on the first and fifteenth of each month. (\$79.17 each pay day.) Their pay is automatically increased yearly to \$2,300 and \$2,450 in large organizations. Advance may be had to Chief Clerk at \$2,700 a year. (\$112.50 each pay day.) Men 18 to 35.

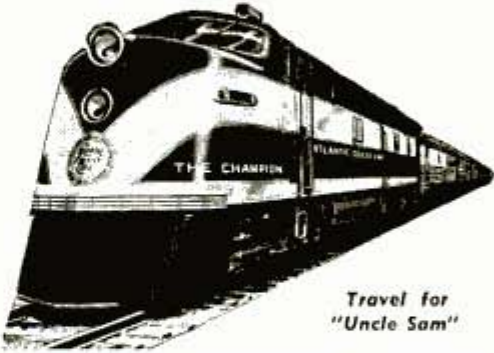

Travel for "Uncle Sam"

3 Days On — 3 Days Off — Full Pay

Railway Postal Clerks on long runs usually work 3 days and have 3 days off duty or in the same ratio. During this off duty their pay continues just as though they were working. They travel on a pass when on business. When they grow old, they are retired with a pension.

City Mail Carriers, Post Office Clerks

Clerks and Carriers now get \$1,700 the first year of regular employment and automatically increase \$100 a year to \$2,100. Open to Men—Women 18 to 48.

Many Other Positions

Many other positions are obtainable. Rural Carriers—Stenographers—Typists—Assistant Statistical Clerks—Accountants—Messengers—Office Machine Operators—etc. Those wishing these positions should qualify at once.

Get Free List of Positions

Fill out the following coupon. Tear it off and mail it today—now, at once.

This investment may result in your getting a big-paid government job.

FRANKLIN INSTITUTE, Dept. F174, Rochester, N. Y.

Rush to me, entirely free of charge (1) a full description of U. S. Government Jobs; (2) Free copy of illustrated 32-page book, "How to Get a U. S. Government Job"; (3) List of U. S. Government Jobs; (4) Tell me how to qualify for one of these jobs.

Name.....

Address.....

Use This Coupon Before You Mislay It. Write or Print Plainly.



AUTO

BOOKS SENT FREE

on approval. Just mail the coupon and we'll send you a set of these Brand New auto books. Whether you are a mechanic or helper, expert or apprentice, auto owner or driver, if you're interested in knowing all about automobile mechanics, take advantage of this FREE EXAMINATION OFFER.

GET A BETTER JOB

A better job—in the gigantic auto industry. BIGGER PAY—a chance to go into business for yourself and get a share of the profits, are waiting for any man who even half tries to improve himself. Learn auto engineering with these wonder books a new way—a quick reference method. Simply use the JIFFY INDEX to look up the answer to any auto problem. Built by eleven of America's great automobile engineers, and written in simple language so you can understand it.

National defense program is adding more opportunities for trained auto mechanics, in factories and in our armed forces.

[A year's consulting privileges with our engineers now given with these books without extra charge.]

CAN YOU FIX IT?

These wonder books tell step by step HOW to make difficult repairs and adjustments, how to keep a car at maximum efficiency, including latest improvements in car design and operation. Engine troubles and how to correct them well covered.

6 BIG VOLUMES

2500 pages, 2000 illustrations, wiring diagrams, etc., including Diesel engines. Beautifully modernistic, washable cloth binding.

AMERICAN TECHNICAL SOCIETY (Publishers—Home Study Courses), 606½ Ave. & 58th St., Dept. A219, Chicago, Illinois

I would like to see the Brand New 6-volume edition of your AUTO BOOKS. I will pay the delivery charges only, but if I choose to, I may return them express collect. If after 10 days use I prefer to keep them, I will send you \$2 and pay the balance at the rate of only \$3 a month until \$24.80 is paid. Please include consulting service, as per your offer above.

Name.....
Address.....
City..... State.....
Please attach letter stating age, occupation and name and address of employer and that of at least one business man as reference.

PLUMBERS & STEAM FITTERS

Audels Plumbers and Steamfitters Guides

4 Vols. \$6



A practical, illustrated, Reference Library and Study-Course for Master Plumbers, Journeymen and Apprentice Steamfitters, Gas Fitters and Helpers, Sheet Metal Workers, Draughtsmen, Master Builders, Engineers and all Building Trade Students. This valuable set of handy, pocket-size Guides explains in practical concise language and well-done illustrations all the principles, advances and short cuts of the Plumbing and Heating trade—based on modern practice. Contains careful, detailed instructions

on how to figure and estimate various jobs. Use FREE COUPON below to examine, without obligation, this valuable work.

INSIDE TRADE INFORMATION ON:

Soldering, tinning. Joint wiping, bending, beading. Pipe—iron—steel, threading. Mathematics, tables, physics. Materials—iron, steel, copper, brass, lead, tin, antimony, etc. Sheet metal—galvanized—plate. Sanitation, siphonage, tanks. Drainage, sewage, purification. Fixtures—bath—kitchen. Pipe fittings, soil pipe, tools. Laying out work. Rounding. Screwed fittings, flanges, joints. Pipe bending, examples. Elbows. Heating, ventilation, air conditioning, refrigeration. Water supply, mains, wells, tanks. Gas-fittings. Sheet metal work, problems, methods. Braising, beading, lead burning. Welding, various welds, methods. Blacksmithing, forges, tools. Air Conditioning.

THEO. AUDEL & CO., 49 W. 23rd St., New York City

Mail Audels Plumbers Guides, 4 vols., on 7 days' free trial, if O. K. I will remit \$1 in 7 days, and \$1 monthly until \$6 is paid. Otherwise I will return them. No obligation unless I am satisfied.

Name.....
Address.....
Occupation.....
Reference..... P.M.



FISHING TACKLE

ALL SPORTING GOODS
LOW PRICES



For sportsmen, big Free 148-page Catalog and Fisherman's Guide. Contains Fishing Calendar. Every item top quality; money-back guarantee. Fishing Tackle, Baseball, Golf, Tennis, Archery, Guns and Clothing. Typical values—

- \$7.00 Split Bamboo Fly Rod, 2 tips \$4.45
- \$4.50 One-Piece Solid Steel Casting Rod \$2.88
- \$4.25 Automatic Fly Rod Reel \$2.65
- \$1.55 Nylon 25 yard Fly Line—Light Amber . . 98¢
- \$1.35 Nylon 50 yard Casting Line 89¢
- \$1.20 Asst. of Bass, Spinner & Bucktail Flies . . 65¢
- \$1.25 Bleeder Casting Bait with 12 tablets. . . 35¢

Free Catalog Send today for big illustrated Catalog with hundreds of bargains to save you real money. WRITE TODAY for FREE 148-PAGE CATALOG.
GATEWAY SPORTING GOODS CO.
740 Gateway Bldg., Kansas City, Mo.

42nd YEAR ENGINEERING DEFENSE COURSES

Short, intensive Defense courses in Aircraft, Sheet Metal, Mechanical, Structural, Architectural Drafting; Electricity; Power Plant; Arc, Aircraft Welding. One and Two-Year courses in Aeronautical, Electrical, Mechanical, Structural, Architectural, Civil Engineering. B.S. Degree 3 Yrs. Low tuition and living costs. Part-time work for room and board. Thousands successful graduates. Extensive equipment. Theory and practice. Non-essentials omitted. No home study courses. Catalog free.

FINLAY ENGINEERING COLLEGE
1001 Indiana Ave. Kansas City, Mo.

HOW TO PICK YOUR BEST CAREER

Don't Choose Your Lifework Blindly

There is a career that will fit you like a made-to-measure suit. And since we can show you how to find it! Our new methods will discover your natural talents and tell you in advance what career they best fit you for.

FREE Send for FREE booklet explaining how you can use this new proven system to achieve greater success and happiness.

Vocational Guidance Associates, Dept. 12-A, 25 N. Mentor, Pasadena, Calif.

RADIO ENGINEERING

broadcasting, aviation and police radio, servicing, marine and Morse telegraphy taught thoroughly. 48 weeks' engineering course equivalent to three years' college radio work. School established 1874. All expenses low. Catalog free.

The Dodge Institute, Dept. D, Valparaiso, Ind.

Free WELDING

Welding offers immediate opportunities for better pay. Learn at home in spare time. Dynamic electric welder furnished for home use. Intensive shop training later. Also day and evening classes. Send for free trial lesson.

CHICAGO TECHNICAL COLLEGE
8-602 Tech Bldg., 2000 S. Mich. Ave., Chicago, Ill.

Learn PHOTOGRAPHY at Home

Splendid opportunities. Prepare in spare time. Easy plan. No previous experience needed, common school education sufficient. Send for free booklet "Opportunities in Photography", particulars and requirements.

American School of Photography
1315 Michigan Ave., Dept. 1352, Chicago, Ill.

NICHOL'S POULTRY BOOK FREE

Tells how Nichol's strains, improved with over 900 R. O. P. and pedigreed males for 1942, will give better growth, greater livability, MORE PROFITS. U. S. H. Pullorum tested, 23rd season. EARLY ORDER BARGAIN on Baby Chicks, sexed or started. Postal brings big FREE book and low 1942 prices. Address—

NICHOL'S POULTRY FARM, Box 32, MONMOUTH, Ill.

BERRY'S New POULTRY BOOK

BERRY'S Champion-Mated, Hand-Picked CHICKS, also SEXED, STARTED, 52 Breeds, 7 HYBRIDS, TURKEY POULTS. All Iowa Inspected, BWD Tested. Over 400 Prizes—30 Shows! LOW PRICES. In Business 46 years. Beautiful POULTRY BOOK FREE, stamps appreciated.

BERRY'S POULTRY FARM, Rt. 25, CLARINDA, IOWA

we-do-it-with SQUABS

Raised in ONLY 25 DAYS. Why breed for small-profit trade when luxury markets want all the squabs you can ship, every day in year? NEW BOOK tells how, personal detailed accounts of large profits. Send 3c stamp for mailing, ask for FREE eye-opening book.

RICE FARM, 640 H. ST. MELROSE, MASS.

NOT ALL DO AS WELL BUT **\$779.81**



LAST MO.

GROSS IN MY OWN BUSINESS

is what G. E. Carpenter reports. In reading these reports of large earnings, note that they are gross earnings made by good men for specific periods and therefore do not reflect continuous operations, but they do give you an idea of what a livewire can do in his busy seasons. We want more reputable, honest men with sufficient ambition to try and do as well. No special experience is necessary nor more than ordinary ability, but honesty and courtesy count in building a high-grade business of your own.

NO SHOP NECESSARY

This rug washer cleans rugs beautifully on the customer's floor. Electricity does the work, removing dirt and grime, thus bringing out the natural beauty of floor coverings. There are hundreds of customers in your vicinity and nearby towns. Simply wash a few rugs or carpets. These customers tell others, and soon you should have a prosperous money-making business. Send coupon for booklet explaining everything.

LOOK WHAT OTHERS HAVE DONE

L. A. Rowe said he took in \$148 his first week and is 61 years old. L. T. Jordan said that he has had weeks running close to \$400. J. W. Benson said his best day was \$54.50, while E. C. Thomas reported that he took in \$1100 in 18 days. You too should be able to enjoy a fine income.

VON SCHRADER MFG. CO., 102 PL., RACINE, WIS.

LEARN MONEY-MAKING CARTOONING

Reveals Simplified Method that has helped train creators of "Terry & Pirates," "Wash, Tubbie," "Out Our Way," "Winnie Winkles," "Hear 'lar Fallers," "Strange As It Seems," "Secret Agent X-9," and many others. Earn while learning. Rush 10c for Picture Chart (to test your ability) and full details. (State age.)

THE LONDON SCHOOL, 4202 National Bldg., Cleveland, Ohio



Always write your name and full address clearly when answering advertisements.

ELECTRICITY

"LEARN BY DOING" in 12 weeks

I'LL FINANCE YOUR TRAINING!



Get ready now for a good job in Electricity. My Big Free Book tells you how we train you in 12 weeks, by actual shop work on real electrical machinery - not by books or correspondence. Amazing plan enables you to get training first... then take 12 Months to pay in small monthly payments starting 60 days after graduation. Experience or advanced education not needed. Many Earn While Learning. Free lifetime employment service. Radio, Electric Refrigeration and Air Conditioning instruction included. MAIL COUPON for FREE BOOK and all facts.

H. C. LEWIS, Pres., COYNE ELECTRICAL SCHOOL, 500 South Paulina Street, Dept. 22-72, Chicago, Illinois

Send free book with Facts on Coyne, the Pay After Graduation plan, and extra 4 weeks Radio course now included.

NAME _____
 ADDRESS _____
 CITY _____ STATE _____

Free Book!
MAIL COUPON now

VON SCHRADER MFG. CO.,
 102 PL., Racine, Wis.

Send at once (no obligation) your free booklet illustrating rug washer and telling how I can own my own permanent business; how I can earn large profits at prices below other methods; how I can become financially independent in a short time; and how I can pay on easy terms.

Name _____
 Address _____
 City _____ State _____



"NEVER A COMPLAINT"

C. J. Wright wrote, "Did \$100 business in six days with never a complaint." That is the nicest part of this business. Customers are more than satisfied because of the fine cleaning job you do, and because you do the work right in the home, so they do not have to be without rugs and carpets.

EVERY MACHINE GUARANTEED

You take no risk. These machines have been manufactured since 1918 and are used by many successful operators throughout the United States. They are fully guaranteed.

EASY TERMS

The complete equipment is inexpensive. A reasonable down payment brings everything to you and the balance is paid monthly. From the start you have your own business—one that is profitable and of which you can be proud.

MAIL COUPON Today

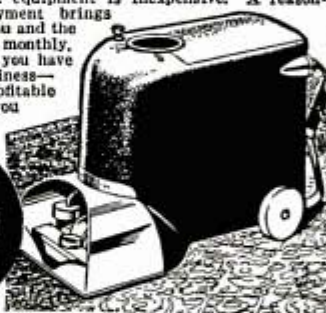

AIRCRAFT DESIGNING and ENGINEERING



HOW is your opportunity to train in spare months with a Ryan Home Study Course in Aeronautical Drafting and Engineering. You can quickly prepare for drafting and design jobs with good pay and unlimited future. Courses prepared by aviation industry leaders in simple and understandable form; no previous training is necessary. Mail this ad today and get free illustrated literature with details.

RYAN AERONAUTICAL INSTITUTE
 422 Lindbergh Field, San Diego, Calif. Home Study Affiliate Ryan School of Aeronautics

Short-Cut Mathematics COMBINED WITH Practical Mechanics Simplified

NEW 2-in-1 reading course! Now you can learn the speedy, simplified system of calculation used by draftsmen, engineers, accountants, "master minds" on the stage. Learn easy way to multiply 4 figures by 4 figures without using old-fashioned multiplication; add long columns of figures this lightning short-cut method. Learn horsepower, slide rule, micrometer, logarithms, wood measure, puzzles, etc., etc. Large illustrated volume complete with answers, only \$1 postpaid. Satisfaction or refund. Amaze friends with your magic-like mental powers. **FREE Complete details... mail coupon TODAY!**

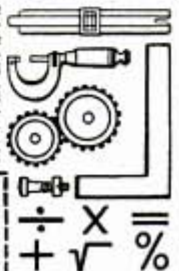

NELSON CO., 500 Sherman St., Dept. B300, Chicago
 Please send free details about "Short-Cut Mathematics and Practical Mechanics Simplified." No obligation.
 Name _____
 Address _____

PATENTS

Booklet Free Highest References
Promptness Assured Best Results

Send drawing or model.

ALL BUSINESS GIVEN PROMPT AND PROPER ATTENTION

Listed Patent Lawyer in the latest editions of the Rand-McNally Directory of Bankers and Bank-Recommended Attorneys, published by Rand-McNally & Co., Chicago, Ill.; American Lawyers Annual, Cleveland, Ohio; Bankers Service Legal Directory, published by Bankers Service Co., Boston, Mass.; and the Snow-Church Directory Co. Lawyers List, published in New York City.

WATSON E. COLEMAN, Victor Building, 724 Ninth Street, N. W.
REGISTERED PATENT LAWYER WASHINGTON, D. C.

INVENTORS PATENT YOUR IDEAS SEND FOR FREE BOOK



HOW TO OBTAIN A PATENT

Written by a Former Member of the Examining Corps (1922-24) of the U. S. Patent Office. If you want to profit by your ideas, you should take steps to apply for a U. S. Patent at once. Your first step is to get this Free Book. This interesting illustrated book contains valuable information you should have. It tells you fully how to obtain a patent on your idea in the quickest way. With this Free Book you will also receive a "Record of Invention" form on which you can easily record your idea. Personal and Confidential Service: Your case will be personally handled only by a Registered Patent Attorney who is also a Former Member of the Examining Corps of the U. S. Patent Office. All communications confidential.

MAIL COUPON TODAY for FREE PATENT BOOK and RECORD OF INVENTION Form.

CARL MILLER
REGISTERED PATENT ATTORNEY
FORMER MEMBER EXAMINING CORPS U. S. PATENT OFFICE

Woolworth Bldg., 35th Floor, Dept. 22-A, New York City
MILLER BUILDING, Dept. 22-A, WASHINGTON, D. C.

Please send me your Free Book, "How to Obtain a Patent," and your "Record of Invention" form.

NAME

ADDRESS

PATENTS—TRADE MARKS

All cases submitted given personal attention
Form "Evidence of Conception" with instructions
for use and "Schedule of Government
and Attorneys' Fees"—FREE!

LANCASTER, ALLWINE & ROMMEL

Patent Law Offices

412 Bowen Bldg. Washington, D. C.

BE PREPARED! SHOOT NEW BENJAMIN TARGET PISTOL



NEW Streamlined Hand Pump
—Longer Shot Barrel—Larger Grip—
More Power—Accurate—Practical
—Economical—Safe—Clean—Quiet.
No smoke or fumes. Bolt Action—
Hammer Fire—Hair Trigger—Safety
Lock. Single Shot BB with 1 lb. shot
\$9.00; Single Shot Cal. .177 or .22 filled—
with 200 pellets \$10.50; Hebler \$2.00. Also a complete line of Benjamin Genuine
Compressed Air Rifles for BB and Cal. .177 or .22 pellets. No license required. Ask your
dealer for a demonstration. Write today for complete specifications and free targets.
BENJAMIN AIR RIFLE CO., 890 Marion St., St. Louis, Mo., U. S. A.

AVIATION

MORE DRAFTSMEN NEEDED on planes, motors, equip-
ment. Big pay. Special Aviation Drafting course trains
you QUICKLY at home in spare time. FREE Bulletin.
No obligation. Address
American School, Dept. A-245, Drexel at 58th, Chicago

STAMMERERS

Before decid-
ing, let us send you
our free helpful
leaflet "SPEECH" and Guild list of ethical, dependable schools
which correct all speech defects. Most advanced methods. Personal
individual instruction. Write today. No obligation.
Stammerers Advisory Guild, 1236-A Maccaebes Bldg., Detroit, Michigan

HELP DEFENSE—PROFIT YOURSELF

Produce more eggs and chickens at new high
prices. American Poultry Journal tells how.
5 years \$1.00, 6 months 10c. Coin or Stamps.
American Poultry Journal, 532 S. Clark, Chicago

WELDERS WANTED!

ELECTRIC ARC—OXY-ACETYLENE
Skilled Welders earn \$8 to \$15 a day. The de-
mand now greater than the supply. Learn this
highly paid trade in 2 weeks by actual shop
work. One of America's leading schools.
Established 1902. 7 floors of shops. En-
dorsed by welding industry. Limited num-
ber of students. 2 weeks course in Electric
Arc or Acetylene Welding, including room
and board, only \$104. Write or wire for res-
ervation. Ask for "Welding Facts." State age.
GREER COLLEGE, Dept 122, 2024 S. Washab Ave., Chicago

Say you saw it in POPULAR MECHANICS

FIBRE ARMS AND LEGS!
Light, correctly fitted, strong and comfort-
able. Natural appearance.
Fair terms.
Scientific Design
BUCHSTEIN-MEDCALF CO.
640 S. 3rd Minneapolis, Minn.

ARTISTS MAKE MONEY

Find out your ability. Send name, age, occupation and
address for Free Vocational Art Test.
ART INSTRUCTION, INC. (Formerly Federal Schools)
2132 Art Instruction Building, Minneapolis, Minnesota

To PROTECT Your INVENTION—Use this coupon, NOW

Delays are dangerous and may be very costly. My personal service assures prompt action, strict confidence, and a minimum of expense. I suggest that you send me a model or drawing, or sketch and description of your invention, and \$5.00. I will make a search and report

promptly as to its patentability and send you a copy of my 72-page booklet. Or, if you prefer to read my booklet first, mail the attached coupon at once. I will also send my "Record of Invention" form. (Over 38 years experience as a Registered Patent Attorney.)

L. F. Randolph, 302-D Victor Bldg., Washington, D.C.

Please send me at once, free of charge, your 72 page booklet and "Record of Invention" form.

Name

Address

A PERSONAL CONFIDENTIAL PATENT SERVICE—

LEARN RADIO

GET READY NOW FOR A REAL JOB IN RADIO

Don't put off your start in Radio any longer! You are needed for a good job that is open now . . . steady work . . . a bright future. Big-time opportunities are waiting in Radio for men who are trained.

LEARN BY DOING

Mail coupon now for my plans to help you get the training you need. Read the list below of interesting subjects which you "Learn-By-Doing" at Coyne School. It's easy . . . practical. You do actual work on real, full-sized radio equipment . . . not by correspondence or by classroom reciting. You "learn by doing". If you need part time work we will get it for you so you can Earn while Learning.

I'll Finance Your Training

Even if you don't have a lot of money, it's still easy for you to learn Radio at Coyne. I'll Finance Your Training. Pay tuition in easy monthly payments after graduation. Many students "Earn-While-Learning". FREE LIFETIME EMPLOYMENT SERVICE. Mail coupon for all details.



SERVICING TRAINING
Prepares you for good-pay radio service job. Includes: Elementary Radio - Television - Electronics - Building and Testing Receivers - Vacuum Tubes, Tuning Coils, Condensers, Transformers, etc. - Auto Radios - Frequency Modulation - Motion Picture Sound Work - Sound Heads, Microphones, Photo-cells, Exciter Lamps, Tone Controls, etc. - Acoustics - and many other branches.

OPERATING TRAINING
Complete, practical course in Radio & Television. Prepares you for Government Radio Operators' License Exam. Operating & Testing transmitting equipment - Code Practice - Handling microphones and equipment - Handling studio programs - Recording machines, record players, and pick-ups - F. M. Transmission - Operation of radio control desk - Remote Control - FCC Rules and Laws - Mobile Radio Apparatus - Etc., Etc.

Get My Story!
Send coupon today for my NEW BIG FREE BOOK telling how you LEARN RADIO at Coyne. I'll also tell you how I'll Finance Your Training. Mail coupon NOW.

H. C. LEWIS, President
COYNE ELECTRICAL SCHOOL, Radio Division
500 S. Paulina St., Dept. 22-3H, Chicago, Ill.
Please send me your BIG FREE BOOK, all details of your courses, and your plans to help me get ahead.

NAME.....
ADDRESS.....
CITY..... STATE.....

COYNE ELECTRICAL SCHOOL
Radio Division — H. C. LEWIS, President
500 S. Paulina Street, Dept. 22-3H, Chicago, Illinois

Say you saw it in Popular Mechanics!

FREE INVENTOR'S KIT

MAKES PATENT PROCEDURE EASY



Send For Yours Today

Protect your idea—see how inventions are sold—with the help of this free kit of books! This 57 year old patent attorney firm shows you how and provides you with a special "Certification of Invention" form—your first important step

in patent protection. Here are the answers to all your questions—yours for asking. Fill out coupon—no obligation—absolutely free.

C.A. SNOW & CO Registered Patent Attorneys Since 1875

122 SNOW BUILDING WASHINGTON, D. C.
NAME.....
ADDRESS.....
CITY & STATE.....

AUTO MECHANICS

KEEP IN STEP



NATIONAL DEFENSE DEMANDS EXPERT AUTO MECHANICS—Be prepared with the only completely new revised shop manual to MEET AMERICA'S CIVILIAN DEFENSE NEED!

Here is the manufacturers' official data for overhauling and adjusting every American made automobile from 1935—including the new 1942 models. Regardless of the car you want to repair, MoToR's new 1942 Factory Shop Manual gives you explicit data for the factory-correct way to do the job! U. S. Army Mechanics, thousands of independent repair shops, car dealers, schools and students use MoToR's Factory Shop Manual daily—and you, too, can extend your knowledge with this easy-to-use, informative book that covers every repair problem that confronts even the expert mechanic.

603 BIG 8 1/2 x 11 PAGES—OVER 900 PHOTOS, DRAWINGS, CHARTS, TABLES—Give Nearly 200,000 Vital Facts on:

- American Beniam — Auburn — Austin — Buick — Cadillac — Chevrolet — Chrysler — Cord — DeSoto — Dodge — Ford — Graham — Hudson — Humphobile — LaFayette — LaSalle — Lincoln — Lincoln Zephyr — Mercury — Nash — Oldsmobile — Overland — Packard — Pierce Arrow — Plymouth — Pontiac — Reo — Studebaker — Terraplane — Willys — major data needed to service 350 models of trucks—plus essential data needed to answer your every question on "how-to-do-it"!

Published by MoToR, 572 Madison Ave., New York, N. Y., The Leading Automotive Business Magazine

PRICE ONLY \$4
Your Money Back if not Satisfied

SEND NO MONEY * MAIL COUPON * PAY C.O.D.

MoToR, Book Department, Room 508, 572 Madison Ave., New York Please RUSH me a copy of MoToR's new 1942 Factory Shop Manual. I will pay postman \$4 plus postage and handling charges; but it is understood that if book does not satisfy me I may return it within 7 days (and in its original condition) and have the \$4 purchase price returned. (Foreign Price \$6 each with order.)

NAME.....
ADDRESS.....
CITY..... STATE.....
OCCUPATION.....



DRAFTING

BOOKS SENT FREE!
ON APPROVAL—5 VOLUMES
BRAND NEW EDITION

For Beginners or Experts

Written so you can understand every word, by well known engineers. De Luxe modernistic, washable cloth binding, over 1600 pages, hundreds of blueprints, charts and diagrams; prepares you for a good drafting job in mechanical lines. Sent for 10 days' free use if you mail coupon immediately.

Big Field • Big Demand • Big Pay

Competent draftsmen are urgently needed in all manufacturing lines at \$30.00 to \$75.00 a week. That's just the beginning—FOR DRAFTSMEN HAVE GOOD CHANCES FOR ADVANCEMENT. Pleasant, fascinating work, easy to learn and do. Learn quickly with these books—send coupon for a set and see for yourself.

[A year's consulting service now given to all buyers of this famous cyclopedia of drafting.]

AMERICAN TECHNICAL SOCIETY

Publishers—Home Study Courses

American Technical Society, Dept. D210, Drexel at 58th St., Chicago, Ill. Send for 10 days' trial, Brand New 5 volume set of "Drafting for Machine Trades." I will pay the delivery charges only. If I wish, I may return books in 10 days and owe you nothing, but if I decide to keep them, I will send \$2.00 after 10 days, then only \$3.00 a month until \$19.80, the total price, is paid. Send Brand New edition and include Consulting Service Certificate.

Name.....
Address.....
Please attach letter stating age, occupation, employer's name and address and that of at least one business man as a reference.

AUDELS Carpenters and Builders Guides

4 vols. \$6



Inside Trade Information for Carpenters, Builders, Joiners, Building Mechanics and all Woodworkers. These Guides give you the short-cut instructions that you want—including new methods, ideas, solutions, plans, systems and money saving suggestions. An easy progressive course for the apprentice and student. A practical daily helper and Quick Reference for the master worker. Carpenters everywhere are using these Guides as a Helping Hand to Easier Work, Better Work and Better Pay. To get this assistance for yourself, simply fill in and mail the FREE COUPON below.

Inside Trade Information On:

How to use the steel square—How to file and set saws—How to build furniture—How to use a mitre box—How to use the chalk line—How to use rules and scales—How to make joints—Carpenters arithmetic—Solving mensuration problems—Estimating strength of timbers—How to set girders and sills—How to frame houses and roofs—How to estimate costs—How to build houses, barns, garages, bungalows, etc.—How to read and draw plans—Drawing up specifications—How to excavate—How to use settings 12, 13 and 17 on the steel square—How to build hoists and scaffolds—skylights—How to build stairs—How to put on interior trim—How to hang doors—How to lay floor—How to paint



THEO. AUDEL & CO., 49 W. 23rd St., New York City

Mail Audels Carpenters and Builders Guides, 4 vols., on 7 days' free trial. If O. K. I will remit \$1 in 7 days, and \$1 monthly until \$6 is paid. Otherwise I will return them. No obligation unless I am satisfied.

Name.....
Address.....
Occupation.....
Reference..... P.M.

Play Easier, Better

WITH NEW SEAMLESS BELL
Coprion TROMBONE



World's only Seamless Bell, made of Coprion, exclusive new metal, makes it impossible to crack or overblow a note. Richer tone quality, easier response, amazingly greater flexibility. Exclusive on Conn trombones, cornets, trumpets. Preferred by leading artists. A Conn Coprion will improve your playing. Homerial. Easy payments. See your Conn dealer or write us. Please mention instrument.

C. G. CONN, Ltd.
231 Conn Building
ELKHART, INDIANA

Write FOR FREE BOOK



WANT FUN... POPULARITY... A CAREER?



Learn to PLAY THE GUITAR: HAWAIIAN, SPANISH, Amazing, SHORT-CUT METHOD right in your own home. No tiresome scales, no old fashioned exercises. PLAY FROM YOUR VERY FIRST LESSON. Entertain yourself, astonish your friends. Play on the radio. Make money teaching. Hundreds of our students now successful in bands, teaching, radio. You can do the same.

FREE ILLUSTRATED BOOKLET

"Learn to Play the Hawaiian Way" tells all about this modern, fascinating way to learn. Write for your copy NOW.

OAHU SCHOOL OF MUSIC
Film Bldg., Cleveland, Ohio
Room 1502

AVIATION NEEDS INSTRUMENT MEN More Than Ever

Ever-increasing numbers of great airliners and mounting thousands of military and private planes mean more and more jobs—and ever-widening opportunities—for trained instrument technicians—in aircraft plants, instrument manufacturers, airlines, and in Civil Service at Army and Navy aircraft maintenance depots. Civil Service allows 6 months training as complete substitution for 2 years experience usually required. Prepare for this interesting, well-paid lifetime calling. Choice of 4 training courses—one all home study. Write American School of Aircraft Instruments, Dept. M-2, Glendale, Calif.

TIRED OF WORKING FOR OTHERS

BE A LANDSCAPE ARCHITECT

Make this healthful, creative, profitable outdoor work your career! Interesting hobby, too! Study at home in your spare time. Lessons include: Garden Design, Landscape Horticulture, Mapping and Field Work, Plant Materials, etc. Many opportunities for trained men and women. Write today for free booklet "Success thru Landscape Training."

American LANDSCAPE School
6295 Grand Ave., Des Moines, Ia.

Correspondence Courses in RADIO and ELECTRICAL ENGINEERING

LOW AS \$25

ELECTRICAL ENGINEERING. Get good grasp of wide electrical field. Modern. Very understandable. Theory made easy. RADIO ENGINEERING. Extra fee course in radio, public address, photo-electric work. Trains you to be super-service man, real vacuum tube technician. Tuition ONLY \$25, either course. Deferred payment plan. Experiment kits furnished.

FREE Write for free copies of school catalog, student magazine, etc. LINCOLN ENGINEERING SCHOOL, Box 933-P-35, Lincoln, Neb.

EARN THE DEGREE

Doctor of Psychology (Ps.D.), Doctor of Divinity (D.D.), many others. Course in business, accounting, law, etc. Low fees. Send for large Bulletin and student picture-folder AT ONCE. No obligation whatever.

TEMPLE BAR EXTENSION COLLEGE
1411 Fourth Avenue, Dept. 4-R, Seattle, Washington, U. S. A.

CRIME DETECTION SECRET SERVICE AND FINGER PRINTS

SECRET SERVICE BOOK FREE

For 30 Days Reading
No Money Down—Actual Crime Cases—
If You Don't Mind! We will send you this stirring book on Crime Detection, Secret Service and Identification Work for 30 days free reading. Send no money, if you decide to keep it, then send me only \$1. If not, return it. WRITE TODAY. Literature will be sent only to persons stating their age.

T. G. COOKE, Dept. 1352, 1929 Sunnyside Ave., Chicago, Ill.

PRESTO! ANYONE CAN MASTER GLAZE

LEAVES HARD GLASS-LIKE FINISH
EASY TO APPLY
PROTECTS THE SURFACE
NO SMEAR OR STREAKS AS WITH WAX
LASTS SIX MONTHS TO A YEAR

SEALS THE PORES OF THE SURFACE
WILL NOT FINGER-MARK
NO GILTY FILM
EASY TO AS WITH POLISH
SAVES YOU MONEY

Car Owners! Meet Master Glaze—the sensationally different luster for new and used cars! Not a wax—not an oil polish—not a paint!—nothing that “smears” over the surface.

MASTER GLAZE is a unique discovery—a creamy liquid—quick and easy to apply! Gives a hard, glass-like surface. Even gasoline cannot dull it! Lasts six months to a year! Amazing luster—beautiful, sparkling clean and brilliant! Doesn't finger-mark—doesn't smear! A match box full glazes an entire car. Seals the pores—protects! **NOTHING LIKE IT!** FREE SAMPLE Write now for FREE BOOK—FREE Offer! LET and FREE TRIAL OFFER. Just send your name and address. Write **MASTER GLAZE CO., 7720-274 W. Harwood Ave., Milwaukee, Wis.**

RUPTURED?

Get Relief This Proven Way

Why try to worry along with trusses that gouge your flesh—press heavily on hips and spine—enlarge opening—fall to hold rupture? You need the Cluthe. No leg-straps or cutting belts. Automatic adjustable pad holds at real opening—follows every body movement with instant increased support in case of strain. Cannot slip whether at work or play. Light. Waterproof. Can be worn in bath. Send for amazing FREE book, “Advice To Ruptured” and details of liberal truthful 60-day trial offer. Also endorsements from grateful users in your neighborhood. Write: **CLUTHE SONS, Dept. 31, Bloomfield, New Jersey**

AIRCRAFT WELDING ENGINEERING

Defense Industries offer Outstanding Opportunities to properly trained Welding Technicians (1 year), Aircraft Draftsmen (1 year), Aircraft Welders and Arc Welding Operators (3 months). Learn By Doing. “Ask how to earn \$1040 while learning.”—Write for free 64-page illustrated Book—“Dawn Of A Giant Industry.” Mention course desired.

MILWAUKEE SCHOOL OF ENGINEERING
PM-242—N. Broadway & E. State, Milwaukee, Wis.

Learn TOOL DESIGN

Qualify quickly as a Machine Tool Designer by home study in spare time. Entire defense program depends largely upon the machine and tool designer. After defense boom, machine and tool designers will be equally necessary for reconstruction. Many now making \$100 to \$125 a WEEK. Rapidly expanding industry calling for more machine and tool designers than now available. Learn quickly with our step-by-step lessons supervised by a recognized professor of machine tool design. Both name and address today for complete facts on Machine or Tool Design. Learn what these fields offer you and how quickly you can qualify for a big pay position. No obligation. State age. A penny postal will do—but hurry.

R. WENDELL DUNKLE, Box 50, Ohio Institute of Technology, Greenville, Ohio

ITALIAN ACCORDIONS

HAND MADE. Very best. Lowest prices. Direct from Factory Representatives. Send your name and address for FREE catalog.

ITALIA & P. SOPRANI ACC. MFG. CO.
323 W. POLK ST., DEPT. PM, CHICAGO, ILL.

Burn Your Name On Tools Electro Name Etcher

Protect valuable tools from thieves and tool borrowers! Electro Etcher BURNS your name, any design, permanently on tools, instruments, any metal. Easy! Simple as writing with pen or pencil. SEND NO MONEY! Rush order today. Pay postman only \$1.00 plus few cents postage on delivery. Use 5 days—money back if not delighted. **Electro Name Etcher, Dept. A-600, 254 Robb St., Cincinnati, O.**

START DRAWING BIG MONEY!

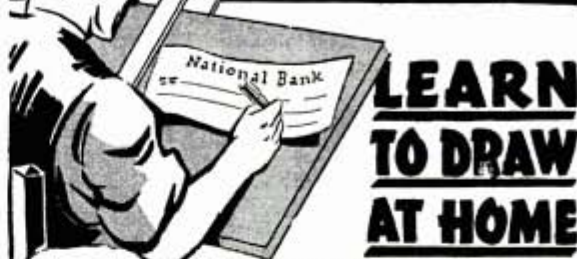

LEARN TO DRAW AT HOME

TRAINED ARTISTS are capable of earning \$30, \$50, \$75 A WEEK!

Plan your future NOW—prepare yourself with modern Art training for a secure career in this pleasant, profitable field. Our effective spare-time study method has trained men and women for successful art careers for over 27 years. No previous art experience necessary. Many of our graduates are now making money in their own art studios, or working for newspapers, publishers, stores, etc.

COMMERCIAL ART CARTOONING, ILLUSTRATING

All in ONE practical course

PICTURE BRINGS \$25
Mrs. G. A. Wemmer of Sedan, Kans., has sold several paintings. One small picture for \$25. (2/37)

\$93.95 IN SPARE TIME
—B. L. Snyder of Scranton, Pa., earned this amount for spare time Art work, while taking our course. (7/39)

THANKS WSA FOR JOB!
—J. J. Beard of Columbus, Ga., credits our course as sole reason for job as Art Director in advertising agency. (9/41)

Mail coupon today for FREE BOOK

Our illustrated book explains course in detail—describes commercial opportunities in Art and also the TWO ARTISTS' OUTFITS included with the course.

FREE BOOK gives details!

WASHINGTON SCHOOL OF ART
Studio 122A, 1115—15th Street, N. W.
Washington, D. C.

I am interested in your course. Without obligation, send full information in your Free Book, “Art for Pleasure and Profit.”

Name..... Age.....
Address.....
City..... State.....

Say you saw it in Popular Mechanics!

The *NEW* OPPORTUNITY in .. ACCOUNTING ..

—and how *YOU* can take advantage of it

NEVER before has there been as great an opportunity as now faces efficient bookkeepers and accountants.

You know, of course, that accounting has always been a profession of outstanding opportunity—a field in which the capable, trained man could go faster and farther than in almost any other field. But we believe that all past opportunities are going to be surpassed in the next five years.

And here's why:

In the first place, the defense situation has accelerated and complicated business. Hundreds of new plants, hundreds of others expanded, priorities, shortages of raw materials, some companies shifting to new products, and millions more men at work necessitate more bookkeeping and accounting—both by government bodies and by private industry.

Then our governmental policy forces the keeping of better and more complete records in every office and plant. It is not a matter of choice with any firm—it is necessity.

For instance Federal Securities Act, with its insistence upon publicity of *complete* facts about every company selling its securities publicly, compels more frequent and more accurate financial state-

ments—and these in turn call for more and better accounting.

Then the Social Security tax, the unemployment regulations, the Wages and Hours Act, the Excess Profits tax and other taxes necessitated by national defense—all center around more complete accounting records.

Thus there is an insistent and growing demand for bookkeepers and accountants, a demand that already exceeds the supply and is still growing. This goes all the way along the line from routine bookkeepers to executive accountants. And it seems likely to increase much farther.

Ask for the Facts

We need not tell you what that means in opportunity for the capable man already in accounting and for the able man who gets into accounting now. Nor need we argue for the practicality and value of LaSalle training in Accountancy—over 500,000 men and women, and 2,000 C. P. A.'s have already tested and proved that.

The only question is about *you*—whether you fit into this field and whether you can and will prepare yourself adequately. For accounting is no magic wand to

summon success—it demands much from the man whom it rewards highly.

You can answer that question wisely only when you know the facts. And the coupon below will bring you full facts about these demands and opportunities in accounting today together with the details about the LaSalle home-study training in Accountancy.

If you are dissatisfied with your present situation—and in earnest about achieving success—get the facts—use the coupon—**NOW.**

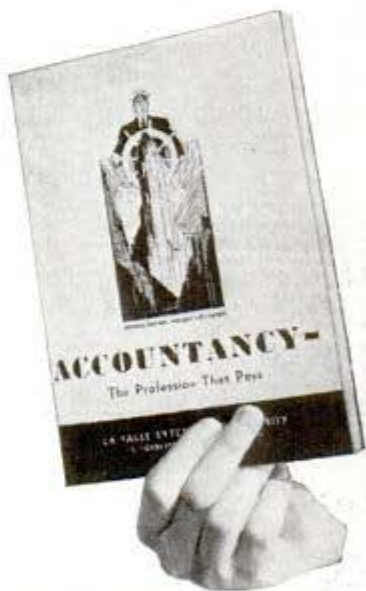

I'd like to see whether I should take up accountancy. Send me, without obligation or cost to me, your booklet, *Accountancy, the Profession That Pays*, and full information about your Accountancy Training program.

Higher Accountancy

LASALLE EXTENSION UNIVERSITY

Dept. 264-HR, Chicago
**A CORRESPONDENCE
INSTITUTION**

Other LaSalle Opportunities:

If more interested in one of the fields indicated below, check and mail now.

- | | | |
|--|---|--|
| <input type="checkbox"/> Business Management | <input type="checkbox"/> Commercial Law | <input type="checkbox"/> Business Correspondence |
| <input type="checkbox"/> Modern Salesmanship | <input type="checkbox"/> Modern Bookkeeping | <input type="checkbox"/> Business English |
| <input type="checkbox"/> Law—Degree of LL.B. | <input type="checkbox"/> C. P. A. Coaching | <input type="checkbox"/> Stenotypy |

Name..... Age.....

Present Position.....

Address.....

**WORLD'S
BEST
WANT AD
MEDIUM**

CLASSIFIED Advertisements



Advertisements in this section, 35 cents per word, each insertion, minimum 10 words, payable in advance
To be inserted under proper classification in March issue, copy should be in our office January 8th

March issue on sale February 1st

Popular Mechanics Magazine, 200 East Ontario Street, Chicago, Illinois

YOU'LL PROFIT

By reading and answering the classified ads in this section. Hundreds of opportunities to make and save money.

Popular Mechanics Magazine,
Chicago, Illinois.

Gentlemen: You just can't argue about an advertising medium which pulls orders across the Atlantic despite war. That's exactly what Popular Mechanics Magazine has been doing since our first advertisement in your September, 1939, issue. Furthermore, each of the nearly 200 letters contained a dime for samples, thus making each inquiry almost self-financing. To date, we have spent less than \$20.00 with you. Sales to your readers of our tweeds, worsteds, ties, scarfs, blankets, etc., total slightly less than \$300.

Yours faithfully,

PAUL BRINDEL.

(Original letter on
file in our office)

AUTOMOBILES—MIDGET CARS

AUTOMOBILE Racing book, fifth edition, well illustrated. Instructions on building bodies, frames, engines. Ford A and B conversions. Plans, AAA rules, specifications. Roadster racing. Indianapolis cars. \$1.00 postpaid. \$1.15 C.O.D. Ray Kuns, Dept. 38, Madisonville, Cincinnati, Ohio

HOW To buy a used car. Avoid costly mistakes. Important information for new and used car buyers. 64 pages. \$1.00 postpaid. Welles, 308 E. 242nd St., New York City.

PROFESSIONAL Midget racers, two-passenger roadsters. Midget motorcycles, motorscooters. Parts, plans, wheels. Handbook catalog—125 illustrations, plans—20c. Midwest, Box 1959-CS, Chicago.

MOTORS For midgets, motorscooters. 50 used, \$5.00 up. List, 20c. (List parts, plans included). Shippis Midgets, Box 543-H, Zanesville, Ohio.

SEAL-MATIC Reconditioned motors without new rings! Devereaux, Box 212-J, Battle Creek, Michigan.

WHIRLGAS Turbinator, \$3. spins and vaporizes carburetor mixture. Guaranteed mileage increase any car 20%. University test. Give make, year. Wrench installs 15 minutes. John Hanley, Manufacturer, 5719 Loraine, Detroit, Mich.

GASOLINE Saving device—25c to \$1.00. Ford 1928-1941. Chevrolet 1932-1941. Walert Co., 3429 N. 10th St., Milwaukee, Wis.

FORD Owners and mechanics—learn how to make your old brakes work like hydraulics. Stop chatter, groans. Costs less than \$5 bill. Free details. Super Brake Floater Company, 4022-P Lake St., Chicago.

BUILD Professional midget racer from second-hand auto parts. Plans complete \$1.00. Midwest, Box 1959-GD, Chicago.

FREE—Big list of helpful books. Popular Mechanics Press, 200 E. Ontario St., Chicago.

AUTO SUPPLIES AND EQUIPMENT

"PETROLINE" Users report up to 50% more mileage! Fuller Publications, 495, Kalamazoo, Michigan.

NEW Gas saver 10c. Amazing. Nu-Deville, 102 Greenwich, Stamford, Conn.

AUTO, Truck, tractor tires; auto supplies. Savings to 50%. Stamp with request. Automotive, 606 Johnson, Urbana, Ill.

PLATING Outfits for auto parts. Connect to a battery. No tanks used. Free particulars and proofs. Gunmetal Co., Ave. J, Decatur, Ill.

RECLEAN Used oil without cost. Particulars. F. Gerwin, Oklahoma City, Okla.

AUTO TRAILERS

READY Now—Plans for nine new Jim Dandy Trailers including six modern house trailers. Catalog 10c. Also new edition of Trailer Builders Manual and catalog of parts, supplies and equipment. Price 25c. Both 35c postpaid. Trailer Supply Co., 5120-A Fulton St., Wausau, Wis.

MOTORCYCLES, BICYCLES, MOTOR-SCOOTERS AND SUPPLIES

BUILD Comet motorscooter now! Save 70%. Simply designed, sturdiest parts available. We supply parts, tires, wheels. Literature, drawing 15c. Comet Cycle Company, Box 3032, Madison, Wisconsin.

BUILD Power scooters, midget cars. We supply tires, wheels, motors. Lowest prices. Send 10c for plans, etc. Build-Own Devices, Dept. 2-A, 536 North Park-side, Chicago.

MOTORCYCLES, Reconditioned. New, used, parts and accessories. All makes. Large stock. Bargains. Illustrated catalog, 15c. Indian Motorcycle Sales, Kansas City, Mo.

MOTORSCOOTERS, Midget cars! Easily built. Complete plans and literature on wheels, tires, motors, transmissions, etc., 10c. Honsakers, Masontown, Penna.

MOTORCYCLE, Parts, accessories. Most complete stock. New and used. We specialize on mail orders. What do you need? 35 page catalog 10c. Whitman Motorcycle & Supply Co., 405-9 Southwest Blvd., Kansas City, Mo.

SEND 10c For Handbook of Information. Lists new and used parts for Indian, Harley, Ex-Hen, Bootz, 622 East Grand, Des Moines, Iowa.

MOTORCYCLISTS. We can save you money on parts and accessories. Bargain list and decal free. Illustrated Henderson list 10c. Triangle, 1111 Washington, Chicago.

PISTONS And parts, new and used, all models. Catalogue and wings pin 10c. Ballak, 811 N. 9th, St. Louis, Mo.

AVIATION

PROPELLERS—Special sled, 3 blade, all types, sizes, lists free. Aircooled A conversion diagrams, 25c. Lightplane literature, supplies. Standard Aircraft, Ft. Worth, Texas.

AEROSLEDS, Blueprints \$4. Supplies. Send stamp. Adastik Bros., Grand Rapids, Mich.

PROPELLERS For aircraft, sleds, boats. Shipped C.O.D. Highest quality, many designs. Approved wood propeller repairing. Catalog 10c. Banks Propellers, R.F.D. 7, Ft. Worth, Texas.

BUILD And fly your own motorcycle powered monoplane, home. Easy, cheap. Tested plans, guaranteed. \$1.00. Aerotech, Dearborn, Mich.

AVIATION Mechanics examinations. Test yourself! 450 multiple-choice questions, answer key. Airplanes, engines, C.A.R. \$1.75. Question-Air System, Kilgore, Texas.

AVIATION Cadet examination preparation by home study course. Rutherford Preparatory School, Long Beach, Calif.

PROPELLERS, Skis, for airplanes and iceless. Price lists 10c. Troyer Aircraft, 742 Bridge St., Grand Rapids, Michigan.

PROPELLERS: 3 Blade airliners for snoplanes. Conversion parts. Converted model A motors. Aircraft supplies. Universal Aircraft Co., Ft. Worth, Texas.

AVIATION Books—Latest titles—Bargain catalog free. Popular Mechanics, 633 St. Clair, Chicago.

BATTERIES, GENERATORS, ETC.

BUILD Electric plant operated by wind from automobile generator. Complete plans and 1942 catalog 10c. LeJay Manufacturing, 447 LeJay Building, Minneapolis, Minn.

GENUINE Edison batteries for light, power. Non-acid. Fifteen year life. Five year unconditionally guaranteed. Low prices. Complete lighting plants. Free literature. See-Jay Company, 82 Sterling Avenue, Yonkers, New York.

EDISON Lifetime storage batteries for light and power. Eliminate acid battery diseases. Long guarantee. All kinds re-built generating plants, motors, and miscellaneous articles at bargain prices. Free interesting literature. T. Hawley Smith Co., Croton Falls, N. Y.

110 VOLT A.C. generator for your car or truck. Operates amplifier, movies, etc. Perfect performance, easily installed. LeJay Manufacturing, 147 LeJay Building, Minneapolis, Minn.

ELECTRIC FENCING

NEW Type fence electrifier made from automobile coil. Complete plans and 1942 catalog 10c. LeJay Manufacturing, 947 LeJay Building, Minneapolis, Minn.

ELECTRICAL SUPPLIES—EQUIPMENT

ATTENTION Fluorescent men—Your questions and problems answered free. Send self addressed stamped envelope. Service Lighting Co., Room 406, 109 N. Dearborn St., Chicago, Ill.

1/2 HORSE, 3450 Speed, repulsion induction alternating motors \$10.75; 500 watt alternating generators \$24.50; other sizes. Butler Electric, 1885 Milwaukee, Chicago.

HOW To refine old crankcase oil. Also simple way to convert into fuel oil. Each 59c. Both \$1.00. Wayne Engineering, Box 11, Greenville, Ohio.

"BIG Profit Money-makers," 28 pages. Money-making magazine, 68 pages. Name on mailing list. All, 25c. Shields, 322-D Shaw, Taylor, Texas.

REAL Money selling oranges, grapefruit. Particulars 25c. Refunded first order. McCants Fruit Service, Wealaco, Tex.

AMAZING New 15-way profit mail order business plan. Few dollars starts. Details. Write Bradley's, Box 1871-M, Raleigh, N. C.

OPERATE A mail order business at home! Zillman, 4446 North Kildare Avenue, Chicago, Ill.

WARTIME Plan. Will you give us 5¢ first \$600 you make? Afternoons free? Work home. \$1,000 month reported (exceptional—fulltime). Expect surprise! National, Box 1240, San Bernardino, Calif.

BUILD Cedar chests, desks, card tables, etc. in your spare time. Projects machined, ready to assemble. Catalog 10c. Long's Woodcraft Supply, Goshen, Ind.

TWENTY Dollars daily reclaiming lube. Boisset, Box 483, New Orleans, La.

WHOLESALE Sources. 500,000 articles. Free directory. Maywood, 1107 Broadway, New York.

YOUR Name on 5,000 mailing lists—25c. Get free samples, opportunities galore from all over world. Eastern, P-961 - 46th, Brooklyn, N. Y.

EARN Money at home! Thousands do! "Home Worker Magazine" tells how. Sample, 25c. Sizemore, Box 7, 4017 North Kostner, Chicago.

BE A metascientist. Remarkable drugless healing system. No manipulation, no apparatus. Inexpensive correspondence course. Free information. Metascience, Deland, Florida.

YOU'LL Like resilvering mirrors, tableware, making chipped glass nameplates, signs. Outfit prices. Sprinkle, Plater, 287, Marion, Indiana.

BUSINESS OPPORTUNITIES

DISTRIBUTOR. Here's your real opportunity. America's newest taste thrill. Three new burgers, Seaburger made from the best lobster and shrimp. Oysterburger made from the finest oysters, and Oceanburger made from choice Florida fish, will be sold and served by every hotel, restaurant, hamburger stand, drug stores serving food in addition to every grocery store and delicatessen and department store selling food. National advertising contracted for and manufacturer also participates and shares in local advertising introducing these products. Exclusive protected 10 year contract should make some local man \$2000 monthly. Finest line in the world today and definitely no other line or opportunity like it. You can control as much territory as you are financially able to handle, if you act promptly. Registered trademarks protect the exclusive distributor on these products. An exclusive food business like this is the kind of business any man will take pride in owning. Write today to 163 Stockton Street, Dept. 1, Jacksonville, Florida, for complete facts and judge for yourself.

WEBER Typewriter Mechanics School. Instructions simplified by mail. Canton, Ohio.

MAILORDER. Opportunities book, large size, 10c postpaid. Waddell's, 245 East 7th, New York.

OPERATE Route used 1c, 5c candy bar, peanut, gum vendors, \$1.50 up. Northside Company, Indianola, Iowa.

HANDY Men—Earn money home operating Community "Fix-It" Shop. Stafford, 708 Rawlings, Carbondale, Illinois.

MAILORDER Tips sent free. M. Volchok, 1098 Gerard Ave., New York.

START Home business making statuary, plaques, art goods, novelties, souvenirs, concrete pottery, garden furniture, artificial marble flooring, liquid marble. Make your own flexible molds. Amazing profits. Valuable folder free. Creative Publishers, (F.M.2), Glencoe, Illinois.

GUARANTEED Mailorder letters, circulars, campaigns expertly planned, written. Big "blitzkrieg" results! Low cost! Les Finkel-Advertising, 1013P Los Angeles, Los Angeles, California.

NO Investment money earning opportunities. Big possibilities. Spare-full time. 12 plans 25c. Delux, 601 Professional, Baltimore, Maryland.

PLASTEX Industries offers industrious men an opportunity to start a business of their own, manufacturing art goods, novelties, souvenirs, etc., in Plastex and marble imitation. 5c material makes \$1 articles. Rubber moulds furnished for speed production. Small investment brings good returns. We are now placing big chain store orders with manufacturers. Write for interesting booklet mailed free. Plastex Industries, Dept. A, 1085 Washington Ave., New York.

"LUMINOUS Paint" shines in dark. Easily made. 150 other formulas, plans—all 25c. Ideal Service, 302, Park Ridge, Ill.

MAIL Order business is your opportunity. Over 100 tested plans, formulas, and valuable information. Particulars free. National Business Service, 355 Imperial, Youngstown, Ohio.

ARE You handy with tools? Be independent. Buy our regrooving equipment. Complete \$12.50. Regroove smooth tires. Litt Miracle, 140 West End Ave., New York City.

PROFITABLE Home business resilvering mirrors, easily learned, almost unlimited opportunities, no capital or experience necessary. Complete instructions, \$2.00. Joyce Mirror Co., Canfield, Ohio.

MOLD Plaster novelties. Big profits. Rubber molds and materials. 24-page catalog and sample XL mold material free. Plastic Arts, 711 Neely, Muncie, Ind.

TURN Tin cans into money. Instructions 25c liquid rubber for making molds, free sample. Chaney, 1130 E. 16th St., Jacksonville, Fla.

MAIL Order business course shows you how to make money, spare or full time. Teaches professional mail order technique—not penny-catching schemes. Free details. Nelson Company, 500 Sherman, Dept. B-404, Chicago.

MAKE More money. Get into defense work? Free catalog lists practical semi-technical books on aviation, radio, mechanics, etc. Cochebo Library, Dover, N. H.

SINGLE-INGREDIENT Formulas. No manufacturing! Information free. B. Kinford, Fort Lauderdale, Florida.

"**RUBBER** Molds." Make them yourself. Formulas, instructions 25c. Ideal Service, 179-RM, Park Ridge, Ill.

PAGING That man or woman who wants dandy home business. No canvassing, no manufacturing, no customers calling. All or part time. Begin small, make excellent income. Easy, profitable, pleasant. Full instructions \$1. Free circular. George Gleich, Publisher, 1224 Union Ave., New York.

RUBBER Molds. Vulcanized. Won't shrink. Maintain finest detail indefinitely. Inexpensive. Illustrations of stock molds and prices. Vulcanized Rubber Mold Co., 2720 Washington Blvd., Saint Louis.

"**DIFFERENT** Mail Business." Profits! Security! Instructions. Swearingen Enterprises, Station S, Los Angeles.

MAKE Artificial marble, glazed tiles, sanitary flooring, superhard figurines, rubber molds, moldless pottery, chemically stained cement. Uncanny secrets. Samples 3c, expect surprise. Payn, 945 Grande Vista (Room 101), Los Angeles, Calif.

SUCCEED in your own business. Home or office. Sure-fire spare-time method brings prosperity. New folio explains how. Quarter. Money back guarantee. Business Builders, 435-H Riverside Drive, New York City.

METALIZING Baby shoes makes you money! (Non priorities process.) New! Simple. Fascinating. Small investment, fine profits! Free details. Novelty Metalizers, Box 933M Church St. Annex, New York.

HIRE Yourself as boss! Manufacturing greatest-selling chemical specialties. Investment small. Profits and demand great. Miller's Analytical Chemists, Tampa, Florida.

CALIFORNIA Nut coated raisins, make, sell, sample, details dime. W. L. Small, Los Molinos, California.

EARN Big money. No canvassing. Send 50c for complete plan. H. E. Marks, Middlefield, Ohio.

BRUSH Plating outfits connect to a battery, no tanks necessary. Almost as simple as painting. Your opportunity to make good income plating autoparts, bathroom fixtures, reflectors, mirrors. Get free proof and particulars that put you in a paying business of your own. Gunmetal Co., Ave. H, Decatur, Ill.

HOW And where to obtain capital. Fully explained, particulars free. Star Service, Wapakoneta, Ohio.

\$50-\$100 **WEEKLY** Using sawdust. Clement, 943 Arthur, Rochester, N. Y.

EXTRA Income—Plenty mail selling opportunities. Write Katz, 4254 N. Kimball, Chicago.

MAIL Order business is your opportunity. Many began small, now earn thousands yearly. No personal contacts. Boundless selection. Have had over 40 years experience; will help you succeed. 25c brings two valuable booklets. None free. B. Brenner, 257 S. 21st, Philadelphia.

POPCORN And potato chip machines. We help start men and women in business. Long-Eakins, 1960 High, Springfield, Ohio.

COLOR Concrete with chemicals. Washing wells. Stucco-rock. Benches. Spin concrete pottery. Cement artistry. Garden ornaments. Cold glaze. Concrete paints. Marbling. Sample 10c. Hollywood Cement Craft, 8527 Wonderland, Hollywood, Calif.

MAKE Colored glazed concrete pottery, cemetery products, tiles, floors. Basement waterproofing. Other projects. Booklet, colorplates, details 10c. National Potteries, Minneapolis, Minnesota.

SELL Books by mail on commission. No stock to carry. Orders come to you. Maywood Publishers, 1107 Broadway, New York.

LIQUID Marble—Colorful, glazed! Mold, brush, spray! Composition floors, rubber-lastic molds. Particulars free. Marbleising Service, Edwardsville, Illinois.

OPPORTUNITIES For local and mail order business. Gilbert Supplies, 5 West 24th, New York.

CHARTERS: Delaware; best, cheapest; free forms. Colonial Charter Co., Wilmington, Del.

ELITE Collection of business plans, contains 127 tested plans and scores of formulas. Start own business; home, office. Particulars free. Elite Co., 214 Grand St., New York.

WHERE To buy at lowest wholesale prices. Information free. Yorena, Box P-312, Bayonne, N. J.

127 WAYS To make money, in home or office, business of your own. Full particulars free. Elite Co., 214 Grand St., New York.

MAKE Money by mail, the way we do. Free information. Maywood, P-1107 Broadway, New York.

SWISS Music box works—\$1.25 to \$2.10. Suitable for many novelties. Mermod Manufacturers, 147 West 46th Street, New York.

YOUR Ad in this space will bring amazing results. I'll prove it to you. Write at once for interesting information. F. W. Johnson, Room 300, 200 East Ontario St., Chicago.

WE Successfully sell inventions, patented and unpatented. Write us, if you have a practical, useful idea for sale. Chartered Institute of American Inventors, Dept. 4-C, Washington, D. C.

YOU'LL Like resilvering mirrors, tableware, making chipped glass nameplates, signs. Outfit prices. Sprinkle, Plater, 127, Marion, Indiana.

RECEIVE Giant mails, opportunities, magazines, samples—10c. Janhonen, Spencer, New York.

MAKE Money at home by mail. Particulars free. Dohrman, Box 109-B, Madison, Wisconsin.

MANUFACTURE At home. 25 single ingredient formulas, 10c. Star, Box 7055, Portland, Oregon.

START Your own magazine agency at home. No capital required. Write for particulars and supplies. American Readers' Service, Hatfield, Penna.

FREE—200 Clevel mailorder, homework, local business offers—all snappy money-makers. Lewis Co., 828-M Carpenter, Oak Park, Ill.

2c DAILY Pays for New York office under your own name. Co-Operative Offices, 126 Lexington Avenue, New York.

MAKE Beautiful glass and illuminated signs, mirrors, emblems, picture mounts. Cheney Sign System, Park Ridge, Ill.

DOLLARS, Quarters, daily. Instructions 25c. Jerome Barnes, 3011 Glasgow, Portsmouth, Virginia.

SPECIALTY Manufacturing — 1000% profit! Formulas especially designed small businesses. Little capital, no machinery. Brochure free! Victor C. Race, Norwalk, Connecticut.

HIGH-GRADE SALESMEN

ADVERTISING Book matches. America's largest manufacturer of union label book matches. Fast selling line. Large sales producing kit. Sample matches. Complete cut catalog. 13 color combinations makes selling easy. Commission in advance. Superior Match Company, 7530 Greenwood, Dept. N-2, Chicago.

BIG Commissions—selling to stores celluloid pricing tickets, metal shelf moulding. To restaurants, menu covers, signs. P. Pricing Press, 124 White St., New York.

CALENDARS, Fans, novelties—Beautiful complete lines all sizes, including jumbos, samples free. Start now, be first in field. Fleming Calendar Company, 6539 Cottage Grove, Chicago.

MEN. Sell handsoap in bulk. Free details. Tom Good Products, Dept. 110, 133 South Central Ave., Marshfield, Wis.

SOMETHING New in fire extinguishers. Red Comet authentic safety sprays. Real fire killers. Low price. Salesmen needed. Splendid outfit furnished. Write today to Red Comet, 704 Comet Building, Littleton, Colorado.

BIG Money daily. Sell business stationery, advertising specialties, book matches, gummed tape, 700 other necessities to stores, offices, professional men. 33-1/3% profit paid daily. Best line of its kind. No experience needed. Big outfit free. David Lionel Press, 312 So. Hamilton, Dept. 72, Chicago.

MAKE More money selling Red Comet Fire Control Products. Write today for free facts. Red Comet, 704 Comet Building, Littleton, Colorado.

BELL-O Abrasivostrop, Gardner, Massachusetts. County rights. Listed at army post exchanges.

ADVERTISING Book matches offer liberal earnings—full, spare time. Experience unnecessary. Factory direct. Low prices for fine quality, quick deliveries, help get orders; faster repeats. All business firms prospects. Free outfit, instructions. American Match & Printing Co., Dept. 62, 4822 South Trumbull Ave., Chicago.

SOMETHING New in fire extinguishers. Red Comet automatic safety sprays. Real fire killers. Low price. Salesmen needed. Splendid outfit furnished. Write today to Red Comet, 704 Comet Building, Littleton, Colorado.

BRANCH-Office-sales-service-manager, for efficiency-reference reports. Plans \$1.00 and 10% royalty. Noble B. Martin, 569, Redmond, Oregon.

EXCELLENT Opportunity selling our complete line of brushes, largest commissions. Write for sales plan. Wire Grip Sanitary Brush Company, 2300 5th Ave., New York.

NEW Specialty—Sells every business and professional man. Four \$15 sales daily pay \$270 weekly. Farrell cleared over \$1,000.00 monthly. Write, F. E. Armstrong, President, Dept. PM, Mobile, Ala.

BLADES—Big profits. Best quality. Factory prices. Ace Blades, Buffalo, N. Y.

EARN Money in your spare time taking subscriptions to Popular Mechanics. Unlimited possibilities, every family a prospect. Easy to sell. Bonus paid in addition to liberal commission. Send postcard for further details today. Circulation Dept., Popular Mechanics Magazine, 200 E. Ontario St., Chicago.

EDUCATIONAL AND INSTRUCTION

MACHINISTS And tool makers urgently needed in Cleveland. If interested in learning these trades, write Krause Engineering Co., 272 Hanna Bldg., Cleveland, Ohio.

NEW Slide rule solves trigonometry problems easily, quickly—locates decimal points. Complete instructions. Send 25c. Nomographic Slide Rule Co., Hightstown, N. J.

WAR Declared on forgetfulness! Learn to remember. Lafayette Institute, 53 West Jackson, Chicago.

STAMMERING Corrected—here is something new! Write today. Speech Projection Institute, 427 Fort Washington Avenue, New York, N. Y.

FOR An extremely profitable lifetime business, operate a collection agency-credit bureau. Inexpensive short course. Write Cole Associates, Syracuse, N. Y.

BASE Eight arithmetic and money. Free leaflets. E. M. Tingley, Oak Park, Illinois.

WELDING Opens the way to good pay and future in important industries. Growing need for trained welders. Prepare now. Practical, personal training spare time at home and Chicago. Write for free facts, Utilities Engineering Institute, 1314 Belden, Dept. 122, Chicago.

LEARN Telegraphy! Splendid opportunities now prevail. All expenses low. Catalog free. Dodge Institute, Dept. M, Valparaiso, Indiana.

WELDING—Electric arc. Learn profitable trade quickly through actual practice. Individual welder instruction at bare cost of materials. Full particulars free. Valuable welding lessons book 50c. Hobart Welding School, Box M-225, Troy, Ohio.

ZEND, Mystic, secret language learned easily in month. Practically short as English. Instructions 25c. Two booklets 40c. Zendu, Burbank, California.

ENJOY Health. Become professional acrobat. Free health book. Write! Emil Knoff, 2154MJ North 52nd Street, Milwaukee, Wis.

YOUR Last hour. Free tract. C-L, Box 154, Willow Springs, Illinois.

LEARN Drugless therapeutics. Practice Naturopathy and Metaphysical healing. Write Dr. Manks, DeLand, Florida.

DRAFTING, Mathematics, blueprints. Mondell Institute, 230 West 41st, New York.

WATCHMAKING—Learn. Material instructions for start and wholesale supply catalog, all \$1.00. Refund not satisfactory. Stewart's, 721 Olive, St. Louis, Mo.

TOOL Designing pays big. Home study course. Low cost. Easy terms. Free booklet. Ohio Institute of Technology, Box 48, Greenville, Ohio.

NOTARY Public, work is dignified. Make more money. Short course. Diploma. Booklet free. Notary School, K-30 W. Washington St., Chicago.

LEARN Dancing easily! Diagrammed home course. Mail \$2.00. Ludwig's, 532 Geary, San Francisco.

CLINICAL Laboratory technic taught in your own home. Practice outfit supplied. Bulletin free. Imperial Technical Institute, Box 973E, Austin, Texas.

LEARN How to box. New book "Push Yourself" gives you simplified and proven boxing instruction program. Price \$1.50. Write Frank Gilmer, Box 202, Libertyville, Ill.

RADIO Engineering, broadcasting, aviation and police radio, servicing, marine and Morse telegraphy taught thoroughly. All expenses low. Catalog free. Dodge Institute, Dept. R, Valparaiso, Ind.

BIG Demand for trained auto mechanics, body men and welders. Practical training. Free catalog. Hanson School, Box 1780-C, Fargo, N. Dak.

NEW Writers needed! Free test shows your ability. It's fun! We show what to write, help you sell. Rush postcard. No obligation. Comfort Writer's Service, Dept. 786-J, St. Louis, Mo.

PREPARE For post office examinations. For free literature write Lakeview Preparatory School, Department P, 1280 East 114 Street, Cleveland, Ohio.

MASSAGE, Hydrotherapy, drugless therapeutics, physiotherapy, chiropody, taught by mail. Evans Correspondence Courses, P.O. Box 1195, San Antonio, Tex.

TOOL Engineering—taught the practical way, pay as you learn. The Tool Engineering Co., 630 N. Taylor Ave., Oak Park, Ill.

IMMEDIATE Openings for arc welder students in expanded famous Lincoln school. Big opportunity for learning arc welding. Now in big demand. Bright future. Write Lincoln Welding School, 12818 Colt Rd., Cleveland, Ohio.

BEST Pay trades all times; short terms. Low cost. Catalogue free. Clean interesting work. Decorating, paperhanging, graining, marbling, sign and pictorial work. Chicago Painting School, 102 West Lake Street, Chicago.

BE A doctor. Learn chiropactic. Fast growing profession. Write for catalog—Dept. D, Texas Chiropactic College, San Pedro Park, San Antonio, Texas.

SECRET Investigation. Experience unnecessary. Detective particulars free. George Wagner, M-2640 Broadway, N. Y.

BECOME A Doctor of Psychology (Ps. D.) Teach secret of contentment, happiness. Solve mental worries. Free book. College of Universal Truth, 20-B East Jackson, Chicago.

LOCKSMITH Course. Lock picking, key fitting, etc. \$1.00 prepaid. Locksmith, Canadian, Texas.

PLAYS, STORIES, MANUSCRIPTS

STORIES, Novels, poems wanted for publication. Many eager markets. Author will help you sell. Manuscripts marketed, revised, typed. Christopher Carr, 3636A Chestnut, Philadelphia, Penna.

CARTOONING, COMMERCIAL ART, SHOWCARD WRITING, SIGN PAINTING

EARN Money evening, copying, duplicating cartoons for advertisers. Ad-Service, Argyle, Wis.

TALENTS Developed. Free lesson. Plaque painting. Retouching negatives. Craft Shop, Fortylene East Washington, Indianapolis, Indiana.

BECOME Cartoonist overnight! Don't copy! Originate comic characters instantly! Have fun! Make money! Rush name for free details! National Artists, 801-A North Marsalis, Dallas, Texas.

MONEY in portrait sketching. Progressive steps teach you. 20 complete lessons \$2.00. Harold Parks, Ypsilanti, Mich., R. 3.

PEN And ink drawings. Let us draw your advertising and catalogue illustrations, from photos, copies or objects. Best work and fair prices. Heraldic Studios, 1914-P Oakdale Avenue, Chicago, Ill.

CARTOONING Course—30 illustrated lessons, over 500 sketches, drawing paper, pens and pencils, complete, \$1.00 postpaid. Montes Studio, Box 985, Pasadena, Calif.

BUSINESS SERVICE

FIVE Reasons how collect delinquent accounts, keeping customers. One dollar. General Adjustment Co., Jordan Bldg., Waco, Texas.

MIAMI, Florida, mail address. Receiving, reforwarding your business, personal mail. Details free. Southern Business Service, Postal Building.

HAWKINS Mail Service, Washington, D. C. will receive, reforward your mail from 908D Fourteenth.

ADVERTISING AGENCIES, LETTER WRITING, FOR ADVERTISERS

MAIL-ORDER Or agent ad reaching 1,000,000 families throughout United States \$14.00 inch. Newspaper, magazine, mailing-list, rate-book, free. Chicago Advertising Agency, 20-PM West Jackson, Chicago.

ADVERTISE: 24 Words, 149 newspapers \$6.50. Lists free. Advertising Bureau, 4515-C Cottage Grove, Chicago.

LEARN Advertising at home. Easy practical plan. No text books. Common school education sufficient. Interesting booklet and requirements free. Page-Davis School of Advertising, 1315 Michigan Avenue, Dept. 343C, Chicago.

FREE—New Advertisers Rate Guide. 44 pages. Includes everything. Lowest rates. E. H. Brown Advertising Agency, Merchandise Mart, Chicago.

ADVERTISING Placed all magazines, newspapers U.S.A., Canada. Lowest rates. Free service, 54-page catalog free. Baker Advertising Agency, A-189 W. Madison, Chicago. Established 29 years.

RUBBER STAMPS AND OFFICE SUPPLIES

CUSHIONED 3 Lines 35c. Signatures \$1.50. Lentz, Box 402, Youngstown, Ohio.

KNOB Handle, cushioned, 2 lines 30c. 3—40c. Stamp Works, Centerport, N. Y.

3 LINES 27c; Cushioned, indexed, 35c. Stamprite, Wauwatosa, Wis.

BEST! Quickest! 2 lines 25c; 3—35c; cushioned. Adcrafts, Lacrosse, Wis.

2 LINES 25c. 3 Lines 35c. Stamp Works, Auburn, Nebr.

TYPEWRITERS, DUPLICATORS, OFFICE DEVICES

"NEW Process' stencils for all makes duplicators, 5 quires (120) \$8.75. One quire \$2.00, inks and supplies. Automatic post card stencil printers \$6.75. Write Pittsburgh Typewriter Supply, Department K-22, Pittsburgh, Penna.

Listen to this Record!



SPEAK SPANISH

FRENCH, GERMAN OR ITALIAN

"Learn by listening" to Cortina records, the NATURAL way—quickly, easily, cheaply.

Sent on 5 Days' Approval

Most fascinating, most satisfactory method ever known for learning or perfecting yourself in a foreign language. Investigate!

Booklet FREE

"The Cortinaphone Short-Cut"—tells just what you want to know. Interesting. Get it!

Write Today--NOW

CORTINA Academy (Language Specialists for 50 Yrs.)
Suite 642, 105 West 40th St., New York City

Please send me—without obligation—your free booklet. I am interested in (mark):

Spanish French Italian German

Name

Address

New York Established 1902
Electrical School
Ask for free illustrated booklet
44 West 17th St., N. Y. C.

MASTER COURSE IN RADIO COMMUNICATION
Fit you for a job, advancement or license examination. Course by A. R. Nilson for home study covers same scope as resident school course. Every Nilson graduate is sure to have commercial license. **FREE** circular 3-M gives full information. Write today!
NILSON RADIO SCHOOL, 51 E. 42nd St., New York

Learn Arc or Aircraft WELDING IN 6 WEEKS

WELDERS EARN BIG PAY IN IMPORTANT INDUSTRIES

- AVIATION
- SHIPBUILDING
- RAILROADS
- CONSTRUCTION
- DIESEL
- MANY OTHERS

Individual Personal Instruction Under Actual Shop Conditions

Get into welding! Trained men in Arc and Aircraft Gas Welding are earning big money. The U.E.I. practical training plan and modern equipped welding shop cuts training time to 6 weeks. Our training standards meet "Navy Yard Test" qualifications. Age limit 18 to 40. Nation-wide job-getting help. Institution founded 1927. Write for full details **FREE** without obligation.

MAIL COUPON FOR FREE FACTS

UTILITIES ENGINEERING INSTITUTE
612 Utilities Bldg., 1314 Belden Ave., Chicago, Ill.

UTILITIES ENGINEERING INSTITUTE
612 Utilities Bldg., 1314 Belden Ave., Chicago, Ill.

Mail me full details about your 6 weeks Practical Resident Course in Welding.

Check which interests you most: ARC AIRCRAFT GAS

Name

Address

City..... State..... Age.....

POPULAR INVENTIONS

For Your Home

Electric Broiler Fits Frying Pan



Any ordinary frying pan can be used with an electric broiler that fits the skillet like a cover. Three wires extend outward to support it on any size pan.

Hooplike Holder for Glass Set

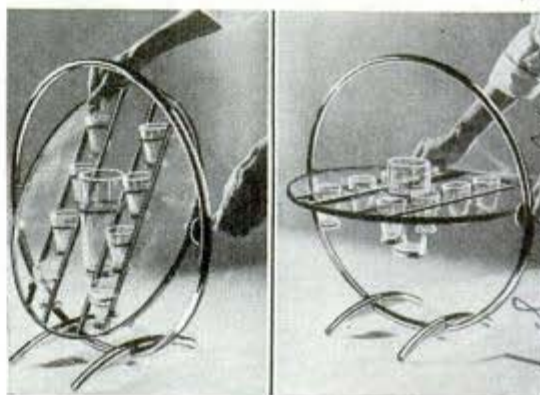

Combining two purposes, a large decorative hoop-shaped holder for tumblers and lemonade container may be changed from vertical to horizontal position to make a serving table. Mounted in swinging holders the glasses remain upright and may be filled without removing them.

WHERE-TO-BUY-IT INDEX OF POPULAR INVENTIONS

- Ironing board turns over for sleeves.....22A
Hy-Gee Cover Co., Worcester, Mass.
- Snap-on chair-seat covers.....22A
Comfy Mfg. Co., 1358 Merchandise Mart, Chicago
- Hand-cranked beverage shaker.....22A
Nat'l Silver Deposit Ware Co., Merchandise Mart, Chicago
- Broiler for frying pan.....52A
Schwarze Electric Co., Adrian, Mich.
- Hooplike holder for glass set.....52A
Nat'l Silver Deposit Ware Co., Merchandise Mart, Chicago

**NEW RADIO INVENTION
AMAZES AMERICA!**
9 BANDS STARTLE
RADIO ENTHUSIASTS

MIDWEST'S NEW METHOD
PLENTY OF ROOM
FOR TUNING STATIONS

ORDINARY METHOD
STATIONS
TOO CROWDED

9 BANDS

(ON SIX DIAL SCALES)

**SAVE UP TO 50%
FACTORY-TO-YOU**

**Super Band Spread Circuit
Makes Foreign Tuning 20 Times Easier!**

THIS NEWEST and most exciting of radio inventions—9 bands in a popular-priced radio—has aroused the interest and enthusiasm of radio fans everywhere. A "headline" development, this new Midwest feature brings a "rich man's" radio within the reach of everyone.

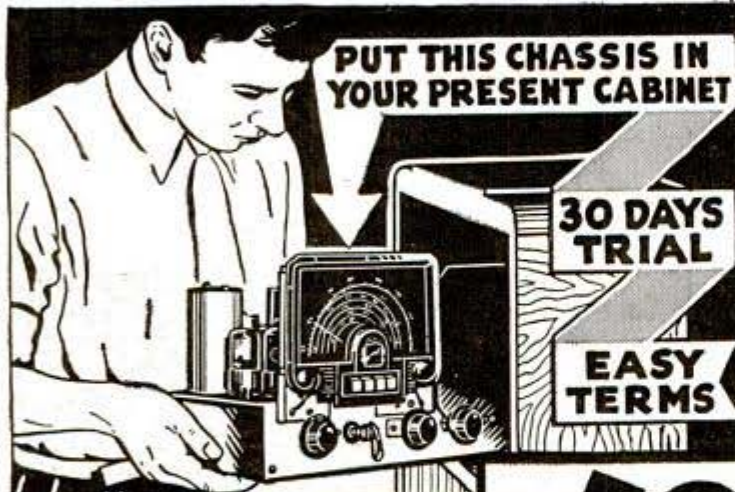

While ordinary prices are going up—Midwest tops its all time record of giving bigger values with this truly great 9-band feature. Now, Midwest gives you not just 3 bands, not just 4 bands, not just 5 or 6 bands—but, **9 BANDS (on 6 dial scales)**.



You get the wholesale factory-to-you price when you buy direct from the Midwest factory—you save up to 50%—and you secure so much more in performance and in exclusive features. Midwest offers many sensational new features, this year, besides 9 Bands, such as—**BAND SPREAD TUNING** which makes Midwest radios 20 times easier to tune—makes them 10 times more sensitive than ordinary radios.

**30 DAYS
TRIAL**

**EASY
TERMS**

UP TO \$50 TRADE-IN
Midwest offers you an amazingly large trade-in allowance for your old radio—on many of the 1942 models shown in the big, FREE 1942 Midwest catalog.

ENJOY TODAY'S FINEST HOME RECORDING
You'll be fascinated by the entertainment you can secure with a Midwest automatic record-playing



8, 11, or 16-tube radio-phonograph. Buy your radio the Midwest HOME-TRIAL way! Write today for big FREE catalog, featuring many beautiful 1942 factory-to-you radio chassis and console values—from 5 to 16 tubes—including Automatic Record-Changing Radio Phonographs, Home-Recorder, etc.—from \$12.95 to \$212.50.

\$19⁷⁵
COMPLETE CHASSIS

With Speaker, Tubes, Push Button Tuning... Magna Tenna Loop Aerial... Ready To Plug In and Play



Acousti-Sonic Louvres with Violin-Type "F" Slot Sounding Board... just one of the 90 features offered in Midwest 16-tube radios. They spread the High Fidelity tone scientifically through the room.

FILL IN COUPON AND MAIL TODAY OR JUST SEND YOUR NAME AND ADDRESS ON A POSTCARD

MIDWEST RADIO CORPORATION
MANUFACTURERS OF QUALITY RADIOS SINCE 1920

Midwest Radio Corporation
Cincinnati, Ohio, U. S. A., Dept. 15-J

Name _____

Address _____

Town _____ State _____

Send me your new FREE Catalog, complete details of your liberal 30-day Trial offer and factory-to-you prices. Use Agents Make Easy Extra Money. Check here () for details.

UP TO 16 TUBES
MIDWEST RADIO CORPORATION
DEPT. 15-J CINCINNATI, OHIO

INVENTIONS WANTED PATENTED OR UNPATENTED

Practical and useful new inventions, or novel improvements on previously protected devices, can now be safely marketed without patenting expense. We have successfully helped inventors for over 17 years in selling their unpatented ideas to manufacturers, with positive safeguards under Federal Court decisions. Send for complete information about this co-operative association. Experienced staff to give you personal service. References: Dun & Bradstreet, Thomas' Register of American Manufacturers, etc.

CHARTERED INSTITUTE OF AMERICAN INVENTORS
DEPARTMENT 4, BARRISTER BUILDING WASHINGTON, D. C.

Do you want

- .. to go to College?
- .. or to enter a Profession?
- .. or get an Office Position?

(Such as Accounting, Architecture, Nursing, Dentistry, Teaching, Social Work, Osteopathy, Beauty Culture, Optometry, Embalming, Chiropody, Law, Medicine, etc.)

To get anywhere, you practically **MUST** finish High School **FIRST**. You can complete our simplified High School Courses in SPARE time at home, as FAST as your time and abilities permit. Equivalent to resident school work—prepares you for college, pre-professional examinations, business, industry. Standard texts furnished. Diploma. Credit for H.S. subjects already completed. Single subjects if desired. Low tuition, easy terms. American School, Chicago, est. 1897—endorsed by educators. Finish your high school education NOW. Write TODAY!

High School Course at Home Many Finish in 2 Years

American School, Dept. H245, Drexel Ave. at 58th St., Chicago, Ill.

Gentlemen: Send me FREE information covering special training in subjects checked below. No obligation on my part.

- | | |
|--|---|
| <input type="checkbox"/> High School Course | <input type="checkbox"/> Diesel Engineering |
| <input type="checkbox"/> Accounting and Auditing | <input type="checkbox"/> Drafting and Design |
| <input type="checkbox"/> Architecture and Building | <input type="checkbox"/> Liberal Arts |
| <input type="checkbox"/> Automotive Engineering | <input type="checkbox"/> Private Secretary |
| <input type="checkbox"/> Business Management | <input type="checkbox"/> Mechanical Engineering |
| <input type="checkbox"/> Aviation | <input type="checkbox"/> Radio and Television |
| <input type="checkbox"/> Electrical Engineering | <input type="checkbox"/> Salesmanship |
| <input type="checkbox"/> Elec. and Gas Refrigeration | <input type="checkbox"/> Business Law |
| <input type="checkbox"/> Air Conditioning | <input type="checkbox"/> Retail Merchandising |

Name

Address

Learn CARTOONING

FREE TRIAL LESSON! Cash in on your sense of humor—AT HOME—BY MAIL. Have fun! Make money! No experience needed to start. Write today for FREE LESSON, mailed postpaid. No obligation.
Moon Gag-Cartoon School, Dept. C, Fall Creek, Wis.



FREE STAMPS TO COLLECTORS

United States Internal Revenues on Original Documents, including \$1-\$2-\$4-\$5-\$10 Stamps plus 40 page illustrated U.S. Price—Check list to U.S. Approval applicants. Enclose Postage.
METROPOLITAN STAMPS, Dept. P, 198 Broadway, N. Y. C.

LEARN AVIATION IN LOS ANGELES • Nation's Aviation Capital



Huge increase in Los Angeles aviation activity has assured splendid positions for graduates. Career training offered for airline piloting, engineering, mechanics, drafting, production mechanics and instruments. Train at America's most modern, fully equipped and strategically located school, fully approved by the U.S. Government for flight, ground and mechanic courses. Write for free 64 page catalog. State age.

CALIFORNIA FLYERS
SCHOOL OF AERONAUTICS DEPT. PM-2
LOS ANGELES MUNICIPAL AIRPORT, INGLEWOOD, CALIF.

Do You Want To Get Ahead? FREE

NOW is the time to get a better job, better pay, knowledge and culture that spell happiness, success. See big 1942 illustrated catalog of authoritative, simplified books on aviation, accounting, engineering, English, drafting, radio, history, typewriting, machine shop work, Spanish, secretarial practice, and a hundred other subjects. Many slightly used, as low as 49c, postpaid. Money back if not satisfied. Write for FREE catalog NOW.

HOME STUDY BOOK CO., Dept. 131
1251 So. Wabash Ave., Chicago, Ill.

Catalog of Success Opportunity Books

Save 1/2



WINN'S NEW IDEA

CHEMICAL KITS and APPARATUS OUTFITS for STUDENTS, BIG VALUE

FREE LITERATURE and CATALOG of CHEMICALS & LABORATORY SUPPLIES. Send 3c for return postage.

J. H. WINN MFG. CO.
Dept. 402—124 W. 23 St., N. Y. C.

Always write your name and full address clearly when answering advertisements.

NEW VOLUME
50¢



FUN AND PROFITS FROM YOUR HOME WORKSHOP

NEW 1942 "WHAT TO MAKE" is biggest value ever published. 224 pages (28 in color) packed with instructions, plans, valuable data and 500 pictures showing what to make and how to make it. Over 300 projects with simple tools. Get book from or in at home with simple tools. Get book from your newsdealer or send 50c to address below.
POPULAR MECHANICS PRESS
Dept. 362 200 E. Ontario Street, Chicago

TOOL & DIE MACHINIST TRADE

Learn these trades on actual work at ALLIED SHOPS. Fully equipped. State approved. Low fee. Day or Evening Training. Free Employment Service. Write today for free book "Practical Machine Shop Training".

ALLIED SCREW MACHINE CO., INC.
Dept. PM-2, 609-13 W. Lake Street, Chicago, Ill.

BROOKLYN YMCA TRADE SCHOOL



Short Trade Courses, including Defense trades, offered day or evening. **5 to 10 week** courses qualify you for Defense Jobs. **Full Shop** Equipment. Unexcelled Instruction. Fireproof Dormitories. Special Privileges. **Check your interests** on coupon to receive free literature.

- | | |
|--|---|
| <input type="checkbox"/> Aircraft Construction | <input type="checkbox"/> Welding |
| <input type="checkbox"/> Machinist | <input type="checkbox"/> Tool and Die Making |
| <input type="checkbox"/> Mechanical Pre-Engineering | <input type="checkbox"/> Diesel Engines |
| <input type="checkbox"/> Diesel Pre-Engineering | <input type="checkbox"/> Oil Burner |
| <input type="checkbox"/> Mechanical Drafting | <input type="checkbox"/> Auto Mechanic |
| <input type="checkbox"/> Refrigeration | <input type="checkbox"/> Talking Pictures |
| <input type="checkbox"/> Television and Radio Mechanic | <input type="checkbox"/> Architectural Drafting |
| <input type="checkbox"/> Armature Winding | <input type="checkbox"/> Electrical |

MAIL COUPON

1123 Bedford Ave., Dept. P. M.
Brooklyn, New York City, N. Y.

Name

Address

NOW a DYNAMIC HEAVY DUTY INDUSTRIAL WELDER

THE BOOM IS ON IN WELDING—EARNINGS ARE SKYROCKETING

**WORKS OFF
110 VOLT
ELECTRIC
LIGHT
CIRCUIT**



Thousands of welders have already left their jobs and shops to get "war-time" pay in plants devoted to defense production, such as ship building, tanks, airplanes, munitions, etc. Also, in the erection of industrial plants, bridge construction work, etc. This creates an unusual opportunity for men everywhere to get in the welding business right in their own communities, and take over the work these men have left behind. No special training is required, for now with the new DYNAMIC Super-Charged Transformer-Type Welder that works off a 110 volt electric light circuit, men without previous experience, by following the simple, concise home instructions can quickly do finished repair jobs. In this way you may fit yourself to qualify for a big pay job in the defense industry.

WELDS BUMPERS, FENDERS, CYLINDER BLOCKS, BODIES, FRAMES, ETC. Does Farm, Factory and Home Repairs

Many welders make as much as \$15 to \$20 a day. Repair jobs that can be done in less than an hour can make as much as \$5.00. Any number of jobs can be done more efficiently with welding. The DYNAMIC Super-Charged Welder, despite its serviceability, is so easily portable it can be carried around by hand and taken right to the job. This is an added feature whose value you will appreciate once you are in welding.

**WORKS ON IRON
STEEL, TIN, BRASS, COPPER,
AND ALL OTHER METALS**

With this Welder you can work on all kinds of metal—nothing will stump you—you can tackle anything and in no time at all you will be able to do finished repair jobs that will do credit to an expert.

**DOES METALLIC AND
CARBON ARC WELDING**

Can be used efficiently on both types of welding. The cost of using the DYNAMIC Super-Charged Welder is amazingly low—costs only a few cents an hour to operate. It is built so strongly that repairs are practically unknown—you'll never have to worry about them. It cools so efficiently that you can use it continuously without ever having to stop in the midst of a job to let it cool down. **COSTS LESS THAN 6c A DAY.** You can buy the DYNAMIC Super-Charged Welder on easy payments. Over a year's time, it would cost you less than 6c a day. Once you have your DYNAMIC outfit, you are all set in a profitable welding business of your own—you boss it yourself. Send coupon for free particulars today.

for Only
\$19.75

EASY PAYMENTS



These pictures show how easy it is to operate the Dynamic Super-Charged Welder.



READ WHAT USERS SAY

Electrician says: "It is the best welding outfit." I wish to tell you that I demonstrated your welding outfit to a great many people, and they all agreed with me that it did the best welding job they ever saw. A. L., Bristol, Conn.

Mechanic Praises Welder
I have received my welder and like it very much. I am a mechanic and electrician by trade, so I can appreciate its usefulness to others. P. C., Perry, N. Y.

Repair Shop Owner Tells About Dynamic
I want to say I operate a repair garage and I am more than satisfied with the welder. It will do more than you say. C. P., Butler, Ohio.

Greatest Portable Outfit
I must say it's the greatest portable outfit any man could wish to own. You may put me on file as a booster. W. J. B., St. John, N. B., Canada.

AGENTS WANTED: Do you want something easy to sell? You can make big profits introducing to garages, factories, mechanics, janitors and maintenance men the new DYNAMIC Super-Charged Welder—we'll let you try it for ten days at our risk so you can be convinced of the immense sales possibilities. Get our big profit plan and ten day trial offer. Just send attached coupon for free particulars today!

DYNAMIC WELDER CO.

2226-TC SILVERTON ROAD

CHICAGO, ILL.

Dynamic Welder Co., 2226-TC Silverton Rd., Chicago, Ill.
Gentlemen: I want to go into the welding business. Send me free particulars on how I can learn welding at home and full details on your Dynamic Welder.

AGENTS: Just mark an "X" here and you will receive full particulars of our big profit plan and 10 day trial offer.

Name

Address

Town..... State.....

WONDERS OF AMERICA

Sky Hotel



WE'RE ROLLING UP THE HIGHEST AUTO ROAD IN THE U.S.

AND I'M ROLLING UP AMERICA'S NUMBER ONE TOBACCO FOR SMOKING JOY—PRINCE ALBERT!

MT. EVANS, COLORADO



HERE WE ARE—AT THE HIGHEST HOTEL IN THE U.S.A. IT'S 14,259 FEET ABOVE SEA-LEVEL.

I HEAR IT WAS BUILT ENTIRELY BY HAND.

PHEW! SOME OF THE GRANITE SLABS IN THOSE WALLS WEIGH 5 TONS APIECE.



NOTICE HOW THE WALLS ARE STREAM-LINED. THE TERRIFIC WINDS HERE BLOW UP TO 150 MILES AN HOUR.

I'D LIKE TO BE IN A COLD BLAST LIKE THAT—MAYBE IT WOULD COOL OFF THIS FURNACE I'M SMOKING!



ISN'T IT THRILLING—WE'RE SEEING 10,000 SQUARE MILES OF MOUNTAINS AND HILLS.

I HATE TO BE NOSEY, BUT HAVE YOU EVER TRIED PRINCE ALBERT TOBACCO FOR COOLER SMOKING? YOU KNOW, IT'S THE COOLER-BURNING BRAND.

IN RECENT LABORATORY "SMOKING BOWL" TESTS, PRINCE ALBERT BURNED

86 DEGREES COOLER

THAN THE AVERAGE OF THE 30 OTHER OF THE LARGEST-SELLING BRANDS TESTED—*COOLEST OF ALL!*



JUST THINK—THAT BEAUTIFUL LAKE IS ALL OF 3,000 FEET BELOW US!

I UNDERSTAND THE WALLS OF THIS HOTEL ARE FROM 5 TO 11 FEET THICK.

SORRY—I DIDN'T HEAR YOU. I WAS JUST THINKING HOW RIGHT YOU ARE ON PRINCE ALBERT—IT BURNS SO COOL—SMOKES SO MILD AND MELLOW.

SUMMIT LAKE



YES, THERE'S NO TOBACCO LIKE PRINCE ALBERT FOR NO-BITE TONGUE COMFORT WITH GOOD, RICH, HIT-THE-SPOT TASTE! BESIDES, RA. IS CRIMP CUT TO PACK AND DRAW BETTER.

THAT GOES FOR RA. 'MAKIN'S' PLUS FAST, EASY ROLLING—NO SPILLING, BUNCHING, OR WASTE. THE TASTE JOY IS THERE, TOO—BUT SO MILD—NO HARSHNESS.

50 PIPEFULS OF FRAGRANT TOBACCO IN EVERY HANDY POCKET TIN OF PRINCE ALBERT

R. J. REYNOLDS TOBACCO CO. WASHINGTON-BALTIMORE, N. C.



PRINCE ALBERT THE NATIONAL JOY SMOKE

Popular Mechanics Magazine

REGISTERED IN U. S. PATENT OFFICE AND CANADA

WRITTEN SO YOU CAN UNDERSTAND IT

Vol. 77

FEBRUARY, 1942

No. 2



Garbed in fantastic aluminum helmets and heavy fleece-lined horse-leather suits, cold-room workers test hydraulic control system to find how it would work in the high altitudes

AMERICAN Boeing-built Flying Fortresses that bomb from the upper limits of the troposphere are revolutionizing aerial warfare in Europe. Bombs are dropping from the blue sky, from airplanes so high that they are nearly out of sight and hearing of ground observers.

From 30,000 feet a battleship looks the size of a pinhead. For even larger targets the bombardier six miles up must squint through a telescope to find his mark. Yet at such altitudes the Flying Fortresses are carrying more bombs faster, farther and more safely and are dropping them more

FEBRUARY, 1942

Ref: Harold Mansfield
Public Relations Manager,
Boeing Aircraft Co. Seattle Wash

Capt. Thomas E. Stinson, Jr.
3892 Franklin Ave. Los Angeles

21197

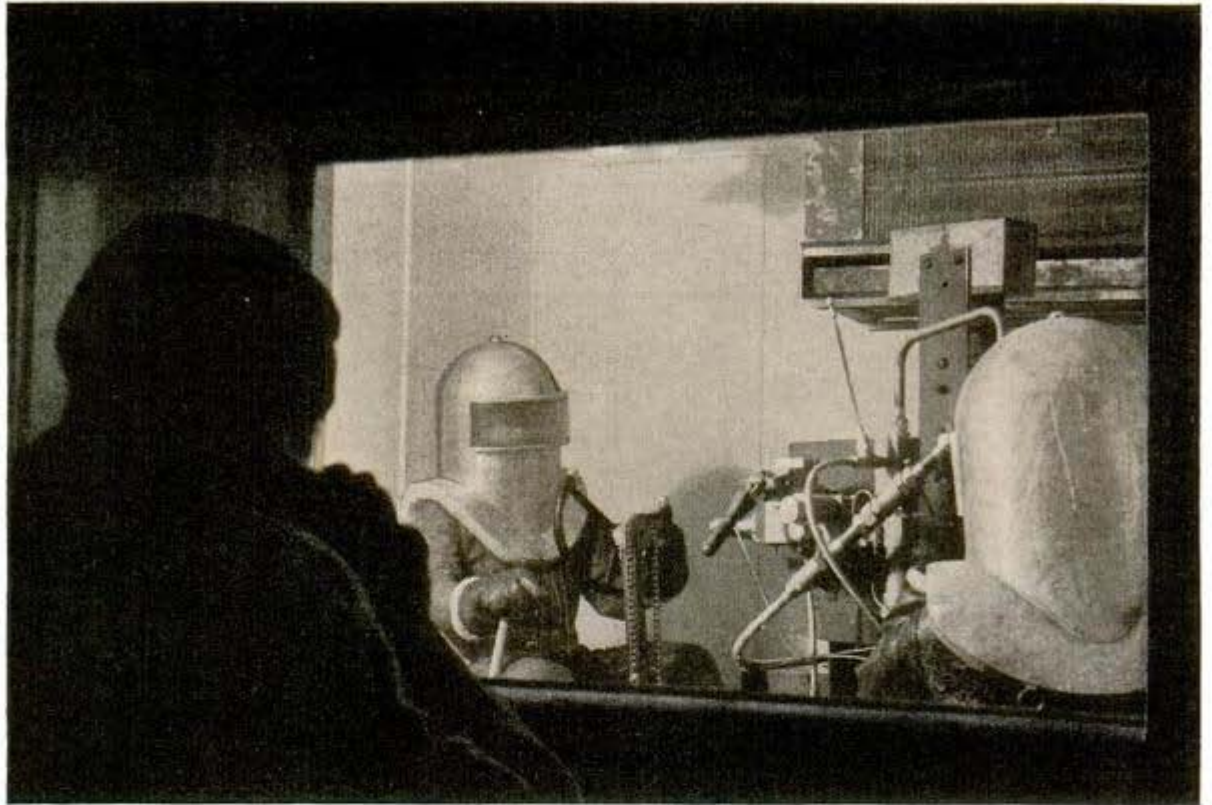

Outside "safety" man in telephonic communication with inside experimenters is constantly on watch through four-paned, fogless window to prevent accidents in the test chamber

accurately than can low-flying airplanes of more limited performance. American designers who have been laughed at by foreign experts for going to "unnecessary heights" are now being vindicated.

Having pushed the war up to 30,000 feet the same American designers are now striving for effective operation at the 35,000- and 40,000-foot levels. The battle zone of the future, they believe, may ultimately climb to 50,000 or 60,000 feet, ten miles or more above the earth.

At such heights the aviators may wear queer-looking lightweight pressure suits and helmets. Breathing oxygen, they will talk in high squeaky voices into their radios. They may have to learn new ways to fight, because airplanes, bullets, and bombs all operate strangely in the cold, thin air.

The advantages of high flight, aside from operating economies and extra speed, are many. A bomber, for instance, is above most of the weather and thus becomes a steady platform for accurate bomb sighting. Antiaircraft fire is extremely inaccu-

rate even at present ceilings. Not many pursuit planes can climb as high as the altitudes at which the Flying Fortresses now operate.

On the other hand the standard temperature at 35,000 feet is 67 degrees below zero. Air pressure is 3.45 pounds per square inch, less than a quarter of the pressure at sea level. There is not enough oxygen to sustain life. All sorts of troubles related to



Pilot in low-pressure "strato chamber" writing down his reactions in test

L 119 7



these conditions had to be vanquished before 30,000-foot operation became dependable. The same problems are worse at 35,000 feet, the next step up.

For one thing, the moisture of the pilot's breath condenses on the windows and freezes. Double windows, heated and unheated, are being tried out. The lowered air density makes the engine ignition faulty at these altitudes. Ignition systems may have to be enclosed in a special casing that contains air under pressure. Electrical effects at high altitudes produce static that interferes with radio operation.

The intense cold shrinks an airplane so much that the camouflage paint is loosened and sheds like dandruff on its return to the earth. Rubber de-icer boots turn brittle and crack to pieces. For safety, all such fittings are being replaced with a new composition that doesn't

Above, interior of altitude pressure chamber with which conditions at 55,000 feet can be simulated without leaving ground. Top, left, high-altitude oxygen mask, developed through army and cold-room tests, is now standard equipment for actual flights



Above, Douglas Cameraman Larry Kronquist emerging from cold room after making several of the photos illustrating this story. Left, crew members "supercharged" on ground, enter Flying Fortress where they will connect oxygen lines to plane's tanks



2 119 7



Outside control panel for altitude chambers with operator talking to pilot inside. One chamber also is connected to the cold room

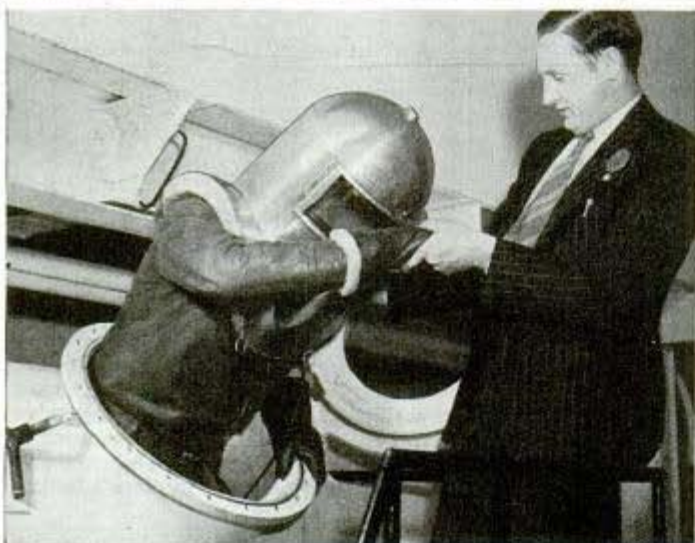

↑ Latest version of the Boeing Flying Fortress showing upper, lower and forward and rear gun emplacements; it is intended for high flying

become brittle in the cold. Ball bearings freeze up in their grease, the greased controls stiffen and resist the pilots, and even oil in the propeller domes becomes stiff. The needles on the engine oil-pressure indicators slowly drop even though the oil pressure is normal. This confuses the pilots. Fluid in the hydraulic systems isn't affected at the temperatures so far encountered but new formulas for most of the other oils and greases used for high flying must be worked out. All the materials in the planes not only must function normally in extreme cold but through a temperature range of 150 degrees as well.

Engine operation is possible because of the development of the positive turbo-supercharger that is driven by the discharge of engine gases and that packs the thin air into the carburetors. Given the chance, gasoline would boil away slowly into gas in the tanks at high altitude. Boosting the pressure

↓ Pilot being helped from cold compression chamber. In flight, heated cockpit makes this heavy suit unnecessary

L1197

L1268

in the tanks, plus using oversize lines, is necessary. Likewise the fuel lines must make long smooth bends instead of sharp turns in going around corners. The fuel tends to vapor lock at sharp corners.

To help solve these problems, the flight and aerodynamics departments at Boeing Aircraft Company in Seattle are making test flights with full crews up to 35,000 feet. Conditions at this altitude are so critical that extra oxygen masks, with oxygen constantly flowing through them, are placed in the cabin for instant emergency use in case a crew member happens to kink or break the line to the mask he is using.

Boeing's new B-17E, the latest model of the Flying Fortress series and larger and more deadly than its predecessors, is now in mass production. The plane has power gun turrets in the roof and floor of the fuselage and a gun turret in the tail as well. Tail surfaces are extremely large to provide more stability, just as desirable in a bomber as in a passenger transport.

Boeing, and other manufacturers such as Douglas, are carrying on a great deal of their stratosphere research right on the ground. Test flights cost around \$1,000 an hour for flying time, so much research is done instead in big pressure chambers from which the air is exhausted to produce the same partial vacuum that exists at high altitudes. Low pressures simulating altitudes of up to 60,000 feet can be manufactured. Likewise, cold rooms are used in which the temperature can be dropped to minus 70 degrees or more. Boeing has built a combination cold and "strato" chamber, covered with a 12-inch cork sheathing, in which both pressure and temperature can be dropped to reproduce the exact conditions that exist aloft.

The Boeing cold room is large enough to test a full sized tail group control system, for example. In the Douglas cold room the research men wear horsehide and wool suits surmounted with aluminum helmets that are equipped with nonfogging Plexi-glass windows and interior telephones. To avoid catching pneumonia the men breathe air that is warmed by their own bodies and that exhausts through valves in their helmets. One man never works in the sub-zero icebox alone and there is always an observer outside the chamber, watching through a quadruple plate-glass window.

Along with the study of how materials

(Continued to page 192)

FEBRUARY, 1942

Dog With Radio Set on Back ✓ Obeys Distant Master



This radio equipment permits remote control of dog

Apparel for war dogs of the future will doubtless be a harness-pack housing a radio receiver and headphones. A dog so equipped was exhibited by Carl Spitz, trainer of dogs, at the Los Angeles Kennel Club dog show. It is said that with a short-wave receiver on his back, a dog can be controlled within a radius of three miles under adverse battlefield conditions.

L1240

Liquid Dispenser for Sauce Bottle ✓ Serves an Ounce at a Time

Made to fit snugly on most sauce bottles, a syphon server delivers small uniform servings of fruit juice, salad dressing or olive oil from the bottle by pressure on a plunger. It is a timesaver in the kitchen when preparing several dishes of salad, since there is no danger of "flooding" any one dish. The plunger in "up" position seals the bottle.



Prof. Blath. B. nos. Italy and Van Buren Ill.

U. S. railroads operate 75,000 miles of daily mile-a-minute or faster trains.

Railway Age. 11/22/41

Q 10 78.

Coil for Fluorescent Lamp Corrects Color of Light

Flashcoil



Colored plastic coils slide easily on tubular light

New effects in fluorescent lighting can be obtained by slipping colored coils of translucent plastic over the tubular lamps. Covering the whole tube, the springlike coil controls its brilliance, corrects color distortion and may be used for decorative purposes alone. Best results are obtained with coils made of red and clear strands of Tenite plastic wound together. Red helps make up for the deficiency of that color in white and daylight fluorescent lamps. Pink coils act as diffusers, passing more than 70 percent of the light, and also aid in correcting color distortion.

Tenite

Flashlight With Rubber Case Resists Water and Shock

Completely insulated in a watertight rubber case molded in one piece, a flashlight designed for hard wear may be

Duck-Rite Lite



Rubber case, top, guards flashlight against damage

dropped on hard pavement from six stories or left in water three months and still work. It is safe for use near electric wires, cannot be magnetized and is not affected by change in temperature. The shatterproof plastic lens throws a clean, long-range spot from an aluminum-plated reflector. A side-opening feature for easy removal of batteries prevents corroded batteries from sticking permanently. Switch problems are avoided with a patented two-button snap switch. The flashlight is made in two-cell and three-cell sizes, with either fixed or adjustable focus.

Oval-Shaped Sprocket for Bicycle Takes Less Pedaling Effort

More power, quicker pickup and greater speed with less energy on the part of the rider are claimed for an oval-shaped "easy

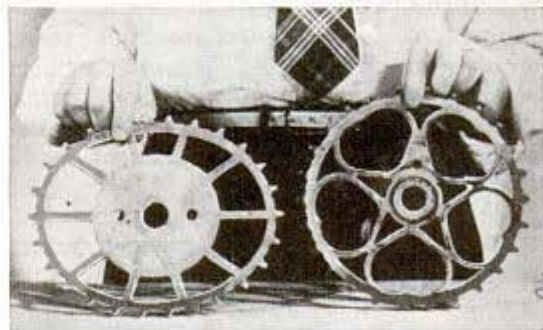
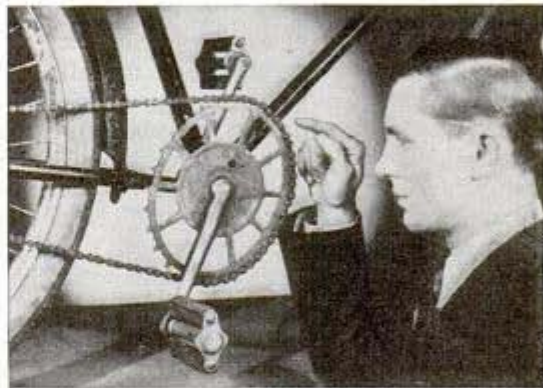

Oval bike sprocket compared with standard type

pedaling sprocket." The pedals extend from the elongated end of the oval, which is said to give added leverage on the downward thrust, of special help when pushing against heavy headwinds. The new sprocket does not increase the number of gear teeth or change the ratio.

To learn where to buy commercial products described in these pages, see the index.

Schwab & Frank, Inc. Detroit 243 W. Congress, Mich.

Williams M. Longtin, Inc. 1508 Lyndale St. S. Minneapolis, Minn.

*Cherry, 1243
Stanley J. Valenke, 4437 S. Marquette Ave. Chicago, 4603 S. Hermitage*

L1192.

British Paint Grim Faces on American Planes

When American Tomahawk fighting planes arrive in Africa, British artists paint them with fierce faces to match their relentless power. The contour of the fuselage lends itself most readily to transformation into the likeness of a man-eating shark poised for attack upon its prey.

The vicious grin of a man-eating shark is the fighting face painted by men of the British R.A.F. on Tomahawk pursuit planes made by Curtiss-Wright corporation and shipped to Africa



acme

Frozen Food Delivered at the Door by Refrigerated Truck

Frozen food products can be delivered direct to homes with a special refrigerated motor truck, permitting the wholesaler to serve consumers on regularly established routes. Food may be preserved indefinitely in two compartments, each containing four freezing cylinders, mounted one on each side of the truck with a catwalk between them. Beneath each battery of cold cylinders is a one-horsepower gasoline compressor that maintains sub-zero temperatures. Compressor units are inexpensive to operate, easy to start and accessible for service. The trucks are made in two sizes, one containing 77 cubic feet of payload space, and the smaller unit having a 36 cubic foot capacity.



Housewives receive frozen foods direct from refrigerated truck

*Developed by W.L. Morrison
Chicago, Ill.*

*Henry Motor Co.
Freeport, Ill.*

Welded Steel "Igloo" Like an Eggshell Has No Beams or Supports

Shaped like an egg, a steel "igloo," completed for use as a lunchroom and recreation parlor for employes of Chicago Bridge and Iron Company of Chicago, is without beams or supports of any kind. The entire structure is made of "dished" plates only 3/16-inch thick, which were welded together piece by piece on the job. It is 108 feet in diameter and 28 feet high. The air-conditioned building has no windows, and is fireproof, soundproof and heatproof.



No beams or supports are needed in this shell-like structure

acme

1305 W. 105th, Chicago



Lighter-than-air craft, including five barrage balloons, one new naval airship and two Goodyear blimps

Members of barrage balloon's ground crew hanging sandbags on a balloon at Camp Davis, training center



SWARMS of great, fat "spiders," which float high in the air and dangle webs of steel to entangle enemy warplanes, are being assembled rapidly to protect America's defense bases and harbors, factories, the Panama Canal and other vital spots.

Already found absolutely indispensable in the defense of critical areas across the Atlantic, these spiders are barrage balloons, some of which can rise to 15,000 feet and ride at anchor, tethered to earth by cables that form a dangerous web. An actual hazard—a collision with a cable usually sends a plane to destruction—the big, hydrogen- or helium-inflated bags also create a tremendous mental hazard because they can be moved readily from place to place and the enemy pilot never knows where he will encounter the web. And this fear of striking a cable, particularly at night, forces raiding bombers to fly so high that their



Here are three striking photographs of barrage balloons and ground crew in action. Above, the crew hauling down a balloon in preparation for bedding it down for the night. Speed in raising and lowering the balloons is highly essential. Upper right, spectacular view of two balloons caught in searchlight beams in night operation at Camp Davis. In this picture the balloons resemble big, white spiders. Bottom, a four-lobe balloon being inflated with helium at Goodyear air station, Wing-foot Lake, near Akron, O. Goodyear is one of several companies making balloons

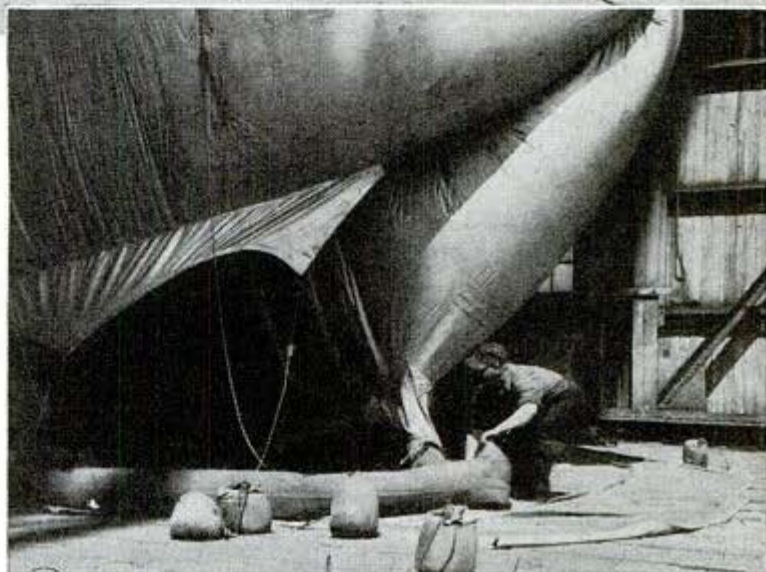

FEBRUARY, 1942

Tyre & Rubber Co. Akron Ohio



Four-fin balloon (above) inflated and ready for ascent after removal from hangar. Below, odd-looking barrage balloon of type being built for the Army by General Tire & Rubber Company

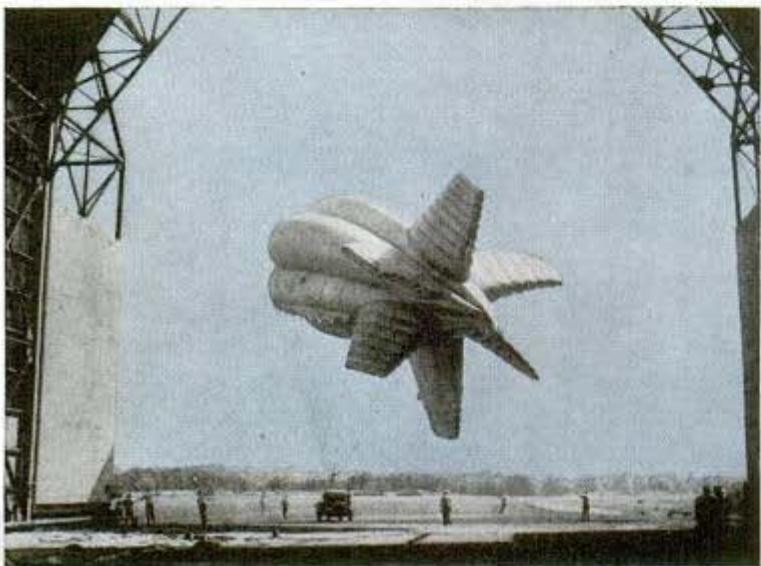
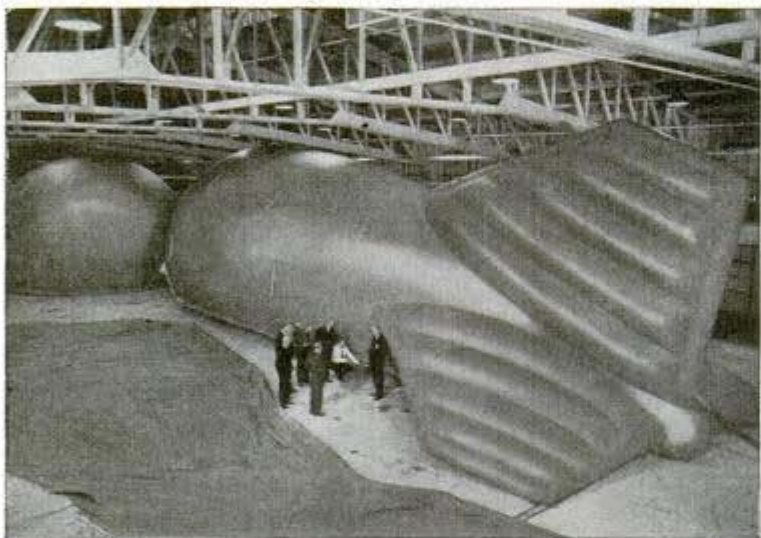

accuracy may be affected.

Hundreds of the balloons are being constructed and thousands of men are being trained to handle them. Responsibility for instructing U. S. Army officers and enlisted personnel in this specialized work lies with the Coast Artillery Corps. Before completion of the permanent training center, Camp Tyson, near Paris, Tenn., where there are facilities for over 7,000 men, a temporary school was conducted for several months at Camp Davis, N. C., with both officers and enlisted men attending six- and 12-week courses and then helping to train others, thus building up a large force to man balloons, trucks, winches and related equipment now coming out of factories in such quantities as to make possible the organization of a large number of battalions.

At Camp Davis balloons 28 feet wide and 85 feet long were used. Classified as 27,000 cubic-foot balloons, they were inflated from small cylinders of helium, with each balloon requiring from 115 to 130 cylinders. Only partly trained crews were found capable of inflating a balloon in less than 30 minutes. Since speed is highly essential in getting the bags into the air to ward off raiding planes, great emphasis was placed on reducing inflation time.

In use as protectors of military objectives, the

Six-fin Strato-Sentinel balloon leaving hangar. It can rise to 15,000 feet

Abram



Several barrage balloons at low altitude while three Goodyear blimps cruise overhead in recent demonstration

balloons are controlled by gasoline-driven winches, either of the mobile type that can be transported from position to position by truck or of the type designed for mounting permanently on a truck. The balloons can be released "up" or hauled "down" at the rate of 1,000 feet per minute, with the winches unwinding or reeling in the cable on a large spool or drum. Three-sixteenths-inch cable was used on the Camp Davis balloons, which were of a type capable of reaching 7,500 feet.

When the balloons are not supporting their steel web, they are "bedded down"—pulled to earth by the ground crew and staked down. What is known as the balloon bed is a space large enough to bed down an inflated balloon. Preparation of the bed is accomplished by clearing the ground of all obstacles, covering the space

(Continued to page 189)

Members of the ground crew at Camp Davis attaching heavy tackle for controlling flight of balloon



L1220

"Kolok"

Control for Antiaircraft Weapon ✓ "Predicts" Position of Plane



Tracer control box aims antiaircraft gun at "predicted" position of plane

In firing from the ground at enemy planes in flight, guns must be aimed at the spot where the ship will be when the projectiles reach the prescribed height. Soldiers of the Coast Artillery antiaircraft unit from Camp Edwards, Mass., are among the military units using a central tracer control box which "anticipates" the position of a plane overhead.

threads so they resist wear. Oddly enough, the microscopic riveting appears to take place at the very points where the threads would be most likely to part. The process also has been applied to underwear, mittens and blankets.

L1132

Blazing Magnesium Is Extinguished by ✓ New Powder

Magnesium fires, cause of much of the damage in bombed cities overseas and a bugbear of American defense industries where magnesium alloys are fabricated, are the special business of a new extinguishing powder. Magnesium burns with a brilliant flash which is almost explosive in the presence of water. The new chemical powder, however, is said to quell the fire quickly.

Socks 'Riveted' Chemically Give Longer Wear

Men's woolen socks, given a new treatment which "rivets" them chemically, are reported to last three times as long as untreated socks, and their shrinkage is almost eliminated. The process will be licensed to men's hosiery manufacturers by U. S. Rubber company in whose laboratory it was developed and tests conducted. Fabrics are treated by immersing them in a bath of certain colloidal substances suspended in water. During immersion microscopic particles of the substance, say the chemists, do a job throughout the fabric that may be described as riveting the fibers in the twisted



Powder (left) quells magnesium fire but water spreads flames

Rockefeller Center
1230 6th Ave. New York
L702

Com. Murray Brooklyn Panama Cal.

no. internal

6178. Third N. Los Angeles

West. Roy L. Davis Co.

L1269 Glenn L. Martin Co. Baltimore, Md

Largest Flying Boat Launched, Named "Mars"



Left wing of aerial battleship tilted toward water after launching because the ship was empty

Ceremonial honors traditionally reserved for surface vessels were bestowed in the christening and launching of the United States Navy's 67-ton Martin patrol bombing plane. Named "Mars" as a bottle of champagne was smashed across its silver

bow, the \$2,500,000 flying warship slid down the ways at Baltimore. Now in the water, the ship, with its wingspread equal to the height of a 20-story building, is being tested. It could carry a bomb load to Europe and return, nonstop.

L1216

Rubber Soles With Nonskid Treads Grip Wet Surfaces

Cutting special treads in rubber-bottom shoes has produced a nonslip sole which grips virtually any wet surface. The tread consists of deep crosswise cuts in wavy or zigzag lines. Being close together the cuts permit the rubber to spring open, forming

3,700 individual tentacles, each of which acts like a drying squeegee on wet surfaces and also produces a suction effect that prevents skidding. The sole comes on all kinds of sport shoes and also on boots.

L1160

Heat-Resistant "Vanishing Oil" Used in High Temperatures

A "disappearing" oil for use in the extreme temperatures of industrial kilns has been developed by the Standard Oil (New Jersey) Development company. Ordinary oil or grease at temperatures above 400 degrees Fahrenheit would decompose and leave carbon and other solid deposits injurious to bearings. The new disappearing oil vanishes slowly, leaving behind a clean, carbon-free surface. It is used to oil bearings of kiln cars, to coat molds in which molten glass is to be poured, and similar applications. In cases where fresh oil cannot be applied before complete evaporation has occurred, colloidal graphite in the disappearing oil is left in a dust-thin deposit to prevent metal-to-metal contacts until the bearing can be reoiled.

Sperry Top. Sider Footwear Co. 15 main St. Beacon Falls Conn



Bending the sole reveals deep-cut, nonskid tread

FEBRUARY, 1942

The Lamp, Aug 4

Capt. Prof. Norman W. Modell.
 21193 Co. B 1st Bn Camp Wheeler, Ga



The arrow points to the target, not much more than a dot on the horizon 700 yards away—but these .50-caliber guns create a danger area 9,500 yards behind the targets. This is what the range looks like to the man behind the anti-tank gun sights

WHILE American tanks endure their baptism of fire on Libyan sands, Uncle Sam's young men are learning how to stop these land battleships to the accompaniment of a terrific tattoo of anti-tank weapons at Camp Wheeler, Georgia. Tracer bullets stream from .50-caliber machine guns to rip through targets that race, crawl and double back unexpectedly on a winding track hundreds of yards distant.

The armored tank has been the Goliath of land warfare in World War II, terrifying to the infantry



Officers of Company B, 1st Battalion, direct the firing from the control stand as rolling targets move across the range at Camp Wheeler. As the firing orders come from the loudspeaker, tracer bullets start streaming toward three white dots

The 3½ by 6 foot target emerges from behind shield at 5 to 35 miles an hour and gunner must take sight in front of it. At right, he would aim at spot where target now stands at the moment when its nose first appeared from behind wood shield





↑ Fifty-caliber machine guns in foreground are effective against light tanks. Thicker-barreled guns beyond are water-cooled .30-caliber machine guns



Above, the target carriage rounds a bend in the track, which is three feet wide and a foot deep. The wooden parapet, rising 40 inches above bottom of track, hides carriage from view of gunner

Range soldiers receiving orders from the control stand by telephone operate the old truck which moves the targets back and forth by means of an endless cable, driven by a cable wheel on rear axle

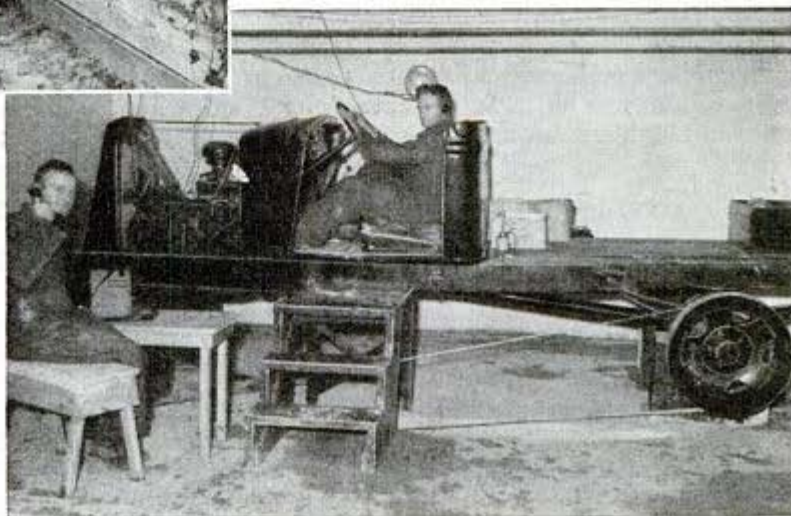

soldier and a destroyer of backline communications. Defense against them is both passive and active. Passive defense is primarily an effort to obstruct their movement or hide from them. The army digs traps, sets up wooden posts to block their advance; soldiers dig "fox holes" in which they hide safely as tanks roll over them.

But the best way to stop a tank is to attack it. This means guns with penetrating fire, capable of biting through several inches of steel, as well as trained personnel to operate them. We have such guns—37

(Continued to page 192)

20/282

Big Planes to Span Atlantic on Nonstop Flights

U.S. United Aircraft Corp
Stratford Conn

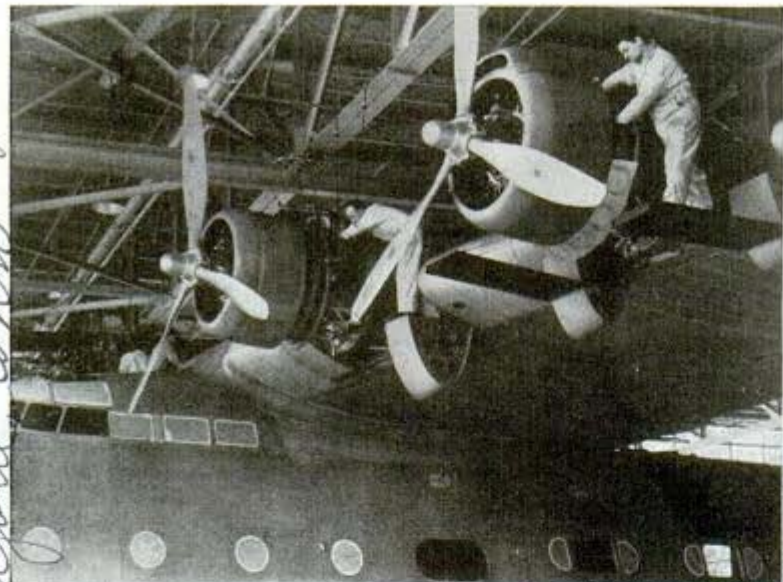

Mechanics installing two of the power units that will contribute their share in non-stop crossings of the Atlantic. Propellers have three full-feathering type blades

Eighty-foot flying boat, first of the fleet of three, as it received final touches before launching. The planes cost \$2,100,000, have been in construction about a year

New speed records for scheduled air-crossings of the Atlantic ocean are promised by three great passenger planes built by Vought-Sikorsky Aircraft for American Export Airlines. Four Pratt and Whitney air-cooled engines, delivering a total of 4,800 horsepower, will pull the ships at a top speed of 235 miles per hour and a cruising speed of 175 miles per hour in long-distance hops.



Capable of spanning the ocean in nonstop flights, the air liners will offer full-size sleeping accommodations for 16 passengers, or can be outfitted to carry 40 daytime riders. In each ship is a complete galley where full-course, hot meals can be prepared in the air. Tails of the ships, reaching higher than a three-story build-

ing, have a surface area greater than the entire surface area of the average military pursuit ship. The eighty-foot-long hulls are divided into 12 compartments, besides the flight bridge on the upper deck. The three-bladed propellers have a diameter of 12½ feet. The air-conditioning system is of new design, and each passenger will have an individual cold-air valve control.

Gene Devore 10/31/41

New Process Produces Aluminum From Plentiful Clay

This country may be made independent of foreign sources of aluminum ores as a result of a new process by which aluminum is manufactured from clay instead of the mineral bauxite, of which it is estimated that we have only about three years' supply at the present rate of consumption. Developed under the direction of Prof. Arthur W. Hixon of Columbia University,

the process is said to involve a technique never before employed in metallurgy. Selected high-silica clays are digested with hydrochloric acid and the resulting product is decomposed to get aluminum oxide. From that point the usual method of extracting the metallic aluminum by electrolysis is used. The chemicals used are by-products of other industrial processes.

New York City

SOLVING MYSTERIES of the DEEP

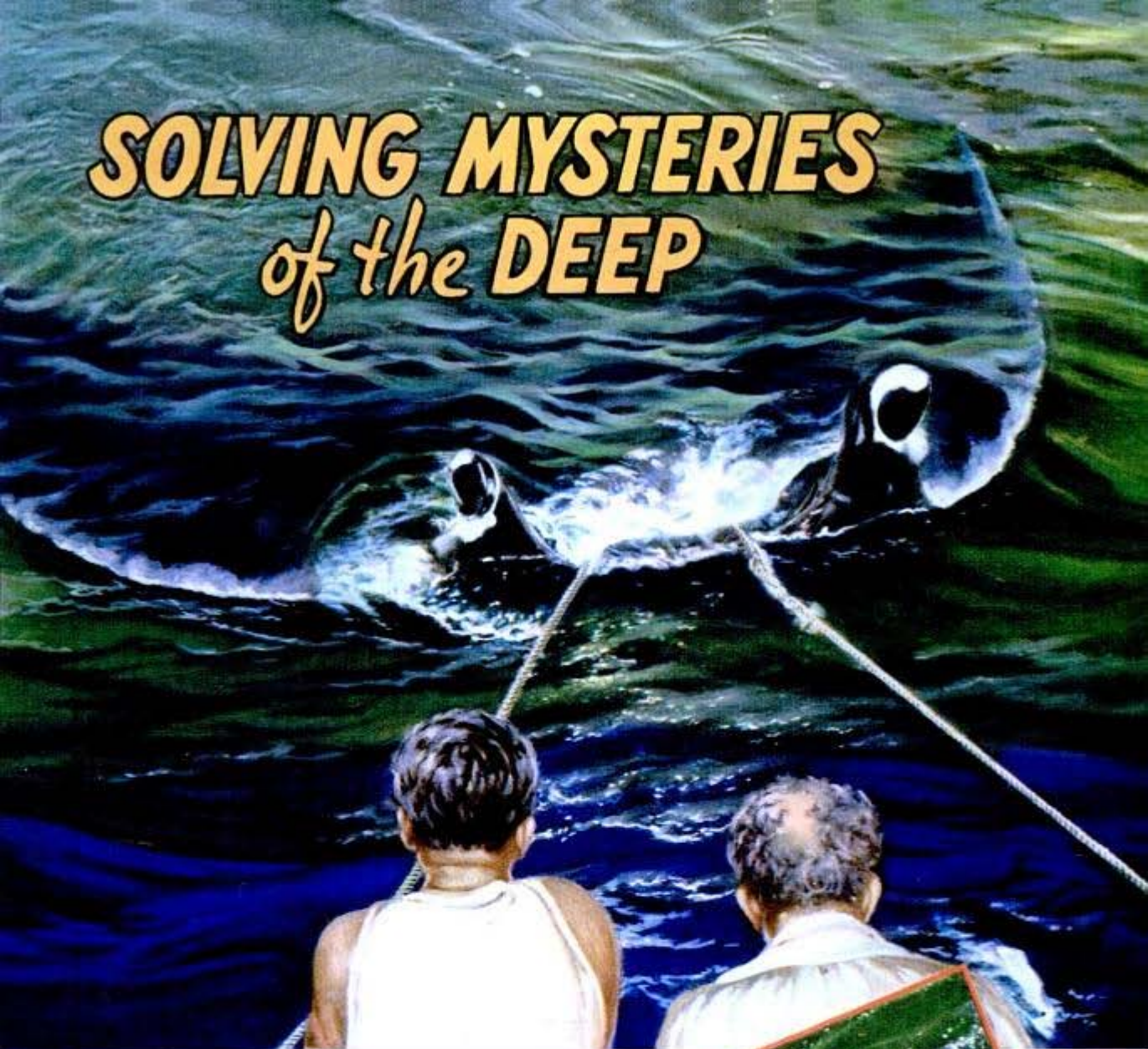

1879
† Two weird eyes protruding from the ocean surface are those of a giant manta measuring 20 feet from tip to tip of its wings, weighing three tons. It was harpooned off Cape Blanco, Peru

Bringing in one of these enormous, batlike mantas is no child's play. Here a Peruvian fisherman, riding the harpooned manta like a surfboard, helps the expedition crew make it fast to the boat →



Cont. Allen
W. Carruth
343 E. 3rd
Nagsack



2879 From his lofty perch, the lookout of the expedition's outrigger launch "Alone" has just sighted a killer whale in the Pacific, off the shore of Ecuador

THERE are billions of tons of succulent food down in the depths of the ocean, but until now man has done very little about harvesting it.

Americans consume chiefly salmon, tuna and sardines because they can be caught in great quantities at certain places and seasons, so that it pays to erect canning factories. We catch the easy ones, and let it go at that. We know so little of the life habits of the bigger game fish of the deep sea that we have never been able to put them on a "quantity production" basis.

Now, at last, thanks to a fresh line of research started by a New York and Miami sportsman with a scientific turn of mind, and by the learned ichthyologists of the American Museum of Natural History, the world is starting to ride herd systematically on the huge game fish which feed in the cool green depths and offer unsurpassed food value. These men are beginning to solve one of the great secrets of the sea—the mystery of mass migration.



← This giant squid's appetite proved fatal. Grabbing a smaller squid already hooked, he held on until boated. The tentacles are those of the big fellow, ready to swallow his prey

With all of our modern biological information, no man today can tell where the American broadbill swordfish spawns, or where it spends its earliest days, although it is one of the first fish mentioned in all human history. Two reasons exist for this public attention. One is its delicious flavor, recorded by the ancient Greeks. The other is for its nerve-wracking habit of plunging into fishing boats at express-train speed, ramming the sword through both sides of a skiff, or burying it in the timber of a larger vessel. The great natural historian Pliny who died in 79 A.D., and who wrote the first book ever printed on fishes, though it wasn't published until 1,400 years later, told of a swordfish sinking a ship.

A more modern instance was attested to in 1826 when the whaler "Fortune" returned to Plymouth, Mass., with a broken-off sword embedded in the hull. It was found to have penetrated the copper sheathing, a one-inch board, a three-inch hardwood plank, a solid oak timber twelve inches thick, a hard oak ceiling plank two and one-half inches thick and finally the head of an oil cask.

Still, comparatively little of practical importance is known of its personality and habits, except that it grows from pinpoint size to six or eight hundred pounds and some ten feet in length in a year or so, has formidable teeth when it is very young and loses the teeth before it is four feet long, developing the rather flat sword, also about four feet long. This sword it uses to impale larger fishes or to slash into a school of smaller ones, stunning or killing them.

One scientific theory is that the swordfish is born at very great depth, shortly after



Michael Lerner, expedition leader, and the captain haul in a striped marlin caught on rod and reel off New Zealand coast



↑ A striped marlin puts up a terrific battle against the hook

↓ Making a cast of a blue marlin taken in New Zealand waters





The fight over, a blue marlin weighing 708 pounds is hauled up at the stern and measured

the secrets of such hard-hitting fellows as the swordfish, sailfish, and marlin is Michael Lerner, who turned from fishing for sport to fishing for science. Trustee of the American Museum of Natural History and Field Associate for its Department of Ichthyology, he is also one of the moving spirits back of the recently founded International Game Fish Association, which is studying the habits of game fish, deciding upon all

2879 which he fastens his teeth in a larger fish and permits his host, or other hosts, to carry him around until his sword is grown and he can shift for himself.

But now modern science is attempting to trace every step of his life, every move in his migratory cycle as well as those of other desirable game fish whose incalculable aggregate bulk would add considerably to the world's food supply.

The man behind the move to catalogue

world record rod and reel catches, and generally acting as the clearing house for angling problems and information. Already reports are flowing into the New York headquarters at the Museum from outposts ranging from Africa to Australia.

As each piece of data comes in, a dot is placed on a map devoted to the species, an arrow indicates the currents, water tem-

Two expedition members help bring in a big sea turtle





2879

peratures, and so on. Charts take form and soon the information is put into general shape. Dealing with Atlantic sailfish, this might read: "Distribution: Brazil, north to Woods Hole, Mass.; and Devon, England. Greatest Concentration: Bahamas, Dec. and Jan.; Florida, all year, particularly Jan. to Mar.; Port Isabel, Texas, May to Nov., particularly July and Aug."

An example of the unpredictable behavior of the swordfish which the organization is trying to solve is cited by Dr. Roy Chapman Andrews, former Director of the American Museum of Natural History.

Michael Lerner and his wife admire a day's catch off New Zealand. Left to right, a mako shark, two striped marlin, a thresher shark

Raft of balsa logs, so light four men could carry it, was used by Peruvian fishermen assisting expedition in catching local reef fish

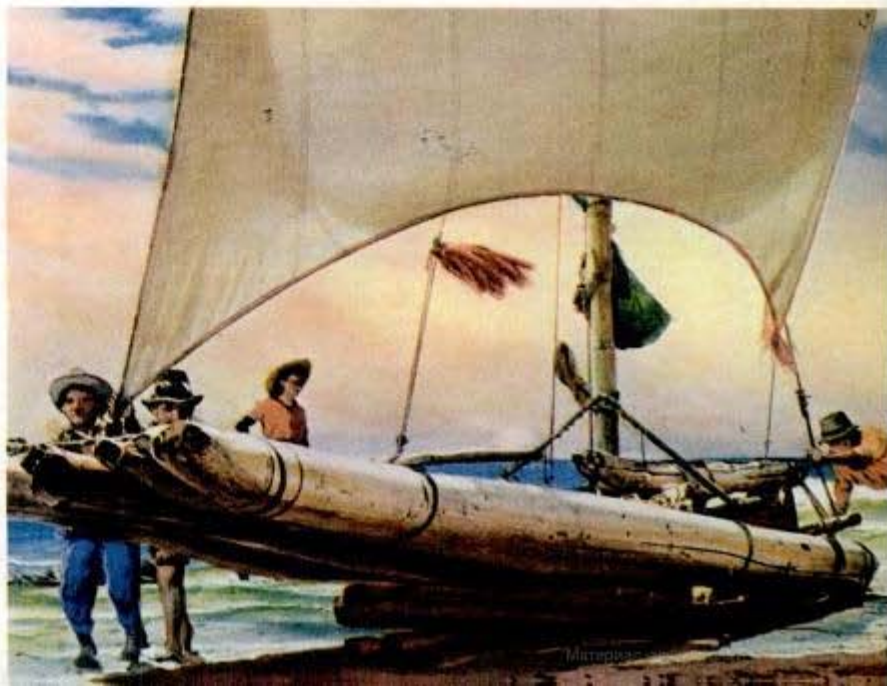



2879
One glance at the mouth of this mako shark demonstrates why it is one of the most dangerous creatures in the ocean

He says: "A very important question to which commercial fishermen would like to know the answer, is why the range of swordfish off the coast should vary each year in spite of the general distribution of their food. For instance, the fishing communities of Cape Breton, and other parts of Nova Scotia were lucky when the swordfish were running only 30 miles from their harbors in 1936. Their small boats could set out in the morning, catch a large fish or two and return to port by night, well repaid for a day's labor. But the following summer, in 1937, the swordfish ran 200 miles off the coast for some unknown reason. Fishermen who depended on this source for the markets and their winter food supply were destitute. Their small boats were not equal in speed or equipment to this great distance.

"If the Lerner survey can find out what conditions govern the swordfish migrations, it will be possible to predict the supply."

One reason science knows so little about the movements of the ocean game fish is that full-grown examples are too large to be transplanted into laboratories where patient research and mathematical deduction would reveal many of their obscure aspects. Commercial fishermen regularly land many swordfish weighing more than 400 pounds.

Even if these could be transported quickly to the dissection tables of a museum, by the time they have been harpooned, tussled with and hauled up from the ocean's depths, they are not fit laboratory specimens.

So Michael Lerner set out to

After numerous giant squid had bitten off large hooks, Lerner brought them in by making tassels of smaller hooks which enmeshed in the tentacles

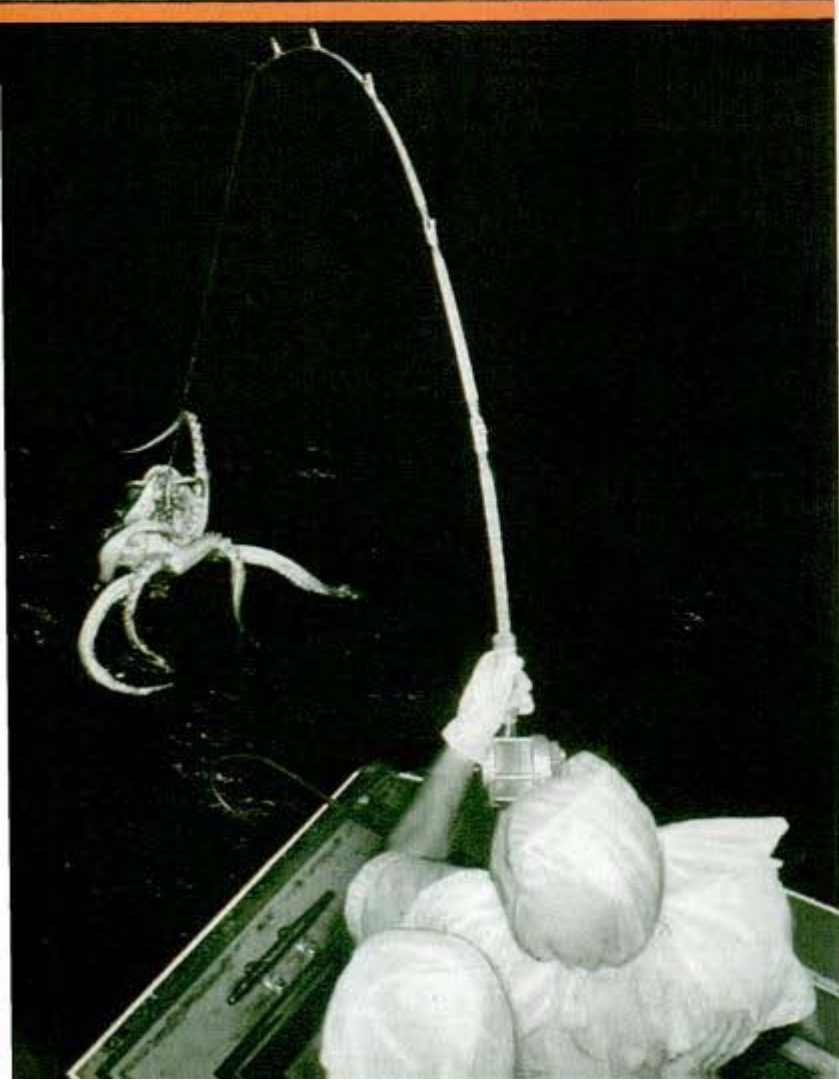

2879

do two things, first to catch his big game fish with rod and line to avoid mutilation, and, second, to take science to the fish. Thus, on expeditions going out under the auspices of the American Museum of Natural History, which have found him trolling off Australia, New Zealand, Nova Scotia, Chile, Peru and the Island of Bimini, he has been accompanied by other expert game fish anglers, ichthyologists, and photographers. Also by Mrs. Lerner, who holds the women's world record for white shark and was the first woman to land a broadbill swordfish on rod and reel in Canadian waters. She also holds the women's record for striped marlin, with a 403-pounder, caught off Tocopilla, Chile. Less than 300 of the species have even been caught by rod and reel. Of these, Michael Lerner has landed 17.

Lookouts on an expedition schooner watch for swordfish off Nova Scotia

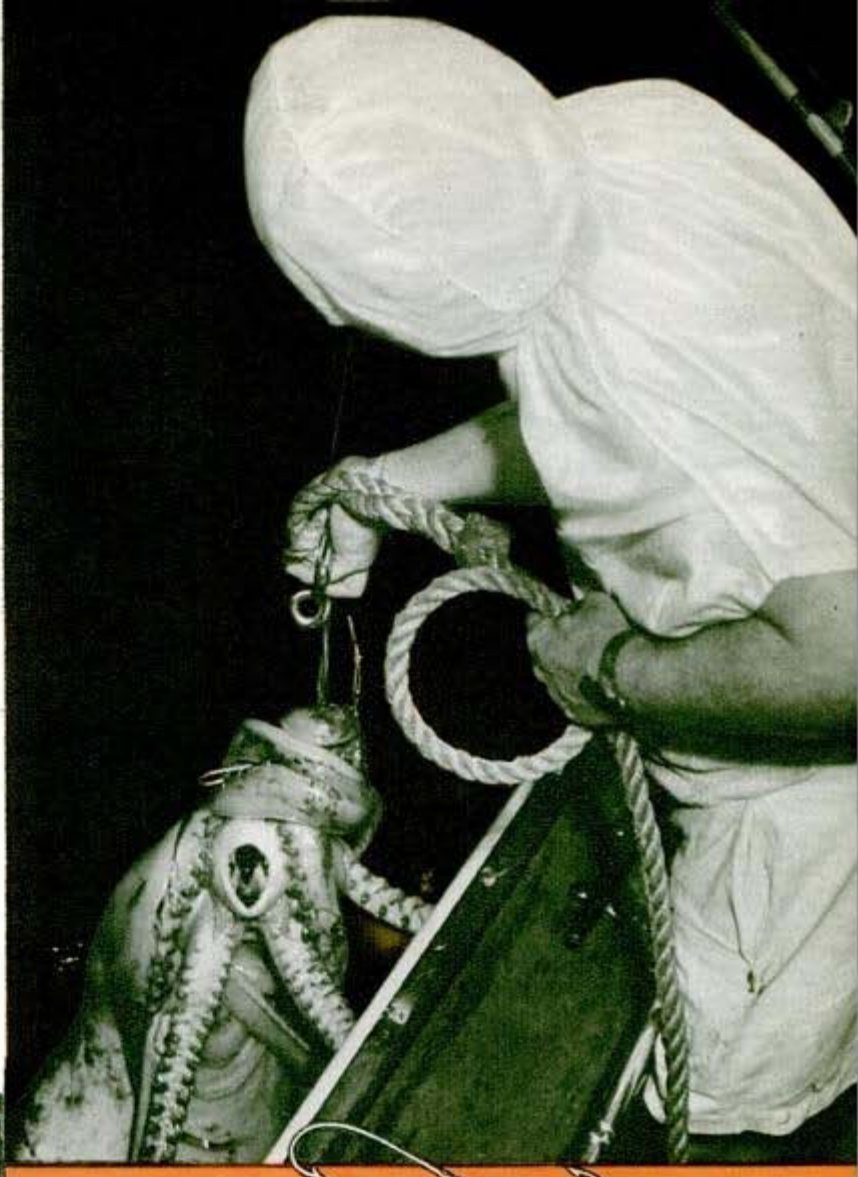

Hooded for protection from the squid's "ink," a fisherman brings a gaffed squid to boat off Peru. The oval orifice is the squid's powerful beak

On the expeditions, the results of which are now being compiled, the Lerner's were accompanied by American Museum staff members; Florida fishing captains; and moving picture and still cameramen.

For months before an expedition sets out, the members are busy preparing. Finally, the last specimen tank is hoisted on board, the staff checks the equipment to make sure everything is on board, and the expedition is off. When the Chile-Peru expedition landed at their first base camp, 109 cases and boxes of equipment—tackle trunks, camera cases, tripods, formalin tanks, instrument cases, and special supplies—were lowered into the waiting tender.

This expedition was particularly seeking broadbill swordfish and the several

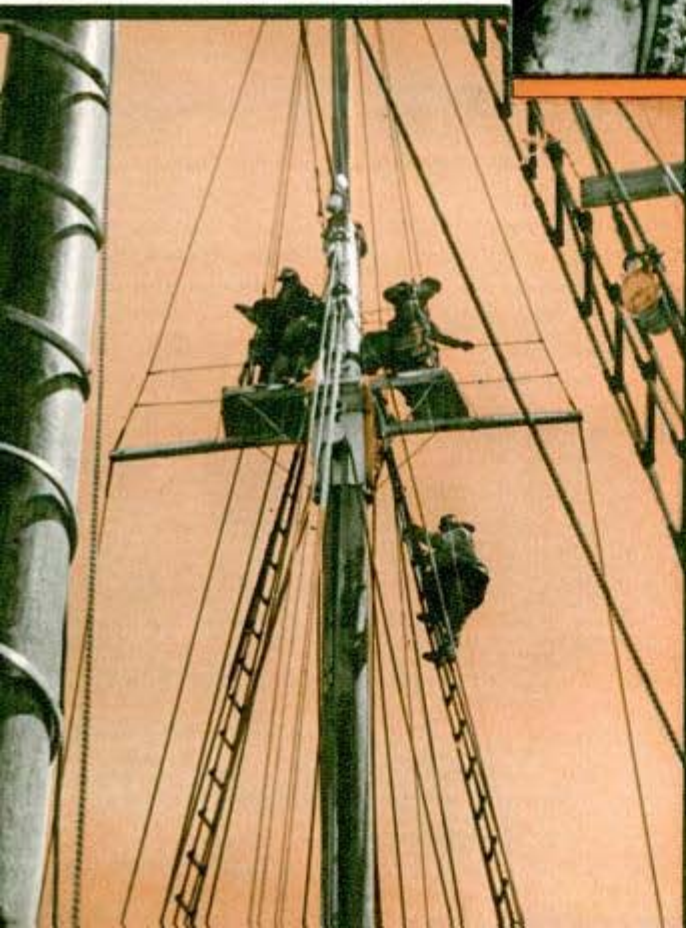



2899

Block and tackle were necessary to haul in a 667-pound broadbill swordfish off Tocopilla, Chile

varieties of marlin, which are distant cousins in the mackerel family. Persistent reports had it that giants of the swordfish tribe had been seen off the coast of Peru. But when they arrived at Talara, Peru, disappointing news awaited them. Local fishermen told them that they had come at the wrong time of the year to catch the battling monsters.

"We felt pretty low," says Lerner. "Even if they were plentiful, experience had taught us that on the average only about one out of four swordfish will strike at the bait with his sword, which is the creature's way of 'killing' its food. Then, about one out of four of this number will swallow the hook, and even with the hook embedded, about one out of four will be landed."

But, as Lerner points out, a fishing enthusiast first of all is an optimist, so the party went to work patrolling the sea from

40 to 80 miles out in two 30-foot outriggered launches with lookouts stationed as high as possible to watch for the two-in-line fins which spell broadbill. This daily routine continued fruitlessly day after day.

There were plenty of fish and huge ones too—sharks, huge batlike manta rays, killer whales, and marlin. For the first time it has ever been accomplished, they even caught the dreaded Pacific squid, relative of the octopus, on rod and line. These too were valuable museum specimens, the first of the kind to be brought into its collections. But no gargantuan swordfish.

Then patience was rewarded. A swordfish was discovered circling around the surface, sunning his lean, lithe body.

Lerner seated himself on his chair, a platform mounted on a revolving stem with an adjustable footrest; dropped the butt

(Continued to page 176)

Mt. Rushmore Memorial Ready After 15 Years

After nearly 15 years under the skilled hands of sculptors, the great Mount Rushmore National Memorial has now been finished. Machinery and scaffolding are being dismantled, so visitors for the first time may have an uncluttered view of the gigantic figures of Washington, Jefferson, Theodore Roosevelt and Lincoln. The busts, proportionate to men 465 feet tall, are carved in a 700-foot monolith of granite in the Black Hills of South Dakota. From the top of Washington's head to the tip of his chin is 60 feet. Work on the monument was started in 1927 under the direction of Gutzon Borglum, who died last year. It was carried to completion by his son, Lincoln Borglum.

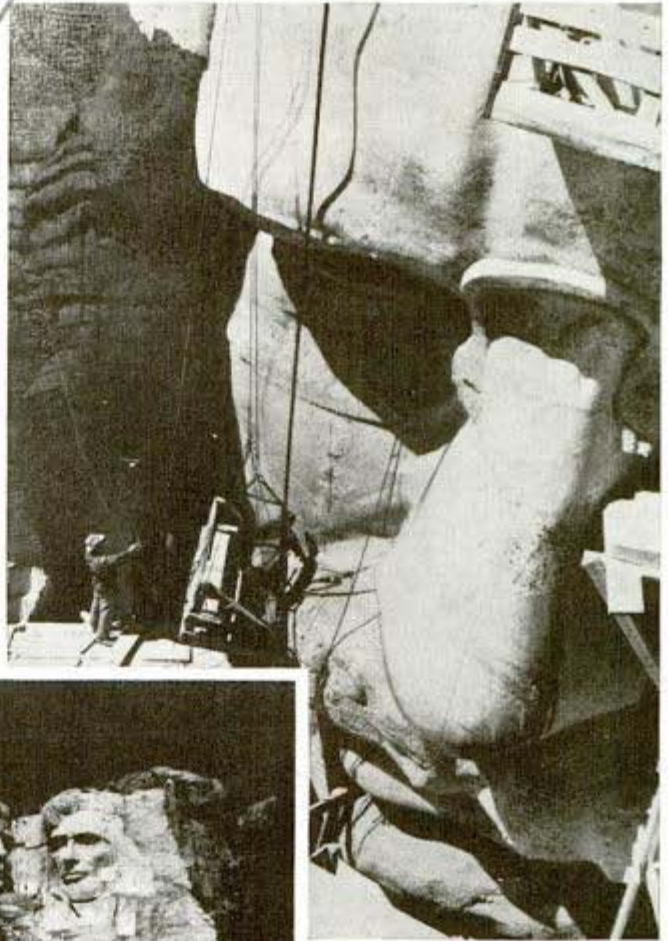

↑
Close-up view of Theodore Roosevelt's face as sculptors give it final touches. Man pointing is Lincoln Borglum

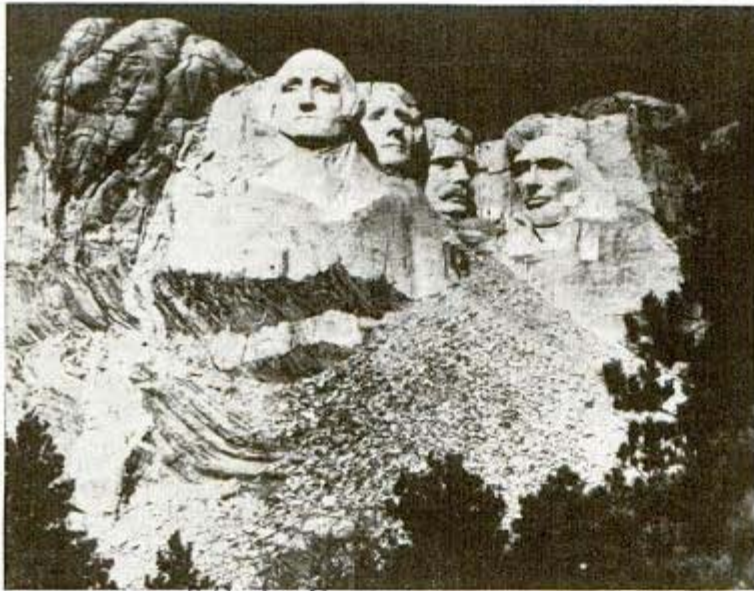

← Here is how Mount Rushmore National Monument appears from highway nearby. Faces are hewn in granite cliff

Air-Conditioned Operating Room Keeps Drafts Off Patient

Draftless air conditioning, safe for use in hospital operating rooms and bringing relief from summer heat to surgeons, attendants and nurses, has been achieved with a unit installed in St. Francis' Hospital, Poughkeepsie, N. Y. Only outside air is taken in, its temperature and humidity regulated as desired, and the conditioned air distributed gently about the room. Four outlet ducts, located in the corners of the room, are so arranged that the clean air

passes down the walls and across the floor to the middle of the room where it rises about the operating table without allowing drafts that might endanger the patient. For protection against explosion, humidity is not permitted to drop below 55 percent.

☛ The 200-inch Mt. Palomar telescope weighs 520 tons and is over eight stories high, yet it is balanced so delicately that it can be moved with a finger.

Cayser Corp. N.Y.
S. of Granite

21142

Chemical Frees Roof Drain Of Ice and Snow

Brooklyn, N.Y.

*Eastern States Supply Co
127 Manhattan St.*



Installed in drain, this device melts ice and snow

Roof drains and leaders can be kept clear of ice and snow by a chemical device that adjusts to fit all shapes of drains from two to six inches in size. The chemical which melts ice is dispensed only when in contact with the snow or ice, and one filling suffices for a season. Harmless to roofing materials, it is installed without tools.

Short, Lightweight Infantry Rifle Adopted by U. S. Army

*290
266*

To be carried by infantry troops, the Winchester carbine adopted by the United States Army can be used both defensively



Acme

New infantry weapon shorter and lighter than Garand

and offensively. It will largely replace the .45 caliber pistol, which is essentially a defensive weapon. The new rifle weighs almost 4½ pounds less than the Garand, basic rifle of the Army, and is 7½ inches shorter. After exhaustive tests of five different lightweight rifles, the Winchester carbine was found best suited to the rugged handling it will have in military service.

Snowplow Hooked to Car Bumper Clears Driveway With Ease

21286

You can use your own car or truck for removing snow from driveways, parking lots, walks or other areas, by fitting it with a snowplow easy to attach and remove. Slipping two hooks over the bumper bar completes the connection to the car. The

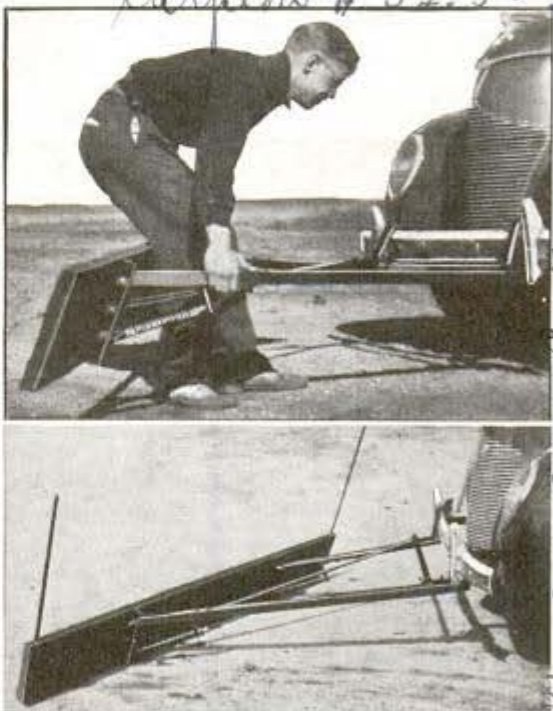

Top, attaching plow to car; bottom, ready for action

steel hooks are lined with webbing to protect the bumper finish, while shock absorbers take the strain from the bumper when passing over bumps. Runners at the bottom of the blade maintain the correct angle for pushing snow and raise the plow above sidewalks when crossing cleared areas.

Thirty-four new streamline trains have been added to the American railway fleets during the last year, bringing the total to 121 trains; 26 more are being built.

POPULAR MECHANICS
Railway Age 11/22/40

Am. M. Coon Co., 72 Middlesex Road, Buffalo, N.Y.

✓ L1209

Air Corps Headquarters
Randolph Field, Tex.

Planes Parked on Noses Await Call to Service



Removing primary training planes from storage at Randolph Field, whence they flew to aviation schools

When the six new primary flying schools of the Gulf Coast Air Training Center opened to train pilots for national defense, primary training planes aplenty were ready for instructors and students. The planes,

built while the fields were under construction, had been ferried to Randolph Field, Tex., and parked on their noses to save hangar space. It was a simple task to haul them out and fly them to the new fields.

L1210

Grand Piano "Floating on Air" Has a Transparent Base

Supported on a base of transparent plastic curved to conform with the lines of the instrument, a grand piano appears to hang in the air when viewed from several feet distant. Despite its "invisibility," the plastic base is strong enough to carry the heavy burden.



Almost invisible, the base of this grand piano seems to hang like a transparent curtain. It is a sheet of strong plastic

FEBRUARY, 1942

Rudolph Wurlitzer Co 27
242 Kaber Hall

L1186

SUBWAY for BLACK GOLD

By
Roderick M. Grant

ONE HUNDRED oil tankers are blasted to the bottom of the sea. Fifty more are loaned to Britain. Down-east motorists jam filling stations to beat the twilight curfew and growl at a threat of rationing in a land that has been a land of plenty producing 65 percent of the world's petroleum.

And as the ships go down, America becomes suddenly and pleasantly aware of its vast "underground railway" of pipe lines. It is growing like an adolescent. Crude oil has just begun to flow through a new 236-mile line from Portland, Me., to Montreal, saving a 10-day, 2,000-mile trip by tankship up the St. Lawrence. Pure Oil and Gulf have completed a 450-mile tube to carry 30,000 barrels of gasoline per

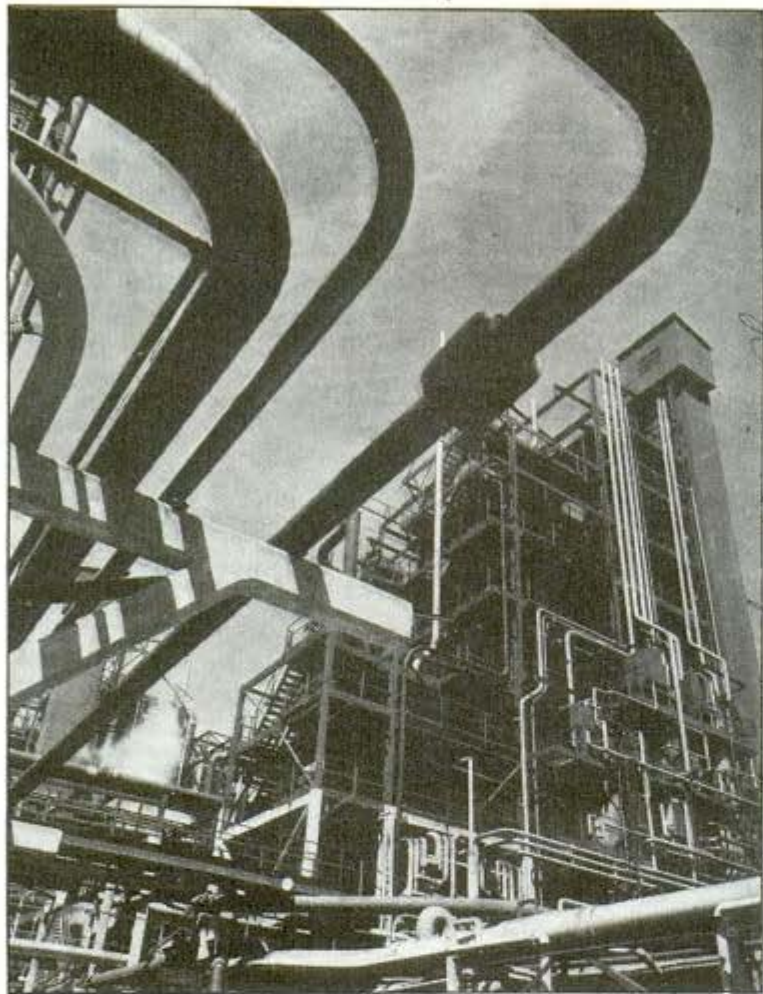

3.5 to 4 inches steel, Chicago

Pittsburgh, Pa. 3800 Inlet Bldg. Nat Corp.

Here is a pipe line's terminus, the Standard Oil refinery, Whiting, Indiana

An oil line makes a high jump on a trestle

A Caterpillar tractor gently drops the huge pipe into trench

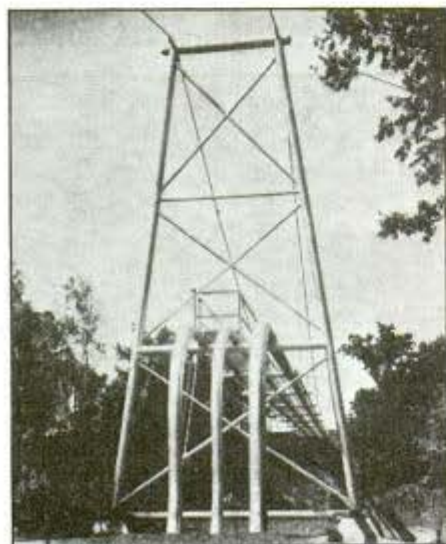

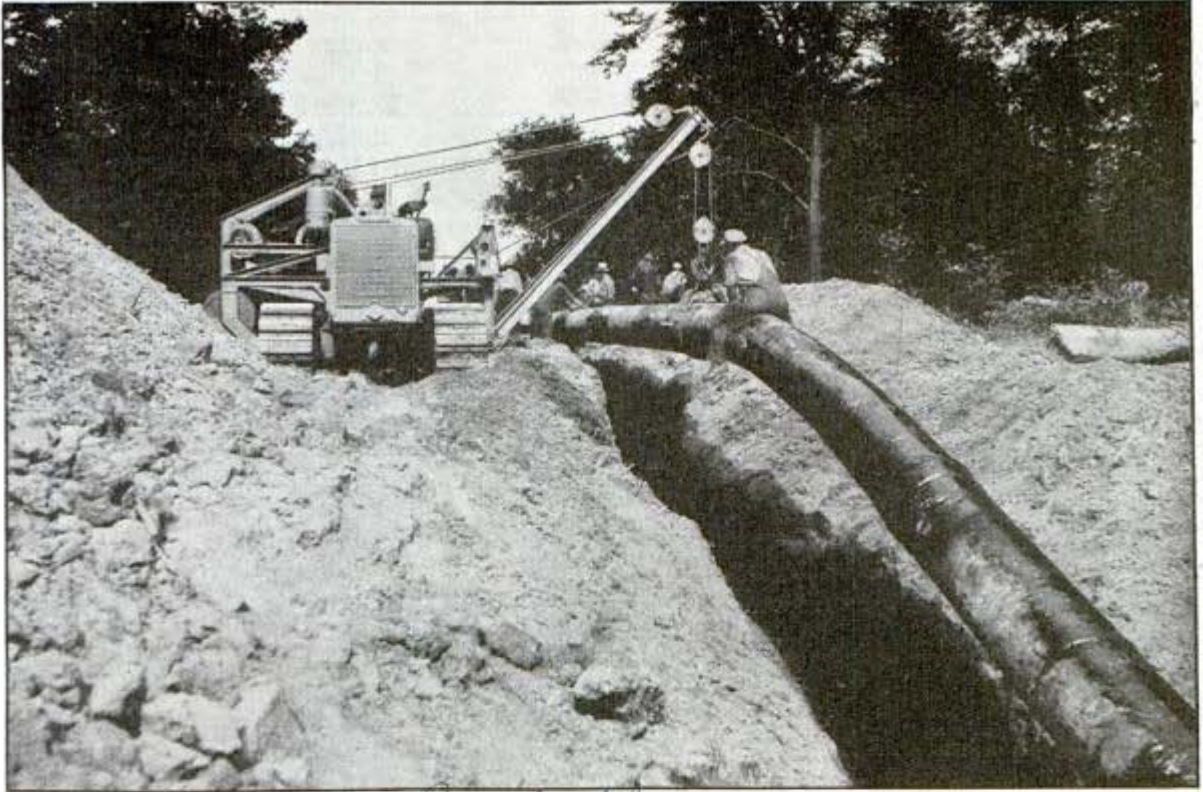

Caterpillar Tractor Co. photo

Georia, Del.
Sections of pipe 118 feet long, bent to fit contours of hill country, are eased into position by boom

day from Florida coast docks to Chattanooga. From Baton Rouge to Greensboro, N. C., a 1,260-mile gasoline line is being laid. When it starts its river eastward it should release ten coastwise tankers. Socony-Vacuum has just built new gasoline arteries from Syracuse to Elmira and Binghamton, N. Y., and from Topeka, Kan., to Sioux Falls, S. D. And vaster than any oil line ever built is the projected National Defense Pipe Line, already surveyed by aerial mappers but halted momentarily at least by refusal of steel from priorities authorities. If built, this gigantic 24-inch pipe would deliver 250,000 barrels a day from Texas to Philadelphia and New York, more than 1,500 miles away.

Together, arteries of black gold stretch more than 126,400 miles across the states, more than a mile of pipe for every four miles of paved highway

or of railway in the United States. They form in themselves a tremendous reservoir through which at this moment 21,000,000 barrels of crude oil and gasoline and petroleum derivatives are creeping at three to four miles an hour from well to refinery and refinery to your tractor or furnace or automobile or parlor lamp. Pipe lines bridge the Louisiana swamps on stilts, lie

Examining a three-dimension aerial survey map of an oil-line route
Aero Exploration Co., Tulsa, Okla.



21186

James. Nordstrom Valve Co
378 W. Lexington Ave Pittsburgh Pa

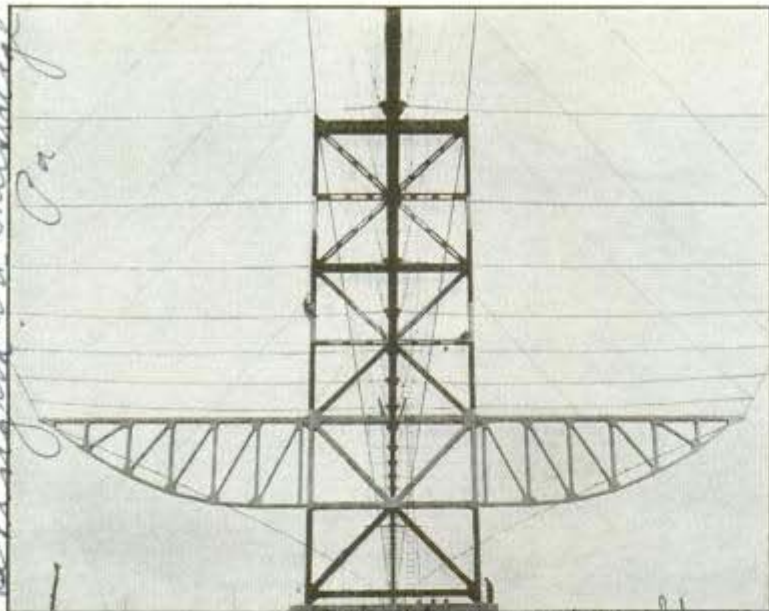

American Hoist & Derrick Co. Robert & Water St
A 16-inch pipe line crosses Missouri river on half-mile suspension bridge



hidden at plow depth beneath farmlands, climb the Rockies and the White Mountains, vault the Missouri river on a half-mile suspension bridge and are cradled in the bed of the Mississippi.

This is no infant industry. Pipe lines had their abortive beginning 80 years ago when a Pennsylvania oil man proposed to elude the losses of foundered wagon trains and flood-wrecked barges by feeding oil by gravity in a four-inch wooden pipe to the Oil City refineries. Teamsters saw their livelihood menaced and the Pennsylvania legislature forbade the

pipe. However, by 1863 pipe lines two or three miles long were being built, and they worked. Today they are growing by 10,000 miles a year.

This business of building and operating a pipe line has been revolutionized in the last ten years. Today, paradoxically, the "groundwork" for a new line is done in the air. Before snowfall the Aero Exploration company of Tulsa finished mapping the route of the National Defense Pipe Line. Two

"Switchman," left, reroutes oil at pumping station by turning Nordstrom valve. Below, the pipe line's rival: Socony-Vacuum tug pushes 3,500,000 gallons of gasoline up the Mississippi

Hubert
26 Broadway
Cal Ca





First pipe line to cross continental divide, from Wyoming to Salt Lake City, is lowered to river bed

planes, carrying pilot and cameraman, flew 15,300 feet above ground level over the course from Longview, Tex., and Wood River, Ill., to Salem, Ill., and on to Bayonne, N. J., flying at 140 miles an hour. Every 20 to 30 seconds, according to ground speed,

the cameraman turned a crank to expose the film; in a strip map the pictures must overlap and an exposure a second too late might miss the overlap. At the end of 100 exposures the film must be changed, the

(Continued to page 194)

Dot-dash lines on map indicate oil lines being built or just completed; single dotted line marks route planned for the now deferred National Defense Pipe Line. Others are principal existing lines

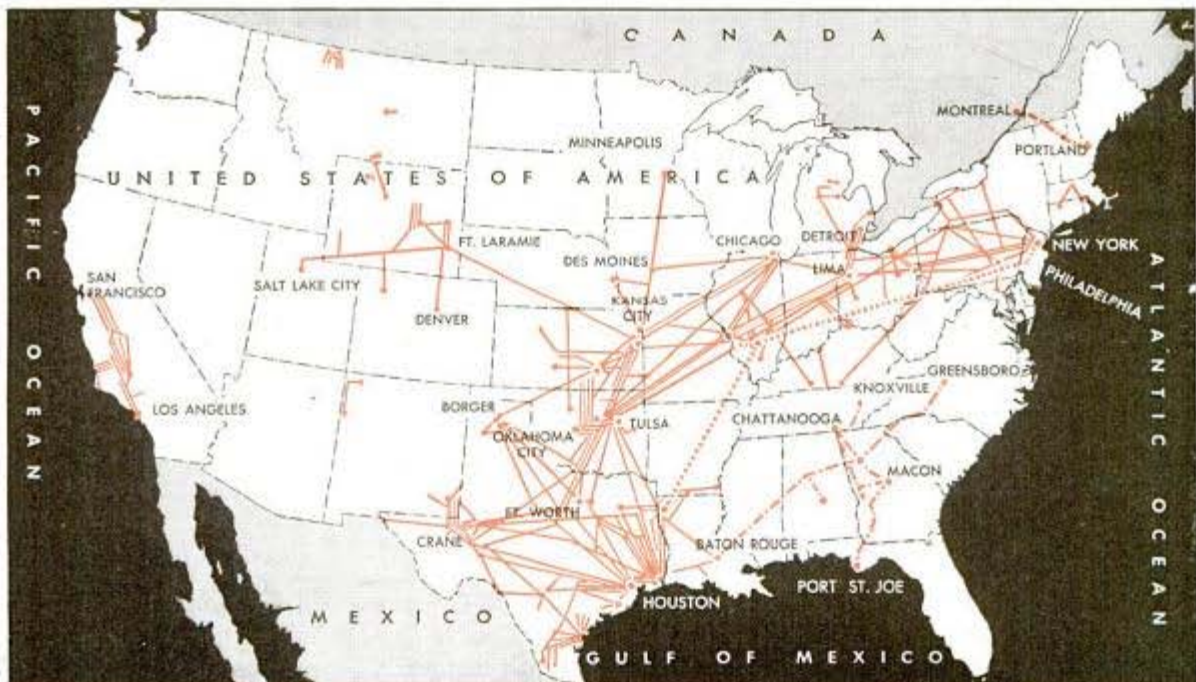

21250

Chair Built to Be Straddled Has Tea Tray on Back



Chair as it should be straddled; inset, front view

Refreshments may be enjoyed in comfort if you have an upholstered "straddle chair" that answers a long-felt need for a different kind of sitting relaxation. Across the top of the back is a broad, level surface on which a cup and saucer will rest safely as you sit at ease straddling the back support. Of course, the chair may be used in the ordinary manner, also.

Sand Blaster for Small Articles Is Cheap to Operate

Sand blasting small glass or metal articles, such as signs, name plates, house



Designs sand blasted on glass in simple operation

numbers and ground glass for cameras, can be accomplished in a simple operation with a compact, portable machine now available for small shops and home craftsmen. Cheap glassware and pottery can be given a more expensive finish. Run by a quarter-horsepower motor, the eight-pound machine operates by centrifugal force instead of compressed air, and handles any piece of work that can be placed on top of it and moved about as cutting progresses. For cutting designs on wood, tape may be applied and the parts to be sanded cut out with a knife and peeled off.

Adjustable Winter Front for Auto Fits Many Models

Made in two sections fastened together by a series of button-clasps, a self-adjusting winter front fits most automobile models of the last three or four years. The two



Two-piece winter front adjusts to fit car radiator

parts are placed against the radiator behind the grille and joined at a point which permits them to cover the largest possible area. Two straps at the upper corners are passed around the radiator and hooked together to hold it in place. A coil spring at the end of one strap allows for various radiator thicknesses.

(A new revolving door controlled by an electric eye turns automatically and lets you walk through without pushing it.

Merchandise Mart Chicago

West Unity Ohio
Hany Strang
Shaw mfg Co

Van Buren

Ed. State

Stearns
Chicago

International Steel Co

POPULAR MECHANICS

Merchandise Mart Chicago

Mine Explodes by Sound From Ship's Engines

E.C.Y. 2/4

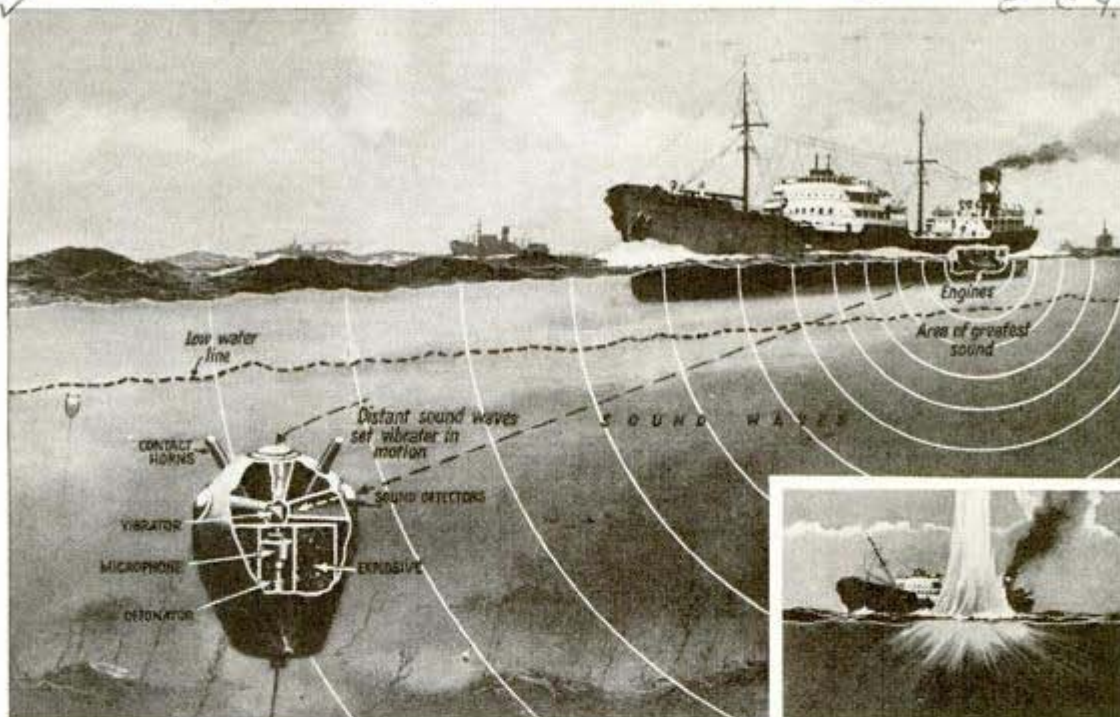

Acoustic mine does not wait for contact but explodes when ship draws near, as shown in the inset

Acoustic mines are now being used by Germany in attempts to block English coastal waters, Prime Minister Churchill disclosed recently. Laid by night in the approaches to harbors, the latest mines are equipped with sound-detectors that pick

up sound waves from a ship's engines. The vibrations act on a vibrating reed, producing electrical impulses, and when these become powerful enough, due to the nearness of the ship, they set off the explosive charge contained by the mine.

L1214

Portable Runway for Airport Follows Advancing Army

As today's United States Army rolls forward, it will carry along a portable airfield packed in trucks or railroad cars, which will permit the establishment of an air base

for protection of its advanced position and for harassing enemy troop concentrations. The portable field consists of steel planks, weighing 50 pounds each, which are laid on

Ashton or Aberton, N.C.



level ground to form runways and held together with clips to prevent sliding. In this way a landing area 3,000 feet long and 350 feet wide can be laid out, although only 150 feet of the width is of the steel planks and the remainder hard and level sand. If the terrain is rough, "bulldozers" and carryalls make it level.

Enough of these steel planks can be carried by an army to lay a landing strip 350 feet wide and 3,000 feet long

acme

21171

EVERY OUNCE COUNTS *on a* CLIPPER



One of four scales on which great Pan American flying boat is placed for weighing at specified intervals

One of mighty engines which propels the Clipper is shown being serviced; replacement of parts usually adds to weight

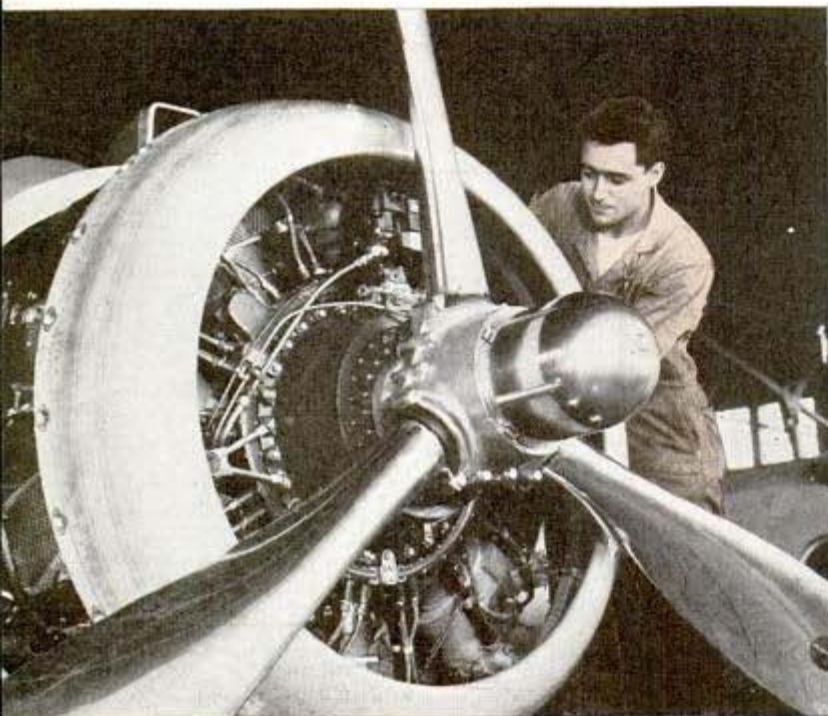

THE 41½-ton flying boat was nearly ready to depart on the first leg of its 9,000-mile flight across the Pacific. The weigh master checked his figures, then held up an arm.

"Hold it," he called. "You are two and a half pounds overweight."

A steward carried a bucketful of ice from the galley and dumped it overboard. Not until then did the transoceanic air liner have permission to depart.

Ridiculous? Not at all. Pan American handles every routine departure just as carefully as if it were the first test flight of an experimental plane. Every piece of equipment, every passenger and letter, even the butter in the galley, had been weighed. The weigh master

21191 Capt. Thomas E. Stinson, Jr.
3892 Franklin Ave. Pas

knew the total down to the last ounce.

It would have been perfectly safe to have taken off with the extra two and a half pounds or with a hundred times this overload, but such extra weight would have eaten into the plane's reserve cruising radius. As it was, the plane was some 300 pounds overweight when the crew first went on board. Fifty extra gallons had been added to her fuel supply for warm-up and take-off. The weigh master knew that the 300 pounds



↑ Navigator of a Clipper is shown taking star sight through transparent "astro dome"

← Checking the control lines on one of the flying boat's triple tail surfaces

Clipper with full load of passengers, mail and express getting off the water
↓

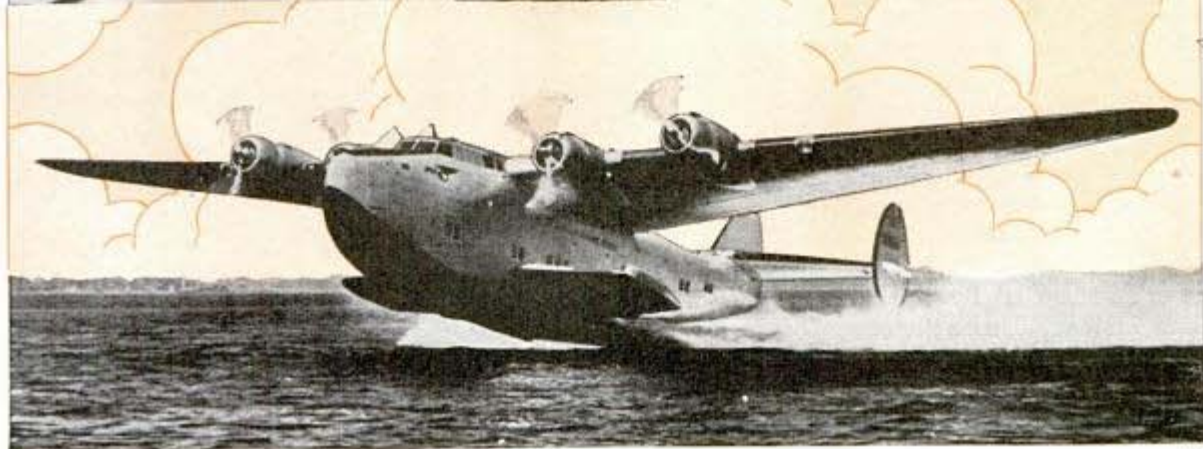
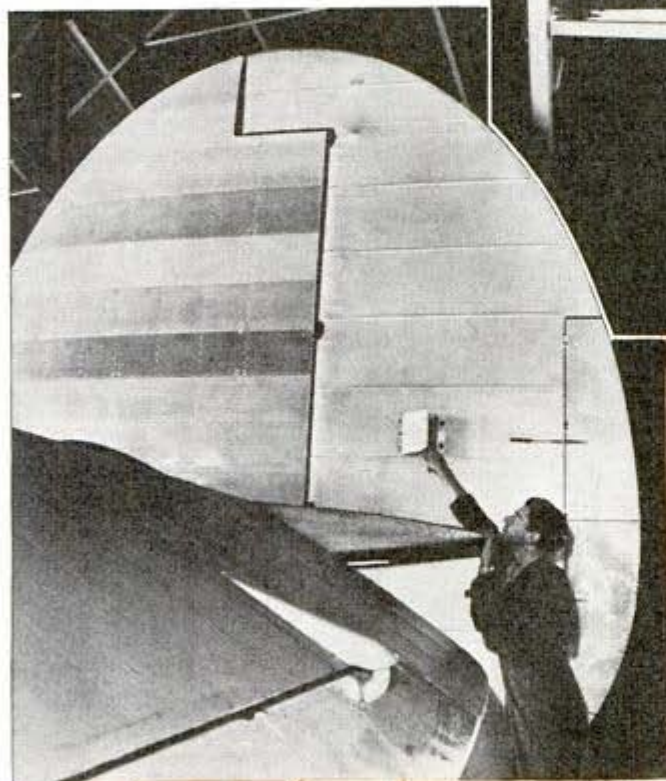

George Gardner, Cable Operations Manager
Pan American Airways Co. I. Warner & Sons
San Francisco, Calif.

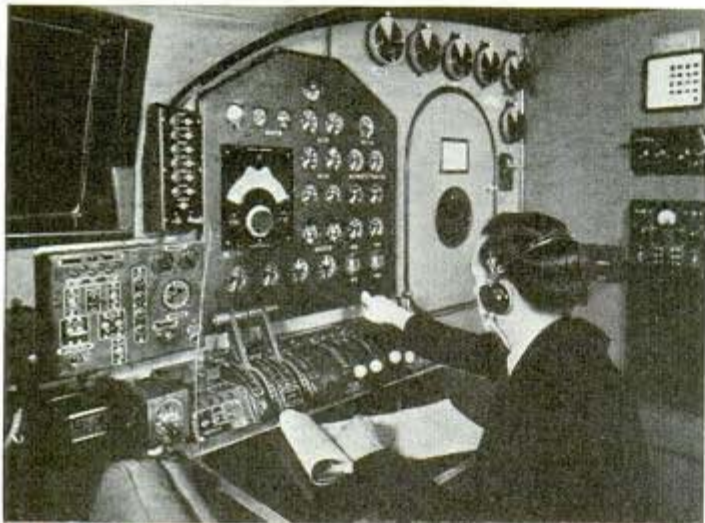

↑
Chief engineer, at control panels, is in charge of engine operations

One of the powerful searchlights, enclosed in wing, used as wing light
↓

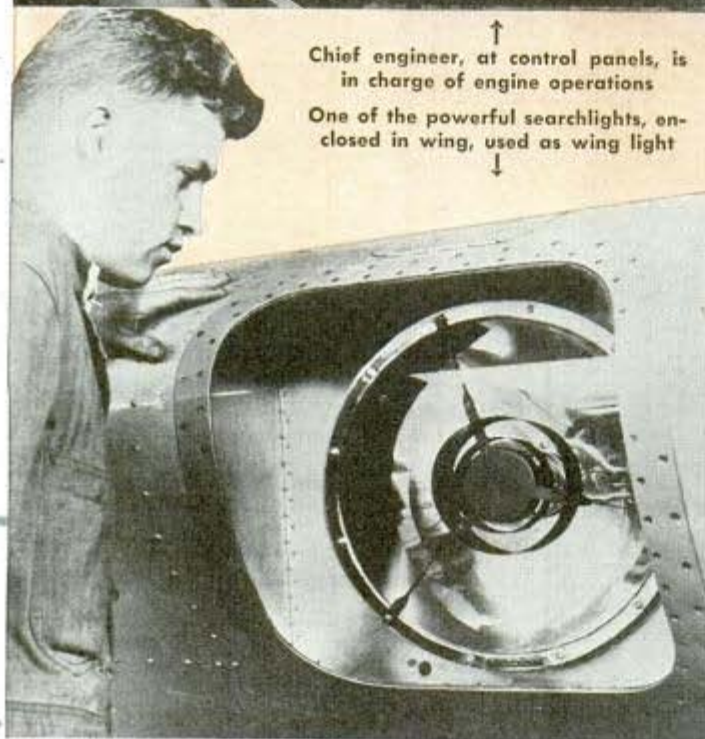

ority. The passenger list may fluctuate from seven or eight to 28, depending on the fuel and mail loads. These days there is always a waiting list.

Pan American's Clippers normally land at their destinations with enough fuel left in their tanks to take a fleet of automobiles across the United States and back. This reserve is for emergencies only and nothing short of an unexpected headwind is allowed to reduce it. That is why the air line insists that passengers be prompt. A 10 minute delay at the dock waiting for a tardy passenger really means a delay of more than half an hour because the additional fuel used in idling the engines or restarting them must be replaced before the plane departs. In flight, the boat begins to lose weight the instant it leaves the water. On the crossing from the mainland to Honolulu, for instance, the plane loses nine tons of its original fuel load.

Inevitably, a plane grows heavier with age. Trying to keep the weight down is a losing battle although the maintenance crews fight it ounce

Navigator of Clipper at his chart table in plane's control cabin
↓



of fuel would be consumed by the time the flying boat got off the water and that by then her weight would match his figures.

Weight control and the weather decide how many passengers and what weight of mail and cargo can be taken. The captain rarely flies the shortest distance between points. He takes advantage of existing winds to fly the shortest time instead. Enough fuel for such a trip, with an almost 40 percent reserve, is the first item to go aboard. Next the mail has pri-



Part of control cabin showing navigator and radio man at left and right
 Any item removed from or added to Clipper is weighed and entry made in log

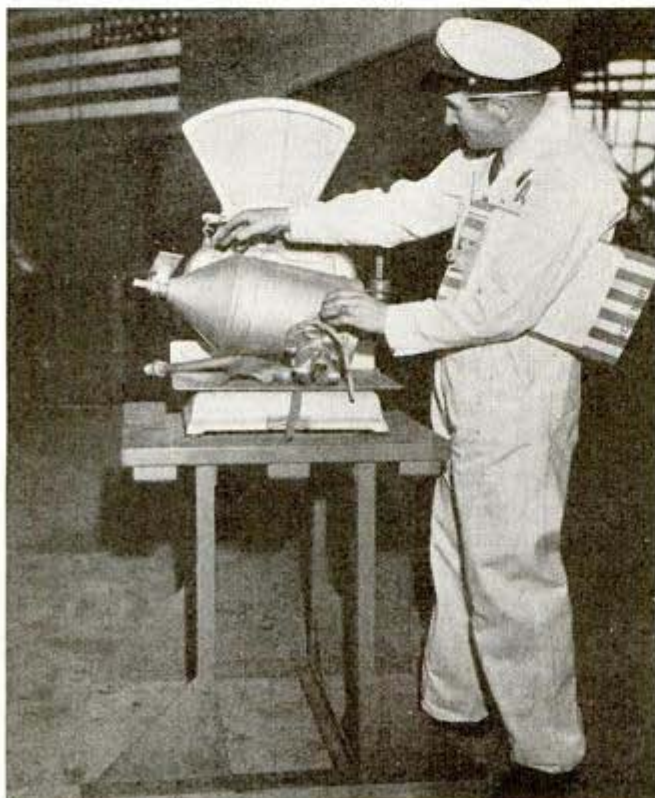

by ounce. Every pound of weight added to a big flying boat, it is estimated, reduces payload capacity by \$90 a year.

Some of this extra poundage can't be helped and some of it can be prevented. Residue oil clinging to the walls of the oil tanks and lines adds 100 pounds to the plane's original dry weight. This increase remains constant. Moisture absorbed by the plane's cushions and soundproofing adds another 100 pounds, so between flights the interior is dried out as much as possible by batteries of infrared lamps. Not even the dirt tracked into the plane by passengers and crew can be disregarded. Between flights the cleaners remove some 20 pounds of material, mostly in the form of floor dirt and grease from behind the exhaust stacks.

Repairs cause a plane to grow heavy because replacements are ordinarily of heavier material, larger than the original parts when lap joints must be made. A few rivets added here and there, some spot painting inside the plane, all add up. As new developments in radio and other safety devices are made, such new

(Continued to page 185)

7/206

Suspension Test for Wheel Shows How It Balances



Checking auto-wheel balance with suspension tester

Testing the wheel and tire assembly for balance in one simple operation, a suspension device now on the market does not require spinning the wheel. With the wheel suspended by its center, the unit acts as a delicate beam balance, instantly showing any condition of unbalance and the direction thereof. It also tells when the right amount of weights have been added to restore the wheel balance.

Flow of Air Measures Gun Bore Without Injuring the Rifling

To guard against damaging the inner surface of the gun barrel, which is likely to be injured by contact with metal, a new

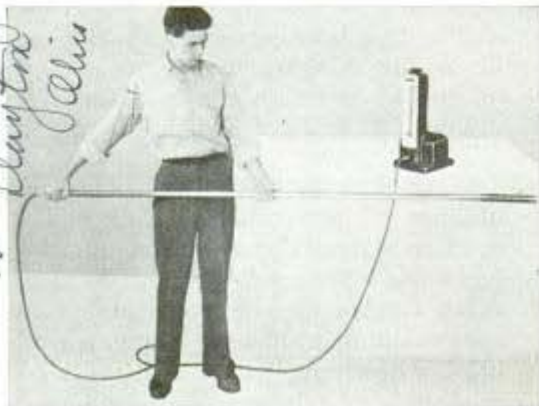

Gauge uses air pressure to measure the bore of gun

gauge for measuring the bore uses air instead of a contacting finger. As the gauge is passed through the bore, any difference in the diameter from the norm will increase or decrease the velocity of air, and this is registered on an easily read indicator. The instrument shows the location and extent of out-of-round, taper or bell condition.

Nonreflecting Surface for Glass Clarifies Television Image

Following up a clue given by Lord Rayleigh, English physicist, Dr. F. H. Nicoll of RCA research laboratories has developed a new method for ridding glass of reflections. The famed physicist had noted that one part of hydrofluoric acid, diluted in 200 parts of water, removed a thickness of glass corresponding to about one-quarter



Nonreflecting glass covers left half of this picture

wavelength of light each hour. Dr. Nicoll's formula involves exposing the glass surface to hydrofluoric acid vapor, which etches away a small amount of glass and leaves a thin, transparent film of calcium fluoride about one-quarter wavelength of light in thickness. The result is a surface that eliminates 10 percent of the visible reflection. It withstands hard rubbing; can be washed with water, alcohol and a number of other solutions, and can be exposed to reasonably high temperatures without los-

Sutton, Inc. Co. Berkeley, Calif. 2952 College Ave. The Sheffield Forge Corp. Clayton, Ohio. All Jan. 1942-81

Away Adhesives
481 E 2nd St.

L1204

Los Angeles Calif

ing its nonreflective qualities. Applied to television, the treated glass surface will produce clearer pictures, since the images are first "painted" on the glass face of a cathode-ray tube, then passed through a thick glass protector plate to a glass mirror. It will also eliminate glare from show windows, framed pictures and ground-glass screens on cameras. Reflectionproof glass on instrument dials of airplanes and automobiles will minimize the chance of error in reading. The light-transmitting quality of lenses can be increased by reducing the amount of light lost by reflection.

L1154

Dry Adhesive on Gummed Labels Sticks Without Moistening

Gummed with a dry adhesive that needs no moistening to stick them on objects, labels now available may be applied, removed and applied again, leaving no marks. Neither moisture nor extreme dryness can cause them to peel off. The labels are delivered on rolled-up strips of thin material from which they can be removed easily, each roll being packed in a dispensing carton. Prices, identification marks, etc., can be written on the label with pen or typewriter before peeling the label from the backing material. It will adhere to almost any nonporous surface such as polished metals and wood, plastics, glass, enamel, paint or smooth leather. For sealing flaps of transparent wrappings, as Cellophane and Pliofilm, the dry labels are especially handy since they permit the flaps to be opened and resealed without destroying the label or wrapper.

Kum Klean



Labels, torn off as needed, stick to most objects

FEBRUARY, 1942

Electric Beverage Fountain Keeps Drinks Flowing

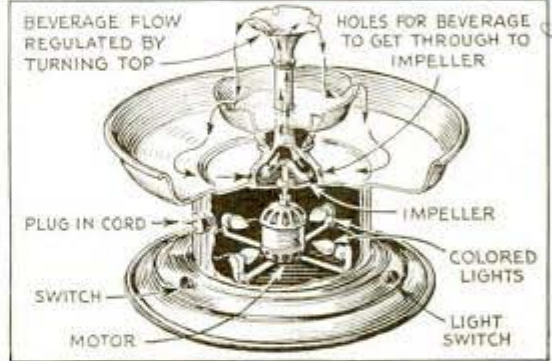

Guests may fill their glasses at electric fountain

Eight streams of beverage pour constantly from a decorative electric fountain designed for parties. After the liquid falls into a large bowl at the base, it passes through holes to an impeller that drives it again to the top of the funnel-shaped spout. Thence it flows down to a smaller pan dividing into the eight streams where guests may fill their glasses. Colored lights make the beverage glow invitingly.

L1208

Changeable Speed-Limit Signs Show Lower Speed at Night

On U. S. highways 40 and 50, east of Wendover, Utah, traffic signs provide for a speed limit of 60 miles an hour in daytime, but at night they change to read 50 miles an hour. The signs are of a new type which in natural daylight show a higher speed than they do against the rays of automobile headlights.

Illinois Automobile Club
Chicago

National Silver-Clayworth Ware Co. Merchandise Mark Chicago

Grant

7/2

BATTLING WAR'S FIRE BUGS

*National Fire Protection Association
60 Batterymarch St. (Boston) Mass
612 N Michigan Chicago*



Picked men of the Boston fire department, above, practice anti-aircraft gunnery with a gun mounted on a fire engine. National guardsmen and coast artillery help train them. Below, London firemen demonstrate with 200 trailer pumps

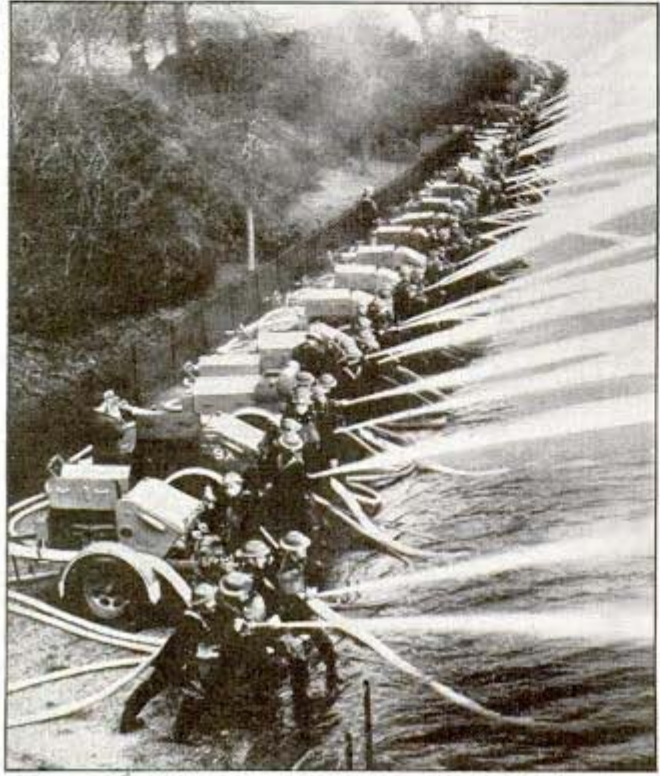

AGENTS of the Federal Bureau of Investigation were hunting danger spots in a wharf area at Hoboken, N. J. The fire protection plans seemed complete. One company had installed 97 barrels of water, and above each a bucket labeled "Fire."

The G-men noticed that every barrel was brimful—but the surface looked suspiciously oily. Investigation developed that each barrel was topped with five gallons of fuel oil. A bucket of that "water" thrown on a small fire might have started a conflagration.

Sabotage? No. There had been trouble with mosquitoes, and an exterminating company had doused the barrels with oil to stop mosquito breeding.

Throughout the country the Bureau of Investigation has been surveying defense industries for fire hazards, incendiary or natural. Other agencies, too, are marshaling forces against fire. All fire-fighting forces in Maryland are being coordinated for mutual as-

sistance among cities in emergencies. The Massachusetts State Fire Marshal—partly under the spur of the hurricane of 1938 which cost more than 500 lives and found few communities prepared for rescue work—has taken a statewide inventory of fire department equipment. When fire or flood or sabotage occurs, necessary equipment can be located instantly. In several regions, notably coastal cities, airplane watchers and fire spotters are being organized after the British rooftop watch system.

Readying for war? Not necessarily. For defense, yes—defense against fire. For fire is the great destroyer in war, as in peace, and government and industry are taking all possible steps to prevent fire, incendiary or otherwise, in defense factories.

One of the toughest hazards the war has brought, both in Europe and America, is the magnesium fire. Abroad, it is

Is. Garrard, Bush

Invented by a Briton, this 10-pound "bomb grab" can be handled by a housewife as easily as a carpet sweeper. It is of sheet metal, asbestos lined

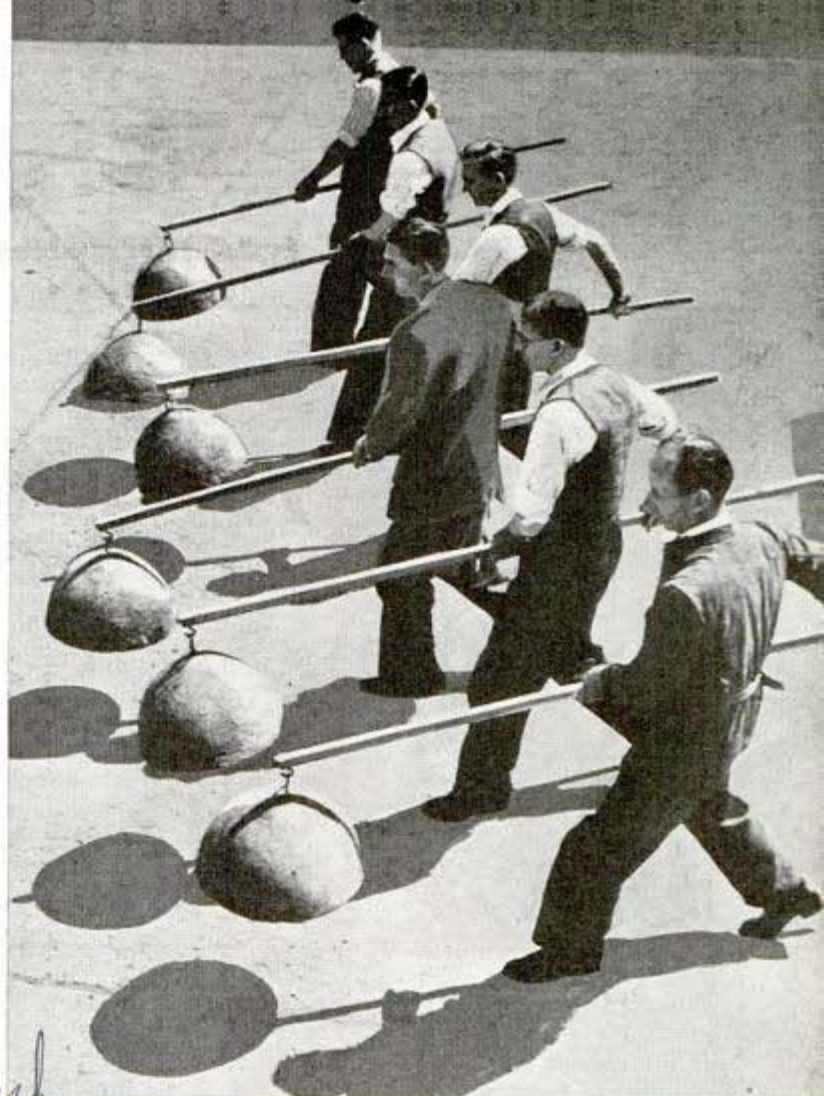

Thousands of these long-handled snuffers are spotted around English cities to fight incendiary bombs, which burn out under the asbestos dome. Below, control room of London's civil defense organization from which fire fighting and rescue work are directed



2-81-2



The "Ghost Squad"—firemen of the Royal Air Force and air raid groups—wear asbestos suits

British firemen had to learn this treacherous characteristic of magnesium through disastrous experience. One fire started in a shed housing 15 tons of magnesium scrap. Firemen turned 20 hoses on the blaze. Feeding on oxygen in the water, the magnesium exploded violently, 14 men were injured, and the flames spread to sheds containing aluminum scrap and burned for 48 hours. Sparks from a tool set fire to magnesium turnings in a New Jersey plant. The fire was almost quenched by smothering it with talc when a sprinkler opened, the water washed off the talc and intensified the fire.

Incendiary bombs were used in the first world war, but they were not very effective. Thermit bombs, steel shells filled with a mixture of aluminum powder and iron oxide which burns violently when ignited, often burned out soon after the heat penetrated the steel skin. But the new "electron bomb" has proved horribly efficient.

the most paralyzing of aerial weapons. Here, increasing use of magnesium alloys in aircraft construction has multiplied the chances of factory fires, and the peculiarities of this combustible metal have multiplied the problems of fire fighters. Trying to smother a magnesium blaze with water is like spraying a fire with gasoline.

It weighs only two pounds, and a bombing plane can carry 2,000. It can penetrate four inches of reinforced concrete; the chances are it will pierce the roof and lodge in the attic, often a difficult place to fight fire. Its thermit center is ignited by a percussion cap on impact, burning for perhaps a minute at 4,532 degrees Fahrenheit. Instead of

"Bomb taxi" is used by Bridgeport, Conn., police for exploding bombs

Steel-helmeted women of the British fire watching corps show how to subdue a small fire, caused by incendiary bomb, with stirrup pumps

Suppl. of Police Chas. A. Wheeler



Mayor Gasper Inc King

a steel shell its covering is magnesium, and jets of flame from the thermit core shoot from vents in the shell, scattering bits of molten magnesium for 50 feet. Then the magnesium shell burns brilliantly 10 or 15 minutes.

These are the flame pellets that have made blackened shells of British factories, homes, stores and historic shrines. They would do worse here, if the aerial "blitz" came to America; for wooden shingle roofs, which have disappeared in most of Europe, are a dangerous conflagration element in the United States. There is, of course, a percentage factor in favor of the defense. A bomber may carry 1,000 to 2,000 electron bombs; but it is estimated that only 15 percent of the ground space of an urban area is covered by buildings, so that about 150 of 1,000 bombs dropped would hit buildings. Of these, probably half would glance off or fail to penetrate the roof, and perhaps only 75 fires would result. A plane flying 200 miles an hour at 5,000 feet would drop 1,000 bombs, 20 per second, within three miles, setting fires every 60 yards. Multiply that by 100 or more planes and you conceive the burden falling on fire watchers.

Buildings can be protected by reinforcing roof timbers and flooring to prevent the bomb from penetrating, covering the flooring with some fire-resistant material—two inches of dry sand, brick dust, asbestos board or

(Continued to page 167)



↑ These are the small bombs that scatter flames over Europe. Loading the racks of a bomber at a British field

Darey

← Auxiliary fire fighters of Manchester, England, wear glass-windowed "smoke helmets" during air raids



While other employes go to shelters, women in asbestos uniforms tackle a factory fire with snuffers and pumps



2112 General Electric
 L 570 Lexington
 New York

Service Service
 10/15/41

✓ **Fixtures Direct Heat Rays From Self-Reflecting Lamp**



These two fixtures aim self-reflecting heat lamps

Two special electric fixtures in modern style are now available for convenience in using the new self-reflecting heat lamps, which need no separate aluminum reflectors. One fixture is a floor model, the other for table use, the latter having a hole at the base so it may be hung on the wall if desired. Both provide for adjustment to a wide variety of positions for directing the angle of radiation.

✓ **Lack of Vitamin A for One Day Increases Night Blindness**

Just one day's deficiency of vitamin A in your diet is enough to increase night blindness, Dr. C. W. Brown of University of California found from experiments with ten students. In order to avoid this night driving peril, automobile drivers and airplane pilots do well to include in their daily fare foods containing the A vitamin. The tests showed that, after eating foods high

in vitamin A content for 12 days, one group of students averaged 18.03 seconds in recovery from glare blindness, while the second group, which omitted A-containing foods from their diet took 22.70 seconds to regain vision. In determining the extent of night blindness, a light was flashed in front of the students for a short period and the time required to recover vision in a dimly lighted room was measured. After the initial test, the first group was switched to foods deficient in vitamin A, and within one day they began to lose their more rapid recovery ability. Some of the foods rich in vitamin A are carrots and sweet potatoes, green vegetables such as lettuce, peas, green beans, cabbage, also eggs and milk.

21135
Metal Chimney for Gas Furnace Reduces Building Cost

Where gas is used to heat the home, the cost of building a brick chimney can be avoided by installing instead a less expensive welded-seam metal chimney which is coated with acid-resistant vitreous enamel. This coating resists weathering and the attacks of the products of combustion.

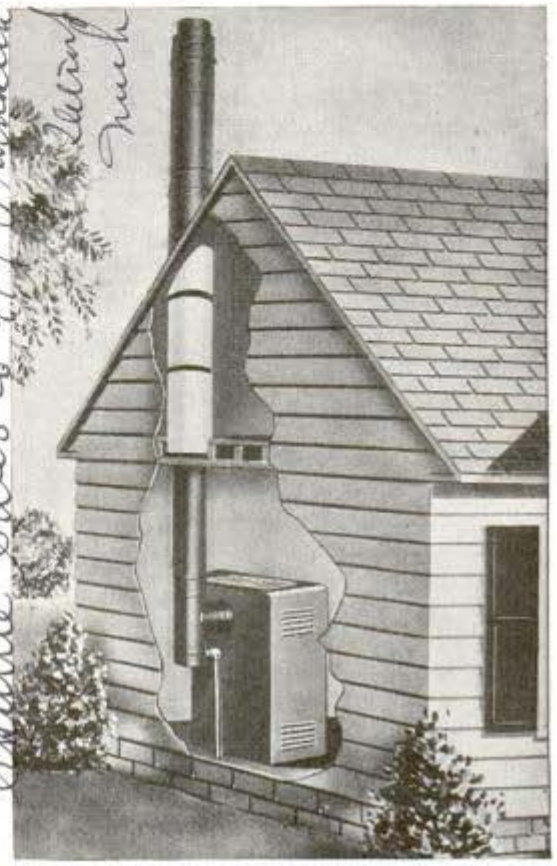

Enamel-coated metal chimney resists weather and acid

FR-486.98 FR-5 89.95

Parbelly.

Seattle Sales Co 999 Broadway
 Electric
 Truck

21246

Spring Dresses to Be Woven From Cow's Milk

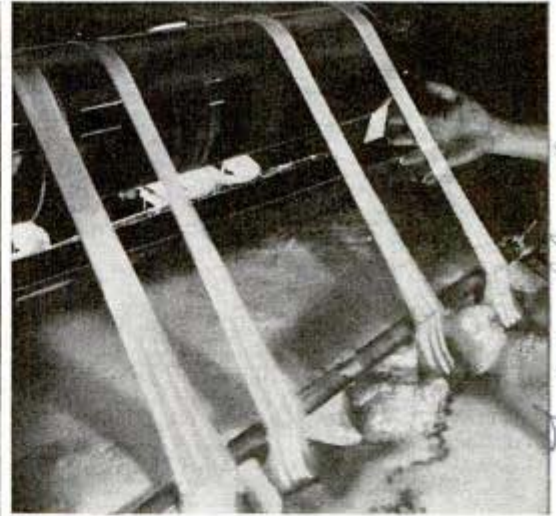

Thousands of strands of "Aralac" fiber make up the four tapes above, emerging from spinnerets. The hand in upper corner shows how translucent this new textile fiber is. It is processed from cow's milk. In the vat at left, resembling a huge washing machine, the fiber is squeezed under tremendous centrifugal pressure, and then is washed again.

Aralac, div. Jayville, Conn.



Already felt hats are being made from fibers derived from the casein in America's skim milk surplus, and by spring there will be slacks, dresses and other apparel woven of textile fibers developed by National Dairy Products Corporation. This fiber can be blended with mohair, wool, cotton, rayon or fur. The finished fluffy fiber above is ready to be pressed into 450-pound bales. The picture at left shows a spinneret through which honey-like viscous casein is forced under hydrostatic pressure, emerging as strands of fiber. One new use for the fiber is to protect hair during permanent waving.

FEBRUARY, 1942

230 Park Ave. 45
New York City



↑ An amateur "caver" maps an underground cavern; paper and pencil, chalk and tape are essential equipment. A principal purpose of the Speleological Society is to gather accurate data on caverns

CAVE MEN UP-TO-DATE



FLASHING his light against the roof of the cave, William J. Stephenson shouted: "Look! This ceiling's coming down! A while ago I couldn't touch it with my paddle; now I can."

He was leading a party of amateur "cavers" exploring Gandy Sinks, underground river in West Virginia. The spot of light on the ceiling disclosed bits of weeds, grass and leaves.

"Out of here at once," Stephenson ordered, and 20



At the mouth of a cave, above, a party takes notes over the telephone from a group exploring deep in the earth. Two quarter-mile spools of telephone wire are carried

One slip and "caving" would be ended for the enthusiast at right. There is a deep pool just below the slippery ledge, only a few inches wide, on which he is crawling





↑
Stringing telephone cable in a cave in Bald Mountain, N. C.

minutes later they sighed with relief as the little exploring craft sped out of the river's mouth. A few minutes longer and they would have been trapped and drowned like rats. But Stephenson, who is president of the Speleological Society of Washington, D. C., organization of amateur cave explorers, had noticed a heavy rain cloud as the party started underground and was alert for rising water.

"Cavers," whose hobby is one of the most unusual and least known, practice utmost caution and always go well equipped. They carry both spiked and tennis shoes for use on rock or slime. Hard hats, like miners' helmets, protect their heads against falling or jutting

(Continued to page 182)



Traversing precipitous face of Chimney Rock on way to cave opening

"Hard hats," similar to miners' helmets, should be worn in cave explorations to protect the head from jutting rocks and falling debris



L1145

Automatic Gas Lock
Mfg. Co. 21 E. Van

Patent
Chicago

Illuminated Soldering Stand Has Built-In Magnifier

Photobell Corp. 116 Cassan
New York City



Soldering jobs handled under magnifier as in circle

More efficient and cleaner soldering can be achieved by using a stand equipped with a built-in magnifier and electric lights. Illumination from two bulbs is reflected by a white matte surface to the work which is viewed through a five-inch lens with either two, four or six-power magnification. A 30-inch chimney carries away fumes and heat. The stand takes a space 12 3/4 by 15 inches on the bench.

can be saved by using ready-made patches which are "vulcanized" over the hole with a flatiron. A paddle is inserted into the stocking, and the worn part is spread over a small disk. Then a patch in a matching color is placed over the hole and pressed in place, the entire task requiring only a few seconds. Patches are available in various sizes and many colors.

L1175

Handy Tabulator for the Car Keeps Record of Expenses

Keeping account of the gasoline and oil used and of money spent in operation of your automobile can be simplified by using a pocket-size adding machine now on the market. To operate the flat, oblong device it is necessary to keep in mind a few simple instructions. Each time gasoline is bought or money is spent, the amount is added by inserting a pointed pencil opposite the cor-

Kell Pa-Count

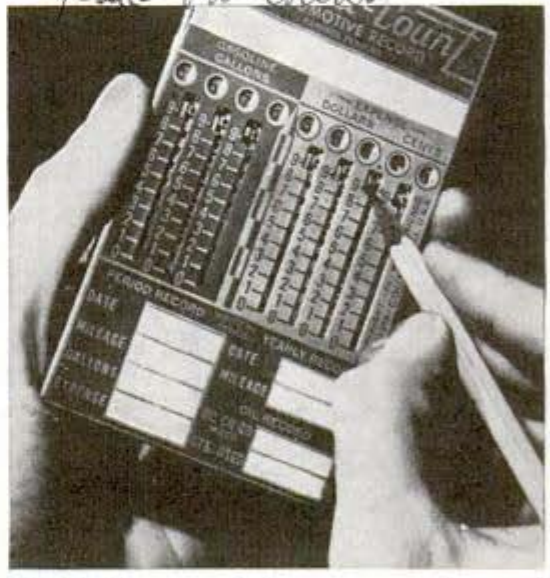

Calculator keeps record of car expense and gas used

rect digits, one at a time, and moving them to the top or bottom of the column according to the instructions. The final total is always shown at the top of the column. Two columns are provided, one for entering dollars and cents, and the other for number of gallons of gasoline or quarts of oil. A durable pin at the back provides means for fastening the device to the sun visor or other handy place.

L1212

'Vulcanizing' Patches to Stockings Saves the Darning Time

Tedious hours of labor spent darning socks, as well as the attendant eye strain,

Wm. Darn, 219 W
Chicago, Ill.

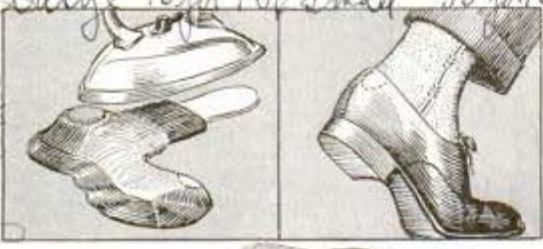

Flatiron presses patch on sock with neat result

Look in the index to find where to buy articles described in this magazine. Say You Saw It in Popular Mechanics.

21203

Racks Under British Bomber Carry Big Load

Running parallel nearly the whole length under the huge Stirling bomber used by the Royal Air Force are three bomb racks with trap doors which may be opened or closed as needed. In "bombing up" a plane for a raid over Germany, bombs are attached to a cable and hoisted into the racks by a motor

21232

Steam Boiler Could Shoot Water a Mile Into Air

It probably won't ever have to, but the new steam boiler of the Indiana and Michigan Electric company at Twin Branch, Ind., is capable of throwing a stream of water a mile into the air. The plant is as high as a ten-story building, and its steam-turbine generator is described as the most efficient steam-electric unit in the United States. Engineers estimate it will use only a pound of coal to produce a kilowatt hour of electricity, compared with 1.67 pounds of equal-quality coal in the average plant. In 1905 the average was 7.36 pounds of coal per kilowatt hour. Boiler pressure is 2,500 pounds per square inch, at 940 degrees Fahrenheit.

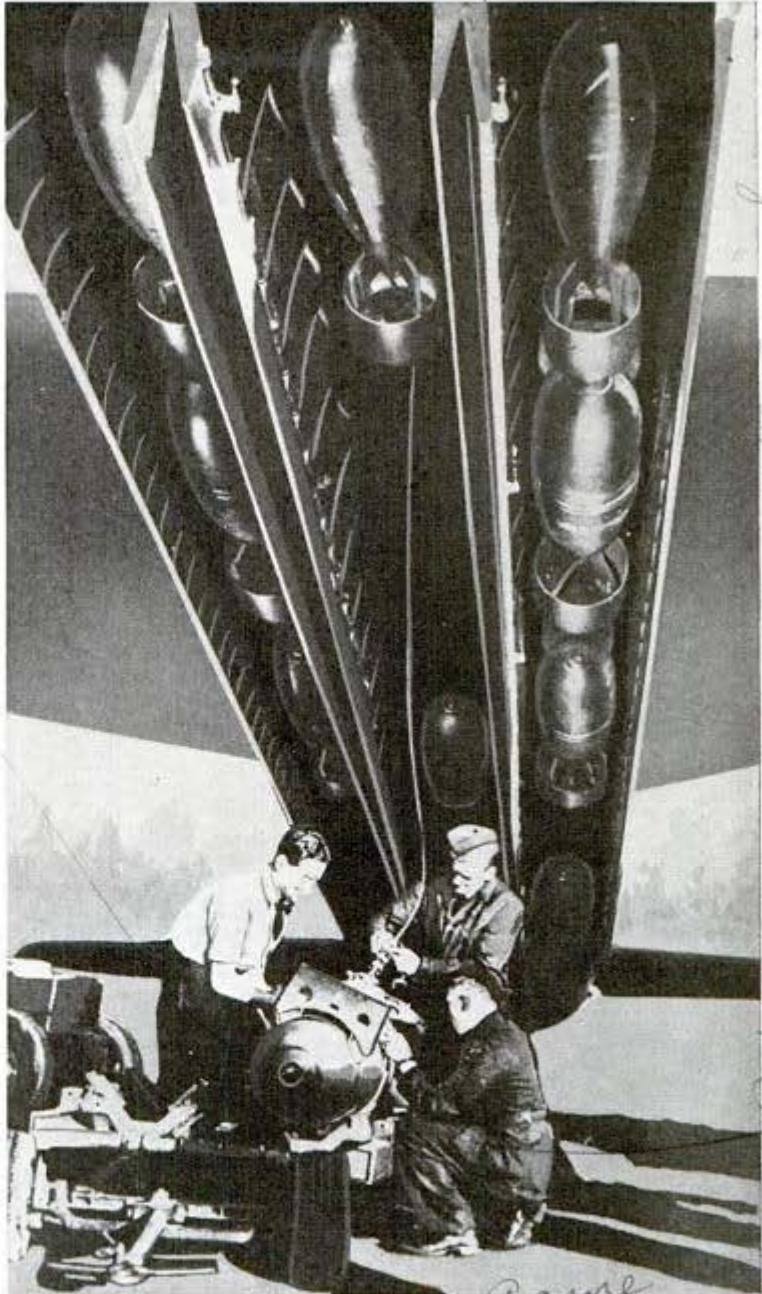

At "bomb filling station" cable and motor speed the loading of a raider

Molasses Is Made Into Auto Fuel of High Octane Quality

Automobile fuel with a high octane rating has been produced experimentally from blackstrap molasses by a newly discovered process. This discovery may open a new industry in the sugar-growing regions where blackstrap, the cane juice residue after the sugar has been removed, is to a large extent wasted. The blackstrap

is processed into butyl alcohol, then polymerized into a chemical equivalent of high-octane gasoline. It costs about 15 cents a gallon to produce at present, and could not compete with petroleum products except in sugar countries such as Cuba and Jamaica where there is a blackstrap surplus and imported gasoline is costly.

FEBRUARY, 1942

Mr. W. L. Owen, Louisiana State University, Baton Rouge, La. 49

Christie Science Museum Cal 3.

21139

Prof. American Exp. Electronic Service Corp. New York City
Stambridge 30 Chick. Bk.

1055

Prof. Thomas G. ...
3897. ...
Los Angeles

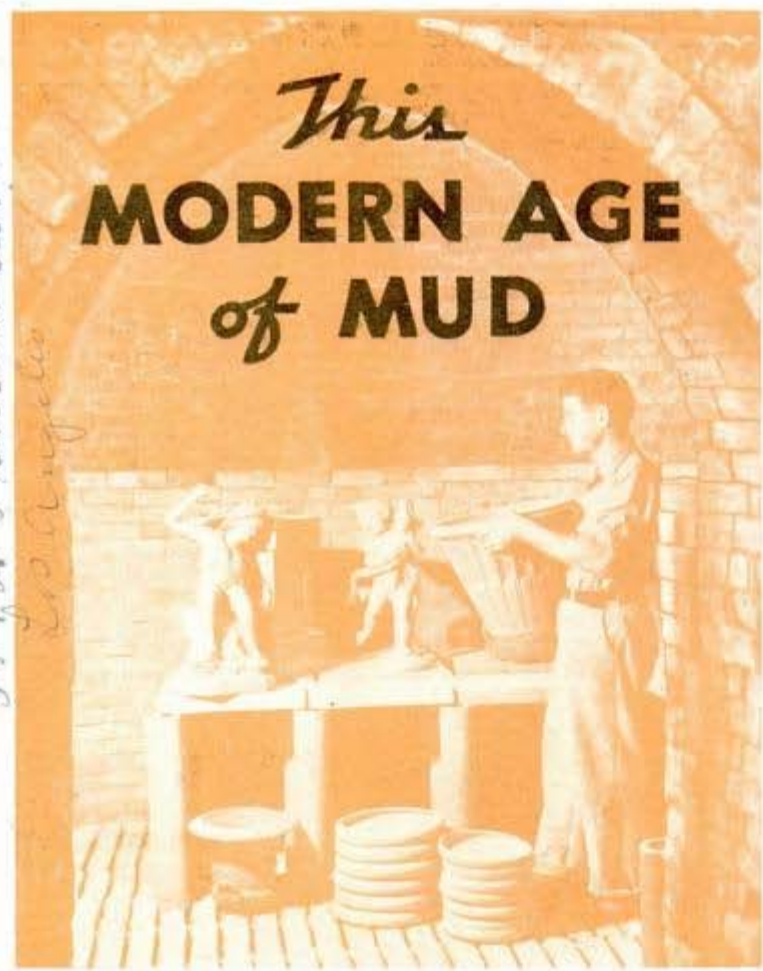

This MODERN AGE of MUD

Stacking terra cotta articles in a beehive kiln, ready for firing

A porcelain high-tension line insulator is turned to shape on a lathe



This ornate European porcelain ware is about 200 years old

CLAY, the original plastic, is one of the oldest, yet one of the newest materials used by man.

Begun as a crude art by uncivilized ancients, clay-working has helped make civilization what it is and today we build houses of clay brick, walk on clay tile floors, eat from clay dinnerware, and decorate our homes with artistic objects cast in clay.

In turn, civilization is finding new uses for clay and is constantly improving and refining it with the result that airplanes and automobiles owe their performance to the clay porcelain insulators of their spark plugs, electricity is transported for hundreds of miles with the aid of clay insulators that guard the high tension lines, and even television in part is made possible by the specially designed clay insulating fittings that keep its circuits sep-

...the ...

81055 Rep: Clay Products Institute
 571 Chambers & Commerce Bldg

arated. Clay vacuum tubes 30 feet tall are helping in the search for atomic power. All in all, the Twentieth Century could well be called the modern age of mud.

In its widest sense, ceramics has to do with all earths that are fired in an oven and includes glazed and unglazed clay materials, terra cotta, glass, porcelain enamel, and even cement. Most of these substances are easily worked, have considerable strength, are fireproof and impervious to moisture, are indestructible as far as the elements are concerned, and are nonconductors of electricity. It is because of these properties that they are so widely used today. America, long a leader in developing structural and electrical clay products, is now competing with Europe in perfecting fine dinnerware and artware.

The mud that a porcelain worker selects for producing insulators that will hold 220,-

Photo at right *6008 mubh*
 Copyright Dings Magnetic Separator Co.

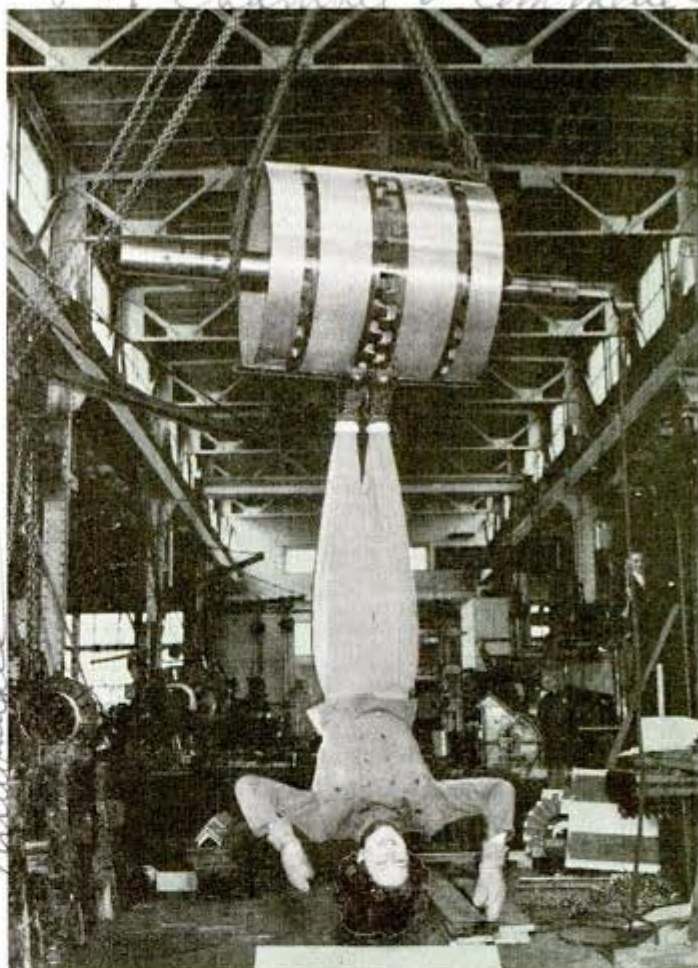

Facing page

Clay cakes from which water has been squeezed preparatory to making porcelain line insulators ↓

Magnetic pulley wheel, used to ↑ remove iron particles from clay, supports girl by iron in shoes ↓

Fluorescent tubes being filled with liquid phosphors which coat the interior to produce light ↓



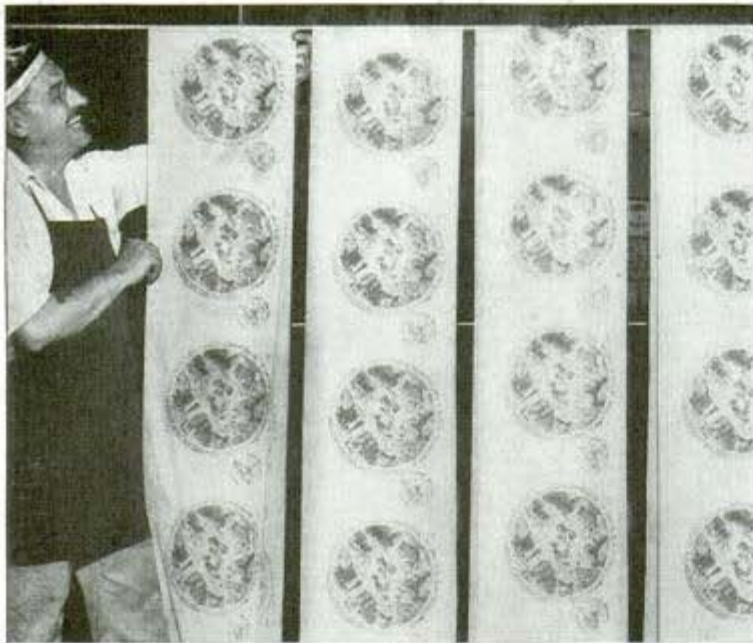

Dinnerware designs are printed with mineral paints on tissue paper

000 volts in leash, or that a potter mixes to make quality chinaware are vastly different materials from the common mud that the first craftsmen dug from a riverbank and molded into bricks and jugs. Ceramic bodies today may be compounded from half a dozen or more different clays carefully selected for strength, density, shrinkage rates, and other qualities. Some of the glazes that protect and add beauty to clay objects consist of rare minerals that are sought after in many parts of the world. Alumina, talc, and silica may go into an ultra-high-frequency insulator, and such materials as selenium oxide and lapidolite are used among others for adding color to glazes and porcelains.

Even the lowly common brick has been transformed into an object of strength and beauty, the latter being due to new architectural treatments. Clay is often passed through a vacuum chamber for de-airing, the result being a denser, more uniform plastic that is then pressed into structural clay tile, roof tile, sewer pipe, face brick, paving brick, or common

These are samples of plates in paint room of a modern American pottery



brick. New shapes and indentations for common brick, together with the use of reinforcing steel in laying them up, make possible sturdy earthquake- and stress-resistant construction.

Refractory bricks and shapes that are used to line furnaces and kilns now last two or three times longer than before because of new raw materials that are used. Lightweight fire brick, especially needed for marine installations, is manufactured by mixing ground walnut shells and sawdust into the clay. These particles burn out when the bricks are fired in the kiln,

leaving minute air spaces that insulate as well as save weight.

Similar research is responsible for the fine types of chinaware that are on the market today at prices only a fraction of what such ware used to command. Most dinnerware is first shaped on automatic jigs, then dried in warm air, then goes into the kiln for preliminary firing. Here the clay is burned into a strong but porous body called biscuit. After cooling, underglaze decorations are applied either by

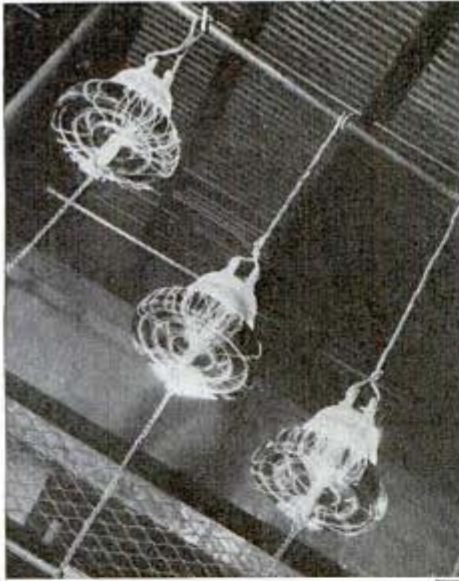

Porcelain insulators receiving a 100,000-volt flash-over test

Workman removing plaster of Paris form from terra cotta statue →



hand painting with special mineral paints or by transferring printed designs from thin tissue paper. The ware is then sprayed with glaze material and goes back into the kiln for a more intensive firing that turns the glaze into a permanent glasslike surface. This, in general, is the way chinaware is made though numerous variations of the method are used for obtaining various effects.

Twenty years ago most good china came from Europe but now American potters are equaling the best. America led the style change away from the conventional white ware and is specializing in dinner services in attractive solid colors, in pastels, and most recently in two-tone effects.

Similarly, American designers of figurines, flower holders, and other art objects have struck out for



(Continued to page 172)

Spraying color on a figurine, typically American in simplicity and humor

L1110

Portable "One Track" Bridge Carried by Soldier



Soldier carries bridge section overhead as he crosses ditch on another

Light enough for one soldier to carry on his shoulder, a bridge section consisting of two tubular girders, which is used by the British army, speeds the crossing of small streams. Each span is a narrow channel, and two of them properly spaced form tracks over which vehicles and equipment can pass with ease.

Black and White Film Projected As Natural Color Movies

By a simple but revolutionary process black and white film can be projected as color movies, using special lenses in the camera and projector which were developed by Prof. Lucien Henri Roux, member of the Institute d'Optique of Paris. Both the camera and projector are fitted with a lens divided into four equal sections, each

section being in a different color—red, green, blue and yellow. Pictures are taken on a single film in black and white, but the color filters give each a different depth of blacks and whites. In projection the four images are cast on the movie screen, being exactly superimposed so they make a single image. The colors are strikingly natural. The method permits showing news reels in color as soon after the event as black and white movies, and it is much cheaper than the processing of color films.

L109

Self-Locking Link Mends Broken Skid Chain

Quick repair of a broken automobile skid chain is possible with a self-locking link which can be hooked to the severed ends without tools. The link cannot become unhooked or unlocked while it is taut, and the spreading of the tire plus the motion of the wheel prevents it from slackening.

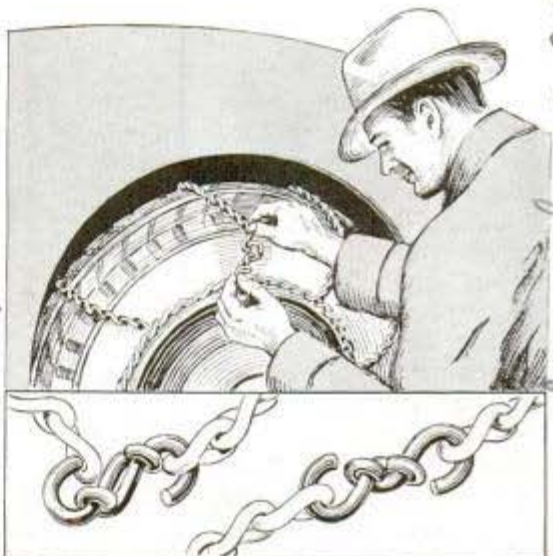

Hooks open when slack, left; lock when taut, right

Chance

100c

54 Chicago Tribune 3/24/41

mebyan an 2326

Leviton Specialty Co

21194 Comb. L. H. Houch, 5911
 Custaces Tampa, Fla

Plane Model Teaches Correct Use of Controls

To aid in teaching student pilots how to fly, a Florida air school demonstrates problems in flying with a model airplane fitted with a set of standard controls. Placing the tiny ship in a certain position in the air, the instructor asks the students to set the controls as they should be in actual flight. Another method is to adjust the controls to a given setting and require students to place the model in the position such a setting would give a flying plane. Instruction in all manner of maneuvers and acrobatics, is thus simplified for beginners.

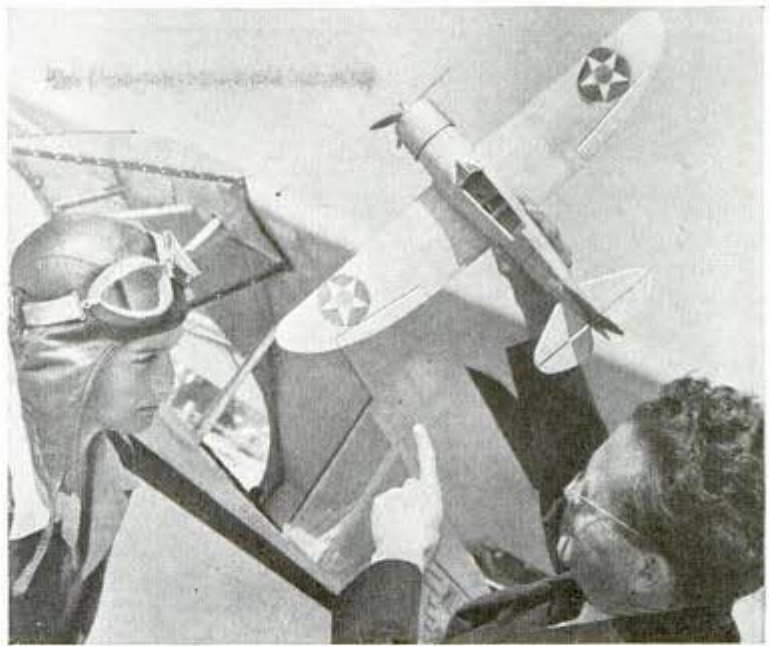

Students demonstrate correct use of controls with aid of airplane model

Bamboo, Called Most Useful Plant, Finds New Application in War

Choosing bamboo as the world's most universally used plant, Dr. Willard M. Porterfield, Jr., of the U. S. Soil Conservation Service declared there is not a category of human needs which cannot be supplied by bamboo or its product in some form. Articles made from it include food, weapons, shelter, implements, clothes, furniture,

baskets and containers, bridges, conduction pipes, paper, cable and ornaments. The war in Asia has brought out some unusual applications. To protect buildings from bombs, Chinese construct a three-story bamboo framework on top and pack it full of bamboo. When a bomb hits, it explodes before reaching the building.

Flying Bombardier Lies Prone to Help Gain Accuracy



Keen-eyed Canadians, being trained in the highly specialized art of dropping bombs with deadly accuracy from dizzy heights, undergo many months of schooling. To direct his missile at a target, the bombardier lies prone on the floor of the plane as he peers through the bomb sight, keeping a tense thumb on the release button.

Face downward in the bottom of his bomber, this Canadian student flyer keeps a keen eye riveted to the bomb sight, with his thumb ready to release a bomb

21097
 Washington D.C.
 Navy Service - Sept 16
 RCAF School
 acme.
 Hairey.

Материал, защищенный авторским правом

20818

3872 Franklin Ave
Los Angeles

SPEED DEMONS of the AIR

By Thomas E. Stimson, Jr.



"Z-1 TO DOG 10. Hypo 28, high. 217 degrees. Target six heavy bombers. Acknowledge."

Dog 10, the leader of a dozen pursuit planes on patrol guard at 9,000 feet, acknowledged the radio message and opened his throttle, pointing his plane in the direction he had been instructed to fly. The rest of the squadron fell in behind. On his map the leader located Hypo 28, the area in which the bombers were reported. It was 60 miles away.

Soon another radio message came in and Dog 10 changed course to the left. The interception service on the ground was tracking the invading bombers as they flew inland and each time the bombers changed course, new instructions went out to the pursuits, guiding them closer to their target. Finally

Pilot sighting through electric gunsight. Below, formations used by pursuit plane groups. Note the formations employed in combat

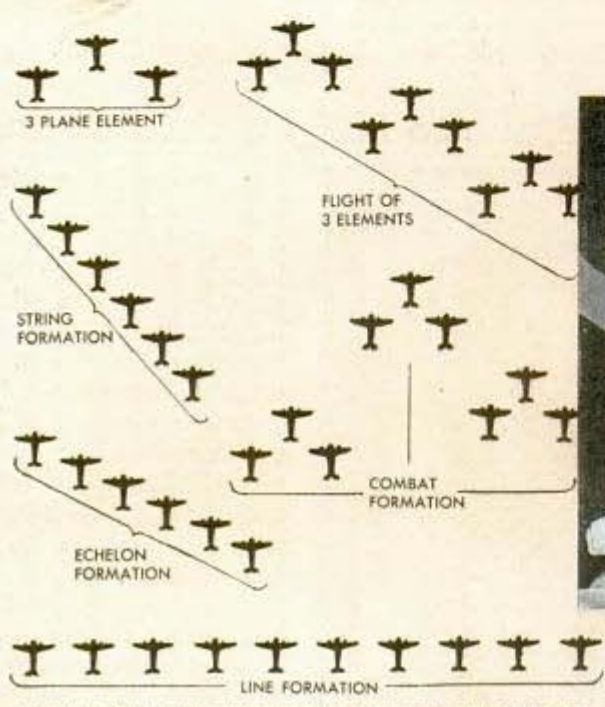

Mechanics wearing gas masks as they install .50-caliber machine gun on pursuit plane

Material, authorized for reproduction

2878

FORCES



Loading .50-caliber ammunition into guns of a pursuit ship

Pilot turning selector switch controlling guns to be fired

one of the pilots located the hostile planes and he spoke into his microphone, alerting the leader and the rest of his squadron. "Dog 21. Target 45 degrees right, below." The leader rapidly estimated the best method of attack, gave his orders over the radio, and the dozen pursuit planes tilted downward toward the bombers. There was only a fraction of a second in which they could fire as they hurtled past, then they reformed and climbed for another stab at the bombers.

Pursuit planes are the best defense against enemy aircraft but the pursuits have to close in on the enemy before they can knock him out. Helping them to do so is the job of



Ref: Capt. W. E. Evans, Public Relations Officer, March Field, Calif.

8-8-19

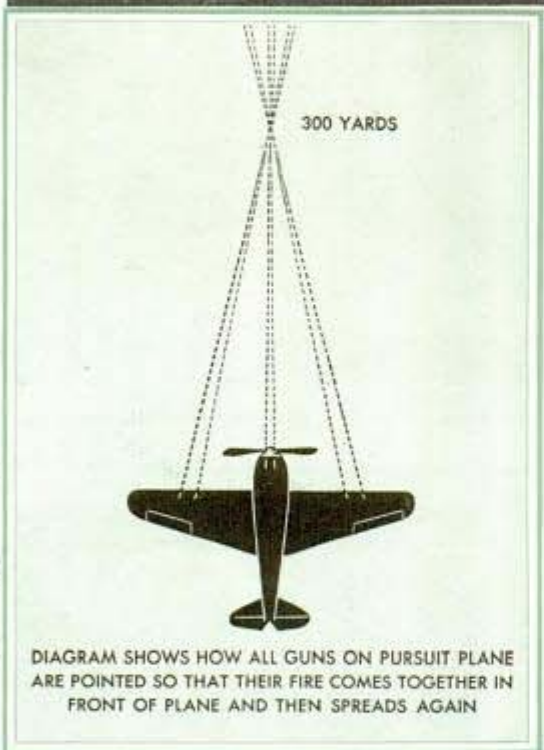

DIAGRAM SHOWS HOW ALL GUNS ON PURSUIT PLANE ARE POINTED SO THAT THEIR FIRE COMES TOGETHER IN FRONT OF PLANE AND THEN SPREADS AGAIN

↑ Formations of pursuit planes at high altitude. Combat levels are rising and fighting today is at 15,000 feet and higher

the interception service. Scores of observers spotted over the countryside telephone in when bombers pass overhead and the interception service plots the path of the bombers from this information, then radios the pursuit leader the course to fly to intercept them. Radio orders are in simple code. This week the squadron leader's name may be Dog 10; next week he may be called Apple Five or Cat Six.

Tracking down their targets in this way is one of the training exercises of pursuit groups such as those based at March Field, Calif. Gunnery is next in importance and day after day the pilots fire at towed sleeve

targets, small panels set up on the ground and shadows. Shadow shooting is one of the most realistic of all exercises and to do this one airplane flies over the water in such a way that its shadow is seen on the waves below. The other planes use this shadow as the target, diving and firing and observing the splash of their bullets while the speeding shadow turns and dodges.



Northrup seaplane fighter with two machine guns. Lower gunner lies on stomach to fire

2049

71303

not to be used

Accuracy is what counts. In shooting at a panel target on the ground, simply hitting the panel isn't enough. The pilot must pour shots into a small bullseye, just as in actual air battle he must hit vital parts of the enemy plane instead of merely shooting holes in the wings.

The pursuit pilot is literally the superman of the air force. Pilot, navigator, radio operator, gunner—he must be his own four-man crew. Acrobatics and tight formation flying are the rudiments of his training, but they aren't as simple as they used to be because the high speeds of today's pursuit planes are a complicating factor. A pilot uses all the speed he has to catch up with another plane, then he has to slow down to fight. The pilot who can make the tightest turns is most often the victor, so he slows down a bit in order to turn sharper. He still maneuvers so fast that he blacks out in some turns, though he can train himself to reduce the interval of this unconsciousness both by practice and by tightening his stomach muscles as he goes into the turn, pushing his chin down tightly on his chest and shouting at the top of his voice.

Add to all this the fact that most air fighting today is at a minimum of 15,000 feet and much of it at 30,000 feet and higher where the lack of air slows down all his reactions, and you begin to see that a pursuit pilot has to keep himself in tip-top physical condition. Calisthenics and handball are as important parts of his daily routine as is flight training.

In single combat a pilot must be a rugged individualist, yet half his fighting is done in formation and when he is part of a formation he has to follow the leader without daring to use his own initiative. In a formation fight he doesn't even aim at the target and he fires his guns only when told to do so. The leader of the flight aims his own plane at the target and gives a radio signal for the others to fire. The leader knows that the other planes, hugging his own wings, are pointed in the same direction that he is, and that their bullets will be as effective as his own.

High speed, too, has affected the science of gunnery. It is almost invariably true that a pilot will never hit a target that he catches squarely in the center of his electric gunsight. Instead of aiming his plane like a rifle he has to point it like a shotgun,

(Continued to page 173)

Barbecue Table for Indoors Burns Smokeless Charcoal

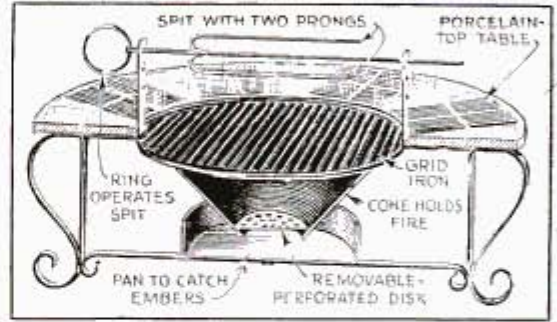

Indoor barbecue table cooks meat on spit or grill

You can bring the spirit of camping right into your home with an indoor barbecue table of porcelain. It is especially useful for enclosed or open porches. In the center is a gridiron over which a two-pronged spit, turned by means of a ring, holds the meat to be roasted. The fire is encased in a steel cone, embers being caught by a pan below. Charcoal is used, to avoid smoke.

Cloud Charge Indicator for Plane Warns of Lightning Peril

Airplane pilots can tell when they approach dangerous thunderclouds by fitting their ships with a "cloud charge indicator." The delicate instrument consists of a neon tube and microammeter. These are connected to a pointed tungsten rod protruding, like a lead pencil, 14 inches from the plane, which picks up electrical discharges from clouds and sends them through the instrument. This flashes the neon tube and deflects a needle on the meter.

Has to be used with care
Has to be used with care
Has to be used with care

21198
See also Electric Co
Scheuchly, N.Y.

Allen B. Engineering / Weeks, Inc. Kearns Bldg. 45 North St. New Haven Conn.

Tiny Explosionproof Pump Operates by Air Pressure

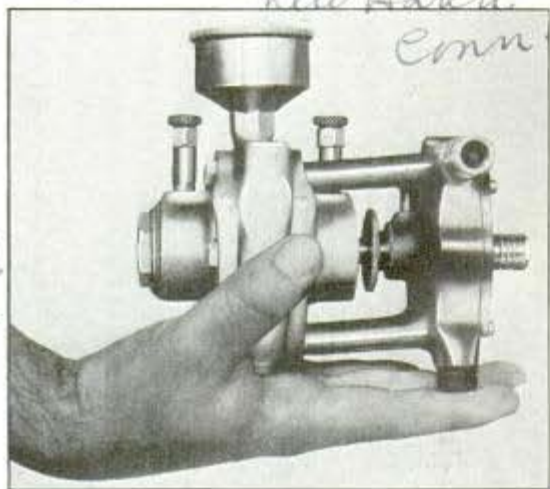

Pump operated by air eliminates danger of explosion

To safeguard workers where volatile liquids or inflammable gases are handled, a tiny explosionproof pump operated by compressed air has been designed. It weighs but 10 pounds, measuring 5½-by-6-by-7 inches and may be held in the palm of the hand. Operating on air pressures ranging from 20 to 100 pounds, which may be varied by controlling the speed of the air motor, the pump has a capacity of 7½ gallons a minute at the lower pressure and 15 gallons at the maximum.

2-10447

Self-Inflating Rubber Duck Decoy Is Deflated for Carrying

Two hunters, wearied of toting loads of wooden decoys, drew upon their inventive talents to design a five-ounce, collapsible duck decoy, a dozen of which can be tucked

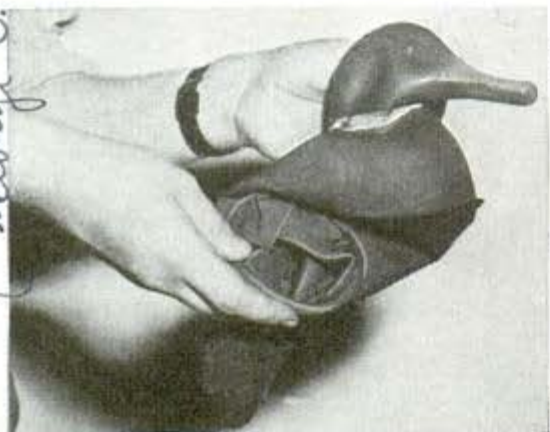

Rubber decoy takes little space when collapsed

into the pocket of a hunting jacket. When tossed on the water, the rubber decoy springs open, thus automatically drawing in enough air to make it float. Air is admitted into the body through an opening at the bottom where a heavy wire ring acts as ballast and keeps the hole from closing. If it floats too high, squeezing a little air out of the body will make it sink deeper; but if it is floating too low to look natural, more air may be admitted by lifting the decoy from the water.

2998.

Television-Camera View Finder Helps Improve Pictures

Television camera operators are now offered an instrument that enables them to see in the view finder the scene exactly as it will be picked up by the camera and



Television operator sees view as camera records it

transmitted over the air. It is called an electronic view finder, which corrects parallax or the apparent displacement of objects when viewed from different points. This condition is present in some degree with most film cameras where the view finder and camera lens are set at slightly different angles or separated positions. The new finder has its own power supply and uses a five-inch cathode-ray tube that forms a finely focused image on either a green or white screen. According to the manufacturer the unit also serves as a focusing means and as a monitor to aid in correcting faulty images at the camera.

Allen B. Engineering

21161

Scale Model of "Sub Cheater" Makes Trial Run

Trial runs were made recently with a one-third-size working model of a revolutionary type cargo ship which is designed as a challenge against submarine blockade. The 1,900-ton ships will be 270 feet long and will be propelled by a six-foot propeller sunk amidships. Sixteen gasoline engines will supply the power. Antiaircraft batteries will be installed on the vessels, known as "Sea Otters."



Built for testing purposes, this working model of the "sea otter" is one-third of full-size

21036

Plastic Models of Light Show the Range of Street Lamps



These translucent plastic models show how far street lamps spread light

Models of so intangible a thing as light are being made of translucent plastic by engineers at General Electric Illuminating Laboratory in Schenectady, N. Y. Called Photometric Visualizers, they show in three dimensions the light distribution from luminaires used in modern highway lighting. A model for each lamp design gives a lucid view of both the amount and direction of light which will be cast by the lamp it represents.

see April 1942

Lightweight Metal Hand Sander Has Time-Saving Release for Paper

Sandpaper can be inserted quickly in a time-saving metal hand sander equipped with a trip lever that releases the paper immediately when it is raised. The tool uses band belt of a standard size, and two screws on one side permit adjustments that tighten or loosen the belt. The only nonmetal parts in the sander, which weighs less than two pounds, are wooden grips.

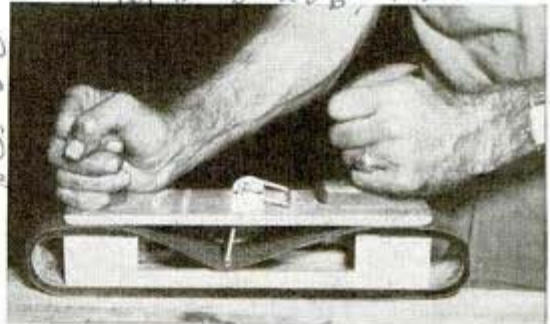

Lever on top of sander releases hold on sandpaper for easy adjustment or replacement with new belt

21164
Pat # 2,206,482
J.B. Mc Gennis
400 W. South St.
New Brunswick, N.J.

21151

Reggett

CUTTING 'EM UP TO SHOW 'EM



What makes the wheels go 'round is interesting to almost everyone, so the automobile industry has been working out ways of showing clearly how various parts of the modern car operate. Engines have been built that open like a book, cars have literally been cut in two and whole sections have been stripped from some models—the better to show what goes on. Above, a Pontiac constructed to open up automatically, giving onlookers a view of the engine and of space in the driver's compartment. At left, a "book motor" that opens and closes itself like the leaves of a book—and operates during the performance. Thousands of man-hours went into its construction



Running mechanism of an automobile can be inspected closely by means of this arrangement—a chassis complete with engine but lacking fenders, hood and body. It is mounted so that it revolves slowly, showing top, sides and bottom. At the moment this Packard Six was snapped, it was bottom up

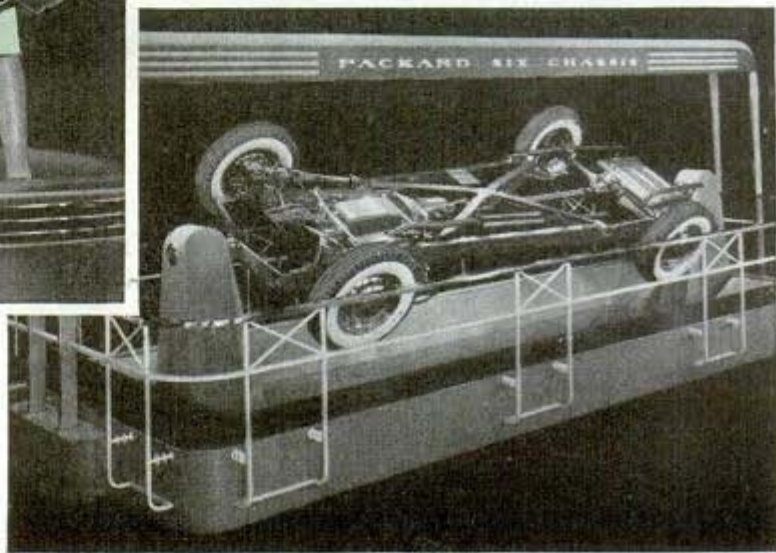

21151

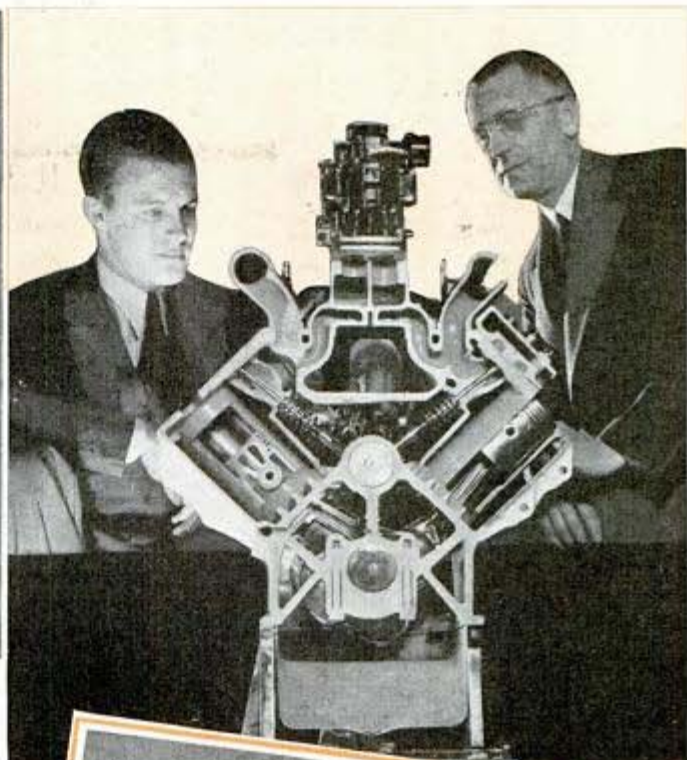

And this chassis (above) rotates, end over end, in a spectacular demonstration. Note how it is mounted in carefully balanced position on the horizontal bar. Top, right, a Cadillac V-8 engine split crosswise. It automatically divides and each half completes a full revolution while pistons, valves and other working parts continue operating. Center, a Cadillac engine set up like a rare gem in a jeweler's box. Bottom of page, cutaway chassis showing a Lincoln's unit-body-and-frame construction. These showmanship methods have been developed through years of staging large automobile exhibits, most of which were cancelled last fall when the 1942 models gave up the spotlight to national defense

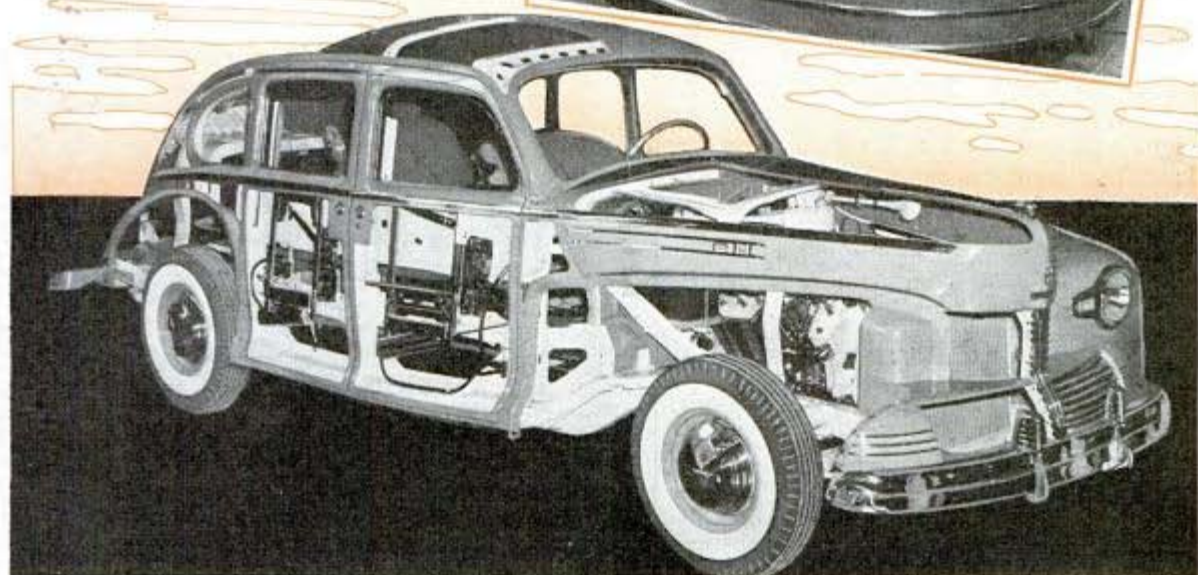

"Walking" Tank of Water Has Its Own Cup Supply



Jacket insulates water tank as it makes the rounds

Equipped with a faucet and a supply of paper cups, a "walking" water tank makes the rounds of factories and outdoor work crews, bringing the drinking water to them and saving time taken out from machines to go to a drinking fountain. The five-gallon insulated tank is strapped comfortably to the water boy's shoulders.

Hand-Saw Cover Guards Teeth And Prevents Rusting

Accidental contact with the teeth of a hand saw can be prevented by fitting it with a metal guard now available. Made of copper-plated dead soft steel, the guard is arched in such a way that it touches only the teeth of the saw.

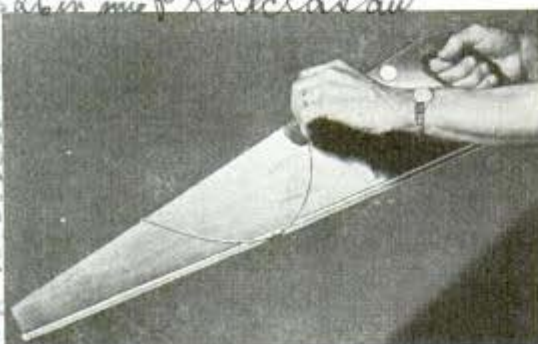

Guard held against saw teeth by spring steel wire

Ref: R.W. Sherman
Editor, *Architectural Record*, 1190, 404
extreme front and rear points but covers all the teeth. It is held in place with a spring steel wire clip while the saw is not in use. The channel may be filled with vaseline to prevent rusting.

L1139

Most Home "Traffic" Accidents Occur on Porch and Stairs

Porches and outside stairways are the locale of the most dangerous "traffic" accidents in the home, according to a report to the National Safety Council. Despite popular assumption that falls in the bathroom make it the most hazardous room, it has the lowest percentage of accidents among rooms and is only one-seventh as dangerous as porches and outer stairs. It is recommended that these places be protected by guard rails, nonslip treads, adequate light and a minimum of changes in grade.

L1093

Triangle Provides Six Angles With or Without T-Square

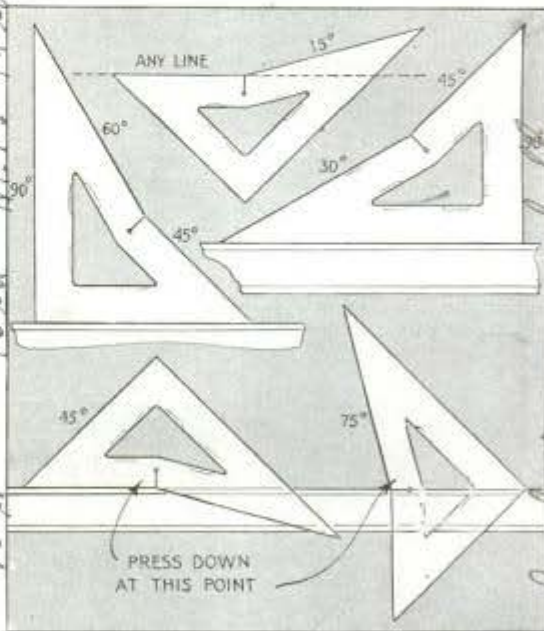

Sketch shows various settings to draw six angles

Used with or without a T-square, a transparent triangle now on the market draws angles of 15, 30, 45, 60, 75 and 90 degrees and eliminates the necessity of carrying two triangles. Angles can be drawn to a base line or any other line in the drawing. A slit in the center of the triangle permits it to overlap the T-square in using the extended angle.

Elmer Coffey

201

Universal Paper Products Co
 1156
 1133
 1000
 6-2-26
 407 S. Williams St. Chicago
 C. L. Atkinson & Co
 407 S. Williams St. Chicago

Ref: R.W. Sherman
 Editor, Architectural Record
 extreme front and rear points but covers all the teeth. It is held in place with a spring steel wire clip while the saw is not in use. The channel may be filled with vaseline to prevent rusting.
 L1139
 L1093
 Sketch shows various settings to draw six angles
 Used with or without a T-square, a transparent triangle now on the market draws angles of 15, 30, 45, 60, 75 and 90 degrees and eliminates the necessity of carrying two triangles. Angles can be drawn to a base line or any other line in the drawing. A slit in the center of the triangle permits it to overlap the T-square in using the extended angle.
 201

21170

Amphibian Tanks Haul 40 Men on Land or Sea



Land-and-water tanks plow through sea at nine miles an hour; they can run at 25-mile clip on land

Troop-carrying amphibian tanks being built for the United States Navy were recently put through their paces in the Gulf of Mexico by Marines, who reported the craft easy to handle in mud or water and capable of going anywhere land tanks can travel. The sea-going tanks, invented by Donald Roebbing of Clearwater, Fla., can

carry 40 men at nine miles an hour in water and 25 miles on land. Originally developed as a means of getting assistance to communities marooned by hurricanes, the tank was equipped with track-laying tread which had large cleats serving as paddles in water or mud. The Navy's machines are 20 feet long, 8 feet wide and 6 feet high.

Motorcycle Sidecar Ambulance Speeds Injured to Hospital



Swift ambulance is created by mounting stretcher on motorcycle sidecar

Capable of transporting a patient at 90 miles an hour, a motorcycle-driven ambulance was demonstrated recently to civilian defense officials by the inventor, William E. Detler, of Detroit, Mich. The vehicle consists of a seven-foot ambulance mounted as a sidecar with a new kind of spring suspension.

Write to the firms listed in the Where-to-Buy-It index when you want more information about products described in this magazine. Say You Saw It in Popular Mechanics.



The SHIP that NEVER SAILS



↑
Trainees load a four-inch broadside gun while other apprentices aim it at ships passing the New York island

← Seamen practice with hand winches for lifting and lowering lifeboats from the deck of the training "ship"

THEY call it the ship that never sails. Day after day the seas pound its sides and the wind whines through its rigging. Its lifeboats sway in the breeze. Smoke from its stack drifts over New York harbor. Its cargo booms swing up and down incessantly as though feeding a bottomless hold. Its modern guns are always ready to growl defiance at the thousands of craft which slide past, but the command of "Fire," is never given, except in practice.

Its crew of 658 men, alert and disciplined, down to the last man longs for the feel of Atlantic swells beneath their feet. But the ship that never goes to sea is anchored by wood and steel piles to a reef

8891 Com. Allen Warren Elliott
 343 & 33rd New York



Top, left, scrambling up to the crow's nest of the ship that never sails; right, studying mechanism of three-inch gun in classroom

between the tip of Brooklyn and Staten Island. It will never move.

For this ship is merely a dot in the waves, an island of seven and one-half acres—Hoffman Island—little known even to the average New Yorker and practically never heard of beyond the city. By queer coincidence it is shaped like a ship, with pointed bow, parallel sides and rounded stern. Yet it is important in America's maritime destiny, for from here go the crews trained to serve aboard United States liners and cargo carriers—able seamen, who, seven months before, were clerks, farm lads, college students, or high school graduates still wondering which career to pick.

The island "ship" is training mariners for Uncle Sam, teaching them seamanship that required three years apprenticeship at sea in the past. True, their education will have been forced along by wartime expediency, but those sailors will be worth their salaries, ranging from \$72.50 to \$84 a month, plus living quarters and food, to say nothing of bonuses paid on ships touching certain dangerous ports. One of these bonuses hit an all-time high recently when \$500 was awarded every



Two maritime fleet apprentices, above, practice signaling. This is the semaphore for "W." Below, a gunnery class studies guns on model of "North Carolina"



Maritime Service Training Station, Hoffman Island, N.Y.

Chief Gunner's Mate E. J. Over Counselor

RSYI

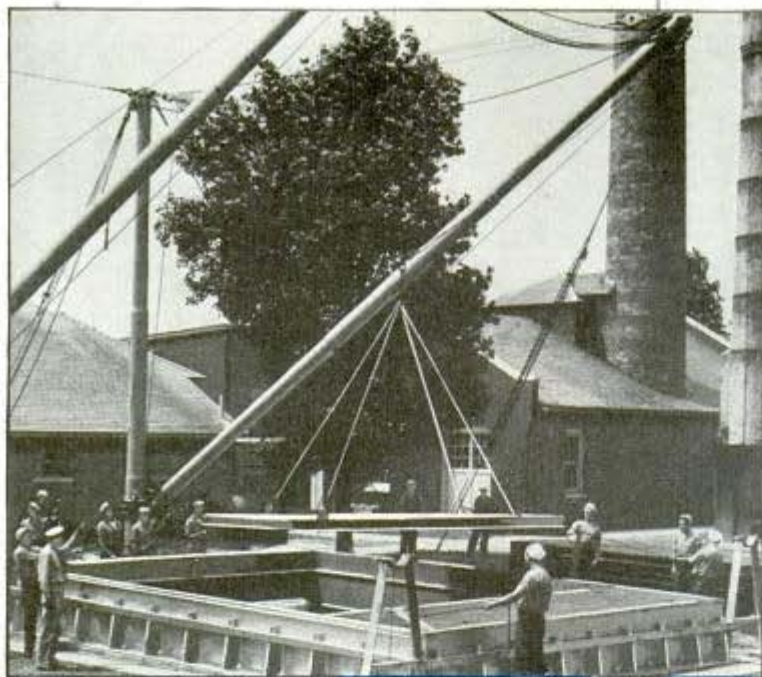

↑
Cargo hatch is an exact duplicate of that of a freighter, even to booms, winches and cover—but its hold is four feet deep

Coast Guard Lieut. C. I. Steele shows how to use signal searchlight like → those used on Uncle Sam's liners and freighters



Its very outline resembling that of a ship, this is the Maritime Service Training School located on Hoffman Island, N. Y.
↓



crewman on a ship headed into a war zone.

If they were not competent, they would have been weeded out early in the training course by the officers loaned to the island organization by the United States Coast Guard, headed by Commander George E. McCabe and Lieut. Commander William J. Austermann. Up to now, an average of 14 percent has failed to make the grade.

Early in the present emergency, the pressing need for cargo ships was recognized by Washington officials. Vessels were ordered by the hundreds. New shipyards were built, old ones reopened. But soon officials began to wonder who were going to man all these vessels. If there is anything more important than the ship itself, it is the type of men who operate her, and good seamen are so scarce today as to threaten the nation's welfare in time of war.

So the United States Coast Guard, which could

2891

L1124

furnish excellent instruction and administrative personnel, was requested by the Maritime Commission to administer the U. S. Maritime Service and produce thousands of seamen who deserve the description "ablebodied." But ships are scarce and these perilous times are not propitious for sending green men aboard any craft which sails the deep. So the little speck of artificial land that once had been a quarantine station was taken over.

The result is the grass and cement "decked" ship, Hoffman Island, where men from 18 to 23 who have had a reasonable amount of education are learning the ways of the sea, the twist of a rope or the feel of a deck gun. Their textbooks are nothing like the ones they studied back home. They deal with the intricacies of gunnery, the stowing of cargo, the handling of machinery, fire extinguishing, the use of gas masks, lifesaving and in general the ways of the sea in these times of modern ships and modern wars.

They "cram" at their lessons willingly, because only three months at the training station are needed before the successful ones are placed aboard a training ship for four months of actual experience off the American coasts. They know that 6,000 jobs are now awaiting the ones who make the grade, divided as follows: 40 percent for deck work, 40 percent for engine room work and 20 percent in the steward's department.

The apprentice steps from a stripped-down former Coast Guard patrol boat to behold an island looking very small in the wide expanse of the sea, and equipped with a variety of docks, slips, towers, masts, guns, cargo booms, offices, school buildings and red brick barracks. The first week or so he learns to make up his bunk, care for his clothes, keep his locker orderly. In this period he also gets acquainted with his fellow apprentices, examines the island ship and its many devices for training, receives rudiments of discipline, which is not as strict as in the armed forces, begins to get his muscles in shape with exercise, and takes the antitoxins which are necessary if he is to sail to tropical ports.

The second week he is likely to find himself in the galley of the good ship Hoffman Island, picking up the tricks of waiting on tables, baking, broiling, boiling, roasting and frying. He is also shown that spotless

(Continued to page 164)

FEBRUARY, 1942

Auto Vacuum Sucks Poison From Snake Bite Wound



Cups use auto vacuum to draw venom from wound

Vacuum created by the automobile engine is now being used for treatment of rattlesnake bites. Invented by Geo. K. End, who cans rattlesnake meat at Tampa, Fla., the outfit consists of two glass cups and a length of rubber tubing that attaches to the vacuum system of any automobile in place of the windshield wiper. This permits the automobile engine to suck out the poison. The fang marks are first crisscrossed with a razor blade.

L1201

Bumper Extending at Side of Car Prevents Hooking Onto Others

Bumpers are prevented from hooking at the ends, and greater protection is afforded in case of accident, by adding extension bumpers that skirt the sides of the automobile fenders. The extensions, made in the thickness and width of regular bumpers, are finished in colors to match the cars and add to their streamline appearance. It takes only 30 minutes to install them, and one unit can be removed in 10 seconds for changing tires.



Side bumpers guard fenders and wheels from scrapes

Don't let your car interfere,

done by 5911... amp

Rattlesnake, Florida

4999 Copley St. Akron, Ohio

1092

*Automatic Electric Co.
103 W. Van Buren St.*

Phone Set Does Its Own Dialing When Lever Is Pushed

Autodial



Pointer (inset) and lever make telephone call without dialing

Considerable time can be saved with a telephone set that automatically dials the number wanted. You set a pointer at the name of the person to be called, press a lever, and the instrument does the rest. The phone is offered in two styles, one providing the automatic feature for 12 phone numbers, and the other for 52 stations.

66

Mildew Proofing for Fabric Lasts Many Months

66

Cotton and other fabrics can be made highly resistant to mildew by an inexpensive and nontoxic process just developed at the U. S. Bureau of Home Economics. Valuable for home as well as commercial use, the treatment has no effect on the appearance, color or pliability of the material and remains effective even after five washings and after six months' storage. It can be applied to sails, awnings, shower curtains, tents, tarpaulins and similar articles subject to mildew. The process



Ladder and platform can be folded quickly to a compact bundle

depends upon forming an insoluble compound between morpholine—a complex organic compound—and certain inorganic salts, principally those of cadmium and copper. This compound is formed right in the fabric, by immersing it under specified conditions in a solution of cadmium or copper salts, then in morpholine.

21158

Platform on Erect Ladder Rises as Worker Climbs

Mounted on a tip-proof base, a mobile ladder with an elevating platform provides a working height of 17 feet, which is especially useful in building-maintenance work. The platform, weighing 25 pounds, is fitted with shoulder straps with which the workman carries it up and down like an elevator as he climbs the ladder. It may be anchored at any height by hooking it to the ladder rungs. Easy to move about, the scaffold rolls on rubber-tired casters, two of which can be locked by built-in brakes. The entire unit weighs 195 pounds.

R. W. Fieroh Co. Inc.

21120

Light Flows Like Sap in Animated Tree Model

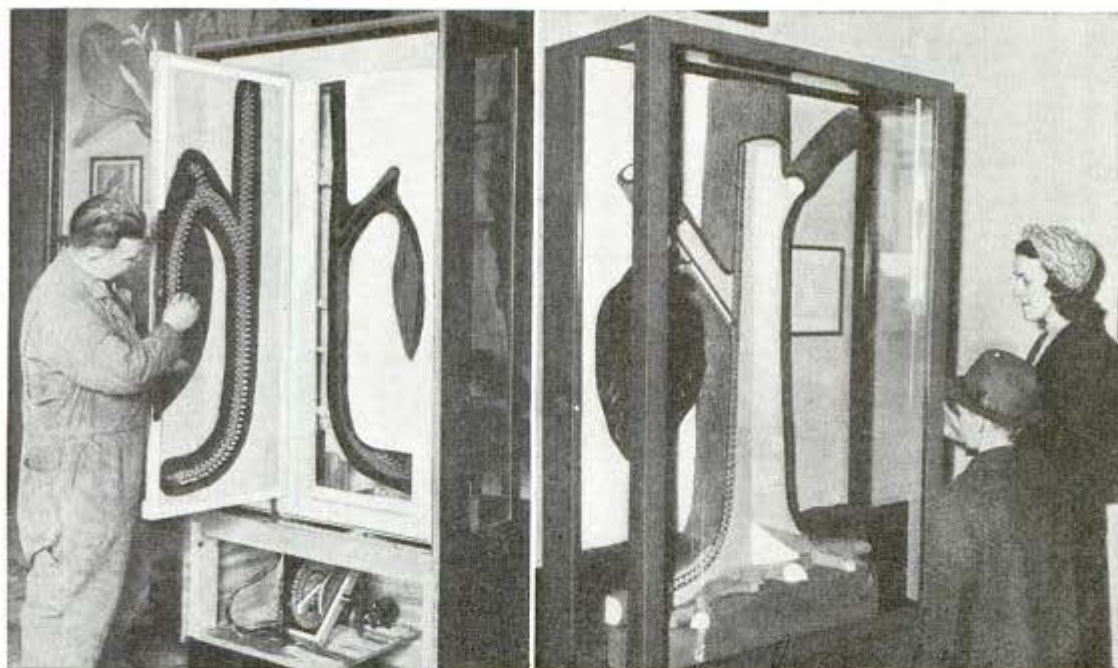

Courtesy, Buffalo Museum of Science

Left, checking up 6-volt light bulbs behind model; visitors, at right, see how fluids flow in tree

Humboldt Park, Buffalo, N.Y.

Animated when a visitor presses a button, a new exhibit at the Buffalo Museum of Science represents a section of a tree trunk and its roots, indicating by a series of colored lines the system of channels which carries vital fluids between the roots and leaves. Press the button and on goes a procession of 214 lights illuminating these channels of sap which seem to flow up and down throughout the tree. The lights are mounted within colored glass tubes. A red one moving upward represents water and dissolved minerals absorbed by the roots

and taken to the leaves and fruit. The downward movement, amber colored, shows the passage of the food manufactured in the leaves. Although the result is a simple portrayal of tree life, the mechanism is a complex maze of eight pounds of wire and 48 electric circuits, the operation of which is coordinated by a rotor flasher driven by an electric motor located in the base of the cabinet. Only eight of the lamps burn at one time, four indicating progressive motion upward and four downward through the tubes.

Table Clock With Two Faces Handy for Home or Office

*2966
Two face*

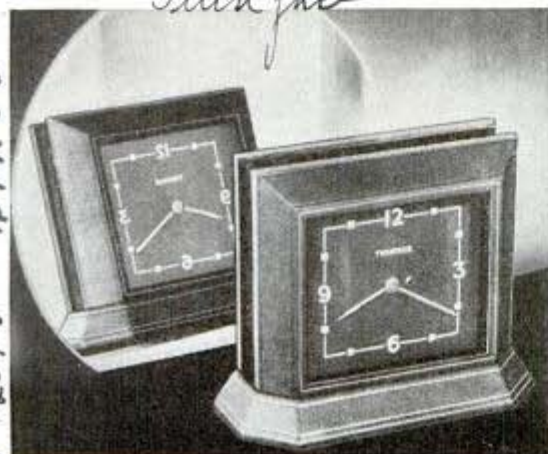

With a face on two sides and lacking the usual unsightly nuts, bolts and knobs, a table-type clock is decorative when set in the open in any room, not needing to be backed against a wall. Actually it has no back, but is two clocks in one, with two standard dials and two sets of hands operated by a single mechanism. Placed between twin beds it ends bickering as to which bed it shall face. Its two-way feature likewise is suited for use on an executive's desk in an office. A specially designed reversed gear keeps hands working together in a clockwise direction.

Mirror behind clock gives a view of the other face

\$12.75 \$17.50

*The Heber Co. 208-208
Superior Ave. Buffalo*

8937

HITCH-HIKING on the



↑ Here we go! One rider has just caught a "peaking" wave and the other is about ready to get it. The wave is only four feet high at this point

Rusty, perched on the end of the board, is a surfing fan and is widely known → on the California beaches for his love of the sport

Two riders have caught this wave; a third seems likely to take a "pearl dive," but skillful handling might get him going ↓



IT IS the dead of winter, and the waves pounding California beaches are so cold-black that one would half expect to see stray icebergs. But at a few points where rolling waves pile in long and high, hardy surf riders will be paddling through the chilly brine on their wooden boards to ride the giant swells ashore.

Water sports are generally regarded as for warm weather only, but surf riding is at its best in the winter, when the waves are large and rushing. Only when tons of water hurl themselves as high as a house do the tough and daring surf riders get a real test for their skill.

This sport requires the stoutest muscles and courage, the grace of a dancer, the skill of a major league batting champion. It looks easy from the shore, just as the big waves look like gently rolling masses of whipped cream—until you get under one.



no blueprint. plan July 1937. 114.

Cont. Marshall Perham
1128. Stearns Drive.

POPULAR MECHANICS
Los Angeles, Calif

Материал, опубликованный в журнале "Популярная механика"

BIG WAVES

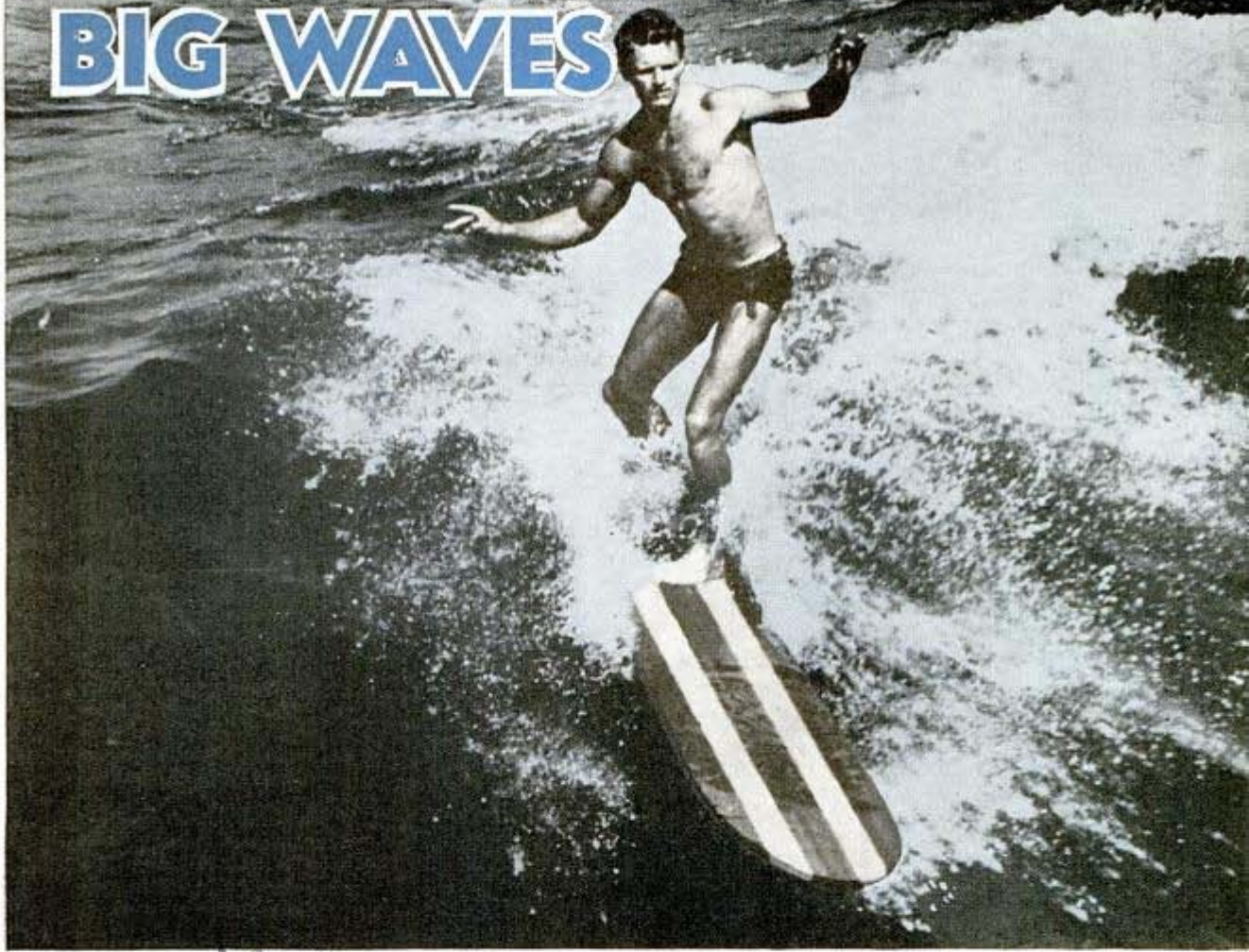

1937

Beginners get their first experience in quiet waters, where they learn to propel and manipulate their boards. No one dares try surfing before he has learned this—it would be as much as his life was worth. Even a small roller descending on an unmanaged board might produce a serious spill.

Steering is done in one of two ways. Either the foot is dipped in the water, or the rider leans far over; sometimes both. The preference is often governed by how the board is built. Propelling is not a job everyone can do; many persons are not strong enough. The rider

When white water closes in, it's the rider's cue to head for safer spots

To avoid "clean up," rider shoved board through wave, and as it rose in the swell, he leaped over crest and is coming down safely on other side



2937

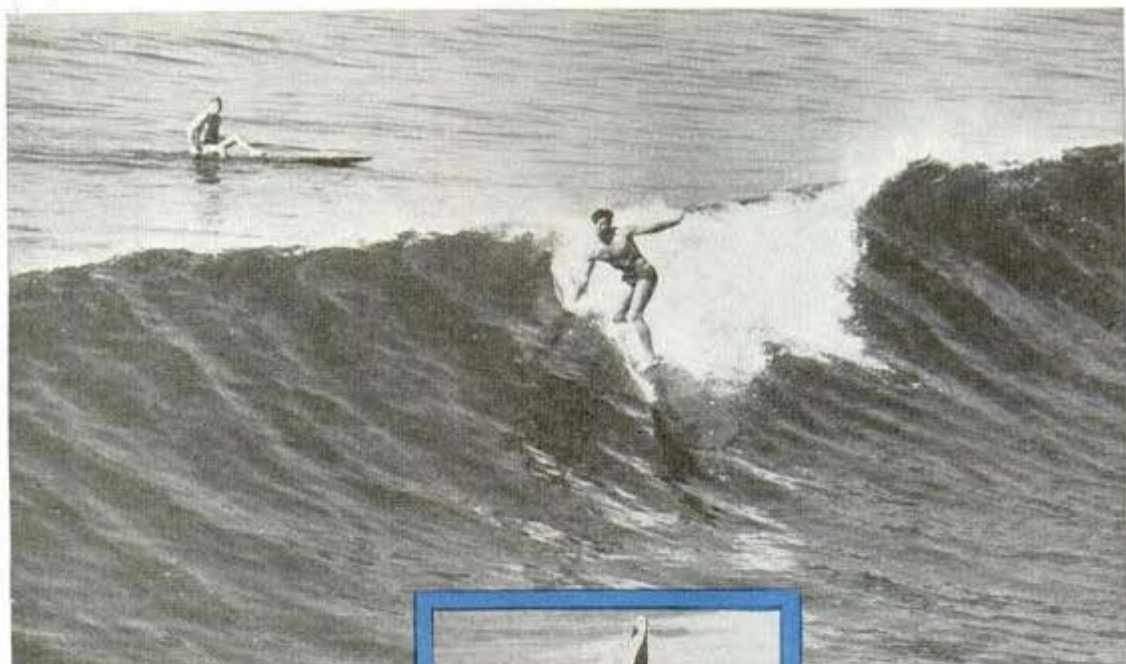

lies flat on his board, and strokes with both arms in the form of the American crawl, except that the arms move in unison, rather than alternately. This is a powerful physical developer, as a glance at the torso of any surf rider will tell.

After the novice has learned to paddle and guide his board, he is ready to try one of the smaller, or "nursery" surfs. Now the fun—with the bruises—begins. He launches his twelve-foot board, and cautiously starts to make his way "outside"—that is, the region where the waves start to "peak up." The chances are overwhelming that before he reaches the outside, he will have been soundly "cleaned up." This happens when a big one comes along, and the rider is not able to get through it. So down goes our beginner, head on the bottom, feet in the foam, while churning water whirls and beats half the sense out of him. Some quit right there, but a real fighter will come up half drowned, grab his board and



↑
As this wave peaks rapidly, the rider turns, partly by using his hand, partly by leaning, getting him out of zone threatened with a clean-up

← If you think surf-boarding is a gentle sport, take a look at what is left of this board after one of those big waves gave it a going over

Right slide by the tilting technique enables rider to evade clean-up. You can imagine what would happen if he were caught by wall of water pounding perilously near at the rider's left



L937

L1138

start again. Presently he will learn that when a clean-up comes, he may get through it by careful maneuvering—and if not, his cue is to get off that board, dive under the wave, retrieve his board wherever it may end up, and try again.

Finally, he will manage to get outside safely, without getting "the works," as surf riders and onlookers gleefully call it when someone gets smeared by a clean-up. After a short wait outside, a good wave generally comes along. He hastily lines up his board by dragging one foot while he paddles simultaneously with both hands. The roar is on him. He tries to stand up—and boom! Down comes a mountain of foam, soft and fluffy, and gentle as a herd of elephants. Over and over goes our novice, bumping on the bottom, until he knows he will never live to tell the horror of it.

But live he does, and if he still has the courage he tries again and again until he at last rides a wave. He has done it! He rides a dozen in succession, perhaps, without once getting cleaned up.

Now bring on the big ones!

The waves he has ridden so far have been perhaps four to six feet high. At a few spots along the coast, where the real surf riders gather, anything under eight feet is regarded with contempt. You don't really do any bragging until you have ridden one of those twenty-foot swells.

But the beginner is now ready to try them, or he thinks he is, so off he goes to one of the famous surf beaches, probably at Palos Verdes or San Onofre, and in high excitement he launches his board. Perhaps half a mile or more off shore, the waves are forming. They look like mountains, but far outside he sees a group waiting, and sets out to join them.

Let us hope he arrives without getting the works. The chances are against it; these waves are killers. Out there he finds a bronzed, chatty gathering of veterans who give him the critical eye of appraisal, and discourse on the particularly vicious quality of the swells this day. Suddenly there are cries of, "She's humping!"

A hundred yards seaward, the entire ocean seems trying to stand on end. The horizon is blotted by its mass, even distant clouds are obscured, and this roaring, hissing monster is bearing down on the frail boards with the speed of an express train.

For a fleeting moment, he considers div-

(Continued to page 166)

Auto 'Scoop' on Tow Truck Stops Swaying on Road



Upper view shows scoop lifting a car by front axle

Safer and more rapid towing service is made possible by a scoop-up wrecker vehicle. A long arm at the back of the truck slides under either knee-action or conventional cars, picking them up by either the front or rear axle with ease and in a minimum of time. The disabled car is held rigidly in a turntable on the end of the boom which insures proper tracking and protects the car from damage. No high rigging is used and it is not necessary to carry extra anchors or supports.

☐ You can obtain additional information about products described in this magazine by writing to the firms listed in the Where-to-Buy-It index. Say You Saw It in Popular Mechanics.

Dear Mr. & Mrs. C. L. ...

L1163

Mobile Engineering "Lab" Stages Science Show

Prof Van Walger

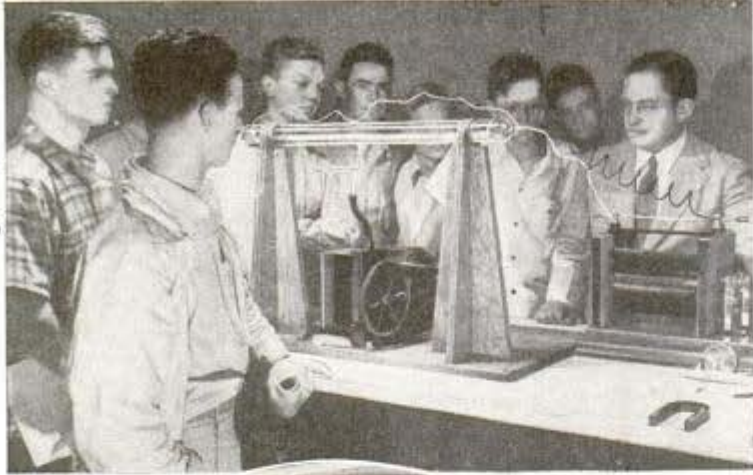

In the top scene, students see "northern lights" created by a 15,000-volt charge shot into the rarefied gas of vacuum tube

At the lower left, cases of scientific equipment are loaded aboard mobile laboratory for a tour of Pennsylvania

Below, a student hangs from iron disk held by a magnet powered by a flashlight battery. It could support 400 pounds

Central & Western office State College Pa.



Carrying vivid lessons in chemistry and physics to classes throughout the state, mobile laboratories have been touring Pennsylvania under the sponsorship of the State College. During last summer alone two of these traveling "labs" covered nearly 20,000 miles, staging scientific demonstrations before 10,000 students enrolled for special defense training courses in 100

centers. In one "show," students watched man-made "northern lights" as a 15,000-volt charge sent molecules bombarding one another in the rarefied gas of a vacuum tube. In another an iron disk held by a magnet drawing power from an ordinary flashlight battery proved able to support 400 pounds. In the two-hour demonstrations, 36 basic experiments were performed.

2601

Members of Club Pledge Their Eyes to Restore Sight to the Blind

1459 Boulevard

Its members pledged by a legally binding agreement to donate their eyes at death to the living blind, the Dawn Society, sponsored by the International Order of Good Templars, has been organized in California to aid in giving sight to the blind. Doctors

have been successful in grafting corneas from one eye to another, and the society's aim is to give them enough cornea tissue to restore eyes blinded by damaged corneas but otherwise healthy. About five percent of all types of blindness come with-

in this classification, many being due to industrial accidents. Both eyes of the donor will be removed within six hours after death, and stored in a light saline solution under refrigeration. The tissues can be grafted up to two weeks after being removed, but because of the great demand it will not be necessary to store the eyes more than a few hours or days.

Submarine Cargo Vessel Towed by Warship

What looks like a huge football is the experimental model of a queer cargo vessel designed to be towed under water. The inventor, Gaston Desagnat, New York, offers the idea as a national defense experiment. Ships of this type, it is said, could be loaded with war material for Britain and towed behind warships or cargo steamers in strings of ten to twenty. Fully submerged, the craft would make a poor target for enemy submarines and airplanes attempting to destroy them. Built at the yard of Sound Marine and Machinery Corporation, Mamaroneck, N. Y., it has a framework of wood, covered with a coating of concrete which was sprayed on.

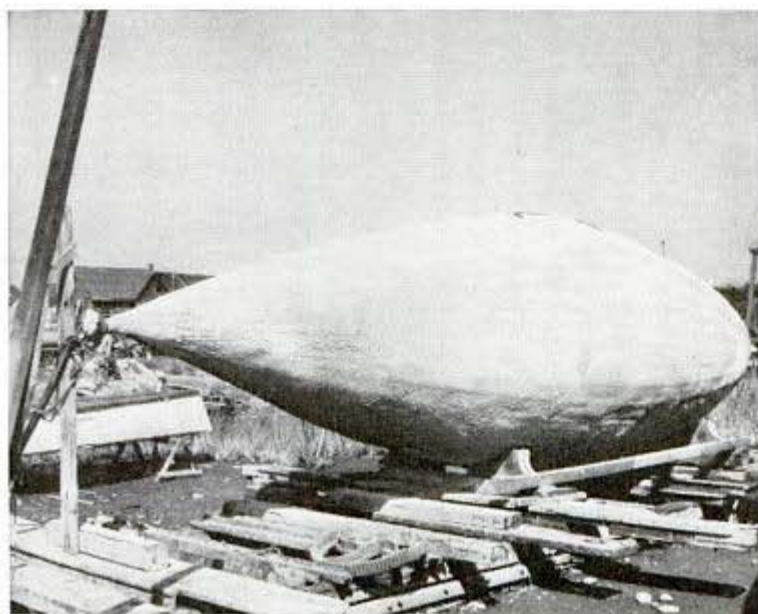

Concrete-coated submarine towed by warship, carries cargo under water

FEBRUARY, 1942

*Constructed by Sound
marine & machinery Corp.
Mamaroneck, N.Y.*

"Xylophone" Made of Rock Bars Is Tuned With a Chisel



Rock bars were chipped down until they gave the desired tone

His interest aroused in musical rocks when he heard beautiful, clanking tones emanating from stalactites struck across the middle, Prof. Edward L. Troxell, state geologist of Connecticut and a teacher of geology at Hartford's Trinity College, fashioned a xylophone in which rock is used in place of the usual wooden bars. Trap rock found in a million-year-old bed atop Avon Mountain near the professor's home proved to have the resonance needed. He gathered a load of the stones, set them in a row and with a chisel chipped each one until it produced the right tone, tuning them with the aid of a ten-cent pitch pipe. However, since "xylo" is derived from a Greek word meaning wood, the professor calls his rocky instrument a petrophone. It has a complete C Major scale three octaves long, on which he can play many pieces.

11/68

Cont. Warner Ogden / Knoxville
2519 Colleson Ave
Tenn

4204. Kingston Pike
Knoxville Tenn

SMOKELESS TOWN of ALL-ELECTRIC HOMES

plumbing; cedarized closets; dry crack-resisting construction; solid brass door locks; chromium bath accessories; a gravel driveway; a garage with over-the-top door; a sturdy foundation; a basement or utility room; poplar or pine hand-sanded, molded trim; long-life roof; beautiful

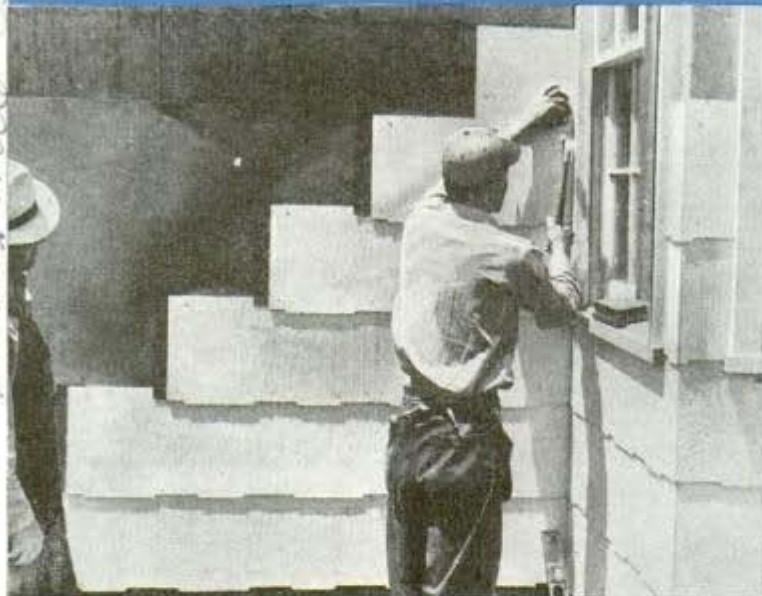

Nailing asbestos siding over plywood on home in "smokeless community"
Meadow Hills
Automatic electric heating unit being installed in a Fonde-built home
↓



SMOKELESS communities are a reality in subdivisions developed on the edge of Knoxville, Tenn.

Stewart Fonde, who is building homes-of-tomorrow and who is executive head of H. C. Fonde & Son, constructed one community known as Forest Court. The homes had various kinds of automatic heat; were weath-erstripped and insulated, had tile bath and kitchen walls; linoleum drainboard with chromium trim; all copper

One of the all-electric homes—therefore smokeless—in Knoxville community. One difference from other homes is absence of chimney

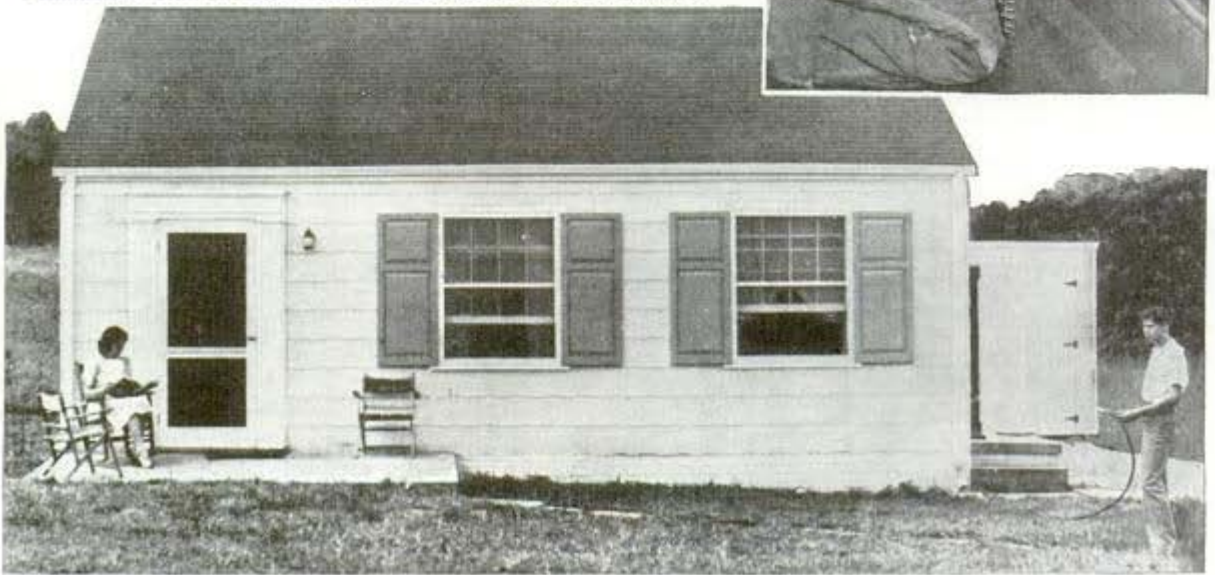

21165

medicine cabinet; butted wallpaper; termite insulation; ample closets and cabinets. The prices of those first homes ranged from \$2,500 to nearly \$4,000. They sold fast, of course.

All the homes were electrically equipped throughout—electric ranges, electric refrigerators, electric washing machines, and anything else electric desired. Forest Court was intended to show that low-cost quality homes could be built, rather than to entirely eliminate smoke. Then followed communities in which smoke elimination, as well as modern low-cost quality homes, became important.

Highland Hills, "Knoxville's first smokeless community," was built. Most of the homes in it are electrically heated and entirely electrically equipped. Prices of the electrically heated homes began at \$4,450, complete with lot.

Then Fonde undertook
(Continued to page 171)



↑
Installing insulation in all-electric house; this work must be done properly to hold heating costs at reasonable levels

→
Drainboard has a portion of the side on hinges so it can be pulled out and rested on wooden arms

↓
Simplified drawing of Fonde house with roof removed to show the various electrical appliances and the location of electric heating units



Rebel Worsham House

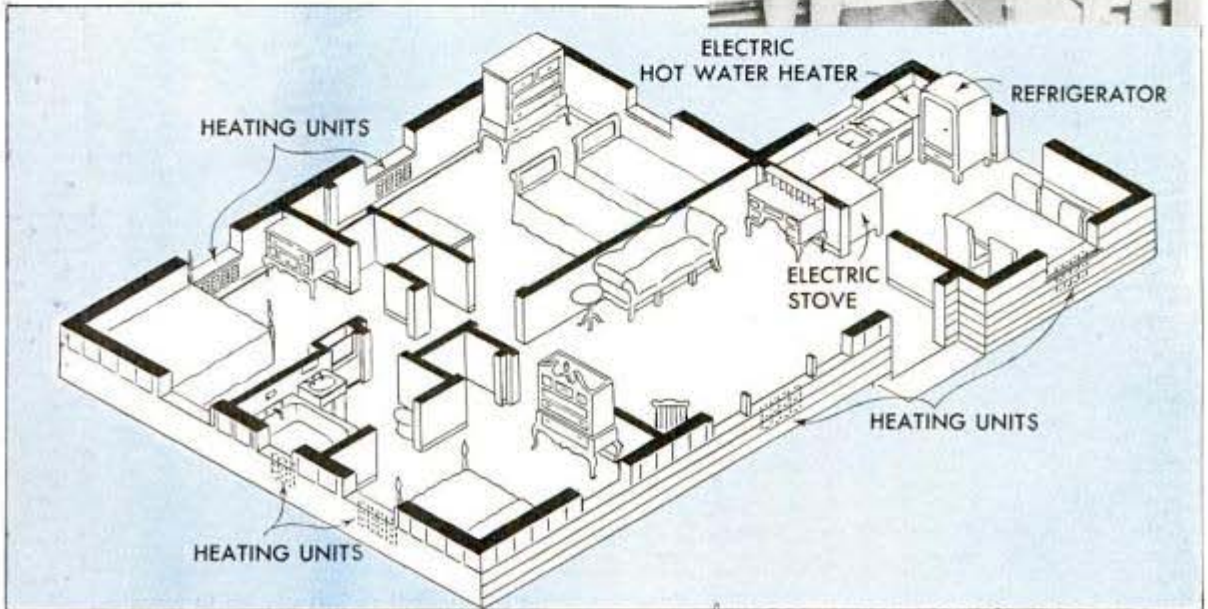

L1083

Ton Crane Mounted on Trailer Lifts Engine From Plane



Trailer crane eases and quickens removal of airplane engines

Handling airplane engines has been made easier by a combination trailer and crane that can lift the engine from a plane and carry it about the airport. Designed by a staff member of Boeing School of Aeronautics of Oakland, Calif., the unit was constructed by Colson Equipment and Supply Company of San Francisco. The trailer has a two-ton carrying capacity and the adjustable crane can lift one ton. Vacuum booster brakes on the trailer are controlled from the steering column of the towing car. Legs at the rear are held in vertical position by a pin-in-slot and fold flat on the trailer when not needed. The front end is supported by a small wheel that may be raised while the trailer is in motion. The trailer-crane is 12 feet long, 8 feet wide and 14 feet high.

L1217

City Pigeons Are Put to Work Sorting Grain for Drug

Even the pigeons of New York have found jobs because of the war. They're sorting raw ergot from rye in a Staten Island warehouse. Ergot, a valuable drug, is obtained from parasite-infected rye ker-

nels, and before the war the infected kernels were sorted from the good by European peasants. Now the rye arrives in this country unsorted. Officials of the warehouse conceived the idea of calling on the pigeons for cooperation. They spread the rye on a table, opened a big window, and hundreds of pigeons flocked in to eat. They chose only the good grains, rejected kernels containing ergot.

L1021

Plastic Tape for Glazing Seals Out Water

Sealing windows permanently against the elements, a plastic glazing material applied like tape, with only a putty knife, requires no experience on the part of the workman. It consists of pliable plastic mounted on flexible lead foil, and because it remains pliable the material will not harden, shrink or crack. It is especially suitable for greenhouses as it can be raised in replacing broken window panes. The outer coating being of plastic, no putty or paint is needed, and if a portion of the tape becomes destroyed, a new piece can be patched in.



Glazing tape unrolls as it is applied to window

2:1095

Balloon or Kite Lifts Antenna in Emergencies

Radio amateurs recently demonstrated their readiness to augment the nation's communication system with portable equipment whenever the usual channels are disabled. Two methods of erecting emergency antennas for short-wave radio transmitters were shown. From an automobile wheel hub a large kite carrying the antenna takes off at the end of 500 feet of chalk line with breaking strength of 130 pounds. The line is fed from a special reel

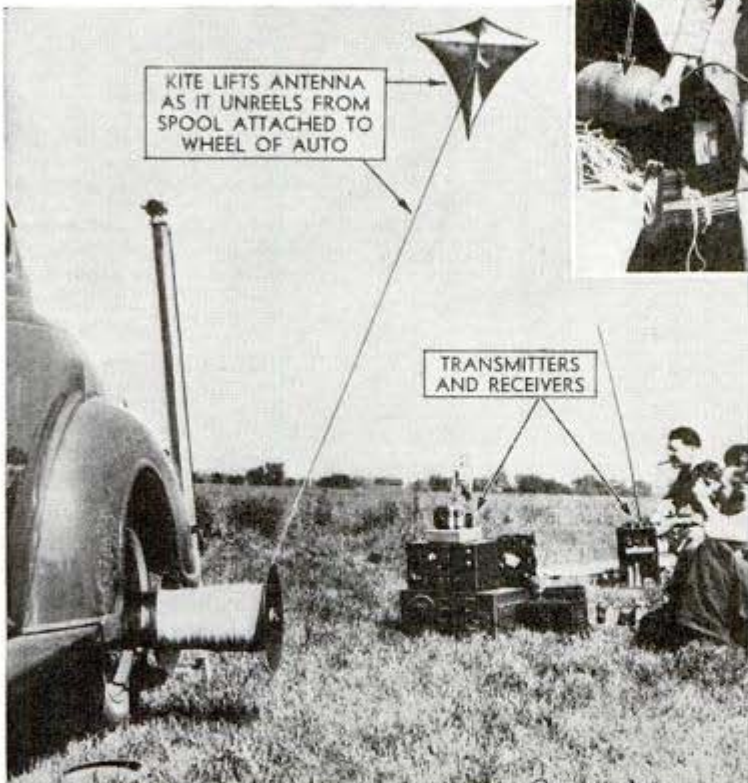

Two methods used by amateur radio operators for erecting emergency antennas. Above, inflating balloon with hydrogen, and, left, sending up kite attached to spool mounted on auto wheel

fastened with the wheel's lug bolts, using engine power while the car is jacked up. A four-foot balloon inflated with hydrogen was also used. Having a lifting power of five pounds, the balloon can hoist an antenna several hundred feet into the air.

Hot-Dog Steamer for Home Has Automatic Heat Control

Three dozen hot dogs can be steamed at one time in professional manner for home parties with an electric steamer. An adjustable thermostatic control automatically turns off the current at the desired temperature, and switches it on again when additional heat is needed. The chromium unit makes an attractive stand when not in use as a steamer, and if a cake is stored inside it may be kept moist by placing water in the removable bottom.



Thermostatic control regulates the temperature of electric steamer that heats three dozen hot dogs at once

To learn where to buy commercial products described in these pages, see the index.

FEBRUARY, 1942

Lux. Radio Corp.
208 Jackson Blvd
Chicago

Consolidated
Edison

78 41

Warren Elliott
New York City
343 & 33rd

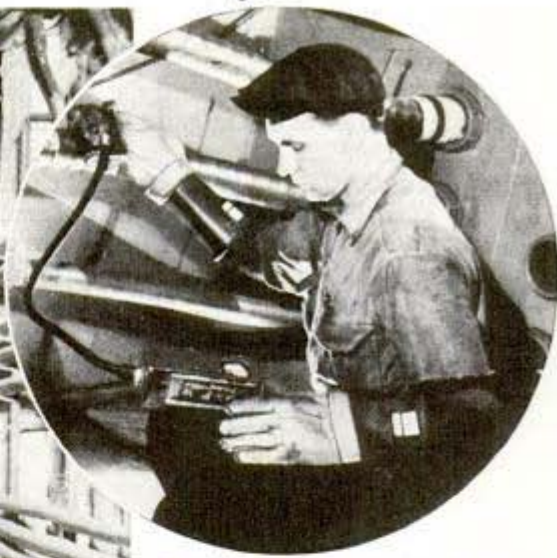
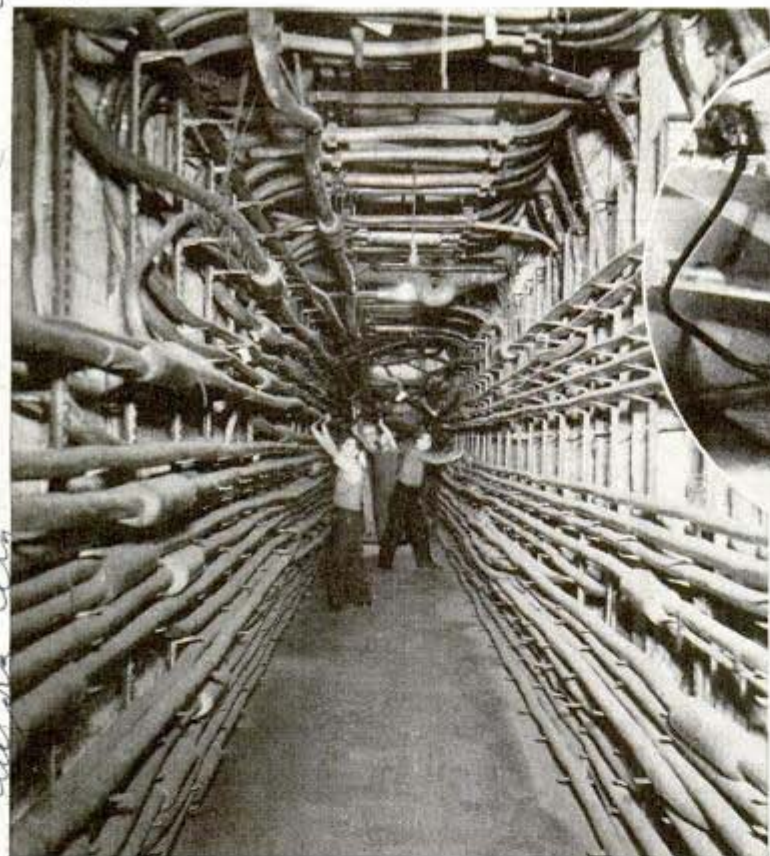

Specialists night and day hunt faults in 21,800 miles of power lines under New York pavement

Through vault, left, in a large office building, cables from the street are routed to upper floors

HUMAN ANT HILL

Cont. Allen



NEW YORKERS, accustomed to pointing with pride at the city's skyline of towering skyscrapers, have suddenly turned their attention downward — underneath the sidewalks they pound in the daily routine of their lives.

In other parts of the globe great numbers of urban peoples live like gophers, ready on an instant's notice to pop into a subway tube, a basement or an air-raid shelter. All the world knows that Gotham is the most shining target left for bombers on the face of the earth. So New Yorkers are discovering a striking fact: that as its millions of population packed themselves onto the narrow island of rock called Manhattan, they not only built their city skyward, but they also dug deep into the ground.

Unwinding from its spool, a new coaxial cable starts underground

New York Telephone Co.



Consolidated Edison Co., New York
A worker in a subterranean gas plant wields a mighty wrench

So crowded is the below-pavement space from building to building in some locations, such as Broadway at Times Square and at 34th Street, that it is actually impossible in places to insert anything as large as a broom handle between wires, cables, conduits, pipes and mains. The 322 square miles of city sub-surface is so honey-combed with more than 1,100 miles of subway trackage, scores of miles of underground foot passages, vehicular tunnels and railroad terminals, that during the morning and evening rush hours it is estimated there are nearly as many New Yorkers below the sidewalks and streets as there are on them.

New Yorkers are aware of the transportation angle of what is underneath the sidewalks, because they are a part of it. But few realize the extent and importance of the maze of conduits, pipes and ducts which add up to 45,000

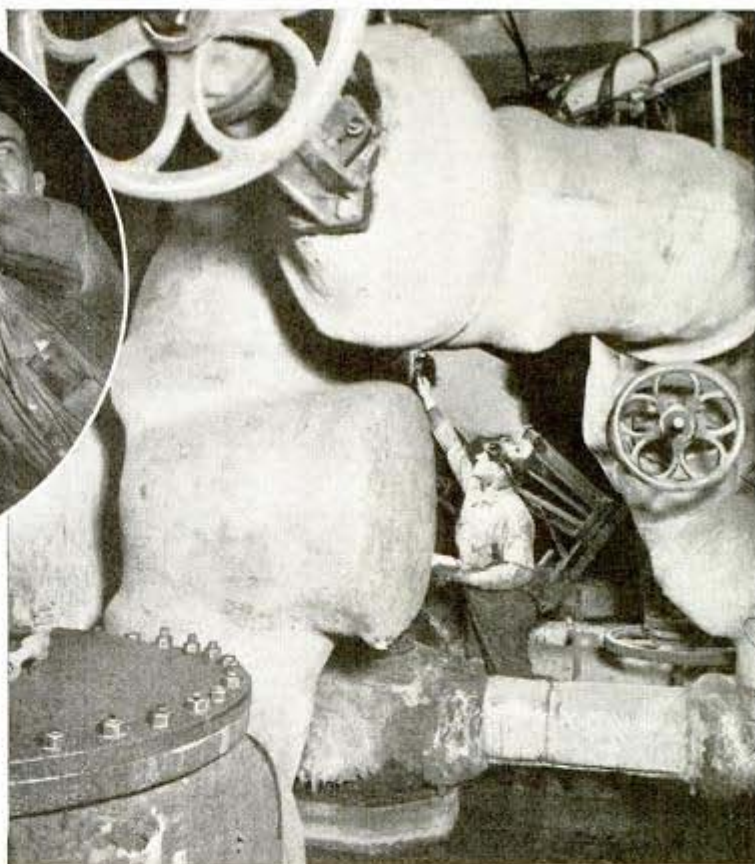

Reading meters that measure water passing through two 20-inch mains

Since this model of 34th and Broadway was built, the elevated and street car lines have been removed and a new subway added nearby

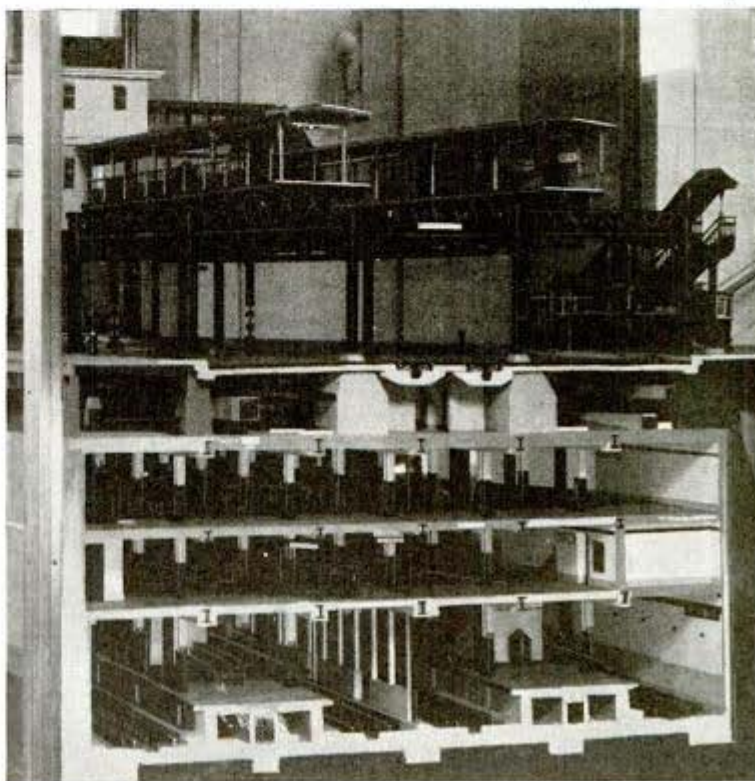

Franklin Institute photo

2841



Trouble shooters for Consolidated Edison company are underground one minute, high in air the next. Below, carriers containing eight telegrams travel 1,300 feet a minute in Western Union pneumatic tubes

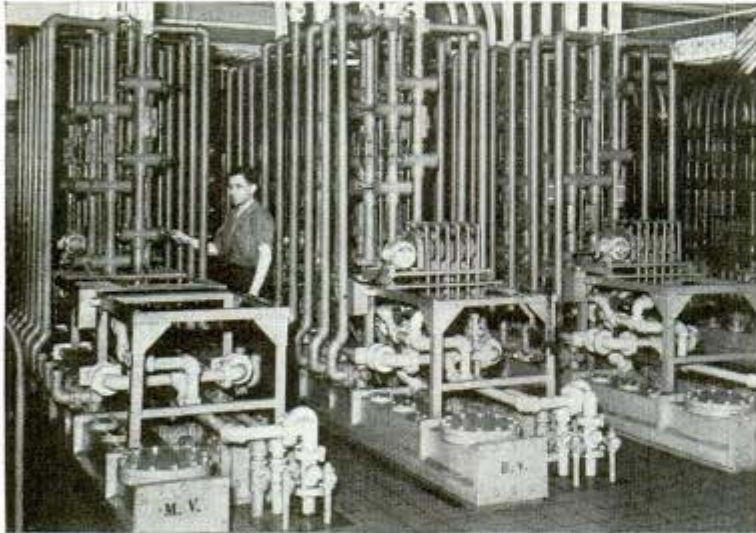

ity company alone owning 41,000 miles of electrical conductors. And four-fifths of some 9,400,000 miles of telephone wires run through the ground, as well as millions of miles more of wire which are a part of light, power, telegraph and alarm services.

The Consolidated Edison System alone, which sells most of the electricity for light and power, has installed subterranean lines containing 1,300,000 pounds of metal, including 118,000 tons of copper. This is sufficient copper to produce 37,500,000 pennies, more than five times as many as Uncle Sam has minted since 1792. Stretched into a wire, it would reach 3,700,000 miles.

This one corporation group has installed beneath the streets 400,000 tons of iron and steel, more than enough to build the San Francisco-Oakland Bay Bridge, and

Tunnel Authority inspector examines one of 23 huge blowers that change air 42 times an hour in Queens Midtown Tunnel



miles, or the thousands of vaults, subbasements and private passageways which make the metropolis a human ant hill.

Round iron manhole covers on nearly every corner in the city, sometimes eight or ten to a corner, tell them that there must be a system of some kind beneath the concrete, but if a New Yorker were asked to locate the largest copper mine in the world, the chances are Montana or Chile would be mentioned. The fact is that the greatest single, concentrated copper supply in existence is right underneath their feet in incredible miles of cable, one util-

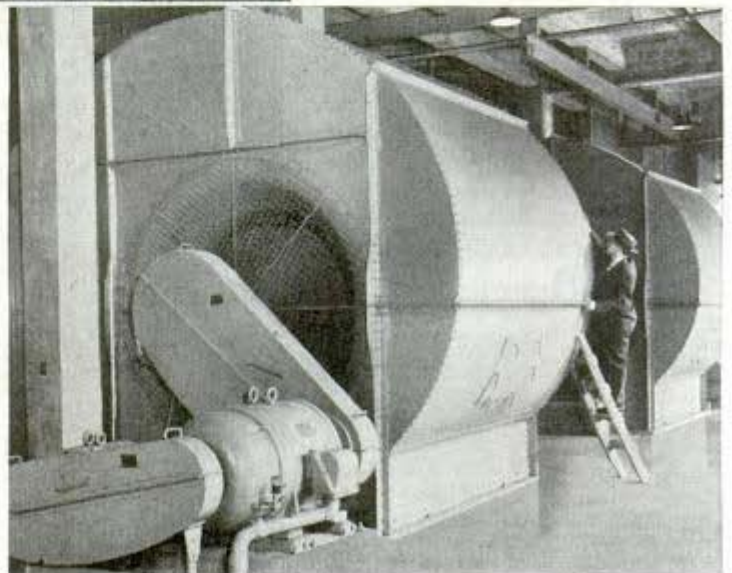

2841

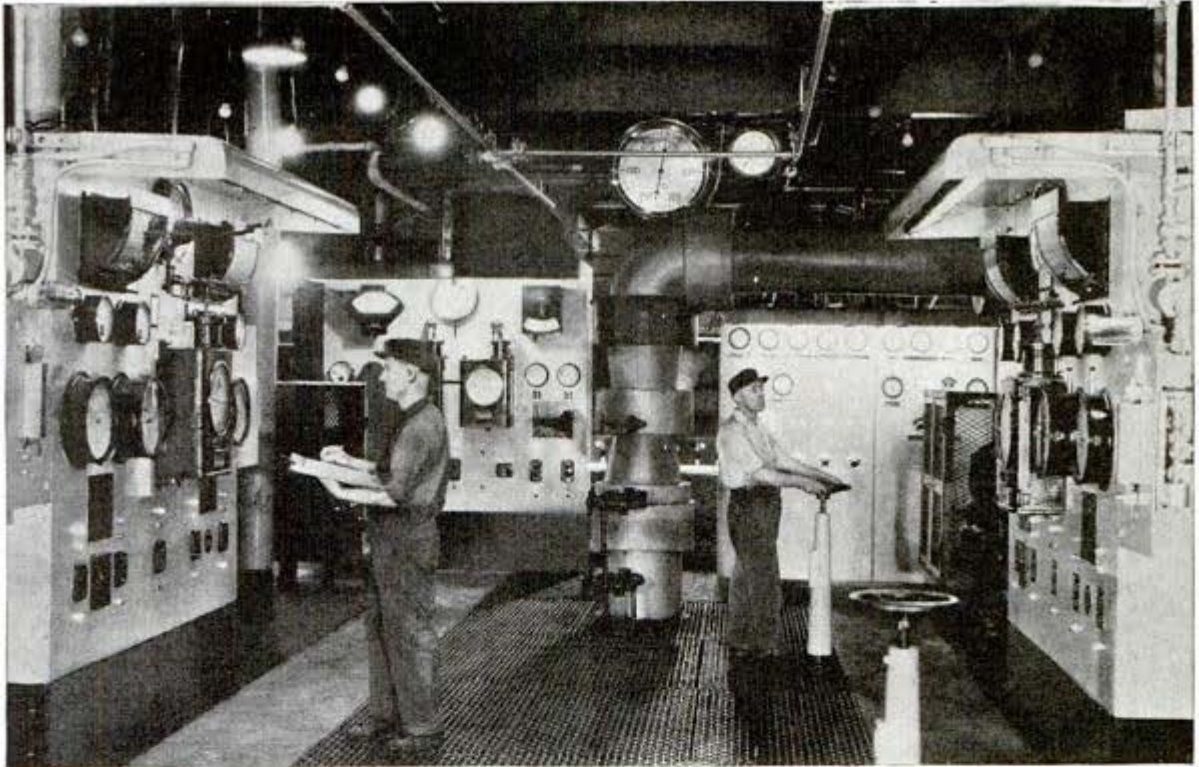

Space is so valuable and coal trucking so costly that most New York buildings have no heating plants. Steam is piped to them from Kip's Bay Station of New York Steam Corporation. This is its control room

New York City's Triborough and George Washington bridges.

New Yorkers bathe without knowledge that 4,000 miles of water mains are needed to fill the tubs and 3,000 miles of sewers, many big enough to row boats in, carry the waste water off. They cook without realizing that it takes 5,000 miles of gas mains to connect their stoves with the huge plants and tanks scattered throughout the city. Yet, throughout the crowded area, every one of these necessities flows through the soil just under the skin of concrete on which the populace walks or rides.

From 6,000,000 to 10,000,000 letters shoot through the thin layer of dirt atop Manhattan Island daily, an average of about 500 letters contained in each 28-pound metal torpedo which is projected through tubes by air pressure at about 30 miles an hour. Mil-

Manhattan
In a cable vault a telephone company lineman uses an exploring coil to locate trouble

lions of New Yorkers are ignorant of the fact that telegrams also speed under the streets in tubes. One of these is 12,500 feet long. In busy periods, carriers, each containing eight telegrams, are snapped into tubes, at 20-second intervals; thus a single tube can move more than 1,400 telegrams an hour at a quarter of a mile a minute. Air pressure at one end and vacuum pumps at the other are required in long tubes.

(Continued to page 162)



1020

**Skylight Washer on Aerial Car
Cleans High Windows**



All windows in factory roof can be reached from an aerial car

Riding high above the assembly lines at the new engine plant of Wright Aeronautical Corporation in Cincinnati, O., window washers scrub the inside surfaces of skylights in the roof without interfering with the workmen below. The 33-acre factory has a saw-toothed roof containing 350,000 square feet of glass. Within each peaked section is a set of tracks on which a car, big enough to hold a man and necessary cleaning material, is operated from one end to the other. To reach the 28 rows of windows, each 1,320 feet long, 56 of these cars are needed.

1086

**Polarized Lights on Cars
Create New Problems**

If polarized headlamps are adopted for autos, it is probable they will have to be $2\frac{1}{2}$ to $3\frac{3}{4}$ times brighter than ordinary lights, calling for more battery power, according to tests reported by Val Roper and K. D. Scott, lamp research engineers of General Elec-

Nela Park, Cleveland, Ohio

tric Company. This is because the polarizing screen in front of the lamp lens stops all light except that vibrating in a particular direction, or about 60 percent of the light. Too, the "analyzer" which would be worn as glasses or attached to the windshield would absorb additional light reflected from objects or pedestrians on the road. During the transitional period, before all drivers were provided with analyzers, the new cars would require two beams, one polarized and the other a less bright depressed beam that could be used when the approaching drivers without analyzers signaled for it.

21073

**Drag-Bucket Digger Fills
Eight Trucks an Hour**

In one hour one man operating a combination digger and loader of simple design can load eight five-ton trucks. The shovel is a drag bucket of one cubic yard capacity that digs dirt, clay or gravel, hauling it up a ramp to load it into the truck. A drag line permits operation at 200 feet from the loading unit. All of the movements are controlled by manipulating four levers. Furnished with either an electric, gasoline or Diesel motor, the machine can be moved on crawlers by its own power. Hydraulic rams raise the loading ramp from the ground for shifting the unit to a new position.

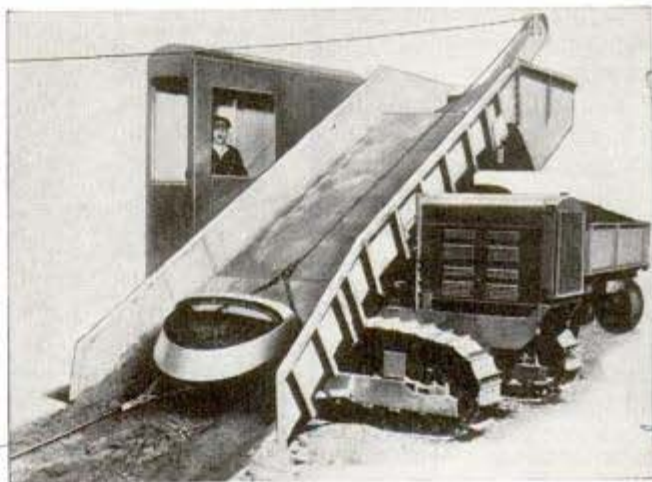

Cable hauls drag-bucket up chute to empty contents into truck

21125.

Rapid "Direct Process" Prints Defense Plans



Fed by hand, this printer develops daily thousands of easy-to-read "positive" copies of defense plans

Four operators feeding exposed prints of mechanical drawings into a "direct process" developing machine can turn out 18,000 copies in a 24-hour day at the Westinghouse works in East Pittsburgh, Pa. Applying the developing solution to prints, the 80-inch-wide Goliath produces "positives" with black lines on white paper, instead of white lines on a blue background as in blueprinting. Ordinary transparent drawings, or "tracings," are used as orig-

inals in the printing machine which shines a powerful carbon arc lamp through the tracing onto the coated paper. Where the light strikes the paper, the coating is dissolved by the developing process, but the chemical remains where shadows are cast by the lines of the tracing. The high-speed production of prints is an aid to defense, putting into the hands of machinists, assemblers and others exact plans for the parts on which they are working.

21180

Heater in Cowl Ventilator Draws Outside Air Into the Car

Fresh, outside air is brought into the car and warmed to the desired temperature by a heater attached to the cowl ventilator of Chevrolet, Ford and Mercury cars. A filter removes dust before the air passes over the heat radiation surface. Fingertip control at the dash permits the driver to regulate the amount of heat delivered. Although the incoming air is barely noticeable, the pressure is strong enough to drive out all foul air and distribute warm air to all parts of the car.

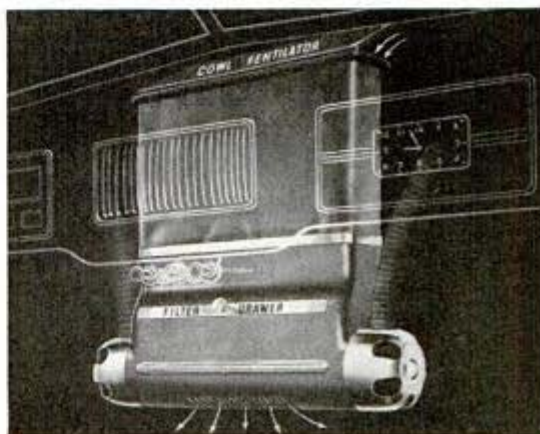

Cowl ventilator forces air through filter and heater

(To learn where to buy commercial products described in these pages, see the index.

FEBRUARY, 1942

Liberty Frontiers 87
Rockford Ill

21031

"Gun Torpedo" Fires Eight-Inch Shell Into Hull

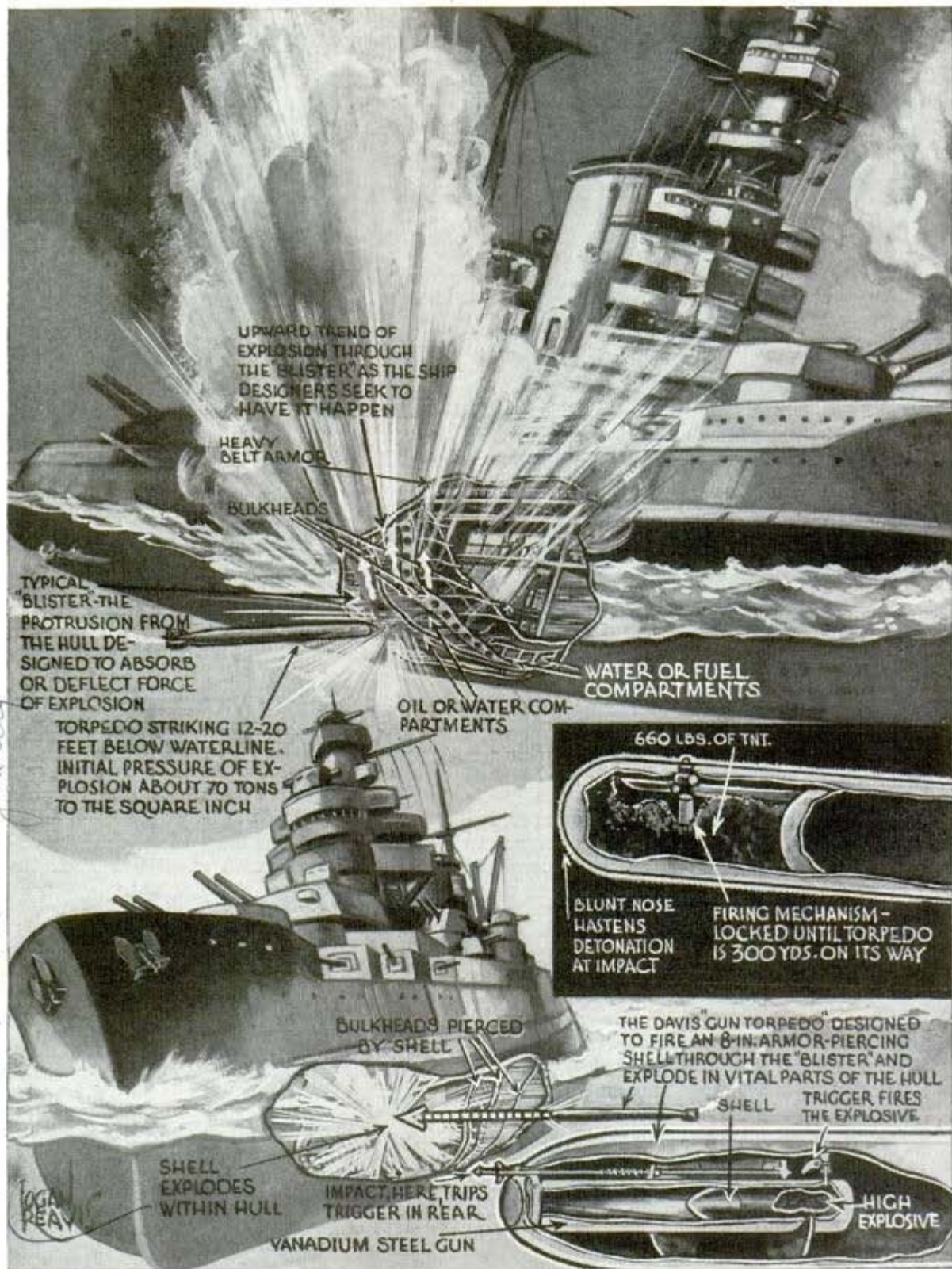

195 Oct. 45 Ch. Naval City

War experience indicates no hull design has yet been perfected that is proof against the terrific explosive power of the torpedo. Now comes the Davis "Gun Torpedo," which fires an eight-inch shell through the warship's protective "blister," the shell then exploding against the hull

Weapon Strikes Ship's "Blister," Then Explodes

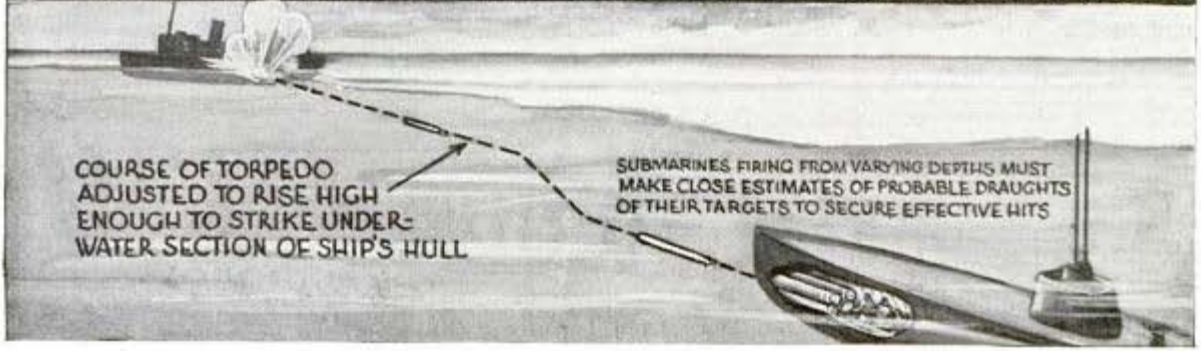
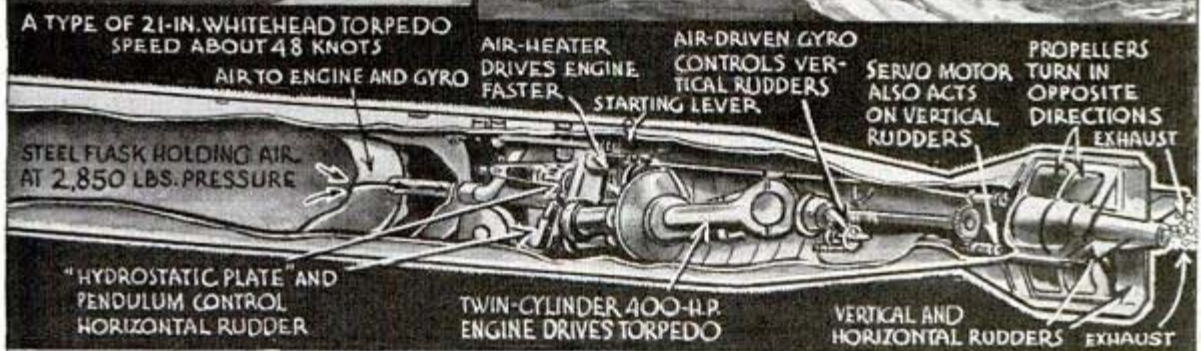
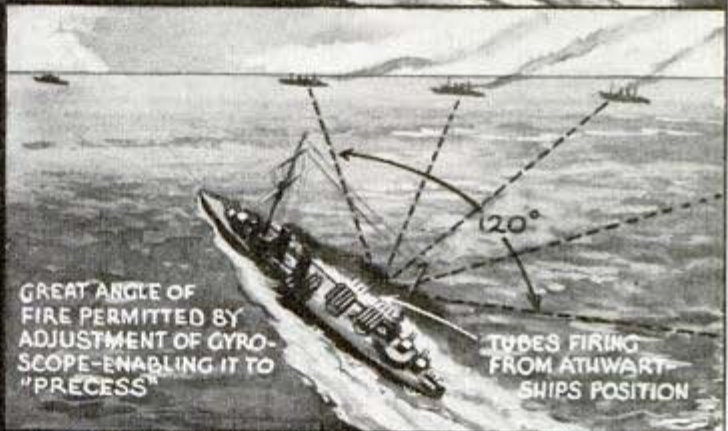
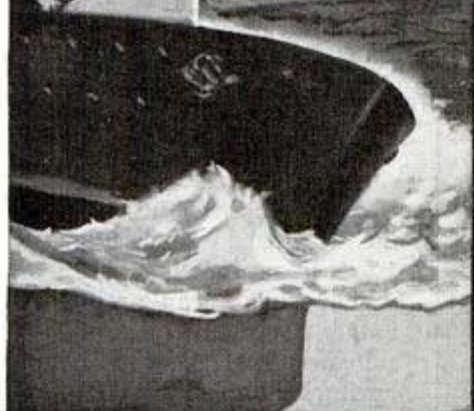

One of the most intricate and precise of weapons, the torpedo costs \$9,000 to \$10,000, can cripple or sink a \$10,000,000 battleship. Since its inception in 1866 it has revolutionized naval and air warfare. The new "Gun Torpedo" is fired by a trigger upon impact with its target

L 1169.

Telescopic Truck Hoists Ice To the Roof of a Railway Car

*Yale & Louie
Stamford, Conn*

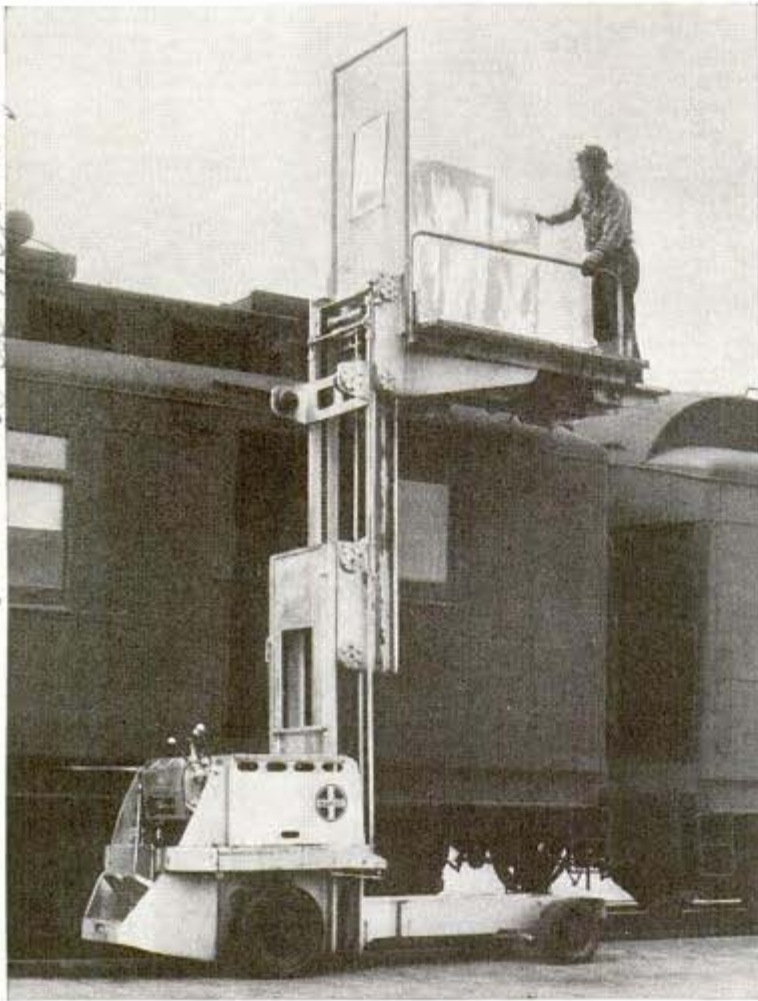

The "skyscraper" truck shoulders a ton of ice to roof bunkers of a car

To service its passenger trains with ice in a minimum of time, the Santa Fe railway employs a new high-lift truck that can hoist more than a ton to the level of the car roof in a few seconds. The telescopic truck is operated by storage batteries, with remote control from the loading platform. Formerly the task of filling rooftop ice bunkers required two men, one tossing ten-pound chunks of ice up to the helper.

L 1128.

Spark Plug for U. S. Air Forces Is Kin to Precious Stones

To endure the punishing heat and high compression of aviation engines and withstand the effects of lead in the gasoline, a new spark plug has been developed for the

U. S. Air Forces. Its insulator is chemically akin to sapphires, rubies and oriental amethysts, and is harder than any substance save the diamond. The entire output of the new plug is going to the U. S. government for air-planes and tanks and to commercial airlines for use in transport planes. The basic material of the insulator is aluminum oxide, which is mixed with a binder, molded to shape and then baked in a high-heat kiln.

L 1153

Sliding Cutter Guide Helps Trim Prints To Uniform Size

Especially handy for photographers is a new cutting board with an adjustable metal guide which measures accurately the extent of trimming or cut. A strong spring lock holds the sliding guide firm while cutting. A spring attachment keeps the knife from falling when it is poised in the air, preventing it from injuring the hands or damaging the material.

Always



Movable guide may be set to govern amount of trim

1323-d Muehling Co

*90 Spark Plug
Div. General Motors
Corp. Detroit Mich*

Photo Materials Co

POPULAR MECHANICS

21119

Young Racer Models Soap Box Derby Track

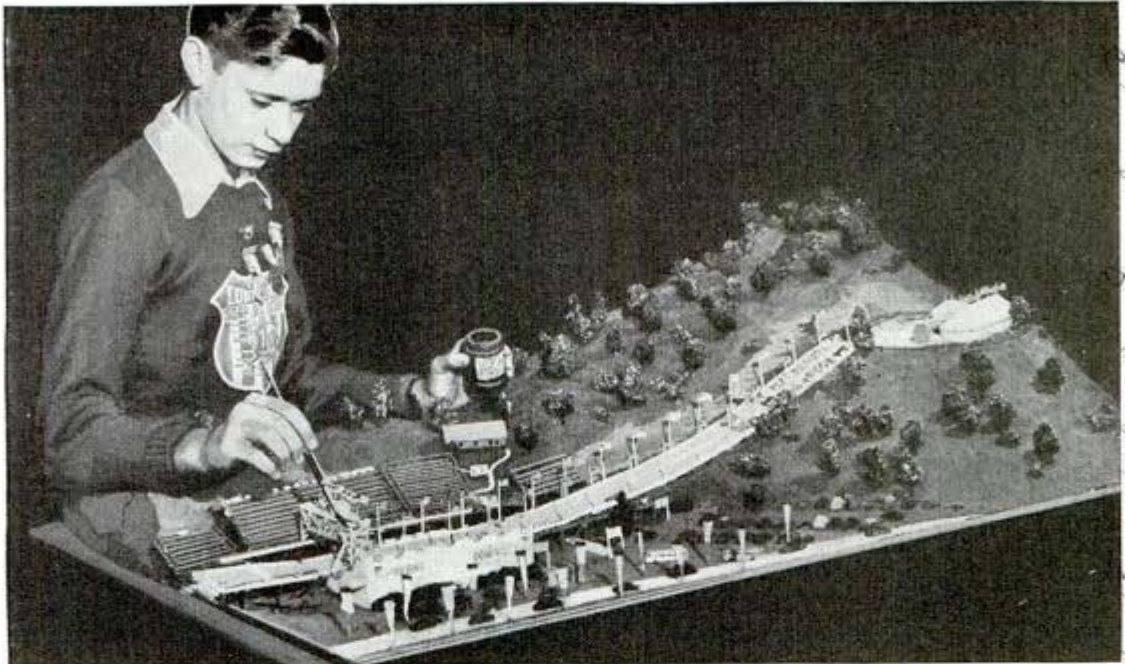

Fifteen-year-old modeler touching up his miniature replica of Akron course of the Soap Box Derby

Spending two years at the task, a young Soap Box Derby racer, Jerry Trimble of Terre Haute, Ind., has completed a model of the course at Akron, O., where the national finals are held each summer. Made

of papier mache, cardboard, balsa, tooth-picks, matches, paper and sponges, the miniature, which is 26 inches wide and 48 inches long, includes such tiny details as flags, a ticket office and buses pulling in.

Light-Reflecting Letters for Signs Cut From Large Sheet

Signs that reflect light for visibility at night can be made by anyone with a reflective material which resembles oilcloth and comes in rolls 12 and 24 inches wide. The flexible sheet is easily cut with scissors or knife to form any letters or design, and can be stuck to wood or metal. An adhesive on the back is exposed by removing the Cellophane cover, and with a hot iron the material is pressed down, using a sheet of kraft paper to protect the "sparkle" side. This quickly vulcanizes it to metal or wood. The material comes in white, silver and yellow, their brilliant surfaces having a reflective distance of 800 feet for the first two, and 1,500 feet for the yellow finish. A wide variety of uses includes advertising signs, road markers, house numbers, posts, trees or fences.

Write to the firms listed in the Where-to-Buy-It index, to learn more about products described in this magazine. Say You Saw It in Popular Mechanics.

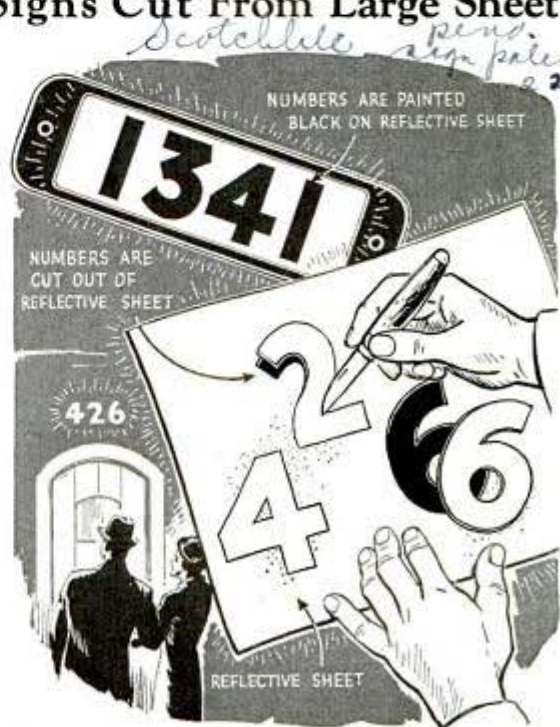

Figures may be cut out or painted on sheet as shown

*Cont. Campbell would be...
Behead Motors City Detroit*

*Minnesota...
St. Paul Minn*

WANTED: 200,000 MEN



Trainees replace damaged rail on a U. S. Navy patrol boat
Repairing plates on a scow at a Work Experience Center



PLENTY of jobs today. But will the employment window slam shut with a sickening bang when the war and the production boom end?

Many a worker would be happier if he knew his job would last a year or more past the next armistice. Well, Uncle Sam has found a spot like that for about 200,000 men—a spot where wartime jobs will not only outlast the war, but will probably last 10 to 20 years after the world settles down to peace.

The job is in one of the many shipyards which dot the coasts of the United States and in the dozens more which are being built or reopened.

Shipbuilding experts insist that a competent man can go into a shipyard today in his twenties and be fairly certain of still drawing his pay in his forties because of the tremendous tonnage of shipping which has been transferred and sunk. It takes only a few minutes to sink a ship by mine, shell,

Capt. Allen Warren Ellsitt, 343 E. 93rd Ave., 826

Microfilm, 35mm and microfiche editions

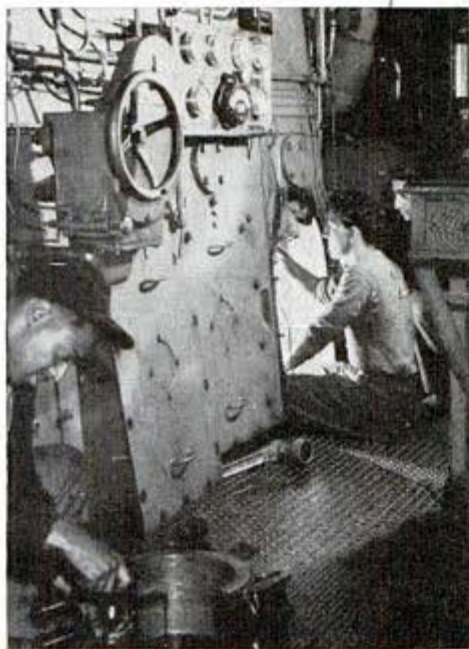

Overhauling a boat's Diesel engines in N. Y. A. shipyard

bomb, or torpedo, but it takes one to four years to build one.

The average man hesitates to try to land a job in the field because he knows nothing about shipbuilding. Comparatively few of the present generation have had shipyard experience; the Social Security Board combed its files for shipyard workers at the beginning of the defense emergency and could find only 2,400 such men needing employment.

There are two simple ways to get into this rather lush field. One is to get training from any good school which will fit men as expert boilermakers, carpenters, copper-smiths, cranemen, electricians, joiners, machinists, painters, patternmakers, pipe fitters, riveters, sheet metal workers or

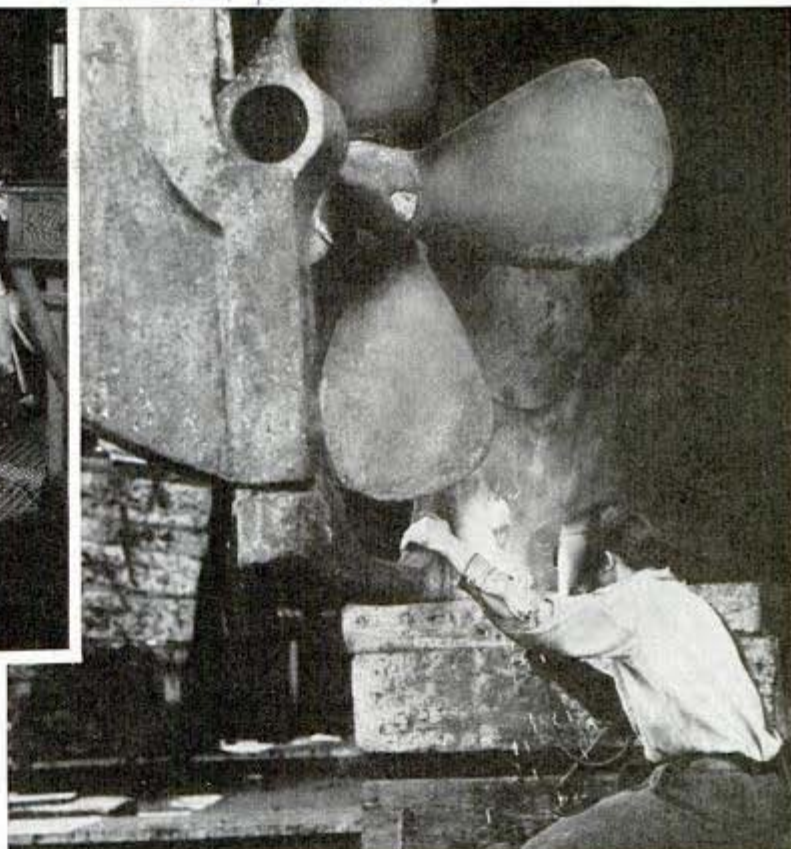

While a welder (above) repairs a coast guard cutter in drydock at the Staten Island work center and shipyard, another trainee (below) holds a white hot bar under a giant hammer in blacksmith shop. Several hundred men given experience here have moved to jobs in private industry



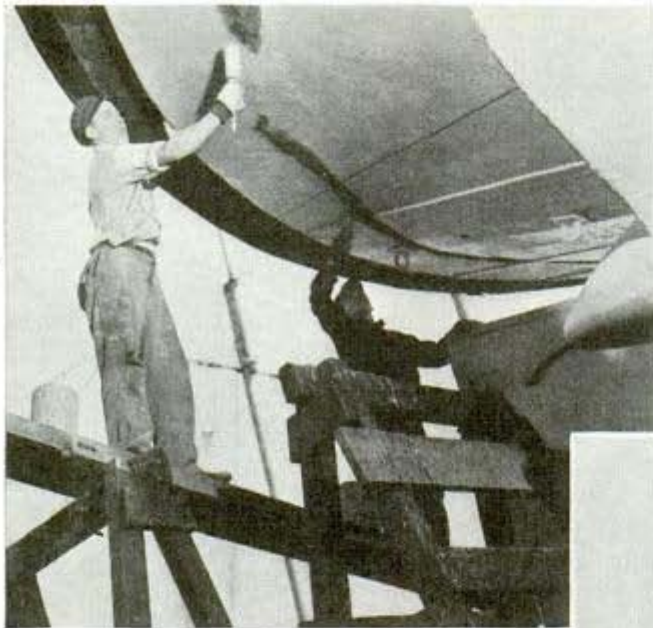

Having cleaned the hull and faired the plates of an excursion steamer used for outings of underprivileged New York children, young workers apply fresh paint

The hull of the "Colonel Clayton," right, was chipped and scaled before getting its new paint. N. Y. A. workers gave the steamer a complete overhauling

Below, one of the twin screws of the New York City excursion steamer is being chipped and repainted by one of 900 young men assigned to the Staten Island work center and shipyard for practical experience



welders. A report by the Bureau of Labor Statistics of the Department of Labor indicates that shipyards will be grabbing such trained specialists right up until November, 1942, which gives any young man plenty of time to get the necessary knowledge so that he can go to work in a shipyard and add the specialized experience his job will require.

Uncle Sam himself has figured out the other way to train ship-

yard workers. While the number thus far turned out is only a drop in a bucket compared with the 10 to 15 thousand new shipyard men needed every month, the plan has proved so successful it is going to be expanded from New York City, where it was tried experimentally, to cities along the Atlantic Coast, the Gulf of Mexico and on the Pacific Coast.

An executive in the National Youth Administration conceived the double-barreled idea—first, of grabbing off an old shipyard on Staten Island, employing veteran shipyard mechanics as foremen and giving thousands of young men the chance to learn shipbuild-

2826

21174

ing by work on ship repair. The second angle was to let the novices get their skill by repairing vessels of the navy, coast guard, maritime commission and the City of New York. This would relieve other shipyards trying to digest Uncle Sam's order for 312 emergency cargo ships and hundreds of other craft.

As a result, the man who conceived the idea, Harold C. Baker, is operating the most unusual shipyard in the world.

While other shipyards are clamoring for men, this one is glad to have a labor turnover and is anxious to get rid of its best workers as soon as possible.

At first, the officials in charge of government vessels needing repairs were hesitant to trust their craft to the yard, but after a few cutters and patrol boats had been overhauled and sent off shipshape by the eager young men and their competent veteran foremen, the skippers of damaged ships began making applications in such number that a long waiting list now exists.

More than 1,000 trainees between the ages of 17 and 24, are now on the job, working under 90 instructors with an average experience of 30 years. Vessels ranging from launches to 250-foot craft, including cutters, patrol boats, scows and tugs are moving in and out of the drydocks at a rate of 16 to 18 a month.

A waiting list exists for trainees, too, because it has gotten around that a physically able and fairly intelligent young man, regardless of his education, can draw \$25 a month and his lunch, plus medical services, while he works six hours a day, five days a week for three months. If he is exceptionally intelligent and willing, or has had some specialized experience, he is likely to be put to work at good pay in a shipyard before his training period elapses. He also receives related classroom training.

A man who has had no special practice at any of the occupations valuable in a shipyard is likely to find himself spending the first few days chipping rust and barnacles off a steel hull with hammer and chisel.

As soon as the novice gets familiar with the shipyard, he usually expresses a desire to become a specialist, such as a welder, or a blacksmith, or a joiner. If he seems apt at the occupation he suggests, he is placed in a position where he can learn by doing.

If he decides to be a chipper or scaler, he is likely to find himself, first with hammer

(Continued to page 174)

FEBRUARY, 1942

Fluorescent Lamp Is Bent Without Impairing Light

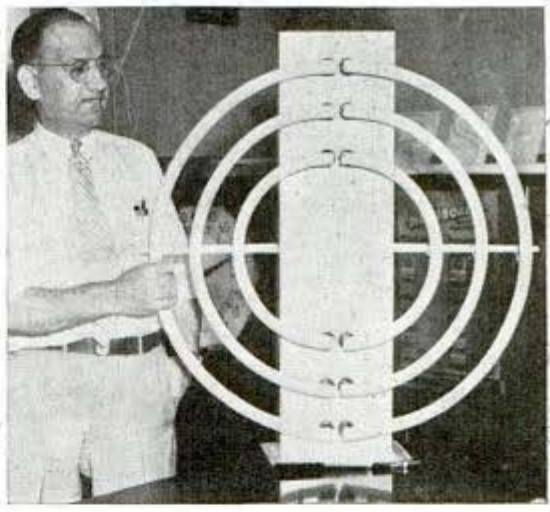

Circles can be formed by bending fluorescent tubes

Fluorescent light tubes now being manufactured may be bent into any shape, even in a complete circle, to meet individual requirements. The fluorescent powder is fused permanently into the tube by a 15,000-volt charge, so it does not crack when the tube is bent or twisted. In addition to its bending properties, the new lamp is said to last 1,000 hours longer than former tubes, it gives two and one-half times as much light, lights immediately without a "warming up" period, and operates in temperatures 20 degrees below zero.

Rubber Pneumatic Door Silencer Stops Rattling and Slamming

Tiny rubber silencers for doors are available to prevent noises of slamming and latch rattle. Hardly noticeable when installed, they are effective for use in homes, hotels, hospitals and public buildings. They are made of live molded rubber



and are anchored in holes drilled in the stop-strip of the door frame. The silencer forms a cushion with an air pocket beneath, assuring sufficient tension when the door is closed.

Everhite Electric Co. Inc. 1440 N. 4th St. Milwaukee Wis.

Wm. Johnson Corp. 1821
Bertan Co.
95
Мітраскі запісанні ў гісторыі прэсы

2110 2

Vibrating Reed Takes Pulse Of Industrial Machine



Testing a machine with the meter's vibrating reed

Quick diagnosis of vibration troubles in machinery can be made with a simple meter recently developed. No larger than a foot ruler, it consists primarily of a thin strip of spring steel, called the reed, clamped between two pairs of small steel rollers. In making a test, the meter is held against the "ailing" machine and a knob turned to extend or retract the reed until it is "in tune" with the machine's vibrations. A scale on the back of the meter then shows the frequency of the vibrations, and from this the engineer can usually identify the cause of trouble.

21136

Pan Insert for Steaming Foods Adjusts Self to Fit Any Size

Foods can be steamed in an ordinary cooking pan with the aid of a self-adjust-

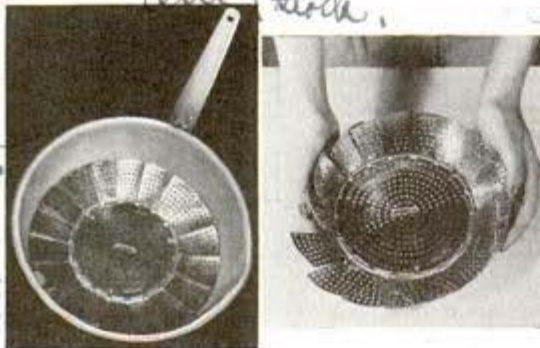

Left, steamer in large pan; right, how "petals" fold

ing "bottom" that raises the food above the bottom of the pan so that it cannot burn. The unit is a perforated disk surrounded by a series of overlapping leaves which fold upward like the petals of a flower when they strike the sides of the pan. In this way the steamer "shrinks" when it is placed in a smaller pan. Three legs supporting the disk allow space beneath for the boiling water.

21017

Buoyant Safety Belt Inflates Itself With Gas Stored in Cartridge

For the safety of sportsmen, loggers, bridge workers and others who face the risk of falling into deep water, a self-inflating belt may be worn that will support a 250-pound man in the water for 24 hours. Pressing a section of the belt at left of the buckle fills it with gas immediately, as this



Squeezing belt, top, releases gas from cartridge

forces a pin into the cartridge head and releases the gas which is stored under pressure. If desired the belt may be inflated by blowing through a tube fitted with a valve. A snap arrangement allows the belt to fit neatly around the waist for ordinary wear, but when inflation takes place these snaps give way, permitting the belt to become fully distended.

Look in the index to find where to buy articles described in this magazine. Say You Saw It in Popular Mechanics.



The CRAFTSMAN

Grille-Door Bookcase Has Whatnot Shelves at Ends

SIMPLICITY of this grille-front bookcase, with its flanking niches, Fig. 1, makes it so attractive. Enameled white to contrast with books and pottery, or beautifully finished in walnut, it will harmonize with most furnishings.

Fig. 2 shows how the main members of the case should look after they are cut. Note that shelves Nos. 2 and 3 are recessed across the front to receive the doors, and that a right and a left-hand side are required. The rabbeted edges can be cut neatly by hand by clamping a guide strip to the work and chiseling carefully to the proper depth. When cutting the half-lap notches be sure that a snug fit will be had when the two parts are slipped together. Fig. 6 shows the case partly assembled, the shelves being glued, and then nailed to the sides from below in the manner shown in the detail above Fig. 7. Each shelf fits flush with the rabbet at the back, Fig. 5, while the pieces covering the back of the niches are placed even with the back edge of the sides. You will notice in Fig. 3, that



- MATERIAL LIST**
(white-pine stock)
- 5 pcs. $\frac{3}{4}$ x 9 x 46 in.—Shelves
 - 2 pcs. $\frac{3}{4}$ x 9 x 42 in.—Sides
 - 2 pcs. $\frac{3}{4}$ x $8\frac{1}{4}$ x $42\frac{3}{8}$ in.—Corner backs
 - 1 pc. $\frac{1}{4}$ x $28\frac{1}{4}$ x $42\frac{3}{8}$ in.—Plywood back
 - 1 pc. $\frac{3}{4}$ x $8\frac{1}{4}$ x 34 in.—Corner base pieces
 - 1 pc. $\frac{3}{4}$ x 3 x 28 in.—Front base piece
 - 1 pc. $\frac{3}{4}$ x 9 x $28\frac{1}{2}$ in.—Door frame
 - 2 pcs. $\frac{1}{8}$ x $12\frac{1}{2}$ x 27 in.—Door grilles
 - 1 pc. $\frac{1}{8}$ x 3-in. plywood strip for base

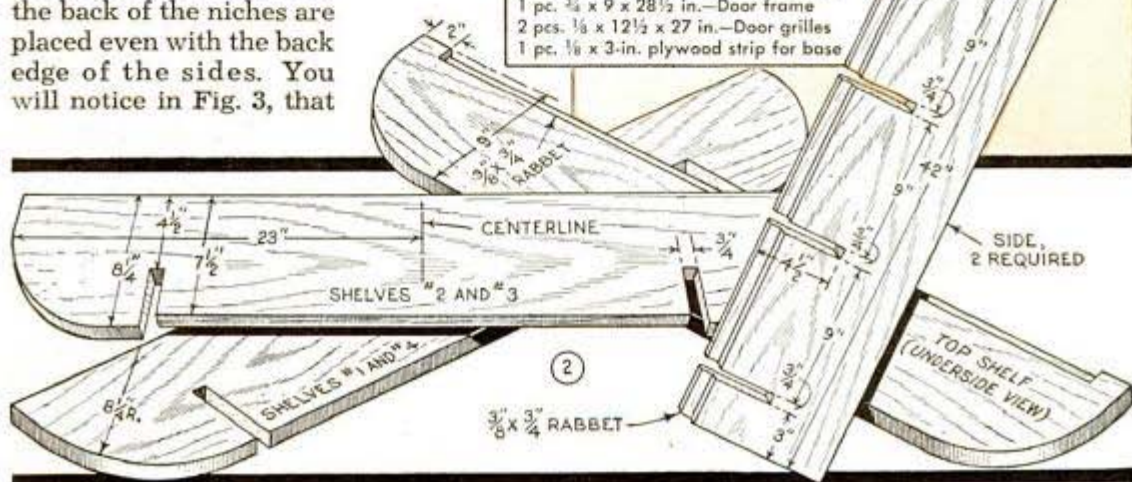

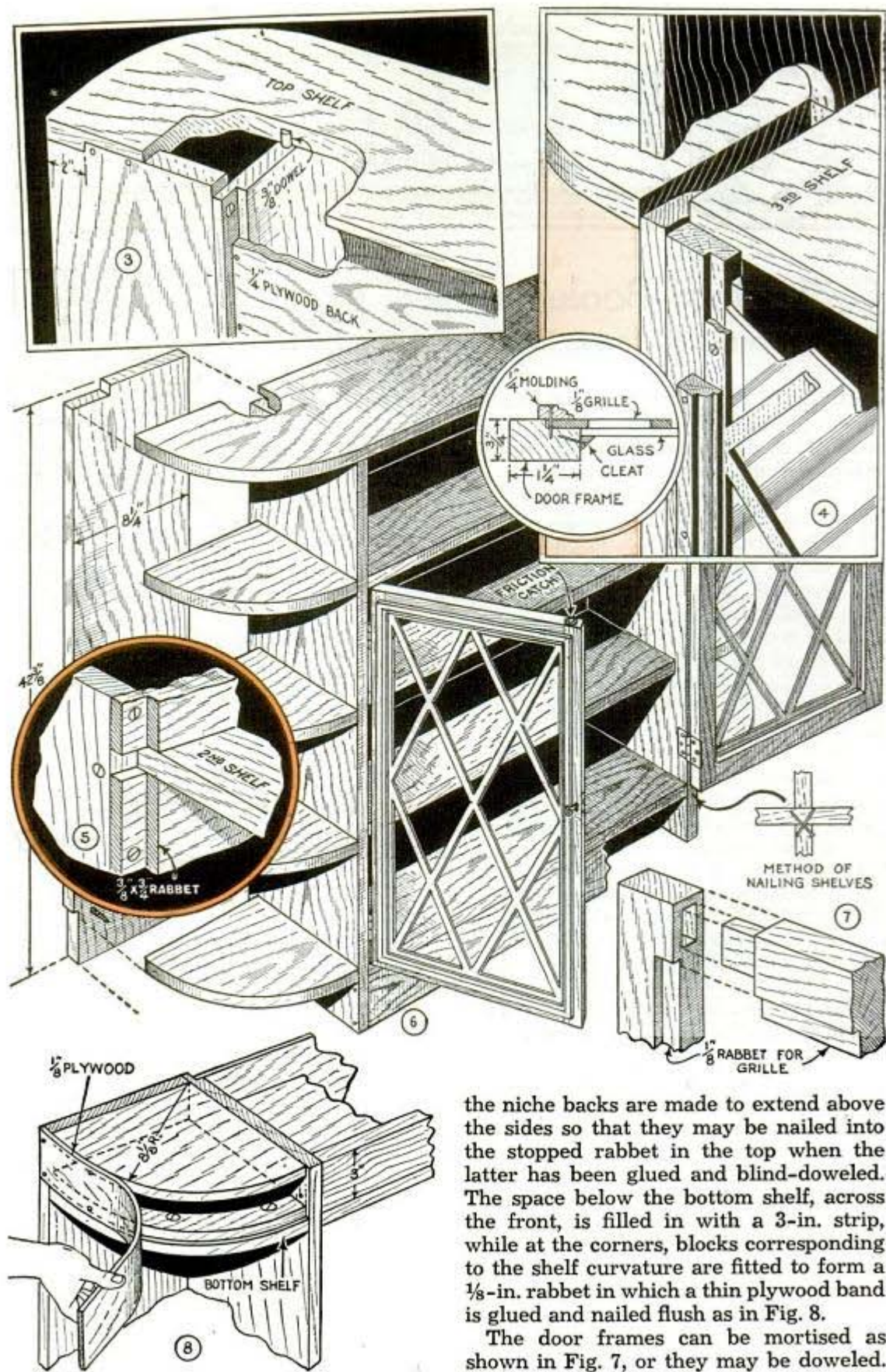

the niche backs are made to extend above the sides so that they may be nailed into the stopped rabbet in the top when the latter has been glued and blind-doweled. The space below the bottom shelf, across the front, is filled in with a 3-in. strip, while at the corners, blocks corresponding to the shelf curvature are fitted to form a 1/8-in. rabbet in which a thin plywood band is glued and nailed flush as in Fig. 8.

The door frames can be mortised as shown in Fig. 7, or they may be doweled.

The rabbets need not meet perfectly at the corners as they will be covered later with a mitered molding placed over the screws holding the grille. See Fig. 4. After the grille has been cut from $\frac{1}{8}$ -in. plywood, the edges of the fretwork strips can be sanded to a uniform width of $\frac{1}{2}$ in. with a bevel-edge block to get into the corners. The doors are trimmed and hinged to swing between the two shelves, after which they are fitted with glass, using a small quarter-round molding on the inside to hold it in place. An elbow, and a friction catch can be used to keep the doors closed, while the key of a small mortise-type lock will serve as a handle.

Rugged Bar Clamps Made From Auto Tie Rods

Tie rods having left and right hand threads on the ends can be made into handy bar clamps. Metal plates welded to the ends form the jaws, and two pieces of angle iron welded to the center section provide a shoulder for tightening the clamp with a wrench. Although the jaw spacing of such a clamp is rather limited, its inexpensive construction will permit making up several of them of different widths, by cutting a section from the center and then welding the severed ends together.

—C. W. Tanner, Cranston, R. I.

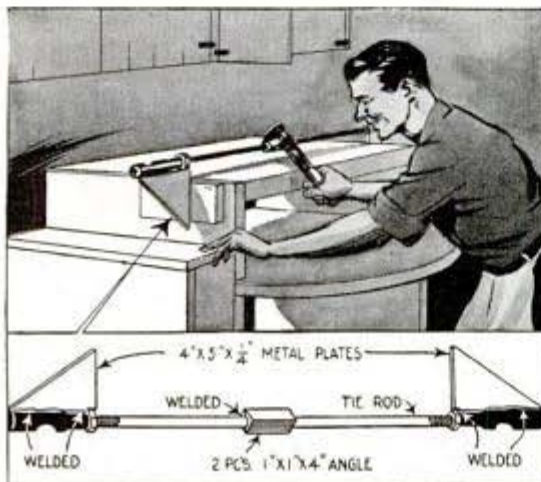

Attachment for Vanishing Points Beyond the Edge of Board



The problem of drawing perspectives when the drafting board is not large enough for a long vanishing point, is solved by this simple attachment. It consists of a wood arm having pegs at 6-in. intervals to serve as vanishing points. The arm is fitted at one end with a piece of metal drilled for attachment to the screw of a camera tripod, which supports it. The other end is fastened to the drafting board with a C-clamp.

—Harold M. Haag, Elyria, Ohio.

Nail Aids in Driving Cotter Key

When driving a cotter key in a hole where the fit is snug, you can avoid crushing the eye of the key by using a nail. This is slipped through the eye of the cotter key to reinforce it and prevent it from folding together.



Solving HOME



Heat from a register is deflected toward a chair by setting a metal card table over the register as shown

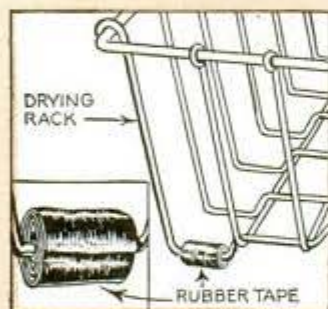

Drying racks for dishes slip less in the kitchen sink if some rubber tape is wrapped around the lower corners

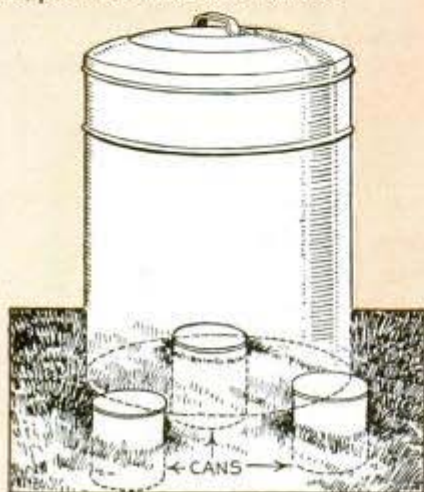

Inverted tin cans are ideal for leveling a garbage can on rolling ground, and elevating it to prevent the bottom from rusting out

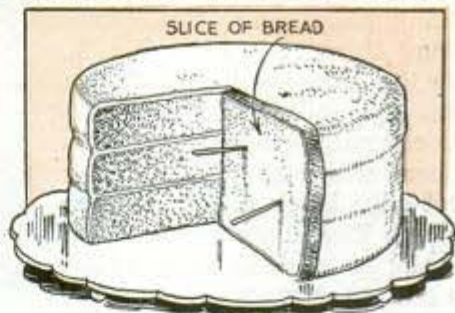

Cakes will remain fresh much longer after cutting if slices of bread are pinned to both cut sides with toothpicks



Your wringer stick will always be at hand if a vacuum cup is attached to one end so it can be pressed against the tub when not in use

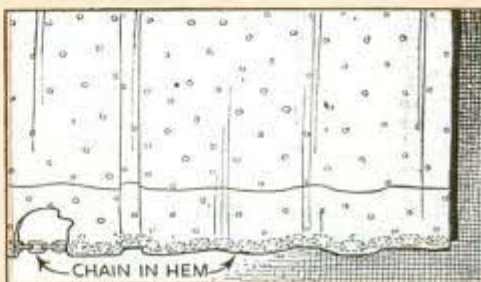

To prevent curtains from blowing out the window and becoming soiled, insert a small chain in the hem. Paint or lacquer on the chain will keep it from staining the curtain

PROBLEMS



You can exert more pressure on a stubborn jar lid without slipping if a strip of sandpaper is wrapped around it



Turned upside down, a chest or dresser drawer makes a handy table at convenient height for typing



Scratches and worn spots on porch floors caused by racking chairs can be avoided if you tack felt weather-stripping on the rockers



If the nap has worn off your rug in front of a davenport or chair, making noticeable spots, mix dye the color of the rug, and apply it to the worn spots with an insect sprayer

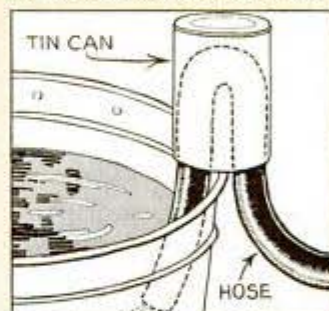

End of filling hose is held on the washtub by looping the hose and slipping a tin can over it

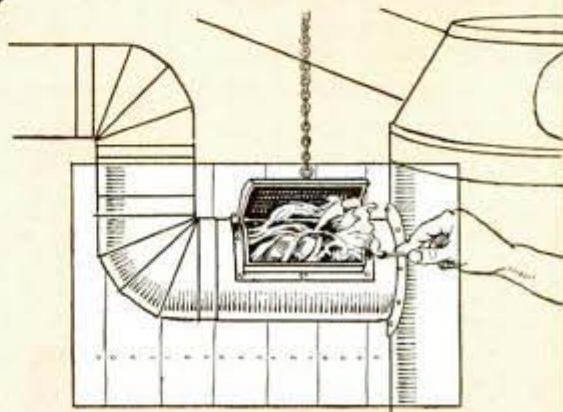

When occasional furnace fires are started in the spring or fall, and heavy air in the flue causes poor draft, smoking can often be prevented by first stuffing a newspaper in the check draft and igniting it

Head of Nail Serves as a Nail Set In an Emergency

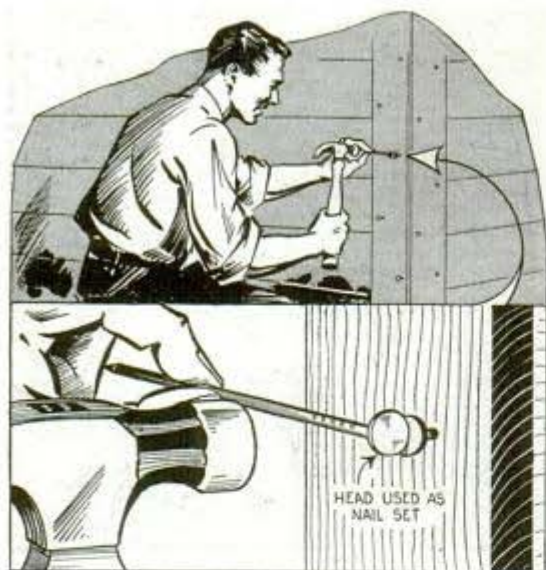

The next time you are making a simple repair around the home that requires the use of a nail or two, and you do not have a nail set at hand just use the head of a loose nail as shown. This, of course, is recommended only where the work is not too critical.—Opie Read, Jr., Chicago.

Tool Compresses Edges of Planks To Make Tight Boat Seams

By compressing the wood along the edges of boat planking before screwing it in place, you can get exceptionally tight seams. When the compressed portions of the planks get wet, they swell to resume their original positions and make a tight seam. A good tool for compressing the planks is made from a piece of hardwood

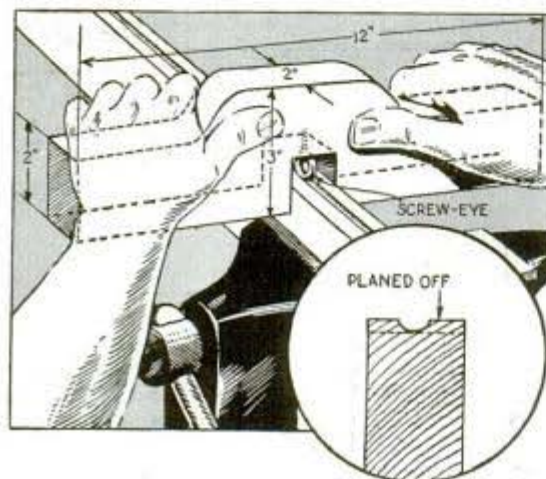

cut to the shape shown and fitted with a screw eye to serve as the compressor. After a groove has been compressed in the plank, the edge is planed down flush with the bottom of the groove.—George W. Neidermair, West New Brighton, N. Y.

Brush Fastened on Paste Jar With Rubber Band

You will never have to hunt for the paste brush if it is slipped under a rubber band snapped around the jar. If necessary, two bands can be used, spacing them an inch or so apart to keep the brush in a vertical position with the end projecting above the jar cover.



Horseshoe Is Practical Handle For Heavy Cans of Oil



When it is necessary to carry a heavy oil can about the farm, slip one side of a discarded horseshoe through the wire finger loop usually provided on such cans. The horseshoe will give you a comfortable handle for carrying the can, also one that is easily removed when not in use.

Simple Way to Hold Garden Hose While Filling Pail

Here is an unusually simple way to hold the end of a hose in a pail while filling it. Just insert the hose end through and around the bail while it is held in vertical position, ending with the end of the hose pointing downward into the bucket.



AT A glance this candy bowl appears to have been turned from a built-up block of several pieces. However, it consists of several concentric rings and a small disk scroll-sawed from two pieces of $\frac{3}{4}$ -in. wood, the rings being pulled out to form the cone-shaped body and the inverted cone-shaped base. The circular detail shows clearly how the taper compensates for the saw cut. If you use a fine blade and are careful in sawing to line, the edges of the rings will fit perfectly, requiring little sanding before finishing with filler, shellac and varnish. The first thing you do is to draw five concentric circles for the bowl part, making the outer one a little wider for the rim as indicated. After this, a tiny hole is drilled straddling each line for inserting the saw blade. The sawing is done with the table tilted 10 degrees. For the two-ring base you follow

Telescoping CANDY BOWL

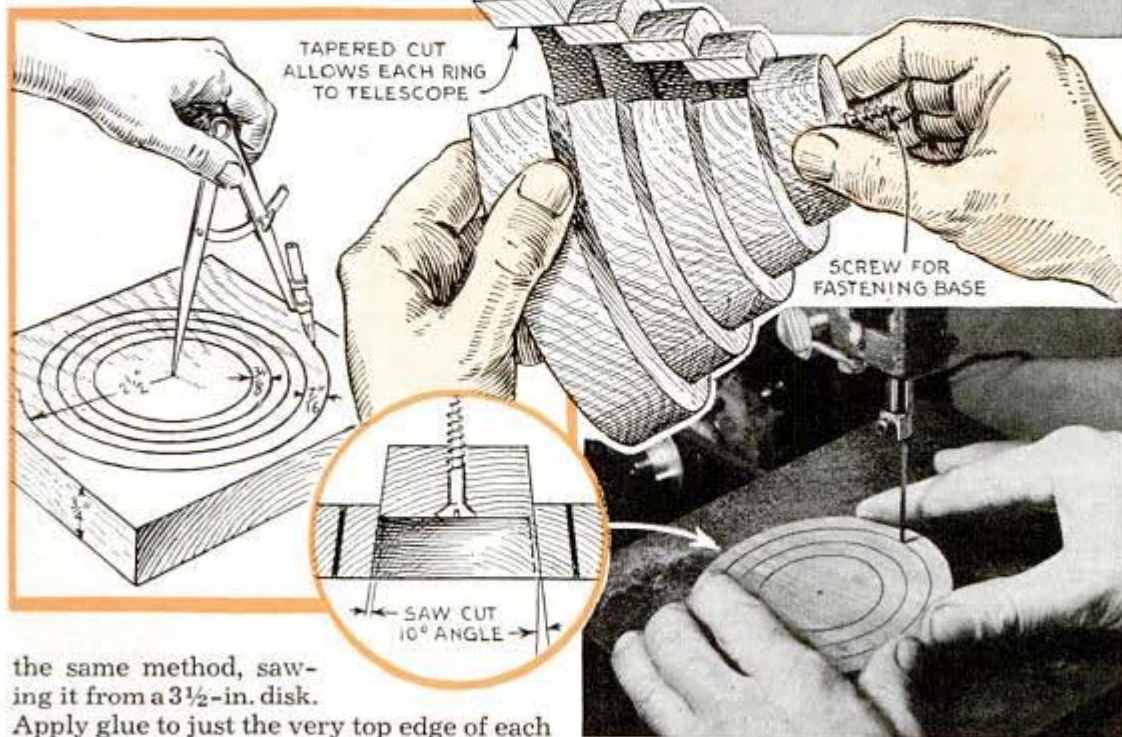

the same method, sawing it from a $3\frac{1}{2}$ -in. disk.

Apply glue to just the very top edge of each ring to avoid getting glue on the exposed end grain which would spoil the finish.

You do not have to stick to plain circular shapes—you can add variety by cutting the rings triangular, square or oval shape, and by varying the cuts from straight lines to scallops. Lamp bases, urns for artificial flowers, fruit dishes, etc., are a few of the many articles that can be made by this economical method of construction.

—Benjamin Nielsen, Aurora, Nebr.

Save That Broken Nail Set

Don't throw away that broken nail set just because the cup point may be broken off. It can be made practically as good as new simply by regrinding it to its original size, and then cutting a nonslip surface on the flat end of the point by standing it on a mill file and striking a sharp blow, after which it is turned 90 degrees and struck again.—James H. Gosch, Scotia, N. Y.

Dog Won't Tear Off Bandage If It Is Soaped



If your dog has a bandaged leg or foot and tears off the bandage with his teeth, wet a cake of soap and rub it over the bandage as indicated. A dog does not like the taste of soap and therefore will not bother the bandage.

—William Swallow, Brooklyn, N. Y.

Toy Steam Engine Is "Fired" By Cigar Lighter

Instead of heating a toy steam engine with the usual alcohol lamp, which needs constant attention, remove the lamp and



install a cigar lighter. In making the installation, take care to insulate the lighter and wires from the metal parts of the engine so that there will be no possibility of a short circuit.

—Geo. Kilpatrick, Jr., Drexel Hill, Pa.

Repair for Porcelain Tanks

A porcelain flush tank that has been cracked can be repaired temporarily until it can be replaced with a new one, by using resin glue. First, be sure to dry the tank thoroughly inside and out. Then apply the glue to the crack with a brush and rub it into the fracture thoroughly with the fingers. Wipe off the excess glue and let the repair dry for 24 hours before allowing water to run into the tank.—Hi Sibley, Pasadena, Calif.



Penny Bank From Rubber Ball

You will be surprised what a dandy little penny bank you can make from a hollow rubber ball. Just cut a slit in it to take a coin snugly. Any possibility of a child removing the coins from the ball is very remote because it is a difficult job. The natural tendency of a child would be to squeeze the ball in order to widen the slot, but this tends to shorten the length of the slot and the coins will not come out.



One simple way to separate tough clumps of peonies is to drive two garden forks, back to back, into the center of the clump and then push the handles in opposite directions. If this is done carefully it will split the clumps apart without destroying the eyes.

How to Alter and Repair SLIDE FASTENERS

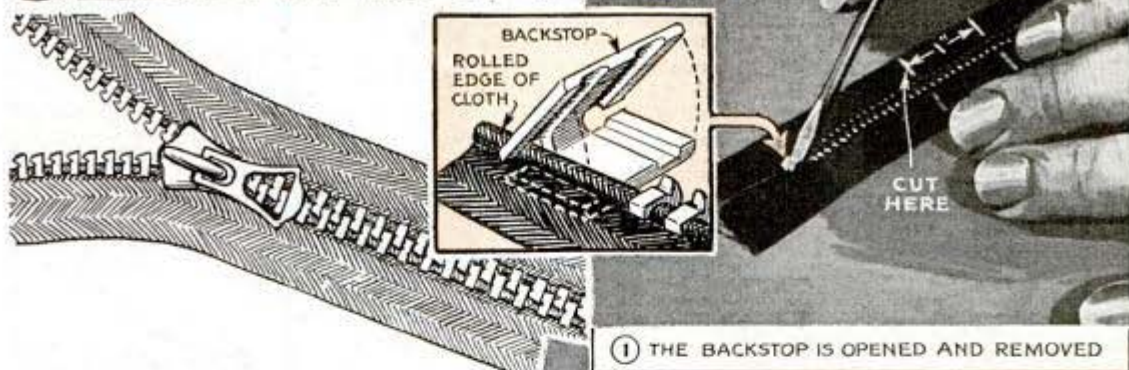

A SLIDE fastener that does not work properly can be repaired by anyone, once its construction is understood. First, examine the fastener carefully. You will notice that it consists of two strips of fabric to which are attached the metal parts. The teeth, which are fitted to engage each other when brought together, are clamped to the edge of the fabric, Fig. 3. At the bottom of the fastener is a metal clasp that bridges the two strips of fabric, clamping down over both rolled edges to hold the two halves together. This clasp also acts as a stop for the slide. At the other end of the fastener are two metal clasps forming a stop for the slide.

When it is necessary to shorten a slide fastener, first mark off the desired length. Then make a second mark about 1 in. below the first to allow some extra material. Next, remove the backstop, Fig. 1, by prying it open. The next step is to cut away the rear part of the fastener up to the second mark, and remove all the teeth from the rear of the remaining part up to the first mark, Fig. 2. To remove a tooth, it is only necessary to grip the end with a pair of long-nosed pliers and pull it away from the material, as in Fig. 4. The fastener can be re-assembled by slipping the two ends into the slide, Fig. 7, and drawing this up until the teeth are properly engaged. The backstop is now replaced and clamped down over the two edges of the material with long-nosed pliers.

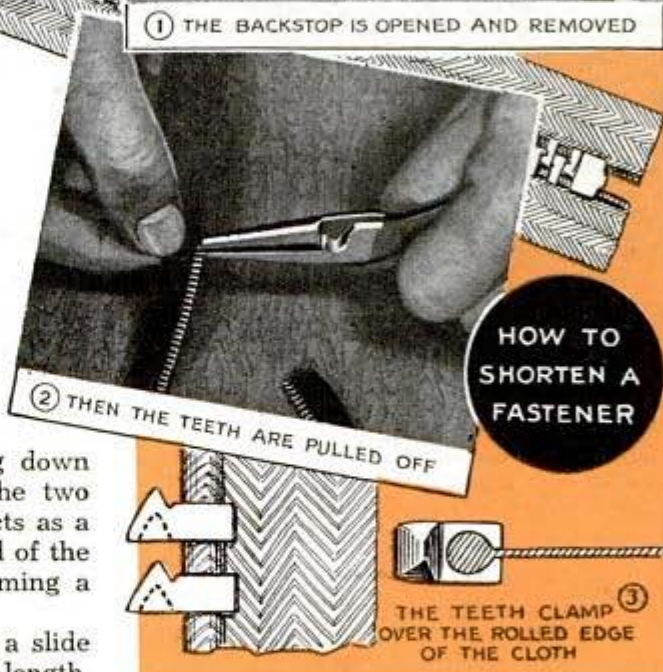

Knowing how to do this much, it is a simple matter to repair a fastener that has become damaged. One of the most common troubles is where the closed portion of the fastener has opened up due to a missing tooth, Fig. 5. In this case, it is necessary to replace the missing tooth by removing one from the end and clamping it in place. After removing the tooth, the forked opening is spread so that it can be slipped over the rolled edge of the fabric, Fig. 4. In most cases, the fastener can be closed by grasping the slide firmly and drawing it back sharply until it hits the open part. This will close several of the teeth, and if repeated several times, will eventually close all the teeth.

Should the accessory be of such a design

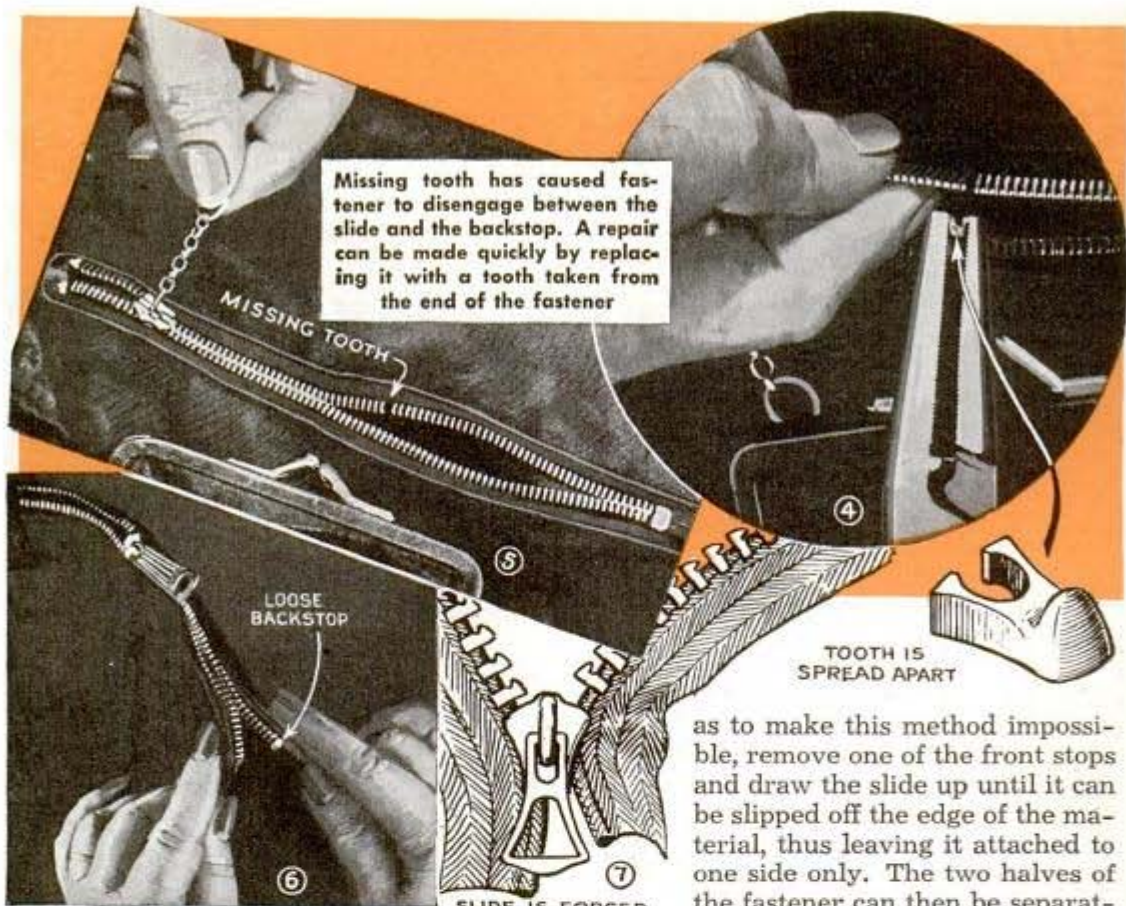

Loose backstop caused this fastener to open at rear. Repeatedly moving the slide against it will usually close it



The fastener shown on the sport jacket above has been improperly closed. The combination backstop has not been fitted together before closing the fastener with the result that it has been opened at the rear end as shown in the photo at the right



If the lining of a garment gets caught in the fastener, remove the front stop and the backstop, spread the fastener apart, remove the lining, and then reassemble. This is much better than attempting to force the slide back over the tangled area to free the lining. Fig. 6 shows a fastener that has become opened in the rear due to a loose backstop. To repair this the backstop should be removed and the fastener closed by drawing the slide back sharply several times.

In Fig. 8, a sport jacket has been improperly fastened. Fig. 9 shows the result. The fastener has become opened at the rear. The backstop in this case is a combination of two parts which must be fitted together before the fastener can be closed. If a slide moves freely back and forth without fastening the two halves, it has become spread. Remove the backstop and the slide, and with a pair of pliers, bend the slide back into its original position.

This Dutch-Girl Tray Holds Six Beverage Glasses

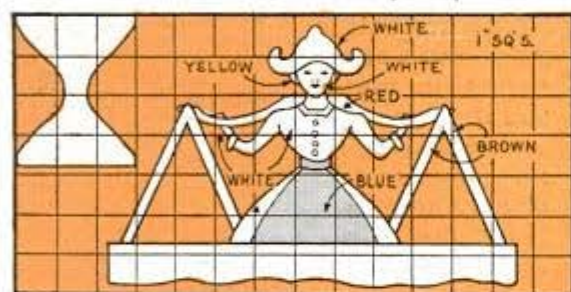
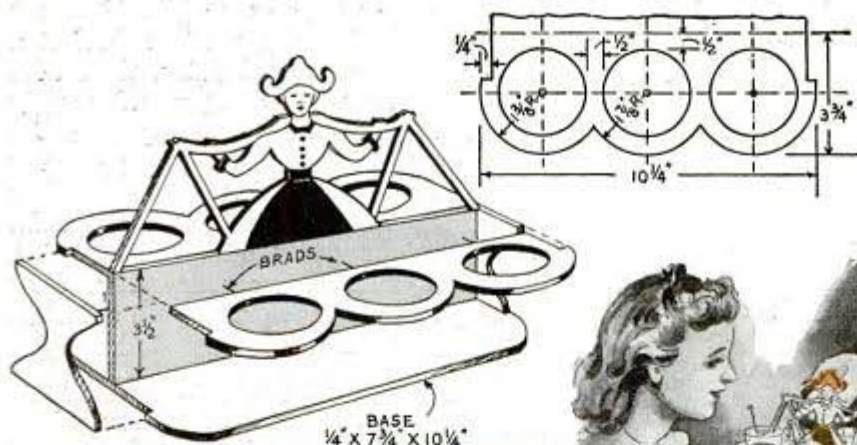

Made entirely of $\frac{1}{4}$ -in. plywood, this unusual carrying tray which holds six beverage glasses has a Dutch-girl cutout that serves as a decorative handle. Parts are assembled with glue and brads, while the shape and method of fitting the end pieces provide rigid bracing. Although the entire tray can be varnished, painting the cutout as suggested will make it more attractive



Pictures Are Hung Straight With Improved Plumb Bob

It's a simple matter to straighten large pictures on a wall when an improved plumb bob of the type shown is used to line up the edges. All you need to make one is a nut and a piece of string slightly

longer than the height of the largest picture. In use, just grasp the string near the upper end with the right hand and hold it against the wall near one side of the picture frame, which leaves the left hand free to adjust the picture until the edge is parallel to the string.

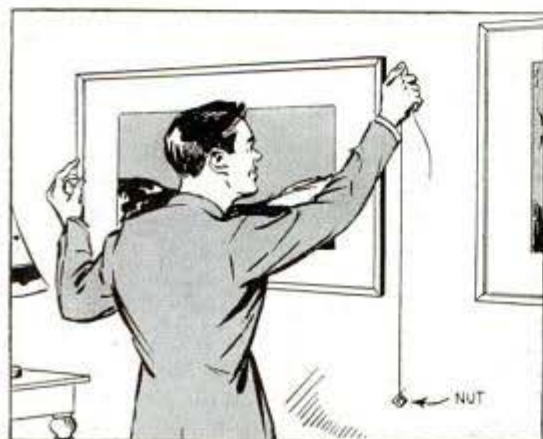

Rustproofing Metal Fixtures

Mix a good grade of clear synthetic resin with lamp black or any colored pigment and apply two heavy coats to all metal that is exposed to the weather to insure longer rust-free life. For electrical fixtures that might oxidize and discolor outside paint or stucco, use the same clear synthetic resin without any coloring added. Two coats will be sufficient.

—Dana Anderson, Topeka, Kans.

Crayon Marks Help to Hold Rule While Cutting Glass



To help keep a rule or straightedge from slipping while using it as a guide for a glass cutter, make heavy marks on the glass with a wax crayon. This will afford sufficient friction to hold the rule in place.

—G. E. Hendrickson, Argyle, Wis.

Bird Feeder From Mixing Bowls



Here is a simple bird feeder that anyone can make with little work. It consists of two wooden mixing bowls, one about 2 in. larger than the other, and a length of large dowel. Three drain holes are drilled in the smaller bowl, after which both

Tinting and Matching Paint

bowls are attached to the ends of the dowel with screweyes as shown. The feeder can be suspended between two tree branches.

While mixing your own paint colors, don't tint the entire amount needed at once, but stir color into part of your white to avoid overtinting. After the desired shade is attained, tint balance to conform, then

mix together. If you have underestimated the amount needed, do not use all the tinted paint before trying to match it. The best way to match is to retain in a bucket a small amount of tinted paint, then take your additional white and gradually apply tinting color, repeatedly comparing the two buckets of paint by dipping stirring paddle from the new batch into the first mix so that both mixes appear on paddle. If there is danger of running short of paint, break off clean at a corner. Any slight shading variation then cannot be detected.

Chucking Thin Metal Washers For Turning in a Lathe

The next time you have some very thin metal washers or disks to machine, here is an easy way to chuck them in a lathe. Just solder each one to the end of a piece of rod or shafting and then chuck this in the lathe. The solder is melted to remove the work from the shaft. Fiber or plastic may be handled in a similar manner by gluing it to the end of a hardwood rod.



Cards Are Held Vertical in File By Spring-Wire Stop

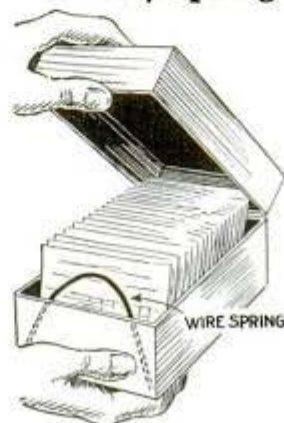

If cards kept in a hinged-box file have a tendency to fall forward and interfere with closing the cover, a spring-wire stop will prevent this trouble. The wire is bent to the shape shown and inserted in the front of the box.

When cleaning "washable" wall papers, make heavy suds, using warm water and a mild soap, and apply it with a clean cloth. Do not let suds remain on paper too long.

Decorative Lamps From Two Simple Turnings



Used in pairs, these lamps are neat on a dressing table, and they can be turned from wood

to match the room furnishings. Each one consists of a disk standard and base, the hexagonal one being shaped by sawing or sanding the flat surfaces on the disks. After turning the standards, they are bored out in the center and then are drilled from edge to edge for a lamp cord and nipples on which to screw lamp sockets. When the cords have been installed in the base and standard, the two are assembled with dowels, and turned rosettes are glued over the openings in the standards. Wood of a contrasting color is used for making the rosettes.

—Dale Van Horn, Lincoln, Nebr.

Adjustable Light Over Workbench Slides on Taut Wire

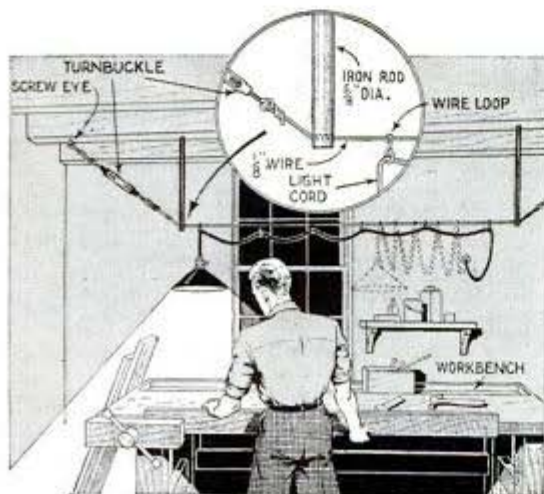

It takes only a second to move this adjustable light over any section of the workbench as it slides on a taut wire fastened to a joist. Two $\frac{5}{8}$ -in. rods hold the wire at a convenient height, and a turnbuckle connected near one end provides a means of tightening it. Several wire loops or rings spaced along the lamp cord prevent it from sagging.

☞ The greenish corrosion usually found on storage battery terminals provides an effective flux for soldering cast iron. The iron must first be scraped to a shiny brightness and then coated with the corrosion, which provides a copper base to which the solder will adhere.

WOOD CHEST and BELLOWS

NOTE, DOOR IS OPENED BY PULLING UP TO CLEAR BASE MOLD, THEN SWINGING OUT AS AT (B). WHEN DOOR IS HORIZONTAL IT IS PUSHED BACK TO REST ON SLIDE.

PLYWOOD OR WHITE PINE, USED FOR THE PANELS.

TOP, 3/4" x 17 3/4" x 30 1/4" FOREST GREEN
 1/4" SECURED TO CASE WITH 20 FINISH NAILS
 NAILS SET & PUTTIED

EDGE-BLACK
 RAIL 3/4" x 1" x 27"

DOOR HORIZONTAL
 DOOR SLIDE
 EDGE ROUNDED

1/4" PLYWOOD OVERLAY
 1/2" PLYWOOD RECESS-LIGHT GREEN

DOOR 3/4" x 18" x 27"
 HANDLE
 EDGES ROUNDED

BACK 3/4" x 21 5/8" x 27" NAILED IN PLACE
 CLEAT 3/4" x 1 3/8" x 25 1/2" - NAILED
 GUIDE
 CLEAT 3/4" x 1 3/8" x 14 1/2"

MITERED
 MOLD 3/8" x 1 3/4" x 16 3/4"
 END 3/4" x 1 1/2" x 21 5/8"
 SIDE-FOREST GREEN

BASE 3/4" x 14" x 17 1/2" BLACK
 CORNER MITERED

3/4" x 4" x 30" BASE
 BACK BASE IS IDENTICAL

DETAIL OF DOOR

DETAIL OF RECESS IN DOOR PANEL

DOOR
 2"
 1" SQUARES
 27"
 16 1/8"
 2"

TOP OMITTED FOR CLARITY
 TOP MOLD

END SLIDE 3/4" x 1 1/2" x 14 1/2"
 1 1/2" R
 GUIDE 3/4" x 1 1/2" x 14 1/2"
 RAIL 3/4" x 1" x 27"
 3/8" SPACE
 (INSIDE OF DOOR)
 DOOR 3/4" x 18" x 27"
 1/2"

BOTTOM 3/4" x 15 1/4" x 27"
 CLEAT
 BASE
 DOOR-SLIDE DETAIL
 CLEAT BASE

MATERIAL LIST

- 1 pc. 3/4 x 17 3/4 x 30 1/4 in. white pine—Top
- 1 pc. 3/4 x 21 5/8 x 27 in. white pine—Back
- 2 pcs. 3/4 x 16 x 21 5/8 in. white pine—Ends
- 1 pc. 3/4 x 15 1/4 x 27 in. white pine—Bottom
- 2 pcs. 1/4 and 1/2 x 18 1/8 x 27 in. plywood—Door
- 1 pc. 3/4 x 1 3/8 x 27 in. white pine—Front cleat
- 1 pc. 3/4 x 1 3/8 x 25 1/2 in. white pine—Back cleat
- 2 pcs. 3/4 x 1 3/8 x 14 1/2 in. white pine—End cleats
- 4 pcs. 3/4 x 1 1/2 x 14 1/2 in. white pine—Slides and guides
- 1 pc. 3/4 x 1 x 27 in. white pine—Top rail
- 9 linear feet 3/4 x 4 in. white pine—Base mold
- 9 linear feet 3/8 x 1 1/4 in. white pine—Top mold

Procedure:

1. Glue and square up top, back, ends and bottom pieces
2. Locate, nail and glue cleats, guides and slides in place
3. Assemble carcass and apply molding, mitering corners
4. Enlarge and trace door scroll. Saw opening and sand edges
5. Glue up two part door and fit in opening
6. Putty nail holes, sand and apply undercoat and enamel

for Your Fireplace

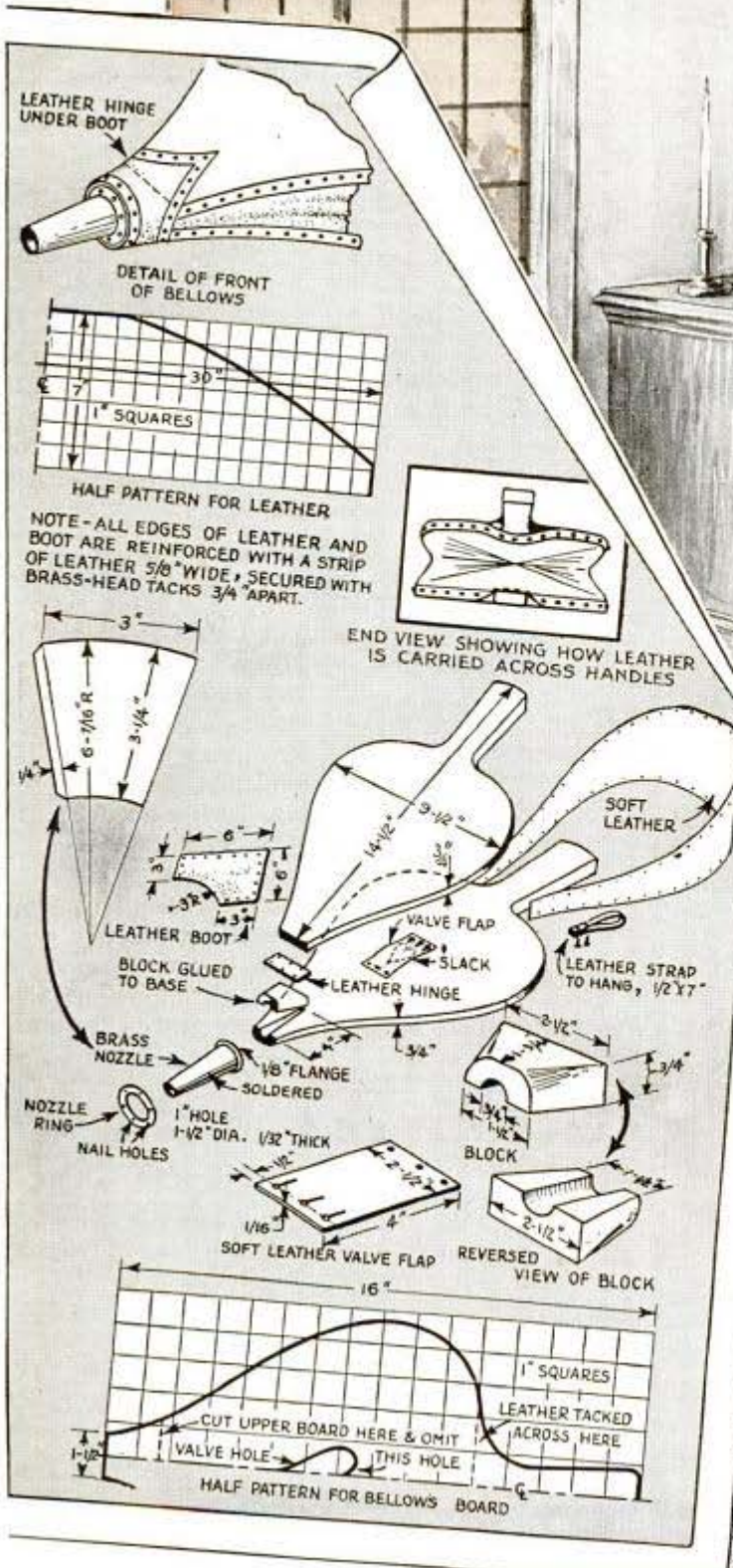
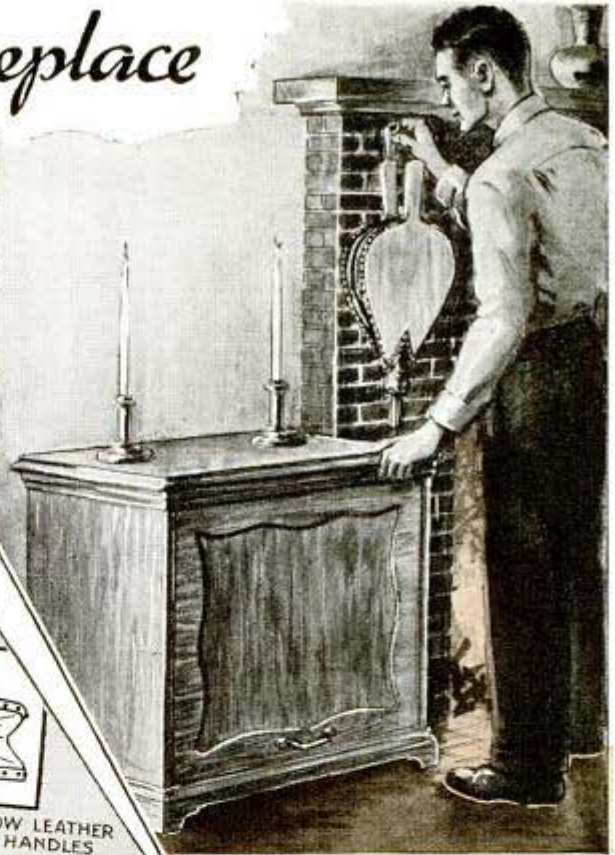

Work Lifted Easily on Sawhorse By Prying Action

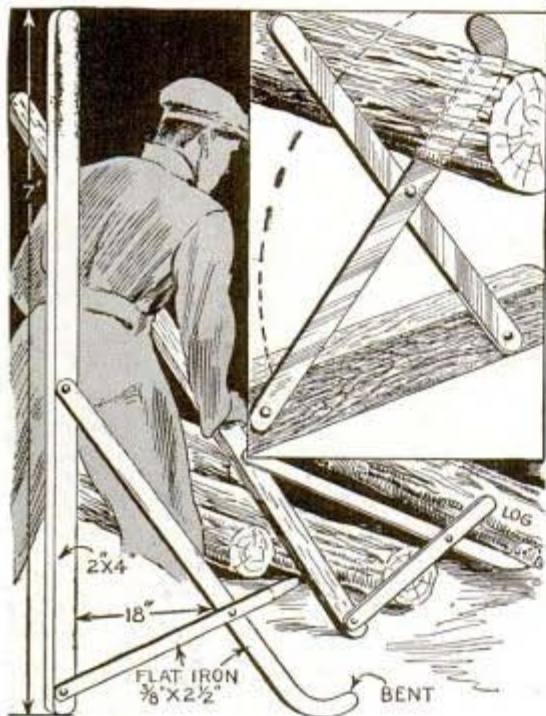

With the type of sawhorse shown, you can insert it underneath a log or other work and raise it into position for sawing. The horse consists of a couple of pieces of flat iron bent to the shapes shown and bolted to a piece of hardwood 2 by 4 stock. The two pieces of flat iron are pivoted near the top so that a fork is provided in which the work lies, one side of the fork being bent so that it can be slipped under the work to be lifted.

—A. S. Wurz, Jr., Rockyford, Alta., Can.

Keeping Firing Tools Out of Sight And Close to Stove



In order to keep the shaker and poker for my heating stove close at hand, yet out of sight, I hung them on the back of the stove. I used wire coat hangers to do this. The hangers were bent as shown, and hooked over the top of the outer casing, first re-

moving the top of the stove to get the hangers in place.

—W. E. Boswell, Greenville, N. C.

Lengthening Nails Used as Hooks To Hang Things on Walls

When a nail that has been driven into a wall to hang articles on is too short for the thing at hand, you can lengthen it by slipping a 6 or 8-in. length of small pipe over it. This idea is especially handy when it is not desired to drive long, large nails into a wall.

—Theron G. Cady, Palo Alto, Calif.



Lathe Work Centered Quickly With Tin-Box Cover

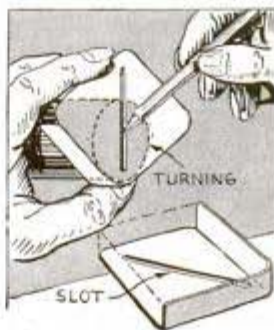

A centering gauge for round lathe-turning stock can be made by cutting a diagonal slot across a tin-box cover, such as that of a typewriter-ribbon box. The box is used by placing it on the end of the

work as shown and marking through the slot, then turning it 90 degrees and making another mark.

Pieces of Pipe Bolted Together Make Emergency V-Block

If you need a V-block to support round work for drilling and there is none at hand, you can make one from two pieces of pipe by bolting them together. The size of pipe to use will be determined by the size of work.



Crew of Two Can "Sail" in This Nursery Yacht

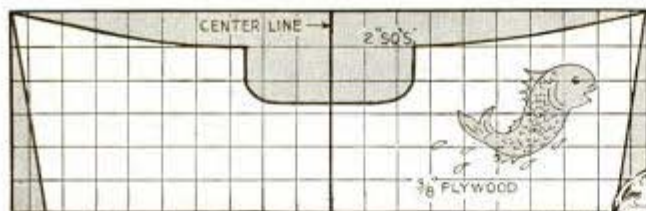

On rainy days, this rocking sailboat will provide pleasure for the youngsters indoors. Construction of the boat is simplified by using $\frac{3}{8}$ -in. plywood for sides, while the flat bottom is cut from two pieces of $\frac{3}{4}$ -in. pine. Seats are fastened to the sides with screws, and the two supporting cross members are attached to the rockers with dowels and angle-iron braces. The tapered mast, which lifts out, has a sail of alternate black and yellow cloth strips hemmed to fit the sail supports or yards, which are bolted to the mast

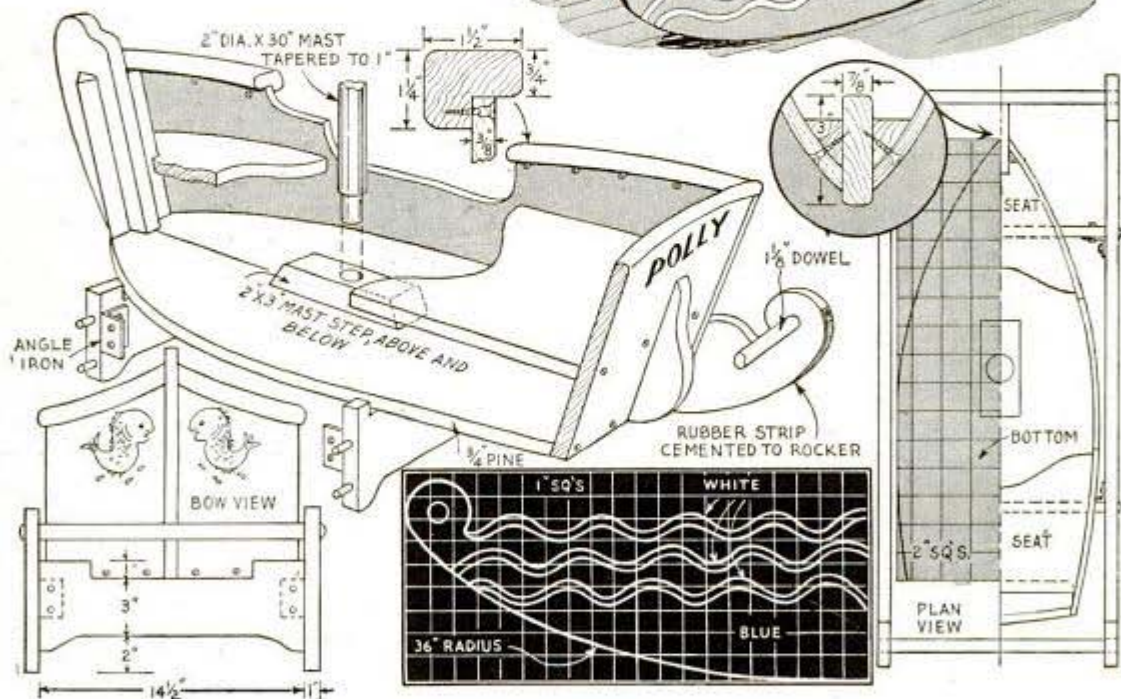

Thin Coating of Paraffin Improves Shot Used in Air Rifles

At a recent air-rifle meet, one of the contestants consistently outshot all others. Upon examining the shot used by the winner, it was found coated with a thin film of paraffin, which had been added to reduce friction and thus increase range and accuracy. To coat the shot, a small piece of paraffin was melted in a pie tin set over an alcohol burner near an open window,

after which just enough shot was added to take up most of the paraffin. The finishing touch consisted of quickly dumping the shot into a tub of cold water on the ground about 10 ft. below the open window.

☐ Slices of onion barely covered with water in the bottom of a deep bowl will tend to draw the odor of paint from a room.

This Homemade Printing Outfit Handles Work Rapidly

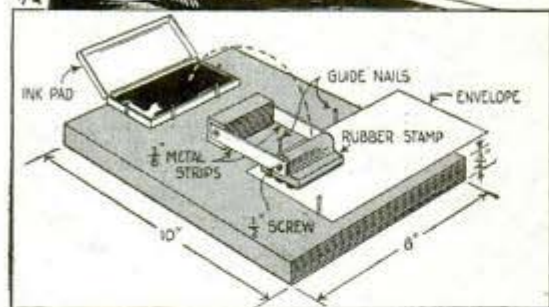

Having several hundred envelopes on which I wanted the return address stamped, I made up this simple printing set to do the job rapidly. It consists of an ordinary rubber-type printing set, the holder of which is pivoted to a block in such a position that it can be swung over on a stamp pad and then back onto the work. By arranging a couple of stop pins or guide nails so that the portion of the work to be printed will always be in the same position under the stamp, the job can be done very rapidly. Be sure to close the cover when you have finished to prevent drying of the ink pad.

—John A. Zampino, Brooklyn, N. Y.

Repellent Will Keep Insects Out of Garbage Can

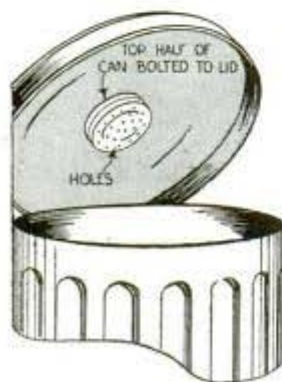

polish can is bolted or soldered to the cover, the lower part of the can is removed easily for replenishing the ammonia when-

Insects and pets will not try to get into a garbage can if there is a strong odor of ammonia inside it. A good way to keep the ammonia in it is to fasten a perforated shoe-polish can to the garbage-can cover as indicated. If the lid of the

ever it is necessary. The polish can is packed with cotton to retain the ammonia, the fumes of which are dissipated slowly into the garbage can.

—John Krill, Youngstown, Ohio.

Bolt Hung in Top of Funnel Speeds Flow of Liquids

When using a funnel to fill a container, passage of the liquid through the funnel can be speeded up by hanging a bolt over the edge as shown. This tends to prevent the liquid from whirling as it is poured and permits it to feed through the funnel neck faster with less danger of spilling.

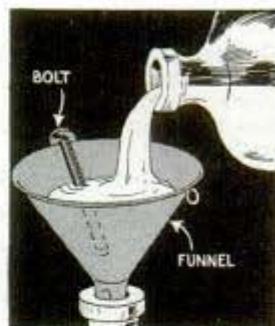

When using a funnel to fill a container, passage of the liquid through the funnel can be speeded up by hanging a bolt over the edge as shown. This tends to prevent the liquid from whirling as it is poured and permits it to feed through the funnel neck faster with less danger of spilling.

Improvised Tool Is Handy to Use For Locking Smoke-Pipe Seams

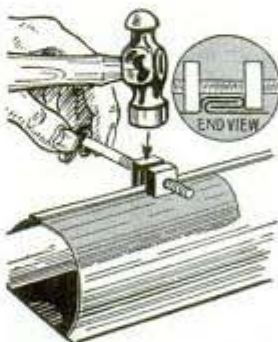

Next time you order some stove or smoke pipe and it is delivered with the seams unlocked, make this simple tool and it will enable you to lock them in a jiffy. The tool consists of a bolt with two nuts turned onto it, the nuts being spaced a distance equal to the width of the seam to be closed.

T-Square Kept From Slipping By Piece of Sandpaper

You can keep a T-square from slipping on a drawing board, and hold it steady without undue finger strain by using a piece of sandpaper. This is glued, sanded side out, to the underside of the blade of the square as shown in the illustration.

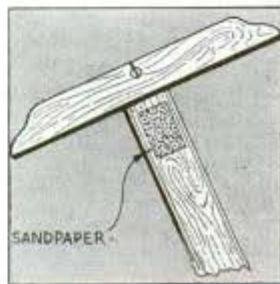

You can keep a T-square from slipping on a drawing board, and hold it steady without undue finger strain by using a piece of sandpaper. This is glued, sanded side out, to the underside of the blade of the square as shown in the illustration.

HEALTHY PLANTS grown from cuttings by Bess Livings

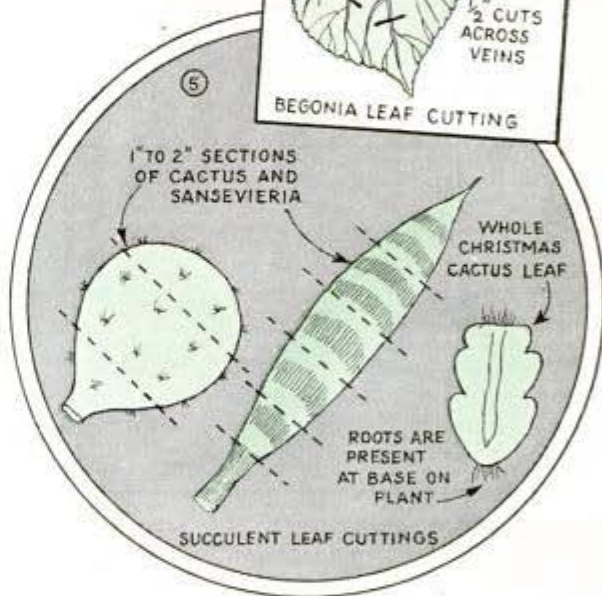
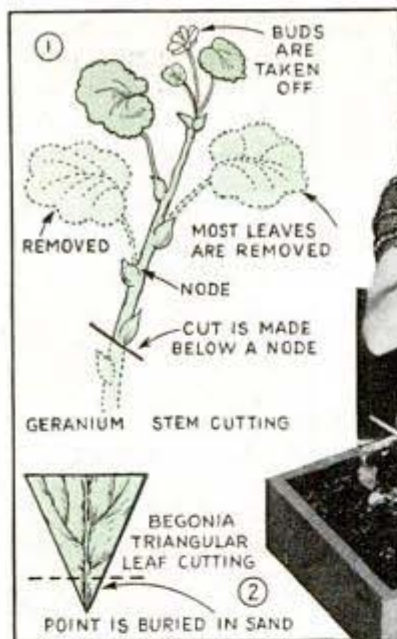

YOUNG plants grown from cuttings make excellent gifts, bridge prizes, or bazaar items, besides adding materially to your own window garden. Favorite plants can thus be shared or exchanged with friends and neighbors. Many outdoor annuals can be started in this way for winter blooming indoors. Petunias, verbenas, lobelias and dwarf snapdragons are particularly adaptable.

Stem cuttings and leaf cuttings are two types used in propagating house plants. Stem cuttings are made from softwood plants, such as geraniums, coleus, impatiens, heliotrope, fuchsia and lantana, as well as ivy, philodendron, periwinkle, marguerite, flowering maple, and some begonias. Brittle, young shoots that break with a snap when bent should be chosen. Those that bend without breaking are too old, and those that crush are too young to root rapidly. A clean cut is made at a slant with a sharp knife or razor blade just below a node (the point where the leaf joins the stem), Fig. 1. No cutting should be more than 6 in. long. Lower leaves are removed and the largest ones trimmed to prevent wilting. All flowers and buds are taken off. It is advisable to include a small piece of the main stem in cutting side shoots. This is called "heel-cutting," Fig. 3.

Leaf-cuttings are made from succulent and fleshy-leaved plants, such as African violet, gloxinia, begonias, crassula, eche-

veria (hen-and-chickens), sansevieria, and cacti of the *Opuntia* (prickly pear) type. Begonias and gloxinias grow readily from leaves in which $\frac{1}{2}$ -in. cuts have been made across several of the thick veins radiating from the base of the leaf, Fig. 4. These are placed flat on moist sand in a propagating box or pot and are weighted down with pebbles. A plantlet will appear at each cut. Or a leaf cut into triangular sections, each with a strong vein near the center, will produce a new plant when the point is buried in moist sand, Fig. 2. Many plants start from leaves with stems attached. Some of these are English ivy, peperomia, African violet, gloxinia (which develop

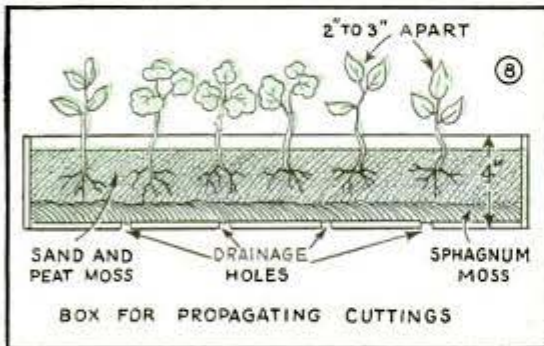
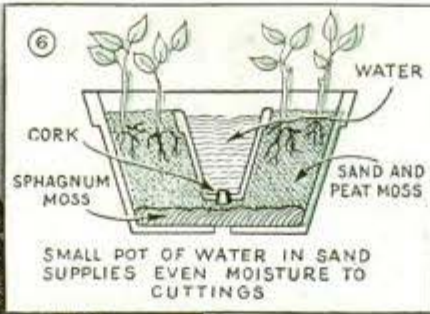

tubers at the base), and hoyo (wax plant). Hyacinth leaves often form bulblets at the base. All these can be rooted in either sand or water. Succulent cuttings, such as sansevieria leaves and cactus pads, which are cut into 1 or 2-in. sections, should be ex-

posed to the air to dry for a few days before planting. This callouses the cut and helps prevent decay. Crassula, echeveria and crabs claw (Christmas) cacti start from whole leaves, and branched cacti from severed branches treated in this way, Fig. 5.

Sand or a mixture of sand and peat moss is the favorite medium in which to root cuttings, but many kinds of plants root well in clear water. Clean, gritty sand free from pebbles is used. Sterilizing by baking helps prevent damping-off and decay from fungi. Sand is placed in containers at least 4 in. deep, clay pots or wooden boxes with drainage holes in the bottom. A layer of sphagnum moss over the holes keeps the sand from running out. The sand is leveled and soaked thoroughly with water, then packed down firmly. Cuttings are planted in rows 2 or 3 in. apart in holes made with a pointed stick, inserting them just deep enough to hold them upright, Fig. 8. Loose sand is pressed around the stems and watered with a fine sprinkler. Cuttings should be shaded or kept out of sun and strong light for a week or so after planting to prevent wilting. Sand must be kept as uniformly moist as possible. Covering cuttings with glass tumblers or jars will preserve humidity, Fig. 9. But no water should be allowed to stand on the leaves. Containers may be watered from below by placing them in a pan or saucer of water and adding more as it is absorbed. Another way of supplying even moisture is by sinking a small pot inside a large one filled with sand, plugging the hole in the small one and filling it with water, which gradually seeps through it and moistens the sand, Figs. 6 and 7. Most plants will root in from 10 to 30 days, the appearance of new leaves indicating the presence of root formation. When roots have become $\frac{1}{2}$ to 1 in. long, cuttings are moved to small pots of sandy loam. When roots fill these they are transplanted to the next size and so on until the plant is full grown.

STUBBY GIANT CANDLES

easily made at home



Glowing, translucent shells—that's what these decorative candles become when lighted, as only the center melts, leaving a wall around the flame. A No. 2 can is used for a mold to cast the candle shown above. The cover of the can is laid on the bottom, suspended by the wick, and the can is lined with waxed paper to facilitate removal of the wax. Pieces of candle of one color are melted in a can set in hot water and impurities are skimmed off the molten wax. The depression around the wick, caused by contraction as the wax cools, can be refilled to bring it up level

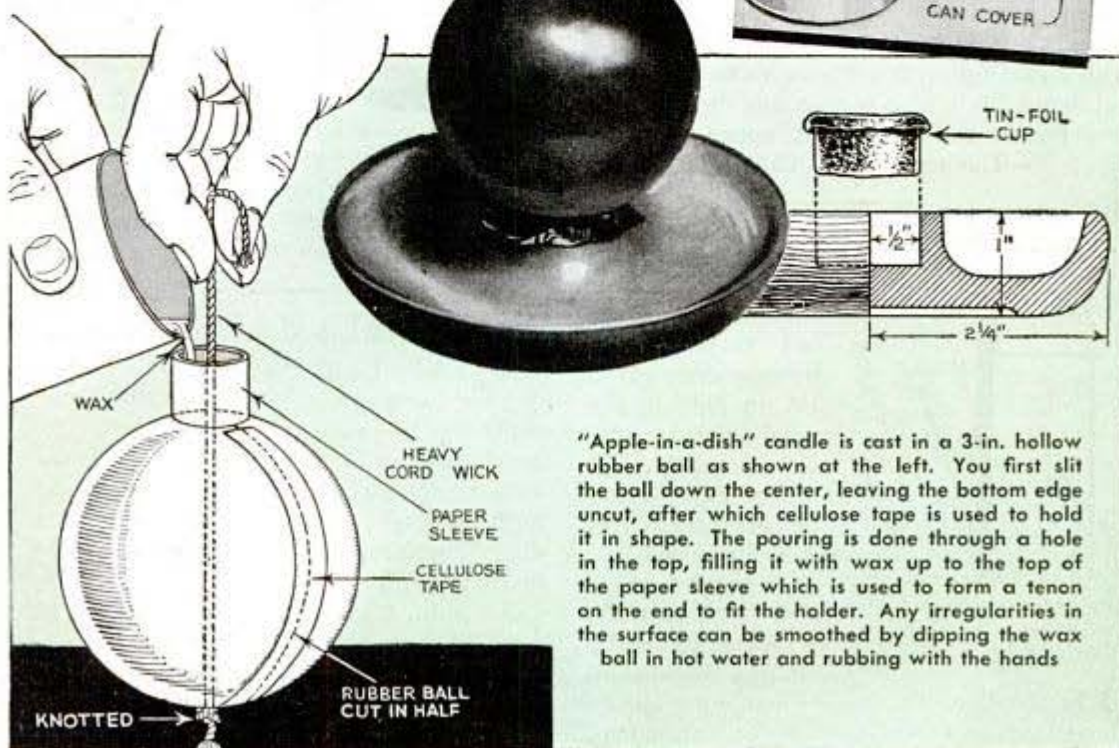

"Apple-in-a-dish" candle is cast in a 3-in. hollow rubber ball as shown at the left. You first slit the ball down the center, leaving the bottom edge uncut, after which cellulose tape is used to hold it in shape. The pouring is done through a hole in the top, filling it with wax up to the top of the paper sleeve which is used to form a tenon on the end to fit the holder. Any irregularities in the surface can be smoothed by dipping the wax ball in hot water and rubbing with the hands

Lower Fish-Pool Water Under Ice To Provide Air Space

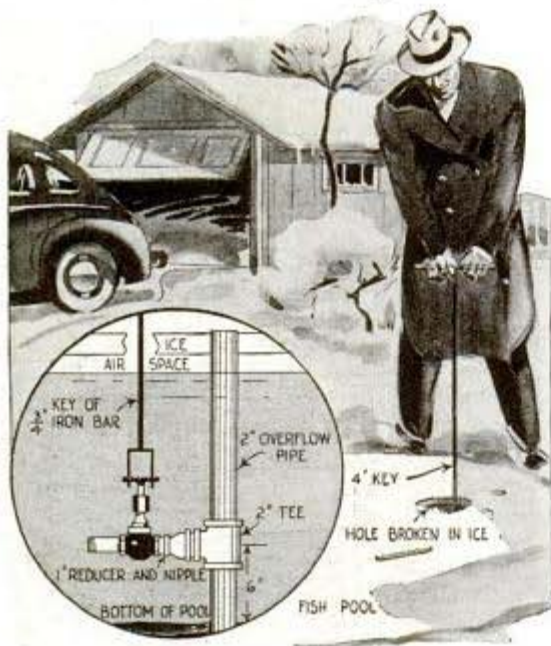

One home owner who has a fish pool in which the fish are left throughout the winter prevents them from smothering when the pool is frozen over by lowering the water level to provide an air space under the ice. The water is lowered as indicated in the circular detail. A tee is put in the overflow pipe and a valve screwed into it. Then, when the pool is frozen over, he breaks a hole in the ice directly above the valve and opens it with an extension key, allowing the water to run out through the overflow to provide the air space.

—Herbert F. Zeh, Cincinnati, Ohio.

An Aid When Mortising Hinges



of the mortise. The pencil lead, or graphite deposited on the hinge will be rubbed off

A good job of hanging a door with mortised hinges depends a lot on getting the mortise bottoms cut correctly. An aid in doing this is to rub the back of the hinge with a soft lead pencil and then rub the hinge firmly against the bottom

on the high spots, which can then be seen clearly for smoothing down.

—T. K. MacDonell, Coconut Grove, Fla.

Auxiliary Wood Jaws to Hold Oval Work in a Vise

The next time you have a small oval piece of work that you want to clamp in a vise, make up a set of these wood jaws for the job. With them, the work can be gripped firmly in a vise without marring it in any way. The

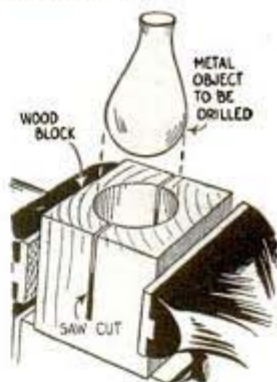

jaws are made from a block of soft wood drilled to take the work, and then split with a saw through the hole to get a good clamping action.—C. Hardy, Los Angeles, Calif.

Fastening Twisted Wire Brushes Securely on Wooden Handles

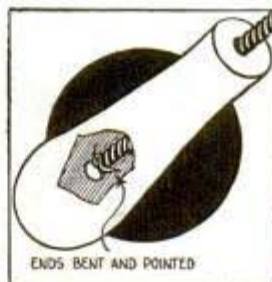

If the handle of a twisted wire brush loosens, it may be tightened permanently as shown. The ends of the twisted wires are bent outward and slightly upward,

after which they are pointed with a file. When pushed back into the handle, the sharp ends dig into the wood.

Auto Valve Used as Tack Hammer

A handy hammer for tacking up signs can be made by fitting an old auto-motor valve with a chisel handle. The latter is drilled to take the valve stem with a snug fit.



☐ A stiff feather will be found ideal for dusting the rigging on a ship model.

Warm Air Drives This Lamp Merry-Go-Round

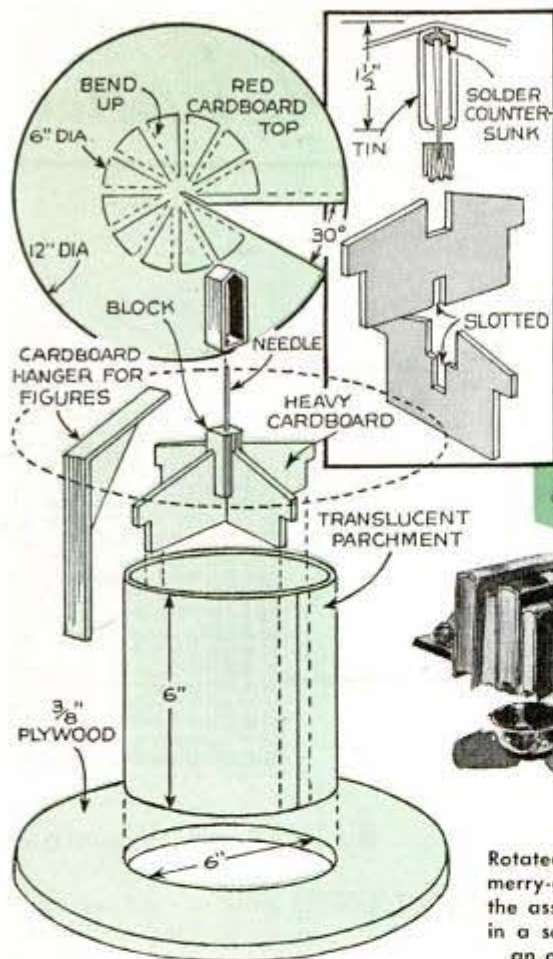

Rotated by a current of warm air rising from a lamp bulb, this merry-go-round is an instructive novelty. The rotating part of the assembly is supported on the point of a needle, which fits in a solder bearing. A paper or parchment cylinder fits over an opening in the base to provide a flue for the rising air.

Stream of Air Above Fuel Bed Consumes Waste Gases

By directing air above the fuel bed of a heating plant in which a blower is used to burn buckwheat coal, gases that ordinarily escape up the flue are consumed, and the possibility of mild explosions of accumulated gases from careless firing is reduced. To make the installation, the air is carried from the ashpit by means of two lengths of pipe and a rubber hose as shown. The pipe above the fire can be run in through a hole in the fire door, or it can be taken in through any other convenient opening. If run through the fire door, it must be short enough to permit opening the door. A valve to control the flow of air can be made from a tee, a nipple and a pipe cap as shown in the upper detail.

—R. Boettinger, Englewood, N. J.

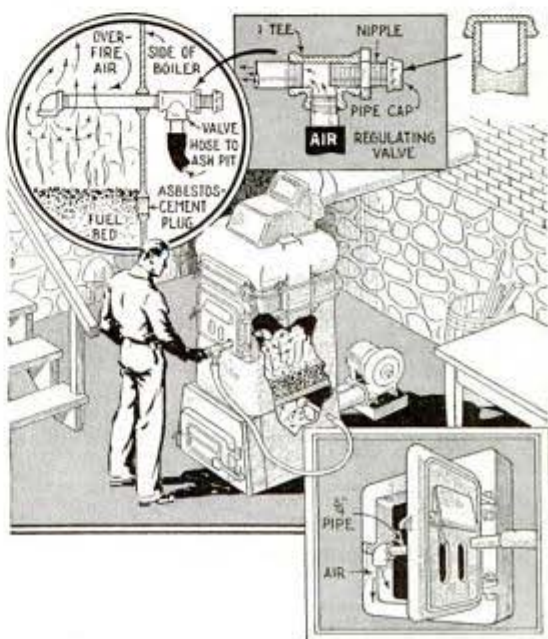

☞ You will find that cheese will grate more easily if it is chilled first.

Decorative SHIP of metal and

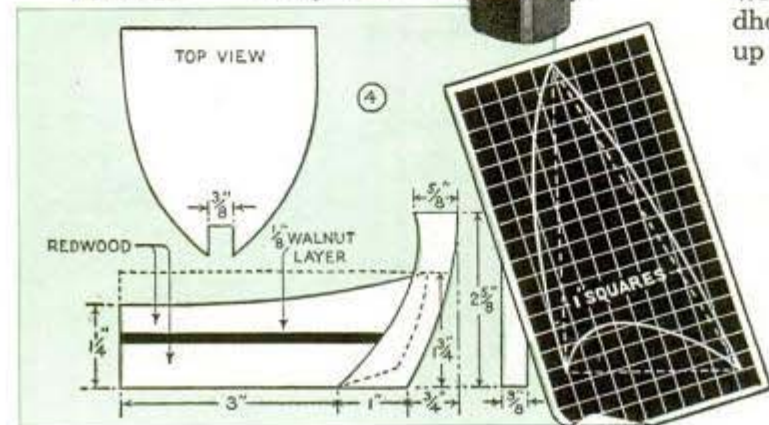
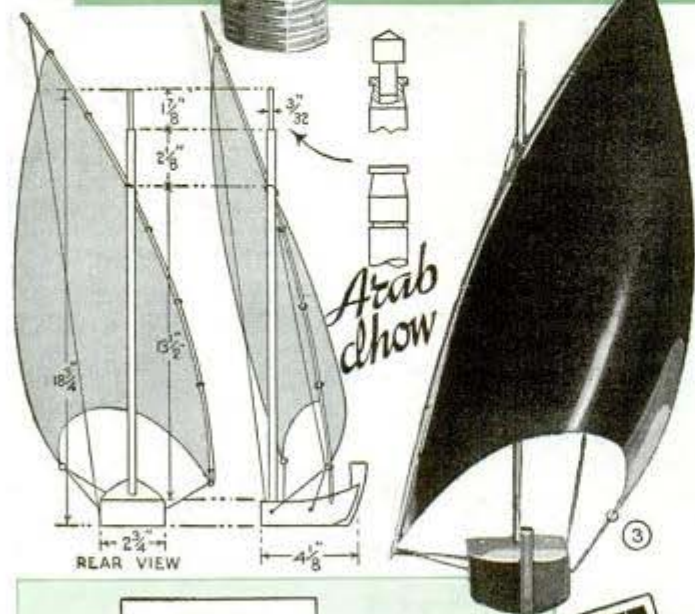
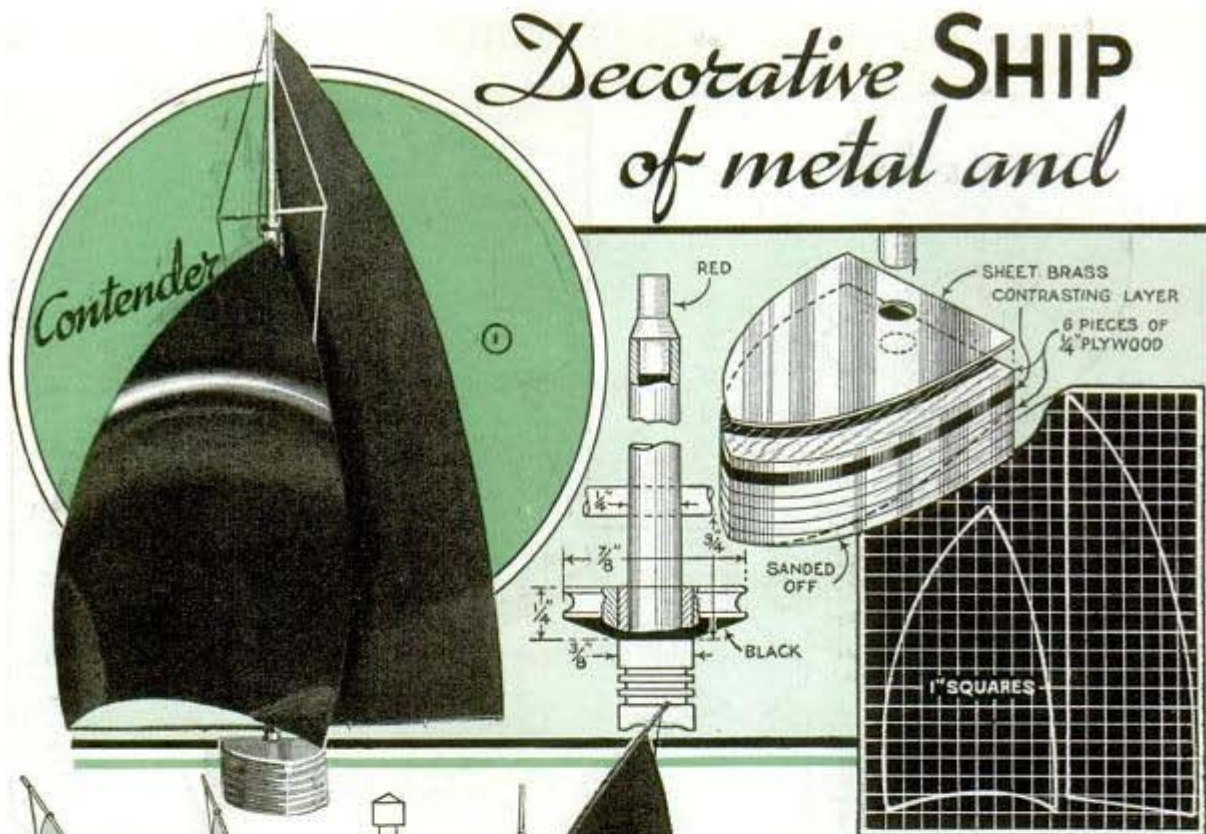

By Walter T. Warde

WITH sails of metal and contrasting hulls of laminated woods, these ship plaques offer something new in wall and mantel decoration. If available, "paper thin" plastic will give a colorful effect when used for the sails, in which case the rigging is relied upon to hold them in shape. All five models, Figs. 1, 3, 5, 9 and 10, are of similar construction. With the exception of the Arab dhow, Fig. 4, the hulls are built up from scraps of fir plywood, the plies of the wood providing an attractive decoration. For variation, a layer of colored plastic or wood may be sandwiched between the pieces as indicated. The hulls are finished with shellac and wax. Fig. 7 shows how the mast and yards of the windjammer are attached, the others being

PLAQUES

wood

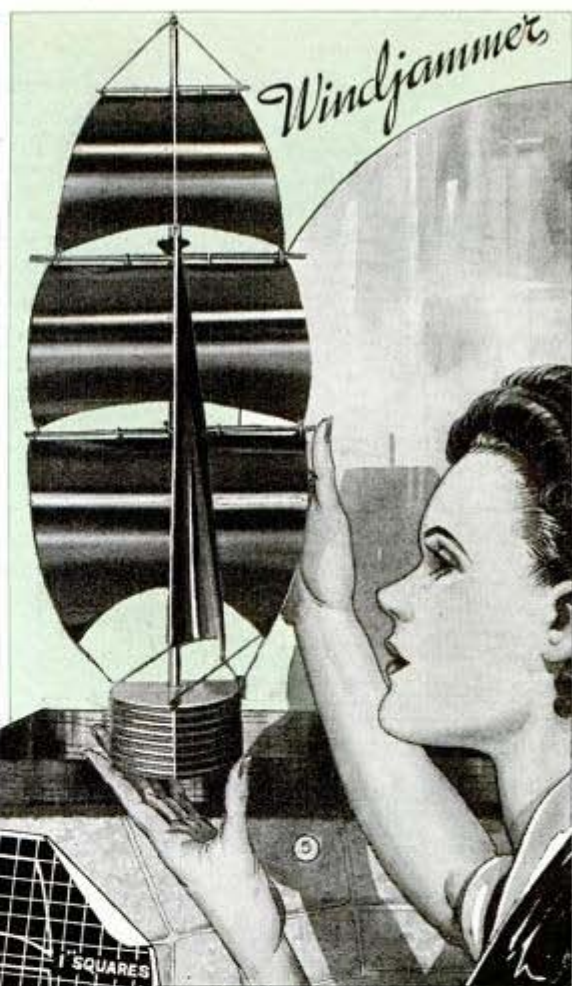
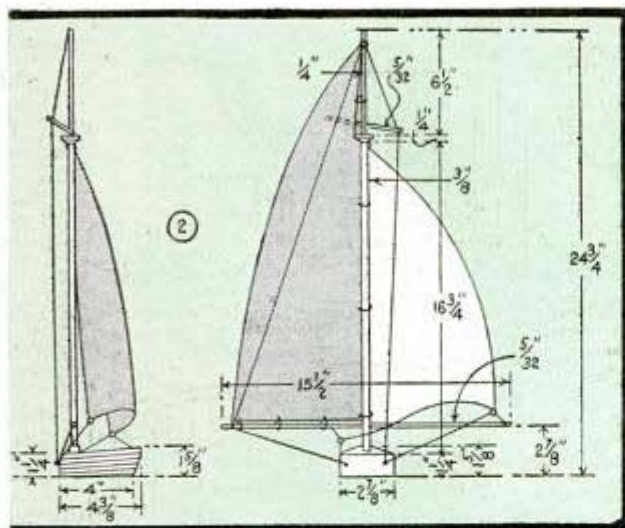

fitted similarly, while Fig. 6 gives the correct spacing of the yards for drilling the two-part mast. The metal is buffed to a high luster as in Fig. 8, and then given a thin coat of shellac or lacquer to prevent tarnishing. The upper part of the mast fits tightly inside the lower piece at the crow's-nest. The sails are belled by placing the

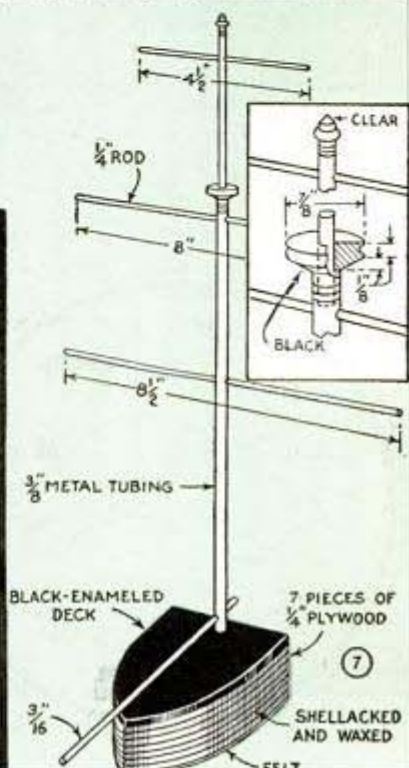
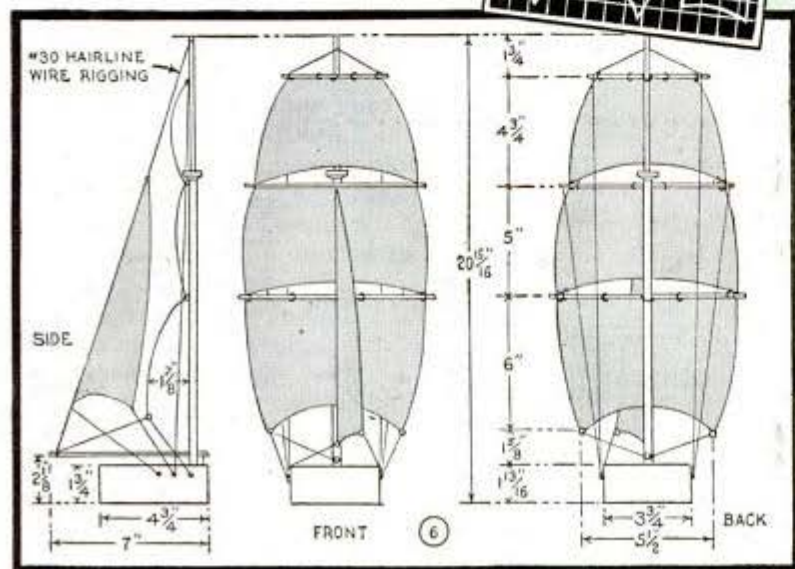
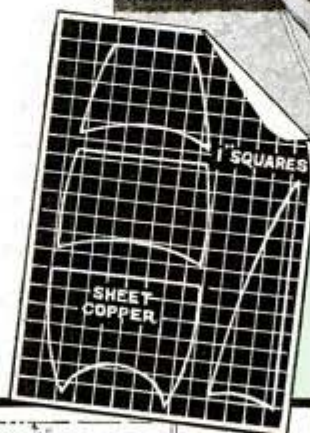

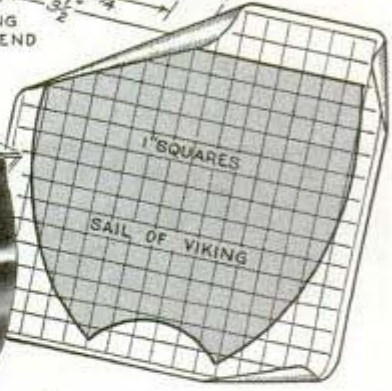
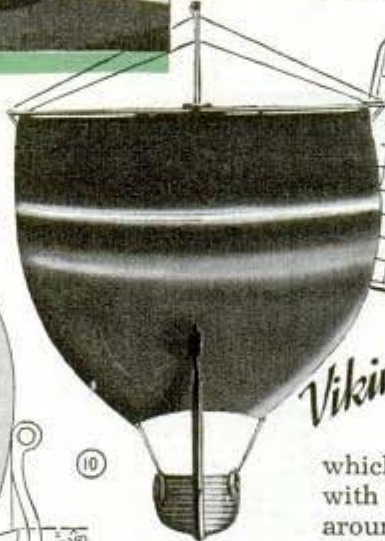
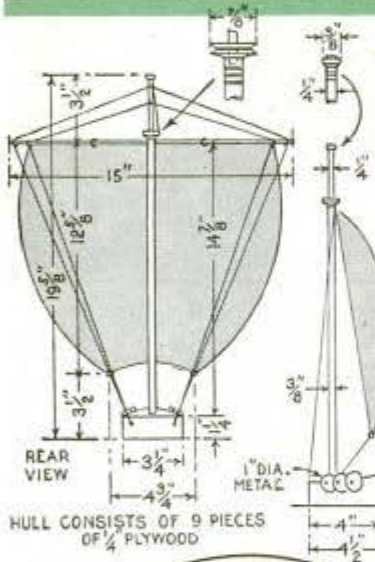
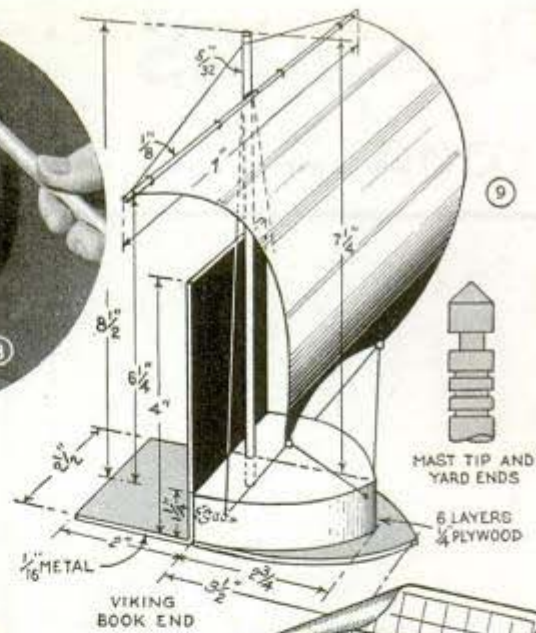

Viking

metal on a thick cloth pad and rolling with a 1-in. dowel, after which they are hung on the yards with rings, formed by coiling wire around a piece of tubing of the right size and then cutting it apart. To curve plastic sails, it will be necessary to immerse them in a solution of hot water and glycerin until pliable, and then in cold water to retain their shape. Figs. 2, 3, 6 and 10 show the way the rigging is strung, the wires being fastened to the hull with escutcheon pins.

The book end shown in Fig. 9 is a simplified copy of a Viking ship, the back and base being formed by bending sheet copper or brass as indicated and screwing the hull to it. For mounting the ships on the wall, a hanger like the one shown in Fig. 11 will be needed to which the hull may be fastened with screws.

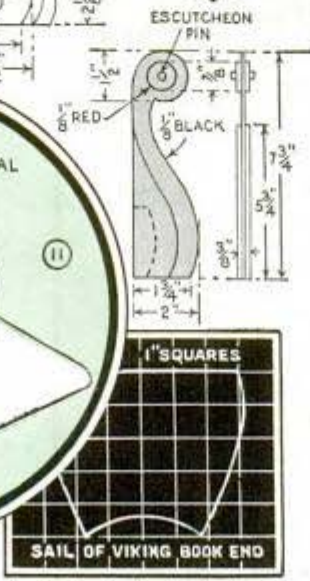
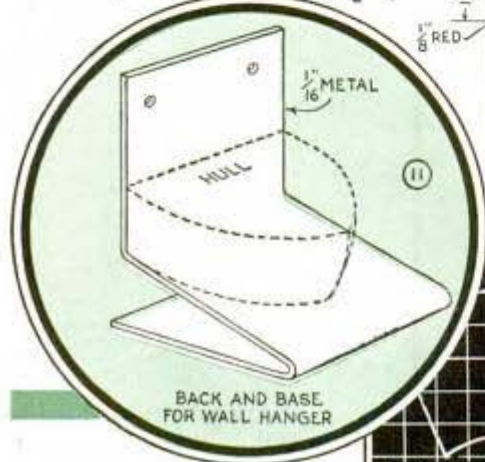

Many Variations Are Possible With These Dolls

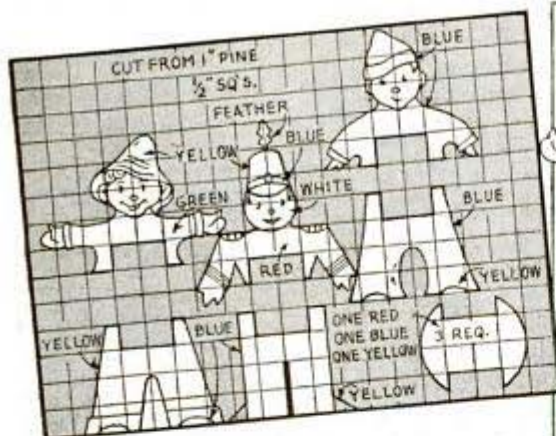

Any small child will be delighted with these three block dolls. The parts of each one are interchangeable, making many variations possible. On all three the center sections are the same but the legs and head-and-shoulder pieces are different. Be sure that the pieces are notched carefully so they will fit together snugly. The squared detail gives the sizes and various shapes of the different pieces along with a suggested color scheme.

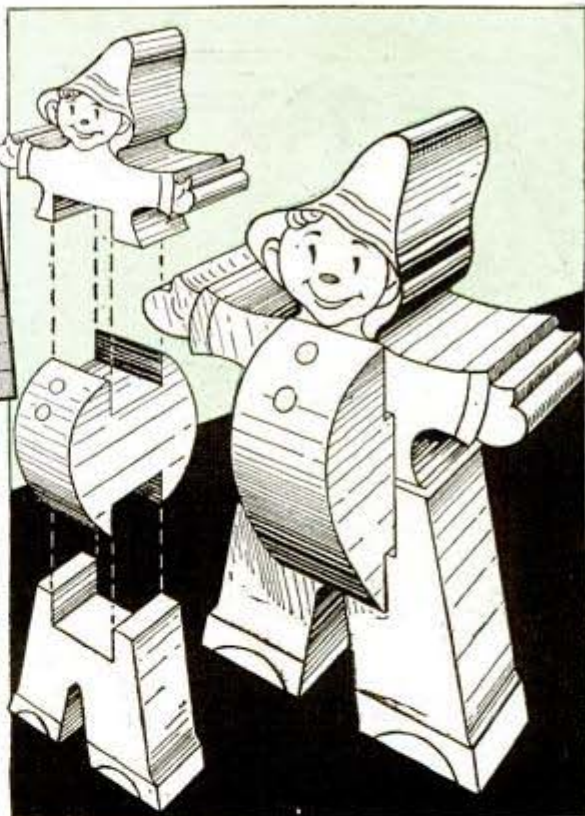

Tracing Easel Made From an Inexpensive Picture Frame

You can make a tracing easel that will enable you to copy maps and designs, work on negatives and the like, by means of natural or artificial light. All you need is a

11 by 14-in. picture frame and glass, a small piece of 1-in. white pine and a couple of small angle irons. First, make up a frame of 1-in. stock as indicated, beveling the front ends at a 45-degree angle. Then attach the picture frame to the beveled portions of the ends with screws, and screw the angle irons to the sides as shown, to serve as brackets. This completes the easel. In use, it can be attached to a window sill by means of the angle brackets to use natural light. Lowering the window shade so that light passes only under the frame will help.—R. W. Corrigan, Mahaffey, Pa.

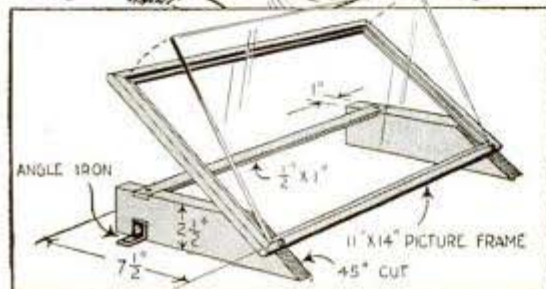

WRITE FOR POPULAR MECHANICS!

Readers are paid cash for ideas printed on these pages. You too, may know of a simpler, faster or better way to do some daily chore about the home, farm, office, shop or garage; an aid to amateur photographers, model makers, workshop fans, car owners, hobbyists, etc. Or, perhaps it's something of unusual juvenile appeal. Just send a short but complete description plus a sketch or photo to the Homecraft Editor of Popular Mechanics. Checks sent promptly for accepted ideas.

Dust Cleaned From Typewriter By Using Compressed Air



Dust and lint combined with the lubricant on a typewriter will soon gum the moving parts so that they work hard. To avoid this, just take the typewriter to your local filling station and ask the proprietor if you can use the tire hose to blow out the dust. Doing this occasionally will make frequent dismantling and cleaning of a typewriter unnecessary.

Books Having Covers Interlocked Easy to Carry in Your Arms



When carrying a number of books, just put the cover of one inside that of the one next to it as shown. This tends to interlock the books so that one cannot slip off easily.

Coloring Crack Filler to Match The Surrounding Wood

In filling cracks or saw marks in jig-sawed wooden figures, such as blocked letters for window display signs, a very serviceable filler can be made from show-card paint and fine sawdust. It is much faster than regular putty, for it can be used any

time after the figures have been painted, and leaves them completely finished as soon as dry. The filler is mixed by taking a dab of show-card paint and pinches of the fine sawdust, mixing them with a knife to the consistency of cake frosting.

—Don W. Sigler, Lincoln, Nebr.

Skin Taken Off Top of Paint With Raveled Screen Wire

Screen wire tacked to a stick, then raveled at the end makes a handy paddle for removing the thin skin that forms on top of a bucket of paint. The screen should be raveled for about 1 inch and the remaining wires spread slightly to form a kind of a broom, as indicated in the drawing.



Remove Wax Before Painting

Paint will not dry properly over waxed surfaces, or if it does, the new paint will chip and scale shortly. It is best to thoroughly remove all wax with a cleaning solvent and, in turn thoroughly wash all surfaces to remove the solvent. Do not apply paint until surfaces are dry.

—Harold J. Ashe, Los Angeles, Calif.

Staples in Wall Guide Yardstick When Hanging It on a Nail

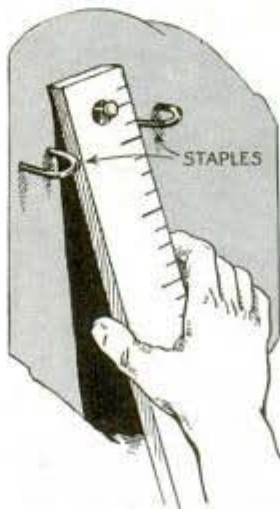

If you keep a yardstick hanging on a wall in your workshop, drive a couple of staples at each side of the nail on which the stick hangs, spacing them a distance equal to the width of the stick. These serve as guides so the stick can be pulled down over the nail, which will slip into the hole.

Simple MUSIC CABINET

has 14 drawers



By George E. Ressler

CLASSIFYING your sheet music as to composer, type, etc., and filing it in the shallow drawers of this neat little cabinet, Fig. 1, not only makes it possible to select the desired copy quickly, but saves the numbers from becoming faded and torn with excessive handling.

Plywood and solid stock are combined in the construction, Fig. 5 showing a cutaway view of the assembly. Grooves in the back legs to house the fifteen drawer frames are made first. These are cut $\frac{1}{2}$ in. deep across one face of the stock and enter a rabbet for the back panel as shown in Fig. 4. To assure identically spaced grooves in both legs, clamp the stock together temporarily and pass both faces over the saw at the same time. In each front leg a door rabbet, extending between the top and bottom crossrails, is made following the detail in Fig. 6.

Corresponding mortises to receive the tenoned crossrails can be cut accurately by hand by boring a $\frac{3}{4}$ -in. hole, Fig. 2, and then forming it square with a narrow chisel. Locate these mortises to bring the rail flush with

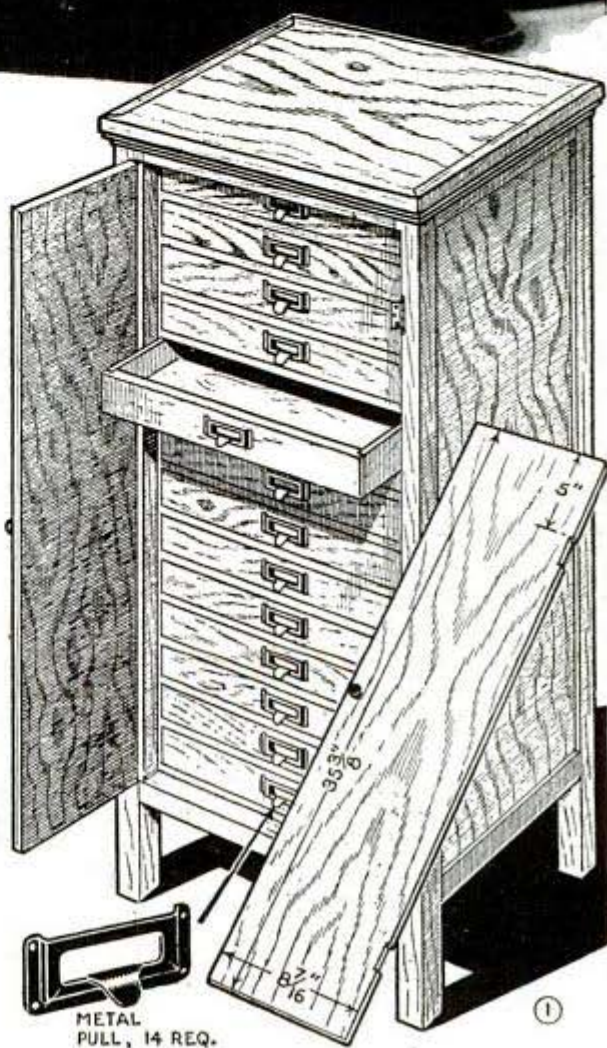

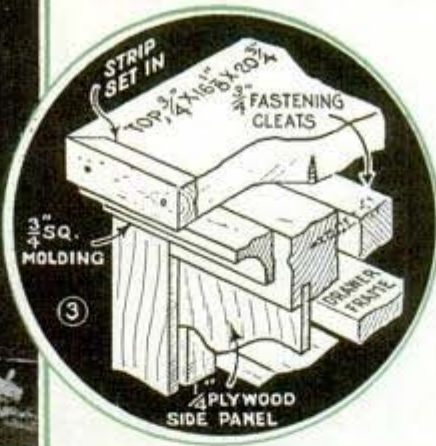

drawer frames, which are assembled and fitted with guides as in Fig. 7, are slipped in place through the back of the cabinet to engage the grooves at the front and come flush with the face of the strip. Fig.

8 details the assembly of the drawers which should be fitted with sufficient clearance to allow them to slide freely when finished. Only the fronts of the drawers and their frames are made of choice stock, the inner parts being assembled from cheaper wood to save cost. Small bullet-type friction catches fitted in the lower edge of the plywood doors keep them closed.

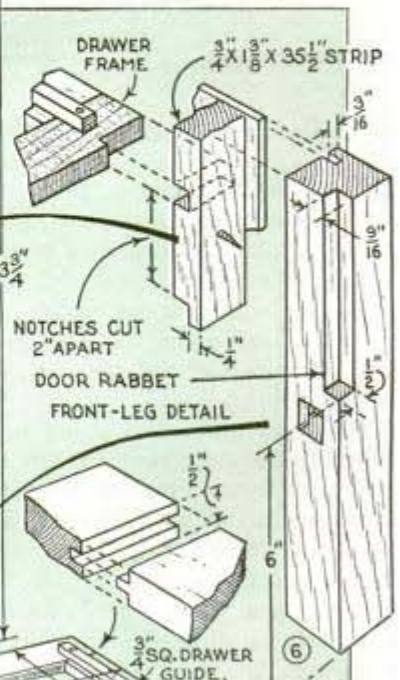
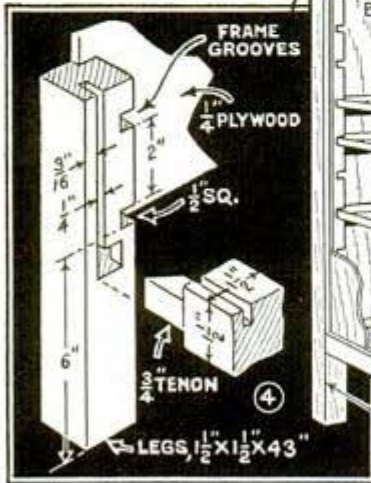
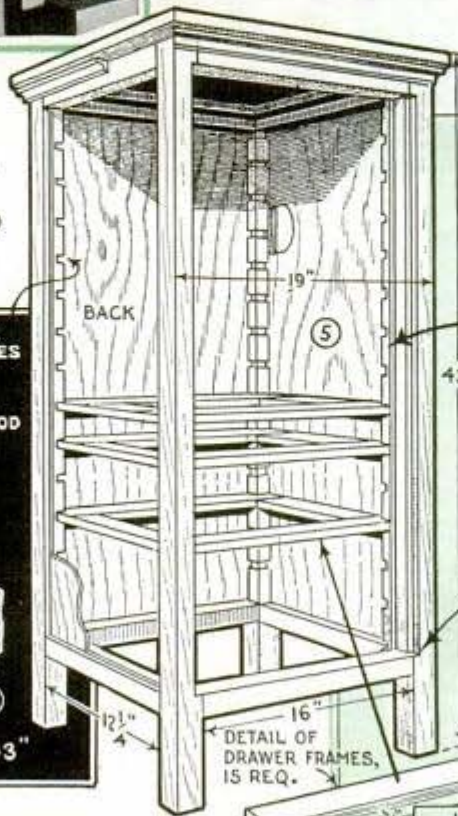
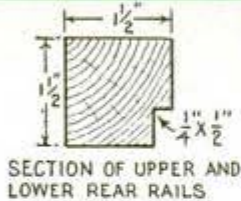

the face of the leg. In gluing the ends of the cabinet together, apply glue only to the tenons of the rails, leaving the plywood panels free to contract in the grooves. Fig. 3 shows how the top is held with cleats and finished with a cove molding beneath the overhang.

Now, strips having grooves corresponding with those cut in the back legs are screwed to the inner face of the front legs in line with those at the rear, Fig. 6. The

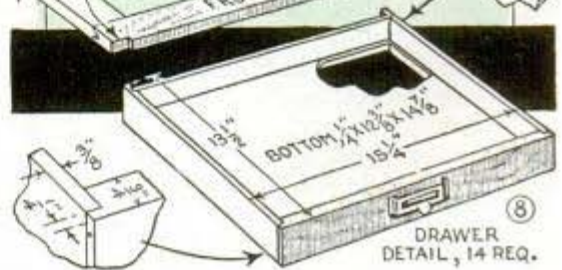
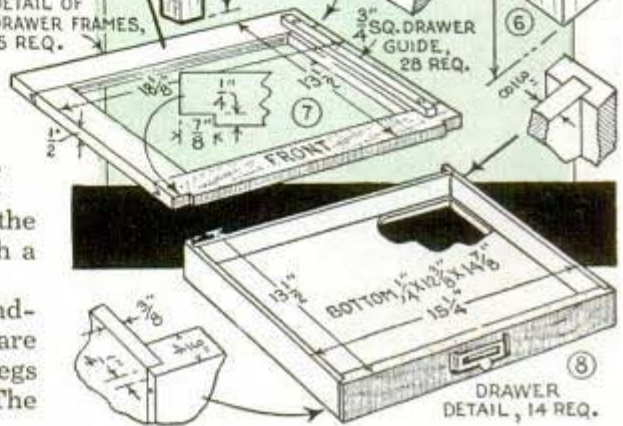

Utility Drawing Table for the Home Draftsman

After doing drawing at home for several years without a suitable drawing table, I designed and built this one in which are incorporated many ideas convenient for the home draftsman. The hard-pressed board top can be used as a drawing board, or as a table top for a regulation board. The wooden framework supporting it is hinged at the front end to one of the cross members. At the back, a slotted T-hinge permits vertical adjustment of the top. A tray under the top provides a place to keep drawing paper, drawing set, T-square, etc. It rests loosely on the frame cross members and is easy to remove for cleaning and rearranging. I purposely kept the front end of the table free of any supports to allow plenty of leg room. As you will notice, the lower side cross members are nailed to the outer edges of the legs. In this position, they form handy ledges on which to set an extra drawing board, letting it lean against the slanting legs. This is handy

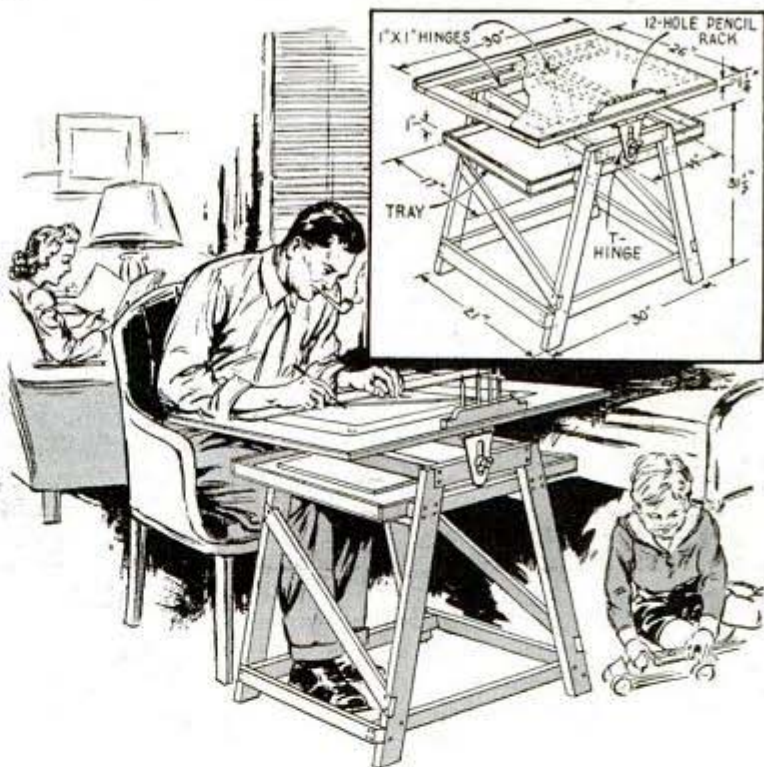

in my case as I usually work with two boards. The pencil rack is a great convenience. The holes in it are $\frac{3}{8}$ in. and are spaced 1 in. apart. An important item to most draftsmen is an ash tray. I have one mounted on a swivel bracket at the extreme right side of the front of the table.

—Henry Ruskin, Chicago.

Nails Coated With Rosin to Make Them Hold Firmly



The next time you use nails where there will be unusual strain between the parts that are to be put together, treat the nails with rosin before using them. The rosin coating will make them less likely to pull out under the strain. To treat the nails, dip them in a solution mixed in the proportion of rosin, 1 lb., to benzol, 1 gal. After dipping the nails, allow the coating to dry before using them.

Removing Paraffin From Container

You can remove paraffin easily from a container in which it has been melted by filling the container with boiling water, then allowing it to cool. The paraffin will float on the surface of the water.

Iron Bucket Hooks on Stepladder Help the Painter



Two or three iron hooks and cross links from auto skid chains will enable you to hang buckets of paint or other material any place on a ladder conveniently within reach. The hooks are shaped to slip over the ladder steps, rungs or sides as desired, the open links of the skid cross chains being handy to take the bucket bail.

—W. Cleveland, Lake Tahoe, Calif.

Replacing Worn Veneer Seats With Upholstery

Worn veneer seats on metal stools and chairs can be repaired by making a new seat of $\frac{1}{2}$ -in. plywood and bolting this on top of the old seat. First cut the plywood to the shape of the original seat and drill three small bolt holes through it, drilling three corresponding holes in the old seat. Then upholster the new seat, pulling the material over the edge and tacking it to the



underside. Now put it in place, inserting the projecting bolts through the old seat and pulling them up tightly with nuts.

—Herbert Bast, Sheboygan, Wis.

Shipping Tags Mark Boat Parts To Be Repaired

One motorboat owner who checks over the motor and boat when time and weather permit during the winter months, marks the parts to be repaired with tags. By doing this, there is no possibility of overlooking some of the needed repairs when he is ready to overhaul the boat in the spring.



Scroll Invitations for Your Party



If you are looking for something unusual in the way of a party invitation, these scroll ones are just the thing—and fun to make. You will

need some dowels for the sticks, heavy writing paper, a little gaily colored yarn and some cellulose tape. First cut the paper to the desired size and glue each end to a dowel. With the yarn form the letters of the writing and glue it to the paper.

Sash Hanger Holds Lawnmower Close to Garage Wall

To keep your lawnmower close to a garage wall, attach the lower part of a sash hanger on the handle and screw the hook part on the wall. With this arrangement, it takes only a minute to raise the mower and slip it on the hook.



Combination Rubber and Steel Feet for Tripods

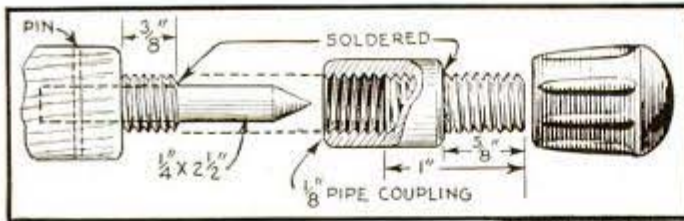

Changed in a few seconds from rubber-cushioned to metal-pointed tips, these combination feet adapt your camera tripod to any surface. Each foot consists of a $\frac{1}{4}$ -in. steel rod, a $\frac{1}{8}$ -in. pipe coupling and a slip-on rubber tip, and two lengths of threaded brass tubing, the kind used on electrical fixtures, which has a $\frac{3}{8}$ -in. outside diameter and a pipe thread. The parts are assembled as indicated in the upper detail. A $\frac{3}{8}$ -in. section of the threaded tubing is soldered to the rod $1\frac{1}{4}$ in. from the blunt end, which is then pinned into the tripod leg. Next, a 1-in. section of the tubing is screwed into the pipe coupling as indicated, and soldered. Then a rubber tip is screwed onto the projecting tubing. The hole in the tip is $\frac{5}{16}$ in. in diameter making a force fit. When you want a rubber foot to support the tripod on a surface to avoid marring, just screw the pipe coupling onto the steel foot.



Rack to Dry Ferrotyped Prints Is Assembled From Wood

Accommodating ten 11 by 14-in. ferro-

type tins, this handy rack can be assembled from almost any kind of wood. Two vertical pieces are drilled for dowel rods, which are spaced 1 in. apart to allow free circulation of air. The rack can be made to hold more tins by increasing the length of the uprights and adding more dowels. For quick drying, an electric fan may be placed in front of the stand.

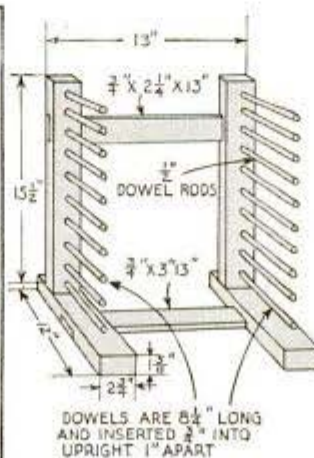
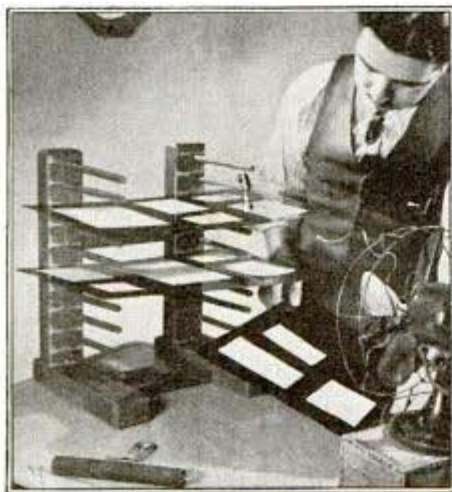

Mark the strap of your camera carrying case at 6-in. intervals with white pencil or paint and it will serve as a handy measure when taking closeups.

Auxiliary Hood on Reflex Camera Makes Focusing Easier

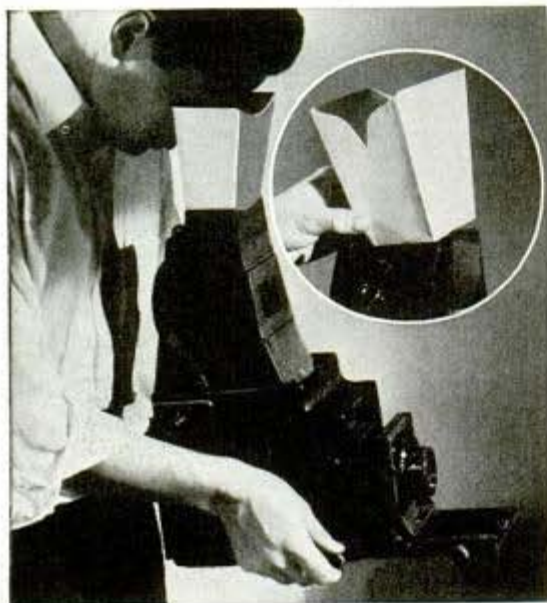

Placed in the opening of the focusing hood of a Graflex or other reflex camera, this extension hood will make focusing easier. It enlarges the opening so both eyes, especially if glasses are worn, can be used. Notice how a notch is cut on one edge to fit over the nose. The four sides of the extension hood are made of cardboard, fastened together with cellulose or adhesive tape. It is best to use black cardboard or paint the inside surfaces with flat black paint.—F. P. Schofield, Ardsley, Pa.

Self-Closing Photo-Paper Boxes

Boxes in which gross or half-gross lots of photographic paper are packed can be converted easily into self-closing compartments for storing different grades of

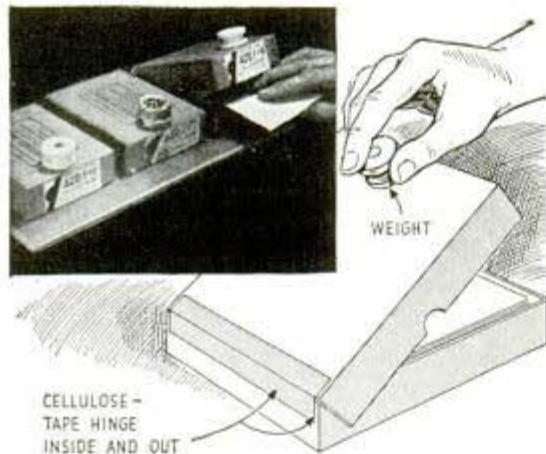

paper in the darkroom. The lid of the box is hinged to the bottom with cellulose tape and provided with a knob for lifting it. The knob should be heavy enough to cause the lid to close as soon as it is released. On the boxes shown, small porcelain electrical insulators served this purpose very well. Three or more boxes may be arranged on a baseboard to form a cabinet for each size and kind of paper commonly used.

Rubber Bands Hold Tripod Legs Between Regular Stops

Telescoping legs of a tripod can be held in any position between the regular stops if a few rubber bands are wrapped tightly around each leg. Just roll the bands to the spot where the leg is to be held and push the outside section of the leg against them. When the tripod is closed, the bands are rolled down to the bottom of each leg.



Tilting an Enlarging Easel To Correct Distortion

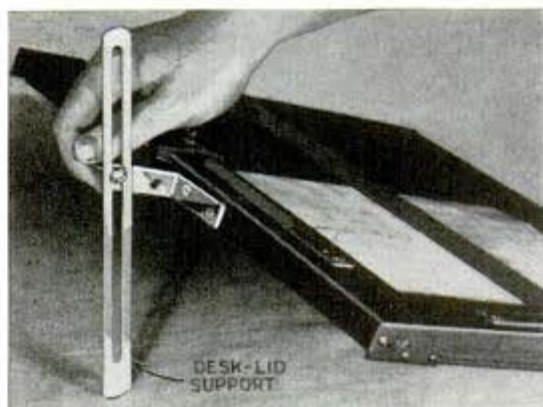

Distortion in photographic negatives frequently can be corrected by tilting the easel when an enlargement is made. A good way to do this is to use a desk-lid support fastened to the back of the easel as indicated. An angle brace is screwed to the easel and the lid support is fastened to it with a bolt and wingnut. If no desk-lid support is available, a piece of metal can be cut to approximately the same shape.

—Robert Scott, Saltsburg, Pa.

CAMERA SHUTTER SPEEDS

checked by twin lights on phonograph

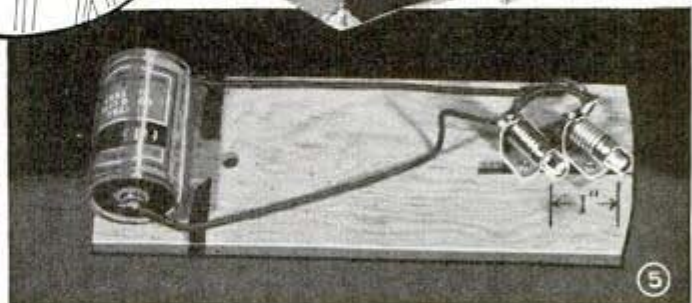
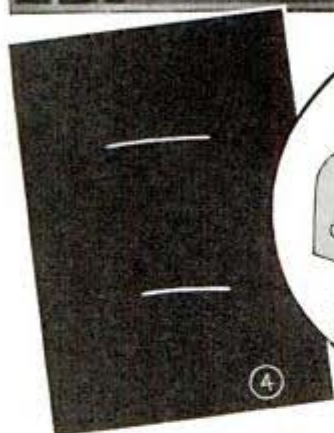
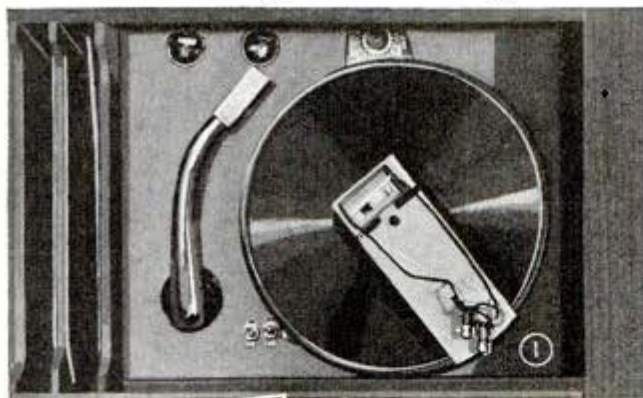

By S. Gordon Taylor

ON MANY cameras, shutter speeds may be highly inaccurate, so that the trusting amateur, shooting at a speed marked $1/300$ second, may be exposing double or triple this time. At higher speeds, few cameras that have been in use for some time are as accurate as they were when new.

To check shutter speeds with precision is much simpler than one would suppose, and the average camera fan can do this with the aid of a phonograph and a home-made attachment that fits on the turntable as shown in Fig. 1. The attachment shown separately in Fig. 5 and detailed in Figs. 6, 7 and 8, has a hole at one end to fit the turntable spindle and a slot at the other end. Two 2.2-volt radio pilot lights are attached over the slot so that their exact distance from the center of the turntable spindle and the distance between them can

be adjusted. A flashlight cell is taped on as shown in Fig. 9, and it is wired to the lights as in Fig. 7. If desired, a small switch can be put in the circuit or one of the wires just hooked to some point to make and break electrical connection. The camera is arranged to make exposures of the turntable as in Fig. 3. If you make up a bracket as in Fig. 2, the camera can be held on any sturdy tripod in the position indicated.

Now you are ready to make the test. The idea is to make an exposure of the lights while they are rotating on the turntable. From the length of black streaks that appear on the negative, or white streaks if a print is made as in Fig. 4, you can tell if your shutter speed is or is not

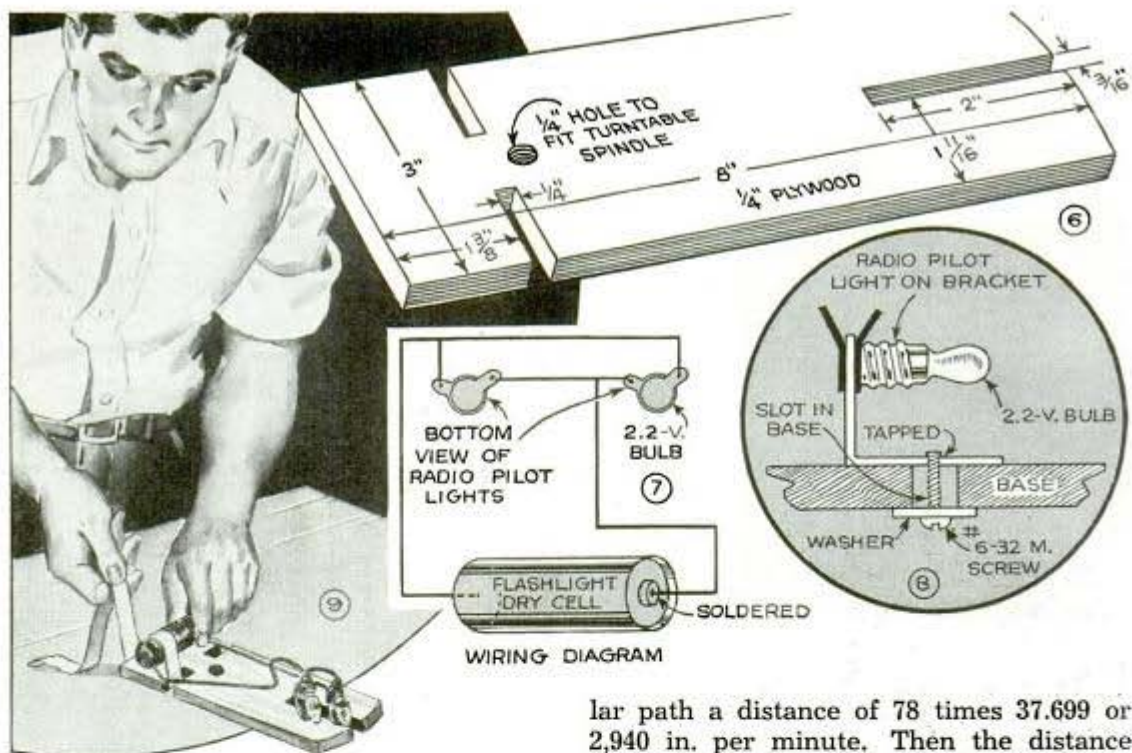

lar path a distance of 78 times 37.699 or 2,940 in. per minute. Then the distance covered in one second would be 2,940 divided by 60 or 49 in. In 1/10th sec. the distance covered would be 4.9 in. So with an accurate shutter set at 1/10th sec., the streak on the negative or print should be 4.9 times as long as the distance between the streaks, which represents 1 in. Any variation from this proportion would indicate a faulty shutter speed. For instance, if under the conditions just stated, the streaks are 25 percent longer than they should be, the shutter speed is 25 percent slower than its rated speed. Calculations can be simplified by making an enlarged print of the negative so that the two light streaks are exactly 1 in. apart. Then it will be unnecessary to figure the percentages, as you can take the actual measurements. The same procedure should be followed in making a test at every shutter speed.

accurate. The filaments of the two lights are spaced exactly 1 in. apart. The distance between the streaks on the negative or print will then represent 1 in., no matter what the actual distance on the negative may be. This provides a unit with which to measure the length of the streaks and translate this into inches. The light closest to the turntable spindle, must be set so that its filament is spaced a known distance from the center of the spindle, say 6 in. This enables you to determine how far the light travels per second. Calculation of this is as follows: As the diameter of the circle made by the light revolving on the turntable is 12 in., its circumference would be 37.699 in., (diameter times 3.1416). With standard phonograph turntable speed of 78 r.p.m., the light would travel in a circu-

Blotting Paper Strips Dry Developing-Tank Reel Quickly

Strips of lintless blotting paper are handy and effective for drying the grooves of a developing-tank reel quickly. After wiping the reel as dry as possible with a cloth, run the blotter strips edgewise around the film track to pick up the remaining moisture. The strips can be dried and used repeatedly.

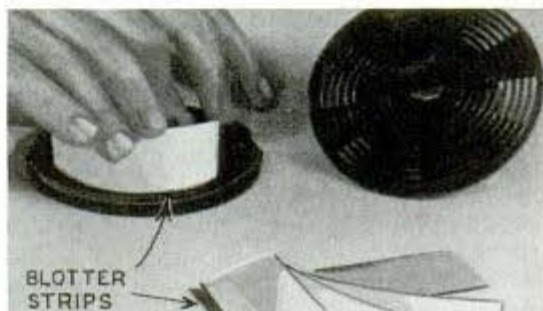

☐ Dull spots on glossy prints will be unnoticed if covered with clear nail polish.

An Inexpensive Slitter for 16-mm. Movie Film

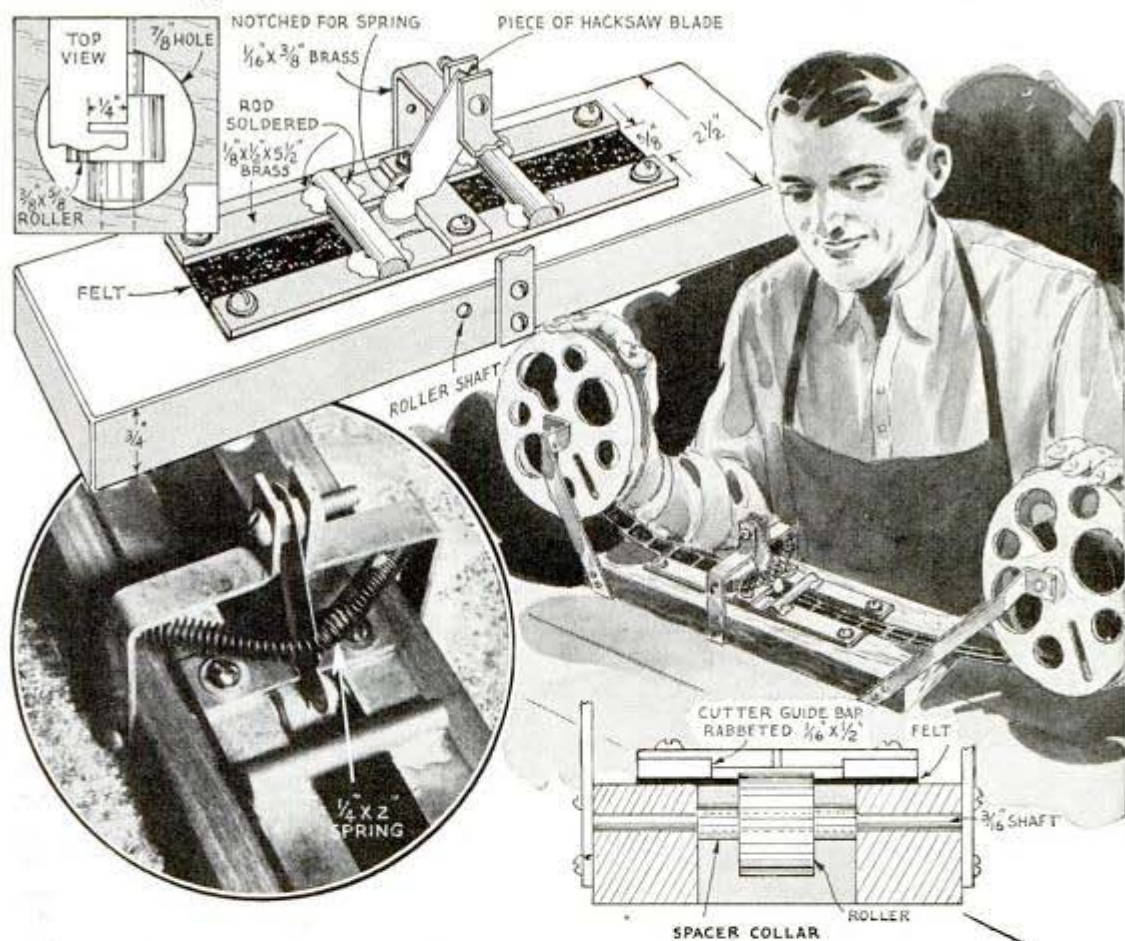

Anyone wishing to process his own 16-mm. motion-picture film and divide it to 8-mm. widths will find this slitter just the thing. It does not actually cut the film, but scores it so that it can be separated by creasing. The details show the construction. The base is bored for the insertion of a roller, as in the lower detail. This is located so that the slitting knife, made from a hacksaw blade, bears on top of it by

spring pressure as indicated in the lower left-hand detail. Brass strips spaced the width of the 16-mm. film are screwed to the base to provide a guide for the film, thin felt being placed between the guide and base to prevent scratching. A U-shaped bracket carries the knife, which rests in a notch on a guide bar screwed across the film guide. Two rods soldered across the latter help to prevent buckling of the film.

Household Bleach Removes Black Spots From Photo Prints

Black spots on photographic prints, resulting from pinholes in the negative, can be removed with any of the common household bleaches containing sodium hypochlorite. Pour a small amount of the bleach into a saucer and use a toothpick to apply it to the print. Touch the black spot very lightly with the end of the toothpick and blot immediately. Work very carefully, continuing the touching and blotting until the spot has been removed or has blended in with the surrounding area.

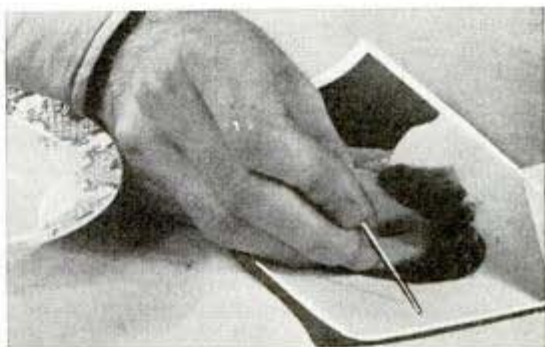

Photo Tray Balanced on Dowel Rocked by Touch of Finger



Rocking the developing tray will not become tiresome when making a large number of prints if you fasten a dowel to the

bottom as indicated. Use two pieces of adhesive tape to attach the dowel. If the tray is carefully balanced, a touch of the finger will cause it to rock for some time.

Marks on the Developer Bottle Show Condition of Solution

Time necessary for developing films in many fine-grain developers increases each time the developer is used. To keep an accurate record, make a small crayon mark on the developer bottle each time a roll is developed. The marks will indicate the necessary increase in time for the next roll.



WHAT KIND OF BOAT DO YOU WANT?

Whether it's a simple rowboat, an outboard runabout or a family cruiser, you'll find something you want among our plans. Build your boat now for the coming season



"Banta," 12-Ft. Runabout—1080-1081

"Banta," 12-Ft. Plywood Runabout—1080 and 1081: Simplified construction makes this plywood runabout easy to build. Here's the boat to take along on that weekend trip. 2 prints 50c.

"Falcon"—1070-1079 Incl.: Trim, sturdy 18-ft. inboard runabout or cabin cruiser. 66 in. beam, 42 in. total depth, 7 or 8 passengers. Makes a speed of about 17 m.p.h. with a 20 h.p. motor. 10 prints, material list and procedure \$2.50.

CATALOGUE OF PLANS

If you have a home workshop and want some new ideas on things to build, just send your name and address with a 3c stamp for our new 32-pp. illustrated plan catalogue. Lists plans on workbenches, motor-driven machines, garden furniture, models of all kinds, boats, radio equipment, juvenile articles, etc.

Address—Plan Service, Popular Mechanics Magazine, 200 E. Ontario St., Chicago

"Arrowhead" Sloop—944 to 951: 21-ft. sailboat that can be built by average craftsman. Accommodates up to 10 passengers. Set of 8 prints \$2.00.

"Hi-Ho," 14-Ft. Family Runabout—840 to 845: Powered by 11 to 22 hp. outboard or light inboard motor. Beam 58 in. Set of six prints \$1.50.

"Roamer"—765 to 770: Outboard cabin cruiser. 16 ft. long, 66 in. beam. Requires outboard motor of 20 to 36 hp. Set of six prints \$1.50.

"Skipper"—1018 to 1023: Low-cost, outboard runabout. Can be built for \$30 to \$40. 14 ft. long, 54 in. beam, weighs about 275 lbs. Set of six prints \$1.50.

12-Ft. Rowboat—707: Flat bottom. Can be used with small outboard motor. 25c.

"Sea Saucer"—893: Lightweight sailboat. Length 9½ ft. Planked with 3/16-in. plywood. 25c.

16-Ft. Canoe—811 and 812: Cedar planking covered with canvas. Two prints 50c.

Canvas-Covered Kayak—928 and 929: Light framework covered with canvas. 17 ft. in length and accommodates single passenger. Two prints 50c.

7½-Ft. Plywood Rowboat—1068: Made from waterproof plywood this boat is easily transported on top of car. Complete instructions and material list included. 25c.



SHOP NOTES



CENTERING FIXTURES for the DRILL PRESS

By Alexander Maxwell

YOU'LL find a set of centers like the one shown in Fig. 1 handy when it comes to holding small cylindrical and spherical-shape work for drilling. Essentially, the set consists of a central base having three interchangeable centers, namely: a vee, a cup, and a cone. The first is used to hold rod and tubular stock, and the second for spherical work as shown in Figs. 2 and 3 respectively. The cone center will be found useful in drill-cutting quadrants in heavy metal, and for roughing-out trunnion slots as shown in Fig. 6. Here the work pivots on the cone

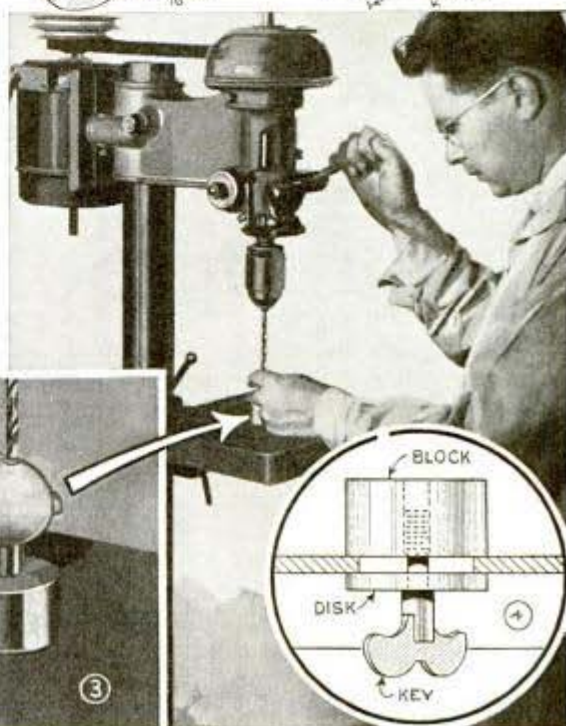

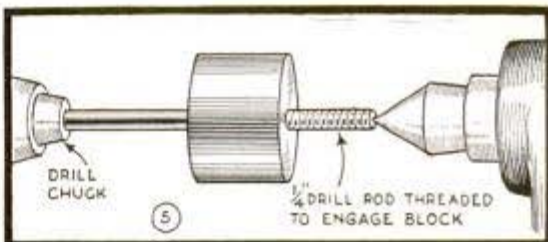
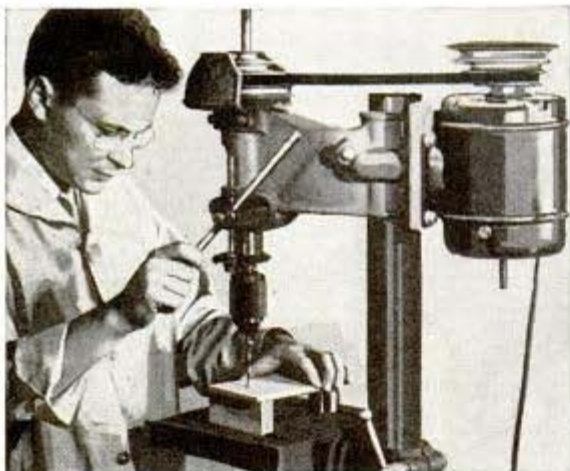

Then mount it between lathe centers as shown in Fig. 5, leaving the rod extending on each side just enough to permit surfacing the ends, yet to prevent chattering. Keep the tool very sharp, the work well oiled and take light cuts at high speed. If the block is to be used as a gauge to set dividers, calipers and other measuring instruments quickly as shown in Fig. 7, remove the last few thousandths of an inch with a toolpost grinder and check the work with a micrometer. In case a grinder is not available, a fairly accurate surface can be had by using a facing cutter and going over the surface three or four times after the final advance of the toolpost. The latter method will do where a critical caliper measurement makes little difference in the work involved.

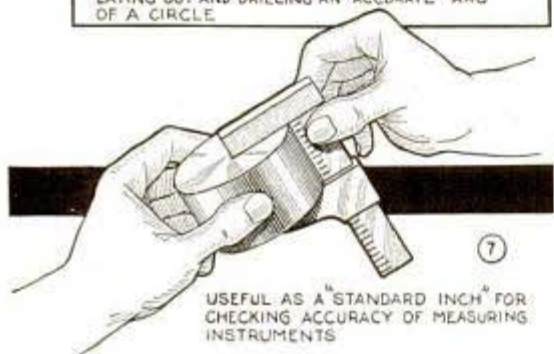
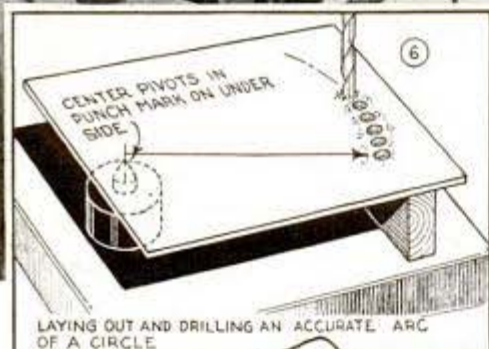

center located over one of the table slots. Fig. 4 shows how the key and washer of the set are used to clamp the base to the table, the key threading midway into the block to allow the tenoned centers to be inserted in the top. The work is centered accurately with the drill by loosening the key and shifting the base.

Unless the parts are to be subject to production work, they need not be hardened. To machine the base, first mount it in a four-jaw chuck and drill a No. 7 hole through it centrally. Counterbore the top of the hole $\frac{3}{8}$ in. deep and tap the bottom with a $\frac{1}{4}$ -20 thread to receive the key. Hold the tap in the tailstock chuck and rotate the work by hand. Now make a mandrel from a length of $\frac{1}{4}$ -in. drill rod and thread it part way to engage the block.

Horseshoe Runners for Ice Sled

Needing a small sled to use about the buildings, one farmer made up a simple one and used discarded horseshoes for the runners. These were attached by means of small lag screws, the holes in the shoes being enlarged to take the screws.



High-Temperature Furnace Has Tin-Can Shell

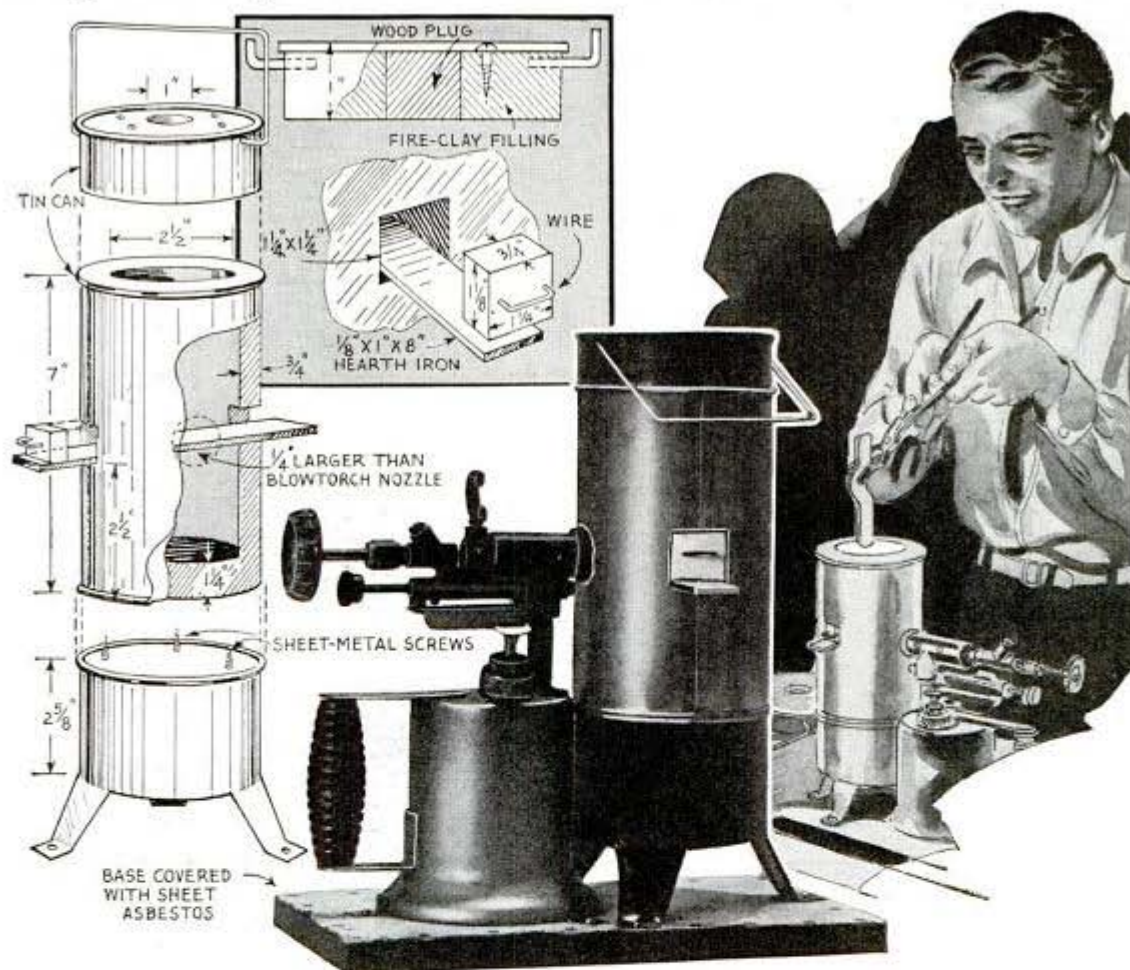

Providing sufficient heat for hardening, tempering and forging small work, this portable furnace uses a blowtorch to supply the heat, and three 4-in. dia. tin cans for the shell. The center can, which forms the heat chamber, has openings for a hearth iron and the torch nozzle, while the lower can is cut so that three legs are formed on the bottom. The cover has a 1-in. center opening and is fitted with a wire handle. Prepared stove lining is satisfactory for lining the furnace although fire clay is better. Before adding the lining, openings for the hearth iron, blow-

torch nozzle, etc., are fitted with soft-wood plugs, while a 2 1/2-in. mailing tube forms the core, after which the fireclay is tamped between it and the can. When the lining is almost dry, the furnace can be fired by cutting a hole in the paper core at the torch-nozzle opening. The torch is then set 1/4 in. from the opening and adjusted to burn with a low flame. After the paper core has burned and the lining is dry on the inner surface, the softwood plugs may be removed and the heat increased. If cracks develop in the lining, the surface should be thoroughly wetted and all cracks filled.

Small Rubber Bands and Washers Cut Quickly in Lathe

If you need a number of small rubber bands or washers that are difficult to obtain, try cutting them from a length of rubber tubing. The job can be done quickly in a lathe without any special equipment by merely slipping the tubing over a dowel

that is slightly larger than the inside diameter of the tubing. The dowel is then chucked in the lathe, and a sharp razor blade used to cut bands of any desired width. If a large quantity is to be cut, mount the razor blade in a sturdy holder.

Dentist Cleans Spatula Quickly On Slotted Scraper



A piece of heavy sheet metal slotted and screwed to the underside of his bench provides one dentist with a good cleaner for his spatula. The spatula is cleaned by pulling it through the slot, the waste dropping into a can below the cleaner.

Three-Speed Pump Jack Controls Water Flow for Various Uses

One farmer who wanted an easy method of controlling the speed of his well pump jack so that he could get different streams of water, did the job with an old auto transmission. This was belted to the motor and connected to the pump-jack shaft by

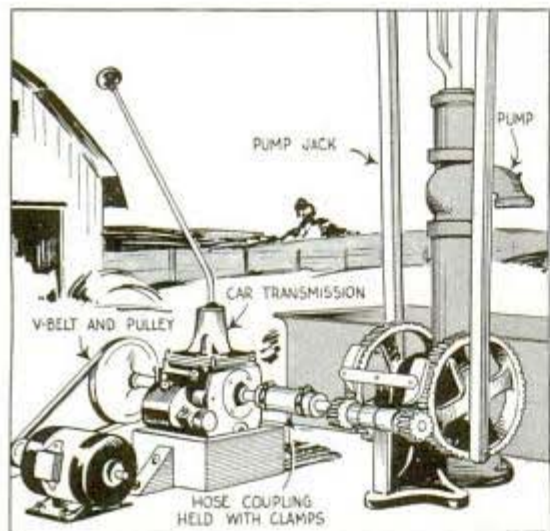

means of a hose coupling. Shifting gears of the transmission enabled him to fill the stock tank quickly, or provide a small stream of water for cooling milk.

Surface Water Kept From Well By Gasket Under Pump

Discovering that his well water was being contaminated by surface water, which was entering around the base of the pump, a farmer stopped the trouble by putting a rubber gasket under the base of the pump. This is a sure cure for this trouble unless the platform is cracked, or does not fit tightly on the well casing and allows the water to enter at these points.

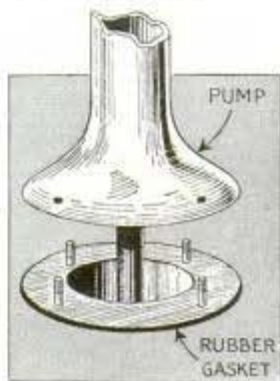

Keeping Sawdust Out of a Motor



When a motor is mounted under a saw, sawdust can be kept from falling on top of it and eventually entering the housing if a shield is provided under the saw

blade. Location of the shield will be determined by the type of saw you have. In most cases, the shield can be made of sheet metal or hard-pressed board, which is fitted around the drive belt as indicated.

—Charles A. King, East Kingston, N. H.

Weighted Grain-Drill Openers Aid Work in Trashy Ground

In trashy fields, corn roots, bunches of grass and weed stalks make it difficult to plant seed at a uniform depth with a grain drill equipped with disk openers of the type most commonly used. To provide the additional weight necessary to



cause the disks to cut through the greater part of the trash and deposit the seed at the proper depth, one farmer attached a 5-lb. sash weight to the drawbar of each opener. Under less trashy conditions and on certain types of drills, a 3-lb. weight is usually sufficient.

—W. C. Lammey, Naperville, Ill.

Prepared Shipping Tags Removed Easily From Closed Hoop

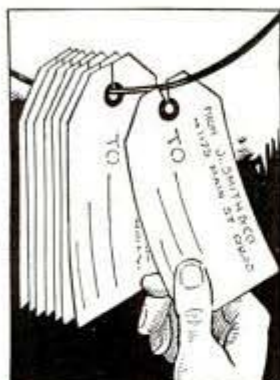

To avoid loss of addressed shipping tags on a loading platform, where the tags are applied to boxes with tacks, one clerk kept them on a wire hoop. The tags are slipped on or off the hoop easily by slitting them as

indicated. This can be done quickly if several of them are stacked at a time so that a stroke of a sharp knife or razor blade can be used to make the slit.

Coil Spring Across Dustpan Aids in Cleaning Broom

Bits of wire, steel shavings, etc., are easy to remove from a shop broom by using a coil spring stretched across the back of a dustpan. Pulling the bristles of the broom over the spring quickly dislodges any particles adhering to it.

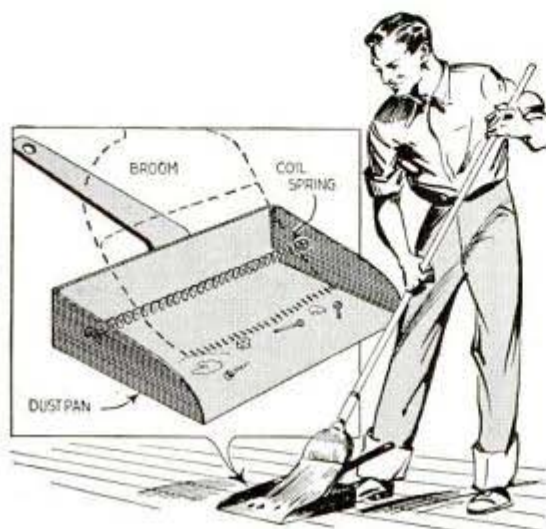

Colored Line on Tympan Sheet Simplifies Press Feeding

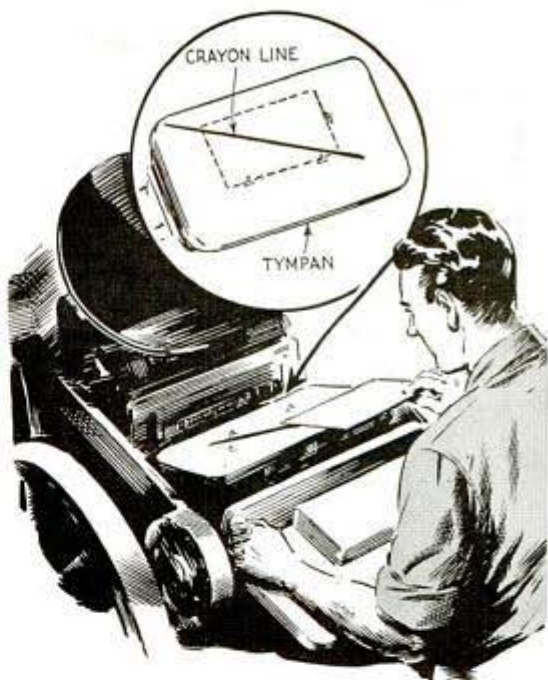

One shop foreman avoids fatigue when printing cards or envelopes at high speed on a platen press by using a colored crayon line drawn diagonally across the tympan sheet. The line directs the press feeder's eyes automatically so that his hand drops the card or envelope in place easily.

Floor Flange as Nontip Holder For Plumber's Candle

Plumbers who are sometimes forced to use a candle as illumination in places where an electric light is not available, will find that a floor flange provides a handy nontip holder for the candle. The opening in the flange can be reduced with bushings to fit the base of a candle.



Ⓛiquid asphalt compound used to repair roofs can be applied much easier and faster by using a discarded or cheap window squeegee instead of a tar brush. The liquid is poured in puddles here and there on the roof then spread neatly and evenly with a long handled squeegee.

YOU CAN

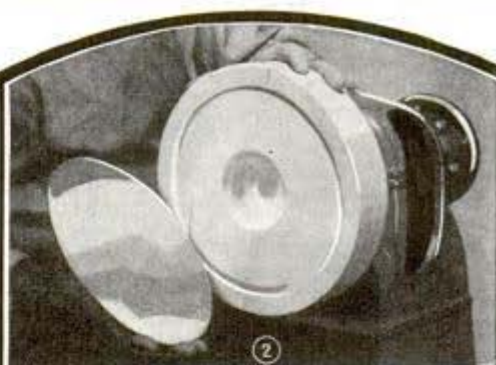
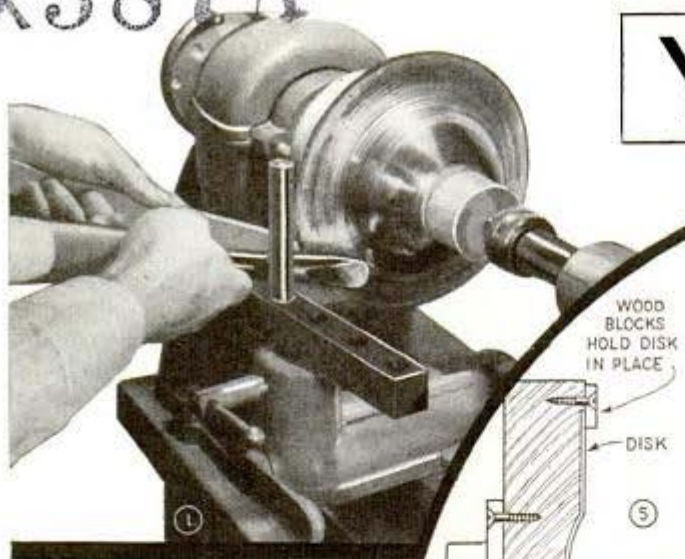

STARTING CHUCK IS RECESSED TO HOLD DISK

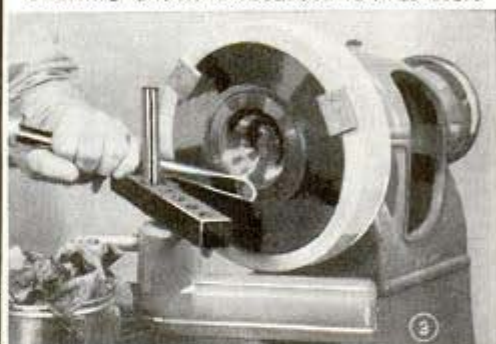

THE METAL DISK IS SPUN INTO THE RECESS



WORK IS FITTED TO EXTERNAL CHUCK TO FINISH

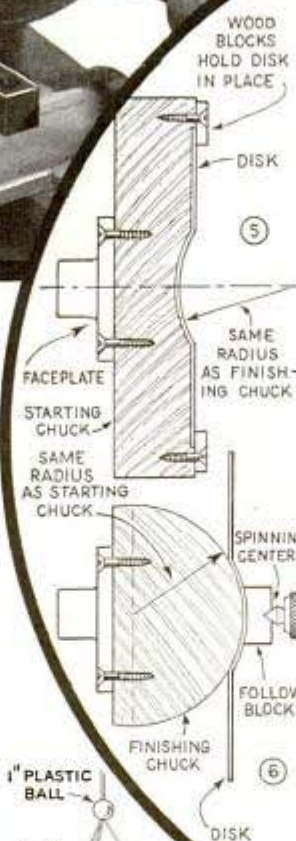

HANGING FLOWER BASKET



ASH TRAY

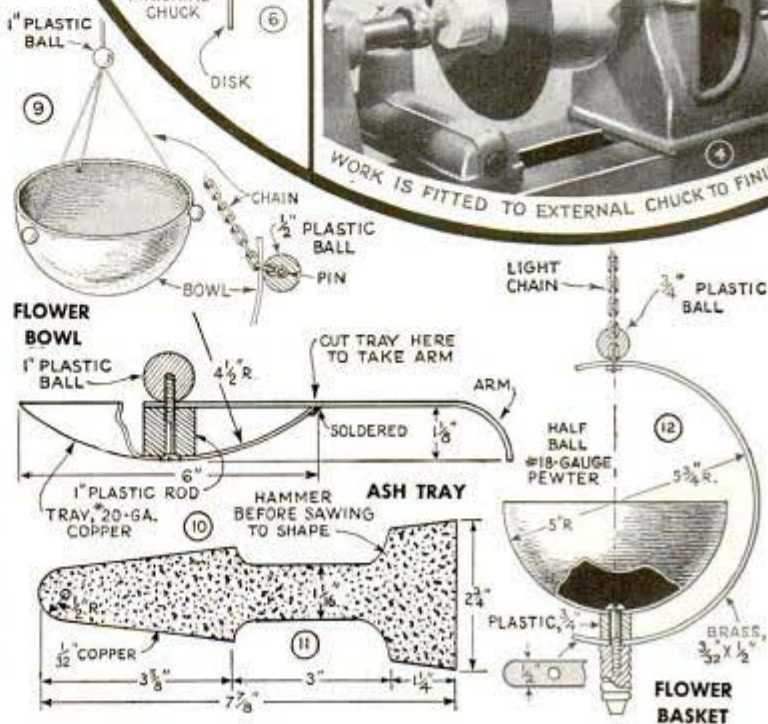

SPIN IT

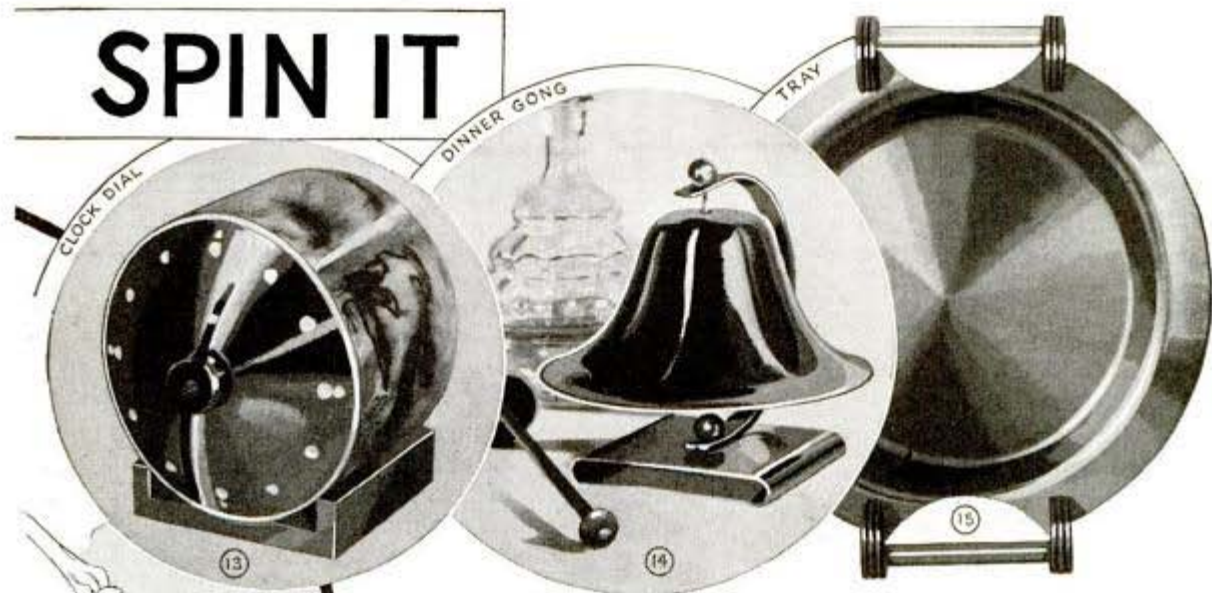

Attractive and Useful Articles in Pewter and Copper That Anyone Can Spin on a Lathe

REQUIRING only a wood-turning lathe and a few added accessories, metal spinning opens a field of interesting, smart projects for the craftsman. Pewter of about 18 gauge should be the first choice of the beginner as it spins easily without annealing, and can be polished to a beautiful mirror finish.

The ball shape: A half ball of polished metal or a smaller portion of it has numerous applications. Typical is the flower bowl, Fig. 9, the hanging flower basket shown in Figs. 7 and 12, the ash tray, Figs. 8, 10 and 11, and the clock dial, Figs. 13 and 18. In many projects featuring this shape, a hole is required in the center of the metal. This is a fortunate feature as it permits the disk to be fastened directly to the chuck, Fig. 16, without the need of preliminary spinning on a starting chuck. Where the work has no center hole, the disk is started on a starting chuck, as in Figs. 2, 3, and 5. After the metal has been spun into the starting chuck, it is mounted on the finishing chuck to complete the spinning, Figs. 4 and 6.

The bell shape: This is very similar to the half-ball shape and requires a starting chuck unless the work specifies a center hole large enough to take a suitable screw. The dinner gong, Fig. 14, is an example of the bell shape. Fig. 17 shows the construction. This project uses a fairly heavy metal (16 gauge) in order to give a mellow tone to the bell when struck with a felt mallet.

Shallow tray shape: The shallow tray or plate shape is probably featured more than any other in spun projects. The various terms applied to the tray shape are given at the top of Fig. 21, which also gives the dimensions of the ash tray and nut bowl shown in the photos, Figs. 19 and 20. This shape can be spun on either an internal or external chuck. An internal chuck indicates that the metal is to be spun into the chuck; an external chuck indicates that the metal is to be spun over the chuck. Fig. 22 shows an internal chuck with recessed rim to take a round metal blank. Fig. 23 shows the preferable method, using a square sheet



WHERE A CENTER HOLE IS PERMISSIBLE, THE DISK FOR THE BALL SHAPE CAN BE SCREWED DIRECT TO CHUCK

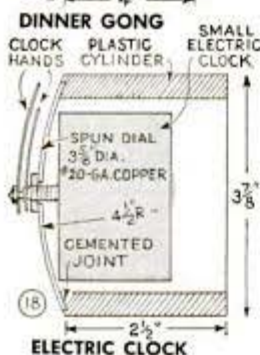
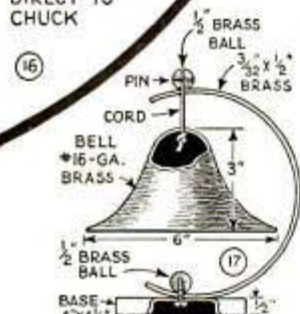



ASH TRAY



NUT BOWL

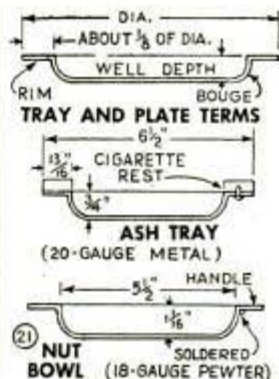

22

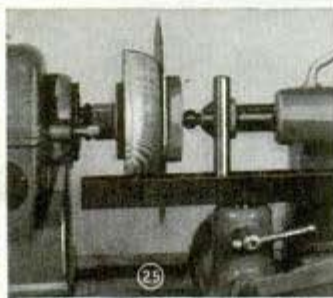

23

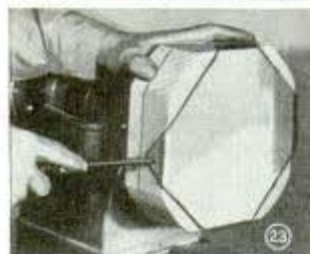

24

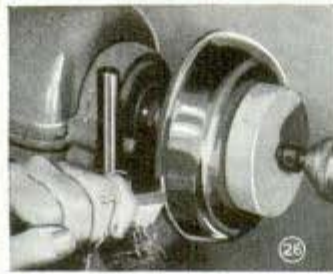

25



26

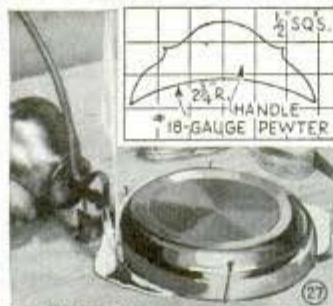

27

SPINNING SHALLOW TRAY SHAPE ON INTERNAL CHUCK

SPINNING SHALLOW TRAY SHAPE ON EXTERNAL CHUCK



DECORATIVE TREATMENT

28

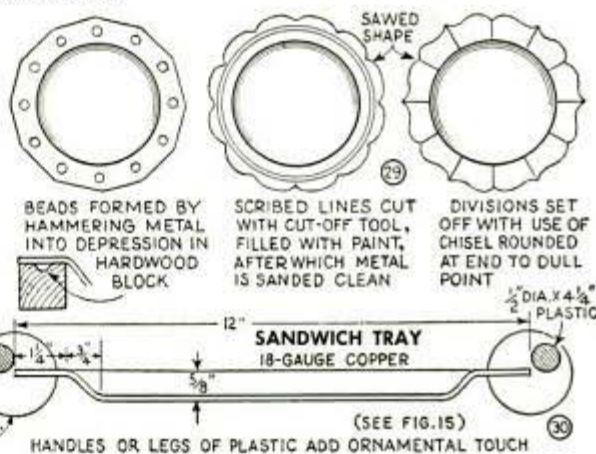

BEADS FORMED BY HAMMERING METAL INTO DEPRESSION IN HARDWOOD BLOCK

SCRIBED LINES CUT WITH CUT-OFF TOOL, FILLED WITH PAINT, AFTER WHICH METAL IS SANDED CLEAN

DIVISIONS SET OFF WITH USE OF CHISEL ROUNDED AT END TO DULL POINT

SANDWICH TRAY

18-GAUGE COPPER

(SEE FIG. 15)

HANDLES OR LEGS OF PLASTIC ADD ORNAMENTAL TOUCH

of metal screw-fastened to the sides of the chuck. The advantage of this mounting is that the face of the metal is completely clear. In any case, spinning is simply a matter of forcing the metal into the chuck shape, as shown in Fig. 24. The stroking action of the spinning tool should be from rim to center. Attention should be concentrated on getting the sharp turn at the rim down to the chuck surface. The rim will tend to lift during the spinning operation and should be hammered flat with a rawhide mallet.

In spinning the tray shape with the use of a standard external chuck, the metal disk is held in place by means of a follow block, which should be about $\frac{1}{8}$ in. less in diameter than the flat bottom of the tray. Pressure of the spinning center on the follow block holds the disk securely for spinning. The starting set-up is shown in Fig. 25. The spinning action is aimed at getting a small section of the metal down to the chuck sur-

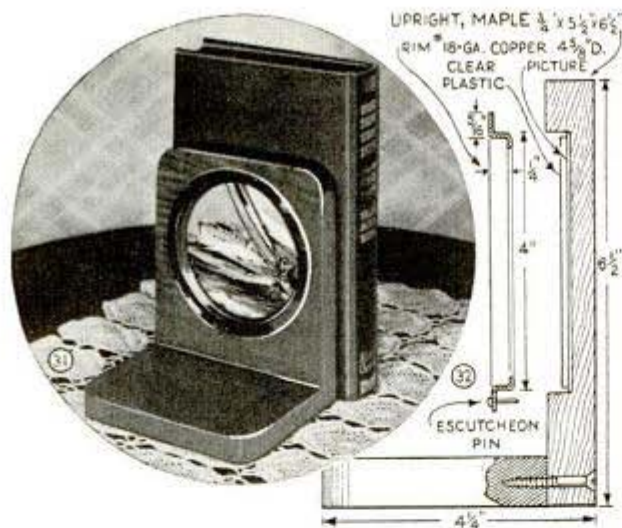

face while keeping the rest of the metal in a straight V-shape. The natural tendency of the metal to form a bell shape should be counteracted by stroking the metal not yet down to the chuck surface, at the same time, backing the spinning tool with a broomstick sharpened to a chisel point. The technique is shown in Fig. 1. After obtaining the V-shape in this manner, the flat tool takes another "bite" in forcing another short section of metal down to the chuck surface. Every time this is done the disk will start to "bell" and must be straightened to the required V-shape. After the metal is all down to the chuck surface, the rim can be trimmed, as shown in Fig. 26. The project shown as an example is the nut bowl, Fig. 20. This requires handles, which are soldered in place with pewter solder melted with a blow pipe, Fig. 27. Excessive heat must be avoided since the melting temperature of pewter is very close to the heat necessary to melt the special solder. Well done, soldered joints in pewter can be filed and polished to make a perfectly invisible joint.

Decorative treatment: Plates and trays can be decorated by hammering after spinning, Fig. 28, or by any of the simple methods shown in Fig. 29. The use of handles or legs of plastic adds an ornamental touch, as can be seen in the sandwich tray, Fig. 15. The dimensions of this tray are given in Fig. 30.

Metal-covered forms: In some projects, notably bases for lamps and candlesticks, the metal can be spun permanently over the chuck. This has an advantage in that narrow, neck shapes can be formed without resorting to complicated sectional



chucks. The base and top of the lamp stem shown in Fig. 33 illustrate the idea.

Metal rims: Metal rims for use on clocks, picture frames, etc., are spun easily by using the same technique as in spinning a shallow tray on an internal chuck. It can be seen that the rim used in the nautical book ends, Figs. 31 and 32, is simply a shallow tray with the center cut out.

General features of spinning: All chucks should be made from hard maple—the use of a softer wood will result in the grain of the wood printing on the metal. A good speed for all spinning operations is 1,000 r.p.m. The metal disk must be kept lubricated at all times. A half-and-half mixture of soft soap and soft grease is satisfactory. Although pewter is the most satisfactory, copper has excellent decorative value and is easy to spin as long as it remains soft. However, action of the spinning tool causes it to harden and become brittle. When this occurs, the metal blank should be removed from the lathe and annealed by heating over a gas ring to a dull red and then quenching in water. 20 gauge is a good all-around thickness for spun projects in copper. The same gauge in aluminum spins readily and has the advantage of requiring no annealing throughout the spinning process.

ⓘ Don't use ordinary outside house paint on porch floors. It is not formulated for foot traffic. Apply one or two coats of porch and deck paint or porch and deck enamel.

Sandpaper Paddle Smooths Cloth On Steam Press



Smoothing the fabric of garments on his steam press without any possibility of burning his fingers, is a simple matter for one press operator, who uses a sandpaper paddle for the job. Use of the paddle also makes it unnecessary to touch the cloth, reducing the chances of getting finger marks on easily soiled garments.

Animals Can't Tip Feed Basket With Pitchfork Through Handle

Animals which must be fed grain outdoors, can be prevented from tipping over the feed basket by using a pitchfork as



shown. The fork handle is run through one of the basket handles, after which the fork tines are pushed into the ground.

Individual Keys in Print Shop Marked by Linotype Slugs

By casting linotype slugs bearing the names of various rooms of a print shop, the proprietor made tags for the keys to the rooms. The heavy slugs also helped prevent any workman from inadvertently carrying a key away from the shop in his pocket.



Thimble Clip Helps Sign Writer Hold Brush Without Strain



Sign and card writers who use a small brush for long periods of time will find that a clip soldered to a thimble will reduce finger strain. The clip is made to fit tightly around the handle of the brush and can be

soldered to the side of the thimble at any angle suitable to the user.

Inverted Tumbler Used as Tray For Mixing Artists' Colors

When you need a small tray for mixing water colors, just invert a glass tumbler and mix the color in the concave bottom of the vessel. It is just about the right size for a small amount of color and it is easy to clean.



Inlaying a Cheek Piece in Your Own Gun Stock

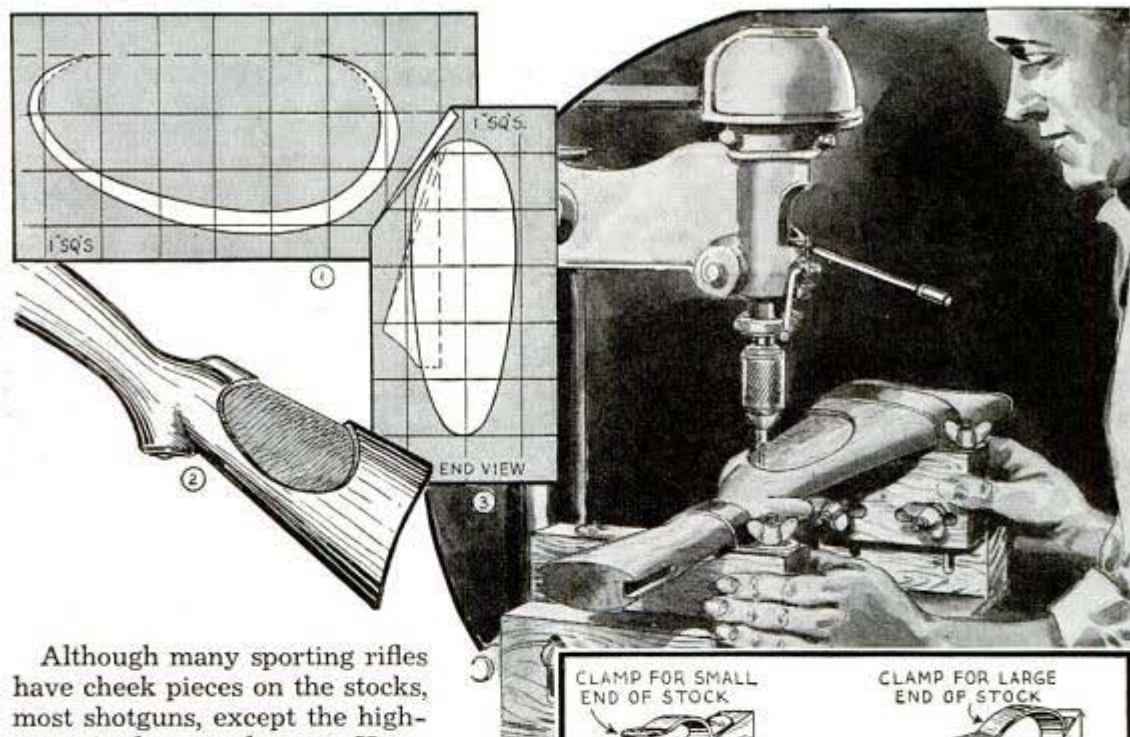

Although many sporting rifles have cheek pieces on the stocks, most shotguns, except the highest priced ones, do not. However, any shotgun owner can make one for his stock. First, the stock must be routed out to form a cavity in which the piece is inlaid. A router bit in a drill press is ideal for this work. You will need a clamping jig like the one shown in Fig. 4 to hold the stock. Notice that the ends of the jig are adjustable in height so that the stock can be held level horizontally under the router bit.

Also notice that the base of the jig is cut out exactly to the shape of the cheek-piece cavity to be routed in the stock. A pattern of this opening is given in the squared diagram of Fig. 1. The white portion indicates the amount of bevel on the edges of the cheek and has nothing to do with the shape of the opening. Just make this to the size and shape of the outside line of the pattern. In use, a pin is put in the drill-press table, and the jig is moved around to outline the cavity on the gun stock, keeping the edge of the opening in the jig against the pin. When the routing has been finished, make the cheek piece and inlay it in the cavity. Fig. 2 shows how the cavity appears on the average stock. The cheek piece is sawed to shape from 1-in. walnut, matching the stock as closely as possible in color and grain. Then it is glued in place, allowing

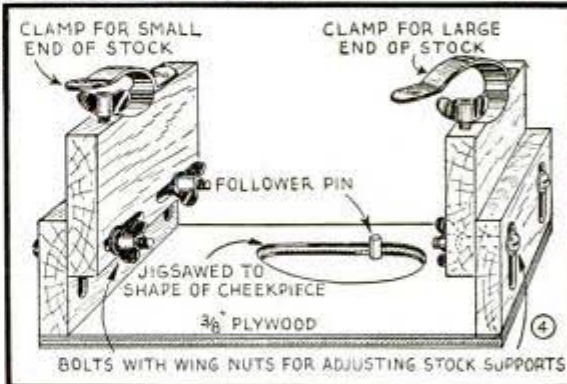

plenty of time to dry. After this, final shaping of the piece is done with a rasp, file and sandpaper, testing it frequently for fit. A general cross section of the piece in place is given in Fig. 3. The job is completed by finishing the work to match the stock.

Mice Kept Out of Binder Canvas

Slipped over the ends of a rolled binder canvas, two tin pails will prevent mice from entering. The canvas can be suspended from a ceiling with twine or wires attached to the bails.

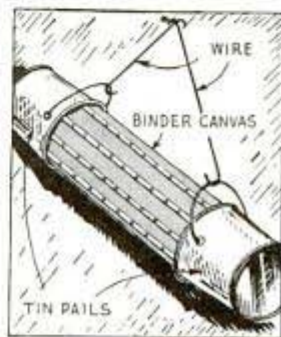

How to Avoid Drying of Paint In Wood-Finishing Shop



Having an occasional job of dip-painting small wooden objects in a trough, one manufacturer keeps his paint covered between batches in a large can. The bottom of the can and the bottom of the dipping trough are connected by means of a rubber hose. When the paint reservoir is raised, the paint runs into the trough. Then, when the reservoir is set on the floor, the paint runs from the trough back into it. With this method, filling or emptying the trough is just a matter of seconds.

—T. E. Stimson, Jr., Los Angeles, Calif.

Rubber Ball Serves as Stopper For Carboy of Acid



Removal of a tight-fitting stopper from a carboy of acid each time a little of the liquid was required was avoided by one dairyman who used a sponge-rubber ball as a stopper. This was pressed inside a glass tumbler and inverted over the mouth of the carboy as indicated. The tumbler provided weight so that the ball sealed the

carboy, and permitted the ball to be lifted without getting acid on the hands. Also, the tumbler prevents the stopper from being knocked off the carboy accidentally.

Spectacle Case Held in Pocket By Pencil and Rubber Band

As a safeguard against losing his spectacle case while working, one carpenter fastens it to his pencil with a rubber band. The pencil is first placed against the case as shown, after which the band is stretched inside the lid and slipped over both ends of the pencil. The clip holds both pencil and case securely in the pocket.

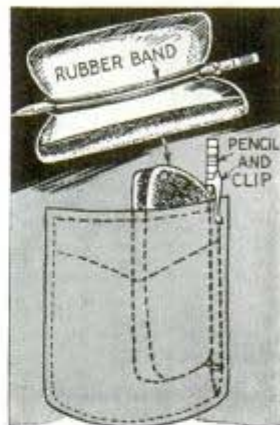

Nail-and-Staple Wire Fasteners On Temporary Stock Fence

If you want to put up a temporary fence that can be taken down quickly, slip a nail in each staple before driving it home as indicated. When the fence has served its purpose, just pull the nails to loosen the wire, which will provide enough space so that a claw hammer can be inserted behind the wire and pull the staples.—A. H. Waychoff, Phoenix, Arizona.

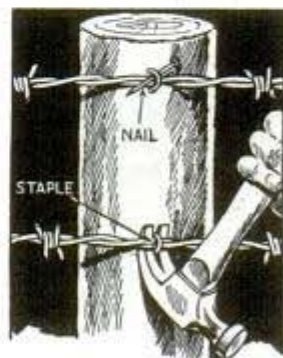

Sharp Tool for Marking Metal

Where exact dimensions must be followed, a sharp tool for marking and laying out metal work can be made in a few minutes by filing off the point of a large nail and drilling a hole in the end of it for a phonograph needle. The needle is either soldered or driven in place so that the point projects about $\frac{3}{8}$ in.

—Ward Williams, Brandon, Wis.

THICKNESS SANDER ON LATHE

has suction dust disposal

DUST is no problem when using this thickness-sanding attachment because it is disposed of by a vacuum-cleaner attachment as shown at the right. Looking at the circular detail below you can see how the sander clamps to the lathe bed. A wood cleat is screwed to the underside of the base to align the table with the ways and it is drilled to take two clamping bolts. It is important to mount the table at the rear side of the lathe so that the direction of rotation is against the direction of feed. The bracket supporting the suction spout must be made to fit the attachment at hand. After making sure that the drum is the same diameter its full length, it is slotted for a paper-locking wedge and covered with rubber. A ball-thrust bearing is used to support the drum at the tailstock, otherwise the center will wear an enlarged hole, eventually causing the drum to cut unevenly. Table trunnions riding the threaded ends of a rod stapled to the underside of the base regulate the depth of cut. While the size of the lathe governs the capacity of the sander, the one shown in the photo will handle stock up to 1½ in. thick.

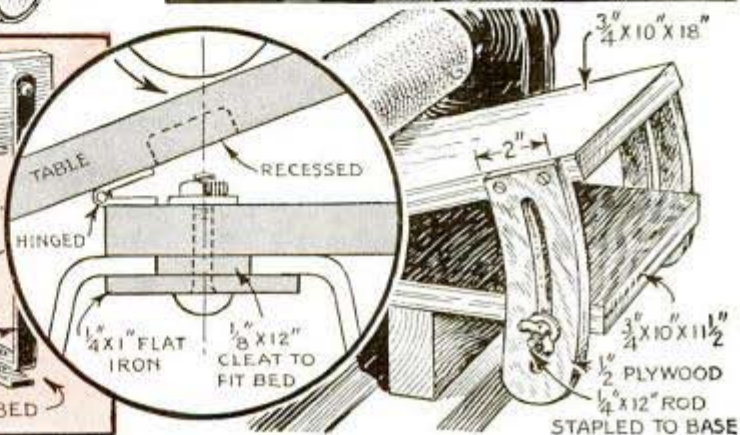
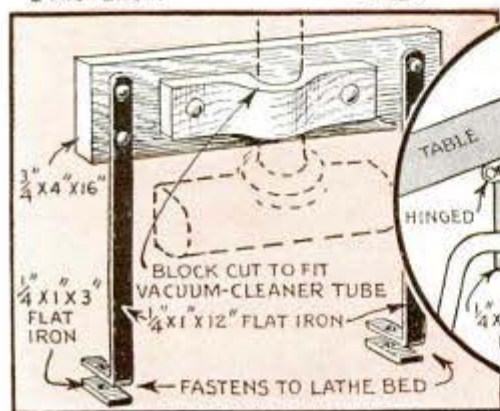
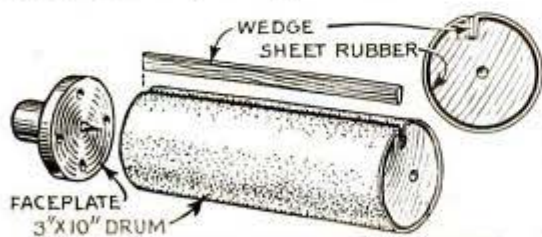

Weighing Drum of Chlorine Gas Determines Amount Left

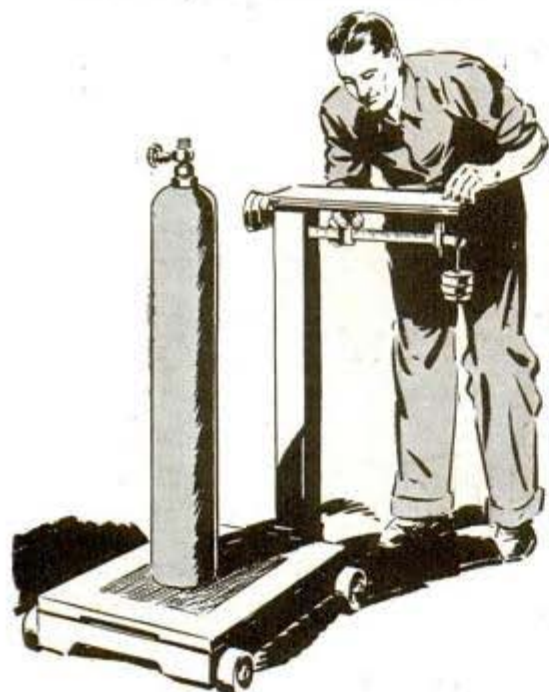

In order to determine the amount of gas remaining in a drum of chlorine gas, I used the following method: I weighed the drum and then subtracted the weight of the drum itself. This gave me the weight of the gas in the drum. Knowing the total weight of a filled drum, it was easy to determine approximately the amount of gas left.—Elmer Kling, Norwalk, Conn.

Pail Elevates Poultry Feed Pan



To keep rodents out of a pan of mash in the poultry house, and to elevate the pan so that the fowls cannot scratch litter into it, set it on a discarded pail. Cut out the bottom of the pail so that the pan will

fit down into it as indicated to keep it from being knocked off.

Printing on Small Brass Strips

Receiving an order for some business cards to be printed on brass, we did the job as follows: The type was first set up

and a rubber stamp made of it, after which the stamp was locked in a chase for the press. After the pieces were all printed, the ink was baked on by holding the brass pieces over a flame.

—W. F. Hagerman, Quincy, Ill.

Extension on an Armature Shaft Fitted With Aid of Solder

When fitting an extension on the armature shaft of a small motor, I found it almost impossible to get a pressed fit by drilling the hole in the extension with a regular drill because it bores a

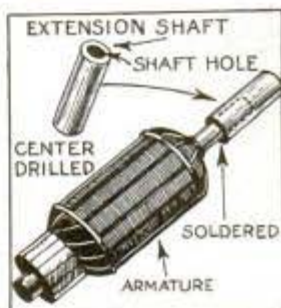

few thousandths oversize. To overcome this, I flowed solder on the extension shaft to enlarge it. This was then pressed on, forming a tight fit which held satisfactorily.

—Warren Taliaferro, Dallas, Tex.

Pin Tags Provide Finger Tabs To Remove Box Covers



Avoiding the annoyance of prying tight covers from cardboard boxes in a store, a clerk attaches pin-type price tags to the covers as shown. The tags provide good finger grips.

Rolls of Screen Wire "Tied" With Tire Sections

One hardware dealer keeps screen wire from unrolling over his workbench by using narrow sections of old auto tire. These are slipped over a roll in a jiffy as indicated, and they automatically adjust themselves to rolls of wire of different sizes.



By C. E. Packer

WHEN a starting motor fails to crank the car engine properly, the trouble will most commonly be found not in the motor itself, but in the starter gear, or in the external circuits. If closing the starter switch puts the lights out, and releasing it causes them to come on again, the fault is likely to be a corroded or loose connection at the battery. You can tell by closing the switch for 20 sec. and then feeling the battery terminals. The faulty one will be very warm. The cure is to remove the terminal, scrape it bright and coat it with vaseline. If the lights merely dim when the switch is closed and brighten after release, the battery usually will be found partially discharged or in poor condition. But, should pressing the starter switch have no effect on the lights, there is an open circuit in the wiring.

However, if pressing the starter switch has little effect on the lights and results in a decided whirring sound, it indicates that the starter gear is not meshing with the flywheel ring gear. In cars with a starter gear as in Fig. 1, the cure is to wash the gear and shaft in kerosene and dry it with air. Use no oil on this. While inspecting, it is well to see that the little spring-actuated pin, indicated by the screwdriver, is not stuck behind the shoulder on the shaft as this would prevent engagement.

Failure to engage in any starter that has a lever extending down into the starter housing as in Fig. 2 indicates a broken engaging spring, seen in Fig. 3. In this type of starter, the pinion is shifted against the teeth of the flywheel under spring tension resulting from the movement of the engaging lever against the spring collar. As the downward movement of the starter pedal continues the lever finally closes the starter switch. If engagement had been delayed due to gear teeth meeting on edge,

Shooting AUTO-STARTER TROUBLES



When inspecting a starter-gear mechanism, always be sure the little spring-actuated pin, shown above, is not stuck behind the shoulder on the shaft as this would prevent engagement of the gear with the gear on flywheel

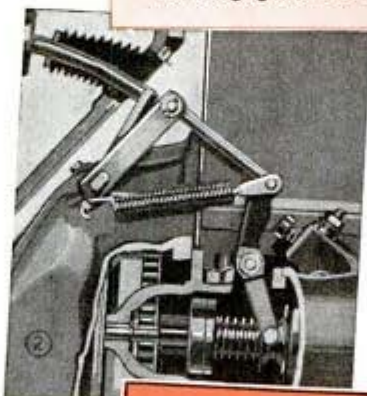

Failure of gear engagement in any starter that has a lever extending down into the starter housing as at the left, indicates a broken engaging spring as shown below. In this type, the pinion is shifted against the teeth of the flywheel under spring tension which results from the movement of the engaging lever against the spring collar. As the lever continues forward the starter switch is closed

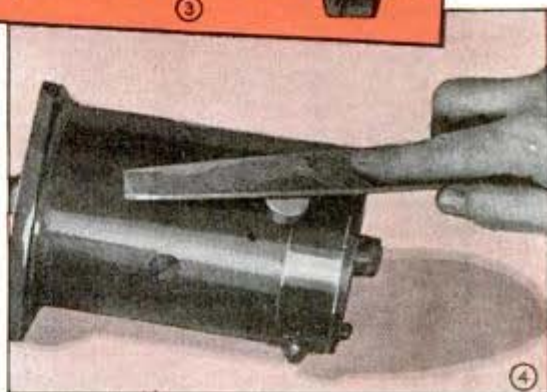

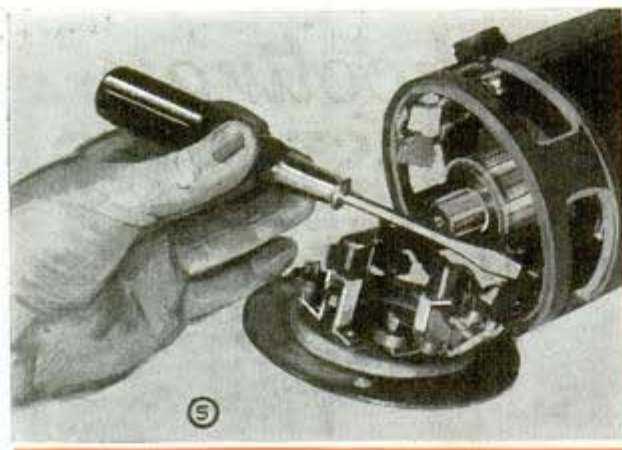

the first movement of the starter shaft would allow the pinion under its spring tension to slip into engagement.

When the car engine starts, the starting motors are protected by two actions. In the construction shown in Fig. 1 the pinion is whirled out of engagement by the spiral shaft. In Fig. 2 there is an overrunning clutch immediately behind the pinion that acts like a coaster brake in a bicycle. Thus when the fly-wheel attempts to whirl the starter it merely spins the pinion until the driver lifts his foot and disengages it. Failure of the starter to make any effort to turn is frequently due to a bad contact within the switch. Removing the switch and filing the contact, as shown in Fig. 4, will generally correct such condition.

Should dimming of the lights result when the starter button is pressed and the battery is known to be fully charged, the trouble is likely caused by excessively heavy oil on a very cold day, mechanical jamming of the starter drive so that the starter

cannot turn, or a ground or short within the starter or switch. A short or ground will generally reveal its location by smoking when the switch is held down for 20 sec. Trouble within the starter generally can be located by visual inspection. Fig. 5 indicates a charred brush lead that was grounded by being squeezed under the commutator cover. Look at all insulation for charred conditions that

would indicate "shorts" or grounds. A test light should be used to check the armature, field and brush ring for grounds also.

It is not unusual for starters to be very weak and to draw too little current. This is commonly due to worn brushes, worn and burned commutator, and too weak brush springs. When turning down a commutator in the lathe it is not necessary or desirable to undercut the mica between the commutator segments indicated by the pencil in Fig. 6. If this mica is undercut the brush dust may accumulate and cause partial shorts between segments, the centrifugal force being insufficient to expel it as on generators.

Probably most common starter trouble is worn brushes. And when replacing brushes don't check for size alone. Be sure that the replacement brush is a real starter brush, not a generator brush. Generator

brushes are primarily carbon and have relatively high resistance. Starter brushes, however, contain a high percentage of copper or bronze, and when they are scraped lightly with a screwdriver, as shown in Fig. 7, they will show a coppery color.



Mica on a starter commutator is not usually undercut as dust would collect in the grooves and cause short-circuits



Be sure new brushes are made for a starter; not a generator. Starter brushes show a coppery color when scraped

Holder to Use Short Lengths of Welding Rods

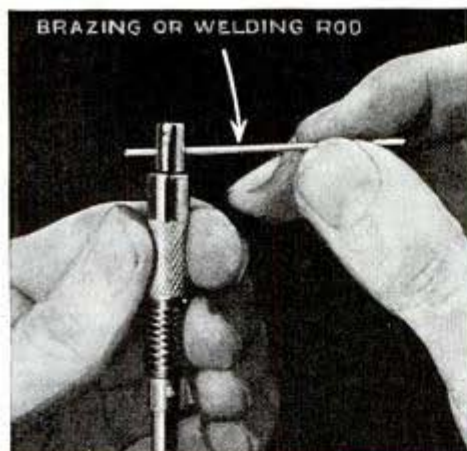

You can save money with this holder because you can use all but about $\frac{1}{2}$ in. of each welding rod. The holder is made of brass, and consists of a rod on which a spring forces a sleeve against the welding rod to hold it in place. A stop pin prevents the sleeve from sliding too far when the work is removed. A wooden file handle provides a good grip for the hand when using the holder close to the torch.

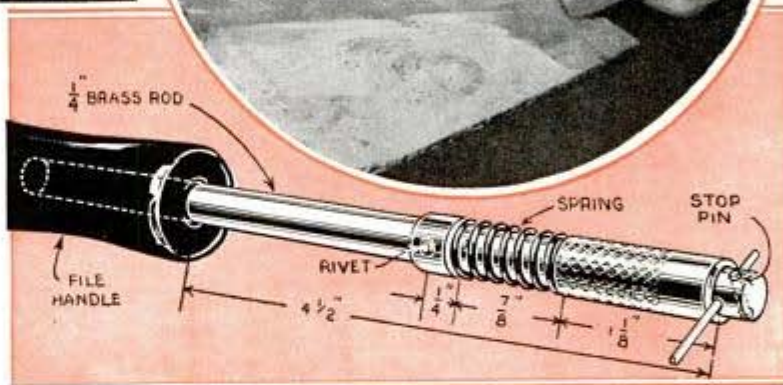

Simple Time Switch to Control Electrical Appliances

Using an alarm clock and a pull-chain lamp socket, or switch, anyone can make a time switch that will open or close an electrical circuit at a predetermined time. The socket is mounted on a bracket of angle iron, which is screwed to a base. The clock is mounted on the same base, and has

a short piece of copper tubing soldered to the alarm-winding key. String wound around this tubing is tied to the pull chain of the socket. In this way, the string winds up on the tubing when the clock alarm goes off, and pulls the chain, closing or opening the circuit, whichever is desired.

—R. V. Banks, Brooklyn, N. Y.

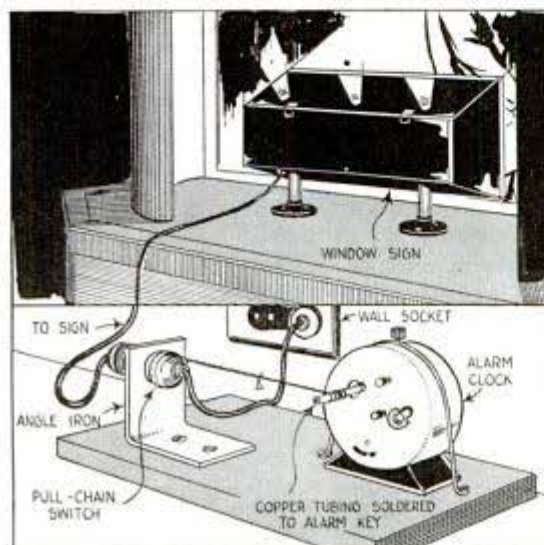

Rubber Plug in Hammer Handle Handy to Tap Work Into Place

You will always have a soft-nosed "mallet" for tapping sanded or planed work into place if you drill a hole in the end of your hammer handle and fit a rubber stopper into it. The stopper should project about $\frac{1}{4}$ in.



Colored Celluloid Softens Glare Of Instrument-Panel Lights



If you have an older car that is not provided with a dimming switch on the instrument-panel lights, and the glare from these lights bothers you on night drives, the glare can be eliminated by putting a piece of colored celluloid over the panel. A couple of small vacuum cups fastened to the celluloid will hold it in place.

Milk Bottle Tests Car Brakes

You can determine whether your car brakes are reasonably safe for moderate driving by making a simple test with a milk bottle. Just pour a pint of water in a quart bottle, cap it and set it on the car floor. Next select a level road or street and drive the car at 20 m.p.h. and apply the brakes. If the bottle does not upset, the brakes will not pass official inspection.

Quick-Change Spring Fasteners For Dealers' License Plates

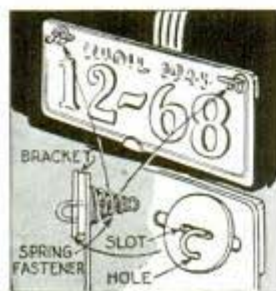

It takes only a few seconds to change a set of plates from one car to another when fasteners of the type shown are used. The set consists of four ordinary winter-

front fasteners, to which are added sheet-metal washers having slots in the center and a small hole to lock the hooks in place.

Scratching of Cylinder Avoided While Fitting Bearing

Any possibility of scratching a cylinder wall while fitting a connecting-rod bearing with the piston removed, is avoided by shielding the end of the rod. A short length of radiator hose is ideal for this purpose when slipped over the wrist-pin end of the connecting rod, as shown.



Mechanic's Apron Held in Place With Sponge-Rubber "Buttons"

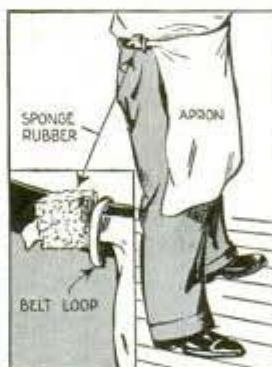

To avoid loss of time in tying and untying the strings of his work apron, one mechanic uses sponge-rubber "buttons" to fasten it in his trouser belt loops. After cutting off the apron strings, leaving each one

about an inch long, he slit squares of sponge rubber to slip over them and stitched the rubber in place as shown.

Slight Electrical Leaks in Car Determined by Compass

Sometimes in older model cars there is an electrical leak, not bad enough to blow a fuse, but enough to run down a battery over the weekend. If such a leak is suspected, you can make sure with a compass. After turning off all switches in the elec-



trical circuit, place the compass on the heavy cable going from the battery to the starter switch. If there is the slightest amount of current passing along the cable, the compass needle will be deflected from normal position.

—Guy E. McAllan, Fernie, B. C., Can.

Flaring Tool for Copper Tubing From Zerk Grease Fitting



The next time you want to flare the end of a copper or brass tube and have no tool at hand for the purpose, just use a zerk grease fitting. The taper on the end of the fitting is just about right to make the flare

if it is tapped lightly into the end of the tube. If a loose fitting isn't at hand, take one off the car and replace it when the job is finished. When using a fitting taken from the car, be especially careful not to damage either the threads or the end that takes the grease gun.

—Emil J. Novak, Omaha, Nebr.

Inexpensive Car-Side Ski Rack Of Bent Flat Iron

Useful for carrying skis, fishing poles, etc., on the side of your car without marring the finish, this simple rack is nothing

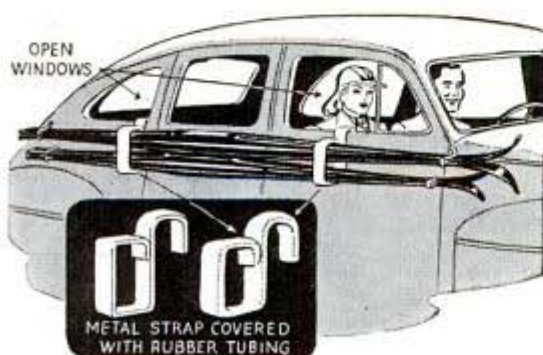

more than a couple of pieces of flat iron bent to the shape indicated and covered with rubber tubing. Allowance for the tubing should be made before bending the pieces as each hanger should be a snug fit over the window opening.

Anti-Spread "Chain" for Truck Utilizes Old Brake Rods

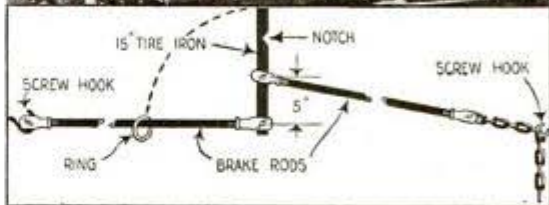

A tire iron and a couple of brake rods with clevises provide a handy anti-spread chain for truck bodies when assembled as shown. Two lengths of chain at the ends permit quick adjustment for width. A notch in the tire iron slips into a ring on one of the rods when the iron is pulled down to tighten the assembly.

—Frank Petrucci, Hazleton, Pa.

Reclaiming Used Motor Oil

Here is the way I reclaim old motor oil for other uses, and it comes out clear and free of carbon or other foreign particles. Just put the used oil in a container on a shelf, box or table. Then hang a rope over the edge of the container with one end in the oil and the other in a second container underneath. A spring or coiled wire over the rope where it contacts the edge of the upper container will keep it in place. Capillary attraction will cause the oil to rise in the rope and run down into the lower container.

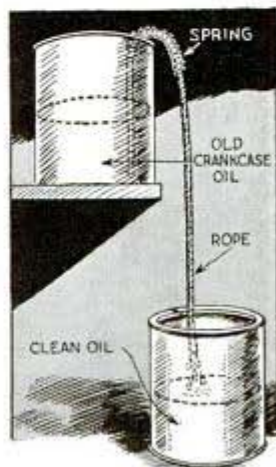

—C. Champion, Birmingham, Mich.

Removable Clearance Lights For Platform Truck

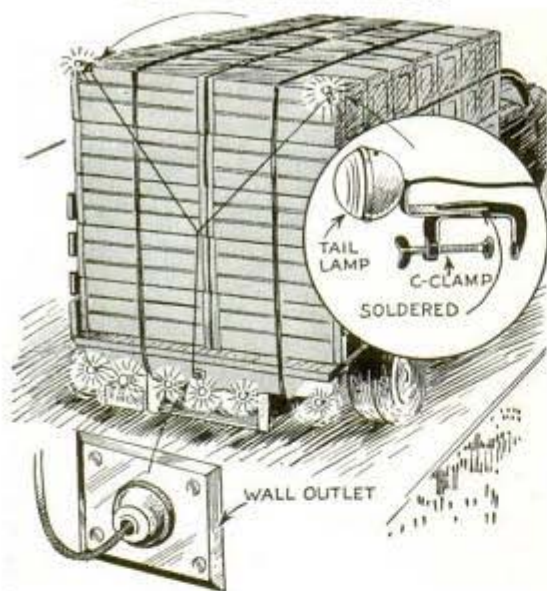

As a sufficient number of clearance lights are very essential, especially on foggy nights, the problem of attaching them in the right locations to a high load on a platform-type truck was solved by one driver who attached them to C-clamps as shown in the circular detail. With this method, the lights can be attached at convenient

positions on the load, and quickly removed when necessary. The lamps are all wired into one individual line in such a manner that they can be plugged into an ordinary wall outlet located within easy reach at the rear of a truck. All wiring must be done carefully, of course, to avoid short-circuits, and rubber-covered wire that is weather-proof should be used.

—John Blackburn, Oakland City, Ind.

Motor Armatures Gripped in Vise By Using Piece of Auto Tire

It is poor practice to clamp an armature directly in the jaws of a vise, even if padding of some kind is used, as there is always the possibility of damaging the laminations or the winding. A better method is

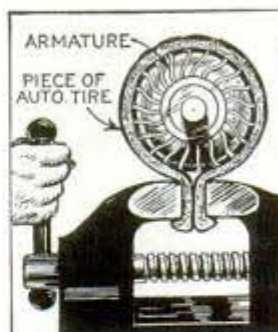

to use a section of old auto tire, clamping the tire around the armature and then clamping the beads of the tire in the jaws of the vise.—Emil J. Novak, Omaha, Nebr.

Forty Motor-Driven Tools You Can Make

Do you want a motorized workshop that is inexpensive, will speed up your work and do it accurately? Then don't fail to get this amazing book! It shows every detail and explains in non-technical style just how to go about making forty different machines. The material used to build them is available almost anywhere—standard iron and brass stock, wood, pipe, old auto parts, etc., which can be picked up for almost nothing. If you want to earn extra money by making things in your spare time to sell, you'll need to employ fast production methods only possible with motorized equipment. Building just one of the tools described in this book will pay for it many times. Send for your copy now and start making the machine you want.

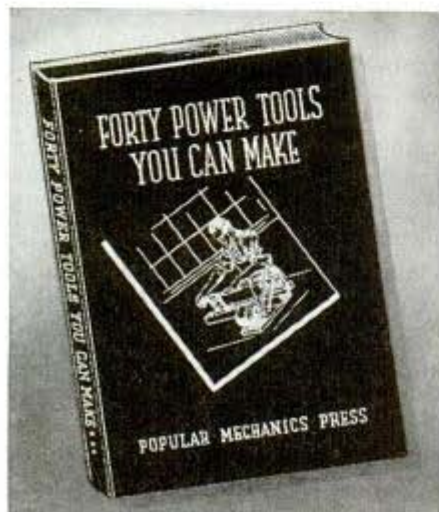

Only \$1.25 postpaid

(money refunded if you are not satisfied)

SOME OF THE MACHINES DESCRIBED

- | | |
|---------------------|------------------------|
| 10-In. Circular Saw | Stroker Belt Sander |
| Midget Circular Saw | Hand Belt Sander |
| Sliding Cut-off Saw | Small Shaper |
| Scroll Saw | Heavy Duty Grinder |
| Band Saw | Small Portable Grinder |
| Drill Press | Metal-turning Lathe |
| Wood-turning Lathe | Hack Saw |
| Disk Sander | Filing Machine |
| Belt Sander | Milling Unit |
| Drum Sander | Abrasive Cut-off Wheel |

POPULAR MECHANICS PRESS

Dept. 344 200 E. Ontario St. Chicago



TELEVISION

for the home

THIS low console television receiver provides a comfortable method of viewing the picture in the home, being designed in such a manner that the screen is actually aimed at the viewer. It is $38\frac{1}{4}$ in. high, 21 in. wide and $25\frac{1}{4}$ in. in depth. Completely a.c. operated from standard 110-volt 60-cycle power lines, it employs 22 tubes including the Du Mont "Teletron," a cathode-ray tube developed for brilliant, large-image television reception. A dynamic speaker is used for sound reproduction and the picture measures a full 8 inches by 10 inches and is viewed directly from the screen of the "Teletron" tube as indicated in photo A.

The various operating controls are conveniently arranged on the front of the receiver as shown in photo B. Although television programs are available only in the immedi-



ate vicinity of a few large cities at the present time, it is estimated that there are probably more than 3,000 television receivers operating in and around New York City. One owner says, "You relax in the comfort of your own living room and a varied television program appears on the screen of your receiver. First you see the news of the day, perhaps at the time it actually occurs, then a

drama created and sent through the air directly from the studio. The pictures are clear, crisp, brilliant and of good contrast. So perfect, in fact, you recall, that during the program you might have thought yourself at the theater. Sports of every description may come to you as they happen in this new era of home television entertainment."

The dipole form of directional antenna shown in Figs. 1 and 2, is generally satisfactory. It consists of two metal rods, each approximately 5 ft. long and placed on a line with each other. If signal level is low due to local conditions, a reflector consisting of a rod about 10 ft. long is placed parallel with the dipole, about 5 ft. back of it.

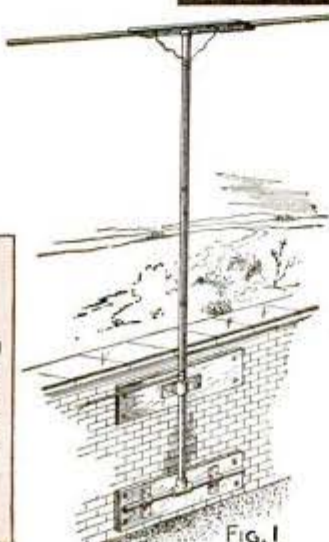
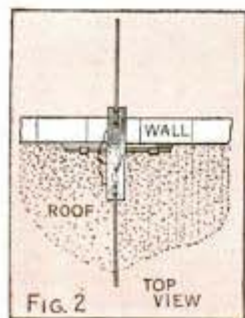

FM ADAPTER

By L. M. Dezettel

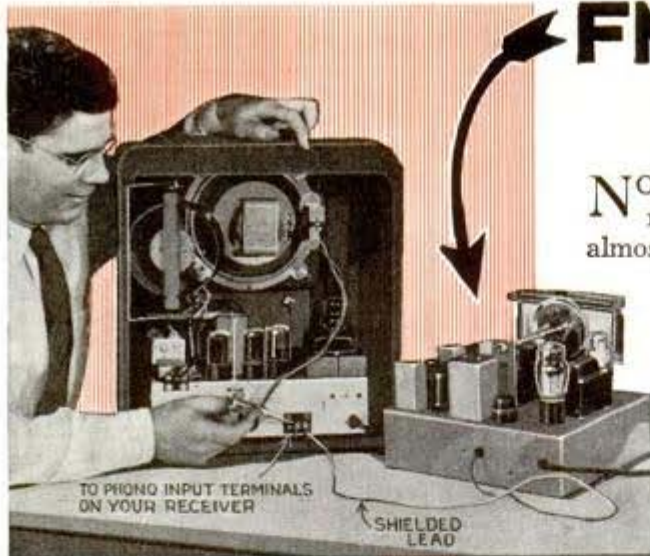

NOW that Frequency Modulation transmitters have brought the high quality, almost noise-free "FM" programs within listening distance of an estimated 38,000,000 people, there is a constant demand for practical information on this fundamentally different type of broadcasting. The only portion of your present standard broadcast receiver that can play any part in the reception of FM programs is the audio amplifier stage and the loudspeaker.

They operate in the same manner as when a record player is plugged into the phono input jacks that are provided in most all high grade modern receivers for record players or television sound. A really good audio stage and loudspeaker are absolutely necessary to reproduce faithfully the high fidelity, noise-free FM signals that are tuned in with this, or any other, FM adapter or receiver.

FM broadcasts are confined to the 42 to 45 megacycle band, and the maximum range is from 25 to 50 miles depending upon the power of the station, the height of its antenna and the height and efficiency of the antenna used for receiving. The simplified adapter illustrated and described has been designed for easy assembly at the lowest possible cost consistent with high quality results. It em-

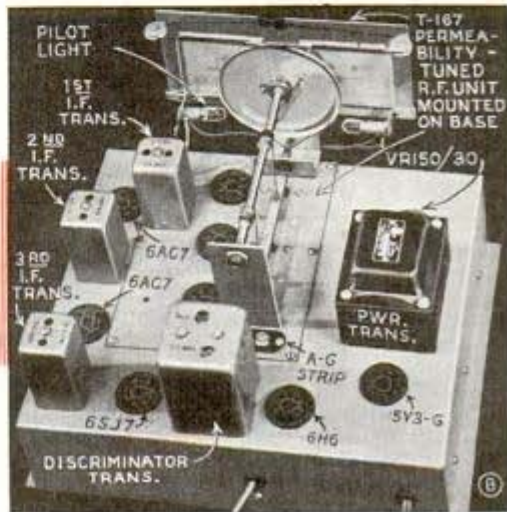
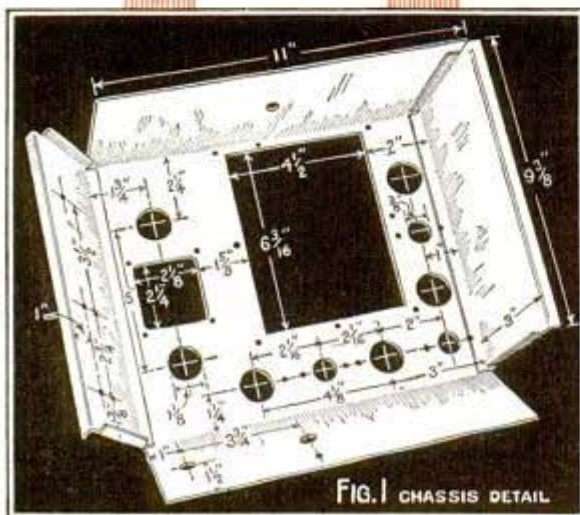
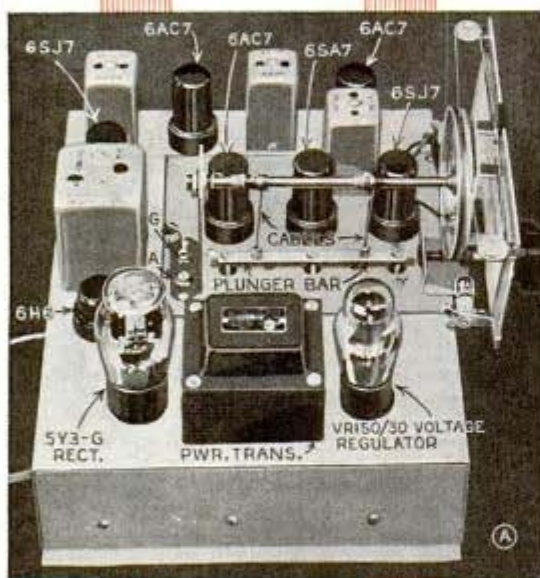

FOR YOUR RADIO

USES PERMEABILITY-TUNED
FM "FRONT END" R.F. UNIT

employs a new and economical pre-wired and balanced r.f. "front end" unit, the coils of which are permeability tuned, thereby eliminating an expensive 3-gang variable condenser. Small plungers made of iron filings suspended in a bonding agent move in and out of the three coils simultaneously. This T-167 Carron r.f. unit includes the dial and may be purchased completely wired for about \$14, ready for mounting in the chassis base detailed in Fig. 1. There are only 6 color-coded leads to connect in the circuit which follows standard superheterodyne practice. These leads are clearly shown in the tinted section on the simplified wiring diagram Fig. 2, and all other radio parts are easily mounted and connected by the builder. The complete schematic circuit diagram and the FM antenna details appear in Fig. 3.

(Continued to page 178)

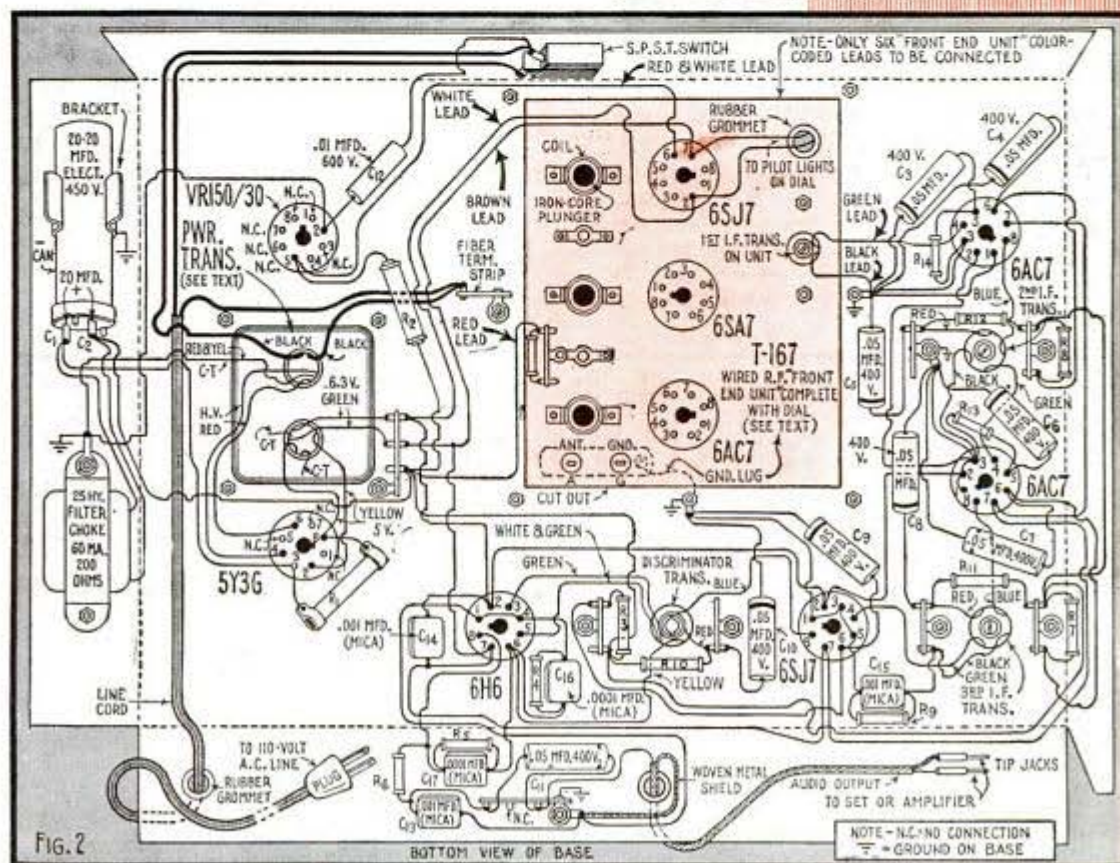
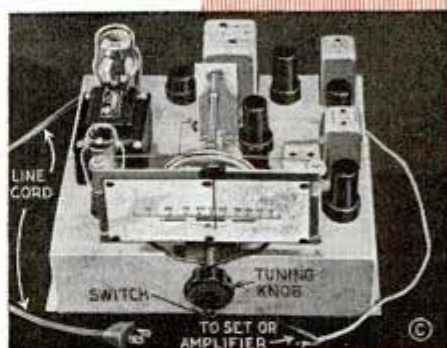

"Black Light" Magic Box Burglar Alarm System



ONLY a few radio parts, a 68-cent infra-red filter, a 45-cent 6-in. focal length lens, etc., are required to build this electronic type burglar alarm system. Operating an alarm bell on an invisible "black light" beam at any distance up to 50 feet, this system is so designed that if an intruder interrupts the beam the alarm bell will ring continuously until the lever on the reset relay is manually reset even though the intruder steps out of the beam. Any interruption of the current in the house or plant building, such as cutting of wires, also will cause the alarm bell to ring as the bell is independently powered by a 6-volt battery.

The units are housed in simple homemade cases of $\frac{3}{8}$ -in. plywood, and must, of course, be light tight. All dimensions, parts and assembly details are clearly shown. The relay unit sensitivity control, line switch and reset relay are all mounted for control on one side. A 1-in.-square hole in the front end admits light to the "Cetron" 23C photo cell, the socket for which is set back about 6-in. from the hole so that extraneous light will not enter.

The light source case contains a 6.3 volt transformer, an automobile headlight bulb and its bayonet-type socket. A lens having a 6-in. focal length, and measuring $1\frac{1}{4}$ in. in di-

(Continued to page 180)

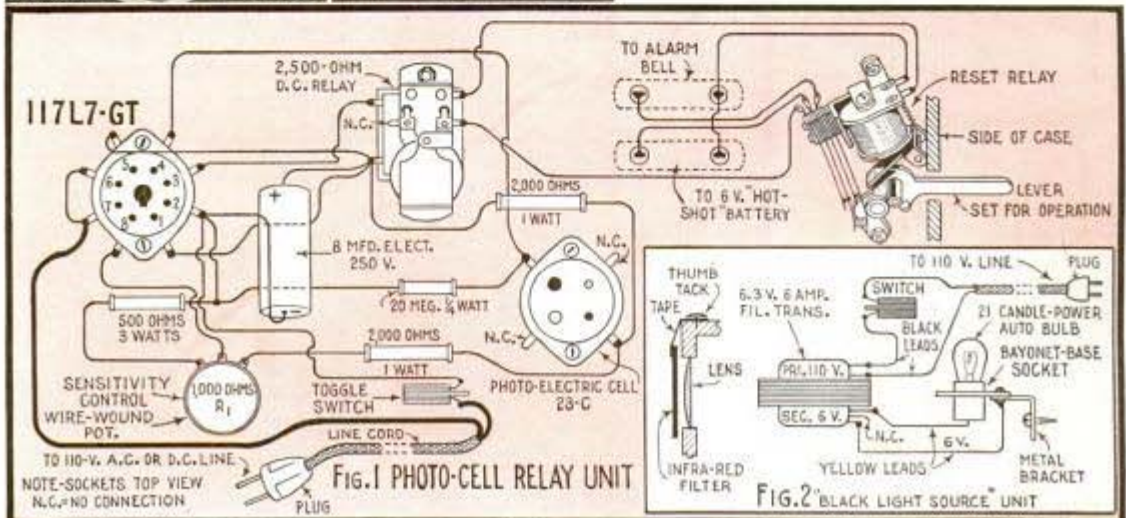
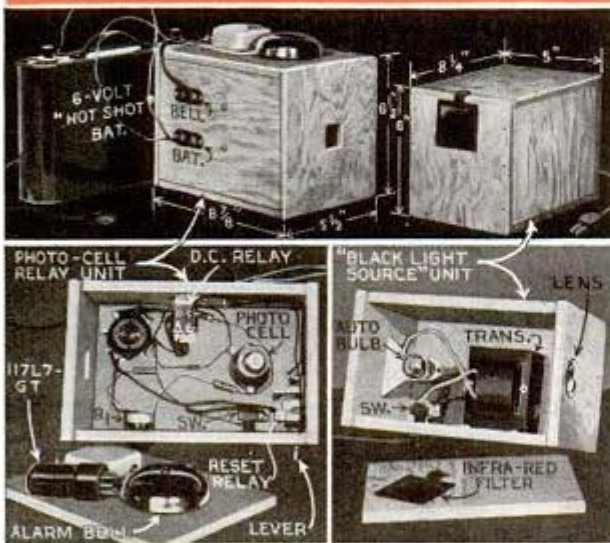

Practical RADIO HINTS



(A) Their colors save you time when selecting a nut driver of correct size. Made with "Xcelite" plastic handles in six different colors, you automatically think of size in terms of color and instantly pick out the one you want. A locking bar extends across the front of this kit rack

(B) Screwdriver kit and specially designed pliers for radio workers. Standard kits are made of fabricoid and come in two colors—green or red. (C) To increase bass response from crystal pickup, insert a $\frac{1}{4}$ -watt carbon resistor in series with one lead

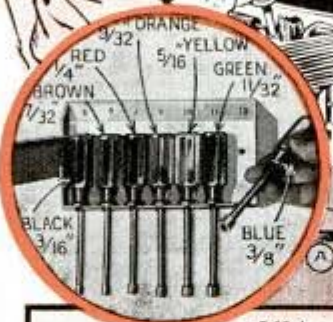

(D) Old spark plug makes good "thru-panel" insulator to pass antenna wire through a thin wall or panel. Take apart and clean; reassemble and cut off the point attached to shell

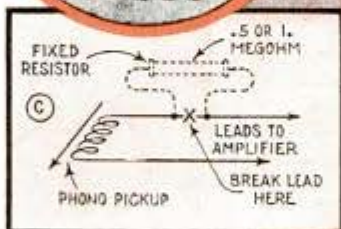

(G) No tools are required to connect this plug; merely insert wires and screw on cap which forces teeth through insulation to make contact. (H) Mounting for octal sockets on a breadboard

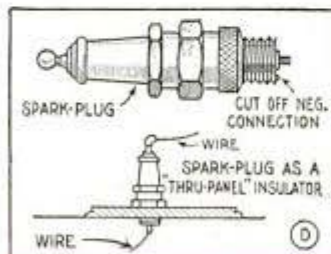

(E) Spillproof rechargeable battery replaces two No. 2 flashlight cells; charger operates from 110-volt a.c. line. When this 3-volt battery is used for small miniature-tube sets, connect a 20-ohm rheostat in series with one A-battery lead to reduce voltage for tubes. (F) To salvage short lengths of copper tubing, solder them together as shown. Grind down the ends to make a perfect butt joint. Supporting rod may be graphite or similar material

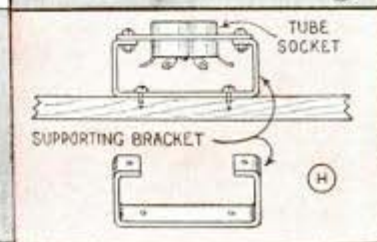
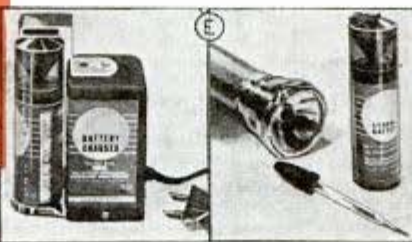
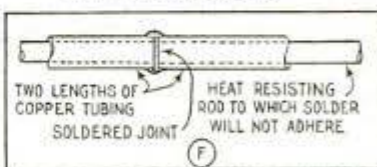

Seven-Tube Chairside Receiver Has Automatic Record Changer



Offering practically everything in luxurious listening comfort, this chairside radio-phonograph combination is an a.c. superheterodyne with phonograph-compensated circuit. Features include: six push buttons, tone control, drift corrected electric tuning, built-in antenna, standard and short-wave bands including band-spread tuning, amplifier for stronger short-wave signals, automatic record changer and record compartment. Dimensions are: 23 $\frac{3}{16}$ in. high, 16 $\frac{1}{2}$ in. wide, 25 $\frac{3}{8}$ in. deep.

One-Hundred Watt Amplifier

Designed for stadiums and large auditorium applications, this powerful amplifier has 4 microphone input channels, and employs an external speaker selector and



matching unit for 6 speakers. This provides for the use of a single 500-ohm line from the amplifier to the speaker selector. The unit can be placed several hundred feet away at the general speaker location.

FM Speaker Has Tone Diffuser

Overcoming a tendency of FM high fidelity high notes and over-tones to focus in a direct beam of sound, one manufacturer claims this built-in tone diffuser gives an even distribution throughout the room.



Super Band-Spread Dial

Twenty times more space is provided on the dial of this new receiver for important

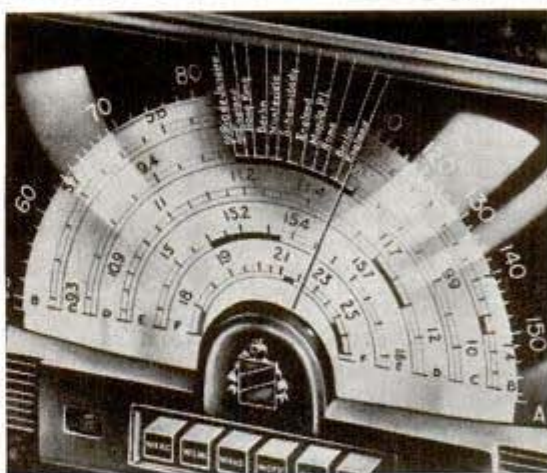

foreign short-wave stations, by spreading out a narrow point on a wave band so that weak distant stations are easily separated.

Blueprints covering simplified radio construction articles in this and past issues are available for 25c each. Many popular tested circuits to choose from. Original detailed parts lists with names of supply sources, can be obtained from Popular Mechanics Radio Department upon receipt of postage.

NEXT MONTH—How to Build the Little Giant A.C.-D.C. Three-Band Super. This 1942 model of the popular low-cost receiver is a 4-tube super that covers the broadcast, intermediate and short-wave bands with plug-in coils. Easy to build; a fine DX performer. Also—A Cigar-Box "Wireless" Record Player.

WINTER SNAPS ARE SIMPLE...SURE

*We're bagging
beauties like this
right through the
winter — with our
regular summer-
time film —*

KODAK VERICHROME



*...and we're
just as good
indoors at night —
thanks to
super-fast*

**KODAK
SUPER-XX**



OUTDOORS—Use Kodak Verichrome Film for your outdoor pictures this winter. It helps overcome small exposure errors, extends the "snapshot day," lets you get swell snapshots even when the weather isn't just right.

INDOORS AT NIGHT—Super-fast Kodak Super-XX Film gives outdoor excellence to indoor pictures. Use it with Photoflood bulbs and cardboard reflectors. **BOOKLET FREE AT YOUR DEALER'S.** Also covers flash pictures... Eastman Kodak Co., Rochester, N. Y.



OUTDOORS...INDOORS... you can always count on KODAK FILM

2841

Human Ant Hill

(Continued from page 85)

Thousands of citizens buy fruits, vegetables, dairy products, fish and meat which have been held in cold storage plants and cooled by brine which flows underground from block to block in insulated pipes in the district in which many of the food warehouses are located.

Probably least known of the larger systems is the network of more than 70 miles of pipes through which steam rushes at a 200-mile-an-hour clip from the huge steam plants, maintained by one of Consolidated Edison's subsidiaries, the New York Steam Corporation, into office buildings, hotels, apartment houses, and other large buildings. Because of the value of subbasement space which would be used for heating plants and fuel storage on the crowded island and the cost of hauling coal and oil and removing ashes, these buildings find it more economical to purchase steam than to build their own steam plants. About 1,000 truckloads of coal and ashes which would otherwise add to the daily traffic jam are thus kept off the streets.

In these steam producing plants, powdered coal is used to generate temperatures of about 2,700 degrees Fahrenheit in gigantic furnaces. Annual consumption of steam piped through the streets is above the 11,000,000,000-pound mark per year. The steam pipes are serviced through 3,100 manholes. The steam is delivered at a pressure of 125 pounds per square inch.

Through 2,500 miles of mains, some of them six feet in diameter, the Consolidated Edison system also distributes more than 34,000,000,000 cubic feet of gas annually. To cover the widely scattered territory, the gas distribution service requires four large tunnels under the rivers, and at five other points, great mains are laid on the river beds. More than 38,000 manholes are necessary to service its electric light and power cables in four boroughs of the city.

Sheathing operations on this one company's electrical conductors require more than 135,000 tons of lead—enough to provide 55,000,000,000 packages of cigarettes with lead foil and have some left over. The total amount of lead buried under the surface of the city in utility service lines is above 230,000 tons. In spite of this and other insulation it is necessary to keep

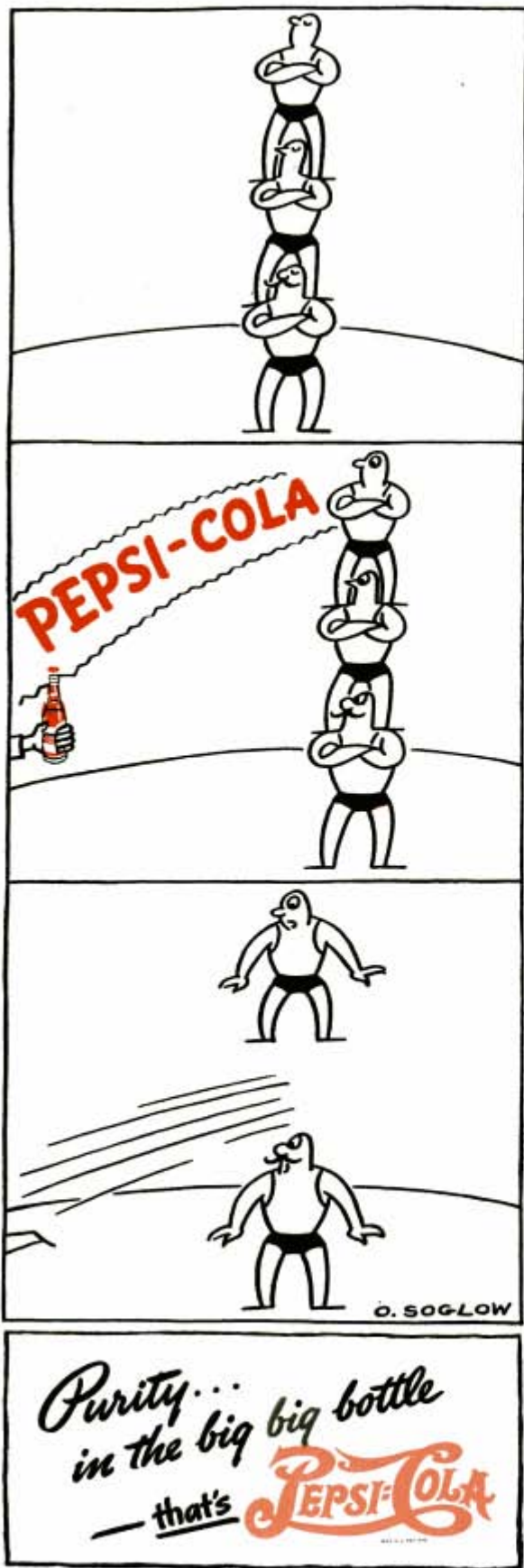

Purity...
in the big big bottle
— that's **PEPSI-COLA**

2841

power lines away from communication lines because of interference. Ducts to carry power lines alone extend 17,500 miles in the twisting jungle of steel, iron, lead and copper below street level.

At peak operation on a dark day, users draw on the power lines of this company for around 25,000,000 kilowatt hours. The city uses almost twice as much electricity as Boulder Dam generates.

It is hard to visualize the subterranean operations of the New York Telephone Company. At one point or another four-fifths of the 9,400,000-mile wire network dips beneath the surface. There are 43,600 tons of copper alone in its underground cables.

Without this subterranean system, it would be impossible to handle the daily average of around 8,800,000 phone calls. Sixty years ago, lower Broadway and the financial district were literally festooned with wires; poles made a veritable forest of the city's streets. In the 1880's there were poles which carried as many as 150 wires on 15 cross-arms.

Thanks to the scientific research of the Bell System and other utility organizations, one of the modern 2,121-pair cables will do the same work which called for 70 rows of poles, each holding aloft 60 wires.

Telephone cables are run through permanent vitrified tile or iron conduits set in concrete. The largest conduit carries 216 ducts and is more than seven feet wide and eight feet high. When trouble is reported, instruments are used that measure the resistance encountered by an electrical current flowing from a maintenance point to the point of the break. From this measurement the location of the break can be computed. If the cable is accessible, the trouble-shooter can locate the break with an "exploring coil" or "fault finder." As he passes this instrument along the cable, he hears a constant buzzing signal until he comes to the spot where the wires are grounded or crossed. The buzzing noise then stops. Whereupon he starts his repair job.

Add up this amazing collection of sub-surface wires and tubes, water mains to carry about a billion gallons of water a day and sewers to remove the waste, and it becomes apparent that New York City is in some respects as "colossal" beneath the sidewalks and streets as it is above.

Stanley Screw Driver

No. 25



Blade tempered entire length. Recesses forged into butt end which is driven into steel bolster . . .

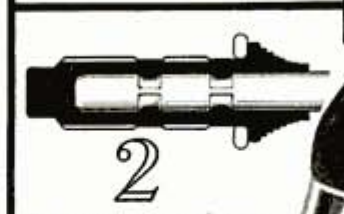

Bosses are swaged into blade recesses. Four sharp wings are swaged on outside of bolster. Blade is now locked into bolster . . .

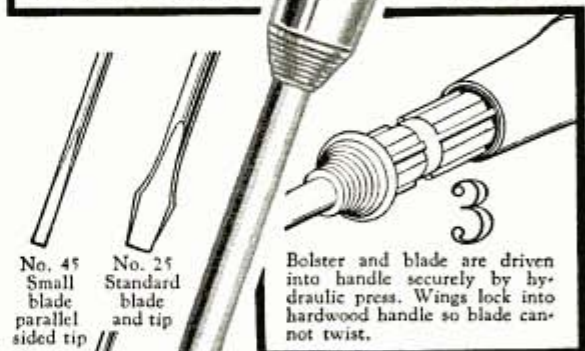

Blaster and blade are driven into handle securely by hydraulic press. Wings lock into hardwood handle so blade cannot twist.



No. 45 Small blade parallel sided tip
No. 25 Standard blade and tip



No. 55 Small blade, flared tip

STANLEY
Trade Mark

This patented construction makes it possible to temper the blade its entire length, providing greater strength. Stronger, better insulated, and with accurately machine cross-ground tips, the Stanley No. 25 Screw Driver is made in 8 lengths, 2½" to 12".

See them at your hardware store, or write for Catalog 35, which describes all Stanley Tools.

STANLEY TOOLS

Division of The Stanley Works, 105 Elm St., New Britain, Conn.

THE TOOL BOX OF THE WORLD

2891

The Ship That Never Sails

(Continued from page 69)

means spotless when it refers to the condition of eating quarters.

The third week usually begins to show whether there is hope of making a sailor out of him. Cooped up with his fellow men for long periods, the seaman cannot be too morose, quarrelsome or of downright bad character. During this week he begins to find out how difficult it is to get into a swaying lifeboat, how quick he must move to his station when the emergency call sounds and he is taught how to raise and lower the boats from their davits.

By this time he is talking the language of the sea and has picked up the spirit of the thing if he is ever going to. He learns

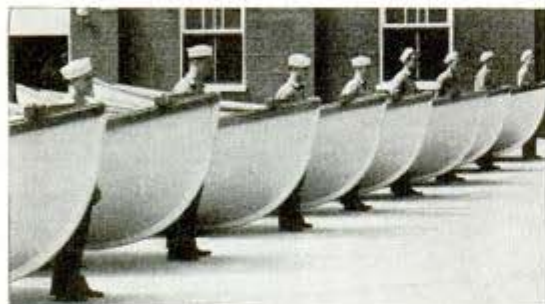

Novices have boat drill on land before dipping oars

to snap into it when a fire alarm is sounded, rush to his post and handle a fire hose, or a carbon dioxide extinguisher. He is introduced to oxygen and gas masks. He hears lectures on disasters at sea such as the Morro Castle and the Halifax blast during the last war and his instructor points out the human errors which were fatal in each case. He is taught to follow routine in case of a fire at sea, or in the tense moments when a great vessel is sinking, but he is also encouraged to use his wits, for no disaster at sea is exactly like another. Motion pictures and lectures acquaint him with the methods of ship propulsion, whether by gas engine, Diesel or steam. He learns to tie knots and grasp the principles of rigging, gets used to climbing ladders of rope and wood.

By the end of the first month, his training is amplified in each of these latter branches with special emphasis on boat drills.

The next two weeks introduce him to the use of weapons, which range from anti-aircraft machine guns to four-inch broad-

side guns which are commonly placed aboard merchant craft in time of conflict. He learns to load and gets the necessary muscle, by toiling hour after hour with the 50-pound dummy projectiles which he must carry to the big guns, thrust in, and catch on the rebound when they are "fired." There are modern range finders and classrooms where gunnery problems are worked out on regular blackboards. He is taught not only to fire weapons, but to take them apart, clean them, and even to make repairs if necessary.

Soon, according to his aptitudes and desires, he begins to be a specialist, whether it be a fireman or an oiler below deck, or a seaman on deck. If he likes the cooking and waiting tables, he slants into a steward's course.

If he becomes a deck seaman, for instance, he is placed on a crew which handles the exact duplicate of a hatch aboard an ocean-going ship. Of steel construction with regulation heavy wooden hatch covers, winches and booms, the dummy hatch receives dummy cargoes hour after hour as the apprentices learn to hoist the great covers, load heavy metal objects in cargo nets, steady them while they are lifted and lowered, and run the steam winches. The hatch is only about four feet deep instead of the 25 or 30 which would ordinarily lead to the hold of a big ship. This saves many an apprentice a tumble below. By the time they have learned to operate the hatch and its engines, they have also learned how to be careful.

Three months aboard Hoffman Island and they are ready to be placed on one of the training ships which the United States Maritime Commission has placed at their disposal. Among these are the American Sailor, the American Seaman, and the Empire State, ships of the 5,000-ton class. Voyages to ports as far away as the Caribbean and tropics put the final polish on their education.

Thus the ship that never sails has saved them nearly two and one-half years in training for a seafaring career.

Write to the firms listed in the Where-to-Buy-It index, to learn more about products described in this magazine. Say You Saw It in Popular Mechanics.

How "Quality" is Built into DELTA 6" JOINTERS

Here's the story of the unseen "hidden" quality that is built into one Delta machine — a story typical of the entire line of Delta machines.

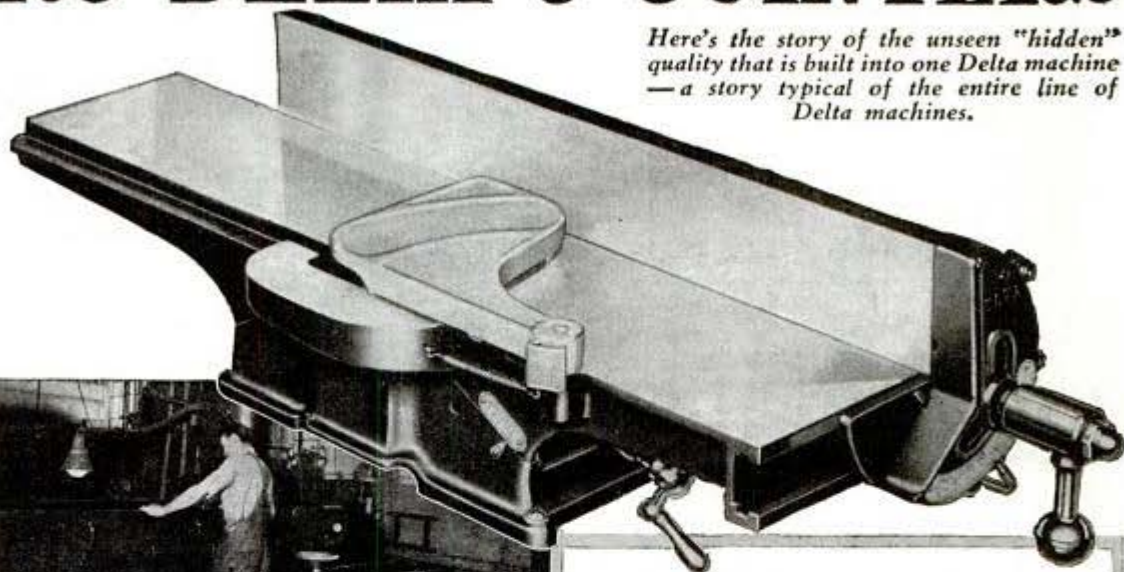

EXTREME accuracy is a vital necessity in building satisfactory jointers. If the tables of a jointer are out of alignment by as little as *five thousandths* of an inch—this can make a piece of work only 3 feet long a full $\frac{1}{8}$ " narrower at one end than at the other! This is impossible with Delta Jointers because of the special precision grinding of the tables. The tables of the jointers are first rough machined singly. The entire jointer is then carefully assembled with the tables mounted on the base—and both tables are then accurately ground at the same time on huge, ex-

ensive surface grinders (illustrated above) within extremely close limits. The tables are then carefully inspected with special gauges (as shown in photo) to insure their being in alignment and absolutely parallel. This is but one



MANY OUTSTANDING FEATURES

make this the finest 6" Jointer available. These include: Heavy Cast Base and Tables; Tables carried on Gibbed Dovetail Ways; Patented Tilting Fence; Patented Automatic Stops; Free-Swing Dual Control; Depth of Cut and Tilt Scales; Double-Seal Ball Bearings, Lubricated for Life; Front Safety Knife Guard; Safety Type Head with 3 High-Speed Steel Knives.

of many processes used in building Delta Jointers to assure you of the dependable accuracy that has become synonymous with the Delta name.

Send for Delta Catalog

Write for the new Delta catalog which is a complete guide book to power tools. It not only lists the entire line of Delta "Quality" wood and metal working tools—but shows you the important points to look for in all power tools. It illustrates and explains the advantages of the many hidden features of design and construction that make for long, better service in power tools. (Also send for Project Book No. 8 crowded with new projects, including working drawings, photographs and full instructions.)

The Delta Manufacturing Co., (Dept. 681-B)
600-634 E. Vienna Ave., Milwaukee, Wis.

Gentlemen: Send me the latest Delta Catalog listing the complete line of Delta Lathes, Circular Saws, Band Saws, Jointers, Scroll Saws, Shapers, Sanders and Drill Presses.
 I enclose 10c (stamps or coin) for which please send me the new Delta Project Book No. 8.

Name

Address

City State.....

Check here if you are a Delta user now.

DELTA MILWAUKEE

2939

Hitch-Hiking on the Big Waves

(Continued from page 75)

ing under the wave and letting it clean him up. But that is against the code when the surf is crowded with riders. It means a loose, thrashing board which is liable to ram somebody, whereas his presence on the board will both weight and guide it.

There is no alternative. He paddles furiously to get his start, then scrambles to his feet, well back on the board to prevent nosing over into a "pearl dive." The upward draft of air sucked by that thundering juggernaut almost takes him off his feet. Behind he sees that the water is "feathering"—that is, it is developing a white cap, which, if it breaks over, will mow him down, give him the works, and hurl him on the beach like a drowned cat. He slides his board down the wave at an angle, and evades the mow down by inches. And suddenly he finds himself riding in triumph with the war-whooping veterans, streaking toward shore, half a mile away.

Magnesium-Thermit Fire Bomb Creates Intense Heat

One of the most destructive bombs, for its size at least, is the "electron bomb" developed by the Germans. It is said to weigh two and two-tenths pounds, making it possible for an airplane to carry 2,000 of them, whereas the limit for high explosive bombs is 50. Its shell, about nine inches long, is 80 percent magnesium, and contains several ounces of thermit. Instead of serving as the incendiary material, the thermit merely ignites the magnesium shell, the latter burning for 10 or 15 minutes at approximately 2,372 degrees Fahrenheit. Jets of flame spurt from vent holes in the shell and bits of molten magnesium scatter in all directions for a distance of about fifty feet to ignite any combustible objects within range. Because of their lightness it is impossible to drop them with any degree of accuracy. Twenty bombs released together from 5,000 feet might strike anywhere within an area of 10,000 square yards. Therefore they are suitable only for indiscriminate bombing.

Look in the index to find where to buy articles described in this magazine. Say You Saw It in Popular Mechanics.

MAKE BIG MONEY
With An
AMERICAN FLOOR SANDER



Get into something for yourself where your income is practically unlimited—surface new and old floors with an American floor sander. Work is easy to get and no previous experience is required. Let us tell you how to be a success and become independent. As little as \$75.00 will start you today on the road to steady profits rather than daily wages.

Be sure to sign and send in the coupon below for complete free details—no obligation.

THE AMERICAN FLOOR SURFACING MACHINE CO.
523 So. St. Clair Street • Toledo, Ohio

Gentlemen:
Send complete free details on how I can make big money with an American floor surfacing machine—no obligation.

Name _____
Street _____
City _____ State _____

LEPAGE'S

HOLDS LIKE IRON 

WATERPROOF plastic resin GLUE

★ **IT'S WATERPROOF**
... even though submerged for months water has no effect on glue.

★ **IT'S SUNPROOF**
... joints hold firm even up to temperature of 160°F.

★ **IT'S TIMEPROOF**
... holds for years with glue stronger than the joints it holds.

Buy a can Today!

4 HANDY SIZES
10¢ 25¢ 50¢ 85¢



Purchase January 10/16/44

28/2

Battling War's Fire Bugs

(Continued from page 43)

similar substance—and providing proper fire extinguishers, as described below.

Water and other common agents—foam, carbon dioxide, carbon tetrachloride, sodium bicarbonate—are worse than useless against burning magnesium. They intensify the flame. Water reacts with magnesium to produce hydrogen—itsself a flammable gas—and magnesium hydroxide. Water feeds oxygen to the flames more rapidly than does air.

British fire fighters use snuffers—inverted bowls of wire mesh sprayed with asbestos—to prevent spread of the fire. They also use long-handled claws to grip the bomb and remove it. Powdered graphite, talc or similar substance inert to magnesium will help localize the flames by smothering. Properly used, water will hasten the burning of the bomb itself and prevent spread of the fire to surrounding combustibles. Automatic sprinklers are useful for wetting down the surroundings, especially if the fire is small, as around magnesium machining operations where chips may ignite. The latest and perhaps most effective material for fighting magnesium flames is a dry powder developed by Dow Chemical company, a leading manufacturer of magnesium alloys, and Pyrene Manufacturing company. It is a noninflammable powder inert to magnesium containing a small amount of material which forms a heavy vapor when heated and shuts out air.

The National Fire Protection Association is leading a preparedness campaign against fire and sabotage. In a handbook, "Fire Defense," it has compiled information on the organization of fire wardens, how to fight various types of fires, the handling of bombs, maintenance of water supply and communications in emergency.

Breakdowns of water lines and communication systems are hazards that must be anticipated. Automatic sprinkler systems are essential, yet they can be nullified by failure of the water supply. A plywood plant in Washington was destroyed with a \$525,000 loss and two employes were burned to death. Afterward the sprinkler system valve was found almost closed. Similarly, a Massachusetts mill was wiped out by fire while its sprinklers were dis-

(Continued to page 168)

TOUGH But oh so Gentle



Tough on Oil-Pumping • Gentle on Cylinder Walls

● An oil-pumper never gets better. The longer you drive with worn piston rings, the more you spend for oil, the greater the danger to your motor.

This is no time to put up with the car that wastes our resources of oil and gas and metal parts (not to mention your money).

At the first sign of oil-pumping get Hastings Steel-Vent Piston Rings. They stop oil-pumping instantly, check costly cylinder wear, and improve performance immeasurably.

Any good mechanic can install them—quickly and economically.

Note to Used Car Buyers: Ask the dealer if it's Steel-Vent Reconditioned. It's a better buy if it is.

HASTINGS MANUFACTURING CO., HASTINGS, MICH.
Hastings Mfg. of Canada, Ltd., Toronto



HASTINGS

STEEL-VENT PISTON RINGS

Stop Oil-Pumping.

IN CARS, TRUCKS AND TRACTORS

FEBRUARY, 1942

60 Battery March, Boston
612 N Michigan Chicago

2817

Power King

WOODWORKING TOOLS OF TESTED QUALITY



7" TABLE SAW

\$18.75

The Only
LOW PRICED
Ball Bearing Saw



It's the tool bargain of the year at \$18.75 less motor! Handles rip, cross-cut, mitre, bevel, and compound cutting. Takes blades and chippers for dado work. Cuts 2 3/8" thick—6" ahead of blade. Ask your dealer to show you this Power King Saw. 8" model \$31.75. Send coupon for catalog with complete specifications.



Send for
FREE
Catalog

POWER KING TOOL CORP., 208 Cleveland St., Warsaw, Ind.
Please send catalog. I am interested in 7", 8" Saws
 Jig Saws Wood Lathes Drill Presses Spindle Shapers
 Jointer Planers Belt and Disc Sanders.

Name.....
Address.....
City and State.....

STANDARD GARDEN AND SMALL FARM TRACTORS

Plow
Seed
Cultivate
Mow Hay
and Lawns

Powerful Gas Tractors for Small Farms, Gardeners, Florists, Nurseries, Fruit Growers, Poultrymen.
1 & 2 Cylinders
High Wheels, Rubber or Steel Tires. Walk or Ride.



Do Belt Work—Free Catalog
STANDARD ENGINE CO.
Minneapolis, Minn. New York, N.Y. Philadelphia, Pa.
3221 Como Av. 617 West 26 St. 1914-15 Fairmount

MOTOR DRIVEN Flexible SHAFT TOOL



WITH PENCIL-SIZE HANDPIECE for "FINGER-TIP" CONTROL Win real pleasure and profit by using a **FOREDOM FLEXIBLE SHAFT TOOL**. Performs countless tasks quickly, efficiently, effortlessly in home or shop on wood, metal, glass, plastics, etc. . . . Sensitive "Finger-tip" control, easy accessibility, unobstructed view. You can grind, polish, mill, engrave, sharpen, slot, saw, carve, clean, sand, etc. Ideal for glass etching, gem-setting and finishing dies, molds, castings, etc. Complete Portable Workshop, including 50 piece accessory set, \$18.15. Order today. Send \$1.00 with C.O.D. order. **FREE, New Complete Catalog**
FOREDOM ELECTRIC COMPANY
Dept. 305, 27 Park Place, New York

at only
\$14.95

connected. Fire brigades in factories must know where the valves are located and how to get water if the usual supply fails. In an air raid, when mains are broken, firemen must cut off the waste by closing valves, then pump from the nearest stream or pond.

Authorities state that practically no city in the United States has enough fire alarm boxes. Signaling and communication systems must be made proof against interruption by any cause, even the seemingly impossible air raid. Police and fire departments are rapidly being equipped with radio, and in this way are well prepared.

America, we hope, will escape aerial bombing. One high explosive 2,200-pound bomb demolished four English houses, seriously damaged 20 more within 200 feet and partly wrecked 119 others. The explosives America is alert for are the infernal machines of the saboteur.

There is no absolutely safe way even for an expert to handle an unexploded bomb. It is a popular and dangerous notion that a bomb can be rendered harmless by "dunking" it in water. Actually, water may detonate the bomb. Water may short-circuit its electric mechanism. The bomb may be made of a metal that bursts aflame when water touches it. The fuse of a dynamite bomb may be waterproof. If a quenching agent is essential, light lubricating oil or kerosene would probably stop any clock-work mechanism. But nothing is quite safe. A bomb expert was called to a post office to investigate a suspicious package. He took every precaution: working with special manipulators from behind an armored steel shield, he watched through a periscope as he endeavored to render the bomb harmless. But it exploded, drove the shield against the wall and crushed him.

When a bomb is discovered, get an expert. Open all windows and doors to let the blast escape. Use sandbags or mattresses to stop flying fragments. Remove flammable materials, shut off gas and other utility lines. If it is possible to move the bomb out of a building, drag it on a rope at least 50 feet long, but avoid any jar.

Sabotage is less likely to occur if we are alert to prevent it and ready to combat fire and explosions effectively where they do break out. And the nation that is ready to fight the incendiary will be better prepared in peace to fight the annual toll of \$300,000,000 in fire losses.

See WOODSTOCK TYPEWRITER

if you're a PIPE SMOKER

you may...like CORTEZ...

Make a Discovery



Often, you've longed to "discover" a really good pipe tobacco—one that always suited you down to the ground! It could easily be that Peper's Pouch Mixture will click, as it did with Mr. W. E. Anderson, of Los Angeles, who says: "It has what it takes to make a fine tobacco... mildness, aroma and body." Costs only 25¢ and is certainly worth a voyage to your favorite tobacco counter... TRY IT!

CORTEZ and his small band of adventurers hacked a painful path through the hardships of infested jungles, to discover the wealth of the Aztecs in 1519... DISCOVERING YOUR TOBACCO is so much easier!

If your dealer cannot supply you, send 25¢ for a serviceable silk pouch filled, to Pouch Mixture Division, 719 N. First St., St. Louis, Mo.



CHRISTIAN PEPER St. Louis

Fine Tobacco Since 1852



FREE TRAILER PARTS CATALOG

We'll save you money on—axles, springs, wheels, couplers, windows, sinks, water pumps, brakes, refrigerators, beds, lamps, inside and out, RV lamps, furniture, jacks—everything. Special discount to mfrs. NATIONAL TRAILER EQUIPMENT CO. Successors to Kar-A-Van Industries, Inc. Dept. P. 714 W. Wisconsin Ave., Milwaukee, Wis.

Complete Plans and Building Instructions, 10¢

ATLAS STICK-ON LETTERS

New "ROMAN" Styles. Large Sizes. Penny Each. Absolutely Beautiful. Tremendous Demand. Amazing Profits. Write for FREE Samples. New Catalog, Starting Outfit. Hurry!

ATLAS Sign Works, 7941-A, Halsted, Chicago



BRUSH PLATING OUTFITS

for autoparts, reflectors, faucets, bicycles. No tanks necessary. Free particulars.

GUNMETAL CO., AVE. M, DECATUR, ILLINOIS

FREE CATALOG

PINS 30¢

Artistic pins, rings and emblems for classes and clubs. Attractive prices. Finest quality, gold plated, silver, etc. Over 300 designs. Write Dept. N, METAL ARTS CO., Inc. Rochester, N. Y.



BUILD YOUR GRANDFATHER CLOCK

Send 25¢ for Simple SHOP TESTED COPYRIGHTED BLUEPRINT. The Simple Sensible Rod-&Kiln way as thousands have. DIME brings PLANS and sixty picture "HOW" Book pricing many fine brass weight Westminster, tube chime, electric and battery movements showing nine beautiful colonial grandfather cases. Build now and save half. KUEMPEL CHIME CLOCK CO., Bldg. 61, Guttenberg, Iowa.



Say you saw it in Popular Mechanics!

Now Ready—Our new 1942 Catalog of "HARD-TO-GET" MATERIALS

For Industrial Arts Departments in Schools, Institutions, etc., Furniture Repair Men, Cabinet Makers, Souvenir and Antique Shops, Homecrafters, etc. Send 10¢ cash or stamps for this new catalog

A few of the items we sell: Chest hardware, locks, hinges, supports, tray lifts, copper trim, also mouldings, overlays, etc. Finishing materials, glue, stain, varnish, abrasive papers, sanding blocks, stick shells, etc. Upholstering supplies, coverings and tools. Electrical findings for lamp manufacture, also clusters and indirect fixtures. Chair case, spines, reeds, craft fibre cord, etc. Trays and glass liners for smoking stands. Large size electric and spring clock movements, with and without dials. Complete line Venetian Blind hardware, cord, tapes, etc. Table slides and supports. Tea wagon wheels and casters. Wood dowels, also dowel screws, dowel centers, wood screw hole buttons. Large line card table leg supports. Bed hardware of every description. Desk sets complete with fumads and fastening without base. Water transfers, inlays, small mouldings, etc. Glides and casters, office chair casters, wood legs and K. D. chair frames. Small box hardware of every description. Large selection pulls, knobs, handles, hinges, locks, catches, etc. Perforated steel panels, chair bases, revolving chair fixtures, rocker base electric and spring clock movements, banquet table hardware, metal drawer glides, brass jack chain, drawer follower blocks, etc. Many styles corner braces, bolts, etc. Step ladder braces, pillar strips, sliding track and shafts. Typewriter desk hardware, binoculars, mirrors, nut bowl hardware, salt and pepper inserts, music box movements, etc. Bar pins for novelties, dress clips, etc. Cast-in plastics, crib hardware, swivel top table fixtures, sectional bookcase hardware, clamp nails, electric pens for burning, etc. Costume jewelry, compact inserts, glass barometers, bud vases, silver glass handles, etc.

THURSTON SUPPLY COMPANY, Dept. P. M., Anoka, Minnesota



OTTAWA TRACTOR SAW
Falls Tree—Cuts Log
Fits rear power take-off shaft.
Drive thru gear reduction. 18-in. stroke, 10-ga. blade. Economical, saws to profit.
FREE Circular and Price List
OTTAWA MFG. CO., 827 Forest Avenue, OTTAWA, KANSAS

"SIMPLIFIED" ARC WELDING prepares you for the BIG PAY JOBS!



Interesting Book on Arc Welding is yours for the asking... Write! It's FREE!



Don't delay getting into the highly profitable arc welding business! With Hobart Arc Welders you can start right away earning big money. Will handle all types of welding, easier, faster and more economically. It's the welder that's used in industries all over the country. Extra profit let you pay for your welder in a short time.

HOBART BROS. CO., Box M-22, Troy, O.
It will pay you to WRITE AT ONCE! Defense needs must be supplied, so your early order will speed delivery



Yes, You Can BUILD YOUR OWN

With this generator, a used auto engine and chassis you can easily build your own Portable Gasoline Drive Arc Welder. Goes everywhere. Write for details.

HOBART saves you as much as \$500 on this welder



KRW ARBOR PRESSES

BENCH TYPE AND HYDRAULIC

Needed in every shop—save time and money—do better work, quicker.

No shop is complete without a small arbor press. Pressing and squeezing operations can be done better and faster on a KRW Arbor Press. Stop using vise and sledge hammer methods—they generally deliver spoiled work in the end. KRW Factory-To-You Prices give you greater value for your money. Order today.

KRW Bench Type Arbor Presses, 3 sizes,

No. 37-P 1/2 Ton, \$13.25*;
 No. 37-O 1 Ton, \$23.00*;
 No. 37-N 3 Ton, \$33.00*.
 *Prices F.O.B. Arcade, N. Y. Slightly higher west of Rockies.

KRW Hydraulic Presses are built in 25, 50 and 75 ton sizes. Prices start at \$198.00*.

K. R. WILSON 17 Lock St., BUFFALO, N. Y.

Builders of Shop Equipment for Ford Dealers Since 1916



TRAILER BUILDERS' GUIDE & CATALOG only 10¢

Build a Trailer easily in spare time with world's best line of trailer parts, axles, hitches. Complete working blue prints only 50c. Universal Draw Bar, readily attached to any car. SEND 10¢ TODAY FOR CATALOG.

HAMMER BLOW TOOL COMPANY, Dept. 102, Wausau, Wis.



GENUINE U.S. BARGAINS

O. D. WOOL BLANKETS (USED) . \$2.19
 MCCLELLAN SADDLES (USED) . 5.95
 U. S. ARMY PUP TENTS (USED) . 2.50
 U. S. MARINE PONCHOS (USED) 1.29

Thousands of Other Bargains in Military, Outdoor & Sport Goods for Hunter, Farmer, Scout Send 10¢ for 32-page catalog returned with first order.

A and N SUPPLY CO.
 EST. 1868 4720 LESTER ST. RICHMOND, VA.



FACTORY TO YOU KITSELMAN FENCE

Buy Farm, Poultry, Lawn Fence, Steel Posts, Gates, Barb Wire at Factory Prices! Save too on quality Paints, Roofing, Hay Tools, Stock Feeders and Founts, Poultry Supplies and other farm needs! **WE PAY FREIGHT.** Write today for FREE CATALOG! **KITSELMAN BROTHERS** Dept. 94 Muncie, Indiana.



Sani-Flush

Cannot Injure Aluminum Cylinder Heads or Fittings

CLEANS OUT AUTOMOBILE RADIATORS

Print Your Own

Cards, stationery, circulars, tags, labels, photo and movie titles, advertising, etc. Save money. Print for Others. Good Profit; easy rules sent. Raised Printing like Engraving, too. Junior outfit \$8. Senior outfits \$16 up. Send for free catalog and all details. **KELSEY INC., 5-37, Meriden, Conn.**



NEW Grinding Attachment

For 8" to 16" Metal Lathes. Build It Yourself.

At last, a precision grinder within your means. You save 2/3 by finishing our semi-machined castings on your own lathe. HURON handles both internal and external grinding. Accuracies to .00025". Mirror finish easily obtained. Grinds valves, pistons, bushings, shafts, hard or soft, holes, lathe centers, sharpness reamers, milling cutters. Does accurate drilling; taps; polishes; scores of other uses, for home workshop, factories, machine shops. Write for FREE illustrated folder and price list of supplementary items. Mention your lathe.

Huron Machine & Tool Co., Dept. B, Yale, Mich.



Semi-Machined Castings Only \$6.45

PCG Garden Tractors

—profitable, low-cost power

A size to fit your job. Plow, disc, cultivate, mow, haul, do belt work, for about 33c a day. Fast, safe, trouble-free. Back-saving plow lift, reverse gear. High clearance. Guaranteed. Used by hundreds of gardeners, farmers, poultrymen, florists, etc. Two weeks trial. Low factory price. FREE catalog—write today. Pioneer Mfg. Co., Dept. V-22, West Allis, Wisconsin.



SAVE! PRECISION BUILT HOME WOODWORKING MACHINERY NOW AT LOWEST PRICES!

Better built for heavy duty work just like this new streamlined Blue Star Lathe. It's a big lathe, 48" structural steel bed, 10" tool rest. Sealed ball bearings. 4-Step Pulley. V-Belt and dozens of other fine features all at amazing low prices. A complete line of accessories, too. Write today for big Blue Star Book of precision built equipment... the kind you've always wanted to own. See the money-saving prices.

BLUE STAR PRODUCTS, 602 Rock St., Fairfield, Iowa

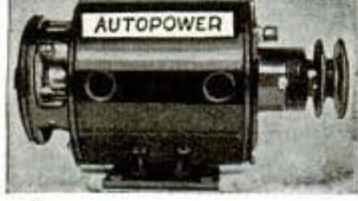

TURN SCRAP INTO MONEY

AUTOPOWER tells you how in plain, easy, simple and illustrated instructions that anyone can follow. Change auto generators into useful, practical A C and D C generators and motors with voltage from 2 to 1,000 volts, for power, light, welding, radio, sound, etc. No previous experience no special tools needed. Generators can be driven by wind, water, fan belt, etc. Already used and endorsed by thousands. Send for your copy of "AUTOPOWER." Only \$1.00 postpaid.

AUTOPOWER, INC. 2125 Pine St., St. Louis, Mo.



AGENTS 300% Profit SIGN LETTERS

For Store Fronts and Office Windows. Anyone can put them on. Free Samples. Liberal Offer to general agents. **METALLIC LETTER CO., 438 N. Clark St., Chicago**

CRESCENT TOOLS Give Wings to Work

ASK YOUR HARDWARE DEALER

BOAT PATTERNS
 full size, cut-to-shape; and blueprints. Big selection. Low prices. Send 10c (coin) for illust. catalog. "HOW TO BUILD BOATS" book, \$1.00 postpaid. **Cleveland Boat Blueprint Co., Station A-6, Cleveland, Ohio**

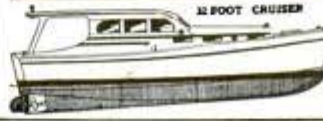

21168

Smokeless Town

(Continued from page 79)

something entirely new in construction—an entire community with every home electrically heated. In his new Meadow Hills, which will have more than 100 homes, the electrically heated homes cost from \$3,100 up.

Meadow Hills homes are built especially for electric heat. "A low-cost home without electric heat is out of date before it is built," Fonde declares. "If properly applied, electrical heat, in my opinion, is cheaper and more desirable than any other automatic heat now in general use.

"The proper construction and insulation of the home is just as important as the use of a good heating unit. Builders should give more attention to sturdy construction, with special attention to the small leaks about the house.

"Weatherstripping of doors and windows is likewise necessary and should be well done. A complete weatherstripping and insulation job will cost only about 4 percent of the cost of the small home and will amortize itself in about 10 years in fuel costs and give added comfort."

Forest Court was used as a proving ground for Fonde's theory that low-cost homes with quality and beauty, using nationally advertised products, could be built.

The system used helped. An order was given in one block to Fonde's affiliated supply company. The supply company detailed all millwork through its shop as one order. Everything possible was done in the shop instead of on the job. Sash and screens were fitted in weatherstripped window frames and painted before being taken to the job. All casings were hand-cleaned, mitered, splined and glued at the shop.

"On the job itself we studied every means to cut corners," said Mr. Fonde. "Electrical equipment was used, templates were made for cutting studs and crews were worked in groups. Certain men were put on joist, others subfloor, others studing and so on. We used the taped joint gypsum wallboard, which permitted the job to go through without the usual delay caused by plastering."

Power tools were found to be a help in keeping down costs of construction. Fonde estimates that a power handsaw will pay for itself on one \$16,000 residential job.

MONEY MAKING OPPORTUNITIES

A New Hobby that Makes Money at Home



HOW WONDERFUL it is when we can turn our interesting hobbies into cash. And it is possible! Brush electroplating offers the opportunity. Right at home some make a good living—as much as \$30 or \$40 a week. Here's what one

home electroplater of Chicago says: "I bought my electroplater to experiment with during my spare time. In a few evenings I earned the cost of the machine by plating jewelry, silverware, headlight reflectors, etc., for friends and neighbors. Now I have all I can do. I recommend this machine to all who want a profitable business."

This man apparently finds business easily. So can you. Besides the articles he lists there are electrical appliances, surgical and dental instruments, restaurant silverware, boat hardware, musical instruments and many automotive parts.

J. J. Wilson, Slidell, La., writes: "After I received my electroplater I practiced for about an hour. I made up four samples and went out after business. One of the large chain restaurants now has me do all their silverware."

Max Hemmert, Idaho Falls, Idaho, states: "I am now spending all my time in plating work. I purchased a brush plater last summer and have worked up a very promising business."

Frank Welde, Philadelphia, goes after garage business. He writes: "I electroplated a few brass strips for samples. I then showed these strips to different people and that's how I got plenty of jobs. I have all the work from a big garage. The owner gets 10% of what is charged his customers, and the rest goes to me for my work."

MAKE BIG MONEY at HOME!
NEW INVENTION
Electroplates by Brush

Now Plates CHROMIUM Too!

New, patented invention makes possible big earnings AT HOME. Replate auto-parts—worn articles in homes, stores, hotels, restaurants, etc., with durable, sparkling, new coat of metal—with stroke of brush. Easy, simple, quick. Genuine Gold, Silver, Nickel, Cadmium, etc. Everything furnished. Outfit complete, ready for use. No shop required. Clear from \$2 to \$5 an hour in lifetime business. Small investment starts you in business. Steady repeat. Machine can pay for itself in week. Send TODAY for FREE SAMPLE and illustrated BOOKLET how you can have a life income from a business of YOUR OWN built upon satisfied customers. Act at once!

FREE SAMPLE and BOOKLET EXPLAINS ALL

WARNER ELECTRIC COMPANY
225 N. Wabash Ave., Chicago, Ill., Dept. 105

New IMPROVED Electric MOTO-SAW

New Blade Holder Faces Blade 4 Ways -- Multiplies Capacity

Safe as a Hand Saw JUST GUIDE IT!

More like mastic than any tool you ever saw. Imagine an electric scroll saw only slightly heavier than a hand coping saw... a tool that takes no effort to run, no pressure to feed. Works at any angle—on big assembly jobs or on the tiniest piece you can hold in your fingers. Runs 7200 strokes a minute... so fast the blade seems to stand still. Sturdily built... only two moving parts... never needs oiling. Easily cuts intricate designs—so smooth it eliminates sanding. Novice or craftsman, a thrill awaits you when you get a Moto-Saw in your hand.

No Limit to Length of Stock It Will Cut. Saws to Center of 19" Widths. It's fast... cuts on an average of 1 ft. per minute up to 1/2" medium hard wood. Operates on 110-120 V. 50 or 60 cycle alternating current. If your dealer does not yet have MOTO-SAW, send \$4.50... we'll pay postage. Or send \$1, pay postman balance plus postage. **MONEY BACK** if not delighted after 5 days trial.

U. S. Patent 2233862
Other Patents Pending
DREMEL MFG. CO.
Dept. 5112-B
RACINE, WISCONSIN

FOR 27,000 R. P. M. INSIST ON A GENUINE

MOTO TOOL

100 Tools in One

- *Has shock-proof bakelite case.
- *Fan-cooled motor can't overheat
- *Has oil-less bearings
- *Dynamically balanced armature



KIT NO. 1 with 23 high grade accessories and Model Moto-Tool in a hard wood case \$17.50
KIT NO. 2 same as above with Master Model Moto-Tool... \$23.50

DREMEL MFG. CO.
Dept. T-112-B
Racine, Wis.

LOST DIRECTIONS ARE WORSE IN WINTER

Keep to the beaten path with the Hull Streamline Auto Compass. The accepted standard of motorists everywhere.
Write for Name of Nearest Dealer

HULL MFG. CO. P.O. Box 246-D2, WARREN - OHIO

Make Fine WOOD CARVINGS

FOR PLEASURE OR FOR PROFIT
THIS EASY WAY

As you trace model, cutter automatically carves the same pattern with perfect accuracy. You will amaze yourself at the astonishing results.

It's Fun To Carve And Profitable, Too

You will find hundreds of beautiful items in plaster, metal, glass, etc., to use as models for making rich carvings in rare woods. Quick success. No special training necessary.

FASCINATING—NO SKILL REQUIRED
Give that PROFESSIONAL TOUCH to your wood-working projects. Trace drawings, designs, photographs to make beautiful carvings in relief. Do intricate routing on curved or flat surfaces. Simple attachment carves complete statuettes, lathe work, etc. Power carving is easy to master. Over 1000 machines in use. Write today for FREE illustrated folder.

ANDERSON TOOL & MFG. CO. 4324 Chicago Ave. Chicago, Illinois

MONUMENT **BIG FREE CATALOG**

Freight Paid Erected if desired. Lettered, Guaranteed. Free Catalog and samples of stone. **WRITE TODAY**

Genuine Marble & Granite. \$10 Up. Direct By Mail. Order Now and receive. **U. S. MARBLE & GRANITE CO. A-18 Oneco, Fla.**

2 1055

This Modern Age of Mud

(Continued from page 53)

themselves and are producing pieces that appeal in simplicity, color, and humor. The heaviness and florid ornateness of European art has been dropped. Much of the best of current artware, it is anticipated, will be future collectors' items just as the work of earlier potters is collected now.

The potters' craft has always kept most of its formulas and methods secret and performed most of its operations by hand. Now, however, mechanical improvements are being made and in some potteries the clay is hardly touched by hand. The traditional beehive kilns have been improved by downdraft firing arrangements. In many branches of the industry the beehives are being replaced by long tunnel kilns in which the ware, stacked on iron carts, is slowly moved through the fire zone in the middle of the kiln.

Potters can't always duplicate the colors of some old pieces, including Egyptian turquoise and Chinese copper red, although the difficulty is not lack of ability but lack of the same raw materials. After fussing for years trying to duplicate the turquoise of a 3,000-year old Egyptian vase, one potter wrote to Egypt for some samples of Nile clay, and achieved the duplication.

By experimenting, potters have achieved a number of curious effects. Titanium oxide when used as a glaze has the curious property of turning lighter when an object rests on its surface for a short time, gradually darkening to its original shade after the object is removed. Glazes that resemble metal are often applied to art objects and by means of one special treatment an actual metallic surface is sometimes used to coat a vase or figurine. Some experimenters have reproduced photographs under a transparent glazed surface, and others have made high-fired ceramic ware as durable as metal pots for stove cooking.

Porcelain enamel, the glasslike and enduring surface that is fired onto metal objects, has found a place in the construction field and is used for decorative store fronts, for permanent roofing, and for roof vents and chimneys. It may become important in shipbuilding, where porcelain enameled handrails and other fixtures can take the place of brass and copper needed for other defense work.

2878

Speed Demons of the Air Forces

(Continued from page 59)

firing far enough in front of the moving target to give his bullets a chance to arrive at a certain spot simultaneously with the target. There are no mechanical adjustments that can be made to the gunsight; marksmanship depends on the pilot's skill alone. That's the reason every pursuit plane base is equipped with its own skeet field. At least once a week the pilots spend an afternoon at skeet shooting. This gives them excellent experience in shooting at flying targets.

Flying at his target, the pilot is taught to get in as close as he dares before firing. Fire from 100 yards is far more effective than from three or four hundred yards away. He has to follow through while firing so that his bullets will continue to pound the target, just as he has to follow through while firing at a clay pigeon on the skeet range. By now he has to be on his toes to avoid a collision, yet he dare not pull out in any direction he pleases. To do so might expose himself to return fire, so he has to turn toward the target's blind spot to avoid being shot down while he is escaping.

The battle for air supremacy is a seesaw. For a while the pursuit planes had an edge over the relatively unprotected bombers, then the bombers added heavier defensive guns and ganged up to keep the pursuits away. The answer to that was to increase the fire power of the pursuits to allow the fighter pilots to get in killing blows before the bombers could blast them out of the sky.

A pursuit plane used to be armed with a couple of .30-caliber machine guns. Now a pursuit plane is apt to have eight or ten guns mounted in its fuselage and wings, including 20 and 37 mm. cannon as well as .30 and .50-caliber machine guns. The result is that when the pilot presses the master firing trigger under his thumb an actual hail of bullets pours out in front of him. Each fifth bullet is a tracer.

Fully loaded, his plane holds several thousand rounds of belt- and clip-fed ammunition. This is enough for only a few seconds of firing, but since the pilot is on his target for only split seconds at a time, the ammunition that he carries is enough for a long battle.

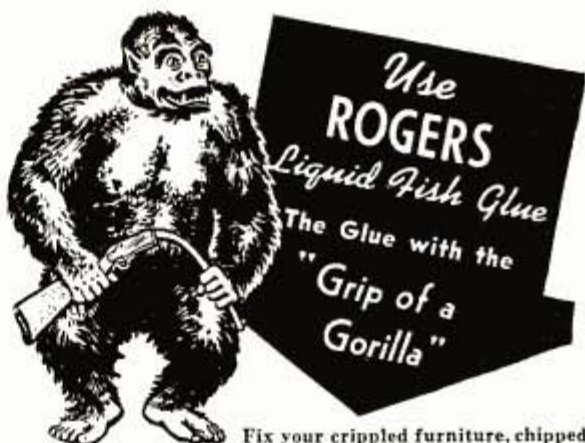

Fix your crippled furniture, chipped veneer, splintered moldings so they look like new . . . Rogers Glue stays put longer because it's stronger . . . also useful for repairing sporting goods, leather, cabinet work, wooden drawer pulls, interior building construction, and the like.

Special Offer! Sells 10 cents and up in tube, jar or can at hardware stores only or send 10 cents for full-size jar, a free project book giving new ideas, new plans on how to make useful articles, plus a free set of project sheets.

ROGERS GLUE CO.
Department L, Gloucester, Mass.

ROGERS

A TON OF STRENGTH IN EVERY DROP



BE PREPARED! LEARN TO SHOOT WITH BENJAMIN

MADE IN U. S. A.



HARD ACCURATE SHOOTING WITH CHAMBERED AIR

You can use new model **BENJAMIN AIR RIFLES WITH LEVER HAND PUMP** anywhere, for practice firing or just plinking, around the house or camping, fishing, hunting, etc., at lowest cost. Shooting force is adjustable with amazing maximum power and accuracy—no recoil or forward lunge to disturb your aim. Bolt Action—Hammer Fire—Hair Trigger—Safety Lock—Hand Pump. Single Shot BB with 1 lb. shot \$9.00! Single Shot Cal. 177 or .22 rifled—with 500 pellets \$10.50. Also a complete line of improved **BENJAMIN GENUINE COMPRESSED AIR TARGET PISTOLS** from dealer or factory. Write for details and **FREE TARGETS, BENJAMIN AIR RIFLE CO., 855 Marion St., St. Louis, Mo., U. S. A.**



PUSH BUTTON CONTROLLED GAS TANK LOCK



NO KEYS—Electrically operated from dashboard. One model fits all cars including fender door type. Greatest thing out! Sells on sight! Fully guaranteed. Distributors, dealers, here is your money making opportunity. Rush name for free literature.

SNAP-UP GAS CAP CO. Dept. K. ASHLAND, KY.

EARN MORE MONEY GRINDING LAWN MOWERS "THE UNIVERSAL WAY"

FULL OR SPARE TIME

Build a Business of Your Own in Your basement or garage and earn \$135 a month. Mr. Felber of Ind., writes, "My UNIVERSAL GRINDER is faster and more accurate than any other grinder. Its efficiency enabled me to sharpen 450 mowers in 4 1/2 months." More than paid for itself the first month. Every customer satisfied. **Only on the UNIVERSAL** can the inside face and edge of stationary blade, as well as the edge of the reel blades, be ground to proper clearance **ALL IN ONE SET-UP** without removing any blade from the mower. Tool Grinding Rest included.



"The Universal Way is the Modern Way" Write for Free Folder
Rogers Mfg. Co., Dept. 9-A, Lindsey, Ohio

Can You Equal This Home for 1095

Shipped
Direct
from Our
Mill



Save 30% to 40%
on Your New Home..

**WE PAY
FREIGHT**

Don't pay several hundred dollars more than necessary when you build a home! Buy it direct from our mill at our low factory price. We ship you the materials—lumber cut-to-fit, ready to erect. Paint, glass, hardware, nails, etc., all included in the price—no extra charges. We pay the freight. Plans furnished—also complete building instructions. No wonder our customers write us that we saved them 30% to 40%, compared with builders' prices. Easy terms—monthly payments.

Send for
**FREE
BOOK**
of Liberty
Homes

Handsome Big FREE CATALOGUE

Pictures wonderful homes in colors at money-saving prices. Designs to suit everyone. Write for your catalogue today.
LEWIS MANUFACTURING CO.
Dept. 1222 Bay City, Michigan

Now Only \$5.95

REAL ENGINE VALUE



The G. H. Q. is a miniature gasoline engine that really operates. Over 15,000 sold in the last year. Now is your chance to buy the *New Improved 1942 model kit* for \$5.95. Absolutely complete with coil, condenser, plug, instructions, etc. Only a screwdriver needed. For boats, planes, midget cars, etc. All parts guaranteed. Send only \$1.—*Shipped Collect C. O. D. same day. Send for FREE literature or 6c for Jumbo catalog and choice of free wings or aviation pin.*

GHQ MOTORS, Dept. B, 40 East 21 St., New York, N. Y.

TRAILER BUILDERS · BUYERS · OWNERS

Send 25c for this Big Book Today

Over 80 pages! Beautifully Printed and Illustrated! Trailer Suggestions and Ideas galore! Catalog shows America's greatest line of Trailer Parts and Equipment at lowest prices. Everything from wheels to top. Rush 25c (in U.S.) today. Satisfaction guaranteed!

TRAILER SUPPLY CO., Box 350-A, WAUSAU, WIS.



PLANS FOR NINE NEW JIM DANDY TRAILERS Ready

Build your own trailer! Send 10c for Jim Dandy's interesting new **TRAILER PLAN CATALOG** which illustrates and describes **NINE** new models including 9 modern house trailers, plus sport camp and utility trailers. Rush 10c (in U.S.) for Catalog today to **JIM DANDY, BOX 125-A, WAUSAU, WIS.**

SANDS 10 Times Faster...



New Guild PORTABLE ELECTRIC Sander

Now, do better sanding this easy way—10 times faster! This sturdy, portable belt sander turns out expert work in minutes—instead of hours of hand-sanding drudgery.

Gives everything you make that expert finish. Works on wood, metal, stone, plastics. Sells at popular price—weighs only 9 pounds. Fully guaranteed. Try it at your hardware dealer's, or WRITE us today for full details.
SYRACUSE GUILD TOOL CO., 1742-2C No. Salina St., Syracuse, N.Y.

ITCH STOPPED QUICKLY

Quick relief from itching of eczema, rashes and other externally caused skin troubles

35c bottle, at druggists, proves it or money back

Use **D.D.D.** Prescription

Wanted: 200,000 Men

(Continued from page 95)

and chisel, knocking off an eighth-inch covering of barnacles and rust from the bottom of a City of New York garbage scow, a tedious job which must be done carefully. As he progresses, he may find himself using a pneumatic hammer and chisel on a steel deck. Here he must be even more careful, or his instrument will knock a hole in the deck. He'll learn to clean the deck or hull with a wire brush.

If he is a painter, he will follow a chipper over a cleaned area of steel hull and coat the exposed metal with red lead, anticorrosion paint and finally an antifouling mixture which discourages barnacles and other underwater growths.

Perhaps the newcomer will get a chance to learn drydock operation. The intricate valves which flood huge tanks with water to lower a drydock, and the valves which pump air into the tanks to raise a vessel will have to be measured and he will learn how to set the drydock blocks which will support the craft without damaging its hull after it has been raised from the water. He will also find out how to rig the ropes to hold a boat where the blocks will catch the hull as the drydock rises.

If he gets a chance to become a shipwright, he may find himself tapping the hull of a wooden coast-guard patrol boat with a hammer until a dull thud instead of a hard ringing sound tells him he has found a weak section. If his foreman verifies his find, he and his crew will chisel away the damaged plank about four feet on both sides of the weak spot and then prepare a fresh plank in the precise dimensions necessary. He will fasten the new plank in place with screws and calk the seams so the patched area will be as sound as the rest of the hull.

In the blacksmith shop he might learn to forge nuts and bolts of special sizes and dimensions; in the carpenter shops he might do many of the hundreds of carpentry jobs that turn up on a vessel which battles the seas. In the machine shops he might be taught not only to use tools, but to repair them.

While the Staten Island shipyard, at which the training program was launched on an experimental basis, is being closed, work is being continued at other yards.

Raise Your Income \$25 a Week } NO EXPERIENCE NEEDED MAKE BIG MONEY IN SPARE TIME

WITH IDEAL LAWNMOWER SHARPENER

FREE PLANS SHOW YOU HOW TO BUILD A PROFITABLE BUSINESS OF YOUR OWN

There's money . . . big money . . . in sharpening lawnmowers. Every home a prospect. Our plan makes orders easy to get. Customers "repeat" year after year. Most men earn up to \$25 a week . . . even in spare time. Walter Roth, Mich., sharpened 867 mowers his first year, over 900 his second year. Howard Heller, Minn., grossed \$1,100 from April 15 to Sept. 15. J. H. Kellogg, Mich., writes: "I paid off \$1,200 on my home." The Ideal Lawnmower Sharpener can put you on the road to greater earnings, too. NO EXPERIENCE NEEDED . . . Just set the mower in the Ideal, make a few simple adjustments . . . the machine does the rest. Sharpens any mower to a perfect edge in 15 to 20 minutes. You get \$1.00 to \$1.50 for every job. SHARPENS LIKE MAGIC . . . Makes old, dull, badly worn mowers cut like new. Customers find mowing easy, pleasant . . . tell their friends. YEAR 'ROUND BUSINESS . . . Attachments for grinding skates, grass and hedge shears, sickles, scythes, axes; gumming saws, make your Ideal Sharpener a year-round money maker. Start in basement or garage. Work spare or full time. FREE PLANS show you how to get orders, build a profitable business. Today, when people have money to spend, is a good time to start.

THE FATE-ROOT-HEATH CO.
1242 Bell Street, Plymouth, Ohio



SIMPLE. FAST. EASY TO OPERATE.
GRINDS MOWERS TO KEEN CUTTING
EDGE IN ONLY 15 TO 20 MINUTES!

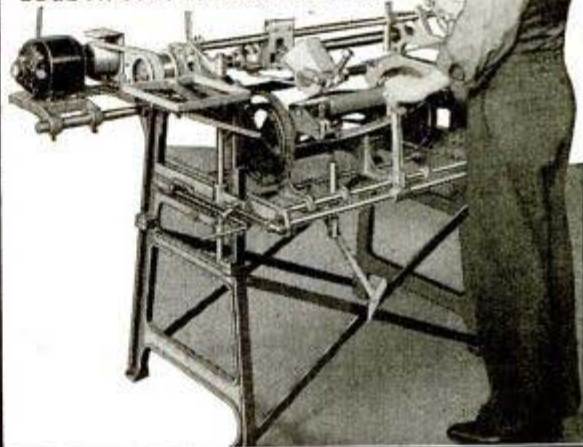

SEND FOR FREE 24 PAGE BOOK



A GERSTNER TOOL CHEST
will serve you best. Free Catalog to machinists and toolmakers.
GERSTNER TOOL CHESTS
442 Columbia St. Dayton, Ohio

Big Money for Workers In Home or Shop



EARN MONEY as Licensed Concrete Specialist. Make lawn pottery without molds. Patented method. Cemetery products, novelties, tiles, floors, colorglazing, patching, basement waterproofing. Other projects. Workers wanted everywhere. Booklet, colorplate, details 10c.

NATIONAL POTTERIES COMPANY
Dept. A, 11 W. 26th St. Minneapolis, Minn.

Wonder-Tone NOISE ELIMINATOR

Just attach to your radio (long, short wave) and enjoy reception free from distracting noises. Send-No-Money Pay Postman 60c plus postage or send 60c and we'll send postpaid. Return in 5 days for refund if not delighted.

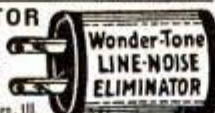

WONDER-TONE COMPANY, Dept. 12, 7078 N. Clark St., Chicago, Ill.

KINKADE GARDEN TRACTOR

and Power Lawnmower
A Practical Power Plow and Cultivator for Gardeners, Suburbanites, Florists, Truckers, Nurserymen, Fruit Growers.

Low Prices - Easy Terms
American Farm Machine Co.
1058 33rd Av. SE. Minneapolis, Minn.



BURN YOUR NAME ON TOOLS WITH THE ARKOGRAF

PROTECT YOUR TOOLS FROM THEFT
Write with electricity any name or design on the hardest and finest tools and instruments, or any metal, like writing on paper with pen or pencil.
Complete Outfit \$3.50—Pigtail Anvil
Interesting illustrated circular free. Write today. Agents wanted.
ARKOGRAF PEN CO., 3927 S.E. Stark St., Portland, Ore.



Say you saw it in Popular Mechanics!



"LET'S TRADE CAMERAS!"

Generous allowance on your camera toward a new or used model of your choice. Write giving description of present camera and tell us what you want. Write for free MOVIE or STILL Bargaining. Dept. P

Bass CAMERA CO.
179 W. MADISON ST., CHICAGO, ILL.



SUCTION SPONGE Cleans Cars New Way!

AMAZING INVENTION! Brushes auto-washing drudgery. Cleans linoleum, woodwork, windows like a flash. Auto owners, housewives wild about it. HOT SELLER FOR AGENTS AND DISTRIBUTORS. Hustlers cleaning up big money.

SAMPLE OFFER Samples sent on trial to first person in each locality who writes. No obligation. Get details. Be first—used in your name TODAY!

KRISTEY CO., 675 Bar St., Akron, O.

TEST-O-LITE

Tests Everything Electrical
From 100 to 550 Volts



\$1.50 At Electrical Stores or Post-paid

A real necessity for electricians and home because it has 1001 uses. Equipped with a Neon light which tells instantly where trouble lies in electric circuits, fuses, cut-outs, motors, radios, all kinds of electric appliances, etc. Tells A. C. from D. C. Far superior to ordinary clumsy test bulb. Fountain pen size with clip for carrying in vest pocket. Lifetime guarantee.

PATENTED

L. S. BRACH MFG. CORP.
55 Dickerson St., Newark, N. J.



FUSES

2879

Solving Mysteries of the Deep

(Continued from Coloroto Section)

of his rod into the socket, and waited for this giant to strike as the boat tempted the fish with bait trailing about 75 feet off the stern. The swordfish struck the bait, and, to everyone's joy, returned to take it.

For two hours the fight continued between Michael Lerner and the fish, which outweighed him several times. Repeatedly it was brought to the boat, but even after 80 minutes of conflict, it was able to sound again more than a quarter of a mile into the ocean's depths. It began to look as if the 30-foot wire leader had wrapped around the fish.

In another ten minutes this fear proved well grounded, and the big one snapped the snarled leader—and got away.

Then one day on the squid grounds, Michael Lerner finally got his broadbill. It came to feed on the slimy "nightmare of the sea." Its capture took him about an hour of toil and was the first swordfish ever taken on rod and line in Peruvian waters!

Patient fishing eventually brought another to boat. The specimens were hurried ashore, and on the beach members of the party immediately made plaster molds. Next, the fish were skinned and the skin preserved so that it could be stretched on casts made from the molds. Internal organs were extracted, and placed in milk cans, immersed in a formalin solution.

The search for giant swordfish, had, of course, enabled the party to land many other game fishes and these were likewise preserved for shipment to New York. Then the expedition moved on to Chile where its success was even greater.

From his experience, extending half way around the world, Michael Lerner has discovered that there is no way of judging how long it will take to land a big fish like a swordfish. One, taken off Chile, weighing 668 pounds was landed in 39 minutes. Another 601-pounder, off Cape Breton, Nova Scotia, fought more than four hours. Mrs. Lerner battled one seven hours, only to lose it right at the boat; and then landed one weighing 570 pounds, off Chile, in 50 minutes. Some put up their battle near the surface, others sound so deeply that 1,500 feet of line go down after them. Marlin are more active battlers, leaping out of the water often 50 times when hooked, and "greyhounding" and "tail-walking" across

the surface. Caught in the corner of the mouth, game fishes, apparently regarding the hook as another and particularly disagreeable parasite, go through remarkable gyrations for long periods of time. If they swallow the bait, however, loss of blood hastens the end of the struggle. If a fish is hooked in the eye or where some vital nerve becomes paralyzed, it can be reeled in with very little effort in a few minutes.

When the expedition's catches have been received at the American Museum of Natural History, in New York, the Museum's scientific detectives begin minute examination of the specimens and plotting maps of the catch. If they can establish that great numbers of very young fish are found in certain localities, their quest for the feeding grounds will be getting warm. If they can find females nearly ready to spawn their 15 to 20 million eggs each, they will presume they are near the breeding places. If males are with the females, another clue would be added. Off Cape Breton, Nova Scotia, where swordfishing is a major industry, scores of female fish were found, but not a single male.

How and where do these most mysterious of game fish meet in the wide expanses of the sea? What draws them together at a certain point and time? Where do the young hide from their predatory fellow inhabitants of the deep? Why do great schools appear at one spot one year and change their wandering path the next? The answers to these questions will fill a blank in science and be of great value to commercial and sports fishermen.

Eyes Get Credit for Equilibrium Once Given to Ears

The controlling factor of a flyer's sense of balance, formerly believed to be in the ears, is now accepted as being in the eyes, according to Col. Louis H. Bauer, consultant in aviation medicine to the Civil Aeronautics Authority. Recent studies indicated that no matter how perfect the mechanism of a flyer's inner ear may be, he is unable to keep his plane on even keel unless he can see the horizon, or has learned to fly blind, or he disregards the sensations resulting from stimulation of his internal ear.

Chicago Tribune 10/21/29

"MY JOB IS MILES AWAY...
but my HARLEY-DAVIDSON gets me there



Fast and Economically"

THOUSANDS of men in vital defense work live miles from their jobs. But they go back and forth quickly and at low cost on dependable Harley-Davidsons. More miles per gallon and minimum oil consumption conserve gas and oil essential for defense. Other advantages: power for faster getaway — easy to get through heavy traffic — no parking worries. Costs less than any other form of motorized travel — for everyday use — or for good times over week ends.

Harley-Davidson motorcycles are doing double duty these days—in defense service as well as for civilian needs. See your Harley-Davidson dealer — learn about the superior performance of these world champion motorcycles. Also look over his special values in reconditioned models.



HARLEY-DAVIDSON

MOTORCYCLES

Send this Coupon NOW!

HARLEY-DAVIDSON MOTOR CO., Dept. P. Milwaukee, Wis.

Send FREE copy of big 24-page "Enthusiast" magazine filled with thrilling motorcycle pictures and stories. Also literature on the latest Harley-Davidsons. Stamp is enclosed for mailing cost.

Name

Address

FM Adapter for Your Radio

(Continued from page 157)

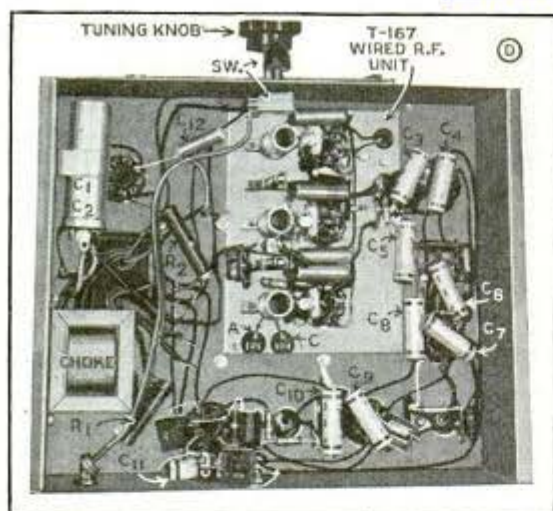

Mount the r.f. tuning unit on the chassis last in order to prevent damage during assembly and wiring. Wire carefully; make all leads from condensers and resistors as short as possible, and locate all of the tube

sockets and tubular by-pass condensers exactly as shown. The I.F. transformers are supplied pre-aligned but some "touching up" may be necessary. Frequency modulated transmitters and receivers reproduce the full musical range up to 15,000 cycles as compared with the 5,000-cycle standard (AM) broadcast stations. This means that musical overtones, sound effects such as sawing wood, washing dishes, dropping coins, bells, etc., are reproduced with lifelike naturalness. All this without the usual background noise of atmospheric or man-made static. Owing to lack of space, further FM circuit comment and additional aligning data are given in the detailed list of original parts which is available from Popular Mechanics radio department without charge, if desired. Photos A, B, C and D clearly show the arrangement of all parts above and below the chassis. The blueprint number of this article is R-299.

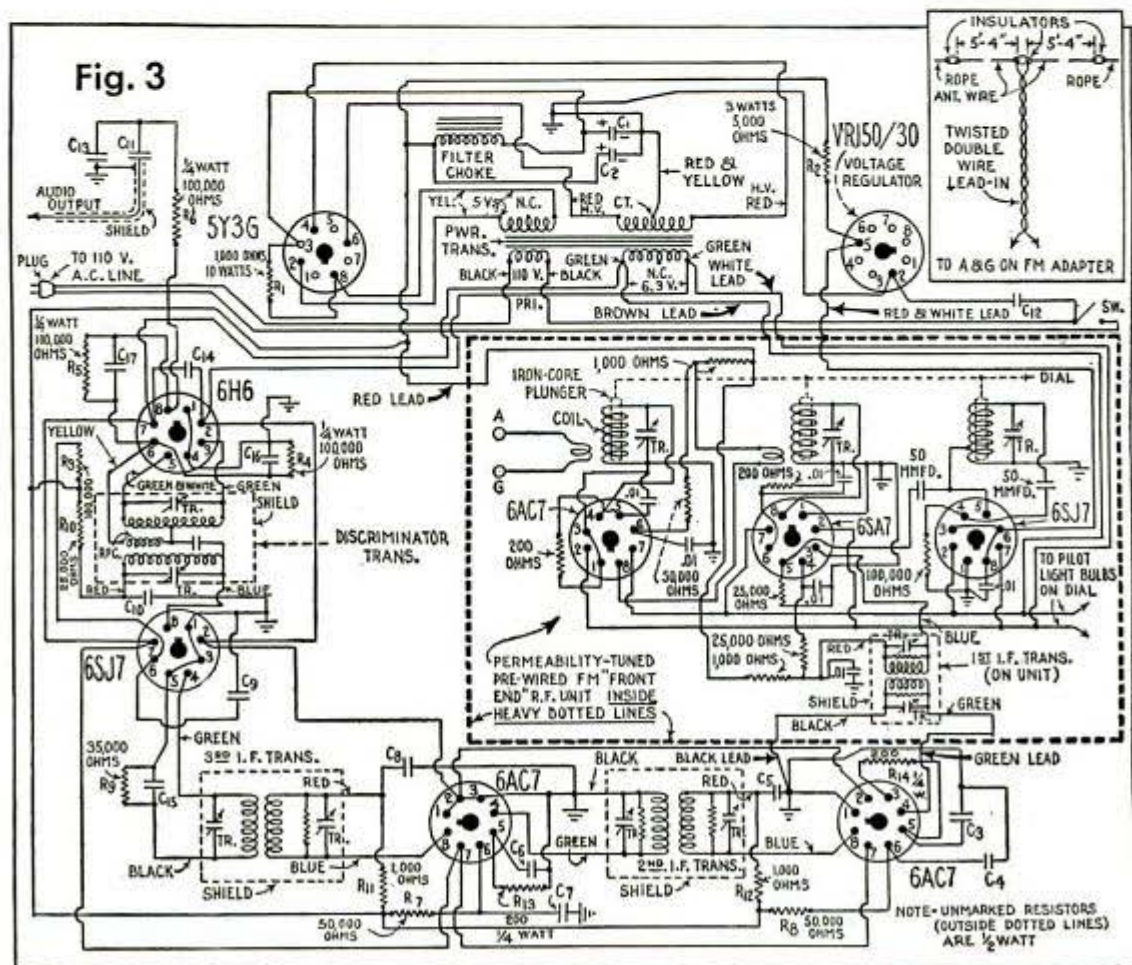

How *Atlas* SERVES THE NATION

One in a series of messages showing how Atlas helps in the armament program.

BAUSCH & LOMB
PRECISION
SHARPENS THE
"EYES FOR DEFENSE"



Before the mighty guns of the Army and Navy thunder into action, powerful "eyes" — telescopes, binoculars, and marvelous range finders — must spot the target. We can all be thankful that the veteran instrument makers of the Bausch and Lomb Optical Company are enlisted for the duration. Absolute and precision dependability are vital in producing the complicated mechanism of modern optical instruments.

The photographs below show some of the Atlas No. 73 Drill Presses on defense production in the Bausch & Lomb plant. The operators are typical of those who since 1853 have carried on the tradition of Bausch & Lomb precision machining. Atlas is glad to serve the nation through them in this critical year.

Photo by U. S. Army Sig. Corp



Photo by Arnold. Floyd Bennett Field



Off. U. S. Navy Photo



Off. U. S. Navy Photo



ATLAS PRESS CO.
243 N. PITCHER STREET
KALAMAZOO, MICH. ★

LATHES • DRILL PRESSES • ARBOR PRESSES • SHAPERS • MILLING MACHINES

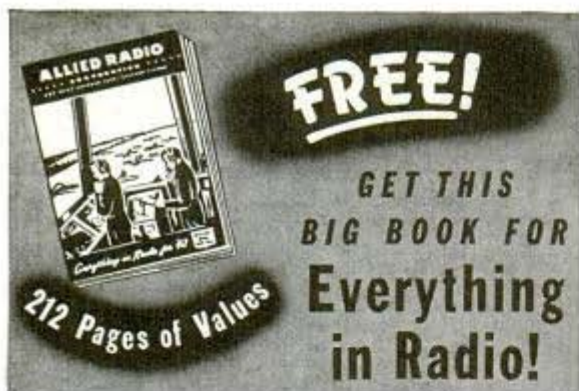

FREE!
GET THIS
BIG BOOK FOR
Everything
in Radio!



NEW 1942 RADIOS



NEW SOUND SYSTEMS



NEW BUILDERS' KITS



AMATEUR SETS

BUY NOW—SAVE MONEY

You'll want this great 1942 Radio Catalog—the biggest and best in the field! It's got Everything in Radio at prices that set the pace for value in today's market. Send the coupon today for your FREE copy of this great catalog.

New 1942 Radios—50 new models, plastic and wood table models, consoles, FM combinations, phono-radios, phono players, recorders, auto sets, farm radios, etc. Before you buy, see this great **Knight** line!

Sound Systems—1942's finest—full line from 7 to 60 watts—with all the new features, better tone quality, greater usable output. 15 Day Trial—Easy Time Payment Plan, too!

Build Your Own—an amazing selection of new Radio Kits, builders' diagrams—everything for the Builder and Experimenter. Learn Radio—let ALLIED help you!

Amateur Gear—all the new Communication receivers—specialized radio and electronic equipment for industrial application, defense instruction, research, etc.

15,000 Items—Everything in radio—test equipment—replacement parts—all at the lowest market prices. Also see the complete section on **Fluorescent Lighting**. Send for your FREE copy today!

MORE THAN 15,000 PARTS READY FOR PROMPT DELIVERY!



LEARN RADIO!

RADIO DICTIONARY
Nothing like it ever before—complete, authoritative, worth many times the price! Compiled by leading Radio authorities under ALLIED supervision. Gives easy-to-understand definitions of all commonly used radio terms. **10c**
A "must" at only

BUILDERS' HANDBOOK
Most popular and widely sold Radio publication—ALLIED's own valuable beginner's book on Radio. Tells how to select circuits, read diagrams, build sets, etc. Fully illustrated. Easy to understand. Order by coupon. It's yours **10c** for only

ALLIED RADIO
833 W. Jackson Blvd., Dept. 5-B-2
Chicago, Illinois

Send me your FREE 1942 Radio Catalog.
 I enclose 10c for Radio Dictionary.
 I enclose 10c for Radio Builders' Handbook.

Name
Address
City State

"Black Light" Burglar Alarm

(Continued from page 158)

ameter, is cemented in a slightly beveled hole in the front end of the case.

A metal bracket supports the bayonet-type socket, and completes the lamp filament circuit, bringing the bulb filament exactly 6 in. from the lens, and in a direct line with it. Figs. 1 and 2 show simplified wiring diagrams of both units; corresponding schematic circuit diagrams appear in Figs. 3 and 4. The "Guardian" T-11-3.5-C1

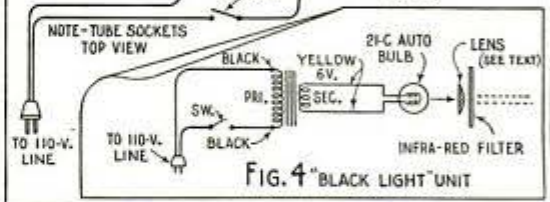
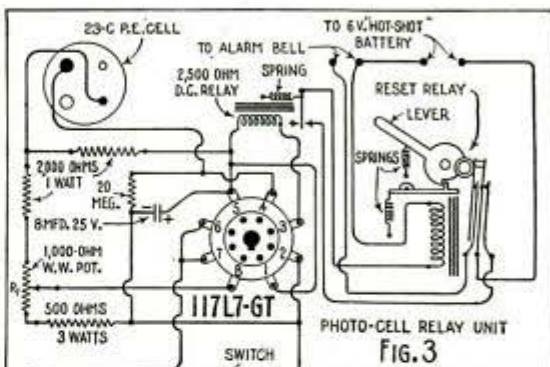

reset relay is mounted so that its lever extends through the case and works freely.

Mount the units at the same level, and, with the infra-red filter temporarily removed, adjust the light beam so that it crosses the doors and windows that are to be protected and reaches the photo electric cell in the relay unit. Mirrors may be used to reflect the light beam around corners. The cases are then permanently bolted in position and the infra-red filter fastened down over the lens. No white light should show from the case. Now before connecting the 6-volt battery, plug in both units and pass your hand back and forth across the opening in the photo-cell case and adjust the sensitivity control (R_1) until the relay can be heard to click up and down. Then pull the reset relay lever down until it catches, and connect the battery and the bell. The bell may be located inside or outside the building at any convenient point. The blueprint number for this article is R-300.

L1330 2072 Wacker Blvd
St. Louis Mo

You Can't Be Too Careful, Odd Accidents Prove

Accidents will happen, but most of them can be prevented by a little foresight. It may be your turn in 1942. Just as a warning that you can't be too careful, look at some of the strange mishaps reported to the National Safety Council in 1941. A student pilot was bounced out of his plane when it hit a down draft over East St. Louis, but he was amazed and pleased to land on the fuselage near the tail. He hung on like a scared jockey, riding backward, while the instructor did an expert job of landing gently. Another flier, less lucky, went into a tailspin at 3,000 feet and crashed. He crawled from the wreckage unhurt, but on his way to the highway he fell and cut two fingers to the bone. You can eliminate most fire hazards, but not the mysterious kind that afflicted an Indiana farm house. In one day it caught fire 28 times. First an upstairs windowsill caught fire, then a downstairs window, then a calendar on the wall, a bed spread, a pair of overalls hanging on a door, a book in a drawer, a layer of paper under a mattress. Finally the farmer tore down the house. No one knows what caused the repeated blazes; one theory was that the house was in a strong magnetic center where static electricity prevailed. A more obliging blaze in Athens, Ga., turned in its own alarm; the telephone fell from the burning wall and the operator, plugging in, heard the crackle of flames and called the fire department. Too often you read of hunters accidentally shot. It was different in the case of a California hunter who was knocked unconscious when the goose he had shot fell on his head. A New York motorist was hit simultaneously on opposite sides by two cars driven by brothers, and a caboose in Minnesota similarly was struck from both sides at a road crossing. A Texas woman sat in her car while it was being greased, forgot she was up on a hydraulic hoist, stepped out and fell to the floor. In one morning a Florida postman was bitten by a dog, stung by a scorpion in a mail box, ran a nail in his foot when porch steps collapsed, and trod on a rattlesnake. And the National Safety Council executive who collected these facts knocked himself out with a blow on the chin when the paint-stuck window he was trying to open gave way suddenly.

KAYAKS

Easy to Build



'42 MODELS
Latest Designs

BOATS for Home Assembly

"U-MAK-IT"

KAYAKS, ROWBOATS, DINGHIES, INBOARDS, OUTBOARDS, RUNABOUTS
Cut-to-fit for quick assembly. Everything complete plus illus. Instructions. No Experience Necessary. Simple as A-B-C. Thousands of Satisfied Builders. Enjoy building your own in evenings.

SEND 10¢ POSTAGE (COIN) TODAY
For Money-Saving Illus. Catalogs showing all latest '42 Models of Lightweight Marine Plywood. Largest selection we ever offered.

New AQUAMOBILE V-18

Cut-to-fit, Especially Designed for Automobile Engines. Adjustable Motorbeds. Open or with cab. Length 18 ft., width 6 ft. 7 in. Ideal for fishing and cruising. Fast VEE Bottom Hull.



Encl. 10¢ (coin). Send all illus. Booklets at once.

Name

Address

MARINE DIVISION OF U-MAK-IT PRODUCTS
KAYAK BOAT CO., 154 P. EAST 129th ST., NEW YORK, N. Y.

Say you saw it in Popular Mechanics!

MECHANICS SEND TODAY

FOR THIS 80 PAGE FREE BOOKLET!

"Cures for Motor Car Ailments" is an 80-page booklet with many short cut ideas for fixing cars. Every mechanic will welcome this helpful booklet. Free for the asking, no obligation.



CHAMP-ITEMS, INC.
6190 Maple Ave., St. Louis, Mo.

WITTE DIESELECTRIC PLANTS

Your present power bill will buy a WITTE that produces power and light for 1c a K.W.H. Save up to 75%. A Size for Every Need. Write today for finance plan, literature and name of dealer.



WITTE ENGINE WORKS, 1742 Oakland Ave., Kansas City, Mo.

SAW-FILING

Pays up to \$2 or \$3 an Hour

A FOLEY Automatic Saw Filer files band, circular and hand saws better than the best hand filer. Cash business, no canvassing, no eyestrain. No experience needed. "Bought a Foley, one year later had all debts paid and \$400 on new home. Many days I earn as much as \$16.00" - J. H. Keltogg. Send coupon for FREE PLAN, no obligation.



FOLEY MFG. CO., 216-2 Foley Bldg., Minneapolis, Minn.
Send Free Plan on Saw Filing business.

Name

Address

21172

WINS LAND'S END AND PIKE'S PEAK HILL CLIMBS WITH BURD "Graf-Flox" PISTON RINGS



There's no more grueling test of man and motor than the Land's End and Pike's Peak hill climbs. Louis Unser set new records in both this year in his Snowberger Special equipped with Burd "Graf-Flox" Piston Rings. The "trial by fire" of roaring racing motors gives positive proof of Burd stamina, their inborn immunity to heat, their resistance to wear through long life. Burd "Graf-Flox" Piston Rings have inherent self-seating surface and self-lubrication that reduces friction to a fraction . . . eliminates the usual "run-in" period. Mail coupon for free folder and your copy of Handy Handbook.



Top: Unser sets the checkered flag at Land's End. Bottom: Unser in his Burd "Graf-Flox" piston ring equipped record breaking car.

Cave Men Up-to-Date

(Continued from page 47)

rocks. Best garb for underground travel is a one-piece coverall; leather jackets are dangerous, as they're likely to roll up over your shoulders and pin you fast when backing out of a tight hole. More than one lighting system is essential: a pocket full of candles and matches, flashlights, and carbide lamps. The caver's knapsack, which can be shifted from chest to back, has nine or ten zipper pockets for map and data equipment, paper, pencils, compasses, measuring tape, chalk for marking stations mapped, a hand level to figure the drop from one point to another, extra flashlight batteries and thermometers.

In addition, cave explorers carry ropes and rope ladders, two quarter-mile spools of lightly insulated telephone wire and equipment for talking with others at the surface, and a special "ceiling indicator" for measuring ceiling heights.

"Following an experience in one cave," says Stephenson, "where one of our party coming to a pool of water and a rock barrier had to strip and dive under the hanging wall to explore beyond, we designed a waterproof capsule for underground swimming. The water is always ice cold and illness may result from naked swimming in it." The most important caution, he says, is never to explore a cave alone.

These modern cave men explore for scientific purposes, bringing out data on caves and life in them—salamanders, crickets, flies, bats, rats, snails; one interesting find was a blind variety of beetle. In eastern caves are beautiful deposits of calcite, travertine and onyx; there are no valuable stones in caves.

The granite caves in the western North Carolina mountains are a strange phenomenon. By all the laws of science a granite cave should not exist, save where rocks topple over on each other. But these are fault caves.

"The most eerie thing in all 'caving,'" says Stephenson, "is the fall of water in the distance. It echoes and re-echoes through the brain, the tiniest drip sounding like a gigantic waterfall about to rush upon you. It is all because sound is so magnified in caves. Your heart in a close passage thunders like a trip-hammer. Caves indeed are eerie places."

COUPON BRINGS HANDBOOK FREE

Burd Piston Ring Co., 102-A, Rockford, Ill.

Please send folder on BURD "Graf-Flox" Piston Rings and a copy of the Automotive Serviceman's "Handy Handbook", and complete story of 1941 Race.

NAME.....

ADDRESS.....

CITY.....

STATE.....



★ Home Craftsmen Like EMPIRE LEVELS!

NEW "CIGAR SHAPED" ALUMINUM "TORPEDO" LEVEL. Won't tear pocket. Serves many uses for workmen or in homes. 9" long. Shows plumb, level. 4 1/2" x 1 1/2" x 1/8" thick. Grooved bottom. Only \$1.50. POCKET LEVEL—FOUNTAIN PEN SIZE. Beautiful Chrome Aluminum. Clips to vest pocket. Always handy. Accurate. Level vial has pitch graduations. Great value. Only 75c.



Patented



EMPIRE LEVEL MFG. CO., Dept. P-216
717 So. Sixth St. Milwaukee, Wis.

★ Order direct, or from local Dealer. Send 10c for catalog. Good Craftsmen Everywhere Use EMPIRE "Extreme Accuracy" Levels.

OTTAWA LOG SAW \$39



PUTS THIS OTTAWA to work for you. MAKE MONEY! Wood is valuable. Does more than 10 men. Easily operated. Falls trees—saws limbs. Use 8-hp. engine for other work. Write for FREE Book. OTTAWA MFG. CO. 5227 Wood St., Ottawa, Kans.

SAW 10 TO 20 CORDS A DAY

816 BOOK FREE

FIRST and FINEST
EMERSON

TOOL OF 1001 USES

A whole toolshop in your hand. Does precision work on metals, alloys, plastics, wood, horn, bone, glass, etc. For your own hobby enjoyment or as a gift.

Uses 300 easy-to-change accessories to grind, drill, polish, cut, rout, carve, saw, sand, sharpen, engrave. 25,000 r.p.m. Wt. 12 oz. With 7 Accessories, postpaid \$18.50. Order on 10 Days' Money-Back Trial.

CHICAGO WHEEL & MFG. CO.
108 S. Aberdeen St. Chicago, Ill.



Plugs in Any Socket

FREE—64-Page Catalog

don't WORRY

Why put up with years of needless discomfort and worry? Try a Brooks Automatic Air Cushion. This marvelous appliance permits the opening to close, yet holds reducible rupture securely, comfortably—day and night. Thousands report amazing results. Light, neat-fitting. No hard pads or stiff springs to chafe or gouge. Made for men, women and children. Durable, cheap, **Sent on trial** to prove it. Never sold in stores. Beware of imitations. Write for **Free Book on Rupture**, no-risk trial order plan, and proof of results. All correspondence confidential. **BROOKS COMPANY, 158 State St., Marshall, Mich.**



NEW CHEAP OIL BURNER

FOR COOKING & HEATING STOVES-FURNACES
HEAT YOUR HOME. COOK YOUR MEALS WITH CHEAP FURNACE OIL

NO MORE SHOVELING COAL OR ASHES. New Fuelizer Starter Vaporizing System turns Cheap 130 Flash Furnace Oil into Oil Gas heat without clogging up. **LIFE-TIME GUARANTEE** against defects. \$1.00-BONUS OFFER FOR TESTING. Big profits. We will let you try it in your own stove or furnace for one month. Get Yours **FREE** for introducing. Be first. Send in your name today. **NORTHWEST MFG. CO., 510-B 5th, Mitchell, So. Dak.**

Always write your name and full address clearly when answering advertisements.

RECLAIM USED OIL

No cost for equipment, or to operate. Good, clean lubricant from waste. Oil never wears out. Merely gets dirty. Free particulars. **K. GERWIN, Cor. S.E. 56 & Bryan, Oklahoma City, Okla.**

★ ★ ★

MAKE YOUR OWN
POWER TOOLS
at Low Cost
from old Auto Parts, etc.



New Book Will Save Hundreds of Dollars Shows How to Make Forty Tools

Now you can have a good lathe, drill press, circular and band saw and other power tools in your home workshop, at a cost of only a few dollars each. Make them yourself from old auto parts, discarded sewing machines and other odds and ends that cost little or nothing. Get this new book—"Forty Power Tools You Can Make." Costs only \$1.25 postpaid. This book gives every detail in plain language you can understand and follow. Hundreds of pictures and plans show every step to follow in making the power tools you want. Actual photographs of finished machines included. Send \$1.25 today. Money back if not satisfied.



MAKE EVERY POWER TOOL NEEDED IN YOUR HOME WORKSHOP

Some of the power tools you can make are:

- | | |
|--------------------|------------------------------|
| 2 Band Saws | 2 Drill Presses |
| 9 Sanding Machines | 1 Scroll Saw |
| 2 Circular Saws | 2 Wood Turning Lathes |
| 1 Metal Lathe | 3 Grinders |
| 1 Power Hack Saw | 1 Shaper or Moulding Machine |
| 1 Jig Shears | 1 Vibrating Pencil |
| 1 Cut-Off Wheel | and others |

Information too, about pulleys, belts, motors and drive methods. Just published. No other book like it. Order today.

POPULAR MECHANICS PRESS

Dept. 358

200 E. Ontario Street, Chicago

BARRON ROTARY WOOD PLANER

TRUES UP · PLANES · PANELS · RABBETS
ROUFS · TENONS · \$7.50 COMPLETE



A WONDER TOOL

Saves hours of tedious hand planing. Parallels and surface finishes to absolute smoothness all knots and tough grained woods. Hi-speed, double edged cutter blades insure extra long wear. Unexcelled for planing, rabbeting, routing, tenoning, grooving, beading and many other workshop uses. Safe—harmless to drill press. Thousands now in use. **Money Back Guarantee** shipped prepaid on receipt of check or money order for \$7.50—or C.O.D. Full five day trial and refund guaranteed if not completely satisfied. You Risk Nothing. Barron Tool Co., 361 Architects Bldg., Detroit



FITS ANY DRILL PRESS

FREE FOLDER

★ *Keep Saws Keen* ★
with
ATKINS PROTECTASAW

NEW SLIP-OVER GUARD PREVENTS INJURY TO TOOTH SET OR EDGES

At last a practical way to save your saws from injury when not in use or in carrying. **Atkins Protectasaw** guards the precise set and razor-keen tooth edges from accidental falls and rough handling. Attached in an instant. Copper-plated—won't rust. Fits hand saws to 24".

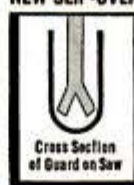

Cross Section of Guard on Saw

Order Now Get One for 25¢ Each Postpaid Cash With Order

E. C. ATKINS and COMPANY 426 S. Illinois Street Indianapolis, Ind.

NEW DESIGNS DECORATIVE NOVELTY FURNITURE OF PLYWOOD



Full size pattern Wall Shelf Tie Rack 25¢. Magazine Basket 25¢. New Catalog contains 500 illustrations of Plywood Novelty Furniture—Lawn Ornaments—Decor Transfer Decorations and many other lines. **SPECIAL INTRODUCTORY OFFER:** Both above patterns and Catalog postpaid 25¢ coin.

CRAFT-SHOP ASHBURN, GEORGIA

BUILD YOUR OWN ARC-WELDER

For Light or Heavy Work
No rewinding necessary—use coils taken from old auto generators. Works on 110 or 220 A.C. Has 20 different heats. Complete plans and BIG Catalog 35¢.

LEJAY MFG. CO., 3347 LeJay Bldg., Minneapolis, Minn.

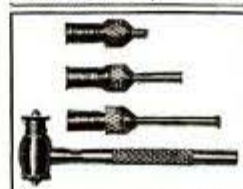

TELESCOPE GAUGE

A REAL 20th CENTURY TOOL. These small instruments measure by the thousandths the exact size of holes and slots using an outside calibre or micrometer to determine measurement and making either shrink or loose fit. Four measuring rods with lock adjustment measuring from 5/8" to 2 1/4"—works like inside micrometer. Guaranteed accurate and durable. Act now! One set packed in box. Postage Prepaid. Delivery C.O.D. Direct from factory to you.

SEABOARD TOOL CO.
Pat. Applied For — Price \$4.75
P.O. Box No. 1214 Baltimore, Md.



Woodworkers: Here it is! Harold 'Bud' big No. 14 wood catalog! Latest UP-TO-DATE IDEAS for experts and amateurs; **SPECIAL BARGAINS** in rare woods, veneers, and ALL kinds of supplies. 148 pages—20 of rare woods in color. Get posted! Send only 10¢ to **CRAFTSMAN WOOD SERVICE CO.**

only 10¢

2729 S. Mary St., Dept. A-18, Chicago, Ill.

You've
got to

EARN MORE MONEY



Here are the Pay Raising—Extra Money—Books that will help you. Use these books to prepare for a better job—bigger pay—to start a profitable spare time or full time business of your own.

Popular Mechanics Press specializes in supplying the outstanding best books on many subjects. As new books of merit appear, we will revise the list accordingly.

- BUILDING INSULATION**
New book covers both heat and sound.....\$3.00
- FORTY POWER TOOLS** (Just Published)
Build own saw, drill, lathe, sander, etc. from scraps—save money.....\$1.25
- SHOP NOTES LIBRARY**
Five big volumes including new 1942 edition (224 pages—28 in color); over 1900 articles on money-making & money-saving ideas.....\$2.45
- FURNISHING HOME GROUNDS**
Build own trellises, garden furniture, etc.....\$1.00
- A THOUSAND WAYS TO MAKE \$1,000**
Tested methods that work.....\$2.50
- TOOL DESIGN**
New book on production tools.....\$4.50
- TIN SMITH'S HELPER**
Seams, piping, gutters, etc.....\$3.00
- MODERN REFRIGERATION**
Electric, gas. Be service expert.....\$5.00
- AUTO BODY AND FENDER REPAIRS**
Shows how to do professional job.....\$3.00
- DYKE'S AUTO ENCYCLOPEDIA** (New Ed. includes Diesels, airplane engines)
World's greatest book for mechanics.....\$6.00
- SHEET METAL WORK**
Self instruction in all phases.....\$2.50
- ARMATURE WINDING**
Construction, winding, repairing AC & DC Motors, generators.....\$2.00
- BUILD YOUR OWN BOAT**
Just published. Describes 17 popular boats—rowboats, sailboats, plywood outboard, etc., 132 pages.....\$1.25
- CIVIL SERVICE HANDBOOK**
Home study for Federal, State, City Jobs.....\$1.00
- FORGING PRACTICE**.....\$1.50
- HIGH SCHOOL SELF TAUGHT**
4 yr. course in one vol.....\$1.89
- CARPENTRY & JOINERY**
Learn modern methods.....\$2.00
- FOUNDRY WORK**
Standard practice.....\$2.00
- WHAT TO MAKE**
5 Big Books, 888 pages of popular handicraft projects.....\$1.47
- PRACTICAL WOOD FINISHING**
Shows woods in full color, describes new finishes.....\$1.25
- AUTO RACING**
Constructing racer, speeding up Ford.....\$1.00
- MACHINE SHOP WORK**
Excellent book on approved methods.....\$2.75
- BLUEPRINT READING**
For machine trades.....\$1.50
- BLUEPRINT READING**
For building trades.....\$1.25
- PAINTING & DECORATING**
Getting most out of common materials.....\$1.50
- PATTERN MAKING**
Wood, metal.....\$2.00
- TOOL MAKING**
For beginners and advanced workers.....\$3.50
- FLUORESCENT LIGHTING AND ITS APPLICATION** (new book).....\$3.00
- LATHE HANDBOOK** (Metal)
How to construct 6-in. lathe, short-cuts, kinks.....\$0.50
- FIVE ACRES AND INDEPENDENCE**
How to make money on small farm.....\$2.50
- KNOTS, TIES, SPLICES**
For everyone who uses rope.....\$1.00
- PLUMBING**
Designing and installing.....\$3.00
- ELECTRIC WIRING**
Includes estimating.....\$2.50
- HOUSE CONSTRUCTION**
Details. Gives every step in House construction.....\$2.89
- MACHINISTS AND TOOL MAKERS HANDBOOK**
Audels new 1600-page book, machine shop practice in all branches.....\$4.00
- FORD V8 CAR AND TRUCK**
Repairing, operating.....\$3.00
- 1001 WAYS TO USE CONCRETE** (New Ed.)
Do work for yourself, others, save, make money.....\$1.98



- STEEL SQUARE POCKET BOOK**
Best methods of using.....\$1.00
- DE LUXE SMALL HOMES**
New plan book shows 210 popular designs.....\$1.00
- MODERN HOMECRAFT**
New 250 page book on modern furniture.....\$3.00
- BLACKSMITHING**
Complete course.....\$1.25
- YOUR CAR**
New 192-page auto-owners guide describes hundreds of simple car repairs, shortcuts, how to operate car economically.....\$1.25
- DIES & DIE MAKING**.....\$1.90
- PLUMBING DRAWING**.....\$1.40
- ARCHITECTURAL DETAILS**
For every type of building.....\$1.50
- SIMPLIFIED CARPENTRY ESTIMATING**.....\$2.50
- AUDELS PLUMBERS & STEAMFITTERS GUIDE**
4-volume reference library.....\$6.00
- UPHOLSTERED FURNITURE**
Covers entire process.....\$2.00
- BIRD HOUSES**
Simple, attractive, permanent.....\$1.50
- EASY-TO-MAKE TOYS**
Sixty-seven projects.....\$1.85
- HOUSE WIRING**
Approved methods.....\$2.50
- PRACTICAL BRICK LAYING**
Step by step instructions in best methods.....\$1.75
- WELDING, ELECTRIC**
Forge, thermit, resistance, arc.....\$1.25
- WELDING, OXY-ACETYLENE**
Welding, cutting.....\$1.25
- GARDEN GUIDE**
All phases of garden- ing.....\$2.00
- METALLURGY**
Stresses physical.....\$1.50
- RADIO PHYSICS COURSE**
Fundamentals made plain.....\$4.00
- AMERICAN MACHINISTS' HANDBOOK**
Standard manual of data, methods.....\$4.00
- BUSINESS COLLEGE SELF TAUGHT**
Get raise or job you're after.....\$2.39
- SLIDE RULE**
How to use.....\$1.00
- MODERN PAINTER'S ENCYCLOPEDIA**
Includes estimating, papering, cal- cimating.....\$2.00
- SIGN PAINTING**
Practical instruction.....\$3.00
- AUDELS DIESEL ENGINE MANUAL**
For engineers, operators.....\$2.00
- MACHINE SHOP OPERATIONS**
Major operations skilled mechanic should know.....\$5.00
- HANDBOOK FOR PROSPECTORS**
Equipment, procedure, laws.....\$3.00
- TECHNICAL BULLETINS**
Simplified data for practical men.
- SILVER SOLDERING AND BRAZING**.....\$1.00
- REWINDING ELECTRIC MOTORS**.....\$1.00
- FLEXIBLE MOLDS FOR CASTING NOVELTIES**.....\$1.00
- WORKING WITH PLASTICS**.....\$1.00
- MIRROR SILVERING**.....\$1.00
- SMALL ELECTRIC LIGHT PLANTS, CONSTRUCTING**.....\$1.00
- HEAT TREATMENT OF IRON & STEEL**.....\$1.00
- DESIGNING & BUILDING TRANS- FORMERS**.....\$1.00



Help FOR THE FELLOW WHO MAKES THINGS
SAVES TIME AND MONEY
25c Each, 5 for \$1., 12 for \$2.
Order by Number

- 1 Photo Enlargers (4 easy-to-make)
- 2 14-Ft. Outboard Runabout
- 3 Plating with Nickel, Chromium, etc.
- 4 Build Own Power Tools
- 5 Homemade Arc & Spot Welders
- 6 Colored Concrete Garden Furniture
- 7 Attractive Bird Houses
- 8 Farm & Garden Tractors
- 9 Taxidermy (for fun or profit)
- 10 Automobile Kinks (money-saving tips)
- 11 Formulas for Cleaning Preparations
- 12 Cosmetic Formulas
- 13 Treasure Finder—Metal Locator
- 14 Log Cabins & Tourist Cottages
- 15 Food Products Formulas
- 16 Garden Woodwork & Furniture
- 17 Soldering & Brazing
- 18 Growing Miracle Plants with B-1 Solution
- 19 Home Work Opportunities
- 20 4-in. Reflecting Telescope
- 21 Metal Plating & Coloring
- 22 Building Class-E Ice Yacht
- 23 Extra Rooms in Attic
- 24 Basement Playrooms
- 25 Photo Printer & Dryer
- 26 14-Ft. Sailing Dinghy
- 27 Midget House & Utility Trailers
- 28 Metal Craft (brass tapping, etc.)
- 29 Magic for Everybody
- 30 Build Own Canoe, Kayak, Surfboard
- 31 Lower Your Fuel Cost
- 32 Wood Turning
- 33 Trapping Small Animals
- 34 Small Gas-Driven Auto-Scoter
- 35 Training Your Dog
- 36 Make Small Castings—Furnace Construction
- 37 Making Money with Hand Loom
- 38 Hanging Wallpaper
- 39 Backyard Gardening
- 40 Plain & Novelty Wood Finishing
- 42 Cutting & Polishing Semi-Precious Stones
- 43 The Boy Electrician
- 45 Curing Leaky Basements
- 46 Fast 21-Ft. Sloop
- 47 Workbenches and Tool Cabinets
- 48 Jigsaw Fun & Profit (lawn ornaments, toys, etc.)

25¢
Little Library
Useful INFORMATION

Books Sent C. O. D. Anywhere in United States
Just check the books and bulletins you want, write your name and address below, and mail this advertisement. It is your order blank. When postman hands you books, pay him the price and few cents postage. Outside U. S. A. enclose remittance and include 15% additional for shipping charges. Ask for big FREE catalog of helpful books.

Name.....
City..... State.....
Address.....

Mail to Popular Mechanics Press, Dept. 357 — 200 East Ontario St., Chicago, Ill.

21191

Every Ounce Counts on a Clipper

(Continued from page 37)

equipment is placed on the plane. Passenger conveniences also may be added.

Pan American's maintenance men won a temporary victory recently when they found that much of the protective paint that covers the flying boats could be removed, replacing it with a coat of lanolin oil that could be sprayed on before each flight. The oil is just as good and weighs 90 pounds less. The six large United States flags painted on the hulls and wings weigh about five pounds.

An even greater victory was won when the original engines were replaced by more powerful ones. Although much heavier and requiring heavier propellers, the power plants more than paid for themselves because their reduced fuel consumption meant an overall saving of half a ton that is now devoted to carrying cargo.

The weight of everything added to one of the big Boeings or removed from it is recorded. Even when material is moved from one part of the plane to another this change must be noted because of its effect on the plane's center of gravity.

Periodically the weight ledger is checked by weighing the plane itself. This is a two-hour job for half a dozen men. Resting on its cradle, the flying boat is pulled ashore and leveled off so that it is in normal flying position. The hull has four strong points built into its bottom and a 20,000 pound capacity scale is placed under each of these strong points. Then a short sturdy hydraulic jack is placed on each scale and is raised until the plane rests on the scales. The scales tell the weight of the plane and also show its center of gravity.

The dry weight of one of the flying boats is close to 49,000 pounds. Some 24,000 pounds of gasoline may be placed on board, leaving 10,000 pounds for equipment, crew, mail, passengers, and express.

Before the war with Japan began, each flight crew crossed the Pacific and returned as a unit, either flying the 9,000 miles to Singapore in six legs or the 8,008 miles to Auckland, New Zealand, in four legs. The Singapore round trip took 14 days, then the crew spent four to five weeks at the Treasure Island base in San Francisco bay in training and ground duties before going

(Continued to page 187)

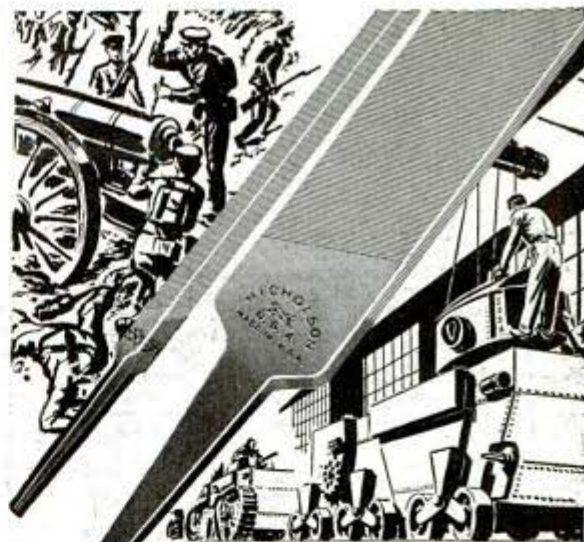

SPIKES for the guns of aggressors

On early American battlefields, captured cannon were put out of action by driving a file into the priming vent. Today files play a far greater role toward "spiking" enemy guns. In thousands of defense activities, millions of these indispensable tools are helping to build and maintain the machines and weapons which eventually must silence the arms of despotism.

Nicholson makes 3000 kinds, cuts and sizes. Regular files for the every-day requirements of machinists, repairmen, lumbermen, oil drillers, contractors; for ordnance kits, battleships, and what not. Special files for die, model, pattern and tool makers; for work on stainless steel, castings, brass, aluminum, plastics; for lathe and machine filing.

Because Nicholson and Black Diamond are the most widely used quality files in the world, the mechanical trainee will do well to become familiar with their uses and superior performance. Available to individuals as well as industrial managements. At hardware and mill-supply houses.

YOU — Send for interesting, 28-page FREE BOOK, "A File for Every Purpose."

Nicholson File Co., 22 Acorn St.
Providence, R. I., U. S. A.
(Also Canadian Plant,
Port Hope, Ont.)



NICHOLSON

FILES FOR EVERY PURPOSE



NEW ZIPPER SHOE

Sensation in Shoes!

"Clipper" ZIPS on and off instantly. Now's the time to build yourself a highly profitable shoe business with Clipper and 249 other sensational shoe styles for men and women. Dress — work — sports shoes. Prices low as \$2.98. Extremely liberal profit for you. Complete sales outfit absolutely FREE. Write now.

VICTOR THOMAS SHOE COMPANY

6805 N. Clark St., Dept. V-6, Chicago, Ill.



NEW! MINIATURE DUST MASK

Wear DUPOR No. 1 when sanding, grinding, paint spraying, sweeping, dusting, furnace cleaning, etc. Handy as a pair of glasses. Just keep mouth closed and breathe through nose is all you do to operate. Protects against nuisance dusts, lint, coal, cement, grain dust. Weighs 1 oz. Has 9 sq. in. filter. Write for FREE literature on DUPOR Respirators—Today!

H. S. COVER, Dept. PM, South Bend, Ind.
PIONEER RESPIRATOR DESIGNER SINCE 1894



Order Today \$1.00 POST PAID



White Hands

Keep them smooth, free from grime, with SKAT, original and best Paste Soap. Cleans almost everything, works fast. If not at dealer's, send 10c for large can. **SKAT CO., Dept. M, Hartford, Conn.**

AGENTS WANTED

GOLDENTONE... 50% OFF



Deal Direct—Factory Prices. Over 75 models to choose from —4 to 12 tubes. Portables \$8.98 up. Farm sets \$8.98 up. Car sets \$8.98 up. Foreign hand sets \$8.98 up. Samples 50% off. Quantity discounts. Free 1942 Bargain catalog gives details of 30 day FREE trial agent's proposition and discounts. No obligation. Mail postcard to **GOLDENTONE RADIO CO., Dept. PM, Dearborn, Mich.**



DO YOU

WANT a permanent business profession of your own? Then BECOME A FOOT CORRECTIONIST. Earnings in this greatly needed profession run as high as \$50-\$100 weekly after a few weeks home training—no medical or chiropody—no further capital needed, no goods to buy. 47th year. Write for free booklet.

Stephenson System of Foot Correction
28 Back Bay, Boston, Mass.

REVOLUTIONARY INTERCHANGEABLE ALL-PURPOSE KNIFE . . .
AT YOUR DEALERS

X-ACTO-CRESCENT PRODUCTS CO.,
Dept. PM, 440 Fourth Ave., New York

Direct Orders Filled
LIGHT DUTY No. 1—50c

Extra Blades 10c Each

HEAVY DUTY No. 2

X-acto
Keener knives, replaceable blades

America Needs Mechanics and Every Mechanic Needs

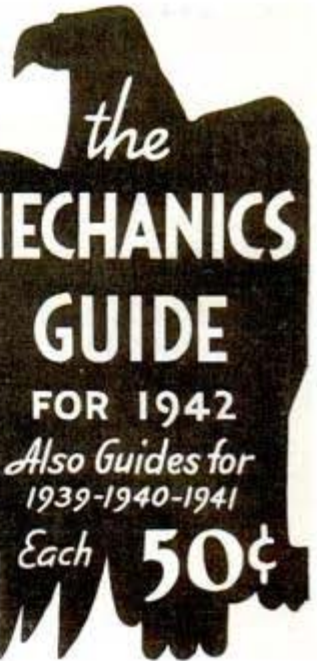

Some Helpful Articles in New 1942 Guide

- Lathe Operations
- Drill and Drill Press Kinks
- Drafting Ideas
- Gun Servicing
- Soldering Helps
- Modern Shop Practice
- Metal Finishes
- Sanding and Grinding
- Thread Cutting
- Using Power Tools
- Using Hand Tools
- Metal Layout Work
- Vise and Bench Work
- Electrical Kinks
- Auto Shop Helps
- Welding Helps
- Wood Working Ideas
- and—Money Saving Articles for Auto and Home Owners

• Everywhere there is a demand for mechanics . . . machinists . . . other men who can read a blueprint . . . work with tools. Men are wanted who can do things and make things. Help America! Help yourself! Keep up-to-date with Popular Mechanics Shop Notes, the yearly MECHANICS GUIDE of money-making facts, time-saving ideas, short cuts, shop kinks, and helpful practical methods.

224 PAGES • 600 PICTURES

The new 1942 MECHANICS GUIDE is the biggest and best ever published. Now 224 pages, 28 in colors, with over 600 pictures and 700 items in the index. It will help you on your job, help you to a better job, give you a new and better understanding of all mechanical processes and make money for you. Get your copy of this 1942 guide. Only 50 cents postpaid.

ORDER TODAY

4 Guides • 500 Pages • 1500 Helpful Articles • Only \$1.95

Start a SHOP NOTES MECHANICS GUIDE LIBRARY. A limited number of previously published books as listed below still available. Order with your 1942 guide. Four volumes, all different \$1.95 postpaid. Single guides 50 cents.

CHECK AND MAIL COUPON!

POPULAR MECHANICS PRESS

200 E. Ontario Street, Dept. 362 Chicago

Send me SHOP NOTES MECHANICS GUIDES as indicated below. I enclose remittance for \$. . . () I will pay postman (U.S.A. only, on orders for two or more books).

- 1942 Shop Notes—50 cents
 - 1940 Shop Notes—50 cents
 - 1941 Shop Notes—50 cents
 - 1939 Shop Notes—50 cents
- Shop Notes for 4 years as above \$1.95

Name
Address
City
State

Note: Outside U.S.A. enclose remittance and add 15% for shipping charges.

21171

out again. Meanwhile other crews kept up the schedule. The New Zealand run, started in 1940, is the only air route that crosses both the international date line and the equator.

To maintain these long runs Pan American established bases at Honolulu, at Midway, Wake, and Guam Islands, and at Manila for the transpacific run. Bases at Canton Island, the Fiji Islands, at Noumea in New Caledonia, and at Auckland were built for the New Zealand run. That means that besides operating airplanes the air line had to go into the construction business, the hotel and restaurant business, and even into vegetable gardening.

Canton Island, for instance, a barren coral atoll 2,000 miles southeast of Honolulu, was uninhabited until it was occupied jointly by American and British representatives. Pan American had to build its base from the ground up. Everything except sand for the concrete was brought in by ship for airplane fueling and servicing facilities, for the meteorology and radio offices, the hotel for passengers, and living quarters for its 34 employees. Radio masts, baseballs and bats, books and toothpicks are only a few of the thousands of items that had to be imported. Even standby apparatus for converting sea water into drinking water had to be provided, as well as collectors and reservoirs for conserving rain water.

286

Flood and Drought Solution Seen In Scientific Planting

There is a veritable river of evaporation returning moisture from earth to sky. A year's study of precipitation and evaporation at a government farm in Virginia showed that nearly half the annual rainfall was returned to the air by evaporation from the soil or transpiration from the leaves of plants—much more, in fact, through the leaves than directly from the soil. Dr. C. W. Thornthwaite of the Soil Conservation Service says this transpiration is an important factor in flood-subject regions, and encouraged maximum coverage of the ground with plants of high transpiration rates. In regions where drought is the major danger, he suggests that vegetation with low transpiration rates be planted so that as much moisture as possible be retained in the soil.

6/28/41
Service

Washington



FIX IT— THIS QUICK, EASY WAY!

- Next time any metalware around your house develops punctures—holes, cracks, messy leaks—conserve that precious metal by mending it with solder. But be sure to use the household solder that's pure, safe, quick, easy to use . . . Kester Metal Mender, the kind people have been using for 42 years. Why, for only a quarter you can solder every pot and pan in the house! Fix pumps and auto parts and lamps and screens and doorknobs and downspouts! Think of the saving! Especially now, when metal is vitally needed for armament!
- Don't think you can't solder. With Kester Metal Mender it's as easy as writing your name. Just apply heat to the metal to be mended, then a touch of Kester Metal Mender, the original flux-filled wire solder. No unsightly and unsafe acid pots to complicate the job, for the flux is inside the solder in just the right amount. That's why you don't need skill to do an expert job of mending metal!
- Find out for yourself—FREE—how easy it is to solder. Send coupon for generous trial sample of Kester Metal Mender and for "How To Use It" Book. Start now to save metal for Uncle Sam, and save money for yourself, with Kester Metal Mender.



KESTER METAL MENDER

You Can Paste this Coupon on a Post Card

Kester Solder Company
4251-2 Wrightwood Avenue, Chicago, Ill.
Please send me free sample of Kester Metal Mender and "How-to-Use-It" Booklet.

Name _____
Address _____
City _____ State _____

Mail the Coupon Now

READY CUT HOMES

\$763.00 and up. Freight paid. Save \$500 on average. Buy direct. Modern production methods prevent waste in material and assembly time. 75 home plans to select from. Including many new feature 1942 designs. All modern, practical, distinctive, complete. Simple plans for easy assembly. Includes all lumber, insulation, roofing, weather stripping, built-in features, attractive one-panel doors, latest hardware, nails, paint, varnish, etc. Information and plans for FHA financing requirements on request. For new 1942 color catalog, with floor plans, send 25 cents to cover mailing. Dept. PM-22, International Mill and Timber Co., City, Mich.

NEW COLOR CATALOG FOR ONLY 25¢

MAKE MONEY

WITH NASH CUSTOM TAILORED CLOTHES

Be your own Sales Manager, take orders; earn money with this famous make of clothes. High quality men's tailoring at popular prices. **WRITE!** Write in today. Territories open.

THE A. NASH COMPANY
1913 ELM STREET - CINCINNATI, OHIO

PHOTO ENLARGEMENTS

5¢ ANY SIZE

Is Photography your hobby? Do you want a profitable easy business at home? Make **PHOTO ENLARGEMENTS** for yourself and others. Your cost 3¢ each and less. The Ideal Photo Enlarger is **AUTOMATIC**. No experience required. Also **COPIES** any picture **\$7.94 COMPLETE**. Interesting circular **FREE**.

Ideal-O, 148 West 23rd St., New York City

CHEAP GAS SAVER

INVENTED FOR CARS

SAVES UP TO 25% ON GAS

OR, WE PAY YOU A BONUS

This amazing new U.S. patented gasoline saver now offered for automobiles, trucks, tractors and airplanes at a ridiculously low price. Users report unbelievable gasoline savings up to 25 percent, better pick-up, smoother running motors. Supercharge principle, self-regulating—easily installed in five minutes—quickly pays for itself. **BONUS OFFERED** to user-agents for testing on their cars. **WRITE** for unusual money-making distributor offer—we will let you **TRY IT FOR 30 DAYS** on your car. Send name today.

J. A. Stranksy Mfg. Co., 751-B Main, Pakwana, S. Dak.

WALL CLEANER

“Erases” dirt like magic—walls, ceilings, window shades, upholstery. Saves Redecorating. Sells like wild.

AGENTS HOT SELLERS

KRISTEE CO., 674 Bar St., Akron, Ohio

WORLD'S LOWEST PRICED ADDING MACHINE

FREE TRIAL ONLY \$250

IDEAL FOR INCOME TAX GUARANTEED ACCURATE. Not a toy. Operates with only a finger flick. Adds, subtracts, multiplies, divides. Counts up to ten million. Pays for itself over and over. **IDEAL GIFT**—for Business, Income Tax and School use. **MONEY BACK GUARANTEE.** Send name and address. Pay postman only \$2.50 plus postage. (Send full cash if outside U. S.) Money back in 10 days if not delighted. **AGENTS WRITE.**

Calculator Machine Company (Mrs.)
DEPT. 126, P. O. BOX 1118 CHICAGO, ILLINOIS

413 Pages Profusely Illustrated

FIVE ACRES and Independence

A PRACTICAL GUIDE TO THE SELECTION AND MANAGEMENT OF A SMALL FARM

By M. G. Kains
B. S., M. S., formerly Special Crop Culturist of U. S. Dept. of Agriculture.

ALL OF US long some day to **OWN A SMALL FARM**, whether it be for permanent residence or as a week-end haven where we may enjoy the relaxation of rural life. When city worries, war, inflation, depression, strikes, high rents, high cost of food get on our nerves we may find the solution in a properly operated small farm where we can eat regularly and abundantly, sleep soundly, have no money worries and live a healthy outdoor life. You don't have to own a large farm, but it is important to have practical advice from one who knows all about how to farm. There are many pitfalls which may easily be avoided. And there are many tried and proved methods which can lead to success.

We have found a practical book that starts at the beginning and takes you step by step into successful farming. This book takes nothing for granted. It tells what kind of farm to buy; how to choose it; how to finance it; what and how to plant, choice and care of livestock, poultry, bees, etc.; especially essentials of fruit and vegetable growing, fertilizers, irrigation, spraying, cultivation, harvesting, storage, sale of products and by-products. Every page is packed with proved ways to make the small farm self-supporting and profitable. Whether you have a farm now or are planning to purchase one, get this book by Mr. Kains and prepare yourself. Don't miss "Five Acres and Independence"; it might change your whole life, it may bring you the independence and security you are now striving so hard to obtain!

Only \$2.50, Postpaid in U.S.A. (Outside U.S. \$2.75). Order Today

POPULAR MECHANICS PRESS Room 360 • 200 East Ontario St., Chicago

BUILD A BOAT

For Pleasure or Profit

Shows How to Build 17 Low Cost Boats

Get this brand new book and build a boat at home. You can do it. Just the boat you've always wanted—power, sail or row boat. They're all here in this new 192 page book prepared especially for the home builder with limited tools, no experience and little money to spend. Hundreds of photos, plans, diagrams show you what to do and how to do it in simple step by step directions.

192 PAGES • OVER 500 PICTURES

Actual working diagrams and photos of real boats under construction makes building easy. Shows materials needed and rock-bottom costs. No chance for mistake. Includes also plans for row boat, reconverting old boats, handling sailing craft, boat kinks.

Order **BUILD A BOAT** on postal card and pay only \$1.25 plus postage on delivery. Return in 5 days if not pleased and get money back. Or send \$1.25 with order. (Outside U. S. \$1.45 with order.) Order Today.

POPULAR MECHANICS PRESS
Dept. 361, 200 E. Ontario Street Chicago

New Book - Just Published - Only \$1.25

21221

Flying "Spiders" on Guard

(Continued from page 11)

with canvas and digging a drain ditch around the area to carry away rain water.

Barrage balloons generally are of two different types, one called ballonnet, the other dilatable. Balloons maintain their shape due to the excess of internal pressure over that of the outside atmosphere. This super-pressure must be high enough to prevent the force of the wind velocity from deforming the shape of the balloon. In the ballonnet type, the lower portion of the balloon is an air chamber separated from the gas chamber. A wind scoop takes air into the air chamber, causing an internal pressure proportional to the wind velocity. In the dilatable type, rubber shock absorber cords permit the balloon to expand or contract as pressure changes.

Pride of the Goodyear Tire and Rubber Company, one of several concerns constructing the "spiders," is what the engineers call the "Strato Sentinel," which has a hydrogen capacity of 68,000 cubic feet, a ceiling of 15,000 feet and a tail from which six finlike lobes protrude. Made of rubberized cotton fabric, it is said to be the highest altitude barrage balloon ever built.

Another Goodyear balloon is the D-5, which has a 30,000 cubic-foot capacity, a 7,500-foot ceiling and is made of synthetic rubber cloth of cotton impregnated with black gum that gives it a dark appearance. It has four lobes which are given a fluted appearance by elastic cords. When gas in the fins expands as the balloon rises, the lobes swell into smooth contour.

A third balloon, especially designed for the Navy's use, is a 5,500 cubic-foot bag designed for altitudes of 3,000 to 4,000 feet. Small balloons of this type are useful to the army, also, for preventing enemy strafing of moving columns of troops. They can be transported by trucks, carried beneath bridges and raised speedily to 1,500 feet.

Regarding the effectiveness of the balloon barrage, Major General J. A. Green, Chief of the Coast Artillery, says: "Barrage balloons are considered by military authorities as ideal for added protection of the locks of the Panama Canal, the Welland Canal and the Sault Ste. Marie. These are small targets. To be assured of obtaining hits, low flying or dive bombing is nec-

(Continued to page 190)



Sometimes you want SPEED . . . sometimes it's extra leverage where a slip would be dangerous . . . sometimes you have to "reach in" and work around a corner. Williams' "Super-sockets" are your answer! These thin-walled, detachable socket wrenches, and the almost endless combinations that can be assembled

with their handles, parts and accessories, provide the world's most flexible wrench system.

Williams' "Super-sockets" are made in five different patterns with openings 3/16" to 2-3/4". Other Williams' Wrenches include both carbon and alloy steel types for practically every class of service. Mill Supply and Automotive jobbers sell



Williams' Drop-forged Wrenches. Industrial workers and mechanics in the various trades can buy them, at a liberal discount, either direct from these suppliers or through their employer. Ask your factory Foreman or Superintendent.

WILLIAMS
YOUR BEST BET FOR
WRENCHES

GET YOUR FREE COPY
An interesting, informative book that every mechanic needs. Data on wrench types, tables of sizes, helpful action photos. The coupon brings your free copy.



J. H. Williams & Co., 227 Lafayette St., New York City. Please send "How to Select and Use Wrenches." PM 242

Name.....
Address.....
City..... State.....

MAIL THIS COUPON

21221



JUST YOU TWO IN YOUR CANOE

• THE rustle of leaves in a whispering breeze, with the light of a moon for your mood. An Old Town Canoe is a world of your own . . . your passage to peace and contentment.

The dip, dip, dip of a Redskin's paddle takes you through quiet enchantment. Paddling or resting, it's steady and strong. It's sturdy and easy to own.

FREE CATALOG shows all kinds of canoes for paddling, sailing or outboards. Also outboard boats, including big all-wood family boats. Sailboats. Rowboats. Dinghies. Write today. Address Old Town Canoe Company, 832 Main Street, Old Town, Maine.

"Old Town Canoes"



8 Mile Range-Wide Vision **BINOCULARS \$4.75** 15 Days FREE TRIAL Postpaid or C. O. D.

Comes complete with case and straps. Well ground powerful lens. Easily focused for all distances and eye widths. Latest features. Ideal all-weather binoculars. **Guaranteed.** If not satisfied after 15 days trial, money refunded. **AGENTS WANTED.**

Vogue Binocular Co., 8420 S. Ashland, Dept. 308, Chicago



BUILD THESE PROJECTS

For garden or lawn. Easy to build. Easy to sell. Detailed Blueprints Model B-25 Dutch Windmill 50c; Model DM-50 Old Mill, 85c. Lawn Picture Patterns—Sumbonnet Girl, Dutch Boy, Tulip Girl, Holland Fair, 25c each, all \$1.00. Catalog illustrating many models, send 10c, today.

CRAFTSMAN'S MODEL CO., Dept. P-61, 2030 N. 41st St., Milwaukee, Wis.

INSTALL IT YOURSELF

CUSTOM-BUILT FLOORS—OUTLAST LINOLEUM

Distinctive designs . . . 15 rich-textured colors. Easily installed over wood or concrete! Ideal for home, cellar, showroom, office! Fun to install! Beautiful to look at! Long-wearing service! Tiles, Paste and Complete Instructions supplied for only 14c sq. ft. (F.O.B. New York) Send for your catalogue and samples today!

ESSEX FLOOR COVERING CO.
Dept. 5, 100 West 42nd St. New York City

ONAN ELECTRIC PLANTS

ALTERNATING AND DIRECT CURRENT



Produce Current, same as City Power Lines, for FARMS, SCHOOLS, THEATRES, PUBLIC BUILDINGS . . . Operate Lights, Radios, Motors, All Appliances.

Over 40 STOCK MODELS—150 to 50,000 Watts.
Any Voltage—Any Frequency.
Combination A. C. - D. C. Types.
Manual, Full Automatic and Self-Starting. \$99 up.
Shipped—COMPLETE, READY FOR OPERATION.
THOUSANDS IN USE IN ALL PARTS OF THE WORLD.
Write for Complete Details.

D. W. ONAN & SONS
1066 Royalston Avenue - MINNEAPOLIS, MINN.

essary. The balloons prevent this. If they are used in sufficient numbers, they force the enemy to fly at such a height that the bombardier's chance of registering a hit, even if he safely weathers anti-aircraft fire, are immeasurably less than they would be were he free to approach close to the locks before releasing his bombs.

"As with canal locks, it is the same with other small but vitally important targets—ship anchorages, overseas bases, sources of power supply, rail terminals, important industrial plants, ammunition supply points, bridges and a hundred other types of critical installations that must be defended at any cost.

"If it becomes necessary, barrage balloons are certain to be used extensively for the defense of our metropolitan and industrial centers.

"Take, for instance, New York and Boston. To ring them completely with anti-aircraft artillery would require a tremendous amount of costly equipment, but to cover certain areas with the less costly balloons and other areas with anti-aircraft artillery would simplify the task and still provide a strong defense.

"During recent months numerous reports from European sources have been carefully studied in the War Department. Some of these reports tell of the number of German aircraft that have come in collision with the British balloon cables. The usual result has been that the plane has crashed or has been forced to land in enemy territory.

"We do not know yet all of the situations under which it will be practical to use barrage balloons to advantage. These problems are being studied intensively. One problem that is receiving very careful study relates to the close coordination that must be effected between the employment of the barrage balloon and our own defending aircraft. You can appreciate the importance of such a study, for the balloon cable does not differentiate between friendly and enemy airplanes. Studies are also being made to determine how best to use the balloons with their supporting anti-aircraft artillery."

Write to the firms listed in the Where-to-Buy-It index, to learn more about products described in this magazine. Say You Saw It in Popular Mechanics.

Sections of Auto Tire on Board Provide Good Bicycle Rack

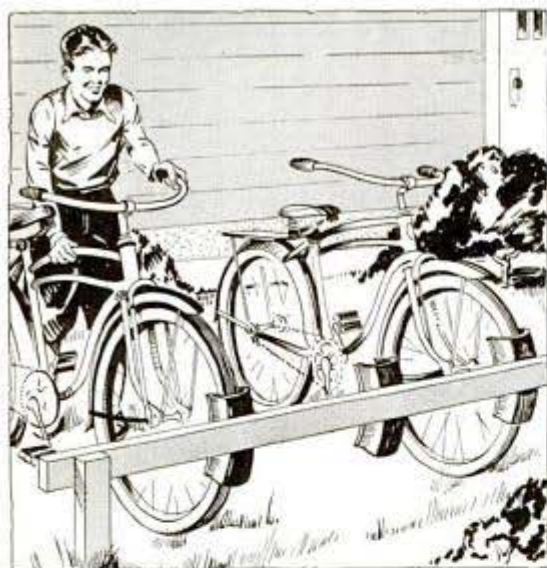

A good rack for bicycles can be made easily by nailing a number of auto tire sections to a support as indicated. The support is nothing more than a length of 2 by 4-in. stock nailed to a couple of posts, which extend above the ground to the correct height.

Drug Helps Prevent Blood Clots After Operations

Two Swedish physicians, describing experiments with heparin, report that the substance helps prevent thrombosis after surgery, in which a clot or plug forms in a blood vessel or heart cavity and may cause prolonged disability or death. They gave the drug, which is known for its ability to prevent blood clotting, to 325 patients after surgery, and not one developed thrombosis. In 302 similar operations where heparin was not given, there were 33 definite cases of thrombosis and 15 others who experienced a rise in pulse rate and temperature indicating slight thrombosis. The physicians, Dr. Clarence Crafoord and Dr. Erik J. Jorpes, of Stockholm, said the 325 selected for heparin treatment were all over 35 years of age and had diseases which made thrombosis a hazard. Heparin exists naturally in the body and is obtained by an extraction process for medicinal use.

☐ To learn where to buy commercial products described in these pages, see the index.

AMAZING CHEAP OIL BURNER

Sweeping the Country!

COOK and HEAT Without Coal or Wood

In Your Present Stove or Furnace—
No Drudgery, Dirt or Ashes—
Clean Heat at SMALL COST,
as much or as little as you
want.

OVER 40,000 SOLD

Beats any cheap burner ever gotten out for low cost, efficient performance. Burns ordinary low priced free flowing oil without pre-generating. No small openings to clog. Heat regulated by Turn of Valve.

30 DAYS' TRIAL

Prove its efficiency, convenience and economical operation without risk.

Write Immediately for SPECIAL OFFER TO AGENTS

**AGENTS
Salesmen
BIG MONEY**

F. Silver says:
"I can dispose of 250 HEAT KINGS before this year ends." Write us now for agents' offer.

A guarantee with each burner.

Slips into Any STOVE RANGE or FURNACE

HEAT Regulated by Turn of Valve!

who will demonstrate and take orders. Write quick, be first to learn how to make REAL MONEY right now, spare or full time—mail 1c postcard today.

UNITED FACTORIES, B-751, Factory Bldg., Kansas City, Mo.

FREE

First Step to Successful Pictures

Send for Central's 64-Page BARGAIN BOOK!

Free illustrated catalog listing latest developments in photography and Home Movie Making, for fun and profit. Offers hundreds of still, movie, cameras, lenses, films, Exposure Meters, Enlargers, Darkroom Supplies—everything photographic. All guaranteed—many at big savings. Central offers you America's most complete, varied stock. Liberal trade-ins on cameras and equipment. Write now for free copy of this newest money-saving bargain book—just out. Limited edition. Hurry!

CENTRAL CAMERA CO., 230 S. Wabash Avenue, Dept. B-16, Chicago, Ill.

HEADQUARTERS FOR PHOTO SUPPLIES Since 1899

THRILLING NEW SOLDIER MODELS

Bring you extra money—Quick

★ You mold and color them at home. The whole family will get a real "kick" out of it. We tell you how and furnish everything you need to make literally hundreds of interesting statuettes—every one perfect—that people will buy on sight.

★ SEND FOR COMPLETE OUTFIT—includes molds of our own American soldiers and six foreign allies fighting on our side—seven in all—sculptured in true detail of their picturesque fighting uniforms—all materials and colors—everything you need—only \$2.50—nothing else to buy. Here's the most fascinating way to turn your spare time into handsome profits—Immediately! Order NOW from your Dealer, or sent postpaid on receipt of \$2.50.

MODEL CRAFT, INC.
330 S. Wells St., Dept. P2, Chicago

LOG SAWS

Make Money—Wood now in big demand—start a sawing business. Turn timber into cash. Low factory prices—Easy Terms. Write for Log Saw and Engine Catalog.

WITTE ENGINE WORKS 4742 OAKLAND AVE. KANSAS CITY, MO.

On the Anti-Tank Firing Range

(Continued from page 15)

millimeters and 75's, in addition to heavy artillery. To a lesser extent the .50-caliber machine gun is effective against light tanks and lightly armored vehicles. It is the first gun an Infantry trainee uses on the anti-tank firing range.

At Camp Wheeler, Infantry Replacement Center near Macon, Ga., the new army is schooled in the elementary use of anti-tank guns.

The range is in a heavily wooded area. It has to be. The fire from .50-caliber guns creates a danger area 9,500 yards behind the targets. The range slopes up to a summit 700 yards away.

Down the line, instructors give the ready signal. Over a loud speaker a voice barks the firing orders. Then, on the slope, three small white objects start moving across the range. You take aim, your hand flicks the trigger, a tracer bullet streaks across the clearing toward its goal—you hope. If you're off, you hastily correct the error and bang away again.

Let's take a look at those targets. They measure 3½ by 6 feet, about the size of the vital portion of a tank. There are three of them, one for each gun, and they move on tracks, the farthest at a constant distance of 700 yards, the nearest at 400 yards, and a middle target moving angularly between the others. Each target is drawn by an endless cable, driven from the rear axle of an old truck. Stripped to its chassis and set up in the control house, the truck can move the targets at 5 to 35 miles an hour.

The control house lies buried at the top of the slope, hidden from the firing line. Walled by one foot of steel-reinforced concrete, it is buffered ten feet ahead by an-

other two-foot wall of concrete, between which is enough sand to sink a dredge. This sandwich of concrete, steel, and sand will withstand the fire of seventy-fives.

The elevated control stand overlooks the line of machine guns, with a clear view of the targets. An officer, in telephone contact with the control house, sits before a microphone and issues orders to the gun crews. Noncommissioned officers behind the gunners see that orders are followed.

Soldiers are trained in the firing routine until it becomes automatic. When the control officer calls "Range!", they respond with the yardage on their target, simultaneously adjusting their guns to the correct range. "Tank!"—the description of the target—is the second order. As soon as the gunners repeat this, the command "One lead" or "Two leads" follows, according to the speed of the tank and its distance. The faster a tank goes, the greater the lead he has to take in advance of the target. Then comes "Track left!" or "Track right!", indicating the direction the targets will move. The last command is "Commence Firing!"

For weeks before the trainees are permitted to try their skill, they spend arduous hours on cardboard targets, using their imagination for ammunition. They learn the principles of firing the rifle, the pistol, the light machine gun, heavy machine gun, and mortars. They get the feel of a gun, become used to the shock of fire, acquire a sense of timing and distance and learn the construction and operation of each mechanism. When they finally go up for their turn on the anti-tank guns, they find the weeks of practice have not been in vain. They're pretty good marksmen.

Fighting at 50,000 Feet

(Continued from page 5)

21197
react at high altitudes a program of pilot research is being carried on. Fliers already have to be supercharged or "denitrogenized" before a high flight. They must breathe oxygen and, if they leave the windows open to handle their guns, must wear electrically heated suits and gloves. At 30,000 feet a flier would become unconscious in less than a minute without oxygen and even with it he begins to suffer from the lack of pressure.

To work efficiently at 35,000 feet and even to exist much higher than that, the crew needs some sort of artificial pressure. A development of the pressure cabin, such as is used by the Boeing Stratoliner, may be a solution although then there is the hazard of a sudden drop in air pressure if the fuselage is ripped open by a lucky hit. Another possibility is that the men who fly at high altitudes may wear reinforced pres-

(Continued to page 194)



Would Uncle Sam Okay YOUR Gluing Jobs?

Casco Glues Meet U.S. Government Specifications!

OUTDOORS:

CASCAMITE POWDERED RESIN GLUE

Meets U.S. Navy Aeronautical Specification—G29—for cold setting resin glue. Waterproof, mold-proof. Instant mixing. Used for building or repairing airplanes, boats, sports equipment, garden furniture...and for stain-free veneering, inlays and fine cabinet work. 10¢ to 85¢.

INDOORS:

CASCO POWDERED CASEIN GLUE

Meets U.S. Army Specification No. 3-152-A and U.S. Navy Department Specification 52G8b for water-resistant casein glue. Used for heavy-duty, weight-bearing interior joints on furniture, doors, cabinets, toys, etc. Glues wood and other materials. Mixes easily in cold water. 10¢ to 65¢.

ODD JOBS:

CASCO FLEXIBLE CEMENT

Exceeds all strength requirements of U.S. Navy Dep't. Specification No. 52C5b. For all joints subjected to jolts or expansion movements of dissimilar materials. Quickly sticks metal, plastics, glass, other "hard to glue" materials. Ready to use. Large tube 25¢.

At Hardware, Paint and Lumber Dealers



CASCO • CASCAMITE
GLUES AND CEMENTS

FREE Casco Gluing Guide

• 36 pages, 56 illustrations. Describes all Casco glues—tells which to use for different jobs. Includes complete mixing directions, liquid life, setting time, veneering, overlays, inlays.

Tells how to make household repairs, gives hints for decorating, building, construction, painting and sizing, making and repairing sports equipment. Also shop and plant helps.



MAIL THE COUPON TODAY!

CASEIN COMPANY OF AMERICA, Dept. PM-242
350 Madison Avenue, New York, N. Y.

Please send my copy of "Casco Gluing Guide"

Name _____

Address _____

City _____ State _____

Save 2¢ — stick coupon on penny post card.

SKI WITH THE BEST!



You're right up there with the finest skiers in the Nation when you ski on Northlands. Winning skiers need the best. They know from 30 years experience that Northland offers the finest woods, remarkable craftsmanship, newest designs!

SEND FOR THIS 48 PAGE SKI BOOK
84 illustrations, edited by Schneider. Send 10c or write for Northland's FREE folder.

NORTHLAND

World's Largest Ski Manufacturers
95 Merriam Park • St. Paul, Minnesota



2197

sure suits and helmets that are kept inflated under pressure. All sorts of problems not yet encountered will be met as the research crews climb higher and higher. The present Flying Fortress is less efficient near the ground than at high altitudes and was built that way to give maximum efficiency at its operating ceiling.

One of the questions to which the engineers will find an answer concerns the possible top speed of airplanes, which for present shapes seems to be limited to the speed of sound. Airplanes can fly faster at high altitudes than they can at low altitudes because of the reduced air pressure aloft. But the speed of sound is clearer at high altitudes than it is at sea level where there are more air molecules per unit of volume. Thus high-flying airplanes will reach their speed limit while flying slower than the speeds that appear possible closer to the ground. Another question that may be encountered when altitudes of 50,000 feet are reached is what will happen to the bombs? Will they freeze solidly in the cold upper air and fail to detonate when they strike the ground? No one knows.

21186

Subway for Black Gold

(Continued from page 31)

pilot circling around overhead meanwhile. A photographic relief map showing precisely the height of hills, the depth of valleys and river levels is prepared by making stereoscopic photographs—but instead of twin lenses at eye-distance apart, as in ordinary stereoscopy, two planes make simultaneous pictures from parallel routes a mile to a mile and a half apart. This exaggerates the stereoscopic angle, and by examining the twin pictures on the strip map with a stereocomparagraph the third dimension reveals the contours of the land.

For a look at pipe laying, follow the gang of Texans and Oklahomans who in less than four months drove Standard Oil of New Jersey's 12-inch line through the rocky passes of the White and Green mountains of New England, to carry 60,000 barrels of oil per day from Portland docks to Montreal refineries.

Woodsmen chop a path through the birches and pines. Giant 14-ton bulldozers follow them, nosing aside great boulders

(Continued to page 196)

JIG SAW \$1.75
COD or outside U.S.A. \$2.00

POST PAID

Including 13 assorted blades, Adapters, and roller Saw Guide formerly found on expensive machines only. All metal, 15" long, 8" high, 6 1/2" table. A swift and easy cutter—best ever made for the money.

A J. & H. Metal Product.

FREE CATALOG describing complete power tool line: Shaper, \$3.25; Circular Saw with oilless bearings, \$2.75; completely equipped Lathes, \$2.25 and \$5.40; Sander, \$1.10; Jointer, \$7.25, etc. Sold direct only. Order today or send card for Catalog.

Taylor-Shantz, Inc. 5 Commercial St. Rochester, N. Y.

ACE
LATHE TOOL SET
\$14.50

Be permanently toolled-up for every operation on your Metal Cutting Lathe

The ACE Set is complete—there's nothing more to buy. Drop forged by the manufacturers of cutting tools used by 90 per cent of the plants and shops in industry they are correctly designed, are of special steel, are finely finished, are stronger—will last a lifetime. You can cut easier, faster and more accurately with ACE TOOLS.

At your Hardware Store—Circular FREE.

ARMSTRONG BROS. TOOL CO.
"The Tool Holder People"

368 N. Francisco Ave., CHICAGO, U.S.A.

3 Tapering Tool, 2 Colling Tool, 2 Knurling Tool, 2 Boring Tool, Threading Tool, High Speed Steel Cutters and Blades, and 2 Wirecuts in Filled Steel Case.

SHAW and "Peppy-Pal"
"DU-ALL" GARDEN TRACTORS

• Low Cost Power for home gardens, poultry and fruit ranches, estates, green houses, small farms, parks, etc. All sizes 1 H.P. to 9 H.P., plow, cultivate, spray, mow, haul, run belt machinery, etc. Write for 10 DAY TRIAL OFFER. LOW PRICES and FREE CIRCULARS.

SHAW MFG. CO., 4592 Front St., Galesburg, Kansas;
668-G N. 4th St., Columbus, O., 5812-G Magnolia Av., Chicago, Ill.

"Peppy-Pal" with Cultivating Tools

TOMBSTONES
DIRECT TO YOU \$9.95 UP

• Genuine beautiful **ROCKDALE** Monuments, Markers, Satisfaction **EASY** or **Money Back**. Free lettering. Free **TERMS** catalog. Freight paid. Compare our prices.

Rockdale Monument Co., Dept. 565 Joliet, Ill.

WOOD WORKERS
SEND FOR MY GREAT BARGAIN BOOK

Here's a Master Manual for every woodworker—craftsman, expert or beginner. Contains complete instructions for making beautiful inlay pictures; for finishing different woods and for doing expert veneering. Gives valuable information you need on nearly every project. Lists many choice, rare woods and veneers not available elsewhere as well as the best in wood-working tools. ALL AT BARGAIN PRICES. Send 25 cents today for your copy. 25c refunded on 1st order so Manual costs you nothing.

Over 980 Items

Albert Constantine & Son, Inc., 791-B E 135th St., New York, N. Y.

FLUORESCENT

Wholesale Catalog **FREE!**



Save up to 60%
Direct from Factory

The most complete fluorescent catalog—listing fixtures, accessories, kits for every type of fluorescent lighting—including new-type kitchen and bed lamps—at lowest wholesale prices direct from factory. New kit and diagram service makes it easy to assemble, install, and sell complete fluorescent set-ups for homes, stores, factories, offices and farms. Send for FREE catalog and special factory representative plans.

JACKSON FLUORESCENT SUPPLIES
427 W. Randolph St., Dept. 50, Chicago, Illinois

SHIPS SCALE KITS & FITTINGS

New model catalog, 128 pages. Profusely illustrated, 25c. Every popular ship model kit made, 10,000 fittings! Accessories, tools, etc. Contains 25c CASH VALUE coupon. Send coin or stamps. POLK'S Model Hobbies, 429-F 7th Av., N. Y. C. Also: Planes, Trains, Race Cars.

Say you saw it in Popular Mechanics!

Money Making
Pay Raising
BOOKS
Catalog
FREE

Send Name and Address Today

Selected books covering all trades, office helps, home workshop, spare time work, hobbies, etc. Learn how to earn more. Write today.

Popular Mechanics Press
DEPT. 364
200 E. Ontario St.
CHICAGO

Extra Money From Books

SEND NO MONEY • Books Sent C.O.D. Anywhere in U. S.

These famous Pay-Raising Extra Money Books have helped thousands of others. Let them help you too. Check this list and mail with your

name and address. Pay postman on delivery plus few cents postage. Ask for big new catalog of helpful mechanical books.



SELECT FROM THIS LIST

- BLUEPRINT READING**
For Building Trades... \$1.25
- STEEL SQUARE**
Best Methods of Using... \$1.00
- AUTO OWNERS GUIDE**
New 192-page book describes hundreds of simple car repairs, shortcuts, how to operate car economically... \$1.25
- MECHANICAL DRAWING**
Learn Drafting; Good Salary... \$1.50
- SHEET METAL WORK**
Both Light and Heavy Metal... \$2.50
- FORGING PRACTICE**... \$1.50
- FOUNDRY WORK**... \$2.00
- AUTO BODY & FENDER REPAIRS**
Up-to-date information... \$3.00
- WHAT TO MAKE**
3-Vol. Library of Worth-while Projects for Craftsmen... \$1.47
- PRACTICAL MATHEMATICS**
Real Help for Everyone Who Uses Figures... \$2.00
- REFRIGERATION**
Electric, Gas. Be a Service Expert... \$5.00
- THE BOY MECHANIC**
New Edition of Famous Book... \$2.00

- SHOP NOTES LIBRARY**
Thousands of Useful Ideas. Set of five Big Volumes... \$2.45
- FORTY POWER TOOLS**
(Just Published)
Build own saw, drill, lathe, sander, etc. from scraps—save money... \$1.25
- AUELS WELDERS GUIDE**
New Book. Covers Electric and Gas... \$1.00
- MONEY MAKING FORMULAS**
480 Page Book... \$4.00
- PAINTING & DECORATING**
New Book... \$1.50
- UPHOLSTERY**
Start Shop of Your Own... \$2.00
- AUTO RACING**
How to Build Cars, Speed Up Fords... \$1.00
- CONCRETE**
1001 Ways to Use... \$1.98
- BLUEPRINT READING**
For Machine Trades... \$1.50
- ROPP'S CALCULATOR**
Cuts Figuring to Minimum... 50c
- ESTIMATING FOR BUILDING TRADES**
Figuring Material and Labor Costs... \$4.75
- REWINDING ELECTRIC MOTORS**
Enables Anyone to become expert... \$1.00
- LATHE HANDBOOK (Metal)**
How to construct 6-in. lathe, shortcuts, kinks... 50c
- DIESEL ENGINE MANUAL**
Practical... \$2.00
- BUILD YOUR OWN BOAT**
Just published. Describes 17 popular boats—rowboats, sailboats, plywood outboard, etc. 192 pages... \$1.25

POPULAR MECHANICS PRESS

Room 363 200 E. Ontario St., Chicago

Gear YOUR Business to ESSENTIAL WORK

Priorities, shortages and increasing costs are forcing adjustments in every line of work and business. Particularly in the building industry, where lumber and steel are hard to get, even at soaring prices.

You can capitalize on these conditions by supplying the trade with Brikerete—the new scientific masonry unit. Better than brick, yet brings wall costs down to frame prices. Fireproof, termite-proof, permanent. Has beauty of color and streamlining, strength and self-contained insulation.

NO PRIORITIES — NO SCARCITIES

Brikerete is made from materials and labor that will always be plentiful and low priced. Unlimited market possibilities—now and in the future. We supply complete plant equipment for local manufacturing in protected territories. Requires but modest investment. Profits up to 150%. Write immediately for The Brikerete Book—free.

BRIKRETE ASSOCIATES, INC.
4670 Division Avenue, S., Grand Rapids, Mich.



SALESMEN! EVERY CAR OWNER WANTS TO KNOW MILEAGE and EXPENSE

Keo-Pa-Count

- * ALL METAL. Adds & Records. Keo-Pa-Count tells gallons of gas & dollars and cents. Totals automatically day to day. Jiffy Recording. Saves writing.
- * No Installation. Attach to Visor with handy device. No hunting for "notebook" or "topper".
- * A REAL Adding Machine. Checks "condition" of car. Keeps period and yearly record. Finish Handsome Maroon, Brass, White. 2-1/8 x 4-7/8 x 3/16, Ind. Ctn.
- * Quick Sale. Compact make. Good Profits. Sells on sight. Get Keo-Pa-Count Machine at SPECIAL 31-to-you sample price for inspection and trial sale. Returnable within 3 days if not **EASIEST SALE YOU EVER MADE**. Special discounts on quantities.

Produced by Makers of Famous Automatic Locking Cop
AUTOMATIC GAS-LOK CO.
Dept. 11, 21 E. Van Buren, Chicago

NEW TRAILER PARTS CATALOG

48 PAGES for TRAILER OWNERS

TRAILER OWNERS and BUILDERS

Get our new 48 page illustrated catalog! All products specially designed for trailer use—windows, combination ice and electric refrigerators, undercarriage equipment, couplers and lifting devices, metal mouldings and rub rails, interior lighting fixtures, stoves, heaters, pumps. Parts you can't get locally. Catalog mailed postpaid on receipt of 10c coin. Write today.

MARVEL TRAILER PARTS CO.
19020 Celestine Ave., Detroit, Mich.

BIG MONEY BUILDING MEAD'S NEW PORTABLE OUTBOARD BOAT

IN A FEW DAYS AT HOME!

Build this light 50 lb. tough, durable, seaworthy portable Outboard Ki-Yak! Take it anywhere by hand or car. Safe, dependable, trouble-free. More speed per horsepower, more miles per gallon. MEAD'S perfected metal-ribbed, cut-up construction kit guarantees successful assembly quickly, easily, economically. New 69 lb. OK-4 uses oars, sail, motors, 9 lb. p. or less. Also 3 "CK" models—sail models from 20 lbs. to 45 lbs. Double Paddle or Oars INCLUDED with your Ki-Yak! Write for FREE lavishly-illustrated circulars, low Factory-Do-You Prices!

MEAD GLIDERS, 15 S. Market St., Dept. B-22 CHICAGO, U. S. A.

Learn ARC WELDING

With training in this modern school you'll quickly be able to qualify for the big pay welding jobs. Shop methods taught by expert operators. Individual instruction on modern equipment. Five weeks course. Tell about yourself in first letter.

HOBART TRADE SCHOOL
Box M-222, Troy, Ohio

SEND FOR FREE BOOKLET

21186

MAKE MONEY

Selling
FLUORESCENT

SAVES

1/2

on
Light Bills

Just Plug in and
Light



NO MORE

Extra Equip-
ment or Spe-
cial Wiring.

Screws

INTO SOCKET JUST LIKE BULB!

SALESMEN!

Once expensive—once costly to install—out of the reach of most people, Fluorescent Lights sold only a million in 1939. In 1940 sales jumped to EIGHT MILLION—Now with invention of fixture that screws in like an ordinary light bulb, a fixture that can be installed in an instant, a fixture that sells complete with tubes for less than \$5.00—the most spectacular sales opportunity of the decade has been opened up for salesmen and distributors. Enormous advance commissions. Exclusive territory. Exceptional factory co-operation includes financing big orders.

FREE If earnings of \$5,000, \$10,000 and \$15,000 a year don't scare you, rush your name by fastest way for sensational facts—sales plans—amazing records being made by others, complete line with pictures and prices. This is the hottest item in direct selling today. Even if you don't answer another ad in this magazine, rush your name on this one—right now.

NORTH AMERICAN MFG. CO., 433 E. Erie St., Dept. 62, Chicago, Ill.



Eye-Appeal Pays Profits



Giving newer beauty to masonry buildings—new or old—is a business opportunity in every territory for one alert, ambitious man. Owners are wide open to accept Colorcrete—the liquid plastic—and at prices that can earn handsome incomes for authorized Colorcrete applicators. At reported costs as low as 2c per square foot, and selling prices up to 7c, the profit angle is evident.



Beauty Comes Out Of A Nozzle
Colorcrete is applied by air pressure, and actually fuses with all masonry surfaces. Color and waterproofing are combined; Colorcrete gives both beauty and protection. Choice of 30 colors and many textures. Write for book "Proven Business Opportunity" and lay first claim to your territory.
COLORCRETE INDUSTRIES, INC.
570 Ottawa Ave., Holland, Mich.

Write for
FREE BOOK

FREE Stove Catalog



Factory Prices

106 Styles and Sizes. Coal-Wood Ranges; Combination Gas-Coal or Oil Ranges; Gas Ranges; Coal-Wood Heaters; Furnaces. 30 Days Trial. 24 hour shipments. 1,700,000 Satisfied Users. Easy Terms. Year to pay. Factory guarantee.

KALAMAZOO STOVE & FURNACE CO., MFRS.

391 Rochester Avenue
Kalamazoo, Mich.
41 years in business

A Kalamazoo Direct to You

and tearing trees from their beds to clear the way for a 35-foot highway. Dynamiters blast a trough in the granite and a ponderous ditching machine churns the earth, digging a four-foot channel three feet deep at 15 feet a minute, its endless belt piling the dirt along the cut to be back-filled over the finished pipe, leaving no trace.

Big "cats"—tracklaying tractors—lift 40-foot, 3/4-ton lengths of pipe into the trench and you shade your eyes from the white glare as "tackers" join the pipe ends with electric-arc welds stronger than the pipe itself. When a mile of line has been welded, each weld is coated with soapsuds and inspected for leaks as 120 pounds of air is forced into the pipe; then water under 900 pounds pressure tests the entire pipe.

To guard it against corrosion and abrasion in the soil, the pipe must be heavily coated; the New England line was enameled, then wrapped in asphalt-impregnated felt. Sometimes heavy paper is used. Automatic machines roll along the pipe wrapping and tarring it in one operation. In some soils electrolysis attacks the metal; engineers licked the problem by feeding a low current into the pipe. Wind generators are used on one Pure Oil company line in sections remote from power lines. Unattended, they do the job.

Pipe lines are built as straight as contours permit: under a New Hampshire golf course fairway, dipping under rivers, detouring around cities. Sometimes bends are made in the factory; often the pipe is "cold bent" at the site. One big "cat" will straddle the pipe, sit on it to hold it down while another loops a line under the pipe and lifts away, bending the 3/8-inch steel pipe to the desired contour.

To test the pipe wrapping, a hoop with wire brushes encircles the pipe and as it moves along, any bare metal encountered by the brushes is revealed by static on an electric dial. Before it is buried, the pipe is cleaned by a "go-devil" which clatters through under compressed-air drive, its rotating blades sweeping the tube.

Once covered with earth, the pipe is invisible save at pumping stations or where it emerges at rivers or swamps. There are eight pumping stations at 30-mile intervals on the New England line. The tendency, however, is to pump at higher pressures—some as high as 2,000 pounds are reported

(Continued to page 198)

Supercharge YOUR CAR



HIGH-FREQUENCY TRANSFORMER
Makes Motor Run Smoother—Start Quicker
ELECTRIC SUPERCHARGER is a patented high-frequency transformer designed for **POWER—ECONOMY and SUPER PERFORMANCE** in motors. Car owners, mechanics and fleet owners report amazing results, even on new cars. Nothing like it on market. Gives engine New Life—Increased Power—50% Longer and Hotter Spark—more complete Combustion—less spark plug fouling. **FITS ALL IGNITION SYSTEMS** except Ford V-8, Mercury and Lincoln Zephyr. **ELECTRIC SUPERCHARGER** is sold on a 15 DAY TRIAL—**MONEY-BACK GUARANTEE** for only \$3.00 Postpaid. Easy to install. Order one today. State car model. Order Model V Supercharger to fit 1942 Ford & Mercury Systems.

HOLTHOUSE LABORATORY

3918 W. Grand Ave., Dept. A-2, CHICAGO, ILL.

CLAMPS

One homecraftsman writes: "Your clamps are more than clamps to me. They serve as helpers, extra hands, setting-up tools, jigs, vices, bench vices, and for all kinds of holding, drawing up and tightening work. They are the most widely used tools in my shop."

ADJUSTABLE CLAMP CO.

"The Clamp Folks"
 421 N. Ashland Ave., Chicago, U. S. A.



PONY Miniatures 8 types 1" to 2 1/2" cap. Not toys but fine tools with 100 uses.

Catalog FREE. Ask your dealer or write direct.

PONY "50" Fittings go on ordinary 3/4" pipe. Air length. Send \$3.00 plus postage (6 lbs.) for two "50" Clamps. Also "Pony" No. 52 Fittings for 1 1/2" pipe—2 sets for \$2.00 plus postage.



Jorgensen Handcrews
 Genuine "Jorgensen" Handcrews grip at all angles—never slip, split or loosen. All sizes. Send \$3.20 plus postage (7 lbs.) for 2 No. 1 Handcrews—open 6".



DRAFT OLD PAINT BRUSHES

New harmless non-inflammable discovery restores hardest brushes to soft pliable condition. No fish-tailing or curling. Send \$1.00 for a quart. Post paid U.S.A. **Technical Development, 261 Broadway, New York.** Salesmen wanted.

LEARN AVIATION DRAFTING

Tool Designers, aviation and mechanical draftsmen and designers needed now as never before. Former **NAVAL AVIATION INSTRUCTOR** will personally teach you at home, through individual, home study lessons. Learn quickly. Aviation draftsmen and design engineers are being paid high salaries and in great demand. Rush name and address for FREE BOOK. Please state your age.

THE OHIO INSTITUTE OF TECHNOLOGY, Box 51, Greenville, Ohio

Say you saw it in
POPULAR MECHANICS

METAL AND WOOD WORKING MACHINE TOOLS

Send for new **FREE** catalog of complete line of Machines, Motors and Accessories

WALKER-TURNER CO., INC. - 122 Berkman St., Plainfield, N. J.

BUY YOUR WELDER WHILE YOU CAN

We still make prompt delivery at money saving prices. Heavy-duty, medium and light metal welders \$32.70 to \$70.00. How long we will have materials is uncertain. There's money in welding. Start now while you can. Send today for illustrated literature. Superior Oxy-Acetylene Co., Dept. A, Hamilton, Ohio.

Genuine
SpeedWay
ELECTRIC
DRILL & GRINDER

KIT \$17.95

No. 59 SpeedWay Drill—by far the best in its price class. Full 1/2-inch capacity in steel. Long life, high torque SpeedWay tool motor. Die cast pistol grip handle and gear casing. 3000 R.P.M.—will not burn drill point.
 No. 29 SpeedWay Grinder—has "Industrial" speed (20,000 R.P.M.) and real power. Comes with 3/32" and 1/8" collets.
 Sold separately, or both Drill and Grinder with 5 grinder Accessories in fitted steel case \$17.95 at leading Hardware, Tool and Automotive Stores everywhere.
 SpeedWay Manufacturing Co.
 2842 So. 52nd Ave., Cicero, Illinois

100 Miles per Gal.
 Plus Sensational
"Floating Drive"

NEW
1942 Cushman

"Ride-thrill of the year!—plus amazing Comfort and Economy!" say owners of the New CUSHMAN! 500 miles on \$1 worth of gas! Featured by **FLOATING DRIVE**—applies power as smoothly as Fluid Drive! Eliminates clutch pedal, gear shift! Merely touch hand-accelerator to start, travel any speed up to 35 mi. per hour, climb ordinary hills! Flashy pick-up! **SMOOTH RIDING**—coil springs, long wheel base, balloon tires. **SAFETY**—low center of gravity, heavy brakes, excellent lights. **RUGGED**—electrically welded all-steel frame. Most durable machine of its kind built. **WRITE!**

WRITE See your dealer who handles the CUSHMAN. Or, send for free booklet with photos, full details, and the very Low Prices! **SEND TODAY!**

CUSHMAN MOTOR WORKS, Dept. 12, Lincoln, Nebr.

Thompson
BEATS
the World
on BOATS

Better Built
Lower Prices

- Canoes \$75 and up
- Rowboats \$48 and up
- Outboards \$48 and up

Safe Boats With Full Length Spray Rails
 Keep passengers perfectly dry—even at high speeds. Catalog also shows today's seven most popular models of sailboats. Two big factories. Prompt shipment.

CATALOG FREE
 Write for your copy. State kind of boat in which you are interested.

THOMPSON BROS. BOAT MFG. CO. (INC)
 213 Ann St. PESHIGO, Wis. (Write to either place)
 Light "Car-Top" Boat 113 Elm St. CORTLAND, N.Y.

BIGGEST \$100 PLANE
IN U.S. GIANT 7-ft. GLIDER

Easily built, beautiful Class E

CLEVELAND CONDOR
 Soars for hours.
 ● 48" Eaglet (Baby Bowlius type) Glider only 50c.
 ● At your dealer, or direct, Catalog of "America's FIRST LINE of Model Airplanes"—all Cleveland Gas, Rubber-powered, Stick and Glider Models, 5c.

CLEVELAND MODEL & SUPPLY CO. INC., 4508B15 Lorain Ave., Cleveland, Ohio

COMPLETE Kit only **\$100**

On orders less than \$1.00 add 15c for packing and postage.

WHOLESALE CATALOG FREE!

SPORS
 Your **KEY** to **PROSPERITY** in 1942
4000 MONEY-MAKERS
FAST-SELLING
DEPENDABLE GOODS

WHOLESALE CATALOG NO. 58
SPORS COMPANY

4000 TESTED SELLERS

For salesmen, dealers and agents. 260 pages of thrilling bargains. Over 4000 Opportunities to Make Money. Household goods, display card items, wearing apparel, cosmetics, foods, jewelry and toys are a few of the thousands of articles shown in this exciting book for salesmen, agents and dealers. Address a postal card to address below and request a copy of this Book Of Opportunity. NOW. No charge for it.

Spors Co., 1241 Huron, Le Center, Minn.

21186

Enjoy SANDING

THIS EASY ELECTRIC WAY!

Makes sanding the job with a thrill!

SKILSAW Zephyrplane Jr.

2 1/4 IN. BELT SANDER

You'll have real fun sanding electrically with ZEPHYRPLANE JR. in your shop. It's 10 times faster and easier on every job... eliminates tiresome "back-and-forth" hand-sanding. Produces a finer, smoother finish, too... without ripples or ridges. Ideal for wood or metal. Easy to handle—weighs only 9 1/2 lbs. Link belt drive. Easy to change belt. Works from light socket.

SKILSAW, INC.
4779 Winnamac Avenue
Chicago

See it at your hardware or mill supply dealer's or write us today for full information!

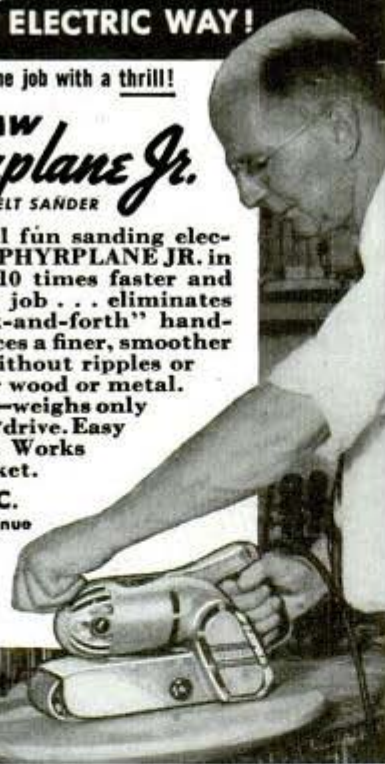

BRONZE FOUNDRY Schools and Home Workshops

Make your own castings of aluminum, copper, bronze, silver. Foundry sets are available in three sizes including 2400 Deg. F. blast Furnaces. \$17.50, \$24.00, \$34.50, f.o.b. Kansas City. Free Circular.

KANSAS CITY SPECIALTIES CO.
P. O. Box 6022, Dept. P-19 Kansas City, Mo.

ONE-MAN SAWMILL LESS THAN \$100.00

Makes Lumber

Turn Trees into Money with a BELSAW

Three capacities: 10, 14 and 20 feet. Accurate set works, positive dogs. Hand or power feed.

Runs on low power—many owners use old auto engine. Pays for itself quickly—thousands in commercial service, everywhere. Write for free lumber handbook and catalog of mills, supplies, tools, saw blades and woodworking equipment.

BELSAW MACHINERY CO.
Dept. 1811, 3542 Main St., Kansas City, Mo.

Model Builders Attention!

	V	V-2	V-3
Hex	1/2"	3/8"	5/16"
Thread	3/8"-24	1/4"-32	1/4"-32
Thread Length	7/32	7/32	3/32
Weight, Grams	8	3 1/2	2 1/2

Actual Size V-Plug

Champion has designed 3 spark plugs for model gas engines which give the same dependable performance as regular Champions. Silliman sealed. Sillimanite insulator. Alloy needlepoint

electrodes for easy starting. One piece construction.

CHAMPION
SPARK PLUG CO.
900 Upton Ave.
Toledo • Ohio

—and space the pumps farther apart. One of the longest jumps is 206 miles between two stations on the Wyoming pipe line.

With the pipe out of sight, extreme vigilance must be exerted to detect leaks. Over one southwestern line aerial inspectors make twice weekly tours, watching for the telltale blotch of black in the snow or the patch of dead vegetation that betrays oil leaking into the soil. Oil lines are operated much as a railroad, their dispatchers always in touch with pumping stations and terminals by private telephone systems paralleling the line. Constant check of the pressure at each point will tell of a break.

Low temperatures, naturally, slow down the movement of oil and call for higher pressures to keep the thicker crude flowing. New England's pipe line will encounter sub-zero temperatures, but the tankers bringing oil to Portland from the Gulf and Colombia will ride the warm Gulf Stream and thus be able to start the oil underground at almost the 80-degree temperature at which it was shipped.

Some interstate trunk lines handle shipments for several different producing or refining companies. The pipe must be kept filled and flowing at all times, a "slug" of Pure Oil gasoline, for example, following a shipment of Gulf's gasoline. The dispatcher notifies all switching points of the shipments, and a spot of dye about five feet long indicates the end of one "slug" and the beginning of another. On sizable quantities, the mixing of slugs is negligible.

The oil pipe line industry represents a billion dollar investment. A 12-inch pipe costs \$2 a foot, and fast crews have laid three miles a day. In 1940 pipe lines carried 939,732,000 barrels of crude oil—nearly 70 percent of the total produced—to refineries, and pumped 97,000,000 barrels, 15 percent of the total, of motor fuel back to market. River barges, ocean tankers, and railway tank cars do the rest. Movement by rail is most costly; pipe line transportation is 30 to 40 percent higher than by ship, but a submarine can't sink a pipe line, a bomber can't see it, and in these critical days industry and the army and the folks at home—particularly in the eastern states which consume around 40 percent of our petroleum and are unhappily far from the wells—figuratively pat the tarred back of the vast system of pipe lines and wish there were even more like them.

MOTORISTS *Wanted!*

TO MAKE THIS *UNIQUE* GAS SAVING TEST



Car Owners: You are invited to make a gas saving road test with the absolute understanding that unless it proves to you that it will save you up to 30% on gas and improve your car performance, the test will cost you nothing. Investigate this remarkable discovery that trims dollars off gasoline bills—gives you worthwhile gas savings—more power—greater speed—quicker pick-up—faster acceleration.

Automatic Supercharge Principle

Vacu-matic is *entirely different!* It operates on the supercharge principle by automatically adding a charge of extra oxygen, drawn free from the outer air, into the heart of the gas mixture. It is entirely automatic and allows the motor to "breathe" at the correct time, opening and closing *automatically* to save dollars on gas costs.

Proven by Test

In addition to establishing new mileage records on cars in all sections of the country, the Vacu-matic has proven itself on thousands of road tests and on dynamometer tests which duplicate road conditions and record accurate mileage and horse power increases.

Fits All Cars—Easy to Install

Vacu-matic is constructed of six parts assembled and fused into one unit, adjusted and *sealed at the factory*. Nothing to regulate. Any motorist can install in ten minutes. The free offer coupon will bring all the facts. Mail it today!

The Vacu-matic Co., Wauwatosa, Wis.

gas saving road test with the absolute understanding that unless it proves to

Sworn Proof of Gas Savings

This certifies that I have carefully read 300 original letters received from Vacu-matic users testifying to gas savings up to 30%, many reporting added power, smoother running, and quicker pick-up. These letters are just a small part of the larger file of enthusiastic user letters that I saw at the company offices.

Signed

Manuel J. Blum
Notary Public



AGENTS Get Yours FREE For Introducing

Vacu-matic offers a splendid opportunity for unusual sales and profits. Every car, truck, tractor, and motorcycle owner a prospect. Valuable territories now being assigned. If you help us introduce it to a friend, you can obtain your own free. Check and mail coupon today.

SEND THIS *Free Offer* COUPON

THE VACU-MATIC COMPANY

7617-638 W. State St., Wauwatosa, Wis.

Please send full particulars about VACU-MATIC, also how I may obtain one for my own car FREE. This does not obligate me in any way.

Name

Address

City..... State.....

Check here if interested in Agency Proposition.

They Work Together for YOU



YES, these two men are working together for you, a prospective user of South Bend Lathes. Together a shop foreman and a designer are finding the answer to one of the problems that must be solved to maintain South Bend standards of quality. Their friendly cooperation is typical of the shoulder to shoulder teamwork of our employees. This coordination of effort contributes much to the service and satisfaction you will receive from a South Bend Lathe.

All of us, here at South Bend, are working together for you—and for National Defense. Production schedules have been doubled and redoubled. But no sacrifice in quality has been made—nor will there be any lowering of our standards.

South Bend Lathes are made in five sizes: 9", 10", 13", 14½" and 16" swing, Toolroom and Manufacturing types. Each size is available in several bed lengths. Complete line of practical attachments, chucks and tools.

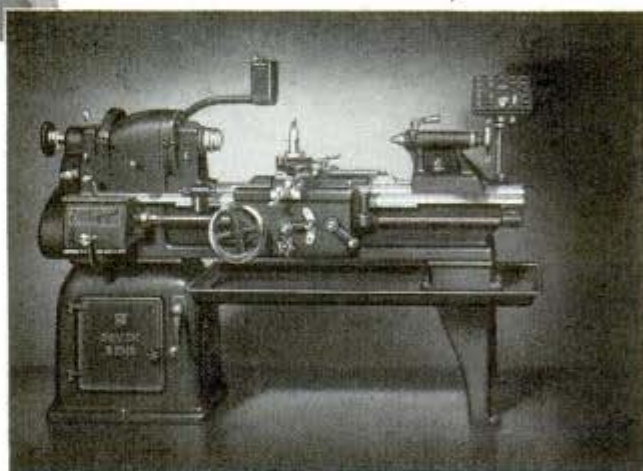

South Bend 16" Toolroom Precision Lathe

SOUTH BEND LATHE DEALERS

Boston, Mass..... South Bend Lathe Works*
Buffalo, N. Y..... R. C. Neal Co., Inc.
Chicago, Ill..... H. J. Volz Machinery Co.
Cleveland, Ohio..... Reynolds Machinery Co.
Detroit, Mich..... Lee Machinery Co., Inc.
Indianapolis, Ind..... Marshall & Huschart Mch'y.
Kansas City, Mo..... Faeth Company
Los Angeles, Cal..... Eccles & Davies Mch'y. Co.
Milwaukee, Wis..... W. A. Voell Machinery Co.
Newark, N. J..... J. R. Edwards Machinery Co.

New York, N. Y..... A. C. Colby Machinery Co.
Philadelphia, Pa..... W. B. Rapp Machinery
Pittsburgh, Pa..... Tranter Manufacturing Co.
St. Louis, Mo..... Colcord-Wright Mch'y. & Sup.
San Francisco, Cal..... Moore Machinery Co.
Seattle, Wash..... Star Machinery Co.
*Boston Sales Office, 67 Broadway, Kendall Square,
Cambridge, Mass., W. H. Packard, Manager, Phone
Trowbridge 6369

SOUTH BEND LATHE WORKS

LATHE BUILDERS FOR 35 YEARS 614 E. Madison St., South Bend, Ind., U. S. A.



PRICE SMASHING SALE!

Genuine-Late
UNDERWOOD
NOISELESS

Now
\$39.85
CASH

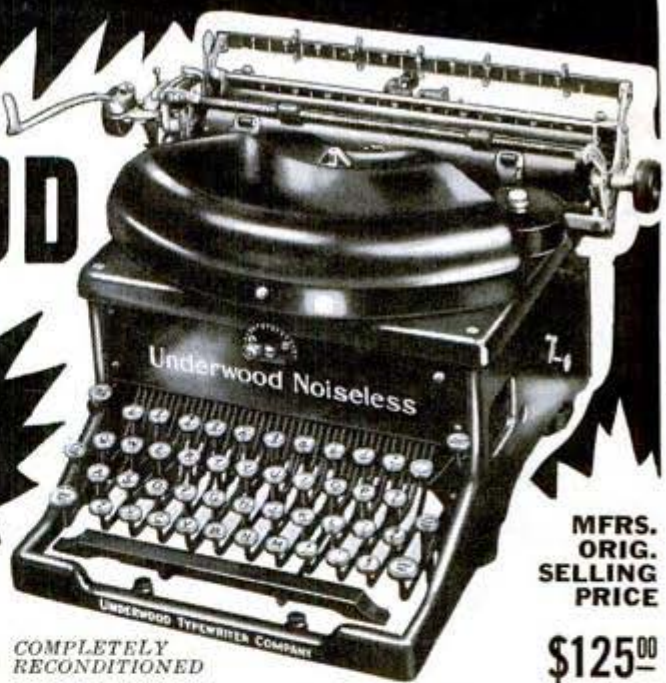

MFRS.
 ORIG.
 SELLING
 PRICE

\$125.00

OR
EASY TERMS—70c A WEEK COMPLETELY RECONDITIONED



Truly an outstanding offer! Only because of an exceptional purchase can I sell these reconditioned Noiseless machines at the sensationally low price of \$39.85 cash, or for only 70c a week on my easy term price. Each one carefully refinished so it looks like a new machine costing three times as much. The mfrs. orig. selling price on this Underwood was \$125.00. It's sent to you in Underwood packing box with Underwood book of instructions on care and operation.

A NOISELESS MACHINE

Latest achievement in typewriters! Provides writing perfection with SILENCE. For those who want the advantages of a quiet home or office. This Underwood eliminates the nerve shattering clatter common to many models. An aid to better work because it allows clear thinking, reduces fatigue, improves accuracy. This typewriter disturbs no one, for it is almost impossible to hear it operate a few feet away. You get all the features of an Underwood PLUS Noiseless typing.

FIRST CHOICE OF TYPISTS

Over 5,000,000 Underwoods now in use! Recognized as the finest, strongest built! Here is an office size Underwood with late modern features that give you SILENT TYPING. Has all standard equipment—keyboard, 2 colors, back spacer, automatic reverse, tabulator, etc. There is no risk! See before you buy on my 10 Day No Obligation Trial Plan. Return machine if not satisfied.

WIDE 14" CARRIAGES

Wide carriage machines for government reports, large office forms, billing, etc., only \$3.00 extra with order. Takes paper 14" wide, has 12" writing line. A Real Buy in a Reconditioned Underwood Noiseless!

International Typewriter Exchange
 231 W. Monroe St. Dept. 201, Chicago, Ill.

EXTRA VALUE! TYPEWRITER STAND



Big Working Surface
 Two metal wings, correct working height.
 All metal mounted on casters

For those who have no typewriter stand or handy place to use a machine, I make this special offer. This attractive stand that ordinarily sells for \$4.85 can be yours for only \$3.50 extra—payable 25c a month. Quality built. Note all its convenient features. (See coupon.)

NO MONEY DOWN 10 DAY TRIAL Easy Terms—10c a Day

No obligation to buy. See machine on wide open 10 day trial. Pay no money until you test, inspect, compare, and use this Underwood Noiseless. You judge for yourself. When you are convinced that this is the biggest typewriter bargain you have ever seen then say, "I'll buy." Send only 70c a week or \$3.00 a month until term price of only \$43.85 is paid. There is no red tape or investigation—My offer is exactly as I state it.

2-YEAR GUARANTEE

I back this machine with my personal 2-yr. guarantee that it is in A-1 condition and will give first class service. Over 30 years of Continuous Service and Fair Dealing backs this guarantee.

FREE! TOUCH TYPING COURSE

Complete Van Sant home study course free with Underwood. It's carefully illustrated, written expressly for home use.

MAIL COUPON NOW - Limited Quantity on Sale!

International Typewriter Exchange
 231 W. Monroe St., Chicago, Ill. Dept. 201

Send Underwood Noiseless (F.O.B. Chicago) for ten days' trial. If I keep it, I will pay \$3.00 per month until easy term price (\$43.85) is paid. If not satisfied I can return it express collect.

10" carriage 14" carriage (\$3.00 extra)

Name..... Age.....
 Typewritten signatures not acceptable.

Address.....

City..... State.....

CAUTION—For quick shipment give occupation and reference.

Check for typewriter stand (\$3.50 extra—payable 25c a month). Stand sent on receipt of first payment on Underwood.



IT'S CHESTERFIELD
says LOIS JANUARY
Star of Stage and Screen

This Year **IT'S CHESTERFIELD**

*always Milder and Better-Tasting
always Cooler-Smoking*... that's what makes Chesterfield
the steady smoke of more smokers every day. You can count on
Chesterfields to give you, day in and day out, *more smoking pleasure
than you ever had before*... So make your next pack Chesterfield and
its right combination of the world's finest cigarette tobaccos will go
to work to give you all you want in a cigarette *They Satisfy*